

SHORTCUT TO GREAT PICTURES

Nikon N50

目次
第一章 基本操作
1.1 照相机各部分名称
1.2 照相机的基本操作
1.3 取景器
1.4 测光系统
1.5 快门速度
1.6 光圈
1.7 感光度
1.8 对焦系统
1.9 闪光灯
1.10 附件

第二章 拍摄技巧
2.1 构图
2.2 光线
2.3 背景
2.4 色彩
2.5 景深
2.6 快门速度
2.7 光圈
2.8 感光度
2.9 对焦
2.10 闪光灯

第三章 维护保养
3.1 清洁
3.2 电池
3.3 镜头
3.4 闪光灯
3.5 附件

第四章 故障排除
4.1 取景器
4.2 测光系统
4.3 快门速度
4.4 光圈
4.5 感光度
4.6 对焦系统
4.7 闪光灯
4.8 附件

INSTRUCTION MANUAL

FOREWORD

Thank you for purchasing the Nikon N50 camera. We are sure that you will enjoy using this camera and that it will make photography a bigger part of your life. In addition to this comprehensive instruction manual, the Nikon N50 comes with—

- **SHOOTING IN SIMPLE MODE—SHORTCUT TO GREAT PICTURES**

A concise, pocketable guide that explains the easiest way to use the N50.

- **PHOTO GUIDE**

A colorful book that shows you which mode and/or program to use for a variety of photographs.

CONTENTS

FOREWORD	2
GETTING TO KNOW YOUR CAMERA	4-5
BEFORE SHOOTING	6-12
MOUNTING LENS	7-8
INSTALLING BATTERY	9
LOADING FILM	10-11
SETTING CAMERA TO AUTOFOCUS MODE	12
SHOOTING IN ADVANCED MODE	13-26
AVAILABLE EXPOSURE MODES	14
OPERATION IN PROGRAMMED AUTO	
EXPOSURE MODE	15-21
OPERATION IN OTHER EXPOSURE MODES	22-25
RESET FUNCTION	26
OPTIONAL FUNCTIONS	27-33
MEMORY SETTING FUNCTION	28-29
AF MODE SELECTION	30
ISO CONFIRMATION/SETTING	31
EXPOSURE COMPENSATION	32-33
OTHER CONTROLS	34-42
SELF-TIMER OPERATION	35
LONG TIME EXPOSURE AT "TIME" SETTING	36
TO SHOOT AN OFF-CENTER SUBJECT	37
USING AE-L BUTTON	38-39
CASES WHERE AUTOFOCUS IS NOT	
ACCEPTABLE	40
MANUAL FOCUS	41
FLASH PHOTOGRAPHY	42-48
USING BUILT-IN FLASH	43-47
SPEEDLIGHT COMPATIBILITY	48
MISCELLANEOUS	49-63
LENSES	50-51
CAMERA CARE TIPS	52-53
NOTES ON BATTERIES	54
SPECIFICATIONS	55-58
ABOUT N50 METERING SYSTEM	59
LCD PANEL/VIEWFINDER INDICATIONS	60-62

GETTING TO KNOW YOUR CAMERA

Learn the parts of your camera.

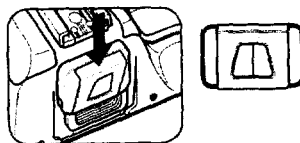

Eyepiece cover DK-5: Attach to viewfinder eyepiece to ward off stray light when using the self-timer.

Accessory shoe: For Nikon dedicated Speedlights.

LCD panel

Self-timer button

Set/adjust buttons

Shutter release button: Press lightly to activate exposure meter and start AF operation; fully depress to release shutter and take picture.

Menu button

Minimum aperture lock: Slide lever to lock position

Power switch: Set to OFF when not using your camera.

SIMPLE/ADVANCED dial

Flash lock release

Self-timer LED

Lens mounting index

Lens release button

Focus switch

Focusing ring: Do not turn when the focus switch is set at AF. (For manual focusing, see page 41).

(Optional lens illustrated:
AF Zoom-Nikkor 35-80mm f/4-f/5.6 D)

AE-L (Auto Exposure Lock) button: See pages 38 to 39 for Auto Exposure Lock.

Camera back

Viewfinder eyepiece

Film cartridge confirmation window

Camera strap eyelet

Camera back lock release

Rewind button

Tripod socket

Battery chamber cover

Battery chamber cover lock release

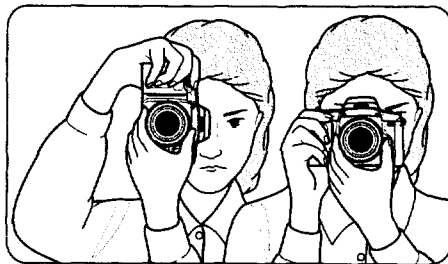
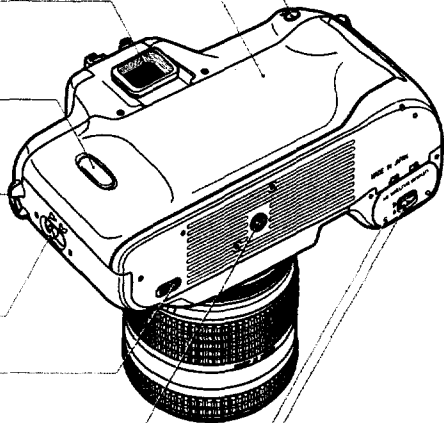

Learn how to hold your camera

- Grasp the camera handgrip with your right hand.
- Use your left hand to cradle the camera with the elbow propped against your body for support, as you look through the viewfinder.
- Use your right hand index finger to depress the shutter release button.
- To hold the camera steady, lean on or against something strong and stable. This will help ensure sharp images.

BEFORE SHOOTING

This section shows you how to prepare the camera for shooting, e.g., how to mount a lens, install the battery and load film.

This section is for both **SIMPLE** and **ADVANCED** modes.

MOUNTING LENS

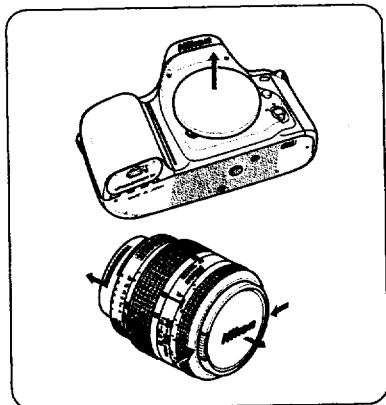

1 Remove the camera body cap and the front and rear lens caps.

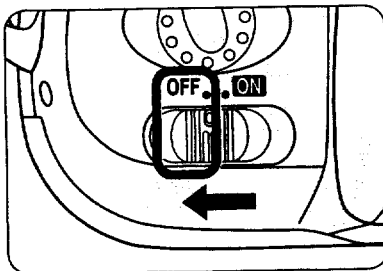

2 Make sure the camera's power is off.

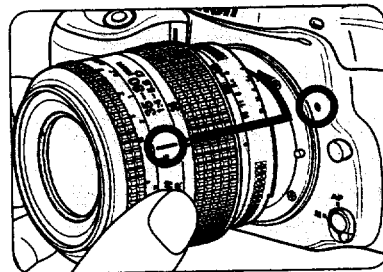

3 Position the lens in the camera's bayonet mount so the mounting indices on the lens and the camera body are aligned. Twist the lens counterclockwise until it locks into place.

Usable Lenses

Use AF Nikkor lenses (or AF-I/AI-P lenses for manual focus only). Other Nikon and Nikkor lenses can be mounted, but you have to use an external exposure meter, and the only usable exposure mode is Manual. (See page 50).

When mounting lens—

- Avoid direct sunlight.
- Do not touch the lens release button.

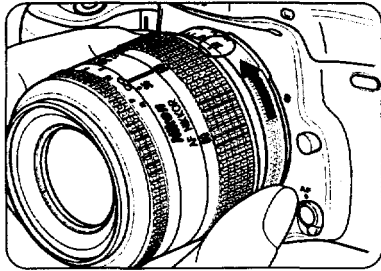

4 Turn the lens aperture ring to its minimum aperture (the largest f-number, marked in orange, on AF Nikkor lenses). Then lock the lens aperture at its minimum setting (see lens instruction manual).

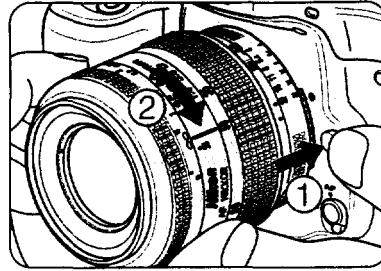

To remove
While pressing the lens release button, turn the lens clockwise.

With the N50, all aperture setting operations are performed with the camera's set/adjust buttons. Do not move the lens aperture ring once it is set to its smallest aperture (largest f-number).

INSTALLING BATTERY

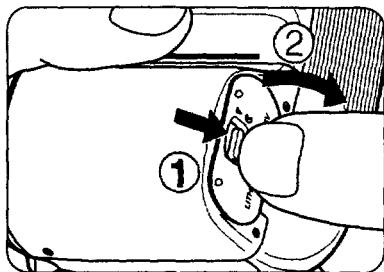

1 Make sure the camera's power is off, then slide the lock release on the battery chamber cover to open the chamber.

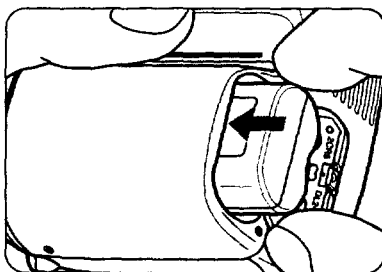

2 Insert a 6V lithium pack with "+" and "-" ends positioned as shown on the inside of the cover. Close the cover by pushing until it clicks.

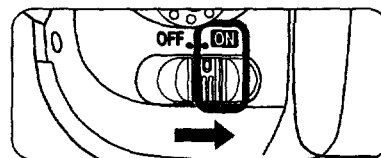

3 Switch the power ON. Check the LCD panel to see if the frame counter shows "E" or the battery mark (☐ or ☐) appears. If ☐ blinks: Battery is nearing exhaustion. Have a fresh one ready.

If Err and ☐ blink: Battery is almost exhausted. Switch power OFF and replace battery with fresh one. If no indication appears on the LCD panel: Battery is completely exhausted or improperly installed. Change the battery.

- Use 6V lithium battery pack (2CR5 or DL245 type).
- See page 54 for "NOTES ON BATTERIES".

LOADING FILM

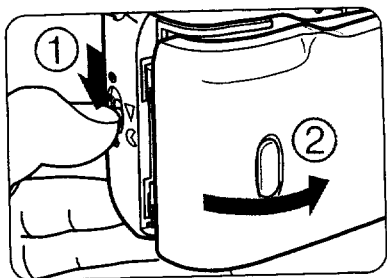

1 Slide the camera back lock release to open the camera back.

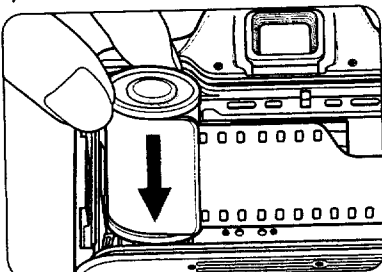

2 Insert film cartridge.

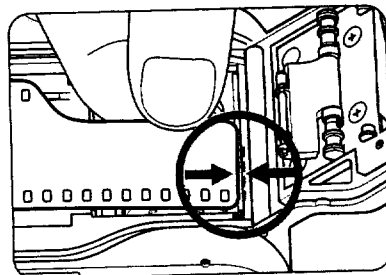

3 Pull the film leader out to the red index mark.

- To avoid fogging film (especially high-ISO film), do not load/unload film in direct sunlight.
- Usable film speed range for DX-coded film is ISO 25 to 5000.

- Opening/closing the camera back resets the frame counter to "E".

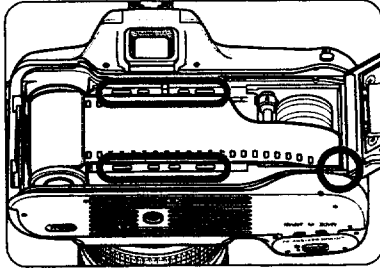

4 Make sure the film is properly positioned with no slack and the film perforations engage the sprockets. (See illustration.)

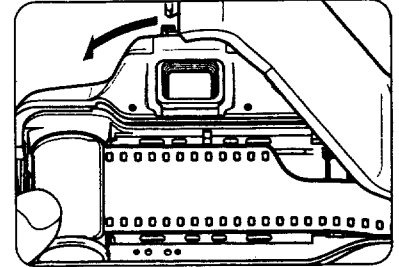

5 Gently close the camera back until the lock release snaps closed. Film automatically advances to frame #1.

- If the frame counter still shows **E** (i.e., if the film does not advance to frame #1), with or without blinking **Er** and **⊙**, the film is incorrectly positioned. Reload film.

- You can confirm the film speed of installed DX-coded film. See page 31.

- With a non-DX-coded film, film speed must be set manually. See page 31.

SETTING CAMERA TO AUTOFOCUS MODE

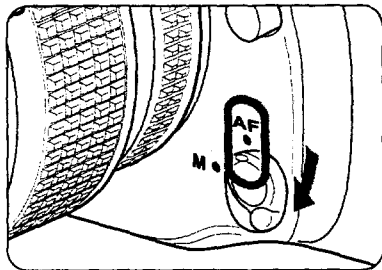

Autofocus should be used for most picture-taking situations, including moving subjects. In general, it is best to leave the focus switch set to AF.

- For situations where autofocus is not possible, see page 40.
- For manual focusing, see page 41.

Regarding the N50's autofocus feature

Your N50 is factory-set to Single Servo AF operation. This means that once your subject is in focus, focus remains locked as long as the shutter release button is lightly pressed. You can recompose the picture, and the subject will remain in focus, provided you maintain the same subject-to-camera distance. (See page 37 for details.) If the subject moves, take your finger off the shutter release button, then lightly press it again to restart autofocus operation.

- In the ADVANCED mode, in addition to Single Servo AF, you can choose Continuous Servo AF which keeps autofocus operation going continuously as long as you keep lightly pressing the shutter release button. (For details, see page 30.) Use Continuous Servo AF for sports and other action photography.

SHOOTING IN ADVANCED MODE









This section shows you how to set your desired Program or exposure mode.

This section is for ADVANCED mode only.

AVAILABLE EXPOSURE MODES

In the Advanced Operation Mode, you can select any of four exposure modes—Programmed Auto (**P**), Shutter-Priority Auto (**S**), Aperture-Priority Auto (**A**) and Manual (**M**).

Programmed Auto Exposure Mode

In addition to the four Programs in SIMPLE mode—General-Purpose , Landscape , Portrait  and Close-Up —four more Programs are available in ADVANCED mode: Sport , Silhouette , Night Scene  and Motion Effect .

The N50 camera's microcomputer automatically chooses the combination of shutter speed and aperture for a correct exposure.

For features and sample pictures of each Program, see attached "PHOTO GUIDE".

Shutter-Priority Auto Exposure Mode

You manually set the shutter speed and the camera sets the matching lens aperture. To freeze action, use a high shutter speed; to create motion effects, choose a low shutter speed. For more information on Shutter-Priority Auto, see pages 22 to 25.

Aperture-Priority Auto Exposure Mode

You manually set the aperture and the camera sets the appropriate shutter speed. Smaller apertures make the background and foreground sharper (recommended for landscape pictures) while larger apertures tend to blur the background (recommended for portraits).

For more information on Aperture-Priority Auto, see pages 22 to 25.

Manual Exposure Mode

You select both the shutter speed and aperture. This mode lets you experiment with and produce different creative effects (e.g., intentional blur, intentional under- or overexposure). For more information on Manual Exposure Mode, see pages 22 to 25.

Metering System

The Programmed, Aperture-Priority and Shutter-Priority Auto Exposure modes employ either 3D Matrix Metering or Advanced Matrix Metering, depending on lens type in use.

In Manual exposure mode, Center-Weighted metering is used. For details about this metering system, see page 59.

OPERATION IN PROGRAMMED AUTO EXPOSURE MODE

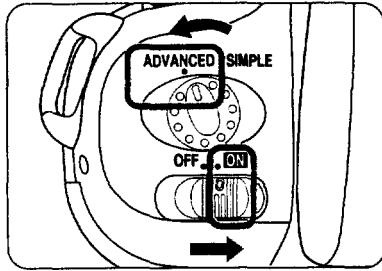

1 Switch power ON and set the camera dial to ADVANCED. The LCD shows the last selected exposure mode/Program. (The original factory setting is for General-Purpose Program.)

- Steps 2 and 3 explain how to set a Program. If the Program shown is what you want, skip steps 2 and 3.

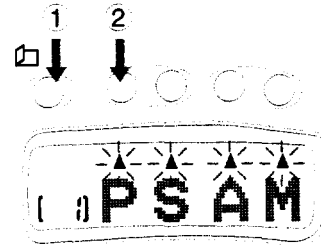

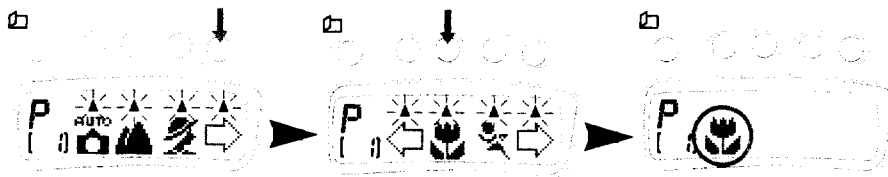

2 Press the menu button ① to access the exposure mode menu, then press the button above **P** ②.

With the Exposure Menu, pressing the menu button activates the Optional-Function Menu (see page 27). To return the LCD to the Exposure Menu, press the menu button again.



(Example: Setting Close-Up Program)

3 The Program menu contains eight Programs in three screens. Pressing the button above  or  moves the menu to the following or previous screen. Select and set the desired Program by pressing the button above it.

For example, set to Close-Up Program:

- a. Press the button above .
- b. Press the button above . Close-Up Program is now set.

If indications on the LCD panel disappear, lightly press the shutter release button to reactivate them.

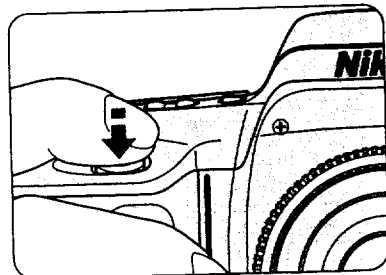
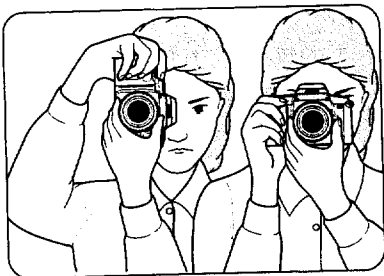

4 Look through the viewfinder and position the focus brackets on your subject.

5 Lightly press the shutter release button to activate autofocus operation and the exposure meter.

In Single Servo AF mode, if a stationary subject moves, remove your finger from the shutter release button, then lightly press it again to restart autofocus.

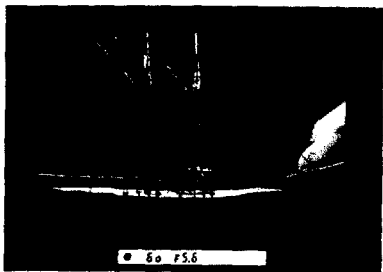

6 Confirm that ● (in-focus indicator), the shutter speed (from 1/2000 to 30 sec.) and an aperture (number with F) appear below the viewfinder screen.

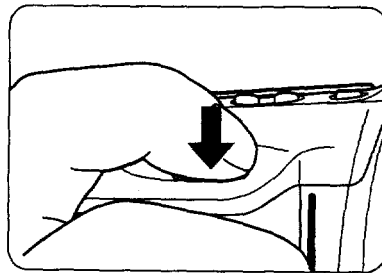

7 Fully depress the shutter release button to take the picture. The film will automatically advance by one frame.

Shutter speed indication without "''" should be read as a reciprocal fraction, i.e., "15" stands for 1/15 second, "15''" for 15 seconds.

Viewfinder Information

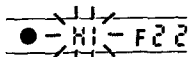

HI blinks—Overexposure possible

Use a filter such as the Nikon ND filter.

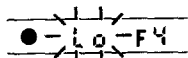

LO blinks—Underexposure possible

Use built-in flash or accessory Nikon Speedlight.

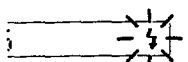

⚡ blinks—Flash recommended

Not enough light. Use built-in flash or accessory Nikon Speedlight.

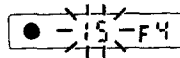

Shutter speed indication blinks inside viewfinder—Picture blur possible

The automatically selected shutter speed is slow and picture blur may occur due to camera shake. To reduce the possibility of blur, hold camera very steady, use a tripod or use the built-in flash or an accessory Nikon Speedlight.

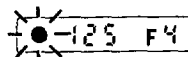

● blinks—Unacceptable autofocus condition

Subject characteristics do not allow autofocus operation. Set focus switch to M and rotate the lens focusing ring until the image in the viewfinder appears clear and sharp. (See page 41 for manual focusing.)

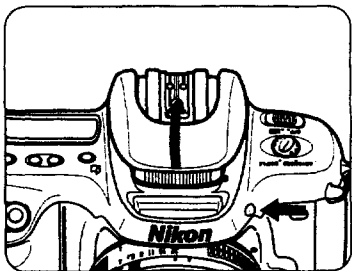

For Err indication, see pages 60 to 62.



Using Built-In Flash

Use the built-in flash not only when the ready-light blinks, but also when your subject is in shadow or backlit. See pages 43 to 47.

Auto Rewind

When the film reaches the end of the roll, auto rewind begins. During rewinding,  and  blink in the LCD panel. After rewind automatically stops, frame counter shows **E** and  blinks for a few seconds. You can then remove film cartridge.

- When battery power is very weak, or when the temperature is very low, film may not rewind at the end of roll and **Err** appears in the LCD panel. In this case, replace battery with a fresh one, or wait for the temperature to rise and then press the rewind button.

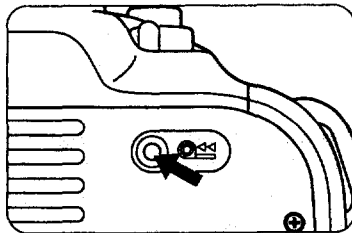

To rewind film at mid-roll: Press the rewind button on the camera bottom.

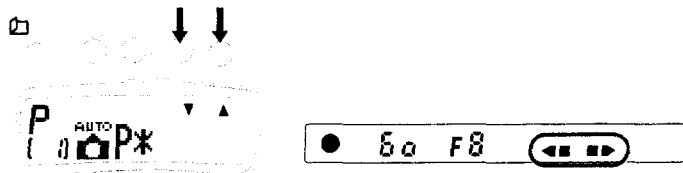

To change a combination of shutter speed/aperture

In the General-Purpose Program, you can change the combination of shutter speed/aperture by pressing the button above ▼ or ▲. Press the button above ▼ for faster shutter speed/wider aperture (smaller f-number); press the button above ▲ for slower shutter speed/smaller aperture (larger f-number). Pressing and holding the button down changes the shutter speed/aperture combination rapidly. P* appears in the LCD panel and ◀ ▶ appears inside the viewfinder, indicating the change in shutter speed/aperture.

- The original shutter speed/aperture combination for General-Purpose Program is recalled when the LCD indication automatically switches off, when you turn the camera power off, when you switch to SIMPLE mode or when you use flash.

OPERATION IN OTHER EXPOSURE MODES

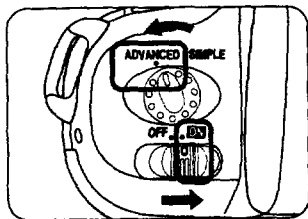

1 Switch camera on and set the dial to ADVANCED. The LCD shows the previously selected exposure mode/Program. (The original factory setting is for General-Purpose Program.)

- Step 2 explains how to set an exposure mode. If the present exposure mode is what you want, skip step 2.

2 Press the menu button to activate the Exposure Mode Menu. To set the exposure mode, press the button above the desired indication.

- With the Exposure Mode Menu, pressing the menu button activates the Optional-Function Menu (see page 27). To return the LCD to the Exposure Mode Menu, press the menu button again.

3 To adjust the shutter speed and/or aperture, press the button above ▲ (up) or ▼ (down) indication.

4 Look through the viewfinder and position the focus brackets ([]) on the main subject. Lightly press the shutter release button to activate autofocus operation and the exposure meter. Confirm that the in-focus indicator ● appears in the viewfinder.

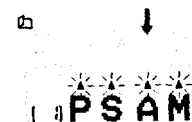

Shutter-Priority Auto

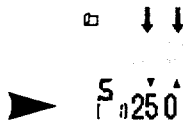

To change shutter speed rapidly, hold the button down.

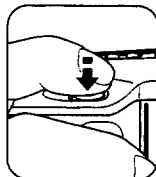

Your selected shutter speed and the automatically set aperture are shown below the viewfinder screen.

Aperture-Priority Auto

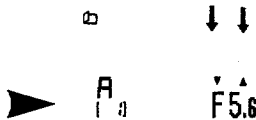

To change aperture rapidly, hold the button down.

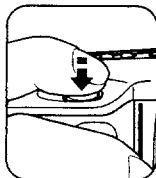

Your selected aperture and the automatically set shutter speed are shown below the viewfinder screen.

Manual

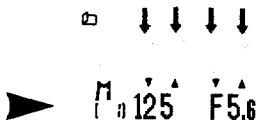

To change shutter speed/aperture rapidly, hold the button down.

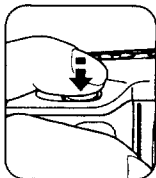

Your selected shutter speed and aperture are shown, along with the exposure indicator, below the viewfinder indication.

••••• Correct exposure

••••• Overexposure

••••• Underexposure

For "TIME"-setting, see page 36.

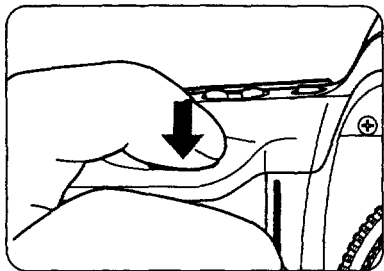

5 Fully depress the shutter release button to take a picture. The film automatically advances by one frame.



- Shutter speed indication without "''" should be read as a reciprocal fraction, i.e., "15" stands for 1/15 second, "15''" for 15 seconds.
- In Single Servo AF mode, if a stationary subject moves, remove your finger from the shutter release button, then lightly press it again to restart autofocus.

Using Built-In Flash

Use the built-in flash not only when the ready-light blinks, but also when your subject is in shadow or backlit.

See pages 43 to 47.

Auto Rewind

When the film reaches the end of the roll, auto rewind begins. During rewinding,  and  blink in the LCD panel. After rewind automatically stops, frame counter shows **E** and  blinks for a few seconds. You can then remove film cartridge.

- When battery power is very weak, or when the temperature is very low, film may not rewind at the end of roll; **Err** appears in the LCD panel. In this case, replace battery with a fresh one, or wait for the temperature to rise and then press the rewind button.

To rewind film at mid-roll: Press the rewind button at the bottom of the camera.

Viewfinder information

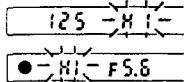

H blinks—Overexposure possibility*

Select smaller aperture (larger f-number) and/or faster shutter speed. Or, use a filter such as the Nikon ND filter.

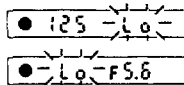

L blinks—Underexposure possibility*

Select a wider aperture (smaller f-number) and/or a slower shutter speed. Or, use the built-in flash or an accessory Nikon Speedlight.

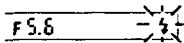

z blinks—Flash recommendation

Not enough light. Use the built-in flash or an accessory Nikon Speedlight.

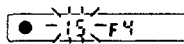

Shutter speed indication blinks—Picture blur possible**

Automatically selected shutter speed is low and picture blur may occur due to camera shake or subject movement. To reduce the possibility of blur, hold camera very steady, use a tripod or use the built-in flash or an accessory Nikon Speedlight. Selecting a wider aperture (smaller f-number) results in a faster shutter speed.

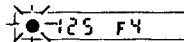

● blinks—Unacceptable autofocus condition

Your subject is inappropriate for autofocus operation. Set the focus switch to M and focus manually. (See page 41.)

For **Err** indication, see pages 60 to 62.

*For Shutter-Priority Auto and Aperture-Priority Auto exposure modes.

**For Aperture-Priority Auto exposure mode.

RESET FUNCTION

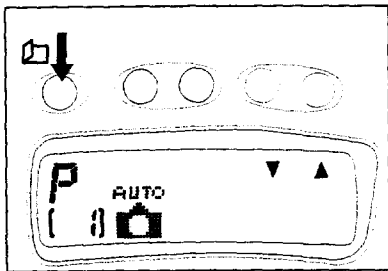

To return to the General-Purpose Program (when Memory Function is not set)*

Press and hold the menu button for at least two seconds.

**With the Memory Function set, pressing and holding the menu button for at least two seconds recalls the memorized exposure mode/Program. (See pages 28 to 29.)*

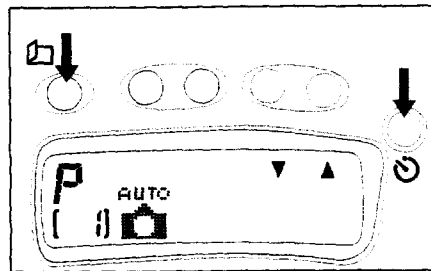

To reset the camera's mode to the original factory setting

Simultaneously press the menu and self-timer buttons for at least two seconds. This will activate the General-Purpose Program and cancel Optional Functions.

OPTIONAL FUNCTIONS

The Advanced Operation Mode also offers four Optional Functions:

 **Memory Setting** (pages 28 to 29)

When Memory is set, you can easily set the desired exposure mode or desired Program by pressing the menu button for at least two seconds.

AF Mode Selection (page 30)

You can switch the AF mode from Single Servo Autofocus to Continuous Servo Autofocus.

ISO Confirmation/Setting (page 31)

With DX-coded film, you can confirm ISO film speed. With non-DX-coded film, you can manually set the ISO film speed number.

 **Exposure Compensation** (pages 32 to 33)

You can compensate exposure from -5EV to +5EV in 1/2 steps.

In SIMPLE mode, the Optional Functions you have set will be ignored.

This section is for **ADVANCED** mode only.

MEMORY SETTING FUNCTION

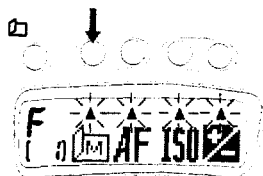

1 With the Exposure Mode menu, press the menu button to activate the Optional-Function Menu. Press the button above .

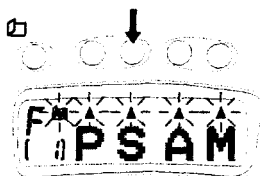

2 Blinking  appears above the frame counter, indicating that Memory setting mode is activated. To select exposure mode, press the button above the corresponding symbol. (In the example shown above, Shutter-Priority Auto exposure mode is selected.)

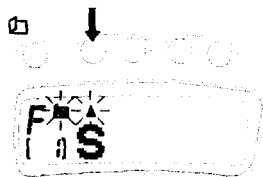

3 The symbol for the selected exposure mode or Program is displayed. Press the button above the symbol to have it memorized.

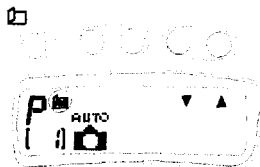

4 Memory is set.  stops blinking and the LCD shows the exposure mode/Program that was set before you activated the Optional-Function Menu. (Example illustration shows General-Purpose Program.) To recall the memorized exposure mode or Program, press the menu button for at least two seconds.

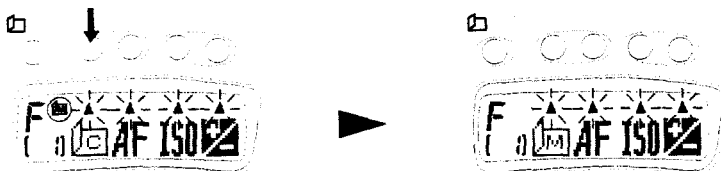

To clear memory

While memory is set, appears in place of in the Optional-Function Menu. Press the button above . is replaced with and above the frame counter disappears.

- Pressing the menu button while is blinking above the frame counter returns the LCD to the Exposure Mode Menu.

- Releasing the shutter while is blinking above the frame counter activates the previously set exposure mode or Program.

AF MODE SELECTION

Single Servo AF and Continuous Servo AF

The default AF setting is Single Servo AF. In the Single Servo AF mode, once the subject is in focus, you can lock focus by keeping the shutter release button lightly pressed, but be sure to maintain the same subject-to-camera distance. In the Continuous Servo AF mode, autofocus is maintained as long as you continuously lightly press the shutter release button, even if the focus distance changes because either you or your subject moves. In either AF mode, the shutter cannot be released when the subject is out of focus.

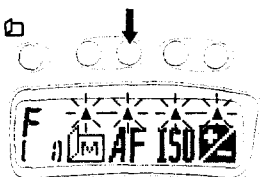

1 With the Exposure Mode Menu, press the menu button to activate the Optional-Function Menu. Press the button above **AF**.

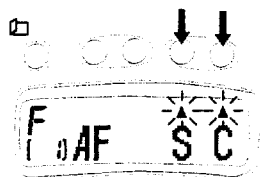

2 For Continuous Servo AF, press the button above **C** for Single Servo AF, press the button above **S**.
The LCD shows the last selected exposure mode/Program.

AF Mode Selection can be performed regardless of the focus switch position (A or M).

ISO CONFIRMATION/SETTING

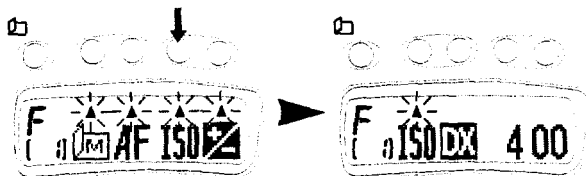

To confirm ISO film speed for DX-coded film:

Usable film speed range of DX-coded film is ISO 25 to 5000.

With the Exposure Mode Menu, press the menu button to activate the Optional-Function Menu. Press the button above **ISO**. The LCD shows the ISO film speed of the loaded DX-coded film.

To return to the last selected exposure mode/Program, press the button above **ISO**.

With a DX-coded film, film speed is automatically set on the camera body; you cannot adjust.

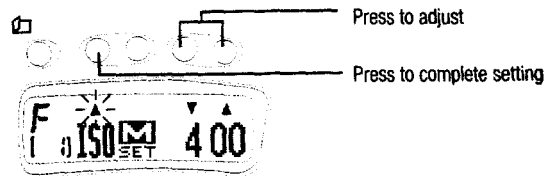

To manually set ISO film speed for non-DX-coded film:

When using non-DX-coded film, manually set the ISO film speed number. Usable film speed range is ISO 6 to 6400.

If you have installed non-DX-coded film and closed the camera back, the ISO setting screen is automatically activated on the LCD panel. Adjust the film speed by pressing the button above the ▲ (up) or ▼ (down) indication. To change film speed rapidly, hold the button down. To complete the setting, press the button above **ISO**. The LCD shows the last selected exposure mode/Program.

- Until setting is completed, the shutter remains locked, and the menu button is deactivated.
- If you want to recall the ISO setting screen after completing the setting, activate the Optional-Function Menu and press the button above **ISO**.

EXPOSURE COMPENSATION

By compensating the exposure, you can vary the exposure results to create different versions of the same picture or put creative emphasis on a specific part of the picture.
You can compensate exposure from -5 EV to + 5 EV in 1/2 steps.

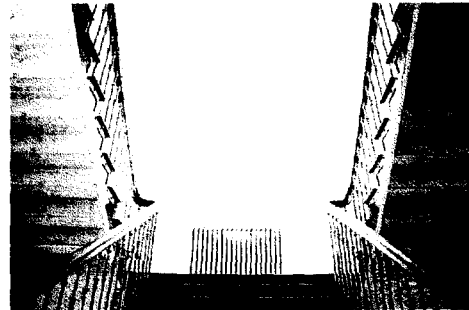

Without compensation (overexposed)

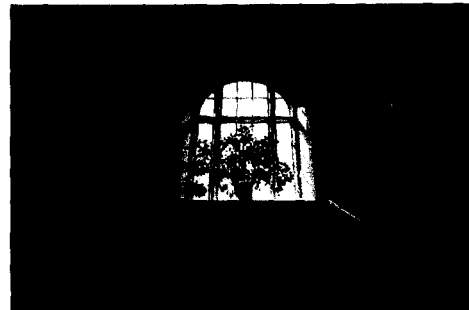



With compensation (correctly exposed)

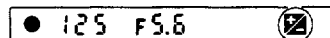
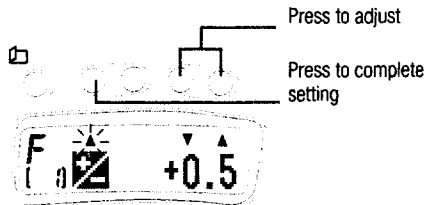

- 1 With the Exposure Mode Menu, press the menu button to activate the Optional-Function Menu. Press the button above the  indication.



- 2 Adjust the compensation value by pressing the button above the ▲ (up) or ▼ (down) indication. + value is for overexposure ; - value is for underexposure. To change the value rapidly, hold the button down. To complete the setting, press the button above . The LCD shows the last selected exposure mode/Program. When you set exposure mode or Program,  appears in the LCD panel and inside the viewfinder, indicating that the exposure has been compensated.
 - If you want to cancel the exposure compensation before completing the setting, press the menu button. The LCD panel will return to the Exposure Mode Menu.

After shooting with compensated exposure, make sure to reset the compensation value to ± 0.0 .

OTHER CONTROLS

This section shows you various photographic techniques—how to shoot an off-center subject, what you should do when autofocus is impossible, how to operate the camera's self-timer, and how to perform a long time exposure.

This section is for both **SIMPLE** and **ADVANCED** modes.

SELF-TIMER OPERATION

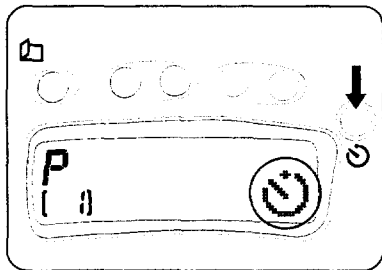

1 Set desired exposure mode or Program, then press the self-timer button.  appears in the LCD panel.

- To cancel self-timer and make  disappear, press the menu button.

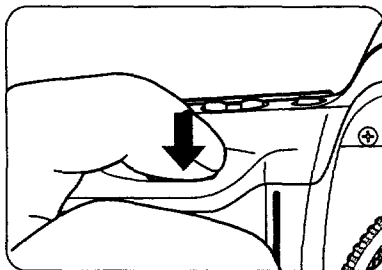

2 Look through the viewfinder, lightly press the shutter release button, and confirm focus and exposure.

3 Fully depress the shutter release button to start self-timer operation. The self-timer LED starts blinking and  in the LCD panel also blinks. The shutter will release after 10 seconds. The LED blinks for eight seconds, then stops blinking to tell you to get ready. After the shot, self-timer operation is automatically deactivated.

To cancel self-timer operation before shooting: Turn the camera's power off.

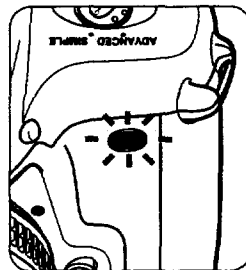

In Programmed Auto, Shutter-Priority Auto or Aperture-Priority Auto exposure mode, attach the eyepiece cover DK-5 (provided) to the viewfinder

eyepiece before setting self-timer. The DK-5 prevents stray light from entering the viewfinder and affecting exposure.

LONG TIME EXPOSURE AT "TIME" SETTING (ADVANCED mode only)

In the Manual Exposure mode, you can set shutter speed to "TIME" to leave the shutter open as long as desired.

When performing long time exposure, you must use a tripod to avoid camera shake which may cause picture blur.

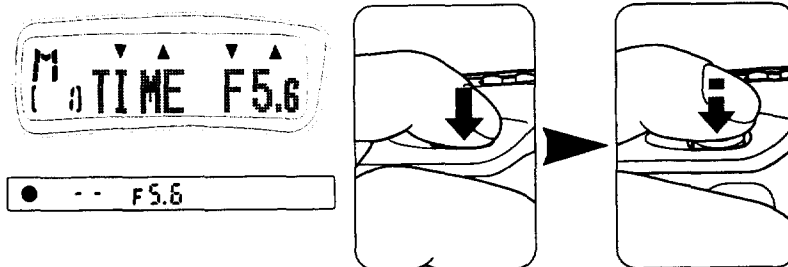

- 1 Set exposure mode to Manual and shutter speed to "TIME" (next to "30'" for 30 seconds). Inside the viewfinder, "- -" appears in place of the shutter speed indication and the exposure indicator disappears.
- 2 Fully depress the shutter release button then remove your finger to start exposure. The shutter is released about 0.5 sec. after you remove your finger from the shutter release button. During exposure, the self-timer LED blinks.
- 3 After the desired duration, lightly press the shutter release button to complete exposure.

TO SHOOT AN OFF-CENTER SUBJECT

In the following procedure, you can take an in-focus picture with an off-center, stationary subject. However, when shooting a moving subject, always position the viewfinder focus brackets on the subject.



1 Position focus brackets on the subject and lightly press the shutter release button to activate autofocus operation.



2 Confirm that ● (in-focus indicator) appears in the viewfinder. Focus remains locked as long as you keep the shutter release button lightly pressed.



3 While keeping the shutter release button lightly pressed, recompose the picture, then fully depress the shutter release button.

- The above procedure is for Single Servo AF mode (original factory setting). If you have set Continuous Servo AF mode in Optional Functions (see page 30), lightly pressing the shutter release

- button will not lock the focus.
- To maintain subject exposure, use the AE-L (Automatic Exposure Lock) button. (See pages 38 to 39.)

USING AE-L BUTTON

When your subject is off-center or very small against an extremely bright background, your subject may come out too dark (underexposed) in the picture. Or, with a background that is too dark, the subject may be washed out (overexposed). In such situations, to correctly expose your subject in the auto exposure mode, use the AE-L (Auto Exposure Lock) button.

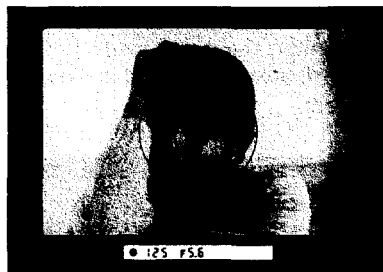
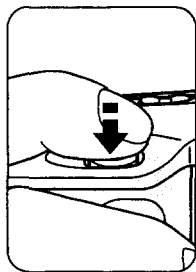

- 2 Lightly press the shutter release button to activate autofocus operation and the exposure meter. Confirm ● (in-focus indicator) and exposure.



- 1 Compose your subject so that the circle in the viewfinder is fully covered by the subject.

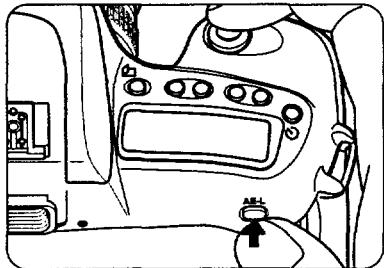

3 Press the AE-L button and hold it.



4 While keeping the AE-L button pressed, recompose the picture, then fully depress the shutter release button.

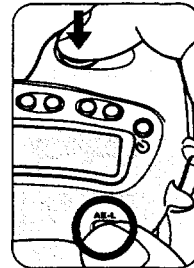

In Single Servo AF mode, if recomposing the picture could change subject-to-camera distance, refocus by briefly removing your finger from the

shutter release button and lightly pressing it again (while holding the AE-L button).

CASES WHERE AUTOFOCUS IS NOT ACCEPTABLE

Autofocus operation depends on general lighting, subject contrast and detail, and other technical points. In those rare situations where autofocus is not possible, ● blinks inside the viewfinder.



- **Very dark subject**

Focus manually (page 41). Or for autofocus, focus on another, brighter subject located at the same distance, recompose with the shutter release button lightly pressed, then shoot.

You can also use the built-in flash, or an accessory Nikon Speedlight.

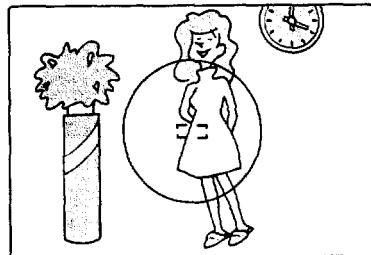

- **Low-contrast subject**

Focus manually (page 41). Or for autofocus, focus on another subject at the same distance but with more contrast, recompose with the shutter release button lightly pressed, then shoot.

When the focus brackets are positioned on the following subjects/scenes, ignore in-focus ● indication and focus manually:

- **Scenes with subjects located at different distances**
- **Bright subjects with a shiny surface, such as silver or aluminum**
- **Strongly backlit subjects**
- **When using a linear polarizing filter, or a special filter, e.g., a soft-focus filter.** (Circular polarizing filters can be used for autofocus.)

MANUAL FOCUS

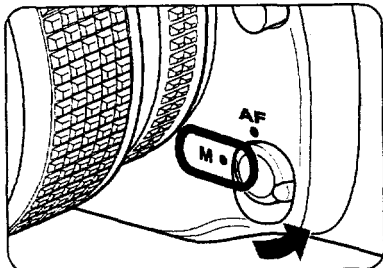

- 1 Set focus switch to M.
If your AF Nikkor lens has an A-M switch, set it to M.

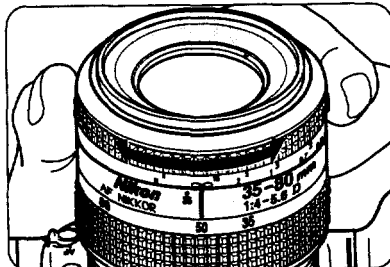

- 2 Look through the viewfinder and rotate the lens focus ring until the subject appears sharp.



For maximum focusing accuracy when using a zoom lens, it is best to focus at the lens' longest focal length setting. Focusing at the shortest focal length setting and then zooming up to the longest

focal length setting will magnify any slight imprecision in focusing and could result in unsharp pictures.

FLASH PHOTOGRAPHY

The thunderbolt symbol (⚡) inside viewfinder will blink if you need flash to take a picture, for example, in dim light. You can then activate the N50's built-in flash and use it. But remember that you can also use flash in bright light to fill in shadows with extra light. This feature, which works with the N50's built-in flash or any dedicated Nikon Speedlight, is called Matrix Balanced Fill-Flash. It operates in all the Programmed exposure modes, as well as in the Shutter-Priority or Aperture-Priority Auto exposure modes, automatically assuring a correct and well-balanced exposure of both the main subject and the background. In the Manual exposure mode, Center-Weighted Fill-Flash, which uses Center-Weighted metering to expose the background, applies.

This section is for both SIMPLE and ADVANCED modes.

USING BUILT-IN FLASH

Notes on using built-in flash

- Do not touch the flash when it is firing; normal operation can cause it to heat up.
- Never fire the flash more than 20 consecutive times at intervals of 5 sec. or shorter. This may impair flash performance. After each major flash shooting, let the flash rest at least 10 minutes before firing again.

When you continuously fire the flash, the camera's handgrip may become hot; this is normal. Continuous firing will result in a longer interval before the ready-light (⚡) comes on because it takes longer for the flash to recharge automatically.

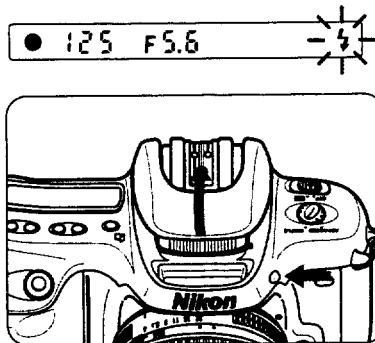

1 When subject brightness is insufficient, the ready-light ⚡ blinks inside the viewfinder when you lightly press the shutter release button to activate the exposure meter. Press the flash lock-release to release and activate the built-in flash.

You can use the built-in flash anytime, regardless of the ambient lighting. For example, if your subject is backlit, you can use the built-in flash to illuminate your subject and fill in shadows.

- When the built-in flash is activated, an accessory Speedlight will not fire. When using a Speedlight, keep the built-in flash in the locked-down position.
- For usable lenses, see page 47.

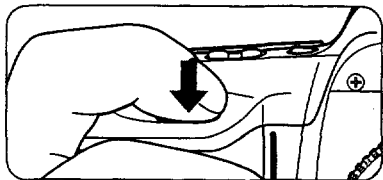
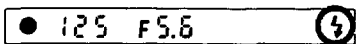

2 Make sure the subject is within the flash shooting distance range and confirm that the ready-light (⚡) is on. Fully depress the shutter release button to take a shot with flash.

After shooting, check the ready-light again. If it blinks for a few seconds after shooting, the light might have been insufficient. Confirm shooting distance and, if necessary, move closer to the subject or select a wider aperture.

Flash shooting distance range

		ISO film speed						Flash shooting distance range
		25	50	100	200	400	800	
Aperture	—	—	—	2	2.8	4	2.8 ~ 9.2m (9.2 ~ 30.2 ft.)	
	—	—	2	2.8	4	5.6	2 ~ 6.5m (6.6 ~ 21.3 ft.)	
	—	2	2.8	4	5.6	8	1.4 ~ 4.6m (4.6 ~ 15.1 ft.)	
	2	2.8	4	5.6	8	11	1.0 ~ 3.3m (3.3 ~ 10.8 ft.)	
	2.8	4	5.6	8	11	16	0.7 ~ 2.3m (2.3 ~ 7.5 ft.)	
	4	5.6	8	11	16	22	0.6 ~ 1.6m (2.0 ~ 5.2 ft.)	
	5.6	8	11	16	22	32	0.6 ~ 1.2m (2.0 ~ 3.9 ft.)	
	8	11	16	22	32	—	0.6 ~ 0.8m (2.0 ~ 2.6 ft.)	

Guide for flash shooting distance range in SIMPLE mode (at ISO 100)

For outdoor subjects on sunny day	0.6 ~ 1.6m (2.0 ~ 5.2 ft.)
For outdoor subjects on cloudy day or in shadows	0.7 ~ 2.3m (2.3 ~ 7.5 ft.)
For indoor subjects	0.7 ~ 4.6 m (2.3 ~ 15.1 ft.)

Use the listed range only as a guide for a lens having maximum aperture of f/2.8 or faster. With slower lenses, the maximum shooting distance will be reduced.

- The wider the aperture (the smaller the f-number) you select, the farther the maximum shooting distance, whereas the smaller the aperture (the larger the f-number), the shorter the maximum shooting distance.

Using guide number to estimate the maximum shooting distance

You can also estimate the maximum shooting distance by guide number of built-in flash.

$$\frac{\text{Guide number}}{\text{Lens full aperture}} = \text{Maximum shooting distance}$$

Guide number for each ISO setting (meters/feet)

ISO film speed					
25	50	100	200	400	800
6.5/ 21.3	9.2/ 30.1	13/ 42.7	18.4/ 60.4	26/ 85.3	36.8/ 120.7

- With a slower shutter speed, a smaller aperture is automatically selected, resulting in a shorter shooting distance range.

-
- In Shutter-Priority Auto or Manual exposure mode, if you set the shutter speed at 1/180 sec. or faster, the camera automatically shifts to 1/125 sec. as soon as the built-in flash is activated.
 - In Aperture-Priority Auto exposure mode, the shutter speed is fixed at 1/125 sec. for flash shooting.

Usable AF Nikkor Lenses with Built-In Flash

- **Usable non-zoom lenses**

- 35 to 300mm AF Nikkor lens (except AF Nikkor 300mm f/2.8 and AF-I Nikkor 300mm f/2.8 D)

- **Usable zoom lenses**

- AF 24-50mm f/3.3-4.5*1

- AF 28-70mm f/3.5-4.5*1

- AF 28-70mm f/3.5-4.5 D*1

- AF 28-85mm f/3.5-4.5*2

- AF 35-70mm f/2.8*3

- AF 35-70mm f/2.8 D*3

- AF 35-70mm f/3.3-4.5

- AF 35-80mm f/4-5.6 D

- AF 35-105mm f/3.5-4.5

- AF 35-135mm f/3.5-4.5*2

- AF 70-210mm f/4

- AF 70-210mm f/4-5.6

- AF 70-210mm f/4-5.6 D

- AF 75-300mm f/4.5-5.6

- AF 80-200mm f/2.8*4

- AF 80-200mm f/2.8 D*4

*1 *Cannot be used at a focal length shorter than 35mm*

*2 *Cannot be used at a focal length shorter than 35mm. At 35mm focal length setting, shoot within 2m (6.6 ft.).*

*3 *Cannot be used at a focal length shorter than 50mm.*

*4 *Cannot be used at a focal length shorter than 100mm.*

- **Do not use a lens hood; it could cause slight vignetting.**

- **With zoom lenses, do not shoot within the macro range (indicated by the orange line on the lens).**

SPEEDLIGHT COMPATIBILITY

Nikon Speedlight		Camera exposure mode				Connection
		P	S	A	M	
SB-25, SB-24, SB-23, SB-22, SB-21B*1, SB-20, SB-16B	TTL auto flash	Yes	Yes	Yes	Yes	Direct
	Other flash mode	No	No	Yes	Yes	Direct
SB-140, SB-14, SB-11 (with SU-2)	TTL auto flash	Yes	Yes	Yes	Yes	Via SC-23
	Other flash mode	No	No	Yes	Yes	Via SC-13 or sync cord with AS-15
SB-21A*2, SB-16A*2	TTL auto flash	No	No	No	No	Via AS-6
	Other flash mode	No	No	Yes	Yes	

*1 Although possible with SB-21B, Matrix Balanced Fill-Flash and Center-Weighted Fill-Flash are not recommended for close-up photography. With the N50 camera, use the SB-21B at manual flash exposure mode.

*2 The difference between SB-21A and SB-21B, or between SB-16A and SB-16B, is the type of controller attached. (For details, see Speedlight instruction manual.)

: Matrix Balanced Fill-Flash

: Center-Weighted Fill-Flash

Controlled aperture in SIMPLE mode with an accessory Nikon Speedlight (at ISO 100)

For outdoor subjects on sunny day	f/8
For outdoor subjects on cloudy day or in shadows	f/5.6
For indoor subjects	f/4

MISCELLANEOUS

This section is for both **SIMPLE** and **ADVANCED** modes.

LENSES

The Nikon N50 is designed for autofocus photography with AF Nikkor lenses (except AF-Nikkor lenses made specifically for the Nikon F3AF camera). To take full advantage of the N50 camera's features, you should use AF Nikkor lenses.

However, the lenses listed on right can be used under the following conditions:

When an AF-I or AI-P Nikkor lens is used:

- Set the focus switch to M and focus by rotating the lens focusing ring*.

When mountable non-AF Nikkor lenses are used:

- Use an external exposure meter.
- Set exposure mode to Manual. (In other exposure modes, shutter is locked.)
- Shutter speed indication appears on the LCD panel and inside the viewfinder. Set shutter speed by pressing the set/adjust button. The f-number of the aperture set will not be visible in the LCD panel and inside the viewfinder. Set the aperture by rotating the lens aperture ring.
- Adjust focus by rotating the lens focusing ring until the subject appears sharp inside the viewfinder.*

* Unless your subject is not acceptable for autofocus operation (page 40), you can confirm the in-focus indicator. Center the focus brackets on the subject, and rotate the focusing ring while lightly pressing the shutter release button. When the subject is in focus, the in-focus indicator ● appears.

Mountable non-AF Nikkor lenses

- AI-P Nikkor lenses
- AF-I Nikkor lenses
- AI-type (AI-S, AI and AI-modified) Nikkor lenses except Fisheye 6mm f/5.6 and Fisheye OP 10mm f/5.6, 180-600mm f/8 (No. 174180 or smaller), 200-600mm f/9.5 (No. 301922) or smaller, 360-1200mm f/11 (No. 174127 or smaller)
- Nikon Series E lenses
- Reflex Nikkor lenses
500mm f/8
1000mm f/11 (No. 143001 or larger)
2000mm f/11 (No. 200310 or larger)
- Medical-Nikkor 120mm f/4
- Teleconverters (except non-mountable TC-16/TC-16A)

Use of other non-AF lenses may damage the camera.

Nikkor lens compatibility

Lenses	Focusing		Exposure mode			
	Autofocus	Manual	P	S	A	M
AF Nikkor (except AF-I Nikkor lenses/AF-Nikkor lenses for F3AF)	○	○	○	○	○	○
AF-I Nikkor/AI-P Nikkor	×	○*2	○	○	○	○
AI- or AI-S type Nikkor (including AI-modified Nikkor) /Reflex Nikkor/Series E *1	×	○*2	×	×	×	○*4
Medical-Nikkor 120mm f/4	×	○	×	×	×	○*4
Teleconverters (except TC-16/TC-16A)	×	○*3	×	×	×	○*4
Bellows Focusing Attachment PB-6 K ring set (K1, K3, K4 and K5) Auto Extension Rings (PK-11A, 12, 13 and PN-11)	×	○*3	×	×	×	○*4

- Compatible
 × Incompatible

*1 Some lenses within these types/series cannot be attached.
 See page 50.

*2 Manual focus with in-focus indicator confirmation is available with lenses that have a maximum aperture of f/5.6 or faster.

*3 Manual focus with in-focus indicator confirmation is available with lenses that have a maximum effective aperture of f/5.6 or faster.

*4 Camera's exposure meter does not work. See page 50.

CAMERA CARE TIPS

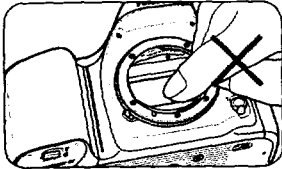

1. Do not touch the camera's reflex mirror or focusing screen. Remove dust with a blower brush.

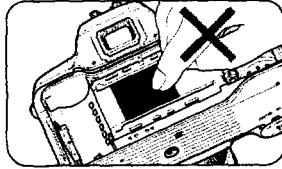

2. Do not touch the shutter curtains.

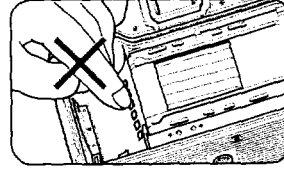

3. Do not touch the DX contacts. Keep them clean with a blower brush.

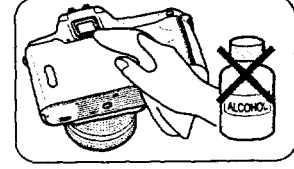

4. Clean the viewfinder eyepiece with a soft, clean cloth. Do not use alcohol.

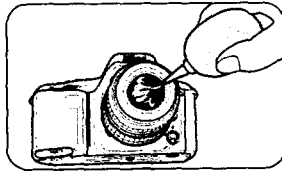

5. Clean glass surfaces, such as the lens or the eyepiece, with a blower brush; do not use lens tissue, silicon type eyeglass tissue, etc. To remove dirt and smudges, use soft cotton moistened with denatured alcohol and wipe surfaces in a spiral motion from center to periphery. Do not leave traces.

Caution!

A spray gun-type blower may damage the optical glass if used to clean the lens, especially if ED glass is used for the front lens element. To avoid damage, hold the blower upright with its nozzle more than 30cm (12 in.) from the lens surface, and keep the nozzle moving so the stream of air is not concentrated in one spot.

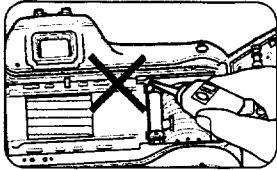

6. Do not lubricate the camera.

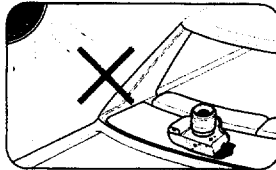

7. Do not leave the camera in an excessively hot place.

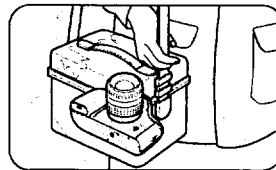

8. Keep the camera away from water or moisture. When using the camera near water, guard against splashes, especially salt water spray.

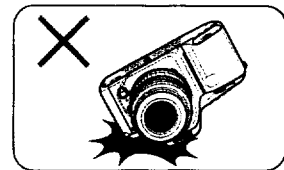

9. Make sure not to drop or bump the camera body/lens against a hard surface. Strong shock may cause malfunction.

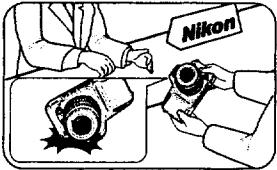

10. If the camera malfunctions, take it immediately to an authorized Nikon dealer or service center.

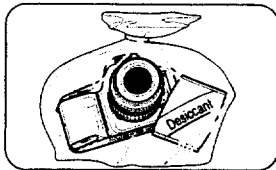

11. Store the camera in a cool, dry place away from naphthalene or camphor (moth repellent). In a humid environment, store the camera inside a vinyl bag with a desiccant to keep out dust, moisture and salt. Note, however, that storing leather cases in vinyl bags may cause the leather to deteriorate.

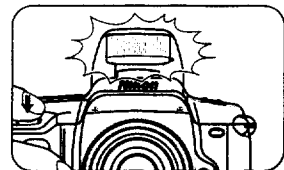
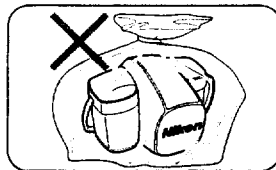

12. To maintain the built-in flash condenser in peak condition, thereby enabling you to use the flash for many years, fire the flash a few times every month.

NOTES ON BATTERIES



1. Keep batteries out of children's reach. If someone accidentally swallows a battery, call a doctor immediately.

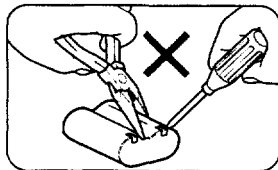

2. Do not disassemble, short circuit or heat batteries. Do not charge batteries.

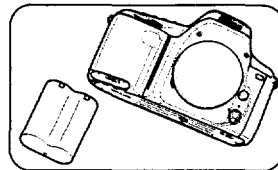

3. If you do not intend to use the camera for a long time, remove the battery.

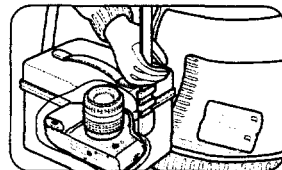

4. Battery power diminishes at extremely low temperatures—make sure the battery you buy is fresh, and wrap the camera body in something warm.

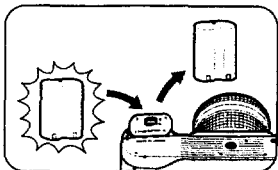

5. When replacing a battery, be sure to use a fresh battery.

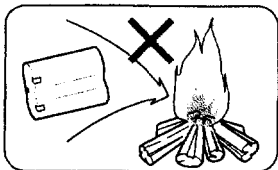

6. Do not throw used batteries into fire.



7. If the battery chamber is contaminated by battery leakage, take the camera to an authorized Nikon dealer.

SPECIFICATIONS

Type of camera	Integral-motor autofocus 35mm single-lens reflex	Exposure modes	Programmed Auto in SIMPLE mode; Programmed Auto, Shutter-Priority Auto, Aperture-Priority Auto and Manual in ADVANCED mode
Picture format	24mm x 36mm (standard 35mm film format)	Programmed Auto exposure control	Both shutter speed and aperture are set; in SIMPLE mode, General-Purpose Program, Landscape Program, Portrait Program and Close-Up Program are available; in ADVANCED mode, General-Purpose Program, Landscape Program, Portrait Program, Close-Up Program, Sport Program, Silhouette Program, Night-Scene Program, and Motion Effect Program are available
Lens mount	Nikon F mount	Flexible Program	Possible with General-Purpose Program in ADVANCED mode when flash is off
Lens	AF Nikkor lenses (except AF-Nikkor 80mm f/2.8, ED 200mm f/3.5 IF, and autofocus converter TC-16/TC-16A), and non-AF Nikkor lenses (with limitation) available	Shutter-Priority Auto exposure control	Aperture automatically selected to match manually set shutter speed
Operation mode	SIMPLE and ADVANCED	Aperture-Priority Auto exposure control	Shutter speed automatically selected to match manually set aperture
Focus modes	Autofocus and manual	Manual exposure control	Both aperture and shutter speed are set manually
Autofocus mode	Single Servo AF and Continuous Servo AF* <i>* Continuous Servo is possible in ADVANCED mode only</i>		
Autofocus detection system	TTL phase detection system using Nikon advanced AM200 autofocus module		
Autofocus detection range	Approx. EV -1 to EV 19 (at ISO 100)		
Autofocus lock	Possible, in Single Servo AF mode, once a stationary subject is in focus as long as the shutter release button is lightly pressed		
Focus tracking	Automatically activated with a moving subject		

Shutter speed/ aperture adjustment	Pressing the adjust button changes shutter speed or aperture in 1/2 step; holding down the adjust button rapidly changes shutter speed or aperture in one step	Shutter	approx. 8 sec. with the built-in flash off or 15 sec. with the built-in flash on
Auto exposure lock	Available by pressing the AE-L button while the exposure meter is on	Shutter release Shutter speeds	Electronically controlled vertical-travel focal-plane shutter Electromagnetic 1/2000 sec. to 30 sec.; electromagnetically controlled Time setting is provided (for ADVANCED mode)
Exposure compensation Exposure metering	Possible in ADVANCED mode within ± 5 EV range in 1/2 steps Matrix Metering (for Programmed Auto, Shutter-Priority Auto, and Aperture-Priority Auto exposure modes); Center-Weighted Metering for Manual exposure mode	Viewfinder	Fixed eye-level pentaprism type; 0.78x magnification with 50mm lens set at infinity; approx. 90% frame coverage
Exposure metering range Exposure meter switch	EV 1 to EV 20 at ISO 100 with f/1.4 lens Activated by lightly pressing shutter release button; when the LCD panel shows the Exposure Mode menu, Program menu, Optional-Function menu, or Optional-Function settings, stays on for approx. 60 sec.; when the LCD panel shows the Program/exposure mode, stays on for	Eyepoint Focusing screen	Approx. 18mm Fixed Nikon advanced B-type BriteView screen with central focus brackets for autofocus operation Shows correct exposure, in-focus/AF-impossible, shutter speed, aperture, exposure information, exposure compensation, and flash recommended-/ready-light Automatically activates when exposure meter is on
		Viewfinder information LCD	
		Viewfinder illuminator	

Film speed range ISO 25 to 5000 for DX-coded films; ISO 6 to 6400 for non-DX-coded films (for ADVANCED mode)

Film speed setting Auto for DX-coded films; manual setting for non-DX-coded films (for ADVANCED mode)

Film loading Film automatically advances to frame one when camera back is closed

Frame counter Accumulative type (counts down during film rewind); displayed on the LCD panel

Film advance Film automatically advances one frame at approx. 1 sec. when shutter is released; film advance stops automatically at end of film roll

Film rewind Automatic by built-in motor at end of film roll; manual mid-roll rewind possible by pressing rewind button

Self-timer Electronically controlled; 10-sec. timer duration

Reflex mirror Automatic, instant-return type

Camera back Hinged back; unchangeable

Accessory shoe Standard ISO-type with hot-shoe contact, ready-light contact, monitor contact, TTL flash contact

Built-in TTL flash Guide number: 13 meters or 42.7 feet (at ISO 100, 20°C or 68°F); angle of coverage: 35mm or longer lens

Flash synchronization speed 1/125 sec. or slower

Automatic Balanced Fill-Flash Possible with built-in TTL flash or Nikon dedicated Speedlights such as SB-25, SB-24, SB-23, SB-22, SB-20, SB-18 and SB-16B; Matrix Balanced Fill-Flash in Auto exposure modes; Center-Weighted Fill-Flash in Manual exposure mode

Flash ready-light Without flash: Blinks when using flash is recommended
With flash: Lights up when built-in flash or Nikon dedicated Speedlight is ready to fire; blinks after flash shooting to warn of insufficient light for correct exposure

Power source 6V lithium battery pack (2CR5 or DL245 type)

Number of 24-exposure (36-exposure) film rolls per fresh battery*

	at 20°C (68°F)	at -10°C (14°F)
Without flash	100 (80)	40 (30)
With 50% flash	20 (15)	13 (10)

* For autofocus operation with AF Zoom Nikkor 35-80mm f/4-f/5.6 D lens covering the full range from infinity to the closest distance and back to infinity before each shot, at 1/125 sec., or faster shutter speed

Dimensions (WxHxD) Approx. 149 x 96 x 70mm or
5.9 x 3.8 x 2.8 in.

Weight (without battery) Approx. 580g or 20.5 oz.

Optional viewing accessory Rubber Eyecup DK-9

*With fresh battery at normal temperature (20°C or 68°F).
Specifications and design are subject to change without notice.*

ABOUT THE N50 METERING SYSTEM

The Nikon N50 has two types of exposure metering systems—Matrix Metering and Center-Weighted Metering.

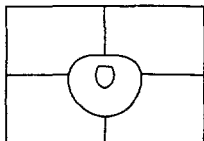

Matrix Metering

With D-type AF Nikkor lenses including AF-I Nikkor: When you set a Program, or Shutter-Priority Auto or Aperture-Priority Auto exposure mode, 3D Matrix Metering automatically activates. Even in extremely complex lighting situations, the six-segment Matrix Meter analyzes scene brightness and contrast, automatically adjusting everything to ensure correct exposure. In addition, the microcomputer built in the D-type AF Nikkor lens sends the information about camera- to-subject distance, enabling the camera's microcomputer to perform more precise exposure analysis.

If non-D-type AF Nikkor lens or AI-P Nikkor lens is used, Advanced Matrix Metering is activated; although there is no information about camera-to-subject distance, correct exposure is assured.

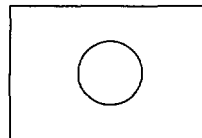



Center-Weighted Metering

When you set Manual exposure mode, the camera automatically switches to Center-Weighted Metering. Center-Weighted Metering places special emphasis on brightness within the 12mm-diameter central area of the viewfinder, and useful to base exposure on a specific area of the scene.

LCD PANEL/VIEWFINDER INDICATIONS

Indications	Shutter	Cause and Remedy
☐ blinks in the LCD panel. (Except in Manual exposure mode.)	Can be released	Battery is nearing exhaustion. Have a fresh one ready.
Err and ☐ blink in the LCD panel.	Locked	Battery is just about exhausted. Turn the power off and replace battery with new one.
Err and Ⓢ blink* in the LCD panel.	Locked	a) Film is not correctly positioned. Reload film. b) Battery is exhausted during film rewind. Turn the power off and replace battery with new one.
Err and Ⓢ blink* in the LCD panel in SIMPLE mode.	Locked	Non-DX-coded film or film with unacceptable DX code is loaded. Switch to ADVANCED mode and set film speed manually.
Err and Ⓢ blink* in the LCD panel in Auto exposure modes (P/S/A).	Locked	Lens attached has no CPU; or no lens is attached. Attach AF Nikkor or AI-P lens.
Ⓢ blinks in the LCD panel in Manual exposure mode.	Can be released	Lens attached has no CPU (see page 50); or no lens is attached.
Err and Ⓢ blink* in the LCD panel.	Locked	Lens is not set to the smallest aperture (largest f-number) setting. Set lens to the smallest aperture.
Err blinks in the LCD panel during film advance or film rewind.	Locked	Camera detects a malfunction. Turn the camera's power off, and on again.

* "Err" also blinks inside viewfinder.

Indications	Shutter	Cause and Remedy
● blinks inside viewfinder.	Locked	Autofocus is impossible with the subject. Set focus mode switch to M to focus manually by rotating the lens focusing ring.
HI blinks in the LCD panel and inside viewfinder (in Auto exposure modes).	Can be released	Overexposure may occur.
Lo blinks in the LCD panel and inside viewfinder (in Auto exposure modes).	Can be released	Underexposure may occur.
[] blinks inside the viewfinder and  blinks in the LCD panel (in SIMPLE mode). Shutter speed indicator blinks inside the viewfinder and  blinks in the LCD panel (in Programmed or Aperture-Priority Auto exposure mode in ADVANCED mode).	Can be released	Automatically selected shutter speed is too slow and picture blur may occur. Use a tripod to avoid camera shake, or use built-in TTL flash or Nikon Speedlight.
Err and "TIME" blink* in the LCD panel.	Locked	"TIME" is set in Shutter-Priority Auto exposure mode. Set another shutter speed, or set exposure mode to Manual.
 blinks inside the viewfinder (without flash).	Can be released	Your subject is too dark. Use the built-in TTL flash or Nikon Speedlight.

* "Err" also blinks inside viewfinder.

Indications	Shutter	Cause and Remedy
⚡ blinks inside the viewfinder after flash shooting.	Locked	Light might be insufficient. Confirm shooting distance and, if necessary, move closer to the subject or select a wider aperture.
Err and  blink* in the LCD panel in Programmed Auto or Shutter-Priority Auto exposure mode.	Locked	Speedlight attached is not set at TTL. Set the Speedlight's flash mode to TTL. Or, use Aperture-Priority Auto or Manual exposure mode.

* "Err" also blinks inside viewfinder.

About LCD

- The camera uses a Liquid Crystal Display (LCD) of the highest quality which, under conditions of normal use, should provide several years of reliable operation. After this period, contrast may deteriorate and display information may start to fade. You can have the LCD replaced at a nominal charge by contacting an authorized Nikon dealer or service facility.
- At temperatures between freezing, the LCD's response time slows down; it goes back to normal when the temperature rises.
- As the temperature rises, the LCD turns reddish; as the temperature drops, the LCD turns bluish. These changes do not affect normal use.

In certain cases, due to static electricity or poorly loaded batteries, the camera's microcomputer may turn the camera off, even with fresh properly installed battery. For the same reason, film may not advance properly. In each of these cases, to resume operation, simply turn the power OFF, then turn ON again, or remove battery and install it again.

Nikon cannot be held responsible for any malfunction resulting from the use of the camera other than as specified in this manual.

No reproduction in any form of this manual,
in whole or in part (except for brief
quotation in critical articles or reviews), may
be made without written authorization from
NIKON CORPORATION.

Nikon

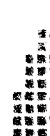

NIKON CORPORATION

FUJI BLDG., 2-3, MARUNOUCHI 3-CHOME, CHIYODA-KU, TOKYO 100, JAPAN

PHONE: 81-3-3214-5311 **TELEX:** NIKON J22601 **FAX:** 81-3-3201-5856

Printed in Japan 9 & 023-AG12(S793)

Nikon N50

PHOTO GUIDE

SHORTCUT TO GREAT PICTURES

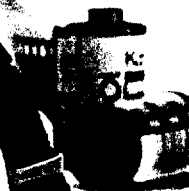

Thank you for selecting the Nikon N50 camera — your shortcut to great pictures. We prepared this Photo Guide to help you enjoy using the N50 and making great pictures with it. Inside you'll see some examples of the type of photographs that you, too, can make.



-
- Turn dial to SIMPLE
 - Set focus switch to AF
(autofocus setting)
 - Set and lock lens at minimum aperture
(orange number)
 - Switch ON camera power
 - Choose from four Programs:



General Purpose



Landscape



Portrait



Close-up

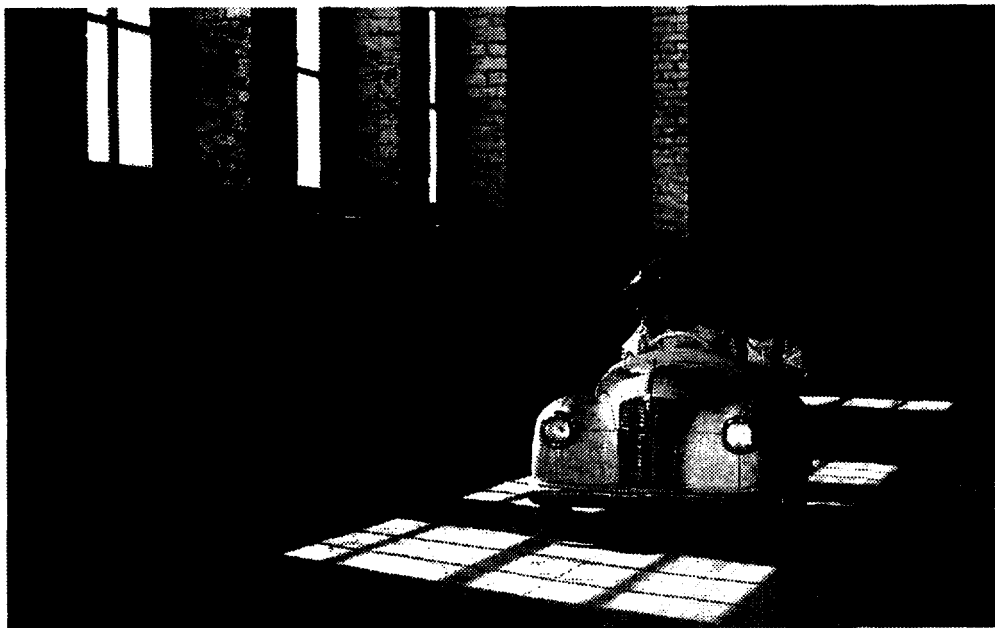

 SIMPLE MODE

General-Purpose Program with AF Zoom-Nikkor 35-80mm f/4-5.6D set at 35mm



General-Purpose Program

Use this Program for most picture-taking situations — indoors or outdoors, for stationary or slowly moving subjects, near or far, in bright or dim light. Use the built-in flash when it's recommended.

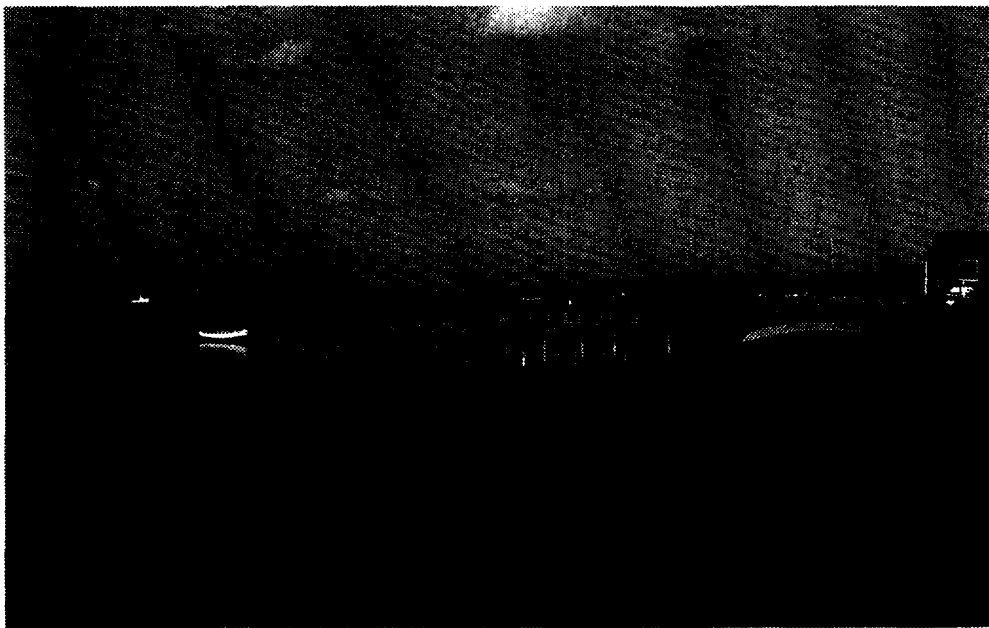

SIMPLE MODE

Landscape Program with AF Zoom-Nikkor 28-70mm 1/3.5-4.5D set at 28mm



Landscape Program

Use this Program whenever you're making a picture of a distant scene, like a boat on a lake, a block of buildings, mountains or the seaside. Don't use flash — the scene may be too far.



Portrait Program with AF Zoom-Nikkor 80-200mm f/2.8D ED set at 200mm



SIMPLE MODE

Portrait Program

Use this Program whenever you're taking pictures of people or pets. It creates an artistically blurred background to accentuate your main subject. Use the built-in flash when it's recommended.

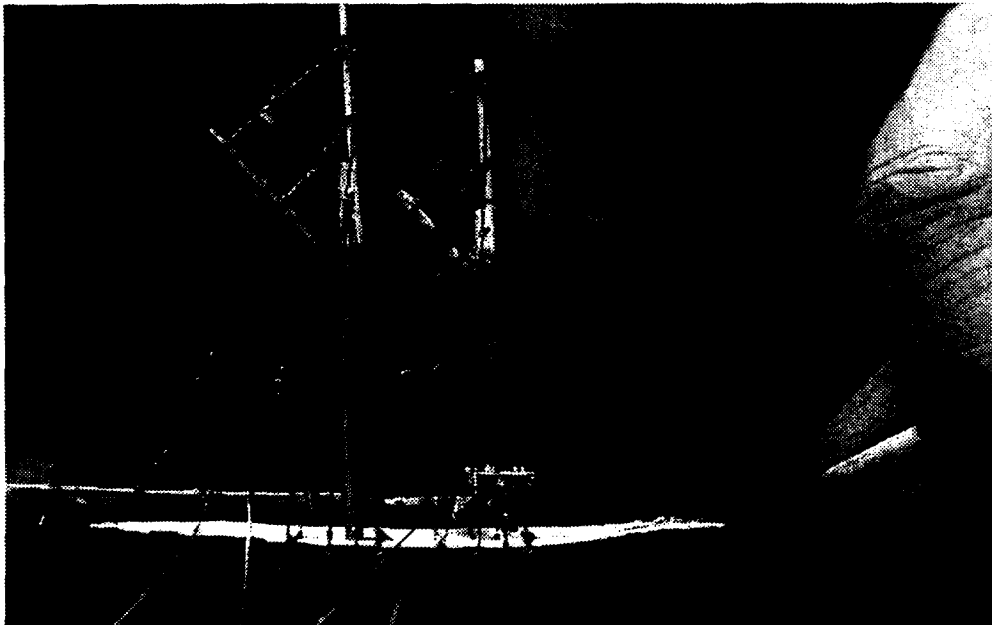

Close-up Program with AF Micro-Nikkor 60mm f/2.8



SIMPLE MODE

Close-up Program

Use this Program when you're taking pictures up close — a flower, an ornamental detail, a butterfly, or if you're copying a picture. Use the built-in flash when it's recommended.

ADVANCED MODE

- Turn dial to ADVANCED
- Set focus switch to AF (autofocus setting)
- Set and lock lens at minimum aperture (orange number)
- Switch ON camera power
- Choose from eight Programs:



Portrait
P



Landscape
L



Portrait
P



Close-up
C



Sport
S



Silhouette
Si



Night Scene
N



Motion Effect
M

- Or choose from three other exposure modes:



Shutter
Priority



Aperture
Priority



Manual
Exposure

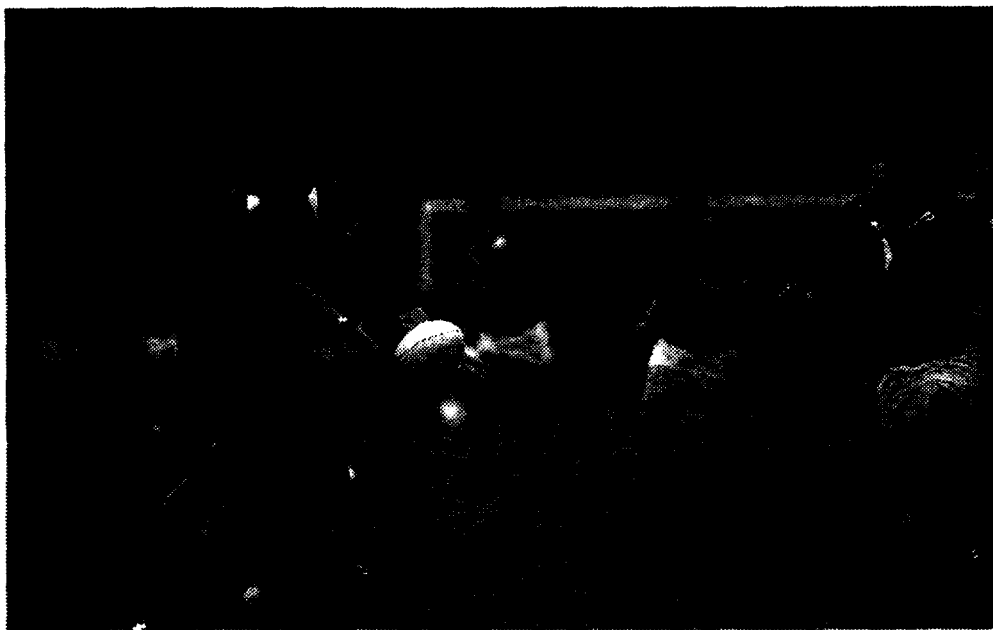

Sport Program with AF Zoom-Nikkor 80-200mm f/2.8D ED set at 200mm



ADVANCED MODE

Sport Program

For creative pictures of moving subjects. Makes the main subject stand out against a blurred background. For maximum effect, use a telephoto lens; the shorter the lens' focal length, the less the effect. Don't use flash because it restricts the available shutter speeds.

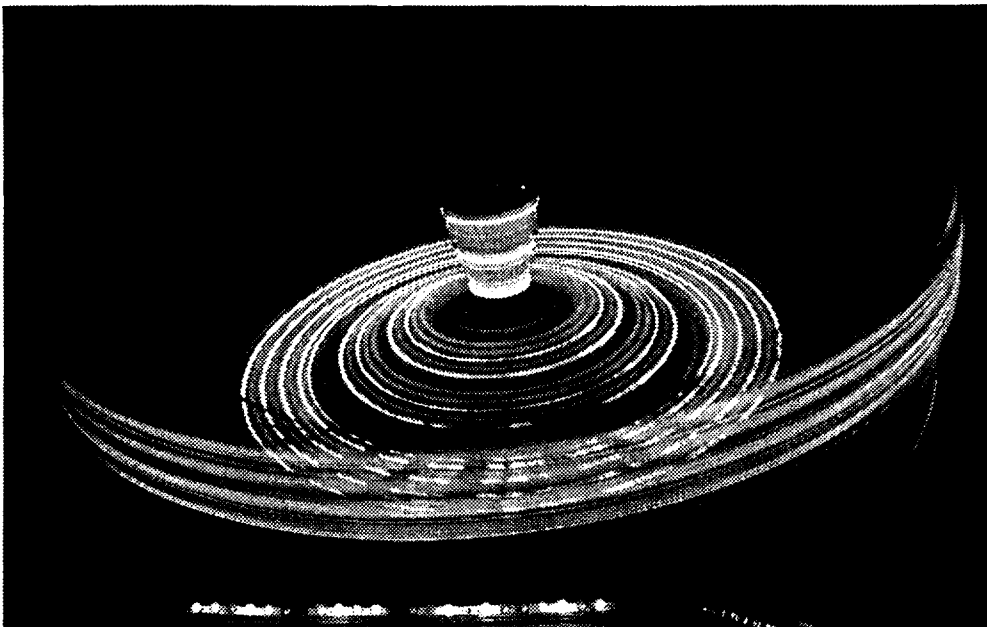

Night Scene Program with AF Zoom-Nikkor 35-80mm 1/4-5.6D set at 35mm



ADVANCED MODE

Night Scene Program

Use this program to capture the beauty of a night scene in available light, such as illuminated monuments, traffic lights or neon signs. But hold the camera steadily or use a tripod to prevent camera shake because the shutter speed will be very slow.



Night Scene Program with AF Zoom-Nikkor 35-70mm f/2.8D set at 35mm



ADVANCED MODE

Night Scene Program with Flash

Captures all the lighting in the scene — including the foreground, which is illuminated by the built-in flash, and the background. This program keeps the whole scene's lighting in balance. Excellent for use with night scenes where the background is interesting and you want to show it.



Motion Effect Program with AF Zoom-Nikkor 35-80mm 1/4-5.6D set at 80mm

ADVANCED MODE



Motion Effect Program

Creates a great visual effect, capturing the blurry effect of flowing water, for example, against a sharp background of trees or that of a moving carousel at an amusement park.

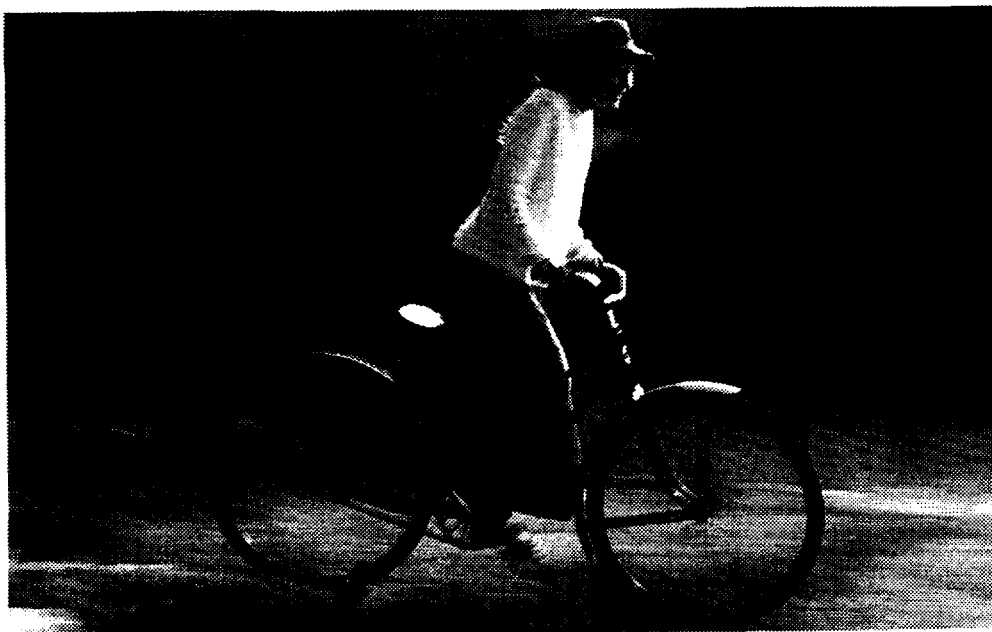

Motion Effect Program with AF Zoom-Nikkor 35-80mm f/4-5.6D set at 80mm

ADVANCED MODE



Motion Effect Program with Panning

Great for when your subject is moving and you're following along with your camera in a panning motion. The subject will come out relatively sharp, with the background becoming a blurred streak of colors and shades.



Silhouette Program with AF Zoom-Nikkor 28-70mm f/3.5-4.5D set at 28mm



ADVANCED MODE

Silhouette Program

Effective only when the background is bright and the subject is in shadow or comparatively dark. The result is dramatic with a wideangle lens — 28mm or wider — although a telephoto can also be used. Excellent for sunsets or pictures of people against the sky. Don't use flash!



High speed
(1/2000 sec.)



Small aperture
(f/22)



Slow speed
(1/90 sec.)



Large aperture
(f/2.8)

S ADVANCED MODE Shutter-Priority Auto Exposure

Depict action in a still photograph by selecting a shutter speed that matches the action. A fast shutter speed can stop action; a slow speed used with a moving subject will create blur. Experiment with different speeds as you photograph a moving subject.

A ADVANCED MODE Aperture-Priority Auto Exposure

Choosing the aperture allows you to control the picture's depth of field (DOF). DOF refers to how much sharpness is apparent from the foreground to the background. Smaller apertures increase DOF; larger apertures decrease it. Notice the difference between the pictures.



Auto exposure

Intentional
underexposure
on Manual

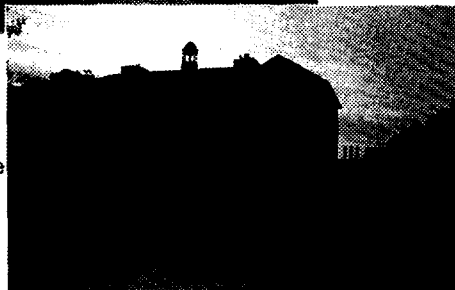

M ADVANCED MODE Manual Exposure

In any auto exposure mode, each time the light changes the N50 automatically adjusts for correct exposure. But perhaps you'll want to create a different version of the same picture by choosing the shutter speed and lens aperture. See for yourself — both pictures look good!

16

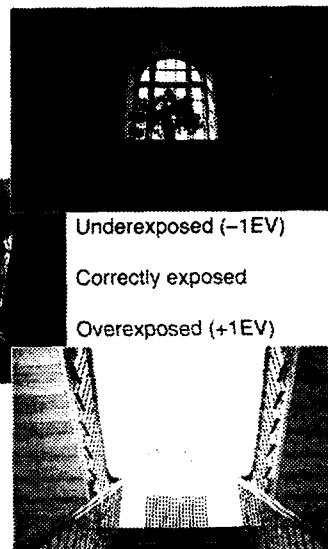

AE ADVANCED MODE Exposure Compensation

This feature allows you to add a personal touch or variety to your pictures. Shoot the same subject three times, each one with a different effect, by compensating the exposure. Don't they look interesting?

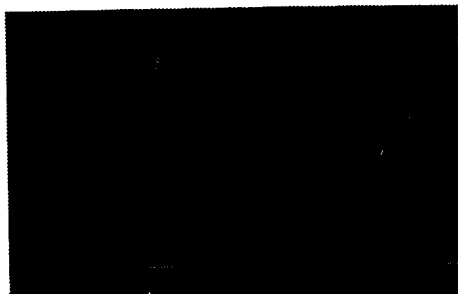

Dark scene
without flash



Backlit scene
without flash



Dark scene
with flash



Backlit scene
with flash

SIMPLE/ADVANCED MODE
Built-in Auto Flash

Use the built-in flash in dark situations and even in bright light. Take a look at the dramatic improvements.

SYSTEM ACCESSORIES FOR ADDED VERSATILITY

For exciting creativity, build your Nikon N50 system with a selection of high-quality Nikon accessories. Choose a wideangle AF Zoom-Nikkor lens like the 28-70mm, 35-80mm or 28-85mm so you can shoot anything from wide interiors to landscapes and portraits with really great results and variety. To capture far-off sports scenes or subjects, or to make effective head-and-shoulders pictures of people or pets, try the 70-210mm or 75-300mm zooms. Add an extra-featured Nikon Speedlight like the SB-23 or SB-25 for special effects. Use filters to create moods and alter colors. For details, visit your local Nikon Authorized Dealer and ask to see Nikon N50 system accessories, or call 1-800-NIKON US. You'll enjoy photography as you never have before!

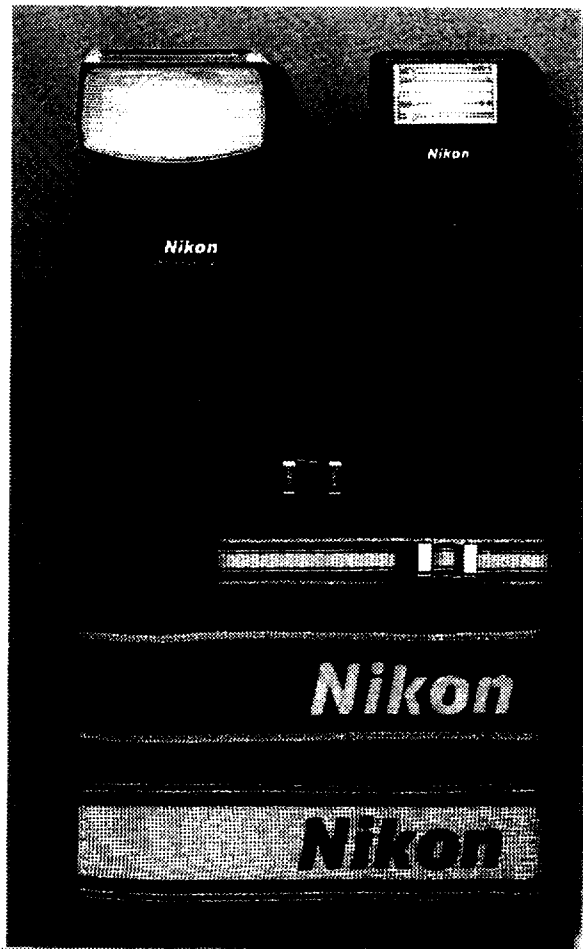

Nikon

88.1.1
Nikon 17-35mm
1:2.8

Nikon 10-180
1:4.5

17-35mm 1:2.8
18-200mm 1:3.5-5.6
28-200mm 1:3.5-5.6
35mm 1:2.8
50mm 1:1.8
70-200mm 1:3.5-5.6
105-300mm 1:3.5-5.6

Nikon®
We take the world's
greatest pictures.™



Nikon

© Nikon Inc., 1994

Nikon Inc., 1300 Walt Whitman Road, Melville, N.Y., 11747-3064, U.S.A.



Printed in Japan