

2 GHz Digitizing Oscilloscope PM3340

Operating Manual

4822 872 00368
880301

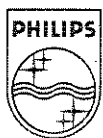
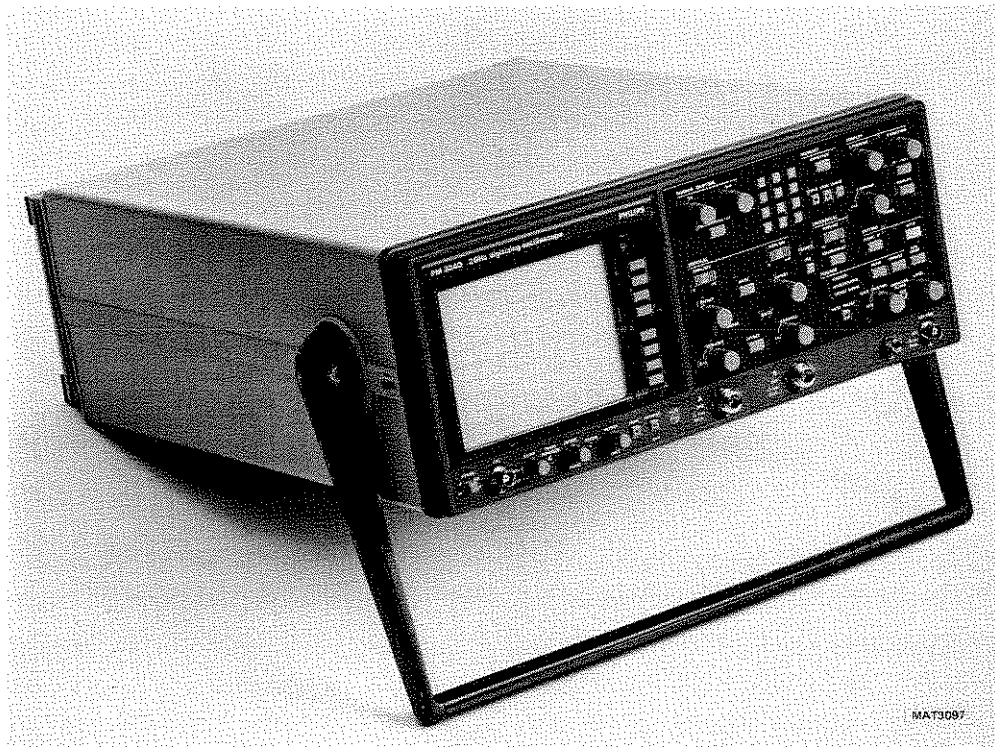

PHILIPS

ARRANGEMENT OF MANUAL

This Operating Manual is arranged in such a way that the essential information on safety and operating procedures is immediately available in the first chapters.

You are strongly advised to read Section 3.2. SAFETY INSTRUCTIONS thoroughly before installing your oscilloscope.

Operating information is given in the remainder of Chapter 4.

Complete information for preventive maintenance on the instrument can be found in Chapter 5. This is followed by details of the functional, mechanical and environmental data, listed in Chapter 6, Characteristics.

Finally, additional information regarding the various versions of the instrument and accessories is given in Chapter 7, and Chapter 8. respectively.



CONTENTS

	Page
1.0 OPERATORS SAFETY	1-1
1.1 Introduction	1-1
1.2 Safety precautions	1-1
1.3 Caution and warning statements	1-1
1.4 Symbols	1-1
1.5 Impaired safety-protection	1-1
2.0 INTRODUCTION	2-1
3.0 INSTALLATION INSTRUCTIONS	3-1
3.1 Initial inspection	3-1
3.2 Safety instructions	3-1
3.2.1 Earthing	3-1
3.2.2 Mains voltage cord and fuses	3-1
3.3 Memory back-up batteries	3-2
3.3.1 General information	3-2
3.3.2 Installation of batteries	3-3
3.4 The front cover	3-4
3.4.1 Removing and fitting of the front-cover	3-4
3.4.2 Acces to inner-cover storage space	3-5
3.5 Operating position of the instrument	3-5
3.6 IEEE-488/RS232-C interface	3-6
4.0 OPERATING INSTRUCTIONS	4-1
4.1 Switching-on and power-up routine	4-1
4.1.1 Switching-on	4-1
4.1.2 Power-up routine	4-1
4.1.3 Default settings after switching-on	4-1

	Explanation of controls and sockets	4-2
4.2.1	Softkeys	4-3
4.2.2	Screen lay-out and text areas	4-7
4.2.3	Auto-set	4-10
4.2.4	CRT section	4-11
4.2.5	Vertical section + menu structure	4-12
4.2.6	Horizontal section + menu structure	4-30
4.2.7	Trigger section + menu structure	4-42
4.2.8	Cursor/analyse section + menu structure	4-49
4.2.9	Memory section + menu structure	4-133
4.2.10	Display section + menu structure and auxiliary section.	4-142
4.2.11	Front no. section + menu structure	4-160
4.2.12	Miscellaneous functions and remote mode	4-172
4.2.13	Rear panel	4-174
4.3	Detailed Operating Information	4-175
4.3.1	Introduction	4-175
4.3.2	Start-up procedure	4-175
4.3.3	Use of internal registers	4-176
4.3.4	High-frequency measurements.....	4-177
4.3.5	Use of probes.....	4-179
4.3.6	Offset adjustment.....	4-179
4.3.7	Add mode and common-mode measurements	4-180
4.3.8	Triggering	4-181
4.3.9	Trigger delay	4-183
4.3.10	Time-base acquisition modes	4-184
4.3.11	Signal processing modes.....	4-185
4.3.12	Horizontal magnifier	4-187
4.3.13	Vertical magnifier	4-187
4.3.14	A versus B mode	4-189
4.3.15	Analog plot mode	4-189
4.4	Principle of operation	4-201
4.4.1	General	4-201
4.4.2	The signal acquisition section	4-201
4.4.3	The storage section	4-204
4.4.4	The display section	4-205
4.4.5	The control section	4-207
4.4.6	The front section	4-208
4.4.7	The power supply section	4-208
4.5	Brief Checking Procedure	4-209
4.5.1	General information	4-209
4.5.2	Preliminary settings	4-209
4.5.3	Trace rotation	4-210
4.5.4	Vertical	4-210
4.5.5	Horizontal	4-211
4.5.6	Triggering	4-211
4.5.7	Display	4-212
4.5.8	Memory	4-212
4.5.9	Cursor control	4-213

5.0	PREVENTIVE MAINTENANCE	5-1
5.1	General information	5-1
5.2	Removing the bezel and the contrast filter	5-1
5.3	Replacing the memory back-up batteries	5-2
5.4	Recalibration	5-2
6.0	CHARACTERISTICS	6-1
6.1	Auto set.....	6-1
6.2	Signal acquisition	6-2
6.3	Vertical channels.....	6-2
6.4	Time base.	6-2
6.5	Triggering.....	6-3
6.6	Memory	6-3
6.7	Display	6-3
6.8	Cursors.....	6-3
6.9	Setting memory.....	6-3
6.10	Calibration output.....	6-3
6.11	Plot outputs.....	6-4
6.12	Cathode ray tube.....	6-4
6.13	Power supply	6-4
6.14	IEEE-488/RS 232-C interfaces.....	6-4
6.15	Mechanical data.....	6-4
6.16	Environmental data.....	6-5
6.17	Safety.....	6-5
6.18	Accessories delivered with the instrument.....	6-5
6.19	Ordering information.....	6-5

6.20	Voltage measurements.....	6-6
6.21	Time measurements.....	6-7
6.22	Mathematical functions.....	6-7
6.23	Vertical processing modes.....	6-8
6.24	Horizontal processing modes.....	6-8
7.0	PM3340 VERSIONS - ADDITIONAL INFORMATION	7-1
8.0	ACCESSORY INFORMATION	8-1
8.1	Accessories supplied with the instrument	8-1
8.1.1	Passive probe PM8911/08 with automatic range indication	8-1
8.1.2	Blue contrast filter	8-5
8.1.3	Front cover	8-5

LIST OF FIGURES

		Page
Figure 2.1	2 GHz digitizing oscilloscope	2-1
3.1	Rear view showing the fuse-holder	3-2
3.2	Rear view showing the battery compartment	3-3
3.3	Removing the front cover	3-4
3.4	Removing the inner front cover (storage space)	3-5
3.5	Carrying handle rotation and sloping positions	3-6
4.1	Front panel function lay out	4-2
4.2	Front panel view (softkeys)	4-3
4.3	Example softkey text	4-4
4.4	Screen lay-out	4-7
4.5	Example screen lay-out	4-9
4.6	Front panel view (auto-set)	4-10
4.7	Front panel view (CRT section)	4-11
4.8	Front panel view (vertical section)	4-12
4.9	Vertical mode menu structure	4-14
4.10	Vertical coupling menu structure	4-21
4.11	Front panel view (horizontal section)	4-30
4.12	Horizontal mode menu structure	4-31
4.13	Horizontal magnifier/delay menu structure	4-38
4.14	Front panel view (trigger section)	4-42
4.15	Trigger coupling menu structure	4-44
4.16	Trigger source menu structure	4-46
4.17	Front panel view (cursor section)	4-49
4.18	Cursor/analyse menu structure	4-51
4.19	Cursor display and control	4-62
4.20	Hamming window for FFT measurements	4-119
4.21	Hanning window for FFT measurements	4-119
4.22	Histogram display	4-122
4.23	Front panel view (memory section)	4-133
4.24	Save/plot menu structure	4-135
4.25	Front panel view (display section)	4-142
4.26	Magnify menu structure	4-144
4.27	Y/5 display	4-145
4.28	Display menu structure	4-147

Figure	4.29	Reduced text display in Y/5	4-157
	4.30	Full text display	4-158
	4.31	Front panel view (front no. section)	4-160
	4.32	Front number menu structure	4-161
	4.33	Contents of the front setting memory (example)	4-162
	4.34	Insert-action	4-166
	4.35	Delete-action	4-167
	4.36	Save-action	4-168
	4.37	End of sequence-action	4-170
	4.38	Front panel view (miscellaneous + remote)	4-172
	4.39	Rear panel view	4-174
	4.40	Screen of R0 contents in dual channel mode	4-176
	4.41	Display of four registers in Y/5 mode	4-177
	4.42	General measuring set-up	4-178
	4.43	Measuring configuration with power splitter	4-179
	4.44	Suppression of common-mode signals	4-180
	4.45	Possible trigger modes as a function of input voltage and frequency	4-182
	4.46	Y/5 mode	4-187
	4.47	Y*1 mode	4-188
	4.48	Y*5 mode	4-189
	4.49	Block diagram	4-196
	4.50	Sequential sampling principle	4-203
	4.51	Display of trace memory contents	4-206
	5.1	Removing the bezel and contrast filter	5-1
	7.1	Rear panel with indicated type plate position	7-1
	7.2	Mains connectors	7-2
	8.1	Admittance at h.f.	8-2
	8.2	Blue contrast filter	8-5
	8.3	Oscilloscope with front cover	8-5
	8.4	Adaptor BNC into N-type of connector.....	8-6

1.0 OPERATORS SAFETY

Read this page carefully before installation and use of the instrument.

1.1 INTRODUCTION

The instrument described in this manual is designed to be used by properly-trained personnel only. Adjustment, maintenance and repair of the exposed equipment shall be carried out only by qualified personnel.

1.2 SAFETY PRECAUTIONS

For the correct and safe use of this instrument it is essential that both operating and service personnel follow generally-accepted safety procedures in addition to the safety precautions specified in this manual. Specific warning and caution statements, where they apply, will be found throughout the manual. Where necessary, the warning and caution statements and/or symbols are marked on the apparatus.

1.3 CAUTION AND WARNING STATEMENTS

CAUTION: is used to indicate correct operating or maintenance procedures in order to prevent damage to or destruction of the equipment or other property.

WARNING: calls attention to a potential danger that requires correct procedures or practices in order to prevent personnel injury.

1.4 SYMBOLS



Read the operating instructions.

1.5 IMPAIRED SAFETY PROTECTION

Whenever it is likely that safety-protection has been impaired, the instrument must be made inoperative and be secured against any unintended operation. The matter should then be referred to qualified technicians. Safety protection is likely to be impaired if, for example, the instrument fails to perform the intended measurements or shows visible damage.



2.0

INTRODUCTION

This compact dual channel digitizing storage oscilloscope features sampling techniques that allow display of signals with a frequency up to 2 GHz. The sampling system can work in normal and in high resolution eye pattern mode. The instrument is extremely easy to use because of the AUTO-SET pushbutton, that automatically adjusts the controls to suit the input signal value.

The brightness is independent of the time base settings. The M68000 microprocessor gives a wide choice of measurement and display possibilities, which can be selected via the ergonomic designed front panel.

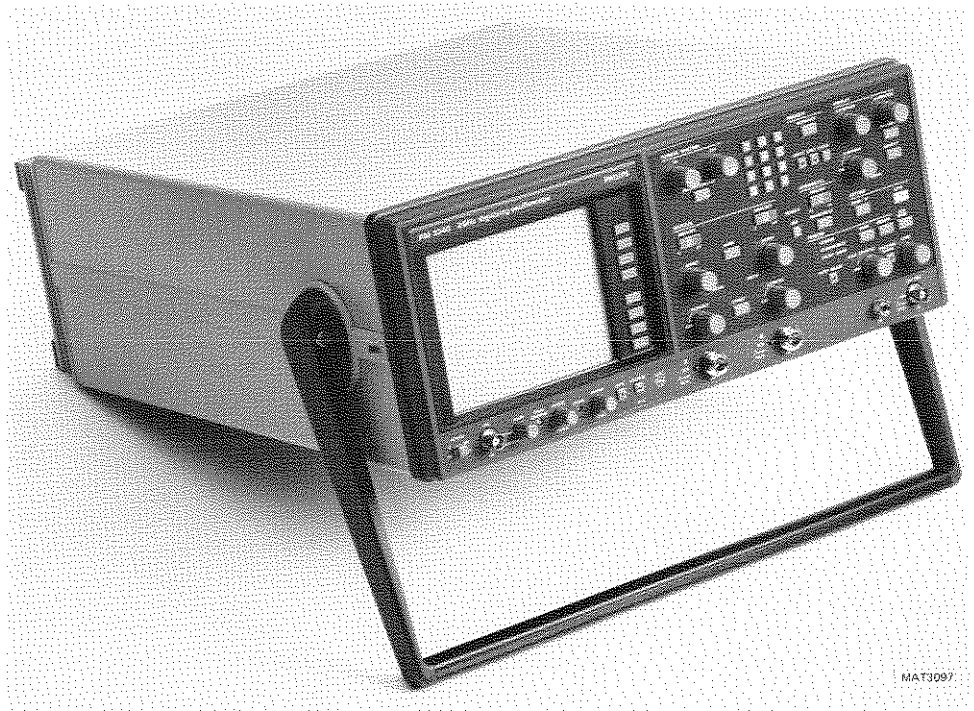

Figure 2.1 2 GHz digitizing oscilloscope.

The oscilloscope is provided with integrated circuits (including thin-film circuits), which guarantee a highly stable operation.

Furthermore, connection to the local mains is simplified by a tapless switched-mode power supply that covers most voltage ranges in use: 90 V...264 V a.c.

All these features make this oscilloscope suitable for a wide range of high-frequency measuring applications such as in telecommunication, component testing and development and in fast computers.



3.0 INSTALLATION INSTRUCTIONS

3.1 INITIAL INSPECTION

Check the contents of the shipment for completeness and note whether any damage has occurred during transport. If the contents are incomplete, or there is damage, a claim should be filed with the carrier immediately, and the Philips Sales or Service organisation should be notified in order to facilitate the repair or replacement of the instrument.

3.2 SAFETY INSTRUCTIONS

3.2.1 Earthing

Before any connection to the input connectors is made, the instrument shall be connected to a protective earth conductor via the three-core mains cable; the mains plug shall be inserted only into a socket outlet provided with a protective earth contact. The protective action may not be negated by the use of an extension cord without protective conductor.

WARNING: Any interruption of the protective conductor inside or outside the instrument is likely to make the instrument dangerous. Intentional interruption is prohibited.

When an instrument is brought from a cold into a warm environment, condensation may cause a hazardous condition. Therefore, make sure that the earthing requirements are strictly adhered to.

3.2.2 Mains voltage cord and fuses

Different power cords are available for the various local mains voltage outlets.

The power cord version delivered is determined by the particular instrument version ordered (see also Chapter 7).

NOTE: If the mains plug has to be adapted to the local situation, such adaptation should be done only by a qualified technician.

This oscilloscope has a power supply that covers most voltage ranges in use: 90 V...264 V a.c. (r.m.s.). This obviates the need to adapt to the local mains voltage by means of switch setting. The mains frequency range is 45 Hz...440 Hz.

WARNING: The instrument shall be disconnected from all voltage sources when replacing a fuse.

Mains fuse rating: 2.5 A delayed-action

The mains fuseholder is located on the rear panel (see Fig. 3.1.). If the mains fuse needs replacing, proceed as follows:

- switch the instrument off and disconnect it from the mains voltage.
- remove the inner part of the fuseholder by means of a screwdriver.
- fit a new fuse of the correct rating and refit the inner part of the fuseholder.

WARNING: Make sure that only fuses of the required current rating, and of the specified type, are used for renewal. The use of repaired fuses, and/or short-circuiting of the fuseholder, is prohibited.



MAT3098

Figure 3.1 Rear view showing the fuse-holder.

3.3 MEMORY BACK-UP BATTERIES

3.3.1 General information

The memory back-up circuit has the following functions:

- after a power source interruption, or when the oscilloscope is switched off in the LOCK mode, the front-settings as well as the stored data values are saved in the internal memory.
- after the power supply is restored, the oscilloscope starts up automatically with the same front setting.

ATTENTION: If the power source is interrupted while the settings are changed by the user, it might happen that the front settings are disturbed and an automatic AUTO SET is performed after switching on the instrument again.

3.3.2 Installation of batteries

To install the batteries, the following procedure must be followed:

- remove the cover of the battery compartment located on the rear panel, by pressing the two locking tongues towards each other and pulling (see Fig. 3.2.). The battery holders are now accessible.
- insert the two penlight batteries, paying attention to the polarity indication marked on the holder (also on Fig. 3.2).

CHECK POLARITY TO ENSURE CORRECT INSTALLATION!

- refit the push-on cover to the rear panel.

NOTE: It is advisable to remove the batteries when the oscilloscope is stored for longer periods than 24 hours at ambient temperatures below -30°C or above 60°C .

IMPORTANT: Under no circumstances should the batteries be left in the oscilloscope at ambient temperatures outside the rated range of the battery specifications!

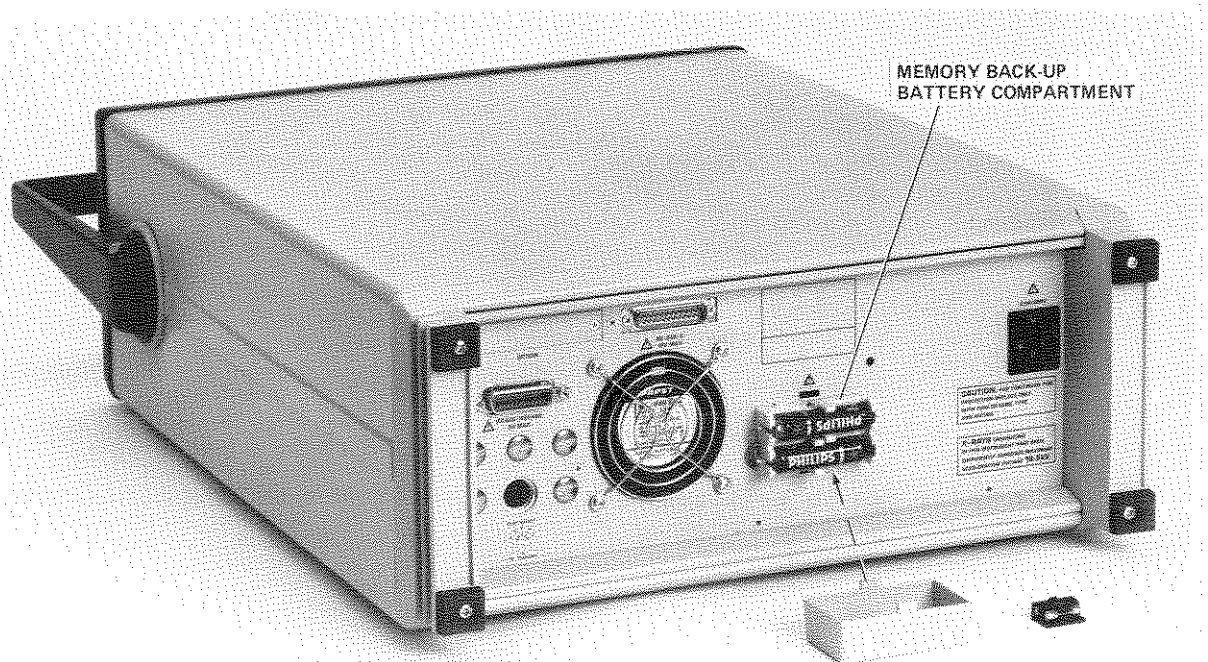

MAT3099

Figure 3.2 Rear view showing the battery compartment.

3.4 THE FRONT COVER

3.4.1 Removing and fitting of the front-cover

For ease of removal and fitting, the front cover has been designed as a simple push-fit on the front of the instrument. The front can be removed as follows:

- depress the pushbuttons in the brackets and turn the carrying handle as far as possible to the lower side of the oscilloscope.
- pull both clamping lips of the front cover outwards.
- lift the cover off the instrument.

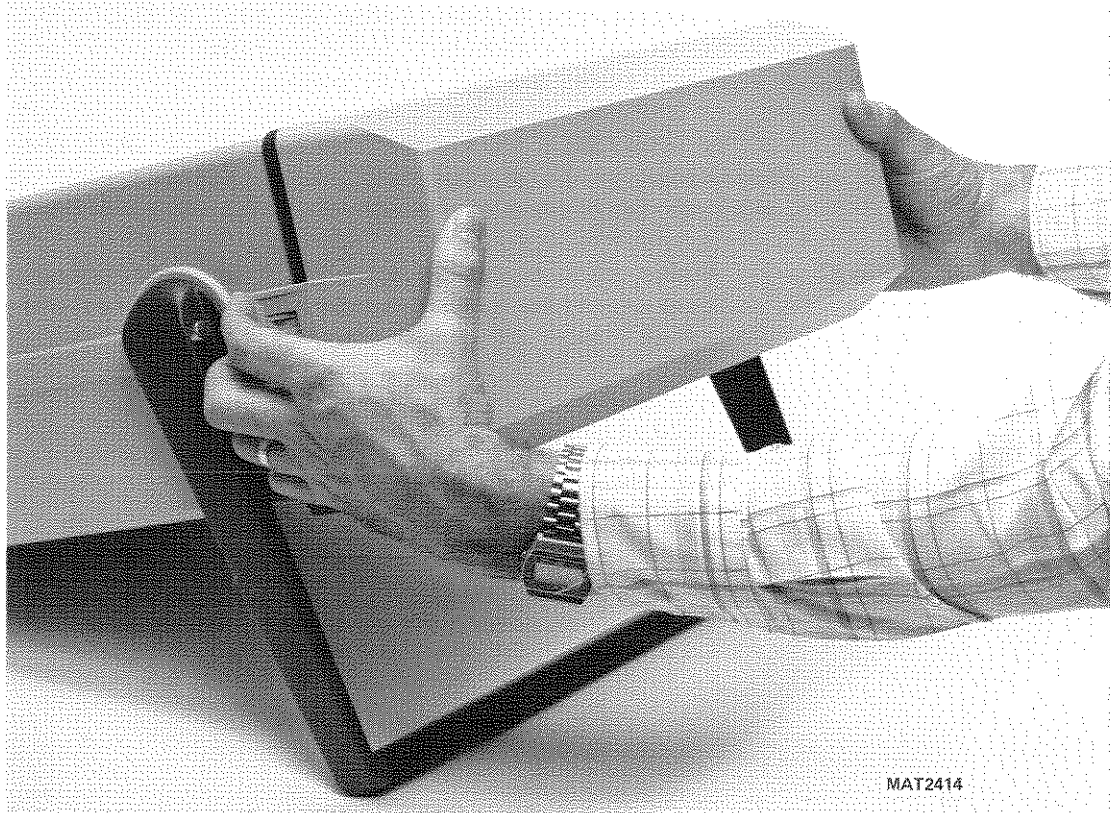

Figure 3.3 Removing the front cover.

The cover can be refitted by simply pushing it on the oscilloscope.

3.4.2 Acces to inner-cover storage space

Storage space for accessories such as probes, is available behind the inner front cover. This inner-cover can be lifted out by pressing the two locking tongues towards each other as indicated.

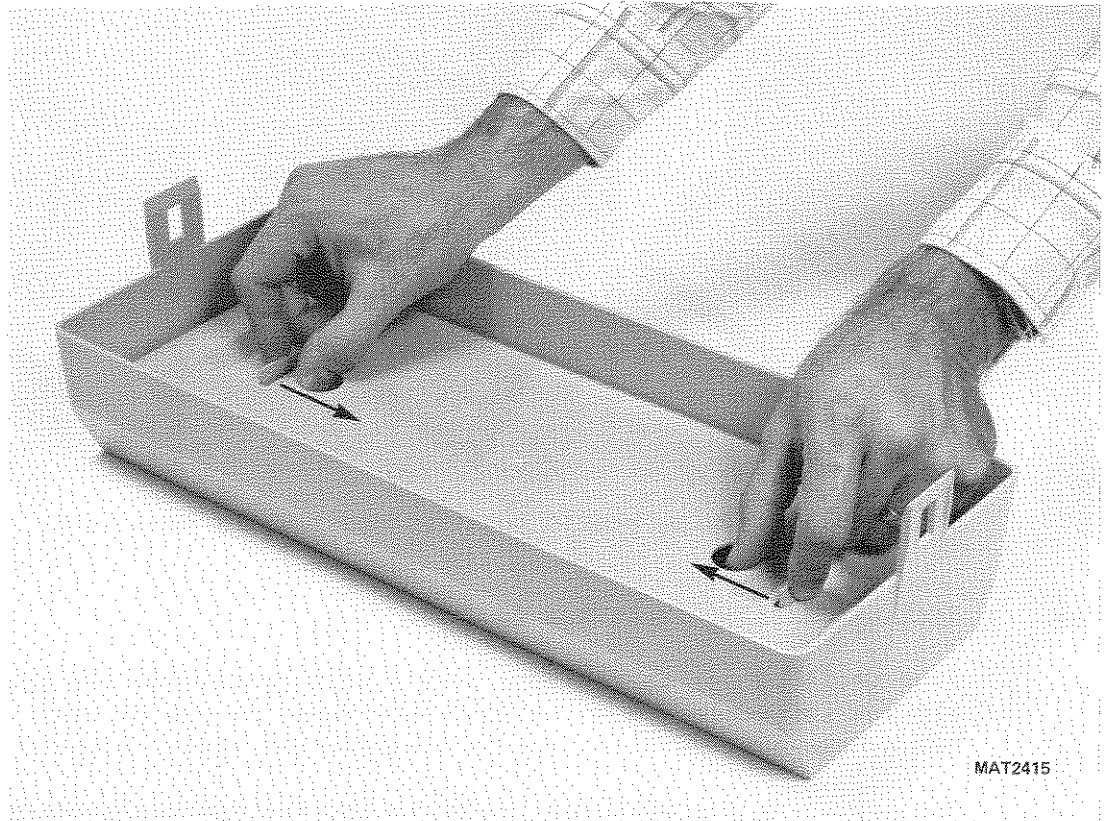

Figure 3.4 Removing the inner front cover. (storage space)

3.5 OPERATING POSITION OF THE INSTRUMENT

The oscilloscope may be used in the following positions:

- horizontally on its bottom feet;
- on the carrying handle in various sloping positions.

The available oscilloscope angles with respect to the working surface can be selected after depressing the push-buttons in the brackets of the carrying handle and turning.

The characteristics given in Chapter 6 are fully guaranteed for all the above-mentioned positions.

ATTENTION: Ensure that the fan hole in the rear cover and the holes in the cover are free from obstruction, for correct functioning of the fan.

Do not position the oscilloscope on any surface which radiates heat, or in direct sunlight.

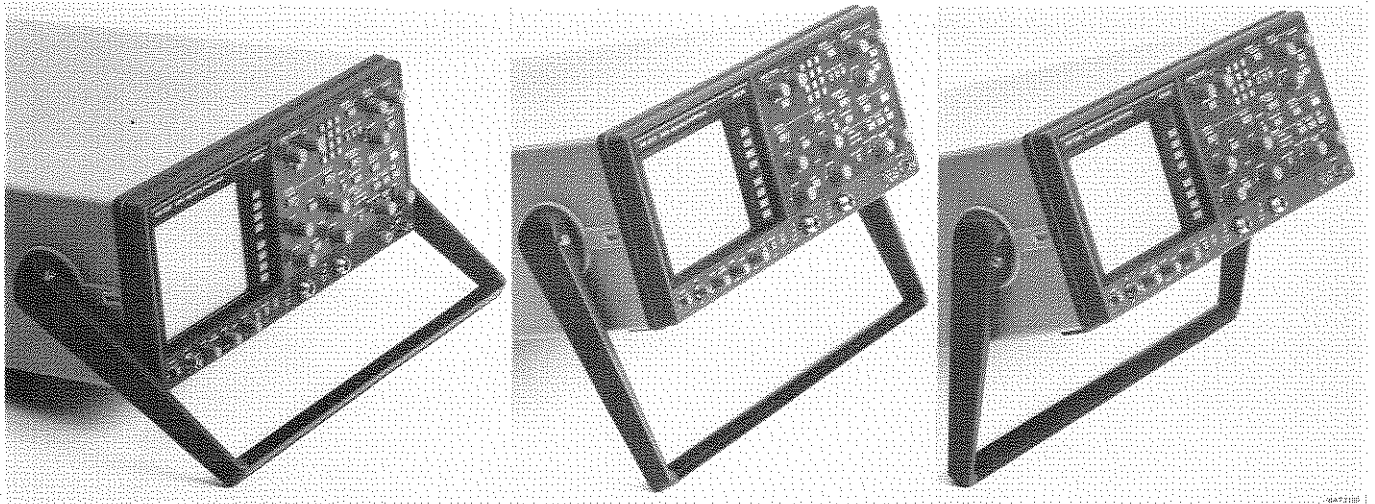

Figure 3.5 Carrying handle rotation and sloping positions.

3.6 IEEE-488/RS232-C INTERFACE PM 8956A

Your oscilloscope is equipped with a unit containing the IEEE 488 bus interface and an RS232-C interface. It can be used in an IEEE bus system configuration and in a system for serial communication.

For operating instructions, refer to the instruction/programming manual belonging to this interface.

4.0 OPERATING INSTRUCTIONS

This chapter outlines the procedures and precautions necessary for operation. It identifies and briefly describes the functions of the front and rear panel controls and indicators, and explains the practical aspects of operation to enable an operator to evaluate quickly the instrument's main functions.

4.1 SWITCHING-ON AND POWER-UP ROUTINE

4.1.1 Switching-on



After the oscilloscope has been connected to the mains (line) voltage in accordance with Section 3.2.1. and 3.2.2. it can be switched on with the POWER ON/OFF switch on the front panel. The associated POWER indicator lamp is adjacent to the POWER ON/OFF switch.

Having switched on the oscilloscope, a power-up routine is performed after which the instrument is ready for use.

With normal installation, according to Chapter 3, and after a warming-up time of 30 minutes, the characteristics according to Chapter 6 are valid.

4.1.2 Power-up routine

When switching-on the instrument, note that the internal micro-processor automatically starts a test for a number of internal circuits.

If during this test a circuit is found to be faulty, the test stops and this will be indicated as follows:

- the instrument fails to operate normally
- some, but not all of the indicator lamps light

If this occurs, it is recommended to switch off the instrument and switch on again after a few seconds.

IMPORTANT: If the fault condition persists, contact your local PHILIPS service department.

If the system blocks during operation, it may be due to extremely high static voltages. In this event, an automatic reset of the microprocessor system is performed and the operation of the instrument is restored.

4.1.3 Default settings after switching-on.

If no back up batteries are installed and the instrument is switched on, an automatic AUTO-SET action is performed. With back up batteries installed, the instrument settings at the moment of switching off are restored and the instrument starts up with the same setting.

4.2 EXPLANATION OF CONTROLS AND SOCKETS

The controls and sockets are listed according to their functional sections and a brief description of each is given.

The next front panel view shows the controls and sockets, and the functional lay-out of the various sections.

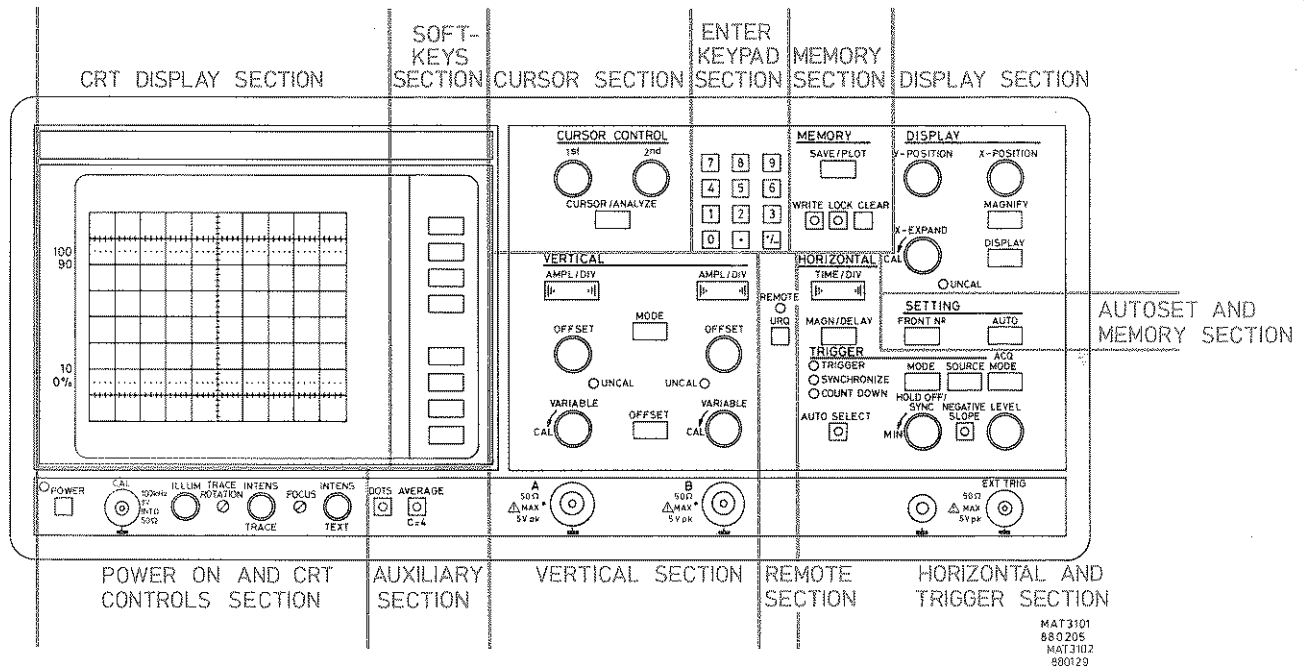

Figure 4.1 Front panel function lay-out.

Section:	See section:
SOFTKEYS SECTION	4.2.1
C.R.T. DISPLAY SECTION	4.2.2
AUTO SET SECTION	4.2.3
POWER ON & CRT CONTROLS SECTION	4.2.4
VERTICAL SECTION	4.2.5
HORIZONTAL SECTION	4.2.6
TRIGGER SECTION	4.2.7
CURSOR SECTION	4.2.8
MEMORY SECTION	4.2.9
DISPLAY SECTION	4.2.10
AUXILIARY SECTION	4.2.10
SETTING MEMORY SECTION	4.2.11
ENTER KEYPAD SECTION	4.2.12
REMOTE SECTION	4.2.12

MAT 3101
880 205
MAT 3102
880129

4.2.1 SOFTKEYS

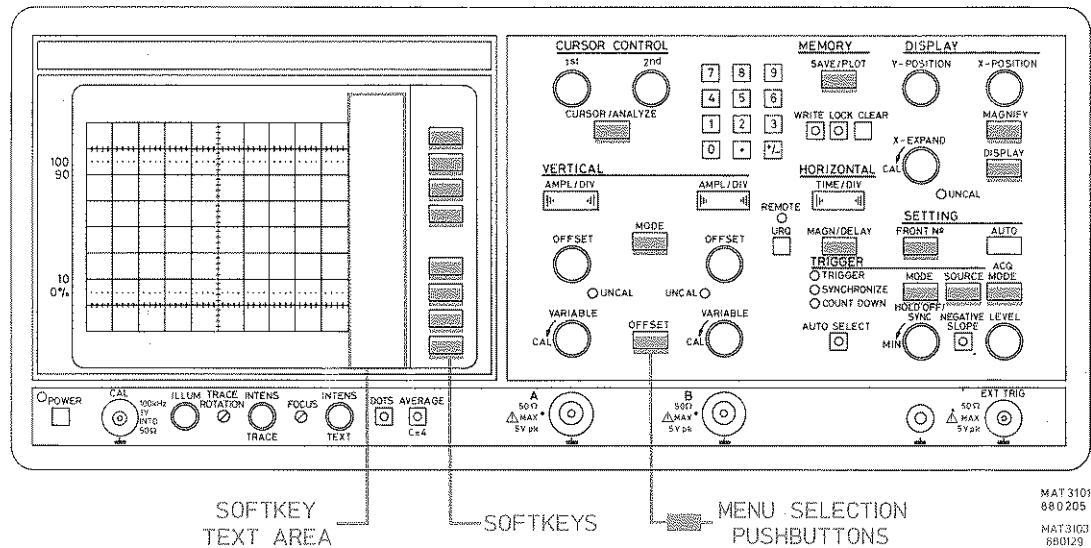

Figure 4.2 Front panel view.

Eight softkeys are located directly at the right side of the C.R.T. screen.

Different functions for these softkeys can be selected with the following eleven menu selection pushbuttons:

Front panel section:	See section:	Menu selection pushbutton:	See section:
VERTICAL	4.2.5	MODE	4.2.5.1
		OFFSET	4.2.5.2
HORIZONTAL	4.2.6	AQU MODE	4.2.6.1
		MAGN/DELAY	4.2.6.2
TRIGGER	4.2.7	MODE	4.2.7.2
		SOURCE	4.2.7.3
CURSOR CONTROL	4.2.8	CURSOR/ANALYZE	4.2.8.1
MEMORY	4.2.9	SAVE/PLOT	4.2.9.1
DISPLAY	4.2.10	MAGNIFY	4.2.10.1
		DISPLAY	4.2.10.2
SETTING	4.2.11	FRONT No	4.2.11

After depressing one of the above mentioned pushbuttons, the selected softkey menu is displayed in the softkey text area on the C.R.T. screen, directly at the left side of the softkeys. In general the selected functions are intensified displayed in this softkey text area.

When for example the frontpanel pushbutton VERTICAL MODE is depressed, the following menu text will appear in the softkey text area.

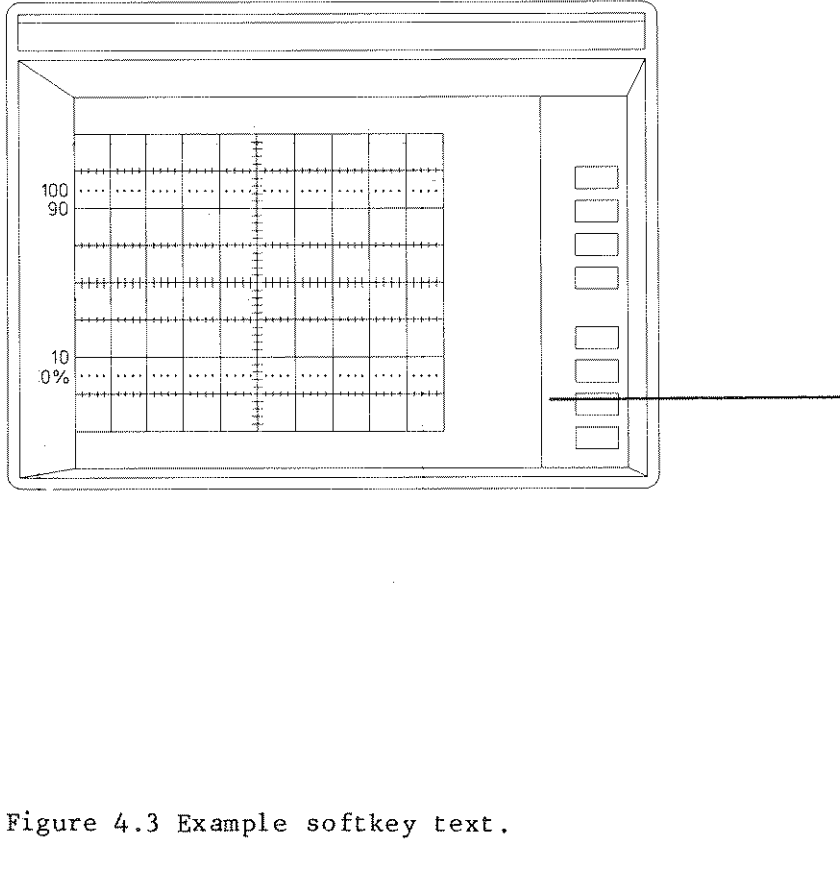

Figure 4.3 Example softkey text.

When the displayed softkey function is followed by a > , this indicates that the relevant softkey can be used to select the next lower function menu level.

RETURN: By depressing the softkey with the function RETURN (always the last softkey in the row of 8) a jump is made to the next higher function menu level.

STOP or

EXECUTE: For some menu's a function STOP or EXECUTE is selectable which gives an automatic RETURN to the next higher function menu level after the STOP or EXECUTE action.

For the detailed explanation of the various menu structures the following explanation structure is used:

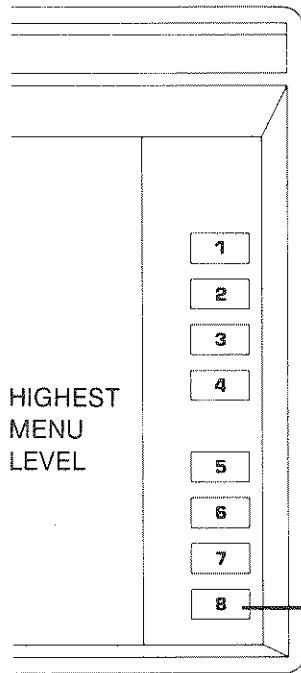

Explanation of the highest menu level which is selected by pressing a MENU SELECTION pushbutton (see figure 4.2).

(Softkey numbers)

- | | | |
|---|-----------|--|
| 1 | Function | Explanation of the function behind softkey 1 |
| 2 | Function | Explanation of the function behind softkey 2 |
| 3 | Function | Explanation of the function behind softkey 3 |
| 4 | Function> | (Jump to the next lower menu level) |

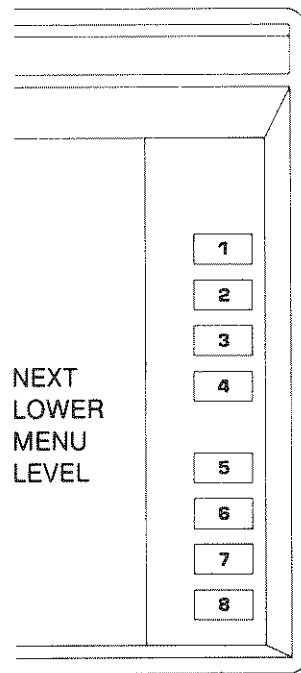

Explanation of the next lower menu level which in this example is selected by pressing softkey number four.

- | | | | |
|---|---|-----------|-------------------------------------|
| 4 | 1 | Function | Explanation of this function |
| 4 | 2 | Function | Explanation of this function |
| 4 | 3 | Function> | (Jump to the next lower menu level) |

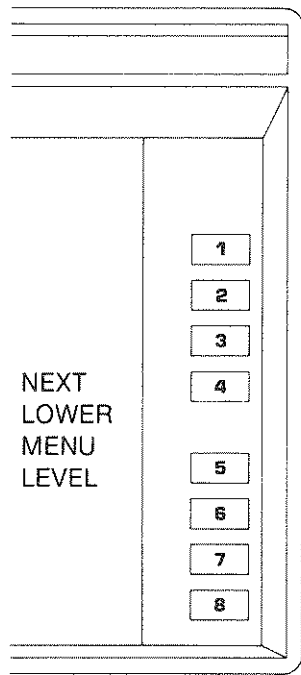

Explanation of the next lower menu level which in this example is selected by pressing softkey number three.

.....

4	3	1	Function	Explanation
4	3	2	Function	Explanation
4	3	3	Function	Explanation
4	3	4	Function	Explanation
4	3	5	Function	Explanation
4	3	6	Function	Explanation
4	3	7	Function	Explanation
4	3	8	RETURN	Return to the next higher menu level

4	4	Function	Explanation
4	5	Function	Explanation
4	6	Function	Explanation
4	7	Function	Explanation
4	8	RETURN	Return to the highest menu level

5	Function
6	Function
7	Function
8	Function

Example:

If via the VERTICAL MODE menu the factor C=2 has to be selected for the AVERAGE mode, it can be done in the following way:

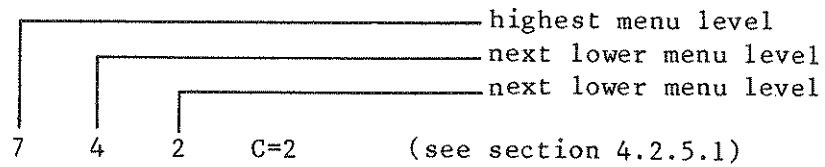

- Press frontpanel pushbutton VERTICAL MODE
- Press softkey 7 function PROCESSING>
- Press softkey 4 function AVERAGE>
- Press softkey 2 function C=2

4.2.2 Screen lay-out and text areas

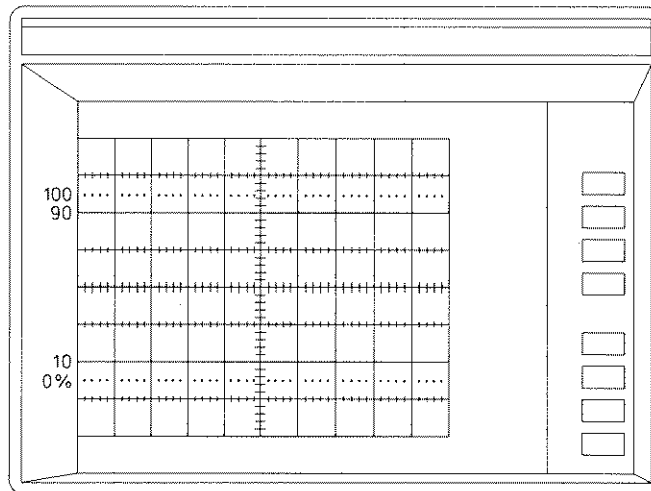
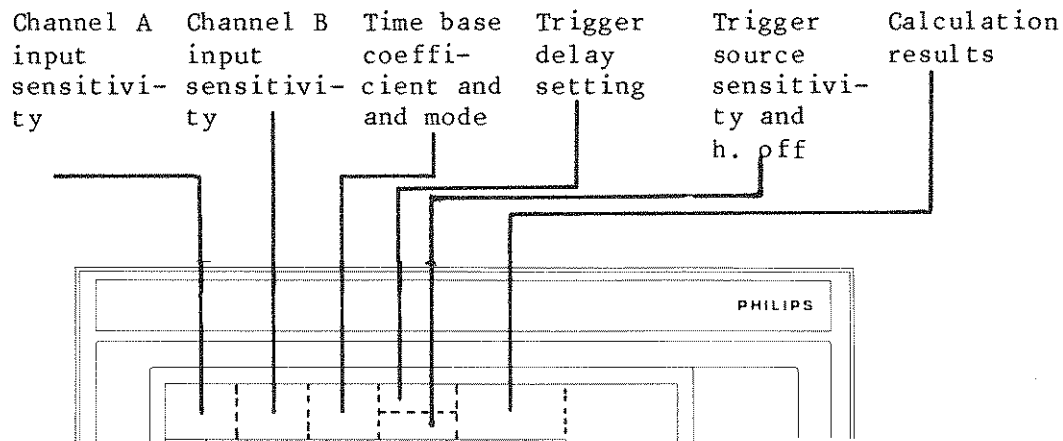

Figure 4.4 Screen lay-out.

Text areas:

ACTUAL FRONT SETTINGS AND CURSOR CALC. RESULTS IN THE TOP TEXT AREA



REDUCED TEXT IN THE TRACE AREA

(selectable via the DISPLAY menu if Y/5 is selected via the MAGNIFY menu)

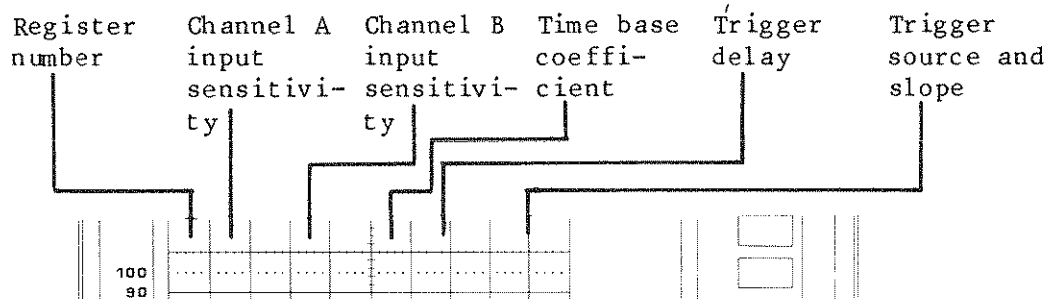

FULL TEXT IN THE BOTTOM TEXT AREA

(selectable via the DISPLAY menu)

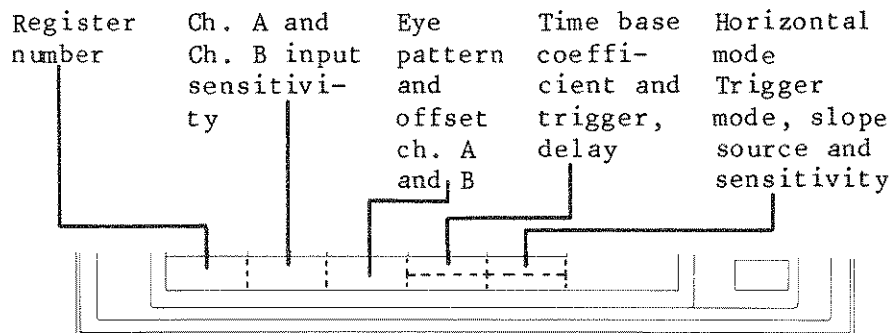

FRONT TEXT IN THE BOTTOM TEXT AREA

(selectable via the DISPLAY menu)

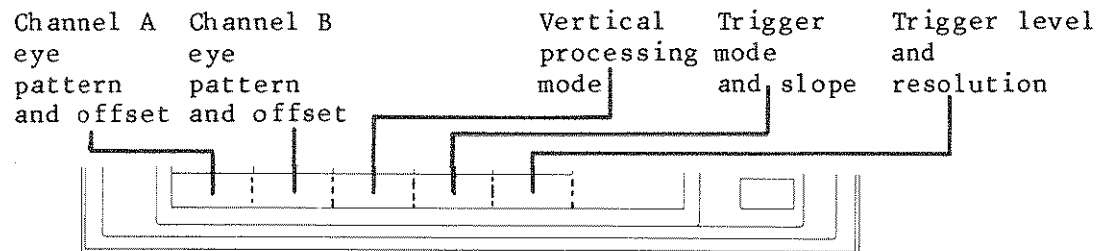

General information about screen lay out and texts:

- Activated functions are always intensified displayed.
- Only softkey functions that can be activated in the actual oscilloscope setting, are displayed.
- Only the registers that are selected for display, are visible in the softkey text area.
- A letter A and/or B can be displayed near the start of each trace on the screen for channel identification. (selectable via the DISPLAY menu).
- ~ indicates lower accuracy for this function; is also indicated by pilot lamps
- / indicates positive trigger slope selection
- \ indicates negative trigger slope selection

Example :

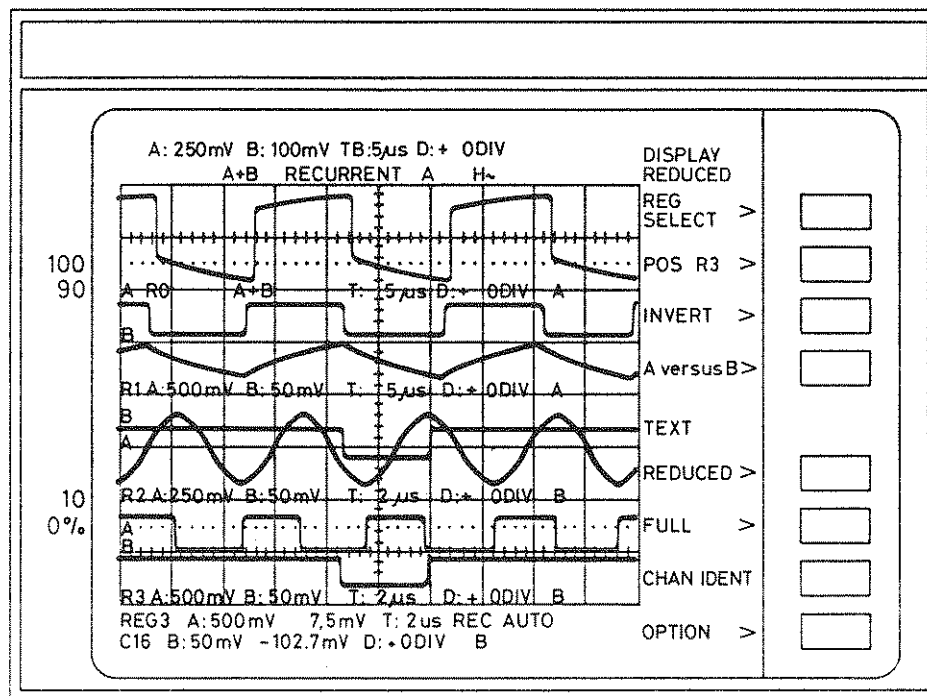
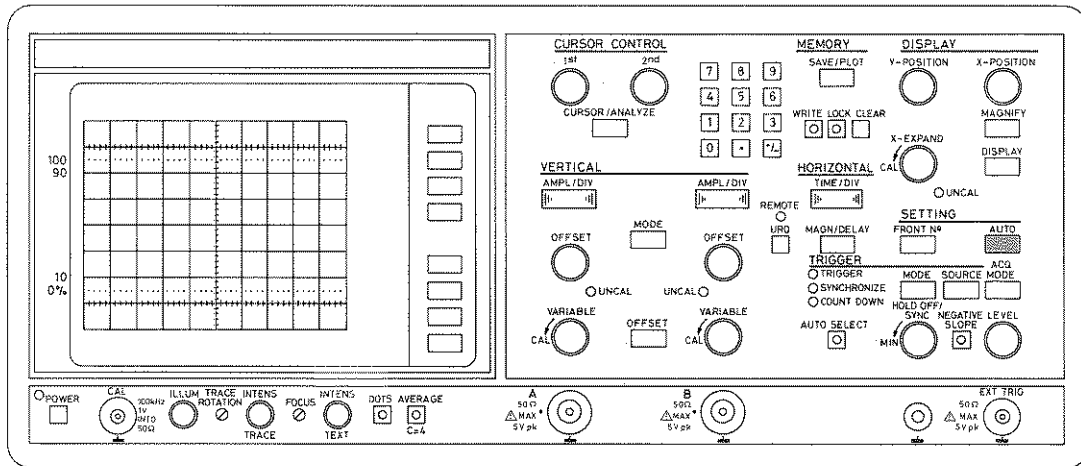

Figure 4.5 Example screen lay-out.

4.2.3 AUTO SET



MAT3101MAT 3105
880205 880129

Figure 4.6 Front panel view.

AUTO

If AUTO is pushed, a number of functions are preselected. Some of these functions are selected in relation to the applied input signals.

During the AUTO SET action, a message

```

* * * * * AUTO SET BUSY * * * * *
* * * * * * * * * * * * * * * * *
    
```

is displayed.

Settings are such, that the contents of register R0 are displayed over the full C.R.T. screen.

The input signals will be displayed as triggered signals of a few periods and with an amplitude of a few divisions.

Details about AUTO SETTING are given in section 6.10 of the CHARACTERISTICS.

In LOCK mode a message

No AUTO SET possible in LOCK mode.

is displayed.

4.2.4. C.R.T. section

MAT 310/MAT 3106
880 205 880129

Figure 4.7 Front panel view.

POWER ON OFF	POWER ON/OFF switch After switching on the instrument, first an automatic power-up test is started (see also section 4.1). The POWER ON LED indicates when the instrument is switched-on.
ILLUM	Continuously-variable control of the graticule illumination.
TRACE ROTATION	Screwdriver control for aligning the trace in parallel with the horizontal graticule lines.
INTENS TRACE	Continuously-variable control of the trace brilliance on the C.R.T. screen.
FOCUS	Screwdriver control for the focussing of the C.R.T. electron beam (including the C.R.T. text).
INTENS TEXT	Continuously-variable control of the brilliance of the C.R.T. text (control settings, cursors, softkey functions and messages).

4.2.5. VERTICAL SECTION AND MENU STRUCTURE

MAT3101MAT3107
880205 880129

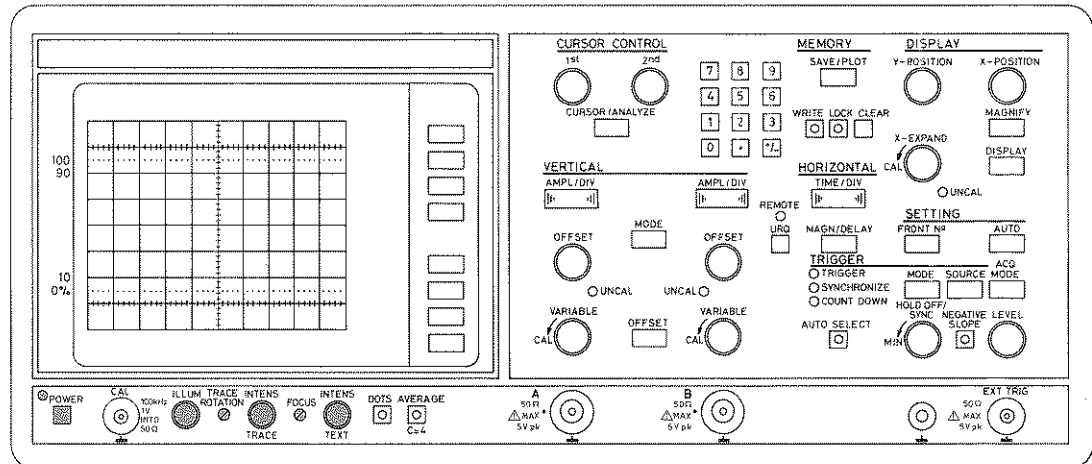
Figure 4.8. Front panel view.

AMPL/DIV

This UP/DOWN control permits selection of the vertical deflection coefficients of the relevant channel in 8 steps from 1 mV/div...200 mV/div in a 1-2-5 sequence.

The selected vertical deflection coefficient for the relevant channel is displayed in the top text area of the C.R.T. screen.

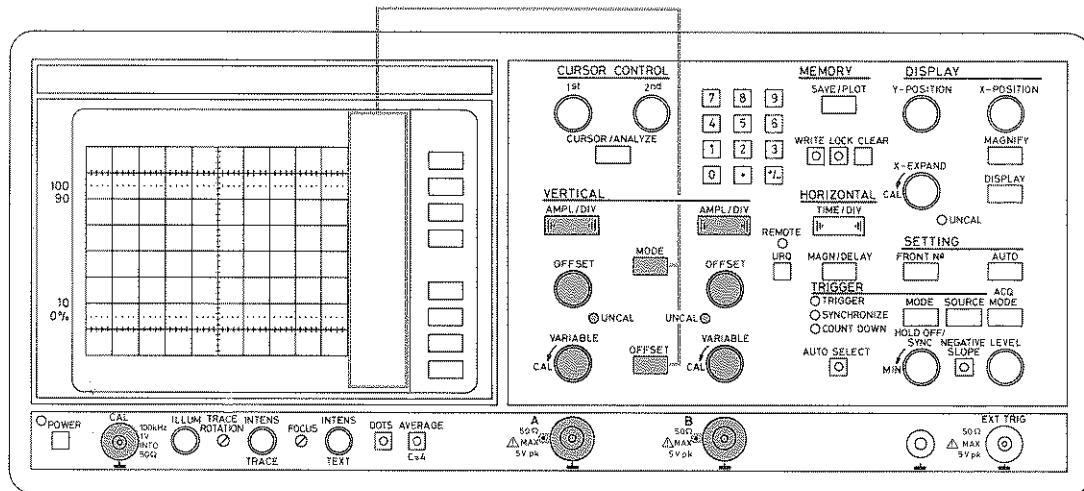
If the left side of the UP/DOWN control (V) is pushed, the amplitude of the signal on the screen decreases. This means that the AMPL/DIV value becomes bigger (e.g. the attenuator jumps from 2 mV/div to 5 mV/div).

If the right side of the UP/DOWN control (mV) is pushed, the amplitude of the signal on the screen increases. This means that the AMPL/DIV value becomes smaller (e.g. the attenuator jumps for 5 mV/div to 2 mV/div)

VARIABLE

Continuously variable control of the deflection coefficients of the relevant channel. The deflection coefficients of the relevant channel are only calibrated when this control is set fully clockwise (UNCAL LED is off). In the UNCAL position, the vertical sensitivity increases. The complete sensitivity range between two AMPL/DIV settings is adjustable.

The adjusting speed increases after turning continuously in one direction. After stopping, starting in the reverse direction resumes with a slow adjusting speed.

- UNCAL Pilot lamp indicating lower accuracy for the relevant vertical deflection coefficients. If the VARIABLE control of the relevant channel is turned fully clockwise, the UNCAL pilot lamp is switched off.
- OFFSET Continuously variable control giving vertical input offset of the trace of the relevant channel.
- The adjusting speed increases after turning continuously in one direction. After stopping, starting in the reverse direction resumes with a slow adjusting speed.
- A(B) N input socket for the channel with probe indication detector. Input impedance 50 ohm. Maximum safe input voltage: 5 V peak.
- CAL BNC output socket for a square-wave calibration signal with an amplitude of 1 Vp-p and a frequency of 100 kHz.
- The output voltage is 1 V if the output is terminated in 50 ohm.
- When the output is short-circuited, the output current is 20 mA p-p.
- The zero line of the square-wave signal is on the base-line level.
- MODE If pushbutton MODE is pushed, the VERTICAL MODE menu is displayed. See 4.2.5.1.
- OFFSET If pushbutton OFFSET is pushed, the VERTICAL OFFSET menu is displayed. See 4.2.5.2.
- This offset is introduced before the sampling gate, attenuation stages and memory. The offset can also be influenced via menu key OFFSET. If the offset-value is out of range, this is indicated with the warning:
- A-OFFSET OUT OF RANGE or
B-OFFSET OUT OF RANGE

4.2.5.1. VERTICAL MODE MENU STRUCTURE

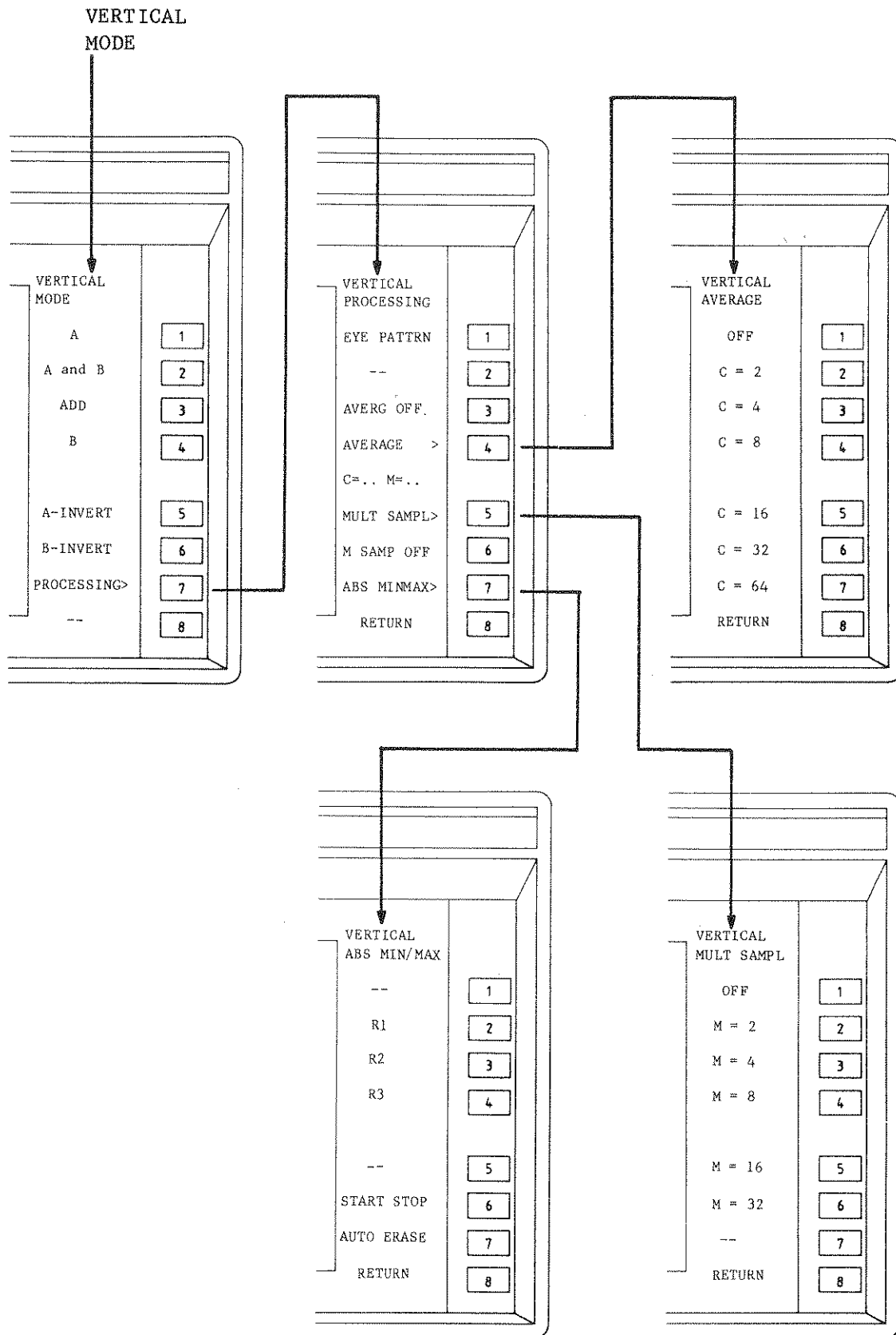
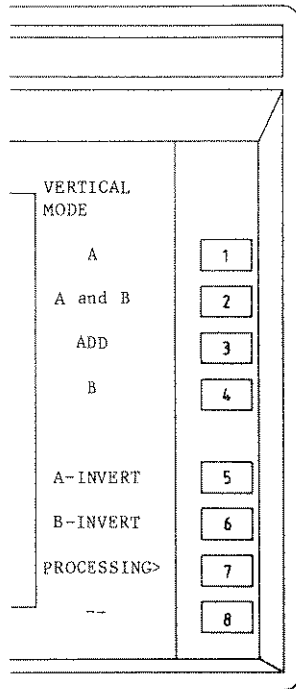

Figure 4.9 Vertical mode menu structure.

VERTICAL MODE MENU



After selection of the VERTICAL MODE menu by depressing pushbutton VERTICAL MODE, various modes related to the signal acquisition can be selected.

1 A

Pushing softkey A gives signal input from channel A only, indicated by an intensified text A.

If softkey A is pushed and function A and B was operative, in A versus B - mode a message will be displayed with the text

No A versus B possible with one channel only.
A versus B is switched off.

and channel A will be selected.

2 A and B

Pushing softkey A and B gives signal input from both channels A and B, indicated by an intensified text A and B.

3 ADD

Pushing softkey ADD gives signal input from channel A and channel B and the algebraic sum of A and B is recorded in the memory, indicated by an intensified text ADD.

If softkey ADD is pushed and A and B was operative, in A versus B -mode a message will be displayed with the text

No A versus B possible with one channel only.
A versus B is switched off.

and ADD will be selected.

4 B

Pushing softkey B gives signal input from channel B only, indicated by an intensified text B.

If softkey B is pushed and A and B was operative, in A versus B - mode a message will be displayed with the text

No A versus B possible with one channel only.
A versus B is switched off.

and channel B will be selected.

5 A-INVERT

6 B-INVERT

After pushing the relevant INVERT softkey the signal of the relevant channel is inverted before it is digitized and recorded in the memory. The text A-INVERT or B-INVERT is then intensified displayed.

7 PROCESSING>

VERTICAL PROCESSING	
EYE PATRN	1
--	2
AVERG OFF	3
AVERAGE >	4
C=.. M=..	
MULT SAMPL>	5
M SAMP OFF	6
ABS MINMAX>	7
RETURN	8

After selecting PROCESSING>, the VERTICAL PROCESSING menu is displayed and input signal processing can be selected.

The text AVERG OFF is only visible if average is selected.

The text M SAMP OFF is only visible if the multiple sampling mode is selected.

7 1 EYE PAT

In this mode, the feedback loop of the sampling system of channel A and B (refer to chapter 4.4, principle of operation) is switched off so that eye pattern signals can be displayed with a minimum of distortion. In EYE PATTERN mode, the acquisition works with a high resolution of 4096 measured points. This instead of 512 measured points, while the remaining points are obtained by means of calculation. A register containing a signal that is obtained in EYE PATTERN mode cannot be expanded via the horizontal expansion mode under pushbutton MAGNIFY. However expansion is still possible with the continuous variable control X-EXPAND. However under other circumstances this mode must be off in order to obtain the highest stability and dynamic range. If you select EYE PATTERN mode with AVERAGE or MULTIPLE SAMPLING mode on, the following message is displayed:

Eye pattern selected:
Average and Multiple sampling switched off!!!!

7 2 --

7 3 AVERG OFF

After pushing softkey AVERG OFF, AVERAGE is switched off. This function is only displayed when AVERAGE is selected.

7 4 AVERAGE>

VERTICAL AVERAGE	
OFF	1
C = 2	2
C = 4	3
C = 8	4
C = 16	5
C = 32	6
C = 64	7
RETURN	8

After selecting AVERAGE, the VERTICAL AVERAGE menu is displayed and the average function can be selected. (See also section 4.3.12). As long as average is operative, this is indicated by an intensified text C= .. in the VERTICAL PROCESSING menu.

If AVERAGE is not operative, it is indicated by an intensified text C=OF in the VERTICAL PROCESSING menu.

AVERAGE is not possible in combination with eye pattern mode and low resolution mode. If you select AVERAGE while one of these two modes is already functioning, the following message is displayed.

AVERAGE is not possible with EYE PATTERN mode and/or LOW RESOLUTION mode. If you select AVERAGE while one of these two modes is already functioning, the following message is displayed:

Averaging selected:
Eye pattern and/or low resolution off.

7 4 1 OFF

Softkey OFF must be pushed to switch the AVERAGE function off.

7 4 2 C=2

7 4 3 C=4

7 4 4 C=8

7 4 5 C=16

7 4 6 C=32

7 4 7 C=64

Different calculation constants between C=2 and C=64 can be selected.

The bigger the value of C is, the stronger the AVERAGE effect is. A direct selection of C=4 is also possible via the front panel pushbutton AVERAGE C=4.

For more detailed information see chapter 4.3.12.

7 4 8 RETURN

After pushing softkey RETURN, the VERTICAL PROCESSING menu is displayed again and the average selection (the value of C) remains as selected before.

7 5 MULT SAMPL >

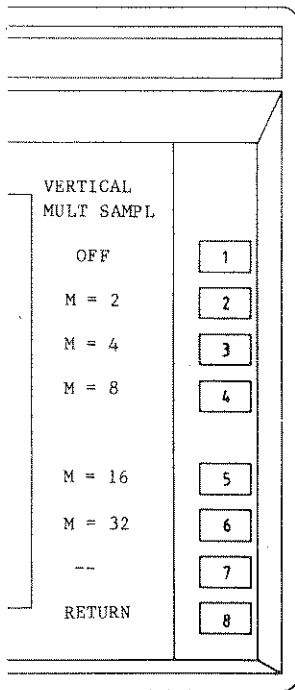

After having selected MULT SAMPL the vertical MULTIPLE SAMPLING mode is active. In this mode you can select via softkeys the figure M = 2, 4, 8, 16 or 32. This figure represents the number of samples that is taken before one of the 512 points is displayed on the screen. If you select M=4 four samples are taken of which the last one is displayed. This mode reduces distortion of fast slopes; but the time to capture a waveform increases with the M-value. The higher the M-figure, the lower the distortion. As long as MULTIPLE SAMPLING is operative, this is indicated by an intensified text M= ... in the VERTICAL PROCESSING MENU.

If MULTIPLE SAMPLING is not operative, this is indicated by an intensified text M=OF.

MULTIPLE SAMPLING is not possible in combination with EYE PATTERN mode. If you select MULTIPLE SAMPLING while EYE PATTERN mode is operative, the following message is displayed:

Multiple sampling selected:
Eye pattern switched off!!!!

7 5 1 OFF

Softkey OFF must be pushed to switch the MULTIPLE SAMPLING mode off.

7 5 2 M = 2

7 5 3 M = 4

7 5 4 M = 8

7 5 5 M = 16

7 5 6 M = 32

7 5 7 --

7 5 8 RETURN

After pushing RETURN, the VERTICAL PROCESSING menu is displayed again and the selections previously made remain active.

7 6 M SAMP OFF

After pushing softkey M SAMP OFF, the MULTIPLE SAMPLING MODE is switched off. This function is only displayed when MULTIPLE SAMPLING is selected.

7 7 ABS MINMAX

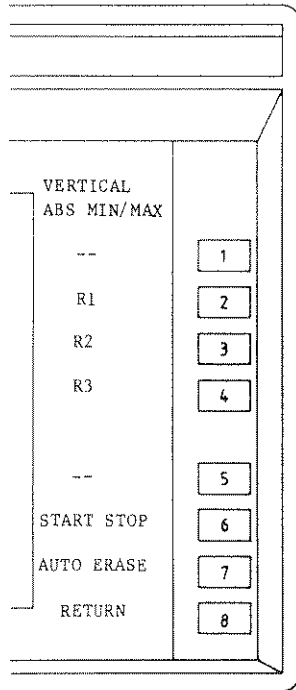

After selecting ABS MINMAX the ABSOLUTE MINMAX menu is displayed and the ABS MINMAX function can be selected. The ABS MINMAX function stores in the even addresses of a selected trace register the maximum values over a number of sweeps. In the odd addresses the minimum values over a number of sweeps are stored. So the register controls shows the limits in a vertical sense between which the input signal varies.

7	7	1	--
7	7	2	R1
7	7	3	R2
7	7	4	R3

With these softkeys the register can be selected in which the ABS MINMAX function is performed.

7	7	5	--
7	7	6	START STOP

The ABS MINMAX function can be activated or stopped with this softkey. The selected function is displayed intensified.

7	7	7	AUTO ERASE
---	---	---	------------

The AUTO ERASE function clears the result of the ABS MINMAX function in the selected register after 10 seconds or after 100 sweeps, depending on whichever comes last.

If the function is active, the function is displayed intensified. Pushing the softkey again switches the function off.

7	7	8	RETURN
---	---	---	--------

After pushing softkey RETURN, the VERTICAL PROCESSING menu is displayed again.

7	8	RETURN
---	---	--------

After pushing RETURN, the VERTICAL MODE menu is displayed again and the selections previously selected remain.

8	--
---	----

4.2.5.2. VERTICAL OFFSET MENU STRUCTURE

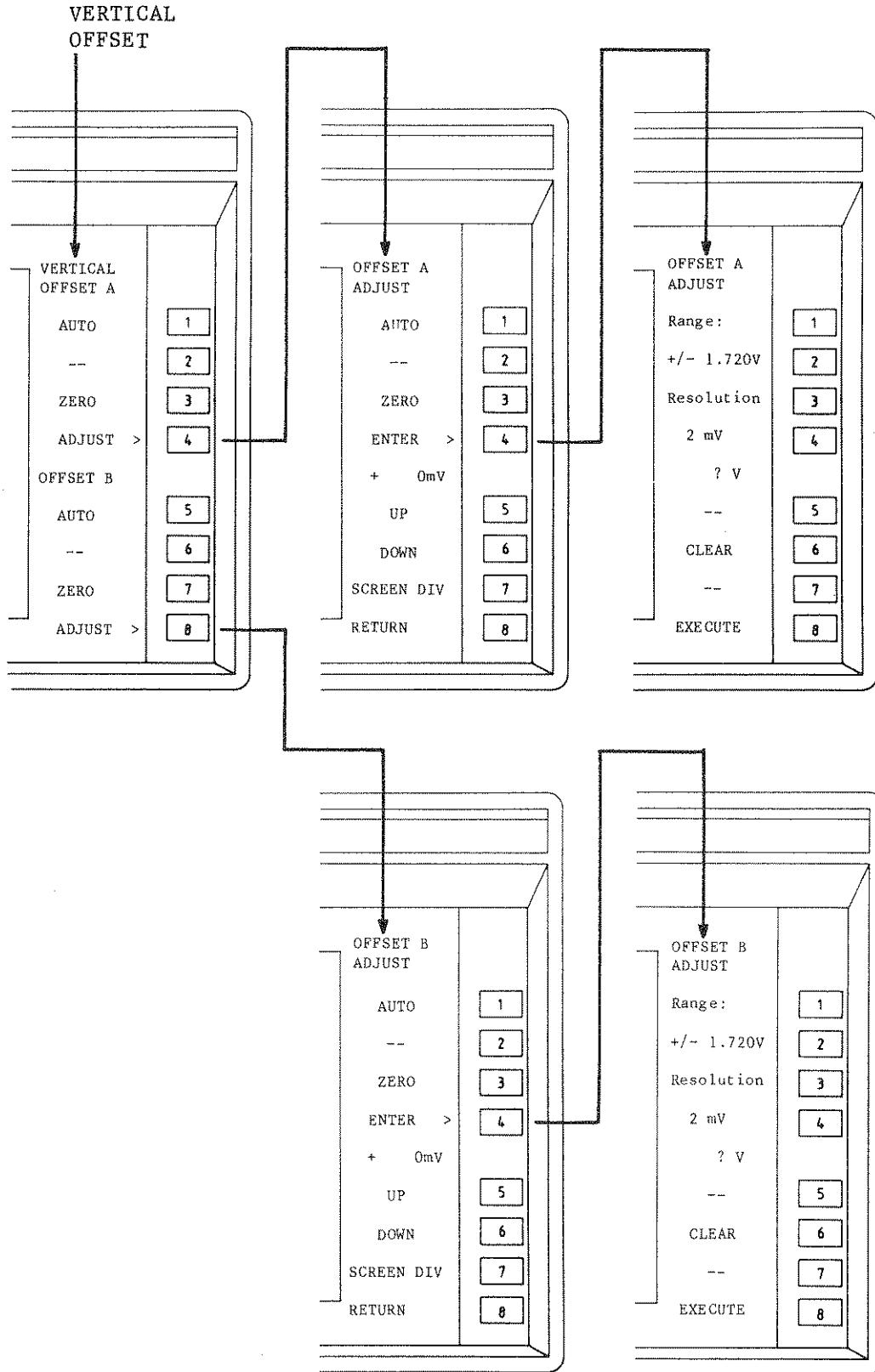
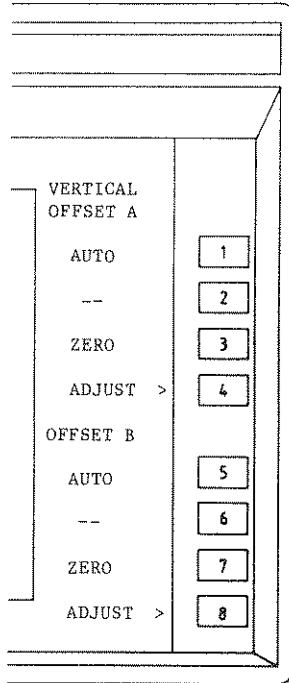

Figure 4.10 Vertical offset menu structure.

VERTICAL OFFSET MENU



After pressing pushbutton VERTICAL OFFSET, the VERTICAL OFFSET menu for channel A and channel B is displayed and the input offset for these channels can be selected. This offset via the softkeys has the same effect as the rotary control OFFSET and is also introduced before the sampling gate, attenuators and memory. The offset adjustment via the softkeys is in steps while the rotary gives a continuous adjustment possibility. If the adjusted offset-value is out of range, this is indicated with the warning:

A-OFFSET out of range or
B-OFFSET out of range

1 AUTO

With softkey AUTO, the offset value of channel A is set to such a level, that the mid-value of the input signal is shifted as much as possible to mid-memory.

A message

```
* * * AUTO OFFSET FOR CHANNEL A * * *
* * * * * * * * * * * * * * * * * * *
```

is displayed.

The new offset value is displayed in the softkey text area. The VERTICAL SHIFT is set to zero.

A message

AUTO OFFSET error : signal offset out of range

is displayed if the input signal is exceeding the offset control range. In this case the original offset value is restored.

2 --

3 ZERO

With softkey ZERO, the offset value of channel A is set to zero.

4 ADJUST> (channel A)

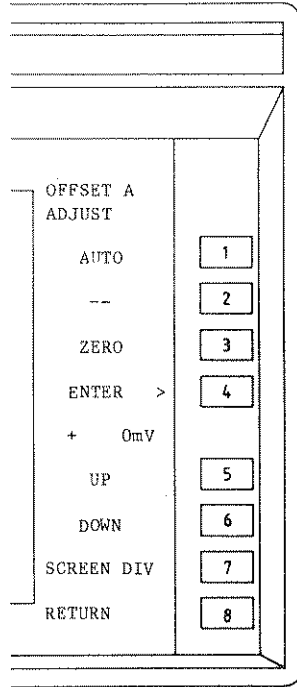

If ADJUST is selected the OFFSET A ADJUST menu is displayed and an offset (vertical shift before sampling gate) value can be selected.

The selected offset value is displayed in the softkey menu.

4 1 AUTO

For description refer to AUTO softkey description given under 1.

4 2 --

4 3 ZERO

With softkey ZERO, the offset value is set to zero.

4 4 ENTER>

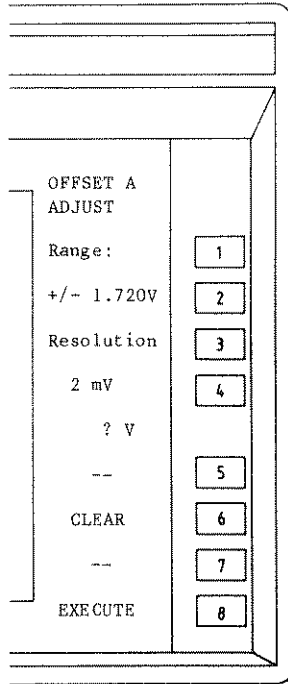

After selecting ENTER, the ENTER menu will be displayed and the offset can be selected with the numeric keypad. The range in Volts is indicated and the selected value is rounded off and made visible in the softkey text area.

A message

Too many digits: total entry is cleared

can be displayed if too many digits are entered on the numeric keyboard.

4 4 1 --

4 4 2 --

4 4 3 --

4 4 4 --

4 4 5 --

4 4 6 CLEAR

If an error is made, the selected offset value can be cleared after pushing softkey CLEAR.

4 4 7 --

4 4 8 EXECUTE

After pushing this softkey, the selected offset value is entered and an AUTO RETURN is performed to menu OFFSET A ADJUST.

If EXECUTE is pressed after CLEAR the previous value remains (in the OFFSET A ADJUST menu).

A message

A- OFFSET out of range.

can be displayed if the entered value exceeds the given range.

4 5 UP

Pushing softkey UP gives a more positive or less negative offset to the signal. The amount depends on the attenuator setting and the setting SCREEN or DIV.

If DIV is selected (DIV intensified) one division is added to the existing offset after each push of the UP softkey.

If SCREEN is selected (SCREEN intensified) a full screen of 10 divisions is added to the existing offset after each push of the UP softkey.

The result is displayed in volts, but the voltage is recalculated from the number of divisions.

For example: when 1.005 V is visible, it becomes 1.025 V, then 1.045 V etc. if the attenuator has been set to 20 mV/div (200 mV for a full screen).

4 6 DOWN

Pushing softkey DOWN gives a less positive or more negative offset to the signal. The amount depends on the attenuator setting and the setting SCREEN or DIV.

If DIV is selected (DIV intensified) one division is subtracted from the existing offset after each push of the DOWN softkey.

If SCREEN is selected (SCREEN intensified) a full screen of 10 divisions is subtracted from the existing offset after each push of the DOWN softkey.

The result is displayed in volts, but the voltage is recalculated from the number of divisions.

For example: when 1.005 V is visible, it becomes 985 mV, then 965 mV etc. if the attenuator has been set to 20 mV/div. (200 mV for a full screen).

4 7 SCREEN DIV

With this softkey, a selection can be made between an offset change in divisions or in screens (10 divisions) when the softkeys UP or DOWN are operated.

Pushing this softkey changes the selection from SCREEN to DIV or reverse. The active selection is displayed intensified.

4 8 RETURN

After pushing softkey RETURN, menu VERTICAL OFFSET A is displayed again.
The selections as made before remain.

5 AUTO

With softkey AUTO, the offset value of channel B is set to such a level, that the mid-value of the input signal is shifted as much as possible to mid-memory.

A message

```
* * * AUTO OFFSET FOR CHANNEL B * * *  
* * * * * * * * * * * * * * * * * * *
```

is displayed.

The new offset value is displayed in the softkey text area.
The VERTICAL SHIFT is set to zero.

A message

AUTO OFFSET error : signal offset out of range

is displayed if the input signal is exceeding the offset control range. In this case the original offset value is restored.

6 --

7 ZERO

With softkey ZERO, the offset value of channel A is set to zero.

8 ADJUST> (channel B)

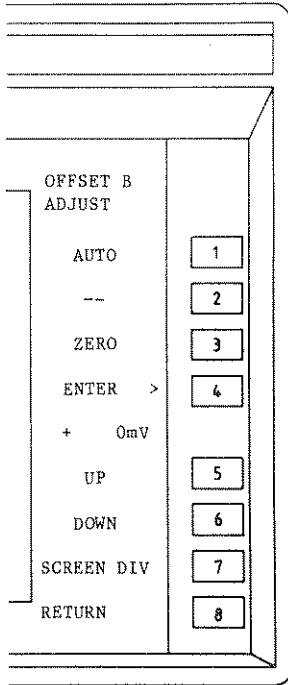

If ADJUST is selected, the OFFSET B ADJUST menu is displayed and an offset (vertical shift before sampling gate) value can be selected.

The selected offset value is displayed in the softkey menu.

8 1 AUTO

For description refer to AUTO softkey description given under 5.

8 2 --

8 3 ZERO

With softkey ZERO, the offset value is set to zero.

8 4 ENTER>

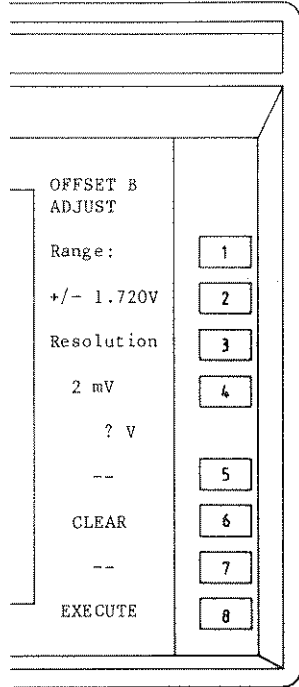

After selecting ENTER, the ENTER menu will be displayed and the offset can be selected with the numeric keypad. The range in Volts is indicated and the selected value is rounded off and made visible in the softkey text area.

A message

Too many digits: total entry is cleared.

can be displayed if too many digits are entered on the numeric keyboard.

8 4 1 --

8 4 2 --

8 4 3 --

8 4 4 --

8 4 5 --

8 4 6 CLEAR

If an error is made, the selected offset value can be cleared after pushing softkey CLEAR.

8 4 7 --

8 4 8 EXECUTE

After pushing this softkey, the selected offset value is entered and an AUTO RETURN is performed to menu OFFSET B ADJUST.

If EXECUTE is pressed after CLEAR the previous value remains (in the OFFSET B ADJUST menu).

A message

B- OFFSET out of range.

can be displayed if the entered value exceeds the given range.

8 5 UP

Pushing softkey UP gives a more positive or less negative offset to the signal. The amount depends on the attenuator setting and the setting SCREEN or DIV.

If DIV is selected (DIV intensified) one division is added to the existing offset after each push of the UP softkey.

If SCREEN is selected (SCREEN intensified) a full screen of 10 divisions is added to the existing offset after each push of the UP softkey.

The result is displayed in volts, but the voltage is recalculated from the number of divisions.

For example: when 1.005 V is visible, it becomes 1.025 V, then 1.045 V etc. if the attenuator has been set to 20 mV/div (200 mV for a full screen).

8 6 DOWN

Pushing softkey DOWN gives a less positive or more negative offset to the signal. The amount depends on the attenuator setting and the setting SCREEN or DIV.

If DIV is selected (DIV intensified) one division is subtracted from the existing offset after each push of the DOWN softkey.

If SCREEN is selected (SCREEN intensified) a full screen of 10 divisions is subtracted from the existing offset after each push of the DOWN softkey.

The result is displayed in volts, but the voltage is recalculated from the number of divisions.

For example: when 1.005 V is visible, it becomes 985 mV, then 965 mV etc. if the attenuator has been set to 20 mV/div. (200 mV for a full screen).

8 7 SCREEN DIV

With this softkey, a selection can be made between an offset change in divisions or in screens (10 divisions) when the softkeys UP or DOWN are operated.

Pushing this softkey changes the selection from SCREEN to DIV or reverse. The active selection is displayed intensified.

8 8 RETURN

After pushing softkey RETURN, menu VERTICAL OFFSET B is displayed again.

The selections as made before remain.

4.2.6. HORIZONTAL SECTION AND MENU STRUCTURE

MAT3101 MAT3106
880205 880129

Figure 4.11 Front panel view.

TIME/DIV

This switch permits selection of the horizontal deflection coefficients of the time base in 14 steps from 1 ns/div ... 20 us/div. in a 1-2-5 sequence.

The selected horizontal deflection coefficient is displayed in the upper text area of the C.R.T. screen.

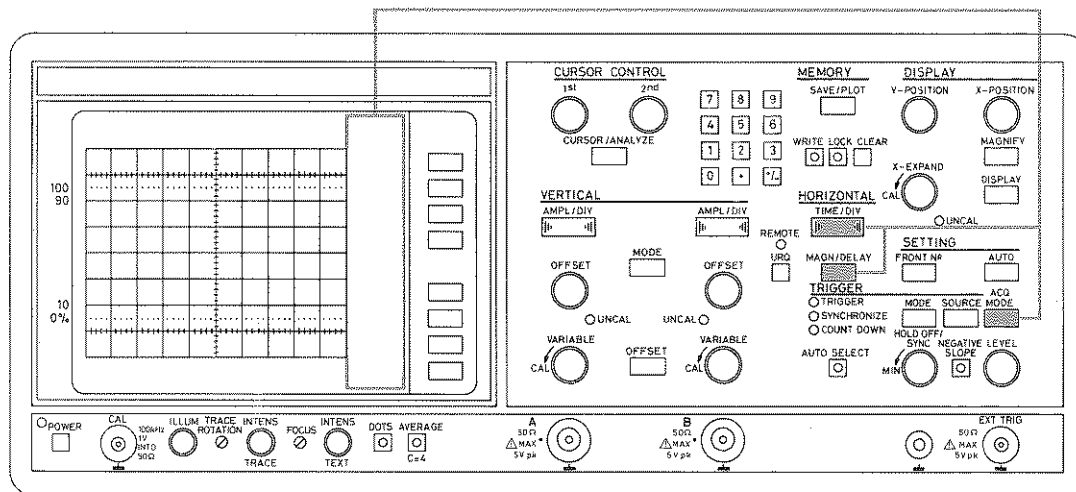
If the left side of the UP/DOWN control(s) is pushed, more signal periods will be displayed. This means that the TIME/DIV value becomes bigger (e.g. the time-base jumps from 2 ns/div to 5 ns/div).

If the right side of the UP/DOWN control (ns) is pushed fewer signal periods will be displayed. This means that the TIME/DIV value becomes smaller (e.g. the time-base jumps from 5 ns/div to 2 ns/div).

ACQ MODE

If pushbutton ACQUISITION MODE is pushed, the HORIZONTAL MODE menu is displayed. See 4.2.6.1.

MAGN/DELAY

If pushbutton MAGN/DELAY is pushed the combined magnifier and delay menu is displayed. See 4.2.6.2.

4.2.6.1. HORIZONTAL MODE MENU STRUCTURE

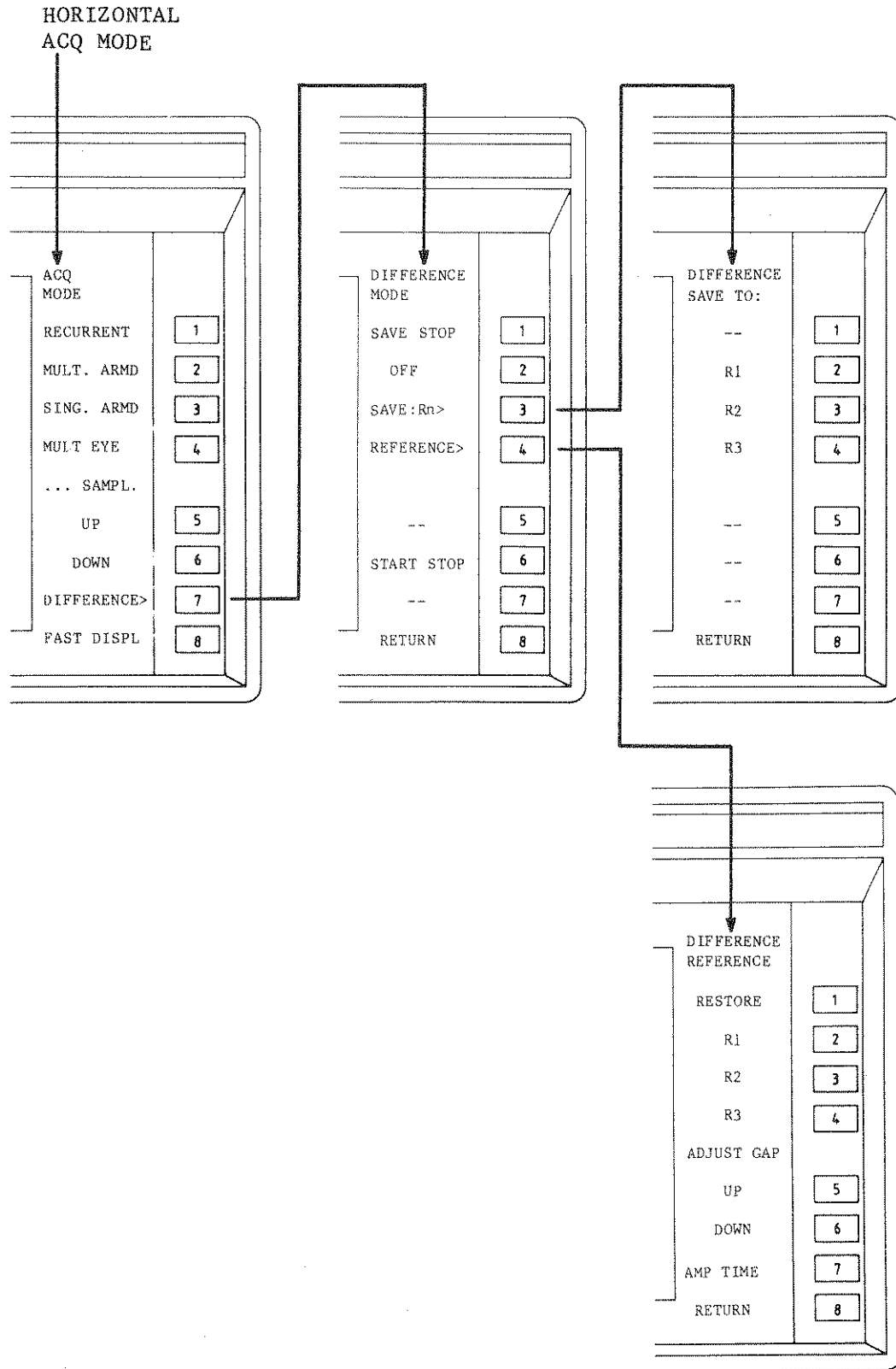
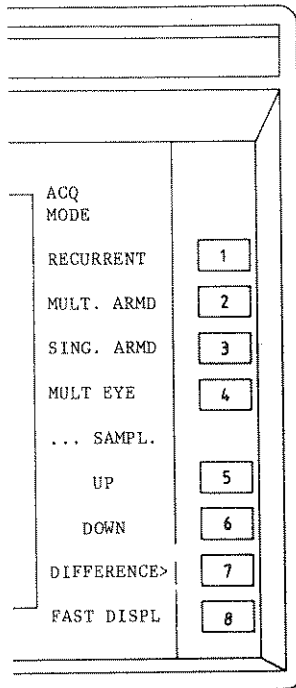

Figure 4.12 Horizontal acquisition mode menu structure.

HORIZONTAL ACQ MODE MENU



After selection of the HORIZONTAL ACQ MODE menu by depressing pushbutton HORIZONTAL ACQ MODE, the required time-base mode can be selected.

1 RECURRENT

If the RECURRENT-mode is selected, a new signal is recorded in register R0 and afterwards after a hold off refreshed each time that the trigger level is passed and that the selected delay has been reached.

2 MULT. ARMD

In MULTIPLE-mode (text MULT. ARMD intensified), four single shot signals can be captured sequentially. The signals are recorded in R3, R2, R1 and the last one in R0. The end of the cycle is indicated by a low intensified text ARMD.

A new cycle can be started by pushing softkey MULT. ARMD or pushbutton CLEAR and the text ARMD is intensified until the last single shot signal is recorded.

3 SING. ARMD

In SINGLE-mode (text SING. ARMD intensified) the contents of register R0 will be overwritten by a new signal when the trigger level is passed and the selected delay has been reached. This is indicated by a low intensified text ARMD.

If afterwards a new single shot signal should be captured the same SING. ARMD softkey or pushbutton CLEAR should be pushed and the text ARMD is intensified until the single shot signal is recorded.

4 MULT.EYE

This MULTIPLE EYE mode is a combination of the modes multiple recurrent and eye pattern. Multiple recurrent means that data captured in register R0 is copied in register R3, the next data captured in R0 is copied in R2, the next data captured in R0 is copied in R1, the next data captured in R0 is copied again in R3 and so on. this is a continuous process. For display R0 is switched off while R1, R2 and R3 are on.

In this mode many functions are preset to a predefined value. These values can be overruled afterwards if desired by the user.

5 UP

A complete picture consists of 4096 points of which normally 512 are obtained by sampling the input signal. The points inbetween are obtained by means of calculation. By means of softkey selection, the number of sampled points can be reduced to respectively 256, 128 or 64. In this way a complete picture is obtained faster; however this may lead to distortion of the displayed signal because the number of measured points decreases while the number of calculated points increases. It may be that we miss certain signal variations. Thus in general a resolution of 512 points is advised. By means of softkey UP, the resolution can be increased from 64 to 128, from 128 to 256 and from 256 to 512.

6 DOWN

This softkey has the opposite effect as softkey UP. So the resolution can be decreased from 512 to 256, from 256 to 128 and from 128 to 64. If you switch from 512 (normal resolution) to 256 samples and the vertical AVERAGE mode is on, the following warning is displayed:

Low resolution selected;
Average switched off!!!

7 DIFFERENCE>

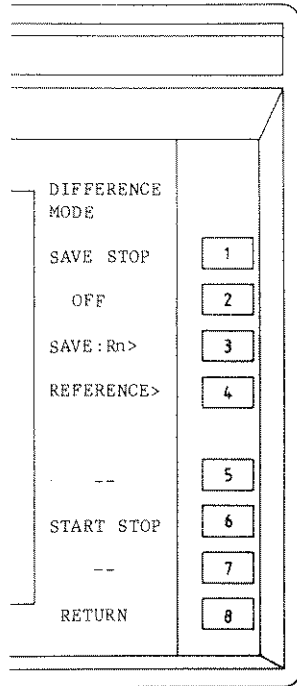

After selecting DIFFERENCE, the DIFFERENCE MODE menu will be displayed and a DIFFERENCE MODE function can be selected.

7 1 SAVE STOP

This softkey allows selection between SAVE ON DIFFERENCE and STOP ON DIFFERENCE.

In both modes, the result of an acquisition stroke in R0 is compared with a reference signal in R1, R2 or R3.

If SAVE ON DIFFERENCE is selected, then the signal in R0 is saved in R1, R2 or R3 if one or more of the dots of R0 exceeds the limits of the reference signal.

If STOP ON DIFFERENCE is selected then the acquisition stops if one or more of the dots of R0 exceeds the limits of the reference signal.

7 2 OFF

Pushing this softkey turns the SAVE ON DIFFERENCE mode or STOP ON DIFFERENCE mode off.

7 3 SAVE:Rn>

Option	Softkey
--	1
R1	2
R2	3
R3	4
--	5
--	6
--	7
RETURN	8

After selection of SAVE:Rn, the DIFFERENCE SAVE TO: menu will be displayed. This selection can only be made if the SAVE ON DIFFERENCE mode was selected before.

7 3 1 --

7 3 2 R1

7 3 3 R2

7 3 4 R3

With these softkeys, the register can be selected in which the contents of R0 will be saved by the SAVE ON DIFFERENCE function.

7 3 5 --

7 3 6 --

7 3 7 --

7 3 8 RETURN

After pushing softkey RETURN, the DIFFERENCE MODE menu is displayed again.

7 4 REFERENCE>

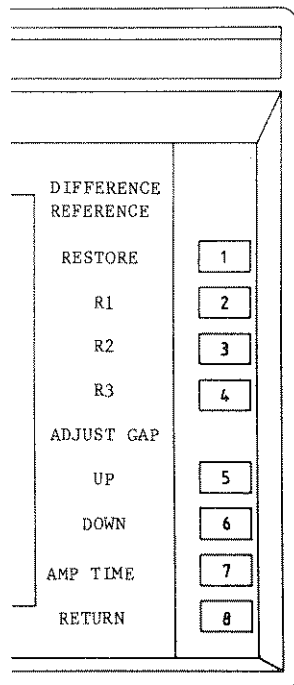

After selecting REFERENCE, the DIFFERENCE REFERENCE menu will be displayed and a reference register can be selected. Also the contents of a reference register can be determined.

7 4 1 RESTORE

This function saves the contents of R0 in the selected reference register.

7 4 2 R1

7 4 3 R2

7 4 4 R3

With these softkeys the register can be selected, which is used as the reference register for the SAVE ON DIFFERENCE and the STOP ON DIFFERENCE functions.

7 4 5 UP

Pushing softkey UP increases the gap of the signal in the selected reference register.

Depending on the AMP TIME setting, the gap increases in a vertical direction (AMP) or in a horizontal direction (TIME). The increment is 40 dots, which is 0.1 division on the screen.

7 4 6 DOWN

Pushing softkey down decreases the gap of the signal in the selected reference register.
Depending on the AMP TIME setting, the gap decreases in a vertical direction (AMP) or in a horizontal direction (TIME). The decrement is 40 dots, which is 0.1 division on the screen.

7 4 7 AMP TIME

If AMP is intensified, the softkeys UP and DOWN operate in a vertical direction.
If TIME is intensified, the softkeys UP and DOWN operate in a horizontal direction.
Pushing the softkey, changes the selection from AMP to TIME or reverse.

7 4 8 RETURN

After pushing RETURN, the DIFFERENCE MODE menu is displayed again.

7 5 --

7 6 START STOP

Pushing this softkey starts or stops the SAVE ON DIFFERENCE or the STOP ON DIFFERENCE mode, depending on which mode was selected. The actual situation is displayed intensified.

7 7 --

7 8 RETURN

After pushing RETURN, the HORIZONTAL MODE menu is displayed again.

8 FAST DISPLAY

The resolution is directly switched to 64 samples for a complete screen. As explained under softkey UP, this mode is only advised to get a quick impression how a signal approximately looks like. For a good display quality a resolution of 512 samples is necessary.

If you switch from 512 samples to FAST DISPL, and the vertical AVERAGE mode is on, the following warning is displayed:

Low resolution selected:
Average switched off!!!

4.2.6.2 HORIZONTAL MAGNIFIER/DELAY MENU STRUCTURE

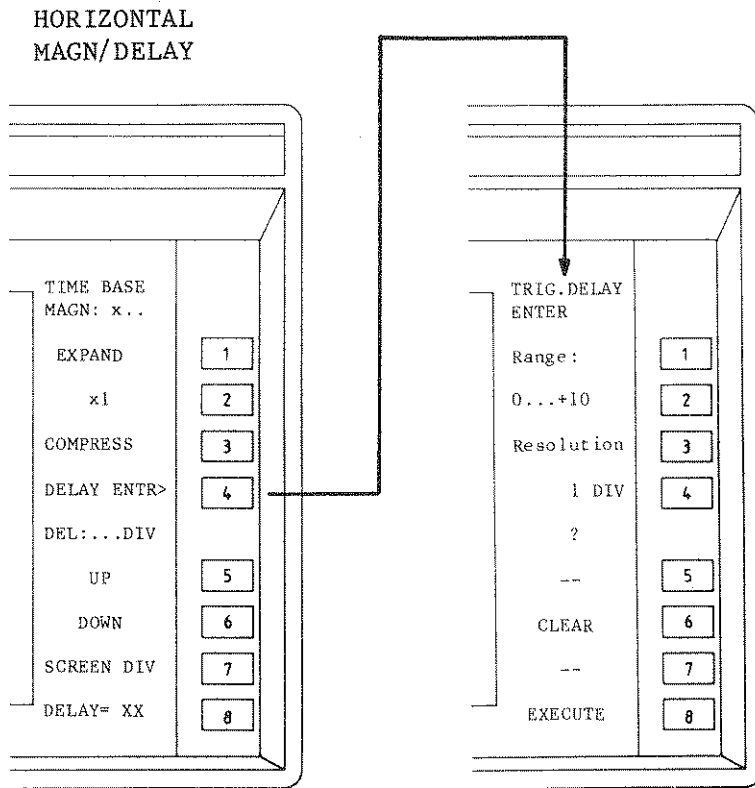
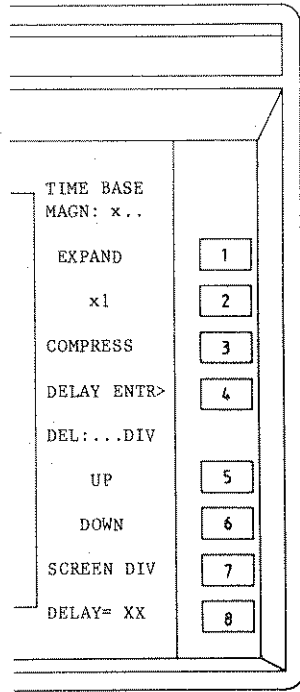

Figure 4.13 Horizontal magnifier/delay menu structure

HORIZONTAL MAGNIFIER/DELAY MENU STRUCTURE



After selection of the MAGN/DELAY menu, the horizontal magnification and the trigger delay can be selected.

The MAGN menu allows adjustment of horizontal magnification factors of *1, *2, *5, *10, *20 and *50. Changing the horizontal magnification factor changes the time base sweep speed. However the horizontal display width is not changed and stays at 10 divisions. The DELAY menu allows adjustment of the number of divisions trigger delay.

- 1 EXPAND With the this softkey, higher horizontal expand factors can be selected until *50 is reached. Then the text EXPAND is not displayed any longer. EXPAND is always with respect the midscreen.
- 2 *1 With softkey *1, the horizontal expand factor is set to X1 which means no expansion.
- 3 COMPRESS With this softkey, lower horizontal expand factors can be selected until *1 is reached. Then the text COMPRESS is not displayed any longer.

4 DELAY ENTR>

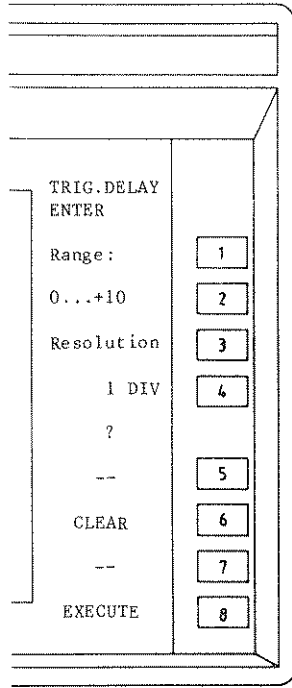

After selecting DELAY ENTR, the TRIGGER DELAY menu will be displayed and the trigger delay can be selected in divisions with the numeric keyboard.

The actual range is indicated and the value is visible in the softkey area.

A message

Too many digits; total entry is cleared.

can be displayed if too many digits are entered via the numeric keyboard.

For DIV a message

No decimal point allowed in this enter menu.

can be displayed if a decimal point is entered via the numeric keyboard.

The trigger delay ranges are always in divisions. The actual range depends on the TIME/DIV setting and the adjusted time base MAGNifier position. The range is always indicated in the softkey menu. In chapter 4.3.9 a table is given with all the possible combinations.

- 4 1 --
- 4 2 --
- 4 3 --
- 4 4 --
- 4 5 --
- 4 6 CLEAR

If an error is made, the trigger delay value can be cleared by pushing softkey CLEAR.

- 4 7 --

4 8 EXECUTE

After pushing this softkey, the selected trigger delay value is entered and an AUTO RETURN is done to menu MAGN/DELAY. If after CLEAR the softkey EXECUTE is pressed, the trigger delay value keeps its previous value in the MAGN/DELAY menu.

A message

TRIGGER DELAY number out of range

can be displayed if the entered value exceeds the given range.

4.2.7 TRIGGER SECTION AND MENU STRUCTURE

MAT 3109 MAT 3101
570122 88 0205

Figure 4.14 Front panel view.

TRIGGER

Pilot lamp indicating that the normal triggered mode for the time base is operative.

SYNCHRONIZE

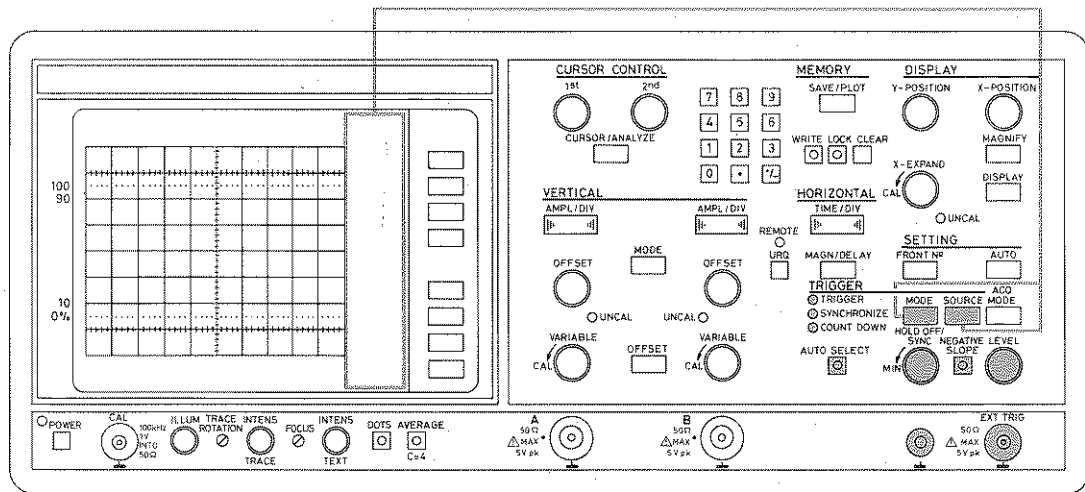
Pilot lamp indicating that the time base is in the synchronized mode. In this mode a stable picture can be obtained by means of synchronizing with the rotary control HOLD OFF/SYNC

COUNT DOWN

Pilot lamp indicating that the triggering is in the count down mode. In this mode, the frequency of the trigger signal is divided by 128 by a prescaler. This mode is only operative for signals of 150 MHz and higher.

AUTO SELECT

After having depressed this pushbutton, the most optimal of the 3 modes TRIGG'ED, SYNC'ED and COUNTDOWN is activated. This is indicated by the pilot lamps TRIG'D, SYNC'D and COUNTDOWN. If the input signal is changed, the AUTOSELECT mode may choose another mode if necessary. TRIGG'D is the normal mode. SYNC'ED is the "free run" mode for the time base. In this mode a stable picture can be obtained in most cases by fine adjustment of the HOLD OFF/SYNC control. The COUNTDOWN mode is selected for signals with frequencies exceeding 160 MHz: the trigger signal is divided by 128 via a prescaler.

	Measuring earth socket.
EXT TRIG	BNC input socket for external triggering, to be used in combination with the trigger source selection facility.
NEGATIVE SLOPE	With NEGATIVE SLOPE off, the time base is triggered on the positive-going edge of the trigger signal. With NEGATIVE SLOPE activated (on), the time base is triggered on the negative-going edge of the trigger signal, which is indicated by the built in pilot lamp. The pilot lamp lights up if NEGATIVE SLOPE is selected. The negative slope can only be selected if TRIGG'ED mode is selected via the TRIGGER MODE pushbutton. NEGATIVE SLOPE can not be selected if AUTO SELECT mode is active.
LEVEL	<p>Continuously-variable control to determine the LEVEL of the trigger point on the trigger signal at which the signal acquisition starts.</p> <p>The adjusting speed increases after turning continuously in one direction. After stopping, starting in the reverse direction resumes with a slow adjusting speed. The LEVEL control is only operative if the pilot lamp TRIGG'D is on. The trigger level is indicated in the CRT text with a value between + 100 and - 100.</p>
HOLD OFF/SYNC	Continuously-variable control to determine the HOLD OFF time for the time base in TRIGG'D and COUNTDOWN mode. During the HOLD OFF time, the time base does not respond to trigger pulses. The HOLD OFF time can be increased in order to suppress unwanted trigger pulses. In the SYNC'ED mode of the time base, this control can be used to SYNChronize the time base for a stable display.
MODE	If pushbutton MODE is pushed, the TRIGGER MODE menu is displayed. See 4.2.7.1.
SOURCE	If pushbutton SOURCE is pushed, the TRIGGER SOURCE menu is displayed. See 4.2.7.2.

4.2.7.1 TRIGGER MODE MENU STRUCTURE

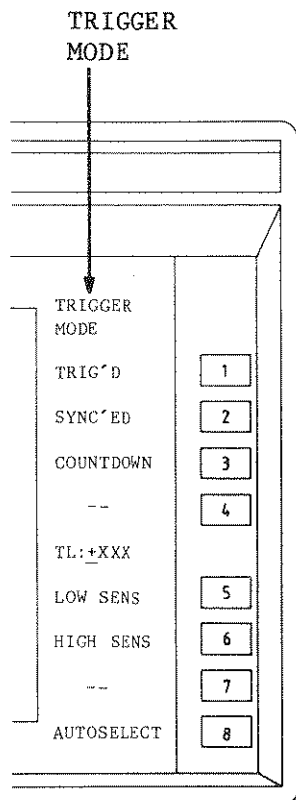

After pushing the MODE pushbutton, the TRIGGER MODE menu is displayed and different trigger modes can be selected

Figure 4.15 Trigger mode menu structure.

TRIGGER MODE MENU

1 TRIGG'ED

This is the normal trigger mode for the time base where it is possible to adjust the LEVEL control to a trigger level between 0...100%. In this mode it is also possible to select NEGATIVE SLOPE for triggering.

2 SYNC'ED

This is the free run mode for the time base. In this mode, a stable picture can be obtained in most cases by fine adjustment of the HOLD OFF/SYNC control. In this mode using the LEVEL control and NEGATIVE SLOPE pushbutton is not possible. If you use these controls, the following messages are displayed:

Leveling not possible when in SYNC-mode

or

Synchronized mode selected:
Trigger slope not operable!!!

3 COUNTDOWN

In this mode the frequency of the trigger signal is divided by 128 by a prescaler. This mode only functions for signals with a frequency of 150 MHz and higher. In this mode the time base is normally triggered and the LEVEL control can be operated. The NEGATIVE SLOPE cannot be selected; if you do so a message is displayed:

Countdown mode selected:
Trigger slope not operable!!!

4 --

5 LOW SENS

In this position is the selected trigger source signal applied to the trigger circuits without extra amplification. Triggering is only possible on signals with a relatively high amplitude.

6 HIGH SENS

In this position is the selected trigger source signal applied to the trigger circuits via an amplifier that increases the trigger sensitivity ten times. Triggering is possible on signals with a low amplitude.

7 --

8 AUTOSELECT

Operating this softkey has the same result as pressing the AUTOSELECT pushbutton at the front panel. For explanation refer to the description belonging to this pushbutton in section 4.2.7.

4.2.7.2 TRIGGER SOURCE MENU STRUCTURE

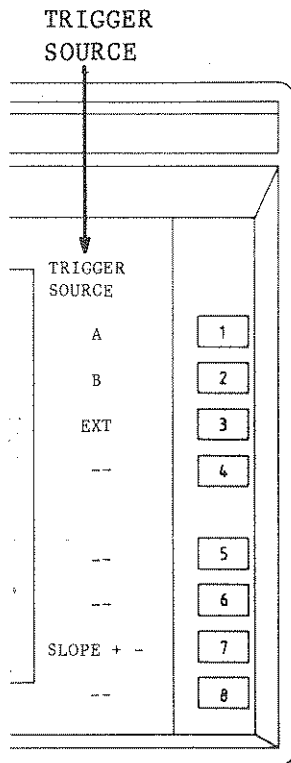

After pushing the SOURCE pushbutton, the TRIGGER SOURCE menu is displayed and different trigger sources and slopes can be selected.

Figure 4.16 Trigger source menu structure.

TRIGGER SOURCE MENU

1 A

With A selected, triggering is achieved on a signal that is internally derived from channel A.

2 B

With B selected, triggering is achieved on a signal that is internally derived from channel B.

3 EXT

With EXT selected, triggering is obtained from an external signal via the EXT TRIG input socket.

4 --

5 --

6 --

7 SLOPE + -

With this softkey, triggering on the positive or on the negative slope of the signal can be selected in the TRIGG'ED mode. This softkey has the same effect as the front panel pushbutton NEGATIVE SLOPE.

8 --



4.2.8 CURSOR SECTION AND MENU STRUCTURE

MAT 3110 MAT 3101
880122 880205

Figure 4.17 Front panel view.

- 1st This control functions when cursor operation is switched on via the CURSORS SELECT menu. Continuously variable control to determine the position of the 1st cursor (most left cursor) on the screen. Range lies between the most left and most right side of the trace visible on the C.R.T. screen. The adjusting speed increases after turning continuously in one direction. After stopping, starting in the reverse direction resumes with a slow adjusting speed. The trace on which the cursor is positioned, can be selected via the CURSOR SELECT menu.
- 2nd This control functions when cursor operation is switched on via the CURSORS SELECT menu. Continuously variable control to determine the position of the 2nd cursor (most right cursor) on the screen. Range lies between the most left and most right side of the trace visible on the C.R.T. screen. The adjusting speed increases after turning continuously in one direction. After stopping, starting in the reverse direction resumes with a slow adjusting speed. The trace on which the cursor is positioned can, be selected via the CURSOR SELECT menu.

CURSOR/ANALYZE	If pushbutton CURSOR/ANALYZE is pushed, the CURSORS SELECT menu is displayed. See 4.2.8.1.
dt	Calculation results are displayed in the top of the C.R.T. screen.
dV	dt time between the cursors.
1st .(dV1)/.(dt1)	dV voltage difference between the cursors.
	1st/.. results of left cursor measurements.
	.(dt1) time between first cursor and trigger.
	.(dV1) voltage between first cursor and zero.
2nd .(dV2)/.(dt2)	2nd/.. results of right cursor measurements.
	.(dt2) time between second cursor and trigger.
	.(dV2) voltage between second cursor and zero.

4.2.8.1 Cursor/Analyze menu structure.

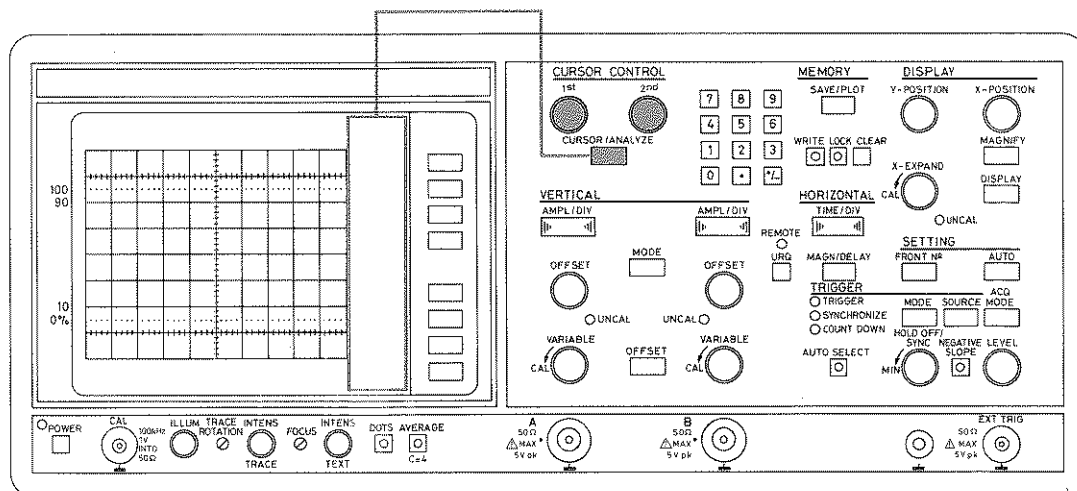
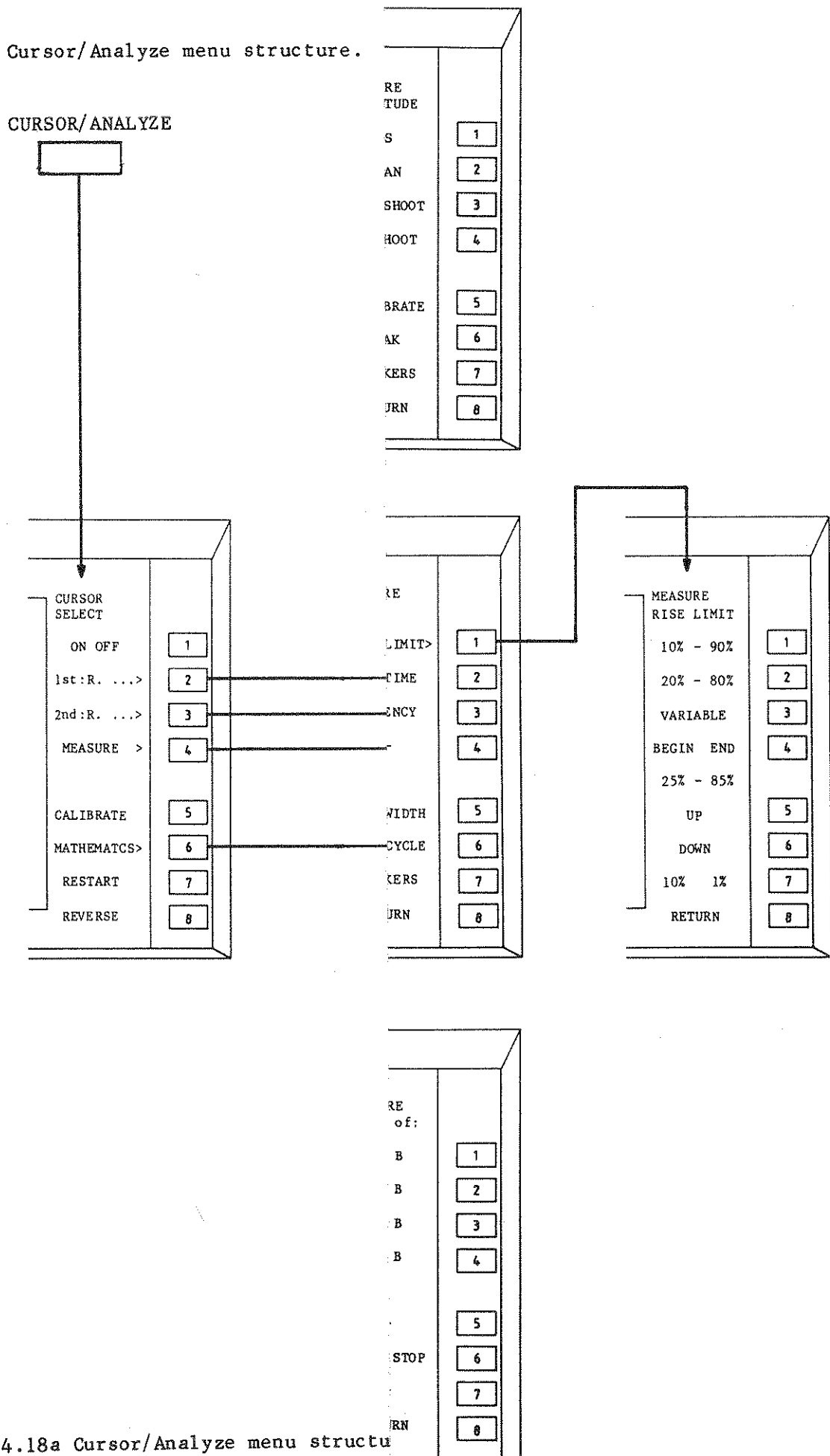

Figure 4.18a Cursor/Analyze menu structure

CURSOR/ANALYZE

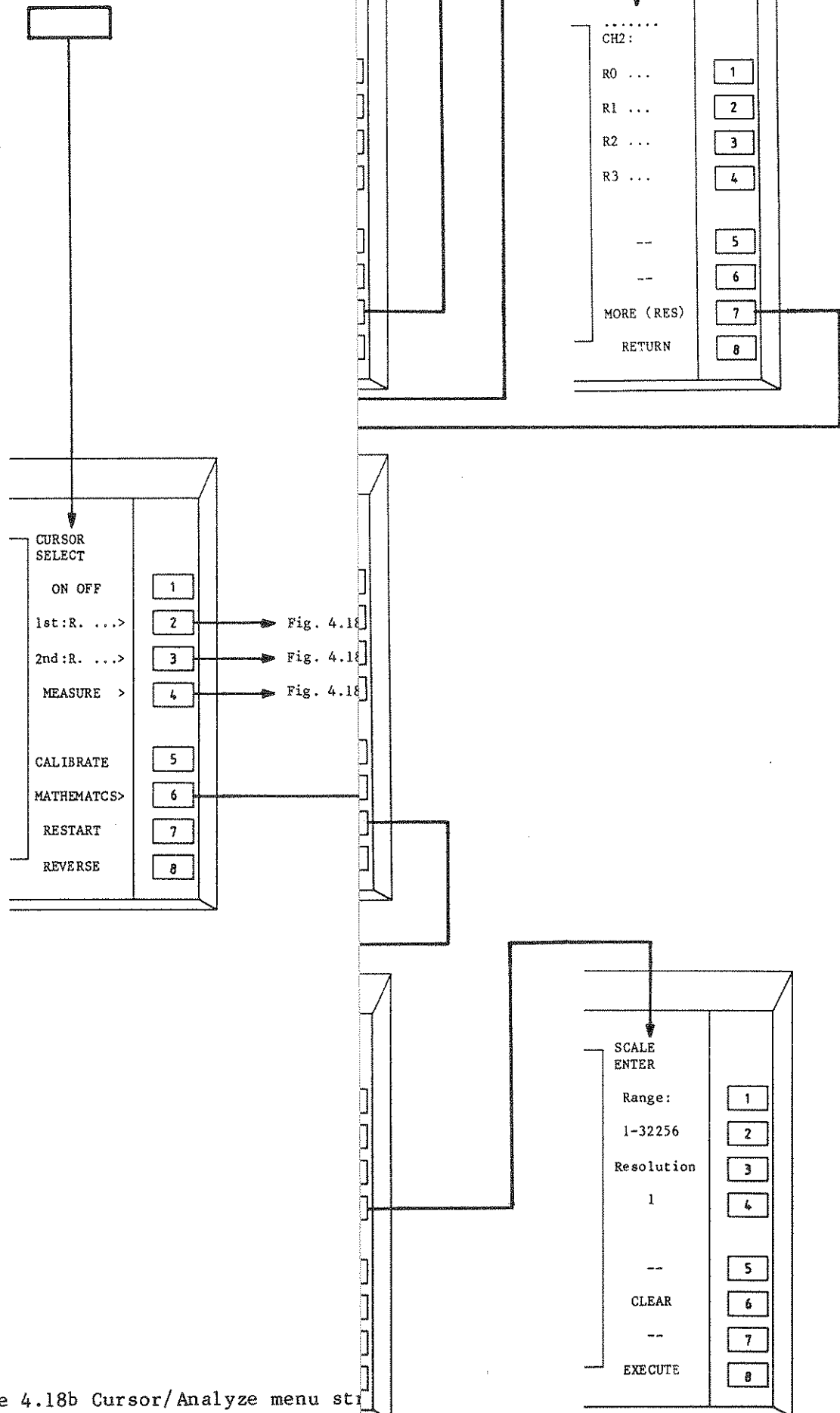
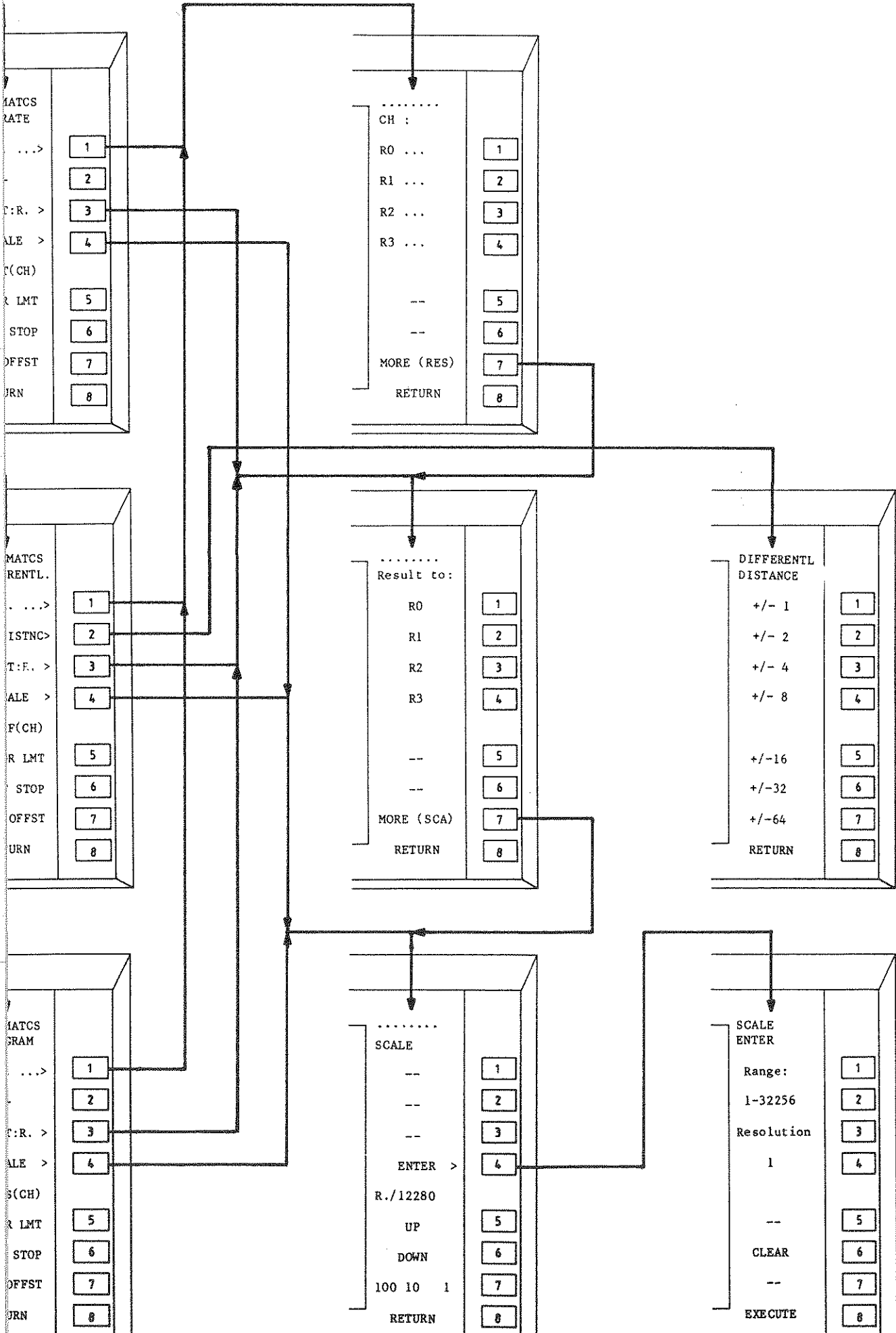
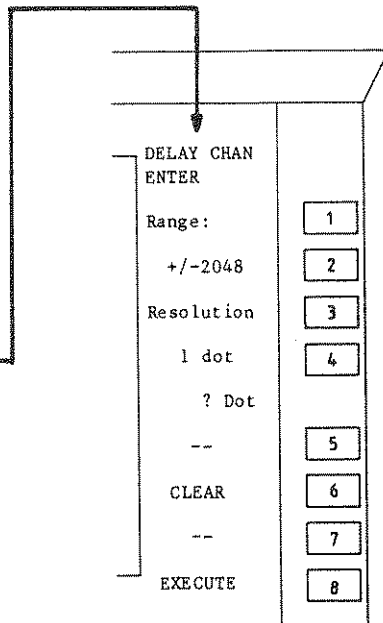
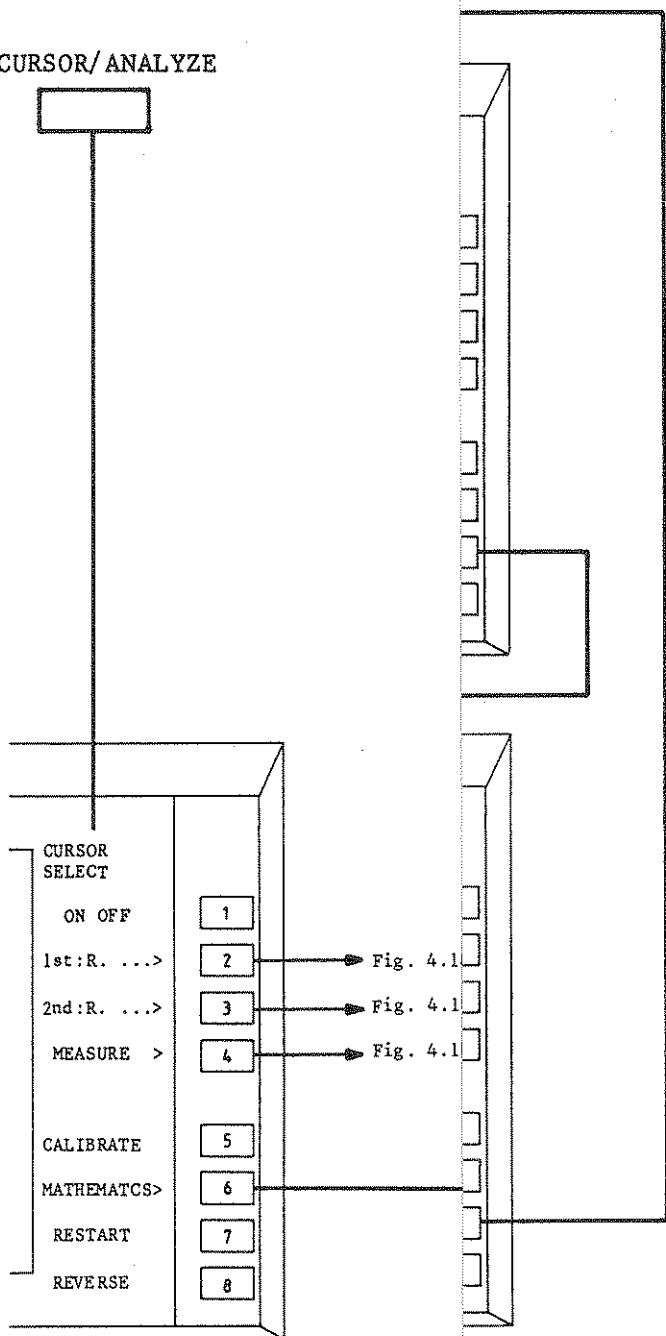

Figure 4.18b Cursor/Analyze menu str



CURSOR/ANALYZE



TCS
...> 1
AM.> 2
R.> 3
4
CH)
LMT 5
TOP 6
7
N 8

F.F.T.
CH :
R0 ... 1
R1 ... 2
R2 ... 3
R3 ... 4
-- 5
-- 6
MORE (RES) 7
RETURN 8

F.F.T.
WINDOW
RECTANG. 1
HAMMING 2
HANNING 3
-- 4
AMP SCALE:
LIN (V) 5
LOG (dB) 6
-- 7
RETURN 8

F.F.T.
Result to:
R0 1
R1 2
R2 3
R3 4
-- 5
-- 6
MORE (CH) 7
RETURN 8

TCS
...> 1
DER> 2
R.> 3
4
CH)
LMT 5
TOP 6
7
N 8

FILTER
ORDER
3 1
5 2
9 3
17 4
33 5
65 6
129 7
RETURN 8

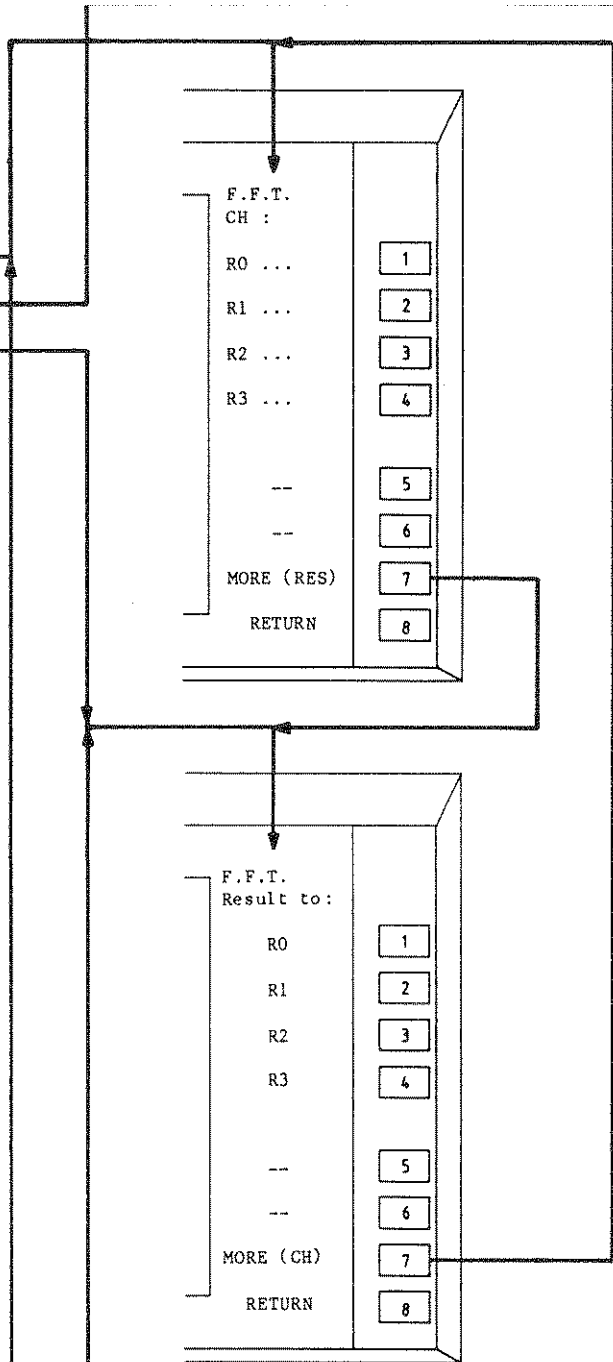

CURSOR MENU

CURSOR SELECT	
ON OFF	1
1st:R. ...>	2
2nd:R. ...>	3
MEASURE >	4
CALIBRATE	5
MATHEMATCS>	6
RESTART	7
REVERSE	8

After pushing pushbutton CURSOR, the CURSOR SELECT menu is displayed and the cursors 1st and 2nd can be set at choice for various measurements using the controls 1st and 2nd.

The cursors are displayed on the previous selected positions.

As soon as the cursors (crossed lines with a length of 2 divisions) are visible, the horizontal distance between the cursors and between cursor and trigger is measured and displayed. The vertical distance between the cursors and between cursor and ground is measured and displayed. The cursors can be positioned on different registers or channels.

The vertical and horizontal distance between the cursors are displayed in the top text area.

When positioning cursor 1st and cursor 2nd, they can not pass each other. Cursor 1st is always the left one and cursor 2nd is always the right one.

Cursors range lies between the left and the right side of the visible traces on the screen.

The displayed calculation results are continuously recalculated.

IMPORTANT NOTE:

In LOCK the TIME/DIV and AMPL/DIV settings can be changed, which is displayed in the top text area of the screen.

The displayed cursor values are valid for the picture on the screen, so they don't correspond with the TIME/DIV and AMPL/DIV settings in the top text area.

The correct settings can be found in the bottom text area, if FULL TEXT display is selected via the DISPLAY menu.

At power-down, the last selected cursor positions are saved in memory.

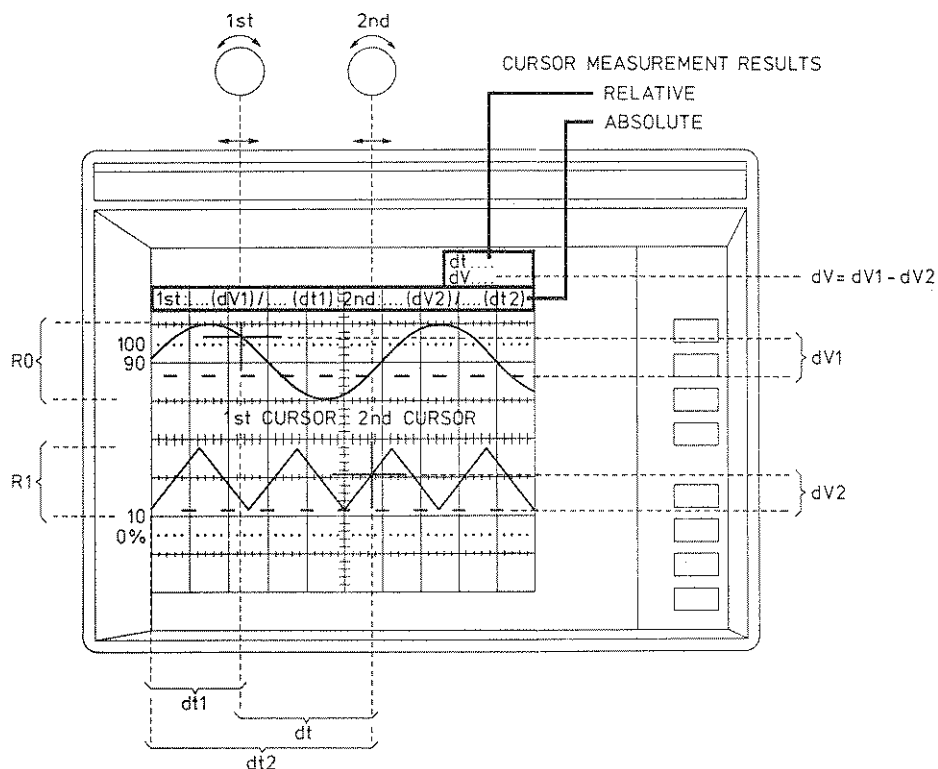

Figure 4.19 Cursor display and control.

1 ON OFF

Softkey 1 has a toggle function and switches ON and OFF the cursors. The actual function is displayed.

When the cursors are switched ON, they will appear on the last selected position.

If one of the registers or channels, in which a cursor was positioned, is switched off (invisible), this cursor will be positioned in the same register and trace as the other cursor.

If both cursors were positioned in a now invisible register or channels, they will be positioned in the first visible trace that is found. Searching starts at Register R0 and channel A.

The cursor result text line, in the top of the graticule, will display the voltage and the time (from the trigger).

2 1st:R. ...>

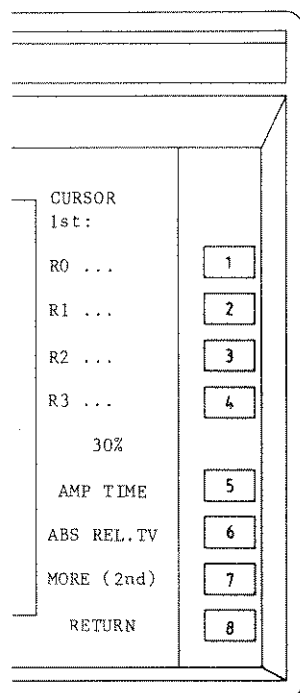

This function is only displayed when cursors are switched ON.

It initiates a menu in which the (cursor) register is selected and the way the cursor is moved.

The cursor can be placed on any channel or register, provided it is displayed.

If a register contains two channels, the corresponding softkey will function as a toggle key between the channels after the register is selected.

The text area of this softkey indicates the register (and channel) in which this cursor is positioned.

The AMP TIME and ABS RELTV selection made here is also valid for the 2nd cursor.

```

2  1  R0 ...
2  2  R1 ...
2  3  R2 ...
2  4  R3 ...

```

If a register is selected for cursor operation the cursor is visible on the screen for the selected (intensified) channel. The other channel can be selected by pushing the softkey once again.

Only displayed registers will appear in the menu.

The previous position of a cursor in a register is displayed when it is selected again.

Possible displays for the cursor positions are:

(R. A B), (R. A), (R. B), (R. ADD), (R. SUB),
 (R. MUL), (R. DIV), (R. INT), (R. DIF), (R. DEL),
 (R. FFT), (R. HYS) or (R. FIL).

If register R0 and one channel is selected for both cursors, the Text RESTART is visible next to softkey 7 and an automatic selection of time base setting and/or delay is possible (see explanation for softkey 7).

If A versus B was selected for the selected register a message

REGISTER IN A VERSUS B: NO CURSORS POSSIBLE

is displayed and the cursors are switched off.

If a register is selected in which no traces and settings are stored, a message

REGISTER HAS NO LEGAL SETTINGS: NO CURSORS

is displayed.

2 5 AMP TIME

AMP TIME is a toggle function which indicates what way the cursor control knob is used. The selection AMP or TIME is valid for both cursors.

AMP function

The AMP function active means, the cursor control will position the cursor in a vertical way.

The text ABS RELTV becomes visible for softkey 6 when AMP is selected. The text line between softkey 4 and 5 indicates the position of the cursor.

TIME function

The TIME function active means, the cursor is moved horizontal.

2 6 ABS RELTV

Displayed when AMP is selected by softkey 5. The selection is valid for both cursors.

ABS function

Indicates that the positioning of the cursor is in Volts. If the voltage of the cursor is not found on the signal, an error message is displayed and the cursor is positioned on the nearest value. The voltage is indicated between softkeys 4 and 5.

RELTV function

This function will put the cursor on a relative vertical position on the signal. The 0% and 100% are the peak-peak values of the signal between the cursors. The percentage is indicated between softkeys 4 and 5.

2 7 MORE (2nd)

If MORE (2nd) is selected, the selection menu for the second cursor will appear. MORE (2nd) has the same result as pressing RETURN and then 2nd:R. ...

2 8 RETURN

After pushing softkey RETURN, the cursor SELECT menu becomes visible.

3 2nd:R. ...>

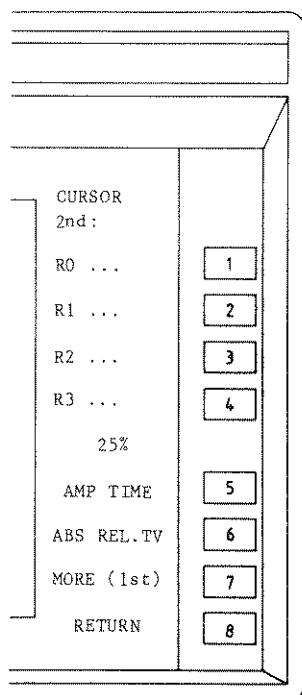

This function is only displayed when cursors are switched ON.

It initiates a menu in which the (cursor) register is selected and the way the cursor is moved.

The cursor can be placed on any channel or register, provided it is displayed.

If a register contains two channels, the corresponding softkey will function as a toggle key between the channels after the register is selected.

The text area of this softkey indicates the register (and channel) in which this cursor is positioned.

The AMP TIME and ABS RELTV selection made here is also valid for the 1st cursor.

```

3   1   R0 ...
3   2   R1 ...
3   3   R2 ...
3   4   R3 ...

```

If a register is selected for cursor operation the cursor is visible on the screen for the selected (intensified) channel. The other channel can be selected by pushing the softkey once again.

Only displayed registers will appear in the menu.

The previous position of a cursor in a register is displayed when it is selected again.

Possible displays for the cursor positions are:

(R. A B), (R. A), (R. B), (R. ADD), (R. SUB),
 (R. MUT), (R. DIV), (R. INT), (R. DIF), (R. DEL),
 (R. FFT), (R. HYS) or (R. FIL).

If register R0 and one channel is selected for both cursors, the Text RESTART is visible next to softkey 7 and an automatic selection of time base setting and/or delay is possible (see explanation for softkey 7).

If A versus B was selected for the selected register a message

REGISTER IN A VERSUS B: NO CURSORS POSSIBLE

is displayed and the cursors are switched off.

If a register is selected in which no traces and settings are stored, a message

REGISTER HAS NO LEGAL SETTINGS: NO CURSORS

is displayed.

3 5 AMP TIME

AMP TIME is a toggle function which indicates what way the cursor control knob is used. The selection AMP or TIME is valid for both cursors.

AMP function

The AMP function active means, the cursor control will position the cursor in a vertical way.

The text ABS RELTV become visible for softkey 6 when AMP is selected. The text line between softkey 4 and 5 indicates the position of the cursor.

TIME function

The TIME function active means, the cursor is moved horizontal.

3 6 ABS RELTV

Displayed when AMP is selected by softkey 5.
The selection is valid for both cursors.

ABS function

Indicates the positioning of the cursor is in Volts. If the voltage of the cursor is not found on the signal, an error message is displayed and the cursor is positioned on the nearest value. The voltage is indicated between softkeys 4 and 5.

RELTV function

This function will put the cursor on a relative vertical position on the signal. The 0% and 100% are the peak-peak values of the signal between the cursors. The percentage is indicated between softkeys 4 and 5.

3 7 MORE (1st)

If MORE (1st) is selected the selection menu for the second cursor will appear. MORE (1st) will have the same result as pressing RETURN and then 1st:R. ...

3 8 RETURN

After pushing softkey RETURN, the cursor SELECT menu becomes visible.

4 MEASURE>

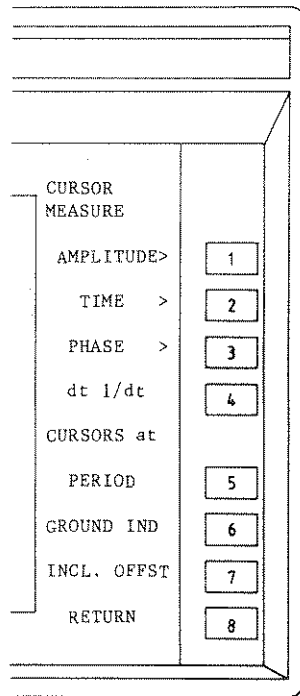

If MEASURE is selected, the CURSOR MEASURE menu is displayed and a choice of cursor related measurements can be selected. The text MEASURE is only visible when the cursors are switched ON. To get the choice of amplitude and time measurements, the cursor must be related to the same trace. A maximum of three measurements can be selected and displayed in the measurement result text area (see also section 4.2.2).

4 1 AMPLITUDE>

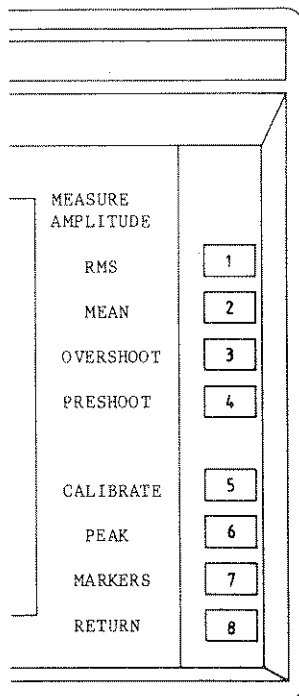

By pushing AMPLITUDE, the MEASURE AMPLITUDE menu is displayed. This function AMPLITUDE is only visible when both cursors are related to one channel. The CALIBRATE function is also in this menu implemented because of the importance of a correct ground-level in the RMS and MEAN calculations. MARKERS will only be visible when OVERSHOOT, PRESHOOT or PEAK is selected and act on the active measurement with the highest position in the menu. Results are displayed at the bottom of the graticule.

4 1 1 RMS

After pushing RMS (Root Mean Square), the RMS value of the signal detail between the cursors is calculated. This RMS is related to the ground level. Therefore it is recommended to calibrate the channel before reading the RMS result.

4 1 2 MEAN

After pushing MEAN, the mean value of the signal detail between the cursors is calculated. This MEAN value is related to the ground level. Therefore it is recommended to calibrate the channel before reading the MEAN result.

4 1 3 OVERSHOOT

After pushing OVERSHOOT, the OVERSHOOT value of the signal detail between the cursors is calculated. This OVERSHOOT value is related to the cursor levels according the formula:

When level 1st is lower than level 2nd:

$$\text{OVERSHOOT} = \frac{\text{level peak} - \text{level 2nd}}{\text{level 2nd} - \text{level 1st}} * 100\%$$

When level 2nd is lower than level 1st:

$$\text{OVERSHOOT} = \frac{\text{level 2nd} - \text{level minimum}}{\text{level 1st} - \text{level 2nd}} * 100\%$$

4 1 4 PRESHOOT

After pushing PRESHOOT, the PRESHOOT value of the signal detail between the cursors is calculated. This PRESHOOT value is related to the cursor levels according the formula:

When level 1st is lower than level 2nd:

$$\text{PRESHOOT} = \frac{\text{level 1st} - \text{level minimum}}{\text{level 2nd} - \text{level 1st}} * 100\%$$

When level 2nd is lower than level 1st:

$$\text{PRESHOOT} = \frac{\text{level peak} - \text{level 1st}}{\text{level 1st} - \text{level 2nd}} * 100\%$$

4 1 5 CALIBRATE

After pushing CALIBRATE, the analog input circuits are calibrated. The CALIBRATE procedure will calculate the ground level correction and the offset correction, which are used to get correct measurement values. Same as CALIBRATE in the main (CURSOR SELECT) menu.

4 1 6 PEAK-PEAK

After pushing softkey PEAK-PEAK, the voltage between the lowest and the highest point of the signal between two cursors, will be calculated and displayed in the measurement result text area.

When PEAK-PEAK is selected, the text MARKERS becomes visible for softkey 7.

4 1 7 MARKERS

After pushing softkey MARKERS, the MARKERS become visible on the signal that is selected for both cursors.

The MARKERS, two vertical lines, are placed on that positions that are used for the selected measurement. Just above the measurement results, the absolute values, of the signal at the marker positions, are displayed in relation to the ground level and the trigger (see section 4.2.2).

4 1 8 RETURN

After pushing softkey RETURN, the CURSOR MEASURE menu will be visible again.

The results of the selected measurements are still displayed.

4 2 TIME>

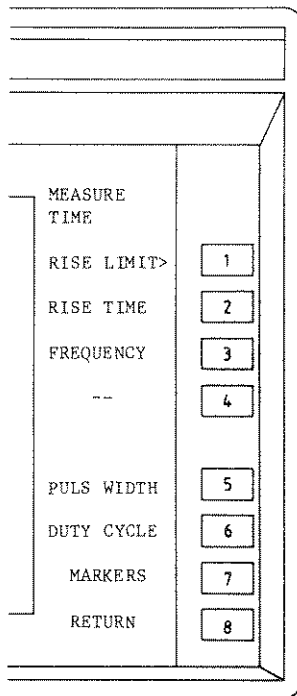

If TIME is selected, the MEASURE TIME menu is displayed and a number of TIME measurements can be selected.

The time measurement results are displayed in the measurement result text area in the the bottom of the graticule.

The text MARKERS becomes visible when a time measurement is selected. The markers are valid for the active measurement with the highest position in the menu.

4 2 1 RISE LIMIT>

MEASURE	
RISE LIMIT	
10% - 90%	1
20% - 80%	2
VARIABLE	3
BEGIN END	4
25% - 85%	
UP	5
DOWN	6
10% 1%	7
RETURN	8

If RISE LIMIT is selected, the MEASURE RISE LIMIT menu is displayed and the limits used for RISE TIME calculation are selected.

Fixed limits are selected by the softkeys 1 and 2, or variable limits by softkey 3 and 4.

When VARIABLE is selected, softkey text is displayed at softkeys 4, 5, 6 and 7, to change the limits of the RISE TIME. The RISE time function is switched ON via the softkey RISE TIME.

4 2 1 1 10%-90%

After pushing softkey 10%-90%, the RISE TIME will be measured from 10% till 90% of the amplitude rise between the cursors.

4 2 1 2 20%-80%

After pushing softkey 20%-80%, the RISE TIME will be measured from 20% till 80% of the amplitude rise between the cursors.

4 2 1 3 VAR (Variable)

After pushing softkey VAR, variable RISE TIME limits can be selected by softkeys 4...7 for which the text is now displayed.

The selected limits are displayed between the softkey text of the softkeys 4 and 5. RISE TIME is measured from the BEGIN value to the END values.

4 2 1 4 BEGIN END

This softkey text becomes visible after pushing softkey VAR.

This softkey has a toggle function. With this softkey, a selection is made between changing the BEGIN or the END function.

The active state is displayed intensified. The values of BEGIN and END are displayed directly below the correspondending softkey text.

4 2 1 5 UP

This softkey text becomes visible after pushing softkey VAR.

Pushing this softkey, results in an increment of the BEGIN or END value, whichever is selected by softkey 4.

The increment itself is selectable by softkey 7.

4 2 1 6 DOWN

This softkey text becomes visible after pushing softkey VAR.

Pushing this softkey, results in a decrement of the BEGIN or END value, whichever is selected by softkey 4.

The decrement itself is selectable by softkey 7.

4 2 1 7 10% 1%

This softkey text becomes visible after pushing softkey VAR.

With this softkey, the increment or decrement is selected for the UP or DOWN softkeys 5 or 6.

4 2 1 8 RETURN

After pushing softkey RETURN, the MEASURE TIME menu is displayed again. The selections as made before remain unchanged.

4 2 2 RISE TIME

If RISE is selected, the RISE time is calculated for the limits set via the RISE LIMIT menu.

The result is displayed in the bottom of the graticule.

4 2 3 FREQUENCY

After pushing FREQUENCY, the FREQUENCY value is calculated as follows.

The MEAN value of the signal detail between the cursors is calculated. From the time difference between the first and the third crossing with this MEAN value the FREQUENCY is calculated.

4 2 4 --

4 2 5 PULS WIDTH

After pushing PULS WIDTH, the PULS WIDTH value is calculated as follows.

The value in the middle between the PEAK-PEAK values is the level where PULS WIDTH is measured.

PULS WIDTH is the time difference between the first and second crossing of the above level.

4 2 6 DUTY CYCLE

After pushing DUTY CYCLE, the DUTY CYCLE value is calculated as followed.

The MEAN value of the signal detail between the cursors is calculated. From the time difference between the first and third crossing with this MEAN value the period time is calculated.

The time difference between the first and second crossing divided by the period time determines the DUTY CYCLE.

4 2 7 MARKERS

If MARKERS is selected, The markers become visible on the trace that is selected for the cursors.

The MARKERS will indicate the measurement positions of the active TIME measurement that has the highest position in the TIME menu.

4 2 8 RETURN

After pushing softkey RETURN, the CURSOR MEASURE menu will be visible again.

The results of the selected measurements are still displayed.

4 3 PHASE>

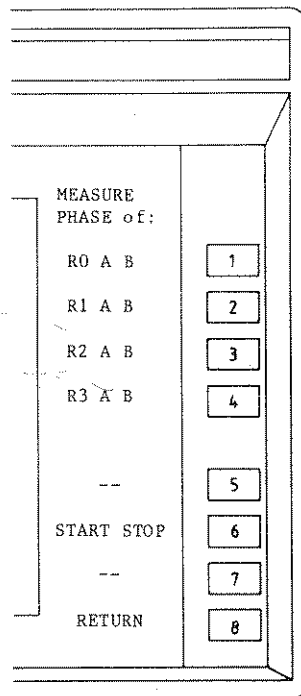

If PHASE is selected, the MEASURE PHASE menu is displayed and a selection can be made between all registers that contain two channels.

If there are no two channel registers, PHASE can not be selected and is not visible. Each valid softkey has a toggle function after it is selected. With this toggle function, the channel can be selected that is used as reference.

From this channel, the period time is determined. From both channels, the MEAN level is determined.

PHASE is the time difference between the first crossings of the two channel signals and their MEAN level, divided by the reference period and expressed in degrees.

The result is displayed in the measurement result text area (see section 4.2.2.2).

The PHASE measurement is started by toggling softkey 6, START STOP.

4 3 1 R0 A B
 4 3 2 R1 A B
 4 3 3 R2 A B
 4 3 4 R3 A B

After pushing one of these softkeys, the selected register is used for measurement of the PHASE between the channel present in this register.

4 3 5 --
 4 3 6 START STOP

After pushing softkey START STOP, the PHASE measurement is started and the result becomes visible. This softkey has a toggle function so pushing it again will stop the measurement.

4 3 7 --
 4 3 8 RETURN

After pushing softkey RETURN, the CURSOR MEASURE menu will visible again. The result of the selected measurement are still displayed.

4 4 dt 1/dt

By pushing this softkey, a selection is made for the representation of the horizontal distance between the cursors.

In dt mode, the value is expressed in seconds.

In 1/dt mode, the value is expressed in hertz.

The result is displayed in the top text area.

If both cursors are positioned on exactly the same position the result will display 1/dt:1/ 0/d.

4 5 CURSORS at PERIOD

After pushing CURSORS at PERIOD, the cursors are placed at the first and third zero crossing of the channel in which the first cursor was situated and the period is measured.

If this period is not found, the cursors are placed on the channel where the second cursor was.

If here also no period is found, an error message is given.

4 6 GROUND IND

By pushing GROUND IND the zero lines of the channels selected for the cursors, is displayed.

The ground level is indicated by, ten (10) lines between the vertical graticule lines, for the channel with the left cursor and by nine (9) lines on the vertical graticule lines for the channel with the right cursor.

4 7 INCL OFFST

After pushing softkey INCL OFFST, the OFFST defined earlier is included in the measurement.

4 8 RETURN

After pushing softkey RETURN, the CURSOR SELECT menu becomes visible.

5 CALIBRATE

After pushing softkey CALIBRATE, the main processor will build up or correct an array of correction factors for ground and offset.

This array will contain:

- The real ground levels for channels A and B, in single channel mode with offset at zero, measured at time bases 2 ms/div, 2 us/div and 100 ns/div.
- The real ground levels for channels A and B, in dual channel mode with offset at zero, measured at time bases 2 ms/div, 2 us/div and 100 ns/div.
- Offset correction at four divisions for channels A and B.

These figures must be measured with the inputs open, in recurrent and auto triggered. In order to obtain a proper calibration, the message:

CALIBRATION of front end. Remove input signals before the end of this message.

is generated during a couple of seconds, during which the user has the opportunity to remove eventual input signals. After the calibration procedure is completed, the oscilloscope returns to the situation as before the calibration was started.

6 MATHEMATCS>

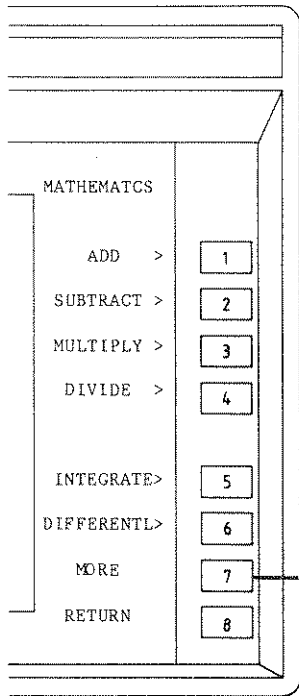

MATHEMATCS is selected, the MATHEMATCS menu becomes visible and a number of mathematical functions can be selected.

Because of the number of mathematical operations exceeds the number of softkeys, a MORE function is introduced to be able to select more functions on this same menu level. A selection in this MATHEMATICS 'MORE' menu is indicated with the numbers 7,1 ... 7,8, where 7, indicates softkey 7 in the first MATHEMATCS menu.

ADD, SUBTRACT, MULTIPLY and DIVIDE are so called type 1 operations that need two source channels (CH1 and CH2). These traces can have different length. Therefore they are expanded over 4096 points with linear interpolated points inbetween. So the operation is always over 4096 points.

The type 2 operations INTEGRATE, DIFFERENTIAL, FFT and HYSTOGRAM always operate on the real resolution. The result is then expanded over 4096 points with linear interpolated points inbetween.

The result can be scaled with a selected value. The amplitude and time indications are updated to give the actual values.

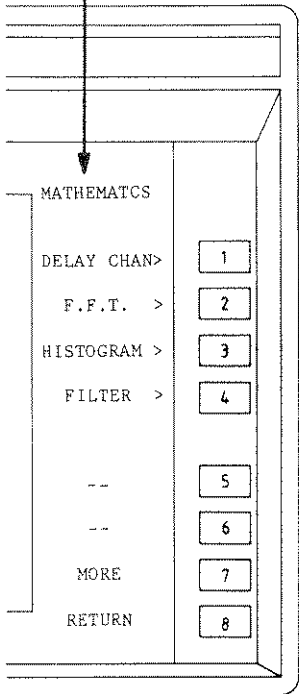

The function is started by pressing START STOP in the selected function menu. It is stopped by pressing START STOP again or by starting another mathematical function.

The operations are restarted if the sources are from the registers R1, R2 or R3, a save action takes place and the operation still is active. If the source is from R0, the operation is continuously restarted.

If there are no registers active that contain two channels the function DELAY CHAN will not be visible

The selection of SOURCE, RESULT or SCALE for any of the mathematic functions is valid for all other mathematic functions.

6 1 ADD>

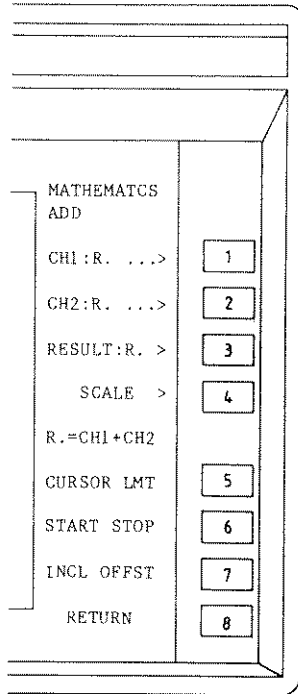

If ADD is selected, the MATHEMATCS ADD menu becomes visible and the sources and destination can be selected.

Note: A change in the parameters of the ADD function will also change the parameters of all other functions, including any active one.

Selecting START (softkey 6) will automatically switch OFF any active MATHEMATCS function and start the ADD function.

CURSOR LMT results in the addition of the part between the cursors.

When one of the sources is updated, the result register is also updated.

6 1 1 CH1:R. ...>

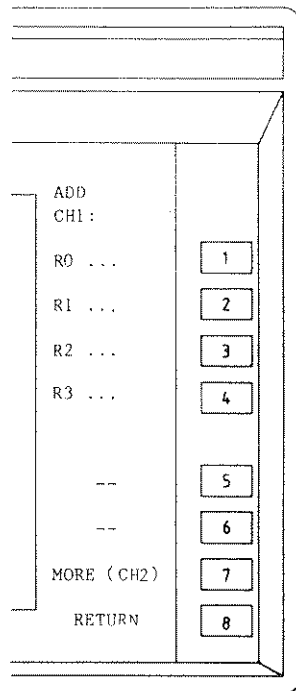

If CH1:R. ... is selected, the CH1 menu becomes visible and channel 1 can be selected from the registers. If there are two channels in a register, the selected channel is displayed intensified.

6	1	1	1	R0 ...
6	1	1	2	R1 ...
6	1	1	3	R2 ...
6	1	1	4	R3 ...

If softkey 1, 2, 3 or 4 is pressed, register R0, R1, R2 or R3 is selected as source CH1. If two channels are present in the selected register then pressing the softkey again will result in toggling between the two channels in the register.

6	1	1	5	--
6	1	1	6	--
6	1	1	7	MORE (CH2)

If MORE (CH2) is pressed, the CURSOR CH2 menu will appear. MORE (CH2) has the same result as pressing RETURN and selecting CH2:R. ...

6	1	1	8	RETURN
---	---	---	---	--------

After pushing softkey RETURN, the MATHEMATCS ADD menu becomes visible.

6	1	2	CH2:R. ...>
---	---	---	-------------

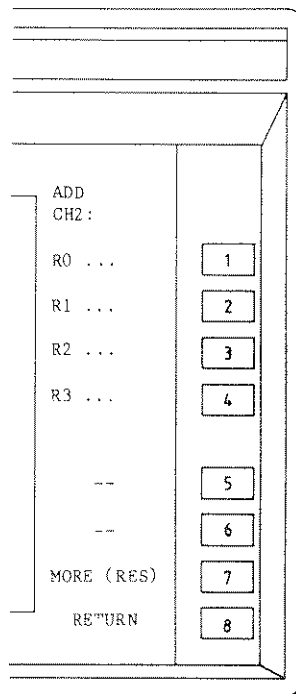

If CH2:R. ... is selected, the CH2 menu becomes visible and channel 2 can be selected from the registers. If there are two channels in a register, the selected channel is displayed intensified.

6	1	2	1	R0 ...
6	1	2	2	R1 ...
6	1	2	3	R2 ...
6	1	2	4	R3 ...

If softkey 1, 2, 3 or 4 is pressed, register R0, R1, R2 or R3 is selected as source CH2.

If two channels are present in the selected register, then pressing the softkey again will result in toggling between the two channels in the register.

6	1	2	5	--
6	1	2	6	--
6	1	2	7	MORE (RES)

If MORE (RES) is pressed, the RESULT R. menu will appear. MORE (RES) has the same result as pressing RETURN and selecting RESULT R..

6	1	2	8	RETURN
---	---	---	---	--------

After pushing softkey RETURN, the MATHEMATCS ADD menu becomes visible.

6	1	3	RESULT: R.>
---	---	---	-------------

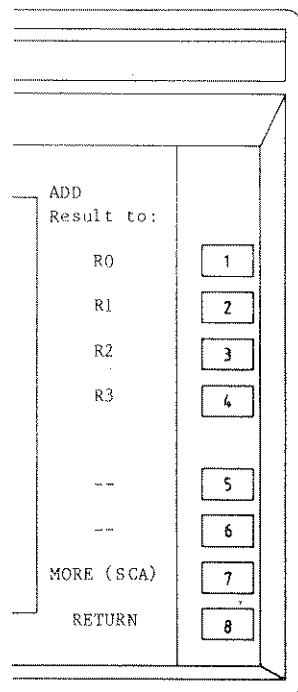

If RESULT: R. is selected, the RESULT menu becomes visible and a register can be selected in which the result is stored.

6 1 3 1 R0
 6 1 3 2 R1
 6 1 3 3 R2
 6 1 3 4 R3

If softkey 1, 2, 3 or 4 is pressed, register R0, R1, R2 or R3 is selected as result register.

6 1 3 5 --
 6 1 3 6 --
 6 1 3 7 MORE (SCA)

If MORE (SCA) is pressed, the SCALE menu will appear. MORE (SCA) has the same result as pressing RETURN and selecting SCALE.

6 1 3 8 RETURN

After pushing softkey RETURN, the MATHEMATCS ADD menu becomes visible.

6 1 4 SCALE>

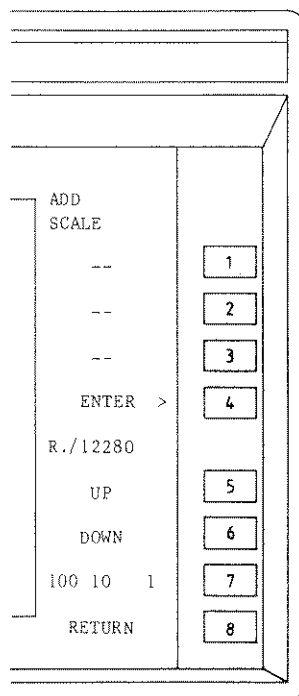

If SCALE is pressed, the SCALE menu becomes visible and a scaling factor can be selected to get the resulting trace of the MATHEMATCS ADD operation inside the vertical register range.

6 1 4 1 --
 6 1 4 2 --
 6 1 4 3 --

6 1 4 4 ENTER>

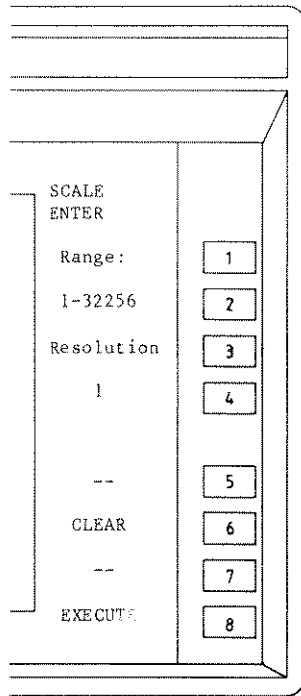

After selecting ENTER, the ADD SCALE menu will be displayed and the scale factor can be selected with the numeric keyboard. The actual range and the value is visible in the softkey text area.

A message

Too many digits: total entry is cleared.

is displayed if too many digits are entered via the numeric keyboard.

Or a message

No decimal point allowed in this enter menu.

is displayed if a decimal point is entered via the numeric keyboard.

6 1 4 4 1 --
 6 1 4 4 2 --
 6 1 4 4 3 --
 6 1 4 4 4 --
 6 1 4 4 5 --
 6 1 4 4 6 CLEAR

If an error is made, the scale value can be cleared by pushing softkey CLEAR.

6 1 4 4 7 --
 6 1 4 4 8 EXECUTE

After pushing this softkey, the selected scale value is entered and an AUTO RETURN is performed to the menu ADD SCALE.

If after a CLEAR the softkey EXECUTE is pressed the scale value keeps its previous value in the ADD SCALE menu.

A message

ADD SCALE number out of range

is displayed if the entered value exceeds the given range.

- 6 1 4 5 UP
- Pushing softkey UP increments the scale factor by 1, 10 or 100, selected by softkey 7.
- 6 1 4 6 DOWN
- Pushing softkey DOWN decrements the scale factor by 1, 10 or 100, selected by softkey 7.
- 6 1 4 7 100 10 1
- Pushing this softkey toggles the size of the increment or decrement step between 100, 10 and 1. The actual value is displayed intensified.
- 6 1 4 8 RETURN
- After pushing softkey RETURN, the MATHEMATCS ADD menu becomes visible.
- 6 1 5 CURSOR LMT
- Pushing softkey CURSOR LMT toggles the function ON or OFF. When the function is switched ON, the MATHEMATCS ADD function is performed on the channels between the cursors only. Display points outside the cursors are put at -512 and are normally not displayed. The function CURSOR LMT can only be selected when the cursors are ON. The cursors are then automatically positioned on CH1. When the function is active CURSOR LMT is displayed intensified.
- 6 1 6 START STOP
- Pushing softkey START STOP starts or stops the MATHEMATCS ADD operation. The actual state is displayed intensified. START will stop any other active MATHEMATCS function.
- 6 1 7 INCL OFFST
- Pushing softkey INCL OFFST will toggle this function. INCL OFFST active will result in the offset of the channels being included in the MATHEMATCS ADD operation. When the function is active, INCL OFFST is displayed intensified.
- 6 1 8 RETURN
- After pushing RETURN, the MATHEMATCS menu becomes visible.

6 2 SUBTRACT>

MATHMATCS	
SUBTRACT	
CH1:R. ...>	1
CH2:R. ...>	2
RESULT:R. >	3
SCALE >	4
R.=CH1-CH2	
CURSOR LMT	5
START STOP	6
INCL OFFST	7
RETURN	8

If SUBTRACT is selected, the MATHMATCS SUBTRACT menu becomes visible and the sources and destination can be selected.

Note: A change in the parameters of the SUBTRACT function will also change the parameters of all other functions, including any active one.

Selecting START (softkey 6) will automatically switch OFF any active MATHMATCS function and start the SUBTRACT function.

CURSOR LMT results in the subtraction of the part between the cursors.

When one of the sources is updated, the result register is also updated.

6 2 1 CH1:R. ...>

SUBTRACT	
CH1:	
R0 ...	1
R1 ...	2
R2 ...	3
R3 ...	4
--	5
--	6
MORE (CH2)	7
RETURN	8

If CH1:R. ... is selected, the CH1 menu becomes visible and channel 1 can be selected from the registers. If there are two channels in a register, the selected channel is displayed intensified.

6	2	1	1	R0 ...
6	2	1	2	R1 ...
6	2	1	3	R2 ...
6	2	1	4	R3 ...

If softkey 1, 2, 3 or 4 is pressed, register R0, R1, R2 or R3 is selected as source CH1.

If two channels are present in the selected register then pressing the softkey again will result in toggling between the two channels in the register.

6	2	1	5	--
6	2	1	6	--
6	2	1	7	MORE (CH2)

If MORE (CH2) is pressed, the CURSOR CH2 menu will appear. MORE (CH2) has the same result as pressing RETURN and selecting CH2:R. ...

6	2	1	8	RETURN
---	---	---	---	--------

After pushing softkey RETURN, the MATHEMATCS SUBTRACT menu becomes visible.

6	2	2	CH2:R. ...>
---	---	---	-------------

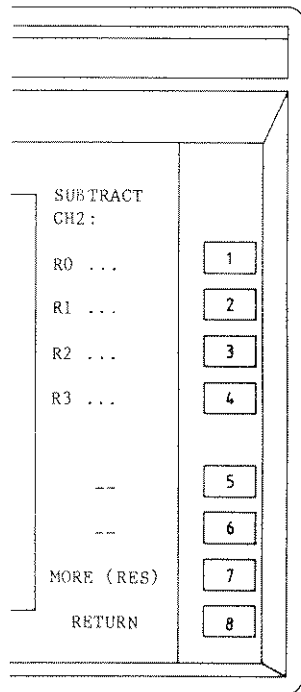

If CH2:R. ... is selected, the CH2 menu becomes visible and channel 2 can be selected from the registers. If there are two channels in a register, the selected channel is displayed intensified.

6 2 2 1 R0 ...
 6 2 2 2 R1 ...
 6 2 2 3 R2 ...
 6 2 2 4 R3 ...

If softkey 1, 2, 3 or 4 is pressed, register R0, R1, R2 or R3 is selected as source CH2.

If two channels are present in the selected register, then pressing the softkey again will result in toggling between the two channels in the register.

6 2 2 5 --
 6 2 2 6 --
 6 2 2 7 MORE (RES)

If MORE (RES) is pressed, the RESULT R. menu will appear. MORE (RES) has the same result as pressing RETURN and selecting RESULT R..

6 2 2 8 RETURN

After pushing softkey RETURN, the MATHEMATCS SUBTRACT menu becomes visible.

6 2 3 RESULT: R.>

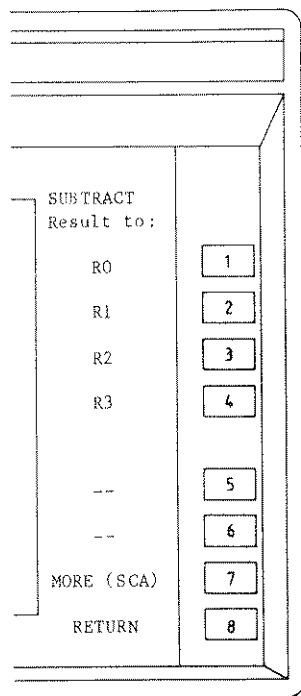

If RESULT: R. is selected, the RESULT menu becomes visible and a register can be selected in which the result is stored.

6 2 3 1 R0
 6 2 3 2 R1
 6 2 3 3 R2
 6 2 3 4 R3

If softkey 1, 2, 3 or 4 is pressed, register R0, R1, R2 or R3 is selected as result register.

6 2 3 5 --
 6 2 3 6 --
 6 2 3 7 MORE (SCA)

If MORE (SCA) is pressed, the SCALE menu will appear. MORE (SCA) has the same result as pressing RETURN and selecting SCALE.

6 2 3 8 RETURN

After pushing softkey RETURN, the MATHEMATCS SUBTRACT menu becomes visible.

6 2 4 SCALE>

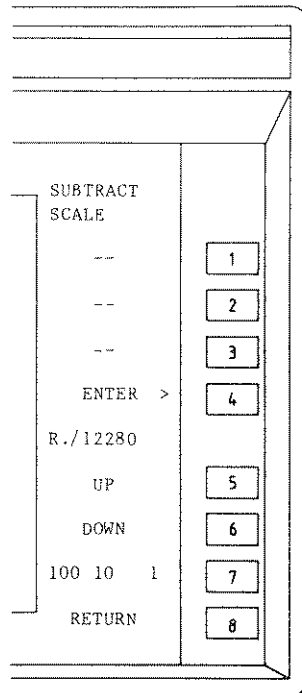

If SCALE is pressed, the SCALE menu becomes visible and a scaling factor can be selected to get the resulting trace of the MATHEMATCS SUBTRACT operation inside the vertical register range.

6 2 4 1 --
 6 2 4 2 --
 6 2 4 3 --

6 2 4 4 ENTER>

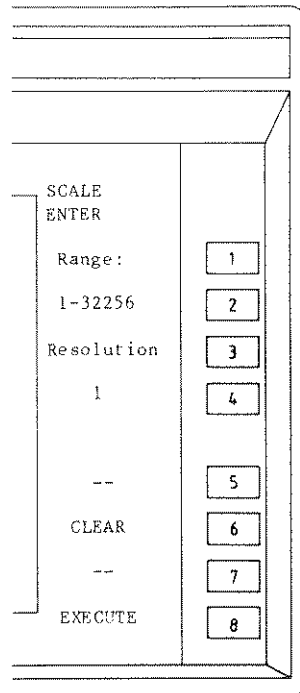

After selecting ENTER, the SUBTRACT SCALE menu will be displayed and the scale factor can be selected with the numeric keyboard. The actual range and the value is visible in the softkey text area.

A message

Too many digits: total entry is cleared.

is displayed if too many digits are entered via the numeric keyboard.

Or a message

No decimal point allowed in this enter menu.

is displayed if a decimal point is entered via the numeric keyboard.

6 2 4 4 1 --

6 2 4 4 2 --

6 2 4 4 3 --

6 2 4 4 4 --

6 2 4 4 5 --

6 2 4 4 6 CLEAR

If an error is made, the scale value can be cleared by pushing softkey CLEAR.

6 2 4 4 7 --

6 2 4 4 8 EXECUTE

After pushing this softkey, the selected scale value is entered and an AUTO RETURN is performed to the menu SUBTRACT SCALE.

If after a CLEAR the softkey EXECUTE is pressed the scale value keeps its previous value in the SUBTRACT SCALE menu.

A message

SUBTRACT SCALE number out of range

can be displayed if the entered value exceeds the given range.

6 2 4 5 UP

Pushing softkey UP increments the scale factor by 1, 10 or 100, selected by softkey 7.

6 2 4 6 DOWN

Pushing softkey DOWN decrements the scale factor by 1, 10 or 100, selected by softkey 7.

6 2 4 7 100 10 1

Pushing this softkey toggles the size of the increment or decrement step between 100, 10 and 1. The actual value is displayed intensified.

6 2 4 8 RETURN

After pushing softkey RETURN, the MATHEMATCS SUBTRACT menu becomes visible.

6 2 5 CURSOR LMT

Pushing softkey CURSOR LMT toggles the function ON or OFF. When the function is switched ON, the MATHEMATCS SUBTRACT function is performed on the channels between the cursors only. Display points outside the cursors are put at -512 and are normally not displayed. The function CURSOR LMT can only be selected when the cursors are ON. The cursors are then automatically positioned on CH1. When the function is active CURSOR LMT is displayed intensified.

6 2 6 START STOP

Pushing softkey START STOP starts or stops the MATHEMATCS SUBTRACT operation. The actual state is displayed intensified. START will stop any other active MATHEMATCS function.

6 2 7 INCL OFFST

Pushing softkey INCL OFFST will toggle this function. INCL OFFST active will result in the offset of the channels being included in the MATHEMATCS SUBTRACT operation. When the function is active, INCL OFFST is displayed intensified.

6 2 8 RETURN

After pushing RETURN, the MATHEMATCS menu becomes visible.

6 3 MULTIPLY

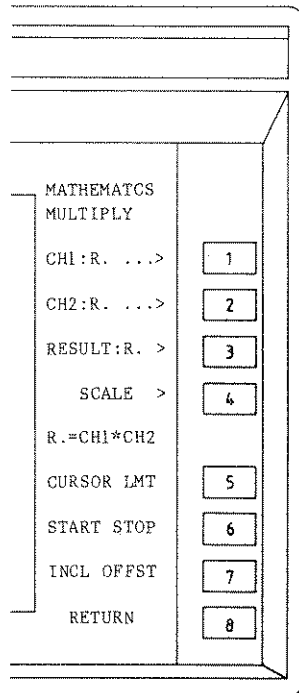

If MULTIPLY is selected, the MATHEMATCS MULTIPLY menu becomes visible and the sources and destination can be selected.

Note: A change in the parameters of the MULTIPLY function will also change the parameters of all other functions, including any active one.

Selecting START (softkey 6) will automatically switch OFF any active MATHEMATCS function and start the MULTIPLY function.

CURSOR LMT results in the multiplication of the part between the cursors.

When one of the sources is updated, the result register is also updated.

6 3 1 CH1:R. ...>

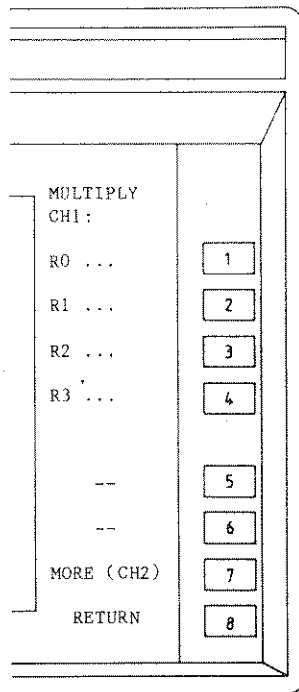

If CH1:R. ... is selected, the CH1 menu becomes visible and channel 1 can be selected from the registers. If there are two channels in a register, the selected channel is displayed intensified.

6 3 1 1 R0 ...
 6 3 1 2 R1 ...
 6 3 1 3 R2 ...
 6 3 1 4 R3 ...

If softkey 1, 2, 3 or 4 is pressed, register R0, R1, R2 or R3 is selected as source CH1. If two channels are present in the selected register then pressing the softkey again will result in toggling between the two channels in the register.

6 3 1 5 --
 6 3 1 6 --
 6 3 1 7 MORE (CH2)

If MORE (CH2) is pressed, the CURSOR CH2 menu will appear. MORE (CH2) has the same result as pressing RETURN and selecting CH2:R. ...

6 3 1 8 RETURN

After pushing softkey RETURN, the MATHEMATCS MULTIPLY menu becomes visible.

6 3 2 CH2:R. ...>

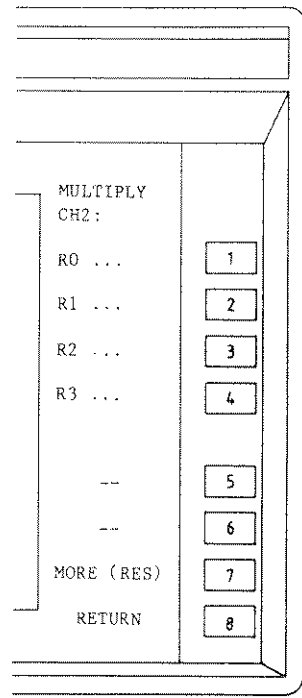

If CH2:R. ... is selected, the CH2 menu becomes visible and channel 2 can be selected from the registers. If there are two channels in a register, the selected channel is displayed intensified.

6 3 2 1 R0 ...
 6 3 2 2 R1 ...
 6 3 2 3 R2 ...
 6 3 2 4 R3 ...

If softkey 1, 2, 3 or 4 is pressed, register R0, R1, R2 or R3 is selected as source CH2.
 If two channels are present in the selected register, then pressing the softkey again will result in toggling between the two channels in the register.

6 3 2 5 --
 6 3 2 6 --
 6 3 2 7 MORE (RES)

If MORE (RES) is pressed, the RESULT R. menu will appear. MORE (RES) has the same result as pressing RETURN and selecting RESULT R..

6 3 2 8 RETURN

After pushing softkey RETURN, the MATHEMATCS MULTIPLY menu becomes visible.

6 3 3 RESULT: R.>

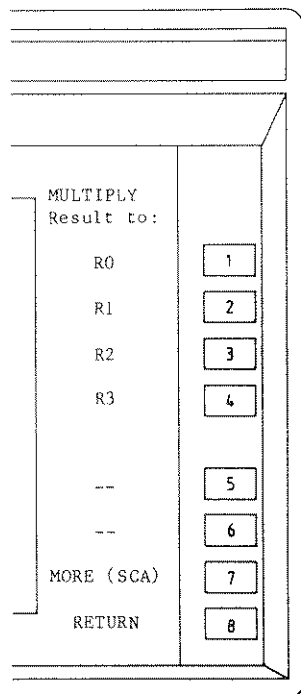

If RESULT: R. is selected, the RESULT menu becomes visible and a register can be selected in which the result is stored.

6 3 3 1 R0
 6 3 3 2 R1
 6 3 3 3 R2
 6 3 3 4 R3

If softkey 1, 2, 3 or 4 is pressed, register R0, R1, R2 or R3 is selected as result register.

6 3 3 5 --
 6 3 3 6 --
 6 3 3 7 MORE (SCA)

If MORE (SCA) is pressed, the SCALE menu will appear. MORE (SCA) has the same result as pressing RETURN and selecting SCALE.

6 3 3 8 RETURN

After pushing softkey RETURN, the MATHEMATCS MULTIPLY menu becomes visible.

6 3 4 SCALE>

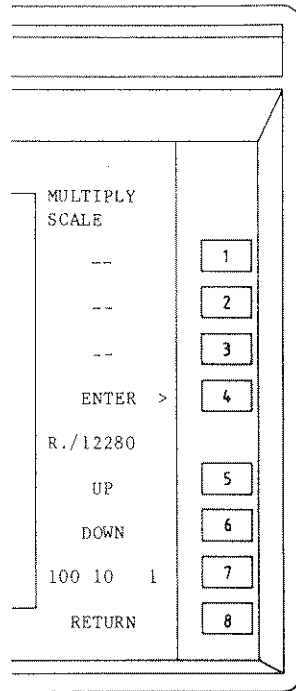

If SCALE is pressed, the SCALE menu becomes visible and a scaling factor can be selected to get the resulting trace of the MATHEMATCS MULTIPLY operation inside the vertical register range.

6 3 4 1 --
 6 3 4 2 --
 6 3 4 3 --

6 3 4 4 ENTER>

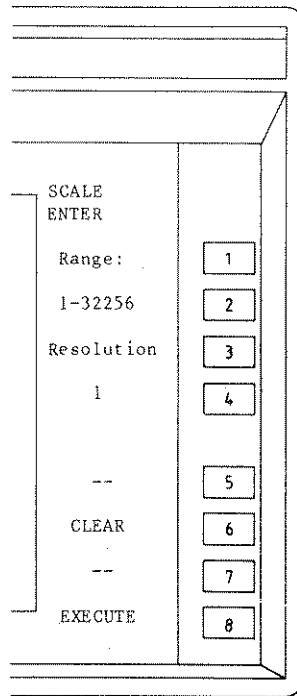

After selecting ENTER, the MULTIPLY SCALE menu will be displayed and the scale factor can be selected with the numeric keyboard. The actual range and the value is visible in the softkey text area.

A message

Too many digits: total entry is cleared.

is displayed if too many digits are entered via the numeric keyboard.

Or a message

No decimal point allowed in this enter menu.

is displayed if a decimal point is entered via the numeric keyboard.

6 3 4 4 1 --

6 3 4 4 2 --

6 3 4 4 3 --

6 3 4 4 4 --

6 3 4 4 5 --

6 3 4 4 6 CLEAR

If an error is made, the scale value can be cleared by pushing softkey CLEAR.

6 3 4 4 7 --

6 3 4 4 8 EXECUTE

After pushing this softkey, the selected scale value is entered and an AUTO RETURN is performed to the menu MULTIPLY SCALE.

If after a CLEAR the softkey EXECUTE is pressed the scale value keeps its previous value in the MULTIPLY SCALE menu.

A message

MULTIPLY SCALE number out of range

is displayed if the entered value exceeds the given range.

6 3 4 5 UP

Pushing softkey UP increments the scale factor by 1, 10 or 100, selected by softkey 7.

6 3 4 6 DOWN

Pushing softkey DOWN decrements the scale factor by 1, 10 or 100, selected by softkey 7.

6 3 4 7 100 10 1

Pushing this softkey toggles the size of the increment or decrement step between 100, 10 and 1. The actual value is displayed intensified.

6 3 4 8 RETURN

After pushing softkey RETURN, the MATHEMATCS MULTIPLY menu becomes visible.

6 3 5 CURSOR LMT

Pushing softkey CURSOR LMT toggles the function ON or OFF. When the function is switched ON, the MATHEMATCS MULTIPLY function is performed on the channels between the cursors only. Display points outside the cursors are put at -512 and are normally not displayed. The function CURSOR LMT can only be selected when the cursors are ON. The cursors are then automatically positioned on CH1. When the function is active CURSOR LMT is displayed intensified.

6 3 6 START STOP

Pushing softkey START STOP starts or stops the MATHEMATCS MULTIPLY operation. The actual state is displayed intensified. START will stop any other active MATHEMATCS function.

6 3 7 INCL OFFST

Pushing softkey INCL OFFST will toggle this function. INCL OFFST active will result in the offset of the channels being included in the MATHEMATCS MULTIPLY operation. When the function is active, INCL OFFST is displayed intensified.

6 3 8 RETURN

After pushing RETURN, the MATHEMATCS menu becomes visible.

6 4 DIVIDE>

MATHEMATCS DIVIDE	
CH1:R. ...>	1
CH2:R. ...>	2
RESULT:R. >	3
SCALE >	4
R.=CH1/CH2	
CURSOR LMT	5
START STOP	6
INCL OFFST	7
RETURN	8

If DIVIDE is selected, the MATHEMATCS DIVIDE menu becomes visible and the sources and destination can be selected.

Note: A change in the parameters of the DIVIDE function will also change the parameters of all other functions, including any active one.

Selecting START (softkey 6) will automatically switch OFF any active MATHEMATCS function and start the DIVIDE function.

CURSOR LMT results in the division of the part between the cursors.

When one of the sources is updated, the result register is also updated.

6 4 1 CH1:R. ...>

DIVIDE CH1:	
R0 ...	1
R1 ...	2
R2 ...	3
R3 ...	4
--	5
--	6
MORE (CH2)	7
RETURN	8

If CH1:R. ... is selected, the CH1 menu becomes visible and channel 1 can be selected from the registers. If there are two channels in a register, the selected channel is displayed intensified.

6	4	1	1	R0 ...
6	4	1	2	R1 ...
6	4	1	3	R2 ...
6	4	1	4	R3 ...

If softkey 1, 2, 3 or 4 is pressed, register R0, R1, R2 or R3 is selected as source CH1.

If two channels are present in the selected register then pressing the softkey again will result in toggling between the two channels in the register.

6	4	1	5	--
6	4	1	6	--
6	4	1	7	MORE (CH2)

If MORE (CH2) is pressed, the CURSOR CH2 menu will appear. MORE (CH2) has the same result as pressing RETURN and selecting CH2:R. ...

6	4	1	8	RETURN
---	---	---	---	--------

After pushing softkey RETURN, the MATHEMATICS DIVIDE menu becomes visible.

6	4	2	CH2:R. ...>
---	---	---	-------------

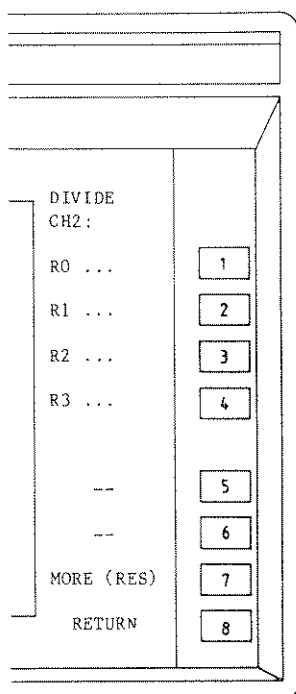

If CH2:R. ... is selected, the CH2 menu becomes visible and channel 2 can be selected from the registers. If there are two channels in a register, the selected channel is displayed intensified.

6 4 2 1 R0 ...
 6 4 2 2 R1 ...
 6 4 2 3 R2 ...
 6 4 2 4 R3 ...

If softkey 1, 2, 3 or 4 is pressed, register R0, R1, R2 or R3 is selected as source CH2.
 If two channels are present in the selected register, then pressing the softkey again will result in toggling between the two channels in the register.

6 4 2 5 --
 6 4 2 6 --
 6 4 2 7 MORE (RES)

If MORE (RES) is pressed, the RESULT R. menu will appear. MORE (RES) has the same result as pressing RETURN and selecting RESULT R..

6 4 2 8 RETURN

After pushing softkey RETURN, the MATHEMATCS DIVIDE menu becomes visible.

6 4 3 RESULT: R.>

If RESULT: R. is selected, the RESULT menu becomes visible and a register can be selected in which the result is stored.

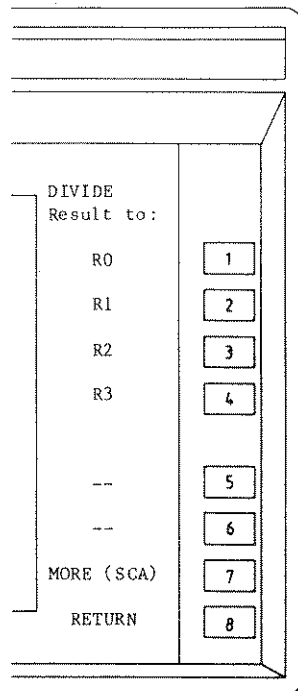

6 4 3 1 R0
 6 4 3 2 R1
 6 4 3 3 R2
 6 4 3 4 R3

If softkey 1, 2, 3 or 4 is pressed, register R0, R1, R2 or R3 is selected as result register.

6 4 3 5 --
 6 4 3 6 --
 6 4 3 7 MORE (SCA)

If MORE (SCA) is pressed, the SCALE menu will appear. MORE (SCA) has the same result as pressing RETURN and selecting SCALE.

6 4 3 8 RETURN

After pushing softkey RETURN, the MATHEMATCS DIVIDE menu becomes visible.

6 4 4 SCALE>

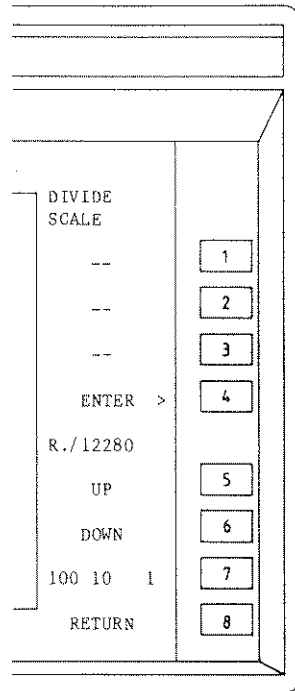

If SCALE is pressed, the SCALE menu becomes visible and a scaling factor can be selected to get the resulting trace of the MATHEMATCS DIVIDE operation inside the vertical register range.

6 4 4 1 --
 6 4 4 2 --
 6 4 4 3 --

6 4 4 4 ENTER>

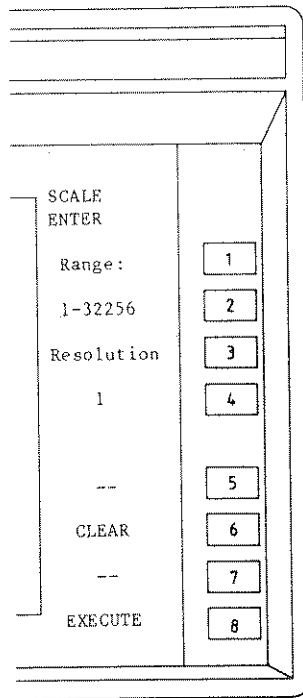

After selecting ENTER, the DIVIDE SCALE menu will be displayed and the scale factor can be selected with the numeric keyboard. The actual range and the value is visible in the softkey text area.

A message

Too many digits: total entry is cleared.

is displayed if too many digits are entered via the numeric keyboard.

Or a message

No decimal point allowed in this enter menu.

is displayed if a decimal point is entered via the numeric keyboard.

6 4 4 4 1 --

6 4 4 4 2 --

6 4 4 4 3 --

6 4 4 4 4 --

6 4 4 4 5 --

6 4 4 4 6 CLEAR

If an error is made, the scale value can be cleared by pushing softkey CLEAR.

6 4 4 4 7 --

6 4 4 4 8 EXECUTE

After pushing this softkey, the selected scale value is entered and an AUTO RETURN is performed to the menu DIVIDE SCALE.

If after a CLEAR the softkey EXECUTE is pressed the scale value keeps its previous value in the DIVIDE SCALE menu.

A message

DIVIDE SCALE number out of range

is displayed if the entered value exceeds the given range.

- | | | | | | |
|---|---|---|---|------------|--|
| 6 | 4 | 4 | 5 | UP | |
| | | | | | Pushing softkey UP increments the scale factor by 1, 10 or 100, selected by softkey 7. |
| 6 | 4 | 4 | 6 | DOWN | |
| | | | | | Pushing softkey DOWN decrements the scale factor by 1, 10 or 100, selected by softkey 7. |
| 6 | 4 | 4 | 7 | 100 10 1 | |
| | | | | | Pushing this softkey toggles the size of the increment or decrement step between 100, 10 and 1. The actual value is displayed intensified. |
| 6 | 4 | 4 | 8 | RETURN | |
| | | | | | After pushing softkey RETURN, the MATHEMATCS DIVIDE menu becomes visible. |
| 6 | 4 | 5 | | CURSOR LMT | |
| | | | | | Pushing softkey CURSOR LMT toggles the function ON or OFF. When the function is switched ON, the MATHEMATCS DIVIDE function is performed on the channels between the cursors only. Display points outside the cursors are put at -512 and are normally not displayed. The function CURSOR LMT can only be selected when the cursors are ON. The cursors are then automatically positioned on CH1. When the function is active CURSOR LMT is displayed intensified. |
| 6 | 4 | 6 | | START STOP | |
| | | | | | Pushing softkey START STOP starts or stops the MATHEMATCS DIVIDE operation. The actual state is displayed intensified. START will stop any other active MATHEMATCS function. |
| 6 | 4 | 7 | | INCL OFFST | |
| | | | | | Pushing softkey INCL OFFST will toggle this function. INCL OFFST active will result in the offset of the channels being included in the MATHEMATCS DIVIDE operation. When the function is active, INCL OFFST is displayed intensified. |
| 6 | 4 | 8 | | RETURN | |
| | | | | | After pushing RETURN, the MATHEMATCS menu becomes visible. |

6 5 INTEGRATE>

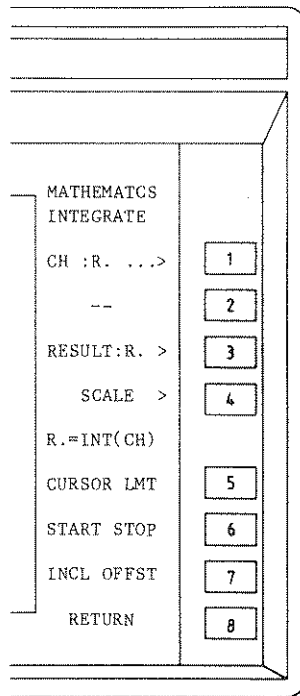

If INTEGRATE is selected, the MATHMATCS INTEGRATE menu becomes visible and the source and destination can be selected.

Note: A change in the parameters of the INTEGRATE function will also change the parameters of all other functions, including any active one.

Selecting START (softkey 6) will automatically switch OFF any active MATHMATCS function and start the INTEGRATE function.

CURSOR LMT results in the integratton of the part between the cursors.

When the source is updated, the result register is also updated.

6 5 1 CH :R. ...>

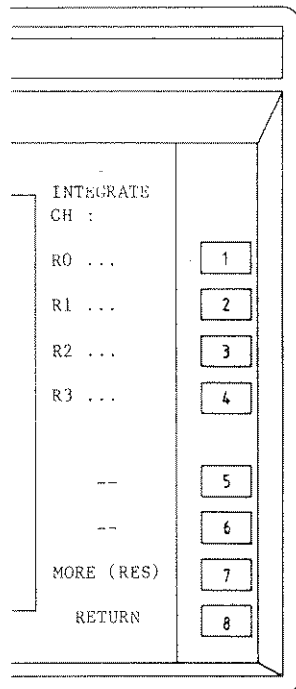

If CH :R. ... is selected, the CH menu becomes visible and the source channel can be selected from the registers. If there are two channels in a register, the selected channel is displayed intensified.

6	5	1	1	R0 ...
6	5	1	2	R1 ...
6	5	1	3	R2 ...
6	5	1	4	R3 ...

If softkey 1, 2, 3 or 4 is pressed, register R0, R1, R2 or R3 is selected as source CH.

If two channels are present in the selected register then pressing the softkey again will result in toggling between the two channels in the register.

6	5	1	5	--
6	5	1	6	--
6	5	1	7	MORE (RES)

If MORE (RES) is pressed, the RESULT:R. menu will appear. MORE (RES) has the same result as pressing RETURN and selecting RESULT:R.

6	5	1	8	RETURN
---	---	---	---	--------

After pushing softkey RETURN, the MATHEMATCS INTEGRATE menu becomes visible.

6	5	2	--
6	5	3	RESULT: R.>

The diagram shows a rectangular menu box with a title bar at the top. Inside the box, the text "INTEGRATE" is at the top left, followed by "Result to:". Below this, there is a vertical list of options, each with a corresponding softkey button to its right. The options and buttons are: R0 (1), R1 (2), R2 (3), R3 (4), -- (5), -- (6), MORE (SCA) (7), and RETURN (8). The softkey buttons are small rectangles with the numbers 1 through 8 inside them.

If RESULT: R. is selected, the RESULT menu becomes visible and a register can be selected in which the result is stored.

6 5 3 1 R0
 6 5 3 2 R1
 6 5 3 3 R2
 6 5 3 4 R3

If softkey 1, 2, 3 or 4 is pressed, register R0, R1, R2 or R3 is selected as result register.

6 5 3 5 --
 6 5 3 6 --
 6 5 3 7 MORE (SCA)

If MORE (SCA) is pressed, the SCALE menu will appear. MORE (SCA) has the same result as pressing RETURN and selecting SCALE.

6 5 3 8 RETURN

After pushing softkey RETURN, the MATHEMATCS INTEGRATE menu becomes visible.

6 5 4 SCALE>

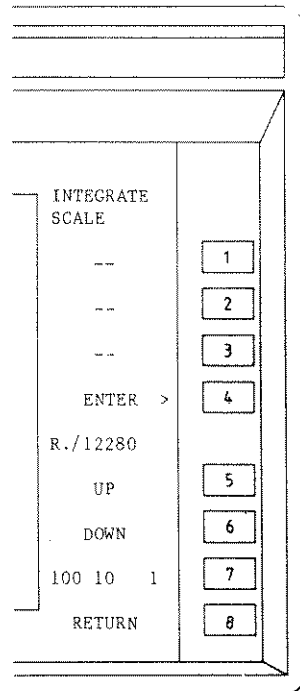

If SCALE is pressed, the SCALE menu becomes visible and a scaling factor can be selected to get the resulting trace of the MATHEMATCS INTEGRATE operation inside the vertical register range.

6 5 4 1 --
 6 5 4 2 --
 6 5 4 3 --

6 5 4 4 ENTER>

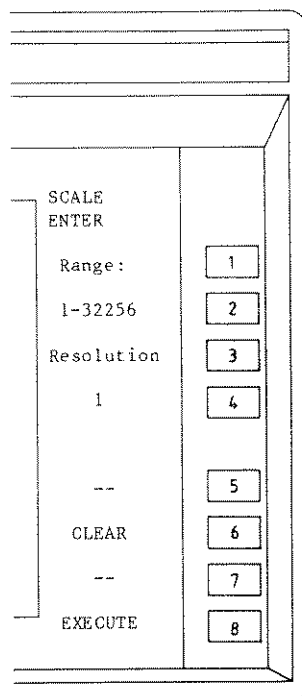

After selecting ENTER, the INTEGRATE SCALE menu will be displayed and the scale factor can be selected with the numeric keyboard. The actual range and the value is visible in the softkey text area.

A message

Too many digits: total entry is cleared.

is displayed if too many digits are entered via the numeric keyboard.

Or a message

No decimal point allowed in this enter menu.

is displayed if a decimal point is entered via the numeric keyboard.

6 5 4 4 1 --

6 5 4 4 2 --

6 5 4 4 3 --

6 5 4 4 4 --

6 5 4 4 5 --

6 5 4 4 6 CLEAR

If an error is made, the scale value can be cleared by pushing softkey CLEAR.

6 5 4 4 7 --

6 5 4 4 8 EXECUTE

After pushing this softkey, the selected scale value is entered and an AUTO RETURN is performed to the menu INTEGRATE SCALE.

If after a CLEAR the softkey EXECUTE is pressed the scale value keeps its previous value in the INTEGRATE SCALE menu.

A message

INTEGRATE SCALE number out of range

is displayed if the entered value exceeds the given range.

6 5 4 5 UP

Pushing softkey UP increments the scale factor by 1, 10 or 100, selected by softkey 7.

6 5 4 6 DOWN

Pushing softkey DOWN decrements the scale factor by 1, 10 or 100, selected by softkey 7.

6 5 4 7 100 10 1

Pushing this softkey toggles the size of the increment or decrement step between 100, 10 and 1. The actual value is displayed intensified.

6 5 4 8 RETURN

After pushing softkey RETURN, the MATHEMATCS INTEGRATE menu becomes visible.

6 5 5 CURSOR LMT

Pushing softkey CURSOR LMT toggles the function ON or OFF. When the function is switched ON, the MATHEMATCS INTEGRATE function is performed on the channel between the cursors only. Display points outside the cursors are put at -512 and are normally not displayed. The function CURSOR LMT can only be selected when the cursors are ON. The cursors are then automatically positioned on CH. When the function is active CURSOR LMT is displayed intensified.

6 5 6 START STOP

Pushing softkey START STOP starts or stops the MATHEMATCS INTEGRATE operation. The actual state is displayed intensified.

6 5 7 INCL OFFST

Pushing softkey INCL OFFST will toggle this function. INCL OFFST active will result in the offset of the channel being included in the MATHEMATCS INTEGRATE operation. When the function is active, INCL OFFST is displayed intensified.

6 5 8 RETURN

After pushing RETURN, the MATHEMATCS menu becomes visible.

6 6 DIFFERENTL>

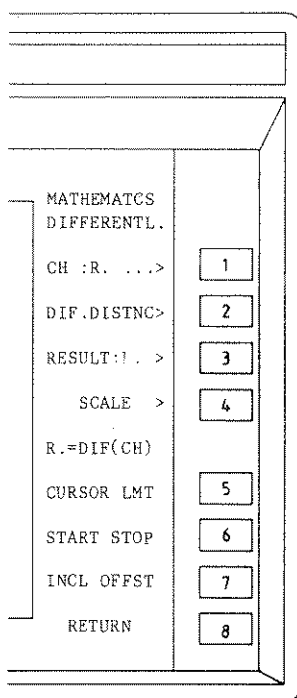

If DIFFERENTL is selected, the MATHEMATCS DIFFERENTL menu becomes visible and the source and destination can be selected. The differentiation formula is:

$$DIF(i) = \text{point } (i+n) - \text{point } (i-n)$$

Where i is the differentiated point and n is the differentiation distance.

At the begin and end of the channel 64 points are extra-polated by rotating the first 64 points 180 degrees around point 0 and the last 64 points 180 degrees around point 4095.

6 6 1 CH :R. ...>

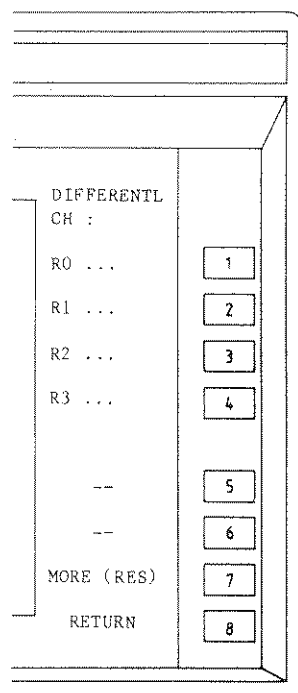

If CH :R. ... is selected, the CH menu becomes visible and the source CH can be selected from the registers. If there are two channels in a register, the selected channel is displayed intensified.

6 6 1 1 R0 ...
 6 6 1 2 R1 ...
 6 6 1 3 R2 ...
 6 6 1 4 R3 ...

If softkey 1, 2, 3 or 4 is pressed, register R0, R1, R2 or R3 is selected as source CH.
 If two channels are present in the selected register then pressing the softkey again will result in toggling between the two channels in the register.

6 6 1 5 --
 6 6 1 6 --
 6 6 1 7 MORE (RES)

If MORE (RES) is pressed, the RESULT:R. menu will appear. MORE (RES) has the same result as pressing RETURN and selecting RESULT:R.

6 6 1 8 RETURN

After pushing softkey RETURN, the MATHEMATCS DIFFERENTL menu becomes visible.

6 6 2 DIF.DISTNC>

If DIF.DISTNC is selected, the DIF.DISTNC menu becomes visible and the differential distance is selected.

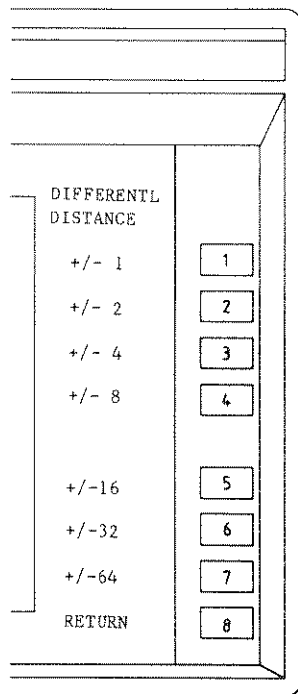

6	6	2	1	+/- 1
6	6	2	2	+/- 2
6	6	2	3	+/- 4
6	6	2	4	+/- 8
6	6	2	5	+/- 16
6	6	2	6	+/- 32
6	6	2	7	+/- 64

These softkeys select the differential distance used for the MATHEMATCS DIFFERENTL operation. The default value is +/- 1.

6	6	2	8	RETURN
---	---	---	---	--------

After pushing softkey RETURN, the MATHEMATCS DIFFERENTL menu becomes visible.

6	6	3	RESULT: R.>
---	---	---	-------------

The diagram shows a rectangular menu box with a title bar at the top. Inside the box, the text "DIFFERENTL" is at the top, followed by "Result to:". Below this, there are eight rows of options, each with a label on the left and a small rectangular button on the right containing a number. The options are: R0 (button 1), R1 (button 2), R2 (button 3), R3 (button 4), -- (button 5), -- (button 6), MORE (SCA) (button 7), and RETURN (button 8).

If RESULT: R. is selected, the RESULT menu becomes visible and a register can be selected in which the result is stored.

6	6	3	1	R0
6	6	3	2	R1
6	6	3	3	R2
6	6	3	4	R3

If softkey 1, 2, 3 or 4 is pressed, register R0, R1, R2 or R3 is selected as result register.

6 6 3 5 ---
 6 6 3 6 ---
 6 6 3 7 MORE (SCA)

If MORE (SCA) is pressed, the SCALE menu will appear. MORE (SCA) has the same result as pressing RETURN and selecting SCALE.

6 6 3 8 RETURN

After pushing softkey RETURN, the MATHEMATCS DIFFERENTL menu becomes visible.

6 6 4 SCALE>

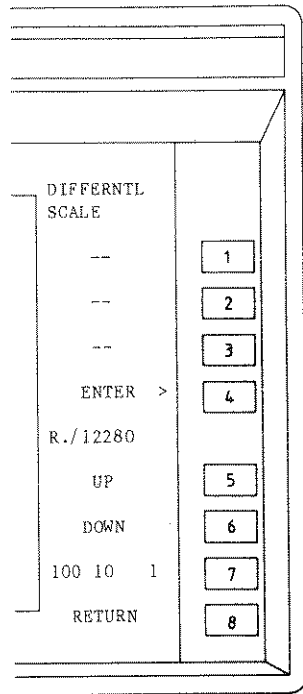

If SCALE is pressed, the SCALE menu becomes visible and a scaling factor can be selected to get the resulting trace of the MATHEMATCS DIFFERENTL operation inside the vertical register range.

6 6 4 1 ---
 6 6 4 2 ---
 6 6 4 3 ---

6 6 4 4 ENTER>

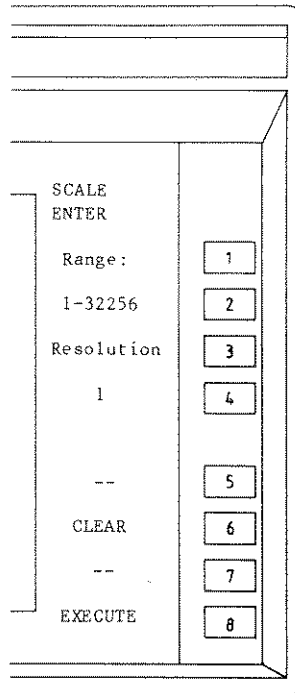

After selecting ENTER, the DIFFERENTL SCALE menu will be displayed and the scale factor can be selected with the numeric keyboard. The actual range and the value is visible in the softkey text area.

A message

Too many digits: total entry is cleared.

is displayed if too many digits are entered via the numeric keyboard.

Or a message

No decimal point allowed in this enter menu.

is displayed if a decimal point is entered via the numeric keyboard.

6 6 4 4 1 --
 6 6 4 4 2 --
 6 6 4 4 3 --
 6 6 4 4 4 --
 6 6 4 4 5 --
 6 6 4 4 6 CLEAR

If an error is made, the scale value can be cleared by pushing softkey CLEAR.

6 6 4 4 7 --
 6 6 4 4 8 EXECUTE

After pushing this softkey, the selected scale value is entered and an AUTO RETURN is performed to the menu DIFFERENTL SCALE.

If after a CLEAR the softkey EXECUTE is pressed the scale value keeps its previous value in the DIFFERENTL SCALE menu.

A message

DIFFERENTL SCALE number out of range

is displayed if the entered value exceeds the given range.

- 6 6 4 5 UP
Pushing softkey UP increments the scale factor by 1, 10 or 100, selected by softkey 7.
- 6 6 4 6 DOWN
Pushing softkey DOWN decrements the scale factor by 1, 10 or 100, selected by softkey 7.
- 6 6 4 7 100 10 1
Pushing this softkey toggles the size of the increment or decrement step between 100, 10 and 1. The actual value is displayed intensified.
- 6 6 4 8 RETURN
After pushing softkey RETURN, the MATHEMATCS DIFFERENTL menu becomes visible.
- 6 6 5 CURSOR LMT
Pushing softkey CURSOR LMT toggles the function ON or OFF. When the function is switched ON, the MATHEMATCS DIFFERENTL function is performed on the channel between the cursors only. Display points outside the cursors are put at -512 and are normally not displayed. The function CURSOR LMT can only be selected when the cursors are ON. The cursors are then automatically positioned on CH. When the function is active CURSOR LMT is displayed intensified.
- 6 6 6 START STOP
Pushing softkey START STOP starts or stops the MATHEMATCS DIFFERENTL operation. The actual state is displayed intensified.
- 6 6 7 INCL OFFST
Pushing softkey INCL OFFST will toggle this function. INCL OFFST active will result in the offset of the channel being included in the MATHEMATCS DIFFERENTL operation. When the function is active, INCL OFFST is displayed intensified.
- 6 6 8 RETURN
After pushing RETURN, the MATHEMATCS menu becomes visible.

6 7 MORE

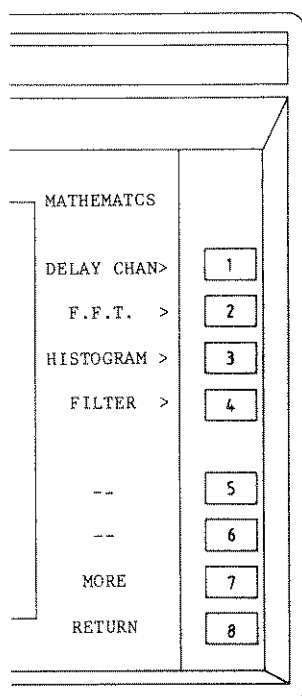

After pushing softkey MORE, the second MATHEMATCS menu becomes visible.

This menu is an extension of the first MATHEMATCS menu, so a selection in this menu has the same level as a selection in the first MATHEMATCS menu. This is indicated by numbers 7,1 ... 7,8, where the first number indicates the MORE selection and the second number indicates the selection in the second MATHEMATCS menu.

6 8 RETURN

After pushing RETURN, the CURSOR SELECT menu becomes visible.

6 7,1 DELAY CHAN>

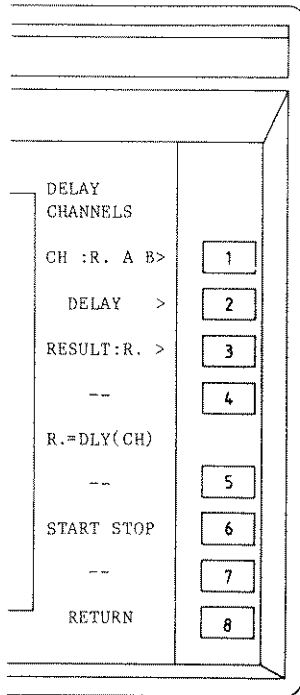

If DELAY CHAN is selected, the MATHEMATCS DELAY CHAN menu becomes visible and the sources and destination can be selected. DELAY CHAN can only operate on registers that contain two channels.

The DELAY CHAN operation will shift in time, one of the two channels with the selected delay. The channel to shift is selected in the sub-menu DELAY.

The dots that are shifted out of a register are lost and can not be recalled. The dots that are shifted in on the other side are put on the minimum level and are indicated as not real samples.

6 7,1 1 CH :R. A B>

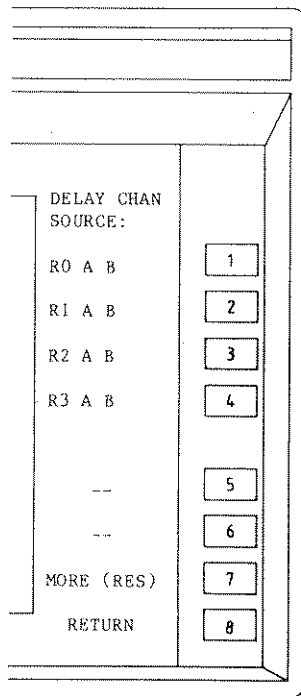

If CH :R. A B is selected, the CH menu becomes visible and the source channel can be selected from the registers. Only registers in which two channels are present can be selected.

6 7,1 1 1 R0 A B

6 7,1 1 2 R1 A B

6 7,1 1 3 R2 A B

6 7,1 1 4 R3 A B

If softkey 1, 2, 3 or 4 is pressed, register R0, R1, R2 or R3 is selected as source CH. Only registers that contain two channels will be displayed and can be selected.

6 7,1 1 5 --

6 7,1 1 6 --

6 7,1 1 7 MORE (RES)

If MORE (RES) is pressed, the RESULT:R. menu will appear. MORE (RES) has the same result as pressing the RETURN and then selecting RESULT:R.

6 7,1 1 8 RETURN

After pushing softkey RETURN, the MATHEMATCS DELAY CHAN menu becomes visible.

6 7,1 2 DELAY>

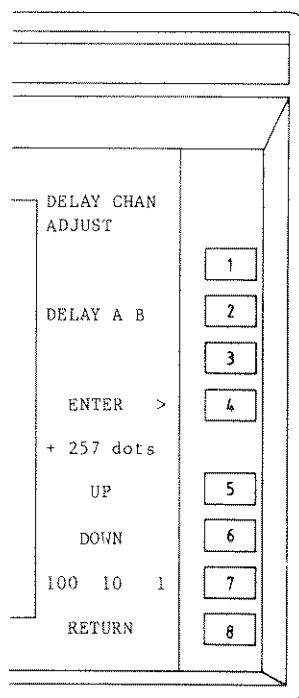

If DELAY is selected, the DELAY CHAN ADJUST menu becomes visible. In this menu the channel can be selected, that has to be delayed and the delay can be entered or changed.

6 7,1 2 1 --

6 7,1 2 2 DELAY A B

If DELAY A B is pressed, the channel to delay is toggled between A and B. The selected channel is displayed intensified.

6 7,1 2 3 --

6 7,1 2 4 ENTER>

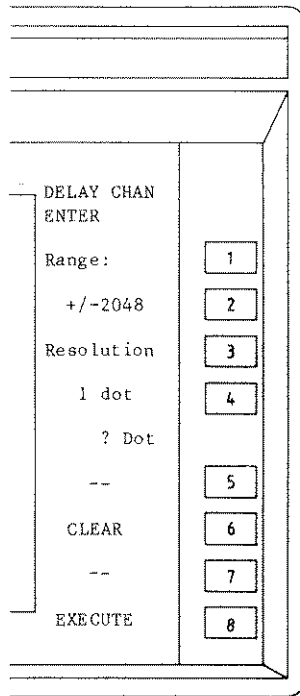

After selecting ENTER, the DELAY ENTER menu will be displayed and the delay can be selected with the numeric keyboard. The actual range and the value is visible in the softkey text area.

A message

Too many digits: total entry is cleared.

is displayed if too many digits are entered via the numeric keyboard.

Or a message

No decimal point allowed in this enter menu.

is displayed if a decimal point is entered via the numeric keyboard.

6	7,1	2	4	1	--
6	7,1	2	4	2	--
6	7,1	2	4	3	--
6	7,1	2	4	4	--
6	7,1	2	4	5	--
6	7,1	2	4	6	CLEAR

If an error is made, the delay value can be cleared by pushing softkey CLEAR.

6	7,1	2	4	7	--
6	7,1	2	4	8	EXECUTE

After pushing this softkey, the selected scale value is entered and an AUTO RETURN is performed to the menu DELAY CHAN ADJUST. If after a CLEAR the softkey EXECUTE is pressed the scale value keeps its previous value in the DELAY CHANNEL ADJUST menu.

A message

DELAY CHANNEL ADJUST number out of range

is displayed if the entered value exceeds the given range.

6 7,1 2 5 UP

Pushing softkey UP increments the scale factor by 1, 10 or 100, selected by softkey 7.

6 7,1 2 6 DOWN

Pushing softkey DOWN decrements the scale factor by 1, 10 or 100, selected by softkey 7.

6 7,1 2 7 100 10 1

Pushing this softkey toggles the size of the increment or decrement step between 100, 10 and 1. The actual value is displayed intensified.

6 7,1 2 8 RETURN

After pushing softkey RETURN, the DELAY CHANNELS menu becomes visible.

6 7,1 3 RESULT: R.>

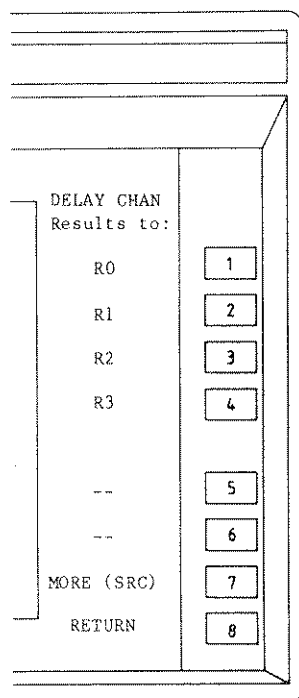

If RESULT: R. is selected, the RESULT menu becomes visible and a register can be selected in which the result is stored.

6 7,1 3 1 R0

6 7,1 3 2 R1

6 7,1 3 3 R2

6 7,1 3 4 R3

If softkey 1, 2, 3 or 4 is pressed, register R0, R1, R2 or R3 is selected as result register.

6 7,1 3 5 --

6 7,1 3 6 --

6 7,1 3 7 MORE (SRC)

If MORE (SRC) is pressed, the CH :R. A B menu will appear. MORE (SRC) has the same result as pressing RETURN and then selecting CH :R. A B

6 7,1 3 8 RETURN

After pushing softkey RETURN, the MATHEMATCS DELAY CHAN menu becomes visible.

6 7,1 4 --

6 7,1 5 --

6 7,1 6 START STOP

Pushing softkey START STOP starts or stops the DELAY CHAN operation. The actual state is displayed intensified.

6 7,1 7 --

6 7,1 8 RETURN

After pushing RETURN, the second MATHEMATCS menu becomes visible.

6 7,2 F.F.T.> OPTIONAL

MATHEMATCS	
F.F.T.	
CH :R. ...>	1
FFT PARAM.>	2
RESULT:R. >	3
--	4
R.=FFT(CH)	
CURSOR LMT	5
START STOP	6
--	7
RETURN	8

If F.F.T. is selected, the MATHEMATCS F.F.T. menu becomes visible and the source and destination can be selected.

The result register will contain the frequency spectrum of the source CH.

When a window is selected, the source is multiplied by the WINDOW function, before the F.F.T. is performed. Windowing is used to reduce the effect of leakage at the edges of the source channel. (F.F.T. assumes the register to be exactly one period of a periodic signal, which normally is not the case.)

The F.F.T. is started and stopped with the START STOP softkey. Starting F.F.T. will stop any other active MATHEMATCS function.

6 7,2 1 CH :R. ...>

F.F.T.	
CH :	
R0 ...	1
R1 ...	2
R2 ...	3
R3 ...	4
--	5
--	6
MORE (RES)	7
RETURN	8

If CH :R. ... is selected, the CH menu becomes visible and the source channel can be selected from the registers. If there are two channels in a register, the selected trace is displayed intensified.

6 7,2 1 1 R0 ...
 6 7,2 1 2 R1 ...
 6 7,2 1 3 R2 ...
 6 7,2 1 4 R3 ...

If softkey 1, 2, 3 or 4 is pressed, register R0, R1, R2 or R3 is selected as source CH. If there are two channels in the selected register then pressing the softkey again will result in switching between the two channels in the register.

6 7,2 1 5 --
 6 7,2 1 6 --
 6 7,2 1 7 MORE (RES)

If MORE (RES) is pressed, the RESULT:R. menu will appear. MORE (RES) has the same result as pressing RETURN and selecting RESULT:R.

6 7,2 1 8 RETURN

After pushing softkey RETURN, the MATHEMATCS F.F.T. menu becomes visible.

6 7,2 2 FFT PARAM.>

The FFT PARAM menu consists of 2 parts. In the top half the WINDOW is selected. The bottom part gives a selection for the amplitude scaling. The time scaling is always linear and depending on the time-base of the source register. The source CH is multiplied by the WINDOW, which is used to reduce the effect of leakage.

6 7,2 2 1 RECTANG.

If RECTANG. is selected, the source channel is multiplied by a window with the value 1 over the selected part of the channel. So the real channel values are used for the FFT calculation.

6 7,2 2 2 HAMMING

If HAMMING is selected, the source CH is multiplied by the function:

$$f(t) = 0.08 + 0.46(1 - \cos^2 t/T)$$

In which T is the length of the source channel or the part limited by the cursors.

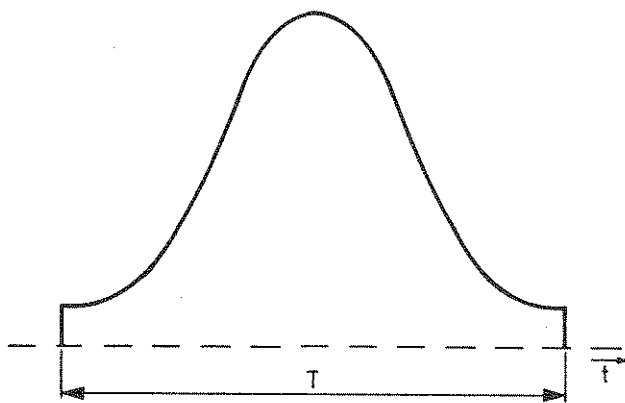

MAT3167

Figure 4.20 Hamming window.

6 7,2 2 3 HANNING

If HANNING is selected, the source CH is multiplied by the function:

$$f(t) = 0.5 (1 - \cos^2 t/T)$$

In which T is the length of the source channel or the part limited by the cursors.

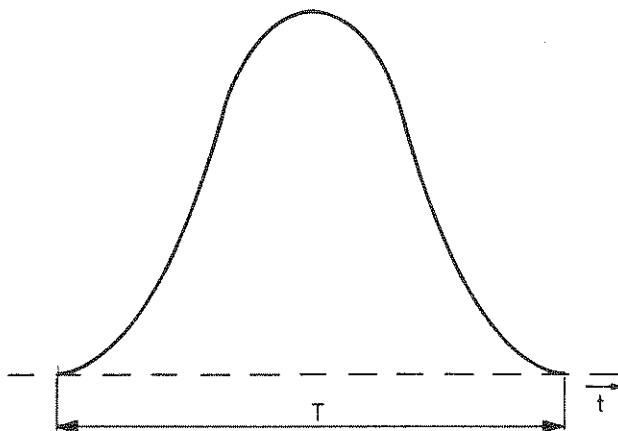

MAT3166

Figure 4.21 Hanning window.

6 7,2 2 4 --

6 7,2 2 5 LIN (V)

The result of the FFT is vertically displayed on a linear (voltage) scale.

6 7,2 2 6 LOG (dB)

The result of the FFT is vertically displayed on a logarithm (dB) scale. The dynamic range is 49.8 dB and smaller results are all set to -49.8 dB.

6 7,2 2 7 --

6 7,2 2 8 RETURN

After pushing softkey RETURN, the MATHEMATCS F.F.T. menu becomes visible.

6 7,2 3 RESULT: R.>

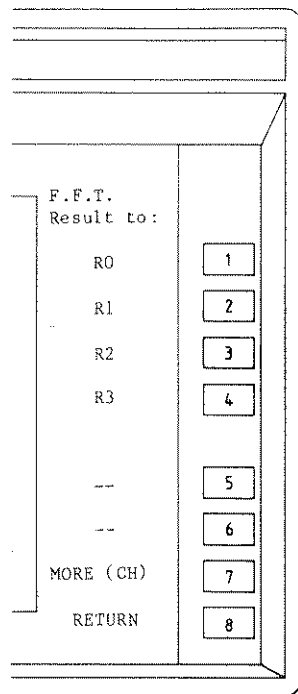

If RESULT: R. is selected, the RESULT menu becomes visible and a register can be selected in which the result is stored.

6 7,2 3 1 R0

6 7,2 3 2 R1

6 7,2 3 3 R2

6 7,2 3 4 R3

If softkey 1, 2, 3 or 4 is pressed, register R0, R1, R2 or R3 is selected as result register.

6 7,2 3 5 --

6 7,2 3 6 --

6 7,2 3 7 MORE (CH)

If MORE (CH) is pressed, the CH :R... menu will appear. MORE (CH) has the same result as pressing RETURN and then selecting CH :R...

6 7,2 3 8 RETURN

After pushing softkey RETURN, the MATHEMATCS F.F.T. menu becomes visible.

6 7,2 4 --

6 7,2 5 CURSOR LMT

Pushing softkey CURSOR LMT toggles the function on or off. When the function is switched on, the MATHEMATCS F.F.T. function is performed on the channel between the cursors only. Channel points outside the cursors are put at 0 (zero filling).

The function CURSOR LMT can only be selected when the cursors are ON. The cursors are then automatically positioned on CH.

When the function is active CURSOR LMT is displayed intensified.

6 7,2 6 START STOP

Pushing softkey START STOP starts or stops the MATHEMATCS F.F.T. operation. The actual state is displayed intensified.

6 7,2 7 INCL OFFST

Pushing softkey INCL OFFST will toggle this function. INCL OFFST active will result in the offset of the traces being included in the MATHEMATCS F.F.T. operation. When the function is active, INCL OFFST is displayed intensified.

6 7,2 8 RETURN

After pushing RETURN, the second MATHEMATCS menu becomes visible.

6 7,3 HISTOGRAM>

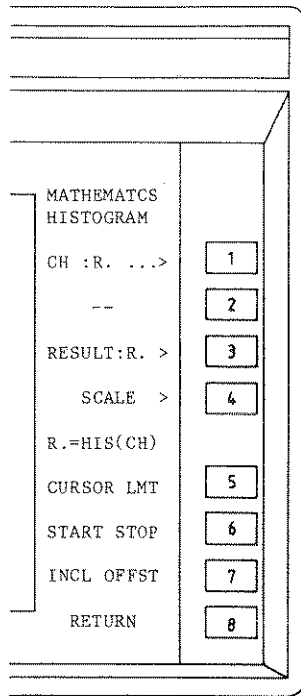

If ADD is selected, the MATHEMATCS HISTOGRAM menu becomes visible and the sources and destination can be selected. Histogram indicates the probability that a time varying signal will assume a value within a fixed amplitude range.

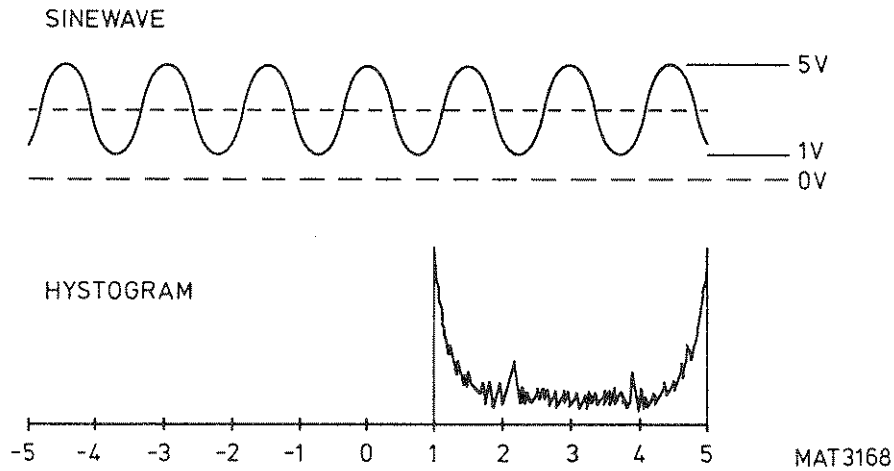
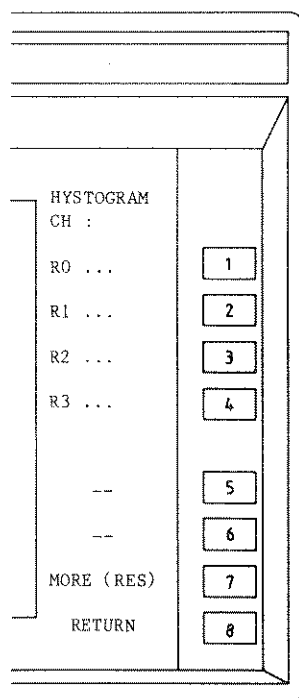

Figure 4.22 Histogram display.

6 7,3 1 CH :R. ...>



If CH :R. ... is selected, the CH menu becomes visible and the source trace can be selected from the registers. If there are two traces in a register, the selected trace is displayed intensified.

6 7,3 1 1 R0 ...

6 7,3 1 2 R1 ...

6 7,3 1 3 R2 ...

6 7,3 1 4 R3 ...

If softkey 1, 2, 3 or 4 is pressed, register R0, R1, R2 or R3 is selected as source CH.

If there are two channels in the selected register then pressing the softkey again will result in toggling between the two channels in the register.

6 7,3 1 5 --

6 7,3 1 6 --

6 7,3 1 7 MORE (RES)

If MORE (RES) is pressed, the RESULT:R. menu will appear. MORE (RES) has the same result as pressing RETURN and selecting RESULT:R.

6 7,3 1 8 RETURN

After pushing softkey RETURN, the MATHEMATCS HYSTOGRAM menu becomes visible.

6 7,3 2 --

6 7,3 3 RESULT: R.>

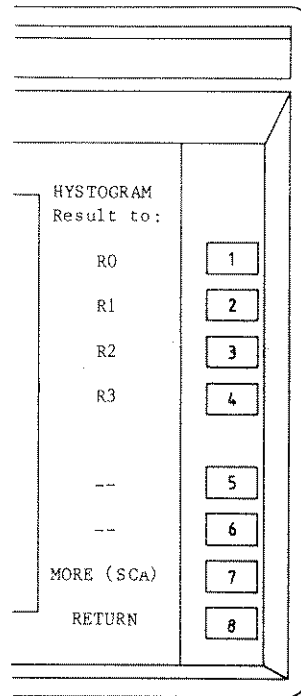

If RESULT: R. is selected, the RESULT menu becomes visible and a register can be selected in which the result is stored.

6 7,3 3 1 R0

6 7,3 3 2 R1

6 7,3 3 3 R2

6 7,3 3 4 R3

If softkey 1, 2, 3 or 4 is pressed, register R0, R1, R2 or R3 is selected as result register.

6 7,3 3 5 --

6 7,3 3 6 --

6 7,3 3 7 MORE (SCA)

If MORE (SCA) is pressed, the SCALE menu will appear. MORE (SCA) has the same result as pressing RETURN and selecting SCALE.

6 7,3 3 8 RETURN

After pushing softkey RETURN, the MATHEMATCS HYSTOGRAM menu becomes visible.

6 7,3 4 SCALE>

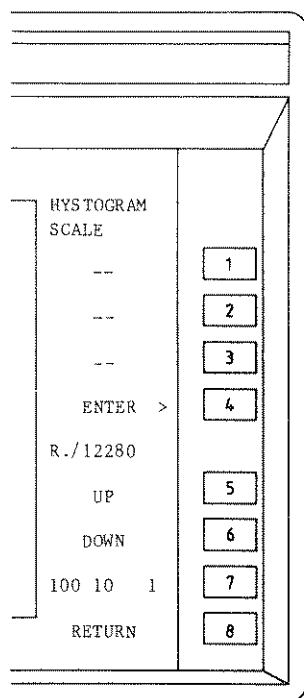

If SCALE is pressed, the SCALE menu becomes visible and a scaling factor can be selected to get the resulting trace of the MATHEMATCS HYSTOGRAM operation inside the vertical register range.

6 7,3 4 1 --
 6 7,3 4 2 --
 6 7,3 4 3 --
 6 7,3 4 4 ENTER>

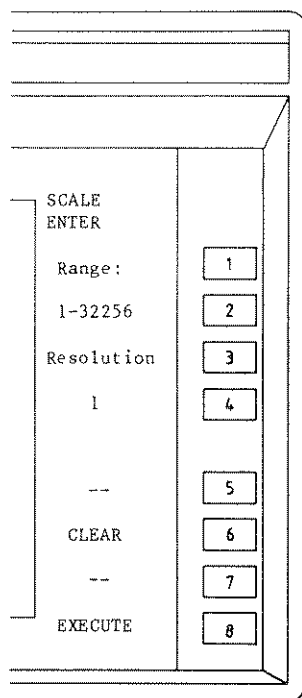

If ENTER is selected, the HYSTOGRAM SCALE menu will be displayed and the scale factor can be selected with the numeric keyboard. The actual range and the value are visible in the softkey text area.

A message

Too many digits: total entry is cleared.

is displayed if too many digits are entered via the numeric keyboard.

Or a message

No decimal point allowed in this enter menu.

is displayed if a decimal point is entered via the numeric keyboard.

6	7,3	4	4	1	--
6	7,3	4	4	2	--
6	7,3	4	4	3	--
6	7,3	4	4	4	--
6	7,3	4	4	5	--
6	7,3	4	4	6	CLEAR

If an error is made, the scale value can be cleared by pushing softkey CLEAR.

6	7,3	4	4	7	--
6	7,3	4	4	8	EXECUTE

After pushing this softkey, the selected scale value is entered and an AUTO RETURN is performed to the menu HISTOGRAM SCALE. If after a CLEAR the softkey EXECUTE is pressed the scale value keeps its previous value in the HISTOGRAM SCALE menu.

A message

HISTOGRAM SCALE number out of range

is displayed if the entered value exceeds the given range.

6	7,3	4	5	UP
---	-----	---	---	----

Pushing softkey UP increments the scale factor by 1, 10 or 100, selected by softkey 7.

6	7,3	4	6	DOWN
---	-----	---	---	------

Pushing softkey DOWN decrements the scale factor by 1, 10 or 100, selected by softkey 7.

6	7,3	4	7	100 10 1
---	-----	---	---	----------

Pushing this softkey toggles the size of the increment or decrement step between 100, 10 and 1. The actual value is displayed intensified.

6	7,3	4	8	RETURN
---	-----	---	---	--------

After pushing softkey RETURN, the MATHEMATCS HISTOGRAM menu becomes visible.

6 7,3 5 CURSOR LMT

Pushing softkey CURSOR LMT toggles the function on or off. When the function is switched on, the MATHEMATCS HISTOGRAM function is performed on the traces between the cursors only. Display points outside the cursors are put at -512 and are normally not displayed. The function CURSOR LMT can only be selected when the cursors are ON. The cursors are then automatically positioned on CH. When the function is active CURSOR LMT is displayed intensified.

6 7,3 6 START STOP

Pushing softkey START STOP starts or stops the MATHEMATCS HISTOGRAM operation. The actual state is displayed intensified.

6 7,3 7 INCL OFFST

Pushing softkey INCL OFFST will toggle this function. INCL OFFST active will result in the offset of the traces being included in the MATHEMATCS HISTOGRAM operation. When the function is active, INCL OFFST is displayed intensified.

6 7,3 8 RETURN

After pushing RETURN, the second MATHEMATCS menu becomes visible.

6 7,4 FILTER> OPTIONAL

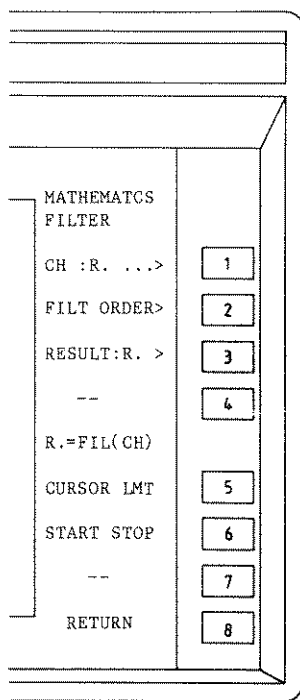

If FILTER is selected, the MATHEMATCS FILTER menu becomes visible and the source and destination can be selected.

The FILTER function is smoothing the source register and storing the result in the result register.

The FILTER ORDER is the number of points that is used to calculate 1 resulting point. Each resulting point is the addition of the corresponding source point and its neighbours each multiplied by a factor according the filter formula.

$$\text{Filter}(n) = \frac{1 - \cos(2\pi n/(N+1))}{N \sum_{k=1}^n (1 - \cos(2\pi k/(N+1)))}$$

for $1 \leq n \leq N$

The sum of these filter factors is always 1.

e.g. When $N=3$ then $\text{Filter}(1) = 0.250$
 $\text{Filter}(2) = 0.500$
 $\text{Filter}(3) = 0.250$

The formula for the resulting points is:

$$\text{Result}(n) = \sum_{k=n-(N-1)/2}^{n+(N-1)/2} (\text{filter}(n-k+(N+1)/2) * \text{Source}(k))$$

6 7,4 1 CH :R. ...>

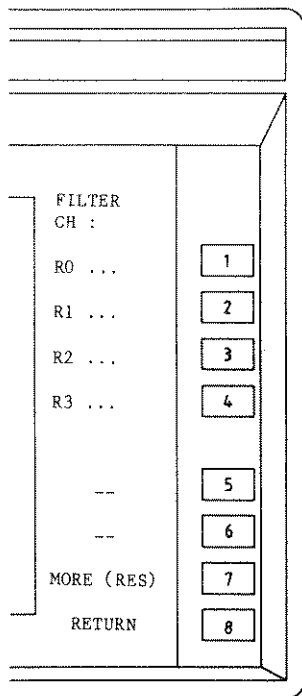

If CH :R. ... is selected, the CH menu becomes visible and the source channel can be selected from the registers. If there are two channels in a register, the filter function will operate on both channels

6	7,4	1	1	R0 ...
6	7,4	1	2	R1 ...
6	7,4	1	3	R2 ...
6	7,4	1	4	R3 ...

If softkey 1, 2, 3 or 4 is pressed, register R0, R1, R2 or R3 is selected as source CH.

If two channels are present in the selected register, the filter operation will be performed on both channels.

6	7,4	1	5	--
6	7,4	1	6	--
6	7,4	1	7	MORE (RES)

If MORE (RES) is pressed, the RESULT:R. menu will appear. MORE (RES) has the same result as pressing RETURN and selecting RESULT:R.

6	7,4	1	8	RETURN
---	-----	---	---	--------

After pushing softkey RETURN, the MATHEMATCS FILTER menu becomes visible.

6	7,4	2	FILT ORDER>
---	-----	---	-------------

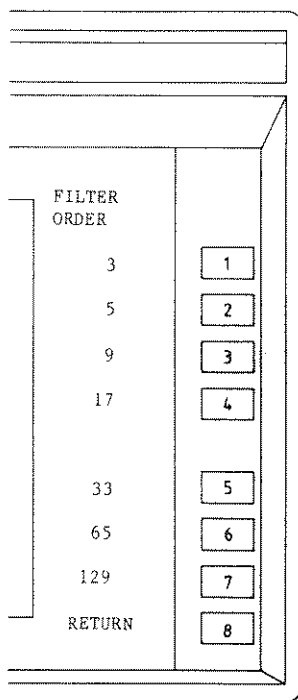

If FILT ORDER is selected, the FILTER ORDER menu becomes visible and the order can be selected.

6 7,4 2 1 3
 6 7,4 2 2 5
 6 7,4 2 3 9
 6 7,4 2 4 17
 6 7,4 2 5 33
 6 7,4 2 6 65
 6 7,4 2 7 129

Pressing one of the softkeys 1 ... 7 will select the filter order.
 Filter order is the number of points that is used to calculate 1 resulting point (see description at FILTER menu above).

6 7,4 2 8 RETURN

After pushing softkey RETURN, the MATHEMATCS FILTER menu becomes visible.

6 7,4 3 RESULT: R.>

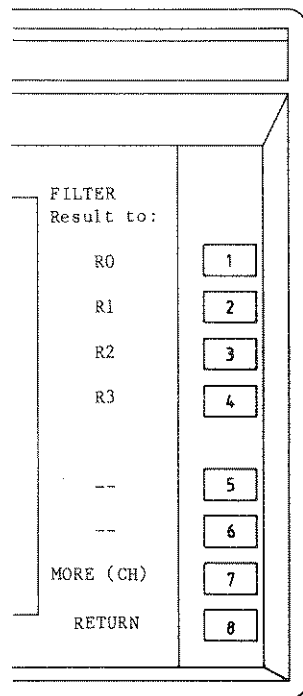

If RESULT: R. is selected, the RESULT menu becomes visible and a register can be selected in which the result is stored.

6 7,4 3 1 R0
 6 7,4 3 2 R1
 6 7,4 3 3 R2
 6 7,4 3 4 R3

If softkey 1, 2, 3 or 4 is pressed, register R0, R1, R2 or R3 is selected as result register.

6 7,4 3 5 --

6 7,4 3 6 --

6 7,4 3 7 MORE (CH)

If MORE (CH) is pressed, the CH :R. ... menu will appear. MORE (CH) has the same result as pressing RETURN and selecting CH :R. ...

6 7,4 3 8 RETURN

After pushing softkey RETURN, the MATHEMATCS FILTER menu becomes visible.

6 7,4 4 --

6 7,4 5 CURSOR LMT

Pushing softkey CURSOR LMT toggles the function on or off. When the function is switched on, the MATHEMATCS FILTER function is performed on the traces between the cursors only. Display points outside the cursors are put at -512 and are normally not displayed. The function CURSOR LMT can only be selected when the cursors are ON. The cursors are then automatically positioned on CH. When the function is active CURSOR LMT is displayed intensified.

6 7,4 6 START STOP

Pushing softkey START STOP starts or stops the MATHEMATCS FILTER operation. The actual state is displayed intensified.

6 7,4 7 --

6 7,4 8 RETURN

After pushing RETURN, the second MATHEMATCS menu becomes visible.

6 7,5 --

6 7,6 --

6 7,7 MORE

If MORE is pressed, the first MATHEMATCS menu will appear. MORE has the same result as pressing RETURN and then selecting MATHEMATCS.

6 7,8 RETURN

After pushing softkey RETURN, the CURSOR SELECT menu becomes visible.

7 RESTART

If the cursors are positioned on different traces or in the registers R1, R2 or R3, the text RESTART is not visible.

If the cursors are in one of the traces of register R0 the text RESTART is displayed.

After pushing softkey RESTART an automatic horizontal acquisition expand is performed for the signal part between the two cursors. A new trigger-delay setting (related to the first cursors) and a new and faster time-base setting (related to the time between the cursors) is automatically selected. After this selection a new signal is recorded with this new settings on the first active trigger.

The new settings are displayed in the top text area and the text RESTART is visible in high intensity.

The new settings are chosen in such a way, that the original signal part between the cursors, remains completely visible on the screen and is recorded with the maximum possible resolution.

If further expansion is not possible, this is indicated by one of the messages

No further expansion possible!!
RESTART not executed.

or

RESTART not fully executed because of
overflow in time base or trigger delay.

or

No more than 9 RESTART calculations possible.

Note: The first messages appears, if the distance between the cursors is so big, that even in one time-base setting faster, the original part between the cursors can't be displayed completely.
It also appears in the fastest time-base setting or if further expansion requires exceeding of the maximum trigger delay.

8 REVERSE

Normally the text REVERSE is not visible.

After the first operation of the RESTART function, the text REVERSE is visible.

If softkey REVERSE is pushed, then the settings as before performing the RESTART action are recalled.

REVERSE can stay visible, after the conditions for RESTART disappear or the cursors are switched OFF. This because the number of RESTART's is larger than the number of REVERSE's already given.

4.2.9 MEMORY SECTION AND MENU STRUCTURE

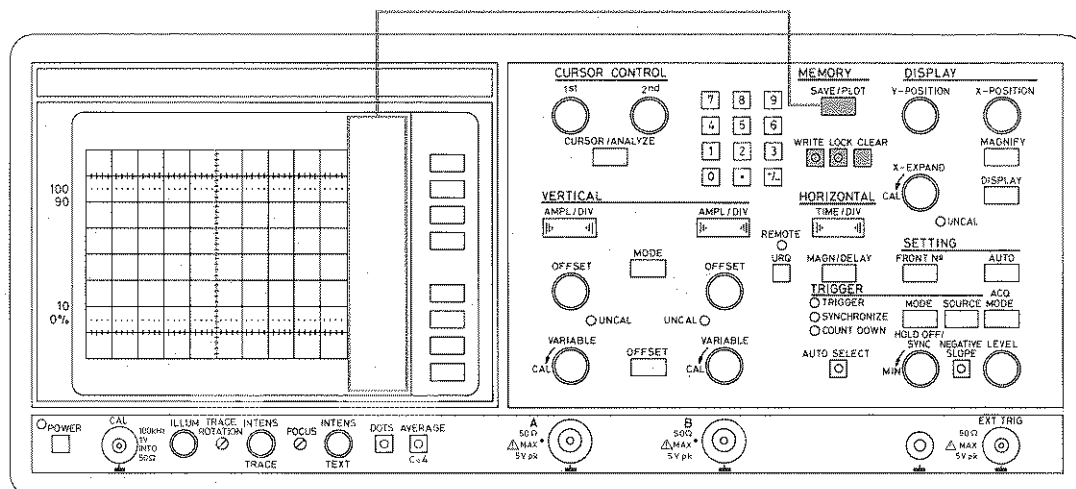

MAT 3111MAT 3101
880122 88 0 205

Figure 4.23 Front panel view.

WRITE

The acquisition functions only when pushbutton WRITE is pushed.

The status is indicated by a pilot lamp in this switch.

LOCK

If pushbutton LOCK is pushed, no signal acquisition (new input) is possible.

The status is indicated by a pilot lamp in this switch.

The following actions are still possible:

- Plot actions.
- Display actions.
- Cursor control actions.
- Setting of the acquisition system.
- Not possible are all acquisition actions which directly influence the contents of register R0.
- Data can be saved in a register after a message has been given.
- Front number actions (also RECALLs).

If pushbutton AUTO-SET is pushed when the instrument is in the LOCK-mode, the message

NO AUTO SET possible in LOCK mode.

is displayed in the bottom text area.

CLEAR

If pushbutton CLEAR is pushed and dots are selected for display, a zero line is written into the accumulator (R0) and no traces are displayed on the screen.

If DOTS is off or SMOOTH is selected for display and pushbutton CLEAR is pushed, a zero line is written into the accumulator (R0) and displayed on the C.R.T. screen.

The cleared contents of the accumulator can be saved in one of the other registers R1...R3, to clear the contents of these registers.

When pushbutton CLEAR is pushed during a SINGLE-shot, a MULTIPLE-shot or a ROLL-mode operation, the CLEAR pushbutton has a RESET function. The function CLEAR is not possible in the LOCK mode.

SAVE/PLOT

If pushbutton SAVE/PLOT is pushed, the SAVE/PLOT menu is displayed. See 4.2.9.1.

4.2.9.1 SAVE/PLOT MENU STRUCTURE

SAVE/PLOT

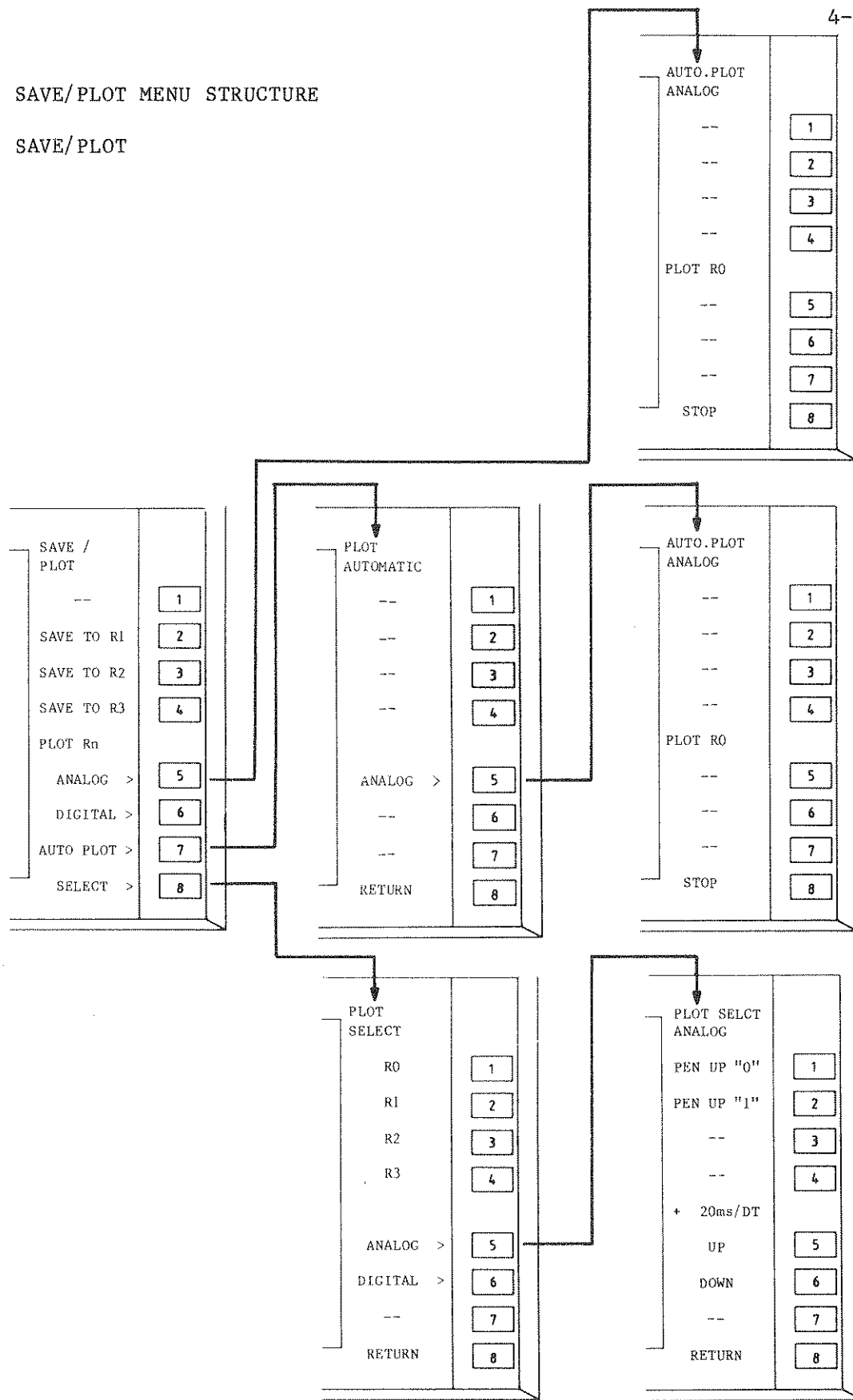
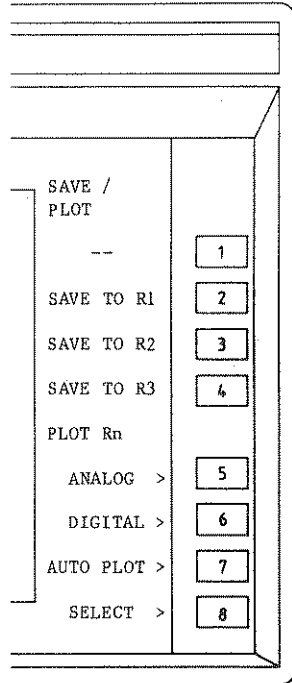

Figure 4.24 Save/plot menu structure.

SAVE/PLOT MENU



After selection of the SAVE/PLOT menu by depressing pushbutton SAVE/PLOT, various SAVE and PLOT selections can be done. The register Rn which is selected for PLOT actions via the PLOT SELECT menu, is displayed on the screen.

Note: the softkey function DIGITAL that you may find in certain menu's, has to be used in case that a digital plotter is connected to the instrument's interface PM8956A. For operating details refer to the instruction manual of the interface that also gives the complete menu structure.

- 1 --
- 2 SAVE TO R1
- 3 SAVE TO R2
- 4 SAVE TO R3

If a SAVE function is selected, register R0 is copied in the selected register. The SAVE action is performed as long as the softkey is pressed, so that register R0 is copied again after each acquisition.

A message

No direct SAVE in LOCK mode.

Press SAVE again during the display of this message.

becomes visible in the bottom text area for a short moment when the instrument is in the LOCK-mode. A SAVE action is then only possible as long as the message is displayed.

5 ANALOG>

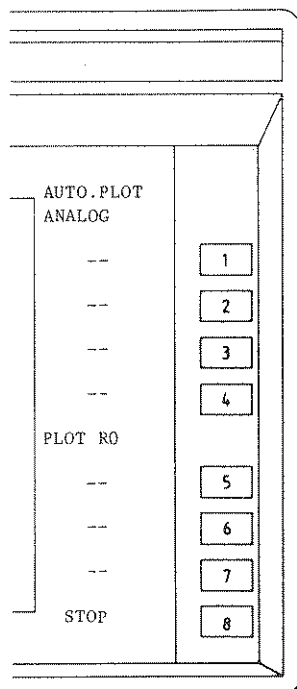

If ANALOG is selected, the contents of the displayed register Rn is transferred to the analog plot output. The default register is R0. Other registers to plot as well as the plot speed can be selected via the SELECT function of the SAVE/PLOT menu (softkey 8). During the PLOT action, the PLOT ANALOG menu is displayed and a dot, which moves from the left to the right (over 10 divisions) is displayed in the bottom text area of the screen to show the progress of the plot action and a message

```

***** PLOTTER ACTIVE *****
Changes are possible after plotter has stopped
  
```

is displayed.

At the end of the PLOT action, the menu SAVE/PLOT is displayed again.

```

5 1  --
5 2  --
5 3  --
5 4  --
5 5  --
5 6  --
5 7  --
5 8  STOP
  
```

A PLOT action can be interrupted by pushing softkey STOP. The SAVE/PLOT menu is then displayed again. During a plot action, it is not possible to switch to another softkey menu.

```

6  --
  
```

7 AUTO PLOT>

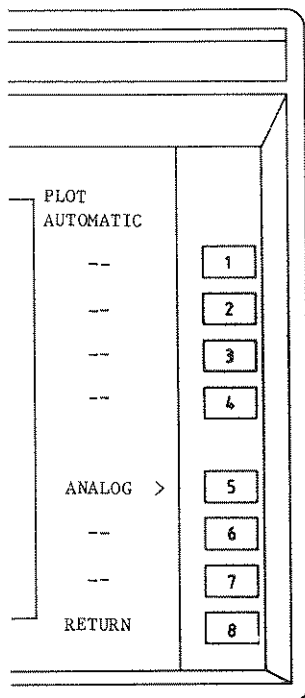

AUTO PLOT functions only in the SINGLE-shot mode. If AUTO PLOT is selected, the contents of register R0 is automatically transferred to an analog X-Y recorder.

The text AUTO PLOT is not visible in an other horizontal mode.

The contents of R0 is automatically plotted after each refreshment of the memory when a valid trigger is received.

- 7 1 --
- 7 2 --
- 7 3 --
- 7 4 --
- 7 5 ANALOG>

After selecting ANALOG, the AUTO PLOT ANALOG menu is displayed and the function is active for an analog X-Y recorder.

The PLOT speed can be selected via the SELECT function of the SAVE/PLOT menu (softkey 8). During the PLOT action, the AUTO.PLOT ANALOG menu is displayed and a dot, which moves from the left to the right is displayed just above the bottom text area of the screen and a message

***** PLOTTER ACTIVE *****
 Changes are possible after plotter has stopped

is displayed.

At the end of the PLOT action, a new acquisition takes place on receipt of a trigger signal, after which a new plot is initiated.

7	5	1	--
7	5	2	--
7	5	3	--
7	5	4	--
7	5	5	--
7	5	6	--
7	5	7	--
7	5	8	STOP

A PLOT action can be interrupted by pushing softkey STOP. The PLOT AUTOMATIC menu is then displayed again. During a plot action it is not possible to switch to another softkey menu.

7	6	--
7	7	--
7	8	RETURN

After pushing softkey RETURN, the SAVE/PLOT menu is displayed again. The selections as made before remain unchanged.

8 SELECT>

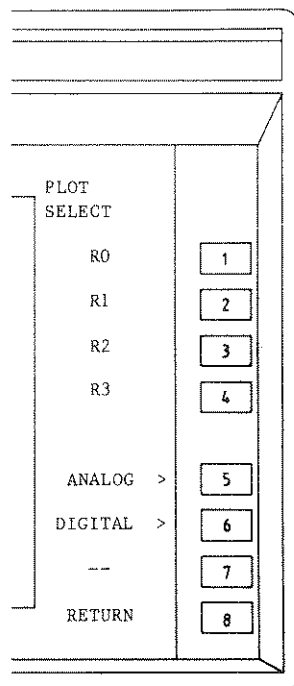

If SELECT is selected, a selection can be made for a register, a plot output speed and the penlift output polarity.

Only the registers which are selected for display, can be selected for plot actions.

- 8 1 R0
- 8 2 R1
- 8 3 R2
- 8 4 R3

Hard copies are made from the selected register.

- 8 5 ANALOG>

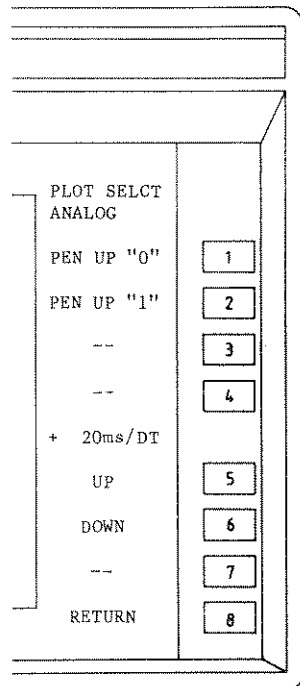

If ANALOG is selected, the PLOT SELECT ANALOG menu is displayed and the plot output speed as well as the penlift polarity can be selected.

- 8 5 1 PEN UP "0"

If the text PEN UP "0" is intensified, the instrument will generate a low level TTL signal on its PENLIFT output.

- 8 5 2 PEN UP "1"

If the text PEN UP "1" is intensified, the instrument will generate a high level TTL signal on its PENLIFT output.

- 8 5 3 --
- 8 5 4 --
- 8 5 5 UP

The actual analog plot output speed is displayed on the screen. This speed is always a multiple of 20 ms/dot. Pushing softkey UP increases the value in steps of 20 ms, which means that the actual plot output speed decreases. Above 200 ms/dot the value increases in steps of 100 ms/dot. The fastest possible output speed is 20 ms/dot.

If 2000 ms/DT is displayed, and UP is depressed, a message

PLOT TIME out of range. Range is 20 .. 2000 ms.

is displayed.

The real plot time may be different than selected, due to automatic plot control speed adaption related to the signal shape.

NOTE: This plot speed must be adapted to the speed of a relative slow X-Y recorder.

8 5 6 DOWN

The actual analog plot output speed is displayed on the screen. This speed is always a multiple of 20 ms/dot. Pushing softkey DOWN decreases the value in steps of 20 ms, which means that the actual plot output speed decreases. Above 200 ms/dot the value decreases in steps of 100 ms/dot.

The slowest possible plot output speed is 2000 ms/dot. If 20 ms/DT is displayed and DOWN is depressed, a message

PLOT TIME out of range. Range is 20 .. 2000 ms.

is displayed.

The real plot time may be different than selected, due to automatic plot control speed adaption related to the signal shape.

8 5 7 --

8 5 8 RETURN

After pushing softkey RETURN, the PLOT SELECT menu is displayed again. The selections as made before remain unchanged.

8 6 --

8 7 --

8 8 RETURN

After pushing softkey RETURN, the SAVE/PLOT menu is displayed again.

4.2.10. DISPLAY SECTION AND MENU STRUCTURE AND AUXILIARY SECTION

MAT3112 MAT3101
880122 88 0 205

Figure 4.25 Front panel view.

Y POSITION

Continuously variable control giving vertical shift of one of the four registers R0, R1, R2, R3 (including channels in the registers) can be addressed via the DISPLAY menu.

The adjusting speed increases after turning continuously in one direction. After stopping, starting in the reverse direction resumes with a slow adjusting speed.

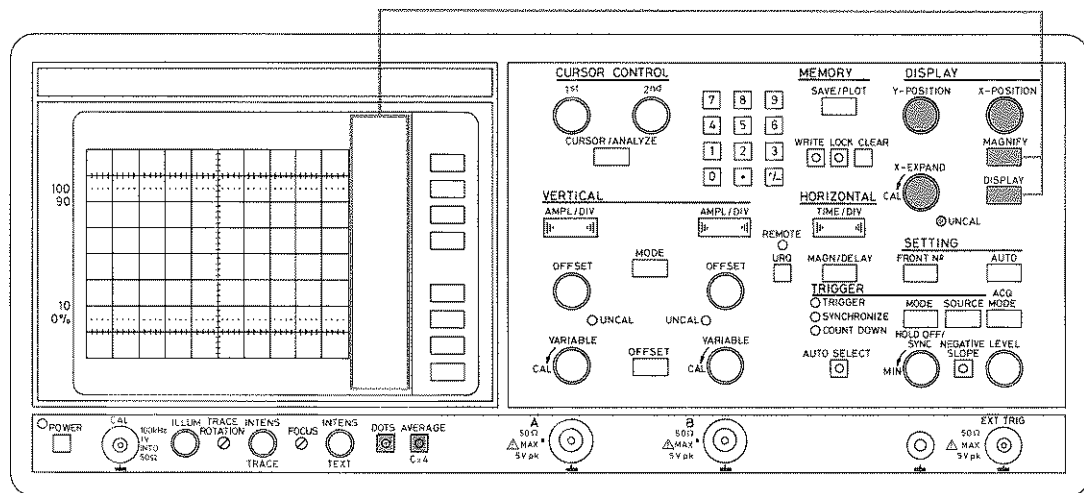
X POSITION

Continuously variable control giving horizontal shift of the total trace display.

Can also be addressed to one of the four registers R0, R1, R2, R3 (including channels in the registers) as long as menu DISPLAY Rn POSITION is selected.

The adjusting speed increases after turning continuously in one direction. After stopping, starting in the reverse direction resumes with a slow adjusting speed.

X EXPAND

Continuously variable control for horizontal expand of the total trace display.

Can also be addressed to one of the four registers R0, R1, R2, R3 (including channels in the registers) as long as menu DISPLAY Rn POSITION is selected.

The adjusting speed increases after turning continuously in one direction. After stopping, starting in the reverse direction resumes with a slow adjusting speed.

UNCAL Pilot lamp indicating that the X-EXPAND function is active for one or more registers. If the X-EXPAND control is fully turned anti clockwise, the UNCAL pilot lamp is switched off.

DOTS Selection between a display of discrete dots or a display of joined dots for all registers. DOTS can also be selected in A VERSUS B mode.

AVERAGE C=4 Direct selection of the AVERAGE mode with an averaging factor C=4. This averaging factor and a number of other factors can also be selected via the menus VERTICAL MODE and PROCESSING. The AVERAGE mode minimizes noise on the signal that is displayed on the screen.

AVERAGE is not possible in combination with EYE PATTERN mode and/or LOW RESOLUTION mode. This combination gives a warning on CRT.

MAGNIFY If pushbutton MAGNIFY is pushed, the MAGNIFY menu is displayed. See 4.2.10.1.

DISPLAY If pushbutton DISPLAY is pushed, the DISPLAY menu is displayed. See 4.2.10.2.

4.2.10.1 MAGNIFY MENU STRUCTURE

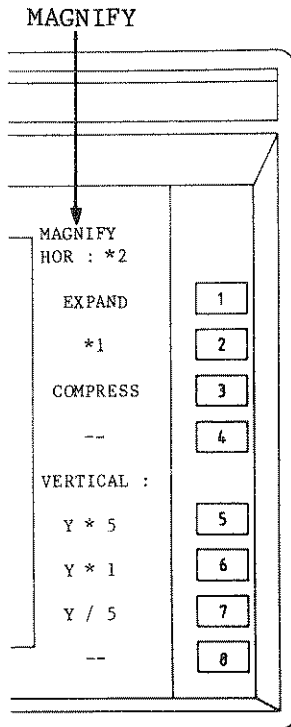

After selection of the MAGNIFY menu by depressing pushbutton MAGNIFY, the signal(s) can be expanded in horizontal or vertical direction.

Expand factors *1, *2, *4, *8, *16, *32 or *64 can be selected.

Each part of the complete register can be displayed using the HORIZONTAL POSITION control.

Figure 4.26 Magnify menu structure.

MAGNIFY MENU

1 EXPAND

With softkey EXPAND, higher horizontal expand factors can be selected until *64 is reached. Then the text expand is not displayed any longer. EXPAND is always with respect to mid-screen.

The selected factor is displayed in the second line of the softkey menu header.

With A VS B selected, the maximum expand factor is *8.

2 *1

With softkey *1, the horizontal expand factor is set to *1 which means -no expand-.

3 COMPRESS

With softkey COMPRESS, lower horizontal expand factors can be selected until *1 is reached. The selected factor is displayed in the second line of the softkey menu header.

The text COMPRESS is not visible if the expand factor is *1.

4 --

5 Y*5

After pushing softkey Y*5, the vertical expand factor is set to *5 and 1/5 of the contents of the selected registers is displayed over 10 vertical divisions of which 8 divisions are visible. Mid-memory is displayed on the center-line of the graticule.

6 Y*1

After pushing softkey Y*1, the vertical expand factor is set to *1 and the contents of the selected registers is displayed over 10 vertical divisions of which 8 divisions are visible. Mid-memory is displayed on the center-line of the graticule.

7 Y/5

After pushing softkey Y/5, the contents of each memory is displayed over 2 vertical divisions. If the Y-positions are in zero position, the registers are equally divided over the screen.

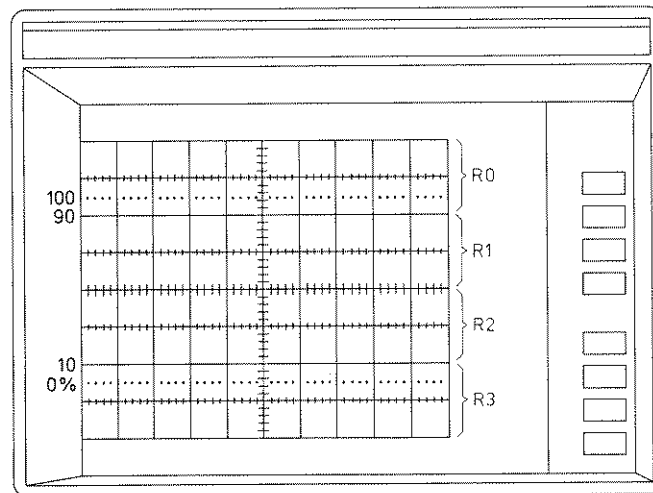

Figure 4.27 Y/5 display.

8 --

4.2.10.2 DISPLAY MENU STRUCTURE

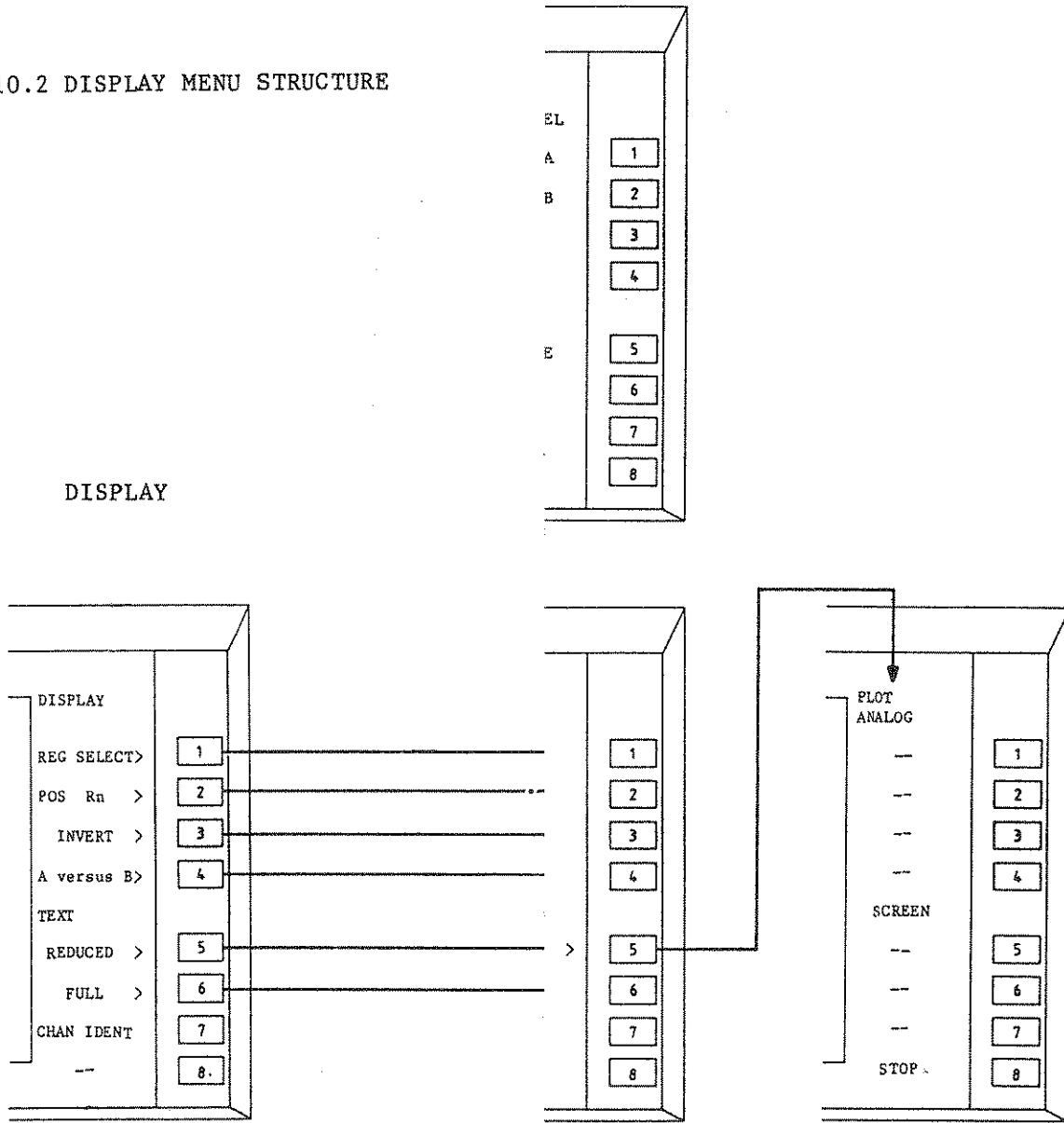
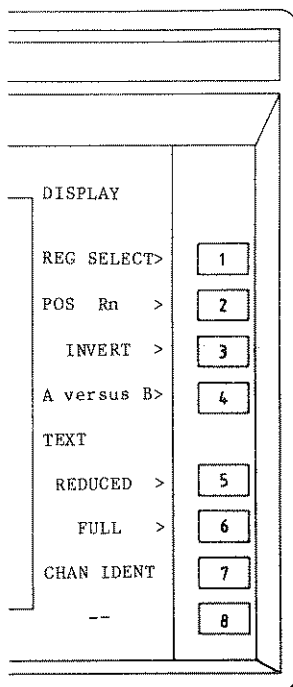

Figure 4.28 Display menu structur

DISPLAY MENU



After selection of the DISPLAY menu by depressing pushbutton DISPLAY, various DISPLAY selections can be made.

Note: the softkey functions OPTION and DIGITAL have to be used in case of address setting of the instrument's interface bus and when using a digital plotter. For operating details refer to the instruction manual of the interface PM8956A. This instruction manual gives also the complete menu structure.

1 REG SELECT>

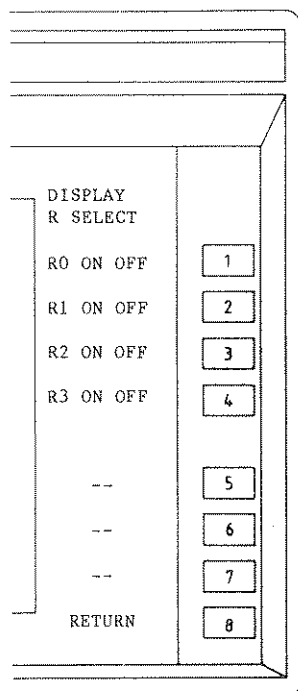

After selecting REG SELECT, the DISPLAY/R SELECT menu is displayed and a selection can be made of the registers which have to be displayed.

1 1 R0 ON OFF

1 2 R1 ON OFF

```

1   3   R2   ON   OFF
1   4   R3   ON   OFF
    
```

One or more registers can be selected for display. Depending on the selection, the text ON or OFF is intensified. Pushing the relevant softkey changes the situation from ON to OFF or reverse.

If a register is switched OFF, the POSITION controls which are eventually addressed to this register, are from that moment on addressed to the next displayed register.

If a register which is not yet displayed, is selected for display, the POSITION controls are addressed to this register.

If cursors are selected, the cursors are on the selected register now.

```

1   5   --
1   6   --
1   7   --
1   8   RETURN
    
```

After pushing softkey RETURN, the DISPLAY menu is displayed again. The selected registers remain displayed.

2 POS Rn>

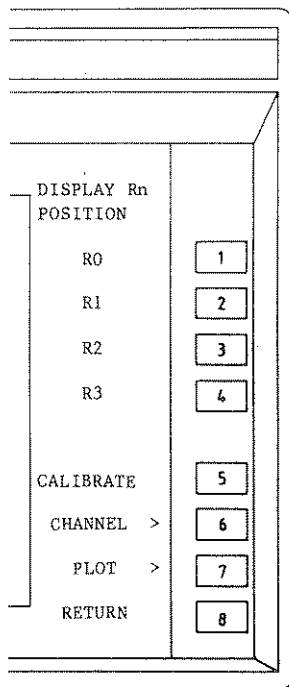

As long as softkey POS Rn is not pushed, the text POS Rn is displayed and the position of the selected register can be set with the VERTICAL POSITION and HORIZONTAL POSITION control. The HORIZONTAL POSITION control controls all other registers as well at the same moment. The X-EXPAND control functions also for the selected register.

After selecting POS Rn, the DISPLAY Rn POSITION menu is displayed and the Y-POSITION control, the X-POSITION control as well as the X-EXPAND control can be assigned to one of the four registers. The selected register number is intensified.

If a register is not selected for display, this register can not be selected for positioning. The text Rn for this register is then not displayed.

2 1 R0
 2 2 R1
 2 3 R2
 2 4 R3

The Y-POSITION, X-POSITION and X-EXPAND controls are addressed to the selected register.

2 5 CALIBRATE

After pushing softkey CALIBRATE, the traces are set as before pushing softkey CHANNEL (see next description). The Y-POSITION is set so, that mid-memory is mid-screen in Y*1 and Y*5 mode and on +3, +1, -1 and/or -3 divisions in the Y/5 mode.

The X-POSITION is set so, that the beginning of the trace is situated on the most left graticule line.

The X-EXPAND is set to its calibrated position.

2 6 CHANNEL>

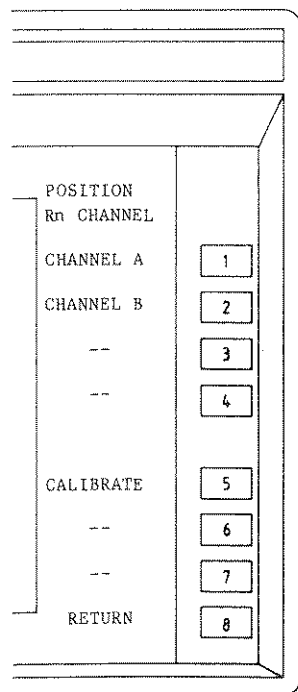

If CHANNEL is selected, the POSITION Rn CHANNEL menu is displayed.

Traces within the same register can now be positioned in relation to each other.

If only one channel is recorded in the selected register, this menu can not be reached and the text CHANNEL is not visible.

2 6 1 CHANNEL A
 2 6 2 CHANNEL B

The position of the selected channel A or B in the selected register Rn can be changed with the Y-POSITION, the X-POSITION and the X-EXPAND controls.

2 6 3 --
 2 6 4 --
 2 6 5 CALIBRATE

After pushing softkey CALIBRATE, the display modifications made under channel control are ignored and the traces are adjusted as follows.

The Y-POSITION is set so, that mid-memory is mid-screen in Y*1 and Y*5 mode and on +3, +1, -1, and/or -3 divisions in the Y/5 mode.

The X-POSITION is set so, that the beginning of the trace is situated on the most left graticule line.

The X-EXPAND is set to its calibrated position.

The controls are not longer addressed to one of the channels A or B but to the selected register.

2 6 6 --
 2 6 7 --
 2 6 8 RETURN

After pushing softkey RETURN, the DISPLAY Rn POSITION menu is displayed again.

All settings done before remain unchanged.

2 7 PLOT>

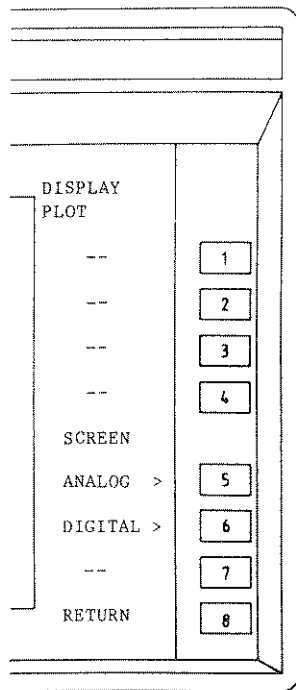

After selecting PLOT, the DISPLAY PLOT menu is selected and a plot can be made from the trace area of the screen.

In this way a copy of the trace area can be made including the selected trace position changes.

2 7 1 --

```

2 7 2  --
2 7 3  --
2 7 4  --
2 7 5  ANALOG>

```

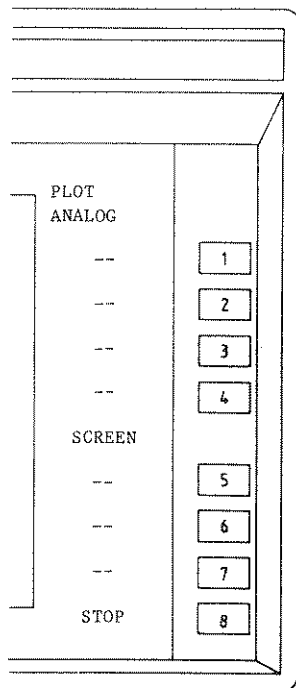

After selecting ANALOG, a copy of the screen is made on an analog X-Y recorder. During the PLOT action, the PLOT ANALOG menu is displayed and a dot which moves from the left to the right (over 10 divisions) is displayed just above the bottom text area of the screen to show the progress of the plot action and a message

```

* * * * * PLOTTER ACTIVE * * * * *
* * *

```

Changes are possible after plotter has stopped.

is displayed.

The settings made with the Y-POSITION control, the X-POSITION control and the X-EXPAND control remain.

At the end of the plot action the menu DISPLAY PLOT is displayed again.

```

2 7 5 1  --
2 7 5 2  --
2 7 5 3  --
2 7 5 4  --
2 7 5 5  --
2 7 5 6  --
2 7 5 7  --
2 7 5 8  STOP

```

A PLOT action can be interrupted by pushing softkey STOP. The DISPLAY PLOT menu is then displayed again.

```

2 7 6  --
2 7 7  --

```

2 7 8 RETURN

After pushing softkey RETURN, the DISPLAY Rn POSITON menu is displayed again.

2 8 RETURN

After pushing softkey RETURN, the DISPLAY menu is displayed again and the selected register (e.g. R2) can still be positioned. This is indicated by the text POS R2. All modifications made between traces in X- as well as Y-direction (with the exception of Y changes, which are made via the CHANNEL menu), are eliminated.

3 INVERT>

DISPLAY	
INVERT	
R0 ON OFF	1
R1 ON OFF	2
R2 ON OFF	3
R3 ON OFF	4
--	5
--	6
--	7
RETURN	8

If INVERT is selected, the DISPLAY/INVERT menu is displayed and a selection can be made of the registers of which the display has to be inverted. If a register is not selected for display, the inversion is not possible and the register number is not displayed.

3 1 R0 ON OFF

3 2 R1 ON OFF

3 3 R2 ON OFF

3 4 R3 ON OFF

One or more registers can be selected for inverted display. Depending on the selection, the text ON or OFF is intensified.

Pushing the relevant softkey changes the situation from ON to OFF or reverse.

3 5 --

3 6 ---
 3 7 ---
 3 8 RETURN

After pushing softkey RETURN, the DISPLAY menu is displayed again. The selections as made before remain unchanged.

4 A versus B>

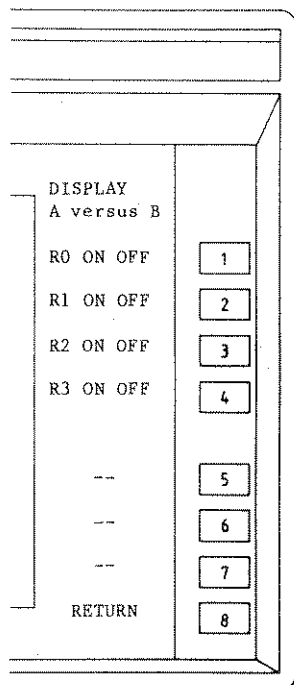

If A versus B is selected, the DISPLAY A versus B menu is displayed.

One or more registers can be selected for A versus B display.

If a register is not selected for display, or if only one channel is recorded in a register, the text Rn ON OFF is not displayed and A versus B display is then not possible for this register.

If no register is displayed with two channels, A versus B is not possible and the text A versus B is not displayed and the function can not be selected.

NOTE: If a register is deselected via the DISPLAY/R SELECT menu, then A versus B is switched off for that register.

4 1 R0 ON OFF
 4 2 R1 ON OFF
 4 3 R2 ON OFF
 4 4 R3 ON OFF

One or more registers can be selected for A versus B display. Depending on the selection the text ON or OFF is intensified. Pushing the relevant softkey changes the situation from ON to OFF or reverse.

If the CURSORS were selected for the selected register, a message

Register in A versus B : no cursors possible.

is displayed and the cursors are switched off.

If a horizontal expand greater than *8 is selected via the MAGNIFY menu, a message

Max. horizontal expand in A versus B is *8

is displayed and horizontal expand is set to *8.

- 4 5 --
- 4 6 --
- 4 7 --
- 4 8 RETURN

After pushing softkey RETURN, the DISPLAY menu is displayed again. The selections as made before remain unchanged.

5 REDUCED>

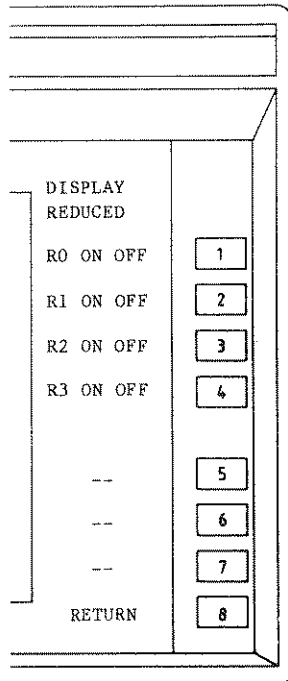

If REDUCED is selected, the DISPLAY REDUCED menu is displayed. Only in Y/5 one or more registers can be selected for REDUCED text.

The text REDUCED is only visible if Y/5 is selected via the MAGNIFY menu.

If a register is not selected for display, the text Rn ON OFF is not displayed and the action is not possible.

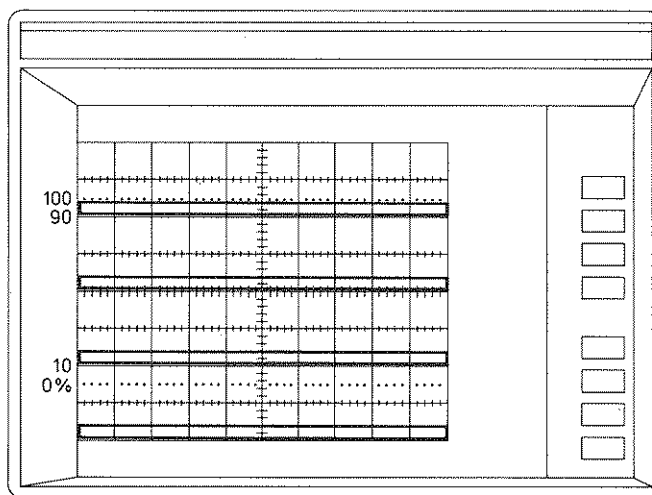

Figure 4.29 Reduced text display in Y/5.

5	1	R0	ON	OFF
5	2	R1	ON	OFF
5	3	R2	ON	OFF
5	4	R3	ON	OFF

One or more registers can be selected for REDUCED TEXT display. Reduced text means that the parameters of the signal(s) of the selected register are displayed in the trace area. See also 4.2.2.

Pushing the relevant softkey changes the situation from ON to OFF or reverse.

5	5	--
5	6	--
5	7	--
5	8	RETURN

After pushing softkey RETURN, the DISPLAY menu is displayed again. The selections as made before remain unchanged.

6 FULL>

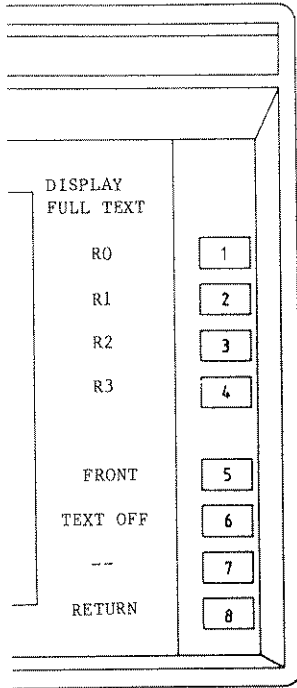

If FULL is selected, the DISPLAY/FULL TEXT menu is displayed.

The most important information of the front panel settings is always visible in the top text area but selection of the display of full information of a certain register or the additional information of the front panel setting, is possible.

If a register is not selected for display, the text Rn is not displayed and the action is not possible for this register.

If a register which is selected for full text is turned off via the REGISTER SELECT menu, full text is turned off.

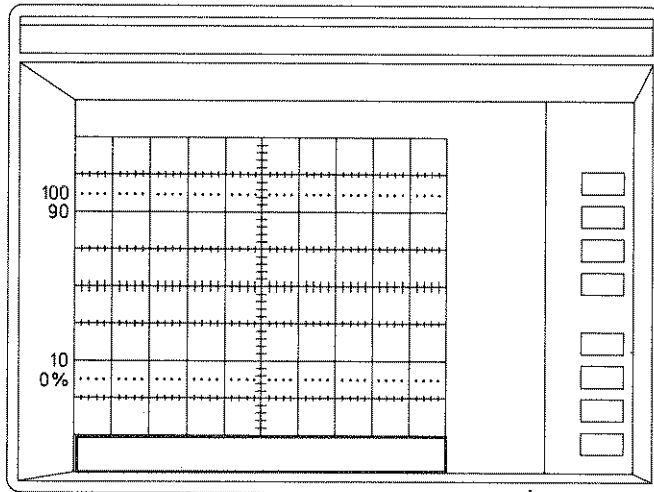

Figure 4.30 FULL text display.

- 6 1 R0
- 6 2 R1
- 6 3 R2

6 4 R3

The parameters of the selected register can be selected for display in the bottom text area.

Front information in the bottom text area, selected by softkey FRONT is not longer displayed then.

Pushing the relevant softkey changes the situation from ON to OFF or reverse.

6 5 FRONT

With softkey FRONT, two extra lines with front panel information are visible in the bottom text area.

Register information in the bottom text area, selected by one of the softkeys R0, R1, R2 or R3 is not longer displayed then.

6 6 --

6 7 TEXT OFF

This text is only visible if full text is selected.

The bottom text area is blanked when softkey TEXT OFF is pushed.

6 8 RETURN

After pushing softkey RETURN, the DISPLAY menu is displayed again. The selections as made before remain unchanged.

7 CHAN IDENT

After pushing softkey CHAN IDENT, the channel identification (A and/or B) on the C.R.T. screen can be switched on or off.

Pushing this softkey changes the situation from ON to OFF or reverse, indicated by a high or a low intensity of the text CHAN IDENT.

8 --

4.2.11. FRONT No. SECTION AND MENU STRUCTURE

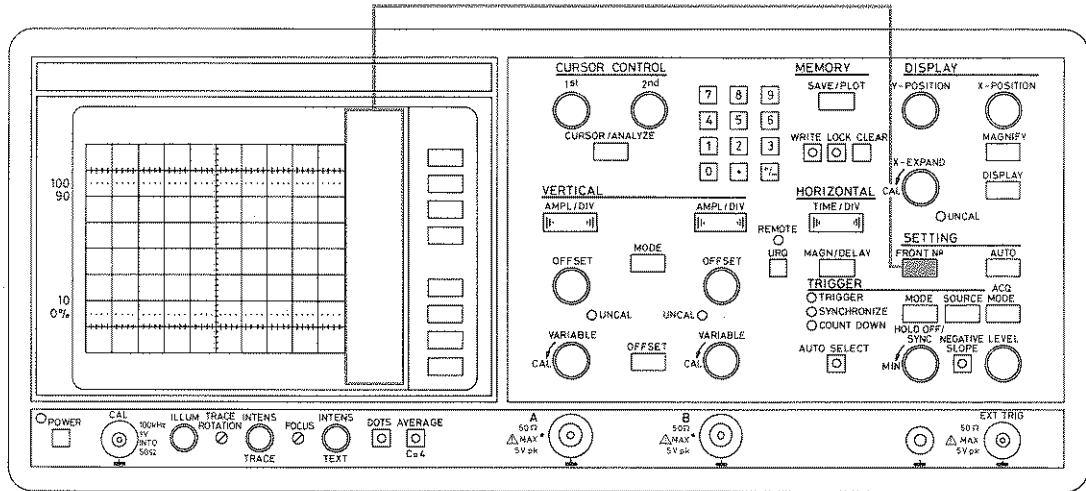

MAT 3113 MAT 3101
800129 880 205

Figure 4.31 Front panel view.

FRONT No

If pushbutton FRONT No. is pushed, the FRONT NUMBER menu is displayed. See 4.3.11.1.

4.2.11.1 FRONT NUMBER MENU STRUCTURE

FRONT No .

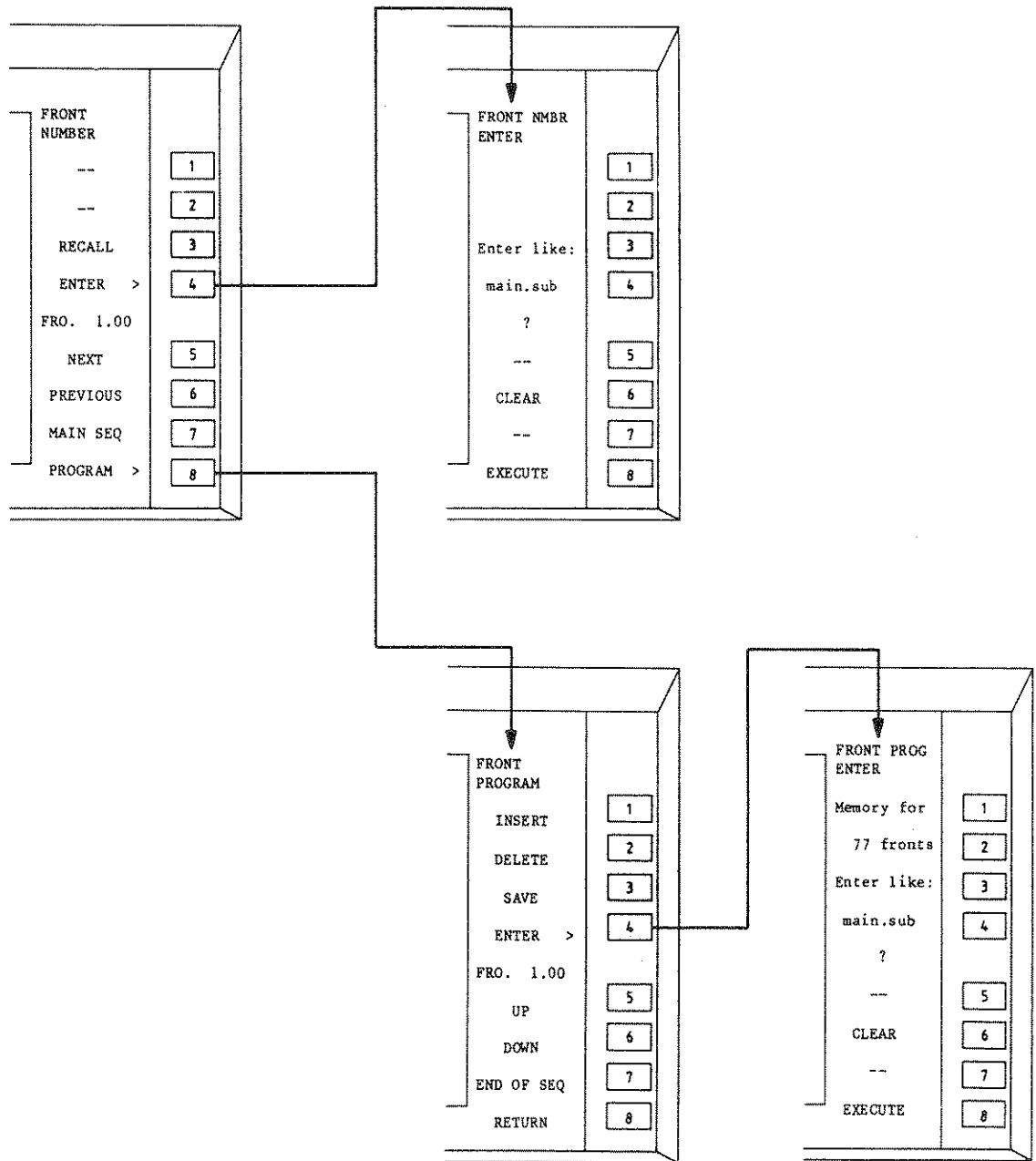
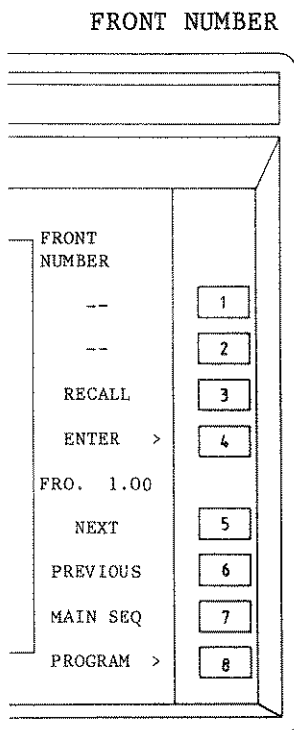

Figure 4.32 Front number menu structure.



If pushbutton FRONT No. is depressed, the FRONT NUMBER menu will be visible on the screen and the front setting memory can be controlled.

The last used front number is visible in the softkey text area.

In this front setting memory, a number of sequences of different front settings can be saved and later on recalled.

When memory back-up batteries are installed, all saved front settings remain in memory after switching off the instrument.

A complete front setting, which will be called FRONT, is stored in the front setting memory with a front number.

The fronts are placed in a SEQUENCE. The first front of a sequence is called MAIN FRONT. The sequence is terminated with an EOS (END OF SEQUENCE).

In the front setting memory a number of different sequences can be programmed, as shown in figure 4.33.

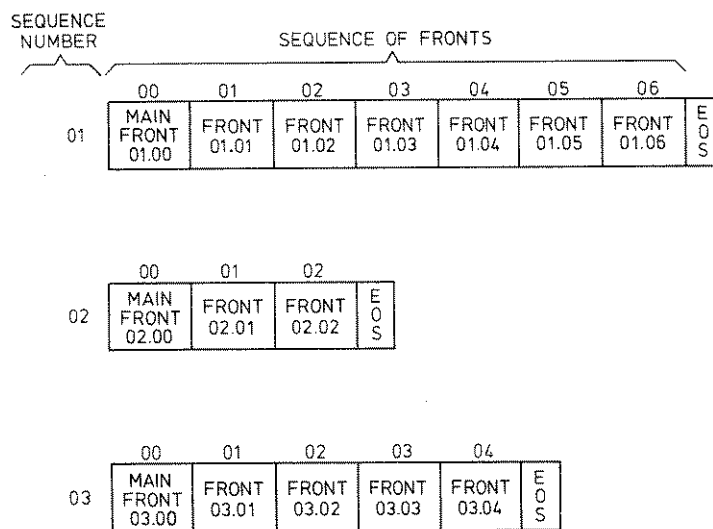

MAT2437A
871001

Figure 4.33 Contents of the front setting memory (Example)

There are two fronts with a special meaning:

∅ contains the actual front setting

9999 is a backup front, which can be used to restore a front that is deleted or overwritten by mistake.

- 1 --
- 2 --
- 3 RECALL

If softkey RECALL is pushed, the front number which is displayed in the softkey text area is made actual. This means that the oscilloscope is set according to the front setting that is stored in the front setting memory. The old front setting is saved in the backup front. After selection of the FRONT NUMBER menu, the displayed front number can be made actual by pressing softkey RECALL.

- 4 ENTER>

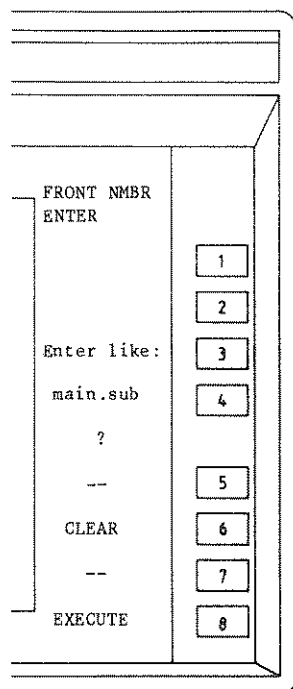

If softkey ENTER is pushed, the FRONT NMBR/ENTER menu is displayed and a front number between FRO. 01.00 and FRO. 99.99 can be entered using the numeric keypad. The selected frontnumber is visible in the softkey text area.

- 4 1 --
- 4 2 --
- 4 3 --
- 4 4 --
- 4 5 --
- 4 6 CLEAR

If an error is made, the selected front number can be cleared by pressing softkey CLEAR.

- 4 7 --

4 8 EXECUTE

By pressing softkey EXECUTE the selected front number is recalled and a RETURN is performed resulting in the display of the FRONT NUMBER menu.

If EXECUTE is pressed after CLEAR the previous front setting remains.

The number is tested against the real setting memory and if the number does not exist or can not be selected, one of the following messages

Selected front doesn't exist.
FRONT number not changed.

or

FRONT 0 cannot be selected because it is the actual front panel setting.

or

Front number cannot go beyond 99.

can be displayed.

5 NEXT

The action of the softkey NEXT depends on the MAIN SEQ setting.

If softkey NEXT is pushed, while SEQ is active, the next higher front number of the selected sequence is displayed in the softkey text area and made actual.

If NEXT goes to a number after the end of the sequence, the first front in the sequence will be made actual and a message

End of sequence detected.
First front of sequence is selected.

is displayed.

If there is only one front in the sequence and softkey NEXT is pushed, a message

There is no sequence to this main front

is displayed.

If softkey NEXT is pushed, while MAIN is active, the next higher main front number is displayed in the softkey text area and made actual.

If there is only one main front programmed, a message

There is only one main front in the memory.

is displayed.

At all NEXT actions the old front setting is saved in the backup front.

6 PREVIOUS

The action of the softkey PREVIOUS depends on the MAIN SEQ setting.

If softkey PREVIOUS is pushed, while SEQ is active, the next lower front number of the selected sequence is displayed in the softkey text area and made actual.

If PREVIOUS goes to a number before the begin of the sequence, the last front in the sequence will be made actual and a message

Begin of sequence detected.

Last front of sequence is selected.

is displayed.

If there is only one front in the sequence and softkey PREVIOUS is pushed, a message

There is no sequence to this main front

is displayed.

If softkey PREVIOUS is pushed, while MAIN is active, the next lower main front number is displayed in the softkey text area and made actual.

If there is only one main front programmed, a message

There is only one main front in the memory.

is displayed.

At all PREVIOUS actions the old front setting is saved in the backup front.

7 MAIN SEQ

With this softkey a selection can be made of the actions of the NEXT and PREVIOUS softkeys. These softkeys can step between main fronts (MAIN) or between fronts in a sequence (SEQ).

Pushing the softkey changes the selection from SEQ to MAIN or reverse. The active selection is displayed intensified.

8 PROGRAM>

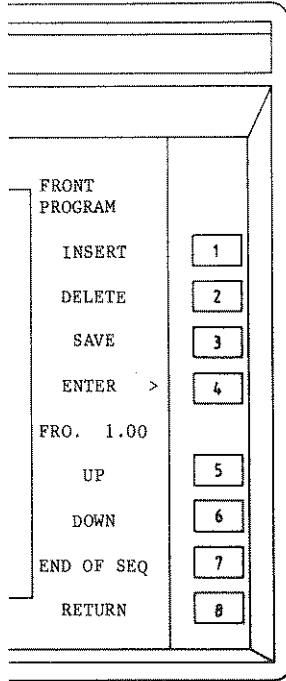

If softkey PROGRAM is pushed, the menu FRONT PROGRAM will be visible on the screen and new front setting sequences can be programmed or existing sequences can be altered.

Depending on the number of programmed fronts, a part of the softkey texts may not be displayed.

8 1 INSERT

If softkey INSERT is pushed, the actual front setting is inserted after the front number which is displayed in the softkey text area. Next the number of the inserted front is displayed.

When the new front setting is inserted, all higher front numbers are increased by one.

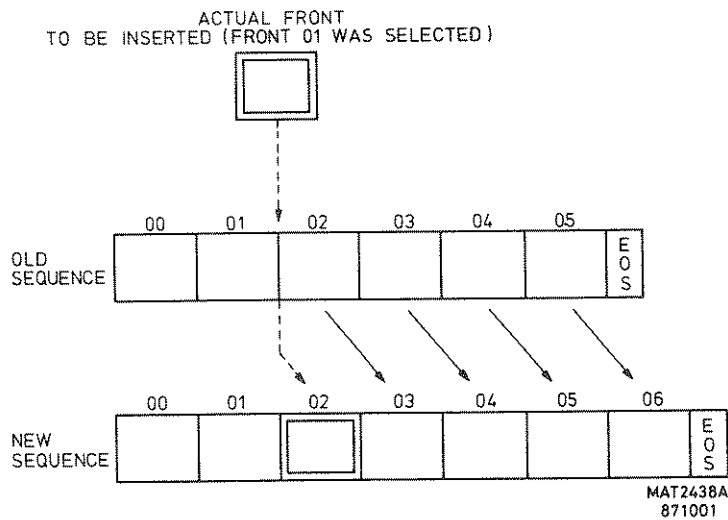

Figure 4.34 INSERT-action.

If there is not enough room in the front setting memory, a message

Not enough memory to SAVE or INSERT front.
DELETE a front before continue.

is displayed.

8 2 DELETE

If a programmed front setting should be removed from a sequence, the number of this front setting has to be selected first.

After pressing softkey DELETE, the selected front setting is removed from the sequence and all higher front numbers are decreased by one.

The deleted front setting is saved in the backup front.

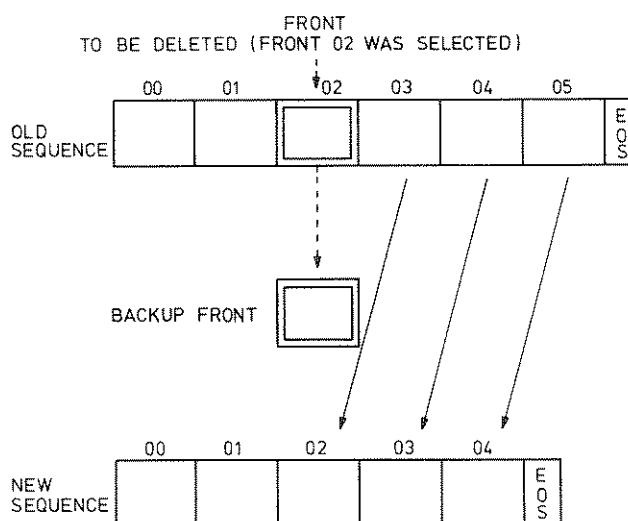

Figure 4.35 DELETE-action.

NOTE: If a main front number is deleted, the complete sequence of fronts is deleted!

8 3 SAVE

If SAVE is depressed, the actual front setting is saved under the number which is visible in the softkey text area. SAVE can only be used to create a main front or to overwrite an already existing front.

The overwritten front setting is saved in the backup front.

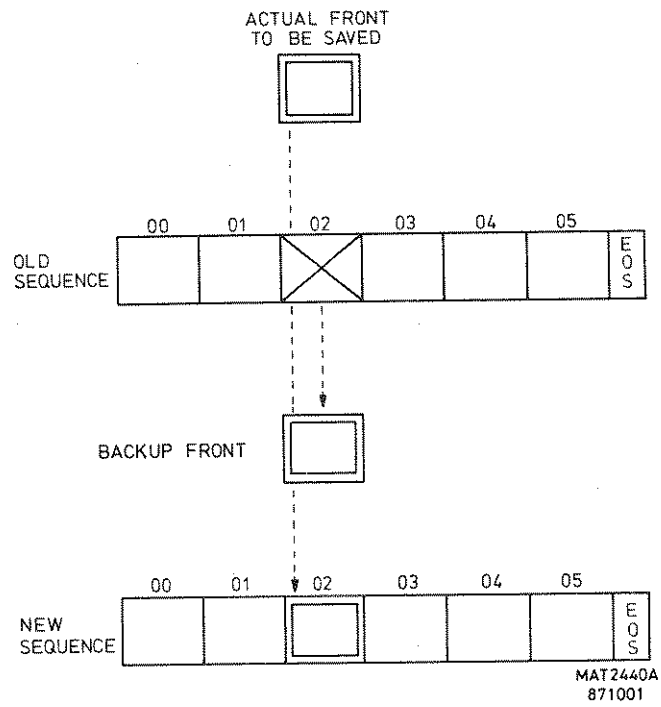

Figure 4.36 SAVE-action.

If there is not enough room in the front setting memory, a message

Not enough memory to SAVE or INSERT front.
DELETE a front before continue.

is displayed.

If SAVE is executed on the backup front, a message
BACK UP FRONT cannot be changed. Action not executed
is displayed.

8 4 ENTER>

FRONT PROG	
ENTER	
Memory for	1
77 fronts	2
Enter like:	3
main.sub	4
?	
--	5
CLEAR	6
---	7
EXECUTE	8

If softkey ENTER is pushed, the FRONT PROG/ENTER menu is displayed and a front number between FRO. 00.00 and FRO. 99.99 can be entered using the numeric keypad. The selected front number is visible in the softkey text area.

8 4 1 --
 8 4 2 --
 8 4 3 --
 8 4 4 --
 8 4 5 --
 8 4 6 CLEAR

IF an error is made, the selected front number can be cleared by pressing softkey CLEAR.

8 4 7 --
 8 4 8 EXECUTE

By pressing softkey EXECUTE the selected front number is entered and a RETURN is performed resulting in the display of the FRONT PROGRAM menu. If EXECUTE is pressed after CLEAR the previous front setting remains.

If a selected front number does not exist, a message

Selected front doesn't exist.
 Number set at last available front in sequence.

is displayed and the last front number in the sequence is selected.

8 5 UP

By pressing softkey UP, the next higher front number of the selected sequence is displayed in the softkey text area. UP functions until the EOS (END OF SEQUENCE) is reached. Then the following message

Begin or end of the sequence reached.

is displayed.

8 6 DOWN

By pressing softkey DOWN, the next lower front number of the selected sequence is displayed in the softkey text area. DOWN functions until the first front in the sequence is reached.

Then the following message

Begin or end of the sequence reached.

is displayed.

8 7 END OF SEQ

If softkey END OF SEQ is pushed, the selected front number becomes the last front number in the sequence and all the fronts after the selected front are deleted.

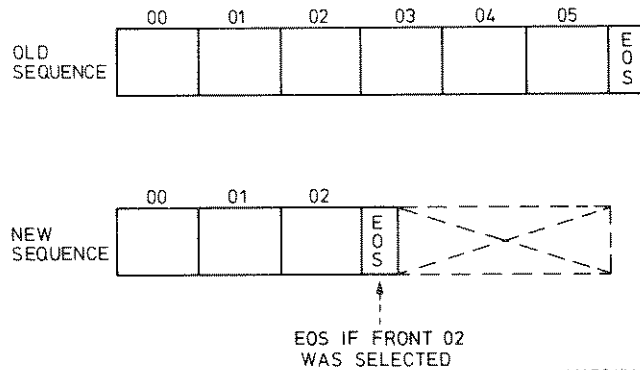

MAT2441A
871001

Figure 4.37 END OF SEQUENCE action.

NOTE: There is no way to restore the fronts that are deleted by the END OF SEQ action.

8 8 RETURN

If softkey RETURN is pushed, the FRONT NUMBER menu is displayed again.

In a number of situations an old front setting is saved in the backup front. This backup front can be made actual again by entering the FRONT NMBR/ENTER menu, keying 9999 and pressing the softkey EXECUTE.

The backup front can also be used to restore a front, which is deleted by mistake.

The example below shows how to do this.

It is assumed that front 13.13 is just deleted by mistake in the FRONT PROGRAM menu.

Key	Comment
RETURN	Return to FRONT NUMBER menu.
ENTER	Enter FRONT NMBR/ENTER menu.
9999	Key backup front number.
EXECUTE	Make backup front actual and return to FRONT NUMBER menu.
PROGRAM	Enter FRONT PROGRAM menu.
ENTER	Enter FRONT PROG/ENTER menu.
13.12	Key front number minus one.
EXECUTE	Call front number 13.12 and return to FRONT PROGRAM menu.
INSERT	Insert actual front behind front number 13.12; so at 13.13.

4.2.12 MISCELLANEOUS FUNCTIONS AND REMOTE MODE

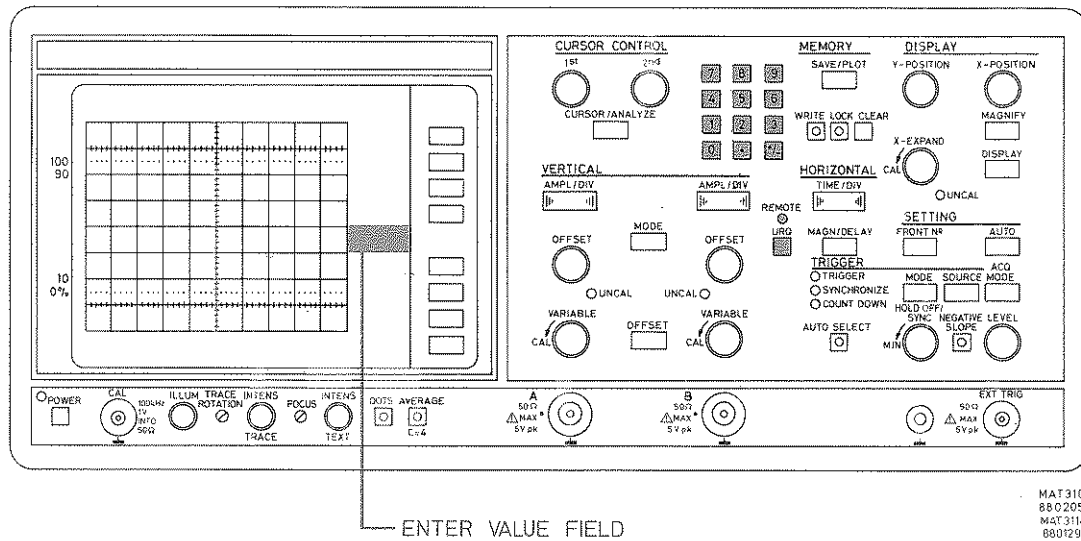

ENTER VALUE FIELD

Figure 4.38 Front panel view.

7	8	9
4	5	6
1	2	3
0	.	+/-

Numeric key pad for data entering after selection of one of the following ENTER functions.

ENTER VERTICAL OFFSET A	4.2.5.2
ENTER VERTICAL OFFSET B	4.2.5.2
ENTER TRIGGER EVENTS	4.2.7.1
ENTER TRIGGER DELAY	4.2.7.1
ENTER FRONT NUMBER	4.2.11.1

If an ENTER menu is selected, the data selected via the numeric keypad will be displayed in the ENTER VALUE FIELD of the softkey text area. Pushing softkey CLEAR, clears this enter value field. If too many digits or a too high value is entered, an automatic clear is performed and a message.

Too many digits: total entry is cleared.

is displayed.

The data entered via the numeric key pad, is activated after pressing softkey EXECUTE.

MAT 3101
880205
MAT 3116
880129

REMOTE

Pilot lamp indicating that the instrument is in its REMOTE-state and that the interface overrules all the manually selected front panel settings. The last with the exception of POWER ON, ILLUM, TRACE ROT, INTENS TRACE, FOCUS and INTENS TEXT and PROBE INDICATION.

Resetting the instrument back to its LOCAL-state can be provided from a controller or by switching the instrument OFF and ON.

URQ

The operator is able to ask an installed option for service by pushing the URQ (user request) pushbutton.

The kind of service which is given then depends on the user's program.

4.2.13 REAR PANEL

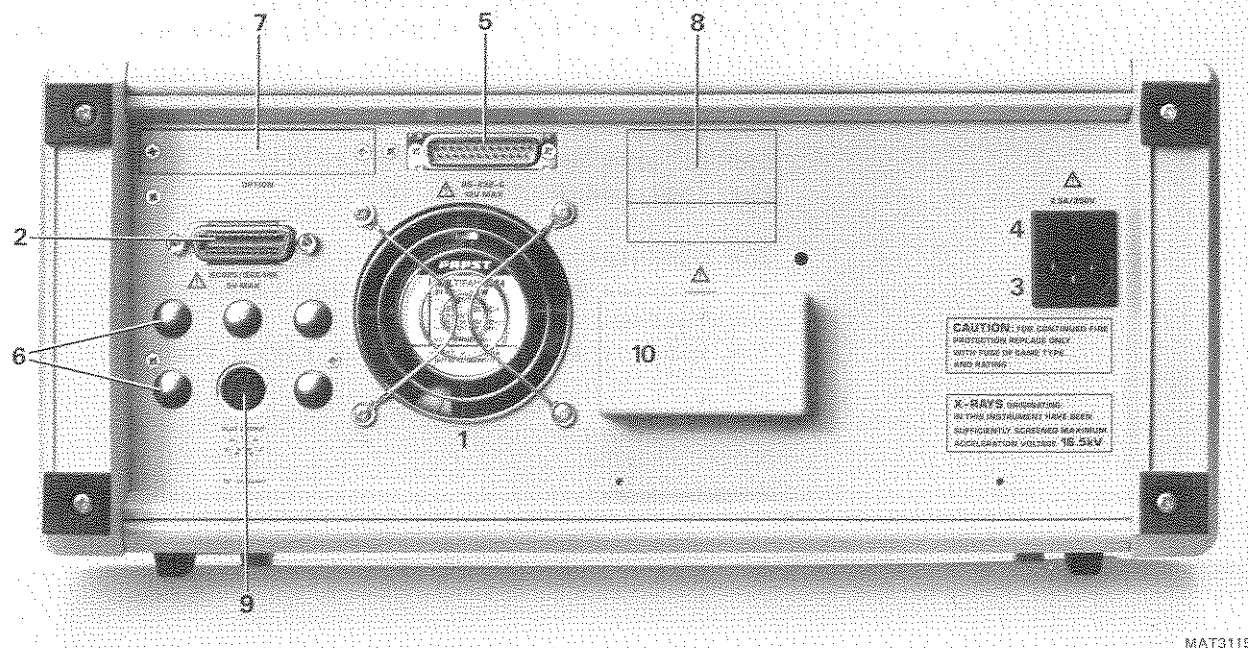

Figure 4.39 Rear panel view.

- 1 - Fan.
- 2 - IEEE-488 connector.
- 3 - Mains input socket (90 V ... 264 Vac, 45 Hz ... 440 Hz). For safety instructions, read section 3.2.2.
- 4 - Mains fuse holder (Fuse rating 2.5 A delayed action). For safety instructions, read section 3.2.2.
- 5 - RS-232C connector.
- 6 - Space for optional BNC sockets.
- 7 - Space for optional connector.
- 8 - Type plate with 12-number code and type number.
- 9 - Analog plot output socket.
- 10 - Memory back - up battery compartment with removable cover. For installation instructions, read section 3.3.

4.3 DETAILED OPERATING INFORMATION

4.3.1 Introduction

Before switching on, ensure that the oscilloscope has been installed in accordance with the instructions given in Chapter 3 and that the various precautions outlined have been observed.

The following sections give more detailed information regarding the specific functions of the instrument. It also gives a suitable starting routine before any measurements are made.

Before reading this chapter, it is recommended that Chapter 4.2., explanation of controls and sockets, is read first.

This detailed information is especially useful for those operators who are not familiar with this type of oscilloscope.

The following subjects are described:

Start up procedure	4.3.2
Use of internal registers	4.3.3
High frequency measurements	4.3.4
Use of probes	4.3.5
OFFSET adjustment	4.3.6
Added mode and common-mode measurements	4.3.7
Triggering	4.3.8
Trigger delay	4.3.9
Time-base acquisition modes	4.3.10
Signal processing modes	4.3.11
Horizontal magnifier	4.3.12
Vertical magnifier	4.3.13
A versus B mode	4.3.14
Analog PLOT-mode	4.3.15

4.3.2 Start-up procedure

Switch the instrument on, check that the power-on lamp is on and that the power-up routine is executed.

At the end of the power-up routine, the instrument is ready to accept input signals on the channel A and B input sockets.

Pushing pushbutton AUTO-SET will set the instrument for a triggered display on the C.R.T. screen. The INTENS controls can be set for a suitable trace and text intensity.

The channel A and B signals are stored now in register R0, which is one of the four internal registers R0, R1, R2 and R3, and the contents of register R0 are displayed. Eight of the ten vertical divisions are visible on the C.R.T. screen.

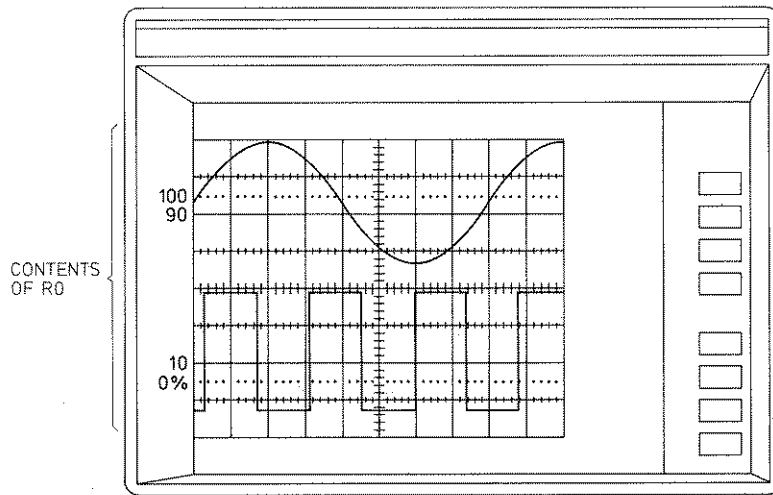

Figure 4.40 Screen of R0 contents in dual channel mode.

Both signals can vertically be shifted over the screen using the (softkey selectable) OFFSET facilities. The signal amplitude and the number of displayed periods can directly be influenced by the AMPL/DIV controls and the TIME/DIV control. The selected settings can be read in the top text area on the C.R.T.

4.3.3 Use of internal registers

The procedure to save information in the internal registers or to clear the contents of these registers is now described.

Four internal registers R0, R1, R2 and R3 are available and in each of these registers a signal from channel A as well as a signal from channel B can be stored.

New signal information will always be stored in register R0 and the contents of this register can later be saved, if required, in one or more of the other three registers R1, R2 and/or R3 using the SAVE/PLOT menu by pressing the SAVE/PLOT pushbutton.

Using the DISPLAY menu by pressing pushbutton DISPLAY, gives the facility to the user to select one or more of the four internal registers to display their contents on the CRT screen. Then displayed signals are overlapping each other on the screen.

To avoid this, the MAGNIFY menu can be selected by pressing pushbutton MAGNIFY to select the Y/5 magnify mode which results in the following display of four registers.

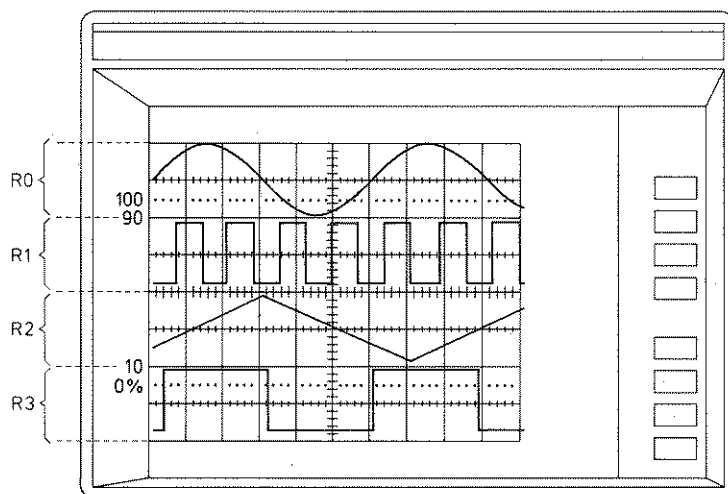

Figure 4.41 Display of four registers in Y/5 mode.

The memory system can be locked by depressing pushbutton LOCK and from that moment on no new signal acquisition can take place. By depressing pushbutton WRITE, the system can be enabled again for new signal acquisition.

Register R0 can be cleared (in WRITE-mode only) using the CLEAR pushbutton.

The other registers can be cleared then by saving the cleared contents of register R0 in the selected register. In other words, clearing a register R1, R2 or R3 can be done by saving the blank contents of register R0 in the selected register.

4.3.4 High frequency measurements

A general measuring set-up for high frequency measurements has the configuration as given in fig. 4.42. This configuration consists of a signal source (the device-under-test), an interconnection cable and the measuring oscilloscope.

The signal from the device under test must be displayed on the oscilloscope screen with the highest possible accuracy.

The figure shows that the internal impedance of the device-under-test and the input impedance of the oscilloscope both have the same value of 50 ohms.

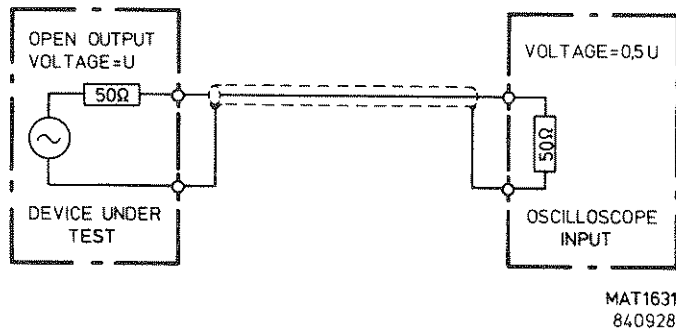

Fig. 4.42 General measuring set-up.

Also the coaxial interconnection cable must have a characteristic impedance of 50 ohms. Impedance deviations will lead to pulse reflections at the oscilloscope input and device-under-test output. This results in measuring faults. The mechanical requirements of the cable are the required length. Of course it must have suitable connectors.

If the device-under-test has an internal impedance different from 50 ohms (e.g. 75 ohms), we must use an impedance adaptor from 75 into 50 ohm.

Such a device is often combined with an attenuator (e.g. 10:1).

Hints for measurements:

- When measuring with the oscilloscope, always ensure that the maximum input voltage is not exceeded. This is especially important when measuring a.c. voltages are superimposed on a d.c. voltage. A too high input voltage can damage the oscilloscope's sampling gate and 50 ohm termination resistor.
- An input voltage that is too high can be attenuated by a 10:1 or 100:1 attenuator piece of good quality that must be inserted between the end of the cable and the oscilloscope's input socket.
- If the energy from the device-under-test (e.g. a transmitter) is too high for the oscilloscope input, a power splitter may be a good solution. By using a power splitter, only a part of the device-under-test energy is applied to the oscilloscope input: the remaining energy is applied to the normal load.

Fig. 4.43 gives configuration where only a quarter of the energy (and half the voltage) from the device under test is applied to the oscilloscope input. Note that the 50 ohm impedance in this system is not disturbed by introducing the power splitter. Other resistance values for the impedances of the power divider make different power division rates possible. The power splitter in this example is built up by a resistor network. In this case, half the energy is dissipated in the splitter.

Other types of splitters making use of transformers do not have these losses; however, they have a limited bandwidth.

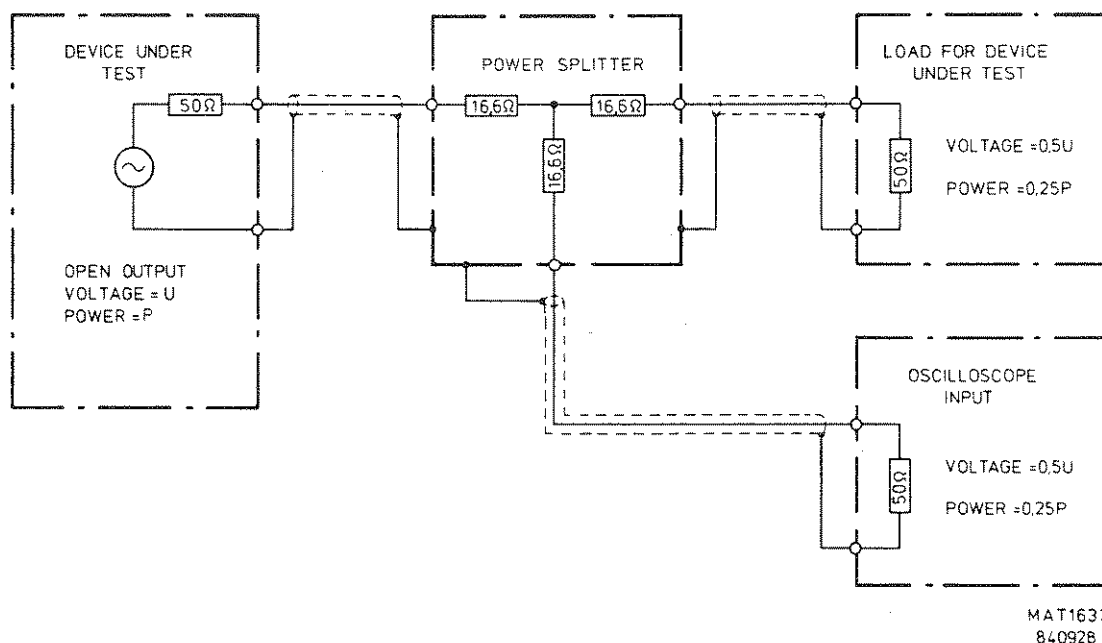

Fig. 4.43 Measuring configuration with power splitter.

4.3.5 Use of probes.

In the explanations in the previous chapter it is more or less assumed that there is a coaxial cable between oscilloscope and one point (e.g. the output socket) of the device-under-test. However in many cases it is necessary to measure different spots on a printed circuit board. For this purpose special 100:1 and 10:1 attenuator probes are available that can be plugged on to the 50 ohm input of the oscilloscope. The input impedance at the probe tip is 5 kilohm for the 100:1 type and 500 ohm for the 10:1 type.

Generally, when using probes it is most important that the earth wire is as short as possible since this presents a certain self-inductance for high-frequency signals. The longer the wire, the higher the self-inductance, with a correspondingly higher signal distortion. Most probes designed for high frequency measurements are delivered with accessories for a short earth connection. An example of this is a miniature coaxial socket that can be soldered on to a printed circuit board and in which the probe tip fits.

4.3.6 OFFSET adjustment

The OFFSET adjustment gives the possibility to give a vertical shift to the signal displayed on the screen. This can be done separately for channel A and B. Adjustment is possible both via a rotary control OFFSET and via softkey menu's. The softkey menu's give the possibility to make shifts in steps of one division, ten divisions (one screen) and in predefined values entered via the numerical keyboard.

The OFFSET gives us the possibility to bring the display of channel A and B at such a d.c. level that an optimal use can be made from the instrument's vertical resolution.

4.3.7 Add mode and common mode measurements

If the ADD mode is selected, the signal voltages of both vertical channels are added.

Depending on the selection of the INVERT-mode of the A or B channel, either the sum or the difference of the input signals is displayed. The ADD mode also enables differential measurements to be made. With these measurements, advantage is taken on the common mode rejection in the ADD mode. When the channel B is selected for inversion (and channel A INVERT not activated), the common mode portions of the signals on input sockets A and B will only be subjected to very slight amplification compared with the differential mode portions (see Fig. 4.44).

In measurements where signal lines carry substantial common mode signals, e.g. hum, the differential mode will largely cancel out these signals and leave the remainder of interest (A-B). The capability of the oscilloscope to suppress common mode signals is given by the Common Mode Rejection (CMRR) factor. To obtain the degree of common mode rejection as specified, channel A and B gains must first be equalised. This can be done by connecting both channels to the CAL output connector, and adjusting one of the vertical VARIABLE controls for minimum deflection on the screen.

When passive attenuator probes are used, a similar equalisation process is recommended by adjusting their compensating control for minimum deflection.

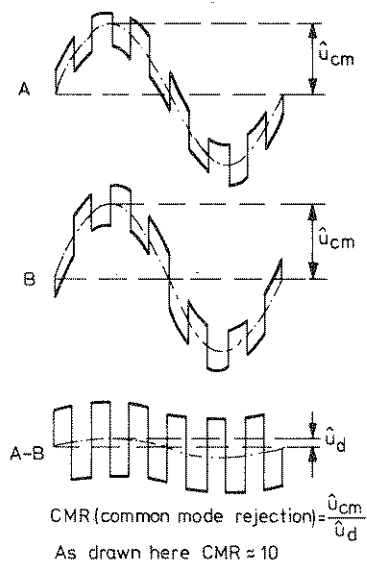

Figure 4.44 Suppression of common mode signals.

4.3.8 Triggering

Trigger sources.

The signal acquisition system can be triggered on one of the vertical channels A or B or on a signal applied to the EXTERNAL TRIGGER input sockets. If you have the choice to trigger on two or even three time-related signals, a stable triggering is only obtained if you select the signal with the lowest frequency to trigger on.

Bear in mind that the trigger circuit is always a.c. coupled, so that triggering is not possible on low-frequency and d.c. signals.

LEVEL control and NEGATIVE SLOPE selection.

In the TRIGGER MODE TRIGGERED and COUNTDOWN we are able to determine the starting point of the signal on the screen with the LEVEL control. In other words: the position of the LEVEL control determines the start of the signal acquisition system.

The circuit behind the LEVEL control functions as follows:

The trigger signal is fed to the input of a comparator and the voltage on the other input of this comparator is determined by the position of the LEVEL control.

If the trigger signal reaches the voltage level of the LEVEL control, a trigger pulse is generated by the comparator and the signal acquisition parts.

In this way, signal acquisition is started at a fixed point of the trigger signal, which means that by using the level control, it is possible to start the acquisition at any point of the waveform.

The NEGATIVE SLOPE pushbutton permits selection of the trigger slope. If NEGATIVE SLOPE is selected, the signal acquisition starts on the negative-going slope of the trigger signal, otherwise on the positive-going slope. NEGATIVE SLOPE can only be selected in TRIGGERED.

TRIGGER MODE selection

The triggering can function in three different modes:

TRIGGER, SYNCHRONIZE or COUNT DOWN. Figure 4.45 indicates the approximate ranges of these modes depending on frequency and voltage of the trigger signal. These values are valid for all possible trigger sources being channel A, B, or EXT and for the sensitivity range SENS HIGH. The voltage levels must be multiplied by a factor of 10 if SENS LOW is active.

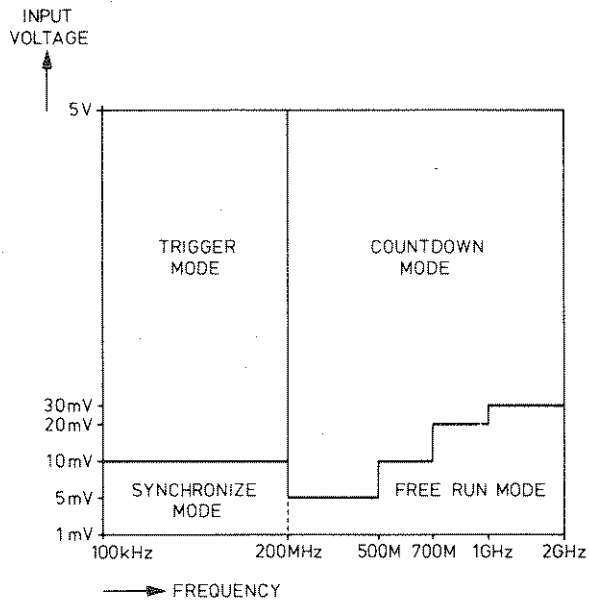

MAT3193
880205

Fig. 4.45 Possible modes as a function of input voltage and frequency

TRIGGERED mode can be selected for displaying repetitive signals with a frequency that does not exceed 200 MHz and with sufficient amplitude.

COUNTDOWN mode can be selected for displaying repetitive signals with a frequency that exceeds 150 MHz and with sufficient amplitude. In this mode the trigger signal is divided by 128 in a prescaler.

If the input signal is such that the signal can not trigger on it or if there is no input signal at all the SYNC'ED mode must be selected. In this mode an input signal can be made stable by means of adjustment of the HOLD OFF/ SYNChronise control.

In the AUTO SELECT mode, the instrument always selects the most suitable out of the three modes that are explained above. Switching from TRIGGER to COUNTDOWN mode happens if the increasing signal frequency passes 160 MHz approximately. Switching backwards occurs if the decreasing frequency passes 150 MHz approximately.

4.3.9 Trigger delay

With the trigger delay facility the time between the trigger moment and the start of the CRT display (left-hand side of the screen) can be adjusted.

Trigger delay can be selected under softkey MAGN/DELAY.

The trigger delay ranges are always in divisions.

The range depends on TIME/DIV setting and the adjusted time base MAGNifier position.

The table below indicates the possible combinations:

	Time base magnifier:					
	*1	*2	*5	*10	*20	*50
time/div possible delay	20us 0...10	10us 1...30	4us 2...90	2us 4...190	1us 8...390	400ns 20...990
time/div possible delay	10us 0...10	5us 1...30	2us 2...90	1us 4...190	500ns 8...390	200ns 20...990
time/div possible delay	5us 0...10	2.5us 1...30	1us 2...90	500ns 4...190	250ns 8...390	100ns 20...990
time/div possible delay	2us 0...10	1us 1...30	400ns 2...90	200ns 4...190	100ns 8...390	40ns 20...990
time/div possible delay	1us 0...10	500ns 1...30	200ns 2...90	100ns 4...190	50ns 8...390	20ns 20...990
time/div possible delay	500ns 0...10	250ns 1...30	100ns 2...90	50ns 4...190	25ns 8...390	10ns 20...990
time/div possible delay	200ns 0...10	100ns 1...30	40ns 2...90	20ns 4...190	10ns 8...390	4ns 20...990
time/div possible delay	100ns 0...10	50ns 1...30	20ns 2...90	10ns 4...190	5ns 8...390	2ns 20...990
time/div possible delay	50ns 0...10	25ns 1...30	10ns 2...90	5ns 4...190	2.5ns 8...390	1ns 20...990
time/div possible delay	20ns 0...10	10ns 1...30	5ns 2...90	2ns 4...190	1ns 8...390	500ps 20...990
time/div possible delay	10ns -1...9	5ns -2...28	2ns -5...85	1ns -10...180	500ps -20...370	200ps -50...940

	Time base magnifier:					
	*1	*2	*5	*10	*20	*50
time/div possible delay	5ns -2...8	2.5ns -4...26	1ns -10...80	500ps -20...170	250ps -40...350	100ps -100...890
time/div possible delay	2ns -4...5	1ns -8...18	500ps -20...60	200ps -40...130	100ps -80...270	50ps -200...690
time/div possible delay	1ns -9...0	500ps -18...6	200ps -45...30	100ps -90...70	50ps -180...150	20ps -450...390

4.3.10 Time base acquisition modes

The time base can function in four different softkey selectable modes. These modes can be selected via the HORIZONTAL ACQ MODE menu over the entire TIME/DIV range of the instrument. The modes are:

RECURRENT mode:

This is the normal time-base mode in which the contents of register R0 is continuously refreshed on the receipt of new incoming trigger signals.

SINGLE mode:

When the SINGLE-mode is selected, the contents of register R0 is refreshed once after a trigger pulse and the selected delay-time, and the refreshed contents of register R0 is displayed on the C.R.T. screen.

As long as the instrument is waiting for a trigger pulse, the softkey text SING.ARMD (SINGLE ARMED) is intensified. After the trigger has occurred, only the word SING. is intensified.

MULTIPLE mode:

When the MULTIPLE-mode is selected, the previously described SINGLE-action is repeated four times. The result of the first SINGLE action in register R0 is copied to register R3, the second result is copied to register R2, the third to register R1 and the fourth stays in register R0. This is independent of the registers being displayed or not. As long as the instrument is waiting for a trigger pulse, the softkey text MULT. ARMD (MULTIPLE ARMED) is completely intensified. After the trigger has occurred, only the word MULT. is intensified.

The number of single actions to be executed is counted down in the top text area on the C.R.T.

MULT EYE

The MULTiple EYE pattern mode is a combination of the mode MULTIPLE and EYE PATTERN: 12K memory is available for optimal display quality. In this mode many functions are preset to a predefined value in order to obtain optimal display quality for eye pattern signals. These presets can be overruled afterwards by the user. The most important presets are:

- X and Y MAGN are set to *1.
- X and Y positions in DISPLAY section are set to zero (CALIBRATE function is activated).
- Register R0 off; R1, R2 and R3 are switched on.
- Cursors and signal processing modes are switched off.
- EYE PATTERN mode is switched on
- Y-POSITION knob is influencing register R1.
- DOT mode is switched on.

4.3.11 Signal processing modes.

The oscilloscope has a number of build-in modes that can be used to display a voltage waveform on the screen with a maximum of quality. These modes are:

AVERAGE mode:

This mode can be reached via VERTICAL MODE and then softkey PROCESSING. AVERAGING is a way to suppress noise without losing bandwidth and can only be used in RECURRENT mode.

Every dot is calculated after every sweep in the following way.

$$\text{new} = \text{previous} + \frac{\text{measured} - \text{previous}}{C}$$

In this formula "previous" is a sample on the same position of the previous sweep.

If C=1 every new dot is the measured dot; AVERAGE if OFF. If C>1, the dot positions change slower.

The bigger C is, the slower the dot positions change. The following values for C can be selected:

C = 2, 4, 8, 16, 32 or 64.

The pushbutton AVERAGE C=4 allows direct selection of the averaging factor C=4. This pushbutton is located under the C.R.T.

Note: AVERAGE is not effective during SINGLE and MULTIPLE SHOT mode.

MULTIPLE SAMPLING mode

This mode can be reached via VERTICAL MODE and then softkey PROCESSING. In this mode you can select via softkeys a value for "M". This value can be 2, 4, 8, 16 or 32. This value represents the number of samples that is taken in sequence before the last sample is used to display one point on the screen.

This mode reduces signal distortion in fast changing signals like square waves. The higher "M" has been chosen, the lower the distortion. A disadvantage of this mode is that the acquisition time increases with the "M"-value.

EYE PATTERN mode

This mode can be reached via VERTICAL MODE and then softkey PROCESSING. This mode is only necessary for displaying eye pattern signals with a minimum of distortion. Eye pattern signals can be measured in data communication systems. Because this mode results in considerable distortion for other signal types, it must only be used for eye patterns. In EYE PATTERN mode the acquisition works with a high resolution of 4096 measured points. This instead of 512 measured points, while the remaining points are obtained by means of calculation.

A register containing a signal that is obtained in EYE PATTERN mode cannot be expanded via the horizontal expansion mode under pushbutton MAGNIFY. However expansion is still possible with the continuous variable control X-EXPAND.

LOW RESOLUTION/FAST DISPLAY

This mode can be reached via HORIZONTAL MODE. Via the softkeys UP and DOWN you are able to select a horizontal resolution of 512, 256, 128 or 64.

A complete picture consists of 4096 points of which normally 512 are obtained by sampling the input signal. The points inbetween are obtained by means of calculation. By means of softkey selection, the number of sampled points can be reduced to respectively 256, 128 or 64. In this way a complete picture is obtained faster; however this may lead to distortion of the displayed signal because the number of measured points decreases while the number of calculated points increases. It may be that we miss certain signal variations. Thus in general a resolution of 512 points is advised. If you press softkey FAST DISPLAY, resolution of 64 is obtained instantly. This mode is only advised to get quickly a rough indication how a signal looks like.

Possible combination of signal processing modes.

	AVERAGE MODE	MULTIPLE SAMPLING	EYE PATTERN MODE	LOW RESOL./ FAST DISPLAY
AVERAGE	-	YES	NO	NO
MULTIPLE S.	YES	-	NO	YES
EYE PATTERN	NO	NO	-	YES
LOW RESOL.	NO	YES	YES	-

4.3.12 Horizontal magnifier

When the continuous horizontal expand (X-EXPAND) control is used, the display on the screen expands horizontally to more than 2x the TIME/DIV setting. The reduced time window provides a more detailed display. Using the X POSITION control, any portion of the trace can be shifted into the display area.

Via the MAGNIFY menu the following horizontal expand factors can be selected:

*1, *2, *4, *8, *16, *32 and *64.

Note: The MAGNIFY menu gives horizontal magnification that is achieved in the display section of the oscilloscope.

The instrument has a second possibility to make horizontal magnification. This is done in the acquisition part via the softkey MAGN/DELAY and results in a change of the time base sweep speed.

However the horizontal display width stays always 10 divisions in this mode.

4.3.13 Vertical magnifier

Via the MAGNIFY menu, three different vertical expand factors, Y/5, Y*1 and Y*5 can be selected.

Y/5

All four registers R0, R1, R2 and R3 can be displayed in their own trace area, each with a vertical trace height of two divisions.

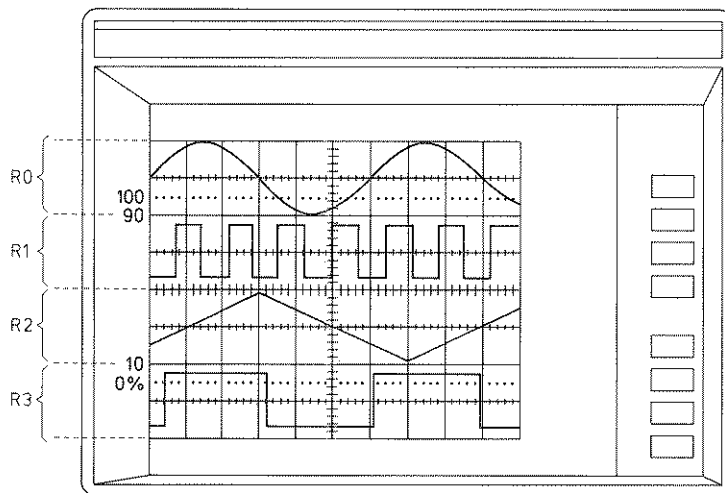

Figure 4.46 Y/5 mode.

In this mode it is also possible to add reduced register texts in the trace area of each register via the DISPLAY menu.

Y*1

This is the normal vertical expand factor, in which each register can be displayed over 10 vertical divisions of which 8 divisions are visible on the C.R.T. screen.

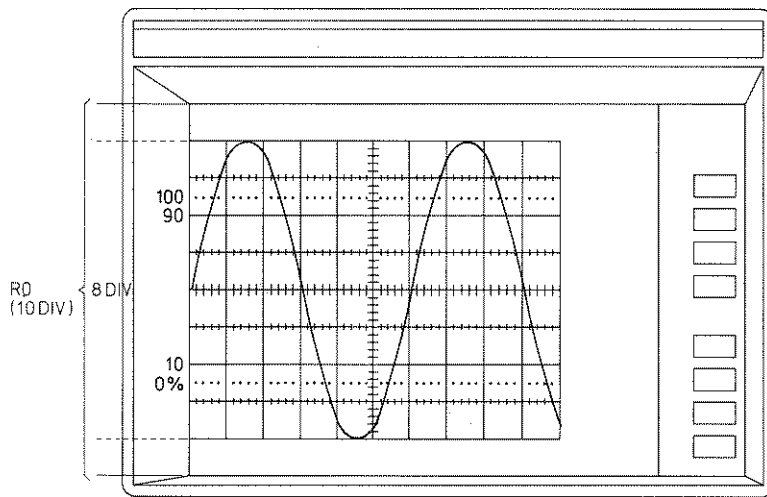

Figure 4.47 Y*1 mode.

Y*5

In this mode a vertical expand from 10 divisions to 50 divisions is possible of which only 8 divisions are visible on the C.R.T. screen.

Using the Y position control, any vertical portion of the trace can be shifted into the trace area of the C.R.T. screen.

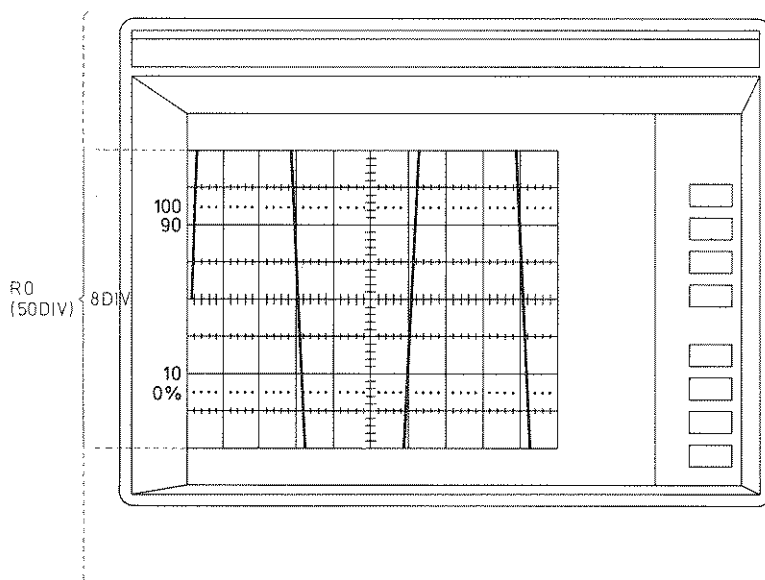

Figure 4.48 Y*5 mode.

4.3.14 A versus B mode

With a A versus B selected, XY display is obtained from the samples derived from the channel A and channel B inputs.

The samples derived from the channel A input signal are used for horizontal deflection and the samples derived from the channel B input for vertical deflection.

This A versus B mode is principally a different mode than the real time X-Y mode in a real time oscilloscope.

In this case it is only a different way of displaying the contents of the registers. The storage of signal information is influenced by the position of the TIME/DIV switch, trigger selection and trigger SLOPE and LEVEL, so the A versus B display of this information is also influenced by these factors.

4.3.15 Analog plot mode

Two different PLOT-modes can be selected:

- Register PLOT via the SAVE/PLOT menu:

The contents of the selected register can be plotted. The Y-POSITION, the X-POSITION, and the X-EXPAND controls and the MAGNIFY selection have no influence.

- Screen PLOT via the DISPLAY menu:

The picture on the trace area of the C.R.T. screen can be plotted including the influence of the Y-POSITION, the X-POSITION and the X-EXPAND controls and the MAGNIFY selections.

The picture will be similar to the picture on the screen.

The X and Y plot outputs on the rear panel of the oscilloscope generate 1 V full memory or 1 V full screen. (See characteristics).

The PEN LIFT output is an open collector output; max 12 V (TTL compatible).

Via the SAVE/PLOT menu the following selections can be done.

- PEN UP "0"
- PEN UP "1"
- PLOT speed
Range: 20 ms/dot ... 2000 ms/dot.
- Register R0, R1, R2 or R3 (only for register PLOT).

During plotting, the oscilloscope is in the LOCK-mode, which means that the contents of all registers cannot be changed.

In case of dual channel plotting, first channel A will be plotted and then channel B.

The PLOT operation is provided with a short delay at the start and end of the action to give sufficient time for manual pen positioning if no automatic pen lift function is available on the recorder.

If the SINGLE-shot mode and register plot is selected, the AUTO PLOT function can be activated.

The contents of register R0 is then automatically plotted after each refreshment of the register when a valid trigger is received.

The progress of the plotting is indicated by a dot on the C.R.T. screen, which moves from the left to the right and which is displayed in the bottom text area.

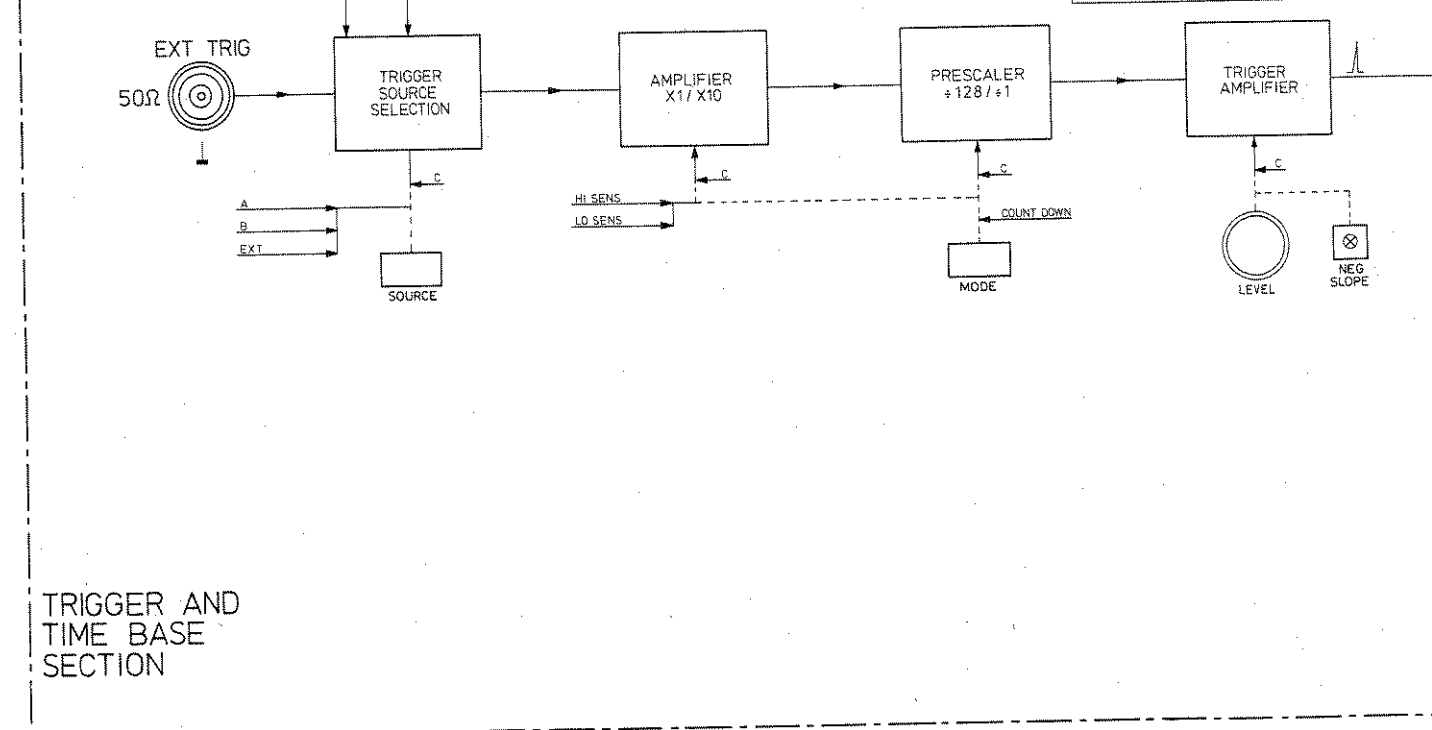
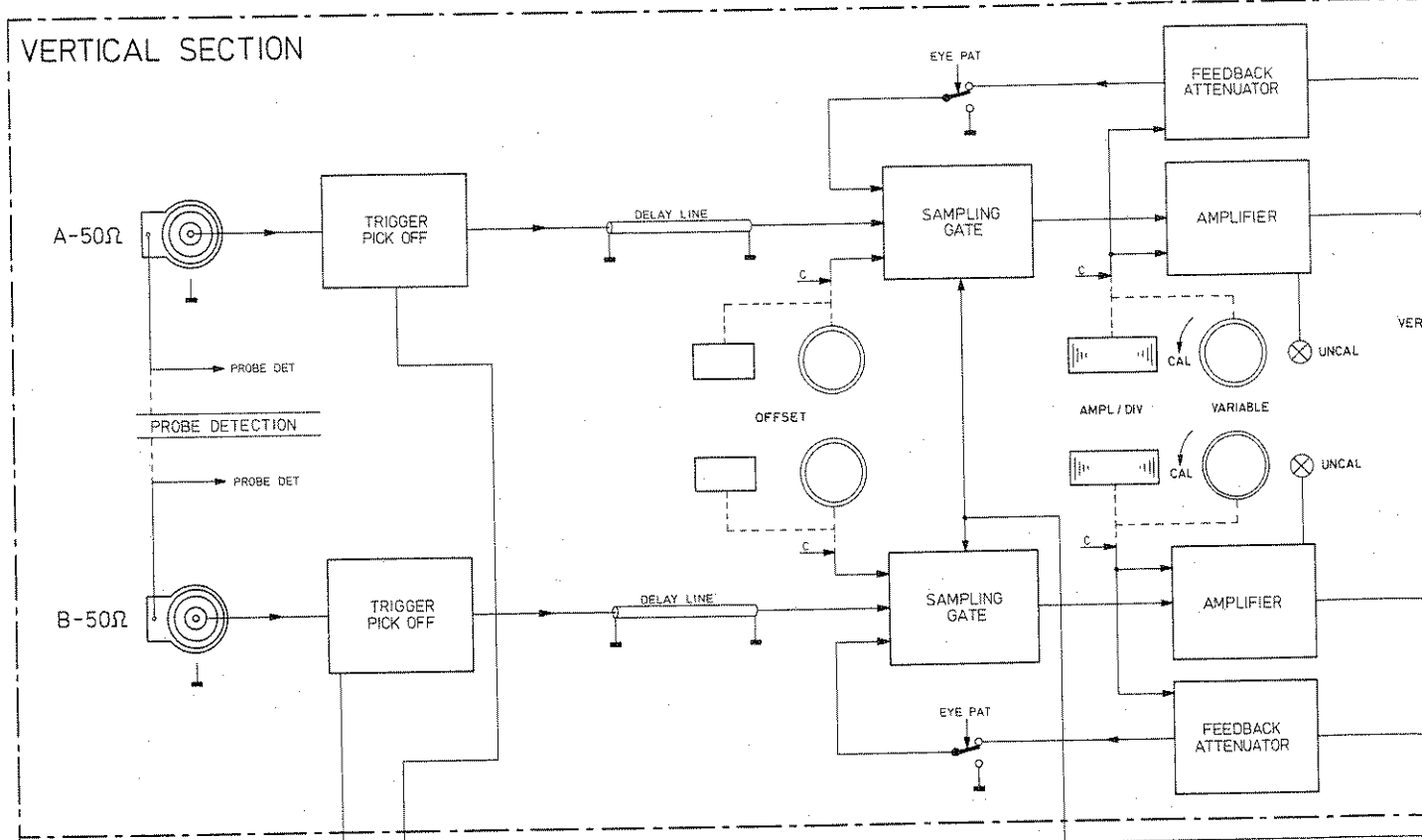

CONVERSION AND PROCESSING SECTION

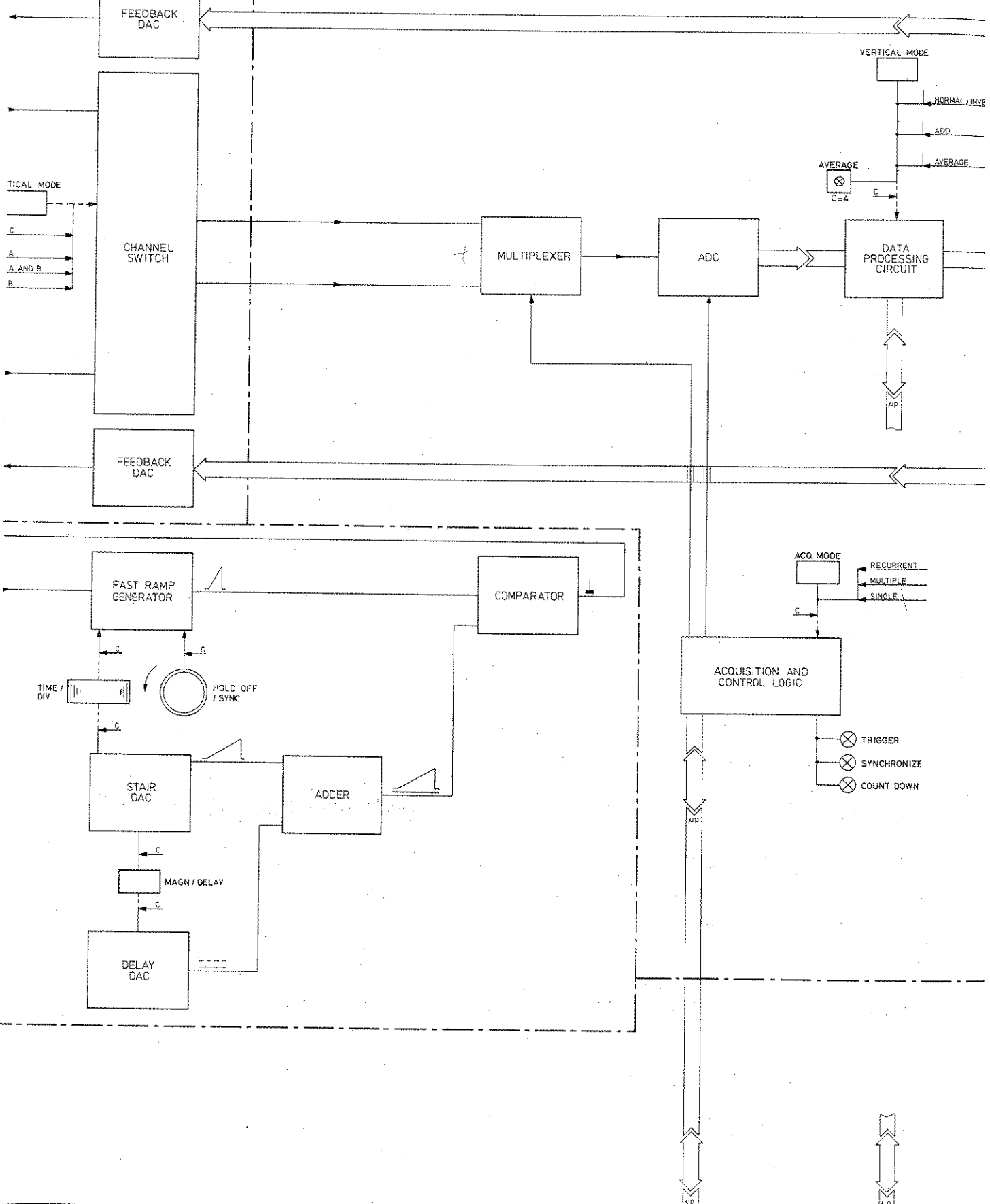

STORAGE SECTION

DISPLAY SECTION

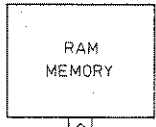
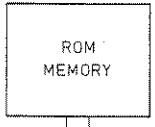
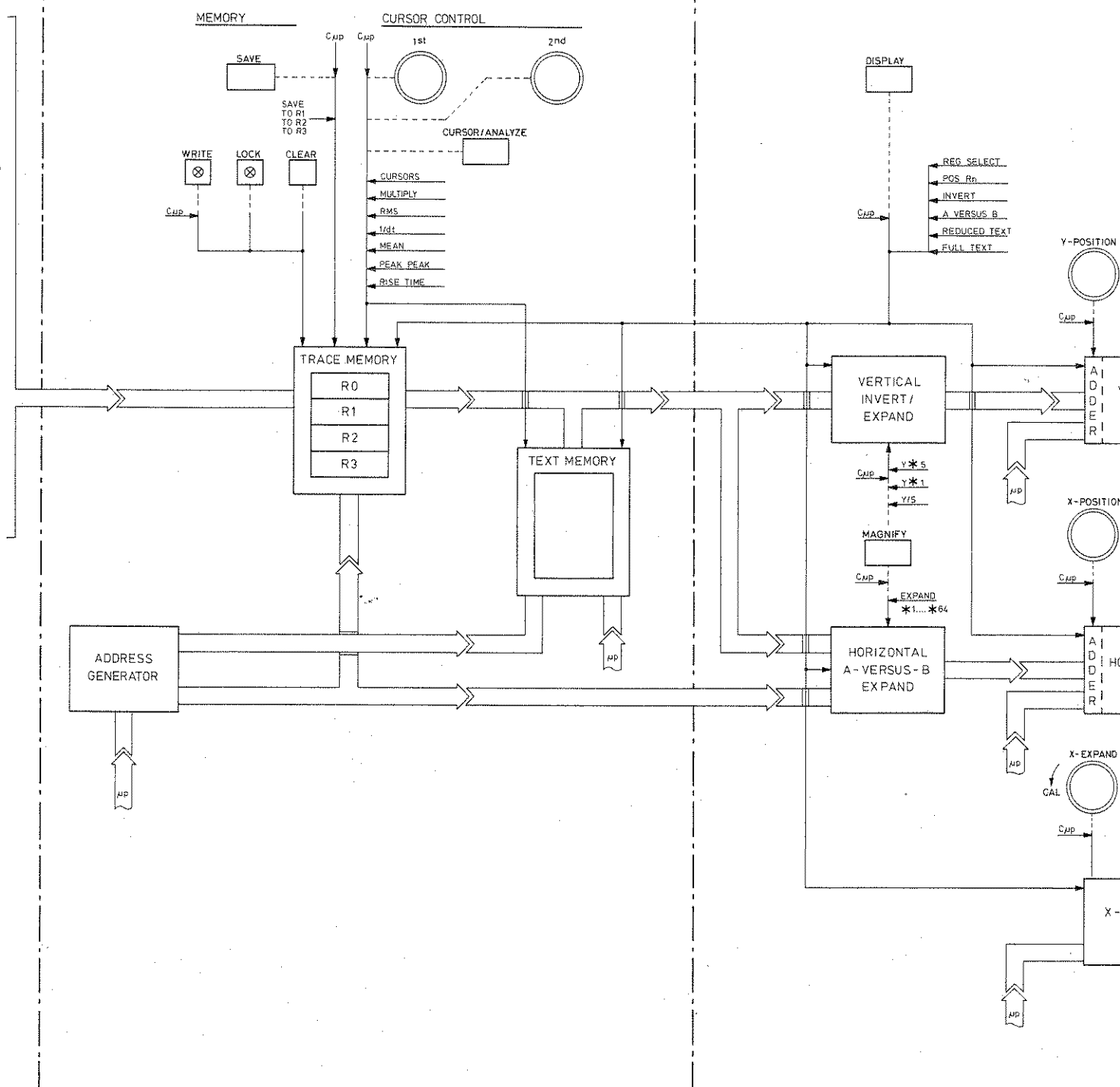

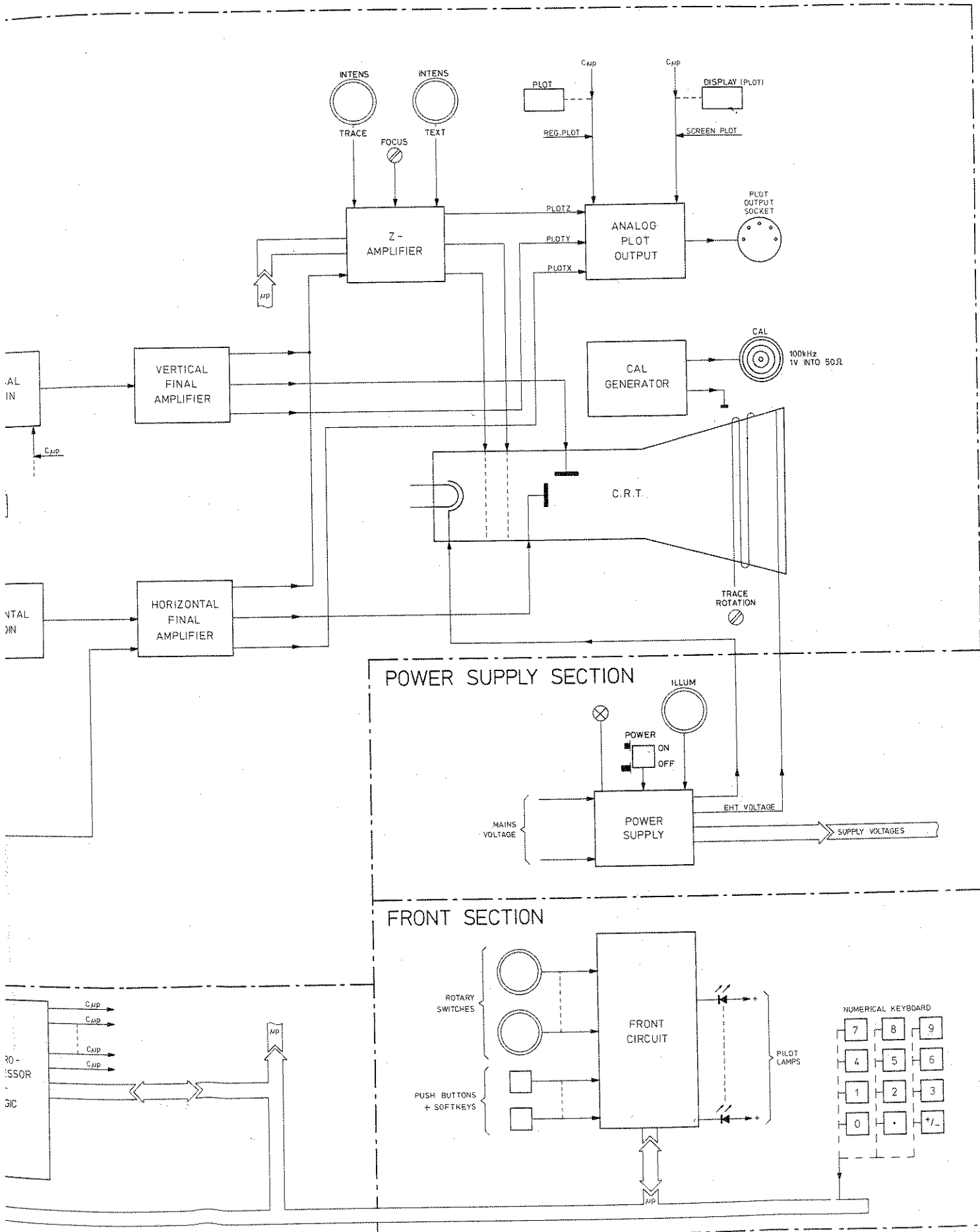

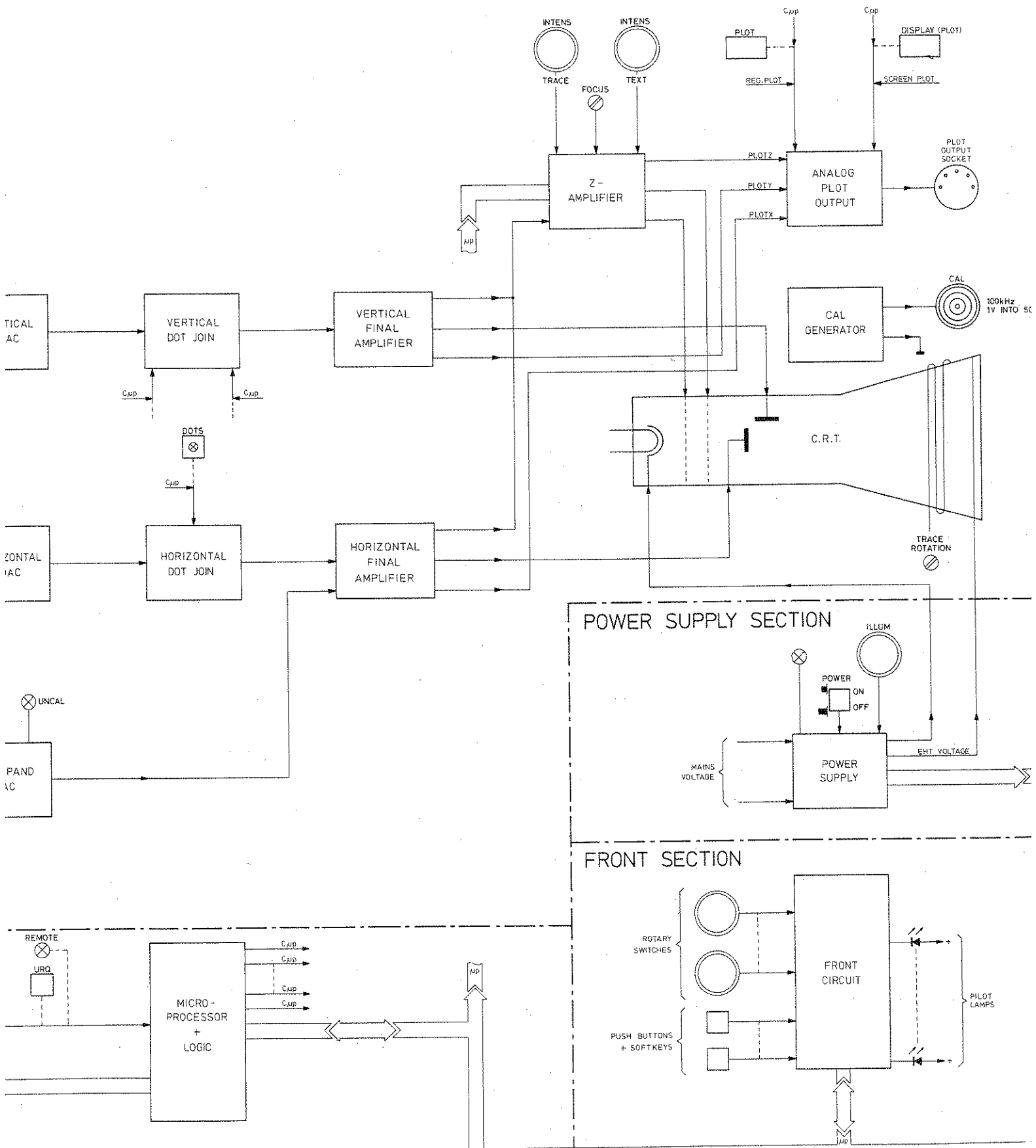

4.4 PRINCIPLE OF OPERATION

In this section, the principles of operation are discussed at block diagram level, with special emphasis being applied to those parts of the circuit that differ from normal oscilloscope practice; i.e. the digital storage and control facilities.

4.4.1 General

This digital storage oscilloscope comprises the following sections:

- a signal acquisition section which can be divided in a vertical section, a trigger and time base section and a conversion and processing section.
- a storage section
- a display section
- a control section
- a front section
- a power supply section

Note: almost all the controls of this oscilloscope are read by a microprocessor. The microprocessor on its turn controls the relevant circuitry in the instrument. This occurs via the CONTROL SECTION. Where this happens it is indicated with C--> in this blockdiagram.

4.4.2 The signal acquisition section

Vertical section

The vertical section consists of two channels A and B. Because both channels are identical, only channel A is explained in this description.

The input signal must be applied to the N type input socket A. This input socket is provided with a pin for the PROBE DETECTION. The pin is connected with the microprocessor system of the oscilloscope. If a probe with an indication ring is connected to the oscilloscope's input, the microprocessor knows the type of probe. As a result of this, the CRT read-out of the input sensitivity is adapted to the attenuation factor of the probe.

The channel A input signal is applied to the TRIGGER PICK OFF. This block incorporates a transformer that picks off a small part of the input signal for triggering of the time base. Because of the fact that a transformer is used, the trigger channel is a.c. coupled. Behind the trigger pick off, the signal is applied to a 30 ns DELAY LINE that compensates for propagation delays in the trigger circuits. As a result of this, it is possible to observe also the leading edge of fast rising signals.

The output signal of the DELAY LINE is applied to the input of the SAMPLING GATE. This gates takes samples of the input signal at regular time intervals. The sample moments are determined by sample pulses generated in the TRIGGER AND TIME BASE SECTION. The SAMPLING GATE receives also the adjustable d.c. OFFSET voltage that gives an adjustable vertical shift of the input signal. The input signal of the SAMPLING gate is added with a signal from a feedback loop. This feedback is the inverted value of the preceding sample that is already stored in the instrument's memory. Because the contents of the memory is digitised, the feedback loop contains the block FEEDBACK DAC for conversion back to analog.

The loop gain is normally unity for the best possible drift reduction and a high dynamic range. However if the input sensitivity is 1 or 2 mV/div, the loop gain is decreased in order to suppress noise. In the EYE PATTERN mode the feedback loop is not operative and the feedback input of the SAMPLING GATE is constantly at 0 volt. The result is a reduction of stability, accuracy and dynamic range

The SAMPLING GATE is followed by an a.c.-amplifier that has an adjustable gain in order to make the AMPL/DIV steps and the VARIABLE gain.

In parallel with the amplification factors, the FEEDBACK ATTENUATOR in the feedback loop is adjusted to keep the loop gain at unity.

The output signals of the AMPLIFIER of channel A and B are both applied to the CHANNEL SWITCH. In this block the selection between channel A only, channel B only or channel A and B together is done. From the CHANNEL SWITCH the A and B signals are routed to the CONVERSION AND PROCESSING SECTION where they are digitised and stored.

Trigger section

This section makes it possible to start the FAST RAMP GENERATOR at an adjustable level of the signal displayed via vertical channel A or B or via a signal applied to the EXTERNAL TRIGGER input socket. The block TRIGGER SOURCE SELECTION permits selection between channel A, channel B or input EXT TRIG as trigger source. The selected trigger source is applied to an AMPLIFIER with amplification factors of x1 and x10. The x1 amplification is activated if LOW SENSITIVITY has been selected. If HIGH SENSITIVITY has been selected the amplification is x10. After selection and amplification, the signal is applied to the PRESCALER :128/:1. This block divides the frequency by 128 if the COUNTDOWN mode is active. This division is necessary if the frequency of the trigger signal exceeds 160 MHz, because the TRIGGER AMPLIFIER can not work properly on these signals. Prescaling is not necessary for signals under 160 MHz: in this case the signal is applied directly to the TRIGGER AMPLIFIER. The LEVEL control of the TRIGGER AMPLIFIER determines at what level of the trigger signal a trigger pulse is generated at the output of the trigger amplifier. Via the pushbutton NEGATIVE SLOPE can be selected if this trigger pulse occurs at the positive or at the negative slope of the trigger signal.

Time base section

The sampling principle that is used in this oscilloscope is called SEQUENTIAL SAMPLING. This means that samples are taken from the channel A and/or B input signals in the VERTICAL SECTION at regular time intervals. These time intervals are determined by the time base. The input signals are sampled during the time that the sampling pulse generated by the time base is present. How the sampling pulses are generated is illustrated with the following figure.

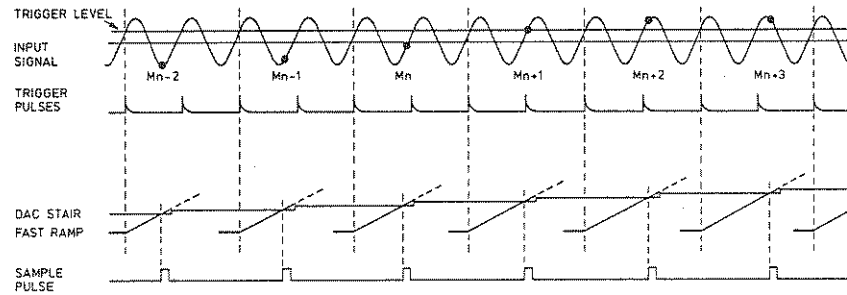

Figure 4.50 Sequential sampling principle.

MAT3116

At the moment that the TRIGGER AMPLIFIER applies a trigger pulse to the FAST RAMP GENERATOR, the latter starts to generate a fast ramp. This fast ramp is a sawtooth voltage of which the sweep time can be adjusted with the TIME/DIV control. After every sweep there is a certain time - of which the duration can be adjusted with the HOLD OFF/SYNC control - that the FAST RAMP GENERATOR does not respond to a trigger pulse. The COMPARATOR compares the fast ramp with a relatively slow-rising "staircase" signal that is generated by the STAIR DAC. At the moment where the fast ramp has the same voltage level as the slow-rising staircase, a sampling pulse is generated and applied to the sampling gates of vertical channel A and B. The staircase is increased every time after a sample has been taken. As a result of this, the sampling moment of the input signal (moment M_{n-1} in fig. 4.50.) is shifted in phase compared with the sampling moment of the preceding sample (moment M_{n-2} in fig. 4.50.). Comparing the phase of the signal where the succeeding samples M_{n-2} , M_{n-1} , M_n , M_{n+1} , M_{n+2} and M_{n+3} occur, shows us that every state of the sine-wave input signal is captured if we take enough samples. So many signal periods are necessary to capture one complete period in the instrument's memory. The advantage of this process is that the circuitry of the vertical channels behind the sampling gate only has to deal with low-frequency signals. The only parts that carry very high frequency signals are TRIGGER PICK OFF, DELAY LINE and SAMPLING GATE in channel a and B, the TRIGGER SOURCE SELECTION and $x1/x10$ AMPLIFIER.

The instrument's DELAY function is achieved by a combination making the rising of the staircase signals faster (less delay) or slower (more delay) and adding this signal to an adjustable d.c. voltage from the DELAY DAC. The addition of the staircase and the d.c. voltage is done in the ADDER. The higher the d.c. voltage, the longer the delay.

Conversion and processing section

In the conversion and processing section the vertical input signals are digitised, processed and stored in a digital memory. This is done by an Analog to Digital Converter, which receives the vertical input signals via a MULTIPLEXER from the VERTICAL CHANNEL SWITCH.

This MULTIPLEXER is provided with track and hold circuits, which can hold samples that are taken from both channels at the same moment.

The samples are converted then in sequence by the ADC.

Data from the ADC is processed by the DATA PROCESSING CIRCUIT, which performs e.g. the softkey selectable AVERAGE function.

Data from the DATA PROCESSING CIRCUIT is transported to the STORAGE SECTION.

The MULTIPLEXER and ADC are controlled by the ACQUISITION AND CONTROL LOGIC.

The ACQUISITION AND CONTROL LOGIC performs the following horizontal modes:

- RECURRENT
- MULTIPLE
- SINGLE

The ACQUISITION AND CONTROL LOGIC also controls the pilot lamps TRIGGER, SYNCHRONIZE and COUNTDOWN.

The ACQUISITION AND CONTROL LOGIC is controlled by the microprocessor system, which also controls the DATA PROCESSING CIRCUIT.

4.4.3 The storage section

After each conversion of a sample into a 10-bits digital code, the code will be stored in a digital memory in the DATA PROCESSING CIRCUIT. The capacity of this memory is 4096 digital values, which is a complete picture of ten horizontal divisions. This memory is configured as a shift register.

When a number of samples is converted and stored in this digital memory, this memory contents is copied into register R0 of the TRACE MEMORY. The number of samples depends on the time base setting. The addresses for the TRACE MEMORY are generated by the ADDRESS GENERATOR under microprocessor system control.

It is possible to save the contents of TRACE MEMORY register R0 in one of the other registers R1, R2 or R3 by means of the softkey functions under the SAVE/PLOT pushbutton.

Each of the four registers is able to store 4096 digital 10-bit codes in single channel mode. With both input channels ON, each register capacity is equally divided into 2048 digital 10-bit codes for each input channel.

The TRACE MEMORY can be cleared by pushbutton CLEAR, locked by pushbutton LOCK and enabled for new signal acquisition by pushbutton WRITE.

A TEXT MEMORY is also part of the storage section. In this TEXT MEMORY all display texts are stored under microprocessor control.

Cursor control can be operated via the frontpanel controls 1st and 2nd and the softkey menu under the frontpanel CURSOR/ANALYSE pushbutton. It is a microprocessor controlled function which uses the contents of the TRACE MEMORY as input for calculations and the determination of the position of the cursors, and which uses the TEXT MEMORY to store the cursors and the calculation results.

4.4.4 The display section

This section controls the display of the contents of registers R0, R1, R2 and R3 as well as the display of text on the CRT screen under the control of softkey functions.

The trace and text data is separated in a vertical and a horizontal component and applied to two signal paths for vertical and horizontal deflection.

Horizontal deflection

Each address of a register corresponds to a specified vertical line of the CRT display along the X-axis; i.e. the display of 10 divisions into 4000 lines.

The address sequence generated by the ADDRESS GENERATOR can be expanded in the HORIZONTAL A versus B / EXPAND circuit and influenced by an additional horizontal position information from the X-POSITION control before they are applied to a HORIZONTAL DIGITAL TO ANALOG CONVERTER.

To provide the discrete steps for the horizontal time base display, the output of the DAC is a linear staircase voltage, which is applied to the horizontal final amplifier via a DOT JOIN filter and from there to the horizontal deflection plates of the C.R.T.

Via the X-EXPAND DAC an horizontal expand information is applied to the HORIZONTAL FINAL AMPLIFIER for an additional horizontal expand. This information comes from the front panel X-EXPAND control.

Vertical deflection

The contents of each trace register is 4096 10-bit digital codes, each capable of indicating one out of 1024 different signal amplitudes.

These 10-bit digital codes can be inverted or expanded in the VERTICAL INVERT/EXPAND circuit and influenced by an additional position information from the Y-POSITION control before they are converted into the analog representation of the measured input signals by means of a VERTICAL DIGITAL TO ANALOG CONVERTER. From here the signal is applied to the VERTICAL FINAL AMPLIFIER and the vertical deflection plates of the C.R.T. via a VERTICAL DOT JOIN filter.

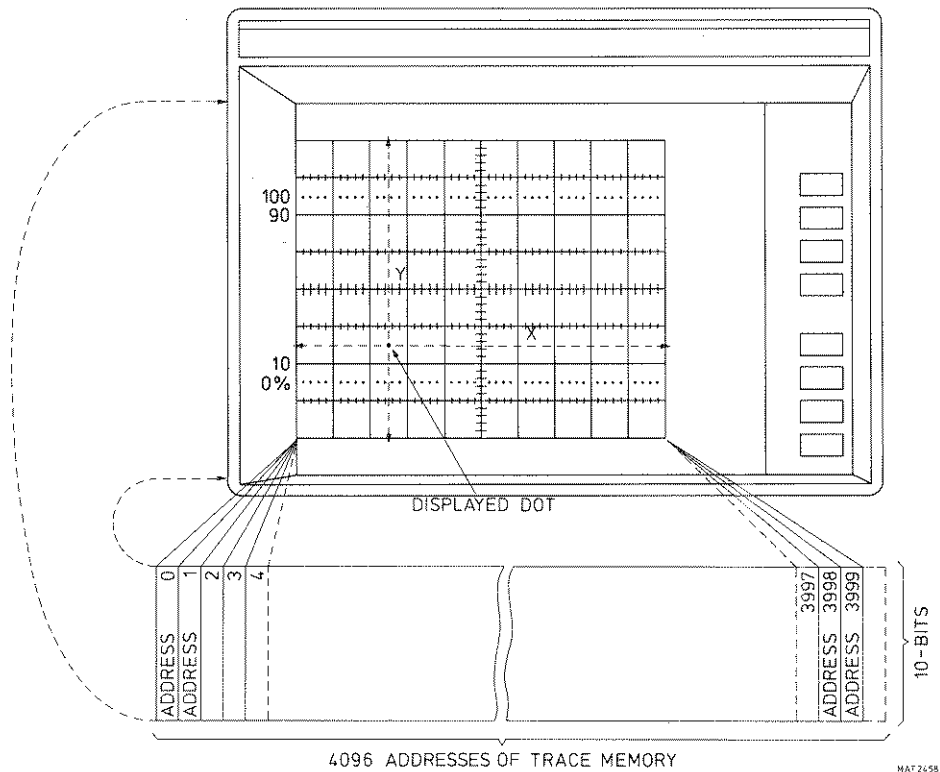

Figure 4.51 Display of trace memory contents.

Display functions

With the pushbutton DISPLAY, a softkey menu is activated which makes selection of the following functions possible:

- Register selection
- POSITION selection: assignment of the frontpanel controls Y-POSITION, X-POSITION and X-EXPAND to a selected register and channel.
- Register INVERT
- A versus B display
- Reduced register text display
- Full register text display

With pushbutton MAGNIFY, a softkey menu is activated for the following functions:

- HORIZONTAL EXPAND *1...*64
- VERTICAL EXPAND Y*5, Y*1 or Y/5

Z-control

The Z trace blanking/unblanking signal for the C.R.T. depends on a number of factors, like register selection, A versus B or X=t display, dot join, text and so on.

The Z-AMPLIFIER is therefore controlled by the microprocessor, a control signal from the vertical and horizontal signal path, the frontpanel INTENSITY controls and the frontpanel FOCUS control.

Plot

Signals PLOT X, PLOT Y and PLOT Z are applied to the ANALOG PLOT OUTPUT circuit and from there to the PLOT OUTPUT socket on the rear panel.

Via the SAVE/PLOT menu a "register plot" function can be selected and via the DISPLAY menu a "screen plot" function can be selected.

Cal

A CAL GENERATOR generates a 1 Vpp/100 kHz signal for calibration purposes (if terminated into 50 ohm).

4.4.5 The control section

The control signals which are routed to the various circuits are indicated with "C -->" for the MANAGEMENT INTERFACE and with "CuP -->" for the MICROPROCESSOR.

A MICROPROCESSOR system including a ROM MEMORY for the system program and a RAM MEMORY for the variable data is controlling the instrument.

The following functions are under its control:

- Watching the frontpanel rotary switches
- Reading the actual front panel keys and softkeys and displaying the actual softkey functions on the C.R.T. screen
- Setting of the acquisition circuits via the MICROPROCESSOR MANAGEMENT INTERFACE
- Performance of calculations
- Control of frontpanel pilot lamps
- CRT display control for traces as well as for text
- Plot output control.
- Performance of the AUTO-SET function (with pushbutton AUTO)
- Programming of the front settings (with pushbutton FRONT No)

Microprocessor management interface

All the frontpanel controls, except the CRT CONTROLS, ILLUM, INTENS, INTENS TEXT, TRACE ROT and the POWER ON switch, are activating the various circuits via the microprocessor control circuits and the MICROPROCESSOR MANAGEMENT INTERFACE.

In this MANAGEMENT INTERFACE also various control signals for the signal acquisition are generated under command of the microprocessor.

Interfaces

The pilot lamp REMOTE as well as the pushbutton URQ can be used when the IEEE-488/RS232-C interface card is operative.

4.4.6 The front section

All the frontpanel rotary switches, pushbuttons, numerical keyboard and softkeys inform the MICROPROCESSOR system about the user's settings via the FRONT CIRCUIT. The MICROPROCESSOR controls the frontpanel pilot lamps via this FRONT CIRCUIT.

4.4.7 The Power supply section

The power supply, which accepts most mains voltage ranges in use (90-264 Vac), produces the various voltages which are used for the electronic circuits, the EHT voltage for the CRT inclusive.

4.5 BRIEF CHECKING PROCEDURE

4.5.1 General information

This procedure is intended to check the oscilloscope performance with a minimum of test steps and actions required.

It is assumed that the operator doing this test is familiar with oscilloscopes and their characteristics.

WARNING: Before switching-on, ensure that the oscilloscope has been installed in accordance with the instructions mentioned in Chapter 3.

NOTE: The procedure does not check every facet of the instrument's calibration; rather, it is concerned primarily with those parts of the instrument that are essential to measurement accuracy and correct operation.

Removing the instrument covers is not necessary to perform this procedure. All checks are made from the outside of the instrument.

If this test is started a few minutes after switching-on, bear in mind that test steps may be out of specification, due to insufficient warm-up time.

The check is set up in a logical sequence. The complete flow should be followed carefully to prevent repeating all control settings and input signals at the start of every single check.

For a complete check of every facet of the instrument's calibration, refer to the section "Performance Check" in the service manual (for qualified persons only).

No additional test equipment is necessary apart from a coaxial cable with BNC-connectors and an adaptor from BNC into N-type of connector.

4.5.2. Preliminary settings

- Switch the oscilloscope on and check if the power-up routine is executed.
- Connect the CAL signal from the CAL output socket to the A input via the coaxial cable and the BNC into N adaptor.
- Press the green pushbutton AUTO; a square wave should become visible on the CRT screen.
- Set the two INTENS controls for the right intensities for trace and text.
- Adjust the FOCUS screwdriver control for a well defined sharp trace and text.
- Set the ILLUM control for the right intensity of the graticule illumination.

4.5.3. Trace rotation

- Disconnect the channel A input signal; a straight line should become visible on the screen.
- Set the trace of channel A in the vertical mid-position of the screen by turning the channel A OFFSET control.
- Check that the trace lies in parallel with the horizontal graticule lines; if necessary, readjust the TRACE ROT screwdriver control.
- Connect the channel A input signal again: a square wave becomes visible again on the screen.

4.5.4 Vertical

As channels A and B are identical, only the procedure for channel A is described.

4.5.4.1 Vertical mode

- Press the green pushbutton AUTO; a square wave with a vertical amplitude of 5 divisions becomes visible on the screen provided that the vertical sensitivity is 200 mV/div.
- Press pushbutton VERTICAL MODE. Check that channel A is selected.
- Press softkey A and B. Channel B is visible as a straight line.
- Position the channel B line in the vertical mid of the screen with the OFFSET control.
- Press pushbutton VERTICAL MODE.
- Press softkey ADD; only the square wave is visible.
- Press softkey A.
- Press softkey A-INVERT; the square wave is inverted.
- Press softkey A-INVERT; the square wave is normal again (invert off)
- Press softkey PROCESSING; the VERTICAL PROCESSING menu is visible.
- Press softkey EYE PATtern and check that the amplitude of the square wave decreases a little. The belonging softkey text is intensified now.
- Press softkey EYE PATtern again and check that the amplitude of the square wave is again 5 divisions. The softkey text dims again.
- Press softkey AVERAGE; the vertical AVERAGE menu is visible.
- The softkey menu gives the possibility to select "C"-values between 2...64. Check that suppression of noise on the displayed square wave increases with the "C"-value.
- Press softkey OFF.
- Press softkey RETURN.
- Press softkey MULTiple SAMpling; the vertical MULT SAMPL menu is visible.
- The softkey menu gives the possibility to select "M"-values between 2...32. Check that the time between two succeeding screen updates increases with the "M"-value.
- Press softkey OFF.
- Press softkey RETURN.
- Press softkey RETURN; the VERTICAL MODE menu appears.

4.5.4.2 Vertical offset

- Press pushbutton VERTICAL OFFSET. You are in the vertical OFFSET menu.
- Turn the A OFFSET to the left until the warning "A-OFFSET out of range" appears in the bottom of the CRT.
- Press softkey AUTO and check that the square wave becomes visible approximately in the vertical mid of the screen.
- Turn the A OFFSET to the left until the warning "A-OFFSET out of range" appears in the bottom of the CRT.
- Press softkey ZERO and check that the bottom of the square wave becomes visible in the vertical mid of the screen.
- Press softkey ADJUST and thereafter UP or DOWN and check that the signal moves up or down in steps of 1 div (softkey function DIV intensified) or 1 screen/ 8 div (softkey function SCREEN intensified)
- Press softkey ENTER
- Enter via the numerical keyboard: 0,6 (volt)
- Press softkey EXECUTE and check for a vertical shift of 3 div.

4.5.4.3 Vertical controls

- Press UP/DOWN control AMPL/DIV on it's left side. Check that the amplitude of the square wave on the screen decreases.
- Press UP/DOWN control AMPL/DIV on it's right side. Check that the amplitude increases.
- Turn VARIABLE left. Check that the amplitude increases and pilot lamp UNCAL lights up.
- Turn VARIABLE right. Check that the amplitude decreases and pilot lamp UNCAL extinguishes.
- Turn OFFSET to the right to move the signal up and to the left to move it down.

4.5.5 Horizontal

- Press the green pushbutton AUTO; a square wave of a few periods becomes visible on the screen.
- Press pushbutton HORIZONTAL ACQ MODE. Check that RECURRENT is selected.
- Press softkey SING ARMD; after one sweep the screen should stay steady.
- Press softkey SING ARMD again. Check that a new sweep is done.
- Press softkey RECURRENT.
- Press UP/DOWN control TIME/DIV on it's left side. Check that more signal periods appear on the screen.
- Press UP/DOWN control TIME/DIV on it's right side. Check that the number of displayed periods decreases.

4.5.6 Triggering

4.5.6.1 Trigger source

- Press the green pushbutton AUTO.
- Press pushbutton SOURCE. Check that channel A is selected and the pilot lamp TRIGGER lights up.

- Press softkey B. Check that the oscilloscope is not triggered; the pilot lamp SYNCHRONIZE lights up and the displayed signal is unstable.
- Press softkey A, the oscilloscope is stable triggered.

4.5.6.2 Trigger delay

- Press the green pushbutton AUTO.
- Select 1 us/div via the TIME/DIV control.
- Press pushbutton MAGN/ DELAY.
- Press softkey UP. Check that the signal shifts 1 division to the left.
- Press softkey DOWN. Check that the signal shifts 1 divisions to the right.

4.5.7 Display

- Press the green pushbutton AUTO.
- Turn the X-POSITION control. Check that the signal shifts horizontally.
- Turn the Y-POSITION control. Check that the signal shifts vertically.
- Turn the X-EXPAND control. Check that the signal expands and shrinks and check if the pilot lamp UNCAL functions properly (off in CAL position).

4.5.7.1 Magnify

- Press pushbutton MAGNIFY. Check that *1 is selected.
- Press softkeys Y*5, Y*1 and Y/5 and check if vertical magnify functions correctly.
- Press softkey Y*1.
- Press softkey EXPAND several times until *64 is reached.
- Press pushbutton DOTS. Check that the pilot lamp in the pushbutton lights up and the dots are not joined anymore. Press DOTS again and check that dots are joined again and pilot lamp dims.
- Press pushbutton AVERAGE C=4 and check that the trace becomes less noisy and the pilot lamp in the pushbutton lights up.
- Press pushbutton AVERAGE C=4 again and check that the pilot lamp is off and that signal noise increases a little.
- Press softkey *1.

4.5.8 Memory

- Press pushbutton SAVE/PLOT. Check that the menu appears.
- Press pushbutton CLEAR and check that the screen is cleared and refreshed again.
- Press pushbutton LOCK and check that the screen becomes steady and the pilot lamp in the pushbutton lights up.
- Press pushbutton WRITE and check that the pilot lamp in the pushbutton lights up.

4.5.9 Cursor control

- Press the green pushbutton AUTO.
- Press pushbutton CURSOR/ANALYZE and check that the menu appears.
- Press softkey R0 A. Check that two cursors appear on the screen.
- Turn control "1st" and check that the left cursor moves along the signal and that the cursor read out on the C.R.T. is updated.
- Turn control "2nd" and check that the right cursor moves and the read out is updated.



5.0 PREVENTIVE MAINTENANCE

5.1 GENERAL INFORMATION

This instrument normally requires no maintenance, since none of its components is subject to wear. However, to ensure reliable and trouble-free operation, the instrument should not be exposed to moisture, heat, corrosive elements or excessive dust.

5.2 REMOVING THE BEZEL AND THE CONTRAST FILTER

To clean or replace the contrast filter, proceed as follows:

- Push the bezel gently to the right and pull it from the instrument as shown in figure 5.1.
- Remove the contrast filter.
- To prevent scratches, when cleaning the filter, ensure that a clean soft cloth, free from dust and abrasive particles, is used.



MAT3117

Figure 5.1 Removing the bezel and contrast filter.

5.3 REPLACING THE MEMORY BACK-UP BATTERIES

When message

Back up Battery power too low: consult manual

is displayed, the batteries have to be replaced.

To save the settings and traces which are stored in the memory, it is recommended to switch-on the oscilloscope during the replacement of the batteries.

The two 1.5 V penlight batteries (e.g. Philips LR 6 - see also section 6.15) must be installed as described under section 3.3.

NOTE: It is advisable to remove the batteries when the oscilloscope is stored for longer periods than 24 hours at ambient temperatures below -30°C or above 60° .

IMPORTANT: Under no circumstances should the batteries be left in the oscilloscope at ambient temperatures outside the rated range of the battery specifications!

5.4 RECALIBRATION

From experience, it is expected that the oscilloscope operates within its specifications for a period of at least 1200 hours, or for one year if used infrequently. Recalibration must be carried out by qualified personnel only.

6.0 CHARACTERISTICS

a. General.

This instrument has been designed and tested in accordance with IEC publication 348 for Class I instruments.

This publication is valid after the instrument has warmed up for 30 minutes.

Properties expressed in numerical values with tolerances stated, are guaranteed by the manufacturer.

Numerical values without tolerances are typical and represent the characteristics of an average instrument.

For definition of terms, reference is made to IEC publications 351,395 and 548.

For a more extensive specification of this instrument, refer to the service manual.

b. Contents.

- 6.1. Auto set.
- 6.2. Signal acquisition.
- 6.3. Vertical channels.
- 6.4. Time base.
- 6.5. Triggering.
- 6.6. Memory.
- 6.7. Display.
- 6.8. Cursors.
- 6.9. Setting memory.
- 6.10. Calibration output.
- 6.11. Plot outputs.
- 6.12. Cathode ray tube.
- 6.13. Power supply.
- 6.14. Interfaces.
- 6.15. Mechanical data.
- 6.16. Environmental data.
- 6.17. Safety.
- 6.18. Accessories delivered with the instrument.
- 6.19. Ordering information.
- 6.20. Voltage measurements.
- 6.21. Time measurements.
- 6.22. Mathematical functions.
- 6.23. Vertical processing modes.
- 6.24. Horizontal processing modes.

- 6.1. AUTOSET Sets display, text, vertical settings, horizontal settings and triggering for instant overall-view display of input signals.

6.2. SIGNAL ACQUISITION

Sampling	Sequential
Sources	Ya, Yb
Modes	Single channel, dual-channel, added
Polarity	Each channel can be inverted
Processing	Normal, eye pattern (single- or dual channel modes only), average, multiple sampling, absolute min/max
Range	Vertical: 10 div. Horizontal: 10,2 x time/div.
Resolution	Vertical: 1:1024 (10 bit) Horizontal: 1:512, 1:256, 1:128, 1:64 In fast display mode: 1:64
Min. acquisition time	< 25 ms for max horizontal resolution

6.3. Y CHANNELS

Input impedance	50 ohm ; + or - 1%
VSWR	1:1,3 up to 1 GHz 1:1,4 up to 2 GHz
Input coupling	d.c.
Max. input voltage	5V peak, positive and negative
Deflection coefficient	1mV/div ... 200mV/div in 1, 2, 5 steps
Error limit	1,5%. In eye pattern mode 5mV/div ... 200mV/div: 10%.
Continuous control between steps	Range 3:1. Resolution 1:4096 (12 bit). Error limit 3%.
Frequency response	d.c. ... 2GHz (-3dB)
Pulse response	Rise time 175 ps (calculated value via formula $t_r = 0,35/\text{Bandwidth}$)
Visible signal delay	9 ns
Dynamic range	- 0,8 V ... + 0,8 V
D.c. offset	
- range	- 1,6 V ... + 1,6 V
- resolution	0,01 div
Common mode rejection ratio	1 GHz: 40:1 } after adjustment of gain and 2 GHz: 20:1 } phase
Channel isolation	2 GHz: 1000:1
Noise	5mV/div ... 200mV/div: 0,5 mV (rms) 1mV/div, 2mV/div: automatic smoothing
Averaging	x2 ... x64 in powers of 2
Multiple sampling	x2 ... x32 in powers of 2

6.4. TIME BASE

Acquisition mode	Recurrent, single scan, multiple scan, multiple eye, save/stop on difference
Deflection coefficient	1ns/div ... 20 us/div
Error limit	3%
Magnifier	x1 ... x50 (fastest sweep speed 20 ps/div)
Error limit	Add 2% for magnifier x2 ... x 50
Delay	Controllable in steps of div or in screens
Max. negative delay	9ns
Max. positive delay	10 div at time base setting of 20us/div and magnifier x1
Hold-off time	30us ... 75us at max horizontal resolution

6.5. TRIGGERING

Sources	Ya, Yb, EXTERNAL
Input impedance	50 ohm; + or - 1%
Coupling	a.c. (RC time: 1us)
Max. input voltage	5V peak, positive and negative
Modes	Trigger, synchronize, countdown, autoselect
Sensitivity	Trigger mode: 10 mV up to 100 MHz Synchronize mode: 2 mV up to 100 MHz Countdown mode: 50 mV up to 2 GHz
Level range:	
- high sensitivity	+ 4 mV ... - 4 mV
- low sensitivity	+ 40 mV ... - 40 mV
Level resolution	1:16384 (14 bit)
Slope selection	+ and -
Jitter	< 7 ps (rms, time base at 1ns/div)

6.6. MEMORY

Memory	4 memories of 4K x 10 bit words
Functions	Clear, save, write, lock

6.7. DISPLAY

Modes	Dot join, dots only, invert, A versus B
Registers	Register R0, R1, R2 and R3 can be displayed in any combination
Expansion:	
- horizontal	1 ... 64 in powers of 2 (Y versus t) 1 ... 8 in powers of 2 (A versus B) Continuous control between steps
- vertical	x0,2, x1, x5
- position	All registers can be positioned independently Horizontal: + 5 div ... - 5 div (expansion: x1) Vertical: + 5 div ... - 5 div (expansion: x1)

6.8. CURSORS

Vertical resolution	1:1024 (10 bit)
Vertical error limit	1,5%
Horizontal resolution	1:4096 (12 bit)
Horizontal error limit	3%

6.9. SETTING MEMORY

Memory size	251 front-panel settings
Functions	SAVE, INSERT, DELETE for storage on erasure of settings. RECALL, NEXT, PREVIOUS for recall of settings.

6.10. CALIBRATION OUTPUT

Square-wave voltage:	
- amplitude	1V + or - 1% into 50 ohm
- frequency	100kHz ; + or - 0,1%
- impedance	50 ohm + or - 1%
- rise-time	1,5ns

6.11. PLOT OUTPUTS

Analog plot output:	Screen dump or register dump
- output voltage	vertical: 1V
	horizontal: 1V
- error limits	3%
- pen lift	TTL compatible
- plot time	Adjustable between 20ms and 2s per dot
Digital plot out	HPGL and Philips language compatible up to 4 screens on standard A4 size
Printer plot out	Compatible with Epson (FX40) and HP Thinkjet

6.12. CRT

Type	Philips 18cm rectangular PDA tube
Useful screen area	10cm x 12cm
Graticule	Internal, with variable illumination
Acceleration voltage	16kV

6.13. POWER SUPPLY

Voltage	90V ... 264V a.c.
Frequency	45Hz ... 440Hz
Power consumption	110W
Memory back-up	2 LR6 batteries
Retention time	2 Years

6.14. INTERFACES

Interface functions	IEEE-488/IEC625 interface} For full specification
	RS232C interface } refer to instruction/
	Real time clock } programming manual of
	PM8956A interface

6.15. MECHANICAL DATA

Height	176 mm (6,9 inch)
	250 mm (9,8 inch) with feet and pouch
	5E in 19 inch rackmount version
Width	419 mm (16,5 inch)
	465 mm (18,3 inch) with handle
Depth	570 mm (22,5 inch)
	670 mm (26,4 inch) with handle
Weight	18,7 kg (41,2 lb), excl. accessories

- 6.16. ENVIRONMENTAL DATA Meets environmental requirements of MIL-T-28800D Type III, Class 5, Style D
- Temperature range:
 - operating within specification + 15°C ... + 35°C
 - limits of operation 0°C ... + 50°C
 - storage - 40°C ... +70°C
 Max. humidity 95% relative humidity
 Max. altitude:
 - operating 4,5 km (15 000 feet)
 - non-operating 12 km (40 000 feet)
 Vibration:
 - frequency 5Hz ... 55Hz
 - max. acceleration 30m/s²
 Shock 6 Shocks on each axis, half sine-wave, pulse duration 11ms, peak acceleration 300m/s²
 Bench handling MIL-STD-810 method 516, procedure V
 EMI MIL-STD-471 Class B, VDE 0871 and VDE 0875
- 6.17. SAFETY Meets the requirements of of IEC 348 Class I, VDE 0411 Class I, UL 1244 and CSA 556 B
- 6.18. ACCESSORIES DELIVERED WITH THE INSTRUMENT
- 2 Passive probes 10:1, PM8911/08; for characteristics refer to chapter 8.1.1. in this manual
- Blue contrast filter
- 2 Adaptors BNC-N Type: PM9063
- Front cover
- Adaptor probe-BNC Type: PM9353
- Operating manual
- Programming manual
- Quick operating guide
- Plot out cable For analog plot out function
- 6.19. ORDERING INFORMATION
- PM3340/40 2GHz digitizing oscilloscope} Incl. IEEE488/
 PM3340/80 19 inch rackmount version } RS232C interface
- Power cord options:
 - option 001 Universal European 220V/16A, 50Hz
 - option 003 Standard North American 120V/15A, 60Hz
 - option 004 United Kingdom 240V/13A, 50Hz
 - option 005 Switzerland 220V/10A, 50Hz
 - option 008 Australia 240V/10A, 50Hz
- Note Refer also to chapter 7.0. in this manual

6.20. VOLTAGE MEASUREMENTS

RMS voltage Including or excluding offset voltage

Mean voltage Including or excluding offset voltage

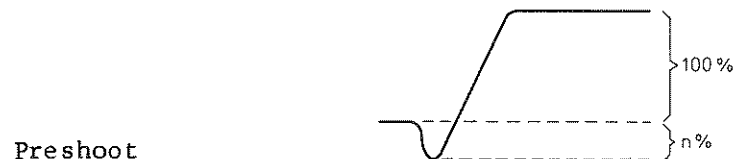
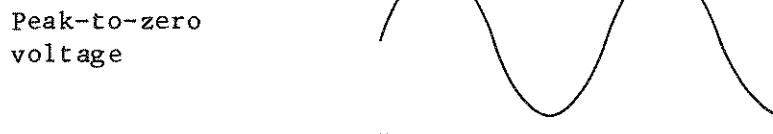
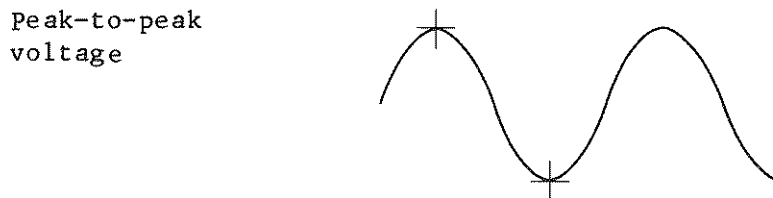

6.21 TIME MEASUREMENTS

Rise-time Tr over 10%...90% or 20%...80% or within variable boundaries

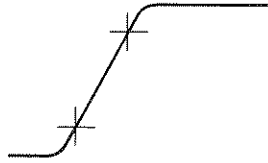

Fall-time Tf over 10%...90% or 20%...80% or within variable boundaries

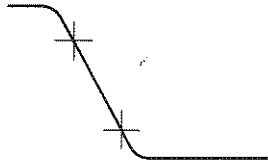

Pulse width

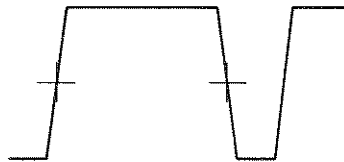

Duty cycle Expressed as a percentage of period

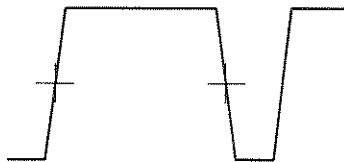

Frequency

Phase

6.22. MATHEMATICAL FUNCTIONS

Add	}	
Subtract	}	Result of calculation displayed in selected
Multiply	}	register and scalable for optimum display
Divide	}	
Differentiate	}	
Integrate	}	
Amplitude histogram		Displays amplitude density versus absolute amplitude of an input signal
FFT:		Displays frequency domain presentation of input signal
- window		Rectangular, Hamming, Hanning
- vertical scale		Linear or logarithmic
- dynamic range		49,8 dB
- horizontal scale		Linear
Filter		Digital filter of order 3, 5, 9, 17, 33, 65 and 129
Delay channel		Allows compensation of delay between channels or signal probes

6.23. VERTICAL PROCESSING
MODES

Eye pattern	Displays pseudo-random pulse pattern, showing eye height and width
Absolute min/max	Measures and stores maximum and minimum amplitudes of an input signal in a selected register (envelope mode)

6.24.

HORIZONTAL
PROCESSING MODES

Save/stop on difference	Input signals outside the limits of a reference signal are saved in a selectable register or stop the acquisition.
Multiple eye	Displays eye pattern in 12K memory size for optimal signal representation

7.0 PM3340 VERSIONS - ADDITIONAL INFORMATION

The version of your oscilloscope is indicated on the type plate situated on the rear panel (see fig.7.1.).

The version is indicated as follows:

1 PM3340/XY :in type number

2 12nc: 9444 W33 40XYZ :in code number

WXYZ are represented by numbers.

These numbers are given in this section and each version is briefly described.

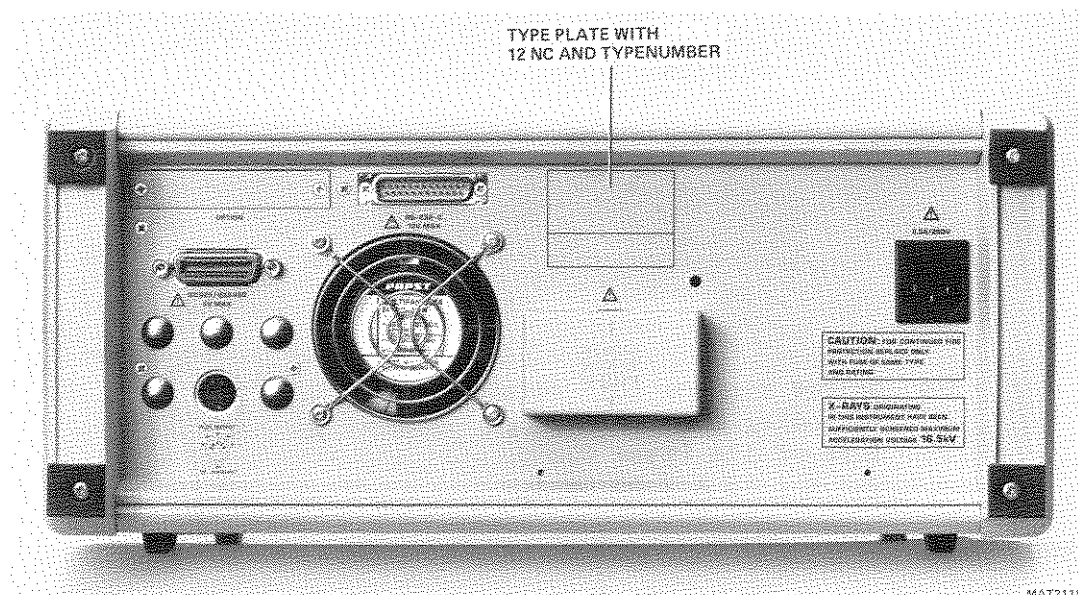

Figure 7.1 Rear panel with indicated type plate position.

Typenumber: PM3340/XY

Codenummer: 9444 W33 40XYZ

W=0:	Standard version
XY=40	Basic instrument with IEEE 488/RS232-C option installed.
XY=80	Basic instrument with IEEE 488/RS232-C option installed and with 19 inch rackmount parts.
W≠0:	Non standard version

Z: Power-cord-version indication

On type plate on instrument: Z always 0

In the codenumber on the packing in which the instrument was shipped the indication is as follows:

Z=1 Standard European version
220 V / 16 A / 50 Hz

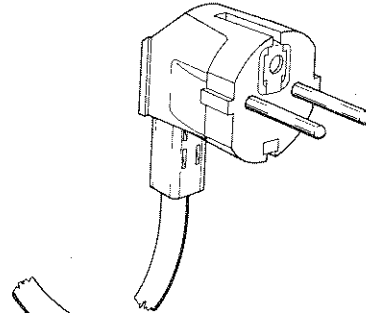

Z=3 U.S.A. version
(U-version)
120 V / 15 A / 60 Hz

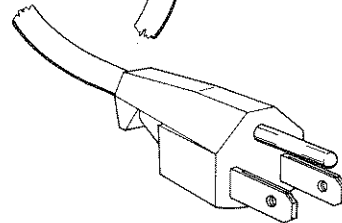

Z=4 United Kingdom (UK) version
including line cord plug
fuse of 13A (type C)
240 V / 13 A / 50 Hz

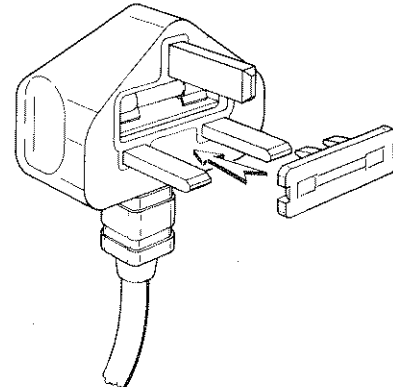

Z=5 Swiss version
220 V / 10 A / 50 Hz

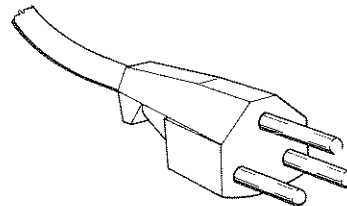

Z=8 Australian version
240 V / 10 A / 50 Hz

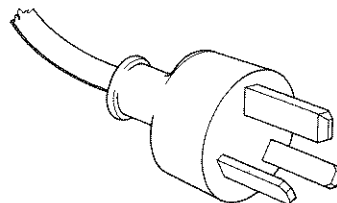

Figure 7.2 Mains connectors.

8.0 ACCESSORY INFORMATION

8.1 ACCESSORIES SUPPLIED WITH THE INSTRUMENT

8.1.1 Passive probe PM8911/08 with automatic range indication

8.1.1.1 Introduction

This 10 x attenuator probe is provided with a special male N plug with built-in resistor for automatic range indication to advance the V/DIV reading by 10x. The probe is designed for oscilloscopes with 50 ohm input impedance.

The probe consists of 2 separate units:

- the cable assembly, incl. N-connector with automatic range indication possibility
- the probe body.

The V/div reading of the oscilloscope is automatically adapted to the 10x attenuation of the probe by a resistor that is mounted in the holder of the N-connector. The resistor value is related to the type of probe.

8.1.1.2 Characteristics

- Properties expressed in numerical values with tolerances stated, are guaranteed by the manufacturer.
- Numerical values without tolerances are typical and represent the characteristics of an average probe.

Electrical

NOTE: These characteristics are valid with a termination of 50 ohm oscilloscope input.

Designation	Specification	Additional information
Attenuation (d.c.)	10 x + or - 2 %	
Input impedance		
-parallel resistance at d.c.	500 ohm + or - 2%	
-parallel capacitance up to 100 MHz	1 pF	(for parallel capacitance as function of frequency, see figure 8.1).

Bandwidth

-probe only band- width at osc. input cap. d.c. ... 4 GHz (-3 dB)

Signal delay 7,7 ns + or - 200 ps Measured between tip to N-output connector.

Maximum voltage:

-max. non destruc- tive input voltage (d.c. + a.c. rms) 11V

-max. non destruc- tive input voltage (pulse peak) 100 V

Max. 50 mJ during any 100 ms

-test voltage 2,42 kV

Probe not connected to oscilloscope input

-type test 1,7 kV

During 1 min

-performance check 1,7 kV

During 1 sec

Mechanical

-Dimensions	length	width
probe body	37 mm	11 mm(max)
cable assy	1500 mm	9,6 mm(max)
pouch	275 mm	195 mm

-Mass 124 g

Standard probe with accessories in pouch.

MAT3067

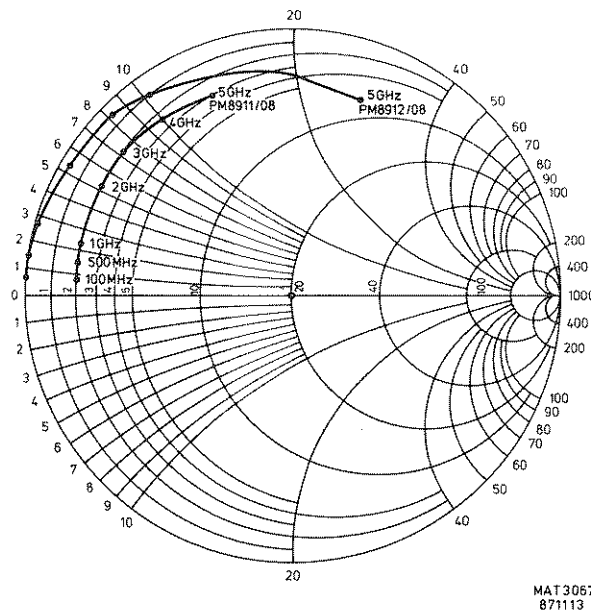

MAT 3067
871113

Fig. 8.1 Admittance at h.f. (centre value: 20 mS)

Environmental

The characteristics are valid only if the instrument is checked in accordance with the official checking procedure. Details on these procedures and failure criteria are supplied on request by the PHILIPS-organisation in your country, or by PHILIPS, INDUSTRIAL AND ELECTRO-ACOUSTIC SYSTEMS DIVISION, EINDHOVEN, THE NETHERLANDS.

Operating temperature	-10 °C ... +55 °C
Storage temperature	-51 °C ... +71 °C
Maximum humidity	95 % relative humidity
Altitude:	
-operating	To 4500 m
-non-operating	To 12000m
Vibration (operating)	
* freq. 5...15 Hz	7 min each axis, excursion 1,5 mm (p-p) and 7 m/s ² (0,7 g) acceleration at 15 Hz.
* freq. 15...25 Hz	3 min each axis, excursion 1 mm (p-p) and 13 m/s ² (1,3 g) acceleration at 25 Hz.
* freq.25...55 Hz	5 min each axis, excursion 0,5 mm (p-p) and 30 m/s ² (3 g) acceleration at 55 Hz.
Resonance dwell	10 min at each resonance freq.
Shock (operating)	300 m/s ² (30 g), half sine-wave shock, duration is 11 ms.(3 shocks per direction for a total of 18 shocks).
Accessories	
-Accessory kit, contents:	-Earth cable -Spring-loaded test clip -Set marking rings -Mini connector (2x) -Insulating cap -SO cap and DIL cap -Wrap pin adapter -Earth bus
- Instruction manual	

8.1.1.3 Description of accessories

Earth cable: To minimize ringing in a signal, an earth cable is provided. This cable must first be plugged onto the probe body and then be connected to the nearest earth point of the circuit to be measured.

Spring-loaded test clip: This is a provision for hands-free connection to a test point or component lead.

Marking rings: At delivery a set of 6 rings with 3 different colour marking rings (red, white and blue) are provided. This can be used to help identify the specific probes when using more than one probe on an oscilloscope.

Mini connector: can be soldered on to a p.c.b. track of the circuit to be measured. The probe tip fits exactly into this connector.

Insulating cap: An insulating cap is provided to cover the metal part of the probe during measurements in densely wired circuits.

SO cap and DIL cap: this is a cap facilitating measurements on respectively surface mounted and dual-in-line integrated circuits.

Wrap pin adapter: The wrap pin adapter is a provision to make hands-free connection to a wire wrapped pin circuit.

Earth bus: This is a provision to minimize ringing in VHF signals, when earthing must be as short as possible.

8.1.2 Blue contrast filter

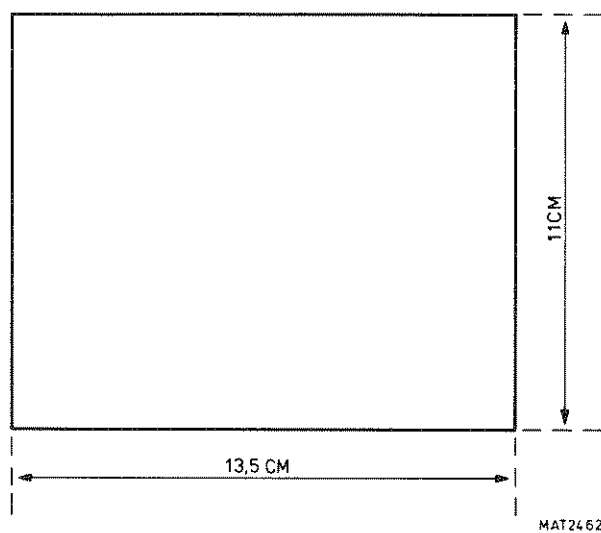

Figure 8.2 Blue contrast filter. (Factory installed !)

8.1.3 Front cover

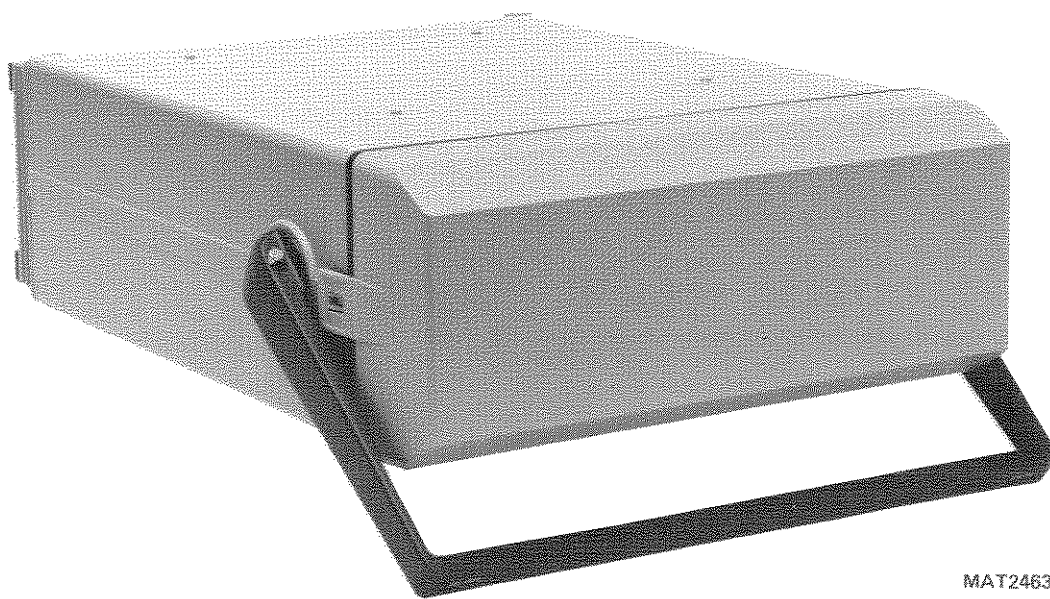
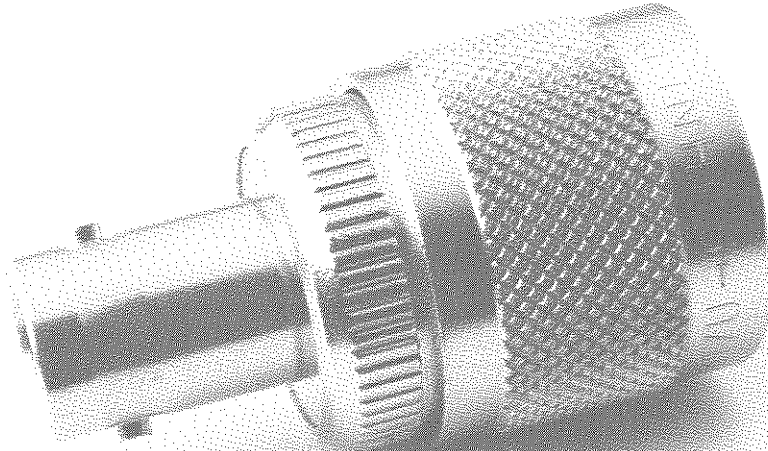

Figure 8.3 Oscilloscope with front cover.

8.1.4. Adaptor BNC into N-type of connector.



MAT3218

Figure 8.4 Adaptor BNC into N-type of connector.