



ROHDE & SCHWARZ

Measuring Instruments
and Systems Division

Operating manual

**TEST RECEIVER
ESVP**

354.3000.52

354.3000.53

354.3000.56

Printed in the Federal
Republic of Germany

1. The first part of the document discusses the importance of maintaining accurate records of all transactions and activities. It emphasizes the need for transparency and accountability in financial reporting.

2. The second part of the document outlines the various methods and techniques used to collect and analyze data. It includes a detailed description of the experimental procedures and the tools used for data collection.

3. The third part of the document presents the results of the study, including a comparison of the different methods and techniques used. It discusses the strengths and weaknesses of each method and provides a summary of the findings.

4. The fourth part of the document discusses the implications of the study and provides recommendations for future research. It highlights the need for further investigation into the effectiveness of the different methods and techniques used.

5. The fifth part of the document provides a conclusion and a summary of the key findings. It reiterates the importance of maintaining accurate records and the need for transparency and accountability in financial reporting.

Table of Contents of ESVP Manual

Operating manual

1. Data sheet
2. Preparation for Use and Operating Instructions
3. Maintenance

Service manual

Volume 1

4. Servicing Instructions for Entire Instrument
5. Servicing Instructions for Individual Modules

	Order No.	Index No.
Indication Board	354.3717.02	1
Computer Board	354.4813.02	2
Attenuator Control and Preamplifier.	354.5610.02	3
Attenuator	342.9215.00	4
Calibration Generator	354.6016.23	5
Synthesizer 2	342.5003.12	6
Synthesizer 1	342.5410.12	7
Filter Control and Pulse Generator..	822.7311.23	8
Reference Oscillator	358.1154.03	9

Volume 2

5. Servicing Instructions for Individual Modules

RF Module 1	342.6000.22	1
RF Module 2	353.6029.22	2
2nd Mixer	342.6700.12	3
	342.6700.56	
10.7-MHz Amplifier	822.8018.12	4
	355.0211.12	
	355.0211.53	
Indication and AF Demodulation Board	342.8002.13	5
Analog Board	354.6916.12	6
SSB Board	354.7812.12	7
Recorder Driver	354.8919.02	8
Power Supply	354.9215.02	9

Table of Contents

<u>1.</u>	<u>Data sheet</u>	
<u>2.</u>	<u>Preparation for Use and Operating Instructions</u>	<u>2.1</u>
2.1	Legends for the Front- and Rear-panel Views ...	2.1
2.2	Preparation for Use	2.13
2.2.1	Setting up the Receiver	2.13
2.2.1.1	Operating Position and Ambient Light	2.13
2.2.1.2	Temperature and Condensed Moisture	2.13
2.2.1.3	Vibration and Low-frequency Magnetic Fields ...	2.14
2.2.1.4	RF Fields	2.14
2.2.1.5	Grounding	2.14
2.2.1.6	Rackmounting	2.15
2.2.2	Power Supply	2.15
2.2.2.1	AC Supply Operation	2.15
2.2.2.2	Battery Operation	2.16
2.2.2.3	AC-supply and Battery Operation	2.16
2.2.3	Instrument Switch-on	2.16
2.2.4	Short Functional Check	2.17
2.3	Operating Instructions	2.18
2.3.1	Connection of the Voltage to be Measured	2.18
2.3.1.1	Sinewave Signals and DC Voltages	2.18
2.3.1.2	Pulse Signals	2.18
2.3.2	Frequency Setting	2.19
2.3.2.1	Automatic Frequency Scanning	2.19
2.3.3	Selection of IF Bandwidth	2.21
2.3.4	Selection of Indicating Mode	2.23
2.3.5	Selection of Operating Level Range	2.26
2.3.6	Setting of Attenuation, Measurement Ranges, Preamplifier	2.27
2.3.6.1	Manual Setting	2.28
2.3.6.2	Operating with Preamplifier	2.29
2.3.6.3	Automatic Setting (Autoranging)	2.29
2.3.7	Calibration and Measuring Accuracy	2.31
2.3.8	Setting the Data Output	2.33
2.3.9	Setting the Measuring Time	2.35
2.3.10	Setting the Display Time	2.36
2.3.11	Time of Day and Date	2.36
2.3.12	Setting the Demodulation Mode and Squelch	2.37
2.3.13	Operating Modes TWOPORT and REM. FREQ. 40	2.37.1

2.3.14	Special Functions	2.38
2.3.15	Storage and Recalling of Settings with STO and RCL	2.58
2.3.16	Connection of Test Antennas and Probes	2.58
2.3.17	Data Output on a Listen Only Recording Device (Printer, Magnetic Tape Memory, etc.)	2.60
2.3.18	IF, AF and Recorder Outputs	2.61
2.3.19	Operation of ESVP with an External Reference Frequency	2.63
2.3.20	Connection of Recorders to Output 61	2.64
2.3.20.1	Wiring Scheme for Connecting Cables	2.66
2.3.20.2	Setting the ESVP for Output to a Recorder	2.67
2.3.21	Error Messages	2.69
2.3.22	Control of the ESVP via the IEC Bus	2.71
2.3.22.1	Interface Functions	2.72
2.3.22.2	Entering the Device Address/Talk Only Mode	2.72
2.3.22.3	Setting Instructions	2.74
2.3.22.4	Data Input	2.76
2.3.22.5	Data Output	2.81
2.3.22.6	Addressed and Universal Commands	2.85
2.3.22.7	Service Request	2.87
2.3.22.8	Parallel Poll	2.89
2.4	Examples of Measurements	2.91
2.4.1	Measurement of Sinewave Signals	2.91
2.4.1.1	Measurement Accuracy (Noise Effects)	2.91
2.4.1.2	Influence of Amplitude Modulation	2.95
2.4.1.3	Measurements of Frequency and Frequency Offset (SF31 to 39)	2.97
2.4.1.4	Measurement of Modulation Depth (SF21, 23, 25)	2.98
2.4.1.5	Measurement of Frequency Deviation (SF41, 43, 45)	2.99
2.4.2	Use of the ESVP for Interference Measurements	2.100
2.4.2.1	Radio Interference Measurements according to VDE and CISPR Standards	2.101
2.4.2.2	Interference Measurements according to MIL-STD and VG Standards	2.105
2.4.3	Measurement of TV Signals and Monitoring of CATV Systems	2.108
2.4.3.1	Measurement of RMS Value of Vision Carrier at the Sync Peak of TV Signals with Negative Modulation	2.108
2.4.3.2	Measurement of Sound Carrier	2.108
2.4.3.3	Measurement of TV Signals with Positive Modulation	2.108
2.4.3.4	S/N Ratio in CATV Systems	2.108
2.4.3.5	Hum Modulation in CATV Systems	2.109
2.4.3.6	Measurement of Crossmodulation on Pilot Carrier	2.110
2.4.3.7	Intermodulation Measurements in CATV Systems ..	2.110
2.4.3.8	Interference Radiation in CATV Systems	2.110
2.4.3.9	Measurements of Intermodulation and Cross- modulation on TV Transmitters	2.111

2.4.4	Use of ESVP in Radiomonitoring	2.111
2.4.5	Use of ESVP in Laboratories and Test Departments	2.113
2.4.5.1	Two-port Measurements between Generator Output and RF Input	2.113
2.4.5.2	Measurement of Harmonics	2.117
2.4.5.3	Measurement of Spurious Signals and Sideband Noise	2.117
2.4.5.4	Linearity Measurements on Amplifiers and Tuners (Compression, Intermodulation, Crossmodulation) .	2.118
2.4.5.5	Measurement of Noise Figure of Amplifiers and Tuners	2.119
2.4.6	Recording of Signals	2.119
2.4.6.1	Signal Level as Function of the Frequency	2.119
2.4.6.2	Frequency-band Occupancy as Function of the Time	2.120
2.4.6.3	Signal Level and Frequency Offset as a Function of Time	2.120

Figures

Fig. 2-1	Test Receiver ESVP, Front view (in Appendix)	
Fig. 2-2	Test Receiver ESVP, Rear View (in Appendix)	
Fig. 2-3	Effective IF Selectivity	2.22
Fig. 2-4	Typical RF selectivity (3-dB and 6-dB bandwidths) Selection prior to 1st mixer stage	2.22
Fig. 2-5	Difference in pulse weighting by the indicating modes AV., CISPR and PEAK or MIL as a function of the pulse frequency (IF bandwidth 120 kHz) ...	2.25
Fig. 2-6	Rectified voltage at output of AM demodulators ..	2.45
Fig. 2-7	Signal at output of FM demodulator	2.47
Fig. 2-8	Correction curve with sampling points	2.55
Fig. 2-9	Pin allocation of the 12-way socket <u>47</u> (Tuchel type)	2.59
Fig. 2-10	Pin allocation of recorder output <u>61</u>	2.64
Fig. 2-11	Example of possible allocation of start and stop frequencies of three subranges for output to an XY recorder	2.67
Fig. 2-12	Pin allocation of IEC-bus connector 60	2.71
Fig. 2-13	IEC-bus syntax diagram	2.76
Fig. 2-14	Status byte	2.87
Fig. 2-15	Reading error of an unmodulated sinewave signal due to noise with average-value and peak-value indication as a function of the signal-to-noise ratio S-N1	2.92
Fig. 2-16	Indication error due to noise with average-value and peak-value indication	2.94

Fig. 2-16.1	Typical CISPR-weighted indication	2.94.1
Fig. 2-16.2	Error of CISPR indication caused by noise	2.94.2
Fig. 2-17	Increase in peak-value indication as against average-value indication with amplitude modulation	2.95
Fig. 2-18	Decrease in indication of average value when measuring amplitude-modulated signals in the 40 and 60-dB operating ranges for modulation frequencies < 1 kHz	2.96
Fig. 2-19	Influence of the S/N ratio on the frequency measurement error	2.97
Fig. 2-20	Modulation depth indication for an unmodulated sinewave signal as a function of the S/N ratio	2.98
Fig. 2-21	Deviation indication for an unmodulated sine- wave signal as a function of the S/N ratio. IF bandwidth 12 kHz, operating range 60 dB, f_r 100 MHz, nominal deviation 2.4 kHz	2.99
Fig. 2-22	Deviation indication for an unmodulated sine- wave signal as a function of the S/N ratio. IF bandwidth 120 kHz, operating range 60 dB, f_r 100 MHz, nominal deviation 40 kHz	2.99
Fig. 2-23	The reflected wave influences particularly strongly the gain, radiation pattern and interference field-strength measurements	2.102
Fig. 2-24	Test configuration for determining the test setup factor for absolute field-strength measurements and finding a favourable test setup	2.104
Fig. 2-24.1	Peak- and average-value indication as a function of the pulse repetition rate	2.104.1
Fig. 2-24.2	Weighting curves for the frequency range 30 to 1000 MHz	2.104.2
Fig. 2-25	Setup for measuring interference current	2.106
Fig. 2-26	Flow diagram of controller program and service routine for accepting and processing measured values	2.107
Fig. 2-27	Setup with test tube	2.115
Fig. 2-28	Open test setup	2.116
Fig. 2-29	Insertion loss of a 0.1- μ F ceramic capacitor in a 50- Ω system	2.116
Fig. 2-30	Measurement of crosstalk between two adjacent 10-cm-long conductors of a printed circuit ...	2.117

Table of Contents

	Page
3	3.1
3.1	3.1
3.2	3.3
3.2.1	3.3
3.2.1.1	3.3
3.2.1.2	3.4
3.2.1.3	3.6
3.2.1.4	3.6
3.2.1.5	3.7
3.2.1.6	3.7
3.2.2	3.8
3.2.2.1	3.8
3.2.2.2	3.8
3.2.3	3.9
3.2.3.1	3.9
3.2.3.2	3.9
3.2.3.3	3.9
3.2.3.4	3.10
3.2.4	3.11
3.2.5	3.12
3.2.6	3.12
3.2.7	3.13
3.2.8	3.13
3.2.9	3.14
3.2.10	3.14
3.2.11	3.15
3.2.12	3.16
3.2.13	3.18
3.2.14	3.18
3.2.15	3.19
3.2.15.1	3.19
3.2.15.2	3.19
3.2.15.3	3.19
3.2.15.4	3.19
3.2.15.5	3.20
3.2.15.6	3.21
3.2.15.7	3.21
3.2.15.8	3.21
3.2.15.9	3.21
3.3	3.21
3.4	3.22
3.5	3.22

Index

A

AC supply operation 2.15
AFC 2.44
AM demodulation (A3)..... 2.37
AM demodulation depth 2.45/2.95 pp
AM output 2.62
Antenna factor 2.53
Attenuation RF, IF 2.27/2.28
Autoranging 2.29
Average value indication 2.23/2.92

B

Bandwidth, IF 2.21
Bandwidth, RF 2.22
Basic setting 2.17/2.75
Battery operation 2.16

C

Calibration 2.31
Carrier level 2.23/2.108
CATV systems 2.108
CISPR interference measurement 2.23/2.101
CISPR weighting 2.23
Coding input 2.53/2.58
Compression 2.118
Conversion factor 2.53
Correction factor 2.54
Crossmodulation 2.110/2.118

D

Data input 2.76
Data output 2.81
Date 2.36

Demodulation mode 2.37
Display time 2.36

E

Error codes 2.31/2.69/2.88
Error messages 2.31/2.69/2.88
External reference frequency 2.63
External trigger 2.41

F

Fast A/D 2.42
Field-strength measurement 2.42/2.53
Field-strength statistics 2.49/2.83
FM demodulator output 2.62
FM deviation measurement 2.47/2.48
FM peak deviation 2.48
Frequency-band occupancy 2.51/2.52
2.68/2.120
Frequency measurement 2.38/2.47/2.97
Frequency offset measurement .. 2.46/2.47
2.97/2.120
Frequency record 2.51
Frequency scanning 2.19/2.48
Frequency setting 2.19/2.77
Front view 2.130
Functional check 2.17

H

Harmonics measurement 2.117

I

IEC-bus address 2.41/2.72
IEC-bus control 2.71
IF selectivity 2.21
Indicating mode 2.23
Input, RF 2.18
Interference measurement to CISPR .. 2.23
2.101
Interference measurement to MIL 2.24
2.105
Interference radiation 2.105/2.110
Intermodulation measurement .. 2.110/2.118
Internal classification 2.49/2.83

Level measurement, switchoff 2.44
Linearity measurement 2.118
Line spectrum 2.52

M

MAX.MIN. indication 2.26
Mean value indication 2.23/2.92
Measuring accuracy 2.31/2.91
Measuring Data output 2.33/2.60/2.81
Measuring time 2.35
MIL interference measurement .. 2.24/2.105
MIL.-STD. 461 A/B 2.24
Modulation depth, AM 2.45/2.95 pp

N

Noise figure measurement 2.119

O

Operating level range 2.26
Operating modes 2.37.1
Output format IEC 625/IEEE 488 2.81
Outputs (IF, AF, recorder) 2.61

P

Parallel Poll 2.89
Peak value indication 2.23/2.92
Polygonal curve 2.52
Preamplifier 2.29/2.44
Preparation for use 2.13
Pulse signals 2.18
Pulse weighting 2.23/2.101

Radio interference field strength .. 2.102
Radio interference power 2.54/2.101
Radiomonitoring 2.111
Rear view 2.130
Recorder coding 2.52
Recorder control 2.64 pp
Recorder lin/log 2.51/2.52
Recorder outputs 2.62 pp
Remote control 2.71
RF attenuation 2.27/2.28
RF input 2.18
RF selectivity 2.22

S

Scan 2.19/2.48/2.56
Selectivity, IF, RF 2.21/2.22
Service request 2.87
Setting instructions 2.74 pp
Signal-to-noise ratio 2.46/2.91 pp
2.108
Sinewave signals 2.18/2.91
S/N ratio 2.46/2.91 pp
2.108
Sound carrier 2.108
Special functions 2.38/2.78
Special scan 2.51
Spurious signal measurement 2.117
Squelch 2.37/2.44
Status byte 2.88
Step size lin/log 2.48

T

Time of day 2.36/2.44
Trigger command 2.85
Trigger functions 2.41
TV vision carrier 2.108
Twoport measurement 2.37.1/2.113

V

Vision carrier 2.108

X

X output 2.64

XY recorder 2.52/2.67

Y

Y output 2.64

YT recorder 2.52/2.67

Z

ZSG3 2.68

Supplement to Data Sheet
354 300 E-2 of
ESVP

In the frequency range 1020 to 1300 MHz the image rejection differs from the value in the Data Sheet:

Interference rejection, nonlinearities

Image frequency rejection

1020 ... 1300 MHz >70 dB, typ. 100 dB



**Supplement A
to the Operating Manual
Test Receiver
ESVP**

Bug report for ESVP firmware

The ESVP firmware, version 1.85, contains the following bug:

The receiver's IF Bandwidth will not be set correctly after a RCL 0 (default setting), if IF Bandwidth has been changed before RCL 0 and Indication Mode after RCL 0.

For example:

After sequence

- RCL 0
- IF-Bandwidth 1 MHz
- RCL 0
- Indicating Mode A3

IF Bandwidth will not be set to 120 kHz but to 1 MHz.

This bug will be corrected in the next firmware version.



ROHDE & SCHWARZ

Test Receiver ESVP

20 to 1300 MHz / -20 to +137 dB μ V

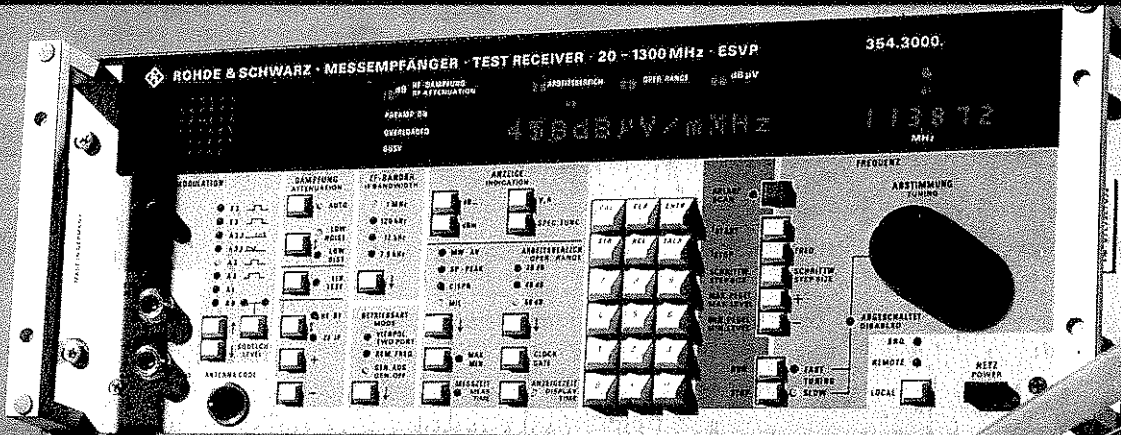

IEC 625 Bus IEEE 488

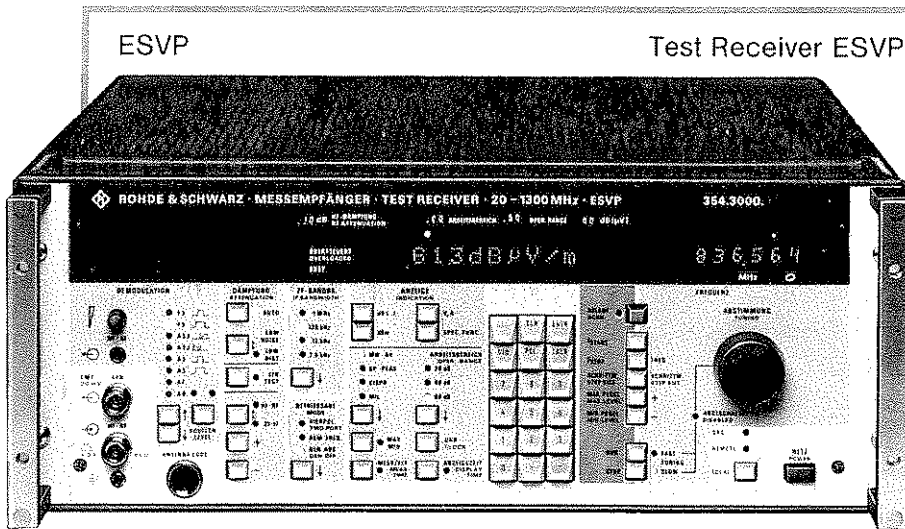

Test Receiver ESVP ♦ 20 to 1300 MHz -20 to +137 dB μ V

- Programmable test receiver for selective voltage measurements and twoport measurements in laboratories and test departments
- Field-strength measurements with test antennas
- RFI measurements to CISPR, VDE and FCC
- Interference measurements to MIL and VG standards (with model 56)
- Radiomonitoring
- AC supply and battery operation

IEC 625Bus
IEEE 488

The Test Receiver ESVP measures and demodulates AM double-sideband, single-sideband, pulse-modulated and FM signals as well as narrowband and broadband interference in the frequency range 20 to 1300 MHz. High overload capacity, a wide dynamic range and numerous evaluation capabilities make the ESVP suitable for

selective voltage and twoport measurements – in automatic test systems too –

and all applications in the field of radiomonitoring and EMC measurements.

In its frequency-related characteristics and application capabilities the ESVP is very similar to the ESV (data sheet PD 756.4514), in measurement convenience, intelligence and system compatibility to the ESH 3 (data sheet PD 756.4414). Its frequency range overlaps and extends that of the ESH 3.

Different ESVP models are available for the main fields of application:

Model	Frequency (MHz)	Bandwidths (kHz)	Application
52	20 to 1300	7.5/10/120/1000	Radiomonitoring/CISPR VDE/MIL, VG standards
53	20 to 1300	7.5/12/120/200	Radiomonitoring, FM radio/CISPR, VDE
56	20 to 1300	10/100/120/1000	CISPR, VDE, MIL, DEF STAN, VG standards

Special features of ESVP

- Synthesizer; frequency resolution 1 kHz, with SSB 100 Hz
- High measurement accuracy (error <1 dB)
- Wide dynamic range: noise figure typically 8 dB (preamplifier on) 3rd-order IP typically +20 dBm (preamplifier off)
- Automatic frequency scanning with constant and frequency-proportional step sizes; automatic scanning with up to 50 preset fixed frequencies
- Automatic gain correction in the whole frequency range after calibration (sinewave calibration as well as pulse calibration for broadband interference measurements)
- Measurement of voltage, field strength, current, spectral pulse density and twoport attenuation with display of physical units; automatic consideration of probe and

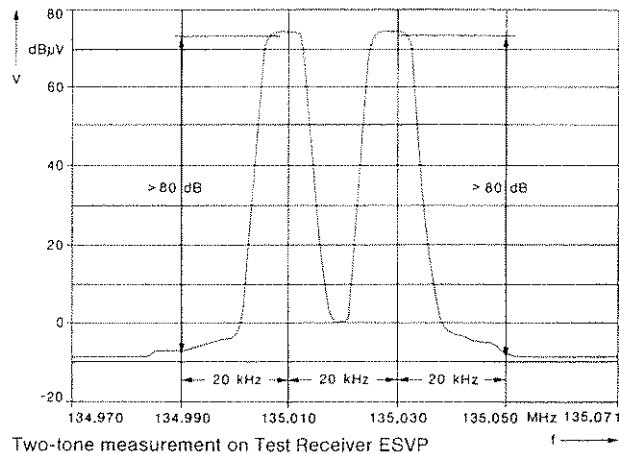

Two-tone measurement on Test Receiver ESVP

bandwidth correction factors; input of any frequency-dependent correction factors (current probes, antennas) as well as of frequency-dependent attenuation or gain possible

- Additional evaluation capabilities for radiomonitoring: modulation-depth and frequency-deviation measurements, remote frequency and frequency-offset measurements with the aid of built-in IF counter, recording of band occupancy, SSB demodulator, AF filter and squelch with programmable response threshold, built-in loudspeaker, indication of date and time of day
- Fast automatic field-strength recording in moving vehicle (field-strength statistics)
- Facilities for connection of XY, YT recorders and up to 5 Radiomonitoring Recorders ZSG 3 from Rohde & Schwarz
- IEC-bus interface with listener and talker function; talk-only mode for data recording without controller
- Non-volatile storage of 10 complete device settings, 5 data sets for automatic frequency scanning, one data set with 50 fixed frequencies and two data sets for correction factors
- Full compatibility with Test Receiver ESH 3 (9 kHz to 30 MHz) with respect to operational concept and IEC-bus commands
- Connectors for AC supply and 24-V battery

CHARACTERISTICS AND USES

Selective voltmeter With its measurement range from -20 to $+137$ dB μ V the ESVP does not need any add-ons to operate as an automatic high-precision selective voltmeter for laboratory, testing and servicing applications. RF currents in the frequency range 20 to 300 MHz can be measured in conjunction with the VHF Current Probe ESV-Z1. Excellent receiver selectivity permits the measurement of adjacent-channel power, non-harmonic spurious signals of generators, intermodulation and cross-modulation and distortion, as well as the determination of noise figures. The ESVP is capable of performing low-noise and low-distortion measurements both with and without RF preamplifier (10 dB) and of distinguishing any inherent non-linearity from that of the test item by means of an automatic linearity test.

Calibration generator The output of the calibration generator (90 dB μ V ± 0.3 dB into 50 Ω) is ideally suited for frequency-response measurements on amplifiers and filters; attenuation can be measured up to 110 dB and gain up to 47 dB. The VHF Current Probe ESV-Z1 and the Absorbing Clamp MDS-21 facilitate measurement of screening effectiveness of cables and connectors and the VSWR Bridge ZRB 2 can be used for measuring the return loss of two-terminal networks (e.g. antennas) and twoports.

Thanks to the reconversion method internally used in the REM. FREQ. measurement mode, the generator output is suitable for connection of a frequency counter for accurate (remote) frequency measurement of the signal received. With this kind of frequency measurement, the measuring accuracy depends on the accuracy of the external frequency counter, whereas when the built-in IF counter is used the accuracy is determined by the internal ESVP reference oscillator.

Remote control The IEC/IEEE-bus interface possesses all standard listener and talker capabilities. Commercial controllers without parallel poll capability can be used.

Signal evaluation capabilities

Four switch-selected IF bandwidths:

Model 52: 7.5/12/120/1000 kHz

Model 53: 200 kHz instead of 1000 kHz

Model 56: 10 and 100 kHz instead of 7.5 and 12 kHz

Average and peak indication, pulse weighting to CISPR 16 and VDE 0876, Part 1, with programmable measuring times

Demodulation of classes of emission NON (A0), A1A (A1), A3E (A3), J3E (A3J, USB and LSB) and F3E (F3); built-in loudspeaker and headphones connector; switch-selectable AF filters for A3A and F3E; squelch with programmable threshold level

Analog indication of level and frequency offset in addition to digital readout

Indication of overload in essential stages and switch-selectable linearity test

Broadband 10.7-MHz IF output for panoramic display and spectrum analyzer

Narrowband 10.7-MHz IF output for oscilloscope

AM and FM demodulator outputs

Recorder outputs for level and frequency offset

Generator output for signal frequency measurement

Digital measurement of modulation depth, frequency, frequency offset and frequency deviation

Trigger input for level and frequency measurement of short-time signals

Recording Harmonic and non-harmonic spectra as well as gain and attenuation characteristics can readily be plotted on an XY recorder. The recorder writing area is defined by entering the start/stop frequency and the maximum/minimum level. The frequency axis can be linear or logarithmic. Chart paper complying with VDE/FCC/MIL/VG can be used.

Oven-controlled Crystal Oscillator Option ESV-B1 The oven-controlled crystal oscillator reduces the setting error and the frequency measurement error of the ESVP down to $< 2 \times 10^{-7}$. This is mainly important when the ESVP is used for frequency measurements in radiomonitoring. A 10-MHz output of this option can be brought out on the rear panel of the ESVP and used for connection of a second receiver, e.g. ESH 3.

Typical dynamic selectivity of ESVP

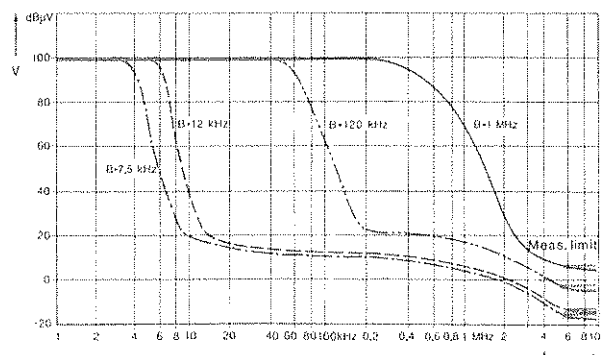

Insertion and return loss of a bandpass filter

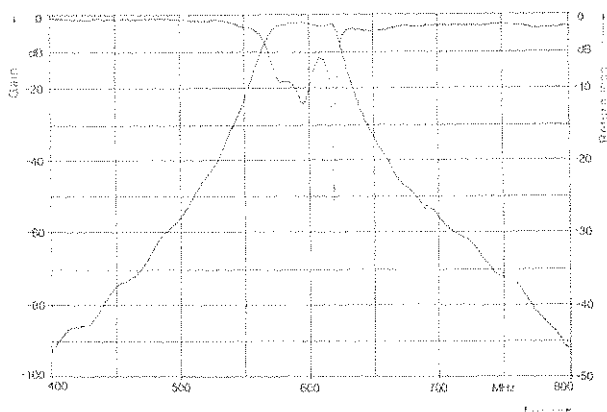

TYPICAL APPLICATIONS

Interference measurements Thanks to the programmable automatic frequency scanning with direct control of printer and XY recorder for data logging, the ESVP features considerable advantages over conventional test receivers in this field of application. For measurement of interference voltages, currents, power and field strengths to the relevant standards (CISPR, VDE, MIL, VG), the following accessories are available (see also accessories for ESV and ESVP, data sheet PD 756.4520 and test antennas for near-field measurements and measurements to MIL-STDs, data sheet PD 756.4337):

- V-network (5 μ H \pm 50 Ω)	ESH 3-Z6
- VHF Current Probe (20 to 300 MHz)	ESV-Z1
- Absorbing Clamp (30 to 1000 MHz)	MDS 21
- Broadband Dipole (20 to 80 MHz)	HUF-Z1
- Biconical Antenna (20 to 200 MHz)	HUF-Z2
- Log-periodic Antenna (200 to 1000 MHz)	HUF-Z3
- Conical Log-spiral Antenna (200 to 1000 MHz)	HUF-Z4
- Log-periodic Broadband Antenna (80 to 1300 MHz)	HL 023 A1

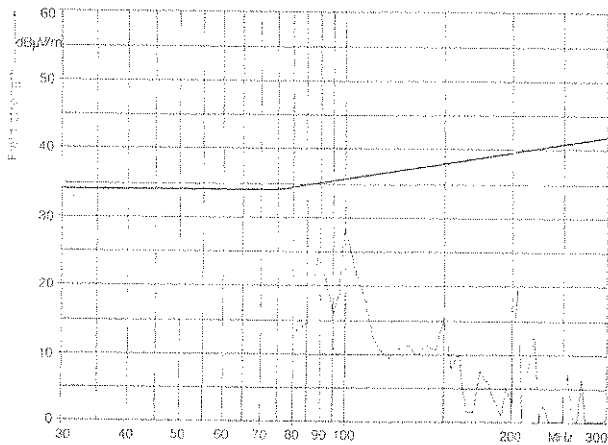

Interference field strength of a motor vehicle: automatic frequency scanning of ESVP with 50 fixed frequencies

Further advantages of ESVP in interference measurements:

- Automatic consideration of correction factors of any probes and indication of physical unit (e.g. $\text{dB}\mu\text{A}$, $\text{dB}\mu\text{V}$, $\text{dB}\mu\text{V}/\text{m}$, dBpW)
- Suitable bandwidths for measurements to MIL STDs provided by model 56 (also in line with SAE draft for MIL STD 462 B), British DEF STAN 59-4 and VG standards
- Bandwidth correction factors considered in measurement of spectral pulse density to MIL and VG: readout of measured data in $\text{dB}\mu\text{V}/\text{MHz}$, $\text{dB}\mu\text{A}/\text{MHz}$, $\text{dB}\mu\text{V}/\text{m MHz}$
- Frequency range 20 Hz to 1.3 GHz together with ESH 3 and EZM (see interference measurement system for 20 Hz to 1.3 GHz, data sheet PD 756.4920).
- Programmable measuring times for optimum adaptation of automatic measurements to time-dependent variations of the interference:

Peak indication with programmable hold time for narrowband and broadband interference measurements to MIL and VG standards

Average indication with programmable integration time for narrowband interference measurements

Indication conforming to CISPR with determination of maximum within the programmed measuring time

- 60-dB operating range ideally suited for measurements to MIL and VG standards
- 10-dB operating range for measurements to CISPR; auto-ranging with consideration of settling times for error-free results, CISPR standards being fully complied with even for single pulses

Logarithmic frequency axis for data logging on XY recorder permitting direct recording of measured data on tolerance charts

Since pure broadband noise spectra exhibit a continuous characteristic, frequency scanning in constant or frequency-proportional steps which are greater than the IF bandwidth, is possible and recommendable. Automatic frequency scanning of the ESVP with 50 programmed fixed frequencies is ideal in free-field measurements, e.g. measurement of ignition interference from motor vehicles to VDE 0879 and SAE J551. For this purpose the frequencies are selected so that they do not fall within the channels occupied by radio services.

Radiomonitoring, propagation and coverage measurements Thanks to its outstanding RF characteristics, such as high setting accuracy, high overload capacity and overall selectivity, its switch-selected IF bandwidths and types of demodulation, the wide range of available test antennas and its programmability, the ESVP is ideal for use in radiomonitoring with remote frequency measurement, modulation-depth and frequency-deviation measurements, recording of band and channel occupancy, as well as for propagation and coverage measurements. It offers the following capabilities:

- Graphical representation of field-strength results in particular frequency bands, in the form of line spectra or continuous curves, on an XY recorder, with additional output of field-strength levels and, for instance, frequency offset on a printer
- Measurement of the TV vision carrier
- Measurement of the range of field-strength variations within a preset time (1 to 1000 s)
- Recording of field strength as a function of time for plotting antenna radiation patterns, e.g. in helicopters and for channel occupancy measurement
- IF panoramic display in conjunction with Spectrum Monitor EZM (data sheet PD 756.5356)
- Recording of band occupancy as a function of time, using the Radiomonitoring Recorder ZSG 3
- Reduction of data volume in automatic scanning mode: only signal levels above the preset threshold are transferred to the computer
- Trigger functions:
 1. "internal" for automatic monitoring of intermittent carriers;
 2. "at time x" and
 3. every x seconds, minutes, hours for exact observation of the occupancy and of level fluctuations
- Use in automatic field-strength test sets (see next page).

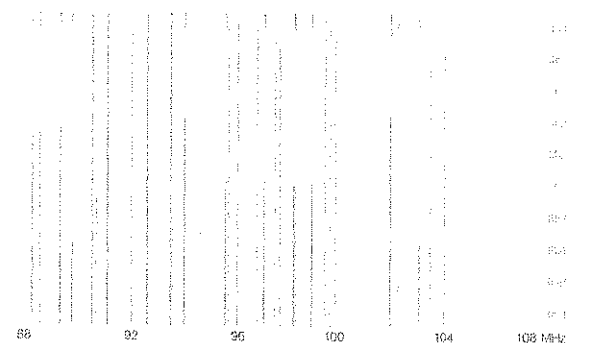

Recording of band occupancy in VHF range

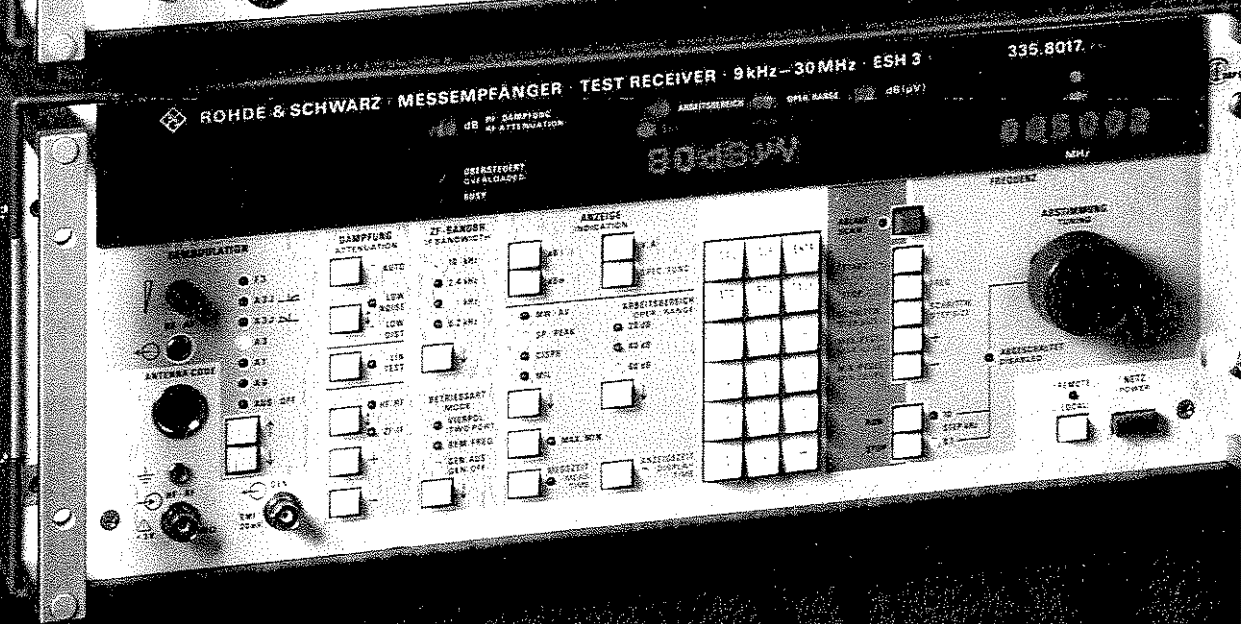

EMI Test System EP-6 for 20 Hz to 1.3 GHz,
consisting of Receivers ESH 3 and ESVP and Spectrum Monitor EZM (model)

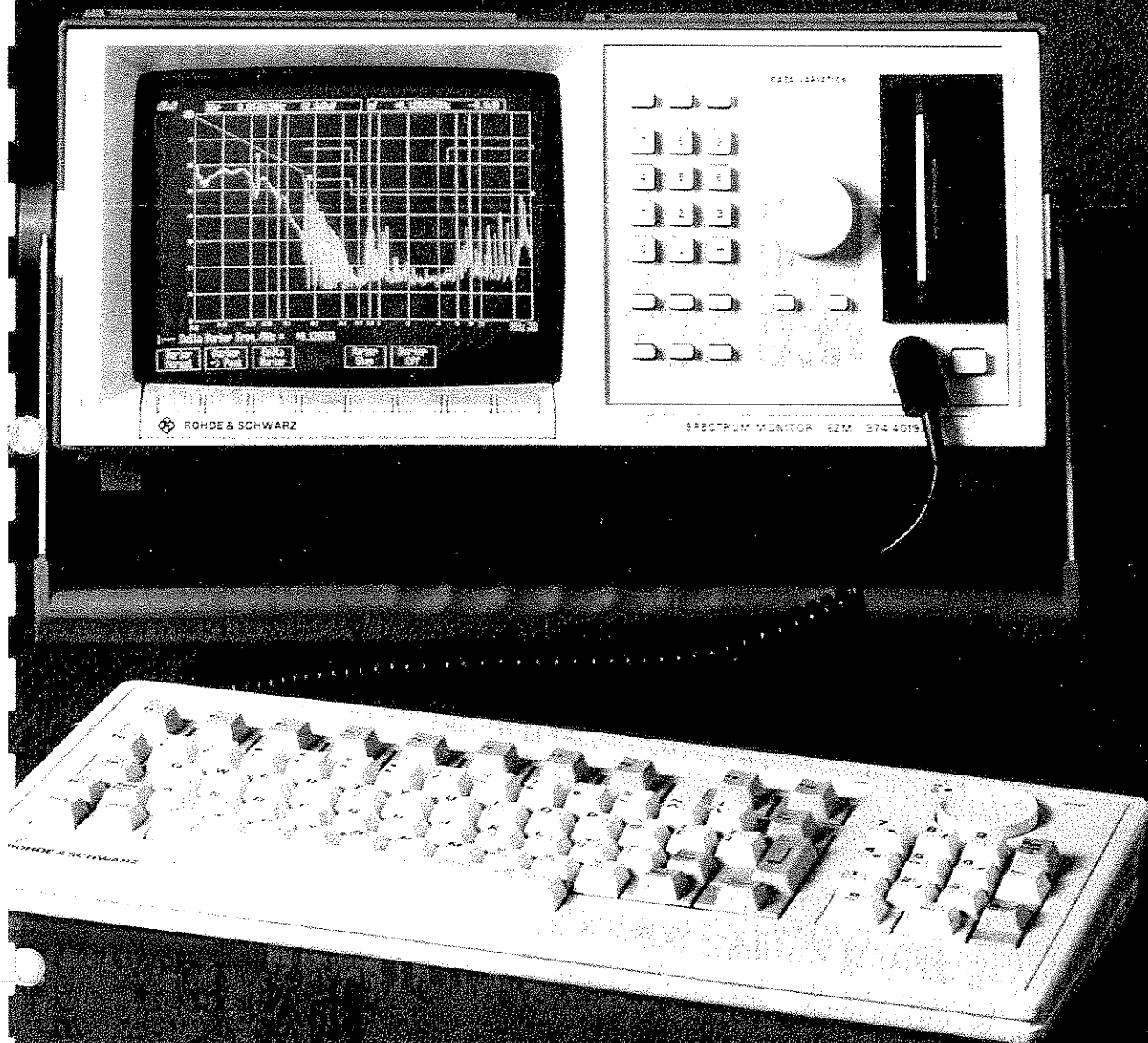

OPERATION

The front-panel controls are clearly arranged in functional groups; all settings are indicated by LEDs.

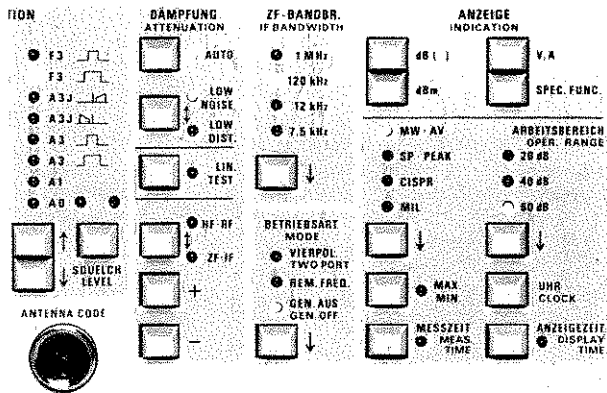

Front-panel detail with operating controls for demodulation, attenuation, IF bandwidth and indication

Operation is backed up by the following indicators and responses of the ESVP: when a logically inhibited key is pressed, the LED of the inhibiting function blinks; when the demodulator operating range is exceeded or essential stages are overloaded (even with pulses), the display blinks; when illegal data is input or an essential module fails, a coded error message appears together with an acoustic signal. The end of lengthy, time-consuming measurements is also indicated audibly.

The 15-digit **alphanumeric display** of the ESVP outputs the measured data complete with physical unit and is also used for checking the formatted input of setting data.

Non-volatile memory A battery-buffered memory in the ESVP can store the last and another nine complete device settings. It also stores all correction values obtained from an automatic calibration process for frequency response, IF bandwidths and demodulator characteristic and thus ensures maximum accuracy at all times.

Frequency setting is facilitated by a tuning aid (offset indication with centre calibration) and is possible in various ways:

- quasi-continuous in steps of 1 kHz or 100 kHz (switch-selected) and of 100 Hz or 100 kHz in SSB mode, using rotary knob
- in steps of any preset size, e.g. corresponding to channel spacing, or in steps of the fundamental frequency for measurement of harmonics
- by digital entry via the keyboard
- by automatic frequency scanning over a maximum of five subranges with programmable start/stop frequencies and step sizes.

The level measurement range is selected either manually by separate setting of RF and IF attenuation or by automatic setting of the RF attenuation with the IF attenuation setting being determined by the selected IF bandwidth and indication mode. A 1-dB and a 4-dB attenuator are provided for additional linearity testing. The use of probes with the ESVP does not cause any extra work in the performance of measurements, since the physical unit is selected automatically and correction factors are taken into account. Reading errors are practically done away with.

The frequency-dependent correction factors of the Test Antennas HUF-Z1 and HL 023 A1 are also automatically taken into account when a special function is selected. Furthermore, the correction factors of another two probes or correction values of test setups can be entered into the battery-buffered CMOS RAM of the ESVP for permanent storage and called up via a special function.

Demodulator operating ranges Depending on the measurement task, one of three demodulator operating ranges can be selected: 20/40/60 dB. Accordingly, the automatic attenuation setting is in steps of 10, 20 or 30 dB.

Like the Test Receiver ESV, the ESVP also fulfills the CISPR linearity requirements with a valid operating range of 10 dB, which considerably speeds up CISPR interference measurements. The operating range also determines the range of the analog level indication which consists of a row of 31 LEDs. The range limits and RF attenuation are digitally displayed.

Calibration By a short or long push of the calibration key, two different processes can be triggered:

1. Adjustment of IF gain and frequency offset to the rated value of 100 MHz, with subsequent checking of the level measurement at the original frequency.
2. Measurement and storage of all calibration correction values that are constant over a long time: frequency response, gain differences between IF bandwidths and demodulator linearity.

During operation the IF gain is adjusted whenever a new frequency and IF bandwidth is set, so that the rated levels are also obtained at the IF and recorder outputs.

Thanks to this method, calibration of individual functions is very seldom necessary, and automatic measurements take much **less time** than would be required if a calibration were performed at each new frequency.

Operating principle The Test Receiver ESVP provides for double conversion of the test signal. It features the following characteristics:

RF attenuator switchable in steps of 10 dB from 0 to 140 dB; a 1-dB and a 4-dB attenuator being provided for linearity testing.

Low-noise preamplifier with high linearity can be switched on to increase the measurement sensitivity.

High-linearity diode mixer following 10 tracking bandpass filters, providing extremely wide dynamic range.

Test IF bandwidth can be switched from 7.5 to 12/120/1000 kHz on model 52; model 53: 200 kHz instead of 1000 kHz; model 56: 10/100 kHz instead of 7.5/12 kHz; additional 2.4-kHz filter for SSB demodulation in all models.

Signal evaluation with average and peak indication as well as pulse weighting to CISPR Publ. 16 and VDE 0876, Part 1.

Programmable measuring times (5 ms to 100 s) to suit the test requirements.

MIL display mode, peak indication with automatic consideration of IF bandwidth correction values for the measurement of broadband interference.

MAX-MIN display mode for measuring the input signal variation range in a sequence of single measurements of 100 ms duration each.

Display time separately programmable; to ensure sufficiently long indication and monitoring of signals exceeding a programmed threshold in automatic frequency scanning mode.

All oscillators using synthesizer technique

1st IF 810.7 MHz or 310.7 MHz

2nd IF 10.7 MHz

Active, high-linearity demodulator with subsequent average- and peak-value derivation and CISPR weighting.

Demodulator circuits for FM and AM and with BFO for NON (A0) and A1A (A1); 2.4-kHz filter in SSB demodulator for upper and lower sideband; automatic IF gain control for all AM demodulators; built-in loudspeaker; switch-selected squelch with threshold programmable in terms of the RF input level; FM demodulators are also used as signal sources for frequency deviation measurement.

Calibration generator with highly stable sinewave source (tracking generator) and pulse generator for CISPR and spectral pulse density calibrations.

12-bit A/D converter with extremely short conversion time; digital averaging and fast-acting RF level switch ensure rapid autoranging.

Design The modular design, signature analysis capability and self-test routines afford great ease of servicing. All modules are independently exchangeable; all RF and μ P modules are of state-of-the-art cassette design ensuring excellent RF screening and minimum EMI.

Rear view of ESVP

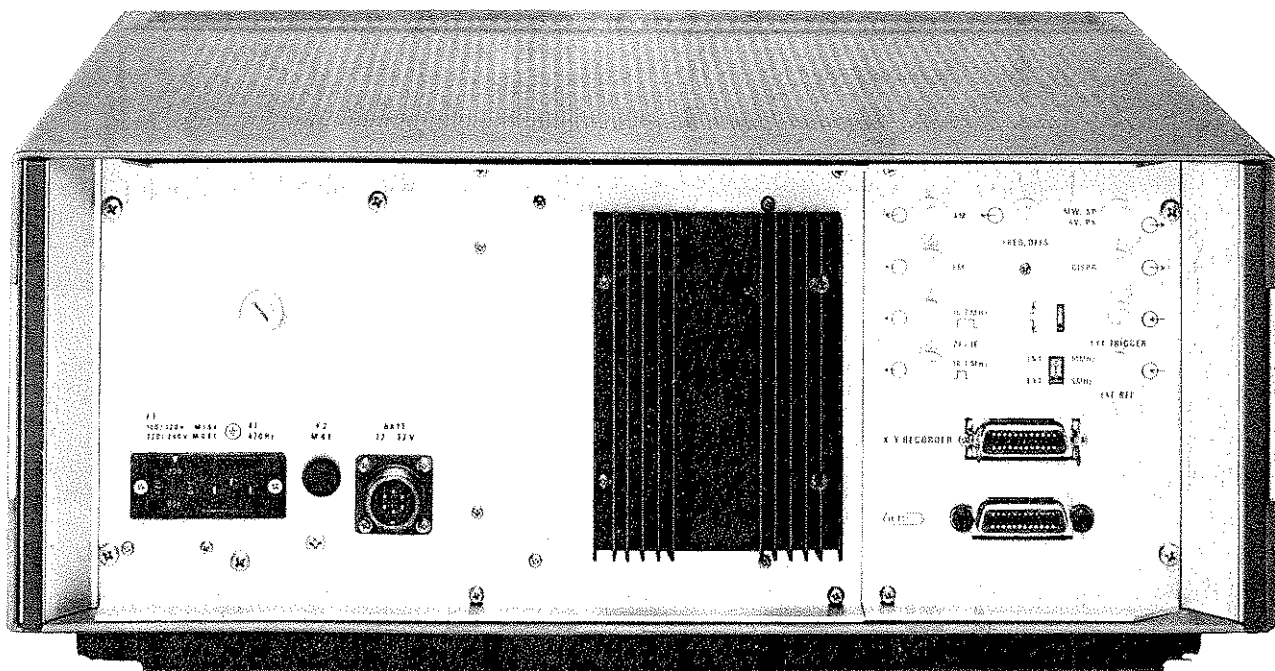

SPECIFICATIONS

Frequency range	20 to 1300 MHz
Frequency setting	1. with tuning knob in 1-kHz or 100-kHz steps (switch-selected); least increment in SSB mode: 100 Hz 2. keyboard entry 3. in steps of any preset size 4. automatic scanning
Indication	8-digit LED display
Resolution	1 kHz/100 Hz (SSB)
Setting error (freq.-prop.)	$< 5 \times 10^{-6}$ (max. 5 kHz at 1 GHz)
With Oven-controlled Crystal Oscillator Option ESVP-B1	
Setting error	
in temperature range +5 to +45 °C	$< 1 \times 10^{-9}/^{\circ}\text{C}$
Warmup time	< 10 min at 5 °C < 5 min at 25 °C
Aging	$\leq 1 \times 10^{-9}/\text{day}$
Pulling range of oven-controlled crystal oscillator (with built-in potentiometer)	$\geq 1 \times 10^{-6}$
RF input	$Z_{in} = 50 \Omega$, N female connector
VSWR	< 1.2 with RF attenuation ≥ 10 dB < 2 with RF attenuation 0 dB, typ. 1.3 < 2.5 with RF attenuation 0 dB, and preamplification, typ. 1.5
Oscillator reradiation at RF input without preamplifier and with 0 dB RF attenuation	< 10 dB μV for $f_{in} = 20$ to < 520 MHz, < 20 dB μV for $f_{in} = 520$ to < 1020 MHz, typ. 30 dB μV (for $f_{in} = 520$ to < 1020 MHz), typ. 50 dB μV ($2 \times f_{in}$) for $f_{in} = 1.02$ to 1.3 GHz (with preamplifier approx. 15 dB less) can be switched into circuit between RF attenuator and input filter: gain $\approx +10$ dB 10 tracking filters
Preamplifier	
Input filters	
Maximum input level (with and without preamplifier)	
RF attenuation 0 dB	
DC voltage	7 V
Sinewave AC voltage	130 dB μV
Spectral pulse density	96 dB $\mu\text{V}/\text{MHz}$ (100 V x 0.5 ns)
RF attenuation ≥ 10 dB (no DC isolation)	
DC voltage	7 V = 1 W
Sinewave AC voltage	137 dB $\mu\text{V} = 1$ W
Max. pulse voltage	150 V
Max. pulse energy (10 μs)	1 mWs
Interference rejection, non-linearities	
Image frequency rejection	off preamplifier on 20 to 1020 MHz: >80 dB, typ. 100 dB; 1020 to 1300 MHz: >70 dB, typ. 100 dB
Rejection of spurious responses in range 1020 to 1300 MHz for frequencies $2 \times f_{in} - 932.1$ MHz	typ. 30 to 80 dB (increasing with receiver frequency) >80 dB, typ. 100 dB
IF rejection	
Intercept point d_3	>13 dBm, typ. +20 dBm >1 dBm, typ. +8 dBm
Intercept point k_2	>40 dBm, typ. +50 dBm >20 dBm, typ. +40 dBm
Desensitization	
An interfering signal spaced >2 MHz from the receive frequency varies the indication of the measured signal by <1 dB (RF attenuation 0 dB) at a level of	typ. 110 dB μV typ. 100 dB μV
RF screening	
Voltage indication at a field strength of 3 V/m	< 0 dB μV
Radio interference from internal microcomputer etc.	below the limits specified in FTZ-Vfg. 527/1979 and MIL-STD 461-B
IF frequencies	
1st IF $f_{in} < 520$ MHz	810.7 MHz
$f_{in} > 520$ MHz	310.7 MHz
2nd IF	10.7 MHz
IF bandwidths (for average and peak values)	
Nominal bandwidth	-3 dB -6 dB typ. ratio ($\pm 20\%$) ($\pm 10\%$) 6:60 dB
7.5 kHz (models 52/53)	7.5 kHz 8.3 kHz 1:1.8
10 kHz (model 56)	9 kHz 10 kHz 1:1.8
12 kHz (models 52/53)	12 kHz 13.4 kHz 1:1.8
100 kHz (model 56)	90 kHz 100 kHz 1:2.1
120 kHz (all models)	110 kHz 120 kHz 1:2.1
200 kHz (model 53)	200 kHz 225 kHz 1:2.5
	($\pm 10\%$) ($\pm 20\%$)
1 MHz (models 52, 56)	0.8 MHz 1 MHz 1:3.5
IF bandwidth (-6 dB) for radio interference measurements to CISPR Publ. 2 and 4 and VDE 0876, Part 1	120 kHz
IF bandwidth (-3 dB) for SSB demodulation (aural monitoring only)	2.4 kHz
AF bandwidths (-3 dB; aural monitoring for A3E (A3) and F3E (F3))	
narrow	300 Hz to 3.3 kHz
broad	50 Hz to > 15 kHz

Noise indication	off preamplifier on
Average value, B = 7.5/10 kHz	
20 to <520 MHz	<-10 dB μV , typ. -13 dB μV
520... 1300 MHz	<-8 dB μV , typ. -11 dB μV
Peak value (typ. increase as against average value)	+11 dB
CISPR	typ. +4 dB μV
MIL ($B_{IF} = 1$ MHz)	typ. +20 dB $\mu\text{V}/\text{MHz}$ typ. -4 dB μV , typ. 14 dB $\mu\text{V}/\text{MHz}$
Voltage measurement range (with preamplifier)	
Lower limit	3 dB above noise level (see noise indication) 137 dB μV (RF attenuation ≥ 10 dB)
Upper limit	
Inherent spurious responses	<-5 dB μV (equivalent input voltage)
Readout	
digital in dB μV , dBm	4 digits max., resolution 0.1 dB
in μV , mV, V	3 digits
analog	LED row (31 LEDs) over operating range of IF rectifier and with digital display of range limits
Operating ranges of IF rectifier	20, 40, 60 dB
Display modes	average value (programmable averaging time), peak value (programmable hold time), spectral pulse density measurements to MIL (programmable hold time), CISPR (Publ. 16, programmable measuring time), programmable averaging, hold and measuring times: 5 ms to 100 s
Max. and min. level measurement	the maximum and minimum levels are determined from individual measurements of 0.1 s duration each; programmable measuring time: 1 to 1000 s
Measuring error (level indication)	
Error of average indication for unmodulated sinewave signal ≥ 16 dB above noise indication (AV)	<1 dB
Additional error in operating ranges 40 and 60 dB	typ. <0.5 dB
Error of CISPR-QP indication ($S/N > 15$ dB, LOW NOISE setting)	<1.5 dB
Level calibration facility	
Average/peak	tracking generator (sinewave)
CISPR, MIL in addition	pulse generator (for compensation of bandwidth tolerance)
Error of analog level indication	
Operating range 20 dB	typ. <2 dB
40, 60 dB	typ. <4 dB
Frequency offset	
Indication	
digital in kHz (with built-in IF counter)	resolution 0.1 to 100 Hz (depending on measuring time) LED row (16 LEDs)
analog	depending on IF bandwidth
Measurement range	10 ms to 10 s
Measuring times	depending on int./ext. reference; internal: 5×10^{-8} ; with option ESVP-B1: see setting error (left column top)
Measuring error (relative to f_{in})	
Frequency deviation (positive, negative and average peak deviation)	
indication	digital in kHz, 4 digits 0.1/0.01 kHz
Resolution	
Measurement range (deviation + $f_{mod} \leq B_{IF} \times 3 \text{ dB}/2$)	1 to 400 kHz
Measurement error for $S/N = 40$ dB (mod. meas. filter switched in)	
at $B_{IF} = 7.5/10/12$ kHz, deviation $< B_{IF}/2$, $f_{mod} \leq 1$ kHz	<0.5 kHz (typ.)
at $B_{IF} = 100/120$ kHz, deviation $< B_{IF}/2$, $f_{mod} \leq 1$ kHz	<2 kHz (typ.)
at $B_{IF} = 200$ kHz, deviation < 100 kHz, $f_{mod} \leq 1$ kHz	<5 kHz (typ.)
at $B_{IF} = 1$ MHz, deviation < 400 kHz, $f_{mod} \leq 1$ kHz	<5 kHz + 0.02 deviation/kHz (typ.)
Modulation depth (positive and negative peak, average AM, mod. meas. filter switched in)	
Indication	digital in %, 3 digits max. 0.1%
Resolution	
Measurement range	≈ 1 to 99% (150% pos. peak)
Measuring error for $S/N = 40$ dB ($f_{mod} = 1$ kHz)	<5% abs. (typ.)
Gain measurement	
Indication	digital in dB, 4 digits max. 0.1 dB
Resolution	
Measurement range	-110 to +47 dB
Error	<1 dB; typ. <0.5 dB
Demodulation modes	A0 (zero beat) A1 (1-kHz beat note) A3 for A3E emissions A3J (LSB, USB) for R3E and J3E F3 for F3E emissions

Squelch	carrier squelch, programmable response threshold compared with indicated voltage
Setting range of response threshold	-20 to +137 dB μ V
Date, time of day	internal clock module, permanently in operation from internal battery
Error of internal clock reference	typ. <1 x 10 ⁻⁴
Remote control	interface to IEC 625-1 (IEEE 488)
Interface functions	AH1, L4, SH1, T5, SR1, PP1, DC1, DT1, RL1, C0
Max. data rate in Talker mode	approx. 25 Kbyte/s
Listener mode	approx. 20 Kbyte/s
Setting times	
Internal frequency (e.g. scan mode)	
in steps <100 MHz	typ. 20 to 40 ms
exceeding a 100-MHz digit	typ. 70 ms
Internal RF level switch	25 ms/step
Max. measuring rate with Process Controller PUC, measuring time 5 ms	
with autom. frequency scanning	16 measurements/s
with pseudo frequency scanning (measurement at one frequency)	30 measurements/s
with special function Fast A/D	1000 measurements/s
Remote-control connector	24-contact Amphenol female
Front-panel outputs	
Generator output (switch-selected) EMF	Z _{out} = 50 Ω , N female connector 96 dB μ V \pm 0.3 dB
Connector for supply and coding of test antennas etc.	12-contact Tuchel female
AF output	Z _{out} = 10 Ω , telephone jack JK34 adjustable up to 3.5 V
EMF, undistorted	
Rear-panel outputs	
IF 10.7 MHz	
wide (B = 2 MHz)	Z _{out} = 50 Ω , BNC female connector
gain ref. to RF input (RF attenuation 0 dB)	typ. 7.5 dB (without preamplifier) typ. 17.5 dB (with preamplifier)
narrow (B = IF bandwidth)	Z _{out} = 50 Ω , BNC female connector
EMF (rms values) in range of analog level indication	
Operating range 20 dB	10 to 100 mV
40 dB	10 to 1000 mV
60 dB	1 to 1000 mV
AM demodulator	Z _{out} = 330 Ω , BNC female connector
EMF	1 V _{pp} at m = 50%
B -3 dB max.	\geq 0.3 MHz
FM demodulator	Z _{out} = 330 Ω , BNC female connector
EMF at IF bandwidth	
7.5/10/12 kHz	\pm 1 V/ \pm 1 kHz offset
100/120/200/1000 kHz	\pm 1 V/ \pm 100 kHz offset
B -3 dB max.	\geq 0.3 MHz
Analog recording outputs	
Frequency offset	Z _{out} = 10 k Ω , BNC female connector
EMF at IF bandwidth	
7.5/10/12 kHz	\pm 1 V/ \pm 1 kHz offset
100/120 kHz	\pm 1 V/ \pm 10 kHz offset
120/200 kHz (model 53)	\pm 1 V/ \pm 20 kHz offset
1000 kHz	\pm 1 V/ \pm 100 kHz offset
Level 1	Z _{out} = 10 k Ω , BNC female connector
in AV, PEAK, CISPR, MIL display modes	+4 V for max. indication in operating range
Level 2	Z _{out} = 10 k Ω , BNC female connector
in CISPR display mode	+2 V for max. indication in operating range (contains a lowpass filter for simulating meter response to CISPR 2/4)
Recorder output (via D/A converter)	24-contact Amphenol female connector (contains D/A-converted X and Y analog outputs for recording the scanning process) X = 0 V: start frequency = +10 V: stop frequency Y = 0 V: min. level = +10 V: max. level pen lift control: low level = pen up, form feed for ZSKT, high pulse, 10 ms duration, connection of 5 Radiomonitoring Recorders ZSG3 possible
Rear-panel inputs	
Ext. trigger	Z _{in} \geq 3 k Ω , BNC female connector
Trigger threshold	TTL (H \geq 2 V, L \leq 0.8 V hysteresis) switch-selected positive or negative slope
Ext. reference frequency	BNC female connector
Required level	EMF = 1 V from 50 Ω , sinewave
Frequency	5/10 MHz (switch-selected)

General data

Rated temperature range	+5 to +45 °C
Storage temperature range ¹⁾	-25 to +70 °C
Power supply	
AC supply	100/120/220/240 V \pm 10%, 47 to 440 Hz (100 VA) safety class I to VDE 0411 (IEC 348)
Battery	22 to 32 V, 3 A at 24 V
Dimensions (WxHxD), weight	492 mm x 205 mm x 514 mm, 29 kg

Ordering information

Order designation	► Test Receiver ESVP
B _{IF} = 7.5/12/120/1000 kHz	354.3000.52
B _{IF} = 7.5/12/120/200 kHz	354.3000.53
B _{IF} = 10/100/120/1000 kHz	354.3000.56

Accessories supplied	
Power cable	025.2365.00
Battery cable	252.0084.00
Manual	

Option	
Oven-controlled Crystal Oscillator	ESVP-B1 358.1119.02

Recommended extras	
VHF Current Probe (20 to 300 MHz)	ESV-Z1 353.7019.02
Absorbing Clamp (30 to 1000 MHz)	MDS-Z1 194.0100.50
Adapter BNC/N	118.2812.00
Broadband Dipole (20 to 80 MHz)	HUF-Z1 358.0512.52
Log-periodic Broad-band Antenna (80 to 1300 MHz)	HL 023 A1 577.8017.02
Tripod	HFU-Z 100.1114.02
Mast (for tripod)	HFU-Z 100.1120.02
RF connecting cable (7 m)	HFU 2-Z5 252.0055.55
Probe (BNC connector)	HFV-Z 204.1010.02
Adapter BNC/N	118.2812.00
Headphones	110.2959.00
Service Kit	ESVP-Z1 358.1019.02
V-network 5 μ H 50 Ω	ESH 3-Z6 836.5016.52
Biconical Antenna (20 to 200 MHz)	HUF-Z2 837.2010.52
Log-periodic Antenna (200 to 1000 MHz)	HUF-Z3 837.2110.52
Conical Log-spiral Antenna (200 to 1000 MHz)	HUF-Z4 837.2210.52
Wooden tripod	HZ-1 837.2310.02
Mast adapter	HZ-2 837.2510.02

Recommended add-on units	
XYT Recorder	ZSKT 301.9010.02
Connecting Cable	
ESVP-ZSKT	ESH3-Z1 349.6011.02
Radiomonitoring Recorder	ZSG 3 242.6015.92
Universal Impact Printer (220 V)	PUD 2 359.5018.02
Universal Ink-jet Printer (220 V)	PUD 3 359.5501.02
Universal Ink-jet Printer (117 V)	PUD 3 359.5501.03
IEC-625 Interface Option (for PUD 2 and PUD 3)	PUD 2-B4 359.5418.02
Spectrum Monitor	EZM 374.4019.03
VSWR Bridge (50 Ω , 5 to 2500 MHz)	ZRB 2 373.9017.53

1) The ESVP contains a Li-battery for buffering the CMOS-RAMs. Storage at high temperatures over extended periods curtails the lifetime of this battery.



ROHDE & SCHWARZ









GmbH & Co. KG · D-8000 München 80 · Mühldorfstr. 15 · Tel. (089) 41 29-0 · Telefax (089) 41 29-2164 · Telex 5 23703
Printed in the Fed. Rep. of Germany · Subject to change without notice · Order of magnitude only

2 Preparation for Use and Operating Instructions

(See Figs. 2-1 and 2-2 in appendix. The Ref.No's in the following table are the call-out numbers in these illustrations.)

The values specified in this section are not guaranteed. Only the specifications given in the data sheet are binding.

2.1 Legends for the Front- and Rear-panel Views

Ref. No.	Labelling	Function
<u>1</u>	NF·AF	AF output socket with switching contact for loudspeaker <u>3</u> . $Z_{out} = 10 \Omega$; $P_{out \text{ max}} = 0.4 \text{ W}$.
<u>2</u>		Volume control for <u>1</u> and <u>3</u> .
<u>3</u>		Built-in loudspeaker, which is switched off when a phone jack PL55 is inserted into <u>1</u> .
<u>4</u>	DEMODULATION	LEDs for indicating the selected form of AF demodulation.
	F3 	→ for FM signals (F3E) (AF filter 0.3 - 3 kHz switched in).
	F3 	→ for FM signals (F3E) (AF filter switched out).
	A3J 	→ for SSB signals (J3E, upper sideband).
	A3J 	→ for SSB signals (J3E, lower sideband).
	A3 	→ for AM signals (A3E) (AF filter 0.3 - 3 kHz switched in).
	A3 	→ for AM signals (A3E) (AF filter switched out).
	A1	→ 1-kHz beat note.
	AØ	→ for frequency tuning to zero beat.
		Key for stepping the AF demodulation. Upper key for next higher function. Lower key for next lower function. AF out: no LEDs lit.

Ref. No.	Labelling	Function
<u>5</u>	IF BANDWIDTH 1 MHz (mod. 52) 200 kHz (mod. 53) 120 kHz 100 kHz (mod. 56) 12 kHz (mod. 52, 53) 10 kHz (mod. 56) 7.5 kHz (mod. 52, 53) ↓	LED indication and key for stepping the selected IF bandwidth. The 120-kHz bandwidth is always switched in for indicating mode CISPR. With the SSB demodulation modes (A3J), a 2.4-kHz IF bandwidth is switched in the audio channel, the measurement IF bandwidth is 7.5 kHz.
<u>6</u>	BUSY	LED for indicating extended measuring and calibration processes and internally controlled frequency scanning.
<u>7</u>	OVERLOADED	LED for indicating an overload condition a) when the overload detection circuit in the 2nd mixer responds. b) when nonlinearity is detected by means of LIN TEST <u>43</u> and AUTO <u>41</u> .
<u>8</u>	PREAMP. ON	LED lights when the 10-dB preamplifier (with special function 17) is switched in.
<u>9</u>	dB RF ATTENUATION	3-digit 7-segment display of the RF attenuation set.
<u>10</u>	dB	Key for setting the RF input level display to dB μ V, etc. (see section 2.3.8).
<u>11</u>	dBm	Key for switching the RF-input level indication to dBm. (Only when AV or PEAK is set at <u>37</u> ; and not if a test antenna or probe is connected to <u>47</u> or if the mode switch <u>40</u> is set to TWO PORT.)
<u>12</u>		15-digit alphanumeric LED display for readout of measured values, input and output of setting values, and output of error messages. The readout blinks when the operating range is exceeded at either end or when an overload condition exists.
<u>13</u>	SPEC.FUNC.	Key, used in conjunction with keypad <u>33</u> and ENTR key, for entering the special functions (modulation-depth, frequency-offset, frequency-deviation measurements, etc.) and calling such entered functions. The function codes are listed in section 2.3.14.

Ref. No.	Labelling	Function
<u>14</u>	V, A	Key for switching RF input level readout to desired unit: μ V, mV, V, etc. (see section 2.3.8).
<u>15</u>	OPER.RANGE ... dB μ V	<p>Analog level indication over selected operating range (with <u>34</u>).</p> <p>LED array consisting of 31 LEDs, with one individual LED each for indication if the operating range is exceeded at either limit, and three 3-digit 7-segment displays marking the beginning, centre and end of the selected demodulator operating range. The LED row displays the voltage level at input <u>50</u> in dBμV in all cases.</p>
<u>16</u>	CAL	<p>Key for initiating calibration processes:</p> <ul style="list-style-type: none"> → pressed momentarily (< 3 s): testing and, if necessary, correcting level and frequency-offset calibration; → held down (> 3 s): measuring and storing the RF frequency response, IF bandwidth corrective values and demodulator characteristics. <p>During the calibration processes, the BUSY LED <u>6</u> is on.</p> <p>For details see section 2.3.7.</p>
<u>17</u>	STO RCL	<p>Keys for storing (STO) and recalling (RCL) complete device settings.</p> <p>STO 1 to 5 and RCL 1 to 5 cover the device settings and data for automatic frequency scanning.</p> <p>STO 6 to 9 and RCL 6 to 9 cover only device settings (no frequency scanning).</p> <p>STO \emptyset is not possible; RCL \emptyset selects the basic setting of the receiver.</p> <p>For details see section 2.3.14.</p>
<u>18</u>	CLR	Key for clearing the last numerical entry via <u>33</u> .









Ref. No.	Labelling	Function
<u>19</u>	ENTR	Key for issuing a transfer command after completion of the data entry (key functions <u>13</u> , <u>27</u> , <u>28</u> , <u>30</u> , <u>31</u> , <u>32</u> , <u>35</u> , <u>36</u> , <u>39</u> , <u>46</u> engraved in red).
<u>20</u>	TALK	Key for initiating data output to a printer if the automatic frequency scanning mode of the ESVP is not switched on. The printer must be set to LISTEN ONLY. It is connected to the IEC-bus output <u>60</u> . The ESVP must be set to TALK ONLY by means of special function 01 (IEC-bus address > 32, see section 2.3.14).
<u>21</u>	MHz	6-digit display of current receiver frequency.
<u>22</u>		Analog display of frequency offset of sinusoidal input signal which lies in the IF passband from the receiver centre frequency. LED array consisting of 16 LEDs plus a LED for indication of centre frequency tuning (positive offset: indication to left of centre). The centre of this analog display is calibrated as part of the automatic calibration process initiated by key <u>16</u> .
<u>23</u>	TUNING DISABLED	Knob for quasi-continuous setting of receiver frequency in 100- and 1-kHz steps (in SSB demodulation in 0.1-kHz steps). This knob is disabled if the DISABLED LED lights (disabled by means of the keys <u>26</u> and <u>29</u> and in remote operation: LED <u>25</u> lights up).
<u>24</u>	POWER	Power switch for switching ESVP on and off in network or battery operation.





Ref. No.	Labelling	Function
<u>25</u>	SRQ REMOTE LOCAL	<p>The REMOTE LED is lit whenever the ESVP is remote-controlled via the IEC-bus connector <u>60</u>.</p> <p>Unless a Local Lockout command has been issued, the REMOTE state can be interrupted during the program by pressing the LOCAL key. The next addressing operation by the IEC-bus controller restores the REMOTE state.</p> <p>The SRQ LED is lit, so long as the SRQ line is true, i.e. until the bus controller has executed a serial poll.</p>
<u>26</u>	SCAN	<p>On/off key for automatic scanning. The LED lights up to indicate that the engravings on the left-hand side (dark background) apply to the entire row of keys <u>27</u>, <u>28</u>, <u>29</u>, <u>30</u>, <u>31</u> and <u>32</u>.</p>
<u>27</u>	+ MAX.LEVEL	<p>Key with two functions:</p> <p>a) The SCAN LED <u>26</u> is not on. The receiver frequency is increased at each push of the key by the amount selected with key <u>30</u>. If the key is held down, the key function is repeated automatically.</p> <p>b) The SCAN LED <u>26</u> is on. The upper level limit for automatic scanning which is essential for setting the output to an XY recorder can be called up and entered (see section 2.3.20). For data transfer, ENTR key <u>19</u> is pressed.</p>
<u>28</u>	- MIN.LEVEL	<p>Key with two functions:</p> <p>a) The SCAN LED <u>26</u> is not on. The receiver frequency is decreased at each push of the key by the amount fixed with key <u>30</u>. If the key is held down, the key function is repeated automatically.</p> <p>b) The SCAN LED <u>26</u> is on. The lower level limit essential for the detection of signals and for setting the output to an XY recorder when using automatic scanning can be called up and entered (see sections 2.3.17 and 2.3.20). For data transfer, ENTR key <u>19</u> is pressed.</p>

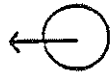
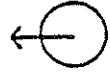

Ref. No.	Labelling	Function												
<u>31</u>	<p>FREQ.</p> <p>fSTOP</p>	<p>Key with two functions:</p> <p>a) The SCAN LED <u>26</u> is not on. By pressing this key, the receiver frequency can be keyed in via the numerical keyboard. For data transfer, press ENTR key <u>19</u>.</p> <p>b) The SCAN LED <u>26</u> is on. By pressing this key, the stop frequency of the automatic scan can be called up and entered. For data transfer, ENTR key <u>19</u> is pressed.</p>												
<u>32</u>	fSTART	<p>Key with two functions:</p> <p>a) The SCAN LED <u>26</u> is not on - no function.</p> <p>b) The SCAN LED <u>26</u> is on. By pressing this key, the start frequency of the automatic scan can be called up and entered. For data transfer, ENTR key <u>19</u> is pressed.</p>												
<u>33</u>	<table border="0"> <tr><td>7</td><td>8</td><td>9</td></tr> <tr><td>4</td><td>5</td><td>6</td></tr> <tr><td>1</td><td>2</td><td>3</td></tr> <tr><td>0</td><td>.</td><td>-</td></tr> </table>	7	8	9	4	5	6	1	2	3	0	.	-	Keyboard for entry of numerical values for the functions of <u>13</u> , <u>17</u> , <u>27</u> , <u>28</u> , <u>29</u> , <u>30</u> , <u>31</u> , <u>32</u> , <u>35</u> , <u>36</u> , <u>39</u> and <u>46</u> .
7	8	9												
4	5	6												
1	2	3												
0	.	-												
<u>34</u>	<p>OPER. RANGE</p> <p>20 dB</p> <p>40 dB</p> <p>60 dB</p> <p>↓</p>	LEDs plus selector switch for the operating range of the analog indication <u>15</u> . The steps of automatic attenuation setting by means of <u>41</u> are set together with the operating range (see section 2.3.6).												
<u>35</u>	CLOCK DATE	Key for calling up and entering time of day and date via display <u>12</u> . With the first push of the key, the time is read out, with the second push, the date.												
<u>36</u>	DISPLAY TIME	Key for calling up and entering the time the measured data is displayed on <u>12</u> . If the display time is different from the measuring time, the associated LED lights up. The display time is always greater or equal to the measuring time set using <u>39</u> .												

Ref. No.	Labelling	Function
<u>37</u>	AV PEAK CISPR MIL ↓	LEDs plus switching key for the indicating modes: + average value + peak value + interference measurement according to CISPR + broadband interference measurement according to MIL standards. In the MIL indicating mode, the peak value in dB μ V/MHz is read out.
<u>38</u>	MAX. MIN.	On/off switch for special indicating mode MAX. MIN., which permits the range of variation of the RF input level to be determined. Maximum and minimum are determined from individual measurements within the measuring time fixed by means of <u>39</u> , and indicated side by side. The individual measurements are carried out in accordance with the mode of demodulation selected by means of <u>37</u> . For details see section 2.3.4.
<u>39</u>	MEAS. TIME	Key for calling up and entering the measuring time = time of average- or peak-value measurement with steady-state rectified voltage at the A/D converter input. LED lights to indicate difference from basic setting. For details see section 2.3.9.
<u>40</u>	MODE TWO PORT REM. FREQ. GEN. OFF ↓	LEDs plus key for the ESVP operating mode: a) Gain measurement on twoport networks (-110 to +47 dB). The generator outputs <u>48</u> with an EMF of 96 dB μ V at the receiver centre frequency is switched on. b) Remote frequency measurement. The ESVP operates as a tunable, active filter. The generator output <u>48</u> delivers the RF input signal which is filtered according to the selected IF bandwidth and has an EMF of 96 dB μ V for connection of a frequency counter. The receiver otherwise functions as in the GEN. OFF mode. c) The generator output <u>48</u> is switched off.

Ref. No.	Labelling	Function
<u>41</u>	AUTO	Key for switching over from manual to automatic RF attenuation setting with low-noise or low-distortion IF attenuation setting depending on <u>42</u> .
<u>42</u>	↑ LOW NOISE ↓ LOW DIST.	<p>Key for selecting low-noise or low-distortion measurement.</p> <p>For low-distortion measurement, the IF attenuation is always 10 dB less. For details see section 2.3.6.</p>
<u>43</u>	LIN. TEST	<p>On/off key for linearity test. To check the linearity of the RF and IF stages of the ESVP, the RF attenuation is increased by 1 dB for average- and peak-value indication and by 4 dB for CISPR and MIL indication. The actual RF attenuation is always read out on display <u>9</u>.</p> <p>If automatic attenuation setting is selected by means of <u>41</u>, the difference is automatically indicated after two consecutive measurements.</p> <p>If manual RF and IF setting is selected by means of <u>45</u>, only the result is indicated. The additional attenuation can be switched off or on by pressing key <u>43</u>.</p>
<u>44</u>	↑ RF ↓ IF	<p>Key with two functions for manually setting the RF and IF attenuation:</p> <p>a) Switches over from the automatic attenuation setting mode (<u>41</u>) to manual RF attenuation.</p> <p>b) Switches over from manual RF to manual IF attenuation setting and vice versa. The LEDs indicate whether the RF or IF attenuation can be varied by means of <u>45</u>. The RF attenuation is read out on display <u>9</u>. The IF attenuation can be determined in accordance with section 2.3.6.</p>
<u>45</u>	+ -	Keys for manual increase (+) and decrease (-) of RF or IF attenuation selected by means of <u>44</u> . If the key is held down, the keying is repeated automatically.

Ref. No.	Labelling	Function
46	 SQUELCH LEVEL	<p>Key for call-up and formatted input of the squelch level, in dBμV.</p> <p>The left LED indicates that the squelch function is in operation (special function 13). The right LED lights when in squelch operation the AF is suppressed because of the low RF level. Therefore: Careful when adjusting the volume with headphones!</p>
47	ANTENNA CODE	<p>12-pole supply and coding socket for connection of active or passive test antennas or probes, attenuation elements or amplifiers.</p> <p>Outputs: +10 V, -10 V (max. 50 mA). Coding inputs to set conversion factor and quantity to be measured, see section 2.3.16.</p>
48	EMF GEN. 96 dB μ V 	<p>Generator output (N-socket) for two-port or remote frequency measurements. This function is selected with the operating mode key 40.</p>
49		<p>Socket (4 mm diameter) for ground connection.</p>
50	 RF 50 Ω  <3 V	<p>RF input (N-socket, not adaptable)</p> <p>Do not exceed the maximum input voltage specified in section 2.3.1!</p>
51	10.7 MHz  	<p>BNC output socket for the narrowband 2nd IF (10.7 MHz). The bandwidth is the same as the selected IF bandwidth (5).</p> <p>EMFs (rms value) in the range of the level analog indication ($Z_{out} = 50 \Omega$): Operating range 20 dB: 10 to 100 mV Operating range 40 dB: 10 to 1000 mV Operating range 60 dB: 1 to 1000 mV</p>
52	10.7 MHz  	<p>BNC output socket for the broadband 2nd IF (10.7 MHz) for connection of an IF-panorama adapter. The bandwidth is about 2 MHz, $Z_{out} = 50 \Omega$.</p> <p>Amplification compared to RF input (RF attenuation 0 dB): without preamplifier: 7.5 dB typical with preamplifier: 17.5 dB typical</p>

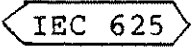
Ref. No.	Labelling	Function
<u>53</u>	AM 	BNC output socket for the demodulated AM signal; DC-coupled out of AGC demodulator. $Z_{out} = 330 \Omega$, 1 V for 100% modulation depth.
<u>54</u>	FM 	BNC socket for the FM discriminator output voltage, DC-coupled. EMF for IF bandwidth (5) ($Z_{out} = 330 \Omega$): 7.5 kHz, 12 kHz (mod. 52, 53) 10 kHz (mod. 56): ± 1 V for ± 1 kHz 100 kHz (mod. 56) 120 kHz (all mod.) 200 kHz (mod. 53) 1 MHz (mod. 52, 53): ± 1 V for ± 100 kHz
<u>55</u>	FREQ. OFFS. 	BNC output socket for the frequency offset ($Z_{out} = 10 \text{ k}\Omega$, EMF as for <u>54</u>).
<u>56</u>	CISPR 	BNC output socket for level recording voltage weighted in accordance with CISPR; output circuit includes a lowpass filter for simulation of panel-meter response. $Z_{out} = 10 \text{ k}\Omega$; EMF at maximum analog reading: +2 V.
<u>57</u>	AV/PK 	BNC output socket for level recording voltage in the indicating modes AV, PEAK, CISPR and MIL. $Z_{out} = 10 \text{ k}\Omega$; EMF at maximum analog reading: +4 V.
<u>58</u>	 EXT. TRIGGER	BNC input socket for an external trigger signal, $Z_{in} > 3 \text{ k}\Omega$. Triggering threshold: TTL-level (high > 2 V, low < 0.8 V with hysteresis). Selector switch for positive- and negative-going edge.
<u>59</u>	EXT. REF.  INT. 10 MHz EXT. 5 MHz	BNC input socket for external reference frequency of 5 or 10 MHz. BNC output socket for internal reference frequency: see section 2.3.19. Dual switch for Internal reference: left-hand switch up External reference: 5 MHz: left-hand switch down right-hand switch down 10 MHz: left-hand switch down right-hand switch up

Ref. No.	Labelling	Function
<u>60</u>		24-pole socket for remote control of the ESVP in accordance with IEC 625-1 (IEEE 488). See section 2.3.22. The IEC-bus address is set by use of special function Ø1. See section 2.3.14.
<u>61</u>	X-Y RECORDER	24-pole socket for controlling XY or YT recorders or up to five Radiomonitoring Recorders ZSG3. See section 2.3.20.
<u>62</u>	BATT. 22...32 V	Connection for an external battery via the battery cable provided.
<u>63</u>	F2 M4E	Battery fuse.
<u>64</u>	 47... 420 Hz	AC-supply connector.
<u>65</u>	F1 100/120 V T2.5 220/240 V T1.6	AC voltage selector with fuse.

2.2 Preparation for Use

2.2.1 Setting up the Receiver

The following sections describe the environmental conditions required or to be avoided.

2.2.1.1 Operating Position and Ambient Light

The normal operating position of the ESVP is horizontal. When using the receiver in the laboratory, it is advisable to set it up on the legs provided on its bottom cover, for easy operation on the work bench and reading convenience. Operation in any other position, however, does not affect its performance. Bright ambient light, in particular sunlight, naturally makes reading the LED displays on the front panel more difficult. The front panel should therefore be screened off from bright ambient light.

Reasons for using LED displays rather than LCD displays are:

- LED displays require no illumination,
- LED displays respond faster to the data inputs - even at low ambient temperatures,
- Multiplexed LCD displays would strongly restrict the viewing angle.

2.2.1.2 Temperature and Condensed Moisture

The ESVP complies with the provisions of the IEC 359 safety class I regulations. The temperature range within which the performance specifications of the ESVP are valid is +5 to +45°C. The receiver - despite its complexity - is a low-power design so that special cooling measures are not called for. Nevertheless, adequate convection of the surrounding air should be ensured when the receiver is rackmounted, by means of a plug-in ventilator unit. Also, the receiver should not be exposed to strong sunlight for any length of time. High temperatures increase the failure rate of the instrument components and also the self-discharge rate of the lithium battery, which provides for continued data storage in the CMOS RAMs.

Since the ESVP contains high-impedance circuits, it should not be used in the presence of condensed moisture. Condensation cannot always be avoided - for example, when the cold instrument is brought into a warm room with a high relative humidity. In such cases, the measurements must be delayed until the moisture has evaporated.

2.2.1.3 Vibration and Low-frequency Magnetic Fields

The ESVP contains several varactor-tuned phase-locked oscillators. Strong magnetic fields and heavy vibration may cause the sideband noise of these oscillators to worsen. Prolonged exposure to vibration will also increase the failure rate of the instrument. Receivers used permanently or frequently in land vehicles or aircraft should therefore be supported on shock-absorbent mountings.

2.2.1.4 RF Fields

The ESVP has been tested for field strengths up to 3 V/m. The following cases must be distinguished:

a) Measurement of field strengths with antenna

The RF immunity of the ESVP is sufficient for correctly measuring field strengths up to 3 V/m. The indication with terminated RF input is less than 0 dB μ V. In cases of doubt, the IF attenuation should be as high and the RF attenuation as low as possible, in order to maximize the measured signal at the output of the RF attenuator.

b) Field-strength measurements in the presence of strong interfering fields at other frequencies

For such measurements, the data sheet must be consulted in regard to RF immunity and nonlinearity.

c) Voltage measurements in the presence of strong fields

Field strengths up to 10 V/m (140 dB μ V/m) have a negligible affect on the measurement accuracy of the ESVP. This assumes the RF tightness of the RF cable, which should be a double-screen, solid-jacket type.

d) Field strengths of the order of 10 V/m

The overall calibration could possibly be influenced. For such calibration, the ESVP should be brought to an area of lower field strength.

2.2.1.5 Grounding

For normal requirements, the grounding provided by the protective conductor in the AC-supply connector 64 or the chassis connection in the battery connector 62 is sufficient. If a better ground is required, an earthing cable can be connected to the connector 49 or to the milled spot (Philips screw) to the left of the RF input.

2.2.1.6 Rackmounting

The ESVP can be mounted in a 19" rack. To do so, the cover panels of the receiver must be unscrewed, which is best done in the following order:

- + Unscrew the upper and the lower cover of the cabinet.
- + Remove the side strips (with the recessed grips) from the front and the rear panel.

The front-panel screws which held the side strips can be used for fastening the ESVP in the rack. Adequate cooling of the instrument in the rack must be provided for.

2.2.2 Power Supply

2.2.2.1 AC Supply Operation

The ESVP complies with the safety regulations for instruments of safety class I of VDE 411. Safety class I specifies that the AC supply circuits must be insulated during operation and all accessible conductive parts of the device which may immediately carry voltage in case of a failure must be reliably and permanently connected to each other and to the non-fused earthed conductor.

The power plug should, therefore, only be connected to an earthing-contact type power outlet. If a separate earth terminal is provided, it must be permanently connected to a non-fused earthed conductor.

The ESVP is designed for operation from AC supply voltages of 100 V, 120 V, 220 V and 240 V. It is adjusted at the factory for operation from 220 V. To adapt it for operation from another AC supply voltage, the fuse holder in the AC voltage selector 65 (Fig. 2-2) is taken out and with the specified fuse so inserted that the AC supply voltage marked on the cap is positioned under the arrow in the plug fuse housing.

The instrument is then ready for operation with the new voltage. The fuses for all permitted AC voltages are included in the accessories supplied.

For 100 V and 120 V: fuse type T2,5 DIN 41571,
for 220 V and 240 V: fuse type T1,6 DIN 41571.

The connection to the AC supply is made via the AC-supply connector 64. AC supply voltage variations of between -10% and +10% of the nominal value do not affect the performance. If greater variations cannot be avoided, a transformer or regulator must be connected ahead of the test assembly.

2.2.2.2 Battery Operation

The ESVP can be operated from a 24-V battery. A cable for this purpose is supplied with the instrument. The required input voltage, to connector 62, is +22 to +32 V. If the input voltage falls below +21 V, the instrument automatically switches off. The current drain is typically 3 A. The input circuit is fused (63) (see marking on rear panel).

2.2.2.3 AC-supply and Battery Operation

If the AC-supply and battery are connected at the same time, the instrument selects the AC supply. The battery is not charged in this case.

If the AC supply fails, the battery is automatically switched in, if its output lies over +22 V. At switchover, transients may cause an error message to appear briefly, but any frequency scans in process are not interrupted.

2.2.3 Instrument Switch-on

After the instrument has been adjusted for the available AC supply and connected to the AC supply and/or battery, it is switched on with the power switch 24 (Fig. 2-1). After switch-on, the instrument setting at the time of the last switch-off is restored (assuming that the lithium back-up battery for the CMOS RAM of the ESVP is properly charged), except that a minimum RF attenuation of 10 dB is always set.

During the switch-on process, the following information is read out in succession on the display 12:

1st phase: R&S ESVP

2nd phase: Version (Version of the built-in
1.n/1.m firmware for the I/O
or M/E processor).

3rd phase: BUS ADDR#18 (The IEC-bus address set
by means of special
function 01;
for TALK ONLY, the readout
is BUS ADDR ton.)

During the first minute after switch-on, calibration by means of the key CAL 16 or the corresponding IEC-bus instructions is not possible. "WAIT FOR WARMUP" is displayed.

2.2.4 Short Functional Check

With entry RCLØ (keys 17, 33), the ESVP is reset to its basic setting:

Demodulation <u>4</u>	F3 
Attenuation <u>41</u> , <u>42</u>	AUTO, LOW NOISE
IF bandwidth <u>5</u>	120 kHz
Mode <u>40</u>	GEN. OFF
Readout <u>10</u>	dB ...
SPEC. FUNC. <u>13</u>	(All special functions are in the basic setting, see section 2.3.14)
Indicating mode <u>37</u>	AV.
MAX.MIN. <u>38</u>	Switched off
Meas. time <u>39</u>	0.1 s
Operating range <u>34</u>	60 dB
Time of day, date <u>35</u>	not affected
Display time <u>36</u>	0.1 s
Scan <u>26</u>	Switched off
Frequency	100.000 MHz (adjustable by means of <u>23</u> in 1-kHz steps)

The basic setting also replaces IEC-bus instructions (see section 2.3.22.4). By pressing the CAL key 15 for a short time (< 3 s), level and frequency offset indications are calibrated. Instead of a measured value, "CAL. CHECK" is displayed. The analog level indication reaches the right-hand end of the LED row 15 and the offset indication 22 is in the centre of the LED row. The calibration process is completed in about a second if it proceeds without finding a fault. If not, an error message is output.

Settings stored with the STO key are not affected by the RCLØ entry.

By pressing key 16 for a longer time (> 3 s), the level measurement over the entire frequency range, and all the IF bandwidths and operating ranges 34 are calibrated. This calibration process takes about one minute. Here too error messages are output in the case of any malfunctions.

For checking the level calibration, the ESVP can be switched to the operating mode TWOPORT 40. A short connecting cable between the generator output GEN. 48 and the RF input 50 introduces an attenuation of < 0.4 dB over the entire frequency range. The indication of small attenuation values may deviate slightly from the actual value, but the error will generally be less than 0.3 dB.

A thorough performance check can be carried out as described in section 3.

2.3 Operating Instructions

2.3.1 Connection of the Voltage to be Measured

The RF voltage to be measured is connected to the RF input 50 via a 50- Ω coaxial cable. The input impedance of the receiver is 50 Ω . The ESVP permits sinewave and pulse voltages to be measured over the 20 to 1300 MHz frequency range. The maximum permissible sum voltage of all the signals applied to the RF input socket that will not cause permanent damage, depends on the RF attenuation, the RF bandwidth and the frequency (see data sheet).

2.3.1.1 Sinewave Signals and DC Voltages

With an RF attenuation of 0 dB, the sum voltage must not exceed 3 V into 50 Ω . Since no DC voltage isolation is provided at the input to the RF level switch, no DC voltages above 7 V may be applied.

2.3.1.2 Pulse Signals

With an RF attenuation of 0 dB, the pulse spectral density must not exceed 96 dB μ V/MHz (measured with a 100-V x 0.5-ns pulse) into 50 Ω . An RF attenuation of 10 dB can be switched in manually (see section 2.3.6) to prevent the RF attenuation of 0 dB from being switched in by the action of the autoranging circuit.

With an RF attenuation $>$ 10 dB, the maximum permissible pulse energy is 1 mWs (milliwatt-second) into 50 Ω . This means, for example, that a 100-V surge must not last any longer than 5 μ s.

The exceeding of these values may result in the destruction of the input attenuator, preamplifier, RF filter, or input mixer. Appropriate measures (such as the insertion of a power attenuator ahead of the input) must be taken to prevent this.

When the ESVP is connected to artificial mains networks, the switching on or off of connected test items may result in high-energy pulses on the test-receiver input. Meant here are artificial mains networks simulating motor-vehicle or shipboard networks and artificial networks in accordance with MIL standards, which in general can be used up to 100 MHz. The R&S artificial mains network ESH2-Z5 together with the ESH3 can be used up to 30 MHz. The pulse limiter ESH3-Z2 provides protection of the RF input.

2.3.2 Frequency Setting

The frequency of the ESVP can be set in three different ways, not including automatic scanning:

→ **With the control knob 23 in 100- or 1-kHz steps**

For demodulation types A3J and A1 (4), the fine-tuning step size is automatically set to 0.1 kHz. This fine-tuning step size is only effective in the audio branch. For this reason, the detuning can be heard in these types of demodulation - the analog offset indication however jumps every 1 kHz. The switching between coarse and fine step size is determined by the pair of keys 29. If the same key is pressed twice, the tuning knob is switched off; the DISABLED LED 23 lights.

→ **By pressing the keys 27 and 28**

At each push of these keys, the receiver frequency is increased or decreased, respectively, by the amount fixed by the STEP SIZE key 30. If 27 or 28 is held down, the keying is repeated automatically.

→ **By numeric entry**

By pressing the FREQ. key 31, the current frequency is read out on the alphanumeric display 12 in MHz. A new frequency can then be entered via the keypad 33.

The recalling of front-panel settings stored by means of the STO key can be considered as a fourth way to set the frequency.

The switch-in of AFC is accomplished with special function 15.

2.3.2.1 Automatic Frequency Scanning

A special feature of the ESH 3 and ESVP is automatic frequency scanning.

By pressing the SCAN key 26, the engravings to the left of the keys 27 to 32 (darker background) are applicable. The start and stop frequencies and step size for automatic scanning can then be selected.

The MIN. LEVEL key 28 determines the lower level limit from which signals are scanned. The MAX. LEVEL key 27 permits scaling of the Y axis for output to an XY recorder. Automatic scanning is triggered by pressing the RUN key 29.

To interrupt automatic scanning, it is only necessary to press the STOP key 29.

The front-panel settings can then be altered. Automatic scanning is continued from where it has been interrupted by pressing the RUN key 29 again. Pressing the STOP key 29 twice, terminates the automatic scanning.

An automatic scanning cycle that has not been completed may cause the ESVP to act in an unexpected way. Thus: A scanning cycle should always be terminated (by pressing the STOP key 29 twice) if the results of the current operation are no longer required.

By storing several sets of scanning settings using STO 1 to 5, it is possible to arrange for several automatic scanning processes to follow one another. Start and stop frequencies can be set to overlap; between the individual subranges, ranges can be skipped.

The minimum levels (threshold levels) set for the individual sub-ranges may also differ. For starting multiple-range scanning, the figures 1 to 5 for the range settings (storage locations) and the RUN key 29 must be pressed. For details about output to recorders see section 2.3.20.

Frequency steps in a constant ratio (logarithmic) are particularly important for automatic scanning in interference measurements. The special functions 52 LIN STEP and 53 LOG STEP permit individual selection of scanning ranges with frequency steps in a constant number of Hz (linear) or ratio. The special function 53 is used to automatically enter the menu for STEP SIZE in %. For reasons of simplicity, the ESVP rounds the values off to steps of 100%, 50%, 25% to 0.01%. The switchover 53 ↔ 52 automatically clears the step size memory.

The automatic frequency scan is considerably speeded up with special function 91: FAST SCAN. The minimum level determines the RF and IF attenuations in such a way that the IF attenuation corresponds to the setting LOW NOISE and the RF attenuation puts the minimum level at the lower end of the 60-dB operating range which in this case is automatically selected. With every frequency setting, a single measurement is made to check if the minimum level is exceeded. In this case only, the set measuring time is effective and the measured value is output. Only the indicating modes AV, PEAK and MIL are admissible; in case of the CISPR mode, switchover to PEAK is made (since the FAST SCAN would otherwise make no sense).

Normally the unit of the MIN. LEVEL is the unit determined by the coding at 47 or the special functions 80 to 85. The consequence of this is that it is not possible in the case of, for example, field-strength measurements with antennas of constant gain (such as log-periodic antennas) and thus of increasing antenna factor, to measure values above the constant noise indication of the receiver. This disadvantage is overcome by special function 93 (MIN. LEVEL = input voltage). Independently of the test antenna or probe used, the receiver noise indication then has a practically constant separation from MIN. LEVEL. This has special significance for interference field-strength measurements in accordance with MIL Standard 461. In this case, with special function 93, the MIN. LEVEL lies, converted to field strength, very nearly parallel to the limit value of the interference field strength.

2.3.3 Selection of IF Bandwidth

The IF bandwidth 5 is selected according to the modulation bandwidth of the signal to be received:

- + 1 MHz (mod. 52) for broadband interference measurements and for measurement of the vision carrier at sync peak.
- + 200 kHz (mod. 53) for measurement and demodulation of FM broadcasting transmitters.
- + 120 kHz (all mod.) for FM broadcasting, interference measurements according to CISPR.
- + 100 kHz (mod. 56) for broadband interference measurements
- + 12 kHz (mod. 52, 53) for radiotelephony channel raster 20 and 25 kHz.
- + 10 kHz (mod. 56) for broadband interference measurements
- + 7.5 kHz (mod. 52, 53) for radiotelephony channel raster 12.5 kHz and for A3E (double-sideband emissions); furthermore for noise sideband and intermodulation measurements.

The IF bandwidth is predetermined by the following functions:

Indicating mode CISPR $B_{IF} = 120$ kHz (all mod.)
Demodulation modes A3J, A1, AO $B_{IF} = 7.5$ kHz (mod. 52,
53)
10 kHz (mod. 56)

These functions automatically select the IF bandwidth as shown above. If it is attempted to change the bandwidth, the LED of the function that is causing the bandwidth to remain fixed - for example, the CISPR LED - blinks for about 3 seconds.

In the modulation mode A3J (USB, LSB), an additional 2.4-kHz filter is switched into the audio branch (SSB demodulator, see ESVP block diagram). The measurement bandwidth however remains 7.5 kHz.

The 7.5-kHz bandwidth is the most suitable one for two-port measurement of attenuation values above 90 dB. However, the other bandwidths are not blocked.

The four IF bandwidths correspond for the 7.5-kHz, 12-kHz and 200-kHz filters (mod. 53) to the 3-dB and for the 120-kHz, 1-MHz (mod. 52 and 56), 10-kHz (mod. 56) and 100-kHz filters (mod. 56) to the 6-dB bandwidth (see also data sheet). The effective selectivity of the individual filters, shown in Fig. 2-3, results from the static IF selectivity characteristics of the filters used and from the sideband noise of the receiver oscillators.

For special purposes, the 7.5- and 12-kHz filters can be replaced with filters of either somewhat narrower or broader bandwidth but with the same input and output impedances. The replacement of the 120-kHz filter by one with narrower passband would require some modification of the control circuit and/or of the motherboard. The 1-MHz filter (mod. 52) is not a compact unit and cannot be exchanged.

In any case, the exchange of a filter could result in a change in the measurement functions: the CISPR indication mode is valid only in association with the 120-kHz bandwidth and the bandwidth correction factors apply only for the bandwidths as supplied.

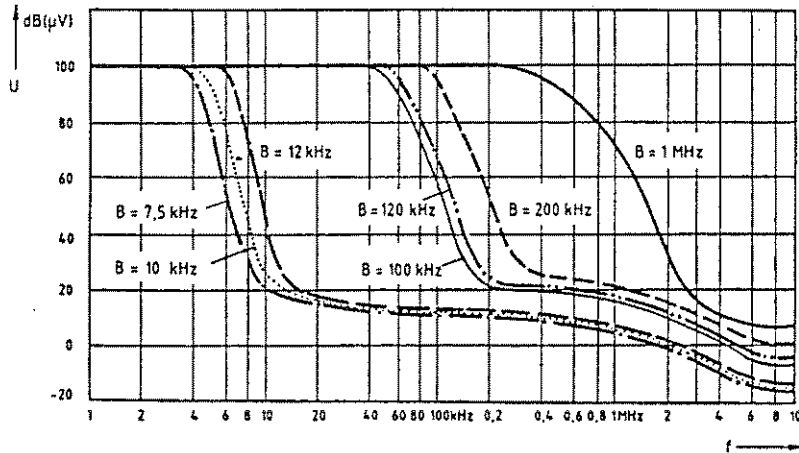

Fig. 2-3 Effective IF Selectivity

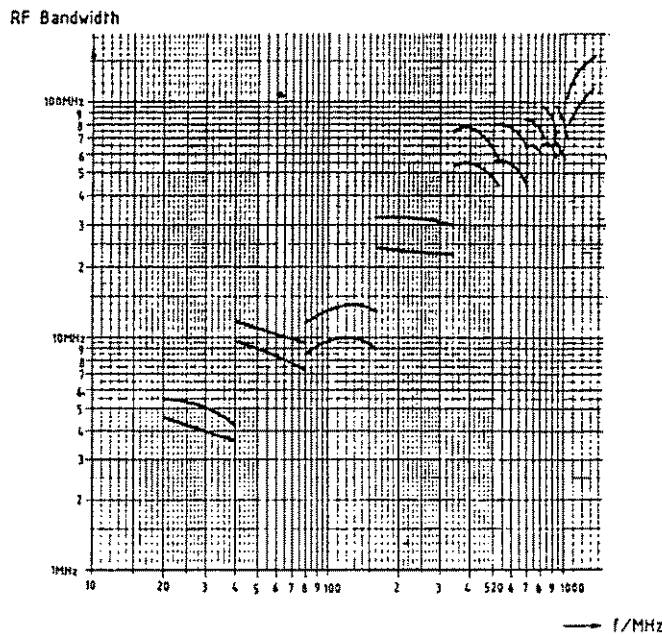

Fig. 2-4 Typical RF Selectivity (3-dB and 6-dB bandwidths) Selection prior to 1st mixer stage

2.3.4 Selection of Indicating Mode

Key 37 is used to select the type of rectifier for the level measurement.

The following indicating modes can be selected:

AV. the mean value of the input signal, more exactly, the linear time-averaged value of the demodulated voltage at the output of the envelope demodulator, calibrated in the rms values of an unmodulated sinewave signal.

Hence, with an unmodulated sinewave signal, the exact rms value is indicated, and with a symmetrically modulated AM signal, the rms value of the carrier. For more details about the influence of the modulation see section 2.4.1. The AV value indication is used for measuring sinewaves with non-suppressed carrier.

PEAK the peak value of the input signal, more exactly, the maximum demodulated voltage at the output of the envelope demodulator calibrated in the rms values of an unmodulated sinewave signal from which the same rectified voltage is obtained.

Basically, the average and peak values of an unmodulated sinewave signal should give the same indication. For example, if the measured values are indicated in dB μ V, an unmodulated sinewave signal with an rms value of 10 μ V produces both an average-value and peak-value indication of 20 dB μ V. The actual indications differ because the noise voltage at the output of the demodulator is weighted higher in peak-voltage measurements than in average-value measurements (see section 2.4.1). The peak-value indication is used for measuring the power of keyed carriers and the peak power of AM and SSB emissions.

CISPR the quasi-peak value of the input signal with pulse weighting in accordance with CISPR Publ. 2 and 4 or Publ. 16.

This indicating mode is identical with the indicating mode specified or recommended in VDE 0876 for radio interference measurements according to VDE 0871, 72, 75, 79 and other German specifications.

The time constant of an analog meter enters into the design of the pulse weighting in accordance with CISPR. The meter is simulated by a network with the same time constant. As a result, the time response of the analog indication 15 for CISPR with logarithmic response corresponds to that of a mechanical meter without logarithmic response.

On account of this meter time constant and the charging and discharging time constant of the weighting circuit, settling time must be allowed for every new frequency and level setting before a valid test result can be obtained. It is, therefore, pointless to select a measuring time of less than 1 s (by means of MEAS. TIME 39) for radio interference measurements according to CISPR, above all for automatic measurements.

MIL the peak value of the input signal as for PEAK, but as pulse spectral density: that is, with a different unit. The designation MIL originates from the American MIL (Military) standards, which specify that broadband interference be measured as spectral pulse density in dB μ V/MHz.

The pulse amplitude is for an IF bandwidth of 1 MHz because the pulse amplitude at the output of the IF filter is directly proportional to the pulse bandwidth of the filter, so long as the pulse frequency is low enough that the individual pulses at the output of the filter do not interfere with one another. The measured result is therefore indicated in μ V/MHz, mV/MHz or dB μ V/MHz and the peak value PEAK is increased by the bandwidth factor

$$\frac{1 \text{ MHz}}{B_{IF}} \text{ or } 20 \cdot \log \frac{1 \text{ MHz}}{B_{IF}}$$

This bandwidth factor is for the four IF bandwidths (the corresponding pulse bandwidths in parentheses) as follows:

B_{IF}	1 MHz	1	or	0 dB	(mod. 52)
	200 kHz	(225 kHz)	4.4	or	13 dB (mod. 53)
	120 kHz	(126 kHz)	8	or	18 dB (all mod.)
	100 kHz	(100 kHz)	10	or	20 dB (mod. 56)
	12 kHz	(13.4 kHz)	80	or	38 dB (mod. 52, 53)
	10 kHz	(10 kHz)	100	or	40 dB (mod. 56)
	7.5 kHz	(8.3 kHz)	120	or	42 dB (mod. 52, 53)

Pulses of a very low repetition frequency (PRF < 1 kHz) yield approximately the same result with all the IF bandwidths so long as the RF input is not overloaded. Real pulse interference (from commutator motors, ignition systems) may contain more or less high pulse frequencies.

Moreover, the individual pulses are often not correlated with each other but stochastically distributed in time. This may under certain circumstances considerably increase the indication in μ V/MHz or dB μ V/MHz when switching to the next lower bandwidth. In the most adverse case (where the interference has the characteristics of white noise), the indication is increased by the reciprocal of the square root of the IF bandwidth ratio.

Increase =

$$\sqrt{\frac{B_{IF \text{ wide}}}{B_{IF \text{ narrow}}}} \quad \text{or} \quad 20 \log \sqrt{\frac{B_{IF \text{ wide}}}{B_{IF \text{ narrow}}}} = 10 \log \frac{B_{IF \text{ wide}}}{B_{IF \text{ narrow}}}$$

In any case, independently of the degree of correlation, the results obtained with the 120-kHz and 1-MHz (mod. 52), 120-kHz and 200-kHz (mod. 53) or 120-kHz and 100-kHz (mod. 56) bandwidths come closest to the value referred to 1 MHz. These bandwidths are permitted as test bandwidths by the MIL standards.

If narrowband interference (sinewave signals) is present in the noise spectrum, the best way to detect it is to switch to average-value indication.

The following diagram shows that the average-value indication heavily suppresses pulses up to relatively high pulse frequencies while the full amplitude of sinewave signals is indicated.

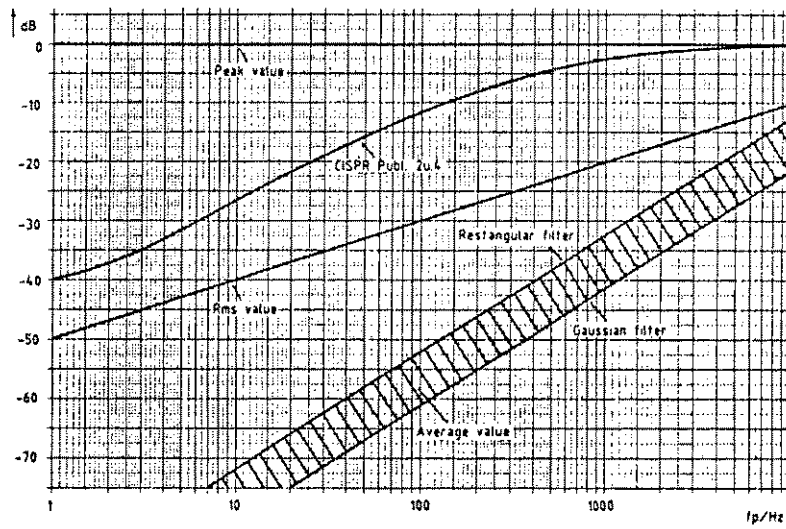

Fig. 2-5 Difference in pulse weighting by the indicating modes AV., CISPR and PEAK or MIL as a function of the pulse frequency (IF bandwidth 120 kHz).

MAX.MIN. the range of variation of the input signal

Single measurements at 100-ms intervals (i.e. the measuring time for the single measurement is 100 ms irrespective of whether AV., PEAK, CISPR or MIL is switched on) are carried out in the selected MEAS. TIME 39 (1 to 1000 s).

The highest (MAX.) and the lowest (MIN.) test result are at the end displayed together side by side. Since the indication of the unit would require more places than provided by the 15-digit alphanumeric display 12, it is abbreviated to dB*, where "*" stands for the unit which would be indicated without MAX.-MIN. measurement). To determine the unit, just switch off MAX. MIN. 38 briefly. The indicating mode MAX. MIN. can be combined with any of the indicating modes AV., PEAK, CISPR and MIL.

Since it is not possible to take measurements while the setting of the RF level switch is being changed, fixed RF and IF attenuation (44) values are selected in the MAX. MIN. indicating mode. Hence, the user must make sure that the operating range of the analog indication is not exceeded during the measurement. With the indicating modes AV., PEAK and MIL it is, therefore, best to select the 60-dB operating range. After each alteration of the front-panel settings, the measurement starts again from the beginning. If the operating range is exceeded, the display blinks.

2.3.5 Selection of Operating Level Range

The selection of the operating level range has the following consequences:

- The range of the analog indication 15 is determined.
- The coverage of widely varying signals without the need for attenuator switching is provided over wide operating ranges (40 and 60 dB).
- In a wide operating range, the signal-to-noise ratio of the test and AF demodulators in the proximity of the maximum analog indication is higher than in a narrow operating range.
- With automatic RF attenuator setting, the level switch step size increases with the operating range. The relationship is as follows:

Table 2-1

Operating range dB	Level switch step size dB
20	10
40	20
60	30

Moreover, the switchover hysteresis and, as a result, the range of analog voltage at the A/D converter input is increased with automatic attenuation setting (AUTO key 41 depressed):

Table 2-2

Operating range	Range of the analog voltage below the max. analog indication
20 dB	-12 to 0 dB
40 dB	-25 to 0 dB
60 dB	-40 to 0 dB

For automatic frequency scanning with large level jumps, it is advisable to use the widest possible indicating range to minimize setting time.

- The maximum measuring accuracy slightly decreases with increasing operating range. The uniformity of the logarithmic level conversion is corrected by the overall calibration of the ESVP according to section 2.3.7 but the measuring accuracy is some tenths of a decibel higher in the 20-dB range than in the 40- and 60-dB ranges.
- At low modulation frequencies, the error of the average-value measurement increases with increasing modulation depth in the operating ranges 40 and 60 dB (see section 2.4.1.2).
- In the CISPR indicating mode, the 20-dB range is automatically selected (see section 2.3.4).

2.3.6 Setting of Attenuation, Measurement Ranges, Preamplifier

The attenuator (RF level switch) built into the ESVP permits attenuation to be set over the range 0 to 140 dB. A 1-dB attenuator pad (4-dB pad for CISPR and MIL modes) can be cut in or out, as desired for checking the linearity. In addition, the 10.7-MHz amplifier circuit is switchable in 10-dB steps and permits IF attenuation between 0 and 40 dB. With this and the 20, 40 and 60-dB operating level ranges, signals can be measured over the entire measurement range (-20 to 137 dB μ V) specified in the data sheet.

2.3.6.1 Manual Setting

The RF and the IF attenuation can be set in steps using the key 44 and the pair of keys 45. It should, however, be borne in mind that the IF attenuation must not be too low (high noise voltage) nor too high (if high-level signals are simultaneously applied, intermodulation products may be generated, etc.). The RF attenuation is displayed on 9.

By means of the 10-dB preamplifier, the sensitivity of the ESVP can be increased by about 8 dB. Correspondingly, the lower limit A_U of the operating range of the analog indication 15 is lowered by 10 dB, when the PREAMP. ON LED 8 is lit. With the RF and IF attenuation both set to 0 dB, the lower limit A_U of the operating range is -20 dB μ V with and -10 dB μ V without preamplification.

For the determination of the IF attenuation I where R = RF attenuation in dB (indication 9):

without preamplification: $I/\text{dB} = A_U + 10 - R$
with preamplification: $I/\text{dB} = A_U + 20 - R$

Example: Preamplification switched in, RF attenuation = 20 dB:
 $A_U = 40$ dB μ V, so that $I = 40$ dB.

A hint for the rapid determination of I:

with preamplification: if $R = A_U$, then $I = 20$ dB,
without preamplification: if $R = A_U$, then $I = 10$ dB.

The preamplifier is switched in with special function 17 (see section 2.3.14).

If the LIN. TEST key 43 is pressed with manual attenuation setting, the 1-dB attenuator pad is continuously in circuit. From the change in the level indication, the user can recognize whether any nonlinearity exists and must then cut off again the 1-dB attenuator pad. If there is no change in the level indication, no overloading, in general, is present. The OVERDRIVEN LED 7 does not light even in the case of an obvious nonlinearity (e.g. with intermodulation measurements) unless one of the overload detection circuits indicates that a certain stage is overloaded (see functional diagram 354.3000 FS in the Appendix Vol. II), i.e. when the 1-dB compression of the stage is obtained.

2.3.6.2 Operating with Preamplifier

The preamplifier is cut in with special function 17, between the RF attenuator and the preselection with the 1st mixer.

It reduces the noise figure of the ESVP from typically 14 - 16 dB to 6 - 8 dB. Naturally, the compression level (desensitization) and IP_3 are reduced by about 10 dB. As a result of its linearity, the preamplifier itself contributes practically nothing to the desensitization and intermodulation except for the amplification of the interference level. Broadband interference signals (pulse interference) however arrive at the input of the preamplifier in full strength, so that the CISPR weighting and broadband interference measurements according to MIL Standard 461/462 are adversely affected. The 1-dB compression lies for a level pulse spectrum in the range 20 to 1300 MHz typically at a value of 65 dB μ V/MHz.

This is nevertheless a value that still permits CISPR weighting for pulse frequencies of 5 to 10 Hz with setting AUTO 41 and broadband interference measurement according to MIL 461, which in many practical cases is sufficient.

2.3.6.3 Automatic Setting (Autoranging)

The RF attenuation is automatically set if the key AUTO 41 is pressed, the IF attenuation being fixed, in steps determined by the OPERATING RANGE 34 (see section 2.3.5). The attenuation is always so set, that the analog voltage at the input of the A/D converter lies in the upper half of the analog indication. This is the range in which the signal-to-noise ratio is highest and the measurement therefore most accurate.

The value of the IF attenuation is determined by the function 42, the IF bandwidth and the indicating mode.

The following table lists the IF attenuation values with the keys 42 in the LOW DIST. position, that means the highest possible RF attenuation, so that the input mixer is supplied the signal at the lowest possible level.

At the LOW NOISE setting, all the IF attenuation values are 10 dB higher.

Table 2-3 IF attenuation values in the LOW DIST position

IF bandwidth kHz	Indicating mode			
	AV.	PEAK	CISPR	MIL
7.5 (mod. 52, 53)	0	10	-	10
10 (mod. 56)	0	10	-	10
12 (mod. 52, 53)	0	10	-	10
100 (mod. 56)	10	20	-	20
120 (all mod.)	10	20	10	20
200 (mod. 53)	10	20	-	20
1000 (mod. 52, 56)	20	30	-	30

The LOW NOISE setting is preferable for measurements in non-critical measurements because of the higher measuring accuracy. For measurements with very high interference levels and low signal levels the LOW DIST. setting should be chosen, likewise for broadband interference measurements according to MIL standards with an operating range of 60 dB. In the LOW NOISE setting, the IF attenuation is reduced by 10 dB if the minimum RF attenuation is reached and the analog value falls below the minimum specified in 2.3.5. This corresponds to the LOW DIST. setting. When the signal level goes up, this IF attenuation is cut in again immediately.

With automatic attenuation setting, two measurements are always initiated for each test result when the LIN. TEST key 43 is pressed, the MEAS. TIME 39 applying to each single measurement. The result M1 of the measurement without the additional attenuator pad is indicated in the lefthand section of the display 12 and the difference M2 - M1 (M2 = test result with additional attenuator pad) in the righthand section of the display (indication always in dB!).

Example: 51.8 dB* +0.2

The cause of a positive difference could be a desensitization of the input stages of the ESVP and the cause of a negative difference could be that the signal being indicated is a noise product (intermodulation, harmonics) that has developed in the ESVP. When measuring field strength, the cause could also be input voltage fluctuations.

With the indicating modes AV. and PEAK, the 1-dB attenuator of the RF level switch is cut in for the LIN. TEST.

With the indicating modes CISPR and MIL, a 4-dB attenuator is used instead of the 1-dB attenuator, since differences between two measurements of the order of 1 dB are normal in the case of broadband noise. For this reason, a 1-dB attenuator would be inappropriate. The OVERLOADED LED 7 lights to indicate nonlinearity. The limit for the detection of nonlinearity is a difference of > 0.3 dB with the 1-dB attenuator and a difference of > 1 dB with the 4-dB attenuator.

At switch-on of the ESVP, at least 10-dB RF attenuation is always cut in regardless of whether manual or automatic attenuation setting has been selected. This attenuation is maintained as a minimum attenuation with automatic attenuation setting until it is set to 0 dB after pressing the RF-IF key 44. If now the AUTO key 41 is pressed again, the last 10-dB attenuator can also be automatically cut out. The 10-dB RF attenuation can be cut in again as a protective measure with automatic attenuation setting by pressing the key "+".

2.3.7 Calibration and Measuring Accuracy

The calibration processes for level and frequency offset measurements are initiated with the CAL key 16:

- a) If the CAL key is briefly pressed (< 3 s), the calibration of level and frequency offset are recalibrated at 100 MHz. Subsequently, at the frequency and bandwidth set, the actual correction value is compared with the correction value measured under b) and in the case of an undue difference, an error message is output. This brief calibration is intended to compensate for gain drifts during operation.
- b) If the CAL key is held depressed for more than 3 seconds, an overall calibration process is initiated during which the required frequency response correction values, the IF bandwidth and attenuation correction values and the demodulator characteristics (in 10-dB steps) are measured and stored. This complete calibration replaces frequent recalibration at each change of frequency and bandwidth and enhances the accuracy of the level measurement while maintaining the full speed of the measurement. The correction values are constant over an extended period of time and need not be re-established every day. An overall calibration should only be made with the instrument fully warmed up - after about 30 minutes of operation.

If a fault is found with the hardware during calibration, an error message is output:

- Error 03 Occurs in the brief calibration if the difference between frequency response correction value and the actually required correction value is > 0.5 dB. An overall calibration should be performed.
- ERROR 05 Error in brief calibration:
The IF-amplifier setting range or range for the offset correction are insufficient.
- ERROR 07 A correction value of > 5 dB is obtained in the overall calibration. The calibration is terminated. The overall calibration is also terminated in case of other hardware errors: ERROR 10 to 15, 51 to 59.

If the calibration values are lost for any reason, e.g. when the ESVP is switched off during the overall calibration process, the remaining correction values remain at 0, and it is possible to continue with the measurement, with reduced accuracy.

Measurement Accuracy

The measurement accuracy of a test receiver is determined basically by three quantities:

→ Accuracy of the internal sinewave calibration generator

The calibration generator of the ESVP has a frequency response flat within (typically) ± 0.1 dB. This is achieved with a precision meter rectifier, which rectifies a level of +6 dBm. At this level, the meter rectifier has practically no temperature variation. The frequency-dependent attenuations of the internal RF cables and relays are compensated with a frequency-dependent corrected DC voltage reference of the level control. The correction of the DC voltage reference is performed by the microprocessor at the frequency setting with the use of a D/A converter. The calibration level can be checked at any time with the use of an accurate thermal power meter at the GEN output 48.

In addition to the sinewave calibration generator, the ESVP has a pulse generator which serves only for the recording of the broadband correction value for the 1-MHz and 120-kHz IF bandwidths for the MIL indicating mode and the CISPR absolute calibration. For this reason, the pulse calibration is performed only for 100 MHz, the pulse generator being adjusted precisely for this frequency.

→ Accuracy of the internal RF and IF attenuation switches

The frequency-dependent basic attenuation of the RF attenuator is compensated by the overall calibration. The manufacturing tolerances of the individual RF attenuation elements is monitored with DC-voltage and frequency-response tests during production.

The typical error is

- < 0.05 dB for 10-dB attenuation elements,
- < 0.05 dB for 20-dB attenuation elements, and
- < 0.08 dB for 40-dB attenuation elements.

Thus for an RF attenuation of 70 dB (= 40+20+10), the attenuation error is typically less than 0.2 dB.

The attenuation error of the RF attenuator cannot be corrected by the overall calibration since the RF attenuator is used in the overall calibration as reference for the recording of test demodulator characteristics, including those of the A/D converter and of the IF attenuation correction values.

→ Accuracy of the section from test demodulator to A/D converter

With the RF attenuator as reference, this entire section is registered in 10-dB steps. Because of the outstanding linearity of the test demodulators, with typically less than 0.2 dB deviation from linearity, only a few key values are needed for an optimum correction.

Information regarding the influence of signal-to-noise ratio on measurement accuracy is contained in section 2.4.1.

2.3.8 Setting the Data Output

The unit of the data output on display 12 is set by means of the keys dB ... 10, dBm 11, SPEC. FUNC. 13 and V,A 14. The keys 10, 11 and 14 determine the unit for voltage, field-strength and RF current. The key 13 is dealt with in detail in section 2.3.14.

dB ...

a) without test antenna/probe connected to ANTENNA CODE socket 47, this key determines the units

- for the voltage level dB μ V
(in decibels above 1 μ V)
- with indicating mode MIL 37
for the broadband interference level dB μ V/MHz
- in the operating mode TWOPORT
for the amplification dB
(attenuation is negative amplification)

b) with test antenna/probe connected to ANTENNA CODE socket 47 or with the special functions 83, 84, 85, this key determines the units

- for electrical or free-space field strength dB μ V/m
with MIL indication mode dB μ V/mMHz
- for RF current dB μ A
with MIL indicating mode dB μ A/MHz
- for magnetic field strength dB μ A/m
with MIL indicating mode dB μ A/mMHz
- for radio interference power (CISPR, MDS
absorbing clamp) dBpW

dBm

without test antenna connected to ANTENNA CODE socket 47, this key determines the unit

for the power level into 50 Ω dBm

This indication does not mean that the ESVP functions as an rms meter. Only the power of sinewaves which are not amplitude modulated is correctly indicated.

Since the unit dBm is to be used only for power levels relative to 1 mW, only attenuators or amplifiers with defined power loss or gain may be coded on 47.

Example:

A resistive matching pad 75 Ω /50 Ω is to be connected and the indication is to be in dBm. The conversion factor of 10 dB can be coded at the input 47. Hence, the matching pad must have a power attenuation of 10 dB. This would correspond to a voltage attenuation of 11.8 dB.

V,A

a) without antenna connected to ANTENNA CODE socket 47, this key determines the units

→ for the voltage on socket 47 μ V, mV, V

→ with the indicating mode MIL 37
for the pulse spectral density μ V/MHz
mV/MHz
V/MHz
kV/MHz

→ Switching from μ V → mV → V → mV → μ V
is without hysteresis effect.

b) with test antenna/probe connected to ANTENNA CODE socket 47 or with special functions 83, 84, 85, this key determines the following additional units

→ for the electrical field strength μ V/m to V/m
with the indicating mode MIL 37 μ V/mMHz
to kV/mMHz

→ for the RF current μ A to A
with the indicating mode MIL 37 μ A/MHz to
A/MHz

→ for the magnetic field strength μ A/m to A/m
with the indicating mode MIL 37 μ A/mMHz to
kA/mMHz

→ for radio interference power (CISPR, MDS clamp) pW to mW

The function of keys 10, 11 and 14 is restricted as follows:

In the operating mode TWOPORT 40, the amplification and attenuation can only be output in dB. The TWOPORT LED blinks when the V,A key 14 is pressed.

"dBm" 11 can only be selected when there is no test antenna/probe connected to ANTENNA CODE socket 47 for field-strength or RF current measurement (see section 2.3.16). A constant power gain or loss may, however, be coded in 10-dB steps.

* V,A 14 cannot be selected if the functions LIN. TEST 43 and MAX. MIN. 38 are switched on.

2.3.9 Setting the Measuring Time

The measuring time in seconds can be called up or altered by means of the MEAS. TIME key 39. This is true for voltage level measurement as well as for the following special measurement functions SF 21, 23, 25 (AM modulation depth) and SF 41, 43, 45 (FM frequency deviation) (SPEC. FUNC. 13). It corresponds either to the averaging time or to the peak-value measurement time for each single measured value depending on the selected indicating mode. With MAX. MIN. it is the total measuring time (see section 2.3.4). There is no fixed time for automatic frequency scanning but it is to a great extent determined by the measuring time for each single measurement (MEAS. TIME 39).

A measuring time of 0.1 s was chosen for the basic setting. Unmodulated signals and signals of a relatively high modulation frequency can also be measured with a shorter measuring time. Signals at a lower frequency, in particular most broadband interference signals, require longer measuring times.

The measuring time is always counted from the moment the RF level switch reaches its final setting and the input voltage at the A/D converter has reached a steady state.

The following measuring times can be set (in steps of 1, 2, 5, 10...):

With indicating modes

AV., PEAK, CISPR and MIL 0.005 s to 100 s

With indicating mode

MAX. MIN. 1 s to 1000 s

2.3.10 Setting the Display Time

The display time (DISPLAY TIME 36) is at least as long as the measuring time (MEAS. TIME 39). It can be longer than the measuring time if this is required for reading off the test result. The setting ranges are, however, the same as for the measuring time.

The display time begins at the moment that the measuring time ends. If the display time is longer than the measuring time, the value last measured is read out upon termination of the last display function. After each new setting, the measuring time must have elapsed before the first value measured is displayed. The display time can be longer if a long frequency measuring time has been selected (SF 31...39).

To explain the concepts of measuring time and display time by way of an example, a broadband interference with a pulse frequency of approx. 2 Hz is to be measured. To make sure that a pulse occurs in every test cycle, a measuring time of 1 s is selected. The pulse height can be observed during the measurement on the analog level indication 15. The arrival of a pulse does not trigger a measurement. The peak-voltage rectifier is discharged at the end of the measuring time and a new measurement starts. The maximum value obtained during the measuring time is converted and indicated during the new measurement.

For measurement with linearity test (LIN. TEST 43), the display time is automatically at least twice the measuring time since each result involves two single measurements.

A long display time is particularly useful in automatic scanning operation, where short measuring times for each single measurement are desirable to ensure a short total scanning time, but each value measured that is above the minimum level set by means of MIN. LEVEL 28 should be displayed long enough to allow the user to note it down. In radiomonitoring, senders exceeding the threshold can be listened on during the display time.

2.3.11 Time of Day and Date

The ESVP includes a CMOS clock chip, which is useful in the automatic production of measurement records. Time of day and date run continuously, even when the instrument is shut off.

To call the time, key 35 is pressed, a second pressing of the key calls the date. To correct the time, key 35 is pressed, the new time of day in hours and minutes is keyed in and when the keyed-in time is reached, it is entered by pressing the ENTR key 19.

If the time of day or data is being indicated on display 12, it can be output to a LISTEN ONLY IEC-bus printer by pressing the TALK key 20.







Special function 09 also serves for outputting the time of day to a printer along with the data output.

The demodulation modes 4 are selected as described in section 2.1. With the indicating mode CISPR, A3 demodulation is always cut in unless AF has been switched off. In the TWOPORT operating mode, the demodulation modes are automatically switched off.

For better distinction of pulse interference in the noise, the volume of the AM signal is adjusted as a function of its peak value in the PEAK mode. In addition, a quasi-peak-responding rectifier with fixed rise and fall times is connected into circuit instead of the AF lowpass filter. However, sinewave signals are thus distorted. If sinewave-modulated signals are to be reproduced without distortion in the PEAK mode, the position of X220 on the evaluation PCB should be changed.

Difference between A1 and A0:

With an unmodulated sinewave signal input at the receiver centre frequency, a beat note of 1 kHz is obtained with A1, and zero beat with A0. With demodulation modes A3J USB and LSB, A1 and A0, the 7.5-kHz measurement IF bandwidth is always switched on, the audio IF bandwidth is 2.4 kHz.

In the F3  and F3  demodulation modes, the AF level for the same frequency deviation is higher by a factor of about 10 with the 7.5-kHz and 12-kHz (mod. 52, 53) or 10-kHz (mod. 56) IF bandwidths as with the 120-kHz or 100-kHz (mod. 56) IF, and again about 10 times higher with the 120-kHz IF as with the 1-MHz IF bandwidth. The AF bandwidths at output 1 are about 0.3 to 3 kHz for F3  and A3  and about 50 Hz to 15 kHz for F3  and A3  .

Setting the Squelch:

Squelch can be switched in with special function 13. In this case, the left (yellow) LED lights. The squelch threshold can be read out in display 12 in dB μ V and a new value entered by means of the squelch key. The ESVP microprocessor sets the squelch comparator via a D/A converter. The analog signal voltage switches the AF on and off without any participation by the microprocessor.

The squelch threshold also serves with use of special function 03 (TRIGGER INTERN) as triggering threshold for the measurement process. Level, frequency, and, with sufficient time, also the modulation values of short-term signals can thus be determined automatically.

2.3.13 Operating Modes TWOPORT and REM. FREQ. 40

In the TWOPORT operating mode, the gain of a twoport network whose input is connected to GEN. 48 (Fig. 2-1) and output to RF 50 is measured in dB (attenuation is negative gain). The measurement range extends from -110 to +47 dB. The bandwidth is switched over to 7.5 kHz. The bandwidth selector is, however, not blocked.

To make allowance in the indication of insertion losses in test setups, test adapters and, for example, VSWR test bridges, frequency responses can be stored in memory with use of special functions 83 and 84.

In the operating mode REM. FREQ. 40, the ESVP operates as a tunable active filter with the bandwidth selected with IF BANDWIDTH key 5. After reconversion, the input signal applied to RF 50 is brought out at GEN. socket 48 at the same frequency as the input and with an EMF of 96 dB μ V. This permits the input signal frequency to be measured exactly by means of a frequency counter connected to 48 (cf. "Frequency Measured Remotely with VHF-UHF Receivers ESU2 and ESM2" by K. Danzeisen, News from R&S, No. 77, pp. 28 to 30).

Special functions 31 to 34 are also used in connection with remote frequency measurements.

2.3.14 Special Functions

The special functions (key 13) extend the range of application of the ESVP. The functions may be grouped as follows:

1. Basic setting SF00
2. Auxiliary functions SF01, 08, 09
3. Trigger functions SF02, 03, 04, 05,
06, 07, 54, 55
4. Measurement functions SF11, 20 to 45
5. Instrument setting functions SF13, 15, 17, 19
6. Automatic frequency scan SF50, 53, 56 to 59,
90 to 93
7. Recorder code and control SF60 to 71
8. Converter correction factors SF80 to 89
9. Service functions SF95 to 98

Special functions 21 to 45 can each be switched in alone or together with other functions. In the second case, the measured levels, for example, are first indicated, printed, or output via the IEC bus, followed in order by the results of the other special functions switched in. Special functions 03 to 07 (trigger functions) are reset at switch-in to the basic state (SF02).

Storage:

Special functions 10 to 45, 52 and 53 can be individually assigned to every instrument setting in registers 1...(5)...9 and thus stored. Special functions 02 to 09, 50, 51 and 60 to 93 are valid, so long as compatible, for all memory registers. Thus, it is not possible, for example, to assign special function 70 (Polygonal connection) to register 1 and special function 71 (Line spectrum) to register 2.

Special function 01, 59 and 89 cannot be controlled via the IEC bus.

For switching in the special functions, the following code is used (function keyed in after pressing key 13, termination and entry of instruction with ENTR key 19):

List of Special Functions

* = Basic setting RCL0 or SF00

- *00 Basic setting
- 01 IEC-bus address
- *02 Trigger OFF
- 03 Trigger internal
- 04 Trigger external
- 05 Trigger at clock time x
- 06 Trigger every x seconds
- 07 A/D conversion with Trigger Ext.
- *08 Printout w/o time of day
- 09 Printout with time of day

- 10 Level measurement OFF
- *11 Level measurement ON
- *12 Squelch OFF
- 13 Squelch ON
- *14 AFC OFF
- 15 AFC ON
- *16 Preamplifier OFF
- 17 Preamplifier ON
- 18 Filter mod.measurement OFF
- *19 Filter mod.measurement ON

- *20 AM modulation depth OFF
- 21 AM modulation depth ON
- *22 Pos. modulation peak OFF
- 23 Pos. modulation peak ON
- *24 Neg. modulation peak OFF
- 25 Neg. modulation peak ON
- 26 -
- 27 -
- 28 -
- 29 -

- *30 Frequency offset OFF
- 31 " ON 100 Hz
- 32 " ON 10 Hz
- 33 " ON 1 Hz
- 34 " ON 0.1 Hz
- *35 Frequency meas. OFF
- 36 " ON 100 Hz
- 37 " ON 10 Hz
- 38 " ON 1 Hz
- 39 " ON 0.1 Hz

- *40 FM frequency deviation OFF
- 41 FM frequency deviation ON
- *42 Pos. peak deviation OFF
- 43 Pos. peak deviation ON
- *44 Neg. peak deviation OFF
- 45 Neg. peak deviation ON
- 46 -
- 47 -
- 48 -
- 49 -

- *50 Single frequency scan
- 51 Automatic repetition of freq. scan
- *52 Linear stepsize
- 53 Logarithmic stepsize
- *54 SF07: Internal classification OFF
- 55 SF07: Internal classification ON
- *56 Special scan OFF
- 57 Special scan ON
- 58 Special scan - record - new input
- 59 Record for special scan editing

- *60 Linear recorder X-axis
- 61 Logarithmic recorder X-axis
- 62 -
- *63 No recorder connected
- 64 YT recorder provided for
- 65 XY recorder provided for
- 66 Recorder ZSG3 provided for
- 67 -
- 68 -
- 69 -

- *70 XY recorder: polygonal conn.
- 71 XY recorder: line spectrum
- 72 -
- 73 -
- 74 -
- 75 -
- 76 -
- 77 -
- 78 -
- 79 -

- *80 For E field coding via 47: $\mu\text{V}/\text{m}$
- 81 For E field coding via 47: $\mu\text{A}/\text{m}$
- *82 Coding 47 effective
- 83 k-factor, broadband dipole + HLO23A1
- 84 Free k-factor A
- 85 Free k-factor B
- *86 k-factor check OFF
- 87 k-factor check ON
- 88 k-factor new input
- 89 k-factor correction, insert and delete

- *90 Normal frequency scan
- 91 Fast frequency scan
- *92 MIN. level = measurement quantity
- 93 MIN. level = voltage level
- *94
- 95
- 96 } reserved for service functions
- 97
- 98
- 99 -

The special functions marked with * are set with SF00 or RCL0. To call the functions entered, key 13 is repeatedly pressed. In order that the call proceed as rapidly as possible, practically all special functions that are part of the basic setting are not displayed.

To enter a function, the 2-digit code must be keyed in and entered with ENTR key 19. When the function is then called, the code readout is supplemented with a brief note which saves having to check in the code list.

Description of the Special Functions

- SF00 For establishing the basic instrument setting.
- SF01 Calling and entering the IEC-bus address.
Addresses 00 to 30 can be entered. Address codes > 31 set the TALK ONLY mode of the ESVP. (Factory setting of address: 18)
- SF02 Trigger function switched off (= basic setting).
In manual operation, this means continual measurements according to the selected measurement and display times.
- SF03 Trigger internal
The squelch threshold 46 serves in this case as the triggering threshold. The RF and IF attenuation for automatic operation are so set that the trigger level lies in the operating range, except when the RF and IF attenuations are set to fixed values with 44.
All measured functions set are run off once after each triggering. As long as SF03 is switched on, an automatic frequency scan cannot be initiated. SF13 is automatically switched in with SF03. By changeover to SF02, SF13 remains switched in.
- SF04 Trigger external
In this case, the ESVP responds to the edge of a trigger pulse on input 58. A switch at input 58 is set to have the instrument respond to either a positive-going or negative-going pulse edge. It is mostly advisable to pre-set the RF and IF attenuation to an optimal value, but if enough time is available, autoranging may be used. A frequency scan is initiated by the arrival of the external trigger pulse, if the RUN key has previously been pressed.
- SF05 Trigger at a preset clock time x.
When the code 05 is entered, the input request ... (hh, mm, ss) is read out. After entry of the clock time x in hours, minutes and seconds, the ESVP monitors the internal clock and starts the measurements or frequency scan set when the entered start time is reached. (A frequency scan starts at the entered start time only if the RUN key has previously been pressed.) Until then the ESVP shows the time left to the start of measurement.

SF06

Trigger every x hours, minutes, seconds.
A single set of measurements is started at intervals of time x. Automatic frequency scans can also be repeated at such intervals. If the entire measurement time is longer than the interval x, the measurements are repeated without interruption - no error message is generated. When the code 06 is entered with ENTR, either the input request REPEAT 00:00:00 appears or, if special function 06 was already switched on, the last entered time interval. The entry of a new interval or a resetting to the start of the interval must be concluded with an ENTR. The simple checking of the entered time during the interval without resetting is concluded by pressing CLR.

SF07

Fast A/D conversion with external triggering

Purpose

Computer-controlled field-strength recording with measuring vehicles for supply measurements.

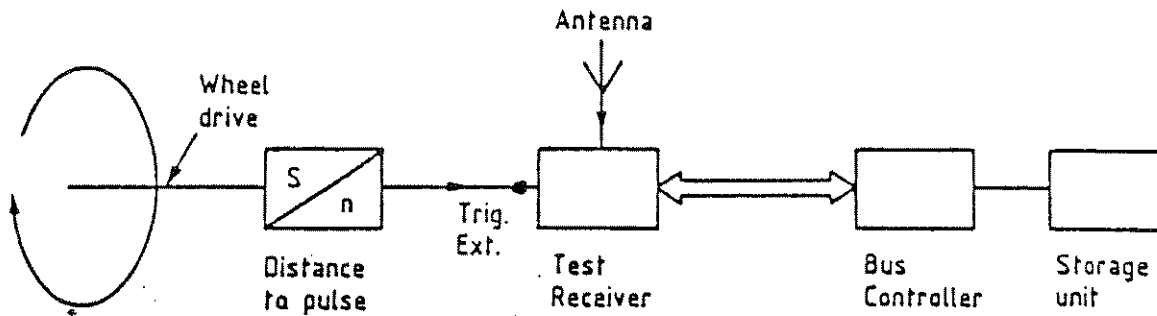

To assure that the field-strength measurements along a route are not affected by the speed of the measuring vehicle, a distance indicator generates pulses each of which initiates an A/D conversion in the ESVP. A pulse rate at the EXT. TRIGGER input 58 of up to 1000 Hz is permitted.

There are two ways of evaluating the A/D-conversion outputs:

- a) binary data output of all samples to an IEC-bus controller,
- b) internal classification according to n samples with output of the relative field-strength distribution via the IEC bus (SF07 with SF55).

For method a), an efficient IEC-bus controller is required for the rapid acceptance and evaluation of a large mass of data.

For method b), a simpler IEC-bus controller will serve or, for recording of the data, a printer with an IEC-bus interface with Listen-only capability.

Operation:

- a) Binary data output to a controller: only SF07. SF54 is only used to switch off the internal classification (SF55). The output of binary data only makes sense in controller operation.

With the entry of SF07 + ENTR, the ESVP responds by

- fixing the RF and IF attenuation (no autoranging),
- setting the 60-dB operating range,
- disabling the CISPR and MIL indicating modes, *
- displaying the message FAST A/D,
- enabling the EXT. TRIGGER input 58.

* In order to use the high, 1000/s, measuring rate even in the PEAK mode, the duration of the discharge must be reduced from 1 ms to 0.1 ms for the PEAK value indication.

For this, resistor R199 of the 10.7-MHz amplifier 355.0211 is changed from 1 M Ω to 100 k Ω . (This is deliberately left to the user of the ESVP to do, because the peak-value holding capacitor with a discharge time of 0.1 ms is discharged to half of the voltage, i.e. is discharged about 30 dB in the 60-dB operating range.)

The A/D-conversion results are with insertion loss coded to 2 bytes binary each and output to the controller. See section 2.3.22.5 for the output format and interpretation of the binary data.

The instruction "SF07" can be given by the controller, in which case the ESVP goes into the remote state. The instruction can however also be entered manually, while the controller is addressing the ESVP only as Talker to request data output.

In this case the ESVP remains operable. The measurements are however interrupted in case of a menu call or a change in the instrument settings. In particular, even in controller operation the keys 45 +/- of the attenuation setting are accessible so long as local-lockout is not in effect. It is thus possible to change the RF attenuation when the analog display 15 approaches the end of the range. Switch-off of SF07 with SF02.

- b) Internal classification (see SF55).

- SF08 Printout without time of day.
- SF09 Printout with time of day.
 The ESVP can output to a IEC-bus printer in the TALK ONLY mode. The clock time is often of importance, particularly in the case of radio-monitoring records. In order not to have to call the clock time into the ESVP display, the printer records can be automatically provided with the clock time with SF09 when a) the TALK key 20 is pressed for output of a measured value and b) the RUN key 29 is pressed at the start of an automatic measurement run.
- Since the date does not have to be repeated, it is output by calling it into the display and pressing the TALK key.
- SF10 Level measurement switched out.
 This function is used when, for example, only the frequency deviation is to be observed.
- SF11 Level measurement switched in (basic setting).
- SF12 Squelch switched off (basic setting).
- SF13 Squelch in operation.
 When the squelch threshold set with key 46 is exceeded, the AF is switched in on 1 and 3. With SF13 in operation, the left, yellow LED 46 lights. When the signal drops below the squelch threshold, the AF is switched off and the red LED 46 lights to warn against an excessive AF level in headphone operation.
- SF14 AFC switched off (basic setting)
- SF15 AFC switched on
 During every measurement cycle (level measurement, etc.), a 10-ms offset measurement is carried out with the internal IF counter and the ESVP frequency thereby adjusted to the frequency of the input signal. This adjustment is performed only if the input level is high enough for an unambiguous frequency measurement. With this adjustment, the ESVP frequency can track a slowly changing signal frequency and, for example, register the signal level. In automatic frequency scanning and in SSB operation, SF15 is ignored, since it does not apply. In AUTO RANGE operation, unnecessary switching of the attenuator may occur.
- SF16 Preamplifier switched out (basic setting).

SF17 Preamplifier switched on to obtain a noise figure of typically 6 to 8 dB.

More information regarding the use of the preamplifier is given in section 2.3.6.2.

SF18 Lowpass filter at input to modulation-depth and FM-deviation measuring circuit switched out.

In this case, the
lowpass limit frequency (-1 dB) is about 53 kHz
lowpass limit frequency (-3 dB) is about 100 kHz.

This lowpass limit frequency is of such value that the FM stereo modulation is also correctly indicated, but higher-frequency noise components are suppressed.

SF19 Lowpass filter at input to modulation-depth and FM-deviation measuring circuit switched on.

In this case, the
lowpass limit frequency (-1 dB) is about 6 kHz
lowpass limit frequency (-3 dB) is about 12 kHz.

This lowpass limit frequency should be of such value that modulation frequencies that have passed the 7.5-kHz and 12-kHz IF filters are not further affected. Since in many types of measurements (including also such with $B_{IF} = 120$ kHz and 1 MHz), low modulation frequencies are involved (e.g. 1 kHz), the selection of SF19 is preferable. Higher-frequency noise components are suppressed.

SF20 AM modulation depth switched off (basic setting)

SF21 AM modulation depth ON

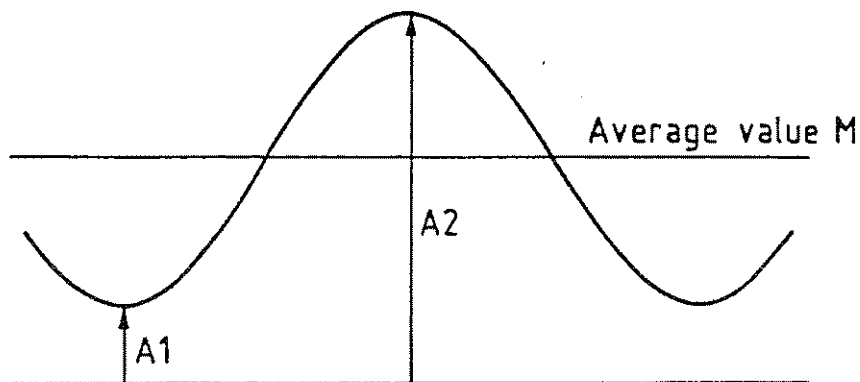

Fig. 2-6 Rectified voltage at output of AM demodulators

With SF21, the value $m = \frac{A2-A1}{A2+A1} \cdot 100\%$ is read out.

With pure sinewave modulation $M = \frac{A2+A1}{2}$ and $A2-M = M-A1$,
i.e. positive and negative modulation peaks are equal.

The accuracy of the modulation measurements increases as the S/N ratio increases. The rectified voltage of the AM demodulator has the best S/N ratio for maximum IF attenuation (40 dB) and the 60-dB operating range.

The modulation-depth measurement is also affected by the ripple of the IF filter cut in. This ripple becomes smaller as the bandwidth of the filter increases.

SF22 Positive modulation peak OFF (basic setting)

SF23 Positive modulation peak ON

With SF23, the value $m+ = \frac{A2-M}{M} \cdot 100\%$ is indicated.

SF24 Negative modulation peak OFF (basic setting)

SF25 Negative modulation peak ON

With SF25, the value $m- = \frac{M-A1}{M} \cdot 100\%$ is indicated.

SF30 Frequency offset measurement OFF (basic setting)

SF31 Frequency offset measurement ON Resolution 100 Hz
Measurement time 10 ms

The frequency of the RF input signal is counted in the 10.7-MHz IF stage. With SF31, the offset from the entered receiver frequency is indicated with a resolution of 100 Hz. Since the frequency measurement corresponds to the formation of an average value, it is much less affected by the S/N ratio than the modulation-depth and deviation measurements. Quite accurate results are obtained with a S/N ratio of only a few dBs.

The accuracy of the frequency and frequency-offset measurement depends on the accuracy of the internal or external reference.

Note: As the ESVP is set to steps of 1 kHz, the offset from the set kHz position is indicated. In the case of measuring signals with a channel raster below 1 kHz, the indication must be converted accordingly.

SF32	Frequency offset measurement ON	Resolution 10 Hz Measurement time 100 ms
SF33	Frequency offset measurement ON	Resolution 1 Hz Measurement time 1 s
SF34	Frequency offset measurement ON	Resolution 0.1 Hz Measurement time 10 s
SF35	Frequency measurement OFF	(basic setting)
SF36	Frequency measurement ON	Resolution 100 Hz Measurement time 10 ms

As in the offset measurements, the frequency of the input signal is determined in the 10.7-MHz IF stage, with consideration of the conversion-oscillator frequency. When both the frequency and offset measurements are selected, only one measurement is made and the two results indicated one after the other. If, on entering special functions, different frequency resolutions are chosen, the function last entered determines the resolution. Thus if SF33 and SF36 are entered, the resolution of the output is 100 Hz.

SF37	Frequency measurement ON	Resolution 10 Hz Measurement time 100 ms
SF38	Frequency measurement ON	Resolution 1 Hz Measurement time 1 s
SF39	Frequency measurement ON	Resolution 0.1 Hz Measurement time 10 s
SF40	FM deviation measurement OFF	(basic setting)
SF41	FM deviation measurement ON	

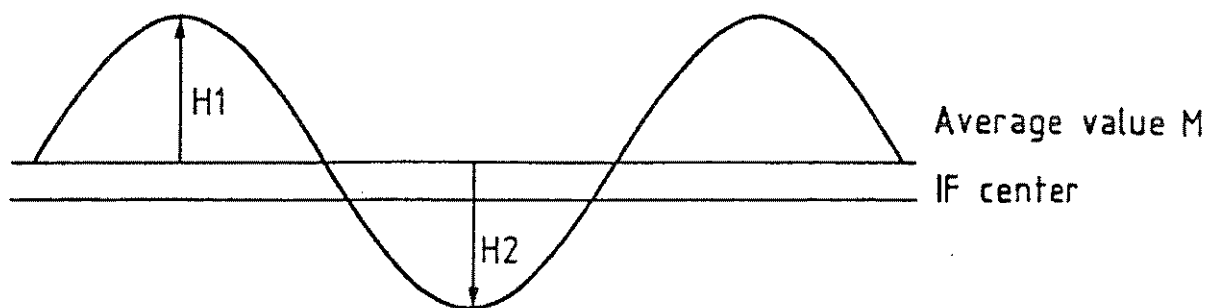

Fig. 2-7 Signal at output of FM demodulator

With SF41, the value $\Delta f = \frac{H1+H2}{2}$ is indicated.

As for the modulation-depth measurement, the measurement accuracy is affected by the S/N ratio and IF bandwidth, and the best results are obtained with maximum IF attenuation, the 60-dB operating range, and an IF bandwidth $B_{IF} > 2 \cdot (\Delta f + f_{mod})$.

- SF42 Positive FM peak deviation OFF (basic setting)
- SF43 Positive FM peak deviation ON
With SF43, the value $\Delta f+ = H1$ is indicated.
- SF44 Negative peak deviation OFF
- SF45 Negative FM peak deviation ON
With SF45, the value $\Delta f- = H2$ is indicated. For exact sinewave modulation $\Delta f+ = \Delta f- = \Delta f$, within the accuracy of the ESVP.
- SF50 Single frequency scan after pressing key 29.
- SF51 Automatic repetition of the entered frequency scan after a single pressing of key 29. This mode is useful for the recording of a frequency band with a slightly modified XYT-recorder ZSKT: The modification results in a slow paper advance of the ZSKT, also in XY operation. With every pass, an XY curve is obtained slightly displaced along the time axis from the curve of the previous pass. In this way, the level variations with time are clearly presented.
- SF52 Linear stepsize (basic setting, LIN.STEP)
Input with 30 in MHz.
The steps of the frequency scan are constant. Application for narrow-band frequency scans, measurement of harmonics, stepsize of a channel raster, interference spectra with narrowband interference.
- SF53 Logarithmic stepsize (LOG.STEP)
Input with 30 in %.
The stepsize is during the automatic frequency scan proportional to the last entered frequency. Application for the recording of wideband interference spectra and, for example, for two-port measurements on low- and high-pass filters.

To simplify the processor software, the stepsize is 2^{-n} (entered frequency), where n is an integer. The ESVP corrects the input automatically so that the nearest lower value is always set. Values of 100%, 50%, 25%, 12.5 to 0.01% are accepted. The switching 53 + + 52 automatically clears the memory for the stepsize.

SF54 Internal classification with rapid A/D conversion OFF.

SF55 Rapid A/D conversion with external triggering with internal classification (see also SF07). With the entry of SF55 + ENTR, the message SAMPLES appears to request the input of the number n of samples to be combined into a single classification interval. n is a whole-number multiple of 100 (value range 100 to 65500, tens and units digits are automatically set equal to zero). If a trigger pulse is produced every 10 cm, 1000 samples cover a distance of 100 meters. SF07 is automatically switched on along with SF55. SF55 can be switched off with SF54, but SF07 then remains switched on.

Every trigger pulse causes an A/D-converter result. With a 9-bit resolution, the individual A/D converter results are assigned to a total of 512 classes. After n samples, the frequencies per class are added up and the probabilities of overstepping are output along with applicable field-strength levels onto the IEC bus.

Example:

Frequency of a 9-bit A/D converter value per class

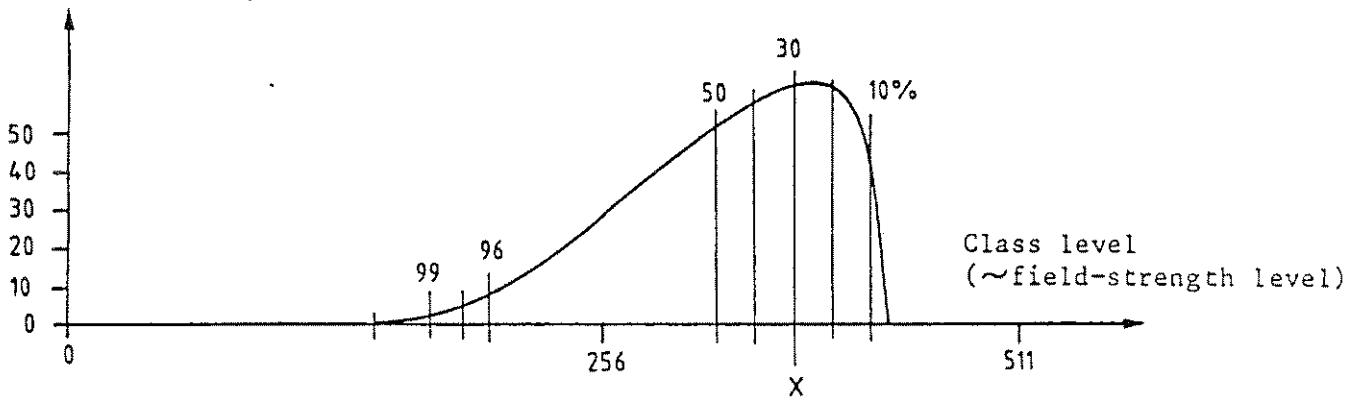

With a sufficiently large number of samples, the classes in a particular subrange are quasi-continuously occupied. The percentage values represent the probability of overstepping for the applicable fieldstrength levels.

Example:

The level x is overstepped by 30% of the measured values.

In controller operation, there results a SRQ (with status byte 80) if the ESVP is not already addressed as Talker.

See section 2.3.22.5 regarding the output format and the interpretation of the data.

On a Listen-only printer, the following classification record is printed.

Example:

98.500 MHz	
%	dB μ V
1	38.4
10	36.1
20	35.5
30	34.7
40	33.7
50	30.6
60	20.7
70	17.1
80	14.2
85	12.2
90	10.4
93	9.1
96	7.2
98	5.7
99	5.2

The median (50% value) is read out on display 12:
30.6 dB μ V F50

With SF64, the median value can furthermore be output on a YT recorder. The current values of the MIN and MAX levels determine the scale of the recorder field. Analog information regarding the field-strength pattern thus is already obtainable during the measuring trip. It can be used for example to quickly decide if the field strength has fallen below a minimum level and the measurements can be ended.

The ESVP requires about 50 ms for the evaluation of the classification. During this time, the trigger pulses are ignored. If the setting of ESVP is changed during a classification interval, a reset of the class frequencies obtained to that point results.

SF56 Special scan OFF

SF57 SF57 activates the special-scan function. If the RUN key is pressed, the frequency settings entered with SF58 (and SF59) are performed with the specified measurements. If no frequency data are present, the ERROR 41 message is output.

Unless SCAN is activated and the SCAN data is predefined an error message is output on SCAN start.

To obtain an output with an XY recorder, the current SCAN data (27, 28, 30, 31, 32) must fit the frequency record.

SF57 is switched out with SF56.

SF58 Specification of frequency record for special scan.

Note! With the call of SF58 + ENTR, any previously specified record is deleted.

With the entry of SF58 + ENTR, the following readout appears:

No. of FREQ. ?..

in response to which the number n of frequencies (n = 2 to 50) must be entered. After this, the n frequencies must be input in the order of increasing value.

SF59 for editing of frequency record for special scan.

This special function is not usable via the IEC bus. With it, the specified frequency record can be checked and corrected (similar to SF89). The following value is called into the display with the ENTR key.

With Code No. 1 "CORRECT", the frequency of the current index number can be changed.

With Code No. 2 "INSERT", all frequencies from the current index number on are shifted one place backward, to permit the new frequency to be input.

With Code No. 3 "DELETE", the displayed frequency is deleted and all following frequencies are shifted forward one place.

SF60 Linear recorder X-axis (basic setting)
For the frequency axis of the XY recorder, linear subdivision must always be set (with SF60) if the ratio

$$\frac{f_{STOP}}{f_{START}} < 1.4.$$

fSTART

Application example: Occupancy of broadcast bands.

SF80 Field-strength indication $\mu\text{V}/\text{m}$ for coding "electrical field strength" on socket 47 (basic setting)

SF81 Field strength indication $\mu\text{A}/\text{m}$ for coding "electrical field strength" on socket 47.

Test antennas and probes with the coding "electrical field strength" or "magnetic field strength" can be connected to socket 47. However, particularly in the short-wave range, loop antennas are used that are calibrated in $\mu\text{V}/\text{m}$ for far-field-strength measurements.

In this case $E = Z_0 \cdot H$, where
E = electrical field strength, unit $\mu\text{V}/\text{m}$
H = magnetic field strength, unit $\mu\text{A}/\text{m}$
 Z_0 = characteristic impedance of free space (377 Ω)

Loop antennas respond to the magnetic field component.

In case of a far field, the specification of field strength in $\mu\text{V}/\text{m}$ is permissible and customary.

In order to express the magnetic field component in the near field in $\mu\text{A}/\text{m}$ instead of $\mu\text{V}/\text{m}$, SF81 corrects the conversion factor coded on socket 47 by the amount -51.5 dB (= $-20 \cdot \log(377)$).

This correction is valid only for the coding 47, and not for the correction factors SF83, 84 and 85.

SF82 Coding input 47 effective (basic setting)

SF83 K-factors of broadband dipole HUF-Z1 and log-periodic broadband antenna HL023A1 are provided for.

With this special function, the antenna factors of the HUF-Z1 for the 20-to-80-MHz range (attenuator of antenna in the 15-dB position) and of the HL023A1 for the 80-to-1300-MHz range are automatically taken into account in the field-strength indication. This is possible because of the high degree of reproducibility in the antenna factors achieved by close control of manufacture. The antenna factors include the attenuation of the 7-m-long RF connecting cable HFU2-Z5. Whenever the 80-MHz limit is exceeded in the scan mode, the command CHANGE ANTENNA is displayed on the ESVP. When the antenna has been changed, the scan is continued by pressing the RUN key again. In controller operation, a SRQ results with status byte 83. After antenna change (or switch-over), the scan is resumed with "SR".

SF84 Free programmable correction factor A

SF85 Free programmable correction factor B

SF86 Correction value indication OFF

SF87 Correction value indication ON
For checking of freely programmable correction factors which have previously been entered either with SF88 or via the IEC-bus interface.

By use of the TALK key, the values can be output to a LISTEN ONLY printer. With the automatic frequency scan, the correction curves in the SF87 can also be output to an XY-recorder or via the IEC-bus connector where a capability for checking the accuracy of the interpolation exists.

SF88 For input of a new free-programmable correction factor via the front panel. Before entering SF88, one of the two special functions SF84 or SF85 must be entered.

Note! With the calling of SF88, the data set for 84 or 85 is erased. Only completely entered sets of data are valid (check with SF89).

All values must be entered in the following sequence:

- 1) Number of value pairs ENTR
Measured quantities code ENTR
Measured quantities code:

1 = Voltage and attenuation measurement (dB μ V, dB)
2 = Current measurement (dB μ A)
3 = E-field-strength measurement (dB μ A/m)
4 = H-field-strength measurement (dB μ A/m)
5 = Interference power measurement (dBpW)

- 2) Value pairs
Frequency/MHz ENTR
Correction value/dB ENTR

Every time the ENTR key is pressed, the request for the next value appears automatically. So long as the ENTR key is not pressed, the keyed-in values can be corrected by pressing the CLR key - after that only with SF88 and SF89.

The input via the front panel is only an expedient in case a bus controller is not connected.

Example: Correction curve of RF current probe
ESV-Z1.

```
20 ENTR 2 ENTR      (20 value pairs,  
                    measurement quan-  
                    tities code = 2)  
  
20 ENTR -19.1 ENTR (1st value pair)  
22 ENTR -19.3 ENTR (2nd value pair)  
  
25 ENTR -19.5 ENTR (3rd value pair)  
.  
.  
.  
100 ENTR -20.1 ENTR (20th value pair)
```

The number of value pairs for SF84 and SF85 must not exceed 50 each.

For the selection of the correction-curve sampling points, it should be noted that the ESVP internally performs quadratic interpolation and uses for this four consecutive points. The sampling points are most valuable at maxima, minima and points of inflection of the correction curve. In intervals of high curvature, the sampling points should lie closer together.

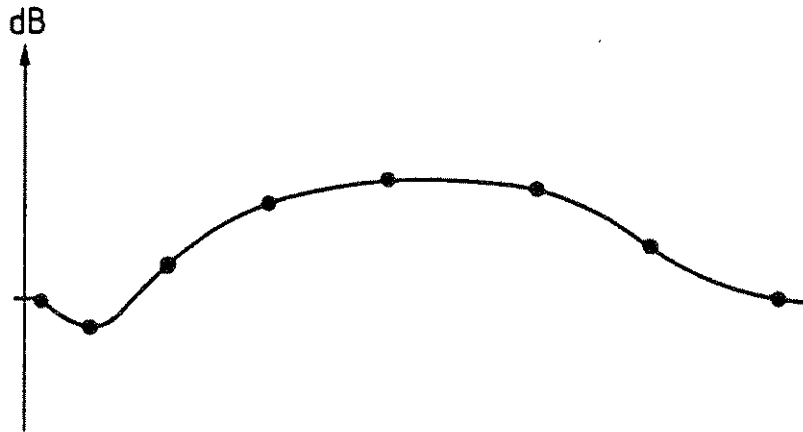

Fig. 2-8 Correction curve with sampling points

With a very unfavourable combination of value pairs, an overflow of the internal number range can occur (which results in Error 34 when SF84 or SF85 is selected). If error message 34 appears, it can be eliminated by reducing the separation between the sample frequencies where the error occurred.

The following formula may be used for a check:

$$f_i - f_{i-1} < \left| \frac{320 \text{ dB} - a_{i-1}}{a_{i-1} - a_{i-2}} * (f_{i-1} - f_{i-2}) \right| \text{ for } i > 2$$

where f_i = sample frequency
and a_i = associated correction value in dB.

SF89 For correction, insertion (INSERT) and deletion (DELETE) of correction value pairs.

With code number 1 "CORRECT", the sampling frequency and the correction value of the current index can be changed one after the other.

With code number 2 "INSERT", all value pairs from this index are shifted back one place and the new value pair can be entered.

With code number 3 "DELETE", all value pairs following this index are shifted one place forward.

SF89 is not callable via the IEC-bus because it is easier with the IEC-bus controller to replace the entire set of sample values.

SF90 Normal frequency scan (basic setting)

SF91 Fast frequency scan
With this special function, the automatic frequency scan is speeded up considerably. The operating range is set to 60 dB. The RF and IF attenuation is set in such a way, that with an IF attenuation which corresponds to LOW NOISE, the minimum level is at the lower end of the operating range (0 to 9.9 dB).

A frequency setting is at first followed only by an A/D conversion (duration 0.3 ms). The A/D conversion value is compared with that of the minimum level. If the value exceeds the minimum level, the set time of measurement becomes effective (see section 2.3.2.1).

To avoid slowing down the scanning speed, the conversion factors according to SF83, 84 and 85 are ignored. Only the conversion factors coded at input 47 are observed.

SF92 Minimum level in the unit of the measured quantity dB μ V with correction factor, dB μ A, dB μ V/m, dB μ V/m.MHz, dBpW, etc. (basic setting)

In this case, the mostly frequency-dependent antenna or probe correction factor is added to the test-receiver voltage level and it is then checked whether the measured value thus obtained exceeds the minimum level.

SF93 Minimum level in dB μ V (without correction factor)
In this case, the voltage level at the RF input is directly compared with the minimum level. This has the advantage that the minimum level can be adjusted to a fixed separation from the receiver noise level.

Application in interference measurements.

SF94 Special functions for servicing.

.
.

SF98

2.3.15 Storage and Recalling of Settings with STO and RCL

Up to nine different sets of instrument settings can be stored. By pressing the STO key 17 and entering a digit 1 to 9 on the keypad 33, a complete set of settings is stored in the associated CMOS RAM storage area.

In storage locations 1 to 5, the data for automatic frequency scanning (27, 28, 30, 31, 32) are stored with each of the five settings. In storage locations 6 to 9, on the contrary, the setting data stored does not include the data for automatic frequency scanning.

In addition, a storage area is provided for the last setting before switching off the ESVP. When the ESVP is switched back on, this setting is restored (exception: 10-dB RF attenuation, see section 2.3.6).

Since the CMOS-RAM memory is buffered by a lithium battery, the stored settings are preserved even when the ESVP is switched off. The software is designed to prevent incorrect instrument setting arising from incomplete storage of data sets.

The RCL key 17 and entry of the same digit, 1 to 9, permits the setting stored by means of STO 16 to be recalled. Since it is possible to include more than one automatic frequency scan in a single operation (see section 2.3.2), it is sufficient in this case (LED 26 lit) to enter the figure referring to the desired frequency ranges previously stored via keypad 33 and press the RUN key 29. To call up the basic setting, RCL \emptyset is entered according to section 2.2.4. Special functions $\emptyset 2$ to $\emptyset 9$, 50, 51 and 60 to 93 are valid for all memory registers. They cannot therefore be stored individually.

2.3.16 Connection of Test Antennas and Probes

Probes for high-impedance voltage measurements, for RF current measurements (VHF Current Probe ESV-Z1) and antennas for field-strength measurements are connected to the RF input 50 and the supply and coding socket 47.

All the active antennas/probes obtain their supply voltages via socket 47. The conversion factors (coded in 10-dB steps) and the quantity to be measured (field strength, voltage, current) are communicated to the ESVP via the coding inputs, so that the test result is read out on the display 12 with the correct unit.

Special function 81 also permits the indication of magnetic field strength in $\mu\text{A/m}$ when the input to socket 47 is coded for "electrical field strength $\mu\text{V/m}$ " (see section 2.3.14).

For measurement of field strength in a screened enclosure, the ESVP is normally operated outside the enclosure. If an active antenna is used, the shielding of the supply and coding cable to the antenna must be passed through the enclosure wall in such a way that no interfering radiation is introduced into the enclosure.

In addition to the accessories for its test receivers ESH2 and ESH3 (9 kHz to 30 MHz), R&S can provide the following transducers with the appropriate coding for socket 47.

- + VHF Current Probe ESV-Z1
for frequency range 20 to 300 MHz
(usable up to approx. 500 MHz), and
- + Broadband Dipole HUF-Z1
for frequency range 20 to 80 MHz
(level frequency response in range 25 to 80 MHz,
k-factor in 20-dB setting).

In both cases however, it is better to use the more exact correction provided by special functions 83, 84 and 85 (see section 2.3.14).

Since the coding inputs may also be used for connection of antennas/probes from other manufacturers, the pin allocation of the socket 47 is given below (front panel view):

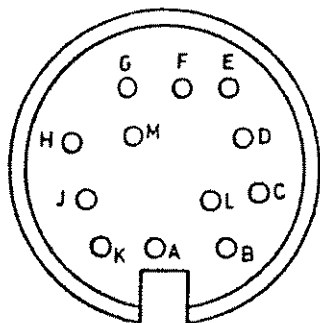

- A: Ground
- B: +10 V (max. 50 mA)
- C: $\mu\text{V/m}$ (electrical field strength)
- D: μA
- E: 10 dB
- F: 20 dB
- G: 40 dB
- H: 80 dB
- J: $\mu\text{A/m}$ (magnetic field strength)
- K: -10 V (max. 50 mA)
- M: Reverses sign of the factor

Fig. 2-9 Pin allocation of the 12-way socket 47 (Tuchel type)

In remote operation of the ESVP via the IEC bus, the antenna coding can be suppressed by the instruction "ZØ".

For coding, a 12-way plug connector (Tuchel T3635/2, R&S order number 018.5362.00) is used. The coding inputs must be connected to ground.

Example: An antenna has an antenna factor of 30 dB, i.e. a field strength of 30 dB ($\mu\text{V}/\text{M}$) produces a voltage of 0 dB (μV) at the RF input. The pins C, E and F are grounded.

The "reverses sign of the factor" coding input permits an amplifier to be included in the coding.

Example: An amplifier with a constant gain of 10 dB is connected to the input of the ESVP. The input voltage to the amplifier is to be displayed. Therefore, pins E and M are grounded.

2.3.17 Data Output on a Listen Only Recording Device (Printer, Magnetic Tape Memory, etc.)

To facilitate data logging, a printer with an IEC-625 (IEEE-488) interface can be connected to the IEC bus connector 60 of the ESVP. The printer must be switched over to Listen Only operation and ESVP to TALK ONLY. Data can then be sent from the ESVP to the printer.

In the place of the printer, another Listen Only device such as a cartridge tape drive or disk drive may be connected to temporarily store the test results for evaluation by a computer.

All measured values, together with the particular test frequency and the complete units, are output in a fixed format, separated by comma and space (SP), in one record delimited by carriage return (CR) and line feed (LF).

Example:

Frequency MHz	Level dB μV	Mod. depth %	Offset kHz	Dev. kHz	CRLF
92.345 MHz	*117.4 dB μV	*13%	*0.12 kHz	*0.15 kHz	CRLF

* Instead of the space that in the normal case precedes every measured value (level, modulation depth, etc.), the letter U/H is output if the value falls below/above the operating range and the letter X in case of an overload.

The format is designed to obtain easily readable tables of long test series so that data strings not exceeding a line length are printed.

If the readout or a special function is switched over, the format is changed. The ESVP offers three possibilities for Talk Only output:

→ **Manual operation:**

To prevent every measured value read out on the display 12 also being printed, the user can decide which test result are to be printed by means of the TALK key 20. When the TALK key is pressed, a new measuring procedure is triggered, the result of which is printed.

→ **Continuous observation at a fixed frequency:**

To automatically obtain an output after each individual measurement, the ESVP is switched to automatic pseudo-frequency-scanning with $f_{START} = f_{STOP}$.

→ **Values measured over one or several frequency bands:**

The test results are output if the level is above minimum level (MIN. LEVEL 28) at the frequency set.

To facilitate output on a printer, the contents of the menu output on the display 12 can be output in the TALK ONLY mode by pressing the TALK key 20.

Example: Data for an automatic frequency scan,
date, time of day, special functions.

```
STRT 88.0000MHz
STOP 104.0000MHz
STEP 0.1000MHz
MIN 40.0dB*
TIME 18:06:09
DATE 25. OCT. '83
```

Frequency	Level	Offset	Input-Freq.	dev
88.100MHz	41.7dB μ V	-0.03kHz	88.09997MHz	10.2kHz
88.200MHz	42.5dB μ V	-0.02kHz	88.19998MHz	25.5kHz

2.3.18 IF, AF and Recorder Outputs

A number of outputs are provided (in addition to 61) to permit signal evaluation with oscilloscopes, analyzers, and YT recorders.

→ 10.7-MHz IF output  51

The bandwidth is the same as that set on IF bandwidth key 5.

Output voltages (EMF, $Z_{out} = 50 \Omega$):

Operating range 20 dB	7 to 70 mV
Operating range 40 dB	7 to 700 mV
Operating range 60 dB	0.7 to 700 mV

Suitable for evaluation with oscilloscope, spectral analyzer and modulation analyzer.

→ 10.7-MHz IF output  52
Bandwidth approx. 2 MHz; gain compared to RF input 50 with 0 dB
RF attenuation:

without preamplification	typical 7.5 dB
with preamplification	typical 17.5 dB

Suitable for connection of an IF Panorama Adapter (e.g. EZM or EZP) or a spectrum analyzer.

Note: The EZP can be connected to the ESVP by means of a BNC cable. The EZP must for this purpose be internally modified:

Remove cable K1 from input filter (K1 is thus open circuit). Disconnect cable K3 from oscillator input and in place of K1 connect it to the input filter.

→ AM demodulator output 53
Output voltage (EMF_{pp} , $Z_{out} = 1\text{ k}\Omega$) for $m = 50\%$: 1 V

This output is DC-coupled and furnishes an output of 1 V max. with an unmodulated carrier. Maximum bandwidth 0.3 MHz.

Suitable for connection to an oscilloscope or a S/N-ratio meter.

→ FM demodulator output 54
Output voltage (EMF , $Z_{out} = 1\text{ k}\Omega$):

for IF bandwidths 100 kHz (mod. 56), 120 kHz (all mod.), 200 kHz (mod. 53)	
and 1 MHz (mod. 52, 56):	1 V/100 kHz offset
for IF bandwidths 7.5 kHz and 12 kHz (mod. 52, 53) or 10 kHz (mod. 56):	1 V/1 kHz offset
maximum bandwidth: 0.5 MHz	

Suitable for input to an oscilloscope and for connection to an S/N-ratio meter. The frequency-transients behaviour of mobile radio transmitters can also be measured on this output.

→ Frequency offset output 55
Output voltage (EMF , $Z_{out} = 10\text{ k}\Omega$)
for IF bandwidth 1 MHz (mod. 52, 56): 1 V/100 kHz offset
IF bandwidths 120 kHz/200 kHz
(mod. 53, 55): 1 V/20 kHz offset
IF bandwidth 100 kHz (mod. 56): 1 V/10 kHz offset
IF bandwidth 120 kHz (mod. 52, 54, 56): 1 V/10 kHz offset
IF bandwidth 10 kHz (mod. 56): 1 V/1 kHz offset
IF bandwidths 7.5 kHz
and 12 kHz (mod. 52, 53): 1 V/1 kHz offset

Suitable for the analog recording of frequency variations with a YT recorder.

→ Level analog output 57
Output voltage (EMF , $Z_{out} = 10\text{ k}\Omega$): 0 to 4 V.

For use with indicating modes AV., PEAK, and MIL for the analog recording of level variations with a YT recorder.

In the PEAK and MIL mode, the output voltage contains the discharge pulse in time with the measurement rate.



- Level analog output 56
Output voltage (EMF, $Z_{out} = 10\text{ k}\Omega$): 0 to 2 V with built-in lowpass filter ($T = 100\text{ ms}$) according to CISPR 2/4 and 16.

For use for analog recording of level variations with a YT recorder.

- An additional output is point X210 of the 10.7-MHz amplifier on the inside of the instrument. It can be brought out to the rear panel, preferably by means of cable W24 of the external reference 59:

the test demodulator output which accurately follows the envelope of the IF signal and can thus serve for oscilloscopic investigations.

Output voltages (EMF) 0 to 4 V, $Z_{out} = 50\ \Omega$, but only connectible to a high-impedance ($> 1\text{ k}\Omega$) load.
Bandwidth 0.5 MHz.

Cables W20 (FM)
W21 (AM)
W22 (10.7-MHz )
W23 (10.7-MHz )

can also be used.

2.3.19 Operation of ESVP with an External Reference Frequency

To enhance the frequency accuracy of the ESVP, it is possible to connect an external frequency standard to BNC socket REF EXT 59. A 5-MHz or 10-MHz signal is required from the reference source with a voltage of $>1\text{ V}$ (sinewave) at an impedance of $50\ \Omega$.

To activate the external reference, the left-hand slide switch "INT/EXT" at the rear of the instrument must be switched to "EXT", i.e. switch down. Right-hand slide switch "5 MHz/10 MHz" is switched down for 5-MHz signals and up for 10-MHz signals.

BNC socket EXT.REF 59 can also be used as an output for the internal reference frequency (10 MHz). In this case, link X4 on the Reference Oscillator module must be in position pin 1 + pin 2 (indicated in the circuit diagram as solid line). The ESVP must always be switched to internal reference (slide switch "INT/EXT" on rear up), for otherwise the internal reference is not effective. If this operating mode is selected, no application of the ESVP with external reference frequency is possible.

To further enhance the frequency accuracy of the ESVP, the Option "Oven-controlled Crystal Oscillator ESVP-B1" can be used, which is fitted in the ESVP instead of the Reference Oscillator (see Manual for Option ESVP-B1).

2.3.20 Connection of Recorders to Output 61

The 24-way XY RECORDER socket 61 contains analog outputs which are driven from the ESVP microprocessor via D/A converters. YT, XY and radio monitoring recorders (ZSG3) can be connected to these analog outputs for the graphic representation of the output of the automatic frequency scans.

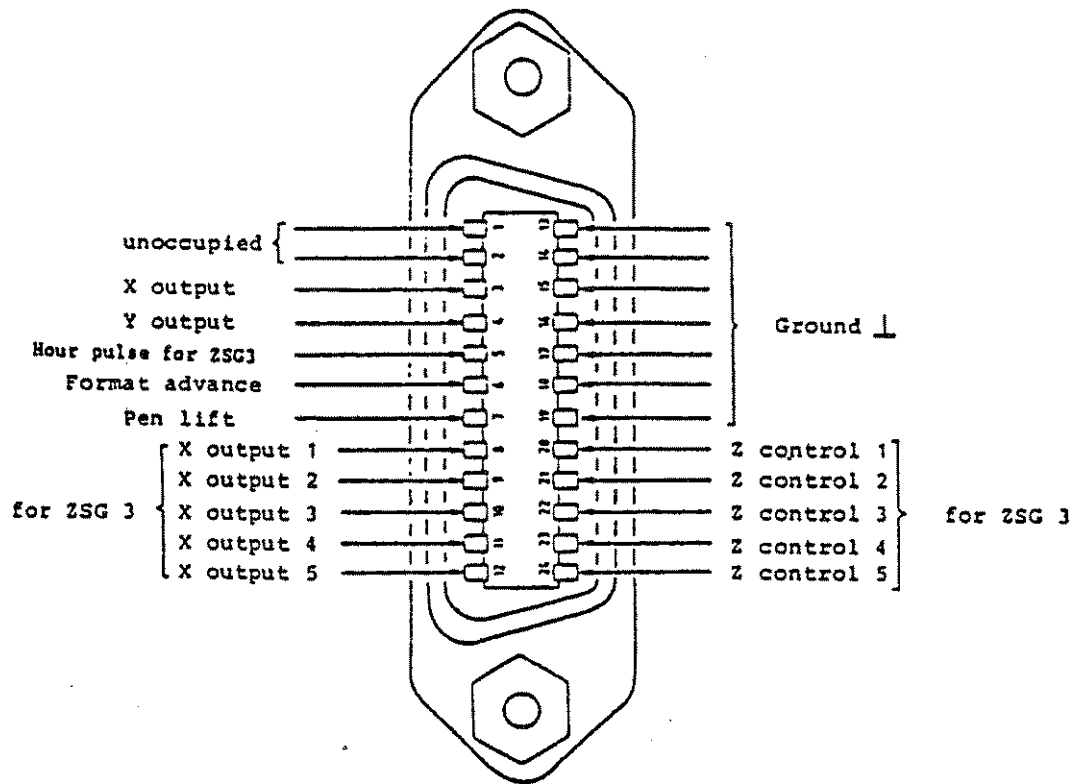

Fig. 2-10 Pin allocation of recorder output 61

In test receiver ESVP, the type of recorder attached is not input by means of a code through the recorder connection, as it is in the ESH3, but by means of special functions 63 to 66:

- SF63 No recorder
- SF64 YT recorder provided for
- SF65 XY recorder provided for
- SF66 Frequency-band recorder provided for

The settling times of the XYT recorder ZSKT are provided for in the measurement run. If the automatic frequency scan is to be performed at the fastest possible rate, special function 63 must be selected. In this case, no plot is made.

Except for cable ESH3-Z1 (Ident No. 349.6011.02), for connecting the ZSKT to the ESH3 or ESVP, ready-made cables cannot be supplied with the receiver, since any commercial recorder may be used (Exception: Recorder ZSG3 is only available from R&S).

The following connectors are required for the connecting cables:

24-way male connector for ESVP recorder output
Ident No. 080.2711.00
Amphenol ordering number: 5730240

36-way elbow connector for Radio Monitoring
Recorder ZSG3 and
XY Recorder ZSK2
Ident No. 247.7055.00
Amphenol ordering number: C57-159A 5036P

6-way round connector for XYT Recorder ZSKT
Ident No. 018.6646.00
Amphenol-Tuchel ordering number T 3400/1

Banana plug for the XY Recorder ZSK2 and the
XYT Recorder ZSKT;
available from any electronics dealer.

See section 2.3.20.1 for the wiring scheme.

When the ZSG3 is used, the format-advance pulse is generated after each scanning operation. This pulse controls the line feed of the ZSG3.

When a ZSKT and a ZSG3 are connected in parallel, the format-advance line on the ZSKT must remain free. The ZSKT must be switched off when ZSG3s are being driven.

The format-advance pulse can be generated by the controller command V1 (see Table 2-10).

Logic levels on the penlift and format-advance lines:

Penlift (TTL level) L = pen up H = pen down
(factory-set)

Changed with switch S1 to
position 5-4 on the
writer control: H = pen up L = pen down

The hour pulse output (H pulse) is used for generating the hour markings on Radiomonitoring Recorder ZSG3.

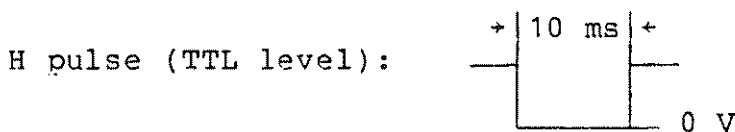

2.3.20.1 Wiring Scheme for Connecting Cables

a) ESVP ZSKT as a YT recorder
ESVP

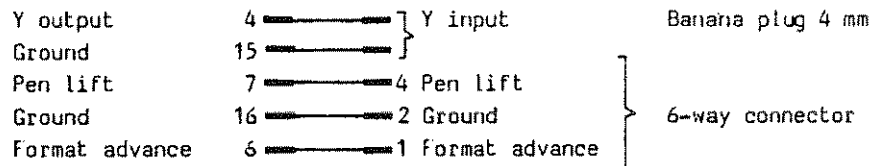

b) ESVP - ZSKT as a XY recorder
(ESH3-Z1 IN 349.6011.00 can be used here)
ESVP

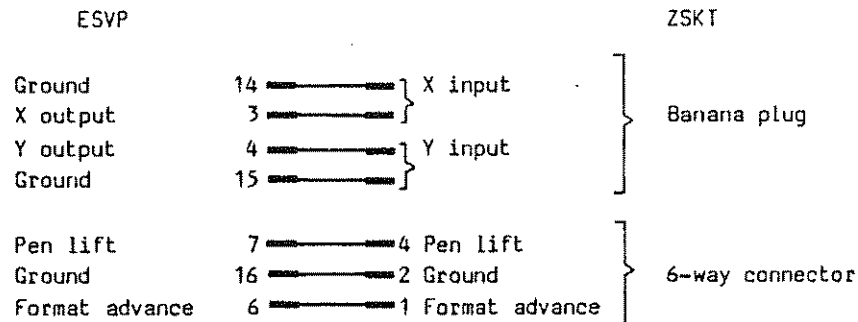

c) ESVP - ZSG3 (1 to 5 units)

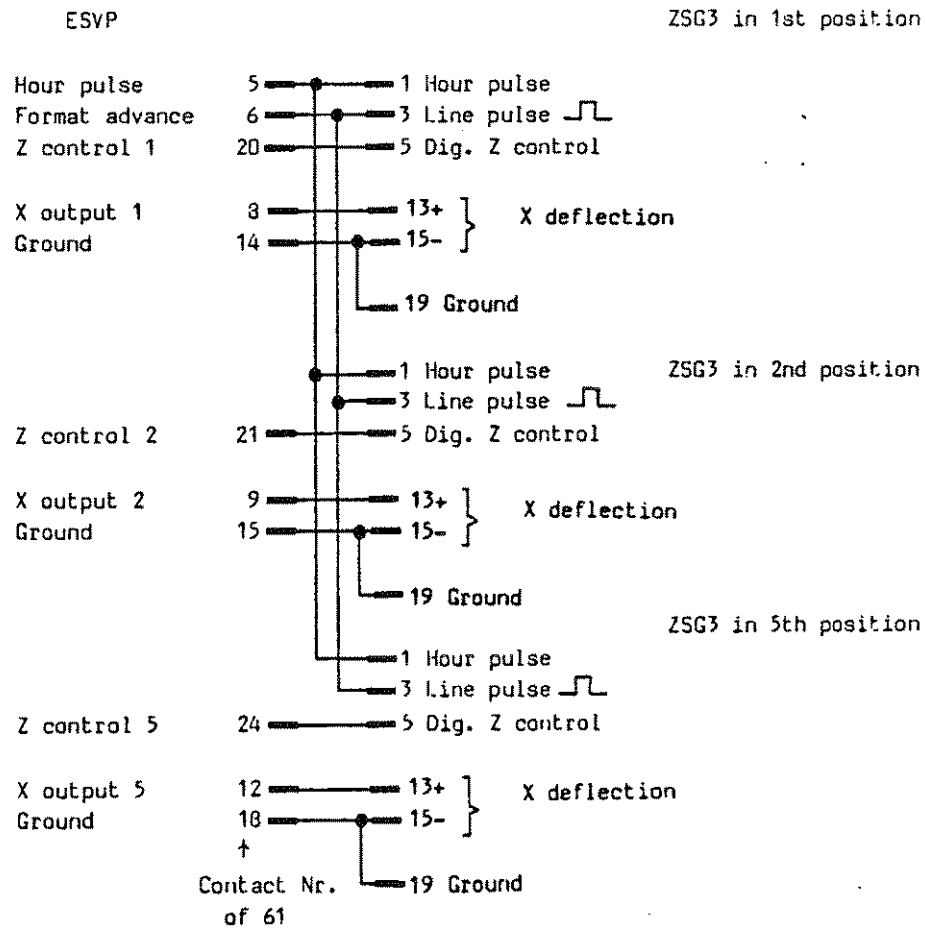

2.3.20.2 Setting the ESVP for Output to a Recorder

- a) YT Recorder
(Y = level; T = automatic time base)

Long-term measurement of level fluctuations at a particular frequency: Note, when setting the ESVP: start frequency = stop frequency. After pressing the RUN key 29, the pen is applied and the level is recorded (a "polygonal" curve is produced, in which the points representing each level measurement are joined by straight lines) until the STOP key is pressed. Simultaneously data can be output in the Talk Only mode.

Calibration of the Y axis: As long as RUN and MAX. LEVEL are not pressed, the Y voltage is 0 V ~ MIN. LEVEL. If MAX. LEVEL is pressed, the Y voltage goes to its maximum (= +10 V).

- b) XY Recorder
(Y = level, X = frequency)

For recording frequency spectra (lines SPEC FUNC 71) and frequency response (polygonal curves SPEC FUNC 70).

The settling times of a normal XY recorder (ZSKT) are taken into consideration. After pressing the RUN key 29, the pen is applied and a single recording operation is carried out. Simultaneously data can be output in the Talk Only mode. In multiple frequency scanning (e.g. 1, 2, 3 RUN), the limit values of f_{START} , f_{STOP} , MIN. LEVEL and MAX. LEVEL determine the scaling of the recording.

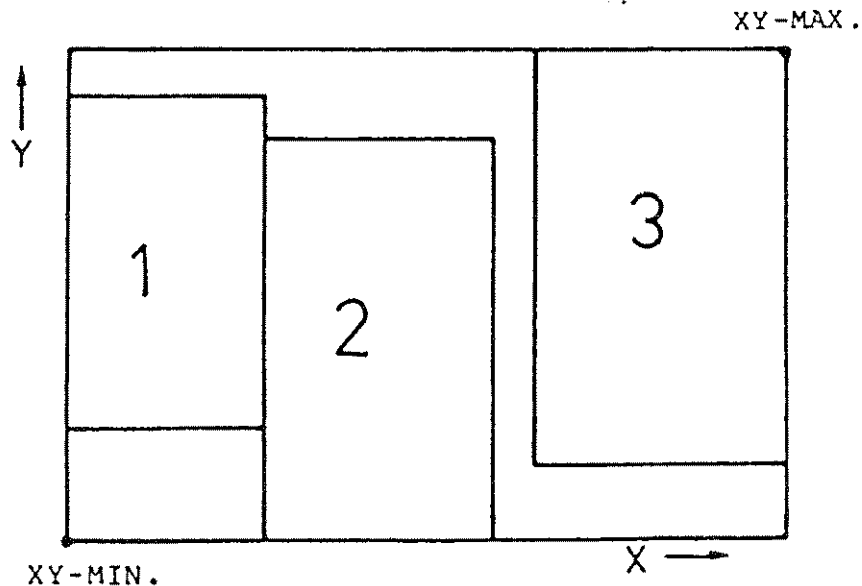

Fig. 2-11 Example of possible allocation of start and stop frequencies of three subranges for output to an XY recorder

For frequently performed recordings it is recommended to prepare forms with the axes, limit values and a field for the test item and the data, already printed on the sheet.

Calibration of X and Y axes: As long as neither RUN nor MAX. LEVEL is pressed, the X and Y voltages are 0 V. If MAX. LEVEL is pressed, the X and Y voltages go to their maximum (= +10 V).

c) Radio Monitoring Recorder ZSG3

The Radio Monitoring Recorder ZSG3 is used for recording the band occupancy over a longer period of time. The minimum levels entered for each frequency range determine the threshold above which a mark is produced on the recording paper. After all the frequency ranges called up at the start (1, 2, 3 RUN) have been scanned, all the ZSG3s connected are sent a line feed, and recording automatically begins again at the first start frequency.

If no range number is called at the start, the current frequency band (newly entered values or called up by means of RCL) is recorded by means of the recorder at X output 1 (see wiring diagram).

For fastest possible recording of the frequency bands, no precise level measurement is made but only a check of whether the level falls above the minimum value within the set measuring time. For this reason, simultaneous Talk Only output is not possible.

The following ESVP settings are ignored when a ZSG3 plot is started: TWOPORT, MAX./MIN., LIN.TEST, AUTO, SPEC.FUNC. 91. If special function SF91 is switched in, an error message (Error 40) results. SF91 must therefore first be switched off. If the 40-dB or 60-dB operating range has been selected, switchover to the correct RF attenuation and to the 20-dB operating range takes place when the scanning operation is started. It is, however, advisable to adjust the RF and IF attenuation to the desired measurement range for the 20-dB operating range. Any of the indicating modes can be used.

There are two ways of generating continual scanning:

1. By use of special function 51: repeated frequency scan.
2. By use of special function 06: trigger every x seconds (minutes). With special function 06, the time of day per scan can also be measured. The time remaining at the end of a scan until the beginning of the next scan is indicated.

For band-occupancy measurements according to CCIR specifications, the results are generally required on DIN-A4-format paper within 24 hours. For example, for 675 scans in 24 hours, 2 minutes and 8 seconds are required per scan. The paper advance per scan is 0.41 mm. For 675 scans, the format length is therefore 276.7 mm.

Setting of frequency markers: Set start and stop frequencies of required frequency range. After pressing the RUN key, press the STOP key once. Now the frequency of the ESVP can be set to the required frequency marker, whereby the X deflection of the ZSG3 concerned is accurately set.

2.3.21 Error Messages

Error messages from the ESVP signal faulty operation, illegal or missing data entries and recognizable internal failures. They are output on the display 12 which reads out ERROR and a two-digit code number (table 2-4).

In addition to the error messages, the following indications of faulty operation or detection of internal overloading are provided:

a) Intermittent LEDs

When one instrument setting is blocked by another setting, the LED of the blocking function blinks when the key of the blocked function is pressed.

Example: When, in the CISPR indicating mode, the IF bandwidth key is pressed, the "CISPR" LED blinks.

b) Intermittent measured-value indication when

- the operating range is under- or overranged at fixed RF/IF attenuation,
- the operating range is exceeded at maximum RF attenuation and AUTO,
- nonlinearity in autoranging (nonlinearity can also be simulated by rapid signal variations),
- with special functions 84 or 85 selected, the receiver frequency exceeds the frequency range defined by SF84 or SF85.

Table 2-4 Error code list

01	Frequency entered above limit	
02	Frequency entered below limit	
03	CAL: CHECK. Comparison frequency response correction/ current value > 0.5 dB, occurs, for example, after an interrupted overall calibration (overall calibration required).	
04	No listener on IEC bus (Fault in IEC-bus controller)	
05	Level or offset calibration is not accomplished within the fixed time (hardware error)	
06	Syntax error in input via IEC bus and illegal time-of-day and data input	
07	Correction value at CAL. TOTAL > 5 dB; complete calibration discontinued.	
08	Memory register not occupied at RCL	
10	+10 V	} Failure of a supply voltage (the failure of the +5-V supply voltage cannot be output)
11	-10 V	
12	+12 V	
13	+20 V	
14	+30 V	
20	Current register	} At start of an automatic frequency scan, one or more values are not defined.
21	Register 1	
22	Register 2	
23	Register 3	
24	Register 4	
25	Register 5	
30	START frequency > STOP frequency	
31	START frequency = STOP frequency and XY recorder or ZSG3 connected	
32	MAX. level < MIN. level	
33	SPEC.FUNC. 61	Log. X axis and $\frac{f_{stop}}{f_{start}} < 1.4$
40	ZSG3 error: Error message if SPEC.FUNC. 61 is switched in at SCAN RUN with ZSG3.	
41	No frequency record exists with SF57 + RUN	
52	Synthesizer 1 (n x 100 MHz)	} Control loop errors
53	Synthesizer 1 (1st Oscillator)	
54	Synthesizer 2	
55	SSB board	
56	Mixer 2 (800-MHz- or 300-MHz oscillator)	
57	Filter control (range start indication)	
58	Evaluation (10.7-MHz oscillator)	
59	Calibration generator (oscillator loop or level control)	

2.3.22 Control of the ESVP via the IEC Bus

The Test Receiver ESVP is provided with a remote-control interface conforming to IEC Publication 625-1 (corresponding to IEEE 488-1975) for transfer of setting and measured data using a byte-serial bus system. IEC-bus connector 60 is located on the rear panel of the test receiver.

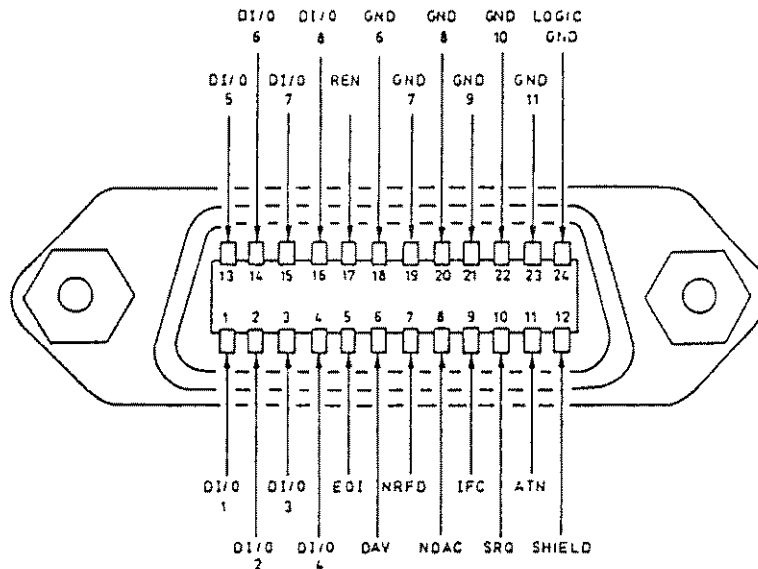

Fig. 2-12 Pin allocation of IEC-bus connector 60

For data transfer, the characters of the ISO 7-bit code (ASCII code) are used. For the interface specifications (control lines, handshake lines, data lines) and data transfer sequence see IEC standard.

Under the title "Operating Software ESVP", R&S provides, free of charge, technical information regarding the R&S Process Controller PUC, including information regarding the command syntax of the computer. Information regarding available application software may be obtained from the local R&S sales agency.

2.3.22.1 Interface Functions

The ESVP implements the following interface functions:

SH1	Source handshake function, complete capability
AH1	Acceptor handshake function, complete capability
T5	Talker function Capability to answer serial poll, Unaddressing if MLA, Talk Only mode
L4	Listener function Unaddressing if MTA
SR1	Service request, complete capability
RL1	Remote/local switchover function, complete capability
PP1	Parallel poll function, remote-controllable configuration
DC1	Device clear function, complete capability
DT1	Device trigger function, complete capability
C0	Control function, <u>no</u> capability

2.3.22.2 Entering the Device Address/Talk Only Mode

When the instrument is switched on, the device address and Talk Only mode are entered and called by means of the ESVP front-panel controls.

The address (0 to 30), which is the same for Listener and Talker, is indicated and entered in the decimal equivalent.

Input values larger than 30 are interpreted as change in the Talk Only mode.

The address is output after calling special function 01, at which the display 12 reads out the message

IEC-BUS ADR: 18

or

IEC-BUS ADR: ton

A new device address can be entered by keying in the digits and pressing the ENTR key. Because of the battery buffering of the microprocessor's RAM, the entered address is preserved even during switch-off phases of the instrument.

Table 2-5 Setting the Device Address

ASCII character		Decimal equivalent
Listen address	Talk address	
(SPACE)	a	00
!	A	01
"	B	02
#	C	03
\$	D	04
%	E	05
&	F	06
'	G	07
(H	08
)	I	09
*	J	10
+	K	11
,	L	12
-	M	13
.	N	14
/	O	15
0	P	16
1	Q	17
2	R	18*
3	S	19
4	T	20
5	U	21
6	V	22
7	W	23
8	X	24
9	Y	25
:	Z	26
;	[27
<	\	28
=]	29
>	^	30

* Value set at the factory

2.3.22.3 Setting Instructions

The Test Receiver ESVP responds to the IEC-bus setting instructions and data in remote operation exactly as it does to direct, manually keyed in instructions in local operation. Therefore the same sequence of settings that is used for manual operation can be used as a basis for preparing the controller to set the receiver functions and measuring procedures.







The programming instructions consist of an alphanumeric header, the numeric data content and a delimiter which separates several instructions from each other or terminates a sequence of instructions. The header consists of one or two alphanumeric characters (ASCII upper-case letters); the data content consists of one or several numeric characters (0, 1 to 9, decimal point, exponent, polarity sign) and the delimiter character.

Table 2-6 Delimiter characters

Symbol	Name	ASCII decimal equivalent	Application
,	Comma	44	Separating delimiter
CR	Carriage Return	13	Terminating delimiter
LF	Line feed	10	
ETB	End of transmission block	23	
ETX	End of Text	3	
END	EOI with last byte	-	Terminating delimiter

A combination of the above terminating delimiters is also permitted (e.g. CRLF = Carriage Return, Line Feed).

Table 2-7 Key functions

Instruction code	Function	Key	
A1*	Low noise	<u>41</u>	
A2	Autoranging Low distortion	<u>42</u>	
B1	IF bandwidth	<u>5</u>	
B2*	1 MHz (mod. 52, 56), 200 kHz (mod. 53)		
B3	120 kHz (all mod.)		
B4	12 kHz (mod. 52, 53) 100 kHz (mod. 56) 7.5 kHz (mod. 52, 53) 10 kHz (mod. 56)		
C1	Check	<u>16</u>	
C2	Total Calibration		
D0	AF off	Demodulation <u>4</u>	
D1	A0		
D2	A1		
D3	A3 		
D4	A3 		
D5	A3 		
D6	A3 		
D7*	F3 		
D8	F3 		
G0*	OFF	Lin. test <u>43</u>	
G1	ON		
K0*	OFF	MAX./MIN. <u>38</u>	
K1	ON		
L1	20 dB	Operating range <u>34</u>	
L2	40 dB		
L3*	60 dB		
M0*	Gen. off	Operating mode <u>40</u>	
M1	Remote freq. meas.		
M2	Twoport meas.		
N1*	AV.	Indicating mode <u>37</u>	
N2	PEAK		
N3	CISPR		
N4	MIL		
O1*	dB ...	Data output <u>10</u>	
O2	dBm		<u>11</u>
O3	V, A		<u>14</u>

* This function is already set with basic setting "RC0" and need not be programmed again.

2.3.22.4 Data Input

All data input commands begin with a header consisting of two alphanumeric characters. The numerical part of the data input is processed as shown in the following IEC-bus syntax diagram and tested for conformance to the limit values. The number of significant places and the assignment to a particular unit corresponds to the menu input of the keyboard.

Example for the PUC:

Receiver frequency 98.56 MHz, measuring time 5 ms
IECOUT18, "FR98.56,TS5E-3"

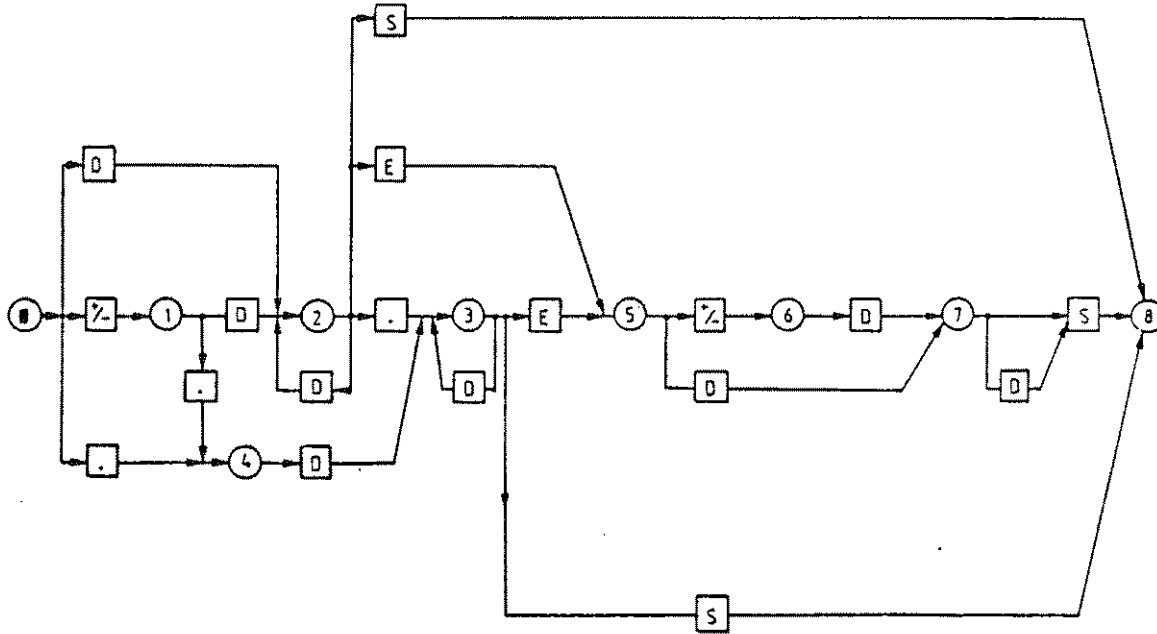

Fig. 2-13 IEC-bus syntax diagram
(Only to illustrate the processing by the ESVP. It shows, among other things, that the ESVP can also process numbers in exponential form.)

Diagram Symbols:

- D digit '0' to '9'
- +/- algebraic sign '+', '-'
- . decimal point '.'
- E exponent 'E'
- S separating or terminating delimiter

Table 2-8

Command code	Numeric range	Function/Unit
FR	20.0000 to 1300.0000	Receiver frequency (MHz)
SA	20.0000 to 1300.0000	Start frequency (MHz)
SO	20.0000 to 1300.0000	Stop frequency (MHz)
SE	0 to 1300.0000	Stepsize (MHz) SF52
	or 0.01 to 100	or (%) SF53
SU	-140.0 to 200.0	Max. Level (dB*)
SL	-140.0 to 200.0	Min. Level (dB*)
TS	0.005 to 1000	Measuring time (sec)
RA	0 to 140	RF attenuation (dB)
IA	0 to 40 (10-dB steps)	IF attenuation (dB)
SQ	-140 to 200 (1-dB steps)	Squelch level (dB μ V)
ST	1 to 9	Store
RC	0 to 9	Recall
CS	0000 to 2359	Set time of day (hh:mm)
DS	010100 to 311299	Set date (dd:mm:yy)
AS	000000 to 235959	Set start time (hh:mm:ss)
IS	0 to 235959	Time interval (s..hh:mm:ss)
CN	1 to 99	Number correction value pairs
CU	1 to 5	Units code*
CO	20.0000 to 1300.0000 -140.0 to 200.0	Correction value: Freq. (MHz) Correction value: (dB*)
SN	100 to 65500	Number of samples for a classification interval(S055)
FN	2 to 50	Number of frequencies for
FO	20.0000 to 1300.0000	SF58

* Units code:

- 1 = Voltage and attenuation measurement (dB μ V, dB)
- 2 = Current measurement (dB μ A)
- 3 = E-field strength measurement (dB μ V/m)
- 4 = H-field strength measurement (dB μ A/m)
- 5 = Interference power (dBpW)

With basic setting "RC0" the frequency is set to 100 MHz and the measurement time to 0.1 s.

SF	00**	Basic setting	
	02	Trigger	OFF
	03	Trigger internal	
	04	Trigger external	
	05	Trigger at time of day x	
	06	Trigger every x seconds	
	07	A/D conversion with Trigger Ext.	
	08, 09	Printer log with, without time of day	
	11, 10	Level measurement	ON , OFF
	12, 13	Squelch	OFF, ON
	14, 15	AFC	OFF, ON
	16, 17	Preamplifier	OFF, ON
	19, 18	Filter mod. meas.	ON , OFF
	20, 21	AM modulation depth	OFF, ON
	22, 23	Positive mod. peak	OFF, ON
	24, 25	Negative mod. peak	OFF, ON
	30, 31 to 34	Frequency offset	OFF, ON
	35, 36 to 39	Frequency measurement	OFF, ON
	40, 41	FM deviation	OFF, ON
	42, 43	Positive peak dev.	OFF, ON
	44, 45	Negative peak dev.	OFF, ON
	50, 51	Single, repeated frequency scan	
	52, 53	Stepsize	lin./log.
	54, 55	with SF07: Internal classification	
	56, 57	Special scan	OFF, ON
		New input, frequency record	
	58		
	60, 61	X recorder axis	lin./log.
	63	No recorder connected	
	64	XT recorder provided for	
	65	XY recorder provided for	
	66	Recorder ZSG3 provided for	
	70, 71	XY recorder: polygonal curve, line spectrum	
	80, 81	E-field coding $\mu\text{V}/\text{m}$, $\mu\text{A}/\text{m}$	
	82	Code input 47 enabled	
	83	k-factors for broadband dipole + HL023A1	
	84 & 85	Free factor A & B	
	86, 87	k-factor check	OFF, ON
	88	New input	
	90, 91	Normal, fast frequency scan	
	92, 93	MIN. level = measured quantity, voltage level	

Commands RA and IA automatically switch off autoranging.

** Notes on the special functions:

The command code in the left column is operative in the basic setting (RCL 0). Special functions SF05 and SF06 also serve as start commands for the servicing cycles involved. X1 or GXT can be given, but this is not required.

Input of correction-value curves (SF84 or SF85 and SF88):
 The input of sample frequencies and correction values via the IEC bus is done in the same sequence as in manual input via the keyboard.

Example for the PUC:

```
IECOUT 18, "SF84,SF88,CN15,CU1"
IECOUT 18, "C080.0/-12.5,C0120.5/-6.7, ..."
```

or

```
FOR I=1 TO 15
IECOUT 18,"CO"+STR$(F(I))+"/"+STR$(K(I))
NEXT I
```

The control commands for automatic scanning reproduce the manual entry exactly. No data is required for the "Stop" and "Stop and reset" commands, but the start command "RUN" has a data field of variable length (Ø to 5 characters), depending on the number of desired scan runs.

Table 2-9 Scanning Instructions

Command code	Data	Function
SR	Max. 5 digits (1 to 5)	Run
SP	-	Stop (interrupt)
SC	-	Stop and reset

Example for the PUC

The scan programs stored in registers 1, 2 and 4 are to run in sequence:

```
IECOUT18,"SR124"
```

Input of a frequency record for special scan

Example for the PUC

```
IECOUT18,"SF58, FN3, F089.5, F093.7, F098.5"
```

or

```
IECOUT18,"SF58, FN3"
FOR I=1 TO 3
IECOUT18,"FO"+STR$(F(I))
NEXT I
```

Table 2-10 Direct Commands

Command code	Function																		
B0	Trigger beep																		
H0	Penlift																		
H1	at recorder output Pendown																		
J0	OFF SRQ when pressing																		
J1	ON TALK key in local state																		
P0	OFF SRQ when measured value is ready / CAL-test end																		
P1	ON																		
V1	Format advance on recorder output																		
WT a1 to a15	Text output on 15-digit display ASCII symbols 20H - 7FH																		
X1	Trigger command (= GET)																		
X4	Output time of day																		
X5	Output date																		
XP 0 to 1023 YP 0 to 255	D/A converter: load X register D/A converter: load Y register																		
Z0	OFF disabled																		
Z1	ON Measurement conversion code enabled																		
WZ 0 to 8	Termination symbol in talker operation, with <table style="margin-left: 40px;"> <tr><td>0</td><td>EOI</td></tr> <tr><td>1</td><td>CR + EOI</td></tr> <tr><td>2</td><td>LF + EOI</td></tr> <tr><td>3</td><td>ETB + EOI</td></tr> <tr><td>4</td><td>ETX + EOI</td></tr> <tr><td>5</td><td>CR</td></tr> <tr><td>6</td><td>LF</td></tr> <tr><td>7</td><td>ETB</td></tr> <tr><td>8</td><td>ETX</td></tr> </table>	0	EOI	1	CR + EOI	2	LF + EOI	3	ETB + EOI	4	ETX + EOI	5	CR	6	LF	7	ETB	8	ETX
0	EOI																		
1	CR + EOI																		
2	LF + EOI																		
3	ETB + EOI																		
4	ETX + EOI																		
5	CR																		
6	LF																		
7	ETB																		
8	ETX																		

The basic setting (RC0) replaces the following commands:
H0, J0, P1, Z1. As delivered and at cold starts (CMOS-RAM cleared)
WZ5 is set.

2.3.22.5 Data Output

Data output by the ESVP in the Talk Only mode to a printer or other Listen Only device has already been described in section 2.3.17. The following deals with data output when the Talker is addressed by the IEC-bus controller.

After a trigger command or, in automatic operation, as soon as a measurement value above the programmed minimum level is found, a varying number of measurement results are output depending on the special functions switched in, each result being identified with two letters to differentiate them. The order in which the measurements are made, the data output format and the unit (not transmitted) are all preset. Each measurement value forms a complete output unit and is terminated with the programmed terminating delimiter as well as, if set, the END message.

Normally a space separates the identifier of the measured quantity and the numerical data. However, if the measured value falls outside the measurement range or in case of an overload, a letter is inserted in this space to qualify the validity of the measurement result:

Table 2-11 Special Identifier

Code	Meaning
Space	Valid measurement value
H	Value exceeds measurement range
U	Value falls below measurement range
X	Overload
C	SF84 or SF85: Receiver frequency outside the entered correction curve

The receiver frequency setting is only output in automatic scanning operation along with the associated measurement values.

The first identification letter output with the level defines the antenna or probe connected, if any, and the second identification letter the unit of measurement.

Table 2-12 Data format

Quantity to be measured	Code data	Unit	Setting
Receiver frequency	FR 123.456	MHz	
Level	VL 123.4	dB μ V, dB**	SF11
Voltage	VN 1.23E+03	μ V	
Power	VM -123.4	dBm	
RF current	CL 123.4 CN 1.23E+03	dB μ A μ A	
Electr. field strength	EL 123.4 EN 1.23E+03	dB μ V/m μ V/m	
Magn. field strength	ML 123.4 MN 1.23E+03	dB μ A/m μ A/m	
Interference power	PL 123.4 PN 1.23E+03	dBpW pW	
AM modulation depth	AM 34.5	%	SF21
Pos. modulation peak	AP 56.7	%	SF23
Neg. modulation peak	AN 12.3	%	SF25
Freq. offset	OS -123.4567*	kHz	SF31 to SF34
Signal frequency	FI 1122.3344556*	MHz	SF36 to SF39
Freq. deviation	DF 123.45	kHz	SF41
Pos. peak deviation	DP 134.56		SF43
Neg. peak deviation	DN 112.34		SF45
Time of day	TC 123015	hh:mm:ss	X4
Date	TD 210783	dd/mm/yy	X5

* Resolution is programmable

** The second letter, "L" or "N", also indicates the spectral pulse density in, for example, dB μ V/MHz, μ V/MHz.

Data format for SF07 without internal classification (SF54):

- 2 bytes binary-coded: 1. low-order byte
2. high-order byte with EOI

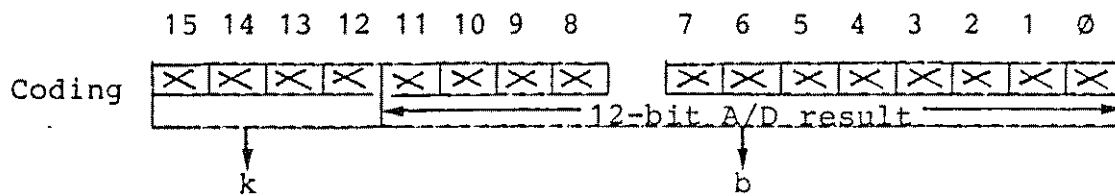

$$k = (\text{RF attenuation} + \text{IF attenuation}) \cdot 0.1 + 1 - \text{preamplification}$$

Example:

$k = 0101 = 5$ when RF attenuation = 20 dB
 IF attenuation = 20 dB
 Preamplification = 0 (0 with SF16,
 1 with SF17)
 Value range for k: 0 to 15

The RF input level can be computed as follows:

The A/D converter yields the following results in the 60-dB operating range:

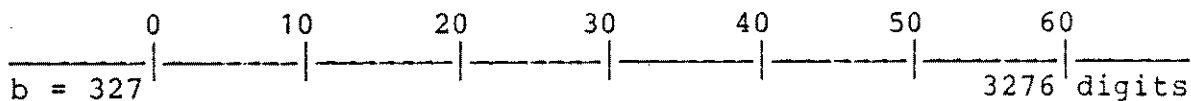

The ranges below 327 and above 3276 function as reserves.

In the AV indicating mode, the ESVP has an over-drive reserve of 6 dB, so that values between 0 and 3570 digits can be accepted as valid.

Because of the smoothness of the ESVP's logarithmic converter, we have 491.5 digits per 10-dB step and 49.15 digits per 1-dB step.

RF input level:

$$V_{in} = -20 \text{ dB}\mu\text{V} + k \cdot 10 \text{ dB} + \frac{b - 327}{49.15} \text{ dB}$$

2.3.22.6 Addressed and Universal Commands

a) Remote/Local

If the ESVP receives its listener address from a controller, it normally goes over into the remote status and remains in this status even after the data transfer is completed. In the remote status - indicated by LED 25 - all front-panel controls are disabled. The ESVP returns to local status in response to the IEC-bus command GTL (Go to Local) or when the LOCAL key is pressed, after which manual settings can be made.

The controller can disable the LOCAL key by sending the command LLO (Local Lockout).

b) Device Clear

If the controller outputs the universal command DCL (Device Clear) or the addressed command SDC (Selected Device Clear), the ESVP goes into its basic setting (see section 2.2.4).

The basic setting is also established by the IEC-bus command RCØ or by keying in RCLØ (17, 33).

c) Device Trigger

On receiving the addressed command GET (Group Execute Trigger), the ESVP starts at once with the previously programmed measurement routines. This trigger command corresponds to the IEC-bus command X1.

Table 2-13 General IEC-bus Commands

Command	PPC/PUC	hp 9835/45	hp 9825	Tekt. 4051/52
Go to Local	IECLAD18 IECGTL IECUNL	LOCAL 718 or LOCAL 7 *	lcl 718 lcl 7*	WBYTE050,1,63:
Local Lockout	IECLLO	LOCAL LOCKOUT 7	llo 7	WBYTE017:
Device Clear	IECDCL	RESET 7	clr 7	WBYTE020:
Selected Device Clear	IECLAD18 IECSDC IECUNL	RESET 718	clr 718	WBYTE050,4,63:
Group Execute Trigger	IECLAD18 IECGXT IECUNL	TRIGGER 718	trg 718	WBYTE050,8,63:
Parallel Poll Configure	IECLAD18 IECPPC IECPPE s1 s2 IECUNL	PPOLL CONFIGURE 718; mask	polc 718, mask	---
Parallel Poll Unconfigure (universal)	IECPPU	PPOLL UNCONFIGURE 7	plu7	---
Parallel Poll Unconfigure (addressed)	IECLAD18 IECPPD IECUNL	PPOLL UNCONFIGURE 718	plu 718	---
Parallel Poll	IECPPL v%	PPOLL (7)	pol(7)A	---
Serial Poll	IECSPL18,s%	STATUS 718; s	rds(718)A	POLL A,S;18

* LOCAL 7 switches off the REMOTE line.

Before output of a new IEC-bus command, the REMOTE line must be reactivated with REMOTE 7.

2.3.22.7 Service Request

Test receiver ESVP is an autonomous IEC-bus device, i.e. it receives an assignment from the controller, carries it out independently without further help and reports its completion via an asynchronous Service Request to the controller, which in the meantime has been able to do other tasks. A Service Request is also generated by the ESVP if an error condition occurs.

The controller can query the status of the device by means of a serial-poll sequence.

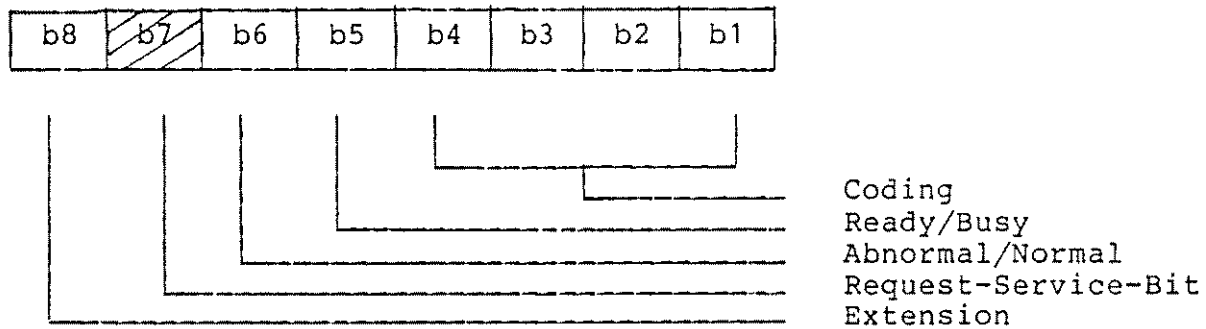

Fig. 2-14 Status byte

The generation of a Service Request at the completion of a measurement process or a calibration can be suppressed by IEC-bus commands (P0, P1).

Table 2-14 Coding Ready/Busy (bit 5)

Device status	Status byte
Measurement completed	80
Calibration completed	81
Scan run completed	82
80 MHz exceeded	83
Key press TALK	84
Clock interrupt	88

Table 2-15 Coding of Abnormal/Normal (Bit 6)

Device status	Status byte (dec.)	Error code Table 2-4
Syntax error in IEC-bus instruction also illegal time-of-day and date input	96	06
IEC setting instruction incompatible with current device setting	97	-
Data above limit	98	01
Data below limit	99	02
Memory register not occupied if RCL	100	08
Level or offset calibration defective	101	05
CAL. Checking error	102	03
Correction value at CAL total > 5 dB	103	07
At start of an automatic frequency scanning operation one or more parameters are not defined.	104	20 to 25
Start frequency > stop frequency	105	30
Start frequency = stop frequency and XY recorder or ZSG3 connected	106	31
Max. level < min. level	107	32
SF61 (log. X axis) and $\frac{f_{STOP}}{f_{START}} < 1.4$	108	33
SF61 (log. X axis) and ZSG3	109	40
Faulty synthesizer synchronization	110	52 to 59
Faulty supply voltages	111	10 to 14
Talker mode: no listener at IEC bus	224	04
Overflow of internal number range in SF84 or SF85 operation (cf. SF88)	225	34

2.3.22.8 Parallel Poll

The ESVP can be configured so as to answer a Parallel Poll request sent from the IEC-bus controller via the primary command "PPC" and the subsequent secondary command "PPE", the latter consisting of 'X 1 1 0 S P P P'. The three least significant bits P P P define the data line, on which the answer is to be sent. The sense bit S together with the current device status "ist" (individual status bit) determines whether the answer sent is a "1" (ist = S) or a "0" (ist ≠ S).

NOTE: With the IEC-bus, "1" (i.e. true) corresponds to a low level on the data line.

Example: PPE = 01101010 assigns the bus data line DI03.
Ist = "1" yields the PP answer "1".

The ist bit of the ESVP is identical with the Ready/Busy bit 5 of the status byte in a Serial Poll, i.e.

ist = 1 if data is ready
ist = 0 if measurement is not yet terminated.

This permits the IEC-bus controller to recognize the termination of the measuring process without the need for the relatively time-consuming Serial Poll.

2.4 Examples of Measurements

2.4.1 Measurement of Sinewave Signals

See also sections 2.3.4, 2.3.6 and 2.3.7

2.4.1.1 Measurement Accuracy (Noise Effects)

The measurement accuracy of a test receiver is mainly determined by the accuracy of the calibration level, the accuracy of the RF and the IF attenuation switch, the linearity of the meter rectifier and the logarithmic conversion (in the 40-dB and the 60-dB operating range).

These parameters are extremely stable in the ESVP, as verified by very exacting tests. The measuring error is less than 1 dB in the 20-dB operating range. The maximum measuring error is slightly higher in the 40-dB and the 60-dB operating ranges. In practice, however, the measuring error is much less.

In addition, the measurement accuracy is influenced by the inherent receiver noise. The error introduced is relatively small in average-value indications but considerably larger in peak-value indications. The influence of the inherent receiver noise is expressed by the following formulae:

With average-value indication:

$$\text{Error/dB} \approx 20 \times \log \left(1 + 0.3 \frac{N_1}{S} \right)$$

With peak-value indication

$$\text{Error/dB} \approx 20 \times \log \left(1 + 0.8 \frac{N_2}{S} \right)$$

where

- S = level of an unmodulated sinewave signal in dB μ V
- N1 = noise with average-value indication in dB μ V
- N2 = noise with peak-value indication, N2 \approx N1 + 11 dB.

Table 2-17 Indications as Functions of the S/N-ratio S-N1

S/N ratio S-N1/dB	Average value dB	Peak value dB
0	2.27	13.15
1	2.87	13.38
2	3.50	13.63
3	4.21	13.91
4	4.97	14.20
5	5.78	14.52
6	6.63	14.87
7	7.50	15.24
8	8.40	15.64
9	9.32	16.07
10	10.25	16.53
11	11.20	17.02
12	12.96	17.53
13	13.12	18.07
14	14.01	18.64
15	15.08	19.24
16	16.06	19.87
17	17.05	20.52
18	18.04	21.20
19	19.03	21.91
20	20.02	22.63
22	22.01	24.15
24	24.01	25.75
26	26.00	27.42
30		30.92
40		40.30
50		50.09

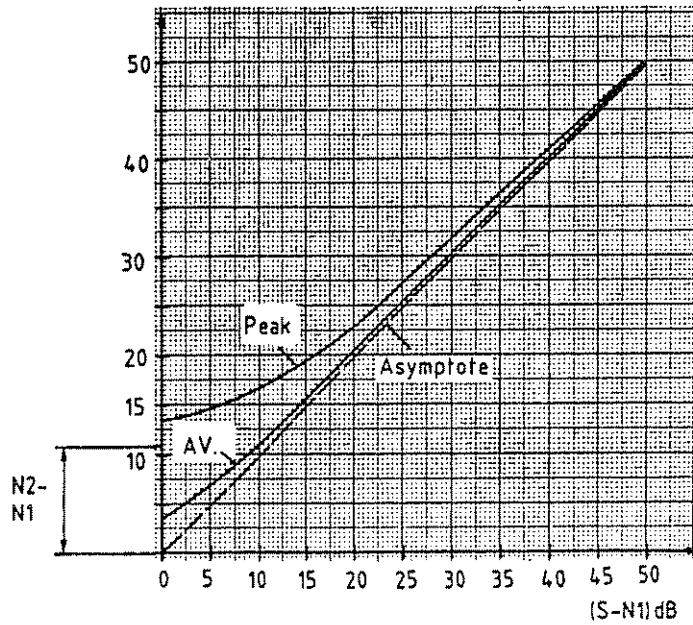

Fig. 2-15 Reading error of an unmodulated sinewave signal due to noise with average-value and peak-value indication as a function of the signal-to-noise ratio S-N1

Table 2-18 Error when measuring an unmodulated sinewave signal with peak-value indication or average-value indication as a function of the signal-to-noise ratio S/N_2 and S/N_1 , respectively.

S/N1 or S/N2	Indication error/dB	
	AV	PEAK
0	2.28	5.10
1	1.86	4.67
2	1.50	4.27
3	1.21	3.98
4	0.98	3.54
5	0.79	3.22
6	0.63	2.92
7	0.50	2.65
8	0.40	2.39
9	0.32	2.16
10	0.26	1.95
12	0.16	1.59
14	0.10	1.28
16	0.06	1.03
18	0.04	0.83
20	0.02	0.67
25	0.01	0.382
30		0.217
40		0.07
50		0.02

$$\text{Error of AV indication/dB} \approx 20 \log \left(1 + 0.3 \frac{N_1}{S} \right)$$

$$\text{Error of PEAK indication/dB} \approx 20 \log \left(1 + 0.8 \frac{N_2}{S} \right),$$

$\frac{N_1}{S}$ or $\frac{N_2}{S}$ being the respective S/N ratio.

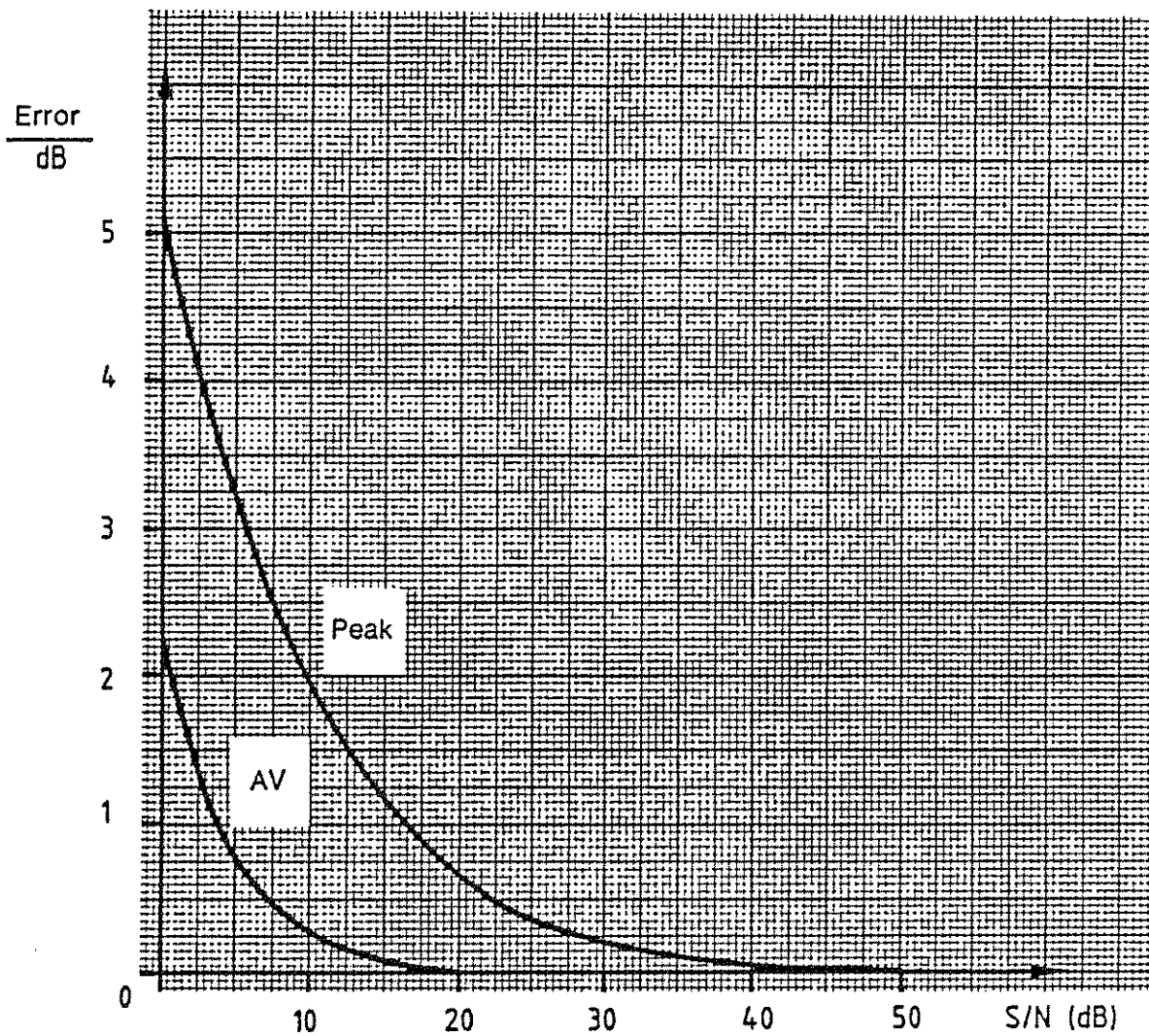

Fig. 2-16 Indication error due to noise with average-value and peak-value indication

Three rules can be derived from these relationships:

- For high measurement accuracy, the signal-to-noise ratio must be as high as possible, i.e. the highest possible IF attenuation must be cut in. However, when measuring signals of widely different levels, section 2.3.7 should be observed.
- Average-value indication is always preferable when measuring the level of CW signals. Average-value indication also offers high suppression of interference pulses (see section 2.3.4).
- Due to the higher accuracy, the LOW NOISE setting is recommended for the CISPR measurement of unknown interference. The LOW DIST setting is used for the measurement of broadband noise with pulse frequencies < 5 Hz in the frequency range > 300 MHz.

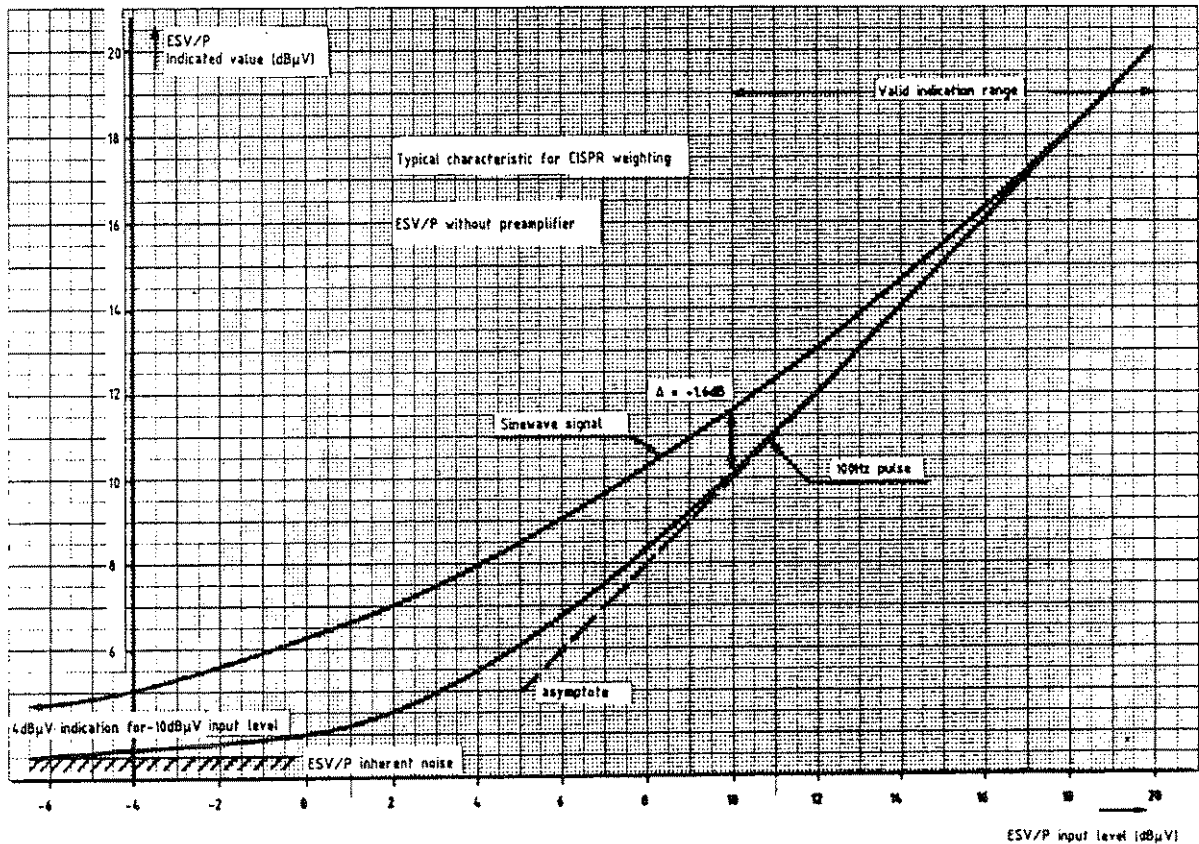

Fig. 2-16.1 Typical CISPR-weighted indication

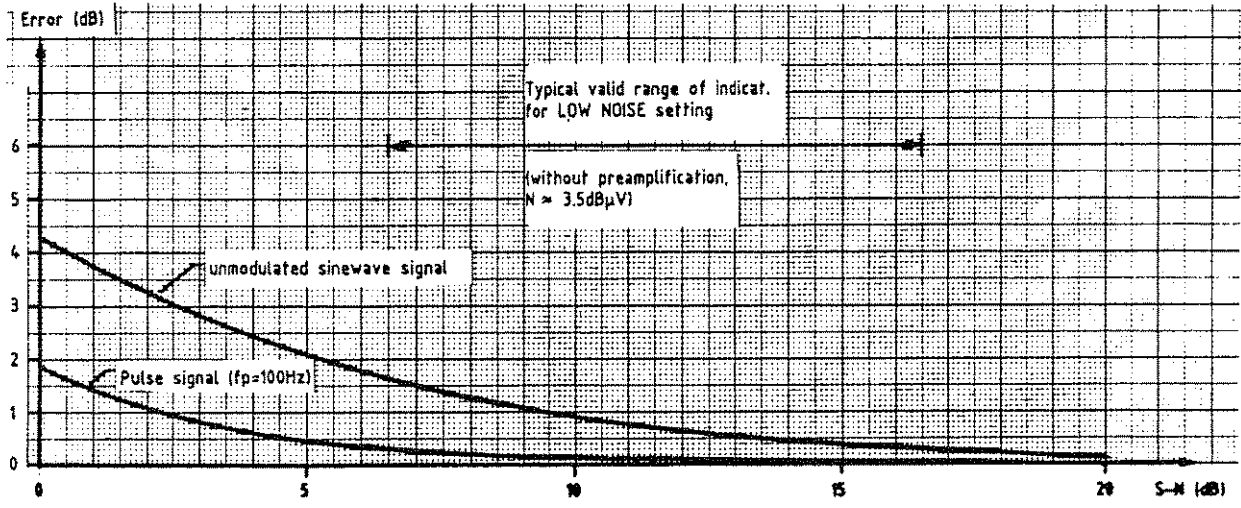

Fig. 2-16.2 Error of CISPR indication caused by noise

2.4.1.2 Influence of Amplitude Modulation

According to the definition of the indicating modes in section 2.3.4, the peak-value indication increases with the modulation depth as against the average-value indication.

With a sufficiently high signal-to-noise ratio, the function shown in Fig. 2-17 holds for the increase in the peak-value indication as against average-value indication.

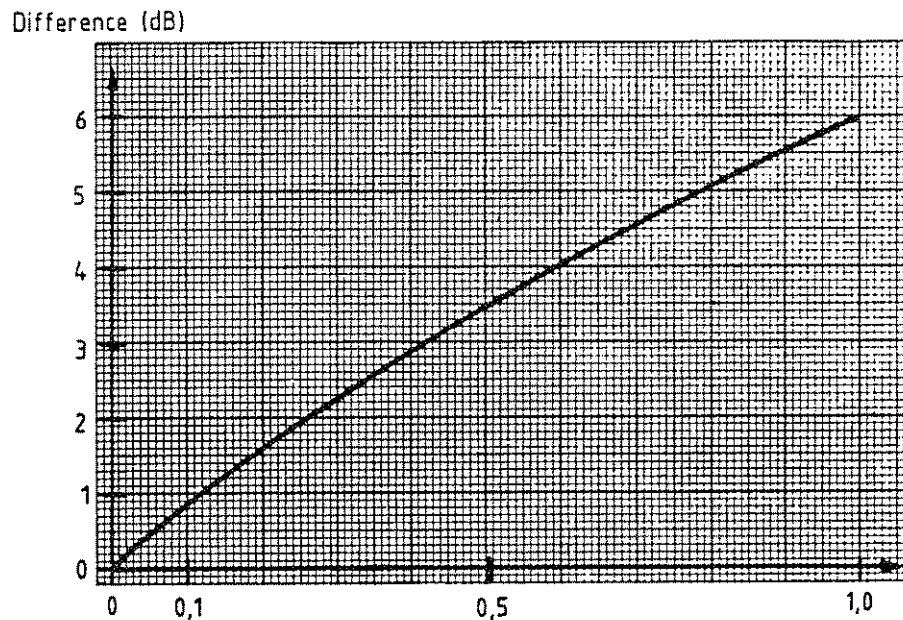

Fig. 2-17 Increase in peak-value indication as against average-value indication with amplitude modulation

Fig. 2-17 applies only to the 20-dB operating range. In the 40 and 60-dB ranges, for reasons of measuring speed, a 2nd-order lowpass filter with a cutoff frequency of 1 kHz is switched in ahead of the logarithmization. A true average-value measurement is thus obtained only for modulation frequencies greater than 1 kHz in the 40 and 60-dB ranges. Modulation frequencies below 1 kHz reduce the average-value indication by an amount which increases with the modulation depth. Table 2-20 and Fig. 2-18 show the relationship between average-value indication and modulation depth for this case.

Table 2-20

Modulation depth m	Decrease in indication
0	0 dB
0.1	-0.022
0.2	-0.088
0.3	-0.202
0.4	-0.370
0.5	-0.602
0.6	-0.915
0.7	-1.340
0.8	-1.938
0.9	-2.878
1	-6.021

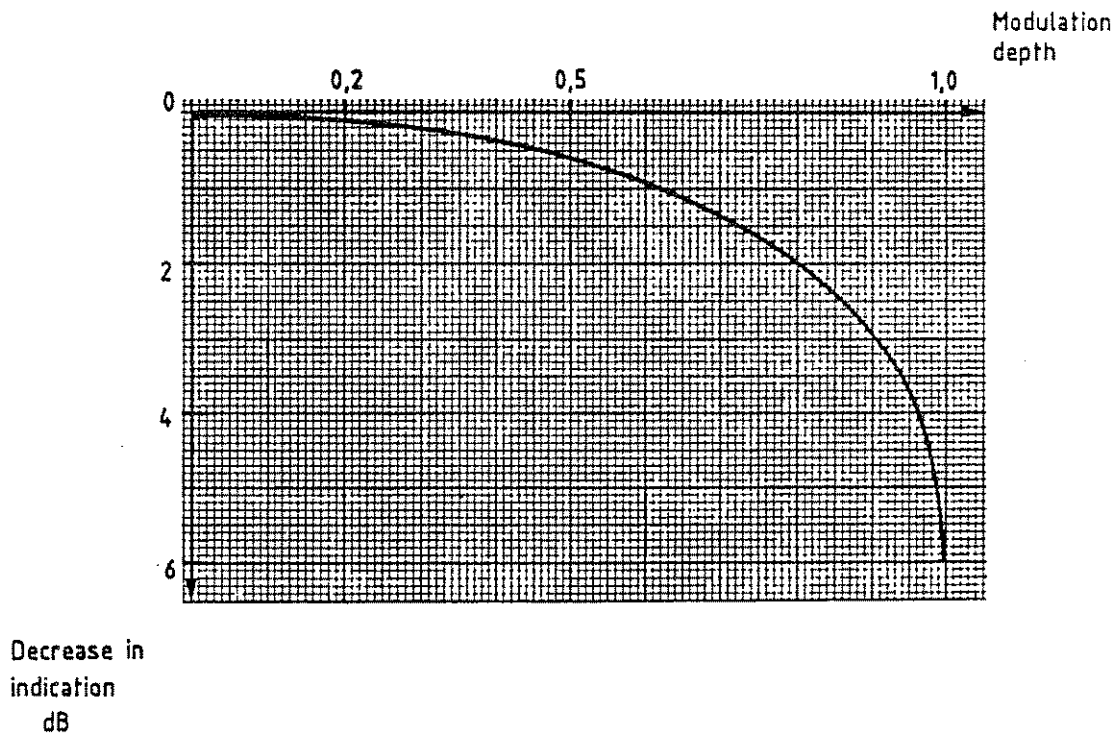

Fig. 2-18 Decrease in indication of average value when measuring amplitude-modulated signals in the 40 and 60-dB operating ranges for modulation frequencies < 1 kHz

As shown in Fig. 2-18, the error is practically negligible below a modulation depth of 50% but is considerable with a modulation depth of 100%

2.4.1.3 Measurement of Frequency and Frequency Offset (SF31 to 39)

As explained in section 2.3.14, the frequency and frequency-offset measurements are the same except for the result displayed. The relationship between these quantities is

$$\text{Offset frequency} = \text{Signal frequency} - \text{Receiver frequency}$$

Thus, with SF31, the input signal frequency and with SF36 the offset of the input signal frequency from the receiver centre frequency is indicated.

Since the frequency-counting process can only be falsified by noise peaks, the measurement error is very small for signals lying more than 12 dB above the mean noise indication.

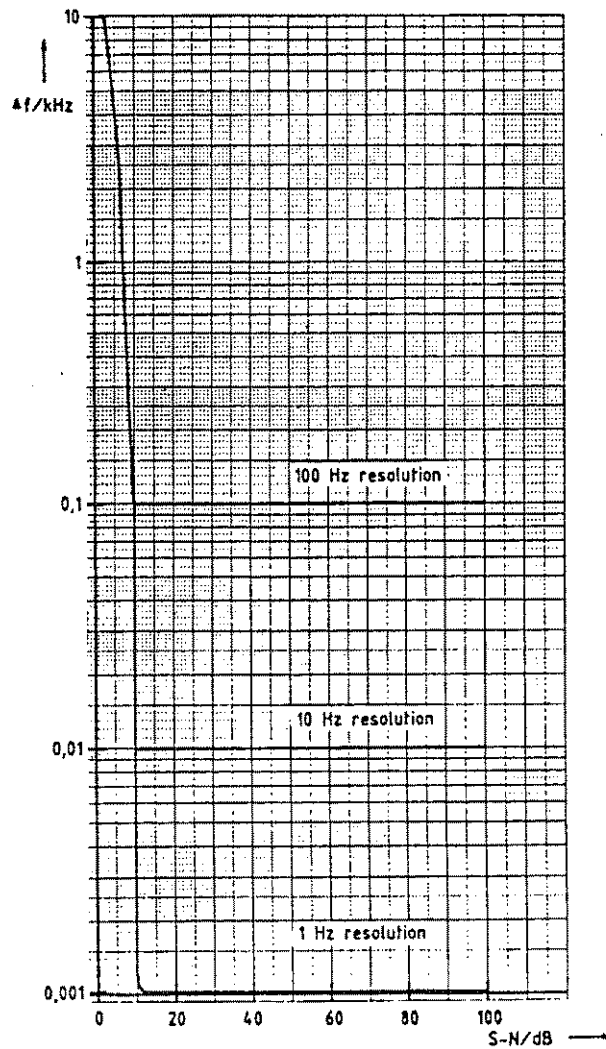

Fig. 2-19 Influence of the S/N ratio on the frequency measurement error

2.4.1.4 Measurement of Modulation Depth (SF21, 23, 25)

The modulation depth measurement is the result of two peak-value measurements - of the positive and negative modulation peaks - and therefore requires, like the peak-value level indication, a high signal/noise ratio.

In order for an unmodulated sine-wave signal to appear as unmodulated (< 1%), the S/N ratio S-N1 must be greater than 50 dB. The error decreases with increasing modulation depth.

Indicated modulation depth

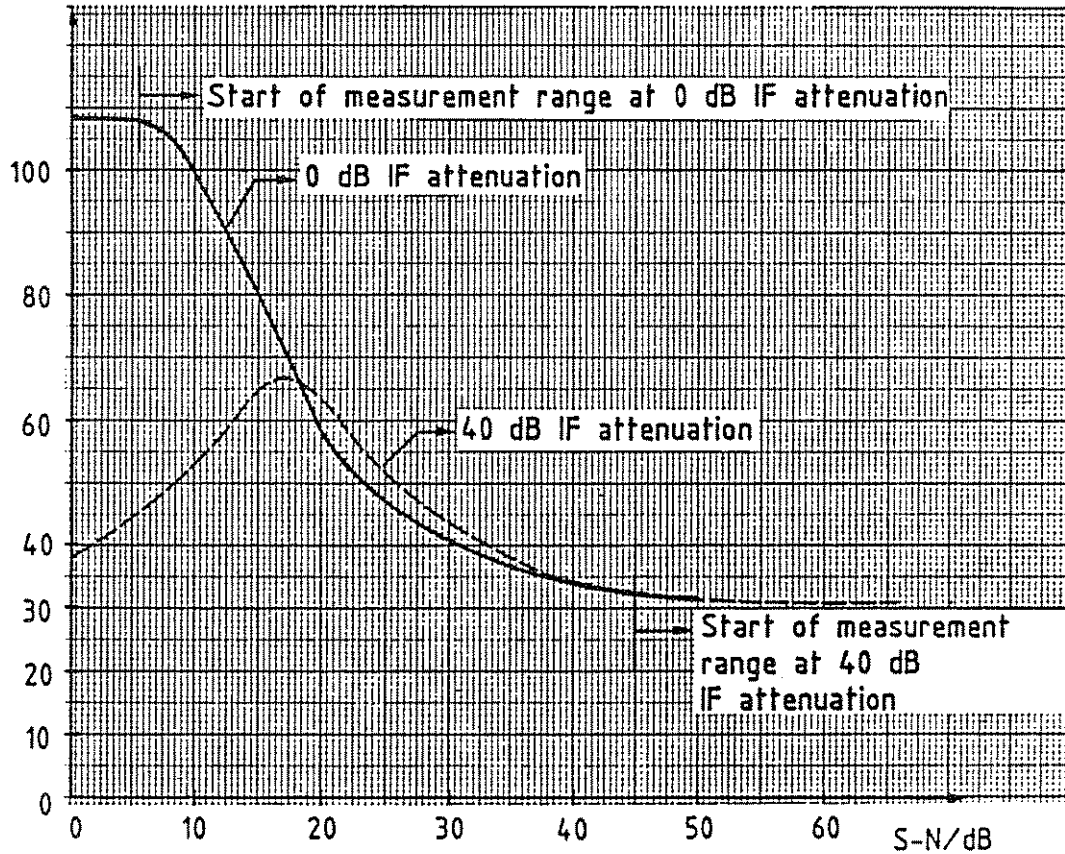

Fig. 2-20 Modulation depth indication for an unmodulated sine-wave signal as a function of the S/N ratio

IF bandwidth 7.5 kHz
Operating range 60 dB
 $f_r = 100$ MHz
Modulation frequency 1 kHz
Modulation depth 30%

2.4.1.5 Measurement of Frequency Deviation (SF41, 43, 45)

The frequency deviation determination is also obtained as the result of two peak-value measurements - positive and negative peak deviations, but the requirement on the S/N ratio is less stringent.

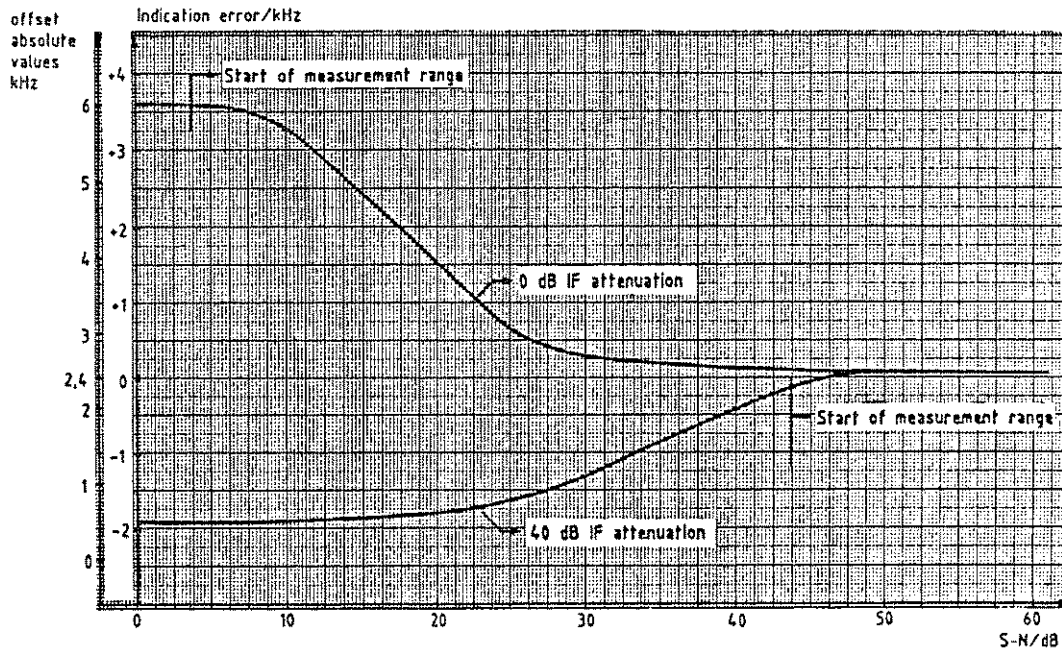

Fig. 2-21 Deviation indication for an unmodulated sinewave signal as a function of the S/N ratio. IF bandwidth 12 kHz, operating range 60 dB, f_r 100 MHz, nominal deviation 2.4 kHz.

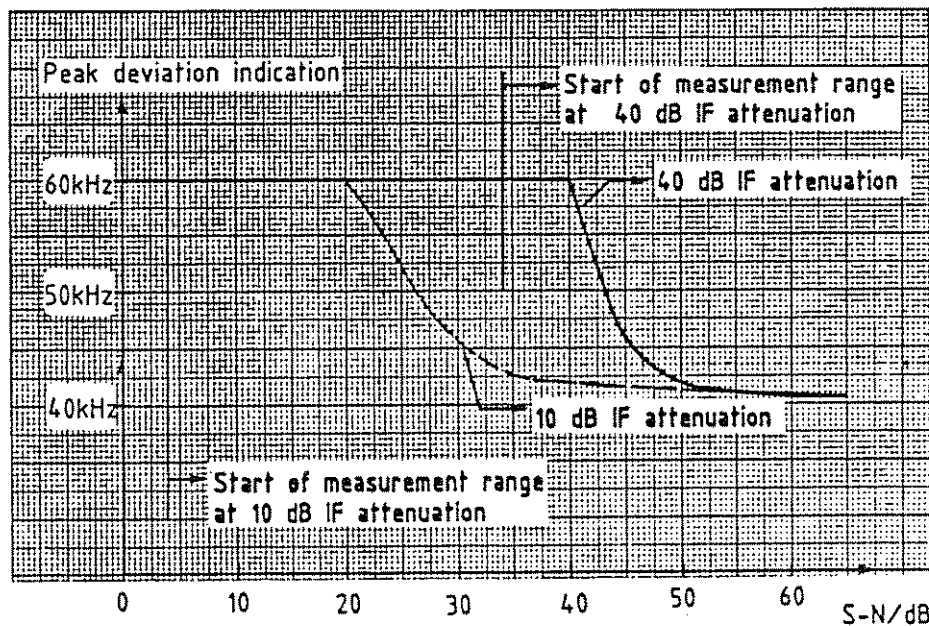

Fig. 2-22 Deviation indication for an unmodulated sinewave signal as a function of the S/N ratio. IF bandwidth 120 kHz, operating range 60 dB, f_r 100 MHz, nominal deviation 40 kHz.

2.4.2 Use of the ESVP for Interference Measurements

Interference measurements cover frequency-selective measurement of all types of interference signals - interference voltages and currents on power-supply and control lines as well as interference radiation - and fall under the general heading of electromagnetic compatibility (EMC). Interference susceptibility (EMS) falls also under EMC.

For investigating electromagnetic susceptibility, the test receiver can be used for measuring the interfering quantity - voltage, current, or EM field strength - and the screening characteristics of cable and housing shields. However, EM susceptibility will not be considered any further here, since in this field signal generators and broadband amplifiers or pulse generators are for the most part used and the influence on the test item observed.

In the field of interference measurements, the civil standards, such as those of the CISPR, VDE and FCC, as well as military standards, for example the American MIL-STD 461/462 and the German standards VG 95371 to 95377, are applicable.

The function of interference measurement is the complete coverage of the interference spectrum, whereby in the main frequency range of 10 kHz to 1000 MHz (the combined range of the ESH3 and ESVP) a differentiation of broadband and narrowband interference is required. On the whole, signals are designated as broadband interference when their frequency spectrum is considerable wider than the IF bandwidth used and their individual spectral line cannot be resolved with the IF filter. Broadband interference is caused by pulse noise (arising from low-frequency rapid switching processes, ignition sparks, commutator motors, rectifiers, and the like).

Broadband and narrowband interference may be distinguished by comparing the average-value and peak-value indications of the interference. The average value of broadband interference is considerably smaller than the peak value. However, there are special cases of keyed narrowband interference that also show a large difference between the average and peak values. In this case, the bandwidth of the interference must be determined by shifting the receiver frequency by the IF bandwidth. MIL-STD 461/462 in principle allows only this solution, but it does not prohibit the use of the average and peak values as an aid.

Simple narrow and broadband interference measurements may be carried out with the ESVP and an XY recorder. The automatic differentiating of narrow and broadband interference requires a computer (for example, the R&S Process Controller PUC).

2.4.2.1 Radio Interference Measurements according to VDE and CISPR Standards

The correct pulse weighting for the frequency range 25 to 1000 MHz according to CISPR Publications 2, 4 and 16 is automatically cut in when the CISPR indicating mode (see section 2.3.4) is selected. In this frequency range, radio interference power measurements (with use of the MDS21 absorbing clamp) and radio interference field-strength measurements are made. For the latter measurements, the Broadband Dipole (20 to 80 MHz) HUF-21 and the Log-periodic Broadband Antenna (80 to 1300 MHz) HL 023 A1 are available. The antenna factors are taken into account in the direct indication of the field strength with special function 83.

The measuring time is selectable between 0.005 and 100 s. The standard measuring time is 1 s. The reason for the relatively long measuring time of 1 s is the time constants required by CISPR, viz. the discharge time-constant and the time constant of the filter provided for the simulation of the meter response. The ESVP, however, relieves the user of the chore of observing the maximum pointer deflection. It determines the maximum analog voltage during the measuring period and reads out this value as the test result.

If slowly varying components are dominant in the interference signal, the variation of the weighted analog voltage can be watched on the analog indication. Autoranging takes a little longer in the CISPR indicating mode. Nevertheless, autoranging is the only reliable method for measuring interference spectra over a wide dynamic range with automatic frequency scanning. Low-noise mode measurements can generally be carried out without overloading the ESVP. Only in the frequency range > 300 MHz with pulse repetition rates of less than 5 Hz should the LOW DIST. mode be selected for the measurement of pulse interference. In special cases it is possible to check with the use of the LIN. TEST function whether an overloading of the RF input exists. For CISPR with LIN. TEST, a 4-dB RF attenuator is switched out and in and difference in the levels for these settings in dB is indicated next to the result in dB μ V. In the measurement of true broadband interference with a low pulse repetition rate, preamplification should not be switched in.

The measurement of radio interference power requires a shifting of the MDS absorbing clamp along the power cable and the measurement of the radio interference field strength, a height variation of the test antenna. For the effective use of the automatic run, the following procedure is recommended:

1. Recording of the interference spectrum in basic setting (MDS clamp near the test item and antenna at maximum height).
2. Determination of the frequency of the maximum interference level, taking into account the limit value variation.
3. Determination of the setting of the MDS clamp or the antenna giving the interference maximum (approach to or exceeding the limit value).
4. Check of the interference spectrum with this setting of the transducer.

For computer-controlled interference measurements, the following combination of automatic and manual measurement is useful: Steps 1 and 2 automatically, followed by presetting of the ESVP to the spectrum maximum and switchover to manual control with SRQ by pressing the TALK key. Step 3 manually; after determining the interference maximum pressing the TALK key so that the interference spectrum is recorded automatically for this new setting.

For optimizing and checking the test setup for the interference field-strength (recording of the test-setup factor), the following procedure with the ESVP and two broadband antennas is recommended:

In field-strength measurements near the ground, in addition to the directly received wave (path D of Fig. 2-23), a reflected wave (path D_r) also in general arrives at the receiving point E (h_s, h_e : height of transmitter and receiver antennas above ground; d : distance from transmitter antenna S):

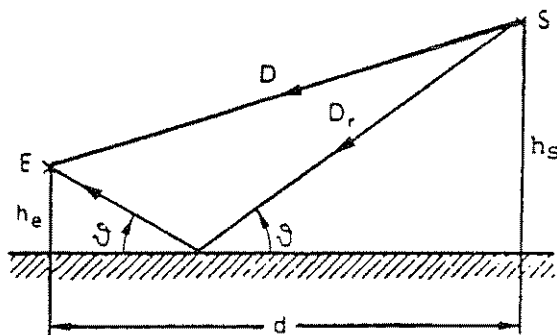

Fig. 2-23 The reflected wave influences particularly strongly the gain, radiation pattern and interference field-strength measurements.

Direct field-strength component:

$$E_{dir} = (1/D) \sqrt{(Z_0/4) P_S G_S}, \quad \text{or}$$

$$\frac{E_{dir}}{\text{dB}\mu\text{V/m}} = 134.8 + 10 \cdot \log \frac{P_S}{\text{W}} + 10 \cdot \log G_S - 20 \cdot \log \frac{D}{\text{m}}$$

where

P_S = transmitter power,

G_S = gain, referred to an isotropic radiator.

The total field strength is

$$E_{ges} = E_{dir} [1 + |k| e^{-j(\mathcal{Y} + \Delta 2\pi/\lambda_0)}]$$

where

$|k| < 1$, and is proportional to the ratio of the path lengths D/D_r , and furthermore dependent on the radiation patterns of the transmitter and receiver antennas and the ground reflection.

\mathcal{Y} is the phase change at reflection and $\Delta = D_r - D$.
Furthermore $|k|$ and \mathcal{Y} are functions of the polarization and angle of incidence ψ . For small values of ψ ,

$$E_{ges} = 2 \cdot E_{dir} \cdot \sin 2\pi (h_s \cdot h_e / \lambda_0 \cdot d).$$

Of particular interest are the two extreme cases

$$h_s h_e / \lambda_0 d = 1/4 \quad \text{and} \quad 1/2,$$

because for these $E_{ges} = 2 \cdot E_{dir}$ and 0 respectively.

Near the extinction point, small changes in frequency, antenna height and polarization produce large relative changes in the measured field strength.

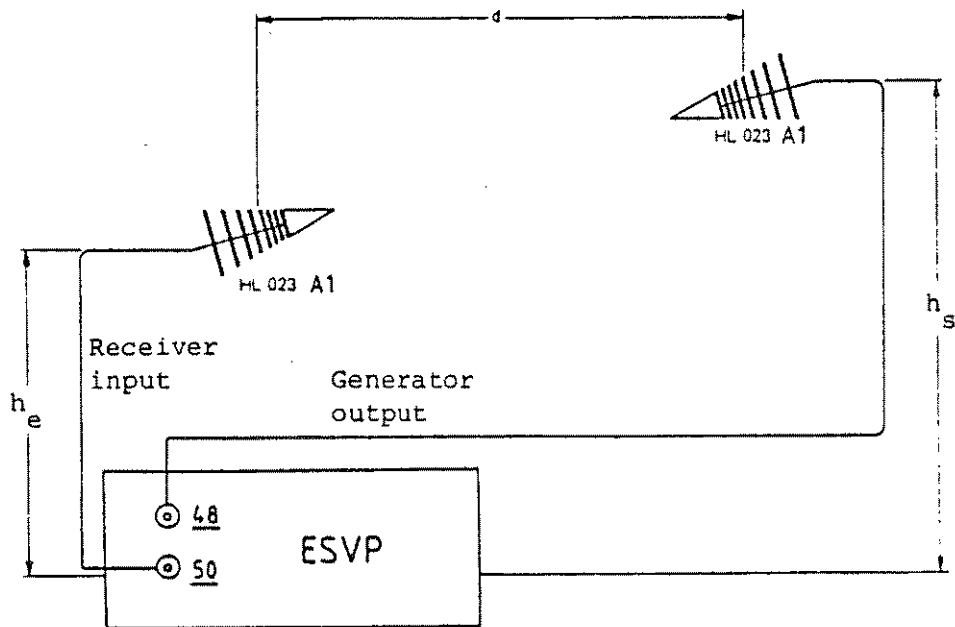

Fig. 2-24 Test configuration for determining the test setup factors for absolute field-strength measurements and finding a favourable test setup

The ESVP delivers -17 dBm into 50Ω exactly at the receiver frequency. With the HL 023 A1. ($10 \cdot \log G_s \approx 6.5$ dB) as transmitter antenna and with $d = 30$ m, a field strength of 65 dB μ V/m is produced at the receiving point. The measurement range of the ESVP begins (depending on the frequency) at -7.5 to 13 dB μ V/m.

The far-field condition $d > 4 \cdot \lambda_0$ is satisfied at this distance.

Use of average-value indication of the ESVP for radio interference measurements

The suitability of average-value indication of test receivers for pulse noise measurements is determined according to VDE 0876 Part 3. As can be obtained from Figs. 2-24.1 and 2-24.2, the average-value indication of the ESVP is suitable for all indicating ranges.

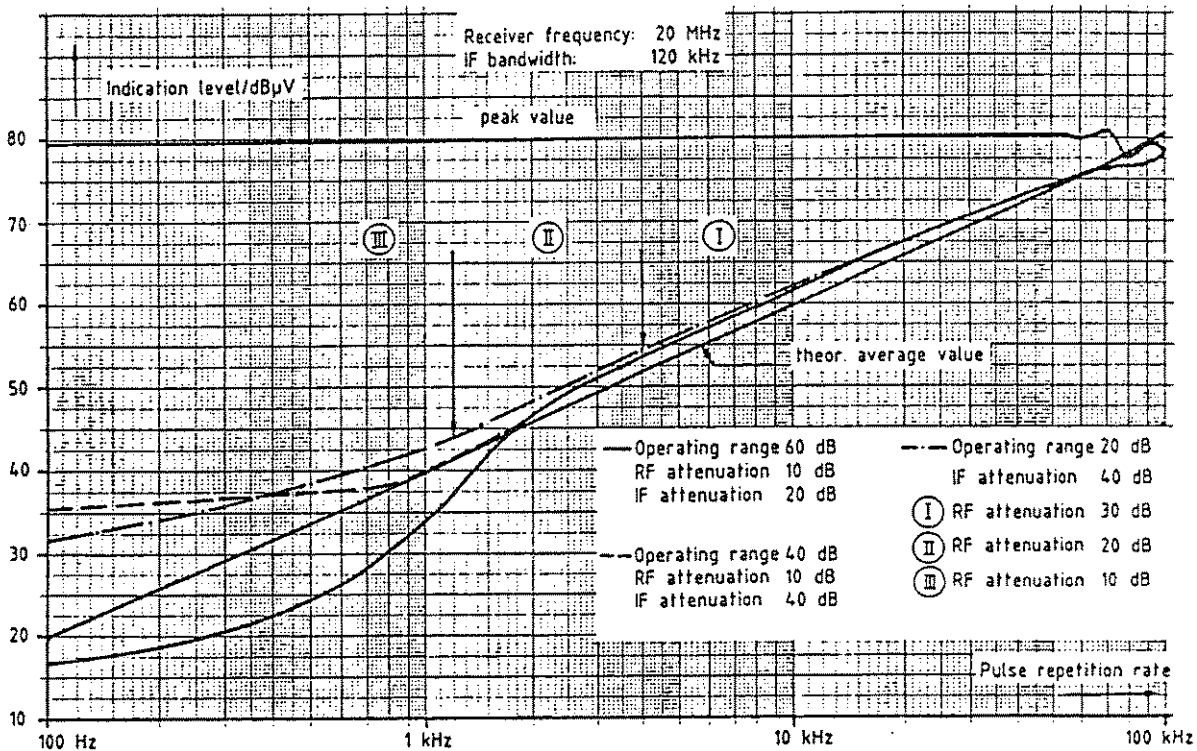

Fig. 2-24.1 Peak- and average-value indication as a function of the pulse repetition rate

The limit pulse repetition rate for a valid average-value indication is about 1.6 kHz for the 40-dB and 60-dB indicating ranges and about 1 kHz for the 20-dB indicating range. The validity of average-value indication can be checked as follows:

If the peak-value indication of the ESVP is less than 10 dB above full-scale deflection, the average-value indication is correct. With average-value indication, the IF attenuation must always be set to the highest possible value (40 dB).

The latest CISPR publications (CISPR 22, CISPR 14) specify limit values both for quasi-peak as well as for average-value indication. Since the quasi-peak limit values exceed the average-value limit values by roughly 10 to 13 dB, the pulse-weighting curves (Fig. 2-24.2) permit to determine the overload reserve required for the average-value indication range to be used. It is 14 dB and is required for correct measurement of pulse noise with a pulse repetition rate of approx. 25 kHz with average-value indication.

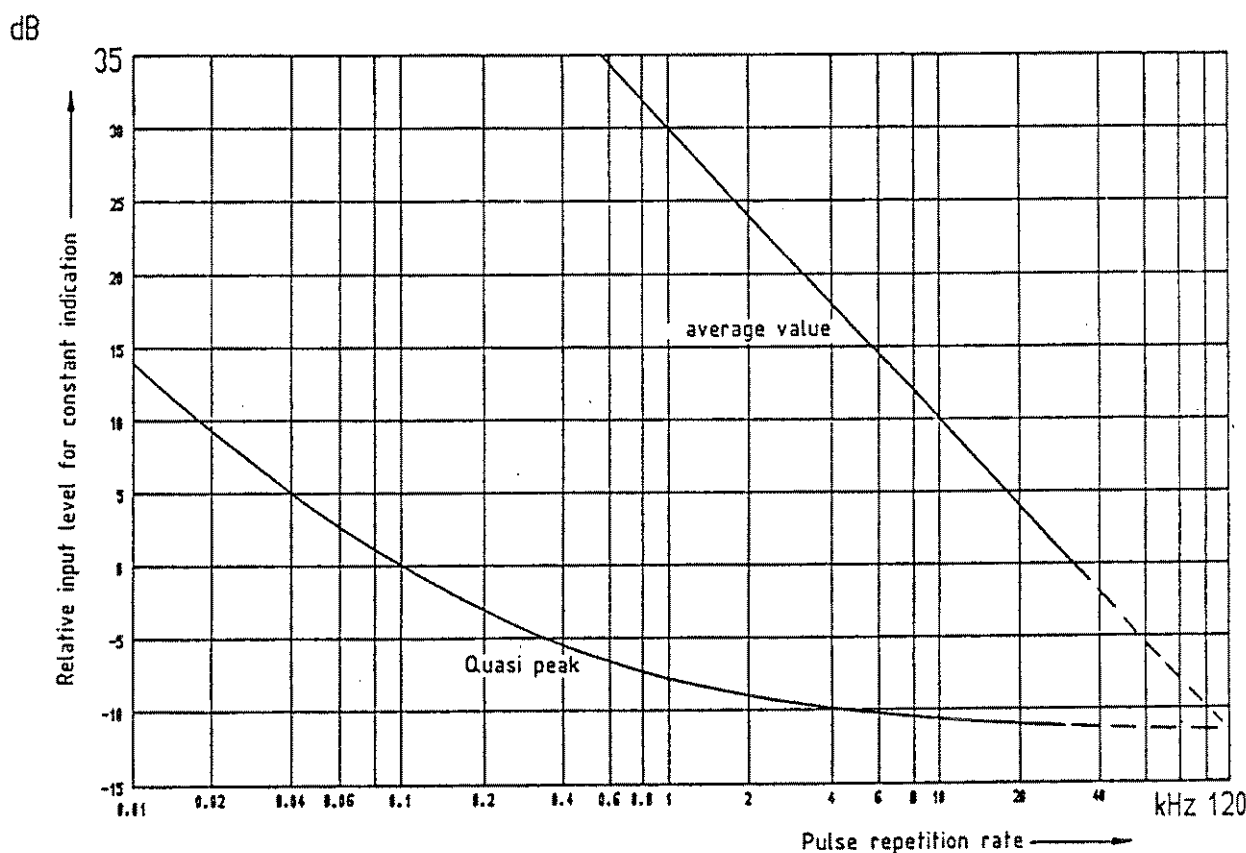

Fig. 2-24.2 Weighting curves for the frequency range 30 to 1000 MHz

The overload reserve of the average-value indication of the ESVP is approx. 10 dB at full-scale deflection. For this reason, the usable indicating range of the analog meter is

35 to 57 dB for 60-dB operating range
15 to 37 dB for 40-dB operating range
0 to 17 dB for 20-dB operating range

Thus, the procedure for using average-value indication to CISPR is for manual measurements as follows:

- Set high IF attenuation (30 or 40 dB).
- Set RF attenuation manually.
- Set indicating mode 37 to MW AV.
- Read off the indication on 12, taking into account the analog meter reading as specified in the above table.

For automatic measurements, the following procedure is recommended:

- Measure the RFI spectrum using the peak-value indication.
- Measure RFI again, using the quasi-peak indication (CISPR), at those points where the quasi-peak limit value has been exceeded.
- Measure RFI again, using the average-value indication, at those points where the average-value limit has been exceeded.

The following settings are required for automatic measurements:

IF attenuation: 40 dB
Indicating mode: MW AV
Operating range: 20 dB

Set RF attenuation so that the peak value measured before remains below full-scale deflection [$a_{RF} = 10 \times \text{INT}(\text{PK}/10) - 40$]. If the level of the input signal falls below the operating range in the subsequent measurement (third letter of measured-value string = U), the RF attenuation or - if the RF attenuation is already 0 dB - the IF attenuation can be reduced by 10 dB.

2.4.2.2 Interference Measurements according to MIL-STD and VG Standards

For the measurement of broadband interference, the MIL indicating mode must be used, since the interference level values are in this mode automatically indicated as pulse spectral density referred to a pulse bandwidth of 1 MHz. The dynamic range of the measurement is thereby larger, the larger the IF bandwidth is. To avoid overloading the RF input with broadband interference pulses, the LOW DIST. setting should be selected and, for highest measurement rates, the 60-dB operating range. Preamplification can also be used in measuring broadband interference, so long as the input level without RF attenuation does not exceed about 60 dB μ V/MHz. 60 dB μ V/MHz is the 1-dB compression point of the preamplifier for pulses with an approximately level spectrum up to 1 GHz.

Narrowband interference is generally measured in the peak indicating mode. A valuable help in distinguishing broadband from narrowband interference is the comparison of average and peak values (see Fig. 2-5). In the case of a keyed carrier, only the shift of the receiver frequency an amount equal to the IF bandwidth provides a clear indication of the bandwidth of an interfering signal.

A speeding up of automatic measurements with the bus controller is achievable with automatic frequency scanning with a setting of the minimum level (threshold) barely (e.g. 10 dB) under the limit value so that data has to be transferred to the controller only when this threshold is exceeded. In order that receiver noise and detection threshold for interfering signals remain at an approximately constant separation, special function 93 must be switched in, particularly for measurements of interference radiation.

Interference measurements to the MIL-STD and VG standards are almost always made in conjunction with the 9-kHz to 30-MHz test receiver ESH3. Interference radiation measurements require three different antenna types:

- + Rod antenna for 0.014 to 25 MHz
- + Double cone antenna for 25 to 200 MHz
- + Conical-logarithmic spiral antenna for 200 to 1000 MHz.

Because of the small separation from the test item (1 m), the antennas cannot be set up together. For this reason, the interference radiation measurements must be made in accordance with the range. (The test antennas must always stand on the side with the maximum interference radiation of the test item.) On the other hand, the RF current probes have practically no effect on each other in the measurement of interference currents on power supply and signal lines. For this reason, RF current probe ESH2-Z1 may be connected to ESH3 and VHF current probe ESV-Z1 with the ESVP and both receivers operated with automatic frequency scanning. In some specifications, interference currents must be measured up to 200 MHz.

Fig. 2-25 shows the test setup and Fig. 2-26 the flow diagram of a controller program with service routine for accepting and processing the measured values.

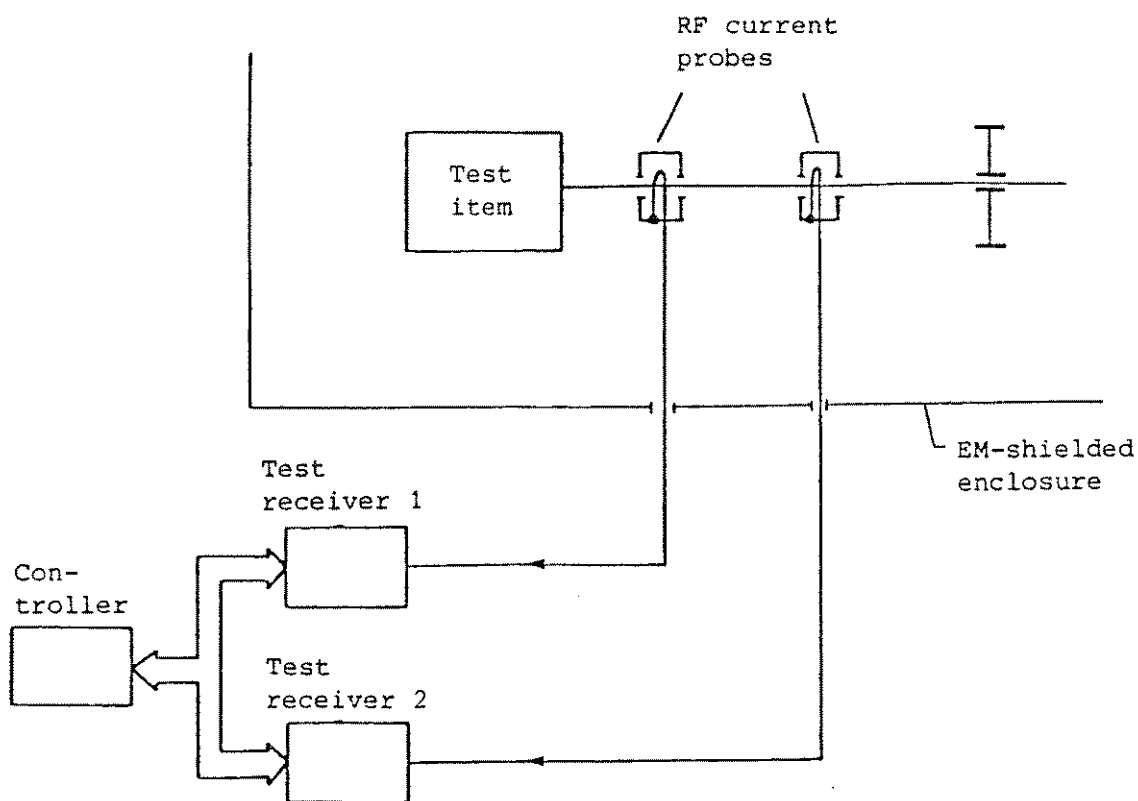
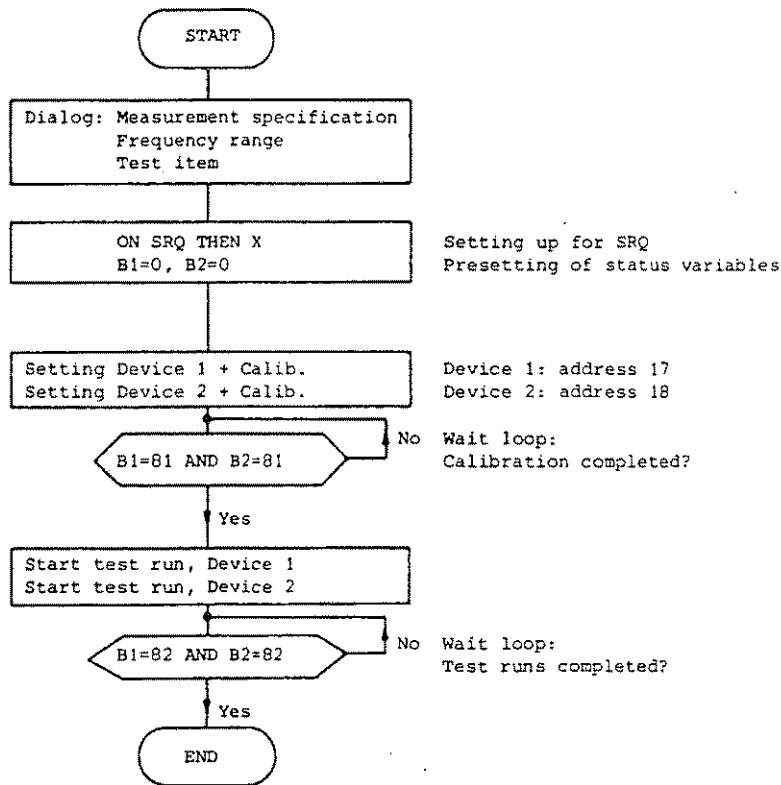

Fig. 2-25 Setup for measuring interference current



Status variable B, B1, B2
 = 80: Data ready
 = 81: Calibration completed
 = 82: Test run completed

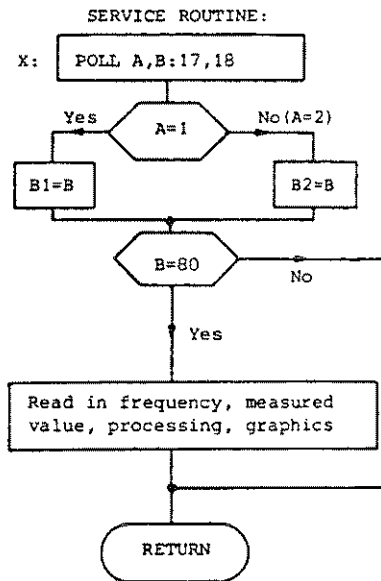



Fig. 2-26 Flow diagram of controller program and service routine for accepting and processing measured values

2.4.3 Measurement of TV Signals and Monitoring of CATV Systems

2.4.3.1 Measurement of RMS Value of Vision Carrier at the Sync Peak of TV Signals with Negative Modulation

IF bandwidth 1 MHz
Peak-value indicating mode
Setting LOW NOISE (see section 2.4.1)
Audio monitoring with A3 
Measuring time > 50 ms

For analog recording of the carrier levels at output 57, measure either the vision carrier with the shortest possible measuring time (5 ms) and peak-value indication or the sound carrier with average-value indication.

2.4.3.2 Measurement of Sound Carrier

IF bandwidth 120 kHz
Average-value indication
Measuring time immaterial
Audio monitoring with F3 

2.4.3.3 Measurement of TV Signals with Positive Modulation

For the measurement, a white pulse of 40- μ s duration is in general satisfactory. To avoid ringing of the white pulse at the output of the IF filter, the IF bandwidth should be made as large as possible (1 MHz).

Peak-value indicating mode (highest possible S/N ratio)
Measuring time > 50 ms
Audio monitoring with A3 

2.4.3.4 S/N Ratio in CATV Systems

For this, the system noise must be determined: the measurement of the noise level N_E is made with the ESVP in a frequency range near the carrier which is free of modulation and intermodulation products with a bandwidth of, for example, 120 kHz, and average-value indication. The system bandwidth B_S is 4 MHz or 5 MHz, depending on the system.

The system noise N_S is obtained from the measured noise level E by the addition of the bandwidth factor

$$k' = 10 \cdot \log(B_S/B_{3dB}) \text{ dB.}$$

For $B_S = 5 \text{ MHz}$ and $B_{3dB} = 115 \text{ kHz}$ (with $B_{IF} = 120 \text{ kHz}$):
 $k' = 16.4 \text{ dB.}$

The noise level N_S is then: $N_S/\text{dB}\mu\text{V} = N_E/\text{dB}\mu\text{V} + k'/\text{dB.}$

With a carrier level S_T , the S/N ratio is $S_T - N_S$.

Example: $S_T=68 \text{ dB}\mu\text{V}$, $N_E=8 \text{ dB}\mu\text{V}$, $B_{IF}=120 \text{ kHz}$, $B_S=5 \text{ MHz}$:
 $(S - N_S)/\text{dB} = 68 - 8 - 16.4 = 43.6 \text{ dB.}$

2.4.3.5 Hum Modulation in CATV Systems

- a) Measurement of the hum on an unmodulated pilot carrier:
with the highest possible S/N ratio with the modulation depth measurement (SF21)
or
at AM output 53 with an oscilloscope. (The ratio of the hum amplitude $V_{Brss}/2$ to the mean value of DC voltage is the hum modulation depth.)
- b) Measurement of the hum on the vision sync pulses, by determining the ratio of the vision carrier at the sync peak to the hum voltage $V_{Brss}/2$.

For this, the AM output of the ESVP cannot be used, particularly with the system in operation, because the height of the vision sync pulse is influenced by the vision content via the AGC.

Instead of this, the rectified output voltage of the test detector can be brought out to connector 59 as described in section 2.3.18.

Measurement procedure:

Set the ESVP for optimum S/N ratio. Calibrate the oscilloscope display with the sync pulses (up to the black shoulder). Adjust sync pulse, for example, to the full picture height. Then increase the sensitivity of the oscilloscope by a factor of 10 and measure the now visible hum voltage (peak to peak).

Example:

Height of video sync pulse	8 cm
Height of hum voltage $V_{Brss}/2$ (after 10 x magnification)	4 cm
Ratio	26 dB

When the correction factor is considered (ratio of vision sync pulse to carrier amplitude), a value of 37.3 dB is obtained according to the German TV standard.

Correction factor for

German Standard: $20 \cdot \log(100/27.3) = 11.3$ dB

American Standard: $20 \cdot \log(100/25) = 12$ dB

2.4.3.6 Measurement of Crossmodulation on Pilot Carrier

Since hum modulation is nothing else than crossmodulation, the procedure a) of section 2.4.3.5 can also be used here.

2.4.3.7 Intermodulation Measurements in CATV Systems

- a) Same as the measurement of the RMS value of the vision carrier according to section 2.4.3.1 within free channels, or
- b) for accurate measurements by feeding test signals into neighbouring channels with exact frequency and level settings corresponding to the frequency and level of vision, sound and colour subcarriers normally occupying these channels. The additional utilization of an IF spectrum analyzer facilitates the finding of the intermodulation products (level measurement with average-value indication). In all measurements of system linearity, the ESVP should be set to minimize the harmonic content of the signal. By means of the LIN.TEST (see section 2.3.6), it can be checked if the ESVP is contributing to the intermodulation.

2.4.3.8 Interference Radiation in CATV Systems

For reasons of cost, cable shields used in cable-TV systems do not have a high degree of coverage. The interference radiation must nonetheless lie below certain limit values. For measuring the interference field strength, the broadband antennas with mast and tripod of the HUF system can be used. Field strength indication with use of special function 83.

2.4.3.9 Measurements of Intermodulation and Crossmodulation on TV Transmitters

As for all linearity measurements, the ESVP is to be operated in the LOW DIST setting and the 20-dB operating range. Narrowest possible IF bandwidth, setting according to modulation.

2.4.4 Use of ESVP in Radiomonitoring

In the framework of radiomonitoring and spectrum management, test receivers are used in the routine checking of a series of parameters. The applications of the ESVP are as follows:

- The limiting of undesired radiation from electrical devices and installations as well as from sound and television broadcasting receivers and industrial, scientific and medical equipment.

This activity falls in the field of civil interference measurements (see section 2.4.2.1).

- Rapid field-strength measurements by radiomonitoring units. The highly effective calibration process of the ESVP and the accuracy of its internal references and attenuators assure the basic accuracy of the instrument without the need for constant recalibration at every new frequency setting (see section 2.3.7).

The accuracy of the field strength measurements thus are determined to a large extent by the accuracy of the antenna conversion factors used. For the R&S test antenna Broadband Dipole HUF-Z1 (20 to 80 MHz) and the Log-periodic Broadband Antenna HL 023 A1 (80 to 1300 MHz), the antenna factors are specified and held to an accuracy of ± 1 dB, so that the overall measurement error does not exceed ± 2 dB (see special functions 83, 84, 85).

- Remote frequency measurements by radiomonitoring units. The ESVP can be equipped with the option "High-precision Reference" (frequency error approx. 10^{-9} /day), or driven by an external precision reference. With such a reference and the built-in IF counter, remote frequency measurements for monitoring the frequency tolerances of transmitters are possible to an accuracy which depends only on that of the reference (see special functions 31 to 34, 36 to 39).
- Measurement of frequency-band occupancy with the radiomonitoring recorder ZSG3 (see section 2.3.20) or with the help of a bus controller (e.g., the PUC).

- Measurement of field-strength variations as a function of time with a YT recorder at output 57 or 61 or with a bus controller.

Measurements for determining with the bus controller the statistics of the frequency variations - median and decile values.

Measurement of field-strength variations along a path (e.g. a railway line).

Measurements in a helicopter or aircraft for determining the directivity diagrams of transmitter antennas with a bus controller.

- Measurement of modulation depth and frequency deviation (SF21, SF41).
- Measurement of RF noise and noise of industrial origin.
- Measurement of spurious and harmonics radiation from transmitters.
- Measurement of radiation due to switching transients in mobile radio transmitters and radiotelephone equipment (see section 2.3.18).
- Measurement of short-term signals by means of an internal or external triggering facility (level, frequency, modulation, see SF03 and SF04).
- The following feature of the ESVP should be noted: In automatic frequency scanning, the Display time serves for making audible all signals that exceed the threshold value.

2.4.5 Use of ESVP in Laboratories and Test Departments

The use of test receivers as general measuring instruments has decreased in favour of spectrum analyzers. However, a number of special characteristics assure their continued use:

- Because of their calibration with tracking generators, the measurement accuracy of test receivers is greater than that of spectrum analyzers.
- The noise figure is lower than that of analyzers (typically 8 dB with and 15 dB without preamplifier; for spectrum analyzers 25 to 30 dB).
- High overload capacity; this and the low noise figure result in a high dynamic measurement range.

Tracking preselection, and thus suited for measuring broadband signals and harmonics.

- Tracking generator for two-port measurements of all types.
- Storage of reference curves with SF84 and 85.
- Smaller shape factor of IF filter (typically $B_{6dB}/B_{60dB} < 2$ for test receivers and < 10 for analyzers).

These characteristics make the instrument particularly suitable for a number of special applications.

4.5.1 Two-port Measurements between Generator Output and RF Input

- a) Gain to 47 dB
Attenuation to 110 dB
Particularly suited for measurements on crystal filters and filters with greatly differing attenuation values.
- b) Reflection coefficient measurement (return loss measurement):
With use of a VSWR bridge (e.g. SWOB4-7), return loss values up to 40 dB can be measured. Because of its selective measurement, the ESVP is particularly suited for VSWR measurements on antennas in the open where the low measurement level (10 mW) at the measurement input is an advantage. With additional attenuation elements between output 48 and the VSWR bridge, the level can be reduced still further, if required.

- c) Measurement of gain and radiation patterns of antennas:
 Here also the selective measurement with tracking generator is superior to broadband measurements because of possible interference in the latter case from external emission sources (broadcasting stations, etc.).

By calibrating the test setup and storing the calibration curve as function of frequency (SF84, 85), gain measurements are simplified to the extent that the gain of a test item can be directly indicated.

- d) Screening attenuation of cable shields and housings:
 The screening characteristic of a cable shield is expressed by the coupling resistance R_k which can be calculated from the screening attenuation factor a_s with the formula

$$R_k = 50 \cdot 10^{-\frac{a_s}{20}}$$

The factor a_s can be measured in accordance with DIN 47250 Part 4, IEC Publication 96-1 and VG 95373 Part 41 with use of a test tube into which an approximately 1-m length of the cable is soldered, as sketched in Fig. 2-27.

With a fast setup consisting of Signal Generator SMS, a test tube and Test Receiver ESH2, ESH3 or ESVP, screening attenuation values a_s of up to 150 dB can be measured. The SMS generator can be dispensed with by using the generator output of the test receiver but in this case the measurement range for a_s is limited to 110 dB.

Measurement range with measuring tube:

SMS + ESH2 or ESH3 (0.1 to 30 MHz)	$a_s = 0$ to 150 dB
ESH2 or ESH3 (0.009 to 30 MHz)	$a_s = 0$ to 110 dB
SMS + ESVP (20 to 300 MHz)	$a_s = 0$ to 150 dB
ESVP (20 to 300 MHz)	$a_s = 0$ to 110 dB

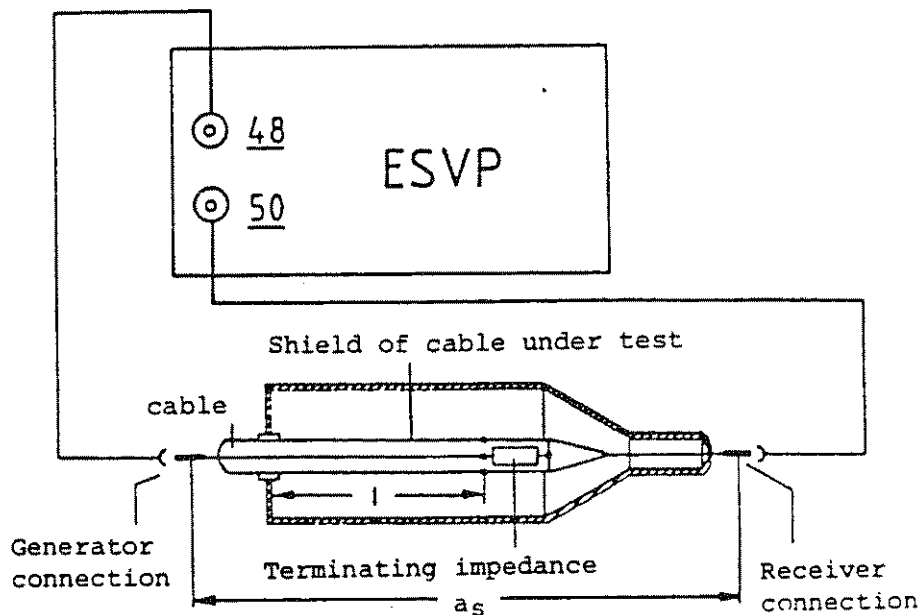

Fig. 2-27 Setup with test tube

What is required in many cases is a rough but quick estimate of the value of a_s , a comparison of two cable shields or measurement of the RF shielding of a plug and socket connection against strong interference signals. For such cases, the test tube setup may be too elaborate. Since in EMI engineering a screened room with coaxial RF lead-throughs is generally available, the test tube can be dispensed with and the measurement made with an open setup.

In this case, a 1-m length of the cable is mounted on a test plate mounted on insulating supports (e.g. of foam plastic). A shorter cable length must be used for measurements above 100 MHz. The generator output level and terminating impedance (50 Ω) determine the current in the inner conductor. The current coupled out through the shield is measured with an RF current probe mounted over the outer conductor (probe ESH2-Z1 for 0.009 to 30 MHz and ESV-Z1 for 20 to 300 MHz). The value of the screening attenuation factor a_s is obtained from the level difference of the currents. Automatic control of the measurement run and graphic representation of the result is possible with the Process Controller PUC.

Measurement ranges with the open test setup:

SMS + ESH3 + PUC + ESH2-Z1	(0.1 to 30 MHz)	$a_s = 0$ to 116 dB
ESH2 or ESH3 + ESH2-Z1	(0.009 to 30 MHz)	$a_s = 0$ to 76 dB
SMS + ESVP + PUC + ESV-Z1	(20 to 300 MHz)	$a_s = 0$ to 120 dB
ESVP + ESV-Z1	(20 to 300 MHz)	$a_s = 0$ to 94 dB

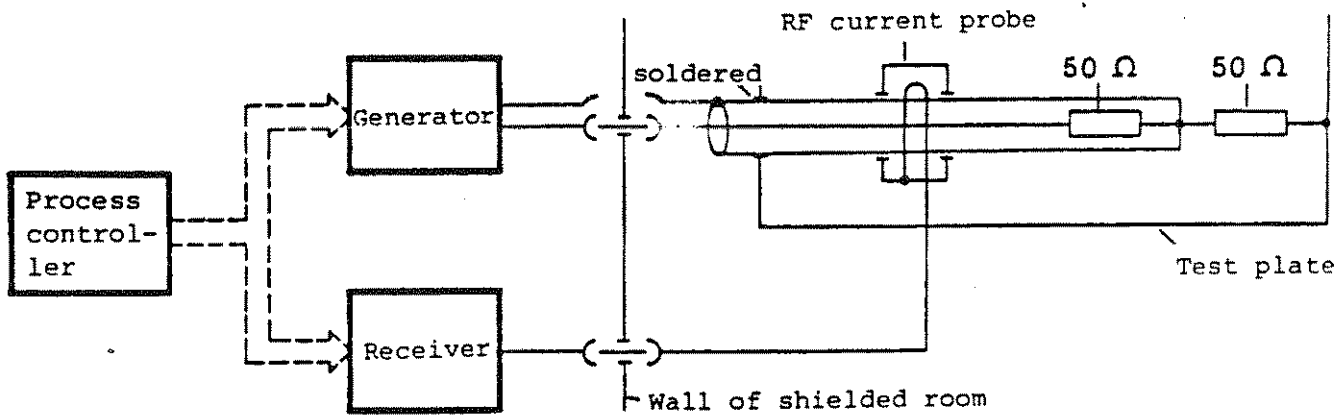

Fig. 2-28 Open test setup

e) Measurement of crosstalk attenuation of adjacent lines, check of effectiveness of shielding.

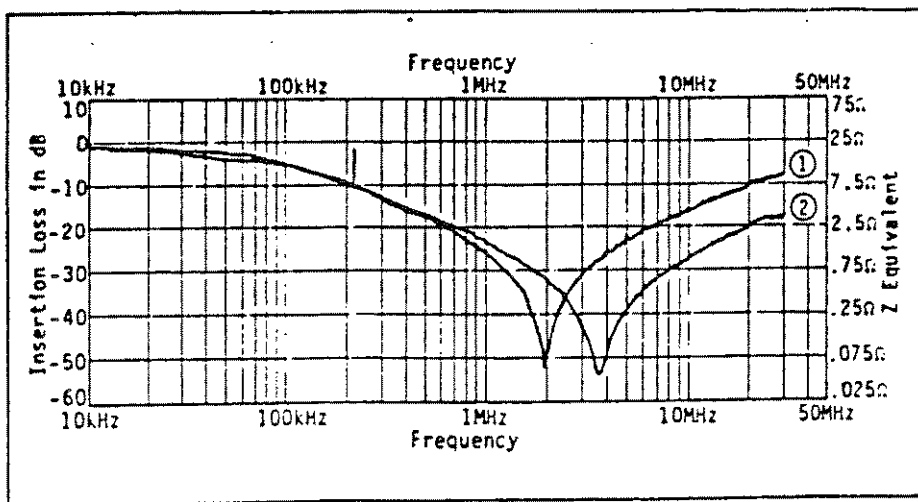

Fig. 2-29 Insertion loss of a 0.1- μ F ceramic capacitor in a 50- Ω system

Curve 1 with 25-mm connecting leads, curve 2 with 3-mm leads, recorded with an ESH3 over its frequency range.

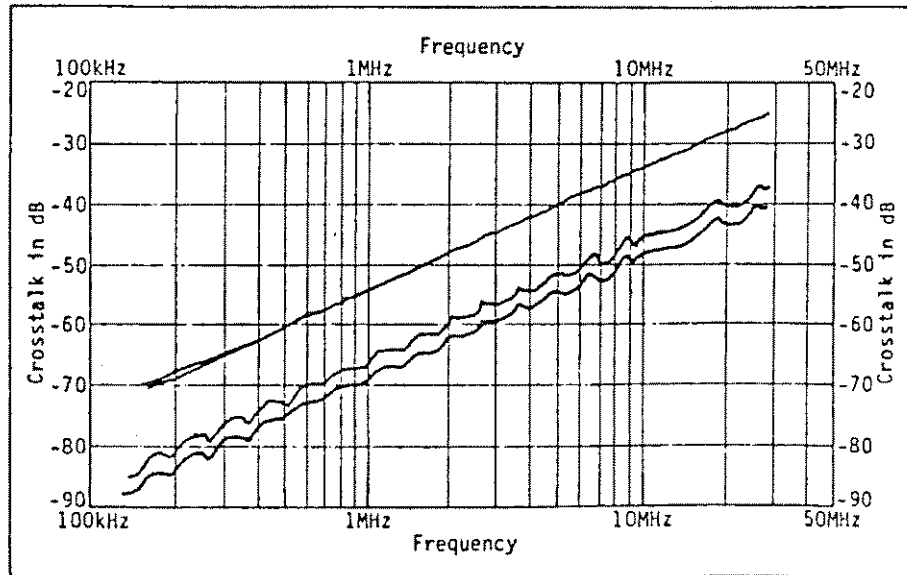

Fig. 2-30 Measurement of crosstalk between two adjacent 10-cm-long conductors of a printed circuit.

The upper curve is for a separation of 2.5 mm. The lower curves are for a greater separation and with shielding strip. Recorded with an ESH3 over its frequency range.

2.4.5.2 Measurement of Harmonics

Thanks to its high K2 intercept point (see data sheet), the ESVP is ideally suited for measuring oscillator and transmitter harmonics. A frequency step size equal to the frequency of the fundamental is chosen for automatic frequency scanning. Low-distortion measurement (LOW DIST.) (possibly with LIN. TEST). Indicating mode: AV., 20-dB operating range for highest possible RF attenuation, IF bandwidth to suit the stability of the fundamental.

With the attenuator frequently cut in and out, the ESVP detects an overload condition (OVERLOADED LED 7 lights). The linearity test (LIN TEST) will then indicate non-linearity. For the greatest possible harmonic rejection, connect an external attenuator in series and measure the harmonic directly above the noise.

2.4.5.3 Measurement of Spurious Signals and Sideband Noise

For these measurements also, the settings LOW DIST., 20-dB operating range and average-value indication should be selected.

2.4.5.4 Linearity Measurements on Amplifiers and Tuners (Compression, Intermodulation, Crossmodulation)

The excellent linearity of the ESVP makes it also particularly suitable for linearity measurements on active components. The measurements must, however, be carried out with the aid of signal generators that

- supply sufficiently high levels with low sideband noise,
- allow adequate fine variation of the output level, and
- feature a remote-control interface in accordance with IEC-625.1 (IEEE 488) for automatic measurements.

Furthermore, more than one signal frequency is generally required (intermodulation, crossmodulation, desensitisation). The built-in linearity-test facilities (LIN. TEST) of the ESVP prevent virtually any measuring errors due to non-linearity. The automatic linearity test can also be triggered and evaluated by the computer.

Best setting: AUTO LOW DIST
 Operating range 20 dB
 Indicating mode AV
 IF bandwidth minimum

Since several devices are always involved in a linearity measurement, automatic measurements are only possible with the aid of a computer.

- **Measurement of compression:**
The test item input level is increased until 1-dB compression is obtained.
- **Measurement of intermodulation (e.g. 3rd order IM product):**
The level of the signals from two signal generators at the test item input is increased until an intermodulation product can be measured with the ESVP.
- **Measurement of crossmodulation:**
The level of a 30% amplitude-modulated signal generator is increased until an AM of 3% can be measured on a second signal generator with an unmodulated carrier.

For all linearity measurements, the minimum IF attenuation and the maximum RF attenuation should be set on the ESVP. In some cases, direct computer setting of the RF and the IF attenuation may prove still more effective even for automatic measurements than autoranging with low-distortion measurement, as it is then possible to adjust the indicated voltage closer to the noise indication, thus minimizing the level at the 1st mixer.

2.4.5.5 Measurement of Noise Figure of Amplifiers and Tuners

With the use of a noise generator and possibly an attenuator set, the noise figure of amplifiers and tuners with IF outputs in the range of the ESVP can be measured.

Measurement setup without attenuator set:



Increase the ESVP noise indication with the noise generator by 3 dB: The noise generator then reads out the noise figure.

Measurement setup with attenuator set:

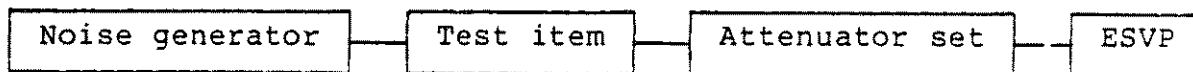

Increase the attenuation of the attenuator set by 3 dB: Then increase the noise-generator output level until the previous ESVP noise indication is reached.

The noise generator then reads out the noise figure.

2.4.6 Recording of Signals

All the following considerations are based on recording without an external computer. Information on data recording is also contained in sections 2.3.17, 2.3.18 and 2.3.20.

2.4.6.1 Signal Level as Function of the Frequency

This can be done in two ways:

- a) Driving an XY recorder via output 61 in an automatic frequency scan.

This method is fully described in section 2.3.20. The following settings are most suitable for this method:

- + line spectrum (special function 71), if average- or peak-value indication is selected and the stepsize of the scan is larger than one-half the IF bandwidth.
- + polygonal curve (special function 70), if
 - average- or peak-value indication is selected and the stepsize of the scan is less than or equal to one-half the IF bandwidth.
 - CISPR or MIL indication is selected without influence of the step-size.
 - the two-port operating mode is selected.

b) Driving a printer via output 60

Frequencies and corresponding level values are always printed out together. Other measured values can be printed out by use of the special functions. Values lying below the MIN LEVEL are not printed out.

The recorder and printer can be driven in parallel.

2.4.6.2 Frequency-band Occupancy as Function of the Time

In addition to computer control, the driving of up to five radio-monitoring recorders ZSG3 as described in section 2.3.20 is possible. The recording threshold is determined by the MIN. LEVEL entered.

2.4.6.3 Signal Level and Frequency Offset as a Function of Time

The signal level as a function of time can be recorded in three different ways:

- a) Use of the outputs CISPR 56 for CISPR recording and AV/PEAK 57 for average-value and peak-value recording on a YT recorder. Measurements with the MIL indicating mode can also be made at this output.

In contrast to the XY RECORDER output 61, these outputs offer the advantage that the output voltage follows the input voltage without any delay (to be exact, only with average-value indication, since the peak-value hold time is always equal to the measuring time). On the other hand, these outputs have the drawback in contrast to 61 that fluctuations that require autoranging are not correctly recorded. Automatic scanning is not necessary in this case.

- b) Use of the output 61 for all level recordings on YT recorders. The Y output voltage changes in case of SF64 with each new data output on the display 12. To assure that rapid changes are correctly recorded, the measuring time should be set with key 39 to the lowest possible value. A waiting time that would permit in every case a full settling of the YT-recorder on the end-value of the Y-voltage is not provided for, since this would result even with short measuring times in a step-shaped recording. However, to trigger such a recording process, a pseudo-automatic frequency-scanning with $f_{START} = f_{STOP}$ is required. To stop this pseudo-automatic frequency scanning process, the STOP key must be pressed twice.

- c) Data output to a printer in the Talk Only mode. Simultaneously with each output on the display 12, the data is output to the printer. This method produces less easy-to-grasp results than graphic methods, but it offers the advantage of statistical data evaluation if no desktop computer is used for control. The output to the printer is also triggered by automatic frequency scanning with $f_{START} = f_{STOP}$. The start of this pseudo-frequency scanning process initiates continuous printer output.

Recording methods b) and c) are also possible simultaneously.

For recording the frequency offset as a function of time, the following methods are possible:

- Use of output 55 for output to an XY recorder without automatic scanning.
- Talk Only output of the measured data in automatic scanning operation with $f_{START} = f_{STOP}$ (31).

3 Maintenance

3.1 Required Measuring Equipment and Accessories

Item	<ul style="list-style-type: none"> ○ Type of instrument Required characteristics ● Recommended R&S instr. 	Type	Identifi- cation No.	Application see section
1	<ul style="list-style-type: none"> ○ Multimeter, 20 V, 2 A, Accuracy better than 1%. ● Digital Multimeter 	UDL4	346.7800.02	<ul style="list-style-type: none"> 3.2.15.4 3.2.15.5 3.2.15.6 3.2.15.7
2	<ul style="list-style-type: none"> ○ Generator, 20 to 1300 MHz, level 0 dBm, low sideband noise, harmonics suppres- sion > 35 dB, with modu- lation ● Signal Generator, 0.05 to 1360 MHz 	SMPC	300.1000.52	<ul style="list-style-type: none"> 3.2.1.1 3.2.1.2 3.2.1.5 3.2.1.6 3.2.2 3.2.3 3.2.4 3.2.5 3.2.9 3.2.10 3.2.11 3.2.12 3.2.13 3.2.14 3.2.15
3	<ul style="list-style-type: none"> ○ Power meter, 50 Ω, Accuracy < 0.1 dB, Frequency range 20 to 1300 MHz 			<ul style="list-style-type: none"> 3.2.1.1 3.2.1.4
4	<ul style="list-style-type: none"> ○ Calibrating attenuator 50 Ω, 0 to 110 dB, Accuracy < 0.3 dB ● Programmable attenuator 	DPVP	214.8017.55	<ul style="list-style-type: none"> 3.2.1 3.2.1.5 3.2.6 3.2.11
5	<ul style="list-style-type: none"> ○ Pulse generator with pulse according to CISPR, 50 Ω, adjustable pulse repetition freq., e.g. Schwarzbeck MeBelektronik: VHF-UHF Calibrating Pulse Gene- rator CISPR 2/4 IGU 			<ul style="list-style-type: none"> 3.2.1.1 3.2.1.2 3.2.1.3

Item	o Type of instrument Required characteristics ● Recommended R&S instr.	Type	Identifi- cation No.	Application see section
6	o Oscilloscope, 10 MHz, Single-channel, 10 mV/cm ● Oscilloscope	BOL	374.2000.02	3.2.15.3
7	o Impedance meter, 50 Ω , 20 to 1300 MHz, 0 to 100% ● Vector Analyzer with Tuner	ZPV ZPV -E2	291.4012.92 292.0010.02	3.2.7
8	o Selective microvoltmeter 50 Ω , 600 to 1350 MHz, 1 μ V e.g. Takeda Riken TR4172			3.2.8
9	o Lowpass filter 50 Ω , Attenuation of 2nd harmonic > 60 dB			3.2.11 3.2.12 3.2.13
10	o Power divider 50 Ω Decoupling > 25 dB, 20 to 1300 MHz			3.2.12 3.2.13
11	o Broadband dipole antenna 20 to 80 MHz ● Log-periodic Antenna 80 to 1300 MHz, (Normal field 10 V/m)	HL0- 23A1	577.8017.02	3.2.14
12	o Power amplifier, 10 W, 50 Ω , 20 to 1300 MHz			3.2.14
13	o Frequency counter Sensitivity < 10 mV			3.2.1.4

3.2 Check of Nominal Characteristics

Before undertaking a check of the nominal characteristics, a functional check of the test receiver is made according to section 2.2.4. The purpose of this is to avoid testing a not fully functional instrument.

3.2.1 Check of Level-measurement Accuracy

The accuracy of the level measurement in the ESVP is determined by the accuracy of the

- + Calibration generator
- + Internal calibration attenuators
- + A/D converters

The resulting, permissible total error in the average-value indication for an unmodulated sinewave signal ($S/N > 16$ dB) is < 1 dB.

In the tests, the measuring time should be set to the standard value (0.1 sec or 1 sec for CISPR) unless otherwise specified.

3.2.1.1 Check of Level Indication in 20-dB Operating Range

a) Average value

```
ESVP settings:  Indicating mode ... AV
                 IF attenuation  ... 40 dB
                 RF attenuation  ... 50 dB
                 IF bandwidth    ... 120 kHz
                 Calibrate ESVP
```

Measure a sinewave signal of $98 \text{ dB}\mu\text{V} \pm 0.1 \text{ dB}$ in the frequency range 20 MHz to 1300 MHz (level check with thermal power meter).

```
Nominal indication ..... 98.0 dB $\mu$ V
Permissible error in
level indication ..... < 0.6 dB
```

b) Peak value

```
ESVP settings:  Indicating mode ... PEAK
                 IF attenuation  ... 40 dB
                 RF attenuation  ... 40 dB
                 IF bandwidth    ... 1 MHz (mod. 52, 56)
                                     200 kHz (mod. 53)
                 Calibrate ESVP
```

Apply a pulse level of 88 dB μ V/MHz with a pulse frequency of 100 Hz to the RF input of the ESVP. This corresponds in the Schwarzbeck CISPR 2/4 Standard Pulse Generator to a setting of 58 dB (Note: This pulse generator has a frequency response usable to 1000 MHz).

Nominal indication 88.0 dB μ V (mod. 52, 56)
 75.0 dB μ V (mod. 53)
 Permissible error in
 level indication < 2 dB

c) Spectral pulse density:

ESVP settings: Indicating mode ... MIL
 (other settings as
 in 3.2.1.1 b)

Nominal indication 88.0 dB μ V/MHz
 Permissible error in
 level indication < 2 dB

d) Check of indication response and analog level indication:

ESVP settings: (same as in 3.2.1.1 a)

Test setup:



From full deflection of the analog indication, reduce the level 20 dB in 1-dB steps by switching the external calibration attenuator.

Check the LEDs of the analog level indication from maximum to minimum (left end of scale).

Check of indications:
 Permissible indication error < 0.2 dB

3.2.1.2 Check of Level Indication in 40/60-dB Operating Range

a) Average value:

ESVP settings: Indicating mode ... AV
 IF attenuation 40 dB
 RF attenuation 30/10 dB
 IF bandwidth 120 kHz
 Calibrate ESVP

Measure a sinewave signal of 98 dB μ V \pm 0.1 dB in the frequency range 20 to 1300 MHz.

Nominal indication 98.0 dB μ V
 Permissible error in
 level indication < 1.5 dB

3.2.1.3 Check of Level Indication in Indicating Mode CISPR

ESVP settings: Indicating mode CISPR
Attenuation AUTO, LOW NOISE

Connect to the RF input of the ESVP a standard-pulse generator that furnishes a standard CISPR pulse with an EMF or 0.044 μVp ($Z_{\text{out}} = 50 \Omega$) with a pulse repetition frequency of 100 Hz.

Nominal indication 60.0 dB μV
Permissible error in indication < 1 dB

When the pulse frequency is changed in accordance with Fig. 4-4, the ESVP indication must remain within the tolerance limits specified there.

3.2.1.4 Check of Generator Output

a) In the TWO PORT operating mode:

ESVP settings: Operating mode ... TWO PORT

Connect a thermal power meter to the generator output 48 of the ESVP.

Nominal indication -17 dBm
Permissible deviation < 0.3 dB
(independent of the receiver frequency set)

b) In the REM. FREQ. operating mode:

ESVP settings: Operating mode ... REM. FREQ.

Connect a counter with a sensitivity of <10 mV to the generator output.

Insert a signal of known frequency into the RF input of the ESVP. When the ESVP is detuned within the 3-dB limit frequencies of the IF bandpass, the frequency indication on the counter must not change.

3.2.3 Check of Special Functions

3.2.3.1 Check of AM Modulation-depth Measurements

ESVP settings: Special Function "10"
Operating range 60 dB
RF attenuation 20 dB
IF attenuation 40 dB
IF bandwidth 120 kHz
Calibrate ESVP

To the RF input of the ESVP apply a signal of 108 dB μ V with an AM modulation depth of 50% and $f_{\text{mod}} = 1$ kHz at the ESVP receiver frequency.

- a) Modulation depth m, Spec. Func. .. "21"
Nominal indication 50% m
Permissible deviation 5%
- b) Pos. modulation peak m+,
Spec. Function "23"
Nominal indication 50% m+
Permissible deviation 5%
- c) Neg. modulation peak m-,
Spec. Function "25"
Nominal indication 50% m-
Permissible deviation 5%

3.2.3.2 Check of Frequency Measurement

ESVP settings: Special Functions "10", "38"
ESVP receiver frequency 1000 MHz

Insert a 78-dB μ V signal of frequency 1000.0000 MHz (± 100 Hz) into the RF input of the ESVP.

Nominal indication 1000.000.000 MHz
Permissible deviation < 5 kHz

3.2.3.3 Check of Frequency Offset Measurement

ESVP settings: Special Functions "10", "33"
ESVP receiver frequency 100.0 MHz

Insert a 78-dB μ V signal of frequency 1000.0100 MHz (± 100 Hz) into the RF input of the ESVP.

Nominal indication 10.000 kHz
Permissible deviation < 100 Hz
(with consideration of deviation from section 3.2.3.2)

3.2.3.4 Check of Frequency Deviation Measurement

ESVP settings: Special Functions "10, 41, 43, 45"
Attenuation AUTO, LOW NOISE
Operating range 60 dB

Apply a signal to the RF input of the ESVP:





level = 118 dB μ V, FM deviation as shown in table below,
and $f_{\text{mod}} = 1$ kHz.

IF bandwidth	FM deviation	Nominal indication dev, dev+, dev-	Permissible deviation
10 kHz (mod. 56)			
12 kHz (mod. 52, 53)	3 kHz	3 kHz	± 0.5 kHz
120 kHz (all mod.)	30 kHz	30 kHz	± 2 kHz
200 kHz (mod. 53)	50 kHz	50 kHz	± 6 kHz
1 MHz (mod. 52, 56)	100 kHz	100 kHz	± 7 kHz

3.2.4 Check of AM Demodulation

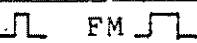
ESVP settings: Basic setting "RCLØ"

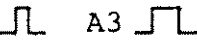
Connect a signal generator for supplying AM and FM modulated signals to the RF input of the ESVP. Check the functioning of the AF demodulators by aurally monitoring the audio volume.

ESVP settings	Signal generator	Check
FM  B_{IF} 7.5 kHz (mod. 52, 53) 12 kHz 10 kHz (mod. 56) 120 kHz (all mod.) 100 kHz (mod. 56) 1 MHz (mod. 52, 53) 200 kHz (mod. 53)	FM: f_{mod} = 1 kHz Deviation = 2.8 kHz Deviation = 40 kHz Deviation = 40 kHz	same volume lower volume
A3J  A3J 	AM: f_{mod} = 1 kHz m = 0.3	same volume and pitch
A3  B_{IF} 7.5 kHz (mod. 52, 53) 12 kHz 10 kHz (mod. 56) 120 kHz (all mod.) 1 MHz (mod. 52, 56) 200 kHz (mod. 53) 100 kHz (mod. 56)	AM: f_{mod} = 1 kHz m = 0.3	same volume
A1	f_e : 100 MHz, unmodulated	1-kHz tone
AØ	f_e : 100.001 MHz 99.999 MHz unmodulated	 1-kHz tone
AF Out: B_{IF} 120 kHz	FM: f_{mod} = 1 kHz Deviation = 40 kHz	AF not (or at most weakly) audible

3.2.7 Check of Input Reflection Coefficient

Test setup:

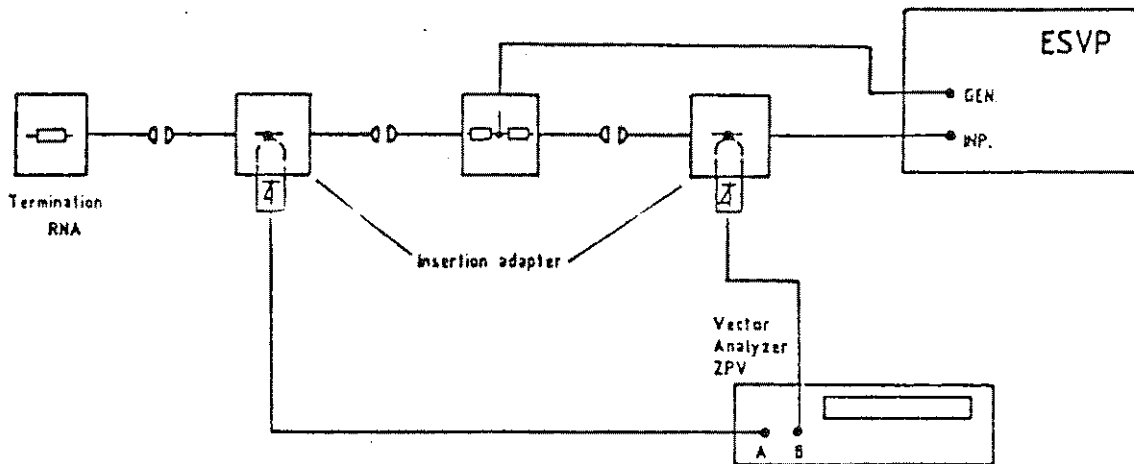

The Vector Analyzer (e.g., a ZPV) operates at the tuning frequency of the receiver.

RF attenuation: 0 dB
 Return loss > 9.5 dB (S < 2)
 > 7.5 dB (S < 2.5) with preamplification

RF attenuation: > 10 dB
 Return loss > 20 dB (S < 1.2)

3.2.8 Check of Oscillator Interference Radiation at RF Input

ESVP settings: RF attenuation 0 dB

Connect a selective indicator (e.g., analyzer) to the RF input of the ESVP, whose reception frequency must be as follows:

For frequencies 20 to < 520 MHz: $f_e + 810.7$ MHz
 520 to < 1020 MHz: $f_e + 310.7$ MHz

f_{01} : 1020 to 1300 MHz: $f_e - 310.7$ MHz
 $2 \cdot f_{01}$: 1020 to 1300 MHz: $2 \cdot (f_e - 310.7$ MHz)

3.2.11 Distortion Factor of 2nd Order (a_{K2})

A signal of frequency f_1 and low harmonic content is applied to the RF input of the ESVP. Because of the nonlinearity of the input mixer, a signal of frequency $f_2 = 2 \cdot f_1$ is generated. The level of this signal is measured and related to the level of the generating signal. A quadratic relationship exists between the level of the interference product and the generating level. This means that if the signal level is increased by n dB, the interference product is increased by $2 \cdot n$ dB and that the level separation between the two signals is decreased by n dB.

The requirements on the test setup for the measurement of distortion and intermodulation are especially high because of the ESVP's outstanding dynamic characteristics.

Test setup:

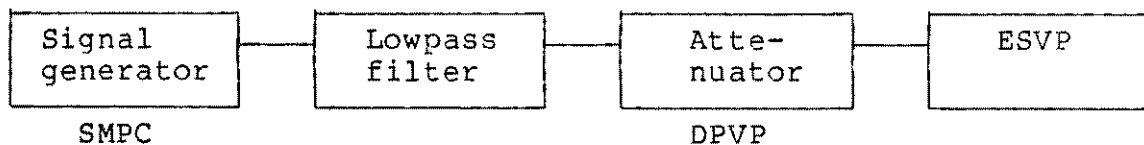

The lowpass filter should attenuate the second harmonic of the generator signal at least 60 dB, the harmonic suppression of the generator should be at least 35 dB.

Calculation of the distortion factor and the K_2 -intercept:

Input signal to ESVP:	Level P_1 (dBm), frequency f_1
Generated interference signal:	Level P_2 (dBm), frequency f_2
Distortion factor:	a_{K2} (dB) = $P_1 - P_2$
Intercept point:	K_2 -intercept (dBm) = $P_1 + a_{K2}$

ESVP settings:	Indicating mode	AV
	RF attenuation	0 dB
	IF bandwidth	7.5 kHz (mod. 52, 53)
			10 kHz (mod. 56)

K_2 -intercept point without preamplification > 40 dBm

K_2 -intercept point with preamplification > 20 dBm

3.2.12 3rd-order Intermodulation Products (a_{D3})

Apply two signals of frequency f_1 and f_2 respectively and low harmonic content to the RF input of the ESVP. Because of the non-linearity of the input mixer, the following signals of third order are generated:

$$\begin{aligned}f_3 &= 2 \cdot f_2 - f_1 \\f_4 &= 2 \cdot f_1 - f_2\end{aligned}$$

The levels of the f_3 and f_4 signals are measured, the mean of the level differences between P_1 , P_2 and P_3 , P_4 yields the intermodulation attenuation factor a_{D3} .

The signals f_1 and f_2 must differ in frequency by more than 2 MHz. The requirements on the setup for measuring the intermodulation products are especially high because of the ESVP's outstanding dynamic characteristics.

The inherent intermodulation-level/signal ratio of the test setup should be about 20 dB better than the ESVP values being measured.

Calculation of the intermodulation attenuation factor and the corresponding intercept:

Input signals

$$\begin{aligned}\text{Level } P_1 & \text{ (dBm), frequency } f_1 \\ \text{Level } P_2 & = P_1, \text{ frequency } f_2\end{aligned}$$

Generated 3rd-order
difference tones

$$\begin{aligned}\text{Level } P_3 & \text{ (dBm), frequency } f_3 = 2 \cdot f_2 - f_1 \\ \text{Level } P_4 & \text{ (dBm), frequency } f_4 = 2 \cdot f_1 - f_2\end{aligned}$$

$$\text{Intermodulation attenuation factor} \quad a_{D3} = P_1 - \frac{P_3 + P_4}{2}$$

$$\text{Intercept point} \quad D_3 = P_1 + \frac{a_{D3}}{2}$$

3.2.13 Desensitization

Test setup: (same as in section 3.2.12)

Level of the generator tuned to the
ESVP receiver frequency: 39 dB μ V

Level of the generator whose output frequency is more than 2 MHz
higher than the ESVP receiver frequency:

without preamplification 110 dB μ V
with preamplification 100 dB μ V

Indication on ESVP typ. < 1 dB

3.2.14 Check of RF Leakage

Test setup:

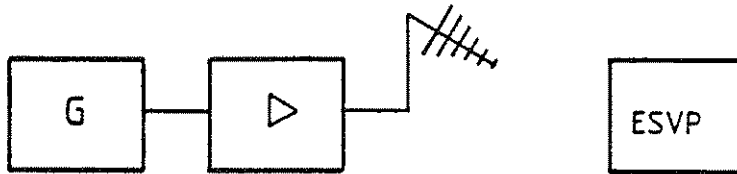

Electromagnetic field strength 3 V/m

Maximum level indication at all
ESVP receiver frequencies < 0 dB μ V

3.2.15 Check of Outputs

3.2.15.1 IF Output 10.7 MHz (broad) (52)

ESVP settings: RF attenuation 0 dB
Receiver frequency 500 MHz

Apply a signal of 80 dB μ V to the RF input of the ESVP.

Output level on 50 Ω (with 6-dB bandwidth > 2 MHz)

without preamplification typ. 87.5 dB μ V
with preamplification typ. 97.5 dB μ V

3.2.15.2 IF Output 10.7 MHz (narrow) (51)

ESVP settings: (same as in section 3.2.15.1)

Output level on 50 Ω > 100 dB μ V

The bandwidths for 3- or 6-dB fall-off correspond to the entered IF bandwidths.

3.2.15.3 AM-demodulator Output (53)

Make the measurement with a high-impedance (\gg 10-k Ω) device with a 50% modulated signal on the RF input of the ESVP (modulation sidebands lying within the IF passband).

V_{pp} 1 V
Permitted deviation 10%

3.2.15.4 FM-demodulator Output (54)

Apply a signal of exactly known frequency (operate signal generator and ESVP with an external reference) to the RF input of the ESVP and measure the receiver tuned to the latter's frequency on the FM demodulation output.

Voltage 0 V

Permissible deviation < \pm 500 mV corresp.
IF bandwidth 7.5 kHz/12 kHz (mod. 52, 53) to \pm 0.5 kHz
10 kHz (mod. 56)

Permissible deviation < \pm 150 mV corresp.
IF bandwidth 100 kHz (mod. 56)/120 kHz/ to \pm 15 kHz
200 kHz (mod. 53)/1 MHz (mod. 52, 56)

When the receiver is detuned to higher frequencies, then with every 1-kHz step (10-kHz step) for bandwidths 7.5/12 kHz (mod. 52, 53), 10 kHz, 100 kHz (mod. 56), 120 kHz/1 MHz (mod. 52, 56) or 200 kHz (mod. 53) the voltage must increase by 1 (0.1) V +80 mV.

When detuning similarly to lower frequencies, the voltage increases negatively. Measure the voltage across a high resistance (>> 10 kΩ) by detuning an amount

5 kHz (IF bandwidth 12 kHz (mod. 52, 53) or 10 kHz (mod. 56))

Offset voltage ±5 V
 Permissible deviation < 400 mV

500 kHz (IF bandwidth 1 MHz), only with model 52 and 56

Offset voltage ±5 V
 Permissible deviation 400 mV

100 kHz (IF bandwidth 200 kHz), only with model 53

Offset voltage ±1 V
 Permissible deviation 80 mV

3.2.15.5 Frequency Offset Output (55)

ESVP setting as in 3.2.15.4.

Level:

Voltage 0 V

Permissible deviation < ±500 mV corresponding
 to 0.5 kHz

IF bandwidth 7.5 kHz/12 kHz (mod. 52, 53)
 10 kHz (mod. 56)

Permissible deviation < ±250 mV corresponding
 IF bandwidth 120 kHz (all mod.)/
 100 kHz (mod. 56) to 2.5 kHz

Permissible deviation < ±150 mV corresponding
 IF bandwidth 1 MHz (mod. 52, 56)/
 200 kHz (mod. 53) to 15 kHz

When the receiver is detuned to higher frequencies, the following voltage variations result depending on IF bandwidth and step-width:

IF bandwidth	Voltage variation (±80 mV)
7.5/12 kHz (mod. 52, 53)	1 V/1 kHz
10 kHz (mod. 56)	1 V/10 kHz
120 kHz/100 kHz (mod. 56)	1 V/100 kHz
1 MHz (mod. 52, 56)	1 V/20 kHz
120 kHz/200 kHz (mod. 53, 55)	

3.2.15.6 Level Output AV/PEAK (57)

ESVP settings: Indicating mode: AV or SP or MIL

Measure a positive output voltage with a high-resistance (>> 10 k Ω) device for full scale deflection of the ESVP (digital indication).

Voltage (for fsd) 4 V
Permissible error ± 75 mV

For CISPR indication:

Voltage (for fsd) 4 V
Permissible error ± 75 mV

3.2.15.7 Level Output CISPR (56)

ESVP settings: Indicating mode CISPR

Voltage (for fsd) 2 V
Permissible error ± 50 mV

This output contains an instrument-simulating lowpass filter according to CISPR (Publications 2 and 4).

3.2.15.8 External Reference (59)

ESVP settings: (See section 3.2.3.2.)
However, supply the signal generator and ESVP with a common reference frequency (5 MHz or 10 MHz).
Switch ESVP to external reference frequency (59).

Nominal indication 1000.000.000 MHz
Permissible deviation < 100 Hz

3.2.15.9 External Trigger (58)

ESVP settings: Special Function "04"

Initiate a measurement by applying a positive (or negative) going pulse (TTL signal).

3.3 Electrical Maintenance

Because of its design, the test receiver ESVP requires very little electrical maintenance.

The following periodic checks and adjustments are recommended:

- + Check the frequency accuracy according to section 4.2, and adjust the reference oscillator once a year.

- + Check the calibration levels according to section 4.2 once a year.
- + Check the lithium battery G1 on the computer board (voltage 3.6 V) every six months.

3.4 Mechanical Maintenance

The ESVP has very few moving parts, so that very little mechanical maintenance is required. The necessary work will depend on the type and frequency of use of the instrument.

An instrument frequently used in a helicopter or a land vehicle will require more maintenance than one in laboratory use.

The following maintenance work should be done:

- + If the front panel becomes soiled, wipe it clean with a soft cloth moistened with alcohol.
- + Check that all cable and other electrical connectors seat firmly and that all screws are firmly seated.

3.5 Storage

The ESVP can be stored for longer periods at temperatures between -25°C and $+70^{\circ}\text{C}$. The self-discharge rate of the lithium battery however increases with temperature. If stored at high temperature and humidity, the instrument should be kept in a plastic, if possible airtight, sack, as a precautionary measure.

If the instrument has been stored at high humidity for any length of time, it should be dried out as follows before it is placed in operation:

- + Unscrew and remove the top and bottom panels,
- + Unscrew and remove the top, bottom and side covers.
- + Dry the instrument for 4 to 6 hours at $+40$ to $+45^{\circ}\text{C}$.
- + Check the functioning of the instrument according to section 2.2.4.