



**ROHDE & SCHWARZ**

Measuring Instruments  
and Systems Division

**Operating manual**

**RADIOCOMMUNICATION**

**TESTER**

**CMT**

**802.2020.52**

**802.2020.54**

Printed in the Federal  
Republic of Germany

# Contents of CMT Manual

## Operating manual

1. Data Sheet
2. Preparations and Operation
3. Maintenance

## Service manual

### Volume 1

#### 4. Service Manual for Complete Instrument

5. Service Instruction for Modules	Order No.	Index
Power Pack .....	802.2814.02	..... 1
Digital Unit .....	802.4517.02	..... 2
Analog Unit.....	802.8435.02	..... 3
1st Modulation Generator Module .....	802.5713.02	..... 4
RF Oscillator Module including .....	802.8835.02	..... 5
Reference Oscillator (OCXO) CMT-B1 . ]	803.8916.02	..... 5
Output Stage .....	802.7616.02	..... 6
Attenuation Set Module .....	802.4223.02	..... 7

### Volume 2

#### 5. Service Instruction for Modules

Oscilloscope Module .....	803.1111.00	..... 1
Display/Keyboard Module .....	802.3662.00	..... 2
Adjacent-channel Power Meter CMT-B6 ..	803.7810.02	..... 3
2nd AF Synthesizer CMT-B7 .....	803.2618.02	..... 4
IEC Bus/Control Interface CM-B4 .....	803.3914.02	..... 5
Autorun Control/Printer Interf. CM-B5	803.3314.02	..... 6
RF Millivoltmeter CM-B8 .....	803.6813.02	..... 7
Duplex Modulation Meter CM-B9 .....	803.5317.02	..... 8
DTMF Decoder CM-B11 .....	803.4610.02	..... 9
Transfer Memory Module CM-Z1 .....	803.7510.02	..... 10



# Table of Contents

	Page
<u>1</u> <u>Data Sheet</u>	
<u>2</u> <u>Preparations and Operation</u> .....	2.1
2.1            Switching-On .....	2.1
2.1.1          Mains Operation .....	2.1
2.1.2          Battery Operation .....	2.2
2.2            Explanation of the Controls .....	2.3
2.2.1          Front panel .....	2.3
2.2.2          Rear Panel .....	2.30
2.3            Manual Operation .....	2.33
2.3.1          General Operating Notes .....	2.33
2.3.1.1        Switch-on Status, Permanent Memory and Master Reset .....	2.33
2.3.1.2        Transmitter Test / Receiver Test .....	2.36
2.3.1.3        General Syntax Rules for Entries .....	2.37
2.3.1.4        Variation of Setting Values .....	2.42
2.3.1.5        Representation of the Measured Values/ Setting Values in the Displays .....	2.44
2.3.2          Connection Between CMT and Device Under Test ....	2.47
2.3.3          Frequencies.....	2.51
2.3.3.1        RF Meter .....	2.51
2.3.3.2        Operating Frequency in the Transmitter Test Mode	2.51
2.3.3.3        Operating Frequency in the Receiver Test Mode ...	2.52
2.3.3.4        Operation Without Duplex Modulation Meter (Option CM-B9) .....	2.53
2.3.3.5        AF Meter .....	2.54
2.3.3.6        AF Generator Settings .....	2.55
2.3.3.7        CODE/DECODE .....	2.58
2.3.3.7.1      Selection of a Particular Code .....	2.59
2.3.3.7.2      CODE Transmission .....	2.60
2.3.3.7.3      CODE Reception .....	2.63
2.3.3.7.4      Automatic Repeat .....	2.68
2.3.3.7.5      Frequency Tables of the Fixed Tone-sequence Standards .....	2.69
2.3.3.7.6      Programming the User Codes USER 0 to USER 2 ....	2.69
2.3.3.7.7      Measurements on Transceivers with Acknowledgement Call .....	2.74

2.3.4	RF Power / RF Level .....	2.75
2.3.4.1	RF Power Measurements .....	2.75
2.3.4.2	RF Synthesizer Output Level .....	2.76
2.3.4.3	Probe Measurements .....	2.77
2.3.4.4	Adjacent-Channel Power Measurements (ACP) .....	2.78
2.3.4.5	Selective RF Millivoltmeter .....	2.79
2.3.4.5.1	General Information .....	2.79
2.3.4.5.2	Calibration through Entry of Currently Applied Power .....	2.80
2.3.4.5.3	Calibration through Reference Measurement Using the RF Power Meter .....	2.81
2.3.4.5.4	Calibration Sources .....	2.82
2.3.4.5.5	Error Handling .....	2.82
2.3.4.5.6	Application Hint: Measurement of Forward and Reflected Power .....	2.83
2.3.5	Demodulation/Modulation .....	2.84
2.3.5.1	Modulation Selection .....	2.84
2.3.5.2	Modulation Meter .....	2.86
2.3.5.3	Transmitter Distortion .....	2.87
2.3.5.4	Filter Weighting of the Demodulated Signal .....	2.87
2.3.5.5	Modulation of the RF Test Generator .....	2.88
2.3.5.6	Calibration of the Modulation Sensitivity of the External Input .....	2.91
2.3.5.7	Modulation Sensitivity .....	2.91.1
2.3.6	Modulation Generator Level / AF Voltmeter .....	2.92
2.3.6.1	AF Generator Level .....	2.92
2.3.6.2	AF Voltmeter .....	2.93
2.3.6.3	Receiver Distortion Depth (SINAD/DIST) .....	2.94
2.3.6.4	Signal-to-Noise Measurements .....	2.95
2.3.6.5	Filter Weighting of the AF Signal .....	2.96
2.3.6.6	Averaging of Noisy Signals at AF VOLTM Input and Demodulator Input .....	2.96
2.3.7	Numeric Keypad + Special Functions .....	2.97
2.3.7.1	Numeric Keypad .....	2.97
2.3.7.2	ΔVAR .....	2.99
2.3.7.3	RANGE HOLD .....	2.101
2.3.7.4	α DISPL SELECT .....	2.104
2.3.7.5	ANALOG SELECT .....	2.105
2.3.7.6	REF .....	2.106
2.3.7.7	STORE/RECALL .....	2.108
2.3.7.7.1	Storing Complete Instrument Settings .....	2.108
2.3.7.7.2	Storing RF Frequencies .....	2.109
2.3.7.8	Squelch Measurement .....	2.110
2.3.7.9	Bandwidth Measurement .....	2.111
2.3.7.10	Quieting Measurement .....	2.111
2.3.7.11	Aborting Search Routines .....	2.111.1
2.3.7.12	Selftest .....	2.111.1

2.3.8	SPEC Function .....	2.112
2.3.8.1	General Instrument Functions .....	2.112
2.3.8.2	Control Functions for the Option Autorun Control (A...SPEC) .....	2.116.1
2.3.8.3	Control Functions for the Option IEC Bus CM-B4 (B...SPEC) .....	2.119
2.3.8.4	Control Functions for Frequency Counter and CODE(DECODE) (C...SPEC) .....	2.120
2.3.8.5	Control Functions to Call Calibration Routines and the Self-test (D...SPEC) .....	2.125
2.3.8.6	Display of the Options Fitted .....	2.127
2.3.9	Oscilloscope .....	2.128
2.3.10	Autorun Control .....	2.130
2.3.10.1	Control Modes of the CMT with Autorun Control .....	2.130
2.3.10.2	Memory Allocation and Configuration of a Control Program .....	2.131
2.3.10.3	Generating a Control Program .....	2.132
2.3.10.3.1	Program Call/Program Termination .....	2.132
2.3.10.3.2	Storing the Commands .....	2.132
2.3.10.3.3	Selection of Program Lines/ Checking the Commands .....	2.133
2.3.10.3.4	Insertion of Commands .....	2.134
2.3.10.3.5	Deletion of Commands and Command Blocks .....	2.134
2.3.10.3.6	Representation of the Commands in the α Display .....	2.135
2.3.10.3.7	Program Example .....	2.136
2.3.10.4	Special Functions in Conjunction with Autorun Control .....	2.137
2.3.10.4.1	Measurement Tolerances .....	2.137
2.3.10.4.2	STOP Function .....	2.138.1
2.3.10.4.3	Conditional Program Continuation .....	2.139
2.3.10.4.4	Programming of Messages .....	2.140
2.3.10.4.5	Repetition of Program Blocks .....	2.144
2.3.10.5	Execution of a Control Program .....	2.145
2.3.10.5.1	Starting a Program .....	2.146
2.3.10.5.2	Program Interrupt .....	2.145
2.3.10.5.3	End of Program .....	2.145
2.3.10.5.4	Special Features During Program Run .....	2.146
2.3.10.6	Deletion of Programs/ Initialization of Autorun Control .....	2.147
2.3.10.7	List of Commands of Autorun Control .....	2.148

2.3.10.8	Printing of Test Logs / Program Listings .....	2.150
2.3.10.8.1	Facilities and Control of Printer Function ...	2.150
2.3.10.8.2	Program Listings .....	2.152
2.3.10.8.3	Test Logs .....	2.152
2.3.10.8.4	Error Handling .....	2.159
2.3.10.8.5	Printer Interface .....	2.159
2.3.10.9	Operation of Transfer Memory .....	2.160
2.3.10.9.1	Size of Transfer Memory Space .....	2.160
2.3.10.9.2	Initialization of Transfer Memory .....	2.160
2.3.10.9.3	Copying a Program from the CMT to the Transfer Memory .....	2.161
2.3.10.9.4	Copying a Program from the Transfer Memory to the CMT .....	2.163
2.3.10.9.5	Appending a Transfer Memory Program to a CMT Program .....	2.164
2.3.10.9.6	Deletion of a Transfer Memory Program .....	2.165
2.3.10.9.7	Display Directory of Transfer Memory .....	2.166
2.3.10.10	Control Instructions (Brief Summary) .....	2.167
2.4	IEC-bus Control .....	2.170
2.4.1	Introduction .....	2.170
2.4.2	General Command Entry .....	2.173
2.4.2.1	Entry of Numbers .....	2.175
2.4.3	Device-specific IEC-bus Commands .....	2.175
2.4.3.1	IEC-bus Commands of the CMT .....	2.178
2.4.4	Examples for IEC-bus Operation .....	2.186
2.4.5	Device-independent Commands .....	2.189
2.4.5.1	Service Request and Status Registers .....	2.190
2.4.6	Special Features of the CMT in Remote Mode .	2.193.1
2.4.6.1	Readout of Decoded Selective Call via IEC Bus / Autorun Control .....	2.193.1
2.4.6.2	PK HOLD Function via IEC Bus and Autorun Control .....	2.193.2
2.4.6.3	Automatic Background Calibration of the CMT	2.193.3
2.4.6.4	Waiting Times and Transient of the CMT in IEC-bus Programs .....	2.193.4
2.5	Installation of Options .....	2.194
2.5.1	IEC Bus and/or Autorun Control (CM-B4/CM-B5) .	2.194
2.5.2	OCXO Reference Oscillator (CMT-B1) .....	2.194
2.5.3	Adjacent-channel Power Meter (CMT-B6) .....	2.194
2.5.4	2nd AF Synthesizer (CMT-B7) .....	2.195
2.5.5	RF Millivoltmeter (CM-B8) .....	2.195
2.5.6	Duplex Modulation Meter (CM-B9) .....	2.195
2.5.7	DTMF Decoder (CM-B11) .....	2.196
2.5.8	Testing the Fitted Options .....	2.196

# Table of Contents

	Page
3	3.1
3.1	3.1
3.2	3.5
3.2.1	3.5
3.2.2	3.5
3.2.3	3.6
3.2.4	3.7
3.2.5	3.8
3.2.6	3.9
3.2.7	3.10
3.2.8	3.11
3.2.9	3.12
3.2.10	3.13
3.2.11	3.14
3.2.11.1	3.14
3.2.11.1.1	3.14
3.2.11.1.2	3.15
3.2.11.1.3	3.16
3.2.11.1.4	3.17
3.2.11.2	3.18
3.2.11.2.1	3.18
3.2.11.2.2	3.19
3.2.11.3	3.20
3.2.12	3.22
3.2.12.1	3.22
3.2.12.1.1	3.22
3.2.12.1.2	3.23
3.2.12.1.3	3.24
3.2.12.2	3.25
3.2.12.2.1	3.25
3.2.13	3.26
3.2.14	3.27
3.2.15	3.28
3.2.15.1	3.28
3.2.15.2	3.29
3.2.15.3	3.30
3.2.15.3.1	3.30
3.2.15.4	3.31
3.2.16	3.32
3.2.16.1	3.32
3.2.16.2	3.32
3.2.16.3	3.33
3.2.17	3.35
3.2.17.1	3.36
3.2.17.2	3.36
3.2.18	3.37
3.2.19	3.38



		Page
3.2.20	RF Counter .....	3.39
3.2.20.1	Counter Sensitivity at Connector RF IN/OUT <u>77</u>	3.39
3.2.20.2	Counter Sensitivity at Connector INPUT2 <u>79</u> ...	3.40
3.2.20.3	Counter Accuracy .....	3.41
3.2.21	Power Meter .....	3.42
3.2.21.1	VSWR of the Power Meter .....	3.43
3.2.22	Frequency Deviation Meter .....	3.44
3.2.22.1	300-Hz Highpass Filter .....	3.45
3.2.22.2	Residual FM of the Deviation Meter .....	3.46
3.2.23	Phase Deviation Meter .....	3.46
3.2.24	Modulation Depth Meter .....	3.47
3.2.24.1	Residual Modulation of the AM Meter .....	3.47
3.2.25	Oscilloscope (CMT Model 54, 58) .....	3.48
3.2.25.1	Frequency Response at Connector EXT .....	3.48
3.2.25.2	Measurement Dynamic Range at Input EXT .....	3.49
3.2.25.3	Oscilloscope Time Base .....	3.50
3.2.25.4	Representation of Internal Signals .....	3.50
3.2.26	DTMF Decoder (Option CM-B11) .....	3.51
3.2.27	Adjacent-channel Power Meter (Option CMT-B6) .	3.52
3.2.28	RF Millivoltmeter (Option CM-B8) .....	3.54
3.2.29	Autorun Control/Printer Interface (Option CM-B5) .....	3.56
3.2.29.1	Memory Function .....	3.56
3.2.29.2	Printer Function .....	3.58
3.2.29.3	Relay Functions .....	3.58
3.2.29.4	Battery .....	3.59
3.2.30	Transfer Memory (Accessory CM-Z1) .....	3.60
3.2.30.1	Memory Function .....	3.60
3.2.30.2	Battery .....	3.60
3.2.31	IEC Bus (Option CM-B4) .....	3.61
3.2.31.1	Listener Function .....	3.61
3.2.31.2	Talker Function .....	3.61
3.2.31.3	Relay Functions .....	3.62
3.3	Performance Test Report .....	3.63
3.4	Maintenance .....	3.74
3.4.1	Electrical Maintenance .....	3.74
3.4.2	Mechanical Maintenance .....	3.74
3.5	Storage .....	3.74

## 2 Preparations and Operation

The values specified in this section are not guaranteed; only the technical data on the data sheet are binding.



Section 2.1 "Switching-On" must be referred to before applying an operating voltage.

### 2.1 Switching-On

The radio test assembly CMT can be powered from the mains or from a battery.

The instrument is immediately set to standby mode when an operating voltage is applied. This has the advantage that the frequency accuracy and constancy of the reference crystal is unaffected by frequent switching on and off.

The CMT is switched on and off by pressing the STANDBY key.

#### 2.1.1 Mains Operation



Before connecting the power supply, ensure that the instrument is set to the correct operating voltage and that the correct fuse is fitted.

To change the value set in the factory, set the required voltage on selector 117 and replace the mains fuse 118.

The CMT can be connected to any power supply with a protective earth and a voltage of 100 V, 120 V, 220 V oder 240 V (rated value  $\pm 10\%$ ) at 50 to 440 Hz. The power consumption is approx. 100 VA in the basic design.

Fuses required: 100 V/120 V T4  
220 V/240 V T2



Certain parts of the instrument are in operation even in standby mode (temperature-controlled oscillator, option CMT-B1). Complete shut-down is obtained by isolating from the power supply.

## 2.1.2 Battery Operation

Battery mode is automatically selected if a voltage  $>11$  V (with simultaneous AC supply operation  $>24$  V) is applied to terminals 100.

The permissible voltage range is 11 to 30 V with a maximum current consumption of 16 A.

The battery input is protected against incorrect polarity and has a 16 A slow-blow fuse.



The CMT draws a small residual current from the battery even in standby mode (required for the reference crystal). In order to prevent battery discharge over a longer period, it is recommendable to disconnect the CMT from the battery.

## 2.2 Explanation of the Controls



### 2.2.1 Front Panel

(See Figs. 2-1 to 2-9 in the Appendix)

The front panel is divided into fields of different colours to facilitate operation of the instrument. The individual controls are described below in accordance with this division.

In addition to an item number, an unequivocal label is assigned to each control.

Item	Label	Designation and function
	<div style="border: 1px solid black; padding: 2px; display: inline-block;">Fig. 2-1</div> RF FREQUENCY AF	<b>Frequency field:</b>  → To set and measure all used frequencies.  → Alphanumeric display for various applications (code, alternative display, instrument messages).
<u>1</u>		<b>Frequency display:</b>  10-digit, for display of measured or set RF values.
<u>2</u>		<b>α display:</b>  14-digit, alphanumeric display for measured or set AF frequencies and selective call; additional display for instrument messages or for measured/setting values from other fields.
<u>3</u>		<b>Key acknowledgement:</b>  Appears above each key as long as the respective function is switched on.

Item	Label	Designation and function
<u>4</u>		<p>Red LED (transmitter test) Green LED (receiver test)</p> <p>The functions labelled in red are assigned to the keys if the red LED lights up.</p> <p>The functions labelled in green are assigned to the keys if the green LED lights up.</p> <p>Functions labelled in black are valid for transmitter and receiver tests.</p>
<u>5</u>	<p>COUNT f</p>  <p>f</p>	<p>COUNT f: (transmitter test)</p> <p>Switch on built-in RF counter.</p> <p>Output in the frequency display.</p> <p>Following each frequency count in transmitter test mode, the operating frequency is automatically set to the corresponding value.</p> <p>SET f RX: (receiver test)</p> <p>Set output frequency of RF test transmitter to fixed value.</p> <p>Output in the frequency display.</p>
<u>6</u>	<p>f SET</p>  <p>Δf</p>	<p>SET f TX: (transmitter test)</p> <p>Transmitter test operating frequency set to fixed values.</p> <p>Output in the frequency display.</p> <p>Δf: (receiver test)</p> <p>Setting of channel spacing (important with ACP measurement).</p> <p>Output in the α display.</p>

Item	Label	Designation and function
<u>7</u>	DECODE <input type="checkbox"/> CODE	<p><b>DECODE:</b> (transmitter test)</p> <p>Switch on tone sequence evaluation circuit. The contents of a received data message are output in the <math>\alpha</math> display.</p> <p><b>CODE:</b> (receiver test)</p> <p>Transmit data message to device under test. The contents of the transmitted message are output in the <math>\alpha</math> display.</p>
<u>8</u>	DEMOD·BEAT <input type="checkbox"/> AF EXT	<p><b>DEMOD·BEAT:</b> (transmitter test)</p> <p>The demodulated AF is measured if this key is pressed once ("DEMOD" is output in front of the measured value in the <math>\alpha</math> display as an identification).</p> <p>The BEAT measurement (counting of difference between operating and input frequencies of the CMT) can be called by pressing the key again, provided function SET f TX is active ("BEAT" and measured value in the <math>\alpha</math> display).</p> <p>Switch off BEAT function by pressing the same key again or by pressing a key in the modulation field (Fig. 2-3).</p> <p><b>AF EXT:</b> (receiver test)</p> <p>Measure frequency at input AF VOLTM. <u>84</u>. Output in the <math>\alpha</math> display.</p>
<u>9</u>	AF INT <input type="checkbox"/> 1	<p><b>AF INT 1:</b> (transmitter/ receiver test)</p> <p>Set modulation generator frequency 1. Output in the <math>\alpha</math> display.</p>

Item	Label	Designation and function
<u>10</u>	AF INT <input data-bbox="295 353 359 392" type="checkbox"/> 2	AF INT 2:            (transmitter/ receiver test)  Set modulation generator frequency 2 (only with option CMT-B7 fitted).  Output in the $\alpha$ display.

Item	Label	Designation and function
	<div data-bbox="240 271 456 331" style="border: 1px solid black; padding: 2px; width: fit-content; margin-bottom: 10px;">Fig. 2-2</div> <p data-bbox="363 376 528 439">RF POWER RF LEVEL</p>	<p data-bbox="659 282 951 309"><b>RF level field:</b></p> <p data-bbox="659 376 1238 439">For setting and measurement of used RF levels such as:</p> <ul style="list-style-type: none"> <li data-bbox="659 472 1334 499">→ RF output level of test generator</li> <li data-bbox="659 504 1278 530">→ RF output power of transceiver</li> <li data-bbox="659 535 1238 562">→ Results of RF millivoltmeter</li> <li data-bbox="659 566 1238 629">→ Adjacent-channel power ratio (option CMT-B6)</li> </ul>
<u>12</u>		<p data-bbox="659 730 983 757"><b>RF level display:</b></p> <p data-bbox="659 790 1350 853">3 1/2-digit, for display of RF level in W, dBm, V and dBμV.</p>
<u>13</u>		<p data-bbox="659 954 927 981"><b>Analog display</b></p> <p data-bbox="659 1014 1414 1111">Quasi-analog output of the RF level display of measured values (see Section 2.3.7.5 for deviations).</p>
<u>14</u>	<p data-bbox="363 1200 456 1227">POWER</p> <div data-bbox="363 1249 432 1290" style="border: 1px solid black; width: 20px; height: 10px; background: repeating-linear-gradient(45deg, transparent, transparent 2px, black 2px, black 4px); margin: 2px 0;"></div> <p data-bbox="363 1301 392 1328">V<sub>0</sub></p>	<p data-bbox="659 1200 1302 1227"><b>POWER:</b> (transmitter test)</p> <p data-bbox="659 1261 1254 1323">Call RF power measurement. Output in the RF level display.</p> <p data-bbox="659 1391 1270 1417"><b>V<sub>0</sub> SYNTH.:</b> (receiver test)</p> <p data-bbox="659 1451 1334 1547">This key can be used to adjust the output level of the RF generator in the CMT.</p> <p data-bbox="659 1581 1254 1608">Output in the RF level display.</p> <p data-bbox="659 1641 1430 1771">The analog display indicates the levels at which the RF attenuation set switches (with short interruption in output signal).</p>



Item	Label	Designation and function
<u>15</u>	ACP <input type="checkbox"/> +6 dB	<p><b>ACP:</b> (transmitter test)</p> <p>Call adjacent-channel power measurement. The ratio of the interfering noise in the upper or lower and 1st or 2nd adjacent channels is measured (option CMT-B6). The selective RF millivoltmeter is switched on via <input type="checkbox"/> 0 <input type="checkbox"/> ACP .</p> <p>Output in the RF level display.</p> <p><b>V<sub>0</sub> SYNTH. +6 dB:</b> (receiver test)</p> <p>The level of the RF generator is increased by 6 dB when this key is pressed. The original value is set again by pressing the key again.</p> <p>Key selection indicated by bar.</p>
<u>16</u>	V <sub>0</sub> OFF <input type="checkbox"/> V <sub>0</sub> OFF	<p><b>V<sub>0</sub> OFF:</b></p> <p>The RF synthesizer can be switched off using this key in both the transmitter and receiver tests.</p> <p>Key selection indicated by bar.</p>
<u>17</u>	PROBE <input type="checkbox"/> PROBE	<p><b>PROBE:</b></p> <p>Call RF level measurement with millivoltmeter (option CM-B8).</p> <p>Output in the RF level display.</p>

Item	Label	Designation and function
<div style="border: 1px solid black; padding: 2px; width: fit-content; margin-bottom: 5px;">Fig. 2-3</div>	DEMODULATION MODULATION	<p><b>Modulation field:</b></p> <p>The transmitter modulation analysis (transmitter test, DEMOD function) and the test generator modulation setting (receiver test, MOD function) are combined here. The CMT mode determines the unit displayed in this field, where <math>\%</math> stands for AM, kHz or Hz for FM and rad for <math>\phi</math>M.</p>
<u>21</u>		<p><b>Modulation display:</b></p> <p>3 1/2-digit, for display of the modulation depth in <math>\%</math>, kHz, Hz or rad, or the modulation distortion in <math>\%</math> (dB).</p>
<u>22</u>		<p><b>Analog display</b></p> <p>Quasi-analog output of the results in the modulation display (see Section 2.3.7.5 for deviations).</p>
<u>23</u>	MAX PK  INT 1	<p><b>MAX PK:</b> (transmitter test)</p> <p>Call modulation measurement. The maximum value is output in the modulation display. By entering a unit, the test set modulation (AM, FM, <math>\phi</math>M) is determined in both the transmitter and receiver tests.</p> <p>Output in the modulation display.</p> <p><b>INT 1:</b> (receiver test)</p> <p>The modulation depth of the RF generator can be displayed and modified via the built-in first AF generator using this key. Additional entry of a unit determines the test set modulation (AM, FM, <math>\phi</math>M) both in the transmitter and receiver tests.</p> <p>Output in the modulation display.</p>

Item	Label	Designation and function
<p><u>24</u></p>	<p>+ ±/2 -</p> <p><input type="checkbox"/></p> <p>INT 2</p>	<p><b>POLARITY SELECT:</b> (transmitter test)</p> <p>Call modulation measurement. The positive or negative peak can be specifically evaluated by pressing the key (several times if necessary), or the mean peak modulation can be evaluated.</p> <p>Sequence: <span style="border: 1px solid black; padding: 2px 10px;">→ + → ±/2 → - →</span></p> <p style="text-align: center;">←</p> <p>An entered unit is ignored since this is only determined by MAX PK or INT 1.</p> <p>Output in the modulation display.</p> <p><b>INT 2:</b> (receiver test)</p> <p>The modulation of the test generator can be displayed and modified via the second AF generator (option CMT-B7) using this key.</p> <p>Two-tone modulation is only possible with INT 1, i.e. the unit and thus the type of modulation is determined by INT 1.</p> <p>Output in the modulation display.</p>

Item	Label	Designation and function
<u>25</u>	PK HOLD <input data-bbox="368 344 432 383" type="checkbox"/> EXT	<p><b>PK HOLD:</b> (transmitter test)</p> <p>This function is used to detect the maximum of short modulation peaks and can be switched on and off using this key.</p> <p>Key selection indicated by bar.</p> <p><b>EXT:</b> (receiver test)</p> <p>This key can be used to modulate the test generator with a signal applied to the MOD EXT jack. AM + FM/PM is possible in addition to two-tone and double modulation.</p> <p>The type of modulation is determined for INT 1 and INT 2 by the unit of INT 1 and MAX PK respectively, for EXT by the entered unit.</p> <p>Output in the modulation display.</p>
<u>26</u>	DIST <input data-bbox="360 1200 424 1238" type="checkbox"/> OFF	<p><b>DIST:</b> (transmitter test)</p> <p>Measurement of the transmitter modulation distortion is called using the DIST key. The display is in % or dB (selectable via unit).</p> <p>Output in the modulation display.</p> <p><b>MOD OFF:</b> (receiver test)</p> <p>Used to switch off the test transmitter modulation.</p> <p>Key selection indicated by bar.</p>

Item	Label	Designation and function
<u>27</u>	HP <input type="checkbox"/> 1 V <sub>RMS</sub>	<p>HP: (transmitter test)</p> <p>A 300 Hz highpass filter is connected in series with the demodulators using this key (e.g. to suppress pilot tones).</p> <p>Key selection indicated by bar.</p> <p>1 V<sub>RMS</sub>: (receiver test)</p> <p>After pressing this key, the displayed EXT modulation corresponds to a reference level of V<sub>RMS</sub> at connector MOD EXT <u>82</u>.</p> <p>Key selection indicated by bar.</p>
<u>28</u>	CCITT <input type="checkbox"/> EXT CAL	<p>CCITT TX: (transmitter test)</p> <p>A weighting filter to CCITT guidelines is switched into the demodulation branch using this key. Interaction with the CCITT RX function results.</p> <p>Key selection indicated by bar.</p> <p>EXT CAL: (receiver test)</p> <p>The AF voltage at input MOD EXT is measured by pressing the key EXT CAL and an internal calibration is carried out if it is different from the reference level 1 V<sub>RMS</sub>.</p> <p>Key selection indicated by bar.</p>

Item	Label	Designation and function
	<div data-bbox="236 264 450 331" style="border: 1px solid black; padding: 2px; display: inline-block;">Fig. 2-4</div> MODULATION GEN AF VOLTMETER	<p><b>AF level field:</b></p> <p>The analysis of the AF signal applied to connector AF VOLTM and the setting of the modulation generator level at connector MOD GEN are combined here.</p>
<u>30</u>		<p><b>AF level display:</b></p> <p>3 1/2-digit, for output of modulation generator output level or AF input level / SINAD / DIST / S/N.</p>
<u>31</u>		<p><b>Analog display:</b></p> <p>Quasi-analog representation of the results in the AF level display (see Section 2.3.7.5 for deviations).</p>
<u>32</u>	<p><math>V_0</math></p> <div data-bbox="363 1120 427 1160" style="border: 1px solid black; width: 40px; height: 18px; background: repeating-linear-gradient(45deg, transparent, transparent 2px, black 2px, black 4px);"></div> <p>LEVEL</p>	<p><b><math>V_0</math> MOD GEN:</b> (transmitter test)</p> <p>Adjustment and display of output level at connector MOD GEN.</p> <p>If the 2nd modulation generator option is fitted, a double tone can be generated at connector MOD GEN using a SPEC function.</p> <p>Output in the AF level display.</p> <p><b>AF-LEVEL:</b> (receiver test)</p> <p>Call AF level measurement at connector AF VOLTM.</p> <p>Output in the AF level display.</p>

Item	Label	Designation and function
<u>33</u>	+20 dB <input type="checkbox"/> SINAD·DIST	<p><b>V<sub>0</sub> MOD +20 dB:</b> (transmitter test)</p> <p>The level at connector MOD GEN can be increased by a factor of 10. The factor is cancelled by pressing the key again.</p> <p>Key selection indicated by bar.</p> <p><b>SINAD·DIST:</b> (receiver test)</p> <p>In order to measure the receiver SINAD value with a defined test generator level, it is sufficient to simply press the SINAD·DIST key once.</p> <p>The receiver distortion is displayed if this key is pressed again.</p> <p>If a number is entered before the SINAD·DIST key is pressed (unit dB), the test generator output level is changed until the SINAD result reaches the set value.</p> <p>If the unit for the numeric input is <math>\mu</math>, the DIST measurement is called instead of the SINAD measurement.</p> <p>Output in the AF level display.</p>
<u>34</u>	<input type="checkbox"/> S/N	<p><b>S/N:</b> (receiver test)</p> <p>The signal-to-noise ratio is called.</p> <p>If a number is entered before the S/N key is pressed (unit dB), the test generator output level is changed until the S/N result reaches the set value.</p> <p>Output in the AF level display.</p>

Item	Label	Designation and function
<u>35</u>	V <sub>0</sub> OFF <input data-bbox="371 342 435 376" type="checkbox"/> V <sub>0</sub> OFF	V <sub>0</sub> OFF: (transmitter/ receiver test)  Switch-off of modulation generator.  Key selection indicated by bar.
<u>36</u>	<input data-bbox="371 600 435 633" type="checkbox"/> CCITT	CCITT RX: (receiver test)  A weighting filter to CCITT guidelines located before the AF voltmeter is switched on or off using this key.  The function alternates with the CCIFF TX function.  Key selection indicated by bar.



Item	Label	Designation and function										
	<div style="border: 1px solid black; padding: 2px; display: inline-block;">Fig. 2-5</div>	<p><b>Numeric field:</b></p> <p>Numeric keypad to enter any numbers (up to 25 digits).</p>										
<u>39</u>	<div style="border: 1px solid black; padding: 2px; display: inline-block;">0</div> ... <div style="border: 1px solid black; padding: 2px; display: inline-block;">9</div>	<p><b>Numbers 0 to 9 for all inputs</b></p>										
<u>40</u>	<div style="border: 1px solid black; padding: 2px; display: inline-block;">-</div> * E	<p><b>Minus sign:</b></p> <p>(A number is always positive if the minus sign is not entered)</p> <p><b>Input of tone sequences:</b></p> <p>* With code DTMF  E With all other codes</p>										
<u>41</u>	<div style="border: 1px solid black; padding: 2px; display: inline-block;">.</div> # F	<p><b>Decimal point:</b></p> <p><b>Input of tone sequences:</b></p> <p># With code DTMF  F With all other codes</p>										
<u>42</u>	MHz mV % <div style="border: 1px solid black; padding: 2px; display: inline-block; width: 20px; height: 10px;"></div> A	<p><b>Dimension key:</b></p> <table style="width: 100%; border-collapse: collapse;"> <tr> <td style="width: 70%;">Frequency</td> <td>MHz</td> </tr> <tr> <td>Level</td> <td>mV</td> </tr> <tr> <td>Modulation</td> <td>% (AM)</td> </tr> <tr> <td>Distortion</td> <td>%</td> </tr> <tr> <td>Code</td> <td>A</td> </tr> </table>	Frequency	MHz	Level	mV	Modulation	% (AM)	Distortion	%	Code	A
Frequency	MHz											
Level	mV											
Modulation	% (AM)											
Distortion	%											
Code	A											
<u>43</u>	kHz $\mu$ V W <div style="border: 1px solid black; padding: 2px; display: inline-block; width: 20px; height: 10px;"></div> B	<p><b>Dimension key:</b></p> <table style="width: 100%; border-collapse: collapse;"> <tr> <td style="width: 70%;">Frequency</td> <td>kHz</td> </tr> <tr> <td>Level</td> <td><math>\mu</math>V</td> </tr> <tr> <td>Modulation</td> <td>kHz (FM)</td> </tr> <tr> <td>Power</td> <td>W</td> </tr> <tr> <td>Code</td> <td>B</td> </tr> </table>	Frequency	kHz	Level	$\mu$ V	Modulation	kHz (FM)	Power	W	Code	B
Frequency	kHz											
Level	$\mu$ V											
Modulation	kHz (FM)											
Power	W											
Code	B											

Item	Label	Designation and function
<u>44</u>	Hz dB $\mu$ V <input type="checkbox"/> C	<b>Dimension key:</b>  Frequency      Hz Level            dB $\mu$ V Modulation      Hz (FM) Code             C
<u>45</u>	dB dBm rad <input type="checkbox"/> D	<b>Dimension key:</b>  Level            dBm (50 $\Omega$ RF, 600 $\Omega$ AF) Power            dBm Modulation      rad ( $\phi$ M) Code             D
<u>46</u>	VAR	<b>Spin wheel:</b>  Any set value can be varied using the tuning knob. The step size can be set as required using the $\Delta$ VAR key.  The spin wheel is always assigned to the last setting.
<u>47</u>	LOCAL <input type="checkbox"/>	<b>LOCAL:</b>  The CMT can be switched from REMOTE mode back to manual operation using this key.
<u>48</u>	REMOTE	<b>REMOTE:</b>  The CMT only accepts commands via the IEC bus if the REMOTE LED lights up, the front panel keys, except LOCAL are disabled.

Item	Label	Designation and function
<u>49</u>	CLEAR <input data-bbox="304 309 363 344" type="checkbox"/>	<p><b>CLEAR:</b></p> <p>A command can be aborted using the CLEAR key as long as it is incomplete (terminating key not yet pressed).</p> <p>Certain functions (such as ANALOG SELECT, ΔVAR, REF) can be switched off by subsequently pressing the CLEAR key.</p>
<u>50</u>	RANGE HOLD <input data-bbox="304 725 363 761" type="checkbox"/>	<p><b>RANGE HOLD:</b></p> <p>This key can be used to fix the measuring range of the analog displays to a desired value.</p> <p>The AUTO RANGE function then has no effect.</p>
<u>51</u>	ANALOG SELECT <input data-bbox="304 1084 363 1120" type="checkbox"/>	<p><b>ANALOG SELECT:</b></p> <p>In conjunction with certain terminating keys (call of measurements), this key enables analog displays to be used independent of the associated digital displays.</p> <p>Function cleared using:</p> <div style="display: flex; justify-content: space-around; align-items: center;"> <div style="border: 1px solid black; padding: 2px 10px;">ANALOG SELECT</div> <div style="border: 1px solid black; padding: 2px 10px;">CLEAR</div> <div style="border: 1px solid black; padding: 2px 10px;">Terminating key</div> </div>
<u>52</u>	α-DISPL SELECT <input data-bbox="304 1568 363 1603" type="checkbox"/>	<p><b>α-DISPL SELECT:</b></p> <p>In conjunction with certain terminating keys (settings) this key enables the display to be transferred to the α display.</p> <p>The display which has now become free can be used for other measurements or settings.</p> <p>Function cleared by pressing a key in frequency field which uses the α display.</p>

Item	Label	Designation and function
<u>53</u>	Δ VAR <input data-bbox="376 327 437 367" type="checkbox"/>	<p><b>ΔVAR:</b></p> <p>By entering ΔVAR before certain terminating keys (settings), the spin wheel increment is set to the last entered value.</p> <p>Exception: In the case of frequency settings for AF INT 1 and AF INT 2, a series of fixed frequencies is used as the default step size and not the minimum increment.</p> <p>The parameter increment can be freely selected by additional entry of a number.</p>
<u>54</u>	REF <input data-bbox="368 965 429 1005" type="checkbox"/>	<p><b>REF:</b></p> <p>In conjunction with certain terminating keys (settings and measurements), the result (or set parameter) is displayed referred to a reference value by pressing the REF key. The reference value is either the current value in the display or an entered value.</p>
<u>55</u>	SPEC <input data-bbox="365 1352 426 1393" type="checkbox"/>	<p><b>SPEC:</b></p> <p>Certain functions are combined using this key in conjunction with command numbers (see Section 2.3.8).</p>

Item	Label	Designation and function
<u>56</u>	STORE <input data-bbox="300 297 360 331" type="checkbox"/>	<b>STORE:</b> Used to store complete instrument settings (in conjunction with memory numbers) or individual parameters. See Section 2.3.10 for particular function with the AUTOTEST function.
<u>57</u>	RECALL <input data-bbox="300 622 360 656" type="checkbox"/>	<b>RECALL:</b> Used to recall stored instrument settings.





Item	Label	Designation and function
	<div style="border: 1px solid black; padding: 2px; display: inline-block;">Fig. 2-6</div>	<p><b>Changeover:</b> (transmitter/ receiver test)</p> <p>Changeover of all settings or of individual fields.</p>
<u>58</u>	XMITTER	<p><b>XMITTER TEST LED:</b></p> <p>Lights up if the CMT is in transmitter test mode.</p>
<u>59</u>	RECEIVER	<p><b>RECEIVER TEST LED:</b></p> <p>Lights up if the CMT is in receiver test mode.</p>
<u>60</u>	XMITTER <input type="checkbox"/> TEST RECEIVER	<p><b>TXRX key:</b></p> <p>For manual changeover from transmitter test to receiver test and vice versa.</p>
<u>61</u>	LOCK	<p><b>LOCK LED:</b></p> <p>The CMT remains in the current mode (transmitter or receiver test) irrespective of the entered RF power as long as this LED lights up.</p>
<u>62</u>	LOCK <input type="checkbox"/>	<p><b>LOCK key:</b></p> <p>To define the mode (transmitter or receiver test) independent of the applied RF power.</p> <p>The function is cleared by pressing the key again.</p>





Item	Label	Designation and function
<u>63</u>	ACK TEST	<p><b>ACK TEST LED:</b></p> <p>Lights up if the ACK TEST function is activated.</p>
<u>64</u>	ACK TEST <input data-bbox="279 510 339 544" type="checkbox"/>	<p><b>ACK TEST key:</b></p> <p>The CMT is prepared for measurement of transient data messages of the transceiver at the start of each transmission by pressing the ACK TEST key (acknowledgement call test).</p> <p>(PK HOLD, SET f TX, DECODE and LOCK are automatically activated when switching from RX to TX test.)</p>
<u>65</u>	DISPLAY CHANGE <input data-bbox="279 992 339 1025" type="checkbox"/>	<p><b>DISPLAY CHANGE:</b></p> <p>This key is used together with the dark grey keys (items <u>5</u>, <u>14</u>, <u>23</u>, <u>32</u>) to change the operating mode of the respective field (transmitter test ↔ receiver test).</p>

Item	Label	Designation and function
	<div style="border: 1px solid black; padding: 2px; display: inline-block;">Fig. 2-7</div>	<p><b>AUTOTEST:</b></p> <p>All controls for automatic mode are combined in this field (option CM-B5).</p>
<u>66</u>	START	<p><b>START LED:</b></p> <p>The LED above the START key lights up when a test program is running.</p>
<u>67</u>	START <input data-bbox="368 741 432 786" type="checkbox"/>	<p><b>START key:</b></p> <p>Start programmed measuring sequences. A start address must always be entered.</p>
<u>68</u>	CONT <input data-bbox="368 965 432 1010" type="checkbox"/>	<p><b>CONT:</b></p> <p>A program which has been interrupted can be continued by pressing the CONT key.</p>
<u>69</u>	STOP	<p><b>STOP LED:</b></p> <p>This LED lights up when a test program is interrupted.</p>
<u>70</u>	STOP <input data-bbox="360 1447 424 1491" type="checkbox"/>	<p><b>STOP key:</b></p> <p>This key is used to interrupt a test program. The STOP and START LEDs light up simultaneously when pressed once and the program can be processed further using CONT.</p> <p>The AUTOTEST function is switched off by pressing the STOP key twice. The test program can be called again using START.</p>







Item	Label	Designation and function
<u>71</u>	PRINT	<p><b>PRINT LED:</b></p> <p>This LED lights up as long as data are output to the printer port.</p>
<u>72</u>	PRINT <input data-bbox="280 555 341 591" type="checkbox"/>	<p><b>PRINT key:</b></p> <p>Program listings or test logs can be output on a printer (Centronics interface) using this key.</p>
<u>73</u>	TOL IN OUT	<p><b>TOL IN/OUT LED, TOL LIMITS:</b></p>
<u>74</u>	UPPER <input data-bbox="280 994 341 1030" type="checkbox"/>	<p>An upper tolerance limit can be set during programming of a test program using the UPPER TOL key and a lower tolerance limit using the LOWER TOL key.</p>
<u>75</u>	LOWER <input data-bbox="280 1184 341 1220" type="checkbox"/>	<p>The TOL OUT LED lights up and the program is stopped if a measured value is outside the defined range, otherwise the TOL IN LED lights up whilst the program is running.</p>

Item	Label	Designation and function
	<div style="border: 1px solid black; padding: 2px; width: fit-content; margin: 0 auto;">Fig. 2-8</div>	<p><b>Connector strip:</b></p> <p>This field contains the most important connections for the device under test and a number of control keys.</p>
<u>76</u>		<p><b>Loadspeaker:</b></p> <p>For monitoring various AF signals (demodulated signals, BEAT, signals at the AF VOLTM input) depending on the assignment of the AF meter to AF signals.</p>
<u>77</u>	RF  50 Ω 50 W <sub>MAX</sub> 	<p><b>RF IN/OUT:</b></p> <p>Usually connected to the antenna connector of the transceiver.</p>
<u>78</u>	INPUT SELECT 	<p><b>INPUT SELECT:</b></p> <p>Selection of required input (RF IN/OUT ↔ INPUT 2).</p> <p>The selected input is displayed by the LED next to the INPUT SELECT key.</p>
<u>79</u>	INPUT 2 ~50 Ω 	<p><b>INPUT 2:</b></p> <p>Second RF input for low input powers (especially for remote measurements).</p>
<u>80</u>	NARROW 	<p><b>NARROW:</b></p> <p>Connection of a narrowband IF filter into the demodulation branch to increase the selectivity (indicated by the LED above the key).</p>

Item	Label	Designation and function
81	DEMOD SIGNAL 	<b>DEMOD SIGNAL:</b>  Output connector for the demodulated AF signal.
82	MOD EXT 10 k $\Omega$ 	<b>MOD EXT:</b>  Input connector for external modulation signals.
83	MOD GEN ~0 $\Omega$ 	<b>MOD GEN:</b>  Output connector of the AF generator.
84	AF VOLTM >100 k $\Omega$ 	<b>AF VOLTM:</b>  The level, distortion and S/N ratio of an AF signal connected to this input connector are analyzed. The frequency of the input signal can also be measured.
85	RF PROBE 	<b>RF PROBE:</b>  Connector for the various RF millivoltmeter probes (option CM-B8).
86	MEMORY	<b>MEMORY:</b>  Connector for accessory "Transfer memory" (CM-Z1) (used to transfer test programs between various CMTs).
87	VOLUME	<b>Volume control</b>

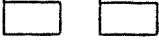

Item	Label	Designation and function
<u>88</u>	STANDBY	<p><b>STANDBY LED:</b></p> <p>The LED lights up if the complete instrument is switched off except for the crystal reference (STANDBY mode).</p>
<u>89</u>	STANDBY <input data-bbox="379 607 443 645" type="checkbox"/> ON	<p><b>STANDBY key:</b></p> <p>The instrument is switched on and off by pressing the STANDBY key.</p>

Item	Label	Designation and function													
	<div style="border: 1px solid black; padding: 2px; display: inline-block;">Fig. 2-9</div>	<p><b>Oscilloscope:</b> (model 54)</p>													
<u>90</u>		<p><b>Oscilloscope screen:</b></p> <p>Display of various AF signals.</p> <p>The horizontal and vertical screen scales are also output on the screen.</p>													
<u>91</u>	<table style="border: none; width: 100%;"> <tr> <td style="padding-right: 10px;">AC</td> <td rowspan="2" style="font-size: 2em; vertical-align: middle;">}</td> <td rowspan="2" style="vertical-align: middle;">EXT</td> </tr> <tr> <td>DC</td> </tr> <tr> <td colspan="3" style="padding: 10px 0 0 20px;"> </td> </tr> <tr> <td style="padding-right: 10px;">BEAT</td> <td rowspan="4" style="font-size: 2em; vertical-align: middle;">}</td> <td rowspan="4" style="vertical-align: middle;">INT</td> </tr> <tr> <td>DEMOD</td> </tr> <tr> <td>AF</td> </tr> <tr> <td>AUTO</td> </tr> </table>	AC	}	EXT	DC				BEAT	}	INT	DEMOD	AF	AUTO	<p><b>Status line:</b></p> <p>The oscilloscope can display signals from various sources. A mark appears in the status line on the oscilloscope above the selected source.</p> <p>AC/DC corresponds to external mode with input signals connected to the EXT connector.</p> <p>BEAT, DEMOD and AF are internal signals corresponding to the measured values displayed in the respective fields.</p> <p>In AUTO position, either the BEAT, DEMOD or AF signal is output on the screen depending on which signal was applied to the AF counter via key <u>8</u>.</p>
AC	}	EXT													
DC															
BEAT	}	INT													
DEMOD															
AF															
AUTO															
<u>92</u>	<p>+</p> <div style="border: 1px solid black; width: 20px; height: 10px; margin: 5px auto;"></div>	<p><b>Mode keys:</b></p> <p>Used to select the various input signals identified in the status line (autorepeat).</p>													
<u>93</u>	<p>+</p> <div style="border: 1px solid black; width: 20px; height: 10px; margin: 5px auto;"></div>	<p>Acknowledgement as described for item <u>91</u> via a mark on the oscilloscope screen.</p>													

Item	Label	Designation and function
<u>94</u>	++    ++  TIME/DIV	<p><b>Horizontal deflection:</b></p> <p>The horizontal deflection coefficient can be changed using the TIME/DIV keys. The selected deflection coefficient is output on the screen (autorepeat).</p>
<u>95</u>	↓    ↑ ↑    ↓  AMPLITUDE/DIV	<p><b>Vertical deflection:</b></p> <p>Function corresponding to item <u>94</u> for vertical deflection.</p>
<u>96</u>	BEST RANGE INT 	<p><b>BEST RANGE INT:</b></p> <p>If the oscilloscope outputs AF or DEMOD, the optimum vertical deflection is set by briefly pressing this key.</p> <p>(Only with current level or modulation measurement.)</p> <p>The yellow LED lights up if this key is pressed longer (&gt;0.3 s) and the vertical deflection is continuously matched to the represented signal.</p> <p>This function is switched off by pressing briefly again or by switching off the AF level / modulation measurement.</p>
<u>97</u>	EXT 1 MΩ 	<p><b>INPUT EXT:</b></p> <p>Maximum permissible voltage 100 V(V<sub>pp</sub>).</p>
<u>98</u>	Y POS	<p><b>Controller:</b></p> <p>To shift the beam in the vertical direction.</p>

**2.2.2 Rear Panel**  
 (See Fig. 2-10 in the Appendix)

Item	Label	Designation and function
<div style="border: 1px solid black; padding: 2px; width: fit-content; margin: 5px auto;">Fig. 2-10</div>		<p>→ <b>Connectors</b></p> <p>for power supply,            printer, (option CM-B5)            process controller, (option CM-B4)            other test devices            (spectrum analyzer or similar)</p> <p>→ <b>Control outputs</b> of the CMT</p>
<p><u>100</u></p>	<p>11...30            VDC</p> <p>○ ○            (⊥) +</p>	<p><b>Battery terminals:</b></p> <p>Connection for any power source with            an output voltage of 11 to 30 V DC            and of sufficient power (approx. 70 W            depending on configuration).</p>
<p><u>101</u></p>	<p>T 16,0</p>	<p><b>Battery fuse:</b></p> <p>A 16 A fuse is provided according to            the maximum current (at minimum            operating voltage).</p>
<p><u>102</u></p>	<p>PRINTER            PARALLEL            INTERFACE</p>	<p><b>Printer output:</b> (Centronics, parallel)            (Only if option CM-B5 is fitted)</p>
<p><u>103</u></p>	<p>⎓ IEC 625 ⎓</p>	<p><b>Connection for IEC bus:</b>            (Only if option CM-B4 is fitted)</p>

Item	Label	Designation and function
<u>109</u>	REF 10 MHz 0 dBm 	The 10-MHz reference signal for synchronization of further instruments can be coupled out at this connector or can be coupled in from an external source (input/output controllable using SPEC function; level >100 mV, max. TTL level).
<u>110</u>	RF POWER INDICATION (TTL) 	A High potential (TTL level) at this connector indicates that an RF signal with a sufficient level for transmitter/receiver test changeover is present at RF IN/OUT <u>77</u> .
<u>111</u>	RF -30 dB 	Bidirectional RF connector for other instruments such as the 2nd test generator (for two-signal measurements) or spectrum analyzer. The connection between the input RF IN/OUT <u>77</u> and RF 30 -dB corresponds to a 30 dB attenuator.
<u>112</u>	FOCUS	<b>Focus control</b> for the oscilloscope (model 54)
<u>113</u>	INTENSITY	<b>Intensity control</b> for the oscilloscope (model 54)
<u>114</u>		<b>Blower:</b>  The CMT must be adequately cooled since the output power of the transceiver tested must be converted into heat in addition to the power loss of the CMT during operation. The air flow along the rear of the instrument, through the holes at the sides and behind the fan must remain unhindered at all times.



Item	Label	Designation and function
<u>115</u>	CONTROL B	<p>8 programmable control outputs (only if option CM-B4 is fitted).</p> <p>All switches are floating (relays) with a max. switching load of 25 V/0.25 A.</p> <p>If required, the make contact can be replaced by a changeover contact.</p>
<u>116</u>	CONTROL A	<p>3 programmable control outputs (only if option CM-B5 is fitted).</p> <p>Design as in item <u>115</u>.</p>
<u>117</u>	100/120 V 220/240 V	<p><b>Voltage selector:</b></p> <p>For matching to the local power supply.</p>
<u>118</u>	T 4 T 2	<p><b>Power fuse:</b></p> <p>The fuse fitted depends on the local power supply:</p> <p>T 4 A with 100/120 V T 2 A with 220/240 V</p>
<u>119</u>	47...420 Hz	<b>Power connection</b>

## 2.3 Manual Operation

The terms used in this section and in the following sections for the controls and displays largely correspond to the labelling on the front panel. Certain designations which would not be clearly enough emphasized in the text (no coloured printing) have been replaced by the terms defined in Section 2.2.

### 2.3.1 General Operating Notes

#### 2.3.1.1 Switch-on Status, Permanent Memory and Master Reset

The instrument automatically enters standby mode when an operating voltage (AC supply or battery) is applied and the STANDBY LED 88 lights up. If the instrument is fitted with a temperature-controlled reference oscillator (OCXO), the reference crystal is already now in operation.

The complete instrument is switched on if the STANDBY key 89 is pressed.

All front-panel displays (LEDs and LCD segments) are switched on for testing for the first half of the self-test routine which the instrument carries out during each switch-on phase. All displays are switched off again after approx. 1 second.

Continuation of the self-test is signalled in the  $\alpha$  display 2 and the IEC-bus address is output in the frequency display 1 provided the IEC-bus option CM-B4 is fitted.

The CMT outputs "CMT OK" in the  $\alpha$  display 2 if the self-test has been completed without faults and the display illumination is switched on. The CMT subsequently assumes the following defined switch-on status:

- Operating mode: Transmitter test
- Demodulation : FM

**Results / setting parameters in the displays:**

Frequency display <u>1</u>	Output frequency of device under test (if the input signal is of sufficient magnitude, the RF frequency meter sets the operating frequency of the fully automatic modulation meter)
$\alpha$ display <u>2</u>	Frequency of the modulation generator
RF level display <u>12, 13</u>	RF power of device under test
Modulation display <u>21, 22</u>	Modulation meter The type of modulation is defined by the dimension in this field (kHz corresponds to FM, %AM, rad $\phi$ M)
AF level display <u>30</u>	Output level of the modulation generator

or:

- Operating mode: receiver test

**Results / setting parameters in the displays:**

Frequency display <u>1</u>	Output frequency of RF signal generator
$\alpha$ display <u>2</u>	Frequency of modulation generator 1
RF level display <u>12</u>	Output level of RF signal generator
RF level display <u>13</u>	Position of the electronic level control in the attenuator of the RF signal generator (see also Sections 2.3.1.5, 2.3.4.2)
Modulation display <u>21</u>	Modulation of the RF signal generator. The type of modulation is determined by the dimension in this field (kHz corresponds to FM)
AF level display <u>30, 31</u>	AF level at connector AF VOLTM <u>84</u>

In order to ensure clear operation, the display assignment is fixed as described in the switch-on status.

All setting parameters such as generator level, frequencies or modulation are not affected by switching off and on, however (memory with battery back-up).

In order to reestablish the condition upon delivery, it is also possible to carry out a master reset (99 SPEC, see also Section 2.3.8).

Complete instrument settings can be stored using STORE 56 and recalled using RECALL 57 (see Section 2.3.7.7).

→ Instrument PRESET (also via autorun control and IEC bus)

Function:

The presetting of the CMT instrument functions corresponds to the factory setting (cf.   ):

- Switching on of the appropriate measurements
- Switching on of all default special functions
- Front-panel settings  
(e.g. key INPUT SELECT → selection of input RF IN/OUT)

As opposed to master reset

- IEC bus (remote/local, address)
- autorun control (LEARN mode, RUN mode, etc.)
- user-specific standard-tone sequences USER0 to USER2, "double-SPEC" values, e.g.   <value>  )

remain uninfluenced.

### 2.3.1.2 Transmitter Test / Receiver Test

The CMT has two main operating modes, the transmitter test and the receiver test.

The set mode is indicated by the XMITTER TEST LED 58 or RECEIVER TEST LED 59. In addition, red or green LEDs 4 in the frequency, RF level, modulation and AF level fields indicate the operating mode of the respective field independent of the complete instrument.

Switching between the receiver and transmitter tests can be carried out in two ways:

- \* Press key TXRX 60
- \* Apply an RF signal of sufficient power to connector RF IN/OUT 77

The CMT automatically switches back to the receiver test if the applied RF power falls below a certain level.

The automatic switchover can be suppressed by pressing the key LOCK 62. As long as the LOCK LED 61 lights up, the operating mode can only be changed using the TXRX key 60. The LOCK function is cancelled by pressing the LOCK key again.

If it is necessary in practice to display or call a function associated with the opposite mode (especially with duplex radio sets) each of the four fields can be switched over individually using the key DISPLAY CHANGE 65.

#### Command syntax:

DISPLAY CHANGE	COUNT $f$ / $f$	(frequency field)
DISPLAY CHANGE	POWER / $V_0$ SYNTH	(RF level field)
DISPLAY CHANGE	MAX PK / INT 1	(modulation field)
DISPLAY CHANGE	$V_0$ MOD GEN / AF LEVEL	(AF level field)

### 2.3.1.3 General Syntax Rules for Entries

The CMT is controlled manually using the front panel keyboard by combining various keys (= command). A command may consist of up to 4 syntax elements:

[Number] [Unit] [Special function] Terminating key

→ **Terminating key:**

The instrument evaluates all previous inputs as soon as the terminating key has been pressed and executes the command. All keys are terminating keys except the numeric keys, unit keys and the special functions (RANGE HOLD 50, ANALOG SELECT 51, α DISPL SELECT 52, ΔVAR 53, REF 54 and DISPLAY CHANGE 65).

→ **Special function:**

Special functions such as RANGE HOLD 50, ΔVAR 53 and REF 54 must be entered immediately before the respective terminating key. No numerical inputs are permissible with the special functions ANALOG SELECT 51, α DISPL SELECT 52 and DISPLAY CHANGE 65. Only one special function is permissible per command.

→ **Number/unit:**

Setting values may be a number, a unit or a combination of both and must always be entered first.

#### Echo of entered data

For checking the entered value, each keystroke on the numeric keypad is successively indicated in the α display 2 as described below:

Figures <u>39</u>	0 to 9
Minus <u>40</u>	-
Decimal point <u>41</u>	.
Units keys <u>42</u> to <u>45</u>	a to d

Since the key function is selected after the figures have been entered, the above indications are the same for multifunction keys (e.g. A / MHz / mV / %).

The display is cleared by pressing a key outside the numeric keypad (command or CLEAR).

Incomplete commands can be aborted at any point using the key CLEAR.

The following command is used to switch off the special functions RANGE HOLD, ANALOG SELECT, ΔVAR and REF:

Special function	CLEAR	Terminating key
------------------	-------	-----------------

## Single-element commands:

### → Terminating key

The associated measurement is called by pressing the terminating key assigned to a measurement.

A terminating key which refers to settings causes the current setting to be displayed.

In the case of toggle keys such as POLARITY SELECT 24 or DEMOD·BEAT 8, repeated pressing of the same key switches between the various functions.

This toggle function is switched off with longer commands (two-element, three-element and four-element commands).

### Examples:

V<sub>0</sub> MOD GEN 32

Setting value of modulation generator level is displayed and set.

Repeated pressing does not lead to any further reaction.

POLARITY SELECT 24

Call modulation measurement, the positive peak modulation is displayed.

Repeated pressing switches between positive, average and negative peak modulation.

## Two-element commands:

### → Unit Terminating key

If output of a measuring/setting parameter is meaningful in different dimensions (e.g. power in dBm or W), the unit to be displayed can be selected as required by entering the unit before the terminating key.

It should be noted that changing a unit with key 23 (MAX PK in transmitter test or INT 1 in receiver test) switches the operating mode of the CMT (FM,  $\Phi$ M, AM) and the units of POLARITY SELECT 24 and INT 2 24 are also changed.

#### Example:

Display of RF power in dBm

### → Number Terminating key

Numbers are entered using the numeric keypad 39 (including the decimal point 41 and the minus sign 40).

Leading zeros before the decimal point need not be entered.

The nearest possible value is set and displayed if the value entered cannot be set (e.g. with output levels of the RF synthesizer whose minimum increment is 0.1 dB).

Inputs without a minus sign are always evaluated as positive numbers. Repeated input of the minus sign also results in a negative number.

→ - not + !

The unit can be obtained from the display (or memory).

#### Example:

(Unit from display or memory:  $\mu$ V)

Synthesizer level is set to 10.0  $\mu$ V.



→ **Special function    Terminating key**

Special functions must always be entered last before the terminating key.

**Example:**

The analog value in the AF level display is fixed to the current measurement range.

**Three-element commands:**

→ **Number    Unit    Terminating key**

The additional input of a unit is useful when changing the unit or if a value is entered for the first time which has not yet been displayed (unit is only in the memory).

**Example:**

Synthesizer level is set to 10.0 µV even if the value in the RF level display is in dBm.

The synthesizer is modulated with a deviation of 1.25 kHz and the CMT is in FM mode independent of the previous status.

→ **Number    Special function    Terminating key**

The entered number refers to the special function in this case (e.g. RANGE HOLD).

The unit can be obtained from the display (or memory).

**Example:**

Measured value in display: 3.05 % (distortion)

The measurement range is defined at 10 % full-scale.

→ Special function CLEAR Terminating key

The special functions

RANGE HOLD	50
ANALOG SELECT	51
ΔVAR	53
REF	54

can be cancelled using the key CLEAR. The associated values (e.g. 20 kHz for ΔVAR SET F TX ) remain unaffected.

**Four-element commands:**

→ Number Unit Special function Terminating key

The number and the unit refer here to the special function.

Input of the unit has the same effect as with the two-element and three-element commands, i.e. measured values are displayed in the new unit and the operating mode of the CMT is also switched over (FM, φM or AM).

**Example:**

Current unit for power measurement: dBm

1 W RANGE HOLD POWER

The measurement range of the power measurement is fixed at 1 W, the display is also in W.

#### 2.3.1.4 Variation of Setting Values

The setting values are mainly varied using the spin wheel. The spin wheel 46 is always assigned to the setting parameter last displayed by pressing a key (identified by the symbol "VAR" next to the associated display). The value is increased by rotating the wheel clockwise and decreased by rotating counterclockwise.

Any increment can be entered using the key  $\Delta$ VAR 53 (special function) which remains unchanged until the next input independent of whether the instrument is switched on and off.

#### Example:

The RF synthesizer level is increased or decreased in 10 μV steps if the resolution of the 3-digit RF level display is less than the entered 10 μV.

As soon as the 10 μV steps can no longer be output in the display (10.00 mV, 10.01 mV, 10.02 mV etc.), the variation is made with the smallest step value which can be displayed (in this case with 100 μV steps: 10.1 mV, 10.2 mV, 10.3 mV etc.).

It is possible to return to the minimum step level by entering    . The smallest possible step is set for each value when the instrument leaves the factory and after a master reset.

If a continuous variation is not required, any required value can of course be set by direct input (including any possible unit).

#### Special cases:

##### a) Modulation generator frequency

It is often useful to set the frequency of the modulation generator in a standard tone sequence,

e.g. upon delivery: 0.3/0.6/1/1.25/2.7/3/6/10 kHz

The tuning steps of the modulation generator frequency therefore always correspond to this frequency sequence unless a different increment has been requested using the key  $\Delta$ VAR 53.

**Example:**

The frequency is set in steps of 100 Hz.

The frequency can be varied again in the standard tone sequence following the command.

**b) Oscilloscope**

The oscilloscope ranges can be switched over by repeatedly pressing the mode keys X-deflection and Y-deflection (92 to 95). An autorepeat function is available which automatically switches the ranges further when pressed longer.

### 2.3.1.5 Representation of the Measured Values/Setting Values in the Displays

The representation of the individual measured/setting parameters can be divided into four groups:

#### a) Frequencies

All used frequencies are represented in the frequency display and in the  $\alpha$  display. The resolution with the RF meter is 1 Hz or 10 Hz; MHz is the selected unit.

The resolution is 10 Hz or 100 Hz depending on the frequency range used if the operating frequency of the CMT (function SET f TX, SET f RX) is output in the frequency display; the unit can be selected as required using the unit keys (Hz, kHz, MHz).

The AF meter is output in the  $\alpha$  display (max. 10 digits, right-justified) with the unit kHz and a resolution of 0.1 Hz (AF < 4 kHz) or 1 Hz (AF > 4 kHz, via SPEC or also 0.1 Hz selectable with 10-s gate time).

The AF settings are displayed in kHz or Hz (depending on the input) with the maximum resolution which can be achieved in each case.

#### b) Outputs on the $\alpha$ display

In addition to AF outputs, the  $\alpha$  display is used to output all instrument messages (ready message, error messages) in English and to alternately output the measured/setting values from the other displays.

The code of the respective measured/setting parameter (corresponding to the front panel designation), the unit and the number (3 (4) digits) appear at the start of the line if the  $\alpha$  display is used as an alternate display.

#### c) Setting values in the displays:

Frequency, RF level, modulation and AF level

Setting values are output in the 3 1/2-digit display, the associated analog display on the right remains switched off (unless used for other purposes, see ANALOG SELECT 51).

The entered unit is used in the display provided a value of 100 (unit e.g. Hz) is not exceeded. The instrument otherwise converts the value into a suitable format.

Example:

+ display = 1.20 kHz



e) Representation of two measured values in one display

If an analog display is set for a fixed measured value using the key ANALOG SELECT 51 (only permissible for certain parameters, see Section 2.3.7.5), the second measured/setting value of the same display is only output in the digital display with the associated unit. The unit and code of the measured value in the analog display are additionally output underneath the bargraph.

Example:

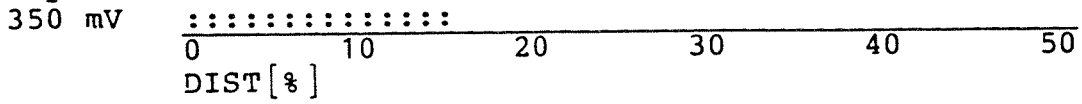

LEVEL



SINAD·DIST

### 2.3.2 Connection Between CMT and Device Under Test (see Figs. 2-11 and 2-12)

All connections between the CMT and the device under test are made via the connectors on the front panel (Fig. 2-8).

At least three connections are necessary:

#### Connection 1:

- a) **Bidirectional RF connection between antenna connector of the transceiver and connector RF IN/OUT 77 of the CMT**

The CMT automatically switches to the transmitter test mode if an RF signal  $> 0.5$  W is applied to this connector. The power, frequency, spectral purity (adjacent channel power measurement) and maximum modulation (positive, negative and average modulation peaks) of the applied signal can be examined.

Connection 3 must also be made to measure the transmitter modulation distortion (key DIST 26).

The CMT switches back to the receiver test mode if the RF power drops. The RF test signal is then applied to the receiver via this connection. All necessary receiver measurements are possible via connection 2 if the test generator has been correctly set to the receiver frequency of the transceiver.

Only this input/output must be used with duplex radio sets and the receiver test mode (also for reasons of RF power compatibility), in the case of transmitters with a lower power (e.g. radiotelephone) or coupling of the CMT to a transmitter via antenna (telemetry) it may be more favourable to use the more sensitive input (INPUT 2 79). RF power measurements are not possible in this case.

- When the RF input INPUT 2 is used, the 20-dB attenuator at the CMT input can be switched on and off by means of  20  SPEC /  21  SPEC .

When the input RF IN/OUT is used, this is done automatically according to the result of the RF power measurement.

The automatic 20-dB attenuation can be switched off by means of

19  SPEC : automatic 20-dB attenuation off

The settings

20  SPEC : 20-dB attenuation on

21  SPEC : 20-dB attenuation off

can then be performed even when the input RF IN/OUT is used.

The automatic 20-dB attenuation can be switched on again by means of

18  SPEC : automatic 20-dB attenuation on (default).



**Connection 2:**

- b) **AF output signal of transceiver to AF voltmeter (connector AF VOLTM 84) of the CMT**

The level of any AF signal, even weighted by a CCITT filter, can be measured at this connector.

The receiver sensitivity (keys SINAD 33, S/N 34) and the receiver distortion (key DIST 33) can only be measured if connection 1 is present.

**Connection 3:**

- c) **Modulation signal of CMT (connector MOD GEN 83) to microphone input of transceiver**

A defined modulation signal must be applied to the microphone input of the transceiver in order to measure the modulation sensitivity and the transmitter modulation distortion via this connection.

**Connection 4:**

- d) **Measurement of various RF levels in the device under test**

RF levels from 1 mV to 100 V in the frequency range from 10 kHz to 2000 MHz can be measured via various probes at connector RF PROBE 85 if the RF millivoltmeter option CM-B8 is fitted.

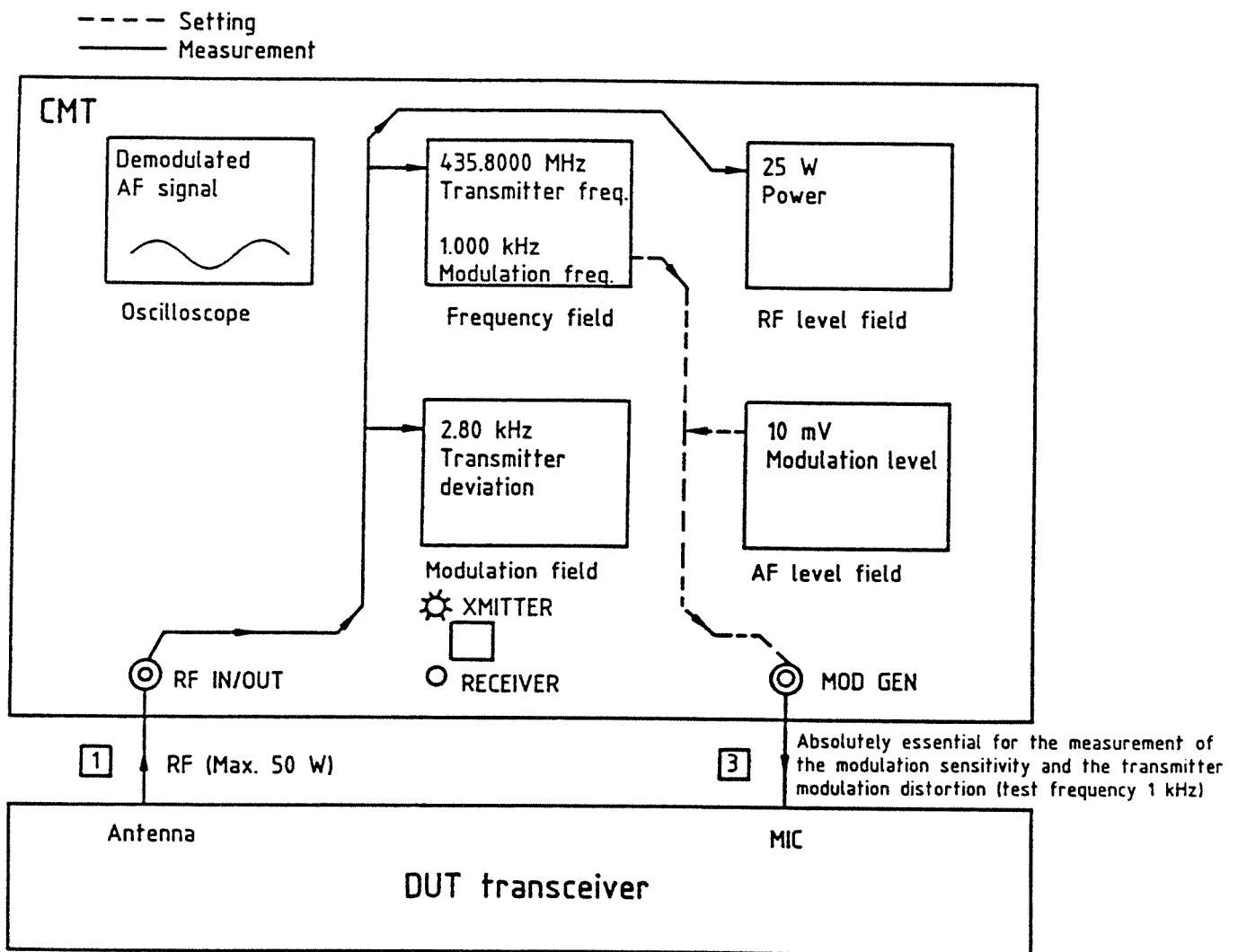

Fig. 2-11 Transmitter test

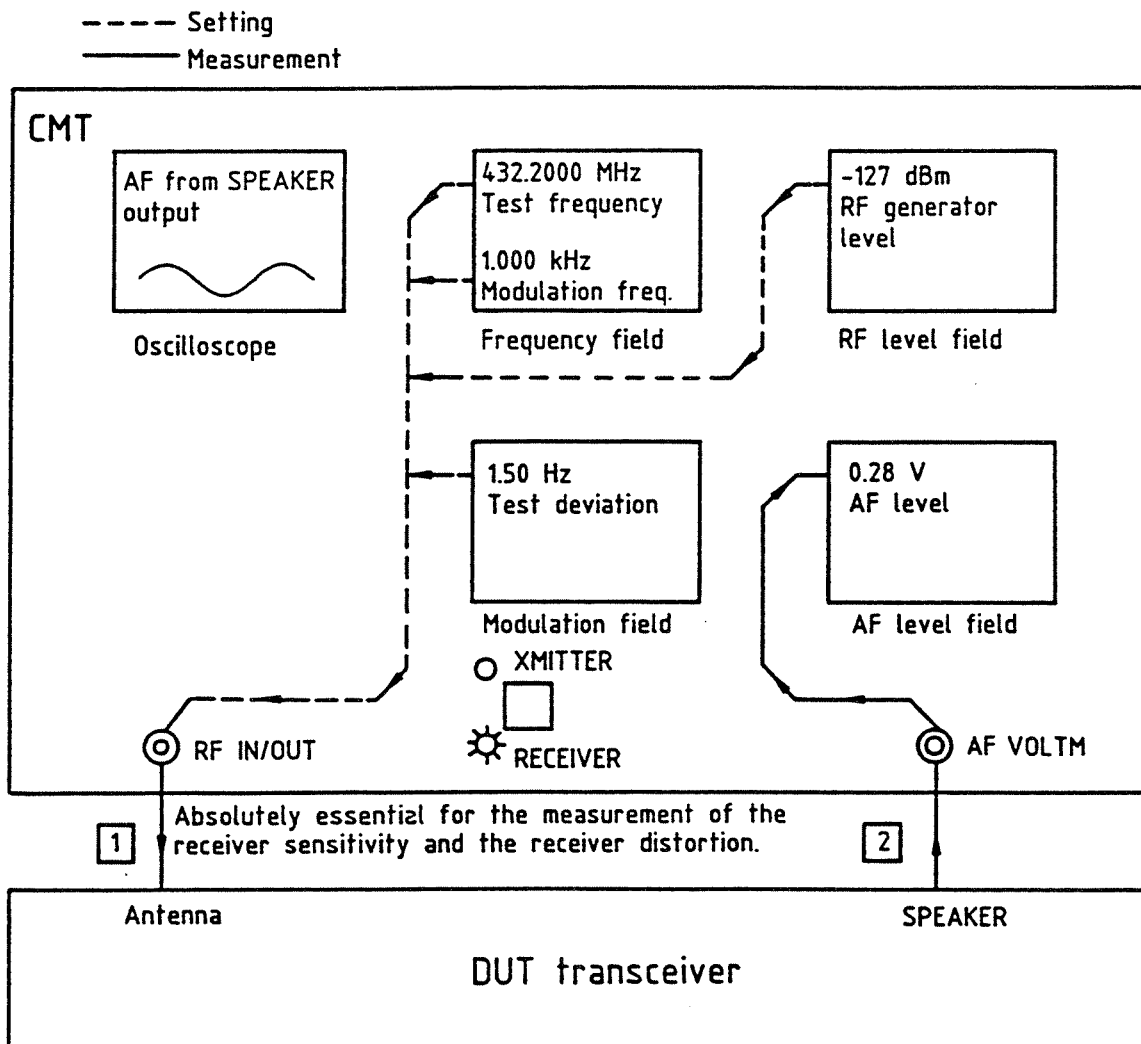

Fig. 2-12 Receiver test

### 2.3.3 Frequencies

All frequencies are input and output in the frequency field (Fig. 2-1).

#### 2.3.3.1 RF Meter

The RF meter is switched on when the instrument is switched on for the first time or when the key COUNT f 5 is pressed. It processes input signals between 0.4 MHz and 1000 MHz if the level is high enough (min. 5 mV at RF INPUT 2 79 or 5 mW at connector RF IN/OUT 77) and outputs the result in frequency display 1 with a resolution of 10 Hz.

0.00000 MHz appears in the display if the level is too small or if no signal is present.

In addition to the frequency measurement, the meter correctly sets the operating frequency of the fully automatic modulation meter in the transmitter test mode. This operating frequency is therefore undefined with a meter value of 0.00000 MHz.

The gate time is 100 ms up to a frequency of 400 MHz and 400 ms at higher frequencies (4:1 prescaler). The controller carries out the switchover fully automatically.

The gate time can be increased to ten times this value using     in order to switch the resolution of the results from 10 Hz to 1 Hz.

BEAT and ACP measurements are not possible in this mode.

#### 2.3.3.2 Operating Frequency in the Transmitter Test Mode

The operating frequency can also be entered directly if the level is too low to permit correct operation of the RF meter or if there are other reasons (e.g. telemetry) why automatic operation of the modulation meter is impossible.

##### **Example:**

This switches off the RF meter and the local oscillator is set according to the entered frequency; the oscillator frequency is calculated as follows:

Entered frequency	Modulation measurement	BEAT measurement
$f_{in} < 3.65 \text{ MHz}$	$f_{osc} = f_{in} + 455 \text{ kHz}$	$f_{osc} = f_{in}$
$f_{in} > 3.65 \text{ MHz}$	$f_{osc} = f_{in} - 455 \text{ kHz}$	$f_{osc} = f_{in}$

The IF offset of 455 kHz is automatically taken into account by the controller and the entered operating frequency is always displayed.

**Example:**

Frequency from the RF meter or set by hand: 438.95 MHz

Displayed frequency: 438.9500 MHz

Frequency of local oscillator: 438.4950 MHz

**2.3.3.3 Operating Frequency in the Receiver Test Mode**

The synthesizer output frequency must always be entered manually using the key SET f RX 5 since the receiver frequency of the transceiver cannot be automatically determined.

The displayed frequency then always corresponds to the frequency of the output signal.

**Example:**

The frequency of the test generator signal is 153.3 MHz.

**Frequency transfer function:**

This function permits to transfer the RF frequency measured or set in the transmitter test into the receiver test. The duplex spacing, if required, may be taken into account as well.

Each time the operating frequency of the transmitter test is set (SET f TX or COUNT), the new frequency is automatically stored. When switching from transmitter test to receiver test (manually or automatically), the value last stored is modified according to the duplex spacing entered (    ) and the resulting operating frequency of the receiver test is automatically set (SET f RX).

The duplex spacing between transmit and receive frequency is entered via    <Dup.- $\Delta$ f> [kHz] . Positive values result in a receive frequency of the transceiver that lies above the transmit frequency, negative values produce one that lies below. The values range from -99999.99 kHz to 0 to +99999.99 kHz.

This function is switched on via

and off via

### 2.3.3.4 Operation Without Duplex Modulation Meter (Option CM-B9)

The RF synthesizer is used as the local oscillator in the transmitter test as well as the RF test generator in the receiver test if the duplex modulation meter (option CM-B9) is not fitted.

The frequency is automatically switched over depending on SET f RX, SET f TX or COUNT f when a change is made from transmitter test to receiver test or vice versa.

The frequency of the RF synthesizer remains unchanged, however, if the mode of the frequency field is changed individually using the key DISPLAY CHANGE 65.

The message "Add-b9" appears in the frequency display with the functions SET f RX and SET f TX to indicate this special case.

SET f TX or SET f RX can still be used after switching over the frequency display and the oscillator frequency is correspondingly adjusted when these keys are pressed.

#### Examples:

Operating mode: Receiver test  
Test generator frequency: 145.2 MHz

An operating frequency of 145.8 MHz was previously set in the transmitter test mode.

→ frequency field in the transmitter test

COUNT f is switched on: The frequency of an RF signal is measured, the test generator frequency (145.2 MHz) remains unaffected.

SET f TX is switched on: The message "Add-b9" appears in the frequency display.

The test transmitter frequency is set to 145.8 MHz if the key SET f TX is now pressed.

Since the frequency may no longer agree with the received frequency, measurements associated with it (SINAD, S/N etc.) can no longer be made.

Operating mode: Transmitter test  
 Operating frequency: 145.8 MHz

A test transmitter frequency of 438.5 MHz was previously set in the receiver test mode.

DISPLAY CHANGE  SET f RX → frequency field in the receiver test

The message "Add-b9" appears in the frequency display, the transmitter test frequency (145.8 MHz) remains unaffected, the modulation meter operates further at the set frequency.

The frequency is set to 438.5 MHz and displayed if the key SET f RX is pressed.

### 2.3.3.5 AF Meter

The meter operates according to the principle of period measurements (0.1 Hz resolution) in the range from 10 Hz to 4 kHz. It has therefore been possible to reduce the time per measuring cycle to a minimum (< 100 ms at 1 kHz) despite the high accuracy of 0.1 Hz.

It is possible to switch the meter to gate time frequency counting (measuring cycle 1 s, resolution 1 Hz) using  C  10  SPEC in order to also achieve greater insensitivity to noise pulses in this frequency range. It is possible to return to period measurements using  C  11  SPEC .

The principle of gate time frequency counting is always used for frequencies > 4 kHz.

The resolution of the gate time frequency measurement can be increased from 1 Hz (measuring cycle > 1 s) to 0.1 Hz (measuring cycle > 10 s) in the complete frequency range using  C  12  SPEC .

The AF meter can be operated with three different sources:

DEMOM	Measurement of the demodulated AF signal
BEAT	Measurement of the difference between the set operating frequency and the RF input signal frequency
AF EXT	Measurement of the AF at connector AF VOLT

DEMOM measurements are only meaningful if the transmitter test operating frequency is correctly set which is usually the case when using COUNT f.

On the other hand, BEAT measurements can only be called if a transmitter test operating frequency has previously been set using SET f TX.

Independent of any other settings, the measurement AF EXT is always available for analysis of the signals applied to the connector AF VOLTM.



The oscilloscope and the test loudspeaker are automatically operated with the same source if the AF meter is switched on (identified in the status line).

The oscilloscope and the loudspeaker can only be operated as desired using the three available sources (selection using mode keys 92, 93) if the meter has been switched off by pressing AF INT 1, AF INT 2 or Δf.

### 2.3.3.6 AF Generator Settings

The basic configuration of the CMT possesses an AF generator whose frequency can be set in the range from 20 Hz to 30 kHz using the key AF INT 1 9.

Variation with the spin wheel takes place according to a standard tone sequence with 8 frequencies which can be defined as required:

Factory setting:

1st tone	0.3 kHz
2nd tone	0.6 kHz
3rd tone	1.0 kHz
4th tone	1.25 kHz
5th tone	2.7 kHz
6th tone	3.0 kHz
7th tone	6.0 kHz
8th tone	10.0 kHz

These frequencies can be reprogrammed as required at any time using the key SPEC 55 (see Section 2.3.8 "SPEC Function").



Furthermore, a continuous variation with any increments is possible using the key  $\Delta$ VAR 53.

**Example:**

- The modulation generator is set to 1 kHz.
- Variation using spin wheel in standard tone sequence.

- Variation with smallest possible resolution (0.1, 1 or 10 Hz)

- Variation in standard tone sequence

- Variation with smallest possible step value

- Variation now in 500 Hz steps

- Variation in standard tone sequence again

The generated AF signal is available directly at connector MOD GEN 83 or internally for modulation of the RF test generator (INT 1).

The modulation generator can be switched off completely by entering   independent of the settings V<sub>0</sub> MOD GEN and INT 1.

Important with CODE:

Since the level settings by V<sub>0</sub> MOD GEN and INT 1 refer to the data telegram when using CODE, muting of the generator before and after transmission of a tone sequence can only be achieved using   .

The 2nd AF synthesizer (option CMT-B7), if fitted, can be operated using key AF INT 2.

The above-mentioned also applies in this case except that the signal of this AF generator is not usually available at connector MOD GEN but is primarily used to modulate the synthesizer.

The signal of the 2nd AF generator can be added to the signal of the first using  122  SPEC if a two-tone signal is required at this connector (see Section 2.3.6.1).

### 2.3.3.7 CODE/DECODE

In its basic configuration, the CMT can transmit and receive single-tone sequences to all common standards. The option CMT-B7, if fitted, additionally permits transmission, the option CM-B11 reception of special double-tone sequences.

The different tone sequence standards are selected using

C  110  SPEC            CODE and DECODE (if possible)

C  111  SPEC            only DECODE

where the different standard codes are represented by the following numbers:

#### Fixed single-tone sequences

Code number (No)	
00	ZVEI1 (default after master reset)
01	ZVEI2
02	CCIR
03	CCIR 70 ms
04	EEA
05	EIA
06	VDEW
07	EURO
08	CCITT
09	NATEL
10	reserved
11	reserved
12	only DECODE: socket D 11 on CM-B11
13	only DECODE: socket D 12 on CM-B11
14	only DECODE: socket D 13 on CM-B11

#### Fixed double-tone sequences

(only with option CMT-B7)

Code number (No)	
15	DTMF    DECODE: only with option CM-B11
16	VDEW    only DECODE, only with option CM-B11
17	reserved
18	reserved
19	reserved

**Freely programmable tone sequences (single tones)**

Code number (No)	
20	USER 0
21	USER 1

**Freely programmable double-tone sequence**  
(only with option CMT-B7, only code transmission!)

Code number (No)	
22	USER 2

**2.3.3.7.1 Selection of a Particular Code**

It is possible to select a standard (Active Code) from the fixed codes and USER 0 to USER 2 using    <No>  (0 <No> <22). In the case of single-tone sequences, this Active Code applies to both CODE and DECODE.

If CODE reception is not possible for the newly selected standard (option CM-B11 not fitted with DTMF), the previously set standard remains valid.

**Example:**

Set standard: No = 2 (CCIR)

Input:

New standard for CODE/DECODE: No = 5 (EIA)

Input:

New standard for CODE: No = 15 (DTMF)  
(CMT-B7 fitted)

Standard for DECODE: No = 5 (EIA)  
(CM-B11 not fitted)

Following selection of the CODE/DECODE tone-sequence standard

using    <No>

another standard can be selected for CODE reception (DECODE) only

using    <No>  (0 <No <22)

The selected standard is retained for the tone sequencer. Using these two SPEC functions, the standards selected can also be displayed:

Input	α display	Remark
<input type="text" value="C"/> <input type="text" value="110"/> <input type="text" value="SPEC"/>	C110 * 5	(5 = EIA)
<input type="text" value="SPEC"/>	---	
<input type="text" value="C"/> <input type="text" value="111"/> <input type="text" value="SPEC"/>	C111 * 4	(4 = EEA)
<input type="text" value="SPEC"/>	---	

### 2.3.3.7.2 CODE Transmission

If Active Code is loaded with the desired code via    <No> , a selective call can be sent by entering the call number and pressing the CODE key. The call number is displayed in the α display and remains stored until the next input so that the call can be repeated as often as desired by pressing the CODE key.

If the tone sequence is to be sent as burst, the modulation generators 1 and 2 can be switched off using   and  .

The modulation setting of the test generator is not internally checked. INT1 (with DTMF also INT2) should therefore be set to standard deviation before pressing the CODE key. The selective call is also sent at the connector MOD GEN with automatic switch-over to double tone.

Example:

Input	α display	Remark
<input type="text" value="345705509"/> <input type="text" value="CODE"/>	345705509	This selective call is simultaneously sent.
<input type="text" value="CODE"/>	345705509	(last entered call number) This call is simultaneously sent.

The sent tones can be varied with regard to frequency and tone duration using the following SPEC functions:

- C  160  SPEC <T(ms)>  SPEC Duration of first tone in ms (10 ms <T <5000 ms)
- C  161  SPEC <T(ms)>  SPEC Duration of following tones in ms (10 ms <T <5000 ms)
- C  162  SPEC <T(ms)>  SPEC Pause duration in ms (T = 0 and 10 ms <T <5000 ms)
- C  163  SPEC <f tol(%)>  SPEC Frequency deviation of the sent tones from the nominal frequency in % (-10 % to +10 %)

These SPEC functions always refer to the standard code selected using  C  110  SPEC .

With each new call of  C  110  SPEC , the parameters tone duration of 1st tone, tone duration of all following tones, pause duration and frequency deviation are cancelled again by the default values of the selected standard.

**Example:**

- a)  C  110  SPEC  2  SPEC CCIR standard is selected

The telegram 12345 is sent as follows:  
Each tone is 100 ms long, no pauses, all tone frequencies correspond to the respective nominal frequencies.

b)

Input	α display	Remark
<input type="checkbox"/> C <input type="checkbox"/> 160 <input type="checkbox"/> SPEC	C160* 100 ms	Duration of 1st tone 100 ms
<input type="checkbox"/> 500 <input type="checkbox"/> SPEC		now: 500 ms
<input type="checkbox"/> C <input type="checkbox"/> 161 <input type="checkbox"/> SPEC	C161* 100 ms	Tone duration: 100 ms
<input type="checkbox"/> 80 <input type="checkbox"/> SPEC		now: 80 ms

The telegram 12345 is sent as follows:  
Tone 1 is 500 ms long, tones 2, 3, 4, 5 are 80 ms each, no pauses, all tone frequencies correspond to the respective nominal frequencies.

Input	α display	Remark
C 162 SPEC 50 SPEC	C162* 0 ms	Pause duration: 0 ms now: 50 ms
C 163 SPEC - 4 SPEC	C163* 0 PERC	Tone frequencies: ±0 % now: -4 %

The telegram 12345 is sent as follows:

1 500 ms long, frequency 4 % below nominal frequency  
P 50 ms pause

2 80 ms long, frequency 4 % below nominal frequency  
P 50 ms pause

3 80 ms long, frequency 4 % below nominal frequency  
P 50 ms pause

4 30 ms long, frequency 4 % below nominal frequency  
P 50 ms pause

5 80 ms long, frequency 4 % below nominal frequency

C 110 SPEC 2 SPEC : CCIR standard is reloaded,  
the changes produced by

C 160 SPEC

to

C 163 SPEC

are cancelled.

### 2.3.3.7.3 CODE Reception

By pressing the DECODE key, the selective-call decoder is switched on and its readiness to receive signals indicated in the  $\alpha$  display by the message "DECODE". Provided that the tone is applied constantly for more than 30 ms, the signal which is demodulated or applied to the connector AF VOLTM is assigned to a code number of the standard sequence defined by  $\boxed{C}$   $\boxed{110}$   $\boxed{SPEC}$  /  $\boxed{C}$   $\boxed{111}$   $\boxed{SPEC}$  and subsequently output using the code numbers 0 to 9 and A to F.

Pauses (50 ms < pause < 100 ms) are marked in the display by means of "P", tones not in line with the standard are handled as errors and marked by an "X".

Since the decoding only starts when the first valid tone has arrived, faulty tones can only be marked within a tone sequence.

If automatic repeat is switched on (Section 2.3.3.7.4) E (repeat tone) is not displayed, but the previous code number is displayed twice instead.

Pauses longer than 100 ms cause the tone sequence evaluation to be aborted. The tones received until then are output in the  $\alpha$  display.

Further pressing of the DECODE key clears the call number in the  $\alpha$  display and reactivates the tone-sequence decoder.

#### **Example:**

$\boxed{C}$   $\boxed{111}$   $\boxed{SPEC}$   $\boxed{2}$   $\boxed{SPEC}$

Tone sequence to CCIR standard is selected

$\boxed{DECODE}$

Tone-sequence decoder waits for reception of a selective call (max. 1 min.).  
Output in the  $\alpha$  display:  
\*DECODE\*

The transceiver sends 123E3 (pause) 567 (frequency outside the standard) 9ABC.

100 ms after reception of the last tone, the call number can be read on the  $\alpha$  display as follows:

1 2 3 3 3 P 5 6 7 X 9 A B C

If a continuous tone remains applied after the last call number, decoding is only aborted after 250 measurements. The associated wait time is about

$$T_w = 1300 \times (1/f)$$

$T_w$  = wait time until decoding is aborted (s)  
 $f$  = frequency of continuous tone (Hz)

e.g.:  $f$  continuous tone = 310 Hz  $\rightarrow T_w$  = approx. 4.2 s  
 $f$  continuous tone = 4 kHz  $\rightarrow T_w$  = approx. 330 ms



**Reducing the decoding time:**

Enter:    <t>

This special function can be used to reduce the decoding time following the arrival of the first valid tone to t (10 ms < t < 10000 ms).

Thus the call is evaluated and displayed after max. t ms.

For t = 10000 ms (e.g. after   or master reset), this function is switched off.

**Example:**

A five-digit telegram (each tone 70 ms) is expected.

When      is entered (= 350 ms total duration), the end of decoding coincides exactly with the end of the last tone.

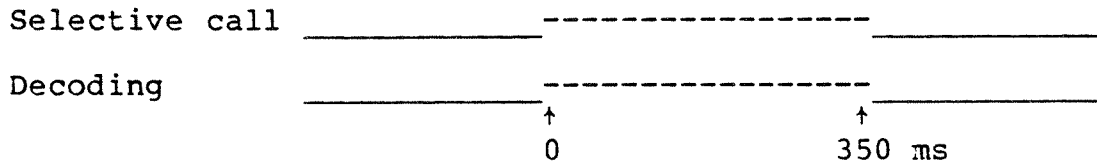

**Advantage of this operating mode:**

After the selective call has been started, the CMT will again be able to execute autorun control commands (or IEC-bus commands) at a defined point in time and is thus able to respond faster (useful in the case of NATEL).

**Accuracy:**

±10 ms after detection of the first tone.

The detection of the first tone may be delayed by up to 12 periods (AF frequency/1st tone).

**Extension of permissible pauses between two tones or telegrams (selective-call decoder)**

The detection of the end of telegram is delayed in order to bridge possible pauses between the tones. After switching on the instrument, the maximum permissible pause is set to approx. 100 ms (no AF signal during the pause).

The delay time can be adjusted in three stages:

**C** **173** **SPEC** : Decoding aborted approx. 100 ms after last tone (default after switching on)

**C** **174** **SPEC** : Decoding aborted approx. 400 ms after last tone

**C** **181** **SPEC** : Decoding aborted approx. 2 s after last tone

It is thus possible to simultaneously display several telegrams arriving in quick succession (pause <400 ms/2s).

**Example:**

**C** **174** **SPEC** : pause <400 ms

**C** **181** **SPEC** : pause < 2 s

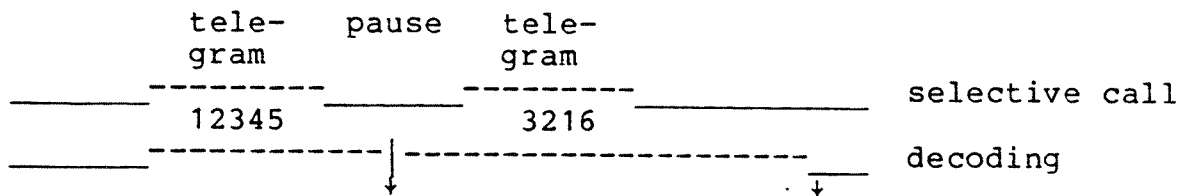

The call is only aborted if the pause is longer than 400 ms/2s.

Decoding is aborted, earliest display after 400 ms/2s.

Readout on the alphanumeric display: 1 2 3 4 5 P 3 2 1 6

Extension of the maximum permissible pauses can also be employed in combination with limitation of the decoding time ( **C** **180** **SPEC** <t> **SPEC** ).

**Example:**

Two five-tone sequences with a pause of 800 ms are to be decoded. At the end of the last tone, the CMT (autorun control, IEC bus) is to respond immediately. The duration of a tone is 70 ms.

Total decoding time = (2 x 5 x 70 ms) + 800 ms = 1500 ms

Enter: **C** **180** **SPEC** **1500** **SPEC**

**C** **181** **SPEC** : pause >400 ms

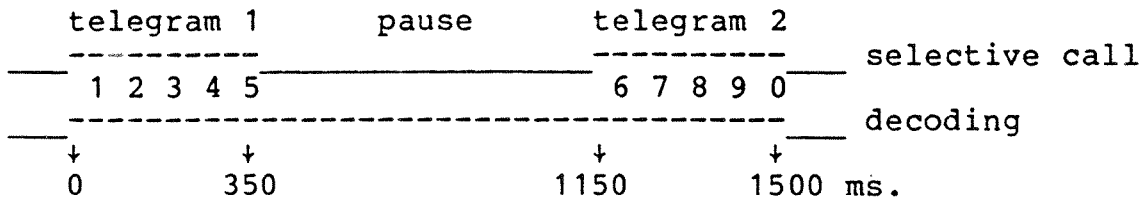

Readout on alphanumeric display: 1 2 3 4 5 P 6 7 8 9 0

**Source selection of the decoder:**

Although, in general, the demodulated signal is fed to the tone-sequence decoder, switchover to the signal applied to the connector AF VOLTM is also possible for testing.

C  171  SPEC

Signal at the connector AF VOLTM is evaluated.

C  170  SPEC

DEMOM signal is evaluated (default following switch-on).



Switching between the signal sources has also effect on the display of the oscilloscope in internal mode, i.e., with the decoder switched on, the oscilloscope can only display the internal signal which is also fed to the decoder; the arrow above the symbol AUTO in the status line of the oscilloscope appears.

**Frequency tolerances:**

The single tone decoder (code numbers 0 to 9 and 20, 21) detects only the tones whose frequency falls within the tolerance window of the nominal value. This tolerance is  $\pm 2\%$  after switching on and master reset, but can be easily changed using the command

C  172  SPEC <f tol. (%)>  SPEC (0.5 % <f tol. <10 %).

The option CM-B11 enables decoding of DTMF signals. With double tones, the dynamic range ensuring correct evaluation is smaller than with single tones. Therefore, depending on the selected source and the type of modulation, preamplification of the signal is matched to the current conditions. In the event that this default setting does not lead to satisfactory results for some reason or other, a different gain setting can be selected using the following SPEC functions:

C  176  SPEC

-6-dB gain

C  177  SPEC

0-dB gain

C  178  SPEC

+6-dB gain

C  175  SPEC

Automatic gain setting (default)

VDEW direct dialling:

(5-tone sequence to ZVEI1, then DTMF signalling)

Code number 16 is provided for the signalling of VDEW direct dialling:

C  111  SPEC  16  SPEC (16 = VDEW decoding)

Selective-call decoder and DTMF decoder are simultaneously started when pressing the DECODE key (selective call standard = ZVEI1).

The selective-call decoder is immediately switched off by the first incoming DTMF tone. After the last DTMF tone, the results of the selective-call decoder and the DTMF decoder are combined (a hyphen is used as separator) and indicated on the alphanumeric display.

**Example:**

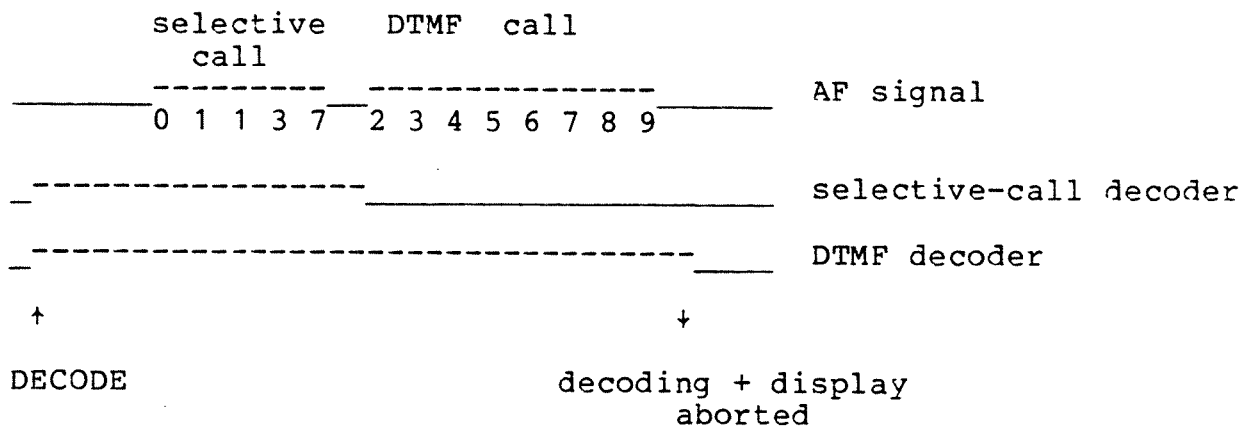

Readout on the alphanumeric display: 01137-23456789  
(and test report or IEC bus)

The tone combination 697Hz/1633Hz (= 'A' in the CMT) is used as separator in the VDEW direct dialling system. Therefore, the facility to suppress the display of separators is provided.

C  190  SPEC : The separators are also displayed.

C  191  SPEC : The display of separators is suppressed.  
(Default, only with VDEW signalling, code number 16 effective!)

#### 2.3.3.7.4 Automatic Repeat

If the repeat tone (E) is to be used automatically for CODE transmission of two identical successive tones, the automatic repeat facility must be switched on. Otherwise, a single tone with overlength (possibly with short pauses in between) would be transmitted instead of a sequence of several call numbers.

For testing, this automatic repeat facility can be switched off using  C  151  SPEC .

To switch it on again,  C  150  SPEC is entered.

#### **Example:**

Selective call:	111233
Automatic repeat on:	1E123E is sent
Automatic repeat off:	1 (triple tone duration)
	2
	3 (double tone duration)

During DECODE, with automatic repeat switched off, the repeat tone (E) is directly displayed; otherwise, the last sent tone is doubled.

#### **Example:**

Received telegram:	1E2E345E5E
Automatic repeat on:	1122345555 displayed
Automatic repeat off:	1E2E345E5E displayed

### 2.3.3.7.5 Frequency Tables of the Fixed Tone-sequence Standards

All frequencies are given in Hz.

Code	ZVEI1	ZVEI2	CCIR	CCIR	EEA	EIA	VDEW	EURO	CCITT	NATEL	Code	DTMF	
Tone dur.	70 ms	70 ms	100 ms	70 ms	40 ms	33 ms	100 ms	100 ms	100 ms	70 ms	Tone dur.	70 ms	
Pause	0 ms	0 ms	0 ms	0 ms	0 ms	0 ms	0 ms	0 ms	0 ms	0 ms	Pause	0 ms	
Tone no.											Tone no.	Tone 1	Tone 2
0	2400.0	2200.0	1981.0	1981.0	1981.0	600.0	2280.0	979.8	400.0	1633.0	0	941.0	1336.0
1	1060.0	970.0	1124.0	1124.0	1124.0	741.0	370.0	903.1	697.0	631.0	1	697.0	1209.0
2	1160.0	1060.0	1197.0	1197.0	1197.0	882.0	450.0	832.5	770.0	697.0	2	697.0	1336.0
3	1270.0	1160.0	1275.0	1275.0	1275.0	1023.0	550.0	767.4	852.0	770.0	3	697.0	1477.0
4	1400.0	1270.0	1358.0	1358.0	1358.0	1164.0	675.0	707.4	941.0	852.0	4	770.0	1209.0
5	1530.0	1400.0	1446.0	1446.0	1446.0	1305.0	825.0	652.0	1209.0	941.0	5	770.0	1336.0
6	1670.0	1530.0	1540.0	1540.0	1540.0	1446.0	1010.0	601.0	1335.0	1040.0	6	770.0	1477.0
7	1830.0	1670.0	1640.0	1640.0	1640.0	1587.0	1240.0	554.0	1477.0	1209.0	7	852.0	1209.0
8	2000.0	1830.0	1747.0	1747.0	1747.0	1728.0	1520.0	510.7	1633.0	1336.0	8	852.0	1336.0
9	2200.0	2000.0	1860.0	1860.0	1860.0	1869.0	1860.0	470.8	1800.0	1477.0	9	852.0	1477.0
10 (A)	2799.9	2599.9	2400.0	2400.0	1055.0	2151.0	2000.0	433.9	1900.0	1633.0	10 (A)	697.0	1633.0
11 (B)	810.0	2799.9	930.0	930.0	930.0	2432.9	2100.0	400.0	2000.0	600.0	11 (B)	770.0	1633.0
12 (C)	970.0	810.0	2246.9	2246.9	2246.9	2010.1	2200.0	368.7	2100.0	1995.0	12 (C)	852.0	1633.0
13 (D)	886.0	886.0	991.0	991.0	991.0	2292.0	2300.0	1153.1	2200.0	2205.0	13 (D)	941.0	1633.0
14 (E)	2599.9	2400.0	2110.0	2110.0	2110.0	459.0	2400.0	1062.9	2300.0	1805.0	14 (*)	941.0	1209.0
15 (F)	0	0	0	0	0	0	0	339.9	0	0	15 (#)	941.0	1477.0

### 2.3.3.7.6 Programming the User Codes USER 0 to USER 2

Following master reset, the standard tone sequences USER 0 and USER 1 are loaded according to ZVEI1, USER 2 is loaded according to DTMF. There are two ways of programming special tone sequences:

#### a) Setting all tone sequence parameters individually

Each user code has the following individual parameters:

- 16 x tone frequency (tones 0 to F)
- 16 x 2nd tone frequency (only with two-tone sequences, USER 2)
- 1 x tone duration of the first sent tone
- 1 x tone duration of the following tones
- 1 x pause duration

For USER 0 to USER 2, these parameters can be varied at any time by means of the following SPEC functions:

to    for USER 0  
   to    for USER 1  
   to    for USER 2

Each of the 16 different tones can be assigned a frequency in the range from 310 Hz to 4 kHz in any sequence desired using

<f (Hz)>  (USER 0)  
   <f (Hz)>  (USER 1)  
   <f (Hz)>  (USER 2)

(310 Hz <f <4 kHz and f = 0 kHz). xx corresponds to one of the tones as shown in the following table:

xx	0	1	2	3	4	5	6	7	8	9	10	11	12	13	14	15
Tone	0	1	2	3	4	5	6	7	8	9	A	B	C	D	E	F

**Example:**

USER 0 is to be loaded (first digit: 5)

Tone	Input					Call No.	Frequency
0	<input type="text" value="C"/>	<input type="text" value="500"/>	<input type="text" value="SPEC"/>	<input type="text" value="3150"/>	<input type="text" value="SPEC"/>	0	≅ 3.15 kHz
1	<input type="text" value="C"/>	<input type="text" value="501"/>	<input type="text" value="SPEC"/>	<input type="text" value="1200"/>	<input type="text" value="SPEC"/>	1	≅ 1.2 kHz
5	<input type="text" value="C"/>	<input type="text" value="505"/>	<input type="text" value="SPEC"/>	<input type="text" value="800"/>	<input type="text" value="SPEC"/>	5	≅ 800 Hz
B	<input type="text" value="C"/>	<input type="text" value="511"/>	<input type="text" value="SPEC"/>	<input type="text" value="960"/>	<input type="text" value="SPEC"/>	B	≅ 960 Hz
F	<input type="text" value="C"/>	<input type="text" value="515"/>	<input type="text" value="SPEC"/>	<input type="text" value="3400"/>	<input type="text" value="SPEC"/>	F	≅ 3.4 kHz

In the case of USER 2, it is additionally required to enter the frequency of the second tone generator (double tone!) using   to    <f (Hz)>  for the different tones (see table).

xx	20	21	22	23	24	25	26	27	28	29	30	31	32	33	34	35
Tone	0	1	2	3	4	5	6	7	8	9	A	B	C	D	E	F

**Example:**

Key 0 is to be assigned two frequencies:

C	700	SPEC	340	SPEC	Frequency of generator 1: 340 Hz
C	720	SPEC	2300	SPEC	Frequency of generator 2: 2.3 kHz

The other parameters of USER 0 to USER 2 can be checked and set using similar SPEC functions.

**Tone duration of the first sent tone:**

C	560	SPEC	<T (ms)>	SPEC	for USER 0
C	660	SPEC	<T (ms)>	SPEC	for USER 1
C	760	SPEC	<T (ms)>	SPEC	for USER 2

(10 ms <T <5000 ms)

**Tone duration of all following tones:**

C	561	SPEC	<T (ms)>	SPEC	for USER 0
C	661	SPEC	<T (ms)>	SPEC	for USER 1
C	761	SPEC	<T (ms)>	SPEC	for USER 2

(10 ms <T <5000 ms)

**Pause duration:**

C	562	SPEC	<T (ms)>	SPEC	for USER 0
C	662	SPEC	<T (ms)>	SPEC	for USER 1
C	762	SPEC	<T (ms)>	SPEC	for USER 2

(10 ms <T <5000 ms and T = 0 ms)



b) Setting all parameters according to a standard tone sequence

If the special code differs from a fixed standard tone sequence in a few parameters only, the latter can be loaded into USER 0 to USER 2 (two-tone sequences only into USER 2). All that remains to be entered then are the variations as indicated under a).

The parameters frequency, tone duration of 1st tone, tone duration of the following tones and pause duration are defined as required using the following SPEC functions:

C  100  SPEC  <No>  SPEC (No = 0 to 14) for USER 0

C  101  SPEC  <No>  SPEC (No = 0 to 14) for USER 1

C  102  SPEC  <No>  SPEC (No = 15 to 19) for USER 2

Variation of these tone sequences has an effect only when the code is loaded into Active Code using  C  110 /  111  SPEC  <No>  SPEC .

**Example:**

Loading USER 0

Definition of frequency:

C  500  SPEC  <f>  SPEC to

C  515  SPEC  <f>  SPEC

Tone duration:

C  560  SPEC  500  SPEC Tone duration of 1st tone:  
500 ms

C  561  SPEC  100  SPEC Tone duration of the  
following tones: 100 ms

C  562  SPEC  0  SPEC No pauses.

This standard tone sequence determined by the user is available at any time until a further variation is made, but does not act directly on the current setting, even if USER 0 is loaded in Active Code. Only following  C  110  SPEC  21  SPEC do the changed parameters take effect. These relationships are shown in detail in Fig. 2-13.



Bild 2-13 Relationships and control of CODE/DECODE

### 2.3.3.7.7 Measurements on Transceivers with Acknowledgement Call

The acknowledgement call test is carried out as follows:

- a) Set the expected transmit frequency of the transceiver in the transmitter test, e.g.:

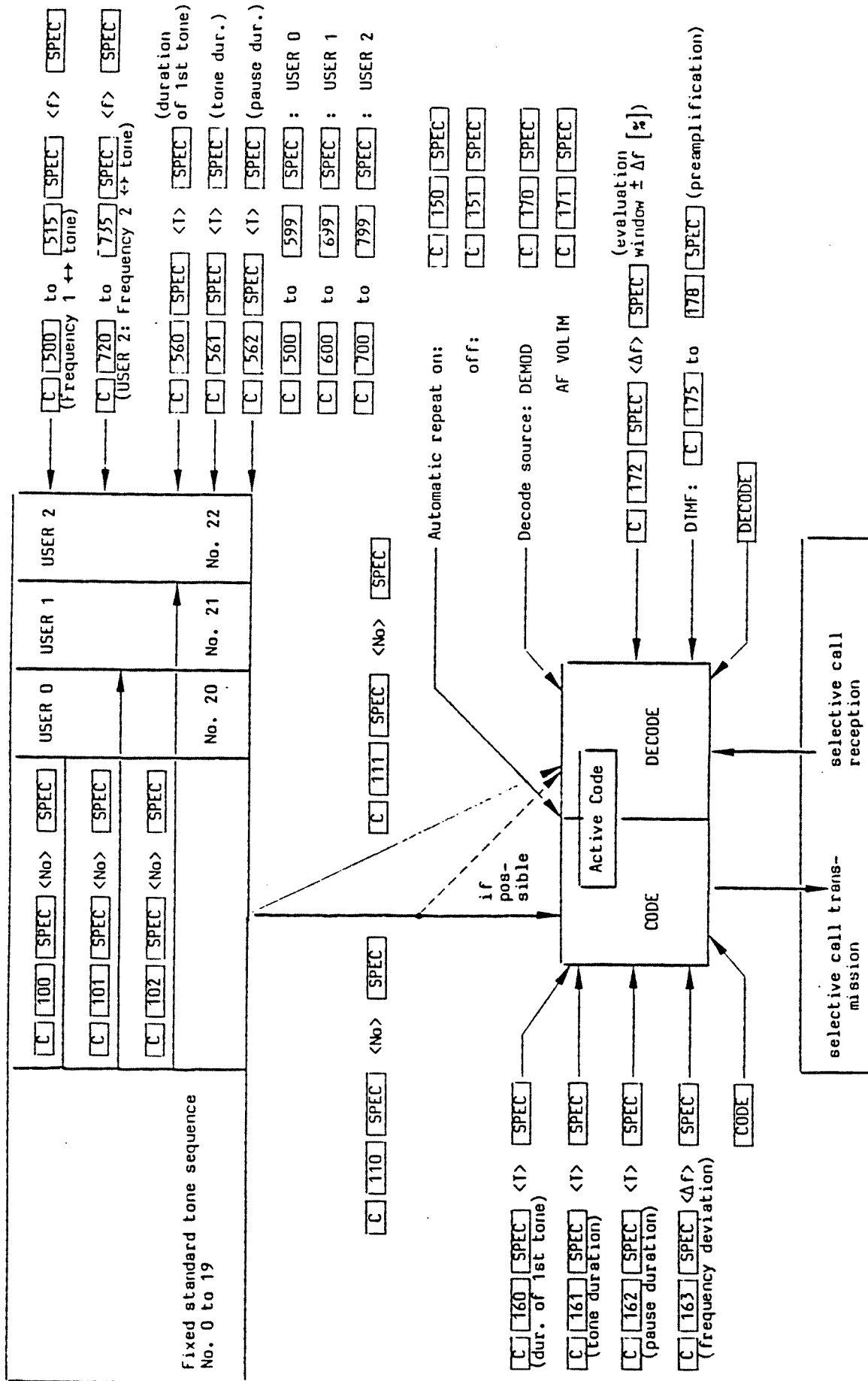
- b) Switch over to receiver test and switch on the acknowledgement call test function (ACK TEST)

(ACK TEST LED lights up)

- c) Call the transceiver by sending the selective call, e.g.:

After sending the last tone (5), the CMT automatically switches over from receiver to transmitter test if ACK TEST is activated. Furthermore, the following preparations for reception of the transceiver reply are made:

- + Set the transmitter test operating frequency (SET f TX) to be able to demodulate as fast as possible.
- + Switch on the PK HOLD function to store the maximum deviation or modulation depth of the transmission.
- + Switch on the tone sequence evaluation (DECODE).
- + Switch on the LOCK function to prevent the CMT from switching back to the receiver test mode if the RF power decreases after reception of the transceiver reply.

### 2.3.4 RF Power / RF Level

All RF level measurements and settings are made in the RF level field (Fig. 2-2).

#### 2.3.4.1 RF Power Measurements

RF power measurements are called when the instrument is switched on or when the key POWER 14 is pressed. All levels in the range from 1 mW to 50 W (0 to 47 dBm) are measured at high accuracy and simultaneously output in digital and analog form in the displays 12 and 13.

A linear or logarithmic representation according to the following relationship can be selected using the commands   and   :

$$P \text{ dBm} = 10 \log (P [\text{mW}] / 1 [\text{mW}])$$

Since the power display 0.00 W corresponds to a level of  $-\infty$  dBm, the display "Negative overflow" appears if the input signal is missing with the logarithmic scale (-1 in the digital display 12 and full analog bar in display 13).

The test diode of the power meter can be removed from the circuit using   in order to prevent RF distortions at the connector RF -30 dB 111. Power measurements are then no longer possible (identified in three dashes in the digital display). The function is switched on again using   (see Section 2.3.8).

An attenuating element of 0 to 40 dB connected to connector RF IN/OUT 77 can be taken into account during power measurements. The attenuation value is entered using the SPEC function.

.

The basic status is selected again by entering

.

If required, temperature influences on small RF levels can be largely compensated using an offset adjustment.

The connector RF IN/OUT 77 must be terminated with 50  $\Omega$  in this case (an RF power must not be present) and the key sequence    entered. The offset voltage of the equipment measured in this manner is stored and taken into account during the following power measurements.

The power meter can only be used for RF signals at connector RF IN/OUT 77.

If the RF input is thermally overloaded, the messages "OVERHEAT" and "REMOVE RF-POWER" are alternately output on the alphanumeric display. In this case, immediately switch off the RF power source and make sure that sufficient ventilation is provided (slots on the rear of the instrument!). When the message "OK,TEMP NORMAL" appears, the measurement can be continued where interrupted.

### 2.3.4.2 RF Synthesizer Output Level

The built-in RF synthesizer provides signals of 0.032  $\mu\text{V}$  (-137 dBm, -30 dB $\mu\text{V}$ ) and 1 V (+13 dBm, +120 dB $\mu\text{V}$ ), but the maximum level is limited to 0.5 V (+7 dBm) in AM mode.

The RF synthesizer level is reduced to a maximum of 1 mV (-47 dBm) by switching from receiver test to transmitter test or applying an RF signal > 0.5 W.

The synthesizer level is doubled (= + 6.02 dB) by pressing the key  $V_0$  SYNTH. + 6 dB and the acknowledgement appears above this key.

Adjustments and variations can still be carried out as usual and the current synthesizer level is always halved by pressing the key  $V_0$  SYNTH. + 6 dB again and the acknowledgement is switched off. The maximum possible level is set if the limit is exceeded by pressing this key; subsequent pressing results in half of this voltage.

The key  $V_0$  OFF 16 can be used to switch the synthesizer level off and on again (toggle key) in both transmitter and receiver tests. The minimum possible level is 0.032  $\mu\text{V}$  (-137 dBm, -30 dB $\mu\text{V}$ ).

The mechanical attenuation set is activated if the synthesizer output level is changed using the keys  $V_0$  SYNTH.,  $V_0$  SYNTH. + 6 dB and  $V_0$  OFF and short interruptions in the output level are possible at the switchover points.

The function   <Att.>  also produces an effect on the synthesizer output level, i.e. the actually set level is increased by the value of the attenuator connected ahead and the maximum level is reduced correspondingly.

If negative attenuation values (0 to -40 dB) are entered (corresponds to preamplification), the actually set synthesizer level is reduced by this value. This can be used e.g. for representing the RF level in EMF.

**Example:**     (gain 6 dB)

→ RF level set: 0.5  $\mu\text{V}$  rms = 1  $\mu\text{V}$  EMF  
Readout: 1  $\mu\text{V}$

If the level is reduced using the tuning knob, a continuous (electronic) fine level variation free from interruptions is guaranteed within a range up to 20 dB. The position of the electronic attenuator is output in the analog display 13 for orientation purposes (bar display from right to left corresponds to 0 to 20 dB attenuation). The attenuator is switched over if the bar reaches the end points of the analog display (with AM, the center  $\hat{=}$  -10 dB).

If the level is increased using the tuning knob, the mechanical attenuation set switches over when the fine variation range is left (0 dB attenuation) as in the case of level inputs via the keyboard.

All RF level inputs and outputs produce the voltage or power with a terminating resistor of 50  $\Omega$ . The actual output voltage is always displayed, the EMF has doubled this value.

The synthesizer output level can be displayed in  $\mu$ V, mV or dB $\mu$ V, dBm.

The conversion is carried out using the following equations:

$$U \text{ [dB}\mu\text{V]} = 20 \log (U \text{ [\mu V]} / 1 \text{ }\mu\text{V})$$
$$P \text{ [dBm]} = 20 \log (U \text{ [mV]} / 223.6 \text{ mV})$$

The remaining power is decreased by reflection if the connected test object or the load is incorrectly matched. Depending on the standing wave ratio  $s$ , the output power is then:

$$P \text{ (load)} = p \text{ (display)} * 4 s / (1 + s)^2$$

### 2.3.4.3 Probe Measurements

The RF millivoltmeter is switched on using the key PROBE 17 provided the CMT is fitted with the CM-B8 option, otherwise an error message is output in the  $\alpha$  display.

If the probe measurement is switched off in the receiver test by pressing keys 14 and 15, power measurements are active again when switching to the transmitter test.

The data output can be matched via the SPEC functions 111 to 115 when using probes with different impedances (50/75  $\Omega$ ) or different sensitivities (1:1 / 10:1 / 100:1) (see also Section 2.3.8).

When the instrument is switched on, the setting corresponds to a 1:1 probe with 50- $\Omega$  impedance.

111 SPEC	1:1 ( 0 dB)	Default
112 SPEC	10:1 (-20 dB)	
113 SPEC	100:1 (-40 dB)	
114 SPEC	75- $\Omega$ impedance	
115 SPEC	50- $\Omega$ impedance	Default

#### 2.3.4.4 Adjacent-Channel Power Measurements (ACP)

The adjacent-channel power meter is switched on by pressing the key ACP 15 if the CMT is fitted with the CMT-B6 option, otherwise an error message is output in the  $\alpha$  display.

The centre frequency of the useful channel is determined by the input SET f TX 6, the channel width by  $\Delta f$  6.

ACP measurements can be carried out with channel spacings of 10, 12.5, 20 or 25 kHz. If a different channel spacing has been entered, a request to set the correct spacing (" \*\*CH. SP.\*\* " in the  $\alpha$  display) appears when ACP measurements are called and 3 dashes appear in the digital display.

Any channel spacing can be entered using 140 SPEC (cancel using 141 SPEC ) and the test bandwidth is made to be approx. 4 kHz. The channel spacing then only defines the respective deviation from the useful channel.

The channel to be measured is selected by entering a number before pressing the ACP key.

The following inputs are permissible:

- |           |            |  |                        |
|-----------|------------|--|------------------------|
| <u>-2</u> | <u>ACP</u> | Noise power<br>two channels below useful channel | $f = f_0 - 2 \Delta f$ |
| <u>-1</u> | <u>ACP</u> | Noise power<br>in bottom adjacent channel        | $f = f_0 - \Delta f$   |
| <u>1</u>  | <u>ACP</u> | Noise power<br>in top adjacent channel (default) | $f = f_0 + \Delta f$   |
| <u>2</u>  | <u>ACP</u> | Noise power<br>two channels above useful channel | $f = f_0 + 2 \Delta f$ |

The adjacent-channel power ( $\mu W$ , mW or W) is output following the instruction W ACP , provided the measurement at the input RF IN/OUT is performed with at least 0 dBm in the useful channel.

The adjacent-channel power spacing (dB) can be called by

dB ACP .

The combined inputs -1 dB ACP or 2 W ACP are also permissible.

At specific RF frequencies (integer multiples of 100 MHz), selection of the ACP measurement may cause the measured value to fluctuate in some cases. These fluctuations occur only if the option CM-B9 (Duplex Modulation Meter) is fitted and if, in addition, the frequency of the internal RF synthesizer is a multiple of 100 MHz. These fluctuations can be avoided by selecting a different frequency setting of the RF synthesizer.

## 2.3.4.5 Selective RF Millivoltmeter

### 2.3.4.5.1 General Information

If the option CMT-B6 is fitted in the CMT, the selective voltmeter can be switched on using  0  ACP. The result can be displayed in mV, dBm, W,  $\mu$ V or dB $\mu$ V according to the input.

**Example:**

0	W	ACP
↑	↑	
Selective voltmeter selected	Display unit (watts)	

The measuring bandwidth is approx.  $\pm 2$  kHz about the set receive frequency (SET f TX 6).

The source is selected by means of INPUT SELECT.

The dynamic range differs according to the input:  
(internal 20-dB attenuator not switched on!)

- a) RF IN/OUT: = 50  $\mu$ V to 500 mV  Can be extended up to 50 W  
b) INPUT 2: = 0.5  $\mu$ V to 5 mV  using external attenuators!

The sensitivity is frequency-dependant to a small degree, ie if the test frequency is varied by more than 10 MHz, the voltmeter should be calibrated again.

If the option CM-B9 (Duplex Modulation Meter) is fitted, make sure when measuring via the socket RF IN/OUT that the signal generator of the CMT does not operate with a high level at the test frequency of the voltmeter, since this would falsify the result.

**Note:** Harmonic measurements are not possible!



## 2.3.4.5.2 Calibration through Entry of Currently Applied Power (applicable to both inputs)

### Procedure:

→ Select input

(Switch off internal 20-dB attenuator first)

→ Only if socket RF IN/OUT is used:    
(Switch off automatic control of internal attenuator according to the power applied)

→ Enter appropriate RF frequency

→ Switch on voltmeter (   )

→ Apply signal with test frequency and known amplitude to the selected input (RF IN/OUT or INPUT2).

→ In the event that the message "\*RED.RF-POWER\*" is displayed, the sensitivity can be reduced by about 20 dB by means of   (internal attenuator on).

If this is not sufficient, an additional external attenuation facility must be provided ( $\Delta$ ATT.).

→ The key sequence   <power/dBm>  can be used to enter on the CMT the RF power (in dBm) to which the currently measured voltage corresponds

e.g.     (13.5 dBm)

It is irrelevant whether the power applied actually corresponds to 13.5 dBm. Thus, attenuators or amplifiers connected to the input can be included in the reference measurement and thus in the subsequent measurement results.

When the input of the CMT is changed (via INPUT SELECT), the measurement result obtained is either 40 dB too low (calibration at INPUT 2, measurement at RF IN/OUT) or too high (calibration at RF IN/OUT, measurement at INPUT 2) owing to the difference in sensitivity between the two inputs.

### 2.3.4.5.3 Calibration through Reference Measurement Using the RF Power Meter

For calibration using the RF power meter, the amplitude of the RF voltage applied need not be known and entered.

#### Procedure:

- + Select input RF IN/OUT
- +   (switch off internal 20-dB attenuator first)
- +   (switch off automatic control of internal attenuator according to the power applied)
- + Enter appropriate RF frequency.
- + Switch on voltmeter (   )
- + Apply signal with test frequency to the selected input (RF IN/OUT or INPUT 2 in combination with RF IN/OUT, e.g. directional coupler).
- + In the event that the message "\*RED.RF-POWER\*" is displayed, the sensitivity can be reduced by about 20 dB by means of   (internal attenuator on).

If this is not sufficient, the external attenuation of the CMT must be increased at the input.

- + By means of   , the RF power measured at socket RF IN/OUT is defined as reference level.

If the power applied to RF IN/OUT is smaller than 0 dBm when   is called, the user is prompted to increase the RF power by means of "INC. RF POWER".

When the input of the CMT is changed (via INPUT SELECT), the measurement result obtained is either 40 dB too low (calibration at INPUT 2, measurement at RF IN/OUT) or too high (calibration at RF IN/OUT, measurement at INPUT 2) owing to the difference in sensitivity between the two inputs.

#### 2.3.4.5.4 Calibration Sources

When using   , an RF power of at least 10 mW (possible from 1 mW onwards) is required for the power measurement in the selected frequency range.

When using   , a calibrated RF signal in the range 50  $\mu$ V to 5 mV is all that is needed.

If the option CM-B9 (Duplex Modulation Meter) is fitted, the signal of the built-in signal generator is also sufficient for calibration.

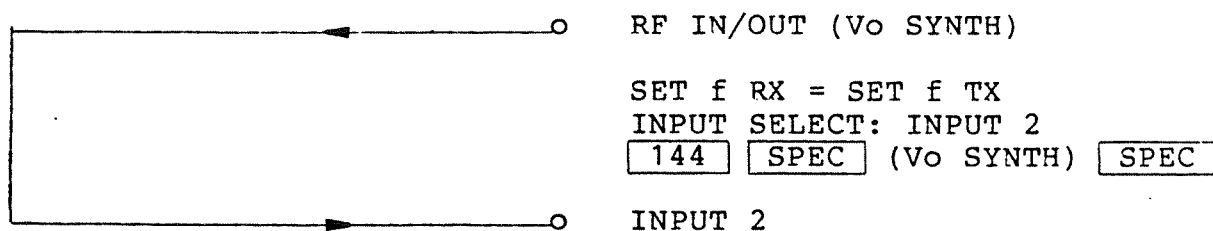

#### 2.3.4.5.5 Error Handling

As long as an error condition exists when using the selective voltmeter, the output of the measurement result on the RF level display is suppressed, and three strokes are displayed instead!

Following "RAM-ERROR", which may occur when switching on the instrument for the first time or after replacing the battery, no reference value is available. After the measurement has been called, the CMT indicates the lacking reference value by reading out the request »CALIBRATE« on the alphanumeric display.

The input of   xx  or   , respectively, causes the measurement result to be immediately read out on the alphanumeric display.

If the maximum permissible input voltage of the voltmeter is exceeded, the user is prompted to reduce the input power by the message "\*RED.RF-POWER\*".

### 2.3.4.5.6 Application Hint: Measurement of Forward and Reflected Power

#### Calibration:

- + Enter appropriate RF frequency.
- + Switch on voltmeter (   ).
- + Apply the greatest occurring signal.

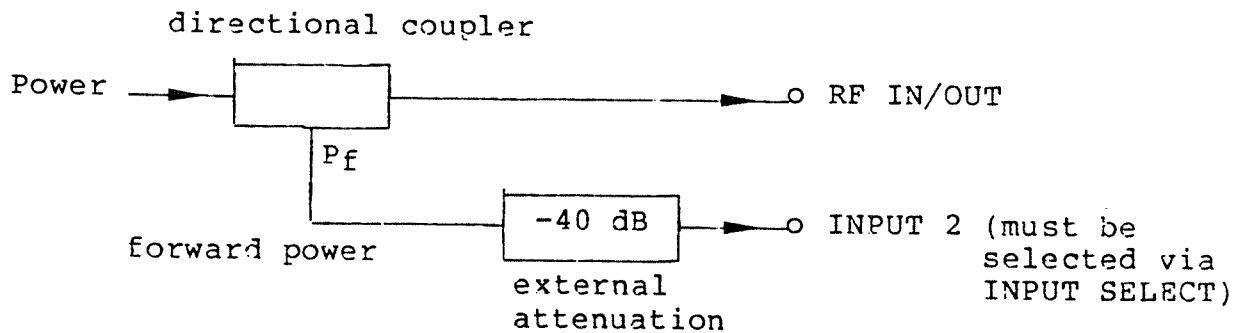

- +   (power measurement + forward power)

#### Measurement:

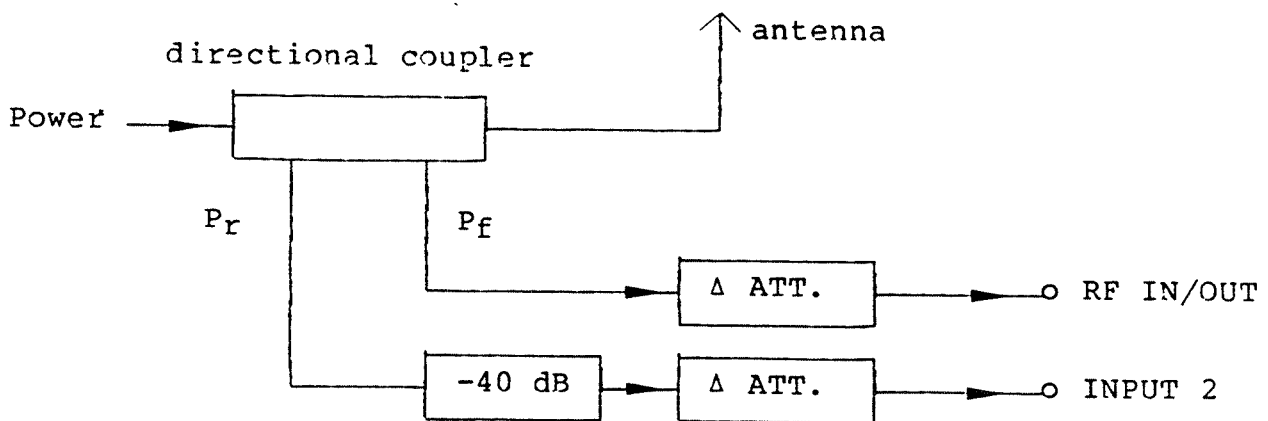

By inserting an additional 40-dB attenuator, the difference in sensitivity between both inputs is balanced.

By switching between the two inputs via INPUT SELECT, the forward and reflected power can be measured separately; it is however possible that different coupling factors are not taken into account then. This error source can be eliminated by using only one coupling line and reversing the directional coupler for measurement of the forward and reflected wave.

### 2.3.5 Demodulation/Modulation

The analysis of the transmitter modulation and the settings of the RF test generator modulation are combined in the modulation field (Fig. 2-3).

If the adjacent-channel power meter (option CMT-B6) is fitted, self-reception at the transmitter test operating frequency may give rise to disturbances at low RF input levels.

#### 2.3.5.1 Modulation Selection

The possible types of modulation AM, FM and  $\phi$ M are selected using the following key combinations:

<input data-bbox="97 620 161 656" type="text" value="%"/>	<input data-bbox="217 620 371 656" type="text" value="MAX PK"/>	/	<input data-bbox="472 620 611 656" type="text" value="INT 1"/>	→	AM
<input data-bbox="97 685 188 721" type="text" value="kHz"/>	<input data-bbox="217 685 371 721" type="text" value="MAX PK"/>	/	<input data-bbox="472 685 611 721" type="text" value="INT 1"/>	→	FM
<input data-bbox="97 750 172 786" type="text" value="Hz"/>	<input data-bbox="217 750 371 786" type="text" value="MAX PK"/>	/	<input data-bbox="472 750 611 786" type="text" value="INT 1"/>	→	FM
<input data-bbox="97 815 188 851" type="text" value="rad"/>	<input data-bbox="217 815 371 851" type="text" value="MAX PK"/>	/	<input data-bbox="472 815 611 851" type="text" value="INT 1"/>	→	$\phi$ M

If the selection is made in the receiver test (function INT 1), input of the deviation or the modulation depth is also possible simultaneously using the 1st modulation generator:

<input data-bbox="97 1046 172 1081" type="text" value="50"/>	<input data-bbox="217 1046 276 1081" type="text" value="%"/>	<input data-bbox="331 1046 470 1081" type="text" value="INT 1"/>	→	AM, 50 % modulation depth
<input data-bbox="97 1111 156 1146" type="text" value="1"/>	<input data-bbox="217 1111 308 1146" type="text" value="kHz"/>	<input data-bbox="331 1111 470 1146" type="text" value="INT 1"/>	→	FM, 1 kHz deviation
<input data-bbox="97 1176 188 1211" type="text" value="2.5"/>	<input data-bbox="217 1176 308 1211" type="text" value="rad"/>	<input data-bbox="331 1176 470 1211" type="text" value="INT 1"/>	→	$\phi$ M, 2.5 rad deviation

All set values are stored in the RAM with battery backup when the modulation mode is changed. These values include:

INT 1, INT 2, EXT:	Setting value
	REF value
	$\Delta$ VAR value
	$\Delta$ VAR memory on/off
	Display unit (Hz/kHz)

MAX PK, +PK, +/-2PK, -PK:	REF value
	RANGE HOLD value
	RANGE HOLD on/off
	Display unit (Hz/kHz)

The corresponding parameters of the new modulation mode are then fetched from the memory and set. MAX PK is always switched on in the transmitter test following selection, and the RF synthesizer is only modulated by the AF generator 1 (INT 1).

The set modulation mode applies to both transmitter and receiver tests. A modulation mode deviating from the complete mode is only possible with modulation of the RF synthesizer by an external source (connector MOD EXT 82).

Possible combinations with double modulation:

INTERNAL	EXTERNAL
FM / $\phi$ M	AM
AM	FM / $\phi$ M

The selection takes place according to the overall mode selected whilst using the characteristic units:

Mode: transmitter test, FM

<input type="checkbox"/> %	<input type="checkbox"/> EXT	→ AM with modulation depth last stored	
<input type="checkbox"/> 50	<input type="checkbox"/> %	<input type="checkbox"/> EXT	→ 50 % AM via external modulation source

Mode: transmitter test, AM

<input type="checkbox"/> kHz	<input type="checkbox"/> EXT	→ FM with FM deviation last stored	
<input type="checkbox"/> 1	<input type="checkbox"/> kHz	<input type="checkbox"/> EXT	→ 1 kHz deviation via external modulation source
<input type="checkbox"/> rad	<input type="checkbox"/> EXT	→ $\phi$ M with $\phi$ M deviation last stored	

If double modulation is set as a result of changing the overall operating mode, the value of the EXT modulation is not stored.

### 2.3.5.2 Modulation Meter

The modulation meter is accessed using the keys MAX PK, POLARITY SELECT and PK HOLD. The output is made simultaneously in the digital display 21 and in the quasi-analog display 22.

In order for the demodulators to work properly, the appropriate operating frequency must be correctly set, i.e. either the RF counter can count the receive signal (counter status  $\langle \rangle$  0), or the correct RF frequency has been set manually via SET f TX.

Besides, it is to be noted that the function   is active following master reset. It is therefore possible that the (RF) limit sensitivity is not reached. The demodulated output signal can be connected through via  .

**MAX PK** The positive and negative peak modulations are measured alternately, but only the larger of the two results is displayed.

**POLARITY SELECT** This is a toggle key with which specific measurement of the positive peak modulation (+PK), negative peak modulation (-PK) or arithmetic mean of both (+-/2PK) can be selected.

**PK HOLD** Even short modulation peaks are stored and can be displayed if the PK HOLD key is pressed (important with short modulation bursts such as tone sequences etc.). This is only possible in +PK or -PK mode; if the MAX PK or +/-2PK function is active when PK HOLD is switched on, an automatic switchover is made to +PK.

PK HOLD is an analog memory circuit which guarantees acquisition of all modulation peaks without gaps. This also means, however, that the peak-value meter is no longer available for other purposes such as e.g. peak-weighted AF level measurements (see Section 2.3.6.2).

Modulation measurements can be made with peak weighting or RMS weighting. When the instrument is switched on or a master reset made, a frequency deviation  $< 100$  Hz or a phase deviation  $< 0.1$  rad and a modulation depth  $< 1$  % are considered as spurious modulation and automatically RMS weighted; peak weighting is selected if these limits are violated.

This automatic function can be switched off using

(only RMS weighting)

and

(only peak weighting)

and switched on again using

.

### 2.3.5.3 Transmitter Distortion

Measurement of the transmitter distortion is called by pressing the key DIST 26. The frequency of the first modulation generator is automatically set to the value entered via   <f (Hz) >  (and displayed). It is factory-set to 1 kHz (operating frequency of distortion meter), but it can be matched to a frequency conversion in the transceiver (e.g. voice encoding) in the range from 20 Hz to 9.999 kHz. Modulation of the transmitter must also be ensured by the signal at connector MOD GEN (no two-tone).

If the transceiver is also modulated by a pilot tone (< 300 Hz), this signal must be suppressed by switching on the 300-Hz high-pass filter (see Section 2.3.5.4).

Logarithmic or linear output of the result can be selected by entering the unit % or dB before pressing the DIST key.

The receiver distortion measurement or SINAD measurement is switched off when the transmitter distortion measurement is selected.

In order to examine the signal/noise ratio of the transmitter signal, the DIST key can be assigned to the transmitter S/N measurement by  . Subsequent pressing of this key does not call, as described previously, the transmitter distortion measurement but calls the transmitter S/N measurement.

The output signal at the MOD GEN connector is switched on and off alternately, and the FM deviation and the spurious FM with an unmodulated carrier measured. The ratio of these two measurements results in the displayed S/N value in % or dB.

Peak-value measurement by means of

rms measurement by means of   and

Distortion measurements are selected again using   and by subsequent pressing of the key DIST.

### 2.3.5.4 Filter Weighting of the Demodulated Signal

The frequency response of the demodulated signal (50 Hz to 20 kHz) can be clipped using two filters:

- By a highpass with a cut-off frequency of 300 Hz, especially to suppress pilot tones.
- By a bandpass (300 Hz to 3 kHz) according to the CCITT standard.

Switching on and off is carried out by repeatedly pressing the keys HP (= highpass) and CCITT (= filter to CCITT standard).

Cutting the CCITT filter into the demodulation branch switches off the filter in the AF voltmeter branch.



### 2.3.5.5 Modulation of the RF Test Generator

The RF test generator can be modulated with up to three sources:

Modulation source	Modulation mode	
Modulation generator 1	AF INT 1 INT 1	Frequency setting Deviation or modulation depth
Modulation generator 2 *)	AF INT 2 INT 2	Frequency setting Deviation or modulation depth
Signal at connector MOD EXT	EXT	Deviation or modulation depth 1 Vrms

\*) Only if option CMT-B7 fitted

The two modulation generators INT 1 and INT 2 always have the same modulation mode (AM, FM or  $\phi$ M), the respective modulation intensity is adjustable independently.

In order to modulate the generator with very low AF frequencies (<150 Hz) in FM, it is necessary to slow down the RF synthesizer control loop.

This is done by means of  17  SPEC .



In this operating mode, the setting time of the RF frequency is 3 s (except an offset from the final frequency of  $2 \times 10^{-6}$  or 250 Hz for RF <31.25 MHz). This is independent of the type of modulation (AM, FM,  $\phi$ M) or the operating mode (transmitter test/receiver test).

This operating mode is switched off via

16  SPEC (default following switch-on)

A large number of combinations is possible when using the modulation input MOD EXT; the possibilities are listed in Table 2-1.

Table 2-1

INT 1	INT 2	EXT
AM1	AM2	$A_{Me} = AM1$ $AM1 > AM2$ $A_{Me} = AM2$ $AM1 < AM2$ $A_{Me}$ any $AM1 = AM2 = 0$  $F_{Me}$ any  $\phi_{Me}$ any
FM1	FM2	$A_{Me}$ any  $F_{Me} = FM1$ $FM1 > FM2$ $F_{Me} = FM2$ $FM1 < FM2$ $F_{Me}$ any $FM1 = FM2 = 0$  $\phi_{Me}$ not permissible
$\phi M1$	$\phi M2$	$A_{Me}$ any  $F_{Me}$ not permissible  $\phi_{Me} = \phi M1$ $\phi M1 > \phi M2$ $\phi_{Me} = \phi M2$ $\phi M1 < \phi M2$ $\phi_{Me}$ any $\phi M1 = \phi M2 = 0$

The respective modulation is switched on by pressing the key INT 1, INT 2 or EXT. The deviation or the modulation depth and the key acknowledgement appear in the digital display 21 (the key acknowledgements indicate which modulation sources are used to modulate the RF generator).

The complete modulation is switched off using the key MOD OFF 26, individual modulation sources can be switched off using the key sequences  0  INT 1 /  0  INT 2 or  0  EXT .

Since peak deviations or modulation depths are involved, the total of the individual modulations must not exceed the respective limit value; all entries which do not satisfy this condition are rejected.

**Example:**

Maximum deviation  
in frequency range 31.25 to 62.5 MHz ..... 50 kHz  
Switched on modulation INT 1 ..... 30 kHz

The instruction  kHz  (connection of INT 2 with 20 kHz deviation) is permissible (total deviation 50 kHz).

The instruction  kHz  (connection of INT 2 with 30 kHz deviation) would exceed the limit of 50 kHz and is rejected.

FM with an external signal is not possible in this example since the additional condition EXT = INT 1 applies in this case and the limit value of 50 kHz would be exceeded if EXT were connected ( $2 * INT 1 = 60$  kHz).

Depending on the frequency range, the RF generator has a maximum deviation of 50 to 800 kHz or 5 to 80 rad (see data sheet). If this limit is exceeded by the frequency variation, the deviations of all connected modulation sources must be reduced by the same factor until the limit value condition is fulfilled.

**Example:**

Test frequency 550 MHz

INT 1 .....	300 kHz	
INT 2 .....	200 kHz	
EXT .....	300 kHz	
Total .....	<u>800 kHz</u>	permissible: 800 kHz

Test frequency 450 MHz

The deviations are reduced by half:

INT 1 .....	150 kHz	
INT 2 .....	100 kHz	
EXT .....	150 kHz	
Total .....	<u>400 kHz</u>	permissible: 400 kHz

The EXT modulation depth/deviation is always equal to the larger value of INT 1 and INT 2 in the case of double or tripple tone modulation between EXT and INT 1, INT 2 or INT 1 + INT 2. If INT 1 or INT 2 is now varied, the messages

**EXTMOD - INT1MOD or EXTMOD - INT2MOD**

in the  $\alpha$  display indicate the coupling of two modulations.

If EXT is displayed in the alphanumeric display and INT1 or INT2 in the modulation display, this message is suppressed and the indication in the alphanumeric display remains unchanged even if EXT is varied (by varying INT1 or INT2)

With EXT, the VAR symbol has no meaning in this case.

→ The modulation switch-off time (FM, low modulation frequencies) when changing the RF frequency is adjustable; it is factory-set to 40 ms (default).

24 SPEC <delay [ms]> SPEC

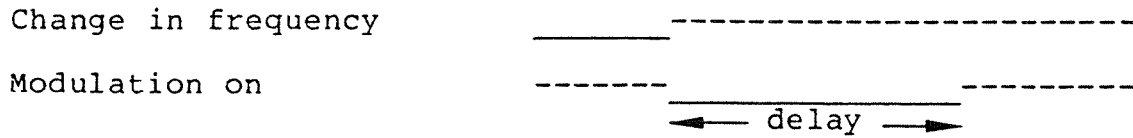

### 2.3.5.6 Calibration of the Modulation Sensitivity of the External Input

The display of the modulation depth or deviation in the case of external modulation is referred to an input level of 1 V<sub>rms</sub>, deviations from this standard level lead to differences between the displayed modulation and the actually set modulation.

If the level at connector MOD EXT is in the range 0.1 V to 2 V, the modulation sensitivity of the external input can be tuned to the respective level by pressing the key EXT CAL 28.

If, however, the level does not lie within the permissible range, the gain setting is calibrated only as far as possible and no error message is produced.

The modulation sensitivity is set back to the standard level of 1 V<sub>rms</sub> by pressing the key 1 V<sub>RMS</sub> 27 (display in each case via key acknowledgement).

#### **Example:**

Level at connector MOD EXT ... 0.5 V<sub>rms</sub>  
 Display 21 ..... 3 kHz  
 Actual deviation ..... 1.5 kHz

Command: EXT CAL  
 Actual deviation ..... 3 kHz

Command: 1 V<sub>RMS</sub>  
 Actual deviation ..... 1.5 kHz

Since parts of the adjustable amplifier simultaneously act on the internal modulation sources when using external modulation, a deviation between the displayed modulation and the actually set modulation by INT 1 / INT 2 of up to ± 30 % is possible in the position EXT CAL.



### 2.3.5.7 Modulation Sensitivity

The automatic modulation sensitivity measurement is selected by indication of a rated value in the MAX PK measurement:

	Number	[unit]	MAX PK
e.g	<input type="text" value="2.8"/>	<input type="text" value="kHz"/>	<input type="text" value="MAX PK"/>

Starting from the currently set value, the AF level at socket MOD GEN is increased or reduced according to the following formula until the measured value of the modulation (MAX PK) corresponds to the rated value ( $\pm 2\%$ ):

$$\text{New level} = \frac{\text{rated modulation}}{\text{actual modulation}} * \text{old level}$$

The end of the search routine is indicated in the alphanumeric display by the message "DONE", the associated AF level can then be read on the AF level display.

This search routine is aborted and an error message output on the following conditions:

- AF level is  $<10 \mu\text{V}$  or  $>2.5 \text{ V}$  → CHECK INST.
- The modulation measurement result is  $0\%$  / kHz / rad → CHECK INST.
- The rated value ( $\pm 2\%$ ) is not achieved after 2 minutes.
- AF level or type of modulation has been changed during a running search routine → PARAMCHANGED

The running modulation sensitivity routine can be switched off again by pressing

MAX PK (without numbers!)  
+  $\pm/2$  - PK  
DIST (TK)

as well as via function   .



The rated value entered always refers to peak weighted signals. If the measurement result delivered by the MAX PK measurement is rms weighted, it is converted to the peak value for comparison with the rated value (MAX PK peak =  $\sqrt{2}$  \* MAX PK rms).



## 2.3.6 Modulation Generator Level/AF Voltmeter

The evaluation of the AF signals applied to the connector AF VOLTM 84 and the level setting of the AF signal from connector MOD GEN 83 are presented in the AF level field (Fig. 2-4).

### 2.3.6.1 AF Generator Level

An AF signal with a frequency of 20 Hz to 30 kHz in the range from 10  $\mu$ V to 5.1 V is available at connector MOD GEN 83. The frequency of this signal is determined in the frequency field using the key AF INT 1 9 (with double tone also AF INT 2 10), the level can be adjusted using the keys  $V_0$  MOD GEN 32,  $V_0$  MOD +20 dB 33 and  $V_0$  OFF 35.

The AF level can be directly entered in  $\mu$ V, mV, dB $\mu$ V and dBm (at 600  $\Omega$ ) via the key  $V_0$  MOD GEN. The RMS voltage is displayed at the output (this corresponds to the EMF with an output impedance of 0  $\Omega$ ).

The displayed value is multiplied by 10 by pressing the key  $V_0$  MOD +20 dB and the associated key acknowledgement appears. Settings and variations can still be carried out as before. Pressing the key  $V_0$  MOD +20 dB again reduces the currently displayed value by a factor of 10 and the key acknowledgement is switched off.

Exceeding limits when using this key results in the maximum possible value, subsequent pressing reduces this voltage to one tenth.

The key  $V_0$  OFF can be used in the transmitter and receiver tests to switch off the AF level and to switch it on again (toggle key).

If the option CMT-B7 is fitted, a double tone can be generated at the connector MOD GEN by pressing   or  . The output level displayed corresponds to the total RMS value of the added signal in the case of  . When using  , it corresponds to the RMS value of an individual signal, in which case the individual amplitudes of the two tones are always the same.

$$\text{122} \quad \text{SPEC} : V_{\text{disp}} = V_{\text{tot}} = \sqrt{2} \cdot V_1 = \sqrt{2} \cdot V_2$$

$$\text{123} \quad \text{SPEC} : V_{\text{disp}} = V_1 = V_2 = V_{\text{tot}} / \sqrt{2}$$

$$\text{121} \quad \text{SPEC} : V_2 \text{ is switched off again.}$$

Two-tone (at socket MOD GEN) is indicated by "1.2.MOD" on the AF level display.





### 2.3.6.2 AF Voltmeter

The AF voltmeter is switched on by pressing the key LEVEL. All voltages at the connector AF VOLTM are measured in the range from 0.1 mV to 35 V and output in digital and analog form in the AF level display 30/31 in the units  $\mu\text{V}$ , mV, V, dB $\mu\text{V}$  or dBm (600  $\Omega$ ).

This measurement can be switched between RMS and peak weighting or various measuring rates can be selected using the following SPEC functions (see also Section 2.3.8).

#### RMS measurements

40  SPEC

Two measuring rates can be selected for RMS measurements:

26  SPEC : SLOW (default setting following switch-on)

25  SPEC : FAST

The selected speed also applies to modulation measurements if these are RMS weighted.

#### Peak-value measurements

41  SPEC : Positive half-wave

42  SPEC : Negative half-wave

The peak-value weighting of the AF level can only be switched on with the PK HOLD function (modulation measurement) switched off.

Table 2-2

Measurement	RMS		Peak
	Fast	Slow	
Lower frequency limit	150 Hz	50 Hz	20 Hz
Maximum measuring speed	80 ms	220 ms	80 ms

43  SPEC  $\langle R (\Omega) \rangle$   SPEC : Setting of reference resistance with AF voltmeter measurements ( $2 \Omega < R < 3000 \Omega$ ).

### 2.3.6.3 Receiver Distortion Depth (SINAD/DIST)

#### Measurements

The SINAD measurement (unit dB) is switched on by pressing the key SINAD·DIST. The receiver distortion depth (unit %) is displayed if this key is pressed again.

The frequency of the first modulation generator is automatically set to the value entered via   <f (Hz)>  (and displayed). It is factory-set to 1 kHz (operating frequency of the distortion meter) but can be matched to a frequency conversion in the transceiver (e.g. voice encoding) in the range from 20 Hz to 9.999 kHz.

It is also possible to directly select the distortion measurement without using the toggle function by additionally entering the unit %.

If a number is entered before the key SINAD·DIST (unit dB) is pressed, the output level of the test generator is varied until the SINAD result reaches the preset value ( $\pm 1$  dB or 2 dB).

The DIST measurement is correspondingly called instead of the SINAD measurement if the unit for the entered number is %.

These search routines can be influenced by the following SPEC functions:

: The search routine is terminated if the result falls within the tolerance window of the desired SINAD value (default).

: The search routine is also activated again when the preset value is reached and the output level of the test generator is adjusted correspondingly if the parameters are changed.

: The tolerance window of the preset value is  $\pm 1$  dB.

: The tolerance window of the preset value is  $\pm 2$  dB (default).

The search routines are switched off by pressing the key SINAD·DIST again, influencing the RF test generator level (adjustment, switch-off, variation) or the modulation or switching off the SINAD·DIST measurement.

Further abort conditions for the search routines are the attainment of the time limit (approx. 2 min) and increasing of the RF level to  $> -27$  dBm.

In the case of jumps in input voltage, the internal control of the CMT requires max. 6 s until a stable measurement result can be displayed.



As a result of this, it is possible that the first measurement result does not correspond to the actual value in IEC-bus operation and operation with the autorun control.

#### 2.3.6.4 Signal-to-Noise Measurements

The receiver signal-to-noise measurement is switched on by pressing the key S/N 34.

If a number is entered before pressing the key S/N (unit dB), the output level of the signal generator is varied until the S/N result reaches the preset value ( $\pm 1$  dB or 2 dB).

The search routine remains activated even after the preset value has been reached if 59 SPEC was previously entered, otherwise only the S/N measurement is continued and the RF signal generator level is no longer influenced (58 SPEC), see SINAD search routines, Section 2.3.6.3).

As with the SINAD search routine, the tolerance window can also be switched in this case to  $\pm 2$  dB by 61 SPEC and to  $\pm 1$  dB by 60 SPEC.

The search routine is switched off by pressing the key S/N again, influencing the RF signal generator level (adjustment, switch-off, variation) or switching off the S/N measurement.

Further abort conditions for the search routine are the attainment of the time limit (approx. 2 min) and increasing of the RF level to  $> -27$  dBm.

The modulation of the RF signal generator is constantly switched on and off with the S/N measurement. Since the CMT has three modulation sources (INT 1, INT 2 and EXT), influencing of INT 2 and EXT can be controlled using the following SPEC functions:

- 50 SPEC : INT 2 remains uninfluenced (default).
- 51 SPEC : INT 2 is also switched on and off.
- 52 SPEC : EXT remains uninfluenced (default).



This only applies if  $INT\ 2 > INT\ 1$  or  $INT\ 2 = 0$  since otherwise the EXT value is switched between  $EXT = INT\ 1$  and  $EXT = INT\ 2$  by the condition  $EXT = INT\ 1$  or  $INT\ 2$  (maximum value in each case).

- 53 SPEC : EXT is also switched on and off.

For the noise measurement (modulation of signal generator switched off), the control loop is usually switched to "loop fast" which improves the broadband spurious FM of the signal generator and thus the measurement limit of the S/N measurement.

However, if this measurement is performed with the CCITT filter switched on, it is often better to switch the control loop to "loop slow" even if the modulation is switched off. Though the broadband spurious FM is somewhat deteriorated, the spurious FM in the transmission range of the filter and thus the measurement limit of the S/N measurement is improved.

This special operating mode is switched on via  105  SPEC and switched off via  104  SPEC (default).

#### 2.3.6.5 Filter Weighting of the AF Signal

The AF signal at connector AF VOLTM is analyzed for all frequencies up to approx. 100 kHz min. (depending on measurement).

This wide test bandwidth can be limited to the frequency range from 300 Hz to 3 kHz by switching on the CCITT filter (key CCITT RX 36). This also switches the filter out of the demodulator branch (key acknowledgement via CCITT TX 28 extinguished).

The filter is switched off again by pressing the key CCITT RX or CCITT TX again.

#### 2.3.6.6 Averaging of Noisy Signals at AF VOLTM Input and Demodulator Input

For stable measurement of noisy signals, measurement repetition and averaging (arithmetic mean) can now be selected in four steps:

<input type="checkbox"/> 45	<input type="checkbox"/> SPEC	no averaging (default after switching on)
<input type="checkbox"/> 46	<input type="checkbox"/> SPEC	30 measurements
<input type="checkbox"/> 47	<input type="checkbox"/> SPEC	60 measurements
<input type="checkbox"/> 48	<input type="checkbox"/> SPEC	140 measurements
<input type="checkbox"/> 49	<input type="checkbox"/> SPEC	255 measurements

This averaging refers to all measurements performed using the rms meter (also for search routines):

AF voltmeter (if "RMS" is displayed)  
S/N  
SINAD  
DIST (RX)  
DIST (TX)  
MAX PK (if "RMS" is displayed)  
±/2 - PK (if "RMS" is displayed)

The relatively high number of measurement repetitions reduces the measuring rate accordingly!

## 2.3.7 Numeric Keypad + Special Functions

### 2.3.7.1 Numeric Keypad

This keypad is used for entering the required numerical values. The inputs are evaluated in such a manner that incorrect entries are corrected as far as possible.

#### Setting values

Setting values can be entered as a unit, numbers or unit + numbers.

Although a unit is usually specified before or after the number, units (also minus) entered between the individual numbers are also evaluated by the CMT; the last entered unit is then valid.

If the decimal point is pressed several times by mistake, the first one is assumed to be the separation between the digits before and after the decimal point.

#### Example:

Input:

1 . 3 2 5 kHz INT 1

kHz 1 . 3 2 5 INT 1

1 . kHz 3 2 . 5 INT 1

1 . 3 Hz 2 . 5 % kHz INT 1

Following evaluation:

1.325 kHz modulation (FM) by 1st modulation generator (INT 1) in all 4 cases.

The number of times keys can be pressed before the terminating key is limited to 25; further inputs are ignored.

Irrelevant or meaningless inputs are also ignored:

- 100  $\mu$ V V<sub>0</sub> MOD GEN : Minus sign is ignored (AC voltage)

100 Hz MAX PK : 100 is ignored since only units are permissible for the modulation switchover.

- - + - not + ! A minus sign once entered cannot be cancelled by pressing it again.

### Control values (e.g. SPEC number)

In the case of control values such as numbers of the SPEC function or with STORE/RECALL, entered decimal points and the minus sign are ignored and the unit keys always have the meaning A to D.

### Code/Decode

When entering code numbers, the keypad has the same function as the corresponding keyboard on the transceiver:

0 to 9 A B C D E F or  
0 to 9 A B C D \* #

Each input generates the corresponding tone in the standard series. Leading zeros are not suppressed.

### 2.3.7.2 $\Delta$ VAR

The key  $\Delta$ VAR 53 can be used to assign any step size (within the limits listed below) to all setting values which can be varied using the spin wheel. The input corresponds to a normal numerical input (see Section 2.3.7.1) prior to key  $\Delta$ VAR.

$\Delta$ VAR can be used:

SET f TX	<u>6</u>	10 Hz to 500 MHz	Increment
SET f RX	<u>5</u>	10 Hz to 500 MHz	Increment
AF INT 1	<u>9</u>	0.1 Hz to 15 kHz	Increment
AF INT 2	<u>10</u>		
V <sub>0</sub> SYNTH	<u>14</u>	0.1 dB to 100 dB	Increment (log)
		0.01 $\mu$ V to 0.5 V	Increment (lin)
INT 1	<u>23</u>	1 Hz to INT 1 max./2 kHz	Increment (FM)
INT 2	<u>24</u>	0.001 rad to INT 1 max./2 rad	Increment ( $\phi$ M)
EXT	<u>25</u>	0.001 % to 50 %	Increment (AM)
V <sub>0</sub> MOD GEN	<u>32</u>	10 $\mu$ V to 2.5 V	Increment (lin)
		0.1 dB to 50 dB	Increment (log)

The variation is made using the smallest step size which can be represented in the display if the minimum resolution of the display is larger than the entered step size.

Command:  $\Delta$ VAR CLEAR Terminating key

Response: The variation is made again using the original step size, the contents of the  $\Delta$ VAR memory are not destroyed.

Example: AF INT 1 → Variation of 1st modulation generator frequency 0.3/0.6/1/1.25/2.7/3/6 kHz

100 Hz  $\Delta$ VAR AF INT 1 → Variation in 100-Hz steps

$\Delta$ VAR CLEAR AF INT 1 → Variation in standard tone sequence again

$\Delta$ VAR AF INT 1 → Variation in 100-Hz steps again



The CLEAR key does not have a command abort function in this case. A command abort following  $\Delta$ VAR can only take place with an illegal input or by pressing the key CLEAR twice.



Example: [ 10 ] [  $\mu$ V ] [  $\Delta$ VAR ] [ CLEAR ] [ CLEAR ]  
 [ 1 ] [ kHz ] [  $\Delta$ VAR ] [ AF LEVEL ]  
 [  $\Delta$ VAR ] [ CLEAR ] [ CCITT RX ]

Special features of the  $\Delta$ VAR memory with level settings ( $V_0$  MOD GEN,  $V_0$  SYNTH):

The output voltage changes logarithmically if a logarithmic step size is entered into the  $\Delta$ VAR memory of  $V_0$  MOD GEN or  $V_0$  SYNTH (e.g. 3.01 dB) and the level display is linear (e.g. 1.00 mV).

Example: Display of  $V_0$  MOD GEN: + 1.00 mV  
 [ 6.02 ] [ dB ] [  $\Delta$ VAR ] [  $V_0$  MOD GEN ] + 6.02 dB  
 corresponds to doubling of the value

Variation:

e.g. 6.02 dB	e.g. 20 dB
+ 8.00 mV	+ 1000.00 mV
+ 4.00 mV	+ 100.00 mV
+ 2.00 mV	+ 10.00 mV
1.00 mV	1.00 mV
- 500 $\mu$ V	- 0.10 mV
- 250 $\mu$ V	- 0.01 mV



The internal accuracy of the calculation is 0.01 dB, i.e. an input of 6 dB would not exactly lead to doubling (= 6.02 dB).

### 2.3.7.3 RANGE HOLD

The measurement range of the analog displays can be set to a specific value using the key RANGE HOLD 50 (corresponds to switching off of function AUTO RANGE). Larger values (up to 1999) can be output in the associated digital display despite an overflow in the analog display (full analog bar), but the unit is no longer automatically switched over (e.g.  $\mu\text{V} \leftrightarrow \text{mV} \leftrightarrow \text{V}$ ).

RANGE HOLD can be used for:

POWER	<u>14</u>	
ACP	<u>15</u>	
PROBE	<u>17</u>	
MAX PK	<u>23</u>	
+ +/2 -	<u>24</u>	] same measurement range
DIST	<u>26</u>	
LEVEL	<u>32</u>	
SINAD·DIST	<u>33</u>	(each function individually)
S/N	<u>34</u>	

Command: RANGE HOLD Terminating key

Response: The measurement range just set is retained, the symbol RANGE HOLD appears in the associated display.

Example: Measured value: . 0.35 V with RF level measurement  
(PROBE)  
Measurement range: 0.50 V  
Command: RANGE HOLD PROBE

The range of 0.50 V is now retained (identified by symbol RANGE HOLD). Values from 0.001 V to 1999 V (theoretically) can be output in the digital display, the analog display is limited to values from 0.005 to 0.5 V.

Command:

Response: The measurement range is set corresponding to the entered number and then retained, the current unit remains unchanged. The symbol RANGE HOLD appears.

The entered number must not exactly correspond to the possible ranges (0.025 - 0.05 - 0.1 - ... - 100 - 250 - 500 - 1000), the CMT automatically rounds up.

Example: Measured value: 0.35 V with RF level measurement  
(PROBE)

Measurement range: 0.50 V

Command:

The measurement range is fixed to 1.00 V.

Command:

The measurement range is fixed to 2.5 V.

Command:

Response: Additional input of a unit causes the measured values to be output in the new unit in the range defined by the number.

Example: Measured value: 0.15 V with RF level measurement  
(PROBE)

Measurement range: 0.25

Command:

The measurement range is fixed to 500 mV. The output in the digital display is also in mV (in this case: 150 mV).

Command: [Unit] [RANGE HOLD] [Terminating key]

Response: The output is made in the new unit, the current range is retained. (Caution with linear and logarithmic units!)

Example: Measured value: 120 mV with RF level measurement  
(PROBE)  
Measurement range: 250 mV  
Command: [dBm] [RANGE HOLD] [PROBE]

The measurement range is fixed to 250 dBm (!).

#### Switching off of RANGE HOLD:

The function RANGE HOLD is switched off when the unit is changed since the measurement ranges are bound to the associated unit.

Example: Measured value: 1.5 W with RF power measurement  
(POWER)  
Measurement range: 10 W with RANGE HOLD active  
Command: [dBm] [POWER]

Display of measured value: +31.8 dBm  
Measurement range: 50 dBm, no RANGE HOLD

Switching off is also possible by entering

[RANGE HOLD] [CLEAR] [Terminating key]



The CLEAR key does not have a command abort function in this case. A command abort following RANGE HOLD can only take place with an illegal input or by pressing the key CLEAR twice.

Example: [10] [μV] [RANGE HOLD] [CLEAR] [CLEAR]

[1] [kHz] [RANGE HOLD] [TXRX]

[RANGE HOLD] [CLEAR] [CCITT RX]

Note: The ranges 0 to 250, 0 to 500 and 0 to 1000 can still be directly selected even though they are only required in exceptional cases. The scales 0 to 25, 0 to 50 and 0 to 100 are used in the displays in these cases.

### 2.3.7.4 $\alpha$ DISPL SELECT

The  $\alpha$  DISPL SELECT function is used for transferring the following setting parameters to the  $\alpha$  display:

Vo SYNTH.	14
INT 1	<u>23</u>
INT 2	<u>24</u>
EXT	<u>25</u>
Vo MOD GEN	<u>32</u>

If one of these parameters is output in the  $\alpha$  display using the command  $\alpha$ -DISPL SELECT Terminating key, the display which has now become free can be used for other measured/setting parameter of the corresponding setting field.

Furthermore, the output in the  $\alpha$  display is retained even when switching over from transmitter to receiver test or vice versa, thus enabling variation (using the spin wheel) and checking of this setting value in both modes. When calling up measured/setting parameters which can only be output in the  $\alpha$  display, the  $\alpha$ -DISPLAY SELECT function is switched off again.

This applies to the following parameters:

DEMODO-BEAT	8
AF EXT	<u>8</u>
CODE	<u>7</u>
DECODE	<u>7</u>
AF INT 1	<u>9</u>
AF INT 2	<u>10</u>
$\Delta f$	<u>6</u>

#### Example:

10  $\mu$ V Vo SYNTH

Output level of test generator is output in the RF level display.

$\alpha$ -DISPL SELECT Vo SYNTH

Output level of test generator is output in the RF level display and in the  $\alpha$  display.

PROBE

Result of RF millivoltmeter is output in the RF level display, output level of test generator is only output in the  $\alpha$  display.

TXRX

In the transmitter test, the output level of the test generator is also output in the  $\alpha$  display.

1 KHz AF INT 1

Frequency of 1st modulation generator is output in the  $\alpha$  display, the  $\alpha$ -DISPL SELECT function is switched off.

### 2.3.7.5 ANALOG SELECT

Using ANALOG SELECT, two measured/setting parameters can be simultaneously output in the RF level, modulation and AF level display. This is done by splitting up the displays into digital and analog display.

Using the command `ANALOG SELECT` `Terminating key` , one of the parameters

```
DIST TX    26
DIST RX    33
SINAD      33
ACP        15
```

is assigned the associated analog display (marked by the unit and code of the measured value displayed underneath the bargraph, see Section 2.3.1.5).

The digital display remains available for output of other measured/setting parameters.

This function is switched off again using the command `ANALOG SELECT` `CLEAR` `Terminating key` .

Example:

`MAX PK`

The result of the modulation measurement is output in the digital and analog display.

`ANALOG SELECT` `DIST TX`

The result of the transmitter distortion measurement is output in the analog display, the result of the modulation measurement is further output in the digital display. (The ANALOG SELECT function is marked by DIST (%) displayed underneath the bargraph).

`ANALOG SELECT` `CLEAR`

`DIST TX`

The MAX PK measurement result is again output in both the digital and the analog display.

### 2.3.7.6 REF

The REF function is used for the representation of measured/setting values referred to a reference value and can be applied to the following functions:

POWER	<u>14</u>
Vo SYNTH.	<u>14</u>
PROBE	<u>17</u>
MAX PK	<u>23</u>
±/2-	<u>24</u>
INT 1	<u>23</u>
INT 2	<u>24</u>
EXT	<u>25</u>
Vo MOD GEN	<u>32</u>
LEVEL	<u>32</u>

Using the command   the measured/setting value just visible in the display is defined as reference value (new display: 0.0 dB). All following measured values or settings are referred to this value and output in the display according to the following formula:

Displayed value (dB) = 20 x log (new value / reference value)

It is likewise possible to enter the appropriate reference value using the command

(e.g., if the reference value is not displayed yet and can only be taken from the memory).

The REF function (marked by the unit dB which is not used for these parameters, usually) can be switched off using

.

Example:

Display of AF voltmeter: 1.00 V

Input:    
Display: 0.0 dB

Variation of AF level  
to 0.5 V

Display: -6.0 dB

Variation of AF level  
to 3 V

Display: 9.5 dB

Input:     
Display: 3.00 V

RF level: 100 mV  
Displayed: PROBE measurement result

Input:      
Display: -6.0 dB

Input:     
Display: -86.0 dB

Input:    
Display: 0.0 dB

Input:     
Display: 10.0  $\mu$ V



## 2.3.7.7 STORE/RECALL

### 2.3.7.7.1 Storing Complete Instrument Settings

Each of the memories 1, 2 and 3 contains the complete information on an instrument status.

For storing, the command   to    
and for recalling the stored setting, the command   to    
is used.

When storing complete instrument settings, all parameters of the transmitter and receiver test are stored:

- All functions indicated by the key acknowledgements and LEDs (transmitter/receiver test of the individual fields and the complete instrument, INPUT SELECT, HP, CCITT etc.)
- Type of modulation (AM, FM,  $\phi$ M)
- Setting values (also  $\Delta$ VAR, RANGE HOLD and REF values)
- SPEC functions
- Oscilloscope setting

The user specific standard tone sequences USER 0 to USER 2 and RF levels  $>-27$  dBm (protection of receiver) are not stored.  
The beat measurement is not stored.

#### **Example:**

The current instrument status is loaded into memory 1.

The CMT is now reset, e.g. for another measurement.

The stored instrument status is recalled.

### 2.3.7.7.2 Storing RF Frequencies

Memories 10 to 30 contain an RF frequency setting and are loaded with the value output in the frequency display (COUNT f / SET f TX in the transmitter test or SET f RX in the receiver test) using   to  .

When reading out the memory content using   to  , the corresponding value is loaded into SET f TX (transmitter test) or SET f RX (receiver test) and set at once.

If the RF counter is switched on in the transmitter test, the command   to   is ignored; an internal setting which cannot be controlled by the user is not made.

#### **Example:**

COUNT f switched on and 438.5 MHz displayed

This value is loaded into memory 10.

Switchover to receiver test  
SET f RX (output frequency of synthesizer is displayed).

The output frequency of the synthesizer is now 438.5 MHz.

All memories can be read as often as required; the content is only cleared by overwriting (STORE) or master reset.

### 2.3.7.8 Squelch Measurement

The squelch measurement is called up using the command 80 SPEC . The level of the RF test generator is reduced from the currently set value until the squelch function starts. Then, the level is again increased until the squelch function stops again. The squelch hysteresis is now output in the  $\alpha$  display; on the RF level field, the level at which the squelch function stops again can be read.

Manual variation of the modulation, the RF frequency or the RF level immediately switches off the current measurement.

Likewise , the measurement is aborted on the following conditions:

- + The level is 0.032  $\mu$ V and the squelch function does not start.
- + The squelch function has already stopped when calling up the measurement.
- + The level is 10 mV and the squelch function does not stop.
- + After 2 minutes at the latest ("TIMEOUT ERROR")

When the measurement is aborted for these reasons, the error message "CHECK INST." is output in the  $\alpha$  display.

#### Example:

Output level: 1.5  $\mu$ V

80 SPEC                      Switching on the squelch measurement.

The level of the test generator is reduced in steps of 0.1 dB, provided that a sufficient AF signal is applied to the connector AF VOLTM (loudspeaker connector of transceiver).

The squelch function starts at 0.75  $\mu$ V; no signal is applied to the connector AF VOLTM any longer.

The level of the test generator is now increased in steps of 0.1 dB until a signal can again be measured at the connector AF VOLTM.

The squelch function stops at 1.2  $\mu$ V.

The squelch hysteresis can be read on the  $\alpha$  display ("SQUELCH 4 dB"), the level at which the squelch function stops is output in the RF level field.

If the function 79 SPEC is carried out, RF level reduction in the first part of the squelch measurements is in 1-dB steps.

This considerably increases the measurement speed (at the expense of the accuracy when the squelch hysteresis is indicated).

RF level increase in the second part of the search routine is in 0.1-dB steps.

With the aid of 78 SPEC the original state of the squelch measurement can be restored (0.1-dB steps in both directions).



### 2.3.7.9 Bandwidth Measurement

The bandwidth measurement is called up in the receiver test using   . The two -6-dB points (sensitivity loss of receiver) are located from the currently set output frequency of the RF signal generator. After completion of the measurement, the bandwidth is output in the  $\alpha$  display and the deviation from the centre frequency can be read on the RF frequency display. Note that the modulation of the signal generator must be switched off when calling up the bandwidth measurement and not switched on again when the routine is finished.

### 2.3.7.10 Quieting Measurement

The interesting measurement result of the quieting measurement is the RF level at which the receiver noise has decreased by a particular rated value (mainly 12 dB or 20 dB) compared with the noise without RF signal. The rated value can be set to values between 6 dB and 52 dB via

<rated value (dB)>

(factory setting: 20 dB).

The measurement is called up via   in the receiver test. The synthesizer level is switched off (-137 dBm) and the receiver noise measured at the output of the loudspeaker.

The receiver noise being continuously monitored, the RF level is then increased in 5-dB steps, reduced in 1-dB steps and finally increased again in 0.1-dB steps until the noise has been reduced by the rated value (e.g. 20 dB). The exact quieting measurement result is indicated in the alphanumeric display "QUIET. 20.2 dB", the associated RF level in the RF level display.

If the modulation, the RF frequency or the RF level are manually changed while a search routine is running, it is immediately switched off (error message "PARAMCHANGED" in the alphanumeric display).

The measurement is likewise aborted on the following conditions:

- Synthesizer level increases to over -10 dBm
- Final value is not yet obtained after approx. 2 min.
- The noise voltage measured at the input AF VOLTM is <-40 dBm (into 600  $\Omega$ ).

When the measurement is aborted for one of these reasons, the error message "CHECK INST" or "TIMEOUT" appears in the alphanumeric display.

It is to be noted that the modulation of the signal generator is switched off when the quieting measurement is selected and not switched on again at the end of the routine!



A possibly present squelsh of the transceiver must be switched off for this measurement.



### 2.3.7.11 Aborting Search Routines

Each running search routine can be aborted via the function  .

This applies to

<input type="text" value="80"/>	<input type="text" value="SPEC"/>	Squelch measurement
<input type="text" value="82"/>	<input type="text" value="SPEC"/>	Quieting measurement
<input type="text" value="84"/>	<input type="text" value="SPEC"/>	Bandwidth measurement
<input type="text" value="2.8"/>	<input type="text" value="kHz"/> <input type="text" value="MAX PK"/>	Modulation measurement
<input type="text" value="20"/>	<input type="text" value="dB"/> <input type="text" value="SINAD"/>	Receiver sensitivity



When aborting search routines, possibly changed RF and AF level values, signal generator modulation and frequency variations (bandwidth measurement) are not reset to their original status.

### 2.3.7.12 Selftest

Checksums had been allocated to those calibration values of the CMT (see   ,   ,   ) which are not continually updated.

Every 6 s the CMT tests these values and in the case of data loss (e.g. after battery change or software update) displays an error message ("CAL\*D1 D30 D2\*" when all calibration data are lost).

Carry out the SPEC functions indicated in the message as described in the CMT manual.

Calibration function    (calibration of modulation characteristic) may be carried out with built-in option CM-B9.

Care should only be taken that no RF power is applied to the RF IN/OUT input.

If calibration has been successful (133 values with message "CAL OK .. " in the  $\alpha$  display), calibration is terminated with ">>>> DONE <<<<", otherwise "> ERROR <" is indicated.

With the EXT CAL function (section 2.3.5.6), "CHECK INST" is not displayed if the level applied to the MOD EXT input is outside the permissible range.





### 2.3.8 SPEC Function

The SPEC function incorporates various instrument functions which have not been assigned separate keys because they are only used rarely.

The functions are selected by entering a code number from 1 to 10000, in certain cases one of the keys A to D must be additionally entered before the key SPEC.

#### 2.3.8.1 General Instrument Functions

- 11  SPEC : Display illumination is switched on/off.  
(Default: illumination on)
- 16  SPEC : Synthesizer control loop normal rate (default)
- 17  SPEC : Synthesizer control loop super low (FM modulation up to min. 20 Hz)
- 18  SPEC : Automatic 20-dB attenuation on
- 19  SPEC : Automatic 20-dB attenuation off } (Connector RF IN/OUT 77)
- 20  SPEC : The RF signal applied to INPUT 2 79 is attenuated by 20 dB.
- 21  SPEC : The 20-dB attenuator at INPUT 2 is switched off.  
(Default)
- 22  SPEC : 10-MHz crystal reference is synchronized with external signal source.  
(Apply 10-MHz signal > 100 mV to connector REF 10 MHz 109)
- 23  SPEC : Internal 10-MHz reference signal is output at connector REF 10 MHz (approx. 0 dBm).  
(Default)
- 24  SPEC <time>  SPEC :  
Modulation switch-off time (FM) in the case of RF frequency change
- 25  SPEC : RMS measurement is switched to FAST mode (80 ms)  
(only possible for input frequencies > 150 Hz).
- 26  SPEC : RMS measurement is switched to SLOW mode  
(250 ms).  
(Default)



- 28 SPEC : Test diode of power meter (low distortion) is switched off.
- 29 SPEC : Power diode is switched on.  
(Default)
- 30 SPEC ATT SPEC :  
Input of attenuation value of an external attenuator at connector RF IN/OUT 77.  
(Protect, 0 Default)
- 35 SPEC : Modulation measurement with RMS or peak weighting depending on result.  
(Default setting)  
AM : < 1 % (RMS)  
FM : < 100 Hz (RMS)  
ϕM : < 0.1 rad (RMS)
- 36 SPEC : Modulation measurement always peak weighted.
- 37 SPEC : Modulation measurement always RMS weighted.
- 40 SPEC : AF voltmeter measurement RMS weighted.  
(Default)
- 41 SPEC : AF voltmeter measurement peak weighted (positive)
- 42 SPEC : AF voltmeter measurement peak weighted (negative)
- 43 SPEC <R (Ω)> SPEC : Setting of reference resistance with AF voltmeter measurements  
(2 Ω <R <3000 Ω).
- 45 SPEC : No averaging (default after switching on)
- 46 SPEC : Averaging over 30 measurements for all RMS weighted measurements.
- 47 SPEC : Averaging over 60 measurements for all RMS weighted measurements.
- 48 SPEC : Averaging over 140 measurements for all RMS weighted measurements.

- 49 SPEC : Averaging over 255 measurements for all RMS weighted measurements.
- 50 SPEC : Modulation of the synthesizer by the 2nd tone generator INT 2 remains uninfluenced with the S/N measurement.  
(Default)
- 51 SPEC : INT 2 is also switched on and off with the S/N measurement.
- 52 SPEC : Modulation of the synthesizer by the external modulation input EXT remains uninfluenced with the S/N measurement.  
(Default)
- 53 SPEC : EXT is also switched on and off with the S/N measurement.
- 55 SPEC : Switch on transmitter S/N measurement instead of DIST measurement.
- 56 SPEC : Switch off transmitter S/N measurement.  
(DIST measurement again)  
(Default)
- 58 SPEC : S/N, SINAD, DIST measurement:  
Search routine is terminated when the preset value is reached.
- 59 SPEC : S/N, SINAD, DIST measurement:  
Search routine is continued even when the tolerance window is reached.
- 60 SPEC : Tolerance window of the final value of the SINAD, DIST and S/N measurement is  $\pm 1$  dB.
- 61 SPEC : Tolerance window of the final value of the SINAD, DIST and S/N measurement is  $\pm 2$  dB.
- 65 SPEC <f> SPEC : Entry of frequency of 1st modulation generator which is automatically set when SINAD/DIST is called. (Protect, entry in Hz, 1000 Hz default)
- 70 SPEC : Demodulator control: squelch on.  
(Default)

- 71 SPEC : Demodulator control: switch off output signal.
- 72 SPEC : Demodulator control: connect output signal.
- 75 SPEC : Switch on 750  $\mu$ s deemphasis with FM.  
( $\sqrt{\quad}$  symbol in the display)
- 76 SPEC : Switch off 750  $\mu$ s deemphasis.  
(Default)
- 78 SPEC : The original state of the squelch measurement can be restored.
- 79 SPEC : The RF level reduction in the first part of the squelch measurements is in 1-dB steps.
- 80 SPEC : Start squelch measurement (see 2.3.7.8).
- 82 SPEC : Switch on quieting measurement
- 83 SPEC <rated value> [dB] SPEC : Entry of rated value for quieting measurement  
(20 dB default)
- 84 SPEC : Start bandwidth measurement (see 2.3.7.9).
- 85 SPEC : Switch-off of all running search routines, the currently set instrument status being retained.
- 95 SPEC : Instrument preset (also via autorun control and IEC bus)
- 99 SPEC : Master reset of instrument (factory setting).
- 104 SPEC : The PLL of the synthesizer is optimized for minimum broadband spurious FM in S/N operation (default).
- 105 SPEC : The PLL of the synthesizer is optimized for minimum narrowband spurious FM (useful for S/N measurement with CCITT filter switched on).
- 111 SPEC : 0-dB attenuation for probes selected.  
(default)



- 112 SPEC : 20-dB attenuation for probes selected.
- 113 SPEC : 40-dB attenuation for probes selected.
- 114 SPEC : Probe measurement: the output in dBm is referred to 75  $\Omega$ .
- 115 SPEC : Probe measurement: the output in dBm is referred to 50  $\Omega$ .  
(Default)
- 121 SPEC : Single tone at connector MOD GEN.  
(Default)
- 122 SPEC : Double tone at connector MOD GEN (both tones have the same level, the RMS value of the total signal is displayed).  
 $V_{disp} = V1 \times \sqrt{2}$
- 123 SPEC : Double tone at connector MOD GEN (both tones have the same level, the RMS value of one signal is displayed).  
 $V_{disp} = V1$
- 130 SPEC : Oscilloscope preset (switch-on status)
- 131 SPEC : The distortion signal without the fundamental wave is displayed on the oscilloscope.
- 132 SPEC : Switch back oscilloscope to normal mode (switch off 131 SPEC).  
(Default)
- 140 SPEC : Any channel spacing ACP.
- 141 SPEC : Fixed channel spacing ACP:  
10, 12.5, 20 oder 25 kHz.
- 144 SPEC <RF level [dBm]> SPEC : Calibration of the selective RF millivoltmeter ( 0 ACP ) through indication of the currently applied power.
- 145 SPEC : Calibration of the selective RF millivoltmeter ( 0 ACP ) by means of the power applied to RF IN/OUT.



**180** **SPEC** : Collection of the result of the PK HOLD measurement via IEC bus and autorun control.

**181** **SPEC** <waiting time [s]> **SPEC**: Setting the waiting time between PK HOLD command and start of PK HOLD measurement. Works only in remote control mode (IEC bus and autorun control). (0.5 s default)

**182** **SPEC** <measuring time [s]> **SPEC** : Setting the measuring time of PK HOLD measurement. Works only in remote control mode (IEC bus and autorun control). (0.5 s default)

**967** **SPEC** : All settings and parameters not visible are protected against being changed unintentionally.

Protected parameters:

- programs of the autorun control
- all store facilities of the STORE key.
- all SPEC functions that are particularly marked (Protect)

**968** **SPEC** : All parameters can be changed as required (switch off **967** **SPEC** ).  
(Default)

2.3.8.2 Control Functions for the Option Autorun Control  
CM-B5 (A...SPEC)

A 00 SPEC to A 31 SPEC

Three programmable control outputs are available if the CM-B5 option is fitted (CONTROL A).

1st digit: 1 to 3 corresponds to control output 1 to 3  
0 means all control outputs 1 to 3 simultaneously

2nd digit: 0 corresponds to "N/O contact open"  
1 corresponds to "N/O contact closed"

**Example:**

A	1	0	SPEC
CONTROL A	N/O contact 1	Open	

A	0	1	SPEC
CONTROL A	N/O contacts 1 to 3	Close	

A 800 SPEC STORE

Initialization of autorun control. Required after each battery replacement and new fitting of option (only in manual mode).



A	100	SPEC	to	Start of programming = switchover to LEARN mode.		
A	199	SPEC		100 to 199 = program 00 to 99 (only in manual mode).		
A	200	SPEC		End of programming = switchover to manual mode (only in LEARN mode).		
A	300	SPEC	STORE	to	Deletion of a program 300 to 399 = program 00 to 99 (only in manual mode).	
A	399	SPEC	STORE			
A	500	SPEC			Start of message entry (only in LEARN mode).	
A	505	SPEC	1	SPEC	to	Start of a repetition block to be executed 1 to 1000 times (only in LEARN mode).
A	505	SPEC	1000	SPEC		
A	506	SPEC				End of a repetition block (only in LEARN mode).
A	510	SPEC				If the tolerance is exceeded during the program run (red LED lights up), the program is interrupted (Default).
A	511	SPEC				Exceeding of the tolerance is only stored in the protocol, the program run is continued without interruption.
A	512	SPEC				After calling up this special function, the memory capacity still available is indicated (in blocks). Each command line consists of at least one block.
A	513	SPEC				Small format of test reports
A	514	SPEC				Medium format of test reports
A	515	SPEC				Large format of test reports
A	520	SPEC				Start of message input with input requested in RUN mode (only in LEARN mode).

A	525	SPEC	Edit the printer configuration string			
A	526	SPEC	Output the printer configuration string to the printer (string is generated before by A 525 SPEC .)			
A	527	SPEC	Enter a control character sequence for the autotest. In RUN mode, the programmed string is output to the printer.			
A	530	SPEC	Copy CMT program to transfer memory.			
A	531	SPEC	Copy transfer memory program to CMT.			
A	532	SPEC	Append transfer memory program to CMT program.			
A	533	SPEC	Delete transfer memory program.			
A	540	SPEC	Initialize transfer memory.			
A	600	SPEC	0	SPEC	to	Setting of minimum time between execution of the individual commands. 0 to 10000 = 0 to 10000 ms. (only in manual mode and HOLD mode).
A	600	SPEC	10000	SPEC		
A	605	SPEC	Display of directory of programs in the α display (only in manual mode).			
A	606	SPEC	Directory switched off.			
A	607	SPEC	Enter the function display directory of transfer memory			
A	610	SPEC	Output of the Autorun Control Directory on a printer.			
A	611	SPEC	Output of the Transfer Memory Directory on a printer.			

A	1000	SPEC	to	Selection of a particular line. 1000 to 1999 = line 000 to 999 (only in LEARN mode).
A	1999	SPEC		
A	2000	SPEC	to	Deletion of a program block. 2000 to 2999 = deletion of lines 000 to 999 from the set position (only in LEARN mode).
A	2999	SPEC		

The error message "ADD OPT. CM-B5" is output in the α display if the option CM-B5 is not fitted and the corresponding SPEC function is called.

### 2.3.8.3 Control Functions for the Option IEC Bus CM-B4 (B...SPEC)

B 00 SPEC to B 81 SPEC

8 freely programmable control outputs are available if the option CM-B4 is fitted. Control takes place via the SPEC function as with CONTROL A (8 control outputs in this case):

**Example:**

B 8 1 SPEC

CONTROL B N/O contact 8 Close

B 0 0 SPEC

CONTROL B N/O contacts 1 to 8 Open

B 100 SPEC to Control functions of IEC bus

B 1000 SPEC

B 100 SPEC <xx> SPEC Setting of IEC-bus address in listener and talker mode. (0 < xx < 30).

B 101 SPEC : The CMT only sends CR/LF to the controller at the end of a string (default).

B 102 SPEC : In addition to CR/LF, the CMT also sends EOI to the controller at the end of a string.

The error message "ADD OPT. CM-B4" is output in the alphanumeric display if the option CM-B4 is not fitted and the corresponding SPEC function is called.

#### 2.3.8.4 Control Functions for Frequency Counter and CODE(DECODE) (C...SPEC)

##### AF counter

- C** **10** **SPEC** : Gate time counting also in range from 7 Hz to 4 kHz (1 Hz or 0.1 Hz resolution)  
Advantage: High S/N ratio  
Disadvantage: Relatively low measuring rate
- C** **11** **SPEC** : Period measurements in frequency range from 7 Hz to 4 kHz (0.1 Hz resolution)  
Advantage: Very high measuring rate  
Disadvantage: Slightly more sensitive to interference
- C** **12** **SPEC** : Gate time counting of AF counter with resolution of 0.1 Hz (10 s gate time).
- C** **13** **SPEC** : Gate time counting of AF counter with resolution of 1 Hz (1 s gate time).
- C** **30** to **C** **37** **SPEC** <f> **SPEC** : Modification of variation sequence of 1st modulation generator.  
(f = frequency in the range of the 1st modulation generator.)
- C** **40** to **C** **47** **SPEC** <f> **SPEC** : Modification of variation sequence of 2nd AF synthesizer.  
(f = frequency in the range of the 2nd AF synthesizer.)

##### RF counter

- C** **20** **SPEC** : RF counting with resolution of 1 Hz (measuring cycle < 1.2 s or 4.2 s depending on frequency range).
- C** **21** **SPEC** : RF counting with resolution of 10 Hz (measuring cycle < 300 ms or 700 ms depending on frequency range).

**C** **50** **SPEC** : Switch on frequency transfer function

**C** **51** **SPEC** : Switch off frequency transfer function

**C** **52** **SPEC** < $\Delta f$ > **SPEC** :

Duplex spacing for frequency transfer function

-99999.99 to 0 kHz receive frequency of  
transceiver below transmit  
frequency

0 to 99999.99 kHz receive frequency of  
transceiver above transmit  
frequency

### Control functions CODE/DECODE

**C** **100** **SPEC** <xx> **SPEC** : Load the user-specific standard  
tone sequence USER 0 with a fixed  
sequence  
(xx = 0 to 10)  
(Protect)

**C** **101** **SPEC** <xx> **SPEC** : Load the user-specific standard  
tone sequence USER 1 with a fixed  
sequence  
(xx = 0 to 10)  
(Protect)

**C** **102** **SPEC** <xx> **SPEC** : Load the user-specific standard  
tone sequence USER 2 with a fixed  
sequence  
(xx = 15 to 19)  
(Protect)

**C** **110** **SPEC** <xx> **SPEC** : Activate a standard tone sequence  
for CODE/DECODE  
(xx = 0 to 10, 15, 20 to 22)

**C** **111** **SPEC** <xx> **SPEC** : Activate a standard tone sequence  
for DECODE exclusively  
(xx = 0 to 10, 15, 20 to 22)

**C** **150** **SPEC** : Automatic repeat on  
(E = repeat tone)  
11111 + 1E1E1  
123322444 + 123E2E4E4



**C** **151** **SPEC** : Automatic repeat off  
 11111 + 11111

**C** **160** **SPEC** <T> **SPEC** : Duration of 1st tone in ms  
 (T = 10 ms to 5000 ms)

**C** **161** **SPEC** <T> **SPEC** : Duration of the following tones  
 in ms (T = 10 ms to 5000 ms)

**C** **162** **SPEC** <T> **SPEC** : Pause duration in ms  
 (T = 0 and 10 ms to 5000 ms)

**C** **163** **SPEC** <f tol.> **SPEC** : Frequency deviation of the sent  
 tones from the nominal frequency  
 in % (-10 % to +10 %).

**C** **170** **SPEC** :  
 DECODE : DEMOD (Default)

**C** **171** **SPEC** :  
 DECODE : AF VOLTM

**C** **172** **SPEC** <f tol.> **SPEC** : Evaluation window for selective  
 call decoder ( $\pm 1$  % to  $\pm 10$  %)

**C** **173** **SPEC** :  
 Decoding aborted approx. 100 ms  
 after the last tone. (Applies to  
 selective call decoding only (de-  
 fault after switching on).

**C** **174** **SPEC** :  
 Decoding aborted approx 400 ms  
 after the last tone. (Applies to  
 selective call decoding only (de-  
 fault after switching on)

**C** **175** **SPEC** :  
 Automatic gain setting for DTMF  
 decoder (default).

**C** **176** **SPEC** :  
 -6-dB gain for DTMF decoder

**C** **177** **SPEC** :  
 0-dB gain for DTMF decoder

**C** **178** **SPEC** :  
 +6-dB gain for DTMF decoder

**C** **180** **SPEC** <T> **SPEC** :  
 Decoding is restricted to time T  
 [ms]. (Applies to selective-call  
 decoding only) (default: 1000 ms  
 corresponds to switch-off of this  
 function).

- C** **181** **SPEC** : Decoding aborted approx. 2 s after the last tone. (Applies to selective-call decoding only)
- C** **185** **SPEC** : Decoding started via IEC bus and autorun control (= DECODE command) with the possibility of sending further commands to the CMT before the end of decoding.
- C** **186** **SPEC** : Readout of DECODE result via IEC bus and autorun control without restart of decoding.
- C** **190** **SPEC** : The separators are also displayed
- C** **191** **SPEC** : The display of separators is suppressed (Default, only with VDEW signalling, code number 16 effective!)
- C** **500** **SPEC** <f> **SPEC** : } Load the frequency of each call number (0 to F) of the sequence USER 0 in Hz (300 Hz < f < 4 kHz and f = 0) (Protect)
- C** **515** **SPEC** <f> **SPEC** : }
- C** **560** **SPEC** <T> **SPEC** : Tone duration of the tone 1st sent 10 ms to 5000 ms (USER 0) (Protect)
- C** **561** **SPEC** <T> **SPEC** : Tone duration of the following tones 10 ms to 5000 ms (USER 0) (Protect)
- C** **562** **SPEC** <T> **SPEC** : Pause duration 0 and 10 ms to 5000 ms (USER 0) (Protect)
- C** **600** **SPEC** <f> **SPEC** : } Load the frequency of each call number (0 to F) of the sequence USER 1 in Hz (300 Hz < f < 4 kHz and f = 0) (Protect)
- C** **615** **SPEC** <f> **SPEC** : }
- C** **660** **SPEC** <T> **SPEC** : Duration of the tone 1st sent 10 ms to 5000 ms (USER 1) (Protect)
- C** **661** **SPEC** <T> **SPEC** : Duration of the following tones 10 ms to 5000 ms (USER 1) (Protect)
- C** **662** **SPEC** <T> **SPEC** : Pause duration 0 and 10 ms to 5000 ms (USER 1) (Protect)

C 700 SPEC <f> SPEC to  
 C 715 SPEC <f> SPEC and  
 C 720 SPEC <f> SPEC to  
 C 735 SPEC <f> SPEC :

Load the frequency of each  
 call number (0 to F)  
 of the sequence USER 2 in Hz  
 (300 Hz < f < 4 kHz and  
 f = 0). (Protect)

C 700 SPEC to  
 C 715 SPEC

corresponds to the nominal  
 frequency of AF INT 1 and

C 720 SPEC to  
 C 735 SPEC

corresponds to the nominal  
 frequency of AF INT 2.

C 760 SPEC <T> SPEC : Duration of the tone 1st sent  
 10 ms to 5000 ms (USER 2)  
 (Protect)

C 761 SPEC <T> SPEC : Duration of the following tones  
 10 ms to 5000 ms (USER 2)  
 (Protect)

C 762 SPEC <T> SPEC : Pause duration 0 and 10 ms to  
 5000 ms (USER 2) (Protect)

### 2.3.8.5 Control Functions to Call Calibration Routines and the Self-test (D...SPEC)

- D** **0** **SPEC** : Offset adjustment of DC measuring circuit (A/D converter and DC preamplifier).  
This offset adjustment is automatically repeated at certain intervals.  
Calling this function also produces an offset adjustment at the defined point in time.
- D** **1** **SPEC** : Offset adjustment of power measurement.  
Before calling this function it must be ensured that an RF power is not applied to the input RF IN/OUT.  
The level of the RF test generator is reduced to -47 dBm if it is > -47 dBm.
- D** **2** **SPEC** : Calibration of the modulation characteristic of the RF test generator (CMT in transmitter test, mode FM).  
  
Before calling up this routine, the modulation mode FM must be set.
- D** **5** **SPEC** : Automatic offset adjustment in CMT switched off.
- D** **12** **SPEC** : All LCD segments are switched on for approx. 5 s for checking.
- D** **13** **SPEC** : All LEDs are switched on for approx. 5 s for checking.
- D** **14** **SPEC** : Checking the spin wheel.  
The analog bar in the RF level field is increased by rotating the spin wheel clockwise and decreased by rotating counterclockwise. This test mode is switched off by pressing the key "0".
- D** **15** **SPEC** : Checking the keyboard.  
After switching on this test mode, the key code of each key pressed is output in the  $\alpha$  display corresponding to the numbers in Fig. 2-1 to 2-9. This test mode is switched off by pressing the key "0".

- D** **20** **SPEC** : Measurement of battery voltage in the basic unit. This voltage is output in the  $\alpha$  display; nominal value: 3.6 V; at voltages  $<2.4$  V, the battery should be replaced.
- D** **21** **SPEC** : Measurement of battery voltage of Autorun Control CM-B5. This voltage is output in the  $\alpha$  display; nominal value 3.6 V; at voltages  $<2.4$  V, the battery should be replaced.
- D** **22** **SPEC** : Measurement of battery voltage of Transfer Memory CM-Z1. This voltage is output in the  $\alpha$  display; nominal value: 3.6 V; at voltages  $<2.4$  V, the battery should be replaced.
- D** **25** **SPEC** : Memory test of Transfer Memory (CM-Z1). The state of the memory is indicated in the  $\alpha$  display. Note that the memory test overwrites the transfer memory contents.
- D** **30** **SPEC** : Offset adjustment of RMS meter (DEMOD or AF voltmeter). After replacement of the battery and when maximum accuracy of the AF voltmeter in the 50-mV range is required (eg. **D** **2** **SPEC**), this adjustment is to be carried out as follows:
- Switch on level measurement
  - Switch off CCITT filter, if required
  - Apply 40.00 mV RMS/800 Hz sinewave to connector AF VOLTM with the highest possible accuracy (error  $<0.1$  %)
  - **D** **30** **SPEC**

### 2.3.8.6 Display of the Options Fitted

Enter: 50113 SPEC

The options are indicated on the alphanumeric display in hexadecimal form (4 bits are combined to one digit 0 to F):

Module		Bit No.																
		15	14	13	12	11	10	9	8	7	6	5	4	3	2	1	0	
2nd AF Synthesizer	CMT-B7																1	
Oscilloscope	model 54															1		
Autorun Control	CM-B5														1			
IEC Bus	CM-B4												1					
Duplex Modulation Meter	CM-B9											1						
Select. ZVEI	CM-B11										1							
Select. CCIR	CM-B11										1							
Select. EIA	CM-B11									1								
Select. DTMF	CM-B11								1									
RF Millivoltmeter	CM-B8							1										
Adjacent-channel Power Meter	CMT-B6					1												
SSB/AF Analysis	CMT-B10				1													
-				1														
-			1															
-			1															
-		1																
<b>Example:</b>																		
Readout on alphanumeric display		0				3				0				3				
Binary		0	0	0	0	0	0	1	1	0	0	0	0	0	0	0	1	1

RF Millivoltmeter \_\_\_\_\_

DTMF \_\_\_\_\_

Oscilloscope \_\_\_\_\_

2nd AF Synthesizer \_\_\_\_\_

↑ ↑

↑ ↑

↑ ↑

### 2.3.9 Oscilloscope

The CMT (model 54) has a built-in oscilloscope which can display external or internal signals.

All set parameters such as the connected signal source, horizontal deflection and vertical deflection are output directly on the screen.

The currently selected signal source is indicated by an arrow at the corresponding position in the status line. It can be moved to the left and right using the mode keys 92 and 93.

#### Examples:

Display of signals at INPUT EXT 97 (AC coupling):

```
      ▼
    AC  DC  BEAT  DEMOD  AF  AUTO
```

Display of the demodulated signal:

```
      AC  DC  BEAT  ▼ DEMOD  AF  ▼ AUTO
```

An additional arrow above the symbol AUTO means that only the three positions AC, DC and INTERNAL can be selected using the mode keys and selection of the internal signal source has been determined by the key DEMOD·BEAT / AF EXT 8 on the basic instrument.

The position BEAT cannot be selected using the mode keys; it must be selected using DEMOD·BEAT 8.

The oscilloscope in position INTERNAL is also switched between DEMOD and AF if the CMT mode changes between transmitter test and receiver test.

In addition to the sources specified in the status line, the oscilloscope can also output the signal at connector AF VOLTM without the fundamental wave (1 kHz) used to measure the SINAD value.

The switchover is made using   .

It is possible to return to BEAT, DEMOD or AF using   
 .

The deflection factors are output on the screen and can be increased or decreased using the pairs of keys TIME/DIV 94 and AMPLITUDE/DIV 95.

The horizontal deflection factors can be set between 10  $\mu$ s/div and 20 ms/div.

The vertical scale is displayed in the correct unit corresponding to the applied signal and, with DEMOD, also corresponding to the type of modulation.

Signal	Range		Unit	
	min.	max.		
AC / DC	5 mV	10 V	mV	V
BEAT	---	---	---	
DEMOD				
AM	0.1 %	40 %	%	
FM	5 Hz	40 kHz	Hz	kHz
ϕM	0.01 rad	10 rad	rad	
AF	1 mV	2 V	mV	V
SINAD	---	---	---	

Amplifiers are switched on and off in the basic instrument if necessary with DEMOD and AF to increase the dynamic range; the vertical scale on the oscilloscope is then also changed. Very large ranges with small signals (and vice versa) are also not always selectable using the keys AMPLITUDE/DIV 95.

The CMT has an autorange function to display internal signals. The most suitable display range is automatically selected by pressing the key BEST RANGE INT 96 and the associated LED lights up briefly.

Pressing of the key BEST RANGE INT 96 only produces an effect with DEMOD selected and the modulation measurement active (MAX PK +  $\pm/2$  -) or with AF selected and the AF voltmeter (LEVEL) active.

This adjustment is carried out continuously if the key is pressed longer (> 0.3 s) and the LED lights up continuously. The function is switched off by pressing briefly again.

All oscilloscope function keys except BEST RANGE INT 96 are fitted with an autorepeat capability, i.e. prolonged pressing of a key corresponds to repeated pressing in succession.



### 2.3.10 Autorun Control

The option CM-B5, if fitted, allows up to 100 different test programs defined via the front-panel keys to be stored (in LEARN MODE) and repeated as often as required (in RUN mode) without the need for an external controller.

#### 2.3.10.1 Control Modes of the CMT with Autorun Control

xx corresponds to the program number: 00 to 99

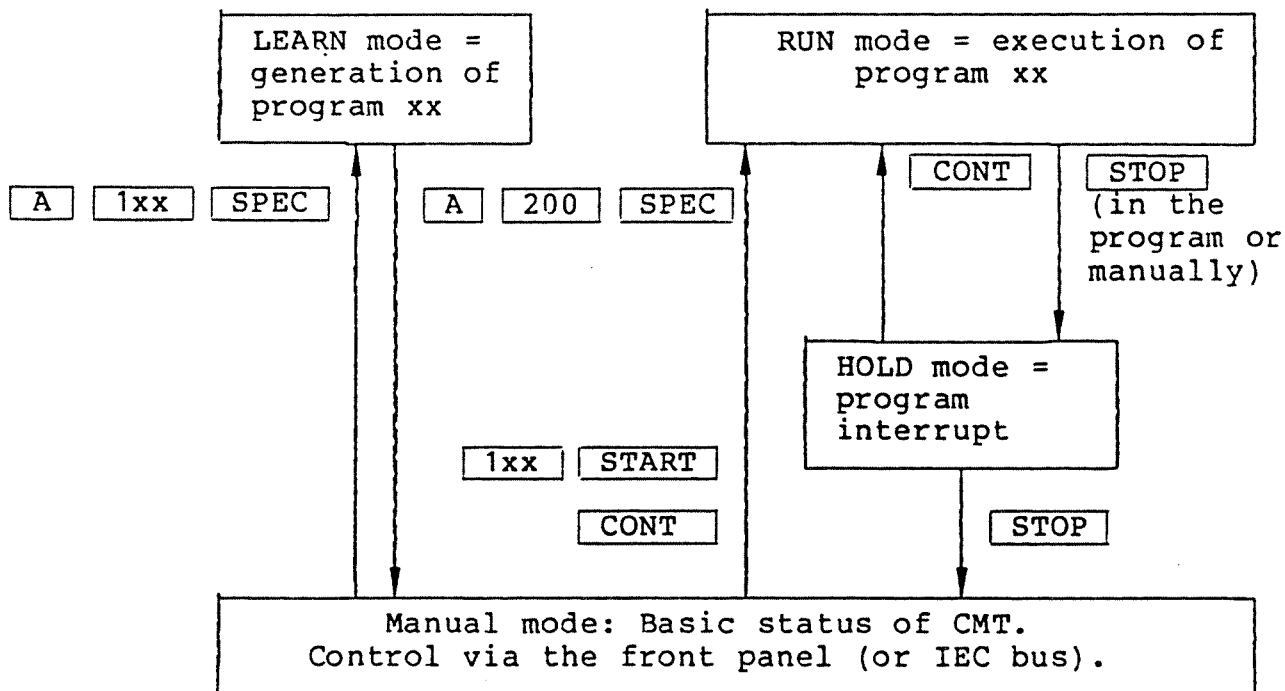

#### Manual mode

After switching on, the CMT automatically enters this status; control is exclusively via the front-panel keys.

#### LEARN mode

The instrument works as in manual mode (except for the rotary knob which is used for selection of program lines). In addition, each pressing of a key is temporarily stored in a buffer. When a command is entered completely, it can be stored in the program by pressing the STORE key.

#### RUN mode (START LED lights up)

After starting a program, the CMT executes all commands successively.

**HOLD-Mode** (START and STOP LED light up)

When the STOP key is pressed or the STOP function occurs in the running program, the RUN MODE is interrupted (HOLD mode).

The program is continued by pressing the CONT key and aborted by pressing the STOP key.

### 2.3.10.2 Memory Allocation and Configuration of a Control Program

Up to 100 different programs identified by the program numbers (00 to 99) can be stored. The maximum available storage space is divided up among the individual programs according to their length. If the available storage space is occupied by several programs with excessive length, generation of further programs is no longer possible (error message: NO MORE MEMORY).

000 PROGRAM 00	to	000 PROGRAM 45	to	000 PROGRAM 99
001 command 1		001 command 1		001 command 1
002 command 2		002 command 2		002 command 2
003 command 3		003 command 3		003 command 3
004 command 4		004 command 4		004 command 4
005 command 5		005 command 5		005 command 5
006 command 6		006 command 6		
007 command 7		007 command 7		
		008 command 8		
to		009 command 9		
999 command 999				

The program configuration is based on lines, i.e., each stored command corresponds to a program line with an associated line number. The storage space required by the individual commands is 6, 12, 18 or 24 bytes, depending on the number of keys pressed.

During the program run, command 1 is executed first (line 0 always contains the head line with program number), followed by commands 2, 3, etc. and finally by the last stored command. For this purpose, autonumbering of lines when writing the program is provided and retained even when lines are inserted or deleted subsequently.

To enable fast location of a particular program, a directory is provided where the content of each line 001 is stored. By entering   , line 1 of the first loaded program and the associated program number are output in the  $\alpha$  display. Variation by means of the rotary knob allows to display the head line of all programs, which are not empty.

Switching off is possible via    .

#### **Example:**

     Output in the  $\alpha$  display: 15 RADIO \$23

15 is the program number of the first loaded program, "RADIO \$23" is contained in line 1 in program 15.

### 2.3.10.3 Generating a Control Program

#### 2.3.10.3.1 Program Call/Program Termination

By entering the command    in manual mode, a program is selected (00 < xx < 99 = program number) and prepared for insertion of new commands.

This causes the following message to be output in the  $\alpha$  display:

```
          000 PROGRAM xx
         /      \
line number    program number
```

From then on, the CMT is in LEARN mode, i.e., all complete commands can be stored in sequence or inserted into an existing program from the indicated line number onwards by pressing the STORE key.

The input    permits to quit the LEARN mode after completion of the program and to return to manual mode. This command is acknowledged in the  $\alpha$  display by the message ">PROG READY<".

Example:

     Output in the  $\alpha$  display: 000 PROGRAM 23

Enter commands

     Return to manual mode

output in the  $\alpha$  display: PROG READY

#### 2.3.10.3.2 Storing the Commands

The commands are stored completely, i.e. after entering the terminating key, the command can be stored once by pressing the STORE key. If the command is not stored, the buffer will be cleared again when the next command is entered. Thus, it is possible to carry out any instrument setting required (e.g. to produce a particular operating status) without incorporating it into the program.

Input errors, such as overflow, underflow, wrong unit, syntax errors, as well as command abort (CLEAR or illegal key) cause the command to be completely deleted so that it can no longer be stored by STORE.

After storing a command, the  $\alpha$  display presents the corresponding output in plain text.

Example:

Input	$\alpha$ display
<input type="text" value="2"/> <input type="text" value="kHz"/> <input type="text" value="AF INT 1"/>	(AF INT1 2.000 kHz)
<input type="text" value="STORE"/>	001 AF INT1 > 001 >kHz 2
<input type="text" value="500"/> <input type="text" value="mV"/> <input type="text" value="V&lt;sub&gt;0&lt;/sub&gt; MOD GEN"/> (too much)	
Correction	
<input type="text" value="5"/> <input type="text" value="mV"/> <input type="text" value="V&lt;sub&gt;0&lt;/sub&gt; MOD GEN"/> (correct)	
Store	
<input type="text" value="STORE"/>	002 AF OUTPUT > 002 >mV 5

### 2.3.10.3.3 Selection of Program Lines/Checking the Commands

In LEARN mode, the rotary knob abandons its normal function (variation of the individual setting parameters) and is used for selection of the individual program lines (turning it clockwise increases the line number).

Furthermore, direct selection of a particular program line is also possible using the SPEC function    (000 < xxx < 999 = line number). The current position can be seen from the command line indicated in the  $\alpha$  display (including line number).

Easy selection by means of the rotary knob and output of each selected command in the  $\alpha$  display permit the program to be checked easily and quickly.

Example:

Select line 34

Output in the  $\alpha$  display:  
034 command 34 ...

#### 2.3.10.3.4 Insertion of Commands

When a particular position in the program has been selected using the rotary knob or    , each newly stored command is inserted in the following line number; the line numbers of the subsequent commands are incremented accordingly.

Example:

or selection using the rotary knob: select command 34

034 command 34	→	new command	→	034 command 34
035 command 35				035 new command
036 command 36				036 command 35
037 command 37				037 command 36
...				038 command 37
				...

#### 2.3.10.3.5 Deletion of Commands and Command Blocks

For deleting commands, the first line to be deleted must be selected. By entering the command    (with  $000 < xxx < 999$ ), a program block with the length xxx is deleted from this position.

The input    (or    ) only deletes the current line.

Example:

: Select line 34

→ 34 command 34  
35 command 35  
36 command 36  
37 command 37  
38 command 38  
39 command 39

: Line 34 is deleted, the following line numbers are decremented.

→ 34 command 35  
35 command 36  
36 command 37  
37 command 38  
38 command 39

: Lines 34, 35, 36 are deleted.

→ 34 command 38  
35 command 39

### 2.3.10.3.6 Representation of the Commands in the $\alpha$ Display

Commands requiring more than 9 characters for representation use several lines with the same number, which can be output in the  $\alpha$  display using the rotary knob.

#### **Example:**

Representation  
of the command:

MAX PK    RANGE HOLD    10.0    kHz

Display:

001 MAX PK > 001>RANGEHOLD> 001>kHz 10.0

↑  
Line number  
(identical  
for all  
following  
lines)

↑    ↑    ↑    ↑  
Symbol for following lines

A complete list of the possible commands and their representation in the  $\alpha$  display can be obtained from Section 2.3.10.7.

### 2.3.10.3.7 Program Example

Input	α display
A 123 SPEC Start of program	000 PROGRAM 23
TXRX	
STORE	001 XMITTER
2 kHz AF INT 1	(AF INT 1 2.000 kHz)
STORE	002 AF INT1 >
500 mV V <sub>0</sub> MOD GEN (too much)	002>kHz 2
Correction	
5 mV V <sub>0</sub> MOD GEN (correct)	
Store	
STORE	003 AF OUTPUT >
COUNT f	003>mV 5
STORE	004 RF COUNT
POWER	
STORE	005 POWER
MAX PK	
STORE	006 MAX PK
1000 STOP	
STORE	007 STOP >
TXRX	007>1000
STORE	008 RECEIVER
145 MHz SET f RX	
STORE	009 SET RF RX >
10 μV V <sub>0</sub> SYNTH	009>MHz 145
STORE	010 RF OUTPUT >
MOD OFF	010>μV 10
STORE	011 MOD OFF
2.8 kHz INT 2	(Omission of STORE: Command is executed on the instrument but not stored in the program.) (Cancel of command)
0 INT 2	
2.8 kHz INT 1	
STORE	012 MOD INT 1 >
LEVEL	012>kHz 2.8
STORE	013 AF LEVEL
2000 STOP	
STORE	014 STOP >
A 200 SPEC End of program	014>2000

2.3.10.4 Special Functions in Conjunction with Autorun Control

2.3.10.4.1 Measurement Tolerances

Each time a measurement is called up in LEARN mode, a lower or upper limit or a tolerance window consisting of both limit values can be specified for evaluation of the result. If, during the following program run, the measured value lies within the limits thus defined, the green TOL IN LED lights up, and the program is executed without interruptions. If the value falls outside the tolerance, the red TOL OUT LED lights up and the program run is interrupted (HOLD mode).

The measurement producing the out-of-tolerance result is continuously repeated, enabling the user to make an adjustment.

Example:

Input	α display
POWER	
STORE	015 POWER
5.5 W UPPER	
STORE	016 UPPER TOL> 016>W 5.5
4.5 W LOWER	
STORE	017 LOWER TOL> 017>W 4.5

→ Total Evaluation

If tolerance limits have been entered into a test program, a tolerance evaluation is automatically accomplished at the end of the program.

Possible cases:

- All tolerances lie within the tolerance window

At the end of the program, the message "TOTAL TOL IN" is output in the α display, the green TOL IN LED lights up and, with the printer in on-line operation, the following line appears in the printout:

```

+-----+-----+-----+-----+-----+
! LINE!   COMMAND .. ! PARAMETER ! RESULT ! TOL !
+-----+-----+-----+-----+
! .. ! .. ! .. ! .. !
! *** ! TOTAL TOLERANCE ! ! ! OK !
+-----+-----+-----+-----+

```



- One or more tolerances lie outside the tolerance window

At the end of the program, the message "TOTAL TOL OUT" is output in the  $\alpha$  display, the red TOL OUT LED lights up and, with the printer in on-line operation, the following line appears in the printout:

! LINE!	COMMAND	..	! PARAMETER	!	RESULT	!	TOL!
! ..!	..	!	..	!	..	!	..!
! ***!	TOTAL TOLERANCE	!		!		!	!FAULT!

Behaviour of autorun control with tolerance evaluation

If special function **A** **510** **SPEC** has been used to switch to tolerance stop (interruption of RUN mode if tolerance is exceeded), the autorun control switches to HOLD mode (STOP LED lights up) to display the evaluation result. The result can now be read off and the program run finished by pressing STOP or CONTINUE.

In the event that **A** **511** **SPEC** has been used to switch to tolerance continue, the instrument does not switch to HOLD mode. The tolerance evaluation messages are only displayed according to the time between the autorun control commands. In this case, the printout is of crucial importance.

The tolerance evaluation of logarithmic values (in unit dB) is internally accomplished such as if these values were negative (10 % corresponds to -20 dB, but +20 dB is displayed). Therefore, the function of Lower/Upper Limit is reversed.

When processing the command sequence

```

SINAD
STORE          015 SINAD
20 dB LOWER
STORE          016 LOWER TOL>
                016>dB 20
10 dB UPPER
STORE          017 UPPER TOL>
                017>dB 10

```

a SINAD result of 15 dB would be within the tolerance limits, whereas 25 dB or 5 dB are beyond the tolerance range.

#### 2.3.10.4.2 STOP Function

If the STOP command is stored in the program in LEARN mode, the CMT enters the HOLD mode at this position in the program run. In this mode, any settings can be carried out on the CMT or the device under test and the program run continued by entering CONT.

Input of the command   (with  $10 < \text{value} < 10000$ ) causes the CMT to stop the program run at this position for a period of time (in ms) corresponding to the numerical value.

If the last command prior to STOP calls up a measurement, this measurement is continued during the complete wait time to enable the user to carry out adjustments.



Example:

Input	α display
STOP	
STORE	005 STOP

The program run is interrupted here; the CMT can be set as required in HOLD mode. When CONT is entered, the program run is continued with command 006.

Input	α display
COUNT f	
STORE	006 RF COUNT
2000 STOP	
STORE	007 STOP > 007>2000

After execution of the command 006, the program is stopped for 2000 ms. After this period, the program is automatically continued in line 008.

Input	α display
POWER	
STORE	008 POWER

#### 2.3.10.4.3 Conditional Program Continuation

Incorporation of the command <No>  (0 < No < 5) into the program causes the CMT to stop the program run and wait for a particular event.

No	Event
0	RF power at connector RF IN/OUT drops
1	RF power >0.5 W is applied to connector RF IN/OUT
2	reserved
3	reserved
4	reserved

#### 2.3.10.4.4 Programming of Messages

If the CMT is to output messages in the alphanumeric display during the program run in order to request particular entries or to specify e.g. type of transceiver and date/number of test report in the test-report printout, the front panel keys can be converted to alphanumeric keys by entering    in LEARN mode. Each key is assigned a letter from the alphabet (see Table 2-3), the normal key functions are suppressed.

Only the following 3 keys have a control function:

Clears the input character by character  
String input is further possible.

Stores the message.  
Switches off string input.

Switches off string input.

A message can contain up to 33 characters, all further inputs are ignored.

In the test-report printout, the complete message is output, whereas the output in the alphanumeric display is confined to 14 characters (can be checked in the following lines in LEARN mode).

The character \$ is used as identification for the display and the program listing.



If, in a program line, commands are sent to the CMT which cause the output on the alphanumeric display to be changed (e.g. search routines), it is possible that an immediately following message does not appear in the alphanumeric display. This problem can be solved by inserting a waiting time prior to output on the alphanumeric display.

#### **Example:**

```
010 SINAD 20 dB
011 STOP 50
012 $ NEXT STEP
```

**Example:**

The following messages are to be incorporated into the program:

Message 1                   RECEIVER TEST - RADIO-SET \$12345  
 Message 2                   TX-FREQUENCY\*

Input	α display
<input type="button" value="A"/> <input type="text" value="101"/> <input type="button" value="SPEC"/>  <input type="button" value="STORE"/>  <input type="button" value="A"/> <input type="text" value="500"/> <input type="button" value="SPEC"/>	000 PROGRAM 01
Input of message 1 on the front panel according to Table 2-3	
<input type="text" value="RECEIVER TEST - RADIO-SET \$ 12345"/>  <input type="button" value="STORE"/>   <input type="button" value="TXRX"/>  <input type="button" value="STORE"/>  <input type="button" value="A"/> <input type="text" value="500"/> <input type="button" value="SPEC"/>	001 RECEIVER > 001>TEST - RA> 001>DIO-SET \$> 001>12345  002 RECEIVER
Input of message 2 on the front panel according to Table 2-3	
<input type="button" value="TX-FRF"/> (error, delete)  <input type="button" value="CLEAR"/>  <input type="text" value="TX-FREQUENCY *"/>  <input type="button" value="STORE"/>  <input type="button" value="STOP"/>  <input type="button" value="STORE"/>  <input type="button" value="MAX PK"/>  <input type="button" value="STORE"/>  <input type="button" value="A"/> <input type="text" value="500"/> <input type="button" value="SPEC"/>  <input type="button" value="TRY"/> (abort superfluous input of message)  <input type="button" value="SPEC"/>  <input type="button" value="HP"/>  <input type="button" value="STORE"/>	003 TX-FREQUE> 003>NCY*  004 STOP  005 MAX PK  006 HP IN

Associated output in the  $\alpha$  display in RUN mode:

Message 1      RECEIVER TEST  
Message 2      TX-FREQUENCY\*

Associated line in test-report printout:

Message 1      RECEIVER TEST - RADIO-SET \$12345  
Message 2      TX-FREQUENCY\*

Table 2-3

Key	Item number (front-panel views)	Alphanumeric characters
0	<u>39</u>	0
1	<u>39</u>	1
2	<u>39</u>	2
3	<u>39</u>	3
4	<u>39</u>	4
5	<u>39</u>	5
6	<u>39</u>	6
7	<u>39</u>	7
8	<u>39</u>	8
9	<u>39</u>	9
A	<u>42</u>	A
B	<u>43</u>	B
C	<u>44</u>	C
D	<u>45</u>	D
COUNT f	<u>5</u>	E
SET f TX	<u>6</u>	F
DECODE	<u>7</u>	G
DEMOD•BEAT	<u>8</u>	H
AF INT 1	<u>9</u>	I
AF INT 2	<u>10</u>	J
POWER	<u>14</u>	K
ACP	<u>15</u>	L
V <sub>0</sub> SYNTH OFF	<u>16</u>	M
PROBE	<u>17</u>	N
MAX PK	<u>23</u>	O
POLARITY SELECT	<u>24</u>	P
PK HOLD	<u>25</u>	Q
DIST TX	<u>26</u>	R
HP	<u>27</u>	S
CCITT TX	<u>28</u>	T
V <sub>0</sub> MOD GEN	<u>32</u>	U
V <sub>0</sub> MOD GEN+20dB	<u>33</u>	V
S/N	<u>34</u>	W
V <sub>0</sub> MOD GEN OFF	<u>35</u>	X
CCITT RX	<u>36</u>	Y
TXRX	<u>60</u>	Z
LOCK	<u>62</u>	SPACE
ACK TEST	<u>64</u>	\$
DISPLAY CHANGE	<u>65</u>	+
START	<u>67</u>	*
CONT	<u>68</u>	!
STOP	<u>70</u>	<
PRINT	<u>72</u>	>
TOL UPPER	<u>74</u>	?
TOL LOWER	<u>75</u>	/
.	<u>41</u>	.
-	<u>40</u>	-



### 2.3.10.4.5 Repetition of Program Blocks

If one or more operations are to be performed repeatedly, they can be combined to a repetition block.

The start of this command sequence and the number of repetitions are set as follows (in LEARN mode):

→ Select the last line before the repetition block.

→ Enter

(xxx corresponds to the desired number of repetitions)

Output in the  $\alpha$  display:           023 REP START>  
  023>xxx

The end of the repetition block is identified after the last line by entering    . Identification in the program: "REP STOP"

Example:

Input	$\alpha$ display
<input type="text" value="TXRX"/>	
<input type="text" value="STORE"/>	001 RECEIVER
<input type="text" value="A"/> <input type="text" value="505"/> <input type="text" value="SPEC"/> <input type="text" value="12"/> <input type="text" value="SPEC"/>	
<input type="text" value="STORE"/>	002 REP START> 002>12
<input type="text" value="SET f RX"/>	
<input type="text" value="STORE"/>	003 SET RF RX
<input type="text" value="STOP"/>	
<input type="text" value="STORE"/>	004 STOP
<input type="text" value="SINAD·DIST"/>	
<input type="text" value="STORE"/>	005 SINAD
<input type="text" value="A"/> <input type="text" value="506"/> <input type="text" value="SPEC"/>	
<input type="text" value="STORE"/>	006 REP STOP

When this section of the program is executed, the output frequency of the test generator is requested 12 times (SET f RX before STOP) and the SINAD value measured subsequently. It is thus possible to measure e.g. the receiver sensitivity on all channels of a 12-channel transceiver.

## 2.3.10.5 Execution of a Control Program

### 2.3.10.5.1 Starting a Program

Each stored program (at least one command line entered) can be called up in manual mode (not via IEC bus) using the command `1xx START` ( $00 < xx < 99$ ). If the same program is to be run again, it will be sufficient to press the CONTINUE key instead of repeating the above entry. If this key is pressed immediately after switching on the CMT, the program 00 is started (corresponds to `100 START`). All current measurements of the CMT are immediately aborted and the front-panel keys switched off (except for STOP and PRINT).

As the initial status of the CMT (TX/RX mode) at the program start does not necessarily correspond to LEARN mode it is recommended to define this status clearly in the first command lines.

Starting with line 1, all commands are executed in sequence according to their line number as fast as possible. To enable observing the program run on the slower LCDs for testing, a pause can be inserted after each command (see Section 2.3.10.4.2).

### 2.3.10.5.2 Program Interrupt

A program interrupt can be caused by

- pressing the STOP key during the program run
- a STOP function in the program  
(STOP or 100 STOP = 100 ms pause)
- a measured value which exceeds or falls below the programmed tolerance values.

The instrument then enters the HOLD mode which permits operation as in manual mode. In addition, the automatic test can be completely switched off by pressing the STOP key once again or the program be continued with the next command via CONT.

### 2.3.10.5.3 End of Programm

After execution of the last command of the called program, the automatic test switches off automatically. It is likewise possible to return to HOLD mode at any point in the program by pressing STOP. By pressing again, the automatic test is switched off completely.

#### 2.3.10.5.4 Special Features During Program Run

Contrary to manual mode, each measurement is made only once during the program run and the result stored in the displays. However, in HOLD mode and if the measured value is outside the tolerance the last command (provided it is a measurement call) is continuously repeated until the program is continued.

When a STOP function occurs in the program and if the last but one command was a setting where no parameter was specified, this measurement parameter is requested in the  $\alpha$  display.

##### Example:

```
032 RF COUNT
033 STOP
```

As long as the CMT is in HOLD mode, the last measurement call is repeated, in the above example the frequency count RF COUNT.

```
034 SET RF TX
035 STOP
```

When this STOP function occurs, the entry of the operating frequency for the transmitter test is requested by the message "\*SET RF TX\*" in the  $\alpha$  display.

```
036 ...
```

As the instrument status may be different for each program run (TX/RX mode, filter on/off, etc.) all important parameters should be set at the start of the program.

##### Example:

Switch on transmitter test

in receiver test

```
[TXRX] [STORE]
```

in transmitter test

```
[TXRX] [TXRX] [STORE]
```

Program line: 001 XMITTER

Switch on receiver test

in receiver test

```
[TXRX] [TXRX] [STORE]
```

in transmitter test

```
[TXRX] [STORE]
```

Program line: 001 RECEIVER

In LEARN mode, each change in the instrument status should therefore be stored in the program.

### 2.3.10.6 Deletion of Programs/Initialization of Autorun Control

#### Deletion of Programs:

(with 00 < xx < 99).

Deletion of complete programs is only possible in manual mode.

When this function is called up, the message "REALLY DELETE?" appears in the  $\alpha$  display of the CMT. When STORE is entered to acknowledge this function, the selected program is deleted. All other entries abort the selected function.

#### Example:

Program 56 is deleted.

#### Initialization of Autorun Control:

This procedure needs only be performed on the option CM-B5 after switching the instrument on for the first time or replacing the battery, all programs, possibly available test reports and control variables being deleted.

## 2.3.10.7 List of Commands of Autorun Control

### Command codes (1st line)

Command (acc. to definition)	Representation
COUNT f	RF COUNT
SET f RX	SET RF RX
SET f TX	SET RF TX
$\Delta f$	CH. SP.
DECODE	DECODE
CODE	CODE
DEMOD	DEMOD CNT
BEAT	BEAT CNT
AF EXT	AFEXT CNT
AF INT 1	AF INT1
AF INT 2	AF INT2
POWER	POWER
V <sub>0</sub> SYNTH.	RF OUTPUT
ACP	ACP
V <sub>0</sub> SYNTH. +6 dB	RFOUT+6dB
	RFOUT-6dB
V <sub>0</sub> OFF	RFOUT ON
	RFOUT OFF
PROBE	PROBE
MAX PK	MAX PK
INT 1	MOD INT1
POLARITY SELECT	+ PK
	- PK
	+-/2 PK
INT 2	MOD INT2
PK HOLD	PKHLD ON
	PKHLD OFF
EXT	MOD EXT
DIST	TX DIST
MOD OFF	MOD OFF
HP	HP IN
	HP OUT
1 V <sub>RMS</sub>	EXT 1VRMS
CCITT TX	CCITT TX
	CCITT OUT
EXT CAL	EXT CAL
V <sub>0</sub> MOD GEN	AF OUTPUT
AF-LEVEL	AF LEVEL
V <sub>0</sub> MOD +20 dB	AF OUT+20
	AF OUT-20
SINAD	SINAD
DIST	RX DIST
S/N	S / N
V <sub>0</sub> OFF	AFOUT ON
	AFOUT OFF
CCITT RX	CCITT RX
	CCITT OUT
SPEC	SPEC
STORE	STORE
RECALL	RECALL

Command (acc. to definition)	Representation
TXRX	XMITTER
	RECEIVER
LOCK	LOCK ON
	LOCK OFF
ACK TEST	ACK ON
	ACK OFF
DISPLAY CHANGE	DISPL1 TX frequency field
	DISPL1 RX
	DISPL2 TX RF level field
	DISPL2 RX
	DISPL3 TX modulation field
	DISPL3 RX
	DISPL4 TX AF level field
	DISPL4 RX
STOP	STOP
CONT	CONTINUE
PRINT	PRINT
TOL LIMITS UPPER	UPPER TOL
TOL LIMITS LOWER	LOWER TOL
INPUT SELECT	INPUT 2
	RF IN/OUT
NARROW	NARROW.IN
	NARROW.OUT
Oscilloscope mode	OSC MODE
Oscilloscope X deflect.	OSC TIME
Oscilloscope Y deflect.	OSC AMPL

1st following line

Numerical values or special functions

Key labelling	Representation
CLEAR	CLEAR
RANGE HOLD	RANGEHOLD
ANALOG SELECT	ANAL.SEL.
$\alpha$ -DISPL SELECT	ALPHA SEL
$\Delta$ VAR	DELTA VAR
REF	REF

2nd and 3rd following line

Numerical values or special functions  
(CLEAR in the 1st following line)

Key labelling	Representation
RANGE HOLD	RANGEHOLD
ANALOG SELECT	ANAL.SEL.
$\Delta$ VAR	DELTA VAR
REF	REF

## 2.3.10.8 Printing of Test Logs / Program Listings

### 2.3.10.8.1 Facilities and Control of Printer Function

If a printer with parallel interface (Centronics), such as PUD2/PUD3, is available, program listings and test logs can be output using the PRINT key 71.

Depending on the operating mode of the CMT, this key has different functions.

#### Manual Mode

to   :

Print listing of control program 100 to 199. Printing starts when the PRINT key is pressed, the PRINT LED lights up.

As long as the PRINT LED is lighting, indicating that a program listing is being printed, this command causes printing to be aborted and the PRINT LED goes out. However, the content of the CMT output buffer or the printer input buffer is still output.

If the PRINT LED is extinguished, generation of a test log can be switched on or off for the subsequent program run by pressing the PRINT key (several times, if required). This is acknowledged by output of the messages "PRINTER ON" or "PRINTER OFF" in the  $\alpha$  display.

#### → Logical Connection of the Printer when Switching on the CMT

- Upon switch-on of the CMT, the printer is connected and switched to on-line operation. CMT declares the printer to be present (logically available).
- Upon switch-on, the printer is not connected or in off-line operation. CMT declares the printer to be not present (logically not available).

#### LEARN mode

Pressing the PRINT key in LEARN mode does not lead to an immediate start of printing, but allows a PRINT ON or PRINT OFF command to be stored in the program. It is thus possible to suppress printing in each program for individual program blocks, e.g. for time-critical program parts. With the printer switched off (PRINTER OFF), these commands have no effect.

If the PRINT LED lights after pressing the PRINT key, PRINT ON is stored using  ; if it is extinguished, this corresponds to PRINT OFF (toggle function).

## HOLD mode

In HOLD mode, the PRINT key has a similar function as in LEARN mode, i.e. by pressing this key it is possible to decide whether a test log is to be generated in the subsequent program part (PRINT LED lights up) or not (PRINT LED goes out). If the printer has been switched off in manual mode (PRINTER OFF), the PRINT key is without function in HOLD mode.

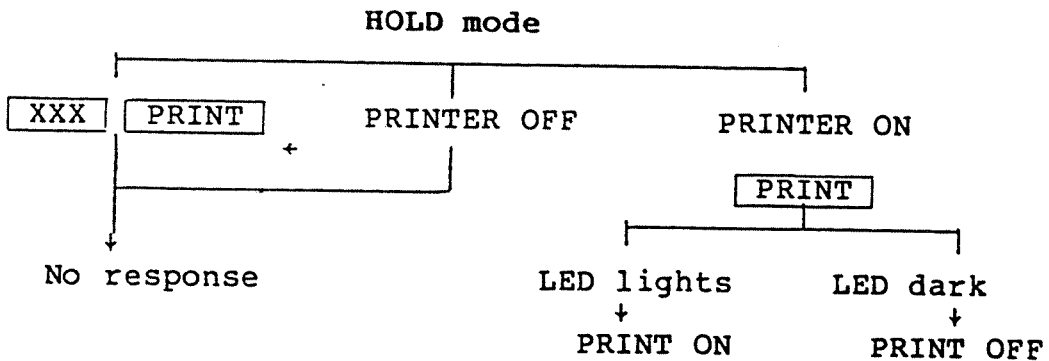
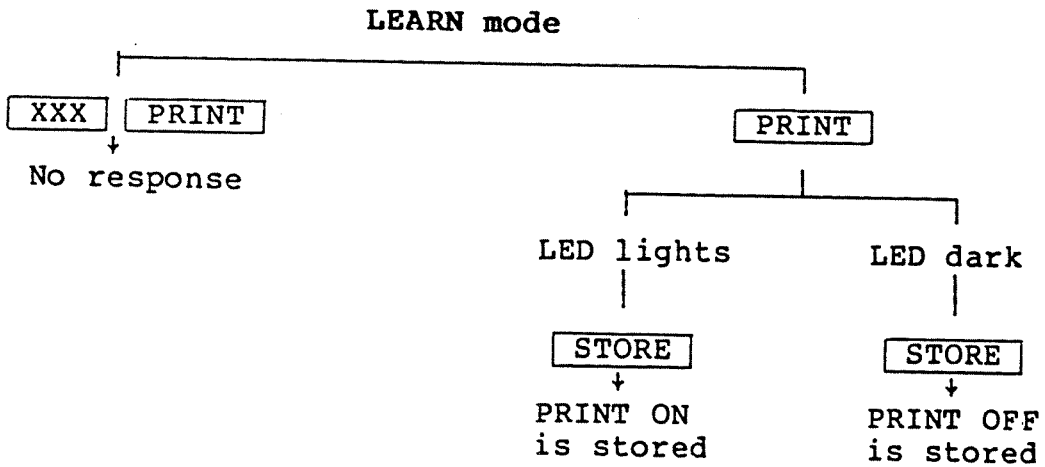
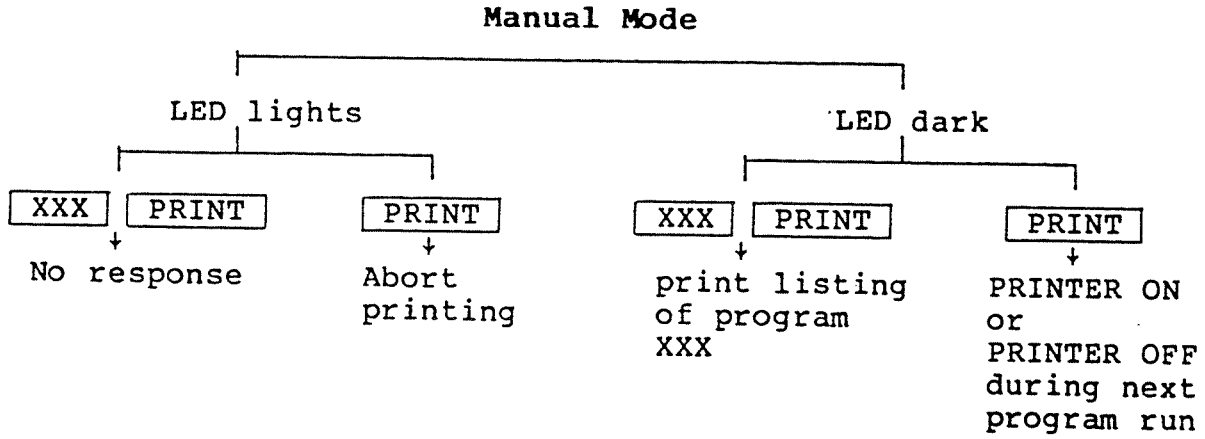



### 2.3.10.8.2 Program Listings

Program listings can only be printed out in manual mode. During printing (PRINT LED lights), it is therefore not possible to start a program, switch over to learn mode or have a look at the directory (   ). Contrary to the readout in the  $\alpha$  display, each program line corresponds to a print line; after 60 lines and at the end of the program, a page-feed (= OCH) is automatically produced.

**Example:** (corresponding to 2.3.10.3.7)

```
000 PROGRAM 23
001 XMITTER
002 AF INT1 2 kHz
003 AF OUTPUT 5 mV
004 RF COUNT
005 POWER
006 MAX PK
007 STOP 1000
008 RECEIVER
009 SET RF RX 145 MHz
010 RF OUTPUT 10  $\mu$ V
011 MOD OFF
012 MOD INT 1 kHz
013 AF LEVEL
014 STOP 2000
```

After aborting a program, the printer head should again be set to the beginning of the next page by means of the following program:

```
000 PROGRAM 99
001 CONTROL 0C (Entry:     )
002 PRINT OFF
```

### 2.3.10.8.3 Test Logs

For logging a program run, the printer must be switched on before starting the program (  or   in manual mode  $\rightarrow$  PRINTER ON in  $\alpha$  display).

#### **$\rightarrow$ Generation of Control Characters for Printer**

- To configure the CMT for different types of printer, a hexadecimal control character set can be generated.

enables to edit this string. It may have a length of up to 14 characters. In this case, the CMT interprets the numbers 0 to 9 and A to F as hexadecimal input. Subsequent pressing of the STORE key causes the string to be stored. The CMT ignores all other key entries.

Transfer of the control character string to the printer is triggered by entering **A** **526** **SPEC** .

- If the autorun control is to transfer control characters to the printer during RUN mode, a control character string can be generated in LEARN mode as described above using **A** **527** **SPEC** . This entry is stored by pressing the STORE key, "001 CONTROL <hexadecimal control characters>" is displayed as command. These control characters are then transferred to the printer in RUN mode.

After the program start, printing always begins with line 000 so that the program number and, if necessary, a head line (in line 001) can be placed at the head of the test log.

Printing of the test log can then be suppressed at any place by means of PRINT OFF commands in the program or by pressing the PRINT key in HOLD mode.

#### a) Structure of the test log

##### Test log head

! LINE!	COMMAND	PARAMETER	RESULT	! TOL !
! 000 !	PROGRAM	! 00		! !
! 001 !	***** TRANSMITTER TEST *****			

Each line (except for messages) is divided into five columns.

##### Line

The content of this column corresponds to the line number of the program, enabling the test log to be compared with the corresponding program listing.

##### Command

In this column, measurement calls and setting instructions to the CMT are printed in plain text corresponding to the command code (Section 2.3.10.7).

! LINE!	COMMAND	PARAMETER	RESULT	! TOL !
! 000 !	PROGRAM	! 00		! !
! : !		!		!
! 005 !	SINAD	!	49.9 dB	!
! 006 !	SET RF RX	! 120.00000 MHz	!	!

### Parameter

This field contains additionally entered parameters for measurement calls (e.g. search routines), settings and control instructions as well as the second parameter for SPEC functions (only numbers).

! LINE!	COMMAND	PARAMETER	RESULT	TOL
! 000 !	PROGRAM	! 00		!
! :				!
! 005 !	SINAD	! 20 dB	! 49.9 dB	!
! -> !	RF LEVEL		! 0.032 uV	!
! 006 !	SET RF RX	! 145.00000 MHz		!
! 007 !	SPEC A600	! 1000		!

### Result

This field contains the result obtained as reply to the command in the command column.

If a measurement call returns two results, e.g. the start of search routines, the setting value coupled with the measurement result (output level of signal generator in this case) or the second result is printed in the following line.

! LINE!	COMMAND	PARAMETER	RESULT	TOL
! 000 !	PROGRAM	! 00		!
! :				!
! 005 !	SINAD	! 20 dB	! 49.9 dB	!
! -> !	RF LEVEL		! 0.032 uV	!
! 006 !	SET RF RX	! 145.00000 MHz		!

### Tol

If a measurement is evaluated with tolerances, the GO/NOGO information appears in the tolerance field which corresponds to the TOL IN/OUT LEDs on the front panel.

OK : green (TOL IN) LED lights  
FAULT : red (TOL OUT) LED lights

### Messages

Messages entered into the program may have a length of up to 33 characters. They are located in the center of the columns Command, Parameter, Result and Tol and printed with a row of stars on each side so that they can be easily recognized.

LINE	COMMAND	PARAMETER	RESULT	TOL
000	PROGRAM	00		
001	***** TRANSMITTER TEST *****			
010	AF LEVEL		20.7 mV	OK
011	UPPER TOL AF LEVEL	30 mV		
012	LOWER TOL AF LEVEL	20 mV		
016	PRINT ON			
017	AF LEVEL		20.7 mV	FAULT
018	UPPER TOL AF LEVEL	55.5 mV		
019	LOWER TOL AF LEVEL	23.6 mV		

### Repetition blocks

With each run, the content of a repetition block is again printed with the current parameters and measurement results but with unchanged line numbers. For identification of the individual runs, the Result field is used.

LINE	COMMAND	PARAMETER	RESULT	TOL
000	PROGRAM	01		
017	REP START	5	1	
017	REP START	5	2	
017	REP START	5	3	
017	REP START	5	4	
017	REP START	5	5	
023	REP STOP			

In the case of relative changes in parameters via  $\Delta$  VAR, the change value is contained in the Parameter field (increment or decrement) and the actually set value in the Result field.

LINE	COMMAND	PARAMETER	RESULT	TOL
000	PROGRAM	02		
018	MOD INT1 DELTA VAR	0.1 KHz	3.00 KHz	

b) Types of test logs

Depending on the intended use of the test log, it is not always necessary to print each command line (e.g. simple GO/NOGO test). For this reason, SPEC functions are provided to select one of three possible log sizes:

- A  513  SPEC : Minimum log size (small)
- A  514  SPEC : Restricted log size (medium)
- A  515  SPEC : Complete log size (large)

Complete test log (large)

LINE	COMMAND	PARAMETER	RESULT	TOL
000	PROGRAM	01		
001	***** RECEIVER TEST *****			
002	RECEIVER			
003	RF OUTPUT	0.500 uV		
004	SET RF RX	145.80000 MHz		
005	AF INT1	1.000 kHz		
006	MOD INT1	2.80 kHz		
007	REP START	4	1	
008	AF LEVEL		14.4 mV	
009	SINAD		OVERFLOW	
010	MOD INT1 DELTA VAR	0.1 KHz	2.90 kHz	
007	REP START	4	2	
008	AF LEVEL		2.1 mV	
009	SINAD		54.4 dB	
010	MOD INT1 DELTA VAR	0.1 KHz	3.00 kHz	
007	REP START	4	3	
008	AF LEVEL		14.6 mV	
009	SINAD		53.6 dB	
010	MOD INT1 DELTA VAR	0.1 KHz	3.10 kHz	
007	REP START	4	4	
008	AF LEVEL		14.5 mV	
009	SINAD		53.6 dB	
010	MOD INT1 DELTA VAR	0.1 KHz	3.20 kHz	
011	REP STOP			
012	***** TRANSMITTER TEST *****			
013	XMITTER			
014	AF INT1	1.000 kHz		
015	AF OUTPUT	10.0 mV		
016	RF COUNT		145.200180 MHz	
017	POWER		0.017 W	
018	MAX PK		-2.66 kHz	OK
019	UPPER TOL MAX PK	3.0 KHz		
020	LOWER TOL MAX PK	2.5 KHz		
021	TX DIST		0.30 %	FAULT
022	UPPER TOL TX DIST	0.1 %		

### Restricted test log (medium)

In this operating mode, printing of the following program lines is suppressed:

- + Control instructions to the CMT (e.g. RECEIVER, SPEC functions)
- + Settings with the associated parameters in the program (e.g. RF OUTPUT 0.5  $\mu$ V)
- + Control instructions to the autorun control (e.g. STOP, CONTINUE)
- + Settings whose parameters are requested by the user during autorun mode are not suppressed

! LINE!	COMMAND	PARAMETER	RESULT	! TOL !
! 000 !	PROGRAM	! D1		!
! 001 !	***** RECEIVER TEST *****			
! 008 !	AF LEVEL		! 9.8 mV	!
! 009 !	SINAD		! 14.2 dB	!
! 008 !	AF LEVEL		! 12.1 mV	!
! 009 !	SINAD		! 54.0 dB	!
! 008 !	AF LEVEL		! 9.9 mV	!
! 009 !	SINAD		! 55.4 dB	!
! 008 !	AF LEVEL		! 9.8 mV	!
! 009 !	SINAD		! 55.9 dB	!
! 012 !	***** TRANSMITTER TEST *****			
! 016 !	RF COUNT		! 145.200080 MHz	!
! 017 !	POWER		! 0.017 W	!
! 018 !	MAX PK		! -2.67 kHz	! OK
! 019 !	UPPER TOL MAX PK	! 3.0 KHz		!
! 020 !	LOWER TOL MAX PK	! 2.5 KHz		!
! 021 !	TX DIST		! 0.31 %	! FAULT!
! 022 !	UPPER TOL TX DIST	! 0.1 %		!

### Minimum test log (small)

This log contains all messages in the program and the measurements (tolerance specifications inclusive) whose result lies outside the tolerance.

! LINE!	COMMAND	PARAMETER	RESULT	! TOL !
! 000 !	PROGRAM	! D1		!
! 001 !	***** RECEIVER TEST *****			
! 012 !	***** TRANSMITTER TEST *****			
! 021 !	TX DIST		! 0.32 %	! FAULT!
! 022 !	UPPER TOL TX DIST	! 0.1 %		!

c) Additional inputs in the program run

If additional information is to be entered into the printout during the program run, e.g. serial number of the radio equipment or the date, this can be prepared when writing the program by the input of    <message input>  . This message input in LEARN mode corresponds to the use of    .

During the program run, this message is output in the  $\alpha$  display and the user can now enter e.g. the current date. This entry is terminated by pressing the STORE key. By pressing SPEC, the input mode is left. CLEAR deletes character by character. The stored prompt string is identified by "?" in the display and the program listing. The maximum length of the text to be entered depends on the length of the prompt. A maximum of 67 and minimum of 37 characters is possible. The maximum length of the prompt is 33 characters (however, only 14 can be output in the  $\alpha$  display).

Example:

LEARN mode

Input	$\alpha$ display
<input type="text" value="A"/> <input type="text" value="520"/> <input type="text" value="SPEC"/>	MESSAGE INPUT
<input type="text" value="D"/> <input type="text" value="A"/> <input type="text" value="T"/> <input type="text" value="E"/> (via alphanumeric keyboard)	
<input type="text" value="STORE"/>	007 DATE

RUN mode

Input	$\alpha$ display
<input type="text" value="02.06.86"/>	DATE
<input type="text" value="STORE"/>	DATE 02.06.86

The program is continued by subsequently pressing CONTINUE.

Printout

```

+-----+-----+-----+-----+
! Line!   Command   ! Parameter ! Result   ! Tol !
+-----+-----+-----+-----+
! 000 ! PROGRAM           ! 01       !         !     !
! :   ! :                 ! :        ! :       ! :   !
! 007 ! DATE : 02.06.86  ! :        ! :       ! :   !

```

The colon separating the request for input and the input is automatically generated by the CMT.

### 2.3.10.8.4 Error Handling

If the printer is not available at the start of printing, the following response of the CMT is to be expected:

#### **Program listings**

First, the output buffer of the CMT is loaded (capacity: approx. 1/2 page). If the complete program can be loaded into the output buffer, the PRINT LED is immediately extinguished and all functions of the autorun control can be used without restriction. In the case of buffer overflow (PRINT LED lights continuously), the CMT waits up to 1 minute for the ready message from the printer to arrive. Use of the autorun control (LEARN, RUN) is not possible in this state, however, all other instrument functions are available without restriction.

After expiration of this waiting time, the CMT outputs "PRINTER ERROR" in the  $\alpha$  display and automatically aborts printing; the PRINT LED is extinguished.

#### **Test logs**

After the program start, the output buffer of the CMT is loaded (capacity: approx. 1/2 page), the program runs at normal speed. If this output buffer is not read out (printer switched off or not connected), the CMT waits up to one minute for the ready message from the printer to arrive, the program run is halted.

After expiration of this waiting time, the CMT outputs "PRINTER ERROR" in the  $\alpha$  display and automatically aborts printing, the PRINT LED is extinguished. The autorun control continues program execution without a test log being printed (PRINTER OFF).

### 2.3.10.8.5 Printer Interface

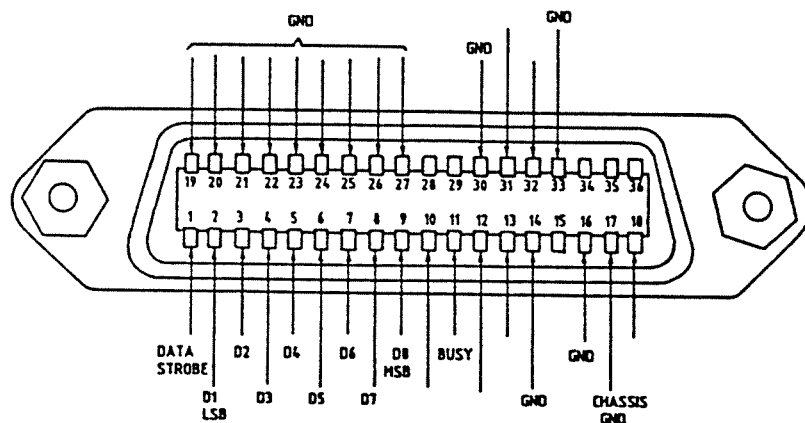

Fig. 2.13-1 PRINTER PARALLEL INTERFACE 102

From the signal lines available at the interface, the CMT only evaluates the BUSY signal.



### 2.3.10.9 Operation of Transfer Memory

The transfer memory CM-Z1 can be compared to a floppy disk for electronic data processing applications. It permits to file 100 programs of the CMT. The transfer memory must first be initialized before being used. Then any test programs can be copied from the CMT into the transfer memory and vice versa. When copying from the transfer memory into the CMT, it is possible to append the copy to already existing programs. The DELETE function allows programs to be deleted from the transfer memory, e.g. in order to provide memory space for other programs. The display directory function permits to display the first line of a program contained in the transfer memory using the spin wheel.

#### 2.3.10.9.1 Size of Transfer Memory Space

The transfer memory has a memory capacity of 7784 bytes. This memory space can be loaded with test programs. In accordance with the specified length of the vacant memory blocks of the CMT, approx. 1946 blocks are to be expected here.

#### 2.3.10.9.2 Initialization of Transfer Memory

Initialization of the transfer memory is necessary before using it for the first time or after replacing the battery.

For this purpose, plug the transfer memory into the CMT and use    to start initialization. In order to avoid inadvertent deletion, the message "REALLY RESET?" appears in the display. The function is only activated when STORE is entered. During initialization, the LED of the transfer memory lights. After execution of the command, the message ">>> DONE <<<" is output in the a display.

During initialization, indicated by lighting of the LED of the transfer memory, the transfer memory should not be disconnected since otherwise the function cannot be terminated.

Initialization of a transfer memory which has already been loaded with programs causes destruction of the programs.



In order to prevent inadvertent overwriting of the data contained in the transfer memory, the CMT should not be switched off or on as long as the transfer memory is connected.

## Possible criteria for aborting initialization:

- 1) Transfer memory is disconnected
  - + Message "FORMAT ERROR", initialization of transfer memory cannot be terminated.
- 2) CMT is switched off
  - + Same result as under 1)
- 3) Transfer memory has not been connected to the instrument
  - + message "FORMAT ERROR"

### 2.3.10.9.3 Copying a Program from the CMT to the Transfer Memory

The corresponding function menu is called up using    . The following message is displayed:

"CMT 00 -> TRA 00"

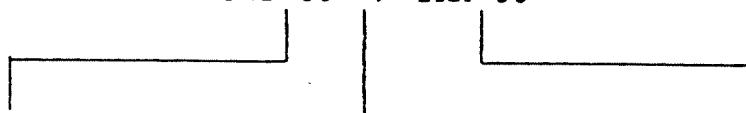

CMT program no.          Copy direction          Transfer memory program no.

CMT program no.:          Number of CMT program to be copied.

Transfer memory no.:      Number of program in the transfer memory where to copy.

The arrow specifies the copy direction, indicating that the program selected is to be copied from the CMT to the transfer memory. When the menu line appears in the display, the parameters can be entered. If more than four numbers are entered, the entry is started again. Subsequent STORE starts the copy procedure, SPEC aborts this function.

During the copy procedure, indicated by lighting of the LED of the transfer memory, the transfer memory should not be disconnected, since otherwise its contents and the initialization will be lost .

Successful termination of this function is indicated in the a display by the message ">>> DONE <<<".

**Possible criteria for aborting the copy procedure:**

- 1) Memory space in the transfer memory is not sufficient.
  - Message "NO MORE MEMORY"
  
- 2) Transfer memory is disconnected although copying is not yet terminated.
  - Message "TRANSFER ERROR", initialization of transfer memory is lost; programs available before are no longer accessible.
  
- 3) CMT is switched off
  - Same result as under 2)
  
- 4) Transfer memory has not been initialized
  - Message "TRANSFER ERROR", program is not copied.
  
- 5) Transfer memory has not been connected to the instrument
  - Message "TRANSFER ERROR"
  
- 6) Program already exists in the transfer memory
  - Message "PGM EXISTS", the existing program must first be deleted (prevents inadvertent deletion of a program).
  
- 7) The program to be copied does not exist
  - Message "NO SUCH PGM"





During the copy procedure, indicated by lighting of the LED of the transfer memory, the transfer memory should not be disconnected, since otherwise the program cannot be properly transferred.

Successful termination of this function is indicated in the  $\alpha$  display by the message ">>> DONE <<<".

Possible criteria for aborting the copy procedure, see 2.3.10.9.4.

#### 2.3.10.9.6 Deletion of a Transfer Memory Program

The corresponding function menu is called up using 

A
---

533
-----

SPEC
------

 .

The following message is displayed: "DELETE TRA 00".

The number of the program to be deleted from the transfer memory must be entered as parameter. The parameter can be deleted by further entry.

During deletion, indicated by lighting of the LED of the transfer memory, the transfer memory should not be disconnected, since otherwise its contents and the initialization will be lost.

Successful termination of this function is indicated in the  $\alpha$  display by the message ">>> DONE <<<".

#### **Possible criteria for aborting deletion:**

- 1) Transfer memory is disconnected although deletion is not yet terminated
  - Message "TRANSFER ERROR", initialization of transfer memory cannot be terminated
- 2) CMT is switched off
  - Same result as under 1)
- 3) Transfer memory has not been connected to the instrument
  - Message "TRANSFER ERROR"

### 2.3.10.9.7 Display Directory of Transfer Memory

This function is called up using    . The first line of the program selected using the spin wheel is output in the  $\alpha$  display. Programs which are not occupied are identified by "PGM EMPTY". When entering this function, the first line of program 00 is displayed (basic setting). This function can be left using    .

2.3.10.10 Control Instructions (Brief Summary)

Input	Effect
<p>A 800 SPEC STORE</p>	<p>Initialization of autorun control. Required after each battery replacement and new fitting of option (only in manual mode).</p>
<p>A 100 SPEC to A 199 SPEC</p>	<p>Start of programming = switchover to LEARN mode. 100 to 199 = program 00 to 99 (only in manual mode).</p>
<p>A 200 SPEC</p>	<p>End of programming = switchover to manual mode (only in LEARN mode).</p>
<p>A 300 SPEC STORE to A 399 SPEC STORE</p>	<p>Deletion of a program 300 to 399 = program 00 to 99 (only in manual mode).</p>
<p>A 500 SPEC</p>	<p>Start of message entry (only in LEARN mode).</p>
<p>A 505 SPEC 1 SPEC to A 505 SPEC 1000 SPEC</p>	<p>Start of a repetition block to be executed 1 to 1000 times (only in LEARN mode).</p>
<p>A 506 SPEC</p>	<p>End of a repetition block (only in LEARN mode).</p>
<p>A 510 SPEC</p>	<p>If the tolerance is exceeded during the program run (red LED lights up), the program is interrupted (Default).</p>
<p>A 511 SPEC</p>	<p>Exceeding of the tolerance is only stored in the protocol, the program run is continued without interruption.</p>
<p>A 512 SPEC</p>	<p>After calling up this special function, the memory capacity still available is indicated (in blocks). Each command line consists of at least one block.</p>



Input	Effect
A 513 SPEC	Small format of test reports
A 514 SPEC	Medium format of test reports
A 515 SPEC	Large format of test reports
A 520 SPEC	Start of message input with input requested in RUN mode (only in LEARN mode).
A 525 SPEC	Edit the printer configuration string
A 526 SPEC	Output the printer configuration string to the printer (string is generated before by A 525 SPEC .)
A 527 SPEC	Enter a control character sequence for the autotest. In RUN mode, the programmed string is output to the printer.
A 530 SPEC	Copy CMT program to transfer memory.
A 531 SPEC	Copy transfer memory program to CMT.
A 532 SPEC	Append transfer memory program to CMT program.
A 533 SPEC	Delete transfer memory program.
A 540 SPEC	Initialize transfer memory.
A 600 SPEC 0 SPEC to A 600 SPEC 10000 SPEC	Setting of minimum time between execution of the individual commands. 0 to 10000 = 0 to 10000 ms (only in manual mode and HOLD mode).

Input	Effect
<input type="text" value="A"/> <input type="text" value="605"/> <input type="text" value="SPEC"/>	Display of directory of programs in the $\alpha$ display (only in manual mode).
<input type="text" value="A"/> <input type="text" value="606"/> <input type="text" value="SPEC"/>	Directory switched off.
<input type="text" value="A"/> <input type="text" value="607"/> <input type="text" value="SPEC"/>	Enter the function display directory of transfer memory
<input type="text" value="A"/> <input type="text" value="610"/> <input type="text" value="SPEC"/>	Output of the Autorun Control Directory on a printer
<input type="text" value="A"/> <input type="text" value="611"/> <input type="text" value="SPEC"/>	Output of the Transfer Memory Directory on a printer
<input type="text" value="A"/> <input type="text" value="1000"/> <input type="text" value="SPEC"/> to <input type="text" value="A"/> <input type="text" value="1999"/> <input type="text" value="SPEC"/>	Selection of a particular line. 1000 to 1999 = line 000 to 999. (only in LEARN mode).
<input type="text" value="A"/> <input type="text" value="2000"/> <input type="text" value="SPEC"/> to <input type="text" value="A"/> <input type="text" value="2999"/> <input type="text" value="SPEC"/>	Deletion of a program block. 2000 to 2999 = deletion of lines 000 to 999 from the set position (only in LEARN mode).
<input type="text" value="100"/> <input type="text" value="START"/> to <input type="text" value="199"/> <input type="text" value="START"/>	Start of program run. 100 to 199 = program 00 to 99 (only in manual mode).
<input type="text" value="STOP"/>	Program interrupt (in RUN mode). Program run switched off (in HOLD mode).
<input type="text" value="CONT"/>	Continuation of an interrupted program run (in HOLD mode).

## 2.4 IEC-bus Control

### IEC-bus interface:

The CMT is provided with the interface functions RL2, which means that the states REMOTE WITH LOCKOUT STATE (IEC-bus command IECLLO) and LOCAL WITH LOCKOUT STATE are omitted.

#### 2.4.1 Introduction

The IEC 625-1 interface allows to remotely control the CMT. If the CMT is remotely controlled via this interface, manual operation via the front panel is switched off. This interface is referred to as IEC bus.

The instrument is controlled via 16 control lines, whose length should not exceed 20 m.

The individual signal lines have the following functions:

- Eight lines make up the data bus via which data, addresses and control commands are transmitted.
- Three further lines handle the so-called handshake.
- The remaining five lines constitute the management bus used for controlling the data bus and transferring particular messages.

Fig. 2-14 shows the pin assignment of the IEC-bus connector 103. Table 2-4 lists the functions of the individual lines.

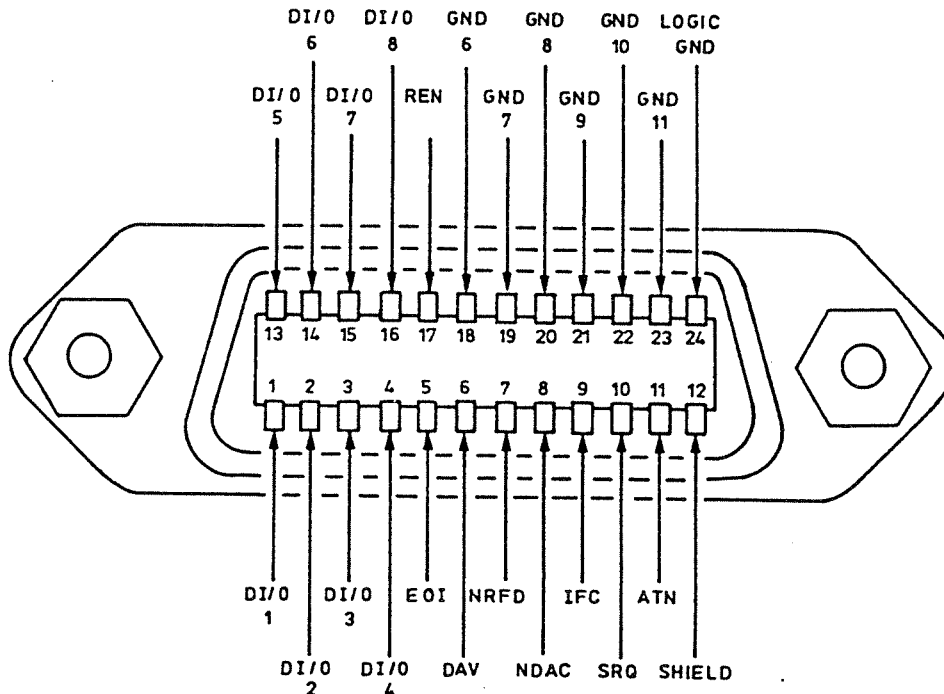

Fig. 2-14 Pin assignment of IEC-bus connector 103

Table 2-4 IEC-bus lines

DIO1 to DIO8	Transfer lines for data, addresses, and commands. DIO1 = LSB; DIO8 = MSB	Data-bus															
NRFD	<b>Not ready for data</b> Listener indicates with NRFD=Low that it cannot accept data at the moment.	Handshake bus															
NDAC	<b>Not data accepted</b> Listener indicates with NDAC=Low that it has not accepted any data.																
DAV	<b>Data valid</b> Talker indicates with DAV=Low that the data applied to DIO1 to DIO8 are valid.																
ATN	<b>Attention</b> For differentiation between device messages (ATN=Low) and interface messages (ATN=High).	Management bus															
EOI	<b>End or identify</b> Signal with two functions depending on ATN:  <table border="1" style="margin-left: 20px;"> <thead> <tr> <th style="border-right: 1px solid black;">EOI</th> <th style="border-right: 1px solid black;">ATN</th> <th>Significance for DIO</th> </tr> </thead> <tbody> <tr> <td style="border-right: 1px solid black;">0</td> <td style="border-right: 1px solid black;">0</td> <td>(data byte)</td> </tr> <tr> <td style="border-right: 1px solid black;">1</td> <td style="border-right: 1px solid black;">0</td> <td><u>END</u>: last data byte of a block</td> </tr> <tr> <td style="border-right: 1px solid black;">0</td> <td style="border-right: 1px solid black;">1</td> <td>(address or command)</td> </tr> <tr> <td style="border-right: 1px solid black;">1</td> <td style="border-right: 1px solid black;">1</td> <td><u>IDENTIFY</u>: request to identify after service request</td> </tr> </tbody> </table>		EOI	ATN	Significance for DIO	0	0	(data byte)	1	0	<u>END</u> : last data byte of a block	0	1	(address or command)	1	1	<u>IDENTIFY</u> : request to identify after service request
EOI	ATN		Significance for DIO														
0	0		(data byte)														
1	0		<u>END</u> : last data byte of a block														
0	1	(address or command)															
1	1	<u>IDENTIFY</u> : request to identify after service request															
IFC	<b>Interface clear</b> With IFC=Low, the controller sets the 100- $\mu$ s remote-control circuit (interface) to a basic status.																
REN	<b>Remote enable</b> With REN=Low, the controller switches the devices connected to the bus from manual operation to remote control. Manual operation is then disabled.																
SRQ	<b>Service request</b> If equipped with this function, each device connected can request a service from the controller via this line by setting SRQ=Low.																

If the instrument is controlled via the IEC bus, the CMT can operate either as listener or as talker.

a) CMT as listener

In this mode, the CMT receives device-specific data sent by the controller via the IEC bus. Several devices may operate as listeners. For this purpose, they must have been addressed by the controller before.

b) CMT as talker

In this mode, the CMT sends device-specific data to the controller or other devices connected to the IEC bus. However, the CMT must have been addressed as talker before. As opposed to listener mode, only one device may operate as talker in this case.

Using the key  LOCAL the CMT can be switched to normal mode, provided that no IEC-bus command is being processed.

## 2.4.2 General Command Entry

The entry of commands or numbers as shown in Figs. 2-15 and 2-16 is an abstract illustration of the possible entries.

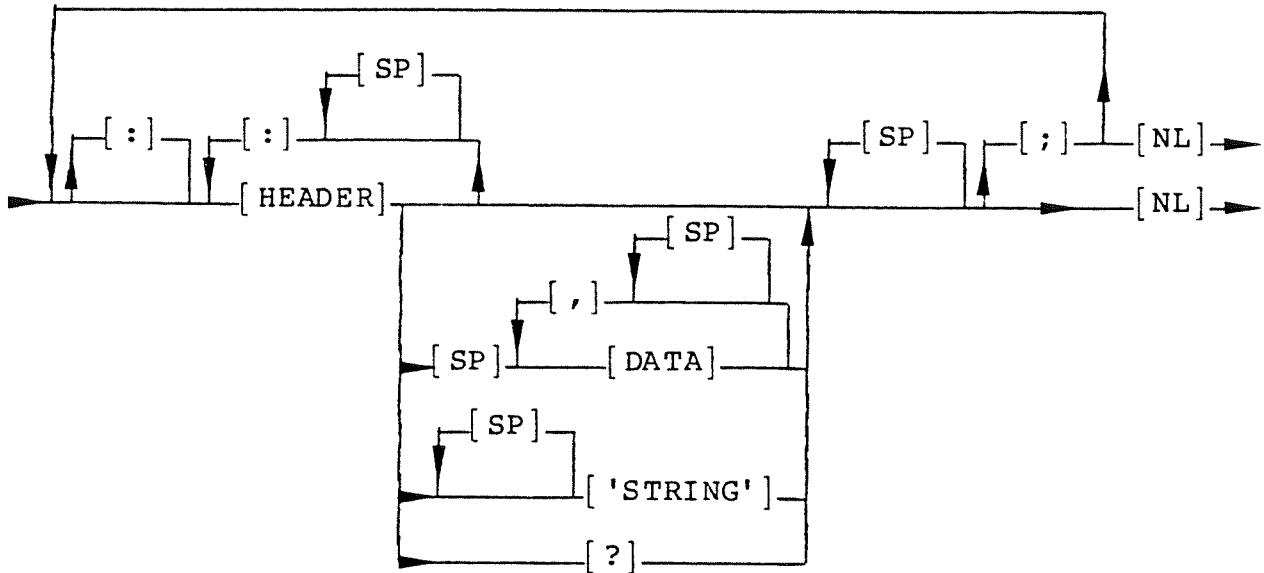

Fig. 2-15 Entry of commands

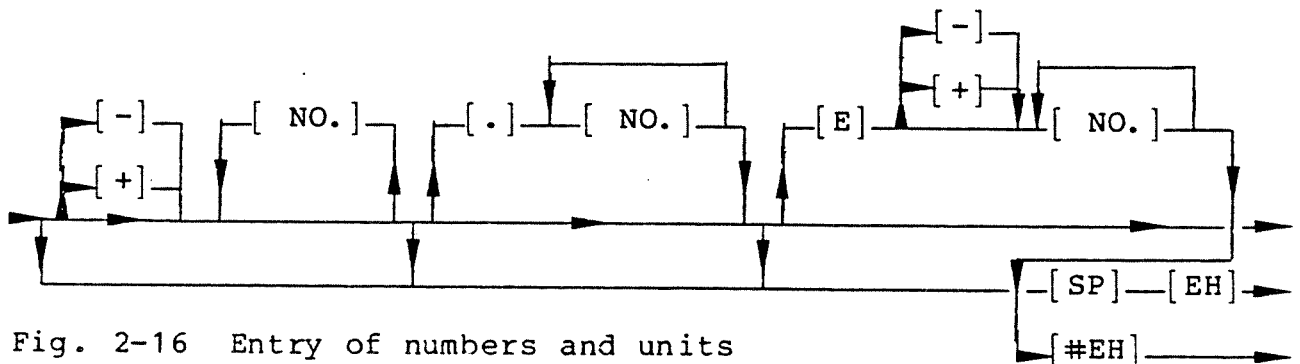

Fig. 2-16 Entry of numbers and units

Meaning of the expressions in Fig. 2-15 and Fig. 2-16:

STRING	numerical entry in inverted comma
+/-	sign
E	exponent (for numerical entry)
.	positions after decimal point
NL	New Line (ASCII ODH, OAH)
SP	space (ASCII 20H)
:	separation of headers
;	separation of commands
?	e.g. measured value is expected
DATA	numbers and/or units
EH	units
NO.	number

►counterclockwise

repeated entry of command or character is possible

►clockwise

single entry of command or character

HEADER is understood to mean a device-specific instruction. This instruction may be a complete command or part of a command.

**Example:**

Pressing of the DECODE key causes the CMT to decode a tone sequence. The corresponding IEC-bus command is:

**DECODE?**

In this case, the command consists of one header only.

For switching over from transmitter test to receiver test, the TX/RX key is pressed. This IEC-bus command consists of two headers.

**MODE:RX\_TEST**

The following is a complete command for setting the frequency of the first internal modulation generator:

**FREQUENCY:AF:INT1 1 KHZ**

The meaning of the command is clear from the headers. There is no need to enter a space after a header. New Line (NL) as termination of the IEC-bus command enables the command to be executed.

As can be seen from Fig. 2-15, a header or a header sequence can be terminated by a semicolon (;) with subsequent New Line (NL).

For entering a further command, it is therefore sufficient to enter only the last header if the first headers are identical.

**Example:**

Entry of the complete command with semicolon via the IEC bus.

**10 IECOUT0,"FILTER:IF:NARROW ;";**

For switching the filter to WIDE, it is sufficient to enter

**20 IECOUT0,"WIDE " (NL)**

after the header NARROW. Renewed entry of the complete command is no longer necessary.

The header NARROW is thus replaced by the header WIDE.

The individual IEC-bus commands can also be entered in abbreviated notation. The possible abbreviations can be obtained from the table containing all IEC-bus commands (see Section 2.4.3.1).

If the CMT is fitted with the IEC-bus option CM-B4, the IEC-bus address appears in the display when the instrument is switched on.

The address can be changed using the special function

<address (0 to 30)>

The address is retained even when the instrument is switched off.

### 2.4.2.1 Entry of Numbers

The entry of numbers, e.g. to set a frequency, corresponds to the path DATA in Fig. 2-15. This path is also shown separately in Fig. 2-16.

Example of complete numerical entry according to Fig. 2-16:

20E-3 dB

This corresponds to the entry of the number 0.02 with the unit dB.

Numbers outside the range of values of the CMT are ignored; before entering numbers, the user should therefore check whether the entry is meaningful.

Units accepted by the CMT:

%	nW
$\mu$ V	$\mu$ W
mV	mW
V	W
Hz	dB
kHz	dB $\mu$ V
MHz	dBm
rad	

### 2.4.3 Device-specific IEC-bus Commands

The individual commands can be easily handled if some basic rules are adhered to.

- Each terminated command ends with New Line.
- Numbers, units and headers are separated by at least one space.



- Numbers/units included in brackets may but need not necessarily be entered (see respective operation via the front panel).
- Numbers/units without brackets must be entered.

Section 2.4.3.1 lists all IEC-bus commands enabling the instrument to be set.

IEC-bus commands enabling the CMT to operate in talker mode are identified by a question mark (?) after the last header or the last character, e.g.

```

MODULATION:INT1 4 kHz?
COUNT:RF? , MODULATION:INT1?
MODULATION:INT1 4?

```

If the CMT is requested to perform a measurement, the result is sent to the controller after completion of the measurement.

The measured value has the following form:

```
<value> <exponent> <unit>
```

The units used correspond to the SI standard. The numerical value consists of a number with exponent or of a number only. If an exponent is output, its value is a multiple of three.

→ When calling up the talker with "#unit", the result is returned in the unit desired. This does not result in an instrument setting.

```

e.g.      IECOUT0,"FR:RF:TX-T 10MHZ?"
          →      10.0E6 HZ   as result.

```

The command

```

then has  IECOUT0,"FR:RF:TX-T #MHZ?"
          →      10.0 MHZ   as result.

```

If a number is entered prior to #, this value is first set in the currently selected unit and the result output in the unit indicated after #.

```

IECOUT0,"FR:RF:TX-T MHZ "
IECOUT0,"FR:RF:TX-T 20#KHZ "
→      20.0E3 KHZ   as result

```

The command IECOUT0,"FR:RF:TX-T 20 MHZ # KHZ" is not permissible.



### 2.4.3.1 IEC-bus Commands of the CMT

Numbers are indicated with xyz in the tables. The range of values can be obtained from Section 2.3.1.3 . The ASCII 95 character (-) in the IEC-bus commands corresponds to <Shift> <Del> with the PCA5 and to (-) with the PUC.

Instrument setting	Response
MODE:TX_TEST MODE:TX_T  MODE:TX_LOCK MODE:TX_L  MODE:RX_TEST MODE:RX_T  MODE:RX_LOCK MODE:RX_L  MODE:LOCK_OFF MODE:LO	Switchover to transmitter test  Switchover to transmitter test and LOCK  Switchover to receiver test  Switchover to receiver test and LOCK  Switch off LOCK
MODE:FREQUENCY_FIELD:TX_TEST MODE:F:TX_T  MODE:FREQUENCY_FIELD:RX_TEST MODE:F:RX_T  MODE:RF_LEVEL_FIELD:TX_TEST MODE:RF_:TX_T  MODE:RF_LEVEL_FIELD:RX_TEST MODE:RF_:RX_T  MODE:MODULATION_FIELD:TX_TEST MODE:MODU:TX_T  MODE:MODULATION_FIELD:RX_TEST MODE:MODU:RX_T  MODE:AF_LEVEL_FIELD:TX_TEST MODE:AF_:TX_T  MODE:AF_LEVEL_FIELD:RX_TEST MODE:AF_:RX_T	Switchover of the individual displays to transmitter or receiver test
MODE:ACKTEST:ON MODE:AC:ON  MODE:ACKTEST:OFF MODE:AC:OF  MODE:INPUT:SELECT_RF MODE:INP:SELECT_R	Acknowledgement call test on  Acknowledgement call test off  Input connector RF IN/OUT <u>77</u>

Instrument setting	Response
MODE:INPUT:SELECT_2 MODE:INP:SELECT_2	Input connector INPUT 2 <u>79</u>
FILTER:IF:NARROW FI:IF:N  FILTER:IF:WIDE FI:IF:W  FILTER:HP:ON FI:H:ON  FILTER:HP:OFF FI:H:OF  FILTER:CCITT:DEMODULATION:ON FI:CC:DEMODU:ON  FILTER:CCITT:DEMODULATION:OFF FI:CC:DEMODU:OF  FILTER:CCITT:AF_INPUT:ON FI:CC:AF_:ON  FILTER:CCITT:AF_INPUT:OFF FI:CC:AF_:OF	IF filter on  IF filter off  300-Hz highpass filter on  300-Hz highpass filter off  CCITT filter in demodulation path on  CCITT filter in demodulation path off  CCITT filter AF voltmeter on  CCITT filter AF voltmeter off
STORE     XY STO XY  RECALL   XY RE XY	Storage of complete instrument settings  Call of complete instrument settings
SPECIALFUNCTION:DATA XYZ SPECIALF:DA XYZ  SPECIALFUNCTION:A XYZ SPECIALF:A XYZ  SPECIALFUNCTION:B XYZ SPECIALF:B XYZ  SPECIALFUNCTION:C XYZ SPECIALF:C XYZ  SPECIALFUNCTION:D XYZ SPECIALF:D XYZ	Entry of special function, e.g. <input type="text" value="72"/> <input type="text" value="SPEC"/>  Entry of special function, e.g. <input type="text" value="C"/> <input type="text" value="151"/> <input type="text" value="SPEC"/>

Instrument setting	Response
<p>SPECIALINPUT:DATA XX,YY SPECIALI:DATA XX,YY</p> <p>SPECIALINPUT:A XX,YY SPECIALI:A XX,YY</p> <p>SPECIALINPUT:B XX,YY SPECIALI:B XX,YY</p> <p>SPECIALINPUT:C XX,YY SPECIALI:C XX,YY</p> <p>SPECIALINPUT:D XX,YY SPECIALI:D XX,YY</p>	<p>Entry of special function, e.g.  <input type="text" value="XX"/> <input type="text" value="SPEC"/> &lt;YY&gt; <input type="text" value="SPEC"/></p> <p>Entry of special function, e.g.  <input type="text" value="A"/> <input type="text" value="XX"/>  <input type="text" value="SPEC"/> &lt;YY&gt; <input type="text" value="SPEC"/></p>
<p>FREQUENCY:AF:INT1 [XYZ] FR:AF:INT1 [XYZ]</p> <p>FREQUENCY:AF:INT2 [XYZ] FR:AF:INT2 [XYZ]</p> <p>FREQUENCY:RF:RX_TEST [XYZ] FR:RF:RX-T [XYZ]</p> <p>FREQUENCY:RF:TX_TEST [XYZ] FR:RF:TX-T [XYZ]</p>	<p>Setting the modulation generator frequency 1</p> <p>Setting the modulation generator frequency 2</p> <p>Setting the output frequency of the RF test generator</p> <p>Setting the operating frequency for the transmitter test</p>
<p>MODULATION:INT1 [XYZ] MODU:INT1 [XYZ]</p> <p>MODULATION:INT2 [XYZ] MODU:INT2 [XYZ]</p> <p>MODULATION:EXT [XYZ] MODU:EXT [XYZ]</p> <p>MODULATION:EXT_CALIBRATION MODU:EXT-C</p> <p>MODULATION:EXT_1VRMS MODU:EXT-1</p> <p>MODULATION:OFF MODU:OF</p>	<p>Setting the type and depth of modulation</p> <p>Calibration of AF voltage at input MOD EXT</p> <p>Nominal level 1 VRMS at input MOD EXT</p> <p>Switch off modulation of test generator</p>

Instrument setting	Response
LEVEL:AF:ON L:AF:ON	Switch on modulation generator
LEVEL:AF:OFF L:AF:OF	Switch off modulation generator
LEVEL:AF:BOOST:ON L:AF:BO:ON	Level increased by 20 dB at output MOD GEN <u>83</u>
LEVEL:AF:BOOST:OFF L:AF:BO:OF	Switch off increase in level
LEVEL:AF:VOLTAGE [ XYZ ] L:AF:V [ XYZ ]	Setting the output level at output MOD GEN
LEVEL:RF:ON L:RF:ON	Switch on RF output level
LEVEL:RF:OFF L:RF:OF	Switch off RF output level
LEVEL:RF:BOOST:ON L:RF:BO:ON	Output level of RF test generator increased by 6 dB
LEVEL:RF:BOOST:OFF L:RF:BO:OF	Switch off increase in level
LEVEL:RF:VOLTAGE [ XYZ ] L:RF:V [ XYZ ]	Setting the RF level
LEVEL:RF:FINE [ XYZ ] L:RF:FI [ XYZ ]	RF level fine variation
CODE [ 'XYZ' ] COD [ 'XYZ' ]	Transmission of data telegram
DELTA_F [ XYZ ] DEL [ XYZ ]	Setting the channel spacing

Measurement	Response
<p>DEMODULATION:MAX_PK DEM:MA</p> <p>DEMODULATION:POS_PK DEM:POS_</p> <p>DEMODULATION:MED_PK DEM:ME</p> <p>DEMODULATION:NEG_PK DEM:NEG_</p> <p>DEMODULATION:DISTORTION DEM:DI</p>	<p>Call of modulation measurement</p> <p>Measurement of transmitter modulation distortion</p>
<p>AF_INPUT:LEVEL AF:LE</p> <p>AF_INPUT:DISTORTION [XYZ] AF:DI [XYZ]</p> <p>AF_INPUT:SINAD [XYZ] AF:SI [XYZ]</p> <p>AF_INPUT:S/N [XYZ] AF:S/ [XYZ]</p>	<p>AF level measurement</p> <p>Measurement of receiver, distortion, SINAD, S/N value</p> <p>Start of search routines when entering a numerical value, e.g. AF_INPUT :S/N 20 dB</p>
<p>COUNT:RF COU:RF</p> <p>COUNT:AF:DEMOD COU:AF:DEMOD</p> <p>COUNT:AF:BEAT COU:AF:BE</p> <p>COUNT:AF:EXTERN COU:AF:E</p>	<p>Switch on RF counter</p> <p>Measurement of demodulated AF signals</p> <p>Measurement of frequency at input AF VOLTM</p>

Measurement	Response
RF_INPUT:POWER RF:POW	RF power measurement
RF_INPUT:PROBE RF:PR	RF level measurement with RF millivoltmeter
DECODE DEC	Decoding a tone sequence
ACP [ XYZ ]	Adjacent-channel power measurement  ACP1 or ACP -1 ACP2 or ACP -2

In order to request the CMT to perform a measurement and transfer the result to the controller, a question mark (?) must be set after the last header.

The same applies if instrument settings, such as frequency, output level, or modulation depth, are requested.

**Example:**

- a) COUNT:RF?                      Call RF frequency measurement and  
   COU:RF?                        send measured value to controller.
- b) MODULATION:INT1?            Call deviation of 1st modulation  
   MODU:INT1?                    generator.

If instrument settings are performed and a question mark (?) appended to the IEC-bus command, e.g.

```
MODE:TX_TEST?
MODE:TX-T?
```

the command is executed but the message

```
* NOT TALKABLE *
```

is read in following the controller command

```
IECIN<address>,<variable>
IECINØ,B$
```



## Reference function via IEC bus

In manual mode, the CMT is able to display new measured/setting values referred to a reference value (cf. 2.3.7.6). This is also possible in IEC-bus mode by means of the following commands:

Switch on	Switch off	Effect
REF:POWER REF:POW	REF_CLEAR:POWER REF_:POW	RF power measurement
REF:RF:VOLTAGE REF:RF:V	REF_CLEAR:RF:VOLTAGE REF_:RF:V	RF level setting
REF:PROBE REF:PR	REF_CLEAR:PROBE REF_:PR	RF millivoltmeter
REF:MAX_PK REF:MA	REF_CLEAR:MAX_PK REF_:MA	Modulation measurement (MAX.PK)
REF:POS_PK REF:POS_	REF_CLEAR:POS_PK REF_:POS_	Modulation measurement (+ PK)
REF:MED_PK REF:MED_	REF_CLEAR:MED_PK REF_:ME	Modulation measurement (+/- PK)
REF:NEG_PK REF:NEG_	REF_CLEAR:NEG_PK REF_:NEG_	Modulation measurement (- PK)
REF:INT1 REF:INT1	REF_CLEAR:INT1 REF_:INT1	Modulation setting (INT 1)
REF:INT2 REF:INT2	REF_CLEAR:INT2 REF_:INT2	Modulation setting (INT 2)
REF:EXT REF:EXT	REF_CLEAR:EXT REF_:EXT	Modulation setting (EXT)
REF:LEVEL REF:LE	REF_CLEAR:LEVEL REF_:LE	AF voltmeter

Without additional indication of a reference value, the "REF" commands only produce an effect on the front-panel display (like in manual mode), ie the command IECOUT0,"REF:LEVEL" switches the output of the measured value to 0.0 dB, and the currently displayed measured value is defined as reference value. Using IECOUT0,"REF\_CLEAR:LEVEL", the absolute measured value (e.g. 1.00 V) is displayed again.

If a measured/setting value is requested (e.g. IECOUT0,"REF:LEVEL?"), two results are always obtained, namely relative and absolute value. If the reference value is indicated in the REF command, the result is referred to this value and can be requested by the controller via the bus.

**Example:**

```
IECOUT0,"LEVEL:RF:V 1μV ?"      Set the RF level to 1 μV
IECIN0,A$:PRINT A$
```

Result displayed on the screen: 1E-6 V

```
IECOUT0,"REF:RF:V ?"
IECIN0,A$:PRINT A$
```

Result displayed on the screen: 0 DB 1E-6 V

```
IECOUT0,"REF:RF:V 10μV ?"
IECIN0,A$:PRINT A$
```

Result displayed on the screen: -20 DB 1E-6 V

**Controlling the Oscilloscope via IEC Bus**

Manual operation of the oscilloscope is simulated by means of the following IEC-bus commands:

Command	Effect
OSCILLOSCOPE:MODE:RIGHT O:MODE:RI	Operating mode setting AC/DC/BEAT/DEMODO/AF
OSCILLOSCOPE:MODE:LEFT O:MODE:L	Operating mode setting AC/DC/BEAT/DEMODO/AF
OSCILLOSCOPE:TIME:UP O:TI:U	Time base setting
OSCILLOSCOPE:TIME:DOWN O:TI:DO	Time base setting
OSCILLOSCOPE:AMPLITUDE:UP O:AM:U	Gain setting
OSCILLOSCOPE:AMPLITUDE:DOWN O:AM:DO	Gain setting

The effect of these settings is only relative to the currently set status. However, a defined basic status can be obtained by means of oscilloscope PRESET (IECOUT0,"SPECIALFUNCTION:DATA 130").

Mode: AC  
Time: 0.2 ms  
Amplitude: 0.2 V

## Special functions returning a result to the controller

```
IECOUT0,"SPECIALFUNCTION:D 20 ?"      (Battery voltage
IECOUT0,"SPECIALFUNCTION:D 21 ?"      measurements)
IECOUT0,"SPECIALFUNCTION:D 22 ?"

IECOUT0,"SPECIALFUNCTION:DATA 80 ?"    (Squelch measurement)
IECOUT0,"SPECIALFUNCTION:DATA 84 ?"    (Bandwidth measurement)
IECOUT0,"SPECIALINPUT:DATA 152,<f> ?"  (only with option CMT-B10)
IECOUT0,"SPECIALINPUT:DATA 153,<Δf> ?" (only with option CMT-B10)
```

### 2.4.4 Examples for IEC-bus Operation

When the CMT is switched on, the IEC-bus address appears in the frequency field. During operation, the IEC-bus address can be changed via special function    <address 0 to 30>  .

By pressing the key  the CMT can be switched to normal operation.

If the IEC-bus address is e.g. 0, the following IEC-bus command is possible:

```
IECOUT0, "FREQUENCY:RF:TX_TEST 10 MHz "
```

Each time the  key is pressed, the command IECDCI should initiate the IEC-bus operation. The following is a complete BASIC program:

```
10 IECDCI
20 IECOUT0,"MODE:TX_TEST "
30 IECOUT0,"FREQUENCY:AF:INT1 20 kHz "
40 IECLAD 0
50 IECGTL
60 IECUNL
70 END
```

This program switches the CMT to transmitter mode and sets the frequency of the first modulator to 20 kHz. The IECGTL command terminates the IEC-bus operation and switches the instrument back to normal operation.

For a detailed description of the IEC-bus commands of the controller, refer to the respective operating instructions, since differences occur with a few commands.

The status byte can be read in by the controller via the IEC-bus command

```
IECSPL <address>,<variable>
```

Example of IEC/IEEE-bus remote control of CMT using SRQ

PUC/SCUD syntax

```

100 IECDCI:IECOFFSRQ                               Initialisation
110 IECTIME10:IECTERM10
120 IECOUTO,"*ESE 255"                             Event mask
130 IECOUTO,"*SRE 32"                              SRQ mask
140 :
150 :
160 IECOUTO,"RECALL 1"                             User program
170 O$="SPECIALF:DATA 80?"
180 GOSUB1200:REM CALL MEASUREMENT
190 PRINT"SQUELCH TEST:":PRINTI$
200 PRINTES$
210 :
220 END
999 :
1200 REM SRQ HANDLING *****
1210 SQ=0:IECOUTO,"*GLS"                            Clear status register
1220 IECSPLD,SP%:REM CLEAR SRQ
1230 IECSRQGO TO 1300                               Activate SRQ
1240 IECOUTO,0$                                     Call measurement
1250 DUMMY=0:IFSQ=0 THEN 1250:REM WAIT FOR SRQ
1260 IECOFFSRQ                                       Disable SRQ
1270 GOSUB1400:REM FETCH RESULT
1280 GOSUB1500:REM CHECK EVENTS
1290 RETURN
1300 :
1300 REM ##### SERIAL POLL                         Serial poll following SRQ
1310 IECSPLD,SPL%
1320 SQ=1
1330 IECRETSRQ
1340 :
1400 REM ##### FETCH RESULT                         Fetch results
1410 IECINO,I$
1420 RETURN
1430 :
1500 REM ##### EVENT STATUS                         Read event register
1510 IECOUTO,"*ESR?"
1520 IECINO,B$:B=VAL(B$)
1530 IFBAND32 THEN ES$="COMMAND ERROR"
1540 IFBAND16 THEN ES$="EXECUTION ERROR"
1550 IFBAND1 THEN ES$="CMT READY"
1560 IFB=0 THEN ES$="NO EVENT OCCURRED"
1570 RETURN
READY.

```

## Example for bandwidth measurement

```
10 REM
20 REM           Bandwidth measurement
30 REM
40 IECDCI
50 IECSP
60 IECOUTØ,"*ESE 255"
70 IECOUTØ,"*SRE 32"
80 ON SRQ GOTO 200
90 IECOUTØ,"SPECIALF: DATA 84?"
.
.
.
200 IECSPØ,A%
210 IF A% = 96 THEN GOTO 300
220 GOTO 1000
.
.
.
300 IECOUTØ,"*ESR?"
310 IECINØ,B$ : B = VAL(B$)
320 IF B = 32 THEN ...      Command Error
330 IF B = 16 THEN ...     Execution Error
340 IF B = 1 THEN ...      Operation complete
.
.
.
1000 END
```



### 2.4.5.1 Service Request and Status Registers

Fig. 2-17 shows the status registers and the links between them. In line with the standard, the status byte (STB) and its associated mask register (SRE), which are also present with older instruments, have been supplemented by the event status register (ESR) and its event status enable (ESE) mask register.

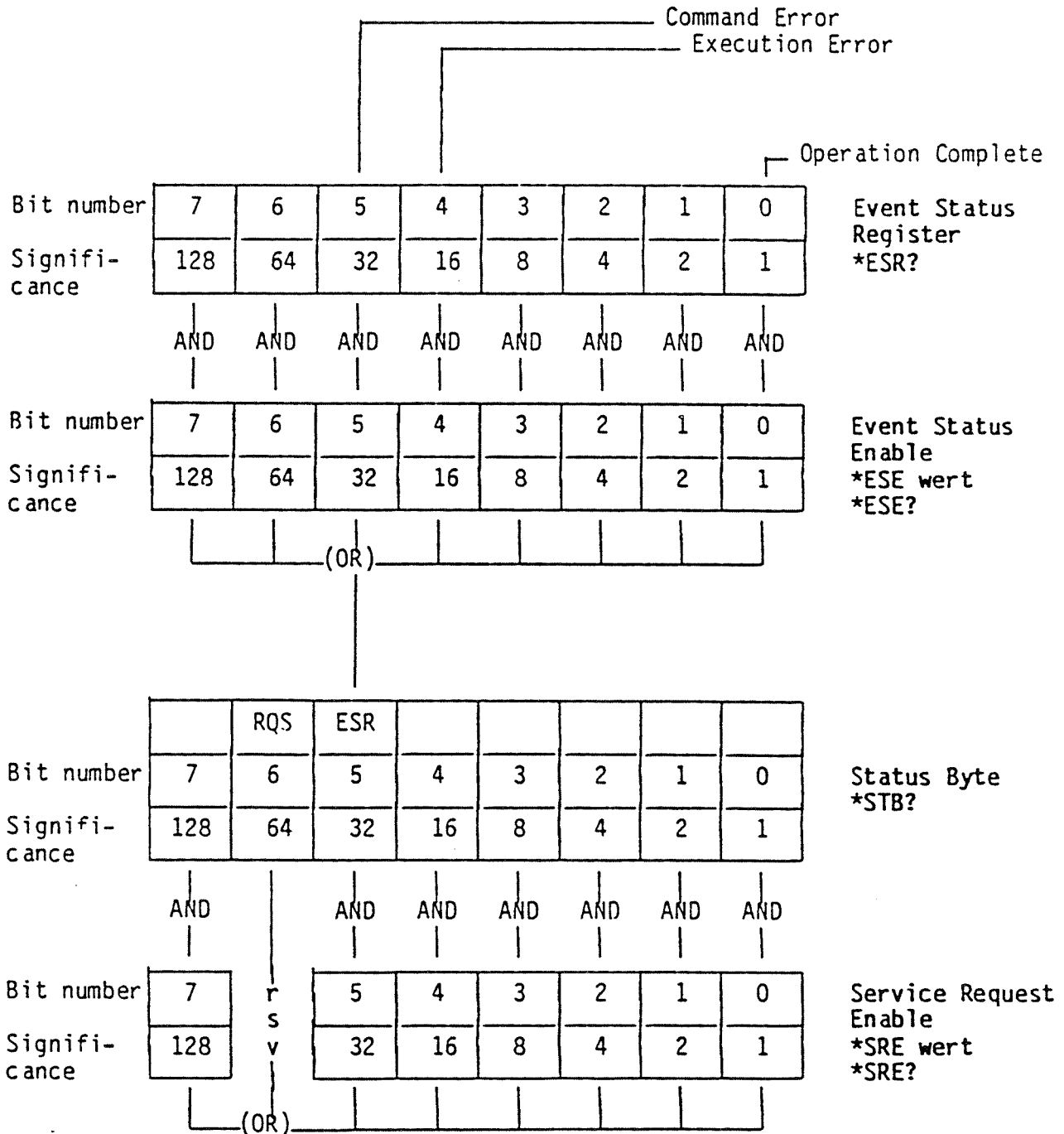

Fig. 2-17 Status register

Table 2-6 Significance of event status register

<p>Bit 5</p>	<p><b>Command Error</b></p> <p>is set if the following errors are detected during analysis of the received commands:</p> <ul style="list-style-type: none"> <li>→ syntax error</li> <li>→ illegal header</li> <li>→ illegal unit</li> </ul>
<p>Bit 4</p>	<p><b>Execution Error</b></p> <p>is set if one of the following messages appears:</p> <ul style="list-style-type: none"> <li>→ ADD OPTION ...</li> <li>→ CHECK MOD..</li> <li>→ CHECK INST.</li> <li>→ TIMEOUT ERROR</li> <li>→ &gt;NOT DEFINED&lt;</li> <li>→ &gt;ERROR&lt;</li> <li>→ *NO CALL*</li> <li>→ &gt;PROTECTED&lt;</li> <li>→ NOT TALKABLE</li> <li>→ ** CH. SP. **</li> <li>→ * SET RF FIRST *</li> <li>→ 0V RF / CH.SP.</li> </ul> <p>These messages can then be read in via the IECIN command.</p>
<p>Bit 0</p>	<p><b>Operation Complete</b></p> <p>is set if all previous commands have been executed.</p>



Using the service request enable mask register (SRE), the user can determine whether the RQS bit of the status byte is also to be set with the ESR bit set and if a service request is to be sent to the controller by activating the SRQ line. The following possibilities exist since each bit in the service request enable mask register is assigned to the corresponding bit in the status byte:

Contents of the SRE (decimal)	Set bit No. in the SRE	Effect
0	-	No service request
32	5	Service request with ESR bit set (at least 1 bit set in the event status register and not masked)

The service request enable mask register (SRE) is written with the command `"*SRE wert"` ("wert" is the contents in decimal) and can be read again using the command `*SRE?`. It is not changed by other commands or interface messages (DCL, SDC).

Several devices can trigger a service request simultaneously, the open collector drivers cause an OR function on the SRQ line. The controller must read the status bytes of the devices to identify the device which has triggered the service request. A set RQS bit (bit 6/DIO 7) indicates that the device is transmitting a service request.

The status byte of the CMT can be read in the following manner:

- Using the command `"*STB?"`:  
The contents are output in decimal. The status byte is not modified by reading and the service request is not cleared.
- Using a serial poll  
(With R&S controllers: IEC SPL adr, status):  
The contents are transferred in binary form as only byte. The RQS bit is subsequently set to zero and the service request becomes inactive, the other bits of the status byte are not changed.

In the event status register (ESR), a bit is set to 1 (see Table 2-6) if certain events occur (e.g. error, ready message).

These bits remain set until they are cleared by reading the event status register (using the command `*ESR?` or `*CLS`).

Using the event status enable mask register (ESE), the user can select the bits in the event status register which also set the sum bit ESR (bit 5 in the status byte). The sum bit is only set if at least one bit in the ESR and the corresponding bit in the ESE are set to 1. The sum bit is automatically cleared again if the above condition is no longer satisfied, e.g. if the bits in the ESR are cleared by reading the ESR or if the ESE is changed.

The event status enable mask register is written with the command "\*ESE wert" ("wert" is the contents in decimal) and can be read again using the command \*ESE?

It is not changed by other commands or interface messages (DCL, SDC).

Only the following bits are used in the status byte (STB):

Bit No.	Bus line	Designation	Meaning
5	DIO 6	ESR	Sum bit of event status register
6	DIO 7	RQS	Request Service



2.4.6 Special Features of the CMT in Remote Mode  
(IEC bus and autorun control)

2.4.6.1 Readout of Decoded Selective Call via IEC Bus /  
Autorun Control

The IEC-bus command IECOUT0,"DECODE ?" starts decoding and delivers as a result the contents of the data telegram received.

In an acknowledgement test (ACK TEST), it must be possible to read out the contents of the data telegram received without having to restart decoding. For this purpose,

IECOUT0,"SPECIALFUNCTION:C 186"

is used.

This command can also be used in a direct way in manual mode (useful only in LEARN mode of autorun control) and in the autorun control program:

C	186	SPEC
---	-----	------

The IEC-bus command IECOUT0,"DECODE ?" is synchronized, ie it must first be terminated before a further command can be sent to the CMT.

In order to be able to send further commands to the CMT after decoding has been started (e.g. control of the relays on CM-B4 and CM-B5), this synchronization must be suppressed.

For this purpose, the following command sequence is used:

IECOUT0,"SPECIALFUNCTION:C 185" (decode unsynchronized)

IECOUT0,"SPECIALFUNCTION:A 31" (switch relay)

:

Wait for the result or read out the result until the buffer is no longer empty!

:

IECOUT0,"SPECIAL FUNCTION:C 186?" (read out result)

This function can also be used with the autorun control!

## 2.4.6.2 PK HOLD Function via IEC Bus and Autorun Control

If the PK HOLD function is switched on in manual mode, the greatest measured modulation value is displayed as a result until the function is switched off.

In addition, particular time conditions are useful in IEC-bus mode:

- Waiting time between incoming IEC-bus command and start of PK HOLD measurement.
- Measuring time (time between start and end of PK HOLD)

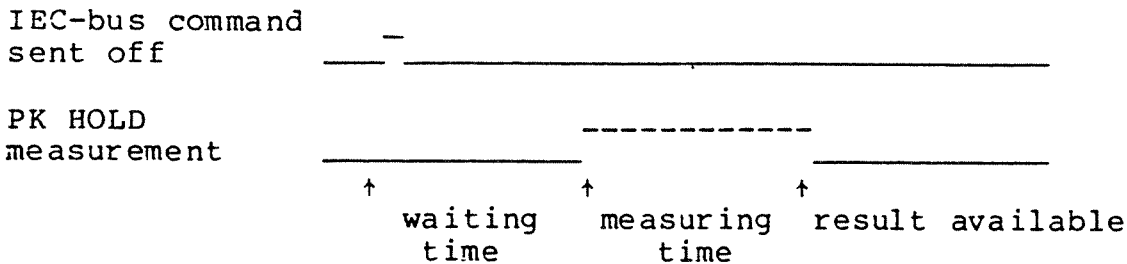

These times can be set between 0.1 and 3 s via the two functions

<waiting time(s)>  (resolution 0.1 s)  
(IECOUT0,"SPECIALINPUT:DATA 181, waiting time")

and

<waiting time(s)>  (resolution 0.1 s)  
(IECOUT0,"SPECIALINPUT:DATA 182, measuring time")

(factory setting 0.5 s).

The IEC-bus command IECOUT0,"DEMODULATION:PK\_HOLD:ON" starts the +PK or -PK measurement with the PK HOLD function activated.

MAX PK  
+ PK activated → PK HOLD with +PK  
MED PK  
- PK activated → PK HOLD with -PK

This command is not synchronized, ie further commands (e.g. switch built-in relays) can be sent to the CMT even before the measurement is terminated.

The measurement result is read out using the command

IECOUT0,"SPECIALFUNCTION:DATA 180?"

and provides the +PK or -PK result (after expiration of the measuring time!).

Operation via the autorun control is performed accordingly.

With the ACK TEST activated (ACK TEST LED lights) and in manual mode, times entered via  /   are ignored.



The function   can be used in the ACK TEST for reading out the determined deviation in IEC-bus and autorun mode.

### 2.4.6.3 Automatic Background Calibration of the CMT

Approximately every 10 minutes, the CMT performs a calibration of the A/D converter (incl. preamplifier), the rms meter and the peak-value meter. During calibration, the measuring mode is interrupted for approx. two seconds which may lead to difficulties in time-critical measurements (above all via IEC bus and autorun control).

The automatic calibration can therefore be switched off via  D  5  SPEC .

It can be switched on again via  D  0  SPEC .

### 2.4.6.4 Waiting Times and Transient of the CMT in IEC-bus Programs

All internal transients of the CMT with respect to switching of amplifiers, attenuators and source selection are taken into account in the individual measurement calls.

In some cases, however, it is not useful to take into account all possible errors in the firmware of the CMT (reduction of measuring rate!):

#### 1. Distortion meter (SINAD/DIST, DIST TX):

If the input voltage varies heavily, the internal CMT control requires up to 6 s until the display of the measured SINAD value is steady and correct. Since the point in time at which such level jumps occur is always known in a fully automatic test program, it is better to wait for the steady-state condition in the control program than reduce the measuring rate in the firmware.

Level jumps at the input AF VOLTM

20 IECOUT0,"AF-INPUT:SINAD" 1st measurement call in order to activate SINAD measurement.

30 HOLD 3000 Waiting time until signal applied is stable

40 IECOUT0,"AF-INPUT:SINAD?" Perform measurement

#### 2. Switchover of type of modulation:

When selecting the MAX PK measurement, the type of modulation can be switched over at the same time via the unit. In order to suppress settling of the demodulators, it is recommended to evaluate the result of a second measurement:

Type of modulation AM is switched on:

50 IECOUT0,"DEMODULATION:MAX-PK KHZ"

60 IECOUT0,"DEMODULATION:MAX-PK ?"

### 3. Changing from BEAT/ACP measurement to demodulation:

Demodulation is not possible while a BEAT/ACP measurement is running, since the local oscillator must be converted for this purpose.

This is why this operating mode should be switched off before measuring the demodulated signal.

BEAT measurement active:

```
50 IECOUT0,"DEMODULATION:MAX_PK"      (BEAT is switched off)
60 IECOUT0,"DEMODULATION:MAX_PK ?"
```

or

```
60 IECOUT0,"DEMODULATION:DISTORTION"
70 HOLD 3000
80 IECOUT0,"DEMODULATION:DISTORTION ?"
```

ACP measurement active:

```
50 IECOUT0,"RF_INPUT:POWER"          (ACP is switched off)
60 IECOUT0,"DEMODULATION:MAX_PK ?"
```

or

```
60 IECOUT0,"DEMODULATION:DISTORTION"
70 HOLD 3000
80 IECOUT0,"DEMODULATION:DISTORTION ?"
```

### 4. BEAT measurement

The first BEAT measurement in an autorun control program shifts the local oscillator by 455 kHz. This may invalidate the measurement result.

The following program section provides a remedy:

Autorun control:

IEC bus:

```
023 PRINT OFF
024 BEAT
025 PRINT ON
026 BEAT
```

```
50 IECOUT0,"COUNT:AF:BEAT"
60 IECOUT0,"COUT:AF:BEAT?"
```

## 2.5 Installation of Options

For installation of most options, the instrument must be opened and the plug-in cards pulled out; the information required for this can be obtained from Section 4 (Service Manual).

**Note:** After fitting the options, the rails must be locked in position and the screws marked A (Fig. 4-2) must be tightened.

### 2.5.1 IEC Bus and/or Autorun Control (CM-B4/CM-B5)

For fitting this (these) option(s), the instrument need not be opened. Unscrew the cover plate fastened to the rear panel with 6 Phillips screws, break out the corresponding straps and fasten the option(s) with the supplied screws. Slide the cover plate with the option(s) carefully into the instrument and fasten with screws.

When fitting the autorun control option, first enter    (initialization) after switching on for the first time.

The adhesive foil supplied with the option may be used as auxiliary means for text input in connection with the autorun control. If required, it can be attached below the three following rows of keys:

E to N    below the upper row of keys (f to PROBE)  
O to Y    below the center row of keys (INT1 to CCITT)  
Z to >    below the lower row of keys (RECEIVER to LOWER)

### 2.5.2 OCXO Reference Oscillator (CMT-B1)

Open the instrument and take out the RF oscillator module. Unscrew the labelled panel and plug in the option; do not forget the insulating washer, provided this has not yet been stuck to the bottom side of the OCXO oscillator.

**Note:** After fitting the option, adjust it (Section 3).

### 2.5.3 Adjacent-channel Power Meter (CMT-B6)

Open the instrument. Plug the option onto location X55 (black color coding); if the DTMF decoder option (CM-B11) is fitted, plug the adjacent-channel power meter (ACP) onto this option. The module is connected up according to the following plan (see also wiring diagram in the cover):

remove	lay	cable	from	to
x	-	W16	analog unit, X609	analog unit X607
-	x	W20	analog unit, X606	option ACP, X918
-	x	W24	analog unit, X607	option ACP, X916
-	x	W21	RF oscill., X304	option ACP, X911
-	x	W23	analog unit, X609	option ACP, X917





#### 2.5.4 2nd AF Synthesizer (CMT-B7)

Open the instrument. Disconnect the cables W4 and W5 from the 1st modulation generator module, and W26 if option CM-B8 is fitted, (location X56, gray color coding) and pull it out; unscrew the panel without inscription and plug in the option. Fasten the new panel covering both modules and plug in the module; do not forget the cables W4 and W5 (and W26, if necessary).

#### 2.5.5 RF Millivoltmeter (CM-B8)

Open the instrument, take off the inscription panel and remove the front panel (see Section 4, Service manual). Replace the plastic cover by the supplied 3-pole connector. Fit the front panel and the inscription panel again.

Disconnect the cables W4 and W5 from the 1st modulation generator module (location X56, gray color coding) and take it out together with the 2nd AF Synthesizer option (CMT-B7), if plugged in. If only the 1st modulation generator is present, unscrew the panel without inscription, and screw the option to the new panel supplied. If the 2nd AF Synthesizer option (CMT-B7) is fitted, plug the option onto it and use the projecting cover as support. Plug in the modules; do not forget W4 and W5.

#### 2.5.6 Duplex Modulation Meter (CM-B9)

Open the instrument and plug the option onto location X53 (yellow color coding). The module is connected up according to the following plan (see also wiring diagram in the cover):

remove	lay	cable	from	to
x	-	W21	RF oscillator, X304	option ACP, X911
-	x	W21	RF oscillator, X304	option CM-B9, X931
-	x	W22	option CM-B9, X932	option ACP, X911
x	-	W3	output stage, X406	analog unit, X608
-	x	W3	option CM-B9, X939	analog unit, X608

To protect against radio interference, screw the supplied screening cover onto connector X406 of the output stage.

### 2.5.7 DTMF Decoder (CM-B11)

Before opening the instrument, remove the option Adjacent-channel Power Meter (CMT-B6), if fitted. Plug the option onto location X55 (black color coding) and fit the Adjacent-channel Power Meter again (see Section 2.5.3).

### 2.5.8 Testing the Fitted Options

The options are checked as described in Section 3.

OCXO Reference Oscillator	CMT-B1	3.2.2.
IEC Bus	CM-B4	3.2.31
Autorun Control	CM-B5	3.2.29
Adjacent-channel Power Meter	CMT-B6	3.2.27
2nd AF Synthesizer	CMT-B7	3.2.15.4
RF Millivoltmeter	CM-B8	3.2.28
DTMF Decoder	CM-B11	3.2.26

The duplex modulation meter CM-B9 is checked according to 3.2.22.2; in addition, vary the frequency of the test generator in the range between 1 MHz and 1000 MHz, preferably use the frequencies as in 3.2.3.

3.1 Measuring Instruments and Aids Required

Item No.	<ul style="list-style-type: none"> <li>○ Instrument type, required specifications</li> <li>● Recommended R&amp;S instrument</li> </ul>	Type	Order No.	Application Section
1	<ul style="list-style-type: none"> <li>○ High-frequency meter</li> <li>0.1 to 1000 MHz</li> <li>Error <math>\leq 1 \times 10^{-9}</math></li> <li>Resolution 1 Hz</li> </ul>			3.2.2 3.2.3
2	<ul style="list-style-type: none"> <li>○ Power meter</li> <li>1 to 1000 MHz</li> <li>Z = 50 <math>\Omega</math></li> <li>1 to 100 mW</li> <li>Error &lt; 0.1 dB</li> <li>● Power Meter</li> </ul>	NAP	392.4017.02	3.2.4 3.2.6
3	<ul style="list-style-type: none"> <li>○ Precision attenuation set</li> <li>0 to 1000 MHz</li> <li>● Precision Attenuation Set</li> </ul>	DPVP	214.8017.52	3.2.5
4	<ul style="list-style-type: none"> <li>○ Test receiver</li> <li>10 to 520 MHz</li> <li>● Test Receiver</li> </ul>	ESV	342.4020.52	3.2.5
5	<ul style="list-style-type: none"> <li>○ RF analyzer</li> <li>1 to 100 MHz</li> <li>Dynamic range &gt; 80 dB</li> </ul>			3.2.7 3.2.8

Item No.	<ul style="list-style-type: none"> <li>○ Instrument type, required specifications</li> <li>● Recommended R&amp;S instrument</li> </ul>	Type	Order No.	Application Section
6	<ul style="list-style-type: none"> <li>○ Modulation analyzer               <ul style="list-style-type: none"> <li>1 to 1000 MHz</li> <li>AM, FM, <math>\phi</math>M</li> <li>Bandwidths: CCITT, 20 kHz, 200 kHz</li> <li>Peak value/rms value evaluation</li> <li>Distortion meter for the demodulated signal and external AF</li> </ul> </li> <li>● Modulation Analyzer</li> </ul>	FAM	334.2015.54	3.2.9 3.2.10 3.2.11 3.2.12 3.2.13 3.2.15.2 3.2.22 3.2.23 3.2.24
7	<ul style="list-style-type: none"> <li>○ AF generator               <ul style="list-style-type: none"> <li>10 Hz to 1 MHz (<math>1 \times 10^{-5}</math>)</li> <li>1 mV to 10 V (<math>\pm 1\%</math>)</li> </ul> </li> <li>● AF Generator</li> </ul>	SPN	336.3019.02	3.2.11 3.2.12 3.2.13 3.2.16 3.2.17 3.2.18 3.2.19 3.2.22 3.2.23 3.2.24 3.2.25
8	<ul style="list-style-type: none"> <li>○ AF bandpass filters               <ul style="list-style-type: none"> <li>One-third octave bandpass filters with 300 Hz / 1 kHz / 3 kHz</li> </ul> </li> </ul>			3.2.11 3.2.12
9	<ul style="list-style-type: none"> <li>○ DC power supply               <ul style="list-style-type: none"> <li>0 to 20 V, 1 A</li> </ul> </li> <li>● DC Power Supply</li> </ul>	NGT20	117.7133.02	3.2.14

Item No.	<ul style="list-style-type: none"> <li>○ Instrument type, required specifications</li> <li>● Recommended R&amp;S instrument</li> </ul>	Type	Order No.	Application Section
10	<ul style="list-style-type: none"> <li>○ Power signal generator 25 to 1000 MHz Output power up to 2 W</li> <li>● Power Signal Generator</li> </ul>	SMLU	200.1009.03	3.2.14 3.2.28
11	<ul style="list-style-type: none"> <li>○ AF meter 10 to 100 kHz Resolution 0.1 Hz</li> </ul>			3.2.15
12	<ul style="list-style-type: none"> <li>○ RF generator 1 MHz to 1 GHz 5 <math>\mu</math>V to 1 V AM, FM capability</li> <li>● RF Generator</li> </ul>	SMPC	300.1000.55	3.2.20 3.2.22 3.2.23 3.2.24 3.2.26 3.2.27 3.2.29
13	<ul style="list-style-type: none"> <li>○ RF power amplifier 1 to 1000 MHz Up to 50 W Z = 50 <math>\Omega</math></li> </ul>			3.2.21
14	<ul style="list-style-type: none"> <li>○ Vector analyzer 1 to 1000 MHz</li> <li>● Vector Analyzer</li> </ul>	ZPV	291.4012.93	3.2.21
15	<ul style="list-style-type: none"> <li>○ VSWR bridge 10 to 1000 MHz</li> <li>● VSWR Bridge</li> </ul>	ZRB2	373.9017.52	3.2.21

Item No.	<ul style="list-style-type: none"> <li>○ Instrument type, required specifications</li> <li>● Recommended R&amp;S instrument</li> </ul>	Type	Order No.	Application Section
16	<ul style="list-style-type: none"> <li>○ Selective call generator</li> <li>● Selective Call Generator</li> </ul>	SCUD	393.7110.02	3.2.26
17	<ul style="list-style-type: none"> <li>○ IEC-bus controller IEC 625 standard</li> <li>● IEC-bus Controller</li> </ul>	PUC or PCA5	344.8900.14 375.2010.02	3.2.31

## 3.2 Testing the Rated Specifications

### 3.2.1 Display, Keyboard and Spin Wheel

A self-test lasting approx. 4 s is carried out when the instrument is switched on. If no faults are registered during the self-test, the instrument reproduces the settings present before the last switch-off. An error code is displayed in the event of a fault.

All segments in the LCDs can be switched on for about 5 s using special function    .

The illumination can be switched on and off using special function   . All LEDs can be switched on briefly using special function    .

The spin wheel is applied to the analog display of the RF level field using special function    . The analog bar is increased by rotating clockwise and decreased by rotating counterclockwise. One step corresponds to one analog bar segment. The special function    can be called to test the keys. Each pressed key is then acknowledged in the alphanumeric display by a number associated with the key. The key and spin-wheel test can be terminated by pressing 0 in the numeric keypad.

### 3.2.2 Reference Frequency

#### **Setting:**

The connector REF 10 MHz  at the rear of the instrument is programmed as the output for the reference frequency of 10 MHz using special function   .

#### **Test setup:**

Connect a high-frequency meter to REF 10 MHz.

#### **Test:**

The error must not be more than:

$\pm 1 \times 10^{-6}$ /month  $\pm 1 \times 10^{-6}$ /°C after 60 min warm-up time for the standard reference oscillator.

Adjust the frequency using R632 on the RF oscillator module.

$1 \times 10^{-9}$ /day after 15 min warm-up time for the crystal reference CMT-B1 (measured with frequency setting of 1 GHz at connector X1).

Adjust the frequency using PT1 on the RF oscillator module.



### 3.2.3 Frequency Setting and Accuracy

Setting (receiver test):

Output voltage 100 mV:         mV

Switch off modulation:     

Test setup:

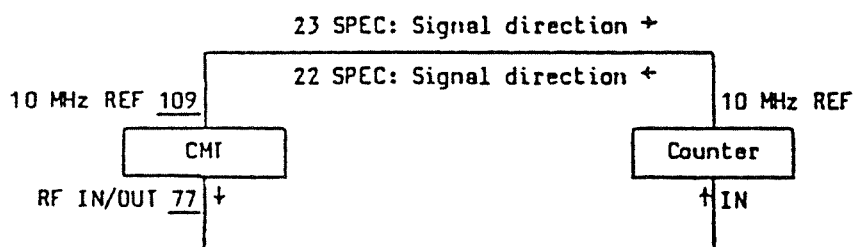

Test:

Set the following frequencies and check on the meter. The frequencies have been selected such that they can be exactly set despite an inherent setting error, so that the frequency meter exactly displays these frequencies to  $\pm 1$  Hz.

Frequency (MHz)	Remarks
1000	] Top oscillator of top octave
830	
820	] Centre oscillator of top octave
660	
650	] Bottom oscillator of top octave
500	
499.9	Range divided by 2
250	Range divided by 4
125	Range divided by 8
62.5	Range divided by 16
31	Mixed range
0.1	Lower limit

**3.2.4      Setting Errors and Frequency Response of the**  
**RF Output Level**

**Setting (receiver test):**

For FM:

Switch off frequency deviation:     

Output voltage 10 dBm:                   

For AM:

Switch off modulation depth:           

Output voltage -20 dBm:                  

**Test setup:**

Connect power meter to RF IN/OUT 77.

**Test:**

Set frequencies between 0.1 and 1000 MHz.

The deviation from the correct value must be less than 0.7 dB.

Adjust the RF level using R514 on the output stage module.

### 3.2.5 RF Divider

#### Setting (receiver test):

Frequency 32 MHz:        MHz

Initial level 10 dBm:      dBm

Switch off modulation:     kHz

#### Test setup:

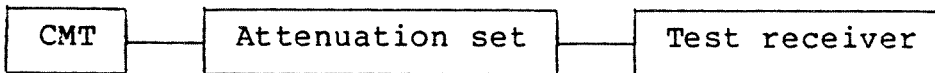

#### Test:

Set the test receiver to the 3- $\mu$ V range and 32 MHz with 15 kHz bandwidth.

Carry out the following settings on the CMT and the attenuation set:

CMT level (dBm)	Attenuation of attenuation set (dB)	Tested RF attenuator (dB)	Permissible deviation (dB)
10	110	Reference	Reference
5	105	5	$\pm 0.2$
0	100	10	$\pm 0.3$
-5	95	5 with 10	$\pm 0.35$
-10	90	20	$\pm 0.4$
-30	70	2 x 20	$\pm 0.8$
-50	50	40 with 20	$\pm 0.8$
-90	10	2 x 40 with 20	$\pm 0.8$

The test receiver indicates the same value with all settings with the deviations specified in the table referred to the 10-dBm setting.

### 3.2.6 Fine Level Setting

#### Setting (receiver test):

Frequency 32 MHz:                 
Switch off modulation:           
Output level 5.1 dBm:      

#### Test setup:

Connect power meter to RF IN/OUT 77.

#### Test:

Once the level setting has been applied to the VAR spin wheel (takes place automatically when the last setting of the output level is made), reduce the level without interruptions in 199 0.1-dB steps by rotating the wheel counterclockwise. Check the jumps in level on the power meter. The reductions must be monotonous.

The deviation from the correct value must be  $< \pm 1$  dB at -4.9 dBm and  $< \pm 2.0$  dB at -14.8 dBm.

If the lowest value of the fine variation range is dropped below by mistake, key in the output level of 5.1 dBm again and then rotate the VAR spinwheel counterclockwise again.

### 3.2.7 Harmonics Ratio

#### Setting (receiver test):

Level 10 dBm:                      dBm

Switch off modulation:         kHz

Set frequencies between 0.1 and 1000 MHz, preferably the following frequencies:

501 MHz                               MHz

354 MHz	63 MHz
251 MHz	45 MHz
177 MHz	32.5 MHz
126 MHz	1 MHz
89 MHz	

#### Test setup:

Connect RF analyzer to RF IN/OUT 77.

#### Test:

The harmonics ratio must be > 30 dB.

### 3.2.8 Non-harmonics Ratio

Setting (receiver test):

Level 10 dBm:                         
Switch off modulation:       

Test setup:

Connect RF analyzer to RF IN/OUT 77.

Test:

The table indicates the frequency setting and the non-harmonics to be looked for:

Frequency setting	Non-harmonics frequency
31.249 MHz	37.502 MHz and 6.253 MHz

The permissible ratio to the carrier is > 60 dB.  
The ratio is inherently much better in the frequency range  
31.25 MHz < f < 500 MHz which is not tested.

### 3.2.9 Spurious FM

#### Setting (receiver test):

Switch off modulation:     

Level 0 dBm:                   

Frequency 499.9 MHz:          

                                  1000 MHz:          

Further significant frequencies: 830/820/660/650/  
500.0004 MHz

#### Test setup:

Connect modulation meter to RF IN/OUT 77.

#### Test:

Measure the spurious FM by connecting the CCITT filter and switching on the rms evaluation on the modulation meter. The spurious FM must be < 6 Hz with  $f < 500$  MHz and < 12 Hz with  $f < 1000$  MHz.

RMS evaluation: bandwidth 30 Hz to 20 kHz

$f < 500$ MHz	< 16 Hz spurious FM	] Internal tolerance
$f < 1000$ MHz	< 32 Hz spurious FM	

### 3.2.10 Spurious AM

#### Setting (receiver test):

Switch off modulation:     

Level 0 dBm:                   

Frequency 30 MHz:             

#### Test setup:

Connect modulation meter to RF IN/OUT 77.

#### Test:

Measure the spurious AM by connecting the CCITT filter and switching on the RMS evaluation on the modulation meter. The spurious AM must be < 0.02%.

RMS evaluation: Bandwidth 30 Hz to 20 kHz  
Spurious AM < 0.3% (internal tolerance)



### 3.2.11 FM Modulation

#### 3.2.11.1 Internal FM

##### 3.2.11.1.1 RF Frequency Response of the Modulation Deviation

Setting (receiver test):

Modulation 25 kHz:              kHz

Modulation frequency 800 Hz:    Hz

Level 0 dBm:                   

Set the following RF values:

31.25001 MHz                            MHz

32.98 MHz	40.293 MHz	50.766 MHz
32.728 MHz	41.235 MHz	51.952 MHz
33.493 MHz	42.198 MHz	53.167 MHz
34.276 MHz	43.185 MHz	54.409 MHz
35.077 MHz	44.194 MHz	55.681 MHz
35.897 MHz	45.227 MHz	56.983 MHz
36.736 MHz	46.284 MHz	58.315 MHz
37.595 MHz	47.366 MHz	59.678 MHz
38.473 MHz	48.473 MHz	61.0725 MHz
39.373 MHz	49.606 MHz	62.5 MHz

#### Test setup:

Connect modulation analyzer to RF IN/OUT 77.

#### Test:

The RF frequency response of the measured deviation must not be more than  $\pm 2\%$ .

If this frequency response is exceeded (e.g. as a result of aging or temperature drift), it can be calibrated again using special function    .

### 3.2.11.1.2 AF Frequency Response of the Modulation Deviation

#### Setting (receiver test):

Modulation depth 25 kHz:      kHz    or  

RF frequency: 44.194 MHz:     .    MHz  

Level 0 dBm:                     dBm  

Set the following AF values or feed into connector MOD EXT 82

150 Hz                               Hz  

300 Hz                    1 kHz  
                                  4 kHz  
                                  25 kHz

#### Test setup:

Set the modulation analyzer to a suitable AF bandwidth and connect to RF IN/OUT 77.

#### Test:

The AF frequency response of the measured deviation may be up to  $\pm 3\%$  dB for  $f < 150$  Hz, up to  $8\%$  ( $\pm 4\%$ ) for  $150 \text{ Hz} < f < 300 \text{ Hz}$  and  $30 \text{ kHz} < f < 100 \text{ kHz}$ , and  $3\%$  ( $\pm 2.5\%$ ) for  $300 \text{ Hz} < f < 30 \text{ kHz}$ .

The frequency response cannot be adjusted.

### 3.2.11.1.3 FM Errors

#### Setting (receiver test):

RF frequency 44.149 MHz:   

Level 0 dBm:                   

AF frequency 1 kHz:           

Set the following modulation deviations:

50 kHz                           

20 kHz	3.2 kHz	0.2 kHz
10 kHz	1.6 kHz	0.1 kHz
5 kHz	0.8 kHz	50 Hz
	0.4 kHz	25 Hz

#### Test setup:

Set the modulation analyzer to an AF bandwidth of 300 Hz to 3 kHz and connect to RF IN/OUT 77.

#### Test:

The variation in the set modulation deviations 50 kHz to 0.4 kHz must not be larger than 5% of the correct value taking into account the frequency responses determined in Sections 3.2.11.1.1 and 3.2.11.1.2.

Because of the spurious FM (approx. 4 Hz peak spurious FM at the set RF frequency, 300 Hz to 3 kHz AF bandwidth, value not guaranteed), the variation from the correct deviation for the modulation deviations 200 Hz to 25 Hz may be larger by this amount.

### 3.2.11.1.4 FM Distortion

#### Setting (receiver test):

RF frequency 44.149 MHz    4   4   .   1   4   9   MHz   f  
Level 0 dBm:                    0   dBm   Vo  
AF 1 kHz:                        1   kHz   AF INT1  
Frequency deviation 25 kHz:   2   5   kHz   INT1

#### Test setup:

Connect modulation analyzer with distortion meter to  
RF IN/OUT 77.

#### Test:

The modulation distortion must be < 1%.

### 3.2.11.2 External FM

#### 3.2.11.2.1 External Modulation with Standard Level

Setting (receiver test):

RF frequency 44.149 MHz:    4   4   .   1   4   9   MHz   f

Level 0 dBm:                    0   dBm   Vo

Frequency deviation 25 kHz:   2   5   kHz   AF EXT

Test setup:

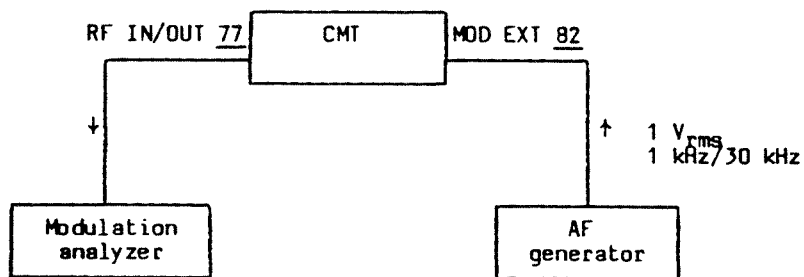

AF bandwidth:    300 Hz to 3 kHz  
                  300 Hz to 200 kHz

Test:

Connection of 30 kHz or 1 kHz with  $1 V_{rms} \pm 1\%$  to MOD EXT 82 of the CMT results in the same deviation from the correct value ( $< 5\%$ ) as in Section 3.2.11.1.3.

### 3.2.11.2.2 External Modulation with Calibration

Setting: ]  
Test setup: ] As in Section 3.2.11.2.1

#### Test:

Set an AF generator to 1 kHz and various levels between 100 mV<sub>rms</sub> and 2.5 V<sub>rms</sub>, preferably approx. 2 V, 1 V, 0.5 V, 0.25 V, 0.125 V. Press key EXT CAL after each change in level and read the modulation value.

The modulation follows the AF level until key EXT CAL is pressed. The correct value is then set again.

A calibration error of < 5% (internal tolerance) may occur in addition to the deviation from the correct value (< 5%).

The guaranteed data sheet values with respect to the modulation do not include the external modulation with calibration.

### 3.2.11.3 Multitone Modulation

#### Setting (receiver test):

RF frequency 44.149 MHz:    4 4 . 1 4 9 MHz f

Level 0 dBm:                    0 dBm Vo

Mod. frequency 1: 0.97 kHz    0 . 9 7 kHz AF INT1

Mod. frequency 2\*: 0.179 kHz 0 . 1 7 9 kHz AF INT2

Mod. frequency 3:                (is determined by the external  
   modulation generator and must be  
   set to 5.6 kHz)

Mod. deviation 1: 5 kHz        5 kHz INT1

Mod. deviation 2\*: 5 kHz       5 kHz INT2

Mod. deviation 3: 5 kHz        5 kHz EXT

Two of the three modulation sources are specifically switched off for pure tone modulation.

#### Example:

Modulation with source 2    0 kHz INT1  
by switching off source 1  
and source 3:                0 kHz EXT

\* With option CMT-B7: 2nd AF synthesizer

### Test setup:

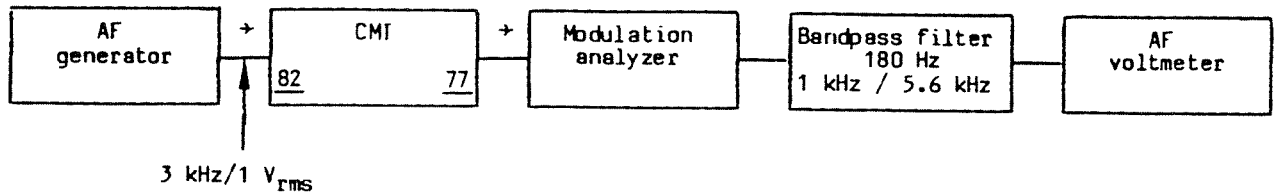

### Test:

The relationship between modulation deviation and voltage is first determined on the AF voltmeter using a modulation analyzer. Set the three modulation values in succession as pure tone modulation with the corresponding bandpass filter.

The modulation analyzer indicates the total deviation (peak value evaluation on the modulation analyzer) in the case of simultaneous 3-tone modulation. The individual deviations can be checked during the 3-tone modulation using the selectable bandpass filter.

The maximum variation from the correct value with the total deviation and the individual deviations must be  $< \pm 5\%$  in each case.

The systematic measuring error on the bandpass filter must be additionally taken into account.



## 3.2.12 AM Modulation

### 3.2.12.1 Internal AM

#### 3.2.12.1.1 Frequency Response of the Modulation Depth

Setting (receiver test):

RF frequency 30 MHz:        MHz

                          1000 MHz:          MHz

Level 0.1 dBm:               dBm

Modulation depth 80%:      %

Set the following AF values:

50 Hz                        Hz

300 Hz                    1 kHz

                              4 kHz

                              25 kHz

#### **Test setup:**

Adjust the modulation analyzer to a sufficiently large AF bandwidth and connect to RF IN/OUT 77.

#### **Test:**

The AF response of the measured modulation depth must be less than 3% ( $\pm 1.5\%$ ). It cannot be adjusted.

### 3.2.12.1.2 AM Error

#### Setting (receiver test):

RF frequency 30 MHz:              MHz

Level 0.1 dBm:                   dBm

AF frequency 1 kHz:             kHz

Set the following modulation depths:

5%                               

10%, 30%, 80%

#### Test setup:

Adjust the modulation analyzer to an AF bandwidth of 300 Hz to 3 kHz and connect to RF IN/OUT 77.

#### Test:

The deviation of the set modulation depth must not exceed 5% of the set value taking into account the frequency response determined in Section 3.2.11.1.1. The AM can be adjusted using potentiometer R503 on the output stage module.

### 3.2.12.1.3 AM Distortion

#### Setting (receiver test):

RF frequency 30 MHz:	3	0	MHz	f	
Level 0.1 dBm:	0	.	1	dBm	Vo
AF frequency 1 kHz:	1	kHz	AF	INT1	
Modulation depth 30%:	3	0	%	INT1	
Modulation depth 80%:	8	0	%	INT1	

#### Test setup:

Connect modulation analyzer with distortion meter to RF IN/OUT 77.

#### Test:

The distortion must be < 1% with 30% modulation depth and < 1.5% with 80 % modulation depth.

### 3.2.12.2 External AM

Setting (receiver test):

RF frequency 30 MHz:	<input type="text" value="3"/>	<input type="text" value="0"/>	<input type="text" value="MHz"/>	<input type="text" value="f"/>	
Level 0.1 dBm:	<input type="text" value="0"/>	<input type="text" value="."/>	<input type="text" value="1"/>	<input type="text" value="dBm"/>	<input type="text" value="Vo"/>
Modulation depth 80%:	<input type="text" value="8"/>	<input type="text" value="0"/>	<input type="text" value="."/>	<input type="text" value="INT1"/>	

Test setup:

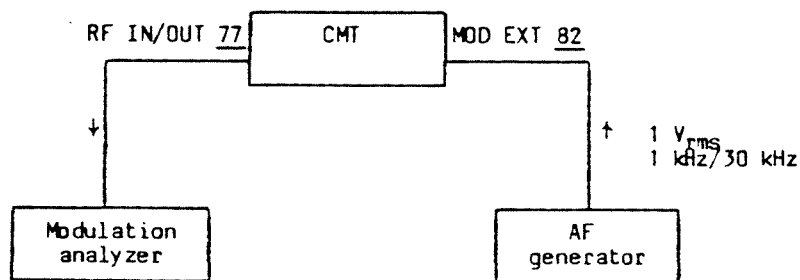

AF bandwidth: 300 Hz to 3 kHz  
300 Hz to 200 kHz

Test:

The same deviation from the correct value (< 5%) as in Section 3.2.12.1.2 must be obtained when 30 kHz or 1 kHz with  $1 V_{rms} \pm 1\%$  are applied to MOD EXT 82 of the CMT.

#### 3.2.12.2.1 Calibration with Multitone Modulation

The external modulation is tested and calibrated using a modulation depth of 80% as in Section 3.2.11.2.2.

The multitone modulation with modulation depths of 25% for each modulation source and with an RF level of 0.1 dBm is tested in an analogous manner to Section 3.2.11.3.

The performance test with respect to external modulation with calibration and multitone modulation is already complete if these characteristics are measured for either AM or FM since the signal path is the same for both types of modulation.

### 3.2.13 Phase Modulation

#### Setting (receiver test):

RF frequency 44.149 MHz: [4] [4] [.] [1] [4] [9] [MHz] [f]

Level 0 dBm: [0] [dBm] [Vo]

Phase deviation 2.5 rad: [2] [.] [5] [rad] [INT1]

Set the following AF values:

300 Hz [3] [0] [0] [Hz] [AF INT1]

1 kHz, 3 kHz, 6 kHz

#### Test setup:

Set the modulation analyzer to phase modulation and a sufficiently large AF bandwidth and connect to RF IN/OUT 77.

#### Test:

The deviation from the correct value must be  $< 7\%$  (corresponds to FM error (5%) + additional frequency response of 2%).

**3.2.14      Response Threshold of the Automatic Receiver/  
Transmitter Setting**

**Setting** (receiver test, LOCK key not pressed):

RF frequency 100 MHz:     

Level 0 dBm:     

**Test setup 1:**

Apply a DC voltage of any polarity to RF IN/OUT 77 and increase continuously from 0 V to 6 V.

**Test 1:**

The switchover can be heard between 2 and 5 V and the LED on the RXTX key changes from green to red.

**Test setup 2:**

Using a power transmitter, apply an RF power of 0 to 2 W at frequencies of 25 and 1000 MHz to RF IN/OUT 77.

**Test 2:**

The overvoltage protection must respond between 0.1 and 1 W.

The response threshold can be adjusted using R34 on the attenuation set drive.



### 3.2.15.2 Distortion of the Modulation Generator

#### Setting (transmitter test)

Level	100 mV:	<input type="text" value="1"/>	<input type="text" value="0"/>	<input type="text" value="0"/>	<input type="text" value="mV"/>	<input type="text" value="Vo"/>	
	5000 mV:	<input type="text" value="5"/>	<input type="text" value="0"/>	<input type="text" value="0"/>	<input type="text" value="0"/>	<input type="text" value="mV"/>	<input type="text" value="Vo"/>
Frequencies:	20 Hz	<input type="text" value="2"/>	<input type="text" value="0"/>	<input type="text" value="Hz"/>	<input type="text" value="AF INT 1"/>		
	301 Hz						
	1 kHz						
	4.001 kHz						
	25 kHz						

#### Test setup:

Connect distortion meter to MOD GEN 83.

#### Test:

Measure the distortion at high impedance (approx. 100 k $\Omega$ ) and under load (350  $\Omega$  at 500 mV and 50  $\Omega$  at 100 mV). The distortion must be below 0.5% for  $f < 10$  kHz and below 1% for  $f > 10$  kHz.



### 3.2.15.3 Output Voltage of the Modulation Generator

Setting (transmitter test):

Frequency 1 kHz:                   

Set the following output voltages:

5100 mV                               

5080 mV	2540 mV
5060 mV	2000 mV
5020 mV	1000 mV
4940 mV	500 mV
4780 mV	200 mV
4460 mV	100 mV
3820 mV	50 mV

Test setup:

Connect AF voltmeter to MOD GEN 83.

#### 3.2.15.3.1 Frequency Response of the Modulation Generator

Setting (transmitter test):

Output voltage 1000 mV:           

Set the following frequencies:

20 Hz	<input type="text" value="2"/> <input type="text" value="0"/> <input type="text" value="Hz"/> <input type="text" value="AF INT1"/>
150 Hz	
299 Hz	
301 Hz	
1000 Hz	
3999 Hz	
4001 Hz	
10000 Hz	
25000 Hz	
30000 Hz	

Test:

The total error from Sections 3.2.15.3 and 3.2.15.3.1 must be less than 3% for  $f < 25$  kHz.

Internal tolerance for  $f > 25$  kHz:  $\pm 6\%$ .

#### 3.2.15.4 Frequency Setting and Accuracy of the 2nd AF Synthesizer (Option CMT-B7)

##### **Setting:**

Special function   is used to output at MOD GEN 83 a double tone generated using two frequencies with the same levels.

##### **Test setup:**

The test setup corresponds to that in Section 3.2.15.1 except that a selectable filter to suppress one of the two tones is connected between MOD GEN of the CMT and the input of the meter.

Select the same frequency on the 2nd AF synthesizer as was selected for the 1st modulation generator in Section 3.2.15.1. Set the selectable filter such that these frequencies are in the passband. Select the frequencies for the 1st modulation generator such that they fall in the stopband of the filter.

##### **Test:**

Test the set frequencies using the frequency meter as in Section 3.2.15.1.

### 3.2.16 AF Voltmeter

#### 3.2.16.1 AF Frequency Response

##### Setting (receiver test):

Call AF level measurements by pressing the AF LEVEL key.  
Call SLOW mode using  .

##### Test setup:

Apply a signal with an amplitude of 1 V and frequencies between 50 Hz and 20 kHz to AF VOLTM 84.

##### Test:

Record the frequency response in order to determine the AF voltmeter error.

The AF measurement can be accelerated using special function  . The bottom cut-off frequency is 150 Hz in this case. An additional frequency response of  $\pm 5\%$  may occur in addition (internal tolerance).

This mode is switched off again for the other measurements using  .

#### 3.2.16.2 Measuring Accuracy Depending on the Input Level

##### Setting:

(as in Section 3.2.16.1)

##### Test setup:

Apply voltages between 5 mV and 5 V with a frequency of 1 kHz to AF VOLTM 84.

##### Test:

The total error of the level measuring accuracy and the frequency response must not exceed  $\pm 3\% + 1$  digit. Calibration with a high-precision external signal is possible using

.

Use: See list of special functions, Section 2.

### 3.2.16.3 Frequency Response of the CCITT Filter

#### Setting:

As in Section 3.2.16.1 except that the CCITT RX key must be additionally pressed.

#### Test setup:

Apply an AF signal of 3 V/800 Hz to AF VOLTM 84.

#### Test:

Record the frequency response at the following frequencies:

Frequency Hz	Attenuation dB	Tolerance ±dB
50	-63	2
100	-41	2
150	-29	2
200	-21	2
300	-10.6	1
400	-6.3	1
500	-3.6	1
600	-2.0	1
800	0	Reference
1000	1	1
1200	0	1
1500	-1.3	1
2000	-3.0	1
2500	-4.2	1
3000	-5.6	1
3500	-8.5	2
4000	-15	3
5000	-36	3
6000	-43	-
>6000	<-43	-

The applied AF signal of 3 V/800 Hz is declared as the reference value by entering     and the measurements are displayed in dB referred to this setting.

Set the frequencies listed in the table. To prevent measuring errors, ensure that a low-distortion (< 0.01%) test signal is used, especially with low frequencies. The tolerances listed in the table must not be exceeded by more than the error determined in Section 3.2.16.1.

Potentiometer R388 on the analog unit module is used to adjust the gain of the CCITT filter, preferably with respect to the reference.

### 3.2.17 Distortion Meter

#### Setting (receiver test):

Call distortion measurements by pressing the SINAD.DIST key twice.

#### Test setup:

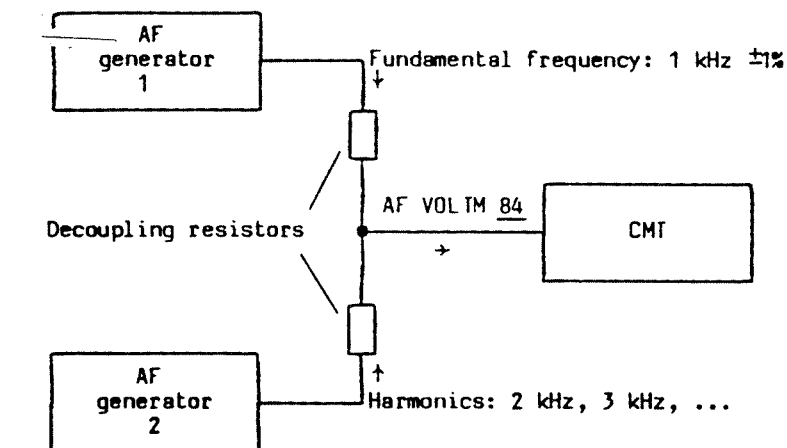

#### Test:

Apply the signal from two AF generators to AF VOLTM 84 of the CMT. The total harmonic distortion THD is determined by the level of the AF generator 2 for the harmonics and the AF generator 1 for the fundamental frequency:

$$\text{THD} = \frac{V(2\text{kHz}) \times 100\%}{\sqrt{V^2(1\text{kHz}) + V^2(2\text{kHz})}} \approx \frac{V(2\text{kHz}) \times 100\%}{V(1\text{kHz})} \quad (\text{for THD} < 10\%)$$

### 3.2.17.1 Inherent Distortion

**Setting:**

(as in Section 3.2.17)

**Test setup:**

Apply a distortion-free signal of 30 mV to 3 V to AF VOLTM 84.

**Test:**

The display must not be greater than 0.3%.

### 3.2.17.2 Display Accuracy of the Distortion Meter

**Setting:**

(as in Section 3.2.17)

**Test setup:**

Set distortions up to 50% (preferably the following) with a total voltage of approx. 1 V:

Set distortion %	Permissible measured value %
10	9.2 to 10.8
3	2.5 to 3.5
1	0.7 to 1.3
0.3	0 to 0.6

**Test:**

The measured value must not exceed the permissible error even if the fundamental frequency is detuned to 990 Hz or 1010 Hz (cut-off bandwidth for the fundamental frequency). The stop-band can be adjusted using potentiometers R556, R558, R566 and R571 on the analog unit module.

### 3.2.18 SINAD Meter

#### **Setting:**

Call SINAD measurements by pressing the SINAD.DIST key once.

#### **Test setup:**

(as in Section 3.2.17)

#### **Test:**

Testing the measurement limit as a result of stopband attenuation corresponds to the measurement of inherent distortion with 3 V applied to connector AF VOLTM 84.

Display: > 50 dB.

Testing the measurement limit as a result of inherent noise cannot be isolated from stopband attenuation, but essentially corresponds to the measurement of inherent distortion with 30 mV applied to connector AF VOLTM 84.

Display: > 47 dB.

Testing the display accuracy.

Set SINAD values up to 6 dB (preferably the following) with a total voltage of approx. 1 V:

Set value	Permissible measured value
20 dB	19.3 to 20.5 dB
30 dB	28.7 to 30.5 dB
40 dB	37.2 to 40.5 dB
50 dB	46.5 to 50.5 dB

The measured value must not exceed the error even if the fundamental frequency is detuned to 990 Hz or 1010 Hz (cut-off bandwidth of the fundamental frequency). The stopband can be adjusted using potentiometers R556, R558, R566 and R571 on the analog unit module.



### 3.2.19 AF Counter

#### Setting (receiver test):

Call AF measurements by pressing the AF EXT key.

#### Test setup:

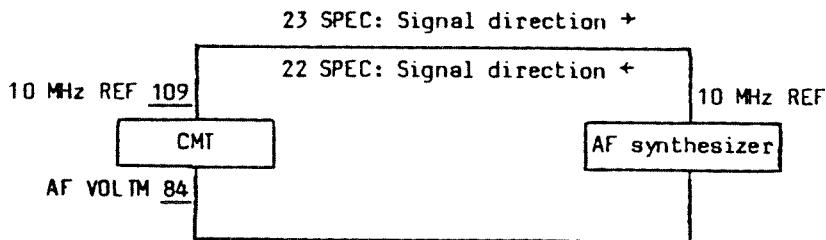

#### Test:

Test the accuracy of the counter at 1 V and with frequencies between 20 Hz and 500 kHz, preferably at 20 Hz, 1 kHz and 4 kHz (resolution 0.1 Hz) and then at 5 kHz, 50 kHz and 500 kHz (resolution 1 Hz). The error is  $\pm 1 \times$  the resolution since the reference frequencies are combined.

Determine the sensitivity of the counter at frequencies of 20 Hz, 30 kHz and 500 kHz. It must be  $< 3$  mV up to 30 kHz and  $< 30$  mV above 30 kHz. An AF signal with a high signal-to-noise ratio is required to test the sensitivity of the counter.

3.2.20 RF Counter

3.2.20.1 Counter Sensitivity at Connector RF IN/OUT 77

Setting (transmitter test):

Transmitter test FM must be selected if unmodulated signals are counted:   .

Transmitter test AM must be selected if amplitude modulated signals are counted:   .

Call RF counting by pressing the COUNT f key.  
Connect RF IN/OUT 77 by pressing the INPUT SELECT key.

Test setup:

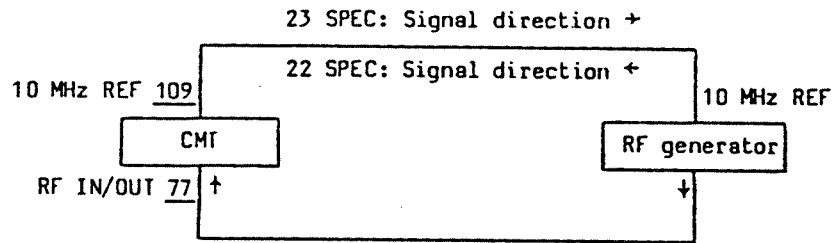

1. Apply unmodulated signals between 400 kHz and 1 GHz.
2. Apply 40% amplitude modulated signals between 400 kHz and 1 GHz.

Test:

Determination of counter sensitivity:

RF	500 kHz	1 MHz to 1 GHz
Unmod- ulated	<20 mW*	<5 mW
40% AM	<80 mW*	<20 mW

\* Internal tolerance

### 3.2.20.2 Counter Sensitivity at Connector INPUT2 79

#### Setting (transmitter test):

Transmitter test FM must be selected if unmodulated signals are counted:   .

Transmitter test AM must be selected if amplitude modulated signals are counted:   .

As in Section 3.2.20.1 except that INPUT2 79 is connected by pressing the INPUT SELECT key.

#### Test setup:

(as in Section 3.2.20.1)

#### Test:

Determination of counter sensitivity:

RF	500 kHz	1 MHz to 1 GHz
Unmodulated	< 10 mV*	< 5 mV
40% AM	< 20 mV*	< 10 mV

\* Internal tolerance

### 3.2.20.3 Counter Accuracy

#### **Setting:**

(as in Section 3.2.20.1)

#### **Test setup:**

(as in Section 3.2.20.1)

#### **Test:**

Since the reference frequencies of the counter and generator are related, the frequency set on the RF generator is also displayed on the meter with an error of  $\pm 1$  digit. The reference frequency which also determines the meter accuracy has been tested in Section 3.2.2. A prerequisite for this test is that the RF synthesizer used has no inherent setting errors.

### 3.2.21 Power Meter

Setting (transmitter test):

Call power measurements by pressing   .

Test setup:

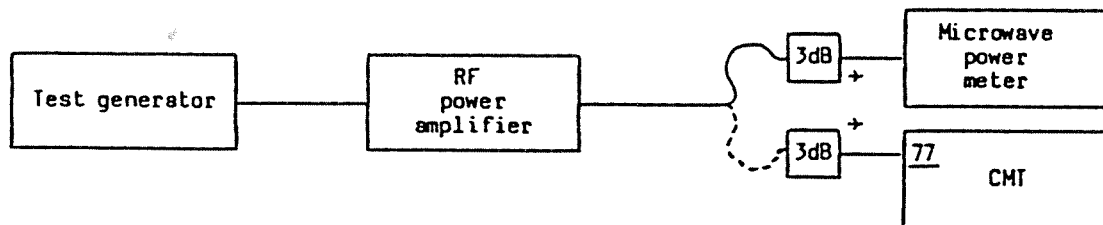

To achieve the accuracy guaranteed by the data sheet, ensure that the coaxial 50- $\Omega$  resistor is connected to RF -30 dB 111 on the rear of the instrument. The correct impedance of the connection from the output of the power amplifier to the CMT and to the microwave power meter is of great importance for the power measurement. An attenuator at the end of the cable near to the CMT or the microwave power meter improves the impedance conditions. A low-distortion RF signal is required for the test (use a lowpass if applicable) since the CMT power test is based on a peak-value measurement.

Test:

P \ f	1,5 MHz	20 MHz	500 MHz	1000 MHz
7 dBm	$\pm 0,6\text{dB} + 1\text{dg}^*$	$\pm 0,6\text{dB} + 1\text{dg}^*$	$\pm 0,6\text{dB} + 1\text{dg}^*$	$\pm 0,6\text{dB} + 1\text{dg}^*$
20 dBm	$\pm 0,4\text{dB} + 1\text{dg}$	$\pm 0,4\text{dB} + 1\text{dg}$	$\pm 0,4\text{dB} + 1\text{dg}$	$\pm 0,4\text{dB} + 1\text{dg}$
47 dBm	$\pm 0,4\text{dB} + 1\text{dg}$	$\pm 0,4\text{dB} + 1\text{dg}$	$\pm 0,4\text{dB} + 1\text{dg}$	$\pm 0,4\text{dB} + 1\text{dg}$

\* Internal tolerances  
 dg  $\hat{=}$  digit

Record the test parameters listed in the table on the microwave power meter for an unmodulated test signal and compare with the results on the CMT. The table lists the maximum deviation from the nominal value determined on the microwave power meter.

Adjust the power to the correct value at  $P > 33$  dBm and  $f \approx 50$  MHz (using R672 on the analog unit module)

### 3.2.21.1 VSWR of the Power Meter

#### Setting:

As in Section 3.2.21, but press the  $V_0$  OFF key in addition (RF level off).

#### Test setup:

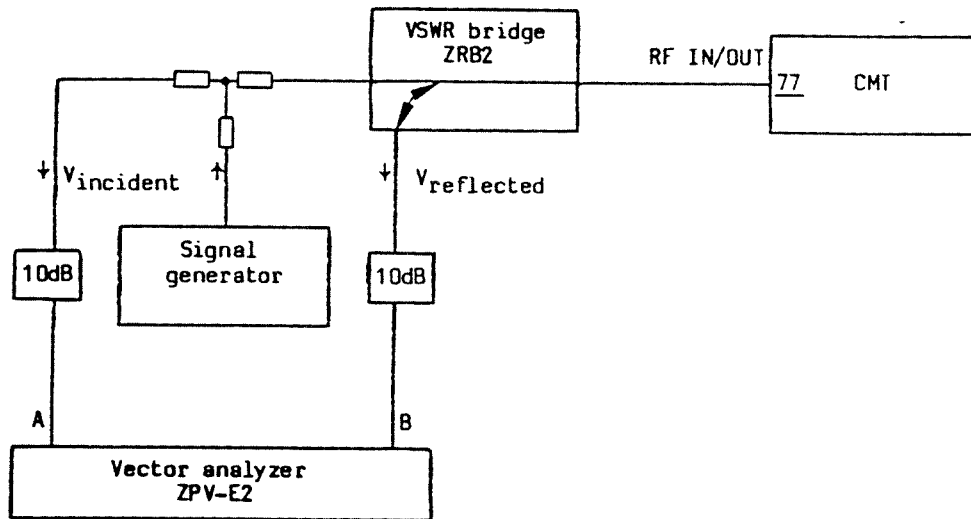

#### Test:

Measure the standing wave ratio  $(V_{return}/V_{forwards})^2$  between 10 and 1000 MHz. It must be  $< 1.2$ .

### 3.2.22 Frequency Deviation Meter

#### Setting (transmitter test):

Presetting of CMT for FM transmitter test:    
Carry out the test in the average deviation mode

$\frac{+/-}{2}$  PK by pressing the +  $\frac{+}{2}$  - key twice.

#### Test setup:

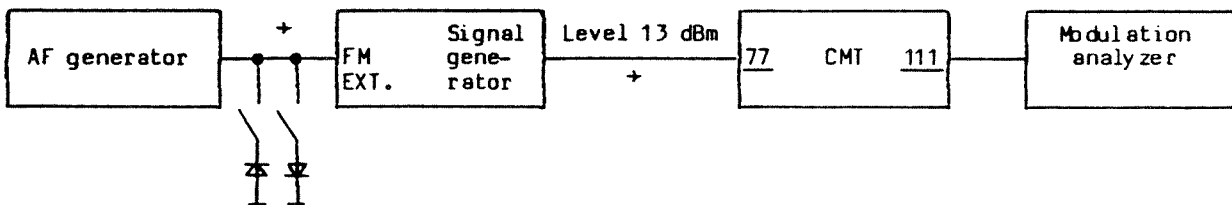

#### Test:

First determine the meter accuracy at 50 MHz with a modulation frequency of 1 kHz in the range of the CMT from 0 to 100 kHz and determine the deviation from the nominal value.

Then measure the AF frequency response from 20 Hz to 20 kHz.

The total error of the AF frequency response and the meter accuracy (100 kHz to 1 kHz deviation) must not exceed  $\pm 3\%$ .

The function test of - PK and + PK (press the +  $\frac{+}{2}$  - key twice again) and PK HOLD (press PK HOLD key, then switch off the modulation on the test generator, the display is retained on the CMT with a finite time constant) is made with a deviation and a modulation frequency of 1 kHz.

The function test of the MAX PK modulation with a modulation frequency and a deviation of 1 kHz is made by applying an AF signal with single-sided limiting as an external modulation signal to the test generator.

The CMT indicates the larger of the two deviations in each case.

### 3.2.22.1 300-Hz Highpass Filter

#### Setting:

As in Section 3.2.22 but press the Hp key in addition.

#### Test setup:

(as in Section 3.2.22)

#### Test:

Measure the frequency response at a deviation of 100 kHz and with modulation frequencies between 190 Hz and 20 kHz, preferably at the frequencies in the following table:

	Frequency	Indication	Frequency response error
Stopband	190 Hz	< 1 kHz	
	240 Hz	< 10 kHz	
Passband	300 Hz	100 kHz	< 7%
	350 Hz	100 kHz	< 7%
	1 kHz	100 kHz	< 7%
	20 kHz	100 kHz	< 7%

\* In addition to the error determined in Section 3.2.22 (internal tolerance)

The readings in the stopband and the frequency response error in the passband are not guaranteed values on the data sheet.



### 3.2.22.2 Residual FM of the Deviation Meter

#### Setting:

As in Section 3.2.22 but press the CCITT key in addition.

#### Test setup:

(as in Section 3.2.22)

#### Test:

Set the test generator unmodulated to the RF values 499 MHz and 1000 MHz. The RF level is +7 dBm in this case. The indication error must be  $< 6$  Hz at 499 MHz and  $< 12$  Hz at 1000 MHz.

### 3.2.23 Phase Deviation Meter

#### Setting (transmitter test):

Presetting of CMT to  $\Phi$ M transmitter test:

#### Test setup:

(as in Section 3.2.22)

#### Test:

Test the meter accuracy at 50 MHz and a modulation frequency of 1 kHz between 0.1 and 25 rad.

Test the AF frequency response with a phase deviation of 10 rad and at 50 MHz (RF) between 300 Hz and 10 kHz (AF).

The error of the phase deviation meter corresponds to the error of the frequency deviation meter (Section 3.2.22) with an additional error of 2% which may occur in the partial measurement "AF response".

### 3.2.24 Modulation Depth Meter

#### Setting (transmitter test):

Presetting of the CMT to AM transmitter test:

Enter the RF value using the SET f key:

e.g. 30 MHz

#### Test setup:

(as in Section 3.2.22)

#### Test:

Test the meter accuracy at an AF frequency of 1 kHz and at the two RF frequencies of 1.5 MHz and 30 MHz between 1% and 99%.

Test the AF response with a modulation depth of 80% and an RF frequency of 30 MHz at the AF frequencies of 50 Hz and 20 kHz.

The total error of the meter accuracy (3% to 80% modulation depth) and the AF response must not exceed 5%. The meter accuracy can be adjusted using R197 on the analog unit module.

The operating modes +PK, +/2 PK, -PK, PK HOLD, MAX PK have already been tested in Section 3.2.22. The test can also be carried out in an analogous manner for the modulation depth meter. The 300-Hz highpass filter has also already been tested in Section 3.2.22.

#### 3.2.24.1 Residual Modulation of the AM Meter

#### Setting:

As in Section 3.2.24 but press the CCITT TX key in addition.

#### Test setup:

(as in Section 3.2.22)

#### Test:

Set the test generator to unmodulated signal of 30 MHz. Set the RF level to 7 dBm. The modulation depth reading must be < 0.03%.

### 3.2.25 Oscilloscope (CMT Model 54 )

The measured values and tolerances mentioned in this section are not specified as guaranteed values on the data sheet. They are to be used to differentiate between faults/maladjustments and correct functioning.

#### 3.2.25.1 Frequency Response at Connector EXT

##### **Setting (receiver test):**

Set screen cursor to position EXT AC.

##### **Test setup:**

Using an AF generator, apply a signal with a constant amplitude (e.g. 0.707 V) and frequencies between 5 Hz and 200 kHz to the connector EXT.

##### **Test:**

The accuracy is approximately equal to the beam width in the frequency range between 10 Hz and 100 kHz. Triggering stops below 5 Hz; a frequency response or approx.  $\pm 3$  dB occurs between 100 and 200 kHz. The frequency response above 100 kHz is influenced by the position of the wires in the cable harness to the tube.

### 3.2.25.2 Measurement Dynamic Range at Input EXT

#### Setting:

(as in Section 3.2.25.1)

#### Test setup:

(as in Section 3.2.25.1)

#### Test:

Carry out the test at a frequency of 1 kHz and with the following voltages:

7.07 mV	70.7 mV	0.707 V	7.07 V
14.1 mV	141 mV	1.41 V	14.1 V
28.3 mV	283 mV	2.83 V	28.3 V

A display with a peak-to-peak value of 4 div and an accuracy approximately equal to the beam width appears in each case with the corresponding settings from 5 mV/div to 10 V/div.

The amplitude error, which is the same for all gain settings, can be adjusted using R81 on the oscilloscope. This also acts on the amplitude of the internal signals (BEAT, DEMOD, AF).

### 3.2.25.3 Oscilloscope Time Base

#### **Setting:**

(as in Section 3.2.25.1)

#### **Test setup:**

(as in Section 3.2.25.1)

#### **Test:**

Carry out the test using a squarewave signal at the following frequencies:

25 Hz, 50 Hz, 100 Hz, 250 Hz, 500 Hz,  
1 kHz, 2.5 kHz, 5 kHz, 10 kHz, 25 kHz and 50 kHz.

Half a cycle appears on the screen with a duration of one graticule unit with the corresponding time scales from 20 ms/div to 0.01 ms/div. The accuracy is approximately equal to the beam width. The error, which is the same for all sweeps, can be adjusted using R61 of the oscilloscope (horizontal deflection of the tube) or R208 (XY character generator)(see Service Manual).

### 3.2.25.4 Representation of Internal Signals

#### **Setting:**

As in Section 3.2.16.1 except that the screen cursor is additionally set to position AF.

#### **Test:**

Repeat the test from Section 3.2.16.2.

It is not necessary to test other internal signals on the oscilloscope since the same signal path is always used.

**Setting (transmitter test):**

Presetting of CMT to FM transmitter test:

Select the tone sequence standard using special function  
     .

Press the DECODE key, the CMT now waits for a tone sequence. This is displayed as soon as a sequence has been decoded.

**Test setup:**

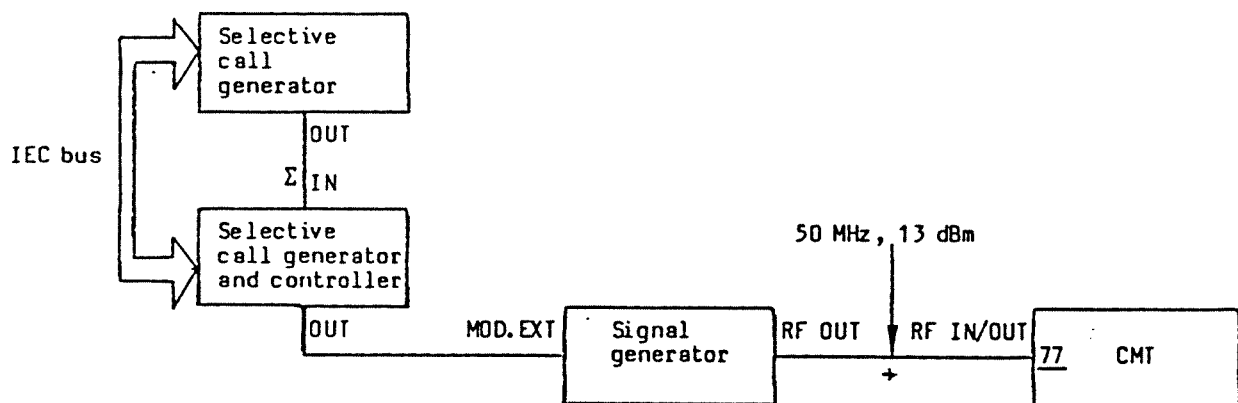

**Test:**

The two selective call generators (SCUD) can best generate the two-tone sequences under program control on the IEC bus. A CMT equipped with the option CMT-B7 is itself able to generate the sequences required for the test. Apply the desired deviation to the test generator, but do not feed a signal to the input MOD.EXT, and apply the unmodulated RF signal to the CMT. Subsequently press the DECODE key. A standard tone sequence with at least 5 digits is now generated on the two-tone generator. The code is output in the alphanumeric display at the end of the two-tone sequence.

**Evaluation:** The dynamic range for the complete deviation is between 250 Hz and 5 kHz for the two-tone sequences. Decoding takes place up to a frequency deviation of approx. ±2.5%.

### 3.2.27 Adjacent-channel Power Meter (Option CMT-B6)

#### Setting (receiver test):

It is possible to select the channel spacing in the receiver test:

e.g. 10 kHz channel spacing:

The adjacent-channel power measurement is carried out in the transmitter test (FM).

Transmitter test FM:

Enter the reference frequency of the generator using the SET f TX key.

e.g. 60 MHz:

Call adjacent-channel power measurement:

Upper adjacent channel:

Lower adjacent channel:

#### Test setup:

Using a test generator, apply a signal with a power > 20 mW and the RF frequencies 60 MHz, 440 MHz and 900 MHz to connector RF IN/OUT 77, each modulated with 2% AM (modulation frequencies 10 kHz, 12.5 kHz, 20 kHz and 25 kHz). Since the result of the adjacent-channel power measurement is highly dependent on the RF frequency, it is recommendable to either synchronize

the test generator with the CMT (   )  
or  
the CMT with the test generator (   ).

**Test:**

Measure at the RF frequencies 60 MHz, 440 MHz and 900 MHz; select each channel spacing once as a spot-check (with the corresponding modulation frequency of the transmitter) and measure in the upper and lower adjacent channels.

The result of the test must be 40 dB in all cases (spacing between a sideband and a signal modulated with 2% AM).

The CEPT/FTZ filter specification permits a tolerance of 2 dB at the channel centre. The result with this test configuration must have a maximum error of  $\pm 2$  dB since the measurement comprises a wanted channel measurement and an adjacent-channel measurement.



### 3.2.28 RF Millivoltmeter (Option CM-B8)

#### Preliminary remarks:

The option attains rated values after a warm-up time of 10 minutes.

The accuracy is slightly dependent on the probe used since the signal is processed in the probe. The fault could be in the instrument itself or in the probe if the display varies considerably. It is essential to connect a correctly operating probe in order to check the accuracy.

#### Setting (transmitter or receiver test):

Select measurement by pressing the PROBE key. The unit can be selected by first pressing the unit key.

#### Test setup:

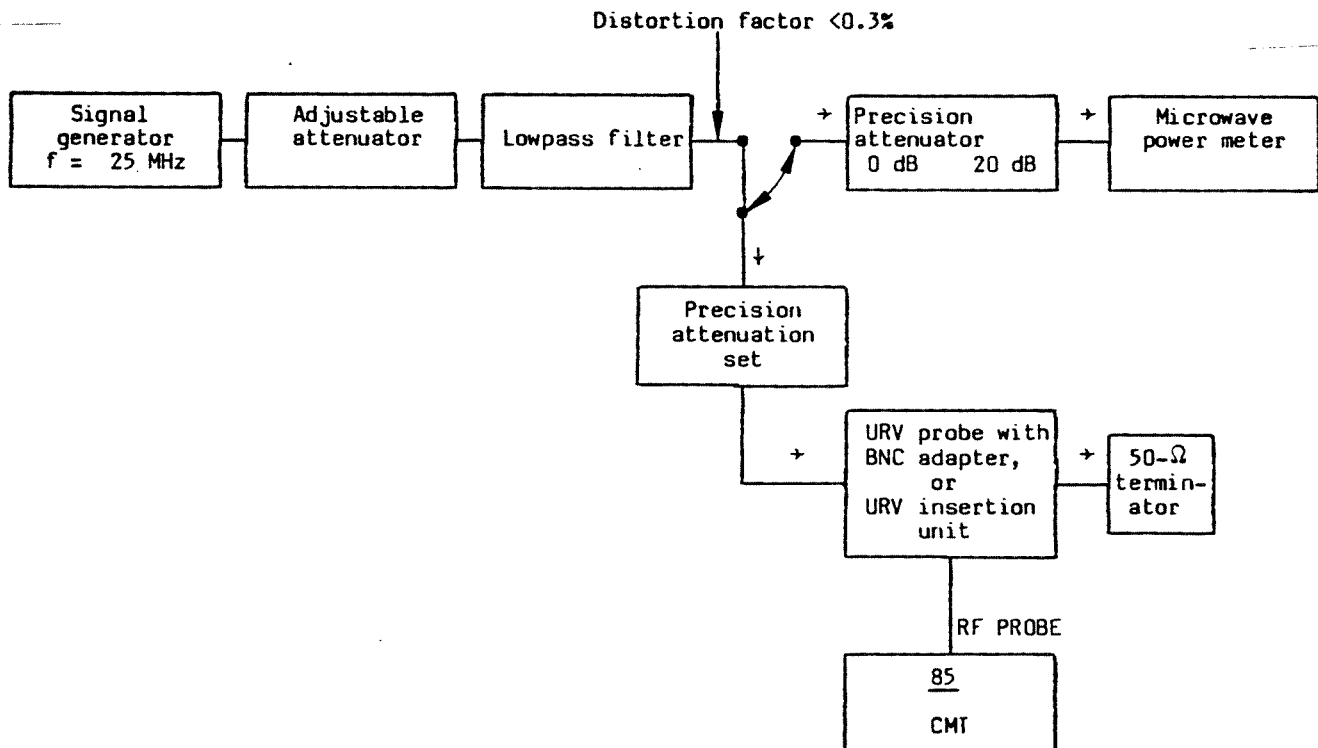

**Test:**

Select the amplitude of the test generator at a frequency of approx. 25 MHz such that the power meter indicates exactly 20 mW (calibrated value) with the attenuation set and attenuating element settings as in the table.

The deviation from the nominal value is then determined on the display of the RF millivoltmeter by reconnecting the signal path.

**Calibration**

Test generator voltage	10 V	10 V	10 V	10 V
Attenuation of attenuation set	0 dB	20 dB	40 dB	60 dB
Precision attenuating element	20 dB	0 dB	0 dB	0 dB
Indication on power meter	20 mW	20 mW	20 mV	20 mW

**Determination of measuring accuracy**

Nominal reading on RF millivoltmeter	10 V	1 V	100 mV	10 mV
Maximum deviation from nominal value	5%	5%	5%	5%

3.2.29.1 Memory Function

A short program is to be read into the memory which is then run to check whether the activated instrument functions correspond to the program. The read and write operations of the memory are tested in this manner.

Instrument setup:

- Connect the output of a test generator (e.g. SMPC from R&S) to output RF IN/OUT 77 of the CMT.
- Set a frequency of 100.000 000 MHz on the test generator with a modulation frequency of 1000 Hz and a modulation depth of 2800 Hz.
- Set the output level of the test generator to 13 dBm.

The program is to measure the transmitter frequency, the output power and the modulation depth.

Program input (see following table)

The instrument must automatically switch to the transmitter test mode when the entered program has been started, and the values for the transmitter frequency, transmitter power and modulation depth appear in the associated displays for 4 s each.

Explanation	Line No.	Key sequence
Call LEARN Mode		A 100 SPEC
Select transmitter test mode (XMITTER LED lights up)	001	TXRX STORE
Measure transmitter frequency (transmitter frequency appears in the frequency display: "100.000 00 MHz")	002 003	COUNTf STORE 4 0 0 0 STOP STORE
Measure the transmitter power (RF power appears in the RF level display: "0.02 W")	004 005	POWER STORE 4 0 0 0 STOP STORE
Measure the modulation depth (the deviation appears in the modulation display: "2.80 kHz")	006 007	kHz MAX PK STORE 4 0 0 0 STOP STORE
Leave the LEARN mode		A 200 SPEC
The program has now been completely entered. The instrument is now set to the receiver test mode and the program started.		
Select receiver test mode (RECEIVER LED lights up, displays switch over)		TXRX
Program 00 of the autorun controller starts at line No.1		1 0 0 START

### 3.2.29.2 Printer Function

The printer interface can be easily tested following input of the program specified for the function test of the autorun controller. It is only necessary to enter the instruction to print program XX(00<XX<99). The CMT must not be in LEARN mode. Connect a printer (e.g. PUD3 from R&S) and enter the following key sequence to activate printing:

The printer must now output the program 0 entered in LEARN mode.

### 3.2.29.3 Relay Functions

The relay functions can be tested by entering relay switching instructions via the CMT keys and checking the positions of the contacts using a suitable instrument (e.g. ohmmeter).

The relays of the autorun controller can be addressed via code A. The numbers 1 to 3 in agreement with the inscription on the option support plate at the rear of the CMT are used to differentiate between the 3 relays.

Explanation	Key sequence	Effect on contacts:
Relay A1 opens	<input type="text" value="A"/> <input type="text" value="1"/> <input type="text" value="0"/> <input type="text" value="SPEC"/>	Opened
Relay A1 closes	<input type="text" value="A"/> <input type="text" value="1"/> <input type="text" value="1"/> <input type="text" value="SPEC"/>	Closed
Relay A2 opens	<input type="text" value="A"/> <input type="text" value="2"/> <input type="text" value="0"/> <input type="text" value="SPEC"/>	Opened
Relay A2 closes	<input type="text" value="A"/> <input type="text" value="2"/> <input type="text" value="1"/> <input type="text" value="SPEC"/>	Closed
Relay A3 opens	<input type="text" value="A"/> <input type="text" value="3"/> <input type="text" value="0"/> <input type="text" value="SPEC"/>	Opened
Relay A3 closes	<input type="text" value="A"/> <input type="text" value="3"/> <input type="text" value="1"/> <input type="text" value="SPEC"/>	Closed

### 3.2.29.4 Battery

#### a) Checking the battery charge

The battery charge can be measured using the CMT. Enter special function    . The battery voltage is then output for 3 s in the  $\alpha$  display. Storage of the program in the autorun controller can no longer be guaranteed if the battery voltage is below 2.20 V in which case it is recommended to replace the battery.

#### b) Replacing the battery

To replace the battery, first remove the option support plate at the rear of the CMT (6 Phillips screws). Remove the options connected to the support plate from its location. Unsolder the lithium battery which is now accessible (axial connections of standard size 1/2 AA (3.4 V, 850 mAh)) and replace by a new battery.

**Caution:** Programs stored in the autorun controller are lost when the battery is replaced. In order to save the programs, first print them out and then enter again following battery replacement.

A more convenient method is to use a transfer memory into which the programs in the autorun controller are copied and then reloaded again later (see Section 2).

Ensure correct polarity.

The autorun controller is protected against incorrect polarity, but programs cannot be protected with the incorrect polarity.

A new battery of the specified type guarantees protection of programs for at least 2.5 years, typically for a period of 10 years.

### 3.2.30 Transfer Memory (Accessory CM-Z1)

#### 3.2.30.1 Memory Function

The CMT contains a special program to test the memory function. This program can be started using special function    . The message TRANS OK or TRANS ERROR appears in the  $\alpha$ -display for approx. 3 s at the end of the test.

#### 3.2.30.2 Battery

##### a) Checking the battery charge

The battery charge can be measured using the CMT. Enter special function    . The battery voltage is then output for 3 s in the  $\alpha$  display. Storage of the program in the transfer memory can no longer be guaranteed if the battery voltage is below 2.20 V in which case it is recommended to replace the battery.

##### b) Replacing the battery

To replace the battery, first open the housing of the transfer memory (4 phillips screws). The battery is accessible with the cover removed and can be desoldered. Replace by a battery with axial connections of standard size 1/2 AA (3.4 V, 850 mAh).

**Note:** Programs stored in the transfer memory are lost when the battery is replaced. In order to save the programs, first print them out and then enter again following battery replacement.

A more convenient method is to use a second transfer memory or an autorun controller into which the programs in the autorun controller are copied and then reloaded again later (see Section 2).

The transfer memory is protected against incorrect polarity, but programs cannot be protected with the incorrect polarity.

A new battery of the specified type guarantees protection of programs for at least 5 years, typically for a period of 10 years.

### 3.2.31 IEC Bus (Option CM-B4)

An IEC-bus-compatible controller (e.g. PCA5 from R&S) is required to test the IEC-bus function.

#### 3.2.31.1 Listener Function

Program the controller with several functions to be executed by the CMT. Establish the IEC-bus connection and send the program from the controller to the CMT. The LED REMOTE must light up on the CMT and the individual functions are executed.

The IEC bus mode can be left by pressing the LOCAL key.

#### 3.2.31.2 Talker Function

Enter a program into the controller which e.g. calls the values from the CMT displays. Set the CMT to receiver test mode by pressing the TXRX key. Start the controller program and check whether the controller has correctly read the values from the CMT displays.



### 3.2.31.3 Relay Functions

The relay functions can be tested by entering relay switching commands via the CMT keys and checking the position of the contacts using a suitable instrument (e.g. ohmmeter). The relays of the IEC bus (option CM-B4) can be addressed via code B. The numbers 1 to 8 in agreement with the inscription on the option support plate at the rear of the CMT are used to differentiate the 8 relays.

Explanation	Key sequence	Effect on change-over contacts
Relay B1 inactive active	<input type="text" value="B"/> <input type="text" value="1"/> <input type="text" value="0"/> <input type="text" value="SPEC"/>	Unenergized pos.
	<input type="text" value="B"/> <input type="text" value="1"/> <input type="text" value="1"/> <input type="text" value="SPEC"/>	Energized pos.
Relay B2 inactive active	<input type="text" value="B"/> <input type="text" value="2"/> <input type="text" value="0"/> <input type="text" value="SPEC"/>	Unenergized pos.
	<input type="text" value="B"/> <input type="text" value="2"/> <input type="text" value="1"/> <input type="text" value="SPEC"/>	Energized pos.

Explanation	Key sequence	Effect on switching contacts
Relay B3 opens closes	<input type="text" value="B"/> <input type="text" value="3"/> <input type="text" value="0"/> <input type="text" value="SPEC"/>	Opened
	<input type="text" value="B"/> <input type="text" value="3"/> <input type="text" value="1"/> <input type="text" value="SPEC"/>	Closed
Relay B4 opens closes	<input type="text" value="B"/> <input type="text" value="4"/> <input type="text" value="0"/> <input type="text" value="SPEC"/>	Opened
	<input type="text" value="B"/> <input type="text" value="4"/> <input type="text" value="1"/> <input type="text" value="SPEC"/>	Closed
Relay B5 opens closes	<input type="text" value="B"/> <input type="text" value="5"/> <input type="text" value="0"/> <input type="text" value="SPEC"/>	Opened
	<input type="text" value="B"/> <input type="text" value="5"/> <input type="text" value="1"/> <input type="text" value="SPEC"/>	Closed
Relay B6 opens closes	<input type="text" value="B"/> <input type="text" value="6"/> <input type="text" value="0"/> <input type="text" value="SPEC"/>	Opened
	<input type="text" value="B"/> <input type="text" value="6"/> <input type="text" value="1"/> <input type="text" value="SPEC"/>	Closed
Relay B7 opens closes	<input type="text" value="B"/> <input type="text" value="7"/> <input type="text" value="0"/> <input type="text" value="SPEC"/>	Opened
	<input type="text" value="B"/> <input type="text" value="7"/> <input type="text" value="1"/> <input type="text" value="SPEC"/>	Closed
Relay B8 opens closes	<input type="text" value="B"/> <input type="text" value="8"/> <input type="text" value="0"/> <input type="text" value="SPEC"/>	Opened
	<input type="text" value="B"/> <input type="text" value="8"/> <input type="text" value="1"/> <input type="text" value="SPEC"/>	Closed

**3.3 Performance Test Report**

Rohde & Schwarz

Date .....

RADIOCOMMUNICATION TESTER CMT

Name .....

Ord.No. 802.2020...

Serial No. ....

Item No.	Characteristic	Measurement as in Section	Min.	Actual value	Max.	Unit
1	Display, keyboard and spin wheel	3.2.1	-	...	-	-
2	Reference frequency standard	3.2.2				
	Aging		-10	...	10	Hz/month
	Temperature influence		-10	...	10	Hz/°C
	Option CMT-B1					
	Aging		-10	...	+10	Hz/day *
3	Frequency setting and accuracy	3.2.3				
	Frequencies					
	1000 MHz		-10	...	+10	Hz
	830 MHz		-10	...	+10	Hz
	820 MHz		-10	...	+10	Hz
	660 MHz		-10	...	+10	Hz
	500.0004 MHz		-10	...	+10	Hz
	499.9 MHz		-10	...	+10	Hz
	250 MHz		-10	...	+10	Hz
	125 MHz		-10	...	+10	Hz
	62.5 MHz		-10	...	+10	Hz
	31 MHz		-10	...	+10	Hz
0.1 MHz	-10	...	+10	Hz		

\* Measure with 1 GHz at connector X1

Item No.	Characteristic	Measurement as in Section	Min.	Actual value	Max.	Unit
4	Setting error and frequency response of RF output level	3.2.4	-0.7	...	+0.7	dB
5	RF attenuator Deviation from correct CMT level  10 dBm 5 dBm 0 dBm -5 dBm -10 dBm -30 dBm -50 dBm -90 dBm	3.2.5	- -0.2 -0.3 -0.35 -0.4 -0.8 -0.8 -0.8	... ... ... ... ... ... ... ...	- +0.2 +0.3 +0.35 +0.4 +0.8 +0.8 +0.8	dB dB dB dB dB dB dB dB
6	Fine level setting  Reduction to -4.9 dBm to -14.9 dBm	3.2.6	-1 -2	... ...	+1 +2	dB dB
7	Harmonics	3.2.7	-	...	30	dB
8	Non-harmonics  37.502 MHz line 6.253 MHz line	3.2.8	- -	... ...	60 60	dB dB
9	Spurious FM (CCITT) f = 499 MHz f = 1000 MHz  Spurious FM (30 Hz to 20 kHz) f = 300 MHz f = 1000 MHz	3.2.9	- -  - -	... ...  ... ...	6 12  16 32	Hz Hz  Hz Hz

Item No.	Characteristic	Measurement as in Section	Min.	Actual value	Max.	Unit
10	Spurious AM (CCITT) Spurious AM (30 Hz to 20 kHz)	3.2.10	-	...	0.02	%
			-	...	0.3	%
11	RF response of modulation deviation	3.2.11.1.1	-2	...	+2	%
12	AF response of modulation deviation f < 150 Hz 300 Hz < f < 30 kHz 150 Hz < f < 300 Hz 30 kHz < f < 100 kHz	3.2.11.1.2	-3		+3	dB
			-2.5		+2.5	%
			-4		+4	%
			-4		+4	%
13	Total FM error	3.2.11.1.3	-5	...	+5	%
14	FM distortion	3.2.11.1.4	0	...	1	%
15	Ext. modulation	3.2.11.2	23.75	...	26.25	kHz
16	Ext. modulation with calibration  Calibration error	3.2.11.2.1				
			-5	...	+5	%
17	Multitone modul.  Deviation 1 Deviation 2 Deviation 3	3.2.11.3	4.75	...	5.25	kHz
			4.75	...	5.25	kHz
			4.75	...	5.25	kHz
18	Frequency response of the modulation depth	3.2.12.1.1	-	...	3	%

Item No.	Characteristic	Measurement as in Section	Min.	Actual value	Max.	Unit
19	AM error Total error	3.2.12.1.2	-5	...	+5	%
20	AM distortion m = 80 % m = 30 %	3.2.12.1.3	- -	... ...	1.5 1	% %
21	Ext. modulation	3.2.12.2	76	...	84	%
22	Phase modulation Total error	3.2.13	-7	...	+7	%
23	Response threshold of automatic receiver/transmitter test setting  DC test AC test	3.2.14	2 0.1	... ...	5 1	V W
24	Modulation generator  Frequency setting and accuracy  Frequencies 22.32 kHz 22.31 kHz 22.30 kHz 22.27 kHz 22.22 kHz 22.12 kHz 21.93 kHz 21.55 kHz 20.83 kHz	3.2.15.1		... ... ... ... ... ... ... ... ...		kHz kHz kHz kHz kHz kHz kHz kHz kHz

Item No.	Characteristic	Measurement as in Section	Min.	Actual value	Max.	Unit
25	Distortion of modulation generator f < 10 kHz f > 10 kHz	3.2.15.2	- -	... ...	0.5 1	% %
26	Output voltage of modulation generator	3.2.15.3	-	...	-	mV
	Frequency response of mod.generator	3.2.15.3.1	-	...	-	%
	Total error of mod.generator	3.2.15.3.1	-3	...	+3	%
27	Frequency setting of 2nd AF Synthesizer	3.2.15.4				
	Frequencies					
	22.32 kHz			...		kHz
	22.31 kHz			...		kHz
	22.30 kHz			...		kHz
	22.27 kHz			...		kHz
	22.22 kHz			...		kHz
	22.12 kHz			...		kHz
	21.93 kHz			...		kHz
21.55 kHz		...		kHz		
20.83 kHz		...		kHz		
28	Frequency response of AF voltmeter	3.2.16.1				
	Frequency response			...		%
	Frequency response with 150 Hz cut-off frequency			...	5	%
29	Measuring accuracy of AF voltmeter	3.2.16.2				
	Deviation from nominal value			-3	...	+3

Item No.	Characteristic	Measurement as in Section	Min.	Actual value	Max.	Unit	
30	Frequency response of CCITT filter	3.2.16.3					
	Fre- quency (Hz)		Nominal value (dB)				
	50		-63		...		dB
	100		-41		...		dB
	150		-29		...		dB
	200		-21		...		dB
	300		-10.6		...		dB
	400		-6.3		...		dB
	500		-3.6		...		dB
	600		-2.0		...		dB
	800		0		...		dB
	1000		1		...		dB
	1200		0		...		dB
	1500		-1.3		...		dB
	2000		-3.0		...		dB
	2500		-4.2		...		dB
	3000		-5.6		...		dB
	3500		-8.5		...		dB
	4000		-15		...		dB
5000	-36		...		dB		
6000	-43		...		dB		
>6000	<-43		...		dB		
31	Distortion meter						
	Inherent distortion	3.2.17.1	-	...	0.3	%	
32	Indication accuracy of distortion meter	3.2.17.2					
	Nominal value						
	10%		9.2	...	10.8	%	
	3%		2.5	...	3.5	%	
	1%		0.7	...	1.3	%	
	0.3%	0	...	0.6	%		

Item No.	Characteristic	Measurement as in Section	Min.	Actual value	Max.	Unit
33	SINAD meter	3.2.18				
	Stopband attenuation		50	...	-	dB
	Inherent noise		47	...	-	dB
	20 dB		19.3	...	20.5	dB
	30.5 dB		28.7	...	30.5	dB
	40 dB		37.2	...	40.5	dB
	46 dB	46.5	...	50.5	dB	
34	AF counter	3.2.19				
	Deviation from correct value with 0.1 Hz resolution		-0.1	...	+0.1	Hz
	1 Hz resolution		-1	...	+1	Hz
	Counter sensitivity					
	for f < 30 kHz	3	...	-	mV	
	for f > 30 kHz	30	...	-	mV	
35	RF counter	3.2.20				
	RF IN/OUT	3.2.20.1				
	Unmodulated		-	...	5	mW
	40% AM	-	...	20	mW	
INPUT2	3.2.20.2					
Unmodulated		-	...	5	mV	
	40% AM	-	...	10	mV	
36	Counter accuracy	3.2.20.3				
	Error		-1	...	+1	Digit



Item No.	Characteristic	Measurement as in Section	Min.	Actual value	Max.	Unit
37	Power meter	3.2.21				
	Power stage 7 dBm					
	f 1.5 MHz			...		dBm
	f 20 MHz			...		dBm
	f 500 MHz			...		dBm
	f 1000 MHz			...		dBm
	Power stage 20 dBm					
	f 1.5 MHz		19.5	...	20.5	dBm
	f 20 MHz		19.5	...	20.5	dBm
	f 1000 MHz		19.5	...	20.5	dBm
	Power stage 47 dBm					
	f 1.5 MHz		46.5	...	47.5	dBm
	f 20 MHz		46.5	...	47.5	dBm
	f 1000 MHz		46.5	...	47.5	dBm
38	VSWR of power meter	3.2.21.1	-	...	1.2	-
39	Frequency deviation meter	3.2.22				
	Deviation from nominal value when testing meter accuracy			...		%
	Frequency response			...		%
	Total error		-	...	3	%
	Function test					
	+PK			...		
	-PK			...		
	PK HOLD			...		
	MAX PK			...		

Item No.	Characteristic	Measurement as in Section	Min.	Actual value	Max.	Unit
40	300-Hz highpass filter	3.2.22.1				
	Test frequencies					
	170 Hz		-	...	316	Hz
	190 Hz		-	...	1	kHz
	240 Hz		-	...	10	kHz
	300 Hz		93	...	107	kHz
	350 Hz		93	...	107	kHz
	1 kHz		93	...	107	kHz
20 kHz	93	...	107	kHz		
41	Residual FM of deviation meter	3.2.22.2				
	RF = 499 MHz		-	...	6	Hz
	RF = 1000 MHz		-	...	12	Hz
42	Phase deviation meter	3.2.23				
	Additional frequency response error		-	...	2	%
43	Modulation depth meter	3.2.24				
	Deviation from nominal value when testing meter accuracy			...		%
	Frequency response			...		%
	Total error		-	...	5	%
44	Residual modulation of AM meter	3.2.24.1	-	...	0.03	%

Item No.	Characteristic	Measurement as in Section	Min.	Actual value	Max.	Unit
45	Oscilloscope Frequ. response at connector EXT	3.2.25.1		...		
46	Oscilloscope Dynamic range	3.2.25.2		...		
47	Oscilloscope Time base	3.2.25.3		...		
48	Two-tone evaluator DTMF	3.2.26		...		
49	Adjacent-channel power meter Frequency 60 MHz 420 MHz 900 MHz  Spot-check, channel spacing 10 kHz 12.5 kHz 20 kHz 25 kHz  Spot-check, lower adjacent channel	3.2.27				
			38	...	42	dB
			38	...	42	dB
			38	...	42	dB
			38	...	42	dB
			38	...	42	dB
			38	...	42	dB
			38	...	42	dB
			38	...	42	dB

Item No.	Characteristic	Measurement as in Section	Min.	Actual value	Max.	Unit
50	RF millivoltmeter	3.2.28				
	Deviation from nominal value					
	10 V		9.5	...	10.5	V
	1 V		0.95	...	1.05	V
	100 mV	95	...	105	mV	
	10 mV	9.5	...	10.5	mV	
51	Autorun control / printer interface	3.2.29.1				
	Memory function			...		
	Relay function			...		
	Printer function			...		
52	Transfer memory	3.2.30				
	Memory function			...		
53	IEC bus	3.2.31				
	Listener function			...		
	Talker function			...		
	Relay function			...		

## 3.4 Maintenance

### 3.4.1 Electrical Maintenance

The self-test carried out each time the instrument is switched on provides information on any faults.

All special functions containing the letter D are intended for maintenance (List of special functions: Section 2.3.8).

Since some adjustments in the instrument are performed via the firmware, the firmware adjustment is not only required following maintenance on the respective module, but also following maintenance on the digital unit (e.g. following battery replacement) or after RAM-ERROR in the self-test.

It is recommended to readjust the reference frequency once a year (see Section 4, Service manual).

### 3.4.2 Mechanical Maintenance

No mechanical maintenance is required under normal operating conditions.

## 3.5 Storage

The storage temperature may be between -40 and +70°C. Note that the service life of the batteries is reduced when storing at high temperatures. The special functions D20, 21, 22 provide information on the battery condition when the instrument is used again.



**ROHDE & SCHWARZ**

**Bilder**

**Figures**

**Figures**





Bild 2-9 Oszilloskop  
Fig. 2-9 Oscilloscope



Bild 2-1 Frequenzfeld  
Fig. 2-1 Frequency field

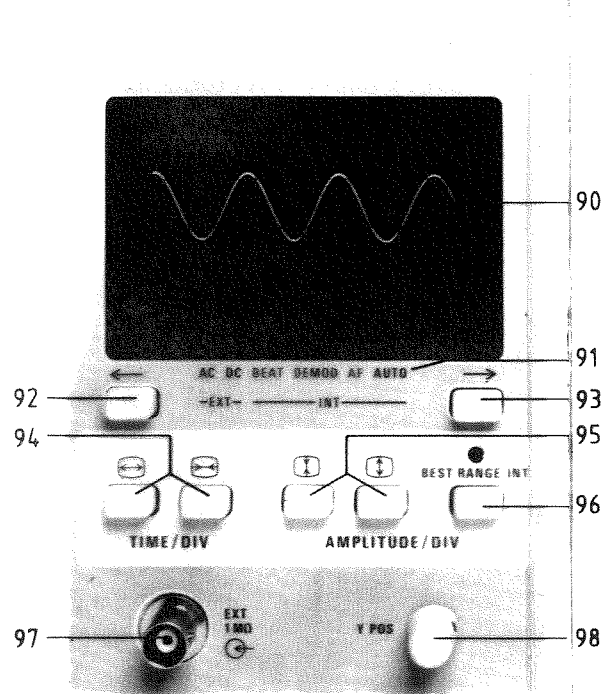

Bild 2-2 HF-Pegelfeld  
Fig. 2-2 RF level field

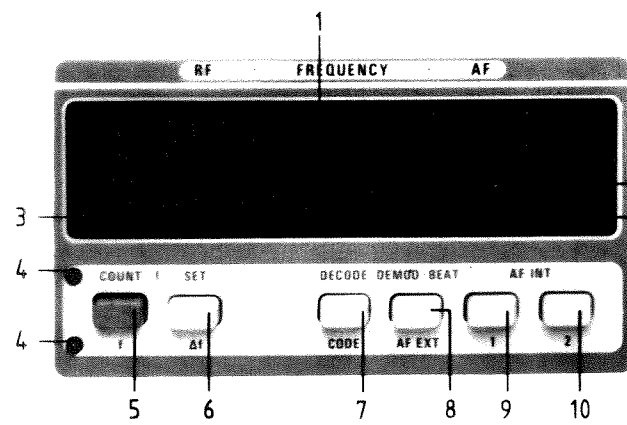

Bild 2-3 Modulationsfeld  
Fig. 2-3 Modulation field

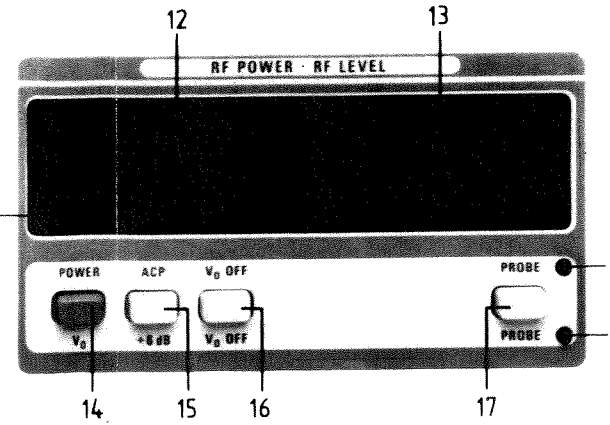

Bild 2-4 NF-Pegelfeld  
Fig. 2-4 AF level field

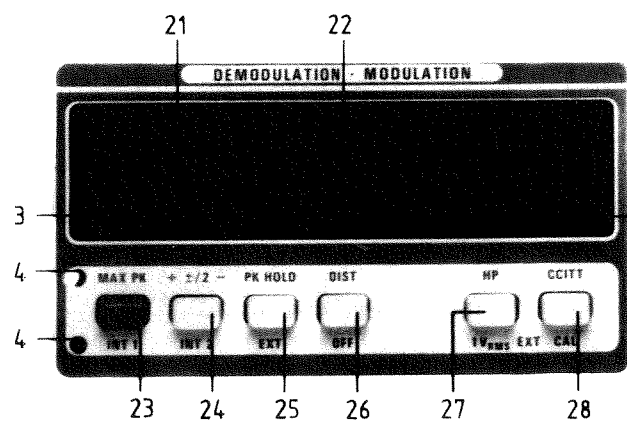

Bild 2-5 Zahlenfeld  
Fig. 2-5 Numeric field

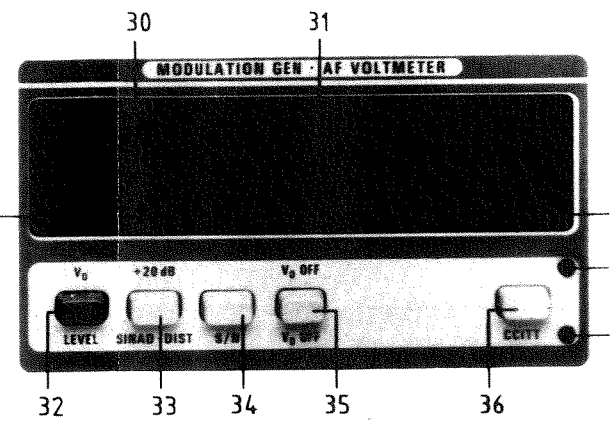

Bild 2-6 Umschalter  
Fig. 2-6 Changeover

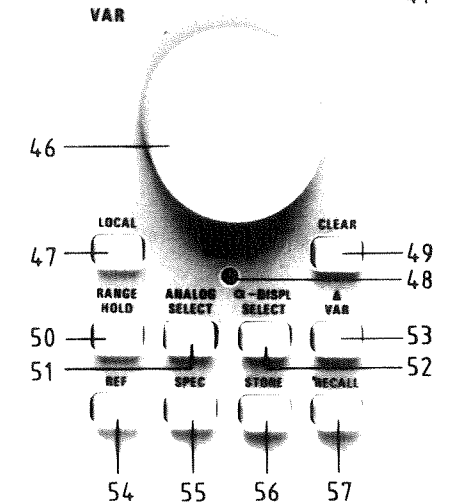
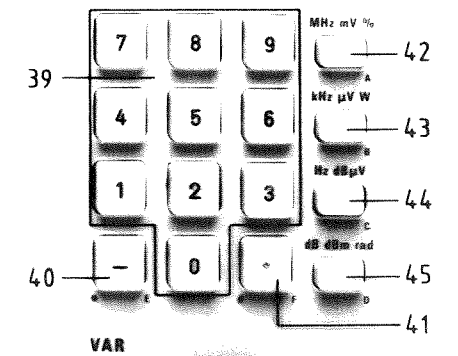

Bild 2-7 AUTOTEST  
Fig. 2-7 AUTOTEST

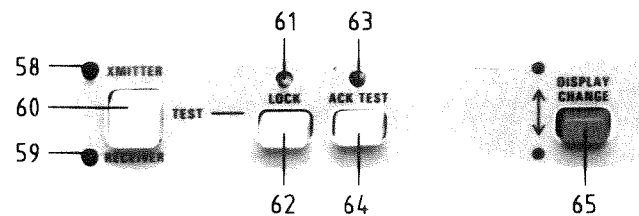

Bild 2-8 Anschlußfeld  
Fig. 2-8 Connector strip



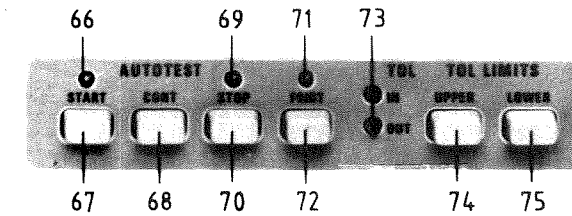

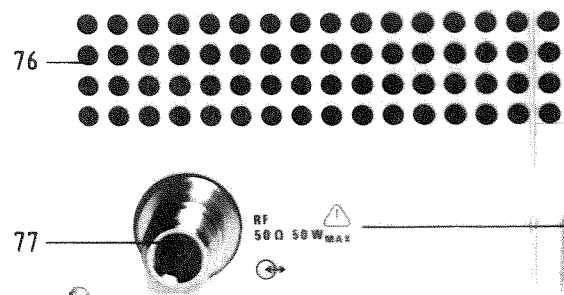
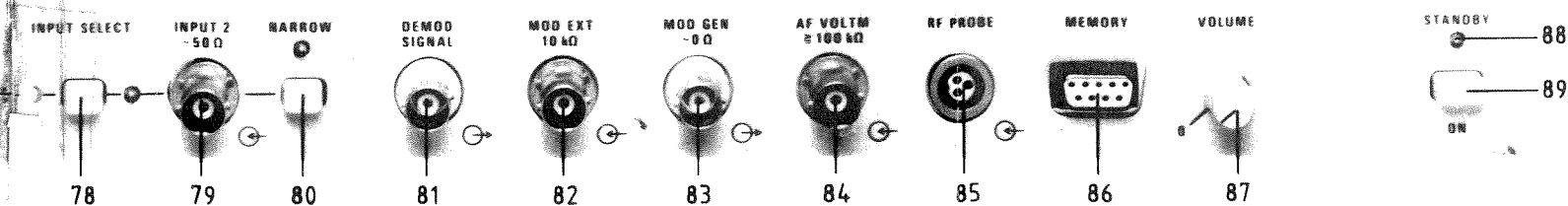
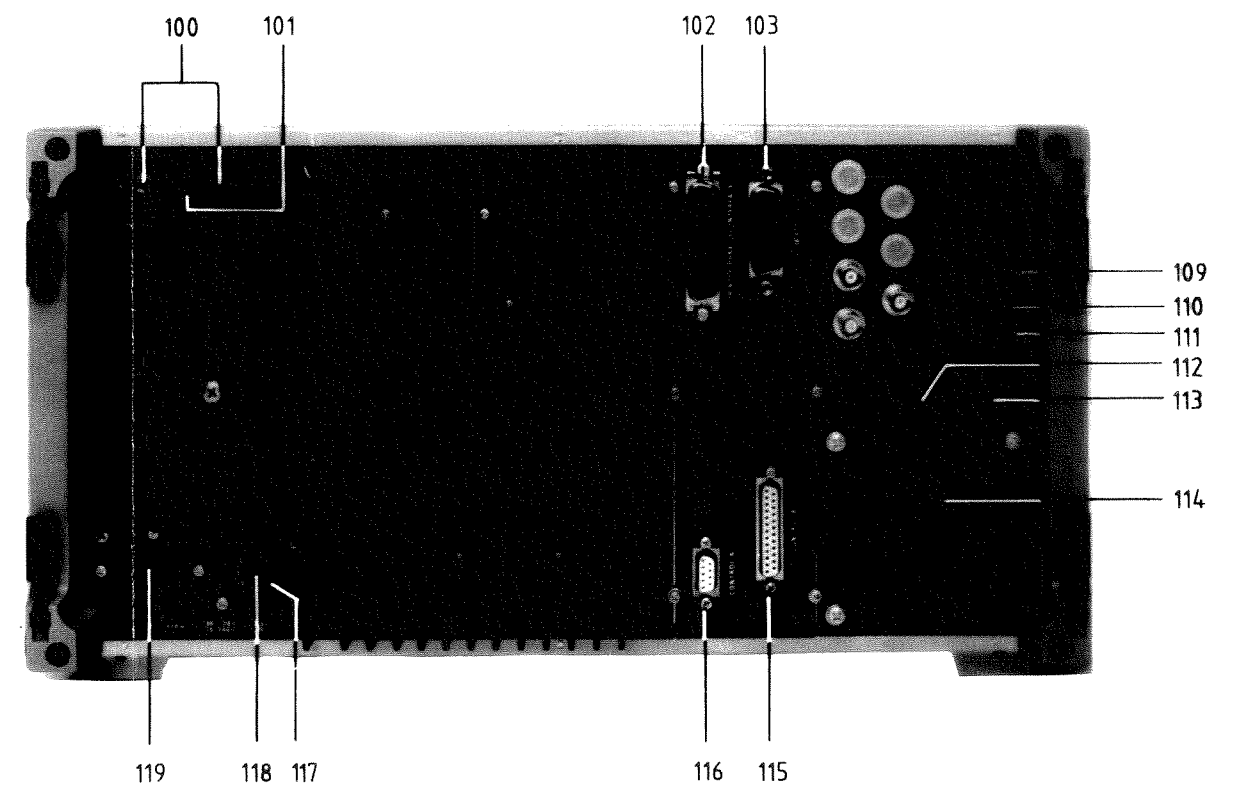

Bild 2-10 Rückansicht  
Fig. 2-10 Rear panel