



**ROHDE & SCHWARZ**

Test and  
Measurement Division

## Operating Manual

# SPECTRUM ANALYZER

### **FSEA20/30**

1065.6000.20/.25/35

### **FSEB20/30**

1066.3010.20/.25/35

### **FSEM20/30**

1080.1505.20/.21/.25

1079.8500.30/.31/.35

### **FSEK20/30**

1088.1491.20/.21/.25

1088.3494.30/.31/.35

*Volume 1*

*Operating manual consists of 2 volumes*

Printed in the Federal  
Republic of Germany



# Tabbed Divider Overview

## Volume 1

### Data Sheet

Safety Instructions

Certificate of quality

EC Certificate of Conformity

Support Center

List of R & S Representatives

### Manuals for Signal Analyzer FSE

#### Tabbed Divider

- |    |            |                        |
|----|------------|------------------------|
| 1  | Chapter 1: | Putting into Operation |
| 2  | Chapter 2: | Getting Started        |
| 3  | Chapter 3: | Operation              |
| 4  | Chapter 4: | Functional Description |
| 10 |            | Index                  |

## Volume 2

Safety Instructions

### Manuals for Signal Analyzer FSE

#### Tabbed Divider

- |    |            |                                     |
|----|------------|-------------------------------------|
| 5  | Chapter 5: | Remote Control – Basics             |
| 6  | Chapter 6: | Remote Control – Commands           |
| 7  | Chapter 7: | Remote Control – Program Examples   |
| 8  | Chapter 8: | Maintenance and Hardware Interfaces |
| 9  | Chapter 9: | Error Messages                      |
| 10 |            | Index                               |











# Safety Instructions

This unit has been designed and tested in accordance with the EC Certificate of Conformity and has left the manufacturer's plant in a condition fully complying with safety standards.

To maintain this condition and to ensure safe operation, the user must observe all instructions and warnings given in this operating manual.

## Safety-related symbols used on equipment and documentation from R&S:

							
Observe operating instructions	Weight indication for units >18 kg	PE terminal	Ground terminal	Danger! Shock hazard	Warning! Hot surfaces	Ground	Attention! Electrostatic sensitive devices require special care

- The unit may be used only in the operating conditions and positions specified by the manufacturer. Unless otherwise agreed, the following applies to R&S products:  
IP degree of protection 2X, pollution severity 2 overvoltage category 2, only for indoor use, altitude max. 2000 m.  
The unit may be operated only from supply networks fused with max. 16 A.  
Unless specified otherwise in the data sheet, a tolerance of  $\pm 10\%$  shall apply to the nominal voltage and of  $\pm 5\%$  to the nominal frequency.
- For measurements in circuits with voltages  $V_{\text{rms}} > 30 \text{ V}$ , suitable measures should be taken to avoid any hazards.  
(using, for example, appropriate measuring equipment, fusing, current limiting, electrical separation, insulation).
- If the unit is to be permanently wired, the PE terminal of the unit must first be connected to the PE conductor on site before any other connections are made. Installation and cabling of the unit to be performed only by qualified technical personnel.
- For permanently installed units without built-in fuses, circuit breakers or similar protective devices, the supply circuit must be fused such as to provide suitable protection for the users and equipment.
- Prior to switching on the unit, it must be ensured that the nominal voltage set on the unit matches the nominal voltage of the AC supply network.  
If a different voltage is to be set, the power fuse of the unit may have to be changed accordingly.
- Units of protection class I with disconnectible AC supply cable and appliance connector may be operated only from a power socket with earthing contact and with the PE conductor connected.
- It is not permissible to interrupt the PE conductor intentionally, neither in the incoming cable nor on the unit itself as this may cause the unit to become electrically hazardous.  
Any extension lines or multiple socket outlets used must be checked for compliance with relevant safety standards at regular intervals.
- If the unit has no power switch for disconnection from the AC supply, the plug of the connecting cable is regarded as the disconnecting device. In such cases it must be ensured that the power plug is easily reachable and accessible at all times (length of connecting cable approx. 2 m). Functional or electronic switches are not suitable for providing disconnection from the AC supply.  
If units without power switches are integrated in racks or systems, a disconnecting device must be provided at system level.
- Applicable local or national safety regulations and rules for the prevention of accidents must be observed in all work performed.  
Prior to performing any work on the unit or opening the unit, the latter must be disconnected from the supply network.  
Any adjustments, replacements of parts, maintenance or repair may be carried out only by authorized R&S technical personnel.  
Only original parts may be used for replacing parts relevant to safety (eg power switches, power transformers, fuses). A safety test must be performed after each replacement of parts relevant to safety.  
(visual inspection, PE conductor test, insulation-resistance, leakage-current measurement, functional test).

continued overleaf

## Safety Instructions

10. Ensure that the connections with information technology equipment comply with IEC950 / EN60950.
11. Lithium batteries must not be exposed to high temperatures or fire.  
Keep batteries away from children.  
If the battery is replaced improperly, there is danger of explosion. Only replace the battery by R&S type (see spare part list).  
Lithium batteries are suitable for environmentally-friendly disposal or specialized recycling. Dispose them into appropriate containers, only.  
Do not short-circuit the battery.
12. Equipment returned or sent in for repair must be packed in the original packing or in packing with electrostatic and mechanical protection.
13. Electrostatics via the connectors may damage the equipment. For the safe handling and operation of the equipment, appropriate measures against electrostatics should be implemented.
14. The outside of the instrument is suitably cleaned using a soft, lint-free dustcloth. Never use solvents such as thinners, acetone and similar things, as they may damage the front panel labeling or plastic parts.
15. Any additional safety instructions given in this manual are also to be observed.

### Patent Information

This product contains technology licensed by Marconi Instruments LTD. under US patent 4609881 and under the corresponding patent in Germany and elsewhere.

# Certified Quality System ISO 9001

**DQS REG. NO 1954-04**

## Qualitätszertifikat

Sehr geehrter Kunde,

Sie haben sich für den Kauf eines Rohde & Schwarz-Produktes entschieden. Hiermit erhalten Sie ein nach modernsten Fertigungsmethoden hergestelltes Produkt. Es wurde nach den Regeln unseres Qualitätsmanagementsystems entwickelt, gefertigt und geprüft. Das Rohde & Schwarz-Qualitätsmanagementsystem ist nach ISO 9001 zertifiziert.

## Certificate of quality

Dear Customer,

You have decided to buy a Rohde & Schwarz product. You are thus assured of receiving a product that is manufactured using the most modern methods available. This product was developed, manufactured and tested in compliance with our quality management system standards.

The Rohde & Schwarz quality management system is certified according to ISO 9001.

## Certificat de qualité

Cher client,

Vous avez choisi d'acheter un produit Rohde & Schwarz. Vous disposez donc d'un produit fabriqué d'après les méthodes les plus avancées. Le développement, la fabrication et les tests respectent nos normes de gestion qualité.

Le système de gestion qualité de Rohde & Schwarz a été homologué conformément à la norme ISO 9001.



**ROHDE & SCHWARZ**







Certificate No.: 9502002

This is to certify that:

Equipment type	Order No.	Designation
FSEA20/30	1065.6000.20/.25/.30/.35	Spectrum Analyzer
FSEB20/30	1066.3010.20/.25/.30/.35	
FSEK20/21	1088.1491.20/.21/.25	
FSEK30/31	1088.3494.30/.31/.35	
FSEM20/21	1080.1505.20/.21/.25	
FSEM30/31	1079.8500.30/.31/.35	

complies with the provisions of the Directive of the Council of the European Union on the approximation of the laws of the Member States

- relating to electrical equipment for use within defined voltage limits  
(73/23/EEC revised by 93/68/EEC)
- relating to electromagnetic compatibility  
(89/336/EEC revised by 91/263/EEC, 92/31/EEC, 93/68/EEC)

Conformity is proven by compliance with the following standards:

EN61010-1 : 1991  
EN55011 : 1998 + A1 : 1999, Klasse B  
EN61000-3-2 : 1995 + A1 : 1998 + A2 : 1998 + A14 : 2000  
EN61000-3-3 : 1995  
EN50082-1 : 1992

Affixing the EC conformity mark as from 1995

Munich, 2001-01-11

**ROHDE & SCHWARZ GmbH & Co. KG**  
**Mühldorfstr. 15, D-81671 München**

Central Quality Management FS-QZ / Becker





Certificate No.: 9502052

This is to certify that:

Equipment type	Stock No.	Designation
FSE-B1	1073.4990.02	Color Display
FSE-B10	1066.4769.02	Tracking Generator
FSE-B11	1066.4917.02	Tracking Generator
FSE-B12	1066.5065.02	Output Attenuator
FSE-B13	1119.6499.02	1 dB Input Attenuator
FSE-B15	1073.5696.02/.03	Computer Function
FSE-B16	1073.5973.02/.03/.04	Ethernet Interface
FSE-B17	1066.4017.02	2nd IEC BUS Interface
FSE-B18	1088.6993.02	Removeable Harddrive
FSE-B19	1088.7248.xx	Second Harddisk
FSE-B2	1073.5044.02	7 GHz Frequency Extension
FSE-B21	1084.7243.02	External Mixer Output
FSE-B23	1088.7348.02	741,4 MHz Broadband Output
FSE-B24	1106.3680.02	44 GHz Frequency Extension
FSE-B3	1073.5244.02	TV Demodulator
FSE-B4	1073.5396.02	OCXO 10 MHz and Low Phase Noise
FSE-B7	1066.4317.02	Signal Vectoranalysis
FSE-B77	1102.8493.02	Signal Vectoranalysis
FSE-B8	1066.4469.02	Tracking Generator
FSE-B9	1066.4617.02	Tracking Generator
FSE-Z2	1084.7043.02	PS/2 Mouse

complies with the provisions of the Directive of the Council of the European Union on the approximation of the laws of the Member States

- relating to electromagnetic compatibility  
(89/336/EEC revised by 91/263/EEC, 92/31/EEC, 93/68/EEC)

Conformity is proven by compliance with the following standards:

EN55011 : 1998 + A1 : 1999, Klasse B  
EN61000-3-2 : 1995 + A1 : 1998 + A2 : 1998 + A14 : 2000  
EN61000-3-3 : 1995  
EN50082-1 : 1992

Affixing the EC conformity mark as from 1995

**ROHDE & SCHWARZ GmbH & Co. KG**  
**Mühldorfstr. 15, D-81671 München**

Munich, 2001-01-11

Central Quality Management FS-QZ / Becker



---

# Support Center

**Telefon / Telephone:** (0180) 512 42 42

**Fax:** (++)89) 41 29 - 137 77

**e-mail:** [CustomerSupport@rsd.rohde-schwarz.com](mailto:CustomerSupport@rsd.rohde-schwarz.com)

---

Für technische Fragen zu diesem Rohde & Schwarz-Gerät steht Ihnen ab sofort unsere Hotline der Rohde & Schwarz Vertriebs-GmbH, Support Center, zur Verfügung.

Unser Team bespricht mit Ihnen Ihre Fragen und sucht Lösungen für Ihre Probleme.

Die Hotline ist Montag bis Freitag von 8.00 bis 17.00 Uhr besetzt.

Bei Anfragen außerhalb der Geschäftszeiten hinterlassen Sie bitte eine Nachricht oder senden Sie eine Notiz per Fax oder e-mail. Wir setzen uns dann baldmöglichst mit Ihnen in Verbindung.

Should you have any technical questions concerning this Rohde & Schwarz product, please contact the hotline of Rohde & Schwarz Vertriebs-GmbH, Support Center.

Our hotline team will answer your questions and find solutions to your problems.

You can reach the hotline Monday through Friday from 8:00 until 17:00.

If you need assistance outside office hours, please leave a message or send us a fax or e-mail. We will contact you as soon as possible.



**ROHDE & SCHWARZ**



**HEADQUARTERS**

	Phone	Fax	E-mail
Rohde & Schwarz GmbH & Co. KG Mühlhofstraße 15 · 81671 München Postfach 801469 · 81614 München	+49 89 4129-0 +49 89 4129-12164	-	-

**PLANTS**

Rohde & Schwarz Messgerätebau GmbH Riedbachstraße 58 · 87700 Memmingen Postfach 1652 · 87686 Memmingen	+49 83 31 1 08-0 +49 83 31 1 08-1 24	-	-
Rohde & Schwarz GmbH & Co. KG Werk Teisnach Kaikenrieder Straße 27 · 94244 Teisnach Postfach 1149 · 94240 Teisnach	+49 99 23 8 50-0 +49 99 23 8 50-1 74	-	-
Rohde & Schwarz GmbH & Co. KG Werk Köln Graf-Zeppelin-Straße 18 · 51147 Köln Postfach 98 02 60 · 51130 Köln	+49 22 03 49-0 +49 22 03 49-3 08	-	-

**SUBSIDIARIES**

Rohde & Schwarz Vertriebs-GmbH Mühlhofstraße 15 · 81671 München Postfach 80 14 69 · 81614 München	+49 89 4129-12007 +49 89 4129-13567	-	-
Rohde & Schwarz International GmbH Mühlhofstraße 15 · 81671 München Postfach 80 14 60 · 81614 München	+49 89 4129-12005 +49 89 4129-3597	-	-
Rohde & Schwarz Engineering and Sales GmbH Mühlhofstraße 15 · 81671 München Postfach 80 14 29 · 81614 München	+49 89 4129-13711 +49 89 4129-13723	-	-
R&S BICK Mobilfunk GmbH Im Landerfeld 7 · 31848 Bad Münder Postfach 2062 · 31844 Bad Münder	+49 50 42 9 98-0 +49 50 42 9 98-105	-	-
Rohde & Schwarz FTK GmbH Wendenschloßstraße 168, Haus 28 12557 Berlin	+49 30 6 58 91-0 +49 30 65 55 02 21	-	-
Rohde & Schwarz SIT GmbH Wendenschloßstraße 168, Haus 28 12557 Berlin	+49 30 6 58 84-222 +49 30 6 58 84-183	-	-

**ADDRESSES GERMANY**

Rohde & Schwarz Vertriebs-GmbH Mühlhofstraße 15 · 81671 München Postfach 80 14 69 · 81614 München	+49 89 4129-2007 +4989 4129-3567	-	-
Zweigniederlassungen der Rohde & Schwarz Vertriebs-GmbH/Branch offices of Rohde & Schwarz Vertriebs-GmbH			
Zweigniederlassung Berlin Ernst-Reuter-Platz 10 · 10587 Berlin Postfach 100620 · 10566 Berlin	030 34 79 48-0 030 3479 48-48	-	-
Zweigniederlassung Bonn Josef-Wirmer-Straße 1-3 · 53123 Bonn Postfach 140264 · 53057 Bonn	0228 918 90-0 0228 25 50 87	-	-
Zweigniederlassung Hamburg Steilshooper Alle 47 · 22309 Hamburg Postfach 60 22 40 · 22232 Hamburg	040 63 29 00-0 040 630 78 70	-	-
Zweigniederlassung Köln Graf-Zeppelin-Straße 18 · 51147 Köln Postfach 900 149 · 51111 Köln	02203 807-0 02203 807-50	-	-
Zweigniederlassung München Mühlhofstraße 15 · 81671 München Postfach 80 14 69 · 81614 München	089 41 86 95-0 089 4047 64	-	-

Zweigniederlassung Nürnberg Donaustraße 36 90451 Nürnberg	0911 64203-0 0911 64203-33	-	-
Zweigniederlassung Telekommunikation + Mitte Siemensstraße 20 63263 Neu-Isenburg	06102 2007-0 06102 2007-12	-	-

**ADDRESSES WORLDWIDE**

<b>Algeria</b>	ROHDE & SCHWARZ Bureau d'Alger 5B Place de Laperrine 16035 Hydra-Alger	+213 (21) 48 20 18 +213 (21) 69 46 08	
<b>Argentina</b>	PRECISION ELECTRONICA S.R.L. Av. Julio A. Roca 710 - Piso 6 1067 Buenos Aires	+54 (14) 331 16 85 +54 (14) 334 51 11	alberto_lombardi@prec-elec.com.ar
<b>Australia</b>	ROHDE & SCHWARZ (AUSTRALIA) Pty. Ltd. Sales Support Unit 6 2-8 South Street Rydalmere, N.S.W. 2116	+61 (2) 88 45 41 00 +61 (2) 96 38 39 88	sales@rsaus.rohde-schwarz.com
<b>Austria</b>	ROHDE & SCHWARZ-ÖSTERREICH Ges.m.b.H. Sonnleithnergasse 20 1100 Wien	+43 (1) 602 61 41-0 +43 (1) 602 61 41-14	office@rsoe.rohde-schwarz.com
<b>Azerbaijan</b>	ROHDE & SCHWARZ Azerbaijan Liaison Office Baku Azerbaijan Avenue 35 370000 Baku	+994 (12) 93 31 38 u. +994 (12) 98 79 01 +994 (12) 93 03 14	r&s-azerbaijan@artel.net.az
<b>Baltic Countries</b>	siehe/see Denmark		
<b>Bangladesh</b>	BIL Consortium Ltd. Corporation Office House No: 95/A, Block - 'F' Road No: 4, Banani Dhaka-1213	+880 (2) 881 06 53 +880 (2) 882 82 91	
<b>Belgium</b>	ROHDE & SCHWARZ BELGIUM N.V. Excelsiorlaan 31 Bus 1 1930 Zaventem	+32 (2) 721 50 02 +32 (2) 725 09 36	info@rsb.rohde-schwarz.com
<b>Bolivia</b>	RIBCO LTDA. Av. Mariscal Santa Cruz # 1392 Ed. Cámara Nacional de Comercio Piso 10, Of. 1010-1011 La Paz	+591 (2) 33 48 05 +591 (2) 39 30 47	gibatta@caoba.entelnet.bo
<b>Brasil</b>	ROHDE & SCHWARZ DO BRASIL LTDA. Av. Alfredo Egídio de Souza Aranha, 177, 1. Andar - Santo Amaro 04726-170 Sao Paulo - SP	+55 (11) 56 41 12 00 +55 (11) 56 41 78 10	andrea.silva@rsdb.rohde-schwarz.com
<b>Brunei</b>	GKL- Equipment PTE. Ltd. #11-01 BP Tower 396, Alexandra Road Singapore 119954	+65 (2) 76 06 26 +65 (2) 76 06 29	gkleqpt@signet.com.sg
<b>Bulgaria</b>	siehe / see Austria		
<b>Canada</b>	ROHDE & SCHWARZ CANADA Inc. 555 March Rd. Kanata, Ontario K2K 2M5	+1 (613) 592 80 00 +1 (613) 592 80 09	cgjrnwauth@rsccanada.ca
<b>Canada</b>	TEKTRONIX CANADA Inc. Test and Measurement 3280 Langstaff Road, Unit 1 Concord, Ontario L4K 5B6	+1 (416) 747 50 00	

<b>Chile</b>	DYMEQ Ltda. Av. Larrain 6666 Santiago	+56 (2) 277 50 50 +56 (2) 227 87 75	<b>Greece</b>	MERCURY S.A. 6, Loukianou Str. 10675 Athens	+30 (1) 722 92 13 +30 (1) 721 51 98 mercury@hol.gr
<b>China</b>	ROHDE & SCHWARZ Representative Office Beijing Room 602, Parkview Center 2, Jiangtai Road Chaoyang District Beijing 100016	+86 (10) 64 31 28 28 +86 (10) 64 37 98 88 info.rschina@rsbp.rohde- schwarz.com	<b>Guatemala</b>	siehe / see Mexico (EPSA)	
<b>Colombia</b>	FERROSTAAL DE COLOMBIA LTDA. Av. El Dorado No. 97-03 Bogotá, D.C.	+57 (1) 401 13 00 +57 (1) 413 18 06 miguel_canon@ferrostaal.c om	<b>Honduras</b>	siehe / see Mexico (EPSA)	
<b>Croatia</b>	siehe / see Austra		<b>Hongkong</b>	Schmidt Co. (H.K.) Ltd.. 36/F Dorset House, Taikoo Place 979 King's Road Quarry Bay Hong Kong	+852 (25) 07 03 33 +852 (25) 07 09 25 kevinpoon@shk.schmidtgrou.com
<b>Czech Republic</b>	ROHDE & SCHWARZ - Praha s.r.o. Evropská 33c 16000 Praha 6	+420 (2) 24 32 20 14 +420 (2) 24 31 70 43 rohdecz@rsoe.com	<b>Hungary</b>	ROHDE & SCHWARZ Budapesti Iroda Etele ut. 68 1115 Budapest	+36 (1) 203 02 82 +36 (1) 203 02 82 rohdehu@rsoe.rohde-schwarz.com
<b>Denmark</b>	ROHDE & SCHWARZ DANMARK A/S Ejby Industrivej 40 2600 Glostrup	+45 (43) 43 66 99 +45 (43) 43 77 44	<b>Iceland</b>	siehe / see Denmark	
<b>Ecuador</b>	REPRESENTACIONES MANFRED WEINZIERL Guanguiltagua 72 ( 39-93) Urbanización Jardines del Batán Quito	+593 (2) 25 22 51 +593 (2) 25 22 51 mweinzierl@accessinter.net	<b>India</b>	ROHDE & SCHWARZ India Pvt. Ltd. 244, Okhla Industrial Area, Phase-III New Delhi 110020	+91 (11) 632 63 81 (-3 85) +91 (11) 632 63 73 sales@rsindia.rohde-schwarz.com services@rsindia.rohde-schwarz.com
<b>Egypt</b>	U.A.S. Universal Advanced Systems 31 Manshiet El-Bakry Street Heliopolis 11341 Cairo	+20 (2) 455 67 44 +20 (2) 256 17 40 an_uas@intouch.com	<b>Indonesia</b>	ROHDE & SCHWARZ Representative Office Jakarta Menara Rajawali; 24th Floor JL Mega Kuningan Lot # 5.1 Kawasan Mega Kuningan Jakarta 12950	+62 (21) 576 16 02 +62 (21) 576 16 04 sales@rsbj.rohde-schwarz.com services@rsbj.rohde-schwarz.com
<b>El Salvador</b>	siehe / see Mexico (EPSA)		<b>Iran</b>	Islam . Rep. Of Iran ROHDE & SCHWARZ IRAN Ave. Dr. Beheshti/Ave. Pakistan/ 12th Street No. 1 Tehran 15317	+98 (21) 873 02 82 und -54 78 +98 (21) 873 02 83
<b>Estonia</b>	ROHDE & SCHWARZ DANMARK A/S Estonian Branch Office Narva mnt. 13 10151 Tallinn	+372 (6) 14 31 23 +372 (6) 14 31 21 margo.fingling@rsdk.rohde- schwarz.com	<b>Ireland</b>	siehe / see Great Britain	
<b>Finland</b>	Orbis Oy P.O.Box 15 00421 Helsinki 42	+358 (9) 47 88 30 +358 (9) 53 16 04 info@orbis.fi	<b>Israel</b>	EASTRONICS LTD. Messtechnik / T&M Equipment 11 Rozanis St. P.O.Box 39300 Tel Aviv 61392	+972 (3) 645 86 22 +972 (3) 648 66 66 david_hasky@easx.co.il
<b>France</b>	ROHDE & SCHWARZ FRANCE Immeuble "Le Newton" 9-11, rue Jeanne Braconnier 92366 Meudon La Forêt Cédex	+33 (1) 41 36 10 00 +33 (1) 41 36 11 73	<b>Israel</b>	J.M. Moss Engineering Ltd. Kommunikationstechnik/ Communications Equipment 9 Oded Street P.O.Box 967 52109 Ramat Gan	+972 (3) 631 20 57 +972 (3) 631 40 58 jmmoss@zahar.net.il
<b>France</b>	Niederlassung/Subsidiary Rennes Sigma 1 Rue du Bignon F-35135 Chantepie	+33 (2) 99 51 97 00 +33 (2) 99 41 91 31	<b>Italy</b>	ROHDE & SCHWARZ ITALIA S.p.a. Centro Direzionale Lombardo Via Roma 108 20060 Cassina de Pecchi (MI)	+39 (02) 95 70 42 03 +39 (02) 95 30 27 72 ornella.crippa@rsi.rohde-schwarz.com
<b>France</b>	Niederlassung/Subsidiary Toulouse Technoparc 3 B.P. 501 F-31674 Labège Cédex	+33 (5) 61 39 10 69 +33 (5) 61 39 99 10	<b>Italy</b>	ROHDE & SCHWARZ ITALIA S.p.a. Via Tiburtina 1182 00156 Roma	+39 (06) 41 59 82 18 +39 (06) 41 59 82 70
<b>France</b>	Aix-en-Provence	+33 (4) 94 07 39 94 +33 (4) 94 07 55 11	<b>Japan</b>	ADVANTEST Corporation RS Sales Department Shinjuku-NS Building, 4-1 Nishi-Shinjuku Tokyo 163-08	+81 (3) 33 42 75 53 +81 (3) 53 22 72 70 yoshimu@inst.advantest.co.jp
<b>France</b>	Office Lyon	+33 (4) 78 29 88 10 +33 (4) 78 29 94 71	<b>Jordan</b>	Jordan Crown Engineering & Trading Co. Jabal Amman, Second Circle Youssef Ezideen Street P.O.Box 830414 Amman, 11183	+962 (6) 462 17 29 +962 (6) 465 96 72 jocrown@go.com.jo
<b>France</b>	Office Nancy	+33 (3) 83 54 51 29 +33 (3) 83 55 39 51	<b>Kazakhstan</b>	ROHDE & SCHWARZ Kazakhstan Representative Office Almaty Pl. Respubliki 15 480013 Almaty	+7 (32) 72 63 55 55 +7 (32) 72 63 46 33
<b>Ghana</b>	KOP Engineering Ltd. P.O. Box 11012 3rd Floor Akai House, Osu Accra North	+233 (21) 77 89 13 +233 (21) 701 06 20			



<b>Kenya</b>	Excel Enterprises Ltd Dunga Road P.O.Box 42 788 Nairobi	+254 (2) 55 80 88 +254 (2) 54 46 79	<b>Norway</b>	ROHDE & SCHWARZ NORGE AS Olaf Helssets vei 1 0694 Oslo	+47 (23) 38 66 00 +47 (23) 38 84 70
<b>Korea</b>	ROHDE & SCHWARZ Korea Ltd. 83-29 Nonhyun-Dong, Kangnam-Ku Seoul, REP. of KOREA 135-010	+82 (2) 514 45 46 +82 (2) 514 45 49 sales@rskor.rohde-schwarz.com service@rskor.rohde-schwarz.com	<b>Oman</b>	Mustafa Sultan Science & Industry Co. LLC. P.O.Box 3340 Postal Code 112 Ruwi	+968 602009 od. 567744 +968 607066 od. 560599 siteam@omantel.net.om
<b>Kuwait</b>	Group Five Trading & Contracting Co. P.O. Box 26645 Safat 13127	+965 (244) 91 72/73/74 +965 (244) 95 28	<b>Pakistan</b>	TelcoNet Communications & Engineering 42-A, Margalla Road, F-8/3 Islamabad	+92 (51) 226 31 20 +92 (51) 226 32 11 tnc@brain.net.pk
<b>Latvia</b>	ROHDE & SCHWARZ DANMARK A/S Latvian Branch Office Merkela iela 21-301 1050 Riga	+371 (7) 50 23 55 +371 (7) 50 23 60 rsdk@rsdk.rohde-schwarz.com	<b>Papua-New Guinea</b>	siehe / see Australia	
<b>Lebanon</b>	ROHDE & SCHWARZ Liaison Office c/o Haji Abdullah Alireza Co. Ltd. P.O.Box 361 Riyadh 11411	+966 (1) 465 64 28 Ext. 303 +966 (1) 465 64 28 Ext. 229 chris.porzky@rsd.rohde-schwarz.com	<b>Peru</b>	BMP INGENIEROS S.A. Av. José Gálvez Barrenechea 645 Urb. Corpac Lima 41	+51 (1) 225 40 30 +51 (1) 475 15 13 wmgelgajejo@bmp.com.pe
<b>Liechtenstein</b>	siehe / see Switzerland		<b>Philippines</b>	MARCOM INDUSTRIAL EQUIPMENT, Inc. 6-L Mezzanine Suite, Vernida I Condominium 120 Amorsolo St. Legaspi Village Makati City/Philippines 3117	+63 (2) 813 29 31 +63 (2) 817 05 07 marcom@i-next.net
<b>Lithuania</b>	ROHDE & SCHWARZ DANMARK A/S Lithuanian Office Lukiskiu 5-228 2600 Vilnius	+370 (2) 22 46 62 +370 (2) 22 46 62	<b>Poland</b>	ROHDE & SCHWARZ Österreich SP.z o.o. Przedstawicielstwo w Polsce ul. Stawki 2, Pietro 28 00-193 Warszawa	+48 (22) 860 64 94 +48 (22) 860 64 99 rohdepl@soe.rohde-schwarz.com
<b>Luxembourg</b>	siehe / see Belgium		<b>Portugal</b>	TELERUS Sistemas de Telecomunicacoes S.A. Rua General Ferreira Martins Lote 6, 2º B 1495-137 Algés	+351 (21) 412 35 90 +351 (21) 412 36 00 telerus@mail.telepac.pt
<b>Malaysia</b>	DAGANG TEKNIK SDN. BHD. No. 9, Jalan SS 4D/2 Taman People's Park Selangor Darul Ehsan 47301 Petaling Jaya	+60 (3) 703 55 68 +60 (3) 703 34 39 danik@tm.net.my	<b>Republic of Cyprus</b>	HINIS TELECAST LTD. P.O.Box 432 Agiou Thoma 18 Kiti 6304 Larnaca	+357 (4) 42 51 78 +357 (4) 42 46 21 hinis@logos.cy.net
<b>Malta</b>	ITEC International Technology Ltd B'Kara Road San Gwann SGN 08	+356 (3) 743 00 or (3) 743 29 +356 (3) 743 53 sales@itec.com.mt	<b>Romania</b>	ROHDE & SCHWARZ Representation Office Bucharest Str. Uranus 98 Sc. 2, Et. 5, Ap. 36 76102 Bucuresti, Sector 5	+40 (1) 410 68 46 +40 (1) 411 20 13 rohdero@soe.rohde-schwarz.com
<b>Mexico</b>	Electroingenieria de Precision, S.A. (EPSA) Uxmal 520 Colonia Vertiz Narvarte 03600 Mexico D.F.	+52 (5) 559 76 77 +52 (5) 575 33 81 rwwolf@epsa-mex.com	<b>Russian Federation</b>	ROHDE & SCHWARZ Representative Office Moscow Kazachy per. 7 109017 Moscow	+7 (095) 234 49 62 +7 (095) 234 49 63 rohderus@soe.rohde-schwarz.com
<b>Mexico</b>	Tektronix S.A. de C.V. Col. Insurgentes Cuicuilco Del. Coyoacán 04530 Mexico, D.F.	+52 (5) 666 63 33 +52 (5) 666 63 36 jose.delgado@tektronix.com	<b>Saudi Arabia</b>	Mr. Chris Porzky ROHDE & SCHWARZ International GmbH c/o Haji Abdullah Alireza Co. Ltd. P.O.Box 361 Riyadh 11411	+966 (1) 465 64 28 Ext. 303 +966 (1) 465 6428 Ext. 229 chris.porzky@ rsd.rohde-schwarz.com
<b>Netherlands</b>	ROHDE & SCHWARZ NEDERLAND B.V. Perkinsbaan 1 3439 ND Nieuwegein	+31 (30) 600 17 00 +31 (30) 600 17 99 info@rsn.rohde-schwarz.com	<b>Singapore</b>	INFOTEL TECHNOLOGIES LTD. 19 Tai Seng Drive #02-01 HeShe Building Singapore 535227	+65 (2) 87 68 22 +65 (2) 84 95 55 general@infotel.com.sg
<b>Nepal</b>	Abishek Trade Links (P) Ltd. P.O.Box 9700 Kathmandu	+977 (1) 25 69 30 +977 (1) 24 25 73 durbar@hotel.mos.com.np	<b>Singapore</b>	ROHDE & SCHWARZ Support Centre Asia PTE Ltd. 1 Kaki Bukit View #04-05/07 Techview Singapore 415941	+65 (8) 46 37 10 +65 (8) 46 00 29 veronica.tan@rsg.rohde-schwarz.com
<b>New Zealand</b>	Nichecom Level 1, Tawa Plaza 210 Main Road Tawa, Wellington	+64 (4) 232 32 33 +64 (4) 232 32 30 rob@nichecom.co.nz	<b>Slovak Republic</b>	Specialne systémy a software, a.s. Svrčia ul. 841 04 Bratislava	+421 (7) 65 42 25 29 +421 (7) 65 42 07 68 3s@internet.sk
<b>Nicaragua</b>	siehe / see Mexico (EPSA)		<b>Slovenia</b>	ROHDE & SCHWARZ Representation Ljubljana Tbilisjska 89 1000 Ljubljana	+386 (61) 423 46 51 +386 (61) 423 46 11 rohdesi@soe.rohde-schwarz.com
<b>Nigeria</b>	Ferrostaal (NIGERIA) Ltd. P.O. Box 72021 27/29 Adeyamo Alkaija Street Victoria Island Lagos	+234 (1) 262 00 60 +234 (1) 262 00 64 fs-nig@linkserve.com.ng			

<b>South Africa</b>	Protea Data Systems (Pty.) Ltd. Communications and Measurement Division Private Bag X19 Bramley 2018	+27 (11) 719 57 00 or -57 91 +27 (11) 786 58 91 unicm@protea.co.za or colin.forbes@protea.co.za	<b>United Arab Emirates</b>	ROHDE & SCHWARZ Liaison Office Dubai P.O.Box 5267 Dubai	+971 (4) 394 48 29 +971 (4) 394 47 94 kahmann@emirates.net.ae
<b>Spain</b>	ROHDE & SCHWARZ ESPANA S.A. Salcedo, 11  28034 Madrid	+34 (91) 334 10 70 +34 (91) 329 05 06 rema@rema.es	<b>United Arab Emirates</b>	ROHDE & SCHWARZ Emirates L.L.C. P.O.Box 31156 Abu Dhabi	+971 (2) 631 20 40 +971 (2) 631 30 40 rsuaeam@emirates.net.ae
<b>Sri Lanka</b>	LANKA AVIONICS 658/1/1, Negombo Road Mattumagala Ragama	+94 (1) 95 66 78 +94 (1) 95 83 11 lankavio@sltnet.lk	<b>United Kingdom</b>	ROHDE & SCHWARZ UK Ltd. Ancells Business Park Fleet Hampshire GU 51 2UZ England	+44 (1252) 81 13 77 +44 (1252) 81 14 47
<b>Sudan</b>	SolarMan Co. Ltd. P.O.Box 11 545 North of Fraouq Cementry 6/7/9 Bldg. 16 Karthoum	+249 (11) 47 31 08 +249 (11) 47 31 38 solarman29@hotmail.com	<b>Uruguay</b>	AEROMARINE S.A. Cerro Largo 1497 11200 Montevideo	+598 (2) 400 39 62 +598 (2) 401 85 97 aeromar@adinet.com.uy
<b>Sweden</b>	ROHDE & SCHWARZ SVERIGE AB Flygfältsgatan 15 128 30 Skarpnäck	+46 (8) 605 19 00 +46 (8) 605 19 80 info@rss.se	<b>USA</b>	ROHDE & SCHWARZ, Inc. Broadcast Equipment Comm. Equipment (US Headquarters) 7150-K Riverwood Drive Columbia, MD 21046	+1 (410) 910 78 00 +1 (410) 910 78 01 rsatv@rsa.rohde-schwarz.com rsacomms@rsa.rohde-schwarz.com
<b>Switzerland</b>	Roschi Rohde & Schwarz AG Papiermühlestr. 145 3063 Ittigen	+41 (31) 922 15 22 +41 (31) 921 81 01 marianne.balsiger@roschi.rohde-schwarz.com	<b>USA</b>	Rohde & Schwarz c/o Tektronix Inc. Marketing & Support Center / T&M Equipment 2540 SW Alan Blumlein Way M/S 58-925 Beaverton, OR 97077-0001	+1 (503) 627 26 84 +1 (503) 627 25 65 info@rsa.rohde-schwarz.com
<b>Syria</b>	Electro Scientific Office  Baghdad Street Dawara Clinical Lab. Bldg P.O.Box 8162 Damascus	+963 (11) 231 59 74 +963 (11) 231 88 75	<b>USA</b>	Rohde & Schwarz c/o Tektronix Inc. System Support Center/ T&M Systems & Services 2540 SW Alan Blumlein Way M/S 58-925 Beaverton, OR 97077-0001	+1 (503) 627 33 06 +1 (503) 627 25 65 info@rsa.rohde-schwarz.com
<b>Taiwan</b>	Lancer/System Communication Co. Ltd.  16F, No. 30, Pei-Ping East Road Taipei	+886 (2) 23 91 10 02 +886 (2) 23 95 82 83 info@lancercomm.com.tw	<b>Venezuela</b>	EQUILAB TELECOM C.A. Centro Seguros La Paz Piso 6, Local E-61 Ava. Francisco de Miranda Boleita, Caracas 1070	+58 (2) 12 34 46 26 +58 (2) 122 39 52 05 r_ramire@equilabtelecom.com.ve
<b>Tanzania</b>	Security Systems Tanzania Ltd. P.O. Box 7512 Dunga Street Plot 343/345 Dar es Salaam	+255 (22) 276 00 37 +255 (22) 276 02 93 sstl@twiga.com	<b>Venezuela</b>	REPRESENTACIONES BOPIC S.A. Calle C-4 Qta. San Jose Urb. Caurimare Caracas 1061	+58 (2) 129 85 46 90 +58 (2) 129 85 39 94 incotr@cantv.net
<b>Thailand</b>	SCHMIDT SCIENTIFIC (THAILAND) Ltd. 63 Government Housing Bank Bldg. Tower II, 19th floor, Rama 9 Rd. Huaykwang, Bangkapi Bangkok 10320	+66 (2) 643 13 30-9 +66 (2) 643 13 40 kamthon@schmidtthailand.com	<b>Vietnam</b>	Schmidt Vietnam Co., Ltd. Intern. Technology Centre 8/F, Schmidt Tower, Hanoi Cau Giay, Tu Liem, IPO Box 89 Hanoi	+84 (4) 834 61 86 +84 (4) 834 61 88 svnhn@schmidtgroup.com
<b>Thailand</b>	TPP Operation Co., Ltd. 41/5 Mooban Tarinee Boromrajchonnee Road Talingchan, Bangkok 10170	+66 (2) 880 93 47 +66 (2) 880 93 47			
<b>Turkey</b>	ROHDE & SCHWARZ International GmbH Liaison Office Istanbul Bagdad Cad. 191/3, Arda Apt. B-Blok 81030 Selamicesme-Istanbul	+90 (216) 385 19 17 +90 (216) 385 19 18 rsturk@superonline.com			
<b>Ukraine</b>	ROHDE & SCHWARZ Representative Office Kiev 4, Patris Loumoumba ul 252042 Kiev	+38 (044) 268 60 55 +38 (044) 268 83 64 rohdeukr@soe.rohde-schwarz.com			
<b>United Arab Emirates</b>	ROHDE & SCHWARZ International GmbH Liaison Office Abu Dhabi P.O. Box 31156 Abu Dhabi	+971 (2) 633 56 70 +971 (2) 633 56 71 michael.rogler@rsd.rohde-schwarz.com			
<b>United Arab Emirates</b>	ROHDE & SCHWARZ Bick Mobile Communication P.O.Box 17466 JAFZ, PPU ZG-07 Dubai	+971 (4) 883 71 35 +971 (4) 883 71 36 www.rsbeck.de			

# Contents of Manuals for Spectrum Analyzer FSE

## Operating Manual FSE

The operating manual describes the following models and options:

- FSEA20/30      9kHz/20 Hz to 3,5 GHz
- FSEB20/30      9kHz/20 Hz to 7 GHz
- FSEM20/30      9kHz/20 Hz to 26,5 GHz
- FSEK20/30      9kHz/20 Hz to 40 GHz
  
- Option FSE-B3      TV Demodulator
- Option FSE-B5      FFT Filter
- Option FSE-B8/9/10/11      Tracking Generator
- Option FSE-B13      1 dB Attenuator
- Option FSE-B15      DOS Controller (Id.-Nr: 1073.5696.02/.03)
- Option FSE-B15      Windows NT Controller (Id.-Nr.: 1073.5696.06)
- Option FSE-B16      Ethernet Adapter
- Option FSE-B17      Second IEC/IEEE Bus Interface

Options FSE-B7, Vector Signal Analysis, and FSE-B21, External Mixer Output, are described in separate manuals.

The present operating manual contains comprehensive information about the technical data of the instrument, the setup and putting into operation of the instrument, the operating concept and controls as well as the operation of the FSE via the menus and via remote control. Typical measurement tasks for the FSE are explained using the functions offered by the menus and a selection of program examples.

In addition the operating manual gives information about maintenance of the instrument and about error detection listing the error messages which may be output by the instrument. It is subdivided into 2 volumes containing the data sheet plus 9 chapters:

### Volume 1

- The data sheet**      informs about guaranteed specifications and characteristics of the instrument.
- Chapter 1**      describes the control elements and connectors on the front and rear panel as well as all procedures required for putting the FSE into operation and integration into a test system.
- Chapter 2**      gives an introduction to typical measurement tasks of the FSE which are explained step by step.
- Chapter 3**      describes the operating principles, the structure of the graphical interface and offers a menu overview.
- Chapter 4**      forms a reference for manual control of the FSE and contains a detailed description of all instrument functions and their application.
- Chapter 10**      contains an index for the operating manual.

### Volume 2

- Chapter 5**      describes the basics for programming the FSE, command processing and the status reporting system.
- Chapter 6**      lists all the remote-control commands defined for the instrument. At the end of the chapter a alphabetical list of commands and a table of softkeys with command assignment is given.
- Chapter 7**      contains program examples for a number of typical applications of the FSE.
- Chapter 8**      describes preventive maintenance and the characteristics of the instrument's interfaces.
- Chapter 8**      gives a list of error messages that the FSE may generate.
- Chapter 9**      contains a list of error messages.
- Chapter 10**      contains an index for the operating manual.

**Service Manual - Instrument**

The service manual - instrument informs on how to check compliance with rated specifications (performance test) and on the self tests.

**Service Manual**

The service manual is not delivered with the instrument but may be obtained from your R&S service department using the order number 1065.6016.94.

The service manual informs on instrument function, repair, troubleshooting and fault elimination. It contains all information required for the maintenance of FSE by exchanging modules. It contains information about the individual modules of FSE. This comprises the test and adjustment of the modules, fault detection within the modules and the interface description.

# Contents - Chapter 1 " Preparing for Operation "

<b>1 Preparing for Operation .....</b>	<b>1.1</b>
<b>Description of Front and Rear Panel Views .....</b>	<b>1.1</b>
Front View.....	1.1
Rear View .....	1.13
<b>Start-Up - Instruments with Windows NT® Controller.....</b>	<b>1.18</b>
Unpacking the Instrument.....	1.18
Setting up the Instrument .....	1.18
Stand-alone Operation .....	1.18
19" Rack Installation.....	1.19
EMI Protection Measures .....	1.19
Connecting to AC Supply.....	1.19
AC Power Line Fuses .....	1.19
Switching the Instrument on/off .....	1.20
Switching on the Instrument .....	1.20
Startup Menu and Booting.....	1.21
Switching off the Instrument.....	1.21
Energy Saving Mode .....	1.21
Battery Backed-up Memory .....	1.21
<b>Function Test .....</b>	<b>1.22</b>
<b>Controller Function - Windows NT .....</b>	<b>1.23</b>
<b>Connecting a Mouse.....</b>	<b>1.24</b>
<b>Connecting an External Keyboard .....</b>	<b>1.25</b>
<b>Connecting an External Monitor .....</b>	<b>1.26</b>
<b>Connecting a Printer.....</b>	<b>1.28</b>
Installation of a Network Printer (with option FSE-B16 only) .....	1.34
<b>Connecting a CD-ROM Drive .....</b>	<b>1.36</b>
<b>Firmware Update.....</b>	<b>1.38</b>
<b>Installing Windows NT Software .....</b>	<b>1.39</b>
<b>Options .....</b>	<b>1.40</b>
Option FSE-B17 – Second IEC/IEEE Interface .....	1.40
Installing the software.....	1.40
Operation.....	1.42
Option FSE-B5 - FFT Filter.....	1.43
Option FSE-B16 – Ethernet Adapter .....	1.44
Hardware Installation.....	1.44
Software Installation .....	1.45
Operation.....	1.49

<b>Start-Up - Instruments with MS DOS® Controller or without Controller .....</b>	<b>1.56</b>
Unpacking the Instrument.....	1.56
Instrument Setup .....	1.56
19" Rack Installation.....	1.56
EMI Protection Measures .....	1.57
Connecting to AC Power .....	1.57
AC Power Line Fuses .....	1.57
Instrument On/Off .....	1.57
Battery-Powered Memory .....	1.58
<b>Functional Test .....</b>	<b>1.58</b>
<b>Connecting a Mouse.....</b>	<b>1.58</b>
<b>Connecting an External Keyboard .....</b>	<b>1.62</b>
<b>Connecting an Output Device .....</b>	<b>1.66</b>
<b>Firmware Update.....</b>	<b>1.70</b>
<b>Options .....</b>	<b>1.71</b>
Option FSE-B17 – Second IEC/IEEE Interface .....	1.71
Installing the software.....	1.71
Operation.....	1.71
Option FSE-B5 - FFT Filter.....	1.72
Prerequisites .....	1.72
Enabling the option.....	1.72
Option FSE-B16 – Ethernet Adapter .....	1.73
Hardware Installation.....	1.73
BNC (Thin Ethernet, CheaperNet; FSE-B16 Var. 03) .....	1.73
AUI (Thick Ethernet; FSE B16 Var. 02) .....	1.74
RJ45 (UTP, 10BaseT, Western Connector).....	1.74
Software Installation .....	1.75
Installation of Network Drivers.....	1.75
Installation of Network Operating System .....	1.78
Operation.....	1.81

# 1 Preparing for Operation

Chapter 1 describes the controls and connectors of the Spectrum Analyzer FSE by means of the front and rear view. Then follows all the information that is necessary to put the instrument into operation and connect it to the AC supply and to external devices. The description is separated for FSE equipped with Windows NT controller (page 1.18) and FSE without controller or equipped with DOS controller (page 1.58).

A more detailed description of the hardware connectors and interfaces can be found in chapter 8. Chapter 2 provides an introduction into the operation of the FSE by means of typical examples of configuration and measurement; for the description of the concept for manual operation and an overview of menus refer to chapter 3. For a systematic explanation of all menus, functions and parameters and background information refer to the reference part in chapter 4. For remote control of the FSE refer to the general description of the SCPI commands, the instrument model, the status reporting system, and command description in chapter 5 and 6.

## Description of Front and Rear Panel Views

### Front View

1

Display Screen

|| see Chap. 3 and 4

2

Softkeys

|| see Chap. 3 and 4

3 **USER**



Writing Macros

|| see Chap. 4

4 **MARKER**



Select and set marker

|| see Chap. 4

NORMAL Select and set the marker

SEARCH Set and start the peak/min search

DELTA Select and set the delta markers

MKR ⇒ Set the active marker

5 **FREQUENCY**

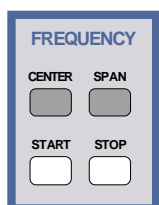

Define frequency axis in the active window

|| see Chap. 4

CENTER Set center frequency

SPAN Set sweep width

START Set start frequency

STOP Set stop frequency

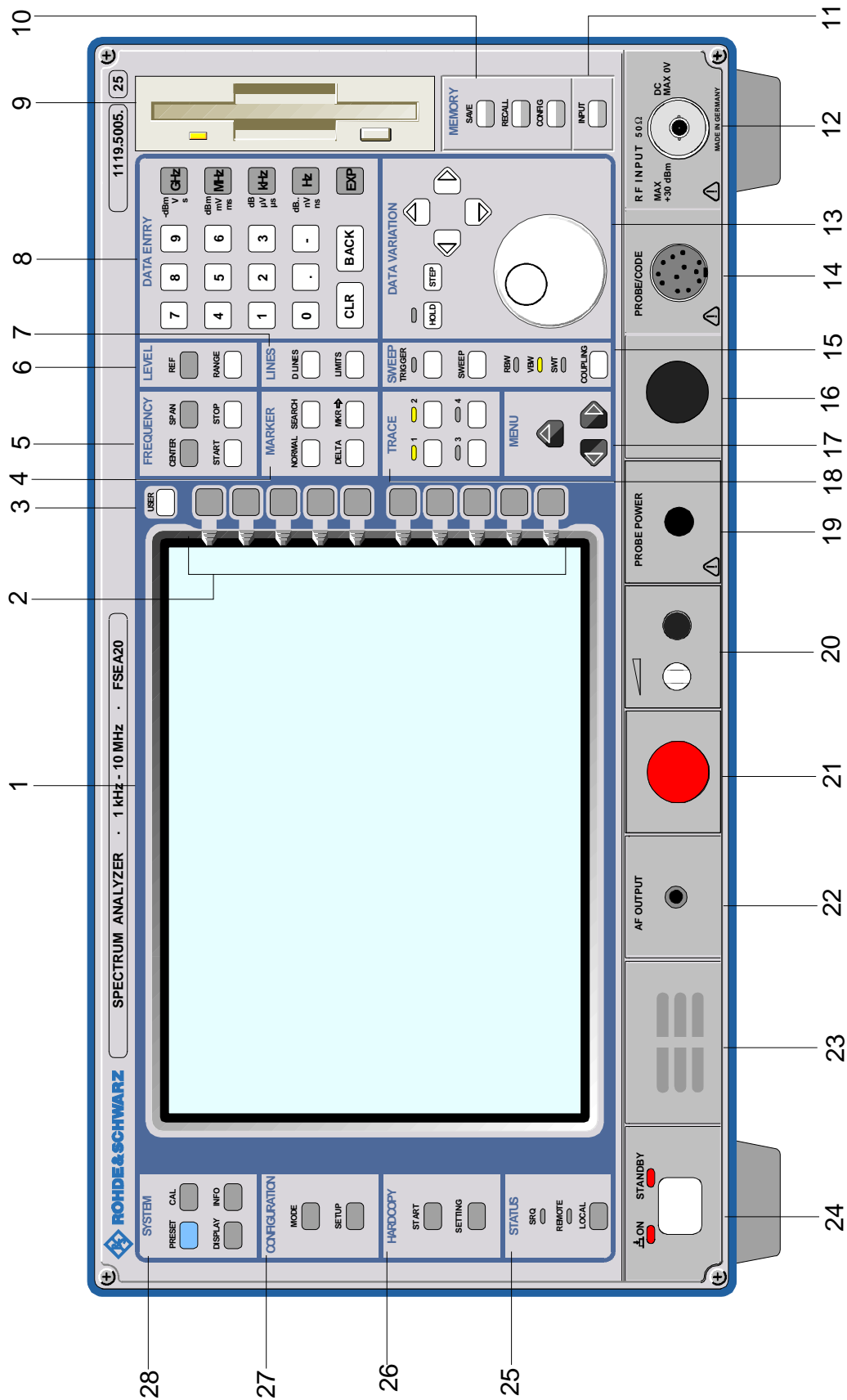
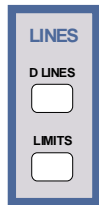

Fig. 1-1 Front View



**6 LINES**



Setup evaluation lines and tolerance limits

D LINES    Setup evaluation lines (display lines)

LIMITS     Definition and recall of tolerance limits

see Chap. 4

**7 LEVEL**

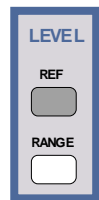

Define reference levels and display range in the active measurement window.

REF        Set reference level  
              (= max. display level)

RANGE     Set range

see Chap. 4

**8 DATA ENTRY**

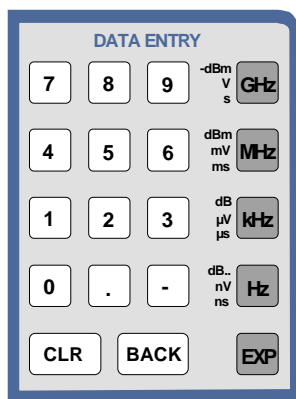

Keypad for data input

0...9     input numbers

.          input decimal point

-          change sign

CLR        - close input field (for uncompleted or already closed inputs, the original entry is kept)

              - erase the current entry in input field (beginning of an input)

              - close message window (status, error and warning messages)

BACK      erase last character input

GHz s     The units keys close the data input and define the multiplication factor for each basic unit.

V -dBm    For dimension-less or alphanumeric inputs, the units keys have weight 1.

MHz ms    They behave, in this case, like the ENTER key.

mV dBm   

kHz μs   

μV dB..   

Hz ns     

nV dB     

EXP        Append an exponent

see Chap. 3

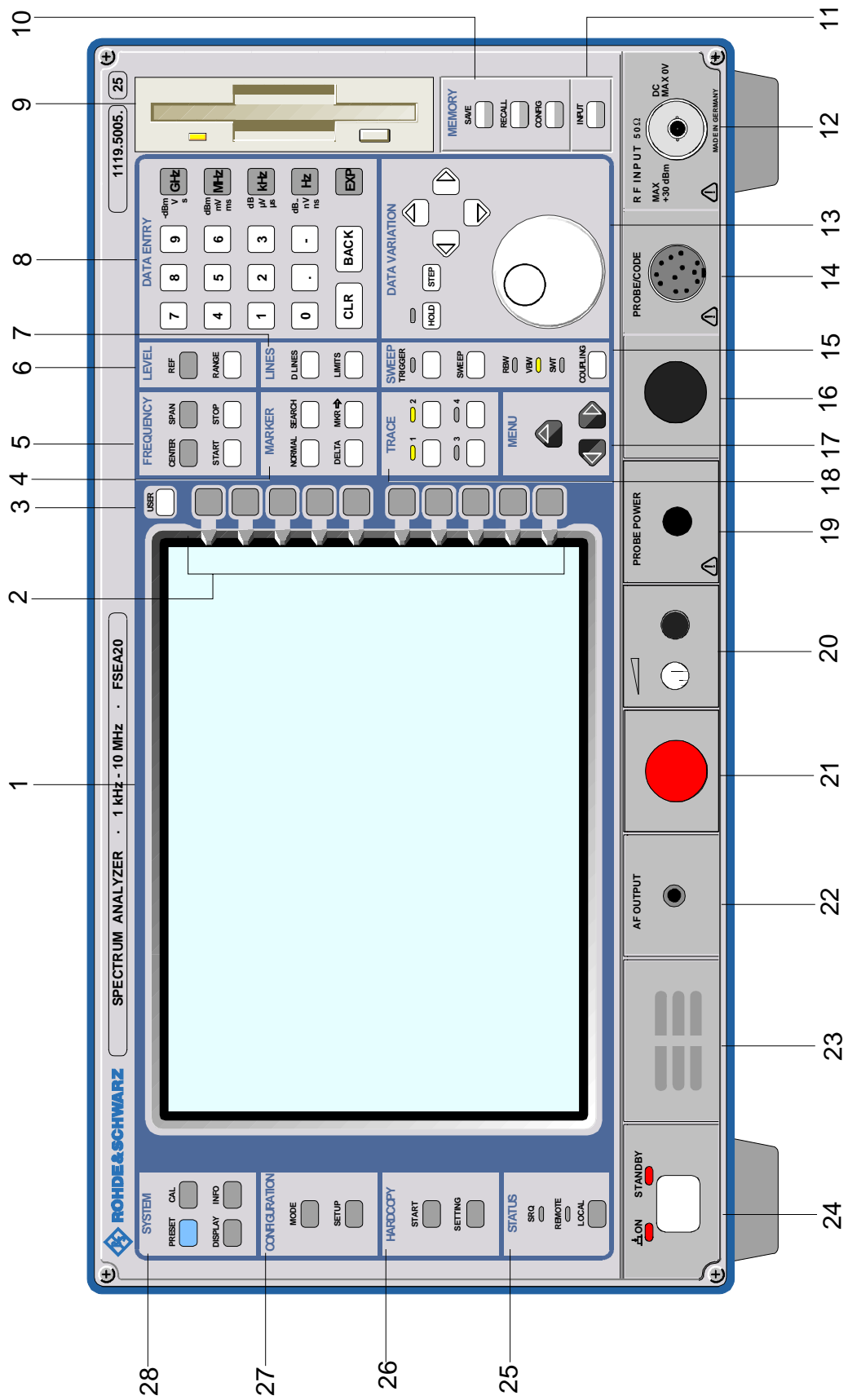

Figure 1-1 Front View

9

3 1/2" diskette drive; 1.44 MByte

10 MEMORY



Memory media and file management

- SAVE Save instrument data
- RECALL Recall instrument data
- CONFIG Configuration of memory media and data

see Chap. 4

11 INPUT

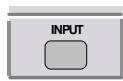

Set impedance and attenuation at the RF input.

see Chap. 4

12 RF INPUT

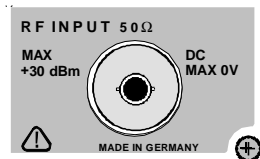

RF-Input



**Caution:**  
The maximum DC voltage is 0 V, the maximum power is 1 W ( $\hat{=} 30$  dBm at  $\geq 10$  dB attenuation)

see Chap. 8

13 DATA VARIATION

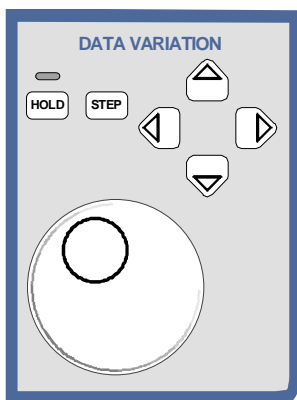

Key group for entering data and for cursor movement

- HOLD** Disable control elements / overall control. The LED indicates the hold condition.
- STEP** Set step size for cursor keys and roll-key.
- Cursor keys** – Move the cursor within the input fields and tables.  
– Vary the input value.  
– Define the direction of movement for the roll-key.
- Roll-key** – Vary input values.  
– Move markers and limits.  
– Select letters in the help line editor.  
– Move cursor in the tables

see Chap. 3

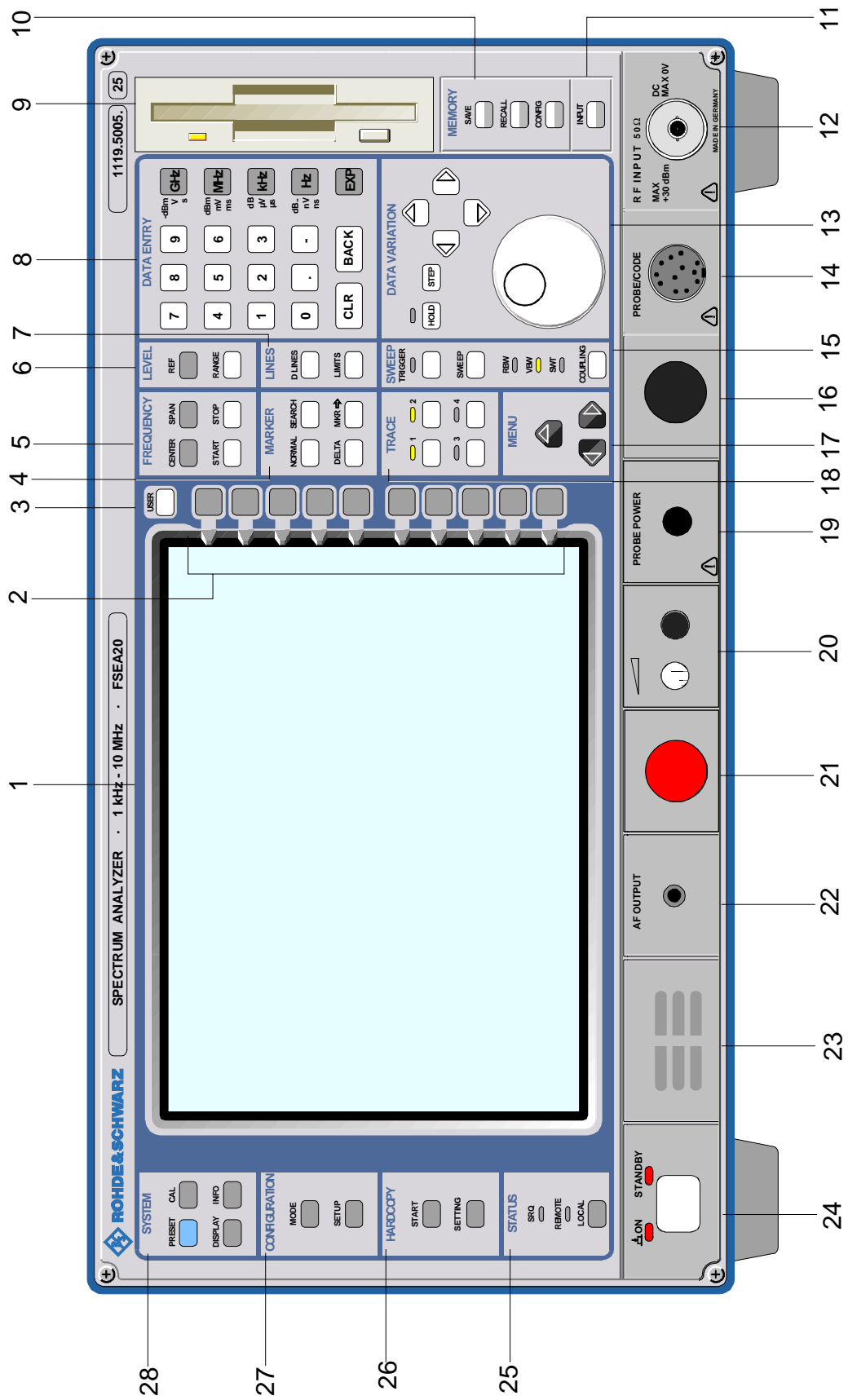
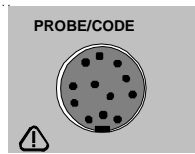

Figure 1-1 Front View

**14 PROBE/CODE**



Power supply and coded socket for R&S accessories.(12-pin Tuchel)

see Chap. 8

**15 SWEEP**

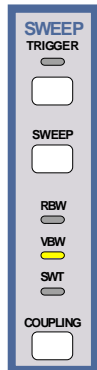

Input sweep parameters

see Chap. 4

**TRIGGER** Set trigger source. The LED illuminates on valid trigger.

**SWEEP** Set type of sweep.

**COUPLING** Set coupled parameters. Resolution BandWidth (RBW), Video BandWidth (VBW) and SWEEP Time (SWT). The LEDs light indicating coupled parameters which are manually cancelled.

**16**

Reserved for options

**17 MENU**

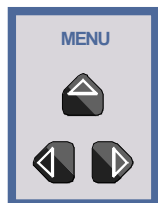

Menu-change keys

see Chap. 3

 Call main menu

 Change to left menu

 Change to right menu

**18 TRACE**

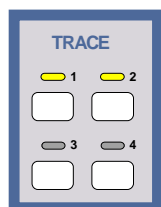

Select and activate measurement traces (Trace 1...4).  
The LEDs indicate traces turned on.

see Chap. 4

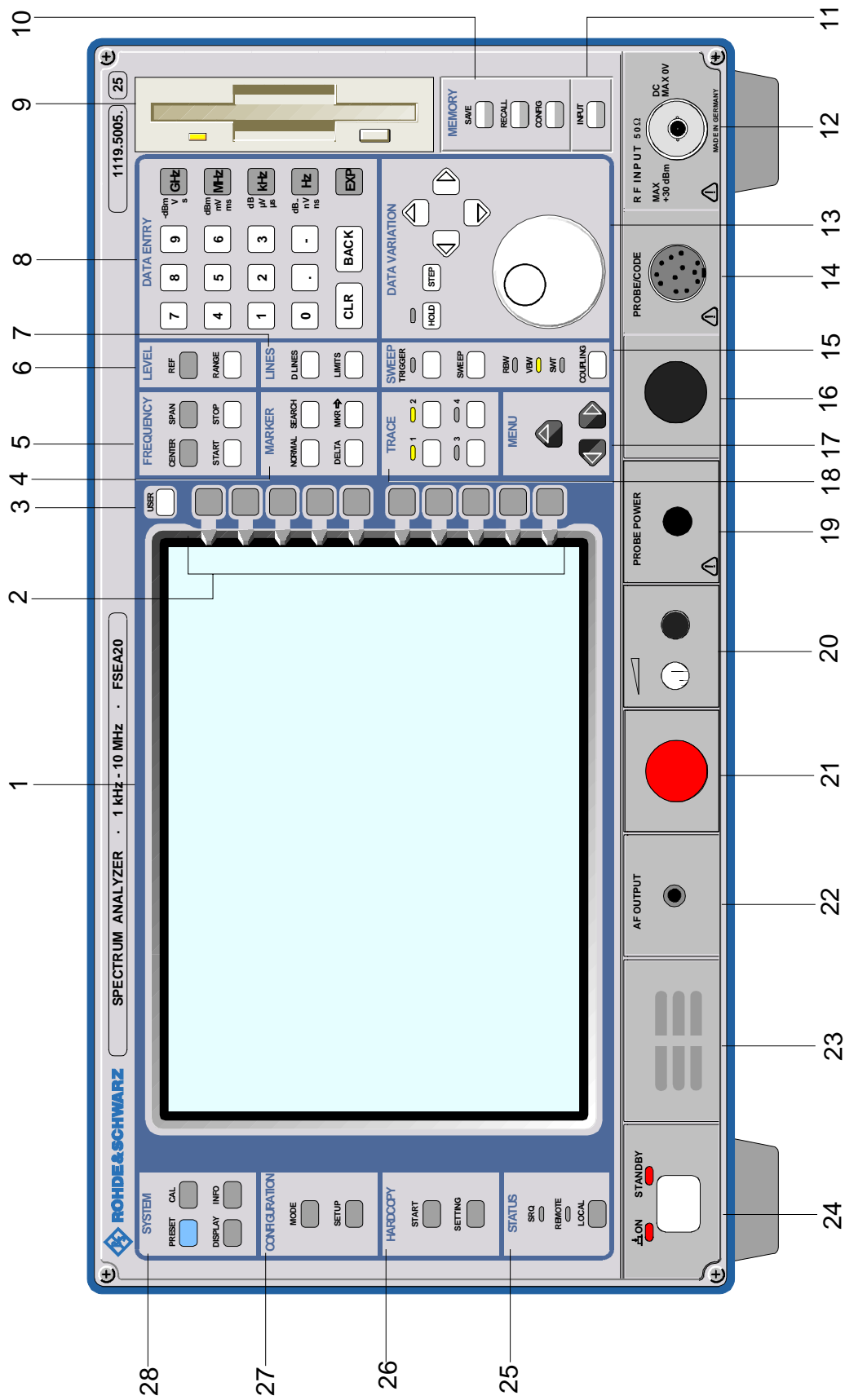
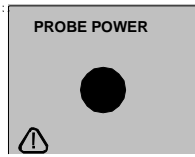

Figure 1-1 Front View

**19 PROBE POWER**



Power supply connector (+15V / - 12.6V) for measurement accessories (probes)

see Chap. 8

**20**

Reserved for options

**21**

Reserved for options

**22 AF OUTPUT**

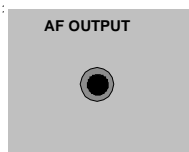

AF output connector (head phones) (miniature phone jack)

see Chap. 8

**23**



Internal loudspeaker

The loudspeaker is disabled when the phone jack is inserted in the AF output.

see Chap. 8

**24**

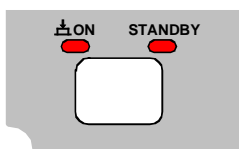

ON/STANDBY



**Caution:**

*In standby mode, the AC line voltage is still present within the instrument.*

see Chap. 1

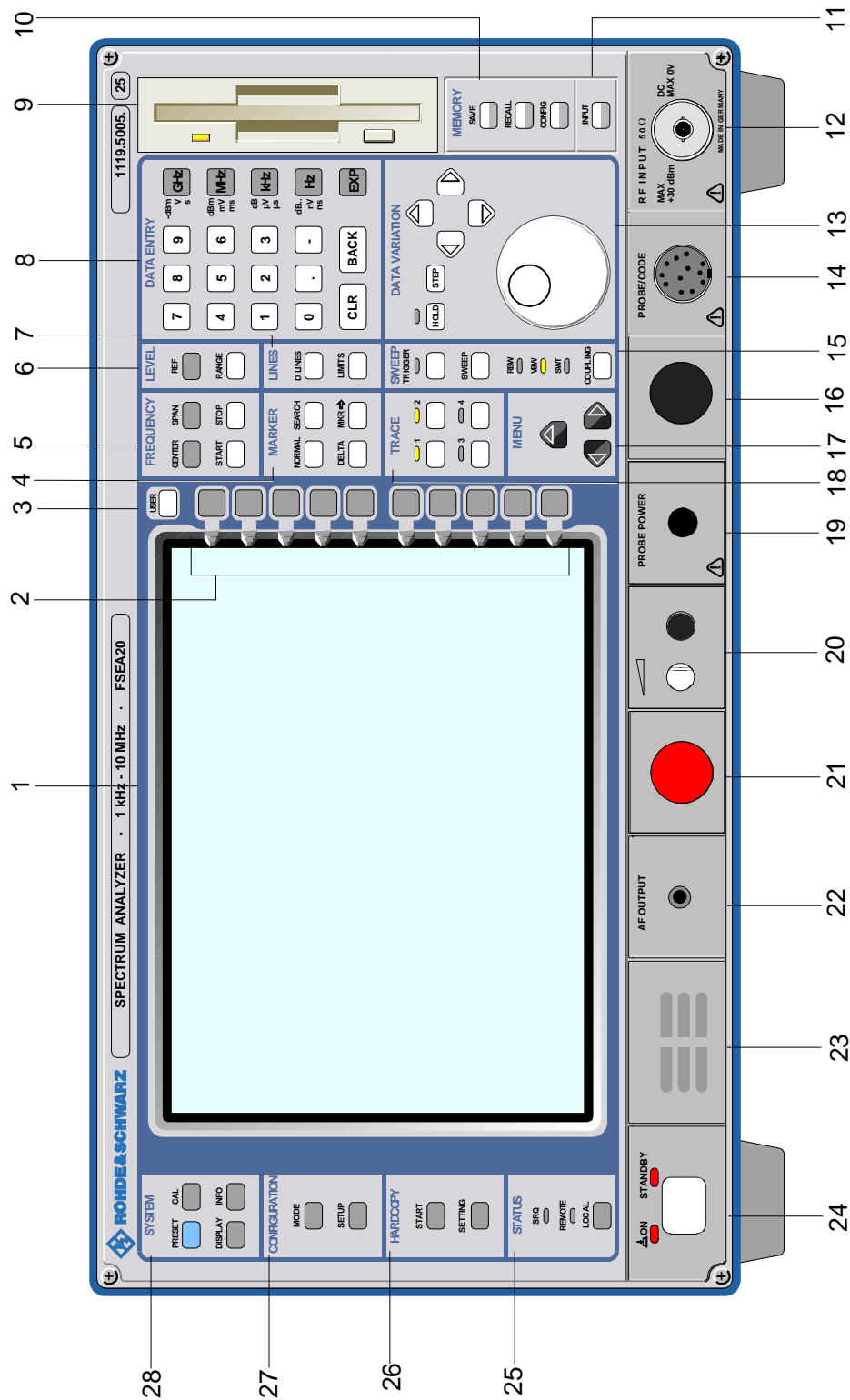
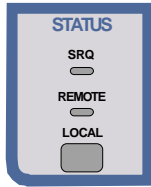

Fig.1-1 Front View



**25 STATUS**

Indicators for remote control and switch for manual control.

see Chap. 4

**LOCAL** Switch from remote to manual control.

The LED SRQ indicates that a service request from the instrument is active on the IEC Bus.

The LED REMOTE indicates that the instrument is under remote control.

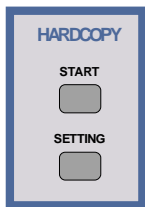
**26 HARDCOPY**

Printer control

see Chap. 4

**START** Start a print job with the setup defined in the SETTING menu.

**SETTING** Configure the diagram, parameter list and measurement protocol outputs on the various output media.

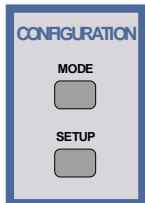
**27 CONFIGURATION**

Select operational modes and define default settings

see Chap. 4

**MODE** Select mode

**SETUP** Define configurations

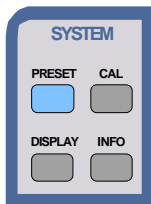
**28 SYSTEM**

General instrument default settings

see Chap. 4

**PRESET** Recall instrument default settings

**DISPLAY** Configure the display screen format

**CAL** Calibrate the analyzer

**INFO**

- Information concerning instrument state and measurement parameters
- Call help functions

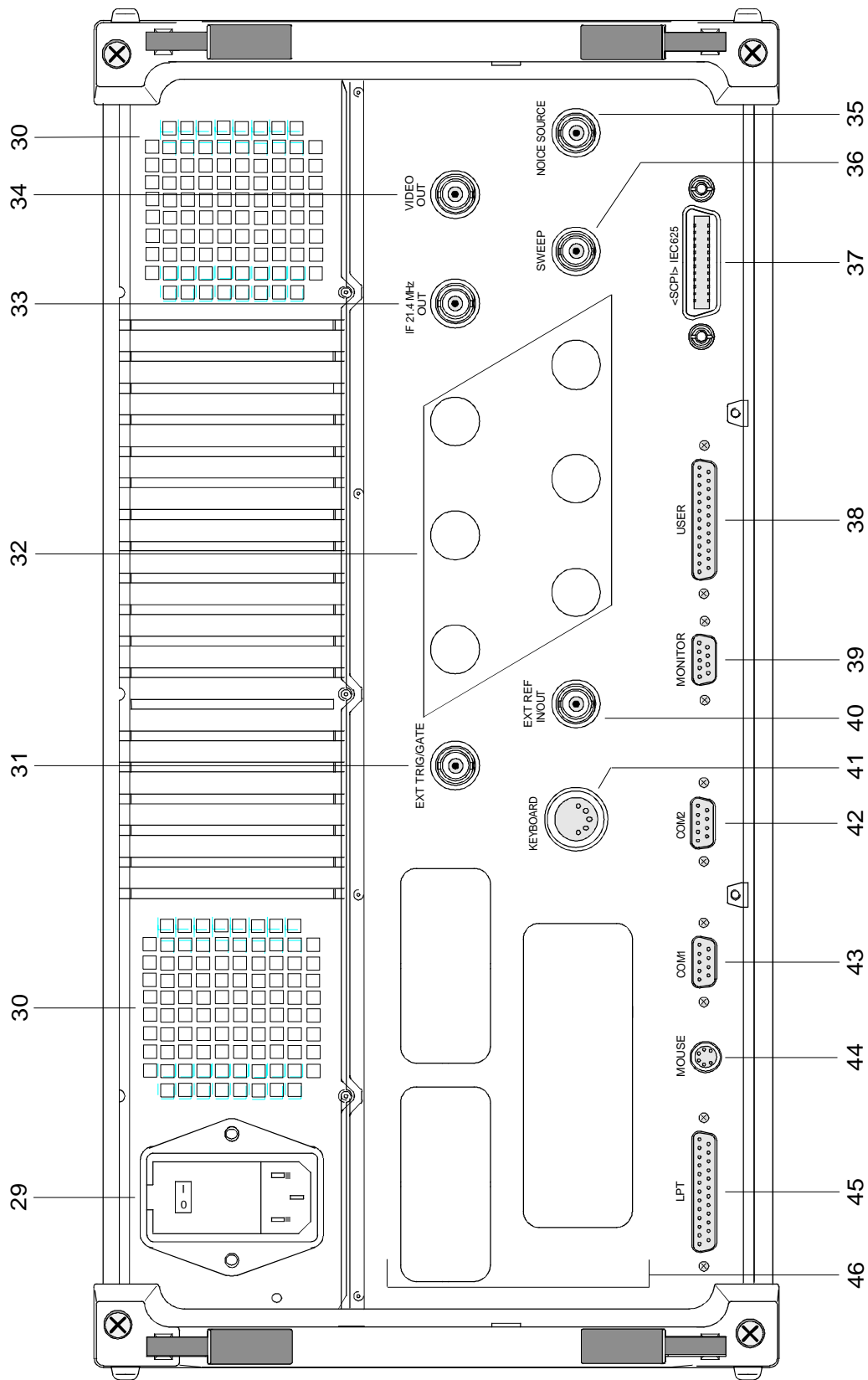
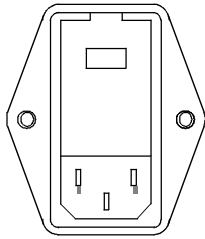

Fig. 1-2 Rear View

Rear View

29



Power switch

Fuse holder

AC power connector

see Chap. 1

30

Power supply fans

31 EXT TRIG/GATE

EXT TRIG/GATE



Input connector for an external trigger or an external gate signal

see Chap. 4 and 8

32

Reserved for options

33 IF 21.4 MHZ OUT

IF 21.4 MHz  
OUT



Output connector for 21.4 MHz IF

see Chap. 8

34 VIDEO OUT

VIDEO  
OUT



Output connector for video signal

see Chap. 8

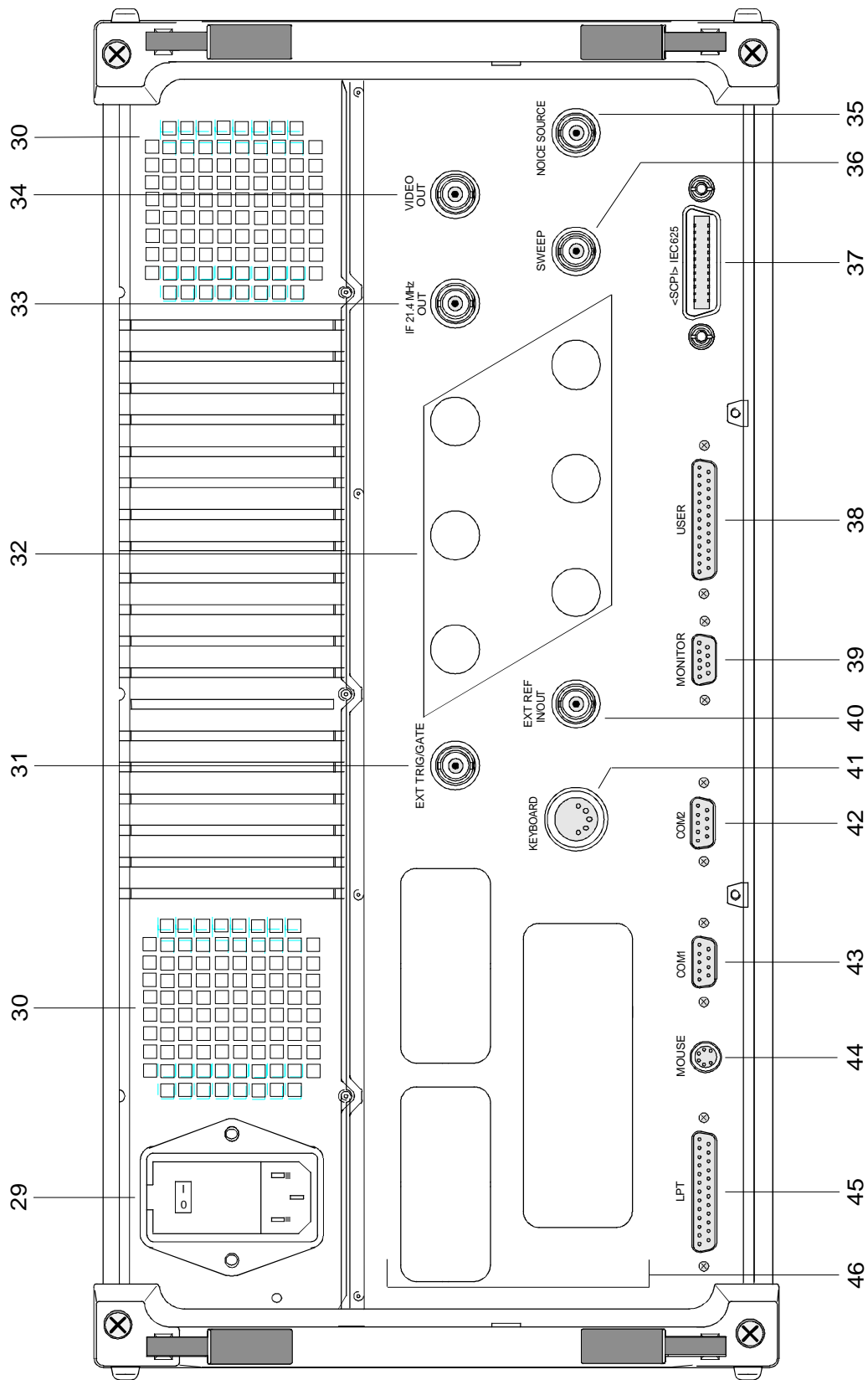

Figure 1-2 Rear View

**35 NOISE SOURCE**

NOISE SOUR



Output connector for a switchable noise source

see Chap. 8

**36 SWEEP**

SWEEP



Output connector

During a sweep, a sawtooth voltage is output which is proportional to frequency.

see Chap. 8

**37 <SCPI> IEC625**

&lt;SCPI&gt; IEC625



IEC/IEEE-bus-connector

see Chap. 8

**38 USER**

USER

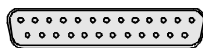

User interface connector with configurable inputs and outputs (USER-PORT A and USER-PORT B)

see Chap. 8

**39 MONITOR**

MONITOR



Connector for an external VGA monitor

see Chap. 8

**40 EXT REF IN/OUT**EXT REF  
IN/OUT

Input connector for an external reference (1 to 16 MHz), switchable to 10 MHz output

see Chap. 4 and 8

**41 KEYBOARD**

KEYBOARD

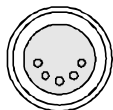

Connector for an external keyboard (5-pin DIN socket)

see Chap. 1 and 8

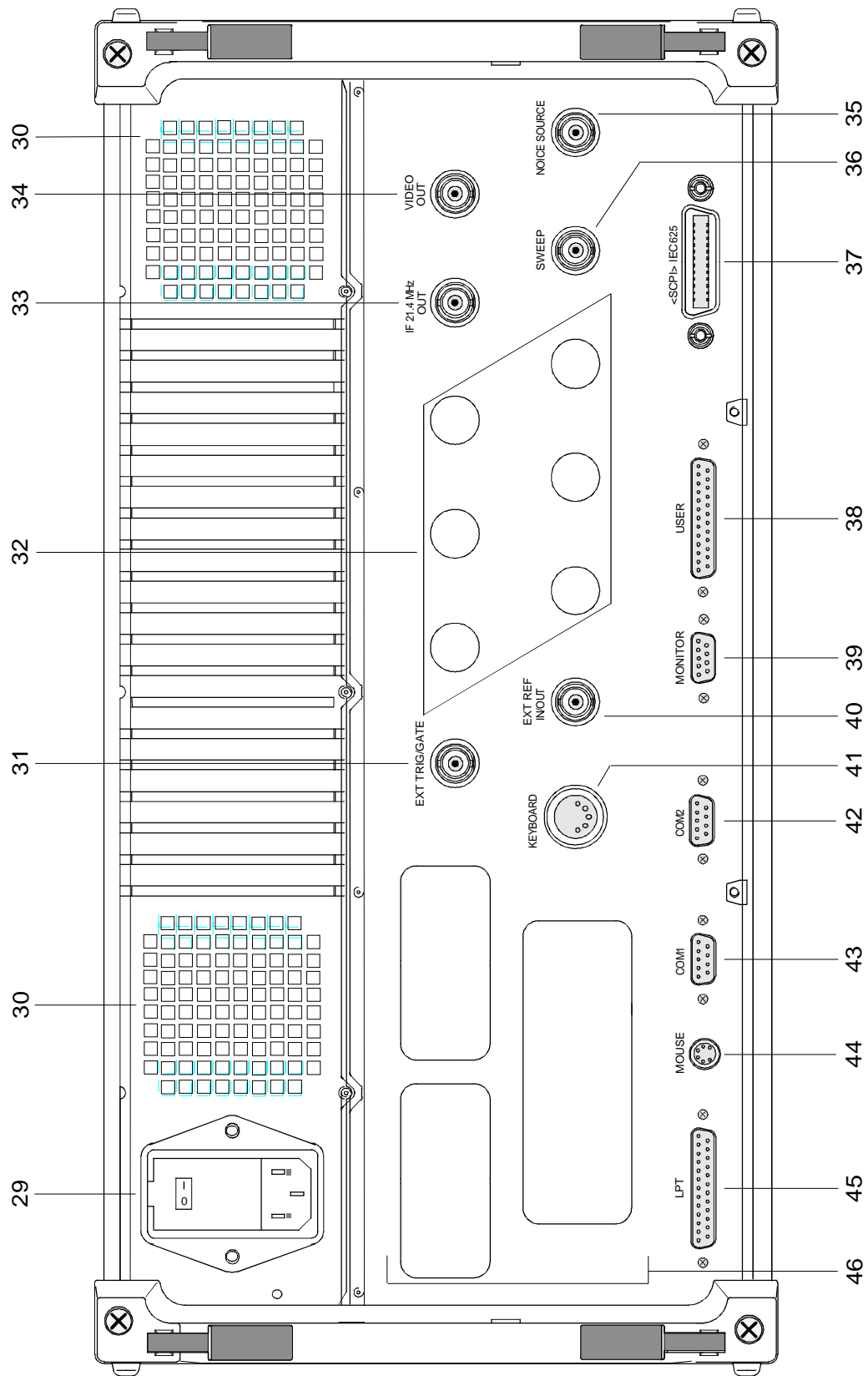

Figure 1-2 Rear View

**42 COM2**

Connector for serial interface 2  
(9-pin socket; COM2)

|| see Chap. 1 and 8

**43 COM1**

Connector for serial interface 1  
(9-pin socket; COM1)

|| see Chap. 1 and 8

**44 MOUSE**

Connector for a PS/2 mouse

|| see Chap. 1 and 8

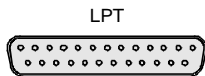
**45 LPT**

Parallel interface connector  
(printer connector, Centronics compatible)

|| see Chap. 1 and 8

**46**

Inputs / Outputs for options  
(cover plates for digital interface expansion)

||

## Start-Up - Instruments with Windows NT<sup>®</sup> Controller

The following section describes how to put the instrument into service and how to connect external devices like eg printer and monitor.



### **Important Note:**

*Before turning the instrument on, check the following:*

- *instrument covers are in place and screwed down,*
- *fan openings are free from obstructions,*
- *signal levels at the input connectors are all within specified limits,*
- *signal outputs are connected correctly and not overloaded.*

***The instrument may be damaged if the above conditions are not observed.***

## Unpacking the Instrument

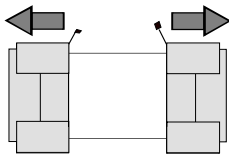

remove protective caps

- Take the instrument out of its transport container and check whether the items listed in the packing list and in the lists of accessories are all there.
- Remove the two protective covers from the front and rear of the FSE and carefully check the instrument for damage.
- Should the instrument be damaged, immediately notify the carrier which shipped the instrument to you and keep the container and packing material.
- For further transport or shipment of the FSE the original packing should also be used. It is recommended to keep at least the two protective covers for the front and rear to prevent damage to the controls and connectors.

## Setting up the Instrument

### Stand-alone Operation

The instrument is designed for use under general laboratory conditions. The ambient conditions must be as follows:

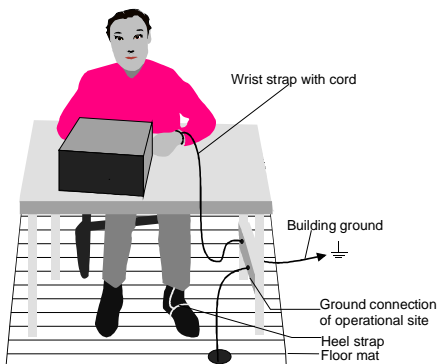

- The ambient temperature must be in the range recommended in the data sheet.
- All fan openings must be unobstructed and the air flow at the rear panel and at the side-panel perforations must not be obstructed. The distance from the wall should be at least 10 cm.
- The FSE should be placed on a level surface.
- In order to avoid damage of electronic components of the instrument or of the device under test due to electrostatic discharge on manual touch, protection of the operational site against electrostatic discharge is recommended.

For applications in the laboratory or on a work bench, it is recommended that the support feet on the bottom of the instrument be extended. For the LCD display, this provides the optimum viewing angle which typically ranges from perpendicular to the display front to approximately 30° below.



## 19" Rack Installation

**Important Note:**

*When the instrument is rack-mounted, ensure that the air flow through the side-panel holes and the air outlet in the rear panel are not obstructed.*

The instrument may be mounted in a 19" rack by using the rack adapter kit ZZA-95 (order number: see data sheet). The installation instructions are included in the adapter kit.

## EMI Protection Measures

In order to prevent electromagnetic interference (EMI), the instrument may be operated only when all covers are correctly in place. Only adequately shielded signal and control cables may be used (see recommended accessories).

## Connecting to AC Supply

The FSE features automatic AC-line voltage selection (range: see power supply name-plate). The AC power connector is located on the rear panel (see below).

- Connect the instrument to the AC power source using the AC power cable delivered with the instrument.

## AC Power Line Fuses

The FSE is protected by two fuses as specified on the power supply name-plate. The fuses are located in a removable fuse holder which is located between the AC power switch and the AC power connector (see below).

## Switching the Instrument on/off



### Caution:

**Do not power down during booting.** This may corrupt harddisk files.

**Note:** On power-up, the drive should contain no disk, since otherwise the instrument will try to boot from the disk.

AC power switch on the rear panel

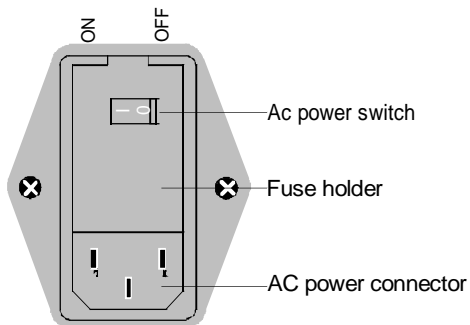

### Power switch

After turn-on (position ON), the instrument is in the ready state (STANDBY) or in operation dependent upon the position of the ON/STANDBY switch located on the instrument front panel (see below).

**Note:** The AC power switch can be left ON all the time.. Switching to OFF is only required when the instrument has to be completely disconnected from the AC power source.

Switching to OFF (position OFF) disconnects the FSE completely from the AC power source.

ON/STANDBY switch on the front panel

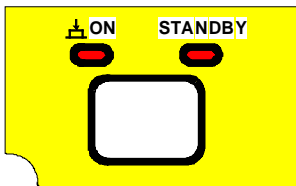

### Caution:

*In standby mode, the FSE is still live.*



### Standby

- ON/STANDBY switch is not depressed.

The yellow LED (STANDBY) is on. Only the FSE's internal power is connected to the AC line. The crystal oven is maintained at the normal operating temperature.

### Operation

- ON/STANDBY is depressed.

The green LED (ON) is on. The instrument is ready for operation. All modules within the instrument are supplied with power.

## Switching on the Instrument

- To switch on the FSE, set the power switch on the rear panel to position I.
- Pressing the ON/STANDBY key on the front panel. The green LED should come on.

## Startup Menu and Booting

When the instrument is switched on, a message indicating the installed BIOS version (eg Analyzer BIOS Rev. 1.2) appears on the screen for a few seconds.

Windows NT is booted first and then the instrument firmware. As soon as boot up is over, the instrument will start measuring. The settings used will be the one that was active when the instrument was previously switched off, provided no other device configuration than *FACTORY* had been selected with *AUTO RECALL* in the *MEMORY* menu.

## Switching off the Instrument

- Remove the disk, if any, from the drive before switching off.
- Press the ON/STANDBY key on the front panel. The yellow LED should come on.

Only when completely disconnecting the FSE from the AC power source:

- Set the power switch on the rear panel to position 0.

## Energy Saving Mode

The FSE offers an energy saving mode for the screen display. The screen goes blank if no entries have been made from the front panel (key, softkey or hotkey and rollkey) for a selectable period of time.

To switch on the energy saving mode:

1. Call the *SYSTEM DISPLAY - CONFIG DISPLAY* submenu to configure the screen display:
  - Press the *DISPLAY* key
  - Press the *CONFIG DISPLAY* softkey
2. Activate the save mode
  - Press the *SCR. SAVER ON* softkey.  
The softkey is highlighted, indicating that the energy saving mode is on. At the same time the data entry for the shutdown time opens.
3. Enter the shutdown time
  - Press the *SCR. SAVER TIME* softkey.
  - Enter the shutdown time in minutes and confirm the entry using the *ENTER* key.  
The screen will go blank when the shut down time elapses.

## Battery Backed-up Memory

The FSE has a battery-powered read/write memory (CMOS-RAM) for backing up instrument settings on power-off. After each power-on, the FSE is reloaded with the operational parameters which were active just prior to the last power-off (STANDBY or AC power OFF) or were set with AUTO RECALL (see Chapter 4 "Saving and Recalling Data Sets").

A lithium battery powers the CMOS-RAM. When the battery goes flat (after approx. 5 years), any data stored in the CMOS-RAM will be lost. If this happens, the factory setup is loaded on power up. As the FSE has to be opened to replace the battery, please contact the representative of our company responsible for you for changing batteries.

## Function Test

On power up, the FSE displays the following message on the screen:

```
Analyzer BIOS  
Rev.x.y  
  
Copyright  
Rohde & Schwarz  
Munich  
  
Booting
```

A self-test of the digital hardware is then performed. If the self-test finds no faults, Windows NT is booted up and the instrument starts measuring.

Any errors which occur in self-test are transferred as ASCII text to the printer interface (LPT). Therefore, an error diagnosis can be carried out, even for serious failures.

A check of the data contents of the instrument is performed in system error correction (*CAL*, *CAL TOTAL* key) The individual results of the correction (*PASSED* / *FAILED*) can be displayed in the calibration menu.

With the aid of the built-in self-test functions (*INFO* key, *SELFTTEST* soft key), the functional integrity of the instrument can be verified and/or defective modules can be localized.

## Controller Function - Windows NT

**Caution:**

*The drivers used in the integrated controller function are specially configured for the instrument. To prevent functions crashing, only the settings described below should be used. Only the update software released by Rohde&Schwarz should be used to update the drivers. Only programs authorized by Rohde&Schwarz for use on the instrument may be run on the instrument.*

***Do not power down during booting.*** This may corrupt the harddisk files.

The instrument has an integrated Windows-NT controller. The user can switch between the measurement screen and the controller screen. When an external monitor is connected, the measurement function and the controller function can be displayed simultaneously (see section "Connecting an External Monitor"). The controller function is automatically booted on power-up. Windows NT operation is described in the supplied manual or in the online help of Windows NT.

### Login

The user has to login to Windows NT by entering his name and password. As a factory default, the instrument is configured for *Auto Login*, i.e. the login is performed automatically and in the background. The user name used is then "instrument" and the password is also "instrument" (lower case).

To login under another name, call up the logout window in the task bar with START - SHUT DOWN. Mark the item "Close all programs and log on as a different user?" in the window and click YES while holding the SHIFT key down until the login window is displayed to enter the user identification. The password should be entered in the correct syntax including lower-case and upper-case characters.

### Administrator identification

Some of the installations (eg CD-ROM drive) described below require the administrator login. This is indicated in the relevant window.

The administrator is an identification which in particular allows system settings which are disabled for the standard user.

The password for the administrator is 894129 for the instrument.

After an installation under the administrator identification, the "Service Pack" of Windows NT has to be re-installed, see section "Installation of Windows NT Software".

On power-up following an installation under the administrator identification, the NT login window is displayed (no autologin). The user name "Administrator" is indicated in the window. This entry is to be replaced by "instrument" and then "instrument" as password entered. An autologin is then possible.

### Changeover between measurement screen and controller screen

To call up the controller screen use key combination <ALT><SYSREQ> (US keyboard).

To return to the measurement screen, activate the window "R&S Analyzer Interface" on the controller.

### Logout

The instrument can be switched off (standby mode). Logging out of Windows NT is not necessary.

## Connecting a Mouse

**Caution:**

*The keyboard may only be connected when the instrument is switched off (STANDBY). Otherwise, correct operation of the keyboard cannot be guaranteed.*

A mouse can be connected to the PS/2 (MOUSE) connector on the rear panel of the instrument to make it easier to use.

MOUSE



During measurements, softkeys, tables and data input fields may also be controlled by mouse. For computer function, the mouse has the usual functions.

The control functions for the mouse during measurement operation are described in Chapter 3 in the section "Mouse Control of Further Display Elements". This section contains a list in which the screen display elements for mouse control of the corresponding softkeys and push buttons of the instrument are described. Chapter 8 describes the connector interface.

After connection of the mouse and subsequent power-on, the mouse will be automatically recognized. Special settings such as mouse cursor speed etc., can be made in the Windows NT menu START - SETTINGS - CONTROL PANEL - MOUSE.

## Connecting an External Keyboard

**Caution:**

*The mouse may only be connected when the instrument is switched off (STANDBY). Otherwise, correct operation of the mouse and instrument cannot be guaranteed.*

The instrument is fitted with a rear-panel 5-contact DIN connector (KEYBOARD) for the connection of an external PC keyboard.



During measurements, the keyboard makes it easier to enter comments, filenames, etc. For computer function, the keyboard has the usual functions.

Chapter 3, in section "External Keyboard Control", contains a list which describes the assignment of the instrument front-panel key functions to the key codes of the external keyboard as well as special key combinations used for quick operations. Chapter 8 describes the interface for the connector.

After connection of the keyboard and subsequent power-on, the keyboard will be automatically recognized. The default setting is for the US keyboard. Special settings such as repetitional rate etc. can be performed in Windows NT menu START - SETTINGS - CONTROL PANEL - KEYBOARD.

## Connecting an External Monitor

**Caution:**

The monitor may only be connected when the instrument is switched off (STANDBY). Otherwise, the monitor may be damaged.

Do not modify the screen driver (display type) as this would cause a malfunction.

**Notes:**

- When connecting the monitor to the PC MONITOR connector, the display of controller function can be adapted to the external screen (eg higher resolution) in the NT menu START-SETTING - CONTROL PANEL - DISPLAY PROPERTIES.
- CHIPS (setting = both) should not be modified since otherwise switching between the external monitor and the instrument screen is not possible.

The instrument is fitted with a rear-panel connector PC MONITOR or ANALYZER MONITOR for an external monitor.



Chapter 8 describes the connector interface.

With an external monitor it is possible to have an enlarged display of the measurement screen (ANALYZER MONITOR connector) or of the controller screen (PC MONITOR connector). The measuring instrument and the Windows NT controller can be operated in parallel. The mouse and the keyboard are allocated to only one mode.

### Display of the measurement screen - Connection to ANALYZER MONITOR connector

**Connection**

After connecting the external monitor the measurement screen is displayed on both the external monitor and the instrument. Further settings are not necessary.

**Operation**

The instrument is operated as usual via its softkeys, the mouse and keyboard, etc..

**Toggle between measurement screen and controller screen**

Key combination <ALT><SYSREQ> is used to call up the controller. After call up, the mouse and keyboard are allocated to the controller function.

By activating the window "R&S Analyzer Interface" the user returns to the measurement screen and the mouse and keyboard are allocated to this screen.

### Display of the controller screen - Connection to PC MONITOR connector

**Connection**

After connecting the monitor external monitor operation should be selected.

Setting is performed in the *SETUP-GENERAL SETUP* menu (key group: *CONFIGURATION*, see in Chapter 4, the section "Presettings and Interface Configuration"):



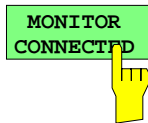
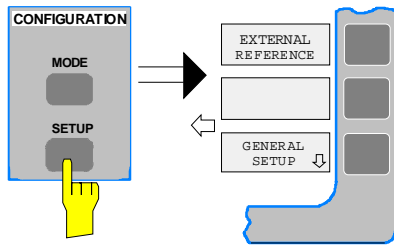

---

### Call *SETUP-GENERAL SETUP* menu

- Press the *SETUP* key in the *CONFIGURATION* field.

The *SETUP* menu is opened.

- 
- Press the *GENERAL SETUP* softkey.

The *GENERAL SETUP* submenu is opened and the current settings of the instrument parameters are displayed on the screen in the form of tables.

---

### Selecting the external monitor mode

- Press the *MONITOR CONNECTED* softkey.

The softkey is in color to indicate that the external monitor mode is activated. The external monitor displays the controller screen.

### Operation

The controller function is operated as usual with the mouse and keyboard. The measuring instrument (displayed on the instrument screen) can be operated with both the softkeys and keys of the instrument.

### Toggle between screens

By activating (clicking) the window "R&S Analyzer Interface" at the controller the mouse and keyboard are allocated to the measurement screen. The mouse and keyboard are allocated to the controller when the window is deactivated.

## Connecting a Printer



### Caution:

The printer may be connected only when the instrument is switched off (STANDBY)

- Notes:**
- The installation of some printer drivers is possible only under the administrator identification (see section "Controller Function").
  - After the installation, the "Service Pack" of Windows NT is to be re-installed, see "New Installation of Windows NT Software".
  - To ensure that the instrument performs an autologin, the user identification is to be reset to "instrument" after the next power-up, see section "Controller Function".
  - If bad printouts are produced after installing the printer driver, it is recommended to obtain the latest drivers from the printer manufacturer (eg via Internet). Experience has shown that printer problems are thus solved in most cases.

The instrument provides an option for connecting up to three different printers to provide screen hardcopy.

The interfaces can also be used for printing in the controller mode. The output formats "WMF" (Windows Metafile) and "Clipboard" are preset. A large number of output devices can be connected under Windows NT after installing suitable printer drivers.

The output devices supported by the instrument can be found in the selection box *DEVICE/LANGUAGE* in the *HARDCOPY –SETTINGS DEVICE1/2* menu (see in Chapter 4, the section "Documentation of Measurement Results"). To print out via the COM interface, the latter must be assigned the controller function in the *SETUP - GENERAL SETUP* menu (owner = OS).

Chapter 8 describes the connector interfaces.

The interface connectors are located on the rear panel:



After the printer has been connected to the appropriate interface connector, the interface needs to be configured, the printer driver has to be installed and assigned to an interface.

### 1. Connecting the keyboard and mouse

To install and configure of printer drivers on the FSE, it is necessary to connect a keyboard to the front panel and a PS/2 mouse to the rear panel (see sections "Connecting a Mouse" and "Connecting a Keyboard").

### 2. Configuring of the interface

LPT1            The LPT1 needs no configuration.

**Note:**        An external CM-ROM drive can be connected to this interface. If this is the case, one of the serial interfaces can be used for the printout.

COM1/COM2    The COM interfaces have to be assigned to the controller function (OWNER = OS) in the *SETUP - GENERAL SETUP* menu. The configuration of serial interfaces COM1 and COM2 can then be performed in the Windows NT menu *START - SETTINGS - CONTROL PANEL - PORTS*. The parameters *COM PORTS BAUDRATE, BITS, PARITY, STOPBITS, HW/SW-HANDSHAKE* must be those specified for the printer in question (see the operating manual for the output device).

**Note:** The serial interfaces can be used for remote control when the analyzer is made the owner (Owner = Instrument). The settings made for the serial interface in the menu *SETUP - GENERAL SETUP* overwrite the settings in the NT menu..  
 However, settings in the Windows NT menu do not overwrite those of the *SETUP* menu. This means that the settings are only valid as long as the interface is assigned to the operating system.

**3. Selection and installation of the printer driver**

The selection and installation of the printer driver, the assignment to the interface and the setting of most of the printer-specific parameters (eg paper size) is performed under Windows NT in the *START - SETTINGS - PRINTER* menu.

**4. Configuration of the connected output device**

The printer connected to the instrument is configured in the *HARDCOPY DEVICE-SETTINGS DEVICE1/2* menu (key group: *HARDCOPY*, see Chapter 4, Section "Selection and Configuration of the Output Device "). The configuration of one or two output devices (*DEVICE1* and *DEVICE2*) can be entered, at least one of which must be activated for printing.

- The parameter *DEVICE/LANGUAGE* determines which printer is used.
- The parameter *PRINT TO FILE* determines if the output is written to a file.
- The parameter *ORIENTATION* sets the page format to horizontal or vertical (landscape or portrait).

Selecting the printer type automatically sets the parameters *PRINT TO FILE* and *ORIENTATION* to values which correspond to the standard mode for this printer. Other printer-dependent parameters such as *FORMFEED*, *PAPERFEED* etc., can be modified under Windows NT in the printer properties window (*START/SETTINGS/PRINTERS/SETTINGS/....*).

Table 1-1 shows the standard factory settings for the two output devices.

The factory settings of *DEVICE 1* correspond to the "WMF" (Windows Metafile) output format, with printout to a file. WMF is a common format which is used to import of hardcopies (eg of measurement windows) to other Windows applications that support this format (eg WinWord).

The factory setting of *DEVICE 2* is "Clipboard". In this setting, the printout is copied to the Windows NT clipboard. Most Windows applications support the clipboard. The clipboard contents can be directly inserted into a document with *EDIT - PASTE*.

Table 1-1 Factory settings for *DEVICE 1* and *DEVICE 2* in the *HARDCOPY-DEVICE SETTINGS* menu.

Parameter	Parameter name	<i>DEVICE 1 settings</i>	<i>DEVICE 2 settings</i>
Output device	DEVICE	WINDOWS METAFILE	CLIPBOARD
Output	PRINT TO FILE	YES	---
Paper orientation	ORIENTATION	---	---

In the following example, an HP DeskJet 660C printer is connected to interface LPT1 and configured as *DEVICE2* for hardcopies of the screen.

---

**Switch off FSE.**

---

**Connect printer to the LPT1 interface .**

---

**Switch on both the FSE and the printer.**

**Select printer driver under Windows NT**

- Press key combination <ALT> <SYSREQ>  
The Windows NT screen is displayed.



- In the Start menu click on "Settings" and then "Printers".  
The printer window is opened.

- Double-click "Add Printer".  
The "Add Printer Wizard" window is opened. This window leads through the following printer driver installation.



- Click first "My computer" and then "Next".  
The available ports are displayed.

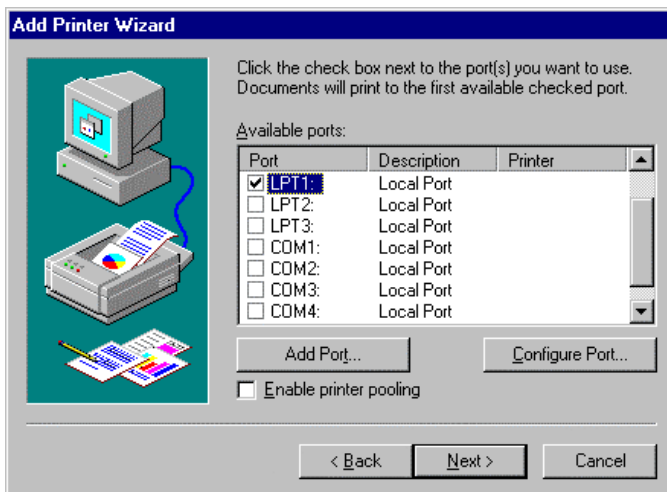

- Select LPT1 port.  
The selection is indicated by a tick.

- "Click "Next".  
The available printer drivers are displayed. The left-hand selection table indicates the manufacturers and the right-hand one the available printer drivers.

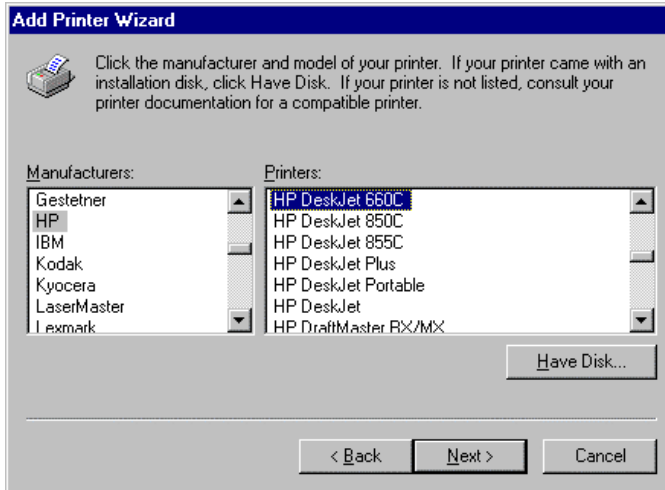

- Mark "HP" in the "Manufacturers" selection table and "HP DeskJet 660C" in the "Printers" selection table .

**Note:** If the required printer type is not in the list, the driver has not yet been installed. In this case click "HAVE DISK". A message box requesting to insert a disk with the printer driver will be displayed. Insert the disk, press OK and select the printer driver. After installation, Service Pack must be reinstalled (see section "Installing Windows NT Software").

- Click "Next".

The entry field for the printer name is displayed.

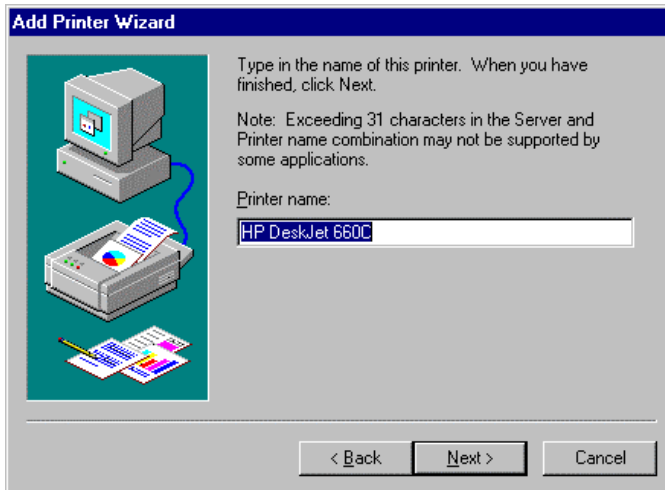

- The printer name can be modified in the entry field "Printer name" (max. 60 characters).

If one or more printers have already been installed, a query is displayed in this window to ask if the printer last installed as the default printer should be selected for the Windows NT applications (Do you want your Windows-based programs to use this printer as default printer?) "No" is preset.

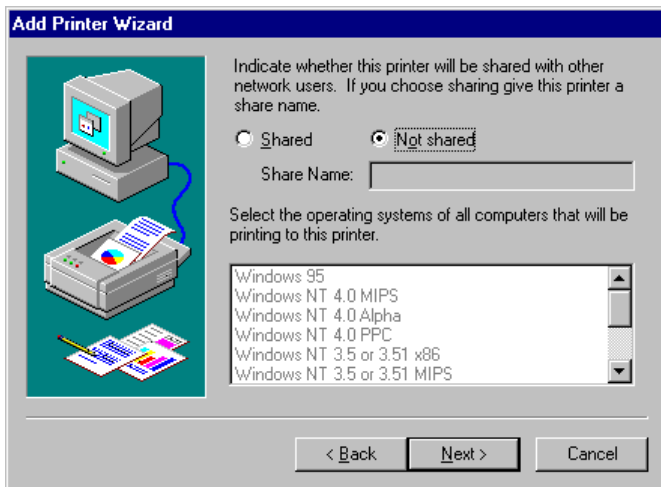

- Click "Next".

A query is displayed whether the printer is to be shared with other network users.. This query is irrelevant when installing a local printer. The answer "Not shared" is preset.

- Click "Next".

The window for printing a test page is displayed. The test page is for checking if the installation was successful.



- Switch on printer.
- Click Yes (recommended)".
- Click "Finish".

A test page is printed out if the installation was successful.

If the test page is not printed out or not completely, the Windows NT online help offers troubleshooting instructions under the entry "Printer Trouble Shooting".

**Note:**

*If a request for the printer driver path appears after clicking "Finish", this printer installation should be performed under the administrator identification (see section "Controller Function").*

Now, the instrument needs to be configured so that hardcopies of the measurement screen can be printed out on this printer.

**Configuring HP DeskJet 660C.**

- Click the "R&S Analyzer Interface" button.  
The measurement screen is displayed.

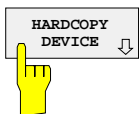
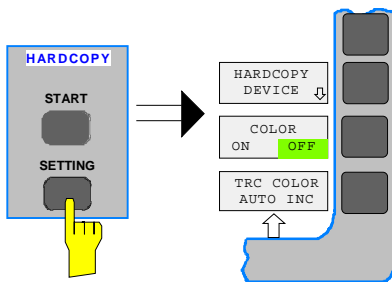

- Press the *SETTINGS* key in the *HARDCOPY* field.  
The *SETTING* menu is opened.

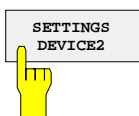

HARDCOPY DEVICE SETTINGS	
Device1	WINDOWS METAFILE
Print to File	YES
Orientation	---
Device2	CLIPBOARD
Print to File	---
Orientation	---

- Press the *HARDCOPY DEVICE* softkey.  
The *HARDCOPY DEVICE* submenu is opened and the current settings of the two possible output devices are displayed in *HARDCOPY DEVICE SETTINGS*-table.

- Press the *SETTING DEVICE2* softkey.  
Line *DEVICE2* is marked with the selection bar.

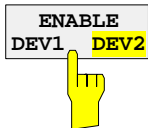
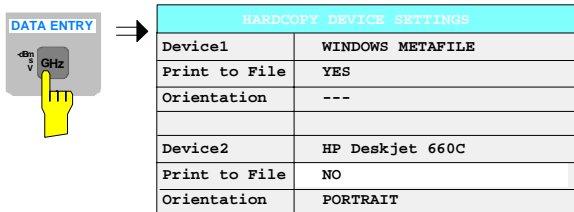
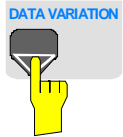
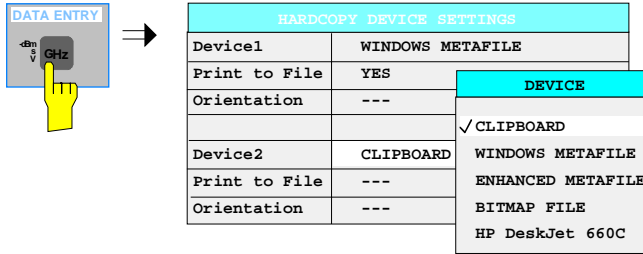

- Press one of the unit keys.

The *DEVICE* selection box is displayed on the screen. The current selection is marked by a tick and highlighted by the selection bar.

- Press the cursor key until the entry *HP DeskJet 600C* is highlighted by the selection bar.

- Press one of the unit keys.

The *DEVICE* selection box is closed and *HP DeskJet 660C* is entered in the *DEVICE2* row.

**Note:**

Selecting the printertype automatically sets the parameters *PRINT TO FILE* and *ORIENTATION* to standard mode values for this printer. Other printer-dependent parameters such as *PAPERSIZE*, can be modified under Windows NT in the printer properties window (*START/SETTINGS/PRINTER/SETTINGS*).

**Start printing.**

- Press the *ENABLE* softkey until *DEV2* is marked on the second softkey line.

Printing can then be started with the *START* key in the *HARDCOPY* menu.

**Return to main menu**

- Press the menu key several times.

**Note:** After the installation, the "Service Pack" of Windows NT is to be re-installed, see "New Installation of Windows NT Software".

## Installation of a Network Printer (with option FSE-B16 only)

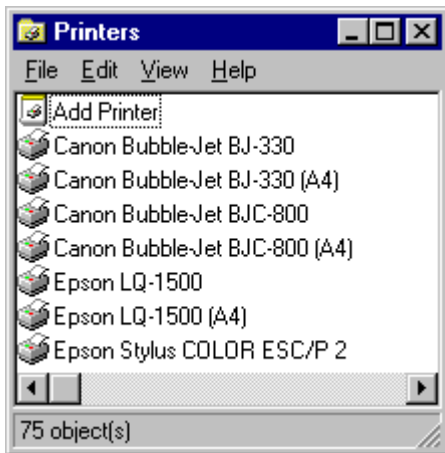

After opening the "Printers" dialog window proceed with the installation as follows:

- Double-click the "Add Printer" line.

The "Add Printer Wizard" window is opened. This window guides the user through the printer driver installation.

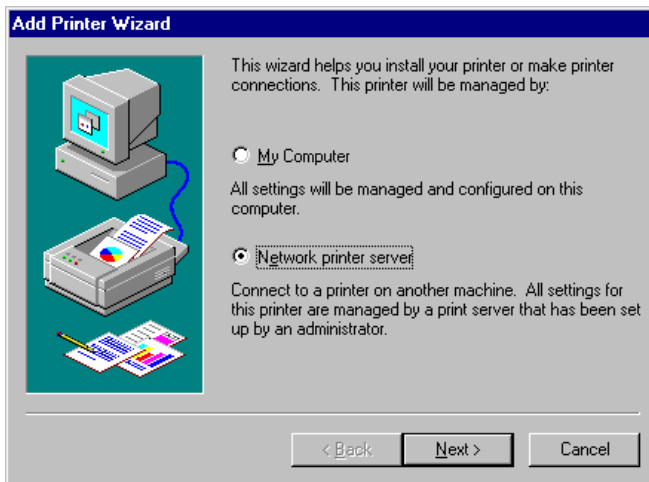

- Click "Network printer server" and then "Next".

A window to set the path to the printer server is displayed.

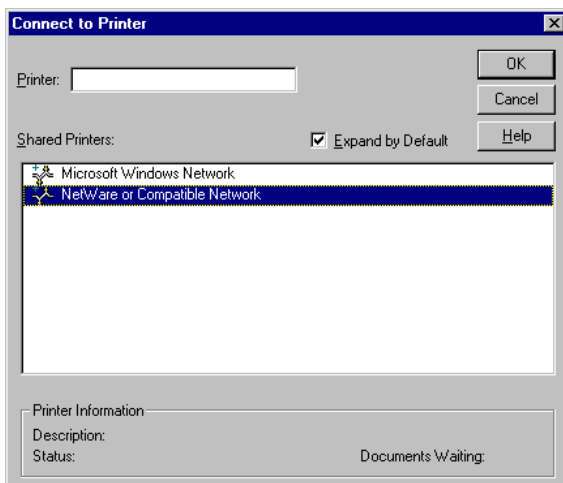

- Set the path to the desired printer server, mark it and select it with OK.

- Confirm the following request for the installation of a suitable printer driver with OK.

The list of printer drivers is displayed. The manufacturers are listed in the window at the left, the available printer drivers at the right.



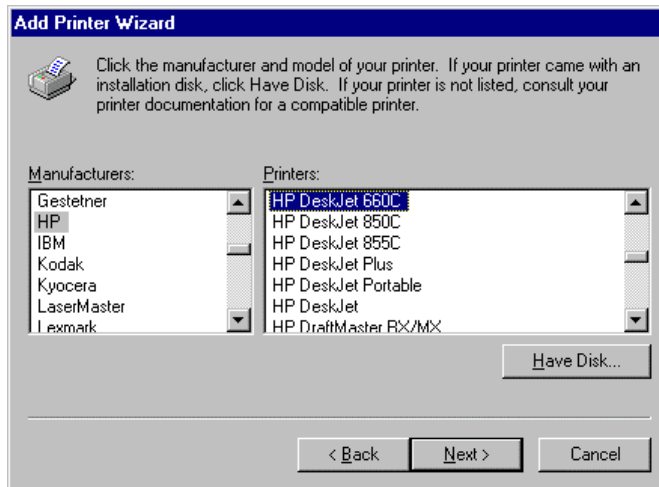

- Select the manufacturer in the "Manufacturers" window and then the printer driver in the "Printers" window.

**Note:**

*If the required type of output device is not included in the list, the driver has not yet been installed. In this case click on button "HAVE DISK". A message box requesting to insert a disk with the corresponding printer driver will be displayed. Insert the disk, press OK and select the required printer driver.*

- Click "Next"

If one or more printers are already installed, a prompt is displayed in this window to ask if the printer last installed as default printer should be selected for the Windows NT applications ("Do you want your Windows-based programs to use this printer as default printer?"). The default selection is "No".

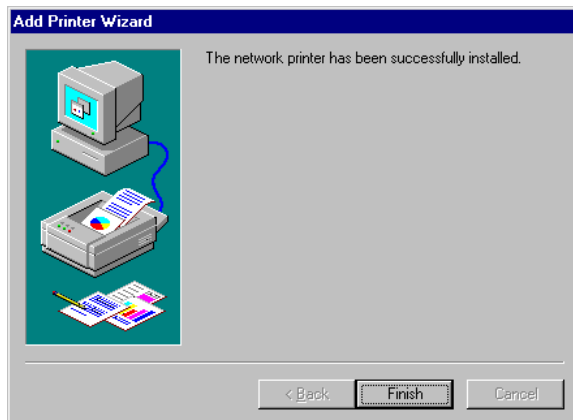

- Start the printer driver installation with "Finish".

**Note:**

*If a prompt for the printer driver path appears after pressing "Finish", the Service Pack must be re-installed after this printer installation (see Chapter 1, section "Installing Windows NT Software").*

After installation, the instrument has to be configured for printout with this printer in the *HCOPY - SETTINGS* menu.

Finally, Service Pack x must be re-installed (see section "Installing Windows NT Software").

## Connecting a CD-ROM Drive



**Caution:**

The CD-ROM may only be connected when the instrument is switched off (STANDBY). If this is not observed correct operation of the CD-ROM and the instrument cannot be guaranteed.

- Notes:**
- The installation of a CD-ROM is possible only under the administrator identification (see section "Controller Function").
  - After the installation, the "Service Pack" of Windows NT is to be re-installed, see "New Installation of Windows NT Software".
  - To ensure that the instrument performs an autologin, the user identification is to be reset to "instrument" after the next power-up, see section "Controller Function",

The instrument is fitted with a rear-panel interface LPT1 for the connection of a CD-ROM drive.

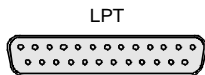

The following CD-ROM drives are supported:

- MICROSOLUTIONS BACKPACK External CD-ROM.
- FREECOM IQ DRIVE
- ADAPTEC Parallel SCSI Adapter + SCSI CD-ROM

After connection, the CD-ROM drive is to be installed under Windows NT.

---

**Switch off FSE.**

---

Connect CD-ROM drive to interface LPT1 of the instrument and to AC power source.

---

**Switch on FSE.**

---

**Administrator identification**

- Press key combination <ALT> <SYSREQ>  
The Windows NT screen is displayed.

- 
- Call the logout window with "Shut Down" in the "Start" menu.

- 
- Mark entry "Shut down and log on as a different user".

- 
- Press the "Shift" key and click button "Yes" at the same time.

The login window is displayed.

- 
- Enter "administrator" under "name" and "894129" under "password", confirm entry with "OK".

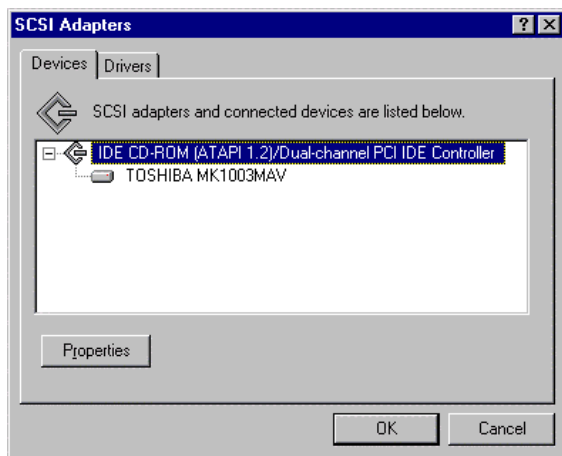

---

### Select driver under Windows NT

- In the Start menu press first "Setting" and then "Control Panel".

The system control window is opened.

- 
- Double-click "SCSI Adapters".

The "SCSI Adapters" window is opened.

- 
- Click the "Driver" index card and then button "Add".

The list of installed drivers is displayed.

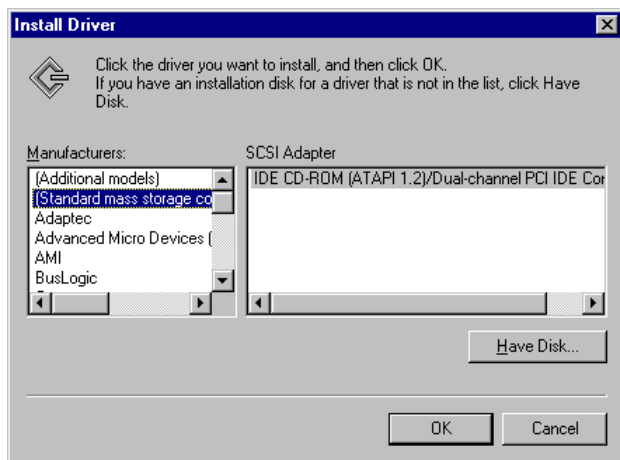

- 
- Click "Have Disk".

This window leads through the following installation.

**Note:** After the installation, the "Service Pack" of Windows NT is to be re-installed, see "New Installation of Windows NT Software."

## Firmware Update

The installation of a new firmware version can be performed using the built-in diskette drive and does not require opening the analyzer. The firmware update kit contains several diskettes. The installation program is called up in the *CONFIGURATION - SETUP* menu.

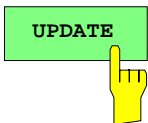
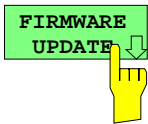
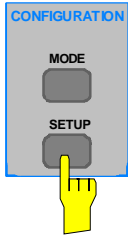

The installation can be cancelled.



---

***Insert diskette 1 into the drive.***

---

***Call SETUP-GENERAL SETUP menu***

- Press the *SETUP* key in the *CONFIGURATION* field.

The *SETUP* menu is opened.

---

- Change to the right-hand menu using the menu key.
- 

- Press the *FIRMWARE UPDATE* softkey.

The submenu is opened.

---

- Press the *UPDATE* softkey.

The installation program starts and leads the user through the remaining steps of the update.

---

- Press the *RESTORE* softkey.

The previous firmware version is restored.

## Installing Windows NT Software

The driver software and the Windows NT system settings are exactly adapted to the measurement functions of the instrument. Correct operation of the instrument can, therefore, be guaranteed only if the software and hardware used is released or provided by Rohde & Schwarz.

The use of other software or hardware may cause the FSE to malfunction.

The latest list of software authorized for use on the FSE can be obtained from your nearest Rohde&Schwarz agency (see list of addresses).

After each software installation requiring the administrator identification, "Service Pack" of Windows NT must be re-installed (also with administrator identification; see section "Controller Function"):

---

### ***Re-installing Service Pack***

- In the Start menu click "Run".  
The entry window opens.

---

### **Service Pack 5:**

- Enter "C:\SP5\I386\UPDATE\UPDATE" into the command line and start installation with "OK".  
The following window leads through the installation.

### **Service Pack 3:**

- Enter "C:\SP3\I386\UPDATE" into the command line and start installation with "OK".  
The following window leads through the installation.

## Options

This section describes options FSE-B17, Second IEC/IEE Interface, FSE-B16, Ethernet Interface.

- Note:**
- Option FSE-B13, 1 dB Attenuator, is described in Chapter 4, Section 'Level Display/RF Input'
  - Options FSE-B8 to B12, Tracking Generator, and FSE-B3, TV Demodulator, are described in Chapter 4, Sections 'Tracking Generator' and 'TV Demodulator'
  - For a description of options FSE-B7, Vector Signal Analysis, and FSE-B21, External Mixer Output, see manuals of options.

### Option FSE-B17 – Second IEC/IEEE Interface

- Notes:**
- The installation of option FSE-B17 is possible only under the administrator identification (see section "Controller Function").
  - After the installation, the "Service Pack" of Windows NT is to be re-installed, see "New Installation of Windows NT Software".
  - To ensure that the instrument performs an autologin, the user identification is to be reset to "instrument" after the next power-up, see section "Controller Function".
  - Interface "COM2" is no longer available after installation of option FSE-B17.

Besides the instrument external devices can also be controlled via the IEC/IEEE bus using the optional 2nd bus interface FSE-B17 and the computer function for instrument. The interface software permits IEC/IEEE-bus commands to be included in user programs. The installation instructions are enclosed with the option.

### Installing the software

The operating software is already installed and need not be loaded from the driver diskettes which serve as backup diskettes.

The driver must be loaded on the start-up of Windows NT. To do this, enter the type of board, configure the board and enter the parameters for the connected equipment. If the option is factory fitted, all this has been done in the factory.

The following parameters may not be changed after selection on configuration of the board:

```
Board Type .....AT-GPIB/TNT
Base I/O Address .....02C0h
Interrupt Level .....3
DMA Channel .....5
Enable Auto Serial Polling...No
```

For further parameters, refer to manual for the board.

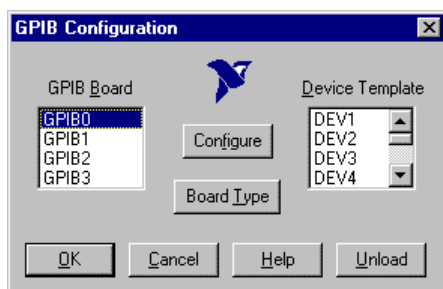

#### Selecting the board type

- Click "Start" in the task bar.
- Click consecutively "Settings", "Control Panel" and "GPIB" in this sequence.
 

The "GPIB Configuration" menu for selecting the board type and configuring the board is opened.
- Click button "Board Type".
 

The "Board Type" menu for selecting the board type is opened.

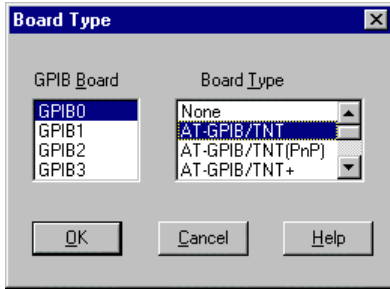

- Mark "GPIB0" in the "GPIB Board" list.
- Mark "AT-GPIB/TNT" in the "Board Type" list.
- Confirm the selection with "OK".

The "GPIB Configuration" menu is displayed again.

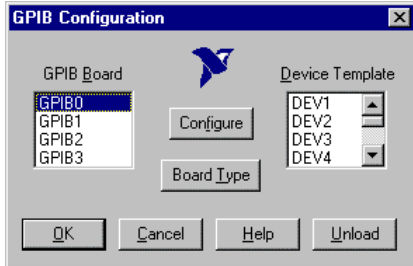

- Click button "Configure".

The "GPIB0 (AT-GPIB/TNT)" menu for configuring the board is opened.

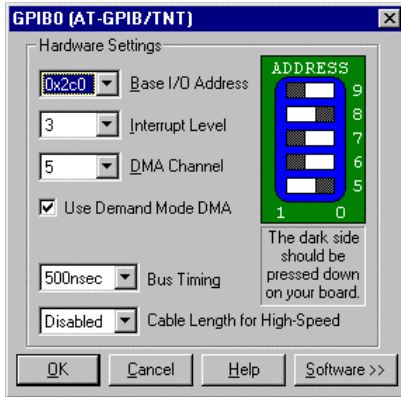

### Configuring the board

- Set "3" in the "Interrupt Level" list.
- Click button "Software".

The menu is extended.

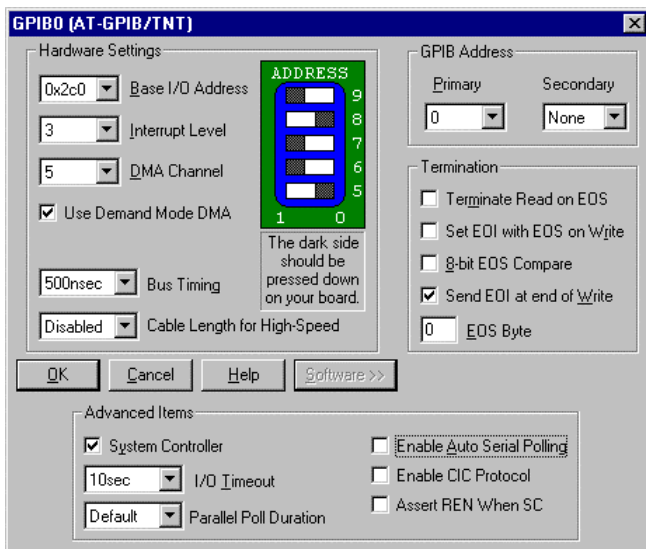

- Deactivate (= no tick) "Enable Auto Serial Polling" in the "Advanced Items" field.

- Quit the menu with "OK".

The "GPIB Configuration" menu is displayed again.

**Note:**

*The settings of the following parameters should not be no longer modified.*

```
Board Type ..... AT-GPIB/TNT
Base I/O Address ..... 02C0h
Interrupt Level ..... 3
DMA Channel ..... 5
Enable Auto Serial Polling .. No
```

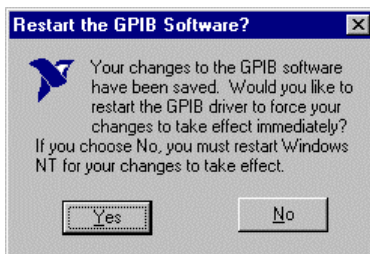
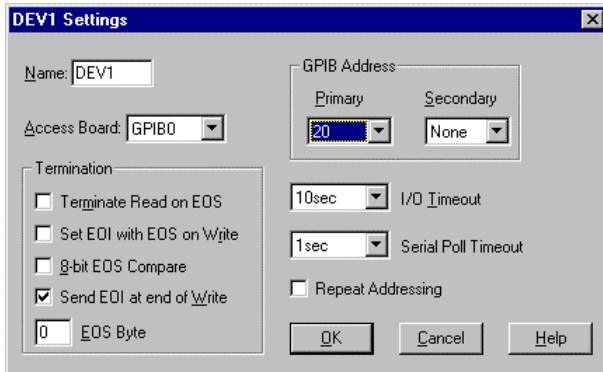
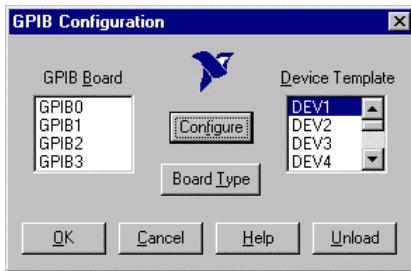

### Setting the parameters for the connected equipment

- Mark the instrument in the "Device Template" list and confirm selection with "OK".

The "DEV.. Settings" menu is opened.

- Perform the settings for the selected unit in the "DEV.. Settings" menu.

The logic name for the instrument is preset with DEV1 and address 20. See board manual for further units.

**Note:** When assigning logic names to connected equipment note that these names do not correspond to the directory names under DOS.

- Terminate setting with "OK".

The query asking if the GPIB software should be re-started is displayed.

- Select "No".

- Re-start controller with Start-Restart in the task bar.

After the controller has been re-started, the settings for the GPIB interface are effective.

**Note:** After the installation, the "Service Pack" of Windows NT is to be re-installed, see "New Installation of Windows NT Software".

## Use of DOS Programs

When using DOS programs, driver GPIB-NT.COM should be loaded. For this to take place, the line `device=C:\PROGRA~1\NATION~1\GPIB\NI488\DosWin16\Gpib-nt.com` has to be activated in the file `C:\WINNT\SYSTEM32\CONFIG.NT`. If the option is factory fitted, this line will have been entered in the factory.

## Operation

The second IEC/IEEE-bus interface corresponds physically to that of the instrument (see Chapter 8). If the instrument is to be controlled via the IEC/IEEE bus, a bus cable must be plugged to both bus connectors. The interface can be driven under DOS/WINDOWS3.1/95/NT by R&S software (FS-K3, Order No. 1057.3028.02, etc.) or by user-written software. The handling of IEC/IEEE-bus commands in user programs is described in the manual for the card.

The files are in directory `C:\Program Files\National Instrument\GPIB\NI488`.



## Option FSE-B5 - FFT Filter

Option FFT Filter FSE-B5 is a firmware option. It has to be enabled by a keyword.

### Prerequisites

#### 1. Keywords

The keyword is printed on a label which is part of the equipment supplied and has to be stuck to the rear of FSE.

#### 2. Hardware

The modification state of module DIGITAL IF has to be either  $\text{MODIF INDEX} > 5$  or  $\text{MODIF INDEX} = 5$  and  $\text{HW CODE} \geq 6$ . The modification state can be checked in the module list *INSTALLED COMPONENTS* in menu *INFO HARDWARE+OPTIONS*.

#### 3. Firmware

The modification state of the firmware has to  $\geq 1.62$ . The modification state can be checked in table *FIRMWARE VERSION* in menu *INFO FIRMWARE VERSIONS*.

### Enabling the option

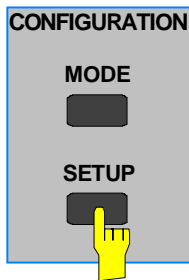

- Call up menu *SETUP* by pressing the *SETUP* key.

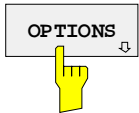

- Call up submenu *OPTIONS* by pressing the *OPTIONS* softkey. Table *FIRMWARE OPTIONS* is displayed, listing the installed options.



- Activate the entry field by pressing the *ENABLE NEW OPTION* soft key.

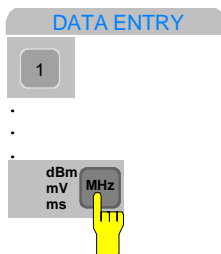

- Enter the 10-digit keyword via the numeric keypad and terminate the entry by pressing one of the unit keys.

Now option FFT filter is listed in table *FIRMWARE OPTIONS*.

**Note:** Message 'option key invalid' indicates an invalid entry.

## Option FSE-B16 – Ethernet Adapter

With the option Ethernet Adapter FSE-B16, the device can be connected to an Ethernet-LAN (local area network). It is possible to transmit data via the network and to use the network printer. The adapter operates with a 10 MHz Ethernet in line with standards IEEE 802.3 10Base2 (Thin Ethernet, CheaperNet, BNC-Net) (B16 model 03) or 10Base5 (Thick Ethernet) (B16 model 02).

### Hardware Installation



**Caution:**

*Prior to installation contact the network administrator, especially in case of complex LAN installations since mistakes in cabling might have influence the whole network.*

If the adapter is installed at the factory, it is preconfigured. In case of retrofitting, refer to the installation instructions. The hardware settings must not be modified since the functions of the device could otherwise be impaired.

The following parameters are factory-set:

I/O Addr. 300,      IRQ 5,      MEM D0000

The connection with the network depends on the connectors used in the network.

### BNC (Thin Ethernet, CheaperNet; FSE-B16 Var. 03)

#### Connection

The device is looped into the LAN segment via rear-panel 2 BNC connectors.

If a cable is not connected to one of the BNC connectors, this BNC connector has to be terminated with 50 Ohm. BNC T connectors must not be used.

#### Network traffic



Note that the network traffic is disturbed if a segment is interrupted.

#### Requirements

Thin Ethernet segment requirements have to be complied with:

- maximum segment length of 185 m
- minimum distance between the connectors of 0.5 m
- maximum of 30 connectors per segment.

If components that comply with enhanced requirements are exclusively used (Ethernet Adapter FSE-B16 complies with the enhanced requirements):

- maximum length of segment of 300 m
- maximum number of connectors of 100

With repeaters used:

- maximum total length of the network of 900 m containing a
- maximum of 3 segments
- maximum of two repeaters between two connectors

## AUI (Thick Ethernet; FSE B16 Var. 02)

<b>Connection</b>	The device is connected to the LAN segment using a transceiver cable (DB-15 AUI connector, not part of the equipment supplied) which is connected to the rear panel and to the transceiver.
<b>Network traffic</b>	The connection does not conflict with the network traffic. The device can also be disconnected from the network without any problems but make sure that data are not being transmitted.
<b>Requirements</b>	<p>The Thick Ethernet segment requirements have to be taken into account.</p> <ul style="list-style-type: none"> <li>- The maximum segment length should be 500 m and the distance between the connectors should at least be 2.5 m.</li> <li>- A maximum of 100 connectors may be used in a segment.</li> </ul> <p>With repeaters used,</p> <ul style="list-style-type: none"> <li>- the total length of the network must not be more than 2500 m containing</li> <li>- a maximum of 3 segments.</li> <li>- There should be no more than two repeaters between two connectors.</li> </ul> <p>If other network components are used, these conditions may vary.</p>

## RJ45 (UTP, 10BaseT, Western Connector)

<b>Connection</b>	The device is connected to the LAN segment using a RJ45 cable (not part of the equipment supplied) which is connected to the rear panel and to the network hub of the LAN segment.
<b>Network traffic</b>	This connection does not conflict with the network traffic. The device can also be disconnected from the network without any problems but make sure that data are not being transmitted.
<b>Requirements</b>	<p>Since RJ45 is not a bus but a star topology no special requirements have to be taken into account for the connection.</p> <p>The LAN requirements should be considered in the installation.</p>

## Software Installation

Data transmission within the network is by means of data blocks, the so-called packets. Besides user data other information, the so-called protocol data (transmitter, receiver, type of data, order) are transmitted. The drivers corresponding to the protocol have to be installed to process protocol information. A network operating system is required for network services (data transmission, directory services, printing in the network) and thus has to be installed.

## Calling up Configuration Menu for Network Settings

- 
- Click "Start" in the task bar.
  - Click consecutively "Settings", "Control Panel" and "Network".

The "Network" configuration menu for network settings is opened.

## Registering the Identification

**Note:** It is important for the computer name to be unique in the network..

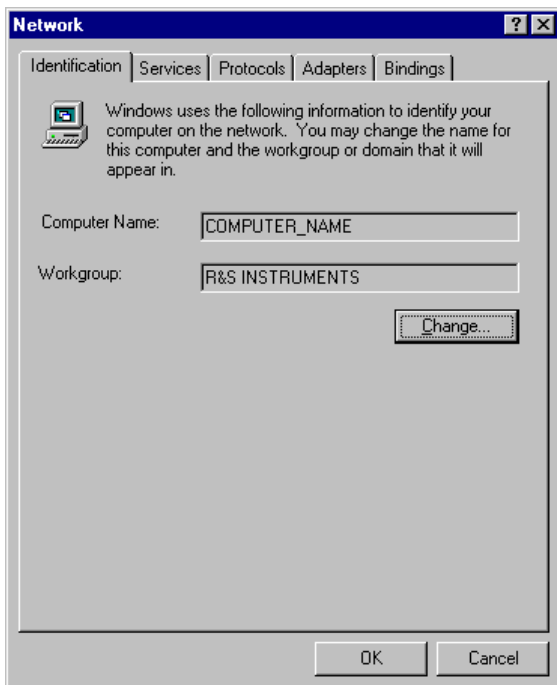

- 
- Select "Identification".
  - Confirm computer and workgroup names with "OK" or enter new names in submenu "Change".

## Installation and Configuration of the Driver for the Network Adapter

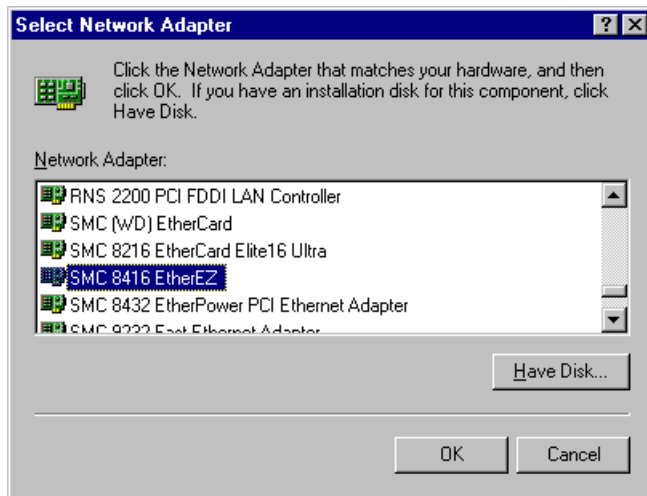

- Select "Adapter".
- Click "Add" and mark network driver "SMC 8416 EtherEZ" and select with "OK".  
The query "Files.." is displayed.

- Answer it by clicking "Continue".  
The "SMCEthernet Card Setup" window is displayed.

- Close the window with "OK".  
Some files are copied and the network adapter is displayed under "Network Adapters".  
The entry "MS Loopback Adapter" refers to a driver which ensures instrument control and should not be modified.

**Note:** *The network adapter settings must not be modified since this may cause problems to the instrument.*

## Installation of Network Protocols

**Note:** *The network administrator knows which protocols are to be used..*

- Select "Protocol".
- Click "Add", mark the desired protocol and select with "OK".  
This operation has to be performed several times when several protocols are selected.

- Execute the installation by clicking "Continue".

**Note:** *If a protocol requires further settings, they can be performed with "Properties" after marking the corresponding entry. If further settings are not possible, this field is gray.*

## Installation of Network Services

To utilize the resources of the network it is necessary to install the corresponding services.

**Note:** The network administrator knows which services are to be used.

- 
- Select "Services".
  - Click "Add", mark the desired service and select with "OK".

This operation has to be performed several times when several services are selected.

Some services are pre-installed and can be cleared with "Remove" if they are not needed.

- 
- Execute the installation by clicking "Continue".

**Note:** If a service requires further settings, they can be performed with "Properties" after marking the corresponding entry. If further settings are not possible, this field is gray.

## Terminating the Installation

- 
- Quit the "Network" configuration menu for network settings with "OK".

The settings are checked and processed. Missing information is queried.

- 
- Answer the query "You must shutdown..." with "Yes".

The settings are valid after computer restart.

**Note:** After the installation, the "Service Pack" of Windows NT is to be re-installed, see "New Installation of Windows NT Software".

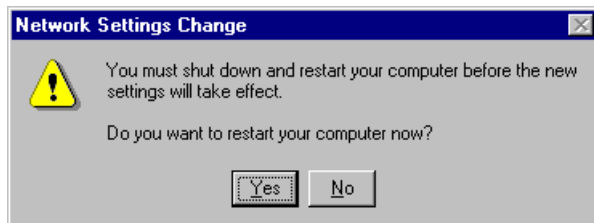

## Examples of Configurations

Network	Protocols	Services	Notes
NOVELL Netware	NWLink IPX/SPX Compatible Transport	Client Service for NetWare	The "Frame Type" used under "Protocols - Properties" should be set.
IP networks (FTP, TELNET, WWW, GOPHER, etc.)	TCP/IP Protocol	Simple TCP/IP Services	An "IP Address" unambiguous in the network should be set under "Protocols - Properties".
MICROSOFT network	NetBEUI Protocol or TCP/IP Protocol	Workstation Server	A name unambiguous in the network should be registered under "Identification - Computer Name".

## Operation

After installing the network operating system it is possible to transfer data between the device and other computers and to use printers in the network. A precondition for network operation is the authorization to use network resources. Resources may be access to the file directories of other computers or the use of a central printer. The network or server administrator will grant the authorizations. The network name of the resource and the corresponding authorization are required. Passwords protect the resources against improper use. A user name is normally assigned to every authorized user. The user also has a password. Resources may then be assigned to the user. The type of access, i.e. whether data are only read or also written as well as a shared access to data has to be defined. Other types are possible depending on the network operating system.

## NOVELL

Operating system NETWARE from NOVELL is as server-supported system. Data transfer between the individual workstations is not possible. Data transfer is between workstation computers and a central computer, the server. This server provides storage capacity and the connection to the network printers. Like under DOS, the data on a server are organized in directories and are offered to the workstation as virtual drives. A virtual drive on a workstation is like a hard disk and data can be processed accordingly. This is called drive mapping. Also network printers can be addressed as normal printers.

Network operating system NOVELL is available in two forms: NETWARE 3 and NETWARE 4 NDS. In the previous version NETWARE 3, each server manages its own resources itself and is independent. A user has to be managed separately on each server. For NOVELL 4 NDS, all resources are managed in the NDS (NOVELL DIRECTORY SERVICE). The user only has to log in once and gains access to the resources released for him. The individual resources and the user are managed as objects in a hierarchical tree (NDS TREE). The position of the object in the tree is called CONTEXT for NETWARE and must be known in order to access the resources.

## MICROSOFT

For MICROSOFT, data can be transferred between workstations (peer-to-peer) but also between workstations and servers. The servers can provide access to individual files as well as the connection to network printers. Like under DOS, the data on a server are organized in directories and are offered to the workstation as virtual drives. A virtual drive on a workstation is like a hard disk and data can be processed accordingly. This is called drive mapping. Also network printers can be addressed as normal printers. A connection to DOS, WINDOWS FOR WORKGROUPS, WINDOWS95, WINDOWS NT is possible.

## Installing a user

After the network software has been installed, the instrument logs with an error message during the next start-up since there is no user "Instrument" (= user identification for NT autologin) in the network. It is therefore necessary to install a user which should be the same for Windows NT and for the network. The network administrator is responsible for the installation of new users in the network.

**Note:** *The installation of new users is possible only under the administrator identification (see section "Controller Function").*

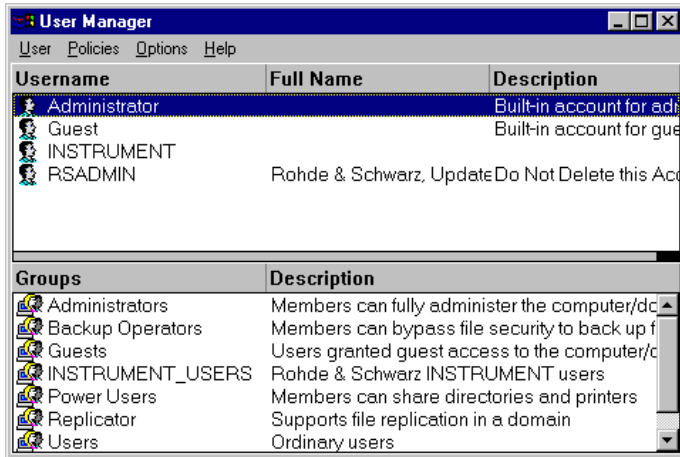

- Click "Start" in the task bar.
- Click consecutively "Programs" "Administrative Tools (Common)" and "User Manager".

The "User Manager" menu is opened.

- Click "User" and select "New User".

The menu "New User" for entering user data is opened.

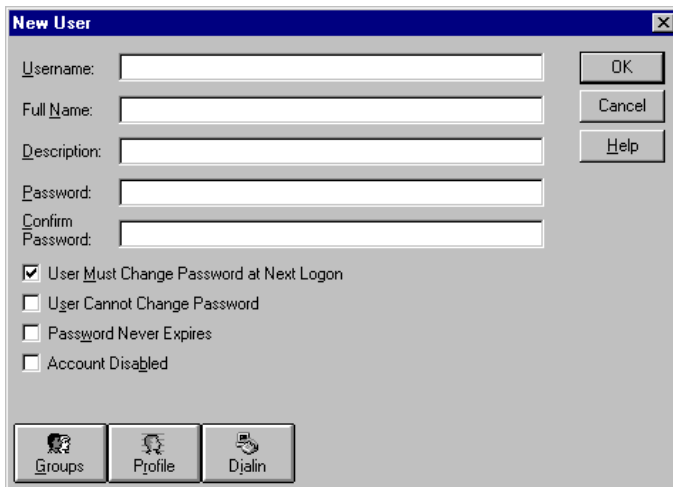

- Fill in the lines "Username", "Password" and "Confirm Password" and confirm the entry with OK.

The user data should correspond to the network settings.



### Only NOVELL network: Configure NOVELL Client

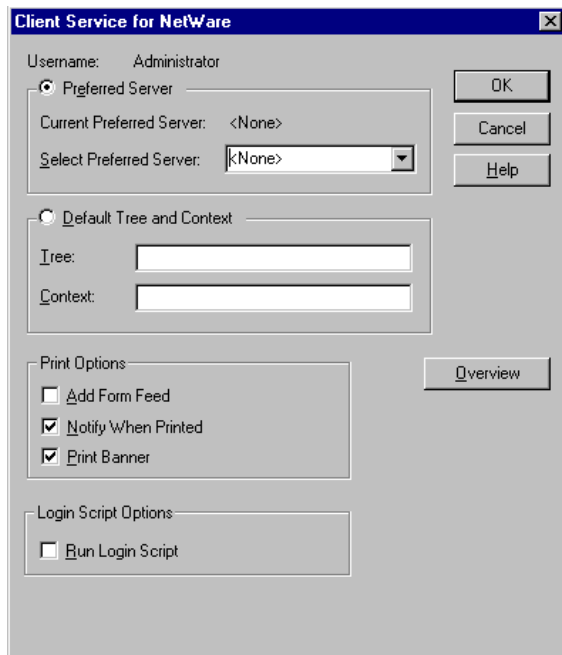

- Click "Start" in the task bar.
- Click consecutively "Settings", "Control Panel", "CSNW".

#### NOVELL 3.x

- Click "Preferred Server".
- Under "Select Preferred Server" select the NOVELL server for which the user has been installed.

#### NOVELL 4.x

- Click "Default Tree and Context" .
- Enter the NDS Tree under "Tree" and, under "Context", the hierarchical path for which the user has been installed.

**Note:** *These specifications can be obtained from the network administrator.*

### Login in the Network

Network login is automatically performed with the operating system login. A prerequisite is that the user name and the password are the same under Windows NT and in the network.

### Use of Network Drives

- Click "Start" in the task bar.
- Click consecutively "Programs" and "Windows NT Explorer".
- Click "Network" line in the "All Directories" list.

A list of available network drives is displayed.

- Click "Tools" and "Map Network Drive".  
In the list "Shared Directories:" the network paths available in the network are displayed.
- Mark the desired network path.

- Select the drive under "Drive:"
- Activate "Reconnect at Logon:" if the link is to be automatically established at each unit start.
- Connect the network path to the selected drive with "OK".

The user name and the password are queried. The drive is then displayed in the "All Directories" list of Explorer.

**Note:** Only drives for which an authorization is available may be connected.

---

Disconnect link:

- Click "Tools" and "Disconnect Network Drive" in Explorer.
- Select under "Drive:" the drive whose connection is to be removed.
- Disconnect link with "OK". The query should be answered with "Yes".

## Printing on a Network Printer

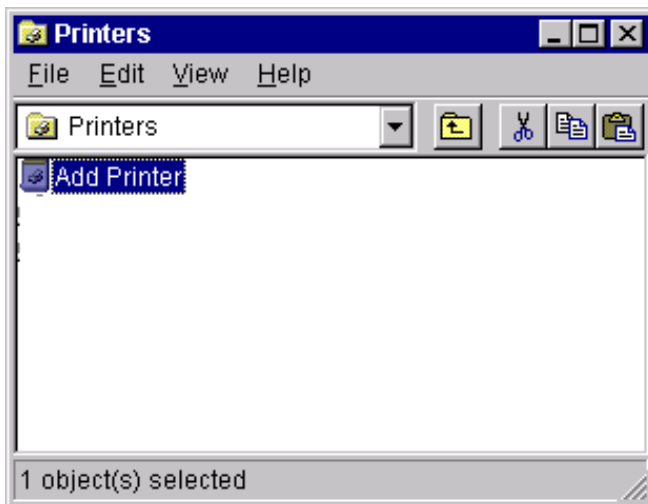

---

### Select printer driver under Windows NT

- Press key combination <ALT> <SYSREQ>  
The Windows NT screen is displayed.
- 
- In the Start menu press first "Setting" and then "Printers".  
The printer window is opened.

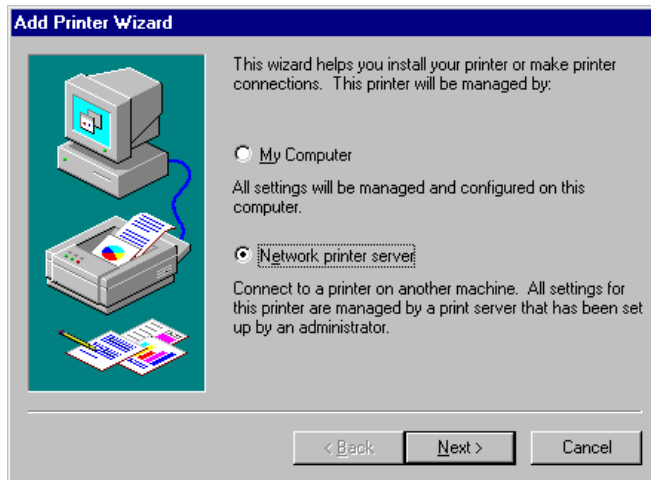

- Double-click line "Add Printer".

The "Add Printer Wizard" window is opened. This window leads through the following printer driver installation.

- Click first "Network Printer Source" and then "Next".

The list of available network printers is displayed.

- Mark the printer and select with "OK".

The available printer drivers are displayed. The left-hand selection table indicates the manufacturers and the right-hand one the available printer drivers.

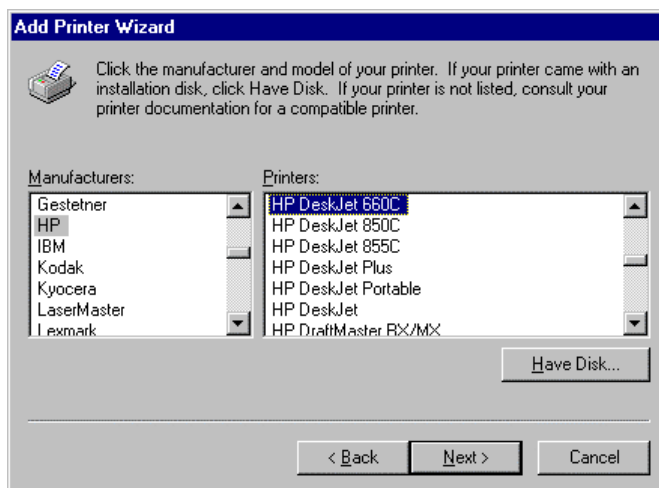

- Mark the manufacturer in selection table "Manufacturers" and then the printer driver in selection table "Printers".



- Click "Next".

The window for starting a test page is displayed. The test print is for checking if the installation was successful.

- Switch on printer.
- Click Yes (recommended)".
- Click "Finish".

A test page is printed out if the installation was successful.

If the test page is not printed out or not completely, the Windows NT online help offers troubleshooting instructions under the entry "Printer Trouble Shooting".

The instrument has to be configured with this printer for the printout of the measurement screen. This configuration is described in this chapter in the section "Connecting an Output Device".

## Server Function

With the server function data can be provided on the instrument for use in other computers. This is possible only in the MICROSOFT network. The server function is released after network installation as standard. If this is not required, it should be deactivated, see "Installation of Network Services".

The availability of instrument data in the network is controlled by releases. The release is a property of a file or of a directory. To grant a release, the object is to be marked in "Windows NT Explorer" and pressed by the right-hand mouse key. The release is performed under Properties -> Sharing by selecting "Shared As". Other computers can then access these objects with the names allocated under "Share Name". The online help gives further information on the network operation.

## TCP/IP

The TCP/IP protocol allows files to be transmitted between different computer systems. A program running on both computers is required to control the data transfer. The same operating or file system need not be used by the two partners. A file transfer is possible between DOS/WINDOWS and UNIX, for example. One partner has to be configured as host the other as client or vice versa. The system performing several processes at the same time (UNIX) will normally be the host. The usual file transfer program used for TCP/IP is FTP (File Transfer Protocol). An FTP host is installed as standard on most of the UNIX systems.

After installing the TCP/IP services, a terminal link can be established with "Start" - "Programs" - "Accessories" - "Telnet" or a data transmission with FTP using "Start" - "Run" "ftp" - "OK". Thus, all controller systems can be accessed which support these universal protocols (UNIX, VMS, ...).

Further information is given in the NT online help which can be called up with "Help".

**FTP**

For a complete description of the functions and commands see the FTP documentation.

**Establishing a connection**

➤ Click "Start" and then "Run" in the task bar.

The program is started with the DOS command

```
FTP
```

The following command sets up the connection:

```
OPEN <xx.xx.xx.xx>
```

xx.xx.xx.xx = IP address, e.g. 89.0.0.13

**File transmission**

To transmit a file to the target system, the following command is used:

```
PUT <file name>
```

file name = name of file e.g. DATA.TXT.

To call a file from the target system, the following command is used:

```
GET<file name>
```

file name = name of file e.g. SETTING.DAT.

```
TYPE B
```

allows the transmission of files in the BINARY format, no conversion is performed.

```
TYPE A
```

allows the transmission of files in the ASCII format. Thus, control characters are converted so that the text files can be read on the target system, too.

**Examples:**

```
PUT C:\AUTOEXEC.BAT
```

sends the AUTOEXEC.BAT file to the target system.

```
LCD DATA
```

changes to subdirectory DATA in the computer function.

```
CD SETTING
```

changes to the subdirectory SETTING on the target system.

**Changing directories**

The command

```
LCD <path>
```

changes the directory as the corresponding DOS command.

```
LDIR
```

lists the directory.

These commands refer to the computer function of the instrument. If the 'L' preceding the commands is omitted, they apply to the target system.

## Start-Up - Instruments with MS DOS<sup>®</sup> Controller or without Controller



**Important Note:**

*Before turning the instrument on, it must be observed that the following conditions are fulfilled:*

- *instrument covers are in place and all fasteners are tightened,*
- *fan openings are free from obstructions,*
- *signal levels at the input connectors are all within specified maximums,*
- *signal outputs are correctly connected and not overloaded.*

***Non-observance may cause damage to the instrument .***

### Unpacking the Instrument

After the instrument has been removed from its packaging, insure that all deliverable items are present as follows:

- FSE spectrum analyzer
- AC power cable
- operating manual

Now check the instrument for visible mechanical damage. If damage is present, promptly inform the delivery firm that delivered the instrument. In case damage is found, retain the carton and the packing materials.

### Instrument Setup

The instrument is designed for use under general laboratory conditions. The ambient conditions required at the operational site are as follows:

- The ambient temperature must be in the range of + 5 to + 45 °C.
- All fan openings must be unobstructed and the air exhaust at the rear panel and at the side-panel perforations must not be covered. The distance to the wall should be at least 10 cm.
- The mounting surface should be flat.

### 19" Rack Installation



**Important Note:**

*For rack installation, insure that the air flow at the side-panel perforations and the air exhaust at the rear panel are not obstructed.*

The instrument may be mounted in a 19" rack by using the rack adapter kit ZZA-95 (order number: 396.4911.00). The installation instructions are included in the adapter kit.

## EMI Protection Measures

In order to prevent electromagnetic interference (EMI), the instrument may be operated only when all covers are correctly in place. Only adequately shielded signal and control cables may be used (see recommended accessories).

## Connecting to AC Power

The FSE is equipped with an AC voltage selection feature and will automatically set itself according to the applied AC voltage (range: 90 to 132 VAC and 180 to 265 VAC, 47 to 440 Hz). The AC power connector is located on the rear panel (see below).

- Connect the instrument to the AC power source using the AC power cable delivered with the instrument.

## AC Power Line Fuses

The FSE is protected by two fuses as specified on the power supply name-plate. The fuses are located in a removable fuse holder which is located between the AC power switch and the AC power connector (see below).

## Instrument On/Off

AC power switch on the rear panel

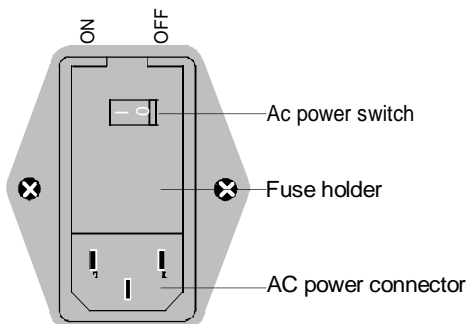

### Power On/Off

- Depress the AC Power Switch to the desired position ON/OFF.

After turn-on (position ON), the instrument is in the ready state (STANDBY) or in operation dependent upon the position of the ON/STANDBY switch located on the instrument front panel (see below).

**Note:** The AC power switch may remain ON continuously. Switching to OFF is only required when the instrument must be completely removed from the AC power source.

Switching to OFF (position OFF) removes all instrument circuitry from the AC power source.

ON/STANDBY switch on the front panel

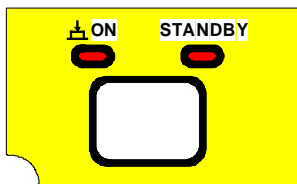

### Caution:



*In standby mode, the AC power voltage is present within the instrument.*

### Standby

- ON/STANDBY switch is not depressed.

The yellow LED (STANDBY) is illuminated. The DC power supply is supplied with power and the quartz oven is maintained at normal operating temperature.

### Operation

- ON/STANDBY is depressed.

The green LED (ON) is illuminated. The instrument is ready for operation. All modules within the instrument are supplied with power.

## Battery-Powered Memory

The FSE is equipped with a battery-powered read/write memory (CMOS-RAM) where instrument settings are saved at power-off. After each power-on, the FSE is reloaded with the operational parameters which were active just prior to the last power-off (STANDBY or AC power OFF).

A lithium battery is used to supply power to the CMOS-RAM. When the battery is depleted (expected life is approx. 5 years), any data stored in CMOS-RAM will be lost. In this case, the factory standard setup is loaded at turn-on. For changing batteries please contact the representative of our company responsible for you.

## Functional Test

After turning on the AC power, the FSE returns the following message to the display screen:

```
Analyzer BIOS
Rev.x.y

Copyright
Rohde & Schwarz
Munich

Booting
```

After appearance of the above message, a self-test of the digital hardware is performed. Any errors which occur in self-test are transferred as ASCII text to the printer interface (LPT). Thus, an error diagnosis can be carried out, even for serious failures. A check of the data contents of the spectrum analyzer is performed in self calibration (CAL, CAL TOTAL key) The individual results of the calibration (PASSED / FAILED) can be displayed in the calibration menu.

With the aid of the built-in self-test functions (INFO key, SELFTEST softkey), the functional integrity of the analyzer can be verified and/or defective modules can be localized.

## Connecting a Mouse



**Caution:**

*The mouse may only be connected when the instrument is switched off (STANDBY). Otherwise, correct operation of the mouse and instrument cannot be guaranteed.*

In order to ease manual operations, the FSE provides an option for connecting a mouse to a PS/2 mouse (MOUSE) or a serial interface (COM1 or COM2) connector.

During measurement operation, softkeys, tables and data input fields may also be controlled via the mouse. With the installed option FSE-B15, the mouse can be selectively assigned to measurement instrument operation, computer operation or both modes of operation. If the option FSE-B15 is not installed, then the mouse can only be assigned to measurement instrument operation.

The control functions for the mouse are described in Chapter 3 in the section "Mouse Operations". This section also contains a list in which the screen display elements for mouse control of the corresponding softkeys and push buttons of the instrument are described. Chapter 8 contains the interface description.

The Microsoft mouse is the supported mouse type and is available under option PS-B1 (order number 1006.6359.02). The mouse connectors are located on the rear panel.

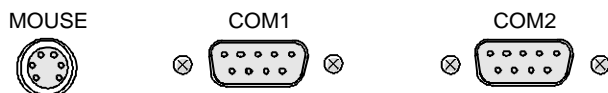



After connection of the mouse, the selected interface must be configured and the mouse assigned to either single or dual mode of operation.

The configuration is performed according to menu *SETUP-GENERAL SETUP* (key group: *CONFIGURATION*, see in Chapter 4, the section "Preliminary Setup and Interface Configuration").

- The parameter *MOUSE INTERFACE* configures the selected interface.
- The parameter *MOUSE OWNER* assigns the mouse to either single or dual mode of operation.

In the following illustrative example, the mouse is connected to the PS/2 interface and is assigned to the dual mode of operation.

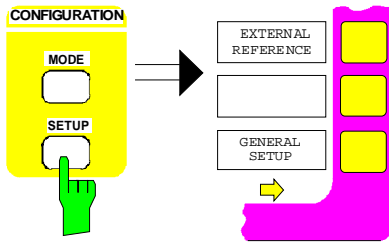

**Select *SETUP-GENERAL SETUP* menu**

- Press the *SETUP* key in the *CONFIGURATION* key group.

The *SETUP* menu is opened.

- Press the *GENERAL SETUP* softkey.

The *GENERAL SETUP* sub-menu is opened and the current settings of the general instrument parameters are displayed in tabular form on the display screen.

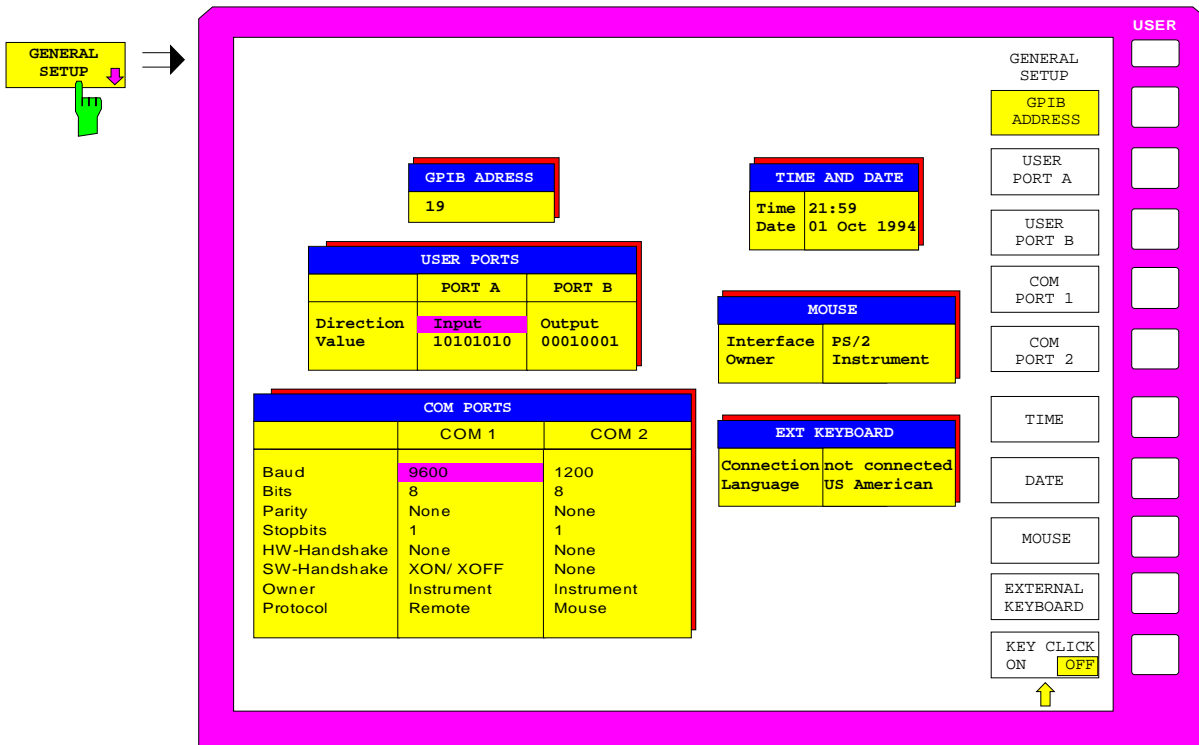

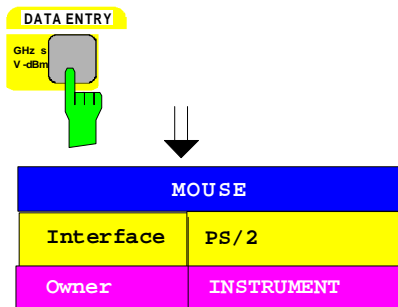
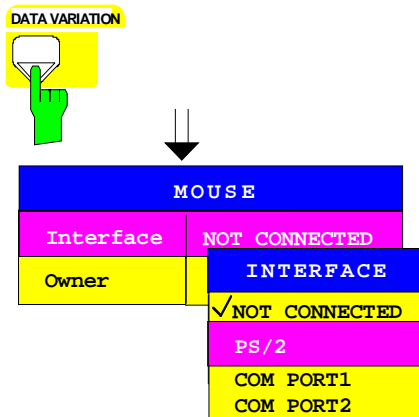
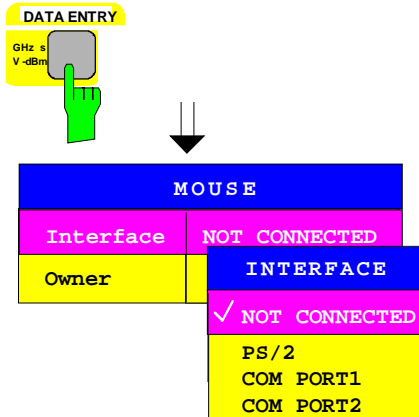
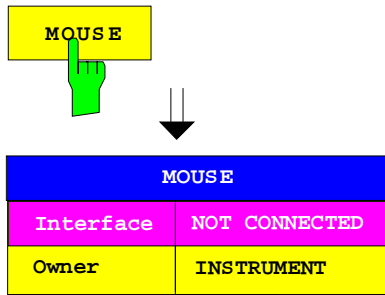

**Select interface**

- Press the *MOUSE* softkey.

The *INTERFACE* parameter in the *MOUSE* table is marked by the selection bar.

- Press one of the units keys.

The *INTERFACE* selection box appears on the display screen. The current state (*NOT CONNECTED*) is indicated by a check mark and the selection bar is in the background.

- Press the cursor key  until the entry PS/2 is indicated by the selection bar.

- Press one of the units keys.

The *INTERFACE* selection box is closed, the setting PS/2 is entered in the *MOUSE* table and the selection bar is automatically set to the *OWNER* parameter.

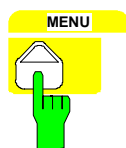
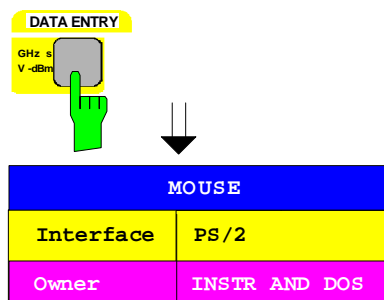
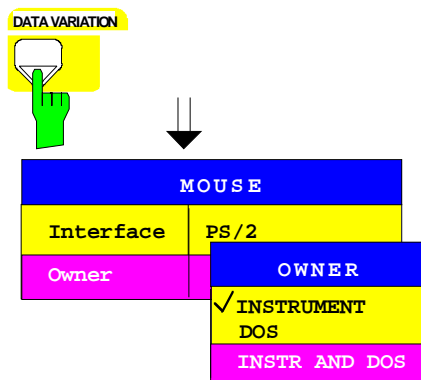
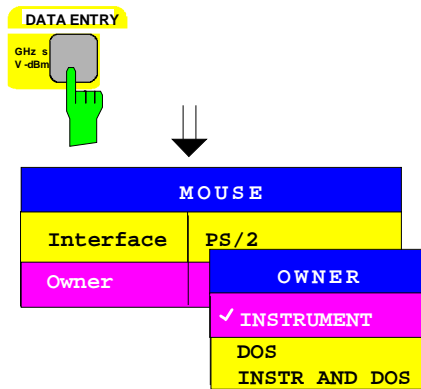

### Assign mouse mode

- Press one of the units keys.

The OWNER selection box appears on the display screen. The current state (INSTRUMENT) is indicated by a check mark and the selection bar is in the background.

- Press the cursor key  until the entry *INSTR AND DOS* is indicated by the selection bar.

- Press one of the units keys.

The OWNER selection box is closed and the setting *INSTR AND DOS* is entered in the MOUSE table.

The mouse is now installed and is available in both the measurement instrument and DOS modes.

### Return to main menu

- Press the menu-change key several times.

## Connecting an External Keyboard

**Caution:**

The keyboard may only be connected when the instrument is switched off (STANDBY). Otherwise, correct operation of the keyboard cannot be guaranteed.

The FSE provides an option for connecting an external PC keyboard to the 5-pin DIN connector at the rear panel.

During measurement operations, the keyboard simplifies the input of commentary text, filenames, etc. If the option FSE-B15 (computer function) is installed, the keyboard has the usual DOS-mode functions.

**Note:** Using the key combination <ALT><S-Abf> (German keyboard) or <ALT><SYSREQ> (US-keyboard), the representation on the display screen can be rapidly toggled between the measurement instrument and the DOS display formats.

Chapter 3 contains a list which describes the assignment of the FSE front-panel key functions to the key codes of the external keyboard as well as special key combinations used for quick operations. Chapter 8 contains the interface description.

The keyboard connection (KEYBOARD) is located on the rear panel.



After connecting the keyboard, the connection must be entered into the instrument and the key assignments for measurement instrument operations must be determined.

The configuration takes place in the menu *SETUP-GENERAL SETUP* (key group: *CONFIGURATION*, see in Chapter 4, the section "Preliminary Setup and Interface Configuration").

- The parameter *EXT KEYBOARD CONNECTION* informs the instrument that an external keyboard is connected.
- The parameter *EXT KEYBOARD LANGUAGE* sets the keyboard language definition for measurement instrument operation (*US-AMERICAN* or *GERMAN*).

**Note:** During measurement instrument operation, the key combination <ALT> <F1> can be used to toggle the language definition.

In the following illustrative example, the instrument is informed that a keyboard has been connected. The GERMAN keyboard definition is selected.

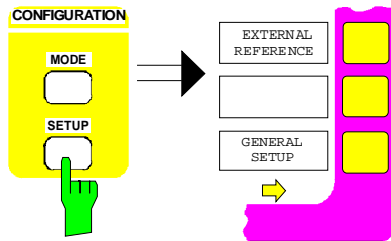

**Call SETUP-GENERAL SETUP menu**

- Press the *SETUP* key of the *CONFIGURATION* key group.  
The *SETUP* menu is opened.

- Press the *GENERAL SETUP* softkey.

The *GENERAL SETUP* sub-menu is opened and the current settings of the general instrument parameters are shown in tabular form on the display screen.

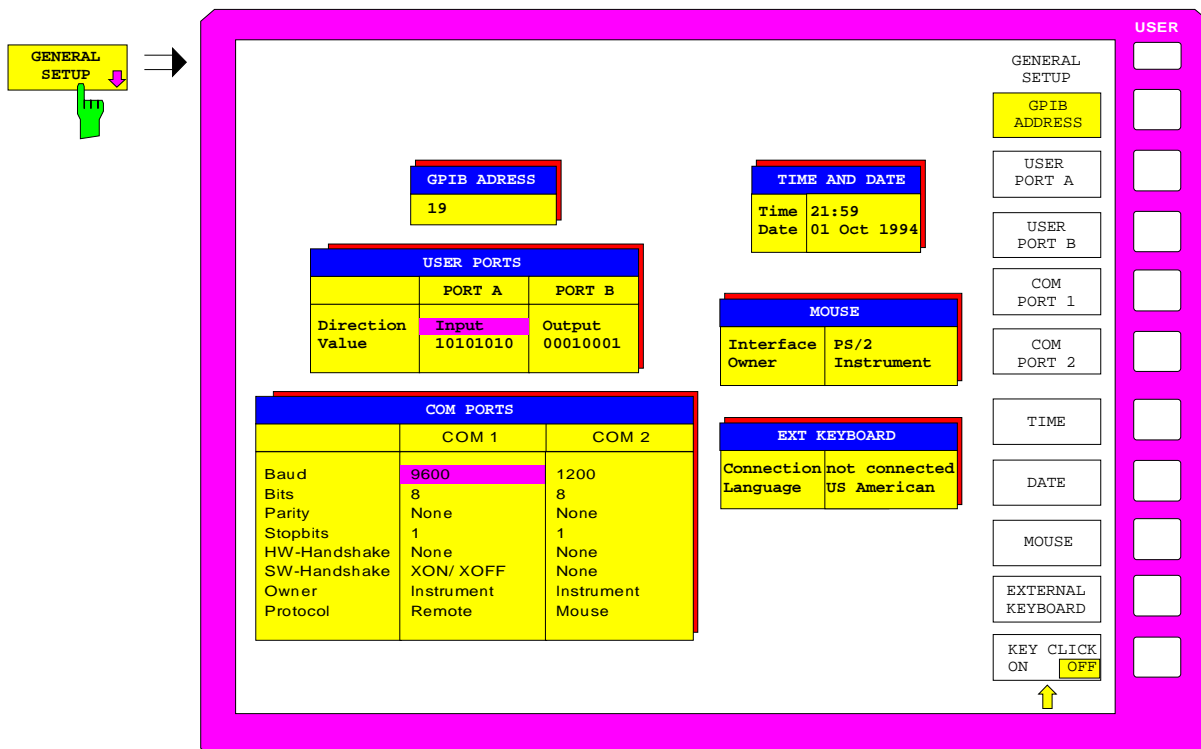

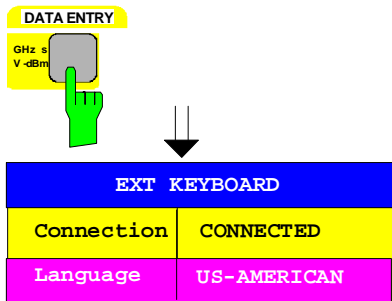
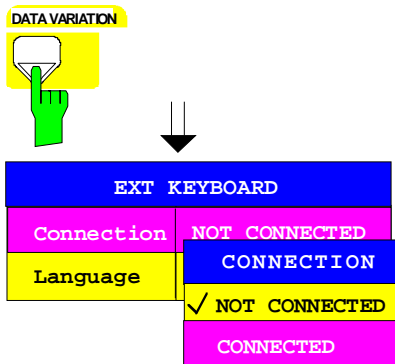
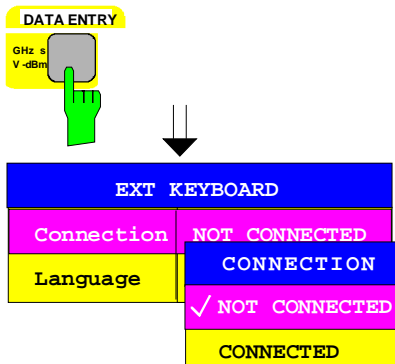
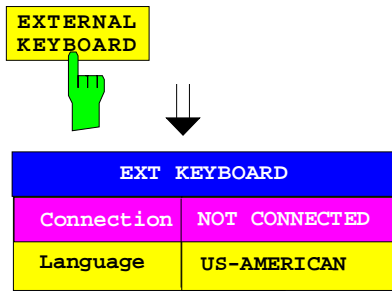

**Setup keyboard connection**

- Press the *EXTERNAL KEYBOARD* softkey.

The *CONNECTION* parameter in the *EXT KEYBOARD* table is marked by the selection bar.

- Press one of the units keys.

The *CONNECTION* selection box appears on the display screen. The current state (*NOT CONNECTED*) is indicated by a check mark and the selection bar is in the background.

- Press the cursor key  until the *CONNECTED* entry is indicated by the selection bar.

- Press one of the units keys.

The *CONNECTION* selection box is closed, the setup *CONNECTED* is entered in the table, *EXT KEYBOARD* is entered and the selection bar is automatically set to the *LANGUAGE* parameter.

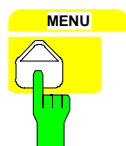
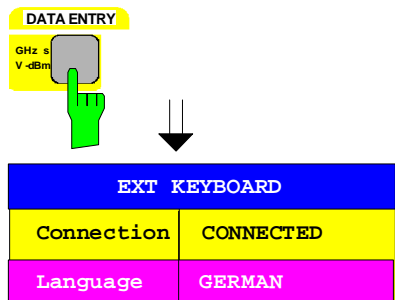
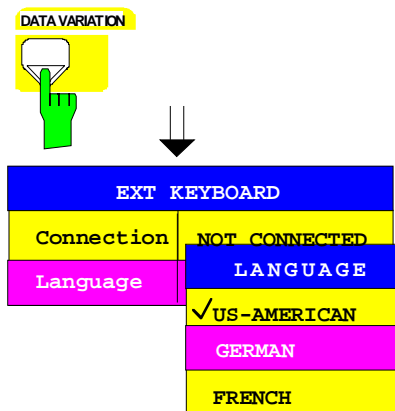
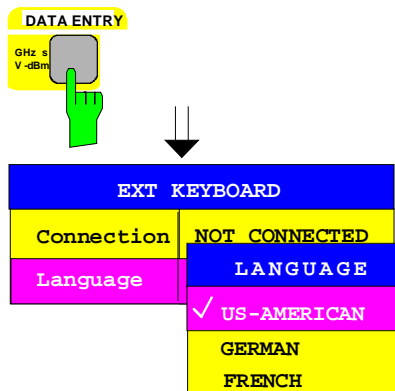

### Select German keyboard

- Press one of the units keys.

The *LANGUAGE* selection box appears on the display screen. The current state is indicated by a check mark and the selection bar is in the background.

- Press the cursor key  until the *GERMAN* entry is indicated by the selection bar.

- Press one of the units keys.

The *LANGUAGE* selection box is closed and the *GERMAN* setting is entered in the *EXT KEYBOARD* table.

**Note:** This setting is valid only for the measurement instrument mode. The keyboard assignment in DOS mode is independently set by using the corresponding MS-DOS command.

### Return to MAIN MENU

- Press the menu-change key several times.

## Connecting an Output Device



**Caution:**





The output device may be connected only when the instrument is switched off (STANDBY)

The FSE provides an option for connecting up to four different output devices to allow printing a hard copy of the display screen. The output devices supported by the FSE can be found in the selection box *DEVICE/LANGUAGE* in the *HARDCOPY –SETTINGS DEVICE1/2* menu (see in Chapter 4, the section "Documentation of Measurement Results").

Chapter 8 contains the interface description of the connectors.

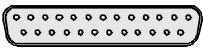
The interface connectors are located on the rear panel (see Table 1-2).

Table 1-2 Interface Connectors for Output Devices

Rear panel interface connectors	LPT 	COM1 	COM2 	<SCPI> IEC625 
Name in instrument control	LPT1	COM1	COM2	GPIB1

After connection of the output device to the appropriate interface connector, the configuration of the interface as well as the output device must be entered and the output device must be assigned to the interface.

The configuration of the selected interface (COM1, COM2 or GPIB1) is performed according to the *SETUP-GENERAL SETUP* menu (key group: *CONFIGURATION*, see in Chapter 4, the section "Preliminary Setup and Interface Configuration").

**Note:** Interface LPT1 cannot be configured. If the option FSE-B15, computer function, is installed, LPT1 can be used for printing in both the measurement instrument mode and the computer mode. However, it can only be used for one mode at a time.

### Interfaces COM1 and COM2

- The parameters *COM PORTS BAUDRATE*, *BITS*, *PARITY*, *STOPBITS*, *HW/SW-HANDSHAKE* determine the transmission parameters of the interface.

**Note:** The transmission parameters must agree with the specifications of the output device (see the operating manual for the output device).

- The parameter *COM PORTS PROTOCOL* informs the instrument that an output device is connected to an interface (REMOTE setting).

- The parameter *COM PORTS OWNER* assigns the interface to one or both operational modes.

**Note:** If printing is required in the measurement instrument mode, then this parameter must be set to *INSTRUMENT* or *INSTRUMENT AND DOS*. If, on the other hand, printing is required in computer mode (Option FSE-B15, computer function), then the parameter must be set to *DOS* or *INSTRUMENT AND DOS*.



**Interface GPIB1**

- The parameter *GPIB ADDRESS* passes the IEC Bus address of the output device to the instrument.

**Note:** *If the output device is operated in "listen only" mode, this setup may be omitted.*

The configuration of the connected output device and the assignment to the interface takes place in the *HARDCOPY DEVICE-SETTINGS DEVICE1/2* menu (key group:*HARDCOPY*, see in Chapter 4, the section "Selection and Configuration of the Output Device "). The configuration of up to two output devices (*DEVICE1* and *DEVICE2*) may be entered, of which, at least one must be activated for printing.

- The parameter *DEVICE/LANGUAGE* determines which output device is to be used.

**Note:** *During the selection of the printer type, it must be observed that the selected printer type and the connected output device are compatible. In case of doubt, consult the operating manual for the output device.*

- The parameter *CONNECTION* sets the interface which is to be used.

The number of additional parameters which need to be entered depends upon the selected interface and the output device used.

- The parameter *ORIENTATION* sets the page format to horizontal or vertical (portrait).
- The parameter *DEVICE RESET* determines if the output device is to be reset before each print job.
- The parameter *FORMFEED* determines if a formfeed should follow each print job.
- The parameter *PAPER FEED* specifies the paper feeder (single sheet or endless paper).

Table 1-3 shows the standard factory settings for the two output devices.

The standard factory settings for *DEVICE 1* correspond to an output device controlled by the command language HPGL, typically, a plotter connected to the IEC-Bus interface.

The standard factory settings for *DEVICE 2* correspond to a Epson printer (and compatible) connected to the parallel interface LPT.

Table 1-3 Factory settings for *DEVICE 1* and *DEVICE 2* in the *HARDCOPY-DEVICE SETTINGS* menu.

Parameter	Parameter Name	<i>DEVICE 1 Settings</i>	<i>DEVICE 2 Settings</i>
Output Device/Descriptive Language	DEVICE/LANGUAGE	HPGL	EPSON 24
Output Channel	CONNECTION	GPIB 1	LPT
IEC Bus Address	GPIB ADDRESS	4	---
Paper Format	ORIENTATION	PORTRAIT	PORTRAIT
Output Device Reset	DEVICE RESET	OFF	OFF
Formfeed	FORMFEED	OFF	ON
Paperfeed	PAPERFEED	MANUAL	MANUAL

In the following illustrative examples, a Postscript printer is connected to the LPT interface.

**Note:** Interface LPT cannot be configured. The configuration of the other interfaces (COM1, COM2 or GPIB1) is performed according to the *SETUP-GENERAL SETUP* menu (key group: CONFIGURATION, see in Chapter 4, the section "Preliminary Setup and Interface Configuration").

**Configure printer and connect to interface**

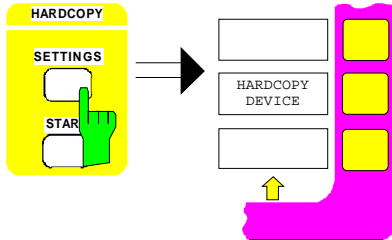

- Press the *SETTINGS* key of the *HARDCOPY* key group.  
The *SETTINGS* menu is opened.

- Press the *HARDCOPY DEVICE* softkey  
The *HARDCOPY DEVICE* sub-menu is opened and the current settings for the two possible output devices are displayed in tabular form on the display screen.

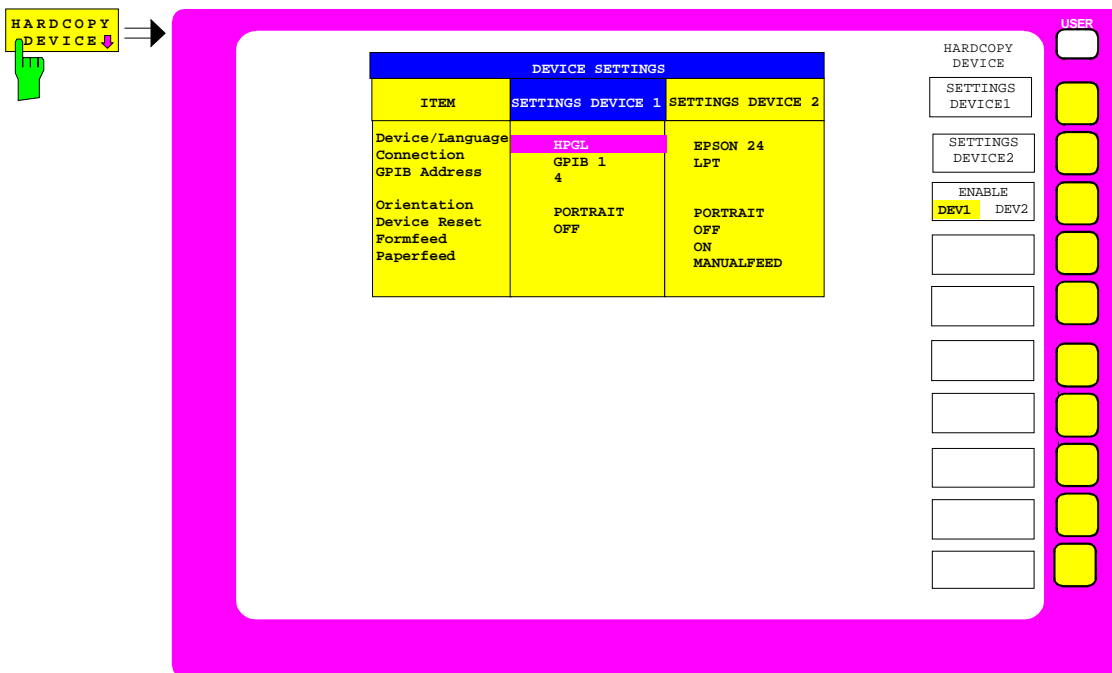

**SETTINGS DEVICE2**



DEVICE SETTINGS		
ITEM	SETTINGS DEVICE 1	SETTINGS DEVICE 2
Device/Language	HPGL	EPSON 24
Connection	GPIB 1	LPT
GPIB Address	4	
Orientation	PORTRAIT	PORTRAIT
Device Reset	OFF	OFF
Formfeed		ON
Paperfeed		MANUALFEED

➤ Press the *SETTINGS DEVICE2* softkey.

The current selection in the first line of the table column *SETTINGS DEVICE2* is marked by the selection bar.

**DATA ENTRY**



DEVICE SETTINGS		
ITEM	SETTINGS DEVICE 1	SETTINGS DEVICE 2
Device/Language	HPGL	EPSON 24
Connection	GPIB 1	LPT
GPIB Address	4	
Orientation	PORTRAIT	POSTSCR
Device Reset	OFF	✓ EPSON 24
Formfeed		HPPCL 4
Paperfeed		HPPCL 5
		HPGL
		PCX
		WMF

**SELECT DEVICE**

➤ Press one of the units keys.

The *SELECT DEVICE* selection box appears on the display screen. The current selection is indicated by a check mark and the selection bar is in the background.

**DATA VARIATION**



DEVICE SETTINGS		
ITEM	SETTINGS DEVICE 1	SETTINGS DEVICE 2
Device/Language	HPGL	EPSON 24
Connection	GPIB 1	LPT
GPIB Address	4	
Orientation	PORTRAIT	POSTSCR
Device Reset	OFF	✓ EPSON 24
Formfeed		HPPCL 4
Paperfeed		HPPCL 5
		HPGL
		PCX
		WMF

**SELECT DEVICE**

➤ Press the cursor key  until the *POSTSCR* entry is indicated by the selection bar.



DEVICE SETTINGS		
ITEM	SETTINGS DEVICE 1	SETTINGS DEVICE 2
Device/Language	HPGL	POSTSCR
Connection	GPIB 1	LPT
GPIB Address	4	
Orientation	PORTRAIT	PORTRAIT
Device Reset	OFF	OFF
Formfeed		ON
Paperfeed		MANUALFEED

- Press one of the units keys.

The *SELECT DEVICE* selection box is closed and the *POSTSCR* setting is entered in the table column *SETTINGS DEVICE2*. The selection bar now indicates the current entry in the next row of the table.

**Note:** The *CONNECTION* parameter is set to *LPT* at the factory and, therefore, must not be changed. The selection of the printer type automatically sets the parameters *ORIENTATION*, *DEVICE RESET*, *FORM FEED* and *PAPER LENGTH* to values which correspond to a standard mode of operation with this output device.



---

### Activate printer

- Press the *ENABLE* softkey until *DEV2* in the second softkey line is selected.

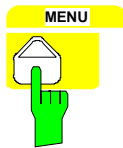

---

### Return to main menu

- Press the menu-change key several times.

## Firmware Update

The installation of a new firmware version can be performed using the built-in diskette drive and does not require opening the spectrum analyzer. The deliverable items contained in the Firmware Update Kit and the installation program call procedure may be found in the documentation accompanying the kit. The installation program then leads the user through the remaining steps of an update.

## Options

### Option FSE-B17 – Second IEC/IEEE Interface

Besides the FSE external devices can also be controlled via the IEC/IEEE bus using the optional 2nd bus interface FSE-B17 and the computer function for FSE (option FSE-B15). The interface software permits IEC/IEEE-bus commands to be included in user programs.

#### Installing the software

1. The operating software is already installed and need not be loaded from the driver diskettes which serve as backup diskettes.
2. The driver GPIB.COM must be loaded on the start-up of DOS. For this to take place, the line DEVICE = C:\AT-GPIB\GPIB.COM has to be entered in the file C:\CONFIG.SYS. If the option is factory fitted, this line will have been entered in the factory.
3. The configuration of the card can be modified with the program C:\AT-GPIB\IBCONF.EXE. The following parameters may not be changed:

Bios version < 3.0:

```
Enable Auto Serial Polling .. No
Base I/O Address ..... 02C0h
Interrupt Level ..... NONE
DMA Channel ..... 5 DMA
```

Bios version ≥ 3.0:

```
Enable Auto Serial Polling .. No
Base I/O Address ..... 02C0h
Interrupt Level ..... NONE
Channel ..... NONE
```

For further parameters, refer to manual for the card.

4. The parameters of units connected are also set with the program IBCONF.EXE. The logic designation for FSE is preset to DEV1 and the address to 20. For further equipment refer to manual for the card.

**Note:** *Ensure that the names assigned to the connected units are not the same as the directory names under DOS.*

#### Operation

The second IEC/IEEE-bus interface corresponds physically to that of FSE (see chapter 8).

If the FSE is to be controlled via the IEC/IEEE bus, a bus cable must be plugged to both bus connectors.

The interface can be driven under DOS/WINDOWS by R&S software (FSE-K3, Order No. 1057.2996.02, etc.) or by user-written software. The handling of IEC/IEEE-bus commands in user programs is described in the manual for the card.

The files for DOS in the computer function are in directory C:\AT-GPIB, those for WINDOWS in directory C:\AT-GPIBW .

**Note:** *The program IBIC.EXE (see manual for the card) may not be used for controlling the FSE (measuring unit section); however external units can be controlled via the bus.*

## Option FSE-B5 - FFT Filter

Option FFT Filter FSE-B5 is a firmware option. It has to be enabled by a keyword.

### Prerequisites

1. Keywords  
The keyword is printed on a label which is part of the equipment supplied and has to be stuck to the rear of FSE.
2. Hardware  
The modification state of module DIGITAL IF has to be either  $\text{MODIF INDEX} > 5$  or  $\text{MODIF INDEX} = 5$  and  $\text{HW CODE} \geq 6$ . The modification state can be checked in the module list *INSTALLED COMPONENTS* in menu *INFO HARDWARE+OPTIONS*.
3. Firmware  
The modification state of the firmware has to  $\geq 1.62$ . The modification state can be checked in table *FIRMWARE VERSION* in menu *INFO FIRMWARE VERSIONS*.

### Enabling the option

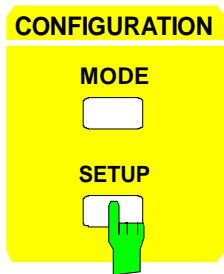

- Call up menu *SETUP* by pressing the *SETUP* key.



- Call up submenu *OPTIONS* by pressing the *OPTIONS* softkey.  
Table *FIRMWARE OPTIONS* is displayed, listing the installed options.

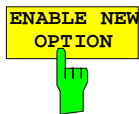

- Activate the entry field by pressing the *ENABLE NEW OPTION* softkey.

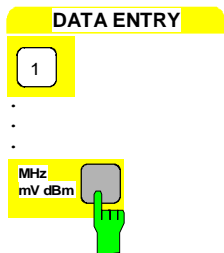

- Enter the 10-digit keyword via the numeric keypad and terminate the entry by pressing one of the unit keys.  
Now option FFT filter is listed in table *FIRMWARE OPTIONS*.

**Note:** Message 'option key invalid' indicates an invalid entry.

## Option FSE-B16 – Ethernet Adapter

With the option Ethernet Adapter FSE-B16, the device can be connected to an Ethernet-LAN (local area network). Together with the option Computer Function FSE-B15 it is possible to transmit data via the network and to use the network printer. The adapter operates with a 10 MHz Ethernet in line with standards IEEE 802.3 10Base2 (Thin Ethernet, CheaperNet, BNC-Net) (B16 model 03) or 10Base5 (Thick Ethernet) (B16 model 02). Operation without the option Computer Function FSE-B15 is not possible.

### Hardware Installation



**Caution:**

*Prior to installation contact the network administrator, especially in case of complex LAN installations since mistakes in cabling might have influence the whole network.*

If the adapter is installed at the factory, it is preconfigured. In case of retrofitting, refer to the installation instructions. The hardware settings must not be modified since the functions of the device could otherwise be impaired.

The following parameters are factory-set:

I/O Addr. 300,      IRQ 5,      MEM CA000

The connection with the network depends on the connectors used in the network.

### BNC (Thin Ethernet, CheaperNet; FSE-B16 Var. 03)

#### Connection

The device is looped into the LAN segment via rear-panel 2 BNC connectors.

If a cable is not connected to one of the BNC connectors, this BNC connector has to be terminated with 50 Ohm. BNC T connectors must not be used.

#### Network traffic



Note that the network traffic is disturbed if a segment is interrupted.

#### Requirements

Thin Ethernet segment requirements have to be complied with:

- maximum segment length of 185 m
- minimum distance between the connectors of 0.5 m
- maximum of 30 connectors per segment.

If components that comply with enhanced requirements are exclusively used (Ethernet Adapter FSE-B16 complies with the enhanced requirements):

- maximum length of segment of 300 m
- maximum number of connectors of 100

With repeaters used:

- maximum total length of the network of 900 m containing a
- maximum of 3 segments
- maximum of two repeaters between two connectors

---

**AUI (Thick Ethernet; FSE B16 Var. 02)****Connection**

---

The device is connected to the LAN segment using a transceiver cable (DB-15 AUI connector, not part of the equipment supplied) which is connected to the rear panel and to the transceiver.

**Network traffic**

---

The connection does not conflict with the network traffic. The device can also be disconnected from the network without any problems but make sure that data are not being transmitted.

**Requirements**

---

The Thick Ethernet segment requirements have to be taken into account.

- The maximum segment length should be 500 m and the distance between the connectors should at least be 2.5 m.
- A maximum of 100 connectors may be used in a segment.

With repeaters used,

- the total length of the network must not be more than 2500 m containing
- a maximum of 3 segments.
- There should be no more than two repeaters between two connectors.

If other network components are used, these conditions may vary.

---

**RJ45 (UTP, 10BaseT, Western Connector)****Connection**

---

A direct connection to a RJ45 star topology is not possible. With a MINI transceiver (AUI → RJ45) used, connection can be made via the AUI port at the rear of the device.

**Network traffic**

---

This connection does not conflict with the network traffic. The device can also be disconnected from the network without any problems but make sure that data are not being transmitted.

**Requirements**

---

Since RJ45 is not a bus but a star topology no special requirements have to be taken into account for the connection.

The LAN requirements should be considered in the installation.



## Software Installation

Data transmission within the network is by means of data blocks, the so-called packets. Besides user data other information, the so-called protocol data (transmitter, receiver, type of data, order) are transmitted. The drivers corresponding to the protocol have to be installed to process protocol information. A network operating system is required for network services (data transmission, directory services, printing in the network) and thus has to be installed.

### Installation of Network Drivers

#### a) ODI

ODI drivers have been developed by NOVELL for the network operating system NETWARE. It is an open standard so that other systems can be based on it, too. The driver system is of modular design and can thus be easily adapted to the hardware.

#### Files required for installation:

---

LSL.COM	(ODI drivers)
SMC8000.EXE	(hardware drivers for the adapter)
NET.CFG	(configuration file)

The NET.CFG file comprises information required for the installation of the network drivers. It is a text file that can be generated by any editor e.g. EDIT.

At least the following information has to be contained in the NET.CFG file:

```

Link Support
  Max Stacks 8
  Buffer 12 1586
  MemPool 8192

Link Driver SMC8000
  Port 300
  Mem CA000
  Int 5
  Frame ETHERNET_II

```

Parameter `Frame ...` depends on the type of packets used in the network. The network administrator can provide information about the frame type used. With a wrong type used, problems will not occur in the network but a connection to other systems cannot be set up.

#### Loading the drivers

---

The drivers have to be loaded under DOS in the following order:

```

LSL
SMC8000

```

To allow for an automatic start, the drivers can be entered into the C:\NETWORK.BAT file. This batch file will be executed automatically when the device is started. The drivers can be unloaded if the programs are called up with the parameter /U. Unloading has to be in the reverse order.

**b) NDIS**

NDIS drivers are mainly used by network operating systems from MICROSOFT (DOS MS-NET, WINDOWS FOR WORKGROUPS, WINDOWS 95, WINDOWS NT). It is an open system so that other systems can be based on it, too. The driver system is of modular design and can thus be easily adapted to the hardware.

**Files required for installation:**

---

```

PROTMAN.DOS
PROTMAN.EXE
NET.EXE
NET.MSG
IFSHLP.SYS
PROTOCOL.INI
NDISHLP.SYS
NETH.MSG
WFWSYS.CFG
SMC8000.DOS      (Hardware drivers for the adapter)
SYSTEM.INI

```

Files PROTOCOL.INI and SYSTEM.INI contain information required for installing the network drivers. They are text files that can be created or modified by any editor, e.g. EDIT.

At least the following information has to be contained in the PROTOCOL.INI file:

```

[network.setup]
version=0x3110
netcard=ms$w8003e,1,MS$W8003E,3
transport=ms$nwlinknb,NWLINK
transport=ms$ndishlp,MS$NDISHLP
transport=ms$netbeui,NETBEUI
lana0=ms$w8003e,1,ms$nwlinknb
lana1=ms$w8003e,1,ms$ndishlp
lana2=ms$w8003e,1,ms$netbeui

[protman]
DriverName=PROTMAN$
PRIORITY=MS$NDISHLP

[NWLINK]

BINDINGS=MS$W8003E
[MS$NDISHLP]
DriverName=ndishlp$
BINDINGS=MS$W8003E

[NETBEUI]
DriverName=netbeui$
SESSIONS=10
NCBS=12
BINDINGS=MS$W8003E
LANABASE=1

[MS$W8003E]
DriverName=SMC8000$
irq=5
iobase=0x300
ramaddress=0xca00

[SMC8000W]
Adapters=MS$W8003E

```

At least the following information has to be contained in the SYSTEM.INI file:

```
[Network]
winnet=wfwnet/00025100
multinet=nonet
FileSharing=Yes
PrintSharing=Yes
LogonDisconnected=yes
EnableSharing=Yes
UserName=FSE
Workgroup=WORKGROUP
ComputerName=FSE
Comment=FSE
[network drivers]
netcard=smcmac.dos
transport=ndishlp.sys,*netbeui
devdir=C:\NDIS
LoadRMDrivers=No

[NWNBLINK]
LANABASE=0
```

Parameter "UserName= ..." comprises the user name for the network.  
 Parameter "Workgroup= ..." comprises the user name for the network.  
 Parameter "ComputerName= ..." determines the name of the device in the network.  
 This name has to be unique in the network.

All drivers should be copied into a directory, e.g. C:\NDIS.

#### Requirements in the CONFIG.SYS file

The C:\CONFIG.SYS file has to be extended by the following line:

```
DRIVER = C:\NDIS\IFSHLP.SYS
```

To do this, the read-only attribute of the file has to be removed by the following DOS command:

```
ATTRIB C:\CONFIG.SYS -R
```

#### Loading the drivers

On startup of the device, the network drivers will be loaded automatically.

### c) Packet Drivers

The "Packet" network driver system has been developed by universities and can be used free of charge. Many free-of-charge network operating systems (KERMIT) are based on this driver system. Although the drivers for these network cards used to be made at universities, manufacturers have now started to supply their own drivers.

#### File required for installation:

---

PKT8000.COM

---

#### Loading the drivers

The driver should be copied into a directory, e.g. C:\PACKET.

The DOS command

```
C:\PACKET\PKT8000 -i 0x7e 5 0x300 0xca00
```

starts the driver.

To allow for an automatic start, the driver can be entered into the C:\NETWORK.BAT file. This batch file will be executed automatically on the startup of the device.

## Installation of Network Operating System

### a) NOVELL NETWARE

ODI drivers are the precondition for NOVELL NETWARE. The access software is available in three models: NETWARE SHELL, NETWARE REQUESTER and NETWARE CLIENT 32. NETWARE SHELL allows access to NETWARE 3 servers only. The NETWARE REQUESTER allows access to NETWARE 3 as well as NETWARE 4 (NDS). NETWARE CLIENT 32 cannot run on the device.

#### NETWARE SHELL

#### Files required for installation:

---

IPXODI.COM

NETX.EXE

The files should be copied into the directory comprising the network drivers.

If a connection to a certain network server is requested, the name of the server can be entered into the NET.CFG file by means of the following line:

```
PREFERRED SERVER = FSESERVER
```

(FSESERVER has to be replaced by the server name in the network).

**Loading the drivers**

The drivers are loaded under DOS in the following order:

```
IPXODI
NETX
```

To allow for an automatic start, the drivers can be entered into the C:\NETWORK.BAT file in addition to the network drivers. This batch file will be executed automatically on the startup of the device. The drivers can be unloaded if the programs are called up with the parameter /U . Unloading has to be in the reverse order.

**NETWARE REQUESTER****Files required for installation:**

```
IPXODI.COM
AUTO.VLM
BIND.VLM
CONN.VLM
FIO.VLM
GENERAL.VLM
IPXNCP.VLM
NDS.VLM
NETX.VLM
NMR.VLM
NWP.VLM
PNW.VLM
PRINT.VLM
REDIR.VLM
RSA.VLM
SECURITY.VLM
TRAN.VLM
VLM.EXE
```

The files should be copied into the directory comprising the network drivers.

**Changes in the CONFIG.SYS file**

In the C:\CONFIG.SYS file line

```
LASTDRIVE = V: has to be replaced by line
LASTDRIVE = Z:
```

To do this, the read-only attribute of the file has to be removed with the DOS command

```
ATTRIB C:\CONFIG.SYS -R
```

**Changes in the NET.CFG file**

The NET.CFG file is extended by the following lines:

```
Netware Dos Requester
NETWARE PROTOCOL = NDS BIND
FIRST NETWORK DRIVE = W
SHOW DOTS = ON
SPX CONNECTIONS = 99
IPX PACKET SIZE LIMIT = 1514
hold= off
```

If a connection to a certain network server is requested, the name of the server can be entered into the NET.CFG file by means of line

```
PREFERRED SERVER = FSESERVER
```

(FSESERVER has to be replaced by the server name in the network).

---

**Loading the drivers**

The drivers are loaded under DOS in the following order:

```
IPXODI
```

```
VLM
```

To allow for an automatic start, the drivers can be entered into the C:\NETWORK.BAT file in addition to the network drivers. This batch file will be executed automatically on the startup of the device. The drivers can be unloaded if the programs are called up with the parameter /U. Unloading has to be in the reverse order.

**b) MICROSOFT NET****Drivers required**

---

The NDIS drivers are the precondition for the MICROSOFT NET. Other drivers are not required.

**Loading the drivers**

---

The start is via the following DOS command:

```
C:\NDIS\NET START
```

To allow for an automatic start, the command can be entered into the C:\NETWORK.BAT file. This batch will be executed automatically on the startup of the device.

**c) TCP/IP**

TCP/IP (Transmission Control Protocol / Internet Protocol) is not a network operating system but a standard. This standard allows to transmit data between computers using different operating systems. The services are managed by utility programs such as FTP, TELNET, KERMIT, HTTP, RSH. TCP/IP only provides services for the transport and network addressing.

**Drivers required**

---

TCP/IP can be based on the ODI or PACKET drivers. Normally, another driver providing the TCP/IP support is required. See corresponding product about the use of the drivers.

## d) KERMIT

### Drivers required

The data transmission program KERMIT is based on the PACKET drivers. To install KERMIT it is required to copy all the files into a directory, e.g. C:\KERMIT. The precondition for this is that an IP address is assigned to the device by the network administrator and that the Sub Net Mask for the network is known. Both addresses are in the form of four digits from 0 to 255 separated by a dot. An IP address in the network has to be unique as problems might otherwise occur. The Sub Net Mask is the same in the whole network.

Examples of IP address:           89.0.0.14

Example of Sub Net Mask:       255.255.0.0

## Operation

After installing the network operating system it is possible to transfer data between the device and other computers and to use printers in the network. A precondition for network operation is the authorization to use network resources. Resources may be access to the file directories of other computers or the use of a central printer. The network or server administrator will grant the authorizations. The network name of the resource and the corresponding authorization are required. Passwords protect the resources against improper use. A user name is normally assigned to every authorized user. The user also has a password. Resources may then be assigned to the user. The type of access, i.e. whether data are only read or also written as well as a shared access to data has to be defined. Other types are possible depending on the network operating system.

## NOVELL

Operating system NETWARE from NOVELL is as server-supported system. Data transfer between the individual workstations is not possible. Data transfer is between workstation computers and a central computer, the server. This server provides storage capacity and the connection to the network printers. Like under DOS, the data on a server are organized in directories and are offered to the workstation as virtual drives. A virtual drive on a workstation is like a hard disk and data can be processed accordingly. This is called drive mapping. Also network printers can be addressed as normal printers. Network operating system NOVELL is available in two forms: NETWARE 3 and NETWARE 4 NDS. In the previous version NETWARE 3, each server manages its own resources itself and is independent. A user has to be managed separately on each server. For NOVELL 4 NDS, all resources are managed in the NDS (NOVELL DIRECTORY SERVICE). The user only has to log in once and gains access to the resources released for him. The individual resources and the user are managed as objects in a hierarchical tree (NDS TREE). The position of the object in the tree is called CONTEXT for NETWARE and must be known in order to access the resources.

**Logging into network**

After all network drivers have been loaded and the device has established a connection with the server, a new drive W: is generated. After a change to this drive, the log in can be started with the

```
LOGIN
```

command. The user name and the password are queried.

For NOVELL 4 NDS it is necessary to set the CONTEXT beforehand using the

```
CX <context>
```

command.

**Virtual drives**

To generate a virtual drive on the computer function of a device, the following command is used

```
MAP [ROOT]<dr>:=<server>/,<volume>:<directory>
```

where:

dr	drive indicator under which the virtual drive is addressed (E to P, R to V)
server	name of the NOVELL server on which the directory is located.
volume	name of the data medium on which the directory is located.
directory	name of the directory which is to be accessed.

If parameter ROOT is specified, the higher directories can no longer be addressed.

**Example:**

```
MAP P:=VENUS/SYS:MESURE\FSE
```

causes that the directory \MESURE\FSE on hard disk SYS of server VENUS appears on the device as drive P . In drive P it is also possible to see the directory structure of MESURE. If the command is called up with the parameter ROOT, it would only be possible to access directory structures below FSE.

The

```
MAP DEL <lw>:
```

command allows drive mapping to be canceled.

**Storage of device data on a server**

Instead of storing device data on hard disks, they can be stored on virtual drives. To do this, it is first required to generate a virtual drive E: in the computer function. The LOADINFO file in directory d:\ has to comprise line

```
ATTACHDEVICE E_DOS AS :C: EDOS
```

to enable the device to recognize the drive. Access to E: is according to normal device functions.



### Printing on a network printer

To be able to use a printer in the computer function, this printer has to be connected first with the computer function by means of the following command

```
CAPTURE L=<lpt> Q=<printer_queue>
```

where:

lpt	printer port (1=LPT1, 2=LPT2, 3=LPT3)
printer_queue	name of printer queue.

#### Example:

```
CAPTURE L=1 Q=PRINTER_FSE
```

causes printer data which are normally sent to printer port LPT1 to be routed to the network printer called PRINTER\_FSE.

### Hardcopy from device to a network printer

It is not possible to directly route a hardcopy from the device to a network printer. It has to be printed first into a file on the hard disk (Print to File). This file is then copied to the printer in the computer function.

This procedure is automated by the following DOS batch file:

```
START:
IF NOT EXIST C:\USER\OUTPUT.PRN GOTO START
COPY C:\USER\OUTPUT.PRN LPT1 /B
DEL C:\USER\OUTPUT.PRN
GOTO START
```

If this batch program is called up, the computer function waits until the device has generated a print file called OUTPUT.PRN, prints this file and deletes it again.

## MICROSOFT

For MICROSOFT, data can be transferred between workstations (peer-to-peer) but also between workstations and servers. The servers can provide access to individual files as well as the connection to network printers. Like under DOS, the data on a server are organized in directories and are offered to the workstation as virtual drives. A virtual drive on a workstation is like a hard disk and data can be processed accordingly. This is called drive mapping. Also network printers can be addressed as normal printers. A connection to DOS, WINDOWS FOR WORKGROUPS, WINDOWS95, WINDOWS NT is possible.

### Logging into network

After all network drivers are loaded and the device has established a connection with the server, a new drive W: is generated. After a change to this drive, the log in can be started with the

```
NET LOGON
```

command. The user name and the password are queried.

**Virtual Drives**

To generate a virtual drive on the computer function of a device, the following command is used

```
NET USE <dr>: \\<server>\<directory>
```

where:

dr	drive indicator under which the virtual drive is addressed (E to P, R to V)
server	name of the server on which the directory is located.
directory	name of the directory which is to be accessed.

**Example:**

```
NET USE P: VENUS\MESSUNG\FSE
```

causes the directory \MESURE\FSE of server VENUS to appear as drive P on the device.

Drive mapping is canceled by means of

```
NET USE <lw>: \\<server>\<directory> /DELETE
```

**Storage of device data on a server**

Instead of storing device data on hard disks, they can be stored on virtual drives. To do this, it is first required to generate a virtual drive E: in the computer function. The LOADINFO file in directory d:\ has to comprise line

```
ATTACHDEVICE E_DOS AS :C: EDOS
```

to enable the device to recognize the drive. Access to E: is according to normal device functions.

**Printing on a network printer**

To be able to use a printer in the computer function, this printer has to be connected first with the computer function by means of the following command

```
NET USE <port>: \\<server>\<printerqueue>
```

port	printer port (LPT1, LPT2, LPT3)
server	name of server on which the directory is located
printerqueue	name of printer queue of printer

**Example:**

```
NET USE LPT1: \\VENUS\PRINTER_FSE
```

uses printer data which are normally sent to printer port LPT1 to be routed to the network printer called PRINTER\_FSE.

**Hardcopy from device to a network printer**

It is not possible to directly route a hardcopy from the device to a network printer. It has to be printed first into a file on the hard disk (Print to File). This file is then copied to the printer in the computer function.

This procedure is automated by the following DOS batch file:

```
START:
IF NOT EXIST C:\USER\OUTPUT.PRN GOTO START
COPY C:\USER\OUTPUT.PRN LPT1 /B
DEL C:\USER\OUTPUT.PRN
GOTO START
```

If this batch program is called up, the computer function waits until the device has generated a print file called OUTPUT.PRN, prints this file and deletes it again.

## TCP/IP

The TCP/IP protocol allows files to be transmitted between different computer systems. A program running on both computers is required to control the data transfer. The same operating or file system need not be used by the two partners. A file transfer is possible between DOS/WINDOWS and UNIX, for example. One partner has to be configured as host the other as client or vice versa. The system performing several processes at the same time (UNIX) will normally be the host. The usual file transfer program used for TCP/IP is FTP (File Transfer Protocol). An FTP host is installed as standard on most of the UNIX systems.

Columbia University provides the KERMIT program which not only allows file transfer via networks but also via modem. KERMIT can be used free of charge. The two procedures provide safe data transmission, i.e. errors normally do not occur.

## FTP

For a complete description of the functions and commands see the FTP documentation.

### Establishing a connection

---

The program is started with the DOS command  
`FTP`

The following command sets up the connection:

```
OPEN <xx.xx.xx.xx>
      xx.xx.xx.xx = IP address, e.g. 89.0.0.13
```

---

### File transmission

To transmit a file to the target system, the following command is used:

```
PUT <file name>
      file name = name of file e.g. DATA.TXT.
```

To call a file from the target system, the following command is used:

```
GET<file name>
      file name = name of file e.g. SETTING.DAT.
```

```
TYPE B
```

allows the transmission of files in the BINARY format, no conversion is performed.

```
TYPE A
```

allows the transmission of files in the ASCII format. Thus, control characters are converted so that the text files can be read on the target system, too.

### Examples:

```
PUT C:\AUTOEXEC.BAT
```

sends the AUTOEXEC.BAT file to the target system.

```
LCD DATA
```

changes to subdirectory DATA in the computer function.

```
CD SETTING
```

changes to the subdirectory SETTING on the target system.

---

**Changing directories**

The command

```
LCD <path>
```

changes the directory as the corresponding DOS command.

```
LDIR
```

lists the directory.

These commands refer to the computer function of the instrument. If the 'L' preceding the commands is omitted, they apply to the target system.

**KERMIT**

KERMIT comprises a large number of functions described in detail in the help file KERMIT.HLP.

---

**Establishing a connection**

The program is started by means of the DOS command

```
KERMIT
```

The

```
SET TCP/IP ADDRESS <xx.xx.xx.xx>
```

```
xx.xx.xx.xx = IP address e.g. 89.0.0.13
```

command allows to set the individual IP address.

The Sub Net Mask is set by means of

```
SET TCP/IP SUBNETMASK <xx.xx.xx.xx>
```

```
xx.xx.xx.xx= Sub Net Mask e.g. 255.0.0.0.
```

These commands can also be entered into the MSCUSTOM.INI file and will be executed automatically when KERMIT is started.

The computer to which data are to be transferred is set by means of

```
SET PORT TCP/IP <xx.xx.xx.xx>
```

```
xx.xx.xx.xx=IP address of target computer.
```

A prerequisite is that the KERMIT program on the target computer is running in the host mode.

KERMIT can be ordered via Internet in WWW (URL: <http://WWW.COLUMBIA.EDU>) from COLUMBIA UNIVERSITY for almost all operating systems.

The

```
CONNECT
```

command sets up the connection.

The

```
HANGUP
```

command allows to stop the connection and the

```
QUIT
```

command to leave the program.

---

**Data transmission**

To transmit a file to the target system, the

```
SEND <file name>
```

file name = name of file e.g. DATA.TXT

command is used. To transmit a file from the target system, the

```
GET<file name>
```

file name = name of file e.g. SETTING.DAT

command is used.

---

**Changing directories**

Like with DOS, the directory is changed by means of the

```
CD <path>
```

command and the contents of the directory is indicated by means of the

```
DIRECTORY
```

command.

These commands concern the computer function of the device. If REMOTE.. is used in front of the commands, they apply to the target system.

**Examples:**

```
SEND C:\AUTOEXEC.BAT
```

sends the AUTOEXEC.BAT file to the target system.

```
CD DATA
```

changes to the subdirectory DATA in the computer function.

```
REMOTE CD SETTING
```

changes to the subdirectory SETTING on the target system.



## Contents - Chapter 2 "Getting Started"

<b>2 Getting Started.....</b>	<b>2.1</b>
<b>Level and Frequency Measurements.....</b>	<b>2.1</b>
Measurement Task.....	2.1
Important Spectrum Analyzer Functions .....	2.2
Sweep, Level and Frequency Measurements – Example 1 .....	2.2
Sweep, Level and Frequency Measurements – Example 2 .....	2.6
Level Measurement Accuracy .....	2.8
<b>Measurement of Harmonic Separation .....</b>	<b>2.9</b>
Measurement Task.....	2.9
Important Spectrum Analyzer Functions .....	2.10
Measurement Procedure - Harmonic Separation – Example 1.....	2.11
Measurement Procedure - Harmonic Separation – Example 2.....	2.16
Measurement Procedure - Harmonic Separation – Example 3.....	2.20
<b>Measurement of Intermodulation Distortions .....</b>	<b>2.24</b>
Measuring Task .....	2.24
Important Spectrum-Analyzer Functions .....	2.25
Measurement.....	2.26
<b>Time-domain Measurements with Pulsed Signals .....</b>	<b>2.31</b>
Measuring Task .....	2.31
Important Spectrum Analyzer Functions .....	2.31
Measurement.....	2.32





## 2 Getting Started

Chapter 2 presents basic measurements performed by a spectrum analyzer to provide fast and easy access to the operation of the instrument.

Before starting any measurement with the FSE, please note the instructions given in chapter 1 for putting the instrument into operation. In chapters 3 you will find detailed information on customizing the instrument and the display.

For a systematic explanation of all menus, functions and parameters and background information refer to the reference part in chapter 4.

In the following description, each step is explained in detail using the FSE so that the instrument can be immediately used without the need for learning all of the available functions. The described measurement applications are:

- Measurement of the level and frequency of a sine wave signal.
- Measurement of harmonics.
- Measurement of third order intermodulation and determination of the intercept point.
- Zero span measurement of a pulsed signal.

All of the following examples assume the standard settings for the analyzer. These are set with the *PRESET* key in the *SYSTEM* key field. The most important standard settings are shown in Table 2-1. A complete listing of standard settings can be found in chapter 4.

Table 2-1 Important PRESET settings

Parameter	Parameter name	Setting			
		FSEA	FSEB	FSEM	FSEK
Mode	Mode	analyzer	analyzer	analyzer	analyzer
Center frequency	Center Frequency	1,75 GHz	3,5 GHz	13,25 GHz	20 GHz
Active Freq. Meas. Range	Span	3,5 GHz	7 GHz	26,5 GHz	40 GHz
Reference Level	Ref Level	- 20 dBm	- 20 dBm	- 20 dBm	- 20 dBm
RF Attenuation	RF ATT	10 dB	10 dB	10 dB	10 dB
Level Display Range	Level Range	100 dB	100 dB	100 dB	100 dB
Resolution Bandwidth	Res Bw	3 MHz	3 MHz	3 MHz	3 MHz
Video Bandwidth	Video Bw	3 MHz	3 MHz	3 MHz	3 MHz
Sweep Time	Sweep Time	5 ms	5 ms	150 ms	225 ms
Trigger	Trigger	free run	free run	free run	free run

## Level and Frequency Measurements

### Measurement Task

The determination of the level and frequency of a signal is one of the most frequently encountered measurement tasks typically performed by a spectrum analyzer. Usually, for the measurement of an unknown signal, the PRESET settings are initially selected. If levels above +30 dBm are expected or possible, then a power attenuator must be inserted ahead of the analyzer input. Without attenuation, these signal levels might damage or destroy the input attenuator or the input mixer.

## Important Spectrum Analyzer Functions

Important parameters for level and frequency measurements are the settings for the *CENTER FREQUENCY*, the selection of the active measurement frequency range (*SPAN*) and the *MARKER* functions.

### Sweep, Level and Frequency Measurements – Example 1

In this example, a signal with a frequency of 200 MHz and a level of -10 dBm are applied to the RF INPUT of the analyzer. The selection of the center frequency and the active frequency range takes place manually.

The necessary setup functions are performed almost without exception by the fixed-function keys. The menus which appear with a key can, for the most part, be ignored. In this manner, fast, key-oriented operation is possible.

The following setup steps are performed:

1. Reset the instrument.
2. Apply the test signal.
3. Set the center frequency to 200 MHz.
4. Reduce the active measurement frequency range (*SPAN*) to 1 MHz.
5. Measure the level and frequency using the marker.
6. Optimize the measurement dynamic range and reduce the level measurement error.
7. Measure the frequency with the internal frequency counter

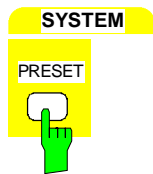

---

#### 1. Reset the instrument.

- Press the *PRESET* key.
- 

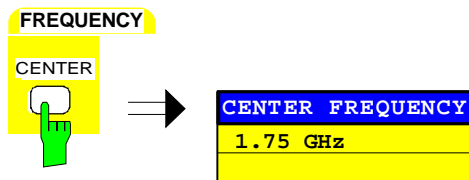

---

#### 2. Connect the test signal to the RF INPUT located on the instrument front panel.

---

#### 3. Set the center frequency to 200 MHz.

- Press the *CENTER* key in the *FREQUENCY* key field.

The input field for center frequency appears on the display screen.

---

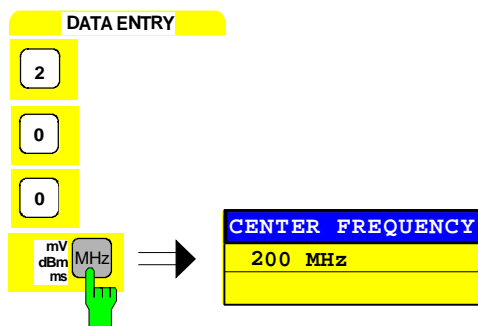

- Enter 200 via the numeric keypad and terminate with the *MHz* key.

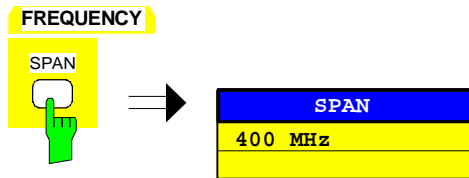

#### 4. Reduce the measurement frequency range (SPAN) to 1 MHz.

- Press the SPAN key in the FREQUENCY key field.

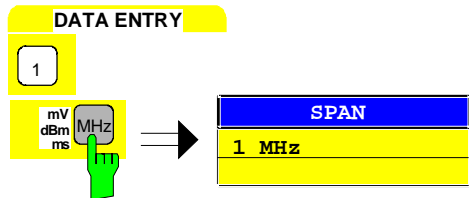

- Enter 1 via the numeric keypad and terminate with the MHz key.

**Note:** In conjunction with the change in measurement frequency range (SPAN), the resolution bandwidth (RES BW), video bandwidth (VIDEO BW) and sweep time (SWEEP TIME) are set to new values since they are defined as coupled functions in the standard PRESET settings.

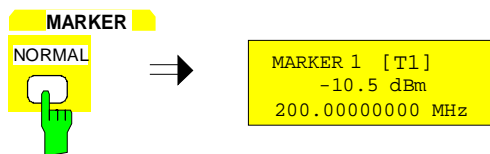

#### 5. Measure level and frequency using the marker and read the resulting values on the display screen.

- Press the NORMAL key in the MARKER key field.

The marker jumps to the largest signal peak shown on the display screen.

**Note:** When the marker is switched on for the first time, it automatically performs the PEAK SEARCH function as demonstrated in this example.

If a marker was already active, the SEARCH key in the MARKER key field must be pressed in order to set the currently active marker to the displayed signal maximum.

The level and frequency measured by the marker can be read in the marker field at the upper edge of the display screen. (see Fig. 2-1).

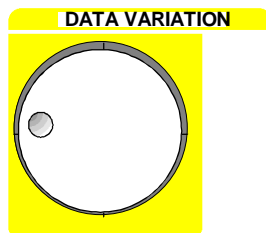

- Using the roll-key, the marker can be moved along the measured curve.

The corresponding level and frequency values appear in the marker field.

Fig. 2-1 shows the measured curve on the display screen over a 1 MHz range as well as the marker level and frequency values.

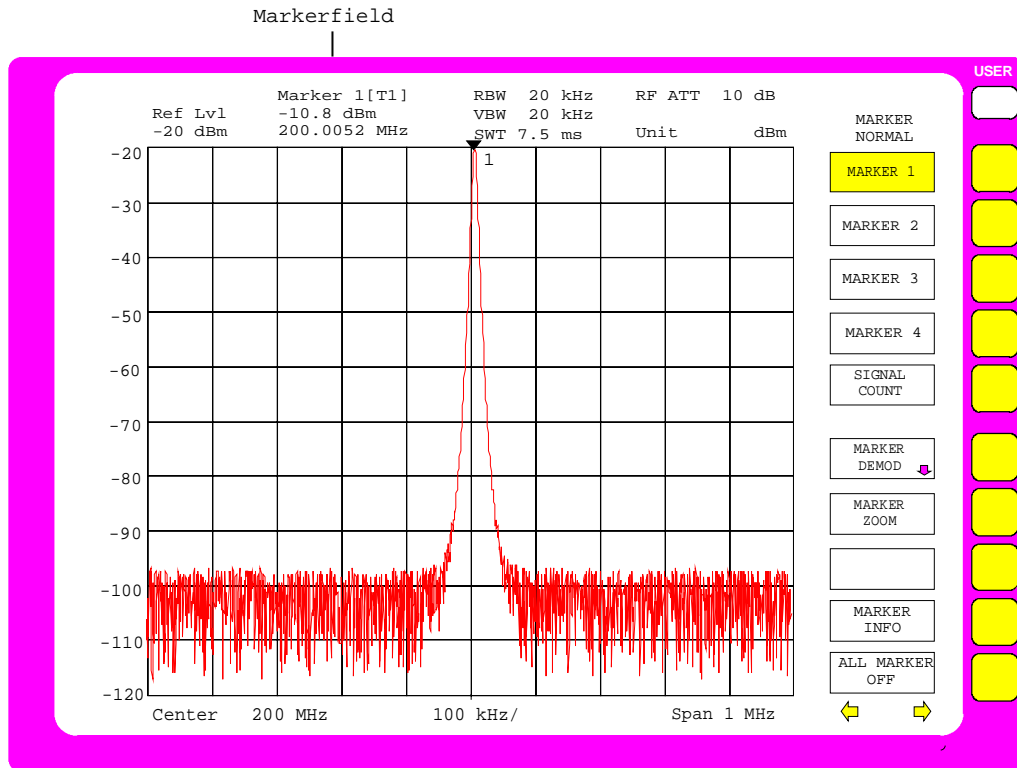
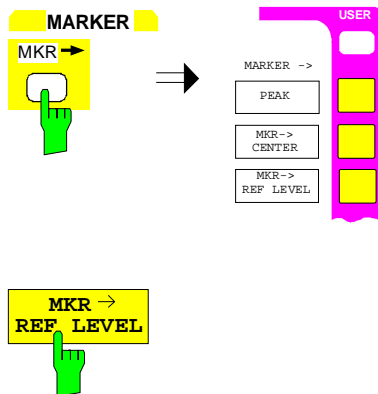

Fig. 2-1 200-MHz signal. The measured values are displayed in the marker field.

At low signal-to-noise ratios, the level measurement accuracy can be improved by an optimum selection of the FSE parameters. The accuracy of the frequency display can also be enhanced by applying the internal frequency counter.



**6. Optimize the dynamic range and reduce the level measurement error.**

- Press the MKR-> key in the MARKER key field. The MARKER-MKR-> menu is opened.

- Press MKR-> REF LEVEL softkey.

The reference level (REF LEVEL) is reduced to the signal level.

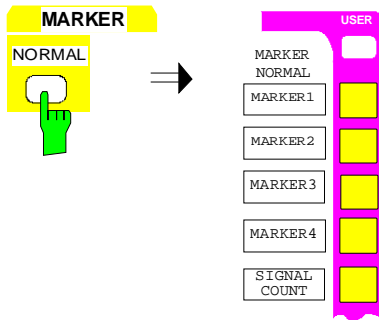

**7: Determine the exact frequency with the internal frequency counter.**

**Note:** The frequency counter measures the frequency of the marked signal with the selected counter resolution and at the accuracy of the internal frequency reference. A frequency measurement made using the marker is, however, limited by the number of horizontal display points and the applicable resolution bandwidth.

- Press the *NORMAL* key in the *MARKER* key field.  
The *MARKER NORMAL* menu is opened.

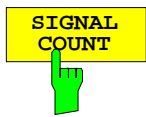

- Press the *SIGNAL COUNT* softkey.

The internal frequency counter is now active and measures the signal frequency with the *PRESET* resolution. The resolution is to be increased to 10 Hz.

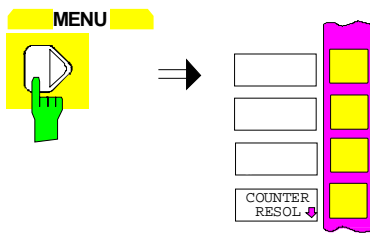

- Press the menu change key .  
The supplementary menu is opened.

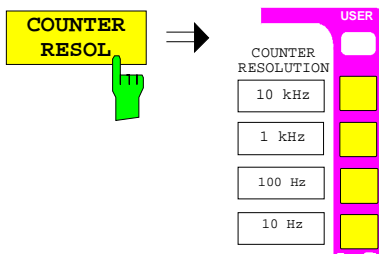

- Press the *COUNTER RESOL* softkey.  
The *COUNTER RESOLUTION* sub-menu is opened.

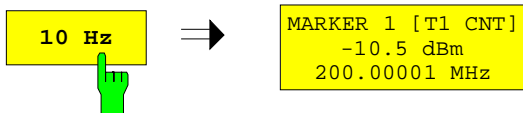

- Press the *10 Hz* softkey.  
The desired frequency resolution (10 Hz) is now selected.  
In the marker field, the item [CNT] indicates that the counter is active (see Fig. 2-2).

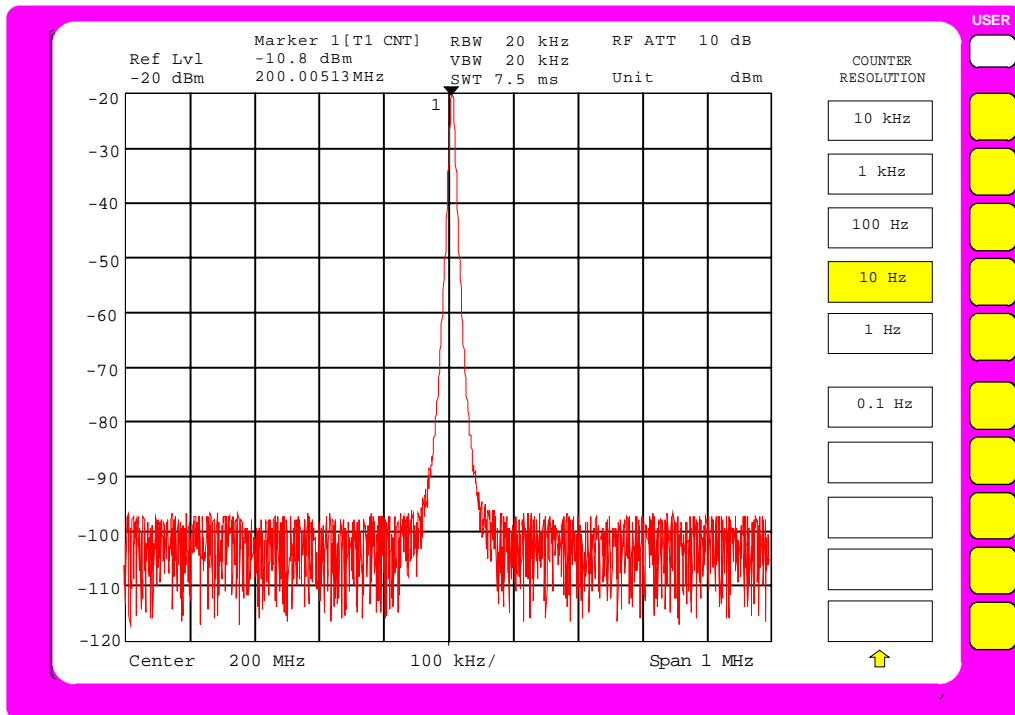

Fig. 2-2 Frequency measurement using the internal frequency counter.

## Sweep, Level and Frequency Measurements – Example 2

The zoom function (*MARKER ZOOM*) operates much faster than the manual input of center frequency and measurement frequency range, and permits the measurement frequency range displayed on the screen to be as narrow as desired.

As in Example 1, a signal with a frequency of 200 MHz and a level of -10 dBm is applied to the analyzer RF INPUT.

The following setup steps are performed:

1. Reset the instrument.
2. Apply the signal.
3. Zoom in on the signal.
4. Measure the level and frequency with the marker.
5. Optimize the dynamic range and reduce the level measurement error.
6. Measure the frequency with the internal frequency counter.

Steps 1 to 2 and 4 to 6 correspond to steps 1 to 2 and 5 to 7, respectively, of Example 1. Step 3 replaces the manual input of center frequency and measurement frequency range. (steps 3 and 4).

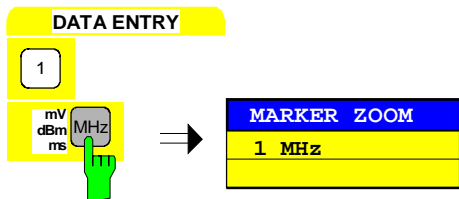
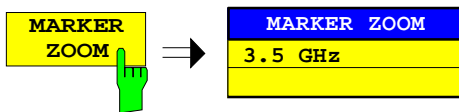
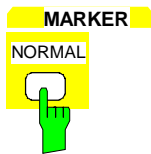

See steps 1 and 2 of example 1

1. **Reset the instrument to standard settings.**
2. **Connect the test signal to the analyzer RF INPUT.**

### 3. Zoom in on the signal.

- Press the *NORMAL* key in the *MARKER* key field .

The marker moves to the largest signal displayed on the screen. In this example, it is the signal at 200 MHz. (PEAK SEARCH function, see step 5 in Example 1).

- Press the *MARKER ZOOM* softkey.

The input field for the measurement frequency range appears on the display screen.

- Enter 1 via the numeric keypad and terminate with the *MHz* key.

After entry of the measurement frequency range, the marked signal is counted and then used as the new center frequency. At the same time, the entered measurement frequency range is set.

**Note:** In conjunction with the active measurement frequency range (SPAN) change, the resolution bandwidth (RES BW), video bandwidth (VIDEO BW) and sweep time (SWEEP TIME) are also set to new values since they are defined as coupled functions in the standard PRESET settings.

See steps 5 to 7 of example 1:

4. **Read the values for level and frequency as measured by the marker.**
5. **Optimize the dynamic range and reduce the level measurement error.**
6. **Determine the frequency with the internal frequency counter.**

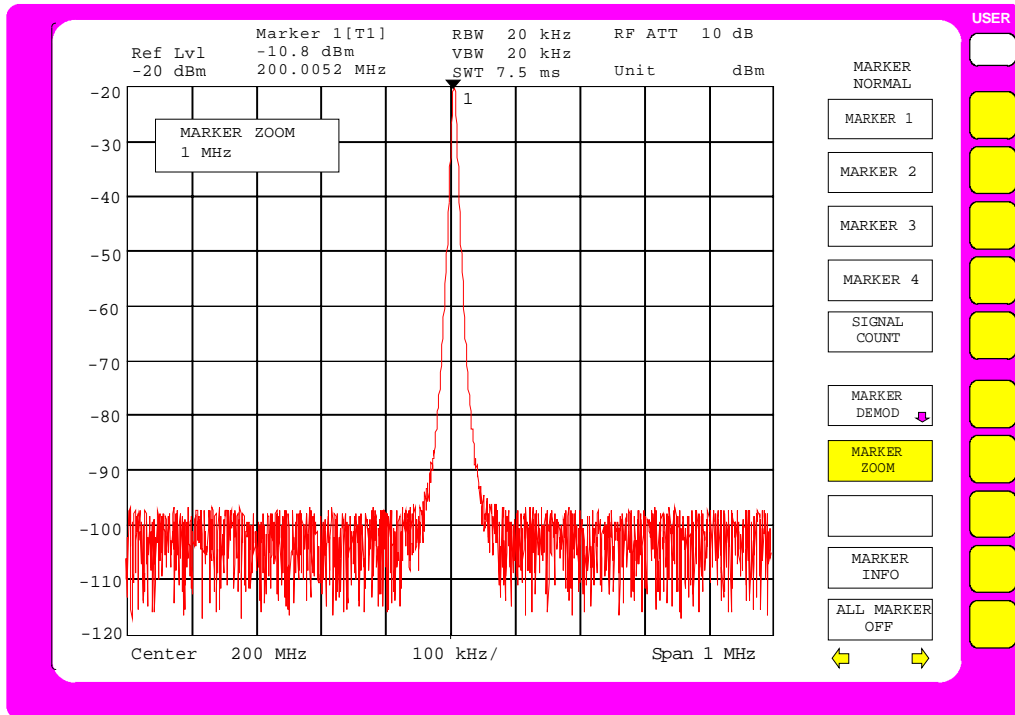

Fig. 2-3 The MARKER ZOOM function requires the entry of the measurement frequency range (span)

## Level Measurement Accuracy

The level measurement accuracy of an analyzer is influenced by the following parameters:

- RF attenuator (*RF-ATT*)
- IF amplification
- Resolution bandwidth (*RES BW*)
- Display range (*LEVEL RANGE*)
- Display linearity (*SCALE FIDELITY*)

The error in a level measurement for the FSE is < 1 dB for frequencies up to 1 GHz and < 1.5 dB for frequencies from 1 GHz to 3.5 GHz. This specification includes all of the above mentioned influential factors. The frequency characteristics of the pertinent modules (RF divider, front end) are stored individually in memory on each module. The FSE initializing routines read out the corresponding values during execution immediately after the analyzer is turned on and corrects the frequency characteristics during the sweep. Any errors in the attenuation settings, the filter bandwidth or the video rectifier are corrected after calling the built-in calibration routines. For calibration purposes, the FSE has an internal 120 MHz calibration source which is switched internally to the RF INPUT.

The measurement accuracy is guaranteed only after running the calibration routines. It should be noted, however, that the individual parameters are so stable that a calibration need only be performed, after approximately 15 minutes warm-up time, for larger temperature variations. Normally, a weekly calibration is more than adequate.



## Measurement of Harmonic Separation

### Measurement Task

The measurement of signal harmonics is a frequently occurring task which can be optimally performed by a spectrum analyzer. In general, all signals will contain harmonics to some degree. Harmonics are especially critical in high-power transmitters, e.g., in radio transmitters, where a significant radiated harmonic component may interfere with the reception of other radio services. Generally, non-linear device characteristics create harmonics which are often selectively reduced through the use of low-pass filters. Since the spectrum analyzer also has non-linear characteristics, e.g., at the first mixer, it is necessary to exercise caution during a measurement to insure that the spurious harmonics generated by the analyzer do not influence the measurement results. If necessary, the fundamental frequency must be selectively attenuated with respect to the harmonics by insertion of an appropriate high-pass filter.

For harmonic-content measurements, the achievable measurement dynamic range is dependent upon the k2 intercept of the spectrum analyzer. The k2 intercept point is defined as the fictitious first-mixer input level where the levels of the first harmonic and of the fundamental frequency are equal. In practice, this level cannot be applied to the mixer since, to do so, would cause its destruction. However, using the k2 intercept point concept, the achievable measurement dynamic range for the harmonics of a Unit Under Test (UUT) can be calculated with relative simplicity.

As can be seen in Fig.2-4, the harmonic level is reduced by 20 dB when the level at the fundamental frequency is reduced by 10 dB.

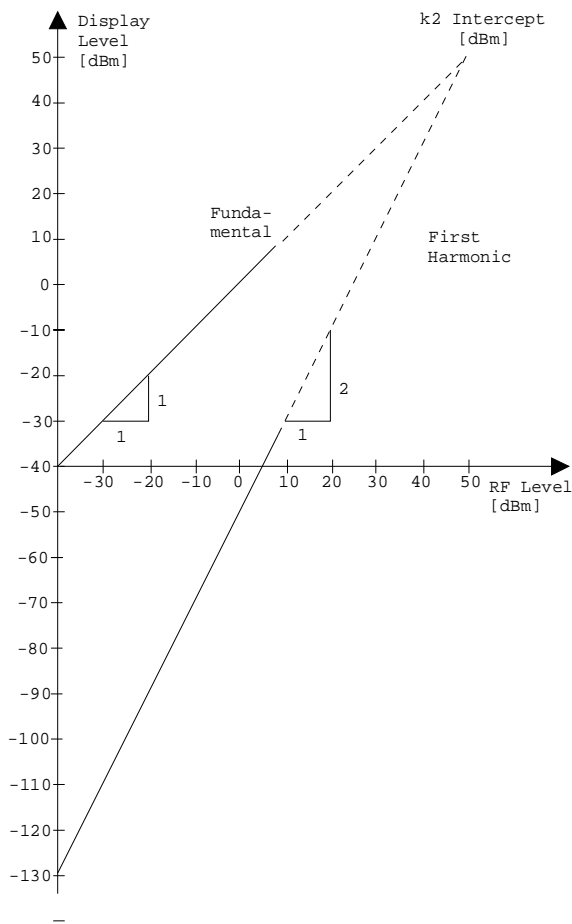

Fig.2-4 Theoretical display curve of fundamental and first harmonic with a k2 intercept of 50 dBm.

From the linear equations and the given intercept point, the following formula can be derived for the achievable harmonic separation  $a_{k2}$  in dB:

$$a_{k2} = IP2 - P_e \quad (1)$$

$a_{k2}$  = harmonic separation  
 $P_e$  = mixer level/dBm  
 $IP2$  = k2 intercept point

The formula for the internally produced level  $P_1$  at the first harmonic in dBm is:

$$P_1 = 2 \cdot P_e - IP2 \quad (2)$$

The lower harmonic measurement limit is dictated by the noise figure of the spectrum analyzer. Through adequate averaging with the video filter, the UUT harmonic level which is to be measured should be at least 4 dB over the noise figure so that the measurement error caused by the input noise is less than 1 dB.

From the above, the following rules for the measurement of large harmonic separations can be derived:

- Select an IF bandwidth as narrow as possible in order to reduce the noise figure.
- Select the RF attenuation as high as required so that the necessary harmonic separation can still be measured.

**Note:** *The mixer amplitude is the applied RF level reduced by the selected RF attenuation. The low distortion (LOW DISTORTION function) mode of the analyzer automatically sets the optimum RF attenuation for the best harmonic separation.*

The maximum harmonic separation is achieved when the harmonics level is equal to the inherent noise level of the receiver. The corresponding level at the mixer according to (2) is:

$$P_e [dBm] = \frac{P_{noise} / dBm + IP2}{2}$$

For a 30 Hz resolution bandwidth, (noise level < -140 dB,  $IP2 = 50$  dBm), this level is -45 dBm. Therefore, according to (1), the maximum measurable harmonic separation is 95 dB less 4 dB minimum signal-to-noise ratio.

## Important Spectrum Analyzer Functions

In addition to frequency and level settings, the harmonic separation measurement requires, above all, the delta markers. Also, the MRK→CF STEP SIZE function (marker frequency = center frequency step-width) is used in order to quickly measure the individual harmonics with the cursor keys.

There are several methods to measure harmonic content:

- The measurement of fundamental and harmonic signals in one measurement frequency range.
- The individual measurement of the harmonic separation in a narrow measurement frequency range. This method is preferred when high harmonic separation is to be measured (requires large dynamic range and, thus, narrow resolution bandwidth) or the frequency of the fundamental is very high, i.e., a very wide measurement frequency range is necessary.
- The measurement of fundamental and harmonics in two independent windows on the display screen (SPLIT SCREEN mode).

Example 1 describes the measurement of fundamental and harmonics in one measurement frequency range.

Example 2 describes the measurement of harmonic separation in separate measurement frequency ranges.

Example 3 shows the measurement of fundamental and harmonics in two independent windows on the display screen.

## Measurement Procedure - Harmonic Separation – Example 1

The analyzer 10 MHz reference signal is used at the input signal. The connector EXT REF IN/OUT on the rear panel is connected to the analyzer front-panel RF INPUT. Since the output level is 7 dBm, the reference level must be set to 10 dBm.

The following setup steps are performed:

1. Reset the instrument.
2. Set the reference level to 10 dBm.
3. Connect the rear-panel 10 MHz reference signal to the analyzer input RF INPUT.
4. Set the start frequency to 5 MHz.
5. Set the stop frequency to 55 MHz.
6. Smooth the displayed noise with the video bandwidth.
7. Measure the fundamental signal with the marker.
8. Measure the harmonic separation with the delta marker.
9. Measure the separation of remaining harmonics.

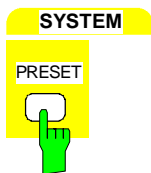

---

### 1. Reset the analyzer.

- Press the *PRESET* key.

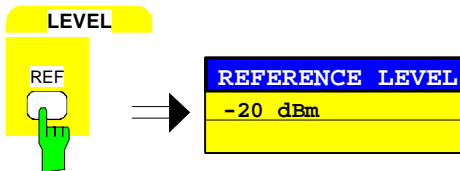



---

### 2. Set the reference level to 10 dBm.

- Press *REF* key in the *LEVEL* key field.

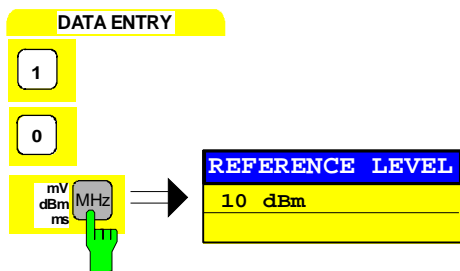
The entry field for the reference level appears on the display screen.



- Enter 10 via the numeric keypad and terminate with the *dBm* key.

---

### 3. Connect the 10 MHz-reference signal (output EXT REF IN/OUT) to the analyzer RF INPUT.

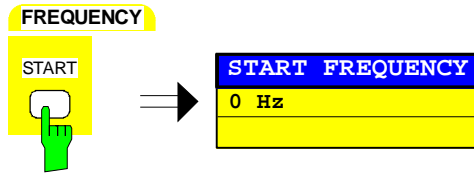

**4. Set the start frequency to 5 MHz**

- Press the *START* key in the *FREQUENCY* key field. The entry window for the start frequency appears on the display screen.

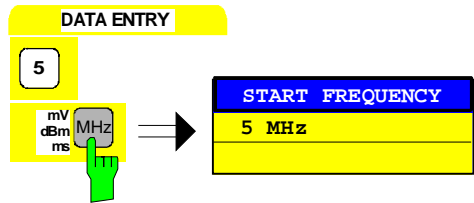

- Enter 5 via the numeric keypad and terminate with the *MHz* key.

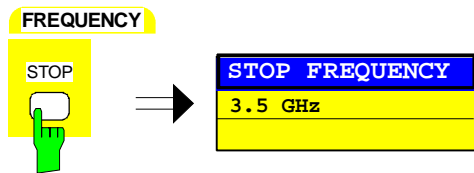

**5. Set the stop frequency to 55 MHz**

- Press the *STOP* key in the *FREQUENCY* key field. The entry window for the stop frequency appears on the display screen.

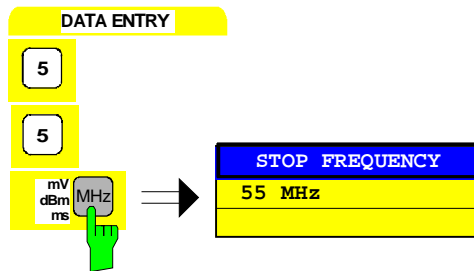

- Enter 55 via the numeric keypad and terminate with the *MHz* key.

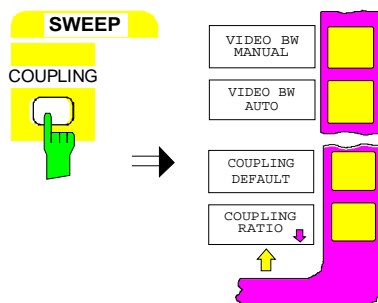

**6. Smooth the displayed noise with the video bandwidth**

- Press the *COUPLING* key in the *SWEEP* key field. The *SWEEP-COUPLING* menu is opened. The video bandwidth can now be either automatically coupled to the resolution bandwidth or manually entered.

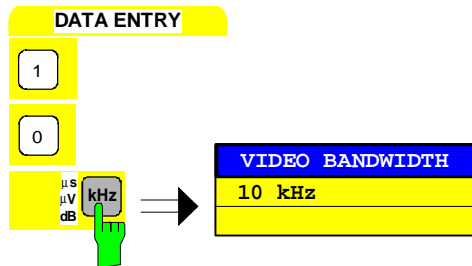
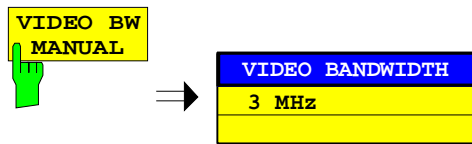
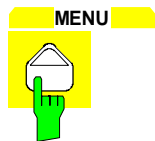
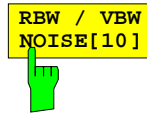
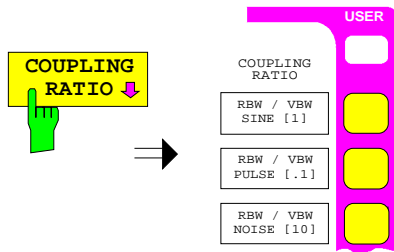

either:

**Automatic coupling of the video bandwidth to the measurement frequency range**

- Press the *COUPLING RATIO* softkey.

The sub-menu for setting the automatic coupling of bandwidths to the measurement frequency range is opened.

- Press the *RBW / VBW NOISE [10]*.

The video bandwidth is set to a factor of 10 less than the resolution bandwidth. This smooths the displayed noise.

- Press the menu change key .

The *COUPLING RATIO* submenu is closed.

or:

**Manual input of the video bandwidth**

- Press the *VIDEO BW MANUAL* softkey.

The entry field for the video bandwidth appears on the display screen.

- Enter 10 via the numeric keypad and terminate with the *kHz* key.

The analyzer displays the fundamental as well as the first to third harmonics (see Fig.2-5).

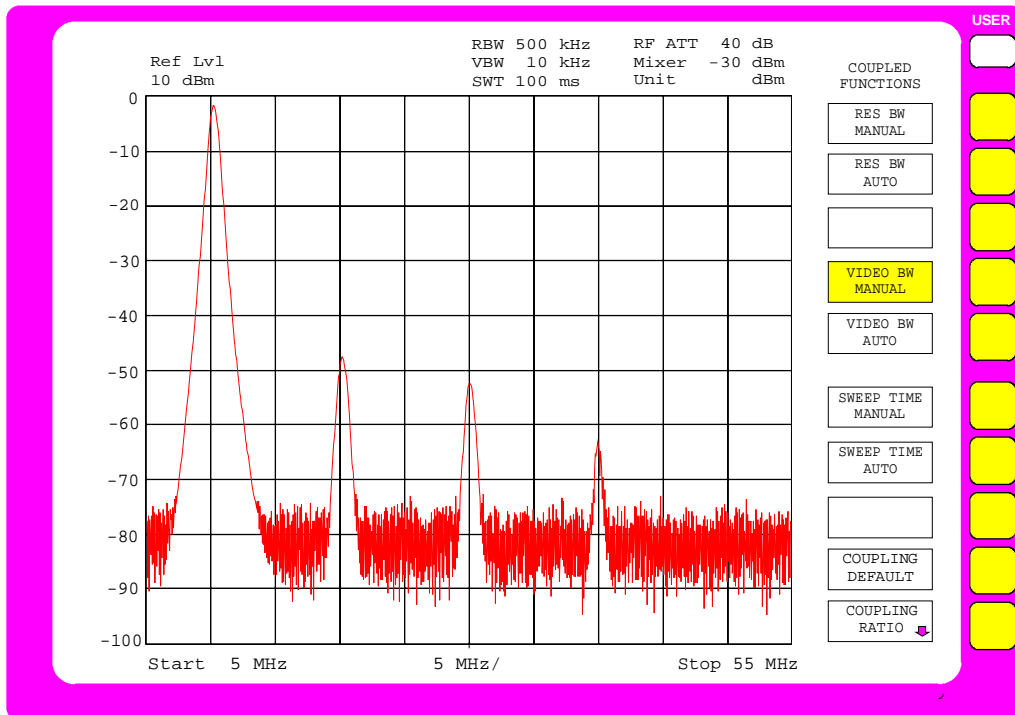

Fig.2-5 The fundamental and harmonics to 55 MHz



**7. Measure the fundamental with the marker.**

- Press the *NORMAL* key in *MARKER* key field.

The marker appears at the fundamental peak (see also level and frequency measurement step 5 of the *PEAK SEARCH* function).

The measured values can be read at the upper left of the display screen.



**8: Activate the delta marker and measure the harmonic separation**

- Press the *DELTA* key in the *MARKER* key field

The delta marker is active and appears on the fundamental.

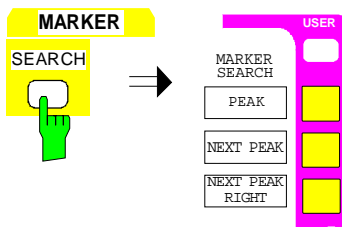

- Press the *SEARCH* key in the *MARKER* key group .

The *SEARCH-MARKER* menu is opened.



- Press the *NEXT PEAK RIGHT* softkey.

The delta marker jumps to the first harmonic and measures the difference between the harmonic and the fundamental. The measured values can be read at the upper left of the display screen. In this example, the harmonic separation is approx. 40 dB (see Fig.2-6).



**9. Measure the separation of additional harmonics**

- Press the *NEXT PEAK RIGHT* softkey.

The delta marker jumps to the next highest harmonic. The measured value can be read as before.

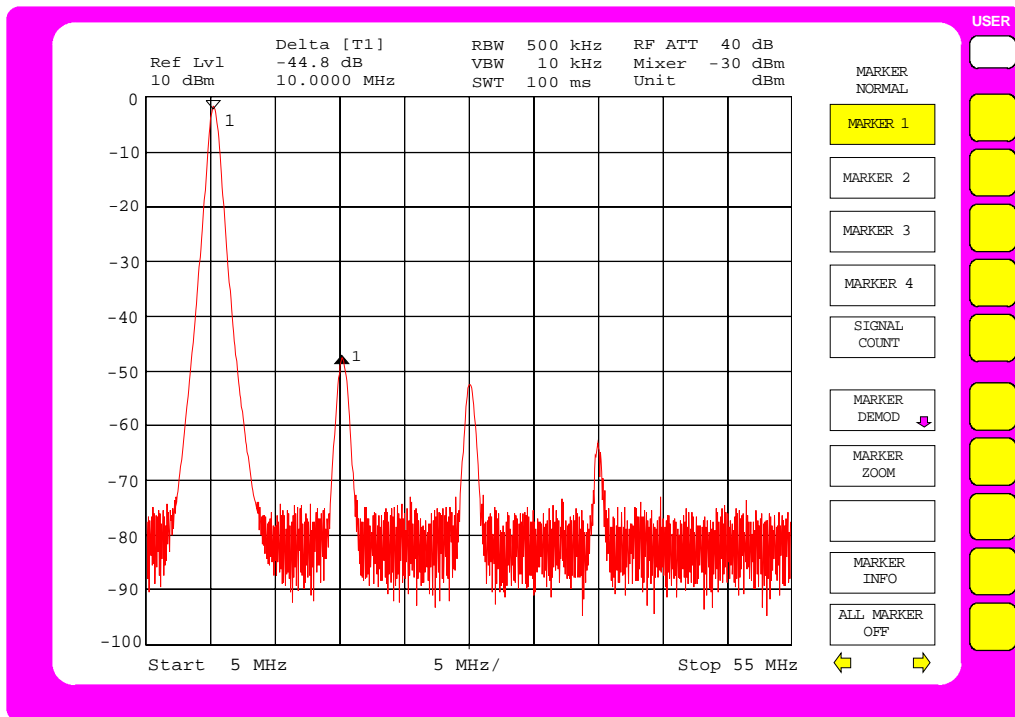

Fig.2-6 First harmonic separation: approx. 40 dB referred to the fundamental

## Measurement Procedure - Harmonic Separation – Example 2

In example 2, the fundamental frequency of the test signal and the separation of the individual harmonics are measured. The reference to the fundamental is established with the REFERENCE FIXED marker, and the movement from harmonic to harmonic is performed with the MKR→ CF STEP SIZE and step keys. This method is recommended when the highest dynamic range is to be achieved.

The following measurement steps are carried out:

1. Reset the instrument.
2. Set the reference level to 10 dBm.
3. Connect the rear-panel 10 MHz reference signal (connector EXT REF IN/OUT) to the analyzer input RF INPUT.
4. Set the start frequency to 5 MHz.
5. Set the stop frequency to 55 MHz.
6. Smooth the displayed noise with the video bandwidth.
7. Measure the fundamental signal with the marker.
8. Reduce the measurement frequency range (ZOOM function):
9. Set the frequency step size to the fundamental frequency.
10. Save the reference value (REFERENCE FIXED)
11. Measure the separation to the first harmonic.
12. Measure the separations to the remaining harmonics.

---

**Set the analyzer according to Example 1 up to and including "Measure the fundamental with the marker" (steps 1 to 7).**

---

### 8. Reduce the measurement frequency range.

- Press the *NORMAL* key in the *MARKER* key field .  
The *MARKER-NORMAL* menu is opened.

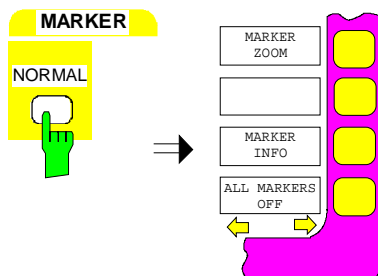

- Press the *MARKER ZOOM* softkey.

The entry field for the measurement frequency range appears on the display screen.

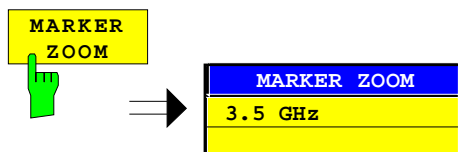



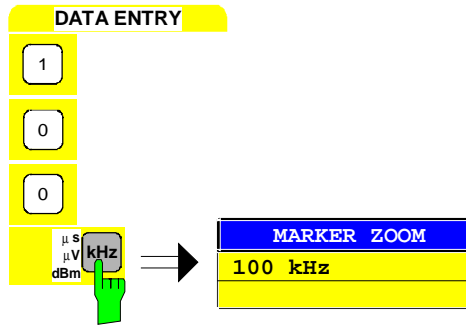

➤ Enter 100 via the numeric keypad and terminate with the kHz key.

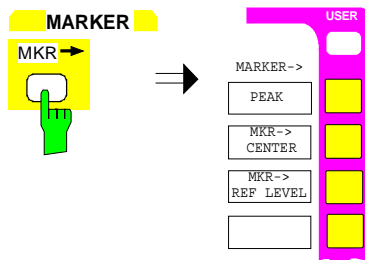

**9. Set the frequency step size to the fundamental frequency**

➤ Press the MKR → key in the MARKER key field  
The MARKER-MKR → menu is opened.

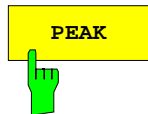

➤ Press the PEAK softkey.

The marker appears at peak of the fundamental signal.



➤ Press the MKR → CF STEP SIZE softkey.

The step size used when setting the center frequency with the cursor keys is set equal to the marker frequency.

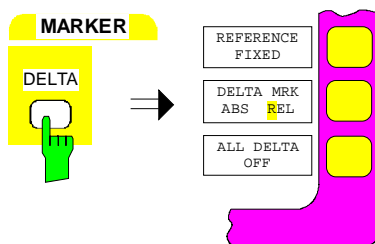

**10. Fix reference value**

➤ Press the DELTA key in the MARKER key field.  
The DELTA-MARKER menu is opened.



➤ Press the REFERENCE FIXED softkey.

The position of the marker is now a curve-independent reference for the delta measurement, even when the actual reference point is not visible on the display screen.

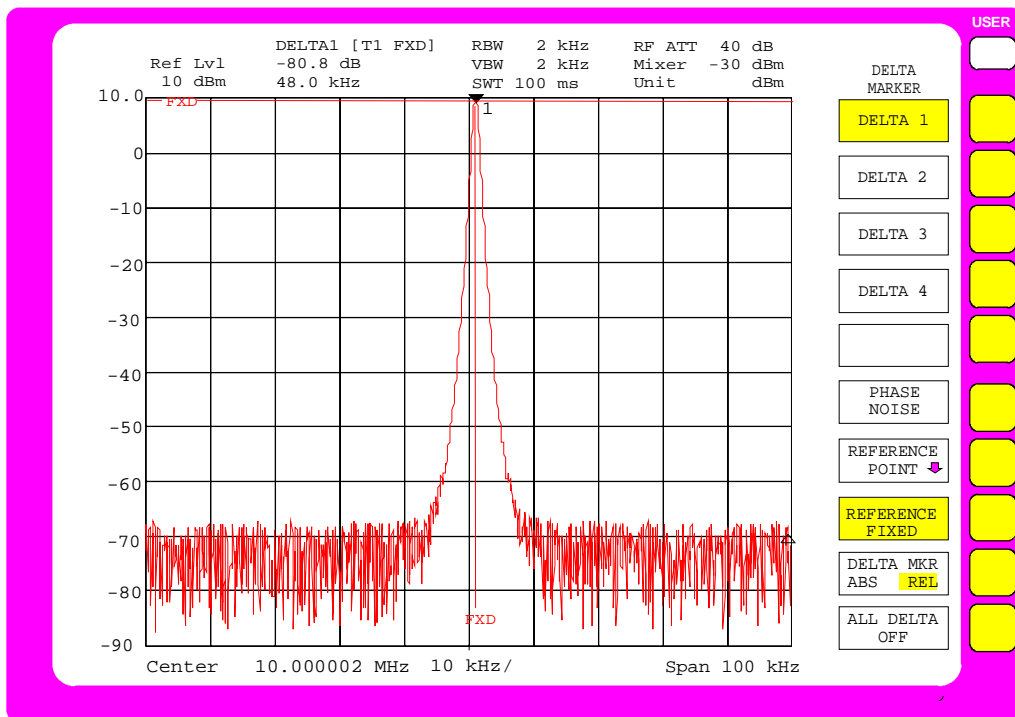
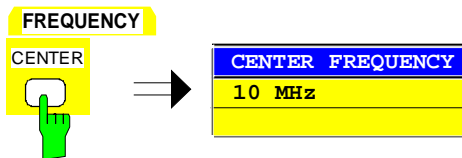

Fig. 2-7 Fundamental with REFERENCE FIXED marker



**11. Measure the harmonic**

- Press the *CENTER* key in the *FREQUENCY* key field.

The entry field for the center frequency appears on the display screen.

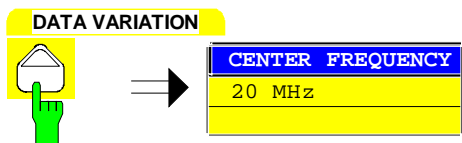

- Press the cursor key  in the *DATA VARIATION* key field.

The center frequency is increased by one step (= fundamental frequency).

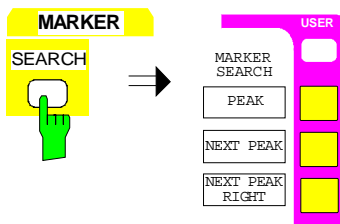

- Press the *SEARCH* key in the *MARKER* key field.

The *SEARCH-MARKER* menu is opened.

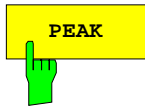

- Press the *PEAK* softkey.

The delta marker appears at the first harmonic and measures the separation from harmonic to fundamental. The measured value is displayed in the marker field at the upper left of the display screen (see Fig. 2-8).

## 12. Measure the separation of additional harmonics

- Repeat all of step 11.

The center frequency is once again increased by the frequency of the fundamental. The delta marker thus appears at the next harmonic.

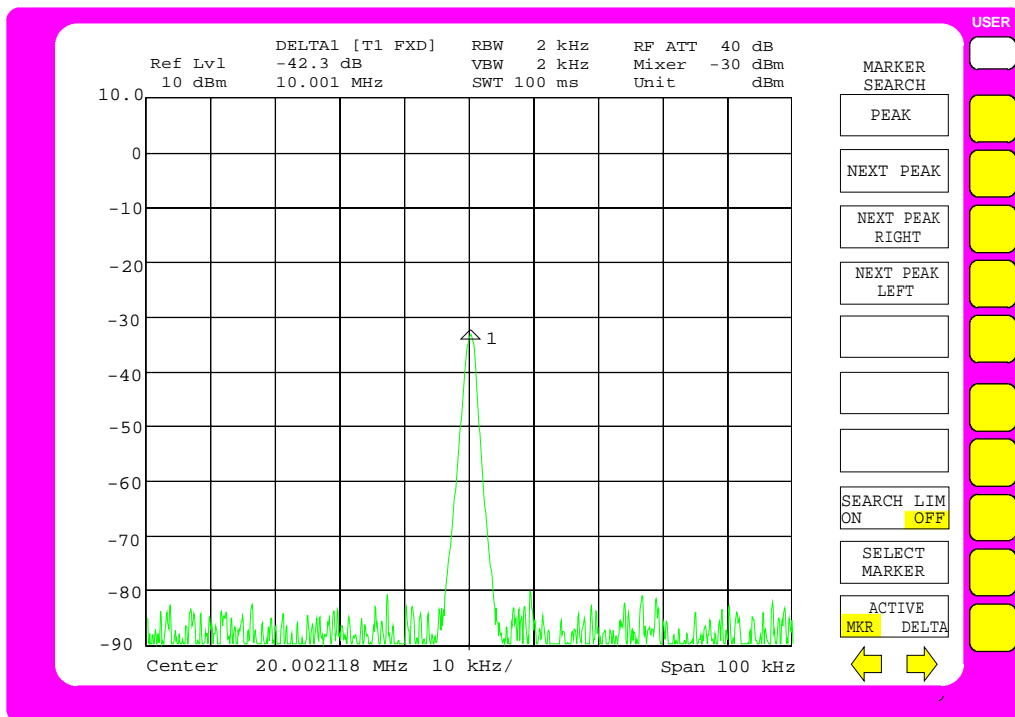

Fig. 2-8 Measurement of the first harmonic

**Note:** The spurious harmonics generated internal to the analyzer can be easily recognised by switching in additional RF attenuation. When an additional 10 dB attenuation is inserted, the displayed level of harmonics generated by the analyzer will be reduced by 10 dB, however, harmonics from the UUT will remain unchanged. This assumes that the receiver noise is substantially below the displayed level.

## Measurement Procedure - Harmonic Separation – Example 3

The measurement of fundamental and harmonics can also be performed in two independent windows on the display screen (SPLIT-SCREEN mode). This mode permits the simultaneous presentation of the fundamental and harmonics with higher resolution and dynamic range.

The following measurement steps are carried out:

1. Reset the instrument.
2. Set the reference level to 10 dBm.
3. Connect the rear-panel 10 MHz reference signal (connector EXT REF IN/OUT) to the analyzer input RF INPUT.
4. Set the start frequency to 5 MHz.
5. Set the stop frequency to 55 MHz.
6. Smooth the displayed noise with the video bandwidth.
7. Measure the fundamental signal with the marker.
8. Reduce the measurement frequency range (ZOOM function):
9. Set the frequency step size to the fundamental frequency.
10. Set the display to two measurement windows.
11. Uncouple the window settings.
12. Measure the harmonic separation.

---

**Set the analyzer according to Example 2 up to and including " Set the frequency step size to the fundamental frequency" (steps 1 to 9).**

---

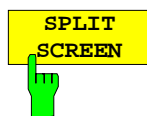
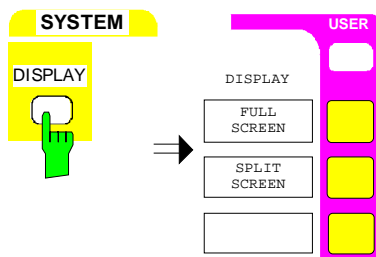

### 10. Set the display to two uncoupled measurement windows.

- Press the *DISPLAY* key in the *SYSTEM* key field.  
The *SYSTEM DISPLAY* menu is opened.

- Press the *SPLIT SCREEN* softkey.

Two windows are displayed simultaneously on the display screen (see Fig.2-9). The upper measurement window is called Screen A and the lower is called Screen B. At the initial turn-on, both measurement windows are coupled, i.e., changes in settings such as frequency or levels take place in both windows.

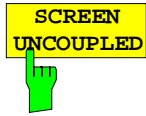
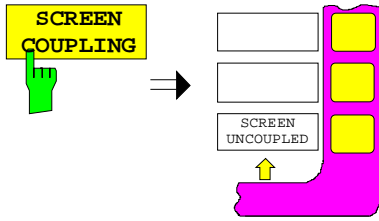

**11. Uncouple the window settings**

- Press the *SCREEN COUPLING* softkey.  
The *SCREEN COUPLING* sub-menu is opened.

- Press the *SCREEN UNCOUPLED* softkey .

The settings for each measurement window can now be selected independently. The entry is assigned to either *ACTIVE SCREEN A* or *ACTIVE SCREEN B* as selected by the softkey in the main menu window.

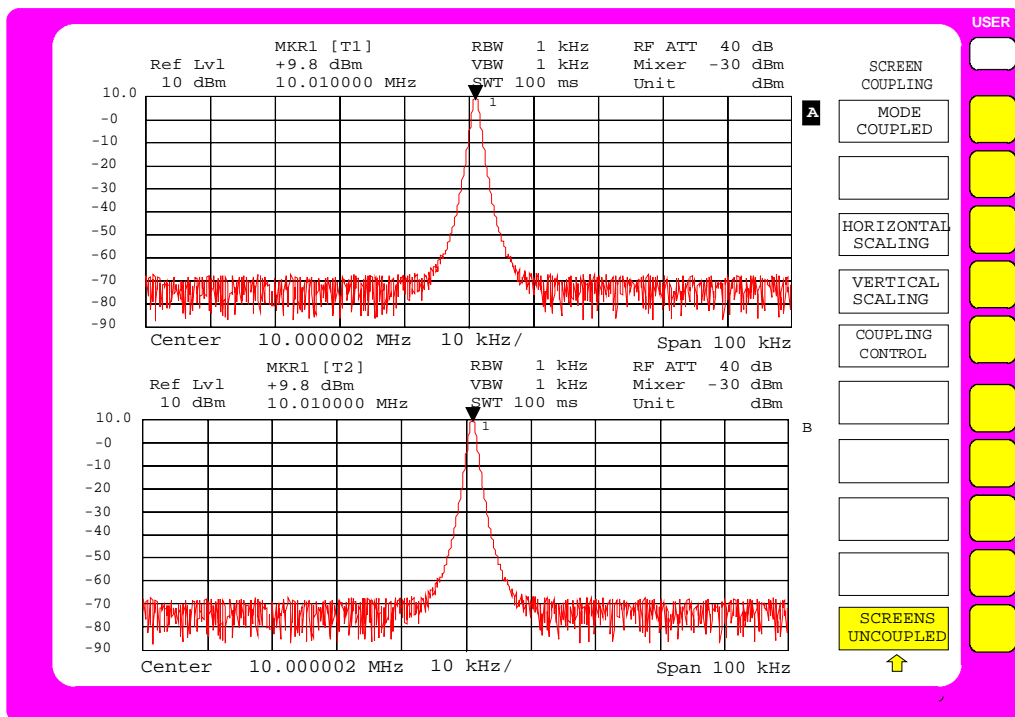
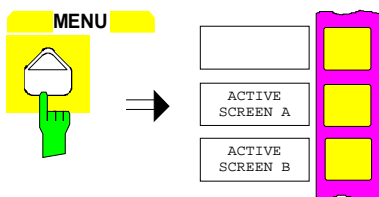

Fig.2-9 SPLIT-SCREEN Mode



**12. Measure the harmonic in the lower measurement window SCREEN B.**

- Press the menu change key .  
The main menu is opened.



- Press the *ACTIVE SCREEN B* softkey.

The following entries are now valid for the lower window which is used to measure the harmonic separation.

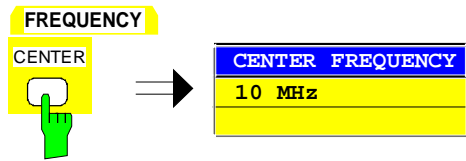

- Press the *CENTER* key in the *FREQUENCY* key field.

The entry field for the center frequency appears on the display screen.

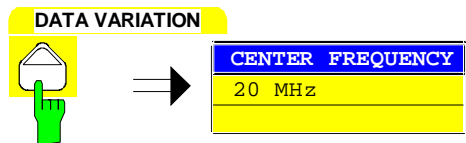

- Press the cursor key  in the *DATA VARIATION* key field.

The center frequency is increased by one step. (= fundamental frequency).

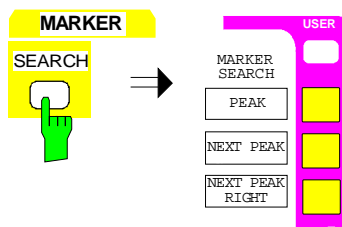

- Press the *SEARCH* key in the *MARKER* key field.

The *SEARCH-MARKER* menu is opened.

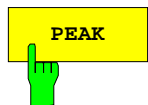

- Press the *PEAK* softkey.

A marker appears at the first harmonic and measures the level of the harmonic. The measured value is displayed in the marker field at the upper left of the second measurement window (see Fig.2-10).

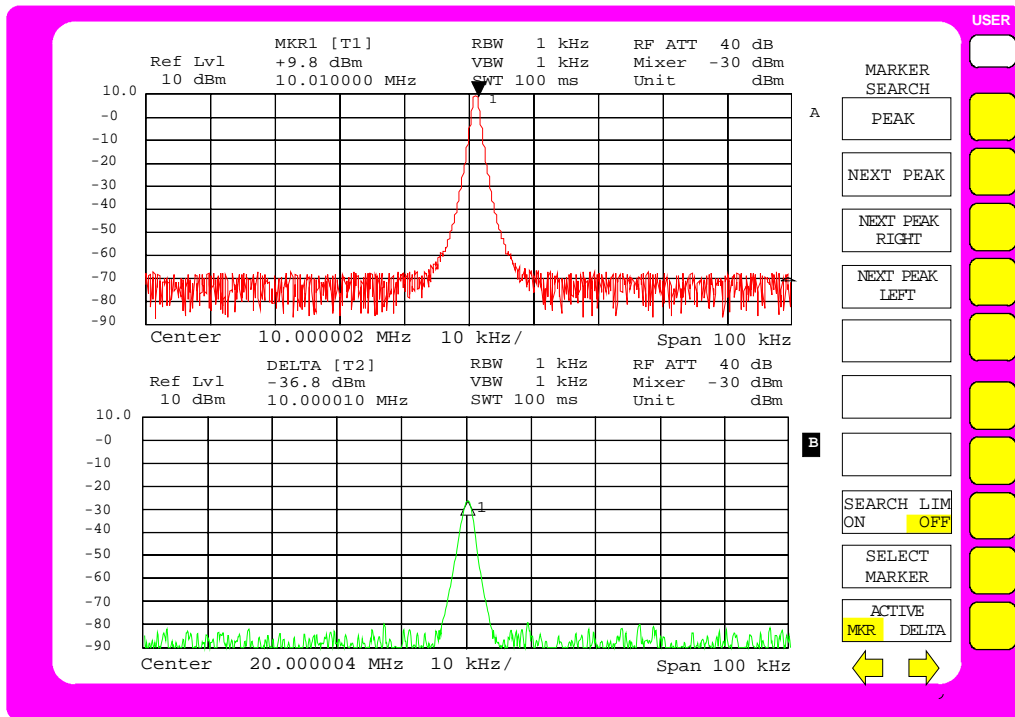

Fig.2-10 Alternate representation of fundamental and first harmonic

# Measurement of Intermodulation Distortions

## Measuring Task

If several signals are applied to a transmission quadripole with a non-linear characteristic, intermodulation products occur at its output due to addition and subtraction of the signals. The non-linear characteristic causes harmonics of the information signals to occur, which are mixed up at the characteristic. The low-order mixture products are particularly significant since they have the highest levels and are close to the information signals. The third-order intermodulation product causes the most significant distortions. In case of two-tone modulation it is the mixture product of the first information signal and the first harmonic of the second information signal.

The frequencies of the spurious signals occur with an offset of the information signals above and below the information signals. Fig. 2-11 shows the intermodulation products  $P_{S1}$  and  $P_{S2}$ , which are obtained from the two information signals  $P_{N1}$  and  $P_{N2}$ .

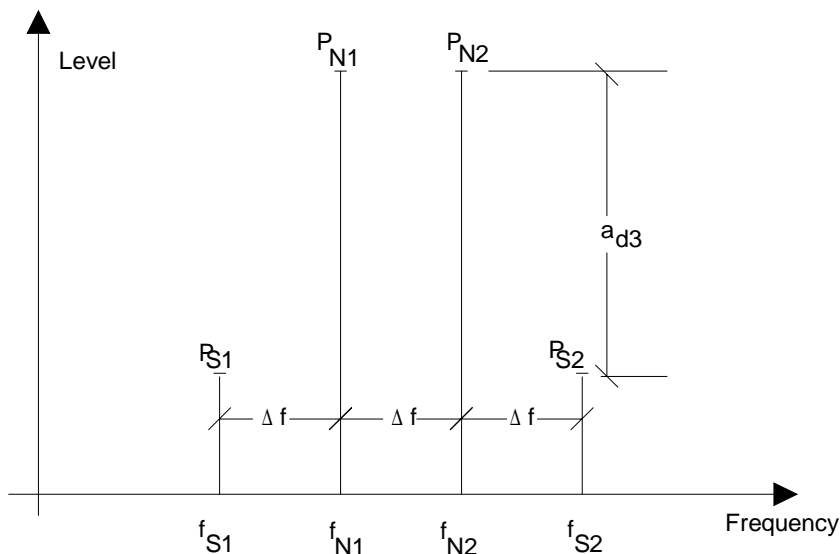

Fig. 2-11 Intermodulation products  $P_{S1}$  and  $P_{S2}$

The intermodulation product at  $f_{S2}$  is obtained by mixture of the first harmonic of the information signal  $P_{N2}$  with the signal  $P_{N1}$ , the intermodulation product at  $f_{S1}$  by mixture of the first harmonic of the information signal  $P_{N1}$  with the signal  $P_{N2}$ .

$$f_{s1} = 2 \times f_{n1} - f_{n2} \quad (1)$$

$$f_{s2} = 2 \times f_{n2} - f_{n1} \quad (2)$$

The level of the spurious products depends on the level of the information signals. If both information signals are increased by 1 dB, the level of the spurious responses increases by 3 dB. I.e., the offset  $a_{d3}$  of the spurious responses decreases by 2 dB. This is illustrated by Fig.2-12.



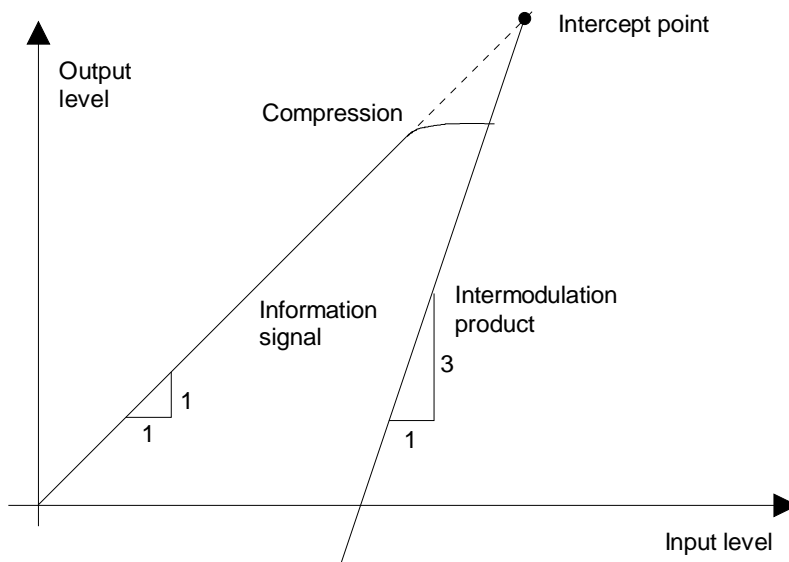

Fig.2-12 Dependence of the spurious product level from the level of the information signals

The information signals at the output of a four-terminal network increase as the input level increases as long as the input level is in the linear range. If the level changes by 1 dB at the input, it also changes by 1 dB at the output. At a specified input level the quadripole compresses and the output level does not increase any more. The third-order intermodulation products increase three times as fast as the information signals. The intercept point is the fictitious level where both lines intersect. It cannot be measured directly since the wanted level is limited by the maximum output power of the quadripole. It can however be calculated from the known gradients of the lines and the measured intermodulation offset  $a_{D3}$  with a given level using the following formula:

$$IP3 = \frac{a_{D3}}{2} + P_N \quad (3)$$

If, e.g., the intermodulation offset is 60 dB and the input level  $P_N$  is -20 dBm, the third-order intercept  $IP3$  is calculated as follows:

$$IP3 = \frac{60}{2} + (-20\text{dBm}) = 10\text{dBm}. \quad (4)$$

## Important Spectrum-Analyzer Functions

Correct setting of the RF attenuation is particularly important for intermodulation measurements. In the **FSE**, the attenuation can be set automatically according to the reference level. There are three coupling methods:

- RF ATTEN AUTO
- ATTEN AUTO LOW DIST
- ATTEN AUTO LOW NOISE

The coupling mode ATTEN AUTO LOW DIST is recommended to be used for measurement of intermodulation distortions since the intrinsic spurious products are minimized.

## Measurement

In the following, measurement of the third-order intercept of an amplifier is described, by way of example.

Two signal generators with the frequencies  $f_1$  and  $f_2$  supply signals to the amplifier via a power divider. The output of the device under test is connected to the RF input of the **FSE**. The level of the two signal generators is the same and is selected such that the DUT is not overloaded.

$f_1 = 99.5$  MHz

$f_2 = 100.5$  MHz

Level at amplifier input = -20 dBm with  $f_1$  and  $f_2$

Test setup:

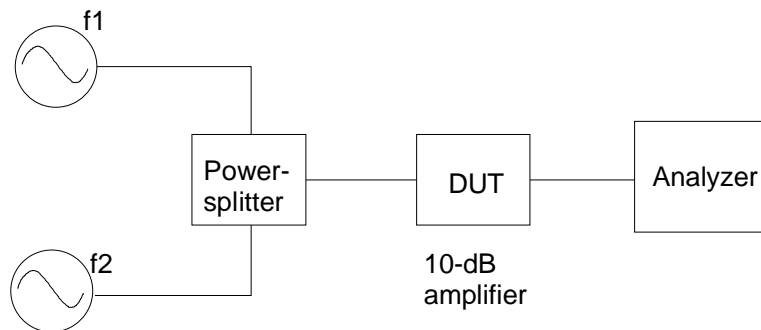

The following measurement steps are carried out:

1. Reset the **FSE**.
2. Set the center frequency to 100 MHz.
3. Set the frequency-display range to 5 MHz (SPAN function).
4. Set the reference level to -10 dBm.
5. Set the resolution bandwidth to 10 kHz.
6. Set the RF attenuation for low-distortion mode.
7. Measure the intercept point using the markers.
8. Calculate IP3 from the measured offset and the signal level according to (4)

*Cf. measurement example Level and Frequency Measurements (steps 1 to 3)*

1. *Reset the instrument.*
2. *Set the center frequency to 100 MHz.*
3. *Set the frequency-display range to 5 MHz.*

---

#### 4. Set the reference level to -10 dBm

- Press the *REF* key in the *LEVEL* key field.

The entry window for the reference level is displayed.

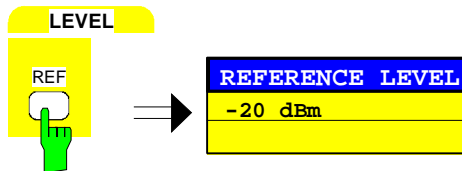

- Enter -10 via the numeric keypad in the entry field and terminate the entry by pressing the *dBm* key.

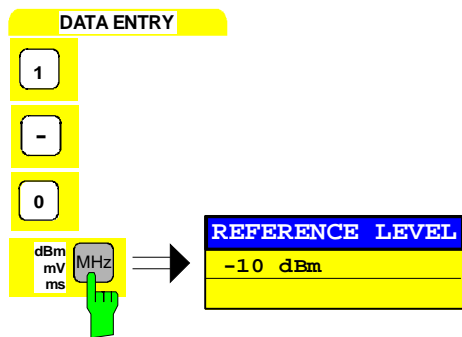



---

#### 5. Set the resolution bandwidth to 10 kHz

- Press the *COUPLING* key in the *SWEEP* key field.

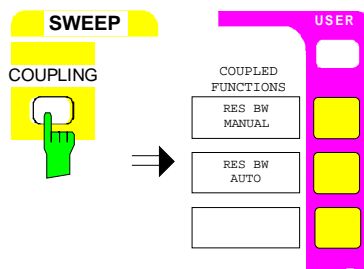
The *SWEEP-COUPLING* menu is opened.



- Press the *RES BW MANUAL* softkey.

The entry field for the resolution bandwidth is displayed.

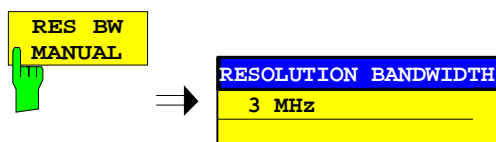

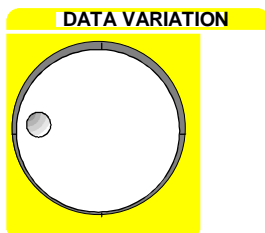
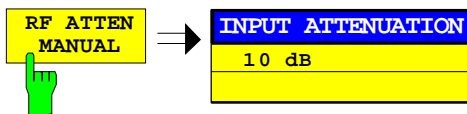
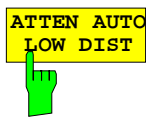
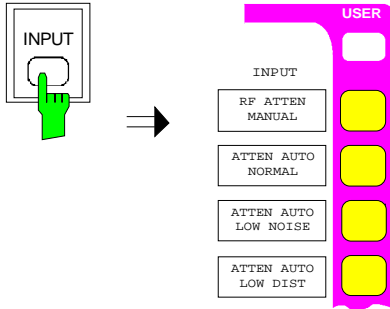
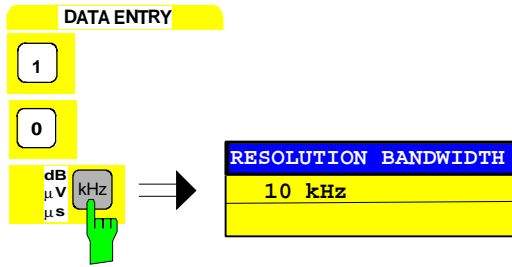

- Enter 10 in the entry field via the numeric keypad and terminate the entry by pressing the kHz key.

### 6. Set low-distortion mode

- Press the *INPUT* key  
The *INPUT* menu is opened.

either

- Press the *ATTEN AUTO LOW DIST* softkey.  
The low-distortion mode is selected. Thus, the combination of input attenuation and IF gain is selected such that the internal intermodulation products are the smallest possible and the intermodulation-free range is as large as possible.

The FSE shows the measuring diagram in Fig.2-13

or

- Press the *RF ATTEN MANUAL* softkey.  
The entry window for the RF attenuation is displayed.

- Vary the RF attenuation using the roll-key.  
If the amplitude of the IM products doesn't change, the existing setting is sufficient (see Fig.2-13)

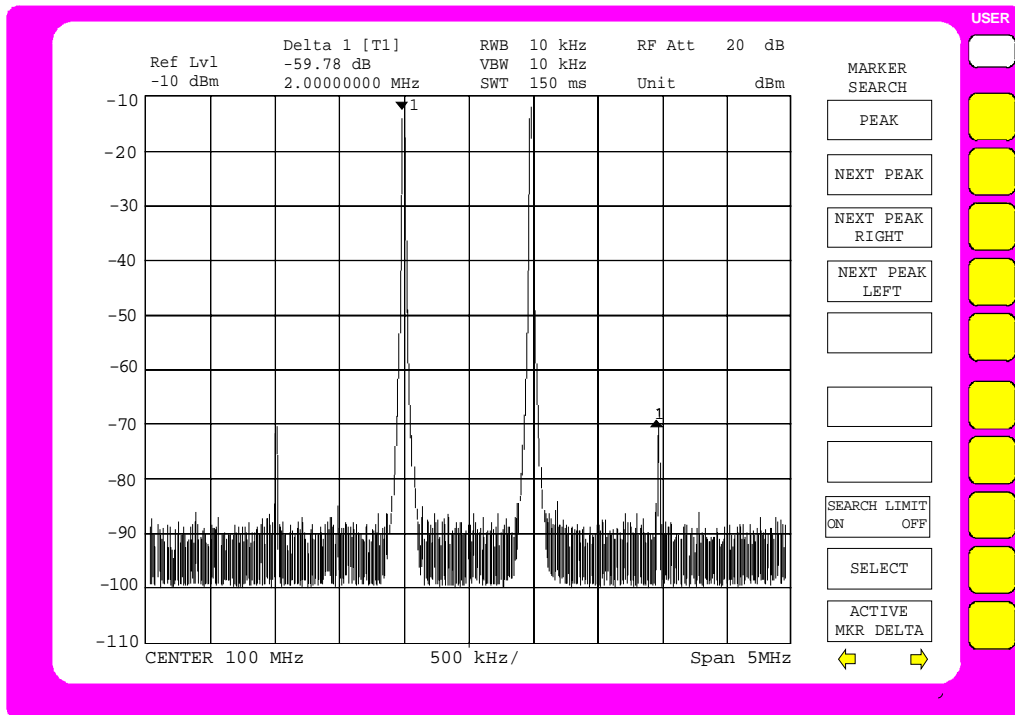

Fig.2-13 Measuring diagram in low distortion mode



**7. Measure the intercept point using the markers**

- Press the *NORMAL* key in the *MARKER* key field.

The marker appears on the fundamental (see also level and frequency measurement step 5, PEAK SEARCH function).

The measured values can be read off at the upper left of screen.



- Press the *DELTA* key in the *MARKER* key field.

The delta marker is active. It appears on the fundamental.

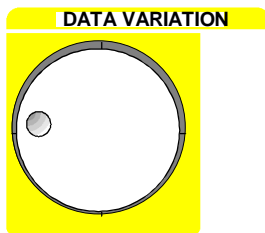

either

- Move the marker to an intermodulation product using the roll-key (see Fig.2-13).

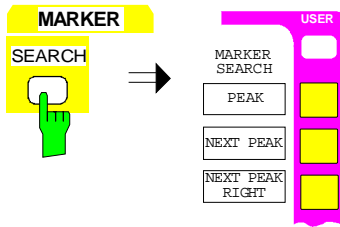

or

- Press the *SEARCH* key of the *MARKER* keys.  
The *SEARCH-MARKER* menu is opened.

- Press the *NEXT PEAK RIGHT* softkey until the delta marker appears on one of the IM products (see Fig.2-13).

#### **8. Calculate IP3 from the measured offset and the signal level according to (4)**

In the example, an intermodulation ratio of approx. 60 dB at a level of -10 dBm was measured. IP3 is thus:

$$IP3 = 60 \text{ dB}/2 + (-10\text{dBm}) = 20 \text{ dBm}$$

## Time-domain Measurements with Pulsed Signals

### Measuring Task

A lot of systems which handle pulsed signals do not only require measurement of the pulse width and the pulse repetition rate which can be derived from the spectrum but also assess the rise and fall time as well as the power ramping during the pulse. In particular, modern digital mobile radio systems which, like GSM e.g., employ the TDMA method, require the power to be measured versus time over a wide dynamic range.

Time-domain measurements are performed using the spectrum analyzer with ZERO SPAN selected. The analyzer operates as fix-tuned receiver on the set center frequency such that the signal power versus time is displayed.

### Important Spectrum Analyzer Functions

Trigger functions such as video trigger and sweep settings such as blanking of the measured value (GAP SWEEP) are of particular importance for time-domain measurements. The pretrigger function of the GAP SWEEP just enables measurement of rise times since it allows for representation of measurements prior to the trigger point. The GAP function, which enables cutout of a part of the pulse signal on the screen at high time resolution. During the GAP time, the sweep and thus data acquisition at the time marked by the "GAP" line is interrupted and thus the pulse is not completely displayed (the part which is not important for this measurement is blanked) (see Fig. 2-14).

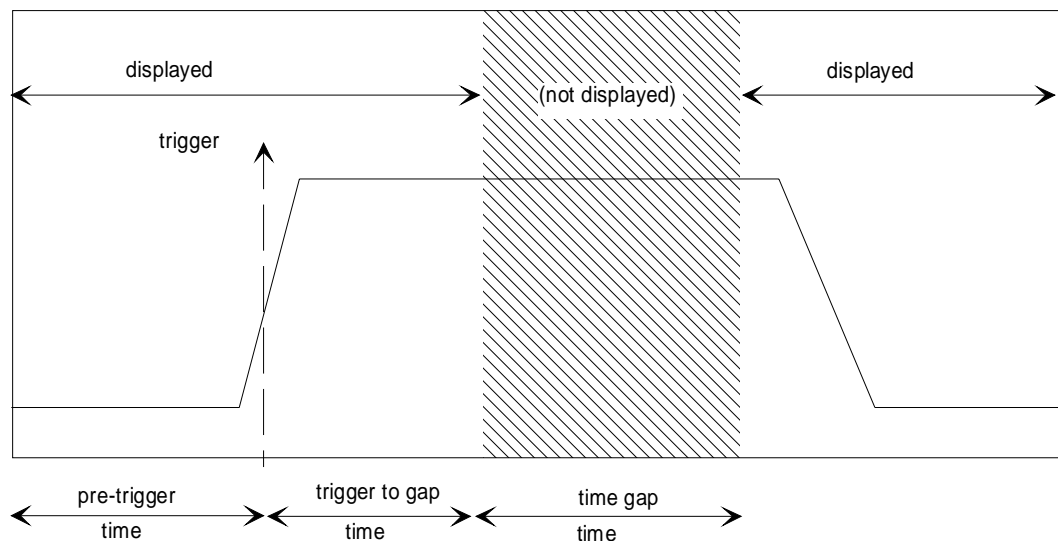

Fig. 2-14 Parameters of Gap Sweep

**Note:** If the pretrigger time and the trg-to-gap time is 0 s, the gap time function has the same effect as a delayed trigger.

## Measurement

This example shows the measurement of the rise and fall times as well as the power ramping during the pulse.

The signal generator SME with built-in pulse modulation source SME-B4 is used as signal source. A signal generator providing for pulse modulation in conjunction with an external pulse generator may be used, instead.

Settings on the signal generator:

Frequency	900 MHz
Level	-5 dBm
Modulation	Pulse
Pulse width	ca. 600 $\mu$ s
Pulse frequency	ca. 500 Hz

The following measuring steps are made:

1. Reset the instrument.  
The video bandwidth is thus set to 3 MHz.
2. Set the center frequency to 900 MHz.
3. Set the frequency display range to zero span.
4. Set the reference level to 0 dBm.
5. Set the resolution bandwidth to 2 MHz.
6. Set the sweep time to 1 ms.
7. Connect the RF output of the SME to the RF input of the **FSE**.
8. Set the video trigger.
9. Set the sweep time to 100  $\mu$ s.
10. Set the trigger points.
11. Activate the gap sweep.

---

***comp. measuring example - level and frequency measurement (steps 1 to 3)***

- 1. Set the instrument to the default state. I.e., the video bandwidth is set to 3 MHz.***
- 2. Set the center frequency to 900 MHz.***
- 3. Set the frequency-display range to zero span.***

**Note:** *With first calling of the zero span following preset, a resolution bandwidth of 1 MHz is automatically set. Apart from that, switching on the zero span always causes that resolution bandwidth to be set that was last set in zero span.*



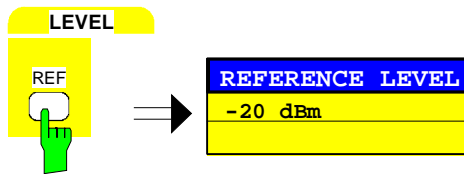

**4. Set the reference level to 0 dBm.**

- Press the *REF* key in the *LEVEL* key field.  
The entry field for the reference level appears on the display screen.

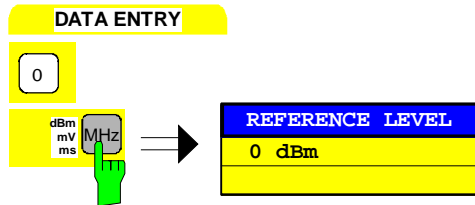

- Enter *0* in the entry field via the numeric keypad and terminate the entry by pressing the *MHz/ms* key.

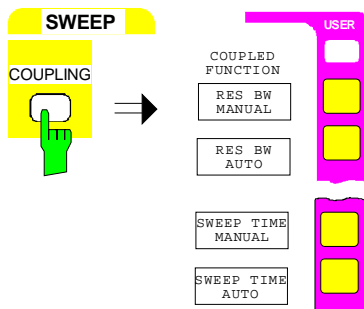

**5. Set the resolution bandwidth to 2 MHz**

- Press the *COUPLING* key in the *SWEEP* key field.  
The *SWEEP-COUPLING* menu is opened.

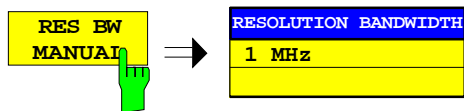

- Press the *RES BW MANUAL* softkey.  
The entry field for the resolution bandwidth appears on the display screen.

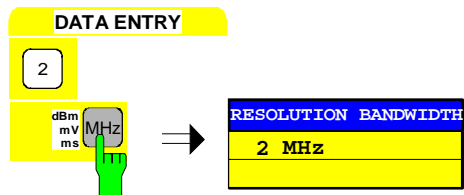

- Enter *2* via the numeric key pad and terminate the entry by pressing the *MHz* key.

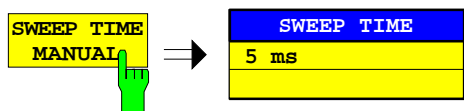

**6. Set the sweep time to 1 ms**

- Press the *SWEEP TIME MANUAL* softkey.  
The entry field for the sweep time is opened.

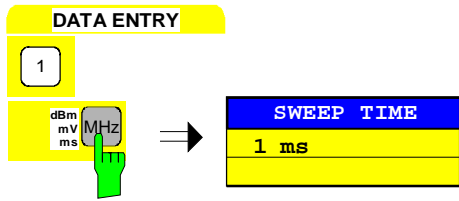

- Enter 1 in the entry field via the numeric keypad and terminate the entry by pressing the MHz key.

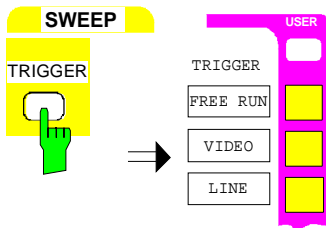

7. Connect the RF output of the SME to the RF input of the FSE.

8. Initiate triggering by means of the display voltage (video trigger)

- Press the TRIGGER key in the SWEEP key field  
The TRIGGER menu is opened.

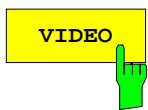

- Press the VIDEO softkey.

A dashed horizontal line is displayed which marks the trigger level.

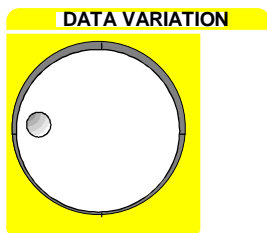

- Set the trigger level using the roll key such that a triggered display is obtained.  
(see Fig. 2-15)

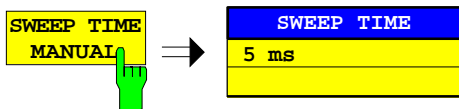

9. Set the sweep time to 100 μs

- Press the SWEEP TIME MANUAL softkey.  
The window for entering the sweep time is opened.

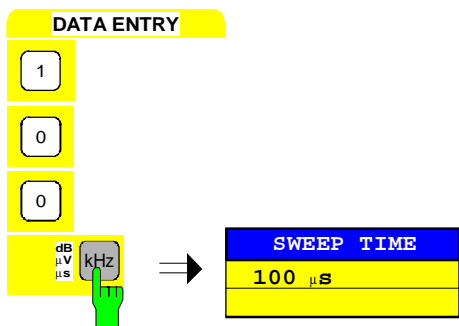

- Enter 100 via the numeric keypad and terminate the entry by pressing the kHz/μs key.

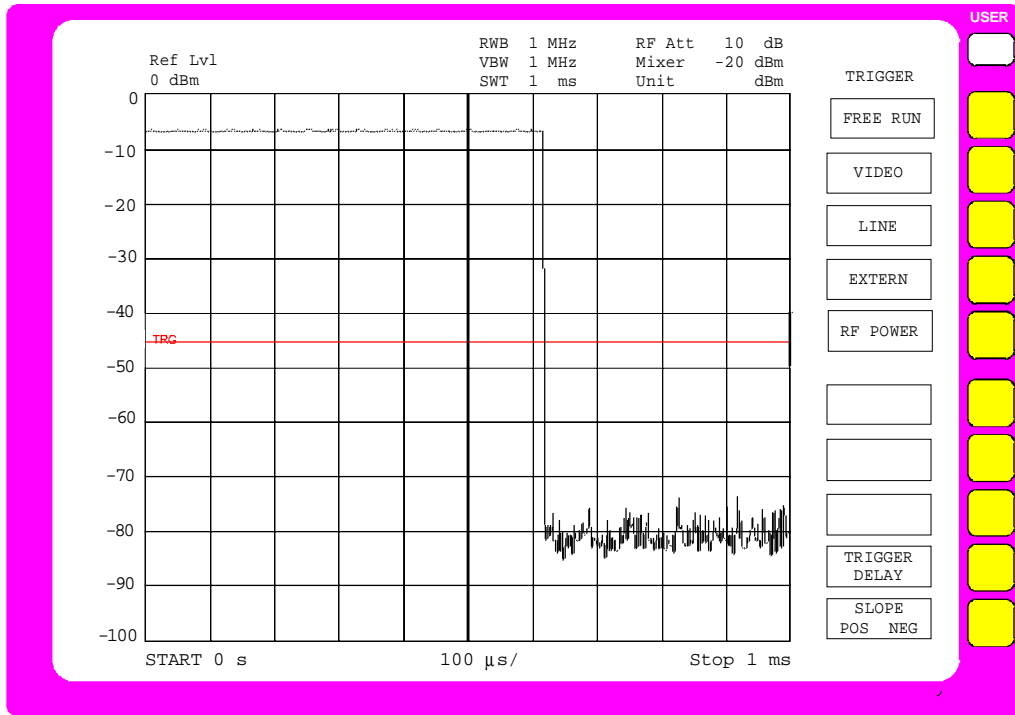
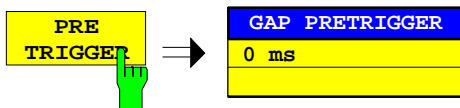
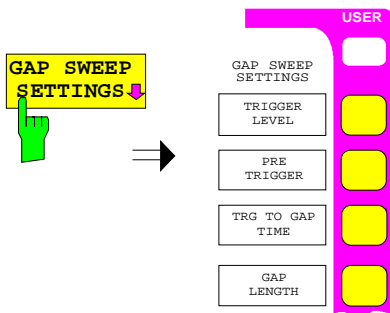
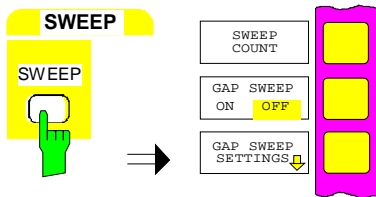

Fig. 2-15 Representation of pulse sequence with video trigger



**10. Set the trigger points.**

➤ Press the *SWEEP* key in the *SWEEP* keyfield.  
The *SWEEP* menu is opened.

➤ Press the *GAP SWEEP SETTINGS* softkey.  
The *GAP SWEEP SETTINGS* submenu for setting the trigger points is opened.

➤ Press the *PRE TRIGGER* softkey.  
The entry field for the pretrigger is opened.

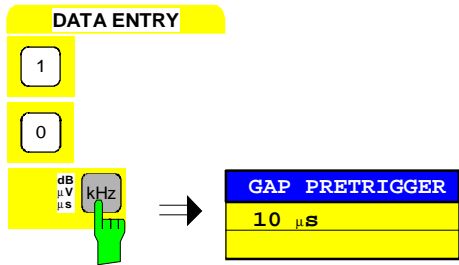

- Enter 10 via the numeric keypad in the entry field and terminate the entry by pressing the kHz/μs key.

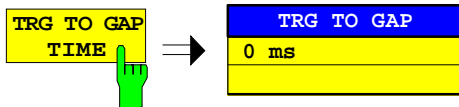

- Press the TRG TO GAP softkey.  
The entry field for the trigger-to-gap-time is opened.

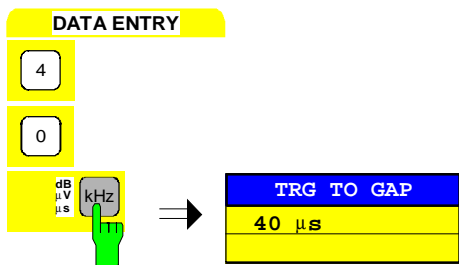

- Enter 40 via the numeric keypad in the entry field and terminate the entry by pressing the kHz/μs key.

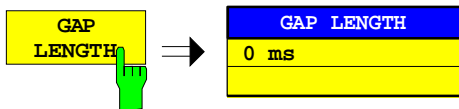

- Press the GAP LENGTH softkey.  
The entry field for the length of the time gap is opened.

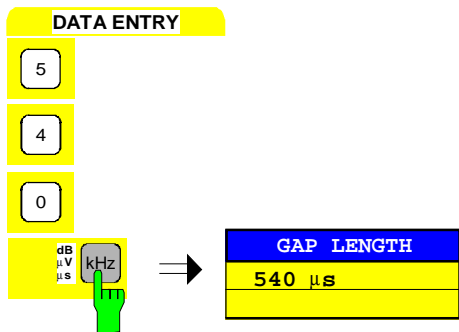

- Enter 540 in the entry field via the numeric keypad and terminate the entry by pressing the kHz/μs key.

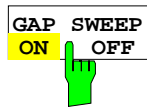
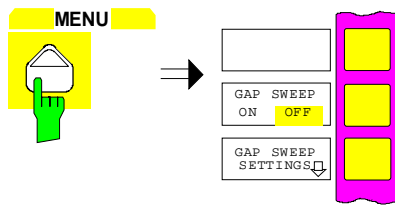

### 11. Activate the measurement with mask-out of measured value

- Press the menu change key.

The right supplementary menu is opened.

- Press the *GAP SWEEP ON/OFF* key.

The measurement with blanking of measured value is activated. The measurement results are shown in Fig. 2-16

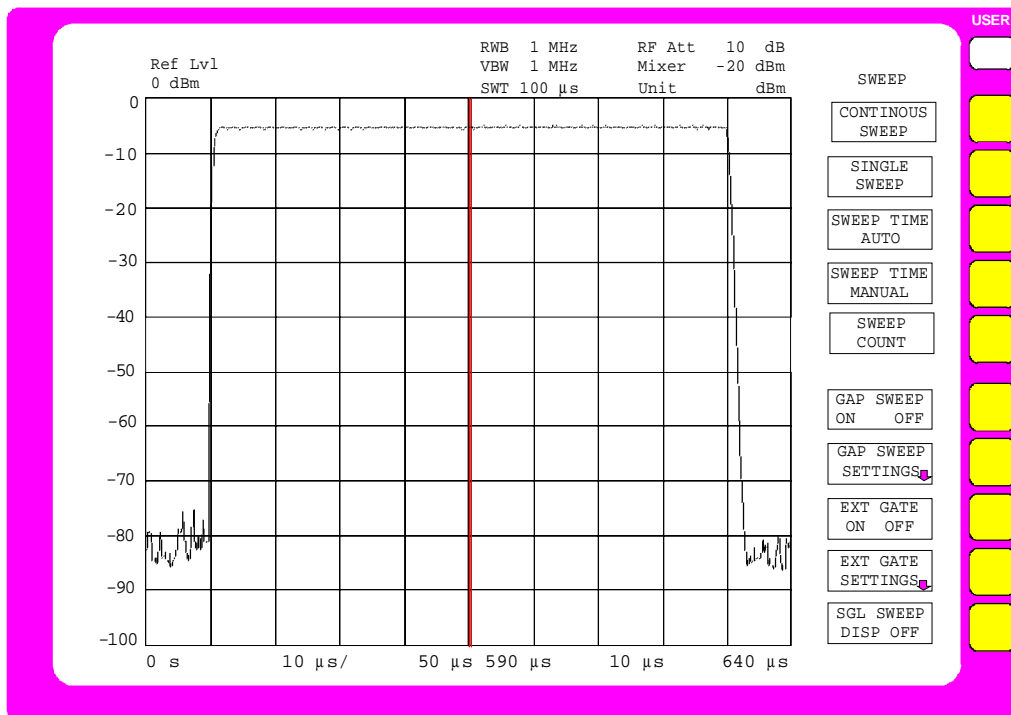

Fig. 2-16 Measured-value blanking for simultaneous display of rising and falling edge of a pulse signal. The position of the gap is indicated by the thick vertical line. The gap time is indicated via the double label 50 μs and 590 μs in the time axis.



## Contents - Chapter 3 "Manual Operation"

<b>3 Manual Operation .....</b>	<b>3.1</b>
<b>The Screen.....</b>	<b>3.2</b>
Diagram Area .....	3.3
Displays in the Diagram Area .....	3.4
Full Screen.....	3.9
Split Screen .....	3.9
Softkey Area .....	3.10
Changing the Menu .....	3.11
<b>Setting the Parameters.....</b>	<b>3.13</b>
Data Entry.....	3.13
Numeric Keypad on the Front Panel .....	3.13
Roll-key and Cursor Keys.....	3.14
Entry Windows.....	3.15
Setting Up the Entry Window .....	3.15
Editing of Numeric Parameters .....	3.16
Editing of Alphanumeric Parameters.....	3.17
Help Line Editor .....	3.17
Table Entry .....	3.18
Shifting Mode.....	3.18
Editing Mode.....	3.18
<b>Disabling the Control Elements - HOLD Key .....</b>	<b>3.19</b>
<b>Setting the Stepsize - STEP Key.....</b>	<b>3.20</b>
<b>Mouse and External Keyboard Control .....</b>	<b>3.21</b>
External Keyboard Control.....	3.21
Data Entry Windows with Mouse Control .....	3.22
Mouse Control of Further Display Elements.....	3.23
<b>Menu Overview .....</b>	<b>3.24</b>
System Key Group.....	3.24
Configuration Key Group .....	3.27
Setup for Instruments with Windows NT Controller Option.....	3.28
Setup for Instruments with MS DOS Controller Option or without Controller.....	3.29
Hardcopy Key Group .....	3.30
Frequency Key Group.....	3.31
Level Key Group, Input Key .....	3.32
Marker Key Group .....	3.34
Lines Key Group .....	3.38
Trace Key Group .....	3.40
Sweep Key Group.....	3.41
Memory Key Group.....	3.43
User Key Group .....	3.46





## 3 Manual Operation

Chapter 3 reviews manual operation of the FSE. This includes a description of the screen, menu operation and the setting of parameters. There is an overview of the menus at the end of this chapter.

The functions of the menus are described in detail in Chapter 4. Chapter 2 contains a short introduction which goes through simple measurements step-by-step. The remote control is described in Chapters 5, 6 and 7.

The FSE is menu-controlled via keys and softkeys. Instrument parameters and test parameters can be set directly via softkeys or by entering values in entry fields and by making selections from tables. Softkeys are used to select operating modes and the screen mode.

If required, data entry windows and tables also be displayed on the measurement screen.

After switching on the instrument a message about the BIOS version installed is displayed for a few seconds (e.g. "Analyzer BIOS Rev. 1.2").

The results of the self test is displayed next.

```
MAINPROCESSOR
SELFTEST STARTING ...
TESTING CMOS ...
DMA CHANNEL ...
INTERRUPTS ...
NMI ...
BASE MEMORY ...
EXTENDED MEMORY ...
HD CAPACITY ...
INIT FLOPPY DRIVE ...
INIT HD ...

SELFTEST DONE,
SYSTEM IS BOOTING ...
```

Subsequently, the instrument then starts measuring. The type of measurement which was activated prior to last switch-off is performed, as long as no other instrument configuration was selected via *AUTO RECALL* in the *MEMORY RECALL* menu. While the measurement is being performed other menus and measuring modes can be entered simultaneously. The measurement results and the settings of the parameters are displayed on the screen.

## The Screen

The screen informs continuously on the results and parameters for the selected measuring functions. The display mode for test results, the softkey labeling and the type of menu depend on the selected measuring function.

The screen is divided into two areas:

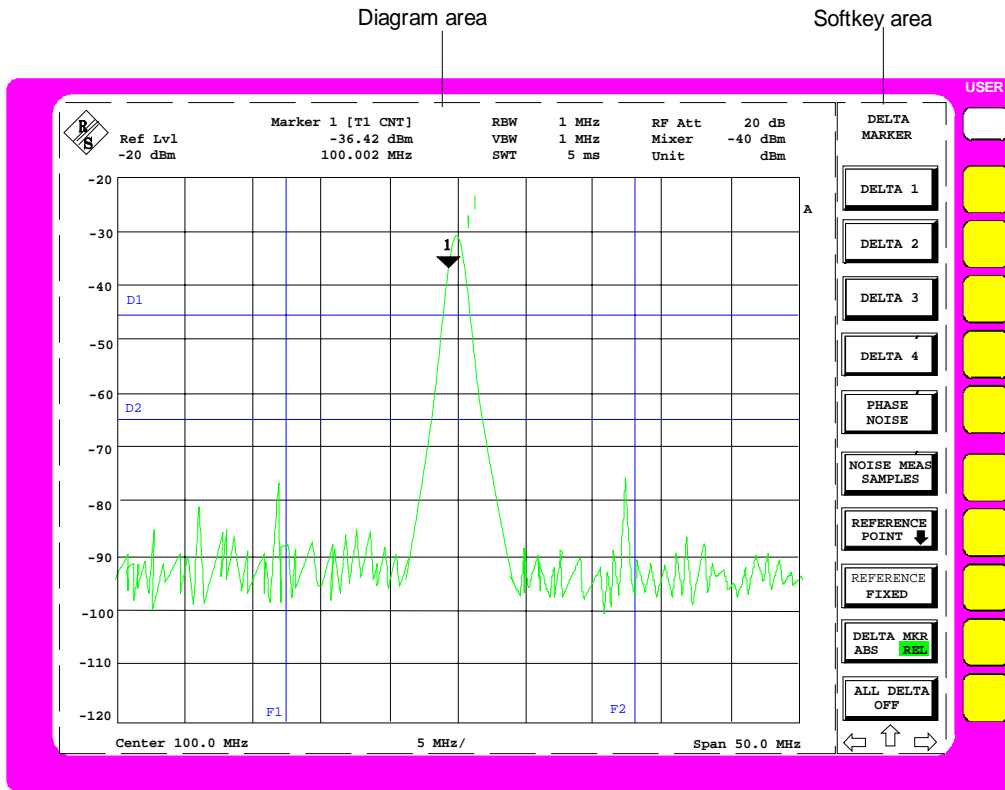

Fig. 3-1 Basic screen areas

### Diagram area

This area contains the measuring diagrams and other result displays as well as the parameters and status information which are important for analyzing the results.

Message fields, entry windows and tables may also be shown in this area.

### Softkey area

This area displays the instrument functions which can be selected via the softkeys. No other images are superimposed on the softkey area.

# Diagram Area

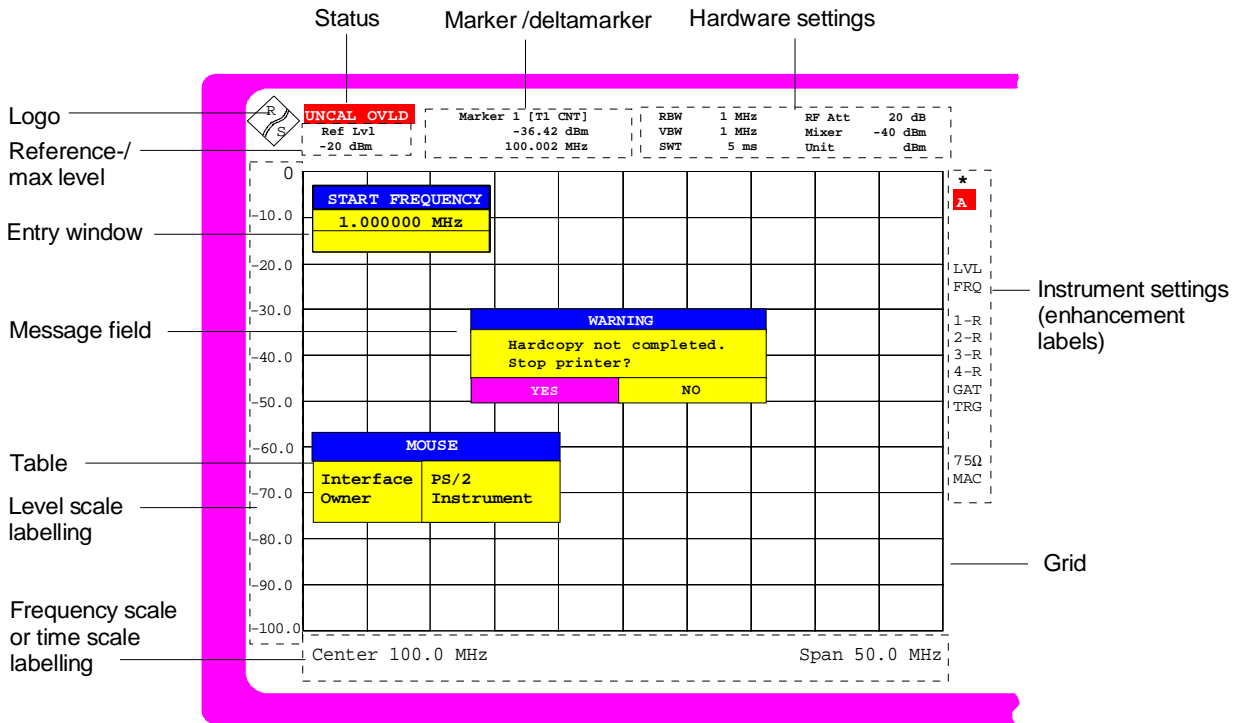

Fig. 3-2 Screen areas in analyzer mode

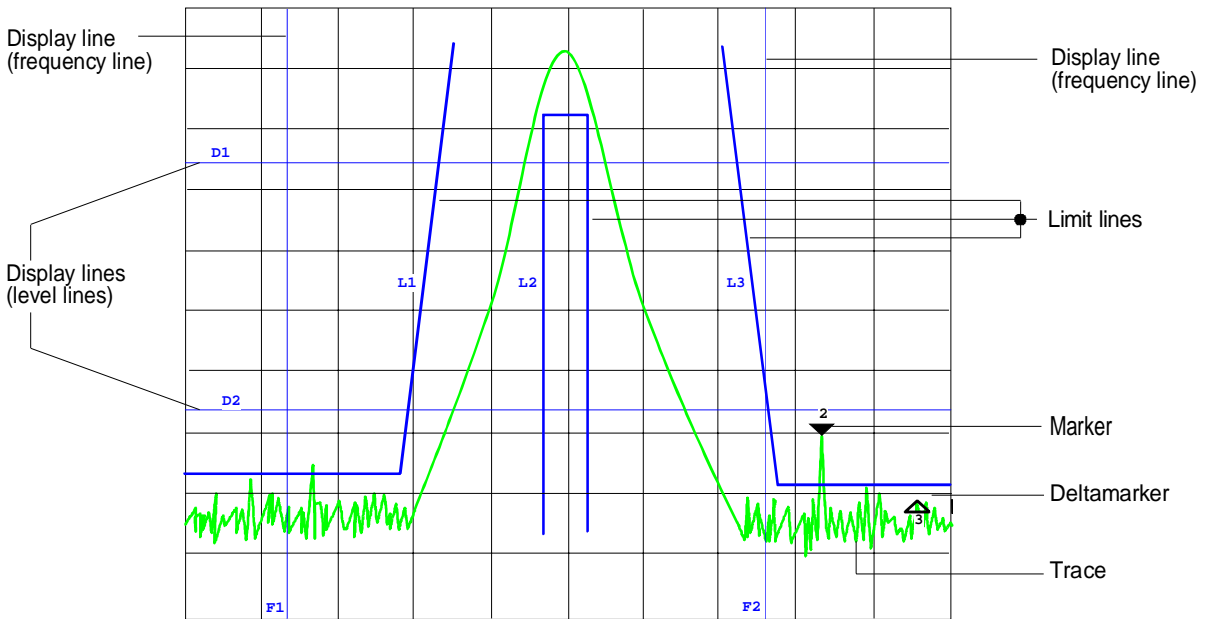

Fig. 3-3 Measuring diagram

## Displays in the Diagram Area

The following graphic elements are displayed in the diagram area:

<b>Status information</b>	A status information indicates that a problem has occurred. In addition the status display displays MAX / REF LVL, if the maximum level and the reference level have different values .
UNCAL	"UNCAL" is displayed under the following circumstances: <ul style="list-style-type: none"> <li>• no valid correction data (Status CALIBRATION FAILED in table CAL RESULTS), may occur after a cold start following a firmware update ⇒ record correction data (CAL TOTAL)</li> <li>• correction data are switched off (menu CAL, CAL CORR OFF). ⇒ switch on CAL CORR ON or PRESET</li> <li>• Sweep time too short for current instrument settings (span, resolution bandwidth, video band width). ⇒ increase sweep time</li> <li>• resolution bandwidth too small for set symbol rate (Vector Analysis, option FSE-B7): digital demodulation) . ⇒ increase resolution bandwidth</li> </ul>
OVLD	„Overload“ is displayed when the input mixer is overloaded ⇒ Increase input attenuation
IFOVLD	„IF Overload“ is displayed when an overload occurs after the input mixer. ⇒ Increase reference level
DIFOVL	„Digital IF Overload“ is displayed when the digital resolution filter is overloaded. ⇒ Increase reference level
ExtRef	„External Reference“ is displayed when the instrument is set to <i>REFERENCE EXT</i> (menu <i>SETUP</i> ), but the reference signal is missing at the rear panel connector. ⇒ Check input signal of external reference
LO unl	„LO unlock“ is indicated when the 1st LO is unlocked (module error).
LO Lvl	„LO Level“ is displayed when the output level of the 1st LO is too small (module error).
LO LvD	„LO Level Digital IF“ is displayed when the output level of the oscillator of module Digital IF is too small (module error).
OCCO	'OCCO cold' is indicated when the crystal oscillator has not yet reached its operating temperature. This indication vanishes after a few minutes after switch on.
UNLD	'Underload' is displayed when the analyzer is not in its optimal dynamic range. In this case the measuring accuracy is not optimal. This indication is only output in vector analyzer operating mode (option FSE-B7). ⇒ Decrease reference level

<b>Marker/Deltamarker</b>	<p>This label displays the position of the last selected marker or deltamarker in the x and y-directions and the marker/deltamarker index. As additional information, 2 fields in square brackets are provided which contain the curve which the marker is assigned to and the active measuring function of the marker indicated. The measuring function of the markers in the second field is indicated by the following abbreviations:</p> <p>CNT    frequency counter active  TRK    signal track active  NOI    noise measurement active</p> <p>The marker text has the same color as the trace which the marker is assigned to. If, for example, the active marker is assigned to trace 1, and trace 1 is yellow, the marker text will be yellow, too.</p>
<b>Hardware settings</b>	
<b>Analyzer mode</b>	Display of the set resolution bandwidth.
RBW	Display of the set video bandwidth.
VBW	Display of the set sweep time.
SWT	Display of the set RF attenuation.
RF Att	Display of the user set level at the input mixer (only when level differs from standard settings) (= level of the reference level REF LVL).
Mixer	Display of the level unit of the measuring results and the associated setting and test parameters in full length. This label is particularly important for selection of units with more than 4 digits, since they can only be indicated as dB* in the other labels (except for marker).
Unit	
<b>Tracking generator mode</b>	Only available with one of the options FSE-B8/9/10/11
TG Lvl	Indication of the set output level of the tracking generator
<b>Vector Analyzer mode</b>	Only available with option FSE-B7
CF	Display of the set center frequency
SR	Display of the symbol rate
Demod	Display of the switched on demodulator.
Standard	Display of the set standard (e.g. GSM)
<b>Grid</b>	X-axis: frequency or time, Y-axis: level

**Instrument settings**  
(Enhancement Labels)

Display of user instrument settings which influence the measuring result and which are not immediately obvious when viewing the measured values.

- \* The current instrument setting is not the same as the setting selected when one of the traces was stored. This occurs under the following circumstances:
  - The instrument setting is modified while a sweep is being performed.
  - The instrument setting is modified in SINGLE SWEEP mode after the end of the sweep and no new sweep is started.
  - The instrument setting is modified after setting the trace to VIEW.

The display will not change until the cause is eliminated by the user. I.e., either a new sweep is started (SINGLE SWEEP mode), or the trace in question is switched to BLANK (all cases).
- A** Identification for screen A. Screen A is activated for the entry of test parameters.
- B** Identification for screen B. Screen B is activated for the entry of test parameters.
- C** If, in the Vector Analyzer (Option FSE-B7) mode, the inphase and quadrature signal is displayed in the measurement window A, the window is subdivided into two diagrams. The upper diagram is marked with an A and the bottom one with C.
- D** If, in the Vector Analyzer (Option FSE-B7) mode, the inphase and quadrature signal is displayed in the measurement window B, the window is subdivided into two diagrams. The upper diagram is marked with an B and the bottom one with D.
- LN** The automatic setting of the input attenuation is set to ATTEN LOW NOISE .
- LD** The automatic setting of the input attenuation is set to ATTEN LOW DISTORTION.
- NOR** Normalization is activated; high accuracy (only with one of the options FSE-B8/9/10/11).
- APP** Normalization is activated; medium accuracy (only with one of the options FSE-B8/9/10/11).
- TDF** An antenna correction factor (*TRANSDUCER FACTOR*) is switched on.
- TDS** A set of antenna correction factors (*TRANSDUCER SETS*) is switched on.
- LVL** A level offset  $\neq 0$  dB has been set. A level offset of the installed tracking generator (option) leads to the same display.
- FRQ** A frequency offset  $\neq 0$  Hz has been set.
- SGL** The sweep is set to SINGLE SWEEP.

<b>1-&lt;n&gt;</b>	Subtraction Trace 1 - Trace <n> active (<n>: numeric value) or subtraction Trace 1 - Reference Line active (<n>: R)
<b>2-&lt;n&gt;</b>	Subtraction Trace 2 - Trace <n> active (<n>: numeric value) or subtraction Trace 1 - Reference Line active (<n>: R)
<b>3-&lt;n&gt;</b>	Subtraction Trace 3 - Trace <n> active (<n>: numeric value) or subtraction Trace 1 - Reference Line active (<n>: R)
<b>4-&lt;n&gt;</b>	Subtraction Trace 4 - Trace <n> active (<n>: numeric value) or subtraction Trace 1 - Reference Line active (<n>: R)
<b>&lt;n&gt;AP</b>	For trace <n> (n = 1 to 4) the detector is set to AUTOPEAK.
<b>&lt;n&gt;MA</b>	For trace <n> (n = 1 to 4) the detector is set to MAX PEAK.
<b>&lt;n&gt;MI</b>	For trace <n> (n = 1 to 4) the detector is set to MIN PEAK.
<b>&lt;n&gt;SA</b>	For trace <n> (n = 1 to 4) the detector is set to SAMPLE.
<b>&lt;n&gt;AV</b>	For trace <n> (n = 1 to 4) the detector is set to AVERAGE.
<b>&lt;n&gt;RM</b>	For trace <n> (n = 1 to 4) the detector is set to RMS.
<b>GAT</b>	The frequency sweep is controlled via the <i>EXT TRIG/GATE</i> connector.
<b>TRG</b>	The instrument is not triggered in <i>FREE RUN</i> mode.
<b>EXT</b>	The unit is configured for operation with external reference
<b>75 Ω</b>	The input impedance of the unit is set to 75 Ω.
<b>MAC</b>	Macro recording active.
<b>PRN</b>	A printout is taking place. PRN overwrites the enhancement label MAC.
<b>&lt;n&gt;VIEW</b>	Trace <n> (n = 1 to 4) is set to VIEW
<b>&lt;n&gt;AVG</b>	Trace <n> (n = 1 to 4) is set AVERAGE
<b>MIX</b>	The external mixer output is switched on (option FSE-B21).
<b>SID</b>	External mixer output: SIGNAL ID is switched on (option FSE-B21).
<b>AID</b>	External mixer output: AUTO ID is switched on (option FSE-B21).

**Frequency axis labeling** Display of the x-scaling.

`{123.4 ms/Div }`

The distance between two grid lines is displayed in this label.

`{Center 1.2345678901234 GHz}`

The set center frequency or start frequency is displayed in this label depending on whether the keys CENTER/SPAN or START/STOP were last pressed.

`{Start 1.2345678901234 GHz }`

If span = 0 Hz, the center frequency is always displayed.

`{Span 1.2345678901234 GHz}`

`{Stop 1.2345678901234 GHz}`

`{Trigger 1.234 ms}`

The set frequency range (*SPAN*) or the stop frequency is displayed, depending on whether the keys CENTER/SPAN or START/STOP were last pressed.  
If span = 0 Hz, the trigger moment (*PRETRIGGER*) is displayed.

### Optional labeling

Optional indication of date, time and comment.

`14.Jun 97 12:13`

### Level axis labeling

Display of the y-scaling.

### Entry window

The data entry window is superimposed in the diagram area, if required.

### Reference level/ Max. level

Display of the set reference level or combined display of maximum level and reference level .

### Limit lines

Limit lines are the upper and/or lower limits for level curves or spectral distributions.

### Traces 1 to 4

Up to 4 traces can be displayed simultaneously.

### Display lines

Utilities for trace analysis.

The FSE provides two display modes:

- Full Screen: 1 window, all traces are displayed in one screen.
- Split Screen: 2 windows, traces, grid and labels are distributed on the two screens.



## Full Screen

In the full-screen mode, the settings and measurements are performed in the active visible window. All indications on the screen refer to this window. The designation (SCREEN A or SCREEN B) is inserted as enhancement label A or B on the right diagram margin.

The *DISPLAY* key is used to switch between the windows. The current measurement is terminated when its window goes blank.

Switching from split-screen to full-screen mode is performed in menu *SYSTEM DISPLAY*.

## Split Screen

In the Split Screen mode, the screen is divided into two halves.

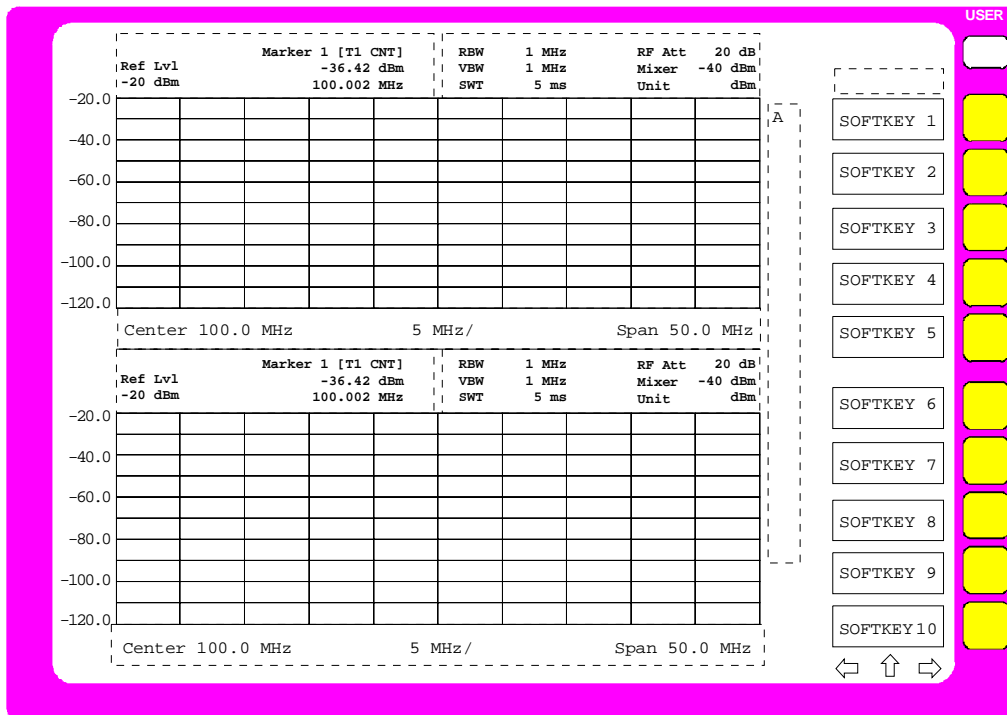

Fig. 3-4 Split Screen mode

The upper half is always assigned to Screen A, the lower to Screen B. The measurement settings can be selected independently for both screens. E.g., a spectrum may be displayed in Screen A and a time amplitude in the time range is displayed in Screen B. The window for entry of the measuring parameters or the marker operation is selected using the *DISPLAY* key.

The indications which apply only to one window appear in the margin of the associated diagram. Indications which apply to the two windows are displayed between the diagrams.

The assignment of traces to the windows is fixed and cannot be modified.

Table 3-1 Assignment of traces to windows with split screen in the signal or vector analyzer mode

Trace 1:	upper (screen A)	Trace 3:	upper (screen A)
Trace 2:	lower (screen B)	Trace 4:	lower (screen B)

The two windows can be subdivided into two measurement diagrams. This applies to separate display of measurement values, eg to the display of the inphase and quadrature signal in vector analysis. Screen A is divided into diagrams A and C, screen B is divided in diagrams B and D.

## Softkey Area

The layout of the softkey area is independent of the operating mode. It consists of the following graphic elements:

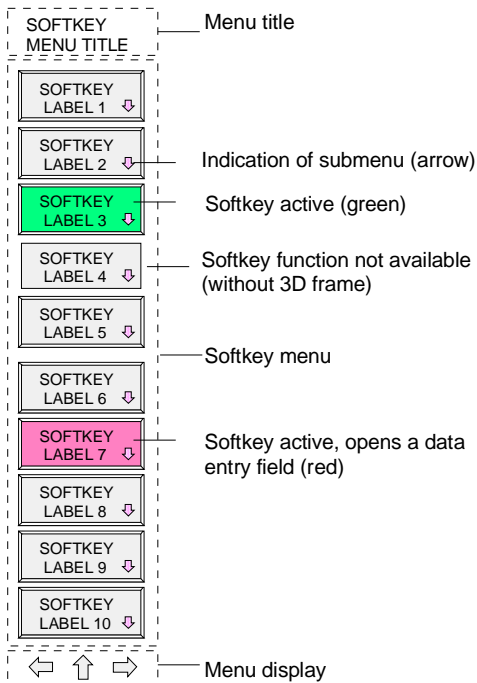

Fig. 3-5 Layout of the softkey area

The softkeys have different functions depending on the instrument state. Therefore, their labeling changes. The current state of the softkeys is indicated by color coding. The color code is factory-set as follows:

Table 3-2 Factory-set color code for softkeys

Softkey color	Meaning
gray	Softkey off
green	Softkey on
red	Softkey on and data entry active

These colors can be changed by the user as desired in the *SYSTEM DISPLAY-CONFIG DISPLAY* menu.

A softkey is switched on or off by pressing it. If a mouse is connected to the instrument, the softkey label on the display can be clicked.

Softkey labels are not displayed if the function they represent is not available. There are two cases:

- If an instrument function depends on an option, and this option is not fitted, the associated softkey label will not be displayed.
- If the instrument function is not available temporarily due to specific settings, the softkey is displayed without the 3D frame.

## Changing the Menu

With manual control, the FSE can be operated via the front-panel keys, the external keyboard or with a mouse.

Operation is menu-controlled. Various **softkey menus** are displayed depending on the instrument status. The menus are organized using a tree structure. The start menu (the root of the menu tree) is always called by pressing a hardkey. The softkeys are then used to branch into further menus (submenus).

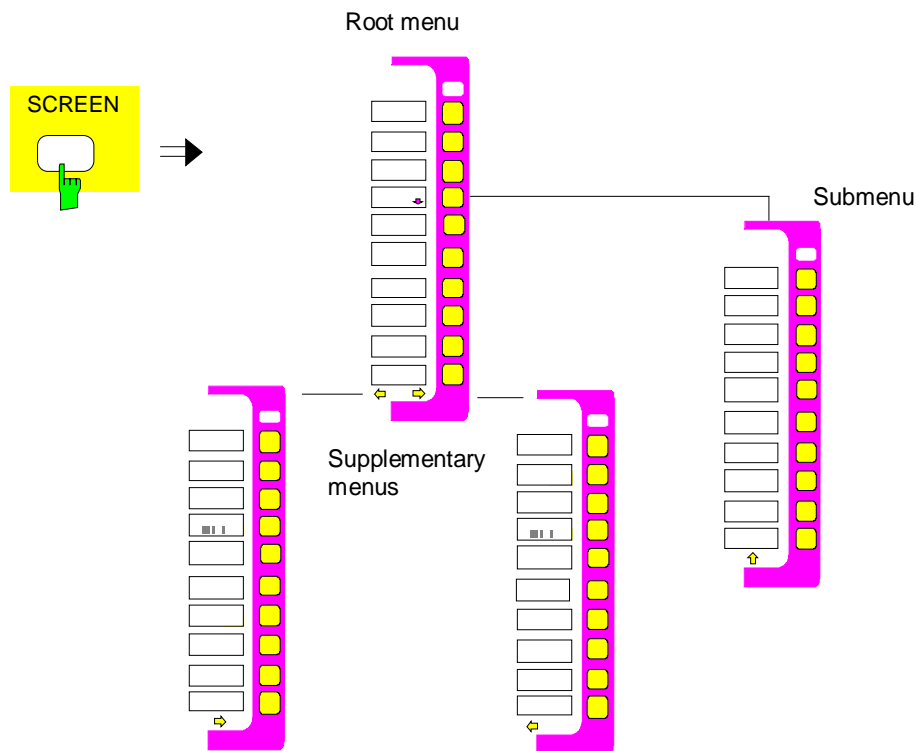

Fig. 3-6 Theory of menu selection

Each softkey menu consists of max. 30 softkeys, 10 softkeys being arranged in a main menu, 10 in a left-hand supplementary menu and 10 in a right-hand supplementary menu. In contrast to empty main menus, empty supplementary menus are not displayed. Arrows at the lower edge of the softkey area indicate whether a supplementary menu exists or not.

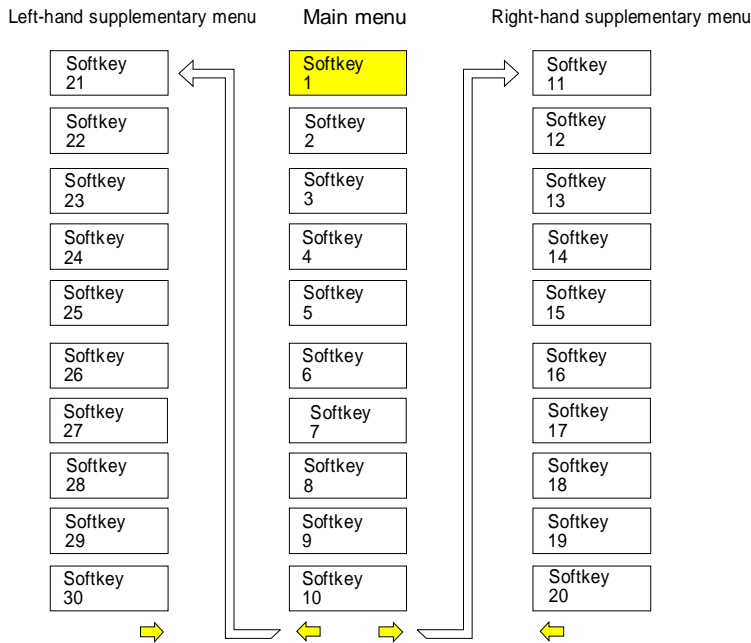

Fig. 3-7 Switching between main menu and supplementary menu

The menu arrows help to orient inside the menu tree.

**Examples:** This menu has a right-hand and a lefthand supplementary menu. It is the root menu since there is no arrow.

Only a right-hand supplementary menu or the upper menu can be accessed from this menu.

**MENU**

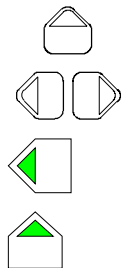

The MENU keys allow for selecting the main menu and the supplementary menus. If a mouse is connected to the instrument, the menu arrows can be selected to enter the respective menus. The MENU keys have the following functions:

When this key is pressed, the FSE enters the left-hand supplementary menu.

This key is pressed to call the upper menu which is located in the next higher hierarchical level in the menu tree. Several menus provide for automatic change, i.e., return to the next higher menu is caused automatically after pressing a softkey.



The right-hand supplementary menu is selected by pressing this key. A supplementary menu cannot be selected from another supplementary menu but only via the main menu.

Submenu are always selected with a softkey.

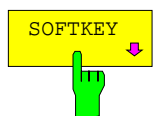

The labeling of all softkeys which call a submenu includes an arrow.

The softkeys are masked out in remote mode and during macro processing.

## Setting the Parameters

### Data Entry

Instrument parameters can be entered in an entry window or in a table via the numeric keypad on the front panel (*DATA ENTRY*), an external keyboard and the roll-key.

The numeric keypad *DATA ENTRY* is provided for entry of numeric parameters (e.g., the start frequency). The roll-key is used for fast incrementing or decrementing of numeric parameters with a defined step size.

It is advisable to use the external keyboard for definition of alphanumeric parameters (e.g., file names) since the front panel does not allow for entry of letters. If no external keyboard is provided, the help line editor is called automatically for entry of alphanumeric parameters.

### Numeric Keypad on the Front Panel

The keys are assigned the following functions:



Number keys



Changes the sign of a numeric parameter. A "-" is inserted at the cursor position in the case of an alphanumeric parameter.



Inserts a decimal point "." at the cursor position in the numeric string.

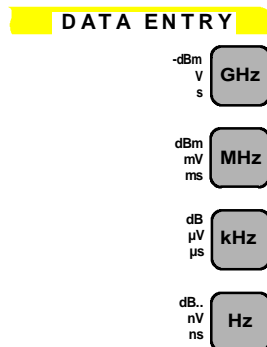

Append the selected unit to the numeric value that has been entered

The unit keys are all assigned the value "1" if quantities are indicated without dimensions in order to prevent faulty operations. The unit keys, therefore, also adopt the function of an ENTER key. The same applies to alphanumeric entries.

## DATA ENTRY



Adds an exponent (E-xx) to the end of the numeric string.

## DATA ENTRY



Deletes the character to the left of the cursor with numeric entry.  
Toggles between the current parameter and the previous value - but not when an entry is being made (UNDO function).

## DATA ENTRY



Closes the entry field when entry has been made.  
Aborts the entry before it has been confirmed.  
Closes the system message windows.

## Roll-key and Cursor Keys

## DATA VARIATION

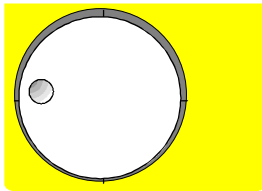

The roll-key has several functions.



- With numeric entry, the instrument parameter is incremented (turning clockwise) or decremented (turning counterclockwise) at a defined step size.  
The step size may be equal to or smaller (e.g., 1/10) than the step size being defined for the cursor keys (see description of the *STEP* key).
- In tables, the roll-key can be used to shift the cursor horizontally or vertically when no entry window is open. The direction (horizontal/vertical) is changed with the cursor keys.
- The roll-key is used with the help-line editor to select the individual letters.
- It can be used to shift markers, display lines, limit lines etc.

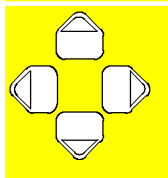

As the roll-key is turned faster, the step size increases so speeding up the setting procedure.

### Cursor keys:

## DATA VARIATION



With numeric entry, the keys  or  are used to increase or decrease the instrument parameter by the selected step size. The keys are disabled With alphanumeric entry, the keys are used to toggle between the editing line and the help line editor.

The keys  and  are used to shift the cursor to the required position within the (alpha)numeric editing line..

In tables, the cursor keys are used to shift the cursor between the lines and columns of the table.

## Entry Windows

### Setting Up the Entry Window

The instrument parameters are not entered at the location where the parameter is displayed but in an individual entry window.

The entry window is called by a softkey or a hardkey and is used for definition of numeric or alphanumeric instrument parameters (START FREQUENCY by way of example):

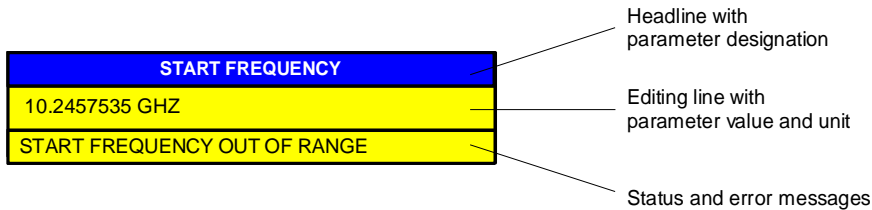

Fig. 3-8 Setup of an entry window

Subsequent to calling the entry window the current parameter value including the unit is displayed in the editing line. Status and error messages which refer to the current entry are displayed in the third and (optionally) fourth line.

The entry window is displayed in the left upper edge of the active measuring window with the default setting. When a mouse is connected to the instrument, open entry windows can be shifted to any position on the screen provided that they do not cover the softkey line. The new position is valid until measuring window is selected. The data entry window is represented transparent or non-transparent, as required.

Alphanumeric parameters are displayed as a simple character string in the editing line. Numeric parameters which consist of mantissa, exponent and unit are set up as follows:

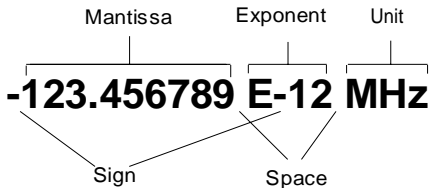

Fig. 3-9 Setup of numeric parameters

**Mantissa:** The first character is the sign of the mantissa, the positive sign is not displayed. The actual numeric value follows. The number of digits depends on the instrument parameter. The cursor may be shifted to the first digit of the mantissa at maximum, however, it may not precede the sign. The decimal point can be set as required.

**Exponent:** The exponent is separated from mantissa by a space character. The sign field of the exponent follows the "E", the positive sign "+" being not displayed similar to the representation of the mantissa. The cursor skips the "E" and the sign field. Two characters are fixed for the exponent value.

**Unit:** The unit (not represented in editing mode) is separated from the exponent by a space character.

The number of digits which can be entered for each instrument parameter is limited by the width of the input field only, but not by the amount which is physically enabled. (Example: Levels should be indicated with two decimals. The user may, however, enter as many decimals as desired - the entered value is rounded accordingly).

There are two types of entry windows:

START FREQUENCY
10.2457535 GHZ
START FREQUENCY OUT OF RANGE

The editing line of the entry window for numeric parameters allows for display of up to 24 characters. Horizontal scrolling is not possible in the editing line.

HARDCOPY TITLE
BANDPASS-FILTER TEST 23A

The editing line of the entry window for alphanumeric parameters allows for display of up to 60 characters (cf. display section). Maximum 256 characters may be entered. Horizontal scrolling is possible.









If no external keyboard is provided, the three-line entry window is replaced by a letter field which allows for individual selection of characters using the cursor keys (see help line editor).

## Editing of Numeric Parameters

### Calling the entry window:

- Subsequent to calling the entry window, the current value of the numeric parameter including the unit is displayed in inverted color. The cursor is not displayed in this state. The transparent data entry window has no background color.
- The entry window is closed upon pressing the key CLR.

### Editing mode:

- Pressing a number, sign or decimal point key causes the value and unit to be deleted. The new value is output left-justified. The individual characters are entered in insert mode. If the maximum amount of characters for the mantissa or the exponent has been entered, no further entry is possible (no horizontal scrolling). If characters are positioned to the right of the cursor, they are shifted right when reaching the maximum length and get lost.
- Pressing the keys DATA VARIATION  or  causes normal representation of the current value. The unit is no longer displayed and the cursor precedes the first digit of the mantissa () or follows the last digit entered (). The DATA VARIATION keys  and  change the numeric value of the cursor.
- Pressing the DATA VARIATION keys  or  or the roll-key causes the original parameter value to be restored and modified according to the defined step size for this parameter.
- The data management of the instrument stores the previous value of a parameter in addition to the current value. The BACK key allows for toggling between these two values.



### Termination and abortion of entry:

- The editing mode is terminated by pressing a unit key. The validity of the new parameter value is checked and accepted for the instrument setting. If an error occurs, a corresponding error message is displayed in the status line of the editing field, e.g., "Out of range", "Value adjusted", etc.
- Editing of a parameter can be aborted by pressing the key CLR. The original parameter is then displayed again. The entry window is closed by pressing the CLR key again.
- Pressing a key or softkey subsequent to starting the entry causes the entry to be aborted and the entry window to be closed. If the same softkey which has opened the entry window is activated during entry, the original value is restored and displayed.



## Editing of Alphanumeric Parameters

Generally, the regulations for numeric parameters analogously apply for alphanumeric parameters. Note the exceptions given below:

- Alphanumeric parameters are not displayed with a unit.
- The four unit keys adopt the function of the ENTER key.
- Horizontal scrolling is possible in the editing line.
- Incrementing or decrementing cannot be effected via the keys ,  or the roll-key.
- Pressing the sign key causes a "-" character to be inserted at the cursor position, the decimal point key causes insertion of a point ".".
- The exponent key has no function.

## Help Line Editor

The help line editor allows for labelling or text entries to be made without an external keyboard being required. In this case, a field containing letters and special characters is added to the standard entry window. The help line editor is displayed automatically if no external keyboard is provided and an entry window for alphanumeric entry is opened.

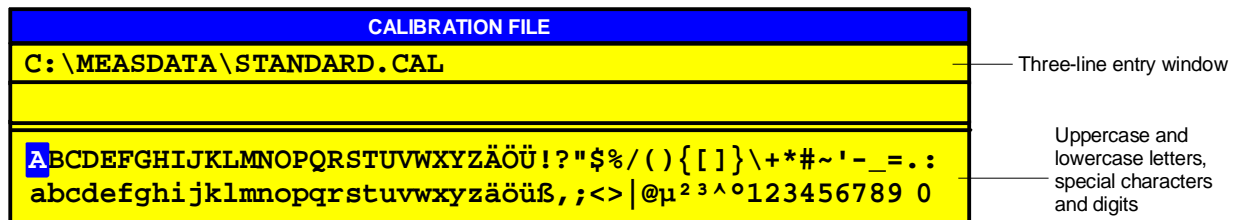



Fig. 3-10 Help line editor

- The keys  and  are used to toggle between the editing line and the help line editor.
- The cursor can be positioned to the required character in the help line editor using the cursor keys and the roll-key.
- A character is entered in the editing line by pressing any of the unit keys.
- If the cursor is already located in the editing line, pressing a unit key terminates data entry.

## Table Entry

The FSE uses numerous tables for indication and configuration of instrument parameters. The tables differ very much in the number of lines, columns and inscriptions and have a different functionality.

Tables are represented in a non-transparent form. The size is predefined and cannot be modified. If a mouse is connected, the tables may be shifted on the display without covering the softkeys. Tables can be superimposed by entry windows or suchlike.

Tables are mostly coupled to a softkey menu which provides further functions for editing table entries, e.g., deletion of tables, copying lines or columns, marking of table elements, restoring of default states etc. Another kind of tables is exclusively used for indication of instrument parameters and cannot be edited.

The definition of individual tables and the operation of particular editing functions can be looked up in the reference section with the description of the corresponding softkey menu.

The basic concept of operation is, however, the same for all tables. A differentiation is made between shifting mode and editing mode.

## Shifting Mode

This mode is active subsequent to opening a table. The **cursor** is shifted between the table elements by means of the cursor keys. The table element which is below the cursor is represented in inverted color.

TRANSDUCER SET			
	Name	Unit	
	Antenna	dB $\mu$ V/m	
	Ant_Cab2	dB $\mu$ V/m	
	Ant_Pre	dB $\mu$ V/m	
✓	Ant_Cab1	dB $\mu$ V/m	←
	Probeset	dB $\mu$ A	
	—		

Cursor

Fig. 3-11 Shifting mode

## Editing Mode

A table element which is marked by a cursor can be edited as follows:

- by pressing one of the unit keys on the front panel or the *ENTER* key on the external keyboard.
- by a double-click of the mouse on the table element. If the clicked element is not yet marked by the cursor, the letter is positioned on the element, additionally.
- For numeric or alphanumeric instrument parameters, the editing operation may be started by entry of any number or letter on the front panel or on the external keyboard.

The data entry window, the selection list or the toggle editor are provided for this purpose.

After the editing operation has been terminated, the table enters the shifting mode again. The cursor is positioned automatically on the next table element.

## Disabling the Control Elements - HOLD Key

The individual softkeys have the following functions:

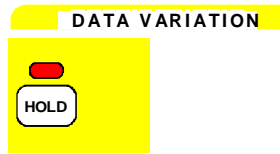

The functions of the *HOLD* menu allow for disabling individual control elements or the complete instrument control. The LED above the *HOLD* key indicates that either the function *LOCK DATA* or *LOCK ALL* has been activated. The control can be enabled again by successively pressing the two *UNLOCK* softkeys in any order.

Switching off the instrument resets control such that the instrument can be normally operated again after subsequent switch-on.



After selecting the two *UNLOCK* softkeys, the instrument keyboard is enabled again. The LED above the *HOLD* key goes out.





Selection of softkey *LOCK DATA* causes the roll-key to be disabled in order to prevent a parameter from being varied by mistake.



Selection of *LOCK ALL* softkey disables the complete front panel (including the *PRESET* key and roll-key, not including the *UNLOCK* softkeys), the mouse and all keys of the external keyboard. Exit from the *HOLD* menu is no longer possible. Control is enabled again by actuating the two *UNLOCK* softkeys.

## Setting the Stepsize - STEP Key

A number of numeric instrument parameters allow for step-by-step incrementing or decrementing the value in the editing line of the entry window using the keys  or  or the roll-key. The stepsize used with the cursor keys can be specified for the selected parameters in the *STEP* menu.

- Notes:**
- It is not possible to set the stepsize by all of the numeric parameters.
  - An extended *STEP* menu is available by some parameters. The extra functions are described by the respective parameter.
  - Setting the step size has no effect on the roll-key (the resolution of the roll-key is higher than that of the step size function)

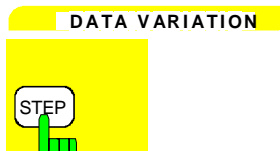

The *STEP* key opens the *STEP* menu for entry of the stepsize.

The stepsize of an instrument parameter can only be varied when this parameter is edited in an entry window.

The softkeys in the *STEP* menu are disabled if no instrument parameter is being varied or if the parameter being edited does not support stepsize variation (as is the case by all of the alphanumeric parameters).

The key  leads to exit from the *STEP* menu and automatic return to the previously active menu.



The softkey *STEPSIZE AUTO* causes the stepsize for the corresponding instrument parameter to be set automatically and be continuously varied with varying instrument settings (in accordance with other parameters).

**Example:**

The stepsize of the *CENTER* frequency depends on the selected span.



The softkey *STEPSIZE NORMAL* calls an entry window for definition of a stepsize by the user. The parameter whose stepsize is varied, is displayed in the headline of the entry window:

START FREQUENCY	STEPSIZE
100 kHz	

The stepsize remains constant until a new value is entered or until the *STEPSIZE AUTO* softkey is activated. It is no longer coupled to other instrument parameters.

# Mouse and External Keyboard Control

## External Keyboard Control

The connection of an external keyboard provides additional characters for the entry (letters and special characters). It is permitted to use both, front panel keys and the external keyboard, for control. The number, cursor and sign keys have the same effect as the corresponding front panel keys. A few keys of the external keyboard provide an extended functionality with entries or tables which is described in the following table. The table shows the external keyboard key combinations through which the functions of the front panel keys can be emulated.

- Note:**
- The key combination <ALT><S (German keyboard) or <ALT> <SYSREQ> (English keyboard) switches between the instrument display screen and the controller display screen (for an installed option FSE-B15, controller option).
  - In instrument mode, the key combination <ALT> <F1> switches the keyboard between the US-American language and the language selected in the GENERAL SETUP menu (instruments without controller option).

Table 3-3 Front Panel Keyboard Emulation

FSE front panel keys		Key assign. for the ext. keyboard
Softkeys:	SK1 SK2 SK3 SK4 SK5 SK6 SK7 SK8 SK9 SK10	F1 F2 F3 F4 F5 F6 F7 F8 F9 F10
Menu select:	Menu left Menu right Menu up	CTRL ← CTRL → CTRL ↑
Cursor control:	Cursor left Cursor right Cursor up Cursor down	← → ↑ ↓
Roll-key:	Turn left Turn right	SHIFT ↑ SHIFT ↓
Numeric keys:	0 to 9	0 to 9
Units keys:	GHz... MHz... kHz... Hz...	ALT-G ALT-M ALT-K <ENTER>
Edit keys:	Clear Backspace	<ESC> BACK
Misc. data entry keys:	Exponent "Exp" Sign "+/-" Decimal point".	ALT-E - .
Hold key:	Hold	SHIFT-F1
User menu:	User	SHIFT-F2
System keys:	Preset Cal Display Info	SHIFT-F4 ALT-F12 ALT-F10 SHIFT-F5
Configuration key group:	Mode Setup	ALT-F2 SHIFT-F8
Hardcopy key group:	Start Settings	SHIFT-F6 SHIFT-F9

FSE front panel keys		Key assign. for the ext. keyboard
Status key group :	Local	SHIFT-F3
Frequency key group:	Start Stop CenterCenter Span	CTRL-F7 CTRL-F8 CTRL-F9 CTRL-F10
Level key group:	Ref Range Input Cal	CTRL-F11 CTRL-F12 ALT-F11 ALT-F12
Marker key group :	Normal Search Delta → Mkr	CTRL-F1 CTRL-F2 CTRL-F3 CTRL-F4
Lines key group :	Display Limit	CTRL-F5 CTRL-F6
Traces key group :	1 2 3 4	ALT-1 ALT-2 ALT-3 ALT-4
Sweep key group :	-- -- -- Coupl. Sweep Trigger	ALT-F3 ALT-F4 ALT-F5 ALT-F6 ALT-F7 ALT-F8
Memory key group:	Config Save Recall	SHIFT-F10 SHIFT-F11 SHIFT-F12
Data entry key group :	Step	SHIFT-F7
Letters and special characters		A to Z (ext.) a to z (ext.) Special characters (ext.)
Edit key		Delete
Cursor control		Home End Page up Page down

## Data Entry Windows with Mouse Control

With a mouse being connected, additional functions are provided in the entry windows. Therefore, buttons are displayed in the entry window.

Essentially, the definitions which have been made for all types of entry window also apply for mouse control. However, note the following deviations:

- The so-called close-button is displayed on the left margin of the headline. Selecting this button via the mouse aborts the entry and closes the entry window. This corresponds to the function of the CLR key with manual control.
- In the numeric entry window, two buttons (↕) are displayed on the left margin of the editing line. Simply clicking the buttons causes the parameter in the editing line to be incremented or decremented (similar to the keys ⬆ / ⬇ or the roll-key with manual control).
- The cursor can be positioned in the entry line by clicking a character using the mouse.
- A character in the letter window of the help line editor can be selected by a single click. A double click copies the character from the letter window into the editing line.
- Open entry windows can be shifted across the complete screen using the mouse; they must not, however, be superimposed on the softkey line. Shifting is performed by clicking the headline and pushing the mouse while the mouse-key is being pressed.

**Example:** Numeric entry window with mouse control

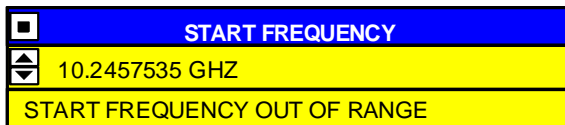

## Mouse Control of Further Display Elements

All display and control elements (enhancement labels, softkeys, function fields, display and limit lines) which can be displayed on the display screen can also be controlled by the mouse. Each softkey or key is assigned to a display element.

Double-clicking an display or control element opens the corresponding softkey menu. The assignment of softkeys/keys to display elements is shown in the following table.

Klicking the right mouse key call all softkey menus one after the other.

Table 3-4 Mouse Control of Display Elements

Display element for mouse control.	Assigned softkey or key
Display field for Softkey 1 to Softkey 10	Softkey 1 to Softkey 10
Display field for menu arrow: right/center/left	Key right/center/left supplementary menu
Enhancement labels * PA PS UNS LVL FRQ 1-x 2-x 3-x 4-x  TRG DC 75Ω MAC	-- SETUP key SETUP key COUPLING key REF key CENTER key TRACE 1 key TRACE 2 key TRACE 3 key TRACE 4 key  TRIGGER key INPUT key INPUT key USER key
Status display UNCAL OVLD ERR	CAL key REF key INFO key
Display fields above the diagram  Ref. Level / Max Level Marker RBW VBW SWT RF Att Mixer Unit	REF key NORMAL key COUPLING key COUPLING key COUPLING key INPUT key INPUT key REF key
Display fields below the diagram  Start Stop Center Span Trigger /Div	START key STOP key CENTER key SPAN key TRIGGER key --

# Menu Overview

## System Key Group

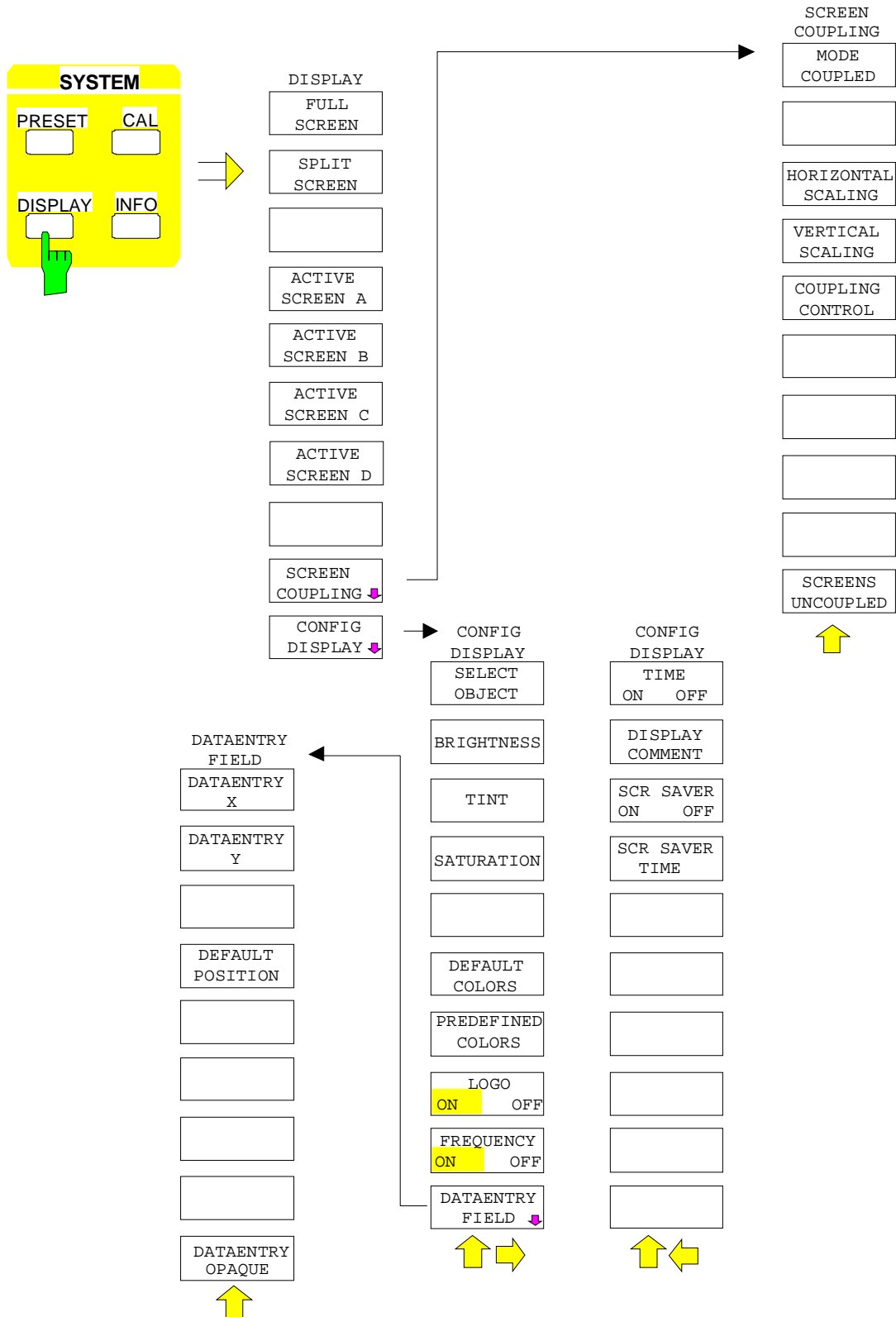



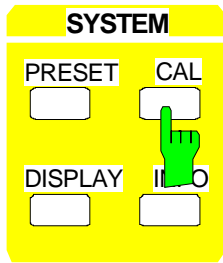

Mod 30

with option  
FSE-B7 only

CALIBRATE	CALIBRATE
CAL SHORT	CAL RESULTS
CAL TOTAL	
CAL RES BW	
CAL LOG	
CAL LO SUPP	
CAL I/Q	
PRESEL PEAK	PAGE UP
CAL CORR ON OFF	PAGE DOWN



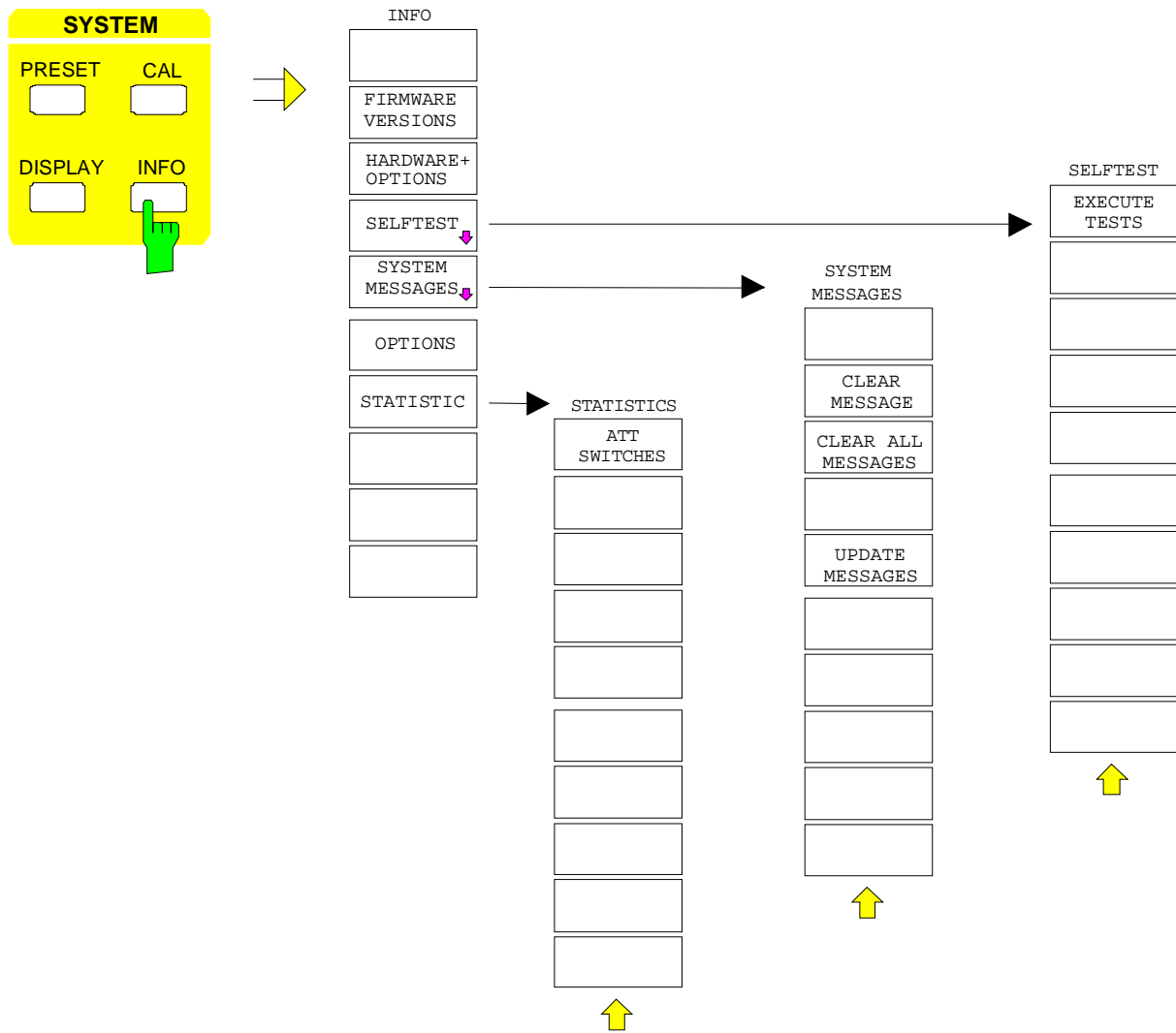

# Configuration Key Group

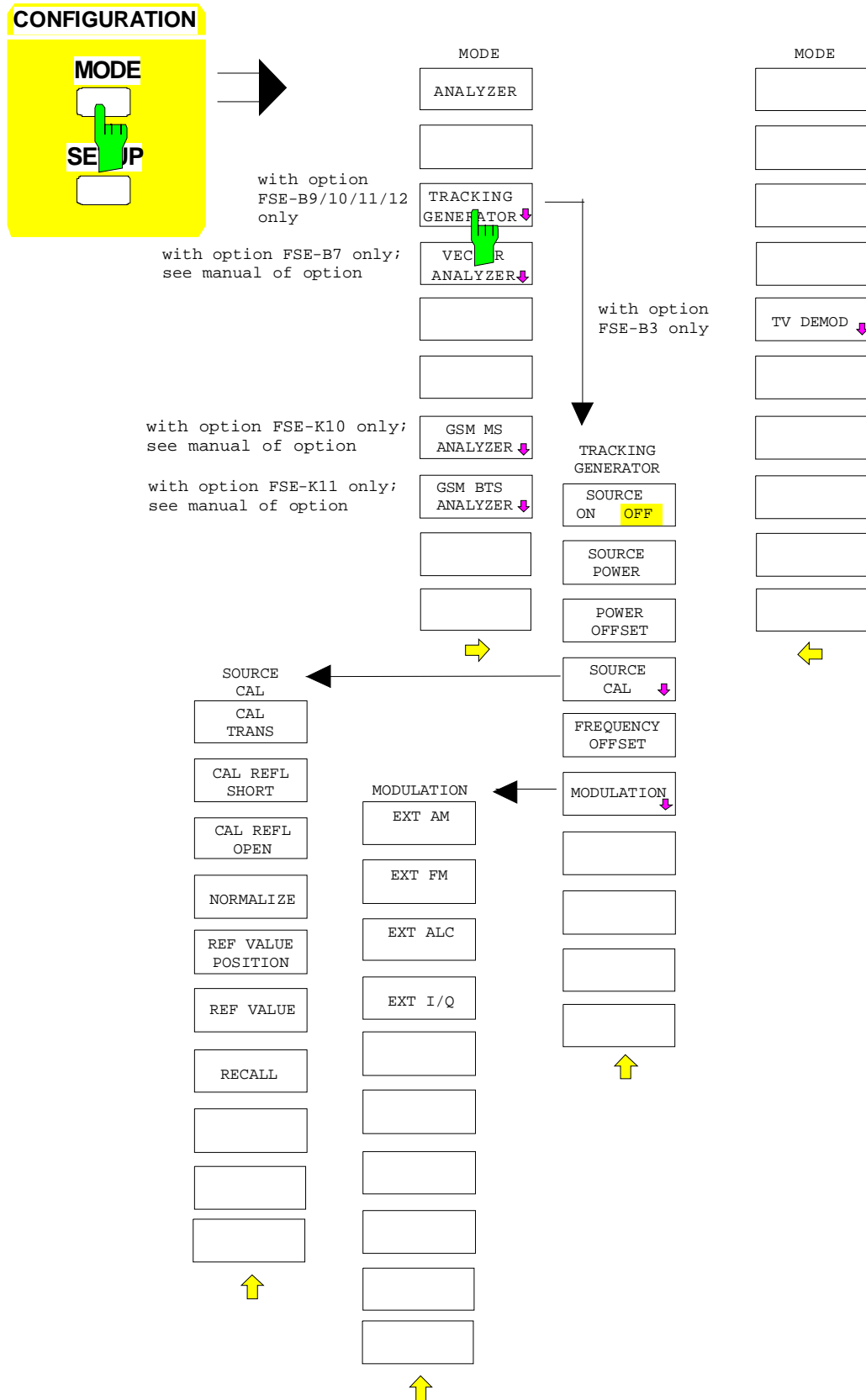

### Setup for Instruments with Windows NT Controller Option

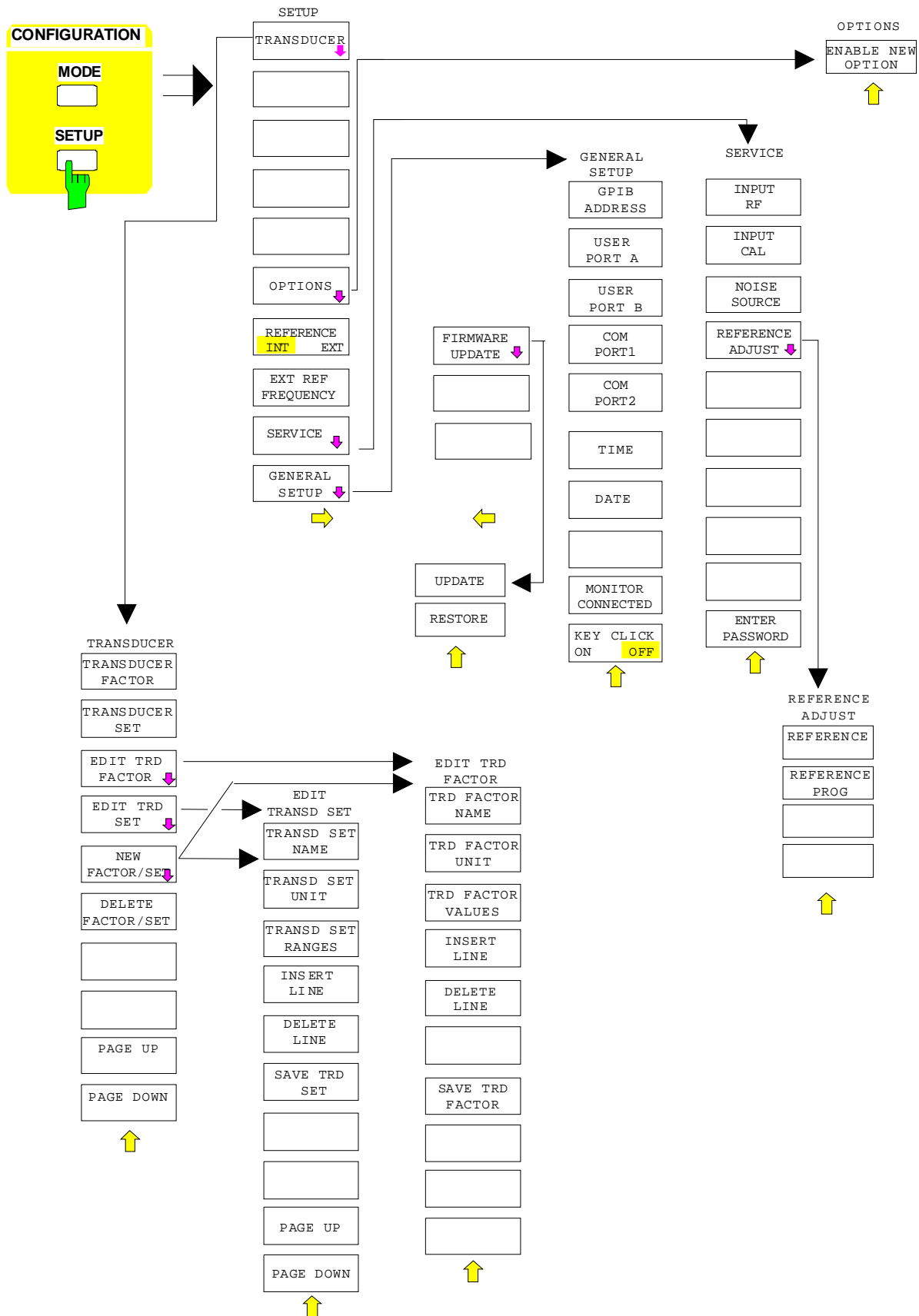

### Setup for Instruments with MS DOS Controller Option or without Controller

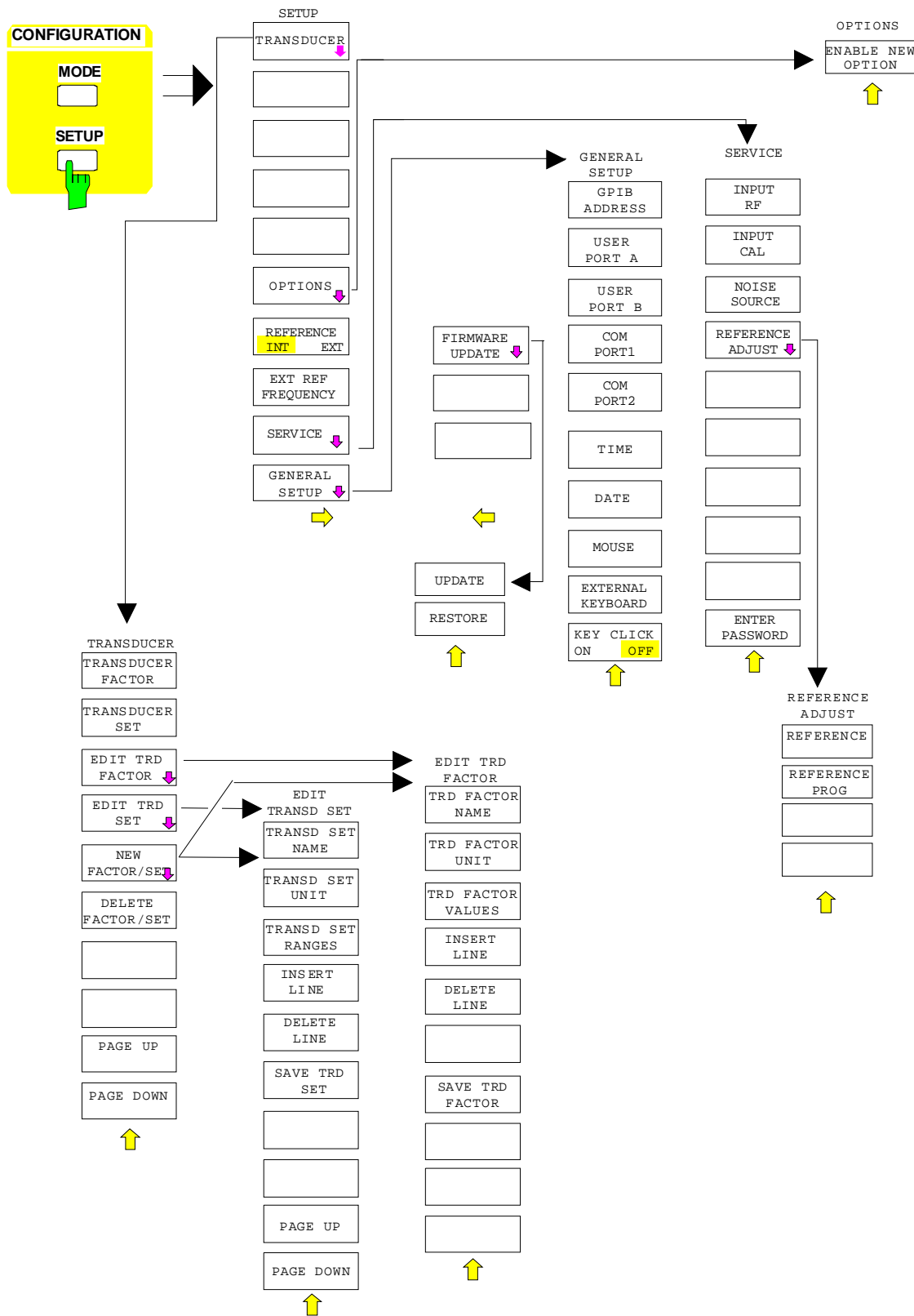

# Hardcopy Key Group

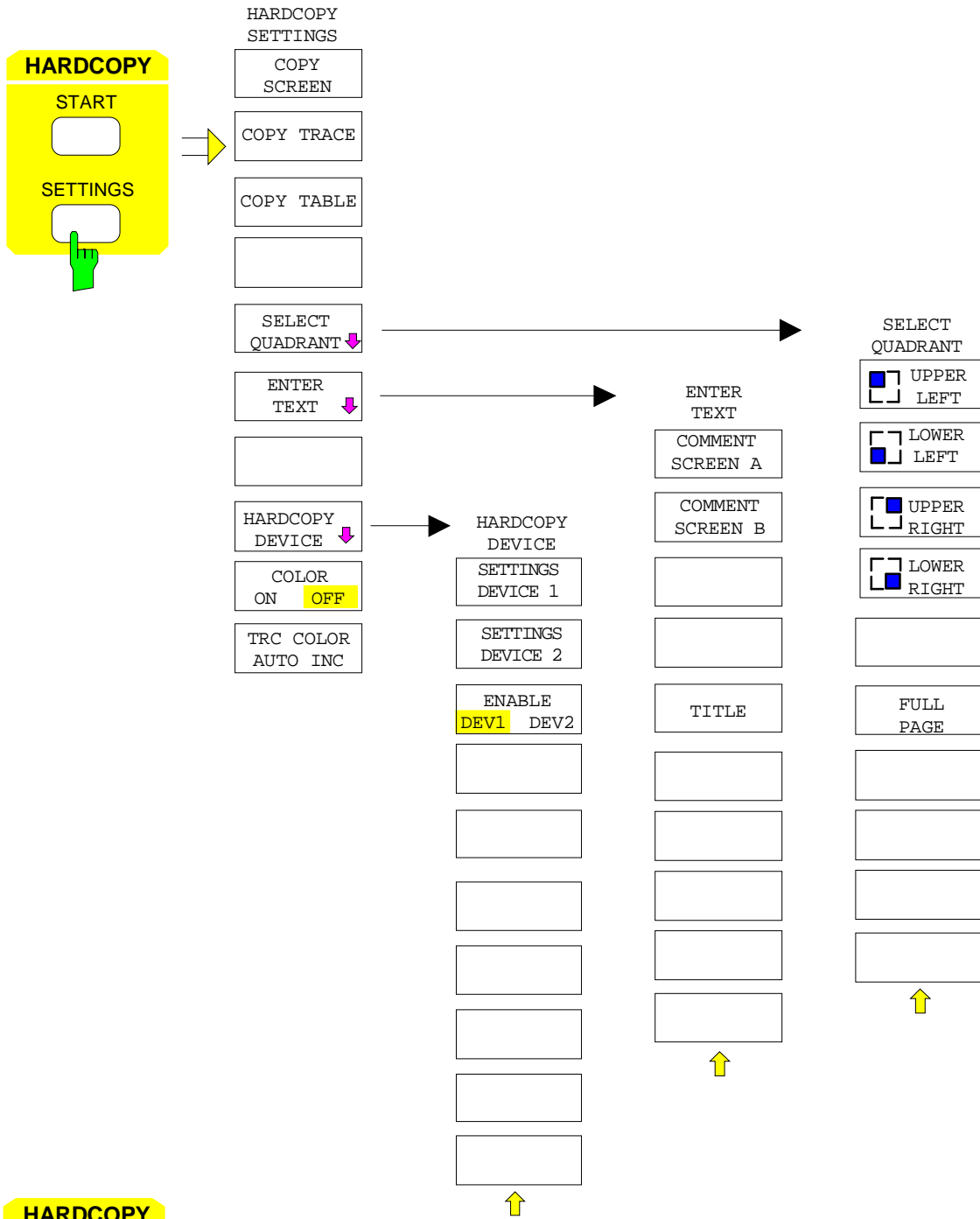

without softkey menu

### Frequency Key Group

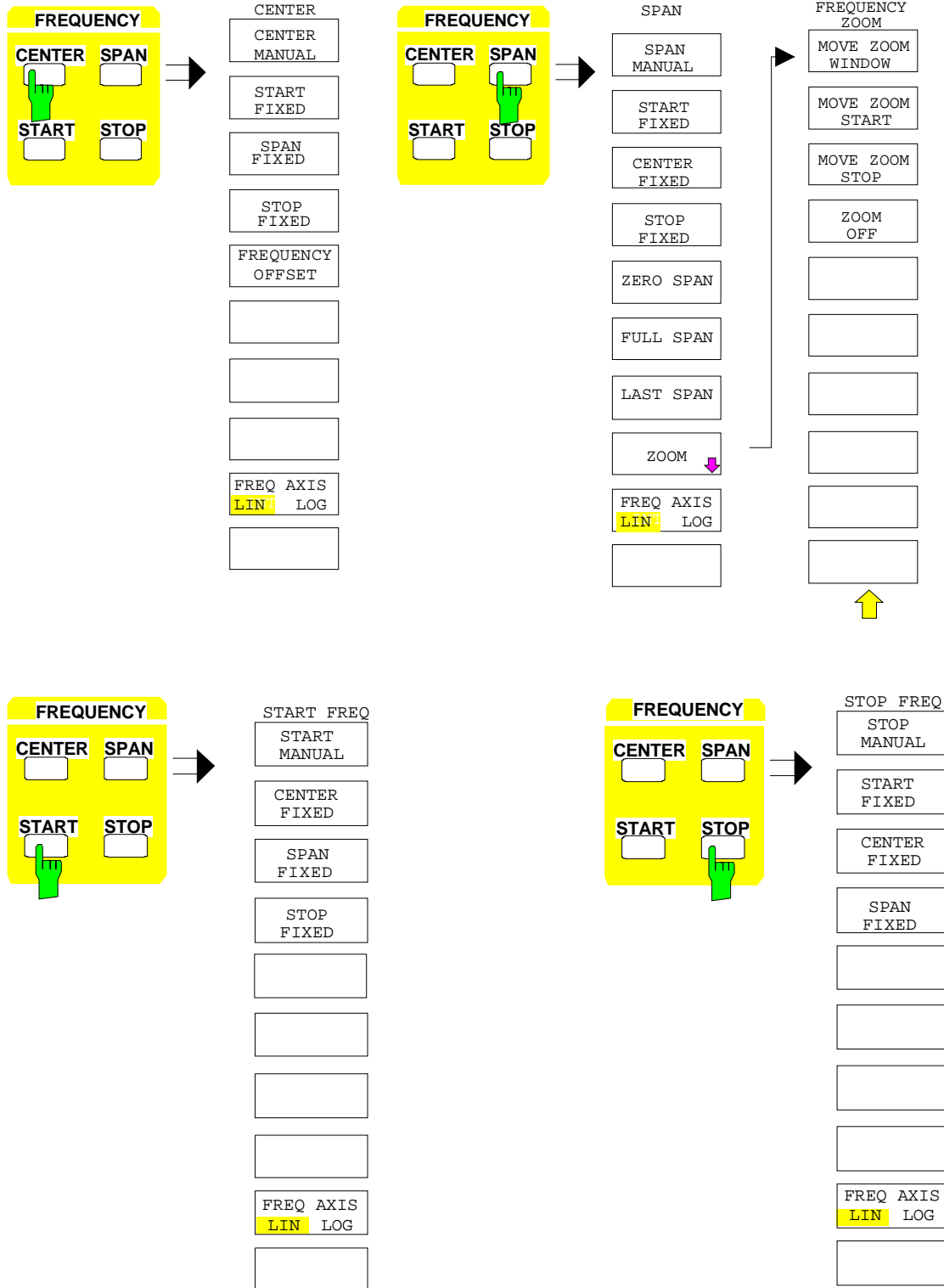

### Level Key Group, Input Key

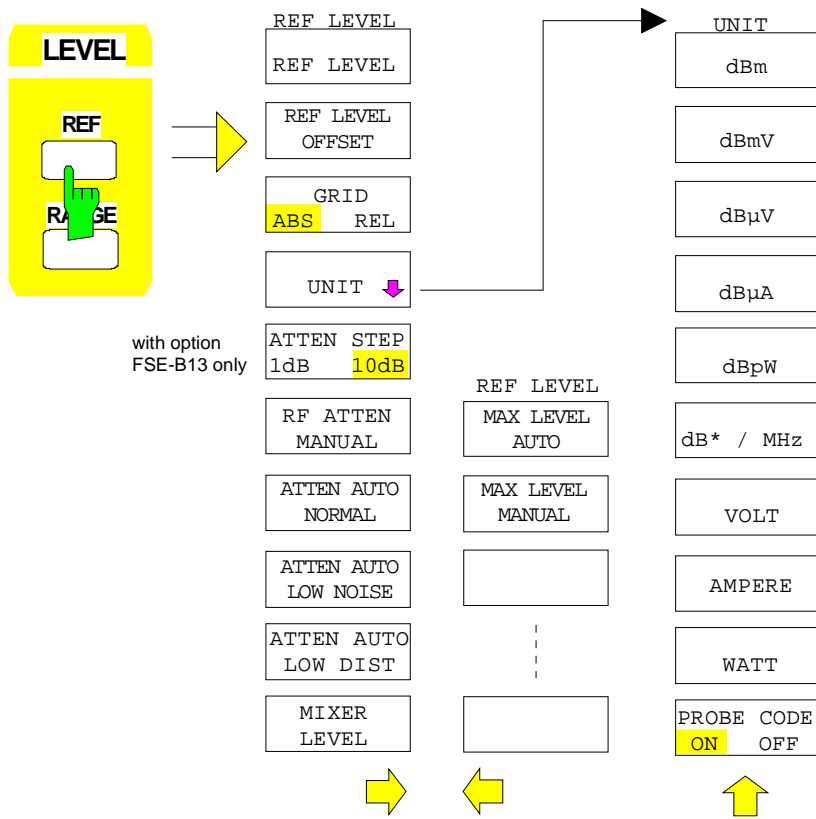



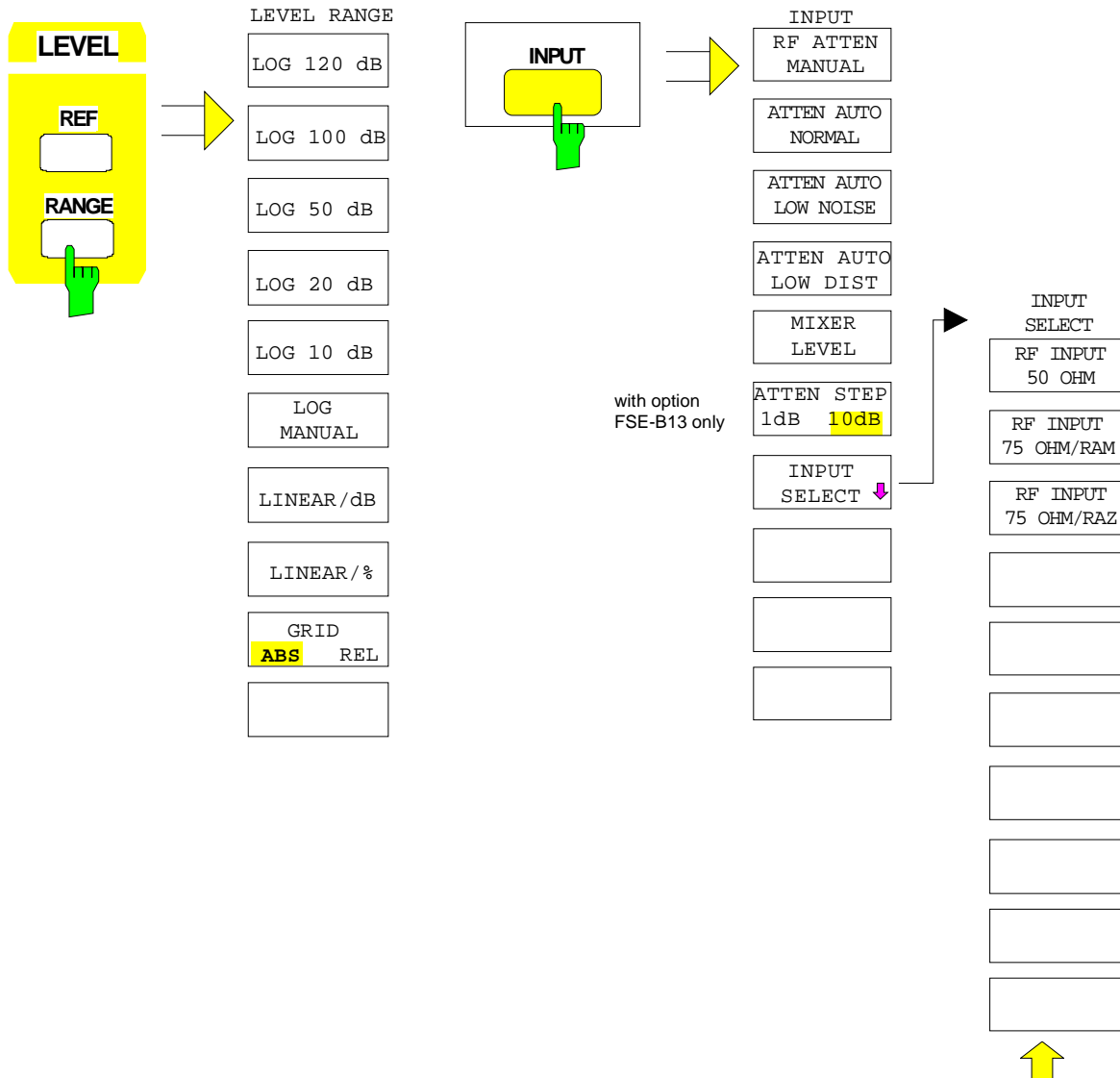

# Marker Key Group

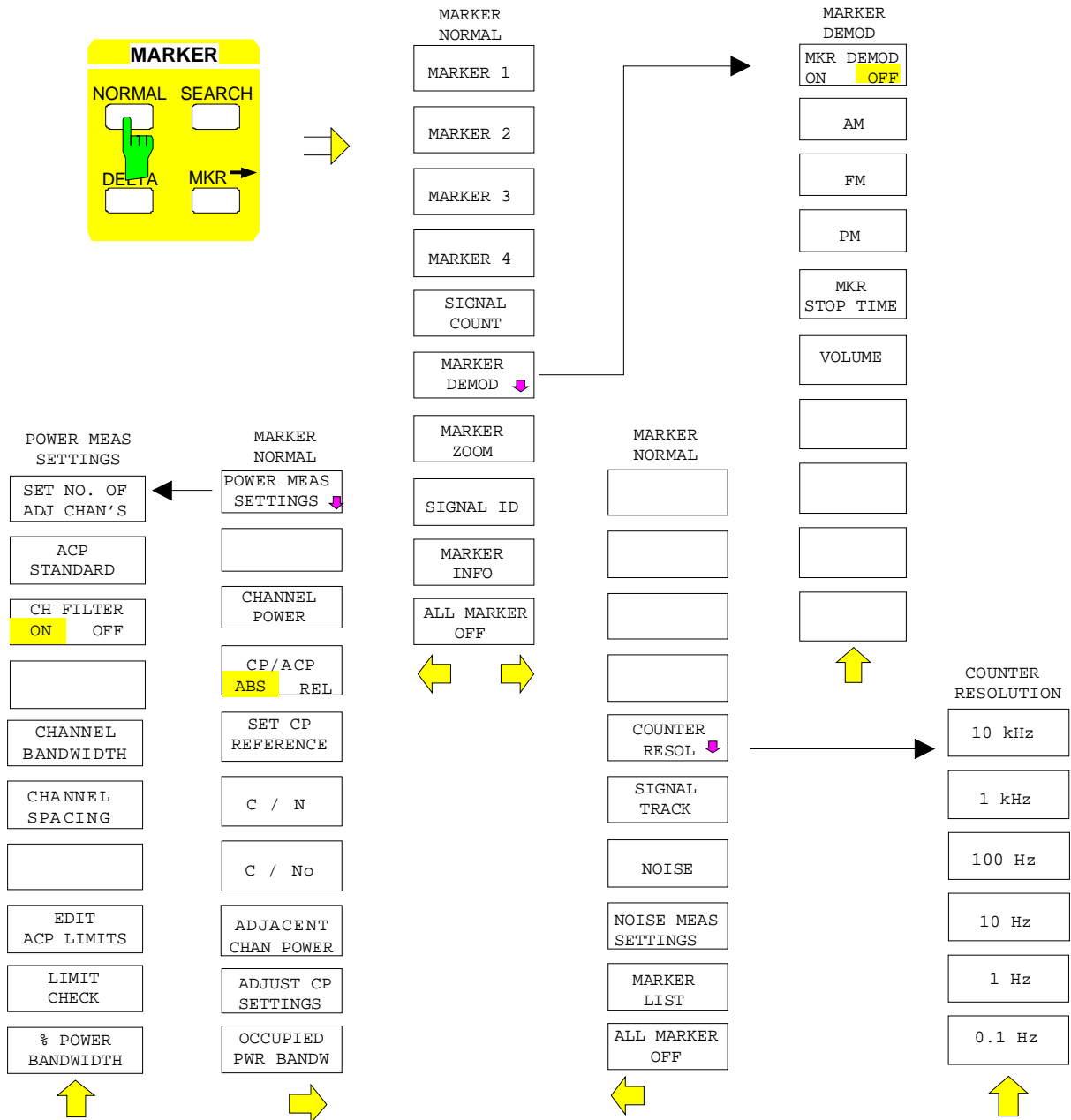

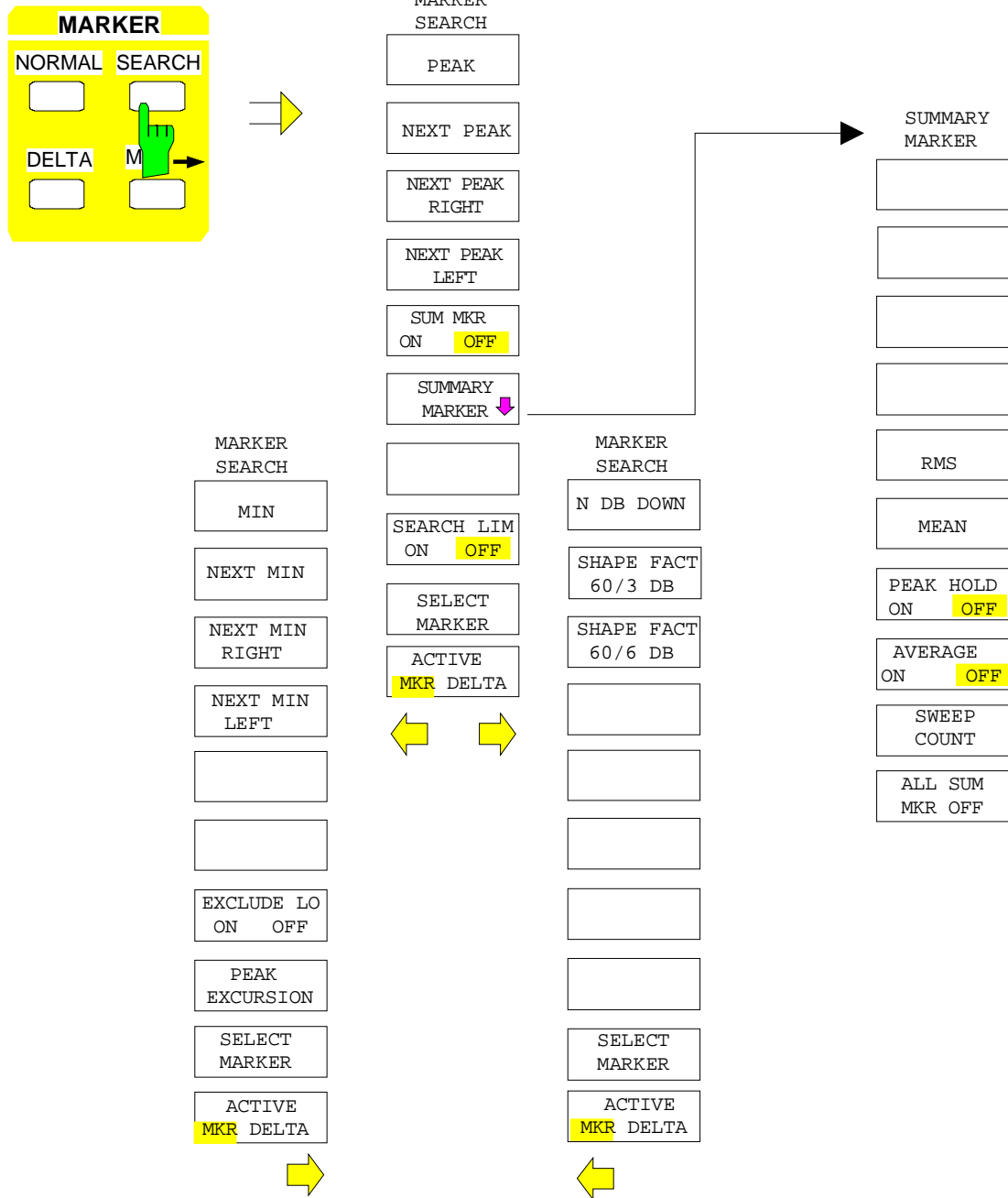

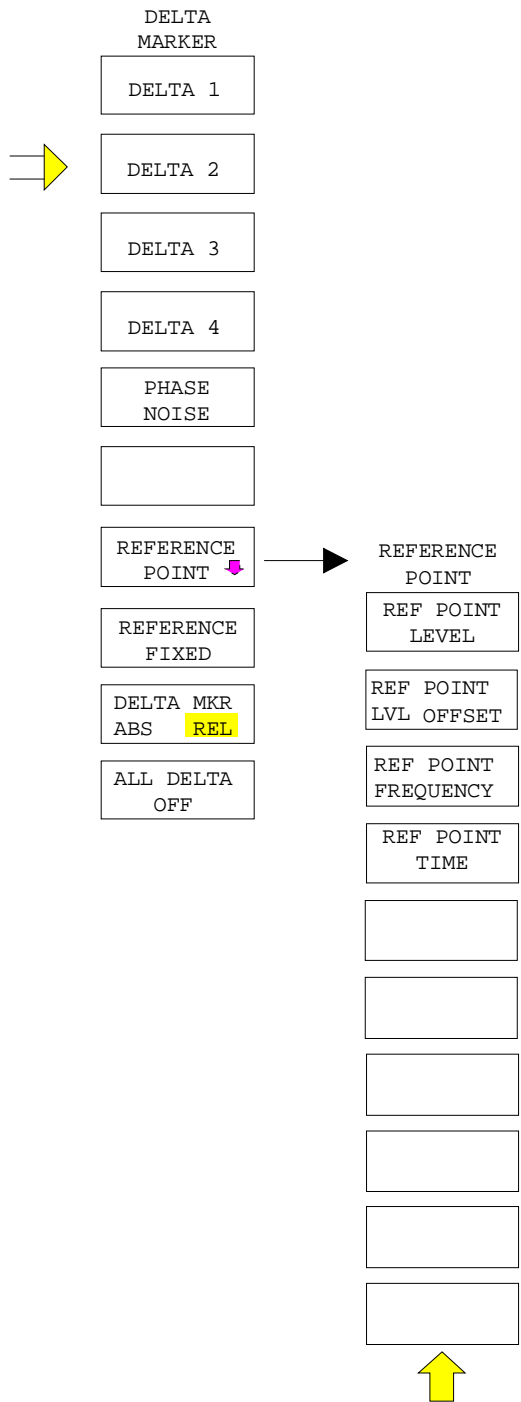
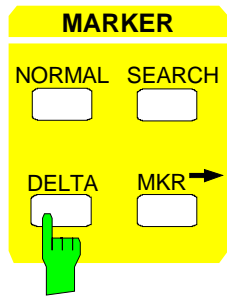

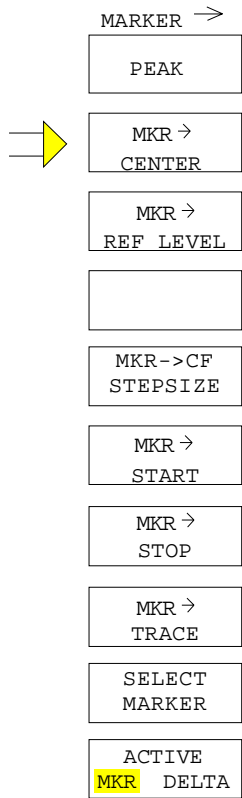
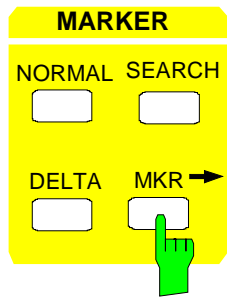

# Lines Key Group

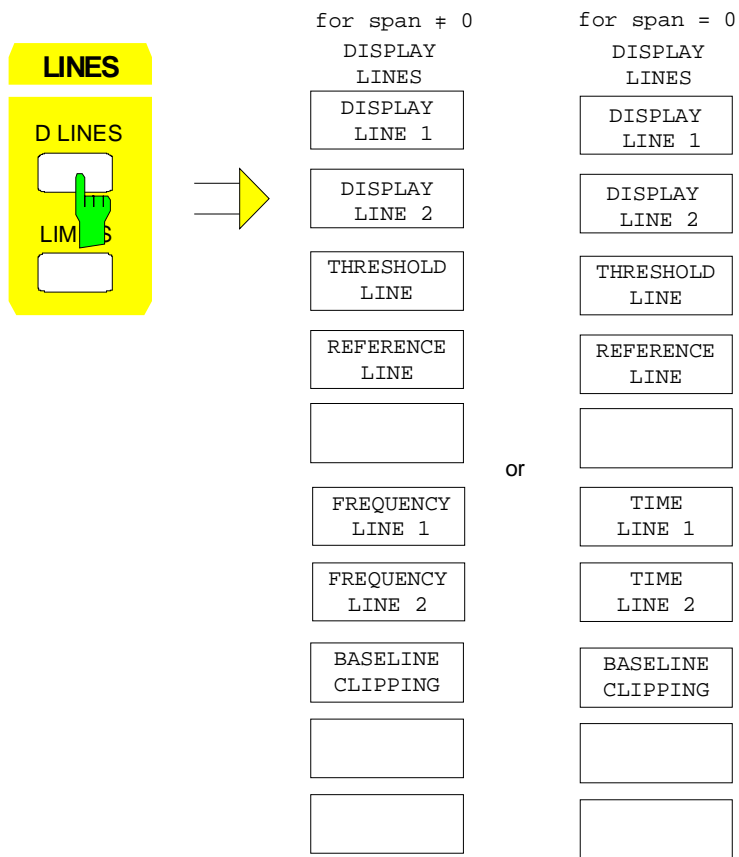

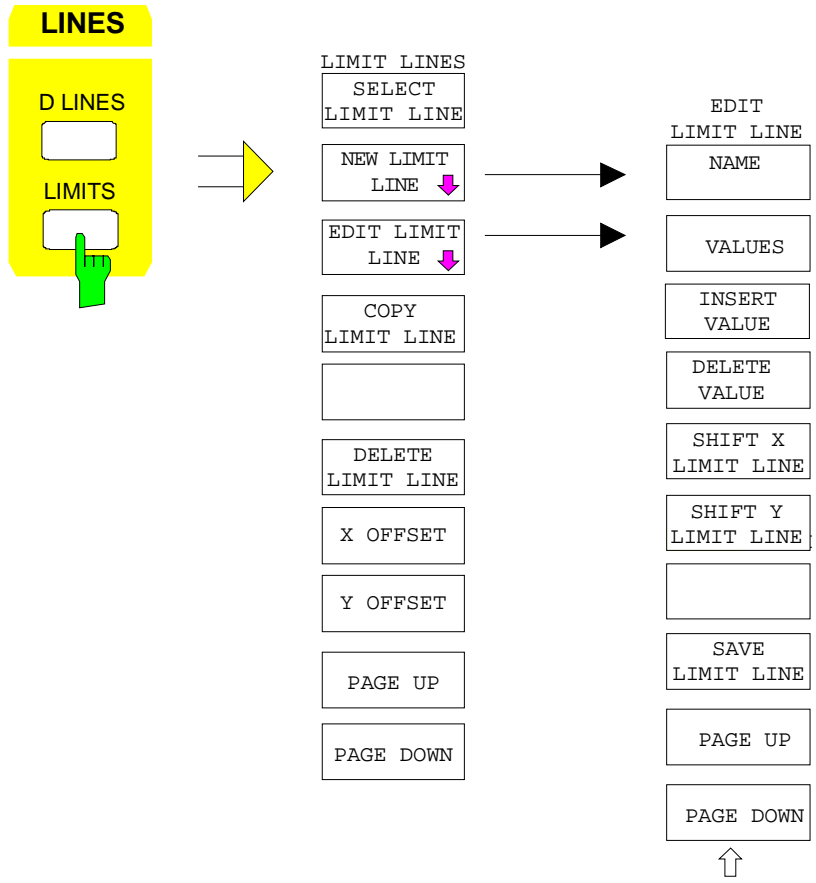

### Trace Key Group

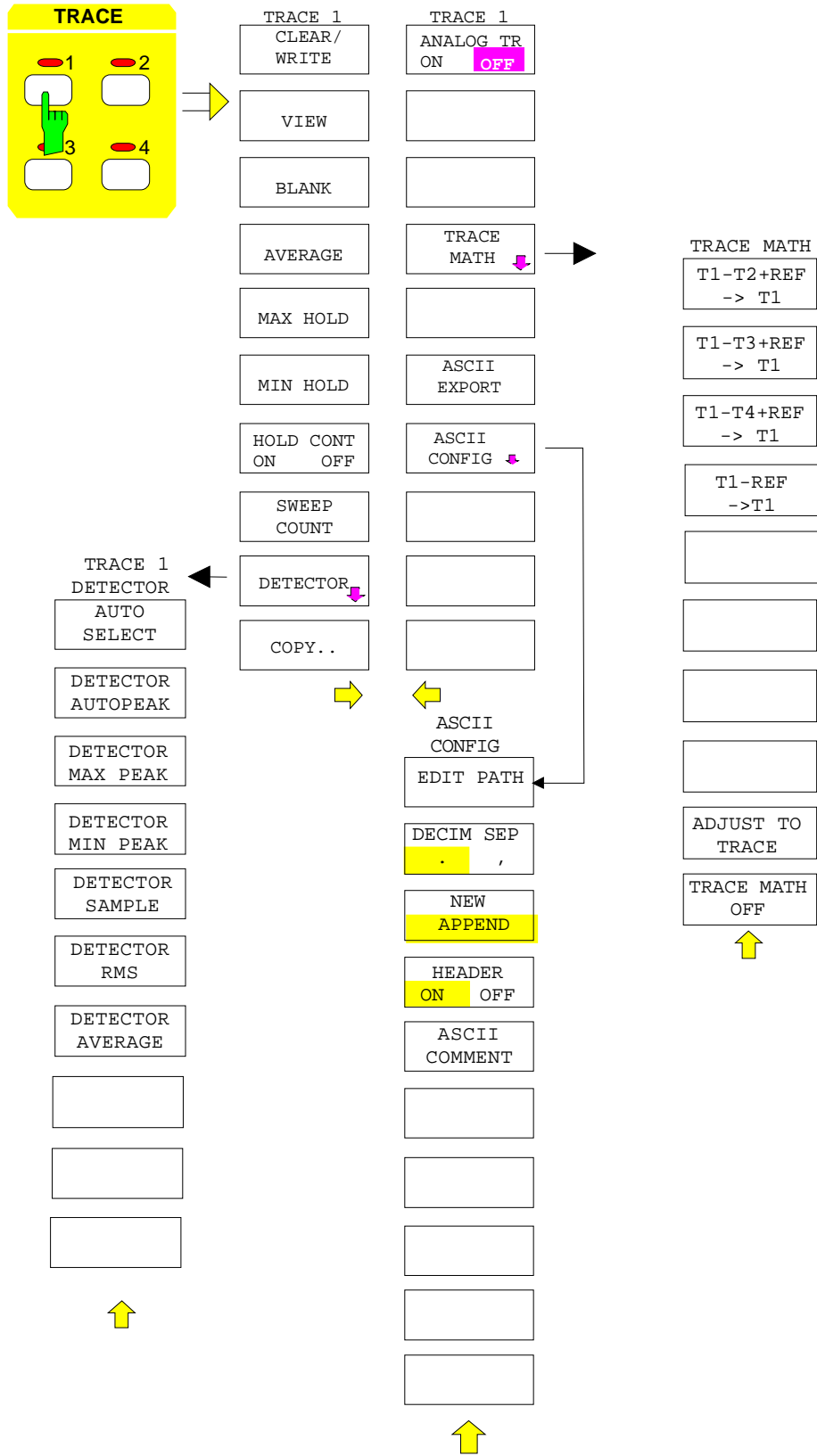



# Sweep Key Group

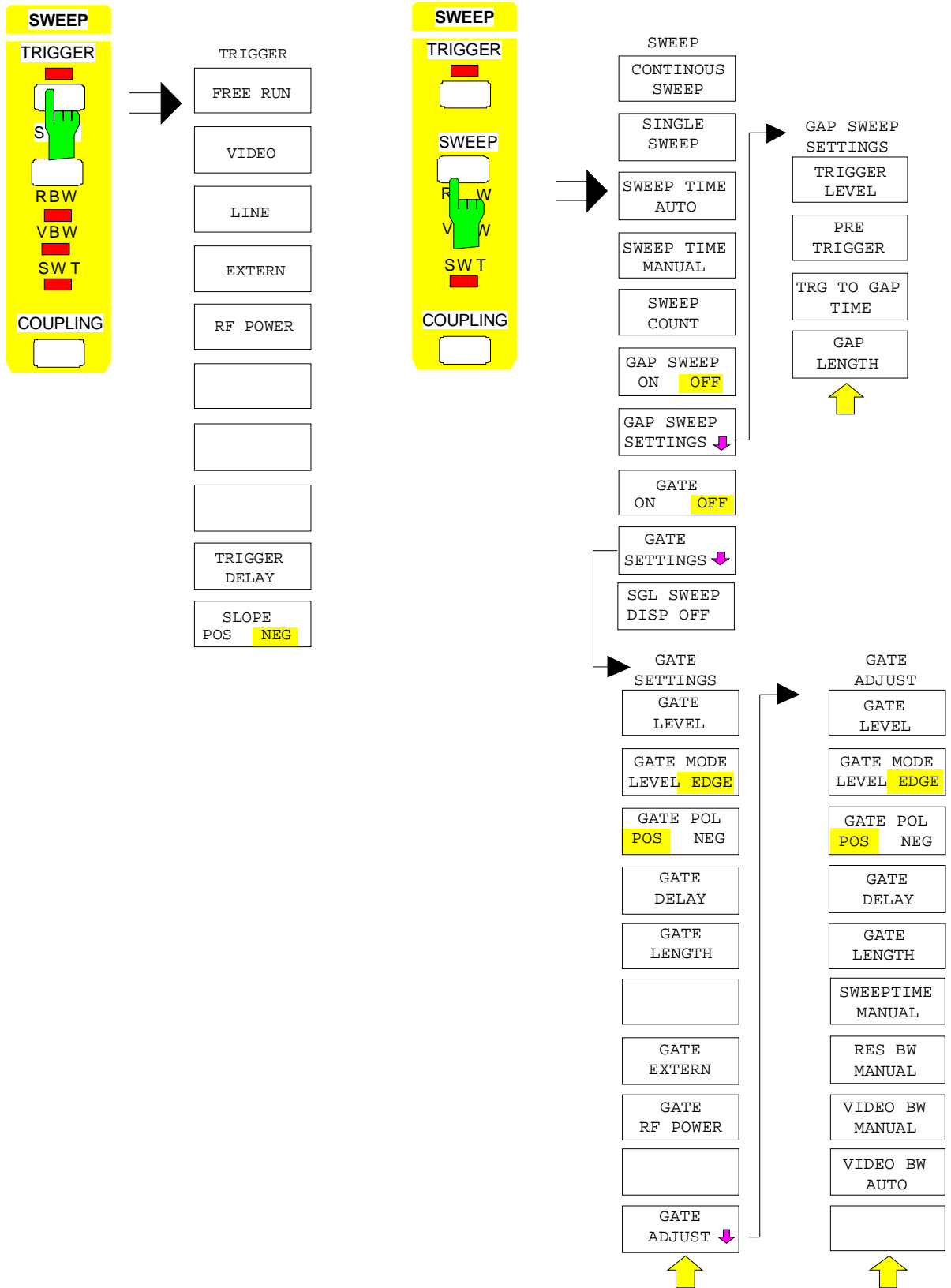

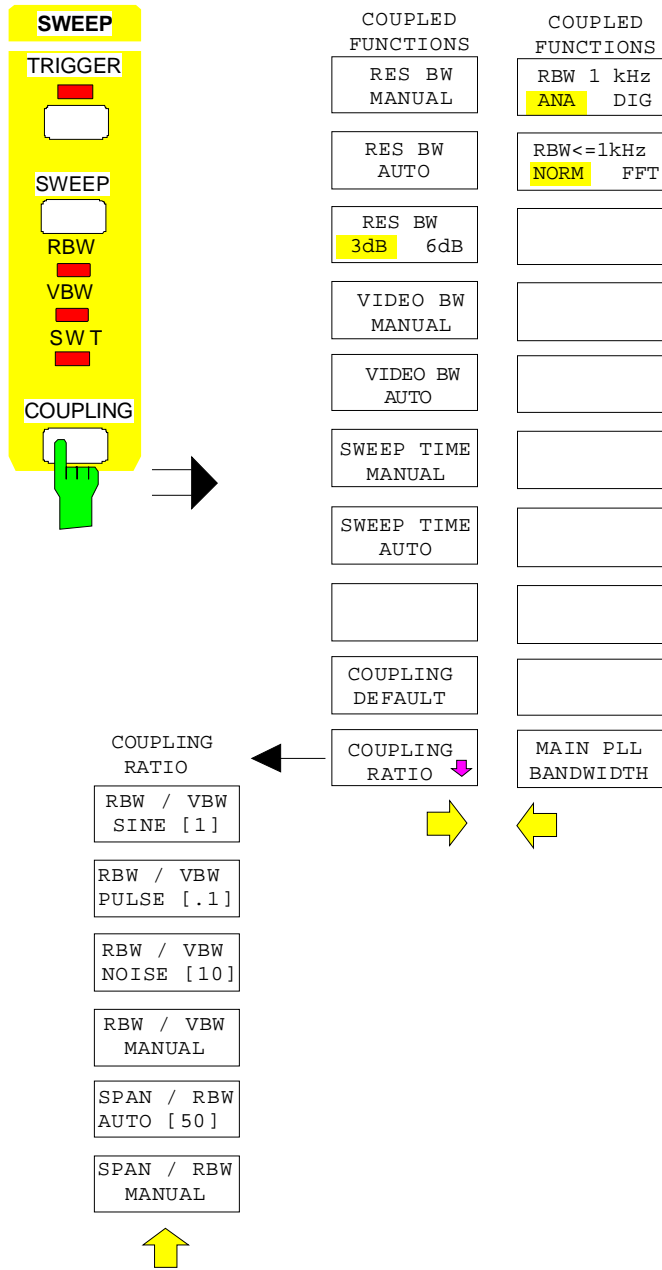





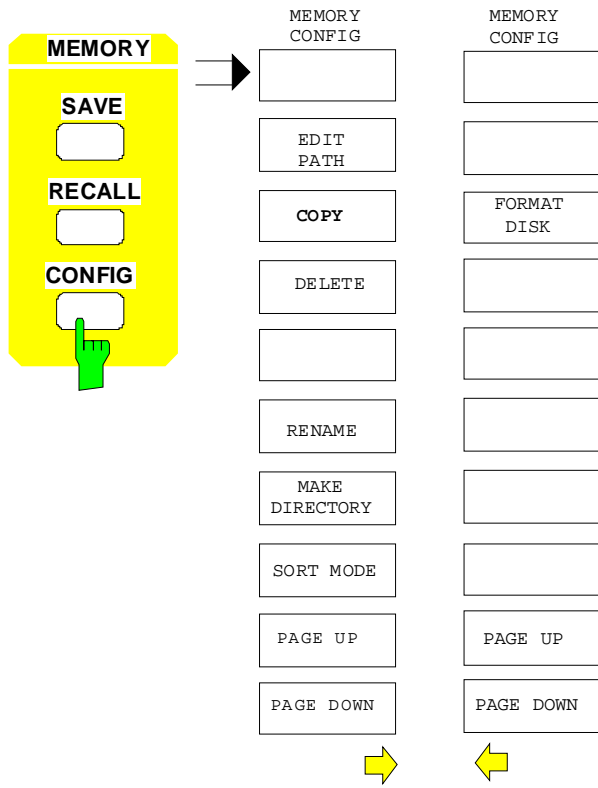

# User Key Group

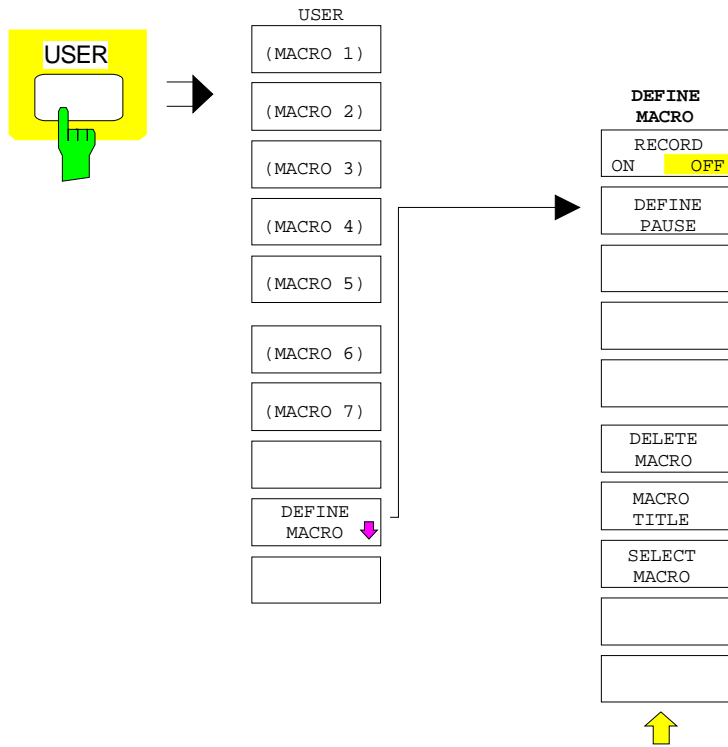

## Contents - Chapter 4 "Instrument Functions"

<b>4 Instrument Functions</b> .....	<b>4.1</b>
<b>General Configuration – SYSTEM and CONFIGURATION Key Groups</b> .....	<b>4.2</b>
FSE Initial Configuration – PRESET Key.....	4.2
Display Configuration – DISPLAY Key.....	4.3
Display Screen Mode Selection.....	4.4
Measurement Window Coupling.....	4.5
Display Screen Configuration.....	4.6
Recording the Correction Data – CAL Key.....	4.9
Correction Function Calls.....	4.10
Results of System Error Correction.....	4.12
Instrument Status and Measurement Parameters – INFO Key.....	4.13
Firmware Versions.....	4.13
Hardware Configuration and Options.....	4.14
Self Test.....	4.15
System Messages.....	4.16
Statistics Function for Input Attenuator Switching.....	4.17
Mode Selection – MODE Key.....	4.18
Preliminary Setup and Interface Configuration – SETUP Key.....	4.20
Using Transducers.....	4.20
Activating Transducer Factors and Transducer Sets.....	4.21
New Entry and Editing of Transducer Factors.....	4.23
New Entry and Editing of Transducer Sets.....	4.27
Enabling Firmware Options.....	4.31
External Reference Oscillator.....	4.31
Service Functions.....	4.32
Setting the Interface Configuration and Time - with Windows NT Controller.....	4.34
IEC/IEEE-Bus Address Selection.....	4.34
User Port Configuration.....	4.35
Serial Interface Configuration.....	4.36
Setting the Date and Time.....	4.39
Connecting the External Monitor.....	4.39
Switching the Beeper ON/OFF.....	4.39
Setting the Interface Configuration and Time - without Controller Option or with MS DOS Controller.....	4.40
IEC Bus Address Selection.....	4.40
Switching the Beeper ON/OFF.....	4.40
User Port Configuration.....	4.41
Serial Interface Configuration.....	4.42
Setting Date and Time.....	4.45
Mouse Configuration.....	4.46
Firmware Update.....	4.47
<b>Status Display-Remote/Manual Control – STATUS Key Group</b> .....	<b>4.49</b>
<b>Measurement Documentation – HARDCOPY Key Group</b> .....	<b>4.50</b>
Printing Data – START Key - with Windows NT Controller.....	4.50
Printing Data – START Key- with MS DOS Controller or without Controller.....	4.52

Printing Configuration – <i>SETTINGS</i> Key .....	4.54
Selection of Displayed Elements and Colour Settings .....	4.55
Selection of Hardcopy Format.....	4.56
Entry of Comment Text .....	4.57
Selection and Configuration of the Printer - with Windows NT Controller .....	4.58
Selection and Configuration of the Printer - with DOS Controller/ without Controller..	4.60
<b>Saving and Recalling Data Sets – <i>MEMORY</i> Key Group.....</b>	<b>4.66</b>
Configuration of Memory – <i>CONFIG</i> Key .....	4.68
Saving Data Sets – <i>SAVE</i> Key .....	4.70
Selecting the Data Set for Saving.....	4.71
Selecting the Data subset for Storage.....	4.73
Recalling of Data Sets – <i>RECALL</i> Key .....	4.75
Selecting the Data Set for Recalling.....	4.76
Building a Data Set.....	4.78
<b>Macros – <i>USER</i> Key.....</b>	<b>4.80</b>
Fundamentals.....	4.80
Starting Macros.....	4.81
Defining Macros.....	4.82
<b>Analyzer Mode.....</b>	<b>4.84</b>
Frequency and Span Selection – <i>FREQUENCY</i> Key Group .....	4.84
Start Frequency – <i>START</i> Key.....	4.84
Stop Frequency – <i>STOP</i> Key .....	4.86
Center Frequency – <i>CENTER</i> Key.....	4.87
Center Frequency Step Size .....	4.89
Frequency Span – <i>SPAN</i> Key .....	4.91
Display Zoom.....	4.93
Level Display and RF Input Configuration – <i>LEVEL</i> Key Group.....	4.94
Reference Level – <i>REF</i> key .....	4.94
Display Units.....	4.96
Level Range – <i>RANGE</i> Key .....	4.98
RF Input Configuration – <i>INPUT</i> Key .....	4.100
Option 1 dB Attenuator - FSE-B13 .....	4.103
Marker Functions – <i>MARKER</i> Key Group .....	4.105
Main Markers– <i>NORMAL</i> Key.....	4.105
LF Demodulation .....	4.109
Frequency Measurement.....	4.111
Noise Power Density Measurement .....	4.112
Channel Power Measurements .....	4.113
Marker Step Size .....	4.127
Delta Markers – <i>DELTA</i> Key .....	4.128
Phase Noise Measurement .....	4.131
Delta-Marker Step Size - <i>STEP</i> Key.....	4.132
Search Functions – <i>SEARCH</i> Key .....	4.133
Summary Marker .....	4.138
Instrument Parameter Changes via Markers – <i>MKR</i> → Key .....	4.141
Setup of Display and Limit Lines – <i>LINES</i> Key Field .....	4.143
Display Lines – <i>D LINES</i> Key.....	4.143
Limit Lines – <i>LIMITS</i> Key .....	4.147
Limit Line Selection .....	4.148
Entering and Editing of Limit Lines .....	4.151



Trace Selection and Setup – <i>TRACE</i> Key Group.....	4.156
Measurement Function Selection - <i>TRACE 1 to 4</i> key.....	4.156
Detector Selection .....	4.161
Quasi Analog Display .....	4.165
Mathematical Functions for Traces .....	4.165
Trace Export.....	4.167
Sweep Control – <i>SWEEP</i> Key Group.....	4.170
Coupled Settings – <i>COUPLING</i> Key .....	4.170
Setting and Coupling the Coupling Res., Video Bandw. and Sweep Time... 4.171	
Sweep Coupling Ratio .....	4.176
Sweep Trigger – <i>TRIGGER</i> Key .....	4.178
Sweep Setup – <i>SWEEP</i> Key.....	4.180
Gated Sweep .....	4.182
Sweep Blanking – Gap Sweep .....	4.188
<b>Tracking Generator Option .....</b>	<b>4.192</b>
Tracking Generator Settings.....	4.193
Transmission Measurement.....	4.194
Calibration of the Transmission Measurement.....	4.194
Normalization.....	4.196
Reflection Measurements.....	4.200
Calibration of Reflection Measurement .....	4.200
Calibration Methods.....	4.201
Frequency-Converting Measurements .....	4.202
External Modulation of Tracking Generator.....	4.203
Option FSE-B3 –TV Demodulator .....	4.206
Configuration of the TV Demodulator.....	4.206
Triggering on TV Signals.....	4.208



## 4 Instrument Functions

All functions of the spectrum analyzer are explained in detail in this chapter.

The instrument functions for general settings, printout and data management are described at the beginning of this chapter – key groups *SYSTEM*, *CONFIGURATION*, *HARDCOPY*, *MEMORY* and the *USER* key.

The sequence of the following key groups depends on their appearance on the front panel: key groups *FREQUENCY*, *LEVEL*, *MARKER*, *LINES*, *TRACE*, *SWEEP* and the *INPUT* key.

All options that provide an additional operating mode and are not supplied with a separate manual are described at the end of the chapter.

The various softkeys in a menu are described from top to bottom and from the left to the right side menu. The submenus are indicated by an indentation or displayed in a separate section. The whole path (key - softkey - ...) is indicated in the line above the menu display.

An overview of the menus is given in chapter 3 which also contains the description of the operating concept.

For fast reference a list of softkeys with the associated IEC/IEEE-bus commands is given at the end of Chapter 6.

An index at the end of the handbook provides as further help for the user.

## General Configuration – *SYSTEM* and *CONFIGURATION* Key Groups

### FSE Initial Configuration – *PRESET* Key

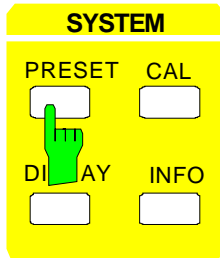

Using the *PRESET* key, the FSE can be brought to a predefined initial state equivalent to the state after power on. All previous settings are deleted if they were not previously saved in memory. Returning to the *PRESET* state is not critical with regard to an arbitrary signal which may still be present at the input as long as the signal is within the specified voltage range.

**Note:** *The initial state set by the PRESET key can be adapted to the user requirements using the AUTO RECALL function. When the PRESET key is pressed, the AUTO RECALL dataset is loaded. For further information refer to Section "Saving and Recalling Data Sets".*

IEC/IEEE- bus command : \*RST

Pressing the *PRESET* key, causes the FSE to enter its initial state according to the following table:

Table 4-1 Initial state of the FSE

Parameter	Setting				
	FSEA	FSEB	FSEM	FSEK	
Mode	analyzer	analyzer	analyzer	analyzer	
Center Frequency	1,75 GHz	3,5 GHz	13,25 GHz	20 GHz	
Center Frequency Step Width	350 MHz	700 MHz	2,65 GHz	4GHz	auto, 0.1xSpan
Span	3,5 GHz	7 GHz	26,5 GHz	40 GHz	
RF Attenuation	10 dB	10 dB	10 dB	10 dB	auto
Ref Level	-20 dBm	-20 dBm	-20 dBm	- 20 dBm	
Level Range	100 dB log	100 dB log	100 dB log	100 dB log	
Detector	auto peak	auto peak	auto peak	auto peak	
Sweep Time	5 ms	5 ms	150 ms	225 ms	auto
Res BW	3 MHz	3 MHz	3 MHz	3 MHz	auto
Video BW	3 MHz	3 MHz	3 MHz	3 MHz	auto
Sweep	cont	cont	cont	cont	
Trigger	free run	free run	free run	free run	
Trace	1	1	1	1	clr write
Trace	2, 3, 4	2, 3, 4	2, 3, 4	2, 3, 4	blink

## Display Configuration – DISPLAY Key

The measurement results are displayed on the screen of the FSE either in a full-screen window or in two split-screen windows. In some cases, the two windows can be subdivided into two diagrams each, e. g. for the representation of the inphase and quadrature signal in the vector analyzer mode (option FSE-B7).

If only one window is used, this window fills the complete display screen. Two measurement windows are always placed over each other. The axes labelling and measurement settings are defined independently in each measurement window.

When two measurement windows are used, the settings can be chosen to be either coupled or fully independent from each other. The measurement procedure is always sequential.

New instrument settings can only be entered in the active measurement window. This window is marked on the upper right corner of the grid. Coupled settings are changed simultaneously in both windows at the time of entry.

The entry of the measurement parameters for each of the two windows can be either independent from one another using numerical inputs, or by graphical definition of the span through the use of level and frequency lines. The former case, e.g., may be used for harmonic or frequency converter measurements, and the latter case, for a zoom display of a frequency or level segment.

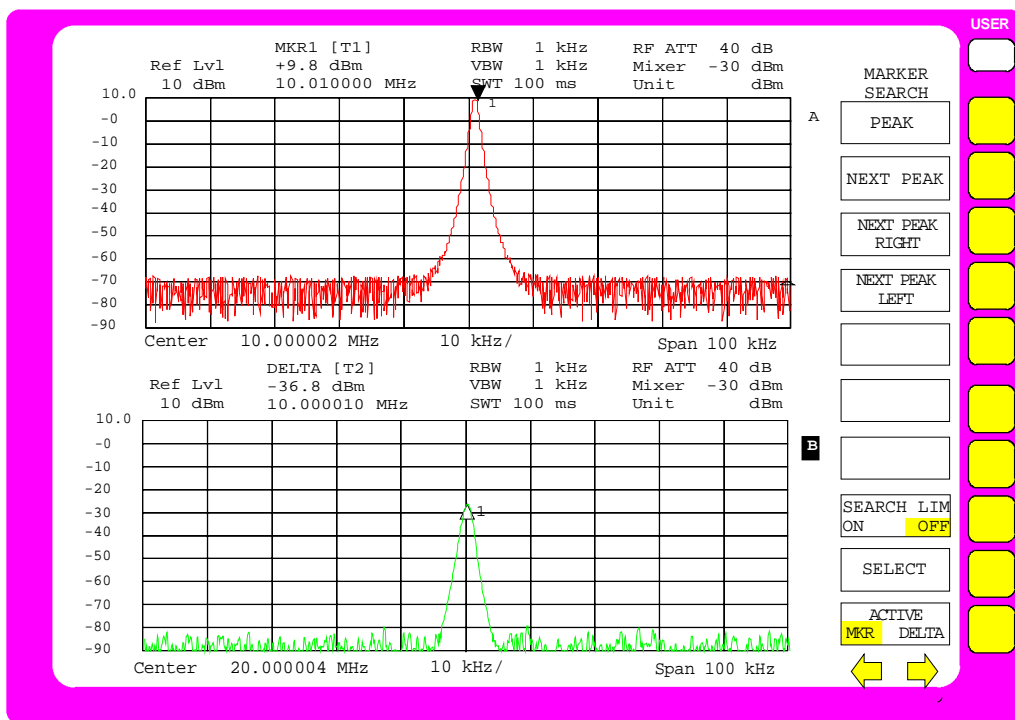
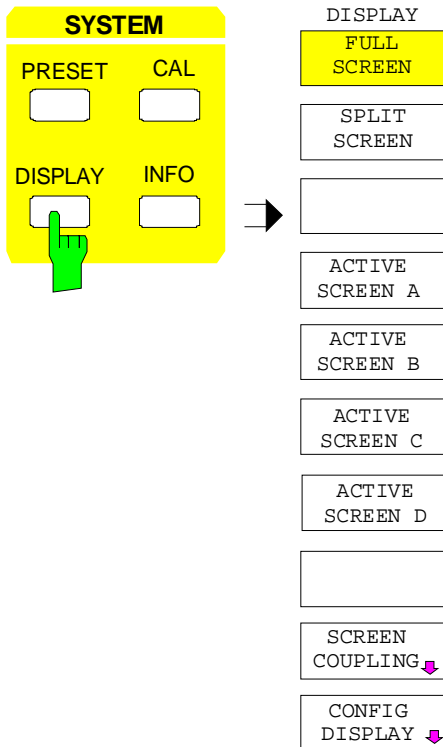

Fig. 4-1 Split screen mode, screens uncoupled

SYSTEM DISPLAY menu:



The *DISPLAY* key calls a menu which is used to configure the display screen and to select the active measurement window in *SPLIT-SCREEN* mode.

### Display Screen Mode Selection

SYSTEM DISPLAY menu:

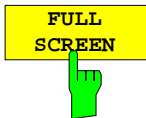

The *FULL SCREEN* softkey selects the full-screen display. This is the default setting of the FSE.

In this mode, the *ACTIVE SCREEN A / ACTIVE SCREEN B* and *SCREEN COUPLING* softkeys are not used.

IEC/IEEE- bus command :DISPlay:FORMat SINGLE

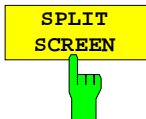

The *SPLIT SCREEN* softkey selects the split screen mode. The upper screen is designated *SCREEN A*, the lower screen *SCREEN B*.

IEC/IEEE- bus command :DISPlay:FORMat SPLit



If *SPLIT SCREEN* display is activated, the *ACTIVE SCREEN A* and *ACTIVE SCREEN B* softkeys activate either screen A or screen B.

The entry of new settings is only possible for the active window.

When switching back to *FULL SCREEN* mode, the active measurement window is displayed.

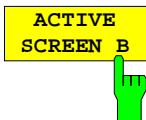

If, in addition, the two screens are both subdivided into two diagrams, the *ACTIVE SCREEN A/B* softkeys activate the upper diagram, *ACTIVE SCREEN C/D* the lower diagram in each screen.

IEC/IEEE- bus command - (the screen is selected via the numeric suffix)

## Measurement Window Coupling

For the most part, the settings for the two windows can be either independently performed or coupled to one another. In many cases, when changes are made in one window (e.g., the reference level) it is desirable to also make the corresponding changes in the second window. The measurement window parameters which are to be coupled may be selected in the *SCREEN COUPLING* menu.

*SYSTEM DISPLAY-SCREEN COUPLING* submenu:

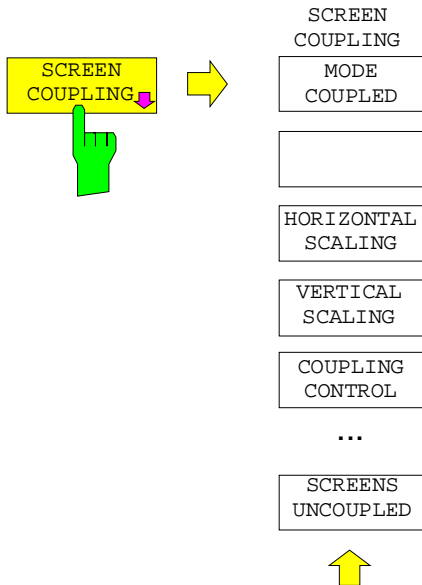

The *SCREEN COUPLING* softkey calls a sub-menu in which the coupling between the two measurement windows *SCREEN A* and *SCREEN B* can be defined. This coupling is only effective when both windows are displayed (*SPLIT SCREEN*).

In the default setting, all of the items which are selectable are also coupled.

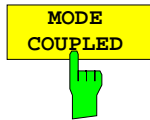

The *MODE COUPLED* softkey switches the coupling of the operating mode (Analyzer, Vector Analyzer) on/off.

IEC/IEEE- bus command : `INSTRument<1|2>:COUPlE MODE`



The *HORIZONTAL SCALING* softkey switches the coupled scaling of the horizontal axes on and off. In the frequency domain, the center frequency and the frequency span are identical. In the time domain, the sweep time for both windows is the same.

IEC/IEEE- bus command : `INSTRument<1|2>:COUPlE X`



The *VERTICAL SCALING* softkey switches the coupled scaling of the vertical axes on and off. For a level measurement, this means that the reference level and the vertical resolution (*LEVEL RANGE*) are set to the same values in both windows.

IEC/IEEE- bus command : `INSTRument<1|2>:COUPlE Y`

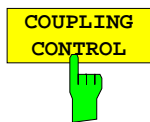

The *COUPLING CONTROL* softkey switches the coupling of the trigger and gate parameters and of *SWEEP COUNT* and *SWEEP SINGLE/CONTINUOUS* on/off.

IEC/IEEE- bus command : `INSTRument<1|2>:COUPlE CONTrol`

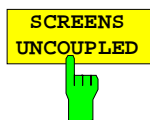

The *SCREENS UNCOUPLED* softkey switches all of the possible couplings between the measurement windows to off.

IEC/IEEE- bus command : `INSTRument<1|2>:COUPlE NONE | ALL`

## Display Screen Configuration

SYSTEM DISPLAY-CONFIG DISPLAY submenu:

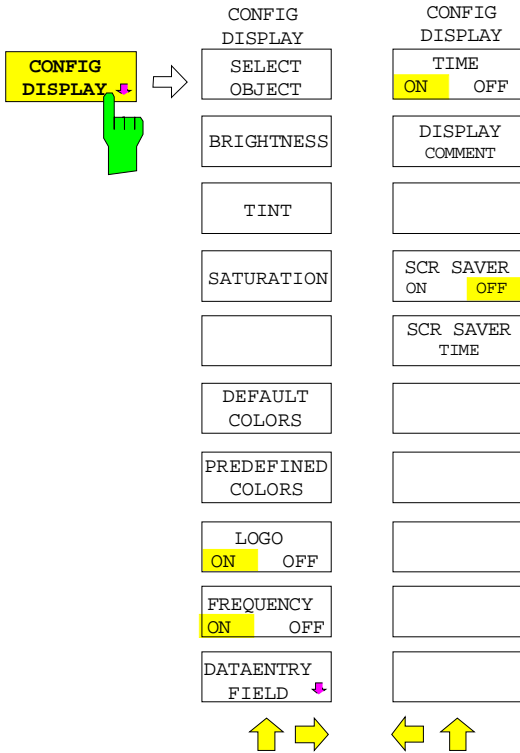

The *CONFIG DISPLAY* softkey calls a submenu, in which the selection of color and brightness for the individual elements on the display screen takes place. The actual selection of the elements takes place in the corresponding menu table.

The color assignment of the softkeys is coupled with the color assignment of other display elements.

Changing for example the color of *SOFTKEY STATE OFF* causes the color of the table background to be changed at the same time. The same applies to *SOFTKEY STATE DATA ENTRY* and display lines, and to *SOFTKEY STATE ON* and enhancement labels.

In the right side menu, date, time and a diagram label can be displayed on the screen and the energy saving mode can be activated.

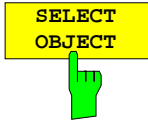

The *SELECT OBJECT* softkey activates the *SELECT DISPLAY OBJECT* table, with which a graphics element can be selected. After selection, the brightness, tint and saturation of the selected element can be changed using the softkeys of the same name. The color changes can be seen immediately on the display screen.

SELECT DISPLAY OBJECT	
✓	TRACE 1
	TRACE 2
	TRACE 3
	TRACE 4
	MARKER
	GRID
	SOFTKEY STATE ON
	SOFTKEY STATE DATA ENTRY
	SOFTKEY STATE OFF
	SOFTKEY SHADE
	TEXT
	TITLE
	BACKGROUND



The *BRIGHTNESS* softkey is used to enter the brightness of the color for the selected element. The range of input values is 0 to 100%.

IEC/IEEE- bus command :DISPlay:CMAP:HSL <hue>,<sat>,<lum>

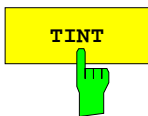

The *TINT* softkey is used to enter the color tint of the selected element. The percentage that is entered specifies a point in a color spectrum ranging from red (0%) to blue (100%).

The *TINT* function is not available for monochrome (black/white) displays.

IEC/IEEE- bus command :DISPlay:CMAP:HSL <hue>,<sat>,<lum>





The *SATURATION* softkey is used to enter the color saturation of the selected element.  
The range is 0 to 100%.

IEC/IEEE- bus command :DISPlay:CMAP:HSL <hue>,<sat>,<lum>

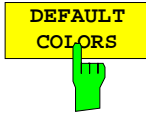

The *DEFAULT COLORS* softkey restores the default settings for brightness, color tint and color saturation for all display screen elements.

IEC/IEEE- bus command :DISPlay:CMAP<1...13>:DEFault



The *PREDEFINED COLORS* softkey activates a table, to select the predefined colors for the display screen elements can be selected.

IEC/IEEE- bus command :DISPlay:CMAP<1...13>:PDEFined BLACK

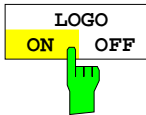

The *LOGO* softkey switches the Rohde & Schwarz company logo displayed in the upper left corner of the display screen on or off.

IEC/IEEE- bus command :DISPlay:LOGO ON | OFF

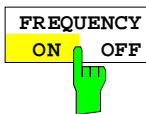

The *FREQUENCY* softkey switches the frequency information on the screen on and off. The softkey is available only in analyzer mode.

ON Frequency information is displayed.

OFF Frequency information is not output to the display. This can be used for example to protect confidential data.

IEC/IEEE- bus command :DISPlay:ANNOtation:FREQuency ON|OFF

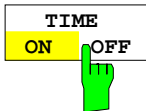

The *TIME* softkey switches on or off the date and time display at the lower edge of the diagram.

IEC/IEEE- bus command :DISPlay[:WINDow<1|2>]:TIME ON | OFF

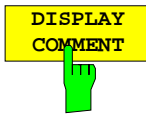

The *DISPLAY COMMENT* softkey activates the entry of a label comprising a maximum of 50 characters. This label is displayed at the lower edge of the diagram.

Pressing the softkey again causes the label to be switched off. The stored text, however, is not deleted.

IEC/IEEE- bus command  
:DISPlay[:WINDow<1|2>]:TEXT[:DATA] <string>  
:DISPlay[:WINDow<1|2>]:TEXT:STATE ON | OFF

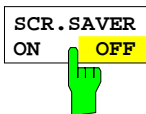

The *SCR. SAVER* softkey is used to switch the energy saving mode for the display on/off.

After the elapse of the shutdown time (*SCR. SAVER TIME*) the display is completely switched off, ie including backlighting.

The screen saver is deactivated by pressing any key or by sending the corresponding IEC/IEEE- bus command.

IEC/IEEE- bus command :DISPlay:PSAVer[:STATE] ON | OFF

**Note:** *If, with option FSE-B15, MS DOS Controller, switchover is made to the screen of the controller function using the ALT SYSREQ key, the screen saver is deactivated.*



The *SCR. SAVER TIME* softkey activates the entry of the time for the screen saver to respond. The shut-down time is entered in minutes between 1 to 100 minutes.

IEC/IEEE- bus command :DISPlay:PSAVer:HOLDoff <num\_value>

SYSTEM DISPLAY-CONFIG DISPLAY DATAENTRY FIELD Untermenü:

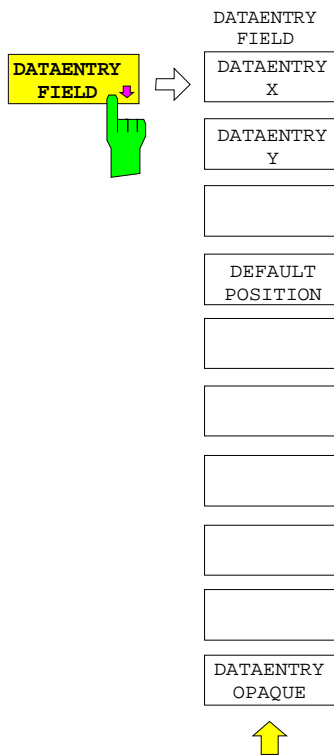

The *DATAENTRY FIELD* softkey displays a submenu used to specify the position and characteristics of the data entry field.

IEC/IEEE- bus command --

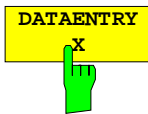

The *DATAENTRY X* softkey shifts the position of the data entry field horizontally.

IEC/IEEE- bus command --

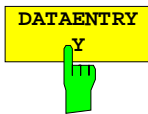

The *DATAENTRY Y* softkey shifts the position of the data entry field vertically.

IEC/IEEE- bus command --

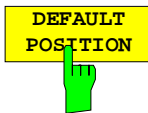

The *DEFAULT POSITION* softkey positions the data entry field automatically. In general, its position is the upper left edge of the grid on the active screen.

IEC/IEEE- bus command --

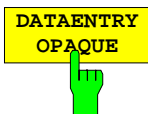

The *DATAENTRY OPAQUE* softkey sets the data entry windows to opaque. This means that entry windows are underlayed with the background color for tables and that diagrams and traces behind an entry window can no longer be seen.

IEC/IEEE- bus command --

## Recording the Correction Data – CAL Key

The FSE maintains its high measurement accuracy thanks to its integrated system-error correction method. The CAL hard key provides a series of correction functions which allow not only the system error correction of the complete instrument, but also correction functions which are specifically applicable to the measurement requirements of relevant instrument sections.

The measurement settings of the FSE are saved and, after system error correction, completely restored. The correction data valid before system error correction are saved and, in case of a correction abort, restored.

A window shows the progress of the correction data recording. ABORT can be used to abort the procedure at any time.

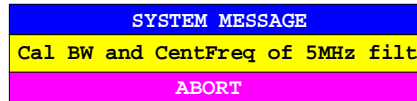

**Note:** The term "Calibration" formerly used for integrated system error correction was often taken to be the "true" calibration of the instrument performed during production and service. It is, therefore, no longer used although it appears in abbreviated form in the name of keys ("CAL...").

SYSTEM CAL menu:

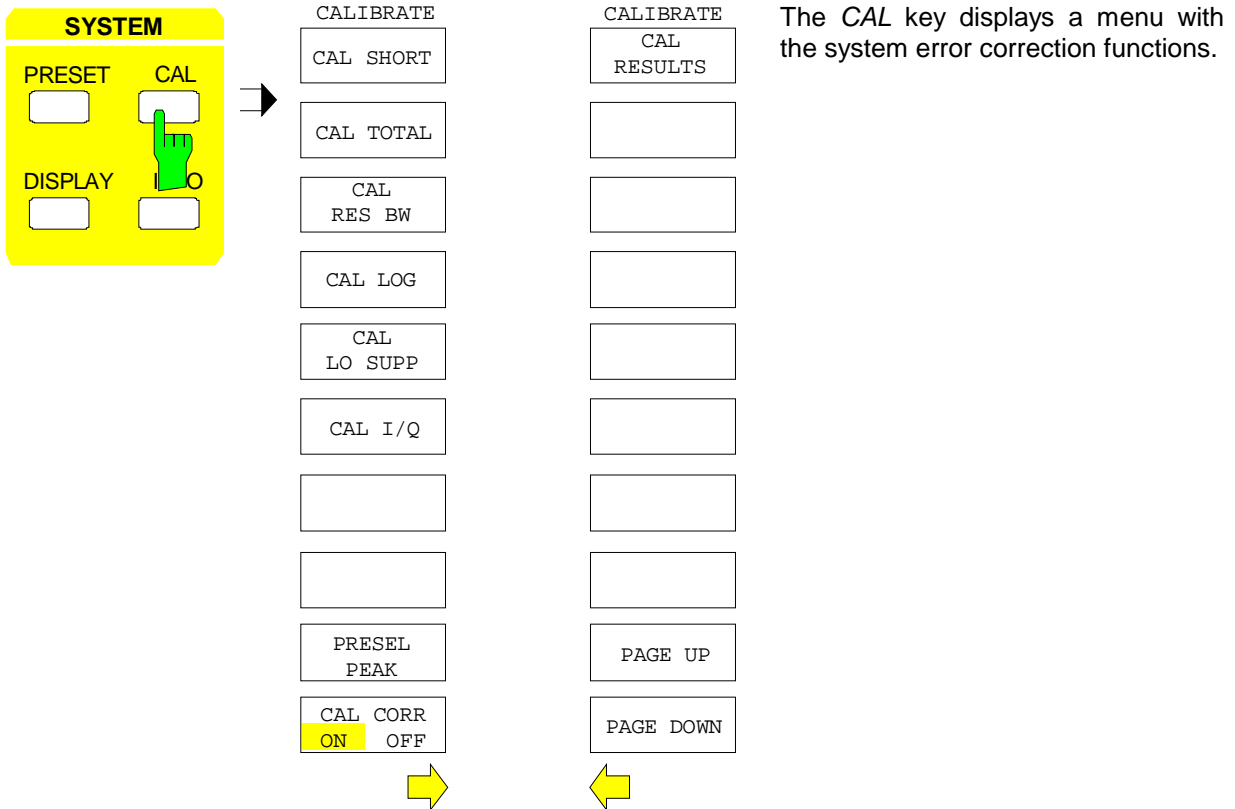

## Correction Function Calls

SYSTEM CAL menu:



The *CAL SHORT* softkey starts a short calibration, in which the absolute gain of the analyzer as well as the gain errors of the selected bandwidth are corrected.

IEC/IEEE- bus command :CALibration:SHORT?

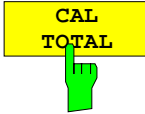

The *CAL TOTAL* softkey starts a complete correction of the analyzer including additional partial corrections shown in the menu.

*UNCAL* is displayed in the status line if the correction data recording has failed or if the correction values are deactivated (*CAL CORR* softkey= *OFF*).

IEC/IEEE- bus command :CALibration[:ALL]?



The *CAL RES BW* softkey starts the correction of the center frequency, the bandwidth and the gain of the resolution filter.

IEC/IEEE- bus command :CALibration:BANDwidth[:RESolution]?



The *CAL LOG* softkey starts the correction of the linearity of the logarithmic amplifier.

IEC/IEEE- bus command :CALibration:LDETEctor?



The *CAL LO SUPP* softkey starts the correction of the compensation of the first oscillator at low frequencies. After correction, the display of the internal oscillator at the frequency 0 Hz is very small.

It is recommended that the correction be performed whenever sensitive measurements are to be made at low frequencies.

The softkey is only available on model 30 of FSE.

IEC/IEEE- bus command ::CALibration:LOSuppression?

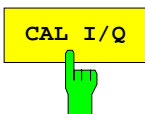

The *CAL I/Q* softkey starts the correction of the gain error of the I/Q demodulator.

The softkey is only available in conjunction with option FSE-B7.

IEC/IEEE- bus command :CALibration:IQ?

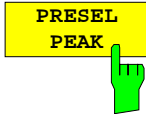

The *PRESEL PEAK* softkey optimizes the tuning of the preselector for input signals in the frequency range above 7 GHz.

This calibration should be used whenever signal levels in the frequency range above 7 GHz are to be measured and high accuracy is desired.

If a marker is not active when the *PRESEL PEAK* softkey is pressed, marker 1 is activated as the reference marker and placed on the signal maximum in the active trace. Otherwise the active marker is used.

The following window is displayed on the screen while the peaking function is running. The function can be aborted at any time using the *ABORT* line. In this case, the correction value determined at the factory is restored.

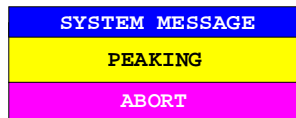

The input signal's signal-to-noise ratio must be at least 10dB in order that the peaking function runs properly. Otherwise, the preselector may be set incorrectly, which would cause level errors by subsequent measurements.

If the instrument setting (start/stop frequency, sweep time) is changed after *PRESEL PEAK* has been called, the correction value for the preselector determined by the function is no longer used. Instead, the correction value determined at the factory is restored.

The softkey is only available by those FSE models which have an input frequency range above 7 GHz.

IEC/IEEE- bus command :CALibration:PPEak?

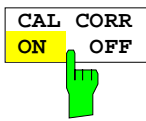

The *CAL CORR ON/OFF* softkey switches the correction data on/off.

ON The status message depends upon the results of the total correction

OFF The message *UNCAL* appears in the FSE status line.

IEC/IEEE- bus command :CALibration:STATE ON | OFF

## Results of System Error Correction

SYSTEM CAL menu:



The *CAL RESULTS* softkey in the right-hand supplementary menu calls the *CALIBRATION RESULTS* table, which displays the correction data that has been recorded.

The *CALIBRATION RESULTS* table contains the following information:  
page 1:

- date and time of the last recorded correction values
- overall results of the correction value recording
- list of the correction procedures according to function/module, including the correction values, the measured results and the individual results for each of the correction procedures

The results for the individual correction procedures are categorised and displayed as follows:

PASSED      system error correction was completely successful  
 CHECK      deviations larger than expected, however, corrections could be performed  
 FAILED      deviations too large, no corrections were possible  
 ABORTED    correction aborted

CALIBRATION RESULTS				
CALIBRATION: PASSED				
Last cal total: 05.Jun 1997 16:24:54				
Calibration of IF Filters      PASSED				
IF GAIN Adjust                    PASSED				
Bandwidth:				
Filter	Cal Val [Hz]	DAC Val	State	
1kHz	2.806e+01	1679	PASSED	
2kHz	1.603e+01	2887	PASSED	
3kHz	-6.012e+00	3238	PASSED	
5kHz	-1.002e+01	3514	PASSED	
10kHz	1.804e+02	3703	PASSED	
20kHz	3.607e+02	3801	PASSED	
30kHz	8.417e+02	3831	PASSED	
50kHz	1.403e+03	3743	PASSED	
100kHz	1.804e+03	3698	PASSED	
200kHz	3.607e+03	3606	PASSED	
300kHz	8.417e+03	3516	PASSED	
500kHz	1.403e+04	3329	PASSED	
1MHz	2.806e+04	2881	PASSED	

IEC/IEEE- bus command    --

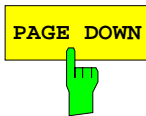

The *PAGE UP* and *PAGE DOWN* softkeys can be used to page through the table of correction results.

## Instrument Status and Measurement Parameters – INFO Key

SYSTEM INFO menu:

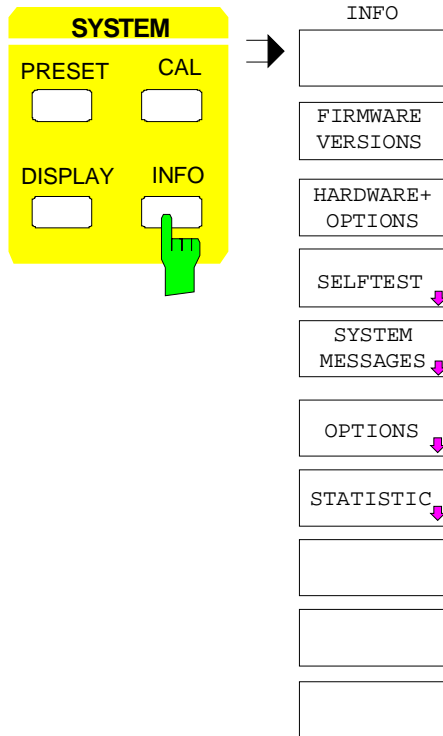

The *INFO* key is used to request general information concerning the instrument. These include:

- firmware version
- installed hardware and hardware options
- modification level of the individual modules
- self-test results with the option of calling self-test functions
- list of generated system messages
- installed firmware and hardware options.
- Statistical evaluations

## Firmware Versions

SYSTEM INFO menu:



The *FIRMWARE VERSIONS* softkey opens two tables, which provide the following informations:

- Table *MODEL* displays the exact instrument model.

MODEL
FSEA 30

- In the *FIRMWARE VERSION* table, the version of each software component installed in the instrument is listed. The versions of programmable logic devices are also included if the firmware version of the device can be determined.

FIRMWARE VERSION	
BIOS	1.2
ANALYZER	1.80
SERIAL NUMBER	101379/005

IEC/IEEE- bus command : \*IDN?

## Hardware Configuration and Options

SYSTEM INFO menu:

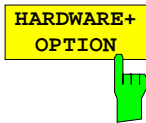

The *HARDWARE+OPTIONS* softkey opens two tables in which the modules (INSTALLED COMPONENTS) installed in the instrument are listed.

- Table *MODEL* lists the instrument name and model:

MODEL
FSEA 30

- Table *INSTALLED COMPONENTS* consists of four columns:

COMPONENT name of module

MODEL INDEX model number of the module

MODIF INDEX main modification index of the module

HW CODE secondary modification index of the module

These lists contain only the modules which are actually present in the instrument, i.e., the modules which were identified by the module recognition software.

INSTALLED COMPONENTS			
COMPONENT	MODEL INDEX	MODIF INDEX	HW CODE
Main Processor	4	n/a	0
Graphic Board	4	n/a	0
I/O Board	4	n/a	0
FRAC SYN	4	0	4
RF Module	4	0	4
2nd IF Converter	3	2	2
Detector	4	0	2
IF Filter	3	2	3
Digital IF	2	0	2

IEC/IEEE- bus command \*OPT?  
:SYSTem:BINFo?

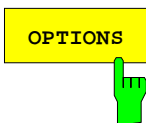

The *OPTIONS* softkey opens two tables listing the options installed.

FIRMWARE OPTIONS		
DESIGNATION	TYPE	CODE
FFT	B5	1938496289

**Note:** New firmware options can be enabled in the *SETUP* menu.

HARDWARE OPTIONS	
DESIGNATION	CODE
Low Phase Noise & OCXO	B4
Vector Signal Analysis	B7

IEC/IEEE- bus command \*OPT?



## Self Test

SYSTEM INFO-SELFTEST submenu:

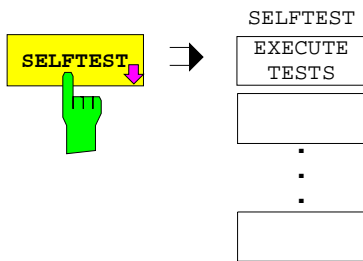

The *SELFTEST* softkey opens a submenu with which the self test can be started.

The instrument has extensive self test functions which comprehensively test instrument functionality. In case of a fault, the instrument can locate a defective module on its own. The self test sequence is described in more detail in the service manual instrument (supplied with the FSE).



The *EXECUTE TESTS* softkey starts the test of the complete instrument. During the self test a window is displayed:

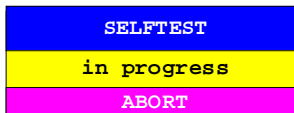

The functions are tested in the following order:

1. Modules main CPU, digital motherboard, graphics and the interfaces
2. Reference frequency conditioning, the synthesizer modules and all LO signals
3. All RF, IF and signal-weighting modules

If no failure occurs during the execution of the self test, the following message is displayed when the complete self test is finished:

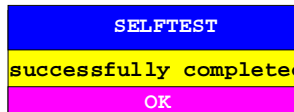

If a failure occurs during the execution of the self test, the self test is immediately aborted and a message indicating the defective module and the defective function is displayed:

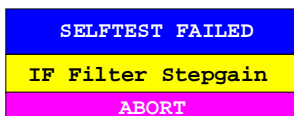

Further testing should be performed by an R&S service department.

IEC/IEEE- bus command : \*TST?

### System Messages

The *SYSTEM MESSAGES* softkey opens a submenu with a table in which the generated system messages are displayed. The most recent messages are at the top of the list.

The following information is presented:

- NO                      Device-specific three-digit error code (shown as XXX in the figure)
- MESSAGE                Brief description of the reason for the message
- DATE/TIME                Date and time of the message

Error messages that have occurred since the *SYSTEM MESSAGES* menu was last called are marked by an asterix "\*\*".

*SYSTEM INFO-SYSTEM MESSAGES* submenu:

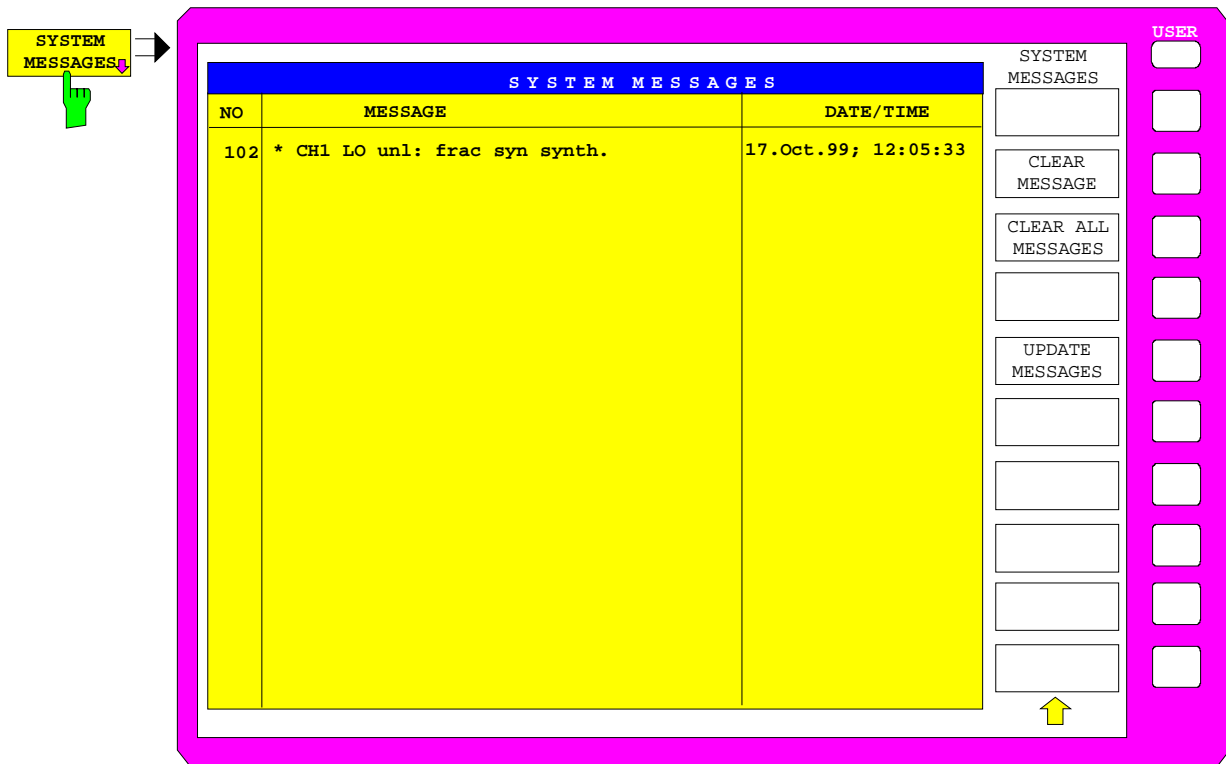

IEC/IEEE- bus command : `SYSTem:ERRor?`

**CLEAR MESSAGE**



The *CLEAR MESSAGE* softkey deletes the message just selected. All subsequent messages are shifted automatically one line upwards so that no empty lines exist. When the last message has been deleted, the selection bar also disappears.

IEC/IEEE- bus command : `SYSTem:ERRor?`

**CLEAR ALL MESSAGES**



The *CLEAR ALL MESSAGES* softkey deletes all messages.

IEC/IEEE- bus command --

**UPDATE MESSAGES**



The *UPDATE MESSAGES* softkey causes all newly arrived messages to be entered at the top of the table. At this time, all messages previously indicated as "new" are displayed as "old" messages

IEC/IEEE- bus command --

### Statistics Function for Input Attenuator Switching

SYSTEM INFO menu:

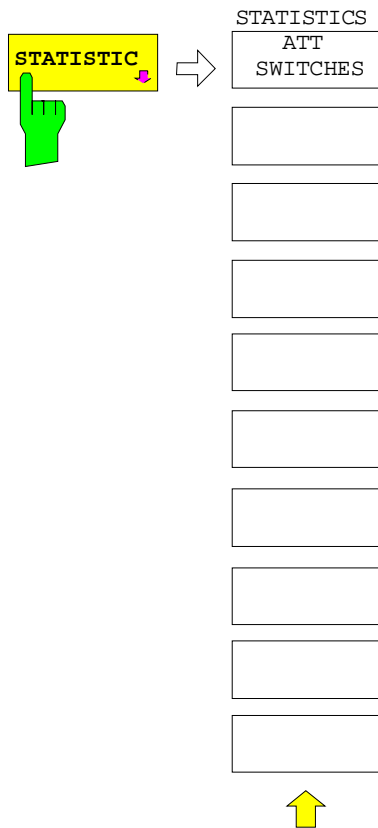

The *STATISTICS* softkey calls a submenu for indication of device statistics.

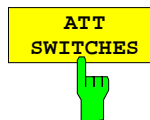

The *ATT SWITCHES* softkey displays various tables listing the mechanical switches and attenuators fitted in the instrument, plus the number of switching operations for the respective switch or attenuator.

INPUT ATTENUATOR	
Date	5 Aug 1999
Calibration Input	6
10 dB	121
20 dB	217
30 dB	137

IEC/IEEE- bus command  
 :DIAGnostic:INFO:CCOunt:ATTenuation <1|2|3>

## Mode Selection – *MODE* Key

The FSE can be operated in one of several modes, each of which is different with respect to functionality and control. The differences in control, however, consist not only in the enabling/disabling of additional softkeys within existing softkey menus, but rather in the fact that existing menus are completely replaced by new menus and menu trees which are tailored to the functional requirements. In the simultaneous application of two measurement diagrams, two modes may also simultaneously enabled. Each mode can be assigned to a measurement window.

### CONFIGURATION MODE menu

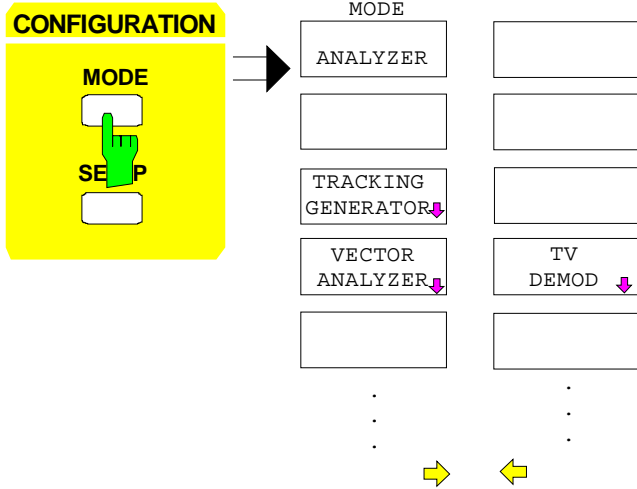

The *MODE* key opens the menu for selection of the mode.

Herein, the modes can be selected according to the available FSE options.

- Analyzer
- Tracking Generator
- Vector Signal Analysis and
- TV Demodulation



The *ANALYZER* softkey selects the *ANALYZER* mode.

This mode is the default setting of the FSE.

The functions provided correspond to those of a conventional spectrum analyzer. The analyzer measures the frequency spectrum of the test signal over the selected frequency range with the selected resolution and sweep time, or, for a fixed frequency, displays the waveform of the video signal.

IEC/IEEE-bus command :INSTRument[:SElect] SANalyzer



The *TRACKING GENERATOR* softkey selects the operating mode Scalar Network Analysis.

The softkey is only available if FSE is equipped with one of the following options: FSE-B8/B9/B10 and B11. For a detailed description of operation see Section 'Option Tracking Generator'.

IEC/IEEE-bus command :OUTPut[:STATe] ON | OFF

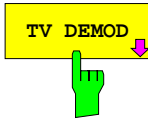

The *TV DEMOD* softkey selects the operating mode TV Demodulation. The softkey is only available if FSE is equipped with Option FSE-B3. For a detailed description of operation see manual of options.

IEC/IEEE-bus command `[ :SENSE ] :TV:STATE ON | OFF`

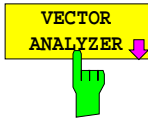

Softkey *VECTOR ANALYZER* selects the vector analysis mode.

The softkey is only available if FSE is equipped with Option FSE-B7.

In the vector analyzer mode the FSE is automatically set to a fixed frequency (center frequency) since vector analysis can only be carried out on one frequency.

The IF signal is digitized by the selected resolution bandwidth after filtering and mixed into the baseband by a digital mixer. Further processing is via digital signal processors which display the time characteristic of the amplitude or phase. As an option, the baseband can also be demodulated and the demodulated signal can be displayed. Principally any type of modulation (digital and analog) can be processed.

The functions of the analyzer mode are supplemented by the vector analysis functions which are described in detail in a separate manual to the option.

IEC/IEEE-bus command `:INSTrument[:SElect] DDEMod`

## Preliminary Setup and Interface Configuration – *SETUP* Key

CONFIGURATION SETUP menu:

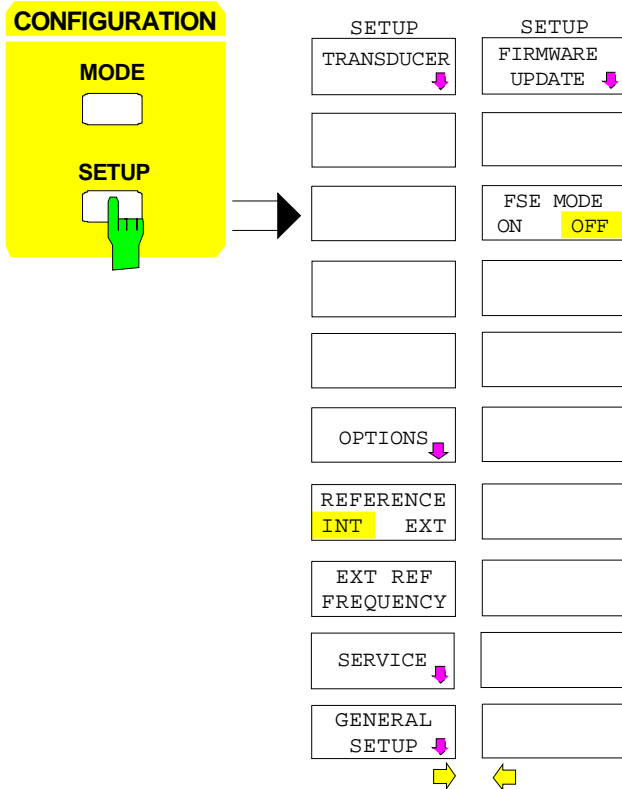

The *SETUP* key opens the menu for configuration of the FSE.

The *TRANSDUCER* softkey opens a submenu for entering correction characteristics for the measurement transducer.

The *OPTIONS* softkey allows the enabling of firmware options (Application Firmware Modules).

The *REFERENCE INT/EXT* and *EXTERNAL REF FREQUENCY* softkeys determine the reference to be used.

The *SERVICE* softkey provides special setup functions which, although not necessary in normal use, are useful in instrument service.

The *GENERAL SETUP* softkey opens a submenu for all the general settings such as date and time as well as the configuration of the device interfaces.

The *FIRMWARE UPDATE* softkey opens a submenu for the installation of a firmware update.

## Using Transducers

A transducer is often connected ahead of FSE both during the measurement of useful signals and EMI and converts the useful or interference variable such as field strength, current or RFI voltage into a voltage across 50 Ohm. Transducers with a frequency-independent transducer factor can be coded in 10-dB steps together with the unit at connector *PROBE CODE*. They are supplied at the same time by this connector. Transducers such as antennas, probes or current probes mostly have a frequency-dependent transducer factor which can be stored in FSE and automatically has the correct unit during level measurement.

If a transducer is switched on it is considered as part of the unit during the measurement, ie the measured values are displayed in the correct unit and magnitude. When working with two measurement windows, the transducer is always assigned to two windows.

FSE distinguishes between **transducer factor** and **transducer set**. A transducer factor takes the frequency response of a single transfer element, eg an antenna into consideration. A transducer set can summarize different transducer factors in several subranges (several transducer factors at the same time), eg an antenna, a cable and a diplexer.

A transducer factor consists of max. 50 reference values defined with frequency, transducer factor and the unit. For the measurement between frequency values linear or logarithmic interpolation of the transducer factor can be chosen.

Several factors can be compiled in a transducer set provided that all factors have the same unit or unit "dB". The frequency range covered by a set can be subdivided into max. 10 subranges (each with up to 4 transducer factors) which follow each other without a gap, ie the stop frequency of a subrange is the start frequency of the next subrange.

The transducer factors used in a subrange have to fully cover the subrange.

The definition of a transducer set is recommended if different transducers are used in the frequency range to be measured or if a cable attenuation or an amplifier has to be taken into consideration.

If a transducer set is defined during a frequency sweep, the latter can be stopped at the interface between two transducer ranges and the user is asked to exchange the transducer.

The following message informs the user that the limit has been reached:

*TDS Range # reached, CONTINUE / BREAK*

He can continue the sweep by confirming the message (*CONTINUE*) or he can switch off the transducer (*BREAK*).

With the automatic switchover of the transducer used, the frequency sweep is not interrupted.

**Note:** *Transducers cannot be used in vector analyzer mode.*

## Activating Transducer Factors and Transducer Sets

The *TRANSDUCER* softkey opens a submenu in which already defined transducer factors or sets can be activated or deactivated, new transducer factors or sets can be generated or existing transducer factors or sets can be edited. Tables with the defined transducer factors and sets are displayed. The table (factor or set) in which a transducer is active is set.

By switching on the transducers all the level settings and outputs are automatically made in the unit of the transducer. A change of the unit in menu *LEVEL REF* is no longer possible as FSE together with the transducer used is regarded as a measuring instrument. Only if the transducer has the unit dB, can the original unit at FSE be maintained and changed.

**Note:** *If one of the units  $\text{dB}\mu\text{V}$ ,  $\text{dB}\mu\text{V}/\text{m}$ ,  $\text{dB}\mu\text{A}$ , or  $\text{dB}\mu\text{A}/\text{m}$  is selected, the *LEVEL REF* key (see *UNIT*-submenu) can be used to switch to the corresponding units referred to the bandwidth, i.e.  $\text{dB}\mu\text{V}/\text{MHz}$ ,  $\text{dB}\mu\text{V}/\text{mMHz}$ ,  $\text{dB}\mu\text{A}/\text{MHz}$ ,  $\text{dB}\mu\text{A}/\text{mMH}$ .*

If a transducer factor is active, TDF is displayed in the column of the enhancement labels and TDS if the transducer set is active.

After switching off all the transducers, FSE continues to use the unit which was selected before a transducer was switched on.

In the analyzer mode, an active transducer for a sweep is uniquely calculated for each point displayed after its setting and added to the result of the level measurement during the sweep. If the sweep range is changed, the correction values are recalculated. If several measured values are combined, only a single value is taken into consideration.

If an active transducer factor/set is not defined over the whole sweep or scan range during the measurement, the missing values are replaced by zero.

CONFIGURATION SETUP Menu

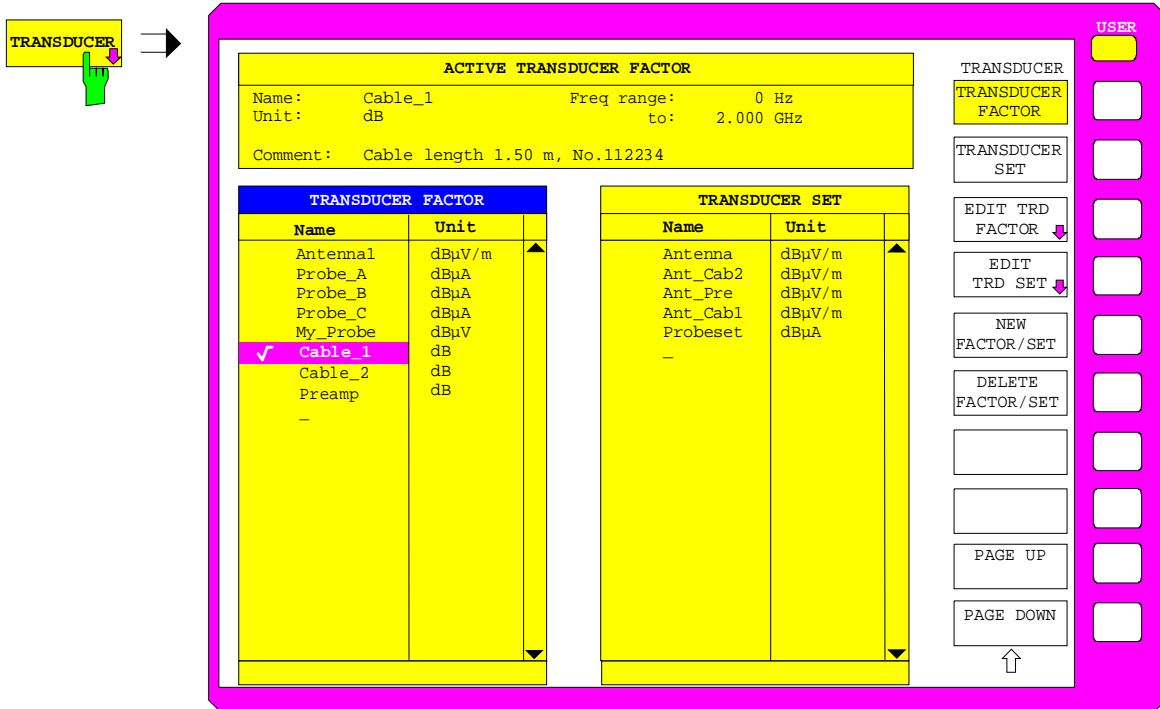

The upper table *ACTIVE TRANSDUCER FACTOR / SET* indicates the active transducer factor or the set with the associated name, frequency range and unit. If no factor or set is active, *none* is displayed in the table. Additional information can be entered in a comment line. If a transducer factor is active, the selected interpolation is displayed in addition, if a set is active, the break setting is displayed.

The left table *TRANSDUCER FACTOR* comprises all the defined factors with name and unit. If the number of defined transducer factors exceeds the number of possible lines in the table, the table will be scrolled.

The right table *TRANSDUCER SET* comprises all the defined transducer sets with the corresponding information.

Only one set or transducer can be activated. An already active transducer factor or set is switched off automatically if another one is switched on. An activated transducer factor or set is marked with a check sign.

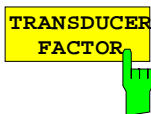

The *TRANSDUCER FACTOR* softkey sets the selection bar to the position of the active transducer factor.

If no transducer factor is switched on, the bar is positioned to the first line of the table.

IEC/IEEE bus commands

```
:[SENSE<1|2>:]CORRection:TRANsducer:SElect <name>
:[SENSE<1|2>:]CORRection:TRANsducer[:STATE] ON | OFF
```

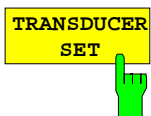

The *TRANSDUCER SET* softkey sets the selection bar to the position of the active transducer set.

If no transducer set is switched on, the bar is set to the first line of the table.

IEC/IEEE bus commands

```
:[SENSE<1|2>:]CORRection:TSET:SElect <name>
:[SENSE<1|2>:]CORRection:TSET[:STATE] ON|OFF
```





The *DELETE FACTOR/SET* softkey deletes the marked factor or set. To avoid deletion by mistake, deletion has to be confirmed.

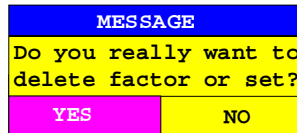

IEC/IEEE-bus command

```
: [SENSe<1 | 2>: ]CORRection:TRANSDUcER:DELEte
: [SENSe<1 | 2>: ]CORRection:TSET:DELEte
```

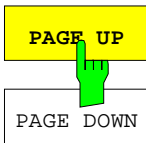

The *PAGE UP* and *PAGE DOWN* softkeys are used to scroll in large tables which cannot fully be displayed on the screen.

## New Entry and Editing of Transducer Factors

A transducer factor is characterized by

- reference values with frequency and transducer factor (*Values*)
- the unit of the transducer factor (*Unit*) and
- the name (*Name*) to distinguish between the different factors.

During the entry, FSE checks the transducer factor according to specific rules that have to be met to ensure trouble-free operation.

- The frequencies for the reference values always have to be entered in ascending order. Otherwise, the entry is not accepted and the following message is displayed:

*Frequency Sequence!*

- The entered frequencies do not necessarily have to be set at FSE, as only the values for the frequency display range are considered for a set sweep or scan. The minimum frequency for a reference value is 0 Hz, the maximum frequency 200 GHz.
- The minimum or maximum value for a transducer factor is -200 dB or 200 dB. The unit "dB" means that the transducer factor is always logarithmic and has nothing to do with the physical transducer factor, which, for example, establishes the relationship between field strength and voltage into 50 Ohm. If the minimum or maximum value is exceeded, FSE signals:

*Min Level -200 dB or  
Max Level 200 dB.*

- Amplifiers have a negative transducer factor, attenuation values have to be entered as a positive transducer factor.

**Note:** A unit activated by switching on the transducer has priority over a coded unit of the connected probe.

With the exception of dB\*/MHz, the softkeys for the unit in the menu under key LEVEL REF are inoperative with the transducer switched on.

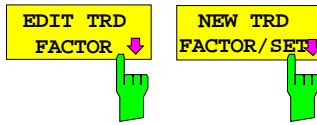

The *EDIT TRD FACTOR* and *NEW FACT/SET* softkeys both open the submenu for editing and entering new transducer factors. A precondition for the *NEW FACTOR/SET* softkey is that the selection bar is located in the table when the table *TRANSDUCER FACTOR* is called up.

**EDIT TRANSDUCER FACTOR**

Name: Antennal  
 Unit: dBuV/m  
 Interpolation: LIN  
 Comment: Ant1 and cable 1

FREQUENCY	TDF/dB..	FREQUENCY	TDF/dB..
20.0000 MHz	25.5		
25.0000 MHz	23.8		
30.0000 MHz	20.5		
40.0000 MHz	19.8		
50.0000 MHz	20.0		
60.0000 MHz	19.5		
70.0000 MHz	19.1		
80.0000 MHz	18.2		

Control Panel (right side):

- EDIT TRD FACTOR
- TRD FACTOR NAME
- TRD FACTOR UNIT
- TRD FACTOR VALUES
- INSERT LINE
- DELETE LINE
- SAVE TRD FACTOR
- USER

The table with the data of the marked factor (the *EDIT TRD FACTOR* softkey) or an empty table is displayed in which the following entries are preset (the *NEW FACTOR/SET* softkey):

- Unit: dB
- Interpolation: LIN for linear frequency scaling  
 LOG for logarithmic frequency scaling

The characteristics of the factor can be entered in the header field of the table, the frequency and the transducer factor in the columns of the table.

- Name* Entry of the name
- Unit* Selection of unit
- Interpolation* Selection of interpolation
- Comment* Entry of a comment
- FREQUENCY* Entry of the frequency of the reference points
- TDF/dB* Entry of the transducer factor.

An overwritten transducer factor remains stored in the background as long as the edited factor is stored with the *SAVE TRD FACTOR* softkey or until the table is closed. A factor overwritten by mistake can be restored by leaving the entry.

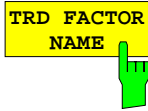

The *TRD FACTOR NAME* softkey activates the entry of the transducer factor characteristics in the header field of the table.

**Name - Entry of name**

A maximum of 8 characters is permissible for the name. The characters have to comply with the convention of DOS file names. The unit automatically stores all transducer factors with the extension .TDS.

If an existing name is changed, the factor stored under the previous name is retained and will not be overwritten automatically with the new name. The previous factor can be deleted at a later time, using *DELETE FACTOR/SET*. Thus, factors can be copied.

IEC/IEEE-bus command : [SENSe<1 | 2>:]CORR:TRAN:SElect <name>

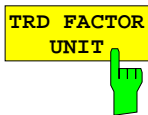

**Unit - Selection of unit**

The unit of the transducer factor is selected from a selection box activated by the *TRD FACTOR UNIT* softkey.

FACTOR UNIT
dB
dBm
dB $\mu$ V
dB $\mu$ V/m
dB $\mu$ A
dB $\mu$ A/m
✓ dBpW
dBpT

The default setting is dB.

IEC/IEEE-bus command : [SENSe<1 | 2>:]CORR:TRAN:UNIT <string>

**Interpolation - Selection of interpolation**

Linear or logarithmic interpolation can be carried out between the frequency reference points of the table. Selection is via the ENTER key which is toggled between LIN and LOG (toggle function).

The following diagrams indicate the effect of the interpolation on the calculated characteristic:

IEC/IEEE-bus command : [SENSe<1 | 2>:]CORR:TRAN:SCAL LIN|LOG

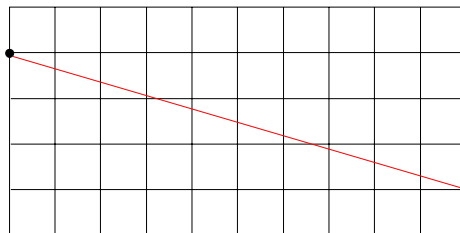

Fig. 4-1 Linear frequency axis and linear interpolation

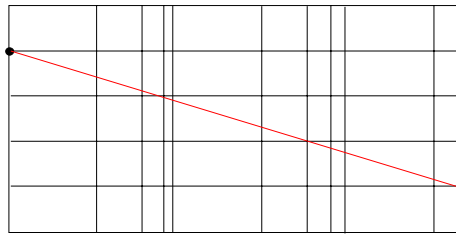

Fig. 4-2 Logarithmic frequency axis and logarithmic interpolation

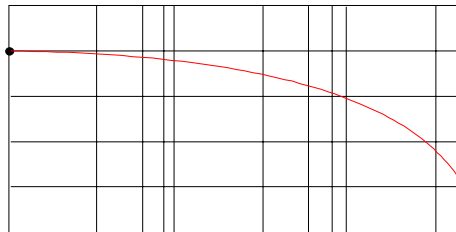

Fig. 4-3 Logarithmic frequency axis and linear interpolation

**Comment - Entry of a comment**

The comment can be freely selected. It can have a maximum number of 50 characters.

IEC/IEEE-bus command : [SENS<1 | 2>:]CORR:TRAN:COMM <string>

The *TRD FACTOR VALUES* softkey activates the entry for the reference values of the transducer factor.

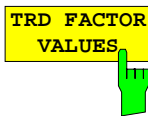

The selection bar marks the first reference value. The desired reference values have to be entered in ascending frequency sequence.

After entering the frequency the selection bar automatically jumps to the corresponding level value. After entering the first reference value the table can be edited. The two *INSERT LINE* and *DELETE LINE* softkeys are displayed. Individual values are changed at a later time by marking the field and by entering the new value.

IEC/IEEE-bus command : [SENS<1 | 2>:]CORR:TRAN:DATA  
 <freq>, <level>

The *INSERT LINE* softkey inserts a free line above the marked reference value. When entering a new reference value into this line watch out for the ascending frequency sequence.

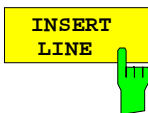

The *DELETE LINE* softkey deletes the marked reference value (the whole line). The following reference values move up.

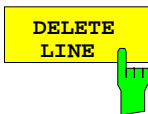

IEC/IEEE-bus command --

The *SAVE TRD FACTOR* softkey saves the changed table in a file on the internal hard disk.



If a transducer factor with the same name already exists, a corresponding query is performed beforehand.

If the factor to be newly saved is currently switched on, the new values will immediately be valid. If a transducer set is switched on comprising the factor, the values will only be used when the set is switched on next time.

IEC/IEEE-bus command - (executed automatically)

### New Entry and Editing of Transducer Sets

A transducer set is characterized by:

- maximum 10 ranges (*Ranges*) in which different transducer factors can be active
- the combination of several transducer factors per range (*Factor*)
- a transducer-set name (*Name*)

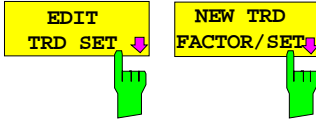

The *EDIT TRD SET* and *NEW FACTOR/SET* softkeys both open the submenu for editing and entering new transducer factors. A precondition for the *NEW FACTOR/SET* softkey is that the selection bar is located in the table *TRANSDUCER SET*.

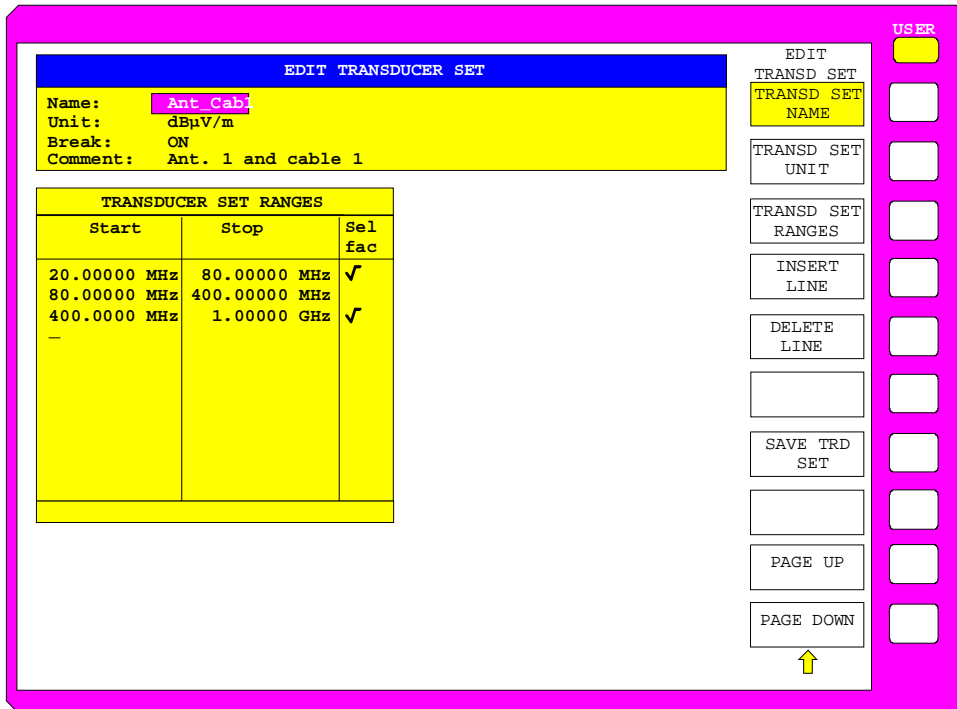

The table with the data of the marked set (the *EDIT TRD SET* softkey) or an empty table in which the following entries are preset (the *NEW FACTOR/SET* softkey) is displayed:

Unit: dB  
 Break: NO

The characteristics of the set can be entered in the header field of the table, the subranges in the columns of the set.

- Name* Entry of the name
- Unit* Selection of unit
- Break* Activating the query when changing the subrange
- Comment* Entry of a comment
- Start* Entry of the start frequency of the subrange
- Stop* Entry of the stop frequency of the subrange
- Sel Fac* Selection of the transducer factors for the subrange

An overwritten transducer set remains stored in the background as long as the edited factor is stored with the *SAVE TRD SET* softkey or until the table is closed. A set overwritten by mistake can be restored by leaving the entry.

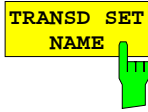

The *TRD SET NAME* softkey activates the entry of the transducer set characteristics in the header field of the table.

**Name - Entry of name**

A maximum of 8 characters is permissible for the name. The characters have to comply with the convention of DOS file names. The unit automatically stores all transducer sets with the extension .TDS.

If an existing name is changed, the set stored under the previous name is retained and will not be overwritten automatically with the new name. The previous set can be deleted at a later time using *DELETE FACTOR/SET*. Thus, sets can be copied.

IEC/IEEE-bus command : [SENSE<1 | 2>:]CORR:TSET:SElect <name>

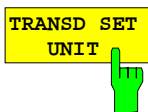

**Unit - Selection of unit**

The unit of the transducer set is selected from a selection box activated by the *TRANSD SET UNIT* softkey.

The unit should be selected prior to the entry as it determines the settable transducer factors. The preset unit for new sets is "dB". The unit can no longer be changed when editing a set as the set of selected transducer factors will otherwise become inconsistent.

SET UNIT
dB
dBm
dBµV
dBµV/m
dBµA
dBµA/m
✓ dBpW
dBpT

IEC/IEEE-bus command : [SENSE<1 | 2>:]CORR:TSET:UNIT <string>

**Break - Activation of query when changing a subrange**

The sweep can be stopped if the user changes the subrange and selects a new subrange of the transducer. A message informs the user that the limit has been attained. He can continue the sweep or switch off the transducer.

The interruption is activated by setting Break to ON. Selection is by the ENTER key which toggles between ON and OFF (toggle function).

IEC/IEEE-bus command : [SENSE<1 | 2>:]CORR:TSET:BREak ON|OFF

**Comment - Entry of a comment**

The comment can be freely selected. It can have a maximum number of 50 characters.

IEC/IEEE-bus command : [SENSE<1 | 2>:]CORR:TSET:COMment <string>



Softkey *TRANSD SET RANGES* activates the entry of subranges and the associated transducer factors. The selection bar marks the frequency values last active.

- Start** - Entry of start frequency of subrange
- Stop** - Entry of stop frequency of subrange

The individual subranges have to be linked without a gap. That is why the start frequency is already defined from the second subrange (= stop frequency of previous range).

After entering the first frequency value the table can be edited. The two *INSERT LINE* and *DELETE LINE* softkeys are displayed. Some values are changed at a later time by marking the field and by entering the new value. It should be noted that both the stop frequency of a particular subrange and the start frequency of the subsequent subrange are changed to the same extent.

```
IEC/IEEE-bus command
: [SENSE<1|2>:]CORRection:TSET:RANGe<1..10>
    <freq>,<freq>,<name>..
```

**Sel fac- Selection of factors for the subrange**

A check sign in column *Sel Fac* (select factor) indicates whether one or several transducer factors were selected for the subrange.

The permissible transducer factors for the marked subrange can be selected in a selection box. Only factors matching with the unit of the set and fully covering the selected subrange are permissible.

After each change of range limits, FSE thus checks the factor list and, if required, rebuilds it.

After reducing the start frequency or increasing the stop frequency of a range it may happen that the factors defined for this range no longer fully cover the range. These factors are deleted for this range when the transducer factor table is opened next time.

A maximum of 4 transducer factors can be switched on at the same time in each subrange. If none of them is switched on, 0 dB is assumed as a factor for the whole subrange.

SELECT TRANSDUCER FACTOR		
Name	Unit	
<input checked="" type="checkbox"/> Antenna1	dBµV/m	▲
Probe_A	dBµV/m	
Probe_B	dBµV/m	
Probe_C	dBµV/m	
My_Probe	dB	
<input checked="" type="checkbox"/> Cable_1	dB	
Cable_2	dB	
<input checked="" type="checkbox"/> Preamp	dB	

```
IEC/IEEE-bus command --
```

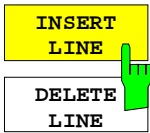

The *INSERT LINE* softkey inserts a free line above the marked subrange.  
 The *DELETE LINE* softkey deletes the marked subrange (whole line). The following subranges move up.  
 In both cases FSE checks that the ranges follow each other without a gap.  
 IEC/IEEE-bus command --



The *SAVE TRD SET* softkey saves the changed table in a file on the internal hard disk. If a transducer name with the same name already exists, a corresponding query is performed beforehand:

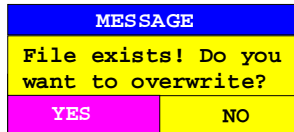

After pressing ENTER, the data set is overwritten on the hard disk. If the saved set is switched on, the new values will be used immediately.  
 IEC/IEEE-bus command -- (executed automatically)

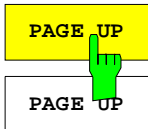

The *PAGE UP* and *PAGE DOWN* softkeys set the table to the next or previous page.  
 The softkeys are locked during selection of factors in the right table.



## Enabling Firmware Options

CONFIGURATION SETUP menu:

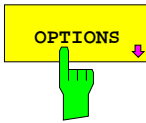

The *OPTIONS* softkey opens a submenu for entering keywords for new firmware options (Application Firmware Modules). Options which are already available are indicated in a table that is opened when the menu is called.

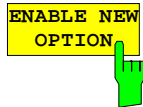

The *ENABLE OPTION* softkey activates the entry of a keyword for a firmware option.

One or several keywords may be specified in the entry field. When a valid keyword is entered, the message *OPTION KEY OK* appears in the info line and the option is written into the *FIRMWARE OPTIONS* table.

The *FIRMWARE OPTIONS* table can also be displayed using the *FIRMWARE OPTIONS* softkey in the *INFO* menu.

If a keyword is invalid the message *OPTION KEY INVALID* is displayed in the info line.

IEC/IEEE-bus command --

## External Reference Oscillator

In general, the FSE can generate all internal oscillators from either the internal or an external reference oscillator. A 10 MHz crystal oscillator is used as the internal reference source. A reference oscillator output is also available at the rear panel via the EXT REF IN/OUT connector.

This output can be used, e.g., to synchronize other instruments to the FSE. This connector can also be used as an input connector for application of an external frequency standard. The FSE requires that the frequency of the external standard be entered so that the internal oscillators can be synchronized to it.

CONFIGURATION SETUP Menu:

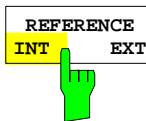

The *REFERENCE INT EXT* softkey toggles between the internal and external references.

IEC/IEEE-bus command : [SENSe<1|2>:]ROSC:SOURce INT | EXT



The *EXT REF FREQUENCY* softkey activates the entry of the frequency of the external source.

Range of input values is 1 MHz to 16 MHz in 1 MHz steps.

IEC/IEEE-bus command : [SENSe<1|2>:]ROSC:EXT:FREQ 13 MHz

## Service Functions

The service menu offers a variety of additional functions which are used for maintenance and/or trouble shooting. The service functions are not necessary for normal measurements, however, incorrect use can impair the functionality and/or data integrity of the FSE. Therefore, many of the functions can only be used after entering a password.

CONFIGURATION SETUP menu:

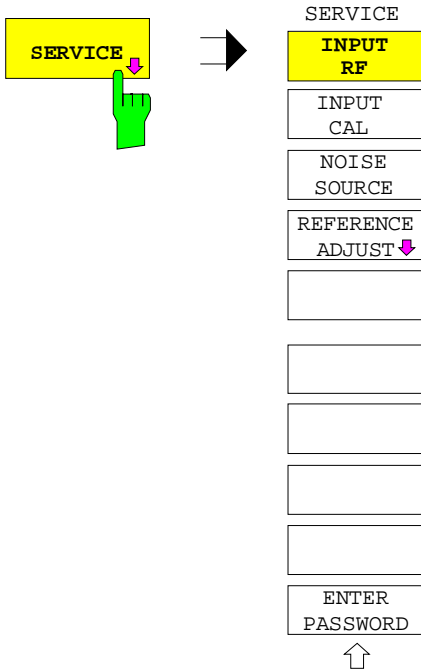

The *SERVICE* softkey calls the service submenu.

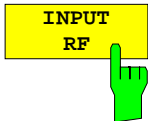

The *INPUT RF* and *INPUT CAL* softkeys are mutually exclusive selection switches. Only one switch can be activated at any one time. They switch the input to the FSE between the *INPUT RF* connector (default) and the internal calibration source (120 MHz, -40 dBm).

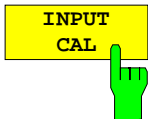

After *PRESET*, *RECALL* or FSE power on, the *INPUT RF* is always selected.

IEC/IEEE-bus command  
`:DIAGnostic:SERvice:INPut[:SElect] RF | CAL`

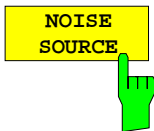

The *NOISE SOURCE* softkey switches the supply voltage for an external noise source on or off. The source is connected to the *NOISE SOURCE* connector on the instrument's rear panel.

The dc voltages on the connector are described in Chapter 8.

IEC/IEEE-bus command `:DIAGnostic:SERvice:NSource ON | OFF`

CONFIGURATION SETUP SERVICE menu:

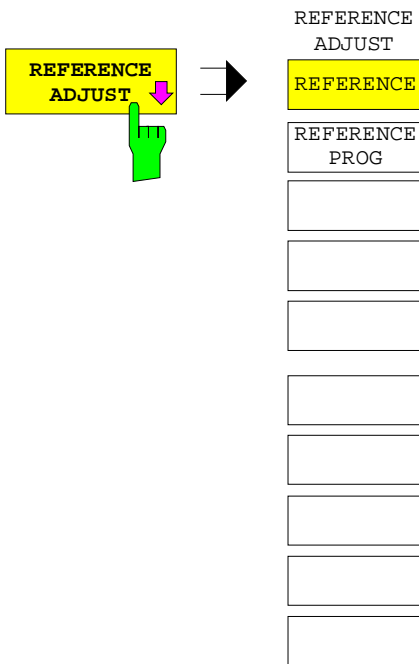

The *REFERENCE ADJUST* softkey opens a submenu used to adjust the frequency precision of the reference oscillator. The value should be modified only after the frequency precision was checked and found to be erroneous (setting range 0 to 4095).

For more information about how to perform the adjustment of the frequency precision refer to service manual instrument (delivered with the FSE).

The modified reference value is preserved when the menu is closed.

The current adjustment value can be permanently stored in an EEPROM in the instrument.

**Caution:** *As the specifications of the whole instrument depend directly on the setting of the reference oscillator (frequency precision), storing incorrect adjustment values should be avoided.*

**Note:** *If no adjustment value has been stored (REFERENCE PROG softkey) before the analyzer is switched off and on again, the factory-set value of the reference frequency or the value that has been programmed last will be used.*

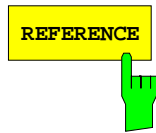

The *REFERENCE* softkey adjusts the frequency precision of the reference oscillator.

IEC/IEEE-bus command  
`: [SENSe<1 | 2>: ]ROSC: [INT: ]TUNe <num_value>`

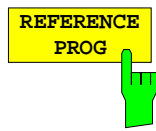

The *REFERENCE PROG* softkey stores the current adjustment value in an EEPROM in the instrument.

IEC/IEEE-bus command  
`: [SENSe<1 | 2>: ]ROSC: [INT: ]TUNe: SAVE`



The *ENTER PASSWORD* softkey allows the entry of a password.

The FSE has a variety of service functions which, if incorrectly used, can impair the functionality of the instrument. These functions can only be accessed with a password (*ENTER PASSWORD*).

IEC/IEEE-bus command `:SYSTem:PASSword[:CENable] <string>`

### Setting the Interface Configuration and Time - with Windows NT Controller

The *GENERAL SETUP* softkey opens a submenu in which the general instrument setup can be entered. The current settings are displayed as tables on the screen where they may be edited.

*CONFIGURATION SETUP* menu:

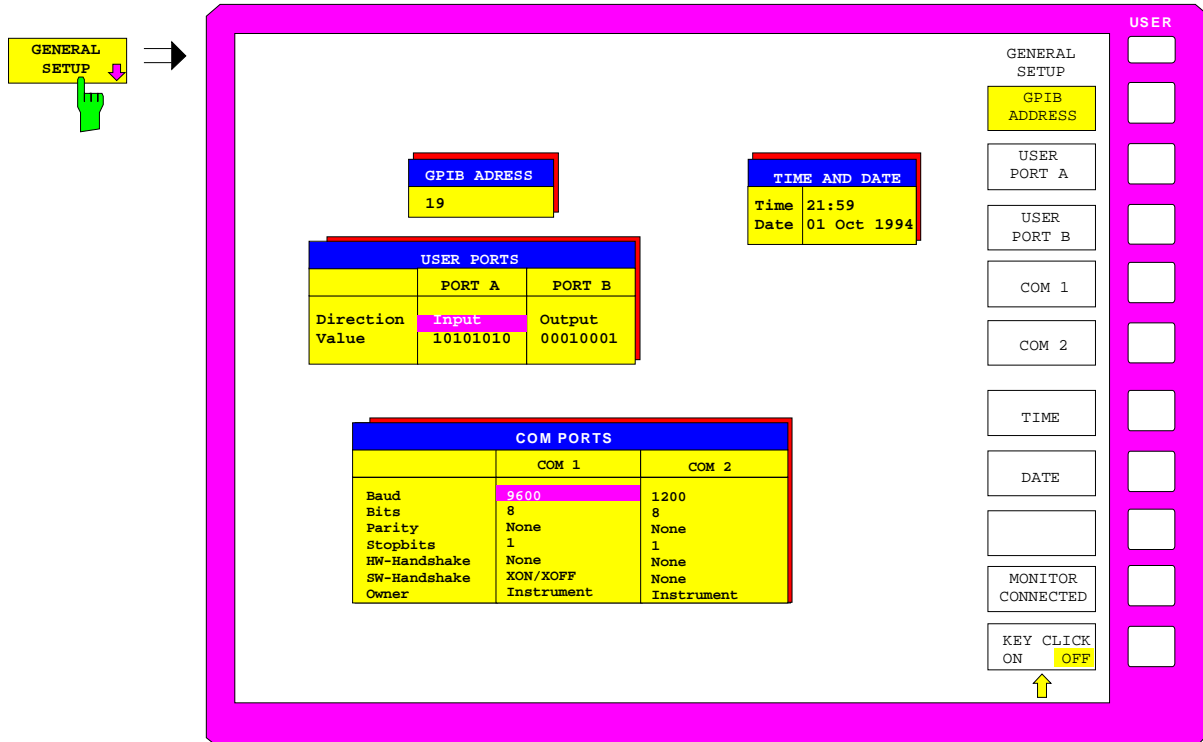

### IEC/IEEE-Bus Address Selection - with Windows NT Controller

*CONFIGURATION SETUP-GENERAL SETUP* submenu:



The *GPIB ADDRESS* softkey activates the entry of the IEC/IEEE-bus address.

The range is 0 to 31. The default setting is 20.

IEC/IEEE-bus command  
`:SYSTem:COMMunicate:GPIB[:SELF]:ADDRess 20`

## User Port Configuration - with Windows NT Controller

The instrument provides two parallel interfaces, each of which is 8 bits wide. Over these ports, arbitrary bit patterns can be output or input. The interfaces are designated *USER PORT A* and *USER PORT B*.

CONFIGURATION SETUP-GENERAL SETUP submenu:

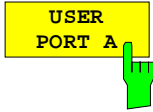

The *USER PORT A* and *USER PORT B* softkeys activate the columns PORT A and PORT B, respectively, in the USERPORTS table for entry of the parameters for both of the parallel interfaces in the instrument. Because the two interfaces are configured in the same manner, how to configure an interface is described in the following using *USER PORT A*.

The following parameters need to be configured in the table:

*Direction*                      Direction of data transmission  
*Value*                              Indication/entry of current value

USERPORTS		
	PORT A	PORT B
Direction	INPUT	OUTPUT
Value	10101010	

### Direction – Direction of data transmission

The *DIRECTION* parameter determines in which direction the interface transmits data.

*INPUT*      read operation  
*OUTPUT*    write operation

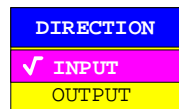

IEC/IEEE-bus command : INPut<1|2>:UPORt<1|2>:STATe ON|OFF  
 :OUTPut<1|2>:UPORt<1|2>:STATe ON|OFF

### Value – Indication/Entry of current value

The *VALUE* parameter shows the current value of the data at the port for data input as well as for data output. The displayed data is in binary format with the least significant bit (LSB) on the right.

If the port is configured as an *OUTPUT* then, the displayed value can be edited. Data entry must also be in binary format (i.e., only the digits 0 and 1 are accepted).

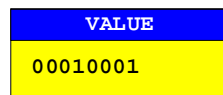

IEC/IEEE-bus command : INPut<1|2>:UPORt<1|2>[:VALue]?  
 :OUTPut<1|2>:UPORt<1|2>[:VALue] <Binary>

## Serial Interface Configuration - with Windows NT Controller

CONFIGURATION SETUP-GENERAL SETUP submenu:

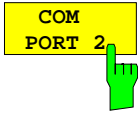
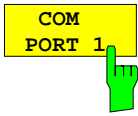

The *COM PORT 1* and *COM PORT 2* softkeys activate the columns COM1 and COM2, respectively, for entry of the serial interface parameters. Since the two interfaces are configured in the same manner, how to configure an interface is described in the following using *COM PORT 1*.

The following parameters must be in the table:

<i>Baud rate</i>	data transmission rate
<i>Bits</i>	number of data bits
<i>Parity</i>	bit parity check
<i>Stop bits</i>	number of stop bits
<i>HW-Handshake</i>	hardware handshake protocol
<i>SW-Handshake</i>	software handshake protocol
<i>Owner</i>	assignment of the serial port to the FSE or computer

COM PORTS		
	COM 1	COM 2
Baud	9600	1200
Bits	8	8
Parity	None	None
Stopbits	1	1
HW-Handshake	None	None
SW-Handshake	XON/XOFF	None
Owner	Instrument	Instrument

**Note:** A serial interface (COM1 or COM2) cannot be used for another purpose if a mouse is connected to it.

### Baud – Data transmission rate

Allowed are the indicated values between 110 and 19200 baud. The default setting is 9600 baud.

BAUD RATE
19200
✓ 9600
4800
1200
600
300
110

IEC/IEEE-bus command

```
:SYSTem:COMMunicate:SERial<1|2>[:RECEive]:BAUD 9600
```

### Bits – Number of data bits per word

For the text transmission without special characters, 7 bits are adequate. For binary data as well as text with special characters, 8 bits must be selected (default setting).

BITS
✓ 7
8

IEC/IEEE-bus command

```
:SYSTem:COMMunicate:SERial<1|2>[:RECEive]:BITS 7 | 8
```

**Parity – Bit parity check***NONE* no parity check (default setting)*EVEN* even parity check*ODD* odd parity check

PARITY	
	NONE
✓	EVEN
	ODD

IEC/IEEE-bus command

```
:SYSTem:COMM:SERial<1|2>[:RECeive]:PARity[:TYPE]
                                     EVEN| ODD| NONE
```

**Stop bits – Number of stop bits**

Available are 1 and 2. The default setting is 1 stop bit.

STOPBITS	
✓	1
	2

IEC/IEEE-bus command

```
:SYSTem:COMMunicate:SERial<1|2>[:RECeive]:SBITs 1|2
```

**HW-Handshake – Hardware handshake protocol**

The integrity of data transmission can be improved through the use of a hardware handshake protocol which prevents uncontrolled transmission of data and the resulting possible loss of data bytes. With the hardware handshaking procedure, additional interface lines are used to transmit acknowledge signals with which the data transmission can be controlled and, if necessary, stopped until the receiver is ready to receive data again.

A prerequisite for handshaking is, however, that the interface lines (DTR and RTS) are provided between the sender and receiver. For a simple, 3-wire connection, this is not the case and a hardware handshake cannot be realized.

Default setting is *NONE*.

HW-HANDSHAKE	
	None
✓	DTR/RTS

IEC/IEEE-bus command

```
:SYSTem:COMM:SERial<1|2>:CONTrol:DTR IBFull|OFF
:SYSTem:COMM:SERial<1|2>:CONTrol:RTS IBFull|OFF
```

**SW-Handshake – Software handshake protocol**

Besides the hardware handshake procedure using interface lines, it is also possible to achieve the same effect by using a software handshake protocol. In this case, control bytes are transmitted in addition to the normal data bytes. These control bytes can be used, as necessary, to stop data transmission until the receiver is ready to receive data again.

In contrast to hardware handshaking, software handshaking can be realized even for a simple, 3-wire connection.

Software handshaking, however, does have one limitation. Software handshaking cannot be used for the transmission of binary data since, the control characters XON and XOFF require bit combinations that are also used for binary data transmission.

Default setting is *NONE*.

SW-HANDSHAKE	
	None
✓	XON/XOFF

IEC/IEEE-bus command

```
:SYSTem:COMM:SERial<1|2>[:RECEive]:PACE XON|NONE
```

**Owner – Assignment of the interface**

The serial interface can be assigned either to the instrument or the computer (operating system, OS).

- INSTRUMENT      Assignment to the instrument means that outputs to the port by the OS are not possible as any output would be lost.
- OS                      Assignment to the operating system means that the instrument cannot use the port, i.e. it is not possible to remote control the instrument via this port.

OWNER	
	INSTRUMENT
✓	OS

IEC/IEEE-bus command      --



### Setting the Date and Time - with Windows NT Controller

CONFIGURATION SETUP-GENERAL SETUP submenu:

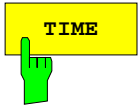

The *TIME* softkey activates the entry of time for the internal real time clock. In the corresponding dialog box, the time is partitioned into two input fields so that hours and minutes can be entered independently.

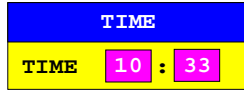

IEC/IEEE-bus command :SYSTem:TIME 0...23, 0...59, 0...59

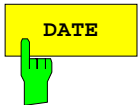

The *DATE* softkey activates the entry of the date of the internal real-time clock. In the corresponding dialog box, the date is partitioned into 3 input fields so that day, month and year can be input separately.

For the selection of the month, pressing a units key opens a list of abbreviations for the months.

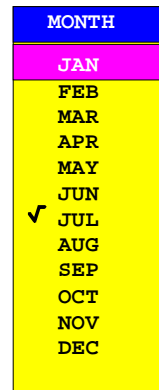
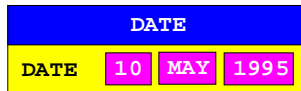

IEC/IEEE-bus command :SYSTem:DATE <num> , <num> , <num>

### Connecting the External Monitor - with Windows NT Controller

Submenu CONFIGURATION SETUP-GENERAL SETUP:

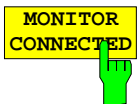

The *MONITOR CONNECTED* softkey informs the unit that an external monitor is available at PC MONITOR connector. The external monitor displays the Windows NT mask.

IEC/IEEE-bus command --

### Switching the Beeper ON/OFF - with Windows NT Controller

CONFIGURATION SETUP-GENERAL SETUP submenu:



The *KEY CLICK ON/OFF* softkey switches the beeper on or off. The beeper acknowledges each key stroke with a beep.

IEC/IEEE-bus command --

## Setting the Interface Configuration and Time - without Controller Option or with MS DOS Controller

The *GENERAL SETUP* soft key branches to a sub-menu in which the basic setup of general instrument parameters may be performed. In addition to the configuration of the digital interfaces (*IECBUS*, *COM*, *LPT* and *MOUSE*), the date and time, the selection of keyboard language as well as the configuration of the *USER PORTS* may be entered.

The current settings are displayed in tabular form on the display screen where they may then be edited.

**Note:** *Interface LPT cannot be configured. If the option FSE-B15, DOS controller function, is installed, LPT1 can be used for printing in both the measurement instrument mode and the computer mode. However, it can only be used for one mode at a time.*

CONFIGURATION SETUP menu:

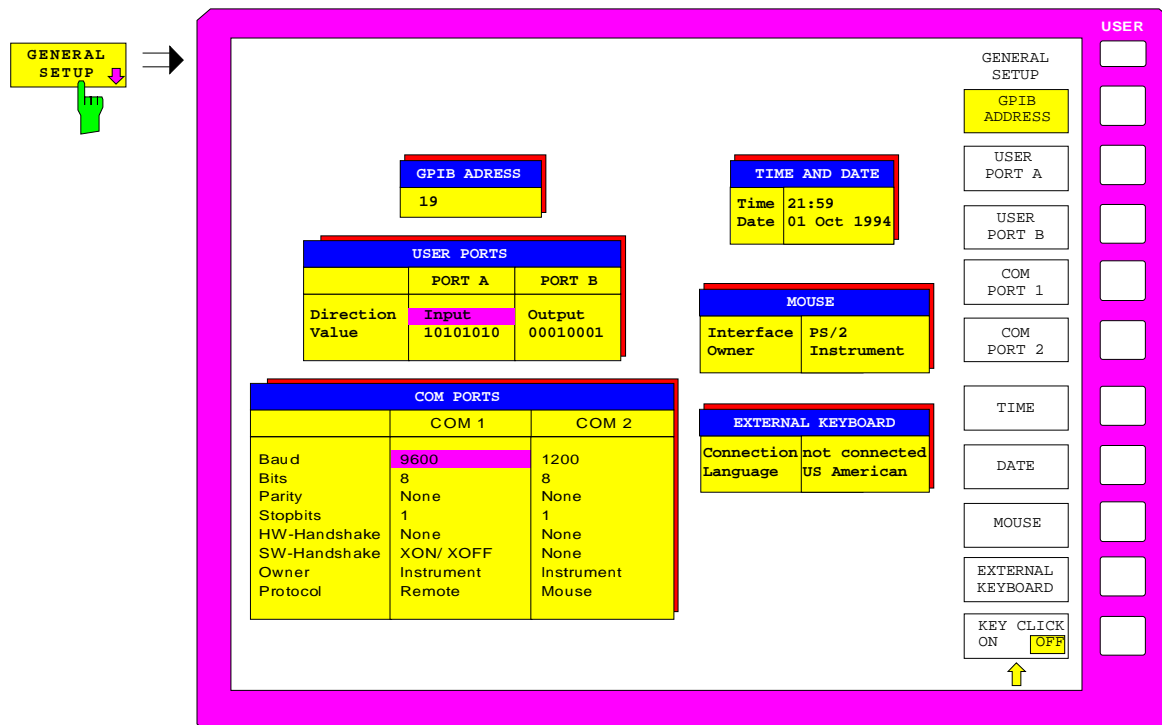

### IEC Bus Address Selection

CONFIGURATION SETUP-GENERAL SETUP submenu:

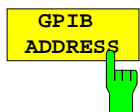

The *GPIB ADDRESS* soft key activates the entry of the IEC Bus address. Permitted addresses are 0 through 30. The default setting is address 20.

### Switching the Beeper ON/OFF

CONFIGURATION SETUP-GENERAL SETUP submenu:

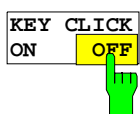

The *KEY CLICK ON/OFF* soft key switches the beeper on or off. The beeper acknowledges each key stroke with a beep.

## User Port Configuration - without Controller Option or with MS DOS Controller

The instrument provides two parallel interfaces, each of which is 8 bits wide. Over these ports, arbitrary bit patterns can be output or input. The interfaces are designated *USER PORT A* and *USER PORT B*.

CONFIGURATION SETUP-GENERAL SETUP submenu:

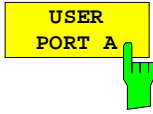

The *USER PORT A* and *USER PORT B* soft keys activate the columns PORT A and PORT B, respectively, in the USERPORTS table for entry of the parameters for both of the parallel interfaces in the instrument. Because the two interfaces are configured in the same manner, how to configure an interface is described in the following using *USER PORT A*.

The following parameters need to be configured in the table:

*Direction*                      Direction of data transmission  
*Value*                              Indication/entry of current value

USERPORTS		
	PORT A	PORT B
Direction	INPUT	OUTPUT
Value	10101010	

### **Direction – Direction of data transmission**

The *DIRECTION* parameter determines in which direction the interface transmits data.

*INPUT*      read operation  
*OUTPUT*    write operation

DIRECTION
✓ INPUT
OUTPUT

### **Value – Indication/Entry of current value**

The *VALUE* parameter shows the current value of the data at the port for data input as well as for data output. The displayed data is in binary format with the least significant bit (LSB) on the right.

If the port is configured as an *OUTPUT* then, the displayed value can be edited. Data entry must also be in binary format (i.e., only the digits 0 and 1 are accepted).

VALUE
00010001

## Serial Interface Configuration - without Controller Option or with MS DOS Controller

CONFIGURATION SETUP-GENERAL SETUP submenu:

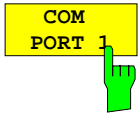

The *COM PORT 1* and *COM PORT 2* soft keys activate the columns COM1 and COM2, respectively, for entry of the serial interface parameters. Since the two interfaces are configured in the same manner, how to configure an interface is described in the following using *COM PORT 1*.

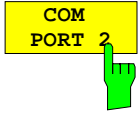

The following parameters need to be configured in the table:

<i>Baud rate</i>	data transmission rate
<i>Bits</i>	number of data bits
<i>Parity</i>	bit parity check
<i>Stop bits</i>	number of stop bits
<i>HW-Handshake</i>	hardware handshake protocol
<i>SW-Handshake</i>	software handshake protocol
<i>Owner</i>	assignment to the measuring instrument or computer
<i>Protocol</i>	transmission protocol

COM PORTS		
	COM 1	COM 2
Baud	9600	1200
Bits	8	8
Parity	None	None
Stopbits	1	1
HW-Handshake	None	None
SW-Handshake	XON/XOFF	None
Owner	Instrument	Instrument
Protocol	Remote	Remote

**Note:** A serial interface (COM1 or COM2) cannot be used for another purpose if a mouse is connected to it.

### Baud – Data transmission rate

Allowed are the indicated values between 110 and 19200 baud. The default setting is 9600 baud.

BAUD RATE
19200
✓ 9600
4800
1200
600
300
150
110

### Bits – Number of data bits per word

For the transmission of text without German umlauts (Ä, ä, Ü, ü, Ö, ö) and special characters, 7 bits are adequate. For binary data as well as text with special characters or umlauts, 8 bits must be selected (default setting).

BITS
✓ 7
8

**Parity – Bit parity check**

*NONE* no parity check (default setting)

*EVEN* even parity check

*ODD* odd parity check

PARITY
NONE
✓ EVEN
ODD

**Stop bits – Number of stop bits**

Available are 1 and 2. The default setting is 1 stop bit.

STOPBITS
✓ 1
2

**HW-Handshake – Hardware handshake protocol**

The integrity of data transmission can be improved through the use of a hardware handshake protocol which effectively prevents uncontrolled transmission of data and the resulting possible loss of data bytes. In the hardware handshaking procedure, additional interface lines are used to transmit acknowledge signals with which the data transmission can be controlled and, if necessary, stopped until the receiver is ready to receive data again.

A prerequisite for handshaking is, however, that the interface lines (DTR and RTS) are provided between sender and receiver. For a simple, 3-wire connection, this is not the case and hardware handshake cannot be realized here.

Default setting is *NONE*.

HW-HANDSHAKE
None
✓ DTR/RTS

**SW-Handshake – Software handshake protocol**

Besides the hardware handshake procedure using interface lines, it is also possible to achieve the same effect by using a software handshake protocol. Here, control bytes are transmitted in addition to the normal data bytes. These control bytes can be used, as necessary, to stop data transmission until the receiver is ready to receive data again.

In contrast to hardware handshaking, software handshaking can be realized even for a simple, 3-wire connection.

One limitation is, however, present in software handshaking. Software handshaking cannot be used for the transmission of binary data since, the control characters XON and XOFF require bit combinations that are also used for binary data transmission.

Default setting is *NONE*.

SW-HANDSHAKE
None
✓ XON/XOFF

**Owner – Assignment of the interface**

When the option FSE-B15, DOS controller, is installed, the serial interface can be assigned alternatively to the instrument measurement section, the DOS section or to both sections of the FSE .

If the interface is assigned to only one section of the instrument, it is not available to the other section.

INSTRUMENT	The interface is assigned to the instrument measurement section. Outputs to the interface from the computer are not possible and, so to say, land nowhere.
DOS	The interface is assigned to the computer section. It cannot be used by the instrument measurement section. This means that hardcopy or remote control of the instrument via the interface is not possible. An attempt to start a print job via the interface results in an error message. The <i>PROTOCOL</i> parameter has no meaning in this mode.
INTR AND DOS	The interface is allocated to both instrument sections. It may be used alternately by each section. This means that a hardcopy job from the measurement section and a data transfer from the computer are not possible at the same time. This would lead to a mixing of the data streams.  The set interface parameters, with the exception of <i>PROTOCOL</i> , are valid for both instrument sections. The <i>PROTOCOL</i> parameter is only of interest for the measurement section.

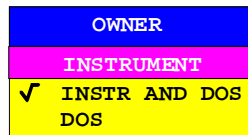

**Note:** *DOS programs cannot independently recognize changed interface parameter settings.*

**Protocol – Transmission protocol**

The parameter allows the selection of special transmission protocols for measurement functions. The interface can be configured for:

- remote control as single instrument
- printer output (hardcopy)

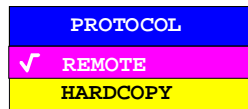

## Setting Date and Time - without Controller Option or with MS DOS Controller

CONFIGURATION SETUP-GENERAL SETUP submenu:

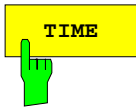

The *TIME* soft key activates the entry of time for the internal real time clock . In the corresponding dialog box, the time is partitioned into two input fields so that hours and minutes can be entered independently.

TIME		
TIME	10	: 33

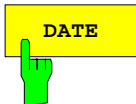

The *DATE* soft key activates the entry of the date of the internal real-time clock. In the corresponding dialog box, the date is partitioned into 3 input fields so that day, month and year can be input separately.

DATE			
DATE	10	MAY	1995

For the selection of the month, pressing a units key opens a list of abbreviations wherein the desired month can be selected.

MONTH	
	JAN
	FEB
	MAR
	APR
	MAY
	JUN
✓	JUL
	AUG
	SEP
	OCT
	NOV
	DEC

## Mouse Configuration - without Controller Option or with MS DOS Controller

How to connect a mouse is described in chapter 1, section "Connecting a Mouse", the operation of the instrument with a mouse is described in chapter 2, section "Mouse and External Keyboard Control".



**Caution:**

The keyboard may only be connected when the instrument is switched off (STANDBY). Otherwise, correct operation of the keyboard cannot be guaranteed.

CONFIGURATION SETUP-GENERAL SETUP submenu:

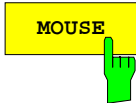

The *MOUSE* soft key activates the *MOUSE* table for configuration of the mouse.

The following parameters need to be configured in the table:

- Interface*      Selection of interface
- Owner*          Assignment of mouse

MOUSE	
Interface	NOT CONNECTED
Owner	INSTRUMENT

**Interface – Selection of the interface**

If one of the serial interfaces is selected (*COM PORT 1* or *COM PORT 2*), its interface parameters are automatically reconfigured so that mouse operation is possible.

- NOT CONNECTED      No connection
- PS/2                      MOUSE connector on the rear panel
- COM PORT 1              COM1 connector on the rear panel
- COM PORT 2              COM2 connector on the rear panel

INTERFACE	
✓ NOT CONNECTED	
PS/2	
COM PORT 1	
COM PORT 2	

**Owner – Assignment of the mouse**

If the processor option FSE-B15 is installed, the mouse can alternately be assigned to the instrument measurement section, the computer section or to both sections simultaneously.

If the mouse is assigned to one section it is not available to the other section.

- INSTRUMENT      The mouse is assigned to the instrument measurement section.
- DOS                      The mouse is assigned to the computer section.
- INTR AND DOS      The mouse is assigned to both sections.

OWNER	
INSTRUMENT	
✓ INSTR AND DOS	
DOS	



## External Keyboard Configuration - without Controller Option or with MS DOS Controller

How to connect a keyboard is described in chapter 1, section "Connecting an External Keyboard", the operation of the instrument with an external keyboard is described in chapter 2, section "Mouse and External Keyboard Control".



**Caution:**

The keyboard may only be connected when the instrument is switched off (STANDBY). Otherwise, correct operation of the keyboard cannot be guaranteed.

CONFIGURATION SETUP-GENERAL SETUP submenu:

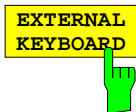

The *EXTERNAL KEYBOARD* soft key activates the *EXTERNAL KEYBOARD* table for configuration of the external keyboard.

*Connection*      Activation of the keyboard connection

*Language*        Language definition for measurement instrument operation

EXTERNAL KEYBOARD	
Connection	NOT CONNECTED
Language	US-AMERICAN

**Connection – Activating the connection**

Activating the connection mainly determines whether or not the help line editor is available.

CONNECTED      A keyboard is connected. When an alphanumeric entry window is opened, the help line editor is no longer displayed automatically because it is no longer needed for editing.

NOT CONNECTED      The help line editor is opened automatically when alphanumeric parameters are edited.

CONNECTION
✓ NOT CONNECTED
CONNECTED

**Language – Language definition for measurement instrument operation**

Available are US-American, German and French.

LANGUAGE
✓ US-AMERICAN
GERMAN
FRENCH

**Note:** The language definition of the keyboard in DOS mode is independent of this setting and is determined by the appropriate MS-DOS command.

## Firmware Update

New firmware versions can be installed from the integral disk drive. The firmware update kit contains several disks.

The installation program is called in the *SETUP* menu.

*CONFIGURATION SETUP* sidemenu:



The *FIRMWARE UPDATE* softkey opens the submenu for the installation of a new firmware version.

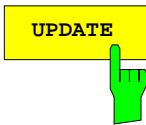

The *UPDATE* softkey starts the installation program and guides the user through the remaining steps of the update procedure.



The *RESTORE* softkey restores the previous firmware version

## Status Display-Remote/Manual Control – *STATUS* Key Group

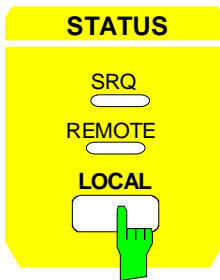

The *SRQ* LED, the *REMOTE* LED and the *LOCAL* key are contained in the *STATUS* key group.

- The *SRQ* LED indicates that a service request from the instrument has been asserted on the IEC Bus.
- The *REMOTE* LED indicates that the instrument is under remote control.
- The *LOCAL* key switches the instrument from remote to manual control, with the assumption that the remote controller has not previously set the LOCAL LOCKOUT function.

A change in the control mode comprises:

- **Enabling the Front Panel Keys**

Under remote control, the softkey menu is turned off and all keys, with the exception of *PRESET* and *LOCAL*, are disabled. Returning to manual mode enables all disabled keys. The main menu of the current mode is selected as the softkey menu..

- **Turning off the *REMOTE* LED**

- **Generating the message *OPERATION COMPLETE***

If the synchronization via *\*OPC*, *\*OPC?* or *\*WAI* is active when the *LOCAL* softkey is pressed, any measurement procedure that is running is aborted and synchronization is achieved by setting the corresponding bits in the registers of the status reporting system.

- **Setting Bit 6 (User Request) of the Event Status Register**

If the status reporting system is configured appropriately, setting this bit immediately elicits a service request (*SRQ*) which is used to inform the controller that the user wishes to return to front-panel control. This information can be used, e.g., to interrupt the control program so that the user can make the necessary manual corrections to instrument settings. This bit is set each time the *LOCAL* key is pressed.

- The *LOCAL* key aborts a running macro. The continuation of the macro is not possible.

IEC/IEEE-bus command            `CALL IBLOC(analyzer%)`

## Measurement Documentation – *HARDCOPY* Key Group

**Note:** *The installation of additional printer drives is described in chapter 1, section "Installation and Configuration of Printers".*

### Printing Data – *START* Key - with Windows NT Controller

**Note:** *Printing data for instruments with MS DOS controller or without controller is described page 4.52*

The instrument uses the printer function of Windows NT to output hardcopies. Any printer supported by Windows NT can be used. In addition, the instrument permits data output in the usual data formats WMF, EWMF and BMP which enable hardcopies to be directly inserted into other documents. Network printers can be used if the instrument is connected to a network.

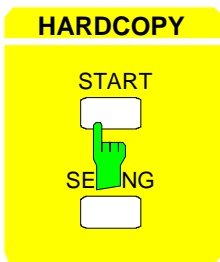

The *START* key initiates the printing of measurement/ instrument status data. The instrument can distinguish between two different printers, each of which may be individually configured, e.g., a laser printer and a ink jet printer. All documents are printed on the printer which is currently active.

IEC/IEEE-bus command :HCOPY[ :IMMEDIATE<1 | 2> ]

Pressing the *HARDCOPY START* key starts the print job. The settings under Windows NT and in the *HARDCOPY SETTINGS* menu determine the printer configuration. All of the display items to be printed out are written to the printer buffer of Windows NT. Since the printer runs in the background, the instrument may be operated immediately after pressing the *START* key.

When *COPY SCREEN* is selected in menu *HARDCOPY SETTINGS*, all the measurement diagrams with traces and status displays are printed as they appear on the screen. Softkeys, open tables and data entry fields are not printed out. Specific traces can be printed out with the *COPY TRACE* function. With *COPY TABLE*, tables can be printed out.

If *CLIPBOARD* is active in the *HARDCOPY DEVICE* submenu the clipboard can be used to directly transfer hardcopies to Windows applications. The copy is written in the clipboard by pressing *HARDCOPY START*. The user can then change to another Word document and insert the clipboard content into the document with EDIT - PASTE by using the key combination CTRL+V.

If the *PRINT TO FILE* option in the *HARDCOPY DEVICE* submenu is selected, the printout is directed to a file. When the *HARDCOPY START* is pressed, the file name to which the output data are to be written is requested.

If the *START* key is pressed while printing is in progress, a second output can be released which can also be joined to the printer queue. Any number of print jobs can be released consecutively.

Current print jobs can be aborted only by cancelling the entries in the Windows NT printer queue. After starting the print a printer symbol is displayed in the task bar near the time indication.



A double-click on this symbol opens a window containing the entries of the printer queue. The relevant print order can be cancelled by marking it with the mouse and pressing the DEL key.

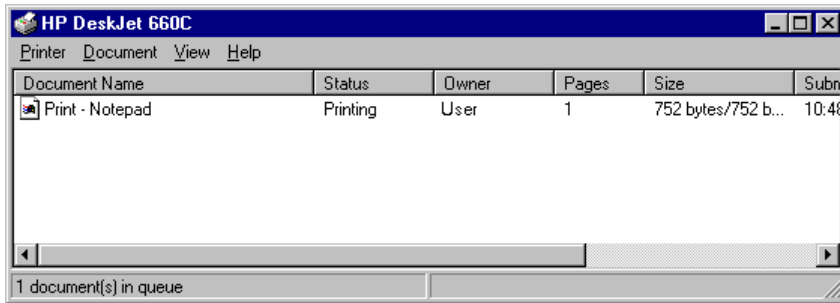

While a print job is in progress, problems may occur in the printer. If, while printing, the printer issues a PAPER OUT message, i.e., no more paper is available, the user will be prompted by the following message

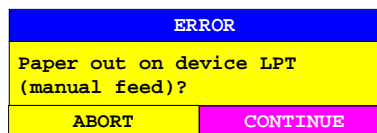

to load paper into the printer. The print job will then be either continued (CONTINUE) or aborted (ABORT).

Switchover between b/w and colored printouts is possible with the *COLOR ON/OFF* softkey provided that an appropriate printer is connected. The colors of the printout correspond exactly to those on the screen, i.e. a red trace will be output in red.

To change the colors of the objects on the printout, the screen colors have to be changed in *DISPLAY-CONFIG DISPLAY* menu. One exception is the color of the background and the color of the diagrams. The output background is always white irrespective of the screen color and the diagrams are always black.

If several traces are to be output one after the other on the same sheet different colors can be chosen for each trace with the *TRC COLOR AUTO INC* softkey (Trace Color Auto Increment).

On most b/w printers, a better printout of the color screen is obtained on hardcopies if the color information is converted into gray shades. For this, the color output in menu *HARDCOPY SETTINGS* is to be activated (COLOR ON).

## Printing Data – *START* Key- with MS DOS Controller or without Controller

**Note:** Printing data for instruments with Windows NT controller is described page 4.50

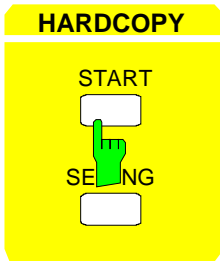

The *START* key initiates the printing of measurement/ instrument status data. The FSE can distinguish between two different output devices, each of which may be individually configured, e.g., a laser printer and a plotter. All documents are printed on the output device which is currently active.

Pressing the *HARDCOPY START* key initiates the print job. The printer parameters defined in the *HARDCOPY SETTINGS* menu are used for setting up the printer configuration. After pressing the *START* key, all of the display items to be printed are written to the printer buffer memory. Since the printer runs in the background, the instrument may be operated immediately after pressing the *START* key.

With *COPY SCREEN* selected in menu *HARDCOPY SETTINGS*, all the diagrams with traces and status displays are printed as they occur on the screen. Softkeys, open tables and data entry fields are not printed out. Function *COPY TRACE* allows to print out individual traces. With *COPY TABLE* tables can be printed out.

If the *FILE* option in the *HARDCOPY DEVICE* submenu of the *HARDCOPY SETTINGS* menu is selected then, upon pressing *HARDCOPY START*, the file name to which the output data are to be written is requested. For this an entry field is opened for entering the file name. If no external keyboard is connected, the help line editor is activated.

If the *START* key is pressed again while a print job is in progress, a new print job will be started directly after completion of the first one. It is not possible to process more than two hardcopies at the same time. With *START* pressed again, the following warning appears on the display screen:

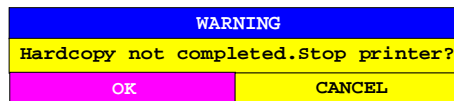

Pressing the *OK* key causes the active print jobs to be interrupted. Selecting *CANCEL* erases the warning and the print job continues.

While a print job is in progress, problems may occur in the output device. If, while printing, the output device issues a *PAPER OUT* message, i.e., no more paper is available, the user will be prompted by the following message

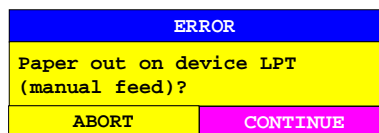

to load paper into the output device. The print job will then be either continued (*CONTINUE* selected) or aborted (*ABORT* selected).

Similar SYSTEM MESSAGES appear, e.g., if the IEC Bus address of the printer is incorrectly set , the printer does not respond, etc.

Switchover between b/w and coloured printouts is possible with softkey *COLOR ON/ OFF* provided that the printer connected is able to output such prints. The colours of the printout correspond exactly to those of the screen, ie a red trace will be output in red.

To change the colours of the objects on the printout, the screen colours have to be changed correspondingly in menu *DISPLAY*, submenu *CONFIG DISPLAY*. One exception is the colour of the background and the colour of the diagrams. The output background is always white irrespective of the screen colour and the diagrams are always black.

If several traces are to be output one after the other on the same sheet different colours can be chosen for each trace with the aid of softkey *TRC COLOR AUTO INC* (Trace Color Auto Increment).

## Printing Configuration – *SETTINGS* Key

*HARDCOPY SETTINGS* menu:

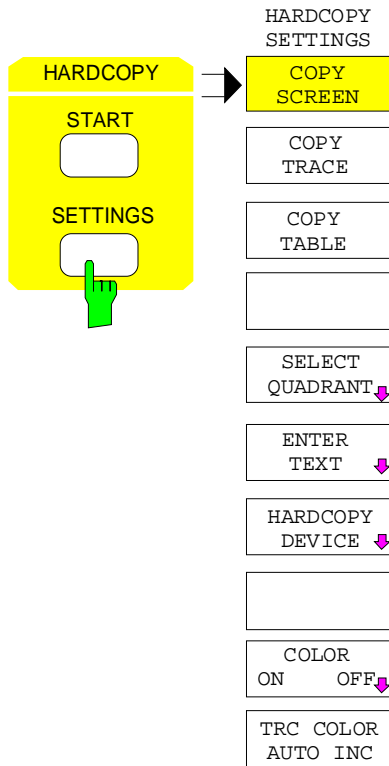

The *SETTINGS* key opens the menu to configure the printout.

The recommended procedure for configuring the printout is as follows:

- Configure the desired printer and select the interface over which the output is to take place by using Windows NT and the *HARDCOPY DEVICE* softkey.
- Select the display items to be printed with the *COPY SCREEN*, *COPY TRACE* softkeys.
- Select between coloured and b/w printouts with the *COLOR ON/ OFF* and *TRC COLOR AUTO INC* softkeys.
- Enter comment applicable to the diagram or add a title for the overall printout by using the *ENTER TEXT* softkey.
- Select the page format (*QUADRANT*, *FULL PAGE*) through use of the *SELECT QUADRANT* softkey.

The *COPY SCREEN*, *COPY TRACE* and *COPY TABLE* softkeys are selection switches, i.e., only one function can be enabled at any one time. The push buttons are used for selection only and do not initiate a print job. The actual printing is initiated by the *HARDCOPY START* key.



## Selection of Displayed Elements and Colour Settings

*HARDCOPY SETTINGS* menu:

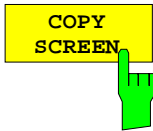

The *COPY SCREEN* softkey selects the output of test results.

All the diagrams, traces, markers, marker lists, display lines, limit lines etc. are printed out as long as they are displayed on the screen. Softkeys, tables and open data entry fields are not printed out. However, comments, title, date, and time entered are printed out at the bottom of the printout. The logo appears at the top left of the printout.

IEC/IEEE-bus command :HCOpy:ITEM:ALL

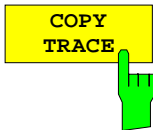

The *COPY TRACE* softkey selects the output of all traces displayed on the screen without any auxiliary information. Specifically, no markers or display lines are printed.

IEC/IEEE-bus command :HCOpy:ITEM:WINDow<1|2>:TRACe:STATe ON|OFF

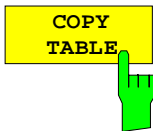

The *COPY TABLE* softkey selects the output of all tables visible displayed on the screen.

IEC/IEEE-bus command :HCOpy:ITEM:WINDow<1|2>:TABLe:STATe ON|OFF

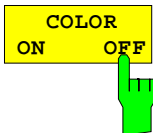

The *COLOR ON/OFF* softkey selects a coloured or b/w printout.

After having changed the printer driver or the hardcopy device (in submenu, *HARDCOPY SETTINGS*) the softkey is automatically switched to *ON*. One exception is printer driver HP PCL4 which only supports b/w printouts. In this case, the softkey cannot be operated.

IEC/IEEE-bus command :HCOpy:DEvIce:COLOr ON | OFF

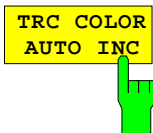

The *TRC COLOR AUTO INC* softkey automatically switches the colours of the traces on to the next printout. On the second printout, trace 1 has the colour of trace 2, trace 2 the colour of trace 3 etc. The fourth printout starts with the first colour. With the softkey switched off, the colours of the traces are reset to their original state.

When changing the printer driver or the hardcopy device (both in submenu *HARDCOPY SETTINGS*) as well as the selection b/w printout (softkey *COLOR ON/OFF* in position *OFF*), softkey *TRC COLOR AUTO INC* is switched off.

IEC/IEEE-bus command :HCOpy:ITEM:WINDow<1|2>:TRACe:CAINcrement ON | OFF

### Selection of Hardcopy Format

HARDCOPY SETTINGS-SELECT QUADRANT submenu:

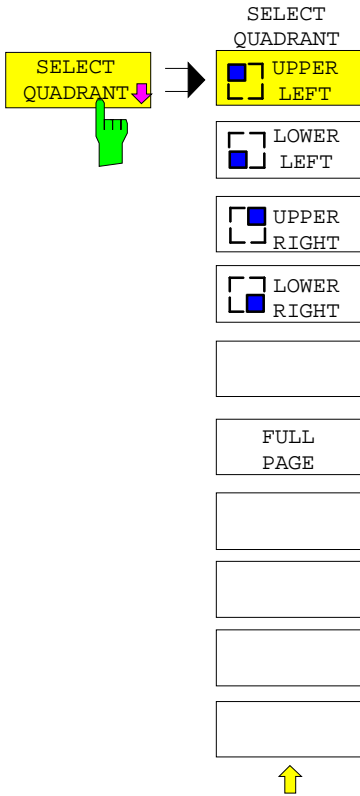

The *SELECT QUADRANT* softkey calls the the submenu for selection of *QUADRANT*the location of the display screen graphics on the printed page.

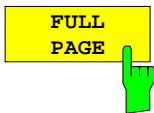

The *FULL PAGE* softkey switches quadrant printing off, i.e., printing now takes place at full size. The information as to which quadrant was last selected is also lost. *FULL PAGE* is the default setting.

IEC/IEEE-bus command :HCOPY:PAGE:DIMensions:FULL

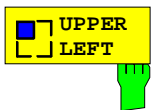

The *UPPER LEFT*, *LOWER LEFT* as well as *UPPER RIGHT*, *LOWER RIGHT* softkeys select the page quadrants where the printed data will be positioned. In this case, the actual size of the data printed on the page is reduced to 25% of normal size. This reduction is independent of how the graphics are distributed on the display screen. Thus, for two measurement windows (*SPLIT SCREEN*), both measurement diagrams shown on the display are placed in the chosen quadrant. Thus, up to a maximum of 8 measurement windows can be printed on one page. (4 print commands for a *SPLIT SCREEN* display, each to a different quadrant)

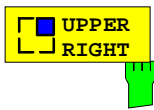
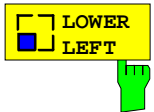

IEC/IEEE-bus command :HCOPY:PAGE:DIMensions:QUADrant 1|2|3|4

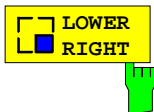

### Entry of Comment Text

HARDCOPY SETTINGS-ENTER TEXT submenu:

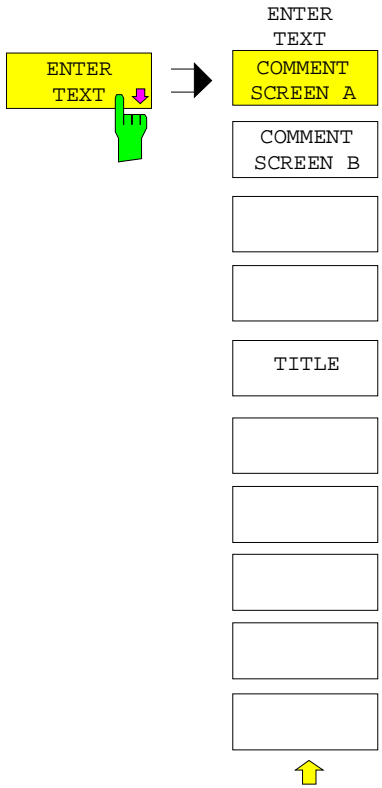

The *ENTER TEXT* softkey calls the submenu for editing the commentary for the individual windows. The comment text appears in the print-out, but does not appear on the display screen.

If a comment is not to appear on the printout, it has to be deleted. By pressing *PRESET*, all comments will be deleted.

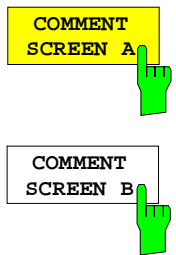

The *COMMENT SCREEN A* softkey opens an entry field in which a comment of at most two lines (60 characters per line) can be entered for screen A or screen B. If the user enters more than 60 characters, the overflow characters appear on the second line on the print-out. At any point, a manual line-feed can be forced by entering the @ character. The comment is printed below the corresponding screen.

```
IEC/IEEE-bus command
:HCOPY:ITEM:WINDOW<1|2>:TEXT <string>
```

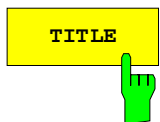

The *TITLE* softkey activates a single line entry box for entering a title for the complete print-out with a maximum of 60 characters.

```
IEC/IEEE-bus command
:HCOPY:ITEM:LABEL:TEXT <string>
```

## Selection and Configuration of the Printer - with Windows NT Controller

**Note:** Selection and configuration of the printer for instruments with MS DOS controller or without controller is described page 4.60

The instrument permits two different printers to be configured. One of the devices is defined as the active device and can be used for hardcopies.

The printers are mainly installed and configured under Windows NT and and the settings are valid for all Windows applications (see Chapter 1, section "Connecting an Printer"). The active device and the settings which concern only the output of hardcopies are selected in menu *HARDCOPY DEVICE*..

*HARDCOPY SETTINGS* submenu:

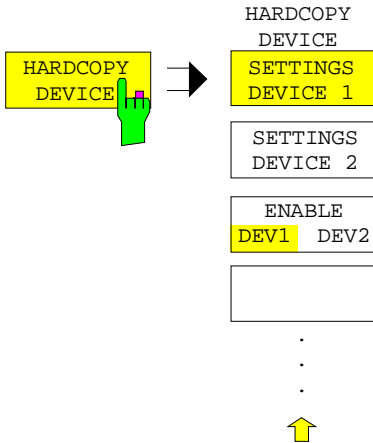

The *HARDCOPY DEVICE* softkey switches to the submenu which is used for the selection/configuration of the two printers.

When the sub-menu is called, the corresponding table is displayed. The *SETTINGS DEVICE 1* softkey is active and the selection bar is located at the *DEVICE1* line in the corresponding column of the table.

HARDCOPY DEVICE SETTINGS	
Device1	WINDOWS METAFILE
Print to File	YES
Orientation	---
Device2	CLIPBOARD
Print to File	---
Orientation	---

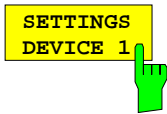

The *SETTINGS DEVICE 1* softkey permits the selection and configuration of the printer *DEVICE 1*. The *SETTINGS DEVICE 2* softkey is used to configure *DEVICE 2*.

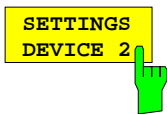

The actual selection of the active printer takes place with the *ENABLE DEV1 DEV2* softkey in the *HARDCOPY DEVICE* sub-menu.

### Device

The selection of the printer/language for *DEVICE 1* and *DEVICE 2* is made in this line.

HARDCOPY DEVICE SETTINGS	
Device1	WINDOWS METAFILE
Print to File	YES
Orientation	---
Device2	CLIPBOARD
Print to File	---
Orientation	---

DEVICE
✓ CLIPBOARD
WINDOWS METAFILE
ENHANCED METAFILE
BITMAP FILE
HP DeskJet 660C

Three file formats and the Windows NT clipboard are always available, even if a printer has not yet been installed under Windows NT. All installed printers are listed below in alphabetic order.

The printer installation is described in Chapter 1, Section "Installation and Configuration of Printers".

**CLIPBOARD** The hardcopies are copied to the Windows NT clipboard. This permits to obtain a printout of high quality which can be directly inserted into other Windows applications (menu EDIT | PASTE or key combination CTRL+V). The lines 'Print to File', 'Orientation' and 'GPIB Address' are deactivated.

#### WINDOWS METAFILE and ENHANCED METAFILE

WMF and EWMF are vector graphics formats which can be imported by most graphics and editing programs. EMF is recommended for recent Windows32 applications.

**BITMAP FILE** BMP is a bitmap format which can also be imported by most programs.

When WMF, EWMF and BMP are selected, the line "Print to File" is automatically set to ON and line "Orientation" deactivated.

#### IEC/IEEE-bus commands

```
:HCOpy:DEvIce:LANGUage WMF|EWMF |BMP |GDI
:HCOpy:DESTination<1|2>
  "MMEM" | "SYST:COMM:PRIN" | "SYST:COMM:CLIP"
:HCOpy:ITEM:FFEEd<1|2>:STATE ON | OFF
```

#### Print to File

With "Print to File" ON, the printout is directed to a file. In this case the user is prompted to enter a file name on starting the printout.

**Note:** This setting is coupled to the corresponding setting under Windows NT.

```
IEC/IEEE-bus commands :HCOpy:DESTination<1|2> "MMEM"
                      :MMEMory:NAME <file_name>
```

#### Orientation

In this line, the print format of the output page is set to either vertical (= PORTRAIT) or horizontal (= LANDSCAPE).



The *ENABLE DEV1 / DEV2* softkey determines the active printer. The default printer is DEVICE 1, i.e., all output takes place on DEVICE 1.

IEC/IEEE-bus command -- (The numeric suffix after HCOpy:IMMEDIATE denotes the first or second device.)

## Selection and Configuration of the Printer - with MS DOS Controller or without Controller

**Note:** Selection and configuration of the printer for instruments with Windows NT controller is described page 4.58

HARDCOPY SETTINGS-HARDCOPY DEVICE submenu:

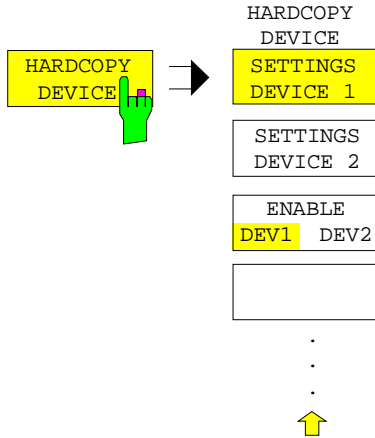

The *HARDCOPY DEVICE* softkey switches to the sub-menu which is used for the selection/configuration of the two output devices and for the connection of the devices to an output medium.

When the sub-menu is called, the corresponding table is simultaneously displayed. The *SETTINGS DEVICE 1* softkey is active and the selection bar is located at the *DEVICE/LANGUAGE* line in the corresponding column of the table.

The screenshot shows the 'HARDCOPY DEVICE' sub-menu. On the left is a table titled 'DEVICE SETTINGS'. The table has three columns: 'ITEM', 'SETTINGS DEVICE 1', and 'SETTINGS DEVICE 2'. The 'HPGL' row is highlighted in pink. On the right is a vertical column of softkeys labeled 'USER' at the top. The 'SETTINGS DEVICE 1' softkey is highlighted in yellow. Below the softkeys is a yellow arrow pointing upwards.

DEVICE SETTINGS		
ITEM	SETTINGS DEVICE 1	SETTINGS DEVICE 2
Device/Language	HPGL	POSTSCR
Connection	GPIB1	LPT
GPIB Address	4	---
Orientation	PORTRAIT	LANDSCAPE
Device Reset	OFF	OFF
Formfeed	OFF	ON
Paperfeed	MANUAL	MANUAL

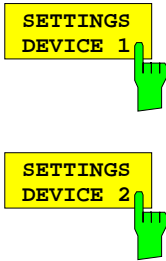

The FSE permits two different output devices to be configured. One of the devices is defined as the active device and can be used for hardcopies.

After calling the menu, the *SETTINGS DEVICE 1* softkey is active and permits the selection and configuration of the output device DEVICE 1. The selection bar is placed the corresponding column of the table. The *SETTINGS DEVICE 2* softkey is used to configure DEVICE 2.

The actual selection of the active output device takes place with the *ENABLE DEV1 DEV2* softkey in the *HARDCOPY DEVICE* sub-menu.

**Device/Language**

The selection of the output device/language for DEVICE 1 and DEVICE 2 is made in this line.

DEVICE SETTINGS																				
ITEM	SETTINGS DEVICE 1	SETTINGS DEVICE 2																		
Device/Language	HPGL	<table border="1"> <thead> <tr> <th colspan="2">SELECT DEVICE</th> </tr> </thead> <tbody> <tr> <td>DESKJC3H</td> <td>▲</td> </tr> <tr> <td>DESKJ_C</td> <td></td> </tr> <tr> <td>DESKJ_CH</td> <td></td> </tr> <tr> <td>DESKJ_H</td> <td></td> </tr> <tr> <td>EPSON24</td> <td></td> </tr> <tr> <td>HP7470</td> <td></td> </tr> <tr> <td>HP7470LS</td> <td></td> </tr> <tr> <td>✓ HPGL</td> <td>▼</td> </tr> </tbody> </table>	SELECT DEVICE		DESKJC3H	▲	DESKJ_C		DESKJ_CH		DESKJ_H		EPSON24		HP7470		HP7470LS		✓ HPGL	▼
SELECT DEVICE																				
DESKJC3H	▲																			
DESKJ_C																				
DESKJ_CH																				
DESKJ_H																				
EPSON24																				
HP7470																				
HP7470LS																				
✓ HPGL	▼																			
Connection	GPIB1																			
GPIB Address	4																			
Orientation	PORTRAIT																			
Device Reset	OFF																			
Formfeed	OFF																			
Paperfeed	MANUAL																			

Sequence, number and name of available devices depends on the driver files stored on the harddisk:

**Data format for printout on a plotter**

- HPGL            standard HPGL format
- HPGL\_LS       output of the traces with variable Line\_styles
- HP7470        plotter hp7470 (reduced HPGL format)
- HP7470LS     special HP7470format allowing output of the traces with variable Line\_styles

**Data format for HP-deskjet series**

- DESKJ            black/white
- DESKJ\_H        black/white, high resolution
- DESKJC3:       Color (3 color cartridges only) e. g. Deskjet 500)
- DESKJC3H:     Color (3 color cartridges only), high resolution
- DESKJ\_C:       Color (3 color cartridges + black cartridge)  
e. g. Deskjet 560)
  
- DESKJ\_CH:      Color (3 color cartridges + black cartridge) , high resolution

**Data format for a 24-pin printer**

- EPSON24 data format for Epson-compatible 24-needle printers, black/white, e. g. Epson LQ-series, R&S PDN
- EPSON24C data format for Epson-compatible 24-needle color printers, e. g. Epson Stylus Color, R&S PDN Color

**Data formats for laser and ink-jet printers**

- HPPCL4 black/white with 300DPI resolution
- HPPCL4HI black/white, high resolution
- HPPCL5 black/white with 300DPI resolution
- LASERJ data format for HP-laserjet starting with series III
- PCL4 black/white
- PCL4\_H black/white, high resolution
- PCL4\_C color (3 color cartridges + black cartridge)
- PCL4\_CH color (3 color cartridges + black cartridge), high resolution
- PCL4\_C3 color (3 color cartridges only)
- PCL4\_C3H color (3 color cartridges only) , high resolution

**Data format PostScript**

- POSTSCR a printer language (PostScript)

**Data formats for output files**

- WMF WINDOWS Metafile format
- PCX pixel graphics (e. g. Paintbrush)

IEC/IEEE-bus command :HCOPY:DEVIce:LANGUage<1|2>  
 HPGL | PCL4 | PCL5 | POSTscript |  
 ESCP | WMF | PCX | HP7470 | EPSON24 |  
 EPSON24C | PCL4\_C | PCL4\_C3 |  
 LASERJ | DESKJ | DESKJ\_C |  
 DESKJ\_C3 | HPGL\_LS |  
 HP7470LS | GDI | EWMF | BMP  
 :HCOPY:DEVIce:RESolution<1|2> 150|300  
 (only for PCL4 and HP deskjet formats)

**Connection**

The output channel to which the output device is connected is defined in this line.

DEVICE SETTINGS		
ITEM	SETTINGS DEVICE 1	SETTINGS DEVICE 2
Device/Language	HPGL	POSTSCR
Connection	GPIB1	LPT
GPIB Address	4	
Orientation	PORTRAIT	
Device Reset	OFF	
Formfeed	OFF	
Paperfeed	MANUAL	

CONNECTION	
COM1	
COM2	
LPT	
<input checked="" type="checkbox"/> GPIB1	
FILE	



By selection of the *FILE* channel, the printer output can be sent to a file. In this case, pressing *HARDCOPY START* results in a prompt for the entry of a file name.

If COM1 or COM2 is selected, recording must be set to *HARDCOPY (CONFIGURATION SETUP - GENERAL SETUP* submenu).

Output channels which, at first glance, do not appear to make sense, are also permitted because, in some cases, adapters are available which allow these devices to be connected to the interface. For example, adapters for RS232 ↔ IECBUS are available.

```
IEC/IEEE-bus command :HCOPY:DESTination<1|2>
                      'SYST:COMM:GPIB' | 'SYST:COMM:SER1' |
                      'SYST:COMM:SER2' | 'SYST:COMM:CENT' |
                      'MMEM'
```

```
Print to file:        :HCOPY:DESTination<1|2> "MMEM"
                      :MMEMory:NAME <file_name>
```

**GPIB Address**

The IEC Bus address of the output device is set in this line .

DEVICE SETTINGS		
ITEM	SETTINGS DEVICE 1	SETTINGS DEVICE 2
Device/Language Connection	HPGL GPIB1	POSTSCR LPT
GPIB Address	4	
Orientation	PORTRAIT	
Device Reset	OFF	
Formfeed	OFF	
Paperfeed	MANUAL	MANUAL

GPIB ADDRESS

4

Range: 0..30

The entry field in the GPIB line can only be opened when GPIB 1 was selected as an output channel in the connection line. Otherwise, this field is blank and can not be reached with the cursor keys.

```
IEC/IEEE-bus command :SYSTem:COMMunicate:GPIB:RDEvice<1|2>:ADDRESS 0...30
```

**Orientation**

In this line, the print format of the output page is set to either vertical (= *PORTRAIT*) or horizontal (= *LANDSCAPE*).

DEVICE SETTINGS		
ITEM	SETTINGS DEVICE 1	SETTINGS DEVICE 2
Device/Language Connection	HPGL GPIB1	POSTSCR LPT
GPIB Address	4	---
Orientation	PORTRAIT	LANDSCAPE
Device Reset	OFF	
Formfeed	OFF	
Paperfeed	MANUAL	

ORIENTATION

✓ PORTRAIT

LANDSCAPE

```
IEC/IEEE-bus command :HCOPY:PAGE:ORIENTATION<1|2> LANDscape | PORTRait
```

**Device Reset**

This line defines if the output device is to be reset (*DEVICE RESET ON*) before the actual print job is started or not (*DEVICE RESET OFF*). Resetting the output device causes, e.g., the loss of any settings which are made directly on the output device. For example, the definition of the drawing range for plotters or the print resolution for printers. The default setting at delivery is, therefore, *DEVICE RESET OFF*.

DEVICE SETTINGS		
ITEM	SETTINGS DEVICE 1	SETTINGS DEVICE 2
Device/Language Connection GPIB Address	HPGL GPIB1 4	POSTSCR LPT ---
Orientation	PORTRAIT	LANDSCAPE
Device Reset	OFF	<b>DEVICE RESET</b>
Formfeed	OFF	
Paperfeed	MANUAL	<input checked="" type="checkbox"/> OFF
		ON

IEC/IEEE-bus command :HCOPY:DEVIce:PRESet<1|2> ON | OFF

**Formfeed**

This line of the table determines whether a formfeed is made (*FORMFEED ON*) at the completion of the print job or not (*FORMFEED OFF*). The entry field in this line can only be selected when the output device permits a formfeed. Therefore, for plotters, it is set to OFF and cannot be changed.

DEVICE SETTINGS		
ITEM	SETTINGS DEVICE 1	SETTINGS DEVICE 2
Device/Language Connection GPIB Address	HPGL GPIB1 4	POSTSCR LPT ---
Orientation	PORTRAIT	LANDSCAPE
Device Reset	OFF	<b>FORMFEED</b>
Formfeed	OFF	
Paperfeed	MANUAL	<input checked="" type="checkbox"/> OFF
		ON

IEC/IEEE-bus command :HCOPY:ITEM:FFEEed<1|2>:STATE ON|OFF

**Paperfeed**

This line of the table determines which paper holder is to be used for the print job. The input field of this line can only be selected when the output device permits a selection between endless and single-sheet paper types. Therefore, for plotters it is set to OFF and cannot be changed.

DEVICE SETTINGS		
ITEM	SETTINGS DEVICE 1	SETTINGS DEVICE 2
Device/Language Connection GPIB Address	HPGL GPIB1 4	POSTSCR LPT ---
Orientation	PORTRAIT	LANDSCAPE
Device Reset	OFF	PAPERFEED
Formfeed	OFF	
Paperfeed	AUTO	<input checked="" type="checkbox"/> AUTO MANUAL

*MANUAL FEED* implies selection of the single-sheet mode so that, after pressing *HARDCOPY START*, the print job is stopped after each page and the user is prompted by the message

ERROR	
Paper out on device LPT (manual feed )?	
ABORT	CONTINUE

to load a new page in the output device. The print job is then either continued (CONTINUE selected) or stopped (ABORT selected).

IEC/IEEE-bus command :HCOPY:ITEM:PFEed<1|2>:STATE ON|OFF

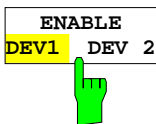

The *ENABLE DEV1 / DEV2* softkey determines the active output device. The default output device is DEVICE 1, i.e., all output takes place on DEVICE 1.

IEC/IEEE-bus command -- (the device is selected via the suffix <1|2> in HCOpy:IMMediate )

## Saving and Recalling Data Sets – *MEMORY* Key Group

The keys in the *MEMORY* group call the following functions:

- Functions for managing storage media (*CONFIG*). This includes among others functions listing files, formatting storage media, copying, and deleting/rename files.
- Save/recall functions for saving (*SAVE*) settings such as instrument configurations (measurement/display settings, etc.) and saving measurement results from working memory to permanent storage media, or for recalling (*RECALL*) stored data.

The FSE can internally store complete instrument settings with instrument configurations and measurement data in the form of data-sets. The data are stored on the internal hard disk or, if required, on an external disk. The hard-disk drive and the floppy-disk drive are assigned logical names as usual in PC applications:

Disk drive	A:
hard disk	C:

In addition to saving and recalling complete instrument settings, it is also possible to save/recall subsets of settings. Configuration data and measurement values are stored in separate files. These files have the same name as the data set but have a different extension. A data set therefore comprises several files which have the same name but different extensions (see Table 4-2).

When saving or recalling a data set, the subsets which are to be saved or recalled can be selected in the corresponding menus. This makes it easy to recall specific instrument settings.

When saving and recalling data via the *SAVE* and *RECALL* menus, data subsets are selected in a table in the sub-menu *SEL ITEMS TO SAVE/RECALL*. The relationship between the designations in the table and the contents of the data subsets is shown in Table 4-2

The saved data set files can be copied from one storage medium (e.g. drive C:) to another (e.g. drive A:) or to another directory using the functions found in the *MEMORY CONFIG* menu. However, do not change the file names and extensions when copying. Table 4-2 shows how extensions are assigned to data subsets..

Table 4-2 Assignment of extensions to data subsets

	Extension	Contents	Designation in the table SEL ITEMS TO SAVE/RECALL
Configuration data:	.SET	current settings of the measurement hardware and designation, if present	HARDWARE SETTINGS
	.LIN	data-point tables for the active limit lines	LINES
	.LIA	all defined limit lines	ALL LINES
	.CFG	current configuration of general instrument parameters	GENERAL SETUP
	.HCS	configuration for hardcopy output	HARDCOPY
	.TCI	tracking generator settings (only with option FSE-B8/9/10/11)	SOURCE CAL
	.TS1 .TS2	settings for source calibration (only with option FSE-B8/9/10/11)	SOURCE CAL
	.TC1 .TC2	correction data for source calibration (only with option FSE-B8/9/10/11)	SOURCE CAL
	.CL	used conversion loss (cvl) tables (only with option FSE-B21, External Mixer Output)	USED CVL TABLES
	.CLA	all conversion loss (cvl) tables (only with option FSE-B21, External Mixer Output)	ALL CVL TABLES
	.TS	activated transducer set	TRANSDUCER
	.TSA	all transducer sets	ALL TRANSDUCER
	.TF	transducer factor	TRANSDUCER
	.TFA	all transducer factors	ALL TRANSDUCER
	.COL	user-defined color settings	COLOR SETUP
Measurement results:	.TR1...4	measurement data trace 1 to trace 4	TRACE1...4

## Configuration of Memory – CONFIG Key

MEMORY CONFIG menu:

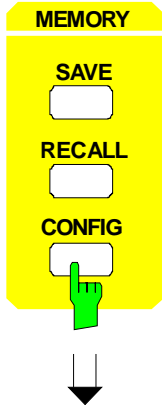

The CONFIG key opens a menu for managing storage media and files.

The *Drive Management* table displays the name and label of the storage medium as well as the free memory.

The *File Management* table displays the files in the current directory and indicates if any subdirectories are present.

If a directory name is selected, the FSE automatically changes to this directory. Selection of the entry '..' moves the FSE to the next highest directory level.

**Note:** It is not possible to change menus as long as a file operation is running.

DRIVE MANAGEMENT		
DRIVE:	HARDDISK C:	FREE MEM: 394:510.336

FILE MANAGEMENT				
PATH: C:\USER\CONFIG				
FILE NAME	DATE	TIME	SIZE	
..				
SETTING1.DRW	10.MAY.93	10:25:18	68.175 kB	
SETTING2.DRW	15.MAY.93	13:08:27	73.283 kB	
SETTING3.DRW	17.MAY.93	08:15:21	174.315 kB	
SETTING4.DRW	28.MAY.93	17:05:42	1.236812 MB	

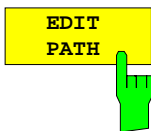

The *EDIT PATH* softkey activates the entry of the directory which will be used for subsequent file operations.

The new path is included in the *FILE MANAGEMENT* table.

IEC/IEEE-bus commands :MMEMory:MSIS 'C:\'  
 :MMEMory:CDIRectory 'C:\user\data'

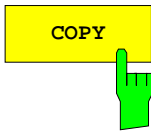

The *COPY* softkey activates the entry of the destination for the copy operation.

By prefixing a disk drive letter (e.g. C:), a file can also be copied to another storage medium. When the *ENTER* key is pressed, the selected files/directories are copied.

IEC/IEEE-bus command  
 :MMEMoRY:COpy 'C:\user\data\setup.cfg', 'A:'

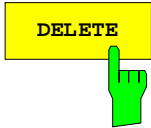

The *DELETE* softkey deletes the selected files. To prevent accidental deletion of data, confirmation by the user is requested.

IEC/IEEE-bus command :MMEMoRY:DELEte 'TEST01.HCP'  
 :MMEMoRY:RDIREctory 'C:\test'

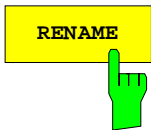

The *RENAME* softkey activates the entry of a new name for the selected file or directory.

IEC/IEEE-bus command  
 :MMEMoRY:MOVE 'TEST.CFG', 'SETUP.CFG'



The *MAKE DIRECTORY* softkey creates directories/sub-directories. The use of sub-directories is recommended as a way of structuring the storage medium to make it easier to navigate.

When entering a subdirectory, entry of an absolute path name (e.g.; "\USER\MEAS") as well as the path relative to the current directory (e.g., "..\MEAS") is possible.

IEC/IEEE-bus command :MMEMoRY:MDIREctory 'C:\user\data'

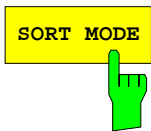

The *SORT MODE* softkey activates the selection of the sort criteria for the files listed in the *FILE MANAGEMENT* table.

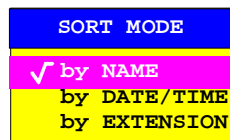

Directory names are at the top of the list after the entry for the next highest directory level ("..").

IEC/IEEE-bus command --

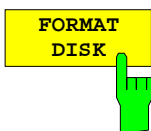

The *FORMAT DISK* softkey formats disks located in drive A:. To prevent accidental destruction of disks data, confirmation by the user is requested.

IEC/IEEE-bus command :MMEMoRY:INITialize <msus>

## Saving Data Sets – SAVE Key

The *SAVE* key activates a menu which contains all functions necessary for saving instrument data.

- Entry of the name of the data set which should be saved. Confirmation of the entry initiates a save operation to store the data set.

Data set names may contain both alphabetical and numeric characters, in the simplest case only numbers. The simplest example for the input of a data set name is illustrated by the following key strokes:

<SAVE> <1> <units key>

- Entry of the directory in which the data set should be saved
- Input of data set description
- Selection of the data subsets to be saved (sub-menu SEL ITEMS TO SAVE)
- Indication of all available data sets
- Deletion of all available data sets

MEMORY SAVE menu

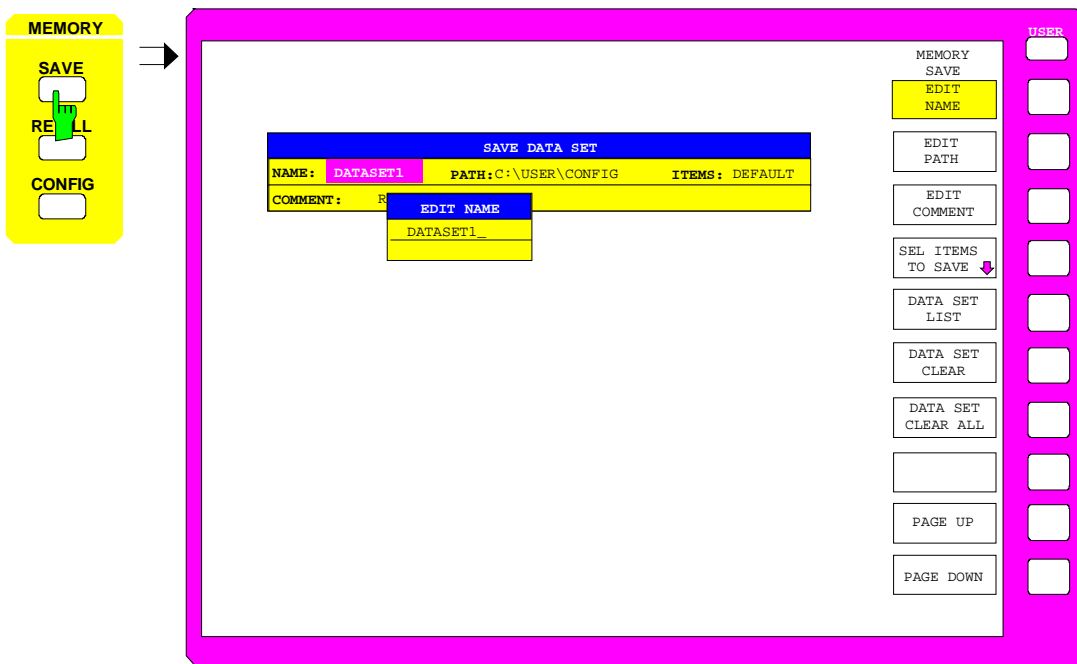

The *SAVE DATA SET* table shows the current settings regarding the data set:

<i>Name</i>	Name of data set
<i>Path</i>	Directory in which the data set will be saved
<i>Items</i>	Indicates whether the default selection of data subsets (DEFAULT) or a user-defined selection (SELECTED) will be saved
<i>Comment</i>	Comments about the data set

The *EDIT NAME* softkey for entering the name of the data set to be saved is activated automatically.



## Selecting the Data Set for Saving

MEMORY SAVE menu:

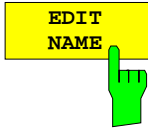

The *EDIT NAME* softkey activates the entry of the name of the data set to be saved.

Data entry is concluded by pressing one of the units keys which initiates a save operation to store the data set.

IEC/IEEE-bus command     :MMEMory:STORe:STATe 1,'test'

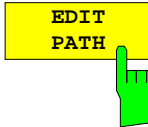

The *EDIT PATH* softkey activates the input of a directory name where the data sets are to be stored. Default path is c:\user\config.

IEC/IEEE-bus command     --

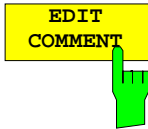

The *EDIT COMMENT* softkey activates the entry of comments for the current data set. A total of 60 characters are available for this purpose.

IEC/IEEE-bus command     :MMEMory:COMMeNt <string>



The *DATA SET LIST* softkey opens the *DATA SET LIST/CONTENTS* table. The *DATA SET CLEAR* and *DATA SET CLEAR ALL* softkeys are also displayed.

The *DATA SET LIST* column lists all the data sets which are stored in the selected directory.

The *CONTENTS* and *COMMENT* lines in the *DATA SET CONTENTS* column indicate the saved data subsets and the comments for the currently selected data set.

IEC/IEEE-bus command     --

**Note:** *The current instrument configuration can be easily stored under the name of an existing data set:*

- *Press a units key after selecting a data set*

*The name and the selection of the data subsets for the currently selected data set will be placed in the SAVE DATA SET table. The DATA SET LIST table is closed and, instead, the entry field for the EDIT NAME function with the name of the selected data set is opened.*

- *Press a units key.*

*The current instrument configuration is saved as a data set under this name.*

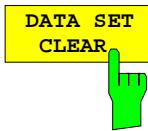

The *DATA SET CLEAR* softkey clears the marked data set.

IEC/IEEE-bus command :MMEMoRY:CLEAr:STATe 1, 'test'

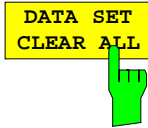

The *DATA SET CLEAR ALL* softkey deletes all data sets in the current directory.

To prevent all the data sets from being accidentally lost, confirmation from the user is required before actual clearing takes place.

IEC/IEEE-bus command :MMEMoRY:CLEAr:ALL

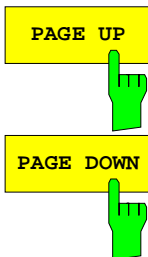

The *PAGE UP* or *PAGE DOWN* softkey sets the *DATA SET LIST* table to the next or previous page.

### Selecting the Data subset for Storage

MEMORY SAVE-SELECT ITEMS TO SAVE sub-menu:

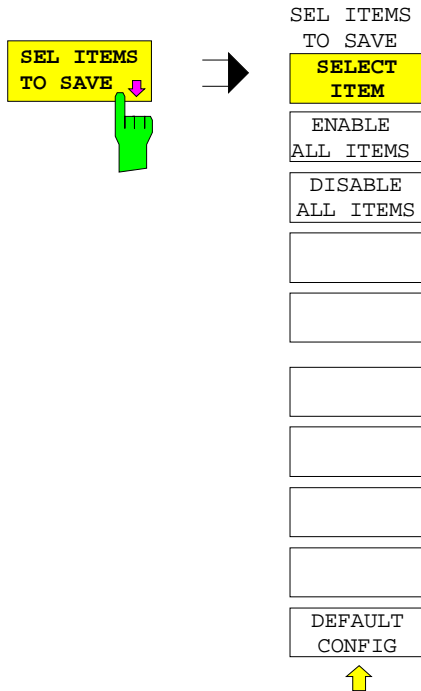

The *SEL ITEMS TO SAVE* softkey opens a sub-menu for selection of the data subsets.

The *ITEMS TO SAVE* table displays the selectable data subsets:

ITEMS TO SAVE	
GENERAL SETUP	✓ COLOR SETUP
✓ HW-SETTINGS	✓ HARDCOPY
TRACE 1	
TRACE 2	MACROS
TRACE 3	
TRACE 4	
✓ ACTIVE LINES	ACTIVE TRANSDUCER
ALL LINES	ALL TRANSDUCER
USED CVL TABLES	
ALL CVL TABLES	

- General Setup* current configuration of general instrument parameters
- HW-Settings* current measurement hardware settings
- Trace1...4* measurement data trace 1 to trace 4
- Active Lines* active limit lines
- All Lines* all limit lines
- Used CVL Tables* activated conversion loss tables
- All CVL Tables* all conversion loss tables
- Color Setup* user-defined color settings
- Hardcopy Setup* configuration for hardcopy output
- Macros* macros
- Active Transducer* active transducer
- All Transducer* all transducer

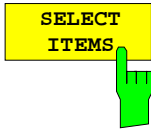

The *SELECT ITEMS* softkey moves the selection bar to the first line, left column of the table.

IEC/IEEE-bus commands

```
:MMEMory:SElect[:ITEM]:GSEtUp ON|OFF
:MMEMory:SElect[:ITEM]:HWSEttings ON|OFF
:MMEMory:SElect[:ITEM]:TRACe<1...4> ON|OFF
:MMEMory:SElect[:ITEM]:LINES[:ACTIve] ON|OFF
:MMEMory:SElect[:ITEM]:LINES:ALL ON|OFF
:MMEMory:SElect[:ITEM]:CSEtUp ON|OFF
:MMEMory:SElect[:ITEM]:HCOPY ON|OFF
:MMEMory:SElect[:ITEM]:CVL[:ACTIve] ON | OFF
:MMEMory:SElect[:ITEM]:CVL:ALL ON | OFF
:MMEMory:SElect[:ITEM]:SCData ON | OFF
:MMEMory:SElect[:ITEM]:MACROs ON|OFF
:MMEMory:SElect[:ITEM]:TRANSDUCER ON|OFF
:MMEMory:SElect[:ITEM]:TRANSDUCER:ALL ON|OFF
```

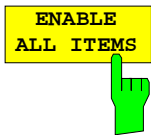

The *ENABLE ALL ITEMS* softkey marks all entries in the *ITEMS TO SAVE* table.

IEC/IEEE-bus command     :MMEMory:SElect[:ITEM]:ALL



The *DISABLE ALL ITEMS* softkey unmarks all entries in the *ITEMS TO SAVE* table.

IEC/IEEE-bus command     :MMEMory:SElect[:ITEM]:NONE

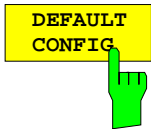

The *DEFAULT CONFIG* softkey establishes the default selection of the data subset to be saved and outputs *DEFAULT* in the *ITEMS* field of the *SAVE DATA SET* table.

IEC/IEEE-bus command     :MMEMory:SElect[:ITEM]:DEFault

## Recalling of Data Sets – *RECALL* Key

The *RECALL* key activates a menu which contains all functions necessary for recalling data sets.

- Entry of the name of the data set which should be recalled. Confirmation of the entry initiates a load operation to recall the data set.
- Entry of the directory in which the data set is stored
- Display of data set description
- Selection of a data set which will be automatically loaded upon power-up
- Indication of all available data sets
- Deletion of all available data sets
- Selection of the data subsets which should be loaded (configurations, measurement and calibration data, sub-menu *SEL ITEMS TO RECALL*)

Any settings not restored when data subsets are loaded will remain unchanged in the instrument. During recall operations, the FSE recognises which data subsets are present in the recalled data set and offers only the corresponding settings for selection in the *SELECT ITEM* sub-menu.

A new instrument data set can be easily constructed from several existing data sets: the desired data subsets are selected and recalled out of various data sets in several *RECALL* operations. When the desired configuration is completed, the new data set can be saved under a new name.

*MEMORY RECALL* menu:



The *RECALL DATA SET* table shows the current settings regarding the data set:

<i>Name</i>	Name of data set
<i>Path</i>	Directory in which the data set is located
<i>Items</i>	Indicates whether the default selection of data subsets (DEFAULT) or a user-defined selection (SELECTED) will be loaded
<i>Comment</i>	Comments about the data set

The *EDIT NAME* softkey for entering the name of the data set to be loaded is activated automatically.

### Selecting the Data Set for Recalling

MEMORY RECALL menu:

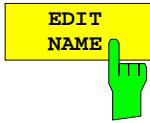

The *EDIT NAME* softkey activates the entry of a data set name. The data input is terminated by pressing one of the units keys which simultaneously initiates the data set recall operation.

IEC/IEEE-bus command :MMEemory:LOAD:STATe 1, 'A:test'

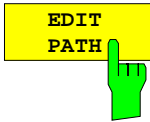

The *EDIT PATH* softkey activates the entry of a directory name in which the data set is located. Default path is c:\user\config.

IEC/IEEE-bus command --

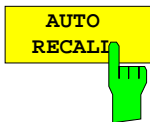

The *AUTO RECALL* softkey activates the selection of a data set which will be automatically recalled when the instrument is powered up. The *DATA SET LIST/CONTENT* table is opened to make the selection (analogous to *DATA SET LIST*).

IEC/IEEE-bus command :MMEemory:LOAD:AUTO 1, 'C:\user\data\auto'

DATA SET LIST	AUTO RECALL SET CONTENT
DATASET1	CONTENTS
DATASET2	GENERAL SETUP ✓ COLOR SETUP
DATASET3	✓ HW-SETTINGS ✓ HARDCOPY
	TRACE 1
	TRACE 2
	TRACE 3
	TRACE 4
	MACROS
	✓ LINES ✓ TRANSDUCER
	CVL TABLES
	COMMENT
	GSM_MASK

The *DATA SET LIST* column displays all the data sets in the selected directory.

The *CONTENTS* and *COMMENT* lines in the *AUTO RECALL CONTENTS* column indicate the saved data subsets and the comments for the currently selected data set.

In addition to the data sets saved by the user, the data set *FACTORY*, which contains the settings of the instrument before it was last switched off (Standby), is always included.

If a data set other than *FACTORY* is chosen the data subsets in the selected data set that are available are recalled when the FSE is powered up. The data subsets which are not in this data set are taken from the *FACTORY* data set.

**Note:** The selected data set is also loaded on *PRESET* if *AUTO RECALL* is active. The preset settings can then be configured as required.

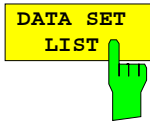

see Chapter "Saving Data Sets"

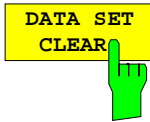

see Chapter "Saving Data Sets"



see Chapter "Saving Data Sets"

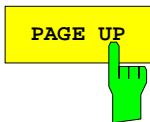

The *PAGE UP* or *PAGE DOWN* softkey sets the *DATA SET LIST* table to the next or previous page.

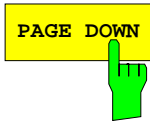

**Building a Data Set**

MEMORY RECALL-SELECT ITEMS TO RECALL sub-menu:

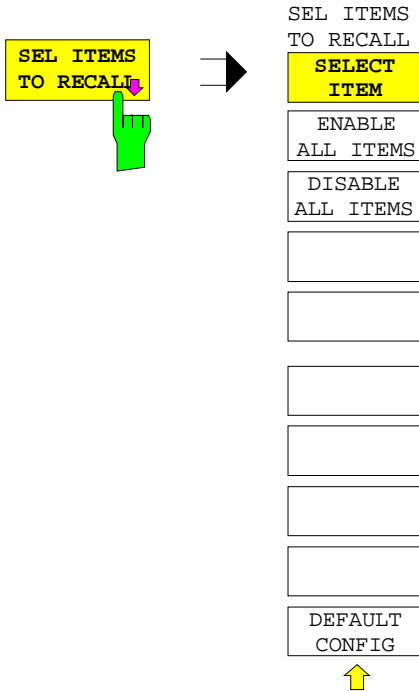

The *SEL ITEMS TO RECALL* softkey opens a sub-menu to select data subsets.

The *ITEMS TO RECALL* table displays the selectable data subsets:

ITEMS TO RECALL	
GENERAL SETUP	✓ COLOR SETUP
✓ HW-SETTINGS	✓ HARDCOPY SETUP
TRACE 1	MACROS
TRACE 2	
TRACE 3	
TRACE 4	
✓ LINES	✓ TRANSDUCER
CVL TABLES	

- General Setup* current configuration of general instrument parameters
- HW-Settings* current measurement hardware settings
- Trace 1...4* measurement data trace 1 to trace 4
- Lines* data point tables for the active limit lines
- CVL Tables* conversion loss tables
- Color Setup* user-defined color settings
- Hardcopy Setup* configuration for hardcopy output
- Macros* macros
- Transducer* transducer factor, transducer set



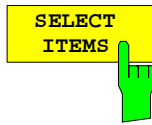

The *SELECT ITEMS* softkey activates the *ITEMS TO RECALL* table and sets the selection bar to the first line, left column of the table.

IEC/IEEE-bus command     see "Selecting the Data subset for Storage"

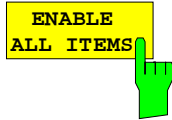

The *ENABLE ALL ITEMS* softkey marks all entries in the *ITEMS TO RECALL* table.

IEC/IEEE-bus command     :MMEMory:SElect[:ITEM]:ALL

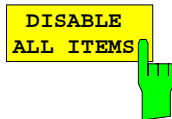

The *DISABLE ALL ITEMS* softkey unmarks all entries in the *ITEMS TO RECALL* table.

IEC/IEEE-bus command     :MMEMory:SElect[:ITEM]:NONE

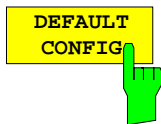

The *DEFAULT CONFIG* softkey establishes the default selection of the data subset to be recalled and outputs *DEFAULT* in the *ITEMS* field of the *RECALL DATA SET* table.

IEC/IEEE-bus command     :MMEMory:SElect[:ITEM]:DEfault

## Macros – USER Key

The FSE menus are so designed that the analyzer can be easily applied to most of the usual measurement tasks with a minimum number of key operations. However, the *USER* menu also permits a tailored adaptation of any necessary setup and measurement functions needed for special applications. Here, a sequence of key operations, which may occur repeatedly, can be listed in the *USER* menu as a key macro, then stored in memory and recalled as required by the application.

### Fundamentals

Macros are defined as arbitrary key sequences which need to be defined only once and then can be recalled as often as desired. Through the use of macros, often-needed measurement functions or instrument setups, which may require a large number of key operations, can be easily performed. The writing of macros is possible only under manual control. Macro generation is not possible under remote control (e.g. via the IEC Bus interface) and when using a mouse.

A total of 7 different macros can be programmed and assigned to the individual softkeys of the *USER* menu. Each macro has a title (arbitrarily defined by the user ) which is also used as a label for the corresponding softkey. To indicate that a macro has not yet been programmed, the softkey label appears in parenthesis (e.g. (MACRO 1)). After a key-sequence macro has been defined, the parenthesis are removed and the softkey is replaced by the title specified by the user.

A macro is executed by pressing the corresponding softkey.

During execution of macros, the key actions are repeated in exactly the **same sequence** as they were programmed. The sequential execution of a macro may be interrupted by using the PAUSE instruction. As soon as a macro is interrupted, adjustments on the Unit Under Test (UUT) may be made, etc. The interrupted macro is allowed to continue by pressing *CONTINUE* in the message window and is aborted by pressing ABORT.

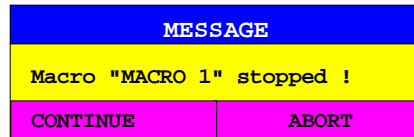

A running macro can be aborted by pressing the *LOCAL* key. At this time, the following message is displayed:

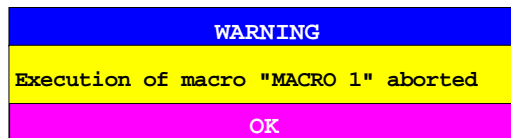

During the time a macro is executing, manual operations on the instrument are not possible, and the softkey panel is disabled. After interruption or conclusion of a macro, the applicable softkey panel is enabled (i.e., menu state at the conclusion of the macro).

## Starting Macros

USER menu

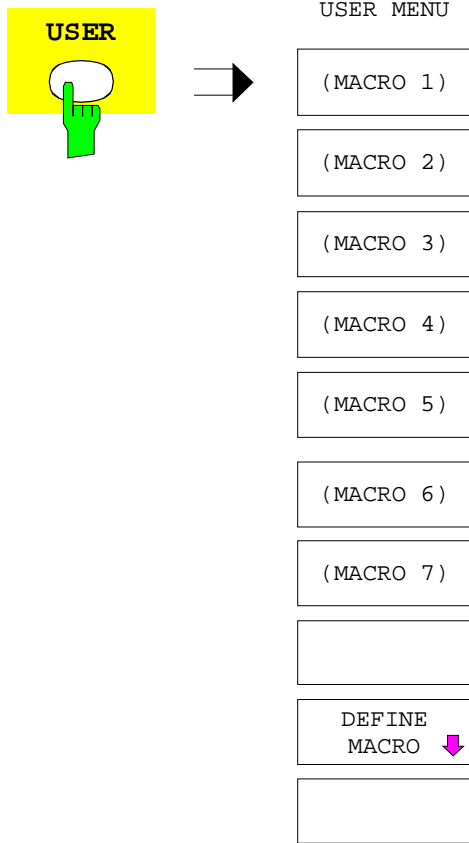

The USER key opens a menu for selection and starting of macros.

The macros can be defined in the *DEFINE MACRO* submenu.

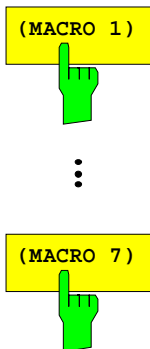

The *MACRO 1* to *7* softkeys start the execution of the macros.  
IEC/IEEE-bus command --

## Defining Macros

In the *DEFINE MACRO* menu, all necessary softkeys needed for macro management are available. Included are functions for starting and ending macro programming, editing of a macro title, etc.

### USER DEFINE MACRO menu

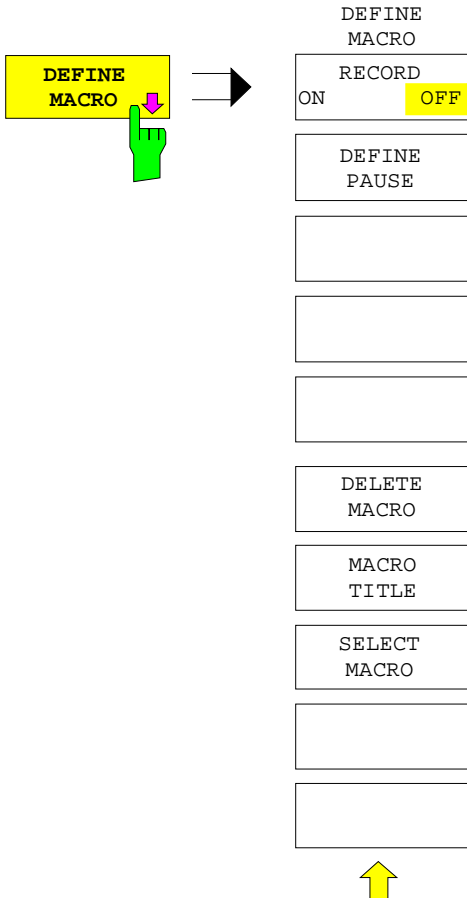

The *DEFINE MACRO* softkey calls the sub-menu to define the macros.

The *SELECT MACRO* softkey is active and opens the box to select the macro to be edited. In case no selection is made, *MACRO 1* is automatically selected.

IEC/IEEE-bus command --

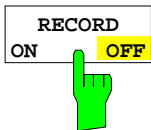

The *RECORD ON/OFF* starts or stops the recording of the macro.

**ON** All key actions are recorded until the softkey is changed to *OFF*. To indicate that macro record is enabled, the enhancement label **MAC** is displayed.

The number of actions which can be stored in a macro is limited. If the limit is exceeded, the error message "Macro too long. Recording aborted" is output and the recording operation is aborted, however, the actions already recorded do remain stored.

**OFF** The recording is stopped. The key actions are stored under the macro chosen by the *SELECT MACRO* softkey.

IEC/IEEE-bus command --

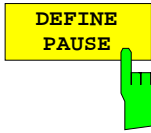

The *DEFINE PAUSE* softkey inserts a pause instruction into the macro sequence which is being recorded. A running macro will pause when it reaches this instruction, at which point settings on the unit under test could for example be made. *CONTINUE* in the message window is used to continue the macro execution.

IEC/IEEE-bus command --

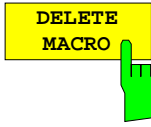

The *DELETE MACRO* softkey deletes the macro which was previously selected by the *SELECT MACRO* softkey. The softkey of the deleted title now carries its default label (*MACRO X*, X = macro number)

IEC/IEEE-bus command --

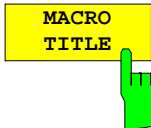

The *MACRO TITLE* softkey activates the entry of the title for the selected macro.

Because the macro title is used for labelling the corresponding softkey, a maximum of only 20 characters is allowed. All text after the 10<sup>th</sup> character is written to the second line. However, entering the character @ forces a new line at any point in the softkey title.

IEC/IEEE-bus command --

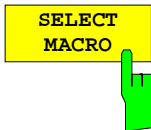

The *SELECT MACRO* softkey open the selection box with a list of all 7 macros. All softkey functions of this menu are related to this macro.

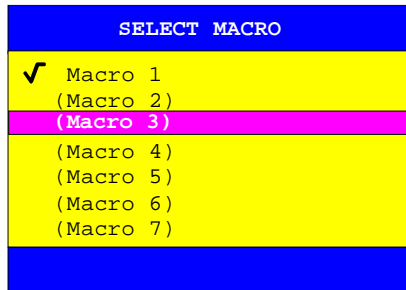

IEC/IEEE-bus command --

# Analyzer Mode

## Frequency and Span Selection – FREQUENCY Key Group

The *FREQUENCY* key group is used to specify the frequency axis of the active measurement window. The frequency axis can be defined either by the start and stop frequency or by the center frequency and span. For the case when two measurement windows (*SPLIT-SCREEN*) are displayed simultaneously, data entered are always related to the window selected in the *SYSTEM-DISPLAY* menu.

When one of the keys *CENTER*, *SPAN*, *START* or *STOP* is pressed, its value can be specified in an entry window. At the same time, a softkey menu appears, which allows selecting the optional parameters.

### Start Frequency – START Key

*FREQUENCY* – *START* menu:

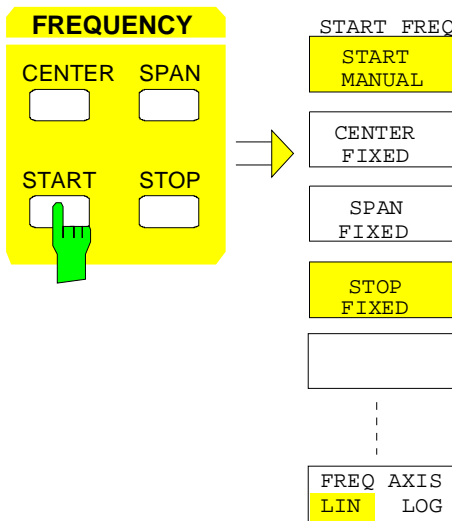

The *START* key opens a menu which displays the various options for setting the start frequency of the sweep. The *START MANUAL* softkey is automatically active and opens the entry window for manual input of the start frequency. At the same time, the coupling of the parameters is set to *STOP FIXED*

The *STOP FIXED*, *SPAN FIXED* and *CENTER FIXED* softkeys are mutually exclusive selection switches. Only one of these switches may be active at any one time. The frequency coupling selected by the softkeys defines which of the dependent parameters stop frequency, center frequency and span is to remain constant when a change in the start frequency is made.

The *FREQ AXIS LIN/LOG* softkey switches between linear and logarithmic scaling of the frequency axis.

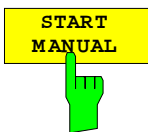

The *START MANUAL* softkey activates manual entry of the start frequency.

The allowed range of values for the start frequency is:

$$0 \text{ Hz} \leq f_{\text{start}} \leq f_{\text{max}} - \text{minspan}/2$$

$f_{\text{start}}$  start frequency  
 $\text{minspan}$  smallest selectable span)  
 $f_{\text{max}}$  max. frequency

IEC/IEEE-bus command : [SENSE<1 | 2>:]FREQuency:STARt 20 MHz

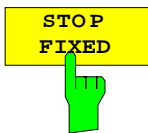

If the *STOP FIXED* key is active, the stop frequency remains constant when the start frequency is changed. The center frequency is adjusted to the new frequency range. *STOP FIXED* coupling is the default setting.

IEC/IEEE-bus command : [SENSE<1 | 2>:]FREq:STARt:LINK STOP

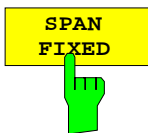

If the *SPAN FIXED* softkey is active, the span remains constant when the start frequency is changed. The stop frequency is adjusted to the new frequency range.

IEC/IEEE-bus command : [SENSE<1 | 2>:]FREq:STARt:LINK SPAN

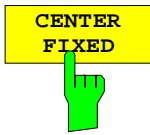

If the *CENTER FIXED* softkey is active, the center frequency remains constant when the start frequency is changed. The stop frequency is adjusted to the new frequency range.

IEC/IEEE-bus command : [SENSE<1|2>:]FREQ:START:LINK CENTER



The *FREQ AXIS LIN/LOG* softkey switches between linear and logarithmic scales on the frequency axis.

When the log scale is used, the following restrictions apply:

- For the start/stop frequency ratio the following holds:

$$\frac{\text{Stopfrequency}}{\text{Startfrequency}} \geq 1.4$$

At ratios below 1.4, a linear frequency scale is automatically selected.

- Up to five decades can be set.

$$\frac{\text{Stopfrequency}}{\text{Startfrequency}} \leq 10^5$$

When the start or stop frequency is changed, the stop or start frequency is adapted to the settable range, as required.

- A frequency offset is not allowed.
- The *CHANNEL POWER*, *C/N*, *C/N0*, *ADJACENT CHAN POWER* and *OCCUPIED PWR BANDW* measurements are disabled.

**Note:** *The function of a limit line is influenced by the FREQ AXIS LIN/LOG setting at the time of the definition.*

*Limit lines are entered as tabulated values (level and frequency). Most regulations and standards prescribe the linking of values by straight lines both for the linear and logarithmic display. When the limit line is defined with the desired frequency scale selected, this is automatically taken into account (linear interpolation).*

*To be able to use the correct limit values among the tabulated values after a scale switchover, the limit line is recalculated after the switchover.*

IEC/IEEE-bus command : [SENSE<1|2>:]SWEp:SPACing LIN | LOG

### Stop Frequency – STOP Key

FREQUENCY – STOP menu:

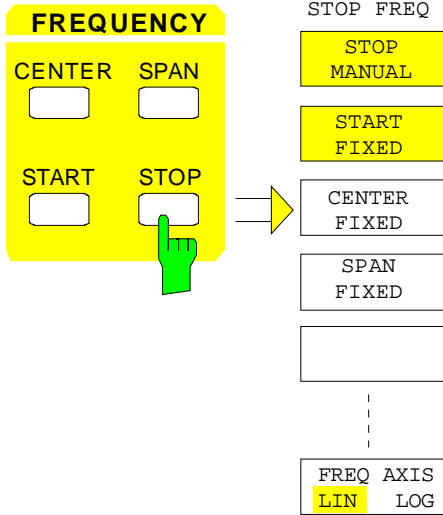

The *STOP* key opens a menu which displays the various options for setting the stop frequency of the sweep.

The *STOP MANUAL* softkey is automatically active and opens the entry window for manual input of the stop frequency. At the same time, parameter coupling is set to *START FIXED*.

The *START FIXED*, *CENTER FIXED* and *SPAN FIXED* softkeys are mutually exclusive selection switches. Only one switch can be active at any one time. The softkeys are used to select the frequency coupling. The frequency coupling defines which of the dependent parameters start frequency, center frequency or span is to remain constant when the stop frequency is changed.



The *STOP MANUAL* softkey activates the manual entry window for the stop frequency.

The allowed range of values for the stop frequency is:

$$\text{minspan} \leq f_{\text{stop}} \leq f_{\text{max}}$$

$f_{\text{stop}}$	stop frequency
$\text{minspan}$	smallest selectable span (10Hz)
$f_{\text{max}}$	max. frequency

IEC/IEEE-bus command : [SENSE<1|2>:]FREQuency:STOP 13 GHz

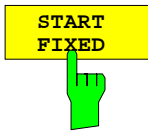

If the *START FIXED* softkey is active, the start frequency remains constant when the stop frequency is changed. The center frequency is adjusted to the new frequency range. The *START FIXED* coupling is the default setting.

IEC/IEEE-bus command : [SENSE<1|2>:]FREQ:STOP:LINK START



If the *CENTER FIXED* softkey is active, the center frequency remains constant when the stop frequency is changed. The start frequency is adjusted to the new frequency range.

IEC/IEEE-bus command : [SENSE<1|2>:]FREQ:STOP:LINK CENTER

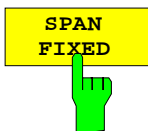

If the *SPAN FIXED* softkey is active, the span remains constant when the stop frequency is changed. The start frequency is adjusted to the new frequency range.

IEC/IEEE-bus command : [SENSE<1|2>:]FREQ:STOP:LINK SPAN



The *FREQ AXIS LIN/LOG* softkey switches between linear and logarithmic scales on the frequency axis (see *START* key).

IEC/IEEE-bus command : [SENSE<1|2>:]SWEep:SPACing LIN | LOG



### Center Frequency – CENTER Key

FREQUENCY – CENTER menu:

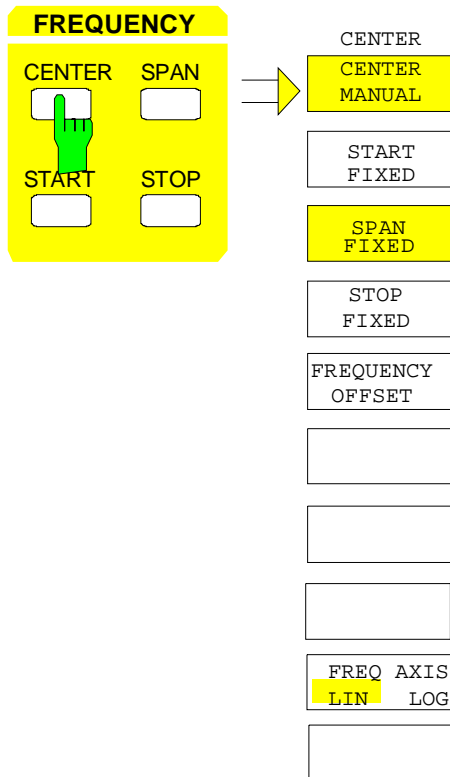

The *CENTER* softkey opens a menu which displays the various options for setting the center frequency of the sweep.

The *CENTER MANUAL* softkey is automatically active and opens the entry window for manual input of the center frequency. At the same time, the coupling of the parameters is set to *SPAN FIXED*.

The *START FIXED*, *STOP FIXED* and *SPAN FIXED* softkeys are mutually exclusive selection switches. Only one switch can be active at any one time. The softkeys are used to select the frequency coupling. The frequency coupling defines which of the dependent parameters start frequency, stop frequency or span remains constant when the center frequency is changed.



The *CENTER MANUAL* softkey opens the entry window for entering the center frequency.

The entry range for the center frequency is:

for the frequency domain (span > 0):

$$0 \text{ Hz} \leq f_{\text{center}} \leq f_{\text{max}} - \text{minspan}/2$$

and for the time domain (span = 0)

$$0 \text{ Hz} \leq f_{\text{center}} \leq f_{\text{max}}$$

- $f_{\text{center}}$  center frequency
- $\text{minspan}$  smallest selectable span (10Hz)
- $f_{\text{max}}$  max. frequency

IEC/IEEE-bus command : [SENSE<1 | 2>:]FREQUENCY:CENTER 1.3 GHz

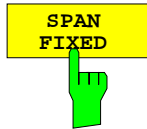

If the *SPAN FIXED* softkey is active, the span remains constant when the center frequency is changed. The start and stop frequency are adjusted to the new frequency range. *SPAN FIXED* coupling is the default setting.

IEC/IEEE-bus command : [SENSE<1|2>:]FREQ:CENTer:LINK SPAN

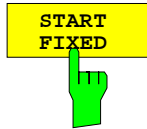

If the *START FIXED* softkey is active, the start frequency remains constant when the center frequency is changed. The span is adjusted to the new frequency range.

IEC/IEEE-bus command : [SENSE<1|2>:]FREQ:CENTer:LINK START

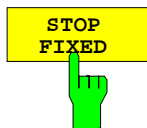

If the *STOP FIXED* softkey is active, the stop frequency remains constant when the center frequency is changed. The span is adjusted to the new frequency range.

IEC/IEEE-bus command : [SENSE<1|2>:]FREQ:CENTer:LINK STOP

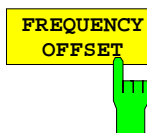

The *FREQUENCY OFFSET* softkey activates the entry of a straight frequency offset which is added to the frequency axis. The offset range is -100 GHz to 100 GHz. The default setting is 0 Hz.

IEC/IEEE-bus command : [SENSE<1|2>:]FREQ:OFFSet 10 GHz



The *FREQ AXIS LIN/LOG* softkey switches between linear and logarithmic scales on the frequency axis (see *START* key).

IEC/IEEE-bus command : [SENSE<1|2>:]SWEp:SPACing LIN | LOG

### Center Frequency Step Size

The *STEP* key in the *DATA VARIATION* key group opens a menu for setting the step size of the center frequency. The step size can be coupled to the span (frequency domain) or the resolution bandwidth (time domain) or it can be manually set to a fixed value.

In order to change the step size, the entry window for the center frequency must already be active. After pressing the *STEP* key, the *CENTER STEP* menu appears. The softkeys are presented according to the selected domain (frequency or time).

Only one of the menu softkeys can be activated at any one time.

Control is returned to the *FREQUENCY CENTER* menu via the menu key .

*DATA VARIATION - STEP* menu      for span ≠ 0      for span = 0

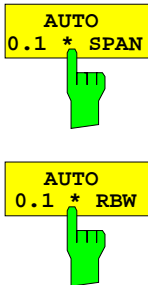
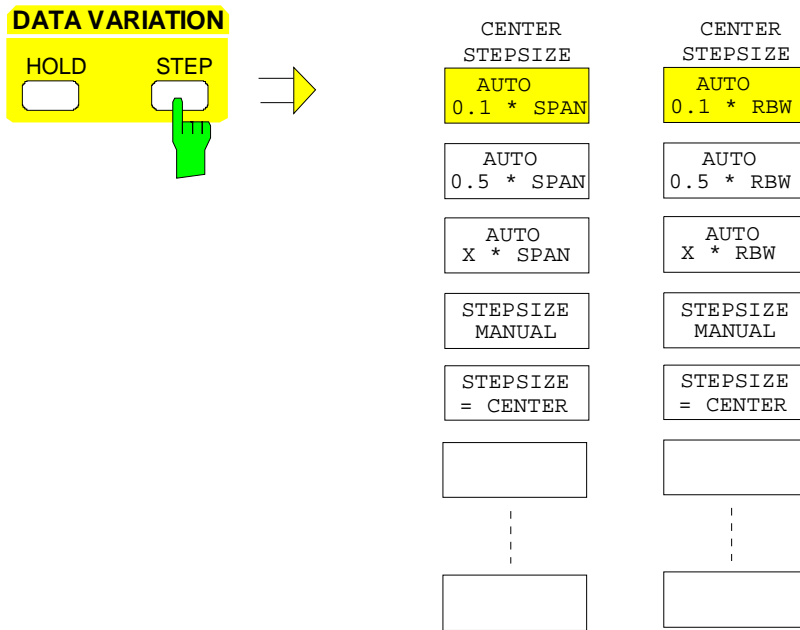

Frequency domain: The *AUTO 0.1 \* SPAN* softkey sets the step size for center frequency entry to 10% of the span.

IEC/IEEE-bus command

```
:[SENSe<1 | 2>:]FREQUency:CENTer:STEP:LINK SPAN;  
:[SENSe<1 | 2>:]FREQUency:CENTer:STEP:LINK:FACTOR 10PCT
```

Time domain: The *AUTO 0.1 \* RBW* softkey sets the step size of the center frequency entry to 10% of the resolution bandwidth

IEC/IEEE-bus command

```
:[SENSe<1 | 2>:]FREQUency:CENTer:STEP:LINK RBW;  
:[SENSe<1 | 2>:]FREQUency:CENTer:STEP:LINK:FACTOR 10PCT
```

*AUTO 0.1 \* RBW* is the default setting.

AUTO  
0.5 \* SPAN



Frequency domain: The *AUTO 0.5 \* SPAN* softkey sets the step size for center frequency entry to 50% of the span.

IEC/IEEE-bus command

: [SENSE<1 | 2>:]FREQUENCY:CENTER:STEP:LINK SPAN;  
: [SENSE<1 | 2>:]FREQUENCY:CENTER:STEP:LINK:FACTOR 50PCT

AUTO  
0.5 \* RBW



Time domain: The *AUTO 0.5 \* RBW* softkey sets the step size of the center frequency entry to 50% of the resolution bandwidth

IEC/IEEE-bus command

: [SENSE<1 | 2>:]FREQUENCY:CENTER:STEP:LINK RBW;  
: [SENSE<1 | 2>:]FREQUENCY:CENTER:STEP:LINK:FACTOR 50PCT

AUTO  
X \* SPAN



Frequency domain: The *AUTO X \* SPAN* softkey activates the entry of the factor defining the center frequency step size as a % of span.

IEC/IEEE-bus command see *AUTO 0.5 \* SPAN*

AUTO  
X \* RBW



Time domain: The *AUTO X \* RBW* softkey activates the entry of the factor defining the center frequency step size as a % of the resolution bandwidth.

IEC/IEEE-bus command see *AUTO 0.5 \* RBW*

Values between 1 and 100% in steps of 1% are acceptable. The default setting is 10%.

STEPSIZE  
MANUAL



The *STEPSIZE MANUAL* softkey activates the entry window for the input of a fixed step size.

IEC/IEEE-bus command

: [SENSE<1 | 2>:]FREQUENCY:CENTER:STEP 1.3 GHz

STEPSIZE  
= CENTER



The *STEPSIZE = CENTER* softkey sets the step size coupling to *MANUAL* and the step size to the center frequency. This function is especially useful when measuring harmonics, because, when the center frequency is entered, each *STEP* key stroke selects the center frequency of the next harmonic.

IEC/IEEE-bus command --

### Frequency Span – SPAN Key

FREQUENCY – SPAN menu:

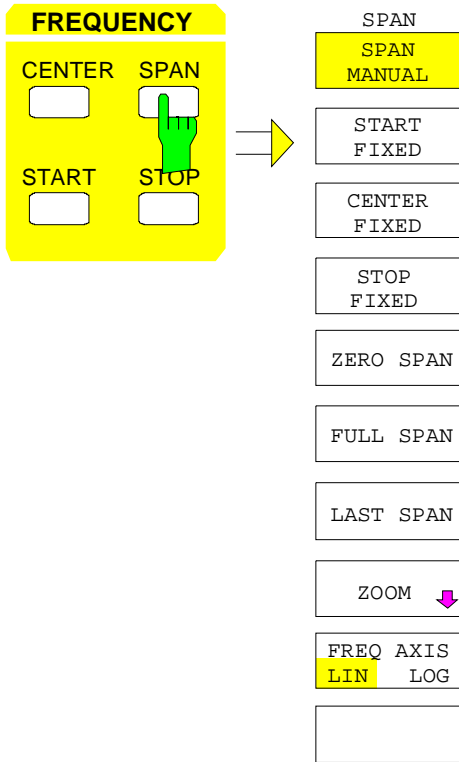

The *SPAN* key opens a menu for setting the sweep span.

The *SPAN MANUAL* softkey is automatically active and opens the entry window for manual input of the span. At the same time, the parameter coupling is set to *CENTER FIXED*.

The *START FIXED*, *CENTER FIXED* and *STOP FIXED* softkeys are mutually exclusive selection switches. Only one switch can be active at any one time. The frequency coupling is selected with these softkeys. The frequency coupling defines which of the dependent parameters start frequency, center frequency or stop frequency is to remain constant when the span is changed

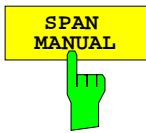

The *SPAN MANUAL* softkey activates the manual entry of the span.

The span entry range is for:  
time domain (span = 0):

0 Hz

frequency domain (span > 0):

$$\text{minspan} \leq f_{\text{span}} \leq f_{\text{max}}$$

$f_{\text{span}}$     frequency span  
 $\text{minspan}$     smallest selectable span (10Hz)  
 $f_{\text{max}}$       max. frequency

IEC/IEEE-bus command    : [SENSe<1 | 2>:]FREQuency:SPAN 10MHZ

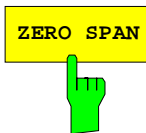

The *ZERO SPAN* softkey sets the span value to 0 Hz. The x axis becomes the time axis. The axis labelling corresponds to the sweep time (on the left, 0 ms, on the right, the current sweep time (SWT)).

IEC/IEEE-bus command    : [SENSe<1 | 2>:]FREQuency:SPAN 0HZ

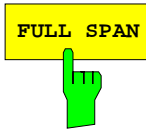

The *FULL SPAN* softkey sets the span value to the maximum span of the FSE.

IEC/IEEE-bus command : [SENSe<1|2>:]FREQuency:SPAN:FULL

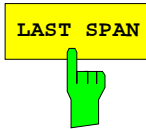

The *LAST SPAN* softkey restores the previous setting if the span has been changed. This makes it possible to switch over between an overview measurement (*FULL SPAN*) and a detailed measurement (manually set center frequency and span).

The *FULL SPAN* softkey modifies the center frequency as well as the selected span. The *LAST SPAN* softkey cancels this change.

IEC/IEEE-bus command --

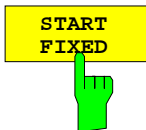

If the *START FIXED* softkey is activated, the start frequency remains constant when the span is changed. The center and stop frequency are adjusted to the new span.

IEC/IEEE-bus command : [SENSe<1|2>:]FREQ:SPAN:LINK START



If the *CENTER FIXED* softkey is activated, the center frequency remains constant when the span is changed. The center and stop frequency are adjusted to the new span. The *CENTER FIXED* coupling is the default setting.

IEC/IEEE-bus command : [SENSe<1|2>:]FREQ:SPAN:LINK CENTER



If the *STOP FIXED* softkey is activated, the stop frequency remains constant when the span is changed. The center and start frequency are adjusted to the new span.

IEC/IEEE-bus command : [SENSe<1|2>:]FREQ:SPAN:LINK STOP



The *FREQ AXIS LIN/LOG* softkey switches between linear and logarithmic scales on the frequency axis (see *START* key).

IEC/IEEE-bus command : [SENSe<1|2>:]SWEp:SPACing LIN | LOG

## Display Zoom

FREQUENCY SPAN- ZOOM submenu:

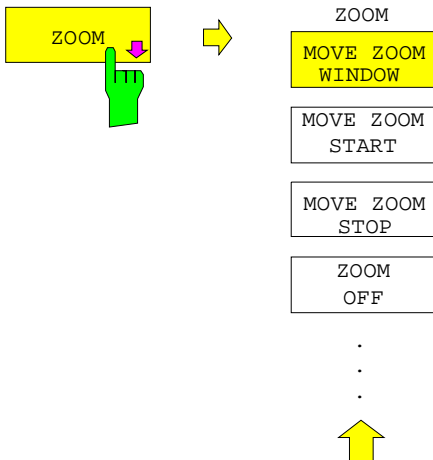

The **ZOOM** softkey activates the zoom mode and opens a sub-menu to define the zoom span.

Two frequency lines, which show and define the frequency range to be zoomed, appear in the active measurement window when the zoom mode is switched on. The default setting is a zoom span of 10% to the left and 10% to the right of the center frequency. The zoomed display is shown in the second measurement window.

The settings for the second measurement window are taken from the original window. The second measurement window thus becomes the active measurement window and its settings can now be changed.

If only one window is active when the zoom function is selected, **SPLIT SCREEN** mode is automatically switched on.

The zoom span can be edited by using the softkeys of the sub-menu to change the position of the frequency lines.

The softkey **ZOOM OFF** switches off the zoom.

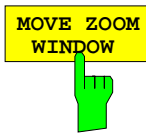

The **MOVE ZOOM WINDOW** softkey shifts the whole zoom window. The window can be shifted until the upper frequency line reaches the stop frequency or the lower frequency line reaches the start frequency of the original window.

IEC/IEEE-bus commands

```
:DISPlay[:WINDow<1|2>]:TRACe<1..4>:X[:SCALe]:ZOOM ON
:DISPlay[:WINDow<1|2>]:TRACe<1..4>:X:ZOOM:CENTer 1GHz
```



The **MOVE ZOOM START** softkey shifts the lower frequency line. The start frequency of the zoomed display can then be modified. The frequency line can be shifted to the start frequency of the original window or to the upper frequency line (= zero span).

IEC/IEEE-bus commands

```
:DISPlay[:WINDow<1|2>]:TRACe<1..4>:X[:SCALe]:ZOOM ON
:DISPlay[:WINDow<1|2>]:TRACe<1..4>:X:ZOOM:START 100MHz
```



The **MOVE ZOOM STOP** softkey shifts the upper frequency line. Thus, the stop frequency of the zoomed display can be modified. The frequency line can be shifted to the stop frequency of the original window or to the lower frequency line (= zero span).

IEC/IEEE-bus commands

```
:DISPlay[:WINDow<1|2>]:TRACe<1..4>:X[:SCALe]:ZOOM ON
:DISPlay[:WINDow<1|2>]:TRACe<1..4>:X:ZOOM:STOP 200MHz
```

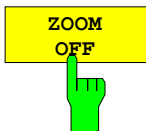

The **ZOOM OFF** softkey switches the zoom function off and then returns control to the main menu.

The frequency lines indicating the zoom range are deleted, **SPLIT SCREEN** mode remains active, the settings of both measurement windows are retained and the coupling of the two measurement windows is cancelled.

IEC/IEEE-bus command

```
:DISPlay[:WINDow<1|2>]:TRACe<1..4>:X[:SCALe]:ZOOM OFF
```

## Level Display and RF Input Configuration – LEVEL Key Group

The *REF* and *RANGE* keys are used to set the reference level (= maximum RF input level, = overload limit), the maximum level (= upper grid level) , and the display range of the active window. The *INPUT* key sets the characteristics of the RF input (input impedance and input attenuation).

### Reference Level – REF key

In addition to the reference level (maximum RF input level), the FSE provides a function to define a maximum level (uppermost grid line on the display):

For a spectrum analyzer, the upper boundary of the measurement diagram (maximum level) is also the limit of its dynamic range (reference level). This means, that a signal which goes beyond the upper grid line also overdrives the analyzer.

For compensation of frequency or antenna characteristics, transducer factors can be applied to increase the signal level. In this case, the calculated values can be above the reference level without actually being physically applied to the instrument. In order to display these signals on the grid, an upper grid level which is different from the reference level of the analyzer can be entered.

LEVEL REF menu:

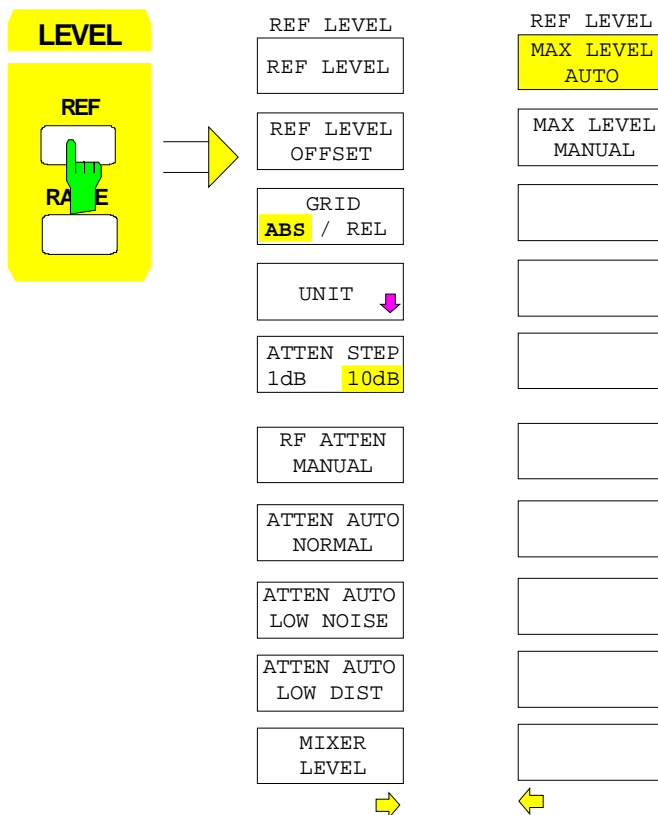

The *REF* key opens a menu to set the reference level and the input attenuation for the active measurement window .

The *REF LEVEL* softkey is automatically active with the menu called up and opens the entry window for manual input of the reference level.

At the same time various settings concerning the level and the attenuation display can be made.

The functions for setting the attenuation are identical to those under the *INPUT* key and are described in Section "Configuration of the RF Input - INPUT Key". Softkey *ATTEN STEP 1dB/10dB* is only available when the FSE is equipped with option FSE-B13, 1dB attenuator (see 'Option 1 dB Attenuator - FSE-B13' at the end of this Section.)





The *REF LEVEL* softkey activates the entry of the reference level. The unit of the entry will be the currently active unit (dBm, dBμV, etc.).

If the *MAX LEVEL MANUAL* softkey is active, a change of the reference level causes an equal amount of change in maximum level. Thus, the separation between the overload limit of the analyzer to the upper grid edge remains the same. Thus, with only one entry, it is possible to make a change to the display and simultaneously to perform an adjustment to the amplifier.

IEC/IEEE-bus command

```
:DISPlay[:WINDow<1|2>]:TRACe<1..4>:Y:RLEVEL -60DBM
```



The *REF LEVEL OFFSET* softkey activates the entry of a straight level offset (±200 dB in 0,1 dB steps). The offset is added to the measured level irrespective of the selected unit. The scaling of the y axis is changed accordingly. The input can be used to take into account an external attenuation.

The setting range is ±200 dB in 0,1-dB steps.

IEC/IEEE-bus command

```
:DISPlay[:WINDow<1|2>]:TRACe<1..4>:Y:RLEVEL:OFFSet -1dB
```

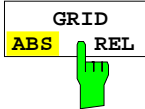

The *GRID ABS/REL* softkey toggles between absolute and relative scaling of the level axis. *GRID ABS* is the default setting.

For absolute scaling the labeling of the level lines is referenced to the absolute value of the reference level.

For relative scaling, the upper line of the grid is always at 0 dB and the scale units are in dB. In contrast, the reference level is always displayed in the set units (dBm, dBμV,...).

The softkey is not displayed for setting *LIN / %* (linear scaling, labelling in %) in the *LEVEL-RANGE* menu since the % unit itself implies a relative scale.

IEC/IEEE-bus command

```
:DISPlay[:WINDow<1|2>]:TRACe<1..4>:Y:MODE ABS | REL
```

The *MAX LEVEL MANUAL* and *MAX LEVEL AUTO* softkeys are mutually exclusive selection switches. Only one switch can be active at one time. The softkeys are used to select whether reference level and maximum level are identical or not:



When *MAX LEVEL AUTO* softkey is active, the reference level and maximum level are identical.

In this case, the reference level is displayed above the upper left corner of the grid in the corresponding function field.

*MAX LEVEL AUTO* is the default setting.

If the *MAX LEVEL MANUAL* softkey was active prior to pressing the *MAX LEVEL AUTO* softkey, the upper boundary of the grid is set to the reference level.

IEC/IEEE-bus command

```
:DISPlay[:WINDow<1|2>]:TRACe<1..4>:Y:RVALue:AUTO ON
```



The *MAX LEVEL MANUAL* softkey activates the entry of the maximum level. The range of input values is ±200dBm with 0.1 dB resolution.

If the *MAX LEVEL MANUAL* softkey is activated, the maximum level is displayed in addition to the reference level to the right above the grid.

IEC/IEEE-bus commands

```
:DISPlay[:WINDow<1|2>]:TRACe<1..4>:Y:RVALue:AUTO OFF
```

```
:DISPlay[:WINDow<1|2>]:TRACe<1..4>:Y:RVALue -20DBM
```

## Display Units

Generally, a spectrum analyzer measures the signal voltage at the RF input. The level display is calibrated in terms of terms values of an unmodulated sine wave. In the initial state, the level is displayed at a power of 1 milliwatt (= dBm). As the input impedance is known to be 50Ω or 75Ω, conversion to other units is possible. The units dBm, dBμV, dBμA, dBpW, V, A and W are directly convertible and can be selected in the *REF UNIT* menu.

Units dB./MHz have a special status. They are applicable for broadband pulse signals. The measured pulse voltage or the pulse current is referred to 1 MHz bandwidth. This conversion is not useful for narrowband or sinewave signals.

If the antenna coded connector on the front panel is used, the coded unit there determines the possible display units. Connecting to the coded connector deactivates the settings of the *UNIT* menu.

By certain codings it is nevertheless possible to select a conversion of the unit in the menu. The dependencies between the unit of the antenna coded connector or the unit of the transducer and the unit which is to be selected for the display are given in the softkey description.

The default coding defined by the connector can be switched off using the *PROBE CODE ON/OFF* softkey. In this case, the unit can be set with the corresponding unit softkeys (dBm, dBμV, ... ) even if a coded connector is plugged in. The coded entries in the connector are then ignored.

**Note:** The units dBμV/m and dBμA/m can only be set via the unit of a transducer or via the unit of the coded connector.

*LEVEL REF UNIT* submenu:

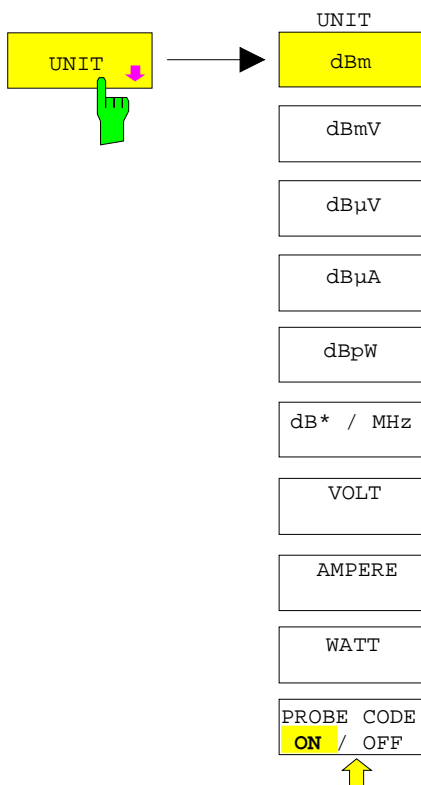

The *UNIT* softkey opens a sub-menu in which the desired units for the level axis can be selected and the coding of the antenna coded connector can be switched on and off.

The selected units are valid for both displays when two measurement windows are displayed.

The unit softkeys are mutually exclusive selection switches. Only one of these switches may be active at any one time.

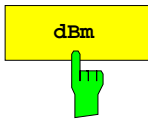

The *dBm*, *dBμV*, *dBmV*, *dBμA*, *dBpW* softkeys set the display units to the corresponding logarithmic units. The *dBm* unit is the default unit in analyzer mode.

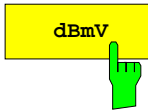

The units *dBm*, *dBμV*, *dBmV*, *dBμA* cannot be selected when the coded antenna connector or the used transducer defines a unit.

Only for coding dB, the conversion to the desired units is permitted.

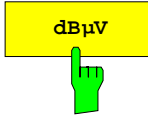

IEC/IEEE-bus command  
`:CALCulate<1|2>:UNIT:POWER DBM |DBMV |DBUV |DBUA |DBPW`

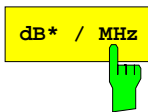
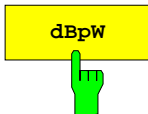
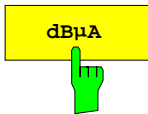

The *dB\*/MHz* softkey activates/disactivates the display of results in units relative to the bandwidth. Those units can be derived from the logarithmic units *dBμV*, *dBμV/m*, *dBμA* and *dBμA/m*.

This leads to the following relative units:

- dBmV* ⇒ *dBmV/MHz*
- dBμV* ⇒ *dBμV/MHz*
- dBμV/m* ⇒ *dBμV/mMHz*
- dBμA* ⇒ *dBμA/MHz*
- dBμA/m* ⇒ *dBμA/mMHz*

Switching over is possible also if a coded antenna connector or a transducer fixes the unit to be used.

Conversion to 1 MHz is via the pulse bandwidth of the selected resolution bandwidth  $B_{imp}$  according to the following equation (example for *dBμV*) :

$$P / (dB\mu V / MHz) = 20 \cdot \log \frac{B_{imp} / MHz}{1MHz} + P / (dB\mu V),$$

where P = display level

The *dBμV/MHz* unit can be combined with the following coded connector or transducer units

dB (the unit *dBμV/MHz* remains )

$\mu V/m$  (yields the display unit *dBμV/mMHz*)

analogous for *dBμA/MHz*:

dB and  $\mu A$  (the unit *dBμA/MHz* remains)

Other combinations are not allowed.

IEC/IEEE-bus command  
`:CALCulate<1|2>:UNIT:POWER DBUV_MHZ |DBUA_MHZ |DBMV_MHZ`

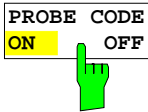
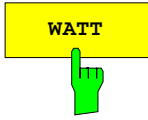
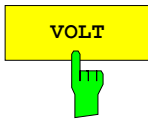

The *VOLT*, *AMPERE*, *WATT* softkeys set the display units to the corresponding linear units.

The units *VOLT*, *AMPERE*, *WATT* cannot be selected when the coded antenna connector or the transducer table defines one of the following as units:

$\mu\text{V/m}$   
 $\mu\text{A}$

For coding dB, the conversion to the desired units is permitted.

The *PROBE CODE ON/OFF* softkey enables or disables the units defined by the coded connector.

IEC/IEEE-bus command :UNIT<1|2>:PROBe ON | OFF

### Level Range – RANGE Key

LEVEL RANGE menu:

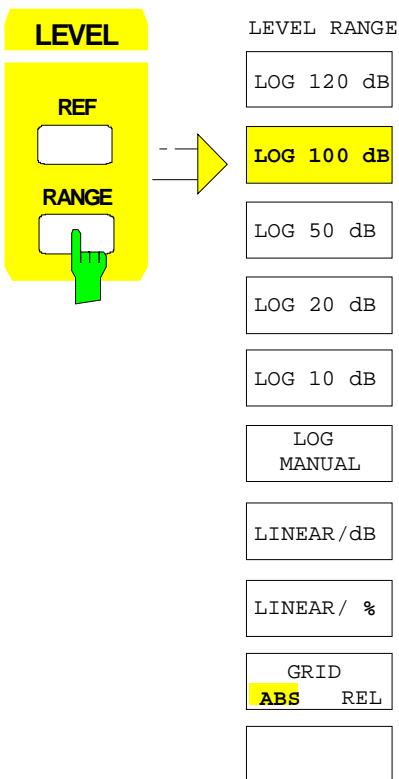

The *RANGE* key calls a menu in which the range, linear or logarithmic the display scale, absolute or relative and the level units for the active window can be selected.

The display range of the analyzer can be set in 10 dB steps from 10 to 200 dB. The default setting is 100 dB.

The most often used settings (120 dB, 100 dB, 50 dB, 20 dB and 10 dB) are each directly selectable by a softkey. All other ranges are chosen with the *LOG MANUAL* softkey.

After pressing the *RANGE* key, the *LOG MANUAL* entry window is enabled if the display range is not set to *LIN*.



The *LOG MANUAL* softkey activates the entry of the level display range. Display ranges from 10 to 200 dB are allowed in 10-dB steps. Values which are not permissible are rounded to the next valid number.

IEC/IEEE-bus commands

```
:DISPlay[:WINDow<1|2>]:TRACe<1..4>:Y:SPACing LOG
:DISPlay[:WINDow<1|2>]:TRACe<1..4>:Y 110DB
```

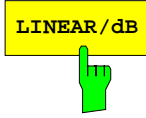

The *LINEAR/dB* softkey switches the display range of the analyzer to linear scaling. The horizontal lines are labelled according to the selection *GRID ABS/REL* in dB\* or \*.

IEC/IEEE-bus command

```
:DISPlay[:WINDow<1|2>]:TRACe<1..4>:Y:SPACing LINear
```

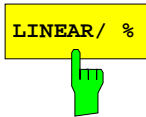

The *LINEAR/%* softkey switches the display range of the analyzer to linear scaling. The horizontal lines are labelled in %. The grid is divided into decades.

IEC/IEEE-bus command

```
:DISPlay[:WINDow<1|2>]:TRACe<1..4>:Y:SPACing PERCent
```

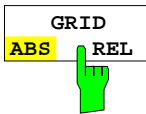

The *GRID ABS/REL* softkey switches between absolute and relative scaling of the level axis. *GRID ABS* is the default setting.

**ABS** The labelling of the level lines is referenced to the absolute value of the reference level.

**REL** The upper line of the grid is always at 0 dB and the scale units are in dB. In contrast, the reference level is always displayed in the set units (dBm, dBμV,...).

The softkey is not displayed for setting *LIN / %* (linear scaling, labelling in %) since the % unit itself implies a relative scale.

IEC/IEEE-bus command

```
:DISPlay[:WINDow<1|2>]:TRACe<1..4>:Y:MODE ABS | REL
```

## RF Input Configuration – INPUT Key

In addition to manual entry of the input attenuation, the FSE provides an option which allows the RF attenuation, dependent on the selected reference level, to be automatically set. Thus, it is guaranteed that an optimum combination of RF attenuation and IF amplification is always used. For the automatic selection process, three modes are provided. The *AUTO LOW NOISE* mode selects the amplification/attenuation combination so that the display of noise on the FSE is at a minimum. The signal/noise ratio is maximised. The *AUTO LOW DISTORTION* mode is tuned for minimisation of the internally generated interference products. This causes, however, a lower signal/noise ratio. The *ATTEN AUTO NORMAL* mode is a compromise between low noise and low distortion.

When the FSE is equipped with option FSE-B13, 1 dB Attenuator, the attenuator can be set with a step size of 1 dB up to an upper limit frequency of 7 GHz.

When the instrument is equipped with option FSE-B21, External Mixer Output, the FSEM and FSEK can be operated with external mixer.

INPUT menu:

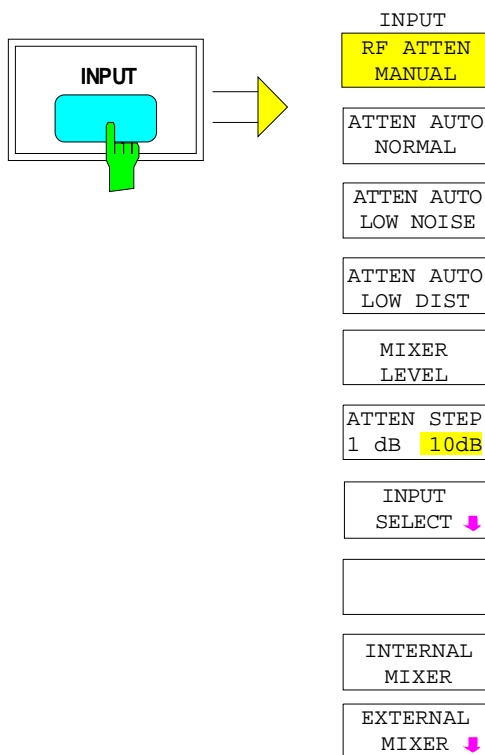

The *INPUT* key opens the menu for configuring the RF input. It contains the input attenuator and mixer level for matching the RF input to the input signal.

The *RF ATTEN MANUAL*, *ATTEN AUTO NORMAL*, *ATTEN AUTO LOW NOISE* and *ATTEN AUTO LOW* softkeys are mutually exclusive selection switches. only one can be active at any one time.

Softkey *ATTEN STEP 1dB/10dB* is only available when the FSE is equipped with option FSE-B13, 1dB attenuator (see 'Option 1 dB Attenuator - FSE-B13' at the end of this Section.)

Softkeys *INTERNAL MIXER* and *EXTERNAL MIXER* are only available when the FSE is equipped with option FSE-B21, External Mixer Input (see manual of option).

The *INPUT SELECT* softkey calls a submenu for selection of the input impedance.

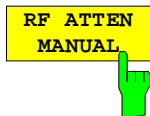

The *RF ATTEN MANUAL* softkey activates the entry of an attenuation factor independent of the reference level.

The attenuation can be modified in 10 dB steps between 0 and 70 dB.

Other inputs will be rounded to the next higher integer value.

If the defined reference level cannot be set for the given RF attenuation, the reference level will be adjusted accordingly and the warning "Limit reached" will be output.

IEC/IEEE-bus command :INPut<1|2>:ATTenuation 40DB



The *ATTEN AUTO NORMAL* softkey sets the RF attenuation automatically as a function of the selected reference level.

IEC/IEEE-bus commands

```
:INPut<1 | 2>:ATTenuation:AUTO:MODE NORMal
:INPut<1 | 2>:ATTenuation:AUTO ON
```



The *ATTEN AUTO LOW NOISE* softkey sets the RF attenuation always 10dB lower than in the *RF ATTEN AUTO* mode. Therefore, for 10 dB RF attenuation, the maximum reference level is -10 dBm. For reference levels which are lower, at least 10 dB is always set (see above).

Setting Low Noise means that the indicated inherent noise level is low. This setting is recommended if signals with a low level have to be measured as the highest S/N ratio is then obtained.

IEC/IEEE-bus commands

```
:INPut<1 | 2>:ATTenuation:AUTO:MODE LNOise
:INPut<1 | 2>:ATTenuation:AUTO ON
```



The *ATTEN AUTO LOW DIST* softkey sets the RF attenuation 10 dB higher than in *RF ATT AUTO* mode. This means that for 10 dB RF attenuation, the maximum reference level is -30 dBm (-40 dBm at the mixer).

This setting is recommended whenever a small signal is to be measured in the presence of larger signals. Here, the intermodulation-free range of the FSE is large and the internal distortion products are minimised.

IEC/IEEE-bus commands

```
:INPut<1 | 2>:ATTenuation:AUTO:MODE LDISTortion
:INPut<1 | 2>:ATTenuation:AUTO ON
```



The *MIXER LEVEL* softkey activates the entry of the maximum mixer level attainable for a given reference level. At the same time it enables softkeys *ATTEN AUTO LOW NOISE* and *ATTEN AUTO LOW DIST*.

Range of input values is -10 to -100 dBm

IEC/IEEE-bus command :INPut<1 | 2>:MIXer -30DBM

INPUT INPUT SELECT submenu:

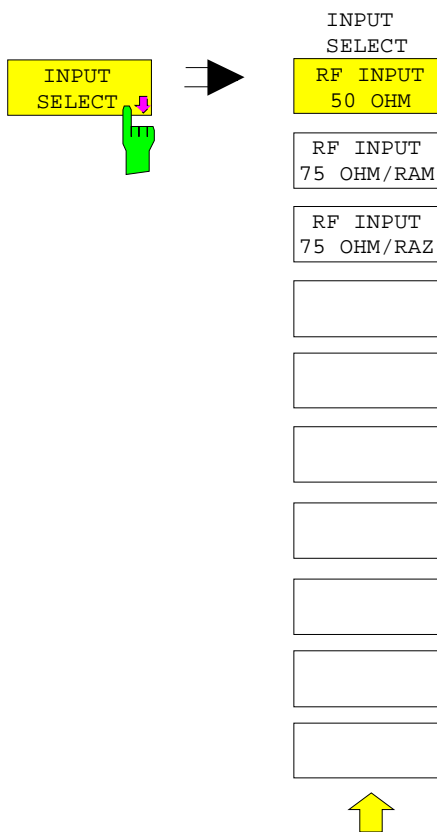

The *INPUT SELECT* softkey calls a submenu for selection of the input impedance of the RF input.

The basic setting is 50 Ohm. By connecting an impedance converter RAM or RAZ ahead, the 50-Ohm input can be transformed to 75 Ohm. FSE automatically takes the corresponding correction values for the level display into account.

The softkeys used to select the input impedance are selection switches. Only one of them can be active at any one time

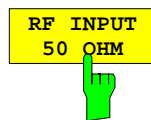

The *RF INPUT 50 OHM* softkey sets the input impedance to 50 Ohm (= default setting). All level indications are referenced to 50 Ohm.

IEC/IEEE-bus command :INPut<1|2>:IMPedance 50

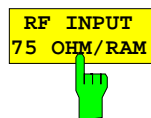

The *RF INPUT 75 OHM/RAM* softkey sets the input impedance of the FSE to 75 Ohm including the matching element RAM. All level indications are referenced to 75 Ohm.

IEC/IEEE-bus command :INPut<1|2>:IMPedance:CORR RAM

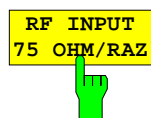

The *RF INPUT 75 OHM/RAZ* softkey sets the input impedance of the FSE to 75 Ohm including the matching element RAZ. All level indications are referenced to 75 Ohm.

IEC/IEEE-bus command :INPut<1|2>:IMPedance:CORR RAZ



### Option 1 dB Attenuator - FSE-B13

The option 1 dB Attenuator FSE-B13 is used to set the attenuator with a step size of 1 dB up to an upper limit frequency of 7 GHz.

The attenuator with 1 dB stepping is connected in series after the main attenuator.

#### Instruments with an Upper Limit Frequency of up to 7 GHz

The optional attenuator is in the signal path for all settable frequencies in instruments with a maximum upper limit frequency of 7 GHz. When it is activated, it is used without any restriction for setting the input attenuation or the reference level.



#### Instruments with an Upper Limit Frequency of more than 7 GHz

In instruments with an upper limit frequency of more than 7 GHz a diplexer is placed before the optional attenuator for separating the frequency ranges  $\leq 7\text{GHz}$  and  $> 7\text{ GHz}$ . The optional attenuator is in the signal path only for frequencies  $\leq 7\text{ GHz}$ .

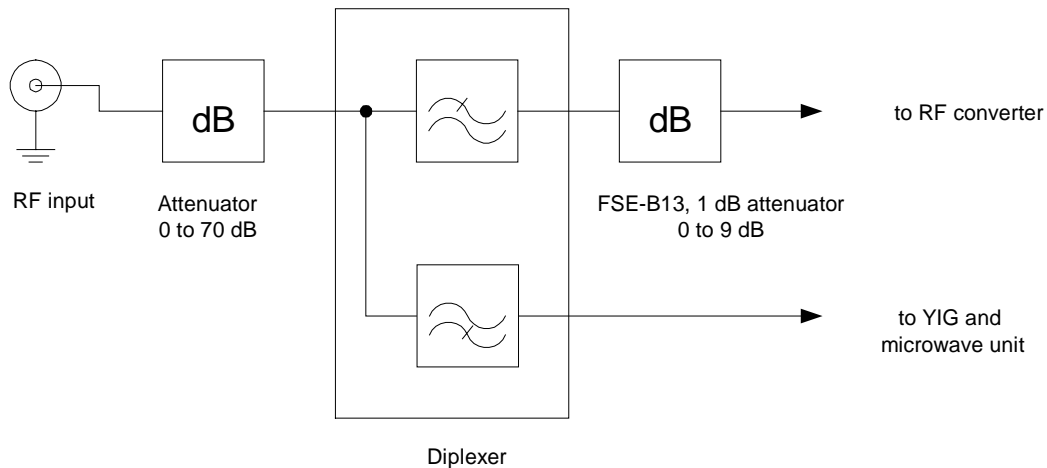

On changing the frequency range for the stop frequency, the attenuator can be set as follows:

**Instrument setting: ATTENUATOR AUTO**

- After switching from  $F_{\text{stop}} \leq 7$  GHz to  $F_{\text{stop}} > 7$  GHz the reference level is re-calculated provided the attenuation previously set contained 1 dB steps. A warning is not displayed.
- After switching from  $F_{\text{stop}} > 7$  GHz to  $F_{\text{stop}} \leq 7$  GHz the reference level is re-calculated. A warning is not displayed.

**Instrument setting: ATTENUATOR MANUAL**

- After switching from  $F_{\text{stop}} \leq 7$  GHz to  $F_{\text{stop}} > 7$  GHz, the attenuation is rounded off to a value divisible by 10 provided the attenuation previously set contained 1 dB steps. A warning is displayed:

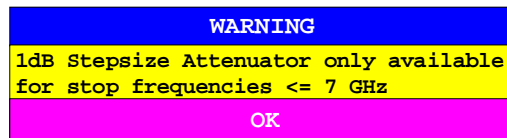

- After switching from  $F_{\text{stop}} > 7$  GHz to  $F_{\text{stop}} \leq 7$  GHz the current value of the input attenuation is maintained.

The 1 dB attenuator is inactive as default. In this case the attenuation can be set only in 10 dB steps, ie the attenuation of the optional attenuator is fixed at 0 dB.

The optional attenuator is activated either in the INPUT menu or in the REF LEVEL menu (the two settings are equivalent):



The *ATTEN STEP* 1dB/10dB softkey switches between the 10 dB step and 1 dB step settings.

After activating the optional attenuator with the *ATTEN STEP 10dB/1dB* softkey, setting in 1 dB steps is possible, the total attenuation is divided into

- a 10 dB contribution from the main attenuator and
- a residual contribution of 0 to 9 dB from the optional attenuator.

The attenuation setting range in the instrument remains to be 0 to 70 dB, it is **not** extended by the optional attenuator.

After a reset the attenuator step size is automatically set to 10 dB.

IEC/IEEE-bus command :INPut<1|2>:ATTenuation:STEPsize 1|10

## Marker Functions – *MARKER* Key Group

The markers are used for marking points on measurement curves (traces), reading out measurement values and for quickly selecting a screen mode. Preselected measurement routines can be called by pressing a key in the marker menu. The FSE has four markers and four delta markers per measurement window. The currently activated marker can be shifted with the cursor keys, the roll-key or the softkeys. The softkeys are defined according to the type of display representation selected (frequency or time domain).

The marker which can be moved by the user is defined as the **active marker**.

Examples of marker displays:

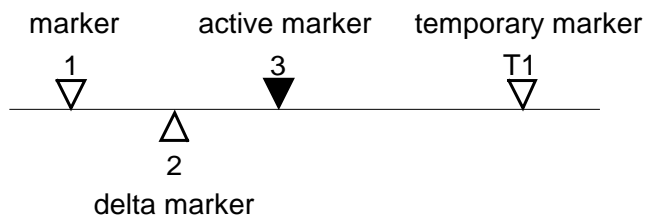

Temporary markers are used in addition to the markers and delta markers to evaluate the measurement results. They disappear when the associated function is deactivated.

The measurement values of the active marker (also called **marker values**) are displayed in the marker field. In the **marker info list**, the measurement values from all enabled markers are sorted in ascending order. The marker info list can be switched off with the *MARKER INFO* softkey so that only the values for the active marker are shown.

The summary markers have a special function. They read out the rms or average value of the current trace or the trace averaged over several sweeps in the marker info list. These markers are not displayed.

### Main Markers– *NORMAL* Key

The *NORMAL* key calls a menu which contains all the standard marker functions. The current state of the markers is indicated by a colored illumination of the softkeys. If no marker is enabled prior to pressing the *NORMAL* key, *MARKER 1* will be enabled as the reference marker and a peak search on the trace is carried out (assumption: at least one trace is active). Otherwise, the peak search is omitted and the entry window for the reference marker is activated.

The marker field in the upper right corner of the display screen shows the marker values, in this case, the frequency, the level and the currently selected trace.

```
MARKER 1 [T1]
-27.5 dBm
123.4567 MHz
```

MARKER NORMAL menu:

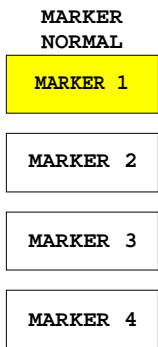
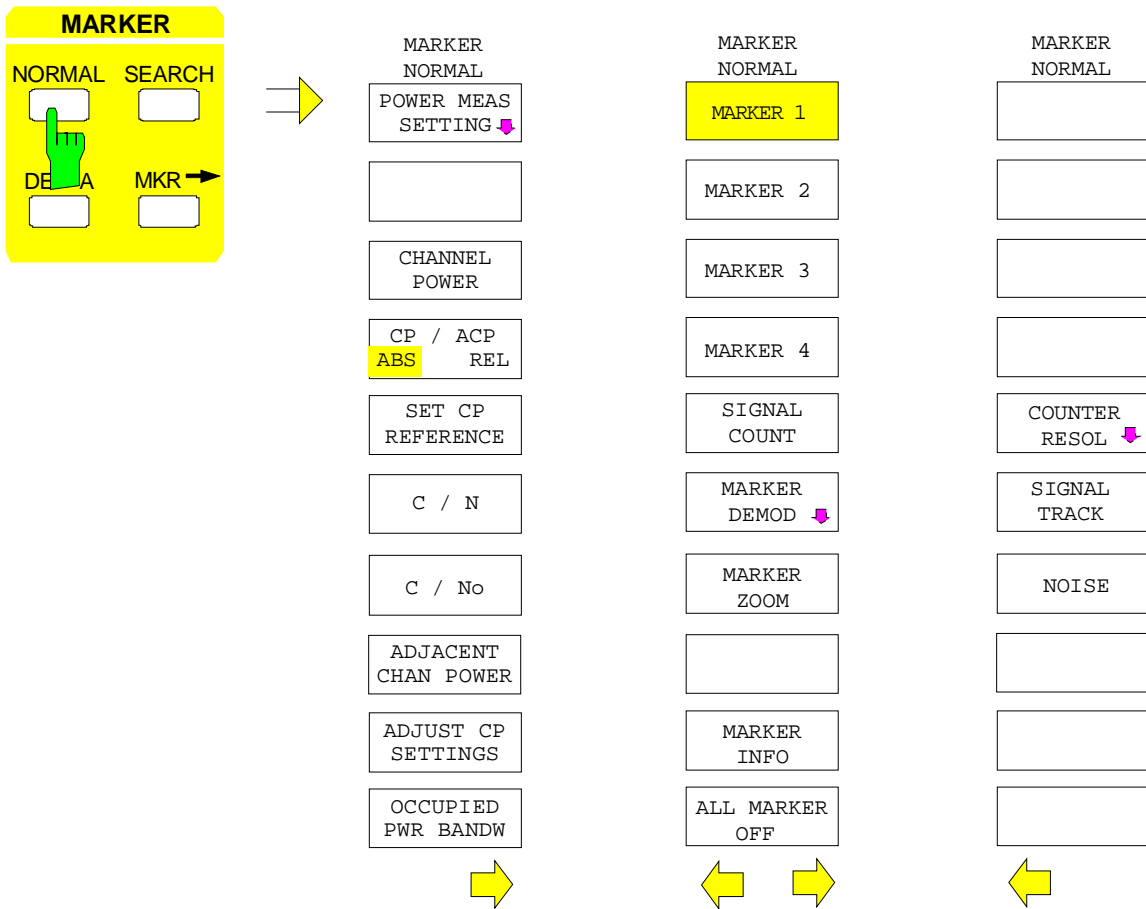

The *MARKER 1* to *MARKER 4* softkeys switch the corresponding marker on/off or activate it as the reference marker. If the marker is activated as a reference marker, an entry field for manually setting the position of the reference marker is opened simultaneously. If the marker is disabled, the softkey is not illuminated. Enabled markers and the reference marker are indicated by illuminating the corresponding softkeys in different colors. (In the instrument default state, the active reference marker is displayed in red and enabled markers are displayed in green.)

**Operating example:**

*MARKER 1* is shown as the reference marker by the colored background illumination. *MARKER 2* through *MARKER 4* are turned off.

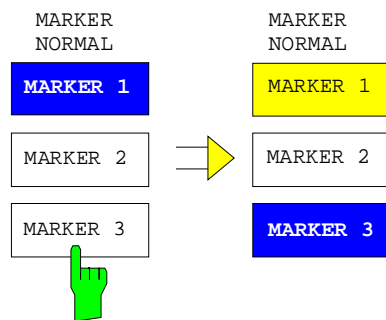

Pressing the *MARKER 3* softkey switches *MARKER 3* on and it becomes the reference maker. The previous reference marker remains enabled and the softkey remains illuminated. However, the entry mode for this marker is not now active. Instead, the entry window for *MARKER 3* is opened and the position of *MARKER 3* can be shifted.

MARKER 3
123.4567 MHz

The information in the marker field also changes to describe the new reference marker.

MARKER 3 [T1]
-27.5 dBm
23.4567891 MHz

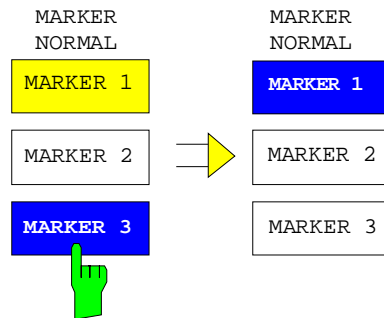

Pressing the current reference marker (*MARKER 3*) softkey again switches *MARKER 3* off. If at least one marker is enabled, the marker with the smallest number will be selected as the new reference marker (in the example, *MARKER 1*). Switching off the last active marker also deletes any delta markers.

#### IEC/IEEE-bus commands

```
:CALCulate<1|2>:MARKer<1..4>[:STATE] ON | OFF;
:CALCulate<1|2>:MARKer<1..4>:X 10.7MHz;
:CALCulate<1|2>:MARKer<1..4>:Y?
```

When several traces are displayed, the marker is set to the maximum value (peak) of the active trace with the lowest number (1 to 4). If a marker is already positioned there, it will be set to the frequency of the next highest level (next peak).

When the split screen mode is active, the marker will be placed in the active window (for *SCREEN A*: trace 1 or 3, for *SCREEN B*: trace 2 or 4). Since markers are attached to a trace, the marker can only be enabled when at least one trace is displayed in the corresponding window.

If a trace is turned off, the markers and marker functions attached to the trace are also switched off. If the trace is switched on again (*VIEW, CLR/WRITE;..*), these markers, along with any coupled functions will be restored to their original positions. A prerequisite for the restoration of the marker positions is that individual markers have not been used on another trace or that the sweep data (start/stop frequency for span > 0 or sweep time for span = 0) have not been changed.

If a marker (or, delta marker) necessary for a marker function is not available, it will be automatically checked whether or not the enabling of the corresponding marker is possible (see above). If this is not the case, a warning is issued.

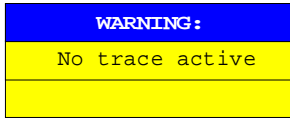

The activation of the desired marker function is then not possible.

On the other hand, if the marker can be enabled, a peak search is automatically performed. Thereafter, the desired marker function can be executed.

MARKER NORMAL menu:



The *ALL MARKER OFF* softkey switches off all markers (reference and delta markers). Similarly, it switches off all functions and displays correlated with the markers/delta markers (signal count, signal track, marker zoom, N dB down, shape factor, marker list and marker info).

IEC/IEEE-bus command :CALCulate<1|2>:MARKer<1..4>:AOFF

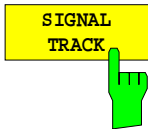

After each sweep, the *SIGNAL TRACK* softkey starts a search for the maximum signal level on the screen (*PEAK SEARCH*) and then sets the center frequency to the frequency of this signal (*MARKER -> CENTER*).

If a threshold line is enabled, only signals above the threshold level are considered. If no signal is over the threshold, the center frequency remains constant until a signal is available which is over the threshold.

If no marker is switched to the active trace, the next unused marker is automatically activated and positioned by the peak search routine.

In order to reduce the search range, it is possible to apply the *SEARCH LIMIT ON/OFF* function (see section: "Search Functions"). If the center frequency is changed, the position of the frequency line relative to the center frequency remains the same, ie its absolute position is correspondingly changed.

The softkey is only available in the frequency domain (spectrum) display mode (span > 0.)

IEC/IEEE-bus commands

```
:CALCulate<1|2>:MARKer<1..4>:COUNT ON |OFF;
:CALCulate<1|2>:MARKer<1..4>:COUNT:FREQUENCY?
```

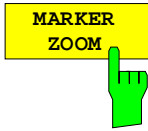

The *MARKER ZOOM* softkey expands the area around the active marker. With the zoom function, more details of the spectrum can be seen. The desired display range can be defined in an entry window.

The sweep is stopped at the reference marker. The frequency of the signal is counted and the measured frequency becomes the new center frequency. The zoomed display is set and the new settings are used by the FSE for further measurements.

As long as the switchover to the new frequency display range has not yet taken place, pressing the softkey will abort the procedure.

If no marker is activated when the softkey is pressed, then *MARKER 1* is automatically activated and set to the highest peak in the measurement window.

If an instrument setting is changed after selection of *MARKER ZOOM*, the function is aborted.

The *MARKER ZOOM* softkey is only available for frequency domain measurements (span > 0).

IEC/IEEE-bus command  
 :CALCulate<1|2>:MARKer<1..4>:FUNction:ZOOM 1KHZ



The *MARKER INFO* softkey opens the display of several markers within the grid. In the upper right corner of the grid, a maximum of 4 markers/delta markers with the marker symbols  $\Delta/\nabla$ , marker number (1 to 4), position and measurement value are listed. For the output of the marker position, the number or displayed characters will be limited as required.

If the number of lines available is not enough for all the enabled markers and delta markers, first the markers and then the delta markers are entered into the info list

In the *SPLIT SCREEN* display, the info list is partitioned into 2 partial lists and assigned to the corresponding measurement window (*SCREEN A* and *SCREEN B*). The info list for *SCREEN A* contains the markers which are assigned to trace 1 or trace 3. The info list for *SCREEN B* contains the markers which are assigned to trace 2 and trace 4.

For the two measurement windows, it is not possible to turn the *MARKER INFO* function selectively on/off .

IEC/IEEE-bus command :DISPlay:WINDow<1|2>:MINfo ON | OFF

## LF Demodulation

The FSE provides demodulators for AM and FM signals. With these demodulators, a displayed signal can be identified acoustically with of the internal loudspeaker or with external headphones. The frequency at which demodulation is activated is coupled to the markers. The sweep stops at the frequency determined by the set marker for the selected time and the RF signal is demodulated.

During time domain measurements (span = 0) the demodulation is switched on continuously.

MARKER NORMAL-MARKER DEMOD submenu:

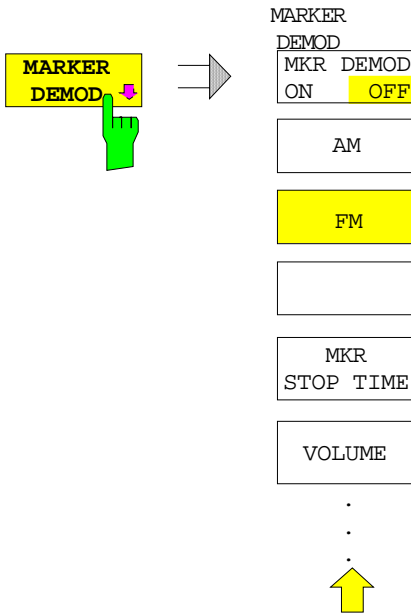

The *MARKER DEMOD* softkey calls a sub-menu in which the type of demodulation desired, the duration of the demodulation and the loudness may be selected

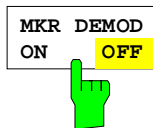

The *MKR DEMOD ON/OFF* softkey switches the demodulation on/off. When the demodulation is on, the sweep is stopped at all marker frequencies, assuming the signal is over the threshold, and the signal is demodulated until the entered sweep stop time elapses. A total of four stopping points (four markers) can be programmed.

If no marker is set when the demodulation is switched on, the FSE switches the first marker on (*MARKER 1*) and positions it on the trace peak.

IEC-Bus-Befehl

```
:CALCulate<1|2>:MARKer<1..4>:FUNCTION:DEM ON|OFF
```



The *MKR STOP TIME* softkey activates the entry window for setting the stop time.

The FSE stops the sweep at the marker or the marker for the duration of the defined stop time and then switches the demodulation on (see also *MKR DEMOD ON/OFF*).

IEC-Bus-Befehl

```
:CALCulate<1|2>:MARKer<1..4>:FUNCTION:DEM:HOLDoff 3s
```

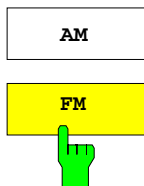

The *AM* and *FM* are selection switches of which only one can be activated at any one time. They are used to set the desired demodulation type, FM or AM. The default setting is AM.

IEC-Bus-Befehl

```
:CALCulate<1|2>:MARKer<1..4>:FUNCTION:DEM:SElect AM|FM
```



The *VOLUME* softkey opens the entry window for setting the loudness. The volume can be set between 0 and 100%.

IEC-Bus-Befehl :SYSTEM:SPEaker<1|2>:VOLume 0.5



## Frequency Measurement

To accurately determine the frequency of a signal, the FSE is equipped with an internal frequency counter. The frequency counter measures the frequency of the RF signal at the intermediate frequency. Using the value found at the intermediate frequency, the FSE calculates the frequency of the RF signal by applying the known frequency conversion relationships.

The frequency measurement error depends only upon the accuracy of the frequency standard used (external or internal reference). Although the FSE always performs the frequency sweep in sync - no matter what frequency range is set - the frequency counter gives a more exact frequency measurement than a measurement performed with a marker. This is explained by the following:

- The marker only gives the position of a pixel on the trace and the frequency of the signal is deduced from this. The trace, however, contains only a limited number of pixels, so each pixel may represent a number of measurement values that depends on the selected span. This reduces the frequency resolution.
- The resolution with which the frequency can be measured is proportional to the measurement time. For measurement time reasons, the bandwidth is normally held as wide as possible and the sweep time is set as short as possible. This results in a loss of frequency resolution.

For the measurement with the frequency counter, the sweep is stopped at the reference marker, the frequency is measured to the desired resolution and then the sweep is allowed to continue (see also Chapter 2, "Measurement Examples").

MARKER NORMAL menu:

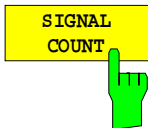

The *SIGNAL COUNT* softkey switches the frequency counter on/off.

The frequency is counted at the position of the reference marker. The sweep stops at the reference marker until the frequency counter outputs a result. The time required for a frequency measurement depends on the selected frequency resolution. The resolution is set in the *COUNTER RESOL* sub-menu.

If no marker is enabled when the *SIGNAL COUNT* softkey is pressed, *MARKER 1* is switched on and set to the trace peak.

The *SIGNAL COUNT* function is also indicated by [T x CNT] in the marker field on the display screen.

Switching the *SIGNAL COUNT* function off is accomplished by pressing the softkey once again.

**Note:** For digital resolution filters (RBW < 1kHz or softkey RBW 1kHz set to DIG), a analog prefilter of 2 kHz is active.

IEC/IEEE-bus command

```
:CALCulate<1|2>:MARKer<1..4>:COUNT ON | OFF;
:CALCulate<1|2>:MARKer<1..4>:COUNT:FREQUENCY?
```

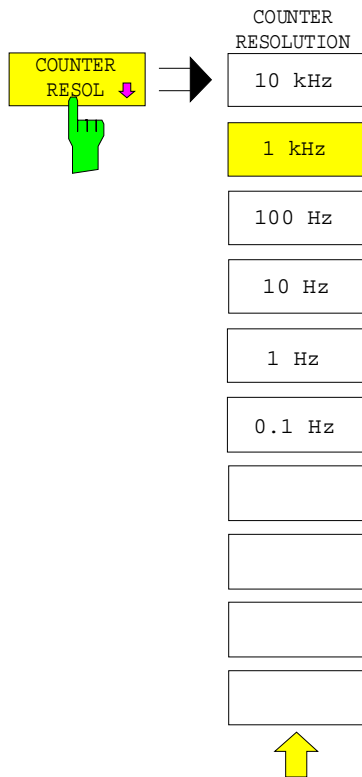

The *COUNTER RESOL* softkey in the right side menu opens a sub-menu in which the resolution of the frequency counter can be defined.

The value can be selected between 0.1 Hz and 10 kHz.

The time which the frequency counter requires for a measurement is proportional to the selected resolution. For example, a 1 Hz resolution will require approximately one second measurement time. In order to prevent slowing the sweep time unnecessarily, it is recommended that the frequency resolution be set as low as possible.

IEC/IEEE-bus command

```
:CALCulate<1|2>:MARKer<1..4>:COUNT:RES 1KHZ
```

## Noise Power Density Measurement

*MARKER NORMAL* menu (right side menu):

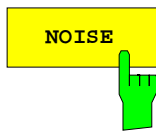

The *NOISE* softkey switches noise measurement on/off.

During a noise measurement, the noise power density is measured at the position of the reference marker. The noise power density is displayed in the marker field dependent upon the vertical units in dBx/Hz (for logarithmic scale) or in V/Hz, A/Hz or W/Hz for linear scales. The correction factors for the selected bandwidth and the conversion of the IF logarithmic converter are automatically taken into consideration.

For trace setting AUTO SELECT, the sample detector is automatically switched on and off with the noise marker to provide for display of the rms value of the noise power. For single sweep, a new sweep has to be started after the marker has been switched on in order to ensure that the trace is recorded with the correct detector.

For all other detector settings, the user is prompted to select the sample detector for optimum results as soon as the noise marker is switched on. In this case the sample detector has to be switched on manually.

In order to produce a smoother noise display, neighboring points (symmetrical to measurement frequency) on the trace are averaged.

In the time domain display, an average of the measurement values takes place in time (after each sweep).

IEC/IEEE-bus command

```
:CALCulate<1|2>:MARKer<1..4>:FUNCTION:NOISe ON | OFF;  
:CALCulate<1|2>:MARKer<1..4>:FUNCTION:NOISe:RESult?
```

## Channel Power Measurements

A modulated carrier is almost always used (exception e.g.,: SSB-AM) for high-frequency transmission of information. Due to the information modulated onto the carrier, the latter covers a spectrum which is defined by the modulation, the data transmission rate and the signal filtering. Within a transmission band, each carrier is assigned a channel taking into account these parameters. In order to ensure error-free transmission, each transmitter must keep within its specified parameters. These include among others:

- the output power,
- the occupied bandwidth, i.e., the bandwidth within which a defined percentage of the power must be contained and
- the power received by adjacent channels.

Using the power measurement function, the FSE is capable of measuring all the specified parameters with high precision and at high speed.

The power measurements settings are performed in the left-hand side-menu *MARKER NORMAL*.

*MARKER NORMAL* menu:

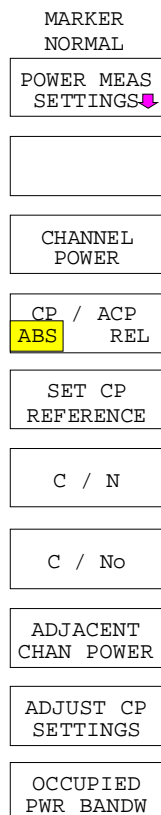

The following measurements can be made:

- channel power (*CHANNEL POWER*)
- signal / noise power (*C/N*)
- signal / noise power density (*C/No*)
- adjacent channel power (*ADJACENT CHAN POWER*)
- occupied bandwidth (*OCCUPIED PWR BANDWIDTH*)

The channel power and the adjacent channel power can be measured either relative (*CP/ACP REL*) to the power in the utilised channel or in absolute terms (*CP/ACP ABS*).

Channel configuration is via sub menu *POWER MEAS SETTINGS*.

The above mentioned power measurements can be performed alternately.

## Channel Configuration

For all power measurements, a specified channel configuration is assumed which is, e.g. oriented on a specific radio communications system.

The channel configuration is defined by the nominal channel frequency (= center frequency of the FSE), the channel bandwidth (*CHANNEL BANDWIDTH*) and the channel spacing (*CHANNEL SPACING*).

The channel is indicated on the display screen by vertical lines located at a half-channel bandwidth to the left and to the right of the channel frequency. For the adjacent channel power measurement, the adjacent channels are also indicated by vertical lines. The lines of the utilised channel are labelled with CO for easier recognition.

Depending on the radio communication service, the power of the 1<sup>st</sup> alternate channel and/or 2<sup>nd</sup> alternate channel can be measured in addition (softkey *SET NO.OF ADJ CHAN'S*).

With the *ACP STANDARD* softkey, the channel configuration can be set automatically according to the regulations of different digital mobile-radio standards. For some standards, the channel power has to be evaluated by means of a root-cosine filter corresponding to the transmit filter. This filter is switched on automatically if the corresponding standards are selected but can be switched off manually (softkey *CH FILTER ON/OFF*).

*MARKER NORMAL - POWER MEAS SETTINGS* submenu:

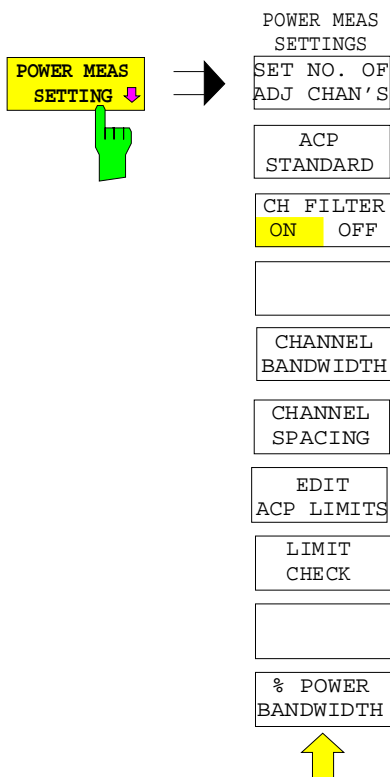

The *POWER MEAS SETTINGS* softkey calls the sub-menu for the definition of the channel configuration.

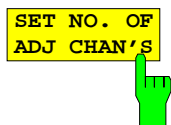

The *SET NO. OF ADJ CHAN'S* softkey activates the input of number  $\pm n$  adjacent channels to be considered for adjacent channel power measurement

The individual powers are indicated separately. Example  $n=3$ :

CH0 Pwr	-20.00 dBm	1, 2 or 3 adjacent channels are possible. ALT1 and
ACP UP	-45.23 dBm	ALT2 (Alternate Channel Power) indicate the channel
ACP LOW	-52.11 dBm	power at $\pm 2 \times$ channel spacing and $\pm 3 \times$ channel
ALT1 UP	-60.04 dBm	spacing from the center of the channel.
ALT1 LOW	-61.00 dBm	
ALT2 UP	-63.34 dBm	
ALT2 LOW	-64.00 dBm	

IEC/IEEE-bus command : [SENSe<1|2>:]Power:ACHannel:ACPairs 2

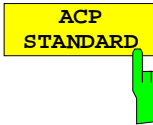

The *ACP STANDARD* softkey activates the selection of a digital mobile-radio standard. The parameters for the adjacent channel power measurement are set according to the regulations of the selected standard.

ACP STANDARD
NONE
NADC
TETRA
PDC
PHS
CDPD
CDMA800 FWD
CDMA800 REV
CDMA1900 FWD
CDMA1900 REV
W-CDMA FWD
W-CDMA REV
W-CDMA 3GPP FWD
W-CDMA 3GPP REV
CDMA2000 MC
CDMA2000 DS
CDMA ONE 800 FWD
CDMA ONE 800 REV
CDMA ONE 1900 FWD
CDMA ONE 1900 REV

The following standards can be selected:

NADC (IS-54 B)  
 TETRA  
 PDC (RCR STD-27)  
 PHS (RCR STD-28)  
 CDPD  
 CDMA800FWD  
 CDMA800REV  
 CDMA1900REV  
 CDMA1900FWD  
 W-CDMA FWD  
 W-CDMA REV  
 W-CDMA 3GPP FWD  
 W-CDMA 3GPP REV  
 CDMA2000 Multi Carrier  
 CDMA2000 Direct Sequence  
 CDMA ONE 800 FWD  
 CDMA ONE 800 REV  
 CDMA ONE 1900 REV  
 CDMA ONE 1900 FWD

If the full dynamic range of the analyzer is to be utilized for the W-CDMA measurement (for a power measurement in this standard), the RF attenuation has to be set to 0 dB.

However this is not done automatically to avoid damaging the analyzer input. Instead, a window displaying the following note is shown if one of the W-CDMA standards is selected: 'Attention: For higher dynamic range use *RF ATTEN MANUAL=0dB*.'

The following parameters change according to the standard selected:

- channel spacing
- channel bandwidth
- modulation filter
- resolution bandwidth
- video bandwidth
- detector

Trace Maths and Trace Averaging are switched off.

The reference level is not changed when a standard is selected. It has to be set for an optimum dynamic range so that the signal maximum is in the vicinity of the reference level.

The basic setting *ACP STANDARD NONE*.

IEC/IEEE-bus command

```
:CALCulate<1|2>:MARKer<1...4>:FUNction:POWer:PRESet
  NONE |NADC |TETRA |PDC |PHS |CDPD |F8CDma |R8CDma|
  F19Cdma |R19Cdma |FWCDma | RWCDma |FW3Gppcdma |
  RW3Gppcdma |M2CDma |D2CDma |FO8Cdma |RO8Cdma |
  FO19cdma |RO19cdma
```

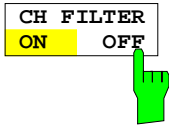

The *CH FILTER ON/OFF* softkey switches a modulation filter for the channel power and adjacent channel power measurement on or off.

When selecting the digital mobile-radio standards NADC, TETRA and W-CDMA 3 GPP (FWD and REV) using the *ACP STANDARD* softkey, the softkey is automatically set to ON. When the other standards are selected, weighting is not selectable and the softkey is not available.

**CH FILTER ON** The channel bandwidth is defined by the filter weighting alone. Therefore, the *CHANNEL BANDWIDTH* softkey cannot be operated.

The activated modulation filter influences the channel and adjacent channel power measurement.

Within the definition range of the filter, the individual pixels are weighted with the calculated filter attenuation as a function of the spacing to the channel center. The weighted display points are then added to the total channel power.

**CH FILTER OFF** No modulation filter is switched on.

IEC/IEEE-bus command

```
:CALCulate<1|2>:MARKer<1..4>:FUNCTION:POWER:CFIL ON|OFF
```

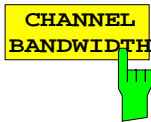

The *CHANNEL BANDWIDTH* softkey opens an entry window for setting the channel bandwidth for the transmission channel and the corresponding adjacent channels.

For all channels, the default setting is 14 kHz.

ACP CHANNEL BW	
CHAN	BANDWIDTH
CH	14 kHz
ADJ	14 kHz
ALT1	14 kHz
ALT2	14 kHz

**Note:** *If the bandwidth of one channel is changed, the new value is also assigned to all subsequent channels in the table. The bandwidths for the individual channels can be set independently, however, by overwriting the table from the top to the bottom.*

IEC/IEEE-bus commands

```
: [SENSE<1|2>:]POWER:ACHannel:BWIDth[:CHANnel] 24KHZ
```

```
: [SENSE<1|2>:]POWER:ACHannel:BWIDth:ACHannel 24KHZ
```

```
: [SENSE<1|2>:]POWER:ACHannel:BWIDth:ALTerate<1|2> 24KHZ
```

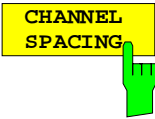

The *CHANNEL SPACING* softkey opens a table for defining the channel spacing. The channel spacing is the spacing of the center frequency of a given channel relative to the center of the transmission channel.

The default setting for channel spacing is 20 kHz.

CHANNEL SPACING	
CHAN	SPACING
ADJ	20 kHz
ALT1	40 kHz
ALT2	60 kHz

**Note:** Channel spacings can be selected separately for each channel. If a spacing value is changed in the table, the following values are changed automatically.

IEC/IEEE-bus commands

```
:[SENSe<1|2>:]POWer:ACHannel:SPACing[:UPPer] 24KHZ
:[SENSe<1|2>:]POWer:ACHannel:SPACing:ACHannel 24KHZ
:[SENSe<1|2>:]POWer:ACHannel:SPACing:ALT<1|2> 24KHZ
```

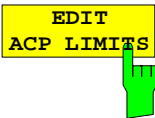

The *EDIT ACP LIMITS* opens a table for defining the limits for ACP-measurement.

ACP LIMITS			
CHAN	CHECK	LOWER CHANNEL LIMIT	UPPER CHANNEL LIMIT
ADJ	✓	-50 dB	-50 dB
ALT1	✓	-60 dB	-60 dB
ALT2			

The limit values are defined either in units of dB (for *CP/ACP REL*) or in dBm (for *CP/ACP ABS*).

**Note:** Measured values that exceed one of the limits are marked with an preceding asterisk.

IEC/IEEE-bus commands

```
:CALCulate<1|2>:LIMit<1..8>:ACP:ACHannel 30DB, 30DB
:CALCulate<1|2>:LIMit<1..8>:ACP:ACHannel:STATE ON|OFF
:CALCulate<1|2>:LIMit<1..8>:ACP:ALT<1|2> 30DB, 30DB
:CALCulate<1|2>:LIMit<1..8>:ACP:ALT<1|2>:STATE ON|OFF
```

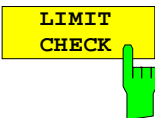

The *LIMIT CHECK* softkey switches on or off the limit check of the ACP measurement.

IEC/IEEE-bus commands

```
:CALCulate<1|2>:LIMit:ACPower[:STATE] ON | OFF
:CALCulate<1|2>:LIMit<1..8>:ACP:ACHannel:RESult?
:CALCulate<1|2>:LIMit<1..8>:ACP:ALTernate<1|2>:RESult?
```

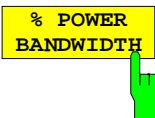

The *% POWER BANDWIDTH* softkey opens an entry window for defining the percentage of the power with respect to the total power in the displayed frequency range. This defines the occupied bandwidth (percent of the total power).

The permitted range is 10 % - 99,9 %

IEC/IEEE-bus command :[SENSe<1|2>:]Power:BANDwidth 99PCT

## Channel Power Measurement

The *CHANNEL POWER* measurement is performed by an integration of the measurement points within the channel bandwidth. The channel is marked by two vertical lines to the left and to the right of the center frequency as defined by the channel bandwidth (see Fig. 4-4).

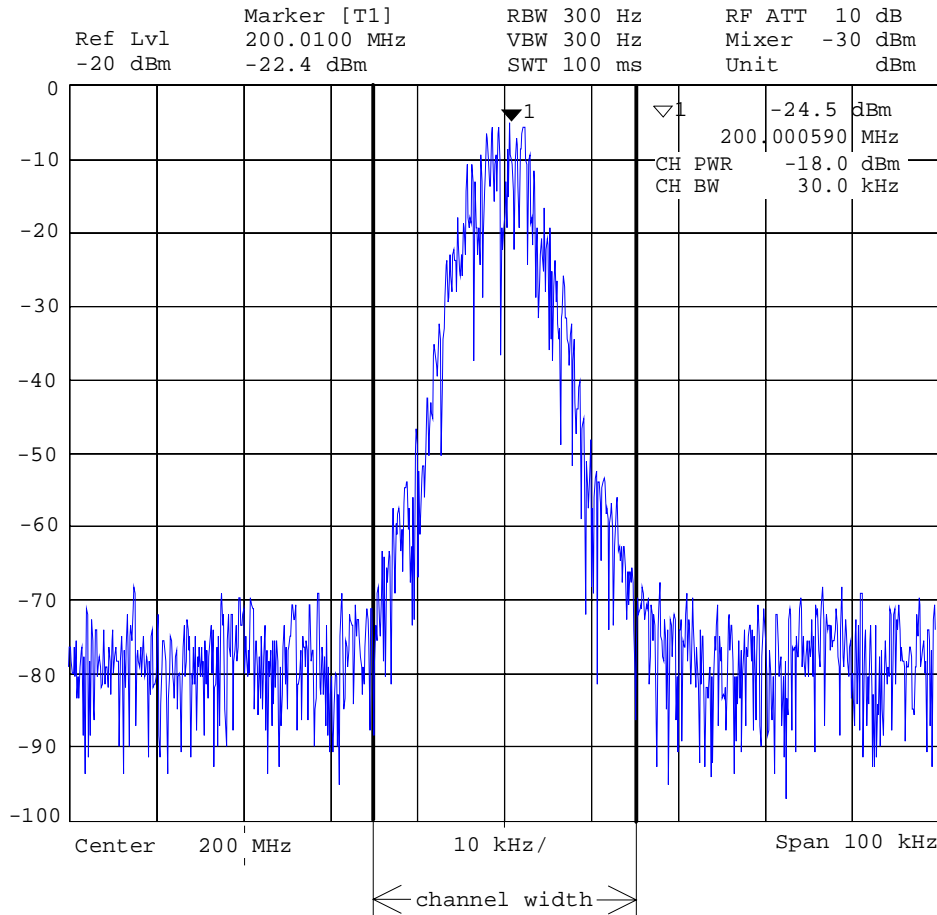
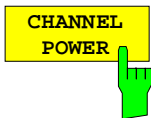

Fig. 4-4 Determination of the channel width

*MARKER NORMAL* menu:



The *CHANNEL POWER* softkey initiates the calculation of the power in the measurement channel. The display takes place in the units of the y axis, e.g., in dBm, dB $\mu$ V.

The calculation is performed by summing the power at the pixels within the specified channel.

The measurement is either absolute or relative to a reference power (see the *CP/ACP ABS/ REL* softkey).

IEC/IEEE-bus commands

```
:CALCulate<1|2>:MARKer<1..4>:FUNC:POW:SElect CPower;
:CALCulate<1|2>:MARKer<1..4>:FUNC:POW:RESult? CPower;
:CALCulate<1|2>:MARKer<1..4>:FUNC:POW[:STATe] OFF
```



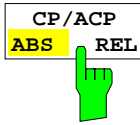

The *CP/ACP ABS/REL* softkey (Channel Power/Adjacent Channel Power Absolute /Relative) switches between an absolute and relative display of the power measured in the channel or adjacent channel.

#### Channel power measurement

**CP ABS** The absolute value of the power is displayed in the unit of the Y axis, eg in dBm, dBV.

**CP REL** The power of a freely selected channel is measured. This power is set in relation to the power of a reference channel. The reference channel power is selected beforehand using the *SET CP REFERENCE* softkey, ie:

1. Declare the power in the currently measured channel as the reference value using the *SET CP REFERENCE* softkey.
2. Set the channel of interest by changing the channel frequency (FSE center frequency).

In case of linear scale of the Y axis the relative power ( $CP/CP_{ref}$ ) of the new channel is displayed in addition to the reference channel. In case of dB scale, the logarithmic ratio  $20 \times \log(CP/CP_{ref})$  is displayed.

Therefore, the relative channel power measurement can also be used for universal adjacent channel power measurements.

#### Example:

Measurement of the 1597-QCDMA adjacent channel power. The useful channel and the adjacent channels have different bandwidths (1.23 MHz or 30 kHz).

#### Adjacent channel power measurement

The power of the adjacent channels is measured. The reference value is the power of the useful channels (see measurement of the adjacent channel power). The useful channel is marked by two vertical lines that are labelled with  $C_0$ .

**ACP ABS** The powers of the useful channel and of the adjacent channels are displayed as absolute values in the unit of the Y axis.

**ACP REL** The logarithmic ratio  $20 \times \log(CP/CP_0)$  of the powers of the adjacent channels to the useful channel is displayed

The softkey is not available for *OCCUPIED PWR BANDWIDTH*, *C/N* and *C/N0*

#### IEC/IEEE-bus command

```
: [SENSe<1 | 2> : ]POWER:ACHannel:MODE ABS | REL
```

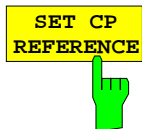

The *SET CP REFERENCE* softkey sets the reference value to the currently measured channel power for an activated *CHANNEL POWER* power measurement,.

#### IEC/IEEE-bus command

```
: [SENSe<1 | 2> : ]POWER:ACHannel:REF:AUTO ONCE
```

## Signal / Noise Power Measurement

MARKER NORMAL menu:

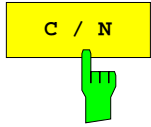

The  $C/N$  (Carrier to Noise) softkey calculates the ratio of carrier power to noise power and the power of interference signals in the channel defined under *POWER MEAS SETTING*. For the measurement, a marker must be set to the carrier of interest.

The unit of  $C/N$  is dB when the display is logarithmic. When the display is linear,  $C/N$  is shown without a unit.

IEC/IEEE-bus commands

```
:CALCulate<1|2>:MARKer<1...4>:FUNction:POW:SElect CN;
:CALCulate<1|2>:MARKer<1...4>:FUNction:POW:RESult? CN;
:CALCulate<1|2>:MARKer<1...4>:FUNction:POW[:STATe] OFF
```

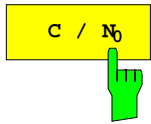

The  $C/N_0$  softkey starts the  $C/N_0$  measurement.

In contrast to the  $C/N$  measurement,  $C/N_0$  calculates the ratio of carrier power to noise and interference signals based on a 1 Hz bandwidth in the channel defined under *POWER MEAS SETTING*.

The unit of  $C/N_0$  is dB/Hz when the display is logarithmic and 1/Hz when the display is linear.

IEC/IEEE-bus commands

```
:CALCulate<1|2>:MARKer<1...4>:FUNction:POW:SElect CN0;
:CALCulate<1|2>:MARKer<1...4>:FUNction:POW:RESult? CN0;
:CALCulate<1|2>:MARKer<1...4>:FUNction:POW[:STATe] OFF
```

### Measurement procedure:

1. Activate a marker and position it to the peak of the carrier signal (e.g., with the *Marker -> Peak* softkey).
2. Select With the desired frequency range (channel) with the *FREQUENCY CENTER* and *CHANNEL BANDWIDTH (POWER MEAS SETTING sub-menu)* softkeys.
3. Press the  $C/N$  or  $C/N_0$  softkey. The marker is set to reference fixed and activates each measurement. It must be observed that the carrier is either located outside of the measurement channel or turned off at the UUT (Unit Under Test).
4. Press the *ADJUST CP SETTINGS* softkey to active the default settings with modified channel parameters.

The measurement values for  $C/N$  or  $C/N_0$  are displayed in the marker info field.

**Notes:** – If no carrier marker was set, only  $N$  or  $N_0$  with the appropriate units is displayed.  
 – Is the carrier located inside the measurement channel,  $C/C+N$  or  $C/C+N_0$  will be displayed

**Example:**

The signal-to-noise ratio of the carrier ( $f = 199.9$  MHz) in the channel with  $+100$  kHz separation from  $200$  MHz (channel center frequency) is to be measured. The channel bandwidth is  $150$  kHz.

1. Using the *CENTER* key, set the center frequency to the channel center frequency  $200$  MHz.
2. Using the *SPAN* key, set the span, e.g., to  $1$  MHz (carrier must be visible).
3. Using the *MARKER NORMAL* key, activate *MARKER 1* (If Marker 1 was not yet active, the function *MARKER*→*PEAK* is automatically executed. In this case, skip step 4.)
4. Using the *MARKER*→*PEAK* key, set *MARKER 1* on the carrier (assumption: the  $200$  MHz carrier has the highest level in the selected span).
5. Press the *MARKER NORMAL* key and change to the left-hand supplementary menu.
6. Using the *POWER MEAS SETTING* softkey, call the sub-menu for defining the measurement channel.
7. Using the *CHANNEL BANDWIDTH*: softkey, set the bandwidth to  $150$  kHz (The channel spacing does not need to be entered for this measurement). Then press  $\uparrow$  menu change key.
8. Using the *C/N* softkey, start the C/N measurement. In the marker info field, the outputs *CHANNEL CENTER*, *CHANNEL BANDWIDTH* as well as the corresponding C/N measurement values appear. *MARKER 1* is also set to reference fixed.
9. Using the *ADJUST CP SETTINGS* softkey, activate the default settings with modified channel parameters (channel bandwidth =  $150$  kHz) for the correct C/N measurement (span =  $2 \times$  channel bandwidth =  $300$  kHz, RBW =  $3$  kHz, VBW =  $10$  kHz, detector: sampling).

Two vertical lines mark the channel  $200$  MHz  $\pm 75$  kHz in which the noise measurement is performed (see Fig.4-5). The reference value is the measurement from *MARKER 1* (Reference Fixed).

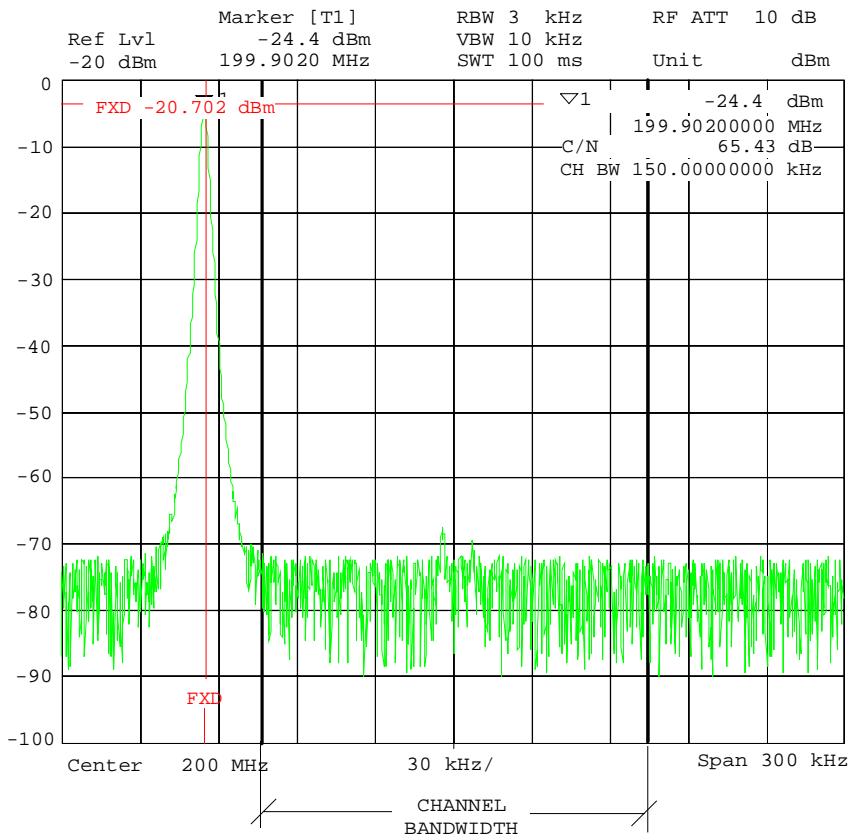
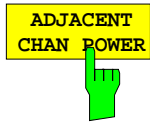

Fig.4-5 Example: measurement of the signal/noise power

## Adjacent Channel Power

MARKER NORMAL menu:



The *ADJACENT CHAN POWER* softkey starts the measurement of the adjacent channel power.

The *ADJACENT CHAN POWER* measures the power which the transmitter delivers to the two adjacent channels (upper channel, lower channel). The measurement values are displayed according to the setting of the *CH/ACD ABS/REL* softkey as absolute values in the scale of the X axis (see Fig.4-6) or as a logarithmic ratio of adjacent channel to useful channel in dB ( $20 \times \log (CP/CP_0)$ ).

If the power of the other neighbouring channels is to be measured in addition to the adjacent channel power, the number of adjacent channels can be extended (on one side only) using *SET NO. OF ADJ CHAN'S* in the submenu *POWER MEAS SETTINGS*.

IEC/IEEE-bus commands

```
:CALCulate<1|2>:MARKer<1...4>:FUNction:POW:SElect ACP;
:CALCulate<1|2>:MARKer<1...4>:FUNction:POW:RESult? ACP;
:CALCulate<1|2>:MARKer<1...4>:FUNction:POW[:STATe] OFF
```

A prerequisite for the correct measurement of the adjacent channel power is the correct setting of the FSE center frequency, the channel bandwidth and the channel spacing. The *CHANNEL SPACING* and *CHANNEL BANDWIDTH* are defined in the *POWER MEAS SETTINGS* sub-menu.

For an activated measurement of adjacent channel power, the analyzer itself optimally sets all other values (span, resolution bandwidth, detector, etc.) after the *ADJUST CP SETTINGS* softkey is pressed. The carrier power in the utilised channel, the power (absolute or relative to the utilised channel) in the upper and lower adjacent channels as well as the largest of the two power values and the channel raster with channel spacing and bandwidth are displayed as the result of the measurement. The C0 lines mark the bandwidth of the carrier channel. Other unlabelled frequency lines mark the adjacent channels (see Fig.4-6). With *SET NO. OF ADJ CHAN'S* 2 selected, the other two neighbouring channels (1st Alternate Channels) are displayed as well, with *SET NO. OF ADJ CHAN'S* 3 selected, an additional channel each (2nd Alternate Channels).

The measurement values are updated and displayed until the *ADJACENT CHAN POWER* softkey is pressed again and the measurement of the adjacent channel power is stopped.

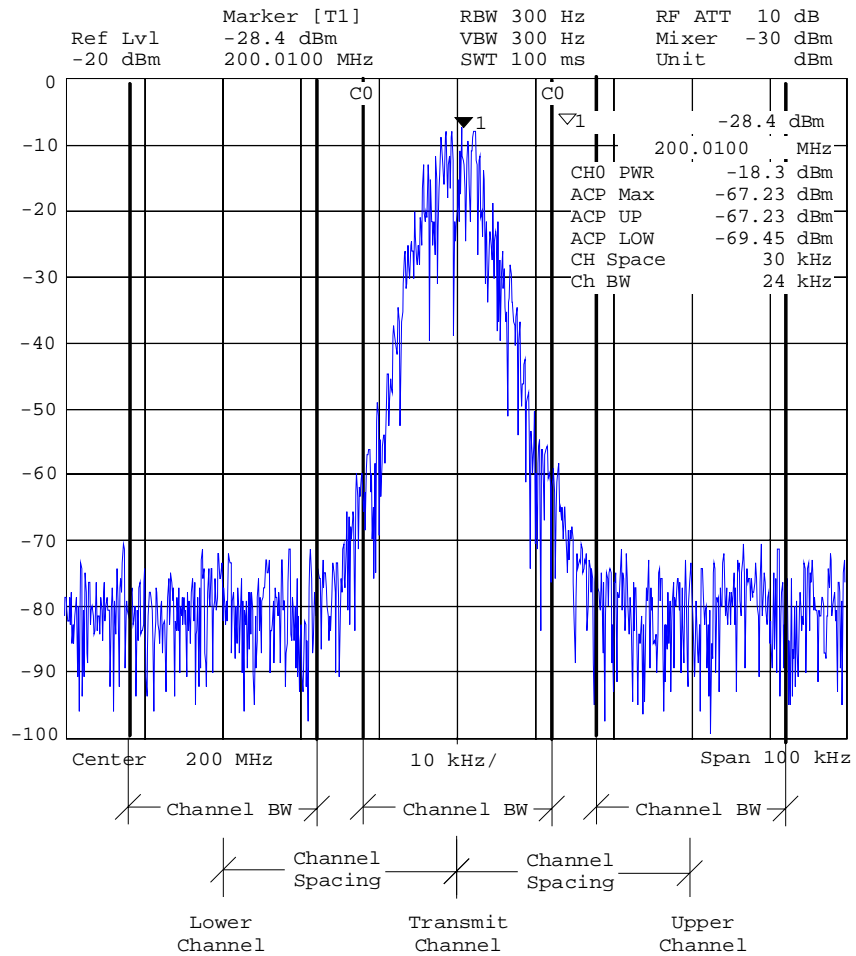

Fig.4-6 Measurement of the adjacent channel power.

If the limit check is activated for ACP measurements, the result of the limit check (PASSED/FAILED) is displayed as well as an asterisk preceding each measured ACP power that exceeded one of the limits.

**Note:** The limit check is activated and the limits are defined in the POWER MEAS SETTINGS menu.

## Occupied Bandwidth Measurement

An important characteristic of a modulated signal is the bandwidth which it occupies. In a radio communications system, for instance, the occupied bandwidth must be limited prevent in adjacent channel interferences. The occupied bandwidth is defined as the bandwidth in which a defined percentage of the total transmitter power is contained. The percentage of the power can be set between 10 and 99% in the FSE.

MARKER NORMAL menu:

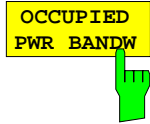

The *OCCUPIED PWR BANDW* (occupied power bandwidth) softkey starts the measurement for determining the occupied bandwidth.

In the spectrum display mode, the bandwidth is determined in which a predefined percentage of the power in the displayed bandwidth is contained. (selectable in the *POWER MEAS SETTINGS* sub-menu with the : % *POWER BANDWIDTH* softkey). The occupied bandwidth is output to the marker display field and marked on the trace with temporary markers.

IEC/IEEE-bus command

```
:CALCulate<1 | 2>:MARKer<1...4>:FUNction:POW:SElect OBW
:CALCulate<1 | 2>:MARKer<1...4>:FUNction:POW:RESult? OBW
:CALCulate<1 | 2>:MARKer<1...4>:FUNction:POW[:STATe] OFF
```

### Measurement principle:

For example, the bandwidth is to be found in which 99% of the signal power is contained. The routine calculates first the total power of all displayed points (pixels) of the trace. In the next step, the measurement points from the right edge of the trace are integrated until 0.5% of the total power is reached. Then the FSE integrates, in an analog fashion, from the left edge of the trace until 0.5% of the power is reached. The delta marker is positioned at this point. Thus, 99% of the power is located between the two markers. The difference between the two frequency markers is the occupied bandwidth which is displayed in the marker info field.

A prerequisite for the correct operation of the measurement is that **only** the signal to be measured is visible on the display screen of the FSE. An additional signal would falsify the measurement.

In order to be able to perform correct power measurements, especially for noisy signals, and thus to achieve the correct occupied bandwidth, the selection of the following parameters should be observed:

RBW	<< occupied bandwidth ( $\leq$ approx. 1/20 of the occupied bandwidth, for voice communications, typ. 300 Hz or 1 kHz)
VBW	$\geq 3 \times$ RBW
detector	sampling
span	$\geq 2$ to $3 \times$ occupied bandwidth

According to the application or other measurement guidelines, it may be necessary or reasonable to average a definite number of sweeps in order to achieve a usable value for the occupied bandwidth.

This is provided by the *TRACE* (1...4) key group and the averaging function. With the *SWEEP COUNT* softkey, the number of averages is defined.

Some measurement instructions (e.g. PDC, RCR, STD-27B) require the occupied bandwidth to be measured by means of a peak detector. In this case, the detector of the FSE must be corrected appropriately.

## Parameters for Channel Power Measurements / Configuration

For the correct measurement of channel power, C/N, C/N0, adjacent channel power and occupied bandwidth, it is recommended that an automatic optimisation of the analyzer settings be performed after enabling the corresponding measurement and selecting the channel configuration (channel power settings).

MARKER NORMAL menu:

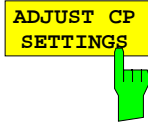

The *ADJUST CP SETTINGS* softkey optimises automatically the settings of the analyzer for the selected power measurement (see below).

All relevant analyzer settings for a power measurement within a defined frequency range (channel bandwidth) are optimally set including:

- span
- resolution bandwidth
- video bandwidth
- detector

dependent upon the channel configuration (channel bandwidth and, if needed, channel spacing).

The trace mathematical functions and trace averaging are switched off.

The reference level is not influenced by the automatic optimisation routine. The reference level is to be so adjusted that the signal maximum is located near the reference level.

The optimisation is performed only once, however, if necessary, the instrument settings may be changed later.

IEC/IEEE-bus command  
`: [SENSe<1|2>:]POWER:ACHannel:PRESet ADJust`

### Span

The span should cover at least the frequency range that is to be observed. For channel power measurements, C/N and C/N0, this is the channel bandwidth. For adjacent channel power measurements, this is the utilised channel bandwidth and the adjacent channels located within the channel spacing. If the span is large compared to the observed frequency band(s), then only a few points on the trace are available for the measurement.

The *ADJUST CP SETTINGS* softkey sets the span as follows:

$2 \times$ channel bandwidth	for channel power, C/N, C/No or
$2 \times$ channel spacing + channel width	for adjacent channel power
$4 \times$ channel bandwidth	for adjacent channel power and NO. OF ADJ CHAN'S 2
$6 \times$ channel spacing + channel width	for adjacent channel power and NO. OF ADJ CHAN'S 3

For measurements of the occupied bandwidth, the span is not influenced.

## Resolution bandwidth (RBW)

In order to achieve acceptable speed as well as the necessary selectivity (to suppress spectral components outside of the channel to be measured and, especially adjacent channels), the resolution bandwidth that is selected must not be too narrow or too broad.

If the resolution bandwidth is too narrow, the measurement speed becomes very slow and it is possible that relative spectral components are not displayed (due to the sampling detector necessary for power measurements and the finite number of points).

On the other hand, the resolution bandwidth should not be so broad that, due to insufficient selection, spectral components outside of the observed frequency range (from adjacent channel) falsify the measurement results.

The *ADJUST CP SETTINGS* softkey sets the resolution bandwidth (RBW) dependent upon the channel bandwidth as follows:

$RBW \leq 1/40$  of the channel bandwidth. The maximum possible RBW, with due regard to the 1, 2, 3, 5 step size and the requirement  $RBW \leq 1/40$  will be selected.

The RBW is not influenced by measurements of the occupied bandwidth.

**Video bandwidth (VBW)** Since a power measurement of the noise components is also necessary (otherwise, errors occur due to the logarithmic characteristics of the spectrum analyzer), the video bandwidth should be selected to be substantially larger than the resolution bandwidth.

The *ADJUST CP SETTINGS* softkey adjusts the video bandwidth (VBW) dependent upon the channel bandwidth as follows:

$VBW \geq 3 * RBW$ . The minimum VVB with regard to the available 1, 2, 3, 5 step size is selected.

**Grid scale** The *ADJUST CP SETTINGS* softkey sets the grid scale to the 100-dB range. Thereby, a wide dynamic range in channel power measurements is achieved.

**Detector** The *ADJUST CP SETTINGS* softkey selects the sampling detector. The sampling detector is to be selected, above all, for correct power measurements of noisy signals within the observed frequency range.



## Marker Step Size

DATA VARIATION – STEP menu:

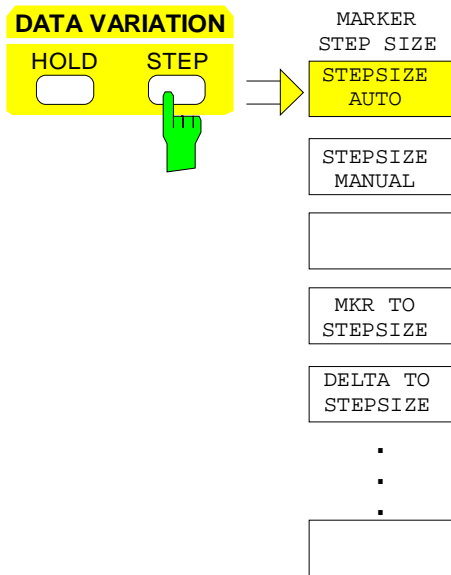

The *STEP* key in the *DATA VARIATION* key group opens a menu to match the marker step size to each individual application. In order to change the step size, the marker entry mode must already be active.

Control is returned to the *MARKER NORMAL* menu via the menu key .

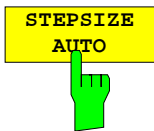

The *STEPSIZE AUTO* softkey sets the marker step size to *AUTO*. In this case, the step size is exactly 10% of the grid. A one-raster movement of the roll-key corresponds to one pixel.

*STEPSIZE AUTO* is the default setting.

IEC/IEEE-bus command

:CALCulate<1|2>:MARKer<1..4>:STEP:AUTO ON|OFF



The *STEPSIZE MANUAL* softkey activates the entry window for defining a fixed value for the marker step size.



Pressing the step key shifts the marker position by the selected step size. The resolution of the roll-key is always one pixel per raster.

IEC/IEEE-bus command

:CALCulate<1|2>:MARKer<1..4>:STEP 10KHZ



The *MKR TO STEPSIZE* softkey sets the marker step size to the current marker frequency or marker time.

In the frequency domain, this function is well suited to harmonic measurements. The marker is set to the largest signal using the peak search function. After activation of the *MKR TO STEPSIZE* function, the marker is set to the corresponding harmonic of the signal each time the cursor key  or  is pressed when entering the marker position (see also Chapter 2, "Measurement Examples").

IEC/IEEE-bus command

:CALCulate<1|2>:MARKer<1..4>:FUNction:MStep



The *DELTA TO STEPSIZE* softkey sets the marker step size to the difference between the reference marker and the last active delta marker.

The softkey is only available when at least one delta marker is enabled.

IEC/IEEE-bus command --

### Delta Markers – DELTA Key

The delta marker.s are used to measure a level or frequency referred to a reference marker. They are always referenced to the marker whose position was last changed. A delta marker is displayed as an empty  $\triangle$  symbol. The reference marker is displayed as a filled  $\blacktriangledown$  symbol.

MARKER DELTA menu:

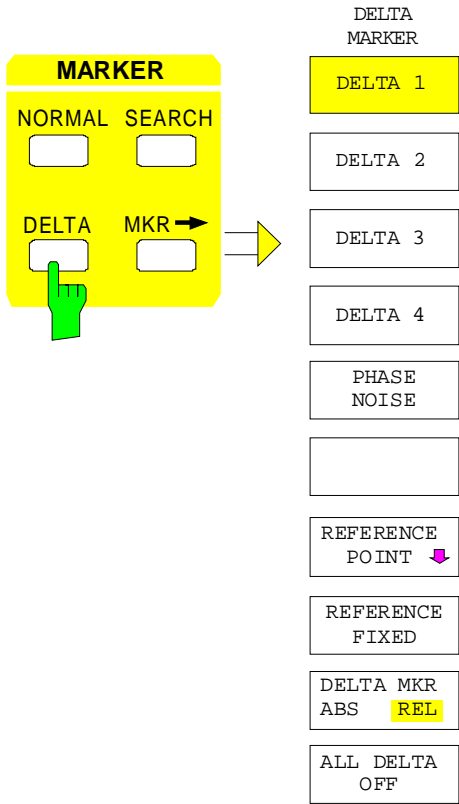

The *DELTA* key switches a delta marker on and calls the menu for its control. If no marker is enabled, *MARKER 1* is automatically activated when the delta marker is switched on. The delta marker activated to entry mode is shown on the display screen as a filled  $\blacktriangle$  symbol.

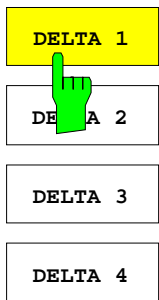

The *DELTA 1 to 4* softkeys are used to enable delta markers 1...4. The control of the delta markers corresponds to that of the markers. After a delta marker has been enabled, all entries are now applicable to this marker. The main marker must be activated anew if its position is to be changed.

The delta marker field on the display screen contains the delta marker number, the difference frequency from the delta marker to reference marker and the level difference between the active delta markers and reference markers.

The indicated differences are, in general, referred to the reference marker. If the *PHASE NOISE* or *REFERENCE FIXED* functions are enabled, the reference values under *REFERENCE POINT* are applicable.

IEC/IEEE-bus commands

```
:CALCulate<1|2>:DELTAmarker<1..4> ON|OFF
:CALCulate<1|2>:DELTAmarker<1..4>:X 10.7MHZ
:CALCulate<1|2>:DELTAmarker<1..4>:X:REL?
:CALCulate<1|2>:DELTAmarker<1..4>:Y
```

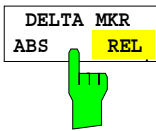

The *DELTA ABS REL* softkey switches between relative and absolute entry modes for the delta-marker frequency.

In the *REL* position, the delta marker frequency is entered relative to the reference marker. In this case, the entry mode for the delta-marker frequencies is also relative.

In the *ABS* position, the entry of the delta-marker frequency is in terms of absolute frequency.

The default setting is *REL*.

IEC/IEEE-bus command

```
:CALCulate<1|2>:DELTAmarker<1..4>:MODE ABS | REL
```



The *ALL DELTA OFF* softkey switches off all active delta markers and any associated functions (e.g. *REFERENCE FIXED*, *PHASE NOISE*).

IEC/IEEE-bus command

```
:CALCulate<1|2>:DELTAmarker<1..4>:AOFF
```

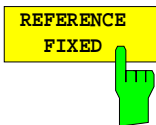

The *REFERENCE FIXED* softkey enables/disables relative measurements with respect to a fixed, measurement-curve-independent reference value.

The information in the delta-marker field on the display screen is referenced to this fixed reference value. For the generation of the marker lists using *MARKER INFO* list, the delta markers are also output relative to a fixed reference. In the lists, the *REFERENCE POINT* is tagged by the number of the reference marker (only one enabled)

When *REFERENCE FIXED* is enabled, the current settings of the reference marker become the reference values. If no marker is active, *MARKER 1* (with peak search) is activated. After transferring the reference values, all markers are deleted, and the active delta marker is set to the position of the reference value. Additional delta markers can be switched on.

The reference value can be subsequently changed

1. by shifting it in the *REFERENCE POINT* sub-menu.
2. by starting a search:

In the *MARKER NORMAL* menu the *REF POINT* is handled as a reference marker (even though it is not bound to the trace). This means, that it will be shown as enabled and can also be changed in position. The co-ordinates of the *REF POINT* are overwritten by the marker values (they lie, by definition, on the trace). Thus, it is possible, even for an enabled *REFERENCE FIXED*, to define a new reference point function with search functions.

The *REFERENCE FIXED* function is particularly useful for measurements which are performed relative to a reference signal that is not available during the whole measurement time (e. g. harmonics measurements, see chapter "Measurement Example").

IEC/IEEE-bus command

```
:CALCulate<1|2>:DELTAmarker<1..4>:FUNCTION:FIXED ON|OFF
```

## MARKER DELTA- REFERENCE POINT submenu:

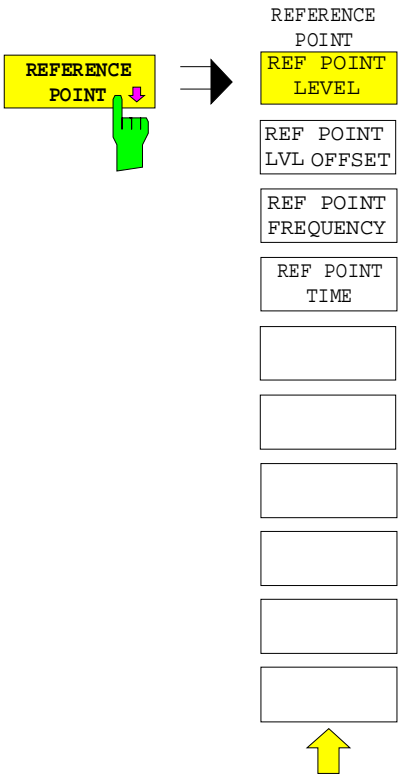

The *REFERENCE POINT* softkey opens a sub-menu in which the reference value the *REFERENCE FIXED* and *PHASE NOISE* functions can be modified.

The position of the reference value is indicated by two additional display lines (horizontal and vertical). In addition, an offset level may be defined which is added to each difference during output.

The softkey is only available when the *REFERENCE FIXED* or *PHASE NOISE* function is switched on.

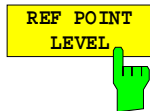

The *REF POINT LEVEL* softkey activates an entry box for setting the reference level relevant to the *REFERENCE FIXED* or *PHASE NOISE* functions.

IEC/IEEE-bus command

```
:CALCulate<1|2>:DELT<1..4>:FUNC:FIXed:RPoint:Y -10DBM
```

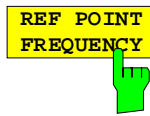

The *REF POINT FREQUENCY* softkey activates the entry box for the input of a reference frequency for the *REFERENCE FIXED* or *PHASE NOISE* functions.

IEC/IEEE-bus command

```
:CALCulate<1|2>:DELT<1..4>:FUNC:FIXed:RPoint:X 10.7MHZ
```

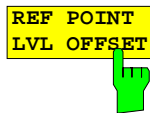

The *REF POINT LVL OFFSET* softkey activates the entry box for the entry of an additional offset level during output when the *REFERENCE FIXED* or *PHASE NOISE* functions are enabled.

The offset level is set to 0 dB when the *REFERENCE FIXED* or *PHASE NOISE* functions are switched on.

IEC/IEEE-bus command

```
:CALCulate<1|2>:DELT<1..4>:FUNC:FIX:RPO:Y:OFFSet 10DB
```



The *REF POINT TIME* softkey activates the entry box for the input of a reference time for the *REFERENCE FIXED* function in the time domain (span = 0).

The entry of a reference time for the *PHASE NOISE* function is not possible.

IEC/IEEE-bus command

```
:CALCulate<1|2>:DELT<1..4>:FUNC:FIXed:RPoint:X 100ms
```

## Phase Noise Measurement

MARKER DELTA menu:

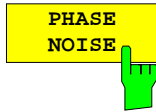

The *PHASE NOISE* softkey switches the *PHASE NOISE* function on/off.

When *PHASE NOISE* measurement is switched on, the frequency and level of the reference marker are used as fixed reference values, i.e. the *REFERENCE FIXED* function is activated.

The difference between this reference point and the active delta markers is determined. The correction factors for bandwidth and the logarithmic converter are automatically taken into account. The sampling detector is automatically selected to allow the effective noise power to be displayed. The measured values are displayed in the delta marker field in units of dBc/Hz.

If several delta markers are enabled, only the measurement value output of the active marker is shown in the marker field. Using *MARKER INFO* and *MARKER LIST* the measurement data of all delta markers can be displayed.

If no marker is present when the *PHASE NOISE* function is enabled, *MARKER 1* is automatically switched on (peak search), and the marker values are saved as reference values. The reference value can be changed later in the *NORMAL* menu, *SEARCH* menu or *REFERENCE POINT* sub-menu (see *REFERENCE FIXED* softkey).

Turning on an additional marker causes the *PHASE NOISE* function to be disabled.

IEC/IEEE-bus commands

```
:CALCulate<1|2>:DELTAmarker<1..4>:FUNC:PNOise ON | OFF
:CALCulate<1|2>:DELTAmarker<1..4>:FUNC:PNOise:RESult?
```

### Delta-Marker Step Size - *STEP* Key

*STEP-DELTA STEP* menu:

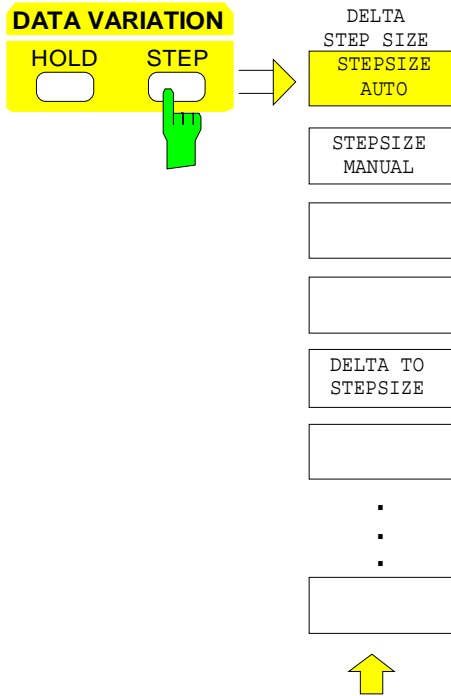

The *STEP* key in the *DATA VARIATION* key group opens a menu to match the step size of the individual delta markers to the specific application. In order to change the step size, the entry mode for a delta marker must already be active.

Control is returned to the *DELTA MARKER* menu via the menu key .

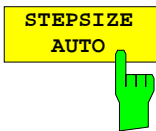

The *STEPSIZE AUTO* softkey sets the delta marker step size to *AUTO*. In this case, the step size of the delta marker is exactly 10% of the grid. The roll-key corresponds to 1/500, i.e., for each rotational pulse, the delta marker is shifted one pixel position.

IEC/IEEE-bus command  
`:CALCulate<1|2>:DELTAmarker<1..4>:STEP:AUTO ON | OFF`



The *STEPSIZE MANUAL* softkey permits the entry of a fixed value for the delta marker step size.

Pressing the step-key shifts the marker position by the selected step size. The roll-key resolution, however, always remains constant at 1 pixel.

IEC/IEEE-bus command    --



The *DELTATO STEPSIZE* softkey sets the delta marker step size to a quantity equal to the difference between the delta and reference markers.

The softkey is only presented when at least one delta marker is switched on.

IEC/IEEE-bus command  
`:CALCulate<1|2>:DELTAmarker<1..4>:STEP 10HZ`

### Search Functions – SEARCH Key

The FSE offers numerous functions useful for peak/min. peak searching. The search functions can be used for marker as well as delta marker functions.

The setups applicable to the available search functions are performed in the *MARKER-SEARCH* menu.

The search functions are always related to the currently active marker. If the *SEARCH* key is pressed while the marker entry mode is active, then all search functions are related to the current reference marker. If the entry mode of a delta marker is active, then the functions will be applied to the corresponding delta marker. For the case where no marker is active, *MARKER 1* will be automatically enabled (with peak search). The *ACTIVE MKR / DELTA* softkey allows toggling between the active marker and the active delta marker.

If the threshold line is turned on, the peak/min. search functions will only evaluate signals which have a level above/below the selected threshold. In addition, the search range can also be limited (*SEARCH LIM ON/OFF* softkey) by the frequency/time lines (*FREQUENCY LINE 1/2, TIME LINE 1/2*).

For all peak search functions, the first local oscillator is omitted at 0 Hz if it happens to be displayed.

In the time domain display, the summary markers can be activated and set in addition to the search functions in menu *MARKER-SEARCH*.

*MARKER SEARCH* menu:

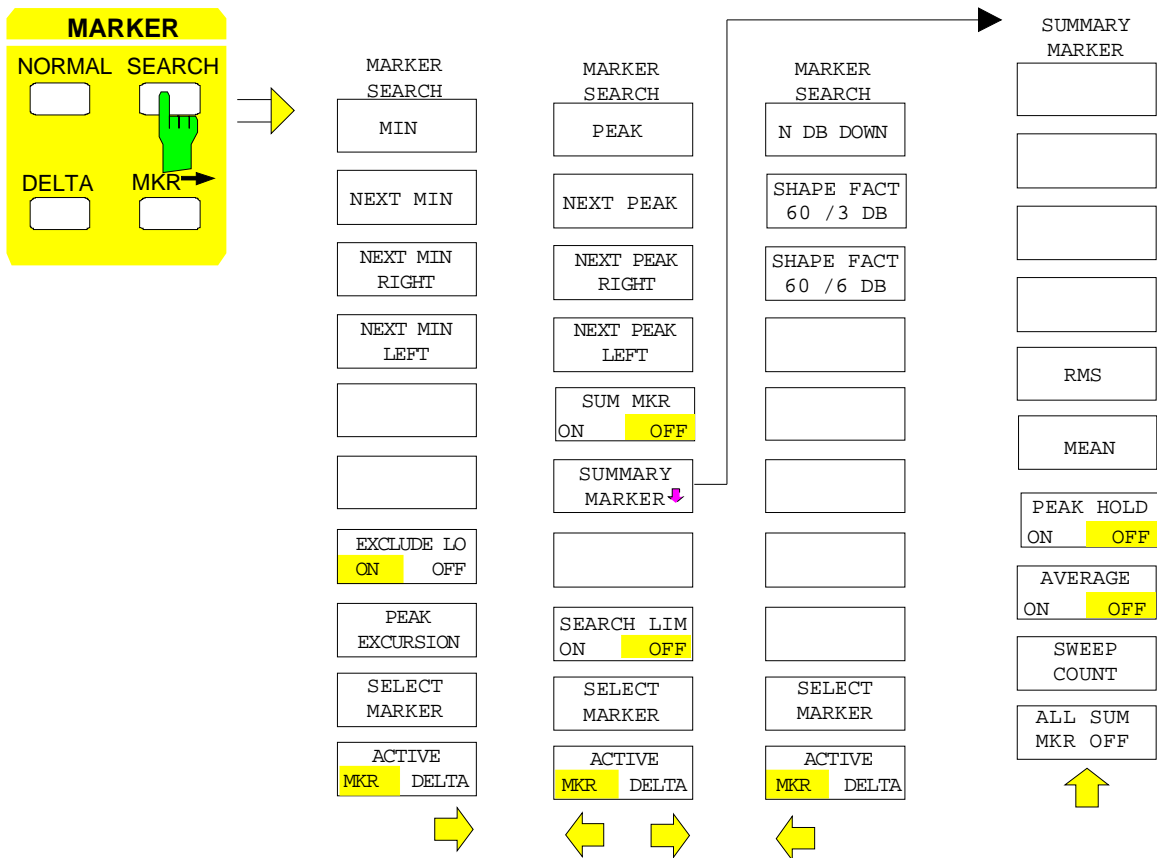

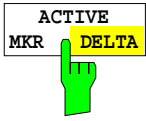

The *ACTIVE MKR / DELTA* softkey toggles between the active marker and the active delta marker.

If *DELTA* is illuminated, the following search functions are performed with the active delta marker.

**Note:** *Switching between marker and delta marker entry modes may also be performed using the NORMAL and DELTA keys.*

IEC/IEEE-bus command --



The *SELECT MARKER* softkey activates the selection of the marker/delta markers. The selection box lists the currently enabled markers/delta markers.

MARKER SELECT	DELTA SELECT
MARKER 1	✓ DELTA 1
MARKER 3	DELTA 2
MARKER 4	DELTA 3

IEC/IEEE-bus command --

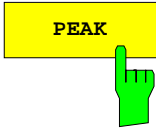

The *PEAK* softkey sets the active marker/delta marker to the maximum displayed value on the corresponding trace.

IEC/IEEE-bus commands  
 :CALCulate<1 | 2>:MARKer<1..4>:MAXimum  
 :CALCulate<1 | 2>:DELTAmarker<1..4>:MAXimum

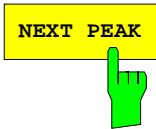

The *NEXT PEAK* softkey sets the active marker/delta marker to the trace value next in magnitude after the peak.

IEC/IEEE-bus commands  
 :CALCulate<1 | 2>:MARKer<1..4>:MAX:NEXT  
 :CALCulate<1 | 2>:DELTAmarker<1..4>:MAX:NEXT

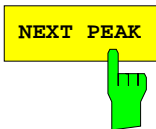

The *NEXT PEAK RIGHT* softkey sets the active marker to the next peak to the right of the current marker position.

IEC/IEEE-bus commands  
 :CALCulate<1 | 2>:MARKer<1..4>:MAX:RIGHT  
 :CALCulate<1 | 2>:DELTAmarker<1..4>:MAX:RIGHT



The *NEXT PEAK LEFT* softkey sets the active marker to the next peak to the left of the current marker position.

IEC/IEEE-bus commands  
 :CALCulate<1 | 2>:MARKer<1..4>:MAX:LEFT  
 :CALCulate<1 | 2>:DELTAmarker<1..4>:MAX:LEFT

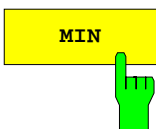

The *MIN* softkey sets the active marker to minimum displayed value on the corresponding trace.

IEC/IEEE-bus commands  
 :CALCulate<1 | 2>:MARKer<1..4>:MIN  
 :CALCulate<1 | 2>:DELTAmarker<1..4>:MIN



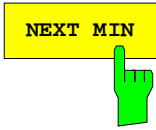

The *NEXT MIN* softkey sets the active marker to the next higher of the low peaks on the corresponding trace.

IEC/IEEE-bus commands

```
:CALCulate<1 | 2>:MARKer<1..4>:MIN:NEXT
:CALCulate<1 | 2>:DELTAmarker<1..4>:MIN:NEXT
```

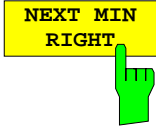

The *NEXT MIN RIGHT* softkey set the active marker to the next low peak to the right of the current marker position.

IEC/IEEE-bus commands

```
:CALCulate<1 | 2>:MARKer<1..4>:MIN:RIGHT
:CALCulate<1 | 2>:DELTAmarker<1..4>:MIN:RIGHT
```

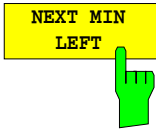

The *NEXT MIN LEFT* softkey sets the active marker to the next low peak to the left of the current marker position.

IEC/IEEE-bus command

```
:CALCulate<1 | 2>:MARKer<1..4>:MIN:LEFT
:CALCulate<1 | 2>:DELTAmarker<1..4>:MIN:LEFT
```

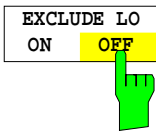

The *EXCLUDE LO ON/OFF* softkey switches between a restricted (*ON*) and an unrestricted search range (*OFF*).

**ON** Because of non-ideal input mixer, the first LO of any analyzer can be seen at 0 Hz. The search functions can possibly respond to this LO level, in particular in the preset setting (FULL SPAN). To prevent this, the search range is restricted according to the following formula:

$$\text{Search range} \geq 6 \times \text{resolution bandwidth}$$

**OFF** No restriction on the search range. The search functions find also signals below the frequency limit quoted above.

IEC/IEEE-bus command

```
:CALCulate<1 | 2>:MARKer<1..4>:LOEXclude ON|OFF
```

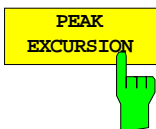

The *PEAK EXCURSION* softkey activates the entry box which sets the minimum amount a signal level must decrease/increase before it is recognised by the search functions (except *PEAK* and *MIN*) as a maximum or minimum.

Input values from 0 dB to 80 dB are allowed with a resolution of 0.1 dB.

IEC/IEEE-bus command

```
:CALCulate<1 | 2>:MARKer<1..4>:PEXCursion 10DB
```

The peak excursion is preset to 6 dB. This is sufficient for the functions *NEXT PEAK* (or *NEXT MIN*) as the next smallest (or next largest) signal is always searched for.

Functions *NEXT PEAK LEFT* and *NEXT PEAK RIGHT* (or *NEXT MIN LEFT* and *NEXT MIN RIGHT*) search for the next relative maximum (or minimum) irrespective of the current signal amplitude.

As for wide bandwidths, the intrinsic noise of the FSE may equal the 6 dB level change preset for *PEAK EXCURSION* and so noise peaks are identified as signal peaks

In this case, a value for *PEAK EXCURSION* which is higher than the difference between the maximum and minimum noise display reading must be entered.

The following example shows the effect of different *PEAK EXCURSION* settings.

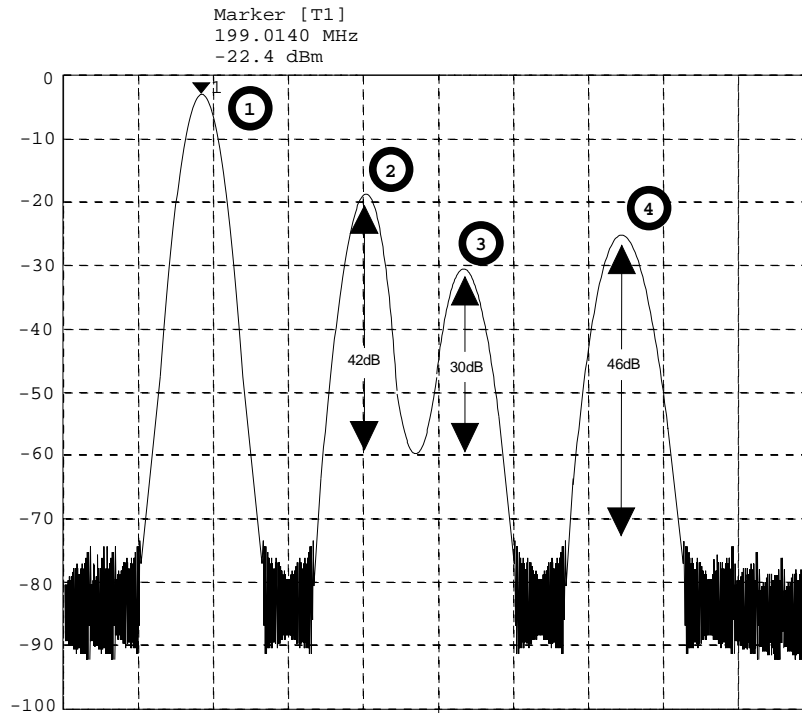

Fig. 4-7 Example for level measurements at various peak excursion settings

Maximum relative level change of the measured signals:

- Signal 2: 42dB
- Signal 3: 30dB
- Signal 4: 46dB

With **Peak Excursion 40dB** signals 2 and 4 are detected by *NEXT PEAK* or *NEXT PEAK RIGHT*. Signal 3 is not detected since it is only decreased by 30 dB before rising again.

Order in which signals are found:

- |            |          |    |                  |          |
|------------|----------|----|------------------|----------|
| PEAK:      | Signal 1 | or | PEAK:            | Signal 1 |
| NEXT PEAK: | Signal 2 |    | NEXT PEAK RIGHT: | Signal 2 |
| NEXT PEAK: | Signal 4 |    | NEXT PEAK RIGHT: | Signal 4 |

With **Peak Excursion 20dB** signal 3 is detected as well since its highest level change of 30 dB is now higher than the peak excursion.

Order in which signals are found:

- |            |          |    |                  |          |
|------------|----------|----|------------------|----------|
| PEAK:      | Signal 1 | or | PEAK:            | Signal 1 |
| NEXT PEAK: | Signal 2 |    | NEXT PEAK RIGHT: | Signal 2 |
| NEXT PEAK: | Signal 4 |    | NEXT PEAK RIGHT: | Signal 3 |
| NEXT PEAK: | Signal 3 |    | NEXT PEAK RIGHT: | Signal 4 |

Whith **Peak Excursion 6dB** all signals are detected, *NEXT PEAK RIGHT* does not produce the required results.

Order in which signals are found:

PEAK: Signal 1  
 NEXT PEAK: Signal 2  
 NEXT PEAK: Signal 4  
 NEXT PEAK: Signal 3

or

PEAK: Signal 1  
 NEXT PEAK RIGHT: Marker in noise between signal 1 and signal 2  
 NEXT PEAK RIGHT: Marker in noise between signal 1 and signal 2



The *SEARCH LIMIT ON/OFF* softkey switches between a limited (*ON*) and unlimited (*OFF*) search range.

For peak and min. search functions, the search range can also be limited by the frequency and time lines (*FREQUENCY LINE 1, 2/TIME LINE 1, 2*). If *SEARCH LIMIT = ON*, the appropriate signal level will only be searched for between the specified frequency/time lines.

The default setting is *SEARCH LIMIT = OFF*.

When only one line is enabled, frequency/time line 1 is defined as the lower limit and the upper limit is defined by the stop frequency. If frequency/time line 2 turned on, then it determines the upper limit.

For the case in which no line is active the search range is unlimited.

IEC/IEEE-bus command

```
:CALCulate<1|2>:MARKer<1..4>:X:SLIMits ON|OFF
```

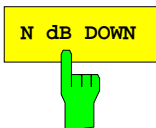

The *N dB DOWN* softkey automatically activates the temporary markers T1 and T2 and sets them n dB below the active reference marker. Marker T1 is located on the left, the marker T2 is located on the right of the reference marker. The value n can be entered in an entry window. The default value is 6 dB.

The frequency difference between the two temporary markers is indicated in the level output field.

If, e.g., due to the noise level, it is not possible to determine the frequency difference for the n dB value, dashes are displayed instead of the measured value.

Entry mode is switched to the reference marker for the case in which the delta maker entry mode is to be active. The position of the reference marker can be changed in the usual way (numeric input, step-keys, roll-key, peak search, etc.).

Pressing the *N dB DOWN* softkey again switches the function off, however, the entry function for the reference marker remains turned on.

IEC/IEEE-bus commands

```
:CALCulate<1|2>:MARKer<1..4>:FUNction:NDBDown 3DB
:CALCulate<1|2>:MARKer<1..4>:FUNction:NDBDown:STATe ON
:CALCulate<1|2>:MARKer<1..4>:FUNction:NDBDown:RESult?
:CALCulate<1|2>:MARKer<1..4>:FUNction:NDBDown:FREQ?
```

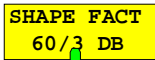
 A yellow rectangular softkey with black text that reads "SHAPe FACT" on the top line and "60/3 DB" on the bottom line. A green hand icon is pointing at the bottom center of the softkey.

 A yellow rectangular softkey with black text that reads "SHAPe FACT" on the top line and "60/6 DB" on the bottom line. A green hand icon is pointing at the bottom center of the softkey.

The *SHAPe FACT 60/3dB* and *SHAPe FACT 60/6dB* softkeys activate the automatic measurement of the form factor for the displayed signals.

For this purpose, four temporary markers are used. The markers T1 to T4 indicate, in increasing order, the 3 dB/6 dB positions below the reference marker level.

In the level output field, the relationship between the two frequency differences  $\Delta f_{60dB} / \Delta f_{3dB}$  and  $\Delta f_{60dB} / \Delta f_{6dB}$  are displayed

The display of the measurement value takes place in the marker field. When the level differences cannot be determined, the measurement value is marked as invalid. The update of the shape-factor display takes place at the end of sweep.

The entry mode is switched to the reference marker if the delta marker entry mode is to be active. The position of the reference marker can be changed in the usual way (numeric input, step-keys, roll-key, peak search, etc.).

The *SHAPe FACTOR* function is turned off by pressing *SHAPe FACTOR* softkey once again, or by enabling another marker.

The *SHAPe FACTOR* function is available only in the frequency domain.

IEC/IEEE-bus commands

```
:CALCulate<1|2>:MARKer<1..4>:FUNction:SFActor
      (60dB/3dB) | (60dB/6dB)
:CALCulate<1|2>:MARKer<1..4>:FUNction:SFActor:STATe ON
:CALCulate<1|2>:MARKer<1..4>:FUNction:SFActor:RESult?
:CALCulate<1|2>:MARKer<1..4>:FUNction:SFActor:FREQ?
```

## Summary Marker

The summary markers are available for measurements in the time domain (SPAN = 0).

Unlike the markers and delta markers, the *summary markers* are not used to mark the pixels of a trace. They activate a measurement of the rms value (*RMS*) or of the average value (*MEAN*) of the whole trace. The result is displayed in the marker info field.

The measured values are either updated after every sweep or averaged according to a defined number of sweeps (*AVERAGE ON/OFF* and *SWEEP COUNT*). In case of maximum peak evaluation (*PEAK HOLD ON*) the measured values are held until the occurrence of the next higher value.

Example:

Marker info field switched on with summary marker: *MEAN*, *AVERAGE ON* and *PEAK HOLD ON*

```
MEAN HOLD      2.33 Watt
MEAN AV        2.29 Watt
```

The evaluation range can be limited with the function *SEARCH LIMITS ON* and the time lines (*TIME LINE1,2*), eg when measuring the average power of a sampled signal from the beginning to the end of a burst.

With the summary marker switched on, the sampling detector is activated (*TRACE-DETECTOR-AUTO*).

*MARKER SEARCH* menu

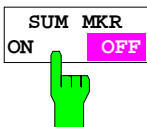
 A rectangular softkey with a white background and black text. The top line reads "SUM MKR". The bottom line has "ON" on the left and "OFF" on the right, separated by a vertical line. A green hand icon is pointing at the "ON" text.

The *SUM MKR* softkey activates the summary marker

The measurement, rms or average value and the settings for maximum peak evaluation and averaging is selected in the submenu *SUMMARY MARKER*.

The softkey is only available in the time domain.

IEC/IEEE-bus command

```
:CALCulate<1|2>:MARKer<1..4>:FUNction:SUMMary ON|OFF
```

MARKER SEARCH menu

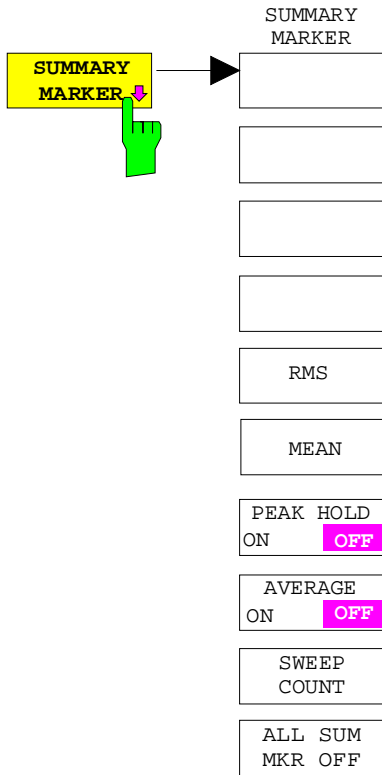

The *SUMMARY MARKER* softkey calls up the submenu for selecting the summary marker measurements.  
 The softkey is only available in the time domain.

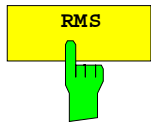

The *RMS* softkey selects the measurement of the rms value of the signal per sweep.

In case of maximum peak evaluation the highest rms value since the activation of *PEAK HOLD ON* is displayed. In case of *AVERAGE ON* the rms values of a trace are averaged and displayed over several sweeps.

The number of sweeps is set with the *SWEEP COUNT* softkey. If *PEAK HOLD = ON* is active at the same time, the display is held until the occurrence of the next higher average value.

IEC/IEEE-bus commands

```
:CALCulate<1 | 2>:MARKer<1..4>:FUNCTION:SUMM:RMS ON
:CALCulate<1 | 2>:MARKer<1..4>:FUNCTION:SUMM:RMS:RES?
:CALCulate<1 | 2>:MARKer<1..4>:FUNCTION:SUMM:RMS:AVER:RES?
:CALCulate<1 | 2>:MARKer<1..4>:FUNCTION:SUMM:RMS:PHOL:RES?
```

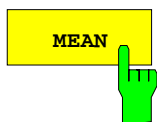

The *MEAN* softkey selects the measurement of the average value of the signal per sweep.

Thus, the mean power can be measured, for example during a GSM burst.

In case of maximum peak evaluation, the highest average value since the activation of *PEAK HOLD ON* is displayed.

In case of *AVERAGE ON*, the average values of a trace are averaged and displayed over several sweeps.

The number of sweeps is set with the *SWEEP COUNT* softkey. If *PEAK HOLD = ON* is active at the same time, the display is held until the occurrence of the next higher average value.

IEC/IEEE-bus commands

```
:CALCulate<1 | 2>:MARKer<1..4>:FUNCTION:SUMM:MEAN ON
:CALCulate<1 | 2>:MARKer<1..4>:FUNCTION:SUMM:MEAN:RES?
:CALCulate<1 | 2>:MARKer<1..4>:FUNCTION:SUMM:MEAN:AVER:RES?
:CALCulate<1 | 2>:MARKer<1..4>:FUNCTION:SUMM:MEAN:PHOL:RES?
```

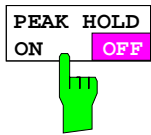

The *PEAK HOLD ON/OFF* softkey switches the maximum peak evaluation on and off.

For all active summary markers, the displays are updated after each sweep only if higher values have occurred.

The measured values can be reset by switching the *PEAK HOLD ON / OFF* softkey on and off again.

IEC/IEEE-bus command

:CALCulate<1|2>:MARKer<1..4>:FUNCTION:SUMMARY:PHOLD ON

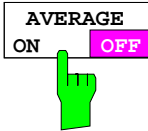

The *AVERAGE ON/OFF* softkey switches the averaging of the summary markers on and off.

The measured values can be reset by switching the *AVERAGE HOLD ON / OFF* softkey on and off again.

IEC/IEEE-bus command

:CALCulate<1|2>:MARKer<1..4>:FUNCTION:SUMMARY:AVERAGE ON



The *SWEEP COUNT* softkey activates the entry of the number of sweeps in the *SINGLE SWEEP* mode.

The permissible range of values is 0 to 32767.

In case of *AVERAGE ON*:

If an averaging has been selected, *SWEEP COUNT* also determines the number of measurements required for averaging.

*SWEEP COUNT* = 0      10 measured values are required for running averaging.

*SWEEP COUNT* = 1      No averaging is carried out.

*SWEEP COUNT* > 1      An averaging is carried out over the set number of measured values.

In the *CONTINUOUS SWEEP* mode averaging is performed until the number of sweeps set under *SWEEP COUNT* is attained and then running averaging is performed.

The maximum peak evaluation is infinite independent of the entry under *SWEEP COUNT*.

**Note:** This setting is equivalent to the settings of the number of sweeps of menus *TRACE* and *SWEEP-SWEEP*.

IEC/IEEE-bus command      :[SENSe<1|2>:]SWEep:COUNT 20



The *ALL SUM MKR OFF* softkey switches all the summary markers off.

IEC/IEEE-bus command

:CALCulate<1|2>:MARKer<1..4>:FUNCTION:SUMMARY:AOFF

### Instrument Parameter Changes via Markers – MKR → Key

MARKER MKR →menu:

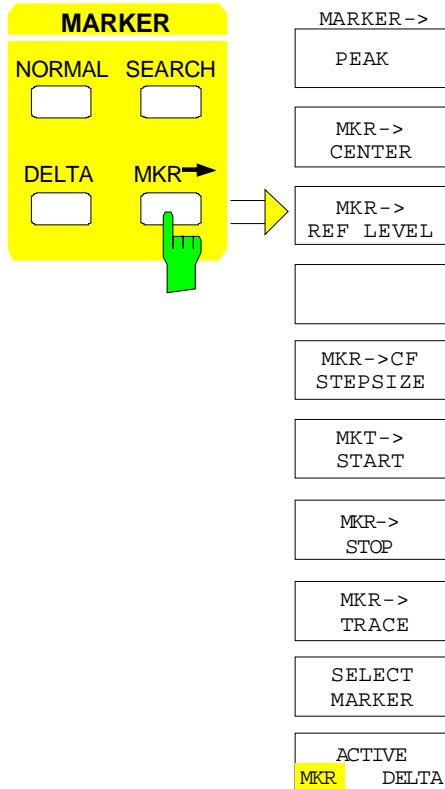

The *MKR →* menu offers functions that can be used to change instrument settings with the currently active marker. Exactly as in the *SEARCH* menu, these functions can also be applied to the delta markers.

The choice between marker and delta marker is made according to the currently active frequency entry mode for the marker/delta marker. If no entry mode is active, the marker with the lowest number will be activated as the reference marker.

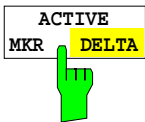

The *ACTIVE MKR /DELTA* softkey toggles between the active marker and the active delta marker.

If *DELTA* is illuminated, the following marker functions are carried out with the active delta marker.

**Note:** *Switching between marker and delta marker can also be done with the NORMAL and DELTA keys.*

IEC/IEEE-bus command --



To simplify control, the *PEAK* search function (see section "Search Functions - *SEARCH* Key") is also available in the *MRK→* menu. Thus, the most important functions *MARKER→PEAK*, *MKR→CENTER* and *MKR→REF LEVEL* can be selected in one menu.

IEC/IEEE-bus commands

```
:CALCulate<1 | 2>:MARKer<1..4>:MAX
:CALCulate<1 | 2>:DELTamarker<1..4>:MAX
```

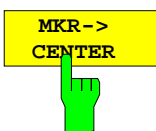

The *MKR→CENTER* softkey sets the center frequency to the current marker/delta marker frequency .

The softkey is not available in the time domain.

IEC/IEEE-bus command

```
:CALCulate<1 | 2>:MARKer<1..4>:FUNctio:n:CENTer
```

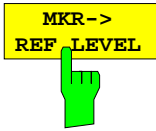

The *MKR→REF LEVEL* softkey sets the reference level to that of the current marker.

IEC/IEEE-bus command  
 :CALCulate<1|2>:MARKer<1..4>:FUNction:REFerence



The *MKR→CF STEPSIZE* softkey sets the step size for the center frequency variation to the current marker frequency, and also sets step-size adaptation to *MANUAL*. The *CF STEP SIZE* remains at this value until the center frequency entry mode in the STEP menu is switched from *MANUAL* to *AUTO* again.

The *MKR→CF STEPSIZE* function is, above all, useful when measuring harmonics with a large dynamic range (small bandwidth and small span).

The softkey is not available in the time domain.

IEC/IEEE-bus command  
 :CALCulate<1|2>:MARKer<1..4>:FUNction:CSTep



The *MKR→START* softkey sets the start frequency to the current marker frequency.

The softkey is not available in the time domain.

IEC/IEEE-bus command  
 :CALCulate<1|2>:MARKer<1..4>:FUNction:START



The *MKR→STOP* softkey sets the stop frequency to the current marker frequency.

The softkey is not available in the time domain.

IEC/IEEE-bus command  
 :CALCulate<1|2>:MARKer<1..4>:FUNction:STOP

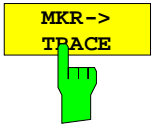

The *MKR→TRACE* softkey places the active marker on a new trace. The traces available for selection appear in the selection window.

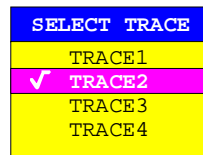

IEC/IEEE-bus commands  
 :CALCulate<1|2>:MARKer<1..4>:TRACe 2  
 :CALCulate<1|2>:DELTamarker<1..4>:TRACe 2



## Setup of Display and Limit Lines – *LINES* Key Field

### Display Lines – *D LINES* Key

Display lines are aids which, similar to markers, make the evaluation of trace data more convenient. The function of display lines is similar to that of a movable scale which can be used to measure absolute and differential values on traces.

In addition, the display lines can also be used to limit the range of search for marker functions.

The FSE provides four different types of display lines:

- two horizontal threshold lines for setting levels or for defining level search ranges – Display Line 1/2,
- two vertical frequency/time lines for indicating frequencies/times or for determining frequency or time search ranges – Frequency/Time Line 1/2,
- a threshold line which, for example, sets the search threshold for maximum levels (Peak Search) – Threshold Line
- a reference line which serves as the basis for mathematical correlation between traces – Reference Line

For purposes of clarity, each line is annotated on the right side of the display diagram by the following abbreviations:

D1	Display Line 1	T1	Time Line 1
D2	Display Line 2	T2	Time Line 2
F1	Frequency Line 1	TH	Threshold Line
F2	Frequency Line 2	REF	Reference Line

The lines for level, threshold and reference are displayed as continuous, horizontal lines over the full width of the diagram. They are movable in the y-direction.

The lines for frequency and time are displayed as vertical, continuous lines over the total height of the diagram. They are movable in the x-direction.

For measurement operations in two separate windows, (Split Screen-Modus), the display lines are available independently in both windows. In the currently active window, the display lines can be activated and/or shifted. Lines previously defined in the currently inactive window remain unchanged.

The *LINES-D LINES* menu, used for switching on and setting the display lines, is dedicated to the chosen display in the active measurement window (span or time). For the display of a spectrum (span  $\neq$  0), the *FREQUENCY LINE 1* and *FREQUENCY LINE 2* softkeys appear, For the time display (span = 0), the *TIME LINE 1* and *TIME LINE 2* softkeys are displayed.

**Note:** The softkeys for setting and switching the display lines on and off operate similar to a three-position switch:

*Initial condition: The line is switched off (softkey has grey background)*

*1<sup>st</sup> press: The line is switched on (softkey has red background) and data entry is activated. The position of the display line can be adjusted by using the roll-key, the step keys or through direct numerical inputs via the data-entry keypad. If some other arbitrary function is requested, the data-entry keypad is disabled. In this case, the display line remains switched on (softkey has green background).*

*2<sup>nd</sup> press: The display line is switched off (softkey has grey background).*

*Initial condition: The line is switched on (softkey has green background)*

*1<sup>st</sup> press: The line is switched on (softkey has red background) and data entry is activated. The position of the display line can be adjusted by using the roll-key, the step keys or through direct numerical inputs via the data-entry keypad. If any other arbitrary function is requested, the data-entry keypad is disabled. In this case, the display line remains switched on (softkey has green background).*

*2<sup>nd</sup> press: The display line is switched off (softkey has grey background).*

Menu *LINES-D-LINES*

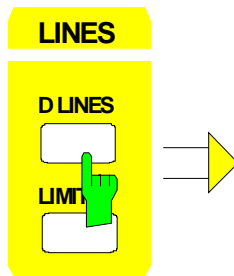

for Span  $\neq$  0

for Span = 0

for Span $\neq$ 0	or:	for Span = 0
DISPLAY LINES		DISPLAY LINES
DISPLAY LINE 1		DISPLAY LINE 1
DISPLAY LINE 2		DISPLAY LINE 2
THRESHOLD LINE		THRESHOLD LINE
REFERENCE LINE		REFERENCE LINE
FREQUENCY LINE 1		TIME LINE 1
FREQUENCY LINE 2		TIME LINE 2
BASELINE CLIPPING		BASELINE CLIPPING

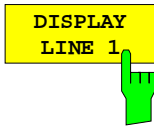

The *DISPLAY LINE 1/2* softkeys switch the display lines on/off and activate the entry of the line location.

The display lines mark the selected levels in the measurement window.

IEC/IEEE-bus commands

```
:CALCulate<1|2>:DLINe<1|2>:STATe ON | OFF;
:CALCulate<1|2>:DLINe<1|2> -20dBm
```

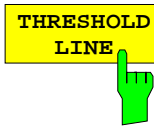
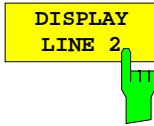

The *THRESHOLD LINE* softkey switches the threshold line on/off and activates the entry of the line location.

The threshold line is a display line which defines a threshold value. This threshold value serves as a lower search limit for maximums/minimums in the marker functions (*MAX PEAK*, *MIN PEAK*, *NEXT PEAK* etc.). For signal tracking (*SIGNAL TRACK function*), this threshold value defines the lower search limit (see section "Marker Functions").

IEC/IEEE-bus commands

```
:CALCulate<1|2>:THReshold ON | OFF;
:CALCulate<1|2>:THReshold -82dBm
```

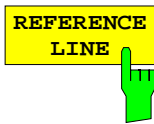

The *REFERENCE LINE* softkey switches the reference line on/off and activates the entry of the line position.

The reference line serves as the basis for mathematical correlation between trace data (see section "Mathematical Operations on Measurement Curves")

IEC/IEEE-bus commands

```
:CALCulate<1|2>:RLINe:STATe ON | OFF;
:CALCulate<1|2>:RLINe -10dBm
```

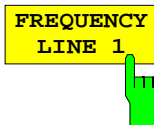

The *FREQUENCY LINE 1/2* softkeys switch the frequency lines 1/2 on/off and activate the entry of the line locations.

The frequency lines mark the selected frequencies in the measurement window or define search ranges (see section "Marker Functions").

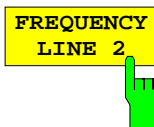

IEC/IEEE-bus commands

```
:CALCulate<1|2>:FLINe<1|2>:STATe ON | OFF;
:CALCulate<1|2>:FLINe<1|2> 120 MHz
```

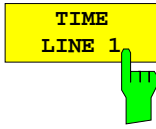

The *TIME LINE 1/2* softkeys switch the time lines 1/2 on/off and activate the entry of line locations.

The time lines mark the selected times or define the search range (see section "Marker Functions").

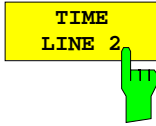

IEC/IEEE-bus commands

```
:CALCulate<1|2>:TLINe<1|2>:STATe ON | OFF;
:CALCulate<1|2>:TLINe<1|2> 10ms
```



The *BASELINE CLIPPING* softkey switches on or off the *BASELINE CLIPPING* function and allows a limit value to be entered.

The *BASELINE CLIPPING* function is for blanking measured values (for example noise) which are below a preset threshold.

If the *BASELINE CLIPPING* function is active and a measured value is below the preset threshold, the value is set to a lower boundary (-400 dBm). Measured values above the clipping level are not changed.

**Note:** *It is advisable not to combine the BASELINE CLIPPING function with the AUTOPEAK detector.*

*If the set clipping value is within the displayed noise band (AUTOPEAK detector), activation of the CLIPPING function and the resulting clipping of the MIN PEAK values will lead to a drastic enlargement of the displayed noise band.*

IEC/IEEE-bus commands

```
:CALCulate<1|2>:CTHreshold:STATe ON | OFF
:CALCulate<1|2>:CTHreshold -82dBm
```

## Limit Lines – *LIMITS* Key

Limit lines are used to define limits for amplitude curves or spectral distributions on the screen. They indicate, for example, the upper limits for interference radiation or spurious waves which are permissible from a Unit Under Test (UUT). In the case of TDMA transmissions (e.g., GSM), the amplitude curve of the bursts in a time slot must fall within a specified tolerance band. The lower and upper limits may each be specified by a limit line. Then, the amplitude curve can be checked either visually or automatically for any violations of the upper or lower limits (GO/NOGO test).

The FSE instrument supports up to 300 limit lines, each of which may have a maximum of 50 data points. For each limit line, the following characteristics must be defined:

- The name of the limit line. The limit line is stored under this name and is displayed in the *LIMIT LINES* table.
- The domain in which the limit line is to be used. A distinction is made between the time domain (span = 0 Hz) and the frequency domain (span > 0 Hz).
- The X-coordinates of the interpolation points. The limit line can be specified either in terms of absolute frequencies or times or in terms of frequencies referred to the set center frequency and times referred to the time represented by the left-hand edge of the diagram.
- The Y-coordinates of the interpolation points. The limit line can be selected either for absolute levels or voltages or referred to the set maximum level (Ref Lvl or Max Lvl). If the reference line is switched on, it is used as reference when relative setting has been selected.
- The type of limit line (upper or lower limit). With this definition and the limit checking function on (*LIMIT CHECK*), the FSE checks for compliance with each limit.
- The limit line units. The units for the limit line must be compatible with the level axis in the active measurement window.
- The trace to which the limit line is assigned. For the FSE, this defines the trace to which the limit is to be applied when several traces are simultaneously displayed.
- For each limit line, a margin can be defined which serves as a threshold for automatic evaluation.
- A comment can also be entered for each limit line, e.g., a description of the application.

In the *LINES LIMIT* menu, the compatible limit lines can be enabled in the *LIMIT LINES* table. The *SELECTED LIMIT LINE* display field provides information about the characteristics of the marked limit lines. New limit lines can be specified and edited in the *NEW LIMIT LINE* and *EDIT LIMIT LINE* sub-menus.

LINES LIMIT menu

Limit Line Selection

The *SELECTED LIMIT LINES* table provides information about the characteristics of the marked limit line :

- Name* name
- Domain* frequency or time
- Limit* upper/lower limit
- X-Axis* linear or logarithmic interpolation
- X-Scaling* absolute or relative frequencies/times
- Y-Scaling* absolute or relative Y-units
- Unit* for vertical scale
- Comment* comment

The characteristics of the limit line are set in the *EDIT LIMIT LINE (=NEW LIMIT LINE)* submenu.



The *SELECT LIMIT LINE* softkey activates the *LIMIT LINES* table and the selection bar jumps to the uppermost name in the table.

The columns headings are as follows:

- Name* Name of the limit line to be selected.
- Compatible* Indicates if the limit line is compatible with the measurement window of the given trace.
- Limit Check* Activates the automatic "within limits" check.
- Trace* Selects the trace to which the limit is assigned.
- Margin* Defines a margin.

### Name and Compatible - Switching on limit lines

A maximum of 8 limit lines can be switched at any one time. A check mark at the left edge of a cell indicates that this limit line is switched on. A limit line can only be switched on when it has a check mark in the *Compatible* column, i.e., only when the display mode of the x-axis (time or frequency) and y-axis units are **identical** to those in the measurement window.

It should be noted that lines with dB scales are compatible with all dB(..) scales of the Y-axis.

If the trace assigned to a line is not switched on, the line is displayed in the window the trace would be displayed in.

Example:

In split screen mode, trace 2 is assigned measuring window B. A line assigned to trace 2 is always displayed in measurement window B.

If the y-axis unit or the domain (frequency or time) are changed, all non-compatible limit lines are automatically switched off in order to avoid misinterpretations. The limit lines must be switched on again when the original display mode is restored.

IEC/IEEE-bus commands

```
:CALCulate<1|2>:LIMit<1..8>:NAME <string>;
:CALCulate<1|2>:LIMit<1..8>:STATE ON | OFF
```

### Limit Check - Activating the limit check

When *LIMIT CHECK ON* is activated, a limit check is performed automatically on the active screen. In the center of the screen, a display window containing the results of the limit check test appears:

LIMIT CHECK: PASSED No out-of-limits conditions.

LIMIT CHECK: FAILED One or more out-of-limits conditions. The message contains the names of the limit lines which were violated or whose margins were not complied with.

LIMIT CHECK: MARGIN The margin of at least one active limit line was not complied with, however, no limit line was violated. The message contains the names of the limit lines whose margins were not complied with.

The following example shows three active limit lines:

```
LIMIT CHECK: FAILED
LINE VHF_MASK: Failed
LINE UHF2MASK: Margin
```

A limit check is performed only if the trace associated with the limit line is turned on.

If *LIM CHECK* is set to *OFF* for all active limit lines, then the limit line check is not executed and the display field not activated.

IEC/IEEE-bus command :CALCulate<1|2>:LIMit<1...8>:FAIL?

**Trace - Selecting the trace to which the limit line is assigned.**

The trace is selected in an entry window. An integer entries 1, 2, 3 or 4 indicating the trace is entered. The default setting is trace 1. If the selected limit line is not compatible with the assigned trace, the limit line is disabled. (display and limit check).

IEC/IEEE-bus command  
`:CALCulate<1|2>:LIMit<1...8>:TRACe 1|2|3|4`

**Margin - Setting a margin.**

The margin is defined as the level difference between the limit line and the signal . When the limit line is defined as an upper limit, the margin means that the level is below the limit line. When the limit line is defined as a lower limit, the margin means that the level is above the limit line. The default setting is 0 dB (i.e., no margin).

IEC/IEEE-bus commands  
`:CALCulate<1|2>:LIMit<1..8>:UPPer:MARGin 10DB`  
`:CALCulate<1|2>:LIMit<1..8>:LOWer:MARGin 10DB`

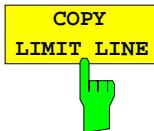

The *COPY LIMIT LINE* softkey copies the data set of the marked limit line and saves it under a new name. In this way, a new limit line can be easily generated by parallel translation or editing of an existing limit line. The name can be arbitrarily chosen and input via an entry window (max. of 8 characters).

IEC/IEEE-bus command  
`:CALCulate<1|2>:LIMit<1..8>:COPY 1..8|<name>`



The *DELETE LIMIT LINE* softkey erases the selected limit line. Before deletion, a message appears requesting confirmation.

IEC/IEEE-bus command  
`:CALCulate<1|2>:LIMit<1...8>:DELeTe`

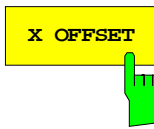

The *X OFFSET* softkey horizontally shift a limit lines which has been specified for relative frequencies or times (X-axis). The softkey opens an entry window, where the value for shifting may be entered numerically or via the roll-key.

**Note:** *When changing the start or the stop frequency, the line on the display only remains unchanged, if SPAN FIXED is set.*

IEC/IEEE-bus command  
`:CALCulate<1|2>:LIMit<1..8>:CONT:OFFSet 100us`



The *Y OFFSET* softkey vertically shifts a limit line, which has relative values for the Y-axis (levels or linear units such as volt). The softkey opens an entry window where the value for shifting may be entered numerically or via the roll-key.

IEC/IEEE-bus commands  
`:CALCulate<1|2>:LIMit<1..8>:UPP:OFFSet 3dB`  
`:CALCulate<1|2>:LIMit<1..8>:LOW:OFFSet 3dB`



## Entering and Editing of Limit Lines

A limit line is characterized by

- its name
- the domain assignment (frequency or time)
- whether the scale is absolute or relative (time or frequency)
- linear or logarithmic interpolation
- the vertical unit
- the vertical scale
- the definition of the limit line as either an upper or lower limit.
- the interpolation points for frequency/time and level

When the limit line is entered, the FSE immediately checks all limit lines according to rules that guarantee correct operation.

- The frequencies/times for each interpolation point must be entered in ascending order, however, for any single frequency/time, two data points may be entered (vertical segment of a limit line).

The interpolation points are allocated in order of ascending frequency/time. Gaps are not allowed. If gaps are desired, two separate limit lines must be defined and then both enabled.

- The entered frequencies/times need not necessarily be capable of selection on the FSE. A limit line may also exceed the frequency or time display range. The minimum frequency for an interpolation point is -200 GHz, the maximum frequency is 200 GHz. For the time domain, negative times may also be entered. The range is -1000 s to +1000 s.
- The minimum/maximum value for a limit line is -200 dB/ +200 dB for the logarithmic scale or  $10^{-20}$ / $10^{+20}$  or -99.9%/ + 999.9% for linear amplitude scales.

LINES LIMIT-EDIT LIMIT LINE menu

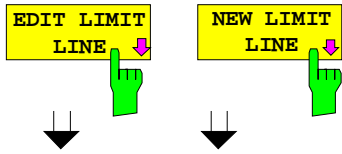

The *EDIT LIMIT LINE* and *NEW LIMIT LINE* softkeys both call the *EDIT LIMIT LINE* submenu used for editing limit lines. In the table heading, the characteristics of the limit line can be entered. The frequency/time and level points are entered in the columns.

- Name* Enter name.
- Domain* Select domain.
- Unit* Select units.
- X-Axis* Select interpolation
- X-Scaling* Entry of absolute or relative values for the X-axis
- Y-Scaling* Entry of absolute or relative values for the Y-axis
- Limit* Select upper/lower limit.
- Comment* Enter comments.
- Time/Frequency* Enter time/frequency points.
- Limit/dBm* Enter level points.

EDIT LIMIT LINE TABLE	
Name:	Limit 22
Domain:	FREQUENCY
Unit:	dBuV/m
X-Axis:	LOG
X-Scaling:	ABSOLUTE
Y-Scaling:	ABSOLUTE
Limit:	UPPER
Comment:	Limit 22
FREQUENCY	LIMIT/dBuV/m
30.000 MHz	30.0000
230.000 MHz	30.0000
230.000 MHz	37.0000
1.000 GHz	37.0000

Press ENTER to edit field.

EDIT LIMIT LINE

NAME

VALUES

INSERT VALUE

DELETE VALUE

SHIFT X LIMIT LINE

SHIFT Y LIMIT LINE

SAVE LIMIT LINE

PAGE UP

PAGE DOWN

↑

USER

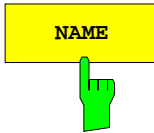

The *NAME* softkey activates the entry of characteristics in the table heading.

### **Name - Entry of name**

A maximum of 8 characters are permitted for each name. All names must be compatible with the MS DOS conventions for file names. The instrument automatically stores all limit lines with the .LIM extension.

IEC/IEEE-bus command

```
:CALCulate<1|2>:LIMit<1..8>:NAME <string>
```

### **Domain - Selection of time or frequency domain**

The domain (frequency/time) can only be changed when the limit-line point table is empty. The default setting is frequency.

IEC/IEEE-bus command

```
:CALCulate<1|2>:LIMit<1..8>:CONTRol:DOMain FREQ | TIME
```

### **X-Axis - Indication of interpolation**

Linear or logarithmic interpolation can be carried out between the frequency reference points of the table. The ENTER key toggles between LIN and LOG selection.

IEC/IEEE-bus commands

```
:CALCulate<1|2>:LIMit<1..8>:CONTRol:SPACing LIN | LOG
:CALCulate<1|2>:LIMit<1..8>:UPPer:SPACing LIN | LOG
:CALCulate<1|2>:LIMit<1..8>:LOWer:SPACing LIN | LOG
```

### **Scaling - Selection of absolute or relative scale**

The limit line scale can either be absolute (frequency or time) or relative. Any of the unit keys may be used to toggle between *ABSOLUTE* and *RELATIVE*, the cursor must in the *X-Scaling* or the *Y-Scaling* line

*X-Scaling ABSOLUTE* The frequencies or times are interpreted as absolute physical units.

*X-Scaling RELATIVE* The frequencies in the limit-line point table are referred to the currently set center frequency. In the time domain, the left boundary of the diagram constitutes the reference.

*Y-Scaling ABSOLUTE* The limit values are absolute levels or voltages.

*Y-Scaling RELATIVE* The limit values refer to the reference level or, in case a reference line is set, to the reference line. Limit values in dB or % are always relative values.

*RELATIVE* scaling is always recommended, if masks for bursts are to be defined in the time domain, or if masks for modulated signals are required in the frequency domain.

An X-offset equal to half the sweep time may be entered to shift the mask in the time domain to the center of the screen.

IEC/IEEE-bus commands

```
:CALCulate<1|2>:LIMit<1..8>:CONTRol:MODE REL | ABS
:CALCulate<1|2>:LIMit<1..8>:UPPer:MODE REL | ABS
:CALCulate<1|2>:LIMit<1..8>:LOWer:MODE REL | ABS
```

**Unit - Selection of the vertical scale units for the limit line**

Units are selected in a selection box. The default setting is dBm.

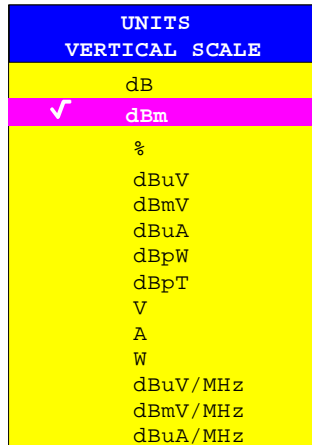

```
IEC/IEEE-bus command :CALCulate<1|2>:LIMit<1...8>:UNIT
                        DB| DBM| PCT |DBUV| DBMW | DBUA |
                        DBPW| DBPT | WATT| VOLT | AMPere |
                        DBUV_MHZ | DBMV_MHZ | DBUA_MHZ |
                        DBUV_M | DBUV_MMHZ | DBUA_M |
                        DBUA_MMHZ
```

**Limit - Selection of upper/lower limit**

A limit line can be defined as either an upper or lower limit.

```
IEC/IEEE-bus command --
(defined by the key words :UPPer or :LOWer)
```

**Comment - Enter comments**

Comments are user selectable, but may not exceed 40 characters in length.

```
IEC/IEEE-bus command
:CALCulate<1|2>:LIMit<1..8>:COMMENT 'string'
```

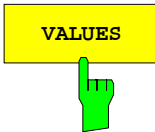

The *VALUES* softkey activates the entry of the data points in the table columns *Time/Frequency* and *Limit/dB*. Which table column appears depends on the *Domain* selection in the table heading.

The frequency/time points are entered in ascending order (two repeated frequencies/times are permitted).

```
IEC/IEEE-bus commands
:CALCulate<1|2>:LIMit<1...8>:CONTRol[:DATA]
<num_value>, <num_value>..
:CALCulate<1|2>:LIMit<1...8>:UPPer[:DATA]
<num_value>, <num_value>..
:CALCulate<1|2>:LIMit<1...8>:LOWer[:DATA]
<num_value>, <num_value>..
```

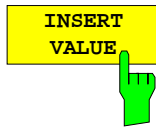

The *INSERT VALUE* softkey creates an empty line above the current cursor position where a new data point can be entered. However, when entering new values, the ascending order for frequency/time values must be kept.

IEC/IEEE-bus command --

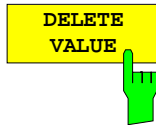

The *DELETE VALUE* softkey erases the data point (complete line) at the cursor position. The data points that follow are moved along to fill the gap.

IEC/IEEE-bus command --

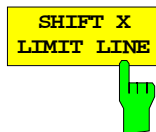

The *SHIFT X LIMIT LINE* softkey calls an entry window where the complete limit line may be shifted horizontally.

The shift units are the same as the horizontal scale units:

- in the frequency domain in Hz, kHz, MHz or GHz
- in the time domain in ns,  $\mu$ s, ms or s

This means that it is easy to create a new limit line from existing limit line which has been shifted horizontally and stored (*SAVE LIMIT LINE* softkey) under a new name (*NAME* softkey).

IEC/IEEE-bus command

```
:CALCulate<1|2>:LIMit<1..8>:CONTRol:SHIFt 50kHz
```



The *SHIFT Y LIMIT LINE* softkey calls an entry window where the complete limit line may be shifted vertically.

The shift units are the same as the vertical scale units:

- for relative logarithmic units in dB
- for linear units, as a factor

This means that a new limit line can easily be created from an existing limit line which has been shifted vertically and stored (*SAVE LIMIT LINE* softkey) under a new name (*NAME* softkey).

IEC/IEEE-bus commands

```
:CALCulate<1|2>:LIMit<1..8>:UPPer:SHIFt 20dB
```

```
:CALCulate<1|2>:LIMit<1..8>:LOWer:SHIFt 20dB
```

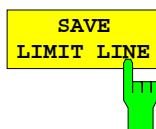

The *SAVE LIMIT LINE* softkey stores the currently edited limit line. The name can be entered in an entry window (max. 8 characters)

IEC/IEEE-bus command -- (automatically executed)

## Trace Selection and Setup –TRACE Key Group

The FSE can display up to four separate traces at a time on a screen. A trace has of a maximum of 500 pixels along the horizontal axis (frequency or time). If more measured values than pixels are available, several measurement values are assigned to one pixel.

The traces are selected using keys 1 to 4 of the *TRACES* key group. When two measurement windows (*SPLIT SCREEN*) are displayed, traces 1 and 3 are assigned to the upper (*SCREEN A*) and traces 2 and 4 are assigned to the lower (*SCREEN B*) measurement window.

The traces can be individually activated for a measurement or frozen after completion of a measurement. Traces that are not activated are not displayed.

A display mode can be selected for each trace. The traces can be overwritten (*CLEAR/WRITE* mode) after each sweep, averaged (*AVERAGE* mode) over several sweeps, or the maximum/ minimum value from several sweeps can be displayed (*MIN HOLD/MAX HOLD*).

Individual detectors are selectable for each of the traces. The auto-peak detector displays the maximum and minimum values on a vertical line. The max-peak detector and min-peak detector display the maximum and /minimum levels represented by a pixel. The sampling detector displays the instantaneous value of the level at a pixel. The rms detector displays the power (rms) of the spectrum at a pixel, the average detector the average value.

### Measurement Function Selection - TRACE 1 to 4 key

The trace functions are categorized as follows:

- type of trace display (*CLEAR/WRITE*, *VIEW* and *BLANK*)
- evaluation of the trace as a whole (*AVERAGE*, *MAX HOLD* and *MIN HOLD*)
- evaluation of the individual pixels of a trace (*AUTOPEAK*, *MAX PEAK*, *MIN PEAK*, *SAMPLE*, *RMS* and *AVERAGE*)

TRACE 1 menu

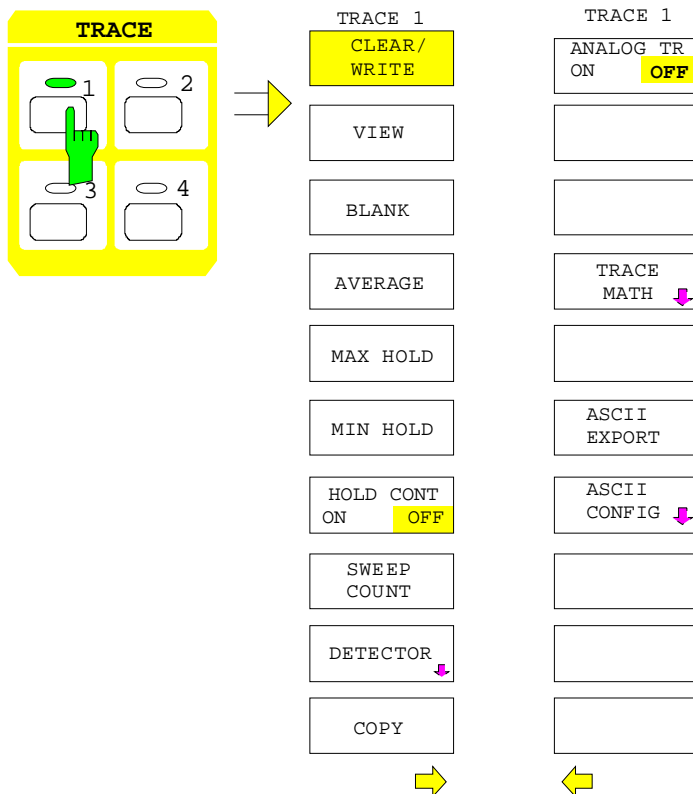

The *TRACE* keys 1...4 call a menu with the setting options for the selected trace.

This menu is used to determine the method for compressing the measurement data in the frequency or time domain to the 500 representable points of the display is determined.

When the measurement is started, a new trace can be displayed or the trace can be based on previous results. The traces can be displayed, blanked and copied.

Traces can also be corrected with the mathematical functions.

The measurement detector for each of the display types may be chosen either directly or selected automatically by the FSE.

All activated traces are marked with a LED at the corresponding key (here, *TRACE 1*). The default setting is *TRACE 1* with *CLEAR / WRITE* selected. The remaining traces 2...4 are switched off (*BLANK*). For the split screen display, the selection of the trace automatically selects the corresponding screen for entry.

Only one of the *CLEAR/WRITE*, *MAX HOLD*, *MIN HOLD*, *AVERAGE*, *VIEW* and *BLANK* softkeys can be activated at any one time.

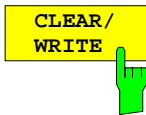

The *CLEAR/WRITE* softkey activates the clear/write display mode.

The trace is displayed without additional trace evaluation. The trace memory is overwritten by each sweep. If more than one data point falls within a pixel, the trace is displayed in bar form with the maximum and minimum values being assigned to one pixel. In the clear/write display mode, all the available detectors are selectable. The autopeak detector is selected in the default mode (detector to *AUTO*).

Whenever the *CLEAR/WRITE* softkey is pressed, the FSE clears the selected trace memory and restarts the measurement.

IEC/IEEE-bus command  
`:DISPlay[:WINDow<1|2>]:TRACe<1..4>:MODE WRITE`

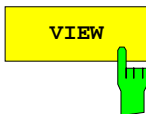

The *VIEW* softkey freezes the current contents of the trace memory and displays them.

If the trace data were formed through *MAX HOLD*, *MIN HOLD* or *AVERAGE*, the sweep is restarted and the trace contents are cleared, after switching to these trace modes.

If a trace is frozen by *VIEW*, the instrument settings can be modified without modifying the displayed trace. The fact that the trace and the current instrument setting do not agree anymore is indicated by an enhancement label "\*" at the right edge of the grid. The initial instrument setting can be restored using the *ADJUST TO TRACE* softkey in the *TRACE MATH* sub-menu.

If *LEVEL RANGE* or *REF LEVEL* is changed in the *VIEW* display mode, the FSE adjusts the measurement data to the changed display range. Thus, an amplitude zoom can be performed after the measurement so that details of the trace can be seen better.

IEC/IEEE-bus command  
`:DISPlay[:WINDow<1|2>]:TRACe<1..4>:MODE VIEW`

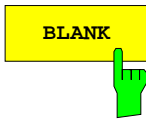

The *BLANK* softkey activates the blanking of the trace. However, the trace remains stored in memory and can be displayed again by pressing *VIEW*. The markers for the blanked trace are also erased. After reactivation of the trace (with *VIEW*, *CLEAR / WRITE*, *MAX HOLD*, *MIN HOLD*, *AVERAGE*) the markers will be restored their their previous positions.

IEC/IEEE-bus command  
`:DISPlay[:WINDow<1|2>]:TRACe<1..4> OFF`

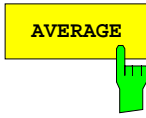

The *AVERAGE* softkey activates the trace averaging function. The average is formed over several sweeps. The average can be calculated for each available detector. If the detector is automatically selected by the FSE , the sampling detector is used.

After enabling the averaging mode, the first trace is recorded in *CLEAR/WRITE* mode with the selected detector. After the second sweep, the average is then formed for each succeeding sweep. Here, the average is formed over the samples/pixels, i.e., according to the LIN or LOG setting, over amplitudes or levels.

Averaging is restarted every time the *AVERAGE* softkey is pressed. The trace memory is also cleared. This is also the case when the trace is switched from the setting *AVERAGE* to *VIEW* or *BLANK*

IEC/IEEE-bus command  
`:DISPlay[:WINDow<1|2>]:TRACe<1..4>:MODE AVER`

### Description of averaging:

Averaging is carried out using the pixels which are derived from the measurement value samples. These pixels may in some cases be comprised of several combined measurement values. This means that the average is formed over linear amplitude values when the level display is linear and over levels when the level display is logarithmic. Because of this, the trace must be measured anew when changing between the LIN and LOG display mode. The settings *CONT/SINGLE SWEEP* and the sliding average apply to the average display analogously.

Two calculation procedures are available for averaging. For *SWEEP COUNT*= 0 , a sliding average is calculated using the following equation:

$$\text{TRACE}_n = \frac{9 * \text{TRACE}_{n-1} + \text{Meas\_Value}}{10}$$

Because of the relative weighting of the new measurement value and the trace average, past values have practically no influence on the displayed trace after about 10 sweeps. For this setting, the signal noise is effectively reduced without the need to restart the averaging process even if the signal is changed.

If the *SWEEP COUNT* is >1 averaging takes place over the selected number of sweeps. In this case, the displayed trace is given by the following formula during averaging::

$$\text{TRACE}_n = \frac{1}{n} \left[ \sum_{i=1}^{n-1} (T_i) + \text{Meas Value} \right]$$

where n is the number of the current sweep (n = 2 ... SWEEP COUNT). For the first sweep, an average is not calculated. The measurement values are stored directly in trace memory. With growing n, the displayed trace becomes increasingly smoother since more individual trace data are available for averaging.

The average is stored in trace memory after the defined number of sweeps. Until this number of sweeps is reached, a preliminary average is displayed.



On completion of averaging, ie when the number of sweeps defined with *SWEEP COUNT* has been reached, a sliding average given by the following formula is obtained with *CONTINUOUS SWEEP*

$$TRACE_n = \frac{(N-1) \cdot TRACE_{n-1} + \text{Meas Value}}{N}, \text{ where}$$

Trace = new trace  
Trace<sub>old</sub> = old trace  
N = SWEEP COUNT

The display "Sweep 200 of 200" then remains constant until there is a new start.

In *SINGLE SWEEP* mode, *SWEEP START* initiates n single sweeps. The sweeps are stopped as soon as the selected number of sweeps has been reached. The number of the current sweep and the total number of sweeps are shown in the display: "Sweep 3 of 200".



The *SWEEP COUNT* softkey activates the entry of the number of sweeps used for averaging.

The range for *SWEEP COUNT* is 0 through 32767. For 0, the FSE performs a sliding average over 10 sweeps. For 1, no averaging takes place.

The default setting is 10 sweeps. The programming naturally influences the sweep duration. The number of sweeps used for averaging is the same **for all 4 traces**.

**Note :** *The setting of the SWEEP COUNT in the trace menu is equivalent to the setting in the sweep menu.*

IEC/IEEE-bus command : [SENSE<1|2>:]SWEEP:COUNT 10



The *MAX HOLD* softkey activates the max hold mode.

In this display mode, the FSE saves for each sweep the largest of the previously stored/currently measured values in the trace memory. The detector is set automatically to *MAX PEAK*. In this way, the maximum value of a signal can be determined over several sweeps.

This is especially useful for measurement of modulated or pulsed signals. The signal spectrum is built up sweep by sweep until all the signal components have been captured.

Pressing of the *MAX HOLD* softkey again clears the trace memory and restarts the max hold mode.

If *MAX HOLD* is enabled, a new start is made after clearing the trace memory for each frequency change, (start frequency, stop frequency, center frequency or frequency span), a reference level change or switching between linear/logarithmic scales.

IEC/IEEE-bus command : DISPLAY[:WINDOW<1|2>]:TRACE<1..4>:MODE MAXH

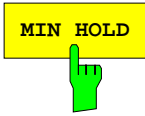

The *MIN HOLD* softkey activates the min hold mode. In this display mode, the FSE saves for each sweep the smallest of the previously stored/currently measured values in the trace memory. The detector is set automatically to *MIN PEAK*. In this way, the minimum value of a signal can be determined over several sweeps. This function is, e.g., useful for making an unmodulated carrier in a signals mixture easier to see on the display. Noise, interference or modulated signals are suppressed by the *MIN HOLD* function, whereas a CW signal maintains a constant level.

Pressing the *MIN HOLD* softkey clears the trace memory and the minimum value function starts anew.

IEC/IEEE-bus command  
`:DISPlay[:WINDow<1|2>]:TRACe<1..4>:MODE MINH`

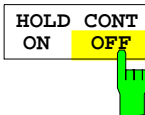

The *HOLD CONT* softkey defines whether the traces in the average mode and min hold/max hold mode are reset after some definite parameter changes.

OFF The traces are reset after some definite parameter changes.

ON This mechanism is switched off.

In general, parameter changes require a restart of the measurement before results are evaluated (e. g. with markers). For those changes that are known to require a new measurement (e. g. modification of the span), the trace is automatically reset so that erroneous evaluations of previous results are avoided.

This mechanism can be switched off for those exceptional cases where the described behavior is unwelcome.

IEC/IEEE-bus command  
`:DISPlay[:WINDow<1|2>]:TRACe<1..4>:MODE HCON ON|OFF`

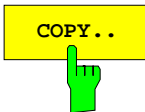

The *COPY* softkey copies the current trace as display on the screen to another trace memory. A table appears in which the copy procedure can be selected.

COPY TRACE 1 TO	
✓	TRACE 2
	TRACE 3
	TRACE 4

For only one window, the selected trace can be copied to any of the other trace memories since here, all four traces are displayed in one diagram with the same frequency boundaries.

In the split screen display, this is only possible as long as the frequencies of screen A and screen B are identical. If this is not the case, the selected trace can only be copied to the corresponding trace memory, i.e., trace 1 to trace 3 and trace 2 to trace 4 or vice versa. In this case, only the available trace is displayed.

After copying, the contents of the destination memory are lost. The destination memory now changes automatically to view mode with the new data.

IEC/IEEE-bus command  
`:TRACe:COPIY TRACE1 | TRACE2 | TRACE3 | TRACE4 ,  
 TRACE1 | TRACE2 | TRACE3 | TRACE4`

## Detector Selection

The FSE detectors are all-digital. The detectors available are the max-peak detector which derives the maximum value from a number of sample values, the min-peak detector which derives the minimum value from a number of sample values and the sampling detector. The sampling detector passes on the sampled data without modification or performs a data reduction by suppressing non-displayable values. The peak detectors compare the current level with the maximum/minimum levels of the previously sampled data. When the number of samples defined by the instrument settings is reached, the samples are combined as displayable pixels. Each of the 500 pixels of the display therefore represents 1/500 of the sweep range and so all the individual measurements (frequency samples) that fall within this subrange in a compressed form. Even though the recording rate is high, there are no recording gaps thanks to the internal pipeline structure. For each trace display mode, an optimized detector is selected automatically. Since the peak detectors and the sample detector are connected in parallel, a single sweep is sufficient for record and display four traces with four detectors.

### Peak value detectors (MAX PEAK / MIN PEAK)

Peak value detectors are implemented with digital comparators. For each of the levels measured at each of the frequencies represented by one of the 500 pixels, they determine the maximum (max peak) of all positive peaks and the minimum (min peak) of all the negative peaks. This is repeated for each pixel so that, for wide frequency spans and in spite of the limited display resolution, a larger number of measurements than would otherwise be possible can be used to display the spectrum.

### AUTOPEAK detector

The *AUTOPEAK* detector combines the two peak detectors. The max-peak detector and min-peak detector determine the maximum and minimum level over a displayed pixel at the same time and display it as a common measurement value. The maximum and minimum level over a frequency point are joined with a vertical line.

### SAMPLE detector

The *SAMPLE* detector passes on all sampled data without further evaluation and either displays them directly or, for speed (short sweep times), first writes them to a memory and subsequently processes them.

Data reduction, i.e., summing of measurement values of neighboring frequencies or time samples is not performed here. If, during a sweep, more measurement values are generated than can be displayed, measurement values will be lost. Discrete signals can thus be lost

Therefore, the sampling detector can only be recommended for a ratio of span-to-resolution bandwidth of up to approximately 250. To ensure that no signal will be suppressed (example: span 1 MHz --> min. bandwidth 5 kHz).

RMS detector	<p>The rms detector finds the rms value of the measured values over a pixel.</p> <p>The FSE uses the linear display voltage after the envelope detection. The linear samples are squared, summed and the sum is divided through the number of samples (= mean of squares). With the logarithmic display, the logarithm of the sum of squares is taken. With the linear display the mean of the squares is displayed directly. Each pixel represents the total power of the measured values assigned to the pixel.</p> <p>The rms detector supplies the power of the signal irrespective of the waveform (CW carrier, modulated carrier, white noise or pulse signal). There is no need for the various waveform correction factors which are required when other detectors are used for the power measurement.</p>
Average detector	<p>The average detector averages the measured values over a pixel.</p> <p>The FSE uses the linear display voltage after envelope detection. The linear samples are summed and the sum is divided by the number of measurement samples (= linear average). With the logarithmic display, the logarithm of the average is taken. With the linear display the average is displayed directly. Each pixel therefore represents the average of the measured values assigned the pixel.</p> <p>The average detector gives the true average of the signal irrespective of the waveform (CW carrier, modulated carrier, white noise or pulse signal).</p>

**Notes:** *During a sweep, the FSE switches the first oscillator frequency in steps which are smaller than approximately 1/10 of the bandwidth. This guarantees that the level of a signal is correctly measured. For narrow bandwidths and wide spans, a very large number of measurement values are generated. The number of frequency steps is, however, always a multiple of 500 (= number of displayable points). In the sampling mode, only every  $n^{\text{th}}$  value is displayed. The quantity  $n$  depends upon the number of measurement values, i.e on the span, resolution bandwidth and the measurement rate.*

For sweep times < 5ms in the time domain, the same detector is used for all active traces.

TRACE 1-DETECTOR submenu

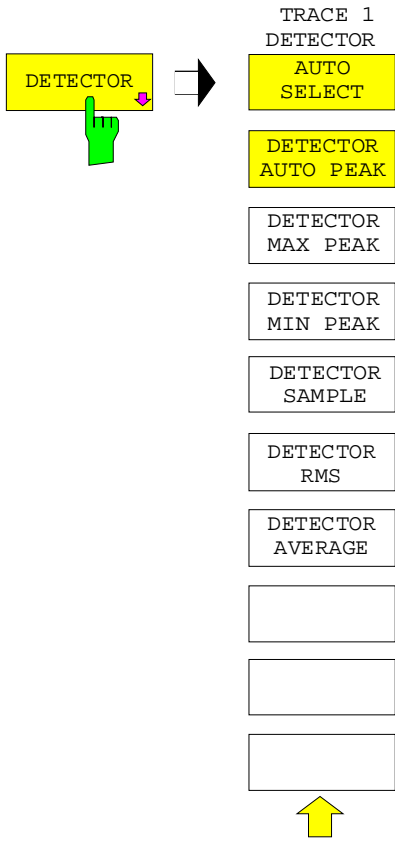

The *DETECTOR* softkey opens a submenu to select the detector.

The detector may be independently selected for each trace. Mode *AUTO SELECT* sets the best suitable detector for each trace display mode (Clear Write, Max Hold oder Min Hold).

Only one of the softkeys for the detectors can be activated at any one time.

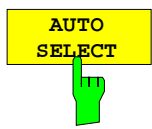

The *AUTO SELECT* softkey (= default) selects the optimum detector for the selected trace display mode (clear write, max hold, min hold).

<u>Trace-mode</u>	<u>Detector</u>
Clear/Write	Autopeak
Average	Sample
Max Hold	Max Peak
Min Hold	Min Peak

IEC/IEEE-bus command  
 :[SENSE<1|2>:]DETEctor<1..4>:AUTO ON|OFF



The *DETECTOR AUTOPEAK* softkey selects the autopeak detector.

IEC/IEEE-bus command :[SENSE<1|2>:]DETEctor<1..4> APEak



The *DETECTOR MAX PEAK* softkey selects the max peak detector. It is recommended for pulse-like signals.

IEC/IEEE-bus command :[SENSE<1|2>:]DETEctor<1..4> POSitive



The *DETECTOR MIN PEAK* softkey selects the min peak detector. Weak sinewave signals can be brought out clearly against noise by using this detector. For a composite signal made up of sinewaves and pulse-like-like signals the pulse signals are suppressed.

IEC/IEEE-bus command :[SENSE<1|2>:]DETEctor<1..4> NEGative



The *DETECTOR SAMPLE* softkey selects the sample detector.

It is used for measuring uncorrelated signals such as noise. The power can be determined by means of fixed correction factors for evaluation and the log amplifier.

IEC/IEEE-bus command :[SENSE<1|2>:]DETEctor<1...4> SAMPlE

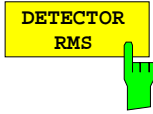

The *DETECTOR RMS* softkey activates the rms detector.

The rms detector gives the true power of the signal irrespective of the waveform. The mean of the squares of all level samples is formed as a pixel is swept. The sweep time, therefore, determines the number of values averaged and, with increasing sweep time, better averaging is obtained. The rms detector is therefore an alternative to averaging over several sweeps (see *TRACE AVERAGE*).

In the time domain ( $SPAN = 0$ ), the rms detector is only available for sweep times  $\geq 5$  ms. Moreover, the combination of the rms detector with the pretrigger function and the gaped sweep function is not permissible.

The video bandwidth has to be set to at least 10 times the resolution bandwidth (RBW) so that the rms value of the signal is not invalidated by video filtering.

IEC/IEEE-bus command :[SENSE<1|2>:]DETEctor<1...4> RMS

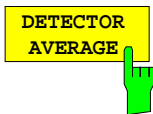

The *DETECTOR AVERAGE* softkey activates the average detector.

In contrast to the rms detector, the average detector supplies the straight average of all the level sampled as a pixel is swept over.

The same restrictions as those of the rms detector apply (see above).

IEC/IEEE-bus command :[SENSE<1|2>:]DETEctor<1...4> AVERAge

### Quasi Analog Display

Normally, when measured values are displayed they are joined together with line segments to form a trace which is deleted and redrawn after each sweep. When analog measurements are performed, the persistence of the screen makes it possible to assess the signal's frequency of occurrence. Frequently occurring events appear brighter on the screen than events that occur less frequently.

The *ANALOG TRACE* function simulates an analog display.

In this case, a measured value is represented by a single pixel on the screen. After the trace has been explicitly cleared with *CLEAR / WRITE*, *this pixel is reset*. As the trace is build up from several sweeps, the frequency distribution is, in effect, indicated by the varying brightness of the trace.

TRACE 1 side menu

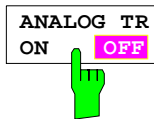

The *ANALOG TR ON/OFF* switches the quasi-analog display mode on and off for the selected trace

The measurement is always made with the selected detector.

IEC/IEEE-bus command

```
:DISPlay[:WINDow<1|2>]:TRACe<1..4>:MODE:ANALog ON | OFF
```

### Mathematical Functions for Traces

TRACE 1-TRACE MATH submenu:

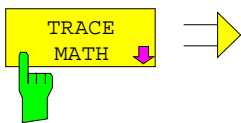

- TRACE MATH
- T1-T2+REF  
-> T1
- T1-T3+REF  
-> T1
- T1-T4+REF  
-> T1
- T1-REF  
->T1
- 
- 
- 
- 
- ADJUST TO  
TRACE
- TRACE MATH  
OFF

The *TRACE MATH* softkey opens a submenu in which a differential curve for the selected trace is calculated.

## TRACE MATH

T1-T2+REF  
-> T1

T1-T3+REF  
-> T1

T1-T4+REF  
-> T1

T1-REF  
->T1



The *T1-T2+REF*, *T1-T3+REF*, *T1-T3+REF* and *T1-REF* softkeys subtract the traces and add the set level to the difference. If the reference line is switched on (see key D LINES), the level value of the reference line instead of the reference level is added to the difference. Thus, the differential curve can be positioned anywhere on the screen by shifting the reference line. The difference of the two traces with respect to the reference line is displayed.

The *T1-REF* softkey subtracts the level of the reference line from the trace level.

To indicate that the trace is a difference trace, an enhancement label is displayed at the right margin of the measurement value diagram (1-2, 1-3, 1-4, 1-R). In *TRACE 1* main menu, the *TRACE MATH* softkey is on a coloured background to show that the function is being used.

**Important:** For a display with two measurement windows, not all combinations are allowed if the sweep data for screen A and screen B are not the same. Only the traces allowed in the screen can be combined (in screen A, only trace 1 with trace 3; in screen B, only trace 2 with trace 4).

IEC/IEEE-bus command

```
:CALCulate<1|2>:MATH<1..4>:STATe ON
:CALCulate<1|2>:MATH<1..4>[:EXPRession][:DEFine] <expr>
```

TRACE MATH  
OFF



The *TRACE MATH OFF* softkey switches the math function off. The softkey is only available when a conversion function is enabled.

IEC/IEEE-bus command :CALCulate<1|2>:MATH<1...4>:STATe OFF

ADJUST TO  
TRACE



The *ADJUST TO TRACE* softkey restores the original instrument settings when the corresponding trace is set to *VIEW* and the current instrument settings are different than those of the trace data.

If a trace is frozen with *VIEW*, changes in the instrument settings can be made without influencing the trace. An asterisk ( \* ) at the edge of the display screen indicates that the current instrument settings are different than those in effect when the trace was recorded. In this case, the *ADJUST TO TRACE* softkey is presented with which the original instrument setting can be restored.

IEC/IEEE-bus command --



## Trace Export

TRACE 1 menu:



The *ASCII EXPORT* softkey stores the active trace in a file with ASCII format. Upon pressing the *ASCII EXPORT* softkey, a file name can be entered. The default name is TRACE.DAT. Then the measured data of the trace are stored. The function can be configured in the *ASCII CONFIG* submenu.

IEC/IEEE-bus command :MMEMory:STORe:TRACe 1..4,<path>

TRACE 1 menu:

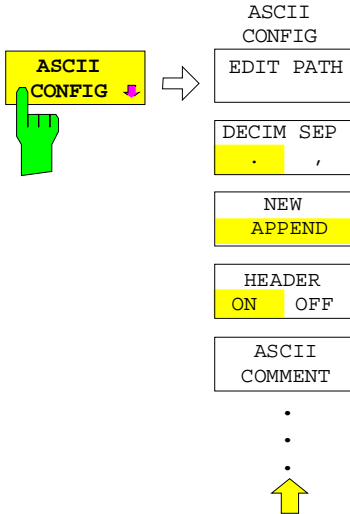

The *ASCII CONFIG* softkey calls a submenu for various settings for the *TRACE ASCII EXPORT* function.



The *EDIT PATH* softkey defines the directory in which the file is to be stored.

IEC/IEEE-bus command --



The *DECIM SEP* softkey selects the decimal separator for the ASCII file. The choice is '.' (decimal point) or ',' (comma). This means that the decimal separator used in various language versions of evaluation programs (e.g. MS-Excel) can be selected so that the packages are supported.

IEC/IEEE-bus command :FORMat:DEXPort:DSEparator POINT|COMMA



The *APPEND NEW* softkey defines whether output data are to be written to an existing file or a new file.

- With *APPEND*, the data are added to an existing file.
- With *NEW*, either a new file is generated or an existing file is overwritten by storage of the data.

IEC/IEEE-bus command :FORMat:DEXPort:APPend ON | OFF

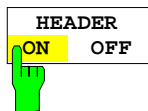

The *HEADER ON/OFF* softkey defines whether important instrument settings should be stored at the beginning of the file.

IEC/IEEE-bus command :FORMat:DEXPort:HEADer ON | OFF



The *ASCII COMMENT* softkey activates the entry of commentary concerning the current ASCII data set. A total of 60 characters are available for this purpose.

IEC/IEEE bus command :FORMat:DEXPort:COMMeNt 'string'

**Structure of the ASCII file:**

The file consists of the header containing important scaling parameters and a data section containing the trace data. The data of the file header consist of three columns, each separated by a semicolon: parameter name; numeric value; basic unit

The data section starts with the keyword " Trace <n> " (<n> = number of stored trace), followed by the measured data in one or several columns (depending on measurement) which are also separated by a semicolon.

This format can be read in from spreadsheet calculation programs, eg MS-Excel. It is necessary to define ';' as a separator.

	Content of file	Description
<b>File header</b>	Type;FSEA 30;	Instrument model
	Version;1.93;	Firmware version
	Date;01..Jul 1999;	Date record storage date
	Comment; test	Comment
	Mode;Spectrum;	Instrument operating mode
	Start;10000;Hz	Start/stop of the display range.
	Stop;100000;Hz	Unit: Hz for span > 0, s for span = 0,
	Center Freq;55000;Hz	Center frequency
	Span;90000;Hz	Frequency range (0 Hz for zero span)
	Freq Offset;0;Hz	Frequency offset
	x-Axis;LIN;	Scaling of x axis linear (LIN) or logarithmic (LOG)
	y-Axis;LOG;	Scaling of y axis linear (LIN) or logarithmic (LOG)
	Ref.Level;-30;dBm	Reference level
	Level Offset;0;dB	Level offset
	Max Level	Maximum level
	Level Range;100;dB	Display range in y direction. Unit: dB for x axis LOG, % for x axis LIN
	RF Att;20;dB	Input attenuation
	RBW;100000;Hz	Resolution bandwidth
	VBW;30000;Hz	Video bandwidth
SWT;0.005;s	Sweep time	
Trace Mode;AVERAGE;	Display mode of trace: CLR/WRITE,AVERAGE,MAXHOLD,MINHOLD	
Detector;SAMPLE;	Detector set: AUTOPEAK,MAXPEAK,MINPEAK,AVERAGE, RMS,SAMPLE	
Sweep Count;20;	Number of sweeps set	
<b>Data section of the file</b>	Trace 1;;	Selected trace
	x-Unit;Hz;	Unit of x values: Hz for span > 0; s for span = 0; dBm/dB for statistics measurements
	y-Unit;dBm;	Unit of y values: dB*/V/A/W depending on the selected unit for y axis LOG or % for y axis LIN
	Values;500;	Number of measurement points
	10000;-10.3;-15.7	Measured values: <x value>, <y1>, <y2>
	10180;-11.5;-16.9	<y2> being available only with AUTOPEAK detector and containing in this case the smaller of the two measured values for a measurement point.
10360;-12.0;-17.4		
...;...;		

**Example:**

```

Type;FSEA 30;
Version;1.93;
Date;20.Sep 1999;
Comment; test
Mode;Spectrum;
Start;0.000000;Hz
Stop;3500000000.000000;Hz
Center Freq;1750000000.000000;Hz
Span;3500000000.000000;Hz
Freq Offset;0.000000;Hz
x-Axis;LIN;
y-Axis;LOG;
Level Range;100.000000;dB
Ref. Level;-20.000000;dBm
Level Offset;0.000000;dBm
Max. Level;-20.000000;dBm
RF Att;10.000000;dB
RBW;3000000.000000;Hz
VBW;3000000.000000;Hz
SWT;0.005000;s
Trace Mode;CLR/WRITE;
Detector;AUTOPEAK;
Sweep Count;0;
TRACE 1:
x-Unit;Hz;
y-Unit;dBm;
Values;500;
0.000000;-44.465958;-60.190887
7014028.056112;-49.233063;-81.451668
14028056.112224;-75.692101;-101.811501
21042084.168337;-75.147057;-101.229843
28056112.224449;-75.114517;-95.358429
35070140.280561;-71.769005;-100.755981
...

```

If all traces are to be stored in one file with the header information stored only once, the following procedure is recommended:

[TRACE 1] [MENU ⇒][ASCII CONFIG]	
[ASCII CONFIG] [NEW]	Generate new file
[ASCII CONFIG] [HEADER ON]	with header
[TRACE 1] [MENU ⇒][ASCII EXPORT]	Store trace 1 with header
[TRACE 2] [MENU ⇒][ASCII CONFIG]	
[ASCII CONFIG] [APPEND]	Append to end of file
[ASCII CONFIG] [HEADER OFF]	without header
[TRACE 2] [MENU ⇒][ASCII EXPORT]	Write trace 2 to file
[TRACE 3] [MENU ⇒][ASCII EXPORT]	Write trace 3 to file
[TRACE 4] [MENU ⇒][ASCII EXPORT]	Write trace 4 to file

## Sweep Control – SWEEP Key Group

Using the *SWEEP* key group, the parameters are entered which determine the sweep characteristics. These are the coupled functions resolution bandwidth, video bandwidth and sweep time (*COUPLING* key), the trigger used for starting the sweep (*TRIGGER* key) and the type of sweep (*SWEEP* key).

## Coupled Settings – COUPLING Key

The *COUPLING* key calls a menu for entering the sweep parameters resolution bandwidth (*RBW*), video bandwidth (*VBW*) and sweep time (*SWT*). The parameters may be coupled as a function of the span, coupled to each other or set by the user. When working with a split screen display, the settings always refer to the active window.

The models of the FSE family offer the following resolution bandwidths:

- models 20: 10 Hz to 10 MHz in 1/2/3/5 steps
- models 30: 1 Hz to 10 MHz in 1/2/3/5 steps

The FSE resolution bandwidths up to 1 kHz have been implemented using digital filters with Gaussian characteristics. They behave like analog filters. The 1-kHz filter has been implemented both as a decoupled quartz filter and as a digital filter. One of the two filter types can be selected. The bandwidths from 2 kHz to 30 kHz have been implemented using decoupled quartz filters, the bandwidths between 50 kHz and 5 MHz using decoupled LC filters. These filters consist of 4 circuits for models 20 and 5 circuits for models 30. Moreover, the filters for models 20 and 30 differ in their shape factor: The 60 dB :3 dB shape factor of the 4-circuit filters is < 15, typ. 12; the shape factor of the 5-circuit filters is < 12, typ. 9.5.

The 10-MHz filter is a critically coupled LC filter.

For bandwidths up to about 1 kHz, the FFT-algorithm, as compared to other filter methods with identical settings, offers clear advantages with respect to the measurement time. The reason is that with analog filters the sweep time required for a particular span is proportional to  $(\text{Span}/\text{RBW}^2)$ . The FFT-algorithm reduces that time to a value proportional to  $(\text{Span}/\text{RBW})$ .

FFT-filters are provided for models 30 and for bandwidths between 1 Hz and 1kHz as an alternative to the analog filters. This function is provided as an option (FSE-B5).

The video bandwidths are available in 1/2/3/5 steps between 1 Hz and 10 MHz. They can be set as a function of the resolution bandwidth. Video bandwidths between 1 Hz and 10 kHz are available for resolution bandwidths up to 1 kHz and video bandwidths between 1 Hz and 10 MHz are available for resolution bandwidths greater than or equal to 2 kHz. The video filters are used to smooth the traces. Small video bandwidths in relation to the resolution bandwidth average out noise peaks and pulse-like signals, so that only the signal average is displayed. A large video bandwidth in relation to the resolution bandwidth is therefore recommended when measuring pulse-like signals ( $\text{VBW} \geq 10 \times \text{RBW}$ ) so that the amplitude of pulses can be measured correctly.

## Setting and Coupling the Coupling Resolution, Video Bandwidth and Sweep Time

### SWEEP COUPLING menu

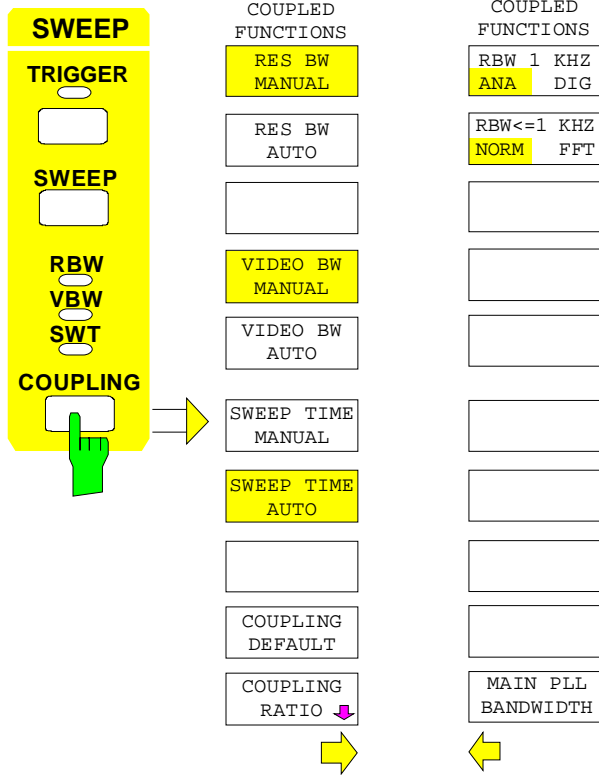

The *COUPLING* key calls a menu and a supplementary menu for setting the resolution bandwidth, video bandwidth, sweep time and their coupled states.

The *AUTO* softkeys are used to couple the functions. The coupling ratios are selected in the *COUPLING RATIO* sub-menu.

The *MANUAL* softkeys request that the respective parameter be entered in the entry window. This parameter is not coupled to the other parameters.



The *RES BW AUTO* softkey couples the resolution bandwidth to the selected span. Changing the span causes automatic compensation of the resolution bandwidth.

Automatic coupling of the resolution bandwidth to span is always recommended when, for the measurement problem on hand, a favorable setting of the resolution bandwidth in relation to the selected span is desired.

The coupling ratio is set in the *COUPLING RATIO* sub-menu.

The coupling is indicated by illumination of the softkey and the active *RBW* LED.

The *RES BW AUTO* softkey is only available in the frequency domain (span > 0 Hz). The softkey is blanked in the time domain.

IEC/IEEE-bus command : [SENSE<1|2>:]BWIDth[:RESolution]:AUTO ON

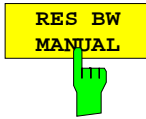

The *RES BW MANUAL* softkey activates the manual entry mode for the resolution bandwidth.

The resolution bandwidth for models 20 can be set in 1/2/3/5 steps in the range between 10 Hz and 10 MHz. The nominal resolution bandwidth is the 3-dB bandwidth. For models 20 equipped with an FFT-filter (option FSE-B5) and for models 30 the lower limit of the bandwidth is 1 Hz.

For numerical inputs, the values are always rounded to the next valid bandwidth. For rollkey or the UP/DOWN key entries, the bandwidth is adjusted in steps either upwards or downwards.

For manual input of the resolution bandwidth (coupling off), the *RBW* LED on the front panel remains off.

IEC/IEEE-bus commands

```
: [SENSe<1 | 2> : ] BWIDth [ : RESolution ] : AUTO OFF
: [SENSe<1 | 2> : ] BWIDth [ : RESolution ] 1MHz
```



The *VIDEO BW AUTO* softkey couples the video bandwidth of the FSE to the resolution bandwidth. If the resolution bandwidth is changed, the video bandwidth is automatically adjusted.

The coupling of the video bandwidth is always recommended when the maximum sweep time for a selected resolution bandwidth is to be obtained. Small video bandwidths require longer sweep times due to the longer settling time. Large bandwidths reduce the signal/noise ratio.

The coupling ratio is set in the *COUPLING RATIO* menu.

The coupling is indicated by illumination of the softkey and the lighted *VBW* LED on the front panel.

The coupling of the video bandwidth to the resolution filter is also permitted for display in the time domain (span = 0).

IEC/IEEE-bus command : [SENSe<1 | 2> : ] BWIDth : VIDEo : AUTO ON



The *VIDEO BW MANUAL* softkey activates the manual entry for the video bandwidth.

The video bandwidth can be selected in 1/2/3/5 steps between 1 Hz and 10 MHz. For bandwidths up to 1 kHz, the maximum video bandwidth is 10 kHz, for larger resolution bandwidths, there is no restriction to the video bandwidth.

For numerical entries, rounding is made to the next valid bandwidth. For rollkey or UP/DOWN entries, the bandwidth is adjusted in steps either downwards or upwards.

For manual input, the video bandwidth (coupling disabled) *VBW* LED on the front panel is turned off.

IEC/IEEE-bus commands : [SENSe<1 | 2> : ] BWIDth : VIDEo : AUTO OFF  
: [SENSe<1 | 2> : ] BWIDth : VIDEo 10kHz

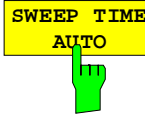

The *SWEEP TIME AUTO* softkey couples the sweep time to the span, video bandwidth (VBW) and resolution bandwidth (RBW). The sweep time is automatically adjusted whenever the span, resolution bandwidth or video bandwidth are changed. The FSE always selects the shortest sweep time which will not lead to spurious measurements.

The coupling is indicated by illumination of the softkey and turning on the *SWT LED*.

The softkey is only available in the frequency domain (span > 0 Hz). The softkey is blanked in the time domain.

IEC/IEEE-bus command : [SENSe<1 | 2>:]SWEep:TIME:AUTO ON



The *SWEEP TIME MANUAL* softkey activates the manual entry for the sweep time. At the same time, the coupling of the sweep is cancelled and the *SWT LED* is turned off. Other couplings (*VIDEO BW*, *RES BW*) remain in effect.

In the frequency domain (span > 0 Hz) and for resolution bandwidths  $\geq 1$  kHz, sweep times from 5 ms through 16000 s are allowed in steps that are at most 5% of the sweep time. The digital resolution filters from 10 Hz to 1 kHz allow a minimum sweep time of 20 ms.

If an FFT-filter is used (models 20 with option FSE-B5 or models 30) the sweep time is fixed by the display range and resolution bandwidth selected and therefore can not be changed.

In the time domain (span = 0 Hz), the sweep time range is 1  $\mu$ s to 2500 s, selectable in steps that are at most 5% of the sweep time.

Numerical entries are rounded to the next valid sweep time. For rollkey or UP/DOWN entries, the sweep time is adjusted in steps either downwards or upwards.

If the selected sweep time is too small for the selected span and bandwidth, measurement errors will occur. This happens because the available settling time for the resolution filter or the video filter is too short. The FSE, therefore, outputs *UNCAL* on the display

IEC/IEEE-bus commands : [SENSe<1 | 2>:]SWEep:TIME:AUTO OFF  
: [SENSe<1 | 2>:]SWEep:TIME 10s

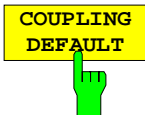

The *COUPLING DEFAULT* softkey sets all coupled functions to *AUTO*. The *RBW / VBW* ratio is also set to *SINE [1]* and the *SPAN/RBW* ratio is set to 50 in the *COUPLING RATIO* submenu (default setting, *COUPLING RATIO* softkey not illuminated).

The relevant softkeys are then illuminated.

IEC/IEEE-bus commands : [SENSe<1 | 2>:]BWIDth[:RESolution]:AUTO ON;  
: [SENSe<1 | 2>:]BWIDth:VIDeo:AUTO ON;  
: [SENSe<1 | 2>:]SWEep:TIME:AUTO ON

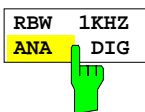

The *RBW 1kHz ANA/DIG* softkey enables either the analog quartz filter (ANA) or the digital filter (DIG) for the instrument's resolution bandwidth of 1 kHz. In the default setting, the instrument uses the analog IF filter for the 1-kHz bandwidth.

IEC/IEEE-bus command : [SENSe<1 | 2>:]BWIDth:MODE ANALog | DIGital

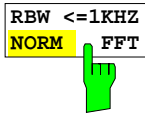

The *RBW<=1kHz NORM/FFT* softkey toggles between fixed filter and FFT-filter.

This softkey for models 30 of the FSE or for models 20 equipped with option FFT-filter (FSE-B5).

*NORM* For resolution bandwidths up to 1 kHz fixed IF-filters are used.

*FFT* An FFT is performed. The filtered IF-signal is digitalized by the 3-kHz resolution filters and then transformed into a spectrum by FFT. The transformation range is equal to the selected span but covers 4 kHz at maximum. If the span is larger than the transformation range, several subsequent transformations are performed, the results are combined to form a complete spectrum. The frequency response of the 3-kHz preselection filter is compensated for so that the amplitude response within the transformation range is offset. A flattop window serves as a window in the time domain so that a high amplitude precision with good selectivity is obtained.

Span:

- minimum display range: 50× resolution bandwidth selected
- maximum display range:
  - Resolution bwidths > 20 Hz: 2 MHz (500 FFT-transf./sweep at maximum)
  - Resolution bwidths < 20Hz: Reduction to 125 kHz at 1 Hz resolution bandwidth

Level display range: 100 dB at max. With greater spans, the trace is limited to 100 dB below the reference level.

Sweep time: fixed by the bandwidth selected and the span.  
(reason: an FFT-filter represents a block transformation). The sweep time can not be changed (softkey inactive).

Detector All settings of the sample detector are fixed, no other detector can be selected (softkeys inactive)

Video bandwidth not defined for FFT-transf. therefore it can not be set (softkeys inactive).

Compared to fixed filters, FFT-filters cut sweep times considerably. For a display range of 50 kHz and a resolution bandwidth of 100 Hz, e. g., the sweep time is reduced from 25 s to 520 ms. FFT-filters are ideal for stationary signals (sinusoidal signals or signals that are continuously modulated in time). For burst signals (TDMA) or pulses, fixed filters should be preferred. The FFT is a block transformation so that the result depends on the time relation between the dataset to be transformed and the burst or pulse signal. A 'gated sweep' measurement for TDMA signals is therefore not provided if FFT-filters are used.

IEC/IEEE-bus command : [SENSE<1 | 2> : ]BWIDTH:MODE:FFT ON|OFF



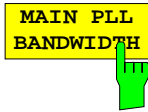

The *MAIN PLL BANDWIDTH* softkey opens a selection window for setting the PLL control bandwidth.

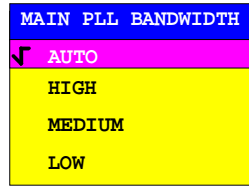

The first local oscillator is synchronized with the PLL control bandwidth. The control bandwidth determines the characteristic of the phase noise. A medium or high control bandwidth improves the phase noise for frequency differences smaller than 10 kHz to the carrier, whereas a low control bandwidth improves the phase noise for frequency differences larger than 100 kHz to the carrier. If the control bandwidth is set unfavorably, the phase noise is deteriorated.

The PLL bandwidth is set in the AUTO mode depending on the RBW and SPAN according to the following tables:

Models 20 without option B4:

MAIN PLL BANDWIDTH	SPAN ≤ 50 kHz and RBW < 1kHz	SPAN > 50 kHz or RBW ≥ 1kHz
HIGH		
MEDIUM	X	
LOW		X

Models 30 or models 20 with Option B4:

MAIN PLL BANDWIDTH	SPAN ≤ 100 kHz and RBW < 3kHz	SPAN > 100 kHz or RBW ≥ 3kHz
HIGH	X	
MEDIUM		X
LOW		

The setting is chosen such that the phase noise for small spans with small resolution bandwidth near the carrier is optimized.

For measurements with small span but with a relatively large frequency difference to the carrier (>100kHz), the automatic bandwidth setting deteriorates the phase noise relative to the optimal setting. The *MAIN PLL BANDWIDTH* softkey allows to by-pass this automatic setting. Optimal settings are, as a function of the carrier difference @:

Models 20 without option B4:

MAIN PLL BANDWIDTH	@ ≤ 10 kHz	@ > 10 kHz
HIGH		
MEDIUM	X	
LOW		X

Models 30 or Models 20 with Option B4:

MAIN PLL BANDWIDTH	@ ≤ 10 kHz	10 kHz < @ < 100 kHz	@ ≥ 100 kHz
HIGH	X		
MEDIUM		X	
LOW			X

If a larger control bandwidth is needed due to the sweep velocity, the processor automatically increases the control bandwidth as far as necessary.

### Sweep Coupling Ratio

*SWEEP COUPLING-COUPLING RATIO* submenu:

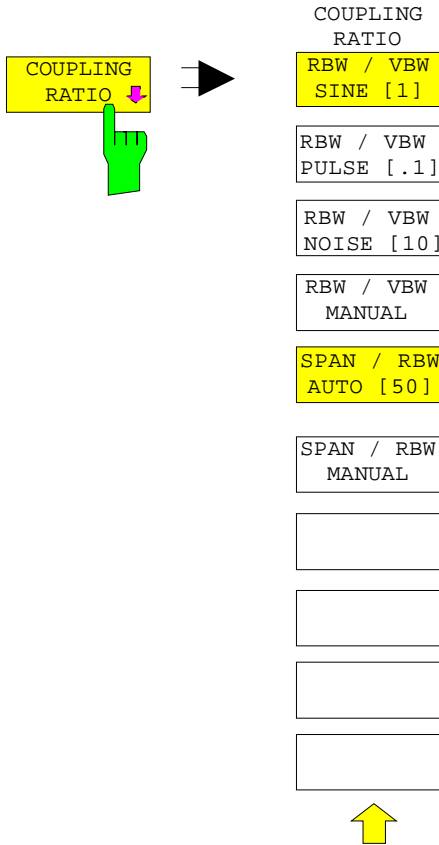

The *COUPLING RATIO* softkey opens a sub-menu in which the coupling ratio between resolution bandwidth, video bandwidth and the span can be defined.

These settings are effective only for the selected parameters in ...*AUTO* of the main menu.

The softkeys *RBW/VBW PULSE*, *RBW/VBW SINE*, *RBW/VBW NOISE*, *RBW/VBW MANUAL* are selection keys. Only one softkey can be enabled (illuminated) at any one time.

The same is valid for the softkeys *SPAN/RWB AUTO [50]* and *SPAN/RWB MANUAL*.

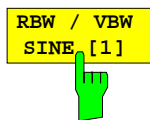

The *RBW / VBW SINE [1]* softkey always sets the video bandwidth equal to the resolution bandwidth.

This is the default setting for the coupling ratio resolution bandwidth to video bandwidth.

This coupling ratio is recommended when sine-wave signals are to be measured.

This setting is only effective for the *VBW AUTO* selection in the main menu.

IEC/IEEE-bus command : [SENSe<1|2>:]BWIDth:VIDeo:RATio SINE

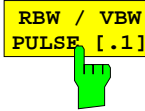

The *RBW / VBW PULSE* softkey sets the following coupling ratio:

video bandwidth = 10 x resolution bandwidth

or

video bandwidth = 10 MHz (= maximum video bandwidth).

This coupling ratio is recommended when the amplitude of pulsed signals is to be measured. The IF filter characteristics alone determine the pulse shape. No additional weighting is provided by the video filter.

This setting is only effective for the *VBW AUTO* selection in the main menu.

IEC/IEEE-bus command : [SENSE<1|2>:]BWIDth:VIDeo:RATio PULSe

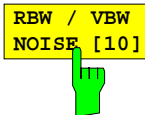

The *RBW / VBW NOISE* softkey sets the following coupling ratio:

video bandwidth = resolution bandwidth/10

At this coupling ratio, noise and pulsed signals are suppressed in the video section. For noise signals, the FSE displays the average value.

This softkey is disabled unless *VBW AUTO* is selected in the main menu.

IEC/IEEE-bus command

: [SENSE<1|2>:]BWIDth:VIDeo:RATio NOISE

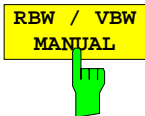

The *RBW / VBW MANUAL* softkey activates the entry of the coupling ratio for resolution bandwidth to video bandwidth.

The range for the RBW/VBW ratio is 0,001 to 1000.

This softkey is disabled unless *VBW AUTO* is selected in the main menu.

IEC/IEEE-bus command : [SENSE<1|2>:]BWIDth:VIDeo:RATio 10

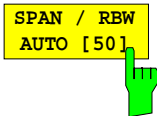

The *SPAN / RBW AUTO [50]* softkey sets the following coupling (rounding is made to the next higher value):  
resolution bandwidth = span/50

This coupling corresponds to the default state.

This softkey is disabled unless *RBW AUTO* is selected in the main menu.

IEC/IEEE-bus command

: [SENSE<1|2>:]BWIDth[:RESolution]:RATio 0.02



The *SPAN / RBW MANUAL* softkey activates the entry for the coupling of resolution bandwidth and span.

The range for the SPAN/RBW ratio is 1 to 10000.

This softkey is disabled unless *RBW AUTO* is selected in the main menu.

IEC/IEEE-bus command

: [SENSE<1|2>:]BWIDth[:RESolution]:RATio 0.1

## Sweep Trigger – TRIGGER Key

*SWEEP TRIGGER* menu:

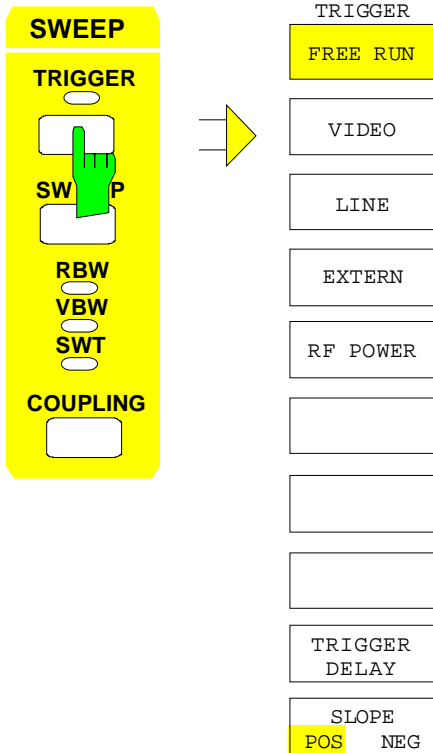

The *TRIGGER* key opens a menu for selecting the various trigger sources and the trigger polarity. The active trigger mode is indicated by illumination of the corresponding softkey.

For triggering modes in which the trigger threshold can be entered, the corresponding entry window is activated and, if appropriate, a horizontal trigger line is displayed.

The *FREE RUN*, *VIDEO*, *LINE*, *EXTERN* and *RF-POWER* softkeys are selection switches. Only one key can be enabled at any one time (illuminated). For sweep operations controlled by a gate signal, the *FREE RUN* setting is the only setting possible.

If triggering has taken place, the trigger LED is turned on at the beginning of the sweep and then turned off at the end of sweep.

To indicate that the FSE is set for triggering (= not free run), the enhancement label **TRG** is shown on the display. If two measurement windows are displayed, TRG appears next to the window which is configured for triggering.



The *FREE RUN* softkey activates the free-run sweep mode (default setting), i.e. the start of a sweep is not explicitly triggered. Once a measurement is completed, another is started immediately.

IIEC/IEEE-bus command  
`:TRIGger<1|2>[:SEquence]:SOURce IMMEDIATE`

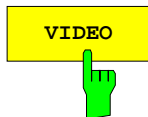

The *VIDEO* softkey activates triggering by the displayed voltage.

For the video triggering mode, a level line showing the trigger threshold is displayed. Using the level line, the threshold can be adjusted with the roll-key or the UP/DOWN keys.

IEC/IEEE-bus commands  
`:TRIGger<1|2>[:SEquence]:SOURce VIDeo`  
`:TRIGger<1|2>[:SEquence]:LEVel:VIDeo 50PCT`

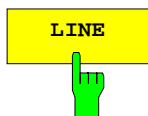

The *LINE* softkey activates triggering derived from the mains (line) frequency. The power supply generates a trigger pulse at the line frequency which is used to trigger a new sweep.

IEC/IEEE-bus commands  
`:TRIGger<1|2>[:SEquence]:SOURce LINE`

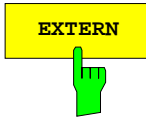

The *EXTERN* softkey activates triggering by an external voltage (-5V...+5V) at the input connector *EXT TRIGGER/GATE* on the rear panel.

The trigger threshold can be set in an entry window within a range of -5V...+5V.

External triggering in the sweep mode "gated sweep" (*SWEEP SWEEP-GATE ON*) is not possible, because the *EXT TRIG/GATE* connector is used to control the sweep. The softkey is not illuminated in these modes.

IEC/IEEE-bus commands

```
:TRIGger<1|2>[:SEquence]:SOURce EXTernal
:TRIGger<1|2>[:SEquence]:LEVel 2.5V
```

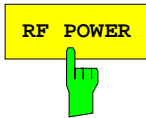

The *RF POWER* softkey activates triggering of the measurement by signals which are outside the measurement channel.

The FSE uses a level detector at the intermediate frequency. The detector threshold is approximately -20 dBm at the input mixer. This means that the actual trigger level at the RF input is approx. -20 dBm plus the set RF attenuation.

The bandwidth at the intermediate frequency is approximately 60 MHz for model FSEA, approx. 160 MHz for FSEB, FSEM and FSEK. Triggering takes place when the trigger threshold is exceeded within a 100 MHz band about the selected frequency. Therefore, the measurement of noise emissions, e.g., for pulsed carriers, is possible. The carrier itself is suppressed via the selected resolution filter.

IEC/IEEE-bus command

```
:TRIGger<1|2>[:SEquence]:SOURce RFPower
```



The *TRIGGER DELAY* softkey activates the entry window for delay time or a pretrigger.

The triggering is delayed or advanced relative to the trigger signal by the entered delay time. The delay time can be set in the range from -100 s to 100 s (default = 0 s).

**Note:** A negative delay time (pretrigger) can be set in the time domain (SPAN < 0 Hz) only. The maximum range and the maximum resolution of the pretrigger is limited by the set sweep time:

max. range = - 499/500 x sweep time

max. resolution = sweep time/500.

Pretriggering is not possible when the rms or the average detector is activated.

IEC/IEEE-bus command

```
:TRIGger<1|2>[:SEquence]:HOLDoff 500us
```



The *SLOPE POS/NEG* softkey selects the trigger slope.

The sweep starts after a positive or negative trigger signal edge. The selected setting is illuminated.

The selection is valid for all trigger modes with the exception of *FREE RUN*.

The default mode is *SLOPE POS*.

IEC/IEEE-bus command

```
:TRIGger<1|2>[:SEquence]:SLOPe POS |NEG
```

## Sweep Setup – SWEEP Key

SWEEP SWEEP menu:

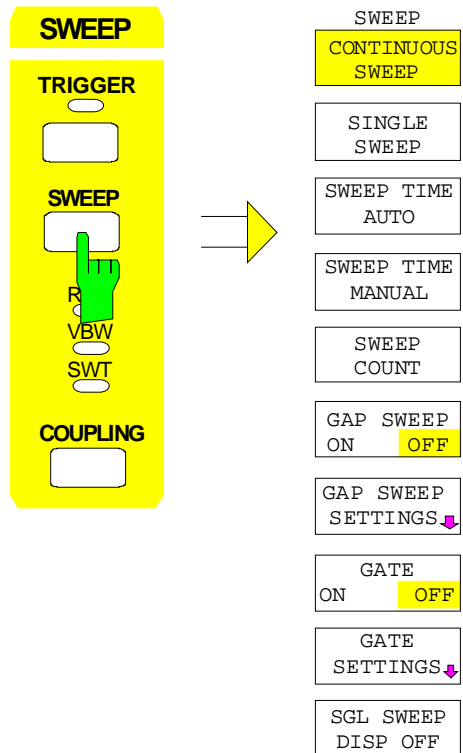

The *SWEEP* key calls a menu in which the type of sweep (sweep mode) is determined. In split screen mode, the entries are valid only for the active measurement window.

In the menu, continuous or single sweep mode, gap-sweep settings or the external gate function can be selected.

The *CONTINUOUS SWEEP* and *SINGLE SWEEP* softkeys are selection switches. Only one softkey can be active at any one time.



The *CONTINUOUS SWEEP* softkey sets the continuous sweep mode. This means, that the sweep takes place continuously according to the trigger conditions.

In the case of split screen display with different settings in each measurement window, screen A is swept first and then screen B. After pressing the softkey, the sweep is initialized and restarted.

*CONTINUOUS SWEEP* is the default setting of the FSE.

IEC/IEEE-bus commands :INITiate<1|2>:CONTinuous ON;  
:INITiate

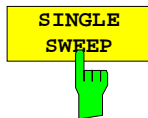

The *SINGLE SWEEP* softkey starts a series of n sweeps according to the triggering definition. The number of sweeps, n, is determined by the *SWEEP COUNT* softkey.

In split screen display mode, the spans of each window are swept sequentially. If a displayed curve is averaged, the span is swept n times (n = sweep count). For n = 0, a single sweep takes place.

To indicate that the FSE is set for single sweep, the enhancement label **SGL** is shown on the display.

IEC/IEEE-bus commands :INITiate<1|2>:CONTinuous OFF;  
:INITiate

SWEEPTIME  
AUTO

SWEEPTIME  
MANUAL

The *SWEEPTIME AUTO* and *SWEEPTIME MANUAL* softkeys activate the automatic or manual selection of the sweep time. These functions are identical to the entries in the *COUPLING* menu (see section "Setting and Coupling the Coupling Resolution, Video Bandwidth and Sweep Time").

IEC/IEEE-bus commands

```
: [SENSE<1 | 2>: ]SWEEp:TIME:AUTO ON | OFF
: [SENSE<1 | 2>: ]SWEEp:TIME 10s
```

SGL SWEEP  
DISP OFF



The *SGL SWEEP DISP OFF* softkey switches off the display during a single sweep. The trace is displayed when the sweep has been completed.

IEC/IEEE-bus commands :INITiate<1|2>:DISPlay ON | OFF;  
:INITiate

SWEEP  
COUNT



The *SWEEP COUNT* softkey activates the entry of the number of sweeps performed by the FSE after the start of a single sweep. If trace average, max hold or min hold is switched on, this also determines the number of averages or minima/maxima that are taken.

Example:

[TRACE1: MAX HOLD]

[SWEEP: SWEEP COUNT: {10} ENTER]

[SINGLE SWEEP]

The FSE performs the max hold function over 10 sweeps.

The sweep count range is 0 through 32767. For sweep count = 0 or 1, a sweep is performed. For trace averaging (*AVERAGE*), sweep count = 0 and continuous sweep, the FSE performs a sliding average over 10 sweeps in average mode. For sweep count = 1, no averaging takes place.

The default setting totals 10 sweeps.

**Note:** *The setting for the number of sweeps in the TRACE menu is equivalent to the setting in the SWEEP menu. In SINGLE SWEEP mode, the measurement is stopped after reaching the chosen number of sweeps.*

IEC/IEEE-bus command : [SENSE<1 | 2>: ]SWEEp:COUNT 0

### Gated Sweep

By using a gate in the sweep mode and stopping the measurement while the gate signal is inactive, the spectrum of pulsed carriers can be displayed without overlaid frequency components caused by switching. Similarly, the spectrum can also be examined when the carrier is inactive. The sweep can be controlled by an external gate or by the internal power trigger.

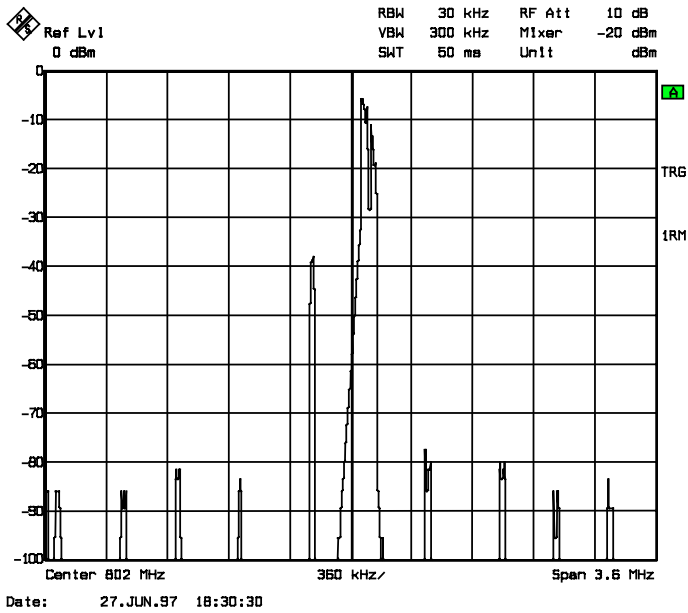

Fig. 4-8 Pulsed signal with GATE OFF

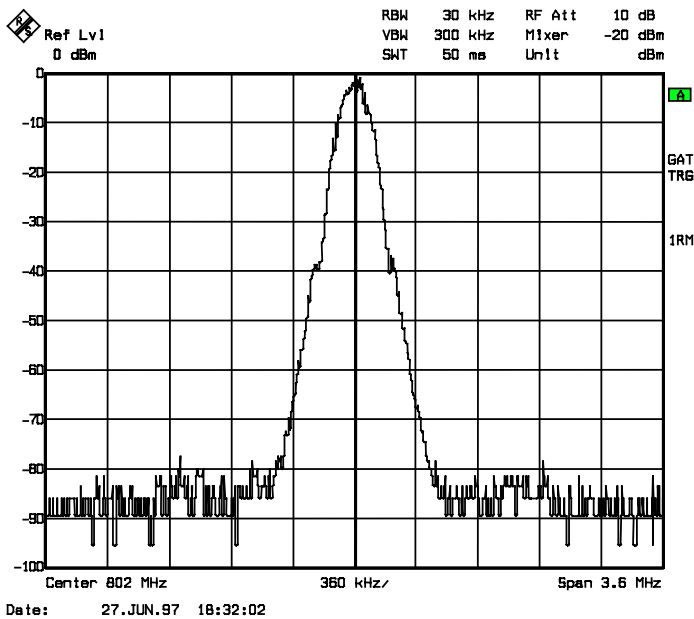
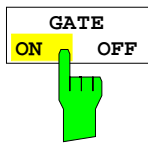

Fig 4-9 TDMA-signal with GATE ON



The 'gated sweep' mode is activated by the *GATE ON/OFF* softkey. The mode is set in the *GATE SETTINGS* sub-menu.

*SWEEP SWEEP* menu:



The *GATE ON / OFF* softkey switches the sweep mode with an internal or external gate on/off.

When *GATE ON* is selected, a signal applied to the rear panel connector *EXT TRIGGER/GATE* or the internal RF power detector controls the sweep of the analyzer. The sweep can be stopped and then continued. A switch from an edge triggered to a level triggered mode can also be made.

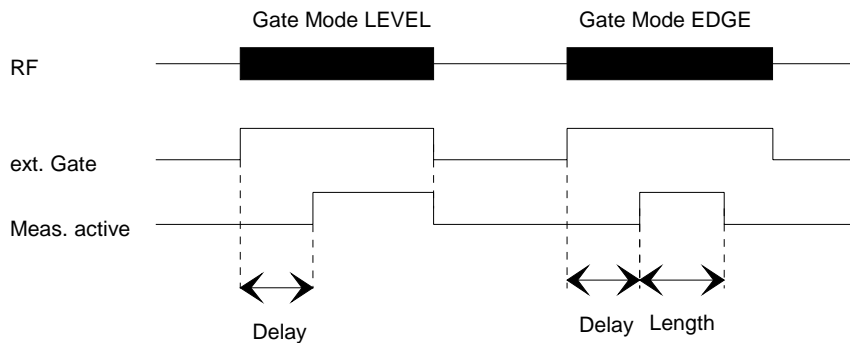

Fig. 4-10 Interaction of the parameters *GATE MODE*, *GATE DELAY* and *GATE LENGTH*

The softkey is only available in the frequency domain (span > 0).

*GATE ON* is only possible when the trigger mode is set to *FREE RUN* (*SWEEP TRIGGER* menu) .

To indicate that the FSE is set for sweep mode with external gate, the enhancement label *GAT* is displayed on the screen. *GAT* appears next to the window for which the gate is configured.

IEC/IEEE-bus command : [SENSe<1 | 2>:]SWEep:EGATe ON | OFF

SWEEP SWEEP-GATE SETTINGS sub-menu:

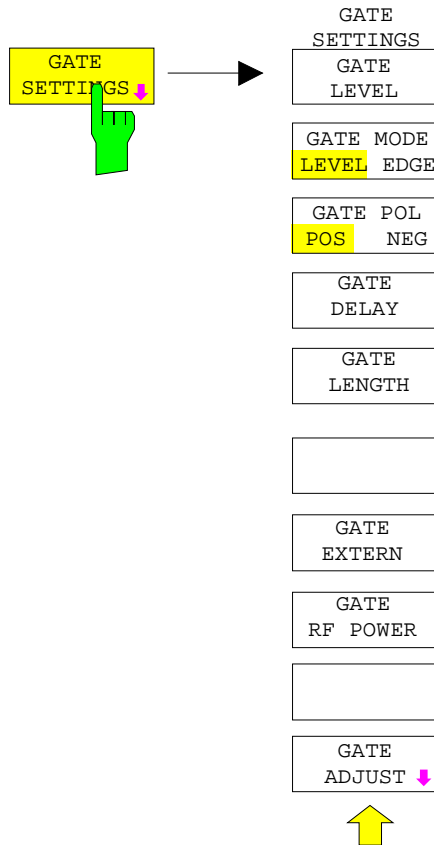

In the *GATE SETTINGS* submenu, all settings are made which are necessary for 'gated sweep' operation.

On switching to the time domain, the *GATE DELAY* and *GATE LENGTH* times are represented by horizontal time lines which allow simple adjustment of the gate time.

The softkeys *GATE EXTERN* and *GATE RF POWER* provide alternative settings, only one of them can be active at one time.



The *GATE LEVEL* softkey activates the entry window for defining the threshold value of the external gate signal.

The threshold can be set between -5V and +5V.

IEC/IEEE-bus command : [SENSE<1|2>:]SWEep:EGATe:LEVel 3V

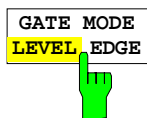

The *GATE MODE LEVEL/EDGE* softkey selects the trigger mode. The sweep mode *GATE* can be operated either as level or as edge triggered.

For level triggering, the *GATE LENGTH* softkey is deactivated and can not be used.

IEC/IEEE-bus command : [SENSE<1|2>:]SWEep:EGATe:TYPE LEVel | EDGE



The *GATE POL* softkey determines the polarity of the *GATE* control line.

If level triggering with *GATE POL POS* is set, the sweep is stopped when the gate signal is a logic '0' (input signal < gate level) at the *EXT TRIGGER/GATE* input and then, when the gate signal goes to a logic '1', the sweep is continued after a delay time of *GATE DELAY*.

In the case of edge triggering, the sweep is continued on a '0' to '1' transition for the duration of *GATE LENGTH* after a delay (*GATE DELAY*) has elapsed.

IEC/IEEE-bus command : [SENSE<1|2>:]SWEep:EGATe:POLarity POS|NEG



The *GATE DELAY* softkey activates the entry window for setting the delay time between the gate signal and the continuation of the sweep.

This may be useful in allowing for a delay between the gate signal and the stabilization of an RF carrier.

Gate delay values can be selected between 1  $\mu$ s and 100 s. The resolution is dependent upon the absolute value of the delay time:

Gate delay	Resolution
0 - 500 $\mu$ s	1 $\mu$ s
0.5 - 5 ms	5 $\mu$ s
5 - 50 ms	50 $\mu$ s
50 - 500 ms	500 $\mu$ s
0.5 - 5 s	5 ms
5 - 50 s	50 ms
50 - 100 s	500 ms

In the time domain, a time line is displayed separated from the trigger point by the gate delay time. This simplifies the adjustment of the necessary delay time.

The values for *GATE DELAY* and *GATE LENGTH* are displayed by two time lines. The duration of the active sweep for span > 0 (continuation of sweep: *GATE DELAY* line, stopping of sweep: *GATE LENGTH* line) is described by these two lines. A change in parameters causes a shift of the corresponding line position. After switching to span > 0, the selected times for the gated sweep are effective.

IEC-bus command : [SENSE<1|2>:]SWEep:EGATE:HOLDoff 100us

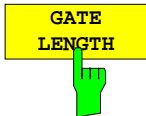

The *GATE LENGTH* softkey activates the entry window for defining the FSE sweep duration.

*GATE LENGTH* can be set to values between 1  $\mu$ s and 100 s. The resolution is dependent upon the absolute value of the gate length:

Gate length	Resolution
0 - 500 $\mu$ s	1 $\mu$ s
0.5 - 5 ms	5 $\mu$ s
5 - 50 ms	50 $\mu$ s
50 - 500 ms	500 $\mu$ s
0.5 - 5 s	5 ms
5 - 50 s	50 ms
50 - 100 s	500 ms

In the time domain (*ZERO SPAN*), a time line is displayed separated from the *GATE DELAY* time by the *GATE LENGTH* time.

The softkey is only available for the *GATE MODE EDGE* setting (edge triggering). It is disabled for the *GATE MODE LEVEL* setting (level triggering).

IEC/IEEE-bus command : [SENSE<1|2>:]SWEep:EGATE:LENGth 10ms



The *GATE EXTERN* softkey selects a signal applied to the *EXT TRIGGER/GATE* connector on the rear panel of the instrument as a gate source.

IEC/IEEE-bus command : [SENSE<1|2>:]SWEep:EGATE:SOURce EXT

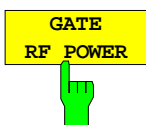

The *GATE RF POWER* softkey selects the internal RF power detector as a gate source.

IEC-bus command : [SENSE<1|2>:]SWEep:EGATE:SOURce RFPower

## Setting the Gate Times

*SWEEP SWEEP- GATE SETTINGS - GATE ADJUST* submenu:

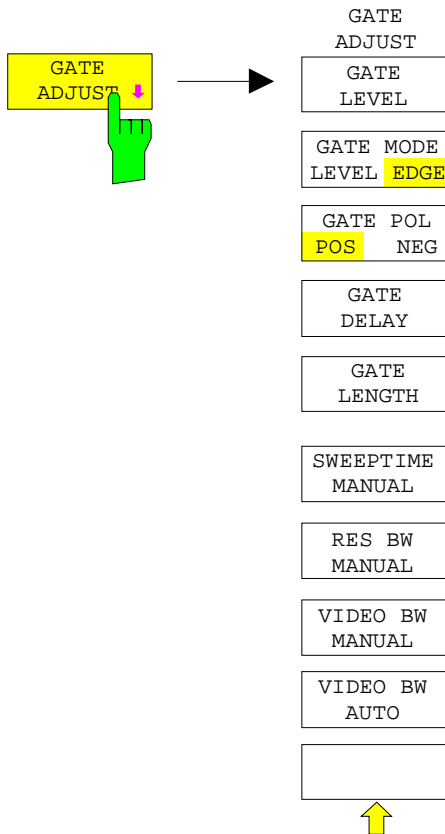

The *GATE ADJUST* softkey opens a submenu comprising all softkeys that are used to set the parameters relevant for the 'gated sweep' function.

On pressing this softkey, the display is switched to the time domain (zero span setting) so that all necessary times can be checked by means of cursor lines.

The values for Res BW, Video BW and sweep time are taken from the corresponding settings in the frequency domain.

To make sure that the times can be set correctly corresponding to the conditions in the frequency domain, the settings for the resolution bandwidth and the video bandwidth should not be changed.

The sweep time must be selected such that, e. g., a full burst is displayed. It usually differs from the sweep time in the frequency range.

Finally, *GATE DELAY* and *GATE LENGTH* can be used to set the times in such a way that the desired section in the spectral range is covered.

On quitting the submenu, the original settings in the frequency range are restored so that the measurement can be directly performed with the required parameters.

### Measurement example:

The modulation spectrum of a GSM or PCS1900 signal to be measured using the 'gated sweep' function. The signal is generated by the test sender SME03. Its RF-output is directly connected to the RF input of the FSE.

#### Settings on the SME03:

FREQ:	802 MHz
Level:	0 dBm: Return
Digital Mod:	Select: GMSK: Select
Source:	Select: PRBS: Select: Return
Level Attenuation:	Select: 60 dB: Return

The SME03 provides a GMSK-modulated TDMA-signal (GSM)

Operation steps on the FSE:

[PRESET]  
 [CENTER: {802} MHz]  
 [SPAN {3.6} MHz]  
 [REF LVL: {0} dBm: RF ATTEN MANUAL: {10} dB]  
 [COUPLING: RES BW MANUAL: {30} kHz]  
 [TRACE 1: DETECTOR: RMS]  
 [SWEEP: SWEEPTIME MANUAL: {50} ms;  
 GATE ON  
 GATE SETTINGS: GATE MODE EDGE: GATE POL POS: GATE RF POWER  
  
 GATE ADJUST: SWEEPTIME MANUAL {1} ms: GATE DELAY {300} μs:  
 GATE LENGTH: {250} μs]

**Note:** [KEY] Menu called by the KEY. All indications inside the bracket refer to this menu.  
 {Number} Numeric value to be entered for the corresponding parameter  
 SOFTKEY Softkey used to select a parameter or enter a value.

The following figure shows the screen display for gate parameter setting: The vertical lines for gate delay (GL) and gate length (GL) can be adapted to the burst signal by entering numbers or with the rollkey.

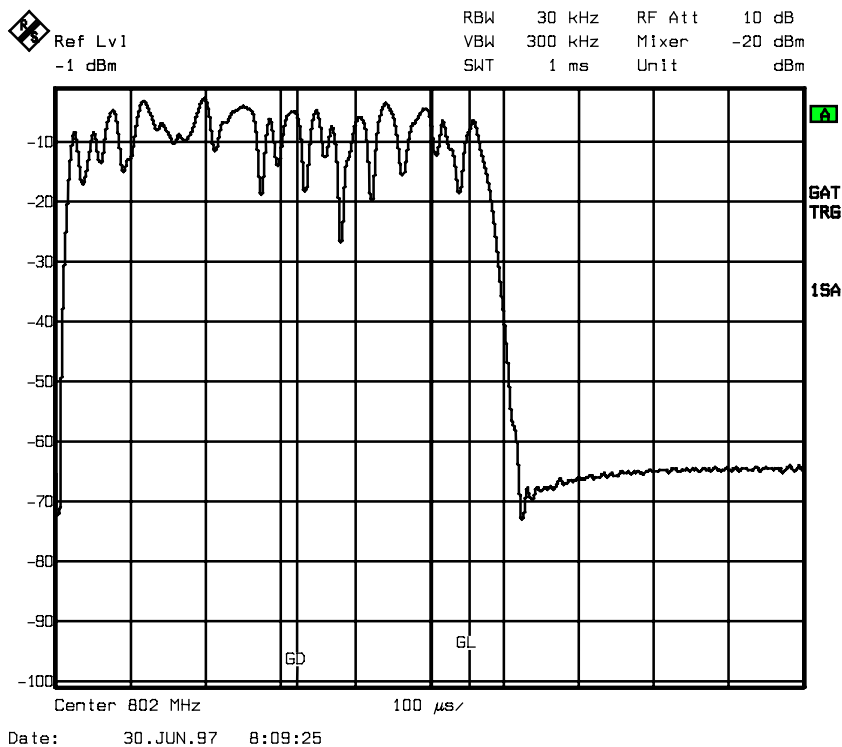

Fig. 4-11 Setting the GATE DELAY and GATE LENGTH times in the time domain using the GD and GL lines

On quitting the menu GATE ADJUST, the FSE returns to spectral representation.

### Sweep Blanking – Gap Sweep

For measurements in the time domain, the *GAP SWEEP* function offers a high degree of flexibility with regard to the display of measurement data. With the *PRE TRIGGER* softkey, it is possible to display measurements taken before the trigger time. With the *GAP TIME* softkey, the measurements within a predefined time range can be blanked. Thus, it is possible to display the rising and falling edge of a signal with high resolution on a single diagram.

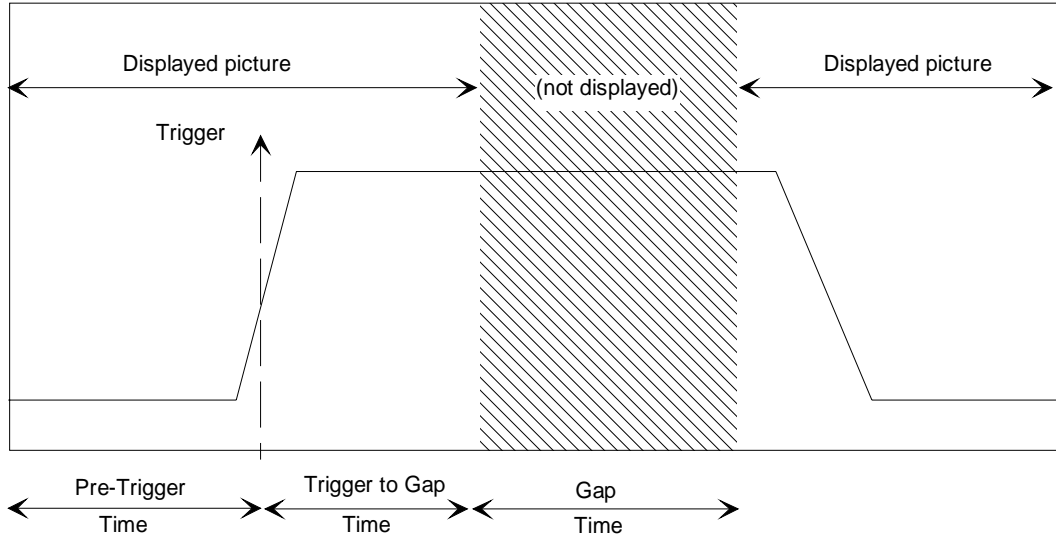

Fig 4-12 Trace blanking in sweep mode.– Gap Sweep

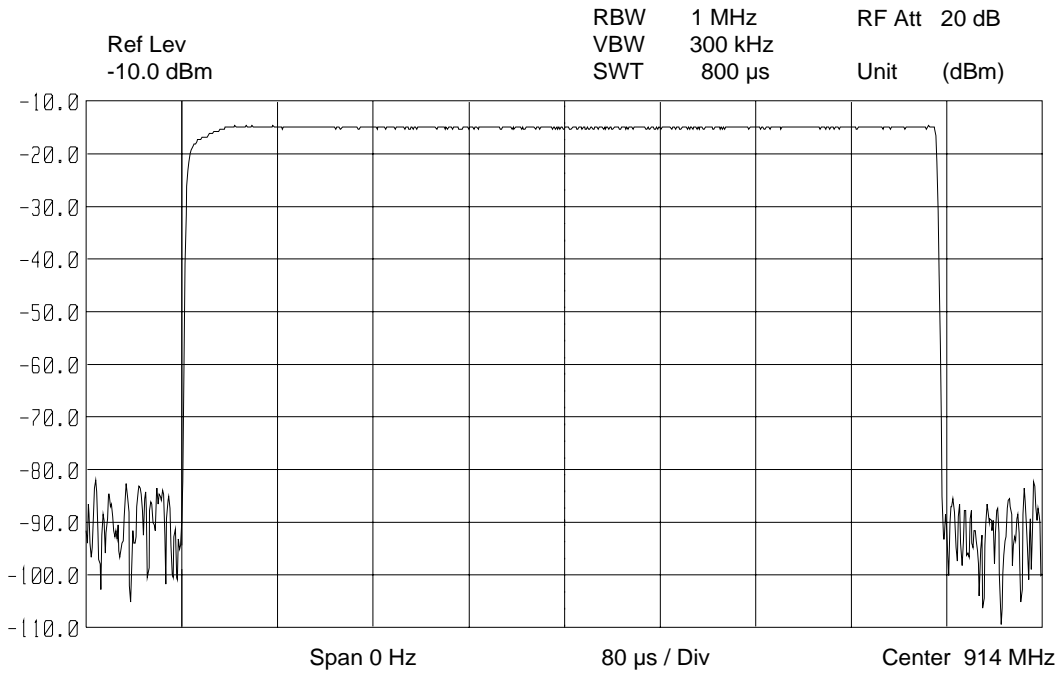

Fig. 4-13 Display of a burst without gaps

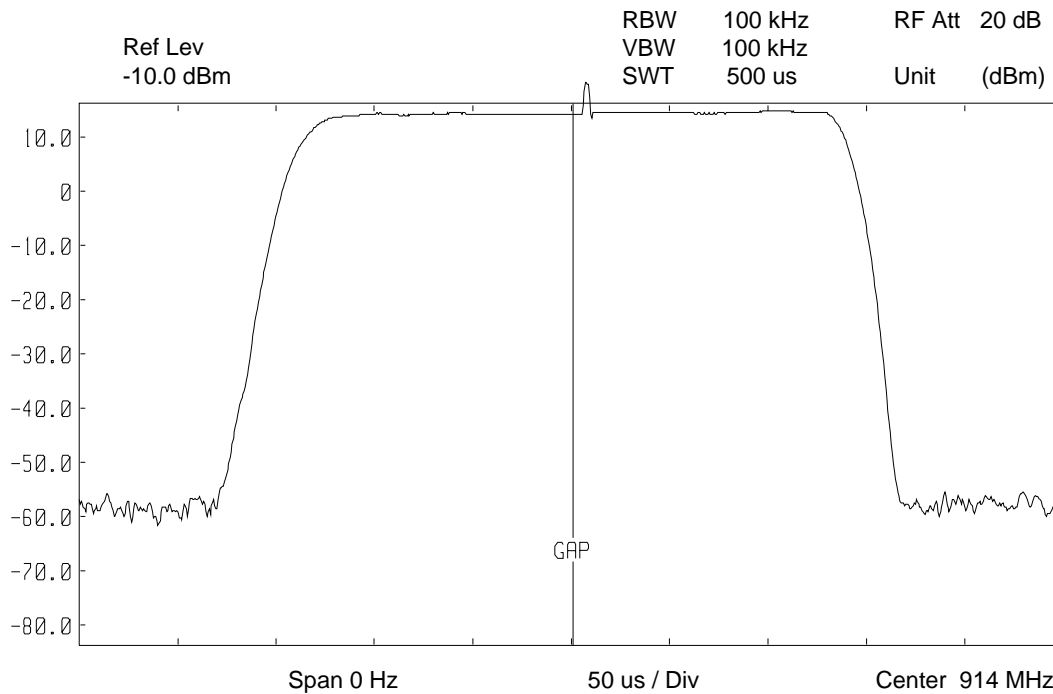

Fig. 4-14 Display of a burst with a gap

The *GAP SWEEP* measurement is activated by the *GAP SWEEP ON/OFF* softkey. The mode settings are made in the *GAP SWEEP SETTINGS* sub-menu.

SWEEP SWEEP menu:



The *GAP SWEEP ON/OFF* softkey switches the *GAP SWEEP* measurement on/off.

The softkey is available only in the time domain.

IEC/IEEE-bus command : [SENSE<1|2>:]SWEEp:GAP ON | OFF

SWEEP SWEEP-GAP SWEEP SETTINGS sub-menu:

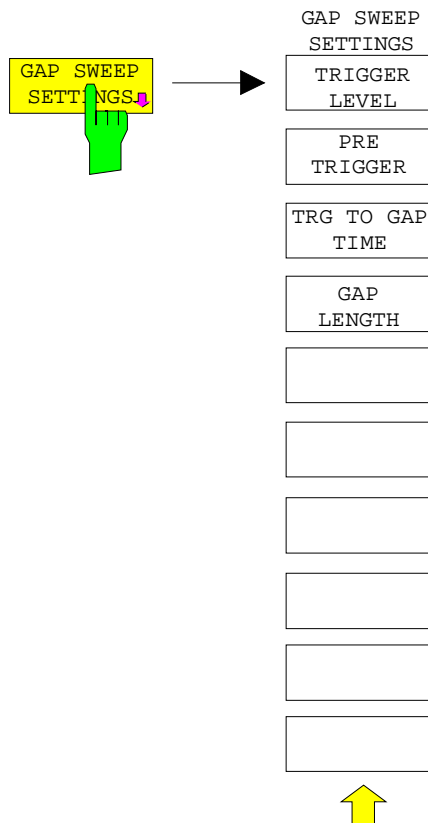

The *GAP SWEEP SETTINGS* softkey opens a sub-menu in which the parameters for the gap can be selected.

The trigger time corresponds to  $t = 0$ . Events occurring before the trigger time are displayed in negative time.



The *TRIGGER LEVEL* softkey activates the entry window for trigger level.

This function corresponds to the setting in the trigger menu.

IEC/IEEE-bus command

```
:TRIGger<1|2>[:SEquence]:LEVel:VIDeo 50PCT
```



The *PRE TRIGGER* softkey activates the entry window for the pre-trigger time. The pre-trigger time defines the separation between the left edge of the grid and the trigger time ( $t = 0$ ).

At the same time the gap sweep is switched on (exception : entry  $t = 0$ )

The minimum pre-trigger time is  $-100$  s, the maximum pre-trigger time depends on the sweep time and the trigger to gap time (max = 100 s). The maximum resolution is 50 ns.

The *PRE TRIGGER* value can be entered in the frequency domain (span  $> 0$ ) as well as in the time domain and *GAP SWEEP OFF* mode. It is, however, only effective when the *GAP SWEEP* measurement is enabled.

IEC/IEEE-bus command

```
:SENSe<1|2>:]SWEep:GAP:PRETrigger 100us
```





The *TRG TO GAP TIME* softkey opens an entry window for defining the distance between the trigger time and the beginning of the gap.

The *TRIGGER TO GAP TIME* range is from 0 to 100 s with a resolution of 50 ns. The length of the gap is defined by *GAP LENGTH*. If the *GAP LENGTH* is 0 s, the entered value of *TRG TO GAP TIME* is only stored.

The *TRG TO GAP TIME* value can be entered in the frequency domain (span > 0) as well as in the time domain and for the *GAP SWEEP OFF* mode. It has an effect on the measurement only after the *GAP SWEEP ON* is switched on.

IEC/IEEE-bus command

```
: [SENSE<1 | 2> : ]SWEep:GAP:TRGTogap 50us
```

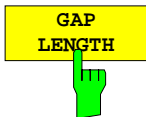

The *GAP LENGTH* softkey activates the entry window for defining the gap within which the measurement values are to be blanked.

The beginning of the gap is defined by *TRG TO GAP TIME*.

*GAP LENGTH* can be set to values between 150 ns and 100 s in 1/2/3/5 steps. The resolution is dependent upon the absolute value of the gap length:

Gap length	Resolution
150 ns - 50 $\mu$ s	50 ns
50 - 500 $\mu$ s	500 ns
0.5 - 5 ms	5 $\mu$ s
5 - 50 ms	50 $\mu$ s
50 - 500 ms	500 $\mu$ s
0.5 - 5 s	5 ms
5 - 50 s	50 ms
50 - 100 s	500 ms

The *GAP LENGTH* value can be entered in the frequency domain (span > 0) as well as in the time domain and for the *GAP SWEEP OFF* mode. It has an effect on the measurement only after the *GAP SWEEP ON* is switched on.

IEC/IEEE-bus command

```
: [SENSE<1 | 2> : ]SWEep:GAP:LENGTh 400us
```

## Tracking Generator Option

In the normal mode, the tracking generator sends a signal exactly at the input frequency of the instrument without a frequency offset.

For frequency-converting measurements it is possible to set a constant frequency offset of  $\pm 200$  MHz between the output signal of the tracking generator and the receive frequency of the instrument. Also, two analog input signals can be used to I/Q or AM and BB-FM modulate the output signal (options FSE-B9, FSE-B11).

The output level is level-controlled and can be set from -20 to 0 dBm in 0.1-dB steps. The level control can also be operated with external detectors. When the tracking generator is equipped with the optional attenuator, the setting range is extended from -90 dBm to 0 dBm.

The tracking generator can be used in all operating modes. The recording of test setup calibration values (SOURCE CAL) and the normalization with this correction values (*NORMALIZE*) is only possible in operating mode *ANALYZER MODE*.

*SYSTEM MODE* menu:

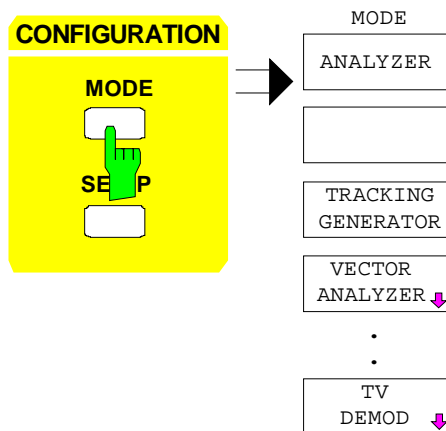

The *MODE* key activates the menu in which the submenu for setting the tracking generator can be selected in addition to different operating modes.

## Tracking Generator Settings

SYSTEM MODE menu:

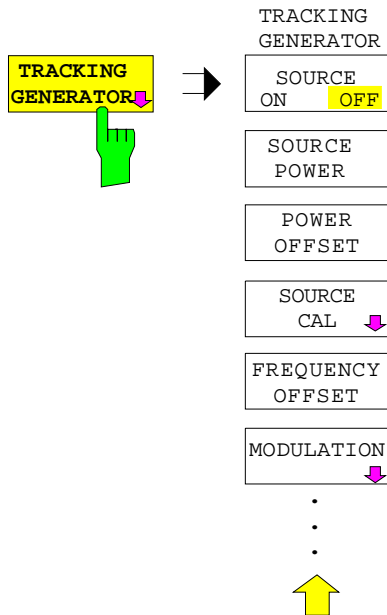

The *TRACKING GENERATOR* softkey opens a menu for setting the functions of the tracking generator.

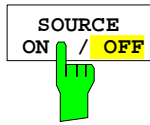

The *SOURCE ON/OFF* softkey switches the tracking generator on or off. Default setting is *OFF*

IEC/IEEE bus command           :OUTPut[:STATe] ON | OFF

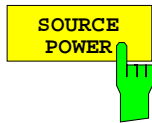

The *SOURCE POWER* softkey activates the entry of the tracking generator output level.

The output level can be set from 0 dBm to -20 dBm in 0.1-dB steps. The setting range is extended to -90 dBm when the tracking generator is equipped with the optional attenuator FSE-B12.

If the tracking generator is off, it is automatically switched on by the *SOURCE PWR* softkey.

Default setting is -20 dBm.

IEC/IEEE bus command

:SOURce:POWer[:LEVel][:IMMediate][:AMPLitude] <num\_value>

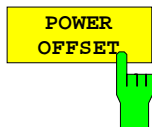

The *POWER OFFSET* softkey activates the entry of a constant level offset of the tracking generator.

With this offset it is possible to consider attenuators or amplifiers at the output connector of the tracking generator during the input or output of output levels, for example.

The permissible setting range is -200 dB to +200 dB in 0.1-dB steps. Positive offsets apply to a subsequent amplifier and negative offsets to an attenuator.

Default setting is 0 dB.

IEC/IEEE bus command

:SOURce:POWer[:LEVel][:IMMediate]:OFFSet <num\_value>

## Transmission Measurement

In this measurement, the transmission characteristic of a two-port network is measured. The built-in tracking generator is the a signal source. The tracking generator is connected to the input of the DUT. The input of the instrument is connected to the output of the DUT.

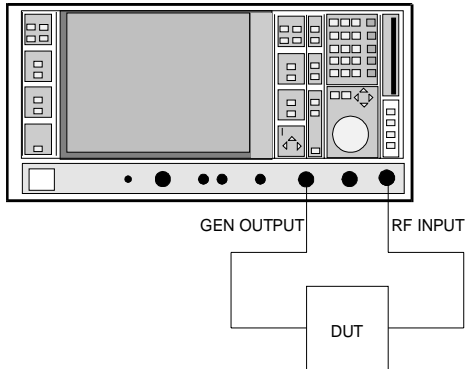
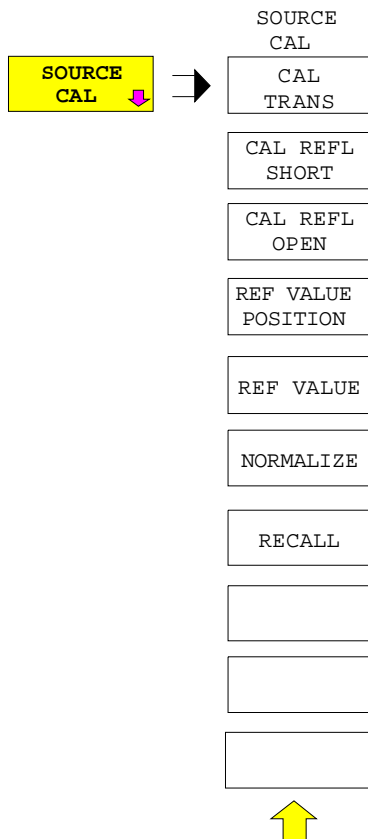

Fig. 4-15 Test setup for reflection measurements

Calibration can be carried out to allow for the effects from the test setup (eg. frequency response of connecting cables).

## Calibration of the Transmission Measurement

SYSTEM MODE-TRACKING GENERATOR menu:



The *SOURCE CAL* softkey opens a submenu with the calibration functions for transmission and reflection measurements.

The calibration for the reflection measurement is described of the following sections .

To carry out a calibration for transmission measurements the whole test setup is through-connected (THRU).

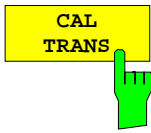

The *CAL TRANS* softkey triggers the calibration for the transmission measurement.

It starts a sweep that records a reference curve. This trace is then used to obtain the differences to the normalized values.

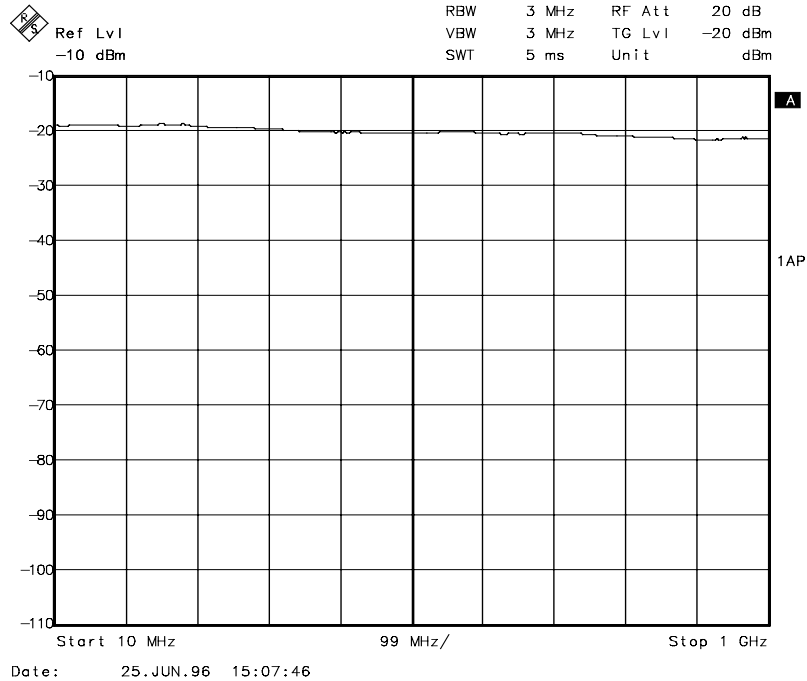
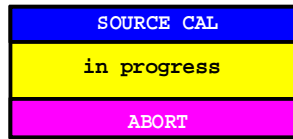
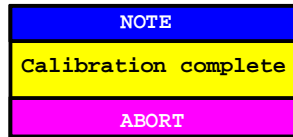

Fig. 4-16 Trace of a transmission calibration procedure

During the calibration sweep the following message is displayed:



After the calibration sweep the following message is displayed:



This message is cleared after approx. 3 seconds.

By saving and recalling the reference data set with the *SAVE* and *RECALL* keys, several calibration datasets can be saved and, then, if necessary, any of these sets can be selected without going through a new calibration routine.

IEC/IEEE bus command

```
:[SENSe:]CORRection:METhod TRANsmission
:[SENSe:]CORRection:COLLect[:ACQuire] THRUgh
```

## Normalization

SYSTEM MODE-TRACKING GENERATOR -SOURCE CAL menu:

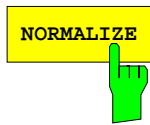

The *NORMALIZE* softkey switches the normalization on or off. The softkey is only enabled if the memory contains a correction trace.

If no reference line is switched on when activating the normalization, all measured values are with reference to the top grid line. The effects of the test setup is corrected in such a way that the measured values are displayed at the top grid margin.

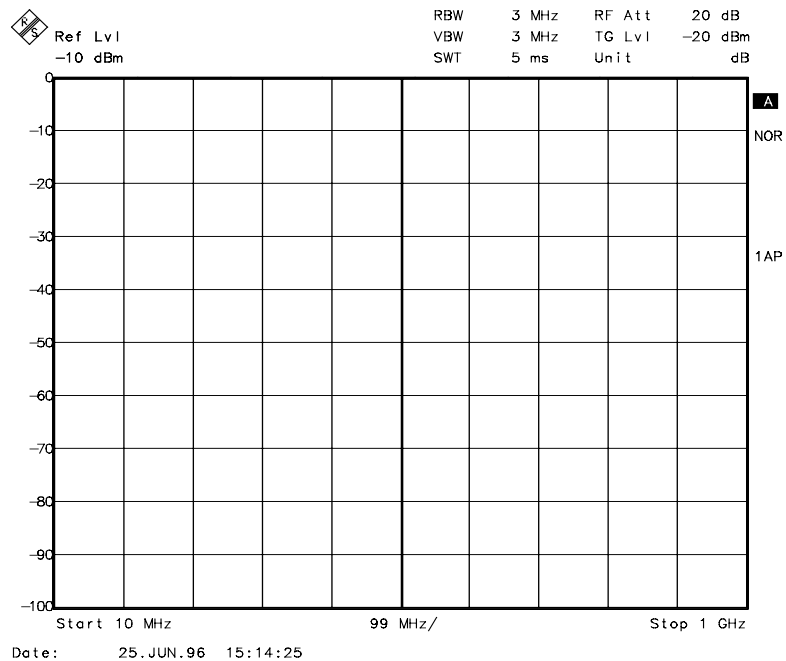

Fig. 4-17 Normalized display

In *SPLIT SCREEN* mode, normalization is switched on in the currently active screen. Different types of normalization can be activated in the two split screens.

Normalization is aborted when the *ANALYZER* operating mode is quit but can be switched on again as long as the reference trace stored in the memory has not been overwritten.

IEC/IEEE bus command :[SENSE:]CORRection[:STATE] ON | OFF

It is now possible to shift the relative reference point within the grid by using the *REF VALUE POSITION* softkey. This means that the trace can be shifted from the upper edge of the grid towards the center of the grid:

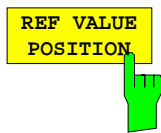

The *REF VALUE POSITION* softkey (reference position) marks a reference position in the active screen at which normalization is performed (difference between trace and reference trace).

If no reference line is switched on, the softkey switches on a reference line and activates the input of its position. The line can be moved within the grid limits.

The reference line is switched off by pressing the softkey again.

The function of the reference line is explained in section "Calibration Method"

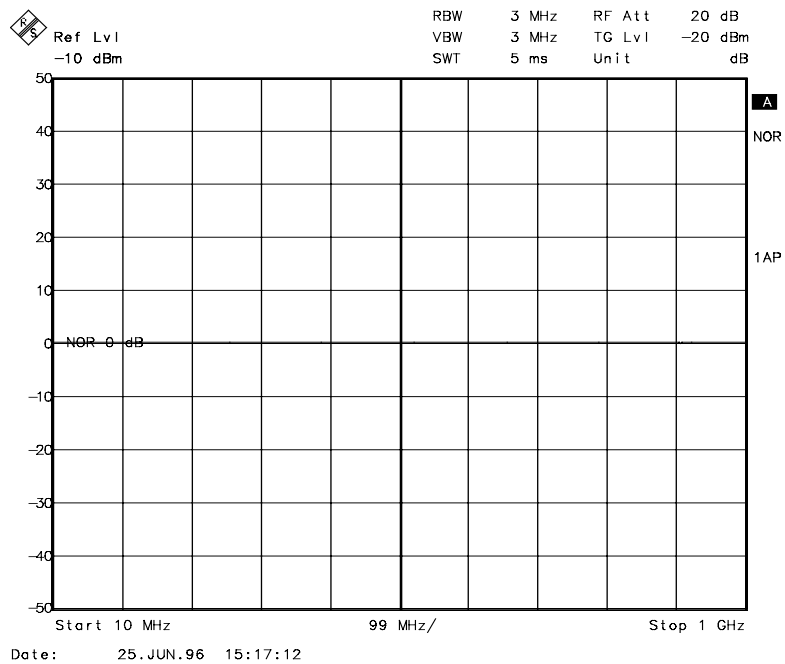
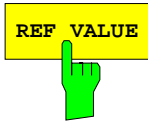

Fig. 4-18 Normalized measurement, shifted with *REF POSITION* 50 %

IEC/IEEE bus command

```
:DISPlay[:WINDow<1|2>]:TRACe<1..4>:Y[:SCALE]:RPosition
0 to 100PCT
```



The *REF VALUE* softkey activates the entry of a level difference which is assigned to the reference line.

With normalization switched on, all measured values are displayed relative to the reference line, or if the latter is switched off relative to the top grid line which corresponds to 0 dB with default setting.

*REF VALUE* always refers to the active screen.

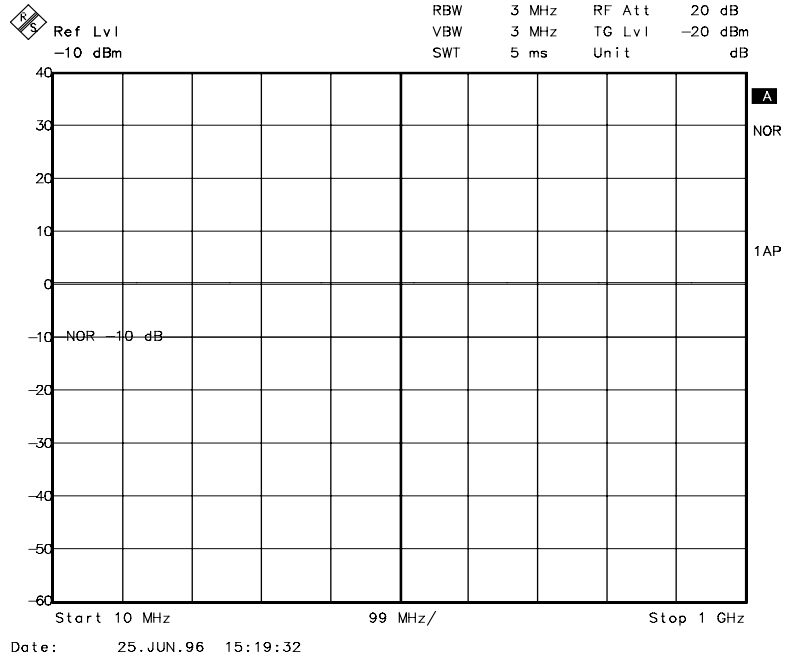

Fig. 4-19 Measurement with REF VALUE 20 dB and REF VALUE POSITION 50%



If, after source calibration, a 10 dB attenuator is inserted into the signal path between DUT and analyzer input, the measurement trace will be moved down by 10 dB. Entering a *REF VALUE* of  $-10$  dB then moves the reference line down 10 dB. This means that the measured trace and the reference trace coincide again.

After the reference line has been moved by entering a *REF VALUE* of  $-10$  dB, deviations from the nominal power level can then be displayed with a high resolution (e.g. 1 dB/div). The power is still displayed in absolute values, which means that in the above example 1 dB below the nominal power (reference line) is equivalent to an attenuation of 11 dB.

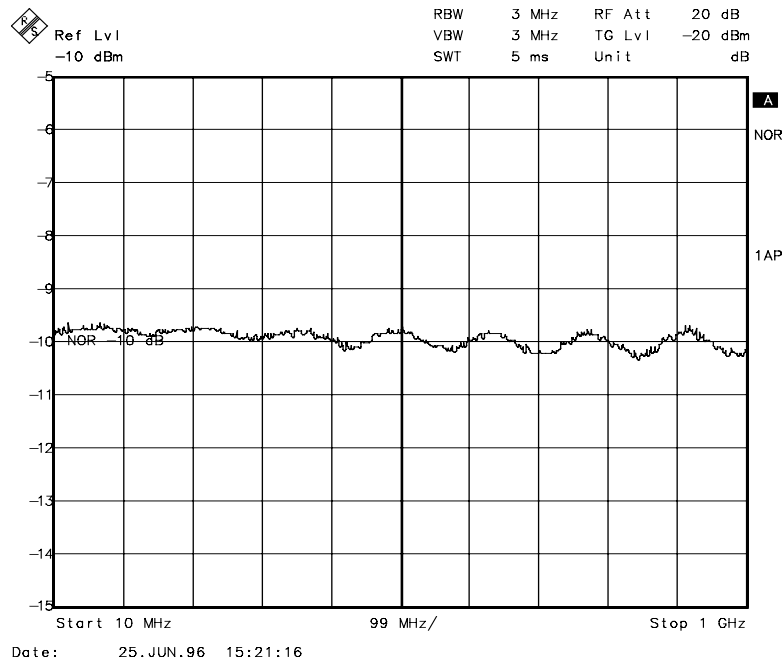
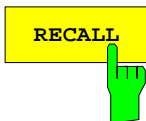

Fig. 4-20 Measurement of a 10dB attenuator pad with 1 dB / Div

IEC/IEEE bus command

```
:DISPlay[:WINDow<1|2>]:TRACe<1...4>:Y[:SCALE]:RVALue
<num_value>
```



The *RECALL* softkey restores the instrument setting that were used during calibration.

This can be useful if the device setting was changed after calibration (eg center frequency setting, frequency deviation, reference level, etc.).

The softkey is only offered if:

- the analyzer mode has been selected
- the memory contains a calibration data set.

IEC/IEEE bus command :[SENSe:]CORREction:RECall

## Reflection Measurements

Scalar reflection measurements can be carried out with a reflection-coefficient bridge.

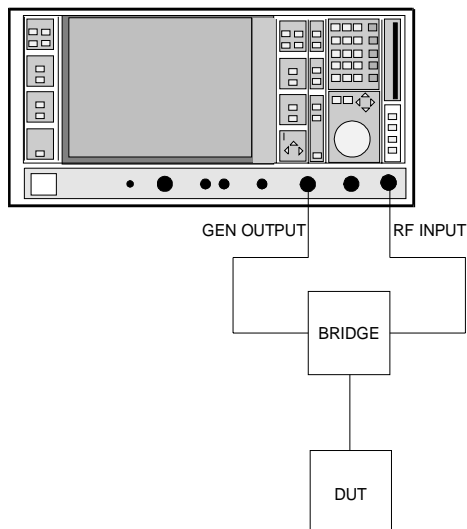

Fig. 4-21 Test setup for reflection measurements

### Calibration of Reflection Measurement

This calibration procedure essentially corresponds to that of the transmission measurement.

*SYSTEM MODE-TRACKING-SOURCE CAL* submenu



The *CAL REFL OPEN* softkey starts the open-circuit calibration.

During calibration the following message is displayed

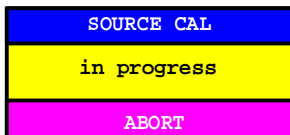

IEC/IEEE bus command

```
:[SENSe:]CORRection:METhod REFLeXion
:[SENSe:]CORRection:COLLect[:ACQuire] OPEN
```



The *CAL REFL SHORT* softkey starts the short-circuit calibration.

If both calibrations (open circuit, short circuit) are carried out, the calibration curve is formed by averaging the two measurements and is stored in the memory. The order of measurements is optional.

The completion of the calibration is indicated by

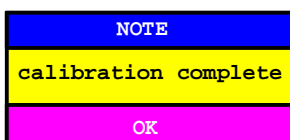

The display is cleared after 3 seconds.

IEC/IEEE bus command

```
:[SENSe:]CORRection:METhod REFLeXion
:[SENSe:]CORRection:COLLect[:ACQuire] ThRough
```

## Calibration Methods

Calibration means forming the difference between current measured values and a reference curve, no matter what the selected measurement type is (transmission/reflection). The hardware settings used for measuring the reference curve are included in the reference dataset.

When normalization is switched on, a wide range of device settings can be changed without aborting normalization. In other words, the number of repeat normalizations is kept to a minimum.

The reference dataset (trace with 500 measured values) is stored internally as a table of 500 points (frequency/level).

Differences in level settings between the reference curve and the current device setting are calculated automatically. For small spans, a linear interpolation is used. If the span is increased, the values at the left or right border of the reference dataset are extrapolated out to the new start or stop frequency; in other words, additional linearly extrapolated values are added to the reference dataset.

An enhancement label is used to mark the different levels of measurement accuracy. This enhancement label is displayed at the right display margin when normalization is switched on and in case of an error from the reference setting. Three accuracy levels are defined:

Table 4-1 Measurement accuracy levels

Accuracy	Enhancement label	Reason/Limitation
High	NOR	No difference between reference setting and measurement
Medium	APP (approximation)	Changes in the following settings: <ul style="list-style-type: none"> <li>• coupling (RBW, VBW, SWT)</li> <li>• reference level, RF attenuation</li> <li>• start or stop frequency</li> <li>• output level of tracking generator</li> <li>• frequency offset of tracking generator</li> <li>• detector (max peak, min peak, sample...)</li> </ul> Change of frequency: <ul style="list-style-type: none"> <li>• at most 500 frozen continuation points within the set sweep limits (corresponds to a doubling of the span)</li> </ul>
-	Abortion of calibration	<ul style="list-style-type: none"> <li>• more than 500 frozen points within the set sweep limits (span doubling)</li> </ul>

**Note:** At a reference level (REF LEVEL) of -10 dBm and at a tracking generator output level of the same value the instrument operates without a headroom. ie the instrument is in danger of being overloaded by any signal whose amplitude exceeds the reference line. In this case, either the message "OVL" for overload is displayed in the status line or the display range is exceeded (clipping the top of the trace = Overrange).

This overload can be avoided as follows:

- Reducing the output level of the tracking generator (SOURCE POWER, SYSTEM-MODE-TRACKING GENERATOR menu)
- Increasing the reference level (REF LEVEL, LEVEL-REF menu)

## Frequency-Converting Measurements

For frequency-converting measurements (eg on converters) the tracking generator is able to set a constant frequency offset between the output frequency of the tracking generator and the receive frequency of the instrument. Up to an output frequency of 200 MHz the measurement can be carried out in inverted and normal position.

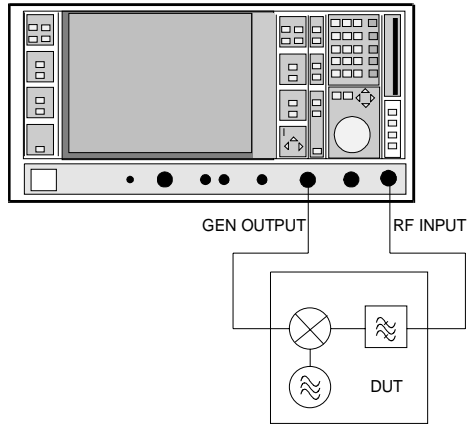
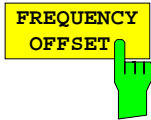

Fig. 4-22 Test setup for frequency-converting measurements

SYSTEM MODE-TRACKING GENERATOR menu:



The *FREQUENCY OFFSET* softkey activates the entry of the frequency offset between the output frequency of the tracking generator and the input frequency of the instrument. The setting range is  $\pm 200$  MHz in 1-Hz steps. The default setting is 0 Hz.

If a positive frequency offset is entered, the tracking generator generates an output signal frequency above the receive frequency of the instrument. With a negative frequency offset it generates a signal frequency below the receive frequency of the instrument. The output frequency of the tracking generator is calculated as follows:

Tracking generator frequency = receive frequency + frequency offset.

A frequency offset cannot be entered if an external I/Q or FM modulation is switched on. In this case, the *FREQUENCY OFFSET* softkey is blocked.

IEC/IEEE bus command

```
:SOURce:FREQuency:OFFSet <numeric value>
```

## External Modulation of Tracking Generator

SYSTEM MODE-TRACKING GENERATOR menu:

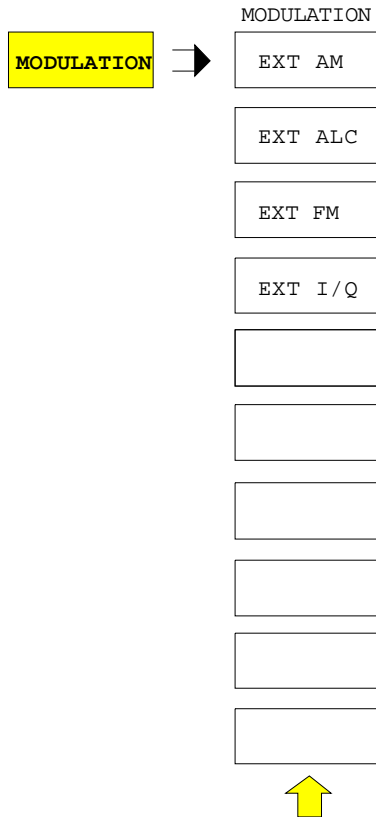

The *MODULATION* softkey opens a submenu for selecting the different modulation types.

The time characteristic of the output signal of the tracking generator can be varied by applying external signals (input voltage range -1 V to +1 V).

The functions for amplitude and frequency modulation and for external level control are always available.

The function IQ modulation is only available in models of tracking generators that are equipped with the IQ modulator (FSE-B9 and FSE-B11).

Two BNC connectors at the rear panel are available as signal inputs. Their function changes depending on selected modulation type:

*TG-INPUT I / AM / ALC* and  
*TG-INPUT Q / FM*

The types of modulation can partly be combined with each other and with the frequency offset function. The following table shows which modulation types can be selected simultaneously and which can be combined with the frequency offset function.

Table 4-2 Simultaneous modulation types (tracking generator)

Modulation	Frequency offset	EXT AM	EXT ALC	EXT FM	EXT I/Q
Frequency offset		•	•	•	
EXT AM	•			•	
EXT ALC	•				
EXT FM	•	•			
EXT I/Q					

- modulations can be combined

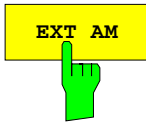

The *EXT AM* softkey activates AM modulation of the tracking generator output signal.

The modulation signal is connected to the *TG-INPUT AM* connector. The maximum possible modulation depth is 80% which corresponds to an input voltage of 0.8 V.

Switching on external AM deactivates the following functions:

- active external level control
- active I/Q modulation.

IEC/IEEE bus command           : `SOURce:AM:STATe ON | OFF`

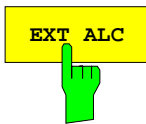

The *EXT ALC* softkey activates the external level control.

In case of external level control the output level of the tracking generator is determined from the signal of an external detector. The external detector has to supply a negative voltage in the range of -0.1 to -1 V which is applied to the *TG-INPUT ALC* connector. The setting of the output level is the same as that of the internal level control but the output level depends on the external detector.

Switching on an external level control deactivates the following functions:

- active external AM
- active I/Q modulation.

IEC/IEEE bus command       : `SOURce:POWer:ALC:SOURce INT | EXT`

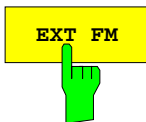

The *EXT FM* softkey activates FM modulation of the tracking generator output signal.

The modulation frequency range is 1 kHz to 100 kHz, the deviation is approx. 1 MHz at an input voltage of 1 V.

The modulation signal is connected to the *TG-INPUT FM* connector.

Switching on external FM deactivates the following function:

- active I/Q modulation.

IEC/IEEE bus command           : `SOURce:FM:STATe ON | OFF`

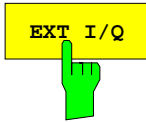

The *EXT I/Q* softkey is only offered with I/Q modulator option built-in. It activates external I/Q modulation of the tracking generator (FSE-B9 and FSE B-11).

The modulation signals are connected to the two input connectors *TG-INPUT IN* and *TG-INPUT Q* at the rear of the unit. The input voltage range is  $\pm 1$  V into  $50 \Omega$ .

Switching on external I/Q modulation deactivates the following functions:

- active external AM
- active external level control
- active external FM or
- a level offset.

Functional description of quadrature modulator:

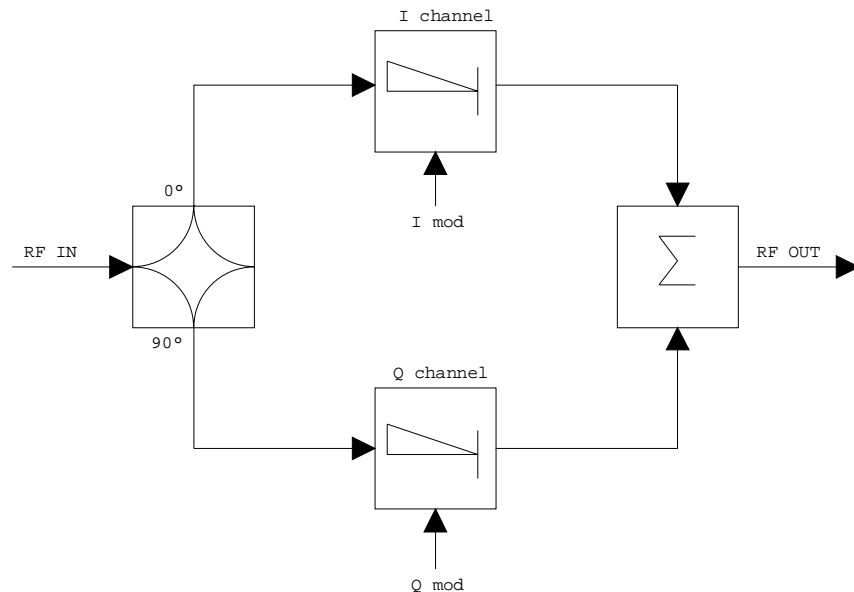

Fig. 4-23 I/Q modulation

I/Q modulation is performed by means of the built-in quadrature modulator. The RF signal is divided into the two orthogonal components, I and Q (inphase and quadrature phase). Amplitude and phase are controlled in each path by the I and Q modulation signal. Adding the two components generates an RF output signal whose amplitude and phase can be controlled.

IEC/IEEE bus command :SOURCE:DM:STATE ON | OFF

## Option FSE-B3 –TV Demodulator

With the Option TV Demodulator FSE-B3, the FSE permits to demodulate TV signals and synchronize the trigger signal with the TV signal.

The demodulated TV signal is available at the rear panel of the FSE as CCVS signal for operation of a TV monitor. The possible settings of video polarity and offset between picture and sound carrier permit to cover all known standards.

In order to represent particular sections of the TV signal in the time domain, the FSE derives different trigger signals from the video signal. It is possible to trigger on the frame repetition and on each individual line of the TV signal.

### Configuration of the TV Demodulator

The TV standard is preset using the MODE menu of the FSE. If the Option TV Demodulator is installed, the MODE menu is supplemented by the softkey *TV DEMOD*. When the demodulation of TV signals is switched on using *TV DEMOD*, the FSE automatically changes to the time domain (zero-span mode). The default settings following preset of the FSE are sweep time 100  $\mu$ s, linear level display (*LIN %*) and 5 MHz IF bandwidth. Measurement of the spectrum is still possible.

Menu: *CONFIGURATION MODE*

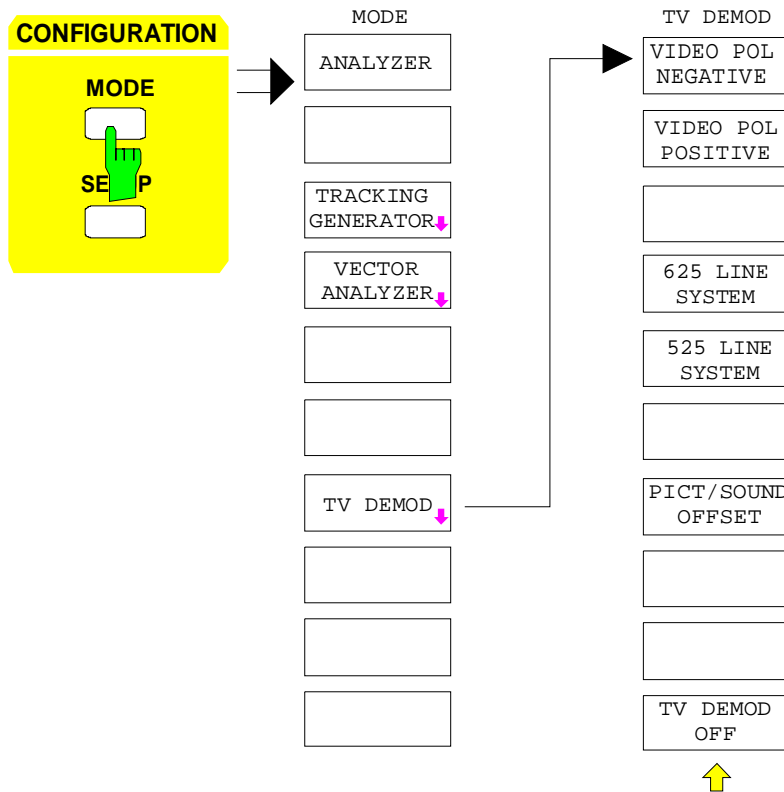

The softkey *TV DEMOD* switches on the TV demodulator and simultaneously opens a submenu in which the parameters of the video signal can be set. If the TV demodulator is switched on, the softkey is backlit. The other available modes are switched off.



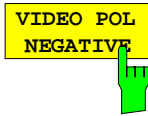

The soft keys *VIDEO POL NEGATIVE* and *VIDEO POL POSITIVE* determine the polarity of the video signal. The two softkeys are selector switches.

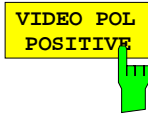

Positive video polarity is to be selected e.g. for standard L signals, negative video polarity for signals according to the standards B/G/I/M (color standard PAL or NTSC). Default setting is *VIDEO POL NEGATIVE*.

IEC/IEEE bus command

```
:TRIGger<1|2>[:SEquence]:VIDeo:SSIGnal:POLarity POS|NEG
```

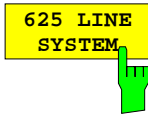

The soft keys *625 LINE SYSTEM* and *525 LINE SYSTEM* permit to select the line system to be used. The two softkeys are selector switches.

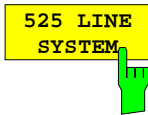

Default setting is *625 LINE SYSTEM*.

IEC/IEEE bus command

```
:TRIGger<1|2>[:SEquence]:VIDeo:FORMat:LPFRame 625|525
```



The soft key *PICT/SOUND OFFSET* is used to set the offset between the demodulated picture carrier and the test channel of the FSE.

The setting range is 0 to 6.5 MHz. The frequency resolution for the offset is 25 kHz.

No offset is set in the default setting.

With the offset 0 MHz, the FSE measures at the frequency of the picture carrier. This setting permits to measure the time characteristic of the video signal.

If an appropriate offset between picture and sound carrier is set, the picture can be seen on a connected TV monitor and the sound simultaneously monitored via the AF demodulator. To this end, the FSE needs to be tuned to the frequency of the sound carrier.

The picture/sound carrier offsets for the most commonly used TV standards are as follows:

Standard B/G and L	5.5 MHz
Standard M and N	4.5 MHz
Standard I	6 MHz

IEC/IEEE bus command `<:SENSe1|2>:TV:POFFset 0 ... 6.5 MHz`

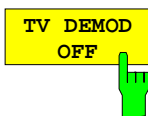

The soft key *TV DEMOD OFF* switches off the TV demodulator.

IEC/IEEE bus command

```
<:SENSe1|2>:TV[:STATe] ON | OFF
```

## Triggering on TV Signals

If the Option TV Demodulator is installed, the trigger menu is supplemented by the TV trigger (softkey *TV*) and the settings for the trigger condition (*TV TRIGGER SETTING*).

Menu: SWEEP TRIGGER

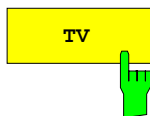
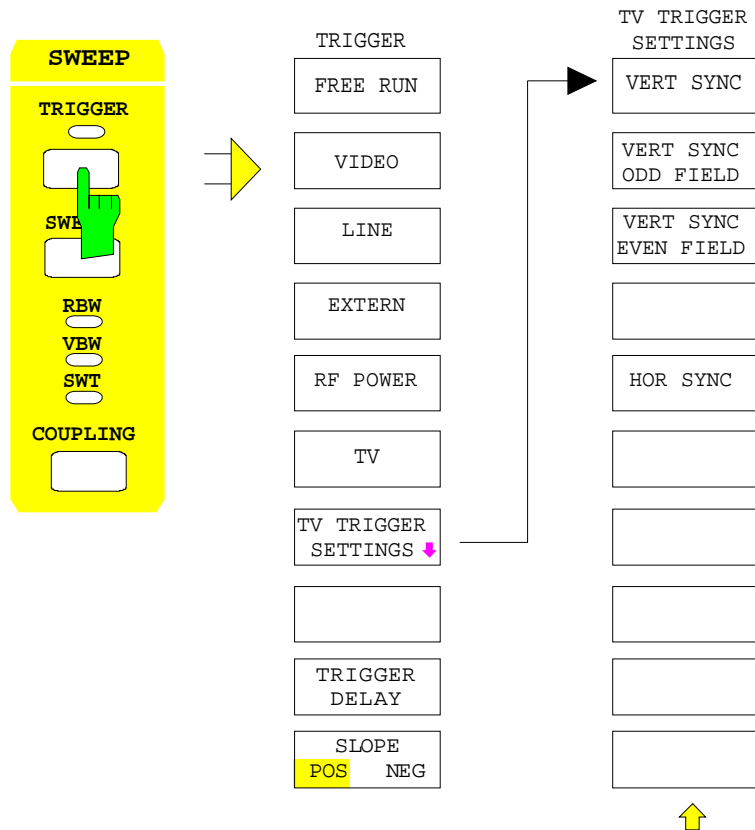

The softkey *TV* sets the trigger of the FSE to a TV signal according to the trigger condition selected under *TV TRIGGER SETTINGS*. The TV trigger can be set as an alternative to the remaining trigger sources.

IEC/IEEE bus command

```
:TRIGger<1|2>[:SEquence]:SOURce TV
```



The softkey *TV TRIGGER SETTINGS* opens a submenu for the TV trigger settings.

The trigger source can be selected:

It is possible to trigger on the frame repetition (*VERT SYNC*), on a field (*VERT SYNC EVEN FIELD* or *VERT SYNC ODD FIELD*) or on any line of the TV picture (*HOR SYNC SIGNAL*).

IEC/IEEE bus command

```
:TRIGger<1|2>[:SEquence]:VIDeo:FIEld:SElect ALL
```

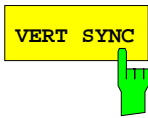

The softkey *VERT SYNC* sets the trigger to the vertical sync signal. It is possible to trigger on the frame repetition without a differentiation being made between the two fields.

IEC/IEEE bus command

```
:TRIGger<1|2>[:SEQuence]:VIDeo:FIELD:SElect ALL
```



The softkeys *VERT SYNC ODD FIELD* or *VERT SYNC EVEN FIELD* set the trigger to the vertical sync signal of the first or second field.

IEC/IEEE bus command

```
:TRIGger<1|2>[:SEQuence]:VIDeo:FIELD:SElect ODD | EVEN
```

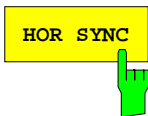

The softkey *HOR SYNC* sets the trigger to the horizontal sync signal. It activates line input.

The trigger can be set to any line. Depending on the setting of the line systems, lines 1 to 525 or 625 are possible. If a higher line number is entered, the trigger is set to the highest possible number.

In order to trigger on test line 17 according to CCIR 473-4, for example, the line value is to be set to 17. This is also the default setting after switching on of the TV demodulator.

IEC/IEEE bus command

```
:TRIGger<1|2>[:SEQuence]:VIDeo:LINE:NUMBer <num_value>
```



# 10 Index

## Note:

- The softkeys are listed alphabetically under the keyword "Softkey".
- For each softkey, the page in chapter 6 containing the description of the corresponding remote command is quoted in addition.
- The assignment between IEEE-bus commands and softkeys is described in Chapter 6, Section "Table of Softkeys with IEC/IEEE-Bus Command Assignment".
- Chapter 6 contains an alphabetical list of all IEEE-bus commands

## A

Abort	
hardcopy .....	4.51, 4.52
macro .....	4.49
ACP measurement .....	4.114
absolute/relative .....	4.119
bandwidth .....	4.116
channel spacing .....	4.117
channels .....	4.114
filter .....	4.116
limits .....	4.117
standard .....	4.115
Addressed command .....	8.5
Adjacent channel power measurement .....	4.114
Administrator identification .....	1.23
Alphanumeric parameter	
editing .....	3.17
AM modulation .....	4.204
Analog trace .....	4.165
Ascii # .....	5.14
Attenuation .....	4.100
Attenuator (tracking generator) .....	4.193
AUI connector .....	1.45, 1.74
Autopeak detector .....	4.163
Average .....	4.158
continuous sweep .....	4.159
signal per sweep .....	4.139
single sweep .....	4.159
summary markers .....	4.140
sweep count .....	4.158
Average detector .....	4.164
Axis labelling .....	3.7

## B

Bandwidth	
channel .....	4.116
occupied .....	4.124
resolution .....	4.171
video .....	4.172
Beeper .....	4.40
Block data .....	5.14
BNC connector .....	1.44, 1.73
Boolean parameter .....	5.13

## C

Calibration .....	4.9
method .....	4.201

CCVS signal .....	4.206
CD-ROM installation .....	1.36
Center frequency .....	4.87
Channel	
bandwidth .....	4.116
power measurement .....	4.118
power, absolute/relative .....	4.119
spacing .....	4.117
Characters, special .....	6.2
Clear/Write .....	4.157
Clock .....	4.39
Colon .....	5.14
COM1/2 interface .....	4.36, 4.42
Comma .....	5.14
Command	
# .....	5.14
addressed .....	8.5
colon .....	5.14
comma .....	5.14
header .....	5.10
line .....	5.12
long form .....	5.11
overlapping execution .....	5.17
query .....	5.12
question mark .....	5.12, 5.14
quotation mark .....	5.14
recognition .....	5.16
sequence .....	5.17
short form .....	5.11
structure .....	5.9
suffix .....	5.11
synchronization .....	5.17
syntax elements .....	5.14
universal .....	8.5
white space .....	5.14
Common commands .....	6.4
CONDition register part .....	5.19
Configuration .....	4.20
recall .....	4.75
reset .....	4.2
save .....	4.66
Copy	
file .....	4.69
limit line .....	4.150
trace .....	4.160
Coupling .....	4.170
default settings .....	4.173
define .....	4.176
Cursor keys .....	3.14

## D

D Lines	4.144
Data set	
creation	4.75
partial	4.73
recall	4.75
save	4.70
Date	4.45
dB*/MHz	4.97
dB $\mu$ A/MHz	4.97
dB $\mu$ A/mMHz	4.97
dB $\mu$ V/MHz	4.97
dB $\mu$ V/mMHz	4.97
dBmV/MHz	4.97
DCL	5.16
Default	
commands	6.1
instrument settings	4.2
Delete	
file	4.69
line of transducer table	4.26
macro	4.83
message	4.16
transducer factor/set	4.23
Delta marker	4.128
step size	4.132
Demodulation	4.109
Detector	
auto select	4.163
autopeak	4.163
average	4.164
max peak	4.163
min peak	4.163
RMS	4.164
sample	4.164
Device	
reset (hardcopy)	4.64
reset (overall)	4.2
status	4.13
DIFOVL	3.4
Directory	
create	4.69
rename	4.69
Disable	
front panel	3.19
keyboard	3.19
Disk formatting	4.69
Display	
configuration	4.3
energy-saving	1.21
mean value	4.139
rms value	4.139
Display mode	
full screen	3.9, 4.4
split screen	3.8, 4.4
Double dagger	5.14
Driver	
installation	1.75
NDIS	1.76
ODI	1.75
packet	1.78
printer	1.28
software	1.39

## E

Electrostatic discharge	1.18
ENABle register part	5.19
Energy saving mode	1.21

Enhancement labels	3.6
Entry	
abortion	3.16
alphanumeric parameters	3.17
mouse control	3.22
numeric parameter	3.16
table	3.18
termination	3.16
window	3.15
Error messages	9.1
Error-queue query	5.33
ESE (event status enable register)	5.22
ESR (event status register)	5.22
Ethernet Adapter	1.44, 1.73
EVENT register part	5.19
Event status enable register (ESE)	5.22
Event status register (ESR)	5.22
EXT ALC modulation	4.204
Ext Trig/Gate input	8.24
External noise source	4.32
ExtRef	3.4

## F

FFT filter	4.174
File	
copy	4.69
delete	4.69
rename	4.69
sort	4.69
Firmware	
options (enabling)	4.31
options (info)	4.14
update	1.38, 1.70, 4.47
version	4.13
FM modulation	4.204
Frequency	
axis labelling	3.7
counter	4.111
line	4.143
measurement window	4.84
offset	4.88
start	4.84
stop	4.86
zoom	4.93
Front panel	
disable	3.19
keyboard emulation	3.21, 3.23
FTP operation	1.55, 1.85
Full screen	3.9, 4.4
Function test	1.22
Fuse	1.19, 1.57

## G

GET (Group Execute Trigger)	5.16
GPIB	
address	4.34
interface	8.2

## H

Handshake	8.8
Hardcopy	
abort	4.51, 4.52
comments	4.57
format	4.59, 4.63
items	4.55

- output device..... 4.60
- position..... 4.56
- printer..... 4.58
- settings..... 4.54
- start..... 4.50, 4.52
- Hardware
  - configuration..... 4.14
  - indication of settings..... 3.5
  - installed options..... 4.14
- Header..... 5.10
- Help line editor..... 3.17
  
- I
- I/Q modulation..... 4.205
- IEC/IEEE-bus
  - address..... 4.34, 4.40
  - interface..... 8.2
  - output device address..... 4.63
- I/OVLD..... 3.4
- Indication
  - hardware settings..... 3.5
  - instrument settings..... 3.6
  - marker information..... 3.5
  - screen..... 3.4
- Input
  - attenuator..... 4.100
  - Ext Trig/Gate..... 8.24
  - external reference..... 8.24
- Input buffer..... 5.15
- Installation
  - CD-ROM..... 1.36
  - firmware update..... 1.38, 4.47
  - keyboard..... 1.25
  - monitor..... 1.26
  - mouse..... 1.24
  - network printer..... 1.34
  - printer..... 1.28
  - rack..... 1.19
  - Windows NT software..... 1.39
- Instrument functions..... 4.1
- Instrument settings
  - indication..... 3.6
  - power up..... 4.76
  - preset..... 4.2, 4.76
- Interface
  - IEC/IEEE-bus..... 8.2
  - printer..... 8.22
  - RS-232-C..... 8.6
  - RSIB..... 8.10
- Interrupt..... 5.32
- IST flag..... 5.22
  
- K
- KERMIT..... 1.86
- Key
  - CAL..... 4.9
  - CENTER..... 4.87, 6.193
  - CONFIG..... 4.68
  - COUPLING..... 4.170
  - cursor..... 3.14
  - D LINES..... 4.143
  - DELTA..... 4.128
  - DISPLAY..... 4.3
  - HOLD..... 3.19
  - INFO..... 4.13
  - INPUT..... 4.100
  - LIMITS..... 4.147
  - LOCAL..... 4.49
  - MENU..... 3.12
  - MKR..... 4.141
  - MODE..... 4.18
  - NORMAL..... 4.105
  - numeric keypad..... 3.13
  - PRESET..... 4.2, 6.231
  - RANGE..... 4.98
  - RECALL..... 4.75
  - REF..... 4.94
  - roll-key..... 3.14
  - SAVE..... 4.70
  - SEARCH..... 4.133
  - SETTINGS..... 4.54
  - SETUP..... 4.20
  - SPAN..... 4.91
  - START (frequency)..... 4.84
  - START (hardcopy)..... 4.50, 4.52, 6.122
  - STEP..... 3.20
  - STOP..... 4.86
  - SWEEP..... 4.180
  - TRACE1 to 4..... 4.156
  - TRIGGER..... 4.178
  - USER..... 4.80
- Keyboard
  - configuration..... 4.47
  - connection..... 1.25, 1.62
  - connector..... 8.25
  - disable..... 3.19
  - external..... 3.21
  
- L
- Level
  - attenuation..... 4.100
  - control, external..... 4.204
  - line..... 4.145
  - maximum..... 4.95
  - mixer..... 4.101
  - offset (tracking generator)..... 4.193
  - range..... 4.98
  - reference..... 4.94
  - unit..... 4.96
- LF demodulation..... 4.109
- Limit line..... 4.147
  - copy..... 4.150
  - delete..... 4.150
  - edit..... 4.151
  - save..... 4.155
  - select..... 4.148
  - shift..... 4.155
  - value..... 4.154
- Line
  - display 1,2..... 4.145
  - frequency 1, 2..... 4.145
  - limit..... 4.148
  - reference..... 4.145
  - threshold..... 4.145
  - time 1, 2..... 4.146
- LO Lvd..... 3.4
- LO Lvl..... 3.4
- LO unl..... 3.4
- Login/logout (NT controller)..... 1.23
- Lower case..... 6.2
- LPT interface..... 8.22

- M**
- Macro
    - abort..... 4.49
    - definition..... 4.82
    - start..... 4.80
  - Maintenance..... 8.1
  - Manual operation..... 3.1
    - return to..... 4.49, 5.3
  - Marker..... 4.105
    - center..... 4.141
    - delta..... 4.128
    - demodulation..... 4.110
    - indication..... 3.5
    - info..... 4.109
    - n-dB-down..... 4.137
    - normal..... 4.105
    - peak..... 4.134, 4.141
    - search..... 4.133
    - search limit..... 4.137
    - signal track..... 4.108
    - step size..... 4.127
    - zoom..... 4.109
  - Max hold..... 4.159
  - Max peak detector..... 4.163
  - Mean power (GSM burst)..... 4.139
  - Measurement
    - frequency-converting..... 4.202
    - recall..... 4.75
    - save..... 4.66
    - transmission..... 4.194
    - window..... 4.3
  - Measurement converters..... 4.20
    - connector..... 8.22, 8.23
  - Memory
    - battery-backed-up..... 1.21
    - battery-powered..... 1.58
    - configuration..... 4.68
  - Menu overview..... 3.24
  - Menu switching..... 3.11
  - MICROSOFT NET operation..... 1.49, 1.83
  - Min hold..... 4.160
  - Min peak detector..... 4.163
  - Minimum search..... 4.134
  - Mixer level..... 4.101
  - Mode..... 4.18
    - signal analysis..... 4.84
    - tracking generator..... 4.192
  - Modification level of modules..... 4.14
  - Modulation
    - AM..... 4.204
    - EXT ALC..... 4.204
    - FM..... 4.204
    - I/Q..... 4.205
  - Modulation filter..... 4.116
  - Monitor
    - connecting..... 4.39
    - connection..... 1.26
    - connector..... 8.25
  - Mouse
    - configuration..... 4.46
    - connection..... 1.24, 1.58
    - connector..... 8.25
    - control..... 3.22
- N**
- NDIS (driver)..... 1.76
  - Network drivers..... 1.75
  - Network operating system
    - FTP..... 1.55, 1.85
    - MICROSOFT NET..... 1.49, 1.80
    - NOVELL NETWARE..... 1.49, 1.78, 1.81
    - TCP/IP..... 1.54, 1.85
    - Network printer connection..... 1.34
    - Noise power density measurement..... 4.112
    - Noise source, external..... 4.32
    - NOVELL NETWARE operation..... 1.49, 1.81
    - NT controller..... 1.23
    - NTRansition register part..... 5.19
    - Numeric keypad..... 3.13
    - Numeric parameter
      - editing..... 3.16
    - Numerical values (command)..... 5.13
- O**
- OCXO..... 3.4
  - ODI drivers..... 1.75
  - Offset frequency..... 4.88
  - Operating mode
    - signal analysis..... 4.84
    - tracking generator..... 4.192
  - Option
    - FSE-B3 - TV Demodulator..... 4.206
    - FSE-B5 - FFT Filter..... 1.42, 1.43
    - FSE-B8/B9/B10/B11 - Tracking Generator..... 4.192
    - FSE-B13 - 1 dB Attenuator..... 4.102, 4.103
    - FSE-B16 - Ethernet Adapter..... 1.44, 1.73
    - FSE-B17 - Second IEC/IEEE bus interface..... 1.40
  - Output
    - AF..... 8.22, 8.24
    - buffer..... 5.17
    - IF..... 8.24
    - level (tracking generator)..... 4.193
    - noise source control..... 8.24
    - reference..... 8.24
    - sweep..... 8.24
    - video out..... 8.24
  - Output device
    - formfeed..... 4.64
    - paperfeed..... 4.65
  - OVLD..... 3.4
- P**
- Packet driver..... 1.78
  - Parallel poll..... 5.33
  - Parallel poll enable register (PPE)..... 5.22
  - Parameter
    - block data..... 5.14
    - boolean..... 5.13
    - numerical values..... 5.13
    - string..... 5.14
    - text..... 5.14
  - Password
    - service function..... 4.33
    - Windows NT..... 1.23
  - Path..... 4.68
  - Peak
    - detector..... 4.161
    - excursion..... 4.135
    - search..... 4.134
  - Plotter connection..... 1.66
  - Power mean..... 4.139
  - Power measurement
    - adjacent channel..... 4.122
    - automatic optimisation of settings..... 4.125
    - bandwidth, occupied..... 4.124



channel..... 4.118  
 channel configuration ..... 4.113  
 signal/noise ..... 4.120  
 PPE (parallel poll enable register)..... 5.22  
 Preset..... 4.2  
 Pre-trigger..... 4.190  
 Printer connection..... 1.28, 1.66, 8.22  
 Printing  
   abort..... 4.51  
   Configuration..... 4.54  
   start..... 4.50  
 Probe Code connector..... 8.23  
 Probe Power connector ..... 8.23  
 PTRansition register part..... 5.19

## Q

Quasi analog display ..... 4.165  
 Query..... 5.12, 5.33  
 Question mark ..... 5.12, 5.14  
 Quotation mark ..... 5.14

## R

Rack installation ..... 1.19, 1.56  
 Range  
   level..... 4.98  
 Recall data set..... 4.75  
 Recording the correction data ..... 4.9  
 Reference  
   dataset (tracking generator)..... 4.201  
   external ..... 4.31  
   line ..... 4.145  
 Reference level..... 4.94  
   offset ..... 4.95  
 Remote control  
   basics..... 5.1  
   IEC-bus ..... 5.3  
   indication ..... 4.49, 5.2  
   RS-232-C ..... 5.4  
   RSIB..... 5.6, 8.10  
   switch over ..... 5.2  
 Rename  
   directory ..... 4.69  
   file ..... 4.69  
 Reset  
   device..... 4.2  
   status reporting system ..... 5.34  
 Resolution bandwidth ..... 4.171  
 RF attenuation ..... 4.100  
   auto ..... 4.101  
   auto low distortion ..... 4.101  
   auto low noise ..... 4.101  
 RF input..... 4.100  
 RJ45 (star topology) ..... 1.45, 1.74  
 RMS detector..... 4.164  
 RMS value (summary marker) ..... 4.139  
 Roll-key ..... 3.14  
 RS-232-C  
   interface ..... 8.6  
   interface functions ..... 8.7  
   transmission parameters ..... 8.7  
 RSIB interface ..... 8.10

## S

Sample detector ..... 4.164  
 Save  
   configuration ..... 4.66  
   data set..... 4.70  
   limit line..... 4.155  
   measurement..... 4.66  
 SCPI  
   conformance information..... 6.1  
   introduction ..... 5.9  
 Screen..... 3.2, 4.4  
   full screen ..... 3.9  
   indications..... 3.4  
   split screen..... 3.9  
 Search  
   limit ..... 4.137  
   minimum ..... 4.134  
   peak..... 4.134  
 Self test..... 4.15  
 Serial interface  
   configuration ..... 4.36, 4.42  
 Serial poll ..... 5.32  
 Service functions..... 4.32  
 Service Pack ..... 1.39  
 Service request (SRQ) ..... 5.21, 5.32  
   indication..... 4.49  
 Service request enable register (SRE) ..... 5.21  
 Setup ..... 4.20  
   general..... 4.34, 4.40  
 Softkey  
   % POWER BANDWIDTH..... 4.117, 6.205  
   ACP STANDARD..... 4.115, 6.52  
   ACTIVE MKR / DELTA ..... 4.134  
   ACTIVE SCREEN A/B ..... 4.4  
   ADJACENT CHAN POWER..... 4.122, 6.50, 6.51  
   ADJUST CP SETTINGS ..... 4.125, 6.205  
   ADJUST TO TRACE..... 4.165, 4.166  
   ALL DELTA OFF..... 4.129, 6.10  
   ALL MARKER OFF..... 4.108, 6.39  
   ALL SUM MKR OFF ..... 4.140, 6.59  
   AM ..... 4.109, 4.110, 6.45  
   AMPERE..... 4.98, 6.62  
   ANALOG TR ON/OFF..... 4.165, 6.99  
   ANALYZER..... 4.18, 4.84, 6.130  
   APPEND NEW..... 4.167, 6.118  
   area ..... 3.10  
   ASCII COMMENT ..... 4.168, 6.118  
   ASCII CONFIG..... 4.167  
   ASCII EXPORT..... 4.167, 6.138  
   ATT SWITCHES ..... 4.17, 6.90  
   ATTEN AUTO LOW DIST ..... 4.101, 6.127  
   ATTEN AUTO LOW NOISE ..... 4.101, 6.127  
   ATTEN AUTO NORMAL ..... 4.101, 6.127  
   ATTEN STEP 1dB/10dB ..... 4.102, 4.104, 6.128  
   AUTO 0.1 \* RBW ..... 4.89, 6.194  
   AUTO 0.1 \* SPAN ..... 4.89, 6.194  
   AUTO 0.5 \* RBW ..... 4.90, 6.194  
   AUTO 0.5 \* SPAN ..... 4.90, 6.194  
   AUTO RECALL ..... 4.76, 6.136  
   AUTO SELECT ..... 4.163, 6.181  
   AUTO x \* RBW ..... 4.90, 6.194  
   AUTO x \* SPAN..... 4.90, 6.194  
   AVERAGE ..... 4.158, 6.98, 6.166  
   AVERAGE ON/OFF ..... 4.140, 6.59  
   BASELINE CLIPPING..... 4.146, 6.16  
   BLANK..... 4.158, 6.99  
   BRIGHTNESS..... 4.6, 6.93  
   C/N ..... 4.120, 6.50, 6.51  
   C/No ..... 4.120, 6.50, 6.51  
   CAL CORR ON/OFF..... 4.11, 6.64  
   CAL I/Q..... 4.10, 6.63

CAL LO SUPP.....	4.10, 6.64	DISPLAY COMMENT .....	4.7, 6.94
CAL LOG.....	4.10, 6.64	DISPLAY LINE 1/2.....	4.145, 6.15
CAL REFL OPEN.....	4.200, 6.172	EDIT ACP LIMITS.....	4.117, 6.33, 6.34, 6.35
CAL REFL SHORT.....	4.200, 6.172	EDIT COMMENT .....	4.71, 6.142
CAL RES BW.....	4.10, 6.63	EDIT LIMIT LINE.....	4.152, 6.22
CAL RESULTS.....	4.12	EDIT NAME .....	4.71, 4.76, 6.135, 6.137
CAL SHORT.....	4.10, 6.64	EDIT PATH.....	4.68, 4.71, 4.76, 4.167, 6.133, 6.137
CAL TOTAL.....	4.10, 6.63	EDIT TRD FACTOR.....	4.24, 6.174
CAL TRANS.....	4.195, 6.172	EDIT TRD SET .....	4.27, 6.176
CENTER FIXED.....	4.85, 4.86, 4.92, 6.194, 6.195	ENABLE ALL ITEMS .....	4.74, 4.79, 6.141
CENTER MANUAL.....	4.87, 6.193	ENABLE DEV1 / DEV2.....	4.59, 4.65
CH FILTER ON/OFF.....	4.116, 6.52	ENABLE OPTION.....	4.31
CHANNEL BANDWIDTH.....	4.116, 6.204	ENTER PASSWORD.....	4.33, 6.230
CHANNEL POWER.....	4.118, 6.50, 6.51	ENTER TEXT .....	4.57
CHANNEL SPACING.....	4.117, 6.203	EXCLUDE LO ON/OFF.....	4.135, 6.40
CLEAR ALL MESSAGES.....	4.16	EXECUTE TESTS .....	4.15, 6.7
CLEAR MESSAGE.....	4.16, 6.230	EXT ALC.....	4.204, 6.213
CLEAR/WRITE.....	4.157, 6.98	EXT AM.....	4.204, 6.212
COLOR ON/ OFF.....	4.55, 6.121	EXT FM .....	4.204, 6.213
COM PORT 1/2.....	4.36, 4.42, 6.227, 6.228	EXT I/Q.....	4.205, 6.212
COMMENT SCREEN A/B.....	4.57, 6.123	EXT REF FREQUENCY .....	4.31, 6.206
CONFIG.....	4.167	EXTERN (trigger).....	4.179, 6.235, 6.236
CONFIG DISPLAY.....	4.6	EXTERNAL KEYBOARD.....	4.47
CONTINUOUS SWEEP .....	4.180, 6.125	FIRMWARE UPDATE.....	4.47, 6.230
COPY.....	4.69, 6.134	FIRMWARE VERSION.....	4.13, 6.5
COPY (TRACE).....	4.160, 6.234	FM.....	4.109, 4.110, 6.45
COPY LIMIT LINE.....	4.150, 6.28	FORMAT DISK .....	4.69, 6.135
COPY SCREEN.....	4.55, 6.122	FREE RUN .....	4.178, 6.235
COPY TABLE.....	4.55, 6.123	FREQ AXIS LIN/LOG.....	4.85, 6.210
COPY TRACE.....	4.55, 6.124	FREQUENCY LINE 1/2.....	4.145, 6.17
COUNTER RESOL.....	4.112, 6.40	FREQUENCY OFFSET .....	4.88, 4.202, 6.196
COUPLING CONTROL.....	4.5, 6.131	FREQUENCY ON/OFF.....	4.7, 6.92
COUPLING DEFAULT .....	4.173, 6.168, 6.207	FULL PAGE.....	4.56, 6.124
COUPLING RATIO.....	4.176	FULL SCREEN.....	4.4, 6.92
CP/ACP ABS/REL.....	4.119, 6.205	FULL SPAN.....	4.92, 6.194
DATA ENTRY FIELD.....	4.8	GAP LENGTH.....	4.191, 6.210
DATA SET CLEAR.....	4.72, 6.138	GAP SWEEP ON/OFF.....	4.189, 6.209
DATA SET CLEAR ALL.....	4.72, 6.138	GAP SWEEP SETTINGS .....	4.190
DATA SET LIST.....	4.71	GATE ADJUST.....	4.186
DATAENTRY OPAQUE .....	4.8	GATE DELAY.....	4.185, 6.209
DATAENTRY X.....	4.8	GATE EXTERN.....	4.185, 6.209
DATAENTRY Y.....	4.8	GATE LENGTH.....	4.185, 6.209
DATE.....	4.45, 6.229	GATE LEVEL.....	4.184, 6.208
dB*/MHz.....	4.97, 6.62	GATE MODE LEVEL/EDGE .....	4.184, 6.208
dB $\mu$ A.....	4.97, 6.62	GATE ON / OFF.....	4.183, 6.208
dB $\mu$ V.....	4.97, 6.62	GATE POL.....	4.184, 6.208
dBm.....	4.97, 6.62	GATE RF POWER.....	4.185, 6.209
dBmV.....	4.97, 6.62	GATE SETTINGS.....	4.184
dBpW.....	4.97, 6.62	GENERAL SETUP.....	4.34, 4.40
DECIM SEP .....	4.167, 6.118	GPIO ADDRESS.....	4.34, 4.40, 6.226
DEFAULT COLORS.....	4.7, 6.93	GRID ABS/REL.....	4.95, 4.99, 6.96
DEFAULT CONFIG.....	4.74, 6.142	HARDCOPY DEVICE .....	4.58, 4.60, 6.121
DEFAULT POSITION.....	4.8	HARDWARE+OPTIONS.....	4.14, 6.6
DEFINE MACRO.....	4.82	HEADER ON/OFF.....	4.167, 6.118
DEFINE PAUSE.....	4.83	HOLD CONT ON/OFF.....	4.160, 6.99
DELETE.....	4.69, 6.135, 6.137	HORIZONTAL SCALING .....	4.5, 6.131
DELETE FACTOR/SET.....	4.23, 6.175, 6.177	INPUT CAL.....	4.32, 6.89
DELETE LIMIT LINE.....	4.150, 6.28	INPUT RF.....	4.32, 6.89
DELETE MACRO.....	4.83	INPUT SELECT .....	4.101, 4.102
DELETE VALUE (limit line).....	4.155	INSERT VALUE (limit line).....	4.155
DELTA 1 to 4.....	4.128, 6.9, 6.10, 6.11	KEY CLICK ON/OFF.....	4.40
DELTA 1/2.....	6.9, 6.10, 6.11	LAST SPAN.....	4.92
DELTA ABS REL.....	4.129, 6.10	LIMIT CHECK.....	4.117, 6.33, 6.34, 6.35
DELTA TO STEPSIZE .....	4.127	LINE (trigger).....	4.178, 6.235
DETECTOR.....	4.163	LINEAR/%.....	4.99, 6.98
DETECTOR AUTOPEAK.....	4.163, 6.181	LINEAR/dB .....	4.99, 6.98
DETECTOR AVERAGE.....	4.164, 6.181	LOCK ALL.....	3.19
DETECTOR MAX PEAK.....	4.163, 6.181	LOCK DATA .....	3.19
DETECTOR MIN PEAK.....	4.163, 6.181	LOG 10dB/20dB/50dB/100dB/120dB.....	4.98
DETECTOR RMS.....	4.164, 6.181	LOG MANUAL .....	4.99, 6.96, 6.98
DETECTOR SAMPLE.....	4.164, 6.181	LOGO ON/OFF.....	4.7, 6.92
DISABLE ALL ITEMS.....	4.74, 4.79, 6.142		

LOWER LEFT .....	4.56, 6.124	REF POINT LEVEL.....	4.130, 6.13
LOWER RIGHT .....	4.56, 6.124	REF POINT LVL OFFSET .....	4.130, 6.13
MACRO 1 to 7.....	4.81	REF POINT TIME .....	4.130, 6.13
MACRO TITLE.....	4.83	REF VALUE.....	4.198, 6.97
MAIN PLL BANDWIDTH .....	4.175, 6.170	REF VALUE POSITION.....	4.197, 6.98
MAKE DIRECTORY.....	4.69, 6.136	REFERENCE.....	4.33, 6.206
MARGIN.....	6.61	REFERENCE FIXED.....	4.129, 6.13
MARKER 1 to 4.....	4.106, 6.39, 6.41	REFERENCE INT/EXT.....	4.31, 6.206
MARKER 1/2.....	6.39, 6.41	REFERENCE LINE.....	4.145, 6.17
MARKER DEMOD.....	4.109, 4.110	REFERENCE POINT.....	4.130, 6.13
MARKER INFO 4.109, 6.14, 6.44, 6.51, 6.57, 6.58, 6.94		REFERENCE PROG .....	4.33, 6.206
MARKER ZOOM .....	4.109, 6.45	RENAME.....	4.69, 6.136
MAX HOLD .....	4.159, 6.98, 6.166	RES BW 3dB/6dB.....	4.172, 6.168
MAX LEVEL AUTO .....	4.95, 6.97	RES BW AUTO.....	4.171, 6.168
MAX LEVEL MANUAL.....	4.95, 6.97	RES BW MANUAL.....	4.172, 6.167
MEAN.....	4.139, 6.58	RESTORE .....	4.47
MIN .....	4.134, 6.12, 6.42	RF ATTEN MANUAL.....	4.100, 6.127
MIN HOLD.....	4.160, 6.98, 6.166	RF INPUT 50 OHM.....	4.101, 4.102, 6.128
MIXER LEVEL.....	4.101, 6.129	RF INPUT 75 OHM/RAM .....	4.101, 4.102, 6.129
MKR -> CENTER.....	4.141, 6.59	RF INPUT 75 OHM/RAZ.....	4.101, 4.102, 6.129
MKR -> CF STEPSIZE.....	4.142, 6.59	RF POWER (trigger).....	4.179, 6.235
MKR -> REF LEVEL.....	4.142, 6.60	RMS.....	4.139, 6.57
MKR -> START.....	4.142, 6.60	SATURATION.....	4.7, 6.93
MKR -> STOP.....	4.142, 6.60	SAVE LIMIT LINE.....	4.155
MKR -> TRACE.....	4.142, 6.10, 6.39	SCR. SAVER ON/OFF.....	4.7, 6.100
MKR DEMOD ON/OFF.....	4.109, 4.110, 6.46	SCR. SAVER TIME.....	4.7, 6.100
MKR STOP TIME.....	4.109, 4.110, 6.46	SCREEN A BARGRAPH.....	4.4
MKR TO STEPSIZE.....	4.127, 6.60	SCREEN A SWEEP.....	4.4
MODE COUPLED .....	4.5, 6.131	SCREEN COUPLING .....	4.5
MODULATION .....	4.203	SCREENS UNCOUPLED .....	4.5, 6.131
MONITOR CONNECTED .....	4.39	SEARCH LIMIT ON/OFF.....	4.137, 6.39
MOUSE.....	4.46	SELECT ITEMS.. 4.74, 4.79, 6.138, 6.139, 6.140, 6.141	
MOVE ZOOM START .....	4.93, 6.95	SELECT LIMIT LINE.....	4.148, 6.21, 6.22, 6.28
MOVE ZOOM STOP .....	4.93, 6.95	SELECT MACRO.....	4.83
MOVE ZOOM WINDOW .....	4.93, 6.96	SELECT MARKER.....	4.134
N dB DOWN.....	4.137, 6.44	SELECT OBJECT.....	4.6
NAME (limit line).....	4.153, 6.28	SELECT QUADRANT.....	4.56
NEW FACT/SET.....	4.24, 4.27, 6.173, 6.175	SELFTEST.....	4.15, 6.7
NEW LIMIT LINE.....	4.152	SERVICE.....	4.32, 6.89
NEXT MIN.....	4.135, 6.12, 6.42	SET CP REFERENCE.....	4.119, 6.205
NEXT MIN LEFT .....	4.135, 6.12, 6.42	SET NO. OF ADJ CHAN'S.....	4.114, 6.204
NEXT MIN RIGHT.....	4.135, 6.12, 6.42	SETTINGS DEVICE 1/2.....	4.58, 4.61
NEXT PEAK.....	4.134, 6.11, 6.41	SGL SWEEP DISP OFF .....	4.181, 6.126
NEXT PEAK LEFT .....	4.134, 6.12, 6.42	SHAPE FACT 60/3dB.....	4.138, 6.46
NEXT PEAK RIGHT.....	4.134, 6.11, 6.41	SHAPE FACT 60/6dB.....	4.138, 6.46
NOISE.....	4.112, 6.45	SHIFT X LIMIT LINE.....	4.155, 6.23
NOISE SOURCE.....	4.32, 6.89	SHIFT Y LIMIT LINE.....	4.155, 6.25, 6.26
NORMALIZE .....	4.196, 6.172	SIGNAL COUNT.....	4.111, 6.40
OCCUPIED PWR BANDW.....	4.124, 6.50, 6.51	SIGNAL TRACK.....	4.108, 6.47
OPTIONS.....	4.14, 4.31, 6.6	SINGLE SWEEP.....	4.180, 6.125
PEAK.....	4.134, 6.11, 6.41	SLOPE POS/NEG.....	4.179, 6.237
PEAK EXCURSION .....	4.135, 6.43	SORT MODE.....	4.69
PEAK HOLD ON/OFF .....	4.140, 6.59	SOURCE CAL.....	4.194
PHASE NOISE.....	4.131, 6.13	SOURCE ON/OFF.....	4.193, 6.143
POWER MEAS SETTINGS.....	4.114	SOURCE POWER.....	4.193, 6.213
POWER OFFSET.....	4.193, 6.213	SPAN / RBW AUTO [50].....	4.177, 6.168
PRE TRIGGER (gap sweep).....	4.190, 6.209	SPAN / RBW MANUAL.....	4.177, 6.168
PREDEFINED COLORS .....	4.7, 6.93	SPAN FIXED .....	4.84, 4.86, 4.88, 6.193, 6.195
PRESEL PEAK .....	4.11, 6.64	SPAN MANUAL .....	4.91, 6.194
PROBE CODE ON/OFF.....	4.98, 6.240	SPLIT SCREEN.....	4.4, 6.92
RBW / VBW MANUAL.....	4.177, 6.169	START FIXED .....	4.86, 4.88, 4.92, 6.193, 6.194, 6.195
RBW / VBW NOISE.....	4.177, 6.169	START MANUAL .....	4.84, 6.195
RBW / VBW PULSE.....	4.177, 6.169	STATISTICS.....	4.17, 6.90
RBW / VBW SINE [1].....	4.176, 6.169	STEPSIZE = CENTER.....	4.90
RBW <= NORM/FFT .....	4.174, 6.168	STEPSIZE AUTO.....	4.127, 6.14, 6.43
RBW 1kHz ANA/DIG .....	4.173, 6.168	STEPSIZE MANUAL.....	4.90, 4.127, 6.14, 6.43, 6.193
RBW UP/DOWN.....	4.173	STOP FIXED .....	4.84, 4.88, 4.92, 6.193, 6.194, 6.195
RECALL .....	4.199, 6.172	STOP MANUAL .....	4.86, 6.195
RECORD ON/OFF .....	4.82	SUM MKR.....	4.138, 6.52
REF LEVEL.....	4.95, 6.96	SUMMARY MARKER .....	4.139
REF LEVEL OFFSET.....	4.95, 6.97	SWEEP COUNT .....	4.140, 4.159, 4.181, 6.208
REF POINT FREQUENCY.....	4.130, 6.13	SWEEP TIME AUTO .....	4.173, 6.207

- SWEEP TIME MANUAL ..... 4.173, 6.207
  - SYSTEM MESSAGES ..... 4.16, 6.230
  - T1-REF ..... 4.165, 4.166, 6.61
  - T1-T2+REF ..... 4.165, 4.166, 6.61
  - T1-T3+REF ..... 4.165, 4.166, 6.61
  - THRESHOLD LINE ..... 4.145, 6.16
  - TIME ..... 4.39, 4.45, 6.231
  - TIME LINE 1/2 ..... 4.146, 6.17
  - TIME ON/OFF ..... 4.7, 6.95
  - TINT ..... 4.6, 6.93
  - TITLE ..... 4.57, 6.123
  - TRACE MATH ..... 4.165
  - TRACE MATH OFF ..... 4.165, 4.166, 6.61
  - TRACKING GENERATOR ..... 4.18, 4.193, 6.130, 6.143
  - TRANSD SET RANGES ..... 4.29, 6.176
  - TRANSD SET UNIT ..... 4.28, 6.176
  - TRANSDUCER FACTOR ..... 4.22, 6.174
  - TRANSDUCER SET ..... 4.22, 6.175, 6.177
  - TRC COLOR AUTO INC ..... 4.55, 6.124
  - TRD FACTOR NAME ..... 4.25, 6.173
  - TRD FACTOR UNIT ..... 4.25, 6.173
  - TRD FACTOR VALUES ..... 4.26, 6.174
  - TRD SET NAME ..... 4.28, 6.175
  - TRG TO GAP TIME ..... 4.191, 6.210
  - TRIGGER DELAY ..... 4.179, 6.236
  - TRIGGER LEVEL (gap sweep) ..... 4.190, 6.236
  - UNIT ..... 4.96, 6.240
  - UNLOCK ..... 3.19
  - UPDATE ..... 4.47
  - UPDATE MESSAGES ..... 4.16
  - UPPER LEFT ..... 4.56, 6.124
  - UPPER RIGHT ..... 4.56, 6.124
  - USER PORT A/B ..... 4.35, 4.41, 6.128, 6.143
  - VALUES (limit line) ..... 4.154, 6.25
  - VECTOR ANALYZER ..... 4.19, 6.130
  - VERTICAL SCALING ..... 4.5, 6.131
  - VIDEO (trigger) ..... 4.178, 6.235, 6.236
  - VIDEO BW AUTO ..... 4.172, 6.169
  - VIDEO BW MANUAL ..... 4.172, 6.169
  - VIEW ..... 4.157, 6.98
  - VOLT ..... 4.98, 6.62
  - VOLUME ..... 4.110, 6.231
  - WATT ..... 4.98, 6.62
  - X OFFSET ..... 4.150, 6.23
  - Y OFFSET ..... 4.150, 6.24, 6.26
  - ZERO SPAN ..... 4.91, 6.194
  - ZOOM ..... 4.93, 6.95
  - ZOOM OFF ..... 4.93, 6.95
  - Span ..... 4.91
    - measurement window ..... 4.84
  - Special characters ..... 6.2
  - Split screen ..... 3.9, 4.4
  - Split screen mode ..... 4.4
  - SRE (service request enable register) ..... 5.21
  - SRQ (service request) ..... 5.21, 5.32
  - Start frequency
    - sweep ..... 4.84
  - Start-Up ..... 1.18, 1.56
  - Status byte (STB) ..... 5.21
  - Status information ..... 3.4
    - DIFOVL ..... 3.4
    - ExtRef ..... 3.4
    - IFOVLD ..... 3.4
    - LO LvD ..... 3.4
    - LO Lvl ..... 3.4
    - LO unl ..... 3.4
    - MAX / REF LVL ..... 3.4
    - OCXO ..... 3.4
    - OVLd ..... 3.4
    - UNCAL ..... 3.4
  - Status register
    - CONDition part ..... 5.19
  - ENABLE part ..... 5.19
  - ESE ..... 5.22
  - ESR ..... 5.22
  - EVENT part ..... 5.19
  - NTRansition part ..... 5.19
    - overview ..... 5.20
  - PPE ..... 5.22
  - PTRansition part ..... 5.19
  - SRE ..... 5.21
  - STATus OPERation ..... 5.23
  - STATus QUEStionable ..... 5.24
    - ACPLimit ..... 5.25
    - FREQuency ..... 5.26
    - LIMit ..... 5.27
    - LMARgin ..... 5.28
    - POWer ..... 5.29
    - SYNC ..... 5.30
    - TRANsducer ..... 5.31
  - STB ..... 5.21
    - structure ..... 5.18
    - sum bit ..... 5.19
  - Status reporting system ..... 5.18
    - resetting values ..... 5.18, 5.34, 6.214
  - STB (status byte) ..... 5.21
  - Step size
    - center frequency ..... 4.89
    - delta marker ..... 4.132
    - marker ..... 4.127
    - setting ..... 3.20
  - Stop frequency
    - sweep ..... 4.86
  - String ..... 5.14
  - Suffix ..... 5.11
  - Sum bit ..... 5.19
  - Supply voltage, external noise source ..... 4.32
  - Sweep
    - count ..... 4.159, 4.181
    - coupling ..... 4.170
    - gap ..... 4.188
    - gap length ..... 4.191
    - gated ..... 4.182
    - mode ..... 4.180
    - single ..... 4.180
    - time ..... 4.173
  - Switching on/off ..... 1.20
  - Switching operations ..... 4.17
  - Syntax elements
    - command ..... 5.14
  - System messages ..... 4.16
- ## T
- Table entry ..... 3.18
  - TCP/IP operation ..... 1.54, 1.85
  - Test functional ..... 1.58
  - Text parameter ..... 5.14
  - Thick Ethernet ..... 1.45, 1.74
  - Thin Ethernet ..... 1.44, 1.73
  - Time ..... 4.39, 4.45
  - Trace ..... 4.156
    - copy ..... 4.160
    - detector ..... 4.161
    - export ..... 4.167
    - mathematics ..... 4.165
  - Transducer ..... 4.20
    - entry ..... 4.23
    - set ..... 4.27
    - switch on ..... 4.21
  - Transmission parameters of RS-232-C ..... 4.194, 8.7

Trigger	
delay .....	4.179
external .....	4.179
free run.....	4.178
gap sweep.....	4.190
line .....	4.178
pre-trigger.....	4.190
RF power.....	4.179
slope .....	4.179
video .....	4.178
TV demodulator .....	4.206
TV-Trigger .....	4.208

## U

UNCAL .....	3.4
Units .....	4.96
Universal command.....	8.5
UNLD.....	3.4
Upper case .....	6.2
User port	
configuration.....	4.35, 4.41
interface .....	8.21

## V

Vector analyzer mode .....	4.19
Video bandwidth .....	4.172
View .....	4.157
Volume .....	4.109, 4.110

## W

White space.....	5.14
Windows NT .....	1.23
administrator.....	1.23
login .....	1.23
password.....	1.23

## Z

Zero span .....	4.91
Zoom .....	4.93, 4.157
amplitude.....	4.157