

Quick Start Guide



Spectrum Analyzer

R&S® FSP3

1164.4391.03

R&S® FSP30

1164.4391.30/39

R&S® FSP7

1164.4391.07

R&S® FSP31

1164.4391.31

R&S® FSP13

1164.4391.13

R&S® FSP40

1164.4391.40

Printed in the Federal
Republic of Germany

ROHDE & SCHWARZ
Test and Measurement Division

1164.4556.62-01-

Contents

Safety Instructions

Certificate of Quality

Support Center Address

List of R&S Representatives

1	Front and Rear View	1.1
	Front view	1.2
	Function Keys on the Front Panel.....	1.4
	Rear View	1.6
	Spectrum Analyzers Connections.....	1.8
	Front Panel of the Instrument	1.8
	Rear Panel of the Instrument.....	1.10
2	Putting into Operation.....	2.1
	Putting into Operation	2.2
	Unpacking the Instrument.....	2.2
	Setting Up the Instrument.....	2.3
	Installation in a 19" rack.....	2.3
	Connecting the Instrument to the AC Power Supply.....	2.4
	Switching on the R&S FSP	2.4
	Functional Test	2.5
	Switching Off the R&S FSP	2.5
	Connecting Peripheral Devices	2.6
	Connecting an External Keyboard	2.6
	Connecting a Mouse.....	2.6
	Connecting an External Monitor	2.7
	Connecting a Printer.....	2.7
	Connecting USB Devices (e.g. a Power Meter).....	2.8
	Connecting External Generators	2.10
	Connecting the R&S FSP to the Generator	2.11
	Configuring the Generator on the R&S FSP	2.12
	Activating the Generator Configuration and Setting the Output Level.....	2.13
	Using an External Generator as a Tracking Generator.....	2.14
	R&S FSP Setup	2.15
	Selecting the Frequency Reference	2.15
	Setting the Date and Time.....	2.15

Setting the IEC Bus Interface	2.16
IEC Bus Address.....	2.16
IEC Bus Language	2.17
ID Response String	2.18
Setting the Screen Colours	2.18
Automatically Switching Off the Internal Screen	2.19
Selecting and Configuring Printers.....	2.20
Selecting Alternative Printer Configurations	2.22
Selecting Printer Colours.....	2.22
Installing Plug&Play Printers	2.23
Installing Non-Plug&Play Printers	2.23
Configuring the LAN Interface (only with Op R&S FSP-B16)	2.24
Connecting the Instrument to the Network	2.24
Configuring the Network Card.....	2.24
Installation von Treibern	2.24
Configuring the Interface	2.25
Configuring Existing Network Protocols (TCP/IP Protocol)	2.26
Installing Additional Network Protocols and Services.....	2.29
Operating System Properties	2.30
Properties Specific to Windows XP	2.30
Windows-XP Service Packs	2.31
Opening the Windows XP Start Menu	2.31
Windows XP Software Approved for the Instrument.....	2.31
3 Firmware-Update and Installation of Firmware Options	3.1
Firmware Update	3.2
Activating Firmware Options	3.3
4 Brief Introduction.....	4.1
Diagram Layout	4.2
Displays in the Diagram Area	4.3
Setting Parameters.....	4.7
The Keypad.....	4.7
The Rotary Knob and Cursor Keys	4.8
Editing Numeric Parameters	4.8
Editing Alphanumeric Parameters.....	4.9
Help Line Editor Type 1:.....	4.9
Help Line Editor Type 2:.....	4.10

5 Introduction	5.1
Measuring a Sinusoidal Signal	5.2
Measuring the Level and Frequency with Markers	5.2
Procedure	5.2
Increasing the Frequency Resolution	5.3
Setting the Reference Level.....	5.4
Measuring the Signal Frequency using the Frequency Counter	5.5
Measuring Harmonics of Sinusoidal Signals	5.7
Measuring the Suppression of the First and Second Harmonic of an Input Signal.....	5.7
Reducing Noise	5.8
Measuring Signal Spectra with Multiple Signals.....	5.11
Separating Signals by Selecting the Resolution Bandwidth	5.11
Separating Two Signals with a Level of –30 dBm each at a Frequency Spacing of 30 kHz.....	5.11
Measuring the Modulation Depth of an AM-Modulated Carrier in the Frequency Domain	5.15
Measurements in the Time Domain.....	5.16
Measuring the Power Characteristic.....	5.16
Example – Measuring the Power of a GSM Burst During the Activation Phase.	5.16
Measuring the Power Characteristic of Burst Signals.....	5.18
Example - Measuring the Edges of a GSM Burst with High Time Resolution...	5.18
Measuring the Signal-to-Noise Ratio of Burst Signals	5.20
Example - Signal-to-Noise Ratio of a GSM Signal.....	5.20
Measurement of AM-Modulated Signals.....	5.23
Example 1 – Displaying the AF of an AM-Modulated Signal in the Time Domain	5.23
Measurement of FM-Modulated Signals.....	5.25
Example - Display of the AF of an FM-Modulated Carrier.....	5.25
Storing and Loading Instrument Settings	5.28
Storing an Instrument Configuration (without Traces)	5.28
Storing Traces	5.29
Loading an Instrument Configuration.....	5.30
Automatic Loading of a Data Record during Booting	5.31
Printing Out the Measurement Results.....	5.32
Selecting the Colour Setting for the Printout.....	5.32
Additional Measurement Examples	5.33

6 Brief Introduction to Remote Control.....	6.1
Basic Steps in IEC Bus Programming.....	6.2
Linking the IEC Bus Library for Visual Basic.....	6.2
Initialization and Default State.....	6.3
Creating Global Variables	6.3
Initializing the Controller	6.3
Initializing the Instrument.....	6.3
Switching the Screen Display On and Off	6.4
Configuring the Power Save Function for the Display	6.4
Sending Simple Instrument Setting Commands.....	6.5
Switching to Manual Operation	6.5
Reading Out Instrument Settings	6.6
Marker Positioning and Readout.....	6.6
Command Synchronization	6.7
Reading Output Buffers.....	6.7
Reading Error Messages.....	6.8
Detailed Programming Examples.....	6.9
Default Setting of the R&S FSP	6.9
Setting the IEC Bus Status Registers.....	6.9
Making Default Settings for Measurements.....	6.10
Using Markers and Delta Markers.....	6.11
Marker Search Functions, Restricting the Search Range.....	6.11
Frequency Counting.....	6.13
Working with a Fixed Reference Point (Reference Fixed).....	6.14
Measuring Noise and Phase Noise	6.15
Reading Out Trace Data	6.16
Storing and Loading Instrument Settings	6.18
Storing Instrument Settings	6.18
Loading Instrument Settings.....	6.19
Setting the Data Record for Startup Recall	6.19
Configuring and Starting a Printout	6.20

Appendix

Appendix A: Printer Interface	A.1
Installing Non-Plug&Play Printers.....	A.1
Local Printer.....	A.1
Network Printer	A.6
Appendix B: LAN-Interface	B.1
Installing Non-Plug&Play Printers.....	B.1
Configuration Examples.....	B.4
Subsequent Changes to the Network Configuration (computer name, domain, workgroup, etc)	B.5
Operating the Instrument without a Network.....	B.7
Operating the Instrument on the Network.....	B.7
Creating Users.....	B.7
Changing the User Password	B.9
NOVELL Network only: Configure NOVELL Client	B.11
Logging on to the Network	B.12
Deactivating the Automatic Login Mechanism	B.12
Reactivating the Automatic Login Mechanism	B.12
Using Network Drives	B.12
Printing on a Network Printer	B.15
Sharing Directories (only with Microsoft Networks).....	B.19
Remote Monitoring of the R&S FSP with XP Remote Desktop	B.22
Introduction	B.22
Configuring the R&S FSP for Use of Remote Desktop	B.22
Configuring the Controller	B.25
Connection Setup with the R&S FSP.....	B.28
Interrupting and Restoring the Remote Desktop Connection with the R&S FSP	B.31
Deactivating the R&S FSP from the Controller	B.31
RSIB Protocol.....	B.31
Appendix C: External Generator Control.....	C.1
List of Generator Types Supported by the R&S FSP.....	C.1



Before putting the product into operation for the first time, make sure to read the following



Safety Instructions

Rohde & Schwarz makes every effort to keep the safety standard of its products up to date and to offer its customers the highest possible degree of safety. Our products and the auxiliary equipment required for them are designed and tested in accordance with the relevant safety standards. Compliance with these standards is continuously monitored by our quality assurance system. This product has been designed and tested in accordance with the EC Certificate of Conformity and has left the manufacturer's plant in a condition fully complying with safety standards. To maintain this condition and to ensure safe operation, observe all instructions and warnings provided in this manual. If you have any questions regarding these safety instructions, Rohde & Schwarz will be happy to answer them.

Furthermore, it is your responsibility to use the product in an appropriate manner. This product is designed for use solely in industrial and laboratory environments or in the field and must not be used in any way that may cause personal injury or property damage. You are responsible if the product is used for an intention other than its designated purpose or in disregard of the manufacturer's instructions. The manufacturer shall assume no responsibility for such use of the product.

The product is used for its designated purpose if it is used in accordance with its operating manual and within its performance limits (see data sheet, documentation, the following safety instructions). Using the products requires technical skills and knowledge of English. It is therefore essential that the products be used exclusively by skilled and specialized staff or thoroughly trained personnel with the required skills. If personal safety gear is required for using Rohde & Schwarz products, this will be indicated at the appropriate place in the product documentation.

Symbols and safety labels

Observe operating instructions	Weight indication for units >18 kg	Danger of electric shock	Warning! Hot surface	PE terminal	Ground	Ground terminal	Attention! Electrostatic sensitive devices

Supply voltage ON/OFF	Standby indication	Direct current (DC)	Alternating current (AC)	Direct/alternating current (DC/AC)	Device fully protected by double/reinforced insulation

Safety Instructions

Observing the safety instructions will help prevent personal injury or damage of any kind caused by dangerous situations. Therefore, carefully read through and adhere to the following safety instructions before putting the product into operation. It is also absolutely essential to observe the additional safety instructions on personal safety that appear in other parts of the documentation. In these safety instructions, the word "product" refers to all merchandise sold and distributed by Rohde & Schwarz, including instruments, systems and all accessories.

Tags and their meaning

DANGER	This tag indicates a safety hazard with a high potential of risk for the user that can result in death or serious injuries.
WARNING	This tag indicates a safety hazard with a medium potential of risk for the user that can result in death or serious injuries.
CAUTION	This tag indicates a safety hazard with a low potential of risk for the user that can result in slight or minor injuries.
ATTENTION	This tag indicates the possibility of incorrect use that can cause damage to the product.
NOTE	This tag indicates a situation where the user should pay special attention to operating the product but which does not lead to damage.

Basic safety instructions

1. The product may be operated only under the operating conditions and in the positions specified by the manufacturer. Its ventilation must not be obstructed during operation. Unless otherwise specified, the following requirements apply to Rohde & Schwarz products: IP protection 2X, pollution severity 2, overvoltage category 2, use only in enclosed spaces, max. operation altitude max. 2000 m.
Prior to performing any work on the product or opening the product, the instrument must be disconnected from the supply network. Any adjustments, replacements of parts, maintenance or repair must be carried out only by technical personnel authorized by Rohde & Schwarz. Only original parts may be used for replacing parts relevant to safety (e.g. power switches, power transformers, fuses). A safety test must always be performed after parts relevant to safety have been replaced (visual inspection, PE conductor test, insulation resistance measurement, leakage current measurement, functional test).
2. Applicable local or national safety regulations and rules for the prevention of accidents must be observed in all work performed. The product may be opened only by authorized, specially trained personnel.

Safety Instructions

3. As with all industrially manufactured goods, the use of substances that induce an allergic reaction (allergens) such as aluminum cannot be generally excluded. If you develop an allergic reaction (such as a skin rash, frequent sneezing, red eyes or respiratory difficulties), consult a physician immediately to determine the cause.
4. Depending on the function, certain products such as RF radio equipment can produce an elevated level of electromagnetic radiation. Considering that unborn life requires increased protection, pregnant women should be protected by appropriate measures. Persons with pacemakers may also be endangered by electromagnetic radiation. The employer is required to assess workplaces where there is a special risk of exposure to radiation and, if necessary, take measures to avert the danger.
5. Operating the products requires special training and intense concentration. Disabled persons should not use the products unless it is made certain that their disability has no adverse effects while they are operating the products.
6. Prior to switching on the product, it must be ensured that the nominal voltage setting on the product matches the nominal voltage of the AC supply network. If a different voltage is to be set, the power fuse of the product may have to be changed accordingly.
7. In the case of products of safety class I with movable power cord and connector, operation is permitted only on sockets with earthing contact and protective earth connection.
8. Intentionally breaking the protective earth connection either in the feed line or in the product itself is not permitted. Doing so can result in the danger of an electric shock from the product. If extension cords or connector strips are implemented, they must be checked on a regular basis to ensure that they are safe to use.
9. If the product has no power switch for disconnection from the AC supply, the plug of the connecting cable is regarded as the disconnecting device. In such cases, it must be ensured that the power plug is easily reachable and accessible at all times (length of connecting cable approx. 2 m). Functional or electronic switches are not suitable for providing disconnection from the AC supply. If products without power switches are integrated in racks or systems, a disconnecting device must be provided at the system level.
10. Never use the product if the power cable is damaged. By taking appropriate safety measures and carefully laying the power cable, ensure that the cable cannot be damaged and that no one can be hurt by e.g. tripping over the cable or suffering an electric shock.
11. The product may be operated only from TN/TT supply networks fused with max. 16 A.
12. Do not insert the plug into sockets that are dusty or dirty. Insert the plug firmly and all the way into the socket. Otherwise this can result in sparks, fire and/or injuries.
13. Do not overload any sockets, extension cords or connector strips; doing so can cause fire or electric shocks.

Safety Instructions

14. For measurements in circuits with voltages $V_{\text{rms}} > 30 \text{ V}$, suitable measures (e.g. appropriate measuring equipment, fusing, current limiting, electrical separation, insulation) should be taken to avoid any hazards.
15. Ensure that the connections with information technology equipment comply with IEC950/EN60950.
16. Never remove the cover or part of the housing while you are operating the product. This will expose circuits and components and can lead to injuries, fire or damage to the product.
17. If a product is to be permanently installed, the connection between the PE terminal on site and the product's PE conductor must be made first before any other connection is made. The product may be installed and connected only by a skilled electrician.
18. For permanently installed equipment without built-in fuses, circuit breakers or similar protective devices, the supply circuit must be fused in such a way that suitable protection is provided for users and products.
19. Do not insert any objects into the openings in the housing that are not designed for this purpose. Never pour any liquids onto or into the housing. This can cause short circuits inside the product and/or electric shocks, fire or injuries.
20. Use suitable overvoltage protection to ensure that no overvoltage (such as that caused by a thunderstorm) can reach the product. Otherwise the operating personnel will be endangered by electric shocks.
21. Rohde & Schwarz products are not protected against penetration of water, unless otherwise specified (see also safety instruction 1.). If this is not taken into account, there exists the danger of electric shock or damage to the product, which can also lead to personal injury.
22. Never use the product under conditions in which condensation has formed or can form in or on the product, e.g. if the product was moved from a cold to a warm environment.
23. Do not close any slots or openings on the product, since they are necessary for ventilation and prevent the product from overheating. Do not place the product on soft surfaces such as sofas or rugs or inside a closed housing, unless this is well ventilated.
24. Do not place the product on heat-generating devices such as radiators or fan heaters. The temperature of the environment must not exceed the maximum temperature specified in the data sheet.
25. Batteries and storage batteries must not be exposed to high temperatures or fire. Keep batteries and storage batteries away from children. If batteries or storage batteries are improperly replaced, this can cause an explosion (warning: lithium cells). Replace the battery or storage battery only with the matching Rohde & Schwarz type (see spare parts list). Batteries and storage batteries are hazardous waste. Dispose of them only in specially marked containers. Observe local regulations regarding waste disposal. Do not short-circuit batteries or storage batteries.

Safety Instructions

26. Please be aware that in the event of a fire, toxic gases that may be hazardous to your health may escape from the product.
27. Please be aware of the weight of the product. Be careful when moving it; otherwise you may injure your back or other parts of your body.
28. Do not place the product on surfaces, vehicles, cabinets or tables that for reasons of weight or stability are unsuitable for this purpose. Always follow the manufacturer's installation instructions when installing the product and fastening it to objects or structures (e.g. walls and shelves).
29. If you use the product in a vehicle, it is the sole responsibility of the driver to drive the vehicle safely.
- Adequately secure the product in the vehicle to prevent injuries or other damage in the event of an accident. Never use the product in a moving vehicle if doing so could distract the driver of the vehicle. The driver is always responsible for the safety of the vehicle; the manufacturer assumes no responsibility for accidents or collisions.
30. If a laser product (e.g. a CD/DVD drive) is integrated in a Rohde & Schwarz product, do not use any other settings or functions than those described in the documentation. Otherwise this may be hazardous to your health, since the laser beam can cause irreversible damage to your eyes. Never try to take such products apart, and never look into the laser beam.



Por favor lea imprescindiblemente antes de la primera puesta en funcionamiento las siguientes informaciones de seguridad



Informaciones de seguridad







Es el principio de Rohde&Schwarz de tener a sus productos siempre al día con los standards de seguridad y de ofrecer a sus clientes el máximo grado de seguridad. Nuestros productos y todos los equipos adicionales son siempre fabricados y examinados según las normas de seguridad vigentes. Nuestra sección de gestión de la seguridad de calidad controla constantemente que sean cumplidas estas normas. Este producto ha sido fabricado y examinado según el comprobante de conformidad adjunto según las normas de la CE y ha salido de nuestra planta en estado impecable según los standards técnicos de seguridad. Para poder preservar este estado y garantizar un funcionamiento libre de peligros, deberá el usuario atenerse a todas las informaciones, informaciones de seguridad y notas de alerta. Rohde&Schwarz está siempre a su disposición en caso de que tengan preguntas referentes a estas informaciones de seguridad.

Además queda en la responsabilidad del usuario utilizar el producto en la forma debida. Este producto solamente fue elaborado para ser utilizado en la industria y el laboratorio o para fines de campo y de ninguna manera deberá ser utilizado de modo que alguna persona/cosa pueda ser dañada. El uso del producto fuera de sus fines definidos o despreciando las informaciones de seguridad del fabricante queda en la responsabilidad del usuario. El fabricante no se hace en ninguna forma responsable de consecuencias a causa del maluso del producto.

Se parte del uso correcto del producto para los fines definidos si el producto es utilizado dentro de las instrucciones del correspondiente manual del uso y dentro del margen de rendimiento definido (ver hoja de datos, documentación, informaciones de seguridad que siguen). El uso de los productos hace necesarios conocimientos profundos y el conocimiento del idioma inglés. Por eso se deberá tener en cuenta de exclusivamente autorizar para el uso de los productos a personas péritas o debidamente minuciosamente instruidas con los conocimientos citados. Si fuera necesaria indumentaria de seguridad para el uso de productos de R&S, encontrará la información debida en la documentación del producto en el capítulo correspondiente.

Símbolos y definiciones de seguridad

							
Ver manual de instrucciones del uso	Informaciones para maquinaria con un peso de > 18kg	Peligro de golpe de corriente	¡Cuidado! Superficie caliente	Conexión a conductor protector	Conexión a tierra	Conexión a masa conductora	¡Cuidado! Elementos de construcción con peligro de carga electroestática

					
potencia EN MARCHA/PARADA	Indicación Stand-by	Corriente continua DC	Corriente alterna AC	Corriente continua/alterna DC/AC	El aparato está protegido en su totalidad por un aislamiento de doble refuerzo

Tener en cuenta las informaciones de seguridad sirve para tratar de evitar daños y peligros de toda clase. Es necesario de que se lean las siguientes informaciones de seguridad concienzudamente y se tengan en cuenta debidamente antes de la puesta en funcionamiento del producto. También deberán ser tenidas en cuenta las informaciones para la protección de personas que encontrarán en otro capítulo de esta documentación y que también son obligatorias de seguir. En las informaciones de seguridad actuales hemos juntado todos los objetos vendidos por Rohde&Schwarz bajo la denominación de „producto“, entre ellos también aparatos, instalaciones así como toda clase de accesorios.

Palabras de señal y su significado

- PELIGRO** Indica un punto de peligro con gran potencial de riesgo para el usuario. Punto de peligro que puede llevar hasta la muerte o graves heridas.
- ADVERTENCIA** Indica un punto de peligro con un potencial de riesgo mediano para el usuario. Punto de peligro que puede llevar hasta la muerte o graves heridas .
- CUIDADO** Indica un punto de peligro con un potencial de riesgo pequeño para el usuario. Punto de peligro que puede llevar hasta heridas leves o pequeñas
- ATENCIÓN** Indica la posibilidad de utilizar mal el producto y a consecuencia dañarlo.
- INFORMACIÓN** Indica una situación en la que deberían seguirse las instrucciones en el uso del producto, pero que no consecuentemente deben de llevar a un daño del mismo.

Informaciones de seguridad elementales

1. El producto solamente debe ser utilizado según lo indicado por el fabricante referente a la situación y posición de funcionamiento sin que se obstruya la ventilación. Si no se convino de otra manera, es para los productos R&S válido lo que sigue:
modo de protección IP 2X, grado de suciedad 2, categoría de sobrecarga eléctrica 2, utilizar solamente en estancias interiores, utilización hasta 2000 m sobre el nivel del mar.
2. En todos los trabajos deberán ser tenidas en cuenta las normas locales de seguridad de trabajo y de prevención de accidentes. El producto solamente debe de ser abierto por personal périto autorizado. Antes de efectuar trabajos en el producto o abrirlo deberá este ser desconectado de la corriente. El ajuste, el cambio de partes, la manutención y la reparación deberán ser solamente efectuadas por electricistas autorizados por R&S. Si se reponen partes con importancia para los aspectos de seguridad (por ejemplo el enchufe, los transformadores o los fusibles), solamente podrán ser sustituidos por partes originales. Después de cada recambio de partes elementales para la seguridad deberá ser efectuado un control de seguridad (control a primera vista, control de conductor protector, medición de resistencia de aislamiento, medición de medición de la corriente conductora, control de funcionamiento).
3. Como en todo producto de fabricación industrial no puede ser excluido en general de que se produzcan al usarlo elementos que puedan generar alergias, los llamados elementos alergénicos (por ejemplo el aluminio). Si se produjeran en el trato con productos R&S reacciones alérgicas, como por ejemplo urticaria, estornudos frecuentes, irritación de la conjuntiva o dificultades al respirar, se deberá consultar inmediatamente a un médico para averiguar los motivos de estas reacciones.
4. Ciertos productos, como por ejemplo las instalaciones de radiación HF, pueden a causa de su función natural, emitir una radiación electromagnética aumentada. En vista a la protección de la vida en desarrollo deberían ser protegidas personas embarazadas debidamente. También las personas con un bypass pueden correr peligro a causa de la radiación electromagnética. El empresario está comprometido a valorar y señalar áreas de trabajo en las que se corra un riesgo de exposición a radiaciones aumentadas de riesgo aumentado para evitar riesgos.
5. La utilización de los productos requiere instrucciones especiales y una alta concentración en el manejo. Personas minusválidas solamente deberán utilizar estos productos si está por seguro de que a causa de su handicap no podrá surgir ninguna restricción en el manejo del producto.

Informaciones de seguridad

6. Antes de la puesta en marcha del producto se deberá tener por seguro de que la tensión preseleccionada en el producto equivalga a la de la red de distribución. Si es necesario cambiar la preselección de la tensión también se deberán en caso de cambiar los fusibles correspondientes del producto.
7. Productos de la clase de seguridad I con alimentación móvil y enchufe individual de producto solamente deberán ser conectados para el funcionamiento a tomas de corriente de contacto de seguridad y con conductor protector conectado.
8. Queda prohibida toda clase de interrupción intencionada del conductor protector, tanto en la toma de corriente como en el mismo producto ya que puede tener como consecuencia el peligro de golpe de corriente por el producto. Si se utilizaran cables o enchufes de extensión se deberá poner al seguro, que es controlado su estado técnico de seguridad.
9. Si el producto no está equipado con un interruptor para desconectarlo de la red, se deberá considerar el enchufe del cable de distribución como interruptor. En estos casos deberá asegurarse de que el enchufe sea de fácil acceso y nabejo (medida del cable de distribución aproximadamente 2 m). Los interruptores de función o electrónicos no son aptos para la el corte de la red eléctrica. Si los productos sin interruptor están integrados en construcciones o instalaciones, se deberá instalar el interruptor al nivel de la instalación.
10. No utilice nunca el producto si está dañado el cable eléctrico. Asegure a través de las medidas de protección y de instalación adecuadas de que el cable de eléctrico no pueda ser dañado o de que nadie pueda ser dañado por él, por ejemplo al tropezar o por un golpe de corriente.
11. Solamente está permitido el funcionamiento en redes de distribución TN/TT aseguradas con fusibles de como máximo 16 A.
12. Nunca conecte el enchufe en tomas de corriente sucias o llenas de polvo. Introduzca el enchufe por completo y fuertemente en la toma de corriente. Si no tiene en consideración estas indicaciones se arriesga a que se originen chispas, fuego y/o heridas.
13. No sobrecargue las tomas de corriente, los cables de extensión o los enchufes de extensión ya que esto pudiera causar fuego o golpes de corriente.
14. En las mediciones en circuitos de corriente con una tensión de entrada de $U_{eff} > 30 \text{ V}$ se deberá tomar las precauciones debidas para impedir cualquier peligro (por ejemplo medios de medición adecuados, seguros, limitación de tensión, corte protector, aislamiento etc.).
15. En caso de conexión con aparatos de la técnica informática se deberá tener en cuenta que estos cumplan los requisitos de la EC950/EN60950.

Informaciones de seguridad

16. Nunca abra la tapa o parte de ella si el producto está en funcionamiento. Esto pone a descubierto los cables y componentes eléctricos y puede causar heridas, fuego o daños en el producto.
17. Si un producto es instalado fijamente en un lugar, se deberá primero conectar el conductor protector fijo con el conductor protector del aparato antes de hacer cualquier otra conexión. La instalación y la conexión deberán ser efectuadas por un electricista especializado.
18. En caso de que los productos que son instalados fijamente en un lugar sean sin protector implementado, autointerruptor o similares objetos de protección, deberá la toma de corriente estar protegida de manera que los productos o los usuarios estén suficientemente protegidos.
19. Por favor, no introduzca ningún objeto que no esté destinado a ello en los orificios de la caja del aparato. No vierta nunca ninguna clase de líquidos sobre o en la caja. Esto puede producir corto circuitos en el producto y/o puede causar golpes de corriente, fuego heridas.
20. Asegúrese con la protección adecuada de que no pueda originarse en el producto una sobrecarga por ejemplo a causa de una tormenta. Si no se verá el personal que lo utilice expuesto al peligro de un golpe de corriente.
21. Los productos R&S no están protegidos contra el agua si no es que exista otra indicación, ver también punto 1. Si no se tiene en cuenta esto se arriesga el peligro de golpe de corriente o de daños en el producto lo cual también puede llevar al peligro de personas.
22. No utilice el producto bajo condiciones en las que pueda producirse y se hayan producido líquidos de condensación en o dentro del producto como por ejemplo cuando se desplaza el producto de un lugar frío a un lugar caliente.
23. Por favor no cierre ninguna ranura u orificio del producto, ya que estas son necesarias para la ventilación e impiden que el producto se caliente demasiado. No pongan el producto encima de materiales blandos como por ejemplo sofás o alfombras o dentro de una caja cerrada, si esta no está suficientemente ventilada.
24. No ponga el producto sobre aparatos que produzcan calor, como por ejemplo radiadores o calentadores. La temperatura ambiental no debe superar la temperatura máxima especificada en la hoja de datos.
25. Baterías y acumuladores no deben de ser expuestos a temperaturas altas o al fuego. Guardar baterías y acumuladores fuera del alcance de los niños. Si las baterías o los acumuladores no son cambiados con la debida atención existirá peligro de explosión (atención células de Litio). Cambiar las baterías o los acumuladores solamente por los del tipo R&S correspondiente (ver lista de piezas de recambio).

Informaciones de seguridad

- Baterías y acumuladores son desechos problemáticos. Por favor tirenlos en los recipientes especiales para este fin. Por favor tengan en cuenta las prescripciones nacionales de cada país referente al tratamiento de desechos. Nunca sometan a las baterías o acumuladores a un corto circuito.
26. Tengan en consideración de que en caso de un incendio pueden escaparse gases tóxicos del producto, que pueden causar daños a la salud.
 27. Por favor tengan en cuenta el peso del producto. Muevanlo cuidadosamente ya que el peso puede causar lesiones de la espalda u otros daños físicos.
 28. No sitúe el producto encima de superficies, vehículos, estantes o mesas, que por sus características de peso o de estabilidad no sean aptas para él. Siga siempre las instrucciones de instalación del fabricante cuando instale y asegure el producto en objetos o estructuras (por ejemplo paredes y estantes).
 29. Si llega a utilizar el producto dentro de un vehículo, queda en la responsabilidad absoluta del conductor que conducir el vehículo de manera segura. Asegure el producto dentro del vehículo debidamente para evitar en caso de un accidente las lesiones u otra clase de daños. No utilice nunca el producto dentro de un vehículo en movimiento si esto pudiera distraer al conductor. Siempre queda en la responsabilidad absoluta del conductor la seguridad del vehículo y el fabricante no asumirá ninguna clase de responsabilidad por accidentes o colisiones.
 30. Dado el caso de que esté integrado un producto de laser en un producto R&S (por ejemplo CD/DVD-ROM) no utilice otras instalaciones o funciones que las descritas en la documentación. De otra manera pondrá en peligro su salud, ya que el rayo laser puede dañar irreversiblemente sus ojos. Nunca trate de descomponer estos productos. Nunca mire dentro del rayo laser.

Safety Instructions

Safety instructions for instruments with fold-out feet



Warning!

The feet must be fully folded in or folded out. Only then can instrument stability and reliable operation be ensured.

The total uniform load on the folded-out feet must not exceed 500 N (combined weight of instrument and equipment stacked on top).

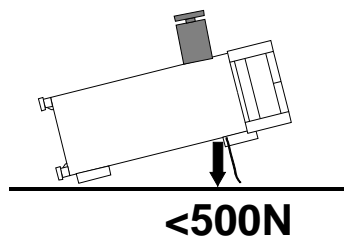

Additional equipment placed on the instrument must be protected against slipping.

When the instrument is shifted with the feet folded out, the feet might fold in. Thus, to avoid injury, the instrument must not be moved with the feet folded out.

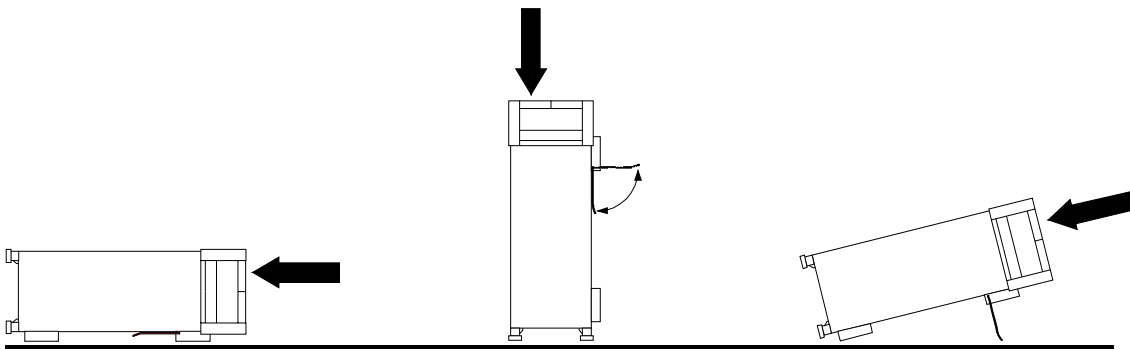

Quality Certificate



Dear Customer,

Thank you for purchasing a Rohde & Schwarz product. This product was created using state-of-the-art production methods. It was developed, produced and tested in accordance with our Quality Management System rules.

The Rohde & Schwarz Quality Management System has been certified in accordance with ISO 9001, ISO 14001 and other standards.



ROHDE & SCHWARZ

Support Center

Telephone: +49 (0)180 512 42 42

Fax: +49 89 41 29 137 77

E-mail: CustomerSupport@rohde-schwarz.com

If you have any questions regarding this Rohde & Schwarz instrument, please call our Support Center hotline at Rohde & Schwarz Vertriebs-GmbH.

Our team will work with you to find a solution.

The hotline hours are 8:00 a.m. to 5:00 p.m. CET, Monday through Friday.

If you wish to contact us outside normal business hours, please leave a voice message or send us a fax or e-mail. We will get in contact with you as soon as possible.



To keep your instrument up to date, please subscribe for your personal newsletter at:

<http://www.rohde-schwarz.com/www/response.nsf/newsletterpreselection>.

You will receive information about the Rohde & Schwarz products of your choice, firmware expansions, new drivers and application descriptions.



ROHDE & SCHWARZ

1 Front and Rear View

Front view

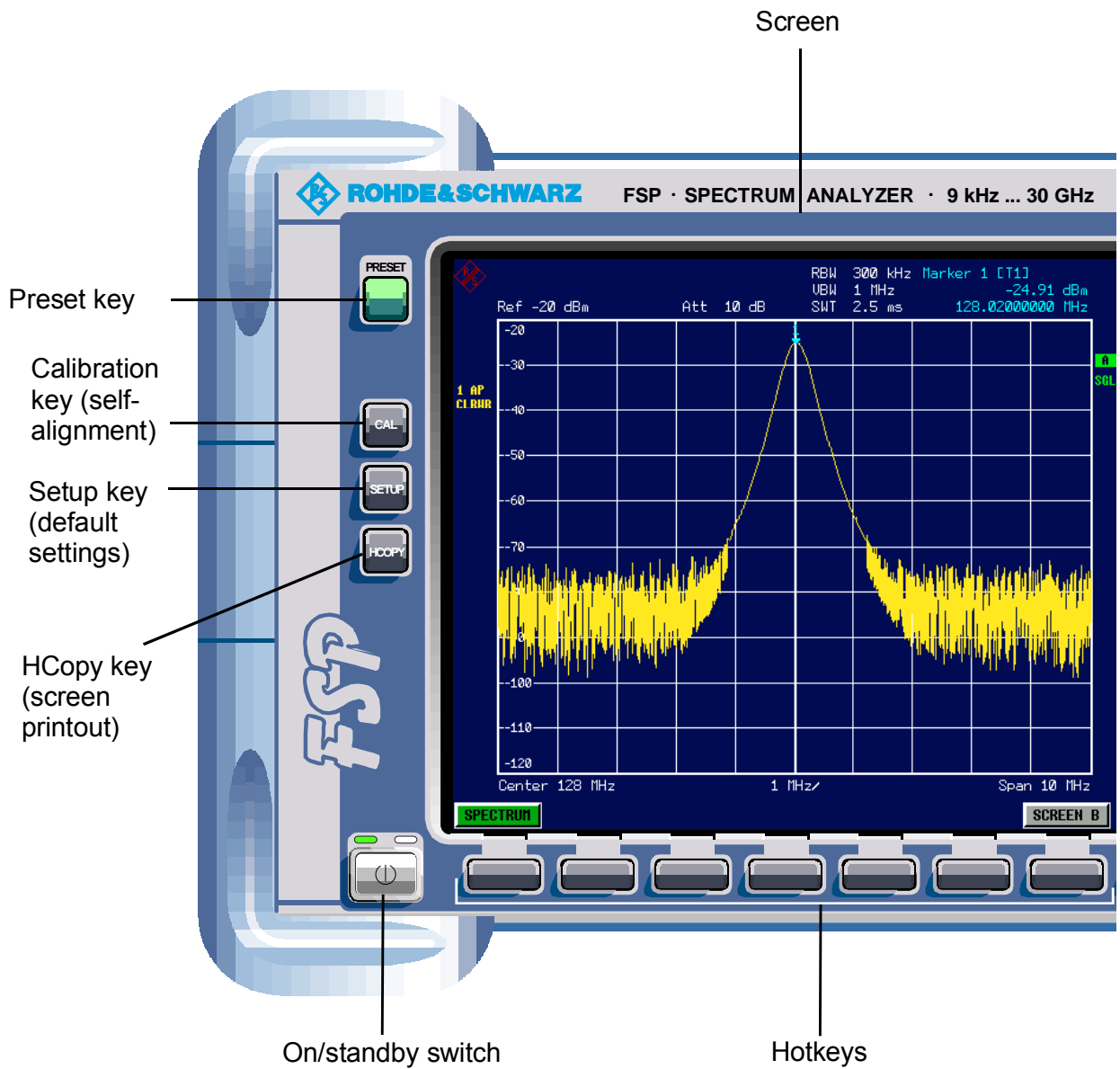
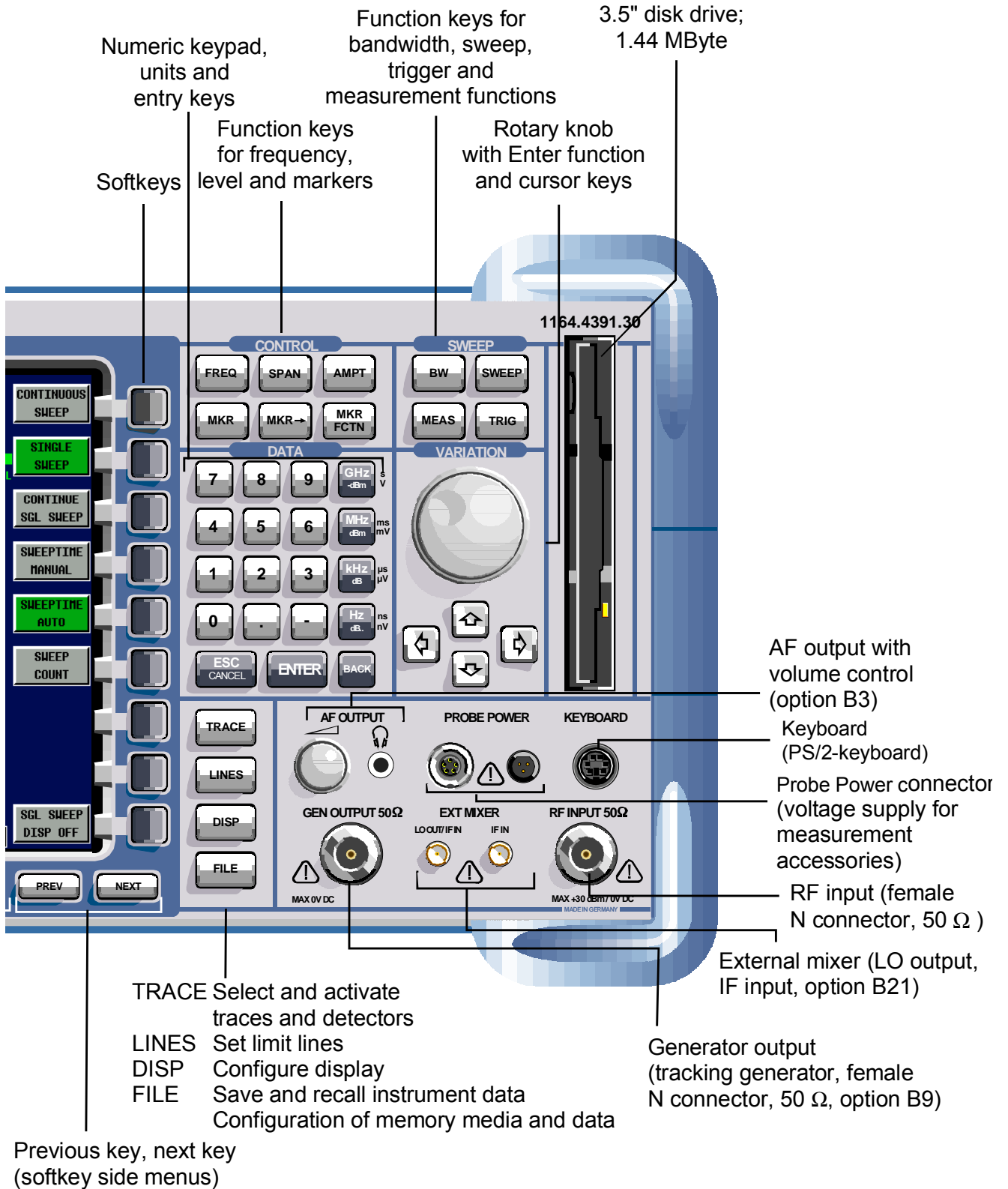

Fig. 1-1 Front view



Function Keys on the Front Panel

Function key	Assigned functions
ON / STANDBY	Switches the instrument on and off.
PRESET	Resets the instrument to the default state.
FREQ	Sets the center frequency as well as the start and stop frequencies for the frequency band under consideration. This key is also used to set the frequency offset and the signal track function.
SPAN	Sets the frequency span to be analyzed.
AMPT	Sets the reference level, the displayed dynamic range, the RF attenuation and the unit for the level display. This key is also used to set the level offset and the input impedance.
MKR	Sets and positions the absolute and relative measurement markers (markers and delta markers). In addition, the following measurement functions are assigned under this key: <ul style="list-style-type: none"> • Frequency counter (SIGNAL COUNT) • Fixed reference point for relative measurement markers (REFERENCE FIXED) • Enlargement of the measurement area (MARKER ZOOM)
MKR->	Used for search functions of the measurement markers (maximum/minimum of the trace). Assigns the marker frequency to the center frequency, and the marker level to the reference level. Restricts the search area (SEARCH LIMITS) and characterizes the maximum points and minimum points (PEAK EXCURSION).
MKR FCTN	Provides additional analysis functions of the measurement markers: <ul style="list-style-type: none"> • Noise marker (NOISE MEAS) • Phase noise (PHASE NOISE) • n dB down function • Peak list • AM/FM audio demodulation (with option R&S FSP-B3)
BW	Sets resolution bandwidth, video bandwidth and the two ratios "resolution bandwidth/video bandwidth" and "span/resolution bandwidth" in the case of automatic coupling.
SWEEP	Sets the sweep time and the number of measurement points. Selects continuous measurement or single measurement.

Funktion key	Assigned functions
MEAS	Used to perform complex measurement functions: <ul style="list-style-type: none"> • Measurement of time domain power (TIME DOM POWER) • Measurement of channel and adjacent channel power (CHANNEL POWER / ACP) • Measurement of multicarrier adjacent channel power (MULT CARR ACP) • Occupied bandwidth (OCCUPIED PWR BANDW) • Signal statistics: amplitude probability distribution (APD) and cumulative complementary distribution function (CCDF) • Carrier to noise spacing (C/N, C/No) • AM modulation depth (MODULATION DEPTH) • Third-order intercept point (TOI)
TRIG	Sets trigger source, trigger threshold, trigger delay, and gate configuration in the case of gated sweep.
TRACE	Configures measured data acquisition (CLR/WRITE; AVERAGE, MAXHOLD; MINHOLD, VIEW). Configures the analysis of the measurement data (DETECTOR) and the mathematical linking of traces (TRACE MATH).
LINES	Configures display lines and limit lines.
DISP	Configures the screen layout (one/two diagrams) and the diagram contents. This key can also be used to configure the screen colors.
FILE	Provides the functions for storing/loading instrument settings and for managing stored files.
CAL	Used to perform instrument self-calibration.
SETUP	Used to set or display the following the default settings of the instrument: <ul style="list-style-type: none"> • Reference frequency, noise source, preamplifier, level correction values (TRANSDUCER), date, time, IEC bus, RS-232-C interface, LAN interface • Firmware update and enabling of options • Information about instrument configuration (SYSTEM INFO) incl. firmware version, module data and system error messages • Service support functions
HCOPY	Configures the screen printout, and selects and configures the printer.

Rear View

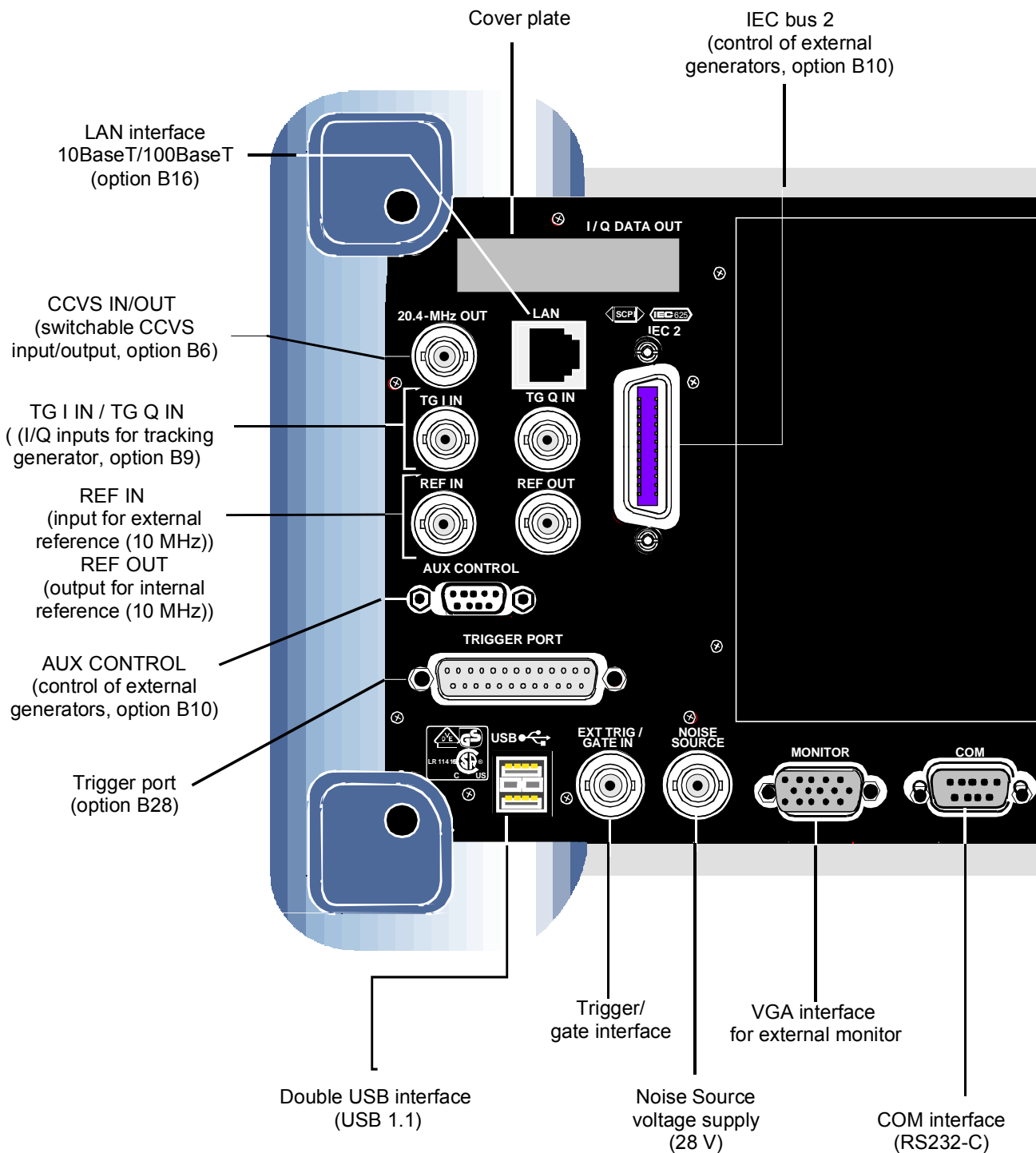
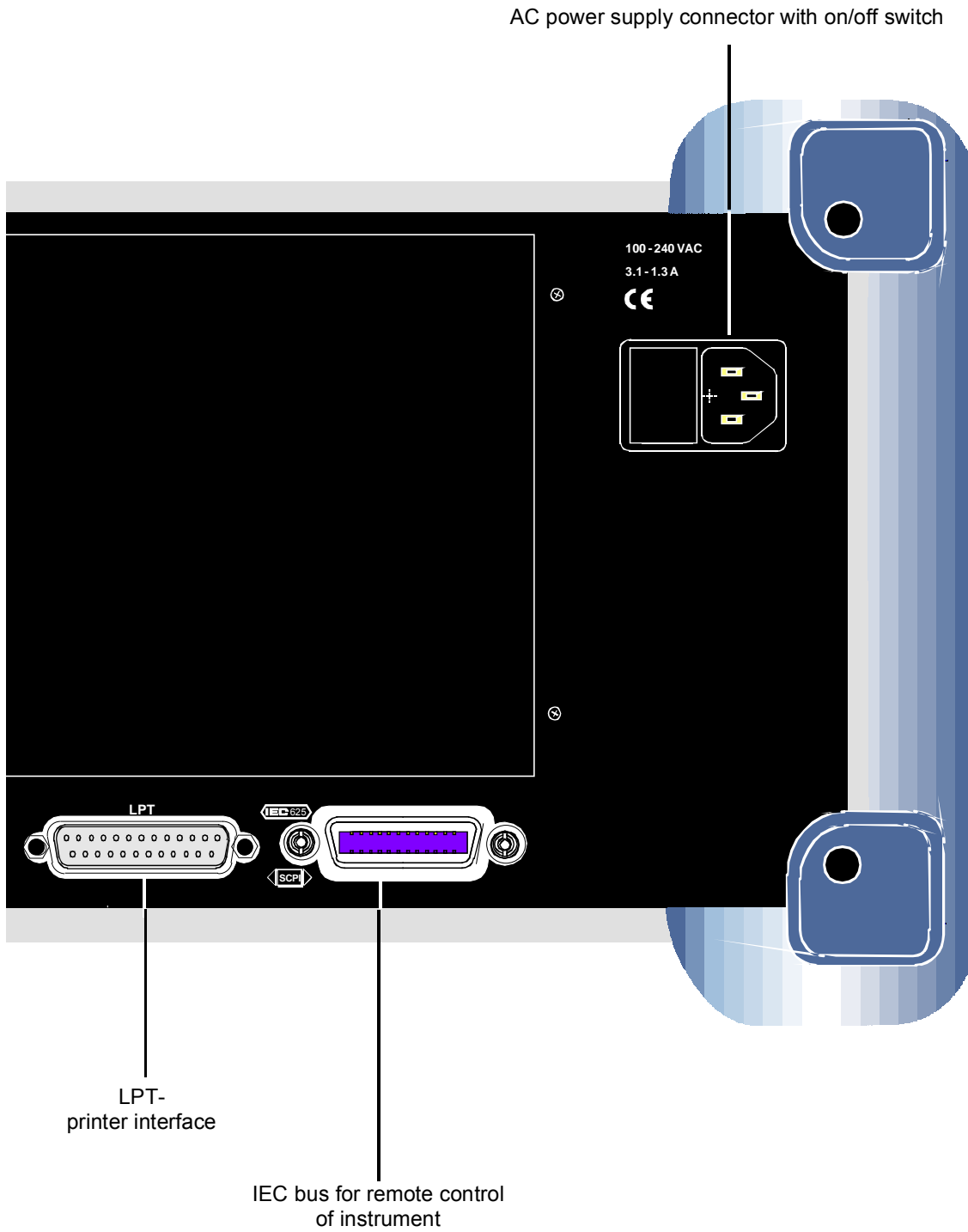

Fig. 1-2 Rear view



Spectrum Analyzers Connections

Front Panel of the Instrument

RF INPUT

The RF input is to be connected to the DUT via a cable equipped with a male N connector. Be sure not to overload the input.

The maximum continuous power at the RF input is 30 dBm (1 W).



In the case of the FSP3 and FSP7, the RF input is AC-coupled. However, an input DC voltage of 50 V must never be exceeded.

On the FSP13, FSP30 and FSP40, the RF input is DC-coupled. DC voltage must not be applied at the input.

In both cases, noncompliance will destroy the input mixers.

Connections for External Mixers (EXT MIXER)

External mixers can be connected at the LO OUT/IF IN and IF IN female connectors.

Two-port mixers can simply be connected to the LO OUT / IF IN female connector. In the case of three-port mixers, the LO input of the mixer must be connected to the LO OUT / IF IN female connector, and the IF output of the mixer to the IF IN female connector.

Connect the remaining mixer connector to the DUT.

The female connector is available only with the external mixer option (R&S FSP-B21).

Tracking Generator Output (GEN OUTPUT 50Ω)

The output of the tracking generator is to be connected to the DUT via a cable equipped with a male N connector.

Note: *In the case of DUTs with sensitive HF characteristics with regard to matching (VSWR) at the input, insert a 20 dB attenuator between the DUT and the tracking generator.*

The female connector is available only with the tracking generator option (R&S FSP-B9).

AF OUTPUT

Headphones equipped with a miniature jack plug can be connected at the AF OUTPUT female connector.

The internal impedance is 10 Ω. The output voltage can be set by using the volume control to the left of the female connector. If a plug is connected, the internal loudspeaker will automatically be switched off.

The female connector and volume control are available only with the audio demodulator option (FSP-B3).

PROBE POWER

To allow you to connect transducers from other manufacturers, the R&S FSP provides two PROBE POWER supply connectors.

The left-hand connector supplies the ± 10 V supply voltages and ground, making it suitable for attaching R&S transducers.

The right-hand connector supplies the +15 V and –12.6 V supply voltages and ground. This connector is suitable for supplying high-impedance probes from Agilent.

KEYBOARD

The front panel provides a PS/2 KEYBOARD female connector for connecting a keyboard. Either keyboard PSP-Z1 (order no. 1091.4000.02, German) or PSP-Z2 (order no. 1091.4100.02, English) is recommended. These units contain not only a PC keyboard but also a trackball for mouse control.

Rear Panel of the Instrument

AC Power Supply Connection and Main Power Switch

An AC power supply connector and main power switch are located in a unit on the rear panel of the instrument.

Main power switch function:

- Position I** After being switched on, the instrument will be either in STANDBY mode or in operation depending on the setting of the ON/STANDBY switch on the front panel of the instrument.
- Position O** Switching the instrument off disconnects the entire instrument from the AC power supply.

Note: *The main power switch also interrupts the power supply of the OCXO located in the instrument. When you switch the instrument back on, be sure to comply with the extended warmup phase specified in the data sheet.*

IEC Bus Interface

The instrument comes with an IEC bus interface in compliance with IEEE488. A controller for remote control can be connected via this interface. Use a shielded cable to set up the connection.

Printer Interface (LPT)

The 25-pin female LPT connector on the rear panel of the R&S FSP is provided for connecting a printer. The interface is compatible with the CENTRONICS interface.

RS-232-C Interface (COM)

The instrument comes with an RS-232-C interface. The interface can be manually activated and configured for remote control by defining the parameters in the *COM PORT* table, which is accessed from the *SETUP-GENERAL SETUP* menu.

R&S FSP Monitor Connection (MONITOR)

The 15-pin VGA monitor connection is used to display the screen contents on an external screen. The procedure for putting the external monitor into operation is described in the section "Connecting an External Monitor".

Noise Source Control (NOISE SOURCE)

The NOISE SOURCE female connector is used to switch an external noise source on and off in order, for example, to measure the noise figure of DUTs.

Conventional noise sources require a voltage of +28 V in order to be switched on. They are switched off at 0 V. The female connector supplies these switching voltages. The output supports a maximum load of 100 mA.

Input for External Trigger (EXT TRIG/GATE IN)

The EXT TRIG/GATE IN female connector is used to control the measurement by means of an external signal.

The voltage levels are TTL levels (low <0.7 V; high >1.4 V). The typ. input impedance is 10 k Ω .

USB Interface (USB)

Der R&S FSP provides a USB female connector for connecting two USB devices (USB 1.1).

Note: <i>Passive USB connecting cables must not exceed 1 m in length.</i>
--

Trigger Port (Option R&S FSP-B28)

The 25-pin trigger port female connector (option B28) provides a signal at pin 21 that signals that the analyzer is ready to receive a trigger pulse. This signal takes into consideration the analyzer's internal waiting and settling times.

In addition, the following pins are assigned: pin 13 +5 V, pin 25 +12 V, and GND at pin 12 and pin 24. The remaining pins are not assigned.

Pin 1 is located at the upper left of the female connector, and pin 25 at the lower right.

Aux Control (Option R&S FSP-B10)

If option B10 (external generator control) is built in, the R&S FSP provides a female connector that allows measurement data acquisition to be synchronized with the output signal of a Rohde & Schwarz generator.

Reference Input and Output (REF IN und REF OUT)

The REF IN female connector is used as an input for a 10 MHz reference signal. The required input level is ≥ 0 dBm. The REF OUT female connector provides the internal 10 MHz reference signal with a 10 dBm output level for other devices.

The *SETUP* menu is used to select between the internal and external references.

If an external reference is used for operation, the external reference signal from REF IN is looped through to REF OUT.

TG I / AM IN; TG Q / FM IN (Option R&S FSP-B9)

The two female connectors TG I /AM IN and TG Q /FM IN are used to modulate the tracking generator (option R&S FSP-B9) by means of an external signal.

The input voltage range is ± 0.5 V; the input impedance is 50 Ω .

20.4 MHz IF Output (20.4 MHz OUT)

The 20.4 MHz IF signal of the R&S FSP is provided at the 20.4 MHz OUT female BNC connector. For resolution bandwidths between 100 kHz and 10 MHz, the bandwidth corresponds to the selected bandwidth. For bandwidths ≤ 100 kHz, the bandwidth of the output is equal to $2.6 \cdot$ resolution bandwidth, where the minimum value is 2.6 kHz (non-FFT). In the analyzer mode, the level at the IF output in the case of a signal at the reference level is 0 dBm if the resolution bandwidth is ≥ 100 kHz; if the resolution bandwidth is < 100 kHz, the level is -10 dBm (for mixer levels ≥ -60 dBm).

Note: *If the option R&S FSP-B6 is installed, this output is replaced by the CCVS IN/ OUT female connector.*

CCVS Output and Input (CCVS IN/OUT, Option R&S FSP-B6)

The CCVS IN/OUT female BNC connector is a switchable CCVS input/output. If TV triggering is activated and triggering occurs in response to the internal demodulator signal (CCVS INT), the demodulated TV signal is provided for operating an CCVS monitors. If triggering occurs in response to an externally supplied CCVS signal (CCVS EXT), the female connector serves as an input.

LAN Interface (Option B16)

The optional LAN interface can be used to connect to a local network. The assignment of the RJ-45 connector supports twisted-pair category 5 UTP/STP cables in a star configuration (UTP stands for “unshielded twisted pair”, and STP for “shielded twisted pair”).

Second IEC Bus Interface IEC2 (Option R&S FSP-B10)

When equipped with option B10 (external generator control), the instrument provides a second IEC bus interface for using external generators.

Note: *The R&S FSP remote control is not supported via the IEC2 interface.*

2 Putting into Operation

Putting into Operation

This section describes how to put the instrument into operation.

**Caution!**

Before putting the instrument into operation, make sure that the following requirements have been met:

- *The air vents are not blocked.*
- *No signal voltage levels exceeding the permitted limits are present at the inputs.*
- *The instrument's outputs are neither overloaded nor incorrectly connected.*

Not complying with these requirements can result in damage to the instrument.

Unpacking the Instrument

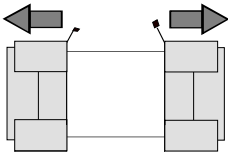

Remove protective caps

- Remove the instrument from its packaging and check the shipment against the packing list to ensure that all items are included. Check the list of accessories for separate articles.
- Remove the two protective covers on the front and rear panels of the R&S FSP and carefully check the instrument for any damage.
- If you find any damage, immediately notify the shipping company. In this case, do not discard the box and packaging material.
- Retain the original packaging in the event that you need to move or ship the R&S FSP in the future in order to avoid any damage to the operating elements and connections. Rohde & Schwarz will accept claims as covered in the warranty only if the instrument is shipped with adequate packaging.

Setting Up the Instrument

The instrument is intended for indoor use. Note the following in this regard:

- The ambient temperature must comply with the range specified in the data sheet.
- Air inflow and outflow via the air vents on the rear panel and through the lateral perforations must not be obstructed. Clearance from walls must be at least 10 cm.
- The mounting surface must be even.

Note: *To protect DUTs against electrostatic discharge in the event of contact, use proper protective equipment:*

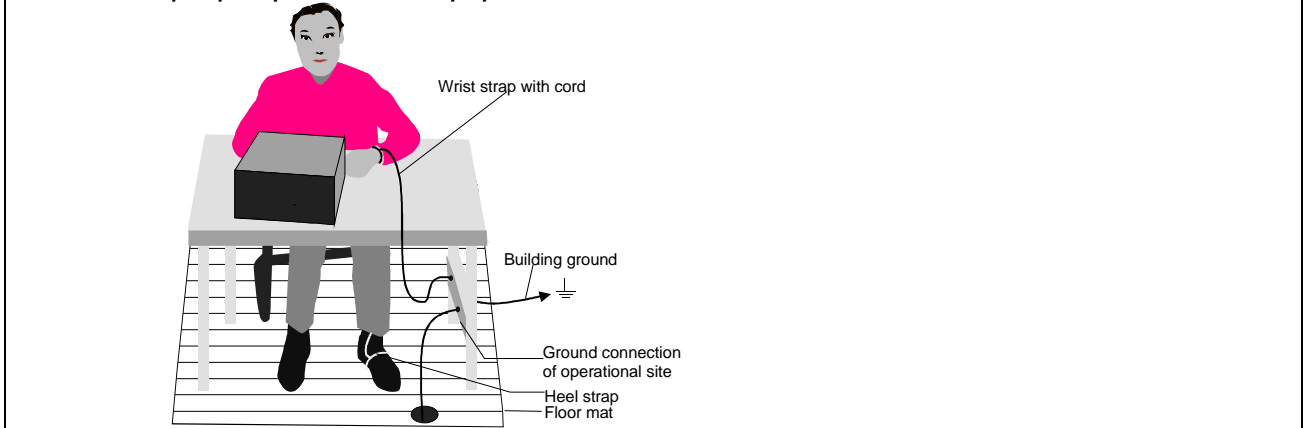

Installation in a 19" rack

The instrument can be installed in a 19" rack by using a rack adapter (see data sheet for order number). The installation instructions are included with the adapter.



Caution!

When the instrument is installed in a rack, make sure that the vents for air inflow on the side panel and the air outlets on the rear panel are not obstructed.

Connecting the Instrument to the AC Power Supply

The FSP is equipped with a mechanism for detecting AC power voltage and automatically sets itself to use the available AC power voltage (range: AC voltage 100 V to 240 V; 50 Hz to 400 Hz). The AC power connector is located on the rear panel of the instrument.

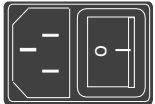

AC power connector

- Connect the R&S FSP to the AC power supply, using the power cable that is supplied.

Since the instrument is assembled in line with the specifications for safety class EN61010, it may only be connected to an outlet that has a ground contact.

Switching on the R&S FSP

- Press the power switch on the rear panel to change it to position I.
- Press the ON/STANDBY switch on the front panel. The green LED will light up.



Caution!

Do not switch off the instrument while it is booting.

Switching it off prematurely can lead to serious data changes on the instrument's hard disk

After being switched on, the R&S FSP displays the following information:

```
Rohde & Schwarz GmbH & Co. KG
Analyzer BIOS      Vx.y
```

A selftest of the computer hardware will be carried out. Windows XP then starts, and the measurement screen will automatically appear with the settings that were present when the instrument was last switched off.

Note: *If you want the instrument to automatically load different settings when it is switched on, define the required configuration in the FILE - STARTUP RECALL menu.*

Functional Test

Note: *The functional test should only be performed when the operating temperature is reached (approx. 15 minutes after the instrument is switched on).*

- Call self- alignment with the CAL key, CAL TOTAL softkey. Once the system correction values have been calculated successfully, the message "Calibration Passed" will appear.
- Start the selftest with the SETUP key, SERVICE – SELFTEST softkeys. Once the instrument modules have been checked successfully, the message "Selftest Passed" will appear.

Once both steps have been completed successfully, the instrument will be ready for operation.

Note: *The selftest does not need to be repeated every time the instrument is switched on. It is necessary only when instrument malfunction is suspected.*

Switching Off the R&S FSP

- Press the ON / STANDBY switch on the front panel.

The R&S FSP will store the current settings on the hard disk and then shut down the software. Once the operation has been completed, the power supply unit will be switched to STANDBY and the yellow LED will come on.



Warning:

In standby mode, the AC supply voltage is still present on the instrument.

- To completely disconnect the instrument from the AC power supply, change the power switch on the rear panel to position O.

Notes:

- 1. The main power switch on the rear panel also interrupts the power supply of the OCXO inside the instrument. When you switch the instrument back on, be sure to adhere to the extended warm-up phase.*
- 2. If you switch off the instrument by using the power switch or by disconnecting the power supply connector, it is not possible to save the current instrument settings on the hard disk. In this case, the last settings that were stored on the hard disk will be loaded when you switch the instrument back on.*

Connecting Peripheral Devices

Connecting an External Keyboard

**Caution:**

Do not connect the keyboard unless the instrument is switched off (STANDBY). Otherwise, proper functioning cannot be ensured due to interactions with the firmware.

An external PC keyboard can be connected to the 6-pin PS/2 KEYBOARD connector on the front panel of the R&S FSP or to the USB interface on the rear panel.

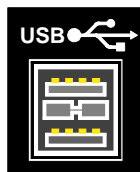
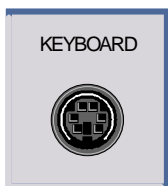

The keyboard simplifies instrument operation and the entry of comments, file names, etc.

Keyboards and mouse devices that conform to USB Standard 1.1 are suitable for connection to the USB interface.

After being connected, the keyboard is automatically detected. The default keyboard language setting is US English. Special settings such as refresh rate, etc, can be made in the Windows XP KEYBOARD menu by selecting START - SETTINGS - CONTROL PANEL - KEYBOARD.

Connecting a Mouse

To simplify Windows XP operation, the R&S FSP allows you to connect a mouse to the USB interface on the rear panel.

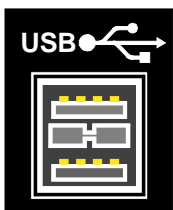

Mouse devices from Microsoft and Logitech are supported.

Note: *If you use a keyboard that contains a trackball for mouse operations, connecting an external mouse in addition may lead to malfunctions.*

After being connected, the mouse is automatically detected. Special settings such as mouse cursor speed, etc, can be made in the Windows XP MOUSE menu by selecting START - SETTINGS - CONTROL PANEL – MOUSE.

Connecting an External Monitor



Caution:

Do not connect a monitor unless the instrument is switched off (STANDBY). Otherwise, you run the risk of damaging the monitor.

Do not change the screen driver ("Display Type") or the screen configuration, as doing so can cause the instrument to malfunction.

You can connect an external monitor at the MONITOR connector on the instrument's rear panel.



After you connect an external monitor, you must restart the instrument so that it will detect the monitor. The measurement display will then appear on both the external screen and on the instrument. No further settings are necessary.

Connecting a Printer

A printer can be connected during operation.

The R&S FSP allows you to create two different printer configurations for printing out a hardcopy of the screen and you can toggle between them by pressing a button. The *DEVICES* table in the *HCOPY* menu lists the available installed printers.

The interfaces for connecting a printer are located on the rear panel.

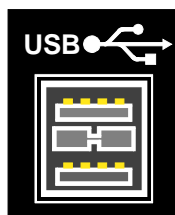
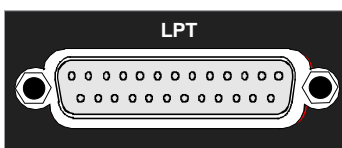

Connecting USB Devices (e.g. a Power Meter)

The USB interface on the rear panel of the R&S FSP allows you to connect up to two USB devices directly to the analyzer. This number can be increased as necessary by inserting USB hubs.

Due to the large number of available USB devices, there is almost no limit to the expansions that are possible with the R&S FSP. The following list shows various USB devices that can be useful for the R&S FSP:

- Power Sensor R&S NRP-Z11 or R&S NRP-Z21
(requires Adapter Cable R&S NRP-Z4)
- Pendrive (memory stick) for easy transfer of data to/from a PC
(e.g. firmware updates)
- CD-ROM drives for easy installation of firmware applications
- PC keyboard for entering comments, file names, etc
- Mouse for easy operation of Windows dialog boxes
- Printer for printing out measurement results
- Modem for remote control of the R&S FSP over large distances

Installing USB devices is easy under Windows XP, because all USB devices are plug&play. All USB devices can be connected to or disconnected from the R&S FSP during operation.

After a device is connected to the USB interface of the R&S FSP, Windows XP automatically searches for a suitable device driver.

If Windows XP does not find a suitable driver, it will prompt you to specify a directory that contains the driver software. If the driver software is on a CD, connect a USB CD-ROM drive to the R&S FSP before proceeding.

When a USB device is subsequently disconnected from the R&S FSP, Windows XP immediately detects the change in hardware configuration and deactivates the corresponding driver.

Example:

Connect a pendrive (memory stick) to the R&S FSP:

1. When you connect the pendrive at the USB interface, Windows XP detects the new hardware:

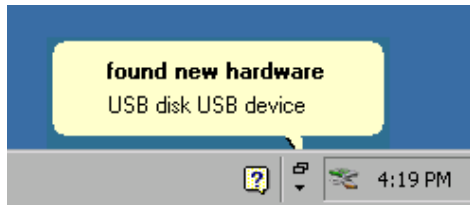

2. Windows XP installs the corresponding driver.
If installation is successful, Windows XP informs you that the device is ready to use:

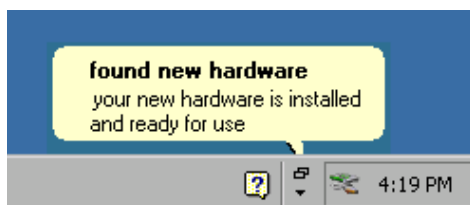

3. The pendrive is made available as a new drive and is displayed under Windows Explorer:

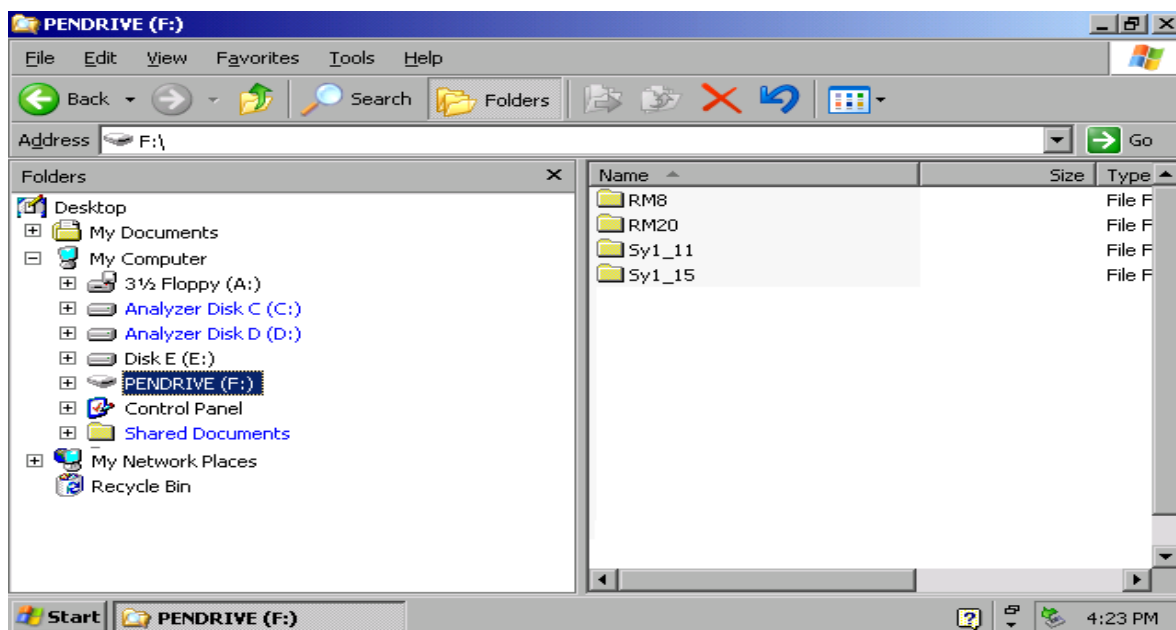

The pendrive can be used like a normal drive to load or store data.

4. If you no longer need the pendrive or if you want to transfer files to another computer, simply disconnect the pendrive. Windows XP will automatically deactivate the driver. If the drive is still selected in Explorer, an error message will appear indicating that the drive is no longer available.

Connecting External Generators

The option External Generator Control R&S FSP-B10 allows you to operate a number of commercially available generators as a tracking generator on the R&S FSP. When suitable generators are used, the R&S FSP thus allows scalar network analysis to be performed also outside the frequency range of the internal tracking generator. Appendix C provides a list of generators supported by the option R&S FSP-B10.

The following figure shows the test setup:

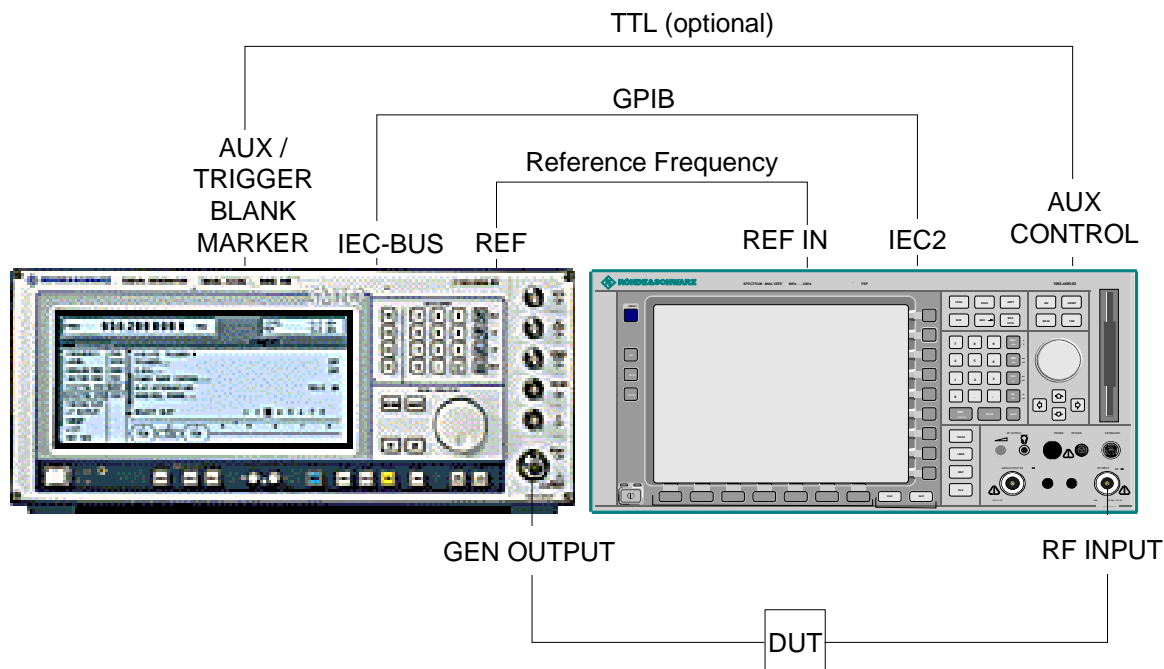

The generator is controlled via the – optional – second IEC bus interface of the R&S FSP (= IEC2, supplied together with the option). With some Rohde & Schwarz generators, it is also controlled via the TTL synchronization interface that is contained in the AUX CONTROL interface of the R&S FSP.

- Notes:**
1. Using the TTL interface allows you to attain significantly higher speeds than possible with a pure IEC bus control, because the frequency switching mechanism of the R&S FSP is directly coupled to the frequency switching mechanism of the generator.
 2. To increase measurement accuracy, use a shared reference frequency to operate the R&S FSP and the generator. If no independent 10 MHz reference frequency is available, connect the reference output of the generator to the reference input of the R&S FSP and use **SETUP – REFERENCE EXT** to configure the R&S FSP to implement the external reference.

Connecting the R&S FSP to the Generator

To couple the frequency setting and level setting of the generator to the R&S FSP, set up the following connections:

1. Connect the IEC bus (GPIB) interface of the generator to the IEC2 connector on the rear panel of the analyzer.
2. (Optional:) Connect the TTL interface of the generator and the R&S FSP.
 - Alternative 1 (R&S SMR, R&S SMU):
Connect the AUX CONTROL connector of the analyzer to the corresponding AUX connector on the rear panel of the generator (the connection cable is supplied together with the option R&S FSP-B10).
 - Alternative 2 (R&S SME, R&S SMP, R&S SMIQ):
Connect the AUX CONTROL connector of the analyzer to the TRIGGER, MARKER and BLANK connectors on the rear panel of the generator (the connection cable is also supplied together with the option R&S FSP-B10). Note the labelling on the TRIGGER, MARKER and BLANK lines.
 - Alternative 3 (R&S SML, R&S SMG/SMGU, R&S SMH/SMHU, R&S SMX/SMY, generators from other manufacturers):
No TTL connection possible.

The generator type determines which one of the possible connections is suitable for the generator. For more information, refer to the operating manual for the generator.

3. Connect the reference frequency output of the generator to the reference frequency input (*REF IN*) of the analyzer.
Alternative:
Connect the reference frequency inputs of the two instruments to an external frequency standard.

Configuring the Generator on the R&S FSP



To configure the generator, press the *NETWORK* hotkey located in the hotkey bar at the lower edge of the screen.



Now complete the following steps:

1. Press the *EXT SOURCE* softkey. The submenu for configuring generators will open
2. Select and configure the generator:
 - Press the *SELECT GENERATOR* softkey. The table containing the generator settings will open. The selection bar will be located in the row *SRC 1* under the column *TYPE*.

SELECT GENERATOR									
SRC	TYPE	IFC	GPIB ADDR	MODE	F MIN	F MAX	P MIN	P MAX	
1	SME03	TTL	28	REMOTE	5kHz	3GHz	-144dBm	16dBm	
2	SMIQ03	GPIB	28	LOCAL	300kHz	3.3GHz	-140dBm	13dBm	

- Press the *ENTER* key. The list of available generators will open.
 - Using the rotary knob, select the desired generator and activate *ENTER* by pressing the rotary knob. The generator list will close, and the selected generator will then appear in the *SELECT GENERATOR* table. Simultaneously, the limits for frequency and output power which you can set on the generator will appear in the *F MIN*, *F MAX*, *P MIN* and *P MAX* fields.
 - Using the  key, move the selection bar to the *IFC* column and press the *ENTER* key. The list of available control interfaces will appear.
 - If the *TTL* interfaces from the R&S FSP and generator are connected, select *TTL* by using the rotary knob and then activate it by pressing the rotary knob.
 - If no *TTL* interface is provided or if the *TTL* interfaces are not connected, select *GPIB* by using the rotary knob and then activate it by pressing the rotary knob.
 - Using the  key, move the selection bar to the *GPIB ADDR* column and press the *ENTER* key. The entry field for the IEC bus address of the generator will open.
 - Enter the IEC bus address of the generator and confirm with *ENTER*. The specified address will be added to the table.
3. Select the reference frequency for the generator:
 - If you want to operate the generator using its internal reference, change the *GEN REF* softkey to the state *INT*.
 - If you want to operate the generator using an external reference, change the *GEN REF* softkey to the state *EXT*.



This concludes the procedure for defining the default setting for the generator.

Note: A second generator configuration can be inserted in advance by repeating the settings in the line SRC 2. This makes it easy to switch from one generator type to another.

Activating the Generator Configuration and Setting the Output Level

To select the active generator configuration, press the *FREQUENCY SWEEP* softkey. The *FREQUENCY SWEEP* table will open, and the selection bar will be located under the *STATE* column in the *SRC 1* row.

FREQUENCY SWEEP						
SOURCE FREQ = REC FREQ * NUM/DEN + OFFSET						
SRC	STATE	POWER[dBm]	NUM	DEN	OFFSET	RESULT
1	✓	-30dBm	1	1	0Hz	0Hz..3GHz *
2		-30dBm	1	1	0Hz	0Hz..3.2GHz

- If you want to use the *SRC 1* generator configuration, insert a checkmark in the field by pressing the *ENTER* key.
- If you want to use the *SRC 2* generator configuration, move the selection bar to the lower line of the table by using the  key. Then activate the generator configuration by pressing the *ENTER* key and set the checkmark in line 2 under the *STATE* column.
- Using the  key, move the selection bar to the *POWER [dBm]* column and press the *ENTER* key.
- Enter the desired output power and confirm with the *dBm* key. The power you entered will appear in the table.

Note: You can also change the output power of the generator by using the *SOURCE POWER* key located in the *NETWORK* menu.

The remaining columns of the table are used to configure frequency-converting measurements. For more information, refer to the section "Option External Generator Control R&S FSP-B10" in the operating manual.

This concludes the procedure for configuring the generator.

Using an External Generator as a Tracking Generator

To activate the external generator as a tracking generator, do the following:

- Switch on the external generator.
- Press the *NETWORK* hotkey on the R&S FSP.
- Press the *EXT SOURCE* softkey.

Tracking generator operation using an external generator will be activated. The external generator will switch to remote control operation and can be used like an internal tracking generator. For more information about measurements with an external tracking generator, refer to the section "Option External Generator Control R&S FSP-B10" in the operating manual.

Test setup:

- Press the *NETWORK* hotkey on the R&S FSP.
- Press the *EXT SOURCE* softkey.
- Change the *EXT SRC* softkey to *OFF* by pressing it.

Note: *When you switch off tracking generator operation using an external generator, control on the IEC bus IEC2 is automatically released and the generator is returned to LOCAL mode.*

R&S FSP Setup

Selecting the Frequency Reference

You can switch the reference signal for frequency processing of the R&S FSP between the internal reference and an external reference signal at 10 MHz as follows:

- Press the *SETUP* key.
The *SETUP* menu will open.
- Press the REFERENCE INT/EXT softkey until it is in the desired state.

Note: *If the reference signal is missing when switchover to the external reference occurs, the message "EXREF" will appear after a few moments, indicating that synchronization has not taken place.
When switchover to an internal reference occurs, note that the external reference signal is removed in order to avoid any interactions with the internal reference signal.*

IEC bus command: ROSC:SOUR INT

Setting the Date and Time

- Press the *SETUP* key.
The *SETUP* menu will open.
- Press the *GENERAL SETUP* softkey.
The submenu with general settings will open.

The *TIME+DATE* softkey activates the *TIME AND DATE* table for entering the time and date for the internal realtime clock.

TIME AND DATE	
Time	12 : 30
Date	11 MAR 2002

Entering the time

Hours and minutes can be entered independently of each other in the entry field:

TIME	
TIME	12 : 30

IEC bus command: SYST:TIME 12,30

Entering the date

The day, month and year can be entered independently of each other in the entry field:

DATE			
DATE	11	Mar	2004

To select the month, use the units key to open a list containing the month names. You can then select the month from the list.

MONTH
JAN
FEB
✓MAR
APR
MAY
JUN
JUL
AUG
SEP
OCT
NOV
DEC

IEC bus command: SYST:DATE 2002,03,11

Setting the IEC Bus Interface

- Press the *SETUP* key.
The *SETUP* menu will open.
- Press the *GENERAL SETUP* softkey.
The submenu with general settings will open.
- Press the *GPIB* softkey.
The submenu for setting the parameters of the remote control interface will open.

IEC Bus Address

- Press the *GPIB ADDRESS* softkey.
The entry field for the IEC bus address will open.

The setting range is from 0 to 30. The default address is 20 if SCPI is selected as the IEC bus language or 18 if an 85xx emulation is selected.

IEC bus command: SYST:COMM:GPIB:ADDR 20

IEC Bus Language

- Press the *GPIB LANGUAGE* softkey.
The list of available remote control languages will open.

The following languages are available:

- SCPI
- 8560E, 8561E, 8562E, 8563E, 8564E, 8565E
- 8566A, 8566B, 8568A, 8568B
- 8594E

Notes: *If "856x" is selected, command recognition uses syntax rules different from those than when "SCPI" is selected. Correspondingly, correct detection of SCPI commands is not ensured in this mode.*

When the selection is changed, the following settings are changed:

SCPI:

- The instrument will perform a PRESET.

856xA/B, 856xE, 8594E:

- The instrument will perform a PRESET.
The following instrument settings will then be changed:

Model	# of Trace Points	Start Freq.	Stop Freq.	Ref Level	Input Coupling
8566A/B	1001	2 GHz	22 GHz	0 dBm	DC (FSU) AC (FSP)
8568A/B	1001	0 Hz	1.5 GHz	0 dBm	AC
8560E	601	0 Hz	2.9 GHz	0 dBm	AC
8561E	601	0 Hz	6.5 GHz	0 dBm	AC
8562E	601	0 Hz	13.2 GHz	0 dBm	AC
8563E	601	0 Hz	26.5 GHz	0 dBm	AC
8564E	601	0 Hz	40 GHz	0 dBm	AC
8565E	601	0 Hz	50 GHz	0 dBm	AC
8594E	401	0 Hz	3 GHz	0 dBm	AC

Notes regarding the selection of 856x for the R&S FSP:

- *The # of trace points is not switched over until the state changes to REMOTE. In the case of switchover to manual operation (LOCAL key), the number of sweep points is always changed to 501.*
- *If necessary, the stop frequency specified in the table is restricted to the corresponding frequency range of the R&S FSP begrenzt.*

```
IEC bus command: SYST:LANG "SCPI" | "8560E" |
                  "8561E" | "8562E" | "8563E" |
                  "8564E" | "8565E" | "8566A" |
                  "8566B" | "8568A" | "8568B" |
                  "8594E"
```

ID Response String

- The *ID STRING FACTORY* softkey selects the default response to the command *IDN?.
IEC bus command: --
- The *ID STRING USER* softkey opens the editor for entering a user-defined response to the command *IDN?. The max. length of the output string is 36 characters.
IEC bus command: --

Setting the Screen Colours

- Press the *DISP* key.
The *DISPLAY* menu will open.
- Press the *CONFIG DISPLAY* softkey.
The submenu for configuring the screen will open.
- The *DEFAULT COLORS 1 and 2* softkeys set the default setting for brightness, tint and colour saturation of all screen objects. The colour schemes are selected in such a manner that all screen elements will be optimally visible regardless whether viewed from above or below. In the instrument's default setting, *DEFAULT COLORS 1* is active.
IEC bus command: DISP:CMAP:DEF1
DISP:CMAP:DEF2

The procedure for setting screen colours and brightness is as follows:

- Press the *NEXT* key.
The side menu for changing the screen colours will open.
The *SELECT OBJECT* softkey activates the selection of screen elements for which the colour setting needs to be changed. Once this selection is made, the *PREDEFINED COLORS*, *BRIGHTNESS*, *TINT* and *SATURATION* softkeys can be used to change the overall colour or the brightness, tint and colour saturation of the selected element.

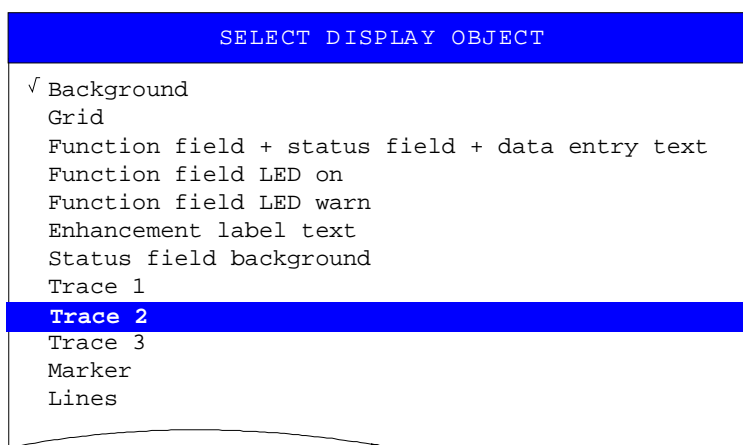

The *BRIGHTNESS* softkey activates entry of the brightness of the selected graphics element.

The entry value is between 0% and 100%.

IEC bus command: DISP:CMAP5:HSL <hue>,<sat>,<lum>

The *TINT* softkey activates entry of the tint for the selected graphics element. The percent value that is entered refers to a continuous colour spectrum that ranges from red (0%) to blue (100%).

IEC bus command: `DISP:CMAP5:HSL <hue>,<sat>,<lum>`

The *SATURATION* softkey activates entry of the colour saturation of the selected element.

The entry value is between 0% and 100%.

IEC bus command: `DISP:CMAP5:HSL <hue>,<sat>,<lum>`

- The *PREDEFINED COLORS* softkey opens a list for selecting predefined colours for the screen objects:



IEC bus command: `DISP:CMAP1 ... 26:PDEF <color>`

Automatically Switching Off the Internal Screen

The R&S FSP provides a feature for automatically switching off the screen after a user-defined period of time. The background lighting will be disabled if no entries are made from the front panel after the selected response time (key, softkey or hardkey and rotary knob).

To activate automatic switch-off:

- Press the *DISP* key.
- Press the *CONFIG DISPLAY* softkey.
- Press the *DISPLAY PWR SAVE* softkey.
The softkey will have a colour background, indicating that the power save mode is active. At the same time, the input window for the response time will open.
- Enter the desired response time in minutes and confirm the entry with the *ENTER* key.
The screen will be disabled (turn dark) after the selected period of time.

To deactivate automatic switch-off:

- Press the *DISP* key.
- Press the *CONFIG DISPLAY* softkey.
- Press the *DISPLAY PWR SAVE* softkey twice.
The colour background of the softkey will disappear.
The power save mode is now switched off.

Selecting and Configuring Printers

- Press the *HCOPY* key.
The *HARDCOPY* menu will open.
- Press the *DEVICE SETUP* softkey.
The dialog box for selecting the file format and printer will open:

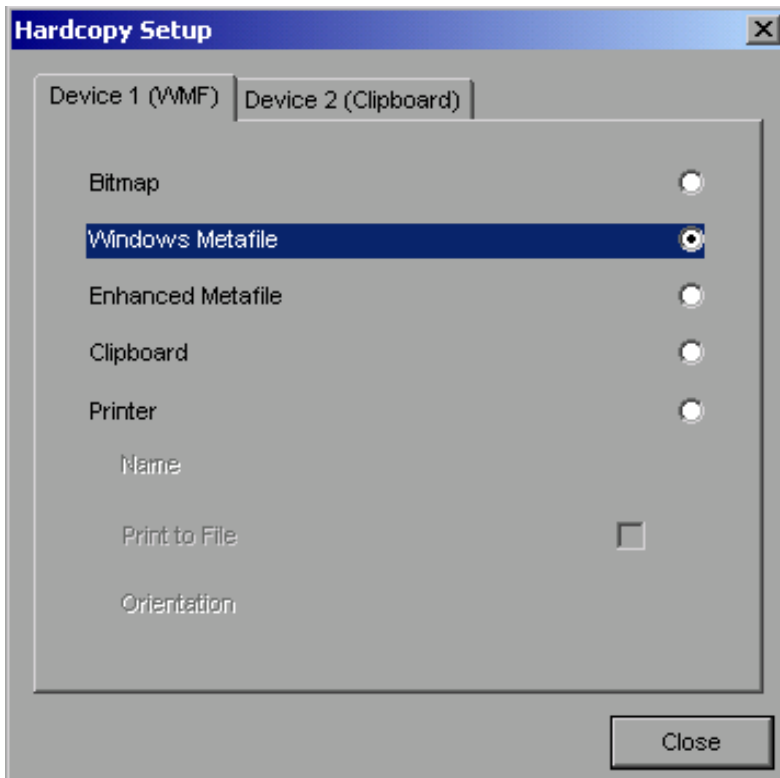

- You can select a connected printer (including a preconfigured network printer) by positioning the selection bar on the *Printer* entry by turning the rotary knob and then confirming the selection by pressing the rotary knob or the *ENTER* key.
After you confirm the selection, the entries *Name*, *Print to File* and *Orientation* will be made available and can also be accessed with the rotary knob.
- To select the printer type, open the selection list by pressing the rotary knob or the *ENTER* key after you access the *Name* field.

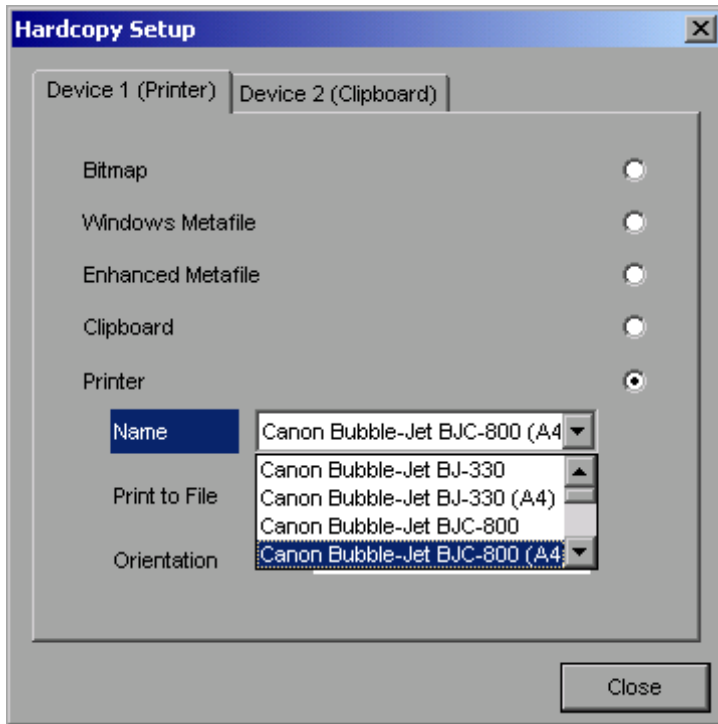

From the selection list, you can now select the printer you want (in the example, this is "Cannon Bubble-Jet BJC800 (A4)") by using the rotary knob again and then confirming your selection with *ENTER* or by pressing the rotary knob. The selection list will then disappear and the entry cursor will return to the *Name* field.

- You can also redirect the output to a file rather than to a printer. To do this, select the field *Print to File* by using the rotary knob and then mark the appropriate selection box or cancel the marking by pressing either the rotary knob or the *ENTER* key:



- You can select orientation for paper printout by using the *Orientation* field. To open the selection list, press the rotary knob or *ENTER*:

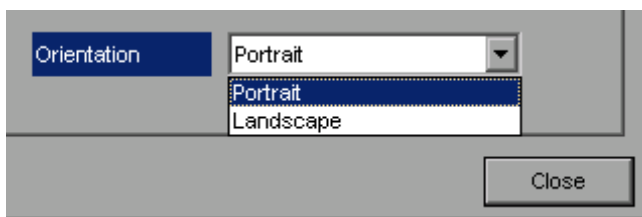

From the selection list, you can now select the orientation you want ("Portrait" in the preceding figure) by using the rotary knob again and then confirm with *ENTER* or by pressing the rotary knob. The selection list will then close and the entry cursor will return to the *Orientation* field.

You can now close the dialog box by pressing the *ESC* key or by selecting and confirming the *Close* button.

Selecting Alternative Printer Configurations

The analyzer can support two independent hardcopy settings. This allows you to quickly switch between output to a file and a printer.

- To make a selection, use the *DEVICE 1 / 2* softkey, which simultaneously shows the associated setting when the "DEVICE SETUP" dialog box is open.

IEC bus command: --

Selecting Printer Colours

- The *COLORS* softkey opens the submenu for selecting the colours for the printout. To make it easier for you to select colours, the selected hardcopy colour combination is displayed on screen when you access the menu. When you exit the menu, the system switches back to the previous colour combination.
- The *COLOR ON OFF* softkey switches from colour output to black-and-white printout. In this case, all background colours will be printed out in white and all colour lines in black. This allows you to improve contrast on the printout. The basic setting is COLOR ON.

IEC bus command: HCOP:DEV:COL ON

- The *SCREEN COLORS* softkey selects the current screen colours for the printout.

Note: *The background will always be printed out in white and the grid in black.*

IEC bus command: HCOP:CMAP:DEF1

- The *OPTIMIZED COLORS* softkey selects an optimized colour setting for the printout in order to improve colour clarity on the printout. With this selection, trace 1 will be printed out in blue, trace 2 in black, trace 3 in green and the markers in turquoise. The other colours correspond to the screen colours of the *DISP – CONFIG DISPLAY - DEFAULT COLORS 1* softkey.

Note: *The background will always be printed out in white and the grid in black.*

IEC bus command: HCOP:CMAP:DEF2

- The *USER DEFINED* softkey opens a submenu for user-defined colour selection (see the *USER DEFINED COLORS* submenu). The procedure for making the settings is similar to that for setting the screen colours.

IEC bus command: HCOP:CMAP:DEF3

Installing Plug&Play Printers

Plug&play printers can easily be installed under Windows XP:

After you connect and switch on a printer, Windows XP automatically detects the printer and installs the associated driver, provided that the driver is contained in the Windows XP installation.

If Windows XP does not find the printer driver, it will prompt you to enter a path for the associated installation files. In addition to the preinstalled drivers, a number of additional printer drivers are found in the D:\I386 directory.

<p>Note: <i>When you install printer drivers that are not preinstalled on the instrument, the installation process will prompt you to specify the path containing the new driver. This can be a disk in drive A. Alternatively, the driver can also be loaded from a memory stick or USB CD-ROM drive (see the section "Connecting USB Devices").</i></p>
--

Installing Non-Plug&Play Printers

The procedure for installing non-plug&play printers is described in the appendix.

Configuring the LAN Interface (only with Option R&S FSP-B16)

The instrument can be connected to an Ethernet LAN (local area network) using the LAN interface connector on the rear panel. This makes it possible to transfer data over the network and to use network printers. In addition, the instrument can be remote-controlled via the network. The network card can be operated with a 10 MHz Ethernet IEEE 802.3 or a 100 MHz Ethernet IEEE 802.3u interface.

Connecting the Instrument to the Network

**Caution:**

Before connecting the instrument to the network, consult your network administrator, particularly in the case of large LAN installations. Connection errors may affect the entire network.

Connect a conventional RJ-45 cable (not supplied) to the rear panel of the instrument and a network hub of the required LAN segment. Since the RJ-45 involves star configuration rather than bus cabling, no special measures need to be taken.

Setting up the connection does not cause any problems on the network. Likewise, disconnecting the instrument from the network does not cause any problems as long as no data traffic to and from the instrument is in progress.

Configuring the Network Card

Installation von Treibern

Under Windows XP, network card drivers do not need to be installed separately if the option FSP-B16 has been factory-installed. All you need to do is connect the network cable to the "LAN-Interface" connector on the instrument rear panel. Windows XP automatically detects the network connection and activates the required drivers.

Configuring the Interface

To configure the interface, do the following:

- Press the SETUP key.
The SETUP menu will open.
- Press the GENERAL SETUP softkey.
The submenu with all general settings will open.
- Press the *CONFIGURE NETWORK* softkey.
The dialog box with the network settings will open.

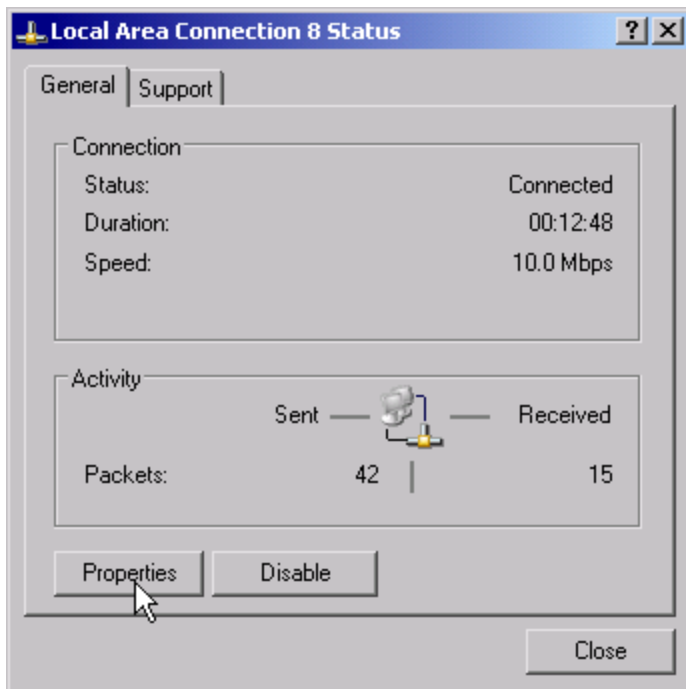

This softkey allows you to change the existing network configuration depending on the selection of the affected registration cards (see section "Configuring Previously Installed Network Protocols" in the section "Option FSP-B16 – LAN Interface").

IEC bus command: -

Note: Before you can configure network support, a PC keyboard with a trackball (or an additional mouse rather than a trackball) must be connected.

Configuring Existing Network Protocols (TCP/IP Protocol)

When you receive the instrument, the TCP/IP network protocol is already preinstalled with IP address 10.0.0.10 and subnet mask 255.255.255.0. The steps that are necessary in order to change this configuration and install additional network protocols are described in this and the following sections.

- Open the Windows XP Start menu by pressing the Windows key or *CTRL-ESC*.
- Click Settings - Network Connections - Local Area Connection.

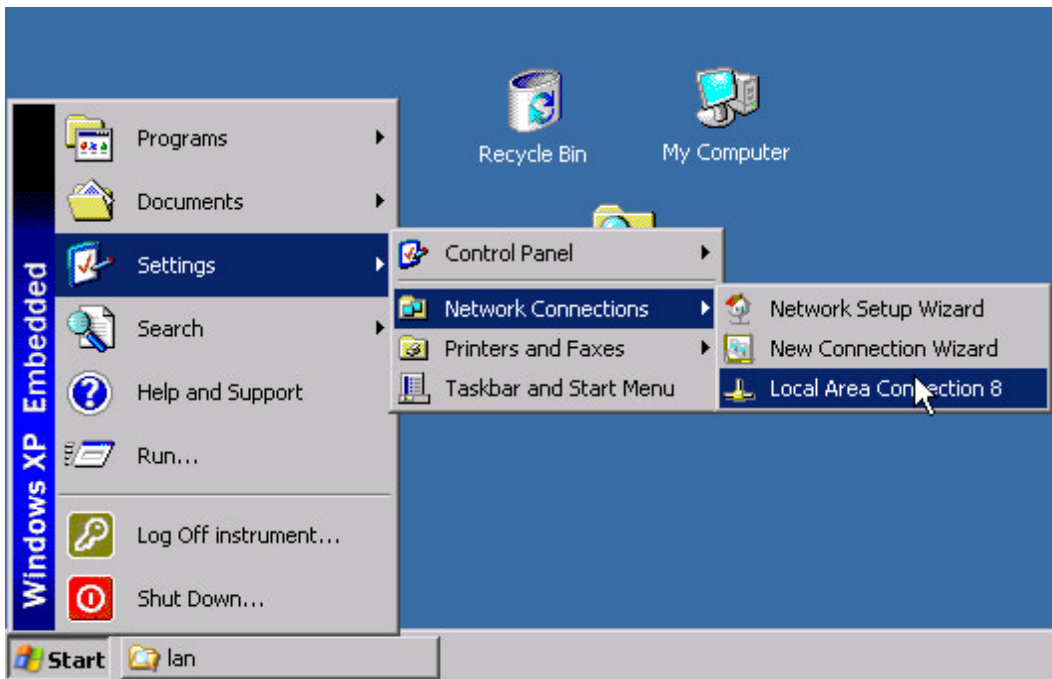

The Local Area Connection Status dialog box will open.

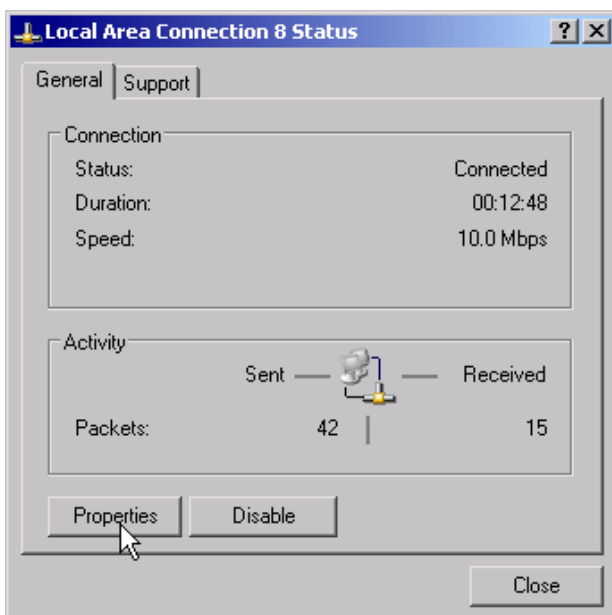

Note: Windows XP automatically appends numbers to the name Local Area Connection Status (e.g. Local Area Connection Status 8) if the configuration is set up using the New Connection wizard. These numbers are not important in the following configuration steps and are therefore omitted.

- Click the *Properties* button.
The window with the available network protocols will open.

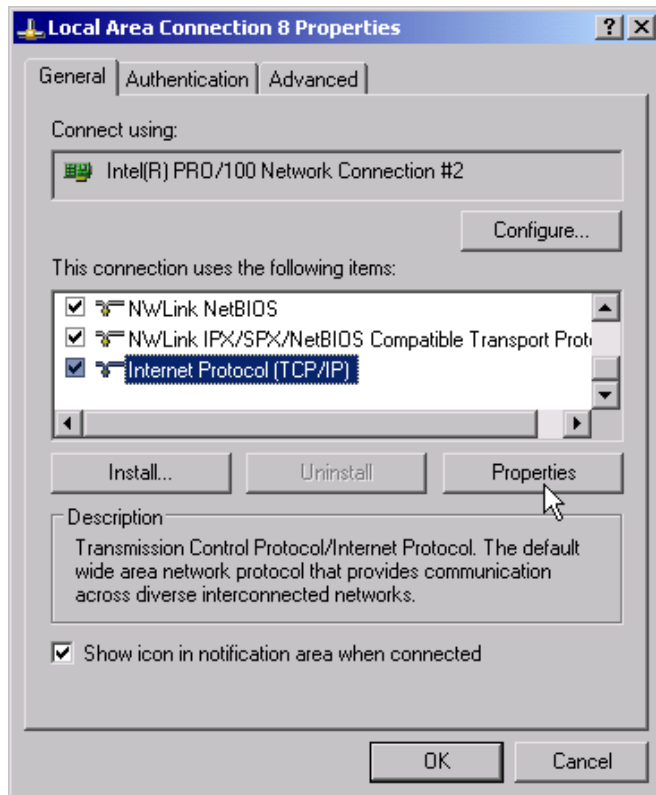

- Click the network protocol you want (TCP/IP in the example).
- Click the *Properties* button.
The dialog box with the settings for the selected network protocol will open.

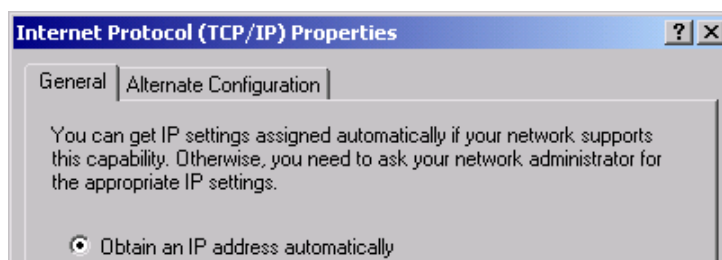

If the IP address will automatically be requested from a DHCP server, select *Obtain an IP address automatically*.

Note: Your network administrator will know whether your network has a DHCP server.

- Click *OK*. Windows will store the configuration.
- If you want to enter a predefined IP address (because, for example, the network does not have a DHCP server), select *Use the following IP address*.

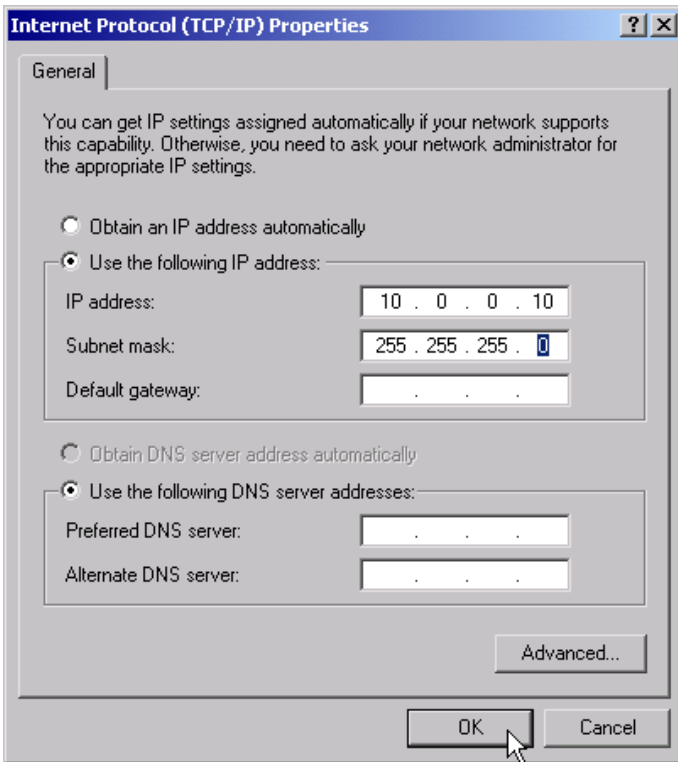

- Select *IP address* and enter the IP address.
- Then select *Subnet mask* and enter the required mask.

Note: *Your network administrator will know which IP addresses and subnet masks are suitable for your network.*

- Click *OK*.
Windows will check the entered settings for correctness and then store the configuration. If you have entered an invalid IP address or subnet mask, an error message will appear that also asks you whether you want to enter a different address or mask:

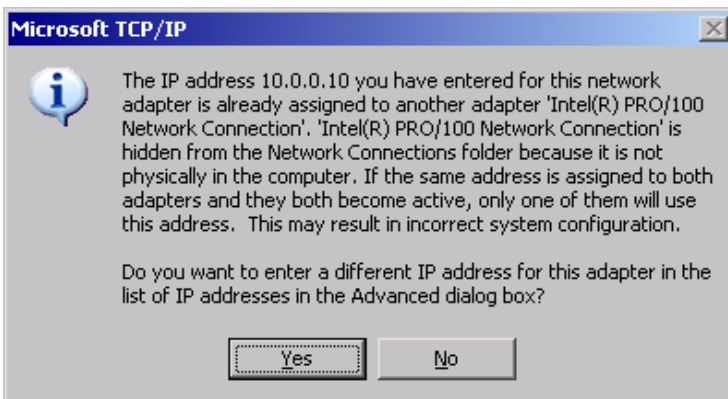

- Click *Yes*.
The dialog box for entering the TCP/IP parameters will open again.
If all settings are correct, you will be prompted to restart the instrument if required by the changes.

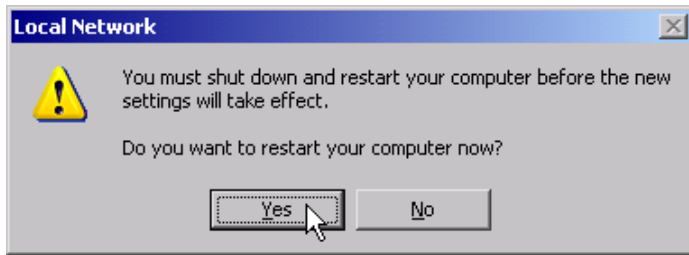

- Click Yes.
Windows will restart the system.

Installing Additional Network Protocols and Services

The procedure for installing additional network protocols and services is provided in the appendix.

Operating System Properties

Properties Specific to Windows XP

The instrument contains the Windows XP Embedded operating system. To ensure that the instrument software functions properly, certain rules must be adhered to when using the operating system.

**Caution:**

The drivers and programs used in the instrument under Windows XP have been adapted to the instrument. To avoid impairments to instrument function, use only the settings described in the operating manual and this manual.

Only update software approved by Rohde & Schwarz may be used to modify existing instrument software.

Likewise, only programs approved by Rohde & Schwarz for use on the instrument may be run on the instrument.

Login

Windows XP requires that users identify themselves by entering a user name and password in a login window. The instrument already includes a factory-installed autologin function, i.e. login is carried out automatically in the background. The predefined user name is "instrument" and the password is also "instrument" (lowercase).

Administrator ID

The ID used by the instrument to perform autologin has administrator rights.

Windows-XP Service Packs

The Windows XP Embedded operating system on the instrument is supplied with pre-installed XP Embedded service packs that are necessary and suitable for operating the instrument.

**Caution:**

To prevent malfunctions, only service packs approved by Rohde & Schwarz may be loaded on the instrument. Malfunctions may necessitate instrument repair in worst cases.

You should be particularly careful not to use service packs from Windows XP Home Edition or Professional Edition because they are not compatible with Windows XP Embedded.

Opening the Windows XP Start Menu

You can open the Windows XP Start menu by pressing the Windows key () or the key combination <CTRL> <ESC>. From the start menu, you can navigate to the submenus by using the mouse or the cursor keys. To return to the measurement screen, activate the "R&S Analyzer Interface" button in the Start bar.

Windows XP Software Approved for the Instrument

The driver software that is used and the system settings of Windows XP have been fine-tuned to support the measurement functions of the R&S FSP. Thus, flawless instrument function is ensured only if software and hardware approved or offered by Rohde & Schwarz are used.

Using other software or hardware may cause the functions of the R&S FSP to perform improperly or fail.

The following program packages have been successfully tested for compatibility with the measurement instrument software:

- R&S FS-K3 – Software for measuring noise factor and gain
- R&S FS-K4 – Software for measuring phase noise
- R&S Power Viewer (virtual power meter for displaying results of the Power Sensor R&S NRP-Z11 and Z21)
- Windows XP Remote Desktop
- FileShredder – For reliable deletion of files on the hard disk
- Symantec Norton AntiVirus – Virus-protection software
- McAfee Virusscan

3 Firmware-Update and Installation of Firmware Options

Firmware Update

You can install a new firmware version by using the built-in disk drive, a memory stick, a USB CD-ROM or a LAN. The firmware update kit contains several disks whose contents must be stored in separate directories (Disk1 to Disk<n>) when a memory stick or LAN is used. Start the installation program from the *SETUP* menu.

- Press the *SETUP* key.
The *SETUP* menu will open.
- Press the *NEXT* key.
The side menu will open.
- Press the *FIRMWARE UPDATE* softkey.
The subdirectory for installing or deinstalling new firmware versions will open.

Press the *UPDATE PATH* softkey (only in the case of firmware updates via a memory stick, CD-ROM or LAN). The entry field for the path with the set of update disks will open.

Enter the drive name and directory and confirm with <ENTER>.

Example: The disk contents are stored on a memory stick in the "Update" directory and in the "Disk1" to "Disk<n>" subdirectories. After you insert the memory stick, it will be detected as drive "E:".

In this case, the required path specification is "E:\UPDATE".

- To start the installation program, press the *FIRMWARE UPDATE* softkey in the submenu. The installation program will then guide you through the remainder of the update procedure.

IEC bus command: "SYST:FIRM:UPD 'E:\UPDATE' "

- To restore the previous firmware version, press the *RESTORE FIRMWARE* softkey.

IEC bus command: --

Activating Firmware Options

Firmware options are enabled by entering license keys via the following operating sequence:

- Press the *SETUP* key.
The *SETUP* menu will open.
- Press the *GENERAL SETUP* softkey.
- Press the *OPTIONS* softkey.
The *OPTIONS* menu will open. Options already available are listed in a table that is displayed when the submenu is opened.

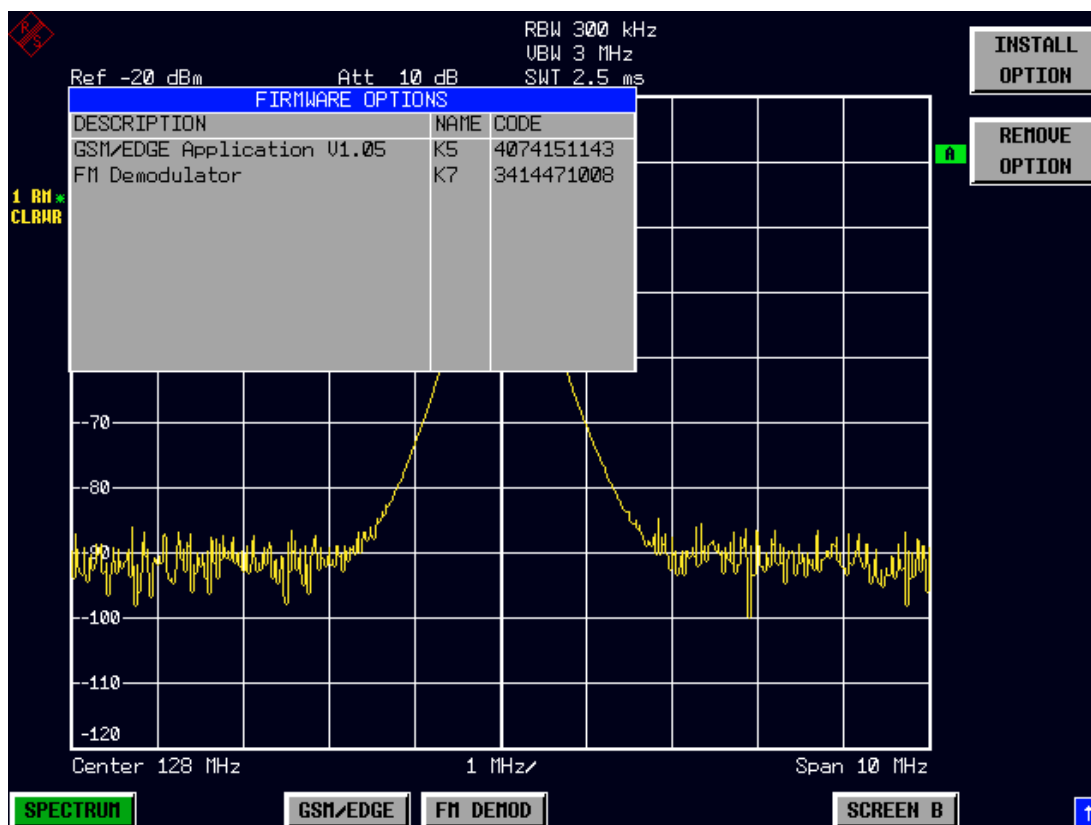

- Press the *INSTALL OPTION* softkey.
The field for entering the license key for the firmware option now appears.
After you enter a valid license key, *OPTION KEY OK* will appear in the message line and the option will be entered in the *FIRMWARE OPTIONS* table.
If you enter an invalid license key, the message *OPTION KEY INVALID* will appear in the message line.
- The *REMOVE OPTION* softkey deletes all existing firmware options. To prevent unintentional deletion, the system asks you to confirm that you really want to perform this operation.

4 Brief Introduction

Diagram Layout

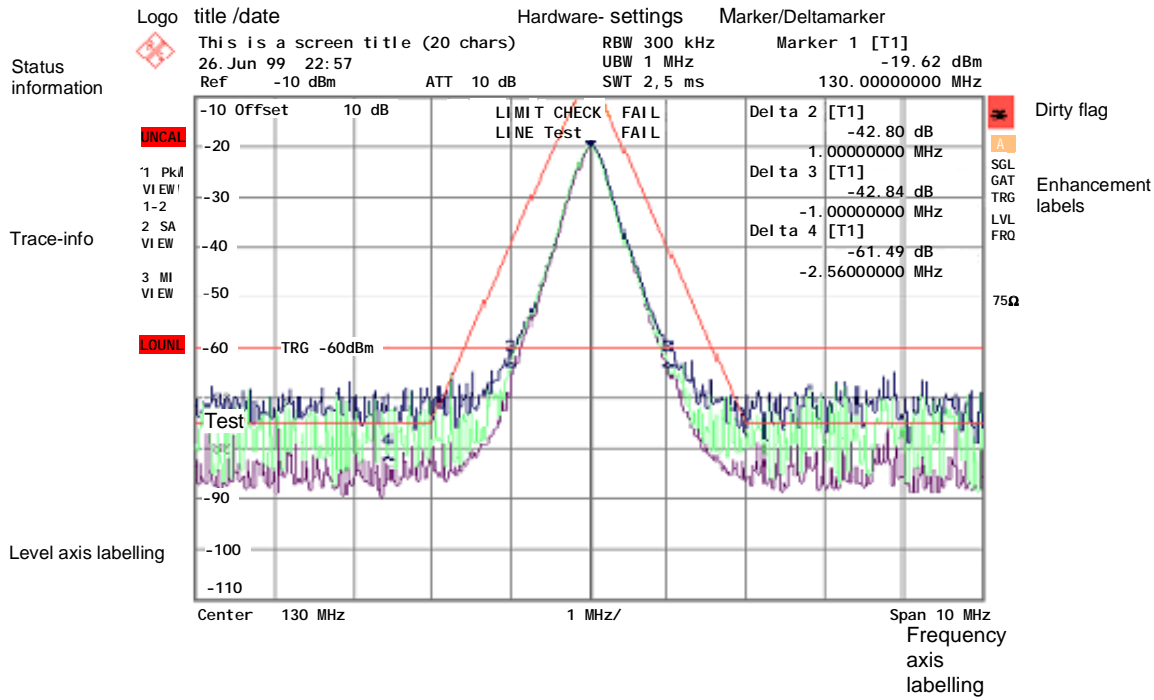

Fig. 4-1 Screen layout of the R&S FSP during analyzer operation

Displays in the Diagram Area

Hardware settings

Ref	Display of the reference level.
Offset	Display of the reference level offset.
Att	Display of the RF attenuation that has been set.
EATT	Display of the set RF attenuation when an electronic attenuator is used (only with option Electronic Attenuator, B25).
RBW	Display of the resolution bandwidth that has been set. If the bandwidth does not correspond to the value for automatic coupling, a green asterisk "*" will appear in front of the field.
VBW	Display of the video bandwidth that has been set. If the bandwidth does not correspond to the value for automatic coupling, a green asterisk "*" will appear in front of the field.
SWT	Display of the sweep time that has been set (<i>SWEEP TIME</i>). If the sweep time does not correspond to the value for automatic coupling, an asterisk "*" will appear in front of the field. The color of the asterisk will turn to red if the sweep time is set below the value for automatic coupling. In this case, the sweep time must be increased.
Marker / Delta	<p>Contains the x and y axis positions of the last marker or delta marker that was set as well as its index. The value in the square brackets after the index indicates the trace to which the marker is assigned as well as the active measurement function.</p> <p>The measurement functions of the markers are indicated with the following abbreviations:</p> <ul style="list-style-type: none"> • FXD Reference fixed marker active • PHN Phase noise measurement active • CNT Frequency counter active • TRK Signal track active • NOI Noise measurement active • MOD Measurement of the AM modulation depth active • TOI TOI measurement active
LIMIT CHECK	Display of the results of the limit check.

Status displays

The status displays on the left side of the diagram indicate any irregularities (e.g. UNCAL).

UNCAL "UNCAL" indicates that one of the following conditions is present:

- Correction data has been switched off (menu CAL, CAL CORR OFF).
⇒ Switch on the correction CAL CORR ON or PRESET.
- No valid correction values are available. This occurs, for example, if a firmware update is performed followed by a cold start of the instrument.
⇒ Record the correction data.

OVLD "OVLD" indicates an overload of the input mixer.

⇒ Increase the RF attenuation.

IFOVL "IFOVL" indicates an overload of the IF signal path after the input mixer.

⇒ Increase the reference level.

LOUNL "LOUNL" indicates that an error was detected in the instrument's frequency processing hardware.

EXREF "EXREF" is displayed if the instrument was set to an external reference but no signal was detected on the reference input.

OVEN "OVEN" indicates that the OCXO reference frequency (option B4) has not yet reached its operating temperature. The message usually disappears a few minutes after power-on.

Trace information

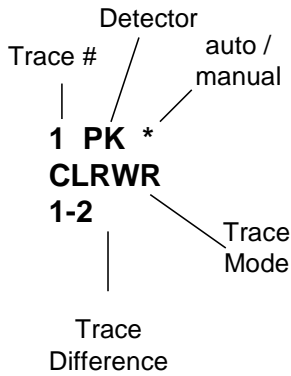

Trace # = Trace number (1 to 3)

Detector = Selected detector:
AP: AUTOPEAK detector
PK: MAX PEAK detector
MI: MIN PEAK detector
SA: SAMPLE detector
AV: AVERAGE detector
RM: RMS detector
QP: QUASIPeAK detector

auto / manual = The selected detector does not match the one for automatic coupling.

Trace Mode = Display of the sweep mode:
CLRWR: CLEAR/WRITE
MAXH: MAX HOLD
MINH: MIN HOLD
AVG: AVERAGE
VIEW: VIEW

Trace-Mathematik = Indicates that the trace difference function is activated.
1 - 2 Trace 1 - Trace 2
1 - 3: Trace 1 - Trace 3

Enhancement labels:

The enhancement labels on the right-hand side of the measurement diagram indicate that the user chose instrument settings that affect the measurement results even though this is not immediately apparent from the display of the measured values.

- * The current instrument setting does not match the one during which the displayed traces were recorded. This occurs in the following cases:
 - The instrument setting is changed while a measurement is in progress.
 - The instrument setting is changed in the SINGLE SWEEP mode after the end of the sweep, and a new sweep is not started.
 - The instrument setting is changed after a trace has been set to VIEW.

The display remains on screen until the user eliminates the cause. In some cases, this involves starting a new sweep (SINGLE SWEEP mode) or switching the affected trace to BLANK.

A / B Designation for screen A / B. If screen A / B is activated for entering measurement parameters, the label background will be in color.

SGL The sweep is set to SINGLE SWEEP.

GAT The frequency sweep is controlled via the *EXT TRIG/GATE* connector.

TRG Instrument triggering is not free running (\neq *FREE RUN*).

LVL A level offset \neq 0 dB is set.

FRQ A frequency offset \neq 0 Hz is set.

TDF A *TRANSDUCER FACTOR* is activated.

PRN Printer output is active.

75 Ω The input impedance of the instrument is set to 75 Ω .

EXT The instrument is configured for operation with an external reference.

PA The RF PREAMPLIFIER is switched on (option B25).

Setting Parameters

The Keypad



The keypad is used to enter numeric parameters. It contains the following keys:

- Numeric keys 0...9
- Decimal point
Inserts a decimal point "." at the cursor position.
- Sign key
Changes the sign of a numeric parameter.
In the case of an alphanumeric parameter, inserts a "-" at the cursor position.
- Unit keys (*GHz/-dBm MHz/dBm, kHz/dB and Hz/dB*)
These keys add the selected unit to the entered numeric value and complete the entry.
In the case of level entries (e.g. in dB) or dimensionless values, all units have the value "1" as multiplying factor. Thus, they have the same function as an *ENTER* key. The same is true for an alphanumeric entry.
In addition, the unit keys open and close selection fields in tables (subtables).
- *BACK* key
 - If a numeric entry has already been started, this key deletes the character to the left of the cursor.
 - If an entry has been completed or not yet started, this key toggles between the currently and previously valid value (UNDO function).
- *ESC/CANCEL* key
 - Closes the entry field if an entry has been started or has not yet been made. The original value is retained.
 - Closes the entry field if an entry has been completed.
 - Closes the "System Messages" window.
- *ENTER* key
 - Concludes the entry of dimensionless entries. The new value is accepted.

Note: With frequency entries, the *ENTER* key corresponds to the Hz key. With time data, it corresponds to the $\mu\text{s}(\text{kHz})$ key.

The Rotary Knob and Cursor Keys

The rotary knob and cursor keys are located next to the keypad.

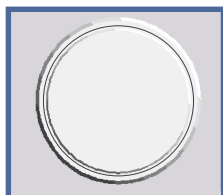

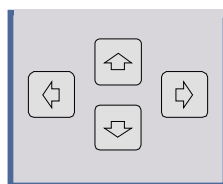

The rotary knob has several functions:

- Increments (clockwise direction) or decrements (counterclockwise direction) the instrument parameter at a defined step width in the case of a numeric entry.
- Shifts the selection bar horizontally or vertically within tables as long as an entry field is not open. The cursor keys are used to change the direction of motion (horizontal/vertical).
- Selects the individual letters when the alphanumeric editor is used.
- Shifts markers, limit lines, etc on the screen.
- When it is pressed, it concludes an entry.



Within a table, the cursor keys move the selection bar to the desired position.

Within the alphanumeric editor, the  or  cursor keys move the cursor to the desired position.

The  or  cursor keys do the following:

- Increase or decrease the instrument parameter in the case of numeric entries.
- Switch between the editing line and the character selection in the case of alphanumeric entries.

Editing Numeric Parameters

Numeric values are always entered in a data entry field that automatically appears after the parameter is selected.

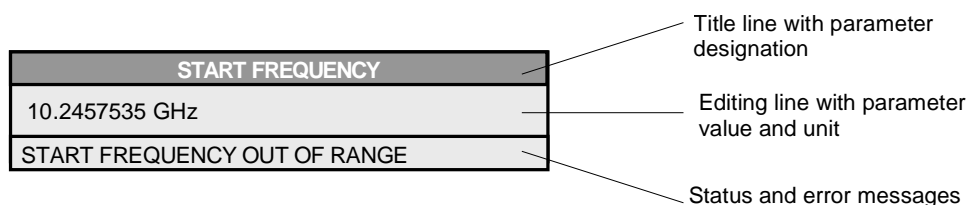

The title line shows the name of the instrument parameter that was selected. The entry is performed in the editing line. After the entry field is opened, it will contain the currently valid parameter value and its unit. The optional third and fourth lines show status and error messages which always refer to the current entry.

Editing Alphanumeric Parameters

If an external keyboard is not available, the character selection field is automatically opened for entering alphanumeric parameters. Two models of the alphanumeric editor are available.

Alphanumeric Editor Type 1:

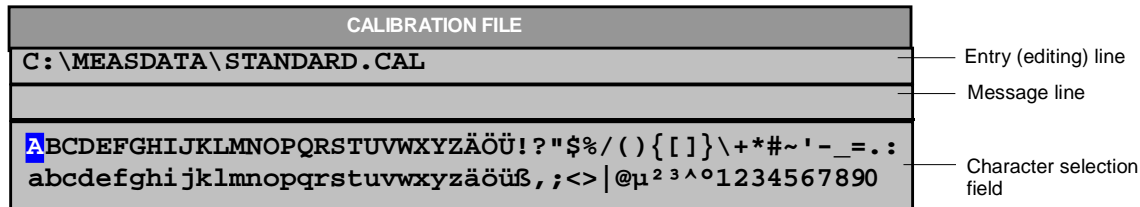

The or cursor keys switch between the editing line and the character selection field.

Entering the text

- Select the parameter.
Data entry is automatically activated after the data entry field is opened. The cursor is now located at the start of the previous entry in the editing line.
- Using the cursor key, place the cursor in the character selection field.
The cursor now marks the first letter of the editor.
- Using the or cursor keys or the rotary knob, place the cursor on the character that you want to enter in the editing line.
- Press either the ENTER key or the rotary knob.
The character will be added to the editing line.

Correcting the entry

- Using the cursor key, place the cursor in the editing line.
- Using the and cursor keys or the rotary knob, place the cursor after the character you want to delete.
- Press the *BACK* key.
The entry to the left of the cursor will be deleted.

Correcting the entry

- Using the key, place the cursor in the editing line.
- Press one of the unit keys or the rotary knob.
The data entry field will close, and the new entry will be accepted by the instrument.

Cancelling the entry



- Press the *ESC* key.
The data entry field will close, and the previous entry will be retained.

Alphanumeric Editor Type 2:





													1	2	3	4	5	6	7	8	9	0
A	B	C	D	E	F	G	H	I	J	K	L	M	:	\	.	/	*	+	-	=	,	
H	O	P	Q	R	S	T	U	V	W	X	Y	Z	<	>	()	{	}	[]	#	~
a	b	c	d	e	f	g	h	i	j	k	l	m	'	@	:		?	!	"	€	\$	%
n	o	p	q	r	s	t	u	v	w	x	y	z	«	»	BACK		EXIT					
SPACE																						

The entry area consists of two parts:

- The editing line
- The character selection field

The  or  cursor keys switch between the editing line and the character selection field.



Entering the text

- Select a parameter.
Data entry is automatically activated after the data entry field is opened. In tables, the character selection field is accessed by using the  cursor key.
The cursor is now located at the start of the existing entry in the editing line.
- Using the  cursor key, place the cursor in the character selection field.
The cursor now marks the first character of the editor.
- Using the  or  cursor keys or the rotary knob, place the cursor on the character that you want to enter in the editing line.
- Press the ENTER key or the rotary knob.
The character will be added to the editing line.

Correcting the entry (alternative 1)

- Using the rotary knob, go to the << character in the character selection field.
- By pressing the rotary knob on << and >>, place the cursor after the character you want to delete.
- Using the rotary knob, select the *BACK* field and press the rotary knob.
The entry to the left of the cursor in the editing line will be deleted.

Correcting the entry (alternative 2)

- Using the  cursor key, place the cursor in the editing line.
- Using the  and  cursor keys or the rotary knob, place the cursor after the character you want to delete.
- Press the BACK key.
The entry to the left of the cursor will be deleted.

Completing the entry (alternative 1)

- Using the rotary knob, select the EXIT field and then press the rotary knob.
The data entry field will close, and the new entry will be accepted by the instrument.

Completing the entry (alternative 2)

- Using the  cursor key, place the cursor by the editing line.
- Press one of the unit keys or the rotary knob.
The data entry field will close, and the new entry will be accepted by the instrument.

Cancelling the entry

- Press the *ESC* key.
The data entry field will close, and the previous entry will be retained.

5 Introduction

This section provides a brief introduction on operating the Spectrum Analyzer R&S FSP. A more detailed discussion of the basic operating steps, e.g. selecting menus and setting parameters, plus measurement examples are provided in chapters 2, 3 and 4 of the operating manual.

Measuring a Sinusoidal Signal

One of the most common measurement tasks that can be handled by using a spectrum analyzer is determining the level and frequency of a signal. When measuring an unknown signal, you can usually start with the PRESET setting.

Note: *If levels higher than +30 dBm (=1 W) are expected or are possible, a power attenuator must be inserted before the RF input of the analyzer. If this is not done, signal levels exceeding 30 dBm can damage the RF attenuator or the input mixer. The total power of all signals that are present must be taken into account.*

In the following examples, a signal generator is used as a signal source.

Test setup:

Connect the RF output of the signal generator to the RF input of R&S FSP.

Settings on the signal generator:

Frequency: 128 MHz
Level: -30 dBm

Measuring the Level and Frequency with Markers

The level and frequency of a sinusoidal signal can be measured easily by using the marker function. The R&S FSP always displays its amplitude and frequency at the marker position. The frequency measurement uncertainty is determined by the reference frequency of the R&S FSP, the resolution of the marker frequency display and the resolution of the screen.

Procedure

1. Reset the instrument.

- Press the *PRESET* key

2. Connect the signal to be measured to the RF INPUT analyzer input on the instrument front panel.

3. Set the center frequency to 128 MHz.

- Press the *FREQ* key.
The entry field for the center frequency appears on screen.
- Using the numeric keypad in the input field, enter 128 and confirm the entry with the *MHz* key.

4. Reduce the frequency span (SPAN) to 1 MHz.

- Press the SPAN key.
- Using the numeric keypad in the input field, enter 1 and confirm the entry with the MHz key.

Note: When the frequency span is defined, the resolution bandwidth (RES BW), the video bandwidth (VIDEO BW) and the sweep time (SWEEP TIME) are automatically reset, because these functions are linked in the PRESET setting.

5. Measure the level and frequency using the marker and read the results from the screen.

- Press the MKR key.
The marker is activated and automatically jumps to the maximum of the trace.

Note: When a marker is initially activated, it automatically performs the PEAK SEARCH function (as shown in the example).
If a marker was already active, you have to press the PEAK key in the MKR-> menu in order to set the currently active marker to the maximum of the displayed signal.

The level and frequency values measured by the marker are displayed in the marker field at the top edge of the screen. They can be taken as the measurement result.

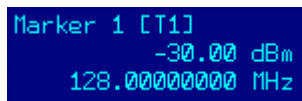

```
Marker 1 [T1]
      -30.00 dBm
      128.00000000 MHz
```

The field header indicates the number of the marker (MARKER 1) and the trace on which the marker is located ([T1] = Trace 1).

Increasing the Frequency Resolution

The frequency resolution of the marker is predefined by the pixel resolution of the trace. A trace uses 501 pixels, i.e. when the frequency span is 1 MHz, each pixel corresponds to a span of approx. 2 kHz. This corresponds to a maximum uncertainty of 1 kHz. You can increase the pixel resolution of the trace by reducing the frequency span.

1. Reduce the frequency span (SPAN) to 10 kHz.

- Press the SPAN key.
- Using the numeric keypad, enter 10 in the entry field and confirm the entry with the kHz key.

The generator signal is measured using a span of 10 kHz. The pixel resolution of the trace is now approx. 20 Hz (10 kHz span / 501 pixels), i.e. the precision of the marker frequency display increases to approx. ± 10 Hz.

Setting the Reference Level

With spectrum analyzers, the reference level (REF LEVEL) is the level at the upper limit of the diagram. To achieve the widest dynamic range possible for a spectrum measurement, use the entire level span of the spectrum analyzer. In other words, the highest level that occurs in the spectrum must be located at the top edge of the diagram (=reference level) or immediately below it.

Note: *If the reference level that is selected is less than the highest signal that occurs in the spectrum, the signal path in the R&S FSP will be overloaded. In this case, the message IFOVL will appear on the left-hand edge of the diagram.*

In the preset setting, the value of the reference level is -20 dBm. If the input signal is -30 dBm, the reference level can be reduced by 20 dB without causing the signal path to be overloaded.

1. Reduce the reference level by 10 dB.

- Press the *AMPT* key.
The *AMPT* menu will appear in the softkey bar. The *REF LEVEL* softkey will be highlighted in red to indicate that it is activated for data entry. The entry field for the reference level is also opened and displays a value of -20 dBm.

- Using the numeric keypad, enter 30 and confirm the entry with the *-dBm* key.

The reference level is now set to -30 dBm. The maximum of the trace is near the maximum of the measurement diagram. However, the increase in the displayed noise is not substantial. Thus, the distance between the signal maximum and the noise display (=dynamic range) has increased.

2. Setting the marker level equal to the reference level

The marker can also be used to shift the maximum value of the trace directly to the top edge of the diagram. If the marker is located at the maximum level of the trace (as in this example), the reference level can be moved to the marker level as follows:

- Press the *MKR*⇒ key.
- Press the *REF LVL = MKR LVL* softkey.
The reference level will be set equal to the measured level where the marker is located.

Thus, setting the reference level is reduced to two keystrokes.

Measuring the Signal Frequency using the Frequency Counter

The built-in frequency counter makes it possible to measure the frequency more precisely than measuring it with the marker. The frequency sweep is stopped at the marker, and the R&S FSP measures the frequency of the signal at the marker position.

In the following example, the frequency of the generator at 128 MHz is shown by using the marker.

1. Set the spectrum analyzer to the default state.

- Press the PRESET key.
The R&S FSP is in the default state.

2. Set the center frequency and the span.

- Press the *FREQ* key and enter *128 MHz*.
The center frequency of the R&S FSP is set to 128 MHz.
- Press the *SPAN* softkey and enter *1 MHz*.
The frequency span of the R&S FSPs set to 1 MHz.

3. Activate the marker

- Press the MKR key.
The marker is activated and set to the signal maximum. The level and the frequency of the marker are displayed in the marker information field.

4. Activate the frequency counter.

- Press the *SIGNAL COUNT* softkey in the marker menu.
The result of frequency counting is displayed in the selected resolution (1 kHz in the default state) in the marker field at the top edge of the screen.

5. Set the resolution of the frequency counter to 1 Hz.

- Go to the right-hand side menu of the marker menu (press the *NEXT* key.).
- Press the *CNT RESOL 1 Hz* softkey.

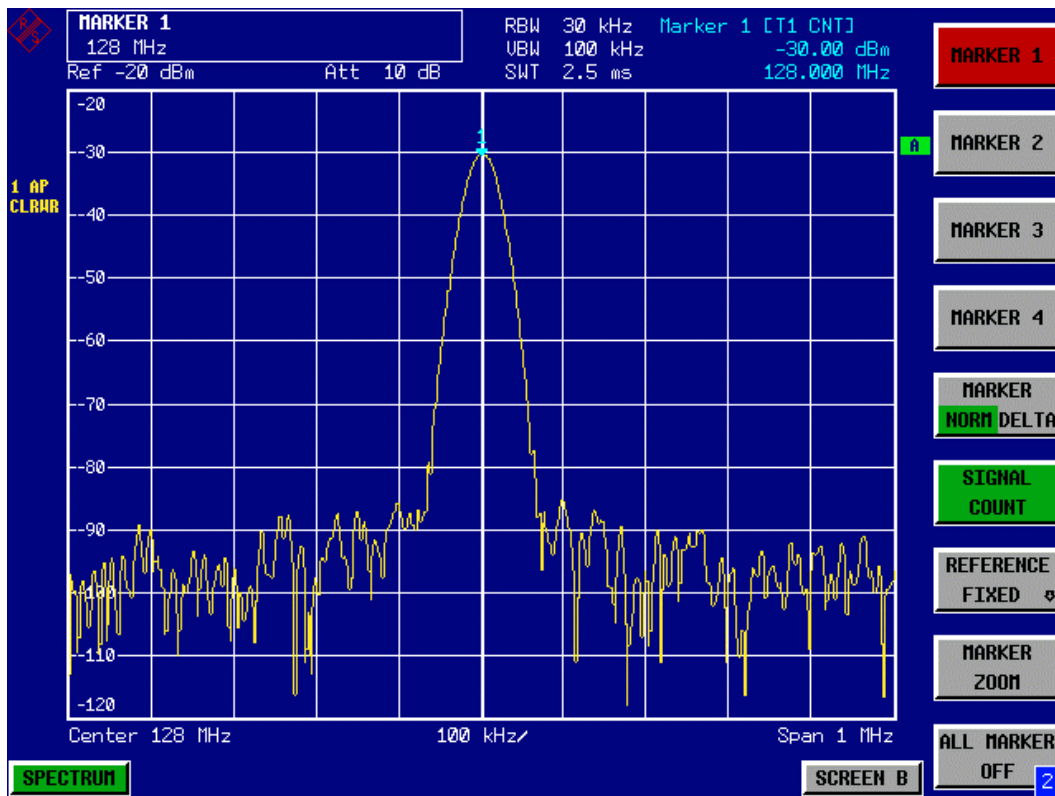

Fig. 5-1 Measurement of the frequency with the frequency counter

Note: Obtaining a correct result when measuring the frequency with the internal frequency counter requires that an RF sinusoidal signal or a spectral line be present. The marker must be located more than 25 dB above the noise level to ensure that the specified measurement accuracy is adhered to.

Tip: For bandwidths between 300 kHz and 10 MHz, the time for measuring the frequency is inversely proportional to the selected resolution, i.e. a resolution of 1 Hz requires a gate time of 1 second for the counter. For digital bandwidths of less than 300 kHz, the time for measuring the frequency is always approx. 30 ms and is not affected by the resolution that is set. Thus, when measuring the frequency of a sinusoidal carrier that has high resolution, set the resolution bandwidth to 100 kHz or less.

Measuring Harmonics of Sinusoidal Signals

Measuring the harmonics of a signal is a very common task that can be optimally performed by using a spectrum analyzer.

In the following example, the generator signal with 128 MHz and -30 dBm is used again.

Measuring the Suppression of the First and Second Harmonic of an Input Signal

1. *Spektrumanalysator in den Grundzustand setzen.*

- Press the *PRESET* key.
The R&S FSP is now in the default state.

2. *Set the start frequency to 100 MHz and the stop frequency to 400 MHz.*

- Press the *FREQ* key.
- Press the *START* softkey drücken and enter *100 MHz* eingeben.
- Press the *STOP* softkey and enter *400 MHz*.
The R&S FSP displays the fundamental and the first and second harmonics of the input signal.

3. *For maximum sensitivity, set the RF attenuation to 0 dB.*

- Press the *AMPT* key.
- Press the *RF ATTEN MANUAL* softkey and enter *0 dB*.

4. *To average (suppress) the noise, reduce the video bandwidth.*

- Press the *BW* key.
- Press the *COUPLING RATIO* softkey.
- Using the cursor keys, select *RBW/VBW NOISE [10]*.

The video bandwidth (VBW) will now always be set to less than the resolution bandwidth (RBW) by a factor of 10.

5. *Activate the marker.*

- Press the *MKR* key.
Marker 1 will be activated and positioned to the signal maximum (fundamental at 128 MHz).
The level and frequency of the marker will be displayed in the marker information field.

6. Activate the delta marker and measure the harmonic suppression.

- Press the **MARKER 2** softkey in the marker menu.
Marker 2 will be activated as the delta marker (Delta 2 [T1]). It automatically appears on the largest harmonic of the signal. The frequency offset and level offset from marker 1 are displayed in the marker field at the top edge of the screen.
- Press the **MARKER 3** softkey in the marker menu.
Marker 3 is activated as the delta marker (Delta 3 [T1]). It automatically appears on the next largest harmonic of the signal. The frequency offset and level offset from marker 1 on the fundamental are displayed in the marker field at the top edge of the screen. (see Fig. 5-3)

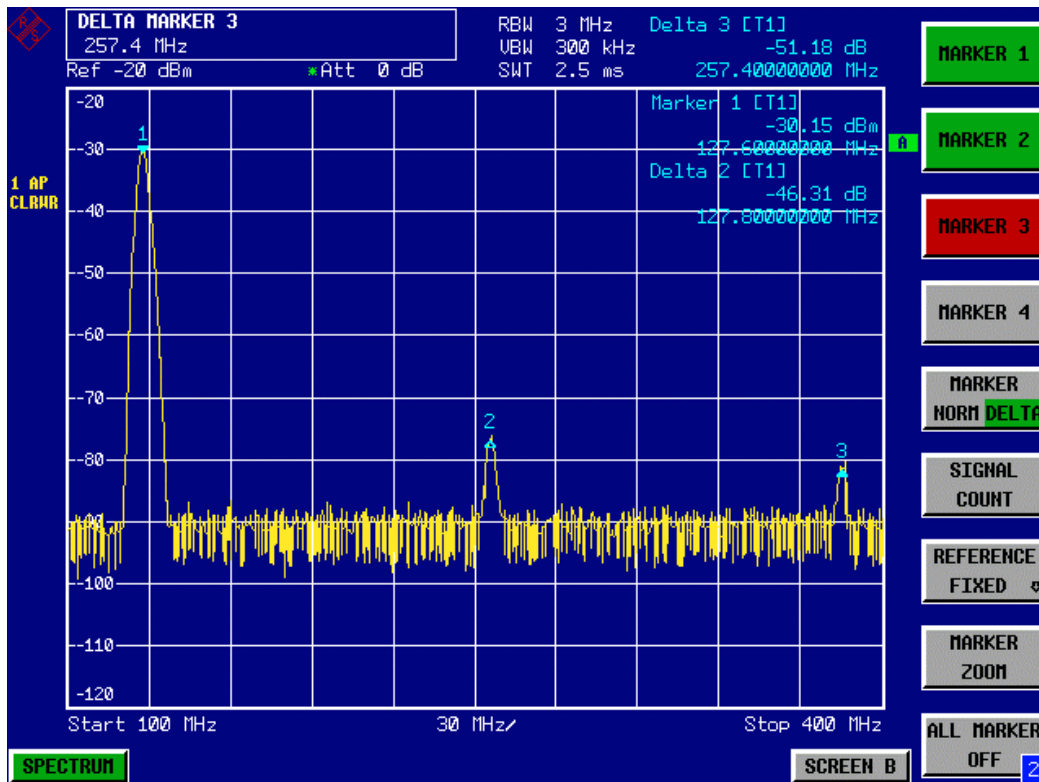

Fig. 5-3 Measuring the harmonic suppression of the internal reference generator. Markers delta 2 [T1] and delta 3 [T1] show the offset of the first and second harmonics from the fundamental.

Reducing Noise

The spectrum analyzer offers three means of effectively differentiating the harmonics of a signal from the noise:

- Reducing the video bandwidth
- Averaging the trace
- Reducing the resolution bandwidth

Reducing the video bandwidth and averaging the traces cause the noise from the analyzer or the DUT to be reduced, depending on which component is larger. Both averaging methods reduce the measurement uncertainty particularly in the case of small signal-to-noise ratios, because the measurement signal is also separated from the noise.

1. Reducing the noise by reducing the video bandwidth.

- Press the *BW* key.
- Press the *VIDEO BW MANUAL* softkey.
- Using the rotary knob (turning it counterclockwise), reduce the video bandwidth to 10 kHz (for example), or enter 10 kHz.

This clearly smooths the noise, and the sweep time will increase to 25 ms. In other words, the measurement will clearly take more time. The video bandwidth that is shown in the display is marked with an asterisk (*VBW) to indicate that it is no longer coupled to the resolution bandwidth (see Fig. 5-4).

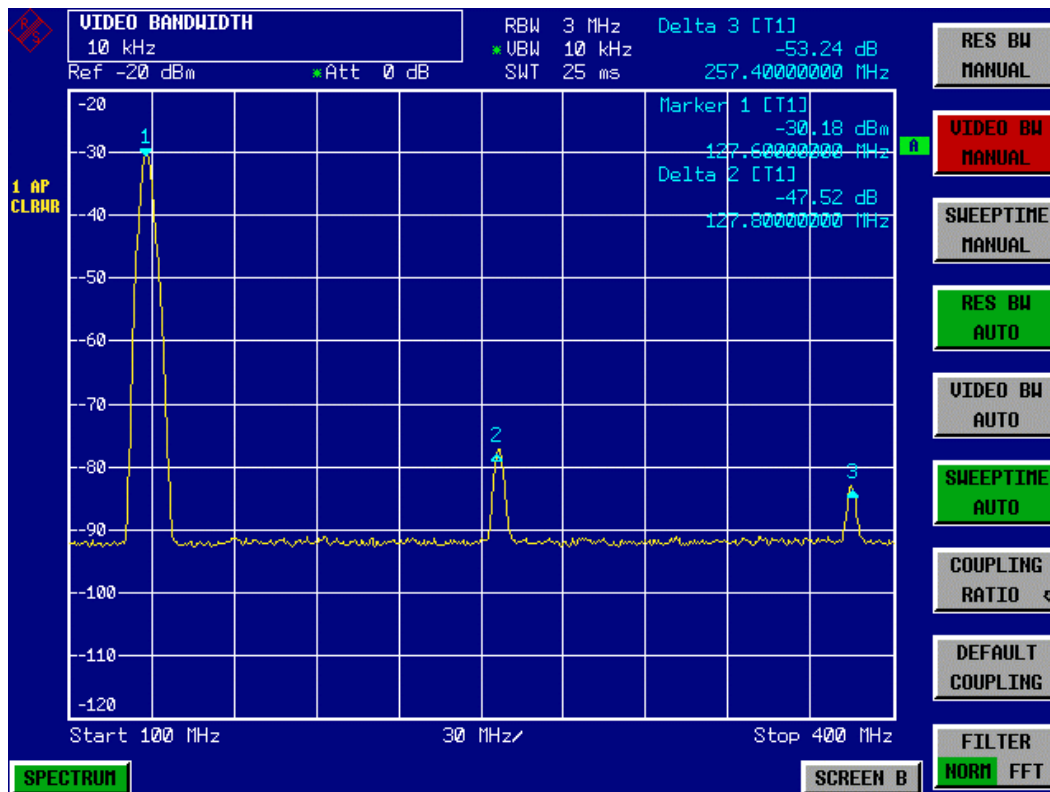

Fig. 5-4 Suppression of noise during harmonics measurement by reducing video bandwidth

2. Recouple the video bandwidth to the resolution bandwidth.

- Press the *BW* key.

3. Reduce the noise by averaging the curve.

- Press the *TRACE* key.
- Press the *AVERAGE* softkey.
The noise component of the trace will be smoothed by averaging 10 successive traces.

4. Switch off trace averaging.

- Press the *CLEAR/WRITE* softkey.

5. Reduce the noise by reducing the measurement bandwidth.

The noise is reduced in proportion to the bandwidth by reducing the resolution bandwidth, i.e. reducing the resolution bandwidth by a factor of 10 also reduces the noise by a factor of 10 (which corresponds to 10 dB). The amplitude of sinusoidal signals is not affected by reducing the resolution bandwidth.

6. Set the resolution bandwidth to 10 kHz.

- Press the *BW* key.
- Press the *RES BW MANUAL* softkey and enter *10 kHz*.
The noise decreases by approx. 25 dB with respect to the previous setting. Since the video bandwidth is coupled to the resolution bandwidth, it is reduced to 1 kHz in proportion to the resolution bandwidth. This causes the sweep time to increase to 60 seconds.

7. Reset the resolution bandwidth (couple it to the span)

- Press the *RES BW AUTO* softkey.

Measuring Signal Spectra with Multiple Signals

Separating Signals by Selecting the Resolution Bandwidth

A basic feature of a spectrum analyzer is being able to separate the spectral components of a mixture of signals. The resolution at which the individual components can be separated is determined by the resolution bandwidth. Selecting a resolution bandwidth that is too large may make it impossible to distinguish between spectral components, i.e. they will appear as a single component.

An RF sinusoidal signal will be shown on the spectrum analyzer screen by means of the passband characteristic of the resolution filter (RBW) that has been set. Its specified bandwidth is the 3 dB bandwidth of the filter.

Two signals with the same amplitude can be resolved if the resolution bandwidth is smaller than or equal to the frequency spacing of the signal. If the resolution bandwidth is equal to the frequency spacing, the spectrum display screen will show a level drop of 3 dB precisely in the center of the two signals. Decreasing the resolution bandwidth makes the level drop larger, which thus makes the individual signals clearer.

The tradeoff for higher spectral resolution at a narrower bandwidth is longer sweep times at the same span. Reducing the resolution bandwidth by a factor of 3 increases the sweep time by a factor of 9.

Separating Two Signals with a Level of -30 dBm each at a Frequency Spacing of 30 kHz

Test setup:

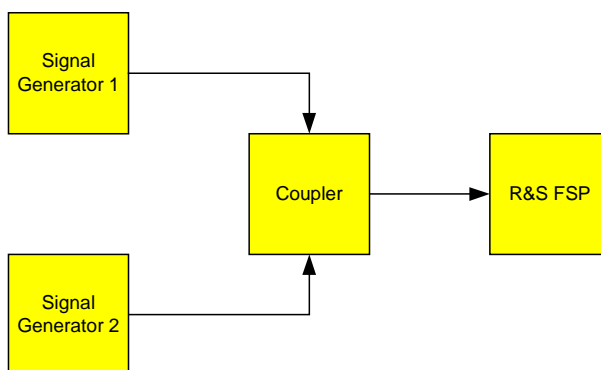

Setting the signal generators:

	Level	Frequency
Signal generator 1	-30 dBm	100,00 MHz
Signal generator 2	-30 dBm	100,03 MHz

Operating steps on the R&S FSP:

1. Set the spectrum analyzer to the default state.

- Die Taste *PRESET* drücken.
The R&SFSP is now in the default state.

2. Set the center frequency to 100.015 MHz and the frequency span (SPAN) to 300 kHz.

- Press the *FREQ* key and enter 100.015 MHz.
- Press the *FREQ* key and enter 100.015 MHz.

3. Set the resolution bandwidth to 30 kHz and the video bandwidth to 1 kHz.

- Press the *BW* key.
- Press the *RES BW MANUAL* softkey and enter 30 kHz.
- Press the *VIDEO BW MANUAL* softkey and enter 1 kHz.
- The two signals can be clearly distinguished by a 3 dB level drop in the center of the screen.

Note: The video bandwidth is set to 1 kHz in order to make the level drop in the center of the two signals clearly visible. At larger video bandwidths, the video voltage that results from envelope detection is not sufficiently suppressed. This produces additional voltages, which are visible in the trace, in the transition area between the two signals.

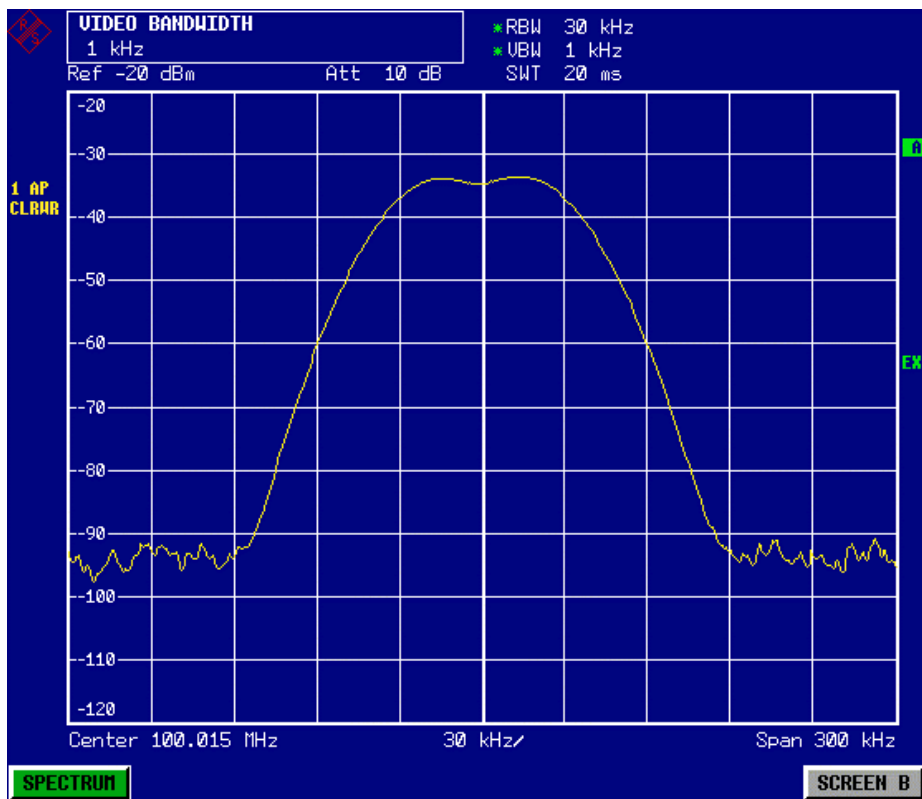

Fig. 5-9 Measurement of two equally-sized RF sinusoidal signals with the resolution bandwidth which corresponds to the frequency spacing of the signals.

Note: The level drop is located exactly in the center of the screen only if the generator frequencies exactly match the frequency display of the R&S FSP. To achieve exact matching, the frequencies of the generators and the R&S FSP must be synchronized.

4. Set the resolution bandwidth to 100 kHz.

- Press the *RES BW MANUAL* softkey and enter 100 kHz. It is no longer possible to clearly distinguish the two generator signals.

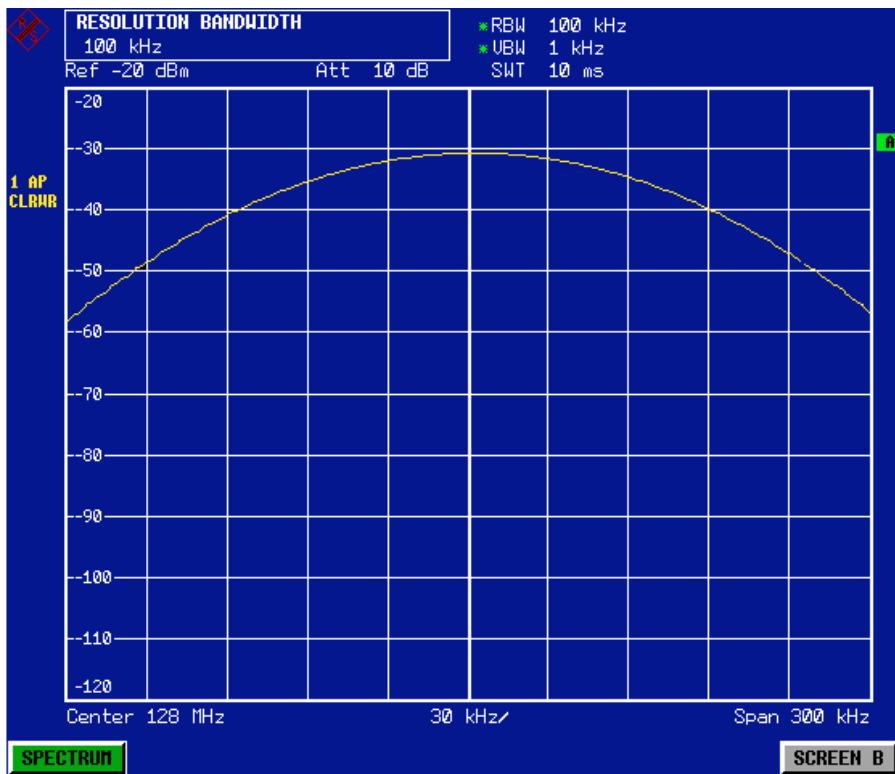

Fig. 5-10 Measurement of two equally-sized RF sinusoidal signals with a resolution bandwidth which is larger than their frequency spacing.

The resolution bandwidth (RBW) can be reduced again by turning the rotary knob counterclockwise, thus yielding a higher frequency resolution.

5. Set the resolution bandwidth to 1 kHz.

- Turn the rotary knob counterclockwise until the bandwidth indicates 1 kHz. The two generator signals are shown with high resolution. However, the sweep time becomes noticeably longer (600 ms), since it increases at a rate of $1/\text{RBW}^2$. At smaller bandwidths (10 dB per a bandwidth factor of 10), the noise display decreases simultaneously.

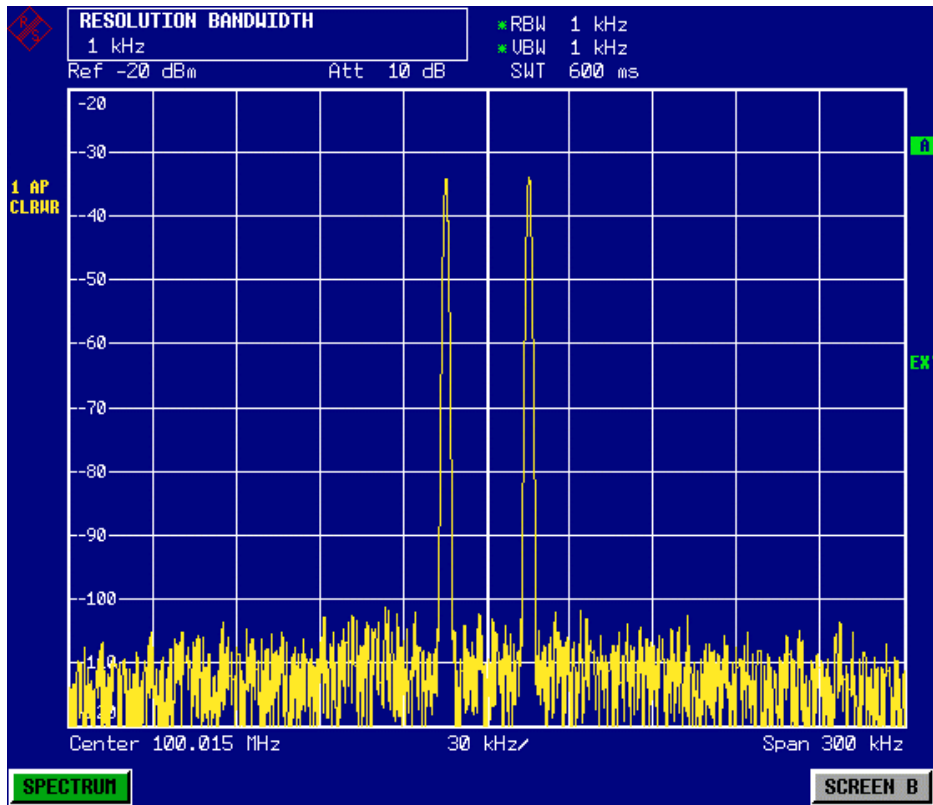

Fig. 5-11 Measurement of two RF equally-sized sinusoidal signals with a resolution bandwidth (1 kHz) which is clearly smaller than their frequency spacing.

6. Activate the FFT bandwidths.

- Using the *FILTER TYPE* softkey in the selection list, set the filter type to *FFT*. IF filtering is now performed using the FFT algorithm. The sweep time decreases significantly from 600 ms to 15 ms (a factor of 40). The display update rate also increases by almost the same ratio.

Measuring the Modulation Depth of an AM-Modulated Carrier in the Frequency Domain

In the frequency range (scan) display, the AM side bands can be resolved with a narrow bandwidth and measured separately. The modulation depth of a carrier modulated with a sinusoidal signal can then be measured. Since the dynamic range of a spectrum analyzer is very large, extremely small modulation depths can also be measured precisely. For this purpose, the R&S FSP provides measurement routines that directly output the modulation depth numerically in %.

Test setup:

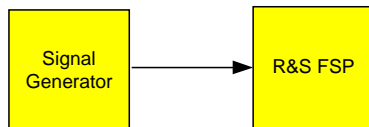

Settings on the signal generator (e.g. R&S SMIQ):

Frequency: 100 MHz
 Level: -30 dBm
 Modulation: 50 % AM, 1 kHz AF

Measurement with the R&S FSP:

1. Set the spectrum analyzer to the default state.

- Press the *PRESET* key.
The R&S FSP is now in the default state.

2. Set the center frequency to 100 MHz and span to 5 Hz.

- Press the *FREQ* key and enter 100 MHz.
- Press the *SPAN* key and enter 5 kHz.

3. Activate the marker function for measuring the AM modulation depth.

- Press the *MEAS* key.
- Press the *MODULATION DEPTH* softkey.
The R&S FSP automatically sets a marker to the carrier signal in the center of the diagram and one delta marker each to the upper and lower AM sidebands. The R&S FSP calculates the AM modulation depth from the level differences of the delta markers to the main marker and outputs the numeric value in the marker information field.

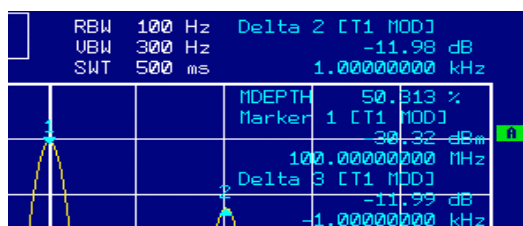

Fig. 5-15 Measurement of the AM modulation depth. The modulation depth shown is MDEPTH. The frequency of the AF signal can be obtained from the frequency display of the delta marker.

Measurements in the Time Domain

In the case of radio transmission systems that use the TDMA method (e.g. GSM or IS136), transmission quality is determined not only by spectral characteristics but also by characteristics in the time domain. However, a timeslot is assigned to each user since several users share the same frequency. Smooth operation is ensured only if all users adhere exactly to their assigned timeslots.

Both the power during the send phase as well as the timing and duration of the TDMA burst and rise and fall times of the burst are important.

Measuring the Power Characteristic

For measuring power in the time domain, the R&S FSP offers easy-to-use functions that measure the power over a predefined time.

Example – Measuring the Power of a GSM Burst During the Activation Phase.

Test setup:

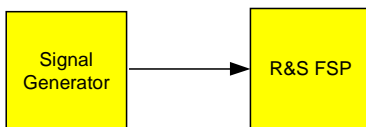

Settings on the signal generator (e.g. R&S SMIQ):

Frequency: 100 MHz
Level: 0 dBm
Modulation: GSM, one timeslot activated

Measurement with the R&S FSP:

1. Set the spectrum analyzer to the default state.

- Press the *PRESET* key.
The R&S FSP is now in the default state.

2. Set the center frequency to 100 MHz, the span to 0 Hz and the resolution bandwidth to 1 MHz.

- Press the *FREQ* key and enter 100 MHz.
- Press the *SPAN* key and enter 0 Hz, or press the *ZEROSPAN* softkey.

3. Set the reference level of the R&S FSP to 10 dBm (= level of the signal generator +10 dB).

- Press the *AMPT* key and enter 10 dBm.

4. Set the sweep time to 1 ms.

- Press the *SWEEP* key and enter 1 ms.
The R&S FSP will show the GSM burst continuously across the display.

5. By using the video trigger, elicit triggering on the rising edge of the burst.

- Press the *TRIG* key.
- Press the *VIDEO* softkey and enter 70%.
The R&S FSP shows a static image with the GSM burst at the start of the trace. The trigger level is displayed as a horizontal line labelled with the absolute level for the trigger threshold in the measurement diagram.

6. Configure power measurement in the time domain.

- Press the *MEAS* key.
- Press the *TIME DOM POWER* ↕ softkey.
- Set the *LIMITS* softkey to *ON*.
- Press the *START LIMIT* softkey.
- By turning the rotary knob clockwise, move the vertical line to the start of the burst.
- Press the *STOP LIMIT* softkey.
- By turning the rotary knob counterclockwise, set the second vertical line to the end of the burst.
The R&S FSP will output on screen the average (mean) power during the activation phase of the burst.

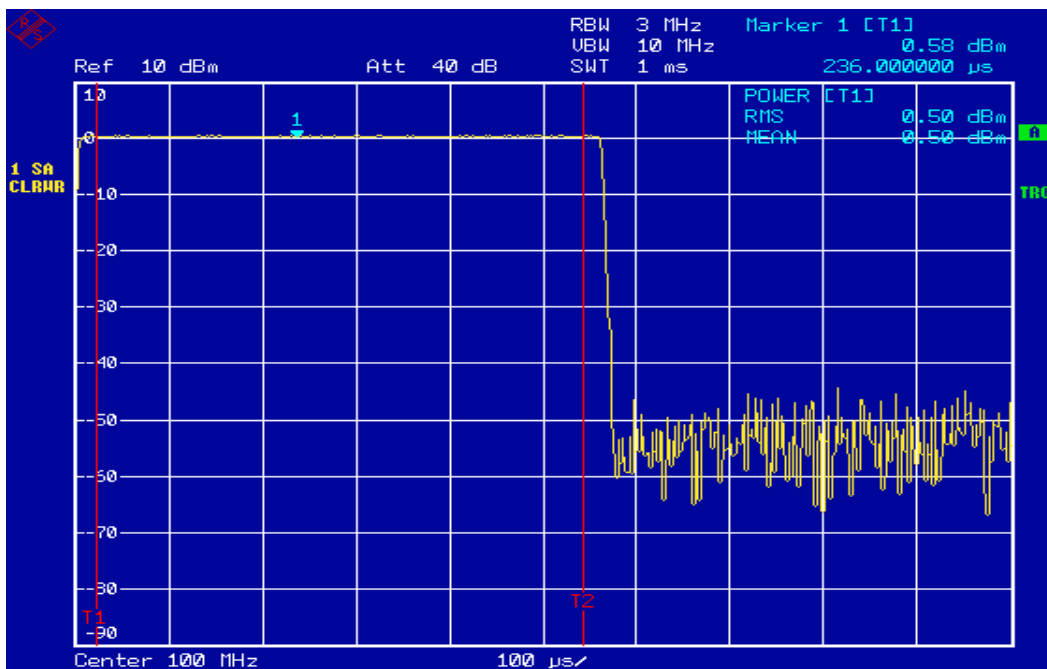

Fig. 5-16 Measurement of the average power during the activation phase of a GSM burst.

Measuring the Power Characteristic of Burst Signals

Because of the high time resolution of the R&S FSP at the 0 Hz display range, the edges of TDMA bursts can be measured precisely. The edges can be shifted to the screen area by using the trigger offset.

Example - Measuring the Edges of a GSM Burst with High Time Resolution

Test setup:

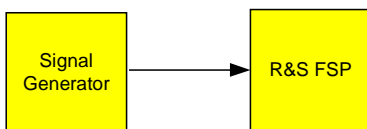

Settings on the signal generator (e.g. R&S SMIQ):

Frequency: 100 MHz
Level: 0 dBm
Modulation: GSM, one timeslot activated

Measurement with the R&S FSP:

The measurement is based on the setting in the above example for measuring the power of the GSM during the activation phase.

1. Switch off the power measurement.

- Press the MEAS key.
- Press the *TIME DOM POWER* ↕ softkey.
- In the submenu, set the *POWER* softkey to *OFF*.

2. Increase the time resolution to 100 μs.

- Press the *SWEEP* key and enter 100 μs.

3. Using the trigger softkey, shift the rising edge of the GSM burst to the center of the screen.

- Press the *TRIG* key.
- Press the *TRIGGER OFFSET* softkey.

By turning the rotary knob counterclockwise, move the trigger offset until the burst edge can be seen in the center of the screen, or enter -50 μs.
The R&S FSP will show the rising edge of the GSM burst.

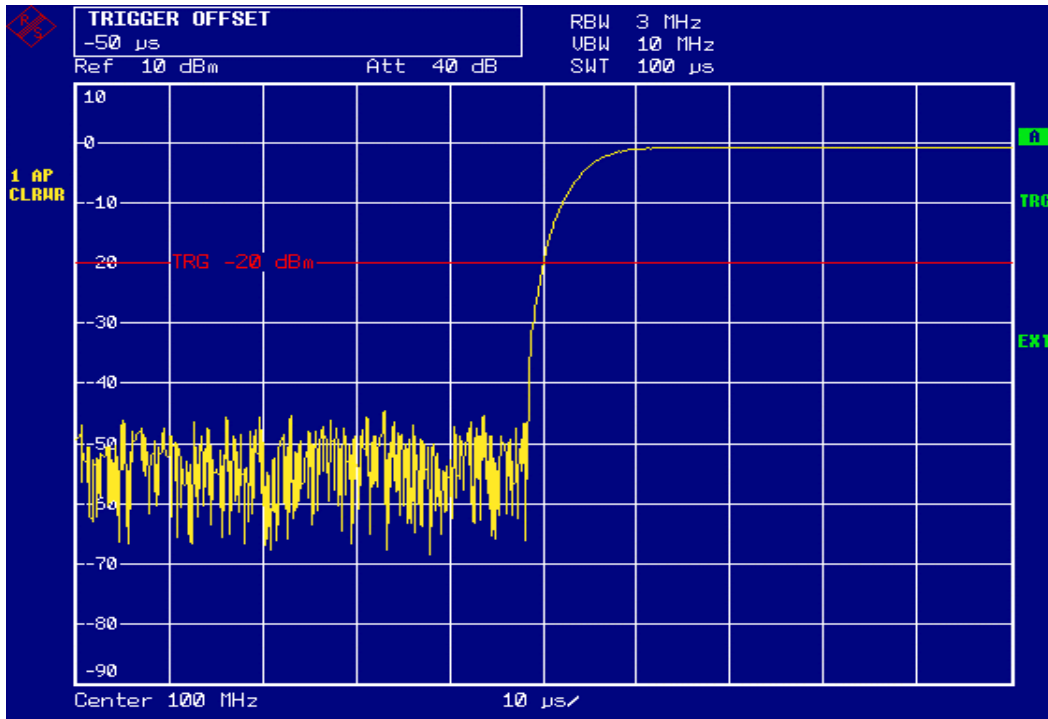

Fig. 5-17 Rising edge of the GSM burst displayed with high time resolution.

4. Using the trigger offset, move the falling edge of the burst to the center of the screen.

- Set the *POLARITY* softkey to *NEG*.
The R&S FSP will show the falling edge of the GSM burst.

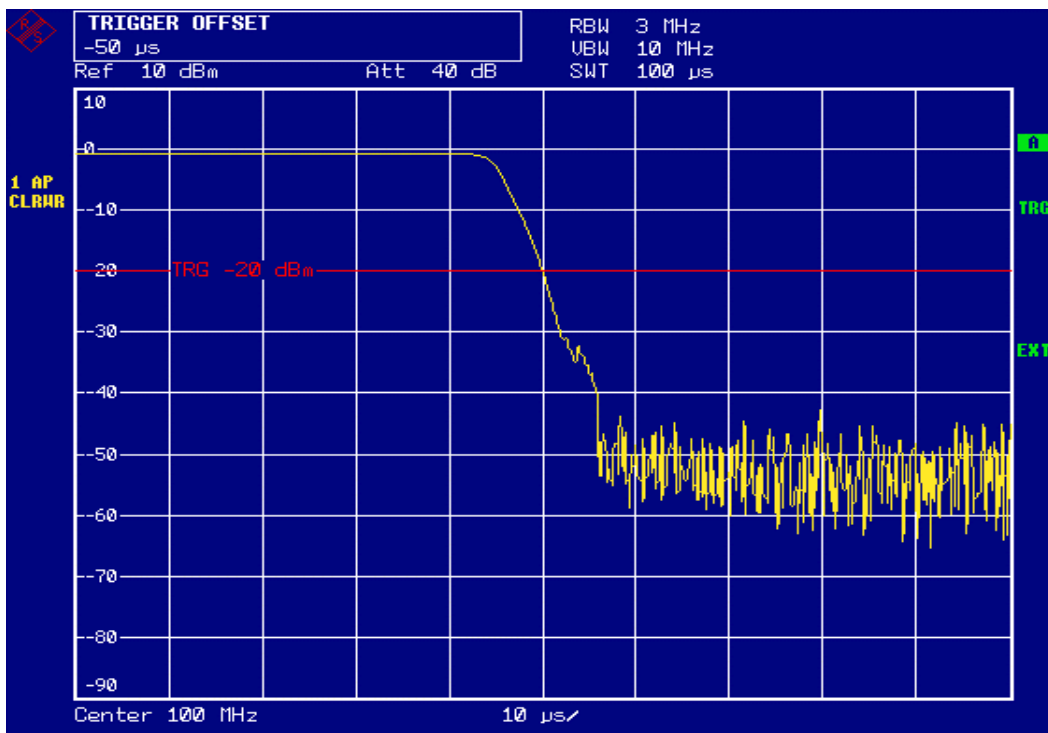

Fig. 5-18 Falling edge of the GSM burst displayed with high time resolution.

Measuring the Signal-to-Noise Ratio of Burst Signals

When TDMA transmission methods are used, the signal-to-noise ratio or the deactivation dynamic range can be measured by comparing the power values during the activation phase and the deactivation phase of the transmission burst. For this purpose, the R&S FSP provides the function for measuring absolute and relative power in the time domain. In the following example, the measurement is performed using a GSM burst.

Example - Signal-to-Noise Ratio of a GSM Signal

Test setup:

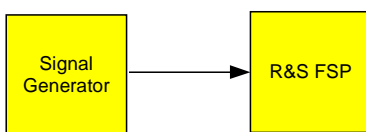

Settings on the signal generator (e.g. R&S SMIQ):

Frequency: 100 MHz

Level: 0 dBm

Modulation: GSM, ein Zeitschlitz eingeschaltet

Measurement with the R&S FSP:

1. Set the spectrum analyzer to the default state.

- Press the *PRESET* key.
The R&S FSP is now in the default state.

2. Set the center frequency to 100 MHz, the span to 0 Hz and the resolution bandwidth to 1 MHz.

- Press the *FREQ* key and enter 100 MHz.
- Press the *SPAN* key and enter 0 Hz.

or

- Press the *ZEROSPAN* softkey.
- Press the *BW* key and enter 1 MHz.

3. Set the reference level of the R&S FSP to 0 dBm (= level of the signal generator) and RF attenuation to 10 dB for maximum sensitivity.

- Press the *AMPT* key and enter 0 dBm.
- Press the *RF ATTEN MANUAL* softkey and enter 10 dB.

4. Set the sweep time to 2 ms.

- Press the **SWEEP** key and enter 2 ms.
The R&S FSP shows the GSM burst continuously across the display.

5. By using the video trigger, elicit triggering on the rising edge of the burst and shift the start of burst to the center of the screen.

- Press the **TRIG** key.
- Press the **VIDEO** softkey and enter 70%.
The R&S FSP shows a static image with the GSM burst at the start of the trace.
- Press the **TRIGGER OFFSET** softkey and enter -1 ms.
The R&S FSP shows the GSM burst in the right-hand half of the measurement diagram.

6. Configure the power measurement in the time domain.

- Press the **MEAS** key.
- Press the **TIME DOM POWER** ↕ softkey.
- Set the **LIMITS** softkey to **ON**.
- Press the **START LIMIT** softkey.
- Using the rotary knob, move the vertical line to the start of the burst.
- Press the **STOP LIMIT** softkey.
- Using the rotary knob, move the second vertical line to the end of the burst.
The R&S FSP outputs on screen the power during the activation phase of the burst.

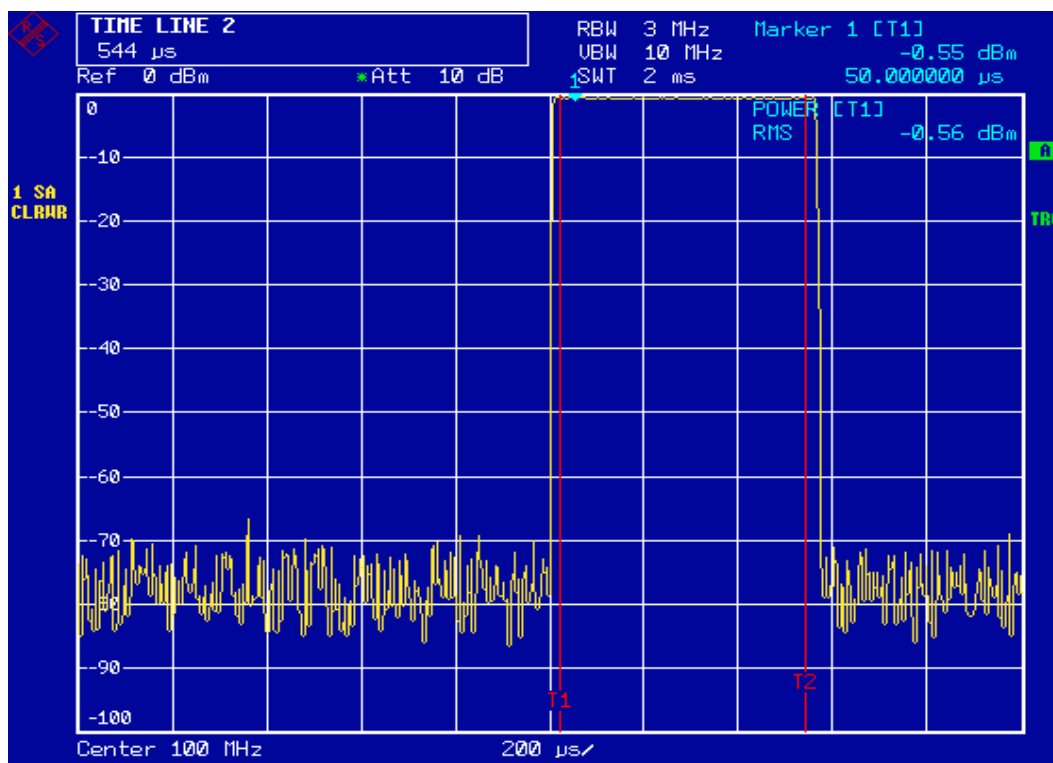

Fig. 5-19 Messung der Leistung während der Einschaltphase des Bursts

7. Set the measured power as the reference and activate relative power measurement.

- Press the *NEXT* key.
The side menu for setting the power measurement will open.
- Set the *POWER ABS/REL* softkey to *REL*.
The power relative to the power during the activation phase of the burst is displayed.
- Press the *SET REFERENCE* softkey.
The measured power of the GSM burst is set as the reference.

8. Measure the power during the deactivation phase of the burst.

- Press the *TRIG* key.
- Set the *POLARITY POS/NEG* softkey to *NEG*.
The R&S FSP initiates triggering in response to the falling edge of the burst. This shifts the burst to the left-hand half of the measurement diagram. The power is measured in the deactivation phase. The start of the burst is shifted to the center of the screen and the power during the deactivation phase is measured relative to the reference power (= burst power).

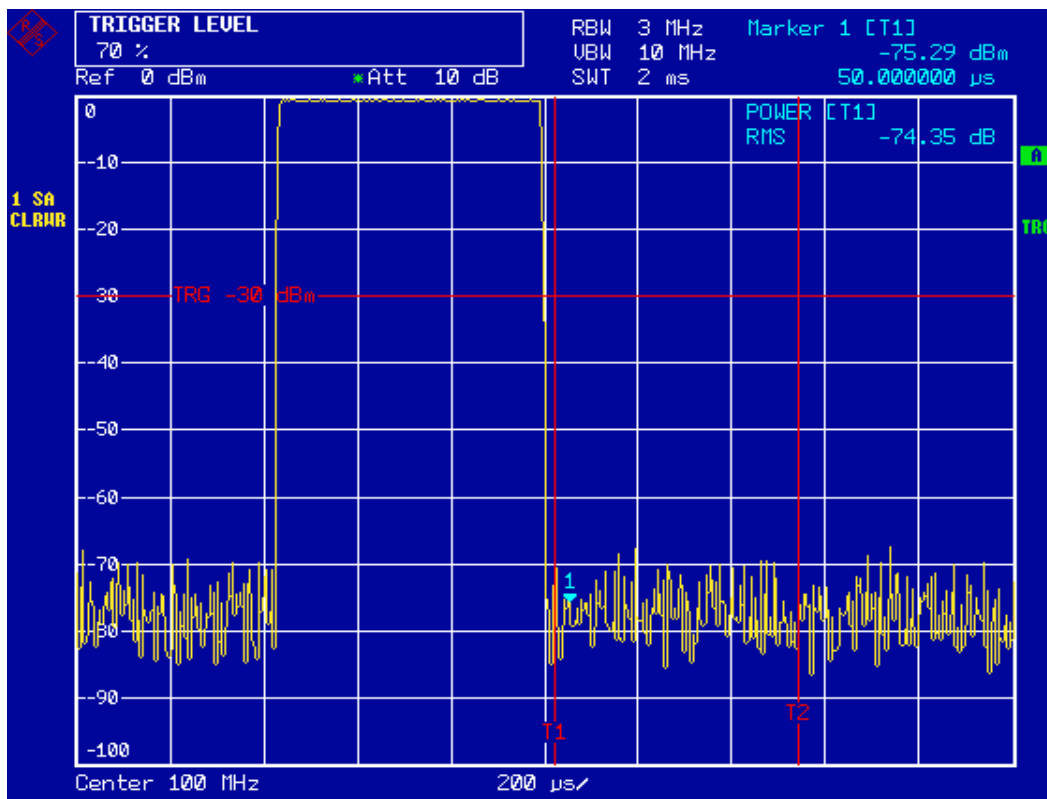

Fig. 5-20 Measurement of the signal-to-noise ratio of a GSM burst signal in the time domain.

Measurement of AM-Modulated Signals

The spectrum analyzer rectifies the RF input signal and displays it as a magnitude spectrum. The rectification also demodulates AM-modulated signals. The AF voltage can be displayed in the time domain if the modulation sidebands fall within the resolution bandwidth.

Example 1 – Displaying the AF of an AM-Modulated Signal in the Time Domain

Test setup::

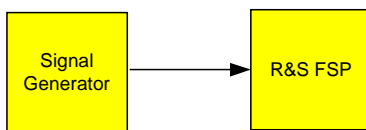

Settings on the signal generator (e.g. R&S SMIQ):

Frequency: 100 MHz
Level: 0 dBm
Modulation: 50 % AM, 1 kHz AF

Measurement with the R&S FSP:

1. Set the spectrum analyzer to the default state.

- Press the *PRESET* key.
The R&S FSP is now in the default state.

2. Set the center frequency to 100 MHz and the span to 0 Hz.

- Press the *FREQ* key and enter *100 MHz*.
- Press the *SPAN* key and enter *0 Hz*.

3. Set the reference level to +6 dBm and the display range to linear.

- Press the *AMPT* key and enter *6 dBm*.
- Press the *RANGE LINEAR* softkey.

4. Elicit triggering in response to the AF signal by using the video trigger to produce a static image.

➤ Press the *TRIG* key.

➤ Press the *VIDEO* softkey.

At initial activation, the video trigger level is set to 50%. The trigger level is displayed as a horizontal line across the entire measurement diagram. R&S FSP displays the 1 kHz AF signal as a static image in the time domain.

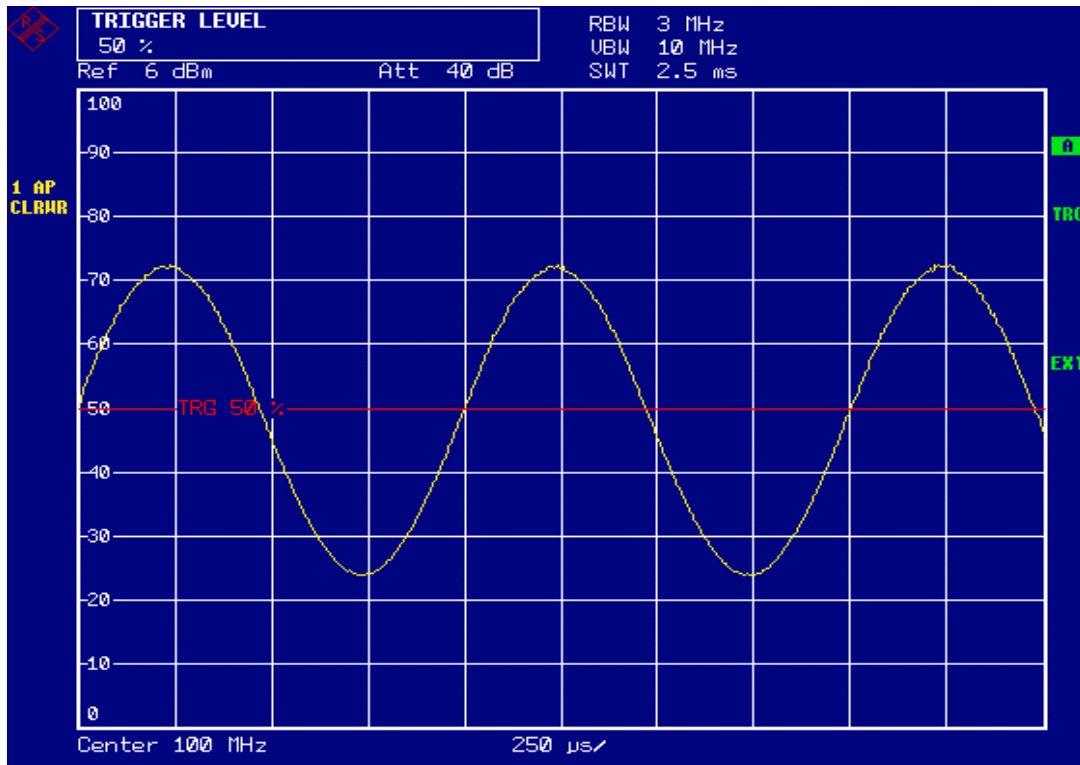

Fig. 5-21 Measurement of the AF signal of a carrier that is AM-modulated with 1 kHz

If the option AM/FM demodulator (R&S FSP-B3) is implemented in the R&S FSP, the AF can be listened to by using the built-in loudspeaker.

5. Activate the internal AM demodulator.

➤ Press the *MKR FCTN* key.

➤ Press the *MKR DEMOD* softkey.

The R&S FSP automatically switches on the AM audio demodulator.

➤ Turn up the loudspeaker volume.

A 1 kHz tone can be heard from the internal loudspeaker.

Measurement of FM-Modulated Signals

Since spectrum analyzers can display only the magnitude of the measurement signal by using the envelope detector, the modulation of FM-modulated signals cannot be measured directly as in the case of AM-modulated signals. The voltage at the output of the envelope detector remains constant for FM-modulated signals as long as the frequency deviation of the signal is located within the flat part of the passband characteristic of the resolution filter that is used. Amplitude variation occurs only if the instantaneous frequency extends into a falling edge of the filter curve. This behaviour can be used to demodulate FM-modulated signals. The center frequency of the analyzer is set in such a manner that the nominal frequency of the measurement signal is located on a filter edge (below or above the center frequency). The resolution bandwidth and the frequency offset must be selected in such a manner that the instantaneous frequency is located in the linear part of the filter edge. As a result, the frequency variation of the FM-modulated signal is transformed into an amplitude variation that can be displayed on screen in the time domain.

In the case of the four-circuit filters from 300 kHz to 3 MHz implemented as analog filters, you can obtain good linearity of the filter edge if the frequency of the R&S FSP is set to 1.2 times the filter bandwidth below or above the frequency of the transmit signal. The useful range for FM demodulation is then approx. equal to the resolution bandwidth.

Example - Display of the AF of an FM-Modulated Carrier

Test setup::

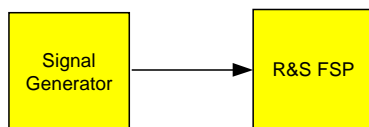

Settings on the signal generator (e.g. R&S SMIQ):

Einstellungen am Signalgenerator (z. B. R&S SMIQ):

Frequency: 100 MHz

Level: -30 dBm

Modulation: FM 0 kHz deviation (i.e. FM modulation is deactivated), 1 kHz AF

Measurement with the R&S FSP:

1. Set the spectrum analyzer to the default state.

- Press the *PRESET* key.
The R&S FSP is now in the default state.

2. Set the center frequency to 99.64 MHz and the span to 300 kHz.

- Press the *FREQ* key and enter 99.64 MHz.
- Press the *SPAN* key and enter 300 kHz.

3. Set the resolution bandwidth to 300 kHz.

- Press the *BW* key.
- Press the *RES BW MANUAL* softkey and enter 300 kHz.

4. Set the display range to 20 dB and shift the filter trace to the center of the screen.

- Press the *AMPT* key.
- Press the *RANGE LOG MANUAL* softkey and enter 20 dB.
- Press the *NEXT* key.
- Set the *GRID* softkey to *REL*.
- Press the *PREV* key.
- Using the rotary knob, set the reference level such that the filter edge at the center frequency intersects the -10 dB level line.
The filter edge of the 300 kHz filter will appear on screen. This corresponds to the demodulator characteristic for FM signals with a steepness of approx. 5 dB/100 kHz.

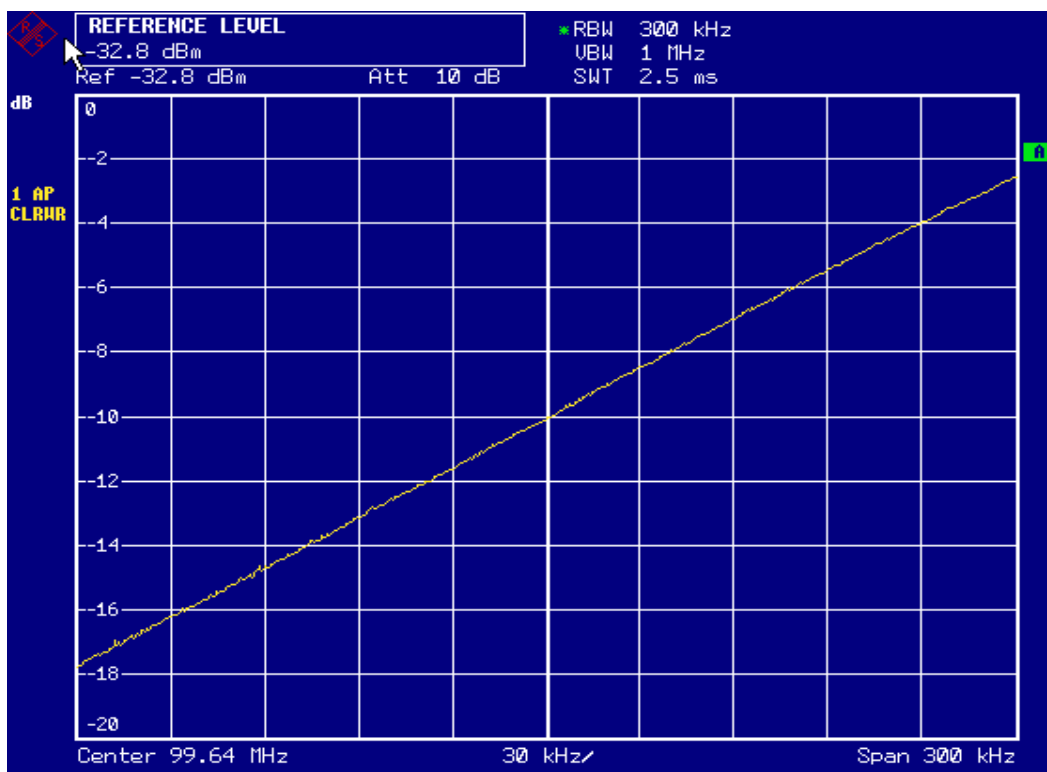

Fig. 5-22 Display of the filter edge of the 300 kHz filter as an FM discriminator characteristic.

5. Set the FM deviation to 100 kHz and the AF to 1 kHz on the signal generator.

6. Set the frequency deviation to 0 Hz on the R&S FSP.

- Press the *SPAN* key.
- Press the *ZERO SPAN* softkey.
The demodulated FM signal will appear on screen. The signal is continuous across the screen.

7. Establish a stable display by using video triggering.

- Press the *TRIG* key.
- Press the *VIDEO* softkey.
A static image for the FM AF signal is produced.

Result: (-10 ± 5) dB; this yields a deviation of 100 kHz when the steepness of the demodulator characteristic is 5 dB/100 kHz.

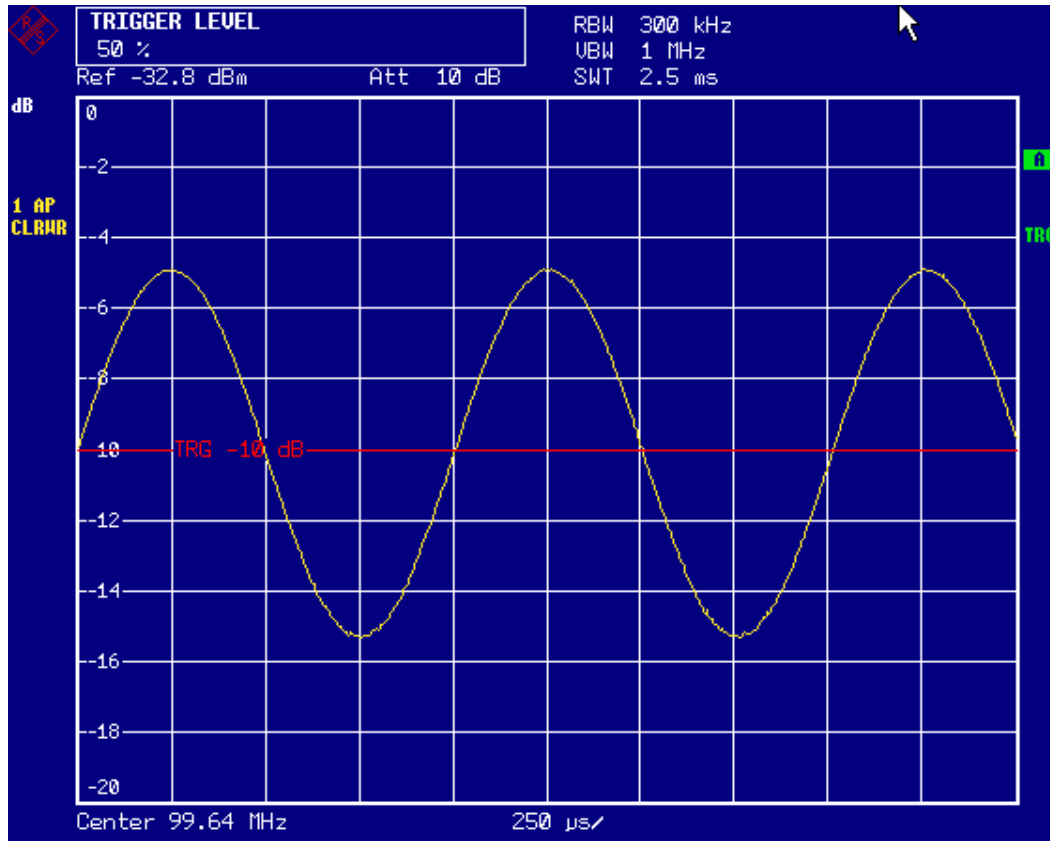

Fig. 5-23 Display of the demodulated FM signal.

Storing and Loading Instrument Settings

The R&S FSP can store complete instrument settings together with instrument configurations and measurement data internally as a data record. The data is stored on the built-in hard disk or – if selected – on a disk or on a network drive. The hard disk and the disk drive have the following drive names:

- Disk drive A:
- Hard disk D: (drive C: is reserved for the operating system)

The preset state (= "Current Settings") includes that the settings of the measurement functions, activated limit lines and the active transducer factor are stored.

Use the *ITEMS TO SAVE/RCL* function to store/load traces and to store additional limit lines and transducer factors.

Storing an Instrument Configuration (without Traces)

You can store an instrument configuration as follows:

- Press the *FILE* key and then the *SAVE* softkey.
The selection dialog box for instrument configurations will open:

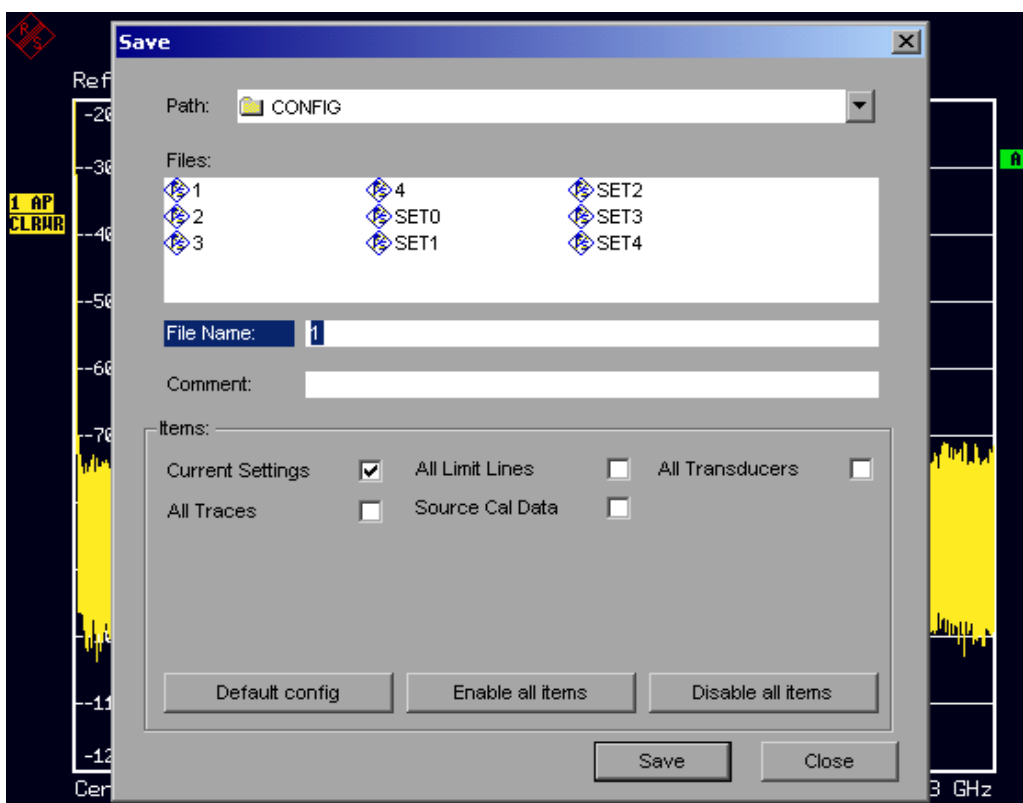

- Enter the name of the data record to be stored (which is a digit from 0 to 9 in the simplest case) and press *ENTER*. The data record will be stored and the dialog box will close.

Notes: *The name of a data record may contain letters and digits. If necessary, the desired directory can be placed in front of the name of the data record (the directory will then automatically be used for any further SAVE and RECALL operations).*
You can enter file names via the front panel keypad by using the alphanumeric editor, which can be called by pressing the Cursor Down key  .
The operation of the editor is described in the section "Editing with the Alphanumeric Parameters".

The default path for the instrument configurations is D:\USER\CONFIG. The file names of the data records end with ".FSP".

Storing Traces

Before you can store traces, you must first select the associated partial data record. For this purpose proceed as follows:

- Press the *FILE* key and then the *SAVE* softkey.
- Press the *ITEMS TO SAVE/RCL* softkey. The entry cursor jumps to the first entry in the *Items* field.
- Using the rotary knob, move the cursor to "*All Traces*" in the *Items* field and then select the partial data record by pressing the rotary knob or *ENTER*.

Notes: *You can cancel the selection by pressing the rotary knob/ENTER again.*
You can select additional instrument settings to be stored by marking additional fields.
In addition, the ENABLE ALL ITEMS / DISABLE ALL ITEMS softkeys are available for selecting all partial data records or for cancelling the selection.

- Using the rotary knob, move the cursor to the *File Name* field and activate text entry by pressing the rotary knob.
- Enter a file name (or digit from 0 to 9) and store the data record by pressing *ENTER*.

Loading an Instrument Configuration

An instrument configuration can be loaded in either of the following two ways:

1. By directly entering the data record name:

- Press the *FILE* key and then the *RECALL* softkey.
- Enter the name of the data record to be loaded (which is a digit from 0 to 9 in the simplest case) and press *ENTER*. The data record will be loaded.

2. By selecting the data record from a list:

- Press the *FILE* key and then the *RECALL* softkey.
- Press the *ITEMS TO SAVE/RCL* softkey.
The list of available data records is shown.

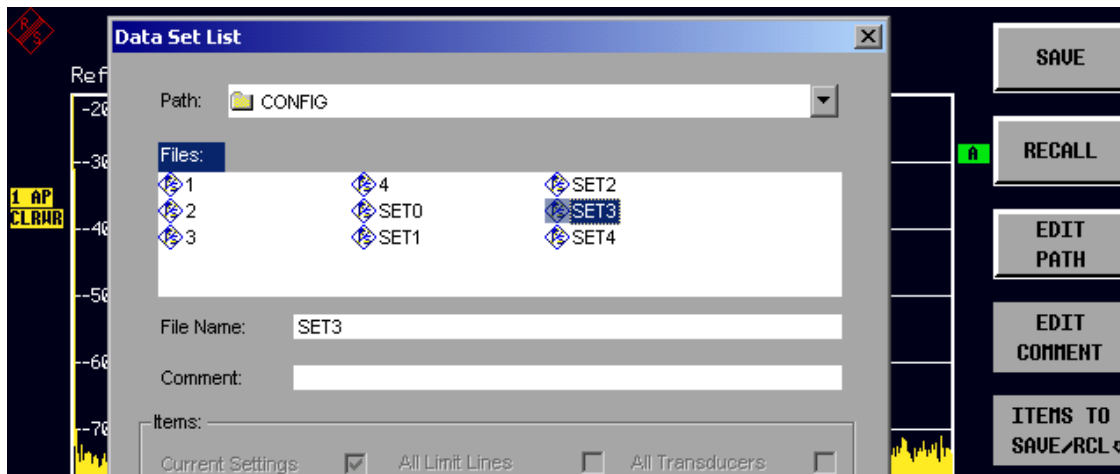

- Select the data record to be loaded by using the rotary knob and confirm by pressing *ENTER* twice. The data record will be loaded.

To change the instrument configuration path, use the *EDIT PATH* softkey.

Notes: To load stored traces, use the *ITEMS TO SAVE/RCL* function to select the "ALL Traces" field.
During loading, the R&S FSP detects which parts the called data record contains and, if applicable, ignores any partial data records that were selected but are not available.

Automatic Loading of a Data Record during Booting

If the R&S FSP is switched on in the factory default state, it loads the instrument settings that it had when switched off (provided that it was switched off using the *STANDBY* switch on the front panel; see chapter 1 "Putting into Operation").

However, the R&S FSP can also automatically load a data record defined by the user. This requires performing the following procedure:

- Press the *FILE* key and then the *RECALL* softkey.
- Press the *STARTUP RECALL* softkey.
The list of available data records is shown.

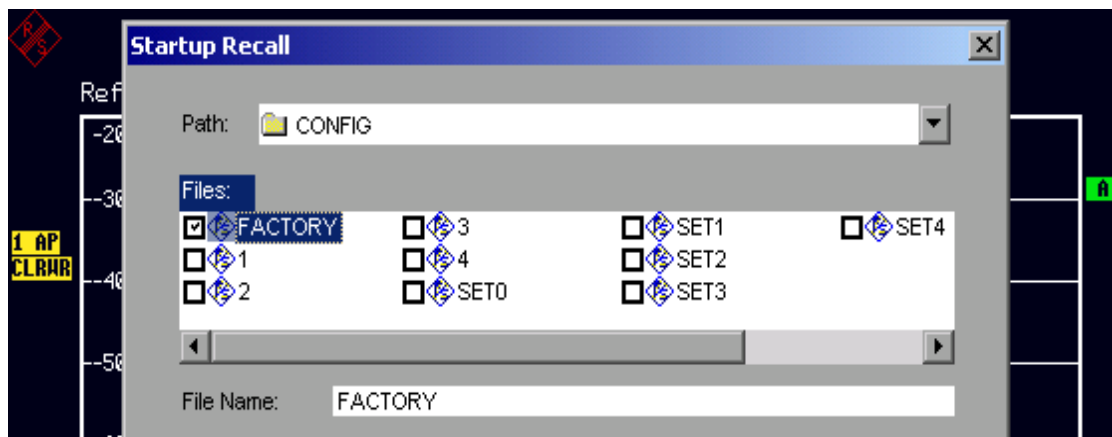

- Select the data record to be loaded by using the rotary knob and mark it with *ENTER*.
- Close the dialog box by pressing *ESC* twice.

Notes:

1. The selected data record will also be loaded by pressing the *PRESET* key.
2. The *FACTORY* entry activates factory-default operation, i.e. the settings that were present at the time of deactivation will be loaded at activation.
3. If you need to change the path for the instrument configuration, do so by using the *EDIT PATH* softkey.

Printing Out the Measurement Results

- Press the *HCOPY* key. The menu for starting and configuring the printout will appear.
- Start the print operation by pressing the *PRINT SCREEN*, *PRINT TRACE* or *PRINT TABLE* softkey. The printout is based on the settings defined in the *DEVICE SETUP* dialog box and the *COLORS* submenu.

Notes:

1. If *PRINT SCREEN* is selected, all diagrams with traces and status displays will be printed out as they appear on screen. Softkeys, open tables and data entry fields will not appear on the printout.
2. If *PRINT TRACE* is selected, only the displayed traces will be printed out. If *PRINT TABLE* is selected, only tables that appear on screen will be printed out.

- Select and configure the output interface by using the *DEVICE 1 / 2* softkey.
- You can redirect the printout to a file by selecting *PRINT TO FILE* from the *DEVICE SETUP* dialog box. Once you start the print operation by pressing one of the *PRINT...* softkeys, you will be prompted for the name of the file to which the output is to be redirected.
- The *COMMENT* softkey is available for labelling the printout (the date and time will automatically be added to the printout).

Selecting the Colour Setting for the Printout

The *COLORS* submenu allows you to switch between black-and-white and colour printouts (default). You can also select the colour setting.

- **SCREEN** Output using screen colours.
- **OPTIMIZED (default)** Instead of the bright colours for traces and markers, dark colours will be used: blue for trace 1, black for trace 2, green for trace 3, turquoise for markers.
- **USER DEFINED** You can use this setting to customize the colours. The possible settings correspond to those in the *DISPLAY – CONFIG DISPLAY – NEXT* menu.

Notes:

1. In the case of the *SCREEN* and *OPTIMIZED* settings, the background is always printed out in white and the grid in black. In the case of the *USER DEFINED* setting, these colours can also be selected.
2. When you open the submenu, the colour display will be switched to the selected printout colours. When you exit the menu, the original colour setting will be restored.

Additional Measurement Examples

The measurement examples provided in this section are intended as an introduction to operating the R&S FSP. For enhanced applications, refer to chapter 2 of the operating manual, which provides a series of additional examples:

- Measuring harmonics with high sensitivity
- Measuring intermodulation
- Measuring signals near noise
- Measuring noise
- Measuring phase noise
- Measuring channel power and adjacent channel power
- Measuring amplitude distribution

Measurement examples for the instrument's options are provided in the operating manuals for the individual options.

6 Brief Introduction to Remote Control

The following programming examples are hierarchical in structure, i.e. the later examples are based on the preceding ones. This makes it possible to easily assemble a well-functioning program by using the modules of the program examples.

Basic Steps in IEC Bus Programming

The following examples explain how to program the instrument and can be used as a basis for solving enhanced programming tasks.

Visual Basic was used as the programming language. However, the programs can be implemented in other languages as well.

Linking the IEC Bus Library for Visual Basic

Programming notes:

- **Outputting texts by using the "Print" function**

The following programming examples are based on the assumption that all subroutines are created as part of a form (file extension .FRM). In this case, the following notation is permitted:

```
Print "Text"
```

However, if the subroutines are created as a module (file extension .BAS), the name of the form that contains the required print method must be placed in front of the print instruction. Thus, if a form is named "Main", the print instruction will be as follows:

```
Main.Print "Text".
```

- **Accessing the functions of the GPIB.DLL**

To enable users to create Visual Basic control applications, the file GPIB.BAS (starting with VB 6.0 VBIB-32.BAS) is being added to a project so that functions of the RSIB.DLL can be called. In addition, the file NIGLOBAL.BAS is being added to the project. This file contains constants and definitions for error handling, timeout values, etc.

- **Declaring the DLL functions as procedures**

All functions return an integer value. Thus, all functions are declared in the file GPIB.BAS as follows:

```
Declare Function xxx Lib "gpib.dll" ( ... ) As Integer
```

The function value with the status variable `ibsta` must be assigned each time a variable is called. However, since this value is also returned via a reference parameter of the functions, the functions can be also be declared as procedures as follows:

```
Declare Sub xxx Lib "rsib.dll" ( ... )
```

- **Creating a response buffer**

Since the DLL returns zero-terminated strings in responses, a string of sufficient length must be created before the functions `ibrd()` and `ilrd()` are called, because Visual Basic inserts a length specification in front of the strings and this specification is not updated by the DLL. The following two means of creating the length specification for a string are provided:

```
- Dim Rd as String * 100
```

```
- Dim Rd as String
```

```
Rd = Space$(100)
```

Initialization and Default State

At the start of each program, the global variables used by all subroutines must be created. The IEC bus and the instrument settings will then be changed to a defined default state. The two subroutines "InitController" and "InitDevice" are used for this purpose.

Creating Global Variables

In Visual Basic, global variables are stored in modules (data extension .BAS). Thus, at least one module (e.g. GLOBALS.BAS) must be created that contains the variable used by all subroutines, e.g. the variables for device addresses used by the IEC bus driver.

For all example programs shown below, the file must contain the following instructions:

```
Global analyzer As Integer
```

```
Global boardId As Integer
```

Initializing the Controller

```
REM ----- Initializing the controller -----
Public SUB InitController()

ieaddress% = 20                'Instrument IEC bus address
CALL IBFIND("GPIB0", boardId%) 'Open channel to IEC bus
                                'controller
CALL IBFIND("DEV1", analyzer%) 'Open channel to instrument
CALL IBPAD(analyzer%, iecaddress%) 'Report instrument address to
                                'controller
CALL IBTMO(analyzer%, 11)      'Response time set to 1 sec

END SUB
REM *****
```

Initializing the Instrument

Set the IEC bus status registers and instrument settings to the default state.

```
REM ----- Initializing the instrument -----
Public SUB InitDevice()

CALL IBWRT(analyzer%, "*CLS") 'Reset status register
CALL IBWRT(analyzer%, "*RST") 'Reset instrument

END SUB
REM*****
```

Switching the Screen Display On and Off

In the default setting, all remote control commands are carried out with the screen display switched off in order to attain optimum measurement speed. During the development phase of remote control programs, however, the screen display is required in order to visually check both the programming of the settings and the measurement results.

The following examples show functions with which the screen display can be switched on or off during remote control operation.

```

REM ----- Switching on the screen display -----
Public SUB DisplayOn()

CALL IBWRT(analyzer%, "SYST:DISP:UPD ON") 'Switch on screen
                                         'display

END SUB
REM*****

REM ----- Bildschirmanzeige ausschalten -----
Public SUB DisplayOff()

CALL IBWRT(analyzer%, "SYST:DISP:UPD OFF") 'Switch off screen
                                           'display

END SUB
REM*****

```

Configuring the Power Save Function for the Display

During IEC bus operation, it is often unnecessary to display the measurement results on screen. Although the command "SYSTEM:DISPlay:UPDate OFF" switches off the display of the measurement results, thus significantly improving speed in remote control operation, the display itself and the background lighting in particular remain switched on.

If you also want to switch off the display itself, you must use the Power Save function by setting the response time in minutes prior to activation.

Note: *The display will be immediately reactivated if you press a key on the instrument's front panel.*

```

Public SUB PowerSave()

CALL IBWRT(analyzer%, "SYSTEM:PSAVE:HOLDoff 1") 'Set response time to
                                                '1 minute
CALL IBWRT(analyzer%, "SYSTEM:PSAVE ON")      'Switch on
                                                'Power Save function

```

Sending Simple Instrument Setting Commands

This example shows how the center frequency, span and reference level of the instrument are set.

```
REM ----- Instrument setting commands -----
PUBLIC SUB SimpleSettings()

CALL IBWRT(analyzer%, "FREQUENCY:CENTER 128MHz") 'Center frequency 128 MHz
CALL IBWRT(analyzer%, "FREQUENCY:SPAN 10MHZ")    'Set span to 10 MHz
CALL IBWRT(analyzer%, "DISPLAY:TRACE:Y:RLEVEL -10dBm")
                                                    'Set reference level to -10dBm

END SUB
REM *****
```

Switching to Manual Operation

```
REM ----- Switching instrument to manual operation -----
CALL IBLOC(analyzer%) 'Switch instrument to local state
REM *****
```

Reading Out Instrument Settings

The settings made above can now be read out. To do so, the abbreviated commands are used.

```

REM ----- Reading out instrument settings -----
PUBLIC SUB ReadSettings()

CFfrequenz$ = SPACE$(20)           'Provide text variable (20 characters)
CALL IBWRT(analyzer%, "FREQ:CENT?") 'Request center frequency
CALL IBRD(analyzer%, CFfrequenz$)  'Read in value
CFspan$ = SPACE$(20)               'Provide text variable (20 characters)
CALL IBWRT(analyzer%, "FREQ:SPAN?") 'Request span
CALL IBRD(analyzer%, CFspan$)      'Read in value

RLpegel$ = SPACE$(20)              'Provide text variable (20 characters)
CALL IBWRT(analyzer%, "DISP:TRAC:Y:RLEV?")
                                   'Request ref level setting
CALL IBRD(analyzer%, RLpegel$)     'Read in value

REM ----- Displaying values on the screen -----
PRINT "Center frequency: "; CFfrequenz$,
PRINT "Span:                "; CFspan$,
PRINT "Reference level:    "; RLpegel$,

END SUB
REM*****

```

Marker Positioning and Readout

```

REM ----- Example of marker function -----
PUBLIC SUB ReadMarker()

CALL IBWRT(analyzer%, "CALC:MARKER ON;MARKER:MAX")
                                   'Activate marker 1 and search
                                   'for peak
MKmark$ = SPACE$(30)              'Provide text variable
                                   '(30 characters)
CALL IBWRT(analyzer%, "CALC:MARK:X?;Y?") 'Query frequency and level
CALL IBRD(analyzer%, MKmark$)      'Read in value

REM ----- Displaying values on the screen -----
PRINT "Marker frequency/level "; MKmark$,

END SUB
REM*****

```

Command Synchronization

The synchronization methods used in the following example are described in chapter 5 of the operating manual, section "Command Sequence and Command Synchronization".

```

REM ----- Commands for command synchronization -----
PUBLIC SUB SweepSync()

REM The command INITiate[:IMMediate] starts a single sweep if the
REM command INIT:CONT OFF has already been sent. The next command
REM must not be carried out until a full sweep has been completed.
CALL IBWRT(analyzer%, "INIT:CONT OFF")

REM ----- First method: Using *WAI -----
CALL IBWRT(analyzer%, "ABOR;INIT:IMM; *WAI")

REM ----- Second method: Using *OPC? -----
OpcOk$ = SPACE$(2)           'Provide space for *OPC? response
CALL IBWRT(analyzer%, "ABOR;INIT:IMM; *OPC?")
REM ----- In this case, the controller can use other instruments -----
CALL IBRD(analyzer%, OpcOk$)      'Wait for "1" from *OPC?

REM ----- Third method: Using *OPC -----
REM In order for the Service Request function to be used with a GPIB
REM driver from National Instruments, the setting "Disable
REM Auto Serial Poll" must be set to "yes" with IBCONF!
CALL IBWRT(analyzer%, "*SRE 32")   'Enable Service Request for ESR
CALL IBWRT(analyzer%, "*ESE 1")   'Set event enable bit for
                                     'operation complete bit
CALL IBWRT(analyzer%, "ABOR;INIT:IMM; *OPC") 'Start sweep with
                                     'Synchronization to OPC
CALL WaitSRQ(boardID%,result%)    'Wait for Service Request
REM Resume main program here.

END SUB
REM *****

```

Reading Output Buffers

```

REM ----- Subroutine for the individual STB bits -----
Public SUB Outputqueue()           'Reading the output queue

result$ = SPACE$(100)              'Create space for response
CALL IBRD(analyzer%, result$)
PRINT "Contents of Output Queue : "; result$

END SUB
REM *****

```

Reading Error Messages

```
REM ----- Subroutine for evaluating the error queue -----  
Public SUB ErrorQueueHandler()  
  
ERROR$ = SPACE$(100)                               Subroutine for evaluating the error queue  
CALL IBWRT(analyzer%, "SYSTEM:ERROR?")  
CALL IBRD(analyzer%, ERROR$)  
PRINT "Error Description : "; ERROR$  
  
END SUB  
REM *****
```

Detailed Programming Examples

Default Setting of the R&S FSP

The following settings provide typical examples of how to change the default setting of the R&S FSP.

Note that only some of the settings are necessary depending on the application example. In many cases, it is not necessary to set resolution bandwidth, video bandwidth and sweep time since these parameters are automatically calculated in the default setting when the span is changed. Likewise, the input attenuation is automatically calculated in the default setting as a function of the reference level. Last of all, the level detectors are linked to the selected trace mode in the default setting.

The settings automatically calculated in the default setting are indicated with an asterisk (*) in the following program example.

Setting the IEC Bus Status Registers

```

REM *****
Public Sub SetupStatusReg()

'----- IEEE 488.2-Statusregister -----
CALL IBWRT(analyzer%,"*CLS")           'Reset status registers
CALL IBWRT(analyzer%,"*SRE 168")      'Enable Service Request
                                       'for STAT:OPER-,STAT:QUES- and
                                       'ESR-Register
CALL IBWRT(analyzer%,"*ESE 61")      'Set event enable bit for:
                                       'operation complete
                                       'command-, execution-,device
                                       'dependent- and query error

'----- SCPI-Statusregister -----
CALL IBWRT(analyzer%,"STAT:OPER:ENAB 0") 'Disable OPERation Status reg
CALL IBWRT(analyzer%,"STAT:QUES:ENAB 0") 'Disable questionable Statusreg

End Sub
REM *****

```

Default Settings for Measurements

```

REM *****
Public Sub SetupInstrument()

'----- Default setting of the FSP -----
CALL SetupStatusReg           'Configure status registers
CALL IBWRT(analyzer%,"*RST")  'Reset instrument
CALL IBWRT(analyzer%,"SYST:DISP:UPD ON") 'ON: screen display on
                                   'OFF: off(improved
                                   '           performance)
CALL IBWRT(analyzer%,"DISP:FORM SINGLE") 'Full screen display
CALL IBWRT(analyzer%,"DISP:WIND1:SEL")  'Active Screen A
CALL IBWRT(analyzer%,"INIT:CONT OFF")   'Single sweep mode

'----- Frequency setting -----
CALL IBWRT(analyzer%,"FREQUENCY:CENTER 100MHz") 'Center frequency
CALL IBWRT(analyzer%,"FREQ:SPAN 1 MHz")        'Span

'----- Level setting -----
CALL IBWRT(analyzer%,"DISP:WIND:TRAC:Y:RLEV -20dBm") 'Reference level
CALL IBWRT(analyzer%,"INP:ATT 10dB")                'Input attenuation (*)

'----- Level scaling -----
CALL IBWRT(analyzer%,"DISP:WIND:TRAC:Y:SPAC LOG")    'Log level axis
CALL IBWRT(analyzer%,"DISP:WIND:TRAC:Y:SCAL 100dB") 'Level range
CALL IBWRT(analyzer%,"DISP:WIND:TRAC:Y:SCAL:MODE ABS") 'Absolute scaling
CALL IBWRT(analyzer%,"CALC:UNIT:POW DBM")           'y meas. unit

'----- Trace and detector setting -----
CALL IBWRT(analyzer%,"DISP:WIND:TRAC1:MODE AVER")   'Trace1 average
CALL IBWRT(analyzer%,"AVER:TYPE VID")              'Average mode video;
                                                    ' "LIN" for linear

CALL IBWRT(analyzer%,"SWE:COUN 10")                'Sweep count
CALL IBWRT(analyzer%,"DISP:WIND:TRAC2:STAT OFF")   'Trace2 blank
CALL IBWRT(analyzer%,"DISP:WIND:TRAC3:STAT OFF")   'Trace3 blank
CALL IBWRT(analyzer%,"CALC:MATH:STAT OFF")         'Trace difference off
CALL IBWRT(analyzer%,"DETECTOR1 RMS")              'Detector Trace1 (*)
CALL IBWRT(analyzer%,"DET2:AUTO ON")               'Detector Trace2 (*)
CALL IBWRT(analyzer%,"DET3:AUTO ON")               'Detector Trace3 (*)

'----- Bandwidths and sweep time -----
CALL IBWRT(analyzer%,"BAND:RES 100KHz")            'Resolution bandwidth (*)
CALL IBWRT(analyzer%,"BAND:VID 1MHz")              'Video bandwidth (*)
CALL IBWRT(analyzer%,"SWE:TIME 100ms")            'Sweep time (*)

END SUB
REM *****

```

Using Markers and Delta Markers

Marker Search Functions, Restricting the Search Range

The following example is based on an AM-modulated signal at 100 MHz that has the following characteristics:

- Carrier signal level: –30 dBm
- AF frequency: 100 kHz
- Modulation depth: 50 %

Marker 1 and then delta marker 2 are set to the largest maximum points on the trace. The frequency and level are then read. In the following measurements, the instrument's default setting can be used for measurements (SetupInstrument) .

```

REM *****
Public Sub MarkerSearch()

result$ = Space$(100)
CALL SetupInstrument           'Default Setting
'----- Peak search without search range limits-----
CALL IBWRT(analyzer%,"INIT:CONT OFF")           'Switch to single sweep
CALL IBWRT(analyzer%,"CALC:MARK:PEXC 6DB")       'Define peak excursion
CALL IBWRT(analyzer%,"CALC:MARK:STAT ON")        'Enable marker 1
CALL IBWRT(analyzer%,"CALC:MARK:TRAC 1")        'Set marker 1 to trace 1
CALL IBWRT(analyzer%,"INIT;*WAI")              'Perform sweep with sync
CALL IBWRT(analyzer%,"CALC:MARK:MAX;X?;Y?")     'Marker to peak; read frequency
CALL IBRD(analyzer%, result$)                   'and level
Print "Marker 1: ";result$
CALL IBWRT(analyzer%,"CALC:DELT2:STAT ON;MAX;MAX:LEFT")
                                                    'Activate delta marker 2,
                                                    'set to peak and then
                                                    'to next peak Left
CALL IBWRT(analyzer%,"CALC:DELT2:X?;Y?")        'Read delta marker 2
                                                    'frequency and level

CALL IBRD(analyzer%, result$)
Print "Delta 2: ";result$

'----- Peak search with search range limit in x direction -----
CALL IBWRT(analyzer%,"CALC:MARK:X:SLIM:STAT ON;LEFT 0Hz;RIGHT 100.05MHz")
                                                    'Activate search limit and
                                                    'set at right below AF
CALL IBWRT(analyzer%,"CALC:DELT3:STAT ON;MAX;MAX:RIGHT")
                                                    'Activate delta marker 3,
                                                    'set to peak and then to
                                                    'next peak right
CALL IBWRT(analyzer%,"CALC:DELT3:X:REL?;:CALC:DELT3:Y?")
                                                    'Read delta marker 3 fre-
                                                    'quency and level; both must
                                                    'have a value of 0

CALL IBRD(analyzer%, result$)
Print "Delta 3: ";result$

'----- Peak search with search range limit in y direction -----

```

```
CALL IBWRT(analyzer%,"CALC:THR:STAT ON")
CALL IBWRT(analyzer%,"CALC:THR -35DBM")           'Activate threshold and
                                                    'set it above the AF
CALL IBWRT(analyzer%,"CALC:DELT3:STAT ON;MAX;MAX:NEXT")
                                                    'Activate delta marker 3,
                                                    'set to peak and then to
                                                    'next peak => is not found
CALL IBWRT(analyzer%,"CALC:DELT3:X:REL?;:CALC:DELT3:Y?")
                                                    'Query and read delta marker
                                                    '3 frequency and level;
                                                    'both must have a value
                                                    'of 0

CALL IBRD(analyzer%, result$)
Print "Delta 3: ";result$

'---- Setting center frequency and reference level with markers -----
CALL IBWRT(analyzer%,"CALC:MARK2:FUNC:CENT")      'Delta marker 2 -> marker and
                                                    'center frequency = marker 2
CALL IBWRT(analyzer%,"CALC:MARK2:FUNC:REF")      'Ref level = marker 2
Call ibwrt(analyzer%,"INIT;*WAI")               'Sweep with sync

END SUB
REM *****
```

Frequency Counting

The following example is based on a signal at 100 MHz with a level of –30 dBm. Also in this measurement, the instrument's default setting can be used (SetupInstrument). The purpose of frequency counting is to determine the exact frequency of the signal at 100 MHz.

```

REM *****
Public Sub MarkerCount()

result$ = Space$(100)
CALL SetupInstrument           'Default setting
'----- Defining signal frequency with frequency counter -----
CALL IBWRT(analyzer%,"INIT:CONT OFF")           'Switch to single sweep
CALL IBWRT(analyzer%,"CALC:MARK:PEXC 6DB")      'Define peak excursion
CALL IBWRT(analyzer%,"CALC:MARK:STAT ON")       'Activate marker 1
CALL IBWRT(analyzer%,"CALC:MARK:TRAC 1")        'Set marker 1 to trace 1
CALL IBWRT(analyzer%,"CALC:MARK:X 100MHz")      'Set marker 1 to 100 MHz
CALL IBWRT(analyzer%,"CALC:MARK:COUNT:RES 1HZ") 'Set count resolution to 1 Hz
CALL IBWRT(analyzer%,"CALC:MARK:COUNT ON")     'Activate frequency counter
CALL IBWRT(analyzer%,"INIT;*WAI")              'Perform sweep with sync
CALL IBWRT(analyzer%,"CALC:MARK:COUNT:FREQ?") 'Query and read measured
CALL IBRD(analyzer%, result$)                  'frequency
Print "Marker Count Freq: ";result$

END SUB
REM *****

```

Working with a Fixed Reference Point (Reference Fixed)

The following example is based on a signal at 100 MHz with a level of -20 dBm. Thus, the harmonics of the signal are located at 200 MHz, 300 MHz, etc. In the case of high-quality signal sources, these harmonics may be located outside the dynamic range of the R&S FSP. Nevertheless, to measure the harmonic suppression, the level setting must be changed to higher sensitivity when measuring the harmonics, in which case it may be necessary to suppress the carrier by using a notch filter in order to prevent the RF input of the R&S FSP from being overloaded.

Thus, two measurements with different level settings are performed in the following example. First, a high reference level is used on the carrier frequency, and then a low reference level is used on the frequency of the third harmonic.

The default setting of the R&S FSP for measurements (SetupInstrument) is also used as a starting point here, after which adaptations for the measurement are carried out.

```

REM *****
Public Sub RefFixed()

result$ = Space$(100)
CALL SetupInstrument           'Default setting
'----- Measuring the reference point -----
CALL IBWRT(analyzer%,"INIT:CONT OFF")           'Switch to single sweep
CALL IBWRT(analyzer%,"CALC:MARK:PEXC 6DB")      'Define peak excursion
CALL IBWRT(analyzer%,"CALC:MARK:STAT ON")       'Activate marker 1
CALL IBWRT(analyzer%,"CALC:MARK:TRAC 1")        'Set marker 1 to trace 1
CALL IBWRT(analyzer%,"INIT;*WAI")              'Perform sweep with sync
CALL IBWRT(analyzer%,"CALC:MARK:MAX")           'Set marker 1 to 100 MHz
CALL IBWRT(analyzer%,"CALC:DELT:FUNC:FIX ON")    'Define reference point
'----- Setting frequency, level and bandwidth for measuring harmonics -----
CALL IBWRT(analyzer%,"FREQ:CENT 400MHz;Span 1MHz") 'Set freq of 3rd harmonic
CALL IBWRT(analyzer%,"BAND:RES 1kHz")           'and suitable RBW
CALL IBWRT(analyzer%,"SWEEP:TIME:AUTO ON")      'Couple sweep time
CALL IBWRT(analyzer%,"INP:ATT:AUTO ON")        'Select more sensitive
CALL IBWRT(analyzer%,"DISP:WIND:TRAC:Y:RLEV -50dBm") 'level setting
CALL IBWRT(analyzer%,"INIT;*WAI")              'Perform sweep with sync
CALL IBWRT(analyzer%,"CALC:DELT:MAX;X:REL?;Y?") 'Read delta marker
Call ibrd(analyzer%, result$)                  'Read frequency and level
Print "Deltamarker 1: "; result$

END SUB
REM *****

```

Measuring Noise and Phase Noise

When phase noise is measured, the noise power related to a bandwidth of 1 Hz is set in relation to the power of an adjacent carrier signal. A commonly used offset between the measured frequency and the carrier frequency is 10 kHz.

When noise is measured, the measured absolute level is related to a bandwidth of 1 Hz.

The following example is also based on a signal at 100 MHz with a level of -30 dBm. Two markers are used to determine both the noise and the phase noise at a 10 kHz offset from the carrier signal.

```

REM *****
Public Sub Noise()

result$ = Space$(100)
'----- Default setting of the FSP -----
CALL SetupStatusReg           'Configure status register
CALL IBWRT(analyzer%,"*RST")  'Reset instrument
CALL IBWRT(analyzer%,"INIT:CONT OFF") 'Single sweep mode
'----- Setting the frequency -----
CALL IBWRT(analyzer%,"FREQUENCY:CENTER 100MHz") 'Center frequency
CALL IBWRT(analyzer%,"FREQ:SPAN 100 kHz")      'Span
'----- Setting the level -----
CALL IBWRT(analyzer%,"DISP:WIND:TRAC:Y:RLEV -20dBm") 'Reference level
CALL IBWRT(analyzer%,"INIT;*WAI")                'Perform sweep with sync
'----- Setting the reference point -----
CALL IBWRT(analyzer%,"CALC:MARK:PEXC 6DB")       'Define peak excursion
CALL IBWRT(analyzer%,"CALC:MARK:STAT ON")        'Activate marker 1
CALL IBWRT(analyzer%,"CALC:MARK:TRAC 1")        'Set marker 1 to trace 1
CALL IBWRT(analyzer%,"CALC:MARK:MAX")           'Set marker 1 to 100 MHz
CALL IBWRT(analyzer%,"CALC:DELT:FUNC:PNO ON")    'Define reference point
                                                    'for phase noise

'----- Measuring the phase noise -----
CALL IBWRT(analyzer%,"CALC:DELT:X 10kHz")        'Position delta marker
CALL IBWRT(analyzer%,"CALC:DELT:FUNC:PNO:RES?") 'Query and output phase
Call ibrd(analyzer%, result$)                   'noise result
Print "Phase Noise [dBc/Hz]: "; result$

'----- Measuring the noise -----
CALL IBWRT(analyzer%,"CALC:MARK:X 99.96MHz")     'Position marker 1
CALL IBWRT(analyzer%,"CALC:MARK:FUNC:NOIS:RES?") 'Query and output
Call ibrd(analyzer%, result$)                   'result
Print "Noise [dBm/Hz]: "; result$

END SUB
REM *****

```

Reading Out Trace Data

In the following example, the trace data obtained with the default setting is read from the instrument and displayed in a list on screen. Readout occurs first in binary format and then in ASCII format, once with the span > 0 and once with the span = 0.

In binary format, the header of the message with the length specification is evaluated and used to calculate the x axis values.

In ASCII format, merely the list of level values is output.

Binary data is read out in three steps:

1. The number of digits in the length specification is read out.
2. The length specification itself is read out.
3. The trace data itself is read out.

The procedure is required in the case of programming languages that only support structures with data types of the same type (arrays) (such as with Visual Basic), because the data types of the header and data sections are different in binary data.

Note: *The arrays for the measured data are dimensioned in such a way that they provide sufficient space for trace data of the R&S FSP (501 measurement points).*

```

REM *****
Public Sub ReadTrace()

'----- Creating variables -----
Dim traceData(1250) As Single           'Buffer for floating point
                                        'binary data
Dim digits As Byte                     'Number of characters in
                                        'length specification
Dim traceBytes As Integer              'Len. of trace data in bytes
Dim traceValues As Integer             'No. of meas. values in buff.
asciiResult$ = Space$(25000)          'Buffer for ASCII trace data
result$ = Space$(100)                 'Buffer for simple results
startFreq$ = Space$(100)              'Buffer for start frequency
span$ = Space$(100)                   'Buffer for span

'----- Default setting of the FSP -----
CALL SetupInstrument                   'Default setting
CALL IBWRT(analyzer%,"INIT:CONT OFF") 'Switch to single sweep
CALL IBWRT(analyzer%,"INIT;*WAI")     'Perform sweep with sync

'----- Defining the frequency range for output -----
Call ibwrt(analyzer%,"FREQ:START?")   'Read start frequency
Call ibrd(analyzer%,startFreq$)
startFreq = Val(startFreq$)
Call ibwrt(analyzer%,"FREQ:SPAN?")    'Read span
Call ibrd(analyzer%,span$)
span = Val(span$)

```

```

'----- Reading out in binary format -----
Call ibwrt(analyzer%, "FORMAT REAL,32")      'Set binary format
Call ibwrt(analyzer%, "TRAC1? TRACE1")      'Read trace 1
Call ilrd(analyzer%, result$, 2)            'Read and store length spec.
digits = Val(Mid$(result$, 2, 1))          'for number of characters
result$ = Space$(100)                       'Reinitialize buffer
Call ilrd(analyzer%, result$, digits)       'Read and store length
traceBytes = Val(Left$(result$, digits))    'specification
Call ibrd32(analyzer%, traceData(0), traceBytes) 'Read trace data into buffer
Call ilrd(analyzer%, result$, 1)           'Read in delimiter <NL>
'----- Outputting binary data as frequency/level pairs -----
traceValues = traceBytes/4                  'Single precision = 4 bytes
stepsize = span/traceValues                 'Calculate frequency step
                                           'size

For i = 0 To traceValues - 1
Print "Value["; i; "] = "; startFreq+stepsize*i; ", "; traceData(i)
Next i
'----- Default setting of the time domain -----
Call ibwrt(analyzer%, "FREQ:SPAN 0Hz")     'Switch to time domain
CALL IBWRT(analyzer%, "INIT;*WAI")        'Perform sweep with sync
'----- Reading out in ASCII format -----
Call ibwrt(analyzer%, "FORMAT ASCII")      'Set ASCII format
CALL ibwrt(analyzer%, "TRAC1? TRACE1")    'Read and output
CALL ibrd(analyzer%, asciiResult$)
Print "Contents of Tracel: ",asciiResult$ 'trace 1

END SUB
REM *****

```

Storing and Loading Instrument Settings

Storing Instrument Settings

In the following example, the settings/measured data to be stored are initially defined, in which case only the hardware settings are stored. However, the selection commands for the other settings are specified with the state "OFF" for the sake of completeness.

```

REM *****
Public Sub StoreSettings()

'----- Default settings of the FSP -----
Call SetupInstrument
CALL IBWRT(analyzer%,"INIT:CONT OFF")      'Change to single sweep
CALL IBWRT(analyzer%,"INIT;*WAI")         'Perform sweep with sync
'----- Selection of settings to be stored -----
CALL IBWRT(analyzer%,"MMEM:SEL:HWS ON")    'Store hardware settings
CALL IBWRT(analyzer%,"MMEM:SEL:TRAC OFF")  'Do not store any traces
CALL IBWRT(analyzer%,"MMEM:SEL:LIN:ALL OFF") 'Store only the activated limit lines
'----- Enter comments -----
CALL IBWRT(analyzer%,"MMEM:COMM 'Test Setup'")
'----- Storing on the instrument -----
CALL IBWRT(analyzer%,"MMEM:STOR:STAT 1,'D:\USER\DATA\TEST1'")
'----- Resetting the instrument -----
CALL IBWRT(analyzer%,"*RST")

END SUB
REM *****

```

Loading Instrument Settings

In the following example, the TEST1 data record stored under D:\USER\DATA is reloaded into the instrument:

```

REM *****
Public Sub LoadSettings()

'----- Default setting of the status register -----
'This subroutine loads the TEST1 data record in the directory
'D:\USER\DATA.
'----- Loading the data record -----
Call SetupStatusReg           'Configure status register
'----- Perform measurement using loaded data record -----
CALL IBWRT(analyzer%,"MMEM:LOAD:STAT 1,'D:\USER\DATA\TEST1'")
CALL IBWRT(analyzer%,"DISP:TRAC1:MODE WRITE") 'Set trace to Clr/Write
CALL IBWRT(analyzer%,"INIT;*WAI")           'Start sweep

END SUB
REM *****

```

Setting the Data Record for Startup Recall

In the following example, the first step is to change the R&S FSP to the default state. In the next step, the TEST1 data record stored under D:\USER\DATA is selected for the STARTUP RECALL function, i.e. the data record is then set after each *RST, PRESET and each time the instrument is started. For demonstration purposes, the command *RST is carried out again.

```

REM *****
Public Sub StartupRecallSettings()

'----- Resetting the FSP -----
CALL IBWRT(analyzer%,"*RST")
'----- Default setting of the status register -----
--
Call SetupStatusReg           'Configure status register
'----- Selecting the startup recall data record -----
CALL IBWRT(analyzer%,"MMEM:LOAD:AUTO 1,'D:\USER\DATA\TEST1'")
'----- Activating the startup recall data record -----
CALL IBWRT(analyzer%,"*RST")

END SUB
REM *****

```

Configuring and Starting a Printout

The following example shows how to configure the output format and output device for printing out a measurement screen.

The procedure is as follows:

1. Set the measurement you want for the printout.
2. Check which output devices are available on the instrument.
3. Select an output device.
4. Select the output interface.
5. Configure the output format.
6. Start the printout with synchronization to the end.

It is assumed that the desired setting is a signal at 100 MHz with a power of -20 dBm. It is also assumed that the sixth printer out of the available printers that are listed is the one you want. The printout is first output to the selected printer and then to a file.

```

REM *****
Public Sub HCopy()

DIM Devices(100) as string           'Create buffer for
                                     'printer name
FOR i = 0 TO 49
    Devices$(i) = Space$(50)         'Preallocate buffer for
                                     'printer name
NEXT i

'----- Default setting of the FSP -----
CALL SetupStatusReg                 'Configure status register
CALL IBWRT(analyzer%,"*RST")        'Reset instrument
CALL IBWRT(analyzer%,"INIT:CONT OFF") 'Single sweep mode
CALL IBWRT(analyzer%,"SYST:DISP:UPD ON") 'Screen display on

'----- Measurement settings -----
CALL IBWRT(analyzer%,"FREQ:CENT 100MHz;SPAN 10MHz") 'Frequency setting
CALL IBWRT(analyzer%,"DISP:WIND:TRAC:Y:RLEV -10dBm") 'Reference level
CALL IBWRT(analyzer%,"INIT;*WAI") 'Perform measurement

'----- Querying the available output devices -----
CALL IBWRT(analyzer%,"SYST:COMM:PRIN:ENUM:FIRSt?") 'Read out and display
CALL IBRD(analyzer%,Devices$(0)) 'first output device
PRINT "Printer 0: "+Devices$(0) '
For i = 1 to 99
    CALL IBWRT(analyzer%,"SYST:COMM:PRIN:ENUM:NEXT?") 'Read out next
CALL IBRD(analyzer%,Devices$(i)) 'printer name
    IF Left$(Devices$(i),2) = "" THEN GOTO SelectDevice 'Stop at end
                                                    'of list
    PRINT "Printer"+Str$(i)+"": " Devices$(i) 'Display printer name
NEXT i

```

```

SelectDevice:
'---- Selection of output device, printer language and output interface ----
CALL IBWRT(analyzer%,"SYST:COMM:PRIN:SEL "+ Devices(6))'Printer selection #6
CALL IBWRT(analyzer%,"HCOP:DEST 'SYST:COMM:PRIN'")      'Configuration:
                                                    '"Printout to
                                                    'printer interface"
CALL IBWRT(analyzer%,"HCOP:DEV:LANG GDI")      'Printers require
                                                    'printer language 'GDI'
'----- Selection of orientation (portrait/landscape) and colour/BW -----
CALL IBWRT(analyzer%,"HCOP:PAGE:ORI PORTRait")'Portrait orientation
CALL IBWRT(analyzer%,"HCOP:DEV:COL OFF")      'Black-and-white printout
'----- Configuring and starting the printout -----
CALL IBWRT (analyzer%,"HCOP:ITEM:ALL")      'All screen contents
'CALL IBWRT (analyzer%,"HCOP:ITEM:WIND1:TRACE:STAT ON") 'Alternative: only
'CALL IBWRT (analyzer%,"HCOP:ITEM:WIND2:TRACE:STAT ON") 'traces in screen
                                                    'A/B
CALL IBWRT (analyzer%,"*CLS")      'Reset status administration
CALL IBWRT (analyzer%,"HCOP:IMMEDIATE;*OPC") 'Start printout
CALL WaitSRQ(boardID%,result%)      'Wait for service request
IF (result% = 1) THEN CALL Srq      'If SRQ detected =>
                                                    'Subroutine for evaluation
'---- Printout in WMF format (BMP format) to file -----
CALL IBWRT(analyzer%,"HCOP:DEST 'MMEM'")      'Configuration:
                                                    '"Printout to file"
CALL IBWRT(analyzer%,"HCOP:DEV:LANG WMF") 'WMF file format
'CALL IBWRT(analyzer%,"HCOP:DEV:LANG BMP") 'BMP file format
CALL IBWRT(analyzer%,"MMEM:NAME 'D:\USER\DATA\PRINT1.WMF'") 'Define file name
CALL IBWRT (analyzer%,"*CLS")      'Reset Status administration
CALL IBWRT (analyzer%,"HCO"P:IMMEDIATE;*OPC") 'Start printout
CALL WaitSRQ(boardID%,result%)      'Wait for service request
IF (result% = 1) THEN CALL Srq      'If SRQ detected =>
                                                    'Subroutine for evaluation

END SUB
REM *****

```



Appendix A: Printer Interface

Installing Non-Plug&Play Printers

Note: The following dialog boxes can be operated either from the front panel or via a mouse and keyboard (see sections "Connecting a Mouse" and "Connecting a Keyboard").

A new printer is installed using the *HCOPY - NEXT - INSTALL PRINTER* softkey.

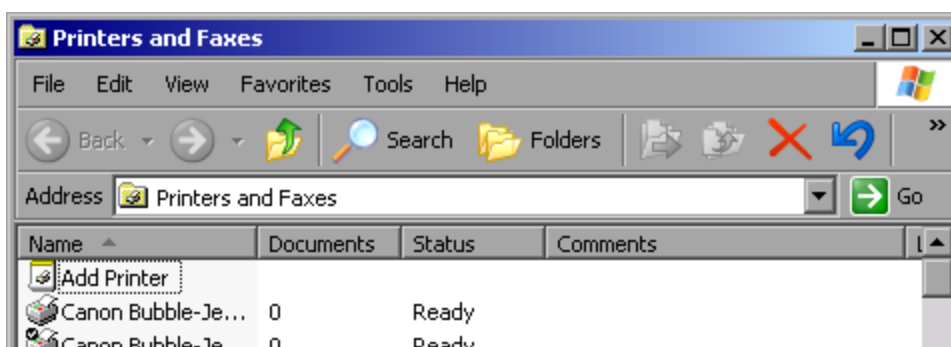
Local Printer



- Using the rotary knob, select *Add Printer* from the list.
- Mark the selected item with *CURSOR RIGHT* and press *ENTER* or the rotary knob to confirm the selection.
The *Add Printer Wizard* will appear.

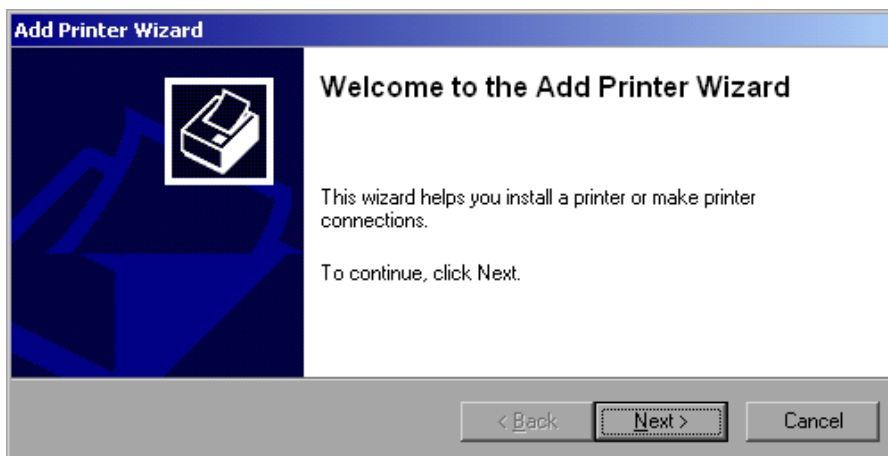

- Using the rotary knob, select *NEXT* and confirm by pressing the rotary knob.

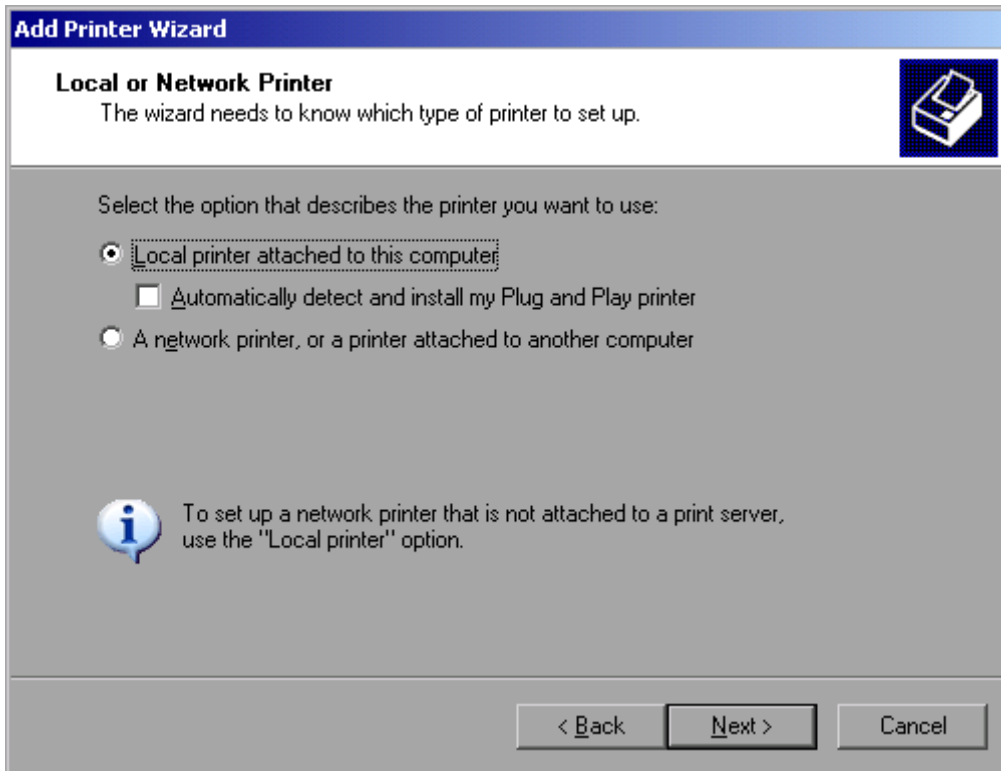

- To install a local printer, select *Local printer attached to this computer* with the rotary knob, confirm by pressing the rotary knob and continue to the next step.
- To install a network printer, select *A network printer or a printer attached to another computer*, confirm by pressing the rotary knob and continue to the next step.

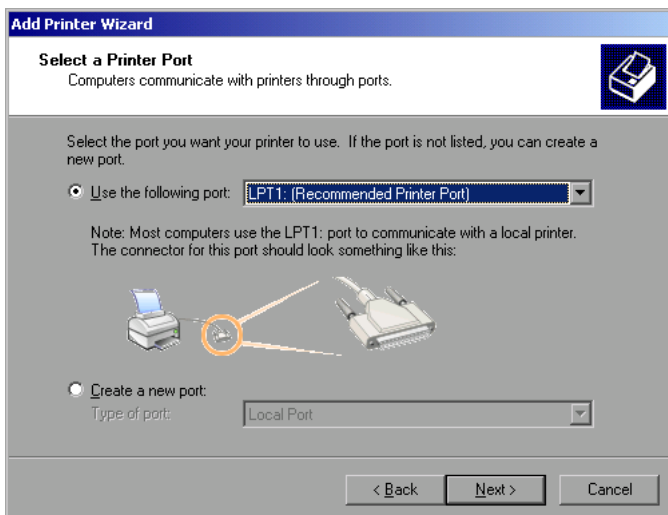

In the following example, a local printer of type Star LC24 is installed.

- To select a USB connection, open the list of available ports by pressing the rotary knob. Using the cursor or rotary knob, select a printer port and confirm by pressing the rotary knob.
- To select an LPT connection, you do not need to open the selection list.
- Using the rotary knob, move the cursor to the *Next* button and confirm by pressing the rotary knob. The *Install Printer Software* dialog panel will open.

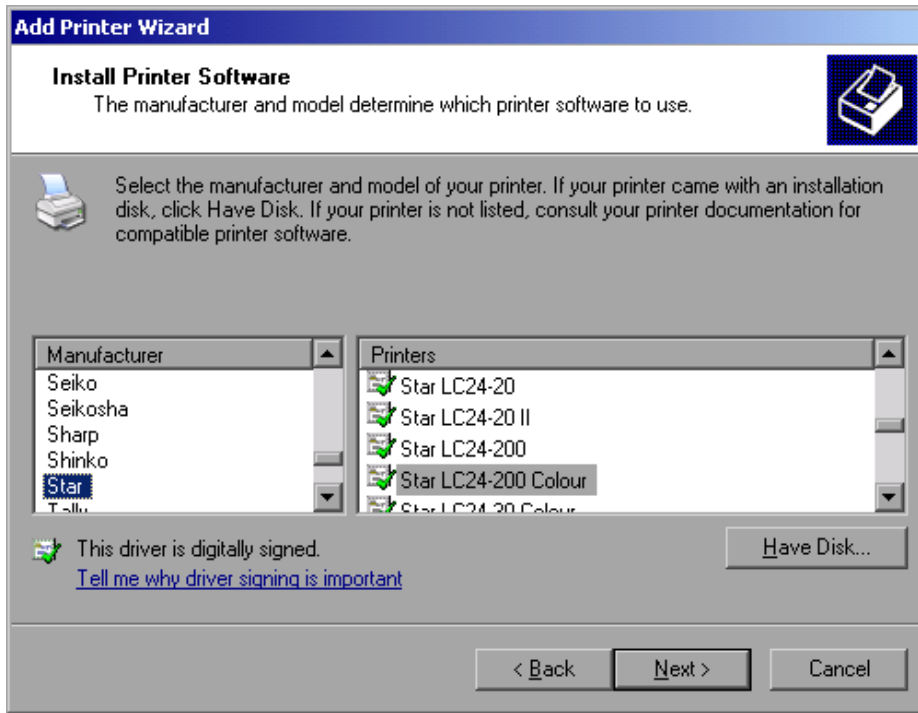

- Using the cursor up/down keys, select the required manufacturer (*Star*) from the *Manufacturers* table.
- Using the rotary move, go to the *Printers* table.
- Using the cursor up/down keys, select the desired printer type ("Star LC24-200 Colour") and confirm with *ENTER*

Note: *If the desired printer type is not in the list, its driver has not yet been installed. In this case, click the "Have Disk" button with the mouse. You will be prompted to insert a disk containing the corresponding printer driver. Press OK and select the desired printer driver.*

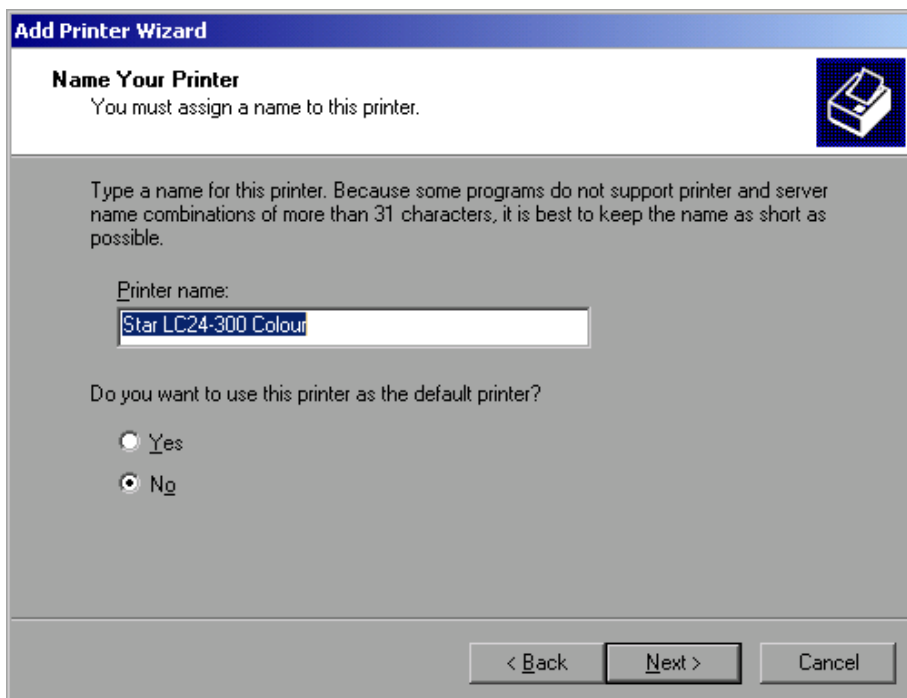

- You can change the printer name in the "Printer Name" field to any name you want (max. 60 characters). However, this requires using a PC keyboard.
- Using the rotary knob, select *Default Printer yes / no*.
- Using the cursor up/down keys, select the desired status.
- Confirm the entry with *ENTER*.
The *Printer Sharing* dialog panel will open.
- Confirm the entry with *ENTER*.
The *Printer Sharing* dialog panel will open.
- Exit the dialog panel by pressing *ENTER*.
The *Completing the Add Printer Wizard* dialog panel will open.

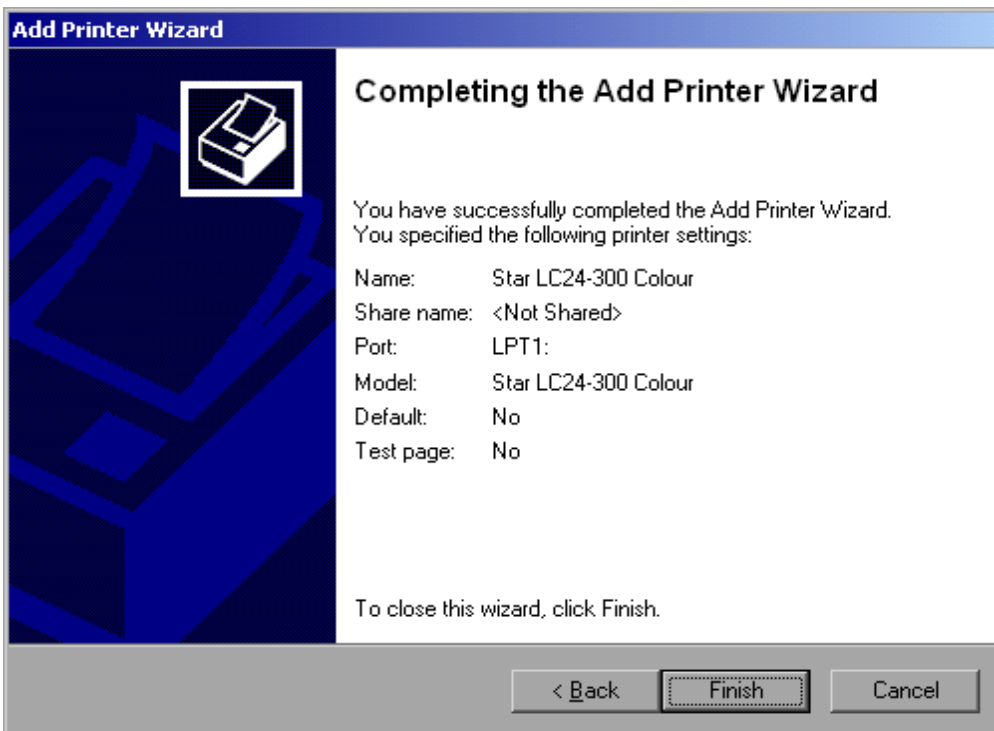

- Check the displayed settings and exit the dialog panel with *ENTER*.
The printer will be installed. If Windows finds the required driver files, the installation will be completed without any further queries.
If Windows cannot find the required driver files, the dialog box for entering the path for files will open.

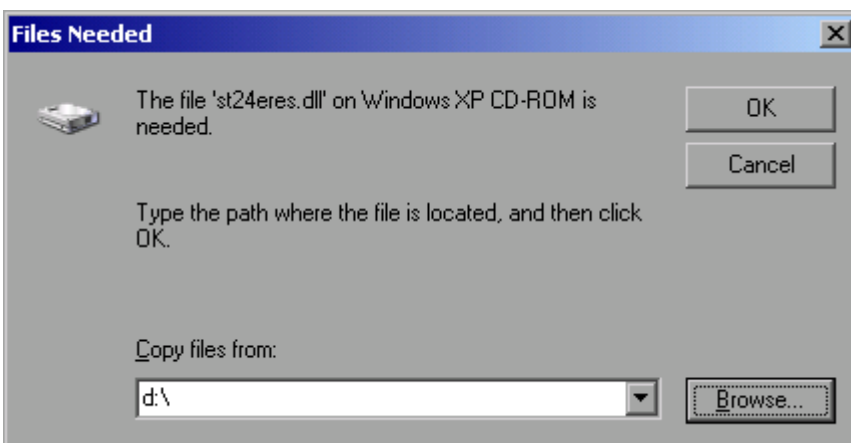

- Using the rotary knob, select the *Browse* button and confirm by pressing the rotary knob. The *Locate File* dialog box will open.

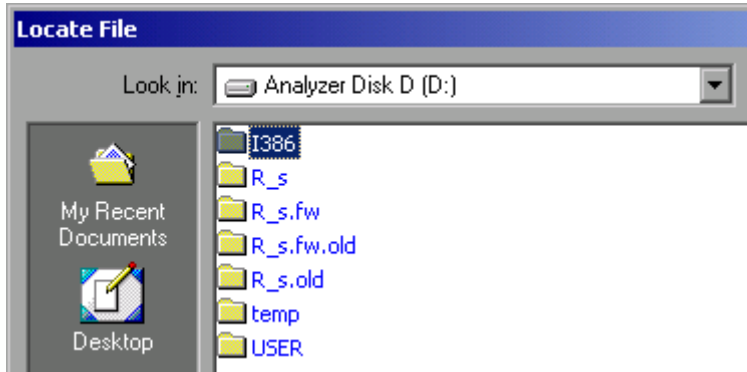

- Select the path D:\I386 by turning the rotary knob and then pressing it. If the background of the selection bar is not blue, the selection must be marked with the cursor up/down keys before the entry can be selected by pressing the rotary knob.

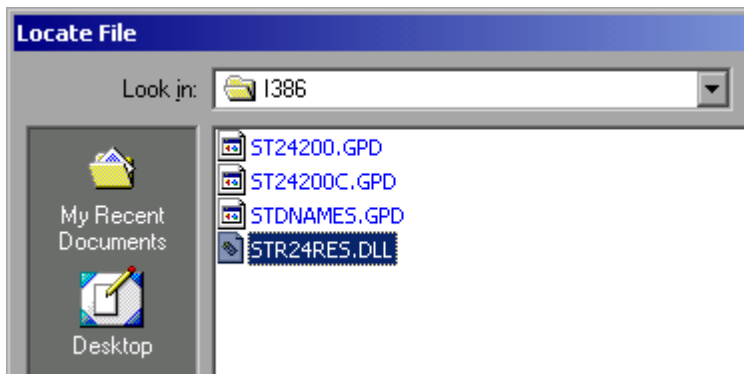

- Using the rotary knob, select a driver file and confirm by pressing the rotary knob. The file will be added to the "Files Needed" dialog box.

Note: If the file is not available in the D:\I386 directory, you will need a disk containing the driver file. In this case, exit the dialog box with ESC and repeat the selection starting with the "Files needed" dialog box.

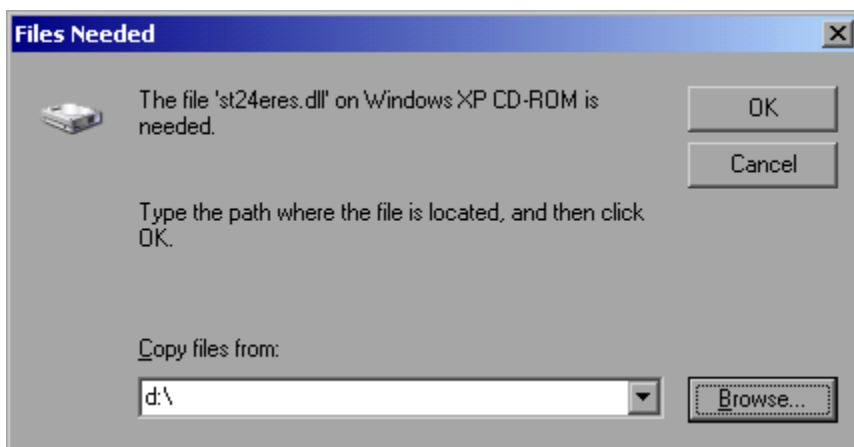

- Using the rotary knob, select *OK* and confirm by pressing the rotary knob. The installation will be completed.

The instrument must then be configured for printout with this printer using the DEVICE SETUP and DEVICE 1/2 softkeys in the hardcopy main menu (see section "Selecting a Printer).

Network Printer

Network printer installation is described in section "Printing on a Network Printer" in Annex B, LAN-Interface.

Appendix B: LAN-Interface

Note: In some of the following dialogs, user names and passwords must be entered. This requires a mouse and an external keyboard is (the connection is described in sections "Connecting a Mouse" and "Connecting an External Keyboard").

Installing Non-Plug&Play Printers

Note: Your network administrator knows which protocols are necessary. In the case of the RSIB protocol and VXI11 support, TCP/IP must always be installed. In the following example, the support for Novell Network will also be installed.

- Press the *SETUP* key.
The *SETUP* menu will open.
- Press the *GENERAL SETUP* key.
The *GENERAL SETUP* menu will open.
- Press the *CONFIGURE NETWORK* softkey.
The *Local Area Connection Status* dialog box will open.

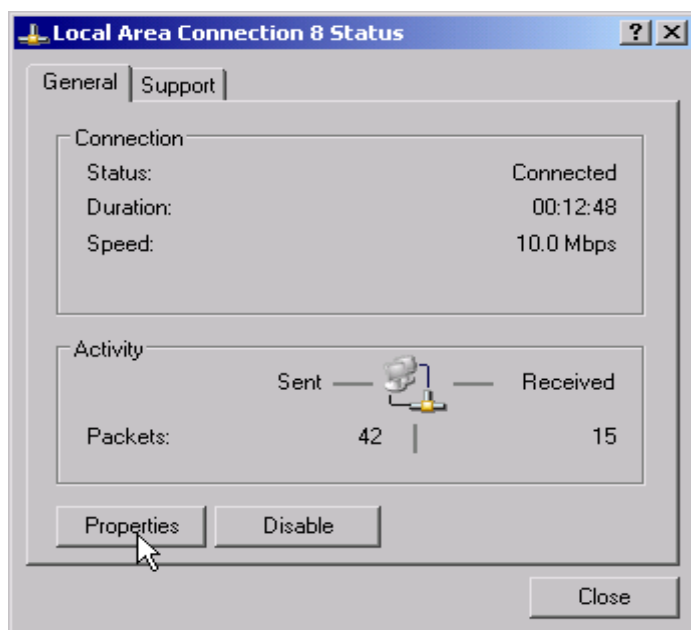

Notes:

1. Windows XP automatically appends numbers to the name Local Area Connection Status (e.g. Local Area Connection Status 8) if the configuration is created using the New Connection wizard. Since these numbers are unimportant in the following configuration steps, they are omitted in the description.
2. Alternatively it is possible to access the dialog using a connected external keyboard. Proceed as follows:
 - Open the Windows XP Start menu with the Windows key or CTRL-ESC.
 - Click Settings - Network Connections - Local Area Connection.The Local Area Connection Status dialog box will open.

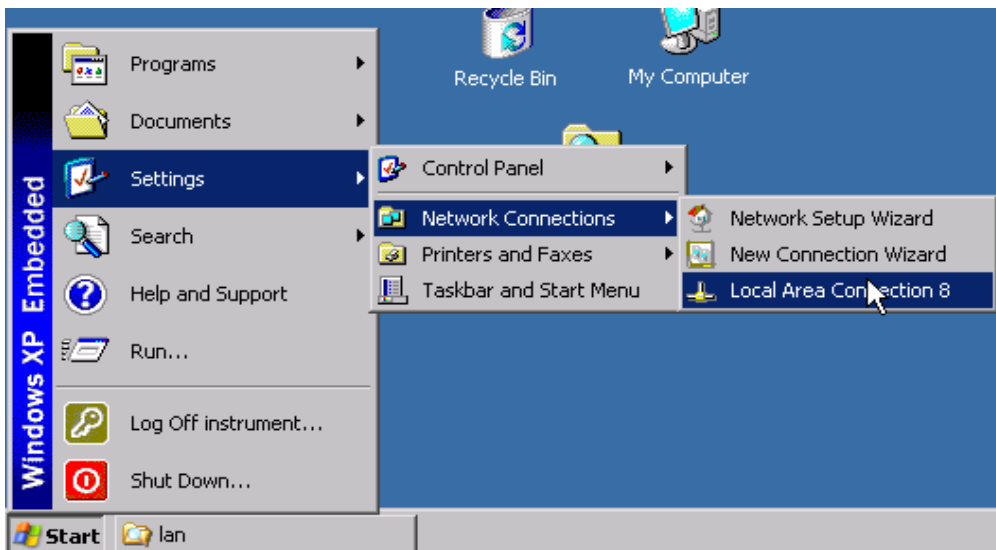

- Click the *Properties* button.
The window containing the available network protocols will open.

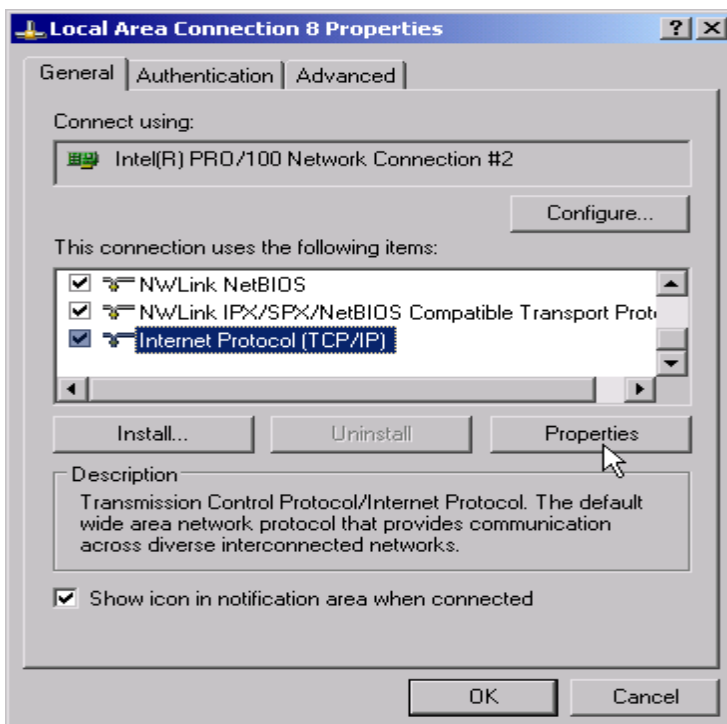

- Click the *Install* button.
The list of installable network components will open.

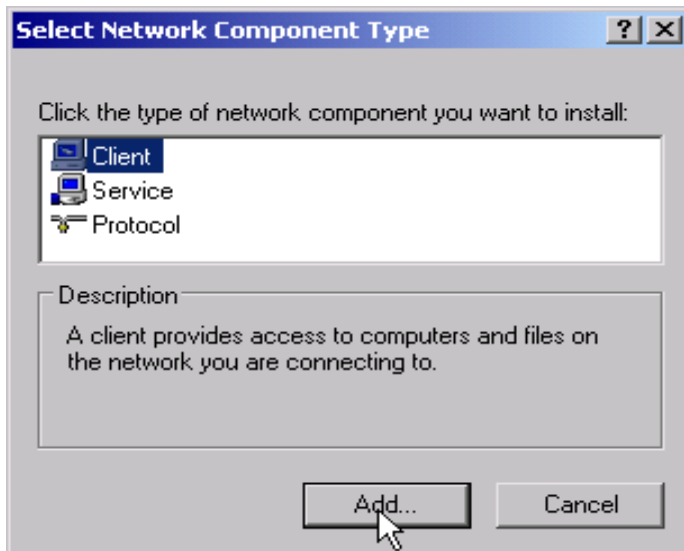

- Select *Client*.
- Click the *Add...* button.
The list of available network protocols will open.

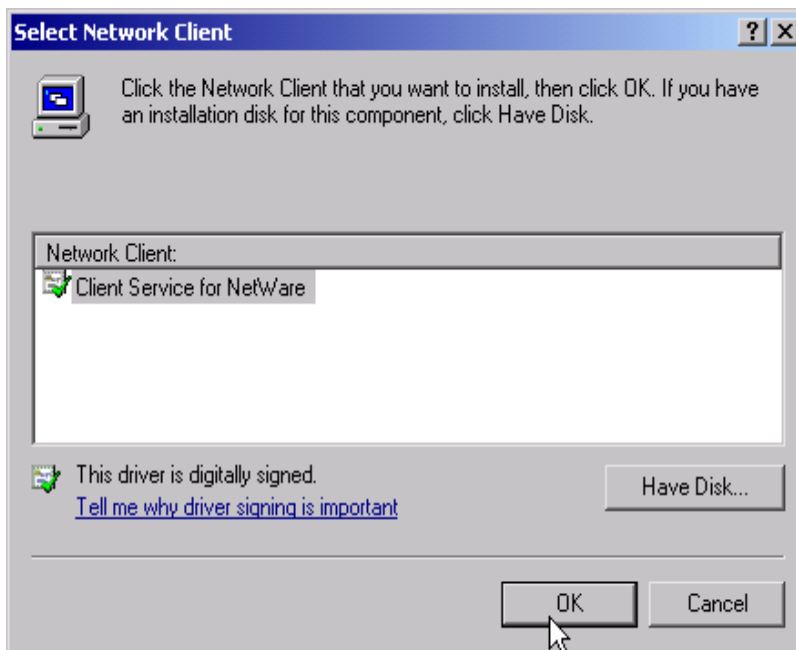

- Select *Client Service for NetWare*.
- Click the *OK* button.
The network driver for Novell NetWare will be installed.

Notes:

- Your network administrator knows which clients, services and protocols must be installed for your network.
- If network components not contained in D:\V386 need to be installed, a disk containing the drivers must be prepared (or a CD that is replayed via a USB CD-ROM drive). In this case, click the *Have Disk...* button and specify the path with the corresponding drivers.

After you complete the installation, you will be prompted to restart the instrument.

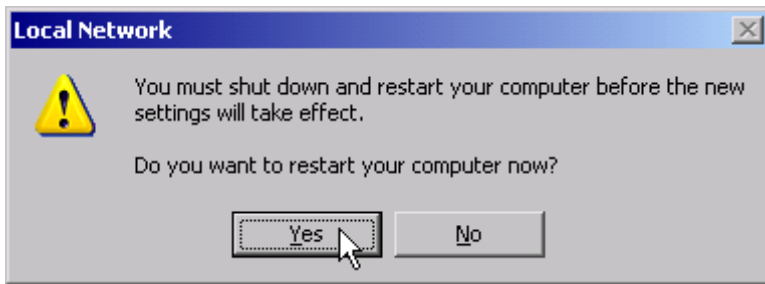

- Click the Yes button.
Windows will restart the system.

Configuration Examples

Network	Protocols	Services	Comments
NOVELL Netware	NWLink IPX/SPX compatible transport	Client service for NetWare	The frame type used in the network must be set under "Protocols - Properties".
IP Networks (FTP, TELNET, WWW, GOPHER, etc)	TCP/IP	Simple TCP/IP services	An IP address that is unique in the network must be set under "Protocols - Properties".
MICROSOFT Network	TCP/IP	Workstation server	A name that is unique in the network must be set under "Identification - Computer Name".

Subsequent Changes to the Network Configuration (computer name, domain, workgroup, etc)

After completing the installation, you can modify the computer name as follows:

- Press the Windows key or <CTRL><ESC>. The Windows Start menu will open.

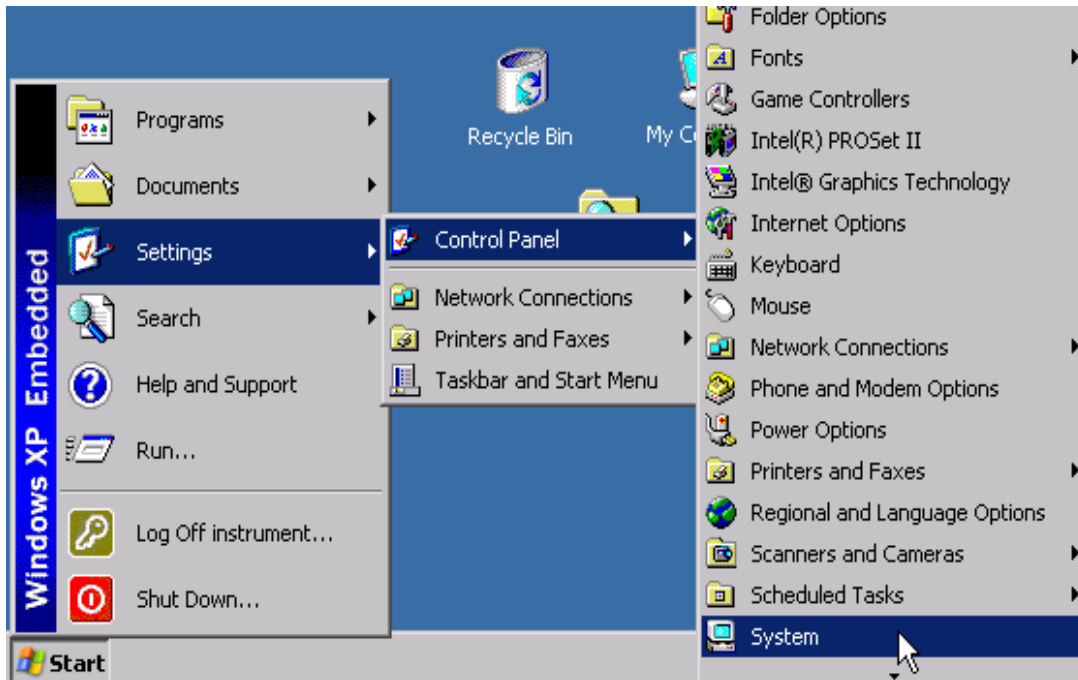

- Select Settings - Control Panel - System. The *System Properties* dialog will open.

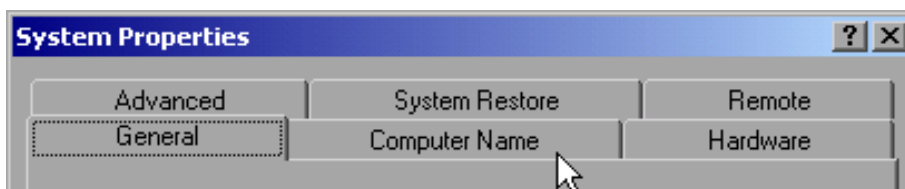

- Select the *Computer Name*.

Note: You can change the other settings after you select the other tabs. Before doing so, however, be sure to check with your network administrator.

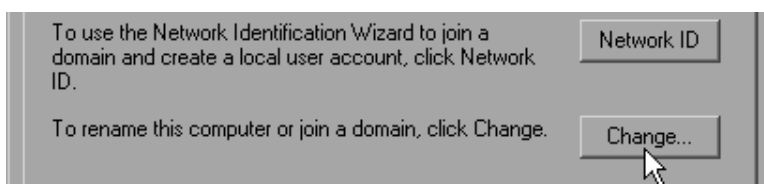

- Click the *Change* button. The dialog box for changing the computer name, domain and workgroup will open.

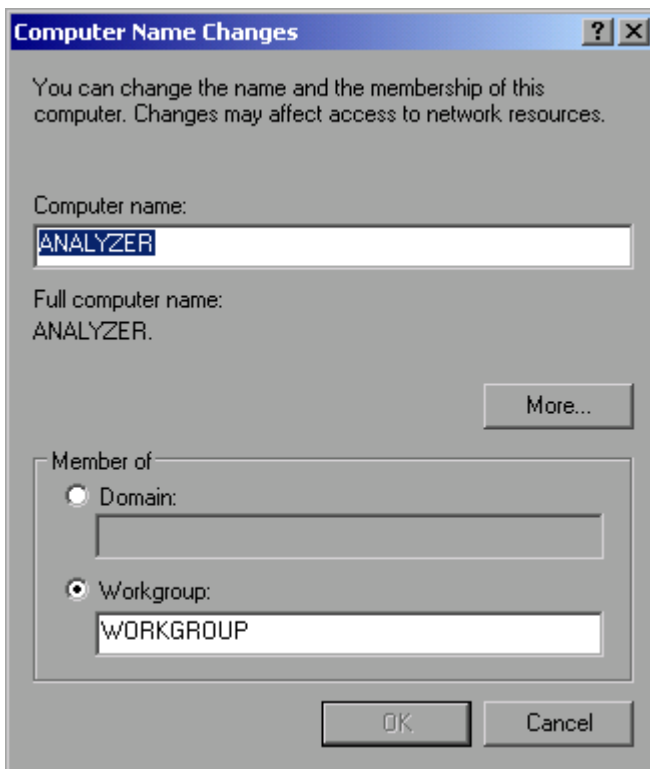

- Enter a new computer name.
- If necessary, enter a *Domain* or *Workgroup*.
- Confirm changes with *OK*.

If you are now prompted to restart the instrument, do the following:

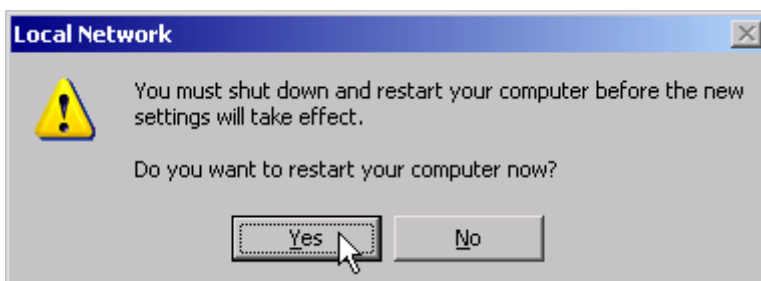

- Click the *Yes* button.
Windows will restart the system.

Operating the Instrument without a Network

If you want to operate the instrument either temporarily or permanently without a network connection, no special measures are necessary in contrast to Windows NT. Windows XP automatically detects the interruption of the network connection and does not set up the connection when the instrument is switched on.

If you are not prompted to enter the user name and password, proceed as described in the section "Reactivating the Automatic Login Mechanism".

Operating the Instrument on the Network

After network support has been installed, data can be exchanged between the instrument and other computers, and network printers can be used.

Network operation is possible only if you are authorized to use network resources. Typical resources are file directories of other computers or even central printers.

Authorization is assigned by the network or server administrator. This requires having the network names of the resources and the corresponding authorizations.

Creating Users

After the software for the network has been installed, the instrument will issue an error message the next time it is switched on, because there is no user named "instrument" (= user ID for Windows XP automatic login) in the network. Thus, a matching user must be created in Windows XP and in the network, the password must be adapted to the network password, and the automatic login mechanism must then be deactivated.

The network administrator is responsible for creating new users in the network. A new user can be created on the instrument by using the User Account wizard:

- Using the Windows key or the key combination <CTRL> <ESC>, call the Windows XP Start menu.

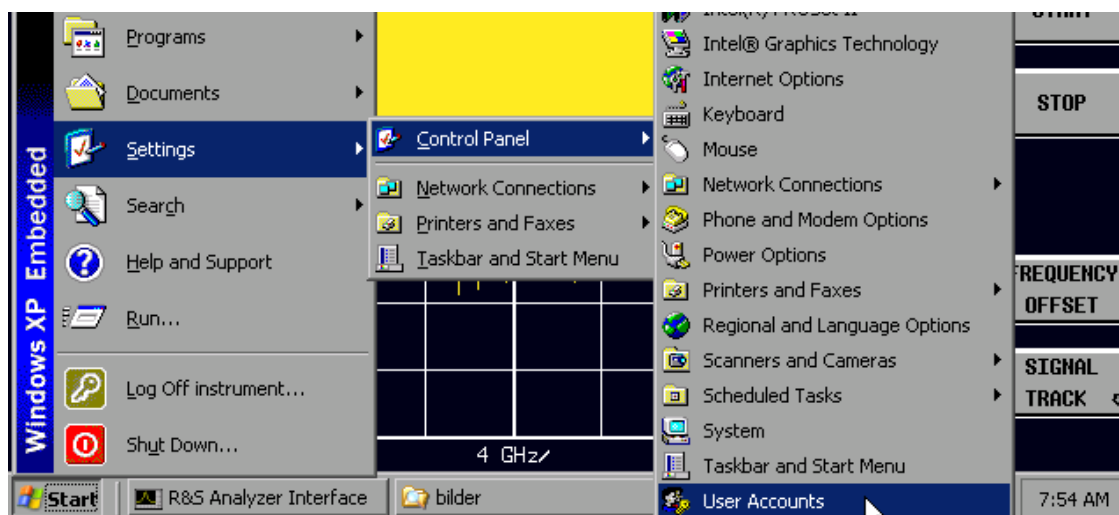

- Click *Settings* and then *Control Panel* and *User Accounts*.
The wizard for managing the user will open with the *Pick a task...* dialog box.

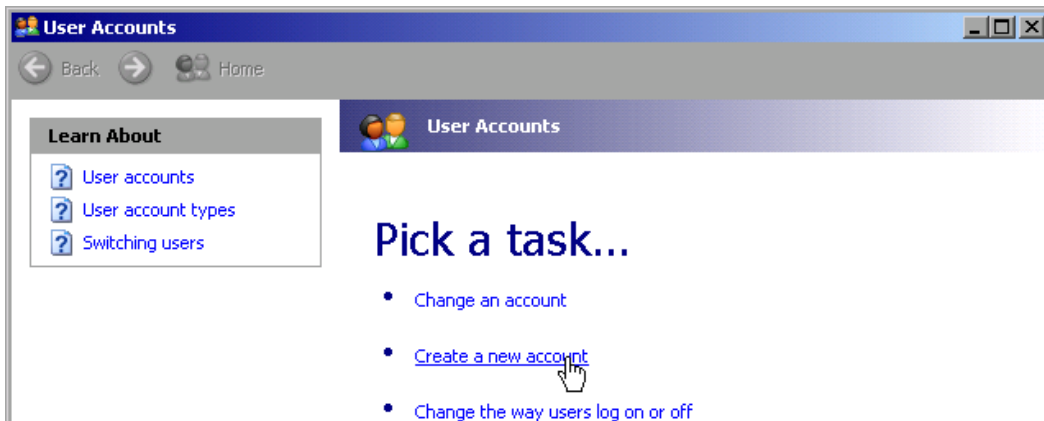

- Select *Create a new account*.
The dialog box for entering a new computer name will open.

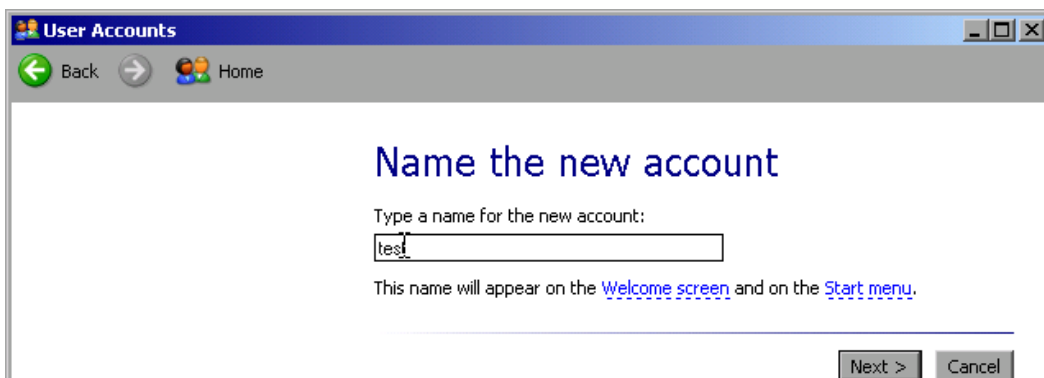

- Enter the name of the new user in the text field and confirm with *Next ->*. The *Pick an account type* dialog box for defining the user's rights will open.



- Select *Computer administrator*.

Note: Proper firmware function requires administrator rights.

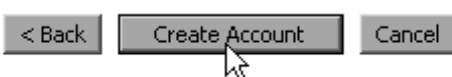

- Conclude the creation of the new user by clicking the *Create Account* button.
The new user has now been created.

Changing the User Password

After the new user has been created on the instrument, the password must be adapted to the network password. This is also done by using the User Account wizard.

- Using the Windows key or the key combination <CTRL> <ESC>, call the Windows XP Start menu.
- Click *Settings* and then *Control Panel* and *User Accounts*.
The wizard for managing the users will open with the *Pick a task...* dialog box.

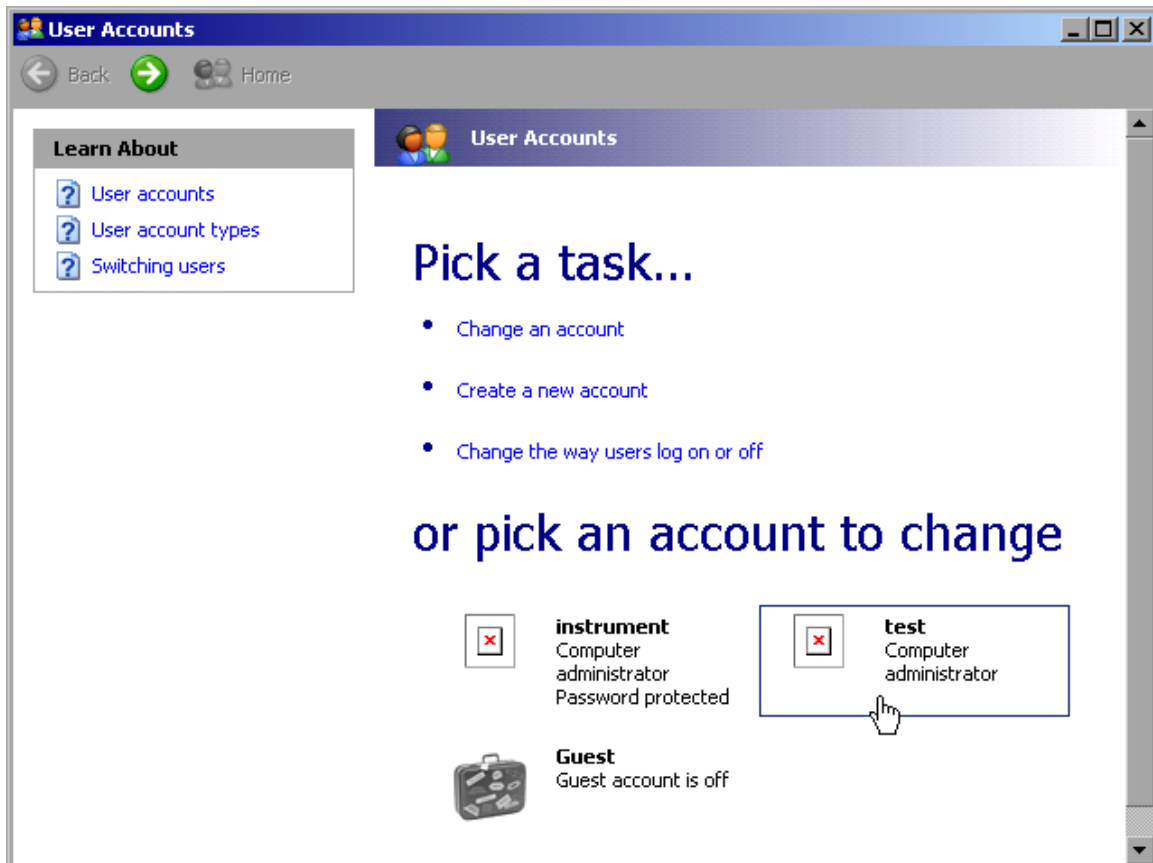

- Click the desired user account (in the example: user *Test*).
The dialog box for selecting the desired action will open.

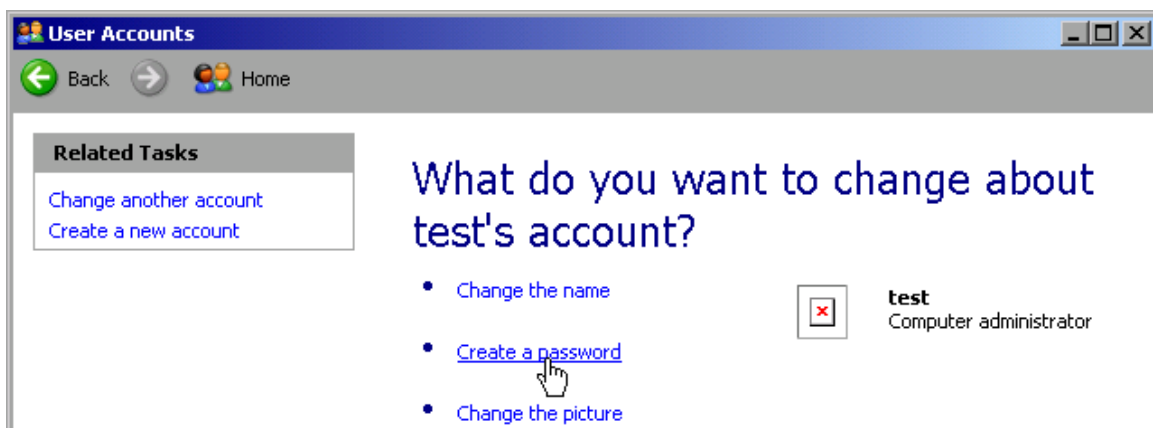

- Click *Create a password*.
The dialog box for entering a new password will open.

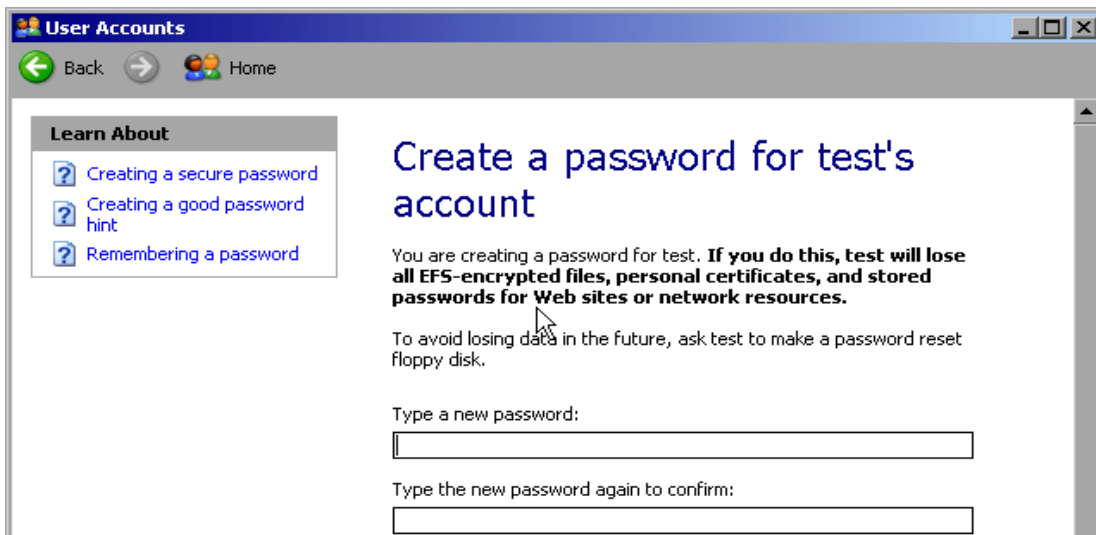

- Enter the new password in the upper text line and repeat it in the following line.
- Scroll the screen contents down.



- Conclude the entry with the *Create Password* button. The new password is now active.

NOVELL Network only: Configure NOVELL Client

- Using the Windows key or the key combination <CTRL> <ESC>, call the Windows XP Start menu.

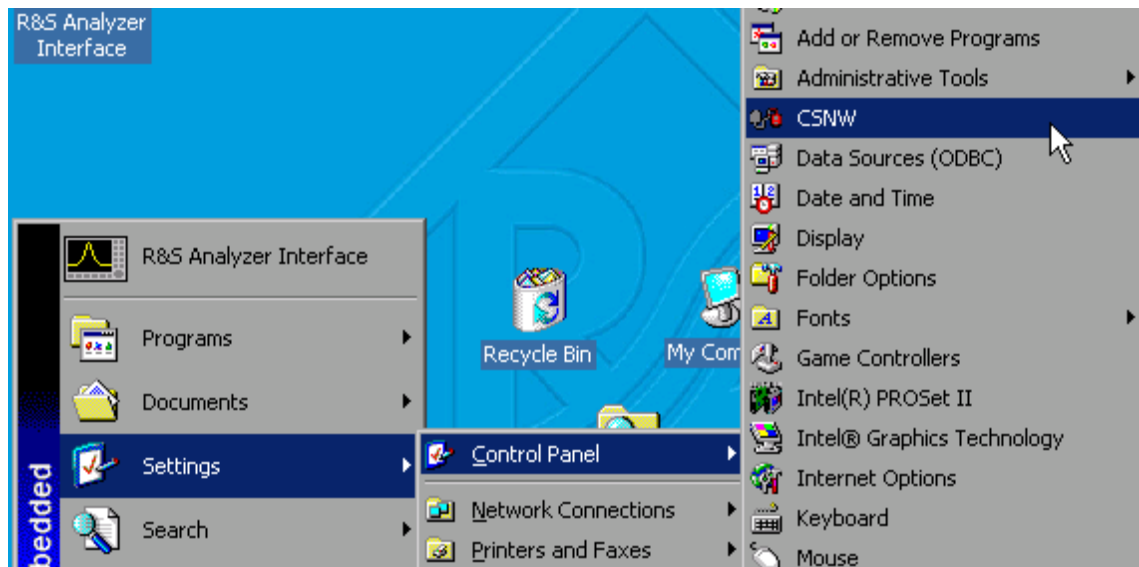

- Click *Settings* and then *Control Panel* and *CSNW*.

Bindary Login (NOVELL 3.x)

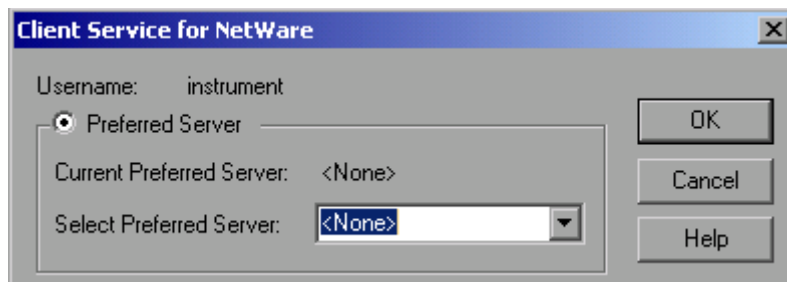

- Click *Default Tree and Context*.
- Under *Select Preferred Server*, select the NOVELL server on which the user has been created.

NDS Login (newer NOVELL versions)



- Click *Default Tree and Context*.
- Under *Tree*, enter the NDS Tree and, under *Context*, the hierarchical path on which the user has been created.
- If desired, click the *Run Login Script* entry.

Note: You can obtain this information from your network administrator.

- Conclude the login configuration with *OK*.

Logging on to the Network

Network logon occurs at the same time you log on to the operating system. For this to be possible, the user name and the password must be identical under Windows XP and on the network.

Deactivating the Automatic Login Mechanism

When shipped, the instrument is already configured to automatically log on under Windows XP. To deactivate the automatic login mechanism, perform the following steps:

- Open the Windows XP Start menu with <CTRL><ESC>.
- Select *RUN* from the menu.
An entry field will open.
- Enter the command "D:\USER\NOAUTOLOGIN.REG" in the entry field and confirm it with <ENTER>.

The automatic login mechanism will be deactivated. The next time you switch on the instrument, you will be prompted to enter your user name and password before the firmware is started.

Reactivating the Automatic Login Mechanism

To reactivate the automatic login mechanism, do the following:

- Open the Windows XP Start menu with <CTRL><ESC>.
- Selectt *RUN* from the menu. The entry field will open.
- Enter the command "D:\USER\AUTOLOGIN.REG" in the entry field and confirm it with <ENTER>.

The automatic login mechanism will be reactivated,. It will be applied the next time the instrument is switched on.

Using Network Drives

- Using the Windows key or the key combination <CTRL> <ESC>, call the Windows XP Start menu.
- Click *Programs* , and then *Accessories* and *Windows Explorer*.
- Under Desktop, click *My Network Places* and *Entire Network*
All available network drives will be displayed.

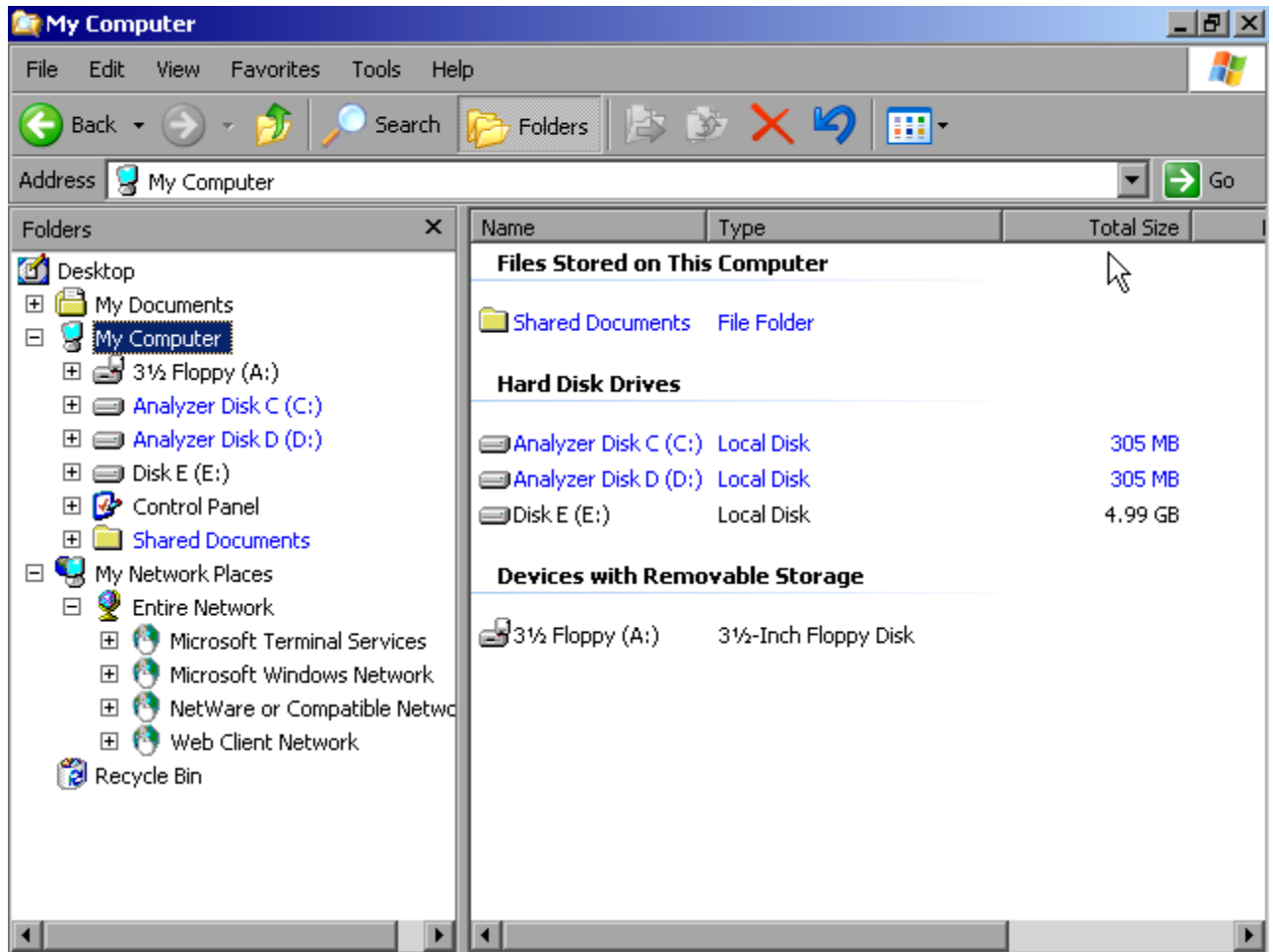

➤ Click *Tools* und dann *Map Network Drive*.

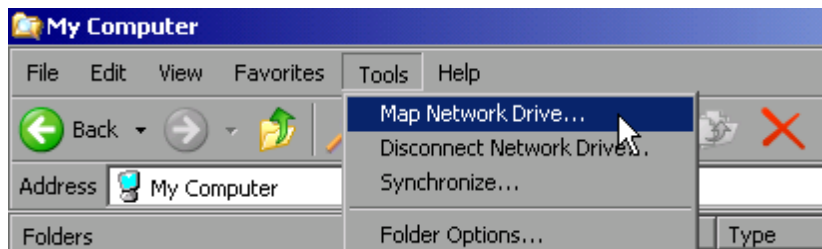

The *Map Network Drive* dialog will open:

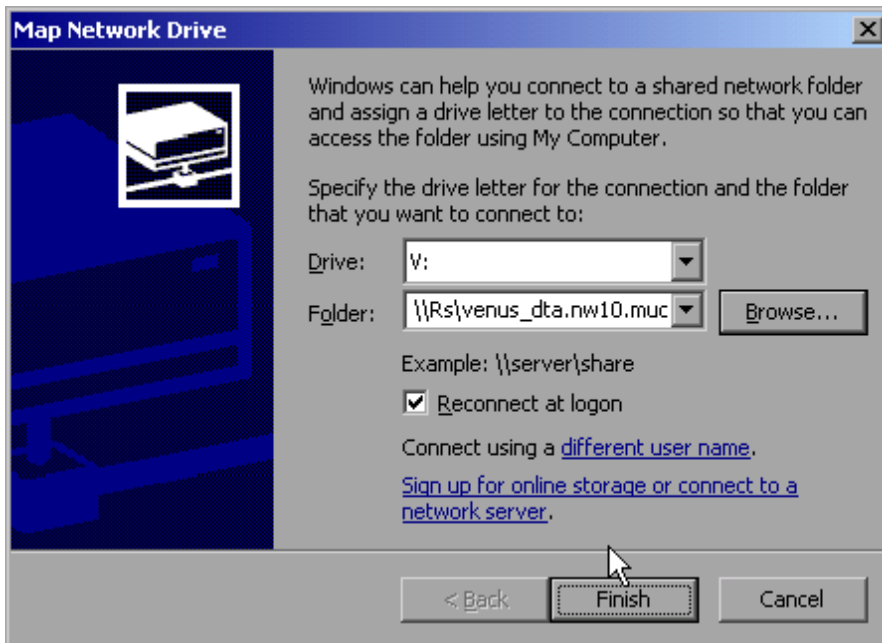

- Under *Drive*: click the drive.
- Using *Browse* , open the list of network paths available in the network.
- Mark the desired network path.
- Activate *SONDZEICHENReconnect at Logon*: if you want the connection to be set up automatically each time the instrument is started.
- Click *Finish* to connect the network path with the selected drive.
You will be now prompted to enter your user name and password.

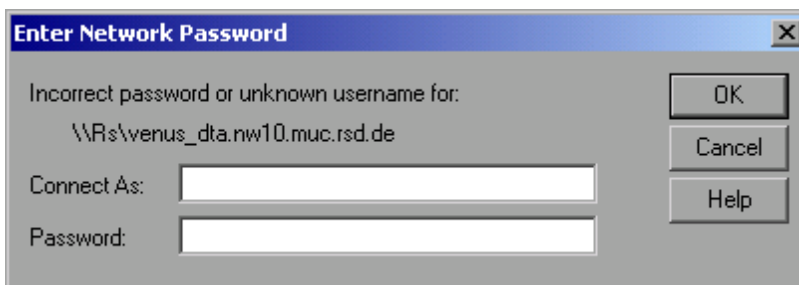

The drive will then appear under *All Directories* in Explorer.

Note: Only networks authorized in the network will be connected.

Terminate the connection:

- In Windows Explorer, click *Tools* and then *Disconnect Network Drive*.
- Under *Drive*: , select the drive whose connection is to be terminated.
- Click *OK* to terminate the connection. You will need to confirm this step with *Yes*.

Printing on a Network Printer

A new printer is installed using the *INSTALL PRINTER* softkey in the *HCOPY* menu.

- Click the *HCOPY* key.
The *HCOPY* menu will open.
- Click the *NEXT* key to go to the side menu.
- Using *INSTALL PRINTER*, open the *Printers and Faxes* dialog box

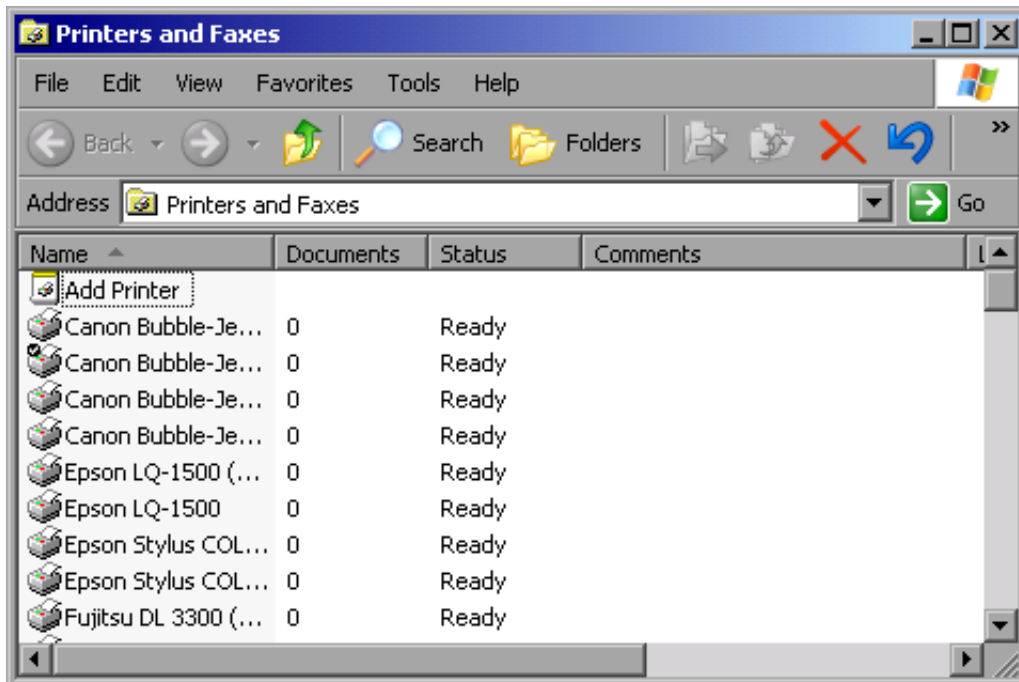

- Using the rotary knob, go to Add Printer in the selection list.
- Using *CURSOR RIGHT*, mark the entry and then confirm by pressing *ENTER* or the rotary knob.
The *Add Printer Wizard* will now appear.

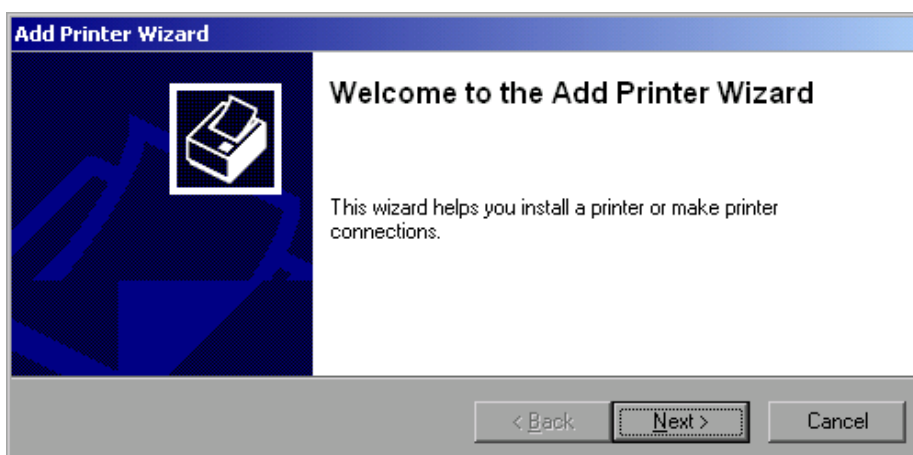

- Select *NEXT* with the rotary knob and then press the rotary knob to confirm.
The *Local or Network Printer* selection will appear.

In the example below, an HP Laserjet 5 printer is installed as a network printer. The Add Printer wizard has already been opened as described in the section Starting the Add Printer Wizard.

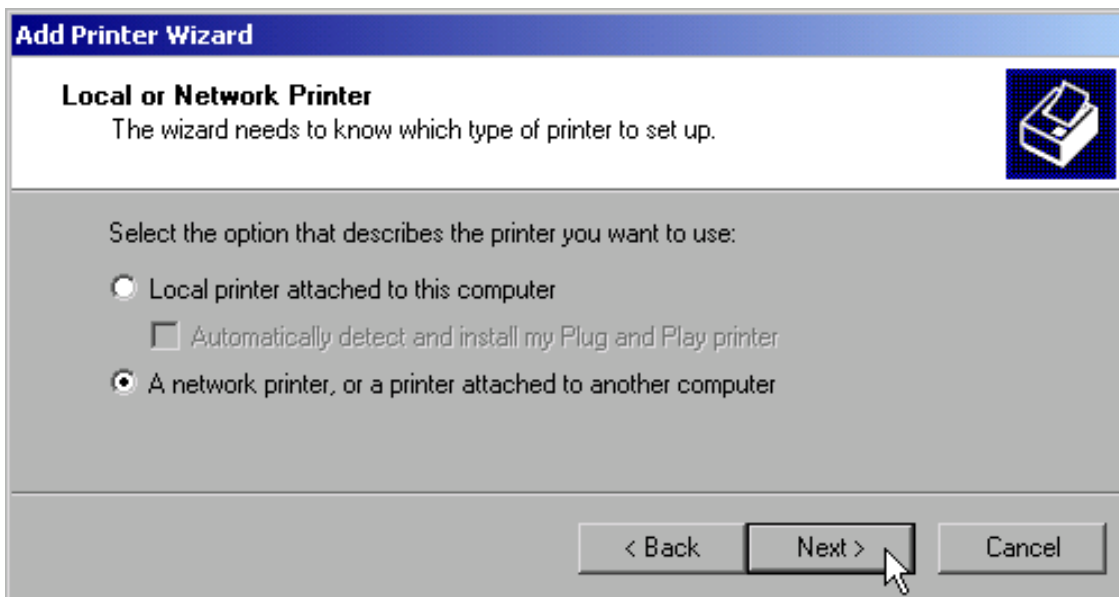

- To select a network printer, click the option *A network printer or a printer attached to another computer*.
- Click *Next* to continue. The *Specify a Printer* dialog will open.

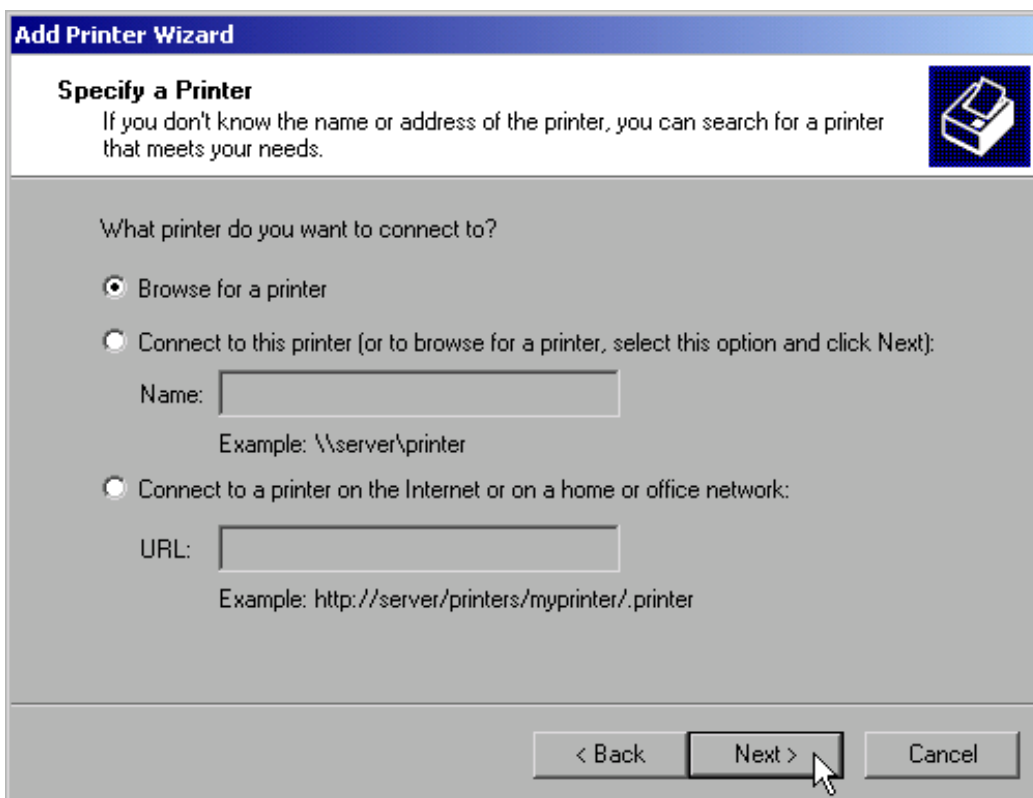

- Click *Browse for a printer* and then *Next*. The selection of enabled printers will appear.

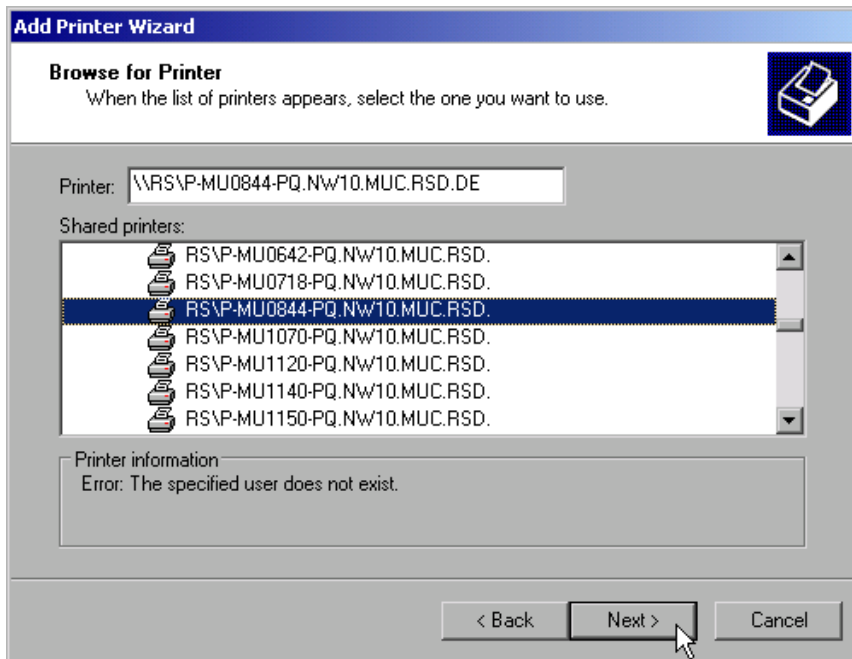

- Mark a printer and confirm with **OK**.
- When you are prompted to confirm the installation of a suitable printer driver, click **OK**. The selection of printer drivers will appear. The left-hand pane will list the manufacturers and the right-hand pane the available printer drivers.

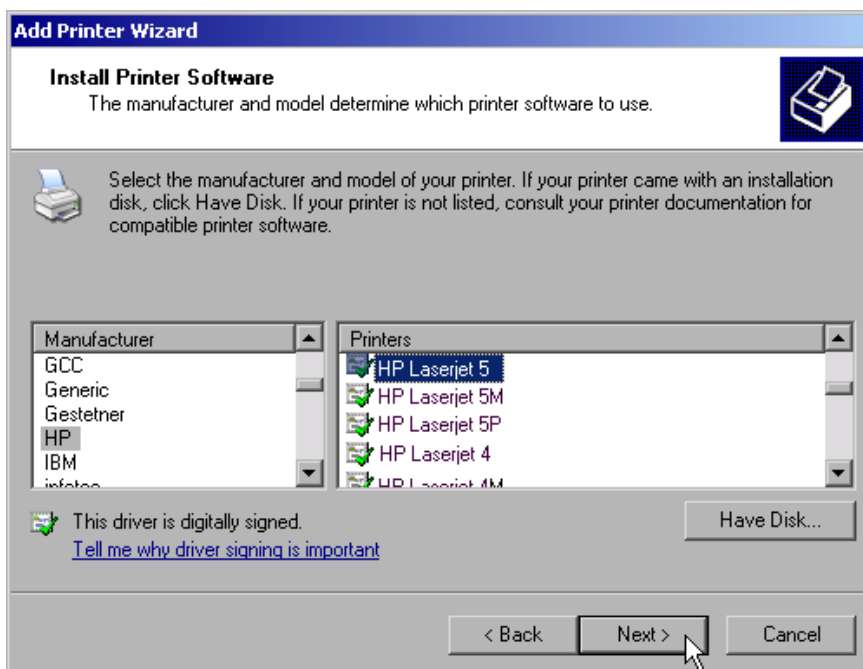

- Select the appropriate manufacturer under *Manufacturers* and then the appropriate printer driver under *Printers*.

Note: *If the printer you need does not appear in the list, the driver has not yet been installed on the instrument. In this case, click the Have Disk button. You will then be prompted to insert a disk containing the required driver. Then press OK and select the printer driver.*

- Click *Next*. The default printer selection dialog is opened.

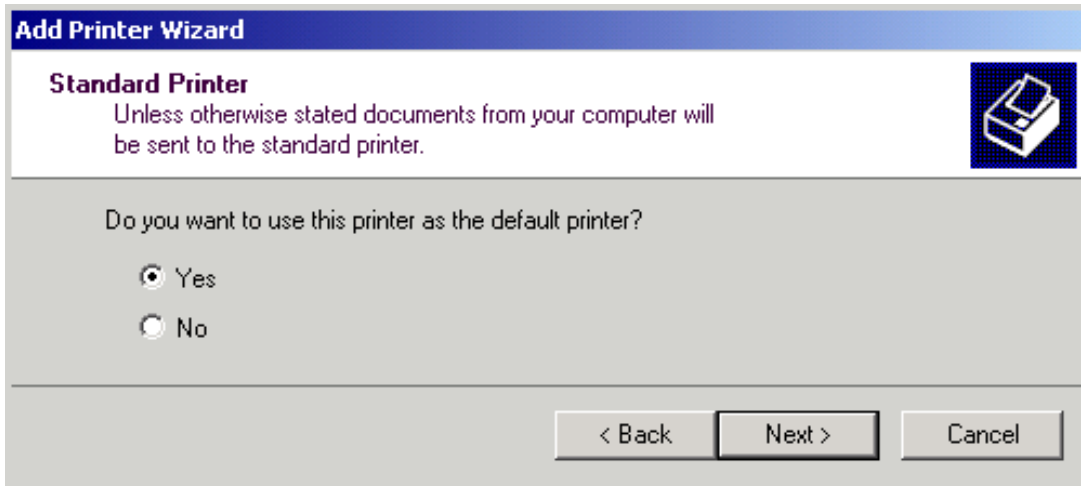

If one or more printers have already been installed, you will now be asked whether you want to use the printer you just installed as the default printer for Windows XP applications. The default response is *No*.

- After selecting the default printer, click *Next*. The final message of the installation wizard is displayed.

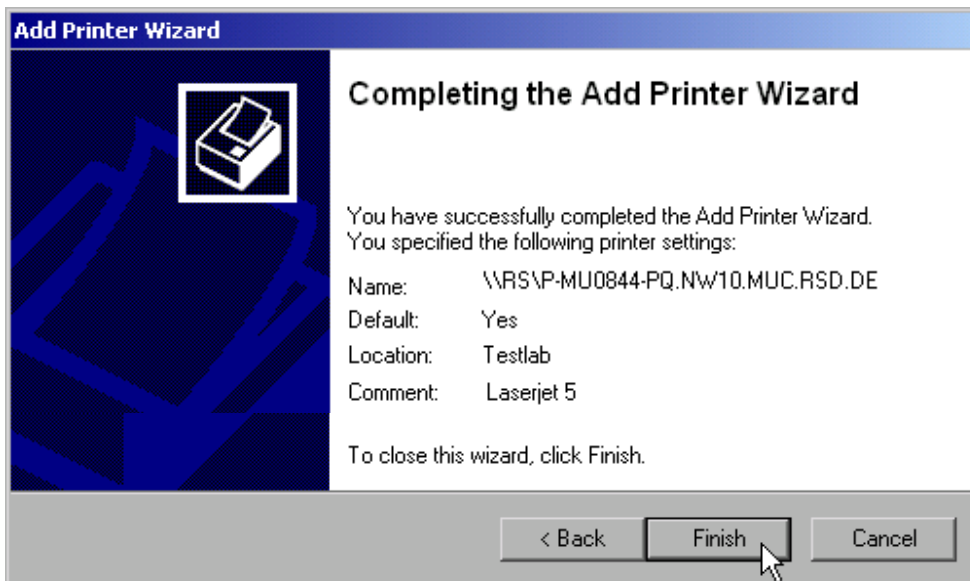

- Click the *Finish* button to start installation of the printer driver.

The instrument must then be configured for printout with this printer using the **DEVICE SETUP** and **DEVICE 1/2** softkeys in the hardcopy main menu (see section **Selecting a Printer**).

Sharing Directories (only with Microsoft Networks)

Sharing directories makes data on the device available for use on other computers. This is possible only in Microsoft networks.

Sharing is a property of a file or directory. The procedure for applying sharing is as follows:

- Open the Windows Start menu with the Windows key or <CTRL><ESC>.

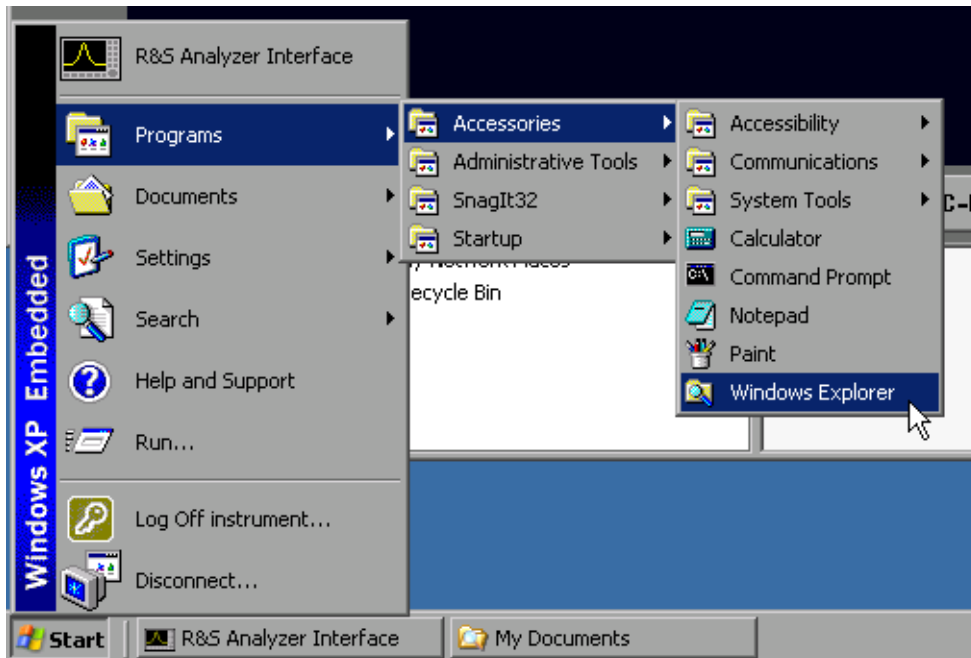

- Click *Programs - Accessories - Windows Explorer* to open Windows Explorer.

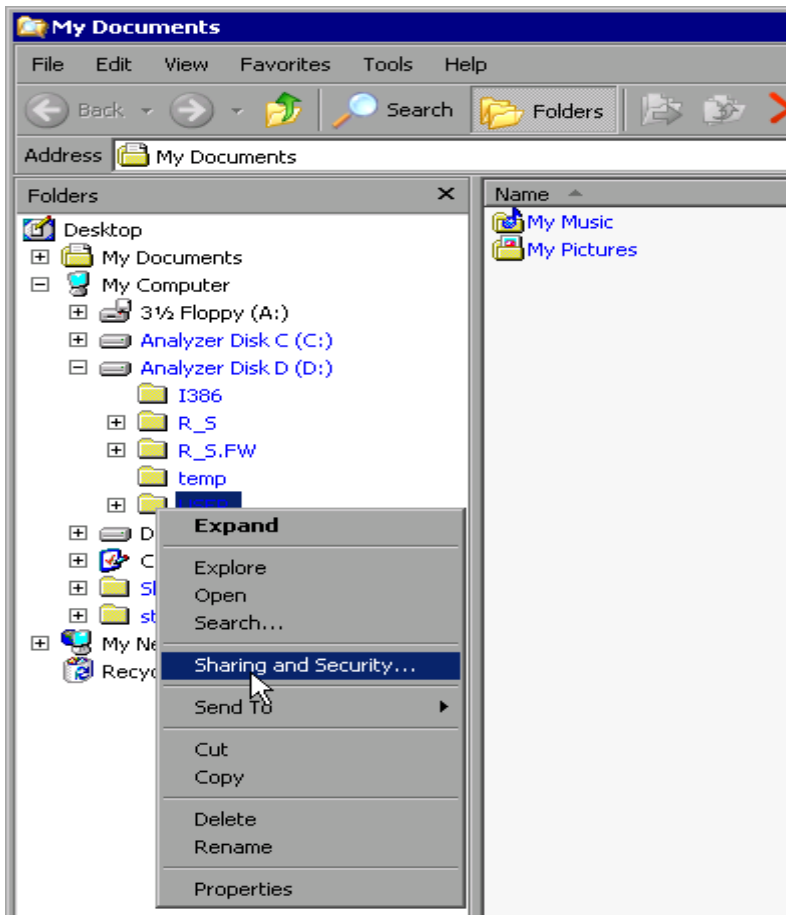

- Click the desired folder with the right mouse button.
- Click *Sharing and Security*.
The dialog for sharing the directory will open.

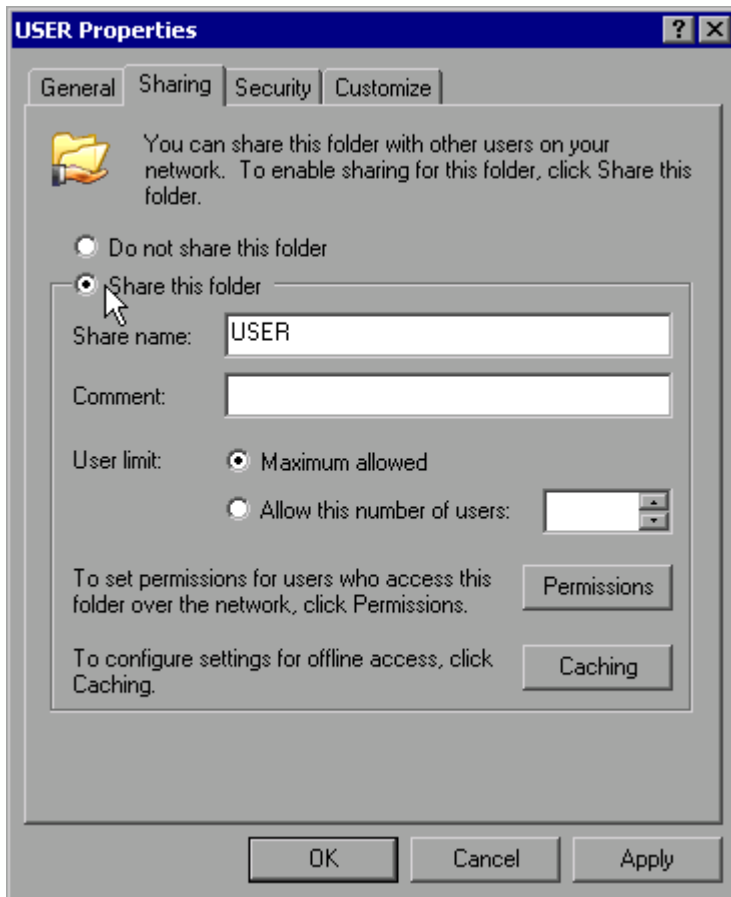

- Click *Share this folder*.
- You can change the following settings as necessary:
 - Share name:* Name under which the directory appears in Explorer
 - Comment:* Comments regarding the shared directory
 - User Limit:* Maximum number of users who can access the directory simultaneously
 - Permissions:* The user access rights (read only, read and write, all)
 - Caching:* Local buffering of the directory contents for quicker access
- Confirm the settings with *OK*.
The drive will be shared and marked with a hand under the directory symbol in Explorer:



Remote Monitoring of the R&S FSP with XP Remote Desktop

Introduction

In production test and measurement, a common requirement is central monitoring of the T&M instruments for remote maintenance and remote diagnostics. Equipped with the Remote Desktop software of Windows XP, the R&S FSP family of spectrum analyzers ideally meets requirements for use in production:

- Access to the control functions via a virtual front panel (*soft front panel*)
- Printout of measurement results directly from the controller
- Storage of measured data on the controller's hard disk

The analyzer is connected via a LAN, in which case Windows XP also supports a connection via a modem. This section describes the configuration of the R&S FSP and Remote Desktop Client of the control PC. Details on how to set up a modem connection are described in the Window XP documentation.

Configuring the R&S FSP for Use of Remote Desktop

To enable an external computer to access the Remote Desktop software of the R&S FSP, proceed as follows:

1. Determine the IP configuration of the network connection:

- Open the Windows XP Start menu with the Windows key or *CTRL-ESC*.

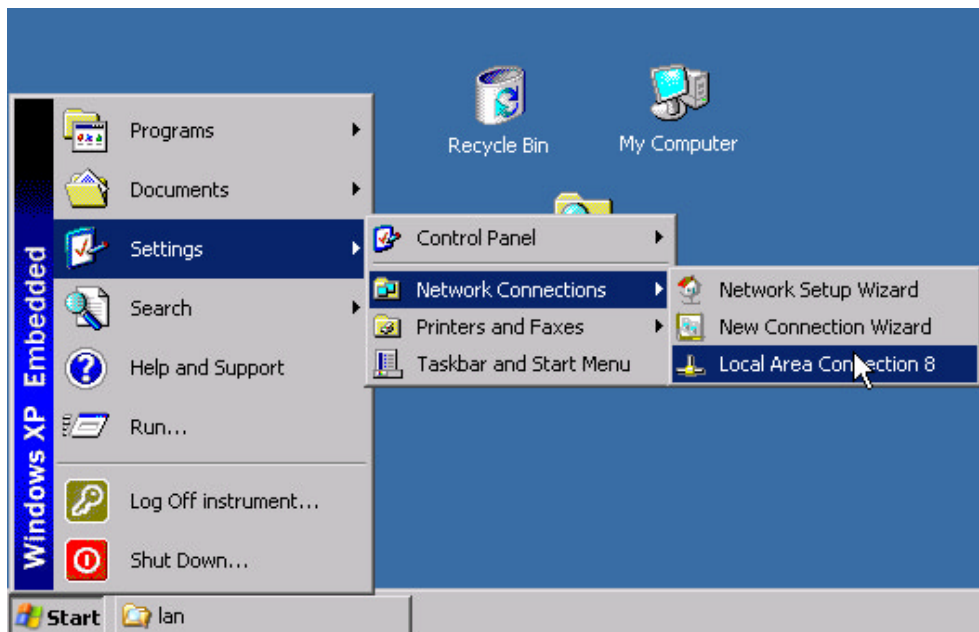

- Click *Settings - Network Connections - Local Area Connection*. The *Local Area Connection Status* dialog box will open.

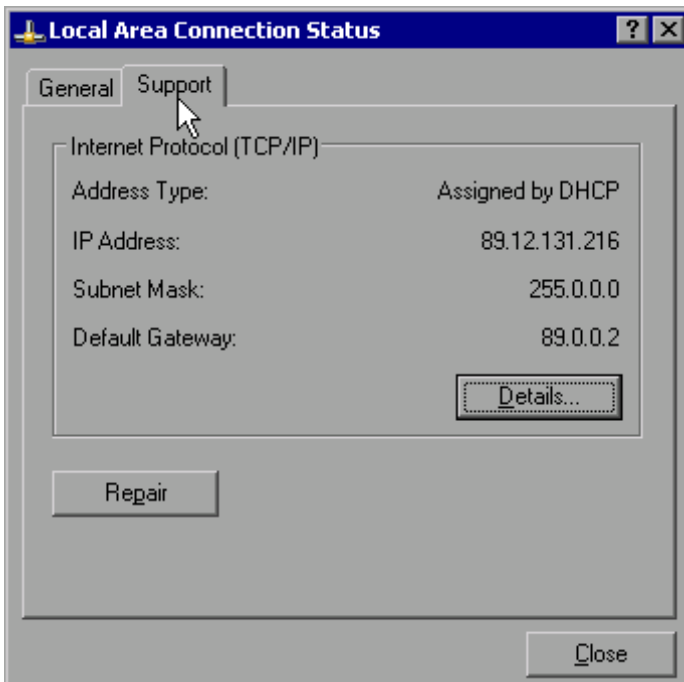

- Click the *Support* tab.
The current TCP/IP configuration will be displayed.
If *Assigned by DHCP* appears in the *Address Type* field, go to step 2 (Create a fixed IP address...). Otherwise, simply note the IP address and go to step 3 (Enable the R&S FSP...).

2. Create a fixed IP address for the TCP/IP protocol as described in the section *Configuring Existing Network Protocols (TCP/IP Protocol)*.

Note: *To avoid problems, use a fixed IP address.
When a DHCP server is used, a new IP address is assigned each time the instrument is restarted. This address must first be determined on the instrument itself.
Thus, using a DHCP server is not suitable for remote operation of the R&S FSP.*

3. Enable the R&S FSP for operation with Remote Desktop

- Press the Windows key or <CTRL><ESC>.
The Windows Start menu will open.

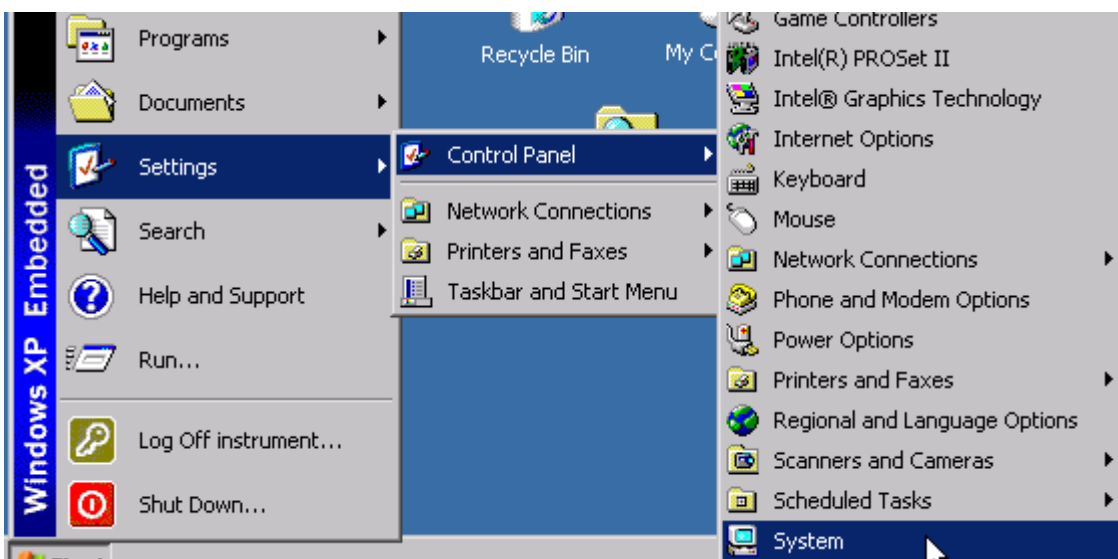

- Select *Settings - Control Panel - System*.
- Select the *Remote* tab.

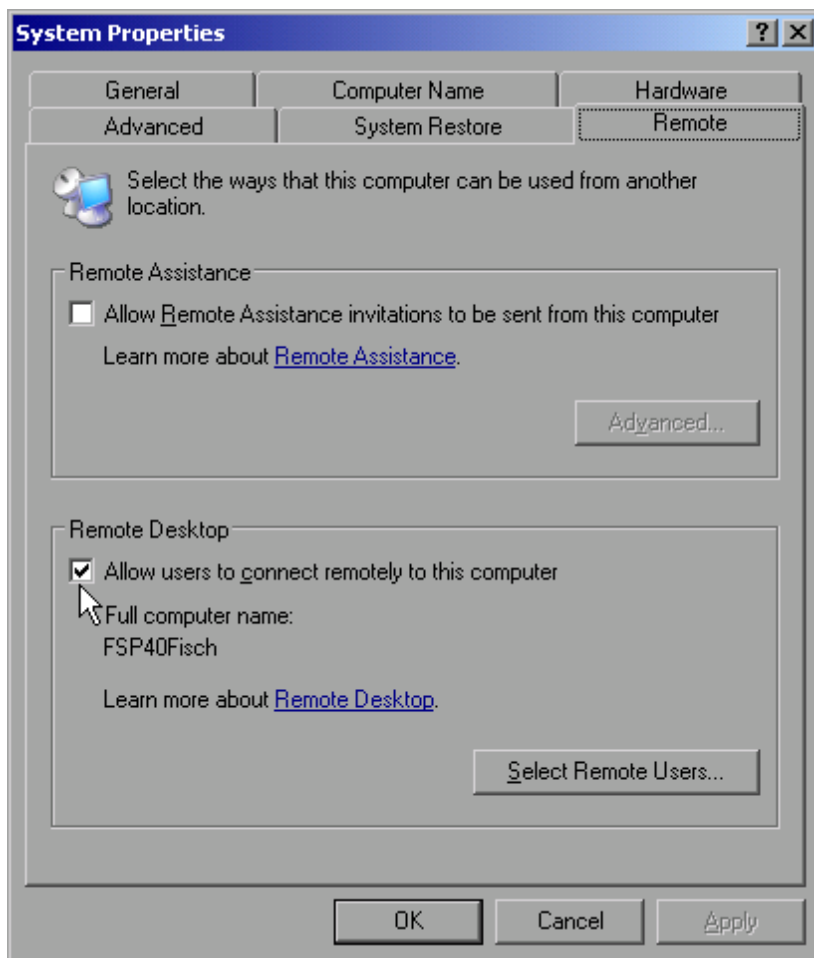

- In the *Remote Desktop* panel, select the check box in front of *Allow users to connect remotely to this computer*.
- If necessary, click *Select Remote Users...* and select users created on the R&S FSP who are to be given access to the R&S FSP also via Remote Desktop

Note: The user account under which configuration is carried out is automatically enabled for Remote Desktop.

- Confirm the setting with *OK*.

The R&S FSP is now ready for connection setup with the Remote Desktop program of the controller.

Configuring the Controller

Before Remote Desktop can be operated, the TCP/IP protocol must be created on the controller and Remote Desktop Client must be installed.

Note: *With Windows XP, Remote Desktop Client is part of the operating system and can be accessed via Start - Programs - Accessories - Communications - Remote Desktop Connection.*

For other versions of Windows, Microsoft offers the Remote Desktop Client as an add-on.

The settings on the Remote Desktop Client of the controller must be made before the connection with the R&S FSP is set up. The procedure is as follows:

- Press the Windows key or <CTRL><ESC>.

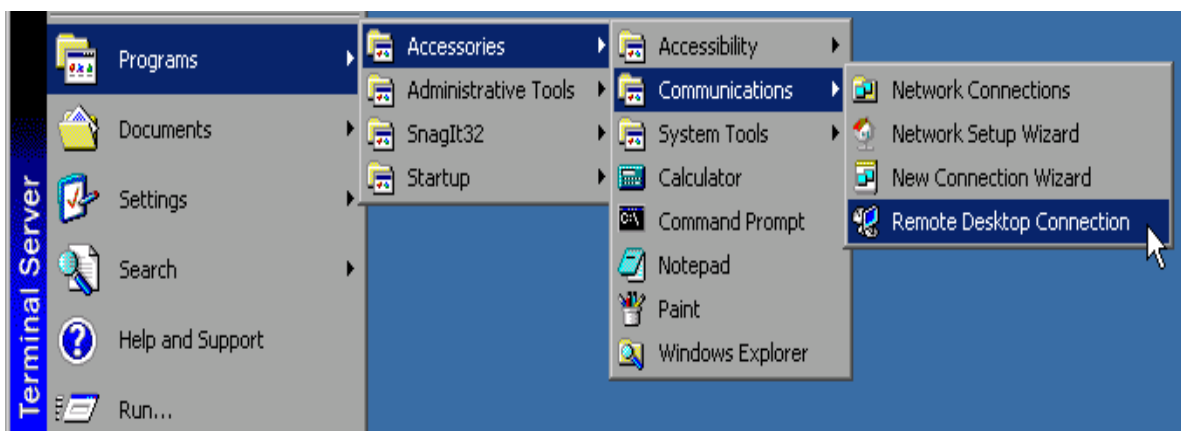

- Select *Programs - Accessories - Communications - Remote Desktop Connection*. The Remote Desktop logon screen will appear.

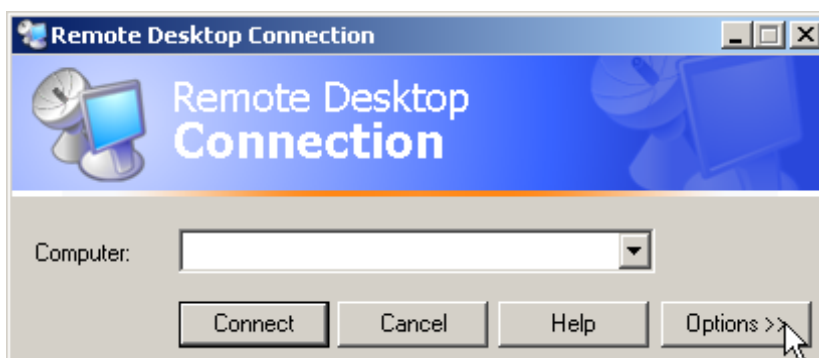

- Select the *Options >>* button. The table with the configuration data will appear.



- Select the *Experience* tab.
These settings are used to select and optimize the connection speed.
- Click the selection list under *Choose your connection speed to optimize performance*.
The list of available configurations will appear.

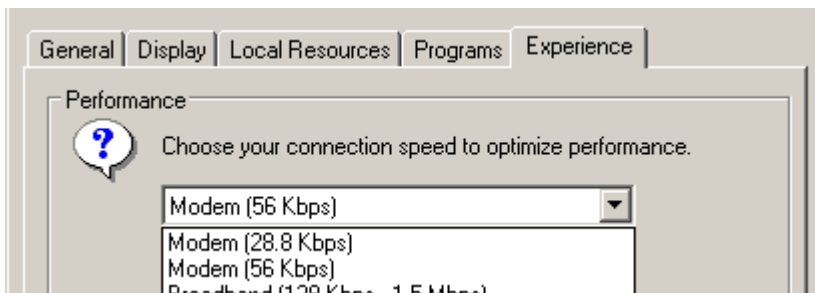

- Select the appropriate connection (for example: LAN (10 Mbps or higher)).
Depending on your selection, various checkboxes will be activated in the list located below (also depends on how powerful the connection is).
- To improve performance, you can deactivate *Desktop background*, *Show Contents of Window while dragging* and *Menu and Window animation*.
- Click the *Local Resources* tab.
The tab for enabling printers, local drives and serial interfaces will appear.
- Click the check box in front of *Disk drives* if you will need to access drives of the controller from the R&S FSP (e.g. in order to store settings or to copy files from the controller to the R&S FSP):

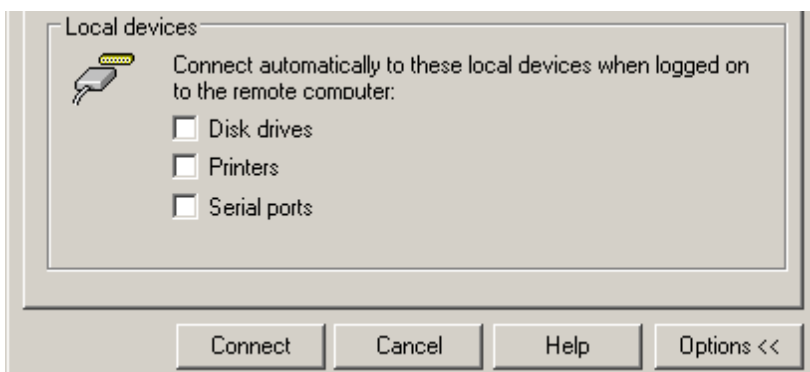

Windows XP will then map drives of the controller to the FSP like network drives.

- Click the check box in front of *Printers* if you want to use printers connected to the controller by accessing them from the R&S FSP.
- Do not change the remaining settings.
- Click the *Display* tab.
The options for configuring the R&S FSP screen display will appear.

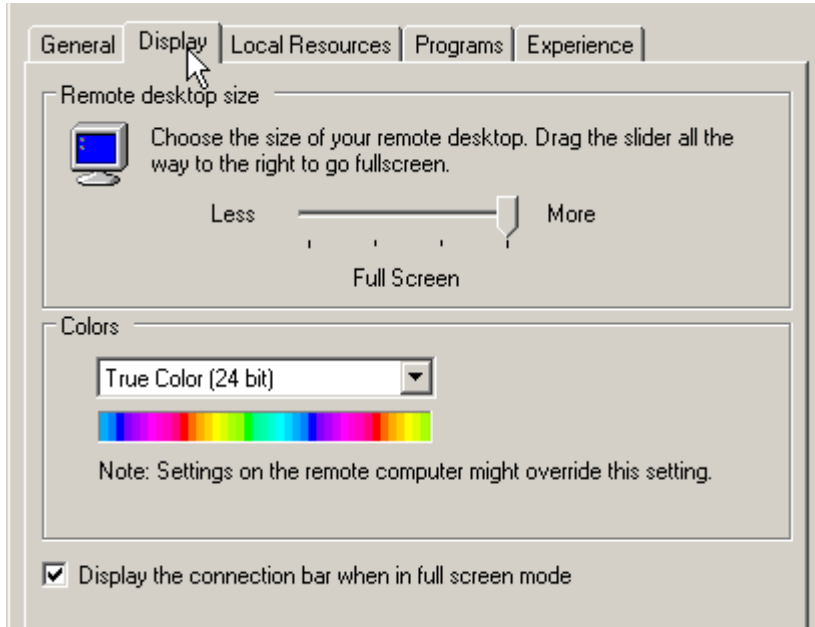

- You can set the size of the R&S FSP window on the desktop of the controller by positioning the pointer in the *Remote desktop size* panel. The default setting is Full Screen.
- Do not change the *Colors* setting.
- Display the connection bar when in full screen mode:

If this option is enabled, a bar showing the network address of the R&S FSP will appear at the top edge of the screen. You can use this bar to reduce, minimize or close the window.

If this option is disabled, the only way you can return to the controller desktop from the R&S FSP screen in Full Screen mode is to select *Disconnect* from the Start menu:

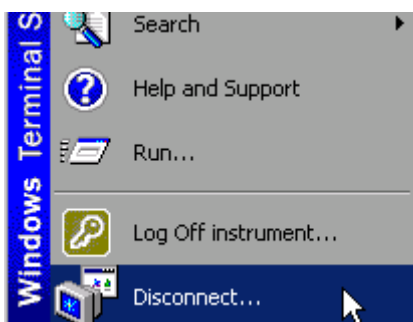

Connection Setup with the R&S FSP

After you configure the Remote Desktop Client, you need to set up the connection to the R&S FSP.

- Click the *General* tab. You can now enter the connection information.

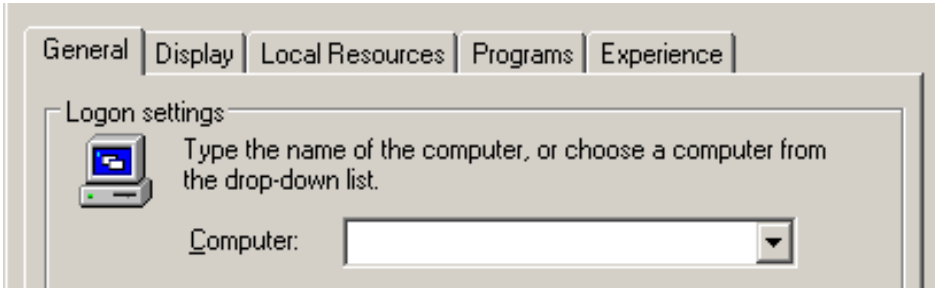

- Enter the IP address of the R&S FSP in the *Computer* field.
- You can save the connection information for later use by clicking the *Save As...* button. You can use the *Open...* button to load an existing connection configuration.

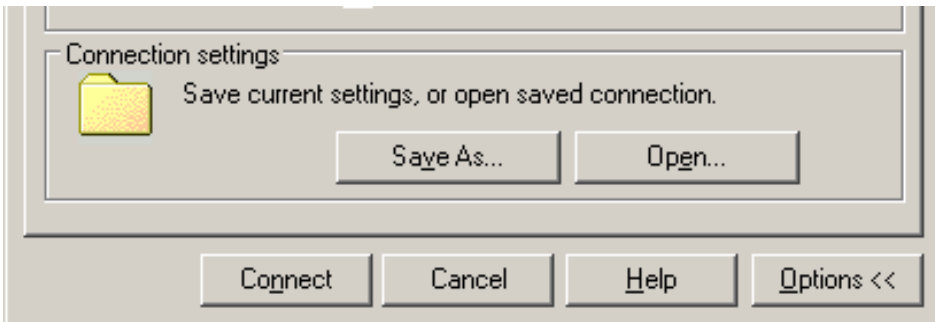

- Press the *Connect* button. The connection will be set up.

Note: If the entry *Disk Drives* is enabled on the *Local Resources* tab, a warning will appear indicating that the drives are enabled for access from the *R&S FSP*:



- Confirm the warning with *OK*. Connection setup will be resumed.

After a few moments, the screen of the R&S FSP will appear on the controller's screen with the prompt for you to log on. To enable remote control of the R&S FSP, do the following:



- Enter “instrument” as both the *user name* and the *password*.
After a few moments, the R&S FSP screen will appear.

If the R&S FSP application appears on screen immediately after connection setup, shutdown and restart are not necessary.

If a dark screen appears or a dark square appears in the upper left-hand corner of the screen, you must restart the R&S FSP in order to see the modified screen resolution:

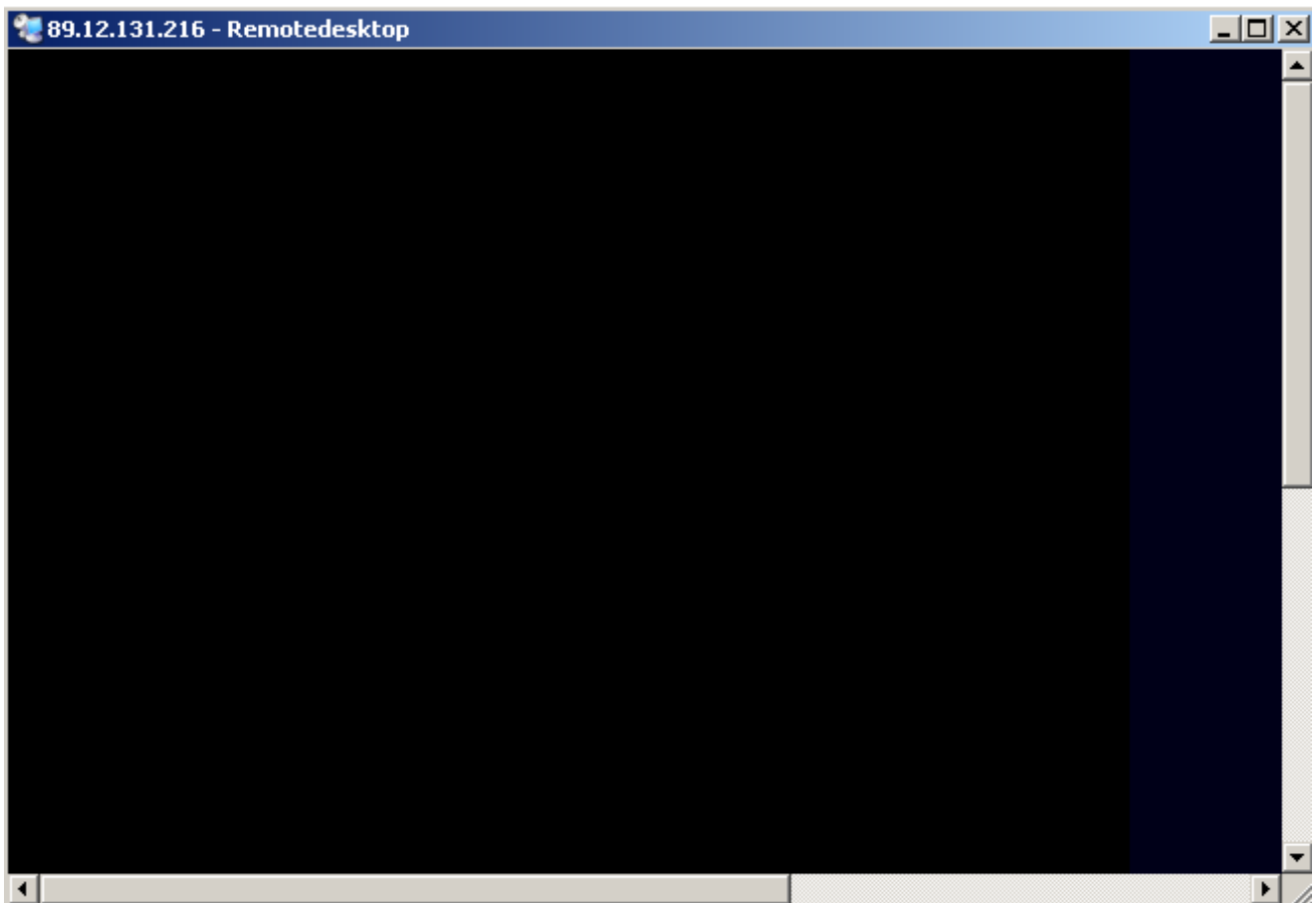

In this case, do the following:

- < Press <ALT><F4>.

The R&S FSP firmware will be shut down, which may take a few seconds.

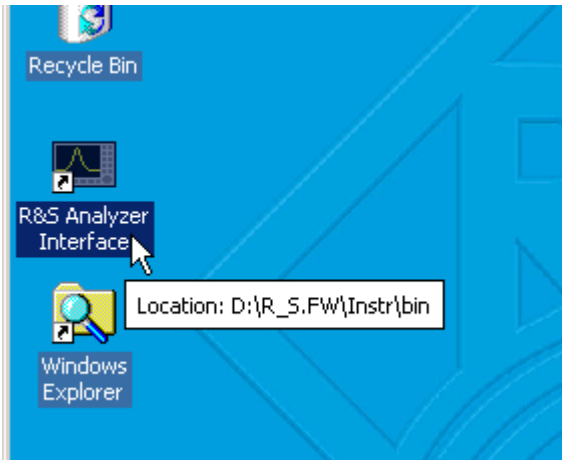

- Double-click *R&S Analyzer Interface*.

The firmware will restart and then automatically open the *Soft Front Panel*, i.e. the user interface on which all front panel controls and the rotary knob are mapped to buttons.

After the connection is established the R&S FSP screen is displayed in the Remote Desktop application window.

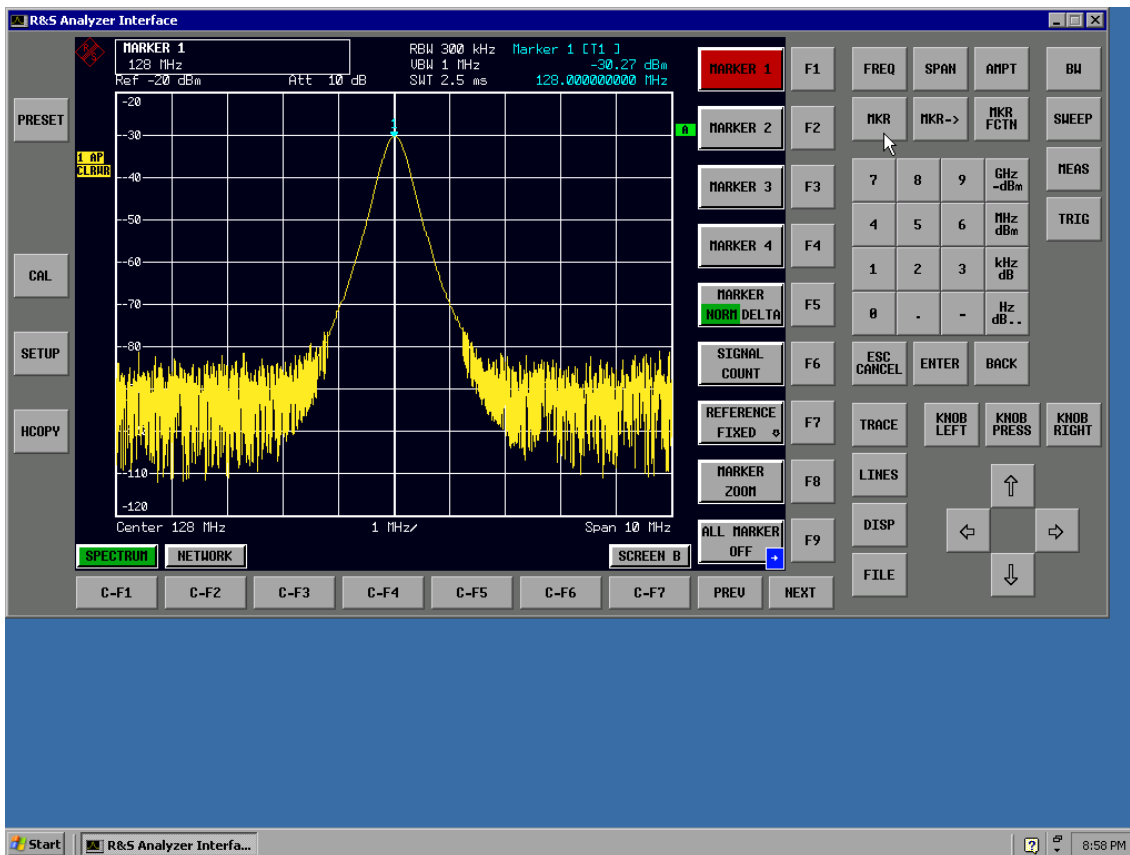

You can operate all hardkeys, softkeys and hotkeys by using the mouse.

The rotary knob is simulated by means of the *KNOB LEFT*, *KNOB RIGHT* and *KNOB PRESS* buttons.

The Windows XP Start menu can be made available by expanding the Remote Desktop window to Full Size.

Interrupting and Restoring the Remote Desktop Connection with the R&S FSP

The connection to the R&S FSP can be interrupted at any time by closing the Remote Desktop window on the controller.

To restore the connection with the FSP, merely follow the instructions provided in the section Connection Setup with the R&S FSP. If the connection is interrupted and then restored, the R&S FSP remains in the same state.

During the connection with the controller, the login entry will appear on the R&S FSP screen. If the login procedure is completed successfully on the instrument, a message will appear on the controller display indicating that another user has assumed control of the instrument and that the connection was terminated as a result.

Deactivating the R&S FSP from the Controller

The R&S FSP can be deactivated via remote control. To do so, proceed as follows:

1. Click the R&S FSP soft front panel and close the application with <ALT><F4>.
2. Click the desktop and press <ALT><F4>.
A safety query will appear that warns you that the instrument cannot be reactivated via remote control and asks you whether you want to continue the shutdown process.
3. Respond to the safety query with YES.
The connection with the controller will then be terminated and the R&S FSP will be deactivated.

RSIB Protocol

The instrument comes equipped with the RSIB protocol, which allows you to control the instrument not only via Visual C++- and Visual Basic programs but also via the two Windows applications WinWord and Excell as well as via National Instruments LabView, LabWindows/CVI and Agilent VEE.

For more information about the RSIB protocol, refer to the operating manual.

Appendix C: External Generator Control

List of Generator Types Supported by the R&S FSP

Generator	Interface Type	Generator Min. Freq.	Generator Max. Freq.	Generator Min. Power dBm	Generator Max. Power dBm
SME02	TTL	5 kHz	1.5 GHz	-144	+16
SME03	TTL	5 kHz	3.0 GHz	-144	+16
SME06	TTL	5 kHz	6.0 GHz	-144	+16
SMG	GPIB	100 kHz	1.0 GHz	-137	+13
SMGL	GPIB	9 kHz	1.0 GHz	-118	+30
SMGU	GPIB	100 kHz	2.16 GHz	-140	+13
SMH	GPIB	100 kHz	2.0 GHz	-140	+13
SMHU	GPIB	100 kHz	4.32 GHz	-140	+13
SMIQ02B	TTL	300 kHz	2.2 GHz	-144	+13
SMIQ02E	GPIB	300 kHz	2.2 GHz	-144	+13
SMIQ03B	TTL	300 kHz	3.3 GHz	-144	+13
SMIQ03E	GPIB	300 kHz	3.3 GHz	-144	+13
SMIQ04B	TTL	300 kHz	4.4 GHz	-144	+10
SMIQ06B	TTL	300 kHz	6.4 GHz	-144	+10
SML01	GPIB	9 kHz	1.1 GHz	-140	+13
SML02	GPIB	9 kHz	2.2 GHz	-140	+13
SML03	GPIB	9 kHz	3.3 GHz	-140	+13
SMR20	TTL	1 GHz	20 GHz	-130 ²⁾	+11 ²⁾
SMR20B11 ¹⁾	TTL	10 MHz	20 GHz	-130 ²⁾	+13 ²⁾
SMR27	TTL	1 GHz	27 GHz	-130 ²⁾	+11 ²⁾
SMR27B11 ¹⁾	TTL	10 MHz	27 GHz	-130 ²⁾	+12 ²⁾
SMR30	TTL	1 GHz	30 GHz	-130 ²⁾	+11 ²⁾
SMR30B11 ¹⁾	TTL	10 MHz	30 GHz	-130 ²⁾	+12 ²⁾
SMR40	TTL	1 GHz	40 GHz	-130 ²⁾	+9 ²⁾
SMR40B11 ¹⁾	TTL	10 MHz	40 GHz	-130 ²⁾	+12 ²⁾
SMR50	TTL	1 GHz	50 GHz	-130 ²⁾	+9 ²⁾
SMR50B11 ¹⁾	TTL	10 MHz	50 GHz	-130 ²⁾	+12 ²⁾
SMR60	TTL	1 GHz	60 GHz	-130 ²⁾	+9 ²⁾
SMR60B11 ¹⁾	TTL	10 MHz	60 GHz	-130 ²⁾	+12 ²⁾
SMP02	TTL	10 MHz	20 GHz	-130 ³⁾	+17 ³⁾
SMP03	TTL	10 MHz	27 GHz	-130 ³⁾	+13 ³⁾
SMP04	TTL	10 MHz	40 GHz	-130 ³⁾	+12 ³⁾
SMP22	TTL	10 MHz	20 GHz	-130 ³⁾	+20 ³⁾

¹⁾ Requires installation of the option R&S SMR-B11.

²⁾ Maximum/minimum power depends on the presence of the option R&S SMR-B15/-B17 and on the frequency range that has been set.

For more information, refer to the R&S SMR data sheet.

³⁾ Maximum/minimum power depends on the presence of the option R&S SMP-B15/-B17 and on the frequency range that has been set.

For more information, refer to the R&S SMP data sheet.

Generator	Interface Type	Generator Min. Freq.	Generator Max. Freq.	Generator Min. Power dBm	Generator Max. Power dBm
SMT02	GPIB	5.0 kHz	1.5 GHz	-144	+13
SMT03	GPIB	5.0 kHz	3.0 GHz	-144	+13
SMT06	GPIB	5.0 kHz	6.0 GHz	-144	+13
SMU200A	TTL	100 kHz	6.0 GHz	-145	+19
SMV03	GPIB	9 kHz	3.3 GHz	-140	+13
SMX	GPIB	100 kHz	1.0 GHz	-137	+13
SMY01	GPIB	9 kHz	1.04 GHz	-140	+13
SMY02	GPIB	9 kHz	2.08 GHz	-140	+13
HP8340A	GPIB	10 MHz	26.5 GHz	-110	+10
HP8648	GPIB	9 kHz	4 GHz	-136	+10
HP ESG-A Series 1000A, 2000A, 3000A, 4000A	GPIB	250 kHz	4 GHz	-136	+20
HP ESG-D SERIES E4432B	GPIB	250 kHz	3 GHz	-136	+10