

R&S® SMA100A Signal Generator Quick Start Guide



1400.0069.62 – 13

This document describes the R&S®SMA100A, stock no. 1400.0000k02 and its options.
This manual describes firmware version FW 3.50.057.xx and later of the R&S®SMA100A.

© 2016 Rohde & Schwarz GmbH & Co. KG
Mühlhofstr. 15, 81671 München, Germany
Phone: +49 89 41 29 - 0
Fax: +49 89 41 29 12 164
Email: info@rohde-schwarz.com
Internet: www.rohde-schwarz.com

Subject to change – Data without tolerance limits is not binding.

R&S® is a registered trademark of Rohde & Schwarz GmbH & Co. KG.

Trade names are trademarks of the owners.

The following abbreviations are used throughout this manual: R&S®SMA100A is abbreviated as R&S SMA.

Basic Safety Instructions

Always read through and comply with the following safety instructions!

All plants and locations of the Rohde & Schwarz group of companies make every effort to keep the safety standards of our products up to date and to offer our customers the highest possible degree of safety. Our products and the auxiliary equipment they require are designed, built and tested in accordance with the safety standards that apply in each case. Compliance with these standards is continuously monitored by our quality assurance system. The product described here has been designed, built and tested in accordance with the EC Certificate of Conformity and has left the manufacturer's plant in a condition fully complying with safety standards. To maintain this condition and to ensure safe operation, you must observe all instructions and warnings provided in this manual. If you have any questions regarding these safety instructions, the Rohde & Schwarz group of companies will be happy to answer them.







Furthermore, it is your responsibility to use the product in an appropriate manner. This product is designed for use solely in industrial and laboratory environments or, if expressly permitted, also in the field and must not be used in any way that may cause personal injury or property damage. You are responsible if the product is used for any purpose other than its designated purpose or in disregard of the manufacturer's instructions. The manufacturer shall assume no responsibility for such use of the product.

The product is used for its designated purpose if it is used in accordance with its product documentation and within its performance limits (see data sheet, documentation, the following safety instructions). Using the product requires technical skills and, in some cases, a basic knowledge of English. It is therefore essential that only skilled and specialized staff or thoroughly trained personnel with the required skills be allowed to use the product. If personal safety gear is required for using Rohde & Schwarz products, this will be indicated at the appropriate place in the product documentation. Keep the basic safety instructions and the product documentation in a safe place and pass them on to the subsequent users.











Observing the safety instructions will help prevent personal injury or damage of any kind caused by dangerous situations. Therefore, carefully read through and adhere to the following safety instructions before and when using the product. It is also absolutely essential to observe the additional safety instructions on personal safety, for example, that appear in relevant parts of the product documentation. In these safety instructions, the word "product" refers to all merchandise sold and distributed by the Rohde & Schwarz group of companies, including instruments, systems and all accessories. For product-specific information, see the data sheet and the product documentation.

Safety labels on products

The following safety labels are used on products to warn against risks and dangers.

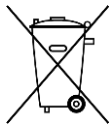
Symbol	Meaning	Symbol	Meaning
	Notice, general danger location Observe product documentation		ON/OFF Power
	Caution when handling heavy equipment		Standby indication
	Danger of electric shock		Direct current (DC)

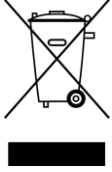
Basic Safety Instructions

Symbol	Meaning	Symbol	Meaning
	Caution ! Hot surface		Alternating current (AC)
	Protective conductor terminal To identify any terminal which is intended for connection to an external conductor for protection against electric shock in case of a fault, or the terminal of a protective earth		Direct/alternating current (DC/AC)
	Earth (Ground)		Class II Equipment to identify equipment meeting the safety requirements specified for Class II equipment (device protected by double or reinforced insulation)
	Frame or chassis Ground terminal		EU labeling for batteries and accumulators For additional information, see section "Waste disposal/Environmental protection", item 1.
	Be careful when handling electrostatic sensitive devices		EU labeling for separate collection of electrical and electronic devices For additional information, see section "Waste disposal/Environmental protection", item 2.
	Warning! Laser radiation For additional information, see section "Operation", item 7.		

Signal words and their meaning

The following signal words are used in the product documentation in order to warn the reader about risks and dangers.



Indicates a hazardous situation which, if not avoided, will result in death or serious injury.



Indicates a hazardous situation which, if not avoided, could result in death or serious injury.



Indicates a hazardous situation which, if not avoided, could result in minor or moderate injury.



Indicates information considered important, but not hazard-related, e.g. messages relating to property damage.
In the product documentation, the word ATTENTION is used synonymously.

These signal words are in accordance with the standard definition for civil applications in the European Economic Area. Definitions that deviate from the standard definition may also exist in other economic areas or military applications. It is therefore essential to make sure that the signal words described here are always used only in connection with the related product documentation and the related product. The use of signal words in connection with unrelated products or documentation can result in misinterpretation and in personal injury or material damage.

Basic Safety Instructions

Operating states and operating positions

The product may be operated only under the operating conditions and in the positions specified by the manufacturer, without the product's ventilation being obstructed. If the manufacturer's specifications are not observed, this can result in electric shock, fire and/or serious personal injury or death. Applicable local or national safety regulations and rules for the prevention of accidents must be observed in all work performed.

1. Unless otherwise specified, the following requirements apply to Rohde & Schwarz products: predefined operating position is always with the housing floor facing down, IP protection 2X, use only indoors, max. operating altitude 2000 m above sea level, max. transport altitude 4500 m above sea level. A tolerance of $\pm 10\%$ shall apply to the nominal voltage and $\pm 5\%$ to the nominal frequency, overvoltage category 2, pollution degree 2.
2. Do not place the product on surfaces, vehicles, cabinets or tables that for reasons of weight or stability are unsuitable for this purpose. Always follow the manufacturer's installation instructions when installing the product and fastening it to objects or structures (e.g. walls and shelves). An installation that is not carried out as described in the product documentation could result in personal injury or even death.
3. Do not place the product on heat-generating devices such as radiators or fan heaters. The ambient temperature must not exceed the maximum temperature specified in the product documentation or in the data sheet. Product overheating can cause electric shock, fire and/or serious personal injury or even death.

Electrical safety

If the information on electrical safety is not observed either at all or to the extent necessary, electric shock, fire and/or serious personal injury or death may occur.

1. Prior to switching on the product, always ensure that the nominal voltage setting on the product matches the nominal voltage of the mains-supply network. If a different voltage is to be set, the power fuse of the product may have to be changed accordingly.
2. In the case of products of safety class I with movable power cord and connector, operation is permitted only on sockets with a protective conductor contact and protective conductor.
3. Intentionally breaking the protective conductor either in the feed line or in the product itself is not permitted. Doing so can result in the danger of an electric shock from the product. If extension cords or connector strips are implemented, they must be checked on a regular basis to ensure that they are safe to use.
4. If there is no power switch for disconnecting the product from the mains, or if the power switch is not suitable for this purpose, use the plug of the connecting cable to disconnect the product from the mains. In such cases, always ensure that the power plug is easily reachable and accessible at all times. For example, if the power plug is the disconnecting device, the length of the connecting cable must not exceed 3 m. Functional or electronic switches are not suitable for providing disconnection from the AC supply network. If products without power switches are integrated into racks or systems, the disconnecting device must be provided at the system level.
5. Never use the product if the power cable is damaged. Check the power cables on a regular basis to ensure that they are in proper operating condition. By taking appropriate safety measures and carefully laying the power cable, ensure that the cable cannot be damaged and that no one can be hurt by, for example, tripping over the cable or suffering an electric shock.

Basic Safety Instructions

6. The product may be operated only from TN/TT supply networks fuse-protected with max. 16 A (higher fuse only after consulting with the Rohde & Schwarz group of companies).
7. Do not insert the plug into sockets that are dusty or dirty. Insert the plug firmly and all the way into the socket provided for this purpose. Otherwise, sparks that result in fire and/or injuries may occur.
8. Do not overload any sockets, extension cords or connector strips; doing so can cause fire or electric shocks.
9. For measurements in circuits with voltages $V_{rms} > 30$ V, suitable measures (e.g. appropriate measuring equipment, fuse protection, current limiting, electrical separation, insulation) should be taken to avoid any hazards.
10. Ensure that the connections with information technology equipment, e.g. PCs or other industrial computers, comply with the IEC 60950-1 / EN 60950-1 or IEC 61010-1 / EN 61010-1 standards that apply in each case.
11. Unless expressly permitted, never remove the cover or any part of the housing while the product is in operation. Doing so will expose circuits and components and can lead to injuries, fire or damage to the product.
12. If a product is to be permanently installed, the connection between the protective conductor terminal on site and the product's protective conductor must be made first before any other connection is made. The product may be installed and connected only by a licensed electrician.
13. For permanently installed equipment without built-in fuses, circuit breakers or similar protective devices, the supply circuit must be fuse-protected in such a way that anyone who has access to the product, as well as the product itself, is adequately protected from injury or damage.
14. Use suitable overvoltage protection to ensure that no overvoltage (such as that caused by a bolt of lightning) can reach the product. Otherwise, the person operating the product will be exposed to the danger of an electric shock.
15. Any object that is not designed to be placed in the openings of the housing must not be used for this purpose. Doing so can cause short circuits inside the product and/or electric shocks, fire or injuries.
16. Unless specified otherwise, products are not liquid-proof (see also section "Operating states and operating positions", item 1). Therefore, the equipment must be protected against penetration by liquids. If the necessary precautions are not taken, the user may suffer electric shock or the product itself may be damaged, which can also lead to personal injury.
17. Never use the product under conditions in which condensation has formed or can form in or on the product, e.g. if the product has been moved from a cold to a warm environment. Penetration by water increases the risk of electric shock.
18. Prior to cleaning the product, disconnect it completely from the power supply (e.g. AC supply network or battery). Use a soft, non-linting cloth to clean the product. Never use chemical cleaning agents such as alcohol, acetone or diluents for cellulose lacquers.

Operation

1. Operating the products requires special training and intense concentration. Make sure that persons who use the products are physically, mentally and emotionally fit enough to do so; otherwise, injuries or material damage may occur. It is the responsibility of the employer/operator to select suitable personnel for operating the products.

Basic Safety Instructions

2. Before you move or transport the product, read and observe the section titled "Transport".
3. As with all industrially manufactured goods, the use of substances that induce an allergic reaction (allergens) such as nickel cannot be generally excluded. If you develop an allergic reaction (such as a skin rash, frequent sneezing, red eyes or respiratory difficulties) when using a Rohde & Schwarz product, consult a physician immediately to determine the cause and to prevent health problems or stress.
4. Before you start processing the product mechanically and/or thermally, or before you take it apart, be sure to read and pay special attention to the section titled "Waste disposal/Environmental protection", item 1.
5. Depending on the function, certain products such as RF radio equipment can produce an elevated level of electromagnetic radiation. Considering that unborn babies require increased protection, pregnant women must be protected by appropriate measures. Persons with pacemakers may also be exposed to risks from electromagnetic radiation. The employer/operator must evaluate workplaces where there is a special risk of exposure to radiation and, if necessary, take measures to avert the potential danger.
6. Should a fire occur, the product may release hazardous substances (gases, fluids, etc.) that can cause health problems. Therefore, suitable measures must be taken, e.g. protective masks and protective clothing must be worn.
7. Laser products are given warning labels that are standardized according to their laser class. Lasers can cause biological harm due to the properties of their radiation and due to their extremely concentrated electromagnetic power. If a laser product (e.g. a CD/DVD drive) is integrated into a Rohde & Schwarz product, absolutely no other settings or functions may be used as described in the product documentation. The objective is to prevent personal injury (e.g. due to laser beams).
8. EMC classes (in line with EN 55011/CISPR 11, and analogously with EN 55022/CISPR 22, EN 55032/CISPR 32)
 - Class A equipment:
Equipment suitable for use in all environments except residential environments and environments that are directly connected to a low-voltage supply network that supplies residential buildings
Note: Class A equipment is intended for use in an industrial environment. This equipment may cause radio disturbances in residential environments, due to possible conducted as well as radiated disturbances. In this case, the operator may be required to take appropriate measures to eliminate these disturbances.
 - Class B equipment:
Equipment suitable for use in residential environments and environments that are directly connected to a low-voltage supply network that supplies residential buildings

Repair and service

1. The product may be opened only by authorized, specially trained personnel. Before any work is performed on the product or before the product is opened, it must be disconnected from the AC supply network. Otherwise, personnel will be exposed to the risk of an electric shock.

Basic Safety Instructions

- Adjustments, replacement of parts, maintenance and repair may be performed only by electrical experts authorized by Rohde & Schwarz. Only original parts may be used for replacing parts relevant to safety (e.g. power switches, power transformers, fuses). A safety test must always be performed after parts relevant to safety have been replaced (visual inspection, protective conductor test, insulation resistance measurement, leakage current measurement, functional test). This helps ensure the continued safety of the product.

Batteries and rechargeable batteries/cells

If the information regarding batteries and rechargeable batteries/cells is not observed either at all or to the extent necessary, product users may be exposed to the risk of explosions, fire and/or serious personal injury, and, in some cases, death. Batteries and rechargeable batteries with alkaline electrolytes (e.g. lithium cells) must be handled in accordance with the EN 62133 standard.

- Cells must not be taken apart or crushed.
- Cells or batteries must not be exposed to heat or fire. Storage in direct sunlight must be avoided. Keep cells and batteries clean and dry. Clean soiled connectors using a dry, clean cloth.
- Cells or batteries must not be short-circuited. Cells or batteries must not be stored in a box or in a drawer where they can short-circuit each other, or where they can be short-circuited by other conductive materials. Cells and batteries must not be removed from their original packaging until they are ready to be used.
- Cells and batteries must not be exposed to any mechanical shocks that are stronger than permitted.
- If a cell develops a leak, the fluid must not be allowed to come into contact with the skin or eyes. If contact occurs, wash the affected area with plenty of water and seek medical aid.
- Improperly replacing or charging cells or batteries that contain alkaline electrolytes (e.g. lithium cells) can cause explosions. Replace cells or batteries only with the matching Rohde & Schwarz type (see parts list) in order to ensure the safety of the product.
- Cells and batteries must be recycled and kept separate from residual waste. Rechargeable batteries and normal batteries that contain lead, mercury or cadmium are hazardous waste. Observe the national regulations regarding waste disposal and recycling.

Transport

- The product may be very heavy. Therefore, the product must be handled with care. In some cases, the user may require a suitable means of lifting or moving the product (e.g. with a lift-truck) to avoid back or other physical injuries.
- Handles on the products are designed exclusively to enable personnel to transport the product. It is therefore not permissible to use handles to fasten the product to or on transport equipment such as cranes, fork lifts, wagons, etc. The user is responsible for securely fastening the products to or on the means of transport or lifting. Observe the safety regulations of the manufacturer of the means of transport or lifting. Noncompliance can result in personal injury or material damage.
- If you use the product in a vehicle, it is the sole responsibility of the driver to drive the vehicle safely and properly. The manufacturer assumes no responsibility for accidents or collisions. Never use the product in a moving vehicle if doing so could distract the driver of the vehicle. Adequately secure the product in the vehicle to prevent injuries or other damage in the event of an accident.

Instrucciones de seguridad elementales

Waste disposal/Environmental protection

1. Specially marked equipment has a battery or accumulator that must not be disposed of with unsorted municipal waste, but must be collected separately. It may only be disposed of at a suitable collection point or via a Rohde & Schwarz customer service center.
2. Waste electrical and electronic equipment must not be disposed of with unsorted municipal waste, but must be collected separately.
Rohde & Schwarz GmbH & Co. KG has developed a disposal concept and takes full responsibility for take-back obligations and disposal obligations for manufacturers within the EU. Contact your Rohde & Schwarz customer service center for environmentally responsible disposal of the product.
3. If products or their components are mechanically and/or thermally processed in a manner that goes beyond their intended use, hazardous substances (heavy-metal dust such as lead, beryllium, nickel) may be released. For this reason, the product may only be disassembled by specially trained personnel. Improper disassembly may be hazardous to your health. National waste disposal regulations must be observed.
4. If handling the product releases hazardous substances or fuels that must be disposed of in a special way, e.g. coolants or engine oils that must be replenished regularly, the safety instructions of the manufacturer of the hazardous substances or fuels and the applicable regional waste disposal regulations must be observed. Also observe the relevant safety instructions in the product documentation. The improper disposal of hazardous substances or fuels can cause health problems and lead to environmental damage.

For additional information about environmental protection, visit the Rohde & Schwarz website.

Instrucciones de seguridad elementales

¡Es imprescindible leer y cumplir las siguientes instrucciones e informaciones de seguridad!

El principio del grupo de empresas Rohde & Schwarz consiste en tener nuestros productos siempre al día con los estándares de seguridad y de ofrecer a nuestros clientes el máximo grado de seguridad. Nuestros productos y todos los equipos adicionales son siempre fabricados y examinados según las normas de seguridad vigentes. Nuestro sistema de garantía de calidad controla constantemente que sean cumplidas estas normas. El presente producto ha sido fabricado y examinado según el certificado de conformidad de la UE y ha salido de nuestra planta en estado impecable según los estándares técnicos de seguridad. Para poder preservar este estado y garantizar un funcionamiento libre de peligros, el usuario deberá atenerse a todas las indicaciones, informaciones de seguridad y notas de alerta. El grupo de empresas Rohde & Schwarz está siempre a su disposición en caso de que tengan preguntas referentes a estas informaciones de seguridad.

Además queda en la responsabilidad del usuario utilizar el producto en la forma debida. Este producto está destinado exclusivamente al uso en la industria y el laboratorio o, si ha sido expresamente autorizado, para aplicaciones de campo y de ninguna manera deberá ser utilizado de modo que alguna persona/cosa pueda sufrir daño. El uso del producto fuera de sus fines definidos o sin tener en cuenta las instrucciones del fabricante queda en la responsabilidad del usuario. El fabricante no se hace en ninguna forma responsable de consecuencias a causa del mal uso del producto.















Instrucciones de seguridad elementales

Se parte del uso correcto del producto para los fines definidos si el producto es utilizado conforme a las indicaciones de la correspondiente documentación del producto y dentro del margen de rendimiento definido (ver hoja de datos, documentación, informaciones de seguridad que siguen). El uso del producto hace necesarios conocimientos técnicos y ciertos conocimientos del idioma inglés. Por eso se debe tener en cuenta que el producto solo pueda ser operado por personal especializado o personas instruidas en profundidad con las capacidades correspondientes. Si fuera necesaria indumentaria de seguridad para el uso de productos de Rohde & Schwarz, encontraría la información debida en la documentación del producto en el capítulo correspondiente. Guarde bien las informaciones de seguridad elementales, así como la documentación del producto, y entréguelas a usuarios posteriores.



Tener en cuenta las informaciones de seguridad sirve para evitar en lo posible lesiones o daños por peligros de toda clase. Por eso es imprescindible leer detalladamente y comprender por completo las siguientes informaciones de seguridad antes de usar el producto, y respetarlas durante el uso del producto. Deberán tenerse en cuenta todas las demás informaciones de seguridad, como p. ej. las referentes a la protección de personas, que encontrarán en el capítulo correspondiente de la documentación del producto y que también son de obligado cumplimiento. En las presentes informaciones de seguridad se recogen todos los objetos que distribuye el grupo de empresas Rohde & Schwarz bajo la denominación de "producto", entre ellos también aparatos, instalaciones así como toda clase de accesorios. Los datos específicos del producto figuran en la hoja de datos y en la documentación del producto.

Señalización de seguridad de los productos

Las siguientes señales de seguridad se utilizan en los productos para advertir sobre riesgos y peligros.

Símbolo	Significado	Símbolo	Significado
	Aviso: punto de peligro general Observar la documentación del producto		Tensión de alimentación de PUESTA EN MARCHA / PARADA
	Atención en el manejo de dispositivos de peso elevado		Indicación de estado de espera (standby)
	Peligro de choque eléctrico		Corriente continua (DC)
	Advertencia: superficie caliente		Corriente alterna (AC)
	Conexión a conductor de protección		Corriente continua / Corriente alterna (DC/AC)
	Conexión a tierra		El aparato está protegido en su totalidad por un aislamiento doble (reforzado)
	Conexión a masa		Distintivo de la UE para baterías y acumuladores Más información en la sección "Eliminación/protección del medio ambiente", punto 1.

Instrucciones de seguridad elementales

Símbolo	Significado	Símbolo	Significado
	Aviso: Cuidado en el manejo de dispositivos sensibles a la electrostática (ESD)		Distintivo de la UE para la eliminación por separado de dispositivos eléctricos y electrónicos Más información en la sección "Eliminación/protección del medio ambiente", punto 2.
	Advertencia: rayo láser Más información en la sección "Funcionamiento", punto 7.		

Palabras de señal y su significado

En la documentación del producto se utilizan las siguientes palabras de señal con el fin de advertir contra riesgos y peligros.



Indica una situación de peligro que, si no se evita, causa lesiones graves o incluso la muerte.



Indica una situación de peligro que, si no se evita, puede causar lesiones graves o incluso la muerte.



Indica una situación de peligro que, si no se evita, puede causar lesiones leves o moderadas.



Indica información que se considera importante, pero no en relación con situaciones de peligro; p. ej., avisos sobre posibles daños materiales.

En la documentación del producto se emplea de forma sinónima el término CUIDADO.

Las palabras de señal corresponden a la definición habitual para aplicaciones civiles en el área económica europea. Pueden existir definiciones diferentes a esta definición en otras áreas económicas o en aplicaciones militares. Por eso se deberá tener en cuenta que las palabras de señal aquí descritas sean utilizadas siempre solamente en combinación con la correspondiente documentación del producto y solamente en combinación con el producto correspondiente. La utilización de las palabras de señal en combinación con productos o documentaciones que no les correspondan puede llevar a interpretaciones equivocadas y tener por consecuencia daños en personas u objetos.

Estados operativos y posiciones de funcionamiento

El producto solamente debe ser utilizado según lo indicado por el fabricante respecto a los estados operativos y posiciones de funcionamiento sin que se obstruya la ventilación. Si no se siguen las indicaciones del fabricante, pueden producirse choques eléctricos, incendios y/o lesiones graves con posible consecuencia de muerte. En todos los trabajos deberán ser tenidas en cuenta las normas nacionales y locales de seguridad del trabajo y de prevención de accidentes.

Instrucciones de seguridad elementales

1. Si no se convino de otra manera, es para los productos Rohde & Schwarz válido lo que sigue: como posición de funcionamiento se define por principio la posición con el suelo de la caja para abajo, modo de protección IP 2X, uso solamente en estancias interiores, utilización hasta 2000 m sobre el nivel del mar, transporte hasta 4500 m sobre el nivel del mar. Se aplicará una tolerancia de $\pm 10\%$ sobre el voltaje nominal y de $\pm 5\%$ sobre la frecuencia nominal. Categoría de sobrecarga eléctrica 2, índice de suciedad 2.
2. No sitúe el producto encima de superficies, vehículos, estantes o mesas, que por sus características de peso o de estabilidad no sean aptos para él. Siga siempre las instrucciones de instalación del fabricante cuando instale y asegure el producto en objetos o estructuras (p. ej. paredes y estantes). Si se realiza la instalación de modo distinto al indicado en la documentación del producto, se pueden causar lesiones o, en determinadas circunstancias, incluso la muerte.
3. No ponga el producto sobre aparatos que generen calor (p. ej. radiadores o calefactores). La temperatura ambiente no debe superar la temperatura máxima especificada en la documentación del producto o en la hoja de datos. En caso de sobrecalentamiento del producto, pueden producirse choques eléctricos, incendios y/o lesiones graves con posible consecuencia de muerte.

Seguridad eléctrica

Si no se siguen (o se siguen de modo insuficiente) las indicaciones del fabricante en cuanto a seguridad eléctrica, pueden producirse choques eléctricos, incendios y/o lesiones graves con posible consecuencia de muerte.

1. Antes de la puesta en marcha del producto se deberá comprobar siempre que la tensión preseleccionada en el producto coincida con la de la red de alimentación eléctrica. Si es necesario modificar el ajuste de tensión, también se deberán cambiar en caso dado los fusibles correspondientes del producto.
2. Los productos de la clase de protección I con alimentación móvil y enchufe individual solamente podrán enchufarse a tomas de corriente con contacto de seguridad y con conductor de protección conectado.
3. Queda prohibida la interrupción intencionada del conductor de protección, tanto en la toma de corriente como en el mismo producto. La interrupción puede tener como consecuencia el riesgo de que el producto sea fuente de choques eléctricos. Si se utilizan cables alargadores o regletas de enchufe, deberá garantizarse la realización de un examen regular de los mismos en cuanto a su estado técnico de seguridad.
4. Si el producto no está equipado con un interruptor para desconectarlo de la red, o bien si el interruptor existente no resulta apropiado para la desconexión de la red, el enchufe del cable de conexión se deberá considerar como un dispositivo de desconexión. El dispositivo de desconexión se debe poder alcanzar fácilmente y debe estar siempre bien accesible. Si, p. ej., el enchufe de conexión a la red es el dispositivo de desconexión, la longitud del cable de conexión no debe superar 3 m). Los interruptores selectores o electrónicos no son aptos para el corte de la red eléctrica. Si se integran productos sin interruptor en bastidores o instalaciones, se deberá colocar el interruptor en el nivel de la instalación.
5. No utilice nunca el producto si está dañado el cable de conexión a red. Compruebe regularmente el correcto estado de los cables de conexión a red. Asegúrese, mediante las medidas de protección y de instalación adecuadas, de que el cable de conexión a red no pueda ser dañado o de que nadie pueda ser dañado por él, p. ej. al tropezar o por un choque eléctrico.

Instrucciones de seguridad elementales

6. Solamente está permitido el funcionamiento en redes de alimentación TN/TT aseguradas con fusibles de 16 A como máximo (utilización de fusibles de mayor amperaje solo previa consulta con el grupo de empresas Rohde & Schwarz).
7. Nunca conecte el enchufe en tomas de corriente sucias o llenas de polvo. Introduzca el enchufe por completo y fuertemente en la toma de corriente. La no observación de estas medidas puede provocar chispas, fuego y/o lesiones.
8. No sobrecargue las tomas de corriente, los cables alargadores o las regletas de enchufe ya que esto podría causar fuego o choques eléctricos.
9. En las mediciones en circuitos de corriente con una tensión $U_{\text{eff}} > 30 \text{ V}$ se deberán tomar las medidas apropiadas para impedir cualquier peligro (p. ej. medios de medición adecuados, seguros, limitación de tensión, corte protector, aislamiento etc.).
10. Para la conexión con dispositivos informáticos como un PC o un ordenador industrial, debe comprobarse que éstos cumplan los estándares IEC60950-1/EN60950-1 o IEC61010-1/EN 61010-1 válidos en cada caso.
11. A menos que esté permitido expresamente, no retire nunca la tapa ni componentes de la carcasa mientras el producto esté en servicio. Esto pone a descubierto los cables y componentes eléctricos y puede causar lesiones, fuego o daños en el producto.
12. Si un producto se instala en un lugar fijo, se deberá primero conectar el conductor de protección fijo con el conductor de protección del producto antes de hacer cualquier otra conexión. La instalación y la conexión deberán ser efectuadas por un electricista especializado.
13. En el caso de dispositivos fijos que no estén provistos de fusibles, interruptor automático ni otros mecanismos de seguridad similares, el circuito de alimentación debe estar protegido de modo que todas las personas que puedan acceder al producto, así como el producto mismo, estén a salvo de posibles daños.
14. Todo producto debe estar protegido contra sobretensión (debida p. ej. a una caída del rayo) mediante los correspondientes sistemas de protección. Si no, el personal que lo utilice quedará expuesto al peligro de choque eléctrico.
15. No debe introducirse en los orificios de la caja del aparato ningún objeto que no esté destinado a ello. Esto puede producir cortocircuitos en el producto y/o puede causar choques eléctricos, fuego o lesiones.
16. Salvo indicación contraria, los productos no están impermeabilizados (ver también el capítulo "Estados operativos y posiciones de funcionamiento", punto 1). Por eso es necesario tomar las medidas necesarias para evitar la entrada de líquidos. En caso contrario, existe peligro de choque eléctrico para el usuario o de daños en el producto, que también pueden redundar en peligro para las personas.
17. No utilice el producto en condiciones en las que pueda producirse o ya se hayan producido condensaciones sobre el producto o en el interior de éste, como p. ej. al desplazarlo de un lugar frío a otro caliente. La entrada de agua aumenta el riesgo de choque eléctrico.
18. Antes de la limpieza, desconecte por completo el producto de la alimentación de tensión (p. ej. red de alimentación o batería). Realice la limpieza de los aparatos con un paño suave, que no se deshilache. No utilice bajo ningún concepto productos de limpieza químicos como alcohol, acetona o diluyentes para lacas nitrocelulósicas.

Instrucciones de seguridad elementales

Funcionamiento

1. El uso del producto requiere instrucciones especiales y una alta concentración durante el manejo. Debe asegurarse que las personas que manejen el producto estén a la altura de los requerimientos necesarios en cuanto a aptitudes físicas, psíquicas y emocionales, ya que de otra manera no se pueden excluir lesiones o daños de objetos. El empresario u operador es responsable de seleccionar el personal usuario apto para el manejo del producto.
2. Antes de desplazar o transportar el producto, lea y tenga en cuenta el capítulo "Transporte".
3. Como con todo producto de fabricación industrial no puede quedar excluida en general la posibilidad de que se produzcan alergias provocadas por algunos materiales empleados —los llamados alérgenos (p. ej. el níquel)—. Si durante el manejo de productos Rohde & Schwarz se producen reacciones alérgicas, como p. ej. irritaciones cutáneas, estornudos continuos, enrojecimiento de la conjuntiva o dificultades respiratorias, debe avisarse inmediatamente a un médico para investigar las causas y evitar cualquier molestia o daño a la salud.
4. Antes de la manipulación mecánica y/o térmica o el desmontaje del producto, debe tenerse en cuenta imprescindiblemente el capítulo "Eliminación/protección del medio ambiente", punto 1.
5. Ciertos productos, como p. ej. las instalaciones de radiocomunicación RF, pueden a causa de su función natural, emitir una radiación electromagnética aumentada. Deben tomarse todas las medidas necesarias para la protección de las mujeres embarazadas. También las personas con marcapasos pueden correr peligro a causa de la radiación electromagnética. El empresario/operador tiene la obligación de evaluar y señalar las áreas de trabajo en las que exista un riesgo elevado de exposición a radiaciones.
6. Tenga en cuenta que en caso de incendio pueden desprenderse del producto sustancias tóxicas (gases, líquidos etc.) que pueden generar daños a la salud. Por eso, en caso de incendio deben usarse medidas adecuadas, como p. ej. máscaras antigás e indumentaria de protección.
7. Los productos con láser están provistos de indicaciones de advertencia normalizadas en función de la clase de láser del que se trate. Los rayos láser pueden provocar daños de tipo biológico a causa de las propiedades de su radiación y debido a su concentración extrema de potencia electromagnética. En caso de que un producto Rohde & Schwarz contenga un producto láser (p. ej. un lector de CD/DVD), no debe usarse ninguna otra configuración o función aparte de las descritas en la documentación del producto, a fin de evitar lesiones (p. ej. debidas a irradiación láser).
8. Clases de compatibilidad electromagnética (conforme a EN 55011 / CISPR 11; y en analogía con EN 55022 / CISPR 22, EN 55032 / CISPR 32)
 - Aparato de clase A:
Aparato adecuado para su uso en todos los entornos excepto en los residenciales y en aquellos conectados directamente a una red de distribución de baja tensión que suministra corriente a edificios residenciales.
Nota: Los aparatos de clase A están destinados al uso en entornos industriales. Estos aparatos pueden causar perturbaciones radioeléctricas en entornos residenciales debido a posibles perturbaciones guiadas o radiadas. En este caso, se le podrá solicitar al operador que tome las medidas adecuadas para eliminar estas perturbaciones.
 - Aparato de clase B:
Aparato adecuado para su uso en entornos residenciales, así como en aquellos conectados directamente a una red de distribución de baja tensión que suministra corriente a edificios residenciales.

Instrucciones de seguridad elementales

Reparación y mantenimiento

1. El producto solamente debe ser abierto por personal especializado con autorización para ello. Antes de manipular el producto o abrirlo, es obligatorio desconectarlo de la tensión de alimentación, para evitar toda posibilidad de choque eléctrico.
2. El ajuste, el cambio de partes, el mantenimiento y la reparación deberán ser efectuadas solamente por electricistas autorizados por Rohde & Schwarz. Si se reponen partes con importancia para los aspectos de seguridad (p. ej. el enchufe, los transformadores o los fusibles), solamente podrán ser sustituidos por partes originales. Después de cada cambio de partes relevantes para la seguridad deberá realizarse un control de seguridad (control a primera vista, control del conductor de protección, medición de resistencia de aislamiento, medición de la corriente de fuga, control de funcionamiento). Con esto queda garantizada la seguridad del producto.

Baterías y acumuladores o celdas

Si no se siguen (o se siguen de modo insuficiente) las indicaciones en cuanto a las baterías y acumuladores o celdas, pueden producirse explosiones, incendios y/o lesiones graves con posible consecuencia de muerte. El manejo de baterías y acumuladores con electrolitos alcalinos (p. ej. celdas de litio) debe seguir el estándar EN 62133.

1. No deben desmontarse, abrirse ni triturarse las celdas.
2. Las celdas o baterías no deben someterse a calor ni fuego. Debe evitarse el almacenamiento a la luz directa del sol. Las celdas y baterías deben mantenerse limpias y secas. Limpiar las conexiones sucias con un paño seco y limpio.
3. Las celdas o baterías no deben cortocircuitarse. Es peligroso almacenar las celdas o baterías en estuches o cajones en cuyo interior puedan cortocircuitarse por contacto recíproco o por contacto con otros materiales conductores. No deben extraerse las celdas o baterías de sus embalajes originales hasta el momento en que vayan a utilizarse.
4. Las celdas o baterías no deben someterse a impactos mecánicos fuertes indebidos.
5. En caso de falta de estanqueidad de una celda, el líquido vertido no debe entrar en contacto con la piel ni los ojos. Si se produce contacto, lavar con agua abundante la zona afectada y avisar a un médico.
6. En caso de cambio o recarga inadecuados, las celdas o baterías que contienen electrolitos alcalinos (p. ej. las celdas de litio) pueden explotar. Para garantizar la seguridad del producto, las celdas o baterías solo deben ser sustituidas por el tipo Rohde & Schwarz correspondiente (ver lista de recambios).
7. Las baterías y celdas deben reciclarse y no deben tirarse a la basura doméstica. Las baterías o acumuladores que contienen plomo, mercurio o cadmio deben tratarse como residuos especiales. Respete en esta relación las normas nacionales de eliminación y reciclaje.

Transporte

1. El producto puede tener un peso elevado. Por eso es necesario desplazarlo o transportarlo con precaución y, si es necesario, usando un sistema de elevación adecuado (p. ej. una carretilla elevadora), a fin de evitar lesiones en la espalda u otros daños personales.

Instrucciones de seguridad elementales

2. Las asas instaladas en los productos sirven solamente de ayuda para el transporte del producto por personas. Por eso no está permitido utilizar las asas para la sujeción en o sobre medios de transporte como p. ej. grúas, carretillas elevadoras de horquilla, carros etc. Es responsabilidad suya fijar los productos de manera segura a los medios de transporte o elevación. Para evitar daños personales o daños en el producto, siga las instrucciones de seguridad del fabricante del medio de transporte o elevación utilizado.
3. Si se utiliza el producto dentro de un vehículo, recae de manera exclusiva en el conductor la responsabilidad de conducir el vehículo de manera segura y adecuada. El fabricante no asumirá ninguna responsabilidad por accidentes o colisiones. No utilice nunca el producto dentro de un vehículo en movimiento si esto pudiera distraer al conductor. Asegure el producto dentro del vehículo debidamente para evitar, en caso de un accidente, lesiones u otra clase de daños.

Eliminación/protección del medio ambiente

1. Los dispositivos marcados contienen una batería o un acumulador que no se debe desechar con los residuos domésticos sin clasificar, sino que debe ser recogido por separado. La eliminación se debe efectuar exclusivamente a través de un punto de recogida apropiado o del servicio de atención al cliente de Rohde & Schwarz.
2. Los dispositivos eléctricos usados no se deben desechar con los residuos domésticos sin clasificar, sino que deben ser recogidos por separado.
Rohde & Schwarz GmbH & Co.KG ha elaborado un concepto de eliminación de residuos y asume plenamente los deberes de recogida y eliminación para los fabricantes dentro de la UE. Para desechar el producto de manera respetuosa con el medio ambiente, dirijase a su servicio de atención al cliente de Rohde & Schwarz.
3. Si se trabaja de manera mecánica y/o térmica cualquier producto o componente más allá del funcionamiento previsto, pueden liberarse sustancias peligrosas (polvos con contenido de metales pesados como p. ej. plomo, berilio o níquel). Por eso el producto solo debe ser desmontado por personal especializado con formación adecuada. Un desmontaje inadecuado puede ocasionar daños para la salud. Se deben tener en cuenta las directivas nacionales referentes a la eliminación de residuos.
4. En caso de que durante el trato del producto se formen sustancias peligrosas o combustibles que deban tratarse como residuos especiales (p. ej. refrigerantes o aceites de motor con intervalos de cambio definidos), deben tenerse en cuenta las indicaciones de seguridad del fabricante de dichas sustancias y las normas regionales de eliminación de residuos. Tenga en cuenta también en caso necesario las indicaciones de seguridad especiales contenidas en la documentación del producto. La eliminación incorrecta de sustancias peligrosas o combustibles puede causar daños a la salud o daños al medio ambiente.

Se puede encontrar más información sobre la protección del medio ambiente en la página web de Rohde & Schwarz.

Customer Support

Technical support – where and when you need it

For quick, expert help with any Rohde & Schwarz equipment, contact one of our Customer Support Centers. A team of highly qualified engineers provides telephone support and will work with you to find a solution to your query on any aspect of the operation, programming or applications of Rohde & Schwarz equipment.

Up-to-date information and upgrades

To keep your instrument up-to-date and to be informed about new application notes related to your instrument, please send an e-mail to the Customer Support Center stating your instrument and your wish. We will take care that you will get the right information.

Europe, Africa, Middle East

Phone +49 89 4129 12345
customersupport@rohde-schwarz.com

North America

Phone 1-888-TEST-RSA (1-888-837-8772)
customer.support@rsa.rohde-schwarz.com

Latin America

Phone +1-410-910-7988
customersupport.la@rohde-schwarz.com

Asia/Pacific

Phone +65 65 13 04 88
customersupport.asia@rohde-schwarz.com

China

Phone +86-800-810-8228 /
+86-400-650-5896
customersupport.china@rohde-schwarz.com



Contents

1	Preface	7
1.1	Documentation Overview.....	7
1.2	Typographical Conventions.....	8
1.3	Notes on Screenshots.....	8
2	Preparing for Use	11
2.1	Front Panel Tour.....	11
2.1.1	Utility Keys.....	11
2.1.2	Standby LEDs and Standby Key.....	12
2.1.3	Display.....	12
2.1.4	Setup Keys.....	13
2.1.4.1	Keys for Setting Parameters.....	13
2.1.4.2	Display Keys.....	14
2.1.5	Keypad for data entry.....	14
2.1.6	Rotary Knob and Navigation Keys.....	15
2.1.7	Front Panel Connectors.....	16
2.2	Rear Panel Tour.....	17
2.2.1	Description of the Connectors.....	18
2.3	Putting into Operation.....	21
2.3.1	EMI Suppression.....	22
2.3.2	Unpacking and Checking the Instrument.....	22
2.3.3	Placing or Mounting the Instrument.....	23
2.3.4	Connecting the Instrument to the AC Supply.....	24
2.3.5	Starting the Instrument.....	25
2.3.5.1	Standby and Ready state.....	25
2.3.5.2	Start Display and Booting.....	25
2.3.5.3	Function Check.....	26
2.3.5.4	Default Settings.....	26
2.3.6	Shutting Down the Instrument.....	27
2.3.7	Power Fuses.....	28
2.4	Connecting External Accessories.....	28
2.4.1	Connecting USB Devices.....	28

2.5 Linux Operating System.....	29
2.6 Setting Up a Network (LAN) Connection.....	31
2.6.1 Connecting the Instrument to the Network.....	31
2.6.2 Assigning the IP Address.....	32
2.6.3 Using Computer Names.....	33
2.7 Remote Access via an External Controller.....	34
2.7.1 Using a Web Browser for Remote Access.....	35
2.7.2 Remote Access via a VNC Client Software.....	36
2.8 LXI Configuration.....	41
2.8.1 LXI Browser Settings.....	42
2.8.2 LAN Configuration.....	44
2.8.2.1 IP Configuration.....	44
2.8.2.2 Advanced LAN Configuration.....	45
2.8.2.3 Ping Client.....	46
2.8.2.4 Web Control.....	47
2.8.2.5 SCPI Remote Trace.....	48
3 Getting Started.....	51
3.1 Brief Introduction to the Instrument's Concept.....	51
3.2 Application Field of the Instrument.....	53
3.3 Description of Individual Diagram Blocks.....	53
3.4 Example of Setup.....	56
4 Manual Operation.....	63
4.1 Key Features.....	63
4.2 Display.....	66
4.2.1 Settings Displayed in the Header Section.....	66
4.2.2 Status Information and Messages.....	67
4.2.2.1 Status Information.....	67
4.2.2.2 Messages.....	67
4.2.2.3 Volatile messages.....	67
4.2.2.4 Permanent Messages.....	68
4.2.3 Info Window.....	68
4.2.4 Block Diagram	69
4.2.4.1 Function Blocks in the Block Diagram.....	69

4.2.4.2	Signal Flow and Input/Output Symbols in the Block Diagram.....	70
4.2.5	Structure of the Dialogs.....	70
4.3	Accessing Dialogs.....	71
4.4	Setting Parameters.....	72
4.4.1	Working with the Cursor.....	73
4.4.2	Selecting a Control Element.....	73
4.4.3	Switching Parameters On/Off.....	74
4.4.4	Entering a Value.....	74
4.4.5	Working with Units	76
4.4.6	Selecting a Value from a List.....	76
4.4.7	Terminating Entries with Confirmation.....	77
4.4.8	Restoring the Previous Value.....	77
4.5	Editors.....	78
4.5.1	Working with List Editor.....	79
4.6	How to Use the Help System.....	80
4.7	File Management.....	81
4.7.1	File Select Dialog.....	83
4.7.2	File Manager.....	84
4.7.2.1	Extensions for User Files.....	84
4.8	Legend of Front-Panel Controls.....	85
4.8.1	Front Panel Key Emulation.....	86
	Annex.....	89
A	Hardware Interfaces.....	89
A.1	GPIB Bus Interface.....	89
A.2	AUX I/O Connector.....	90
	Index.....	93

1 Preface

1.1 Documentation Overview

This section provides an overview of the R&S SMA user documentation. You find it on the product page at:

<http://www.rohde-schwarz.com/product/SMA100A.html> > "Downloads"

Quick start guide

Introduces the R&S SMA and describes how to set up and start working with the product. Includes basic operations, typical measurement examples, and general information, e.g. safety instructions, etc. A printed version is delivered with the instrument.

Online help

Offers quick, context-sensitive access to the complete information directly on the instrument.

Operating manual

Contains the description of all instrument modes and functions. It also provides an introduction to remote control, a complete description of the remote control commands with programming examples, and information on maintenance, instrument interfaces and error messages. Includes the contents of the quick start guide manual.

The **online version** of the operating manual provides the complete contents for immediate display on the Internet.

Service manual

Describes the performance test for checking the rated specifications, module replacement and repair, firmware update, troubleshooting and fault elimination, and contains mechanical drawings and spare part lists.

The service manual is available for registered users on the global Rohde & Schwarz information system (GLORIS, <https://gloris.rohde-schwarz.com>).

Instrument security procedures manual

Deals with security issues when working with the R&S SMA in secure areas.

Basic safety instructions

Contains safety instructions, operating conditions and further important information. The printed document is delivered with the instrument.

Data sheet and brochure

The data sheet contains the technical specifications of the R&S SMA. It also lists the options and their order numbers as well as optional accessories.

The brochure provides an overview of the instrument and deals with the specific characteristics.

Release notes and open source acknowledgment (OSA)

The release notes list new features, improvements and known issues of the current firmware version, and describe the firmware installation.

The open source acknowledgment document provides verbatim license texts of the used open source software.

See <http://www.rohde-schwarz.com/product/SMA100A.html> > "Downloads" > "Firmware"

Application notes, application cards, white papers, etc.

These documents deal with special applications or background information on particular topics, see <http://www.rohde-schwarz.com/appnotes>.

1.2 Typographical Conventions

The following text markers are used throughout this documentation:

Convention	Description
"Graphical user interface elements"	All names of graphical user interface elements on the screen, such as dialog boxes, menus, options, buttons, and softkeys are enclosed by quotation marks.
KEYS	Key names are written in capital letters.
File names, commands, program code	File names, commands, coding samples and screen output are distinguished by their font.
<i>Input</i>	Input to be entered by the user is displayed in italics.
Links	Links that you can click are displayed in blue font.
"References"	References to other parts of the documentation are enclosed by quotation marks.

1.3 Notes on Screenshots

When describing the functions of the product, we use sample screenshots. These screenshots are meant to illustrate as much as possible of the provided functions and possible interdependencies between parameters. The shown values may not represent realistic test situations.

The screenshots usually show a fully equipped product, that is: with all options installed. Thus, some functions shown in the screenshots may not be available in your particular product configuration.

2 Preparing for Use

The following topics help you to get familiar with the instrument and perform the first steps:

- [Front Panel Tour](#)
- [Rear Panel Tour](#)
- [Putting into Operation](#)

This section explains the control elements and connectors of the Signal Generator R&S SMA with the aid of the front and rear views and describes how to put the instrument into operation. It also describes the connection of peripherals such as printer, keyboard or mouse. Specifications of interfaces can be found in the data sheet.

The [Chapter 3, "Getting Started"](#), on page 51 of this manual provides an overview of the generator functions and introduces the operating concept. Detailed operating instructions and an overview of menus follow in [Chapter 4, "Manual Operation"](#), on page 63.

For all reference information concerning manual and remote control of the instrument, refer to the online help system or its printed/printable version. A more detailed description of the hardware connectors and interfaces is also part of the help system.

2.1 Front Panel Tour

The front panel of the R&S SMA consists of the VGA display, some utility keys (left side) and the hardkey area with connectors and control interfaces (right side). The subsequent sections provide brief explanations on the controls and connectors, the hardkey area and the front panel.



For more detailed information, refer to the corresponding description in the Operating Manual.

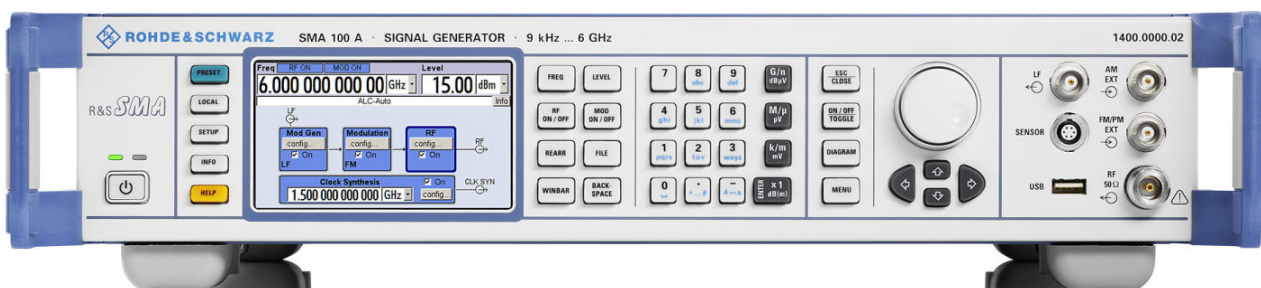

Figure 2-1: Front panel view

2.1.1 Utility Keys



The keys to the left of the display cause the R&S SMA to return to a definite instrument state and provide information on the instrument and assistance.

For more information refer to chapter "Instrument Settings" in the Operating Manual.

PRESET

Sets the instrument to a defined state (see [Chapter 2.3.5.4, "Default Settings"](#), on page 26).

LOCAL

Switches from remote control to local (manual) control.

SETUP

Opens the "Setup" dialog for configuring presets.

INFO

Displays status messages, error messages and warnings.

HELP

Displays context-sensitive help text.

2.1.2 Standby LEDs and Standby Key

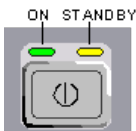

The standby LEDs and the ON/STANDBY key are located in the bottom left corner of the front panel.

The ON/STANDBY key toggles the instrument between standby and ready state (indicated by the standby LEDs).

The standby LEDs indicate the instrument states as follow:

- the green LED (left) is on when the instrument is ready for operation,
- the yellow LED (right) is on in the standby mode.

See also [Chapter 2.3.5.1, "Standby and Ready state"](#), on page 25.

2.1.3 Display

The display clearly shows all main settings and signal generator states.

The display is divided into the following sections:

- Frequency and level display with info line
 - Frequency and level settings containing offset.
 - Status messages
 - Brief error messages.

To access an window with detailed information for a message, use the INFO key.

- **Block diagram**
The block diagram shows the current configuration and the signal flow in the generator with the aid of function blocks containing an on/off switch. Selecting a function block opens a list of associated setting menus. Active menus, info windows and graphs are displayed on top of the block diagram. The block diagram can be displayed in the foreground anytime with the **DIAGRAM** key.

For detailed information, see [Chapter 4.2, "Display"](#), on page 66.

2.1.4 Setup Keys

The keys to the right of the display set parameters, select views and control the windows.

2.1.4.1 Keys for Setting Parameters



These keys provide direct access to the settings in the header of the instrument and can be used for fast changing the state of the modulation and the RF signal.

For more information refer to chapter "Instrument Functions" in the Operating Manual.

FREQ

Activates frequency entry.

RF ON/OFF

Switches the RF signal on and off.

"RF OFF" is displayed in the header next to the "Frequency" field.

LEVEL

Activates level entry.

MOD ON/OFF

Switches the modulations on and off.

"MOD OFF" is displayed in the info line of the header next to the "Level" field.

REARR

Adjusts the size of the active menu to use the whole height of the display.

FILE

Activates the menu for storing or loading files (see [Chapter 4.7, "File Management"](#), on page 81).

WINBAR

Toggles between the active menus.

BACKSPACE

Deletes the character to the left of the cursor.

2.1.4.2 Display Keys

The keys left of the rotary knob arrange different windows on the display.

**ESC**

The function of this key depends on the current cursor position.

- Calls the next higher selection level.
- Closes the open window without accepting new entries; the old value or parameter is retained.
- In dialog boxes that contain a "Cancel" button it activates that button.
- Closes all kinds of dialog boxes, if the edit mode is not active.
- Quits the edit mode, if the edit mode is active.
- Switches between different entry fields of a menu.
- Shifts the entry cursor from the header display to the previously active menu, or to the previously highlighted block in the block diagram if no menu is active.

TOGGLE

- Switches highlighted elements or a function block on and off.
- Switches between two or more settings, e.g. items of selection lists. At the end of a list, the cursor is set on the first entry again.

DIAGRAM

Brings the block diagram to the foreground. Active menus are minimized.

The display of the header section can be enlarged so that it completely covers the display by pressing the DIAGRAM key twice. The frequency, level and status information is indicated in extra large letters.

MENU

Calls the menu tree.

2.1.5 Keypad for data entry

The keys in the data entry keypad are used to enter alphanumeric data and units.

Data entry keys are only enabled while the cursor is placed on a data input field in a dialog. Their function depends on the data type of the input field.



Keys	Description
0...9/abc	Enters the corresponding numbers (in numeric input fields) or characters (character input fields).
.	Inserts a decimal point (numeric input fields) or dot (character input fields) at the cursor position. Multiple decimal points are not allowed.
Unit keys	Selects a unit and thus determine the absolute value, or changes the unit, i.e. trigger a recalculation without changing the absolute value. The function depends on the time at which the UNIT key is used during parameter entry (see Chapter 4.4.5, "Working with Units" , on page 76). For unit-free values, the X1 key is equivalent to ENTER. It confirms the previous entry and deactivates the input field.
_	Adds a blank in a character input field.
*... #	Enters special characters. Toggles through the available characters if the key is pressed several times in a row.
A <-> a	Toggles between uppercase and lowercase characters.
A, B, C, D, E, F	Enters hexadecimal values. The letters assigned to the keys are automatically active when an entry field with a hexadecimal value is active.

ENTER

Pressing the rotary knob has the same effect.

- Concludes the entry of dimensionless entries. For other entries, this key can be used instead of the default unit key. The new value is accepted.
- Confirms ("OK") and closes open input windows.
- In a dialog box, selects the default or focused button.
- In a dialog box, activates the edit mode for the focused area, if available.
- In a dialog box, activates or deactivates the selected option of the focused area, if the edit mode is active.
- Calls the next menu level.

2.1.6 Rotary Knob and Navigation Keys

The rotary knob and the arrow keys are alternative control elements for data variation and navigation in the graphical user interface.



ROTARY KNOB

The rotary knob has several functions:

- Increases (clockwise direction) or decreases (counter-clockwise direction) numeric values at a defined step width in editing mode
- Moves the cursor, e.g. to a function block in the block diagram
- Scrolls within lists, tables or tree views
- Acts like the ENTER key, when it is pressed.
- Shifts the selection bar within focused areas (e.g. lists), if the edit mode is activated.

Note: Turning or pressing the rotary knob is equivalent to pressing the UP and DOWN keys or the ENTER key in the keypad.

NAVIGATION KEYS



The navigation keys consist of 4 arrow keys which are used for navigation, alternatively to the rotary knob.

UP/ DOWN
KEYS

The up and down arrow keys do the following:

- In a numeric edit dialog box, increase or decrease the instrument parameter.
- In a list, table, window or dialog box, scroll vertically.

LEFT/ RIGHT
KEYS

The left and right arrow keys do the following:

- In an alphanumeric edit dialog box, move the cursor forward and back.
- In a list, table, window or dialog box, scroll horizontally.

2.1.7 Front Panel Connectors

The RF and LF connectors and various additional interface connectors are located on the front panel.

LF



Output for internal LF modulation generator signal.

See also data sheet and Operating Manual, section "LF Generator and LF Output".



AM EXT

Input for external AM modulation signals.



FM/PM EXT

Input for external FM or PhiM modulation signals (option R&S SMA-B20/-B22).



RF

Outputs for RF signal.

NOTICE! Maximum Input Levels. Do not overload the RF output.

The instrument is equipped with a reverse power protection that prevents the RF output against back feed, see section "Reverse Power Protection" in the operating manual. However, the maximum permissible reverse power is specified in the data sheet.

The RF signal is output via an N female connector.

NOTICE! Risk of RF connector and cable damage. Excessive tightening of the connectors can damage the cables and connectors. Too weak tightening leads to inaccurate results.

Always use an appropriate torque wrench suitable for this type of connector and apply the torque specified in the application note [1MA99](#).

The application notes are available on the Internet and provide additional information on care and handling of RF connectors.

Rohde & Schwarz offers appropriate torque wrenches for various connectors. For ordering information see the R&S SMA data sheet or product brochure.

USB



USB (universal serial bus) interfaces of type A (host USB).

- Connection of peripherals such as mouse or keyboard
- Connection of memory stick for file transmission
- Firmware update

See also [Chapter 2.4.1, "Connecting USB Devices"](#), on page 28.

SENSOR



Connector for R&S NRP-Zxx sensors.

With the aid of the "User Correction" function, a table with correction values for external test assemblies can be automatically determined, e.g. for compensating the frequency response of cables.

The power sensors are connected by inserting the male connector. To disconnect hold the connector by its sleeve. Pulling on the sensor cable will not release the sensor connector.

2.2 Rear Panel Tour

This section gives an overview of connectors on the rear panel of the instrument. Each connector is briefly described and a reference is given to the chapters containing detailed information. For technical data of the connectors refer to the data sheet.



For more detailed information, refer to the corresponding description in the Operating Manual.



Figure 2-2: Rear panel view

2.2.1 Description of the Connectors



IEC 625/IEEE 488

IEC-bus (IEEE 488) interface for remote control of the instrument.

See also [Chapter A.1, "GPIB Bus Interface"](#), on page 89 and chapter "Remote Control Basics" in the Operating Manual.

Note: In order to avoid electromagnetic interference (EMI) caused by open lines, always terminate any connected IEC-bus cable with an instrument or a controller.

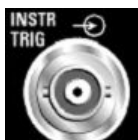

INSTR TRIG

Input for external trigger for sweeps, list mode and Fast Hopping Mode.

AUX I/O

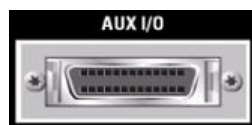

Parallel input for FM/PhiM digital data signals as well as control signals for Fast Hopping mode.

NOTICE! Risk of instrument damage. The maximum permissible input voltage is 3.3 V DC.

For detailed description of the AUX I/O connector, refer to [Chapter A.2, "AUX I/O Connector"](#), on page 90.



USB IN

USB (universal serial bus) interface of type B (device USB).

This interface can be used for remote control of the instrument.



USB CONNECTORS TYPE A

- Connection of peripherals such as mouse, keyboard, etc.
- Connection of memory stick for file transmission
- Firmware update

Further USB interface type A are available on the front panel.

See also [Chapter 2.4.1, "Connecting USB Devices"](#), on page 28.



PULSE EXT

Input of external pulse signal or input of external trigger/gate signal for internal pulse generator.



PULSE VIDEO

Output of internal pulse generator signal or external pulse signal fed in via the PULSE EXT connector (video signal).



PULSE SYNC

Output of sync signal for pulse generator signal. The sync signal is generated at the beginning of each pulse. For double-pulse generation, the sync signal is generated at the beginning of the first pulse.



EXT TUNE

Tuning input for the internal reference frequency.



LAN CONNECTOR

Ethernet interface

- For integrating signal generators in a network
- Remote control of signal generator
- Remote access to the signal generator
- Firmware update

See also:

- [Chapter 2.6, "Setting Up a Network \(LAN\) Connection"](#), on page 31
- chapter "Remote Control Basics" in the Operating Manual

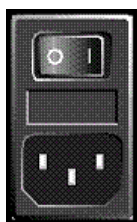

AC SUPPLY AND POWER SWITCH

When the R&S SMA is connected to the AC supply, it automatically sets itself to the correct range for the applied voltage (range: see type label). There is no need to set the voltage manually or change fuses.

The power switch can be set to two positions:

- **0**
The instrument is disconnected from the mains.
- **I**
The instrument is power-supplied. It is either ready for operation (STANDBY) or in operating mode, depending on the position of the ON/STANDBY switch on the instrument front.

See also data sheet and [Chapter 2.3.4, "Connecting the Instrument to the AC Supply"](#), on page 24.

CF MEMORY SLOT



Slot for removable CompactFlash™ Card (option R&S SMA-B80).



REF OUT

Output of internal reference signal.



REF IN

Input for external reference signal.



SENSOR

Rear panel connector for R&S NRP-Zxx power sensors (option R&S SMA-B81).

This option is recommended for use of the instrument in a 19" rack. Installing the instrument in a 19" rack requires a rack adapter (refer to data sheet for Order No.).

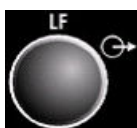

LF

Rear panel output for internal LF generator signal (option R&S SMA-B81).

This option is recommended for use of the instrument in a 19" rack. Installing the instrument in a 19" rack requires a rack adapter (refer to data sheet for Order No.).



FM/PM EXT

Rear panel input for external FM or PhiM modulation signals (option R&S SMA-B81).

This option is recommended for use of the instrument in a 19" rack. Installing the instrument in a 19" rack requires a rack adapter (refer to data sheet for Order No.).

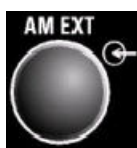

AM EXT

Rear panel input for external AM modulation signals (option R&S SMA-B81).

This option is recommended for use of the instrument in a 19" rack. Installing the instrument in a 19" rack requires a rack adapter (refer to data sheet for Order No.).



RF OUT

Rear panel output for RF signal (option R&S SMA-B81).

This option is recommended for use of the instrument in a 19" rack. Installing the instrument in a 19" rack requires a rack adapter (refer to data sheet for Order No.).

NOTICE! Maximum Input Levels. Do not overload the RF output.

The instrument is equipped with a reverse power protection that prevents the RF output against back feed, see section "Reverse Power Protection" in the operating manual. However, the maximum permissible reverse power is specified in the data sheet.

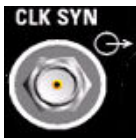
**CLK SYN**

Output of clock synthesizer (option R&S SMA-B29).

NOTICE! Maximum Input Levels. Do not overload the Clock Synthesizer output. The maximum permissible back-feed is specified in the data sheet.

2.3 Putting into Operation

This section describes the basic steps to be taken when setting up the R&S SMA for the first time.

WARNING**Risk of injury and instrument damage**

The instrument must be used in an appropriate manner to prevent electric shock, fire, personal injury, or damage.

- Do not open the instrument casing.
- Read and observe the "Basic Safety Instructions" delivered as a printed brochure with the instrument.

In addition, read and observe the safety instructions in the following sections. Notice that the data sheet may specify additional operating conditions.

NOTICE**Risk of instrument damage**

Note that the general safety instructions also contain information on operating conditions that prevent damage to the instrument. The instrument's data sheet can contain additional operating conditions.

NOTICE**Risk of electrostatic discharge (ESD)**

Electrostatic discharge (ESD) can damage the electronic components of the instrument and the device under test (DUT). ESD is most likely to occur when you connect or disconnect a DUT or test fixture to the instrument's test ports. To prevent ESD, use a wrist strap and cord and connect yourself to the ground, or use a conductive floor mat and heel strap combination.

For details, refer to the basic safety instructions delivered as a printed brochure with the instrument.

NOTICE**Risk of instrument damage during operation**

An unsuitable operating site or test setup can damage the instrument and connected devices. Ensure the following operating conditions before you switch on the instrument:

- All fan openings are unobstructed and the airflow perforations are unimpeded. The minimum distance from the wall is 10 cm.
- The instrument is dry and shows no sign of condensation.
- The instrument is positioned as described in the following sections.
- The ambient temperature does not exceed the range specified in the data sheet.
- Signal levels at the input connectors are all within the specified ranges.
- Signal outputs are correctly connected and are not overloaded.

2.3.1 EMI Suppression

Electromagnetic interference (EMI) may affect the measurement results.

To suppress generated Electromagnetic Interference (EMI),

- Use suitable shielded cables of high quality. For example use double-shielded RF and LAN cables.
Note: USB cables are of varying and often poor quality. Therefore, check the quality of each individual USB cable as described in the service manual.
- Always terminate open cable ends.
- Note the EMC classification in the data sheet

2.3.2 Unpacking and Checking the Instrument

To remove the instrument from its packaging and check the equipment for completeness, proceed as follows:

1. Pull off the polyethylene protection pads from the instrument's rear feet.
2. Carefully remove the pads from the instrument handles at the front.
3. Pull off the corrugated cardboard cover that protects the rear of the instrument.
4. Carefully unthread the corrugated cardboard cover at the front that protects the instrument handles and remove it.
5. Check the equipment for completeness using the delivery note and the accessory lists for the various items.
6. Check the instrument for any damage. If there is damage, immediately contact the carrier who delivered the instrument. Make sure not to discard the box and packing material.

**Packing material**

Retain the original packing material. If the instrument needs to be transported or shipped at a later date, you can use the material to protect the control elements and connectors.

2.3.3 Placing or Mounting the Instrument

The R&S SMA is designed for use under laboratory conditions, either on a bench top or in a rack using a rack adapter kit (order number see data sheet).

Bench Top Operation

If the R&S SMA is operated on a bench top, the surface should be flat. The instrument can be used in horizontal position, standing on its feet, or with the support feet on the bottom extended.

⚠ CAUTION**Risk of injury if feet are folded out**

The feet may fold in if they are not folded out completely or if the instrument is shifted. This may cause damage or injury.

- Fold the feet completely in or completely out to ensure stability of the instrument. Never shift the instrument when the feet are folded out.
- When the feet are folded out, do not work under the instrument or place anything underneath.
- The feet can break if they are overloaded. The overall load on the folded-out feet must not exceed 500 N.

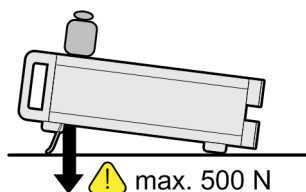

CAUTION**Risk of injury and instrument damage if stacking instruments**

A stack of instruments may tilt over and cause injury. Furthermore, the instruments at the bottom of the stack may be damaged due to the load imposed by the instruments on top.

Observe the following instructions when stacking instruments:

- Never stack more than three instruments with the same dimensions (width and length). If you need to stack more than three instruments, install them in a rack.
- The overall load imposed on the lowest instrument must not exceed 500 N.
- All instruments should have the same dimensions (width and length). If you need to stack smaller instruments on the top, the overall load imposed on the lowest instrument must not exceed 250 N.
- If the instruments have foldable feet, fold them in completely.

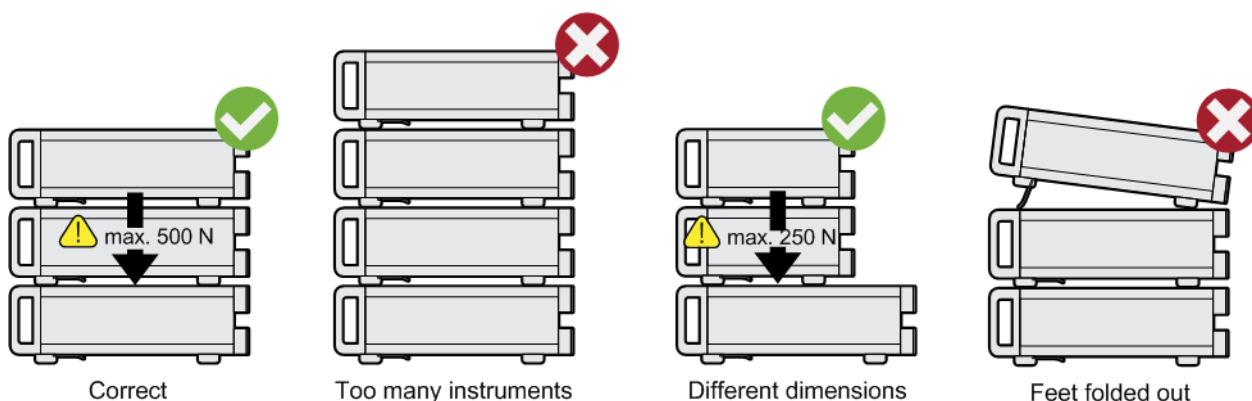
**Rackmounting**

The R&S SMA can be installed in a rack using a rack adapter kit (Order No. see data sheet). The installation instructions are part of the adapter kit.

NOTICE**Risk of instrument damage in a rack**

An insufficient airflow can cause the instrument to overheat, which may disturb the operation and even cause damage.

Make sure that all fan openings are unobstructed, that the airflow perforations are unimpeded, and that the minimum distance from the wall is 10 cm.

2.3.4 Connecting the Instrument to the AC Supply

The R&S SMA is automatically adapted to the AC voltage supplied. There is no need to set the voltage manually or change fuses. The [AC SUPPLY AND POWER SWITCH](#) is at the rear of the unit.

- ▶ Connect the instrument to the AC power source using the AC power cable delivered with the instrument.

Note: The instrument is in compliance with safety class EN61010-1. Connect the instrument only to a socket with earthing contact.

2.3.5 Starting the Instrument



Switching off the AC power

You can leave the AC power on permanently to preserve your last instrument settings. Switching off is required only if the instrument must be completely disconnected from all power supplies.

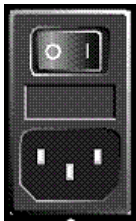

Starting up instruments with power switch

1. [Connect the instrument to the AC supply.](#)
2. To turn the power on, press the main power switch to position I (On).
After power-up, the instrument is in [standby or ready state](#), depending on the state of the ON/STANDBY key at the front panel of the instrument when the instrument was switched off for the last time.
3. In case the instrument is in standby mode, i.e. the yellow LED is on, press the ON/STANDBY key to switch the instrument to ready state.

2.3.5.1 Standby and Ready state

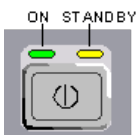

The ON/STANDBY key is located in the bottom left corner of the front panel.

Switching between standby and ready state

- ▶ Press the ON/STANDBY key briefly to switch the instrument from the standby to ready state or vice versa.

In ready state, the left, green LED is on. The instrument is ready for operation. All modules are power-supplied and the R&S SMA initiates its [startup procedure](#).
In standby state, the right, yellow LED is on. The standby power only supplies the power switch circuits and the oven-controlled crystal oscillator to keep it at its operating temperature. In this state it is safe to switch off the AC power and disconnect the instrument from the power supply.

2.3.5.2 Start Display and Booting

The instrument boots the operating system, starts the instrument firmware and automatically performs a selftest. If the previous session was terminated regularly, the instrument uses the last setup with the relevant instrument settings.

Once the startup procedure has been terminated, the block diagram opened in the previous session is displayed and the instrument is ready for operation.



Use the PRESET key to return the instrument to its definite reset/preset state, if the current setup is not anymore relevant.

To customize the start settings, use the "File" dialog.



Rebooting the instrument

Press the STANDBY key for approx. 5 s. to reboot the instrument, if the software stops unexpectedly.

2.3.5.3 Function Check

The signal generator automatically monitors the main functions when the instrument is switched on and continuously during operation.

A detected fault is indicated by a "ERROR" message displayed in the info line together with a brief error description. For in-depth identification of the error, press the INFO key. In response, a description of the error(s) is displayed.

For more information, refer to section "Error Messages" in the Operating Manual.

Additionally to the automatic monitoring, the R&S SMA offers the following capabilities to ensure correct functioning:

- **Internal Adjustments**
Press the SETUP key and select "System > Internal Adjustments" to access the dialog for performing and configuring of the adjustments settings. A maximum level accuracy can be obtained, for instance.
- **Selftest**
A selftest is provided for service purposes.

2.3.5.4 Default Settings

When the instrument is switched on, it is not the preset state that is active, but rather the instrument state that was set before the instrument was switched off. It is also recommended that you use the PRESET key to return the instrument to its defined preset state every time a new configuration is required or the current setup is not anymore relevant.

The R&S SMA offers a two-stage preset concept:

- **Preset the instrument to a predefined state**
The PRESET key calls up a defined instrument setup. All parameters and switching states are preset (also those of inactive operating modes). The default instrument settings provide a reproducible initial basis for all other settings. However, functions that concern the integration of the instrument into a measurement setup are not changed, e.g. GPIB bus address or reference oscillator source settings.

- Preset the instrument to its factory settings
The instrument can also be forced to load its default factory settings. To access the corresponding dialog box, press the SETUP key and select the "Factory Preset". For more information and an overview of the settings affected by the factory preset function, see section "Factory Preset" in the Operating Manual.

Overview of the Most Important Preset States

The following list gives an overview of the presets for the most important generator settings. The other presets can be found in the preset tables of the individual menus and the information accompanying the remote commands.

- "RF frequency" = 1 GHz
- "RF level" RF output switched off
- "Offsets" = 0
- "Modulations State" = Off
- Uninterrupted level settings are switched off
"Level Attenuator Mode" = AUTO
- Internal level control "Level ALC" = AUTO
- User correction "Level Ucor" = OFF
- "LF output State" = Off
- "Sweep State" = Off
- "List mode State" = Off

Settings that are not affected by the PRESET key

- Reference frequency settings ("Ref Oscillator" menu)
- Power on settings ("Level/EMF" menu)
- Network settings ("Setup" menu)
- GPIB address ("Setup" menu)
- *IDN? Identification and emulation ("Setup" menu)
- Password and settings protected by passwords ("Setup" menu)
- Start/Stop Display Update ("Setup" menu)
- Display and keyboard settings ("Setup" menu)



User-defined instrument states can be stored and called up in the "File" dialog.

2.3.6 Shutting Down the Instrument

To shut down the R&S SMA, proceed as described below.

NOTICE**Risk of losing data**

If you switch off the running instrument using the rear panel switch or by disconnecting the power cord, the instrument loses its current settings. Furthermore, program data may be lost.

Press the ON/STANDBY key first to shut down the application properly.

1. Press the ON/STANDBY key to save the current setup, shut down the operating system and set the instrument to standby state.
The yellow LED must be on.
2. To switch off the power, press the main power switch to position 0 (Off).
None of the front-panel LEDs should be on.

2.3.7 Power Fuses

The R&S SMA is fully fused by two fuses IEC60127-T3.15H/250 V.

The fuses are accommodated in the fuse holders next to the power connector. Use only fuses of the mentioned type.

⚠ WARNING**Shock hazard**

Before replacing a fuse, make sure that the instrument is switched off and disconnected from all power supplies.

Always use fuses supplied by Rohde & Schwarz as spare parts, or fuses of the same type and rating.

2.4 Connecting External Accessories

The equivalent USB ports on the front and/or rear panel of the R&S SMA can be used to connect a variety of accessories.

In addition the instrument provides interfaces for network integration (see [Chapter 2.6, "Setting Up a Network \(LAN\) Connection"](#), on page 31).

2.4.1 Connecting USB Devices

Via the USB ports, you can connect external devices directly to the R&S SMA. If you need more interfaces, you just use an USB hub.

The following list shows various USB devices that can be useful:

- Memory stick for easy transfer of data to/from a computer (for example firmware updates)
- CD-ROM drives for easy installation of firmware applications
- Keyboard or mouse to simplify the entry of data, comments, file names, etc.
- Power sensors, for example of the NRP Zxy family

Installing USB devices is easy under Linux, because all USB devices are plug&play. After a device is connected to the USB interface, the operating system automatically searches for a suitable device driver.

If Linux does not find a suitable driver, it will prompt you to specify a directory that contains the driver software. If the driver software is on a CD, connect a USB CD-ROM drive to the instrument before proceeding.

When a USB device is subsequently disconnected from the R&S SMA, the operating system immediately detects the change in hardware configuration and deactivates the corresponding driver.

All USB devices can be connected to or disconnected from the instrument during operation.

Connecting a memory stick or CD-ROM drive

If installation of a memory stick or CD-ROM drive is successful, the operating system informs you that the device is ready to use. The device is made available as a new drive (`/usb`). The name of the drive is manufacturer-dependent.

Connecting a keyboard

The keyboard is detected automatically when it is connected. The default keyboard layout is English – US.

Use the "Setup > Keyboard Settings" dialog to configure the keyboard properties.

Connecting a mouse

The mouse is detected automatically when it is connected.

2.5 Linux Operating System

The instrument uses an embedded Linux operating system. To make sure that the instrument software works properly, certain rules must be adhered to concerning the operating system.

NOTICE**Risk of causing instrument unusability**

The instrument is equipped with the Linux operating system. Additional software can therefore be installed on the instrument. The use and installation of additional software may impair instrument function. Thus, run only programs that Rohde & Schwarz has tested for compatibility with the instrument software.

The drivers and programs used on the instrument under Linux have been adapted to the instrument. Existing instrument software must always be modified using only update software released by Rohde & Schwarz.

The configuration of the operating system is optimally adapted to signal generator functions in the factory. Changes in the system setup are only required when peripherals like keyboard are installed or if the network configuration does not comply with the default settings (see [Chapter 2.6.1, "Connecting the Instrument to the Network"](#), on page 31). After the R&S SMA is started, the operating system boots and the instrument firmware is started automatically.

**Accessing Operating System**

No access to the operating system is required for normal operation.

All necessary system settings can be made in the "Setup" dialog.

The R&S SMA provides a internal CompactFlash™ Card, it does not contain a disk drive. The CompactFlash™ Card holds the firmware and the stored data. However, data transfer is only possible via a memory stick connected to a USB interface. The memory stick and the CompactFlash™ Card are accessed via the "File Manager".

Accessing the File System

The instrument also supports two standard methods to access the file system from a remote client:

- FTP (file transfer protocol)
- File sharing according to the SAMBA/SMB (server message block) protocol.

Both methods allow the access to the folder `/var/user/share`.

**Default password**

The FTP and SAMBA/SMB file access use the user "instrument" with the default password "instrument".

It is highly recommended that you change this password in the "Setup > Security > Change User Password" dialog before connecting the instrument to the network!

Refer also to Application Note 1GP72 "Connectivity of Signal Generators", provided on the Rohde & Schwarz website, at <http://www.rohde-schwarz.com/appnotes>.

Screen saver

A screen saver can be activated in the R&S SMA. When active, the display is shut off when no entries via front panel, external mouse or external keyboard are made for a period of time. The screen saver prolongs the life time of the display.

Use the "Setup > Display Settings" dialog to switch on or off the screen saver and to adjust the screen saver settings.

2.6 Setting Up a Network (LAN) Connection

The R&S SMA is equipped with a network interface and can be connected to an Ethernet LAN (local area network). Provided the appropriate rights have been assigned by the network administrator and the Linux firewall configuration is adapted accordingly, the interface can be used, for example:

- To transfer data between a controller and the instrument, e.g. in order to run a remote control program.
- To access or control the measurement from a remote computer using the R&S VISA or Ultr@VNC programs (or similar tools, like another VNC client or any Web browser supporting Java)
- To transfer data from a remote computer and back, e.g. using network folders

This section describes how to configure the LAN interface. It includes the following topics:

- [Chapter 2.6.1, "Connecting the Instrument to the Network"](#), on page 31
- [Chapter 2.6.2, "Assigning the IP Address"](#), on page 32



Accessing Operating System

No access to the operating system is required for normal operation.

All necessary system settings can be made in the "Setup" dialog.

2.6.1 Connecting the Instrument to the Network

There are two methods to establish a LAN connection to the instrument:

- A non-dedicated network (Ethernet) connection from the instrument to an existing network
- A dedicated network connection (Point-to-point connection) between the instrument and a single computer

In both cases, an IP address has to be assigned to the instrument and the computer, which is usually accomplished automatically. See also [Chapter 2.6.2, "Assigning the IP Address"](#), on page 32.

To set up a network (LAN) connection

NOTICE

Risk of network failure

Before connecting the instrument to the network or configuring the network, consult your network administrator. Errors may affect the entire network.

- ▶ Connect the instrument to the network or to a single PC.

If the instrument is connected to the LAN, the operating system automatically detects the network connection and activates the required drivers.

By default, the instrument is configured to use dynamic TCP/IP configuration and obtain all address information automatically.

The network card can be operated with a 10 Mbps Ethernet IEEE 802.3 or a 100 Mbps Ethernet IEEE 802.3u interface.

NOTICE

Risk of network connection failure

Network cables and cable connectors of poor quality may cause network connection failures.

If the network connection to the instrument fails, check the network infrastructure and contact your network administrator.

For details, see section "Status Information, Error Messages and Troubleshooting" in the R&S SMA operating manual.

2.6.2 Assigning the IP Address

Depending on the network capacities, the TCP/IP address information for the instrument can be obtained in different ways.

- If the network supports dynamic TCP/IP configuration using the Dynamic Host Configuration Protocol (DHCP), all address information can be assigned automatically.
- If the network does not support DHCP, the instrument tries to obtain the IP address via Zeroconf (APIPA) protocol. If this attempt does not succeed or if the instrument is set to use alternate TCP/IP configuration, the addresses must be set manually.

By default, the instrument is configured to use dynamic TCP/IP configuration and obtain all address information automatically. This means that it is safe to establish a physical connection to the LAN without any previous instrument configuration.

NOTICE**Risk of network errors!**

Connection errors can affect the entire network.

If your network does not support DHCP, or if you choose to disable dynamic TCP/IP configuration, you must assign valid address information before connecting the instrument to the LAN.

Contact your network administrator to obtain a valid IP address.

Assigning the IP address on the instrument

1. Press the SETUP key and select the "Network Settings" dialog.
2. Set the "Address Mode" to Static.
3. Select the "IP Address" and enter the IP address, for example *192.168.0.1*.
The IP address consists of four number blocks separated by dots. Every block contains 3 numbers in maximum.
4. Select the "Subnet Mask" and enter the subnet mask, for example *255.255.255.0*.
The subnet mask consists of four number blocks separated by dots. Every block contains 3 numbers in maximum.

**Use computer names to identify the instrument**

In networks using a DHCP server, it is recommended that you address the instrument by its unambiguous computer name, see [Chapter 2.6.3, "Using Computer Names"](#), on page 33.

A computer name (*hostname*) is an unique dedicated identification of the instrument, that remains permanent as long as it is not explicitly changed. Hence, you can address an instrument by the same identification (computer name), irrespectively if a network or a point-to-point connection is used.

To assign the IP address manually on the remote computer

- ▶ Obtain the necessary information from your network administrator. If you use more than one LAN connector, you need separate address information for each connector.

For information on how to perform the configurations, refer to the documentation of the operating system the remote computer uses.

2.6.3 Using Computer Names

In a LAN that uses a DNS server (Domain Name System server), each PC or instrument connected in the LAN can be accessed via an unambiguous computer name instead of the IP address. The DNS server translates the host name to the IP address. This is especially useful when a DHCP server is used, as a new IP address may be assigned each time the instrument is restarted.

Each instrument is delivered with an assigned computer name, but this name can be changed.

The default instrument name is a non-case-sensitive string that follows the syntax `rs<instrument><serial number>`.

The serial number can be found on the rear panel of the instrument. It is the third part of the device ID printed on the bar code sticker:



Querying and changing a computer name

1. Press the "Setup" key and select "Network Settings".
The computer name is displayed under "Hostname".
2. Press the "Setup" key, select "Protection" and enable the "Protection Level 1".
The default password is *123456*.
The parameter "Hostname" in the "Network Settings" dialog is now enabled for configuration.
3. Change the "Hostname".

2.7 Remote Access via an External Controller

The R&S SMA can be remote accessed from a remote computer (external controller) via a network link. This allows convenient operation of the instrument from the desktop although the instrument is integrated in a rack somewhere else.



For an overview of the instrument's operating concept and the different ways to control and operate the instrument, see [Chapter 3.1, "Brief Introduction to the Instrument's Concept"](#), on page 51.

There are different ways to establish a remote access connection to the signal generator but all of them require an established LAN connection between the instrument and the remote computer. The simplest way to remote access the instrument is to use a Web browser, such as Windows Internet Explorer or Mozilla Firefox for instance. Alternatively a remote access via a special application can be used.

For example, the free-of-charge program Ultr@VNC for PCs with Linux/Unix or Windows operating system is available for setting up the remote access connection. Using this application requires additional installation.

See the following table for an overview of the different ways to establish a remote access connection to the signal generator.

Table 2-1: Remote access via an external computer

Remote access via	LAN connection	Installation of the additional application	
		on the instrument	on the remote computer
Any web browser for example Windows Internet Explorer or Mozilla Firefox, see Chapter 2.7.1, "Using a Web Browser for Remote Access" , on page 35	required	no	<i>Java Runtime</i> must be installed and activated in the browser settings.
Web browser with HTML5 for example LXI Browser, see Chapter 2.8.2.4, "Web Control" , on page 47	required	no	<i>Web sockets</i> must be supported.
VNC Client for example Ultr@VNC or other dedicated client software for PCs with Linux/Unix or Windows operating system see Chapter 2.7.2, "Remote Access via a VNC Client Software" , on page 36	required	required	VNC Viewer required

When the connection is set up with a VNC client software (Ultr@VNC), direct control on the instrument is possible while remote access is established.

For return to direct operation on the instrument, the connection must be cut. After cutting the connection, it is still enabled and can be established again any time. The connection is disabled only after deactivation of the program.

This section gives an information on how to use the Web browser for remote access, how to install the applications for remote access and how to establish the connection between the instrument and an external computer with Windows operating system. Remote access via an external computer with Linux/Unix operating system is performed accordingly.



Default password

Remote-access and file access require the user "instrument" with default password "instrument".

NOTICE

Changing the default user and security passwords

It is highly recommended to change the default user and security passwords in the menu "Setup > Security" before connecting the instrument to the network (see section "Security - Setup-Protection" in chapter "General Instrument Settings" of the Operating Manual).

2.7.1 Using a Web Browser for Remote Access

The instrument can be remote-accessed via any web browser, as for example the Windows Internet Explorer or Mozilla Firefox.



Alternatively, you can also make use of the LXI browser, as described in [Chapter 2.8.2.4, "Web Control"](#), on page 47.

To remote access the instrument via a web browser:

1. Connect the instrument and the remote computer to a LAN, see [Chapter 2.6.1, "Connecting the Instrument to the Network"](#), on page 31.
2. Instal the Java Runtime Environment JRE on the remote computer.
3. Type the instruments' IP address in the address field of the Web browser on your PC, e.g. `http://10.111.11.1`

The "VNC Authentication" screen appears.

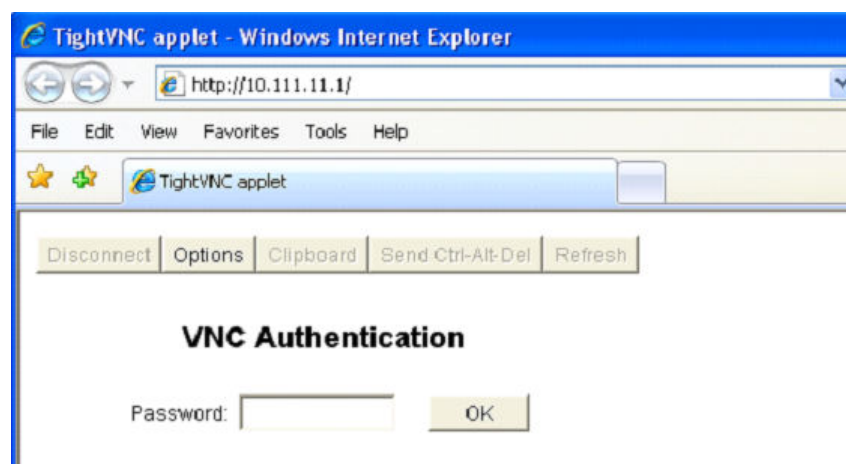

4. Enter the password and select "OK".
The default password is "instrument".

After the connection is established, the current signal generator screen with the block diagram is displayed and the instrument can be remote-accessed from the remote computer.

2.7.2 Remote Access via a VNC Client Software

A VNC client software is an application which can be used to access and control the instrument from a remote computer via LAN.

The following description explains how to establish the remote access, represented by means of the client software Ultr@VNC. The software is included in Linux/Unix operating system, but it is also available as a free-of-charge download on the Internet <http://www.uvnc.com/download/index.html>. Thus, it is also available for remote computers with Windows operating system.



The GUI appearance of Ultr@VNC may vary if you use a later release. Also, similar programs may deviate in some details, but the basic procedure is the same.

NOTICE**Risk of Unauthorized Access**

If the VNC service is enabled on the instrument, any user in the network who knows the computer name and password can access it.

Disable the VNC service on the instrument to prevent unauthorized access.

Setting up a VNC connection

1. Connect the instrument and the remote computer to a LAN, see [Chapter 2.6.1, "Connecting the Instrument to the Network"](#), on page 31.
2. [Install the Ultr@VNC application](#) and enable it on the instrument.
3. In the ICF firewall, enable communication on the network via Ultr@VNC program.
4. Install the VNC Viewer on the remote computer with Windows operating system, see ["Installing the VNC Viewer on a Windows PC"](#) on page 39.
5. Set up the VNC connection between the instrument and:
 - a) the remote computer with Linux/Unix operating system, see ["Setting up the VNC connection on the Linux/Unix remote computer"](#) on page 39;
 - b) the remote computer with Windows operating system, see ["Setting up the VNC connection on the Windows remote computer"](#) on page 40.

**Enabled Direct Control**

The direct control of the instrument is not disabled and the instrument can be controlled from the front panel and via the remote computer alternately.

Installing the Ultr@VNC application

1. Download the program from the internet and copy it to a directory that can be accessed.
2. On the instrument, shut down firmware using the ALT+F4 key combination.
3. Double click on the setup file to start the installation.
The setup wizard leads through the installation. This description focus only on the relevant settings.

a) Select installation of all components.

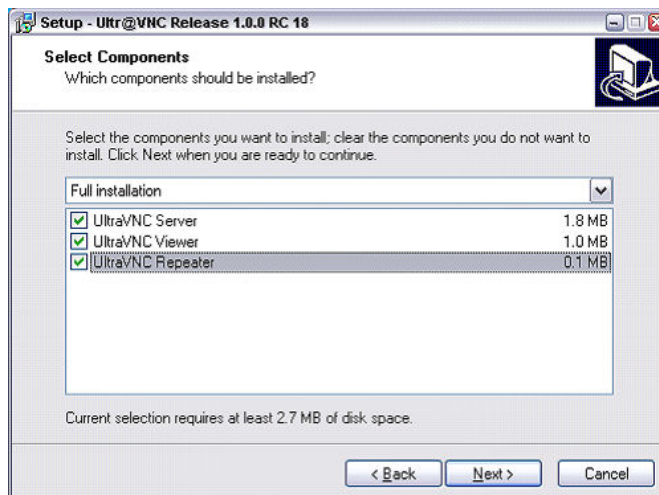

b) In the "Additional Task Panel", enable all entries.

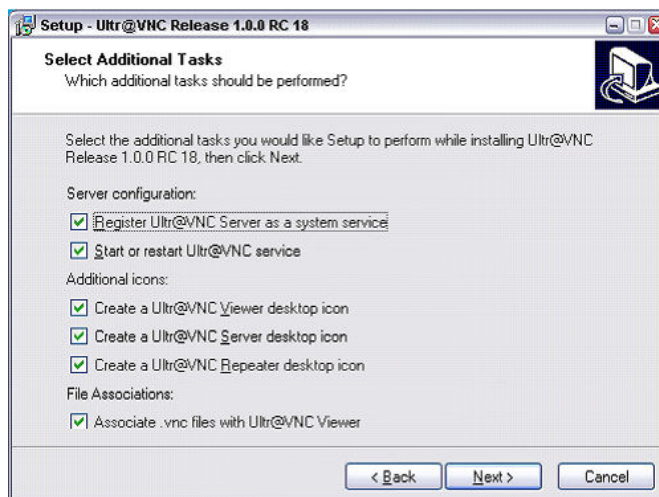

A successful installation is indicated by a message.

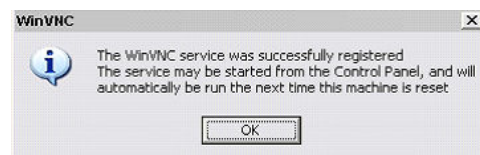

At the same time a warning is displayed stating that a password must be set.



4. Select "OK".

The "Default Local System Properties" panel opens.

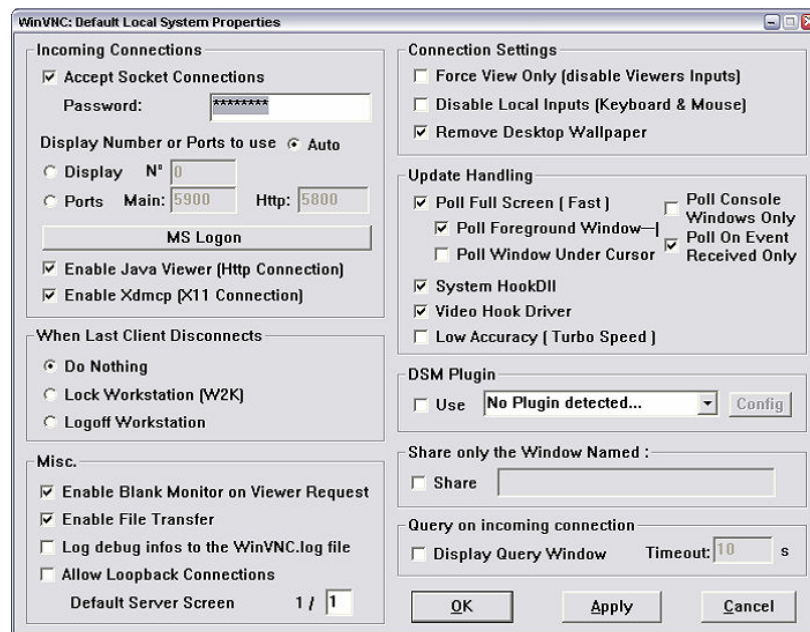

5. Enter a password with a length of at least five digits.
This password is used on the remote computer to access the instrument. Other settings may be changed according to the user-specific security requirements.

After the installation the Ultr@VNC program is automatically started together with the operating system. On mouse over, the IP address of the instrument is indicated.

This IP address and the user-defined password are the prerequisites to enable remote access on the remote computer. Terminated connection is indicated by changed icon color.

Installing the VNC Viewer on a Windows PC

1. Download the Ultr@VNC program from internet and follow the installation instructions.
Only the program component VNC Viewer is required.

Note: The VNC Viewer program is included in the download for the installation of the Ultr@VNC program on the signal generator if "Full installation" was selected in the "Select Component" panel. In this case, the program `ultr@vncviewer.exe` can be copied to the Windows PC.

2. Install VNC Viewer program component on the remote computer.

Setting up the VNC connection on the Linux/Unix remote computer

The VNC program is available per default for Linux/Unix operating systems.

1. Start a Web browser on the remote computer and enter the IP address of the instrument.
2. Enter the following address:
`vnc://<IP-address of the instrument>`, e.g. `vnc://192.168.1.1`.

A dialog is opened and the password for the remote VNC connection is requested.

3. Enter the password as defined in the "Default Local System Properties" panel of the Ultr@VNC program and select "Log On".

The connection is established, the instrument is remote accessed and the current signal generator screen with the block diagram is displayed. The individual functions are operated using the mouse and keyboard.

In contrast to remote access via Remote Desktop, the direct control of the instrument is not disabled and the instrument can be controlled from the front panel and via the remote computer alternately.

Setting up the VNC connection on the Windows remote computer

1. Start VNC Viewer program component on the PC, select "VNC Server" and enter IP address of the instrument.

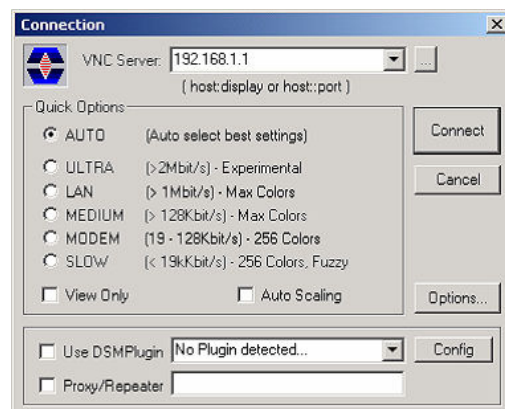

2. To initialize the connection, select "Connect".

A message requesting the password appears.

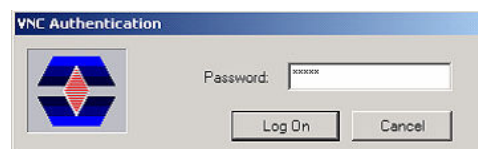

3. Enter the password as defined in the "Default Local System Properties" panel of the Ultr@VNC program and select "Log On".

The connection is established, the instrument is remote accessed and the current signal generator screen with the block diagram is displayed. The individual functions are operated using the mouse and keyboard.



Enabled Direct Control

The direct control of the instrument is not disabled and the instrument can be controlled from the front panel and via the remote computer alternately.

Terminating VNC Connection

The remote access via VNC connection can be terminated either on the R&S SMA or on the external PC. Terminating the connection does not disable it. It can be established again any time. See the notice above concerning unauthorized access due to VNC connection!

1. Terminate the connection on the R&S SMA
 - a) Press the "Windows" key to access the operating system.
 - b) Right-click on the VNC icon on the task bar and select "Kill all clients".
2. To terminate the connection on the external Linux/Unix PC, close the internet browser or close the signal generator window.
3. To terminate the connection on the external Windows PC, close the VNC Viewer program.

The connection is terminated. The color of the VNC icon in the status bar of the instrument changes.

A message on the external PC indicates the disconnection.

Disabling Remote Access via Ultr@VNC

The VNC connection can be disabled by removing the program on the instrument or by deactivating the VNC Server service.

1. Remove the VNC program
 - a) Press the "Windows" key to access the operating system and open the "Add or Remove Programs" by selecting "Start > Settings > Control Panel > Add or Remove Programs".
 - b) Remove the VNC program.
2. Deactivate the VNC Server service
 - a) Press the "Windows" key to access the operating system and open the "Services" by selecting "Start > Settings > Control Panel > Services".
 - b) Deactivate the VNC Server service.

The connection is disabled, the VNC icon disappears from the task bar of the instrument.

2.8 LXI Configuration

LXI ("LAN eXtensions for Instrumentation" is an instrumentation platform for measuring instruments and test systems that is based on standard Ethernet technology. LXI is intended to be the LAN-based successor to GPIB, combining the advantages of Ethernet with the simplicity and familiarity of GPIB.

Like GPIB, LXI determines and standardizes the way the instrument behaves in a LAN. The LXI implementation by the Rohde&Schwarz signal generators allows you to change certain LAN settings, to reset the LAN connection as well as to identify the instrument easily.



For information about the LXI standard, refer to the LXI website at <http://www.lxistandard.org>. See also "News from Rohde & Schwarz, article 2006/II - 190".

The R&S SMA provides an integrated "LXI Status" dialog for LXI status indication and reset of the LAN configuration ("LAN Configuration Initialize", LCI). To access the LXI status dialog, press the SETUP key and select "Remote > LXI Status".

For further information, see section "LXI Status" in the Operating Manual.



Firmware update

After a firmware update, shut down and restart the instrument in order to enable the full LXI functionality.

Default state of the network settings

According to the LXI standard, an LCI must set the following parameters to a default state.

Parameter	Value
TCP/IP Mode	DHCP + Auto IP Address
Dynamic DNS	Enabled
ICMP Ping	Enabled
Password for LAN configuration	LxiWebIfc

The LCI for the R&S SMA also resets the following parameters:

Parameter	Value
Hostname	<Instrument-specific host name>
Description	Vector Signal Generator
Negotiation	Auto Detect
VXI-11 Discovery	Enabled

The LAN settings are configured using the instrument's "LXI Browser Interface".

2.8.1 LXI Browser Settings

To access the instrument via the web browser:

- Type in the instrument's host name or IP address in the address field of the browser on your PC, for example "http://10.113.1.205".

Note: Do not add the missing zeros in the IP address, while opening the instrument home page.

The instrument home page (welcome page) opens.

The screenshot shows the LXI web interface for an R&S SMA100A instrument. The interface has a navigation pane on the left and a main content area. The navigation pane includes sections for LXI (Home, Lan Configuration, Status, Utilities), Instrument Control, Web Control, Diagnostics (SCPI Remote Trace), and Help (Glossary, www.rohde-schwarz.com). The main content area is titled "Instrument Properties" and displays the following information:

Instrument Model	R&S SMA
Manufacturer	Rohde & Schwarz GmbH & Co. KG
Serial Number	110001
Description	Rohde & Schwarz Signal Generator SMA100A 110001
LXI Version	1.4 LXI Core 2011
LXI Extended Features	
DNS Host Name(s)	instrument
MAC Address	08:00:27:ef:40:9b
IP Address	10.113.1.141
Firmware Revision	3.50.057.16
Current Time	Tuesday, 2016/05/24, 15:14:42
Current Time source	Operating System
VISA resource string	TCPIP::10.113.1.141::inst0::INSTR
Device Indicator	<input type="button" value="ACTIVE (press to toggle)"/> ●

At the bottom of the main content area, there is a "Status" section showing "No error". A copyright notice at the bottom right reads "© 2016 ROHDE&SCHWARZ. All rights reserved."

The navigation pane of the browser interface contains the following elements:

- "LXI"
 - "Home" opens the instrument home page. The home page displays the device information required by the LXI standard, including the VISA resource string in read-only format.
 - "Device Indicator" activates or deactivates the LXI status indication. When activated, the LXI LEDs flash, both in the browser dialog and in the LXI dialog of the connected instrument. A green LXI status symbol indicates that a LAN connection has been established; a red symbol indicates that no LAN cable is connected.
 - "Lan Configuration" allows you to configure LAN parameters and to initiate a ping, see [Chapter 2.8.2.3, "Ping Client"](#), on page 46.
 - "Status" displays information about the LXI status of the instrument.
 - "Utilities" provides access to the LXI event log functionality required by the LXI standard.
- "Instrument Control"

- "Web Control" provides remote access to the instrument, see [Chapter 2.8.2.4, "Web Control"](#), on page 47.
- "Diagnostics"
 - "SCPI Remote Trace" records messages exchanged via the remote control interface, see [Chapter 2.8.2.5, "SCPI Remote Trace"](#), on page 48.
- "Help"
 - "Glossary" explains terms related to the LXI standard.
 - www.rohde-schwarz.com opens the Rohde & Schwarz home page.
- ▶ Press the "INACTIVE (press to toggle)" button to activate the connection.

ACTIVE (press to toggle)



A green flashing status LED indicates the active connection. If the LAN connection fails, the LED turns red.

For further information, see section "LXI Status" in the Operating Manual.

2.8.2 LAN Configuration

The "LAN Configuration" web page provides access to the parameters required for identifying the R&S SMA in the network, and allows modification.



Password protection

Changing the LAN configuration is password-protected. The default password is *Lxi-WebIfc* (notice upper and lower case characters). This password cannot be changed in the current firmware version.

It comprises the following navigation entries.

• IP Configuration	44
• Advanced LAN Configuration	45
• Ping Client	46
• Web Control	47
• SCPI Remote Trace	48

2.8.2.1 IP Configuration

The "IP Configuration" page displays all mandatory LAN parameters.

LXI < LAN Parameters

Home

Lan Configuration

- IP Configuration
- Advanced Config
- Ping Client

Status

Utilities

Instrument Control

Web Control

Diagnostics

SCPI Remote Trace

Help

Glossary

www.rohde-schwarz.com

Hostname: Attention! Changing the hostname reboots the device!

DNS Hostname(s):

Domain:

Description:

IP Address Mode: ▾

IP Address:

Subnet Mask:

Default Gateway:

Obtain DNS Server Address automatically:

DNS Server(s):

Register Device at DNS Server dynamically:

(Password required!)

Status: No error

© 2016 ROHDE&SCHWARZ. All rights reserved.

The "IP Address Mode" selects a configuration mode for the IP address of the R&S SMA. With static configuration, the entered IP address, subnet mask, and default gateway are used. With dynamic configuration, DHCP or dynamic link local addressing (automatic IP) are used to obtain the instrument IP address.

See [Chapter 2.6.2, "Assigning the IP Address"](#), on page 32.

2.8.2.2 Advanced LAN Configuration

The "Advanced Config" page provides LAN settings that are not declared mandatory by the LXI standard.

The screenshot shows the LXI configuration web interface. The top navigation bar includes the Rohde & Schwarz logo and the LXI logo. The main content area is titled "LAN Parameters" and contains the following settings:

- mDNS and DNS-SD**: A dropdown menu set to "mDNS & DNS-SD".
- ICMP Ping enabled**: A checked checkbox.
- VXI-11 Discovery**: A checked checkbox.
- A **Submit** button and a password input field with the label "(Password required!)" next to it.

On the left side, there is a navigation menu with the following items:

- LXI** (selected)
- Home
- Lan Configuration** (expanded)
 - IP Configuration
 - Advanced Config
 - Ping Client
- Status
- Utilities
- Instrument Control**
 - Web Control
- Diagnostics**
 - SCPI Remote Trace
- Help**
 - Glossary
 - www.rohde-schwarz.com

At the bottom of the page, there is a "Status" section indicating "No error" and a copyright notice: "© 2015 ROHDE&SCHWARZ. All rights reserved."

The following advanced parameters are available:

- "mDNS and DNS-SD": The additional protocols "multicast DNS" and "DNS service discovery" are used for device communication in zero configuration networks, working without DNS and DHCP.
- "ICMP Ping enabled": Must be enabled to use the ping utility. If you disable this setting, the instrument does not answer ping requests. The setting does not affect the LXI ping client. You can ping other hosts from the instrument, even if the setting is disabled.
- "VXI-11 Discovery": Must be enabled to detect the instrument in the LAN. If you disable this setting, the instrument cannot be detected by the VXI-11 discovery protocol mechanism. The setting does not affect other detection mechanisms. Setting up a VXI-11 connection via the IP address or the host name is independent of this setting.

2.8.2.3 Ping Client

The "Ping Client" page provides the ping utility to verify the connection between the LXI-compliant instrument and another device.

The ping is initiated from the instrument. Using the `ICMP` echo request and echo reply packets, the function checks whether the communication with a device via LAN works. Ping is useful for the diagnosis of IP network or router failures.

The ping utility is not password-protected.

To initiate a ping from the instrument to the device:

1. Enable "ICMP Ping" on the "Advanced LAN Configuration" page.
2. Select the "Ping Client" page.
3. In the "Destination Address" field, enter the IP address of the device you want to ping (without the ping command and without any further parameters), e.g. *10.113.1.203*.
4. Select "Submit".



The screenshot displays the LXI web interface for the R&S SMA100A. The left sidebar contains a navigation menu with the following items: LXI, Home, Lan Configuration, Status, Utilities, Instrument Control, Web Control, Diagnostics, SCPI Remote Trace, and Help. The main content area is titled "Ping Parameter" and features a "Destination Address" input field with "Clear" and "Submit" buttons. Below this, the "Result" section shows the output of a ping command: "PING 10.113.1.141 (10.113.1.141): 56 data bytes 64 bytes from 10.113.1.141: seq=0 ttl=64 time=0.345 ms --- 10.113.1.141 ping statistics --- 1 packets transmitted, 1 packets received, 0% packet loss round-trip min/avg/max = 0.345/0.345/0.345 ms". At the bottom of the interface, a "Status" section indicates "No error". The footer of the page contains the copyright notice: "© 2016 ROHDE&SCHWARZ. All rights reserved."

2.8.2.4 Web Control

The web control functionality provides remote operation via VNC using a Web browser (with HTML5). This mode does not require additional installation or activation. The VNC protocol allows simultaneous operation from several remote devices. The instrument remains locally operable.

The GUI of the R&S SMA is visible. To perform the settings, you can operate the instrument as with the manual control. The instrument controls are available via the front panel simulation. File upload and download between the instrument and the remote PC is also available.

Starting a Remote Control via the LXI web browser

This section assumes that the instrument and the controller PC are connected in the LAN.

1. Start a web browser that supports html5 (W3C compliant).
2. Enter the IP address of the R&S SMA in the browser's address bar.
The R&S SMA's welcome page is displayed.
3. In the navigation pane, select "Instrument Control" > "Web Control".
Remote access to the instrument requires the password. The default password is *instrument*.
4. Enter the password.
5. Confirm with the ENTER key.

After the connection is established, the current screen of the R&S SMA is displayed in the browser window.

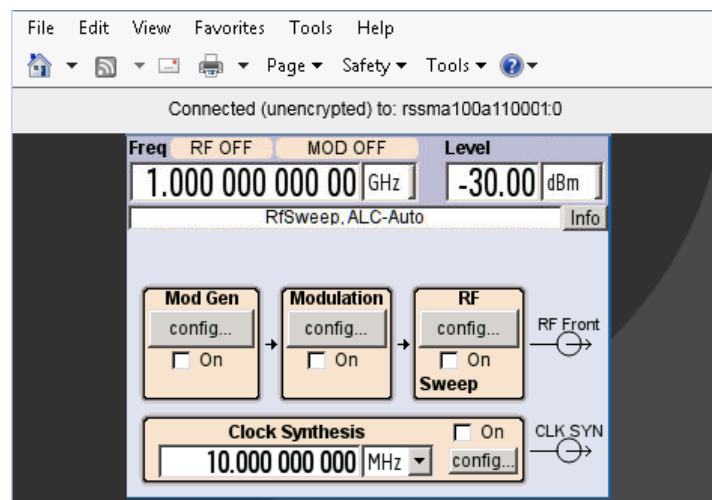

6. Use the mouse cursor and keyboard to access the functionality of the instrument as you would directly perform the settings on the instruments front panel.

2.8.2.5 SCPI Remote Trace

The remote trace functionality allows you to trace input and output strings at the remote control interface of the R&S SMA.

A recorded trace (message log) can be evaluated directly in the dialog. Use the highlighting and navigation functions provided in the lower toolbar to locate error messages and messages containing arbitrary search strings. You can also export the message log to a *.CSV file and evaluate the file using a suitable program.

To trace and display messages:

1. In the navigation pane, select "Diagnostics" > "SCPI Remote Trace".

- In the toolbar bar of the "SCPI Remote Trace" page, select "live mode" > "on" and "logging" > "on".
"live mode > on" displays all commands and responses, and "logging > on" also traces messages.
- If you now control the R&S SMA with SCPI commands, using an appropriate tool, the SCPI remote trace records the information sent and received.

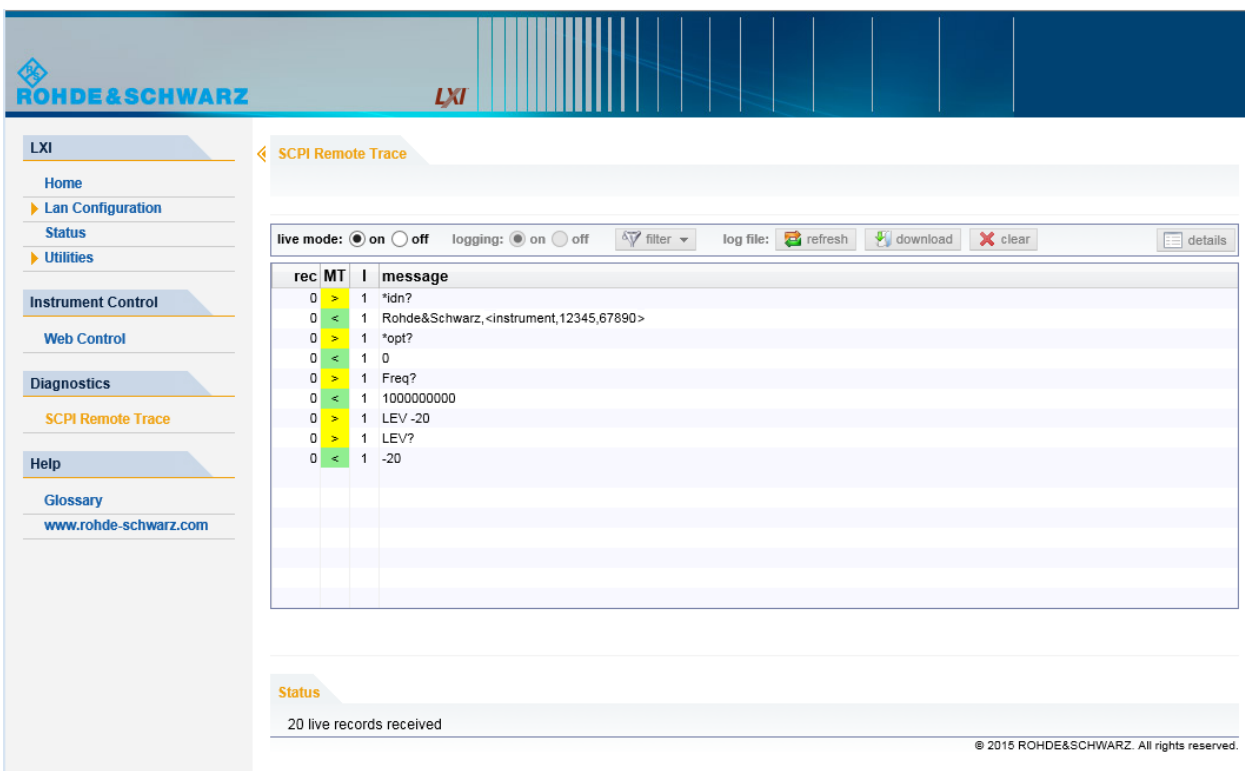

The function records all sent commands, received responses and messages, and stores them in an internal database. If "live mode" is disabled, you can display the recent traces upon request, using the "refresh" button. You can also store the log in a file.

Note: The diagnostics functionality is extended in later releases, e.g. to download or upload SCPI command files from / to the instrument.

Toolbars

The toolbar at the top of the dialog provides basic settings and functions.

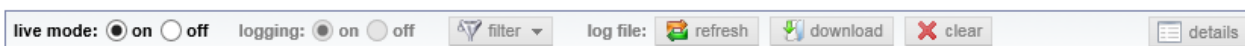

- "Live mode" / "logging": If logging is switched on, messages are traced. They are stored in an internal database and can be displayed upon request, using the refresh button (live mode off) or they can be displayed automatically (live mode on).
- "Filter": applies a filter to columns and/or rows when working (live mode off)
- "Refresh": reads the message log from the internal database and displays it

- "Download": stores the SCPI trace log to a *.csv file
- "Clear": deletes all message log entries in the database and on the screen
- "Details": displays details of the selected message, for example an SCPI command in hex format (also possible by double-clicking a message)

Columns

The following columns are available if no column filter is applied:

- "Rec": record number of the message within the message log
- I: number of the subinstrument
- "MT": indicates the type of the message. Possible values and related message contents are:
 - > = incoming command
 - < = outgoing response to a query
 - E = error message, highlighted by red color
 - T = execution time, i.e. time required by the instrument to process the command internally
- "message": indicates the type of the message. Possible values and related message contents are:
 - > = incoming command
 - < = outgoing response to a query
 - E = error message, denoted in red
 - T = execution time, i.e. time required by the instrument to process the command internally

3 Getting Started

This section helps you to get familiar with the R&S SMA. It provides an introduction to the general concept of the instrument with a sample of the possible application fields, and a description of the main blocks in the signal generation flow.

This section also explains the operating concept in general and includes a brief introduction to operation by a step-by-step description of the configuration. The example is intended to provide a quick overview of the settings provided. No additional equipment is required.

3.1 Brief Introduction to the Instrument's Concept

The **operating concept** of the R&S SMA employs the following three ways of instrument control:

- Manual operation
- Remote control
- Remote access

Manual Operation

The R&S SMA can be entirely operated from the front panel. Peripherals such as mouse or keyboard can be connected but are not essential.

The R&S SMA is equipped with an intuitive user interface. The central element of the display is the block diagram that shows the signal flow and processing from the left on the display to most right, i.e. the generated signal can be seen at a glance.

Each block represents a functional unit of the instrument. Thus you always know the position at which a parameter affects the signal flow. The main settings of a block are indicated in the block. The interconnection of employed inputs and outputs is also shown. The user is thus always informed about the connection of inputs and outputs in the signal flow and where they can be configured. A window is opened for each menu where parameters can be set. When the window is opened, an entry is made in the "Winbar" below the display. All open menus are of equal priority (not modal) and can be accessed any time.

The block diagram in the figure below shows a fully equipped instrument.

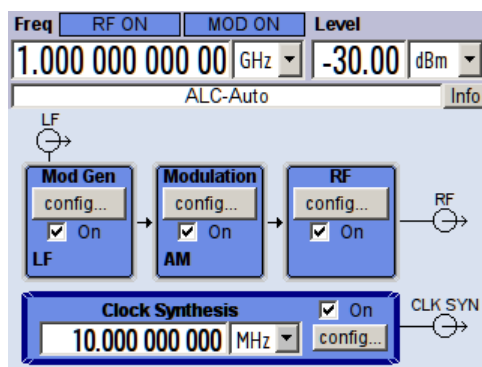

Figure 3-1: Block diagram of a fully equipped R&S SMA

With the rotary knob, you can navigate in the block diagram and the dialogs, and operate the instrument with one hand. The cursor is moved line by line through the block diagram or dialog. Turning the button clockwise advances the cursor. The selected block can be activated or deactivated with the TOGGLE key. Active blocks are highlighted by a colored background.

The instrument comprises a comprehensive info and help system. You can access the context-sensitive help with the HELP (F1) key at any time. The help system indicates the currently selected parameter and offers additional services such as cross references, index and contents. The content of the help system corresponds to the operating manual of the instrument.

Warning and conflict messages caused by incorrect operation as well as further information are displayed in the "Info" line. A complete list of existing conflicts is displayed when the INFO (CTRL+I) key is pressed. Additional information on entries can be requested from the help system. The history function permits display of all messages.

Assistants simplify the completion of tables. After data entry in the assistant, the table is modified only after the "Accept" button has been pressed. Pressing the "Accept" button also stores the assistant data.

For an introduction into the manual operating of the instrument, detailed operating instructions and an overview of menus refer to [Chapter 4, "Manual Operation"](#), on page 63.

For an in-depth description of the dialog boxes and the instrument functions, refer to section "Instrument Functions" in the operating manual.

Remote Control

Remote control is an operation of the instrument by means of remote control commands or programs that automatize repeating settings. The instrument is connected to a computer running the program.

The R&S SMA supports various remote control connections:

- Connecting the instrument to a (LAN) network
- Using the LXI browser interface in a LAN network
- Connecting a PC via the IEC-bus (IEEE 488) interface
- Remote control via the USB interface



Tip: For remote control over LAN or USB, you can use the R&S VISA (Virtual Instrument Software Architecture) library provided for download at the Rohde & Schwarz website <http://www.rohde-schwarz.com/rsvisa>.

This way of operation and the instructions how to set up a connection for remote control are described in the operating manual, chapter "Remote Control Basics". The description of the remote control commands is provided in the operating manual, chapter "Remote Control Commands".

Remote access

Remote access is the operating of the instrument from a remote computer. Both the R&S SMA and the computer are connected in a LAN.

Remote access in contrast to **remote control** does not use remote-control commands but a separate software which is installed on the remote computer. After its start, the software simulates the user interface of the instrument. The instrument can thus be operated from the remote computer as on the unit itself. The individual functions are operated using the mouse and keyboard. Specific instrument functions can be executed using specific key combinations on the keyboard or a front panel key emulation that can be operated with the mouse.

This way of operation and the instructions how to set up a connection for remote access are described in [Chapter 2.7, "Remote Access via an External Controller"](#), on page 34.

3.2 Application Field of the Instrument

The main field of application of the R&S SMA is the generation of sine wave signals with very high spectral purity. These signals are needed for example for adjacent channel or phase noise measurements.

In addition, the RF signal can be modulated with a wide variety of internal modulations waveforms, like sine waves, triangle/rectangular/trapeze signals, and noise. Several modulation signals can be combined with variable weight.

3.3 Description of Individual Diagram Blocks

The signal path of the instrument is configured by installing a frequency option that comprises all required modules including synthesizer, output section and attenuator (optional without attenuator).



One of the following options must be installed.

- R&S SMA-B103 (up to 3.2 GHz)
- R&S SMA-B103L (up to 3 GHz without attenuator)
- R&S SMA-B106 (up to 6 GHz)
- R&S SMA-B106L (up to 6 GHz without attenuator)
- R&S SMA-B131 (up to 31,8 GHz)

Instruments without step attenuator provide a restricted level range at the RF output. Refer to the data sheet for detailed information.

See data sheet for detailed information.

Up-to-date information is available at R&S SMA homepage on the internet <http://www.rohde-schwarz.com/product/sma100a.html>.



Mod Gen block

The internal modulation sources are configured in this block. Also, the "LF frequency sweep" can be activated here.

Two internal LF generators (second is optional) are available as the internal source(s) for the analog modulations AM, FM and PhiM. Different modulation shapes - sine, triangle, rectangle and noise - are offered for the second LF generator. Bandwidth and level distribution can be selected for the noise signal of the noise generator (optional).

Available modulation shapes are:

- sine
- triangle (optional)
- square (optional)
- trapeze (optional)
- noise with selectable bandwidth and level distribution (optional)

The internal modulation signals are provided at the LF output at the front of the instrument. The LF output signal and the modulations sources for the analog modulations AM, FM and PhiM can be selected independently from each other.

A pulse generator provides single and double pulse modulation with selectable pulse widths and periods. Additionally, an option is available to generate pulse train signals.

The R&S SMA offers three different sweep types (frequency sweep, level sweep and LF sweep) to be activated alternatively. Each type has 6 modes which differ with respect to the sweep cycle mode (continuous, individual and step-by-step) and triggering mode (automatic, internal and external). In the "Mod Gen" block, the LF sweep is configured. Frequency and level sweep settings are accessed via the "RF" block.

The status display in the block shows whether LF generator and/or a sweep are active. The selected internal LF generator and/or noise source are switched on or off with the TOGGLE ON/OFF key.

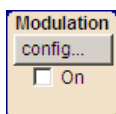

Modulation block

The internal and external analog modulations are configured and activated in this block. The MOD ON/OFF key switches the active modulation(s) on/off.

The internal modulation sources are configured in the "Mod Gen" block. The modulation inputs AM EXT, FM/PHIM EXT and PULSE EXT at the rear of the instrument are provided for external amplitude, frequency, phase and pulse modulation. AC or DC coupling for external feed is possible.

Modulation signals of up to three sources (two internal sources and one external source) can be combined for AM/FM and PhiM modulation.

Available internal and external analog modulation modes are:

- Amplitude modulation (AM)
- Frequency modulation (FM, optional)
- Phase modulation (PhiM, optional)
- Pulse modulation (Pulse)
- Chirp modulation (internal only)

In addition, external digital modulation signal can be used. The external signal for digital FM/PhiM modulation is fed in via the AUX I/O interface.

- Digital Frequency modulation (optional)
- Digital Phase modulation (optional)

Note: For modulation modes that can be simultaneously used, refer to the R&S SMA data sheet.

The status display in the block shows the active modulation(s). Use the TOGGLE ON/OFF key to switch the active modulation of the block on or off.



RF block

In this block, the RF parameters and frequency/level sweep settings are set.

The active sweep is displayed in the block. The RF ON/OFF key switches the RF signal on and off. When the signal is switched off, the switch before the RF output symbol is open.

RF settings include:

- Frequency and reference frequency
- Level settings; if required.
- NRP-Z Power Viewer and Power Analysis using power sensors
- Frequency and level sweep
- List Mode settings. In this mode, extremely fast frequency and level settings can be made.

The RF 50 OHM output connector at the front of the instrument provides the RF signal. An external trigger/gate signal for sweeps is input via the INST TRIG connector at the rear of the instrument

Note: Frequency and level are set fast with the aid of the FREQ and LEVEL keys.

Use the TOGGLE ON/OFF key to switch the RF output on or off.

Clock Synthesis

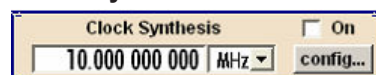

In this block, the clock synthesis is switched on or off and the frequency of the clock signal is set. For instruments equipment with modules with order number 1400.2749.02 DC offset can be defined, in addition.

The clock frequency is displayed in the block. Use the TOGGLE ON/OFF key to switch the generation of clock signal on or off.

3.4 Example of Setup

This section provides an example on how to configure the instrument for generating of an amplitude modulated signal and of a frequency modulated signal with noise.

Generation of an Amplitude-Modulated Signal

To generate a simple AM-modulated signal, proceed as follow:

1. Activate default (preset) state
Press the PRESET key to set a defined instrument state.

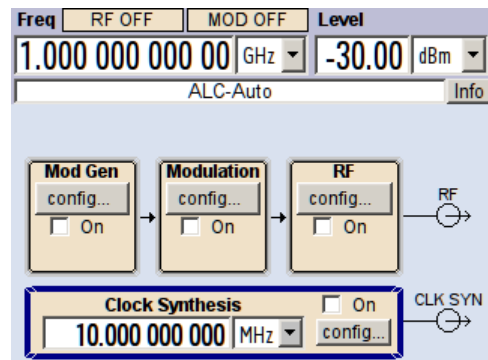

2. Select and activate AM modulation
 - a) Turn the rotary knob and select the "Mod" block.



- b) Press the rotary knob to open the dialog where the modulation can be selected (different modulation modes are available depending on the options installed).

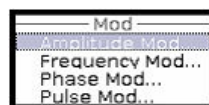

The "Amplitude Mod..." menu is the first menu and is highlighted per default.

- c) Turn the rotary knob and highlight "Amplitude Mod...".
Press the rotary knob to open the "Amplitude Modulation" dialog.

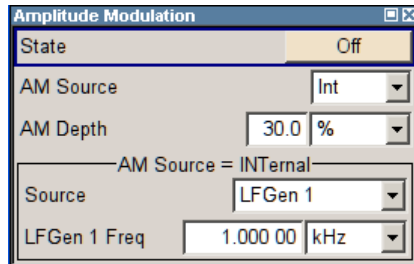

- d) Turn the rotary knob to select parameter "AM Depth", press the rotary knob to allow editing and enter the preferred AM depth with the aid of the numeric keypad and the unit keys.

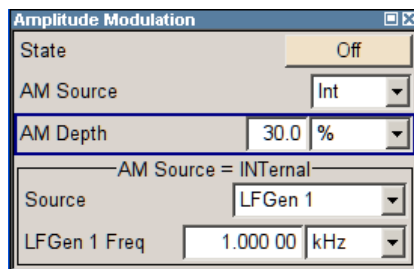

- e) Finally, select "State" and press the rotary knob to switch on the AM modulation.

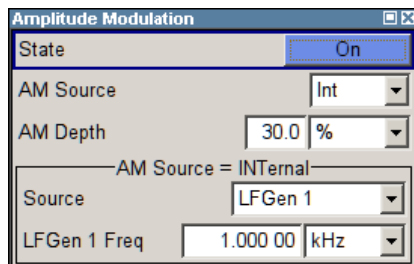

- f) Press the DIAGRAM key to display the complete block diagram.
To indicate the active state, the "Mod" block is displayed in blue. The "RF" is not yet active, which means that no RF signal is output.

3. Set frequency and level and activate RF signal

- a) Press the FREQ key to activate the editing mode for frequency entry. The "Frequency" entry field in the header section of the display is highlighted.

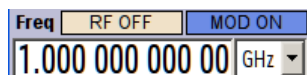

Enter the frequency using the numeric keypad and terminate the entry by pressing a unit key.

- b) Press the LEVEL key and enter the level settings in the same way.

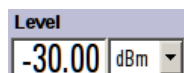

- c) Press the DIAGRAM key to display the complete block diagram.
- d) Turn the rotary knob to select the "RF" block.
Press the RF ON/OFF key to activate the "RF" block.

The AM modulation signal is now present at the RF output.

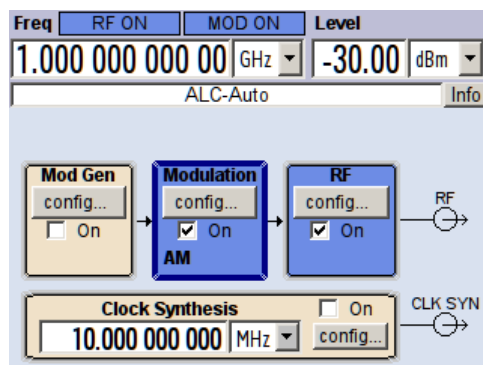

Generation of a Frequency Modulated Signal with Noise

To generate a simple FM-modulated with noise signal, proceed as follow:



This setting requires option Multifunction Generator, R&S SMA-K24.

1. Activate default (preset) state
Press the PRESET key to set a defined instrument state.

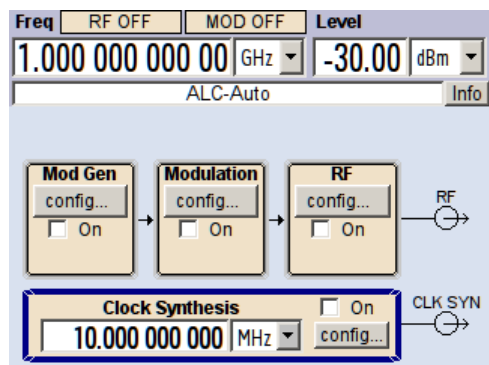

2. Select and activate FM modulation with internal noise signal and a deviation of 500 kHz
 - a) Turn the rotary knob and select the "Mod" block.



- b) Press the rotary knob to open the dialog where the modulation can be selected (different modulation modes are available depending on the options installed).

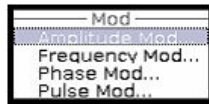

- c) Turn the rotary knob and highlight "Frequency Mod...".

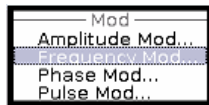

Press the rotary knob to open the "Frequency Modulation" dialog.

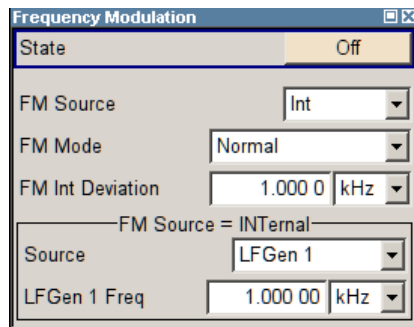

The internal source is the LF generator 1 by default. This setting is not changed.

- d) Turn the rotary knob to select parameter "FM Internal Source", press the rotary knob to open the selection list and select "Noise".

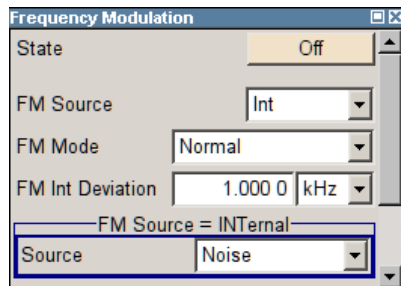

Gauss distribution and full bandwidth (10 MHz) are the default settings for the noise signal. These settings are not changed.

- e) Turn the rotary knob to select parameter "FM Int Deviation", press the rotary knob to allow editing and enter the preferred deviation with the aid of the numeric keypad and the unit keys.

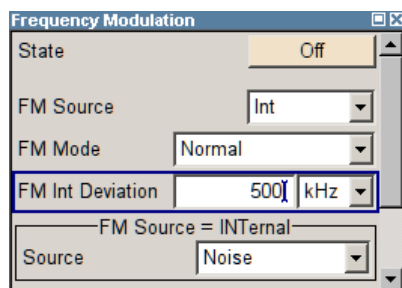

- f) Finally, select "State" and press the rotary knob to switch on the FM modulation.

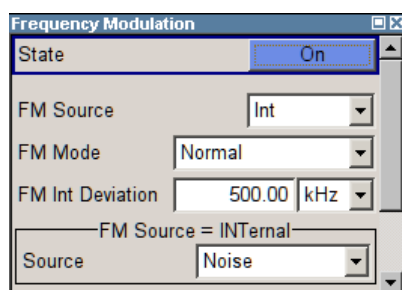

- g) Press the DIAGRAM key to display the complete block diagram.

To indicate the active state, the "Mod" block is displayed in blue. The "RF" is not yet active, which means that no RF signal is output.

3. Set frequency and level and activate RF signal

- a) Press the FREQ key to activate the editing mode for frequency entry. The "Frequency" entry field in the header section of the display is highlighted.

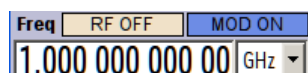

Enter the frequency using the numeric keypad and terminate the entry by pressing a unit key.

- b) Press the LEVEL key and enter the level settings in the same way.

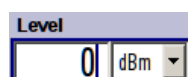

The noise now modulates the RF carrier.

- c) Press the DIAGRAM key to display the complete block diagram.

- d) Turn the rotary knob to select the "RF" block.

Press the RF ON/OFF key to activate the "RF" block.

The FM modulation signal is now present at the RF output. The LF output is not yet activated, i.e., the modulation signal is not output there.

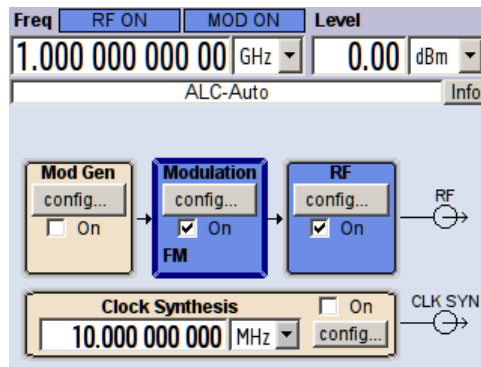

The graph below shows the FM modulated signal with noise (upper blue trace) and the unmodulated signal (lower greentrace).

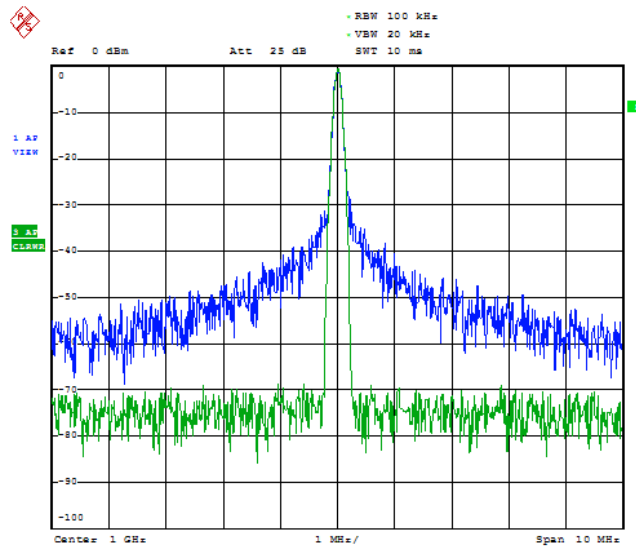

Date: 13. DEC. 2005 15:15:42

4 Manual Operation

The R&S SMA can be operated intuitively either via the interactive block diagram or via a menu tree. All menus are in the form of windows that can be operated in the same way. Rotary knob, keys and softkeys, or alternatively a mouse, allow direct and therefore convenient access to entries and settings.

The clear-cut display shows the current signal generator state. Numerous help functions support the user in signal configuration.

This section describes the concept of manual operation of the signal generator. This includes a description of the general structure of a dialog box, working with dialog boxes and the block diagram and the setting of parameters.

For an in-depth description of the dialog boxes and the instrument functions refer to section "Instrument Functions" in the Operating Manual.

4.1 Key Features

The manual operating concept of the R&S SMA enables the user to make settings as intuitively as possible and at the same time gives a permanent overview of characteristics of the generated signal and of the current instrument state. Numerous online help functions support user settings.

Block diagram

The block diagram is the core of the operating concept.

A graphics display shows the current configuration and the signal flow in the form of a block diagram. All graphical elements can be accessed for operation. An element is selected by means of the arrow keys and the associated setting function is called by pressing Enter. Required menus and graphs are displayed on the block diagram which is displayed again in the foreground whenever the DIAGRAM (CTRL+D) key is pressed.

Permanent frequency and level display

The main characteristics of the RF signal, frequency and level, are permanently displayed in the header section of the screen and can be directly set in the display fields after the FREQ (CTRL+F) or LEVEL (CTRL+L) key is pressed. Status messages for the output signal are displayed in addition to frequency and level.

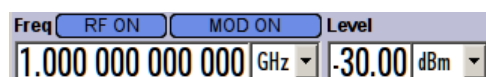

Operation via Graphical User Interface

- **Functional blocks**

Menus are assigned to the specific function blocks in the block diagram. The function blocks represent elements of signal generation. Function blocks displayed with

a blue frame can be directly switched on and off by means of the TOGGLE ON/OFF (CTRL+T) key. The menus of the highlighted function blocks can be called by pressing the ENTER key.

– **Example:**

The "Modulation" block contains all menus required for modulation signal configuration.

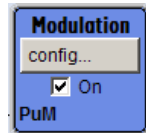

In this block all modulations can be selected.

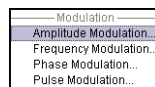

• **Signal flow**

The signal flow between the function blocks and the employed inputs and outputs are also shown.

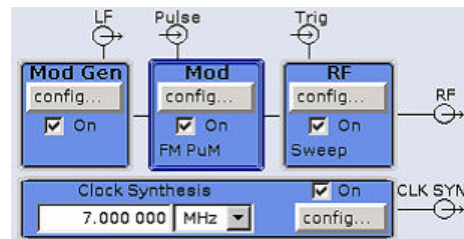

• **Menu tree**

The menu tree can be opened and closed with the MENU (CTRL+M) key. The menu tree is organized in the same way as the directories under Windows. The function blocks correspond to the first directory level, the menus to subdirectories.

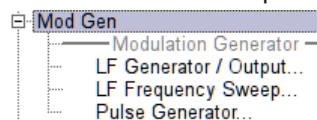

Operation corresponds to the Windows concept

To offer the user a familiar environment, operation is very similar to operation of Windows user interfaces. All menus and tables are made up of known elements, such as selection lists, check boxes and entry fields.

A blue frame indicates that the selected item is active. In the highlighted element, entries can be made.

Rotary knob



Operation is possible via front-panel keys, an external keyboard and the mouse. However, most of the settings can be easily made with the rotary knob:

- Turning the rotary knob shifts the entry focus to the target element.



- Pressing the rotary knob activates the selected entry field. Depending on the parameter, the submenu is called, the numeric value varied, the list entry selected or the check box activated or deactivated.
- If a value is entered, the entry is stored by another click on the rotary knob and the editing mode is exited.

Clear settings with the aid of independent subdialogs

A separate window is opened for each dialog and subdialog. The dialogs can be operated independently of each other, i.e. none of the dialogs requires that settings in other dialogs be completed before it can be closed. This ensures flexible operation at all times.

Keys with assigned simple functions

Most keys on the front panel of the R&S SMA directly perform a simple function.

Since a great number of settings can thus be made by a keystroke, operation is easy. For instance, the CLOSE (ESC) key closes the active menu; with the RF ON/OFF (CTRL+R) key the RF output signal can be switched on or off.

An exception are keys that call a menu such as the MENU (CTRL+M) key which opens the complete menu tree of the instrument, the SETUP (CTRL+E) key which opens the menus for general instrument settings or the FILE (CTRL+S) key which opens the menu for file management.

Help functions for user support

Numerous help functions support the user in signal configuration.

- **Value ranges**

The valid setting range is displayed for each numeric parameter. This requires a short wait after activation of the entry field. The range is then displayed automatically after a few seconds.

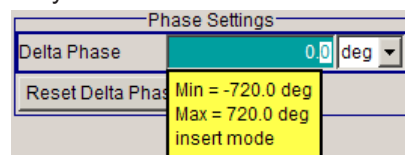

If the entered value is outside the permissible range, the next permissible value is automatically set and a message is output.

- **Context-sensitive help**

Context-sensitive help for each parameter can be called with the HELP or F1 key.

- **Comprehensive online help**

Each help page is part of a comprehensive online help function which can be called by means of an index, a content tree or the "Previous/Next" buttons.

Info line with messages for indication of the current instrument state

A great variety of different messages such as status messages, error messages, warnings or information are displayed in the header field of the screen. With the aid of the INFO (CTRL+I) key, help pages can be called for most of the messages. They provide

background information on the message and indicate operating steps that may be required. All messages are explained in the online help which can be called with the HELP (F1) key.

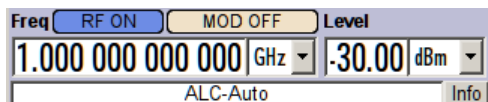

4.2 Display

The display shows the current signal generator state and offers graphical elements for direct operation. It is divided into three sections:

- The frequency and level display with info line indicates the main output signal parameters and reports the current state with status, error and warning messages.
- The block diagram shows the instrument configuration, the signal characteristic as well as the inputs and outputs used and permits interactive operation via graphics elements. Active menus and graphs are displayed on top of the block diagram.
- Winbar with labeled softkeys for menu display.

The block diagram in the figure below shows a fully equipped instrument.

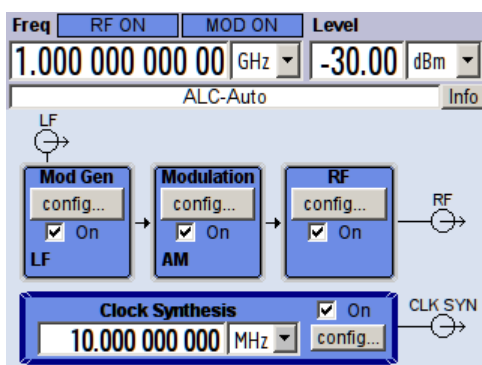

Figure 4-1: Block diagram of a fully equipped R&S SMA

4.2.1 Settings Displayed in the Header Section

Frequency/level settings and a few status messages (see [Chapter 4.2.2, "Status Information and Messages"](#), on page 67) are displayed in the header field of the screen.

The display may vary depending on the instrument's operating mode:

- In the sweep mode, the current frequency or level of the output signal is displayed. The status message "SweepMode" is displayed in the info line.
- In the list mode, neither the current frequency nor level is displayed, the indication is dimmed.
- If user correction is active, the status message "UCorr" is displayed in the info line.



The values displayed in the "Freq" and "Level" fields include a set offset or multiplier factor.

See also "RF Frequency and Phase" and "RF Level" in the Operating Manual.

The frequency and level indication can be enlarged so that it covers the complete display of the R&S SMA by using the DIAGR key. This key toggles between block diagram, magnified frequency and level indication and the display of the active dialog. This requires the "Summary Screen Toggle" to be enabled.

See chapter "Display/Keyboard Settings" in the operating manual.

4.2.2 Status Information and Messages

The instrument indicates status information and messages in the header section of the screen. The messages differ with respect to their importance (errors, warnings, info) and the time of their appearance (brief and permanent messages), and require different treatment

For additional information refer to the info window (see [Chapter 4.2.3, "Info Window"](#), on page 68).

Refer to "Error messages" in the Operating Manual for an overview of all status information and messages and corrective actions.

4.2.2.1 Status Information

The status information gives the user an overview of the main operating states and settings of the instrument. The states are indicated for information only and do not necessitate any action by the user.

Status information is displayed between the frequency and level fields, at the left of the info line or in the info line itself.

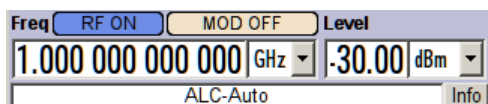

4.2.2.2 Messages

Messages indicate errors in the instrument. They are displayed in the info line in different colors depending on their importance and display duration. Errors (e.g. no calibration data) are displayed in red, information (e.g. file not found) and warnings in black. Warnings indicate less significant errors (e.g. the instrument operates outside specified data).

4.2.2.3 Volatile messages

Brief messages report automatic settings in the instrument (e.g. switching off of incompatible types of modulation) or on illegal entries that are not accepted by the instrument

(e.g. range violations). They are displayed in the info line on a yellow background. They are displayed on top of status information or permanent messages.

Volatile messages do not normally demand user actions and disappear automatically after a brief period of time. They are stored in the history, however.

These messages can be read from remote using `SYST:ERR?` or `SYST:ERR:ALL?`.

4.2.2.4 Permanent Messages

Permanent messages are displayed if an error occurs that impairs further instrument operation, e.g. a hardware fault. The error signalled by a permanent message must be eliminated before correct instrument operation can be ensured.

The message is displayed until the error is eliminated. It covers the status display in the info line. After error elimination, the message automatically disappears and is also recorded in the history.

These messages can be read from remote using `SYST:SErr?`.

4.2.3 Info Window

A few operating states and the current message are displayed in the info line.

The INFO window with a list of current permanent messages and a detailed description of each message can be opened with the INFO (CTRL+I) key.

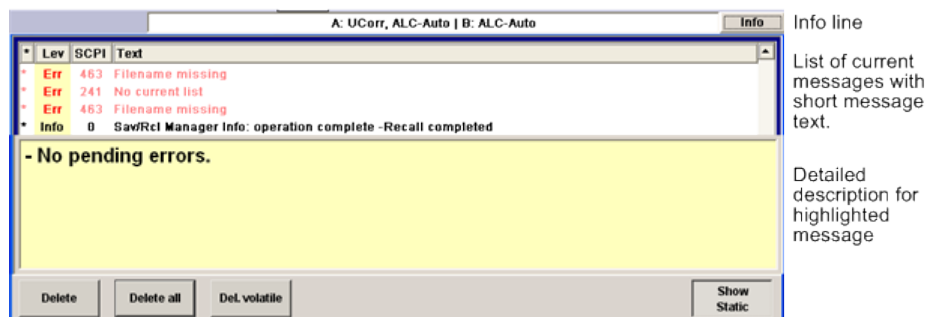

The upper section of the info window contains a list of all current permanent messages in the order of their occurrence, i.e. the most recent message is displayed first. In the lower section of the window, additional information on the highlighted message is displayed. A history of all messages that have occurred since instrument switch-on can be called with the "History" key. The most recent message is displayed first.

The messages are color-coded according to their level. Device-specific messages are red, info and remote control error are black. The level is also indicated in the "Lev" column (Err, Sys or Info). Column "SCPI" indicates the SCPI error code.

With the aid of the softkey buttons, error messages can be cleared and a history of all messages called.

Delete

Clears the highlighted message.

This button is available only if the history of the messages is displayed.

Delete All

Clears all messages.

This button is available only if the history of the messages is displayed.

History

Calls the list of all messages that have occurred since instrument switch-on. The most recent messages are displayed at the top of the list. When the button is pressed again, the list of current messages is displayed.

Remote command:

`SYST:ERR?` or `STAT:QUE?`

Each time a `SYST:ERR?` or `STAT:QUE?` query is sent, the oldest entry in the error queue is returned and at the same time cleared in the list.

4.2.4 Block Diagram

The block diagram shows provided options, signal configuration and the currently selected signal flow of the generator with inputs and outputs used. Signal generation can be completely operated from the block diagram. The highlighted function block can be directly switched on and off with the TOGGLE ON/OFF (CTRL+T) key. Pressing the Enter opens the associated setting menu.

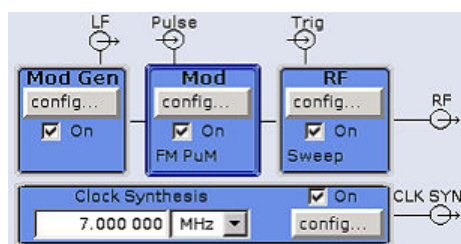
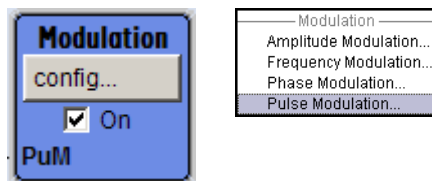

Figure 4-2: Block diagram of the R&S SMA

4.2.4.1 Function Blocks in the Block Diagram

Each block represents a function of signal generation. The function is indicated in the headline of the block. In the check box, the respective function can be quickly activated/ deactivated with the TOGGLE ON/OFF (CTRL+T) key. After activation, the block is displayed in blue. Status information is displayed below the check box. It is different for the different blocks.

Pressing the rotary knob (front panel) or the "Config..." button (mouse) opens the associated setting menu.

Example: Modulation block

In this block, the modulation signals are set. The status information of the "Modulation" block indicates the selected modulation.

4.2.4.2 Signal Flow and Input/Output Symbols in the Block Diagram

The input/output symbols in the block diagram show the currently used inputs and outputs of the signal generator. Unused inputs and outputs are not shown. The lines indicate the signal flow.

Symbols and labels refer to the corresponding inputs and outputs on the front and rear panel of the signal generator. The direction - input or output - is indicated by an arrow.

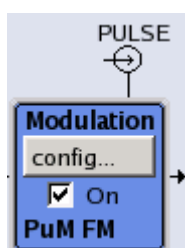
Example:

The symbols indicate the input for the external pulse signal on the instrument rear panel.

4.2.5 Structure of the Dialogs

The parameters are set in the menus. Menus are accessed either via the function blocks in the diagram or by means of the MENU (CTRL+M) key. The menus are displayed on top of the block diagram.

The WINBAR key toggles between the active menus. The REARR key toggles between the enlarged and normal sized menus.

Working with menus and dialog boxes is described in [Chapter 4.3, "Accessing Dialogs"](#), on page 71; the setting of parameters in [Chapter 4.4, "Setting Parameters"](#), on page 72.

The menus are in Windows format. The menus differ in details depending on their function but they consist of the same main elements. Each menu consists of a menu header and one or more menu areas with various fields for setting parameters.

The header line contains the name of the menu and the buttons for minimizing and closing the menu. To operate the buttons, use the mouse or the front key CLOSE (ESC).

Several fields of associated but separately set parameters are organized in menu areas. A menu area is framed and labelled with the function common to all parameters.

Example: Pulse Generator

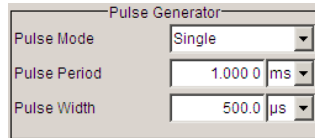

Each of the setting fields is assigned a parameter name. The kind of setting varies depending on the parameter to be set. Some settings can only be made in a specific configuration. If setting is not permitted with the specific configuration selected, the respective item is disabled and displayed in gray and the entry or selection field cannot be accessed.

4.3 Accessing Dialogs

The MENU (CTRL+M) key opens the complete menu tree. Selecting a functional block and pressing the ENTER key opens the menu associated with this block.

An alternatively way to access a dialog is to use the CLOSE (ESC), DIAGRAM (CTRL+D) and REARR (CTRL+A) keys on the front panel.

For a quick access to the dialogs, use one of the following alternative methods.

Displaying the block diagram or a dialog in the foreground

- ▶ Press the DIAGRAM (CTRL+D) key to move the cursor to the block diagram.
All active menus are minimized.

Enlarging the indication of the header section

- ▶ Press the DIAGRAM key twice to enlarge the indication of the header section.
Tip: Use the REARR key to toggle between the enlarged and normal sized dialogs.

Accessing the menu tree

- ▶ Press the MENU (CTRL+M) key to open the complete menu tree.

Calling the File or Setup dialog

- ▶ Use the FILE (CTRL+S) or SETUP (CTRL+E) keys to open the respective dialog.

Closing an active menu

- ▶ Press the CLOSE key to close an active menu.
Tip: If the cursor is at the highest menu level, you can also use the ESC key to close the active menu.

Accessing the header area

- ▶ Press the **FREQ** (CTRL+F) and **LEVEL** (CTRL+L) keys to activate the "Frequency" or "Level" entry fields in the header area.



Keyboard Shortcuts

Keyboard shortcuts (e.g. "Ctrl + D" for the displaying the block diagram in the foreground) provide direct access to all utility dialogs of the instrument (see [Chapter 4.8, "Legend of Front-Panel Controls"](#), on page 85).

4.4 Setting Parameters

The R&S SMA offers several and sometimes alternative possibilities for setting parameters. Operation is possible from the front panel, with the aid of a mouse and/or from a PC keyboard.



The examples within this description focus on the operation from the front panel.



For more information, refer to:

- [Chapter 4.8, "Legend of Front-Panel Controls"](#), on page 85 for an overview of key functions and a cross-reference between the front panel keys and the keyboard shortcuts
- "Instrument Functions" in the Operating Manual for a detailed description of key functions.

Most of the parameters are set in the different menus. The R&S SMA provides alternative ways for accessing the dialogs. Turn the rotary knob and navigate to the corresponding block in the block diagram and press the knob to open the dialog or perform a mouse click on the "Config..." button.

An exception are the "Setup" and "File" dialogs. In the "Setup" dialog, general settings are made which are not directly concerned with signal generation, e.g. setting of the GPIB-bus address. In the "File" dialog, files and lists are managed.

These menus can only be called with the **SETUP** (CTRL+E) and **FILE** (CTRL+S) keys.

Frequency and level are directly set in the header area of the display using the **FREQ** and **LEVEL** keys.

Specific settings can also be made directly in the block diagram, e.g. activating a function block by means of the **TOGGLE ON/OFF** (CTRL+T) key or switching the RF output on and off with the aid of the **RF ON/OFF** (CTRL+R) key. Changes affecting the signal flow are immediately visible in the graphics display.

This section provides an information about the parameter handling that comprises of the following main steps:

- [Chapter 4.4.1, "Working with the Cursor"](#), on page 73
- [Chapter 4.4.2, "Selecting a Control Element"](#), on page 73
- [Chapter 4.4.3, "Switching Parameters On/Off"](#), on page 74
- [Chapter 4.4.4, "Entering a Value"](#), on page 74
- [Chapter 4.4.5, "Working with Units "](#), on page 76
- [Chapter 4.4.6, "Selecting a Value from a List"](#), on page 76
- [Chapter 4.4.7, "Terminating Entries with Confirmation"](#), on page 77
- [Chapter 4.4.8, "Restoring the Previous Value"](#), on page 77

4.4.1 Working with the Cursor

After the instrument is switched on, the cursor is always on the first function block of the diagram (default setting).

Moving the cursor on the display

- ▶ To move the cursor, use one of the following alternative methods:
 - a) Use the rotary knob or the arrow keys.
 - b) Use the WINBAR key to toggle between the active dialogs.
 - c) Use the ESC key.

Tip: Be aware that the function of the ESC key depends on the current cursor position.

The function of this key depends on the current cursor position.

- Calls the next higher selection level.
- Closes the open window without accepting new entries; the old value or parameter is retained.
- In dialog boxes that contain a "Cancel" button it activates that button.
- Closes all kinds of dialog boxes, if the edit mode is not active.
- Quits the edit mode, if the edit mode is active.
- Switches between different entry fields of a menu.
- Shifts the entry cursor from the header display to the previously active menu, or to the previously highlighted block in the block diagram if no menu is active.

Moving the cursor to the heading area

- ▶ Press the **FREQ** (CTRL+F) or **LEVEL** (CTRL+L) key to move the cursor to the header area.

4.4.2 Selecting a Control Element

Control elements are always selected in the same way no matter whether a function block in the diagram, a menu in the menu tree, a parameter in the menu or an entry in a list or table is concerned.

- ▶ To activate an element, put the cursor on it.



An active element is highlighted by a blue frame.

4.4.3 Switching Parameters On/Off

A parameter can be activated and deactivated using a button or a check box.

1. Select the parameter.
2. To change the state of a parameter, use the "Enter" function of the different control media:
 - Press the rotary knob
 - Press ENTER
 - Press the TOGGLE ON OFF (CTRL+T) key.

Colour and label of a button change, the check box is ticked or the tick is removed.

4.4.4 Entering a Value

Numeric and alphanumeric values can be edited in the entry fields. In the editing mode, cursors of different colour are used. A blue cursor indicates the overwrite mode, a green cursor the insert mode.

Numeric and alphanumeric values can either be newly entered or the existing value can be changed. Incorrect entries are cleared with the BACKSPACE key.

Entering a new numerical value

1. Select the parameter.
2. Press a numeric key to activate the editing mode.

The previous value is cleared and the new value can be entered.

Editing a value in the insert mode (default setting)

1. Press the rotary knob (= Enter) to activate the editing mode.

If the cursor is placed at the right of the total value, the insert mode is always active.
2. Set the cursor to the left of the number to be changed using the LEFT/RIGHT arrow keys.

The cursor is displayed in green.
3. Click on a numeric key to insert a new value.



Editing a value in the overwrite mode

1. Activate the editing mode.
2. Set the cursor on the numeric digit to be changed using the LEFT/RIGHT arrow keys.
The cursor is displayed in blue and the number to be replaced is highlighted.

3. Click on a numeric key to overwrite the highlighted value.



Varying a value

1. Activate the editing mode.
2. Set the cursor to the left of the number to be changed using the LEFT/RIGHT arrow keys.
The value at the cursor position is varied.
3. To vary the selected value, use the UP/DOWN arrow key or turn the rotary knob.
The value is increased or decreased.

Entering a new alphanumerical value

1. Select the parameter.
2. Press an alphanumeric key to start the editing mode.
The new value is entered.

Editing an alphanumerical value

An existing value, e.g. a file name, can be changed in the insert mode (see example) or in the overwrite mode.

1. Select the parameter and activate the editing mode.
2. Set the cursor to the left of the alphanumerical value using the LEFT/RIGHT arrow keys.
Tip: If hexadecimal values are to be entered, the numeric front-panel keys are automatically changed to hexadecimal values.
3. Click on an alphanumeric key to insert a new alphanumerical value.

Terminating the entry of a numeric value

To terminate the entry of a numeric value:

1. Press the rotary knob (= Enter).
2. Press a UNIT key on the front panel.
3. Select a "Unit" in the selection field next to the parameter value.

4.4.5 Working with Units

The unit of a parameter is displayed next to the value. When the parameter is edited, the unit is selected either from the list or by means of the front-panel keys. When the entry is completed, the unit can be changed. In this case the value remains unchanged but is automatically adapted to the new unit.



While operating the instrument by means of a mouse, assign the unit to the selected parameter before entering its value.

Assigning a unit

To assign a unit to a value, use one of the following alternatives:

1. Press a UNIT key on the front panel.



2. Select a "Unit" in the selection field next to the parameter value.
Press the ENTER key.

The unit displayed in the entry field next to the value is assigned.

Changing a unit

To subsequently change a unit, i.e. after the entry has been terminated and when the editing mode is not active, use one of the following alternatives:

1. Press a UNIT key on the front panel.
2. Select "Unit" in the selection field next to the parameter value.

The value remains unchanged but the display is automatically adapted to the new unit, i.e. the value is recalculated to suit the new unit.



The new unit is indicated in the value field of the menu.

4.4.6 Selecting a Value from a List

Selection lists provide a list of predefined values for the selected parameter.

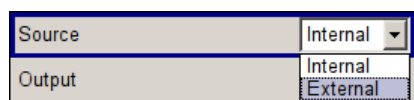

To select a item from a list, proceed as follow:

1. Press ENTER key to open the list.

2. Use one of the following alternatives to navigate through the list:
 - a) Turn the rotary knob or use the UP/DOWN arrow keys.
The selected item is highlighted.
 - b) Press TOGGLE ON/OFF key several times until the preferred entry is displayed in the selection field.
3. To confirm the selection, press the ENTER key.

4.4.7 Terminating Entries with Confirmation

The instrument behaves different by the termination of entries depending on the parameter type and the way this parameter is set.

Confirming settings

- ▶ To confirm the settings, press the rotary knob or one of the UNIT keys (see also [Chapter 4.4.5, "Working with Units "](#), on page 76) .

Note: Variations by means of the rotary knob are immediately set.

Confirming multiple values

In some cases, like for instance when editing data in a user correction table, it is useful first to enter few values and to confirm them together. Such settings require additional confirmation. Not yet confirmed settings are displayed on a yellow background as an indication that the currently displayed values do not represent the target signal.

- ▶ To confirm these settings, select the "Save" or "Accept" button, respectively.

Confirming parameters with On/Off state

Most of the instrument functions with enabled and disabled states are calculated and effective only after this functions have been enabled. However, there are functions like the frequency variation of the reference oscillator for instance, that are immediately set after confirmation.

- ▶ To confirm a parameter with On/Off state, enable the parameter.

4.4.8 Restoring the Previous Value

Parameter variations with the rotary knob are immediately set and therefore not reversible.

Normally, values cannot be restored in the case of mouse control because no explicit confirmation is required in this case and entries are automatically confirmed when the entry or selection field is exited.

Restoring values

In the case of front-panel control or operation from the keyboard, previous values can be restored as long as the new value is not confirmed, i.e. the entry is not completed.

- ▶ To restore the values, press the ESC key.

Restoring values that require confirmation

All settings that are not confirmed with the "Accept" button but require this additional confirmation can be restored.

1. Press the ESC key.

A confirmation query is displayed.

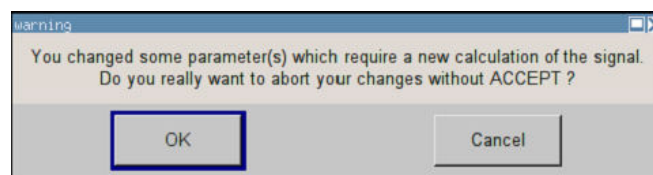

2. Confirm with "OK" to abort the changes.

Select "Cancel" to return to the dialog. The previous selected settings are displayed.

Restoring values after an extended calculation has been started

Calculation and setting might require different period of time. Many settings are made without noticeable calculation times; such operations are indicated by a "BUSY" message displayed in the status field of the header section.

A window with a progress indicates that the instrument performs an extended calculation that requires longer calculation time. The termination of such a calculation restores the previous values.

- ▶ Press the ABORT button to terminate the calculation.

All previous values are restored.

4.5 Editors

The R&S SMA provides user-friendly editors for defining lists. Lists containing frequency and level value pairs are used for the list mode and the user-defined level correction.

The lists are saved to files and may thus have any length. The file name of the lists and the directory to which the files are saved are user-selectable. The file prefix is different for each list type and is permanently assigned by the system.

For information about file handling and overview of the automatically assigned file prefixes, refer to [Chapter 4.7, "File Management"](#), on page 81.

4.5.1 Working with List Editor

The "User Correction" and "List Mode" dialogs provide a list editor for defining the frequency/level value pairs.

Editing list mode data lists

1. To access a list editor and open an existing data list for editing, use the cursor keys to select the associated button "Edit User Correction Data..." or "Edit List Mode Data..." (if available) in the individual menu.

The selected list is displayed and the cursor marks the first row of the "Frequency/Hz" column.

	Frequency/Hz	Power/dBm
1	100 000.000	-140.00
2	100 010.000	-140.00
3	100 020.000	-140.00
4	100 030.000	-140.00
5	100 040.000	-140.00
6	100 050.000	-140.00
7	100 060.000	-140.00
8	100 070.000	-140.00
9	100 080.000	-140.00

Goto Edit Save

If no list has been selected, a blank list of only one row is displayed.

2. Press the LEFT/RIGHT arrow keys to change between the columns. Use the UP/DOWN arrow keys to mark a row.
3. Use the numeric keys to enter the value for the value pairs in the "Frequency/Hz" and "Power/dBm" table columns. A blank row is inserted at the end of the list. Terminate the entry by pressing a UNIT key.
4. To select a row, select the "GoTo" button and press the ENTER key. Use the numeric keys to enter the row index in the entry field and press the ENTER key to confirm the entry. The cursor moves to the selected row.
5. To insert a new row in the table, select the row above which the new row is to be inserted and select "Insert Row(s)".

A row is inserted above the currently marked row.

If no row has been selected, a row is inserted at the beginning of the list.

6. Use the "Save" function to save the edited list under its current name. Enter the file name in the "File Select" dialog and select the directory (see [Chapter 4.7.1, "File Select Dialog"](#), on page 83).

Only complete value pairs are taken into consideration; rows containing an entry in only one column are ignored.

Creating a new list mode data list

A new list can be created under a new name either by generating a blank file in the "File Select" menu (see section [Chapter 4.7, "File Management"](#), on page 81) or by changing an existing list which will then be saved under a new name.

1. To create an empty data list, select "RF > List Mode > List Mode Data... > New List" or respectively "RF > User Correction > User Cor. Data... > New User Correction Data" and enter the file name of the new data list.
2. To open the data list for editing, select the associated button "Edit User Correction Data..." or "Edit List Mode Data..." in the individual menu.
Edit the list and save it under a new name.

4.6 How to Use the Help System

The R&S SMA is equipped with a context-sensitive help function. A help page is available for each parameter and can be called any time during instrument operation.

Calling context-sensitive and general help

- ▶ To display the general help dialog box, press the HELP (F1) key.

The help dialog is displayed. A topic containing information about the current menu or the currently opened dialog box and its function is displayed.

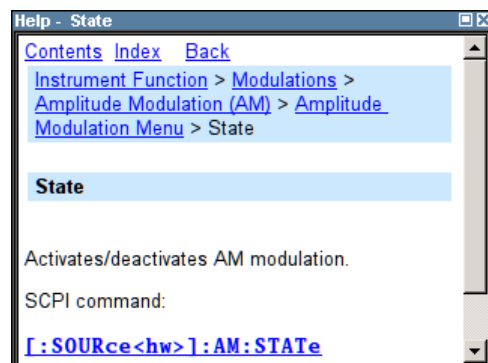

On top, the help dialog box contains a navigation bar with:

- "Contents" - accesses a table of help contents
- "Index" - switches to an index table
- "Back"/"Previous"/"Next" for navigation to further help topics

Navigating in the table of contents

1. To navigate within the table of contents entries, use the UP/DOWN keys. Entries that contain further entries are marked with a plus sign.
2. To display a help topic, press the "ENTER" key.
The corresponding help topic is displayed.

Navigating in the help topics

1. To scroll through a page, use the UP/DOWN arrow keys.
2. To follow a cross-reference, select the link text.
3. To return to the previous page, select "Back".
This function scrolls back all steps that you have performed before.

Using the Index

1. Select "Index".
2. Enter the first characters of the topic you are interested in. The entries starting with these characters are displayed.
3. Press the ENTER key to change the focus.
4. Use the UP/DOWN keys to navigate and select the suitable keyword.
5. Press the ENTER key to display the help topic.
The corresponding help topic is displayed.

Closing the help window

- ▶ Press the HELP (F1) key.

4.7 File Management

The R&S SMA uses files to save all instrument data, i.e. system and user data.

The user data includes saved instrument settings and lists and the user correction.

The files are stored on the CompactFlash™ card of the instrument. The `/var` directory can be used to save user-defined data; any subdirectory structure can be created on `/var`. Some default subdirectories are predefined, but can be changed at any time.

The `/opt` directory is a protected system drive and therefore unaccessible system directory. The files on this directory contain data that must not be changed. Therefore, this drive should not be accessed, since reconstruction of the system partition will lead to data loss. To prevent inadvertent deletion or overwriting of system files, this drive is not specified in the file menus.

Files can be exchanged either via a memory stick or a connected network. A memory stick is connected to the USB interface and is assigned the `var/usb/` drive. In the case of a connected network, all network drives that can be accessed are available. The files are accessed in a "Save/Recall" dialog in the individual menus.

The files are differentiated according to their extensions; each type of file is assigned a specific file content. The extension is usually of no consequence to the user since access to the files occurs in the individual menu where only the relevant type of file is available. See [Chapter 4.7.2.1, "Extensions for User Files"](#), on page 84 for an overview of the supported file extensions.

The user data can be roughly divided into the following data types:

- Settings
Instrument settings can be saved and loaded. In case of saving, the current setting is saved to the specified file.
- Lists
Lists, e.g. user correction lists, can be loaded. They can be generated either externally or internally. For internal generation, a new list must be created in the "File Select" dialog which will then be edited in the list editor of the individual menu.



For more information, refer to:

- [Chapter 4.8, "Legend of Front-Panel Controls"](#), on page 85 for an overview of key functions and a cross-reference between the front panel keys and the keyboard shortcuts
- to "Instrument Functions" in the Operating Manual for a detailed description of key functions.

Accessing files with user data

1. To access an editable user data file, select the "Save/Recall" or "File Manger" function in the individual dialog.

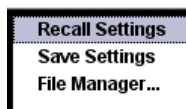

2. To access a loadable data file, select the "Select/New" or "File Manager" function in the individual dialog.

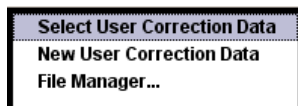

3. To access the "File Manager" function, press the SETUP (CTRL+E) key and select "Save/Recall > File Manager".

A "File Select" window for loading, saving or creating a file or the "File Manager" dialog for managing all files is displayed.



Saving and loading of all instrument settings

All instrument settings are saved and loaded in the "File" menu.

To access the "File" menu, press the FILE (CTRL+S) key.

For more information, see chapter "Storing and Loading Instrument Data - File Key" in the Operating Manual.

4.7.1 File Select Dialog

The "Save/Recall" dialog displays the available drives and directories. In the upper part, "Recent Data Sets", the files last used are listed.

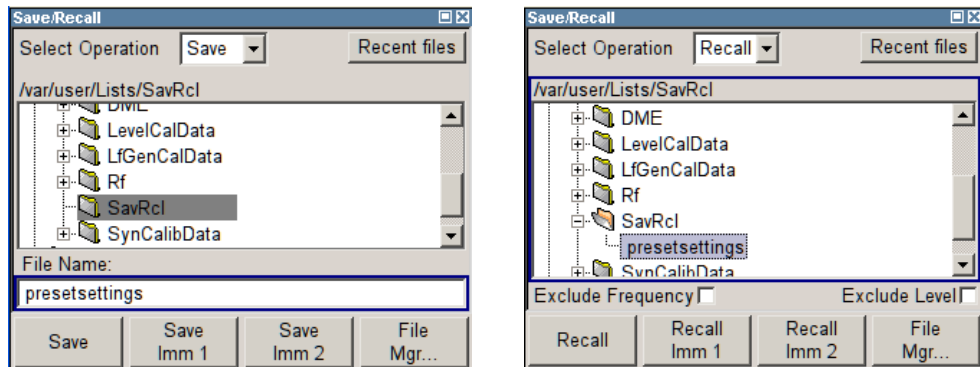

The available drives and directories and the files of the selected directory are displayed. The currently selected path is displayed above the window. Only the relevant files without file extensions are displayed. If the area is opened several times, the path last selected is displayed. When a file is saved or created, its name is user-selectable; the extension is assigned automatically and cannot be entered. The file is saved to the selected path.

In addition to the files saved by the user, some menus also offer files containing predefined contents. These files are saved to a specific directory on system drive; for this reason, this directory cannot be chosen from the "File Select" menu.

Working with the File Select dialog

1. Access the "File Select" dialog (see ["Accessing files with user data"](#) on page 82).
2. Navigate in the "File Select" dialog.
3. Load an existing file.
In the "Recall Settings" dialog, mark a file and press the "Select" button.
4. Save a file.
In the "Save Settings" dialog, enter file name in the "File Name:" field.
Select the directory to which the file is to be saved and then select the "Save" button.
5. Create a new file.
To create a new file, use the "Save Settings" functionality, i.e. specify file name and directory and save the file.

The created file is empty; it must be filled with the necessary values in the individual editor.

4.7.2 File Manager

The "File Manager" allows general file management such as copying, shifting, renaming and deleting files as well as generating new directories.

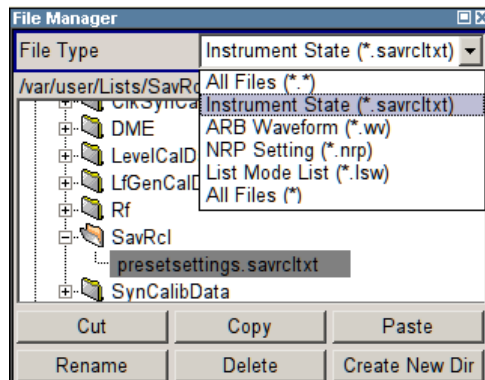

Use the "File Type" to select a file type from the list. This can be used to process either all files (all files (*) selection) or a specific selection of files. See [Chapter 4.7.2.1, "Extensions for User Files"](#), on page 84 for an overview of the supported file extensions. The available drives and directories and the files of the selected directory are displayed. The currently selected path is displayed above the windows. If the area is opened several times, the path last selected is displayed. Unlike the "File Select" window, the "File Manager" displays the full file names including extensions.

Working with the File Manager dialog

1. Accessing the "File Manager" dialog (see ["Accessing files with user data"](#) on page 82).
2. Navigating in the "File Manager" dialog.
Operation is very similar to the operation of a standard Windows explorer.
3. Moving, duplicating, deleting or renaming files
To move a file, select the file and press the "Cut" button. Mark the directory to which the file is to be moved and select the "Paste" button. If the target directory already contains a file with the same name, a confirmation query is displayed to confirm overwriting of this file.
Perform the similar steps and cut/copy/rename/delete the file.
Tip: The operation corresponds to the Windows concept.
4. Creating a new directory
Mark drive or directory level where the new directory is to be created, select the "Create New Directory" button and enter the name of the new directory in the entry window that opens. Confirm with ENTER.

4.7.2.1 Extensions for User Files

The following table lists all available file extensions for user files. The currently available files on the instrument depend on the installed options.

Table 4-1: List of the automatically assigned file extensions in the instrument

Function	List type	Contents	File suffix
Instrument State	Settings	Instrument settings	*.savrc1txt
"User Correction"	List	User-defined level correction values	*.uco
		Export Data	*.txt or *.csv
"List Mode"	List	User-defined frequency/level value pairs	*.lsw
		Export Data	*.txt or *.csv
"Pulse Train List"		User-defined offtime/ontime/repetition values	*.pulstrn
NRP Settings	Settings	NRP Settings	*.nrp

4.8 Legend of Front-Panel Controls

The following table lists all key functions available on the front panel. Key combinations used on the PC keyboard to trigger key functions on the instrument front panel are also described. Keyboard labels are described in alphabetical order.

In addition, a front panel key emulation and an on-screen keyboard can be used for manual operation by mouse only.

Table 4-2: Cross-reference between the front panel keys and keyboard shortcuts

Front-panel key	Key of PC keyboard	Function
Turning the rotary knob	Tab key (towards the right) Shift + Tab (towards the left)	Sets the cursor with the rotary knob.
Pressing the rotary knob	Enter	Pressing the rotary knob confirms an entry; it has the same function as the ENTER key.
Arrow keys	Arrow keys	Moves the cursor.
ENTER / *1 / dB(m)	Enter ALT + F12	Terminates an entry. Confirms entries in the base unit and values without a unit. Selects dBm for the RF level and dB for level offset and level step width.
. / *...#	. / *...#	Enters a period/decimal point. Enters a special character.
- / A->a	- / (shift+) a—z	Enters the sign. Switches between upper-case and lower-case letters.
0-9 / a...z	CTRL+ 0-9 / a...z CTRL	Enters the number/letter.
BACKSPACE	Backspace	Clears the last entry (number, sign or decimal point)

Front-panel key	Key of PC keyboard	Function
ESC / CLOSE	ESC / CTRL + G	Selects the next higher menu/selection level. When the editing mode is exited with ESC, the previous value is restored. Closes an active menu.
DIAGR	CTRL+ D	Sets the cursor on the block diagram and hides all menus.
FILE	CTRL + S	Activates the menu for storing instrument settings.
FREQ	CTRL+ F	Activates the frequency entry.
G/n / dBuV	ALT + F9	Selects the unit Giga/Nano, dBuV for the RF level and dBu for the LF level.
HELP	F1	Opens/closes context-sensitive help.
INFO	CTRL + I	Opens/closes the info window
k/m / mV	ALT + F11	Selects the units kilo/milli and mV for RF levels.
LEVEL	CTRL + L	Activates the level entry.
LOCAL	CTRL + Q	Switches the instrument from remote control to manual control.
M/u / uV	ALT + F10	Selects the units Mega/Micro and uV for RF levels.
MENU	CTRL + M	Calls the menu selection list.
MOD ON/OFF	CTRL + O	Switches modulation on/off. "MOD OFF" is indicated in the status line.
TOGGLE	CTRL + T	Switches a block or parameter on/off. Toggles between the different possibilities of setting a selection parameter.
PRESET	CTRL + P	Restores a defined basic instrument setup.
REARR.	CTRL + A	Adjusts the size of the active dialog to use the whole height of the display.
RF ON/OFF	CTRL + R	Switches the RF output signal on/off. "RF OFF" is indicated in the status line.
SETUP	CTRL + E	Opens the setup menu for general instrument settings.
WINBAR	CTRL + W	Toggles between the active menus.

4.8.1 Front Panel Key Emulation

The R&S SMA provides a front panel key emulation to enable execution of the front panel key functions by mouse e.g. for remote access. The emulation is called by a right mouse click. The front panel key functions are executed by a mouse click on the associated button.

Freq	Diagram
Level	Menu
File	Rearr.
RF On/Off	WinBar
Mod On/Off	Help
Preset	
Local	
Setup	
Hardcopy	
Info	

Annex

A Hardware Interfaces

This section covers hardware related topics, like pin assignment of the GPIB bus interface.

The remote control interfaces are described in details in the Operating Manual, section "Remote Control Basics".

All other interfaces are described in [Chapter 2.1, "Front Panel Tour"](#), on page 11 and [Chapter 2.2, "Rear Panel Tour"](#), on page 17.

For specifications refer to the data sheet.

A.1 GPIB Bus Interface

Pin assignment

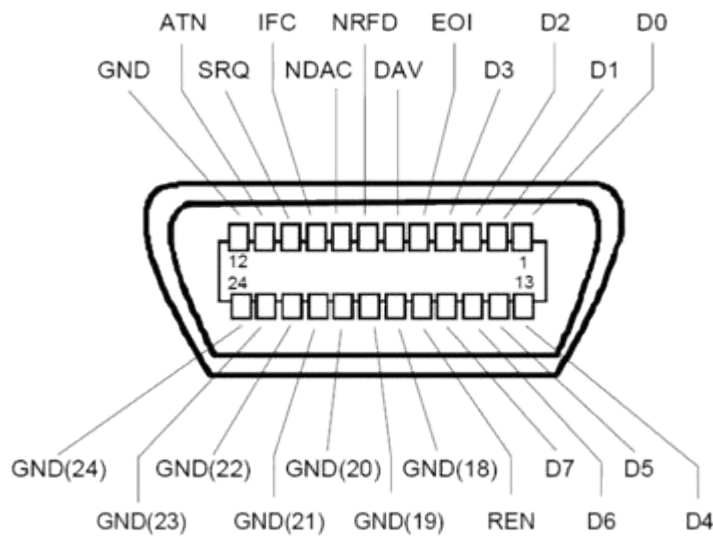

Figure A-1: Pin assignment of GPIB bus interface

Bus lines

- Data bus with 8 lines D0 to D7:
The transmission is bit-parallel and byte-serial in the ASCII/ISO code. D0 is the least significant bit, D7 the most significant bit.
- Control bus with five lines:

IFC (Interface Clear): active LOW resets the interfaces of the instruments connected to the default setting.

ATN (Attention): active LOW signals the transmission of interface messages, inactive HIGH signals the transmission of device messages.

SRQ (Service Request): active LOW enables the connected device to send a service request to the controller.

REN (Remote Enable): active LOW permits switchover to remote control.

EOI (End or Identify): has two functions in connection with ATN:

- ATN=HIGH active LOW marks the end of data transmission.
- ATN=LOW active LOW triggers a parallel poll.

- Handshake bus with three lines:

DAV (Data Valid): active LOW signals a valid data byte on the data bus.

NRFD (Not Ready For Data): active LOW signals that one of the connected devices is not ready for data transfer.

NDAC (Not Data Accepted): active LOW signals that the instrument connected is accepting the data on the data bus.

Interface Functions

Instruments which can be controlled via GPIB bus can be equipped with different interface functions. The interface function for the R&S SMA are listed in the following table.

Table A-1: GPIB bus interface functions

Control character	Interface function
SH1	Handshake source function (source handshake), full capability
AH1	Handshake sink function (acceptor handshake), full capability
L4	Listener function, full capability, de-addressed by MTA.
T6	Talker function, full capability, ability to respond to serial poll, de-addressed by MLA
SR1	Service request function (Service Request), full capability
PP1	Parallel poll function, full capability
RL1	Remote/Local switch over function, full capability
DC1	Reset function (Device Clear), full capability
DT1	Trigger function (Device Trigger), full capability

A.2 AUX I/O Connector

Table A-2: Pin assignment of the AUX I/O Connector connector

Pin	Signal	Description
1	FHOP_DATA	Data input for Fast Hopping list mode. See section "List Mode" in the Operating Manual.
2	Ground \perp	Ground

Pin	Signal	Description
3	FHOP_CLK	Clock input for Fast Hopping list mode. See section "List Mode" in the Operating Manual.
4	FHOP_STRB	Strobe input for Fast Hopping list mode. See section "List Mode" in the Operating Manual.
5	RF OFF	Input for fast switching of the RF output. Active High (1) switches the RF output off. A subsequent Active Low (0) switches the RF output on again. Switching is performed very fast (10us). However, the attenuation of the switched off output is considerably less than after regular switch-off, because the attenuator is not set to maximum attenuation.
6	INST TRIG	Input for external triggering of the analog modulations, sweeps and List mode. HOP input for controlling the frequency hop mode with external source in List mode.
7	BLANK	Output for blank signal. This signal marks the blank times (invalid level indication). The signal is generated automatically.
8	OPC	Output for Operation Complete line. Active High signals that all remote control commands have been executed. The output is always active.
9 .. 10	Ground \perp	Ground
11 .. 26	FM_DAT	Parallel data input with 16-bit word width for digital FM modulation data. The FM-Data bus is directly connected to the DDS of the synthesizer module. Thus, very fast frequency hop (settling times of 10 us) is possible for frequency bandwidth up to 80 MHz. See section "Frequency Modulation" in the Operating Manual.

Index

A

Abort button	78
Abort calculation	78
AC supply	19
Access denied	71
Application cards	8
Application notes	8
Architecture of the instrument	51
Arrow keys	15
ATN	89
Attention	89
Auto-negotiation see Autonegotiation	32
Autonegotiation Failure	32

B

Brochure	8
Browser settings LXI	42

C

CF memory slot	20
Clock synthesis	55
Computer name Changing	33
use instead of IP address	33
Connection to an external controller	34
Connector AM EXT	16, 20
AUX I/O	18
CLK SYN	20
EXT TUNE	19
FM/PM EXT	16, 20
GPIB	18
IEC/IEEE	18
INSTR TRIG	18
LAN	19
LF	16, 20
PULSE EXT	19
PULSE SYNC	19
PULSE VIDEO	19
REF IN	20
REF OUT	20
RF	16
RF OUT	20
SENSOR	17, 20
USB	17
USB type A	18
USB type B	18
Control bus	89
Controller, external	34
Cursor keys	15

D

Data sheet	8
Data Valid	89
DAV	89
Default instrument settings	26
DHCP	32

Display	66
Documentation overview	7

E

Electrostatic discharge	21
EMI suppression	22
EOI	89
Error messages	68
ESD	21

F

Failure Network connection	32
FHOP_DATA	90
Frequency display	66
Front panel key emulation	86
Fuses	24

G

Getting started	51
-----------------------	----

H

Host name see Computer name	33
Hostname see Computer name	33

I

IFC	89
INFO key	68
Input connector	20
Interface functions (GPIB bus)	90
Interface Clear	89
IP address Changing	32

K

Key Arrow key	16
BACKSPACE	14
Cursor key	16
DIAGRAM	14
ENTER	15
ESC	14
FILE	13
FREQ	13
HELP	12
INFO	12
LEVEL	13
LOCAL	12
MENU	14
MOD ON/OFF	13
ON/OFF	14
PRESET	12, 26
REARR	13
RF ON/OFF	13
SETUP	12

TOGGLE	14
WINBAR	14
Key combinations	85
Keypad	14

L

LAN	
Configuration	31
LAN connection	
Not working	32
Level display	66
Linux	29
Linux controller	36
LXI	
Browser interface	42
Browser settings	42
Configuration	41
LAN configuration	44
Ping	46
Remote trace (SCPI)	48
Web Control	47

M

Manual Remote Control	34
Menu structure	
Access denied	71
Header	70
Menu area	71
Mod Gen block	54

N

Navigation keys	15
NDAC	89
Network connection	
Error	32
NRFD	89

O

Online help	7
Working with	80
Online manual	7
Open source acknowledgment	8
Operating concept	51
Operating manual	7
Operating system	29
Option	
R&S SMA-B81	20
OSA	8
Output connector	16, 18, 19, 20

P

Ping	
LXI	46
Point-to-point connection	31
Preset	26
Preset instrument settings	26

Q

Quick start guide	7
-------------------------	---

R

Rackmounting	24
Release notes	8
Remote access	34
Remote connection	
Not working	32
Remote trace	
LXI	48
REN	89
Reset instrument settings	26
RF block	55
Rotary knob	15

S

Safety instructions	7
SCPI remote trace	
LXI	48
Service manual	7
Setting not possible	71
Setting parameters	72
SRQ	89
Standby mode	12

U

Ultr@VNC	36
Units	
Input	14
UNIX controller	36

V

VNC connection	36
----------------------	----

W

Warnings	68
Web Control	
LXI	47
White papers	8