User's Guide

RIGOL

Publication number VS5000-080331

March 2008

VS5000 Series Digital Oscilloscope VS5000D, VS5000

Copyright ©1998-2008 RIGOL Technologies, Inc. All Rights Reserved.

- Copyright © 1998-2008 RIGOL Technologies, Inc. All Rights Reserved.
- **RIGOL** products are protected by patent laws in and outside of the P.R. China.
- Information in this publication replaces all previously corresponding material.
- **RIGOL** Technologies, Inc. reserves the right to modify or change part of or all the specifications and pricing policies at company's sole decision.

NOTE: **RIGOL** is registered trademark of **RIGOL** TECHNOLOGIES, INC.

Safety Notices

Review the following safety precautions carefully before operate the instrument to avoid any personal injuries or damages to the instrument and any products connected to it.

To avoid potential hazards, use the instrument as specified by this user's guide only.

The instrument should be serviced by qualified personnel only.

To Avoid Fire or Personal Injury.

Use Proper Power Cord.

Use only the power cord designed for the instrument and authorized in your country only.

Connect and Disconnect Accessories Properly.

Do not connect or disconnect probes or test leads while they are connected to a voltage source.

Connect the Probe Properly.

Do not connect the ground terminals to a high voltage.

Observe All Terminal Ratings.

To avoid fire or shock hazard, observe all ratings and marks on the instrument. Follow the user's guide for further ratings information before making connections to the instrument.

Do not Operate without Covers.

Do not operate the oscilloscope with covers or panels removed.

Use Proper Fuse.

Use the fuse of the type, voltage and current ratings as specified for the instrument.

Avoid Circuit or Wire Exposure.

Do not touch exposed connections and components when power is on.

Do not Operate with Suspected Failures.

If suspected damage or malfunctions occur with the instrument, have it inspected by qualified service personnel before further operations.

Provide Proper Ventilation.

Refer to the manual's installation instructions for proper ventilation of the instrument.

Use only UL/cUL or cCSAus certified probes with the oscilloscope.

Do not Operate in Wet/Damp Conditions.**Do not Operate in an Explosive Atmosphere.****Keep Product Surfaces Clean and Dry.**

The disturbance test of all the models meet the limit values of A in the standard of EN 61326: 1997+A1+A2+A3, but can't meet the limit values of B.

Measurement Category

The VS5000 series Digital Oscilloscope is intended to be used for measurements in Measurement Category I.

Measurement Category Definitions

Measurement Category I is for measurements performed on circuits not directly connected to MAINS. Examples are measurements on circuits not derived from MAINS, and specially protected (internal) MAINS derived circuits. In the latter case, transient stresses are variable; for that reason, the transient withstand capability of the equipment is made known to the user.

WARNING

IEC Measurement Category I. The HI and LO input terminals may be connected to circuit terminal in IEC Category I installations for voltages up to 300 VAC. To avoid the danger of electric shock, do not connect the inputs to circuit's voltages above 300 VAC.

Transient overvoltage is also present on circuits that are isolated from mains. The VS5000 series Digital Oscilloscopes is designed to safely withstand occasional transient overvoltage up to 500 Vpk. Do not use this equipment to measure circuits where transient overvoltage could exceed this level.

Safety Terms and Symbols

Terms in this manual. These terms may appear in this guide:



WARNING: Warning statements identify conditions or practices that could result in injury or loss of life.



CAUTION: Caution statements identify conditions or practices that could result in damage to this product or other property.

Terms on the Product: These terms may appear on the product:

DANGER indicates an injury hazard may be immediately accessible.

WARNING indicates an injury hazard may be not immediately accessible.

CAUTION indicates that a potential damage to the instrument or other property might occur.

Symbols on the Product: These symbols may appear on the Instrument:



**Hazardous
Voltage**



**Refer to
Instructions**



**Protective
Earth
Terminal**



**Grounding
Terminal
of Chassis**



**Test
Grounding
Terminal**

VS5000 Oscilloscopes at a Glance

RIGOL VS5000 Series Digital Oscilloscopes offer good waveform view and measurements in a compact, lightweight package. VS5000 series are ideal for production test, field service, research and design and all of the applications involving analog circuits test and troubleshooting, as well as education and training.

Product features:

- Dual Channel, Bandwidth:
 - 200MHz (VS5202, VS5202D)
 - 100MHz (VS5102, VS5102D)
 - 60MHz (VS5062, VS5062D)
 - 40MHz (VS5042, VS5042D)
 - 25MHz (VS5022, VS5022D)
- A true Mixed Signal Oscilloscope with 16 channels Logic Analyzer (for some models)
- 400 MSa/s maximum real-time sample rate and 25 GSa/s maximum equivalent sample rate
- Memory depth: 1M points (Single Channel), 512k points (Dual Channels), 512k points (Logic Analyzer)
- Adjustable waveform intensity, more effective waveform view
- One-touch automatic setup for ease of use (AUTO)
- 20 Automatic measurements
- Automatic cursor tracking measurements
- Waveform recorder, record and replay dynamic waveforms
- User selectable fast offset calibration
- Built-in FFT function, Frequency Counter
- Digital filters, includes LPF, HPF, BPF, BRF
- Add, Subtract and Multiply Mathematic Functions
- Advanced trigger types include: Edge, Video, Pulse width, Slope, Alternative, Pattern and Duration
- Adjustable trigger sensitivity

Content

Safety Notices	II
VS5000 Oscilloscopes at a Glance	V
Chapter 1 Quick Start	1-1
The Front Panel and User's Interface.....	1-2
To Inspect the Instrument.....	1-5
To Perform a Functional Check	1-6
To Compensate Probes	1-8
To Use Digital Leads (for VS5***D only)	1-9
To Display a Signal Automatically.....	1-11
To Understand the Vertical Window	1-12
To Understand the Horizontal System.....	1-14
To Trigger the Oscilloscope	1-16
Chapter 2 Operating Your Oscilloscope	2-1
To Set the Vertical system	2-2
To Set the Horizontal System.....	2-23
To Set the Trigger System	2-29
To Set the Sampling System	2-43
To Save/Load and Print Setup.....	2-47
To Set the Measurement Function.....	2-53
To Set the Utility Function	2-66
To Use Run Control Buttons.....	2-72
Chapter 3 Application Examples	3-1
Example 1: Taking Simple Measurements	3-1
Example 2: View a Signal Delay Caused by a Circuit.....	3-3
Example 3: Capture a Single-Shot Signal	3-4
Example 4: To Reduce the Random Noise on a Signal	3-5
Example 5: Making Cursor Measurements.....	3-7
Example 6: The Application of the X-Y Operation	3-9
Example 7: Triggering on a Video Signal.....	3-11
Example 8: FFT Cursor Measurement	3-13
Example 9: Pass/Fail Test.....	3-14
Example 10: Triggering on a Digital Signal.....	3-15

Chapter 4 Prompt Messages & Troubleshooting 4-1
 Prompt Messages 4-1
 Troubleshooting 4-4

Chapter 5 Specifications..... 5-1

Chapter 6 Appendix 6-1
 Appendix A: Accessories 6-1
 Appendix B: Warranty..... 6-1
 Appendix C: Maintenance..... 6-2
 Appendix D: Contact RIGOL 6-3

Index..... 1

Chapter 1 Quick Start

This chapter covers the following topics:

- The front panel and user interface of VS5000 Series
- To inspect the instrument
- To perform a functional check
- To compensate probes
- To use digital leads (for VS5xxxD only)
- To display a signal automatically
- To set up the vertical system
- To set up the horizontal system
- To trigger the oscilloscope

The Front Panel and User Interface

The first thing to do with a new oscilloscope is to become acquainted with its front panel. This chapter will help to be familiar with the layout of the connectors, graphical representations, interfaces, and how to use them. Read the chapter carefully before further operations.

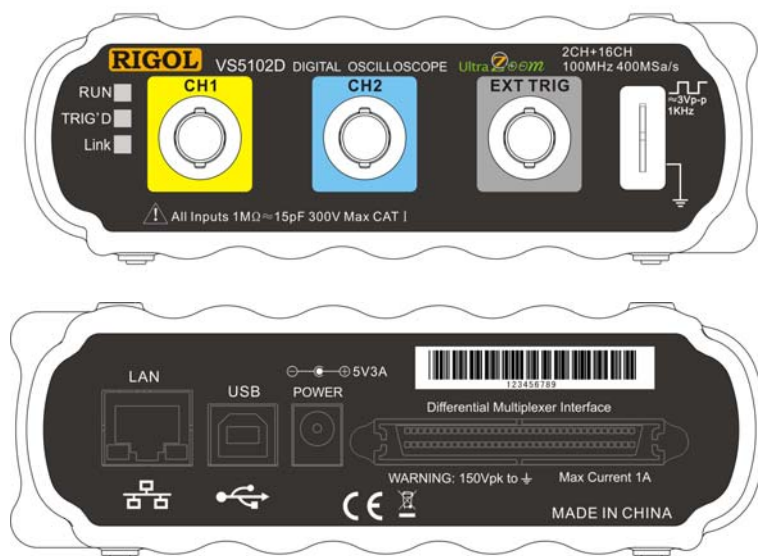

Figure 1-1
VS5000 Series Oscilloscope

VS5000 series oscilloscopes provide an easy-to-use user interface. In the main menu, access the function options from the menu and the drop-down menu to operate VS5000 series oscilloscope. There're shortcuts for some common functions.

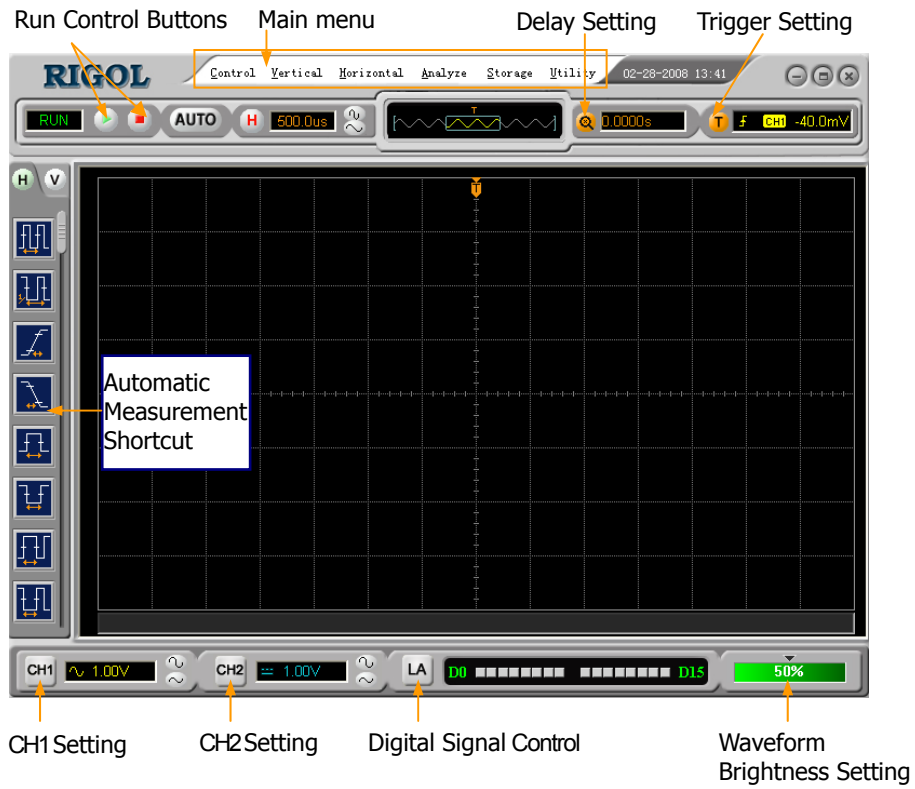

Figure 1-2
VS5000 Operation Interface

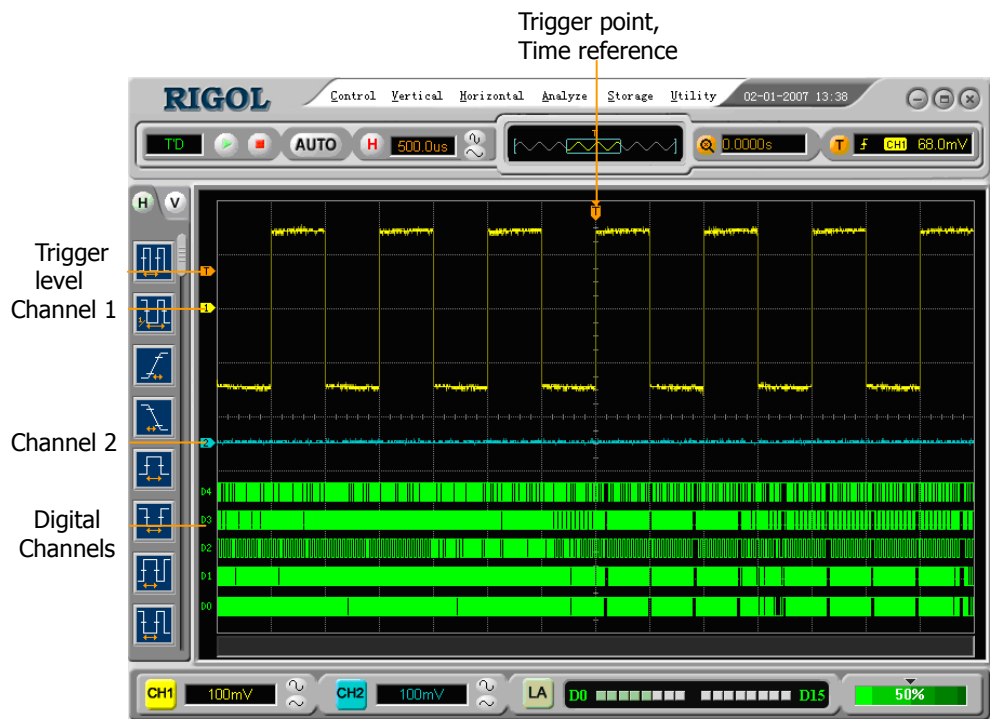

Figure 1-3
Display Interface (Analog and Digital channels)

To Inspect the Instrument

After receiving a new VS5000 series oscilloscope, please inspect the instrument as following steps:

1. Inspect the shipping container for damage.

Keep the damaged shipping container or cushioning material until the contents of the shipment have been checked for completeness and the instrument has been checked mechanically and electrically.

2. Check the accessories.

Accessories supplied with the instrument are listed in "Accessories" in this guide. If the contents are incomplete or damaged notify the **RIGOL** Sales Representative.

3. Inspect the instrument.

In case there is any mechanical damage or defect, or the instrument does not operate properly or fails performance tests, notify the **RIGOL** Sales Representative.

If the shipping container is damaged, or the cushioning materials show signs of stress, notify the carrier as well as the **RIGOL** sales office. Keep the shipping materials for the carrier's inspection.

RIGOL offices will arrange for repair or replacement at option of **RIGOL** without waiting for claim settlement.

To Perform a Functional Check

Perform this quick functional check to verify that the instrument is operating correctly.

1. Prepare for using the instrument.

Use the power cords designed for the oscilloscope only. Connect to a power source that delivers 100 to 240 VAC, 45Hz to 440Hz. Power up the system, initiate the program. Click the **Storage** button, select **Load Default** in the menu box.

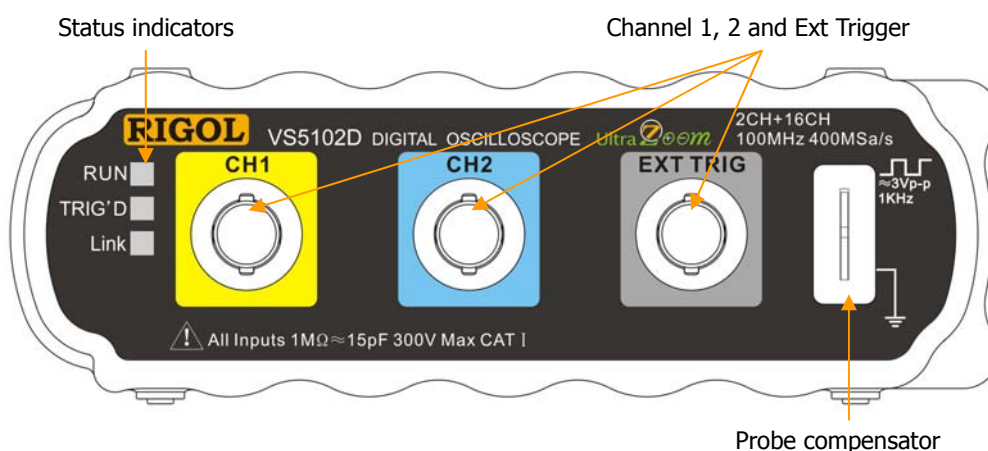

Figure 1-4
Instruction of the Front Panel

2. Input a signal to a channel of the oscilloscope

VS5000 Series are equipped with dual channels plus external trigger, and 16 channels logic analyzer (only for VS5***D models).

Please defer to the following steps to connect to signal:

- 1) Set the attenuation switch on the probe to 10X (Figure 1-6) and connect the probe to CH1 on the oscilloscope. Align the slot in the probe connector with the key on the CH1 BNC connector. Push to connect, and twist to the right to lock the probe in place. Attach the probe tip and ground lead to the Probe compensator connector.

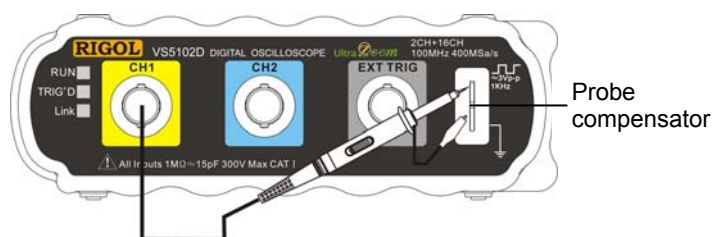

Figure 1-5

Probe Compensation

- 2) Set the probe attenuation of the oscilloscope to X10. (Default probe attenuation is X1).

Method of set the probe attenuation:

Right click the **CH1** button into the **Channel** menu. In the **Probe** menu, select the probe attenuation. Now select the **1:10** option.

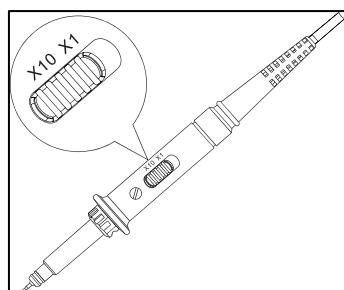

Figure 1-6

To Set the Probe

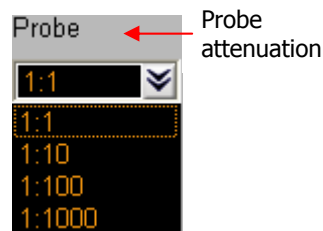

Figure1-7

To Set the Probe Attenuation

- 3) Click the **AUTO** button. Within a few seconds, a square wave will display (approximately 1 kHz 3 V peak- to- peak).
- 4) Click the **CH1** button to turn Channel 1 off, click the **CH2** button to turn Channel 2 on. Repeat steps 2 and 3.

To Compensate Probes

Perform this adjustment to match the characteristics of the probe and the channel input. This should be performed whenever attaching a probe to any input channel the first time.

1. From the Probe menu, select attenuation to 1:10. Set the switch to X10 on the probe and connect it to CH 1 of the oscilloscope. When using the probe hook-tip, insert the tip onto the probe firmly to ensure a proper connection. Attach the probe tip to the Probe Compensator and the reference lead to the ground connector, select CH 1, and then press the **AUTO** button.
2. Check the shape of the displayed waveform.

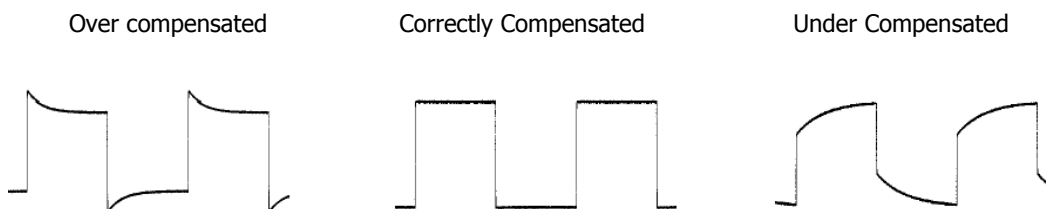

Figure 1-8

Instruction Waveform of Probe Compensation

3. If necessary, use a non-metallic tool to adjust the trimmer capacitor of the probe for the flattest square wave being displayed on the oscilloscope.
4. Repeat if necessary.



WARNING: To avoid electric shock while using the probe, be sure the perfection of the insulated cable, and do not touch the metallic portions of the probe head while it is connected with a voltage source.

To Use Digital Leads (for VS5***D only)

1. Switch off power supply of the Device under Test if necessary to avoid short circuit. Since no voltage is applied to the leads at this step, the oscilloscope may remain on.
2. Connect one end of the flex cable FC1868 to the Logic Analyzer Input; connect the other end to Logic Head LH1116. It is unnecessary to switch off power supply of the oscilloscope while connecting the cable.

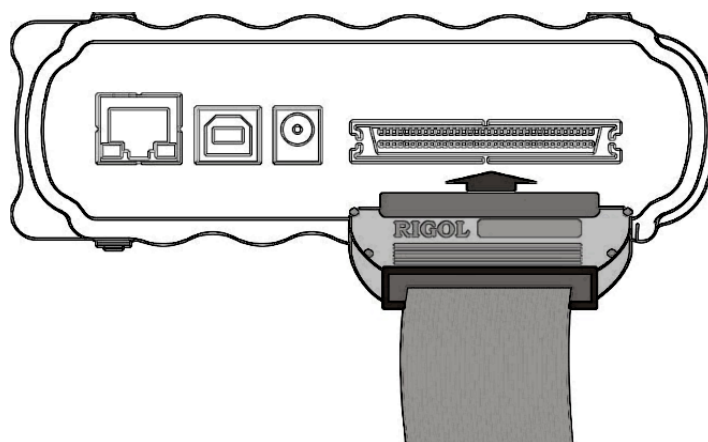

Figure 1-9
Connect the Flex Cable



CAUTION: Use only FC1868, LH1116, TC1100 and LC1150 made by **RIGOL** for specified mixed signal oscilloscopes.

3. Connect a test clip to one lead wire; make sure it is connected well.

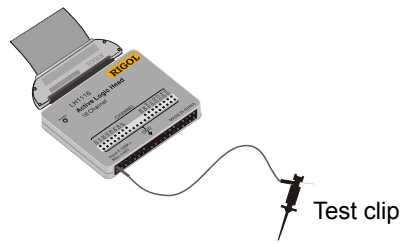

Figure 1-10
Connect the Test Clip

4. Test the device with the clip.

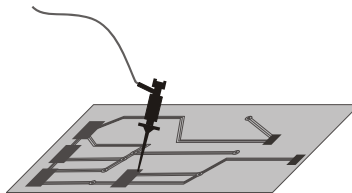

Figure 1-11
Testing Instruction

5. Remember to connect Ground Channel to the ground terminal of the DUT.

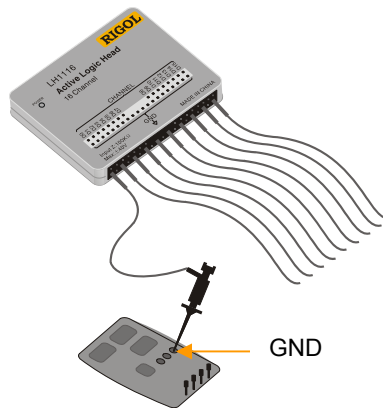

Figure 1-12
Ground Connection

To Display a Signal Automatically

The VS5000 series oscilloscope has an automated function to display the input signal in best fit. This feature requires a 50 Hz or higher and a duty cycle greater than 1% input signal.

Press the **AUTO** button, the oscilloscope automatically sets up **VERTICAL**, **HORIZONTAL** and **TRIGGER** controls to display the input signal. Adjust the controls manually to get the best results if necessary.

Connect a signal to the Channel 1 (CH1) input:

1. Connect a signal to the oscilloscope as described above.
2. Click the **AUTO** button.

The oscilloscope may change the current settings to display the signal, i.e. the vertical and horizontal scale, the trigger coupling, type, position, slope, level, and mode.

To Understand the Vertical Window

Figure 1-13 shows the **Vertical** menu, which leads to the setting of the vertical parameters.

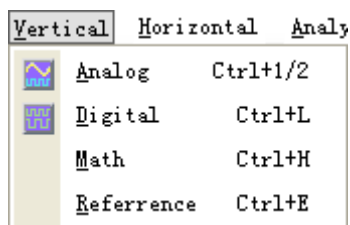

Figure 1-13 Vertical Menu

1. Use the **Analog** function in the **Vertical** menu to adjust the functions of the analog channels. A voltage value is displayed for a short time indicating how far the ground reference is located from the center of the screen. Use the left mouse button to dragging the CH1 symbol, and/or use the **Scale** and **Offset** options to set the scale and offset precisely.

Measurement hints

If the channel is DC coupled, measuring the DC component of the signal by simply noting its distance from the ground symbol.

If the channel is AC coupled, the DC component of the signal is blocked, allowing to use greater sensitivity to display the AC component of the signal.

Vertical offset back to 0 shortcut

Double click the channel sign, as a shortcut, to set the vertical display position back to 0.

2. Change the vertical setup and notice that each change affects the status bar differently.

Left-click the vertical status and use the number keyboard to input the exact Scale value (volt/div); and/or adjust the Scale quickly with the  button.

Click **Analog**, **Digital**, **Math** and **Reference** in the **Vertical** menu, to set analog channels, digital channels, math and waveform reference functions.

To Understand the Horizontal System

Figure 1-14 shows the **Horizontal** menu, which leads the setting of the horizontal parameters.

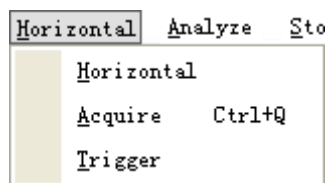



Figure 1-14 Horizontal Menu

1. Using the **Horizontal** function in the **Horizontal** menu to set the waveform horizontal options. In the **Horizontal** window, set the waveform display format (Y-T, X-Y and Roll) and horizontal **Scale** and **Offset**.

Click the  button, changes the sweep speed in a 1-2-5 step sequence and the value is displayed in the status bar. The time base ranges of the VS5000 series are listed as follows. The horizontal scan speed is from 5ns/div^[1] to 50s/div.

Delayed Scan Shortcut key

Click the  button to enter Delayed Scan mode.

[1] **NOTE:** The speed of horizontal scan varies in different models.

2. Click the **Offset** function in the **Horizontal** window to adjust the horizontal offset.

Horizontal offset back to 0 shortcut key

Click the middle circular button "" to set the horizontal offset to 0 as a shortcut key

3. In the **Format** window of the **Horizontal** functions window, select the display mode to **Y-T**, **X-Y** or **Roll**.

Horizontal position control

Trig-Offset: In this setting, the trigger position will be changed horizontally when the offset value changed.

To Trigger the Oscilloscope

Figure 1-15 shows the Trigger Control, use the functions in the **Trigger** window of the **Horizontal** menu. The following exercise guides through the buttons and settings.

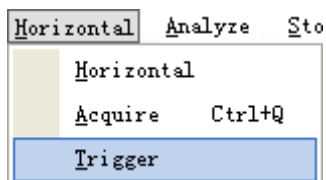

Figure 1-15 Trigger Control

1. To set the trigger function in the **Trigger** menu.

Drag the Trigger level to adjust the trigger level; or input the trigger level directly on the top right corner (Status window right side of the **T** button).

2. Click the **T** button, turn the **Trigger** window on (Figure 1-16), to set the trigger options.

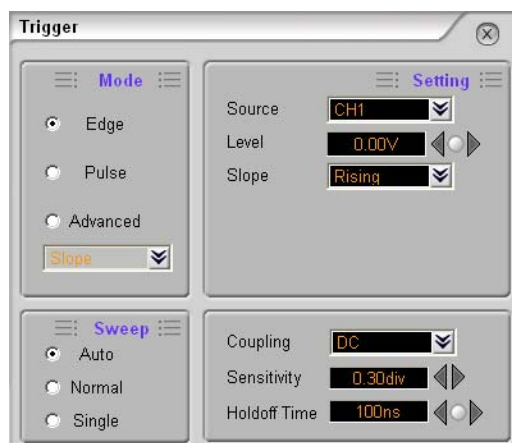



Figure 1-16 Trigger Window

Trigger level back to 0 shortcut key

Double click the trigger level sign to set the trigger level to 0 as a shortcut key.

3. Double click the trigger point, to set the horizontal delayed time to 0 as a shortcut key.
4. Click the  button to start an acquisition regardless of an adequate trigger signal, usually used in "Normal" or "Single" trigger mode. If the acquisition is already stopped, click this button to start the acquisition again.

Key point:











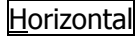

Holdoff: A time interval before the oscilloscope response to next trigger signal. During this holdoff period, the trigger system becomes "blind" to trigger signals. This function helps to view complex signals such as an AM waveform. In order to set the holdoff time, set the **Holdoff Time** option in the **Trigger** menu.

Chapter 2 Operating Your Oscilloscope

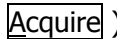
The VERTICAL, HORIZONTAL, and TRIGGER control systems and how to determine the system setup from the status bar of a VS5000 Series oscilloscope were introduced in the previous chapter.

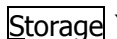
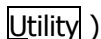
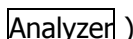
This chapter will go through all groups of buttons, knobs, and menus, expanding the knowledge of operations by hints in this guide.

It is recommended to perform all of the following exercises to get the most of the powerful measurement capabilities of the oscilloscope.

- Understand the vertical system (, ,  ^[1], )
- Understand the horizontal system ()
- Understand the trigger system ()
- To set up the sampling system ()
- To set up the display system ()
- To save and recall ()
- To set up utility ()
- To measure the waveform ()
- To use the run control buttons (,  and )

[1] NOTE: This function is for VS5*D model only.**

To Set the Vertical system

Analog Channel Settings

Each channel of VS5000 has an operation menu.

Right click the **CH1** or the **CH2** button; the "Channel" window will appear.

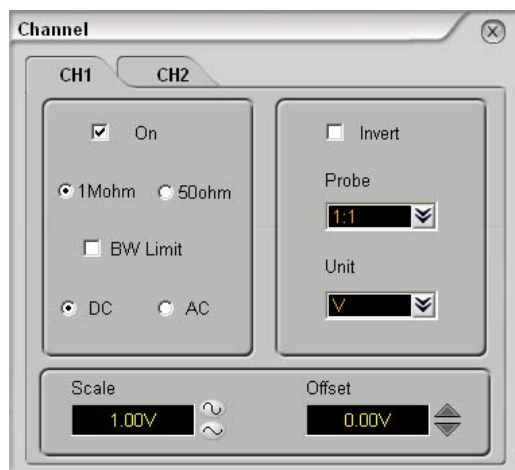

Figure 2-1
Channel Window

Turn the function On/Off:

In front of the function option there is a or choice box, means this function is turned **OFF**, means it is turned **ON**.



CAUTION: 1. To avoid damaging the input part of the oscilloscope, when use 50 ohm settings, make sure that the input voltage do not exceed the limit voltage (5Vrms, corresponding to the 1:1 probe)

2. For the probe provided for the oscilloscope, do not use 50 ohm settings directly.

Table 2-1 Analog Channel Functions

Function	Setting	Description
Channel Switch	ON	Open the Channel
	OFF	Close the Channel
Input Impedance ^[1]	1M ohm	Set the Input Impedance to be 1M ohm
	50 ohm	Set the Input Impedance to be 50 ohm
BW Limit	ON	Limit the channel bandwidth to 20MHz to reduce display noise.
	OFF	Get full bandwidth.
Coupling	DC	Pass both AC and DC components of the input signal
	AC	Block the DC component of the input signal
Probe	1:1	Set this to match the probe attenuation factor to make the vertical scale read correct
	1:10	
	1:100	
	1:1000	
Scale	Coarse	Select the resolution of the  button defines a 1-2-5 sequence.
	Exactitude	Input the scale value directly.
Invert	ON	Turn on the invert function.
	OFF	Restore to original display of the waveform.

[1] NOTE: The Input Impedance option is only used for VS5202D or VS5202.

1. Channel Coupling

To use Channel 2 as an example, input a sine wave signal with DC offset.

Right click the **CH2** button or select the **Analog** function in the **Vertical** menu, and enter the **Channel** window. Set the **Coupling** to **AC**. In this setting, it blocks the DC component of the input signal.

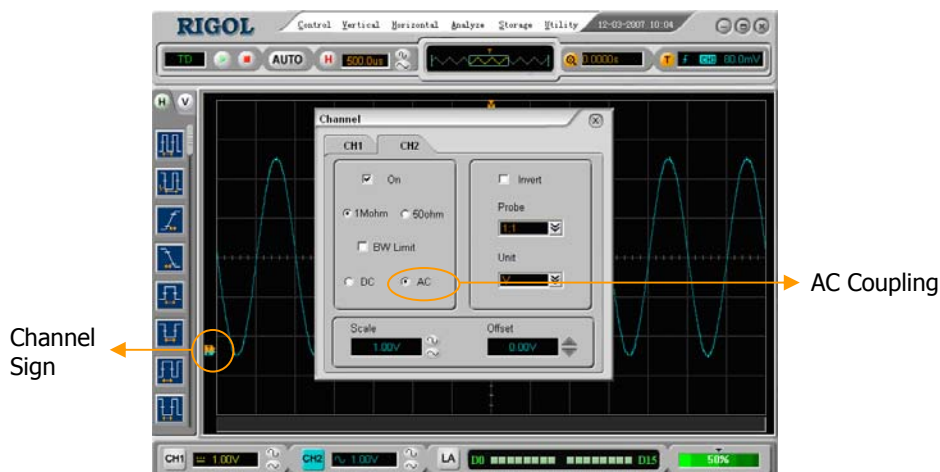

Figure 2-2
To Set AC Coupling

Right click the **CH2** button or select the **Analog** function in the **Vertical** menu, to enter the **Channel** window. Set the **Coupling** to **DC**. In this setting, it blocks the AC component of the input signal.

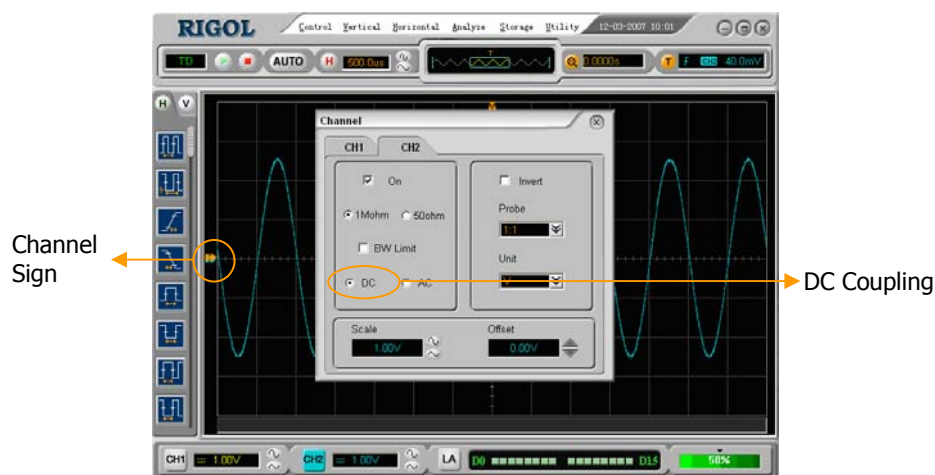

Figure 2-3
To Set DC Coupling

2. Set up the Channel Bandwidth Limit

To use Channel 1 as an example, input a signal that contains high frequency component.

Right-click the **CH1** button, the Channel window will appear. Turn the **BW Limit** function off. The oscilloscope is set to full bandwidth and will pass the high frequency component in the signal.

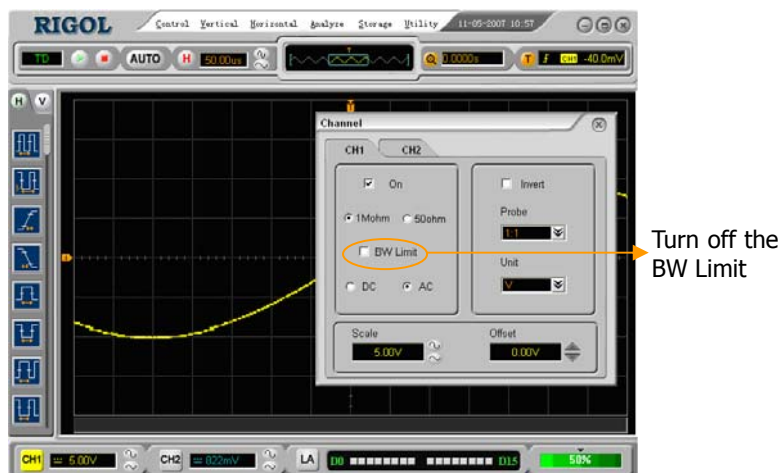

Figure 2-4
Turn off the BW Limit

Right-click the **CH1** button, the Channel window will appear. Turn the **BW Limit** function on. It will reject the frequency component higher than 20MHz.

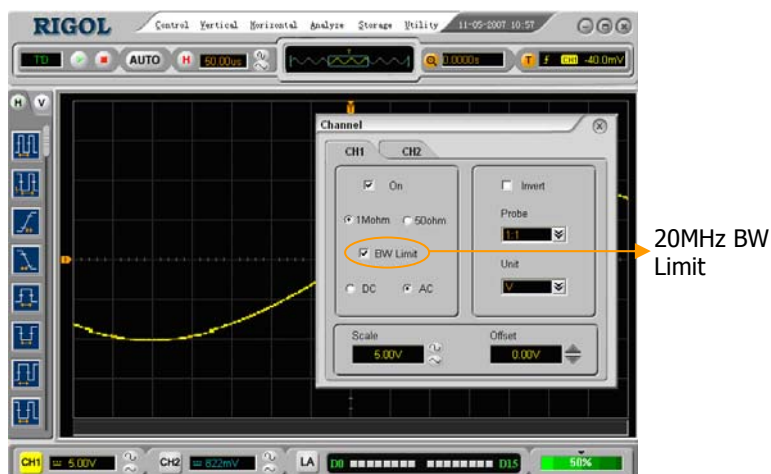

Figure 2-5
Turn on the BW Limit

3. Probe Attenuation Setting

Select the attenuation factor for the probe. The attenuation factor changes the vertical scale of the oscilloscope so that the measurement results reflect the actual voltage levels at the probe tip.

To change (or check) the probe attenuation setting, press the CH1 or CH2 button (according to which channel are in using), toggle the **Probe** soft button to match the attenuation factor of the probe.

This setting remains in effect until changed again.

Figure 2-6 gives an example for using a 1:1000 probe and its attenuation factor.

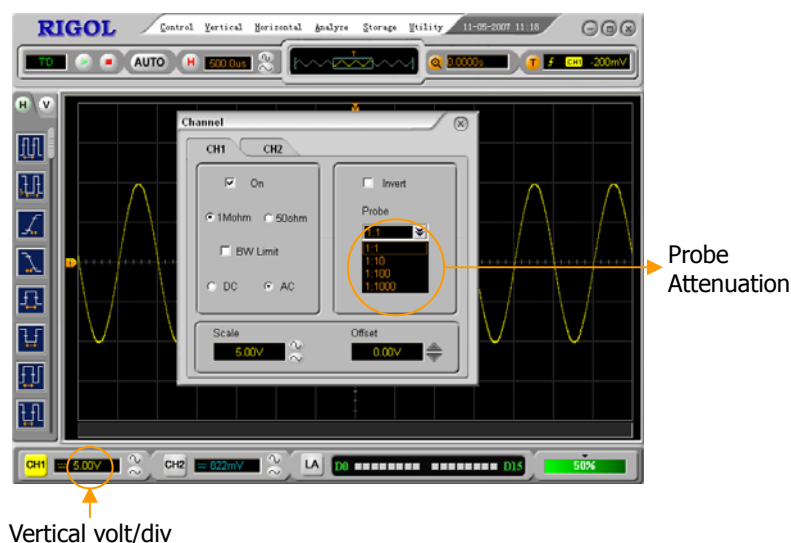

Figure 2-6
To Set the Probe Attenuation

Table 2-2 Probe setting

Probe attenuation factors	Corresponding settings
1:1	1X
1:10	10X
1:100	100X
1:1000	1000X

4. Volts/Div Settings

The **Volts/Div** control has **Coarse** or **Fine** configuration. The Vertical Sensitivity is 2mV-5V/div.

Coarse:

It is the default setting of Volts/Div, in a 1-2-5-step sequence from 2mV/div, 5mV/div, 10mV, to 5 V/div.

Fine:

This setting changes the vertical scale with accurate value.

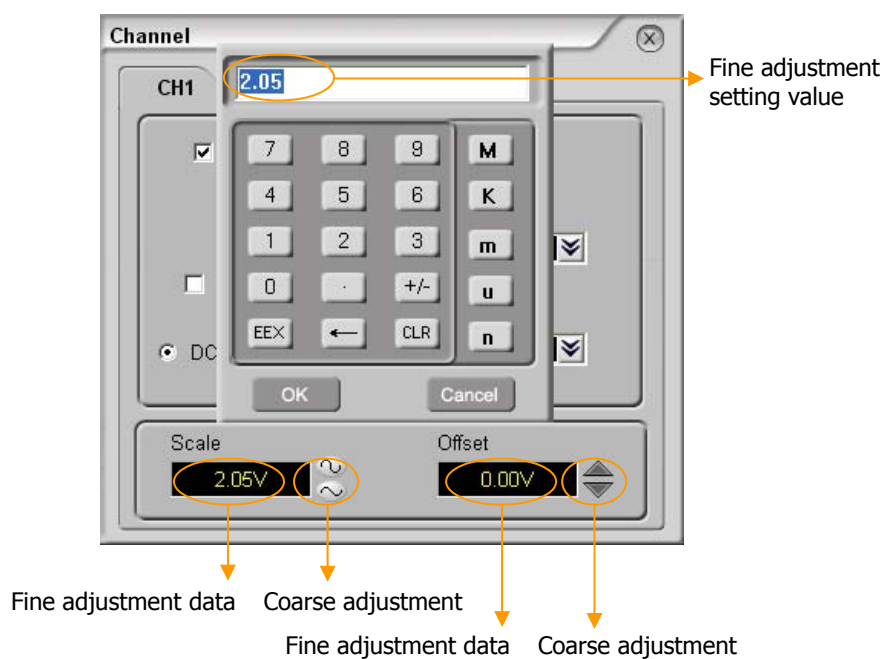

Figure 2-7
Scale and Offset Window

Set the vertical scale and offset in the **Scale** and **Offset** function of the **Channel** window.

5. To Invert a Waveform

Invert turns the displayed waveform 180 degrees, with respect to the ground level. When the oscilloscope is triggered on the inverted signal, the trigger is also inverted.

Figure 2-8 and 2-9 show the changes before after inversion.

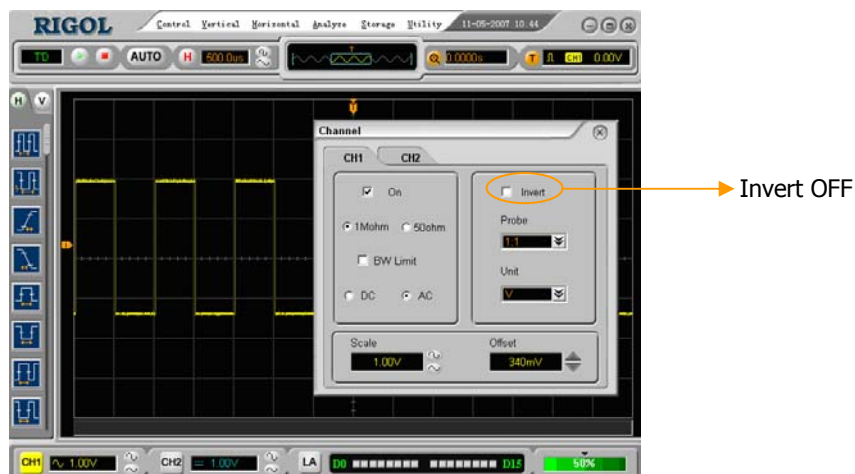

Figure 2-8
The Waveform before Inversion

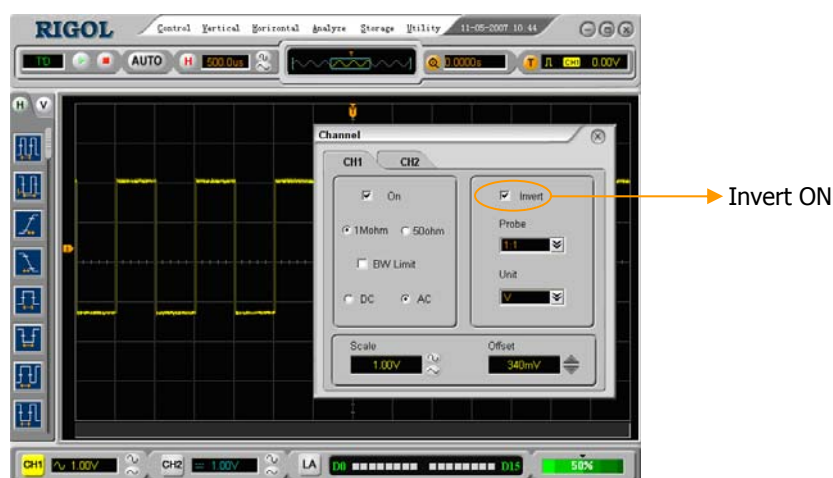

Figure 2-9
The Waveform after Inversion

Digital Channel Settings (for VS5***D only)

It allows to turn single channel or group channels ON or OFF, to set the Wave Size, to change display location of digital channel on screen and to select Threshold Type.

Left click the **Digital** button in the **Vertical** menu, or right click the **LA** button to show the **Logic Analyzer** window.

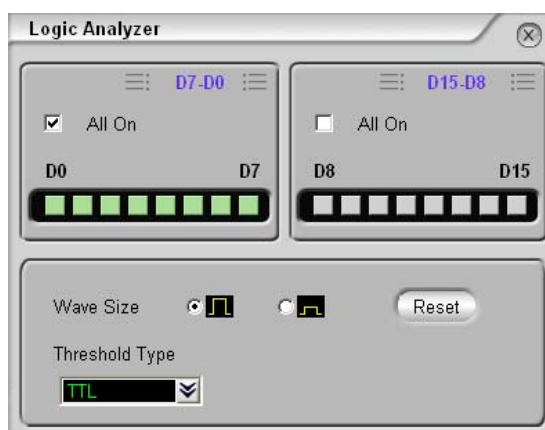

Figure 2-10
Logic Analyzer Interface

Table 2-3 Logic Analyzer Settings

Function	Setting	Description
D7-D0		Set up channel group D7-D0
D15-D8		Set up channel group D15-D8
All on	ON/OFF	Turn all (D7-D0 or D15-D8) digital channels ON/OFF
Wave Size	Big/Small	Select the waveform display size.
Reset		Reset the waveform display position.
Threshold Type	TTL CMOS ECL USER	Select mode of all digital channels. The threshold voltage can be set by user in user-defined style.

1. Display and re-line up the digital channels

- 1) Turn on the **Logic Analyzer** window. Use the options in this window to set the Channel ON/OFF, Wave Size, Threshold Type and Reset the waveform display position.
- 2) Drag the digital channel sign to move the digital waveform to the designated location.
- 3) Click the **Reset** button to reset the waveform position.

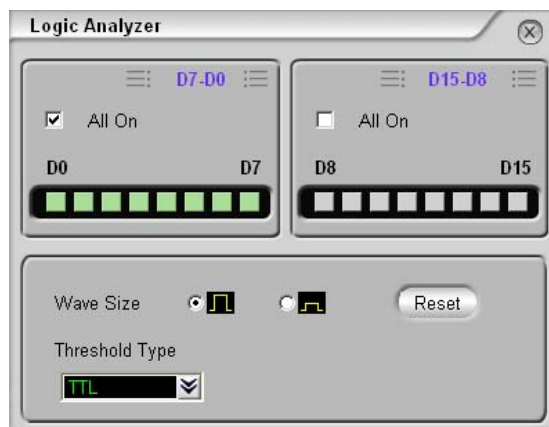

Figure 2-11
Open the Channels of D0~D7

2. Set Threshold Type of Digital Channels

Select logic standard or **User** to define the threshold voltage.

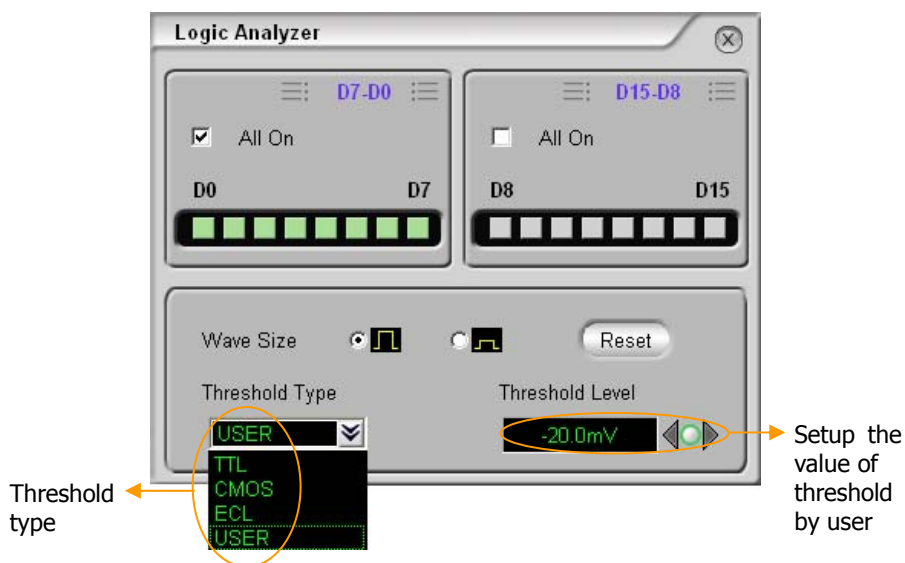

Figure 2-12
To Set the Threshold Type

Threshold explanation

LOGIC STANDARD	THRESHOULD VOLTAGE
TTL	1.4V
CMOS	2.5V
ECL	-1.3V
USER	-8V to +8V

Math Functions

The mathematic functions include “add”, “subtract”, “multiply” and “FFT” for Channel 1 and Channel 2. The mathematic result can be measured by the grid and the cursor. The Math function may turn on four channels, each channel could be operated independently (Except Delayed display).

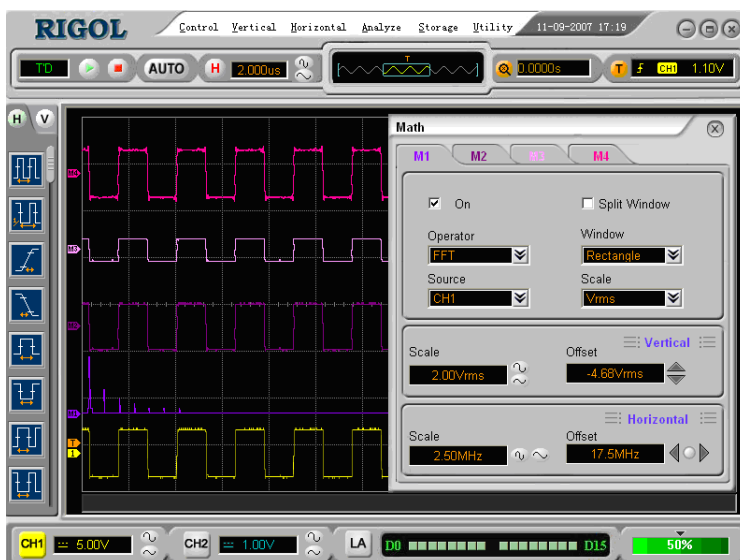

Figure 2-13
Interface of the Mathematic Function

Table 2-4 Mathematic Function

Function	Setting	Description
Math	On	Turn this math channel on.
	Off	Turn this math channel off.
Operation	A+B	Add source A and source B
	A- B	Subtract source B from source A
	A×B	Multiply source A by source B
	FFT	Fast Fourier Transform
	Filter	Digital filter
Source A	CH1	Define CH1 or CH2 as source A
	CH2	
Source B	CH1	Define CH1 or CH2 as source B
	CH2	

1. Digital Filter

Left click the **Math** button in the **Vertical** menu. Select **Filter** function. In Filter Type, select the type of filter: **Low Pass**, **High Pass**, **Band Pass** or **Band Reject**. Set high and low limit of frequency.



Figure 2-14
Interface of the Digital Filter

Table 2-5 Digital Filter Function

Function	Setting	Description
Source	CH1 CH2	Define CH1 or CH2 as source
Digital Filter	Off On	Turn off the digital filter Turn on the digital filter
Filter Type	Low Pass High Pass Band Pass Band Reject	Setup as LPF (Low Pass Filter) Setup as HPF(High Pass Filter) Setup as BPF (Band Pass Filter) Setup as BRJ(Band Reject Filter)
Upper limit	◀●▶	Set high limit
Lower limit	◀●▶	Set low limit

2. Addition, Subtraction and Multiplication Function

In Math function, use the addition, subtraction and multiplication function to operate and analyze the waveform.

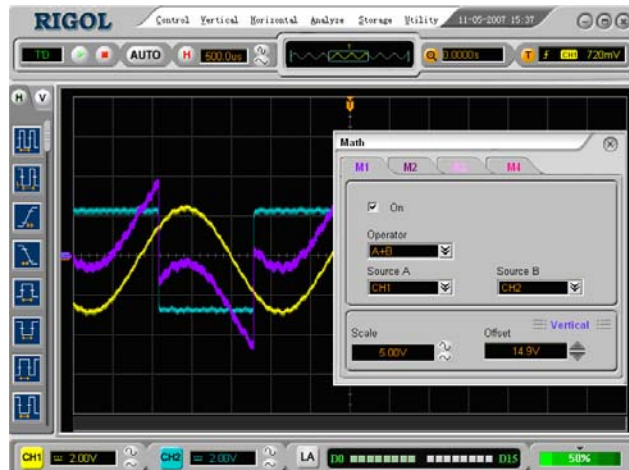

Figure 2-15

The Addition, Subtraction and Multiplication Function

Enter the **Math** window. Select the math function in the **Operator** menu. Select Source A and B. Then adjust the vertical **Scale** and **Offset** to view the math channel clearly.

3. Using the FFT

The FFT (Fast Fourier Transform) process converts a time-domain signal into its frequency components mathematically. FFT waveforms are useful in the following applications:

- Measuring harmonic content and distortion in systems
- Characterizing noise in DC power supplies
- Analyzing vibration

Table 2-6 FFT Function

Function	Setting	Description
Source	CH1 CH2	Define CH1 or CH2 as FFT source
Window	Rectangle Hanning Hamming Blackman	Select window for FFT
Display	Split Full screen	Display FFT waveform on half screen Display FFT waveform on full screen
Scale	Vrms dBVrms	Set "Vrms " as vertical unit Set "dBVrms " as vertical unit

Key points for FFT

1. Signals that have a DC component or offset can cause incorrect FFT waveform component magnitude values. To minimize the DC component, choose **AC Coupling** on the source signal.
2. To reduce random noise and aliases components in repetitive or single-shot events, set the oscilloscope acquisition mode to average.
3. To display FFT waveforms with a large dynamic range, use the dBVrms scale. The dBVrms scale displays component magnitudes using a log scale.

Selecting a FFT Window

VS5000 series digital oscilloscopes provide four FFT window functions. Each window is a trade-off between frequency resolution and amplitude accuracy. It depends on the desired measurements and source signals characteristics to determine the window to use. Use the following guidelines to select the best window.

Table 2-7 FFT Windows description

Window	Features	Best for measuring
Rectangle	Best frequency resolution and worst magnitude resolution. This is essentially the same as no window.	Transients or bursts, the signal levels before and after the event are nearly equal. Equal-amplitude sine waves with fixed frequencies. Broadband random noise with a relatively slow varying spectrum.
Hanning	Better frequency, poorer magnitude accuracy than Rectangular.	Sine, periodic, and narrow-band random noise.
Hamming	Hamming has slightly better frequency resolution than Hanning.	Transients or bursts where the signal levels before and after the events are significantly different.
Blackman	Best magnitude, worst frequency resolution.	Single frequency waveforms, to find higher order harmonics.

Key points:

FFT Resolution

With a fixed FFT points, the lower sampling rate results in better resolution.

Nyquist Frequency

The highest frequency that any real-time digital oscilloscope can acquire without aliasing. It's normally half of the sample rate. This frequency is called the Nyquist frequency. Frequency above the Nyquist frequency will be under sampled, causing a situation known as aliasing.

Set the Reference

Reference Waveforms are saved waveforms to be selected for display. The reference function will be available after saving the selected waveform to non-volatile memory. Click the **Reference** button in the **Vertical** menu, go to the **Reference** window.

Table 2-8 Reference Function

Function	Setting	Description
Source	CH1	Select CH1 as Reference channel
	CH2	Select CH2 as Reference channel
	MATH1	Select Math1 as Reference channel
	MATH2	Select Math2 as Reference channel
	MATH3	Select Math3 as Reference channel
File	Off	Turn the file selection off
	On	Turn the file selection on
Save		Save Reference waveform
Load		Into the Open File window

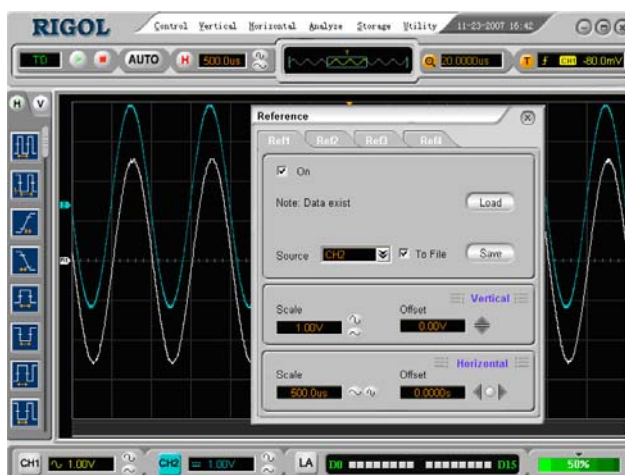

Figure 2-16
Interface of Reference

1. Export

Click the **Load** button in the **Reference** window.

Table 2-9 Export Function

Function	Setting	Description
Open		Load the file that was selected
Cancel		Cancel the current operation
Keyboard		Use the soft-keyboard input the file name

The **Open File** window as shown below:



Figure 2-17
Open a Reference File

2. Import

Click the **Save** button in the **Reference** window.

Table 2-10 Import Function

Function	Setting	Description
Save		Save the file that was named
Cancel		Cancel the current operation
Keyboard		Use the soft-keyboard input the file name

The **Save File** window as shown below:



Figure 2-18
Save a Reference File

3. Open/Save File Window

Click the **Load** button in the **Reference** window to turn on the **“Open File”** window.

Table 2-11 Open/Save Functions

Function	Setting	Description
Driver	Select the driver location	Switch the driver
Open/Save		Open the selected file Save the file with the input File Name
Cancel		Cancel the current operation
Keyboard		Use the soft-keyboard input the file name

The Open/Save File Window as shown below:

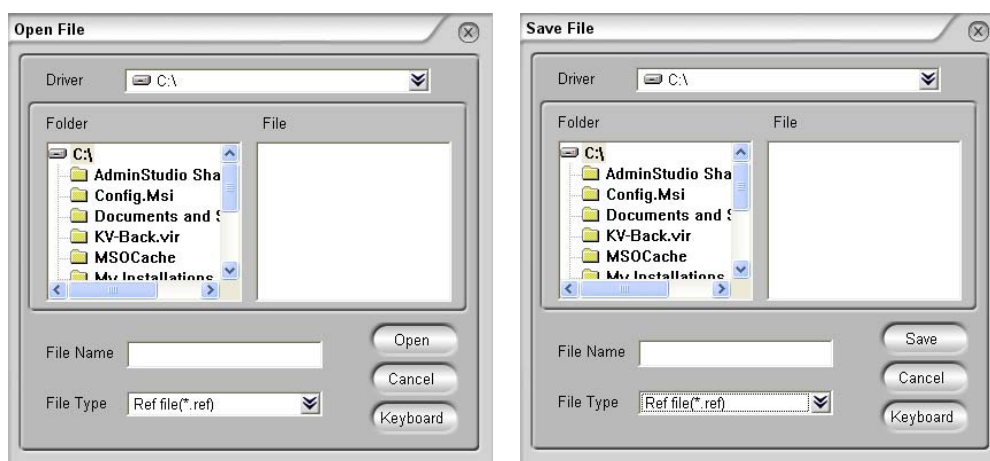

Figure 2-19
Open/Save File Windows

NOTE:

The File function is default Off (File), to save the file in the hard driver, turn the File function On (File).

Operation Comments

- 1) Click On (On) to turn the Reference function on.
- 2) Click **Source** to select CH1, CH2, MATH1, MATH2, MATH3 and MATH4 channel.
- 3) Adjust the **Scale** and **Offset** of the **Vertical** and **Horizontal**.
- 4) Click the **Save** button to save the waveform being displayed on the screen as Reference.

NOTE: The Reference function is not available in X-Y mode.

Turn on/off Channels

The CH1, CH2, Ext Trigger and LA (for VS5***D only) channels on VS5000 series are input channels. All functionalities applied will be based on operating the instrument with channels. So MATH and REF can be regarded as relatively isolated channels.

To turn on/off any one of the channels, press the corresponding button on the front panel. The button turns coloured indicates the channel is currently active. Press the button again or chose **Off** in **Channel/Logic Analyzer** window to turn the channel off.

Table 2-12 Turn On/Off channels

Channel Mode	Settings	Status Indicator
Channel 1 (CH1)	ON	CH1 (yellow background)
	OFF	CH1 (gray background)
Channel 2 (CH2)	ON	CH2 (blue background)
	OFF	CH2 (gray background)
MATH	ON	M1 M2 M3 M4 (to distinguish between the four colors)
	OFF	No indicator
Reference	ON	Ref 1/2/3/4 (white background)
	OFF	No indicator
Logic Analyzer ^[1]	ON	LA (green background)
	OFF	LA (gray background)

NOTE:

The status indicators (CH1, CH2 and LA) of the VS5000 series in the above table are displayed on the lower-left of the main window.

The four MATH function channels are distinguished between the four colors.

Click of  will turn all the digital channels on/off.

[1] Logic Analyzer for VS5*D model only.**

To Set the Horizontal System

The oscilloscope shows the time per division in the scale readout. Since all active waveforms use the same time base, the oscilloscope only displays one value for all the active channels, except when using Delayed Scan, or Alternative Trigger.

The horizontal controls changes the horizontal scale and position of waveforms. The horizontal center of the screen is the time reference for waveforms. Changing the horizontal scale causes the waveform to expand or contract with respect to the screen center.

Horizontal position changes the displayed waveform position, relative to the trigger point.

Scale  : Set the horizontal time/div (scale factor) for the main or the Delayed Scan time base. When Delayed Scan is enabled, it changes the width of the window zone by changing the Delayed Scan time base.

Offset  : Adjusts the horizontal position of all channel (including Math) waveforms. The resolution of this control varies with the time base. Click the Mid-circular button clears trigger offset and moves the trigger point to the horizontal center of the screen.

Table 2-13 Horizontal Setting Function

Function	Setting	Description
Time Base	Y-T	Show the relative relation between vertical voltage and horizontal time.
	X-Y	Show CH1 value at X axis; CH2 value at Y axis.
	Roll	In Roll Mode, the waveform display updates from right to left.
Scale		Set the horizontal scale
Offset		Set the horizontal offset
Delayed	Off	Turn off Delayed Scan mode
	On	Turn on the Delayed Scan mode

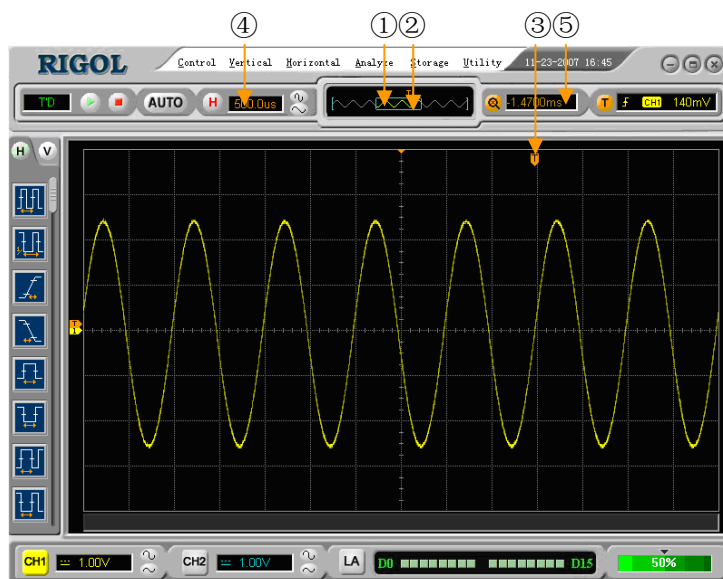

Figure 2-20
Horizontal Setting Information in Main Interface

Marks Indicator

- ①. The current waveform position window in the memory.
- ②. The trigger position in the memory.
- ③. The trigger position in the current waveform windows.
- ④. The horizontal time base (the main time base).
- ⑤. The trigger's horizontal offset according to the center of the window.

Key Points**Y-T:**

The conventional oscilloscope display format. It shows the voltage of a waveform record (on the vertical axis) as it varies over time (on the horizontal axis).

X-Y:

X-Y format displays channel 1 in the horizontal axis and channel 2 in the vertical axis.

Roll Mode:

In this mode, the waveform display rolls from right to left. No trigger or horizontal offset control of waveforms is available during Roll Mode, and it's only available when set to 500 ms/div or slower.

Slow Scan Mode:

This mode is available when the horizontal time base is set to 50ms or slower. In this mode, the oscilloscope acquires sufficient data for the left part to the trigger point, then wait for trigger, when trigger occurs, it continue to draw the rest part from the trigger point to the end of the right side. When choosing this mode to view low frequency signals, it is recommended that the channel coupling be set as **DC**.

Time/Div:

Horizontal scale. If the waveform acquisition is stopped (using the  button), the Time/Div control expands or compresses the waveform.

1. Delayed Scan

The Delayed Scan is a magnified portion of the main waveform window. Use Delayed Scan to locate and horizontally expand part of the main waveform window for a more detailed (higher horizontal resolution) analysis of signal. The Delayed Scan time base setting cannot be set slower than the main time base setting.

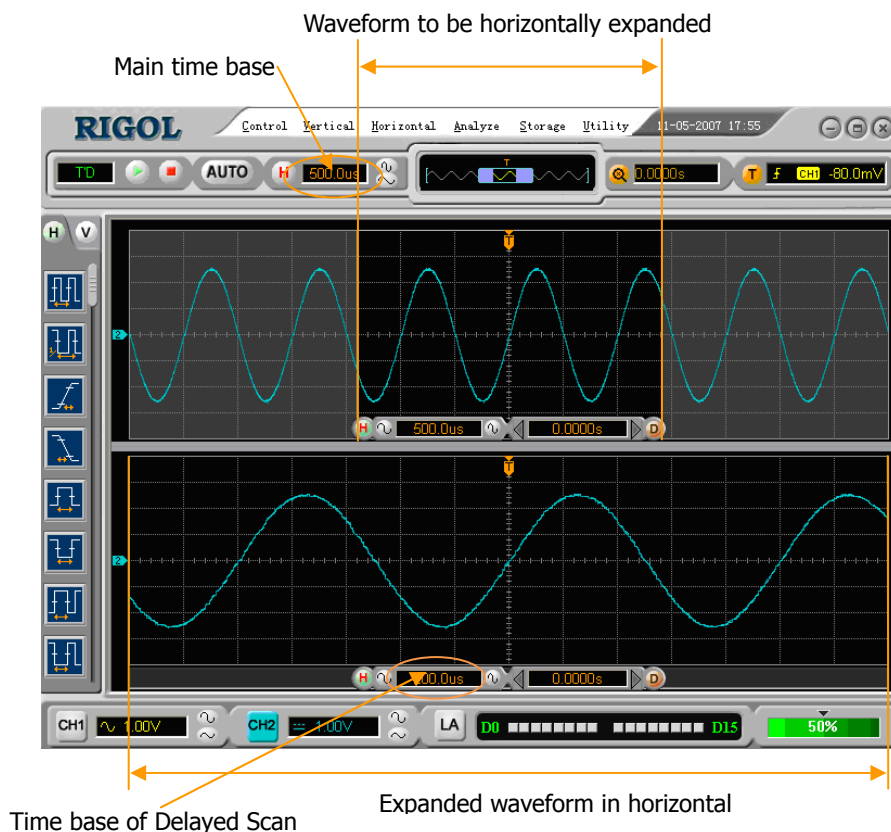





Figure 2-21
Delayed Scan

The following describes the Delayed Scan display.

The screen is divided into two parts. The upper half displays the main waveform window and the lower half displays an expanded portion of the main waveform window. This expanded portion of the main window is called the Delayed Scan window. Two blocks shadow the upper half; the un-shadowed portion is expanded in the lower half. The horizontal  and  knobs control the size and position of the

Delayed Scan. The symbol at bottom of the screen means the main time base and the symbol on the center bottom means the Delayed Scan time.

Delayed Scan shortcut key:

Delayed Scan function can be activated not only by the menu but also by click the .

2. X-Y Mode

This format is useful for studying phase relationships between two signals.

Channel 1 in the horizontal axis(X) and Channel 2 in the vertical axis(Y). The oscilloscope uses a none-trigger acquisition mode, data is displayed as dots.



Figure 2-22
The X-Y Display Format

The following modes or functions will not work in X-Y mode.

- LA Function (for VS5***D only)
- Automatic Measurements
- Cursor Measurements
- REF and MATH Operations
- Delayed Scan Mode
- Vector Display Mode
- Horizontal  Button
- Trigger Controls

To Set the Trigger System

The trigger determines when the oscilloscope starts to acquire data and display a waveform. When a trigger is set up properly, it can convert unstable displays or blank screens into meaningful waveforms.

When the oscilloscope starts to acquire a waveform, it collects enough data so that it can draw the waveform to the left of the trigger point. The oscilloscope continues to acquire data while waiting for the trigger condition to occur. After it detects a trigger, the oscilloscope continues to acquire enough data so that it can draw the waveform to the right of the trigger point.

In the Horizontal of the main menu, there is Trigger menu include:

Mode: Select the trigger mode.

Setting: Set the trigger **Source** channel, trigger **Level** and trigger **Slope** mode.

Sweep: Set the sweep mode to Auto, Normal or Single.

Trigger setting: Set the trigger **Coupling**, adjust the trigger **Sensitivity** and adjust the **Holdoff Time**.

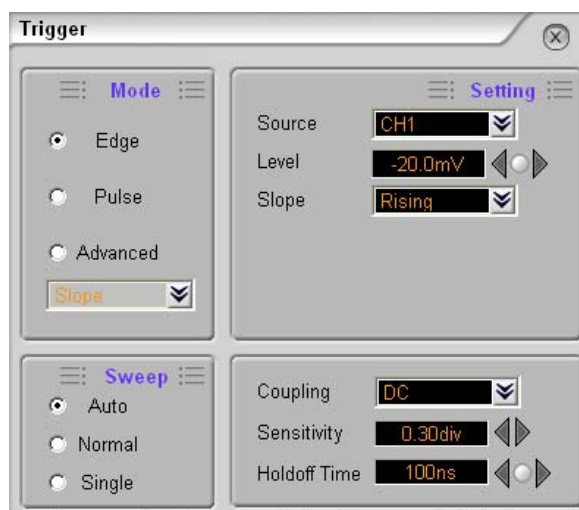

Figure 2-23
Interface of Trigger Settings

Trigger Modes

The oscilloscope provides seven trigger modes: Edge, Pulse, Slope, Video, Alternative, Pattern and Duration trigger (for VS5***D only).

Edge:

An edge trigger occurs when the trigger input passes through a specified voltage level in the specified slope direction.

Pulse:

Use this trigger type to catch pulses with certain pulse width.

Video:

Use video trigger on fields or lines for standard video signals.

Slope:

The oscilloscope begins to trigger according to the signal rising or falling speed.

Alternative:

Trigger on non-synchronized signals

Pattern:

To trigger through detecting specified codes.

Duration:

To trigger within a specified time on the conditions of a specified code.

Settings for Edge Trigger

An edge trigger determines whether the oscilloscope finds the trigger point on the rising or the falling edge of a signal. Select Edge trigger Mode to trigger on Rising edge or falling edge.

Table 2-14 Edge Trigger Settings

Function	Setting	Description
Mode		Select the trigger mode to Edge
Source	CH1 CH2 EXT EXT/5 AC Line D15-D0	Select CH1 as trigger signal Select CH2 as trigger signal Select EXT TRIG as trigger signal Select attenuated EXT TRIG/5 as trigger signal Select power line as trigger signal Select a digital channel in D15-D0 as trigger source (for VS5***D only)
Slope	Rising Falling	Trigger on rising edge Trigger on falling edge
Sweep	Auto Normal Single	Acquire waveform even no trigger occurred Acquire waveform when trigger occurred. When trigger occurs, acquire one waveform then stop
Set Up		To go to the Set Up menu

Settings for Pulse Width Trigger

Pulse trigger occurs according to the width of a pulse. The abnormal signals can be detected through setting up the pulse width condition.

Table 2-15 Pulse Width Trigger Settings



Function	Setting	Description
Source	CH1	Select CH1 as trigger signal
	CH2	Select CH2 as trigger signal
	EXT	Select EXT TRIG as trigger signal
	EXT/5	Select attenuated EXT TRIG/5 as trigger signal
	D15-D0	Select a digital channel in D15-D0 as trigger source(for VS5***D only)
Level		To set the trigger level
When	+More than	+Pulse width more than
	+Less than	+Pulse width less than
	+Equal	+Pulse width equal to
	-More than	-Pulse width more than
	-Less than	-Pulse width less than
	-Equal	-Pulse width equal to
Pulse Width		Set required pulse width
Sweep	Auto	Acquire waveform even no trigger occurred
	Normal	Acquire waveform when trigger occurred.
	Single	When trigger occurs, acquire one waveform then stop
Set Up		To go to the Set Up menu

NOTE: The Pulse width adjusts range is 20ns - 10s. When the rule is met, it will trigger and acquire the waveform.

Settings for Video Trigger

Choose video trigger to trigger on fields or lines of NTSC, PAL, or SECAM standard video signals. Trigger coupling preset to **DC**.

Table 2-16 Video Trigger Settings

Function	Setting	Description
Source	CH1	Select CH1 as trigger source
	CH2	Select CH2 as trigger source
	EXT	Select EXT TRIG as trigger source
	EXT/5	Select EXT TRIG/5 as trigger source
Polarity	 Normal polarity	Triggers on negative going sync pulses
	 Inverted polarity	Triggers on positive going sync pulses
Standard	NTSC PAL/SECAM	Select Video standard
Set up		To go to the Set Up menu
Sync	All Lines	Trigger on all lines
	Line Num	Trigger on an specified line
	Odd field	Select to trigger on odd field
	Even field	Select to trigger on even field

Key points

Sync Pulses: When Normal Polarity is selected, the trigger always occurs on negative-going sync pulses. If the video signal has positive-going sync pulses, use the inverted Polarity.

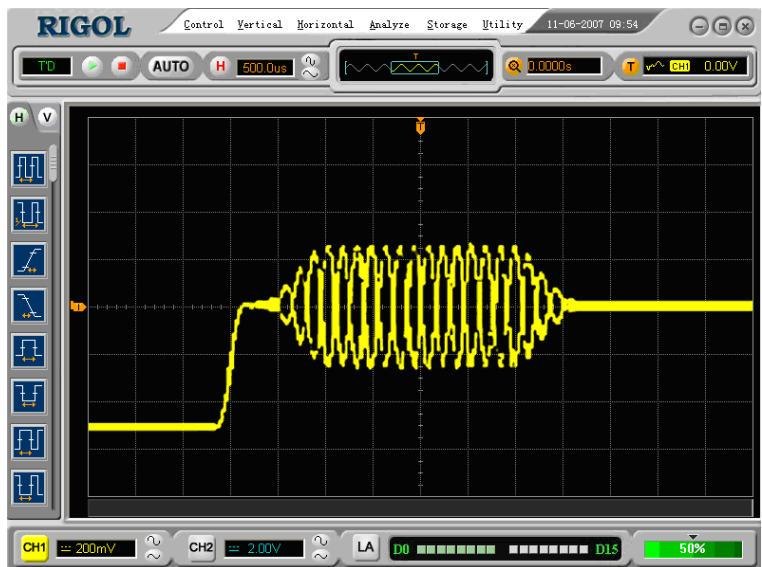

Figure 2-24
Video trigger: Line Synchronization

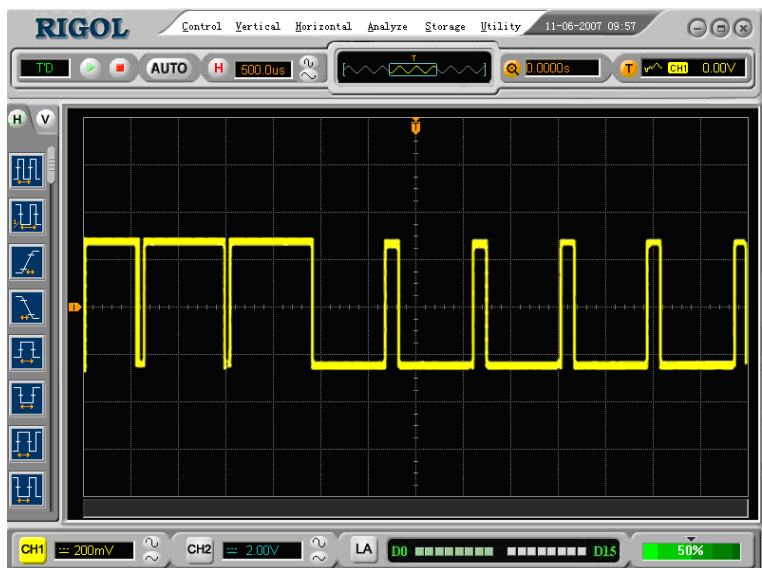

Figure 2-25
Video trigger: Field Synchronization

Settings for Slope Trigger

Slope trigger sets the oscilloscope as the positive/negative slope trigger within the specified time.

Table 2-17 Slope Trigger Settings

Function	Setting	Description
Source	CH1	Set channel 1 as trigger source
	CH2	Set channel 2 as trigger source
	EXT	Set EXT channel as trigger source
	EXT/5	Set EXT/5 as trigger source
When	+More than	+Slope width more than
	+Less than	+Slope width less than
	+Equal	+Slope width equal to
	-More than	-Slope width more than
	-Less than	-Slope width less than
	-Equal	-Slope width equal to
Time		To set slope time
Level A		To set the Level A
Level B		To set the Level B
Set Up		To go to the Set Up menu

NOTE: Slope time can be set from 20ns to 10s. When a signal meets the trigger condition, scope will execute the acquisition. Level A/ Level B is adjustable.

Settings for Alternative Trigger

When alternative trigger is on, the trigger sources are from two vertical channels. This mode can be used to observe two non-related signals. Choose two different trigger modes for the two vertical channels. The options are as follows: Edge, Pulse, Slope and Video. The information of the trigger level of the two channels will be displayed on the upper-right of the screen.

Table 2-18 Alternative Trigger Settings

Function	Setting	Description
Channel	CH1	Set trigger mode for Channel 1
	CH2	Set trigger mode for Channel 2
Trigger Type	Edge/Pulse/Slope/Video	Set Edge/Pulse/Slope/Video Trigger as the trigger type
Set Up		To go to the Set Up menu

NOTE:

In Alternative Trigger, each channel is allowed to set the trigger mode independently.

The trigger setting of CH1 and CH2 are mutually independently. Please make attention to the **Channel** options.

Settings for Pattern Trigger (for VS5***D only)

Pattern trigger identifies trigger terms by checking appointed code. The code is logical relationship of all channels, with High (H), Low (L), Ignore (X), Rising and Falling.

Table 2-19 Pattern Trigger Settings

Function	Setting	Description
Defining	D15-D0	Choose digital channel for Pattern trigger
Pattern	H	High
	L	Low
	X	Ignore
	Rising	Rising
	Falling	Falling
Sweep	Auto	Acquire waveform even no trigger occurred
	Normal	Acquire waveform when trigger occurred
	Single	When trigger occurs, acquire one waveform and then stop
Set Up		To go to the Set Up menu

Key Points:

H (High): Logic high: Voltage is higher than threshold setting.

L (Low): Logic low: Voltage is lower than threshold setting.

X (Ignore): Don't care. If all the channels are ignored, the oscilloscope won't be triggered.

Edge of appointed code

Appoint one code as edge only. If an edge is appointed, then appointed another edge in a different channel and the first appointed edge will be set to X (Ignore).

Settings for Duration Trigger (for VS5***D only)

Trigger in appointed time when code terms are satisfied.

Table 2-20 Duration Trigger Settings

Function	Setting	Description
When	More than Less than Equal	Set time limit terms
Time		Set duration and limit symbol time

Key Points:

Qualifier: A timer begins when code terms are satisfied. Duration trigger occurs in the time set by the qualifier.

Trigger Set Up

In the trigger set up menu, set up different trigger settings according to different trigger modes. When in the mode of Edge and Pulse, the source is D15-D0 (for VS5***D only), only Holdoff is adjustable. When source is non-digital channel and in slope trigger, only trigger coupling, trigger sensitivity and Holdoff can be set. For video trigger, Sensitivity and Holdoff can be set. For Pattern trigger and Duration trigger (for VS5***D only), only Holdoff can be set. When in Alternative trigger, make different settings according to selected different trigger modes.

Table 2-21 (Settings for trigger coupling, trigger sensitivity and holdoff)

Function	Setting	Description
Coupling	DC	Allow all signals pass
	AC	Block DC signals
	HF Reject	Reject high frequency signals
	LF Reject	Reject DC and low frequency signals
Sensitivity		Set trigger sensitivity
Holdoff Time		Set time slot before another trigger event

Table 2-22 (Settings for sensitivity and holdoff)

Function	Setting	Description
Sensitivity	◀▶	Set trigger sensitivity
Holdoff	◀▶	Set time slot before another trigger event

Table 2-23 (Settings only for holdoff)

Function	Setting	Description
Holdoff	◀▶	Set time slot before another trigger event

Trigger Holdoff

Use Trigger Holdoff to stabilize a complex waveform, such as a pulse range. Holdoff time is the oscilloscope's waiting period before starting a new trigger. During Holdoff, oscilloscope will not trigger until Holdoff ends. For instance: To trigger on the first pulse on a group of them, users can set the holdoff time to Pulse cluster width.

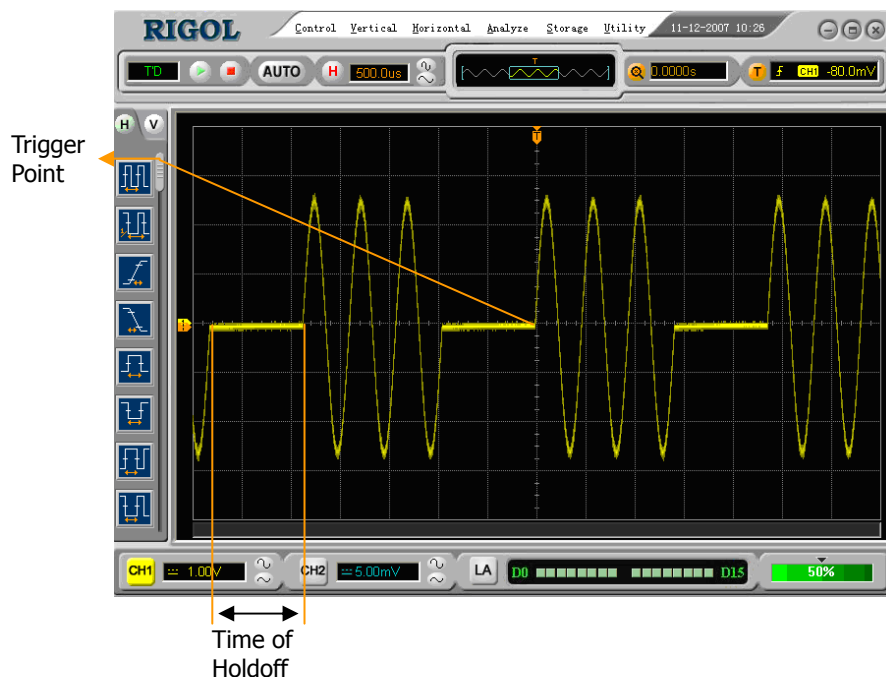

Figure 2-26 Trigger Holdoff

To use trigger Holdoff:

1. Turn on the Trigger window, and go to the Trigger functions Menu.
2. Click the left and the right arrow (◀▶) button to change Holdoff time until waveform is stable.
3. Click the circular button (◀▶) could reset the Holdoff time to its default value.

Trigger Key Points

1. Trigger Source:

Trigger occurs from several sources: Input channels (CH1, CH2 and D15-D0 (for VS5***D only)), AC Line, Ext, Ext/5.

- **CH1 or CH2:** It is the most commonly used trigger source. The channel will work when selected as a trigger source whatever displayed or not.
- **Ext Trig:** The instrument can be triggered from a third source while acquiring data from CH1 and CH2. For example, to trigger from an external clock or with a signal from another part of the test circuit. The Ext, Ext/5 trigger sources use an external trigger signal connected to the Ext Trig connector. It has a trigger level range of +1.2 V to -1.2 V. The Ext/5 trigger source attenuates the signal by 5X, which extends the trigger level range to +6 V to -6 V, allowing the oscilloscope to trigger on a larger signal.

2. Sweep Mode:

The sweep mode determines how the oscilloscope behaves in the absence of a trigger event. The oscilloscope provides three trigger modes: Auto, Normal, and Single.

- **Auto:** This sweep mode allows the oscilloscope to acquire waveforms even when it does not detect a trigger condition. If no trigger condition occurs while the oscilloscope is waiting for a specific period (as determined by the time-base setting), it will force itself to trigger.
When forcing invalid triggers, the oscilloscope cannot synchronize the waveform, and the waveform seems to roll across the display. If valid triggers occur, the display becomes stable on the screen.
Any factor results in the un-stability of waveforms can be detected by Auto Trigger, such as the output of power supply.

NOTE: When horizontal control is set more than 50 ms/div, Auto mode allows the oscilloscope to capture without trigger signal.

- **Normal:** The Normal mode allows the oscilloscope to acquire a waveform only when it is triggered. If no trigger occurs, the oscilloscope keeps waiting, and the previous waveform, if any, will remain on the display.

- **Single:** In Single mode, after pressing the RUN/STOP key, the oscilloscope waits for trigger. While the trigger occurs, the oscilloscope acquires one waveform and then stop.

3. Coupling:

Trigger coupling determines which signal component passed to the trigger circuit. Coupling types include AC, DC, LF Reject and HF Reject.

- **AC:** AC coupling blocks DC components.
- **DC:** DC coupling passes both AC and DC components.
- **LF Reject:** LF Reject coupling blocks DC component, and attenuates all signal with a frequency lower than 8 kHz.
- **HF Reject:** HF Reject coupling attenuates all signals with a frequency higher than 150 kHz.

4. Pre-trigger/delayed trigger:

The data collected before and after trigger.

The trigger position is typically set at the horizontal center of the screen. In the full-screen display 6 divisions data of pre-trigger and delayed trigger can be surveyed. More data (14div) of pre-trigger and 1s delayed trigger can be surveyed by adjusting the horizontal scale and offset.

This feature is very useful to study the events that led up to the trigger point. Everything to the right of the trigger point is called post-trigger information. The amount of delay range (pre-trigger and post-trigger information) depends on the sweep speed selected.

- **Adjustable trigger sensitivity**

To avoid the influence of noise from the environment and get the stable trigger, the trigger circuit has adopted stickiness. In VS5000 series, the stickiness is adjustable from 0.1div-1.0div, which means when it sets to 1.0div, the trigger circuit will not care any signal with peak-peak amplitude less than 1.0div, so as to avoid the influence of the noise.

To Set the Sampling System

The **Acquire** button in the **Horizontal** menu is used for sampling system setup.

Acquire setup button

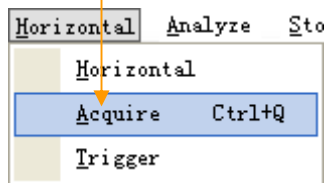

Figure 2-27
Choose the Acquire System

Click the **Acquire** button in the **Horizontal** menu, go to the **Acquire** window.

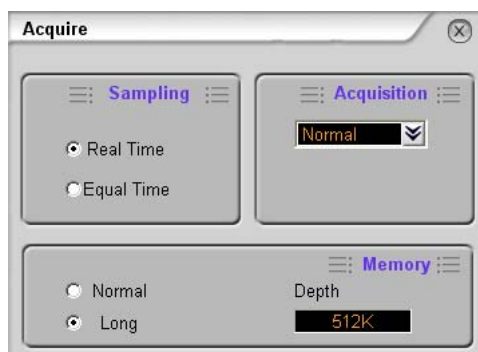

Figure 2-28
To Set the Acquire System

Table 2-24 Acquire System Settings

Function	Setting	Description
Sampling	Real Time Equal Time	Real-time sampling mode Equivalent sampling mode
Acquisition	Normal Average Peak Detect	Normal Acquisition mode Average Acquisition mode Peak Detect Acquisition mode
Averages	2 to 256	Step by multiple of two. Set average times from 2 to 256
Memory	Normal Long	Set up memory as 1k or 2k Set up memory as 512k or 1M

The waveform displayed on the screen will change in conjunction with the setting of the Acquire menu.

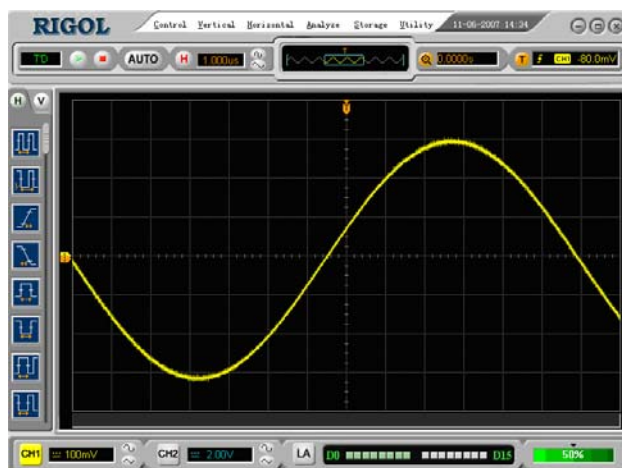

Figure 2-29
Signal that contains noise, and without average sampling

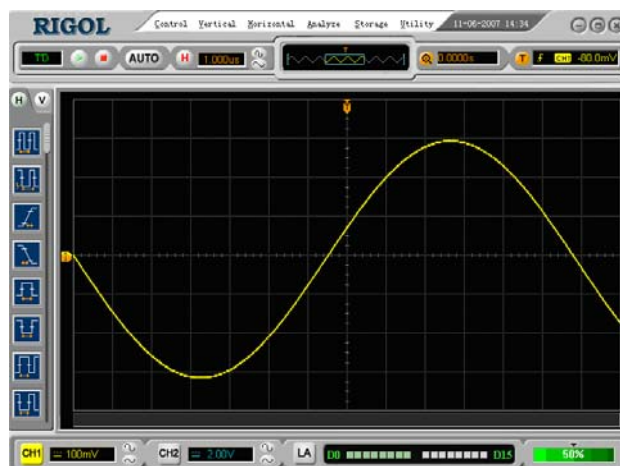

Figure 2-30
Signal after average sampling

NOTE:

- Select **Real Time** acquisition to observe the single-shot or pulse signals.
- Select **Equal Time** to observe high frequency repetitive signals.
- To reduce the displayed random noise, select the **Average** acquisition and this mode would make the waveform update slower.
- To avoid signal aliasing, select **Peak Detect** acquisition.

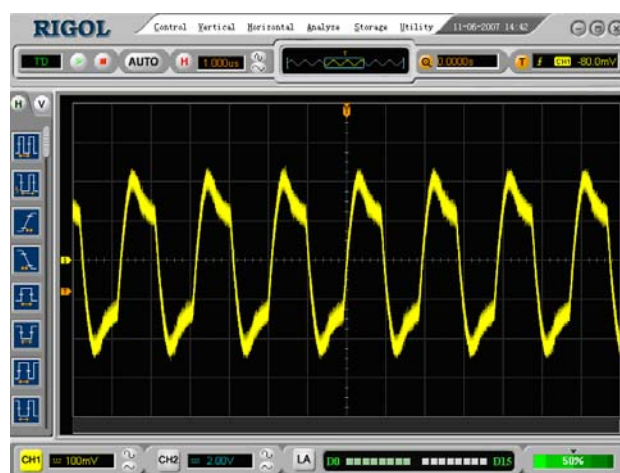

Figure 2-31
The Peak Detect Effect

Stop Acquisition: When the scope is acquiring waveforms, the waveforms are in live status; when acquisition is stopped, a frozen waveform will be displayed. The position and scale can still be adjusted by vertical control and horizontal control.

Key Points**Real-time Sampling:**

VS5000 has Real-time sampling rate up to 400MSa/s. At the time base 50ns or faster, the oscilloscopes use the sine(x)/x interpolation to expand the horizontal time base.

Equivalent sampling:

Known as Repetitive sampling to get up to 40 ps of horizontal resolution (equivalent 25Gsa/s). This mode is good for observing repetitive signals, and it is not recommended for single-shot or pulse.

Normal:

Oscilloscope acquires signal by equal time interval.

Average Acquisition:

Apply averaging to signal to remove uncorrelated noise and improve measurement accuracy. Reduces random or uncorrelated noise in the signal display. The averaged waveform is a running average over a specified number of acquisitions from 2 to 256.

Peak Detect:

Peak Detect mode captures the maximum and minimum values of a signal. Finds highest and lowest record points over many acquisitions.

To Save/Load and Print Setup

Click the **Storage** button to get into the **Save/Load** and **Print** options.

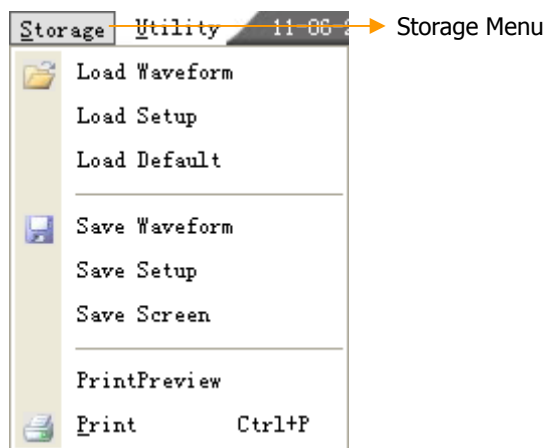

Figure 2-32
The Storage Menu

Use this menu to:

- Save and load the waveform,
- Load default setting,
- Save screen as a .bmp or .JPG file.

Table 2-25 Storage Functions

Function	Setting	Description
Load	Load Waveform Load Setup Load Default	Load the waveform that had saved Load the instrument that had saved Load the instrument default settings
Save	Save Waveform Save Setup Save Screen	Save the current waveform Save the current instrument settings Save the PC software window as a .bmp or .jpg file
Print	PrintPreview Print	Preview the waveform Print setting and do the print operation

1. Save/Load Window

Click the **Load/Save** button in the **Storage** menu.

Table 2-26 The Save/Load Functions

Function	Setting	Description
Open/Save		Open/Save the file that is selected
Window comments		Select folder in the Folder window Select file in the File window Input the file name in the File Name window Select the file type in the File Type
Cancel		Cancel the current operation
Keyboard		Use the soft-keyboard input the file name

An example with the **Open File** window:

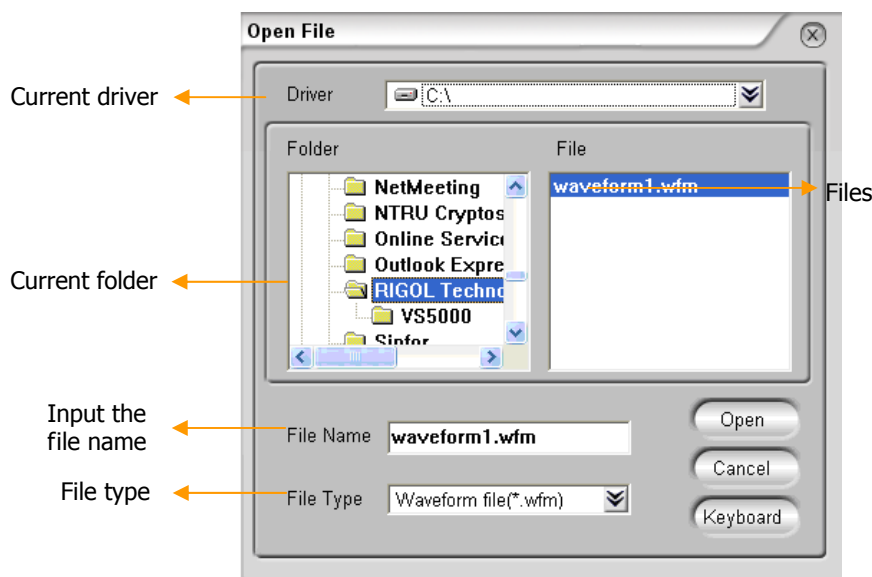

Figure 2-33
Open a Waveform File

2. Load Default

The oscilloscope has default settings and can be recalled at anytime by user.

3. Files location

Specify the files location to save/load the waveform and setup.

4. Load

Recall saved waveform, setup and default settings.

5. Save

Save waveform, setups and screen.

NOTE:

Select **Save Waveform** stores the waveforms, and the current settings of the oscilloscope

6. Print Settings

Set the printer to print the current waveform.

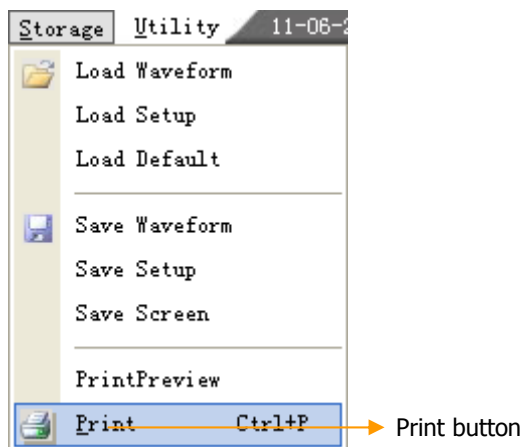

Figure 2-34 The Print Menu

Table 2-27 The Print Functions

Function	Setting	Description
PrintPreview		Preview the waveform which current will be print
Print		Print the current waveform

1. PrintPreview

Click the **PrintPreview** button to get into the Preview window.

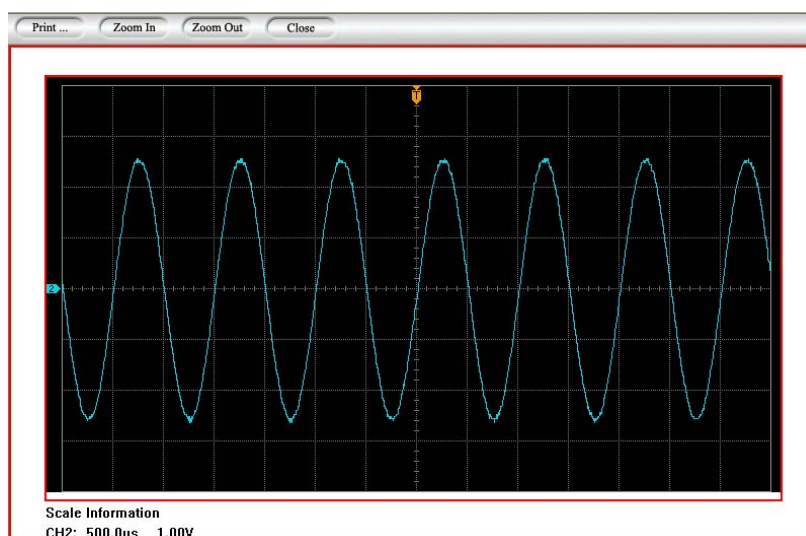

Figure 2-35 Print Preview

In this window, use the **Zoom In** and the **Zoom Out** to change the size of the waveform graph.

Click the **Close** button to turn this window off.

2. Print

Click the **Print** button to get into the **Print Setup** window.

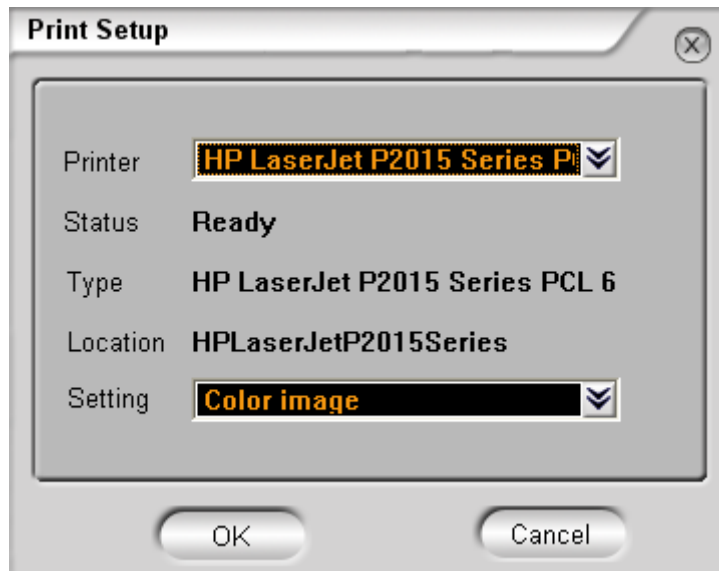

Figure 2-36
The Print Interface

In the **Printer** option select the document to print, and then click **OK** to execute printing operation.

To Set the Measurement Function

The Measure functions are in the **Analyze** menu; to do **Horizontal Measure** and **Vertical Measure**, or to use shortcut buttons to perform measurement operations.

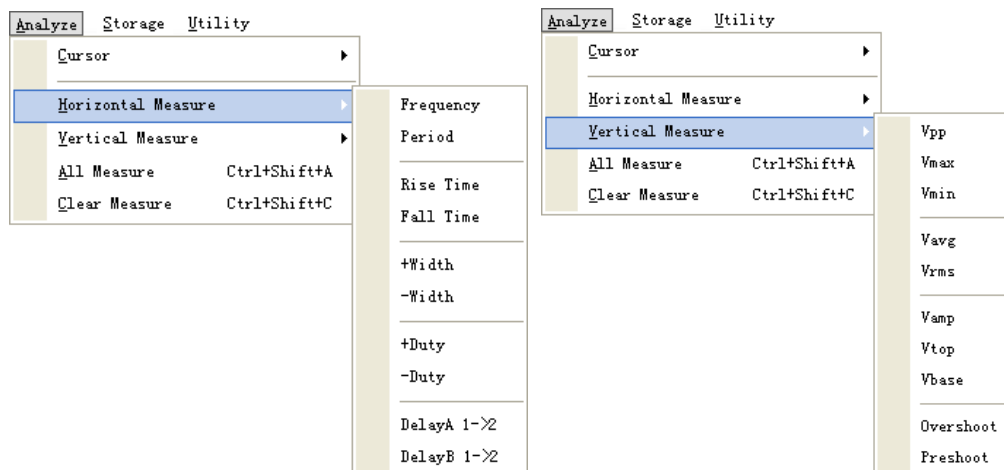

Figure 2-37
Choose the Measurement Menu

Menu explanation:

The oscilloscopes provide 20 parametric auto measurements (10 voltage and 10 time measurements):

- Vpp, Vmax, Vmin, Vtop, Vbase, Vamp, Vavg, Vrms, Overshoot, Preshoot.
- Frequency, Period, Rise Time, Fall Time, +Width, -Width, +Duty, -Duty, Delay1-2 f , Delay1-2 t .

1. Shortcuts for Horizontal Measurements

Figure 2-38 Table 2-28 Horizontal Measurement Functions

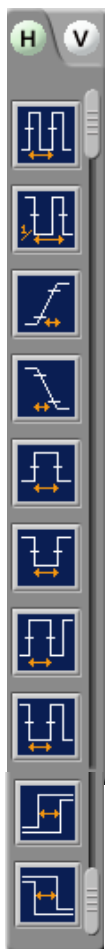

Function	Setting	Description
Period		Measure Period of a waveform
Frequency		Measure Frequency of a waveform
Rise time		Measure Rise Time of a rising edge
Fall time		Measure Fall Time of a falling edge
+Width		Measure +Pulse Width of a pulse wave
-Width		Measure -Pulse Width of a pulse wave
+Duty		Measure +Duty Cycle of a pulse wave
-Duty		Measure -Duty Cycle of a pulse wave
Delay1→2f		Measure the signals delay between two channels at the rising edge
Delay1→2τ		Measure the signals delay between two channels at the falling edge

Drives the automatic measurement shortcut enter the main display interface, starts this automatic measurement.

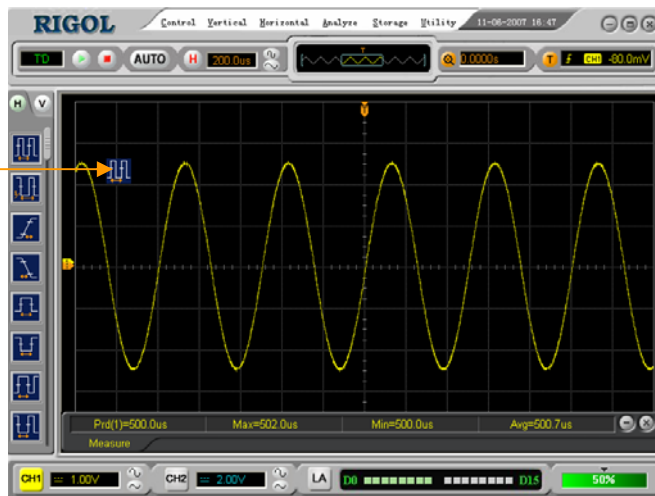



Figure 2-39 Quickly Measurement

2. Shortcuts for Vertical measurements

Figure 2-40 Table 2-29 Vertical Measurement Functions



Function	Setting	Description
Vmax		Measure maximum voltage of a waveform
Vmin		Measure minimum voltage of a waveform
Vpp		Measure Peak-to-Peak voltage
Vtop		Measure a top voltage of a waveform
Vbase		Measure a base voltage of a waveform
Vamp		Measure voltage between Vtop and Vbase
Vavg		Measure average voltage of a waveform
Vrms		Measure Root Mean Square Voltage of a waveform
Overshoot		Measure overshoot in percentage of an edge
Preshoot		Measure preshoot in percentage of an edge

NOTE: The results of the automatic measurements will be displayed on the bottom of the screen. Maximum 3 results could be displayed at the same time. When there is no room, the next new measurement result will make the previous results moving left, out of screen.

Apply Automatic Measurement as the following steps:

1. Select the signal channel for measuring, select CH1 or CH2 according to the signal of interest.
2. To see all the measurement values, click **All Measure** in the **Analyze** menu, 18 measurement parameters will be displayed on the screen.
3. Get the measured value on the screen; select the parameters of interest by clicking the correspond button, and read the data on the bottom of the screen.
4. To Clear the measure values; click **Clear Measure**, and all auto measured values disappear from the screen.

The Automatic Measurement of Voltage Parameters

The VS5000 series oscilloscopes provide automatic voltage measurements: V_{pp} , V_{max} , V_{min} , V_{avg} , V_{amp} , V_{rms} , V_{top} , V_{base} , Overshoot and Preshoot. Figure 2-41 below shows a pulse with some of the voltage measurement points.

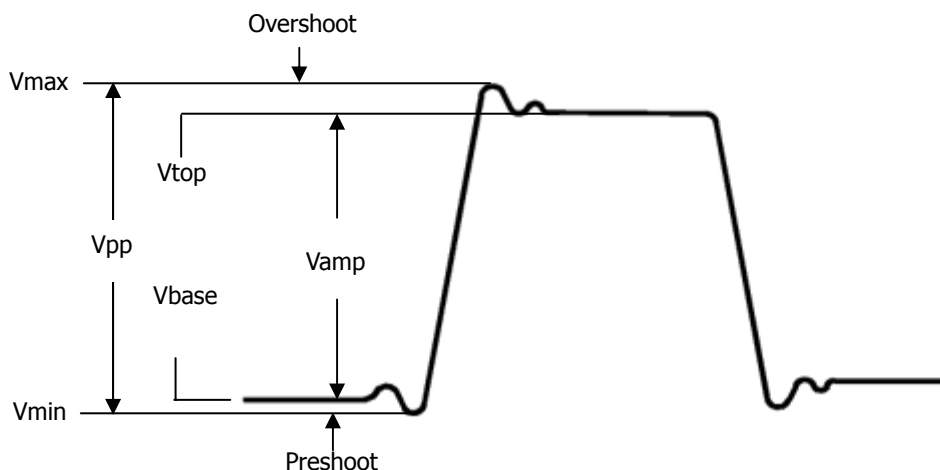

Figure 2-41 Definition of Voltage Parameters

V_{pp} : Peak-to-Peak Voltage.

V_{max} : The maximum amplitude. The most positive peak voltage measured over the entire waveform.

V_{min} : The minimum amplitude. The most negative peak voltage measured over the entire waveform.

V_{amp} : Voltage between V_{top} and V_{base} of a waveform

V_{top} : Voltage of the waveform's flat top, useful for square/pulse waveforms.

V_{base} : Voltage of the waveform's flat base, useful for square/pulse waveforms.

Overshoot: Defined as $(V_{max}-V_{top})/V_{amp}$, useful for square and pulse waveforms.

Preshoot: Defined as $(V_{min}-V_{base})/V_{amp}$, useful for square and pulse waveforms.

Average: The arithmetic mean over the entire waveform.

V_{rms} : The true Root Mean Square voltage over the entire waveform.

The Automatic Measurement of Time Parameters

VS5000 series oscilloscopes provide automatic timing parameters measurements; Frequency, Period, Rise Time, Fall Time, +Width, -Width, Delay 1→2 \uparrow , Delay 1→2 \downarrow , +Duty and -Duty.

Figure 2-42 shows a pulse with some of the time measurement points.

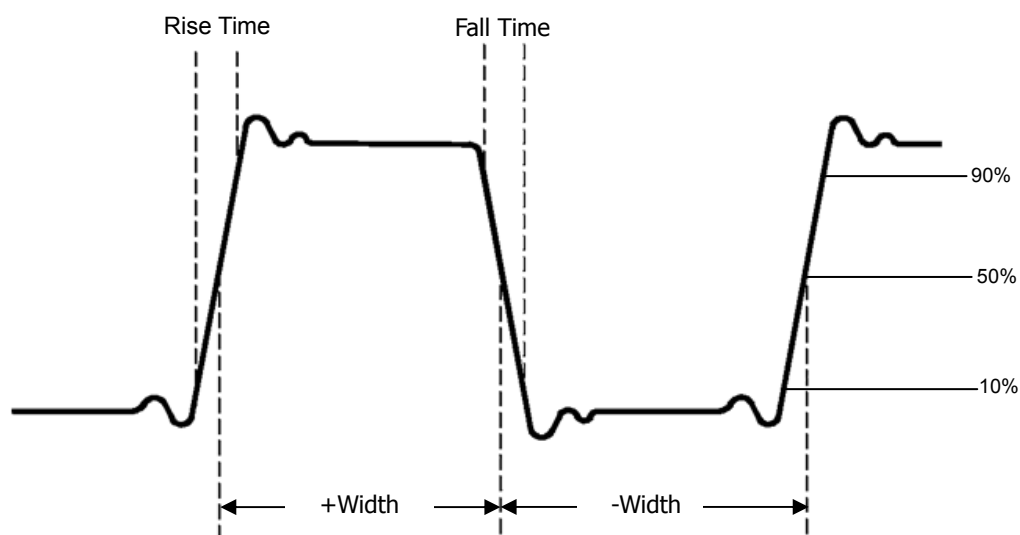

Figure 2-42 Definition of Time Parameters

Rise Time: Time that the rising edge of the first pulse in the waveform takes to rise from 10% to 90% of its amplitude.

Fall Time: Time that the falling edge of the first pulse in the waveform takes to fall from 90% to 10% of its amplitude.

+Width: The width of the first positive pulse in 50% amplitude points.

-Width: The width of the first negative pulse in the 50% amplitude points.

Delay 1→2 \uparrow : The delay between the two channels at the rising edge.

Delay 1→2 \downarrow : The delay between the two channels at the falling edge.

+Duty: +Duty Cycle, defined as +Width/Period

-Duty: -Duty Cycle, defined as -Width/Period

To Measure with Cursor Measurements

Click the **C**ursor button in the **A**nalyze menu to select the Cursor functions.

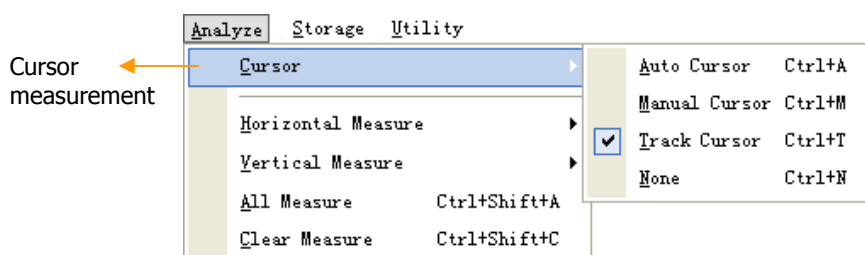

Figure 2-43

Choose the Menu of Cursor Measurement

The Cursor measurement has three modes: Auto Measure, Manual and Track.

Auto Measure:

This mode will take effect with Automatic Measurements. The instruments will display cursors while measuring parameters automatically. These cursors demonstrate the physical meanings of these measurements.

Manual:

In this mode, the screen displays two parallel cursors. Move the cursors to make custom voltage or time measurements of the signal. The values are displayed on the boxes below the menu. Before using cursors, make sure that to set the Signal Source as the channel for measuring.

Track:

In this mode, the screen displays two cross cursors. The cross cursor sets the position on the waveform automatically. Adjust the horizontal position of cursor on the waveform by click the  button or drag the cursor on the screen. The oscilloscope displays the values of the coordinates on the boxes below the menu.

NOTE: The Auto Measure mode for Cursor measuring will take no effect without automatic measurements.

Comments of Cursor Measurements

1. Auto Cursor Mode:

Table 2-30 Auto Cursor Measurement

Function	Setting	Description
Mode	Auto	Display the cursors for the current automatic measuring. (See the following figure)

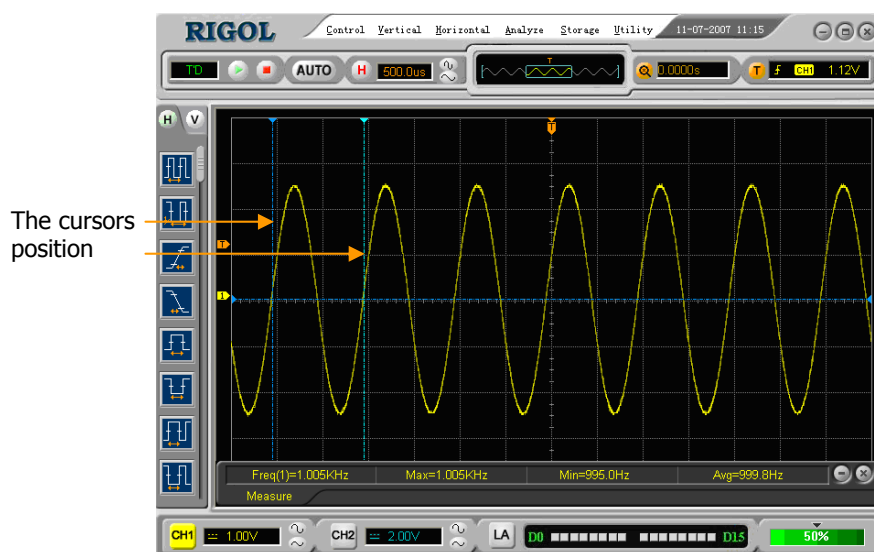

Figure 2-44
Auto Measure Mode of Cursor Measurement

There will be no cursor display if no parameter is chosen in the **Measure** menu. The oscilloscope could move cursor automatically to measure 20 parameters in the **Measure** menu.

2. Manual Cursor Mode

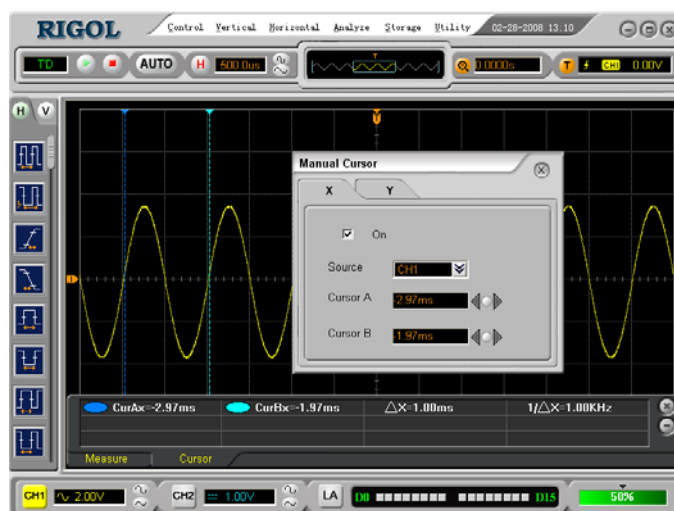

Figure 2-45
Manual Measure Mode of Cursor Measurement

Table 2-31 Manual Cursor Measurement

Function	Setting	Description
Type	X	Shown as vertical line to measure the horizontal parameters
	Y	Shown as horizontal line to measure the vertical parameters
Source	CH1 CH2 MATH (1, 2, 3 and 4) LA	Select the measurement signal source. (LA is applicable for VS5***D only)

In this mode, the oscilloscope measures the Y or X coordinate values of the cursors, and the increments between the two cursors.

Please do as the following steps:

- 1) Select the **Manual Cursor** mode for cursor measurement; click the buttons as: **Analyze** → **Cursor** → **Manual Cursor**.

- 2) Select channel **Source** for measurements, click the buttons as:
Source → CH1, CH2, MATH (1, 2, 3 and 4) or LA (for VS5***D only).
- 3) Select the Cursor type by clicking the appropriate buttons; in the Manual Cursor window, there are X and Y operation windows to select the cursor type.
- 4) Move the cursors to adjust the increment between the cursors: (Details in the following Table)

Table 2-32 Definition of the Manual Cursors

Increment	Cursor	Operation
X	Cursor A Cursor B	Click the ◀▶ button to adjust the cursor A and B horizontally.
Y	Cursor A Cursor B	Click the ◀▶ button to adjust the cursor A and B vertically.

NOTE: Cursor could be moved only when the cursor function menu is displayed.

- 5) To get measurement values:
 - Position of Cursor 1 (time cursor centered on the midpoint of screen; Voltage cursor centered on channel ground level).
 - Position of Cursor 2 (same as above).
 - Horizontal space between cursor 1 and 2 (ΔX): Time between cursors ($1/\Delta X$), units in Hz, kHz, MHz, GHz.
 - Vertical space between cursor 1 and 2 (ΔY): Voltage between cursors.

If the source is LA (for VS5***D only), the measurement value is as follows:

- Position of Cursor 1 (time cursor centered on the midpoint of screen).
- Position of Cursor 2 (time cursor centered on the midpoint of screen).
- Cursor 1 value: Hex.
- Cursor 1 value: Binary.
- Cursor 2 value: Hex.
- Cursor 2 value: Binary.

NOTE: The values will be automatically displayed on the right upper corner of screen when the cursor function menu is hidden or displaying other menus.

Key Points

Cursor Y: Cursors Y appears as horizontal lines on the display to measure the vertical parameters. Usually it is used to measure the Volts. When the source is set as function, the units are assigned to the function.

Cursor X: Cursors X appears as vertical line on the display and measure the horizontal parameters. Usually it indicates the time of trigger excursion. When the source is set as FFT, X means frequency.

3. Track Cursor Mode

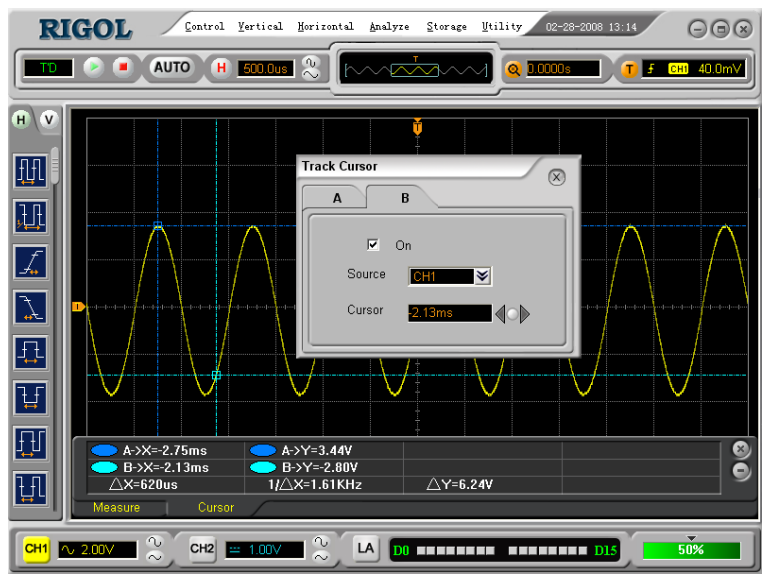

Figure 2-46
Interface of Track Cursor Measurement

Table 2-33 Track Cursor Measurement Functions

Function	Setting	Description
On/Off		Turn the Cursor A or B on/off.
Cursor A	CH1 CH2	Set Cursor A in conjunction with CH1 or CH2. Adjust the cursor A horizontally.
Cursor B	CH1 CH2	Set Cursor B in conjunction with CH1 or CH2. Adjust the cursor B horizontally.



In cursor track mode, the cursor A and cursor B move together with the selected waveform.

Please do as the following steps:

- 1) Select the **Track Cursor** mode for cursor measurement; click the buttons as follows: **Analyze** → **Cursor** → **Track Cursor**.
- 2) Select channel **Source** for measurements; click the buttons as follows: **Source** → **CH1** or **CH2**.

- 3) Move the cursors to adjust the increment between the cursors: (Details in the following Table)

Table 2-34 Definition of the Track Cursor

Cursor	Operation
A (cursor A)	Click the  button to adjust the cursor A horizontally.
B (cursor B)	Click the  button to adjust the cursor B horizontally.

NOTE: Moving cursor horizontally is not allowed when other (not tracking cursor) menu is activated.

- 4) To get measurement values:
- Position of Cursor 1 (Time cursor centered on the midpoint of screen; Voltage cursor centered on channel ground level).
 - Position of Cursor 2 (Time cursor centered on the midpoint of screen; Voltage cursor centered on channel ground level).
 - Horizontal space between cursor 1 and 2 (ΔX): Time between cursors, units in Second, ($1/\Delta X$), units in Hz, kHz, MHz, GHz.
 - Vertical space between cursor 1 and 2 (ΔY): Voltage between cursors, units in V.

NOTE:

Cursor A and B can be dragged on screen.

To Set the Utility Function

Click the **Utility** button to get into the Utility menu.

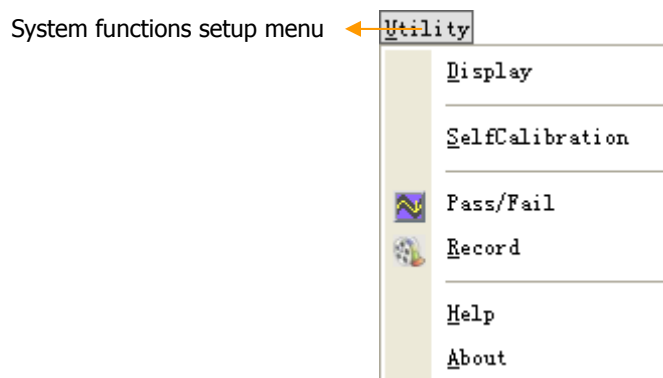

Figure 2-47 The Menu of Utility

Click the **Utility** button to show the menu of the settings of in the Utility system.

Table 2-35 Utility Functions

Function	Setting	Description
Display		Set the display functions
Self Calibration		Execute Self Calibration
Pass/Fail		Setup Pass/Fail test
Record		Setup waveform Record
Help		Get the help of VS5000 series
About		Get the instrument information of this VS5000

NOTE:

Self Calibration: Oscilloscope will calibrate parameters of the vertical system (CH1, CH2, and Ext), the horizontal system and the trigger system.

The Display Setup

Click the **Display** button in the **Utility** menu, to show the **Display** window.

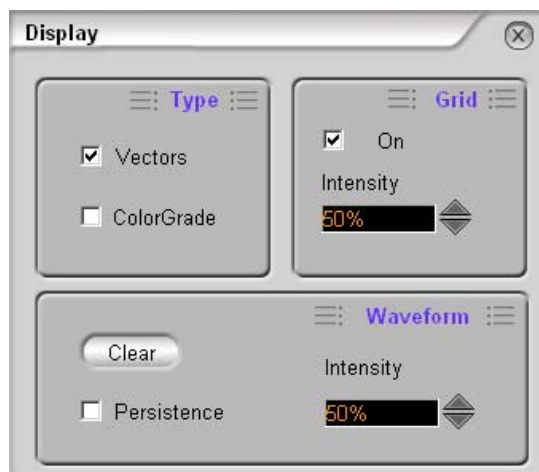

Figure 2-48
Display Setting Interface

Table 2-36 Display Setting

Function	Setting	Description
Type	Vectors Color Grade	Display waveforms as vectors or dots Use color express the density of dots
Grid	On/Off Intensity	Turn the grids On or Off Adjust brightness of the grids
Waveform	Persistence Intensity	The sample points remain displayed until turn the persistence "OFF" or click the Clear button Adjust brightness of the persistence waveform

Self Calibration

The Self Calibration adjusts the internal circuitry to get the best accuracy. Use these functions to calibrate the vertical and horizontal systems.

For maximum accuracy at any time, run this calibration if the ambient temperature changes by 5°C or more.

Before running this procedure, do these steps:

1. Disconnect any probes or cables from all channel inputs, otherwise failure or damage to the oscilloscope may occur.
2. Click the **Self Calibration** button in the **Utility** menu.



Figure 2-49
Self Calibration Interface

NOTE:

The oscilloscope must have been working or warm-up **at least 30-minutes** before running self-calibration to get best accuracy.

Pass/Fail

The Pass/Fail function monitors changes of signals and outputs pass or fail signals by comparing the input signal with the pre-defined mask.

Click the **Pass/Fail** button in the **Utility** menu to show the **Pass/Fail Setup** window.

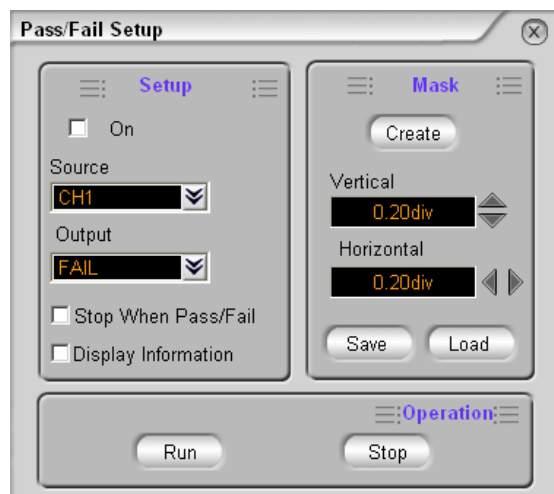

Figure 2-50
Pass/Fail Setting Interface

Table 2-37 Pass/Fail Settings

Function	Setting	Description
On	Off/On	Turn off or on the Pass/Fail test
Source	CH1 CH2	Select Pass/Fail test on CH1 Select Pass/Fail test on CH2
Output	FAIL FAIL+BEEPER PASS PASS+BEEPER	Output when Fail condition detected Output and beep when Fail condition detected Output when Pass condition detected Output and beep when Pass condition detected
Stop When Pass/Fail	Off/On	Continue test when output occurs Stop test when output occurs
Display Information	Off/On	Turn the Pass/Fail information off or on

Mask Setting

Use the operations in **Setup** and **Mask** windows to set the Pass/Fail mask.

Table 2-38 Mask Settings

Function	Setting	Description
Create		Create a Pass/Fail mask as the following Vertical and Horizontal settings
Vertical		Set vertical clearance to the waveform (0.04div-4.00div)
Horizontal		Set horizontal clearance to the waveform (0.04div-4.00div)
Save		Save this Pass/Fail mask as a file
Load		Load a Pass/Fail mask file

Table 2-39 Operation Settings

Function	Setting	Description
Run		Start the Pass/Fail function
Stop		Stop the Pass/Fail function

NOTE: Pass/Fail function is unavailable in X-Y mode.

Waveform Record

Waveform recorder records input waveform from CH1, CH2 and Pass/Fail Out with a maximum record length of 1000 frames. This performance can also be activated by the Pass/Fail test output, which makes this function especially useful to capture abnormal signals in long term without keeping an eye watching it.

Click the **Record** button in the **Utility** menu.



Figure 2-51
Waveform Recording Interface

Waveform recorder: Record the waveforms with specified interval.

Table 2-40 Waveform Recording Functions

Function	Setting	Description
Record Setup	Select Source	Select record source channel
	Max Frames	Set number of record frames, the max frames are 1000
	Save Path	Set save path of the Record file
Play Setup	Time Interval	Set time interval between record frames
	Play Path	Set play path of the Record file

To Use Run Control Buttons

The Run Control buttons include **AUTO** and .

AUTO:

The **AUTO** features automatic adjustments to produce a stable display of the input signal.

Auto-set functions

After the **AUTO** button is clicked the oscilloscope is configured to the following defaults:

Table 2-41 Auto-set Functions

Function	Setting
Display format	Y-T
Acquire mode	Normal
Vertical coupling	Adjust to AC or DC according to the signal.
Vertical "V/div"	Adjusted
Volts/Div	Coarse
Bandwidth limit	Full
Signal Invert	OFF
Horizontal position	Center
Horizontal "S/div"	Adjust to right position
Trigger type	Edge
Trigger source	Find the channel with input signal automatically.
Trigger coupling	DC
Trigger voltage	Midpoint setting
Trigger mode	Auto
 POSITION knob	Trigger offset



Run or Stop waveform acquiring.

NOTE:

In STOP status, the volts/div and horizontal time base can be adjusted in a fixed limit, to zoom in/out the signal in vertical and horizontal directions.

Chapter 3 Application Examples

Example 1: Taking Simple Measurements

The function is used to observe an unknown signal, to display, and to measure the frequency, and the peak-to-peak amplitude.

To quickly display a signal, please do the steps as follows:

1. Set the probe and the channel attenuations to 1:10
2. Connect signal to CH1 with the probe
3. Click the **AUTO** button

The oscilloscopes set the vertical, horizontal, and trigger controls at the best status automatically. To optimize the waveform display, adjust these controls manually to meet the requirements.

Selecting Automatic Measurements

The oscilloscope does automatic measurements on most signals. To measure the frequency and the peak-to-peak amplitude, do these steps as follows:

1. Measure peak-to-peak amplitude
 - 1) Click the **Analyze**→**Vertical Measure**→**Vpp** buttons, or drag the Vpp shortcut  into the waveform display interface.
 - 2) When more than one channel has turned on, click the **Vpp** button, the **Auto Measurement** window will show. In this window set the Source of the measurement function. In similar situation, drag the measurement shortcut on the waveform, the measurement function for this channel will turn on.
2. Measure frequency.
 - 1) Click the **Analyze**→**Horizontal Measure**→**Frequency** buttons or drag the



frequency shortcut  into the waveform display interface.

- 2) When more than one channel has turned on, click the **Frequency** button, the **Auto Measurement** window will show. In this window set the Source of the measurement function. In similar situation, drag the measurement shortcut on the waveform, the measurement function for this channel will be turned on.

Example 2: View a Signal Delay Caused by a Circuit

This example is to test the input and output signals of a circuit and observe the signal delay. First, set the probe and the channel attenuation to 10X and connect CH1 probe to the input, CH2 to the output of the circuit.

Do these steps as follows:

1. Display the signals (CH1 and CH2):
 - 1) Click the **AUTO** button.
 - 2) Click the **Horizontal** button in the **Horizontal** menu to adjust the horizontal scale and offset of the CH1 and CH2.
 - 3) Right-click the **CH1** or the **CH2** button to adjust the vertical scale and offset of the CH1 and CH2.
2. Measure the delay time when a signal going through the circuit.
 - 1) Auto-measuring the delay:
Click the **Analyze** → **Horizontal Measure** → **DelayA 1→2** buttons, the Auto Measurement window will show. It allows selecting the **Source** to CH1.
 - 2) Observe the change of the waveform in the following figure:

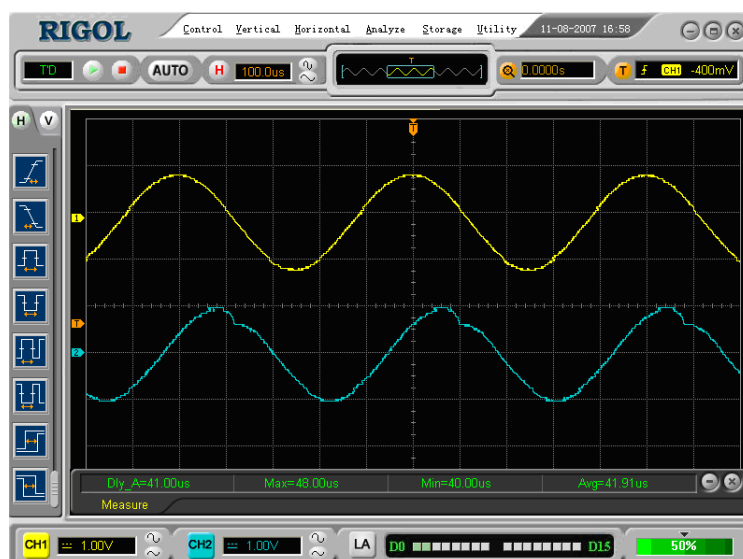





Figure 3-1
Delay of the signals

Example 3: Capture a Single-Shot Signal

To capture a single event, it needs to gather some pre-test knowledge of the signal in order to set up the trigger level and slope correctly. For example, if the event is derived from TTL logic, a trigger level of 2 Volts should work on a rising edge.

Do these steps as follows:

1. Set the probe and the channel attenuations to 1:10.
2. Set up the trigger.
 - 1) Click the  button to show the **Trigger** window.
 - 2) Adjust the trigger Mode to **Edge**. Set the Source to **CH1** and the Slope to **Rising**. Set the Sweep type to **Single**.
 - 3) Adjust the Volts/Div and the time base in a proper range for the signal
 - 4) Set the trigger in the **Setting** window of the **Trigger** window, or drag the trigger level sign on the waveform display screen.
 - 5) Click the  button to start capturing. When the trigger conditions are met, data appears on the display representing the data points that the oscilloscope obtained with one acquisition.

This function helps to capture the signal occurrence easily, such as the noise with large amplitude; set the trigger level higher a little above the normal level and press the  and wait. When noise occurs, the instrument will record the waveform before and after the trigger.

Example 4: To Reduce the Random Noise on a Signal

If the signal is noisy (Figure 3-2), set up the oscilloscope to reduce the noise on the waveform and to avoid its interference to the signal itself.

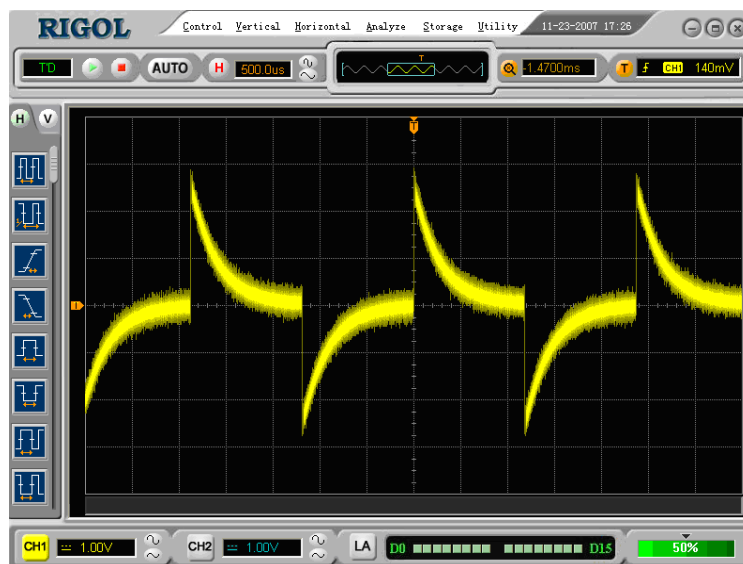

Figure 3-2
Signal with Random Noise

Do these steps as follows:

1. Set the probe and the channel attenuations to 1:10.
2. Connect a signal to the oscilloscope and obtain a stable display.
3. Improve the trigger by setting the Coupling.
 - 1) Click the **T** button to show the **Trigger** window.
 - 2) Select the **Coupling** function to **LF Reject** or **HL Reject**.

LF Reject (Low frequency rejects) adds a high pass filter with the -3 dB cutoff point at 8 kHz. Use LF Reject to remove low frequency signals such as power line noise from the trigger path.

HF Reject (High frequency rejects) adds a low pass filter with the -3 dB cutoff point at 150 kHz. Use HF Rejects to remove high frequency noise such as AM or FM broadcast stations from the trigger path.

4. To reduce the noise by setting the acquisition type and adjust the waveform intensity.
 - 1) If there is noise within the signal and the waveform looks too wide, in this case, choose average acquisition. In this mode the waveform will be thin and easy to observe and measure.

To use average follow these steps.

Click the **Horizontal** → **Acquire** buttons to show the **Acquire** window. Select the acquisition to **Average**. Select the number of averages that best eliminates the noise from the displayed waveform. It can be adjusted from Figure 2-28.

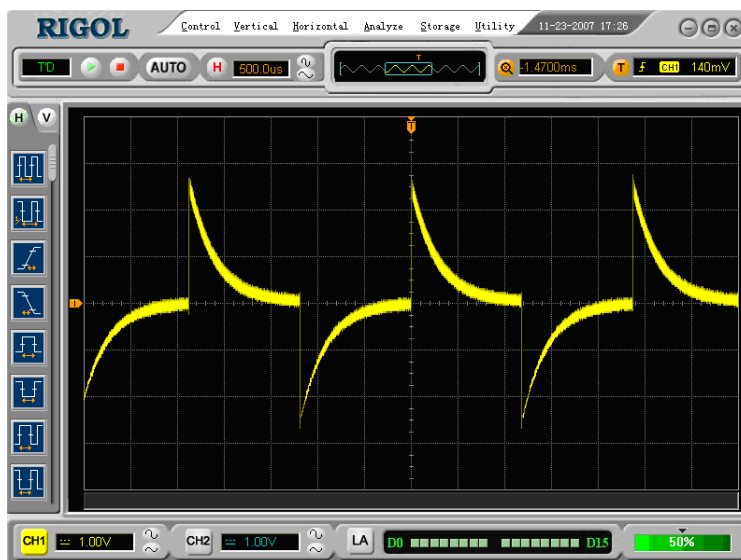

Figure 3-3
Signal after Reducing Random Noise

- 2) To reduce the noise it can also be achieved by reduce the intensity of the waveform.

NOTE:

It is normal that the waveform update rate will slow down when the average acquisition mode is turned on.

Example 5: Making Cursor Measurements

There are 20 built-in automatic measurements. They can also be conducted using cursors to make time and voltage measurements on a waveform quickly.

Measure the Peak Frequency of the First Sinc Waveform

To measure the frequency at the rising edge of a signal, do these steps:

1. Click the **Analyze** → **Cursor** → **Manual Cursor** buttons to show the Manual Cursor window.
2. Click to turn on cursor X () .
3. Drag the cursor A on the first peak of the wave.
Drag the cursor B on the second peak of the wave.



Figure 3-4
Measure the Peak Frequency

Read the deltas in time and frequency.

Measure the Amplitude of the First Waveform Peak of the Sinc.

Please follow these steps:

1. Click the **Analyze** → **Cursor** → **Manual Cursor** buttons to show the Manual Cursor window.
2. Click to turn on cursor Y ()
3. Drag the cursor A to the first peak of the wave.
Drag the cursor B to the second peak of the wave.

Read the following measurements in the cursor menu: (See Figure 3-5)

- The delta voltage (peak-to-peak voltage of the waveform)
- The voltage at Cursor 1
- The voltage at Cursor 2

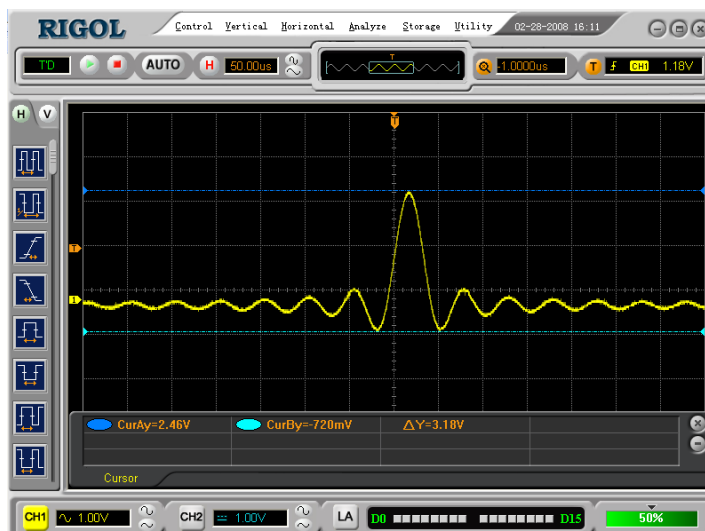





Figure 3-5
Measure the Peak Amplitude

Example 6: The Application of the X-Y Operation

Viewing Phase Changes through a Circuit Network

Connect the oscilloscope to monitor the input and output of the circuit and capture the phase changes.

To view the input and output of the circuit in an X-Y display, do these steps:

1. Set the probe attenuation to 1: 10. Set the switch to 10X on the probes.
2. Connect the CH1 probe to the input of the circuit, and connect the CH2 probe to the output of the circuit.
3. If the channels are not displayed, click the , and the  buttons.
4. Click the  button.
5. Adjust the vertical scale and offset to display approximately the same amplitude signals on each channel
6. Go to the **Horizontal** window.
7. Select **X-Y** mode.
The oscilloscope displays a Lissajous pattern representing the input and the output characteristics of the circuit.
8. Adjust the scale and offset of the horizontal and vertical to a desirable waveform display.
9. Apply the Ellipse method to observe the phase difference between the two channels.

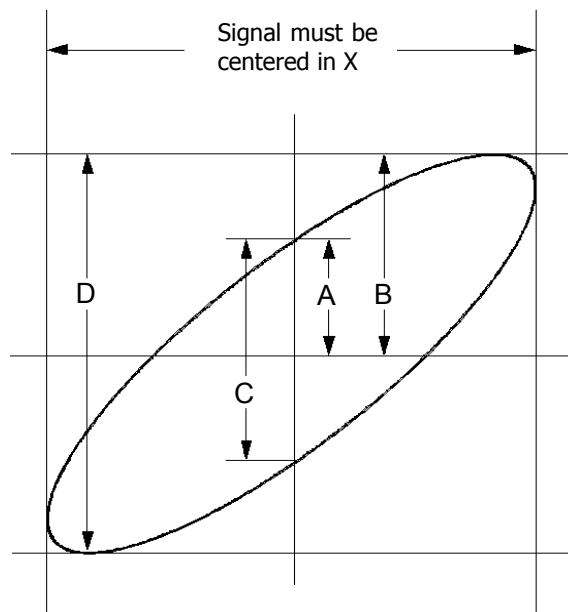

Figure 3-6
Instruction of the Ellipse Method

$\sin\theta = A/B$ or C/D , where θ = phase shift (in degrees) between the two signals.
From the formula above:

$$\theta = \pm \arcsine (A/B) \text{ or } \pm \arcsine (C/D)$$

If the main axis of the ellipse is at I and III quadrant, θ must be in the range of $(0 \sim \pi/2)$ or $(3\pi/2 \sim 2\pi)$. If the main axis is at II and IV quadrant, θ must be in the range of $(\pi/2 \sim \pi)$ or $(\pi \sim 3\pi/2)$.

Example 7: Triggering on a Video Signal

Test a video circuit in the DVD set. Use video trigger to obtain a stable display.

Triggering on Video Fields

To trigger on the video fields, please do as the following steps:

1. Click the **T** button, go to the **Trigger** menu.
2. Select **Advanced** → **Video** in **Mode** window.
3. Select the **Source** to **CH1** in the **Setting** window.
4. Select the **Polarity** to **U** in the **Setting** window.
5. Select the **Sync** to **Odd Field** or **Even Field** in **Setting** window.
6. Adjust trigger level at the video sync pulse to get a stable trigger.
7. Adjust the horizontal scale to see a complete waveform on the screen.

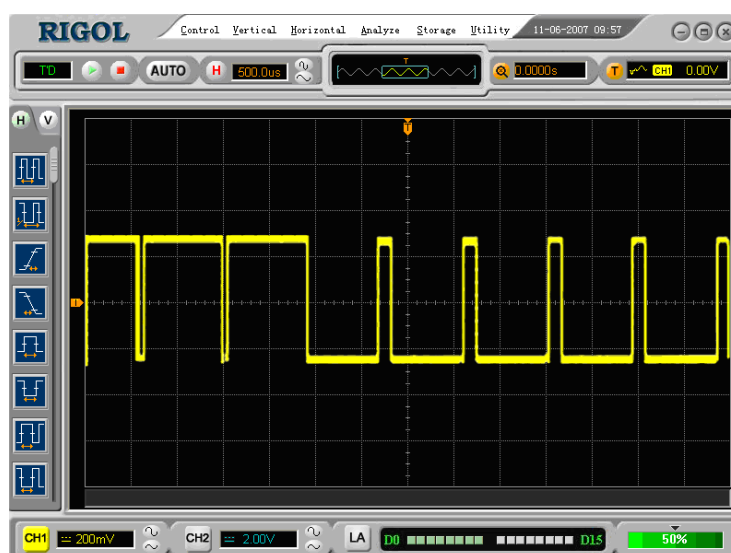

Figure 3-7
Triggering on Video Fields

VS5000 series triggers on the Odd field or Even field. To avoid confusion when Odd field and Even field trigger simultaneously, choose either Odd Field or Even Field as in Step 5 above.

Triggering on the Video Lines

To trigger on the video lines, do the following steps:

1. Click the **T** button to show the **Trigger** menu.
2. Select **Advanced** → **Video** in the **Mode** window.
3. Select the **Source** to **CH1** in the **Setting** window.
4. Select the **Polarity** to **U** in the **Setting** window.
5. Select the **Sync** to **Line Number** in the **Setting** window.
6. Set the line number in **Line** function with the **◀▶** button.
7. Adjust the trigger level at the video sync pulse to get a stable trigger.
8. Adjust the horizontal scale to see a complete waveform on the screen.

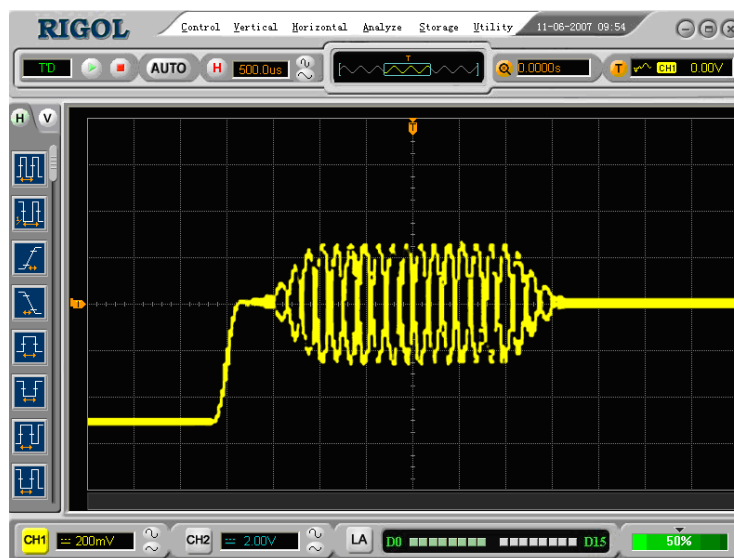

Figure 3-8
Triggering on the Video Lines

Example 8: FFT Cursor Measurement

FFT measurements include: Amplitude measurement (Vrms or dBVrms) and the Frequency measurement (Hz).

Do these steps as follow:

1. Click the **Analyze** → **Cursor** → **Manual Cursor** button to show the **Manual Cursor** window.
2. Turn **X** or **Y** option on, select the cursor type to X or Y.
3. Select the **Source** to **MATH1** (FFT operation) in the **Manual Cursor** window.
4. Drag the Cursor to the point of interest.



Figure 3-9
FFT Measurement (Cursor Type Y)

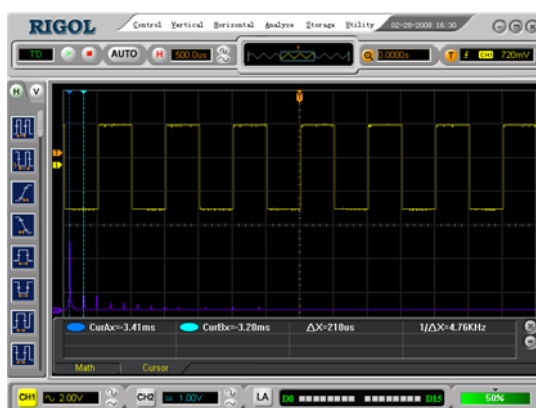

Figure 3-10
FFT Measurement (Cursor Type X)

Example 9: Pass/Fail Test

The Pass/Fail Test is one of enhanced special functions based on VS5000 series. In this function, the oscilloscope compares the input signal to the established waveform mask. If the waveform "touches" the mask, a "Fail" signal occurs. Otherwise the test passes. When needed, a programmable output can be used for external automatic control applications. The output is built in as a standard feature and is optically isolated.

Do the steps as follows:

1. Click the **Utility** → **Pass/Fail** buttons to show the **Pass/Fail Setup** window.
2. Select the **Source** to **CH2** (the input source is CH2). Output to **PASS+BEEPER**. Select the option to in front of the **Stop When Pass/Fail** to choose this option.
3. Create the **Pass/Fail Mask**: Set the div of the **Vertical** and **Horizontal** value. Click **Save** or **Load** to save or load the **P/F Mask**.
4. Click the **Run** button in the **Operation** window to start the Pass/Fail function.

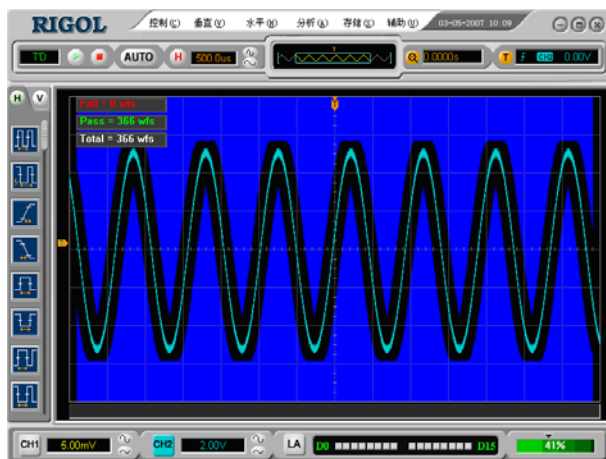

Figure 3-11
Pass/Fail Test

Click the **Pattern** button to do code setting (H, L, X, Rising or Falling)

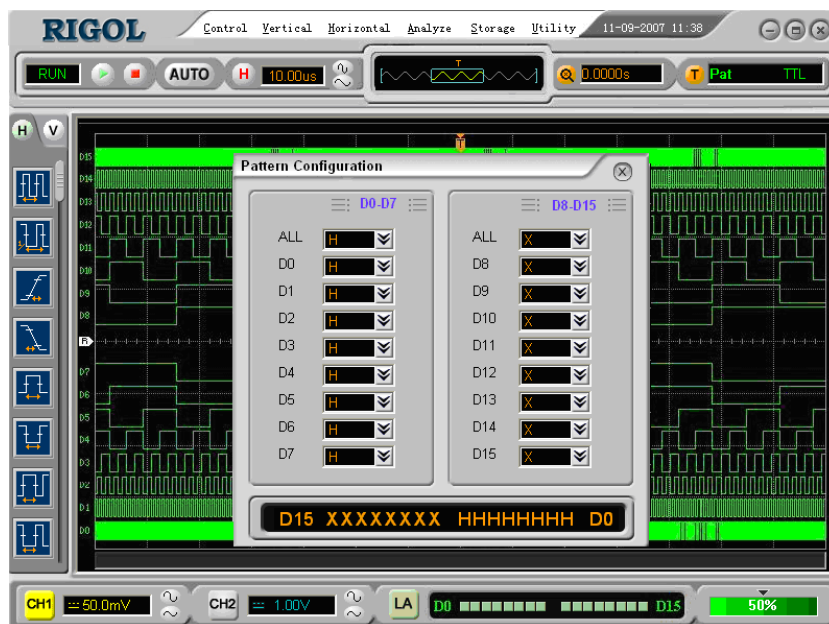

Figure 3-13
Code Settings

Duration

Do the steps as following:

1. Click the **T** button to show the **Trigger** menu.
2. Select **Advanced** → **Duration** in the **Mode** window.
3. Set Rule (More than, Less than or Equal) and Time (set duration).
4. Set up the Sweep type to Auto, Normal or Single.
5. Click the **◀▶** button to adjust the **Holdoff Time**.

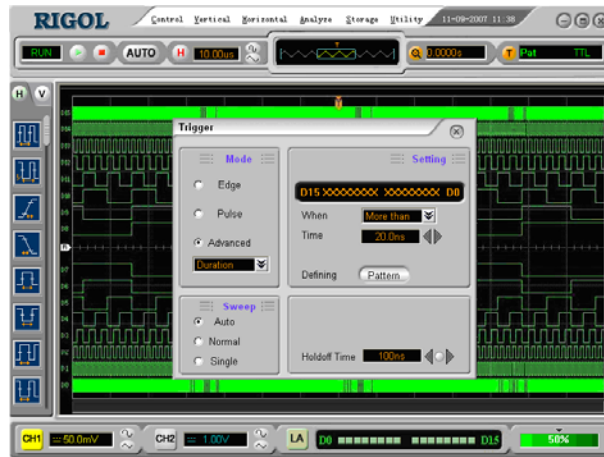

Figure 3-14
Duration Triggering Setting Interface

Click the **Pattern** button do code setting (H, L or X)

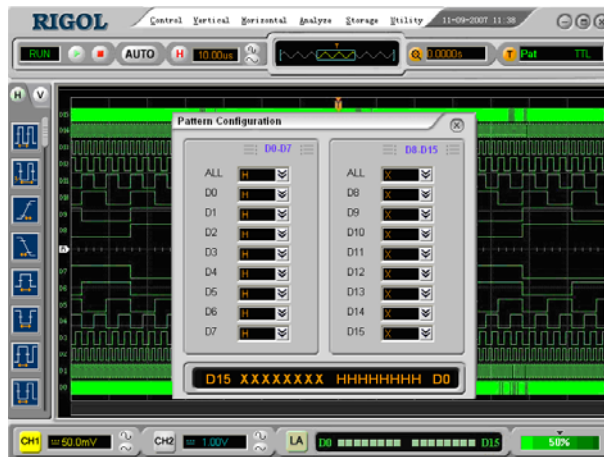

Figure 3-15 Code Settings

Chapter 4 Prompt Messages & Troubleshooting

Prompt Messages

1. **Windows socket failed**
Windows correspondence port initialization is failed.
2. **Function not available**
This function is not available.
3. **Not available record data**
In waveform record function there is no record data available to display or to load.
4. **Function not available at FFT**
This function is not available in FFT function.
5. **Not create PF mask:**
The Pass/Fail mask is not created before the P/F function starts.
6. **Function not available at alternate trigger**
The function selected is not available at Alternate Trigger.
7. **Function not available at XY mode**
The function selected is not available at X-Y mode.
8. **Function not available at rolling mode**
The function selected is not available at rolling mode.
9. **Function not available at network mode**
The function selected is not available at network mode.
10. **Volts/Div at limit**
The Volts/Div is at Min or Max limit.
11. **Volt offset at limit**
The volt offset is at Min or Max limit.
12. **Channel not available**
The channel selected is not available.

- 13. Threshold level at limit**
The threshold level is at Min or Max limit.
- 14. Position at limit**
The position is at Min or Max limit.
- 15. Time/Div at limit**
The Time/Div is at Min or Max limit.
- 16. Trigger position at limit**
The trigger position is at Min or Max limit.
- 17. Filter frequency at limit**
The filter frequency is at Min or Max limit.
- 18. Wave intensity at limit**
The wave intensity is at Min or Max limit.
- 19. Grid intensity at limit**
Grid intensity is at Min or Max limit.
- 20. Cursor Position at limit**
Cursor position is at Min or Max limit.
- 21. Trigger level at limit**
The trigger level is at Min or Max limit.
- 22. Trigger sensitivity at limit**
The trigger sensitivity is at Min or Max limit.
- 23. Trigger holdoff at limit**
The trigger holdoff is at Min or Max limit.
- 24. Pulse width at limit**
The pulse width is at Min or Max limit.
- 25. Slope time at limit**
The slope time is at Min or Max limit.
- 26. Acquire average number at limit**
The acquired number is at Min or Max limit.
- 27. P/F Vertical adjust at limit**
The Pass/Fail vertical adjustment is at Min or Max limit.

-
- 28. P/F Horizontal adjust at limit**
The Pass/Fail horizontal adjustment is at Min or Max limit.
 - 29. Record waveforms completed**
The waveform record is completed.
 - 30. Playback current frame at limit**
The playback of current frame is at Min or Max limit.
 - 31. Channel selected not enabled**
The selected channel is not enabled.
 - 32. Playback interval at limit**
The interval of playback is at Min or Max limit.
 - 33. Record interval at limit**
The interval of waveform record is at Min or Max limit.
 - 34. Load successful**
The file load is successful.
 - 35. Load failed**
The file load is failed.
 - 36. Save successful**
The file saving is successful.
 - 37. Save failed**
The file saving is failed.
 - 38. Save channel is invalid**
The reference waveform channel saved is invalid.
 - 39. Measurement already selected**
The measurement function is already selected.
 - 40. LAN is already selected**
The LAN connection is already selected.
 - 41. USB is already selected**
The USB connection is already selected.
 - 42. This File already exist, Replace existing file**
The filename is already existed, this operation will replace this file.



Troubleshooting

1. **After the oscilloscopes powering on, the screen remains dark (no display). Please inspect the instrument following these steps:**
 - (1) Check the power cable connection
 - (2) Ensure the power switch is turned on
 - (3) After the above inspections, restart the oscilloscope
 - (4) If the problem still remains, please contact **RIGOL** for help

2. **After the signal acquisition the waveform does not appear, please check according to the following steps:**
 - (1) Check the probes connected with the signals
 - (2) Check the probes connected to the BNC connector of channel
 - (3) Check the probes connected with the object being tested.
 - (4) Check the circuit that generates the signal at the test point
 - (5) Repeat the acquisition

3. **The measurement result is 10 times higher or lower than the value expected.**
 - (1) Check if the probe attenuation is the same as the channel attenuation.

4. **If the oscilloscope does not get a stable waveform display, please check according to the following steps:**
 - (1) Check the **Trigger Source** and notice if it is set to the channel in use.
 - (2) Check the **Trigger Type**.
 - (3) Switch the **coupling** into **HF Rejection** or **LF Rejection** in order to filter the noise which disturbs trigger.

5. **After clicking the  /  buttons, the oscilloscope does not display any waveform on screen.**

Check whether the **Trigger Mode** is set to "Normal" or "Single" and see whether the trigger level is out of the signal range. If so, set the trigger level in the **Trigger** menu, or set the Trigger Mode as "AUTO". Moreover, push the **AUTO** button to display the waveform on screen.

6. **After the Acquisition is set to "Averages" or Display Persistence is set ON, the waveform refreshes slowly.**
 - (1) It is normal in these settings.

7. **The signal is displayed as ladder waveform.**
 - (1) Adjust the horizontal scale to increase horizontal resolution to improve the display.
 - (2) The **Display** Type may be set to "Vectors", change it to "Dots" mode to improve the display.

Chapter 5 Specifications

All specifications apply to the VS5000 Series Oscilloscopes and a probe with the Attenuation switch set to 10X unless noted otherwise. To meet these specifications, two conditions must first be met:

1. The instrument must have been working continuously for thirty minutes within the specified operating temperature.

All specifications are guaranteed unless noted "typical".

Specifications

Acquisition		
Sampling Modes	Real-Time	Equ-time
Sampling Rate	400Sa/s, 200MSa/s ^[1]	25GS/s ^[2]
Averages	N time acquisitions, all channels simultaneously, N is selectable from 2, 4, 8, 16, 32, 64, 128 and 256	

Inputs	
Input Coupling	DC, AC
Input Impedance	1M Ω ±2%, in parallel with 15pF±3pF 50 Ω ±2% ^[3]
Probe Attenuation Factors	1X, 10X, 100X, 1000X
Maximum Input Voltage	400V (DC+AC Peak, 1M Ω input impedance)
	40V (DC+AC Peak, 50 Ω input impedance) ^[3]
Time delay between channel (typical)	500ps

Horizontal	
Sample Rate Range	1Sa/s-400MSa/s (Real-Time sample), 25Sa/s (Equivalent sample)
Waveform interpolation	Sin(x)/x
Memory Depth	1M samples for single channel, 512k samples for each channel
Time Base Range (sec/div)	2ns/div-50s/div, VS5202X, VS5102X 5ns/div-50s/div, VS5062X 10ns/div-50s/div, VS5042X 20ns/div-50s/div, VS5022X 1-2-5 Sequence
Sample Rate and Delay Time Accuracy	±50ppm (over any 1ms time interval)
Delta Time Measurement Accuracy (Full Bandwidth)	Single: ±(1 sample interval + 50ppm × reading + 0.6 ns) >16 averages: ±(1sample interval + 50ppm × reading + 0.4 ns)

Vertical	
A/D converter	8-bit resolution, each channel samples simultaneously ^[4]
Volts/div Range	2mV/div-5V/div at BNC input
Offset Range	±40V(200mV-5V), ±2V(2mV-100mV)
Analog Bandwidth	200MHz (VS5202D, VS5202) 100MHz (VS5102D, VS5102) 60MHz (VS5062D, VS5062) 40MHz (VS5042D, VS5042) 25MHz (VS5022D, VS5022)
Single-shot Bandwidth	80MHz (VS5202D, VS5202) 80MHz (VS5102D, VS5102) 60MHz (VS5062D, VS5062) 40MHz (VS5042D, VS5042) 25MHz (VS5022D, VS5022)
Selectable Analog Bandwidth Limit (typical)	20MHz
Lower Frequency Limit (AC -3dB)	≤5Hz (at input BNC)
Rise Time at BNC (typical)	<1.7ns, <3.5ns, <5.8ns, <8.7ns, <14ns On 200MHz, 100MHz, 60MHz, 40MHz, 25MHz respectively
DC Gain Accuracy	2mV/div-5mV/div: ±4% (Sample or Average acquisition mode) 10mV/div-5V/div: ±3% (Sample or Average acquisition mode)
DC Measurement Accuracy, Average Acquisition Mode	Average of ≥16 Waveforms with vertical position at zero: ±(DC Gain Accuracy×reading+0.1div+1mV) Average of ≥16 Waveforms with vertical position not at zero: ±[3%×(reading + vertical position) + (1% of vertical position) + 0.2div] Add 2mV for settings from 2mV/div to 200 mV/div Add 50mV for settings from 200mV/div to 5V/div
Delta Volts Measurement Accuracy (Average Acquisition Mode)	Delta voltage between any two averages of 16 waveforms acquired under same setup and ambient Conditions: ±(DC Gain Accuracy×reading + 0.05 div)

Trigger		
Trigger Sensitivity	0.1div-1.0div (adjustable)	
Trigger Level Range	Internal	±12 divisions from center of screen
	EXT	±1.2V
	EXT/5	±6V
Trigger Level Accuracy (typical) applicable for the signal of rising and falling time ≥20ns	Internal	±(0.3div × V/div)(±4 divisions from center of screen)
	EXT	±(6% of setting + 40 mV)
	EXT/5	±(6% of setting + 200 mV)
Trigger Offset	Normal mode: pre-trigger (262144/ sampling rate), delayed trigger 1s	
	Slow Scan mode: pre-trigger 6div, delayed trigger 6div	
Holdoff Range	100ns-1.5s	
Set Level to 50% (Typical)	Input signal frequency ≥50Hz	
Edge Trigger		
Trigger Slope	Rising, Falling	
Pulse Trigger		
Trigger condition	(>, <, =) Positive pulse, (>, <, =) negative pulse	
Width Range	20ns – 10s	
Video Trigger		
Video standard & line frequency	Support standard NTSC, PAL and SECAM broadcast systems. Line number range: 1-525 (NTSC) and 1-625 (PAL/SECAM)	
Slope Trigger		
Trigger condition	(>, <, =) Positive slope, (>, <, =) negative slope	
Time setting	20ns – 10s	
Alternate Trigger		
Trigger on CH1	Edge, Pulse, Video, Slope	
Trigger on CH2	Edge, Pulse, Video, Slope	
Pattern Trigger ^[4]		
Trigger mode	D0 – D15 select H, L, X, Rising, Falling	
Duration Trigger ^[4]		
Trigger Type	D0 – D15 select H, L, X	
Qualifier	>, <, =	
Time setup	20ns – 10s	

Measurements		
Cursor	Manual	Voltage difference between cursors (ΔV) Time difference between cursors (ΔT) Reciprocal of ΔT in Hertz ($1/\Delta T$)
	Track	Voltage value for Y-axis waveform Time value for Y-axis waveform
	Auto	Cursors are visible for Automatic Measurement
Auto Measure	Vpp, Vamp, Vmax, Vmin, Vtop, Vbase, Vavg, Vrms, Overshoot, Preshoot, Freq, Period, Rise Time, Fall Time, +Width, -Width, +Duty, -Duty, DelayA 1→2 [‡] , DelayB 1→2 [‡]	

NOTE:

- [1] Only one input channel is available when Sample rate is at 400MSa/s.
- [2] This is the highest specification, the specific specifications are as follows:
 VS5202X, VS5102X: 25G/s
 VS5062X: 10G/s
 VS5042X: 5G/s
 VS5022X: 2.5G/s
- [3] Only used for VS5202D or VS5202.
- [4] Specification of VS5000D series Logic Analyzer.

General Specifications

Probe Compensator Output	
Output Voltage(typical)	3 Vp-p into $\geq 1 \text{ M}\Omega$ load
Frequency(typical)	1kHz

Power	
Supply Voltage	100 - 240 VAC, 45-440Hz, CAT II
	Power equipment access for 5V/3A
Power Consumption	Less than 15VA

Environmental	
Ambient Temperature	Operating $+10^{\circ}\text{C} \sim +40^{\circ}\text{C}$
	Non-operating $-20^{\circ}\text{C} \sim +60^{\circ}\text{C}$
Cooling Method	Fan force air flow
Humidity	$+35^{\circ}\text{C}$ or below: $\leq 90\%$ relative humidity
	$+35^{\circ}\text{C} \sim +40^{\circ}\text{C}$: $\leq 60\%$ relative humidity
Altitude	Operating 3,000 m or below
	Non-operating 15,000 m or below

Mechanical		
Size	Width	142 mm
	Height	47 mm
	Depth	209 mm
Heavy	Without package	0.7 kg
	Packaged	1.6 kg

IP Degree
IP2X

Calibration Interval
The recommended calibration interval is one year

Chapter 6 Appendix

Appendix A: Accessories

All the accessories listed below are Standard Accessories for VS5000:

1. Probex2 (1.5m), 1:1, (10:1) Passive Probes
2. A set of Digital probe components (for VS5***D only) include:
 - A data cable (Model: FC1868)
 - An active logic head (Model: LH1116)
 - Twenty test wire (Model: LC1150)
 - Twenty logic clips (Model: TC1100)
3. A Power Cord that fits the standard of destination country.
4. A User's Guide
5. A User Warranty Card
6. A VS5000 PC software for WIN 2000/XP/Vista

All accessories (standard and optional) are available by contacting the local **RIGOL** office.

Appendix B: Warranty

RIGOL Technologies, Inc. warrants its products' mainframe and accessories in materials and technics within the warranty period. During the period concerned, **RIGOL** guarantees the free replacement or repair of products which are approved defective.

To get repair service or obtain a copy of the whole warranty statement, please contact with your nearest **RIGOL** sales and service office.

RIGOL does not provide any other warranty items except the one being provided by this summary and the warranty statement. The warranty items include but not being subjected to the hinted guarantee items related to tradable characteristic and any particular purpose.

RIGOL will not take any responsibility in cases regarding to indirect, particular and ensuing damage.

Appendix C: Maintenance

General Care

Do not store or leave the instrument in where the instrument will be exposed to direct sunlight for long periods of time.



CAUTION: To avoid damage to the instrument or probes, do not expose them to sprays, liquids, or solvents.

Cleaning

If this instrument requires cleaning, disconnect it from all power sources and clean it with a mild detergent and water. Make sure the instrument is completely dry before reconnecting it to a power source.

To clean the exterior surface, perform the following steps:

1. Remove loose dust on the outside of the instrument and probes with a lint-free cloth. Take care to avoid scratching the clear plastic display filter.
2. Use a soft cloth dampened with water to clean the instrument.

NOTE: To avoid damage to the surface of the instrument or probes, do not use any abrasive or chemical cleaning agents.

Appendix D: Contact RIGOL

If you have any problem or requirement during using our products, please contact **RIGOL** Technologies, Inc. or the local distributors.

Domestic: Please call

Tel: (86-10) 8070 6688

Fax: (86-10) 8070 5070

Service & Support Hotline: 800 810 0002

9:00 am –5: 00 pm from Monday to Friday

Or by e-mail:

Service@rigol.com

Or mail to:

RIGOL Technologies, Inc.

156# CaiHe Village, ShaHe Town, ChangPing District, Beijing, China

Post Code: 102206

Overseas: Contact the local **RIGOL** distributors or sales office.

For the latest product information and service, visit our website: www.rigolna.com

Index

- A**
- AC Coupling..... 2-4
 - Accessories..... 6-1
 - Acquire 2-43
 - Acquisition.....2-44, 5-2
 - Alternative Trigger 2-36
 - Analyze 2-59
 - Appendix..... 6-1
 - Auto Button..... 2-72
 - Auto Trigger 2-41
 - Automatic Cursor Mode 2-60
 - Average Acquisition..... 2-46
- B**
- Bandwidth Limit..... 2-5
 - Blackman Window..... 2-16
- C**
- Channel Coupling..... 2-4
 - Cleaning..... 6-2
 - Coarse/Fine..... 2-7
 - Cursor..... 2-59
 - Cursor Measurements.....2-59, 3-7
- D**
- DC Coupling 2-4
 - Default Setup 2-49
 - Delayed Sace..... 2-26
 - Digital Filter..... 2-13
 - Digital Signal 3-15
 - Display Setup 2-67
 - Duration Trigger 2-38
- E**
- Edge Trigger..... 2-31
 - Envelope 2-46
 - Equivalent Sampling 2-46
 - Ext and Ext/5..... 2-41
- F**
- FFT 2-15
 - FFT Cursor Measurement..... 3-13
 - Field Synchronization..... 2-35
 - Front Panel 1-2
 - Functional Check..... 1-6
- H**
- Hamming Window 2-16
 - Hanning Window..... 2-16
 - HF Reject 2-42
 - Horizontal..... 2-23, 5-2
- I**
- Inputs 5-2
 - Invert a Waveform 2-8
- L**
- LF Reject 2-42
 - Logic Analyze Channel 2-9
- M**
- Manual Cursor Mode..... 2-61
 - Mask Setting..... 2-70
 - MATH..... 2-12
 - Measurement Function 2-53
 - Measurements 5-5

N

Normal Trigger.....	2-41
Nyquist Frequency.....	2-16

O

Open File.....	2-18
Open/Save File.....	2-20

P

Pass/Fail.....	2-69
Pattern Trigger.....	2-37
Power.....	5-6
Pretrigger.....	2-42
Print.....	2-52
Print Preview.....	2-51
Print Setting.....	2-50
Probe Attenuation.....	2-6
Probe Compensation.....	1-8
Probe Compensator.....	5-6
Prompting Messages.....	4-1
Pulse Width Trigger.....	2-32

R

Random Noise.....	3-5
Realtime Sampling.....	2-46
Rectangle Window.....	2-16
Reference.....	2-17
Roll Mode.....	2-25

S

Sampling System.....	2-43
Save File.....	2-19
Self Calibration.....	2-68
Single Trigger.....	2-42
Single-Shot Signal.....	3-4
Slope Trigger.....	2-35

Slow Scan Mode.....	2-25
Storage.....	2-47
Sync Pulses.....	2-33

T

Taking Simple Measurements.....	3-1
Time/Div.....	2-25
Track Cursor Mode.....	2-64
Trigger.....	5-4
Trigger Control.....	1-16
Trigger Holdoff.....	2-40
Trigger Level.....	1-16
Trigger Sensitivity.....	2-42
Trigger Setup.....	2-39
Trigger System.....	2-29
Troubleshooting.....	4-4
Turn on/off Channels.....	2-22

U

Utility.....	2-66
--------------	------

V

Vertical.....	5-3
Vertical System.....	2-2
Vertical Window.....	1-12
Video Signal.....	3-11
Video Trigger.....	2-33

W

Waveform Record.....	2-71
----------------------	------

X

X-Y.....	2-25, 2-28, 3-9
----------	-----------------

Y

Y-T.....	2-25
----------	------