

INSTRUCTION MANUAL
DCRA SERIES
DC POWER SUPPLIES

TABLE OF CONTENTS

	PAGE
I. GENERAL INFORMATION	1
II. SPECIFICATIONS	2
III. INSTALLATION & OPERATION	7
IV. PRINCIPLE OF OPERATION	11
V. MAINTENANCE & REPAIR	12



RAYTHEON COMPANY SORENSEN OPERATION
Richards Avenue, Norwalk, Connecticut 06856
Telephone 203-838-6571 TWX 710-468-2940

PRINTED IN U.S.A.

14-5873
1/66
REV 10/67

GENERAL INFORMATION

WARRANTY

Raytheon warrants all parts of equipment of its manufacture, except special purpose tubes and semiconductor devices which carry their own manufacturer's warranty, to be free from defects caused by faulty material or poor workmanship. Raytheon warrants its products to conform to applicable commercial or military specifications when confirmed on the Order Acknowledgment form to be free from defects caused by faulty material or poor workmanship. Raytheon's obligation is limited under the warranty to repair or replacement of products in kind, or at its sole option to issuance of a credit of original purchase price. Returns must be accompanied by a Raytheon Return Authorization form and conform to standard conditions for adjustment. The aforesaid warranty shall expire twelve (12) months following the last day of the month of shipment from Raytheon's plant. The foregoing states the entire warranty extended by Raytheon. No other warranty, express or implied, is made and, specifically, Raytheon makes no warranty of merchantability or fitness for any purpose. In no case shall Raytheon be liable for any special or consequential damages. Authorization must be obtained prior to return of defective items.

RAYTHEON COMPANY, Sorensen Operation

SERVICE INFORMATION

Questions concerned with the operation, repair, or servicing of this instrument should be directed to the nearest Sorensen representative (a list is included with this manual) or to the Service Department, Raytheon Company, Sorensen Operation, Richards Avenue, South Norwalk, Connecticut. *Include the model number and serial number, in any correspondence concerning this instrument.*

SHIPPING DAMAGE

It is possible for equipment to be damaged in shipment. Therefore, it is imperative that the instrument be tested and inspected as soon as it is received. If the instrument shows signs of damage, follow the instructions on the DAMAGE and/or Loss in Shipment form enclosed with the unit and notify the carrier immediately. The carrier's claim agent will then prepare a report of damage and, after you have forwarded this to the Sorensen Service Department, you will be advised as to the action necessary to have the instrument repaired or replaced.

RETURNS TO THE FACTORY

Should it be necessary to return an instrument to the factory for repair, please contact the Sorensen Service Department for authorization to make shipment.

RAYTHEON COMPANY WILL ASSUME NO RESPONSIBILITY FOR MATERIAL RETURNED WITHOUT PRIOR AUTHORIZATION.

II. SPECIFICATIONS

ELECTRICAL SPECIFICATIONS:

MODEL NUMBER	Output Voltage (Vdc)	Output Current (A dc)	Constant Voltage Regulation ¹	Constant Current Range ² (A dc)	Constant Current Regulation ³	Constant Voltage Ripple	Constant Current Ripple (Typ)	Temperature		Typical Efficiency %	Input Voltage I ϕ (Vac)
								Ambient (°C)	Coef. MV/°C		
DCR 20-125A	0-20	0-125	$\pm 0.75\%$ or $\pm 8mV^3$	0-125	$\pm 125mA$.4% + 20mV	0.5%	0-55 ⁵	3	62	187-229, 207-253
DCR 20-250A	0-20	0-250	$\pm .10\%$ or $\pm 8mV^3$	0-250	$\pm 500mA$.8% + 60mV or 160mV ⁴	2.0%	0-55 ⁵	8	66	3 ϕ 187-229, 207-253 ^a
DCR 40-10A	0-40	0-10	$\pm 0.75\%$ or $\pm 15mV^3$	0-10	$\pm 20mA$.4% + 40mV	0.5%	0-55 ⁵	6	60	105-125
DCR 40-20A	0-40	0-20	$\pm 0.75\%$ or $\pm 15mV^3$	0-20	$\pm 25mA$.4% + 40mV	0.5%	0-55 ⁵	6	60	105-125
DCR 40-35A	0-40	0-35	$\pm 0.75\%$ or $\pm 15mV^3$	0-35	$\pm 35mA$.4% + 40mV	0.5%	0-55 ⁵	6	67	105-125
DCR 40-60A	0-40	0-60	$\pm 0.75\%$ or $\pm 15mV^3$	0-60	$\pm 60mA$.4% + 40mV	0.5%	0-55 ⁵	6	66	187-229, 207-253
DCR 40-125A	0-40	0-125	$\pm .10\%$ or $\pm 15mV^3$	0-125	$\pm 250mA$.4% + 60mV or 160mV ⁴	1.0%	0-55 ⁵	16	72	3 ϕ 187-229, 207-253 ^a
DCR 40-250A	0-40	0-250	$\pm .10\%$ or $\pm 15mV^3$	0-250	$\pm 500mA$.4% + 60mV or 160mV ⁴	1.0%	0-55 ⁵	16	75	3 ϕ 187-229, 207-253, 342-418, 390-440, 414-506 ^b
DCR 40-500A	0-40	0-500	$\pm .10\%$ or $\pm 15mV^3$	0-500	$\pm 1000mA$.4% + 60mV or 160mV ⁴	1.0%	0-55 ⁵	16	79	3 ϕ 342-418, 390-440, 414-506 ^b
DCR 60-13A	0-60	0-13	$\pm 0.75\%$ or $\pm 15mV^3$	0-13	$\pm 20mA$.4% + 60mV	0.5%	0-55 ⁵	9	64	105-125
DCR 60-25A	0-60	0-25	$\pm 0.75\%$ or $\pm 15mV^3$	0-25	$\pm 25mA$.4% + 60mV	0.5%	0-55 ⁵	9	69	105-125
DCR 60-40A	0-60	0-40	$\pm 0.75\%$ or $\pm 15mV^3$	0-40	$\pm 40mA$.4% + 60mV	0.5%	0-55 ⁵	9	68	187-229, 207-253
DCR 80-5A	0-80	0-5	$\pm 0.75\%$ or $\pm 20mV^3$	0-5	$\pm 15mA$.4% + 80mV	0.5%	0-55 ⁵	12	64	105-125
DCR 80-10A	0-80	0-10	$\pm 0.75\%$ or $\pm 20mV^3$	0-10	$\pm 20mA$.4% + 80mV	0.5%	0-55 ⁵	12	64	105-125
DCR 80-18A	0-80	0-18	$\pm 0.75\%$ or $\pm 20mV^3$	0-18	$\pm 25mA$.4% + 80mV	0.5%	0-55 ⁵	12	71	105-125
DCR 80-30A	0-80	0-30	$\pm 0.75\%$ or $\pm 20mV^3$	0-30	$\pm 30mA$.4% + 80mV	0.5%	0-55 ⁵	12	69	187-229, 207-253
DCR150-2.5A	0-150	0-2.5	$\pm 0.75\%$ or $\pm 30mV^3$	0-2.5	$\pm 15mA$.4% + 150mV	0.5%	0-55 ⁵	23	68	105-125
DCR150-5A	0-150	0-5	$\pm 0.75\%$ or $\pm 30mV^3$	0-5	$\pm 15mA$.4% + 150mV	0.5%	0-55 ⁵	23	66	105-125
DCR150-10A	0-150	0-10	$\pm 0.75\%$ or $\pm 30mV^3$	0-10	$\pm 20mA$.4% + 150mV	0.5%	0-55 ⁵	23	72	105-125
DCR150-15A	0-150	0-15	$\pm 0.75\%$ or $\pm 30mV^3$	0-15	$\pm 25mA$.4% + 150mV	0.5%	0-55 ⁵	23	72	187-229, 207-253
DCR300-1.25A	0-300	0-1.25	$\pm 0.75\%$ or $\pm 60mV^3$	0-1.25	$\pm 15mA$.4% + 300mV	0.5%	0-55 ⁵	45	64	105-125
DCR300-2.5A	0-300	0-2.5	$\pm 0.75\%$ or $\pm 60mV^3$	0-2.5	$\pm 15mA$.4% + 300mV	0.5%	0-55 ⁵	45	68	105-125
DCR300-5A	0-300	0-5	$\pm 0.75\%$ or $\pm 60mV^3$	0-5	$\pm 15mA$.4% + 300mV	0.5%	0-55 ⁵	45	73	105-125
DCR300-8A	0-300	0-8	$\pm 0.75\%$ or $\pm 60mV^3$	0-8	$\pm 20mA$.4% + 300mV	0.5%	0-55 ⁵	45	73	187-253, 207-253

- Notes: 1. With load change (0 to full or full to 0) and line voltage change ($\pm 10\%$) combined.
 2. At 55°C. For range at other temperatures see Unit Rating chart.
 3. Whichever is greater.
 4. Whichever is smaller.
 5. See Unit Rating chart for safe loads at temperatures to 71°C.

6. Optional auxiliary chassis permits operation from 342-418, 390-440 or 414-506 Input.
 7. Input 187-229, 207-253, or 414-506 at 57-63Hz (0-40Vdc output)
 Input 390-440 at 50-63Hz (0-40Vdc output)
 Input 342-418 at 50-63Hz (0-36Vdc output)
 8. Input 342-418 at 50-63Hz (0-30Vdc output)
 Input 390-440 at 50-63Hz (0-37Vdc output)
 Input 414-506 at 57-63Hz (0-40Vdc output)
 9. From 0-95% load voltage change and $\pm 10\%$ line voltage change combined.

MECHANICAL SPECIFICATIONS:

MODEL NUMBER	DIMENSIONS (inches)			WEIGHT (lbs.)	
	Width	Height	Depth	Net	Shipping
DCR 20-125A	19	10 $\frac{1}{2}$	20	169	200
DCR 20-250A	19	17 $\frac{1}{2}$	22	312	342
DCR 40-10A	19	5 $\frac{1}{4}$	15	55	65
DCR 40-20A	19	5 $\frac{1}{4}$	18	77	90
DCR 40-35A	19	7	18	102	120
DCR 40-60A	19	7	20	131	150
DCR 40-125A	19	17 $\frac{1}{2}$	22	318	348
DCR 40-250A	19	22 $\frac{3}{4}$	24	485	515
DCR 40-500A	25	43 $\frac{3}{4}$	23	805	835
DCR 60-13A	19	5 $\frac{1}{4}$	18	77	90
DCR 60-25A	19	7	18	100	120
DCR 60-40A	19	7	20	130	150
DCR 80-5A	19	5 $\frac{1}{4}$	15	56	65
DCR 80-10A	19	5 $\frac{1}{4}$	18	77	90
DCR 80-18A	19	7	18	98	120
DCR 80-30A	19	7	18	121	140
DCR150-2.5A	19	5 $\frac{1}{4}$	15	52	65
DCR150-5A	19	5 $\frac{1}{4}$	18	77	90
DCR150-10A	19	7	18	95	120
DCR150-15A	19	7	18	115	135
DCR300-1.25A	19	5 $\frac{1}{4}$	15	52	65
DCR300-2.5A	19	5 $\frac{1}{4}$	18	77	90
DCR300-5A	19	7	18	95	120
DCR300-8A	19	7	18	115	135

RESOLUTION (voltage): 0.05% of Output Voltage maximum.

RESOLUTION (current): 0.5% of Output Current maximum.

PARALLEL OPERATION: Up to 4 units may be operated in parallel. However, derate each unit to 90% of maximum current.

SERIES OPERATION: Following is the number of units that may be operated in the series mode:

2	300 volt units
2	150 volt units
4	80 volt units
4	60 volt units
5	40 volt units
5	20 volt units

REMOTE SENSING: The output voltage may be regulated at a load point remote from the power supply.

TRANSIENT RESPONSE: 30 milliseconds (to return to $\pm 1\%$ band with change from half to full or full to half load).

INPUT FREQUENCY RANGE: 50 to 63 Hz.

Below 60 c/s ripple and transient response will deteriorate by a factor of $(60/f)^2$, where "f" is the input frequency.

RFI: Meets MIL-I-26600 and MIL-I-6181D

STABILITY: 0.05% of maximum output voltage -- for 8 hours, after $\frac{1}{2}$ hour warmup.

DCR CROSS OVER CHARACTERISTICS

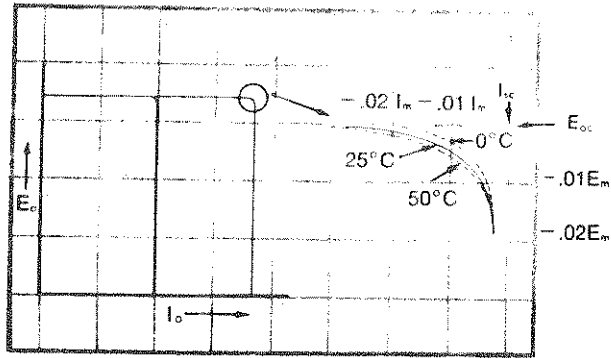

I_o = output current
 E_o = output voltage
 I_m = maximum rated output current
 E_m = maximum rated output voltage
 I_{sc} = preset short circuit current (front panel control)
 E_{oc} = preset no load output voltage (front panel control)

As indicated in the above curves, the cross-over region is bounded by I_{sc} , E_{oc} , $(I_{sc} - .02 I_m)$ and $(E_{oc} - .02 E_m)$

Please refer to Glossary of Terms item #5
AUTOMATIC CROSSOVER . . . fully automatic transition from constant voltage to constant current operation, or from constant current to constant voltage operation, at any operating point.

14-5733

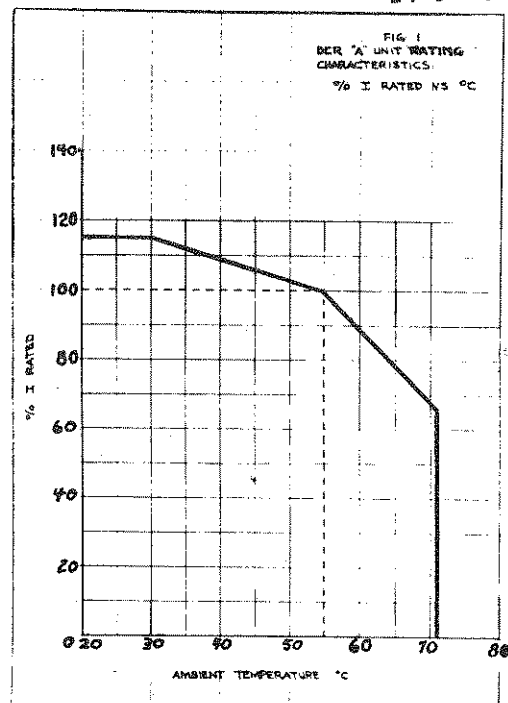

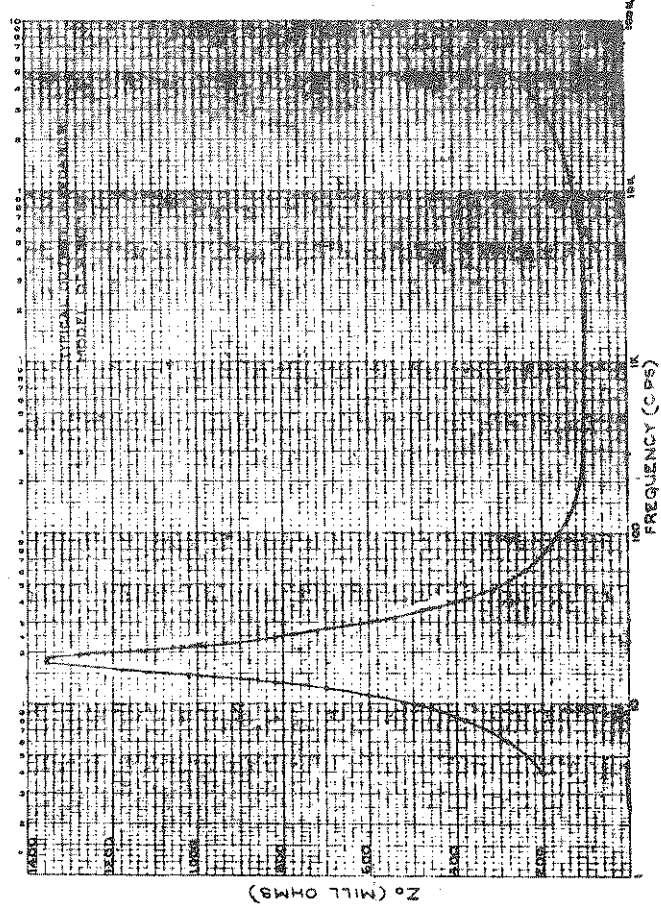
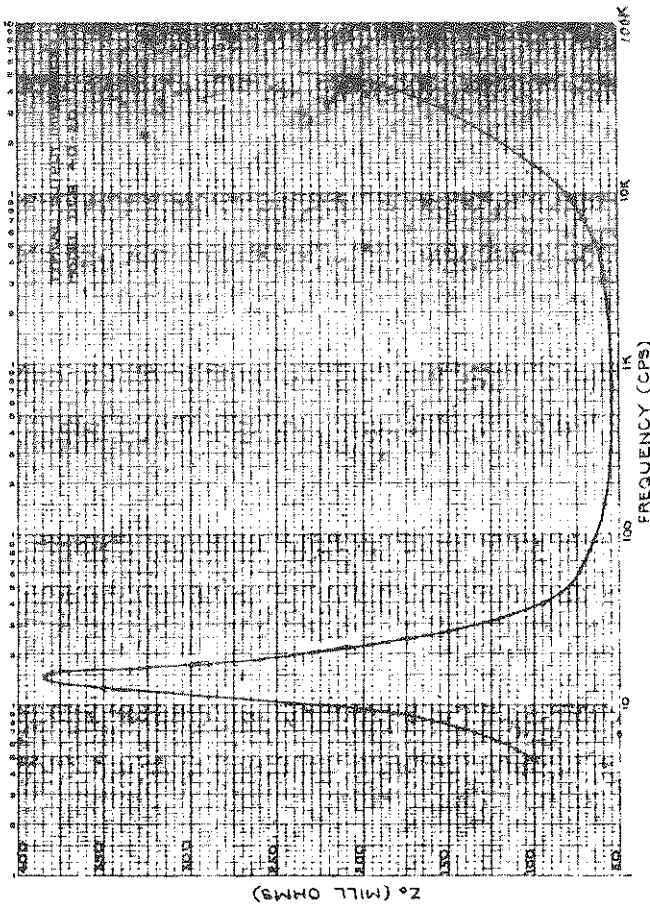
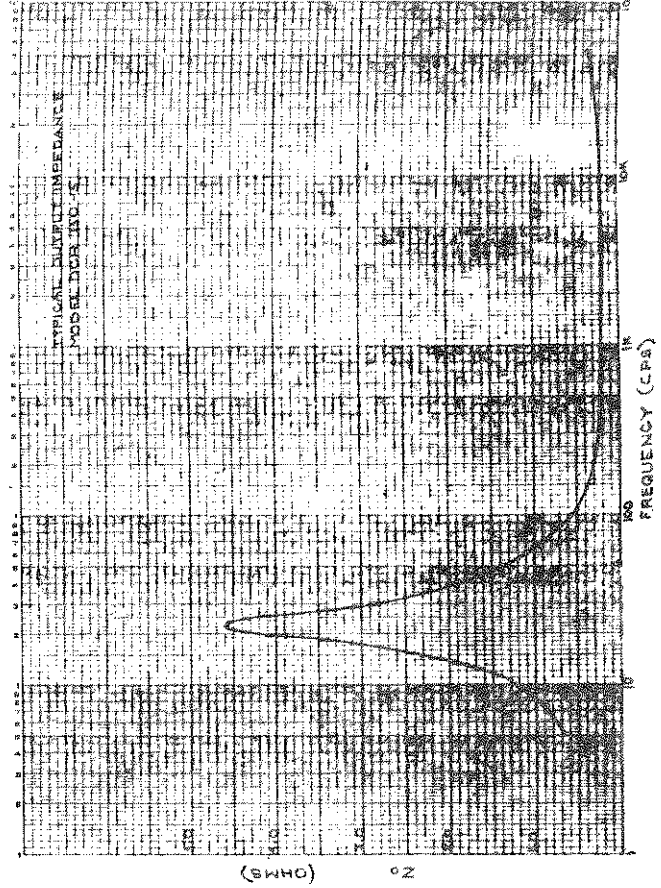
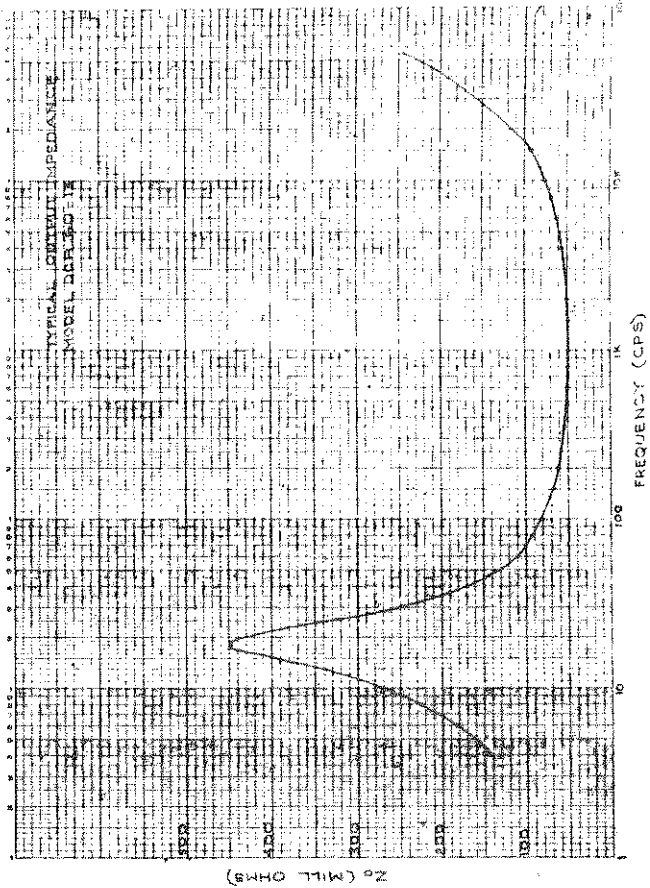

TYPICAL OUTPUT IMPEDANCE DCR 500 WATT SERIES

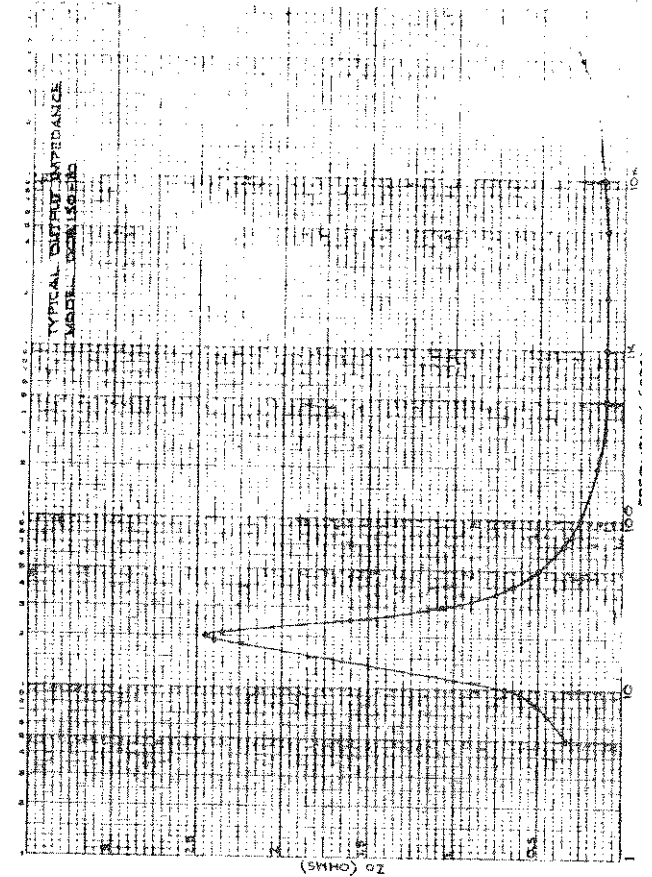
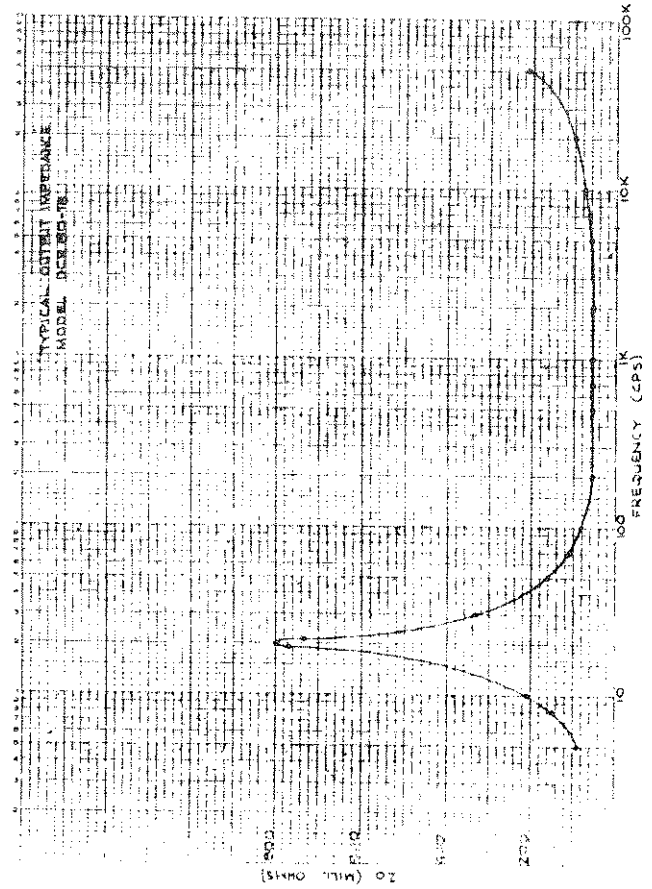
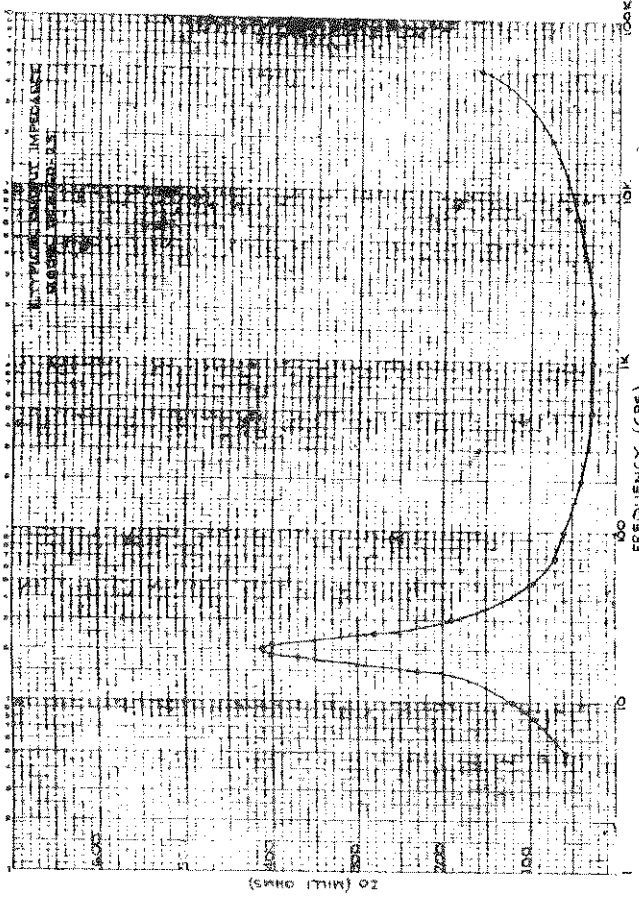
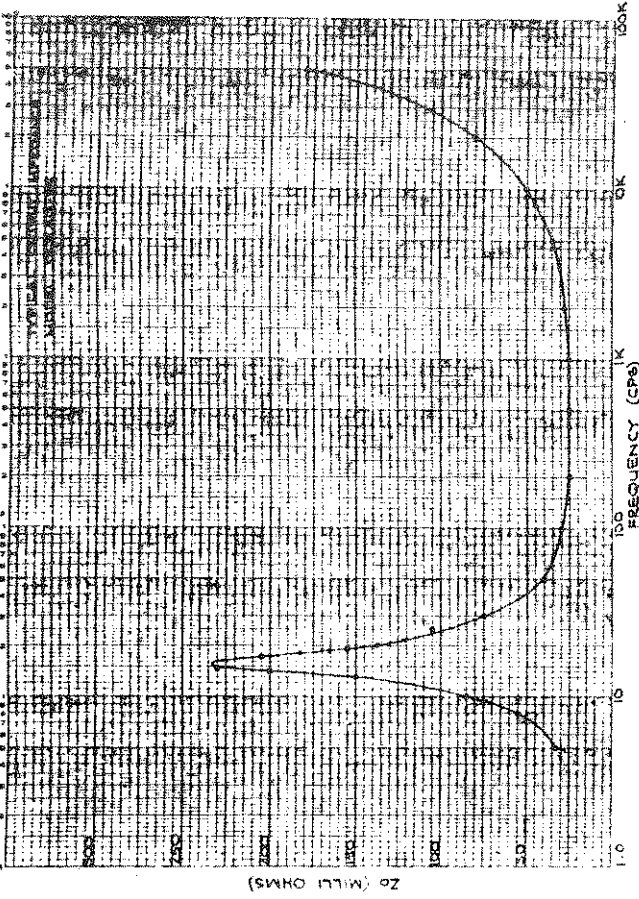

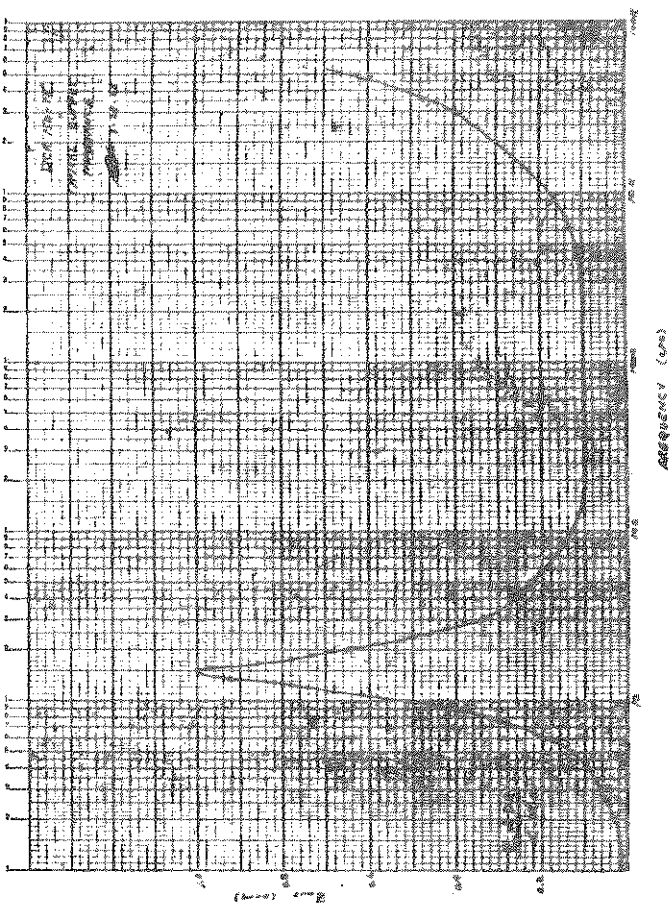
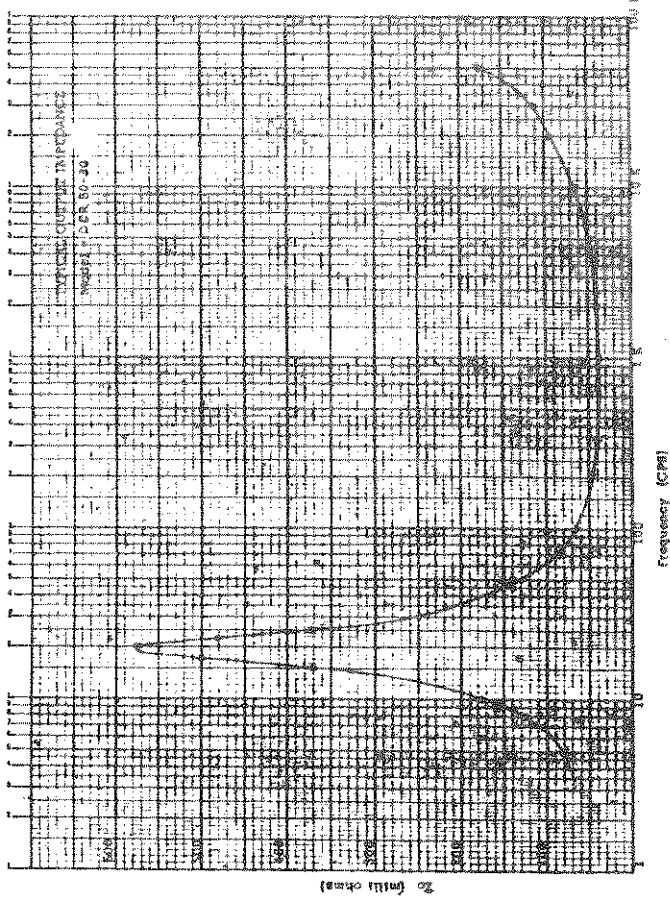
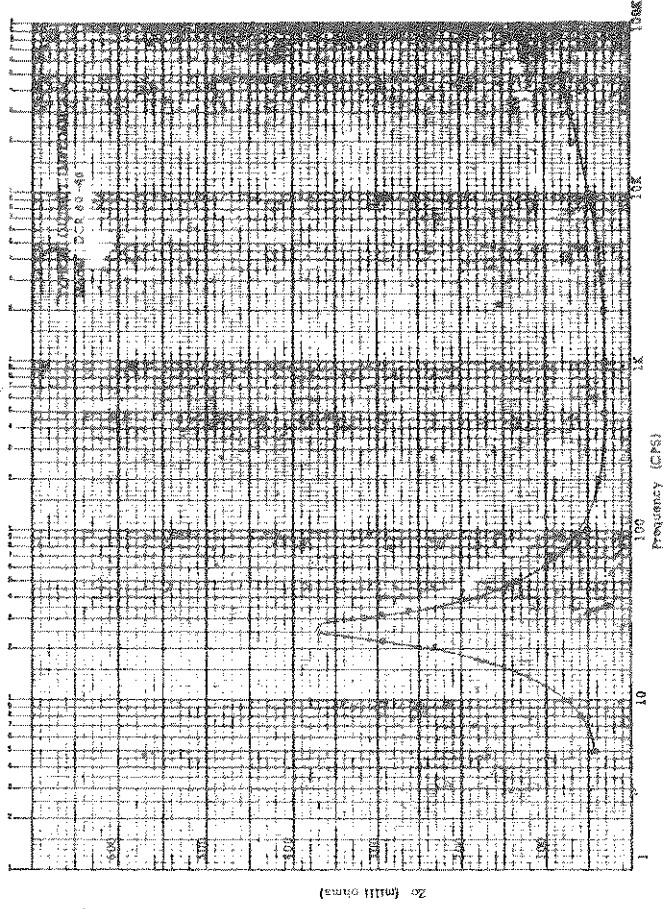
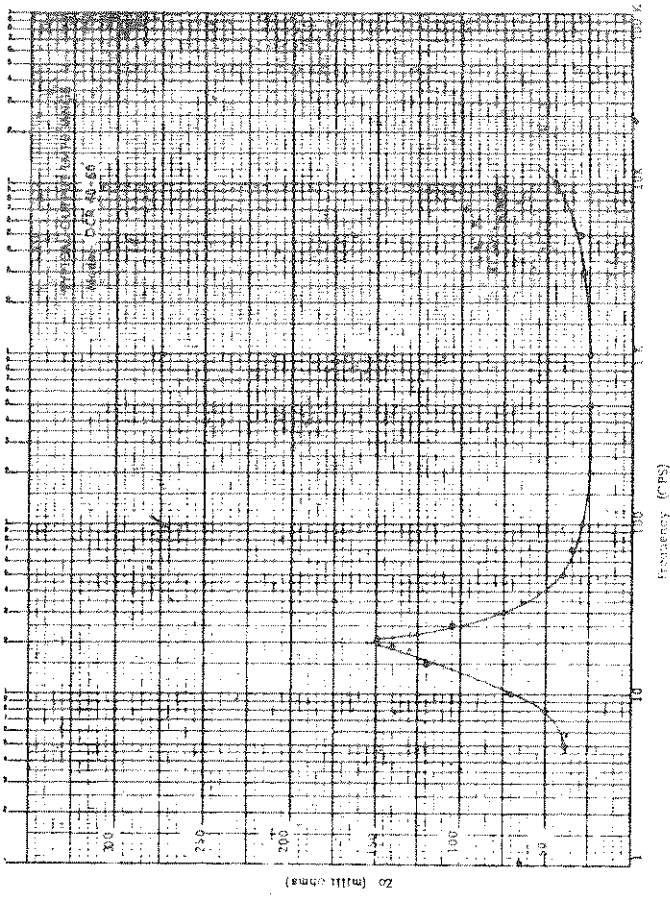

TYPICAL OUTPUT IMPEDANCE DCR 2400 WATT SERIES

III. INSTALLATION AND OPERATION

1. Input Power Connections

The 800 and 1500 watt models operate from 115 VAC single phase, 50 to 63 cps. All units are supplied with input terminal boards on the lower left side at the rear of the chassis. Terminal 1 is for the "hot" lead of the input line. Terminal 3 is for the "neutral" lead of the input line. Terminal 2 is the chassis ground.

The 2400 watt units may be operated from either 208 or 230 VAC single phase, 50 to 63 cps. All units are supplied with input terminal boards on the lower left side at the rear of the chassis. Terminals 1 and 3 are for the input line connection. Terminal 2 is the chassis ground.

208/230 CONVERSION PROCEDURE

To convert from 208 to 230 volt input:

Remove front panel by removing two screws directly below handles and one screw at the top front of each side panel. This will expose transformer T2 at the right side facing the front of the chassis.

Move wire from terminal 3 to terminal 4 of T2.

Transformer T1 is the large transformer at the left side facing the front of the chassis. Remove jumper from terminals 2 and 8. Install this jumper across terminals 3 and 9. Replace the front panel.

To convert from 230 to 208 volt input:

Remove front panel as above. Move wire from terminal 4 to terminal 3 of T2. Remove jumper from terminals 3 and 9 of T1. Install this jumper across terminals 2 and 8. Replace the front panel.

2. Output Power Connections

An output terminal board, located at the rear of the unit, provides the following:

- DC Power Output
- Remote Sensing
- Current Programming
- Voltage Programming
- Parallel Operation

800 watt units in addition have binding posts on the front panel.

3. Switch

The circuit breaker switch CBI, located on the front panel, turns the unit on/off.

4. Panel Lights

The panel light over the switch indicates the input power. The thermal overload panel lamp indicates abnormally high temperature inside the cabinet. Under this condition the output is automatically switched (SI) off until the temperature returns to normal. The output will then reset itself to the correct level.

5. The DC Voltmeter

located on the front panel indicates the output voltage. The DC Ammeter located on the front panel indicates the load current.

6. Controls

Front panel controls consist of coarse and fine output voltage adjustments and current limiting adjustment.

7. Protective Devices

CBI is an overcurrent circuit breaker in the primary circuit. SI is a thermal switch which protects the unit in case of abnormal internal temperature.

APPLICATION NOTES

Parallel Operation

Parallel operation of DCR supplies is accomplished by controlling one or more supplies (slaves) from the sensing and amplifier of another supply (master). The connections for this type of operation are shown in Figure 1.

Additional slave units are connected to the master unit in a like manner to the one slave shown. The load connections shown, using remote sensing (see remote sensing section of Application and Design Considerations) are preferred but not a necessity.

The terminal connections (#2) of TB2 serve to connect the firing circuits of all supplies to the timing circuit of the master unit so that the controlled rectifiers (SCR's) of all supplies are fired from a common signal. If the firing characteristics, the equivalent circuit resistances (from input to output) and certain firing circuit parameters of the master and slave units were identical, the load currents supplied by each would be equal. Practically, because of tolerances in wire resistance, SCR gate characteristics, components, etc., the load currents supplied by the individual units will differ. For this reason, the total load current capabilities of the paralleled supplies should be derated to 90% to allow for unequal currents in the individual supplies.

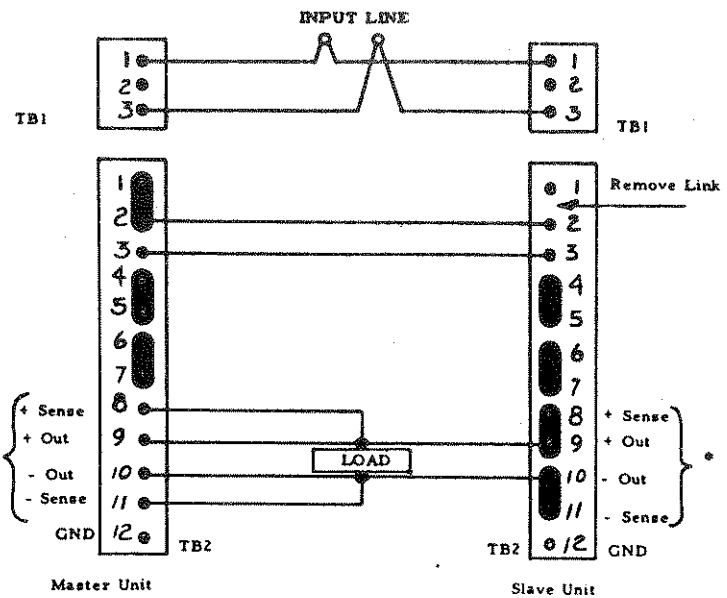

Fig. 1:

* In high current supplies + out "and" - out terminals will be separate terminals, not on TB #2. The connections remain the same, however. Refer to the particular supply involved.

The resistance of the power leads from the supply to the sensing point is a part of the circuit resistance which determines load current sharing. Large differences in power lead length (and resistance) may result in even more inequality in load current between individual units. Thus, the load connection shown in the sketch, with approximately equal load lead lengths, is preferred to minimize current inequality. However, if lead lengths are short (as, for example, in the case of two adjacent rack-mounted units), it would be possible to run leads from the "out" terminals of the slave (s) to those of the master and sense locally at the output terminals of the master unit. Another possible connection would be to run approximately equal output leads from each unit to a common sensing point and from this point to the load. In any case, the ultimate criterion is that the rated current of an individual supply should not be exceeded. An interesting point to note in connection with power lead lengths is that for operation at a given output voltage and current, it is possible to adjust power lead resistance to equalize load current sharing between supplies to within 1% or less difference. This would allow utilization of full rated output current under these conditions. A better approach is given below:

One of the largest sources of unbalance is the variation of R26-C10 time constant from unit to unit coupled with the variation of the standoff ratio " η " of Q8. When SWI opens, (see figure 2) C10 charges up with a time constant $t = R26 C10$. When the voltage across C10 becomes $\eta\beta+$, Q8 fires and the pulse transformer fires the controlled rectifiers. Firing between units will not occur simultaneously because $t_1 \neq t_2$ and $\eta_1 \neq \eta_2$. The value of t is 470 microseconds (nominal) and η varies between .47 and .62. When two units are in parallel, the current drawn from one unit (at full load) will vary approximately 1% for every 10 microsecond shift in firing time. (This is a 2% change in t with η constant).

For parallel operation, therefore, this circuit presents a good possible place to adjust for current balance between units.

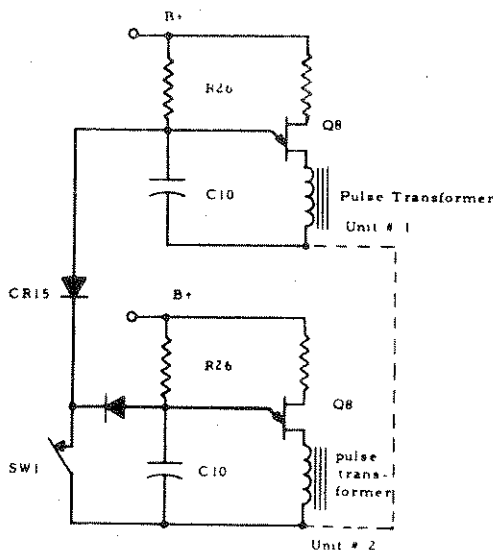

Fig. 2:

A variable capacitor may be placed in parallel with C10 of the unit which is carrying more than its share of the load current or a variable resistor may be placed across R26 of the unit which is carrying less than its share of load current.

The former is the preferred method, but the latter is more practical. This variable resistor should be a 50K potentiometer in series with 15K fixed.

Typical shifts in current with this arrangement are:

R added	% Current Change
65K	+ 3%
15K	+ 11%

If a larger shift is required, a small capacitor may be added to other unit (s).

Figure 2 below shows the firing pulse circuitry (simplified) for 2 units in parallel. SWI is an electronic switch.

Another possible way to connect units in parallel is to just connect the output terminals together and to forget what has been said previously about "slave" and "master". By this method, full current utilization of both supplies takes place. This works as follows:

Both units are turned on at a no load condition and the output voltages are adjusted to be approximately equal. As load is applied, all the current will be supplied by the unit putting out the highest voltage (the high degree of regulation of these units result in very low output impedance. The reader can take it from here).

As more load is applied, the unit supplying current will eventually go into current limiting with the result that its output voltage will drop. When it drops sufficiently low, the unloaded unit will begin to deliver load. All further increase of load will be taken over by the second unit since the "dynamic impedance" of the heavily loaded unit is now extremely high (in current limiting mode).

The following curve will help explain the phenomenon further (Fig. 3).

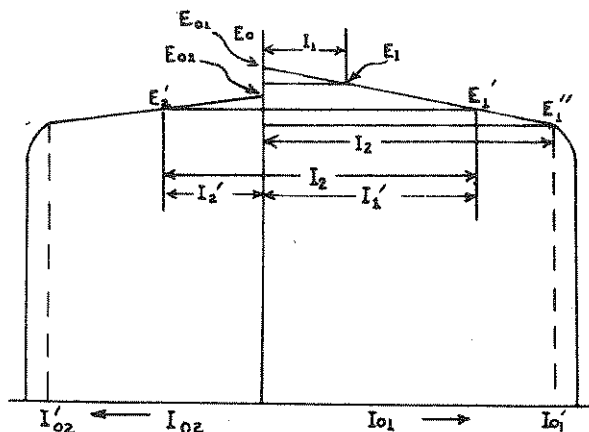

Fig. 3:

The curves represent the E_o vs I_o curves for a power supply. They indicate that the units operate in a voltage mode until the load is approximately I_o' and then go into a current mode. The regulation in the voltage mode is exaggerated for clarity.

- a. For a current of I_1 amps, no. 1 delivers all load since $E_1 > E_2$.
- b. For a load of I_2 unit no. 1 can not deliver all the current for $E_1 < E_2$. We can determine the splitting, however, by drawing a horizontal line between the curves of no. 1 and no. 2 such that the line length is equal to I_2 . This yields $I_1' + I_2'$. The operating points are, therefore, E_1' and E_2' .
- c. Continue this procedure to determine the characteristics up to the short circuit value of unit no. 1 and unit no. 2.

This method is very simple and requires no derating, but has the bad feature of poor regulation. This arises from the fact that the two units can not be set and maintained precisely at the same voltage setting and consequently the regulation of the paralleled system could be the sum of the regulation of the individual supplies plus the difference in the no load settings.

It has also been determined that when units are connected in this mode, they may oscillate when both the units enter the cross-over region. Hence, this method is *not* the preferred one.

The terminal #3 connections place the current sensing resistors of the slave units in parallel with those of the master unit. This permits the current regulating circuit of the master unit to sense the total output current and regulate or limit the total output current. The approximate value of the total regulated current will be the setting of master unit "current limit adjust" times the number of supplies in parallel. Failure to make this connection may result in instability.

Up to four (4) units may be paralleled under all conditions of rated ambient temperature, short circuit, etc. In voltage regulation, at rated ambients, as many as twelve (12) units may be operated in parallel.

Note that all units in parallel must be connected to the same input lines (since parallel operation is achieved by simultaneous firing of SCR's). The On-Off control should be by a single switch controlling the power to all supplies.

CAUTION:

In Master-Slave operation, the master unit must be turned on first. Any attempt to turn on the Slave first will result in failure (the breaker will trip). If the units are on and the Slave kicks off, the Master will attempt to supply all power including the bleeders of the Slave. If the Master kicks off, the Slave will try to go to full output voltage and:

- a. At light loads high voltage output results
- b. At heavy loads the attempt to go to high output results in heavy current drain and the breaker will trip.

Consequently, in shutting off power, the Slave must be shut off first.

NOTE: Simultaneous turning on or off is also permissible.

Series Operation

DCR units may be connected in series up to a total rated output of 320 volts. The connections are shown in the following sketch (Fig. 4).

External sensing should be used, as shown in Figure 4, to avoid the effects of load regulation in the interconnecting wire.

The rectifiers are required, to prevent the application of negative voltage to the output of any supply. Without the rectifiers, negative voltage could result under certain conditions of "turn-on", "turn-off", short circuit or overload, and could possibly damage the electrolytic output capacitors. With the rectifiers, the supplies may be turned on and off individually or as a group. In series operation each supply continues to function as a separate entity. The output of each supply is adjustable, independently of the other supplies. The total regulation is the sum of the regulations of all the supplies.

Input connections to the supply need not be paralleled.

Remote Sensing

The DCR supply has provision for regulating the output voltage at a load point remote from the power supply. This is accomplished by removing the links between "sensing" and "out" terminals and running leads from the sensing terminals to the remote load point. The following precautions must, however, be observed.

1. The sensing leads should be a coaxial pair or twisted pair in order to minimize stray pick-up which might result in instability in the regulator.
2. The power leads must be chosen for a maximum of 3.0 volt drop, in *each* power lead*, from the supply terminals to the sensing point.
3. The rated output of the supply applies at the output terminals. Any lead drops must be subtracted from these ratings to determine the capabilities at the remote load.
4. Operation with remote sensing will shift the current limiting range. To reset current limiting range, connect a short circuit across the load and adjust R32 until the output ammeter reads 110% of rated output current. Current limiting must be reset, if desired, for each change in remote power lead resistance.
5. Open sensing leads may result in high output and/or circuit breaker tripping. Be sure sensing leads are properly connected.
6. In remote sensing operation, both current regulation and voltage regulation are slightly affected. This is usually very slight, however, amounting to about a 20% degeneration at the maximum line drops.

* Theoretically it is possible to go to 4.5 volt drop in the negative power lead alone. However, dependable operation in the current mode becomes questionable since transient operation, stability of setting, and the ability to start into short or near-short circuits is seriously affected.

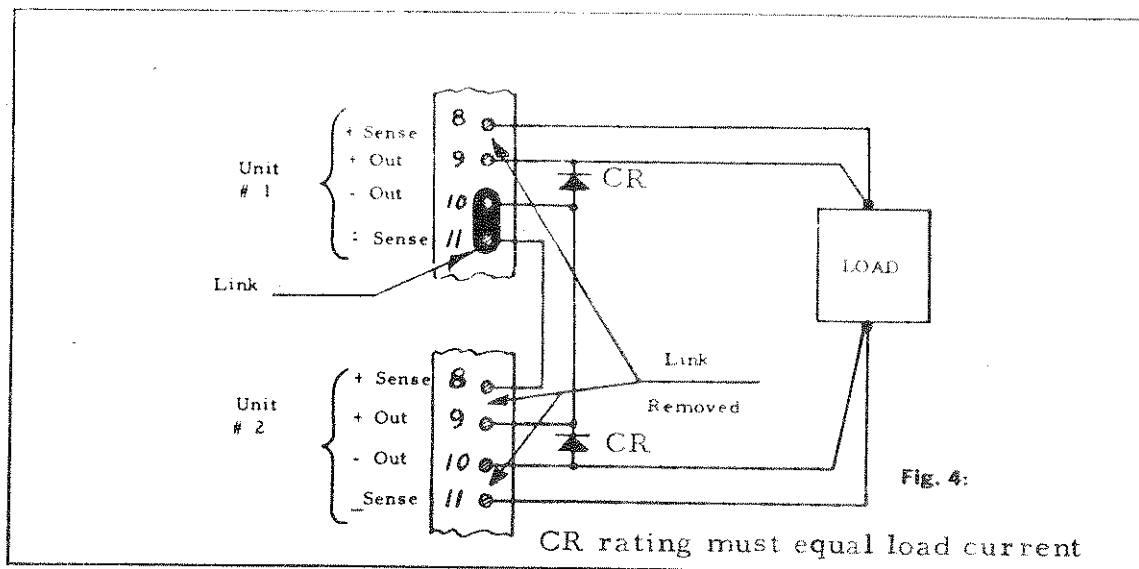

High Frequency Transient Response and Output Impedance

In any regulated power supply the transient due to a load change consists of several component parts. The most familiar of these is the response pattern due to the action of the closed loop system. This is the transient response which is referred to and described in the specifications of the DCR. In addition to this transient, there is an initial transient (before the regulator can begin to act), which is described by the relationship:

$$E = L \frac{di}{dt}$$

where E = transient voltage

L = inductive component of the output impedance

$\frac{di}{dt}$ = rate of change of load current

The inductive component of output impedance is due to the inductance of output capacitors and leads. This value is generally small — the value of L in the DCR 150-15, for example, is approximately 1 microhenry. Applying the expression above, L = 1 microhenry would result in a transient of 1 volt for a load current change of 1 amp per microsecond. This transient would exist only during the time that the current was changing. For slower rates of current change, the transient becomes smaller.

For each DCR model, a typical curve of output impedance is available which indicates the typical value of L for that model. The initial transient for any current change can then be easily calculated.

At high frequencies (above approximately 20 KC) the output impedance is essentially the L noted above. Output impedance tests, to several hundred kilocycles, confirm the constant value of L as the output impedance. Output impedance data is taken at 90% load with $\pm 5\%$ (of full load) load modulation.

Programming

The DCR units have provision for external programming of output voltage or current.

Voltage:

The approximate ohms per volt required for external programming is shown below:

MODEL	OHMS PER VOLT
300 Volt	10
150 Volt	20
80 Volt	40
60 Volt	50
40 Volt	80

Tolerance is approximately 10%. If a precision calibration of ohms per volt is required, see below. To program the output voltage the link between terminal 6 and 7 (T.B. #2) is removed and the appropriate programming resistance is inserted between these terminals (6 and 7). The front panel output controls are in series with the programming terminals so that the front panel controls may be used to set an initial output condition; with the programming resistance used to make a change from this initial condition. The front panel controls may also be set to zero so that complete control of the output voltage is achieved with the programming resistance.

In order to maintain the temperature coefficient and stability specified for the unit, the programming resistance should be a low temperature coefficient ($\pm 30\text{PPM}$) wire wound resistor or should be maintained in a constant ambient.

Note that the output voltage does not appear across the programming resistor as is the case in many other types of supplies. The programming resistance in the DCR unit sees a constant current of approximately 2 to 3 milliamperes.

Caution. If an "open" exists between terminal 6 and 7 the supply will go to high output and the input circuit breaker may trip.

Current:

The current limiting or regulator setting may be programmed externally by setting the front panel control to minimum, removing the link between terminals 4 and 5 (TB #2) and inserting a programming resistance between these terminals. The value of resistance required varies approximately from 0 to 150 ohms to cover a range of setting from 0 to 115% of rated output current. Var-

iation of current with resistance, while not linear, is reasonably so and in many applications true programming is possible. Typically, $\pm 3\%$ linearity can be expected. The approximate ohms per amp required for external programming is 150. For ex-

to Max.

ample, the ohms per amp of the DCR80-30 equals 150 or 5 ohms per amp.

30

Precision Calibration of Voltage Programming

To calibrate precisely the programming ohms per volt, the following procedure is used.

Equipment required:

Precision resistor 3K for the 150 volt and 60 volt unit or 3.2K ohms for the 80 volt and 40 volt units

Precision voltmeter

Procedure

1. Set coarse and fine front panel voltage controls fully counter-clockwise (zero setting)
2. Remove link from remote programming terminals (6 and 7 on TB #2) and connect precision resistor between these terminals.
3. Turn unit on and allow to warm-up for at least 30 minutes.
4. After warm-up adjust R44 (on rear panel) for output voltage reading of approximately full rated output voltage.

5. Short circuit the precision resistor.
6. Adjust R47 (on rear panel) for 0 volts output (± 0.1 volt)
7. Remove short circuit from precision resistor
8. Readjust R44 for output of full rated voltage $\pm 3\%$

Programming ohms per volt is now calibrated to the stated value $\pm (.3\% + \text{tolerances of precision resistor, precision voltmeter and regulation of the power supply})$. The linearity of programming is $\pm .5\%$.

IV. PRINCIPLE OF OPERATION

The operation of this instrument can best be understood by referring to the block diagram (Figure 5), below and to the schematic diagram.

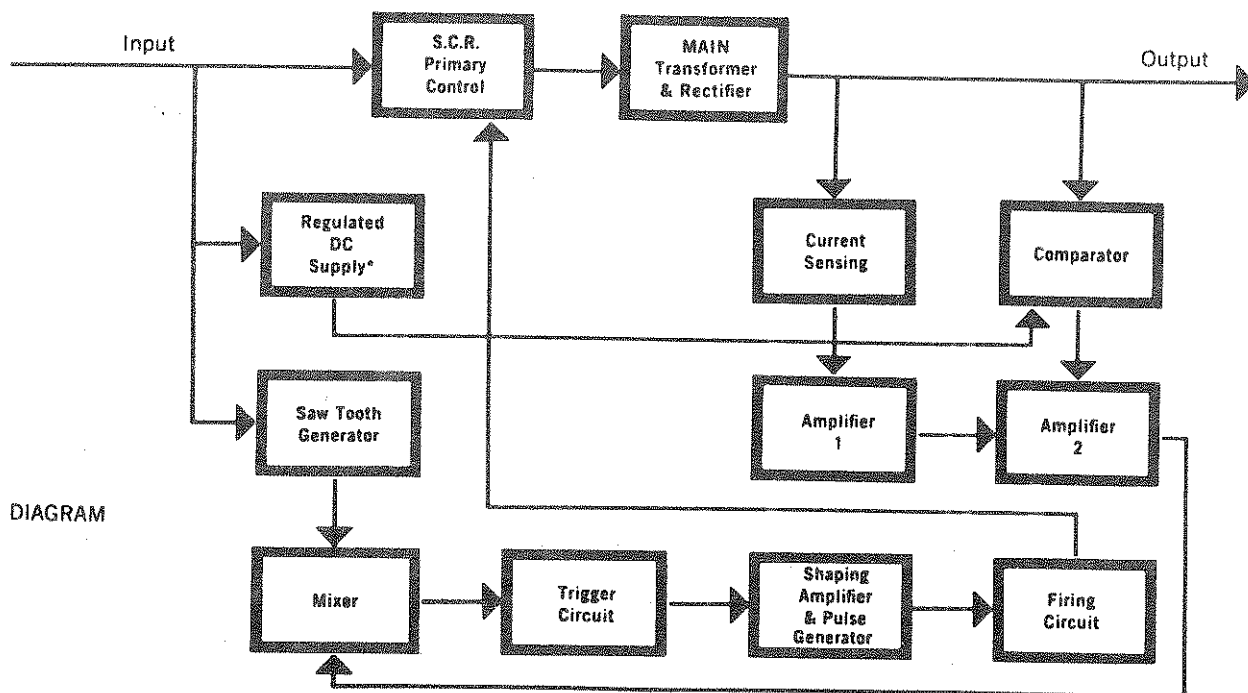

FIGURE 5
TYPICAL BLOCK DIAGRAM
DCR SERIES

* Supplies DC reference voltage for all control circuits

The Main Power Circuit

Input voltage is applied to the primary of the main transformer T1. The secondary voltage of T1 is rectified (CR1-CR4), and filtered (L1, C1) to supply the DC output voltage. This main power supply is regulated by means of controlled rectifiers CR7 and CR8 in the primary circuit of transformer T1. The controlled rectifiers cause phase delay in the correct amount to compensate for any deviation in the output voltage.

The Control Circuits

The amplifier operating the controlled rectifiers first generates a saw tooth wave form. This signal is then superimposed upon a DC voltage. By adjusting the amplitude of the DC voltage we have a variable operating point as a function of time.

Transistors Q1 and Q10 and their associated circuitry provide the proper wave forms and pulses with the correct timing to fire the controlled rectifiers. Transistors Q14 to Q18 and their associated circuitry produce DC voltage of the correct value on which is superimposed the saw tooth wave.

Saw Tooth Generator

The AC voltage of transformer T2 is rectified by the circuit CR12 and CR13. Voltage divider R9 and R10 is across this voltage. The voltage at the center tap of the divider is applied to the base of transistor Q1. The voltage ramp, formed by the RC network R13 and C5, combined with the discharge action of Q1, comprise the saw tooth generator. The saw tooth wave shape across R14 is shown below.



The Mixer

The saw tooth wave form is fed to an emitter-follower Q2 and coupled to resistor R16 which is the mixer block. Mixed DC and saw tooth signal is used to fire the Schmitt trigger circuit.

The Schmitt Trigger

Before the Schmitt trigger fires Q5 is conducting and current flows through R22. Therefore, Q6 and Q7 are saturated and the voltage across C10 is very low. When the voltage from the mixer fires the Schmitt trigger, Q5 cuts off. Q6 becomes non-conducting making Q7 non-conductive and C10 charges, by way of R26. C10 charges

until its potential is equal to the B+ voltage times the stand-off ratio of the unijunction transistor Q8. Then Q8 fires and C10 discharges through Q9 or Q10, depending on the phase of the incoming wave form.

While C10 is charging, DC current flows from bridge circuit CR10-CR13 to the base of either Q9 or Q10, depending on the phase of the secondary of T2. One of these transistors (Q9, Q10) will therefore be saturated and the other will have high impedance. The saturated transistor is the one through which Q8 fires.

As Q9 and Q10 alternately conduct, a pulse is developed alternately across the primaries of transformer T3 and T4. These pulses are transmitted, by means of the secondary windings, to the controlled rectifiers CR7 and CR8 to provide phase delay in the primary circuit of T1.

The DC Amplifier

The divider network R56 and R57 is across the output terminals. It is a sensing element which provides a proper portion of the output voltage to the input of Q16.

A reference voltage is developed at the base of Q15 by constant current generator Q14.

The output of the differential amplifier (Q15-Q16) is developed across R49 and then fed to the base of Q3. The voltage amplifier Q3 supplies the required voltage across the mixer R16. This fires the Schmitt trigger at the proper point to insure the correct phase delay in the primary of T1.

Q17 forms the cathode resistor of the differential amplifier Q15-Q16.

R47 sets the "zero" level of output voltage.

Current Regulator

When load currents are less than the Current Regulator set point (that is in the voltage regulator mode) Q11 is saturated and Q13 is operating with very low current. CR30 is reverse biased.

If the output current rises sufficiently (depending on the Current Regulator set points) Q11 will tend to cut off because of its configuration with R4. The potential across R72 will go up thus reducing the bias on transistor Q17 which will tend to shut off the amplifier. With reduced output from the amplifier, the voltage drop across R49 will be reduced and the potential across R16 in turn will be reduced. This will retard the firing angle of the mixer and diminish the output power of the unit. However, since R4 is controlled by current only, a constant output current is maintained.

V. MAINTENANCE AND REPAIR

During normal life this instrument requires no maintenance other than the care afforded similar equipment. It is suggested that excessive dust and any other foreign matter be removed periodically, exercising care to prevent damage to the instrument by cleaning tools or excessively strong air blasts.

CAUTION: KEEP ALL LINKS TIGHT AT ALL TIMES

Trouble Shooting

Only qualified personnel understanding transistorized regulator circuitry should attempt the repair of this unit, if damage should occur. Major servicing should be done only by the factory or one of its representatives.

SYMPTOM	PROBABLE CAUSE	PROCEDURE FOR REPAIR
1. No output voltage	1a. Always remove Q11, Q12, Q13 and Q18 as a first step. If the trouble corrects, one of these transistors is defective 1b. Defective SCR 1c. Defective amplifier 1d. If thermal overload panel lamp is lighted, S1 has closed because of abnormally high internal temperature	1a. Check and replace 1b. Check and replace 1c. Check reference supply (20 volt). Check wave forms at points indicated on schematic diagram. Start at CR14 and check through T3 and T1. If no wave form appears at R18, check differential amplifier and associated circuit. 1d. Reduce internal temperature and output will reset to the correct value. Check cooling fan and motor. Be sure that cabinet is free of air obstructions.
2. High Output	2a. Shorted SCR 2b. Defective sensing circuit	2a. Check and replace 2b. Check all sensing leads. Tighten all sensing circuit connections and links.
3. Poor Regulation	3. Defective or weak transistor	3. Check and replace
4. High Output Ripple	4. Defective output filter C1	4. Check C1 capacitors

Output Voltage Range Adjustment Procedure

1. Turn the unit on and allow it to warm up for at least 30 minutes.
2. Set fine output voltage adjust fully counter-clockwise (zero setting).
3. Set coarse output voltage adjust fully clockwise (full output).
4. Adjust R44 (on rear panel) for approximately full rated output voltage.
5. Turn coarse output voltage adjust fully counter-clockwise (to zero).
6. Adjust R47 (on rear panel) for zero volts output (± 0.1 volt).
8. Next turn coarse adjust to full output.
9. Re-adjust R44 for full rated output voltage ($\pm 0.5\%$).

Constant Current Range Adjustment Procedure

1. Turn the unit on and allow it to warm up for at least 30 minutes.
2. Connect a short across the output terminals.
3. Adjust R32 (current limit adjust on rear panel) to reach maximum of the output current range.

Note: No minimum adjustment is required.

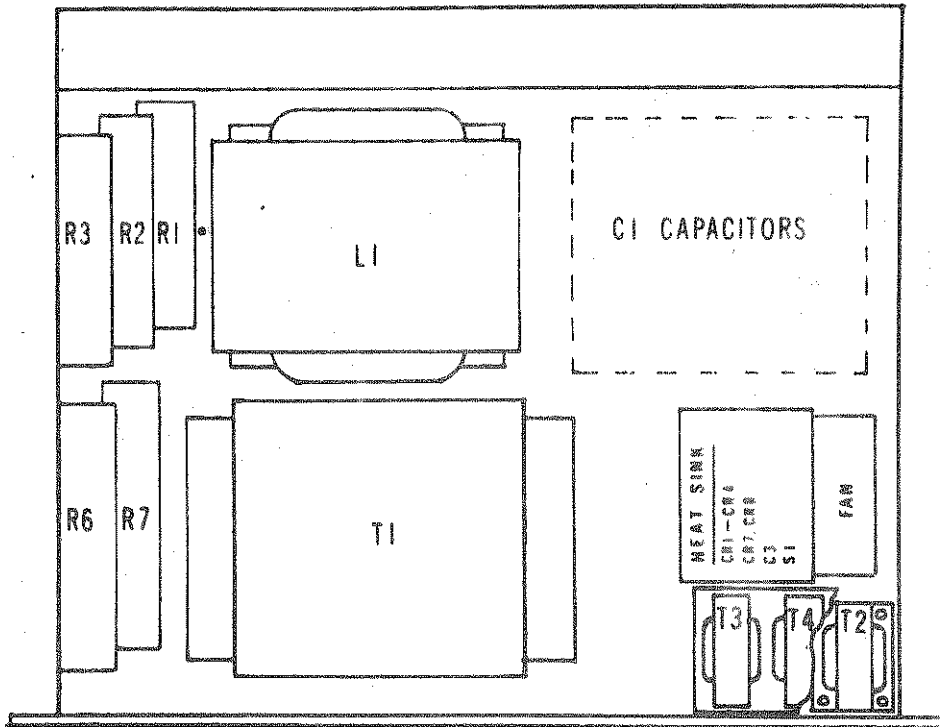

TOP VIEW OF THE CHASSIS
 Models: DCR40-35, DCR60-25, DCR80-18, DCR150-10, DCR300-5, DCR20-125,
 DCR40-60, DCR60-40, DCR80-30, DCR150-15 and DCR300-8

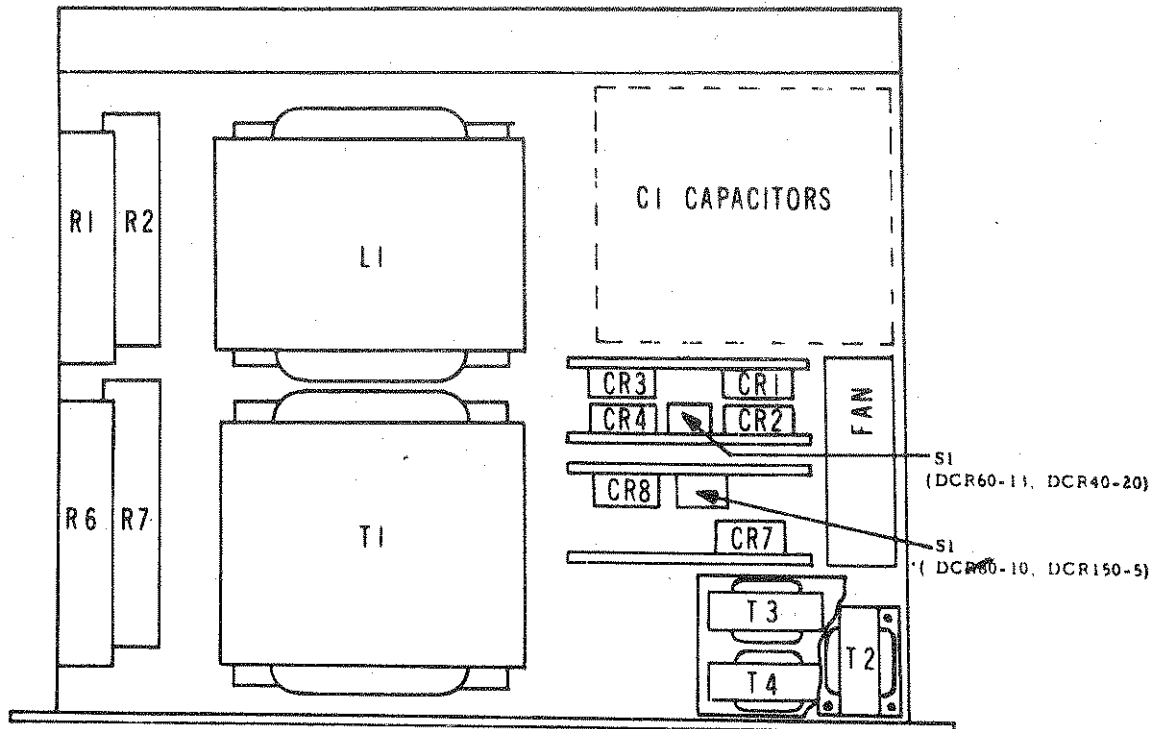

TOP VIEW OF THE CHASSIS
 Models: DCR40-20, DCR60-13, DCR80-10, DCR150-5 and DCR300-2.5

When replacing transistor Q15 or transistor Q16 (P/N 18-125-2), please note the arrangement of the socket holes and the transistor leads.

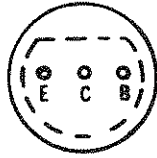

BOTTOM VIEW



TOP VIEW

Of the socket

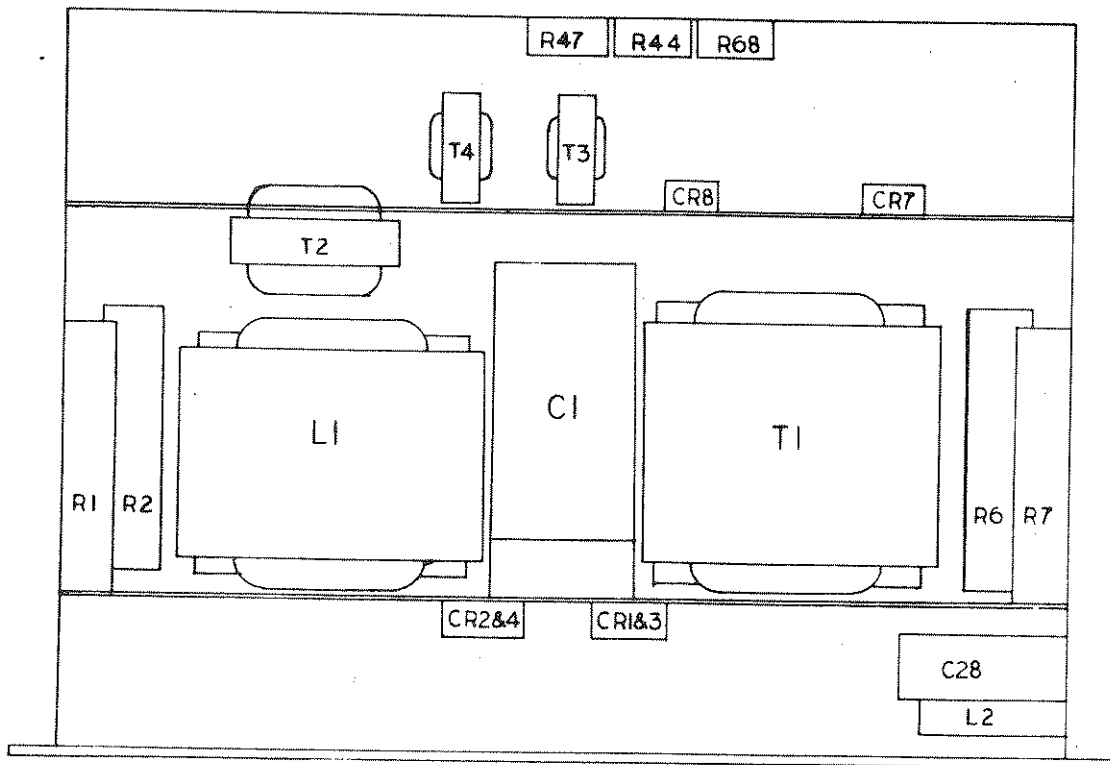

TOP VIEW OF THE CHASSIS

Models: DCR40-10, DCR80-5, DCR150-2, 5 and DCR300-1, 25