

MODEL DS340

Synthesized Function Generator



1290-D Reamwood Avenue
Sunnyvale, California 94089
Phone: (408) 744-9040 • Fax: (408) 744-9049
email: info@thinkSRS.com • www.thinkSRS.com

Copyright © 1999 by SRS, Inc.
All Rights Reserved.

Revision 1.7 (01/2004)

Table of Contents

Condensed Information

Safety and Use	v
Specifications	vii
Abridged Command List	xi

Getting Started

Introduction	1-1
CW Function Generation	1-1
Frequency Sweep	1-2

Operation









Introduction to DDS	2-1
DS340 Features	2-5
Front Panel Features	2-5
Rear Panel Features	2-7
Function Setting	2-9
Setting the Function	2-10
Frequency	2-10
Amplitude	2-11
DC Offset	2-12
Sweeps/FSK	2-13
Frequency Sweeps	2-13
Sweep Type	2-13
Sweep Frequencies	2-14
Sweep/FSK Output	2-14
FSK Input	2-15
Instrument Setup	2-17
Default Settings	2-17
Store and Recall	2-17
GPIB and RS-232 Setup	2-18
Self-Test	2-19
Arbitrary Waveforms	2-21
Sampling Frequency	2-21
Trigger Source	2-21
Trigger Rate	2-22
Triggered output	2-22
Downloading procedure	2-22
Download Errors	2-23

Programming

Programming the DS340	3-1
Communications	3-1
GPIB Communication	3-1
RS-232 Communication	3-1
Data Window	3-1
Command Syntax	3-1
Detailed Command List	3-3
Function Output Commands	3-3
Sweep Control	3-5
Arbitrary Waveform Commands	3-6
Setup Control Commands	3-7
Status Reporting Commands	3-7
Test and Calibration Commands	3-8
Status Byte Definitions	3-9
Programming Examples	3-11
Introduction	3-11
GPIB and C Example	3-12
RS-232 and BASIC example	3-13
Arbitrary waveform example	3-14
Test and Calibration	
Troubleshooting	4-1
Operation Error Messages	4-1
Self-Test Error Messages	4-2
Performance Tests	5-1
Necessary Equipment	5-1
Functional Tests	5-2
Front Panel Test	5-2
Self Tests	5-2
Sine Wave	5-2
Square Wave	5-2
Amplitude Flatness	5-3
Output Level	5-3

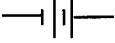
Performance Tests	5-5	Display and Keyboard	8-2
Frequency Accuracy	5-5	System DAC and S/H's	8-3
Amplitude Accuracy	5-5	DDS ASIC and Memory	8-3
DC Offset Accuracy	5-7	DDS Waveform DAC	8-4
Subharmonics	5-7	DDS Output Filters	8-4
Spurious Signals	5-8	Pre-Attenuator	8-5
Harmonic Distortion	5-8	SYNC Generator	8-5
Phase Noise	5-8	Function Selection	8-5
Square Wave Rise Time	5-9	Output Amplifier	8-5
Square Wave Symmetry	5-9	Output Attenuator	8-6
Test Scorecard	5-11	Option Board	8-6
Calibration	6-1	Power Supplies	8-6
Introduction	6-1	GPIB and RS-232 Interfaces	8-7
Calibration Enable	6-1	Component Parts List	9-1
Calbytes	6-1	Front Panel Board Parts List	9-1
Necessary Equipment	6-5	Main PC Board	9-2
Adjustments	6-5	Power Supply and Option Board	9-11
Output Amplifier Bandwidth	6-5	Miscellaneous	9-13
Bessel Filter Adjustment	6-6	Schematic Circuit Diagrams	Sheet No.
Calibration	6-6	Front Panel	
Clock Calibration	6-6	Keypad and LED Display	1/1
Arbitrary Waveform Software		Main/Bottom PC Board	
Introduction	7-1	Microprocessor	1/8
Getting Started with AWC	7-1	Display, Keyboard and Cable	2/8
Hardware Requirements	7-3	System DACs	3/8
Menus	7-3	DDS ASIC, Memory, and Sweep	4/8
File Menu	7-3	DDS Waveform DAC and Filters	5/8
Edit Menu	7-3	SYNC and Pre-Attenuators	6/8
Waveform Menu	7-4	Output Amplifier	7/8
Send Data Menu	7-5	Regulators and Attenuators	8/8
Set DS340 Menu	7-5	Option/Top PC Board	
Trigger Menu	7-6	Power Supply and Cable	1/2
Zoom Menu	7-6	GPIB and RS-232 Interfaces	2/2
Other Menu	7-7	Front Panel Component Placement	
Mouseless Operation	7-7	Main PC Board Component Placement	
File Format	7-7	Option Board Component Placement	
DS340 Circuitry			
Circuit Description	8-1		
Front Panel Board	8-1		
Main Board	8-1		
Microprocessor System	8-1		

Symbols you may find on SRS products

Symbol	Description
	Alternating current
	Caution - risk of electrical shock
	Frame or chassis terminal
	Caution - refer to accompanying documents
	Earth (ground) terminal
	Battery
	Fuse
	On (supply)
	Off (supply)

Safety and Preparation for Use

WARNING: Dangerous voltages, capable of causing death, are present in this instrument. Use extreme caution whenever the instrument covers are removed.

This instrument may be damaged if operated with the **LINE VOLTAGE SELECTOR** set for the wrong ac line voltage or if the wrong fuse is installed.

LINE VOLTAGE SELECTION

The DS340 operates from a 100V, 120V, 220V, or 240V nominal ac power source having a line frequency of 50 or 60 Hz. Before connecting the power cord to a power source, verify that the **LINE VOLTAGE SELECTOR** card, located in the rear panel fuse holder, is set so that the correct ac input voltage value is visible.

Conversion to other ac input voltages requires a change in the fuse holder voltage card position and fuse value. Disconnect the power cord, open the fuse holder cover door and rotate the fuse-pull lever to remove the fuse. Remove the small printed circuit board and select the operating voltage by orienting the board so that the desired voltage is visible when it is pushed firmly back into its slot. Rotate the fuse-pull lever back into its normal position and insert the correct fuse into the fuse holder.

LINE FUSE

Verify that the correct line fuse is installed before connecting the line cord. For 100V/120V, use a 1/2 Amp slow blow fuse and for 220V/240V, use a 1/4 Amp slow blow fuse.

LINE CORD

The DS340 has a detachable, three-wire power cord for connection to the power source and to a protective ground. The exposed metal parts of the instrument are connected to the outlet ground to protect against electrical shock. Always use an outlet which has a properly connected protective ground.

SPECIFICATIONS

FREQUENCY RANGE

<u>Waveform</u>	<u>Maximum Freq.</u>	<u>Resolution</u>	<u>Accuracy</u>
Sine	15.1 MHz	1 μ Hz	± 25 ppm
Square	15.1 MHz	1 μ Hz	± 25 ppm
Ramp	100 KHz	1 μ Hz	± 25 ppm
Triangle	100 KHz	1 μ Hz	± 25 ppm
Noise	10 MHz	(Gaussian Weighting)	
Arbitrary	40 MHz	40 MHz sample rate	± 25 ppm

OUTPUT

All Specifications assume a 50 Ω termination unless stated otherwise

Source Impedance: 50 Ω

Output may float up to ± 40 V (AC + DC) relative to earth ground.

AMPLITUDE

Range into 50 Ω load (limited such that $|V_{ac\ peak}| + |V_{dc}| \leq 5$ V)

Function	V_{pp}		V_{rms}	
	Max.	Min.	Max.	Min.
Sine	10V	50 mV	3.54V	0.02Vrms
Square	10V	50 mV	5.00V	0.03Vrms
Triangle	10V	50 mV	2.89V	0.01Vrms
Ramp	10V	50 mV	2.89V	0.01Vrms
Noise	10V	50 mV	1.62V	0.01Vrms
Arbitrary	10V	10 mV	n.a.	n.a.

Range into a high impedance load (limited such that $|V_{ac\ peak}| + |V_{dc}| \leq 10$ V)
(for frequencies <100kHz)

Function	V_{pp}		V_{rms}	
	Max.	Min.	Max.	Min.
Sine	20V	100 mV	7.07V	0.04Vrms
Square	20V	100 mV	10V	0.05Vrms
Triangle	20V	100 mV	5.77V	0.03Vrms
Ramp	20V	100 mV	5.77V	0.03Vrms
Noise	20V	100 mV	3.24V	0.02Vrms
Arbitrary	20V	100mV	n.a.	n.a.

Specifications

Resolution 3 digits

Accuracy (with 0V DC Offset), 50Ω terminated

Sine: Accuracy
± 0.1 dB

Square: Accuracy
± 2% ≤ 10 MHz
± 8% > 10 MHz

Triangle, Ramp, Arbitrary: Accuracy
±2%

DC OFFSET

Range: ±5V into 50 Ω (limited such that $|V_{ac\ peak}| + |V_{dc}| \leq 5\ V$)
±10V into hi-Z (limited such that $|V_{ac\ peak}| + |V_{dc}| \leq 10\ V$)

Limitation: $|V_{dc}| \leq 2 \times V_{pp}$ in all cases

Resolution: 3 digits

Accuracy: 1.2% of setting (DC only)
±0.8 mV to ±80 mV depending on AC and DC settings

WAVEFORMS

Sinewave Spectral Purity

Spurious (non-harmonic): ≤ -65 dBc to 1 MHz
(+ 6 dB/oct > 1 MHz)

Phase Noise: ≤ -55dBc in a 30 kHz band centered on the carrier,
exclusive of discrete spurious signals

Subharmonic: ≤ -70 dBc

Harmonic Distortion: Harmonically related signals will be less than:

Level	Frequency Range
≤ -70 dBc	DC to 20 kHz
≤ -60 dBc	20 kHz to 100 kHz
≤ -50 dBc	100 kHz to 1 MHz
≤ -40 dBc	1 MHz to 15.1 MHz

Square Wave

Rise/Fall Time: < 15 ±5 ns (10 to 90%), at full output

Asymmetry: < 1% of period + 3 ns

Overshoot: < 2% of peak to peak amplitude at full output

Ramps, Triangle, and Arbitrary

Rise/Fall Time 45 ±20 ns (10 MHz Bessel Filter)

Linearity ±0.1% of full scale output

Settling Time < 200 ns to settle within 0.5% of final value at full output

Arbitrary Function

Sample Rate: 40 MHz/N, N = 1 to 2³⁴-1.
 Waveform Length: 8 to 16,300 points
 Resolution: 12 bits (0.025% of full scale)

FREQUENCY SWEEP

Type: Linear or Log, phase continuous
 Waveform: Up, down, up-down, single sweep
 Rate: 0.01 Hz to 1 kHz
 Span: 1 μHz to 15.1 MHz (100 kHz for triangle or ramp)
 Six decades for Log sweeps

FREQUENCY-SHIFT KEYING (FSK)

Type: Internal rate or External control, phase continuous
 Waveform: Sine, Square, Triangle, Ramp
 Rate: 0.01 Hz to 50 kHz (internal)
 Shift Span: 1 μHz to 15.1 MHz (100 kHz for triangle or ramp)
 External: TTL input, 1MHz maximum

ARBITRARY WAVEFORM TRIGGER GENERATOR

Source: Single, Internal, External, Line, Continuous
 Rate: 0.001 Hz to 10 kHz internal (3 digit resolution)
 External: Positive or Negative edge, TTL input
 Output: TRIG BNC, TTL output

SYNC & SWP/FSK OUTPUTS

SYNC: TTL level, active with all functions
 SWP/FSK: TTL level, synchronous with internal Sweeps and FSK rates

TIMEBASE

Stability: ±25 ppm (0 to 70° C)
 Aging: 5 ppm/year

Optional Timebase

Type: Temperature Compensated Crystal Oscillator
 Stability: +/- 2.0 ppm, 0 to 50°C
 Aging: 5 ppm first year, 2 ppm per year thereafter

GENERAL

Interfaces: RS232-C (300 to 19.2 k Baud, DCE) and GPIB with free DOS Based Arbitrary Waveform Software
 All instrument functions can be controlled over the interfaces.
 Weight: 8 lbs
 Dimensions: 8.5" x 3.5" x 13" (W x H x L)
 Power: 25 Watts, 100/120/220/240 Vac 50/60 Hz

Syntax

Variables *i, j* are integers. Variable *x* is a real number in integer, real, or exponential notation.

Commands which may be queried have a ? in parentheses (?) after the mnemonic. The () are not sent.

Commands that may **only** be queried have a '?' after the mnemonic. Commands which **may not** be queried have no '?'. Optional parameters are enclosed by {}.

Function Output Control Commands

AECL	Sets the output amplitude/offset to ECL levels (1Vpp, -1.3V offset).
AMPL(?) x	Sets the output amplitude to <i>x</i> . <i>x</i> is a value plus units indicator. The units can be VP (Vpp), VR (Vrms. Example: AMPL 1.00VR sets 1.00 Vrms.
ATTL	Sets the output amplitude/offset to TTL levels (5 Vpp, 2.5 V offset).
FREQ(?) x	Sets the output frequency to <i>x</i> Hz.
FSMP(?) x	Sets the arbitrary waveform sampling frequency to <i>x</i> Hz.
FUNC(?) i	Sets the output function. 0 = sine, 1 = square, 2 = triangle, 3 = ramp, 4 = noise, 5 = arbitrary.
INVT(?) i	Sets the output inversion on (i=1) or off (i=0). Used with the ramp function.
KEYS(?) i	Simulates a key press or reads the most recently pressed key.
OFFS(?) x	Sets the output offset to <i>x</i> volts.
SYNC(?) i	Turns the Sync output on (i=1) or off (i=0).
TERM(?) i	Sets the output source impedance to 50Ω (i=0), Hi-Z (i=1).

Sweep and Arbitrary Waveform control commands

FSEN(?) i	Enables FSK on (i=1) or off (i=0). Valid only if SDIR2 is sent first.
LDWF(?) i	Allows downloading an <i>i</i> point arbitrary waveform. After execution of this query the DS340 will return the ascii value 1. The binary waveform data may now be downloaded.
LDWA(?) n	Allows downloading an <i>n</i> point arbitrary waveform. After execution of this query the DS340 will return the ascii value 1. The ascll waveform data may now be downloaded.
*TRG	Triggers single sweeps and arbitrary waveforms if in single trigger mode.
SDIR(?) i	Sets the sweep direction 0 = Ramp, 1 = Triangle, 2 = FSK.
SPFR(?) x	Sets the sweep stop frequency to <i>x</i> Hz.
SRAT(?) x	Sets the sweep rate to <i>x</i> Hz.
STFR(?) x	Sets the sweep start frequency to <i>x</i> Hz.
STYP(?) i	Sets the sweep type. 0 = linear sweep, 1 = logarithmic sweep.
SWEN(?) i	Turns sweeps on (i=1) or off (i=0).
TRAT(?) x	Sets the internal trigger rate to <i>x</i> Hz for arbitrary waveform.
TSRC(?) i	Sets the trigger source for arbitrary waveforms. 0 = single, 1 = internal, 2 = + Ext, 3 = - Ext, 4 = line, 5 = continuous (default).

Setup Control Commands

*IDN?	Returns the device identification .
*RCL i	Recalls stored setting <i>i</i> .
*RST	Clears instrument to default settings.
*SAV i	Stores the current settings in storage location <i>i</i> .

Status Reporting Commands

*CLS	Clears all status registers.
*ESE(?) j	Sets/reads the standard status byte enable register.

*ESR? {j}	Reads the standard status register, or just bit j of register.
*PSC(?) j	Sets the power on status clear bit. This allows SRQ's on power up if desired.
*SRE(?) j	Sets/reads the serial poll enable register.
*STB? {j}	Reads the serial poll register, or just bit n of register.
STAT? {j}	Reads the DDS status register, or just bit n of register.
DENA(?) j	Sets/reads the DDS status enable register.

Hardware Test Control

*TST? Starts self-test and returns status when done.

Status Byte Definitions

Serial Poll Status Byte

<u>bit</u>	<u>name</u>	<u>usage</u>
0	Sweep Done	set when no sweeps in progress
1	Sweep Enable	set when sweep or FSK is enabled
2	User SRQ	set when the user issues a front panel SRQ
3	DDS	set when an unmasked bit in DDS status byte is set
4	MAV	set when GPIB output queue is non-empty
5	ESB	set when an unmasked bit in std event status byte is set
6	RQS	SRQ bit
7	No Command	set when there are no unexecuted commands in input queue

Standard Event Status Byte

<u>bit</u>	<u>name</u>	<u>usage</u>
0	unused	
1	unused	
2	Query Error	set on output queue overflow
3	unused	
4	Execution Err	set on error in command execution
5	Command Err	set on command syntax error
6	URQ	set on any front panel key press
7	PON	set on power on

DDS Status Byte

<u>bit</u>	<u>name</u>	<u>usage</u>
0	Trig'd	set on sweep trigger
1	Rate Err	set when a trigger rate error occurs
2	Not in use	
3	Not in use	
4	Warmup	set when the DS340 is warmed up
5	Test Error	set when self test fails
6	Not in use	
7	mem err	set on power up memory error

Introduction

This section is designed to familiarize you with the operation of the DS340 Synthesized Function Generator. The DS340 is a powerful, flexible generator capable of producing both continuous and swept waveforms of exceptional purity and resolution. The DS340 is also relatively simple to use, and the following examples will lead you step-by-step through some typical uses.

Data Entry

Setting the DS340's operational parameters is done by pressing the key with the desired parameter's name on it (FREQ, for example, to set the frequency). The current value will be displayed. Some of the parameters are labelled above the keys in light gray. To display those values first press the SHIFT key and then the labeled key ([SHIFT][STOP FREQ], for example, to display the type of waveform sweep set). Values are changed by the DATA ENTRY keys. To directly enter a value simply type the new value using the keypad and complete the entry by hitting one of the UNITS keys. If the value has no particular units any of the UNITS keys may be used. If an error is made, pressing the corresponding function key will backspace the cursor. If the key is pressed repeatedly the display will eventually show the previous value. For example, if a new frequency is being entered and the wrong numeric key is pressed, then pressing the FREQ key will backspace the cursor. If the FREQ key is pressed until the new entry is erased, then the last valid frequency value will be displayed. The current parameter value may also be incremented or decremented using the UP and DOWN ARROW keys. Pressing the UP ARROW key will increment the flashing digit value by one, while pressing the DOWN ARROW key will decrement the flashing digit value by one. If the parameter value cannot be incremented or decremented, the DS340 will beep and display an error message. Pressing [SHIFT][UP ARROW] or [SHIFT][DOWN ARROW] changes the position of the blinking digit.

CW Function Generation Our first example demonstrates a CW waveform using the DS340's data entry functions. Connect the front panel FUNCTION output to an oscilloscope, terminating the output into 50 ohms. Turn the DS340 on and wait until the message "TEST PASS" is displayed (if the self tests fail, refer to **TROUBLESHOOTING** section of the manual).

- | | |
|---------------------------------------|--|
| 1) Press [SHIFT][+/-]. | This recalls the DS340's default settings. |
| 2) Press [AMPL]. Then press [5][Vpp]. | Displays the amplitude and sets it to 5 Vpp. The scope should show a 5 Vpp 1 MHz sine wave. |
| 3) Press [FUNC DOWN ARROW] twice. | The function should change to a square wave and then a triangle wave. The DS340 automatically performs a frequency adjustment to match the maximum triangle frequency (100 kHz). |
| 4) Press [FREQ] and then [1][kHz]. | Displays the frequency and sets it to 1 kHz. The scope should now display a 1 kHz triangle wave. |

- 5) Press [UP ARROW].
The frequency will increment to 1.0001 kHz. The flashing digit indicates a step size of 0.1 Hz.
- 6) Press [SHIFT UP ARROW] twice.
Observe that the blinking digit is shifted twice to the left indicating a step size of 10 Hz.
- 7) Press [UP ARROW] three times.
We've changed the output frequency to 10.0301 kHz.

Frequency Sweep

The next example demonstrates a linear frequency sweep. The DS340 can sweep the output frequency of any function over the entire range of allowable output frequencies. There are no restrictions on minimum or maximum linear sweep span. The sweep is phase continuous and may range from 0.01Hz to 1000 Hz.

Attach the FUNCTION output BNC to the oscilloscope, terminating the output into 50 ohms. Set the scope to 2V/div. Attach the SWP/FSK rear-panel BNC to the scope and set to 2V/div. The scope should be set to trigger on the rising edge of this signal.

- 1) Press [SHIFT][+/-].
This recalls the DS340's default settings.
- 2) Press [AMPL] then [5][Vpp].
Sets the amplitude to 5Vpp.
- 3) Press [SHIFT] [STOP FREQ].
Verify linear sweep. "Lin" should be blinking now.
- 4) Press [SWEEP RATE] then [1][0][0] [Hz].
Set the sweep rate to 100 Hz. The sweep will take 10 ms (1/100Hz). Set the scope time base to 1ms/div.
- 5) Press [START FREQ] then [1][0][0][kHz].
Set the sweep start frequency to 100 kHz.
- 6) Press [STOP FREQ] then [1][MHz].
Set the stop frequency to 1 MHz.
- 7) Press [SHIFT][START FREQ].
The SWP LED will light, indicating that the DS340 is sweeping. The scope should show the SWEEP output as a TTL pulse synchronous with the start of the sweep. The FUNCTION output is the swept sine wave. The DS340 also displays the option to switching to single shot sweeps at this time. Pressing the up or down arrows at this time switches the sweeps to single shot. Pressing [SHIFT][START FREQ] triggers one sweep.

Introduction to Direct Digital Synthesis

Introduction

Direct Digital Synthesis (DDS) is a method of generating very pure waveforms with extraordinary frequency resolution, low frequency switching time, crystal clock-like phase noise, and flexible sweeping capabilities. As an introduction to DDS let's review how traditional function generators work.

Traditional Generators

Frequency synthesized function generators typically use a phase-locked loop (PLL) to lock an oscillator to a stable reference. Wave-shaping circuits are used to produce the desired function. It is difficult to make a very high resolution PLL so the frequency resolution is usually limited to about $1:10^6$ (some sophisticated fractional-N PLLs do have much higher resolution). Due to the action of the PLL loop filter, these synthesizers typically have poor phase jitter and frequency switching response. In addition, a separate wave-shaping circuit is needed for each type of waveform desired, and these often produce large amounts of waveform distortion.

Arbitrary Waveforms

Arbitrary function generators bypass the need for wave-shaping circuitry. Usually, a PLL is used to create a variable frequency clock that increments an address counter. The counter addresses memory locations in waveform RAM, and the RAM output is converted by a high speed digital-to-analog converter (DAC) to produce an analog waveform. The waveform RAM can be filled with any pattern to produce "arbitrary" functions as well as the usual sine, triangle, etc. The sampling theorem states that, as long as the sampling rate is greater than twice the frequency of the waveform being produced, with an appropriate filter the desired waveform can be perfectly reproduced. Since the frequency of the waveform is adjusted by changing the clock rate, the output filter frequency must also be variable. Arbitrary generators with a PLL suffer the same phase jitter, transient response, and resolution problems as synthesizers.

DDS

DDS works by generating addresses to a waveform RAM to produce data for a DAC. However, unlike earlier techniques, the clock is a fixed frequency reference. Instead of using a counter to generate addresses, an adder is used. On each clock cycle, the contents of a Phase Increment Register are added to the contents of the Phase Accumulator. The Phase Accumulator output is the address to the waveform RAM (see diagram below). By changing the

Figure 1: Block diagram of SRS DDS ASIC

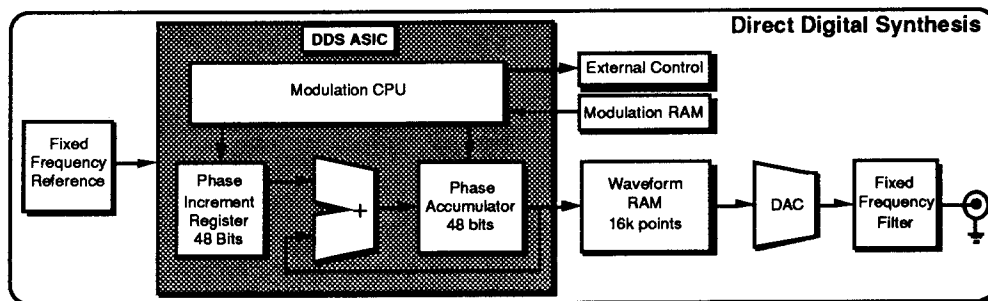

Phase Increment the number of clock cycles needed to step through the entire waveform RAM changes, thus changing the output frequency.

Frequency changes now can be accomplished phase continuously in only one clock cycle. And the fixed clock eliminates phase jitter, requiring only a simple fixed frequency anti-aliasing filter at the output.

The DS340 uses a custom Application Specific Integrated Circuit (ASIC) to implement the address generation in a single component. The frequency resolution is equal to the resolution with which the Phase Increment can be set. In the DS340, the phase registers are 48 bits long, resulting in an impressive $1:10^{14}$ frequency resolution. The ASIC also contains a modulation control CPU that operates on the Phase Accumulator, Phase Increment, and external circuitry to allow digital synthesis and control of waveform sweeps. The Modulation CPU uses data stored in the Modulation RAM to produce frequency sweeps. All sweep parameters are digitally programmed.

DDS gives the DS340 greater flexibility and power than conventional synthesizers or arbitrary waveform generators without the drawbacks inherent in PLL designs.

DS340 Description

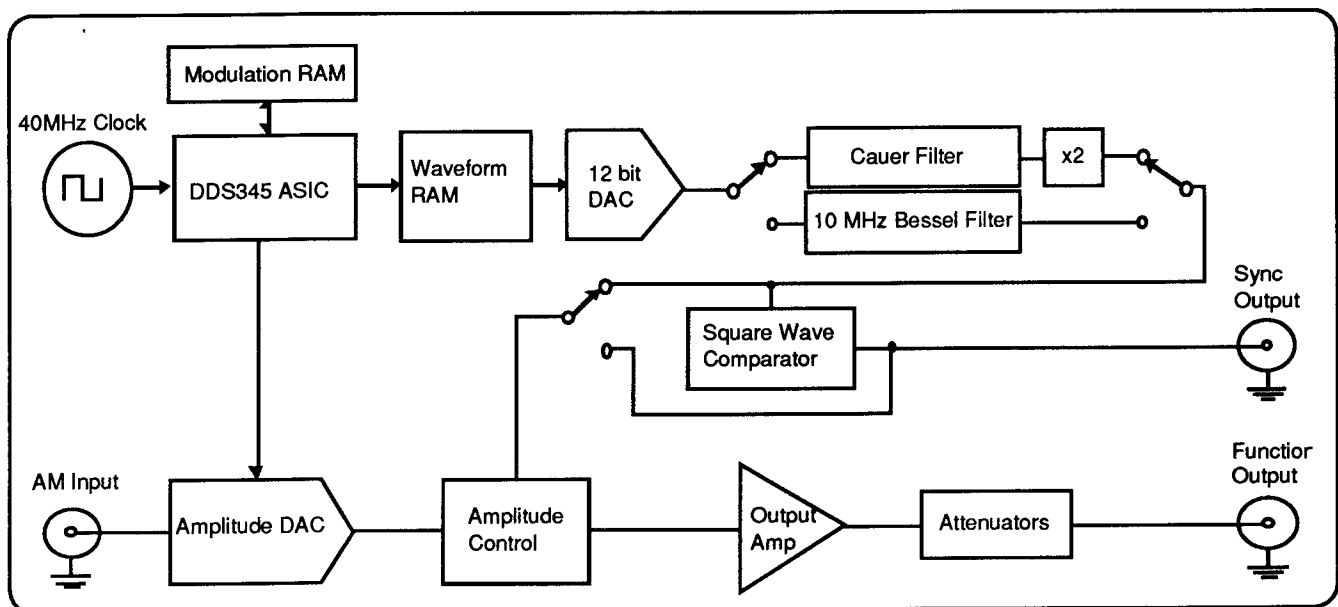

Figure 2: DS340 Block Diagram

A block diagram of the DS340 is shown in Figure 2. The heart of the DS340 is a 40 MHz crystal clock. This clock is internally provided, but may be phase locked to an external reference. The 40 MHz clock controls the ASIC, waveform RAM, and high-speed 12 bit DAC. Sampling theory limits the frequency of the waveform output from the DAC to about 40% of 40 MHz, or 15 MHz. The 48 bit length of the ASIC's PIRs sets the frequency resolution to about

146 nHz. These parameters and the DAC's 12 bit resolution define the performance limits of the DS340.

The reconstruction filter is key to accurately reproducing a waveform in a sampled data system. The DS340 contains two separate filters. For sine wave generation the output of the DAC goes through a 9th order Cauer filter, while ramps, triangles, and arbitrary waveforms pass instead through a 10 MHz 7th order Bessel filter. The Cauer filter has a cutoff frequency of 16.5 MHz and a stopband attenuation of 85 dB, and also includes a peaking circuit to correct for the $\text{sine}(x)/x$ amplitude response characteristic of a sampled system. This filter eliminates any alias frequencies from the waveform output and allows generation of extremely pure sine waves. However, the Cauer filter has very poor time response and is only useful for CW waveforms. Therefore, the Bessel filter was chosen for its ideal time response, eliminating rings and overshoots from stepped waveform outputs. This filter limits the frequency of arbitrary waveforms to 10 MHz and rise times to 35 ns.

The output from the filter passes through pre-amplifier attenuators with a 0 to 14 dB range. The attenuators are followed with a wide bandwidth power amplifier that outputs a 10 V peak-to-peak into a 50 ohm load with a rise time of less than 22 ns. The output of the power amplifier passes through a series of four step attenuators (2, 4, 8, and 16 dB) that set the DS340's final output amplitude. The post amplifier attenuators allow internal signal levels to remain as large as possible, minimizing output noise and signal degradation.

Square waves and waveform sync signals are generated by discriminating the function waveform with a high-speed comparator. The output of the comparator passes to the SYNC OUTPUT and, in the case of square waves, to the amplifier input. Generating square waves by discriminating the sine wave signal produces a square wave output with rise and fall times much faster than allowed by either of the signal filters.

Front Panel Features

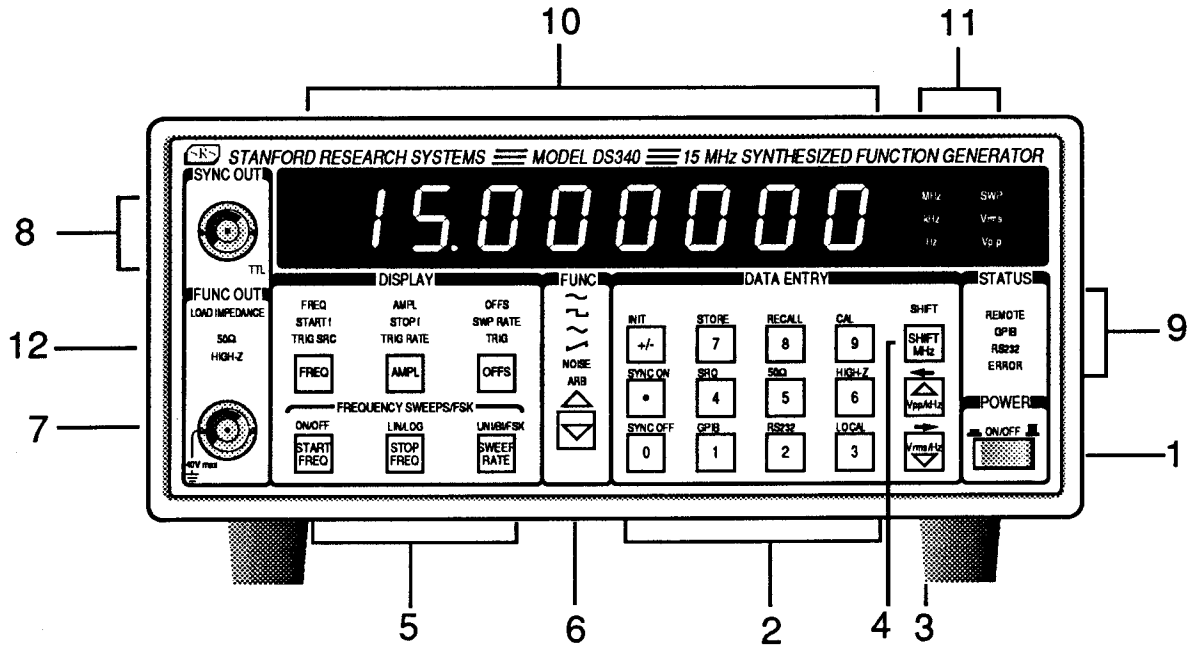

1) Power Switch

The power switch turns the DS340 on and off. The DS340 has a battery backed up system RAM that remembers all instrument settings.

2) Data Entry Keys

The numeric keypad allows for direct entry of the DS340's parameters. To change a parameter value simply type the new value. Entries are terminated by the UNITS keys. A typing error may be corrected by pressing the corresponding function key. For example, if the wrong numeric key is pressed while entering a new frequency, pressing the [FREQ] key will backspace over the last entered digit. If there are no digits left, the current frequency value is displayed. The [+/-] key may be selected at any time during numeric entry.

3) Units Keys

The UNIT keys are used to terminate numeric entries. Simply press the key with the desired units to enter the typed value. Some parameters have no particular units and **any** of the unit keys may be used.

The unit keys also increase and decrease the numeric value in the DS340's display. Pressing the [UPARROW] key adds one to the flashing digit value, the [DOWN ARROW] key subtracts one from the flashing digit value. To change the position of the flashing digit, press [SHIFT] [LEFT ARROW] or [SHIFT] [RIGHT ARROW]. A few of the display menus have more than one parameter displayed at a time. The [SHIFT][LEFT ARROW] and [SHIFT] [RIGHT ARROW] keys select between left and right.

4) Shift Key

The shift key selects the function printed above the keys. Pressing [SHIFT] and then the desired key to select the specific function (for example [SHIFT] [50Ω] sets the source impedance to 50Ω). When the SHIFT key is pressed the SHIFT LED will light. Pressing [SHIFT] a second time will deactivate shift mode.

- 5) Sweep, FSK, & ARB Keys** The bottom three keys control the sweep parameters including: Start and Stop Frequencies, Sweep Rate, Continuous or Single Sweep, Linear or Log Sweep, Unidirectional or Bidirectional Sweeps, and FSK. When shifted, the top three keys (Freq, Ampl, Offs) control the arbitrary waveform trigger source, trigger rate, and single shot triggers.
- 6) Function Keys** These keys control the main function output. The Func [DOWN ARROW] key and [SHIFT][UP ARROW] key select between the output functions. If the output frequency is set beyond the range allowed for a waveform (> 10kHz for triangle and ramp) an error message will be displayed and the frequency will change to the maximum allowed for that function.
- 7) Main Function BNC** This output has an impedance of 50Ω. The shield of this output may be floated up to ±40V relative to earth ground.
- 8) Sync Output BNC** The Sync Output is a TTL square wave synchronized to the function output with a 50Ω output impedance. The shield of this output may be floated up to ±40V relative to earth ground.
- 9) Status LEDs** The four status LEDs indicate the DS340's interface status. They are:
- | <u>name</u> | <u>function</u> |
|-------------|--|
| REMOTE | The DS340 is in GPIB remote state. The [3] key returns local control. |
| GPIB | Flashes on GPIB activity. |
| RS-232 | Flashes on RS-232 activity. |
| ERROR | Flashes on an error in the execution of a remote or local command including range and rate errors. |
- 10) Parameter Display** The 8 digit display shows the value of the currently displayed parameter. The LEDs below in the DISPLAY section indicate which parameter is being displayed. Error messages also appear on the display. When an error message is displayed you can return to the normal display by pressing any key.
- 11) Units LEDs** The Units LEDs indicate the units of the displayed parameter. If no LED is lit the value has no units. The SWP LED indicates that a sweep or FSK is in progress.
- 12) Load Impedance LEDs** These LEDs indicate the load impedance value as set by the user. The amplitude and offset display values will change according to the load impedance setting.

Rear Panel Features

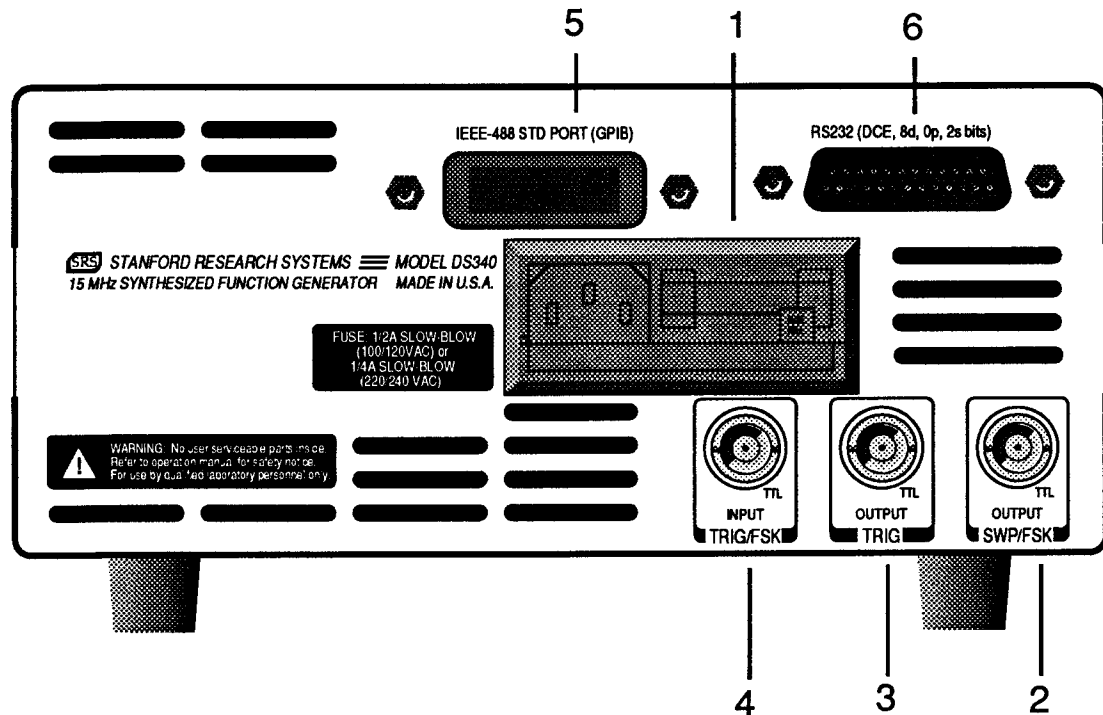
**1) Power Entry Module**

This contains the DS340's fuse and line voltage selector. Use a 1 amp slow blow fuse for 100/120 volt operation, and a 1/2 amp fuse for 220/240 volt operation. To set the line voltage selector for the correct line voltage, first remove the fuse. Then, remove the line voltage selector card and rotate the card so that the correct line voltage is displayed when the card is reinserted. Replace the fuse.

2) Sweep/FSK Output

This output generates a TTL pulse that is synchronous with the DS340's frequency sweep. When the DS340 is in FSK mode, the output voltage reflects the present frequency at the FUNCTION output BNC (TTL LOW = Start Frequency, TTL HIGH = Stop Frequency). The shield of this output is tied to that of the function output and may be floated up to $\pm 40V$ relative to earth ground.

3) Trigger Output

This TTL compatible output goes high when a triggered arbitrary waveform begins and low when it ends. This may be used to synchronize an external device to the arbitrary waveform. The shield of this output is tied to that of the function output and may be floated up to $\pm 40V$ relative to earth ground.

4) TRIG/FSK Input

The FSK/TRIG input allows the user to toggle between two frequencies when the DS340 is in FSK mode. The BNC accepts a TTL level input. When the input is low the start frequency is active, and when the input is high the stop frequency is active. This input is sampled at 10 MHz. When the DS340 is in externally triggered arbitrary waveform mode, the TRIG/FSK input is used to trigger the arbitrary waveform. The polarity of the trigger signal can be set from the front panel or via the RS-232/GPIB ports. The shield of this input is tied to the function output and may be floated up to $\pm 40V$ relative to earth ground.

5) GPIB Connector

If the DS340 has the optional interface, the GPIB connector is used for IEEE-488.1 and .2 compatible communications. **The shield of this connector is connected to earth ground.**

6) RS-232 Connector

If the DS340 has the optional interface, the RS-232 connector is used for RS-232 communication. The DS340 is a DCE and accepts 8 bits, no parity, 2 stop bits at between 300 and 19.2 k Baud. **The shield of this connector is connected to earth ground.**

DS340 OPERATION

Introduction

The following sections describe the operation of the DS340. The first section describes the basics of setting the function, frequency, amplitude, and offset. The second section explains sweeps and FSK. The third section explains storing and recalling setups, running self-test and autocalibration, and setting the computer interfaces. The fourth and last section describes arbitrary waveforms.

Power-On

When the power is first applied to the DS340 the unit will display its serial number and ROM version for about three seconds. The DS340 will then initiate a series of self-tests of the circuitry and stored data. The test should take about three seconds and end with the message "TST PASS". If the self test fails the DS340 will display an error message indicating the nature of the problem (see the **TROUBLESHOOTING** section for more details, page 4-1). The DS340 will attempt to operate normally after a self-test failure, (pressing any key will erase the error message).

SETTING THE FUNCTION

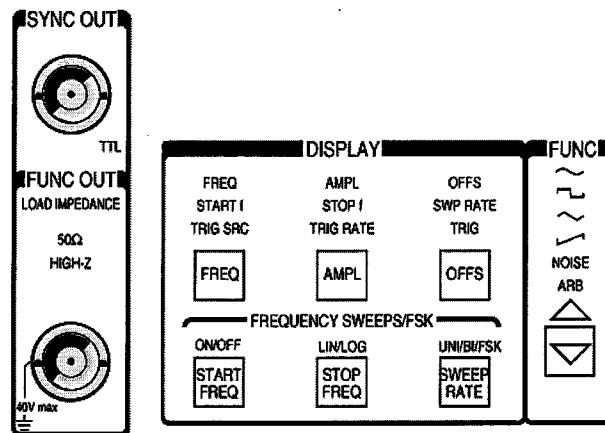

OUTPUTS

The FUNCTION and SYNC BNCs are the DS340's main outputs. Both of these outputs are fully floating, and their shields may be floated relative to earth ground by up to $\pm 40V$. Both outputs also have a 50Ω output impedance. If the outputs are terminated into high impedance instead of 50Ω the signal levels will be twice those programmed (the FUNCTION output may also show an increase in waveform distortion). The output impedance should be set properly from the front panel using the [SHIFT][5] or [SHIFT][6] keys. Incorrect impedance matching may result in output voltages that do not correspond to the displayed amplitudes and offsets. For example, if the DS340 is set for a 50 Ohms source impedance and the output is connected to a scope without a 50 Ohms terminator, then the scope waveform will be twice the amplitude displayed on the DS340. The programmed waveform comes from the FUNCTION output, while the SYNC output generates a TTL compatible (2.5 V into 50Ω) signal that is synchronous with the function output. The SYNC signal is suppressed if the function is set to NOISE or ARB. The SYNC signal can be disabled and enabled with the [SHIFT][0] and [SHIFT][.] keys.

FUNCTION SELECTION The DS340's output function is selected using the FUNCTION UP/DOWN arrow keys. Simply press the keys until the desired function LED is lit. If the programmed frequency is outside of the range allowed for the selected function, an error message will be displayed and the frequency will be set to the maximum allowed for that function.

Ramps Ramp functions usually ramp up in voltage, however, downward ramps may be programmed with the output invert function (see AMPLITUDE section).

Arbitrary Functions Arbitrary functions are created on a computer and downloaded to the DS340 via the computer interfaces. Arbitrary waveforms normally repeat continuously just as other functions do. Single, external, and rate triggering of arbitrary waveforms is accomplished using the DS340's TRIG SRC function from the front panel.

FREQUENCY To display the DS340's output frequency press [FREQ]. The frequency is always displayed in units of Hz. The DS340 has 1 μ Hz frequency resolution at all frequencies, for all functions. The maximum frequency depends on the function selected as listed below:

Frequency is usually displayed by the DS340 with 1 μ Hz resolution. However, if the frequency is greater than 1 MHz the digits below 0.1 Hz cannot be

Function	Frequency Range
Sine	1 μ Hz \rightarrow 15.100000000000 MHz
Square	1 μ Hz \rightarrow 15.100000000000 MHz
Triangle	1 μ Hz \rightarrow 100,000.000000 Hz
Ramp	1 μ Hz \rightarrow 100,000.000000 Hz
Noise	10.0 MHz White Noise (fixed)
Arbitrary	0.002329Hz \rightarrow 40.0 MHz sampling

displayed, but the frequency still has 1 μ Hz resolution and may be set via the computer interfaces.

If the function is set to NOISE, the character of the noise is fixed with a band limit of 10 MHz. The frequency is not adjustable and the FREQ display will read "noise" instead of a numerical value.

If the function is set to ARB, the frequency displayed is the **sampling frequency** of the arbitrary waveform. This number is independent of the usual frequency and is the dwell time that the DS340 spends on each point in an arbitrary waveform. This sampling frequency must be an integer submultiple of the 40 MHz clock frequency. That is, 40 MHz/N where N = 1,2,3... $2^{34}-1$ (40 MHz, 20 MHz, 13.3333 MHz, 10 MHz, 8 MHz...). The DS340 will spend 1/Fsample on each point. When a new sampling frequency value is entered the DS340 will round the value to the nearest integer submultiple of 40 MHz.

Note that the frequency for the standard functions is **never** rounded.

Setting the Frequency

To set the frequency of any function simply type a new value on the keypad and complete the entry with the appropriate units (Hz, kHz, or MHz). The UP and DOWN arrow keys may be used to increase or decrease the frequency by adding or subtracting one unit of the flashing digit.

AMPLITUDE

Press [AMPL] to display the amplitude of the output function. The amplitude may be set and displayed in units of V_{pp} and V_{rms} . The current units are indicated by the LEDs at the right of the display. The amplitude range is limited by the DC offset setting since $|V_{ac\ peak}| + |V_{dc}| \leq 5\ V$ (into 50 Ohm). If the DC offset is zero the amplitude range for each of the functions is shown below:

note: The rms value for NOISE is based on the total power in the output bandwidth (about 10 MHz) at a given peak to peak setting.

Arbitrary function amplitude may **only** be set in units of V_{pp} . The output signal will briefly go to zero as the output attenuators are switched.

Function	V_{pp}		V_{rms}	
	Max.	Min.	Max.	Min.
Sine	10V	50 mV	3.54V	0.02Vrms
Square	10V	50 mV	5.00V	0.03Vrms
Triangle	10V	50 mV	2.89V	0.01Vrms
Ramp	10V	50 mV	2.89V	0.01Vrms
Noise	10V	50 mV	1.62V	0.01Vrms
Arbitrary	10V	10 mV	n.a.	n.a.

50 Ohm Load Impedance

Function	V_{pp}		V_{rms}	
	Max.	Min.	Max.	Min.
Sine	20V	0.1V	7.07V	0.04Vrms
Square	20V	0.1V	10.0V	0.05Vrms
Triangle	20V	0.1V	5.77V	0.03Vrms
Ramp	20V	0.1V	5.77V	0.03Vrms
Noise	20V	0.1V	3.24V	0.02Vrms
Arbitrary	20V	0.1V	n.a.	n.a.

HIGH-Z Load Impedance

- Output Inversion** The DS340's output may be inverted for ramp functions. This is useful for turning positive ramps into negative ramps. Entering a negative amplitude inverts the ramp output.
- D.C. Only** The output of the DS340 may be set to a DC level by entering an amplitude of 0 V. When the amplitude is set to zero, the AC waveform will be completely shut off and the DS340 may be used as a DC voltage source.
- DC OFFSET** When the [OFFS] key is pressed the DC offset is displayed and the V_{pp} indicator LED will be lit. A new value may be entered numerically with any amplitude unit key. In general, the DC offset may range between $\pm 5V$, but is restricted such that $|V_{ac\ peak}| + |V_{dc}| \leq 5\ V$ (into 50 Ohms), or $|V_{ac\ peak}| + |V_{dc}| \leq 10\ V$ (into HIGH-Z). The DC offset is also restricted such that $|V_{dc}| \leq 2 \times V_{pp}$. When the offset is changed, the output signal will briefly go to zero as the output attenuators are switched, and then back to the set offset value.
- SYNC ENABLE** Pressing the [SHIFT] [.] key enables the SYNC OUT function. The [SHIFT] [0] disables the output.

FREQUENCY SWEEPS & FSK

Introduction

The DS340 can perform frequency sweeps of the sine, square, triangle, and ramp waveforms. The sweeps may be up or down in frequency, and may be linear or logarithmic in nature. The frequency changes during the sweep are phase continuous and the sweep rate may be set between 0.01 Hz and 1000Hz. The DS340 has a SWEEP output that may be used to trigger an oscilloscope. The DS340 is also capable of Frequency-Shift Keying (FSK). FSK can be implemented either through the internal rate generator or the back panel external input to toggle between two preset frequencies.

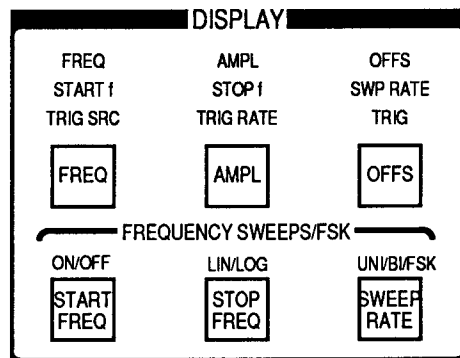

Sweep/FSK Enable

Sweeps are enabled by pressing [SHIFT][START FREQ] in the Frequency Sweeps menu. The DS340 displays the "CONT SNGL" menu which allows the user to choose between continuous and single sweeps. The DS340 will immediately start a continuous sweep unless the user presses the UP/DOWN arrow key to select SINGLE sweep. Once a single sweep is selected, the [SHIFT][START FREQ] key triggers the sweep. If the user has selected the FSK function from the "UNI/BI/FS" (Unidirectional/Bidirectional/FSK) menu, the single/continuous sweep option is disabled and the "FS OFF" menu appears, giving the user the choice to enable or disable the FSK function. Once the FSK function is selected and enabled, the FSK output signal appears at the Function Out BNC.

Sweep Type

Pressing the [SHIFT] [STOP FREQ] key sets the sweep to either a linear or log mode. The UP/DOWN arrow toggles between the two sweep types. The output frequency of a linear sweep changes linearly during the sweep time. The output frequency in a logarithmic sweep changes exponentially during the sweep time, spending equal time in each decade of frequency. For example, in a sweep from 1 kHz to 100 kHz, the sweep will spend half the time in the 1 kHz to 10 kHz range and half the time in the 10 kHz to 100 kHz range). It should be noted that these are digital sweeps, and that the sweep is actually composed of 1500 to 3000 discrete frequency points, depending on the sweep rate.

Sweep Waveform

The type of sweep waveform may be set to UNidirectional (ramp) or BIdirectional (triangle) by pressing the [SHIFT][SWEEP RATE] key and then press-

ing the UP/DOWN arrow keys. If FSK is selected, Frequency-Shift keying is enabled and the sweeps are disabled. If the waveform is UNI (Ramp) the DS340 sweeps from the start to the stop frequency, returns to the start frequency and repeats continuously. For BI directional sweeps the DS340 sweeps from the start to the stop frequency, then sweeps from the stop frequency to the start frequency, and repeats. If the DS340 is set for a single sweep, the sweep occurs only once.

Sweep/FSK RATE

The duration of the sweep is set by [RATE], and the value is entered or modified with the keypad. The sweep rate may be set over the range of 0.01 Hz to 1 kHz. The sweep rate is the inverse of the sweep time, a 0.01 Hz rate is equal to a 100s sweep time, and a 1 kHz rate is equal to a 1 ms sweep time. For a TRIANGLE sweep the sweep time is the total time to sweep up and down. If FSK is selected from the UNI/BI/FSK menu, then the "Sweep Rate" button sets the FSK Rate. If the rate is set to 0 Hz then the rear panel FSK BNC input toggles between the two preset frequencies. For any non zero rate the DS340 will toggle between the two preset frequencies at the specified rate. The maximum internal FSK rate is 50 kHz.

Sweep/FSK FREQUENCIES

The DS340 may sweep over any portion of its frequency range: 1 μ Hz to 15.1 MHz for sine and square waves, 1 μ Hz to 100 kHz for triangle and ramp waves. The sweep span is limited to six decades for logarithmic sweeps. The DS340's sweep range is set by entering the start and stop frequencies. In FSK mode, the DS340 will toggle between any two frequencies: 1 μ Hz to 15.1 MHz for sine and square waves, and 1 μ Hz to 100 kHz for triangle and ramp waves. There are no restrictions on the values of the start and stop frequencies for linear sweeps.

Start and Stop Frequencies

To enter the start and stop frequency press the [START FREQ] and [STOP FREQ] keys. The span value is restricted to sweep frequencies greater than zero and less than or equal to the maximum allowed frequency. If the stop frequency is greater than the start frequency, the DS340 will sweep up. If the start frequency is larger the DS340 will sweep down. If FSK is enabled the DS340 toggles between the Start and Stop frequencies at the Sweep/FSK Rate. If the rate has been set to zero then the rear panel FSK input is active. A TTL low level activates the start frequency and a TTL high level activates the stop frequency.

Sweep/FSK OUTPUT

The rear-panel SWP/FSK output is synchronous with the sweep rate. This output emits a TTL pulse at the beginning of every sweep cycle and can be used to trigger an oscilloscope. When the start frequency is selected, the Sweep output is at 0 Volts, and when the Stop frequency is selected the Sweep level is at 5 Volts. The Sweep output is synchronous with the frequency shifts.

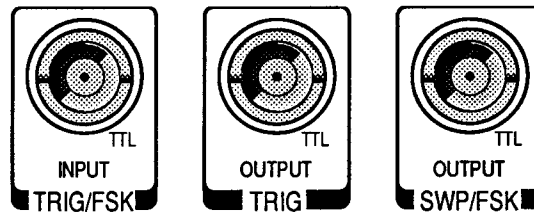

FSK Input

The TRIG/FSK input accepts a TTL level signal. When enabled (FSK rate set to 0 Hz), the input is sampled at 10 MHz by the DS340. A low TTL level selects the start frequency, and a high TTL level selects the stop frequency (see example below). When the FSK Input is being used, the Sweep output is disabled (0 Volts).

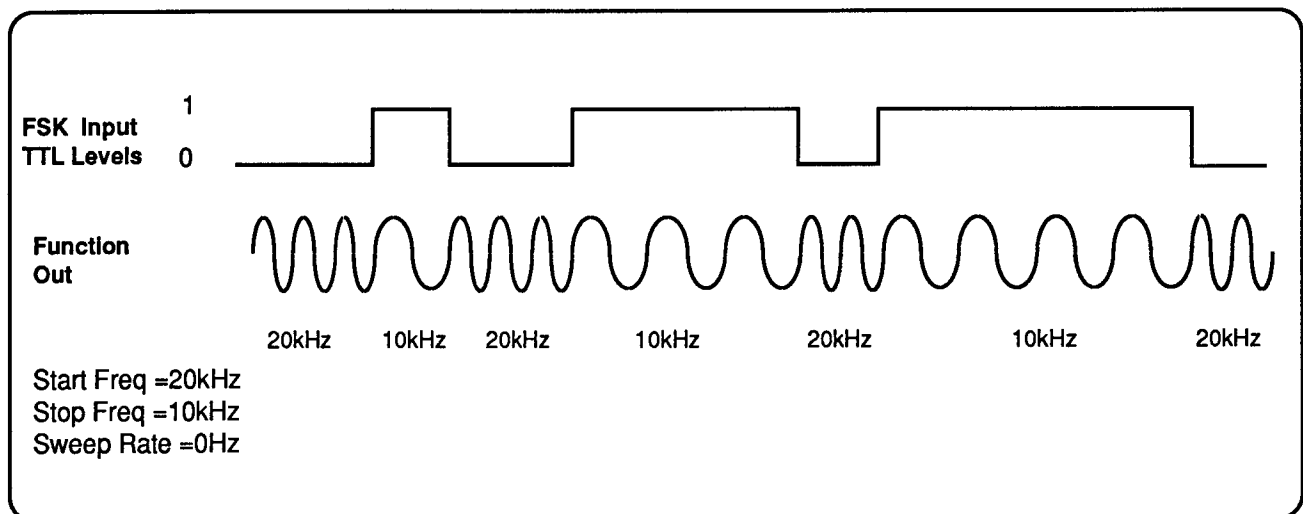

External Frequency-Shift Keying (FSK) Example

INSTRUMENT SETUP

Introduction

This section discusses the DS340's default settings, storing and recalling instrument setups, computer interfacing, and the self-test instrument analysis routine.

Default Settings

The DS340's default settings are recalled by pressing the [SHIFT][+/-] keys. The DS340's default settings are listed below.

<u>Setting</u>	<u>Default Value</u>
Frequency	1 MHz
Arb Sampling Frequency	40.0 MHz
Function	Sine
SYNC ON/OFF	On
Load Impedance	50 Ohms
Display	Frequency
Amplitude	1 Vpp
Offset	0.0 V
Inversion	Off
Sweeps	Off
Start Frequency	1 Hz
Stop Frequency	15.1 MHz
Trigger Source	Internal Rate
Sweep/FSK Rate	100 Hz
Arb Trigger Source	Continuous
Arb Trigger Rate	1000 Hz
Interface	RS-232
Baud Rate	9600
GPIB Address	23

Storing Setups

To store the DS340's current setup press [SHIFT][7] followed by a location number in the range 0 - 9. After pressing any UNITS key to enter the location number, the message "sto done" will be displayed, indicating that the settings have been stored.

Recalling Stored Settings

To recall a stored setting press [SHIFT][8] followed by a location number in the range 0 - 9. After pressing any UNITS key to enter the location number, the message "rcl done" will be displayed, indicating that the settings have been recalled. If nothing is stored in the selected location, or the settings are corrupted, the message "rcl err" will be displayed.

GPIB Setup

To set the DS340's GPIB interface press [SHIFT][1]. The GPIB enable selection will be displayed. Use the [UP ARROW] and [DOWN ARROW] keys to

enable the GPIB interface. Press [SHIFT][1] again to display the GPIB address. Enter the address desired using the numeric keypad or arrow keys. The range of valid addresses is 0 - 30.

NOTE: If the DS340 does not have the optional GPIB/RS-232 interfaces the message "no GPIB" will be displayed when the GPIB menu is accessed. Only one of the GPIB and RS-232 interfaces may be active at a given time. The RS-232 interface is automatically disabled when GPIB is enabled.

RS-232 Setup

To set the DS340's RS-232 interface press [SHIFT][2]. The RS-232 enable selection will be displayed. Use the UP/DOWN ARROW keys to enable the RS-232 interface. Press [SHIFT][2] again to display the RS-232 baud rate selection. The available baud rates of 300, 600, 1200, 2400, 4800, 9600, or 19.2 k baud can be set with the UP/DOWN ARROW keys.

NOTE: If the DS340 does not have the optional GPIB/RS-232 interfaces the message "no RS-232" will be displayed when the RS-232 menu is accessed. Only one of the GPIB and RS-232 interfaces may be active at a given time. The GPIB interface is automatically disabled when RS-232 is enabled.

User Service Requests

While the GPIB is enabled the user may issue a service request (SRQ) by pressing [SHIFT][4]. The message "srq sent" will be displayed, and the GPIB LED will light. The GPIB LED will go off after the host computer does a serial poll of the DS340. Note: the user service request is in addition to the usual service requests based on status conditions (see PROGRAMMING section for details). If the communication option is not installed, the DS340 will display the message ""no intrfc" (no interface) if an SRQ is attempted from the front panel.

Communications Data

Pressing [SHIFT][2] three times displays the last 256 characters of data that have been received by the DS340. This display is a 3 character window into the DS340's input data queue that can be scrolled to view the previous 256 characters. The data is displayed in ASCII hex format, with each input character represented by 2 hexadecimal digits. The most recently received character has a decimal point indicator. Pressing [DOWN ARROW] scrolls the display to the beginning of the queue, and [UP ARROW] scrolls through the queue.

AUTO-TEST

Introduction

The DS340 has a built-in test routine that allows the user to test a large portion of instrument functionality quickly and easily. Self-test starts every time the DS340 is turned ON.

SELF-TEST

The DS340's self-test is always executed on power-up. The test checks most of the digital circuitry in the DS340, and should end with the display "test pass". If the self-test encounters a problem it will immediately stop and display a warning message. See the **TROUBLESHOOTING** section for a list and explanation of the error messages. If the DS340 fails its test it still may be operated.

The DS340 tests the CPU and data memory, ROM program memory, calibration constant integrity, computer interfaces, modulation program memory, waveform RAMs, and ASIC busses.

Items **not** tested are the connections from the PC boards to the BNC connectors, the 12-bit waveform DAC, the output amplifier, the offset and amplitude control circuits, and the output attenuators.

CALIBRATION BYTES

It is possible to recall and modify the DS340 factory calibration bytes. Please refer to the Test and Calibration Chapter for more details.

ARBITRARY WAVEFORMS

Introduction

The DS340 is able to load from 8 to 16,300 arbitrary points over the GPIB or RS232 interfaces. These points are loaded into the system RAM to define the arbitrary waveform. The [ARB] waveform will remain in memory whenever the unit is turned OFF.

After the arbitrary data points are copied from the system RAM into the waveform RAM, the DDS ASIC outputs these points at the **sampling frequency** specified by the user. The waveform can be generated either continuously or it can be triggered by a user specified source.

Sampling Frequency

Range: 0.002329Hz to 40.0 MHz

Default Value: 40.0 MHz

When the function is set to ARB, the frequency displayed is the **sampling frequency** of the arbitrary waveform. This number is independent of the usual frequency (for sine and square wave functions), and it is the dwell time that the DS340 spends on each point of the arbitrary waveform. This sampling frequency is always an integer submultiple of the the 40 MHz clock frequency, ie $40 \text{ MHz}/M$ where $M = 1, 2, 3, \dots, 2^{34}-1$ (40 MHz, 20 MHz, 13.3333 MHz, 10 MHz,...). The DS340 spends $1/F_{\text{sample}}$ time on each point. When a new sampling frequency is entered the DS340 will round the value to the nearest integer submultiple of 40 MHz. For example, if 15.134 MHz is entered, the DS340 rounds the frequency to 13.333333 MHz and displays the rounded frequency.

Trigger Source Menu

[Shift] [Freq] selects the trigger source menu. The user selects between the following trigger source menus with the units UP/DOWN keys:

0) "Src.Sngl" 1) "Src. rate" 2) "Src. Pos"
3) "Src. neG" 4) "Src. Line" 5) "Src.Cont"

0) "Src.Sngl": The arbitrary waveform is triggered when either the [SHIFT] [OFFS] key is pressed or when the *TRG command is received over the communication line.

1) "Src. rate": The Arbitrary waveform is repeated at the selected rate.

2) "Src. Pos": The Back Panel TRIGGER BNC is used to trigger a single arbitrary waveform at the rising edge of the BNC pulse.

3) "Src. neG": The Back Panel TRIGGER BNC is used to trigger a single arbitrary waveform at the falling edge of the BNC pulse.

4) "Src. Line": The Line input is used to trigger the arbitrary waveform at the line frequency rate.

5) "Src.Cont": The arbitrary waveform is generated continuously at the pre-set sampling rate.

Trigger Errors:	When the arbitrary waveform is triggered externally (all above cases except continuous), the DS340 always checks for a trigger rate error. A trigger error occurs when the instrument is triggered while it is still generating an arbitrary waveform. If this condition occurs, the ERROR LED lights along with the TRIG LED to indicate a trigger rate error. A trigger rate error does not affect the DS340 operation in external trigger modes. If the user enters an invalid trigger rate in internal trigger mode, the instrument uses the last valid trigger rate entered and displays a "rate err" message.
Internal Trigger Rate Menu	Range: 0.001 Hz to 10 kHz
Single Trigger & TRIG LED	When set to single trigger mode, pressing [SHIFT][OFFS] triggers the arbitrary waveform once. Any time the arbitrary waveform is triggered, the TRIG LED turns on. If a trigger rate error occurs, both the TRIG and the ERROR LEDs will be lit.
TRIGGERED Output BNC	This output is TTL high while the arbitrary waveform is being generated. There is no output if "Src.Cont" is selected in Trigger Source Menu.
Power up Procedure	<p>If the DS340 output is set to the arbitrary function on power up, the arbitrary waveform is copied from memory and the output will be what was stored in memory during the previous work session.</p> <p>If the DS340 is initiated with a cold boot (Power On INIT), the default arbitrary waveform is an eight point square wave with a 40 MHz frequency rate.</p> <p>If the arbitrary waveform is corrupt at power up, the "Arb.Fn.bad" message appears on the screen and the DS340 switches to the sine wave function. It does not load the default arbitrary waveform.</p>
Downloading Procedure	<p>Arbitrary waveforms can either be downloaded in binary or ASCII formats. The following paragraphs describes the two procedures:</p> <ol style="list-style-type: none">1) When the DS340 receives the LDWF(?)i command ($8 \leq i \leq 16300$) over the RS232 or GPIB interfaces, it calculates the system RAM size and the addresses needed to store the waveform in the system RAM. When the DS340 is ready to receive the i points, it displays a "LoAding" message and sends an ASCII one (1) back to the user. The (1) indicates that the instrument is ready to receive the binary data, at the same time it starts a 10 second timer that checks for time out between data points. <p>The data must be sent low byte first then high byte in BINARY format. The data is checked for out of range values (above 2047 or less than -2048) as it is received. If the data is valid it is stored in the system RAM and its value added to the check sum. After receiving all data points the check sum is received and compared with the calculated checksum.</p> <ol style="list-style-type: none">2) When the DS340 receives the LDWA(?) n command, it can download an arbitrary waveform using ASCII numbers. The number of points in the waveform, n, must be a value between 8 and 16300. The LDWA(?) n command

must be followed immediately by n ASCII numbers (values between -2047 and 2047), separated by commas or LF. The connection with the DS340 will time-out if 10 seconds elapse between sending consecutive points.

Download Errors

- 1) If the checksums do not match the message "Ld cs er" is displayed.
- 2) If an out of range data value is received during download, the message "Ld.rng er" is displayed.
- 3) If a 10 second time out occurs between any data points, the message "Load Err" is displayed.
- 4) If the user tries to download more than 16300 points, the message "Arb Err" is displayed.
- 5) If the user enters an out of range trigger rate value, the message "ratE Err" is displayed.

After any of the above errors, the input buffer is reset and the new waveform ignored. The DS340 ignores any further data.

PROGRAMMING THE DS340

The DS340 Function Generator may be remotely programmed via either the RS232 or GPIB (IEEE-488) interfaces. Any computer supporting either of these interfaces may be used to program the DS340. Only one interface is active at a time. All front and rear panel features (except power) may be controlled.

GPIB Communications

The DS340 supports the IEEE-488.1 (1978) interface standard. It also supports the required common commands of the IEEE-488.2 (1987) standard. Before attempting to communicate with the DS340 over the GPIB interface, the DS340's device address must be set. The address is set in the second line of the GPIB menu (type [SHIFT][1] twice), and may be set between 0 and 30. The default address is 23. Set Time-out of GPIB Card to 100 seconds if downloading long wave forms.

RS232 Communications

The DS340 is configured as a DCE (transmit on pin 3, receive on pin 2) and supports CTS/DTR hardware handshaking. The CTS signal (pin 5) is an output indicating that the DS340 is ready, while the DTR signal (pin 20) is an input that is used to control the DS340's transmitting. If desired, the handshake pins may be ignored and a simple 3 wire interface (pins 2, 3 and 7) may be used. The RS232 interface baud rate may be set in the second line of the RS232 menu (type [SHIFT][2] twice). The interface is fixed at 8 data bits, no parity, and 2 stop bits.

Front Panel LEDs

To assist in programming, the DS340 has 4 front panel status LEDs. The RS232 and GPIB LEDs flash whenever a character is received or sent over the corresponding interface. The ERROR LED flashes when an error has been detected, such as an illegal command, or an out of range parameter. The REMOTE LED is lit whenever the DS340 is in a remote state (front panel locked out).

Data Window

To help find program errors, the DS340 has an input data window which displays the data received over either the GPIB or RS232 interfaces. This window is activated by typing [SHIFT][2] or [SHIFT][1] three times. The menu displays the received data in hexadecimal format. The last 256 characters received can be scrolled through using the MODIFY up/down arrow keys. A decimal point indicates the most recently received character.

Command Syntax

Communications with the DS340 use ASCII characters. Commands may be in either UPPER or lower case and may contain any number of embedded space characters. A command to the DS340 consists of a four character command mnemonic, arguments if necessary, and a command terminator. The terminator may be either a carriage return <cr> or linefeed <lf> on RS232, or a linefeed <lf> or EOI on GPIB. No command processing occurs until a command terminator is received. All commands function identically on GPIB and RS232. Command mnemonics beginning with an asterisk "*" are IEEE-488.2 (1987) defined common commands. These commands also function identically on RS232. Commands may require one or more parameters. Multiple parameters are separated by commas ",".

Multiple commands may be sent on one command line by separating them by semicolons ";". The difference between sending several commands on the same line and sending several independent commands is that when a command line is parsed and executed the entire line is executed before any

There is no need to wait between commands. The DS340 has a 256 character input buffer and processes commands in the order received. If the buffer fills up the DS340 will hold off handshaking on the GPIB and attempt to hold off handshaking on RS232. If the buffer overflows the buffer will be cleared and an error reported. Similarly, the DS340 has a 256 character output buffer to store output until the host computer is ready to receive it. If the output buffer fills up it is cleared and an error reported. The GPIB output buffer may be cleared by using the Device Clear universal command.

The present value of a particular parameter may be determined by querying the DS340 for its value. A query is formed by appending a question mark "?" to the command mnemonic and omitting the desired parameter from the command. If multiple queries are sent on one command line (separated by semicolons, of course) the answers will be returned in a single response line with the individual responses separated by semicolons. The default response terminator that the DS340 sends with any answer to a query is carriage return-linefeed <cr><lf> on RS232, and linefeed plus EOI on GPIB. All commands return integer results except as noted in individual command descriptions.

Examples of Command Formats

FREQ, 1000.0 <lf>	Sets the frequency to 1000 Hz.
FREQ? <lf>	Queries the frequency.
*IDN? <lf>	Queries the device identification (query, no parameters).
*TRG <lf>	Triggers a sweep (no parameters).
FUNC 1 ;FUNC? <lf>	Sets function to square wave(1) then queries the function.

Programming Errors

The DS340 reports two types of errors that may occur during command execution: command errors and execution errors. Command errors are errors in the command syntax. For example, unrecognized commands, illegal queries, lack of terminators, and non-numeric arguments are examples of command errors. Execution errors are errors that occur during the execution of syntactically correct commands. For example, out of range parameters and commands that are illegal for a particular mode of operation are classified as execution errors.

No Command Bit

The NO COMMAND bit is a bit in the serial poll register that indicates that there are no commands waiting to be executed in the input queue. This bit is reset when a complete command is received in the input queue and is set when all of the commands in the queue have been executed. This bit is useful in determining when all of the commands sent to the DS340 have been executed. This is convenient because some commands, such as setting the function, or sweep, take a long time to execute and there is no other way of determining when they are done. The NO COMMAND bit may be read while commands are being executed by doing a GPIB serial poll. There is no way to read this bit over RS232. Note that using the *STB? query to read this bit will always return the value 0 because it will always return an answer while a command is executing- the *STB? command itself!

DETAILED COMMAND LIST The four letter mnemonic in each command sequence specifies the command. The rest of the sequence consists of parameters. Multiple parameters are separated by commas. Parameters shown in {} are optional or may be queried while those not in {} are required. Commands that may be queried have a question mark in parentheses (?) after the mnemonic. Commands that may ONLY be queried have a ? after the mnemonic. Commands that MAY NOT be queried have no ?. Do not send () or { } as part of the command.

All variables may be expressed in integer, floating point or exponential formats (ie., the number five can be either 5, 5.0, or .5E1). The variables i and j usually take integer values, while the variable x take real number values.

Function Output Control Commands

AECL The AECL command sets the output to the ECL levels of 1 V peak-to-peak with a -1.3 V offset. That is, from -1.8V to -0.8V.

AMPL (?) x The AMPL command sets the output amplitude to x. The value x must consist of the numerical value and a units indicator. The units may be VP (Vpp) or VR (Vrms). For example, the command AMPL 1.00VR will set the output to 1.0 Vrms. For arbitrary waveforms the amplitude may **only** be set in terms of peak-to-peak value. Note that the peak AC voltage (Vpp/2) plus the DC offset voltage must be less than 5 Volts (for 50 Ω source). Setting the amplitude to 0 Volts will produce a DC only (no AC function) output controlled by the OFFS command. For arbitrary waveforms the amplitude may **only** be set in terms of peak-to-peak value.

The AMPL? query will return the amplitude in the currently displayed units. For example, if the display is 3.0 Vrms the AMPL? query will return 3.0VR. If a units indicator is sent with the AMPL? query (such as, AMPL? VP) the displayed units will be changed to match the units indicator and the amplitude returned in those units.

ATTL The ATTL command sets the TTL output levels of 5V peak-to-peak with a 2.5V offset. That is, from 0V to 5V.

FREQ (?) x The FREQ command sets the output frequency to x Hertz. The FREQ? query returns the current output frequency. The frequency is set and returned with 1 μ Hz resolution. If the current waveform is NOISE an error will be generated and the frequency will not be changed. This command does **not** set the sampling frequency for arbitrary waveforms- see the FSMP command.

FSMP (?) x The FSMP command sets the arbitrary waveform sampling frequency to x. This frequency determines the rate at which each arbitrary waveform point is output. That is, each point in the waveform is played for a time equal to 1/FSMP. The allowed values are 40 MHz/N where N is an integer between 1 and 2³⁴-1. If x is not an exact divisor of 40 MHz the value will be rounded to the nearest exact frequency. The FSMP? query returns the current arbitrary waveform sampling frequency.

FUNC (?) i The FUNC command sets the output function type to i. The correspondence of i and function type is shown in the table below. If the currently selected

frequency is incompatible with the selected function an error will be generated and the frequency will be set to the maximum allowed for the new function. The FUNC? query returns the current function.

i	Function
0	SINE
1	SQUARE
2	TRIANGLE
3	RAMP
4	NOISE
5	ARBITRARY

INVT (?) I

The INVT command turns output inversion on (i=1) and off (i=0). The INVT? query returns the current inversion status. This function is used with the ramp waveform to set it for positive or negative slope.

KEYS(?) I

The KEYS command simulates the pressing of a front panel key. The KEYS? query returns the keycode of the most recently pressed key. Keycodes are assigned as follows:

Key Name	Key Code
FREQ	1
AMPL	2
OFFSET	3
START FREQ	4
STOP FREQ	5
SWEEP RATE	6
0	7
1	8
2	9
3	10
Vrms/HZ/DOWN	11
SEL FNC	12
Decimal Point	13
4	14
5	15
6	16
Vpp/kHz/UP	17
+/-	19
7	20
8	21
9	22
MHz/SHIFT	23

OFFS (?) x

The OFFS command sets the output's DC offset to x volts. The OFFS? query returns the current value of the DC offset. The DC offset voltage plus the peak AC voltage must be less than 5 Volts (into 50 Ω).

SYNC(?) I

Turns the SYNC output on (i=1) or off (i=0).

TERM(?) I

Sets the output source impedance to 50 Ω (i=0), or hi-Z (i=1). The TERM? query returns the current source impedance setting. Note that all amplitude and offset display settings get doubled when switching from 50 Ohm to High

Impedance. Similarly, when switching from high impedance to 50 Ohm all amplitude and offset display values get halved. The actual BNC output is not affected by this change.

Sweep & FSK Control Commands

note: All sweep & FSK parameters may be set at any time. For the changes to have an effect be sure that the sweep or FSK type is set correctly and that sweep or FSK is enabled (see the STYP and SWEN commands).

FSEN(?) I Enables FSK on (i=1) or off (i=0). This function is valid only if FSK has been selected with the SDIR command (SDIR2) or from the front panel. If the FSK rate has been set between 0.01Hz and 50 kHz then the FSK starts following the "FSEN1" command. If the rate has been set to 0Hz and FSK selected, the command "FSEN1" would enable the FSK BNC input on the rear panel. This TTL signal is sampled at a 10MHz rate and toggles between the Start frequency and the Stop frequency.

***TRG** The *TRG command triggers a single sweep or arbitrary waveform. The trigger source must be set to SINGLE (see the TSRC command below).

SDIR(?)I Sets the sweep direction. 0 = Ramp (unidirectional), 1 = Triangle (bidirectional), 2 = enable FSK (disable sweeps).

STYP (?) I The STYP command sets the sweep type to i. The correspondence of i to type is shown in the table below. The STYP? query returns the current sweep type. Refer to the SDIR command for sweep direction.

i	Waveform
0	LIN SWEEP
1	LOG SWEEP

SPFR (?) x The SPFR command sets the sweep stop frequency to x Hertz. An error will be generated if the sweep frequency is less than or equal to zero or greater than allowed by the current function. The SPFR? query returns the current sweep stop frequency. If the stop frequency is less than the start frequency (the STFR command) a downward sweep from maximum to minimum frequency will be generated. The stop frequency is also used in the FSK mode.

SRAT (?) x The SRAT command sets the trigger rate for internally triggered single sweeps and FSK to x Hertz. x is rounded to two significant digits and may range from 0.01 Hz to 1 kHz for sweeps and 0.01Hz to 50kHz for FSK. The SRAT? query returns the current trigger rate. If the rate is set to 0Hz and FSK is enabled (SDIR = 2) then the external FSK BNC is used to toggle between the start and stop frequencies.

STFR (?) x The STFR command sets the sweep start frequency to x Hertz. An error will be generated if the sweep frequency is less than or equal to zero or greater than allowed by the current function. The STFR? query returns the current sweep start frequency. If the start frequency is greater than the stop frequency (the SPFR command) a downward sweep from maximum to minimum frequency will be generated. The stop frequency is also used in the FSK mode.

SWEN(?) I Enables sweeps on (i=1) or off (i=0). If the continuous sweep is selected, enabling sweeps will start the sweep with the specified rate. If triggered sin-

gle sweep is selected and sweeps are enabled then the DS340 waits for a front panel trigger or a *TRG command to start the sweep.

STRS (?) I

The STRS command sets the trigger source for sweeps to i. The correspondence of i to source is shown in the table below. The STRS? query returns the current trigger source.

i	Waveform
0	SINGLE
1	INTERNAL RATE

For single sweeps the *TRG command triggers the sweep.

Arbitrary Waveform Commands

LDWF(?) I

The LDWF? query allows downloading arbitrary waveforms. i is the number of points in the waveform (16300 maximum). The data is sent as 16 bit binary data words least significant byte first. The data must be followed by a 16 bit checksum to ensure data integrity. The checksum is the 16 bit sum of the data words that have been sent. If the checksum sent does not match the one calculated by the DS340 an error will be generated. If the data sent is valid and the DS340's function is set to ARB the waveform will automatically be output. Otherwise, the function must be set to ARB to output the downloaded waveform. To load a waveform follow these steps:

- 1) Send the query LDWF? i where i is appropriate for the number of points desired.
- 2) Wait until the DS340 returns "1" indicating that it is ready to receive data.
- 3) Send the waveform data (discussed below). There should be i data points sent.
- 4) Send the 16 bit checksum (the sum of i data points).

The waveform data is sent as 16 bit binary data. In point mode each data point consists of a 16 bit amplitude word. Each value should be in the range -2048 to +2047. The checksum is the 16 bit sum of the i words sent in point mode.

LDWA(?) n

The LDWA? query allows downloading arbitrary waveforms to the DS340 using ASCII numbers. The number of points in the waveform, n, must be a value between 8 and 16300. The "LDWA n" command must be followed immediately by n ASCII numbers (values between -2047 and 2047), separated by commas or LF. The connection with the DS340 will time-out if 10 seconds elapse between sending consecutive points.

TRAT (?) x

The TRAT command sets the trigger rate for internally triggered arbitrary waveforms to x Hertz. x is rounded to two significant digits and may range from 0.001 Hz to 10 kHz. The TRAT? query returns the current trigger rate.

TSRC (?) I The TSRC command sets the trigger source for arbitrary waveforms to *i*. The correspondence of *i* to source is shown in the table below. The TSRC? query returns the current trigger source.

i Waveform

- 0 SINGLE (Front Panel or RS232/GPIB)
- 1 INTERNAL RATE
- 2 + SLOPE EXTERNAL
- 3 - SLOPE EXTERNAL
- 4 LINE
- 5 CONTINUOUS

For SINGLE mode the *TRG command triggers the waveform.

Setup Control Commands

- *IDN?** The *IDN common query returns the DS340's device configuration. This string is in the format: StanfordResearchSystems,DS340,serial number,version number. Where "serial number" is the five digit serial number of the particular unit, and "version number" is the 3 digit firmware version number.
- *RCL I** The *RCL command recalls stored setting number *i*, where *i* may range from 0 to 9. If the stored setting is corrupt or has never been stored an execution error will be generated.
- *RST** The *RST common command resets the DS340 to its default configurations.
- *SAV I** The *SAV command saves the current instrument settings as setting number *i*.

Status Reporting Commands

(See tables at the end of the Programming section for Status Byte definitions.)

- *CLS** The *CLS common command clears all status registers. This command does not affect the status enable registers.
- *ESE (?) I** The *ESE command sets the standard event status byte enable register to the decimal value *i*.
- *ESR? {I}** The *ESR common command reads the value of the standard event status register. If the parameter *i* is present the value of bit *i* is returned (0 or 1). Reading this register will clear it while reading bit *i* will clear just bit *i*.
- *PSC (?) I** The *PSC common command sets the value of the power-on status clear bit. If *i* = 1 the power on status clear bit is set and all status registers and enable registers are cleared on power up. If *i* = 0 the bit is cleared and the status enable registers maintain their values at power down. This allows the production of a service request at power up.

- *SRE (?) I** The *SRE common command sets the serial poll enable register to the decimal value of the parameter i.
- *STB? {I}** The *STB? common query reads the value of the serial poll byte. If the parameter i is present the value of bit i is returned (0 or 1). Reading this register has no effect on its value as it is a summary of the other status registers.
- DENA (?) I** The DENA command sets the DDS status enable register to the decimal value i.
- STAT? {I}** The STAT? query reads the value of the DDS status byte. If the parameter i is present the value of bit i is returned. Reading this register will clear it while reading bit i will clear just bit i.

Hardware Test and Calibration Commands

NOTE: These commands are primarily intended for factory calibration use and should never be needed during normal operation. **Incorrect use of some of these commands can destroy the calibration of the DS340.**

- \$CLK?** The \$CLK? command queries the DS340 for the status of its calibration jumper. Shown below are the different status values that the DS340 can return:

<u>Status value</u>	<u>Meaning</u>
0	Calibration disabled
1	Calibration enabled

- \$FCL** The \$FCL command recalls the factory calibration bytes. This command will generate an error if calibration is not enabled.

- *TST?** The *TST? common query runs the DS340 internal self-tests. After the tests are complete the test status is returned. The status may have the following values (see the **TROUBLESHOOTING** section for more details):

<u>Status value</u>	<u>Meaning</u>
0	No Error.
1	CPU Error. The DS340 has detected a problem in its CPU.
2	Code Error. The DS340's ROM firmware has a checksum error.
3	Sys RAM Error. The system RAM failed its test.
4	Cal Data Error. The DS340's calibration data has become corrupt.
5	Function Data Error. The waveform RAM failed its test.
6	Program Data Error. The modulation program RAM failed its test.
7	DS340 not warmed up. At least 2 minutes must elapse between power on and calibration.

\$PRE (?) I

The \$PRE command sets the DS340's pre-amplifier attenuators to range i. The integer i is the attenuation value in dB and ranges from 0 to 14 in increments of two. Resetting the amplitude will return the attenuators to their normal position. The \$PRE? query returns the current attenuator position.

\$PST (?) I

The \$PST command sets the DS340's post-amplifier attenuators to range i. The integer i is the attenuation value in dB and ranges from 0 to 30 in increments of two. Resetting the amplitude will return the attenuators to their normal position. The \$PST? query returns the current attenuator position.

\$WRD (?) j,{,k}

The \$WRD command sets the value of calibration word j to k. Parameter j may have a value from 0 to 554, while k may range from -127 to +65535. This command will generate an error if calibration is not enabled. **NOTE:** this command will alter the calibration of the the DS340. To correct the calibration the factory calibration bytes may be recalled (see the \$FCL command). The calibration bytes cannot be altered unless the warm-up bit has been set.

STATUS BYTE DEFINITIONS

Status Reporting

The DS340 reports on its status by means of three status bytes: the serial poll byte, the standard status byte, and the DDS status byte.

On power on the DS340 may either clear all of its status enable registers or maintain them in the state they were in on power down. The action taken is set by the *PSC command and allows things such as SRQ on power up .

Serial Poll Status Byte:

<u>bit</u>	<u>name</u>	<u>usage</u>
0	Sweep Done	set when no sweeps are in progress
1	Sweep Enable	set when sweep is enabled
2	User SRQ	set if the user sends a SRQ from the front panel
3	DDS	An unmasked bit in the DDS status register has been set.
4	MAV	The gpib output queue is non-empty
5	ESB	An unmasked bit in the standard status byte has been set.
6	RQS/MSS	SRQ (Service Request)bit.
7	No Command	There are no unexecuted commands in the input queue

The DDS and ESB bits are set whenever any unmasked bit (bit with the corresponding bit in the byte enable register set) in their respective status registers is set. They are not cleared until the condition which set the bit is cleared. Thus, these bits give a constant summary of the enabled status bits. A service request will be generated whenever an unmasked bit in the serial poll register is set. Note that service requests are only produced when the bit is first set and thus any condi-

tion will only produce one service request. Accordingly, if a service request is desired every time an event occurs the status bit must be cleared between events.

Standard Event Status Byte:

<u>bit</u>	<u>name</u>	<u>usage</u>
0	unused	
1	unused	
2	Query Error	Set on output queue overflow
3	unused	
4	Execution err	Set by an out of range parameter, or non-completion of some command due to a condition such as an incorrect waveform type.
5	Command err	Set by a command syntax error, or unrecognized command
6	URQ	Set by any key press
7	PON	Set by power on

This status byte is defined by IEEE-488.2 (1987) and is used primarily to report errors in commands received over the communications interfaces. The bits in this register stay set once set and are cleared by reading them or by the *CLS command.

DDS Status Byte:

<u>bit</u>	<u>name</u>	<u>usage</u>
0	Trig'd	Set when a sweep is triggered.
1	Trig Error	Set when a trigger rate error occurs.
2	Trig Done	Set when finished playing single arb (active when TSRC=1 only)
3	Unused	
4	Warmup	Set after the warmup period has expired.
5	Test Error	Set if a self test error occurs.
6	Unused	
7	mem err	the stored setting were corrupt on power up.

The Warmup bit will be set and remain set after the warmup period has expired. The rest of the bits in this register are set when the corresponding event occurs and remain set until cleared by reading this status byte or by the *CLS command.

Program Examples

Introduction

The following examples demonstrate interfacing the DS340 via RS-232 and the GPIB interface using the National Instruments GPIB card. Using a different brand of card would be similar except for the program lines that actually send the data. These examples are intended to demonstrate the syntax of the DS340's command set.

To successfully interface the DS340 to a PC via the GPIB interface, the instrument, interface card, and interface drivers must all be configured properly. To configure the DS340, the GPIB address must be set in the GPIB menu. The default GPIB address is 23; use this address unless a conflict occurs with other instruments in your system.

Make sure that you follow all the instructions for installing the GPIB card. The National Instruments card cannot be simply unpacked and put into your computer. To configure the card you must set jumpers and switches on the card to set the I/O address and interrupt levels. You must run the program "IBCONF" to configure the resident GPIB driver for your GPIB card. Please refer to the National Instruments manual for information. In this example, the following options must be set with IBCONF:

Device name: dds340
Device address: 23
EOS character: 0Ah (linefeed)

Once all the hardware and GPIB drivers are configured, use "IBIC". This terminal emulation program allows you to send commands to the DS340 directly from your computer's keyboard. If you cannot talk to the DS340 via "IBIC", then your programs will not run.

Use the simple commands provided by National Instruments. Use "IBWRT" and "IBRD" to write and read from the DS340. After you are familiar with these simple commands, you can explore more complex programming commands.

The RS-232 program assumes the RS-232 option is enabled ([SHIFT][2]) and the BAUD rate is set to 9600 BAUD.

The GPIB example was written in C and the RS-232 example was written in BASIC.

EXAMPLE 1: GPIB COMMUNICATION. C LANGUAGE

This program communicates with the DS340 via GPIB . The program is written in C.

```

/*
  C Program to demonstrate communication with the DS340 via
  GPIB. Written in Microsoft C and uses National Instruments
  GPIB card. Assumes DS340 is installed as device name DDS340.
  Refer to National Instruments for Device Name setup.
*/

#include <stdio.h>
#include <string.h>
#include <stdlib.h>
#include <dos.h>

#include <decl.h> /* National Instruments header files */

void main(void); /* function declaration */

int dds340;

void main()
{
  char cmd[40];
  char start[20];
  char stop[20];

  if ((dds340 = ibfind("DDS340")) < 0) /* open National driver */
  {
    printf ("Cannot find DDS340\n");
    exit(1);
  }

  /* Now that the driver is located, reset the DS340 */

  sprintf (cmd, "*RST\n");
  ibwrt(dds340,cmd,strlen(cmd)); /* send command */

  /* Setup the DS340 as follows:
     500 kHz Square Wave, 1.5 Vpp, -1.0 Volt offset, display offset */

  sprintf (cmd, "FREQ500000;AMPL1.5VP;OFFS-1.0;KEYS3;\n");
  ibwrt(dds340,cmd,strlen(cmd)); /* send commands */

  /* Now query the DS340 for the sweep start and stop frequencies */

  sprintf (cmd, "STFR?\n"); /* ask for start rate */
  ibwrt (dds340,cmd,strlen(cmd)); /* send query */
  ibrd(dds340,start,20); /* read back start frequency */

  sprintf (cmd, "SPFR?\n"); /* ask for stop rate */
  ibwrt (dds340,cmd,strlen(cmd)); /* send query */
  ibrd(dds340,stop,20); /* read back stop frequency */

  printf("\n\n\n\n ***** DS340 Setup Demo ***** ");
  printf("\n\n\n\nDS340 Sweep Start Frequency = %e Hz\n\n", atof(start));
  printf("DS340 Sweep Stop Frequency = %e Hz\n", atof(stop));

}

```

EXAMPLE 2: RS-232 COMMUNICATION. BASIC LANGUAGE

BASIC Program to demonstrate communication with the DS340 via RS-232. Program assumes the RS-232 option is enabled (use [SHIFT] [2]) and the BAUD rate is set to 9600.

```

10 OPEN "com2:9600,n,8,2,cs,ds,cd" FOR RANDOM AS #1 'Set up com2'
20 PRINT #1, " "
30 PRINT #1, "*rst"           'Reset the DS340'
40 GOSUB 190                 'Query DS340 and diplay result'
50 PRINT #1, "freq1234067"   'Set new frequency'
60 GOSUB 190                 'Query DS340 and diplay result'
70 PRINT #1, "*rst"           'Reset the DS340'
80 FOR I = 0 TO 4           'Step through all functions'
90 PRINT #1, "func", I
100 GOSUB 190                'Query DS340 and diplay result'
110 NEXT I
120 PRINT #1, "*rst"         'Reset the DS340'
130 PRINT #1, "ampl 0vp"     'Set amplitude to 0 volts '
140 FOR I = -5 TO 5         'Set DS340 offset from -5V to +5V'
150 PRINT #1, "offs", I     'and query each time'
160 GOSUB 190                'Query DS340 and diplay result'
170 NEXT I
180 END

190 PRINT #1, "freq?"       'Routine to query the DS340 frequency,'
                             'offset, and amplitude and display them'
200 INPUT #1, F
210 PRINT #1, "ampl?"
220 INPUT #1, A
230 PRINT #1, "offs?"
240 INPUT #1, O
250 PRINT "   Frequ="; F; "   Ampl="; A; "   Offs="; O
260 RETURN

```

EXAMPLE 3: Point Mode Arbitrary Waveform.

This program downloads an arbitrary waveform to the DS340. The data is just a list of the amplitude values at each waveform RAM point. The program is written in C.

```

/* program to download arbitrary waveform points to DS340.
The waveform is a simple ramp. Written in
Microsoft C and uses National Instrument GPIB card. Expects DS340
to be installed as DS340 in IBCONF */

#include <stdio.h>
#include <string.h>
#include <stdlib.h>
#include <dos.h>

#include <decl.h> /* National Instruments header file */

void main(void);

int ds340;
int data[10000]; /* up to 10000 points */

void main ()
{
char cmd[40];
int i, sum, j, number;

if ((ds340 = ibfind("DS340")) < 0) /* open National driver */
{
printf ("Cannot find DS340\n");
exit(1);
}

sum = 0; /* initialize checksum */
j = -2048; /* initial ramp value (-full scale)*/
number = 8192; /* number of points in waveform */

/* will make a 8192 point ramp, increment y value every other point */
for (i = 0 ; i < number ; i++)
{
data[i] = j; /* y value */
sum += data[i]; /* add to checksum */
if (i&1)j++; /* increment y value if i is odd */
}

data[number] = sum; /* checksum */

sprintf (cmd,"LDWF? 8192,%d\n",number); /* command to load waveform */
ibwrt (ds340,cmd,strlen(cmd));

ibrd (ds340,cmd,40); /* read back reply before sending data */
ibwrt (ds340,(char *)data,(long)2*number+2); /* number of bytes = 2 per data
point + 2 for checksum */

sprintf (cmd,"FUNC5\n"); /* arb wf output */
ibwrt (ds340,cmd,strlen(cmd));
}

```

EXAMPLE 4: GPIB Communication Arbitrary Waveform. BASICA.

This program downloads the pictured arbitrary waveform using the LDWF?i command. The program is written in BASICA.

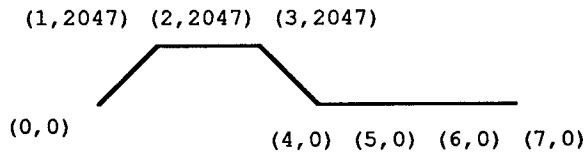

This waveform will be downloaded to the DS340 using National Instruments GPIB and BASICA.

- 1) Assign a GPIB device to the DS340 using IBCONF. In this example the device name is DS34X, and the address is 23.
- 2) Do a power up reset on the DS340 (Hold the +/- key down upon powering up the unit). Turn on GPIB communication by pressing [SHIFT][1], and enabling GPIB with the [UP/DOWN ARROW] keys. Set the DS340 to ARB mode and change the frequency to 100 kHz.
- 3) Load the following BASICA program.

Note: A) The files BIB.M and DECL.BAS (National Instruments) must exist in the directory currently in use. It may be easiest to transfer the BASICA.EXE file to your GPIB directory to satisfy this requirement.

B) This procedure merges the file DECL.BAS from the National Instruments GPIB directory. This file occupies line numbers 1 to 62. Always start your program line numbers after 62.

```

100 REM Find DS34X.
110 BDNAMES="DS34X"
120 CALL IBFIND (BDNAMES, DS34X%)
125 REM
130 REM If DS34X is not found, terminate.
140 IF DS34X%<0 GOTO 1000
145 REM
150 REM Use the LDWF?i command to download the arbitrary waveform.
170 WRT$="LDWF?8"
180 CALL IBWRT (DS34X%, WRT$)
185 REM
190 REM Check to see that the DS340 has returned a '1' indicating it's
200 REM ready to receive data.
210 S$=SPACE$(20)
220 CALL IBRD (DS34X%, S$)
230 PRINT S$
235 REM
240 REM Define an array of the Y coordinates of the arbitrary
250 REM waveform. There are eight Y coordinates,
260 REM and a check sum (the sum of Y data). Integer arrays
270 REM require 2 bytes of storage for each point. This array
280 REM contains 9 points.
290 DIM V%(8)
300 V%(0)=0
310 V%(1)=2047
320 V%(2)=2047
330 V%(3)=2047
340 V%(4)=0

```

EXAMPLE 4: GPIB Communication Arbitrary Waveform. BASICA. (continued)

```
350 V%(5)=0
360 V%(6)=0
370 V%(7)=0
380 V%(8)=6141
420 REM
410 REM Use IBWRTI to transfer the data in the array, in binary
420 REM format, to the DS340. Each integer is sent to the DS340
430 REM in low-byte, high-byte order (required by the DS340).
440 REM CNT% is the number of bytes in the array (18).
450 CNT%=18
460 CALL IBWRTI (DS34X%, V%(0), CNT%)
470 STOP
1000 PRINT "CANNOT FIND DEVICE DS34X"
1010 STOP
```

4) Use the MERGE command to merge the file DECL.BAS with the above program. Type:

```
MERGE "DECL.BAS"
```

If you LIST the program you will see that a number of lines have been added to the beginning. These are needed for proper GPIB communication.

5) Type:

```
RUN
```

The program should download the defined arbitrary waveform to the DS340.

Additional Notes:

1) If the binary sum (check sum) of the data is such that there are more than 16 bits of data, the check sum is only the least significant 16 bits.

2) The LDWF?i command requires 16 bit binary data (least significant byte followed by most significant byte), not ASCII data. Do not separate data with a comma.

TROUBLESHOOTING

If Nothing Happens on Power On

Make sure that the power entry module on the rear panel is set for the proper ac line voltage for your location, that the correct fuse is installed, and that the line cord is inserted **all** the way into the power entry module. The selected line voltage may be seen through the clear window, just below the fuse.

When the unit is plugged in and turned "ON", the firmware version number and serial number will be briefly displayed. Then the self tests should execute.

Cold Boot

If the unit displays no sensible message, the "cold boot" procedure may fix the problem. To do a "cold boot", turn the unit off. Then, while holding the "+/-" button down, turn the unit "ON". This procedure initializes the RAM and recalls all factory calibration values.

ERROR MESSAGES

The following list explains all of the error messages that the DS340 can generate. The messages are divided into operational errors, errors in using the instrument, and self-test errors. The messages are listed alphabetically.

Operational Errors

These error messages may appear during normal front panel operation and generally are warnings of illegal parameter entries.

Message

Meaning

AC Error

Amplitude entered is out of allowable range.

AC-DC Err

The $|V_{ac}| + |V_{dc}|$ has exceeded 5 Volts. Lower either the offset or amplitude.

Arb Err

Tried to download more than 16300 points.

Arb Fn Bad

The stored arbitrary waveform has been corrupted. Not a problem unless occurs frequently. Can be due to faulty battery or memory glitch.

Freq Err

Attempt to set frequency outside of range allowed for current function.

Load Err

Timeout during loading of ARB waveform. There can be no more than 10 s between successive data points. Check that the correct number of bytes have been sent.

Ld CS Er

When downloading an arbitrary waveform, the checksum calculated by the DS340 is different than that received from the computer. Check that the computer is sending the correct # points and calculating the sum correctly.

Ld Rng Er

Arbitrary waveform y value outside of -2048 to + 2047 range.

No GPIB

Cannot access GPIB menus if option board is not installed.

No Intrfc

Cannot execute communication commands if option board is not installed.

No RS-232	Cannot access RS-232 menus if option board is not installed.
Off Error	DC output offset outside of $\pm 5V$ range (into 50 Ohm).
Out q err	Output queue error. The output queue is full due to too many queries that have not been read back.
Range Er	Parameter in command is out of allowed range for that command.
Rate Err	Sweep rate or Arb Trigger rate out of range.
Rcl Err	Memory corrupt on power up, stored settings are corrupt. This is not a problem unless the error occurs frequently in which case the battery should be checked.
Span Err	Logarithmic sweep span error. The start and stop frequencies are apart by more than six decades.
StrtF Er	The sweep start frequency is out of range ($0 < \text{Freq} \leq \text{max}$ for function).
Stop F Er	The sweep stop frequency is out of range ($0 < \text{Freq} \leq \text{max}$ for function).
Syn Err	The command syntax is invalid. See PROGRAMMING section for correct command syntax.
UART Error	The DS340 has detected an error on its computer interface option board.
Uni Err	The units set with AMPL command are not V_{pp} , or V_{rms} .
Self-Test Errors	These errors may occur during the DS340's self- test. In general, these messages indicate DS340 hardware problems. If the errors occur repeatedly the unit may have an electrical problem. The messages are listed alphabetically, along with the status value which is obtained using the *TST? command.

<u>Message</u>	<u>Status Value</u>	<u>Meaning</u>
Cald Err	4	The RAM calibration data has become corrupt. The factory values will be re-loaded from ROM. This message is not a problem unless it occurs frequently, which could indicate a problem with the battery backup circuits.
Cal Dly Err	7	The DS340 is not warmed up. Wait until unit is warmed up for a few minutes before starting a calibration procedure!
Code Err XX	2	The DS340's ROM has a checksum error. XX is the checksum value.
CPU Error	1	The DS340 has detected a problem in its Z80 CPU.
Fn Data Err x	5	Error in read/write to waveform RAM. $x = 1 = U405$, $2 = U406$, $3 = U407$. Can indicate problem with RAMs, ASIC, or bus interface circuits.
Prgd Err	6	Read/write test of modulation RAM (U400) failed. Can be bad RAM, ASIC, or bus problem.
Sysd Err	3	CPU RAM (U206) failed read/write test.

GPIB PROBLEMS

First, make sure that the GPIB interface is enabled. Press [SHIFT][1] to display the enable status line. GPIB should be "ON". If not, turn GPIB on using the UP/DOWN ARROW keys. Second, the GPIB address of the DS340 must be set to match that expected by the controlling computer (The default GPIB address is 23). Any address from 0 to 30 may be set in the GPIB menu. To check the GPIB address, press [SHIFT][1] twice. The entry keys or the UP/DOWN ARROW keys may be used to set the GPIB address.

The DS340 will ignore its front panel key pad when Remote Enable (REN) has been asserted by the GPIB. This "REMOTE" state is indicated by the REMOTE LED. To return to LOCAL operation (ie. to enable the front panel) press [3]. Controlling programs may inhibit the ability to return to LOCAL operation by asserting the Local-Lockout state (LLO).

A linefeed character is sent with an End or Identify (EOI) to terminate strings from the DS340. Be certain that your GPIB controller has been configured to accept this sequence.

RS-232 PROBLEMS

First, make sure that the RS-232 interface is enabled. Press [SHIFT][2] to display the enable status line. RS-232 should be "ON". If not, turn RS-232 on using the UP/DOWN ARROW keys. Second, the RS-232 baud rate must be set to match that expected by the controlling computer. The default baud rate is 9600 baud. The DS340 always sends two stop bits, 8 data bits, and no parity, and will correctly receive data sent with either one or two stop bits.

When connecting to a PC, use a standard PC serial cable, not a "null-modem" cable. The DS340 is a DCE (Data Communications Equipment) device, and so should be connected with a "straight" cable to a DTE device (Data Terminal Equipment). The "minimum" cable will pass pins 2,3 and 7. For hardware handshaking, pins 5 and 20 (CTS and DTR) should be passed. Occasionally, pins 6 and 8 (DSR and CD) will be needed: these lines are always asserted by the DS340.

PERFORMANCE TESTS

INTRODUCTION

The procedures in this section test the performance of the DS340. The first set tests the basic functionality of the DS340 from the front panel. The second set of tests actually measures the DS340's specifications. The results of each test may be recorded on the test sheet at the end of this section.

NECESSARY EQUIPMENT

The following equipment is necessary to complete the tests. The suggested equipment or its equivalent may be used.

Instrument	Critical Specifications	Recommended Model
Analog Oscilloscope	350 MHz Bandwidth	Tektronix 2465
Time Interval Counter	Frequency Range: 20 MHz minimum Time Interval Accuracy: 1ns minimum	SRS SR620
FFT Spectrum Analyzer	Frequency Range: DC to 100 kHz Amplitude Accuracy: ± 0.2 dB Distortion: < 75 dB below reference	SRS SR760
RF Spectrum Analyzer	Frequency Range: 1 kHz to 100 MHz Amplitude: ± 0.5 dB Distortion and Spurious: < -70 dB	Anritsu MS2601/ HP4195A
DC/AC Voltmeter	5 1/2 Digit DC accuracy True RMS AC to 100 kHz	Fluke 8840A
Thermal Converter	Input Impedance: 50 Ω Input Voltage: 3 Vrms Frequency: DC to 10 MHz Accuracy: ± 0.05 dB	Ballantine 1395A-3
10 MHz Frequency Standard	Frequency: 10 MHz $\pm .001$ ppm Phase Noise: < -130 dBc @ 100Hz	SRS FS700
50 Ω Terminator	50 $\Omega \pm 0.2$ %, 1 Watt	HP 11048C
Doubly Balanced Mixer	Impedance: 50 Ω Frequency: 1 - 20 MHz	Mini-Circuits ZAD-3SH

FUNCTIONAL TESTS

These simple tests verify that the DS340's circuitry is functional. They are not intended to verify the DS340's specifications.

Front Panel Test

This test verifies the functionality of the front panel, LED's, and buttons.

- 1) Turn on the DS340 while holding down [FREQ]. Press the [UP ARROW] and a single segment of the leftmost digit should light.
- 2) Use [DOWN ARROW] to light each segment (7 of them) and the decimal point of the leftmost two digits. Only a single segment should be on at a time. [UP ARROW] will step backward through the pattern.
- 3) Push the down arrow key again and all of the segments of all 8 digits should light.
- 4) Press the down arrow key repeatedly to light each front panel indicator LED in turn, top to bottom, left to right. At any time only a single LED should be on.
- 5) After all of the LEDs have been lit, further pressing of the front panel keys will display the key code associated with each key. Each key should have a different keycode.

Internal Self-Tests

The internal self tests check the functionality of the DS340 circuitry.

- 1) Turn on the DS340. The ROM firmware version number and the serial number should be displayed for about 3 seconds. The self tests will execute and the message "TEST PASS" should be displayed. If an error message appears see the TROUBLESHOOTING section for a description of the error.

Sine Wave

This procedure visually checks the sine wave output for the correct frequency and any visible irregularities.

- 1) Connect the DS340's output to the oscilloscope input and terminate in 50Ω.
- 2) Set the DS340 to sine, 1 MHz, 10 Vpp, and 50 Ω load impedance. Set the scope to 2 V/div vertical, and .1us/div horizontal.
- 3) The scope should display a sine wave with one cycle per horizontal division and about five divisions peak-to-peak. There should be no visible irregularities in the waveform.

Square Wave

This procedure checks the square wave output for frequency, rise time, and aberrations.

- 1) Connect the DS340's output to the oscilloscope input and terminate in 50Ω.
- 2) Set the DS340 to square wave, 1 MHz, 10 Vpp, and 50 Ω load impedance. Set the scope to 2 V/div vertical, and 200 ns/div horizontal.

- 3) The scope should display two square waves about 5 divisions peak-to-peak in amplitude.
- 4) Increase the scope sensitivity to 1V/div and measure the size of the overshoot at the beginning of the square wave. It should be less than 0.2 V peak-to-peak.
- 5) Adjust the scope to 2 V/div and 5 ns/div. Measure the 10% to 90% rise time of the square wave. It should be less than 22.5 ns.

Amplitude Flatness

This test provides a visual indication of the sine wave amplitude flatness.

- 1) Connect the DS340's output to the oscilloscope input and terminate in 50 Ω .
- 2) Set the DS340 to sine wave, 10 Vpp, and 50 Ω load impedance. Set to linear sweep with a unidirectional waveform. Set the start frequency to 1 Hz, stop frequency to 15.1 MHz, and the rate to 100 Hz. Turn the DS340's sweep ON.
- 3) Set the scope to 2 V/div vertical, and 1 ms/div horizontal. Trigger the scope on the falling edge of the DS340's SWEEP output (Rear Panel).
- 4) The scope should show a sweep that is essentially flat. The peak-to-peak variations should be less than $\pm 1.2\%$. Ignore any dc variations, using the peak-to-peak measurements for flatness comparison.

Output Level

This test provides a visual check of the DS340's output level control.

- 1) Connect the DS340's output to the oscilloscope input and terminate in 50 Ω .
- 2) Set the DS340 to sine wave, 1 MHz, 10 Vpp, and 50 Ω Load Impedance. Set the scope to 2 V/div vertical and 1 μ s/div horizontal.
- 3) Verify that the DS340's output is about 10 V pk-to-pk.
- 4) Set the DS340 to 5 Vpp verify the output.
- 5) repeat step 4 at 1 Vpp, 0.5 Vpp, 0.1 Vpp, and 0.05 Vpp. Adjust the scope as necessary.

This completes the functional tests

PERFORMANCE TESTS

These tests are intended to measure the DS340's conformance to its published specifications. The test results may be recorded on the test sheet at the end of this section. Allow the DS340 at least 1/2 hour to warm up, run the DS340's self test procedure, and proceed with the tests.

FREQUENCY ACCURACY

This test measures the accuracy of the DS340's frequency. If the frequency is out of specification, the timebase frequency should be adjusted (see CALIBRATION section).

Tolerance: 50 ppm of selected frequency

- 1) Turn the DS340 on and allow it to warm up for at least 1/2 hour. Set the DS340 for sine wave, 10 MHz, 1 Vpp, and 50 Ω load Impedance.
- 2) Attach the output of the DS340 to the frequency counter and terminate into 50 Ω . Attach the reference frequency input of the counter to the frequency standard. Set the counter for a 1s frequency measurement.
- 3) The counter should read 10 MHz \pm 50 Hz. Record the result.

AMPLITUDE ACCURACY

The following tests measure the accuracy of the DS340 output amplitude. There are separate tests for sine, square, and ramp/triangle. The tests measure the accuracy of the amplitude as a function of frequency. The sine wave test also measures the performance of the attenuators. There is only a single test for triangle and ramp functions because they have the same signal path.

Frequency < 100 kHz

Connect the DS340 output to the voltmeter through a 50 Ω terminator. After the DS340 has had at least 1/2 hour to warm up, perform the following tests.

Sine Wave

specification: ± 0.1 dB ($\pm 1.2\%$)

- 1) Set the DS340 to sine wave, 100 Hz, 3.54 Vrms (10Vpp), and 50 Ω load Impedance.
- 2) Read the AC voltage on the voltmeter. Repeat at 1 kHz and 10 kHz, and 75 kHz. The readings should be between 3.498 and 3.582 Vrms ($\pm 1.2\%$). Record the results.
- 3) Set the DS340 to 1 kHz. Set the amplitude to 1 Vrms. Read the voltmeter and record the results. The amplitude should be between 0.988 and 1.012 Vrms. Repeat at 0.5 Vrms, 0.25 Vrms, 120 mVrms, 70 mVrms, 40 mVrms, and 20 mVrms. Record the results. They should be within $\pm 1.2\%$ of the set values.

Square Wave

specification: $\pm 1.2\%$

- 1) Set the DS340 to square wave, 100 Hz, 5 Vrms (10 Vpp), and 50 Ω load impedance.
- 2) Read the AC voltage on the voltmeter. Repeat at 1 kHz and 10 kHz. The readings should be between 4.94 and 5.06 Vrms.

Triangle/Ramp Waves

specification: $\pm 1.2\%$

- 1) Set the DS340 to triangle wave, 100 Hz, 2.89 Vrms (10 Vpp), and 50 Ω load impedance.
- 2) Read the AC voltage on the voltmeter. Repeat at 1 kHz and 10 kHz. The readings should be between 2.85 and 2.93 Vrms.

Frequency > 100 kHz

Sine Waves

specification: ± 0.1 dB ($\pm 1.2\%$), frequency > 100kHz

- 1) Connect the DS340's output to the thermal converter (because the converter has a 50 Ω impedance so no terminator is needed). Connect the thermal converter output to the voltmeter using the most sensitive voltmeter range since the nominal signal level is about 7 mV DC. Allow the DS340 at least 1/2 hour to warm up.
- 2) Set the DS340 to sine wave, 1 kHz, 3.00 Vrms, and 50 Ω load impedance. Allow the thermal converter 15 seconds to stabilize and record the result as the 1 kHz reference value.
- 3) Step the DS340's frequency in 500 kHz steps from 0 Hz to 2.5 MHz, and to 15.0 MHz in 5 MHz steps. Allow the thermal converter to stabilize at each frequency and record the results.
- 4) Verify that the readings are within $\pm 1.2\%$ of the 1 kHz reading for frequencies above 1 kHz.

Square Waves

specification: $\pm 5\%$, frequency < 15.1MHz

- 1) Connect the DS340's output to the oscilloscope with a 50 Ω terminator. Set the DS340 to square wave, 1 kHz, 10 Vpp, and 50 Ω load impedance. Set the scope to 2 V/div and 0.1 ms/div.

- 2) Step the DS340's frequency in 500 kHz steps from 0 kHz to 15.1 MHz.
- 3) Verify that the DS340's output is within $\pm 5\%$ of the 1 kHz amplitude.

DC OFFSET ACCURACY

This test measures the accuracy to the DS340's DC offset function.

DC Only

specification: 1.2% of setting $\pm 2\text{mV}$

- 1) Connect the DS340's output to the voltmeter with a 50Ω terminator. Set the DS340 to 0.0 V amplitude, and 50Ω load impedance.
- 2) Set the DS340 to 5V offset. Read the voltmeter and record the result. The result should be between +4.94 V and +5.06 V.
- 3) Set the DS340 to -5V offset. Read the voltmeter and record the result. The result should be between -5.06V and -4.940 V.
- 4) Set the DS340 to 0V offset. Read the voltmeter and record the result. The result should be between -0.2 mV and +0.2 mV.

DC+AC

specification: $< \pm 80\text{ mV}$ at full output

- 1) Connect the DS340's output to the voltmeter with a 50Ω terminator. Set the DS340 to sine wave, 1 kHz, 10Vpp, 0V offset, and 50Ω load impedance. Set the voltmeter to measure DC voltage.
- 2) Measure the offset voltage and verify that it is between -80 mV and +80 mV. Record the result.
- 3) Repeat step 2 at 100 kHz, 1 MHz, and 3.1 MHz. Record the results and verify that the offset is between -80 mV and +80 mV at all of the frequencies.

SUBHARMONICS

This test measures the subharmonic content of the DS340's sinewave output. The frequencies in this test are picked such that spurious frequencies from the DDS process do not fall on the carrier position.

specification: $< -70\text{ dBc}$

- 1) Connect the DS340 to the RF spectrum analyzer. Set the DS340 to sine wave, (10 Vpp), 0V offset, and 50Ω load impedance.
- 2) Set the DS340 to 102 kHz. Set the spectrum analyzer to 51 kHz center frequency, 10 kHz span. The carrier amplitude at 51 kHz should be less than -70 dBc. Record the result.

3) Set the DS340 to 1.002 MHz, and the spectrum analyzer to 501 kHz. Measure and record the amplitude of the 501 kHz carrier. It should be less than -70 dBc. Repeat for 15.1 MHz.

SPURIOUS SIGNALS

These tests measure the spurious signals on the DS340's sine wave outputs. They check both close-in and wide band spurs.

specification: ≤ -65 dBc to 1MHz
(+ 6 dB/oct > 1MHz)

1) Connect the DS340 to the RF spectrum analyzer. Set the DS340 to sine wave, 1 Vpp, 0 V offset, and 50 Ω load impedance.

2) Set the DS340 to 100 kHz. Set the spectrum analyzer to 100 kHz center frequency, 100 kHz span. Measure the amplitude of the spurious signals and verify that they are ≤ -65 dBc. Increase the span and check again.

3) Set the DS340 to 2 MHz. Set the spectrum analyzer to 2 MHz center frequency, 100 kHz span. Measure the amplitude of the spurious signals and verify that they are ≤ -55 dBc. Increase the span and check again.

HARMONIC DISTORTION

This test measures the DS340's sine wave harmonic distortion.

specification: ≤ -70 dBc, DC to 20 kHz
 ≤ -60 dBc, frequency 20 kHz to 100 kHz
 ≤ -50 dBc, frequency 100 kHz to 1 MHz
 ≤ -40 dBc, frequency 1 MHz to 15.1 MHz

1) Connect the DS340 output to the FFT analyzer input with a 50 Ω terminator. Set the DS340 to sine wave, 100 Hz, 1 Vpp, and 50 Ω load impedance.

2) Adjust the FFT analyzer to view the fundamental and its harmonics. Verify that all harmonics are below -70 dBc.

3) Repeat step 2 at 1 kHz and 10 kHz.

4) Connect the DS340 output to the RF spectrum analyzer input. Set the DS340 to 50 kHz. Verify that the harmonics are at least -60 dBc.

5) Set the DS340 to 500 kHz, and 15 MHz, and verify that all harmonics are at least -50 dBc, and -40 dBc, respectively. Record the results.

PHASE NOISE

This test measures the integrated phase noise of the DS340's output in a 15 kHz band about carrier. This test is performed at 1 MHz to minimize the contribution of discrete spurs to the measurement.

specification: < -60 dBc in a 30 kHz band centered about the carrier, exclusive of discrete spurious signals.

1) Set the DS340 to sine wave, 10.001 MHz, 1 Vrms.

2) Record the Phase noise reading from the FFT screen.

SQUARE WAVE RISE TIME This test measures the rise time and aberrations of the square wave output.

specification: rise time < 22.5 ns
overshoot < 2% of peak-to-peak output

- 1) Connect the output of the DS340 to the 350 MHz oscilloscope with a 50 Ω terminator. Set the DS340 to square wave, 1 MHz, 10 Vpp, and 50 Ω load impedance.
- 2) Set the oscilloscope to 2 V/div vertical and 5 ns/div horizontal. Measure the time between the 10% and 90% points and verify that it is less than 22.5 ns. Record the results.
- 3) Set the oscilloscope to 1 V/div vertical and 100 ns/div horizontal. Verify that the overshoots and undershoots are less than ± 200 mV. Record the results.

SQUARE WAVE SYMMETRY This test measures the symmetry of the square wave output.

specification: < 1% of period + 3ns

- 1) Connect the output of the DS340 to the A input of the time interval counter and terminate into 50 Ω . Set the DS340 to square wave, 1 MHz, 5 Vpp, and 50 Ω load impedance.
- 2) Set the time interval counter to measure the positive width of the A input. Record the reading.
- 3) Set the time interval counter to measure the negative width of the A input. This reading should be equal to the reading in step 2 < ± 13 ns. Record the result.

THIS COMPLETES THE PERFORMANCE TESTS

DS340 PERFORMANCE TEST RECORD

Serial Number: _____

Date: _____

Tested By: _____

Comments:

Functional Tests	Pass	Fail
Front Panel Test	_____	_____
Self Test (at power up)	_____	_____
Sine Wave	_____	_____
Square Wave	_____	_____
Amplitude Flatness	_____	_____
Output Level	_____	_____

Performance Tests	Minimum	Actual	Maximum
Frequency Accuracy	9,999,950 Hz	_____	10,000,050 Hz
Amplitude Accuracy			
sine, 100 Hz, 3.54 Vrms	3.498 Vrms	_____	3.582 Vrms
sine, 1 kHz, 3.54 Vrms	3.498 Vrms	_____	3.582 Vrms
sine, 10 kHz, 3.54 Vrms	3.498 Vrms	_____	3.582 Vrms
sine, 75 kHz, 3.54 Vrms	3.498 Vrms	_____	3.582 Vrms
sine, 1 kHz, 1 Vrms	0.988 Vrms	_____	1.012 Vrms
sine, 1 kHz, 0.5 Vrms	0.494 Vrms	_____	0.506 Vrms
sine, 1 kHz, 0.25 Vrms	0.247 Vrms	_____	0.253 Vrms
sine, 1 kHz, 120 mVrms	118 mVrms	_____	122 mVrms
sine, 1 kHz, 70 mVrms	69.1 mVrms	_____	70.9 mVrms
sine, 1 kHz, 40 mVrms	39.5 mVrms	_____	40.5 mVrms
sine, 1 kHz, 20 mVrms	19.7 mVrms	_____	20.3 mVrms
square, 100 Hz, 5 Vrms	4.94 Vrms	_____	5.06 Vrms
square, 1 kHz, 5 Vrms	4.94 Vrms	_____	5.06 Vrms
square, 10 kHz, 5 Vrms	4.94 Vrms	_____	5.06 Vrms
triangle, 100 Hz, 2.89 Vrms	2.85 Vrms	_____	2.93 Vrms
triangle, 1 kHz, 2.89 Vrms	2.85 Vrms	_____	2.93 Vrms
triangle, 10 kHz, 2.89 Vrms	2.85 Vrms	_____	2.93 Vrms
sine, 1 kHz, 3 Vrms reference = X		_____	
Tolerance $\pm 1.2\%$ of X	_____		_____
	(0.980X)		(1.020X)
sine, 500 kHz, 3 Vrms		_____	
sine, 1.0 MHz, 3 Vrms		_____	
sine, 1.5 MHz, 3Vrms		_____	

Performance Tests

sine, 2.0 MHz, 3 Vrms
 sine, 2.5 MHz, 3 Vrms
 sine, 5.0 MHz, 3 Vrms
 sine, 10.0 MHz, 3 Vrms
 sine, 15.0 MHz, 3 Vrms

square, 10 Vpp

Pass

Fail

DC Offset Accuracy (DC only)

5.0 V 4.940 V
 -5.0 V -5.060 V
 0.0 V -0.0002 V

5.060 V
 -4.940 V
 0.0002 V

DC Offset Accuracy (DC + AC)

1 kHz, 10 Vpp, 0 Vdc -0.08 V
 100 kHz, 10 Vpp, 0 Vdc -0.08 V
 1 MHz, 10 Vpp, 0 Vdc -0.08 V
 15.1 MHz, 10 Vpp, 0 Vdc -0.08 V

0.08 V
 0.08 V
 0.08 V
 0.08 V

Subharmonics

sine, 102 kHz, 10 Vpp
 sine, 1.002 MHz, 10 Vpp
 sine, 15.1 MHz, 10 Vpp

-70dBc
 -70dBc
 -70dBc

Spurious Signals

sine, 100 kHz
 sine, 2 MHz

-65 dBc
 -55 dBc

Harmonic Distortion

sine, 100 Hz, 1 Vpp
 sine, 1 kHz, 1 Vpp
 sine, 10 kHz, 1 Vpp
 sine, 50 kHz, 1 Vpp
 sine, 500 kHz, 1 Vpp
 sine, 1 MHz, 1 Vpp
 sine, 15.1 MHz, 1 Vpp

-70 dBc
 -70 dBc
 -70 dBc
 -60 dBc
 -50 dBc
 -40 dBc
 -40 dBc

Phase Noise

noise

-60 db

Square Wave Rise Time

square, 1 MHz, 10 Vpp. 10% to 90% rise time
 square, 1 MHz, 10 Vpp. Overshoots

22.5 ns
 ±200 mV

Square Wave Symmetry

square, 1 MHz, 5 Vpp. + pulse width
 square, 1 MHz, 5 Vpp. - pulse width
 asymmetry = (+ width) - (- width)

13 ns

CALIBRATION

Introduction

The calibration of the DS340 is composed of two parts: adjustment and calibration. Adjustments are actual physical adjustments to variable resistors and capacitors to correct the DS340's filters and output amplifier response. Calibration is the process of determining the calibration constants ("calbytes") that the DS340 firmware uses to correct the output amplitude, offset, etc..

The factory adjustments are, in general, very stable and should rarely require change. If any factory adjustments are changed a partial or full calibration **must** be performed. However, the DS340 rarely requires complete recalibration to maintain its performance. It is recommended that the unit be sent back to the manufacturer in the case where a full recalibration is required.

Calibration Enable

The DS340 is shipped with calibration byte editing disabled. When calibration is disabled, direct access to the calbytes is prevented. The internal calibration enable jumper must be set to enable calibration. To set the jumper, remove the DS340's top cover by removing its four retaining screws (this will break the calibration seal). In the center of the bottom circuit board is a three pin jumper labeled JP200. Setting JP200 between pins 1 and 2 enables calibration, setting it between pins 2 and 3 disables calibration.

Calbytes

The DS340's calibration is controlled by calibration constants ("calbytes") that the firmware uses to adjust the various output parameters. These calbytes are stored in the DS340's RAM. Recalibration of the DS340 involves determining the values of the calbytes and storing the new values in RAM. The calbyte values at the time of the DS340's production are also stored in ROM and may be recalled at any time.

Direct access to the DS340's calbytes is allowed from both the front panel and computer interfaces after calibration is enabled. From the front panel press [SHIFT][9] to display the calbyte menu line. There are two displayed parameters: on the left is the calbyte number, and on the right is the calbyte value. The calbyte number and value may be modified with either the keypad or the UP/DOWN ARROW keys. To select an item use the [SHIFT][DOWN ARROW] and [SHIFT][UP ARROW] keys. The calbyte number may be set between 0 and 554. The calbyte value may be set between -127 and 65536. The complete set of factory calbyte values may be recalled by pressing [SHIFT][9] twice to bring up the Clear Cal menu and then pressing any of the unit keys. The tables on the following pages lists the DS340 calbytes. Shown is the calbyte number, name, and meaning.

DS340 CALBYTES

Number	Name	Meaning
0	OSC_FREQ	Sets 10 MHz clock. 0 to 4095. Nom:2048
1	SINE_AMP	L.F. Sine amplitude. 29,000 to 36,000. Nom:2 ¹⁵ .
2	SQ_AMP	L.F. Square amplitude. 29,000 to 36,000. Nom:2 ¹⁵ .
3	TRI_AMP	L.F. Triangle amplitude. 29,000 to 36,000. Nom:2 ¹⁵ .
4	RAMP_AMP	L.F. Ramp amplitude. 29,000 to 36,000. Nom:2 ¹⁵ .
5	NOISE_AMP	L.F. Noise amplitude. 29,000 to 36,000. Nom:2 ¹⁵ .
6	OFFS_GAIN	Adjusts gain for output offsets. 29k-36k Nom:2 ¹⁵
7	SW_OFF	+/-127. Nom:0. Value added to 12 bit Offset DAC.
8	0dB_OFF	+/-127. Nom:0. Value added to 12 bit Offset DAC.
9	2dB_OFF	+/-127. Nom:0. Value added to 12 bit Offset DAC.
10	4dB_OFF	+/-127. Nom:0. Value added to 12 bit Offset DAC.
11	6dB_OFF	+/-127. Nom:0. Value added to 12 bit Offset DAC.
12	8dB_OFF	+/-127. Nom:0. Value added to 12 bit Offset DAC.
13	10dB_OFF	+/-127. Nom:0. Value added to 12 bit Offset DAC.
14	12dB_OFF	+/-127. Nom:0. Value added to 12 bit Offset DAC.
15	14dB_OFF	+/-127. Nom:0. Value added to 12 bit Offset DAC.

Pre-attenuator gain calibration values. These values are linear in the measured gain for the pre-attenuator.

16	PRE_0dB	Always set to 2 ¹⁶ -1 (65535). The reference gain.
17	PRE_2dB	+/- 5% from nominal value of 52057.
18	PRE_4dB	+/- 5% from nominal value of 41350.
19	PRE_6dB	+/- 5% from nominal value of 32845.
20	PRE_8dB	+/- 5% from nominal value of 26090.
21	PRE_10dB	+/- 5% from nominal value of 20724.
22	PRE_12dB	+/- 5% from nominal value of 16461.
23	PRE_14dB	+/- 5% from nominal value of 13076.

Post-attenuator gain calibration values. These values are linear in the measured gain for the post-amplifier attenuator. There are two of these tables corresponding to the measured gains in the 50 Ohm, and High-Impedance load conditions. These tables compensate for attenuator errors, finite amplifier output resistance, internal 50 Ohm resistor tolerances, and reflects the fact that the output amplitude of high-impedance loads is twice that of the 50 Ohm cases.

High Impedance table goes first, as its first entry is the reference gain for all other measurements:

24	HI_0dB	Fixed at 2 ¹⁶ -1 (65535). Reference gain level.
25	HI_2dB	+/- 5% from nominal value of 52057.
26	HI_4dB	+/- 5% from nominal value of 41350.
27	HI_6dB	+/- 5% from nominal value of 32845.
28	HI_8dB	+/- 5% from nominal value of 26090.
29	HI_10dB	+/- 5% from nominal value of 20724.
30	HI_12dB	+/- 5% from nominal value of 16461.
31	HI_14dB	+/- 5% from nominal value of 13076.
32	HI_16dB	+/- 5% from nominal value of 10386.
33	HI_18dB	+/- 5% from nominal value of 8250.
34	HI_20dB	+/- 5% from nominal value of 6553.

Number	Name	Meaning
35	HI_22dB	+/- 5% from nominal value of 5205.
36	HI_24dB	+/- 5% from nominal value of 4135.
37	HI_26dB	+/- 5% from nominal value of 3284.
38	HI_28dB	+/- 5% from nominal value of 2609.
39	HI_30dB	+/- 5% from nominal value of 2072.

Now the post amplifier attenuator gains for 50 Ohm case:

40	50_0dB	+/- 5% from nominal value of 32768
41	50_2dB	+/- 5% from nominal value of 26028.
42	50_4dB	+/- 5% from nominal value of 20675.
43	50_6dB	+/- 5% from nominal value of 16422.
44	50_8dB	+/- 5% from nominal value of 13045.
45	50_10dB	+/- 5% from nominal value of 10362.
46	50_12dB	+/- 5% from nominal value of 8230.
47	50_14dB	+/- 5% from nominal value of 6538.
48	50_16dB	+/- 5% from nominal value of 5193.
49	50_18dB	+/- 5% from nominal value of 4125.
50	50_20dB	+/- 5% from nominal value of 3276.
51	50_22dB	+/- 5% from nominal value of 2602.
52	50_24dB	+/- 5% from nominal value of 2067.
53	50_26dB	+/- 5% from nominal value of 1642.
54	50_28dB	+/- 5% from nominal value of 1304.
55	50_30dB	+/- 5% from nominal value of 1036.

The following three tables have a length of 160 entries, and contain sine and square wave leveling values and square wave symmetry values as a function of frequency.

56	SINE_0	Fixed at 127. This is the reference value for dc.
57	SINE_1	0 to 255. Nominal 127. For 78,125 to 156,250 Hz.
58	SINE_2	0 to 255. Nominal 127. For 156,251 to 234,375 Hz.
:		
249	SINE_193	0 to 255. Nominal 127. For 15,0789,125 to 15,156,250 Hz.

The next table of 160 words contains amplitude leveling data for square wave outputs. This data is used to modify square wave amplitude control values as a function of frequency (there is no hardware accommodation for amplitude leveling of square wave sweeps.)

251	SQ_0	Fixed at 2 ¹⁵ (32,768). The dc reference level.
252	SQ_1	For 78,125 to 156,250 Hz. +/-10% from nominal.
253	SQ_2	For 156,250 to 234,375 Hz. +/-10% from nominal.
:		
:		
444	SQ_193	For 15,0789,125 to 15,156,250 Hz. +/-10% from nominal.

The last table of 160 words contains sync symmetry values as a function of frequency when sines or squares are selected. There are three values which precede the table: these are used to control the sync duty cycle for triangles, ramps, and noise.

446	TRI_SYM	Triangle sync symmetry. 0 to 4095. Nominal 2048.
447	RAMP_SYM	Ramp sync symmetry. 0 to 4095. Nominal 2048.
448	NOISE_SYM	Noise sync duty. 0 to 4095. Nominal 2048
449	SYM_0	0 to 4095. Nominal 2048. For dc to 78,125 Hz.

Calibration

450	SYM_1	0 to 4095. Nominal 2048. For 78,125 to 156,250 Hz Hz.
452	SYM_2	0 to 4095. Nominal 2048. For 156,251 to 234,375 Hz.
:		
:		
:		
642	SYM_193	0 to 4095. Nominal 2048. For 15,0789,125 to 15,156,250 Hz.

NECESSARY EQUIPMENT

The following equipment is necessary to complete the adjustments and calibrations. The suggested equipment or its equivalent may be used.

Instrument	Critical Specifications	Recommended Model
Analog Oscilloscope	350 MHz Bandwidth	Tektronix 2465
Time Interval Counter	Frequency Range: 20 MHz min. Time Interval Accuracy: 1ns max	SRS SR620
FFT Spectrum Analyzer	Frequency Range: DC to 100 kHz Amplitude Accuracy: ± 0.2 dB Distortion: < 75 dB below reference	SRS SR760
RF Spectrum Analyzer	Frequency Range: 1 kHz to 100 MHz Amplitude: ± 0.5 dB Distortion and Spurious: < -70 dB	Anritsu MS2601/ HP4195A
DC/AC Voltmeter	5 1/2 Digit DC accuracy True RMS AC to 100 kHz	Fluke 8840A
Thermal Converter	Input Impedance: 50 Ω Input Voltage: 3 Vrms Frequency: DC to 10 MHz Accuracy: ± 0.05 dB	Ballantine 1395A-3
10 MHz Frequency Standard	Frequency: 10 MHz $\pm .001$ ppm Phase Noise: < -130 dBc @ 100Hz	SRS FS700
50 Ω Terminator	50 $\Omega \pm 0.2$ %, 1 Watt	HP 11048C

ADJUSTMENTS

The following adjustments set the values of all of the variable components in the DS340. After an adjustment has been made the associated calibrations **must** be made. All adjustments must be complete before calibration is started. First, remove the DS340's top cover by removing the four retaining screws.) Set the "cal enable" jumper (JP200 switch 2) between pins 1 and 2.

NOTE: The chassis ground and circuit ground float relative to each other. For voltage measurements use the FUNCTION output BNC shield as a ground reference.

Output Amplifier Bandwidth

These adjustments correct the bandwidth of the output amplifier. A complete calibration must be performed if these adjustments are changed. All of the adjustments are on the bottom PCB. Use an insulated adjusting screwdriver.

- 1) Connect the output of the DS340 to the oscilloscope with a 50 Ω terminator. Set the DS340 to square wave, 8 Vpp, 100 Hz. Set the scope to 2 V/div vertical and 5 ms/div horizontal. Adjust R703 for the squarest output waveform.
- 2) Do a complete calibration of the DS340

Bessel Filter Adjustment

This adjustment sets the bandpass of the DS340's Bessel waveform filter.

1) Set the DS340 to RAMP waveform, 8 Vpp, 10 kHz frequency. Connect the DS340's output to an oscilloscope with a 50 Ω terminator. Set the DS340 for 50 Ω load impedance. Set the scope to 2 V/div vertical and 200 ns/div horizontal.

2) Adjust C547, C534, and C539 to make the output rise time as fast as possible while minimizing the peak-to-peak ripple.

CALIBRATION

The DS340 is fully calibrated at the factory with all calibration bytes secured in ROM and RAM. The user can change the calibration bytes in RAM after changing the position of the calibration jumper JP200. The list of calibration bytes on page 6-2 shows the address and function of every byte. The only calibration byte that might need adjustment as the instrument ages is the frequency reference byte. The following procedure describes the adjustment of the DS340's clock calibration calbyte. In the case where the calibration bytes in RAM get corrupted, the user can recall the factory calibration bytes. Please refer to page 6-1 for that procedure.

Allow the DS340 at least 1/2 hour warmup before beginning calibration. All calibrations should be done with the DS340 completely assembled and 1/2 hour of warmup after reassembly. When the new calbyte values are determined they should be entered into the DS340's RAM.

Clock Calibration

This procedure sets the frequency of the DS340's internal 10 MHz clock. The procedure is identical for standard and optional oscillators. Be sure that the DS340 has been completely reassembled and warmed up for at least 1/2 hour before this calibration is started.

1) Connect the DS340's Function output to the frequency counter input with a 50 Ω terminator. Use the frequency standard as the counter's timebase.

2) Adjust the value of calbyte 0 so that the frequency is within 1 Hz of 10 MHz (0.01 Hz for optional oscillators). The range of calbyte 0 is 0 to 4095.

ARBITRARY WAVEFORM COMPOSER SOFTWARE

Introduction

The Arbitrary Waveform Composer (AWC) is a friendly windowed software program that allows simple creation and downloading of arbitrary waveforms to the DS340. AWC has the ability to create arbitrary waveforms, store waveforms to disk, edit stored waveforms, and download waveforms to the DS340. AWC can edit and download both waveforms that it has created and waveforms from other sources (stored in ASCII text files).

AWC will run on IBM compatible PC AT, 386, and 486 based computers having 640k RAM & DOS 2.0 or greater. VGA, EGA, and CGA graphics cards are supported. A mouse is highly recommended but not necessary. A math coprocessor is also recommended. AWC supports EMS memory management for improved program speed. AWC communicates with the DS340 using the RS-232 interface or with either CEC or National Instruments GPIB cards.

Installing AWC

Install AWC (on either a hard or floppy disk drive) by copying all of the files from the master disk to the working disk. Store the master disk in a safe place.

Getting Started With AWC

This section gives a quick introduction to using AWC. The details of the menus and other functions are explained in succeeding sections. This section assumes that the user has a mouse. The section on "Mouseless Operation" explains what to do if a mouse is not available.

1) Type AWC at the DOS prompt

After a few seconds the main AWC display should appear. This display consists of a menu bar and a graph screen. The menu bar allows selection of various program options and functions. The graph display shows the current arbitrary waveform with voltage on the vertical axis and point number on the horizontal axis.

2) Select the **Waveform** menu

Select a menu by placing the arrow cursor on that menu title and clicking the left mouse button. Some of the menus are "grayed" and may not be selected because there is no waveform to edit and the communications parameters have not been set.

3) Select **Sine**

The arbitrary function will be a sine wave. AWC will ask for the number of points in the waveform.

4) Enter 1000.

Any number of points between 8 and 16300 may be entered. AWC will ask for the number of complete periods in the waveform.

5) Enter 10.

Ten complete sine periods in the 1000 points. AWC will now ask for the amplitude of the waveform.

6) Enter 10.

The amplitude will be 10 Vpp. After a brief calculation AWC will draw the waveform on the screen. The display should show 10

sine periods along with new axis labels. The screen shows the Peak-to-Peak amplitude of the waveform in Volts, the minimum and maximum voltages of the waveform, and the current file name. The vertical scale is calculated automatically. The horizontal scale has units of waveform points. The numbers Min and Max in the corners of the screen are the minimum and maximum point number being displayed. These units correspond to the RAM addresses in the DS340's waveform memory. The total number of points displayed is listed, as are the total number of points in the waveform.

7) Select the **Edit** menu

We are going to edit this waveform. We want to invert it and then multiply by an exponential damping factor.

8) Select **Mirror**

The waveform will be mirrored (inverted).

9) Select the **Waveform** menu

10) Select **math**

Math allows mathematical operations on the waveform. Make sure that there is a check mark in the Exp box and that multiply is selected.

11) Select **multiply**, and **Exp**

We will multiply by an exponential damping.

12) Click **Okay**.

The choices are ok. AWC will ask for the damping factor.

13) Enter -4.

The sine wave will be damped by $\exp(-4)$ at its endpoint. After a brief calculation AWC will draw the new waveform.

14) **DONE !**

Throughout this example the **Send Data** and **Trigger** menus were disabled. This is because the communications parameters have not been set. Select the **RS-232/GPIB** submenu from the **Set DS34X** menu to set the communication parameters according to your specific hardware configuration. See the **Set DS34X** menu description for more information on establishing communication with the DS340. Once communication is established use these menu selections to send the data to the DS340.

USERS GUIDE

Hardware Requirements

AWC is designed to work on an IBM PC/XT/AT, IBM PS/2, or compatible computer equipped with at least 640k of RAM. A mouse is highly recommended. A math coprocessor will speed numerical computations. EMS memory will also improve program speed by eliminating temporary storage files on disk. To communicate with the DS340 you will need one of the following: an RS-232 port (other than the mouse port), a Capitol Equipment Corp. or a National Instruments GPIB card.

AWC runs on all CGA/EGA/VGA/HGC compatible graphics display hardware. The display type is automatically determined when the program starts.

MENUS

File Menu

The file menu allows the user to store and recall arbitrary waveforms from disk.

New

New clears the current arbitrary waveform. AWC will check with the user to be sure that the current waveform should be discarded.

Open

Open recalls a previously stored arbitrary waveform. The data file contains all information necessary to restore AWC's state: the waveform data, sampling rate, and trigger conditions. The user will be prompted for a file name. The file name specified can include wild cards such as "*" or "?". The default extension for waveform files is .wav, however, any other extension may be used. A file selection box will be displayed that shows all files that match the entered filename. Select the desired file by clicking on its name and then clicking Okay. If the list of files is too large to fit in the box the scroll bars can be used to scroll through the list. Once the file is selected it will be loaded from the disk and displayed. If the selected file has a format that is incompatible with AWC it will not be loaded and an error message will be displayed.

note: Loading a file with an improper format may yield unpredictable results, causing the program to hang. Refer to the end of this manual for the correct file format.

Save

Save stores the displayed arbitrary waveform to disk. The file may be saved with the default name supplied by AWC (NEW.WAV) or any other file name. Appending the .wav extension to the file name allows easy recognition of waveform files. The data file stores the complete state of AWC: the waveform data, sampling rate, and trigger parameters. Recalling the file will completely restore AWC's state (except communication parameters).

Quit

Quit exits the program. Quit always checks to see if the data should be discarded.

Edit Menu

The Edit menu is used to modify existing waveforms. This menu is enabled only when there is an arbitrary waveform displayed on the screen.

Clear

Clear clears the screen and resets all the waveform values to zero. Clear also sets the file name to new.wav and disables the Edit and Zoom menus.

Set (x1, x2) to DC This sets a segment within the waveform to a DC value. There are three parameters for this selection. The first is the starting point number of the segment. The second is the length of the segment in points, and the third is the DC value (in Volts) to which the segment should be set. The segment can be as short as one point and as long as the whole waveform.

Redraw Redraws the waveform and zooms out to display the full waveform.

Mirror Mirrors the waveform about 0 Volts (multiplies every data point by -1).

Amplitude Sets the amplitude of the waveform. Any value in the range 0.01 Vpp to 10 Vpp may be entered. To add an offset to the waveform, the **Math** selection in the **waveform** menu should be used. Note that $|V_{ac\ peak}| + |V_{dc}| \leq 5\ V$. This command only changes the data in AWC's waveform database. The waveform must be reloaded into the DS340 for the change to take effect.

Waveform menu The Waveform menu is the key to creating new waveforms and modifying existing ones. Seven conventional waveforms can be created: Sine, Square, Triangle, Saw, Exponential, Exponentially Damped Sine wave, and Pulses. The Math menu allows the user to perform math operations on any waveform on the screen. All waveforms are created with zero DC offset. An offset may be added to the waveform using the **math** function. Waveform creation may be aborted by pressing escape (ESC) on the keyboard.

Sine
Square
Triangle
Saw

Three parameters must be entered for these waveforms. The waveform can be between 8 and 16300 points long, and can contain a specified number of complete sine wave cycles. The maximum number of cycles is limited so that each cycle has at least 8 points. The waveform amplitude in Volts peak-to-peak is also entered. The waveform will have zero DC offset.

Exponential Produces an exponentially shaped pulse. The user is asked for three parameters. The waveform can be between 8 and 16300 points long. The exponential damping factor (b) is then set. The waveform will be reduced or increased by a factor $\exp(b)$ at its endpoint, where b is limited to the range -50 to 50. The waveform amplitude in Volts peak-to-peak is entered. The waveform will have zero DC offset level.

Damped Sine This selection produces an exponentially damped sinewave. Four parameters are entered. The number of points, number of cycles, and amplitude are the same as for the normal sine function. The fourth parameter is the damping factor (b). The waveform will be reduced or increased by a factor $\exp(b)$ at its endpoint, where b is limited to the range -50 to 50.

Pulse This selection generates a pulse train. The pulse train can have between 1 and 100 transitions (state changes). AWC first asks for the number of points in the waveform, and the waveform amplitude. The user is then asked for the transition locations (pulse edges) in the waveform. The first transition al-

ways has a positive slope. If a negative starting transition is needed, apply the **mirror** function after the waveform is created.

Math

The math selection applies mathematical operations to the current waveform. This selection is disabled when there is no waveform. The user may mirror the waveform (multiply by -1), or may add, subtract, or multiply the waveform by a constant, sine, square, triangle, sawtooth, or exponential wave. These operations may take place over the entire waveform or just a segment.

Use the math functions by selecting the desired function with the mouse, and clicking Okay. Several parameters must be entered: the starting point number on which the operation should take place, the number of points over which the function should operate, and the amplitude of the function. Exponentials also require that the damping factor b be entered. If the amplitude of the resultant waveform exceeds the range of the DS340 an error message will be displayed.

Send Data Menu

The selections in the send data menu allow transmitting the arbitrary waveform to the DS340. The Send Data menu is enabled only when the communications parameters have been set in the **Set DS34X**.

Waveform

This selection sends the current arbitrary waveform to the DS340. When the waveform is sent to the DS340 the state of the DS340 is set to match that of AWC. That is, the DS340's sampling rate and trigger parameters are set to match the settings in AWC. This selection is disabled if no waveform has been generated. While sending the data, the message "Sending data points to DS34X. Please wait..." is displayed. At the same time the DS340 should display the message "loading..". A 16000 point waveform takes about 5 seconds to transmit. After loading is complete the arbitrary wave can be observed at the output of the DS340 by selecting the ARB function from the front panel or through the **trigger** menu in AWC (see below).

ASCII file

This selection sends an ASCII file directly from disk to the DS340. There is no processing of the file contents- the user must ensure that the contents will be recognized by the DS340. A file selection box is displayed to select the proper file. The ASCII file can be used to send a series of commands to the DS340. It can also be used as a macro facility to perform a series of commands on the unit.

Warning: The ASCII File command does not perform any error checking (syntax or otherwise) on the commands that the user is sending to the DS340. Double checking the ASCII file is a good idea since an error could yield unpredictable results.

Set DS34X Menu

The Set DS34X menu is used to remotely set the sampling frequency of the DS340 and to set communication parameters.

Sampling Frequency

This selection sets the DS340's arbitrary waveform sampling frequency. The selection is disabled when no waveform is displayed on the screen. The frequency range is from .001Hz to 40,000,000.0MHz. Note that the sampling frequency can only be 40 MHz/N where N is an integer. If a frequency is

entered where N is not an integer, the DS340 will round it to the closest 40 MHz/N value.

RS-232/GPIB

This selection is used to set communication parameters for the interface between AWC and the DS340.

RS-232 -For serial communication, click the RS-232 box. Select the Baud rate and the serial port (COM1 or COM2). The baud rate must correspond to that of the DS340. Be sure that the DS340's RS-232 interface is enabled. Do not select the serial port to which the mouse is attached.

GPIB- If the GPIB interface is selected then the user must select between the CEC or National Instruments cards. The setup procedure is slightly different for the two cards. If the CEC card is selected, the DS340's device address has to be entered. The default address is 23. If the National card is selected, the DS340's device name must be entered. This is the name assigned to to DS340 by the National Instruments configuration program ibconf. When sending long waveforms to the DS340 with a National GPIB card, set the timeout to 100 seconds in ibconf

Enable Local

This selection takes the DS340 out of remote mode and enables local front panel control.

Trigger Menu

The Trigger menu allows setting the DS340's trigger generator parameters for triggered arbitrary waveforms. If all of the trigger choices are deselected the DS340's is set to continuous waveforms. The default setting is continuous waveforms. The six trigger choices are the five that are internal to the DS340 plus the PC mouse. If PC mouse is selected a trigger button will appear on the AWC screen. The DS340 will trigger each time the button is clicked. If AWC has problems setting the trigger over RS-232, a slow baud rate of 2400 should be used.

Zoom Menu

The zoom menu allows the AWC display to zoom in and out on features of the arbitrary waveform. This is useful when the waveform has many points. This menu is disabled when there is no waveform on screen.

Zoom

This selection sets the AWC display to any portion of the current waveform. There are two parameters: the starting and ending point numbers to be displayed.

Zoom In

Magnifies the center 50% of the waveform by a factor of two.

Zoom Out

Zooms out from the center of the screen by a factor of two.

Pan Right

Pans to the right by 50% of the screen width.

Pan Left

Pans to the left by 50% of the screen width.

Full View

Zooms out to display the entire waveform.

Other Menu	The selections in this menu provide some useful information about AWC.
SRS/DDS Info	Displays the current version of AWC and general information about SRS.
EMS Memory Info	Displays whether or not an EMS memory driver is present, and if so how much EMS memory is available. AWC can use EMS memory instead of disk space for temporary storage. This speeds AWC's operation.
MOUSELESS OPERATION	Although a mouse is highly recommended, it is possible to operate AWC without a mouse. The arrow cursor may be moved around on the screen by pressing [SHIFT] and an ARROW key (up, down, left, and right). When the cursor arrow is on an object pressing [RETURN] is equivalent to clicking the mouse button. In many cases, menu names and menu items have highlighted letters. Typing the highlighted letter will select the menu or menu item. For example, typing "W" will open the Waveform menu. Pressing escape (ESC) will close an open menu. Pressing the ARROW keys without pressing the SHIFT key will scroll through the menus.
DATA FILE FORMAT	AWC data is saved in a simple ASCII format. Each line of the file consists of a single numerical value followed by a carriage return/linefeed. The first line is the number of data points in the waveform. The second line is the sampling frequency. The third line is the trigger source, and the fourth line the internal trigger rate. The remainder of the lines are the waveform amplitude points. There is one line for each point (between 8 and 16300 lines). The value of the data is the waveform amplitude in volts at that data point. Sample files with extension .wav are included on the AWC disk.
FOR MORE INFO	Be sure to read the readme.doc file on the AWC software disk for any changes in the software. Some examples of waveform files (extension .wav) and ASCII command files (extension .asc) are also included for reference.

DS340 Circuit Description

Front Panel (DS340FP) The front panel pcb has 8 seven-segment displays, 29 LED indicators, and 22 keys. The displays are refreshed by a time multiplexing: there are four strobe lines which enable two digits, a column of seven LEDs, and six keys. The display refresh is synchronized by the Real-Time Interrupt (RTI). The RTI occurs at a 500 Hz rate. The display refresh is the first task in the RTI routine, so as to avoid display flicker. Five RTI's are required to refresh the entire display: four to refresh all of the displays and indicators and to look for key contacts, and a fifth to intensify a particular digit in the eight digit display. Each LED and display has a 1:5 duty cycle. When intensified, the selected display will have a 2:5 duty cycle, making that digit twice as bright. The intensity of the selected digit will blink between 1:5 and 2:5 duty cycle at a 1 Hz rate.

Microprocessor (DS340M1) The CPU is a CMOS Z80 (TMPZ84C00AP, U100) clocked at 5 MHz. The CPU's 64k memory space is divided in two: the lower 32k is occupied by a CMOS ROM (27256, U104), the top 32k has a battery backed-up CMOS RAM (HM62256LP, U206). All other devices in the system are mapped as I/O. I/O port strobes (active low) are provided by the 1:16 decoder (74HC154, U108). Port strobes are separated by eight addresses, leaving room to access registers within particular devices.

Address/Name/Definition: 00 -CS_8253 CS to RD or WR to 8253 triple counter/timer. 08 -LED_STB WR to assert display strobe and speaker enable. 10 -LED_EVEN WR for segment enables for EVEN display digits. 18 -LED_ODD WR for segment enables for ODD display digits. 20 -LED_LAMP WR for LED indicator enables. 28 -KEY_RD RD to read keypad matrix. 30 -DAC_MPX WR to select channel for system DAC (and 4 LSB's). 38 -DAC_STB WR for 8 MSB's to 12 bit system DAC. 40 -RLY_CTL WR to set position of 7 system relays. 48 -ASIC_CTL WR to set state of ASIC control lines. 50 -ASIC_WR WR to strobe opcodes and data into ASIC. 58 -MOD_RAM CS to RD or WR to modulation RAM. 60 -CMD_STB Command strobe to GPIB/RS232 interface. 68 DATA_CLK Serial data clock to RD/WR to interface. 70 -MISC_IN RD eight bit port of miscellaneous inputs. 78. -MISC_OUT WR eight bit port of miscellaneous outputs.

Timing: A 40 MHz crystal oscillator is the source of all timing. This oscillator is on page DS340M5, close to the waveform DAC. For the DDS to work well, it is imperative that this clock be kept clean: hence the oscillator is operated from a separate supply (+5_CLOCK) and its output is passed directly to the waveform DAC. The 40 MHz is buffered to provide clocks to the rest of the system. There is a TCXO option for the 40 MHz clock. When present, the TCXO may be tuned to exactly 40 MHz by the system control voltage, 'OSC_CTL'. When the TCXO is not present, the frequency is calibrated by altering the constant used to compute the PIR value for the ASIC phase accumulator. The buffered 40 MHz is divided by 8 by 4 bit counter (74ACT161, U507) to provide a 5 MHz clock to the CPU and a 2.5MHz clock to the 8254 counter/timer, and to the UART and GPIB controller on the communications interface board. The 8254

provides three additional clocks by dividing its 2.5 MHz input: a 500 Hz RTI is generated by dividing by 5000, a 1 kHz tone for the speaker is generated by dividing by 2500, and a 16x clock for 9600 baud is generated by dividing by 16 (which will have a 1.7% error).

Communications Interface Header: An 18 pin header to the optional GPIB/RS232 interface is shown on sheet DS340M10. The computer interface must be ground referenced, while the function generator (and so its CPU, etc.) must float. To accommodate this, communications between the CPU and the interface are done serially, via opto-isolators. Data and commands are shifted to and from the interface with the port-strobe "DATA_CLK". Commands are executed (a register read, for example) when the port strobe "-CMD_STB" is asserted. A separate, ground referenced power supply is generated on the interface PCB by rectifying and regulating the 9 Vac which is supplied to the header. GPIB and RS232 interrupts can assert the maskable interrupt to the Z80. If no interface is present, this interrupt will not be asserted. The CPU tests for the presence of the interface on power-up by shifting data through the interface and looking for its return (with a 16 cycle delay, of course). Data to the interface is buffered by a D-type flip-flop, (74HC74, U107A). The MSB of the data bus is clocked into the flip-flop on the leading edge of the DATA_CLK, and clocked into the interface's shift register on the trailing edge of the DATA_CLK. This is done to eliminate processor noise on the ribbon cable when there are no communications. A byte is transferred to the interface with eight outputs and eight left-shift instructions.

Battery Back-up: The contents of the 32Kx8 CMOS RAM are preserved when the power is turned off by a Lithium battery. The CS to the RAM is disabled on power down by the -RESET, which turns off the NPN transistor (Q101, a 2N3904).

Display Driver (DS340M2)

The front panel display is time multiplexed: two digits, and seven indicators may be refreshed, and six keys read during each of four successive strobe periods. To refresh a part of the front panel display, one STROBE column is pulled high by writing a zero to the corresponding position in the LED_STB latch (U203, a 74HC374). For example, writing a zero to Q0 will saturate the PNP transistor Q200, and pull STROBE_0 to +5 volts. Digit segments and LED indicators within a particular STROBE column are turned on by writing a zero to the corresponding position in the LED_EVEN, LED_ODD, or LED_LAMP latches (U200-201, 74HC374's). For example, writing a zero to Q0 of the LED_EVEN latch will cause the 'a' segment of the 'even' digit display in the selected strobe column to turn 'on'. There is a watch-dog circuit (U111, D200, C200, and R229) which will turn off the front panel displays if the processor stops refreshing the LED_STROBE latch. The circuit pumps charge onto C200 with every output to the LED_STROBE latch. C200 is discharged by R229 if the port strobes cease, removing the output enable from the 74HC374 display drivers.

System DAC and S/H's (DS340M3)

There are five analog voltages which may be set by the CPU. These five voltages control the output square wave symmetry, square wave amplitude, output offset, TCXO frequency, and waveform amplitude. These analog voltages are on sample and hold amplifiers which are maintained by a 12 bit system DAC (U303, an AD7845). The DAC can output voltages from -5.00 to +5.00V with

input values from 0 to 4095. To refresh a particular sample and hold, the analog multiplexer (U304, a 74HC4051) is inhibited by writing a 'one' to the MSB (Q8) of the DAC_MPX latch (U305, a 74HC273). Next, the address of the desired S/H is written to bits Q5, Q6 and Q7 of the DAC_MPX latch, along with the four LSB's of the desired 12 bit DAC value to Q1-4. Then the 8 MSB's of the 12 bit DAC value is written along with the port strobe -DAC_STB to load the 12 bit value into the DAC. Finally, the inhibit to the DAC multiplexer is removed by writing a zero to the MSB (Q8) of the DAC_MPX latch. A different sample and hold is refreshed with each new RTI. The refresh interval is two milliseconds.

The square wave symmetry control voltage may be set over +/-5V with zero being nominal. This voltage controls the duty cycle of the SYNC and square wave outputs, and varies with frequency to maintain the output at 50% duty cycle per the contents of a calibration table. The square wave amplitude control voltage may be set over +/-5V. The actual output square wave amplitude is linear in the DAC value, and zero when the DAC value is zero. This voltage is set to -5V if a square wave is not selected in order to reduce cross-talk in the function select relay. The output offset control voltage may be set over the range of -10.5 to +10.5V. The higher output levels are due to the gain of x2.1 of the sample and hold amplifier for this control voltage. The front panel function output will have an dc offset equal to this control voltage. Calibration values will offset and gain-correct this control voltage so that the actual output offset equals that set from the front panel. The TCXO control voltage is used to adjust the frequency of the optional crystal oscillator to 40.000000 MHz. This voltage is set by a calibration value which may be entered from the front panel. The waveform amplitude control sample and hold output is level shifted and attenuated to a +3 to +5 Vdc range. This control voltage is used as a reference to the 8-bit amplitude leveling DAC, which is controlled by the ASIC during frequency sweeps. The the weighted sum of the leveling DAC output and amplitude control voltage is scaled to the range of -.75 to -1.25 for the nominal leveling DAC value of 128.

DDS ASIC (DS340M4)

Waveforms are generated in the DS340 by updating a 12 bit DAC at a rate of 40 million samples per second. The waveform (sine, ramp, saw, or noise) is stored in RAM, and the RAM is addressed by a 'phase accumulator' which is implemented in a CMOS ASIC. The ASIC's phase accumulator is a 48 bit adder, with the top 15 bits of the accumulated result serving as the address to the ROM. The frequency of the output waveform is proportional to the rate at which ROM addresses change, so, the larger the number added to the phase accumulator the higher the frequency. The 48 bit number resides in six 8-bit registers in the ASIC. This 48-bit number is called the 'phase increment register', or PIR. To facilitate seamless frequency changes, there are two phase increment registers, PIRA and PIRB. The adder will use one of the PIR's while the host processor (or modulation RAM) is writing to the other, and the adder can shift between the two PIR's without missing a single add cycle. In addition to the PIR's, there are lots of other registers in the ASIC. The other registers are used for mode control, setting prescalers, and setting modulation (sweep) addresses. Three of these registers, are located off the ASIC: strobes are generated which will allow modulation data to be latched into external devices. This allows amplitude leveling during sweeps, etc., by the modulation program. (A more complete description of the ASIC is available.) To set an output frequency, F_{out} , the PIR is set to: $PIR = F_{out} \times 2^{48} / F_{clk}$ where F_{clk} is the 40 MHz ASIC clock. Math operations to compute the PIR must be done to 48

bit precision, so, a 48x48 bit multiply is required to compute a PIR value. The ASIC registers are loaded by providing an op-code (which tells which and how many registers to load) and data (which is loaded into the target registers). These op-codes and data may be provided directly by the CPU after a -HOST_REQ is issued and a HOST_ACK received. Or, a series of op-codes and data may be stored in the 32K x 8 modulation RAM (U400, a 62256). The modulation RAM is used to store data for frequency sweeps. Sweeps can consist of up to 4000 different frequencies together with amplitude leveling data. The modulation RAM is addressed by the ASIC. To load modulation op-codes and data, the start address for the modulation program is written to the ASIC's MODSTRT registers, and loaded into the modulation address counters. Op-codes and data are written sequentially to the modulation RAM as outputs to -MOD_RAM port. The -MOD_RAM port strobe writes data to the modulation RAM and increments the modulation address. There are two eight-bit DAC's which are loaded as if they were ASIC registers. The first DAC (U402, a AD7524) controls the reference voltage to the waveform DAC, and so the output amplitude. DAC values from 0 to 255 control the reference from minus 0.75 to minus 1.25 Vdc. This DAC is used to level the output amplitude during frequency sweeps. The second DAC generates a ramp from 0 to +10 Vdc during frequency sweeps. This output is often used as the x-axis drive for scope displays during frequency sweeps. The DAC is loaded with 0 at the start of a sweep, progressively higher values during the sweep, to 255 at the end of the sweep. (Note: in our next revision, this DAC will be deleted, and replaced by a single bit latch to provide a sweep trigger output.) The waveform addresses generated by the ASIC access data stored in the 16k waveform RAMs (U405, 406 and 407). These RAMs may contain sine, ramp, saw, noise or arbitrary data. Data from the RAMs is latched into two 8-bit latches (U508 and U509, 74F273's).

Waveform DAC (DS340M5) Latched waveform data is converted to ECL, terminated with 470 Ohm pull-downs to -5.2V, and filtered by series 47 Ohm resistor networks before being latched into the 12-bit waveform DAC (U513, a TDC1112) by the rising edge of the 40 MHz CONV clock. The differential current outputs from the DAC have a range from 0 to -40 mA:

Value	+OUT	-OUT
0	0	-40.000 mA
1	-.01	-39.990
7FF	-19.995	-20.005
800	-20.005	-19.995
FFE	-39.990	-00.010
FFF	-40.000	0

Because the DAC outputs can only sink current, part of the output termination network is connected to a positive voltage source which tracks the DAC reference input. This arrangement keeps both outputs centered on 0 Vdc. This improves the performance of the DAC and eliminates any dc current from the output filters.

Output Filters (DS340M5)

There are two output filter types: a Bessel filter and a Cauer filter. Both filters have a characteristic impedance of 50 Ohms: they are driven by, and terminat-

ed into 50 Ohms. The filters are differential filters: they have complementary inputs and outputs, and are closely phase matched between the inputs because they share the same physical core. The Bessel filter is a 5th degree filter with the -3 dB point set to 10 MHz. This filter is used when ramps, triangles or noise functions are selected. The Bessel filter has excellent phase-linear response so that there will be no overshoot or ringing of the output waveform. The Cauer filter is a 9th degree filter with a passband to 16.5 MHz and a stopband attenuation of 86 dB. The Cauer filter is used when sines or square wave outputs are selected. Cauer filters provide steep roll-offs and flat passband characteristics. A $\text{Sin}(x)/x$ compensator precedes the Cauer filter. This circuit compensates for the reduced signal level of the sampled waveform as the frequency of the output approaches the Nyquist limit. The circuit increases the amplitude to compensate for the effect by increasing the termination impedance of the DAC output for higher frequencies. A pair of DPDT relays (U511 and U512, HS-212's) select between the Bessel and Cauer filters. These relays are controlled by the LSB of the -RELAY_CTL latch (U800, a 74HC273) and are driven by an emitter-follower (U801, a CA3082).

- Pre-attenuator (DS340M5)** The output from the selected filter is terminated by a 0 to 14 dB resistive differential attenuator. This attenuator must be used when an output offset other than zero is selected. (The peak ac amplitude plus offset must not exceed 10 V at the output of the amplifier.) The attenuator will also be used for outputs of less than 0.3 Vpp. A pair of 1:8 analog multiplexers (U600 and U604, 74HC4051's) select the attenuation factor in 2 dB steps. The analog multiplexers are controlled by the -MISC_OUT latch (U109, a 74HC273). The multiplexers are inhibited by SQ/-SINE if a square wave output is selected. This will reduce crosstalk in the function select relay (U603, a HS-212).
- SYNC Generator (DS340M6)** The un-attenuated signal from the filters is buffered by emitter followers (Q600 and Q602, 2N3904's). The buffered differential signal drives a differential comparator (U601, an AD9696) to generate a SYNC signal. The positive feedback provides lots of hysteresis, and additional resistive feedback to the emitter followers cancels the kick-back from the comparator. The comparator output is buffered by an octal driver (U602, a 74HC244) which has seven of its outputs wire in parallel to drive the front panel SYNC output. The SYNC output is driven through a 47 Ohm resistor provide reverse termination of reflected pulses. The comparator also drives a pnp differential pair (Q603 and Q604, 2N3906's) to generate a differential square wave at their collectors. The amplitude of the square wave is controlled by the analog voltage, SW_AMPL, which controls the pnp constant current source (Q601, a 2N3906). The externally compensated op-amp (U605, a CA3140) maintains a voltage across the emitter resistor which is proportional to (SW_AMPL + 5.00Vdc). As SW_AMPL varies from -5 to +5V, the constant current source varies from 0 to 11 mA, generating from 0 to 1.1 Vpp square wave output.
- Function Selection (DS340M6)** The DPDT relay (U603, an HS212) selects between the filtered (and perhaps attenuated) waveform DAC output, and the output of the square wave generator. If the square wave output is not being used, then the square wave amplitude will be set to zero (SW_AMPL=-5 Vdc) so as to reduce crosstalk in the function select relay. The selected function is passed to the differential output amplifier.
- Output Amplifier (DS340M7)** The output amplifier is a high speed, low distortion, discrete transistor differen-

tial amplifier. The gain is x-10 for the inverting input, and x12 for the non-inverting input, and the 3 dB bandwidth is 35 MHz, it has a phase linear response to about 175 MHz, and a THD of about 0.05% to 50 kHz. The amplifier has a very low offset drift, as its dc characteristics are stabilized by an external compensated op-amp. The amplifier has a very symmetric design. This, together with its class A operation and high open loop bandwidth, keeps its distortion very low. In this circuit description, only the 'top-half' will be described, as the 'bottom-half' of the amplifier operates in a completely symmetrical and complementary manner. The signal is applied to the input differential pair (Q701 and Q702, 2N5770's). The input pair runs in a constant current configuration, with the constant current source (Q706 with R741 and D701). The pnp transistor (Q700) provides an ac current to absorb the feedback current from R705. Since the input differential pair runs at constant current, independent of the input signal, their base-emitter voltages are constant, and so are not a source of distortion. To understand the operation of the amplifier, consider events when a positive input signal is applied. The base of Q701 goes up, while Q702's base goes down. This increases Q701's collector current, pulling down the base of the emitter follower, Q709, which pulls the base of Q710 and Q711 down, increasing their collector currents. This current will cause the collector voltage of Q710 to slew very quickly, and with lots of gain, because the collector load is a very high impedance. The Darlington pair, Q712 and Q713, buffer this node to drive the output, which is a 100 Ohm load. The current imbalance at the high impedance node will cause the output to continue to slew until the feedback current (through R703 and R747) brings the input differential pair back into balance. The ac gain is adjusted by setting R703. The ac gain is adjusted to match the dc gain (which is controlled by the op-amp and its feedback resistor network.) The ac gain is determined by the ratio of the feedback resistors to the emitter resistors. The op-amp (U700, a CA3140) and its feedback resistors (R700,701,702 and R723) stabilize the dc characteristics. The op-amp is externally compensated so that it will only correct low frequency errors, and so will not affect high frequency performance. The output of U700 is buffered (for extra current drive) by U701A and U701B.

- Output Attenuator (DS340M8)** The output attenuator is a relay controlled, 50 Ohm attenuator, which allows attenuation in a binary sequence of 2 dB steps. When the power is removed (or on RESET) all of the attenuators are switched 'in'. The relays are controlled by bits written to the 8 bit latch, U800, a 74HC273. Outputs from the latch are buffered by npn emitter followers (U801, a CA3082), which drive the relay coils. Each 2 dB attenuator can reduce the output by a factor of 0.794. Output levels between these steps are obtained by adjusting the reference level to the waveform DAC. The total attenuation is 30 dB, or a factor of 0.0316, which will reduce the 7.94 Vpp level from the output amplifier to 0.25 Vpp. For ac levels below this, the pre-attenuator will be used (Sheet FG6) to provide up to 14 dB additional attenuation (for levels down to 50 mVpp). (Note: The shielding of this attenuator is very important. If not done well, lots of hash will be seen at the FUNCTION OUTPUT, from the digital noise of the processor and DDS synthesizer.) Output baluns are used on both the SYNC and FUNC outputs to provide isolation between the instrument ground and the user's ground. These baluns provide an inductive reactance for common mode signals.
- Power Supplies (DS340PS9)** A transformer with multiple primary taps accommodates operation from 100, 120, 220 and 240 Vac mains. The secondaries are full-wave rectified, filtered, and regulated. Linear power supplies which float with the ground applied to the

BNC shields provide ± 15 , $+5$ and -5.2 Vdc. There are three separate regulators for the $+5$ supplies so as to reduce noise in critical circuits: $+5_LOGIC$, $+5_CLOCK$, and $+5_ANALOG$. There is a 9.4 Vac tap on the secondary of the transformer which is rectified, filtered, and regulated on the optional communications interface to provide a $+5$ Vdc which is referenced to the line cord ground. (See sheet DS340PS10). A power-up/power-down reset circuit asserts RESET signals to the system whenever the unit is turned on or off. Clean resets are important for starting the CPU and for RAM protection on power-down.

Communications Interface (DS340PS10-Optional)

The design of the communications interface is dictated by the requirement that it must be ground referenced, while the rest of the system must float with the BNC shield. This requires a separate power supply, and opto-isolators for data and clock. To avoid using large numbers of opto-isolators, it is necessary to transfer data and commands between the CPU and the communications interface serially. The RS232 interface is handled by a 8251 UART, the GPIB interface uses a TMS9914A GPIB controller. Both of these devices have a bi-directional data bus and several internal registers for data and control. To write to a register in one of these devices, sixteen bits must be shifted serially. (Eight bits of data, and eight 'command' bits.) This requires sixteen OUT instructions, and sixteen shift instructions. (Only the MSB of the OUT will be transferred to the communications interface with each OUT instruction.) Consider a write to a register in the UART to illustrate the operation of the communications interface. First, the eight data bits will be sent, with the MSB going first. Next the command byte, 10h, will be sent (MSB first). Both bytes will be clocked serially through the shift registers, U1000 and U1002, with the data byte ending up in U1002 and the command byte in U1000. The command byte, 10h, indicates that this will be a WRITE to the RS232 register 0. Finally, a single OUT instruction will assert -CMD_STB (the command strobe), generating a -CS and -WR to the UART, writing the data byte to register 0. To read a register, only the command byte and command strobe need be sent. For example, if the command byte 49h is shifted into the command shift register (U1000), and the command strobe asserted, then register 01 in the GPIB controller will be read into the shift register (U1002). The contents of the data shift register may then be clocked down to the CPU with eight IN and eight shift instructions.

**NOTICE: Schematics may not show current part numbers or values.
Refer to part list for current part numbers or values.**

PARTS LIST

Front Panel Board Parts List

Ref No.	SRS Part No.	Value	Component Description
D 1	3-00012-306	GREEN	LED, Rectangular
D 2	3-00012-306	GREEN	LED, Rectangular
D 4	3-00175-306	YELLOW	LED, Rectangular
D 5	3-00012-306	GREEN	LED, Rectangular
D 6	3-00012-306	GREEN	LED, Rectangular
D 7	3-00012-306	GREEN	LED, Rectangular
D 8	3-00012-306	GREEN	LED, Rectangular
D 9	3-00012-306	GREEN	LED, Rectangular
D 10	3-00012-306	GREEN	LED, Rectangular
D 11	3-00012-306	GREEN	LED, Rectangular
D 12	3-00012-306	GREEN	LED, Rectangular
D 13	3-00012-306	GREEN	LED, Rectangular
D 14	3-00012-306	GREEN	LED, Rectangular
D 15	3-00012-306	GREEN	LED, Rectangular
D 16	3-00012-306	GREEN	LED, Rectangular
D 17	3-00012-306	GREEN	LED, Rectangular
D 19	3-00012-306	GREEN	LED, Rectangular
D 20	3-00455-310	GREEN COATED	LED, Coated Rectangular
D 21	3-00455-310	GREEN COATED	LED, Coated Rectangular
D 22	3-00455-310	GREEN COATED	LED, Coated Rectangular
D 23	3-00455-310	GREEN COATED	LED, Coated Rectangular
D 24	3-00455-310	GREEN COATED	LED, Coated Rectangular
D 25	3-00455-310	GREEN COATED	LED, Coated Rectangular
D 26	3-00013-306	RED	LED, Rectangular
D 27	3-00004-301	1N4148	Diode
D 28	3-00004-301	1N4148	Diode
D 29	3-00004-301	1N4148	Diode
D 30	3-00004-301	1N4148	Diode
D 31	3-00012-306	GREEN	LED, Rectangular
D 32	3-00012-306	GREEN	LED, Rectangular
D 33	3-00012-306	GREEN	LED, Rectangular
D 34	3-00012-306	GREEN	LED, Rectangular
J 1	1-00038-130	40 PIN DIL	Connector, Male
N 1	4-00498-421	680X4	Res. Network, SIP, 1/4W,2% (Isolated)
N 2	4-00498-421	680X4	Res. Network, SIP, 1/4W,2% (Isolated)
N 3	4-00498-421	680X4	Res. Network, SIP, 1/4W,2% (Isolated)
N 4	4-00498-421	680X4	Res. Network, SIP, 1/4W,2% (Isolated)
N 5	4-00774-421	39X4	Res. Network, SIP, 1/4W,2% (Isolated)
N 6	4-00774-421	39X4	Res. Network, SIP, 1/4W,2% (Isolated)
N 7	4-00707-425	2.2KX7	Resistor Network SIP 1/4W 2% (Common)
PC3	7-00453-701	DS335/340 FP	Printed Circuit Board
SW1	7-00448-740	DS335/340	Keypad, Conductive Rubber
U 1	3-00288-340	HDSP-H101	Integrated Circuit (Thru-hole Pkg)
U 2	3-00288-340	HDSP-H101	Integrated Circuit (Thru-hole Pkg)
U 3	3-00288-340	HDSP-H101	Integrated Circuit (Thru-hole Pkg)
U 4	3-00288-340	HDSP-H101	Integrated Circuit (Thru-hole Pkg)
U 5	3-00288-340	HDSP-H101	Integrated Circuit (Thru-hole Pkg)
U 6	3-00288-340	HDSP-H101	Integrated Circuit (Thru-hole Pkg)
U 7	3-00288-340	HDSP-H101	Integrated Circuit (Thru-hole Pkg)
U 8	3-00288-340	HDSP-H101	Integrated Circuit (Thru-hole Pkg)

Parts List

Main PC Board Parts List

Ref No.	SRS Part No.	Value	Component Description
C 1	5-00299-568	.1U	Cap, Ceramic 50V SMT (1206) +/-10% X7R
C 2	5-00387-552	1000P	Capacitor, Chip (SMT1206), 50V, 5%, NPO
C 3	5-00472-569	4.7U 35V D CASE	Cap, Tantalum, SMT (all case sizes)
C 4	5-00375-552	100P	Capacitor, Chip (SMT1206), 50V, 5%, NPO
C 5	5-00375-552	100P	Capacitor, Chip (SMT1206), 50V, 5%, NPO
C 6	5-00365-552	15P	Capacitor, Chip (SMT1206), 50V, 5%, NPO
C 7	5-00365-552	15P	Capacitor, Chip (SMT1206), 50V, 5%, NPO
C 8	5-00023-529	.1U	Cap, Monolythic Ceramic, 50V, 20%, Z5U
C 9	5-00299-568	.1U	Cap, Ceramic 50V SMT (1206) +/-10% X7R
C 10	5-00387-552	1000P	Capacitor, Chip (SMT1206), 50V, 5%, NPO
C 11	5-00299-568	.1U	Cap, Ceramic 50V SMT (1206) +/-10% X7R
C 12	5-00387-552	1000P	Capacitor, Chip (SMT1206), 50V, 5%, NPO
C 13	5-00472-569	4.7U 35V D CASE	Cap, Tantalum, SMT (all case sizes)
C 100	5-00225-548	.1U AXIAL	Capacitor, Ceramic, 50V,+80/-20% Z5U AX
C 101	5-00192-542	22U MIN	Cap, Mini Electrolytic, 50V, 20% Radial
C 102	5-00225-548	.1U AXIAL	Capacitor, Ceramic, 50V,+80/-20% Z5U AX
C 103	5-00040-509	1.0U	Capacitor, Electrolytic, 50V, 20%, Rad
C 200	5-00027-503	.01U	Capacitor, Ceramic Disc, 50V, 20%, Z5U
C 301	5-00225-548	.1U AXIAL	Capacitor, Ceramic, 50V,+80/-20% Z5U AX
C 303	5-00225-548	.1U AXIAL	Capacitor, Ceramic, 50V,+80/-20% Z5U AX
C 304	5-00225-548	.1U AXIAL	Capacitor, Ceramic, 50V,+80/-20% Z5U AX
C 305	5-00225-548	.1U AXIAL	Capacitor, Ceramic, 50V,+80/-20% Z5U AX
C 306	5-00225-548	.1U AXIAL	Capacitor, Ceramic, 50V,+80/-20% Z5U AX
C 307	5-00027-503	.01U	Capacitor, Ceramic Disc, 50V, 20%, Z5U
C 308	5-00100-517	2.2U	Capacitor, Tantalum, 35V, 20%, Rad
C 400	5-00273-532	100P	Capacitor, Ceramic Disc, 50V, 10% NPO
C 502	5-00225-548	.1U AXIAL	Capacitor, Ceramic, 50V,+80/-20% Z5U AX
C 503	5-00274-532	180P	Capacitor, Ceramic Disc, 50V, 10% NPO
C 504	5-00273-532	100P	Capacitor, Ceramic Disc, 50V, 10% NPO
C 505	5-00273-532	100P	Capacitor, Ceramic Disc, 50V, 10% NPO
C 506	5-00273-532	100P	Capacitor, Ceramic Disc, 50V, 10% NPO
C 507	5-00273-532	100P	Capacitor, Ceramic Disc, 50V, 10% NPO
C 508	5-00273-532	100P	Capacitor, Ceramic Disc, 50V, 10% NPO
C 509	5-00273-532	100P	Capacitor, Ceramic Disc, 50V, 10% NPO
C 510	5-00273-532	100P	Capacitor, Ceramic Disc, 50V, 10% NPO
C 511	5-00273-532	100P	Capacitor, Ceramic Disc, 50V, 10% NPO
C 512	5-00007-501	220P	Capacitor, Ceramic Disc, 50V, 10%, SL
C 513	5-00007-501	220P	Capacitor, Ceramic Disc, 50V, 10%, SL
C 514	5-00274-532	180P	Capacitor, Ceramic Disc, 50V, 10% NPO
C 515	5-00274-532	180P	Capacitor, Ceramic Disc, 50V, 10% NPO
C 516	5-00274-532	180P	Capacitor, Ceramic Disc, 50V, 10% NPO
C 517	5-00274-532	180P	Capacitor, Ceramic Disc, 50V, 10% NPO
C 518	5-00271-532	56P	Capacitor, Ceramic Disc, 50V, 10% NPO
C 519	5-00271-532	56P	Capacitor, Ceramic Disc, 50V, 10% NPO
C 520	5-00182-532	68P	Capacitor, Ceramic Disc, 50V, 10% NPO
C 521	5-00250-532	82P	Capacitor, Ceramic Disc, 50V, 10% NPO
C 522	5-00250-532	82P	Capacitor, Ceramic Disc, 50V, 10% NPO
C 523	5-00206-532	47P	Capacitor, Ceramic Disc, 50V, 10% NPO
C 524	5-00233-532	22P	Capacitor, Ceramic Disc, 50V, 10% NPO
C 525	5-00206-532	47P	Capacitor, Ceramic Disc, 50V, 10% NPO
C 526	5-00233-532	22P	Capacitor, Ceramic Disc, 50V, 10% NPO
C 527	5-00004-501	12P	Capacitor, Ceramic Disc, 50V, 10%, SL
C 528	5-00273-532	100P	Capacitor, Ceramic Disc, 50V, 10% NPO

C 529	5-00206-532	47P	Capacitor, Ceramic Disc, 50V, 10% NPO
C 530	5-00268-532	270P	Capacitor, Ceramic Disc, 50V, 10% NPO
C 531	5-00268-532	270P	Capacitor, Ceramic Disc, 50V, 10% NPO
C 532	5-00274-532	180P	Capacitor, Ceramic Disc, 50V, 10% NPO
C 534	5-00106-530	9.0-50P	Capacitor, Variable, 200V, 5m
C 535	5-00182-532	68P	Capacitor, Ceramic Disc, 50V, 10% NPO
C 536	5-00182-532	68P	Capacitor, Ceramic Disc, 50V, 10% NPO
C 537	5-00178-501	62P	Capacitor, Ceramic Disc, 50V, 10%, SL
C 538	5-00178-501	62P	Capacitor, Ceramic Disc, 50V, 10%, SL
C 539	5-00106-530	9.0-50P	Capacitor, Variable, 200V, 5m
C 540	5-00233-532	22P	Capacitor, Ceramic Disc, 50V, 10% NPO
C 541	5-00233-532	22P	Capacitor, Ceramic Disc, 50V, 10% NPO
C 542	5-00004-501	12P	Capacitor, Ceramic Disc, 50V, 10%, SL
C 543	5-00182-532	68P	Capacitor, Ceramic Disc, 50V, 10% NPO
C 544	5-00273-532	100P	Capacitor, Ceramic Disc, 50V, 10% NPO
C 545	5-00206-532	47P	Capacitor, Ceramic Disc, 50V, 10% NPO
C 546	5-00272-532	39P	Capacitor, Ceramic Disc, 50V, 10% NPO
C 547	5-00257-530	20-90P	Capacitor, Variable, 200V, 5m
C 548	5-00016-501	470P	Capacitor, Ceramic Disc, 50V, 10%, SL
C 549	5-00016-501	470P	Capacitor, Ceramic Disc, 50V, 10%, SL
C 600	5-00225-548	.1U AXIAL	Capacitor, Ceramic, 50V,+80/-20% Z5U AX
C 601	5-00100-517	2.2U	Capacitor, Tantalum, 35V, 20%, Rad
C 602	5-00027-503	.01U	Capacitor, Ceramic Disc, 50V, 20%, Z5U
C 603	5-00225-548	.1U AXIAL	Capacitor, Ceramic, 50V,+80/-20% Z5U AX
C 604	5-00225-548	.1U AXIAL	Capacitor, Ceramic, 50V,+80/-20% Z5U AX
C 605	5-00100-517	2.2U	Capacitor, Tantalum, 35V, 20%, Rad
C 606	5-00027-503	.01U	Capacitor, Ceramic Disc, 50V, 20%, Z5U
C 607	5-00225-548	.1U AXIAL	Capacitor, Ceramic, 50V,+80/-20% Z5U AX
C 608	5-00022-501	.001U	Capacitor, Ceramic Disc, 50V, 10%, SL
C 609	5-00270-532	51P	Capacitor, Ceramic Disc, 50V, 10% NPO
C 700	5-00273-532	100P	Capacitor, Ceramic Disc, 50V, 10% NPO
C 701	5-00022-501	.001U	Capacitor, Ceramic Disc, 50V, 10%, SL
C 702	5-00100-517	2.2U	Capacitor, Tantalum, 35V, 20%, Rad
C 703	5-00267-526	1000U	Capacitor, Electrolytic, 35V, 20%, Rad
C 704	5-00100-517	2.2U	Capacitor, Tantalum, 35V, 20%, Rad
C 705	5-00267-526	1000U	Capacitor, Electrolytic, 35V, 20%, Rad
C 707	5-00107-530	1.8-6P	Capacitor, Variable, 200V, 5m
C 709	5-00206-532	47P	Capacitor, Ceramic Disc, 50V, 10% NPO
C 710	5-00206-532	47P	Capacitor, Ceramic Disc, 50V, 10% NPO
C 711	5-00022-501	.001U	Capacitor, Ceramic Disc, 50V, 10%, SL
C 712	5-00022-501	.001U	Capacitor, Ceramic Disc, 50V, 10%, SL
C 713	5-00001-505	.001U	Capacitor, Ceramic Disc, 100V, 20%, Z5
C 800	5-00100-517	2.2U	Capacitor, Tantalum, 35V, 20%, Rad
C 801	5-00100-517	2.2U	Capacitor, Tantalum, 35V, 20%, Rad
C 802	5-00100-517	2.2U	Capacitor, Tantalum, 35V, 20%, Rad
C 803	5-00100-517	2.2U	Capacitor, Tantalum, 35V, 20%, Rad
C 804	5-00100-517	2.2U	Capacitor, Tantalum, 35V, 20%, Rad
C 805	5-00100-517	2.2U	Capacitor, Tantalum, 35V, 20%, Rad
C 806	5-00100-517	2.2U	Capacitor, Tantalum, 35V, 20%, Rad
C 807	5-00100-517	2.2U	Capacitor, Tantalum, 35V, 20%, Rad
C 808	5-00100-517	2.2U	Capacitor, Tantalum, 35V, 20%, Rad
C 809	5-00100-517	2.2U	Capacitor, Tantalum, 35V, 20%, Rad
C 810	5-00100-517	2.2U	Capacitor, Tantalum, 35V, 20%, Rad
C 811	5-00100-517	2.2U	Capacitor, Tantalum, 35V, 20%, Rad
C 812	5-00225-548	.1U AXIAL	Capacitor, Ceramic, 50V,+80/-20% Z5U AX
C 813	5-00225-548	.1U AXIAL	Capacitor, Ceramic, 50V,+80/-20% Z5U AX
C 814	5-00225-548	.1U AXIAL	Capacitor, Ceramic, 50V,+80/-20% Z5U AX

Parts List

C 815	5-00225-548	.1U AXIAL	Capacitor, Ceramic, 50V,+80/-20% Z5U AX
C 816	5-00225-548	.1U AXIAL	Capacitor, Ceramic, 50V,+80/-20% Z5U AX
C 817	5-00225-548	.1U AXIAL	Capacitor, Ceramic, 50V,+80/-20% Z5U AX
C 818	5-00225-548	.1U AXIAL	Capacitor, Ceramic, 50V,+80/-20% Z5U AX
C 819	5-00225-548	.1U AXIAL	Capacitor, Ceramic, 50V,+80/-20% Z5U AX
C 820	5-00225-548	.1U AXIAL	Capacitor, Ceramic, 50V,+80/-20% Z5U AX
C 821	5-00225-548	.1U AXIAL	Capacitor, Ceramic, 50V,+80/-20% Z5U AX
C 822	5-00225-548	.1U AXIAL	Capacitor, Ceramic, 50V,+80/-20% Z5U AX
C 823	5-00225-548	.1U AXIAL	Capacitor, Ceramic, 50V,+80/-20% Z5U AX
C 824	5-00225-548	.1U AXIAL	Capacitor, Ceramic, 50V,+80/-20% Z5U AX
C 825	5-00225-548	.1U AXIAL	Capacitor, Ceramic, 50V,+80/-20% Z5U AX
C 826	5-00225-548	.1U AXIAL	Capacitor, Ceramic, 50V,+80/-20% Z5U AX
C 827	5-00225-548	.1U AXIAL	Capacitor, Ceramic, 50V,+80/-20% Z5U AX
C 828	5-00225-548	.1U AXIAL	Capacitor, Ceramic, 50V,+80/-20% Z5U AX
C 829	5-00225-548	.1U AXIAL	Capacitor, Ceramic, 50V,+80/-20% Z5U AX
C 830	5-00225-548	.1U AXIAL	Capacitor, Ceramic, 50V,+80/-20% Z5U AX
C 831	5-00225-548	.1U AXIAL	Capacitor, Ceramic, 50V,+80/-20% Z5U AX
C 832	5-00225-548	.1U AXIAL	Capacitor, Ceramic, 50V,+80/-20% Z5U AX
C 833	5-00225-548	.1U AXIAL	Capacitor, Ceramic, 50V,+80/-20% Z5U AX
C 834	5-00225-548	.1U AXIAL	Capacitor, Ceramic, 50V,+80/-20% Z5U AX
C 835	5-00225-548	.1U AXIAL	Capacitor, Ceramic, 50V,+80/-20% Z5U AX
C 836	5-00225-548	.1U AXIAL	Capacitor, Ceramic, 50V,+80/-20% Z5U AX
C 837	5-00225-548	.1U AXIAL	Capacitor, Ceramic, 50V,+80/-20% Z5U AX
C 838	5-00225-548	.1U AXIAL	Capacitor, Ceramic, 50V,+80/-20% Z5U AX
C 839	5-00225-548	.1U AXIAL	Capacitor, Ceramic, 50V,+80/-20% Z5U AX
C 840	5-00225-548	.1U AXIAL	Capacitor, Ceramic, 50V,+80/-20% Z5U AX
C 841	5-00225-548	.1U AXIAL	Capacitor, Ceramic, 50V,+80/-20% Z5U AX
C 842	5-00225-548	.1U AXIAL	Capacitor, Ceramic, 50V,+80/-20% Z5U AX
C 843	5-00225-548	.1U AXIAL	Capacitor, Ceramic, 50V,+80/-20% Z5U AX
C 844	5-00225-548	.1U AXIAL	Capacitor, Ceramic, 50V,+80/-20% Z5U AX
C 845	5-00225-548	.1U AXIAL	Capacitor, Ceramic, 50V,+80/-20% Z5U AX
C 846	5-00225-548	.1U AXIAL	Capacitor, Ceramic, 50V,+80/-20% Z5U AX
C 847	5-00259-501	.002U	Capacitor, Ceramic Disc, 50V, 10%, SL
C 848	5-00225-548	.1U AXIAL	Capacitor, Ceramic, 50V,+80/-20% Z5U AX
C 849	5-00225-548	.1U AXIAL	Capacitor, Ceramic, 50V,+80/-20% Z5U AX
C 850	5-00225-548	.1U AXIAL	Capacitor, Ceramic, 50V,+80/-20% Z5U AX
C 851	5-00225-548	.1U AXIAL	Capacitor, Ceramic, 50V,+80/-20% Z5U AX
C 852	5-00001-505	.001U	Capacitor, Ceramic Disc, 100V, 20%, Z5
C 853	5-00001-505	.001U	Capacitor, Ceramic Disc, 100V, 20%, Z5
C 854	5-00001-505	.001U	Capacitor, Ceramic Disc, 100V, 20%, Z5
C 855	5-00001-505	.001U	Capacitor, Ceramic Disc, 100V, 20%, Z5
C 856	5-00001-505	.001U	Capacitor, Ceramic Disc, 100V, 20%, Z5
C 857	5-00001-505	.001U	Capacitor, Ceramic Disc, 100V, 20%, Z5
C 858	5-00013-501	33P	Capacitor, Ceramic Disc, 50V, 10%, SL
CX859	5-00007-501	220P	Capacitor, Ceramic Disc, 50V, 10%, SL
D 101	3-00004-301	1N4148	Diode
D 102	3-00004-301	1N4148	Diode
D 103	3-00004-301	1N4148	Diode
D 200	3-00004-301	1N4148	Diode
D 700	3-00485-301	1N5237B	Diode
D 701	3-00485-301	1N5237B	Diode
J 1	1-00389-100	64 PIN STRIP	Connector, Misc.
J 2	1-00389-100	64 PIN STRIP	Connector, Misc.
J 3	1-00389-100	64 PIN STRIP	Connector, Misc.
J 4	1-00389-100	64 PIN STRIP	Connector, Misc.
J 5	1-00389-100	64 PIN STRIP	Connector, Misc.
J 6	1-00389-100	64 PIN STRIP	Connector, Misc.

J 7	1-00389-100	64 PIN STRIP	Connector, Misc.
J 8	1-00389-100	64 PIN STRIP	Connector, Misc.
J 100	1-00143-101	TEST JACK	Vertical Test Jack
J 101	1-00143-101	TEST JACK	Vertical Test Jack
J 102	1-00143-101	TEST JACK	Vertical Test Jack
J 103	1-00143-101	TEST JACK	Vertical Test Jack
J 200	1-00038-130	40 PIN DIL	Connector, Male
J 500	1-00143-101	TEST JACK	Vertical Test Jack
J 501	1-00143-101	TEST JACK	Vertical Test Jack
J 800	6-00038-601	.22UH	Inductor
JP100	1-00032-130	14 PIN DIL	Connector, Male
JP200	1-00086-130	3 PIN SI	Connector, Male
JP500	1-00195-130	24 PIN DI	Connector, Male
JP800	1-00071-114	8 PIN, WHITE	Header, Amp, MTA-100
L 1	6-00236-631	FR47	Ferrite bead, SMT
L 2	6-00236-631	FR47	Ferrite bead, SMT
L 3	6-00236-631	FR47	Ferrite bead, SMT
L 4A	6-00416-630	FR73	Ferrite Beads
L 4B	6-00416-630	FR73	Ferrite Beads
L 300	6-00120-630	FB64-101	Ferrite Beads
L 500	6-00120-630	FB64-101	Ferrite Beads
L 600	6-00120-630	FB64-101	Ferrite Beads
N 200	4-00293-421	470X4	Res. Network, SIP, 1/4W,2% (Isolated)
N 300	4-00244-421	10KX4	Res. Network, SIP, 1/4W,2% (Isolated)
N 400	4-00334-425	10KX5	Resistor Network SIP 1/4W 2% (Common)
N 600	4-00775-419	220X13	Res. Network, Dip, 1/4W, 2%, Common
N 701	4-00717-421	22X4	Res. Network, SIP, 1/4W,2% (Isolated)
N 702	4-00717-421	22X4	Res. Network, SIP, 1/4W,2% (Isolated)
N 703	4-00717-421	22X4	Res. Network, SIP, 1/4W,2% (Isolated)
N 704	4-00717-421	22X4	Res. Network, SIP, 1/4W,2% (Isolated)
PC1	7-00467-701	DS340 MAIN	Printed Circuit Board
PC3	7-00820-701	DS340 FIX	Printed Circuit Board
Q 101	3-00021-325	2N3904	Transistor, TO-92 Package
Q 102	3-00022-325	2N3906	Transistor, TO-92 Package
Q 103	3-00026-325	2N5210	Transistor, TO-92 Package
Q 104	3-00026-325	2N5210	Transistor, TO-92 Package
Q 200	3-00022-325	2N3906	Transistor, TO-92 Package
Q 201	3-00022-325	2N3906	Transistor, TO-92 Package
Q 202	3-00022-325	2N3906	Transistor, TO-92 Package
Q 203	3-00022-325	2N3906	Transistor, TO-92 Package
Q 500	3-00021-325	2N3904	Transistor, TO-92 Package
Q 600	3-00021-325	2N3904	Transistor, TO-92 Package
Q 601	3-00022-325	2N3906	Transistor, TO-92 Package
Q 602	3-00021-325	2N3904	Transistor, TO-92 Package
Q 603	3-00022-325	2N3906	Transistor, TO-92 Package
Q 604	3-00022-325	2N3906	Transistor, TO-92 Package
Q 700	3-00024-325	2N5086	Transistor, TO-92 Package
Q 701	3-00027-325	2N5770	Transistor, TO-92 Package
Q 702	3-00027-325	2N5770	Transistor, TO-92 Package
Q 703	3-00022-325	2N3906	Transistor, TO-92 Package
Q 704	3-00028-325	2N5771	Transistor, TO-92 Package
Q 705	3-00028-325	2N5771	Transistor, TO-92 Package
Q 706	3-00021-325	2N3904	Transistor, TO-92 Package
Q 707	3-00025-325	2N5088	Transistor, TO-92 Package
Q 708	3-00028-325	2N5771	Transistor, TO-92 Package
Q 709	3-00027-325	2N5770	Transistor, TO-92 Package
Q 710	3-00022-325	2N3906	Transistor, TO-92 Package

Parts List

Q 711	3-00022-325	2N3906	Transistor, TO-92 Package
Q 712	3-00022-325	2N3906	Transistor, TO-92 Package
Q 713	3-00447-322	2N5943	Transistor, TO-39 Package
Q 714	3-00015-322	2N5583	Transistor, TO-39 Package
Q 715	3-00021-325	2N3904	Transistor, TO-92 Package
Q 716	3-00021-325	2N3904	Transistor, TO-92 Package
Q 717	3-00021-325	2N3904	Transistor, TO-92 Package
R 1	4-01471-461	470	Thick Film, 5%, 200 ppm, Chip Resistor
R 2	4-01447-461	47	Thick Film, 5%, 200 ppm, Chip Resistor
R 3	4-01169-462	3.48K	Thin Film, 1%, 50 ppm, MELF Resistor
R 4	4-01447-461	47	Thick Film, 5%, 200 ppm, Chip Resistor
R 7	4-01463-461	220	Thick Film, 5%, 200 ppm, Chip Resistor
R 8	4-01463-461	220	Thick Film, 5%, 200 ppm, Chip Resistor
R 9	4-01463-461	220	Thick Film, 5%, 200 ppm, Chip Resistor
R 10	4-01463-461	220	Thick Film, 5%, 200 ppm, Chip Resistor
R 11	4-01463-461	220	Thick Film, 5%, 200 ppm, Chip Resistor
R 12	4-01463-461	220	Thick Film, 5%, 200 ppm, Chip Resistor
R 13	4-01463-461	220	Thick Film, 5%, 200 ppm, Chip Resistor
R 14	4-01463-461	220	Thick Film, 5%, 200 ppm, Chip Resistor
R 15	4-01463-461	220	Thick Film, 5%, 200 ppm, Chip Resistor
R 16	4-01463-461	220	Thick Film, 5%, 200 ppm, Chip Resistor
R 17	4-01463-461	220	Thick Film, 5%, 200 ppm, Chip Resistor
R 18	4-01463-461	220	Thick Film, 5%, 200 ppm, Chip Resistor
R 19	4-01431-461	10	Thick Film, 5%, 200 ppm, Chip Resistor
R 20	4-01431-461	10	Thick Film, 5%, 200 ppm, Chip Resistor
R 101	4-00027-401	1.5K	Resistor, Carbon Film, 1/4W, 5%
R 102	4-00027-401	1.5K	Resistor, Carbon Film, 1/4W, 5%
R 103	4-00081-401	470	Resistor, Carbon Film, 1/4W, 5%
R 104	4-00081-401	470	Resistor, Carbon Film, 1/4W, 5%
R 105	4-00031-401	100	Resistor, Carbon Film, 1/4W, 5%
R 106	4-00034-401	10K	Resistor, Carbon Film, 1/4W, 5%
R 107	4-00032-401	100K	Resistor, Carbon Film, 1/4W, 5%
R 108	4-00034-401	10K	Resistor, Carbon Film, 1/4W, 5%
R 109	4-00021-401	1.0K	Resistor, Carbon Film, 1/4W, 5%
R 110	4-00032-401	100K	Resistor, Carbon Film, 1/4W, 5%
R 229	4-00022-401	1.0M	Resistor, Carbon Film, 1/4W, 5%
R 300	4-00218-408	10.00K	Resistor, Metal Film, 1/8W, 0.1%, 25ppm
R 302	4-00034-401	10K	Resistor, Carbon Film, 1/4W, 5%
R 303	4-00185-407	4.02K	Resistor, Metal Film, 1/8W, 1%, 50PPM
R 304	4-00130-407	1.00K	Resistor, Metal Film, 1/8W, 1%, 50PPM
R 305	4-00218-408	10.00K	Resistor, Metal Film, 1/8W, 0.1%, 25ppm
R 306	4-00034-401	10K	Resistor, Carbon Film, 1/4W, 5%
R 307	4-00021-401	1.0K	Resistor, Carbon Film, 1/4W, 5%
R 308	4-00193-407	499	Resistor, Metal Film, 1/8W, 1%, 50PPM
R 309	4-00165-407	200	Resistor, Metal Film, 1/8W, 1%, 50PPM
R 316	4-00138-407	10.0K	Resistor, Metal Film, 1/8W, 1%, 50PPM
R 318	4-00210-407	9.09K	Resistor, Metal Film, 1/8W, 1%, 50PPM
R 400	4-00309-407	3.32K	Resistor, Metal Film, 1/8W, 1%, 50PPM
R 401	4-01599-407	1.15K	Resistor, Metal Film, 1/8W, 1%, 50PPM
R 402	4-00138-407	10.0K	Resistor, Metal Film, 1/8W, 1%, 50PPM
R 403	4-00165-407	200	Resistor, Metal Film, 1/8W, 1%, 50PPM
R 500	4-00506-407	35.7K	Resistor, Metal Film, 1/8W, 1%, 50PPM
R 501	4-00031-401	100	Resistor, Carbon Film, 1/4W, 5%
R 503	4-00776-407	178	Resistor, Metal Film, 1/8W, 1%, 50PPM
R 504	4-00776-407	178	Resistor, Metal Film, 1/8W, 1%, 50PPM
R 505	4-00724-407	226	Resistor, Metal Film, 1/8W, 1%, 50PPM
R 506	4-00719-401	4.7	Resistor, Carbon Film, 1/4W, 5%

R 507	4-00719-401	4.7	Resistor, Carbon Film, 1/4W, 5%
R 508	4-00724-407	226	Resistor, Metal Film, 1/8W, 1%, 50PPM
R 509	4-00138-407	10.0K	Resistor, Metal Film, 1/8W, 1%, 50PPM
R 516	4-00141-407	100	Resistor, Metal Film, 1/8W, 1%, 50PPM
R 517	4-00141-407	100	Resistor, Metal Film, 1/8W, 1%, 50PPM
R 518	4-00141-407	100	Resistor, Metal Film, 1/8W, 1%, 50PPM
R 519	4-00141-407	100	Resistor, Metal Film, 1/8W, 1%, 50PPM
R 601	4-00473-407	11.0K	Resistor, Metal Film, 1/8W, 1%, 50PPM
R 602	4-00473-407	11.0K	Resistor, Metal Film, 1/8W, 1%, 50PPM
R 603	4-00166-407	200K	Resistor, Metal Film, 1/8W, 1%, 50PPM
R 604	4-00142-407	100K	Resistor, Metal Film, 1/8W, 1%, 50PPM
R 605	4-00021-401	1.0K	Resistor, Carbon Film, 1/4W, 5%
R 606	4-00191-407	49.9	Resistor, Metal Film, 1/8W, 1%, 50PPM
R 607	4-00031-401	100	Resistor, Carbon Film, 1/4W, 5%
R 608	4-00031-401	100	Resistor, Carbon Film, 1/4W, 5%
R 609	4-00031-401	100	Resistor, Carbon Film, 1/4W, 5%
R 610	4-00031-401	100	Resistor, Carbon Film, 1/4W, 5%
R 611	4-00130-407	1.00K	Resistor, Metal Film, 1/8W, 1%, 50PPM
R 612	4-00141-407	100	Resistor, Metal Film, 1/8W, 1%, 50PPM
R 613	4-00141-407	100	Resistor, Metal Film, 1/8W, 1%, 50PPM
R 614	4-00132-407	1.10K	Resistor, Metal Film, 1/8W, 1%, 50PPM
R 615	4-00215-407	909	Resistor, Metal Film, 1/8W, 1%, 50PPM
R 616	4-00030-401	10	Resistor, Carbon Film, 1/4W, 5%
R 617	4-00056-401	22	Resistor, Carbon Film, 1/4W, 5%
R 618	4-00302-407	82.5	Resistor, Metal Film, 1/8W, 1%, 50PPM
R 619	4-00685-408	100.0	Resistor, Metal Film, 1/8W, 0.1%, 25ppm
R 620	4-00031-401	100	Resistor, Carbon Film, 1/4W, 5%
R 621	4-00132-407	1.10K	Resistor, Metal Film, 1/8W, 1%, 50PPM
R 622	4-00215-407	909	Resistor, Metal Film, 1/8W, 1%, 50PPM
R 623	4-00030-401	10	Resistor, Carbon Film, 1/4W, 5%
R 624	4-00081-401	470	Resistor, Carbon Film, 1/4W, 5%
R 625	4-00081-401	470	Resistor, Carbon Film, 1/4W, 5%
R 626	4-00112-402	47	Resistor, Carbon Comp, 1/2W, 5%
R 627	4-00477-407	432	Resistor, Metal Film, 1/8W, 1%, 50PPM
R 628	4-00777-407	11.5	Resistor, Metal Film, 1/8W, 1%, 50PPM
R 635	4-00778-407	44.2	Resistor, Metal Film, 1/8W, 1%, 50PPM
R 636	4-00777-407	11.5	Resistor, Metal Film, 1/8W, 1%, 50PPM
R 637	4-00777-407	11.5	Resistor, Metal Film, 1/8W, 1%, 50PPM
R 638	4-00777-407	11.5	Resistor, Metal Film, 1/8W, 1%, 50PPM
R 639	4-00777-407	11.5	Resistor, Metal Film, 1/8W, 1%, 50PPM
R 640	4-00777-407	11.5	Resistor, Metal Film, 1/8W, 1%, 50PPM
R 641	4-00777-407	11.5	Resistor, Metal Film, 1/8W, 1%, 50PPM
R 648	4-00778-407	44.2	Resistor, Metal Film, 1/8W, 1%, 50PPM
R 649	4-00777-407	11.5	Resistor, Metal Film, 1/8W, 1%, 50PPM
R 650	4-00777-407	11.5	Resistor, Metal Film, 1/8W, 1%, 50PPM
R 651	4-00777-407	11.5	Resistor, Metal Film, 1/8W, 1%, 50PPM
R 652	4-00777-407	11.5	Resistor, Metal Film, 1/8W, 1%, 50PPM
R 653	4-00777-407	11.5	Resistor, Metal Film, 1/8W, 1%, 50PPM
R 654	4-00777-407	11.5	Resistor, Metal Film, 1/8W, 1%, 50PPM
R 655	4-00777-407	11.5	Resistor, Metal Film, 1/8W, 1%, 50PPM
R 656	4-00031-401	100	Resistor, Carbon Film, 1/4W, 5%
R 657	4-00031-401	100	Resistor, Carbon Film, 1/4W, 5%
R 660	4-00130-407	1.00K	Resistor, Metal Film, 1/8W, 1%, 50PPM
R 661	4-00193-407	499	Resistor, Metal Film, 1/8W, 1%, 50PPM
R 662	4-00193-407	499	Resistor, Metal Film, 1/8W, 1%, 50PPM
R 663	4-00193-407	499	Resistor, Metal Film, 1/8W, 1%, 50PPM
R 664	4-00193-407	499	Resistor, Metal Film, 1/8W, 1%, 50PPM

Parts List

R 665	4-00158-407	2.00K	Resistor, Metal Film, 1/8W, 1%, 50PPM
R 666	4-00158-407	2.00K	Resistor, Metal Film, 1/8W, 1%, 50PPM
R 667	4-00166-407	200K	Resistor, Metal Film, 1/8W, 1%, 50PPM
R 668	4-00165-407	200	Resistor, Metal Film, 1/8W, 1%, 50PPM
R 669	4-00441-401	9.1	Resistor, Carbon Film, 1/4W, 5%
R 670	4-00472-407	806	Resistor, Metal Film, 1/8W, 1%, 50PPM
R 700	4-00138-407	10.0K	Resistor, Metal Film, 1/8W, 1%, 50PPM
R 701	4-00138-407	10.0K	Resistor, Metal Film, 1/8W, 1%, 50PPM
R 702	4-00142-407	100K	Resistor, Metal Film, 1/8W, 1%, 50PPM
R 703	4-00353-441	100	Pot, Multi-Turn Trim, 3/8" Square Top Ad
R 704	4-00158-407	2.00K	Resistor, Metal Film, 1/8W, 1%, 50PPM
R 705	4-00716-407	1.40K	Resistor, Metal Film, 1/8W, 1%, 50PPM
R 706	4-00158-407	2.00K	Resistor, Metal Film, 1/8W, 1%, 50PPM
R 707	4-00716-407	1.40K	Resistor, Metal Film, 1/8W, 1%, 50PPM
R 708	4-00779-407	133	Resistor, Metal Film, 1/8W, 1%, 50PPM
R 709	4-00779-407	133	Resistor, Metal Film, 1/8W, 1%, 50PPM
R 711	4-00771-407	66.5	Resistor, Metal Film, 1/8W, 1%, 50PPM
R 713	4-00771-407	66.5	Resistor, Metal Film, 1/8W, 1%, 50PPM
R 714	4-00165-407	200	Resistor, Metal Film, 1/8W, 1%, 50PPM
R 716	4-00512-407	80.6	Resistor, Metal Film, 1/8W, 1%, 50PPM
R 717	4-00048-401	2.2K	Resistor, Carbon Film, 1/4W, 5%
R 718	4-00048-401	2.2K	Resistor, Carbon Film, 1/4W, 5%
R 720	4-00165-407	200	Resistor, Metal Film, 1/8W, 1%, 50PPM
R 721	4-00512-407	80.6	Resistor, Metal Film, 1/8W, 1%, 50PPM
R 722	4-00165-407	200	Resistor, Metal Film, 1/8W, 1%, 50PPM
R 723	4-00142-407	100K	Resistor, Metal Film, 1/8W, 1%, 50PPM
R 727	4-00714-401	2.7	Resistor, Carbon Film, 1/4W, 5%
R 728	4-00714-401	2.7	Resistor, Carbon Film, 1/4W, 5%
R 729	4-00525-407	7.50	Resistor, Metal Film, 1/8W, 1%, 50PPM
R 730	4-00714-401	2.7	Resistor, Carbon Film, 1/4W, 5%
R 731	4-00786-439	49.9	Resistor, Metal Film, 1/4W, 1%, 50ppm
R 733	4-00714-401	2.7	Resistor, Carbon Film, 1/4W, 5%
R 736	4-00141-407	100	Resistor, Metal Film, 1/8W, 1%, 50PPM
R 737	4-00141-407	100	Resistor, Metal Film, 1/8W, 1%, 50PPM
R 740	4-00322-407	316	Resistor, Metal Film, 1/8W, 1%, 50PPM
R 741	4-00141-407	100	Resistor, Metal Film, 1/8W, 1%, 50PPM
R 742	4-00141-407	100	Resistor, Metal Film, 1/8W, 1%, 50PPM
R 744	4-00165-407	200	Resistor, Metal Film, 1/8W, 1%, 50PPM
R 745	4-00525-407	7.50	Resistor, Metal Film, 1/8W, 1%, 50PPM
R 746	4-00322-407	316	Resistor, Metal Film, 1/8W, 1%, 50PPM
R 747	4-00780-407	255	Resistor, Metal Film, 1/8W, 1%, 50PPM
R 748	4-00084-401	5.1K	Resistor, Carbon Film, 1/4W, 5%
R 749	4-00056-401	22	Resistor, Carbon Film, 1/4W, 5%
R 750	4-00056-401	22	Resistor, Carbon Film, 1/4W, 5%
R 751	4-00056-401	22	Resistor, Carbon Film, 1/4W, 5%
R 752	4-00056-401	22	Resistor, Carbon Film, 1/4W, 5%
R 753	4-00034-401	10K	Resistor, Carbon Film, 1/4W, 5%
R 800	4-00749-439	432	Resistor, Metal Film, 1/4W, 1%, 50ppm
R 801	4-00749-439	432	Resistor, Metal Film, 1/4W, 1%, 50ppm
R 802	4-00777-407	11.5	Resistor, Metal Film, 1/8W, 1%, 50PPM
R 803	4-00750-439	221	Resistor, Metal Film, 1/4W, 1%, 50ppm
R 804	4-00750-439	221	Resistor, Metal Film, 1/4W, 1%, 50ppm
R 805	4-00751-439	23.7	Resistor, Metal Film, 1/4W, 1%, 50ppm
R 806	4-00752-439	232	Resistor, Metal Film, 1/4W, 1%, 50ppm
R 807	4-00752-439	232	Resistor, Metal Film, 1/4W, 1%, 50ppm
R 808	4-00752-439	232	Resistor, Metal Film, 1/4W, 1%, 50ppm
R 809	4-00752-439	232	Resistor, Metal Film, 1/4W, 1%, 50ppm

R 810	4-00753-439	52.3	Resistor, Metal Film, 1/4W, 1%, 50ppm
R 811	4-00754-439	154	Resistor, Metal Film, 1/4W, 1%, 50ppm
R 812	4-00755-439	137	Resistor, Metal Film, 1/4W, 1%, 50ppm
R 813	4-00755-439	137	Resistor, Metal Film, 1/4W, 1%, 50ppm
R 814	4-00755-439	137	Resistor, Metal Film, 1/4W, 1%, 50ppm
R 815	4-00755-439	137	Resistor, Metal Film, 1/4W, 1%, 50ppm
R 817	4-00272-407	221	Resistor, Metal Film, 1/8W, 1%, 50PPM
R 818	4-00202-407	698	Resistor, Metal Film, 1/8W, 1%, 50PPM
SO104	1-00026-150	28 PIN 600 MIL	Socket, THRU-HOLE
SP100	6-00096-600	MINI	Misc. Components
T 1	6-00128-610	DS335/340	Transformer
T 500	6-00100-601	T37-10-5T	Inductor
T 501	6-00103-601	T37-10-9T	Inductor
T 502	6-00103-601	T37-10-9T	Inductor
T 503	6-00104-601	T37-10-7T	Inductor
T 504	6-00103-601	T37-10-9T	Inductor
T 505	6-00101-601	T37-10-10T	Inductor
T 506	6-00101-601	T37-10-10T	Inductor
T 507	6-00102-601	T37-6-13T	Inductor
T 508	6-00101-601	T37-10-10T	Inductor
T 600	6-00055-630	FB43-1801	Ferrite Beads
T 800	6-00055-630	FB43-1801	Ferrite Beads
T 801	6-00055-630	FB43-1801	Ferrite Beads
TX600A	0-00478-055	1.5"X#30 BLK	Wire, Other
TX600B	0-00479-055	1.5"X#30 ORA	Wire, Other
TX800A	0-00478-055	1.5"X#30 BLK	Wire, Other
TX800B	0-00479-055	1.5"X#30 ORA	Wire, Other
TX801A	0-00478-055	1.5"X#30 BLK	Wire, Other
TX801B	0-00479-055	1.5"X#30 ORA	Wire, Other
U 1X	3-00852-360	SPT5300	Integrated Circuit (Surface Mount Pkg)
U 100	3-00298-340	Z80H	Integrated Circuit (Thru-hole Pkg)
U 102	3-00155-340	74HC04	Integrated Circuit (Thru-hole Pkg)
U 103	3-00045-340	74HC32	Integrated Circuit (Thru-hole Pkg)
U 106	3-00491-340	UPD71054C	Integrated Circuit (Thru-hole Pkg)
U 107	3-00049-340	74HC74	Integrated Circuit (Thru-hole Pkg)
U 108	3-00158-340	74HC154N	Integrated Circuit (Thru-hole Pkg)
U 109	3-00411-340	74HC273	Integrated Circuit (Thru-hole Pkg)
U 110	3-00044-340	74HC244	Integrated Circuit (Thru-hole Pkg)
U 111	3-00039-340	74HC14	Integrated Circuit (Thru-hole Pkg)
U 112	3-00037-340	74HC138	Integrated Circuit (Thru-hole Pkg)
U 200	3-00046-340	74HC374	Integrated Circuit (Thru-hole Pkg)
U 201	3-00046-340	74HC374	Integrated Circuit (Thru-hole Pkg)
U 202	3-00046-340	74HC374	Integrated Circuit (Thru-hole Pkg)
U 203	3-00046-340	74HC374	Integrated Circuit (Thru-hole Pkg)
U 204	3-00044-340	74HC244	Integrated Circuit (Thru-hole Pkg)
U 206	3-00366-341	32KX8-35	STATIC RAM, I.C.
U 300	3-00319-340	AD586JN	Integrated Circuit (Thru-hole Pkg)
U 301	3-00088-340	LF353	Integrated Circuit (Thru-hole Pkg)
U 302	3-00105-340	LM741	Integrated Circuit (Thru-hole Pkg)
U 303	3-00415-340	AD7845	Integrated Circuit (Thru-hole Pkg)
U 304	3-00270-340	74HC4051	Integrated Circuit (Thru-hole Pkg)
U 305	3-00411-340	74HC273	Integrated Circuit (Thru-hole Pkg)
U 306	3-00087-340	LF347	Integrated Circuit (Thru-hole Pkg)
U 307	3-00049-340	74HC74	Integrated Circuit (Thru-hole Pkg)
U 308	3-00316-340	74HC151	Integrated Circuit (Thru-hole Pkg)
U 309	3-00039-340	74HC14	Integrated Circuit (Thru-hole Pkg)
U 310	3-00044-340	74HC244	Integrated Circuit (Thru-hole Pkg)

Parts List

U 400	3-00366-341	32KX8-35	STATIC RAM, I.C.
U 401	3-00088-340	LF353	Integrated Circuit (Thru-hole Pkg)
U 402	3-00058-340	AD7524	Integrated Circuit (Thru-hole Pkg)
U 403	3-00411-340	74HC273	Integrated Circuit (Thru-hole Pkg)
U 404	3-00387-340	74HC245	Integrated Circuit (Thru-hole Pkg)
U 405	3-00433-341	16KX4-20	STATIC RAM, I.C.
U 406	3-00433-341	16KX4-20	STATIC RAM, I.C.
U 407	3-00433-341	16KX4-20	STATIC RAM, I.C.
U 408	3-00421-340	F107563FN	Integrated Circuit (Thru-hole Pkg)
U 410	3-00165-340	74HC08	Integrated Circuit (Thru-hole Pkg)
U 412	3-00045-340	74HC32	Integrated Circuit (Thru-hole Pkg)
U 413	3-00155-340	74HC04	Integrated Circuit (Thru-hole Pkg)
U 415	3-00387-340	74HC245	Integrated Circuit (Thru-hole Pkg)
U 416	3-00411-340	74HC273	Integrated Circuit (Thru-hole Pkg)
U 418	3-00524-340	74AC245	Integrated Circuit (Thru-hole Pkg)
U 500	3-00105-340	LM741	Integrated Circuit (Thru-hole Pkg)
U 506	6-00147-621	40.000 MHZ	Crystal Oscillator
U 507	3-00525-340	74ACT161	Integrated Circuit (Thru-hole Pkg)
U 508	3-00486-340	74F273	Integrated Circuit (Thru-hole Pkg)
U 509	3-00486-340	74F273	Integrated Circuit (Thru-hole Pkg)
U 510	3-00432-340	74F244	Integrated Circuit (Thru-hole Pkg)
U 511	3-00196-335	HS-212S-5	Relay
U 512	3-00196-335	HS-212S-5	Relay
U 600	3-00270-340	74HC4051	Integrated Circuit (Thru-hole Pkg)
U 601	3-00437-340	AD9696KN	Integrated Circuit (Thru-hole Pkg)
U 602	3-00044-340	74HC244	Integrated Circuit (Thru-hole Pkg)
U 603	3-00196-335	HS-212S-5	Relay
U 604	3-00270-340	74HC4051	Integrated Circuit (Thru-hole Pkg)
U 605	3-00066-340	CA3140E	Integrated Circuit (Thru-hole Pkg)
U 700	3-00066-340	CA3140E	Integrated Circuit (Thru-hole Pkg)
U 701	3-00487-340	LM1458	Integrated Circuit (Thru-hole Pkg)
U 800	3-00411-340	74HC273	Integrated Circuit (Thru-hole Pkg)
U 801	3-00195-340	CA3082	Integrated Circuit (Thru-hole Pkg)
U 802	3-00196-335	HS-212S-5	Relay
U 803	3-00196-335	HS-212S-5	Relay
U 804	3-00196-335	HS-212S-5	Relay
U 805	3-00196-335	HS-212S-5	Relay
U 807	3-00114-329	7815	Voltage Reg., TO-220 (TAB) Package
U 808	3-00120-329	7915	Voltage Reg., TO-220 (TAB) Package
U 809	3-00141-329	LM337T	Voltage Reg., TO-220 (TAB) Package
U 810	3-00112-329	7805	Voltage Reg., TO-220 (TAB) Package
U 811	3-00112-329	7805	Voltage Reg., TO-220 (TAB) Package
U 812	3-00112-329	7805	Voltage Reg., TO-220 (TAB) Package
Z 0	0-00014-002	6J4	Power_Entry Hardware
Z 0	0-00025-005	3/8"	Lugs
Z 0	0-00043-011	4-40 KEP	Nut, Kep
Z 0	0-00048-011	6-32 KEP	Nut, Kep
Z 0	0-00050-011	8-32 KEP	Nut, Kep
Z 0	0-00051-056	RG174	Cable, Coax & Misc.
Z 0	0-00079-031	4-40X3/16 M/F	Standoff
Z 0	0-00089-033	4"	Tie
Z 0	0-00111-053	1-3/4"#24B	Wire #24 UL1007 Strip 1/4x1/4 Tin
Z 0	0-00150-026	4-40X1/4PF	Screw, Black, All Types
Z 0	0-00163-007	TO-5	Heat Sinks
Z 0	0-00181-020	6-32X1/4PF	Screw, Flathead Phillips
Z 0	0-00187-021	4-40X1/4PP	Screw, Panhead Phillips
Z 0	0-00207-003	TO-5	Insulators

Z 0	0-00208-020	4-40X3/8PF	Screw, Flathead Phillips
Z 0	0-00231-043	#4 SHOULDER	Washer, nylon
Z 0	0-00237-016	F1404	Power Button
Z 0	0-00243-003	TO-220	Insulators
Z 0	0-00259-021	4-40X1/2"PP	Screw, Panhead Phillips
Z 0	0-00267-052	6-1/2" #22 RED	Wire #22 UL1007
Z 0	0-00268-052	6-1/2" #22 BL	Wire #22 UL1007
Z 0	0-00304-043	7/8X3/8X1/16	Washer, nylon
Z 0	0-00386-003	BNC BUSHING	Insulators
Z 0	0-00407-032	SOLDR SLV RG174	Termination
Z 0	0-00469-000	40MM 12V	Hardware, Misc.
Z 0	0-00500-000	554808-1	Hardware, Misc.
Z 0	0-00514-030	TUBULAR NYLON	Spacer
Z 0	1-00003-120	BNC	Connector, BNC
Z 0	1-00034-113	7 PIN, 18AWG/OR	Connector, Amp, MTA-156
Z 0	1-00048-171	14 COND	Cable Assembly, Ribbon
Z 0	1-00072-112	8 PIN, 28AWG/GR	Connector, Amp, MTA-100
Z 0	1-00073-120	INSL	Connector, BNC
Z 0	1-00087-131	2 PIN JUMPER	Connector, Female
Z 0	1-00108-150	PLCC 68 TH	Socket, THRU-HOLE
Z 0	1-00134-171	40 COND	Cable Assembly, Ribbon
Z 0	1-00172-170	9535	Cable Assembly, Multiconductor
Z 0	2-00023-218	DPDT	Switch, Panel Mount, Power, Rocker
Z 0	4-00541-435	130V/1200A	Varistor, Zinc Oxide Nonlinear Resistor
Z 0	4-00800-401	1.0	Resistor, Carbon Film, 1/4W, 5%
Z 0	5-00262-548	.01U AXIAL	Capacitor, Ceramic, 50V,+80/-20% Z5U AX
Z 0	6-00003-611	.5A 3AG	Fuse
Z 0	6-00158-623	40 MHZ	Temp. Controlled Crystal Osc.
Z 0	6-00212-630	1"X.25"CYL	Ferrite Beads
Z 0	7-00217-735	PS300-40	Injection Molded Plastic
Z 0	7-00451-720	DS335-4 & -5	Fabricated Part
Z 0	7-00452-720	DS335-6C	Fabricated Part
Z 0	7-00455-709	DS340	Lexan Overlay
Z 0	7-00456-709	DS340	Lexan Overlay
Z 0	9-00458-917	DS335/340/345	Product Labels
Z 0	9-00552-924	COPPERFOIL;1"	Tape, All types

Power Supply and Option Board Parts List

Ref No.	SRS Part No.	Value	Component Description
BT1	6-00001-612	BR-2/3A 2PIN PC	Battery
C 900	5-00225-548	.1U AXIAL	Capacitor, Ceramic, 50V,+80/-20% Z5U AX
C 944	5-00201-526	2200U	Capacitor, Electrolytic, 35V, 20%, Rad
C 945	5-00201-526	2200U	Capacitor, Electrolytic, 35V, 20%, Rad
C 953	5-00196-520	6800U	Capacitor, Electrolytic, 16V, 20%, Rad
C 954	5-00196-520	6800U	Capacitor, Electrolytic, 16V, 20%, Rad
C 955	5-00201-526	2200U	Capacitor, Electrolytic, 35V, 20%, Rad
C 956	5-00100-517	2.2U	Capacitor, Tantalum, 35V, 20%, Rad
C 957	5-00225-548	.1U AXIAL	Capacitor, Ceramic, 50V,+80/-20% Z5U AX
C 958	5-00225-548	.1U AXIAL	Capacitor, Ceramic, 50V,+80/-20% Z5U AX
C 959	5-00225-548	.1U AXIAL	Capacitor, Ceramic, 50V,+80/-20% Z5U AX
C 960	5-00225-548	.1U AXIAL	Capacitor, Ceramic, 50V,+80/-20% Z5U AX
C 961	5-00225-548	.1U AXIAL	Capacitor, Ceramic, 50V,+80/-20% Z5U AX
C 962	5-00225-548	.1U AXIAL	Capacitor, Ceramic, 50V,+80/-20% Z5U AX
C 963	5-00027-503	.01U	Capacitor, Ceramic Disc, 50V, 20%, Z5U
C 1002	5-00192-542	22U MIN	Cap, Mini Electrolytic, 50V, 20% Radial
C 1003	5-00192-542	22U MIN	Cap, Mini Electrolytic, 50V, 20% Radial

Parts List

C 1004	5-00192-542	22U MIN	Cap, Mini Electrolytic, 50V, 20% Radial
C 1005	5-00192-542	22U MIN	Cap, Mini Electrolytic, 50V, 20% Radial
C 1006	5-00192-542	22U MIN	Cap, Mini Electrolytic, 50V, 20% Radial
C 1013	5-00007-501	220P	Capacitor, Ceramic Disc, 50V, 10%, SL
D 900	3-00062-340	KBP201G/BR-81D	Integrated Circuit (Thru-hole Pkg)
D 901	3-00226-301	1N5822	Diode
D 902	3-00226-301	1N5822	Diode
D 903	3-00226-301	1N5822	Diode
D 904	3-00226-301	1N5822	Diode
D 905	3-00203-301	1N5711	Diode
D 906	3-00062-340	KBP201G/BR-81D	Integrated Circuit (Thru-hole Pkg)
J 1000	1-00160-162	IEEE488/STAND.	Connector, IEEE488, Standard, R/A, Femal
JP900	1-00080-130	8 PIN SI	Connector, Male
JP1000	1-00032-130	14 PIN DIL	Connector, Male
O10	3-00446-340	6N137	Integrated Circuit (Thru-hole Pkg)
O11	3-00446-340	6N137	Integrated Circuit (Thru-hole Pkg)
O12	3-00446-340	6N137	Integrated Circuit (Thru-hole Pkg)
O13	3-00446-340	6N137	Integrated Circuit (Thru-hole Pkg)
O14	3-00446-340	6N137	Integrated Circuit (Thru-hole Pkg)
O15	3-00446-340	6N137	Integrated Circuit (Thru-hole Pkg)
O16	3-00446-340	6N137	Integrated Circuit (Thru-hole Pkg)
P 1000	1-00016-160	RS232 25 PIN D	Connector, D-Sub, Right Angle PC, Female
PC2	7-00450-701	DS335/40 PS/OPT	Printed Circuit Board
R 900	4-00022-401	1.0M	Resistor, Carbon Film, 1/4W, 5%
R 901	4-00034-401	10K	Resistor, Carbon Film, 1/4W, 5%
R 902	4-00032-401	100K	Resistor, Carbon Film, 1/4W, 5%
R 1000	4-00076-401	390	Resistor, Carbon Film, 1/4W, 5%
R 1001	4-00076-401	390	Resistor, Carbon Film, 1/4W, 5%
R 1002	4-00076-401	390	Resistor, Carbon Film, 1/4W, 5%
R 1003	4-00076-401	390	Resistor, Carbon Film, 1/4W, 5%
R 1004	4-00081-401	470	Resistor, Carbon Film, 1/4W, 5%
R 1005	4-00076-401	390	Resistor, Carbon Film, 1/4W, 5%
R 1006	4-00076-401	390	Resistor, Carbon Film, 1/4W, 5%
R 1007	4-00076-401	390	Resistor, Carbon Film, 1/4W, 5%
R 1008	4-00034-401	10K	Resistor, Carbon Film, 1/4W, 5%
R 1009	4-00034-401	10K	Resistor, Carbon Film, 1/4W, 5%
R 1010	4-00034-401	10K	Resistor, Carbon Film, 1/4W, 5%
R 1011	4-00081-401	470	Resistor, Carbon Film, 1/4W, 5%
R 1012	4-00081-401	470	Resistor, Carbon Film, 1/4W, 5%
R 1013	4-00081-401	470	Resistor, Carbon Film, 1/4W, 5%
R 1014	4-00081-401	470	Resistor, Carbon Film, 1/4W, 5%
R 1015	4-00021-401	1.0K	Resistor, Carbon Film, 1/4W, 5%
R 1016	4-00021-401	1.0K	Resistor, Carbon Film, 1/4W, 5%
T 900	1-00036-116	7 PIN, WHITE	Header, Amp, MTA-156
U 900	3-00112-329	7805	Voltage Reg., TO-220 (TAB) Package
U 1000	3-00303-340	74HC164	Integrated Circuit (Thru-hole Pkg)
U 1001	3-00045-340	74HC32	Integrated Circuit (Thru-hole Pkg)
U 1002	3-00434-340	74HC299	Integrated Circuit (Thru-hole Pkg)
U 1003	3-00039-340	74HC14	Integrated Circuit (Thru-hole Pkg)
U 1004	3-00036-340	74HC00	Integrated Circuit (Thru-hole Pkg)
U 1005	3-00645-340	NAT9914APD	Integrated Circuit (Thru-hole Pkg)
U 1006	3-00078-340	DS75160A	Integrated Circuit (Thru-hole Pkg)
U 1007	3-00079-340	DS75161A	Integrated Circuit (Thru-hole Pkg)
U 1008	3-00493-340	UPD71051C	Integrated Circuit (Thru-hole Pkg)
U 1009	3-00217-340	MAX232	Integrated Circuit (Thru-hole Pkg)
VR900	4-00723-435	82V/2500A	Varistor, Zinc Oxide Nonlinear Resistor

Miscellaneous Parts List

Ref No.	SRS Part No.	Value	Component Description
U 104	3-00449-342	27C256-120	EPROM/PROM, I.C.
Z 0	0-00179-000	RIGHT FOOT	Hardware, Misc.
Z 0	0-00180-000	LEFT FOOT	Hardware, Misc.
Z 0	0-00204-000	REAR FOOT	Hardware, Misc.
Z 0	0-00248-026	10-32X3/8TRUSSP	Screw, Black, All Types
Z 0	0-00315-021	6-32X7/16 PP	Screw, Panhead Phillips
Z 0	0-00326-026	8-32X1/4PP	Screw, Black, All Types
Z 0	0-00396-000	BE CU / DDS	Hardware, Misc.
Z 0	0-00590-066	0097-0555-02	Copper Foil Tape, Self Adhesive
Z 0	7-00122-720	DG535-36	Fabricated Part
Z 0	7-00259-720	SR560-28	Fabricated Part
Z 0	7-00260-720	SR560-27	Fabricated Part