

Operation and Service Manual

High Voltage Power Supplies

PS355, PS365, PS370, PS375

 **Stanford Research Systems**

Certification

Stanford Research Systems certifies that this product met its published specifications at the time of shipment.

Warranty

This Stanford Research Systems product is warranted against defects in materials and workmanship for a period of one (1) year from the date of shipment.

Service

For warranty service or repair, this product must be returned to a Stanford Research Systems authorized service facility. Contact Stanford Research Systems or an authorized representative before returning this product for repair.

Contact Information

Stanford Research Systems, Inc.
1290-D Reamwood Avenue
Sunnyvale, CA 94089 USA

Phone: (408)744-9040
Fax: (408)744-9049
www.thinkSRS.com
info@thinkSRS.com

*Information in this document is subject to change without notice.
Copyright © Stanford Research Systems, Inc., 2008. All rights reserved.
Printed in U.S.A.*

Document number: 9-01637-903

Contents

	General Information	iii
	Symbols	iv
	Notation	v
	Specifications	vi
1	Instrument Overview	1-1
	1.1 Front Panel	1-2
	1.2 Rear Panel	1-3
2	Guide to Operation	2-1
	2.1 Setting Parameters	2-2
	2.2 Reset	2-3
	2.3 Store and Recall	2-3
	2.4 Error Messages	2-4
	2.5 Analog Monitor and Control	2-4
	2.6 Default State	2-5
3	Remote Operation	3-1
	3.1 Index of Common Commands	3-2
	3.2 Alphabetic List of Commands	3-3
	3.3 Introduction	3-4
	3.4 Commands	3-4
	3.5 Status Model	3-12
	3.6 Status Reporting	3-13
4	Troubleshooting	4-1
	4.1 Troubleshooting the PS300	4-2

General Information

The PS300 Series High Voltage Power Supplies are general purpose instruments designed for laboratory environments.

Warning

This unit contains hazardous high voltages. Make certain the high voltage is completely discharged before removing the cable. The charge on the cable can cause injury or damage.

Line Voltage

The PS300 series supplies operate from a 90 VAC to 264 VAC power source having a line frequency between 47 Hz and 63 Hz. Power consumption is less than 80 VA total.

A power entry module, labeled AC POWER on the back panel of the PS300, provides connection to the power source and to a protective ground.

The PS300 uses a detachable, three-wire power cord for connection to the power source. The exposed metal parts of the box are connected to the power ground to protect against electrical shock. Always use an outlet which has a properly connected protective ground.









The rear-panel high voltage connector and the BNC shields are also connected to chassis ground. The PS300 series supplies CANNOT be floated.

The line fuse is internal to the instrument and may not be serviced by the user. Operate only with covers in place to avoid personal injury. Do not remove the product covers or panels. Do not operate the product without all covers and panels in place.

Service

The PS300 does not include any user-serviceable parts inside. Refer service to a qualified technician.

Symbols you may find on SRS products

Symbol	Description
	Alternating current
	Caution - risk of electric shock
	Frame or chassis terminal
	Caution - refer to accompanying documents
	Earth (ground) terminal
	Battery
	Fuse
	On (supply)
	Off (supply)

Notation

Typesetting conventions used in this manual are as follows:

- Front-panel buttons are represented as [Button]
- The [▲] and [▼] keys increment and decrement a digit.
- The [◀] and [▶] keys select a digit.
- Front-panel indicators are represented as *Overload*
- The state of a switch is represented in italics as *ON*
- Remote command names are represented as *IDN?
- Literal text other than command names is represented as OFF

Remote command examples will all be set in monospaced font. In these examples, data sent by the host computer is set as `straight teletype font`, while responses received by the host computer are set as *slanted teletype font*.

Specifications

Model	Output Voltage (\pm)	Maximum Current
PS355	-100 V to -10 kV	1 mA
PS365	+100 V to +10 kV	1 mA
PS370	-100 V to -20 kV	500 μ A
PS375	+100 V to +20 kV	500 μ A

Voltage Output

Voltage set accuracy	0.01 % + 0.05 % of full scale
Voltage display accuracy	V_{set} accuracy ± 1 V, typ. (± 2 V, max.)
Voltage resolution	1 V (set and display)
Voltage resettability	1 V
Voltage limit range	0 to 100 % of full scale
Voltage regulation	0.001 % for ± 10 % line change, 0.04 % for 100 % load change. Specifications apply for >0.5 % (full load) to >1 % (no load) of full-scale voltage.
Output ripple (rms)	<0.01 % of full scale (max.)
Current limit range	0 to 105 % of full scale
Current trip range	0 to 105 % of full scale
Trip response time	<10 ms
Current set accuracy	1 μ A
Current resolution	1 μ A
Current display accuracy	± 1 μ A (typ.), ± 2 μ A (max.)
Stability	0.01 % per hr., <0.03 % per 8 hrs.
Temperature drift	50 ppm/ $^{\circ}$ C, 0 to 50 $^{\circ}$ C (typ.)
Protection	Arc and short circuit protected (programmable voltage limit, current limit, and current trip)
HV output slew rate	7,000 V/s, typ. (PS355 and PS365) 14,000 V/s, typ. (PS370 and PS375)
Recovery time	12 ms for 40 % step change in load current (typ.)
Discharge time	<6 s (to <1 % of full-scale voltage with no load, typ.)

Monitor Output

Output scale	0 to +10 V (0 to full-scale output regardless of polarity)
Current rating	10 mA (max.)
Output impedance	<1 Ω

Accuracy	0.2 % of full scale
Update rate	87.5 Hz

External Voltage Set

Input scale	0 to +10 V (0 to full-scale output regardless of polarity)
Input impedance	1 M Ω
Accuracy	0.2 % of full scale
Update rate	87.5 Hz

Mechanical

HV connector	Kings type 1064-1 (PS355 and PS365) Kings type 1764-1 (PS370 and PS375)
Mating connector	Kings type 1065-1 (PS355 and PS365) Kings type 1765-1 (PS370 and PS375)
Dimensions	8.1" \times 3.5" \times 16" (WHD)
Weight	8 lbs.
Power	50 W, 90 to 264 VAC, 47 to 63 Hz
Warranty	One year parts and labor on defects in materials or workmanship

All performance specifications apply after a one hour warm-up period

1 Instrument Overview

In This Chapter

This chapter gives the user the necessary information to get started with the PS300 Series High Voltage Power Supplies.

1.1	Front Panel	1-2
1.1.1	Power Button	1-2
1.1.2	High Voltage Enable Switch	1-2
1.1.3	Numeric Displays	1-3
1.1.4	Select, Enter, Clear	1-3
1.1.5	Numeric and Cursor Keys	1-3
1.1.6	Instrument Status	1-3
1.1.7	Other Keys	1-3
1.1.8	Store and Recall	1-4
1.2	Rear Panel.	1-4
1.2.1	Power Entry Module	1-4
1.2.2	High Voltage Connector	1-4
1.2.3	Analog I/O	1-5
1.2.4	IEEE-488 Port	1-5
1.2.5	RS-232 Port.	1-5

1.1 Front Panel

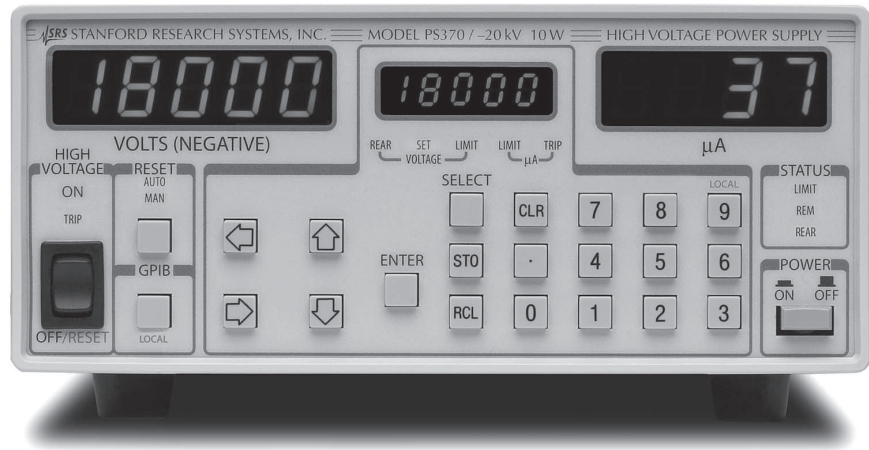

The front-panel features of the PS300 Series High Voltage Power Supplies are examined in this section.

1.1.1 Power Button

The PS300 is turned on by depressing the [POWER] button. The unit always powers up with the high voltage *OFF*. The current instrument configuration and any saved instrument presets are stored in non-volatile memory. The model number (355, 365, 370 or 375), firmware version, and serial number are displayed when power is turned on. If an error appears on power up, the current instrument configuration and any saved presets are lost, and the default settings are used. If the default settings are desired, hold down the clear key [CLR] while turning on the power. Note that this will clear out all buffers and erase any saved presets.

1.1.2 High Voltage Enable Switch

The [High Voltage] enable switch has three positions that perform several functions. In the down position, the high voltage is *OFF*, and all trips are cleared. In this position, the high voltage is locked *OFF* and cannot be turned on over the computer interface. The *UP* position is momentary, and it turns on the high voltage for manual or rear-panel analog control. In the middle position, the high voltage is enabled (but not necessarily *ON*) and can be turned on over the computer interface. The large red *ON* LED above the switch indicates that the high voltage is on; the yellow *TRIP* LED indicates a trip has occurred.

1.1.3 Numeric Displays

The two large displays show output voltage to five significant digits and output current to four significant digits. The polarity is indicated below the voltage display as either POSITIVE or NEGATIVE. The smaller center display shows the value of the parameter that is being entered or adjusted. That parameter is indicated by the row of LEDs directly below the center display.

1.1.4 Select, Enter, Clear

[SELECT] is used to choose which parameter is being displayed in the center display. [ENTER] confirms the entry in the center display. [CLR] erases the value in the middle display and recalls the last value that was entered. To adjust a value, [SELECT] is pressed until the appropriate LED is lit. When the value is being changed, the LED will flash to indicate the value is in a state of change. If an incorrect value is entered, press [CLR] to start over. When the desired value is displayed, [ENTER] updates the unit's actual setting and stops the LED from flashing.

1.1.5 Numeric and Cursor Keys

All parameters may be adjusted using the cursor or numeric keys. When using the cursor, the digit being adjusted in the center display will flash. The [▲] and [▼] keys increment and decrement the digit. The [◀] and [▶] keys select the flashing digit. When using direct numerical entry, simply press the number and decimal point keys until the desired value appears on the center display. Note that the current is specified in microamps.

1.1.6 Instrument Status

Three LEDs indicate the instrument's status. The *LIMIT* LED is on when the unit is in a current limit state. *REM* is on when the front panel is locked out. *REAR* is on when the high voltage setting is programmed by the rear-panel analog input.

1.1.7 Other Keys

[RESET] toggles the reset mode between *AUTO* and *MAN* (manual).

[GPIB] displays the GPIB address in the center display so it can be adjusted. It also functions as the [LOCAL] key when the unit is in the remote mode.

1.1.8 Store and Recall

Store [STO] and Recall [RCL] allow up to nine complete instrument configurations to be saved in nonvolatile memory. [RCL] 0 recalls the default settings.

1.2 Rear Panel

The rear panel of the PS300 Series High Voltage Power Supplies is discussed next.

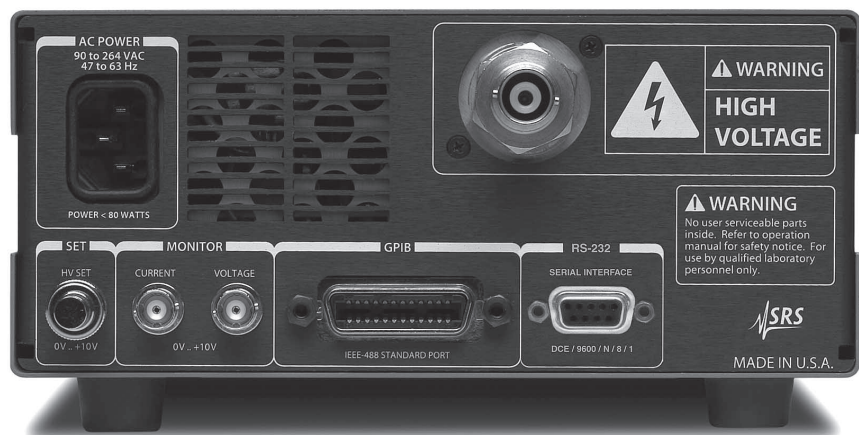

1.2.1 Power Entry Module

The AC line cord plugs into the power entry module. Refer to the General Information section of this manual for instructions on line voltage.

1.2.2 High Voltage Connector

WARNING — This unit contains hazardous voltages. Please make certain that the high voltage is completely discharged before removing or connecting the high voltage cable. High voltage cables can store charge. If they are disconnected from the supply while high voltage is present, electric shock can occur which may cause injury or damage the unit.

The high voltage output connector is a Kings type 1064-1 (PS355 and PS365) or a Kings type 1764-1 (PS370 and PS375). Please make certain that the high voltage is completely discharged before changing the cable. Cables are available from SRS.

1.2.3 Analog I/O

The two MONITOR output BNCs are used to monitor the voltage and current signals. Both are 0 to +10 V outputs corresponding to 0 to full scale. The *SET* input BNC receives an analog programming voltage, 0 to +10 VDC corresponding to 0 to full scale (independent of high voltage polarity). To select the rear *SET* analog high voltage control, press [SELECT] on the front panel until *REAR* is selected, and then use the [▲] and [▼] keys to choose between “Front” and “Rear”. Press [ENTER] to confirm the selection.

1.2.4 IEEE-488 Port

The 24-pin IEEE-488 (GPIB) connector allows computer control of PS300 series supplies. The address is set from the front panel using the [GPIB] key.

1.2.5 RS-232 Port

The 9-pin female D-sub connector allows computer control of power supply via RS-232. The interface settings are fixed as DCE, 9600 baud, no parity, 8 bits, 1 stop bit.

2 Guide To Operation

In This Chapter

This chapter explains how to operate the PS300 Series High Voltage Power Supplies.

2.1	Setting Parameters	2-2
2.1.1	Setting the Output Voltage	2-2
2.1.2	Setting the Voltage Limit	2-2
2.1.3	Setting the Current Limit	2-3
2.1.4	Setting the Current Trip	2-3
2.2	Reset	2-3
2.3	Store and Recall	2-3
2.4	Error Messages	2-4
2.5	Analog Monitor & Control	2-4
2.5.1	Voltage Set	2-4
2.5.2	Voltage Monitor	2-4
2.5.3	Current Monitor	2-4
2.6	Default State	2-5

2.1 Setting Parameters

This section describes how to set the front-panel parameters.

2.1.1 Setting the Output Voltage

The voltage set can be changed with the high voltage in either the *ON* or *OFF* mode.

To set the high voltage output, press the [SELECT] key until the voltage *SET* LED is lit. The present value of the set voltage will be displayed in the center window. To change the value, enter the desired voltage by using either the numeric keys or cursor. After the new value has been entered into the center display, press [ENTER] to update the output voltage. The voltage *SET* LED will flash until [ENTER] or [CLR] is pressed to remind you that the displayed value is not the actual programmed value. If an *Err2* message appears (illegal parameter entered), check the voltage limit to see that it is greater than or equal to the desired set voltage. Use the [CLR] key to clear any error message.

If the *REAR* status LED is lit, the high voltage is programmed from the analog set input on the rear panel. In this mode, if the center display is showing voltage *SET*, the displayed value is the present value of the high voltage programmed by the 0 to 10 V input and cannot be adjusted from the front panel.

2.1.2 Setting the Voltage Limit

The voltage limit is a protection feature to prevent the output voltage from being set too high or overshooting because of dramatic load changes. The output voltage cannot be set higher than the voltage limit. In addition, if the output ever exceeds the limit by more than 2 % of full scale, the unit trips and the high voltage is disabled. If this occurs, a *VTRP* (voltage trip) message appears in the middle display.

After a trip, it is not necessary to clear the trip before turning the high voltage back on. If it is necessary to change a parameter before turning the high voltage back on, pressing [CLR] or putting the high voltage switch in the *OFF* position will clear the trip.

To set the voltage limit, press [SELECT] until the voltage *LIMIT* LED is lit. The present value of the voltage limit is displayed in the center window. Change it with either the numeric keys or the

cursor and press [ENTER] to update the actual limit value. If an *Err2* message appears (illegal parameter entered), check to see that the output voltage is less than or equal to the voltage limit.

2.1.3 Setting the Current Limit

Current limiting varies the output voltage to limit the output current to less than or equal to the programmed current limit value. When the unit is current limited, the *LIMITLED* is lit. The current limit is set in the same fashion as the voltage limit — selecting the present value on the center window, changing it and then entering the new value.

2.1.4 Setting the Current Trip

The current trip shuts off the high voltage when the output current exceeds the trip value. The current trip value is set in the same fashion as the voltage and current limits. After a current trip occurs, the *ITRP* (current trip) message will appear in the middle display. Current trips are cleared just like voltage trips.

2.2 Reset

The reset mode determines how the unit responds after a voltage or current trip.

In *MAN* (manual) mode, the high voltage remains *OFF* after a trip and requires that the operator turn it back *ON*.

In *AUTO* (automatic) mode, the unit waits until the later of the time for the output voltage to fall to 0.5 % of full-scale or two seconds, and then turns the high voltage back *ON*. This is useful when dealing with loads that occasionally short circuit but recover after removing the high voltage.

2.3 Store and Recall

The store and recall functions allow up to nine complete instrument setups to be saved. To store a setup, press the [STO] key followed by a number (1 to 9) and then the [ENTER] key. To recall a setup, press the [RCL] key, followed by a number (0 to 9) and then the [ENTER] key. [RCL] 0 returns the setup to the factory default. Whenever a setup is recalled, the high voltage is turned off for safety. If an *Err3* (recall error) occurs, then that stored setup was lost due to a memory error and must be re-entered.

2.4 Error Messages

The following error messages may appear in the center display. The [CLR] key clears the errors.

- Err1* Memory error – Power on memory error of the unit's last setup. Default setup is recalled.
- Err2* Illegal parameter entered.
- Err3* Recall Error – the stored setup was lost.
- Err4* Illegal storage address.
(Address 0 is reserved for default settings)
- Err5* Device dependent
- Err6* Syntax error over GPIB.
- Err7* Illegal parameter entered over GPIB.
Parameter entered is out of range.
- Err 8* Remote communication error
- Err9* Hardware watchdog

2.5 Analog Monitor & Control

2.5.1 Voltage Set

When configured for rear control (see § 1.2.3) the rear-panel *SET* voltage will set the output voltage. When enabled, the *REAR* (rear panel) status LED is lit, and the output voltage being set by the rear panel is displayed in the middle display (when it is showing voltage *SET*). The voltage limit is still active and does not allow the rear-panel voltage to set the output above the voltage limit. If the rear-panel voltage is too high, the output voltage will stop at the limit voltage. An input from 0 to +10 V will program the high voltage from 0 to full scale, regardless of polarity.

2.5.2 Voltage Monitor

The voltage monitor BNC is a monitor output providing 0 to +10 volts for a 0 to full-scale output, regardless of polarity.

2.5.3 Current Monitor

The current monitor output BNC provides a 0 to +10 volt output for 0 to full-scale output, regardless of the output polarity.

2.6 Default State

The factory default setup can be recalled by pressing the [CLR] key while turning the unit on, or recalling setup 0. Note that pressing the [CLR] key while turning the unit on will also clear all buffers and erase any saved presets. The default setup is also recalled after a power on memory error (*ERR 1*). The default parameters are shown below.

PS355	Voltage Set	0 V
	Voltage Limit	-10,000 V
	Current Limit	-1,050 μ A
	Current Trip	-1,050 μ A
	Reset Mode	MAN
	High Voltage	OFF
	GPIB Addr	14
PS365	Voltage Set	0 V
	Voltage Limit	+10,000 V
	Current Limit	+1,050 μ A
	Current Trip	+1,050 μ A
	Reset Mode	MAN
	High Voltage	OFF
	GPIB Addr	14
PS370	Voltage Set	0 V
	Voltage Limit	-20,000 V
	Current Limit	-525 μ A
	Current Trip	-525 μ A
	Reset Mode	MAN
	High Voltage	OFF
	GPIB Addr	14
PS375	Voltage Set	0 V
	Voltage Limit	+20,000 V
	Current Limit	+525 μ A
	Current Trip	+525 μ A
	Reset Mode	MAN
	High Voltage	OFF
	GPIB Addr	14

3 Remote Operation

In This Chapter

This chapter describes operating the PS300 series over the RS-232 and GPIB computer interfaces.

3.1	Index of Common Commands	3-2
3.2	Alphabetic List of Commands	3-3
3.3	Introduction	3-4
	3.3.1 Power-On Configuration	3-4
	3.3.2 Buffers	3-4
3.4	Commands	3-4
	3.4.1 Command Syntax	3-4
	3.4.2 Notation	3-5
	3.4.3 Examples	3-5
	3.4.4 Output Control Commands	3-6
	3.4.5 Setting Control Commands	3-6
	3.4.6 Interface Control Commands	3-8
	3.4.7 Status Reporting Commands	3-10
3.5	Status Model	3-12
3.6	Status Reporting	3-13
	3.6.1 Serial Poll Status Byte	3-13
	3.6.2 Standard Event Status Byte	3-14
	3.6.3 GPIB Error Messages	3-14

3.1 Index of Common Commands

Symbol	Definition
i	Unsigned integer
x	Assigned value
(?)	Required for queries; illegal for set commands
var	Parameter always required
{ var }	Parameter required for set commands; illegal for queries
[var]	Optional for both set and query commands

Output Commands

HVOF	3-6	High Voltage Off
HVON	3-6	High Voltage On
IOUT?	3-6	Output Current
VOUT?	3-6	Output Voltage

Setting Control Commands

*RCL i	3-6	Recall
*SAV i	3-7	Save
ILIM(?) { x }	3-7	Current Limit
ITRP(?) { x }	3-7	Current Trip
SMOD(?) { i }	3-7	V Set Mode
TCLR	3-7	Trip Clear
TMOD(?) { i }	3-8	Trip Mode
VLIM(?) { x }	3-8	Voltage Limit
VSET(?) { x }	3-8	Voltage Set

Interface Control Commands

*RST	3-8	Reset
*IDN?	3-9	Identify
*OPC(?)	3-9	Operation Complete
LERR?	3-9	Last Error

Status Reporting Commands

*CLS	3-10	Clear Status
*ESE(?) i	3-10	Standard Event Status Enable
*ESR? [i]	3-10	Standard Event Status
*PSC(?) { i }	3-11	Power-On Status Clear
*SRE(?) { i }	3-11	Service Request Enable
*STB(?) [i]	3-11	Status Byte

3.2 Alphabetic List of Commands

*		
*CLS	3-10	Clear Status
*ESE(?) <i>i</i>	3-10	Standard Event Status Enable
*ESR? [<i>i</i>]	3-10	Standard Event Status
*IDN?	3-9	Identify
*OPC(?)	3-9	Operation Complete
*PSC(?) { <i>i</i> }	3-11	Power-On Status Clear
*RCL <i>i</i>	3-6	Recall
*RST	3-8	Reset
*SAV <i>i</i>	3-7	Save
*SRE(?) { <i>i</i> }	3-11	Service Request Enable
*STB(?) [<i>i</i>]	3-11	Status Byte
H		
HVOF	3-6	High Voltage Off
HVON	3-6	High Voltage On
I		
ILIM(?) { <i>x</i> }	3-7	Current Limit
IOUT?	3-6	Output Current
ITRP(?) { <i>x</i> }	3-10	Current Trip
L		
LERR?	3-9	Last Error
S		
SMOD(?) { <i>i</i> }	3-7	V Set Mode
T		
TCLR	3-7	Trip Clear
TMOD(?) { <i>i</i> }	3-8	Trip Mode
V		
VLIM(?) { <i>x</i> }	3-8	Voltage Limit
VOUT?	3-6	Output Voltage
VSET(?) { <i>x</i> }	3-8	Voltage Set

3.3 Introduction

Remote operation of the PS300 series is through a simple command language documented in this chapter. Both set and query forms of most commands are supported, allowing the user complete control of the instrument from a remote computer. Both RS-232 and GPIB (IEEE488.2) interfaces are supported.

3.3.1 Power-On Configuration

The settings for the RS-232 interface are 9600 baud and no parity. The default GPIB address is 14. The complete instrument configuration is retained in non-volatile memory.

When appropriate, the default value for parameters is listed in **boldface** in the command descriptions.

3.3.2 Buffers

The PS300 series stores incoming bytes in a 128 character input buffer. Characters accumulate in the input buffer until a command terminator (either <CR> or <LF>) is received, at which point the message is parsed and executed. Query responses are buffered in a 128 character output queue.

If the input buffer overflows, then all data in *both* the input buffer and output queue are discarded, and an error is reported in the Standard Event Status Byte.

3.4 Commands

This section provides syntax and operational descriptions for remote commands.

3.4.1 Command Syntax

The four letter mnemonic (shown in CAPS) in each command sequence specifies the command. The rest of the sequence consists of parameters.

Commands may take either *set* or *query* form, depending on whether the “?” character follows the mnemonic. *Set only* commands are listed without the “?”, *query only* commands show the “?” after the mnemonic, and *optionally query commands* are marked with a “(?)”.

Parameters shown in { } and [] are not always required. Parameters in { } are required to set a value, and should be omitted for queries.

Parameters in [] are optional in both set and query commands. Parameters listed without surrounding characters are always required.

Do *not* send () or { } or [] as part of the command.

Multiple parameters are separated by commas. Multiple commands may be sent on one command line by separating them with semicolons (;) so long as the input buffer does not overflow. Commands are terminated by either <CR> or <LF> characters. Null commands and whitespaces are ignored. Execution of the command does not begin until the command terminator is received.

3.4.2 Notation

The following table summarizes the notation used in the command descriptions.

Symbol	Definition
<i>i</i>	Unsigned integer
<i>x</i>	Assigned value
(?)	Required for queries; illegal for set commands
<i>var</i>	Parameter always required
{ <i>var</i> }	Parameter required for set commands; illegal for queries
[<i>var</i>]	Optional for both set and query commands

3.4.3 Examples

Each command is provided with a simple example illustrating its usage. In these examples, all data sent by the host computer to the PS300 are set as *straight teletype font*, while responses received by the host computer from the PS300 are set as *slanted teletype font*.

The usage examples vary with respect to set/query and optional parameters. These examples are not exhaustive and are intended to provide a convenient starting point for user programming.

3.4.4 Output Control Commands

HVOF High Voltage Off

The HVOF command turns the high voltage output OFF.

Example: HVOF

HVON High Voltage On

The HVON command turns the high voltage ON, provided the front-panel high voltage switch is not in the OFF position. If the switch is in the OFF position, the high voltage is left off and an execution error is reported. This command also automatically clears any voltage or current trips.

Example: HVON

IOUT? Output Current

The IOUT? query returns the actual output current, in amperes. This is the same value shown on the front-panel meter. The value is always returned as an unsigned number, regardless of the polarity of the power supply.

Example: IOUT?
4.78E-4

VOUT? Output Voltage

The VOUT? query returns the actual output voltage, in volts. This is the same value shown on the front-panel meter. The value returned is a floating point value and includes the sign of the output voltage.

Example: VOUT?
-1.8998E4

3.4.5 Setting Control Commands

*RCL *i* Recall Configuration

The *RCL command recalls stored settings *i*. *RCL 0 restores the default settings. If the stored setting is corrupted, an error is returned.

Example: *RCL 3

*SAV <i>i</i>	Save Configuration
	The *SAV command stores the present setup as setting <i>i</i> . <i>i</i> may range from 1 to 9.
	<i>Example:</i> *SAV 3
<hr/>	
ILIM(?) { <i>x</i> }	Limit Current
	The ILIM command sets (queries) the value of the current limit (to <i>x</i>), in amperes. ILIM may be set from 0 to 105 % of full scale.
	<i>Example:</i> ILIM 120E-6; ILIM? 1.20E-4
<hr/>	
ITRP(?) { <i>x</i> }	Trip Current
	The ITRP command sets (queries) the value of the current trip (to <i>x</i>), in amperes. ITRP may be set from 0 to 105 % of full scale.
	<i>Example:</i> ITRP? 5.25E-4
<hr/>	
SMOD(?) { <i>i</i> }	Rear Programming Mode
	The SMOD? command sets (queries) the VSet setting mode. SMOD 0 means that the voltage value is controlled by the front-panel setting, while SMOD 1 indicates that the output is controlled by the rear-panel VSET voltage control input.
	Note that changing the SMOD value while the high voltage is ON causes the high voltage to be switched OFF.
	<i>Example:</i> SMOD 1
<hr/>	
TCLR	Clear Trips
	The TCLR command clears any voltage or current trips.
	<i>Example:</i> TCLR

TMOD(?) {i}	<p>Trip Mode</p> <p>The TMOD command sets (queries) the trip reset mode {to i}. The value $i = 1$ sets manual trip reset, while the value $i = 0$ sets the trip reset mode to automatic.</p> <p><i>Example:</i> TMOD 1</p>
-------------	--

VLIM(?) {x}	<p>Voltage Limit</p> <p>The VLIM command sets (queries) the value of the voltage limit {to x}, in volts. The sign of value x <i>must</i> match the polarity of the power supply. As with front-panel control, the VLIM value must be greater than or equal to the VSET value or an execution error will be returned.</p> <p><i>Example:</i> VLIM? -2.0000E4</p>
-------------	--

VSET(?) {x}	<p>Voltage Set</p> <p>The VSET command sets (queries) the value of the voltage setting {to x}, in volts. If SMOD 1 (rear-panel control) is enabled, then setting the VSET command returns an error. The value x must match the polarity of the power supply.</p> <p>When SMOD = 0 (front-panel control), the VSET? query returns the set parameter (not the measured output voltage, <i>see</i> VOUT? § 3.4.4). When SMOD = 1 (rear-panel control), the VSET? query returns the high voltage setting programmed by the rear-panel HVSET input. As with front-panel control, the VSET value must be less than or equal to the VLIM value or an execution error will be returned.</p> <p><i>Example:</i> VSET? 19555</p>
-------------	---

3.4.6 Interface Control Commands

*RST	<p>Reset</p> <p>The *RST common command resets the power supply to its default configuration. It is the same as holding the [CLR] button depressed at power on.</p> <p><i>Example:</i> *RST</p>
------	---

***IDN?** Identify

The *IDN? common query returns the PS300's device identification. This string is formatted as follows:

StanfordResearchSystems, PS3XX, <serial>, <version>

where XX is the model number, <serial> is the 6-digit serial number of the unit, and <version> is the 3-digit firmware revision number.

Example: *IDN?
StanfordResearchSystems, PS370, 100003, 0.29

***OPC(?)** Operation Complete

The *OPC common command causes remote command execution to pause until all pending operations are complete. The *OPC? query will return the value "1" when operations are complete, while the *OPC set command will set the OPC bit (bit 0) in the ESR register.

Example: *OPC?
1

LERR? Last Error

The LERR? query returns the error code of the last remote interface error. A list of the possible error codes are as follows:

<i>Code</i>	<i>Meaning</i>
10	Illegal value (execution)
100	Lost data (query)
101	No data (query)
102	No listener (query)
103	Overflow (query)
110	Illegal command (parser)
111	Undefined command (parser)
112	Illegal query (parser)
113	Illegal set (parser)
114	Null parameter (parser)
115	Extra parameter (parser)
116	Missing parameter (parser)
117	Overflow (parser)
118	Bad float (parser)
119	Float overflow (parser)

120	Bad integer (parser)
121	Integer overflow (parser)
122	Bad hex value (parser)
123	Hex overflow (parser)
124	Bad token integer (parser)
125	Unknown token (parser)
126	Syntax error (parser)
151	CMF reset (device dependent)
152	COP reset (device dependent)
153	Illegal reset (device dependent)
154	Recall error (device dependent)
155	Watchdog (device dependent)

Example: *IDN; LERR?
113

3.4.7 Status Reporting Commands

*CLS Clear Status

The *CLS common command clears all status registers.

Example: *CLS

*ESE(?) *i* Standard Event Enable

The *ESE common command sets (queries) the standard event status enable register {to *i*}. The parameter *i* is the decimal value for the enable register, and can range from 0 to 255.

Example: *ESE 16

*ESR? [*i*] Standard Event

The *ESR common command query reads the value of the standard event status register. If the optional parameter *i* is present, then only the value of bit *i* is returned. Reading this register will clear it. Reading bit *i* will clear bit *i* only.

Example: *ESR? 5
1

*PSC(?) {*i*} Power-On Status Clear

The *PSC common command sets (queries) the value of the power-on status clear bit {to *i*}. If *i* = 1, the power-on status clear bit is set, and all status registers and enable registers are cleared on power up. If *i* = 0, the bit is cleared, and the status enable registers maintain the values at power down. This allows the generation of a service request at power up, for example.

Example: *PSC?
1

*SRE(?) {*i*} Service Request Enable

The *SRE common command sets (queries) the value of the service request enable register {to *i*}.

Example: *SRE 6

*STB? [*i*] Standard Byte

The *STB? common command query reads the value of the serial poll status byte. If the optional parameter *i* is present, the value of bit *i* is returned. Reading this register will clear bits 1, 2, and 3; the remaining bits are either real-time monitors of underlying conditions (such as bit 7: HVON), or summary bits (such as bit 5: ESB).

Example: *STB?
129

3.5 Status Model

The PS300 series instruments follow the hierarchical IEEE-488.2 format. A block diagram of the status register array is given in Figure 3.1

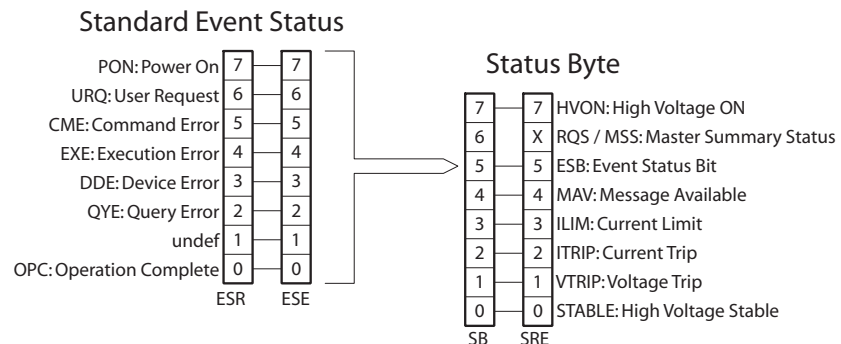

Figure 3.1: Status register model for the PS300 series High Voltage Power Supplies.

The two categories of registers in the PS300 series status model are as follows:

Event Registers

These read-only registers record the occurrence of defined events. If the event occurs, the corresponding bit is set to 1. Upon querying an event register, all set bits within it are cleared. These are sometimes known as *sticky bits*, since once set, a bit can only be cleared by reading its value. Event register names end with SR.

Enable Registers

These read/write registers define a bitwise mask for their corresponding event register. If a bit position is set in an event register while the same bit position is also set in the enable register, then the corresponding summary bit message is set. Enable register names end with SE.

At power-on, all status registers are cleared.

3.6 Status Reporting

The PS300 series reports on its status by means of two status bytes: The serial poll byte and the standard status byte.

Upon power-on, the instrument may either clear all of its status enable registers, or maintain them in the state they were in during power-down. The action taken is set by the *PSC command and allows things such as SRQ on power-on to be produced if desired.

3.6.1 Serial Poll Status Byte

<i>Bit</i>	<i>Name</i>	<i>Usage</i>
0	stable	Indicates VSET or ILIM value is stable. The value depends on whether the PS300 is in constant current or constant voltage mode.
1	vtrip	Indicates a voltage trip has occurred
2	itrip	Indicates a current trip has occurred
3	ilim	Indicates a current limit condition has occurred
4	MAV	Indicates GPIB output queue is non-empty
5	ESB	Indicates an unmasked bit in the standard status byte has been set
6	RQS/MSS	SRQ bit
7	hvon	Indicates high voltage is on

The PS300 will make a service request (SRQ) whenever one of these bits is set *and* the corresponding bit in the serial poll enable register is set. Note that any status condition will produce only one SRQ even if it is never cleared. The vtrip, itrip and ilim bits are latched bits. They are set on the occurrence of the appropriate event and stay set until either the status byte is read or the *CLS command is sent. This allows one to detect if a trip condition has ever occurred. All the other bits indicate the current states of their respective functions.

3.6.2 Standard Event Status Byte

<i>Bit</i>	<i>Name</i>	<i>Usage</i>
0	OPC	Set by *OPC
1	unused	
2	Query Error	Set by an output queue overflow
3	Recall Err	Set if a stored setting is corrupt
4	Execution Err	Set by an out-of-range parameter or incomplete command.
5	Command Err	Set by a command syntax error or an unrecognizable command
6	URQ	Set by any key press
7	PON	Set by a power-on condition

This status byte is defined by IEEE488.2 (1987) and is used primarily to report errors in commands received over the communication interface. Once set, the bits in this register stay set, and are cleared when read or when a *CLS command is received.

If a bit in the standard status register is set, and the corresponding bit in the standard status enable register is set, then the ESB bit in the serial poll register is set.

3.6.3 GPIB Error Messages

If an error occurs due to an incomplete command, the following error messages will appear on the middle display:

Err6 *Syntax Error Over GPIB*

The command has an error in syntax or was unrecognizable. This is the same error as seen in the Command Error (bit 5) of the Standard Event Status Byte.

Err7 *Illegal Parameter Entered Over GPIB*

A parameter was set out-of-range, or a command could not be completed because of an overload condition. This is the same error seen in the Execution Err (bit 4) of the Standard Event Status Byte.

Err8 *GPIB Output Queue Full*

The output queue overflowed and was cleared. This could be due to querying the instrument repeatedly and not

reading back all the bytes. This is the same error seen in the Query Error (bit 2) of the Standard Event Status Byte.

4 Troubleshooting

In This Chapter

This chapter is written to guide a qualified electronics technician through troubleshooting the PS300 Series Power Supplies.

4.1	Troubleshooting the PS300	4-2
4.1.1	Power On Reset	4-2
4.1.2	Stuck Keys	4-2
4.1.3	No High Voltage	4-2
4.1.4	Repeated Trips.	4-2
4.1.5	Rear-Panel Voltage Set	4-3
4.1.6	Front-Panel Test	4-3
4.1.7	Calibration	4-3

4.1 Troubleshooting the PS300

Verify that the line cord is plugged all the way into the power entry module, and the power button on the front panel is pressed in.

4.1.1 Power On Reset

If the instrument turns on with odd combinations of illuminated LEDs, garbled displays, or is unresponsive to the keyboard, the memory contents may have been corrupted. To remedy the situation, turn the unit off, and hold down the [CLR] key while turning the power back on. This causes the unit to initialize the memory and load the default setup.

4.1.2 Stuck Keys

If the center display is filled with a particular number (like 4444), or one particular message (like Err2), and the keyboard is unresponsive, check to see if a key is stuck down. If so, gently flick the stuck key back to the center of its hole.

4.1.3 No High Voltage

Check to make sure that the *HIGH VOLTAGE* LED is *ON*. If the *HIGH VOLTAGE* LED is *OFF*, check the following:

- 1) Check the voltage limit and current trip levels to see that they are not too low for your load.

If the *HIGH VOLTAGE* LED is *ON* but the output voltage is zero or lower than expected, check the following:

- 1) Check if the *LIMIT* LED is *ON*. If so, the current limit value could be too low, or the load could be drawing excessive current.

- 2) Make sure the voltage limit is as large or larger than the desired output voltage.

- 3) Check the *REAR* status LED. If it is *ON*, then the high voltage is being programmed by the analog set voltage input on the rear panel and not by the front panel. If so, make sure the rear-panel programming voltage is correct.

4.1.4 Repeated Trips

Repeated trips can be caused by a change in load, or a load that is

drawing too much current. This may effect the voltage trip or the current trip.

Voltage Trips

A voltage trip may occur if the load changes too rapidly, causing the voltage to overshoot. Raising the voltage limit may eliminate the problem.

Current Trips

Disconnect the load and see if the unit still trips. If it works with no load, there may be a problem with the load. If it still trips, the unit may be damaged. Please contact the factory for further information.

4.1.5 Rear-Panel Voltage Set

If the output voltage output is inaccurate, check the *REAR* status LED and rear-panel connection to see that it is in the *SET* BNC. Make certain the voltage limit is set higher than the desired voltage.

4.1.6 Front-Panel Test

To test the front panel, hold down the [ENTER] key while turning on the unit. After power is turned on, you should see all indicators and numeric segments (except for HV ON) lit. By pressing the [▲] arrow key, individual annunciator lamps will light one by one across the front panel, except again for the HV ON indicator, which is controlled directly by hardware wired to the high voltage enable circuitry. Continue pressing the [▲] key to then test the individual segments of the numeric displays. After the final segment (the decimal point), press [▲] again and all digits will be lit as "8". At this point, press the [AUTO/MANUAL] button (upper-left most button), and the display should read "0". Continue across the front panel, testing each button, which should display a unique key code per button. The codes increase from top to bottom and left to right. After this test, turn the power off and restart the instrument.

4.1.7 Calibration

The calibration parameters are determined by a computer aided calibration procedure at the factory. These values are stored in the permanent memory of each unit. Because of this, there are no user-adjustable components to calibrate.

