

SR1 Audio Analyzer

Operation Manual



Stanford Research Systems

Revision 3.0.0 January, 2014

Table of Contents

Foreword	0
Part I Getting Started	6
1 Unpacking and Safety.....	6
2 Manual Revision History.....	8
3 Overview.....	9
4 User Interface.....	13
5 A Quick Example.....	19
Part II SR1 Operation	28
1 File Menu.....	28
Save SR1 Configuration	29
Save Partial Configuration	30
Load Configuration	31
Print SR1 Screen	32
Print Setup	33
2 Edit Menu.....	34
3 Panels Menu.....	35
Analog Generator Panel	36
Analog Generator Units.....	41
Analog Generator Waveforms.....	43
Digital Generator Panel	57
Digital Generator Units.....	60
Digital Generator Waveforms.....	62
Analog Inputs Panel	76
Digital I/O Panel	79
Channel Status Panel	87
User Status Panel	90
Sweep Panel	91
Settling Panel	98
Monitors Panel	100
Multitone Panel	102
Clock Reference Panel	105
4 Analyzers Menu.....	107
Common Analyzer Features	108
Analyzer Units.....	110
Time Domain Detector	115
FFT (Single Channel)	127
FFT (Dual Channel)	141
THD Analyzer	157
IMD Analyzer	161
Multitone Analyzer	165
Histogram Analyzer	171
Octave Analyzer	175
Jitter Analyzer	177
Digitizer	183

5	Displays Menu	191
	Graph	192
	Trace Calculator.....	199
	Bar Chart	202
	Digitizer Display	205
	Other Display Menu Options	212
6	Tools Menu	213
	Preferences Panel	214
	Events Panel	220
	Switcher Configuration Panel	226
	Hardware Status	230
	Networking	231
	Netw ork Setup.....	231
	Netw ork Places.....	232
	Map Netw ork Drive.....	233
	Remove Netw ork Drive.....	233
	Share SR1.....	234
	Computer Functions	236
	Printers Panel.....	236
	Eject Drive.....	237
	Pow er Options.....	237
	Date Time.....	238
	Virtual Keyboard.....	238
	Updating SR1.....	238
7	Automation Menu	241
	Remote Interface Panel	242
	Scripting Window	243
	Learning Mode	252
8	Quick Measurement Menu	253
	Setup Panel	254
	SNR Panel	255
	Reference Panel	257
	Level Panel	259
	THD+N Panel	261
	Frequency Response Panel	263
	Distortion Panel	265
	IMD Panel	267
	Crosstalk Panel	269
	Interchannel Phase Panel	271
	In/Out Phase	273
	Automated Measurements and Reports	275
9	Setups Menu	278
	Analog-Analog	279
	Analog-Digital	281
	Digital-Analog	283
	Digital-Digital	285
	Digital IO	287
10	Help Menu	288
 Part III SR1 Reference		 291
1	Front Panel Description	291

2	Rear Panel Description.....	293
3	Specifications.....	296
4	Filter Reference	305
5	File Reference.....	306
6	Hardware Reference.....	310
	Index	312

Getting Started

Part

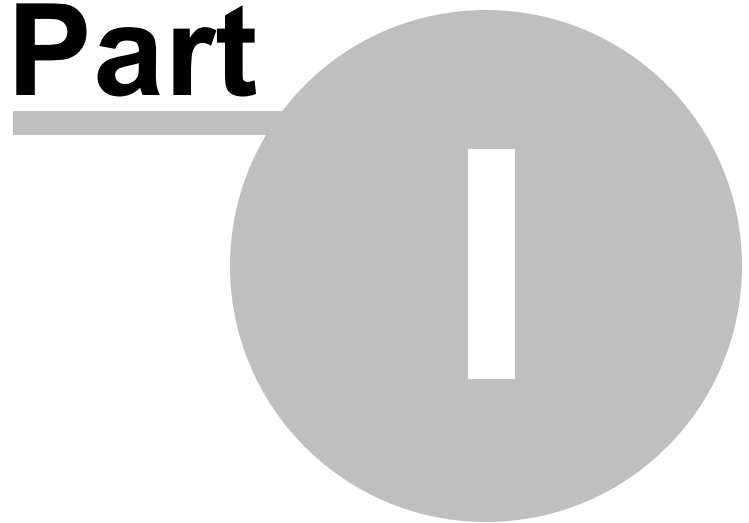

1 Getting Started

1.1 Unpacking and Safety

Removing the Instrument From Its Shipping Container

Use care in removing the instrument from its shipping container. The SR1 weighs approximately 50 lbs, and can be awkward to handle while being removed from the box. In particular, please take care that the front panel LCD screen is not damaged while unpacking. Retain the original packing materials in case the unit ever needs to be returned for service.

Connecting The Power Cord

Your SR1 was shipped with a power cord appropriate to your location. SR1 operates from a 100V, 120V, 220V or 240V nominal AC power source with a line frequency of 50 or 60 Hz. Before connecting the power cord to the rear panel power entry module, please ensure the the LINE VOLTAGE SELECTOR card, located in the rear panel fuse holder, is set so that the correct AC input voltage value is visible. The fuse rating should also be checked to see if it matches the line voltage setting. For 100V/120V operation a 4A fuse is used. For 220V/240V a 2A should be installed. The instrument has a 3-wire power cord. Be sure to connect it to a properly grounded outlet to guard against electrical shock.

After connecting the power cord to an AC power source, the unit can be turned on by pressing the power button at the lower left of the front panel. The green power LED above the power button illuminates to indicate the unit is on. After turning the power on the unit will take about 50 seconds to run through its boot-up sequence before it is ready for use.

Safety



Dangerous voltages, capable of causing injury or death, are present in this instrument. Use extreme caution whenever the instrument cover is removed. Do not remove the instrument's cover while the power cord is connected to a live outlet. Do not expose the instrument to rain or excessive moisture. Do not attempt to disconnect the internal cooling fans or block the fan vents.

Service

Refer all servicing to qualified, SRS-authorized service personnel. Do not attempt to substitute parts or perform any unauthorized modification to the instrument. Contact SRS for instructions on how to return the instrument for authorized service, calibration, or adjustment.

Stanford Research Systems
1290-D Reamwood Ave.
Sunnyvale, CA, 94089
USA

phone 408.744.9040
email info@thinkers.com
web www.thinkers.com

1.2 Manual Revision History

Copyright © 2009-2014 Stanford Research Systems, Inc.

All rights reserved

No part of this manual may be reproduced or transmitted in any form or by any means, electronic or mechanical, including photocopying, recording, or by any information storage and retrieval system without permission in writing from Stanford Research Systems, Inc.

Manual Revision History

Version	Date	Author	Comments
1.0	1/06	jahan	Original Version
2.0	7/09	ajm	Preliminary Version shipped with first SR1s
2.1	10/09	ajm	2nd Preliminary version
2.2	12/09	ajm	Complete Through Tools Menu
2.3	1/10	ajm	Complete Manual
2.4	3/10	ajm	For SR1 v 1.1
2.5	3/10	ajm	Minor Printing Corrections
2.6	5/10	ajm	Updated for SR1 v1.1.6
2.7	7/10	ajm	Updated for SR1 v1.2
2.8	6/11	ajm	Updated for SR1 v1.4
3.0	1/14	ajm	Updated for SR1 v2.1.13

Copyright and Trademark Acknowledgements

Windows is a trademark of the Microsoft Corporation

Apache Xerces

Copyright 1999-2007 The Apache Software Foundation

This product includes software developed at The Apache Software Foundation (<http://www.apache.org/>).

Portions of this software were originally based on the following:

- Software copyright (c) 1999, IBM Corporation., <http://www.ibm.com>.
- Software copyright (c) 1999, Sun Microsystems., <http://www.sun.com>.
- Voluntary contributions made by Paul Eng on behalf of the Apache Software Foundation that were originally developed at iClick, Inc., software copyright (c) 1999.

NI-Device

Copyright © 2009 National Instruments Corporation, All Rights Reserved

FastReport

Copyright © 2009 Fast Reports, Inc., All Rights Reserved

1.3 Overview

SR1 is versatile and complex instrument capable of making a wide a variety of precision audio measurements in both the analog and digital domains. The following is a brief introduction to the different pieces of SR1 and their capabilities.

Measurement Setups

SR1 includes pre-configured setups for many common audio measurements. To get up and running quickly, see the [Setups Menu](#).

Generators

SR1 contains precise and flexible analog and digital audio generators. Each generator is built around several core waveforms which can be either generated individually or combined in the generator and output as a composite signal. For the Analog Generator, the core waveforms include Sine, Low-Distortion Sine, Phased Sine, Noise, USASI Noise, Squarewave, Ramp (triangle), FFT Chirp, Multitone, Arbitrary, and Constant (offset). The analog generator can be output either as a balanced or unbalanced signal and outputs a maximum peak output voltage of 20 V (unbalanced) or 40 V (balanced).

The Digital Generator offers the same core waveforms as the analog generator and additionally offers a number of waveforms optimized for digital interface testing including Digital Constant, Digital Counter, Walking Bits, and a J-test waveform designed to test the jitter susceptibility of devices.

Analog Inputs

SR1 offers both balanced and unbalanced analog inputs with full scale input ranges from 160 Vrms down to 62 mVrms. SR1's analog inputs are autoranging, meaning that for most input signals, the analyzer automatically sets the input range without any user interaction.

Digital Audio Inputs and Outputs

SR1 has 2 sets of XLR and BNC connectors and is compatible with both consumer and professional digital audio signals from 50 mVpp up to 10.2 Vpp. All significant parameters of the digital audio carrier signal are measured including signal amplitude, digital audio effective sampling frequency, and input/output delay. Status bits are fully decoded in both the the professional and consumer standards. User bits are also displayed in raw binary format.

Several impairment signals can be applied to the output digital audio carrier including Common Mode Sinewave, Normal Mode Noise, and Jitter. Jitter waveforms include Sine, Square, Noise, and Bandpass Noise with a peak jitter amplitude of ~13UI.

Analyzers

There are 8 different types of Analyzers in SR1, summarized below.

Time Domain Detector	Makes wideband amplitude, ratio, and THD+N measurements. The time domain detector signal chain includes bandpass or notch filters, bandwidth limiting filters, and a variety of different weighting filters. Peak, RMS and Quasi-Peak responses are selectable
FFT (1 ch)	Provides single-channel FFT functionality. Measurements include power spectrum, time record, phase. Both zoom (changing the FFT frequency range) and heterodyne (moving the FFT frequency range) are included.
FFT (2 ch)	Provides dual-channel FFT functionality. Measurements include power spectrum and time record for both channels, plus frequency response

	(transfer function), and interchannel phase. Zoom (changing the FFT frequency range) is supported in the dual-channel analyzer.
THD Analyzer	Makes frequency selective Total Harmonic Distortion (THD) measurements, both ratio and absolute. Includes the ability to measure only selected harmonics.
IMD Analyzer	Makes standard Intermodulation Distortion measurements including SMPTE/DIN, CCIF (difference frequency), and DIM/TIM.
Multitone Analyzer	Makes single-shot multitone measurements allowing fast measurements of common audio parameters including noise, distortion, and level.
Jitter Analyzer	Measures the jitter of the digital audio carrier in both the time and frequency domain including variable high and low pass filtering.
Histogram Analyzer	Creates histograms of the analog and digital audio input signals.
Octave Analyzer	Displays 1, 1/3, and 1/12 fractional octave spectra.

Each type of analyzer has a corresponding panel with the appropriate controls for that analyzer and readouts for the analyzer's measurements. At any instant, there are two active analyzers, designated **A0** and **A1**. The user can select the type of **A0** and **A1** from any of the allowed analyzer types. Each analyzer has controls which set the input domain to analog or digital audio and select the appropriate input channel.

For analog inputs SR1 offers an additional choice between two Analog-to-Digital converters, each optimized for different measurements. The high-bandwidth (Hi BW) 16-bit ADC operates at a fixed sampling rate of 512 kHz. The high-resolution (Hi Res) ADC is a 24-bit converter which operates at fixed sampling rates of 128 kHz and 64 kHz and variable rates which can be synchronized with the digital audio output or input signal to perform cross-domain measurements.

Sweeps and Free Run

SR1 operates in two different measurement modes: free-run and sweep. In free-run mode the analyzers make continuous measurements and continually updates the measurement results on the analyzer panels. The second mode, sweep mode, requires that several options be set. First, a sweep source must be configured which determines whether SR1 will be sweeping an internal parameter (e.g. generator frequency) over a specified range, an externally measured parameter (e.g. input frequency), or at regular time intervals. Once the sweep source is configured the user must select the measurements (up to 6) that will be recorded during the sweep. Swept measurements must be **settled** to be included in the sweep meaning that the transient variability of the measurement must drop below a user set value before being included in the sweep result. Sweep sources and data are setup on the [Sweep Panel](#), while Settling parameters are set in the [Settling](#) panel.

Displays

Three different types of displays are available for graphically displaying measurement data. The [graph](#) is the main display type and is capable of displaying many different live and off-line data traces both. Graphs include cursors for reading out absolute and delta values, the ability to export to bitmap and Windows Metafiles, movable onscreen annotations, and a variety of data calculations (smoothing, linearity, maximum and minimum, etc.) for manipulating data. The [Bar Chart](#) is a simpler display optimized for displaying a single measurement value which reports the instantaneous value of the measurement as well as maximum, minimum, and standard deviation. The [Digitizer Display](#) is designed to work with the optional digitizer and displays various measurements calculated by the digitizer including full-color eye diagrams.

Digitizer (Optional)

The optional [digitizer](#) digitizes the digital audio carrier signal at an 80 MHz sampling rate. The digitizer calculates the overall clock rate of the signal as well as jitter as a function of time and probability density for pulse width, pulse amplitude, input amplitude, and jitter amplitude. The digitizer also calculates the spectra of both the carrier signal as well as the jitter signal. Finally the digitizer calculates an eye diagram which shows the probability of the carrier signal as a function of amplitude and time. The off-line measurements made by the digitizer complement the real-time jitter measurement capabilities of the Jitter Analyzer.

Remote Interfacing

SR1 Supports a variety of remote interfaces:

IEEE-488.2 (GPIB)

SR1 has a rear-panel IEEE-488 connector and fully supports the IEEE-488.2 standard. All instrument features can be set and queried from the remote interface.

Serial

GPIB commands may also be sent over the rear-panel serial connector which supports baud rates up to 115.2 kBaud.

TCP/IP

GPIB commands may also be sent over a TCP/IP network via the rear-panel ethernet connector. SR1 follows the VXI-11 standard for the transmission of commands over TCP/IP.

COM

SR1 is fully COM enabled allowing applications such as Visual Basic to set and query instrument internals. COM enabled applications may also control and query the instrument remotely over ethernet. Not that firewall settings may need to be changed to fully enable this functionality.

1.4 User Interface

The SR1 audio analyzer user interface is based on software that runs on the Microsoft Windows operating system. As such, the basic user interface, based on standard Windows menus and controls, should be familiar to most users who have used Microsoft Windows. The same software that runs on the instrument is available for free download from Stanford Research Systems (www.thinksrs.com) and can be run on any Windows PC. While no measurements can be made while running on a PC, this mode is perfect for offline viewing of saved datafiles or simply becoming familiar with the software.

Like all Windows software, operating SR1 requires a pointing device and a means of entering text and numeric data. The instrument provides several options depending on the intended environment.

External Mouse and Keyboard Control

SR1 can be used with an external mouse and keyboard. The mouse and keyboard must be connected to the rear-panel connectors **before** the instrument is turned on to be properly recognized by the instrument. Operation with an external mouse and keyboard is convenient when SR1 will be used in a benchtop environment.

Using the Trackpad







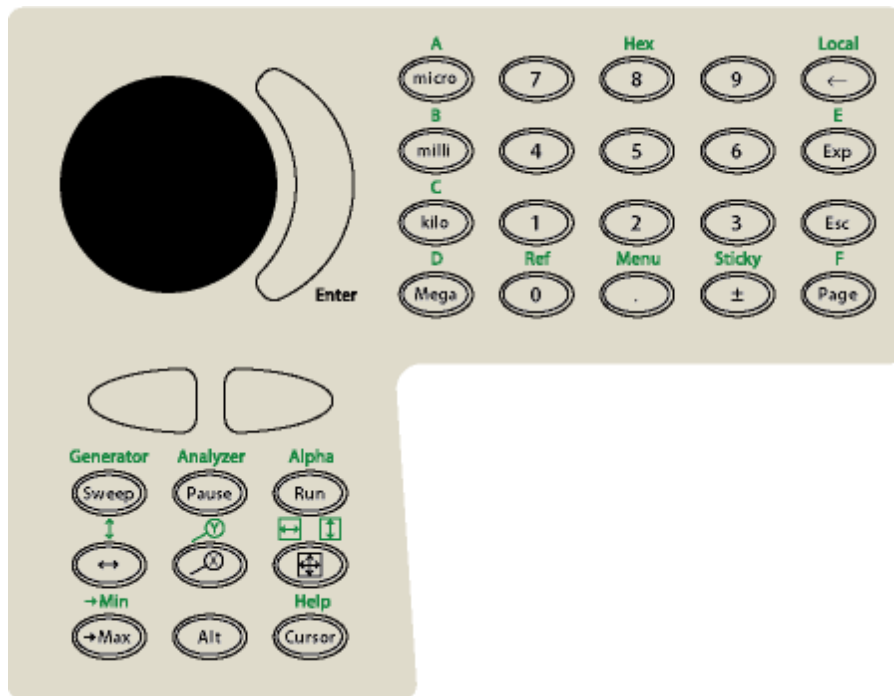

For situations where it's inconvenient to use an external mouse (e.g. rackmount), SR1 has a front-panel trackpad which can be used as a pointing device. (Note that the trackpad is always active, even when an external mouse is connected.) To use the trackpad, drag your finger over the surface of the pad to move the cursor on the screen. To "left-click" gently tap your finger. To "double-click" tap your finger twice. Finally, to "right-click" tap your finger in the upper-right triangle (colored in a lighter shade of gray).













Using the Front-Panel Keypad

The front-panel keypad provides a convenient way to enter numeric values as well to access some commonly used SR1 functions without having to reach for the mouse or keyboard.



Standard Function of Keypad Keys

Key	Function
Numeric Entry Keys	
Numbers 0-9	Enters the corresponding digit at the current cursor position.
. (Decimal Point)	Enters the decimal point at the current cursor position.
±	Changes the sign of the number in the current entry field.
←	Backspace. Deletes the character to the left of the cursor.
Exp	Inserts the "E" character at the current cursor position allowing entry in scientific notation: e.g. 1.2E3
Esc	Aborts numeric entry and returns the value in the selected field to the previous value.
micro	inserts the "u" modifier at the cursor position, interpreted as $\times 10^{-6}$.
milli	inserts the "m" modifier at the cursor position, interpreted as $\times 10^{-3}$.
kilo	inserts the "k" modifier at the cursor position, interpreted as $\times 10^3$.
Mega	inserts the "M" modifier at the cursor position, interpreted as $\times 10^6$.
Enter	Finishes entering the new value.
Function Keys	
Page	Rotates through the seven pages of the page control on the SR1 screen.
 (Tab Left/Right)	Moves the control with "focus" either to the next or previous control.
Sweep	Starts a Sweep. Equivalent to pressing the  button on the speedbar.
Pause	Pauses and resumes both sweeps and free-run mode. Equivalent to pressing the  and  buttons on the speedbar.
Run	Starts free-run mode. Equivalent to pressing  on the speedbar.
↔	Translate graph left/right. Once pressed, the  keys will move the data in the current graph left and right. Press "Esc" to exit this mode.
	Zoom X-axis. Once pressed the  keys will zoom the X-axis in and out. Press "Esc" to exit this mode.
	AutoScale. Autoscales the X and Y axes of the currently selected graph.
→Max	Moves the active cursor in the current graph to the position corresponding to the maximum value displayed in the graph.
Cursor	If the selected graph cursor is off, this key turns cursors on. If they are on, this key toggles the active cursor between the two cursors.
Alt	Selects the Alt function (written in Green above the keys) for the keypad keys.
Alt-Function Keys	
Menu	Moves focus to the main menu. Once Menu is pressed, the knob and enter keys can be used to access the main menu selections without using a pointing device.
Sticky	Normally, the knob varies whatever control on the screen currently has focus. Press Sticky to "Stick" the knob to the current control. Even when focus is moved to a different control the knob continues to modify the sticky control. The sticky control is drawn with a yellow background. Press sticky again to

	exit sticky mode.
Local	Upon receipt of a command from one of the remote interfaces SR1 is placed in "Remote" mode. Using this key returns the unit to local control.
Ref	AutoReference. The contents of the currently focused control is examined. If it is a frequency, the frequency is moved to the frequency reference of the selected analyzer. The analyzer, A0 or A1 is selected by pressing the   keys after pressing "Ref". If the contents of the currently focused window is not a frequency then the contents of the A and B levels for the selected analyzer will be transferred to the dBrA and dBrB references (either analog or digital, depending on the analyzer input.)
Hex, Hex Digits A-F	Hex Entry mode. Places a "0x" character in the currently focused control to begin hexadecimal entry. In this mode, the "A", "B", "C", "D", "E", and "F" characters above the micro, milli, kilo, meta, Exp, and Page keys are active allowing the entry of a hexadecimal value. Hex Entry mode is terminated when "Enter" is pressed.
Generator	After pressing this key press  to open the analog generator panel or  to open the digital generator panel.
Analyzer	After pressing Analyzer press  to open the A0 panel or  to open the A1 panel.
Alpha	Calls up the virtual keyboard .
↑	Translate graph up-down. Once pressed, the   keys will move the data in the current graph up and down. Press "Esc" to exit this mode.
	Zoom Y-axis. Once pressed the   keys will zoom the Y-axis in and out. Press "Esc" to exit this mode.
Autoscale X, Y	After pressing the key, use the   keys to select autoscale of either the the X or Y axis.
→Min	Moves the active cursor in the current graph to the position corresponding to the minimum displayed value in the graph.
Help	Brings up the online help.

Using the Knob

Turning the knob modifies the currently focused control. If the control is a unit entry control, the knob increments and decrements its value with an appropriate resolution. If the control is a drop-down list the knob cycles through the entries in the list. Three different knob acceleration profiles can be selected from the [preferences panel](#). A control can be selected as "Sticky" in which case the knob will continue to control it even though focus is given to another control. When cursors on a graph are active the knob controls the active cursor position.

Using the Virtual Keyboard

For situations where it's necessary to enter text into a control and an external keyboard is not available the Virtual Keyboard can be selected from the [SR1 keypad](#) or from the [Tools Menu](#). The virtual keyboard offers the full functionality of a standard PC keyboard but can be operated with just a mouse or the trackpad.



Keyboard Shortcuts

A number of keyboard shortcuts are available (using either an external keyboard or the virtual keyboard) to simplify the execution of common functions.

Key Sequence	Action
<Ctrl> 1-7	Select the designated page (1-7) on the page control as the active page.
<Ctrl> D	Opens the digital generator panel.
<Ctrl> G	Opens the analog generator panel.
<Ctrl> I	Opens the digital i/o panel .
<Ctrl> A	Opens the analog inputs panel.
<Ctrl> M	Opens the monitors panel.
<Ctrl> W	Opens the sweep controller panel.
<Ctrl> T	Opens the scripting window.
<Ctrl> [Opens the A0 analyzer panel.
<Ctrl>]	Opens the A1 analyzer panel.
F4	Auto-reference analyzer A0. Moves the current A0 level A and B values to the dBrA and dBrB reference values.
<Ctrl> F4	Auto-reference analyzer A1. Moves the current A1 level A and B values to the dBrA and dBrB reference values.
F12	Emergency shutoff. Turns off all channels of the analog and digital generators.
<Ctrl> F12	Restore generators. Turns on generator channels that were turned off with F12.
Scripting Window Shortcuts	
<Ctrl> S	Save the current script.
<Ctrl> O	Open a script.
<Ctrl> N	Create a new script.
<Ctrl> C	Copy selected text to the clipboard.
<Ctrl> X	Cut selected text and copy to the clipboard.
<Ctrl> V	Paste clipboard text at the cursor location.
<Ctrl> F	Brings up the dialog for finding text in the script.
<Ctrl> R	Brings up the dialog for finding and replacing text in the script.
<Ctrl> P	Prints the current script.

Unit Entries

The Unit Entry is a type of control used extensively throughout SR1 that allows entry of numeric data in a range of different units. The example below shows the generator amplitude control for example. When the down-arrow  is clicked, a the current value of the

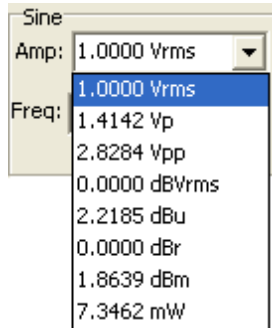

entry is shown in the drop-down list expressed in each of the allowed units. Selecting a different unit makes it the current unit for subsequent entries. To enter a new value into a unit entry first click anywhere on the current text, and then enter a new numeric value followed by an optional modifier character. The allowed modifiers are:

Character	Modifier	Numeric Value
f	femto	$\times 10^{-15}$
p	pico	$\times 10^{-12}$
n	nano	$\times 10^{-9}$
u	micro	$\times 10^{-6}$
m	milli	$\times 10^{-3}$
k	kilo	$\times 10^3$
M	mega	$\times 10^6$
G	giga	$\times 10^9$
T	tera	$\times 10^{12}$

(Note that the front-panel keypad contains dedicated keys for the unit-modifiers just to the right of the Enter key.) To complete the entry press the "Enter" key on the front panel or an external keyboard. To abort the entry press the "Esc" key on the keypad or keyboard.

Sometimes the precision of the value represented by a unit entry may exceed the number of digits displayed. To see the value of any unit entry displayed with full double precision hold the cursor over the unit entry—the full double precision value will be shown as a "hint."

Unit Displays

Unit Displays are the controls with a black background and green text which are used to display measurement results and other quantities whose value can't be changed by the user. As with unit entries, the units of the unit display can be changed by using the mouse or trackpad to click on the  at the right of the control and select a unit from the drop-down list. Right-clicking the Unit Display brings up a menu which offers some more options:

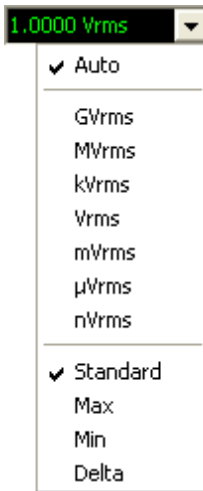

Normally the Unit Display auto-selects the appropriate unit-modifier for the currently displayed value. For instance 1.2×10^{-6} Vrms would be displayed as 1.2 μ Vrms. There are situations where it might be desirable to lock the unit-modifier selection. For instance we might want the display to readout as 0.0012 mVrms. To do this, select the appropriate modifier from the right-click menu. Select "Auto" from the right-click menu to return to normal operation.

The second feature offered by Unit Displays is selected in the bottom half of the right-click menu. In "Standard" mode, the Unit Display displays each new value that is sent to it. If one of the other modes are selected, the current value of the display is saved as the "reference" and subsequent updates are displayed as follows:

Mode	Operation
Standard	Each update to the Unit Display's value is displayed. Data is displayed in Green .
Max	Updates are displayed only if they are greater than the reference value. When the data exceeds the reference that data becomes the new reference value. Data is displayed in Red .
Min	Updates are displayed only if they are less than the reference value. When the data is less than the reference that data becomes the new reference. Data is displayed in Blue .
Delta	The difference between the update value and the reference value is displayed. Data is displayed in Purple .

To reset the reference double-click the display.

Like unit entries, it is possible to see the value represented by a unit display with full double precision by holding the cursor over the unit display—the double precision value will be shown as a "hint."

1.5 A Quick Example...

In this example we'll use the analog generator to create a signal with a known amount of distortion and we'll use the Time Domain Detector to measure the distortion and the FFT analyzer to look at the distortion in the frequency domain. To begin, turn on SR1 and wait for the instrument to finish its startup sequence. No external cables will be necessary for this demo. Feel free to use the front panel trackpad and keypad keys to control the instrument, or if you've got an external mouse and keyboard you can those. We won't go into excruciating detail on how to select items and use the controls because they're standard Windows controls and their operation should be familiar.

Start out by using the speedbar at the top of the SR1 screen to open the Analog Inputs panel and the Analog Generator panel, and from the Analyzers menu, set Analyzer 0 to Time Domain Detector. These three panels may automatically open when SR1 is powered up.

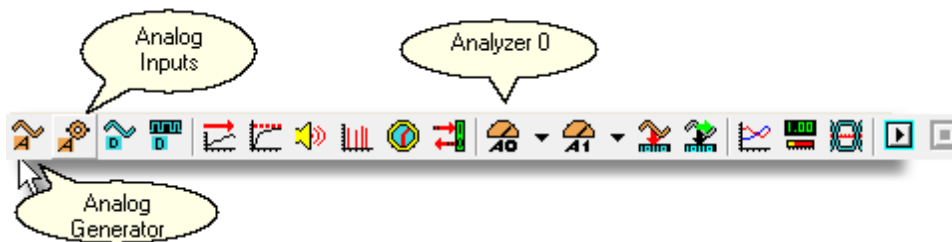

SR1 Speedbar

Note that the icons for the Analog Inputs panels and the Analog Generator panel are both **orange**. SR1 uses **orange** to denote items associated with the analog domain and **blue** to denote items associated with the digital audio domain. Most panels have color bars under the title of the panel indicating the domain associated with the panel.

The three panels you've just opened should look like this:

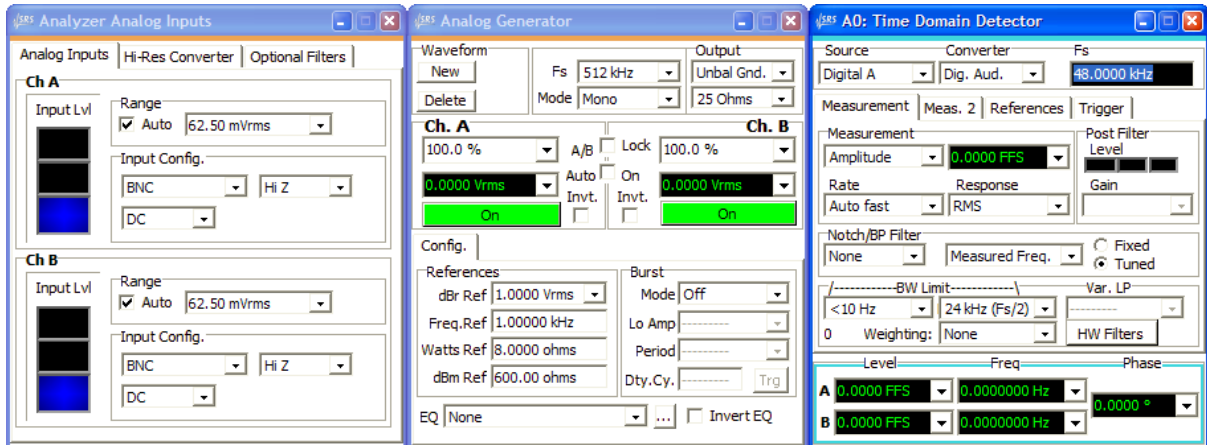

Now let's configure the instrument for this example. On the Analog Inputs panel, change the Input Source for both channels from BNC to GenMon. With the inputs set to GenMon the Ch. A analog input is directly connected to the Ch. A generator output and the Ch. B analog input is directly connected to the Ch. B generator output. Leave the "Auto" box checked for each of the range controls. With Auto Range on, SR1 automatically adjusts the range to the optimum value for the current input signal. Note that the ranges are set to their minimum value (62.5 mVrms) and the Input Level indicators are showing blue (below half scale). That's because the generator hasn't been set up yet.

Take a look at the Analog Generator panel. We haven't selected any waveforms yet, so the tab control at the bottom only contains the configuration tab. By default, the generator is in "Mono" mode which means that the same waveform will be output on the A and B channels. We can adjust the channel amplitudes separately, but the waveform is the same. (In "Stereo" mode we can select different waveforms for A and B but we don't need to do that for this example.) Now press the "New" button on the Analog Generator panel. This brings up the menu of available waveforms. From the Sine submenu choose "Normal Sine". After the Sine waveform shows up in the tab control set an amplitude of 1Vrms. Note how the range controls on the Analog Input panel both move to the 1 Vrms input range and the Input Level indicators turn green, indicating the ranges are optimally adjusted. (The Input Level indicators are also visible at the bottom right of the SR1 screen.) Now we can add a little bit of distortion to the signal. Press the "New" button again on the Analog Generator panel and once again select a "Normal Sine". This time set the frequency to 2 kHz and the amplitude to 1 mVrms. We've just illustrated a key feature of the SR1 generator's architecture—the ability to combine several waveforms in the generator. The 1 kHz 1 Vrms signal and the 2 kHz 1 mVrms signals are added in the generator. Using this technique an almost infinite variety of waveforms can be created in the generator to suit almost any test situation.

Now let's measure the properties of the signals just created. Look at the Time Domain Detector panel and change the source from Digital A to Analog A. The "Converter" field will read "HiRes" indicating that the analyzer is using SR1's 24-bit High-Resolution converter. The current sampling rate for this converter, 64 kHz, is displayed in the "Fs" field next to the converter selection. SR1 uses two high quality analog-to-digital converters (ADCs) for analysis of analog signals— a 24bit high-resolution converter that can operate over a variety of sampling rates and a 16 bit high-bandwidth converter that operates at a fixed sampling rate of 512 kHz giving the instrument an analog bandwidth of 200 kHz. The differences between the two converters will be discussed in detail later but for now we can leave the converter selection at "HiRes."

Press the  button at the top left of the screen to start the measurements. Note that the Status Indicator at the bottom left of the screen. SR1 operates in two distinct measurement modes. In "Free Run" mode, which we just started, all the analyzers make continuous measurements and continuously update the results on the analyzer panels and displays. This mode is useful for benchtop exploration like we're doing now. "Sweep" mode is a more structured measurement mode in which the instrument sweeps a certain parameter and only measures data at certain defined values of that parameter. Sweep mode is more useful for repetitive testing to standards. We'll do a sweep at the end of this demo as an example. For now observe how in Free-Run mode the analyzer's level and amplitude displays are continuously updated.

To measure the "distorted" sine signal we've created, select "THD+N Ratio" as the Measurement in the Time Domain Detector. Change the units of the Amplitude display to dB, and the three panels should appear as they do below:

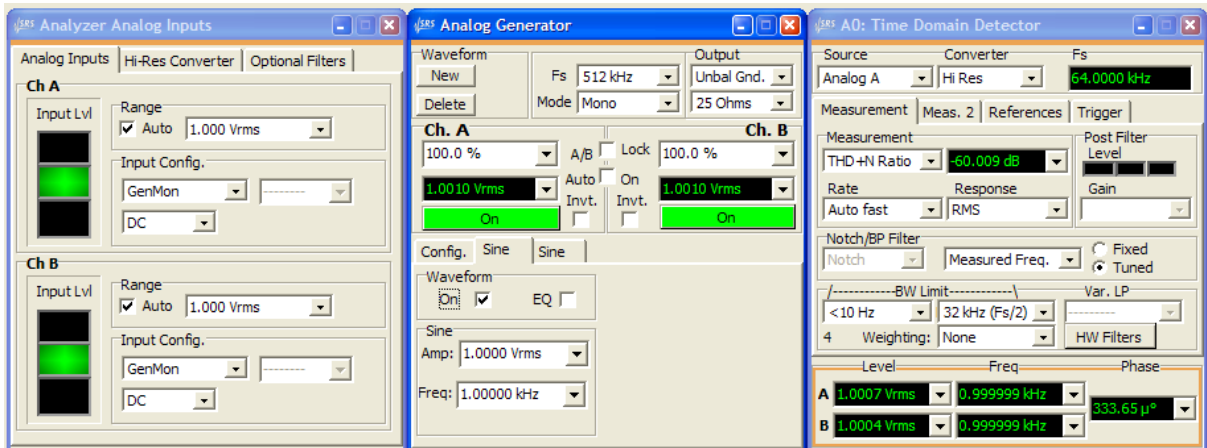

When "THD+N" ratio is selected, the analyzer inserts a deep notch filter at the frequency of the fundamental. In this case, because the notch filter is set to be tuned to the measured frequency, it is set at the 1 kHz dominant frequency of our generator signal. The Time Domain detector then performs an RMS integration of the remaining signal, which is distortion plus noise, and displays the ratio of that signal to the total amplitude of the input. Note that the measured THD+N ratio is -60 dB. ($1 \text{ mV} / 1 \text{ V} = 60 \text{ dB}$).

To show how much more SR1 brings to a standard distortion measurement select the second analyzer (A1) as the FFT1 analyzer. When the panel is displayed, change the source of the Analyzer to "Other Analyzer". In this mode the FFT analyzer and the Time Domain Analyzer work as a team; the FFT analyzer looking at the notch filtered signal from the Time Domain Detector. Take a look at the information displayed on the FFT1 analyzer panel:

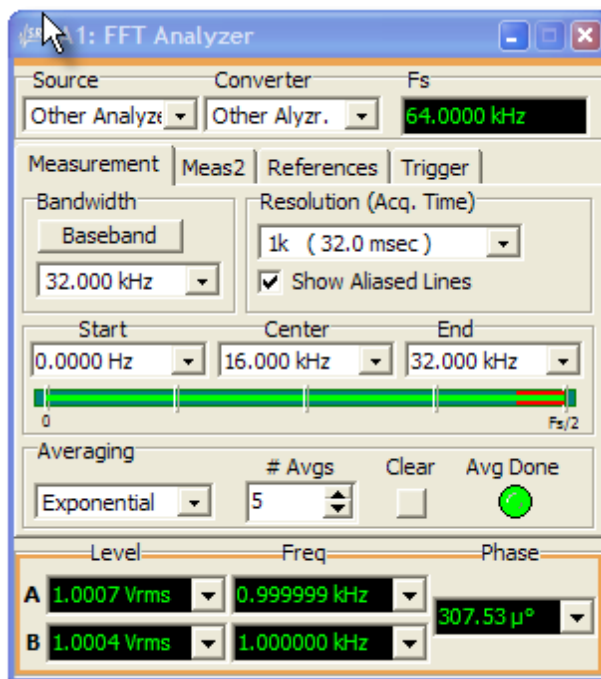





Like all analyzers the input source is displayed at the upper left. The analyzer sampling rate is displayed at the upper right. Because we've connected the FFT analyzer to the output of the Time Domain Detector

the sampling rate for the FFT analyzer is also 64 kHz. Just underneath is the control for setting the number of FFT lines (resolution). The resolution can be set to values between 256 lines and 32k lines. Unlike most Audio Analyzers, SR1's FFT analyzer doesn't operate at a fixed frequency range from DC to $F_s/2$. The Bandwidth control allows setting the measurement range to $F_s/2$, $F_s/4$, etc., all the way down to $F_s/2048$. The full FFT resolution is applied to this narrower frequency range, which can be moved to any position in the range of DC to $F_s/2$ using the "Start," "Center," and "End" controls. We will illustrate this shortly.

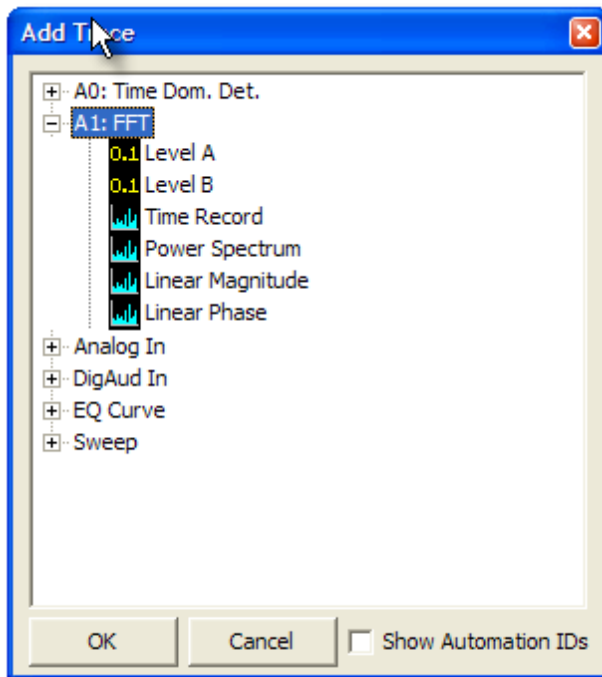
Averaging can be applied to the FFT to lower the shot-to-shot variation in the noise, or in some cases to actually lower the amount of noise. Select 5 averages in the "# Avgs" field to create a nice stable FFT display.

To display the FFT results we'll need to create a graph. Click on "Page 2" of the page control to give us some room for the graph and click on the  icon to create a new graph. Maximize the graph with the standard maximize control in the upper right. Now we need to add some data to the graph. Click the "Plus" sign icon at the top left of the graph to add a trace to the graph. The "Add Trace" menu appears. Open the "A1 FFT" node to see the measurements produced by the A1 FFT analyzer.



Note that scalar measurements, like frequency or level, are denoted with the  icon while vector measurements like spectra are accompanied by the  icon. Select "Power Spectrum", click ok, and the FFT will appear. Since we're looking at a very wide dynamic range, some logarithmic units will help. Click on the "Ymax" Unit Entry and change the Y units to "dBVrms". Now click the "Log" box in the X axis row to select a logarithmic X-axis. Click on the  icon (autoscale) on the graph speedbar to autoscale the display. Now turn on the graph cursors by clicking the  icon. Use the knob or the mouse to drag cursors as shown below. The graph should look like this:

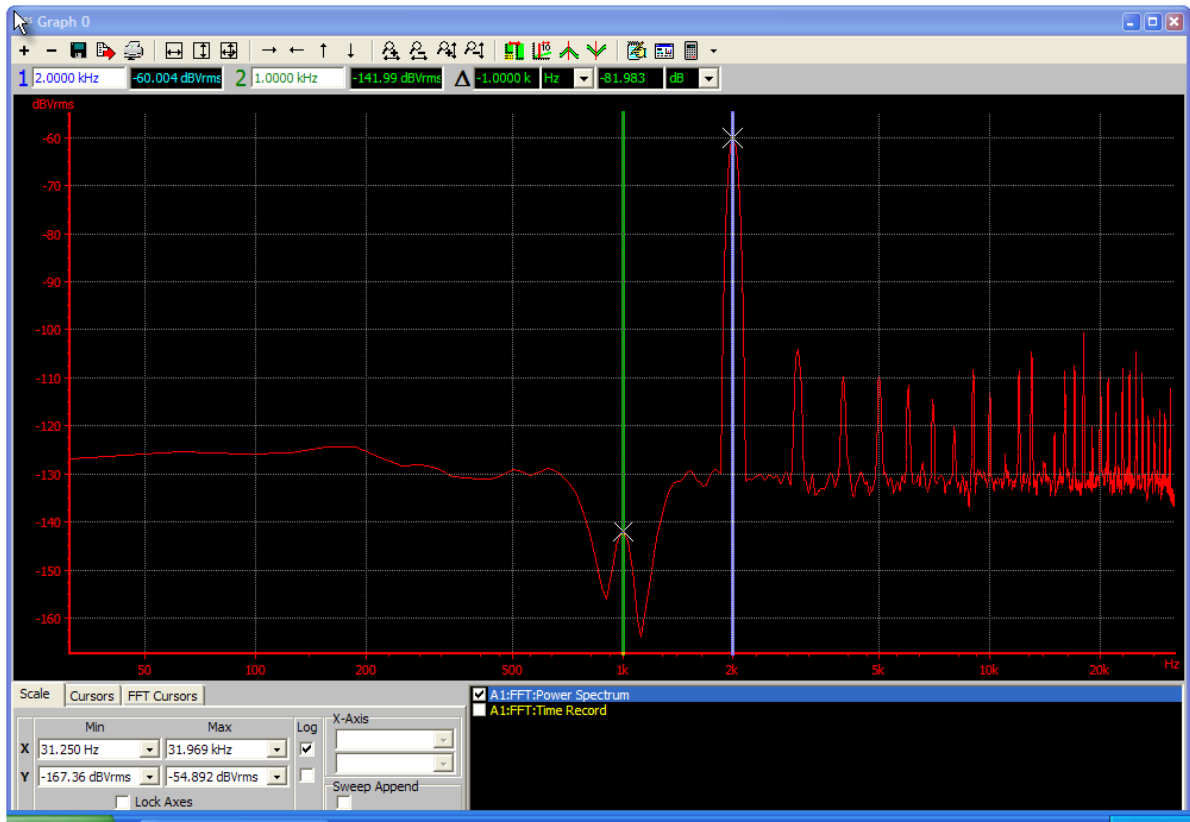

Now we're ready to zoom in on a portion of the the distortion product spectrum. Go back to Page 1 of the page control, and in the bandwidth control of the FFT analyzer select 500 Hz. In the "Center Frequency" field select 1 kHz. We're narrowing the bandwidth by a factor of 64, still using 1k FFT lines, and centering the new bandwidth on the notched out fundamental. Go back to Page 2, autoscale the spectrum, which should now look like this:

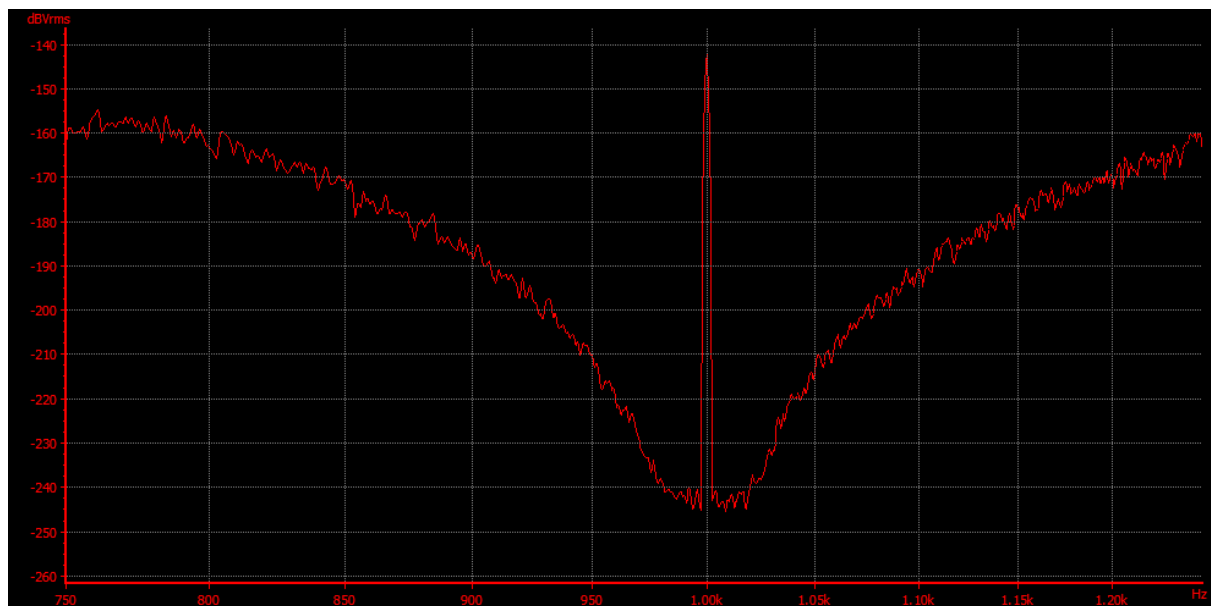

Note how more detail is resolved inside the notch. Go back to the FFT analyzer on page 1 and press the "Baseband" button to return the analyzer to its full measurement range. We're now ready for the last step in the demonstration.

Setting Up a Sweep

On page 1 click on the  icon to open the sweep controller panel. We're going to sweep the amplitude of our "distortion" sine wave and record the measured THD+N from the Time Domain Detector: Click on the Sweep Source button to bring up the sweep source selection menu:

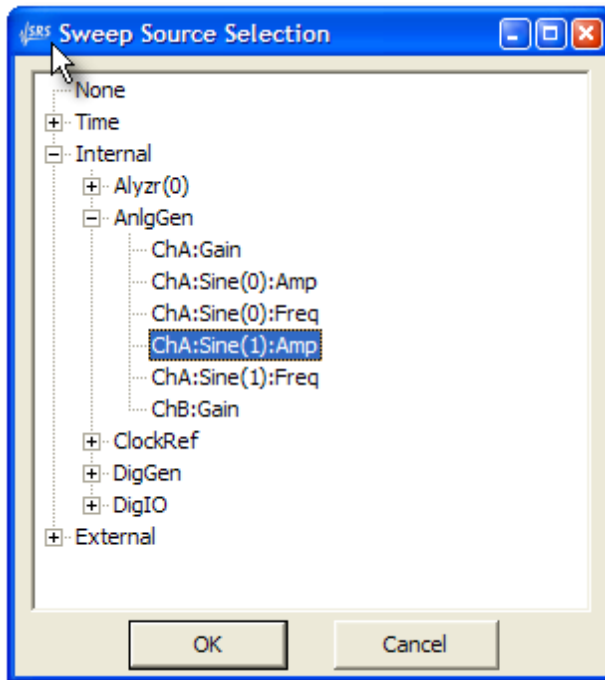

SR1 has 3 main types of sweep sources: Time Sweeps, where the sweep occurs at fixed time intervals, Internal Sweeps, where the sweep occurs at fixed values of some internal parameter, and External Sweeps, where the sweep occurs at fixed values of some externally measured parameter. Since we're going to sweeping the amplitude of the sinewave we created in the generator, this will be an "Internal" sweep. Open the Internal node on the tree, and then open the AnlgGen (Analog Generator) node to show the associated parameters that can be swept. Note that there are two sine amplitudes and frequencies shown, Sine(0) and Sine(1). That's because we created two sinewaves in the generator. The first, Sine(0), refers to the 1 kHz fundamental. The second, Sine(1) is the "distortion" sinewave whose amplitude we're going to sweep. Double-click on ChA:Sine(1):Amp to select it and return to the sweep panel:

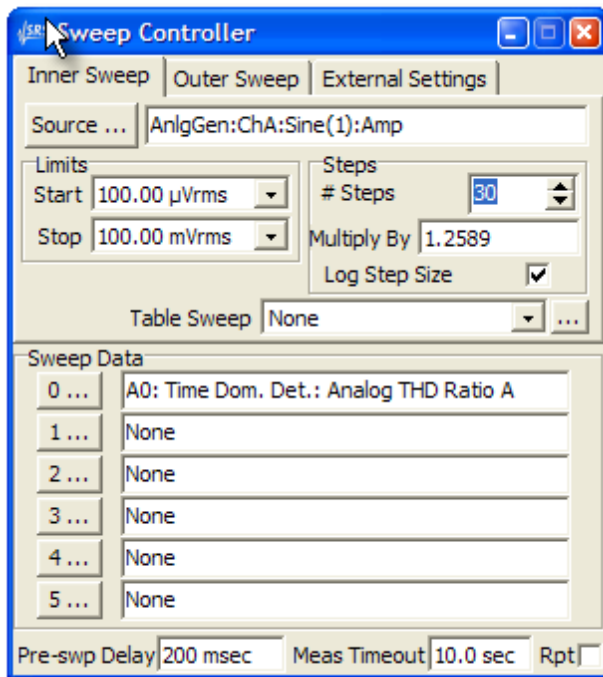

Select the start amplitude as 100 μ Vrms and the stop amplitude as 100 mVrms. Leave the number of sweep steps at 30, but select "Log Step Size." Next we need to select that data that will be measured in the sweep. Up to 6 separate measurements can be recorded at each sweep point. Click on the Sweep Data "()" to specify the sweep data. From the Sweep Data Selection menu, open the A0 node since the measurement we're going to record, THD+N, is made by the currently active Time Domain Detector on A0:

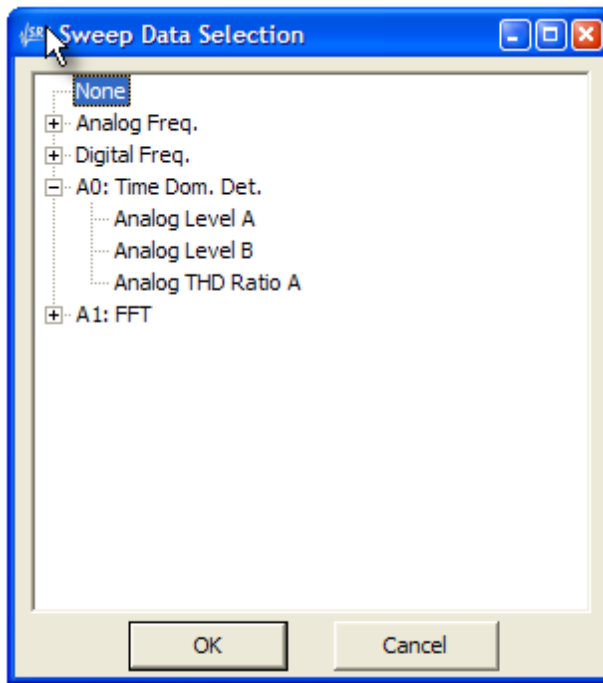

Select Analog THD Ratio A by double-clicking it. We're now ready to set up the graph to display our sweep.

Return to Page 2 of the page control. In the trace listing panel at the bottom of the graph unclick the Power Spectrum trace that we were looking at previously. Now use the "Plus" button at the top of the display to add another trace to graph. This time open the "Sweep" node and select "THD Ratio A". Select a log X-axis (to match the log sweep we just specified, and select dB as the Y-axis units with the unit entry controls. Select a Y axis range from -95 to -10 dB. Now start the sweep by pressing the "Sweep" button on the front panel. After a few seconds you'll see the results of the sweep:

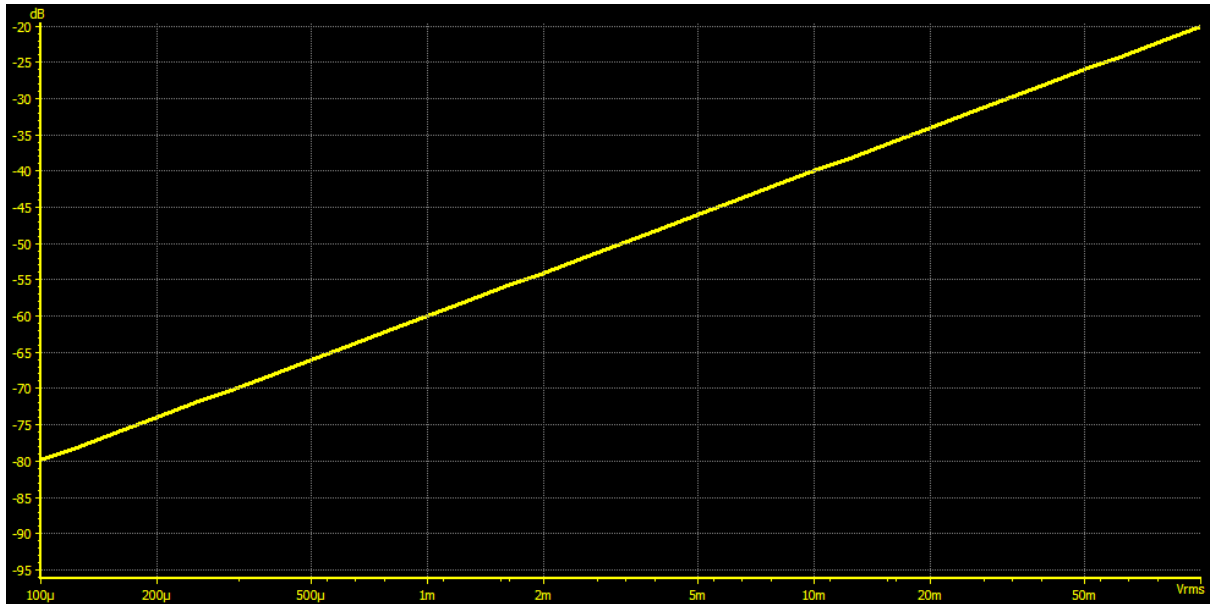

This, of course, is exactly what we expect. At an amplitude of 100 uVrms, the THD+N is simply $20 \cdot \log(100 \text{ uV}/1\text{V}) = -80 \text{ dB}$. At the other of the sweep the the THD+N is $20 \cdot \log(.1\text{V} / 1\text{V}) = -20 \text{ dB}$.

This quick example only scratches the surface of SR1's capabilities, but should give you a feeling for how the instrument operates.

SR1 Operation

Part

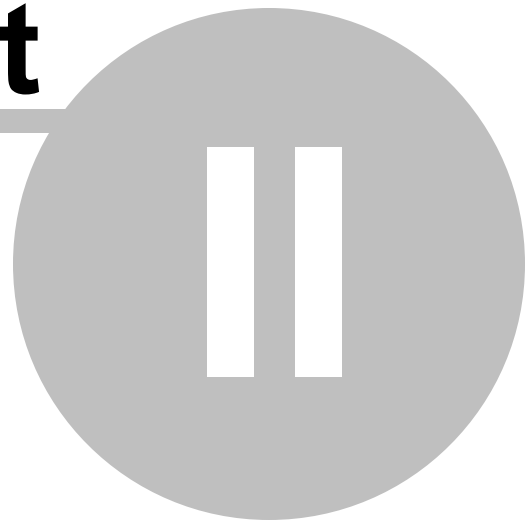

2 SR1 Operation

2.1 File Menu

The File Menu contains options for saving and recalling instrument configurations and also for printing.

• Save SR1 Configuration	Saves the entire instrument setup to a configuration file.
• Save Partial Configuration	Saves the entire instrument setup to a configuration file.
• Load Configuration	Loads setup information from a configuration file.
• Print SR1 Screen	Prints the currently displayed screen to the currently selected printer.
• Print Setup	Displays the standard Windows Print Setup dialog allowing the selection of an installed printer and paper options.

2.1.1 Save SR1 Configuration

Selecting **File**→**Save SR1 Configuration** saves the entire instrument setup to an SR1 configuration file. Configuration files are XML files whose structure is detailed in the [SR1 File Reference](#). The default extension for configuration files is ".XML". All operating parameters, as well as the the position of all panels and displays are recorded in the configuration file. After loading the file the instrument state will be exactly what it was when saved.

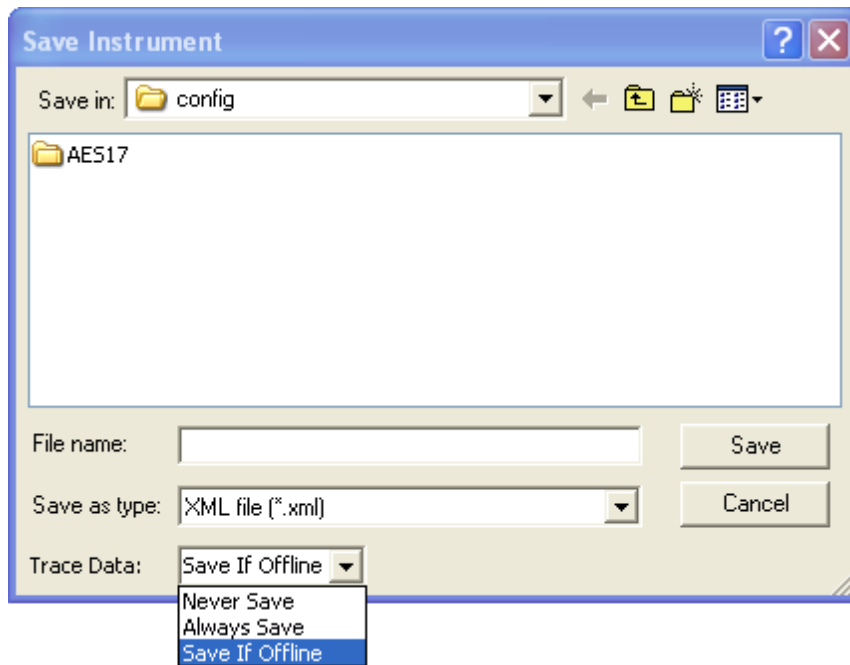

The trace data option governs how SR1 will save data stored in graphs. "Never Save" means that no graph data will be saved along with the configuration file. The file, in this case, is a pure "settings" file. "Always Save" means that all graph data, including live measurements, will be saved with the configuration file. "Save if Offline" means that only offline graph data, such as reference curves or limits, will be saved with the configuration.

2.1.2 Save Partial Configuration

Selecting **File** → **Save Partial Configuration** allows a choice of which portions of the instrument setup will be saved to the SR1 configuration file. After selecting this option, the Save Partial Configuration dialog box is displayed.

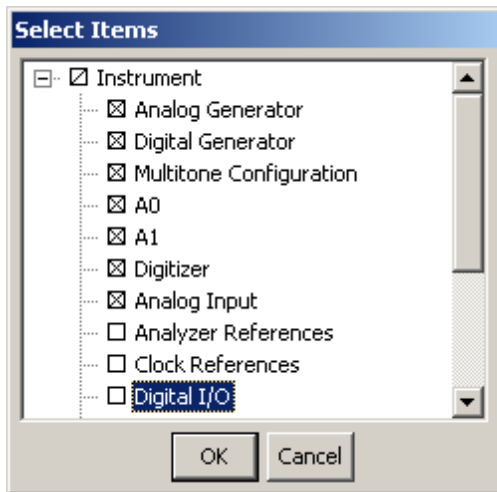

Select the portions of the instrument configuration to save and click "OK" to display the standard SR1 file save dialog box.

2.1.3 Load Configuration

File→Load Configuration loads the instrument's configuration based on the values found in the file selected with the standard Windows file open dialog box. After selecting the file, a dialog is displayed allowing selection of individual configuration areas. The default is to load all the configuration information in the file. Only configuration areas found in the selected file have a clickable checkbox, the rest are grayed out.

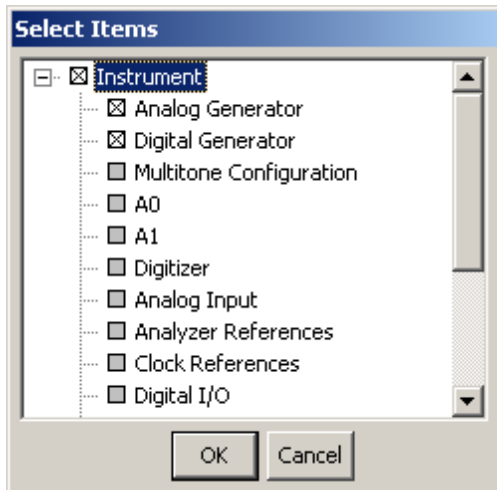

Select the portions of the instrument configuration to load and click "OK".

2.1.4 Print SR1 Screen

File→Print SR1 Screen prints the full main window of the program, including menus and borders, to the current printer. Printer and paper options are selected from the **File→Print Setup** dialog. Note that **File→Print SR1 Screen** always prints the entire screen exactly as it appears. Other options are available for more formatted printing and exporting of data from [displays](#).

2.1.5 Print Setup

File→**Print Setup** displays the standard Windows print setup dialog box.

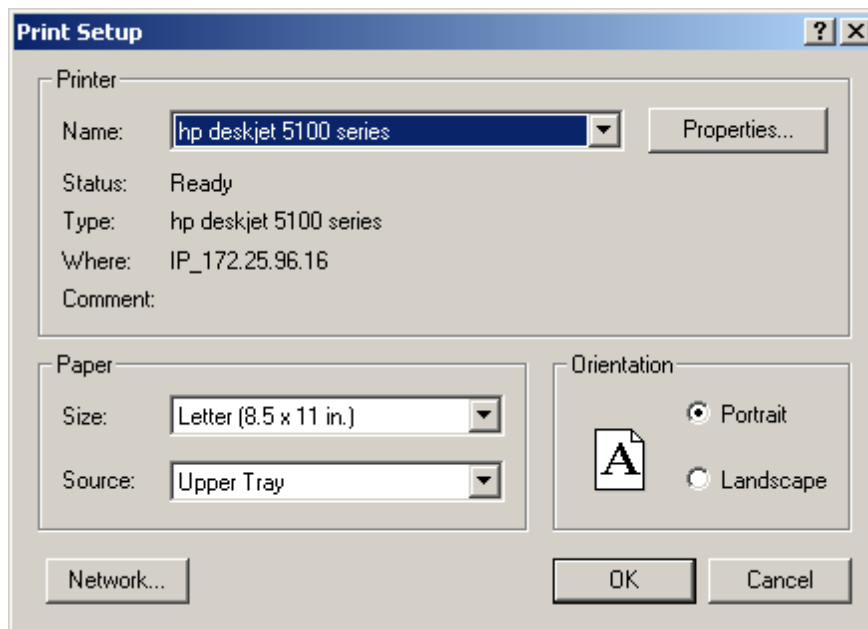

When running the SR1 program from a Windows computer, use whatever printers have already been installed. When using the SR1 instrument, use the [Tools](#) menu to connect SR1 to a network and install and configure network printers.

2.2 Edit Menu

The Edit menu supplies the standard Windows editing functions: Cut, Copy, Paste, and Delete.

Cut	Deletes the currently selected text and copies it to the clipboard.
Copy	Copies the currently selected text to the clipboard without deleting it.
Paste	Copies the clipboard contents to the current cursor location.
Delete	Deletes the currently selected text without copying it to the clipboard.

Note that in addition to being useful for transferring text, the edit commands may be used to transfer Graph Traces between different [graphs](#).

2.3 Panels Menu

The Panels menu provides access to the various panels which control the operation of the instrument. SR1 panels are fixed size windows— they're not resizable. They can be minimized, maximized, or closed with the standard Windows tools: .

Multiple copies of the same panel may be maintained on different pages of the main display. In general, changes made to a panel on one page are automatically updated on the other pages.

Panels are color coded according to the domain to which they apply. Panels relevant to the digital domain have a light blue bar under the title bar

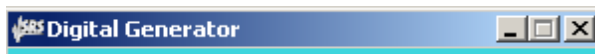

Panels which are relevant to the analog domain have an orange bar under the title.



Analyzer Panels, which can operate in either domain, have either the light blue or orange bar depending on whether the analyzer is operating in the digital or analog domain.

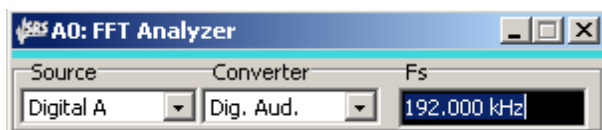

The following panel selections are available from the panels menu.

Analog Generator Panel	Controls the operation of SR1's Analog Generator.
Digital Generator Panel	Controls the operation of SR1's Digital Audio Generator.
Analog Inputs Panel	Configures the analog inputs.
Digital I/O Panel	Configures the Digital Audio Carrier Input and Output configuration.
Sweep Panel	Sets up one or two dimensional sweeps.
Settling Panel	Configure the settling parameters for sweep measurements.
Monitors Panel	Configures the source and level for the monitor outputs.
Multitone Panel	Configures the analyzer and generator settings for multitone measurements.
Clock Reference Panel	Locks the SR1 system clock to a variety of external sources.

2.3.1 Analog Generator Panel

The Analog Generator Panel controls the operation of SR1's analog generator. The generator can be populated with many different waveforms—sines, square waves, ramps, etc. Many of the waveforms can be combined by the generator. For instance, if the generator is populated with sinewave and noise, then the output will be the **sum** of the sinewave and noise signals. The amplitudes of each component of the composite signal are adjustable separately as is the overall amplitude of the combined signal. Some waveforms, (USASI noise, for instance) are special-purpose test signals and may not be combined with other waveforms.

The tabs corresponding to each particular waveform are described in [Analog Generator Waveforms](#) section. This section describes the controls and settings of the analog generator that are relevant to all waveforms.

Note that the SR1 Analog Generator is completely separate and independent of the Digital Audio Generator. The two generators operate simultaneously and independently with different waveforms.

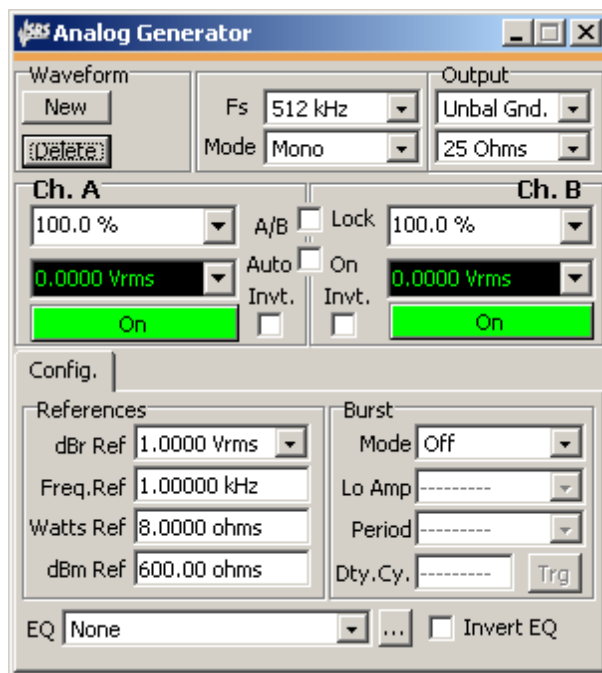

Output Controls

Fs controls the output sampling rate and D/A converter selection for the analog generator. SR1 uses two different types of D/A converters to generate high-quality analog waveforms, a 16-bit converter operating at a fixed output sampling rate of 512 kHz and a 24-bit converter which operates at a variety of sampling rates. Each converter has advantages depending on the specific application. See the [Specifications](#) section for detailed information on each of the converters.

512 kHz	Selects the Hi-Bandwidth 16-bit converter operating at a fixed output rate of 512 kHz. This setting allows a maximum waveform frequency of 200 kHz.
128 kHz	Selects the Hi-Resolution 24-bit converter operating at a fixed sample rate of 128 kHz providing a maximum waveform frequency of 57.6 kHz
64 kHz	Selects the Hi-Resolution 24-bit converter operating at a fixed sample rate of 64 kHz

	providing a maximum waveform frequency of 28.8 kHz
OSR	Synchronizes the sampling rate of the analog generator to the digital audio output sampling rate set in the Digital I/O panel. This setting is useful for performing cross-domain measurements using the FFT Chirp waveform or Multitone techniques. Maximum waveform frequency is 45% of the digital audio sampling rate.
ISR	Synchronizes the sampling rate of the analog generator to the sample rate of the received Digital Audio signal. Maximum waveform frequency is 45% of the digital audio sampling frequency.

Mode controls the output mode of the Analog Generator.	
Mono	The same waveform is output to both the A and B channels. The amplitude of each channel is still separately adjustable, but the waveform is the same.
Stereo	Each channel can be configured with a different waveform.

Output Configuration selects the output connector configuration. (See the diagram below)	
Unbal Gnd.	Outputs to the both the XLR and BNC connectors. The BNC shield and XLR pin 3(-) are connected to chassis ground through a 5Ω resistor. XLR pin 1 is connected directly to chassis ground. The BNC center pin and XLR pin 2 both are connected to the unbalanced signal.
Unbal Float	Outputs to the both the XLR and BNC connectors. The BNC shield and XLR pin 3(-) are connected to chassis ground through a high impedance (~100k, 1uF). XLR pin 1 is connected directly to chassis ground. The BNC center pin and XLR pin 2 both are connected to the unbalanced signal.
Bal Gnd.	Outputs to only the XLR connectors. XLR pin 1 is connected directly to chassis ground. XLR pins 2(+) and 3(-) carry the balanced signal which is symmetric around chassis ground.
Bal Float	Outputs to only the XLR connectors. XLR pin 1 is connected directly to chassis ground. XLR pins 2(+) and 3(-) carry the balanced signal which is unreferenced to chassis ground.
Bal Common	Similar to Balanced Ground except that the same signal is present on pins 2 and 3. This allows testing the Common Mode Rejection Ratio of external devices.

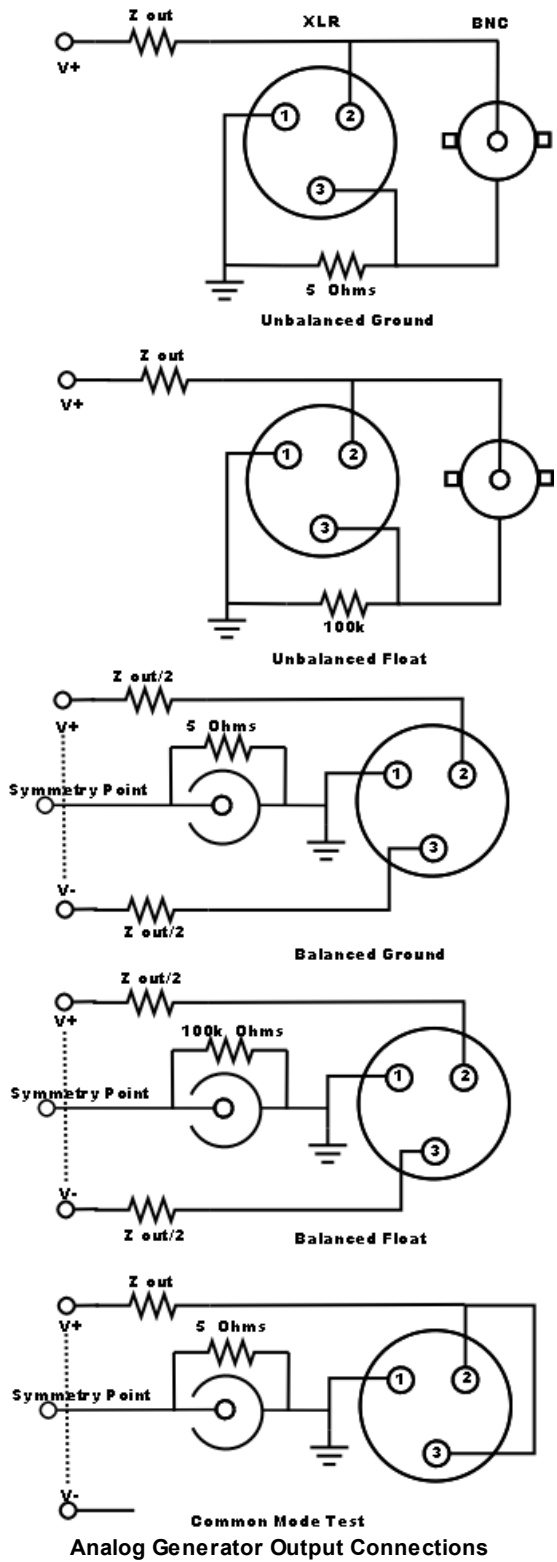

Output Impedance selects the Analog Generator output impedance.

25Ω, 75Ω, 600Ω	Allowed impedance values for unbalanced outputs
50Ω, 150Ω, 600Ω	Allowed impedance values for balanced outputs

Waveform Controls

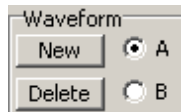

The **New** button displays the Waveform Selection Submenu.

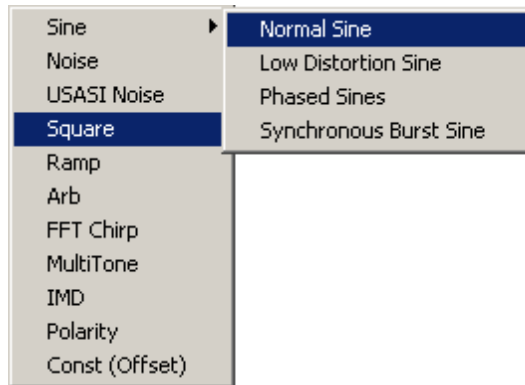

The selected waveform will either be added to the output for one or both channels depending on the **Mode** setting. Certain waveforms (for instance Low Distortion Sine) cannot be combined with other waveforms. When one of these waveforms is selected all of the current waveforms are deleted. Other waveforms simply add to the current output when selected.

The **Delete** button deletes the currently selected waveform.

The **A/B** selection buttons only appear when the generator **Mode** is set to **Stereo**. The buttons determine which channel a newly added waveform will appear on. When the mode is changed to stereo, any waveforms present will be assigned to channel A. When the mode is changed from stereo to mono, all channel B waveforms are deleted and the channel A waveforms are output on both channels.

Amplitude Controls

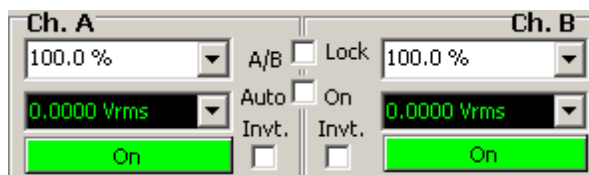

The **Channel Gain** control varies modifies the total output amplitude for the channel from 0% to 1000% of the sum of the waveform amplitudes for that channel. The **Total Channel Amplitude** control displays that value. For instance, if the channel has 2 sine waveforms, one with an amplitude of 1 Vp, and the second with an amplitude of 3 Vp, and if the **Channel Gain** control is set to 50%, then **Total Channel Amplitude** will display 2 Vp. In general, The A and B channels can have separate **Channel Gains**, however, if the **A/B Lock** checkbox is checked, the A and B values are always the same. If the sum of the waveform amplitudes exceeds the maximum output voltage of the generator, then the Channel Gain will automatically adjust to a value such that the total output amplitude remains within range.

Auto-On affects the behavior of the generator output during a [sweep](#). If **Auto-On** is checked the

generator output will automatically turn on (if it was off) at the beginning of a sweep and turn off when the sweep is completed.

The large green/red **On/Off** buttons turn on and off their respective channels, while the **Invert** buttons invert the output for each channel.

Reference Controls

The Reference controls allow setting several parameters used in the computation of different generator amplitude units. See the Generator Units section for a complete description of all these units. Note that there is one set of references for both generator channels.

Burst Controls

The SR1 Analog Generator implements two different types of burst functionality. Synchronous Burst provides a burst sine wave with a variety of triggering options where the burst transitions are guaranteed to be synchronous with the zero crossings of the sine wave. This type of burst is implemented in SR1 as a separate waveform. SR1 also offers the capability of bursting **any** waveform that can be configured in the generator, although with no guarantee that bursting will occur at zero-crossings. This type of burst will be referred to as "generator burst" as opposed to synchronous burst.

Generator Burst Mode selects the burst triggering mode	
Timed	The waveform outputs at the high amplitude then the low amplitude and repeats. The total period is determined by the Burst Period control. The high-amplitude fraction of the period is determined by the Burst Duty Cycle.
Gated (hi)	The waveform amplitude is determined by the TTL gating signal applied to the rear-panel TTL burst trigger input. When the external signal is high the generator output is at the high amplitude, when the external signal is lo the generator runs at the lo amplitude. Burst Period and Burst Duty Cycle are ignored.
Gated (lo)	The waveform amplitude is determined by the TTL gating signal applied to the rear-panel TTL burst trigger input. When the external signal is lo the generator output is at the high amplitude, when the external signal is high the generator runs at the lo amplitude. Burst Period and Burst Duty Cycle are ignored.
Shaped	Similar to Timed Burst except that a cosine-squared window is applied to the signal through the "hi" portion of the burst.
Triggered	The output is zero until a TTL rising edge is detected at the rear panel burst trigger input. The output then goes high for the interval specified by Burst Period .

Lo Amp selects the lo burst amplitude as a fraction of the original generator amplitude. For Triggered

Bursts the lo amplitude is fixed at zero.

Burst Period controls the duration of triggered bursts and the total on/off period for Timed and Shaped bursts.

Burst Duty Cycle controls the fraction of the burst period during which the generator output is at the hi amplitude.

EQ Controls



Certain waveforms can have their amplitudes scaled as a function of frequency according to the information contained in an **EQ File**. EQ files are XML files which specify a relative frequency response as a function of frequency by either interpolating a table of (frequency, response) pairs or by calculation from a set of pole and zero locations. The structure of EQ Files is detailed in the [File Reference](#) section.

Use the  button to open a file dialog to specify the EQ File. Check the Invert EQ box to have the amplitude scaled by the inverse of the EQ file response. Waveforms that are capable of being used with EQ files will have an "EQ" checkbox in their waveform tab. This box must be checked for EQ to be active regardless of whether an EQ file is selected in the file selection control. When an EQ file is selected and the checkbox is checked the amplitude control in the waveform tab will continue to show the constant user-selected waveform amplitude, however, the Total Channel Amplitude control will display the amplitude with the EQ response included.

2.3.1.1 Analog Generator Units

The amplitude and frequency of generator waveforms can be specified using a variety of units all of which are useful in different audio test scenarios. Because of the large number of waveforms that SR1 can generate and because it's useful to define amplitude in a way that simplifies the coupling between the details of the waveform and its amplitude, SR1 uses the following two conventions for analog generator amplitudes:

1. Analog generator amplitudes, regardless of the waveform or the units they are expressed in, refer to the peak value of the waveform. When waveforms are combined in the generator, the amplitudes add simply, regardless of the phase relation of the waveforms.
2. RMS units always, regardless of waveform, have the same relation to peak units that they do for a sine wave.

Thus, a square wave with instantaneous amplitude of $\pm 1V$ is said to have an amplitude of 1 Vp, or .707 Vrms even though this is not the actual value of the RMS amplitude derived from a computation. While this may seem counterintuitive it simplifies the specification of amplitude units and is the convention used by most audio test equipment.

The following table describes the units available for setting the amplitude of analog generator waveforms.

Unit	Description
Vp	Volts Peak, or simply volts. (The p is added to reduce ambiguity with other volt-oriented units) An analog waveform with an amplitude of 1 Vp has an instantaneous peak value of 1 Volt.
Vrms	A sine wave with an amplitude of 1.414 Vp has an RMS amplitude of 1 Vrms. In SR1,

Unit	Description
	Vrms and Vp always have this fixed relationship. Irrespective of waveform, $1 \text{ Vrms} = 1.414 \text{ Vp}$.
Vpp	Similar to rms, Vpp (Volts peak-to-peak) has the same relation to Vp that it does for a sine wave. Thus, $1 \text{ Vpp} = .5 \text{ Vp}$.
dBVrms	Decibels relative to 1 Vrms. A signal with an amplitude of -20 dBVrms has a peak amplitude of 100 mVrms or 141.4 mVp.
dBu	Decibels relative to 0.7746 Vrms. Note that even though historically the value of 0.7746 Vrms was chosen because it represents the voltage required to dissipate 1 mW in a 600 Ω load, in SR1 dBu specifies an open-circuit voltage without regard to the actual load connected to the output.
dBr	Decibels relative to the dBr Reference specified in the References Box .
dBm	Decibels relative to 1 mW into a load specified by the dBm Reference in the References Box . Specifying the waveform amplitude in dBm asks SR1 to set the amplitude necessary to deliver a certain amount of power to a specified load taking into account the output impedance of the generator. If the amplitude is measured across the open-circuited output terminals with a high-impedance meter, you may get a different result.
W	Watts into a load specified by the dBm Reference in the References Box . Specifying the waveform amplitude in dBm asks SR1 to set the amplitude necessary to deliver a certain amount of power to a specified load taking into account the output impedance of the generator. If the amplitude is measured across the open-circuited output terminals with a high-impedance meter, you may get a different result.

	The value of "0" has no exact representation in dB units. When a generator amplitude of 0 is shown in a control displaying dB units the value "-1000 dB" is shown (which may display as "-1.0 kdB"). This is not meant to imply an actual value of negative 1000 dB but merely to provide a convenient way to represent 0 in dB units.
---	--

Analog Generator Frequency Units

The following table describes the units used by SR1 in setting the frequency of digital generator waveforms. All frequency units except Hz make use of the Frequency Reference which is set in the [References Box](#) on the Analog Generator Panel.

Unit	Description
Hz	The fundamental unit of frequency. $1 \text{ Hz} = 1 \text{ cycle-per-second}$.
F/R	Ratio relative to the Frequency Reference. A value of 3 F/R with reference of 2 kHz gives a waveform frequency of 6 kHz.
dHz	Difference relative to the Frequency Reference. A value of 500 dHz with a reference of 2 kHz gives a waveform frequency of 2.5 kHz.
%Fref	Percent of the Frequency Reference. A frequency value of 50 %Fref with a reference value of 10 kHz gives a waveform frequency of 5 kHz.
cents	A "cent" is a logarithmic unit which represents 1/100 of a semitone of the musical scale. 12 semitones make up an octave. Thus a cent is 1/1200 of an octave.
octaves	An octave is a factor of 2 in frequency. Thus, a frequency value of 3 octaves with a reference of 1 kHz gives a waveform frequency of 8 kHz.

Unit	Description
decades	An decade is a factor of 10 in frequency. Thus, a frequency value of 2 decades with a reference of 2 kHz gives a waveform frequency of 200 kHz.

2.3.1.2 Analog Generator Waveforms

SR1's Analog Generator is capable of generating an enormous variety of different audio waveforms, from simple ultra- lo-distortion sines to complex synchronous multitone waveforms. Because of its unique architecture which allows different waveforms to be combined the generator offers almost limitless flexibility in providing the perfect audio test output. In this section each waveform, the building blocks of the generator output, will be described in detail.

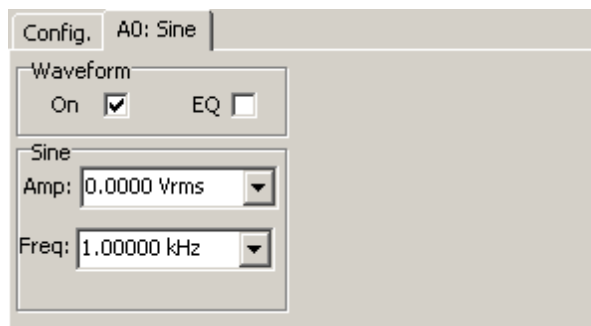

Sine Waveform Tab

When a waveform is added to the generator output using the Waveform Controls, the associated waveform tab shows up on the generator panel. For instance, the Sine Waveform tab is shown above. If the Generator is in the stereo output mode (separate waveforms for each channel) the tab title contains a channel designator indicating which channel the waveform is associated with. If the generator is in mono output mode, the channel designator is omitted and the title contains just the name of the waveform. Some of the controls found on the waveform tabs are common to many waveforms. These will be described first to avoid repetition.

Controls Common to Most Waveforms

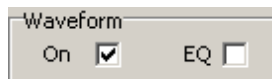

The **Waveform On** checkbox turns the selected waveform on and off. If the selected waveform is currently the only waveform in the generator, checking and unchecking this box has the same effect as turning on and off the generator using the [Amplitude Controls](#) or by simply setting the waveform amplitude to zero and back. When the generator is outputting a combined waveform this checkbox allows the selected waveform to be toggled on and off while still outputting the remainder of the waveforms.

The **EQ** checkbox appears for only certain waveforms. If EQ is checked, and an EQ file is selected on the generator panel, the actual generated amplitude for the waveform will be the nominal amplitude multiplied by the frequency response of the EQ file at the current frequency.

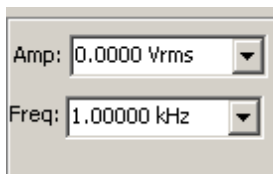

The **Waveform Amplitude** control sets the peak amplitude of most waveforms.

The **Waveform Frequency** control sets the frequency of many waveforms.

Generator Trigger

Certain generator waveforms can generate a trigger, known as a "generator trigger" which can be used by the analyzers to synchronize the analyzer to a certain portion of the waveform. Triggering is a complex subject (which is fully described in the [Analyzers](#) section), and there are many different possible analyzer trigger sources besides generator trigger, so in this section the discussion will be limited to those waveforms that provide generator triggers, and where in the waveform the trigger generated. When the generator is configured with multiple waveforms, the first waveform which is generator-trigger capable will be the source of all generator triggers.

The Analog Generator Waveforms

In the following list, waveforms that may not be combined with other waveforms are marked with an asterisk (*) next to their names.

Normal Sine

Low Distortion Sine*

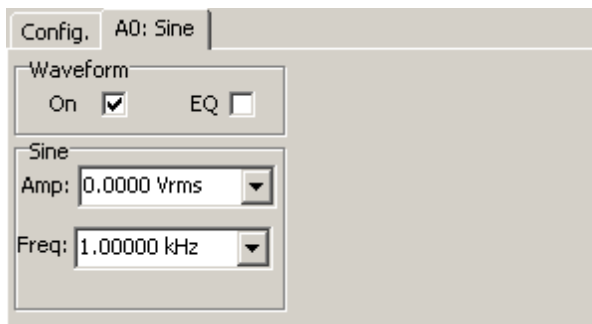

The sine wave is the most basic audio test waveform. Sine waveforms are specified only by their amplitude and frequency. The Normal Sine waveform may be combined with other waveforms. The Low Distortion Sine waveform uses additional signal processing to obtain ultra-low distortion sine waves. Because this extra signal processing would interfere with other waveforms, the Low Distortion Sine may not be combined with other waveforms.

Low Distortion Sine and Phase

Due to the additional signal processing used to obtain ultra low distortion outputs, significant ($\sim 10^\circ$) phase differences may exist between the A and B channel outputs when the low distortion waveform is selected. For this reason it is not recommended to use low distortion sine for testing phase.

Phased Sine*

Config. Phased Sine

Waveform
On EQ

Sine
Amp: 0.0000 Vrms
Freq: 1.00000 kHz
Phase: 0.0000 °

The phased sine waveform consists of two sines, one on channel A and one on Channel B with a specified phase difference between them. This waveform may not be combined with other waveforms.

Synchronous Burst Sine*

Config. Synch Burst Sine

Waveform
On EQ

Sine
Amp: 0.0000 Vrms
Freq: 1.00000 kHz

Burst
Type: Internal
Rep. Rate: 10.00 cyc
On Time: 2.000 cyc
Lo Amp: 10.00 %

The synchronous burst sine is a sinewave capable of fast switching between two amplitude levels. Amplitude shifts occur synchronously with the zero-crossings of the sinewave. In addition to the standard amplitude and frequency controls, the Synchronous Burst Sine tab contains several controls which govern the burst options:

Burst Type selects the burst triggering mode	
Internal	The sine output alternates between the hi and lo amplitudes Both the hi and lo intervals are integer numbers of cycles of the sine. The total period is determined by the Burst Rep. Rate control. The Hi amplitude interval is determined by the Burst On Time control.
Ext. Gated	The waveform amplitude is determined by the TTL gating signal applied to the rear-panel TTL burst trigger input. When the external signal is high the generator output is set to the high amplitude, when the external signal is lo the generator switches to the lo amplitude. Amplitude switching is performed synchronous with the sine zero-crossings regardless of the actual moment at which the external gating signal switches.
Ext. Triggered	The output is at the lo amplitude until a TTL rising edge is detected at the rear panel burst trigger input. At the next zero crossing the output then goes high for the number of cycles specified by Burst On Time .

Burst Repetition Rate is only valid for internal bursts. It sets the total on/off period of the burst cycle. The rate may be entered as a number of cycles, a frequency, or a time interval. In the latter two cases the value will be rounded to the nearest integer number of cycles.

Burst On Time. For internal bursts, Burst On Time specifies the number of cycles the sine is at the

high amplitude during the burst cycle. For externally triggered bursts the Burst On Time specifies the number of cycles the sine is output at the high amplitude following a trigger.

Lo Amplitude specifies the burst "Lo Amplitude" as a fraction of the nominal waveform amplitude.

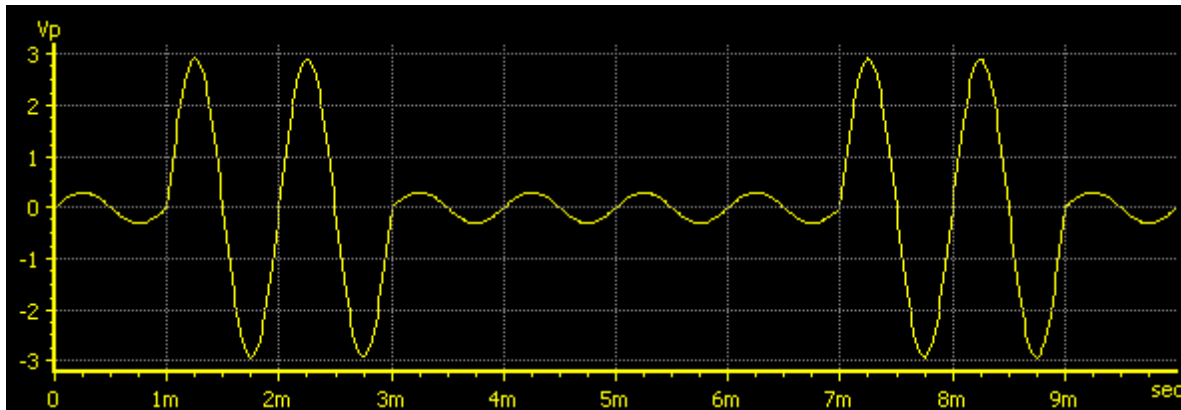

Synchronous Burst Sine, Repetition Rate = 6 cycles, Burst On Time = 2cycles

The green burst indicator will flash when the burst is triggered in either the Ext. Gated or Ext. Triggered modes. The red burst error indicator will flash in the externally triggered mode to indicate a rate error condition.

Noise

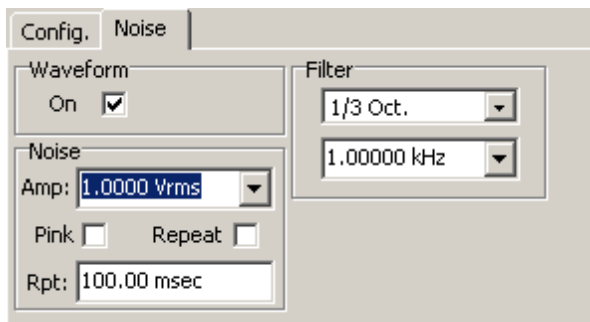

The noise waveform outputs random noise with an almost-gaussian amplitude probability density function with several options. (A true gaussian probability density function has finite probability for any amplitude, no matter how large, which is impractical for a physical device.)

Amplitude controls, as with all SR1 waveforms, the peak value of the noise output. The crest factor of the noise waveform, the ratio of the peak value to the rms value of the noise, is approximately 4.

The **Repeat** checkbox governs the repetition interval of the generated noise. If not checked the repeat interval is sufficiently long that it won't be observable under most conditions. If, however, it is desired for the noise to repeat after a fixed interval, check the Repeat box and enter the Repeat interval below it. If Repeat is selected, the noise waveform produces a generator trigger each time a waveform repeat is initiated.

The **Pink** checkbox specifies that the noise output should be filtered by a 3 dB/octave "pinking" filter. While the power contained in a white noise signal is linearly proportional to the measurement bandwidth, pink noise will have equal power in equal logarithmic frequency intervals, e.g. the power contained in the 100 Hz to 200 Hz interval will be the same as the power contained in the 10 kHz to 20 kHz interval.

White or Pink noise can be further filtered according to the controls in the filter group.

Noise Filter	
None	White or Pink noise is directly output without further filtering.
Lowpass	The white or pink noise is filtered with a 4th order Butterworth lowpass filter at the frequency specified in the filter frequency control.
Highpass	The white or pink noise is filtered with a 4th order Butterworth hipass filter at the frequency specified in the filter frequency control.
1/3 Octave	The white or pink noise is filtered with a 4th order 1/3 octave bandwidth Butterworth bandpass filter at the frequency specified in the filter frequency control.

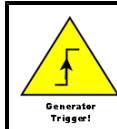

The noise waveform outputs a generator trigger when only when "Repeat" is checked. The trigger occurs each time the waveform is repeated.

MLS Noise

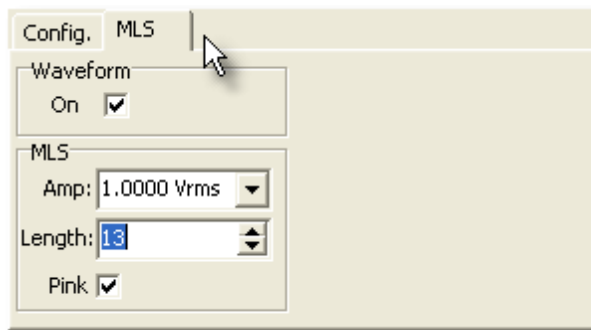

The MLS noise waveform outputs a Maximum Length Sequence with a specified repetition interval and frequency profile. MLS waveforms are typically used as a stimulus in impulse response measurements where several special properties of the MLS (the autocorrelation of an MLS sequence is a delta function) simplify the calculation of the impulse response. Because SR1 uses a full 2-channel FFT analyzer to make impulse response measurements it is not necessary to use MLS noise as a stimulus— any broadband signal will work. Nevertheless SR1 includes the MLS waveform because of its historical association with impulse response measurements.

Amplitude controls, as with all SR1 waveforms, the peak value of the noise output. The crest factor of the MLS waveform, which is essentially a square wave, is close to 1.

The **Length** selection controls the length of the MLS sequence. Selecting "13," for example, chooses an MLS sequence whose repetition interval is $2^{13}-1$ samples.

The **Pink** checkbox specifies that the noise output should be filtered by a 3 dB/octave "pinking" filter. While the power contained in a white noise signal is linearly proportional to the measurement bandwidth, pink noise will have equal power in equal logarithmic frequency intervals, e.g. the power contained in the 100 Hz to 200 Hz interval will be the same as the power contained in the 10 kHz to 20 kHz interval.

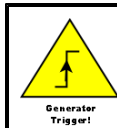

The MLS noise waveform outputs a generator trigger each time the MLS cycle repeats.

USASI Noise*

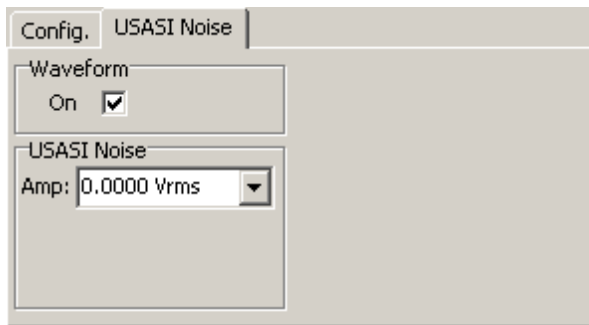

USASI noise is a special type of filtered noise designed to mimic the content of audio program material. USASI noise is typically used in testing broadcast transmitters to measure compliance with transmission bandwidth requirements. Because the frequency content of USASI noise is fixed, only an amplitude control appears on the waveform tab. USASI noise may be used in conjunction with generator [bursting](#) to generate a burst USASI signal suitable for transmitter testing.

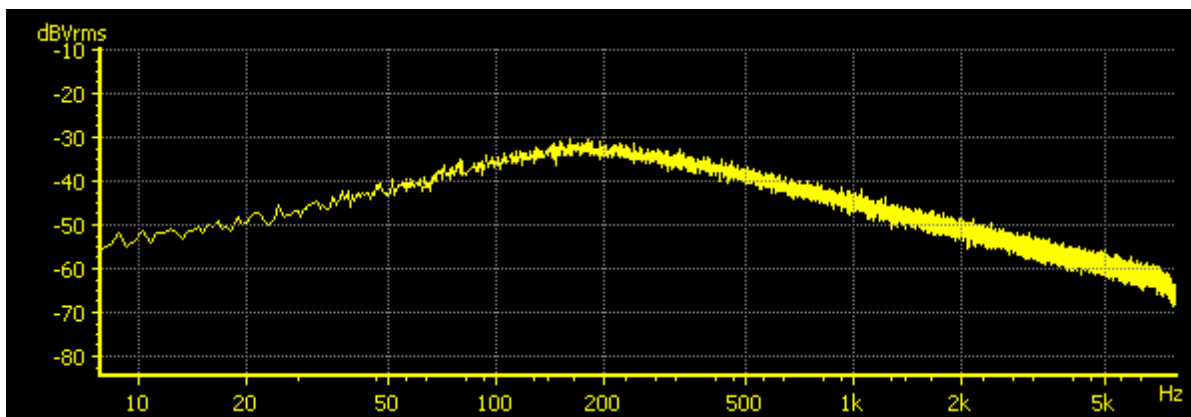

Frequency Spectrum of USASI Noise: 100 Hz 6dB/oct hipass + 320 Hz 6 dB/oct lopass

Square Wave*

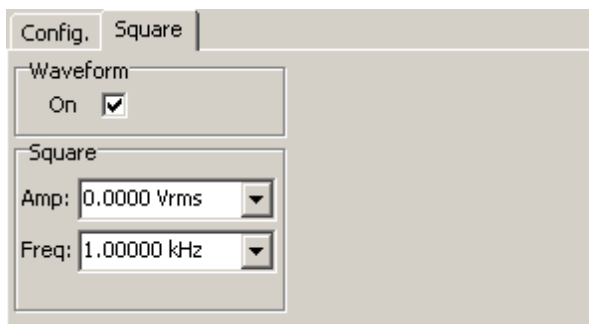

SR1 square waves uses special hardware to generate clean analog square waves. As a result, square waves may not be combined with other waveforms in the analog generator. The square wave frequency is limited to a maximum of 50 kHz regardless of the selected analog generator sampling rate. Because of the finite bandwidth of the analog generator, square waves will have finite risetime and overshoot depending on the frequency and the selected D/A converter.

Ramp

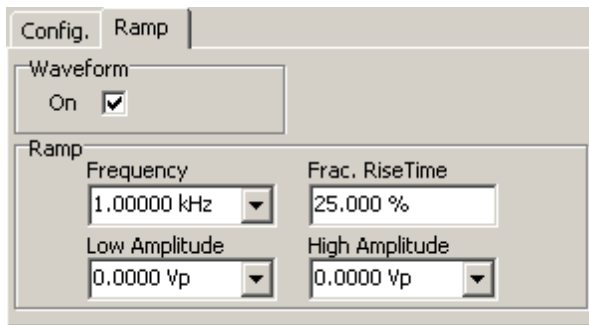

The ramp waveform consists of repetitive runs of integer numbers of "rising" and "falling" samples to produce triangle-like output waveforms. Because the runs are restricted to integer number of samples, the Ramp Frequency and Ramp Fractional Rise Time have limited resolution which is a function of the selected generator sample rate. The lowest amplitude sample has the value assigned in the **Low Amplitude** control. The highest amplitude sample has the value given in the **High Amplitude** control.

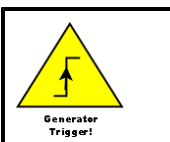
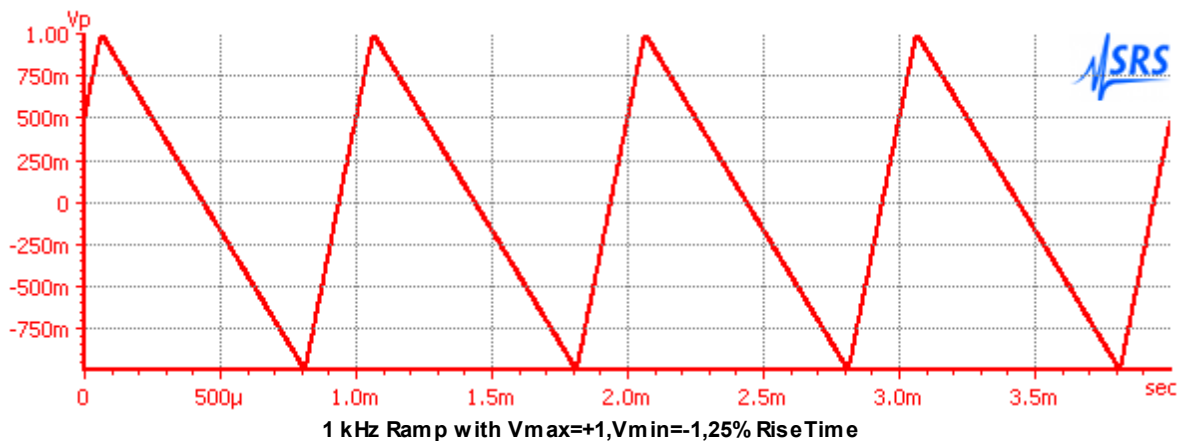

The ramp waveform generates a generator trigger each time the ramp begins its rising segment.

Arbitrary Waveform

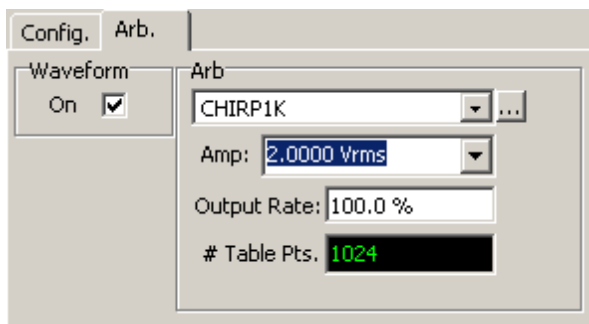

The arbitrary waveform plays a sequence of values found in a user supplied table. Arbitrary waveform files are simple ASCII files with one or more columns of floating point numbers representing the values of the

arbitrary waveform at each sampling interval.. Use the  button to open a file dialog to select an arbitrary waveform file. If multiple columns are detected in the file, SR1 displays a dialog asking which column to load. The number of points read from the table is then displayed in the corresponding control.

The amplitude entered in the Arb amplitude control is assigned to the maximum value found in the table. The absolute scaling of the table values does not affect the output waveform. Thus the following table of values in the file:

0, 0.1, 0.2, 0.3, 0.4, 0.5,

produces a linear ramp from 0 to 2.0 Vrms if the amplitude control is set to 2.0 Vrms. The maximum amplitude for arbitrary waveforms is half that of sinewaves due to the fact that non-bandlimited arbitrary waveforms may exhibit overshoot.

The Output Rate control governs how fast table points are output. At 100% the output rate is 1 table point per output sample. At 200% the generator skips a table point and outputs every other table point each output sample. For fractional output rates the waveform is interpolated. So at 50% Output Rate the generator outputs a table point, then an interpolated point and then the next table point. Bandlimited interpolation is used where memory allows. Otherwise linear interpolation is used. A maximum table length of 128 kpoints is allowed, subject to other waveforms or instrument features using the DSP memory.

 <p>Generator Trigger</p>	<p>The arbitrary waveform generates a generator trigger each time the output returns to the beginning of the table.</p>
--	---

FFT Chirp

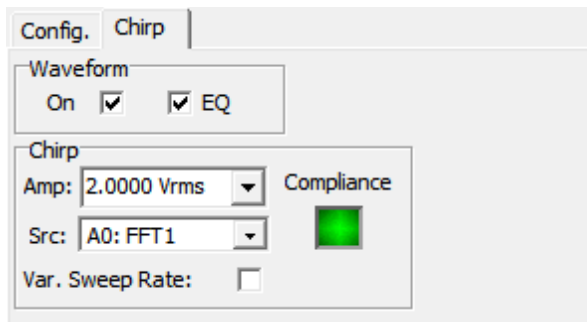

The FFT Chirp waveform is designed to work in combination with one of SR1's [FFT Analyzers](#). The chirp waveform provides a tone exactly at the bin center of each the FFT Analyzer's analysis bins. In the default case, each tone has equal amplitude, however, the Chirp waveform can be used with [generator EQ](#) to generate chirp signals with custom tailored frequency response.

Chirp signals are useful for quickly measuring the frequency response of a device under test. Unlike noise signals which are not deterministic and require long averaging times to measure frequency response, a chirp signal can precisely measure frequency response in a single FFT record.

The Chirp waveform is synchronized to the settings of a particular FFT analyzer. If the resolution or frequency span of that analyzer changes, the chirp waveform automatically reconfigures to provide a full set of bin-center tones. If the corresponding analyzer is set to "[show aliased lines](#)" the chirp outputs a tone in every single FFT bin, from near DC to $F_s/2$. If "show aliased lines" is off, the chirp outputs tones from near DC up to the alias limit for the analyzer's selected converter and frequency span. See the [FFT](#)

[Analyzer](#) section for more details on these topics. Because of the synchronous nature of the chirp signal, a uniform window should be selected in the analyzer when using the chirp waveform.

Selection of the associated FFT Analyzer is done with the Chirp Source control.

Chirp Source	Associated Analyzer
A0: FFT1	Analyzer 0, Single Channel FFT Analyzer
A0: FFT2	Analyzer 0, Dual Channel FFT Analyzer
A1: FFT0	Analyzer 1, Single Channel FFT Analyzer
A1: FFT1	Analyzer 1, Dual Channel FFT Analyzer

Synchronous chirp generation requires there to be a relationship between the selected generator sampling frequency and the associated analyzer sampling frequency. In general, the two frequencies need to be either exactly the same or some integer multiple of one another. If the generator and analyzer sampling frequencies are incompatible, the "Compliance" led will glow red and no waveform will be output. The compliance led may also show red if SR1 runs out of table memory to create a long chirp signal (say for a large number of FFT lines, or when large amounts of fft zoom are used. The chirp waveform may attempt to use interpolation in situations when not enough memory is available for the complete table, in which case the "Compliance" led will glow yellow. Some degradation of flatness can be expected in this case.

Using the chirp signal it is possible to make cross domain measurements of both amplitude and phase. For instance when testing a D/A converter a chirp can be output in the digital domain, and the D/A frequency response and phase recorded in the analog domain. To ensure cross-domain sampling rate compatibility use the following sampling rate selections for the generator and analyzer.

Type of Measurement	Generator Fs	Analyzer Fs
Analog Source, Digital Measurement (ADC)	Select Digital ISR as the analog generator Fs.	Select Digital as the Analyzer source which automatically chooses ISR as the analyzer Fs.
Digital Source, Analog Measurement (D/A)	Select the desired digital audio output frequency using the Digital I/O panel.	Select the Analog Hi-Res converter on the analyzer panel and set the Hi-Res converter Fs to Digital OSR or digital OSRx2 using the Analog Inputs panel.

Because the synchronous chirp source has a time-dependent amplitude profile, it may fool the input autoranging control into switching ranges too frequently. Depending on the FFT bandwidth (which determines the chirp length) it may be useful to turn off input autoranging when using the synchronous chirp signal.



For the same reason, be sure to select the "Uniform" window when using the synchronous chirp. Window functions attenuate the beginning and the end of the time record for the FFT analyzers which when using the chirp means that certain frequencies will be attenuated more than others. This destroys the "flat" nature of the synchronous chirp signal.

Using Chirp With Eq and Inverse Eq

By using the EQ feature of the generator it is possible to tailor a stimulus with a precisely defined frequency profile. EQ files specify a relative frequency response as a function of frequency. The format of EQ files is described in the [SR1 File Reference](#). When an EQ file is on the Configuration tab of the generator panel, the amplitude in each frequency bin will be multiplied by the frequency response of the EQ file at that frequency. If the "Invert EQ" checkbox is checked, the amplitude in each bin will be

multiplied by the inverse of the frequency response of the EQ file.

When EQ is selected with chirp, the "Variable Sweep Rate" feature is enabled. Selecting Variable Sweep Rate changes the chirp sweep rate to equalize the time domain amplitude in a chirp with variable frequency domain amplitude.

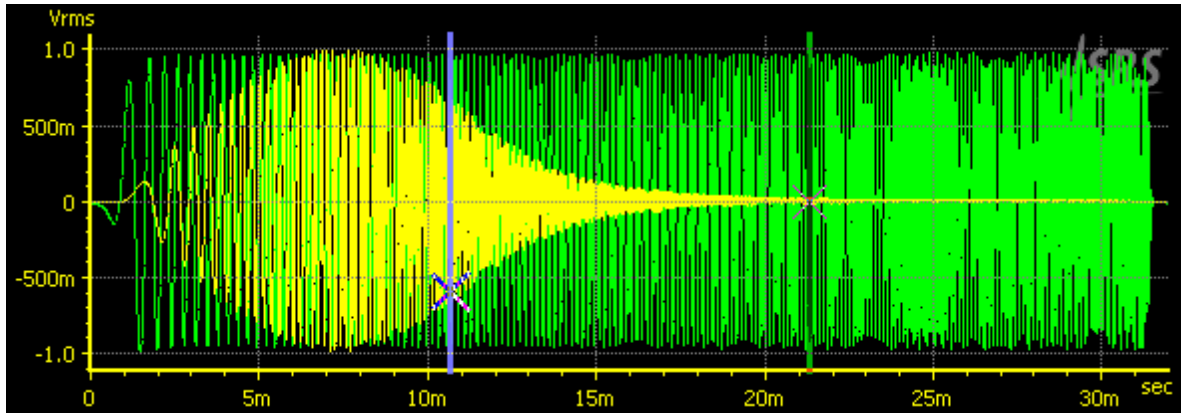

For instance, the graph above shows the time response of a chirp weighted with the CCIR EQ curve. The yellow trace was taken with Variable Sweep rate off, and the green with Variable Sweep Rate on. Even though the two chirps have identical amplitudes in the frequency domain notice how more uniform and how much lower the crest factor the variable sweep rate chirp has. The lower crest factor makes it much more suitable waveform for audio testing.

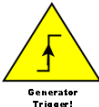

Generator Trigger!

The chirp waveform outputs a generator trigger once each cycle. Be sure to use generator trigger as the analyzer trigger source when using the chirp waveform with the FFT analyzer.

Log-sine Chirp*

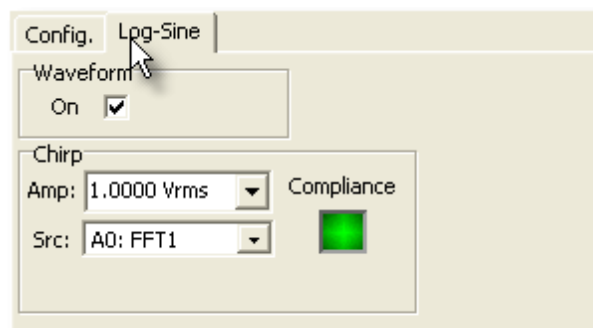

The log-sine chirp waveform is designed to work in combination the dual-channel FFT analyzer to make impulse response measurements. The log-sine chirp waveform is a sinusoid whose frequency is swept in a logarithmic fashion over the frequency span of its associated FFT analyzer. The log-sine chirp waveform has a "pink" frequency roll off of 3 dB/oct.

The log-sine chirp waveform is synchronized to the settings of a particular FFT analyzer. If the resolution or frequency span of that analyzer changes, the log-sine chirp waveform automatically reconfigures to

sweep over the frequency span of the selected analyzer. Because of the synchronous nature of the chirp signal, a uniform window should be selected in the analyzer when using the log-sine chirp waveform.

Selection of the associated FFT Analyzer is done with the Chirp Source control.

Chirp Source	Associated Analyzer
A0: FFT1	Analyzer 0, Single Channel FFT Analyzer
A0: FFT2	Analyzer 0, Dual Channel FFT Analyzer
A1: FFT0	Analyzer 1, Single Channel FFT Analyzer
A1: FFT1	Analyzer 1, Dual Channel FFT Analyzer

If the analyzer span is set to frequencies which are unreachable with the current generator sampling the "Compliance" led will glow red and no waveform will be output.



Be sure to select the "Uniform" window when using the log-sine chirp. Window functions attenuate the beginning and the end of the time record which means that some frequencies will be attenuated more than others by the window.

The advantages using log-sine chirps for impulse response measurements are detailed by Miller and Massarini ("Transfer Function Measurements with Sweeps", *J. Audio Eng. Soc.*, vol. 49, pp. 443-471, June 2001.) They report better results using log-sine stimulus compared to MLS stimulus for a wide range of audio DUTs. One particular advantage concerns the unique ability of the log-sine chirp to differentiate between the linear and non-linear portions of the DUT response. Because of the properties of the group delay of the log-sine chirp waveform, harmonic responses appear offset in time relative to the linear response. This can be clearly seen in this impulse response measurement of a consumer stereo amplifier:

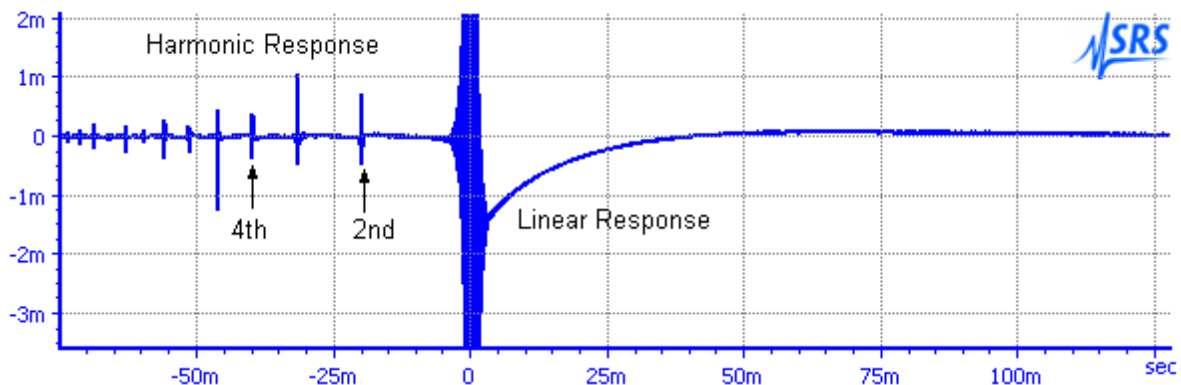

When the purely linear response is gated and transformed back into the frequency domain a much better measurement of the DUT frequency response is obtained. (This is detailed in the [FFT2 analyzer](#) discussion. See "Measurement of audio equipment with log-swept sine chirps", by Thomas Kite, *Presented at the 117th AES Convention, San Francisco, CA, October 2004* for a concise explanation of the unique group-delay properties of the log-sine chirp.)

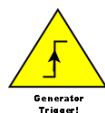

The log-sine chirp waveform outputs a generator trigger at the beginning of each FFT time record. Be sure to use generator trigger as the analyzer trigger source when using the log-sine chirp waveform with the FFT analyzer.

MultiTone*

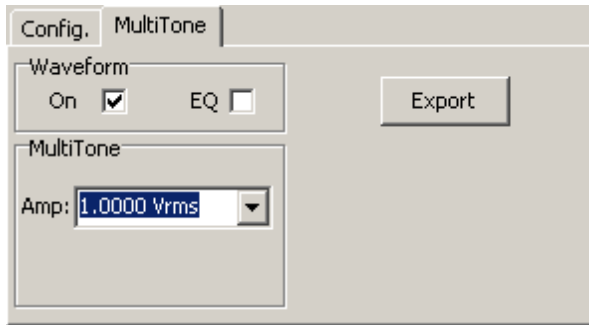

Like FFT Chirp, the MultiTone Waveform is a special waveform containing a series of tones that are generated in synchronous fashion to ensure bin-center placement in the [MultiTone Analyzer](#). Using the MultiTone generator and analyzer many different characteristics of a device—noise, distortion, frequency response, can be measured quickly and simultaneously without the need for multiple swept measurements.

All of the details of the multitone waveform— tone frequency and amplitude, phase, etc. are configured using the [MultiTone Configuration Panel](#). As a result, only the amplitude is specified on the waveform tab. The Export button allows the current multitone waveform to be saved in arbitrary waveform format for off-line analysis. Because of the special properties of the MultiTone waveform it may not be combined with other waveforms. The Multitone waveform cannot be selected from the analog generator panel unless the MultiTone configuration panel specifies the use of the analog generator.

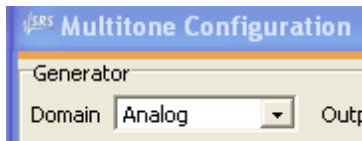

The MultiTone waveform outputs a generator trigger once each cycle. When performing multitone analysis with the local SR1 generator be sure to use generator trigger as the analyzer trigger source to ensure proper phase calibration.

IMD Waveform*

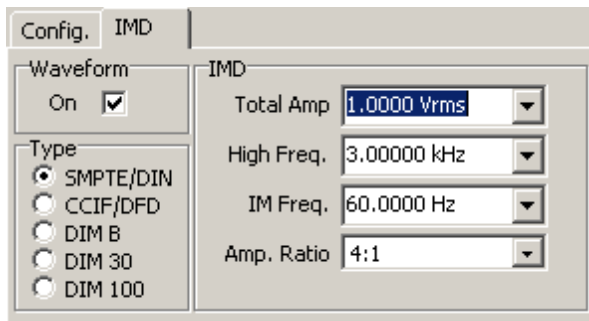

IMD Tab for SMPTE/DIN

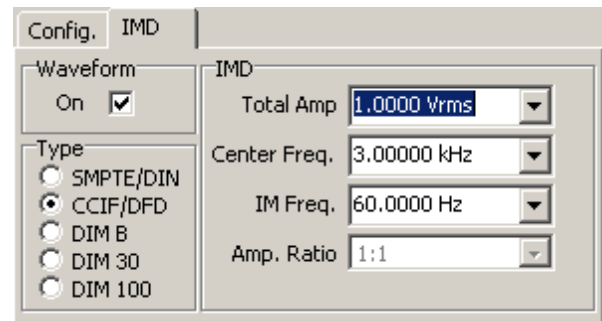

And for CCIF

The IMD Waveform can be configured to output the three classic audio IMD test signals— SMPTE, CCIF, and DIM.

IMD Type		
SMPTE/DIN	Combines a High Frequency Sinewave with a low frequency sinewave. For a generator Fs of 512 kHz the low frequency can be set between 10 Hz and 1 kHz. The High Frequency can be anywhere down to 5x the low frequency. The Amplitude Ratio (low freq/high freq) can be set to either 1:1 or 4:1 with the Amplitude Ratio control.	
CCIF/DFD	Two sines centered around the Center Frequency separated in frequency by the IM frequency. The amplitude ratio is fixed at 1:1.	
DIM B	Outputs a ~14 kHz sinewave and ~2.96 kHz squarewave. Squarewave is filtered with a single pole 30 kHz filter.	For all the DIM options the ratio of the squarewave to sinewave peak-to-peak amplitudes is 4:1. Because the squarewave needs to be "perfect" frequency, with an exactly equal number of positive and negative samples, the exact squarewave frequency is chosen by the generator, depending on the generator Fs, to be as close as possible to the squarewave frequency given by the standard. The sinewave frequency is then set in the same ratio to the squarewave frequency as would be for the signals in the standard.
DIM 30	Outputs a ~15 kHz sinewave and ~3.15 kHz squarewave. Squarewave is filtered with a single pole 30 kHz filter.	
DIM 100	Outputs a ~15 kHz sinewave and ~3.15 kHz squarewave. Squarewave is filtered with a single pole 100 kHz filter.	

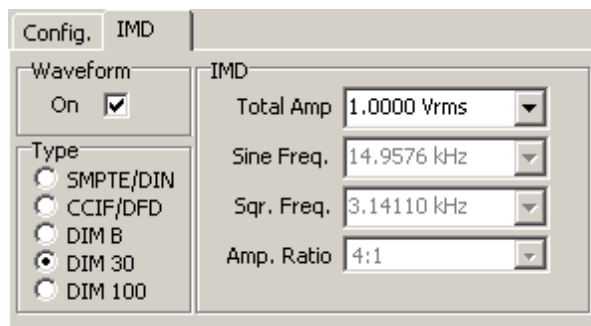

IMD tab for DIM selection

In all cases the **Total Amplitude** control sets the combined amplitude of all signals.

The IMD waveform is designed to be used with the IMD analyzer. The analyzer automatically determines the type of IMD signal is being generated and automatically configures itself for the correct analysis. See the [IMD Analyzer](#) section for more details.

Polarity Check Waveform

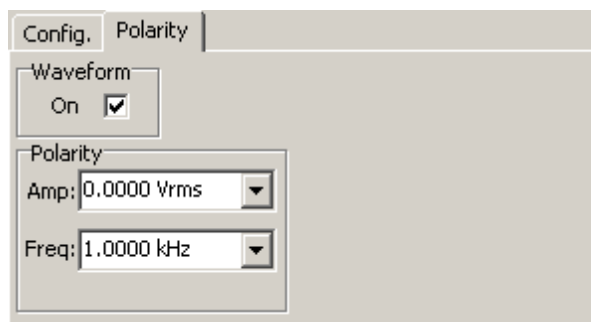

The polarity check waveform uses a phased combination of two sine waves to produce a deliberately asymmetric waveform that points "up". When this waveform is applied to a device under test it is easy to see if the device properly maintains or inverts polarity by checking the output waveform using the time record of the [FFT Analyzer](#). If the output waveform still points "up" the device maintains polarity. If the waveform points "down" the device is inverting.

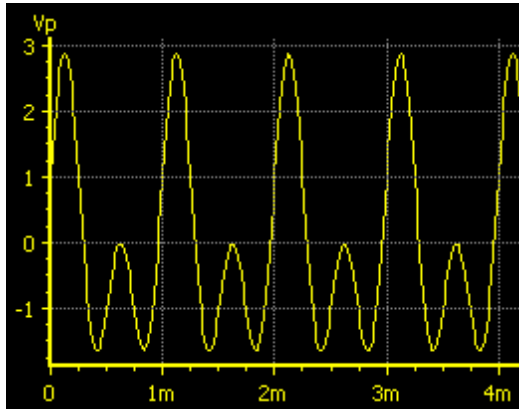

Polarity Waveform Non-Inverted

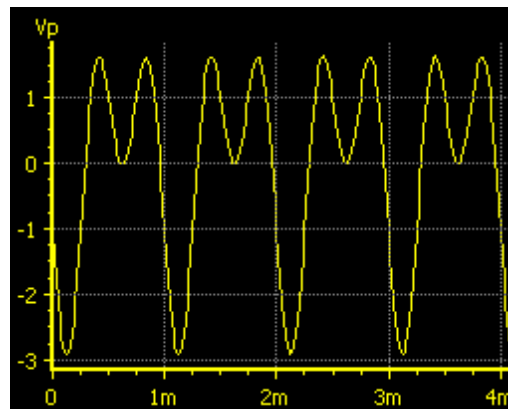

...And Inverted

Constant (Offset)

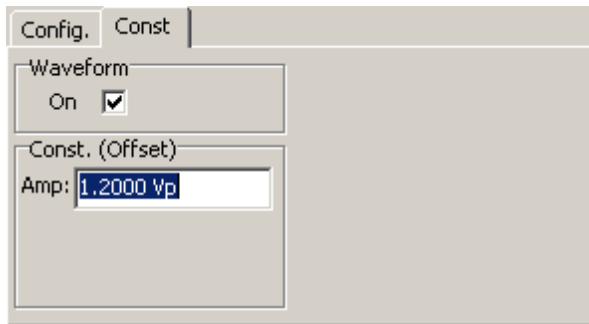

The constant waveform simply adds a DC offset to the output. The offset can be set anywhere over the full positive and negative range of the generator output. Offset waveforms take up space in the generator's D/A converter and reduce the resolution available to other waveforms. For the best distortion and noise keep the offset as small as possible.

2.3.2 Digital Generator Panel

The Digital Generator Panel controls the operation of SR1's digital audio generator. The generator can be populated with many different waveforms—sines, square waves, ramps, etc. Many of the waveforms can be combined by the generator. For instance, if the generator is populated with sinewave and noise, then the output will be the **sum** of the sinewave and noise signals. The amplitudes of each component of the composite signal are adjustable separately as is the overall amplitude of the combined signal. Some waveforms, (USASI noise, for instance) are special-purpose test signals and may not be combined with other waveforms.

The tabs corresponding to each particular waveform are described in the [Digital Generator Waveforms](#) section. This section describes the controls and settings of the digital generator that are relevant to all waveforms. Note that the controls on the generator panel and the waveform tabs are mainly concerned with the properties of the embedded digital audio output—controls which govern the properties of the digital audio carrier signal are found on the [Digital I/O](#) panel.

The SR1 Digital Generator is separate and independent from the Analog Generator. The two generators operate simultaneously and independently with different waveforms. The two generators, however, do share memory used for arbitrary waveforms and FFT chirps. Deleting an arbitrary waveform in the analog generator makes memory available for the digital generator and vice versa.

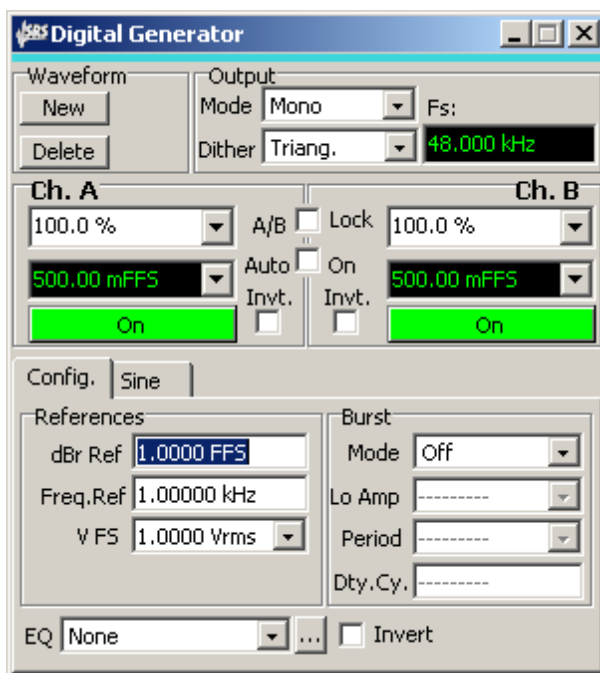

Output Controls

Mode controls the output mode of the Digital Generator.	
Mono	The same waveform is output to both the A and B channels. The amplitude of each channel is still separately adjustable, but the waveform is the same.
Stereo	Each channel can be configured with a different waveform.

Dither controls the type of dither used by the Digital Generator. The digital generator generates the waveform internally with higher precision than the maximum 24-bit digital output word. Noise with the selected probability distribution is added to the internal representation, and the result is truncated to the width specified in the Digital I/O Output Resolution control.	
Off	No dither is used in calculating the output word.
Triangular	Dither with a triangular probability distribution and a width of ± 1 lsb is added to the signal.
Rectangular	Dither with a rectangular probability distribution and a width of $\pm 1/2$ lsb is added to the signal.

Fs displays the current generator output sampling rate. This value is chosen on the [Digital I/O](#) panel.

Waveform Controls



The **New** button displays the Waveform Selection Submenu.

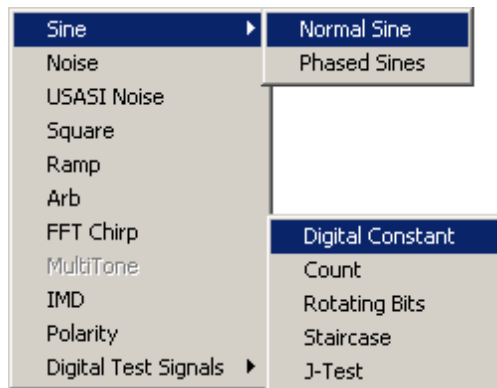

The selected waveform will either be added to the output for one or both channels depending on the **Mode** setting. Certain waveforms (for instance USASI Noise) cannot be combined with other waveforms. When one of these waveforms is selected all of the current waveforms are deleted. Other waveforms simply add to the current output when selected. See the [Digital Audio Waveform](#) section for a detailed description of all available waveforms.

The **Delete** button deletes the currently selected waveform.

The **A/B** selection buttons only appear when the generator **Mode** is set to **Stereo**. The buttons determine which channel a newly added waveform will appear on. When the mode is changed to stereo, any waveforms present will be assigned to channel A. When the mode is changed from stereo to mono, all channel B waveforms are deleted and the channel A waveforms are output on both channels.

Amplitude Controls

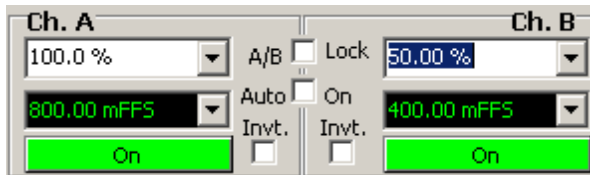

The **Channel Gain** control varies modifies the total output amplitude for the channel from 0% to 1000% of the sum of the waveform amplitudes for that channel. The **Total Channel Amplitude** control displays that value. For instance, if the channel has 2 sine waveforms, one with an amplitude of .3 FFS, and the second with an amplitude of .5 FFS, and if the **Channel Gain** control is set to 50%, then **Total Channel Amplitude** will display .4 FFS. In general the A and B channels can have separate **Channel Gains**, however, if the **A/B Lock** checkbox is checked, the A and B values are always the same. **Auto-On** affects the behavior of the generator output during a [sweep](#). If **Auto-On** is checked the generator output will automatically turn on at the beginning of a sweep (if it was turned off) and turn off when the sweep is completed.

The large green/red **On/Off** buttons turn on and off their respective channels, while the **Invert** buttons invert the output for each channel.

Reference Controls

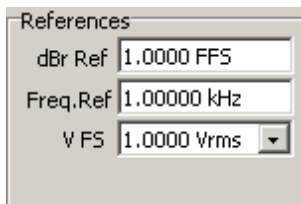

The Reference controls allow setting several parameters used in the computation of different generator amplitude units. See the Digital [Generator Units](#) section for a complete description of all these units. Note that there is one set of references for both generator channels.

Burst Controls

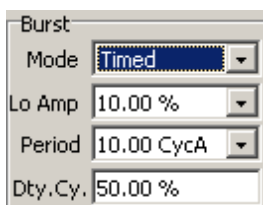

The SR1 Digital Generator implements a Timed Burst mode which switches the overall amplitude of the combined waveform output between two different values.

Burst Mode turns the burst feature on and off.

Lo Amp selects the lo burst amplitude as a fraction of the original generator amplitude.

Burst Period controls the total hi+lo period of the burst cycle. This value may be entered in seconds or in cycles of the current waveform.

Burst Duty Cycle controls the fraction of the burst period during which the generator output is at the hi amplitude.

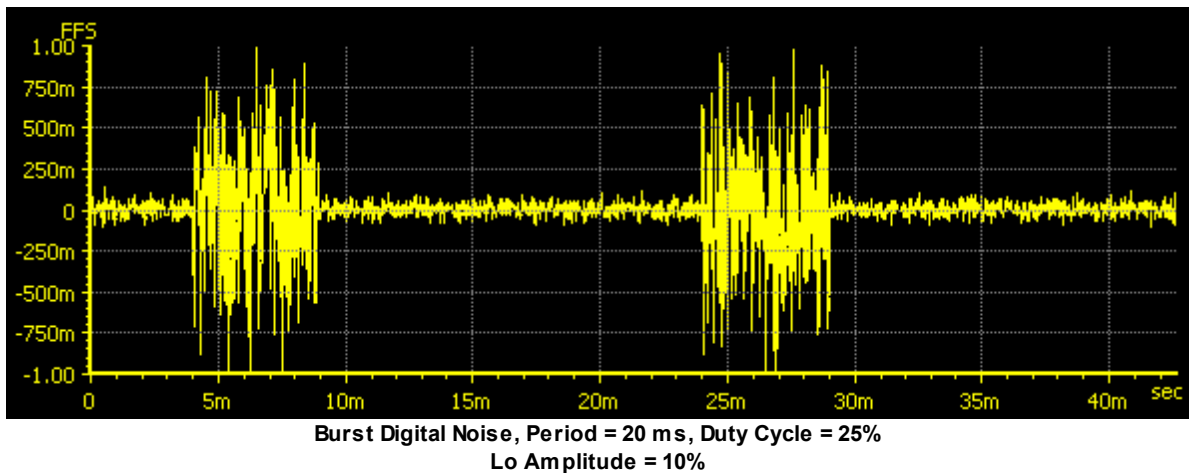

EQ Controls

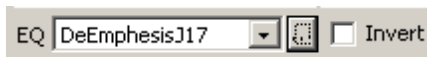

Certain waveforms can have their amplitudes scaled as a function of frequency according to the information contained in an **EQ File**. EQ files are XML files which specify a relative frequency response as a function of frequency by either interpolating a table of (frequency, response) pairs or by calculation from a set of pole and zero locations. The structure of EQ Files is detailed in the [File Reference](#) section.

Use the  button to open a file dialog to specify the EQ File. Check the Invert EQ box to have the amplitude scaled by the inverse of the EQ file response. Waveforms that are capable of being used with EQ files will have an "EQ" checkbox in their waveform tab. This box must be checked for EQ to be active regardless of whether an EQ file is selected in the file selection control. When an EQ file is selected and the checkbox is checked the amplitude control in the waveform tab will continue to show the constant user-selected waveform amplitude, however, the Total Channel Amplitude control will display the amplitude with the EQ response included.

2.3.2.1 Digital Generator Units

The amplitude and frequency of generator waveforms can be specified using a variety of units all of which are useful in different audio test scenarios. Because of the large number of waveforms that SR1 can generate and because it's useful to define amplitude in a way that simplifies the coupling between the details of the waveform and its amplitude, SR1 uses the following two conventions for digital generator amplitudes:

1. Digital generator amplitudes, regardless of the waveform or the units they are expressed in, refer to the peak value of the waveform. When waveforms are combined in the generator, the amplitudes add simply, regardless of the phase relation of the waveforms.
2. RMS and Peak-to-peak units always, regardless of waveform, have the same relation to peak units that they do for a sine wave. In other words, think of rms and peak-to-peak units as simply units with a fixed scale relative to peak units rather than as a quantity derived through a calculation on the waveform.

The following table describes the units available for setting the amplitude of digital generator waveforms.

Unit	Description
FFS	According to AES17-1998 (r2004), "Full-scale amplitude is the amplitude of a 997 Hz sine wave whose positive peak value reaches the positive digital full scale leaving the negative maximum code unused." The FFS (Fraction Full Scale) unit expresses the peak amplitude of any SR1 generator waveform relative to this definition of full-scale amplitude. When dither is on, full scale amplitude is reduced symmetrically by 1 bit to allow for dither. Small values of FFS may be expressed as mFFS (milli-FFS) or uFFS (microFFS).
%FS	Same as FFS (above) but expressed as a percentage of full-scale amplitude. 50 %FS = .5 FFS.
Vrms	This digital waveform amplitude unit is directly convertible to FFS depending on the value of the V FS (Volts Full Scale) set in the references section of the digital generator panel.. If the value of V FS is 2 Vrms, for instance, then an amplitude of 1 Vrms corresponds to an amplitude of .5 FFS. These units allow digital amplitudes to be expressed as analog voltages as is often useful when working with D/A converters where the V FS value can be thought of as the DAC's full scale output voltage.
Vp	This unit of digital wave form amplitude is convertible to FFS depending on the value of the V FS (Volts Full Scale) reference and the fixed relationship of peak voltage to rms voltage for a sine wave. If the value of V FS is 1 Vrms, for instance, then an amplitude of 1.414 Vp would correspond to an amplitude of 1 Vrms which in turn would correspond to an amplitude of 1 FFS.
Vpp	This unit of digital wave form amplitude is convertible to FFS depending on the value of the V FS (Volts Full Scale) reference and the fixed relationship of peak voltage to peak-to-peak voltage for a sine wave. If the value of V FS is 1 Vrms, for instance, then an amplitude of 2.0 Vpp would correspond to an amplitude of 1 Vrms which in turn would correspond to an amplitude of 1 FFS.
dec	The peak value of the waveform expressed as a decimal code. The conversion of decimal code to FFS depends on the setting of the Output Resolution in the Digital I/O panel. For the default 24-bit output resolution setting $1\text{FFS} = 2^{23}-1 = 8,388,607$ dec.
hex	The peak value of the waveform expressed as a hexadecimal code. The conversion of hexadecimal code to FFS depends on the setting of the Output Resolution in the Digital I/O panel. For the default 24-bit output resolution setting $1\text{FFS} = 2^{23}-1 = 0x7ffff$ hex.
dBFS	Decibels relative to the full scale amplitude definition. (See FFS above) For instance, $0.1\text{ FFS} = -20\text{ dBFS}$. ($20 \cdot \log_{10}(0.1)$)
dBV	Decibels relative to the Vrms value calculated with the V FS (Volts Full Scale) reference set in the digital generator panel. For example, with a V FS value of 2 Vrms an amplitude of -20 dBVrms corresponds to .1 Vrms which in turn corresponds to an amplitude of 0.05 FFS.
dBu	Decibels relative to 0.7746 Vrms. (Historically the value of 0.7746 Vrms represents the voltage required to dissipate 1 mW in a 600 Ω load.) If V FS is set to 1 Vrms than an amplitude of 0 dBu corresponds to 0.7746 which in turn corresponds to 0.7746 FFS.
dBr	Decibels relative to the dBr reference set in the references section of the digital generator panel. The dBr reference is always set in units of FFS. Thus, with the dBr reference set to .5 FFS, an amplitude of 0 dBr corresponds to .5 FFS.
Bits	Computed from dBFS using the relation $\text{bits} = 1.76 + (\text{dBFS}/6.02)$. For instance, half scale (-6.02 dBFS) is 0.76 bits.

Digital Generator Frequency Units

The following table describes the units used by SR1 in setting the frequency of analog generator

waveforms. All frequency units except Hz make use of the Frequency Reference which is set in the References Box on the [Digital Generator Panel](#).

Unit	Description
Hz	The fundamental unit of frequency. 1 Hz = 1 cycle-per-second.
F/R	Ratio relative to the Frequency Reference. A value of 3 F/R with reference of 2 kHz gives a waveform frequency of 6 kHz.
dHz	Difference relative the Frequency Reference. A value of 500 dHz with a reference of 2 kHz gives a waveform frequency of 2.5 kHz.
%Fref	Percent of the Frequency Reference. A frequency value of 50 %Fref with a reference value of 10 kHz gives a waveform frequency of 5 kHz.
cents	A "cent" is a logarithmic unit which represents 1/100 of a semitone of the musical scale. 12 semitones make up an octave. Thus a cent is 1/1200 of an octave.
octaves	An octave is a factor of 2 in frequency. Thus, a frequency value of 3 octaves with a reference of 1 kHz gives a waveform frequency of 8 kHz.
decades	An decade is a factor of 10 in frequency. Thus, a frequency value of 2 decades with a reference of 2 kHz gives a waveform frequency of 200 kHz.

2.3.2.2 Digital Generator Waveforms

SR1's Digital Generator is capable of generating an enormous variety of different audio waveforms, from simple sines to complex synchronous multitone waveforms. Because of its unique architecture which allows different waveforms to be combined the generator offers almost limitless flexibility in providing the perfect audio test output. In this section each waveform, the building blocks of the generator output, will be described in detail.

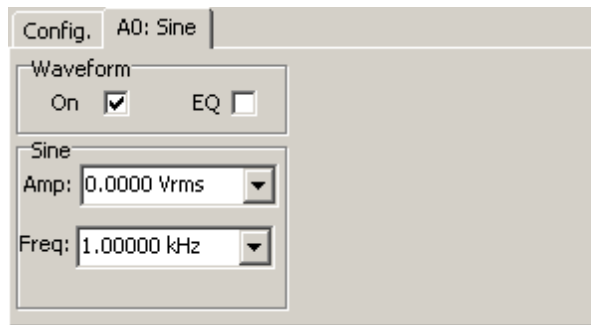

Sine Waveform Tab

When a waveform is added to the generator output using the Waveform Controls, the associated waveform tab shows up on the generator panel. For instance, the Sine Waveform tab is shown above. If the Generator is in the stereo output mode (separate waveforms for each channel) the tab title contains a channel designator indicating which channel the waveform is associated with. If the generator is in mono output mode, the channel designator is omitted and the title contains just the name of the waveform. Some of the controls found on the waveform tabs are common to many waveforms. These will be described first to avoid repetition.

Controls Common to Most Waveforms

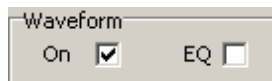

The **Waveform On** checkbox turns the selected waveform on and off. When the generator is outputting

a combined waveform this checkbox allows the selected waveform to be toggled on and off while still outputting the remainder of the waveforms.

The **EQ** checkbox appears for only certain waveforms. If EQ is checked, and an EQ file is selected on the generator panel, the actual generated amplitude for the waveform will be the nominal amplitude multiplied by the frequency response of the EQ file at the current frequency.

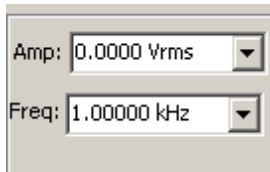

The **Waveform Amplitude** control sets the peak amplitude of most waveforms in one of the [digital generator amplitude units](#). Because generator amplitudes refer to peak waveform values, amplitudes cannot exceed 1 FFS regardless of waveform.

The **Waveform Frequency** control sets the frequency of many waveforms in one of the [digital generator frequency units](#). Digital generator frequencies range from 10 Hz up to $F_s/2$ where F_s is the current digital output sampling rate (OSR). The current OSR is displayed at the top of the digital generator panel.

Generator Trigger

Certain generator waveforms can generate a trigger, known as a "generator trigger" which can be used by the analyzers to synchronize the analyzer to a certain portion of the waveform. Triggering is a complex subject (which is fully described in the [Analyzers](#) section), and there are many different possible analyzer trigger sources besides generator trigger. In this section the discussion of triggering will be limited to those waveforms which provide generator triggers, and where in those waveform is the trigger occurs. When the generator is configured with multiple waveforms, the first waveform which is generator-trigger capable will be the source of all generator triggers.

The Digital Generator Waveforms

In the following list, waveforms that may not be combined with other waveforms are marked with an asterisk (*) next to their names.

Sine

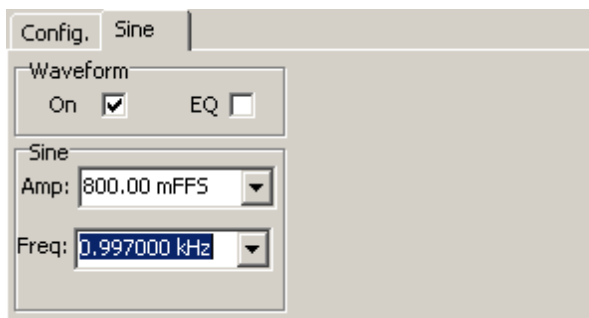

The sine wave is the most basic audio test waveform. Sine waveforms are specified only by their amplitude and frequency. The Normal Sine waveform may be combined with other waveforms.

Phased Sines*

Config. Phased Sine

Waveform
On EQ

Sine
Amp: 800.00 mFFS
Freq: 0.997000 kHz
Phase: 40.000°

The phased sine waveform consists of two sines, one on channel A and one on Channel B with a specified phase difference between them. This waveform may not be combined with other waveforms. Phases may be entered in any 360° interval (for instance 0° to 360° or -180° to 180°) specified on the [Preferences Panel](#).

Noise

Config. Noise

Waveform
On

Noise
Amp: 800.00 mFFS
 Pink Repeat
Rpt: 100.00 msec

Filter
1/3 Oct.
1.00000 kHz

The noise waveform outputs random noise with an almost-gaussian amplitude probability density function with several options. (A true gaussian probability density function has finite probability for any amplitude, no matter how large, which is impractical for a physical device.)

Amplitude controls, as with all SR1 waveforms, the peak value of the noise output. The crest factor of the noise waveform, i.e. the ratio of the peak value to the rms value of the noise, is approximately 4.

The **Repeat** checkbox governs the repetition interval of the generated noise. If not checked the repeat interval is sufficiently long that it won't be observable under most conditions. If, however, it is desired for the noise to repeat after a fixed interval check the Repeat box and enter the Repeat interval below it. If Repeat is selected, the noise waveform produces a generator trigger each time a waveform repeat is initiated.

The **Pink** checkbox specifies that the noise output should be filtered by a 3 dB/octave "pinking" filter. While the power contained in a white noise signal is linearly proportional to the measurement bandwidth, pink noise will have equal power in equal logarithmic frequency intervals, e.g. the power contained in the 100 Hz to 200 Hz interval will be the same as the power contained in the 10 kHz to 20 kHz interval.

White or Pink noise can be further filtered according to the controls in the filter group.

Noise Filter	
None	White or Pink noise is directly output without further filtering.
Lowpass	The white or pink noise is filtered with a 4th order Butterworth lowpass filter at the frequency specified in the filter frequency control.

Highpass	The white or pink noise is filtered with a 4th order Butterworth hipass filter at the frequency specified in the filter frequency control.
1/3 Octave	The white or pink noise is filtered with a 4th order 1/3 octave bandwidth Butterworth bandpass filter at the frequency specified in the filter frequency control.

MLS Noise*

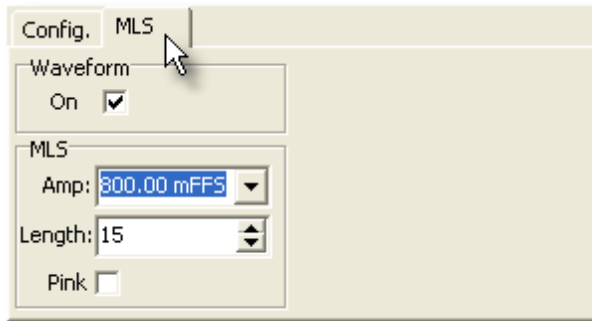

The MLS noise waveform outputs a Maximum Length Sequence with a specified repetition interval and frequency profile. MLS waveforms are typically used as a stimulus in impulse response measurements where several special properties of the MLS (the autocorrelation of an MLS sequence is a delta function) simplify the calculation of the impulse response. Because SR1 uses a full 2-channel FFT analyzer to make impulse response measurements it is not necessary to use MLS noise as a stimulus— any broadband signal will work. Nevertheless SR1 includes the MLS waveform because of its historical association with impulse response measurements.

Amplitude controls, as with all SR1 waveforms, the peak value of the noise output. The crest factor of the MLS waveform, which is essentially a square wave, is close to 1.

The **Length** selection controls the length of the MLS sequence. Selecting "13," for example, chooses an MLS sequence whose repetition interval is $2^{13}-1$ samples.

The **Pink** checkbox specifies that the noise output should be filtered by a 3 dB/octave "pinking" filter. While the power contained in a white noise signal is linearly proportional to the measurement bandwidth, pink noise will have equal power in equal logarithmic frequency intervals, e.g. the power contained in the 100 Hz to 200 Hz interval will be the same as the power contained in the 10 kHz to 20 kHz interval.

USASI Noise*

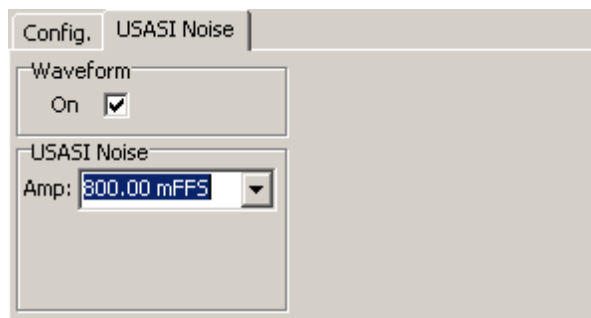

USASI noise is a special type of filtered noise designed to mimic the content of audio program material. USASI noise is typically used in testing broadcast transmitters to measure compliance with transmission bandwidth requirements. Because the frequency content of USASI noise is fixed, only an

amplitude control appears on the waveform tab. USASI noise may be used in conjunction with generator [bursting](#) to generate a burst USASI signal suitable for transmitter testing.

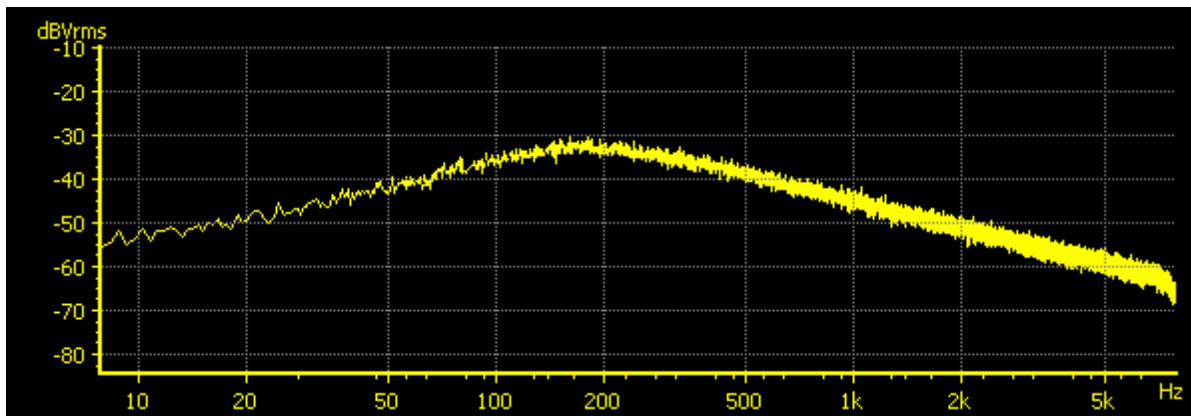

Frequency Spectrum of USASI Noise: 100 Hz 6dB/oct hipass + 320 Hz 6 dB/oct lopass

Square Wave

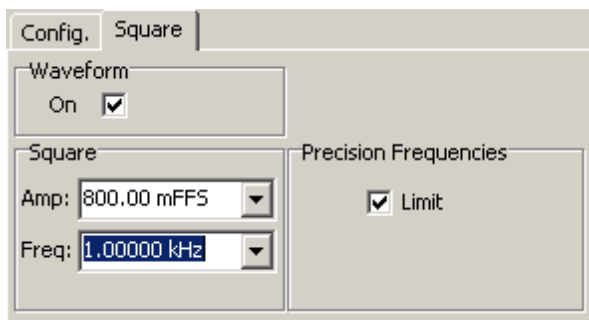

Perfect digital square waves (equal integer numbers of up and down samples) are possible only for a limited number of frequencies for each digital OSR. If **Precision Frequencies** is checked, square wave frequencies will be limited to these "perfect" frequencies. If Precision Frequencies is unchecked, the digital generator will interpolate a square wave at any frequency with significantly less fidelity to an ideal square wave.

Ramp

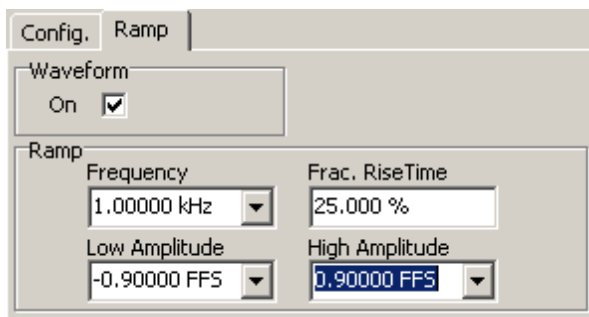



The ramp waveform consists of repetitive runs of integer numbers of "rising" and "falling" samples to produce triangle-like output waveforms. Because the runs are restricted to integer number of samples, the Ramp Frequency and Ramp Fractional Rise Time have limited resolution which is a function of the selected generator sample rate. The lowest amplitude sample has the value assigned in the **Low**

Amplitude control. The highest amplitude sample has the value given in the **High Amplitude** control.

 <p>Generator Trigger!</p>	<p>The ramp waveform generates a generator trigger each time the ramp begins its rising segment.</p>
---	--

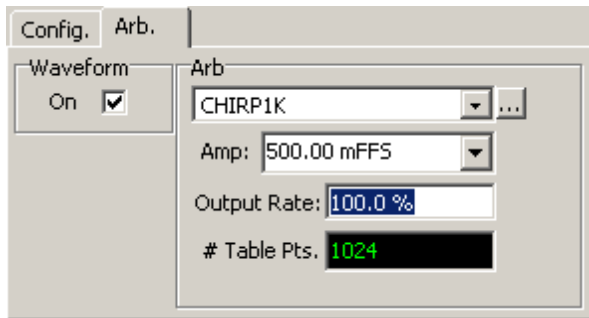
Arbitrary Waveform



The arbitrary waveform plays a sequence of values found in a user supplied table. Arbitrary waveform files are simple ASCII files with one or more columns of floating point numbers representing the values of the arbitrary waveform at each sampling interval.. Use the  button to open a file dialog to select an arbitrary waveform file. If multiple columns are detected in file, SR1 displays a dialog asking which column to load. The number of table points read from the table is then displayed in the corresponding control.

The amplitude entered in the Arb amplitude control is assigned to the maximum value found in the table. The absolute scaling of the table values does not affect the output waveform. However, when operating at arbitrary output rates the SR1 interpolates the user supplied table and normalizes to the peak interpolated value thereby insuring that the peak amplitude remains constant at different output rates. Thus the following table of values in the file:

0, 0.1, 0.2, 0.3, 0.4, 0.5,

produces a linear ramp from 0 to 0.2 FFS if the amplitude control is set to 0.2 FFS.

The Output Rate control governs how fast table points are output. At 100% the output rate is 1 table point per output sample. At 200% the generator outputs every other table point each output sample. For fractional output rates the waveform is interpolated. So at 50% Output Rate the generator outputs a table point, then an interpolated point and then the next table point.

 <p>Generator Trigger!</p>	<p>The arbitrary waveform generates a generator trigger each time the output returns to the beginning of the table.</p>
---	---

FFT Chirp

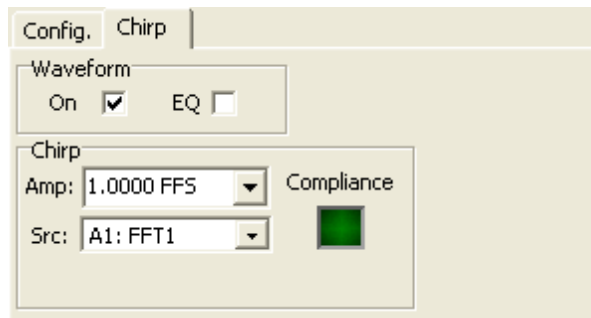

The FFT Chirp waveform is designed to work in combination with one of SR1's [FFT Analyzers](#). The chirp waveform provides a tone exactly at the bin center of each the FFT Analyzer's analysis bins. In the default case, each tone has equal amplitude, however, the Chirp waveform can be used with [generator EQ](#) to generate chirp signals with custom tailored frequency response.

Chirp signals are useful for quickly measuring the frequency response of a device under test. Unlike noise signals which are not deterministic and require long averaging times to measure frequency response, a chirp signal can precisely measure frequency response in a single FFT record.

The Chirp waveform is synchronized to the settings of a particular FFT analyzer. If the resolution or frequency span of that analyzer changes, the chirp waveform automatically reconfigures to provide a full set of bin-center tones. If the corresponding analyzer is set to "[show aliased lines](#)" the chirp outputs a tone in every single FFT bin, from near DC to $F_s/2$. If "show aliased lines" is off, the chirp outputs tones from near DC up to the alias limit for the analyzer's selected converter and frequency span. See the [FFT Analyzer](#) section for more details on these topics. Because of the synchronous nature of the chirp signal, a uniform window should be selected in the analyzer when using the chirp waveform.

Selection of the associated FFT Analyzer is done with the Chirp Source control.

Chirp Source	Associated Analyzer
A0: FFT1	Analyzer 0, Single Channel FFT Analyzer
A0: FFT2	Analyzer 0, Dual Channel FFT Analyzer
A1: FFT0	Analyzer 1, Single Channel FFT Analyzer
A1: FFT1	Analyzer 1, Dual Channel FFT Analyzer

Synchronous chirp generation requires there to be a relationship between the selected generator sampling frequency and the associated analyzer sampling frequency. In general, the two frequencies need to be either exactly the same or some integer multiple of one another. If the generator and analyzer sampling frequencies are incompatible, the "Compliance" led will glow red and no waveform will be output. The compliance led may also show red if SR1 runs out of table memory to create a long chirp signal (say for a large number of FFT lines, or when large amounts of fft zoom are used. The chirp waveform may attempt to use interpolation in situations when not enough memory is available for the complete table, in which case the "Compliance" led will glow yellow. Some degradation of flatness can be expected in this case.

Using the chirp signal it is possible to do cross domain measurements of both amplitude and phase. For instance when testing a D/A converter a chirp can be output in the digital domain, and the D/A frequency response and phase recorded in the analog domain. See the SR1 Applications Manual for more information. To ensure cross-domain sampling rate compatibility use the following sampling rate selections for the generator and analyzer.

Type of Measurement	Generator Fs	Analyzer Fs
Analog Source, Digital Measurement (ADC)	Select Digital ISR as the analog generator Fs.	Select Digital as the Analyzer source which automatically chooses ISR as the analyzer Fs.
Digital Source, Analog Measurement (D/A)	Select the desired digital audio output frequency using the Digital I/O panel.	Select the Analog Hi-Res converter on the analyzer panel and set the Hi-Res converter Fs to Digital OSR using the Analog Inputs panel.

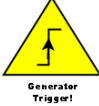
	<p>The chirp waveform generates a generator trigger once each cycle. Be sure to use the generator trigger as the analyzer trigger source when using FFT chirp.</p>
---	--

Log-sine Chirp

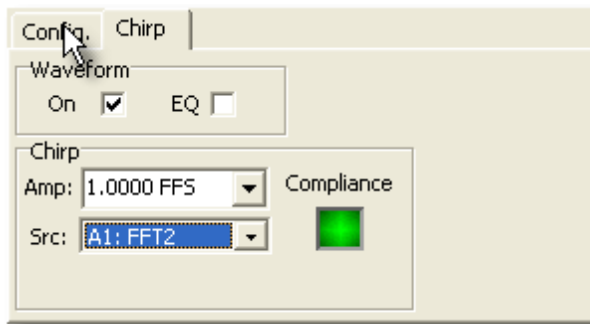

The log-sine chirp waveform is designed to work in combination the dual-channel FFT analyzer to make impulse response measurements. The log-sine chirp waveform is a sinusoid whose frequency is swept in a logarithmic fashion over the frequency span of its associated FFT analyzer. The log-sine chirp waveform has a "pink" frequency roll off of 3 dB/oct.

The log-sine chirp waveform is synchronized to the settings of a particular FFT analyzer. If the resolution or frequency span of that analyzer changes, the log-sine chirp waveform automatically reconfigures to sweep over the frequency span of the selected analyzer. Because of the synchronous nature of the chirp signal, a uniform window should be selected in the analyzer when using the log-sine chirp waveform.

Selection of the associated FFT Analyzer is done with the Chirp Source control.

Chirp Source	Associated Analyzer
A0: FFT1	Analyzer 0, Single Channel FFT Analyzer
A0: FFT2	Analyzer 0, Dual Channel FFT Analyzer
A1: FFT0	Analyzer 1, Single Channel FFT Analyzer
A1: FFT1	Analyzer 1, Dual Channel FFT Analyzer

If the analyzer span is set to frequencies which are unreachable with the current generator sampling the "Compliance" led will glow red and no waveform will be output.



Be sure to select the "Uniform" window when using the log-sine chirp. Window functions attenuate the beginning and the end of the time record which means that some frequencies will be attenuated more than others by the window.

The advantages using log-sine chirps for impulse response measurements are detailed by Miller and Massarini ("Transfer Function Measurements with Sweeps", *J. Audio Eng. Soc.*, vol. 49, pp. 443-471, June 2001.) They report better results using log-sine stimulus compared to MLS stimulus for a wide range of audio DUTs. One particular advantage concerns the unique ability of the log-sine chirp to differentiate between the linear and non-linear portions of the DUT response. Because of the properties of the group delay of the log-sine chirp waveform, harmonic responses appear offset in time relative to the linear response. This can be clearly seen in this impulse response measurement of a consumer stereo amplifier shown below:

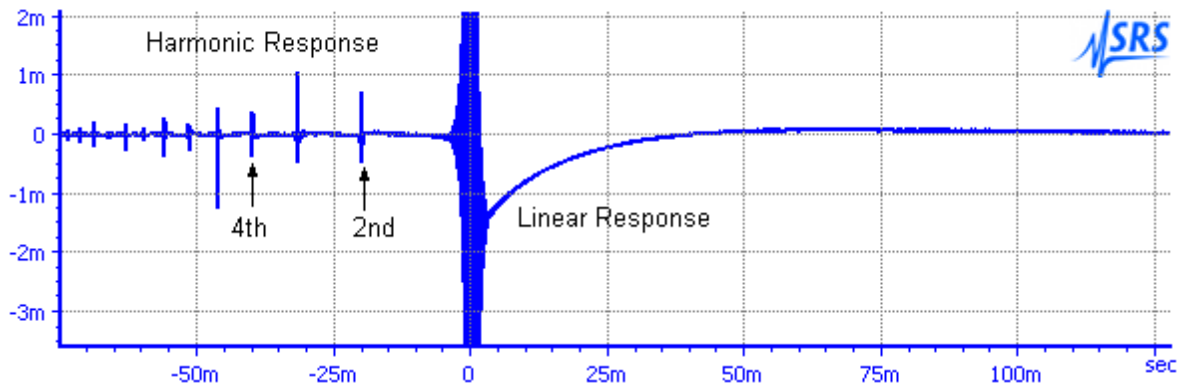

When the purely linear response is gated and transformed back into the frequency domain a much better measurement of the DUT frequency response is obtained. (This is detailed in the [FFT2 analyzer](#) discussion. See "Measurement of audio equipment with log-swept sine chirps", by Thomas Kite, *Presented at the 117th AES Convention, San Francisco, CA, October 2004* for a concise explanation of the unique group-delay properties of the log-sine chirp.)

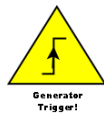

The log-sine chirp waveform outputs a generator trigger at the beginning of each FFT time record. Be sure to use generator trigger as the analyzer trigger source when using the log-sine chirp waveform with the FFT analyzer.

MultiTone*

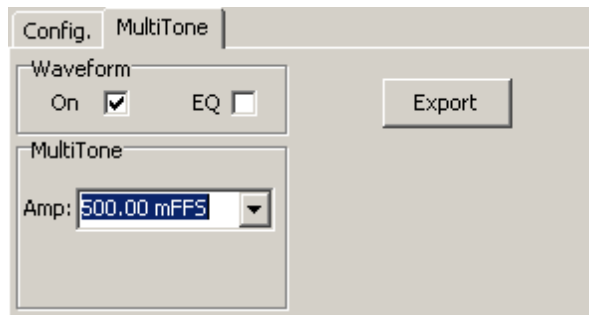

Like FFT Chirp, the MultiTone Waveform is a special waveform containing a series of tones that generated in synchronous fashion to ensure bin-center placement in the [MultiTone Analyzer](#). Using the MultiTone generator and analyzer many different characteristics of a device— e.g. noise, distortion, frequency response, can be measured quickly and simultaneously without the need for multiple swept

measurements.

All of the details of the multitone waveform— tone frequency and amplitude, phase, etc. are configured using the [MultiTone Configuration Panel](#). As a result, only the amplitude is specified on the waveform tab. The Export button allows the current multitone waveform to be saved in arbitrary waveform format for off-line analysis. Because of the special properties of the MultiTone waveform it may not be combined with other waveforms. If the generator domain on the MultiTone configuration panel is not set as "Digital" then the MultiTone waveform cannot be selected in the digital generator.

IMD Waveform*

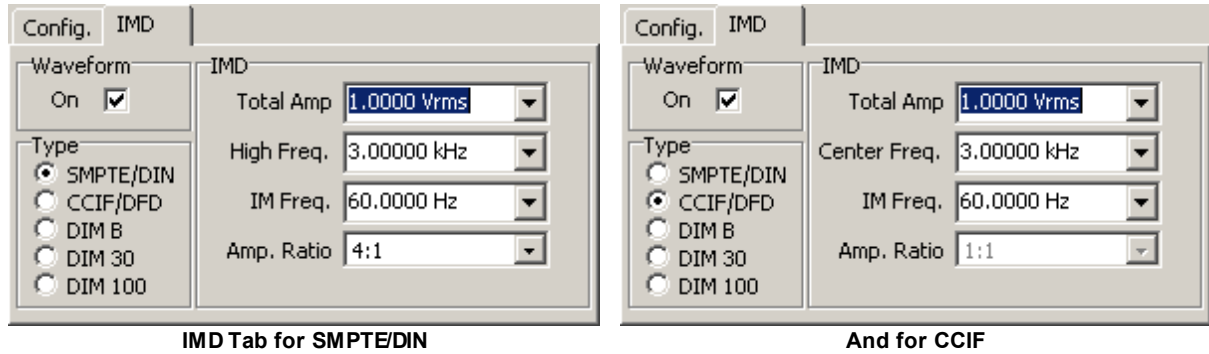

The IMD Waveform can be configured to output the three classic audio IMD test signals— SMPTE, CCIF, and DIM.

IMD Type	
SMPTE/DIN	Combines a High Frequency Sinewave with a low frequency sinewave. For a generator Fs of 192 kHz the low frequency can be set between 10 Hz and 1 kHz. The High Frequency can be anywhere down to 5x the low frequency. The Amplitude Ratio (low freq/high freq) can be set to either 1:1 or 4:1 with the Amplitude Ratio control.
CCIF/DFD	Outputs two sines centered around the Center Frequency separated in frequency by the IM frequency. The amplitude ratio is fixed at 1:1.
DIM	Outputs a ~14 kHz sinewave and ~2.96 kHz squarewave. Squarewave is filtered with a single pole 30 kHz filter. For all the DIM options the ratio of the squarewave to sinewave peak-to-peak amplitudes is 4:1. Because the square needs to be "perfect" frequency, with an exactly equal number of positive and negative samples, the exact squarewave frequency is chosen by the generator, depending on the generator Fs, to be as close as possible to the squarewave frequency specified by the standard. The sinewave frequency is then set in the same ratio to the square wave frequency as would be for the signals in the standard. Note that the DIM waveform cannot be generated if the digital audio generator bandwidth is sufficiently low. (OSR<~30 kHz)

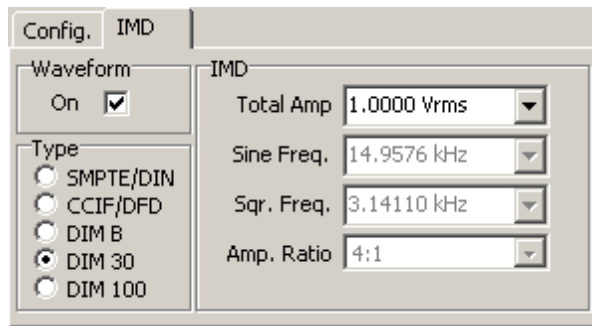

IMD tab for DIM selection

In all cases the **Total Amplitude** control sets the combined amplitude of all signals.

The IMD waveform is designed to be used with the IMD analyzer. The analyzer automatically determines the type of IMD signal is being generated and automatically configures itself for the correct analysis. See the [IMD Analyzer](#) section for more details.

Polarity Check Waveform

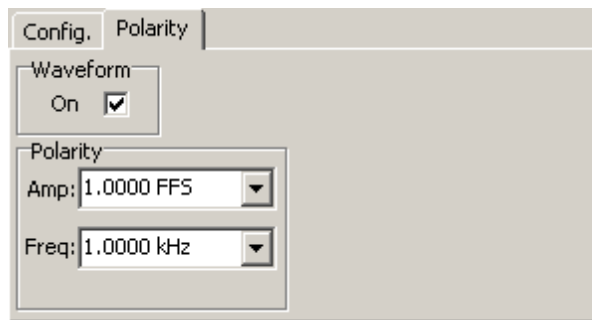

The polarity check waveform uses a phased combination of two sine waves to produce a deliberately asymmetric waveform that points "up". When this waveform is applied to a device under test it is easy to see if the device properly maintains or inverts polarity by checking the output waveform using the time record of the [FFT Analyzer](#). If the output waveform still points "up" the device maintains polarity. If the waveform points "down" the device is inverting.

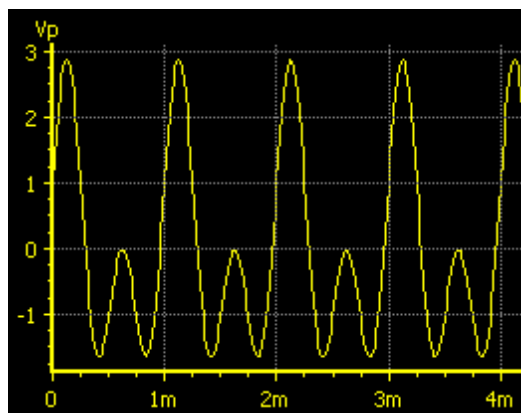

Polarity Waveform Non-Inverted

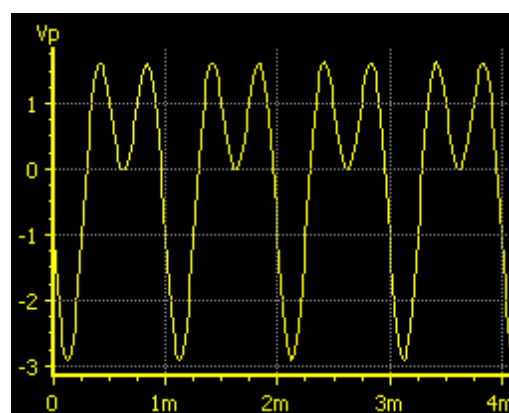

...And Inverted

Special Digital Test Waveforms

SR1's digital audio generator includes several waveforms that are specific to the digital audio domain, i.e. they have no analog counterparts. These waveforms generate specific bit patterns in the embedded digital audio output signal. As such, they cannot be combined with other signals. Dither is not added to the special digital test waveforms.

Digital Constant*

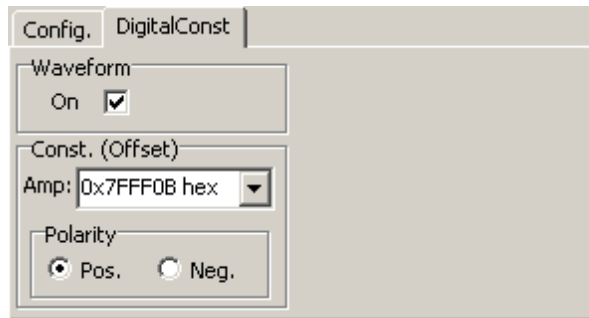

The screenshot shows the 'DigitalConst' configuration panel. It has a 'Config.' tab and a 'DigitalConst' sub-tab. The 'Waveform' section has an 'On' checkbox that is checked. The 'Const. (Offset)' section has an 'Amp:' dropdown menu set to '0x7FFF0B hex'. The 'Polarity' section has two radio buttons: 'Pos.' (selected) and 'Neg.'.

The digital constant outputs a fixed bit pattern to the audio data portion of each digital output sample. The constant can be specified as a hex word, or in any of the standard digital generator amplitude units. The polarity of the constant can be controlled with the radio buttons at the bottom of the panel.

Digital Count*

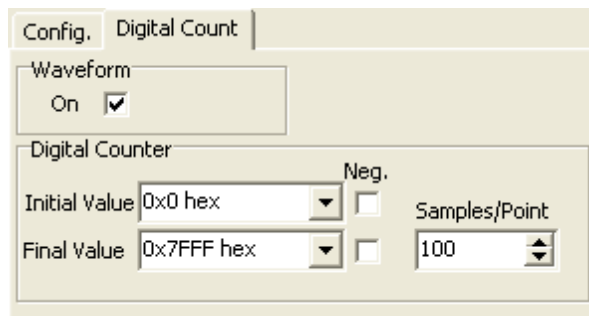

The screenshot shows the 'Digital Count' configuration panel. It has a 'Config.' tab and a 'Digital Count' sub-tab. The 'Waveform' section has an 'On' checkbox that is checked. The 'Digital Counter' section has an 'Initial Value' dropdown set to '0x0 hex', a 'Final Value' dropdown set to '0x7FFF hex', and a 'Samples/Point' spinner set to '100'. There are also checkboxes for 'Neg.' next to both the 'Initial Value' and 'Final Value' dropdowns.

The Digital Count waveform implements a counter which operates between two user specified values. The generator outputs each value for the number of samples specified in the "Samples/Point" control before incrementing the value by one. When the final value has been output for "Samples/Point" samples, the counter output resets to the initial value.

Rotate Bits

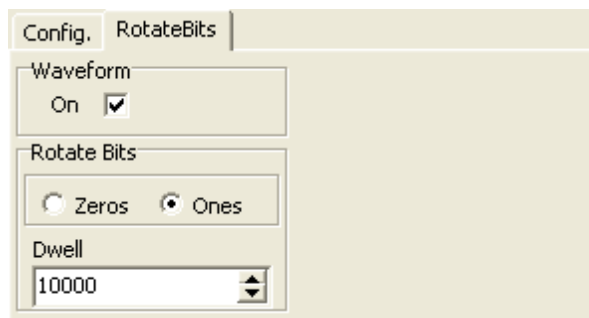

The screenshot shows the 'RotateBits' configuration panel. It has a 'Config.' tab and a 'RotateBits' sub-tab. The 'Waveform' section has an 'On' checkbox that is checked. The 'Rotate Bits' section has two radio buttons: 'Zeros' and 'Ones' (selected). The 'Dwell' section has a spinner set to '10000'.

The Rotating Bits waveform outputs a pattern composed of all zeros and a single "one" (if "Ones" is selected), or all ones and a single "zero" (if "Zeros" is selected). The pattern is output for the number of

samples specified in the "Dwell" control and the the pattern is shifted left by one bit. When the one/zero is shifted out of the leftmost bit of the digital audio word it rotates back into the rightmost bit of the word. Using the Rotating Bits generator and the Active Bits display on the Digital I/O panel is a simple method for detecting stuck or cross-linked bits in digital audio equipment.

Digital Staircase

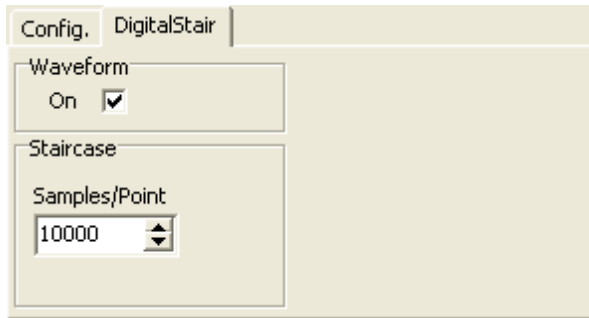

The Digital Staircase waveform is a special digital-only waveform which is useful for testing D/A converters. The staircase waveform outputs 5 complete square wave cycles of the ten smallest digital codes in succession followed by an equivalent interval of digital zero. The length of each half-cycle of a square wave is equal to the digital audio sampling interval times the value of "Samples/Point" parameter on the waveform panel. Thus, in the example below, each half cycle of the square wave is $100/48 \text{ kHz} = 2.083 \text{ msec}$ and therefore the time spent at each code is $5 \times 2 \times 2.083 \text{ msec} = 20.83 \text{ msec}$ as can be seen in the graph.

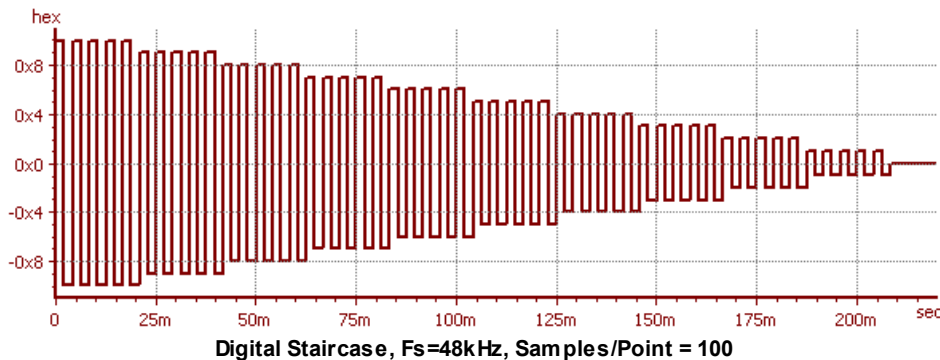

When observing the digital staircase using the FFT time record, be sure to enable the analyzer trigger and set the trigger source to generator. This will ensure that the beginning of the time record is synchronized with the beginning of the staircase.

J-Test

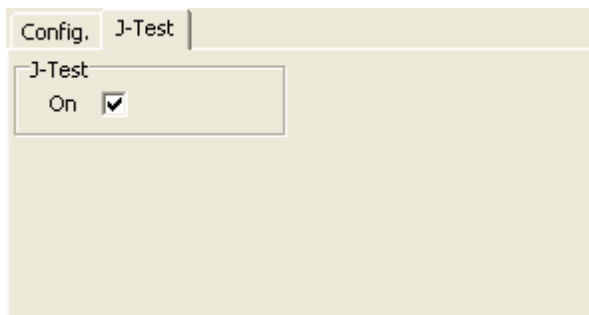

The JTest waveform, conceived of by the late Julian Dunn, is designed to excite jitter due intersymbol interference in digital audio signal paths with reduced bandwidths, such as long cables. The Jtest waveform is primarily a square wave at $OSR/4$, but the dc level is slightly shifted every 192 samples. The resulting jitter will occur at $OSR/192$ and can be seen with the [Jitter Analyzer](#), or the [Digitizer](#).

2.3.3 Analog Inputs Panel

The analog inputs panel controls and monitors the configuration of SR1's XLR and BNC analog inputs.

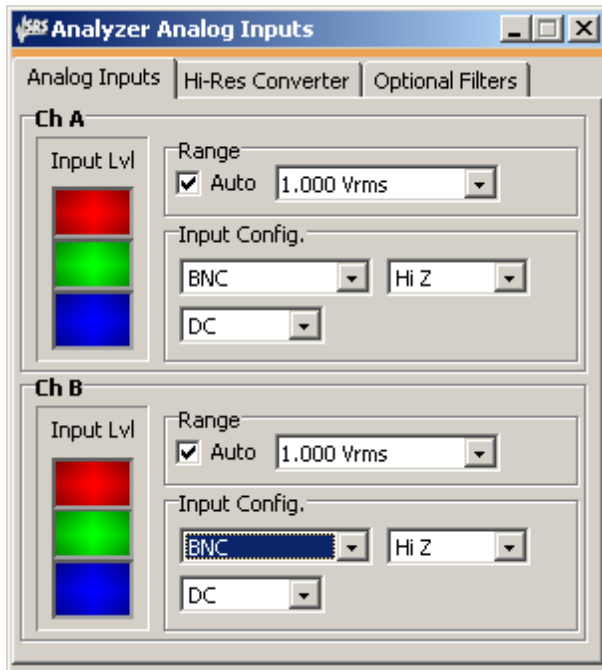

The first tab on the panel, Analog Inputs, contains most of the configuration controls. Note that Channel A and Channel B analog inputs can be configured separately. The Range box contains a checkbox to enable autoranging of the corresponding input. In general, autoranging should be left on, however, for certain low frequencies or slowly-varying input signals it can be useful to turn off autoranging and set the range manually to avoid unnecessary range jumping. The Input Range control displays the current input range when autoranging is on and allows entry of the range, in Vrms or dBVrms, when autoranging is off. The smallest input range allowed by SR1 is 62.5 mVrms, the largest is 160 Vrms.

In the Input Configuration box is the control to set the input connector:

Input Configuration: Connector	
BNC	Select the BNC connector for the corresponding channel. Do not apply balanced inputs to the BNC connectors as the BNC outer conductor is connected to analyzer ground.
XLR	Select the XLR connector for the corresponding channel. The impedance control allows the input impedance to be varied between 300 Ω , 600 Ω , and "Hi-Z" (~100 k Ω). It is possible to use unbalanced inputs with the XLR connectors.
Gen. Mon.	The input is connected directly to the corresponding channel of the Analog Generator.
Digital Audio Common Mode	This special setting allows the analog input to look at the common mode signal present at the balanced digital audio connector. The common mode signal can then be measured or displayed. This can be useful in diagnosing noise problems with the digital audio input.

Input Configuration: Coupling	
DC	DC coupling of the analog inputs.
AC	AC coupling of the analog inputs with ~1.7 Hz corner frequency.

To the left of the controls for each channel is the visual level indicator for that channel. The blue led glows when the input level is below approximately half-scale. The green led glows when the input level is between half scale and full scale, and the red led glows when the input exceeds full scale. If the red led glows continuously then the signal either exceeds the input range of the instrument, or in the case of no autoranging, the range needs to be manually adjusted. Note that the input level indicators are also displayed at the bottom of SR1's main window so that they are visible even when the Analog Inputs Panel is not displayed.



When a potentially damaging high voltage is detected at the input SR1 automatically switches the input range to the largest possible value (160 Vrms) and removes any termination resistors selected by the user in order to protect the instrument. If this occurs, the input voltage range will be shown in red as shown below:

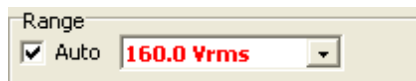

Remove the input and reset the range manually to restore normal operation.

Hi-Res Converter Sampling Rate Selection

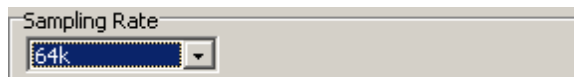

The second tab of the Analog Input Panel contains a single control to select the sampling rate of the Hi-Resolution ADC. SR1's analyzers use two different high-quality audio ADC's— the 16-bit "high-bandwidth" converter operating at a fixed sampling rate of 512 kHz, and the 24-bit "high-resolution" converter which can operate at a variety of sampling rates

Analog Inputs: Hi-Resolution Converter Sampling Rate	
128 kHz	The converter runs at a fixed 128 kHz sampling rate.
64 kHz	The converter runs at a fixed 64 kHz sampling rate.
Digital OSR	The converter runs at the Digital Audio Output Sampling rate that is set in the Digital I/O panel.
Digital OSRx2	The converter runs at twice the Digital Audio Output Sampling rate that is set in the Digital I/O panel.

The last two settings are useful for making cross-domain measurements of D/A converters using FFT Chirp or Multitone signals where the stimulus is generated in the digital domain but the measured signal is in the analog domain. Using Digital OSR or Digital OSRx2 as the converter sample rate maintains synchronicity between the generator and the analyzer.

Optional Input Filters

The screenshot shows a software interface with three tabs at the top: 'Analog Inputs', 'Hi-Res Converter', and 'Optional Filters'. The 'Optional Filters' tab is selected. Below the tabs are two panels. The left panel is titled 'Ch. A Filter Selection' and contains five radio button options: 'None' (selected), 'Filter 1', 'Filter 2', 'Filter 3', and 'Filter 4'. The right panel is titled 'Ch. B Filter Selection' and also contains five radio button options: 'None' (selected), 'Filter 1', 'Filter 2', 'Filter 3', and 'Filter 4'.

The final tab on the Analog Inputs Panel contains the selection controls for the Optional Filters on the analog input boards. See the [SR1 Hardware Reference](#) for details on the optional filters.

2.3.4 Digital I/O Panel

SR1's digital audio inputs and outputs work with both the AES/EBU and S/PDIF standards for digital audio over a wide range of sampling rates from 24 kHz to 216 kHz. SR1 also makes a variety of digital audio carrier measurements including carrier amplitude, sampling frequency, and output-input delay. Finally, to test susceptibility of devices to carrier degradation SR1 provides number of different types of carrier impairments including jitter, common and normal mode interference, and variable rise times. All these functions are controlled from the three tabs of the Digital I/O panel.

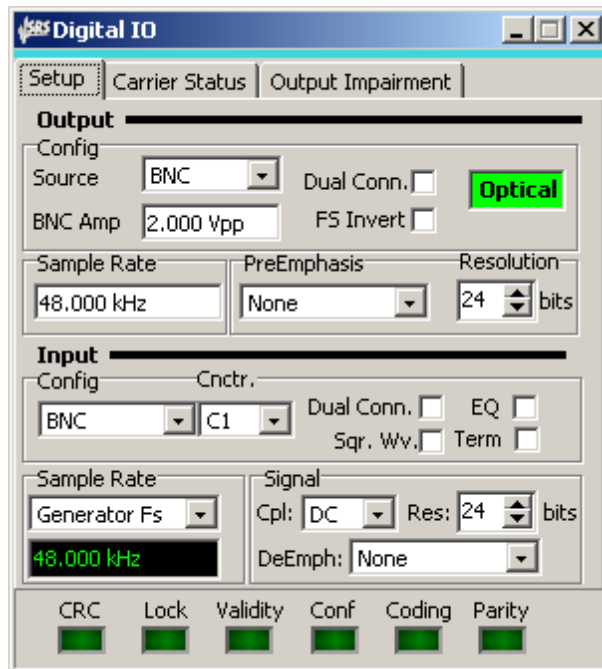

Output Configuration Controls

Select the **output source** as either BNC (Unbalanced) or XLR (balanced). Although the digital audio signal is always output to both connectors, the displayed amplitude is only calibrated for chosen connector. Amplitude ranges from 2 mVpp to 2.55 Vpp can be selected for the BNC outputs while amplitudes from 10 mVpp to 10.2 Vpp are available for the XLR outputs. Output amplitudes are calibrated only when the outputs are correctly terminated, i.e. 75Ω for unbalanced outputs and 110Ω for balanced outputs.

Selecting **Dual-Connector** sets the digital audio output to dual-connector mode. In normal digital audio data streams each frame contains a pair of samples, one left and one right. In dual-connector mode each data stream outputs a set of successive samples for a single channel with an effective single channel sampling rate of twice the frame rate. In dual-connector mode the left channel is output on C1 and the right channel on C2.

The **Optical indicator** indicates whether the TOSLINK (Optical) output is active. The indicator glows green **Optical** to indicate that the optical output is active and red **Optical** to indicate that optical output may not work correctly.

FS Invert controls the polarity of the of the rear-panel Frame Sync signal. This signal is normally high during the first (left) subframe of each digital audio frame. Checking the box inverts this polarity.

Output **Sample Rates** can be chosen for single connector outputs between 24 kHz and 216 kHz. For dual-connector outputs the range is 54 kHz to 216 kHz. Note that for dual connector outputs the chosen sample rate is the effective sample rate of the two digital audio streams, not the physical frame rate for each connector.

The **pre-emphasis** control is included for future expansion. In the current version of SR1 pre-emphasis is not implemented and is fixed at "None".

Output **resolution** can be set between 8 and 24 bits. The embedded digital audio signal is truncated to the specified number of bits after any dither selected in the [Digital Generator](#) panel is applied.

Input Configuration Controls

Select the input connector from one of the following:

Digital Audio Input Connector	
XLR	Selects the balanced (XLR) connectors as the input source.
BNC	Selects the unbalanced (BNC) connectors as the input source.
Optical	Selects the TOSLINK optical connector as the input source.
GenMon	The digital audio input is connected directly to the output of the digital generator.

The Dual-connector checkbox selects dual-connector input mode. In dual connector mode SR1 expects two digital audio data streams (left on C1, right on C2) on the selected connectors (either XLR or BNC) with each frame containing 2 successive samples of the same channel. If the input is set to GenMon then the input dual-connector mode is slaved to the output dual-connector mode.

Checking the Square Wave box tells SR1 that the input signal is not an AES/EBU or consumer digital audio signal but simply a square wave signal. When square wave is checked none of the analysis capabilities related to the embedded digital audio data stream or the channel status bits are active. However, the amplitude and frequency of square wave signals is measured, and square wave signals can be used as an input to the Digitizer or Jitter Analyzer for jitter analysis.

Checking **Terminate** terminates the XLR inputs with 110 Ω and the BNC inputs with 75 Ω .

Checking **EQ** inserts a high-pass equalization circuit into the signal path. EQ can be selected only with XLR and BNC inputs. The frequency response of the EQ circuit is given in AES3-2003 in section 8.3.4.

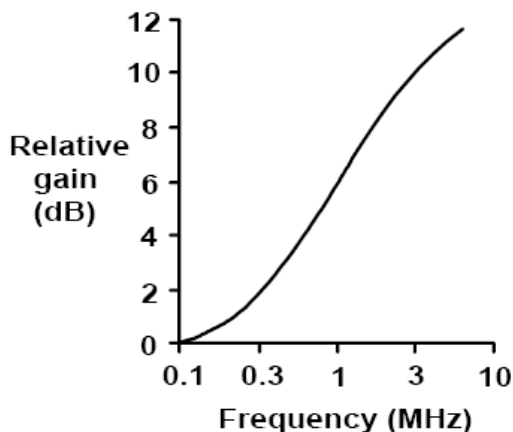

Suggested Eq Characteristic for 48 kHz OSR

The purpose of equalization is to reverse the lo-pass degradation of the digital audio carrier which results from transmission over long cable runs:

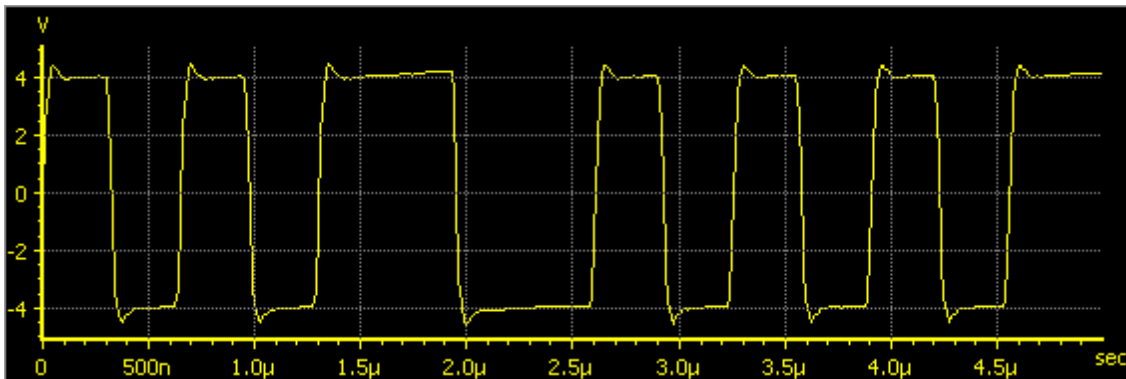

Original Digital Audio Carrier

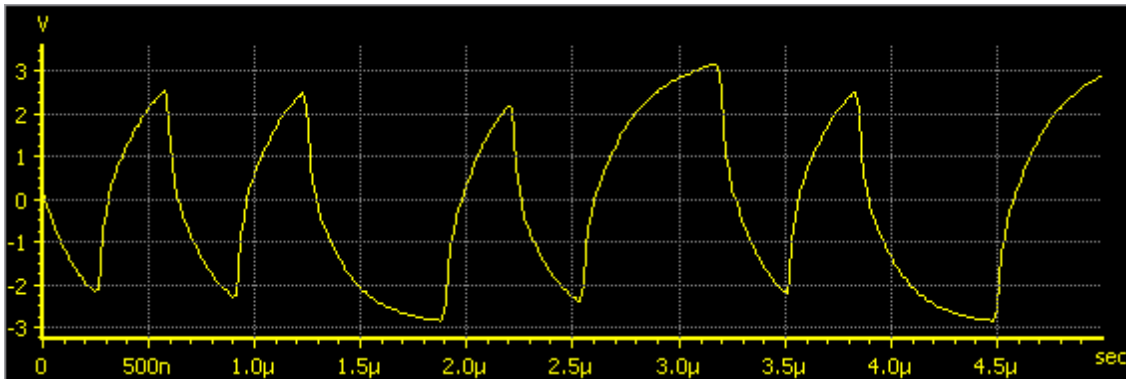

After Long Cable Run (Using SR1's CableSim)

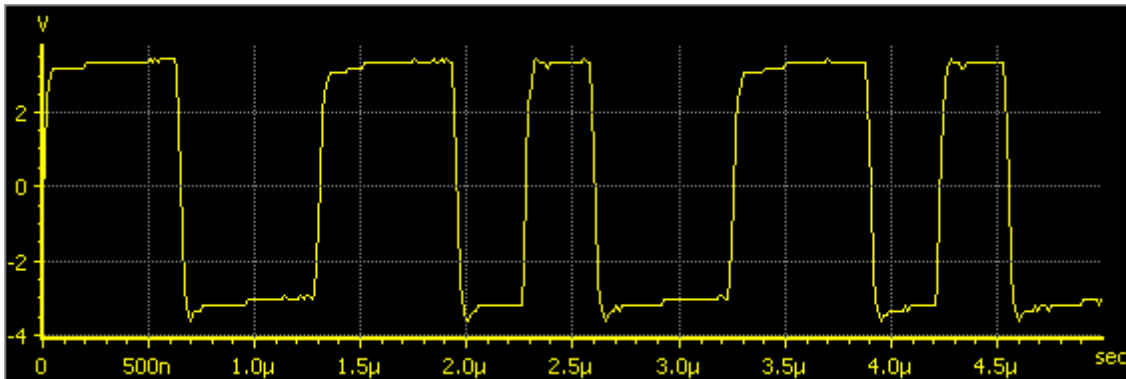

Long Cable Run + Input EQ

Digital Input Sample Rate Controls

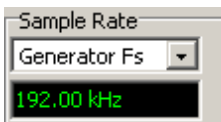

Select the Digital Audio Input Sampling Rate ISR used by all digital domain analyzers. The ISR determines frequency range and resolution for all frequency domain analyzers with digital audio inputs.

Digital Audio Input Sampling Rate	
Generator Fs	Digital Audio Input Sampling Rate (ISR) is set to the Digital Audio Output Sampling Rate (OSR)
Measured Fs	ISR is set to the value measured by SR1.
Status Bits	The sample rate embedded in the digital audio channel status is used as the ISR.
User Reference	The ISR is set to a fixed user-entered value.

Digital Input Signal Controls

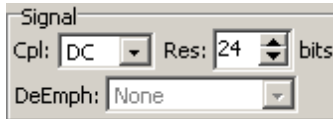

The embedded digital audio signal may be AC or DC coupled. AC coupling inserts a DC blocking filter into the signal path with a pole at ~4 Hz.

The **Deemphasis** control is included for future expansion and is not implemented in the current version of SR1.

Input Resolution may be set between 8 and 24 bits. The input data is truncated to the selected value.

Digital Audio Status Panel

The Digital Audio Status Panel at the bottom indicates the current status of the received digital audio signal. It consists of 6 indicators, each of which glows green when the corresponding status condition is "good" and red when the status condition changes to "bad." The 6 status conditions detected are:

Status Condition	Meaning
CRC	For AES/EBU digital audio streams an 8-bit CRC code is generated from the received channel status bits in each block and compared to the value stored in the last byte of the channel status block. A red indicator indicates a CRC mismatch.
Lock	Green Indicates that the digital audio receiver is locked to an input data stream. Red indicates no lock.
Validity	Red indicates that the validity bit has been set in one of the received sub-frames
Confidence	This indicator glows red when either the Unlock or Bi-phase error is detected.
Coding	Bi-phase error. A valid digital audio signal remains at the same amplitude for no longer than two Unit Intervals (UIs) (Except during preambles). A red indicator indicates that this condition has been violated.
Parity	Each digital audio subframe contains a parity bit which summarizes the parity of the remainder of the bits in the subframe. A red parity indicator means that the received parity bit does not match the parity computed in the remainder of the subframe.

Carrier Status Tab

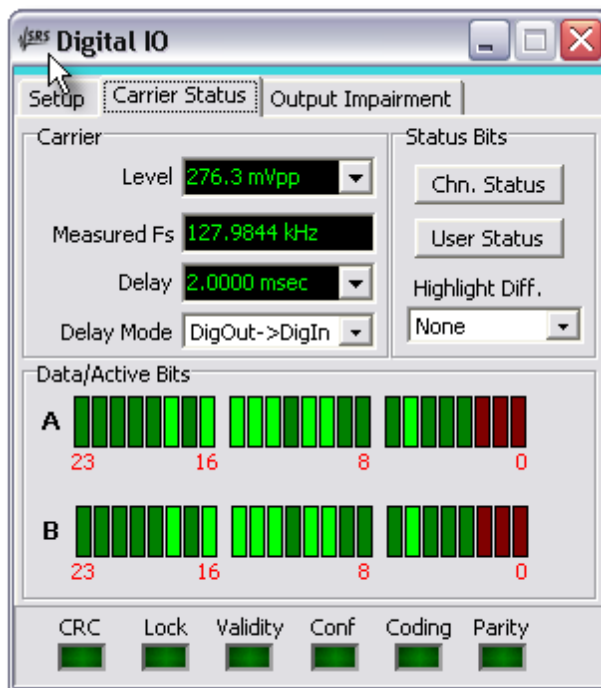

Carrier Level displays the measured peak-to-peak amplitude of the digital audio carrier. The displayed value is only meaningful when the input connector is set to BNC or XLR— for optical or GenMon inputs the display shows the amplitude of an internal signal.

Measured Fs displays the measured frame rate of the digital audio signal. For single connector digital audio inputs this will be equal to the effective sampling rate of the digital audio data. For dual-connector digital inputs this value will be half the effective sampling rate. When "Square Wave" is checked on the input configuration panel, the frequency reported is simply the measured frequency of the input square wave.

Delay measures the delay specified by the **Delay Mode** control. When Delay Mode is set to DigOut->DigIn the Delay field displays the delay from the z-preamble (beginning of digital audio block) of the digital audio output signal to the z-preamble of the digital audio input signal. When Delay Mode is set to RefOut->DigIn the Delay field displays the delay from the z-preamble of the rear-panel [digital audio reference output](#) to the z-preamble of the digital audio input signal. Both these values can be used to measure the transmission delay through a device depending on whether the rear-panel reference or the main digital audio output is used as a source.

Status Bits Controls

The Channel Status Button displays the [Channel Status Panel](#).

The User Status Button displays the [User Status Panel](#).

Highlight Differences controls how status bits are displayed on the User and Channel Status panels	
None	No fields are highlighted.
Diff from Output	Highlights received status fields that differ from the corresponding output status fields.
Diff from Other Ch.	Highlights received status fields that differ from the corresponding received status field in the other channel.

Reserved In Use	Highlights status fields marked "reserved" in the standard but which contain non-zero values.
------------------------	---

Data/Active Bits Display

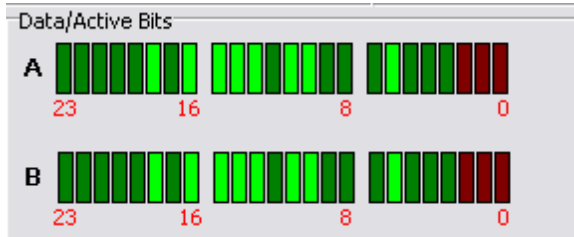

The Data/Active Bits indicator displays 2 rows of indicators, corresponding to the 24 data bits of each digital audio channel. The color of each indicator indicates the status of that bit over 1 digital audio block (1 block contains 192 frames). Red indicates that the bit does not change value over one block. This can be an indication that the bit is "stuck." Dark Green indicates that the bit changes value over the block. Bright green indicates that the bit is "on" in the first frame of the block.



Because the data/active bits display requires examination of the embedded digital audio signal, it is only active if one of the active analyzers, A0 or A1, currently has digital audio selected as its input. If none of the analyzer is currently looking at digital audio, the indicator will be grayed and inactive.

Output Impairment Tab

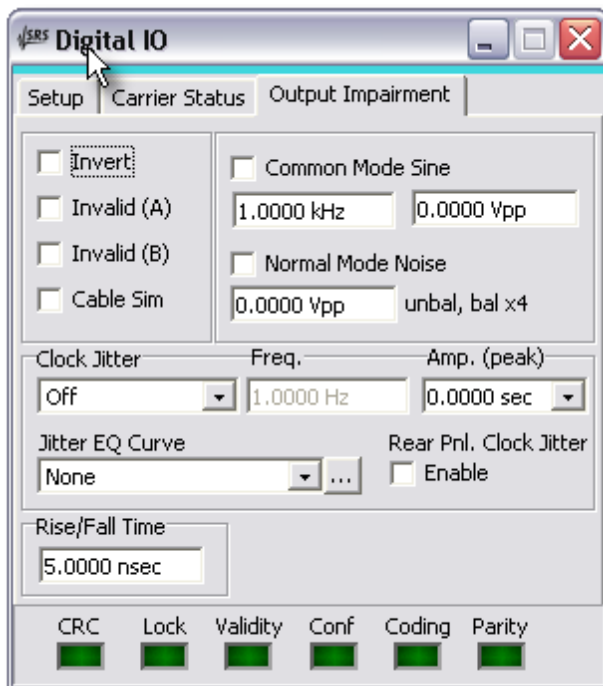

Invert inverts the polarity of the digital audio output carrier signals. Properly operating digital audio equipment should be immune to an overall polarity inversion.

Invalid (A or B) sets the Validity bit (bit 28) in each corresponding subframe of the digital audio output signal. The validity bit has no fixed meaning, but has been used to signal conditions including non-audio data, non linear-pcm data, overload, etc.

Cable Sim applies the cable simulator circuit to the digital audio output (BNC and XLR). The cable simulator is a low-pass filter designed to mimic the signal degradation caused by approximately 1000m of cable. See the discussion of [EQ](#) for an illustration of the effect of the cable simulator.

Checking **Common Mode Sine** applies a sinewave to both pins 2 and 3 of the XLR outputs. The BNC outputs are not affected. The sinewave is variable in frequency from 10 Hz to 100 kHz and in amplitude from 0 Vpp to 20 Vpp. Such a signal is useful for testing the immunity of digital audio equipment with balanced inputs to common mode pickup.

Normal Mode Noise can be applied to the XLR and BNR outputs. Normal mode noise is white noise with a bandwidth of approximately 20 MHz. For BNC outputs the noise is simply added to the output. For XLR signals the signal is added as a "balanced" signal-- with positive polarity to pin 2(+) and with negative polarity to pin 3 (-) . The maximum noise amplitude is 640 mV for BNC outputs and 2.5 Vpp for XLR outputs.

Rise/Fall Time varies the of the digital audio outputs (BNC and XLR). The risetime may be varied between 5 ns, 10 ns, 20 ns, 30ns, and continuously from 40 ns to 400 ns.

Jitter Controls

SR1 is capable of generating a wide variety of jitter waveforms, frequencies, and amplitudes. Jitter represents the deviations of transitions in the digital audio carrier signal from their ideal times. SR1 has two main methods for viewing jitter. The [Jitter Analyzer](#) uses a phased-lock-loop to demodulate the jitter present in the digital audio input carrier and display it in both the time and frequency domains. The [Digitizer](#) records a digitized version of the input carrier and uses mathematical techniques to extract the jitter.

Note that it is easily possible to generate more jitter than can be tolerated at SR1's digital audio inputs. The digital audio inputs will not lock if too much jitter is applied.

Jitter Waveform	
None	The digital audio output is un-jittered.
Sine	The digital audio carrier is modulated with sinusoidal jitter with a frequency between 2 Hz and 200 kHz.
Square Wave Jitter	Applies squarewave jitter with frequencies between 2 Hz and 40 kHz.
Uniform Noise	Applies white, gaussian noise jitter.
Bandpass Noise	Applies 1/3 Octave bandpass noise jitter at the selected frequency.
Chirp	The chirp is a special jitter source designed to work with the frequency domain Jitter Analyzer . The chirp signal outputs an equal amount of power in each FFT bin of the Jitter Analyzer, yielding a "flat" jitter spectrum. When a device is placed between the digital audio output and input the jitter susceptibility at all frequencies can be simultaneously measured eliminating the need for time-consuming swept measurements.

The maximum amplitude for all jitter waveforms is 13 UI. Note that all jitter amplitudes are set in peak seconds or peak UIs. The UI is the smallest time scale on which the digital audio carrier signal changes. The length of a UI can be derived from the sampling frequency by the formula: $UI = 1/(Fs * 128)$. The number 128 can be arrived at by remembering that each digital audio frame contains 2 subframes (left

and right) each with 32 bits and that each bit represents 2 UIs in biphase encoding ($2 \times 32 \times 2 = 128$).

Jitter EQ. Sine and square jitter can be set to have a variable amplitude as a function of frequency by specifying a Jitter EQ file. EQ files are XML files which specify a relative frequency response as a function of frequency by either interpolating a table of (frequency, response) pairs or by calculation from a set of pole and zero locations. The structure of EQ Files is detailed in the [File Reference](#) section. Use the  button to open a file dialog to specify the EQ File. Although the jitter amplitude control will continue to display the nominal amplitude value, the actual output jitter amplitude will be the nominal value multiplied by the EQ file response at the current sine or squarewave frequency.

Rear Panel Clock Jitter, if enabled, applies the currently selected jitter to the rear-panel Master Clock Output. If disabled, the Master Clock outputs the un-jittered digital audio bit-clock.

2.3.5 Channel Status Panel

The channel status panel displays received channel status information and controls the transmitted channel status information. Channel status information is organized according to either the AES/EBU professional standard or the SPDIF consumer standard. SR1 relies on AES3-2003 and AES-2id-2006 for the professional standard and IEC60958-3 as the source for the consumer standard.

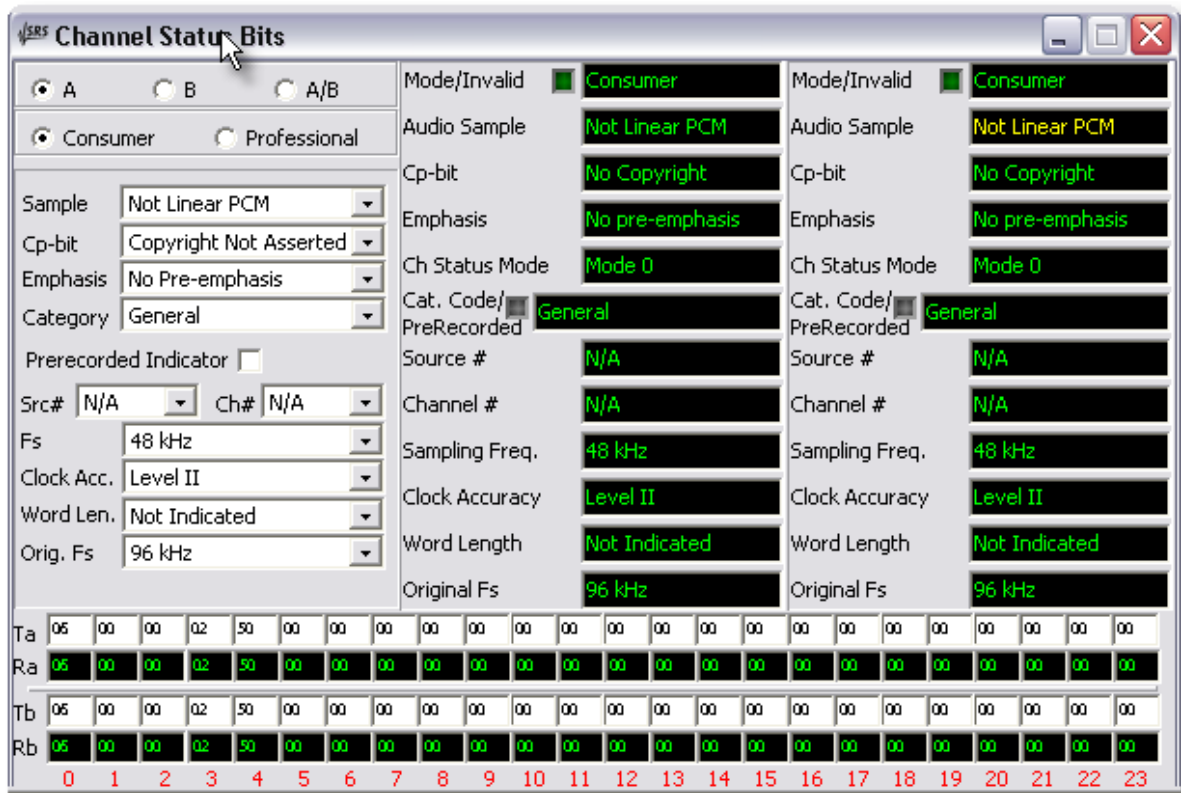

Channel Status Panel (Consumer Mode)

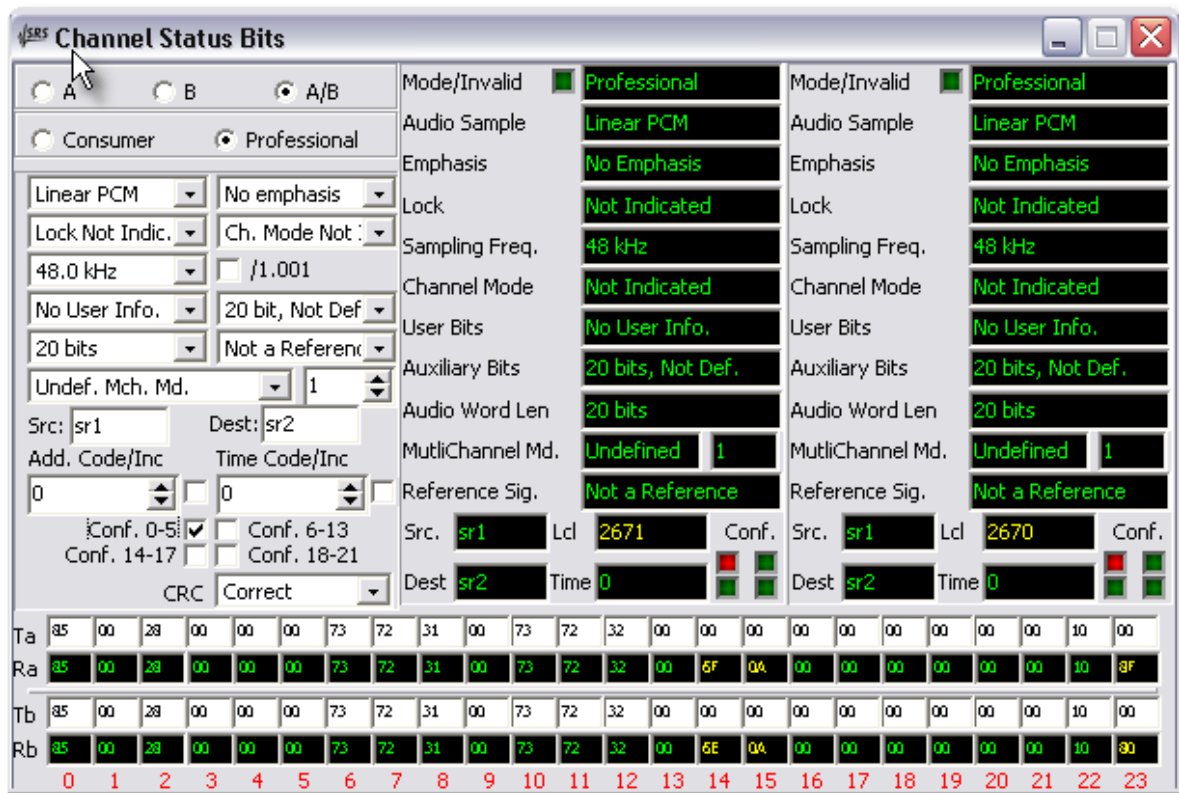

Channel Status Panel (Professional Mode)

The channel status panel is divided into 3 main areas. On the upper left are the controls governing the transmitted status information. On the upper right are the displays indicating the received status information for channels A and B. The bottom of the panel contains the hexadecimal representation of each of the 23 transmitted and received status bytes for both channel A and B.

Transmitted Status Bits

The top 3 radio buttons determine whether the remainder of the transmit status controls refer to channel A, B, or both channels. The next control down determines whether the status bytes are transmitted in professional or consumer standards. The panel redraws itself as shown above according to the selected standard. Changes made to the transmit status controls are immediately reflected in the hexadecimal status display along the bottom of the panel. However, changes made to the hexadecimal transmit panel are not reflected back in the status controls. The status controls and the hexadecimal status panel remain out of sync until the next time a status control is changed when transmitted status reverts to the state reflected by the controls.

Professional Transmit Status Bits

For professional mode only, bytes 14 to 17 specify the local sample address code and bytes 18-21 specify the time-of-day sample address code. These 4 byte counter values can be specified and additionally, if the "increment" checkbox to the right of each entry is checked, SR1 will increment the transmitted value by 1 each digital audio block.

The confidence flags are defined by the professional standard to indicate whether the information carried by the channel status data is reliable. Like the "validity" flag, their sense is reversed from the name, i.e. setting the confidence flag to 1 indicates lack of confidence. The grouping of the 4 confidence flags is

mirrored on the professional receive panel by 4 indicators which glow red if the corresponding flag is set and green if it is not.

The professional standard defines byte 23 as a cyclic redundancy check (CRC) character. SR1 allows several options for the transmission of the CRC byte.

CRC controls the transmission of byte 23.	
Static	The same byte is transmitted with every digital audio block. The value of the byte is whatever was being transmitted when the CRC mode was set to satatic.
Correct	The correct CRC byte is sent with each digital audio block.
Incorrect	A changing, incorrect CRC byte is sent with each digital audio block.
Zero	The CRC byte is set to zero.

Received Status Bits

The grouping of the received status display for both professional and consumer modes is shown above. The topmost display shows the current mode alongside an indicator which glows red if the validity flag for that channel is set. In professional mode, CRC errors are not shown on the status panel but instead on the [Digital Audio Status Panel](#) at the bottom of the Digital I/O panel. Received status bits can be highlighted to call out differences between transmit and receive status or to indicate differences in received status between the two channels. Highlighting is controlled from the [Digital I/O](#) panel. Differences are highlighted in yellow.

2.3.6 User Status Panel

The user status bits panel displays the transmitted and displayed user status bits for both channels grouped as 23 bytes.

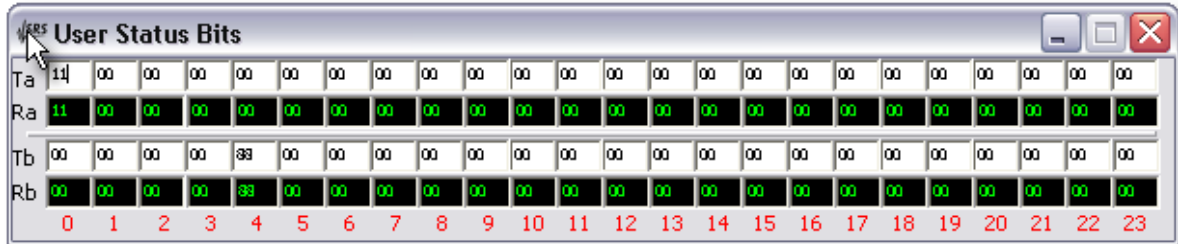

Since no universal standard for the formatting or meaning of the user status bits transmitted with digital audio data, the status bits are presented as raw hexadecimal numbers. The "byte-number" (starting from the beginning of the digital audio block) is given in red on the lowest line. Within each byte, the most significant bit of the hexadecimal word corresponds to the user bit furthest from the start of the block. Thus, setting the value in byte 1 to 80 sets user bit number 15 (out of 184) high. The top line of values for each channel allows setting of each transmitted user bit. The bottom line of hex numbers indicates the current values for each of the received user bits.

Received user bits can be highlighted in yellow when they differ from the corresponding transmitted bit or when they differ from the corresponding received bit on the other channel. The **Highlight Differences** control on the 2nd tab of the [Digital I/O](#) panel controls highlighting in the user status panel and the channel status panel.

2.3.7 Sweep Panel

Sweep Concepts

SR1 operates in two different modes, Free Run and Sweep. In Free Run mode the analyzers make measurements continuously and update measurement results on displays and panels as each new measurement is available. This is convenient way to use the instrument in a benchtop setting while debugging hardware or quickly measuring the performance of a new device.



Sweep is a more structured operating mode suitable for formal, repetitive testing to standards. Sweeps involve choosing a **sweep source** and **sweep data**. The sweep source defines the "X-axis" of the sweep — it specifies a series of points at which SR1 will take measurements. There are four types of sweep sources: **time sweeps**, in which measurements are made at specified time intervals, **internal sweeps**, in which measurements are made at fixed values of some internal parameter, such as generator frequency, **external sweeps**, where measurements are made at specified values of some externally measured parameter, and finally **switcher sweeps**, where measurements are made over some set of inputs and outputs switched by external hardware.



Configuring a sweep also involves selecting the sweep data. Unlike free run mode, where all measurements are continuously updated, in a sweep SR1 only computes the set of measurements selected as sweep data. Additionally in a sweep, each sweep data measurement needs to settle before the instrument will move to the next sweep point. A "settled" measurement is a measurement whose variability has decreased below a user-configured threshold and is considered suitable for final results. Each SR1 measurement can have completely different settling parameters, all configured on the [Settling Panel](#). Note that settling is never applied to measurements when SR1 is running in free run mode.

The Inner and Outer Sweep Axes

SR1 allows both one and two dimensional sweeps with a separate sweep source for each dimension. The two sweep dimensions are referred to as the "outer" and "inner" sweeps. Both the inner and outer sweeps may be swept alone, with no sweep source set for the other axes. When used together the inner sweep is performed for each value of the outer sweep. This allows, for instance, a distortion sweep to be made over both frequency and amplitude. Certain restrictions apply to the type of sweep source that can be used for each sweep dimension. Switcher sweeps can only be used on the outer sweep axis, while external sweeps can only be selected on the inner sweep axis.

Starting and Stopping Sweeps and Free Run

To start free run mode, press the free run start button,  or the <Run> key on the keypad. While in free run mode press the pause button, , which then changes to the resume button, , which resumes free run measurements. (This is equivalent to using the <Pause> button on the keypad.)

To start a sweep, press the sweep start button, , or press the <Sweep> key on the keypad. During the sweep, the pause/resume function is controlled by the  and  buttons as it is for free run.

When the sweep is complete, the sweep done indicator,  is displayed.

The current sweep/free run status is always shown at the bottom of the screen.

Free Run Active

The Sweep Panel

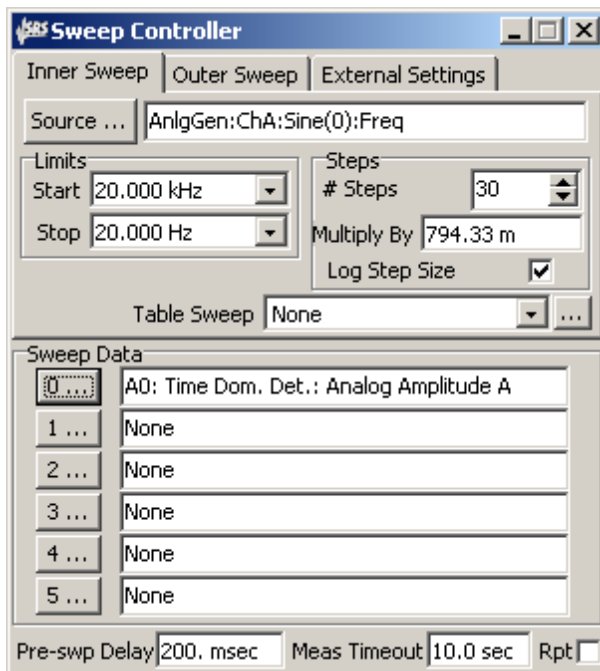

Configuring the Sweep Source

Pressing the Source... button opens the Sweep Source Selection Window.

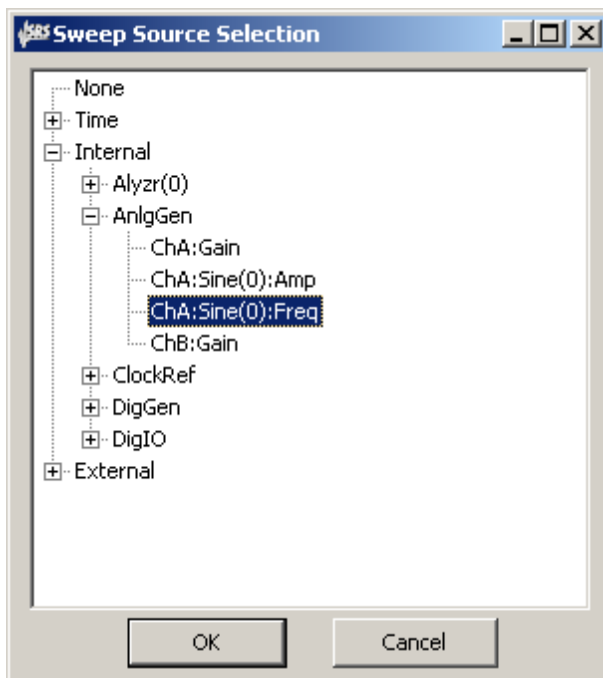

The different sweep sources are organized in a tree structure. Click on the appropriate source: Time, Internal, External, or Switcher Channels to display the options relevant for that particular source.

Configuring Internal Sweeps

Internal sweeps are perhaps the most common type of sweep used in audio measurements. In an internal sweep SR1 sweeps some internal parameter, for instance the analog generator sine frequency, for a fixed number of points between two endpoint values. The progression of the sweep can be linear or logarithmic. When the sweep source selection window is displayed, clicking on Internal displays the major subsections of SR1 containing sweepable parameters. Only the currently active generator and analyzer parameters are visible, so it's important to set up any generators and analyzers **before** configuring the sweep. Clicking on an individual parameter sets that parameter as the sweep source

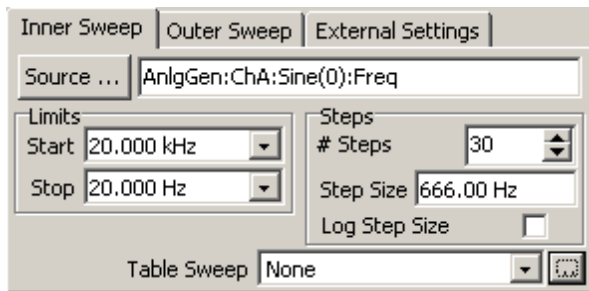

Internal Sweep Controls

When a source parameter is selected, the limits controls will display the default limits for that parameter. Any limits within the allowed range can be selected. When the sweep is started the selected source parameter will be set to the "Start" value and when the sweep is finished the source parameter will have the "Stop" value. The "Stop" value can be greater or less than the "Start" value, i.e. both forwards and backwards sweeps are allowed. "# Steps" sets the number of steps in the sweep (the number of points in the sweep is the number of steps+1 since the sweep always includes the start and end points). When it is selected, the Step Size parameter will automatically adjust to a step which covers the selected source parameter range in that number of steps. If "Log Step Size" is unchecked, then the sweep progression is linear—the source parameter is incremented by the Step Size after each sweep point. If "Log Step Size" is checked, the sweep progression is logarithmic and the source parameter is multiplied by the sweep increment after each sweep point. If the log or linear step size is entered, the # Steps parameter will be adjusted to a value which covers the selected range with the chosen sweep increment, up to a maximum number of 10,000 sweep points.

When an internal sweep is finished, the values of all swept parameters are returned to what they were before the sweep was started.

Internal Table Sweeps

In addition to setting the sweep limits and step size, the X-axis points for an internal sweep can be explicitly set using a Table Sweep. To setup a table sweep create an ASCII text file with the desired sweep parameter values in one column. Then select the file using the file dialog box opened by the  button. When a table sweep is selected the Start/Stop values and the #Steps/Step Size entries are ignored—the sweep simply proceeds from one table value to the next until the table ends.

Configuring Time Sweeps

In a time sweep, the sweep x-axis is based on the passage of time rather than the progression of some parameter value. The start and stop time determine the time of the first and last measurements taken in the sweep. The step size determines the amount of time between sweep points. If the amount of time necessary to obtain settled sweep data exceeds the step size, SR1 can take two different actions depending on whether the sweep source was chosen as "Intersample Delay" or "Absolute Time." If the source is "Intersample Delay," SR1 always waits at least a step size after getting settled sweep data before beginning a new measurement. If "Absolute Time" is chosen, the analyzer will begin a new measurement immediately after finishing the previous measurement if necessary. Note that in both

cases, the final number of points in the sweep may be less than "#Steps" if the amount of time necessary to obtain settled data is significant.

Configuring External Sweeps

External sweeps allow SR1's measurement of an external parameter to determine the the sweep X-axis. For instance, one may want to measure the characteristics of an external sweep generator not controlled by SR1. When performing an external sweep, SR1 measures the frequency of the external source and then determines when that frequency meets preset criteria for starting the sweep, ending the sweep, or beginning a new sweep point. When SR1 measures the external sweep source, it requires that the reading be Settled. Refer to the [Settling Panel](#) for information on the different types of settling

To configure an external sweep first make sure that the appropriate analyzers are active to make the measurement on which the external sweep will be based. For instance to sweep based on a measured amplitude the Time Domain Detector should be selected. Now click on the "External" node in the sweep source selection window. When the "External" branch of the sweep source tree is opened, the various measurements that can be used as external sweep sources are displayed. Click on the desired measurement.

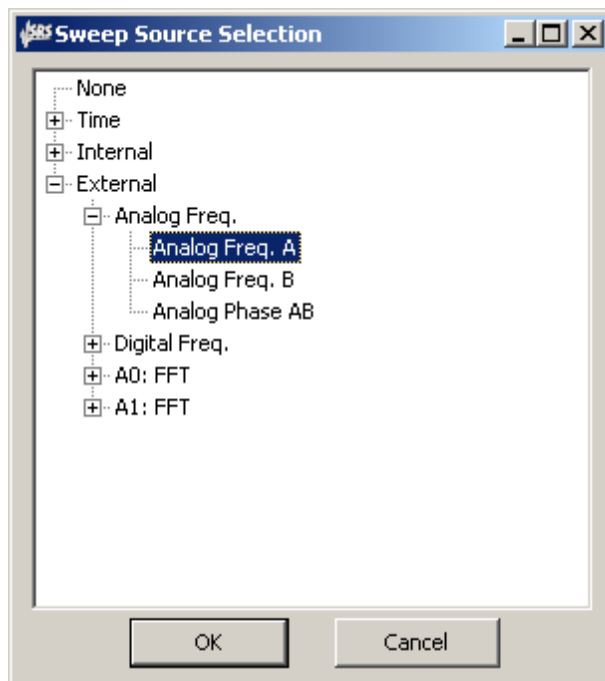

The sweep source selection parameters are now displayed.

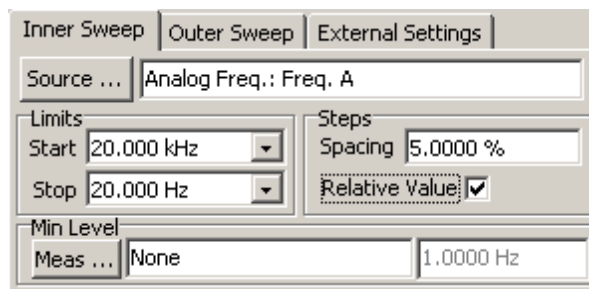

In an external sweep, the Start, Stop, and Spacing parameters can all be thought of as "desired" values rather than guaranteed values because SR1 has no control over the external sweep source. However,

SR1 monitors the swept measurement and attempts to make the actual sweep X-axis correspond as closely as possible to these values. The spacing of the steps in an external sweep can either be specified as a percentage ("Relative Value" checked) or as an absolute value ("Relative Value" unchecked).

It can be useful to condition the external sweep's search for a new sweep point on the value of another measurement. For instance, if both the amplitude and frequency of the external source varies there may be no point in searching for a new frequency sweep-point if the amplitude is zero. SR1 handles this situation by allowing the setting of a "Minimum Level" measurement. Click the Minimum Level "Meas..." button to open a window allowing the selection of any SR1 measurement to act as a qualifier for external sweeps. The analyzer will then need to obtain a settled value of the selected measurement that is greater than the specified minimum value before finding a new value of the actual sweep parameter.

The "External Settings" tab on the Sweep Panel contains a number of additional controls which govern the starting and stopping of external sweeps.

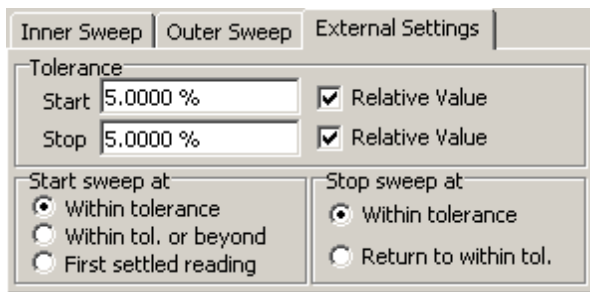

The "Start Sweep At" parameter controls the starting of the external sweep.

Start Sweep At...	
Within Tolerance	The external sweep starts when a settled measurement of the sweep source is within tolerance (\pm) of the "Start" value of the sweep.
Within Tolerance or Beyond	The external sweep starts when a settled measurement of the sweep source is within tolerance (\pm) of the "Start" value of the sweep, or greater than the "Start" value.
First Settled Reading	The sweep starts at the first settled measurement of the sweep source regardless of the relation of that value to the "Start" parameter.

Once the external sweep is started SR1 monitors the sweep source for a settled measurement. The value of the settled measurement is compared to the last sweep point and if it exceeds the "Spacing" value, a new point is declared. External sweeps are unidirectional. The direction is determined by the relative values of the "Start" and "Stop" parameters. Only settled readings that exceed the spacing in the direction of the sweep will result in a new sweep point.

The external sweep ends when...

Stop Sweep At...	
Within Tolerance	The external sweep ends after a settled measurement of the sweep source is within tolerance of the "Stop" value of the sweep
Return to Within Tolerance	The external sweep stops when a settled measurement of the sweep source is within tolerance (\pm) of the "Stop" value of the sweep, or greater than the "Stop" value.

Configuring Switcher Sweeps

SR1 is designed to work with the SR10, SR11, and SR12 Audio Switchers to allow users to switch both outputs from and inputs to SR1 during a sweep to enable testing of multiple devices. Configuration of a switch network, including identification of the physical switch boxes and specification of communication protocols, is performed on the [Switcher Configuration Panel](#). After configuring the details of the switcher network each input and output is assigned a **logical channel number**. For purposes of discussing the switcher sweep all we need to know is the range of logical channel numbers for both the inputs and outputs; the details of the switcher network configuration will be left to the discussion of the Switcher Configuration Panel.

Switcher sweeps can only be configured on the outer sweep axis. The typical measurement configuration will be to first sweep the input or output to a particular device (outer axis) and then perform the sweep which represents the actual measurement being performed on the inner axis. To select a switcher sweep double click on the "Switcher" node in the sweep source selection for the outer sweep axis. This displays the switcher sweep source panel:

There are two tabs on the switcher sweep source panel, one for inputs and one for outputs. Inputs and outputs can be swept simultaneously if the corresponding switcher hardware has been configured on the [Switcher Configuration Panel](#). On each tab the network selection determines whether unbalanced (BNC) or balanced (XLR) inputs or outputs will be swept. The number of steps determines how many points will be taken. (The number of points is the number of steps plus one, i.e. a sweep of one step contains two points, the initial and final ones.) On both the input and output tabs the checkboxes for A and B determine whether the A channel, B channel, or both will be swept. If the checkbox is checked then the corresponding up-down control will be enabled allowing setting of the initial logical channel for each channel. At each step in the sweep the logical channel connected to each checked input or output will be incremented by the amount specified by the "in steps of" control.

For example, consider the output sweep specified by the panel illustrated above. At each point in the sweep the logical channel connections to the A and B outputs will be:

Sweep Point	0 (Initial State)	1	2	3	4	5 (Final State)
A Logical Channel	1	3	5	7	9	11
B Logical Channel	2	4	6	8	10	12

This represents a typical stereo sweep of a single switcher with 12 channels. If a single channel sweep were desired the "B" sweep could be unchecked and the channel increment reduced to one thereby enabling up to 11 sweep steps on a single device. Adding more devices in the Switcher Configuration Panel will increase the available range of logical channel numbers and increase the number of possible steps in the sweep.

When the "Bus" box is checked (output switcher sweeps only), all the output channels are simultaneously connected to SR1's output **except** the one channel that is being sweep. This is useful for testing crosstalk of multiple devices.

Configuring Sweep Data

After a new sweep X-axis point is determined according to the selected Sweep Source, SR1 begins to search for settled values of each of the sweep data measurements. Up to 6 measurements may be selected for each sweep. To select the sweep data measurements, click on the numbered box in the sweep data section of the sweep panel. This opens a tree display of all the available measurement selections. Click on the measurement to add it to the sweep, or click on "None" to remove the current measurement from the sweep. Only measurements from the currently active analyzers will be shown, so it's important to set up the **analyzers** before configuring the sweep.

Other Sweep Parameters

"Pre-Sweep Delay" sets a fixed delay between the time when the sweep starts and the time when the analyzer begins measuring the first data point. "Measurement Timeout" sets the maximum time that the analyzer waits for settled measurements, if a settled measurement is not returned in this time interval the analyzer skips that point and moves on. Checking "Rpt" (Repeat) causes the sweep to automatically restart as soon as it finishes the current sweep.

Sweeps and Events

SR1's [Event](#) panel allows a number of user-defined actions to be associated with the occurrence of certain events. Actions include logging the occurrence to a text file, running a script, or triggering a COM event. Sweeps define several such events: Sweep Start, Sweep New Point Start, Sweep New Point Timeout, Sweep New Point Done, and Sweep Finished.

2.3.8 Settling Panel

While in sweep mode SR1 requires all measurements to "settle" before adding them to the sweep. Settling insures that the variability for the measurement, whether intrinsic to the measurement or due to transients arising from the sweep, is reduced to a predetermined level. Each measurement can have a different settling profile, each characterized by a precision, number of points, profile, threshold, and delay.

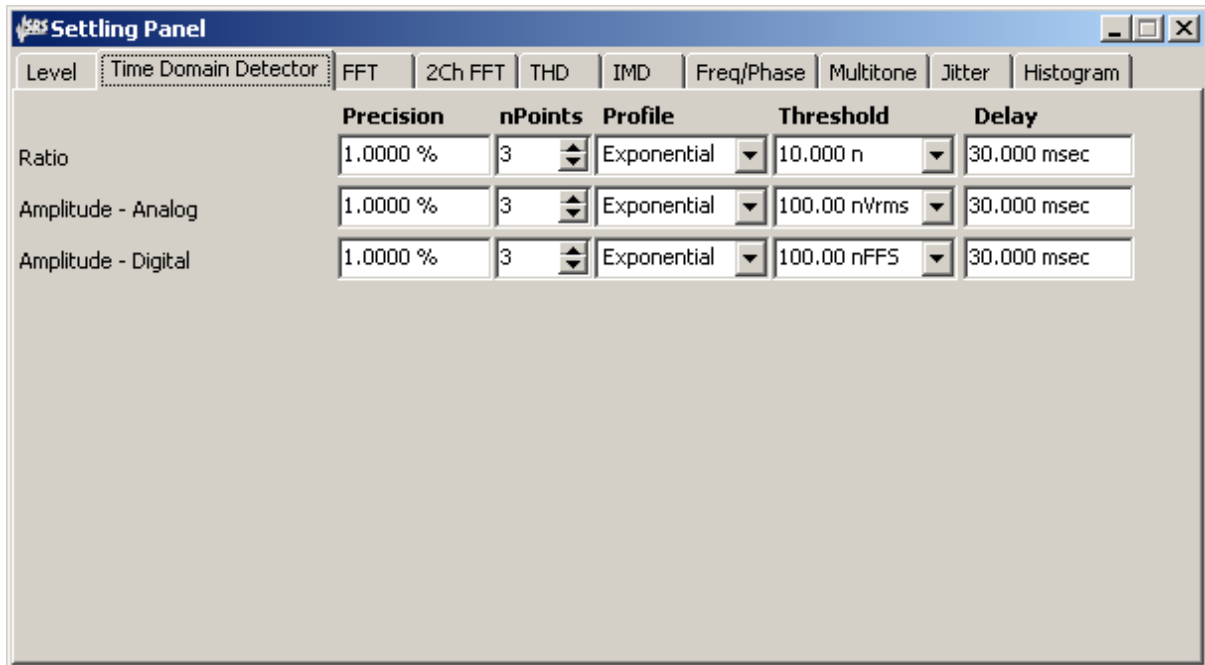

Precision

The precision parameter sets the amplitude scale for what is considered a settled measurement. If the value of the most recent measurement is y , then another measurement is considered to be within tolerance if its value falls in the range of $y \times (1 \pm \text{precision})$. Tightening the precision window increases the precision of the final sweep data at the expense of having to possibly wait longer for a settled measurement. The "correct" value of the precision depends on the measurement and application and can usually only be determined by experimentation—the tight tolerance that might be appropriate for measuring the flatness of a filter passband with sub-dB precision is probably too restrictive for broadband noise measurements.

Profile

The settling profile, along with the value of nPoints, defines an algorithm which determines whether an measurement is settled. Each of the settling profiles is described below:

Settling Profile	Description
None	No settling is performed when this profile is selected. The most recent measurement is always considered settled and added to the sweep
Exponential	In exponential settling the most recent measurement point is compared with the last nPoints-1 previous measurements. For the measurement to be considered "settled," the previous point must be within tolerance of the current point. The 2nd-

	previous point must be within twice the tolerance of of the current point, the 3rd-previous point within 3 times the tolerance, etc. This is the most "lenient" of the settling profiles and reflects the fact that the variability of many measurements decreases as a function of time after a transient change.
Flat	The measurement is considered settled using the flat profile when the previous nPoints measurements are all within tolerance of the current measurement. This is the "strictist" of all the settling profiles.
Sequential	The measurement is considered settled if the current measurement is within tolerance of the previous point, the previous point is within the tolerance of the next previous point, etc., for a total of nPoints.
Average	The result of the last nPoints measurements are averaged together and the average result is considered the settled value

Delay

The delay parameters sets the amount of time after the sweep source has changed to a new value before the analyzer begins to look for a settled measurement. If the sweep appears "glitchy" due to transients from the moving sweep source, increasing the delay value can sometimes help to clean up the sweep.

Threshold

At very low levels, the tolerance window $y \times (1 \pm \textit{precision})$ becomes very small and it is possible that some measurements will not settle. The threshold parameter sets a minimum value for the tolerance window such that if $y \times \textit{tolerance} < \textit{threshold}$, the tolerance window becomes $y \pm \textit{threshold}$.

2.3.9 Monitors Panel

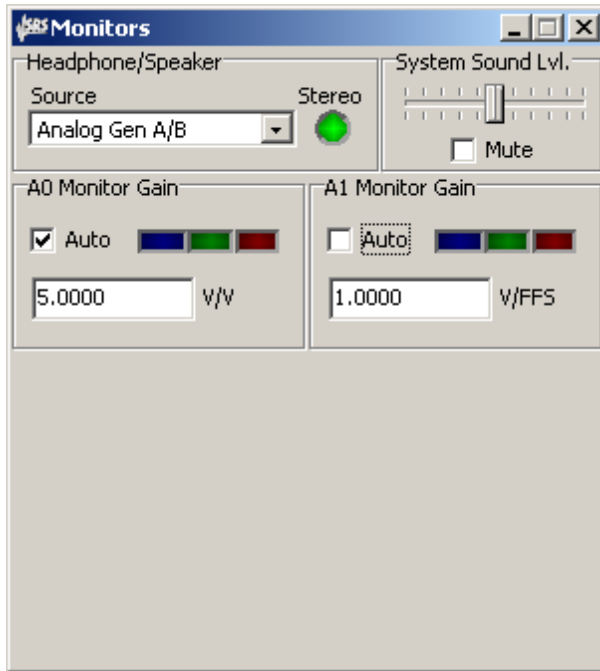

The Monitor Panel controls a number of functions related to SR1's speaker/headphone output and the rear panel analyzer monitor outputs. Several different signals can be routed to the speaker/headphones. Some of these sources are monophonic, and are sent to both channels of the headphones and to the single speaker. Stereo sources are routed to both channels of the headphone output, and the left and right channels are summed and sent to the speaker. The volume of both the headphone and speaker outputs is controlled from the front panel volume knob.

Headphone/Speaker Source (* indicates stereo source)	
Analog Gen. A	The speaker and both headphone channels are fed the current output of the analog generator A channel.
Analog Gen. B	The speaker and both headphone channels are fed the current output of the analog generator B channel.
Analog Gen. A/B*	The left and right headphone channels are fed the A and B channels of the analog generator, the speaker is fed the summed A+B signal.
Analog Level A	The speaker and both headphone channels are fed the signal input on the analog A channel.
Analog Level B	The speaker and both headphone channels are fed the signal input on the analog B channel.
Analog Level A/B*	The left and right headphone channels are fed the analog input A and B channels, the speaker is fed the summed A+B signal.
Digital Level A	The speaker and both headphone channels are fed the embedded digital audio input signal channel A.
Digital Level B	The speaker and both headphone channels are fed the embedded digital audio input signal channel B.
Digital Level A/B*	The left and right headphone channels are fed the A and B channels of the embedded digital audio input signal, the speaker is fed the summed A+B signal.

Monitor A0	The speaker and both headphone channels are fed the A0 monitor signal. See the discussion below on the monitor signals.
Monitor A1	The speaker and both headphone channels are fed the A1 monitor signal. See the discussion below on the monitor signals.
Monitor A0/A1*	The left and right headphone channels are fed the A0 and A1 monitor signals, the speaker is fed the summed A0+A1 monitor signal.
Jitter	The speaker and both headphone channels are fed a signal proportional to the current output of the Jitter Demodulator. See the Jitter Analyzer section for a description of the function and controls pertaining to the Jitter Demodulator.

System Sound Level controls the volume of sound generated by the Windows operating system. Note that sounds generated by the Windows operating system are not affected by the the volume control knob.

Checking **Mute** turns off Windows sounds altogether.

Analyzer Monitor Output Controls

Two identical groups of controls control the A0 and A1 Monitor outputs. The monitor signals are only active if the corresponding analyzer is set to "[Time Domain Detector](#)." The A0 Time Domain Detector outputs a realtime analog signal to the rear-panel A0 Monitor connector which corresponds to the input signal after the notch/bandpass filter and any bandwidth limiting or weighting filters have been applied. In a typical THD+N measurement signal, the monitor signal corresponds the distortion+noise signal after the fundamental has been notched out. Sending the monitor signal to the headphones/speaker allows one to "hear" the distortion.

The **Gain** controls govern the scaling of the monitor output signals. If the corresponding analyzer has an analog input signal, then the gain is displayed in units of Volts/Volt. (Volts output per Volts Input). If the corresponding analyzer has a digital input signal, then the gain is displayed in units of Volts/FFS. (Volts output per FFS input). In either case, the maximum output signal from the monitor outputs is about 2 Vrms.

Checking **Auto** gain automatically sets the gain such that the monitor output signal remains near mid-scale. If the signal has significant time variation auto gain should be disabled so that the gain control doesn't chase the variation in the monitor signal.

The **Monitor Level indicators** display the current level of the monitor outputs. Blue indicates the monitor level is below half scale, red indicates the monitor output is overloaded and may be clipping. Green indicates the monitor level is between half scale and full scale.

2.3.10 Multitone Panel

Multitone Testing is a relatively new technique (compared to traditional audio measurements, many of which have their roots in the 1920s and 1930s) which enables testing of multiple audio parameters using the information contained in the FFT of a short record of audio data. By using a stimulus signal which contains discrete tones at only few of the bin frequencies of the FFT, the Multitone analyzer can examine the amplitude of bins in the FFT which correspond to tones in the original signal (frequency response), harmonics of tones in the original signal (THD and THD+N), intermodulation products of tones in the original signal (IMD) and finally bins where none of the above are present (Noise). All these measurements can be made **simultaneously**, on the data found in a single FFT, instead of by making multiple laborious swept measurements.

Setting up multitone testing on SR1 involves configuring the generator and the analyzer. Details of the analyzer configuration are discussed in the [MultiTone Analyzer](#) section. The MultiTone configuration panel discussed here is concerned with details of the generator configuration. Once the tone placement, signal length, etc. are configured on the Multitone Configuration panel the user needs to select the [MultiTone](#) waveform on the analog or digital audio generator in order to begin generation of the multitone stimulus signal.



Unlike many other audio analyzers, SR1 does not require the user to employ a offline program to calculate a multitone stimulus signal and then load it into an arbitrary waveform generator. Once the multitone waveform is running on SR1, any changes to the waveform made on the Multitone configuration panel are immediately reflected in the generator output.

The Multitone Configuration Panel

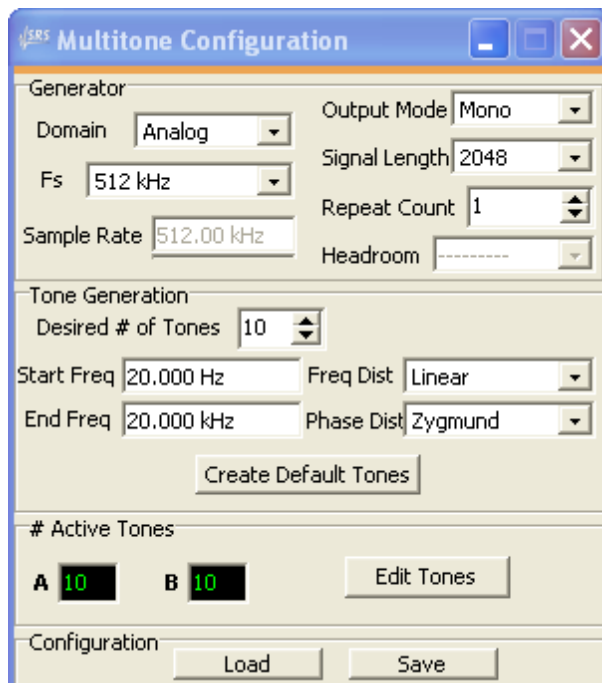

Generator

The Domain control selects whether the Analog or Digital generator will be used. For the Analog Generator, a choice of fixed sampling rates (512 kHz, 128 kHz, and 64 kHz) as well as variable rates (digital audio output sampling (OSR) and input sampling rate (ISR)) can be selected using the "Fs"

control. For the variable cases the "Sample Control" will be initialized with the current OSR or ISR, the user should enter the actual sample rate that will be used during testing.

The multitone generator can output either a "mono" signal, in which the A and B channel output signals are the same, or a "stereo" signal, in which the tone placements for the two channels can differ. The latter mode is useful for measuring crosstalk by the examining the amplitude in bins containing a tone in one channel, but not in the other. Note that the default tones created by the Multitone Configuration panel are always the same on both channels, even if stereo mode is selected. The user must explicitly change the tone placement on one of the channels using the "Edit Tones" panel. This is especially important when configuring crosstalk measurements where the two channels need to have different tone placements.

The signal length determines the frequency resolution of the generated signal. For a signal length of N and a sampling rate of F_s , there are $N/2$ bin frequencies each separated by (F_s/N) ranging from DC to just under $F_s/2$. Increasing the signal length increases the number of possible tone positions and allows for more differentiation of tones, harmonics, and IMD products, but increases the amount of time necessary to acquire the FFT record. The "Repeat Count" is only used when the generator is operated in burst mode. In this mode, each burst will contain the indicated number of repetitions of the complete multitone signal. Increasing the repeat count beyond "one" is useful in burst situations as it gives the analyzer more time to recognize the multitone stimulus and increases the dynamic range of the final measurements.

Tone Generation

Tones are placed at bin frequencies between the values entered in the "Start Frequency" and "End Frequency" fields according to the algorithm selected in the "frequency distribution" control:

Multitone Frequency Distribution	
Linear	The "desired number of tones" will be distributed between the frequency limits with an approximately uniform frequency separation.
Log	The "desired number of tones" will be distributed between the frequency limits with an approximately constant ratio between the frequencies of adjacent tones.
Octave	Starting with the first bin with a frequency greater than or equal to the "Start Frequency", tones will be placed with each tone having a frequency two times greater than the previous tone. The final tone has a frequency less than or equal to the "End Frequency."
Decade	Starting with the first bin with a frequency greater than or equal to the "Start Frequency", tones will be placed with each tone having a frequency ten times greater than the previous tone. The final tone has a frequency less than or equal to the "End Frequency."
Prime	Tones are placed at each prime numbered bin whose frequency falls within the selected range. This placement algorithm guarantees that no tones will fall on harmonics of other tones which is useful in separating the harmonics distortion due to each individual tone.
Linear Prime	The "desired number of tones" are placed on prime-numbered bin frequencies within the selected range with an approximately uniform frequency distribution.
Log Prime	The "desired number of tones" are placed on prime-numbered bin frequencies within the selected range with an approximately uniform ratio between adjacent tone frequencies.

The phase distribution of tones in a multitone signal directly affects the crest factor of the signal. Crest factor is important because it limits the amount of power that can be placed in each tone for a given peak amplitude of the resultant signal. SR1 offers several phase distribution choices for multitone signals. "Zero" simply sets all tone phases to 0 which usually results in a signal with very high crest factor but which may be useful for comparison purposes. "Random" assigns random phases to each tone. The remaining choices, "Newman", "Schroeder", "Zygmund", and "Rudin", are various

approximations to the full crest-factor minimization problem, which has no closed form solution. The various algorithms are described in the paper "Low-Crest-Factor Multitone Test Signals for Audio Testing" by Alexander Potchinkov (JAES v50 #9 p681). Once the tone placement options are selected, press "Create Default Tones" to update the waveform. Note that none of the tone placement options will be reflected in the actual output until "Create Default Tones" is pressed.

Configuration

The Load and Save buttons call up file dialogs allowing the user to save and recall only the configuration information contained in the multitone configuration panel (including any manually edited tone parameters).

Active Tones

The two indicators display the number of active tones the the A and B channel. Usually this will be the same number of tones in the "Desired # of Tones" control. The "Edit Tones" button displays the Edit Tones panel.

The Edit Tones Panel

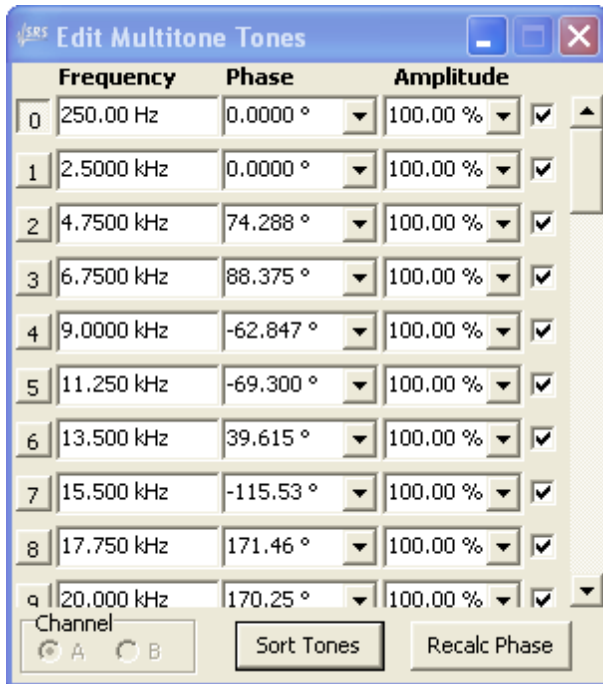

The Edit Tones panel allows modification of individual tone amplitudes, frequencies, and phase. The Edit Tones panel is also the only method by which tones can be placed in different positions on the A and B channels. Frequencies entered will be rounded to the nearest bin frequency. Amplitudes are all relative; the overall amplitude of the signal is set in the generator waveform panel. Each tone may be turned on and off individually with the checkbox at the right-hand side of the panel. Pressing "Sort Tones" sorts the tones in frequency order, while "Recalc Phase" recomputes the phase distribution according to the algorithm selected on the Multitone Configuration Panel." The buttons on the left allow one tone to be the "selected tone." The amplitude of this tone is used for normalization of measurements computed by the [Multitone Analyzer](#).

2.3.11 Clock Reference Panel

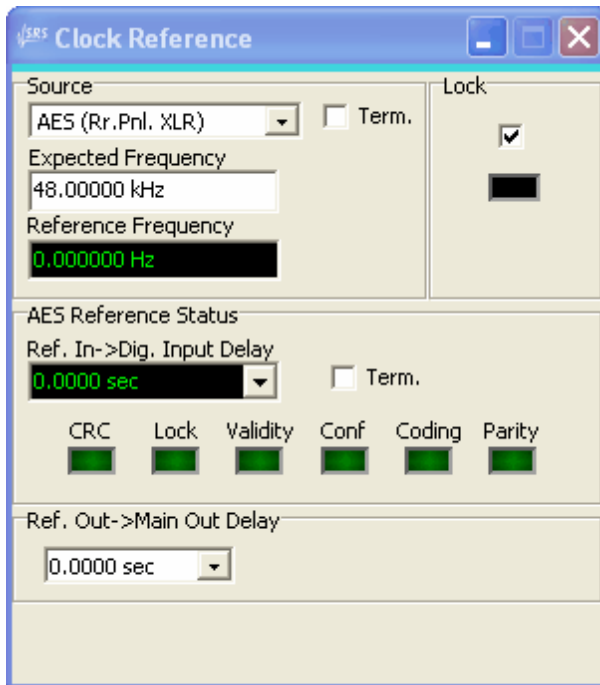

All of SR1's clocks, for both analog and digital audio, can be slaved to an external clock signal specified on the Clock Reference panel. In the absence of an external clock source the sampling clocks are derived from an internal high-quality crystal oscillator.

Source selects the external clock source to lock to.	
AES	Selects an AES/EBU signal connected to the rear panel "AES Ref In" XLR connector. SR1 can lock to signals representing frame rates from 24 kHz to 216 kHz.
External Reference	Selects a (square or sine) clock signal connected to the rear-panel "Ext Ref In" BNC connector. The expected frequency can range from 10 kHz to 29 MHz.
Internal Reference	Selects the optional internal atomic-clock oscillator as the reference signal. (Not currently implemented)
Video NTSC	Selects a standard NTSC composite video signal connected to the rear panel Video Ref In BNC connector. The expected frequency is 15.7343 kHz.
Video SECAM	Selects a standard SECAM composite video signal connected to the rear panel Video Ref In BNC connector. The expected frequency is 15.625 kHz.
Video PAL	Selects a standard PAL composite video signal connected to the rear panel Video Ref In BNC connector. The expected frequency is 15.625 kHz.

Expected Frequency displays the nominal frequency of the selected source. For some sources, such as the video signals, the expected frequency is preset. For the other sources, the correct value of the external reference must be entered.

Reference Frequency displays the current frequency of the selected input clock source. When locked, the Reference Frequency display will match the expected frequency value.

Checking **Lock** begins the process of locking to the selected external source. After a few seconds the

Lock Indicator should glow green indicating a successful lock. If the indicator does not glow green, check that the correct clock is selected, the expected frequency is correct, and the external clock signal is free of excessive noise and jitter. If lock is not checked, SR1 uses its own internal crystal oscillator as a clock source. The phase lock loop attenuates jitter of the reference signal by 6 dB/octave above 5 Hz.

AES Reference Controls

The **Terminate** checkbox terminates the rear panel AES Ref In XLR connector with a 110Ω resistor.

Reference In→Digital Input Delay displays the measured time interval between the z-preambles of the AES reference input (rear panel AES Ref In) and the front panel digital audio input.

The **AES Reference Status** indicators indicate the current status of the AES Reference input.

Status Condition	Meaning
CRC	For AES/EBU digital audio streams an 8-bit CRC code is generated from the received channel status bits in each block and compared to the value stored in the last byte of the channel status block. Red indicates a CRC mismatch.
Lock	Green indicates that the digital audio receiver is locked to an input data stream. Red indicates no lock.
Validity	Red indicates that the validity bit has been set in one of the received sub-frames
Confidence	Red when either the Unlock or Bi-phase error is detected.
Coding	Bi-phase error. A valid digital audio signal remains at the same amplitude for no greater than two Unit Intervals (UIs), except during preambles. A red indicator indicates that this condition has been violated.
Parity	Each digital audio subframe contains a parity bit which summarizes the parity of the remainder of the bits in the subframe. Red indicates that the received parity bit does not match the parity computed in the remainder of the subframe.

Reference Out→Main Output delay sets the delay between the AES Reference Out z-preamble and the main Digital Audio output z-preamble. The delay may be set between 0 and 127.5 UI (128 UI would be 1 complete digital audio frame) in .5 UI intervals.

2.4 Analyzers Menu

The core of SR1's measurement capabilities is found in its collection of analyzers. Each analyzer represents a functionally related group of measurements and the controls related to those measurements. At any given time there are two active analyzers, denoted by A0 and A1. To change the type of the two active analyzers use the following selections from the Analyzers menu:

<u>Time Domain Detector (TDD)</u>	Makes wideband amplitude, ratio, SNR, and THD+N measurements. The time domain detector signal chain includes bandpass or notch filters, bandwidth limiting filters, and a variety of different weighting filters. Peak, RMS and Quasi-Peak responses are selectable.
<u>Single Channel FFT (FFT1)</u>	Provides single-channel FFT functionality. Measurements include power spectrum, time record, phase. Both zoom (changing the FFT frequency range) and heterodyne (moving the FFT frequency range) are included.
<u>Dual Channel FFT (FFT2)</u>	Provides dual-channel FFT functionality. Measurements include power spectrum and time record for both channels, plus frequency response (transfer function), and interchannel phase. Zoom (changing the FFT frequency range) is supported in the dual-channel analyzer
<u>THD Analyzer (THD)</u>	Makes frequency selective Total Harmonic Distortion (THD) measurements, both ratio and absolute. Includes the ability to measure specific sets of harmonics.
<u>IMD Analyzer (IMD)</u>	Makes standard Intermodulation Distortion measurements including SMPTE/DIN, CCIF (difference frequency), and DIM/TIM.
<u>Multitone Analyzer (MTA)</u>	Makes single-shot multitone measurements allowing fast measurements of common audio parameters including noise, distortion,
<u>Jitter Analyzer (JITT)</u>	Measures the jitter of the digital audio carrier in both the time and frequency domain including variable high and low pass filtering.
<u>Histogram Analyzer (HIST)</u>	Creates amplitude histograms of the analog and digital audio input signals.
<u>Octave Analyzer (RTA)</u>	Measures power in fractional-octave bins.

2.4.1 Common Analyzer Features

Analyzer Input Selection

Most of the analyzers share common controls that select the analyzer input:

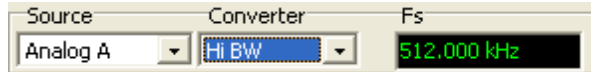

Source

Most analyzers take a single input source, either analog channel A or B or digital audio channel A or B. Details of the analog input connections, such as connector, coupling, etc., are set on the Analog Inputs Panel. Details of the Digital Audio Input connection are set on the "Digital I/O Panel". Some analyzers, such as dual-channel FFT, intrinsically take a pair of inputs as their input source. For these analyzers the input source selection will be simply "Analog" or "Digital." Some FFT-based analyzers (Single Channel FFT, THD, IMD) can also use as input the output of the time domain detector analyzer, allowing these analyzers to examine the post notch-filtered noise and distortion signal.

Converter

For analog signals, SR1 offers a choice of two analog-to-digital converters, each optimized for different measurements. The high-bandwidth (Hi BW) converter is a 16-bit converter operating at a fixed sampling rate of 512 kHz. The high-resolution (Hi Res) converter is a 24-bit converter which operates at fixed sampling rates of 128 kHz and 64 kHz and variable rates which can be synchronized with the digital audio output or input signal to perform cross-domain measurements. (Selection of the Hi Res converter sampling rate is made on the [Analog Inputs Panel](#).) Digital Audio inputs do not involve a choice of converter and the converter field is fixed at "Dig. Aud."

Fs

The current analyzer sampling rate is displayed in the Fs field in the upper right of the analyzer panel. The sampling rate is dependent on the source/converter combination. For analog inputs the sampling rate is dependent on the converter selection as described above. For digital audio inputs, the sampling rate depends on the sampling rate embedded in the digital audio input signal. Note that for dual-connector digital audio inputs, the sampling rate shown is the logical sampling rate representing the actual spacing of the digital audio samples rather than the physical sampling rate on each connector.

When To Use the Hi-Bandwidth and Hi-Resolution Converters

Use the Hi-Bandwidth Converter when....

- The measurement requires a bandwidth greater than the maximum bandwidth of the Hi-Res converter
- When making THD and THD+N measurements of ultra-low distortion devices (<100 dB). The Hi-Bandwidth converter signal chain includes hardware notch filters and hardware post-filter gain to provide the best dynamic range for THD and THD+N measurements.

Use the Hi-Resolution Converter when....

- When making FFT measurements within the bandwidth of the Hi-Resolution converter. FFT measurements made with the Hi-Resolution converter can have an up to a 15 dB lower noise floor than equivalent measurements with the hi-bandwidth ADC.

- When making cross domain measurements that require the input analog sampling rate to be synchronized to the digital audio output
- When making IMD measurements. The Hi-Resolution converter has lower residual IMD distortion.

Level Indicators



For all analyzers except the Jitter analyzer the bottom portion of the analyzer panel displays the levels, frequencies, and relative phase associated with the selected inputs. For the Time Domain Detector, the indicated level is a highly accurate RMS measurement of the two input channels. For all other analyzers the level meter is a less accurate peak-based meter. The phase indicator shows the relative phase between the A and B channels of the analog or digital audio input signals depending on the selected input source. The phase indicator reading is only meaningful when A and B channels have the same frequency.

Analyzer Trigger

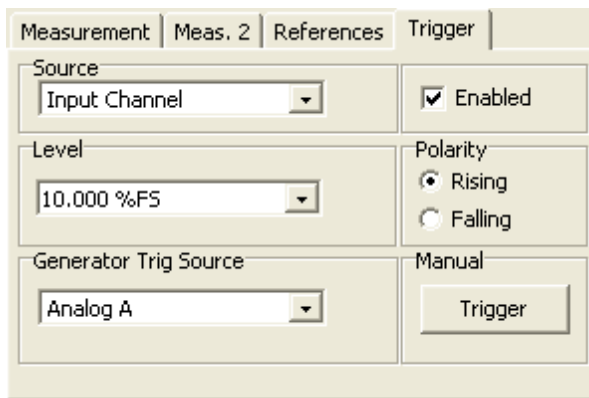

Most analyzers can operate in a "triggered" mode. The FFT analyzers, for instance, use the trigger to synchronize the start of the FFT time record. The Time Domain detector uses the trigger to start the beginning of each measurement interval. To select "triggered" mode for the analyzer check the "Enabled" box on the trigger tab. Although each analyzer uses the trigger differently, the method by which triggers are generated is common to all analyzers.

Trigger Source	
Input Channel	The trigger source is the selected input signal of the analyzer.
Other Channel	The trigger source is the channel not selected as the input of the analyzer. For instance if the analyzer source is "Analog A" then selecting "other channel" as the trigger source selects "Analog B"
External	Selects a TTL signal on the rear panel "Ext Trigger" BNC connector as the trigger source.
Manual	Only allows manual triggers. Manual triggers are generated by clicking on the "Manual Trigger" button.
Generator	Selects the generator as the trigger source. Use the "Generator Trig Source"

	control to select which generator will be the source of triggers. Only certain waveforms generate triggers. See the Analog and Digital Generators section for more information about generator triggers.
Digital Audio Block	Selects the digital audio carrier "Z Preamble" (the beginning of a block) as the trigger source. This option is only allowed when the analyzer source is set to digital audio.
External Burst A,B	Selects the burst as the trigger source.

The "Input Channel" and "Other Channel" triggers are level triggers, i.e. they trigger when the selected signal passes through a level with a specific polarity chosen with the "Level" and "Polarity" controls. All the other trigger sources are "binary" – they either occur or not.

Trigger Indicators



The two trigger indicators on the speedbar at the top of the SR1 screen flash green when the corresponding analyzer is triggered. When an analyzer's trigger is enabled and the corresponding analyzer is waiting for a trigger, the indicator is drawn with a yellow background.

2.4.1.1 Analyzer Units

The relation between various amplitude units in SR1 is always fixed at the same ratio that applies to a sine wave. This can cause some confusion due to the fact that in normal usage an amplitude of 1 Vrms implies not just a magnitude and unit of measurement, but a **method** of measurement, i.e. an rms integration over the waveform. In SR1 this is not the case, the measurement method is specified separately and the units of measurement always have the same fixed sine wave relationship. An example will help to clarify this. Consider the following square wave:

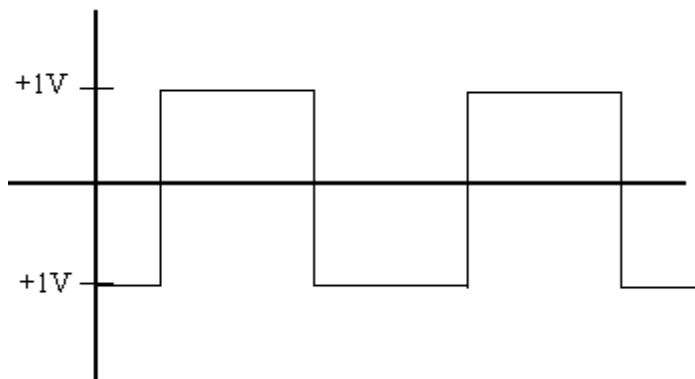

With an RMS voltmeter, the square wave shown would have an amplitude of 1 Vrms. With a peak-responding meter, the square wave would be found to have an amplitude of 1 Vp or 2 Vpp. However, with SR1, things are slightly more complicated in that it's necessary to know the measurement method as well as the units to correctly interpret the answer. If SR1's Time Domain Detector was configured for and RMS response and the amplitude units set to Vrms, SR1 would perform the RMS amplitude calculation and display an answer of 1 Vrms. However, if the units of the answer were changed to Vp, the answer would be 1.414 Vp because that's the sine wave relationship between Vp and Vrms. Likewise, if the Time Domain Detector is configured for Peak response SR1 will display a result of 1 Vp, but if the units of the display are changed to Vrms the display will read 0.707 Vrms.

In other words an answer displayed by SR1 in Vp does not imply that a peak measurement is being performed, nor does an answer in units of Vrms imply that an rms measurement is being made. The units will always have their sinewave ratios but the **method** of measurement must be known separately. Thus in the following table only the sine relationships between the units is considered.

Analyzer Amplitude Units (Analog Inputs)

Unit	Description
Vp	A sine wave with positive and negative maxima of 1 Volt has an amplitude of 1 Vp.
Vrms	A sine wave with positive and negative maxima of $\sqrt{2}$ Volts has an amplitude of 1 Vrms
Vpp	A sine wave with positive and negative maxima of 1 Volt has an amplitude of 2 Vpp.
dBVrms	Decibels relative to 1 Vrms. A signal with an amplitude of -20 dBVrms has a peak amplitude of 100 mVrms or 141.4 mVp.
dBu	Decibels relative to 0.7746 Vrms. Historically the value of 0.7746 Vrms was chosen because it represents the voltage required to dissipate 1 mW in a 600 Ω load back when 600 Ω loads were used in audio signal chains. Even though low output impedance/high input impedance signal chains are more typical in today's audio circuits the dBu retains its importance as a unit of measurement.
dBrA	Decibels relative to the dBrA Reference specified in the References Tab .
dBrB	Decibels relative to the dBrB Reference specified in the References Tab .
dBm	Decibels relative to 1 mW into a load specified by the dBm Reference in the References Tab . $\text{dBm} = 20.0 \cdot \log_{10}(\text{Vrms}^2 / (1\text{mW} \cdot \text{Load Z}))$. Note that the load is for calculation purposes only, the actual input impedance is unrelated to this value.
W	Watts into a load specified by the Watts Reference in the References Tab . $\text{Watts} = \text{Vrms}^2 / \text{Load Z}$. Note that the load is for calculation purposes only, the actual input impedance is unrelated to this value.

Analyzer Amplitude Units (Digital Audio Inputs)

Unit	Description
FFS	According to AES17-1998 (r2004), "Full-scale amplitude is the amplitude of a 997 Hz sinewave whose positive peak value reaches the positive digital full scale leaving the negative maximum code unused." The FFS (Fraction Full Scale) unit expresses the peak amplitude of any SR1 generator waveform relative to this definition of full-scale amplitude. When dither is on, full scale amplitude is reduced symmetrically by 1 bit to allow for dither. Small values of FFS may be expressed as mFFS (milli-FFS) or uFFS (microFFS).
%FS	Same as FFS (above) but expressed as a percentage of full-scale amplitude. 50 %FS = 0.5 FFS.
Vrms	This digital waveform amplitude unit is directly convertible to FFS depending on the value of the V FS (Volts Full Scale) set in the analyzer references tab. If the value of V FS is 2 Vrms, for instance, then an amplitude of 1 Vrms corresponds to an amplitude of 0.5 FFS. These units allow digital amplitudes to be expressed as analog voltages as is often useful when working with A/D converters where the V FS value can be thought of as the

Unit	Description
	ADC's full scale input voltage.
Vp	This unit of digital waveform amplitude is convertible to FFS depending on the value of the V FS (Volts Full Scale) set in the analyzer references tab and the fixed relationship of peak voltage to rms voltage for a sine wave. If the value of V FS is 1 Vrms, for instance, then an amplitude of 1.414 Vp would correspond to an amplitude of 1 Vrms which in turn would correspond to an amplitude of 1 FFS.
Vpp	This unit of digital waveform amplitude is convertible to FFS depending on the value of the V FS (Volts Full Scale) set in the analyzer references tab and the fixed relationship of peak voltage to peak-to-peak voltage for a sine wave. If the value of V FS is 1 Vrms, for instance, then an amplitude of 2.0 Vpp would correspond to an amplitude of 1 Vrms which in turn would correspond to an amplitude of 1 FFS.
dec	The peak value of the waveform expressed as a decimal code. The conversion of decimal code to FFS depends on the setting of the Input Resolution in the Digital I/O panel. For the default 24-bit input resolution setting $1\text{FFS} = 2^{23} - 1 = 8,388,607$ dec.
hex	The peak value of the waveform expressed as a hexadecimal code. The conversion of hexadecimal code to FFS depends on the setting of the Input Resolution in the Digital I/O panel. For the default 24-bit output resolution setting $1\text{FFS} = 2^{23} - 1 = 0x7ffff$ hex.
dBFS	Decibels relative to the full scale amplitude definition. (See FFS above) For instance, $0.1\text{FFS} = -20\text{dBFS}$. ($20 \cdot \log_{10}(0.1)$)
dBV	Decibels relative to the Vrms value calculated with the V FS (Volts Full Scale) reference set in the analyzer references tab. For example, with a V FS value of 2 Vrms an amplitude of -20 dBVrms corresponds to 0.1 Vrms which in turn corresponds to an amplitude of 0.05 FFS.
dBu	Decibels relative to 0.7746 Vrms. (Historically the value of 0.7746 Vrms represents the voltage required to dissipate 1 mW in a 600 Ω load.) If V FS is set to 1 Vrms then an amplitude of 0 dBu corresponds to 0.7746 which in turn corresponds to 0.7746 FFS.
dBr	Decibels relative to the dBr reference set in the references section of the analyzer references tab. The dBr reference is always set in units of FFS. Thus, with the dBr reference set to .5 FFS, an amplitude of 0 dBr corresponds to .5 FFS.
Bits	The Bits unit is related to dBFS by the relationship $\text{bits} = 1.76 + (\text{dBFS}/6.02)$.

Power Spectral Density Units

In addition to the normal analyzer amplitude units FFT results can be displayed in power spectral density (PSD) units. The available PSD units are V/vHz and dBV/vHz. PSD units are useful when examining the amplitude of signals that are spread out in the frequency domain. If the amplitude of such signals is reported in absolute units such as volts, the amplitude will change depending on the FFT number of lines, the FFT frequency range, and the FFT window. Since these factors are normalized out when using PSD units, the measured amplitude reflects only the properties of the input signal rather than the particular FFT setup used.

Jitter Units

Jitter represents the deviation in time between the nominal and actual occurrence of zero-crossings in a signal. As such, time units are used to measure jitter amplitude. In SR1, jitter amplitudes can be expressed in seconds, or in "UI"s. The UI, or unit interval, is for a digital audio signal the smallest pulse width present in the digital audio signal. Since for a normal bi-phase encoded 2-channel digital audio

signal there are 2 pulses used to represent each bit, and there are 32 bits allocated for each sample and 2 channels there are a total of 128 UIs in the time required to transmit one sample of both channels. Therefore the relationship between the UI and the digital audio sampling frequency is:

$$1 \text{ UI (sec)} = 1 / (128 * F_s(\text{Hz}))$$

For frequency domain jitter measurements, power spectral density (PSD) units are available as well. The jitter PSD units are: s/√Hz, dBs/√Hz, and dBc/Hz. The relationship between the jitter expressed in dBc/√Hz and s/√Hz is given by the following relation: (See AES-11id)

$$\text{jitter density in s/}\sqrt{\text{Hz}} = (\sqrt{2/2\pi} f_c) * 10^{(\text{jitter in dBc/Hz} / 20)}$$

where f_c is the carrier frequency.

Analyzer Frequency Units

The following table describes the units used by SR1 in display measured frequencies. All frequency units except Hz make use of the Frequency Reference which is set in the [References Tab](#) of each analyzer.

Unit	Description
Hz	The fundamental unit of frequency. 1 Hz = 1 cycle-per-second.
F/R	Ratio relative to the Frequency Reference. A value of 3 F/R with reference of 2 kHz gives a waveform frequency of 6 kHz.
dHz	Difference relative the Frequency Reference. A value of 500 dHz with a reference of 2 kHz gives a waveform frequency of 2.5 kHz.
%Fref	Percent of the Frequency Reference. A frequency value of 50 %Fref with a reference value of 10 kHz gives a waveform frequency of 5 kHz.
cents	A "cent" is a logarithmic unit which represents 1/100 of a semitone of the musical scale. 12 semitones make up an octave. Thus a cent is 1/1200 of an octave.
octaves	An octave is a factor of 2 in frequency. Thus, a frequency value of 3 octaves with a reference of 1 kHz gives a waveform frequency of 8 kHz.
decades	An decade is a factor of 10 in frequency. Thus, a frequency value of 2 decades with a reference of 2 kHz gives a waveform frequency of 200 kHz.

Engineering Units

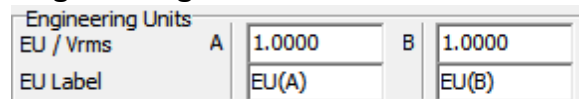

When a transducer is connected to the input of SR1 it is convenient to have measurement results displayed in the units of what the transducer is measuring rather than Volts. For instance, a microphone might be calibrated in V/Pa, or an accelerometer in V/g. The Engineering Units selection allows SR1 to display measurement results in Pa or g in these cases, rather than Volts. Transducer units are known as "Engineering Units." To use Engineering units, enter the Engineering units/Vrms conversion factor for the A and B channels, as well as the label corresponding to the Engineering Units. Engineering units will then show up, when appropriate, in all analyzer unit lists.

Analyzer References

Analog		Digital	
dBrA	1.0000 Vrms	V/FS	1.0000 Vrms
dBrB	1.0000 Vrms	dBrA	1.0000 FFS
dBm	600.00 ohms	dBrB	1.0000 FFS
Watts	8.0000 ohms	Freq	1.0000 kHz
Freq	1.0000 kHz		

The Analyzer References tab has fields which contain the reference quantities for the [analyzer units](#). Note that all analyzers share one set of analyzer units— there are not separate sets of references for the FFT analyzer and the Time Domain detector, nor are there separate references for the A0 analyzer and the A1 analyzer.

2.4.2 Time Domain Detector

The Time Domain Detector (TDD) performs the "classic" audio analyzer measurements— amplitude, ratio, crest factor, and THD+N, on both analog and digital audio signals. The Time Domain Detector operates much the same way that traditional analog audio analyzers worked: a notch filter is used to remove the fundamental to allow amplification of noise and distortion products, bandwidth limiting and weighting filters are applied, and a precision RMS detector is used to measure the amplitude of the resulting signal.

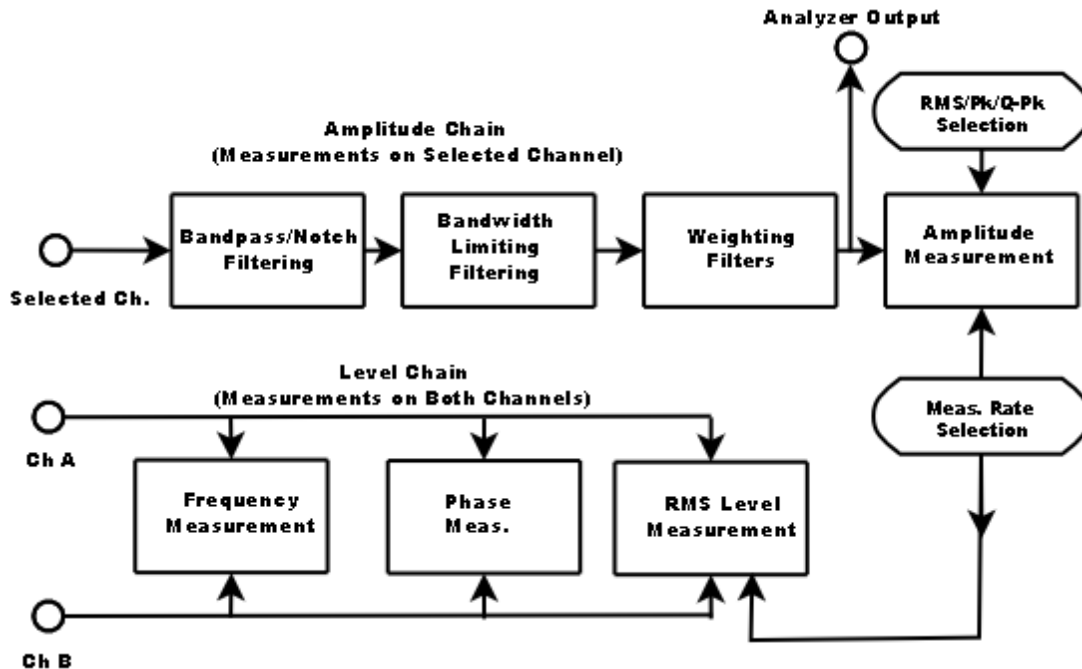

Time Domain Detector: Generic Block Diagram

Two sets of measurements are made by the TDD. The first, the "Level Chain", is made for both channels in the selected domain, and includes an RMS level measurement, a frequency measurement, and a measurement of the phase between the two channels. These values are displayed at the bottom of the analyzer panel.



The second set of operations, the "Amplitude Chain" is performed only on the selected channel. The signal is first passed through a selectable notch or bandpass filter. The notch filter is used to remove the fundamental of the signal to allow measurement of noise and distortion, while the bandpass filter can be selected to measure narrowband signals or noise. The filtered signal is passed through a series of high-pass and low-pass filters to limit the bandwidth of the amplitude measurement. Finally a variety of standard weighting filters can be applied to the signal. The output of the weighting filters is available as an analog signal on the rear panel A0 Monitor Out or A1 Monitor Out BNC connector. This signal can also be passed to the FFT analyzer for real-time spectral analysis of the TDD amplitude signal.

The amplitude of the weighting filter output is measured with a selectable rms/peak/quasi-peak response

and a variable measurement rate. Depending on the selected measurement one of the following functions of the amplitude and levels will be displayed:

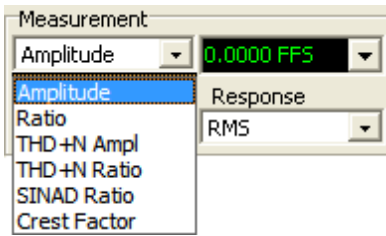

Measurement selects the quantity displayed on the TDD panel	
Amplitude	The selected channel amplitude is displayed. All filtering options are available.
Ratio	The ratio of the selected channel amplitude to the level of the other channel is displayed. This mode can be used, for instance, to make crosstalk measurements.
THD+N Amplitude	The selected channel amplitude is displayed. The notch filter is always selected to filter the fundamental. The amplitude signal then represents the total noise and distortion present in the input signal.
THD+N Ratio	The ratio of the amplitude to the level of the selected channel is displayed. The notch filter is always selected. This selection displays THD+N amplitude relative to the total amplitude of the signal.
Crest Factor	The ration of the peak amplitude of the selected channel to the RMS amplitude of the same channel is displayed.

Time Domain Detector: Analog Hi Bandwidth Inputs

To fully exploit the capabilities of SR1's analyzers it is useful to understand exactly how SR1 functions for each of the three classes of inputs: analog signals using the Hi Bandwidth converter (HiBw), analog signals using the Hi Resolution converter (HiRes), and digital audio signals. Below is a block diagram of the TDD for analog signals when the HiBw converter is selected.

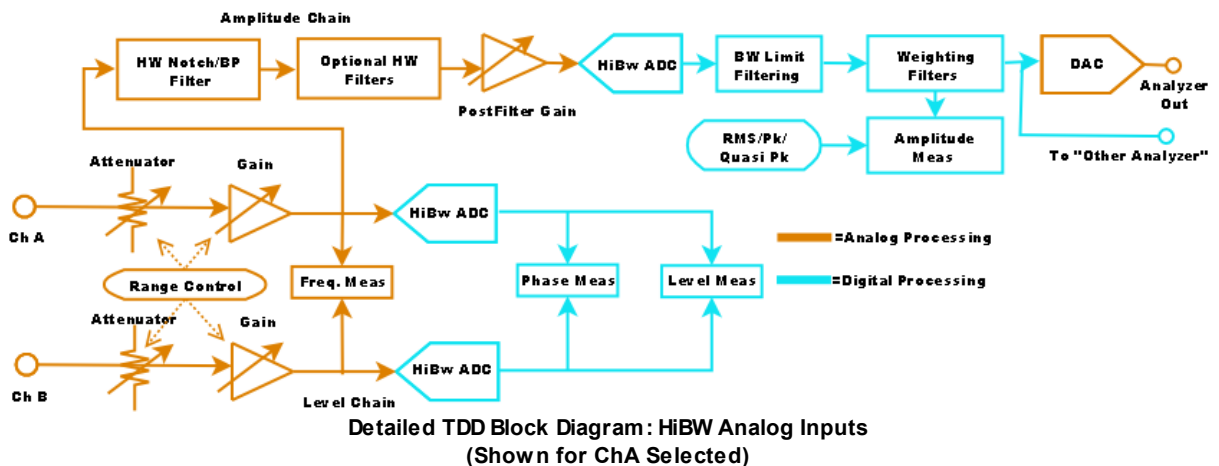

Because of the wide range of input amplitudes handled by SR1 (160 Vrms full scale to 62 mVrms full scale) the input signal may need to be either attenuated or amplified. For most signals, the autorange control can automatically select the appropriate attenuation or gain without user interaction. The level chain starts with a frequency measurement of both channels. For analog signals the frequency is measured using hardware. The two level signals are then digitized with identical 16-bit converters running at a sampling rate of 512 kHz and the resulting digital signal is sent to a high-speed DSP processor. The DSP measures the phase between the two signals and does an RMS integration of the signals to calculate the level of each channel.

The analog signal corresponding to the selected channel, A or B, is sent to the amplitude chain. First the signal is sent through the tunable hardware Notch/BP filter (if the notch or bandpass is selected on the analyzer panel). Next the signal is can be passed through one of the 4 optional hardware filters installed on the analog input board corresponding to the selected channel. Next, adjustable analog gain, from 0 to 66 dB, is applied to the post filter signal. The purpose of this gain is to amplify the post filter signal, which in the case of a THD+N measurement is typically small after the fundamental is removed by the notch filter, so that it will be close to full scale of the third 16-bit ADC which digitizes the amplitude signal with a sampling rate of 512 kHz. After digitizing, the DSP applies the bandwidth limiting and weighting filters. The amplitude of the resulting signal is computed by the DSP with selectable RMS/Peak/Quasi-Peak response and is sent to the host computer for display.

The amplitude signal is reconverted to an analog signal by a DAC and is output on the rear panel "A0 Monitor Out" (or "A1 Monitor Out", depending on which analyzer is being used) BNC connector. Finally, the amplitude signal is sent to the "Other Analyzer" (e.g. A1 if the TDD is active on A0, or A0 if the TDD is active on A1). If the "Other Analyzer" is an FFT analyzer whose input is set to "Other Analyzer," the FFT analyzer will display the spectrum of the post Notch/BP filtered, bandwidth limited, weighted amplitude signal.

Time Domain Detector: Analog Hi Resolution Inputs

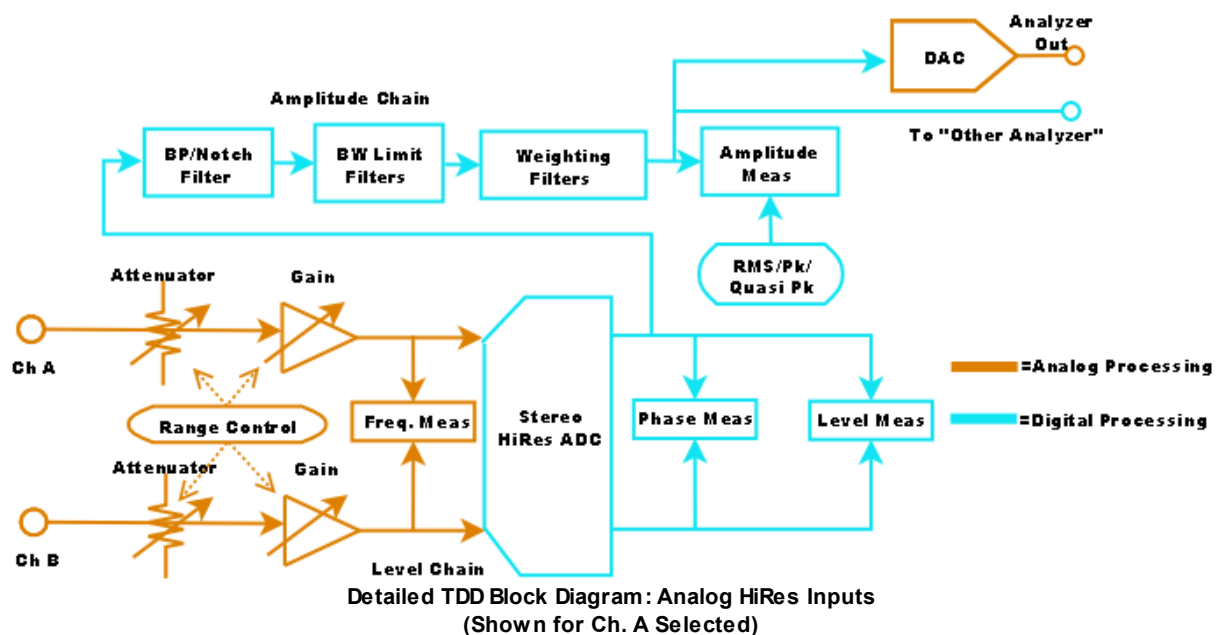

The analog front end is identical for both HiRes and HiBw converter selections. The autorange control

automatically adjusts the input attenuation and gain, and an analog frequency measurement is made on both input channels. When the HiRes converter is selected, the two signals are digitized by a 24-bit stereo ADC. As in the HiBw case, the phase and level measurements are computed by the DSP. The Amplitude Chain, unlike the HiBw case, is implemented purely in the DSP. For the HiRes converter, the Bandpass/Notch filter is implemented digitally by the DSP. There is no post-filter gain. Bandwidth limiting and weighting filters are implemented digitally. The DSP measures the amplitude signal with a selectable RMS/Peak/Quasi-Peak response.

The amplitude signal is reconverted to an analog signal by a DAC and is output on the rear panel "A0 Monitor Out" (or "A1 Monitor Out", depending on which analyzer is being used) BNC connector. Finally, the amplitude signal is sent to the "Other Analyzer" (e.g. A1 if the TDD is active on A0, or A0 if the TDD is active on A1). If the "Other Analyzer" is an FFT analyzer whose input is set to "Other Analyzer" the FFT analyzer will display the spectrum of the post Notch/BP filtered, bandwidth limited, weighted amplitude signal.

Time Domain Detector: Digital Audio Inputs

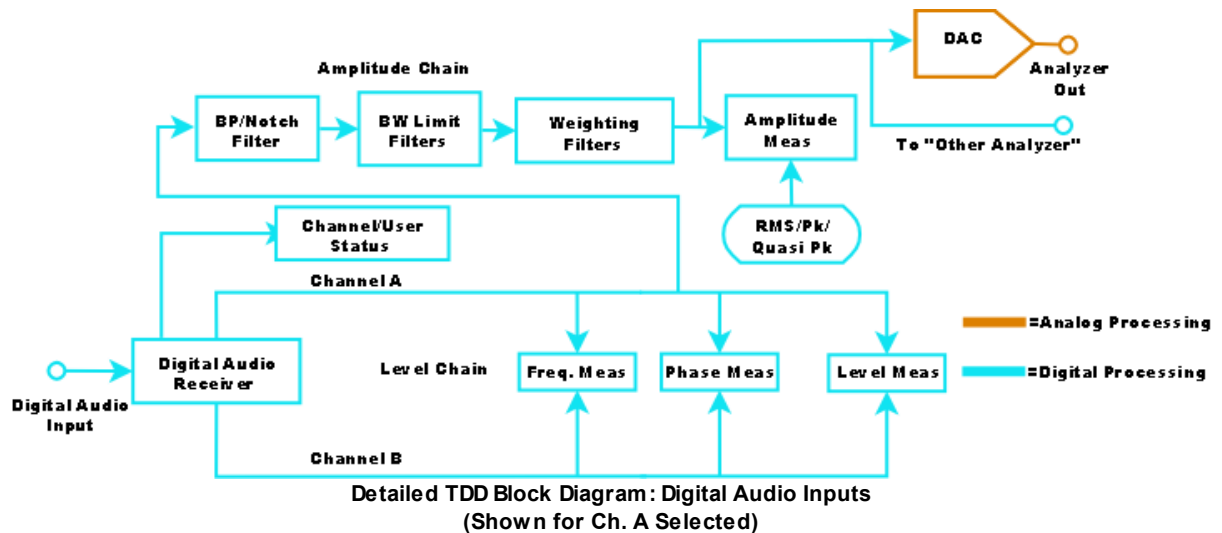

For digital signals all calculations are performed by the DSP. A digital audio receiver decodes and demultiplexes the multiplexed bi-phase encoded digital audio signal and the decoded amplitude data for both channels is sent to the DSP. The DSP calculates the RMS levels for both channels, the frequency and relative phase of the input signals. For the selected channel, a 140dB deep notch or selectable bandwidth bandpass filter is applied followed by bandwidth limiting and weighing filters. The resulting amplitude signal is sent to a DAC where it is transformed into an analog signal available at the rear-panel "A0 Monitor Out" (or A1 Monitor Out) connector. The DSP computes the amplitude of the amplitude signal with a selectable RMS, Peak, or Quasi-Peak response.

Time Domain Detector Panel

The screenshot shows the Time Domain Detector Panel with the following settings:

- Measurement:** Meas. 2, References, Trigger
- Measurement:** THD+N Ampl, 0.0000 Vrms
- Post Filter Level:** [Progress bar]
- Rate:** Auto fast
- Response:** RMS
- Gain:** Auto
- Notch/BP Filter:** Notch, 1.0000 kHz, Fixed (selected), Tuned
- Var. LP:** [Progress bar]
- Weighting:** A Wt
- HW Filters:** [Button]

Rate

The Rate dropdown menu is open, showing the following options:

- Auto fast (selected)
- Auto precise
- 1/s
- 2/s
- 4/s
- 8/s
- 16/s
- 32/s

The rate control sets the time interval over which the amplitude and levels are computed. Six fixed rates are available from 1/sec to 32/sec (the measurement interval is simply the inverse of the rate). The "Auto Fast" and "Auto Precise" options compute an optimum measurement rate based on a specified frequency. The frequency on which the rates are based is selected on the "Meas. 2" tab of the TDD panel.

The Auto Meas. Frequency dropdown menu is open, showing the following options:

- Fixed (radio button)
- Tuned (radio button, selected)
- Measured Freq. (selected)
- Analog Gen A
- Analog Gen B
- Digital Gen A
- Digital Gen B
- Sweep 1
- Sweep 2

The frequency can be **fixed**, or **tuned** to the measured input frequency, any of the generator frequencies, or the current sweep frequency. When possible, "Sweep" or "Generator" should be chosen as relying on the measured frequency while sweeping introduces a small, but noticeable, delay. Using "Measured Frequency" on a signal with noticeable frequency jitter may also result in glitches in sweeps as the filter is constantly being moved to follow the input signal.

Response

The Response dropdown menu is open, showing the following options:

- RMS (selected)
- Quasi Peak
- Peak

The amplitude measurement can be made with a choice of RMS, Peak, or Quasi-Peak response. RMS response calculates the true root-mean-square (RMS) value of the amplitude signal over the

measurement interval selected with the "Rate" control. Peak response calculates the peak value of the amplitude signal over the measurement interval. Quasi-peak filters the amplitude signal with a dual time-constant response to provide the dynamic characteristics specified in ITU-R BS 468.

Notch/BP Filter

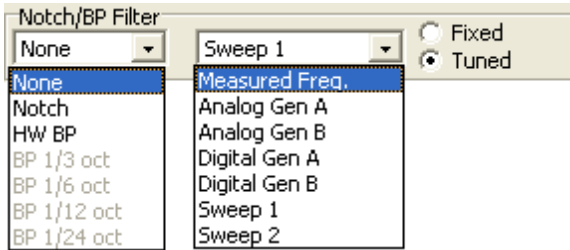

The amplitude chain of the TDD contains a selectable notch/bandpass filter. For HiBandwidth Analog inputs, there are actually two notch filters— an analog notch which cuts the fundamental level enough so that the postfilter gain can amplify the resulting noise/distortion signal to full scale on the amplitude ADC, and a second notch implemented by the DSP processor which cuts the fundamental even further so that residual fundamental is not a measurable component of the final residual THD+N specification. The combined response of the two filters is shown below.

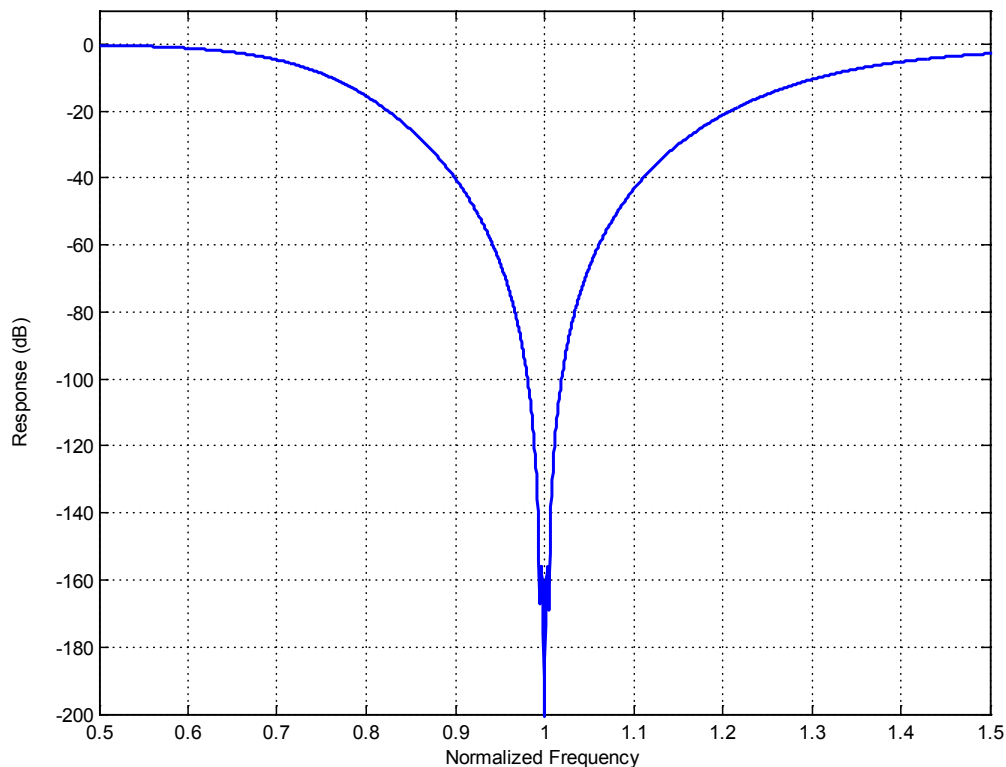

Combined Notch for Analog HiBw Inputs

Because of the wide dynamic range of the 24-bit hi-resolution converter, an analog filter is not necessary. So for HiRes analog inputs and digital inputs a single notch filter is applied by the DSP.

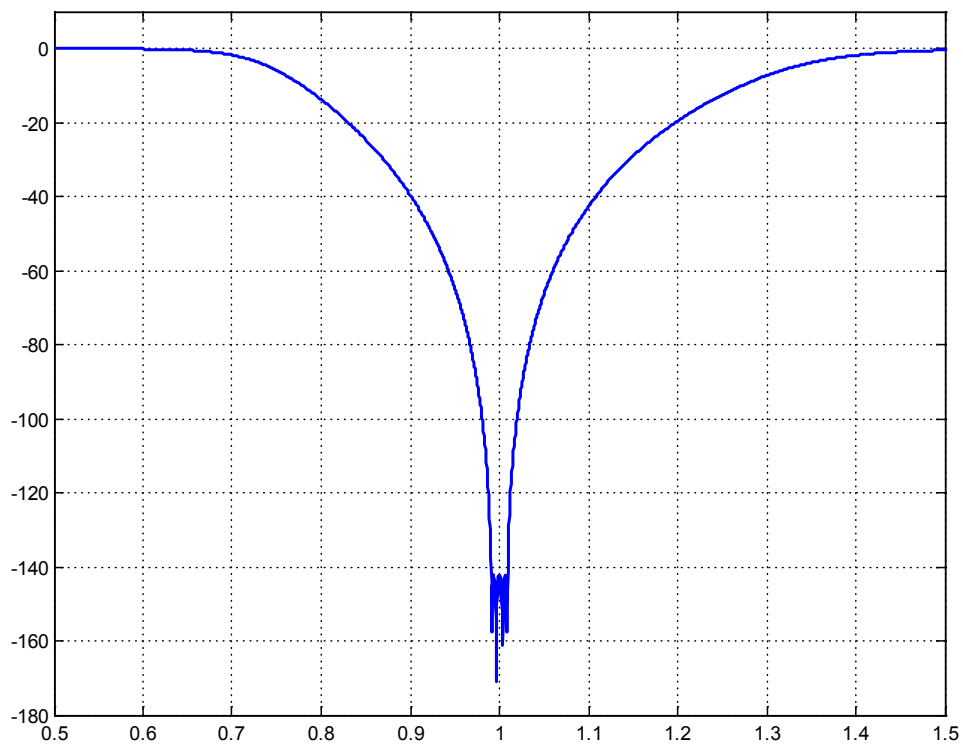

Notch Filter for Digital and Analog HiRes Inputs

For HiRes analog and digital audio inputs, the bandpass filters with 1/3, 1/6, 1/12, and 1/24 Octave responses can be selected.

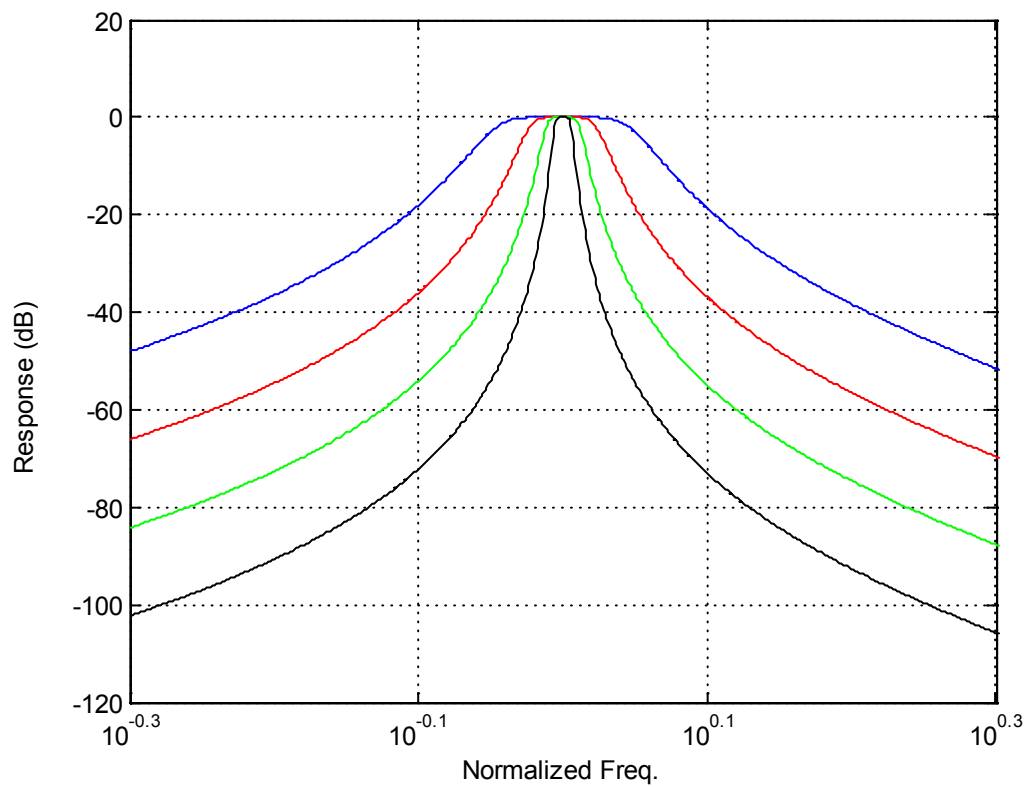

**Software Bandpass Filters: 1/3, 1/6, 1/12, 1/24 Octave
Digital and Analog HiRes Inputs**

for HiBw analog inputs, a single analog bandpass filter may be selected:

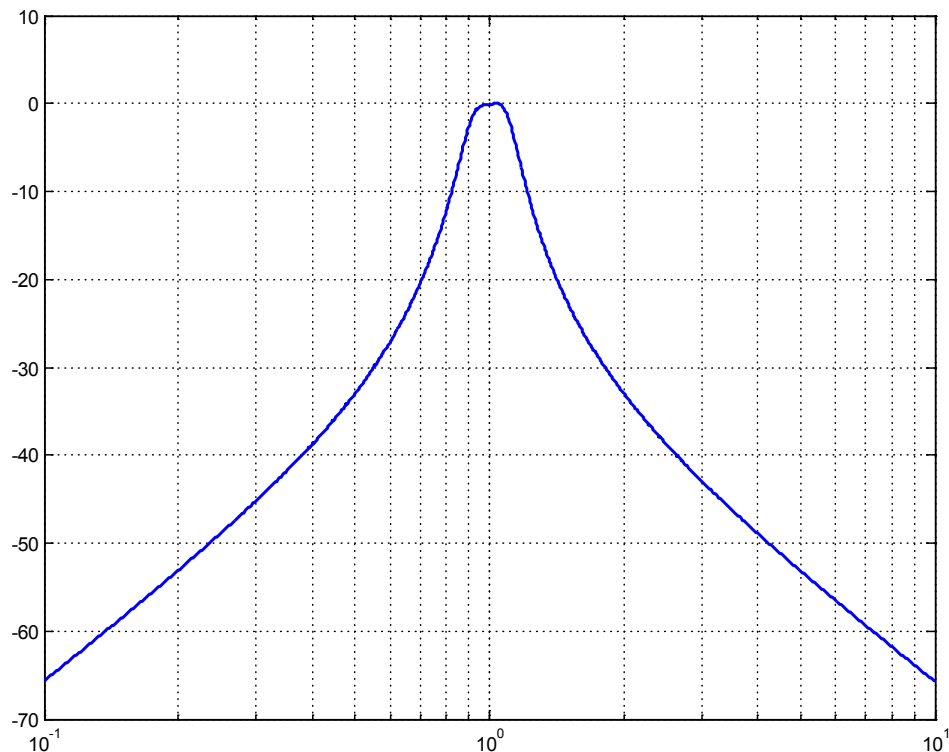

Hardware BP Filter for Analog HiBW Inputs

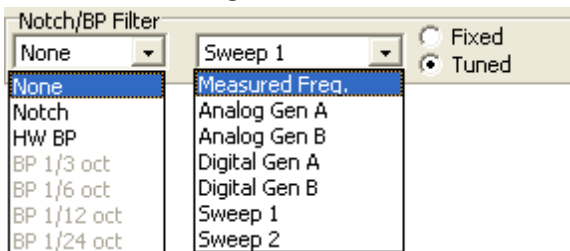
Notch Filter Tuning

The frequency of the tunable notch/bandpass filter can be set to a fixed frequency or *tuned* to one of several sources. To select a fixed notch/bandpass frequency, select the "fixed" radio button at the right of the Notch/BP panel. The fixed frequency is entered in the control which appears to the left of the radio buttons. To select a tuned notch/bandpass filter press the "tuned" button and select the tuning source from the drop-down control. When the tuning source is set to "Measured Freq." the notch/bandpass filter tracks the measured frequency of the selected input. When set to one of the generator channels the filter frequency follows the frequency of the selected channel. (When the generator is in mono mode choose the "A" channel— if there are more than one waveform on the selected channel the first waveform with a definite frequency (i.e. not noise) is chosen.) Sweep 1 follows the frequency of the [Inner Sweep](#) axis, while Sweep 2 follows the frequency of the outer sweep axis. In general it is better to select one of the generator or sweep tuning sources instead of measured frequency when possible to eliminate possible jitter in the filter frequency.

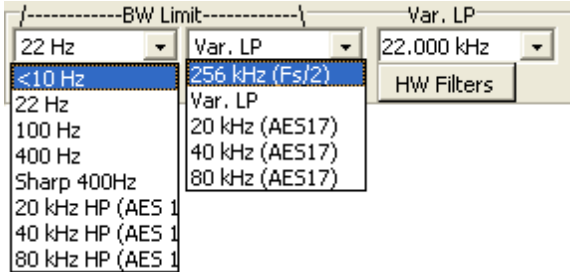
Bandwidth Limiting Filters

Several different high and low-pass filters to limit the bandwidth of the amplitude measurement. These filters are only applied to the amplitude signal, they do not affect the level measurements. For low-frequency (high-pass) bandwidth limiting the following filters can be selected:

BW Limit (High-Pass selection)	
<10 Hz	No high-pass filters are applied.
22 Hz	Selects a fourth order butterworth high-pass filter with a corner frequency of 22 Hz.
100 Hz	Selects a fourth order butterworth high-pass filter with a corner frequency of 100 Hz.
400 Hz	Selects a fourth order butterworth high-pass filter with a corner frequency of 400 Hz.
Sharp 400 Hz	Selects a sharp 10th order elliptical highpass filter with a cutoff of 400 Hz, passband ripple of <.1 dB, and a stopband attenuation of -125 dB.
AES 20 kHz	Selects a 4-pole elliptic high-pass filter with a passband edge of 20 kHz that satisfies the requirements of AES17-1998 (r2004) section 4.2.2.2. Passband ripple is < .2 dB, Stopband attenuation is > -60 dB and the ratio of passband edge to stopband edge is ~1.2.
AES 40 kHz	Selects a 4-pole elliptic high-pass filter with a passband edge of 40 kHz that satisfies the requirements of AES17-1998 (r2004) section 4.2.2.2. Passband ripple is < .2 dB, stopband attenuation is > -60 dB and the ratio of passband edge to stopband edge is ~1.2.
AES 80 kHz	Selects a 4-pole elliptic high-pass filter with a passband edge of 80 kHz that satisfies the requirements of AES17-1998 (r2004) section 4.2.2.2. Passband ripple is < .2 dB, stopband attenuation is > -60 dB and the ratio of passband edge to stopband edge is ~1.2.

For high-frequency (low-pass) bandwidth limiting the following filters can be selected:

BW Limit (Low-Pass selection)	
Fs/2	No Low-pass filters are applied
Variable Low-Pass	Variable Cutoff 4th order Butterworth Filter.
AES 20 kHz	Selects a 4-pole elliptic low-pass filter with a passband edge of 20 kHz that satisfies the requirements of AES17-1998 (r2004) section 4.2.1.1. Passband ripple is < .1 dB, Stopband attenuation is > -60 dB for $f > 24$ kHz.
AES 40 kHz	Selects a 4-pole elliptic low-pass filter with a passband edge of 40 kHz that

	satisfies the requirements of AES17-1998 (r2004) section 4.2.1.1. Passband ripple is < .1 dB, Stopband attenuation is > -60 dB for $f > 48$ kHz.
AES 80 kHz	Selects a 4-pole elliptic low-pass filter with a passband edge of 80 kHz that satisfies the requirements of AES17-1998 (r2004) section 4.2.1.1. Passband ripple is < .1 dB, Stopband attenuation is > -60 dB for $f > 96$ kHz.

Note that the availability of some of the bandwidth limiting filters depends on the current analyzer sampling rate. For instance, if the digital audio inputs are selected and the digital audio sampling rate is 48 kHz giving a nominal bandwidth of 24 kHz, an 80 kHz high-pass filter doesn't make sense and that selection will be unavailable.

Weighting Filters

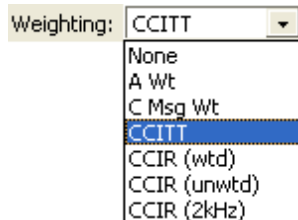

The following standard weighting filters may be applied to the amplitude measurement. These filters are applied to the amplitude signal only; they do not affect the level measurements.

Weighting Filters	
None	No weighting filter is applied.
A-Wt	"A" weighting filter is applied. "A" weighting is specified in ANSI standard S1.4-1983 and is typically used for noise and THD+N measurements with audio applications.
C-Msg Wt	The C-Msg weighting filter, specified in IEEE Std. 743-1995, is intended to be used for noise measurements associated with voice transmission telecommunications.
CCITT	The CCITT weighting filter defined by ITU-T Recommendation O.41 is another telecommunication noise weighting filter.
CCIR (wtd)	Filter defined in ITU (CCIR) Rec. 468-4 for audio noise measurements. Designed to be used with the Quasi-Peak setting on the Time Domain Detector.
CCIR (unwtd)	Filter defined in ITU (CCIR) Rec. 468-4 (Annex II) for making unweighted noise measurements.
CCIR (2 kHz)	This filter is identical to the CCIR(wtd) filter except the normalization is changed so that the filter has unity gain at 2 kHz instead of 1 kHz.

Hardware Filters

Up to 4 optional hardware filters may be installed on each analog input board. Only 1 filter may be selected at any given time. These filters are applied only with the analog HiBw input selection. The filters are inserted in the amplitude chain after the notch/bandpass filter and before the postfilter analog gain.

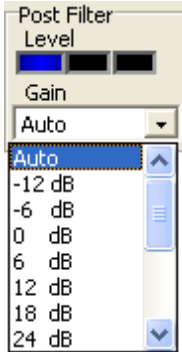
Post Filter Gain

For analog HiBw inputs, the TDD offers variable postfilter gain. Typically the Gain selection can be left on "Auto" and SR1 will automatically optimize the postfilter gain. The level indicator above the gain selection indicates the current level of the postfilter signal, blue for less than half scale, green for greater than half scale, and red for overloaded. The AutoGain setting should keep the indicator in the "green" range. If the level indicator jumps around too much, the gain can be set manually to a setting which maintains the level in the green range.

Time Domain Detector and the Trigger

When the trigger is enabled for the TDD each measurement interval begins synchronously with the receipt of a trigger. While the trigger is not necessary for most audio signals its use can improve the stability of amplitude measurements when using burst or signals of a transient nature.

2.4.3 FFT (Single Channel)

The Single Channel FFT Analyzer (FFT1) computes the frequency spectrum of the selected input signal. The input to the FFT1 analyzer can be either channel of the analog or digital audio input or can be the amplitude output of the [Time Domain Detector](#). SR1's FFT analyzer can operate over the range from DC to $F_s/2$ with a resolution of 32k lines, or the spectrum can be "zoomed" by up to a factor of 1024 to apply the full 32k line resolution to a smaller portion of the frequency located anywhere within the full range. For example, the graph below shows the output of a typical device when subjected to a test signal consisting of two closely spaced sines near 10 kHz ($\Delta = 60$ Hz).

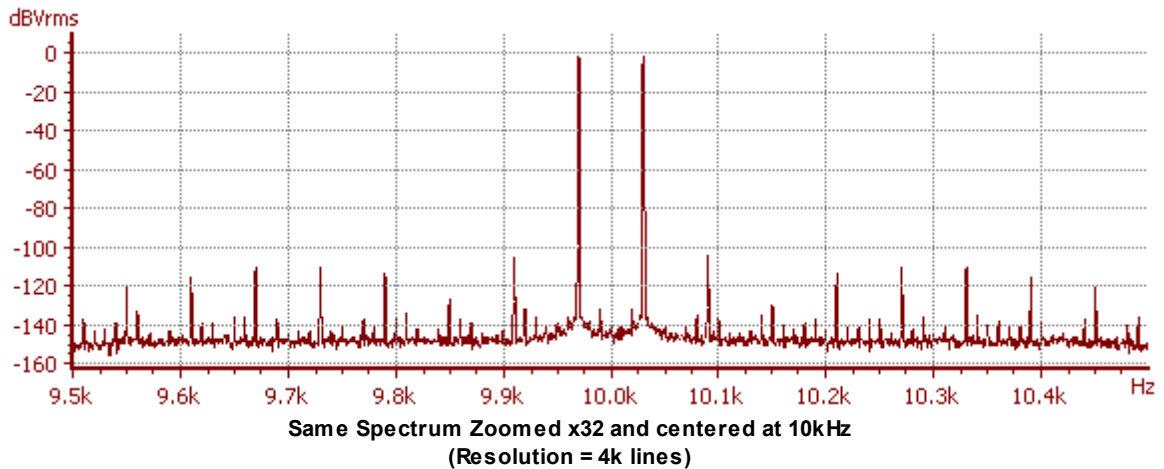
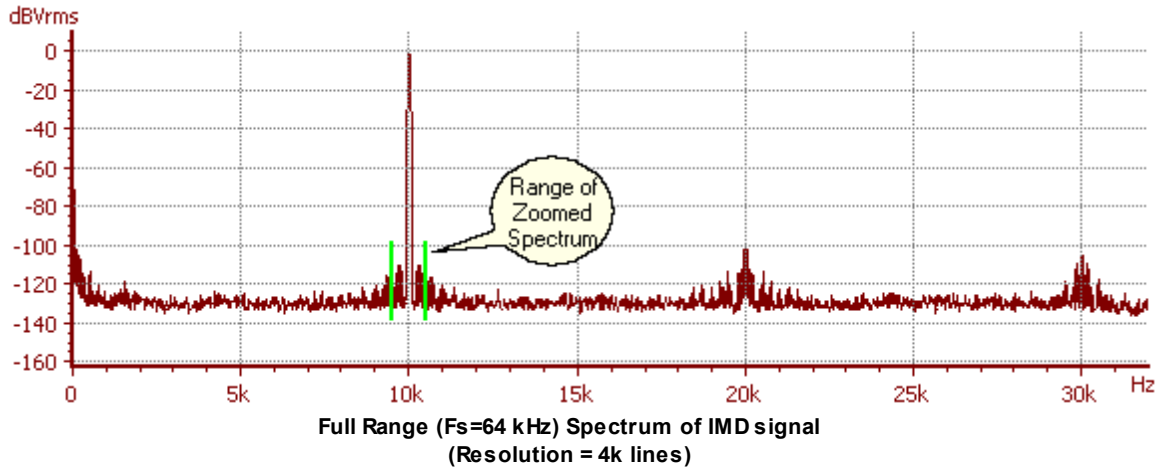

The top diagram shows the original spectrum showing 4k lines over the range from DC to $F_s/2$. The bottom spectrum has been zoomed to a range of 1kHz and centered at the input frequency of 10 kHz to reveal additional spectral detail.

FFT1 Analyzer Block Diagram

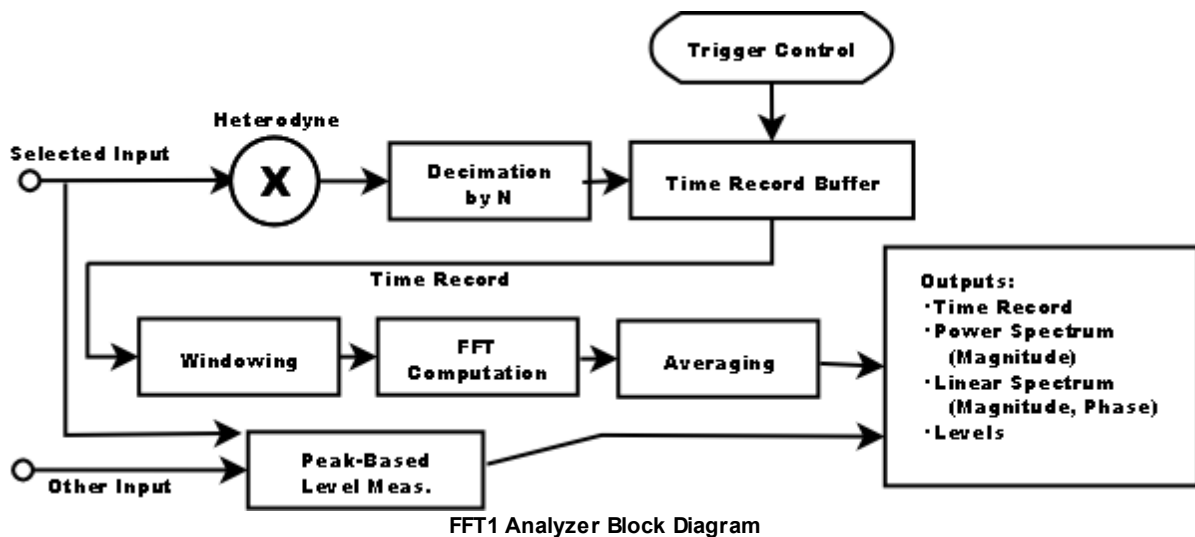

A block diagram of the FFT1 analyzer is shown above. The selected input signal is first optionally heterodyned to move the selected center frequency to the center of the FFT analysis range. The signal is then optionally decimated by up to a factor of 2^{10} in order to reduce the sample rate when using the "zoom" feature. Each stage of decimation includes filtering to eliminate alias effects from the discarded portions of the frequency spectrum. The output is sent to a buffer which serves as the time record for the FFT analyzer. Each time record starts with a trigger. If the [analyzer trigger](#) is not enabled then a trigger is automatically generated as soon as the DSP has finished processing the previous time record. Otherwise, the analyzer waits for a trigger which matches the specified [trigger criteria](#) and begins the time record at the trigger point.

After a trigger occurs and enough time record points have been accumulated to compute a spectrum of the specified resolution, the DSP applies a windowing function to the time-domain data (See [Window Selection](#)). Windowing is necessary due to the finite length of the FFT time record. Unless the input signal happens to be periodic in the time record, discontinuities at the beginning and end of the time record will appear as significant broadening of the true spectrum of the input signal. Window functions are large in the middle of the time record and taper off at the beginning at the end in order to minimize the offending discontinuities.

After windowing, the DSP computes the FFT of the windowed time record. For a resolution of N lines, $2N$ real time record points are used to compute an FFT of N complex points. Each FFT is then averaged in two different ways. The **Power Spectrum** is computed by computing the power for each spectrum (taking the absolute value of the complex FFT points) and averaging that power into the power computed for previous FFTs. This type of averaging does not reduce the noise floor of the spectrum but it does reduce the variation of the noise floor making it easier to see spectral details on the order of the noise amplitude. Phase information is lost when computing the Power Spectrum. In the example below, the unaveraged power spectrum is shown for a signal composed of a 1 kHz sine wave with added white noise. The second spectrum shows the power spectrum with averaging on and $N_{avg} = 10$. Note the substantial reduction in the variation of the noise floor and note also that the average value of the noise floor is the same in the two spectra.

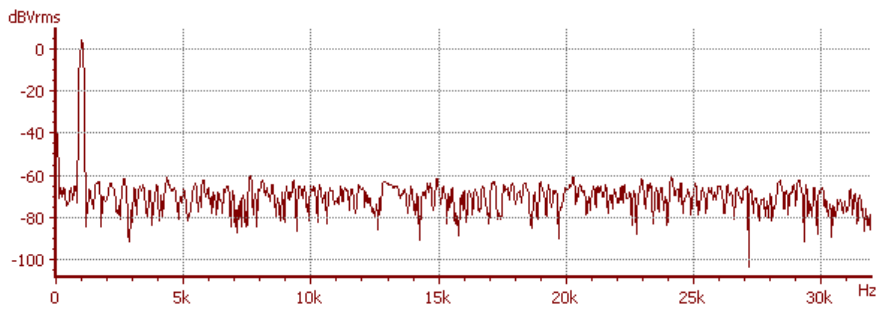

Unaveraged Power Spectrum of Sine+Noise

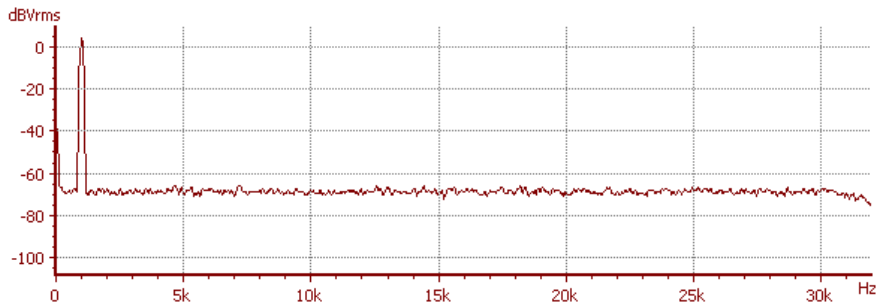

Averaged (N=10) Power Spectrum of Sine+Noise

The second spectral output computed by the FFT1 analyzer is the **Linear Spectrum**. The Linear Spectrum is computed by averaging the real and imaginary parts of each FFT separately. The average of the real and imaginary parts are then used to compute the Linear Spectrum amplitude and phase. In the Linear Spectrum, unlike the Power Spectrum, noise that is uncorrelated to the signal is actually reduced by further averaging. Because of this, use of the Linear Spectrum, unlike the Power Spectrum, requires that the time record be triggered so that the signal waveform will have the same phase relative to the beginning of the time record for each averaged FFT. The linear spectrum has phase information associated with it. It is important to note that the phase of the Linear Spectrum for the single channel FFT analyzer is only meaningful if the time record is triggered so that the signal has a constant phase relationship to the beginning of the time record. Below, the averaged Linear Spectrum ($N_{avg}=100$) is shown plotted with the averaged Power Spectrum for the same number of averages. Note that averaging the linear spectrum does not reduce the variation in the noise floor, but does reduce the amplitude of the noise. In this case averaging 100 spectra has reduced the noise floor by about 20 dB.

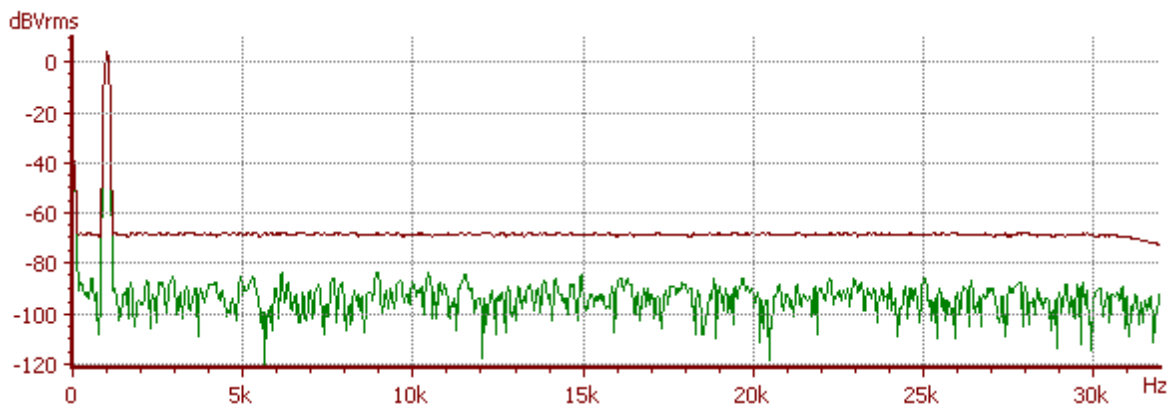

Comparison of Averaged Power Spectrum and Linear Spectrum

Summary of FFT1 Analyzer Outputs

Measurement	Description
Time Record	The underlying time data used to compute spectra. When displayed on a graph this measurement produces an "oscilloscope" type display.
Power Spectrum Amplitude	The amplitude of the power-averaged spectrum.
Linear Spectrum Amplitude	The amplitude of the synchronously averaged spectrum. The amplitude of signals that are synchronous with the time record is preserved, other uncorrelated signals average away.
Linear Spectrum Phase	The phase of the synchronously averaged spectrum.
Level A, B	Peak-based level computation for both input channels

The FFT1 Analyzer Panel

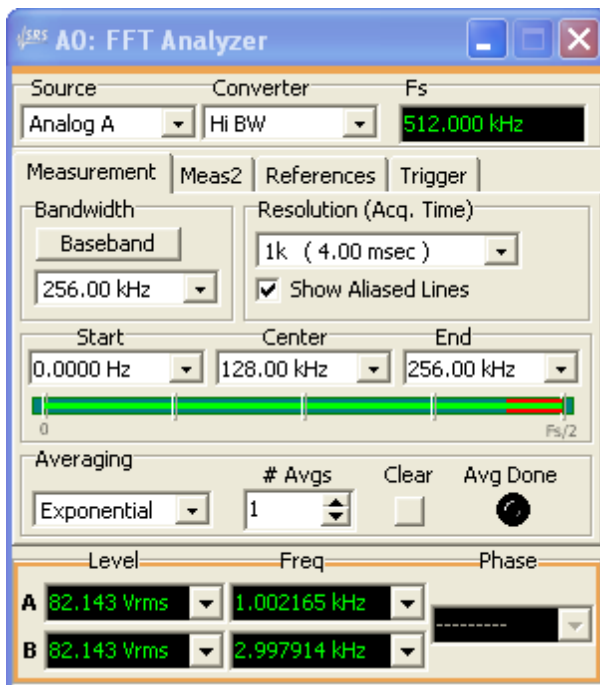

The FFT1 panel contains the normal input source selection controls and level indicators common to all [analyzers](#). However, a few items unique to the FFT1 analyzer are worth noting. Unlike the RMS levels computed by the Time Domain Detector, levels computed by the FFT1 analyzer are peak-based levels. (Remember, the [units](#) the levels may be displayed in are independent of the method of computation.) While the TDD has a continuous input data stream available to it allowing RMS computations, the FFT1 analyzer cannot compute FFTs and maintain a continuous input stream simultaneously. So the levels are based on peak values. Likewise, the fact that continuous data is unavailable means that the A-B phase computation is not available for the FFT1 analyzer. Frequency data is available for analog inputs (which use a hardware-based frequency measurement technique) but not for digital audio inputs.

Bandwidth

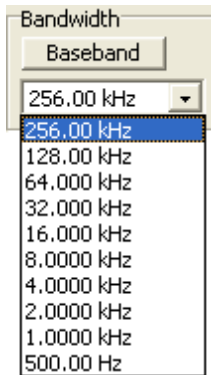

The maximum bandwidth of the FFT is 1/2 of the sampling rate for the selected input source. To instantly switch to full bandwidth, click the "Baseband" button. The "Zoom" feature of the FFT1 analyzer allows selection of narrower bandwidths, in factor of 2 increments, as well. When the bandwidth is decreased, the effective sampling rate is decreased and therefore the amount of time necessary to acquire a time record of a given length will increase. Therefore updates to the FFT display may slow down as the bandwidth is narrowed. When the bandwidth is set to any value other than the maximum the FFT analysis range can be set anywhere within the frequency interval from DC to $F_s/2$ using the spectrum positioning controls:

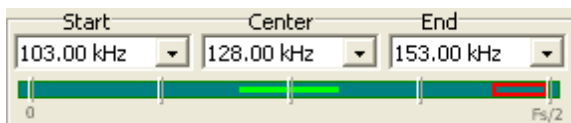

The position of the FFT analysis range can be set with any of the "Start", "Center", or "End" controls—the values of the other two will automatically adjust according to the selected bandwidth. The graphical indicator below the controls shows the position of the analysis range relative to the full DC to $F_s/2$ frequency range.

Aliasing

Aliasing arises in sampled data systems because the real-world filters used to protect A/D converters have finite cutoff slopes. Each of the SR1's A/D converters is protected with either analog or a combination of analog and digital anti-aliasing filtering. For each converter there is some range of frequency below $F_s/2$ that is not fully protected to the level of the ultimate attenuation of the anti-aliasing filter. When using the "zoom" feature of the FFT1 analyzer the analyzer applies digital anti-aliasing filter after each decimation stage meaning that there is a small region at either end of the analysis range that is not alias-protected to the full attenuation of the digital anti-aliasing filter.

When Show Aliased Lines is checked, the analyzer displays all lines in the full analysis range of the FFT without regard to whether they are fully alias protected. This setting is often perfectly useful for many typical audio measurements. However, when aliasing is potentially a problem the box can be unchecked, in which case only FFT lines that are fully alias-protected are displayed. Areas of the spectrum that are not fully protected are shown in red in the graphical frequency indicator on the FFT panel.

Resolution

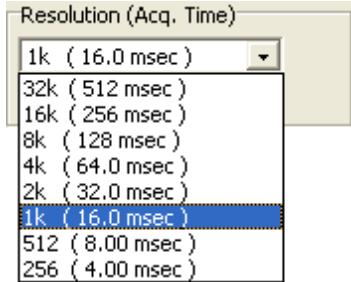

The resolution control determines the number of lines in the FFT spectra. Values from 256 lines to 32k lines can be selected. In the resolution control the time to acquire a time record for the selected resolution and current bandwidth selection is shown alongside the number of lines. Obviously, the higher the selected spectral resolution, the longer it will take to acquire the time record for that spectrum.

Averaging

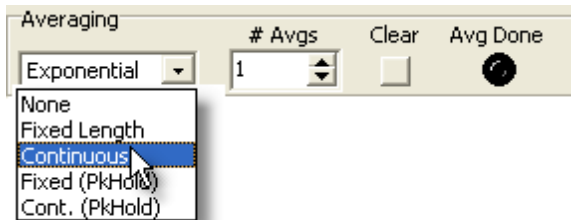

Both the Power Spectrum and Linear Spectrum are averaged— in the case of the Power Spectrum the power in each bin is averaged, while for the Linear Spectrum the complex spectrum is averaged in each bin. The amount and type of averaging for both spectra is specified by the controls above. The averaging type controls determines how each of the spectra is averaged. "None" implies that no averaging is performed. In this case the magnitude of the Power Spectrum and Linear Spectrum are the same and simply become the magnitude of the last individual FFT. "Fixed Length" averaging means that the analyzer will average the selected number of spectra and then stop. "Continuous" averaging continuously averages the spectra weighting more recent results exponentially more than older spectra. The two "Peak Hold" selections only affect the averaging of the Power Spectra. When Peak Hold is selected instead of averaging successive power spectra each bin of the new spectrum is compared to the current buffer— if the value in the new spectrum is greater the value in the buffer is replaced. This hold the maximum value in each bin and is useful for detecting unwanted transient events.

The "Clear" button clears the average buffer and re-starts averaging . The "Avg Done" indicator lights when the required number of averages have been accumulated.

The FFT1 Meas2 Panel

This panel contains additional configuration controls for the FFT1 analyzer.

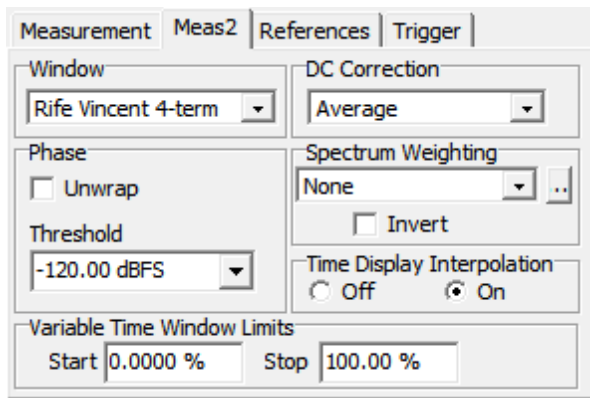

Window Selection

It is well known that the application of a window functions is typically necessary to obtain maximum dynamic range for FFT measurements. The discrete Fourier Transform implemented by SR1 calculates a spectrum assuming the time record repeats continuously. Thus, if the signal being analyzed is not perfectly repetitive in the time record interval the the calculated spectrum will include the discontinuities between the beginning and end of the time record which show up in the frequency domain as wide skirts and a high noise floor around the actual spectrum. The spectrum shown below on the left is the unwindowed spectrum of two sinewaves of arbitrary frequency. The spectrum is completely distorted by the artifacts associated with the time record discontinuities.

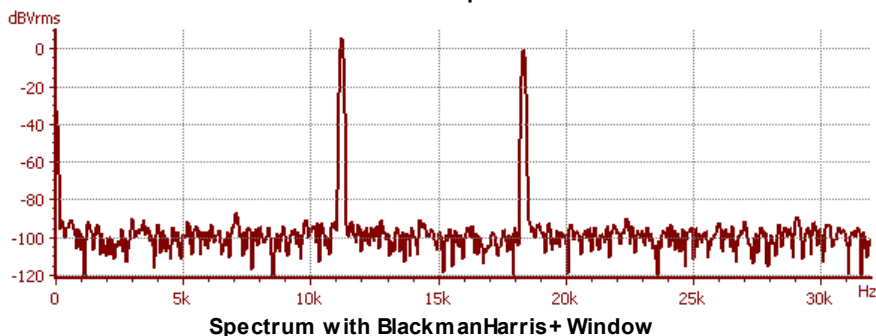
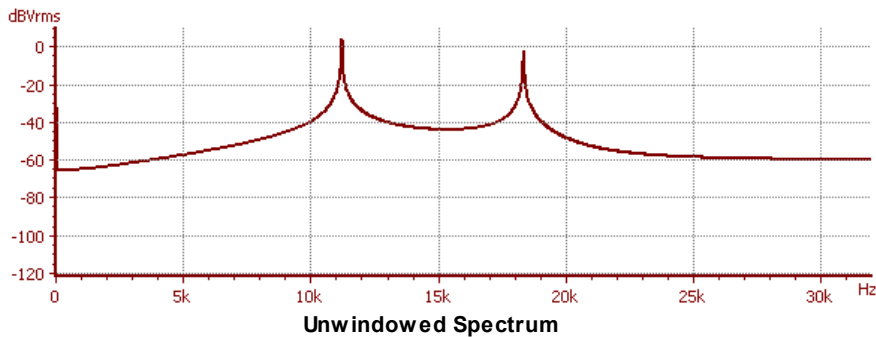

To eliminate the discontinuities between the beginning and end of the time record the time record is typically multiplied by a window function which is large in the middle of the time record and tapers off near the beginning and end of the time record. The spectrum on the right shows the spectrum of the same two sine waves after application of a window function.

Many window functions have been developed over the years, but few have the >120 dB dynamic range necessary for modern audio measurements. For most measurements with SR1, the **Rife Vincent 4-**

term or the **Blackman-Harris+** window are the best windows to use. (The BlackmanHarris+ window is a proprietary improved version of the traditional Blackman Harris window.) These two windows have sufficient dynamic range for most measurements. The other windows are included for historical interest and comparison purposes. The FFT chirp and multitone sources are synchronous with the FFT time record and have different frequency content over different parts of the time record. Therefore, the **Uniform** window should be selected when the FFT analyzer is being used with the FFT chirp or Multitone source.

The Variable Time window is "on" (1) during the portion of the time record specified by the "Variable Time Window Limits". Outside of that interval the window is 0. The transitions between the off and on segments of the window are done using a raised cosine function to minimize disturbance in the frequency domain. The Variable Time window is useful for isolating analysis to a particular region in the FFT time record. Obviously, the time record needs to be repetitive, or the [Analyzer Trigger](#) needs to be used to obtain meaningful results.

Phase Controls

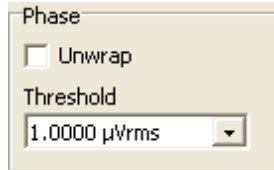

The linear spectrum has phase as well as magnitude associated with it. Checking "Unwrap Phase" instructs SR1 to "unwrap" the phase by adding or subtracting 360° at appropriate break points to create a continuous phase curve.

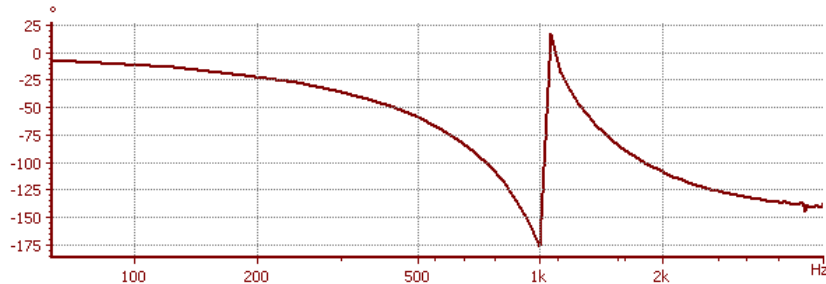

Phase Spectrum of 1 kHz LPF Without Unwrapping

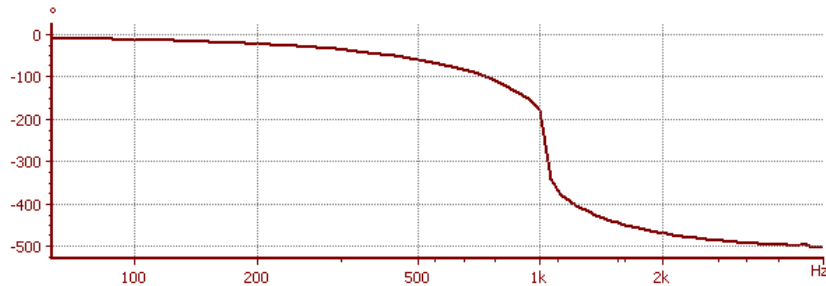

Same Spectrum with Phase Unwrapping On

The Phase Threshold specifies a minimum amplitude at which to compute phase. This can be useful when the spectrum only has amplitude at discrete frequency points. If a phase threshold is not specified important phase information can be lost in the "phase noise" that is generated by the noise floor. In the example below the phase spectrum of a 3 kHz square wave is shown. The spectrum contains power only at the fundamental odd harmonics: 3 kHz, 9 kHz, 15 kHz, 21 kHz, etc. The phase of the odd harmonics alternates between 0 and 180°. However, in the first spectrum the phase pattern of the harmonics is obscured by the noise generated by bins without any amplitude.

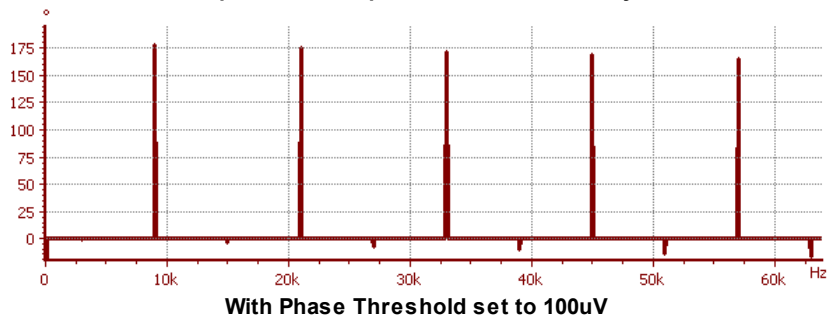
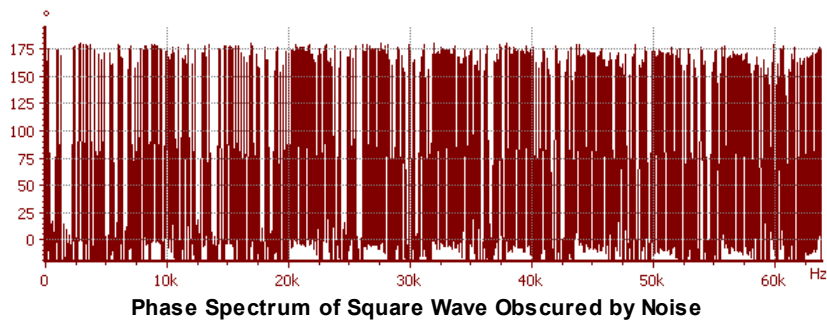

Adding a relatively small phase threshold value (100 μV) suppresses phase calculation for spectral bins with no amplitude and allows the true phase spectrum to emerge.

DC Correction

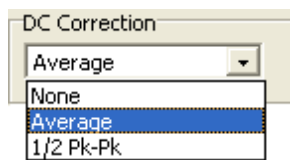

Small amounts of DC in the FFT time record can be removed using the DC Correction control. Selecting Average will subtract the average value of each time record from the time record before taking the FFT. 1/2 Pk-Pk will subtract the average of the maximum and minimum values found in each time record.

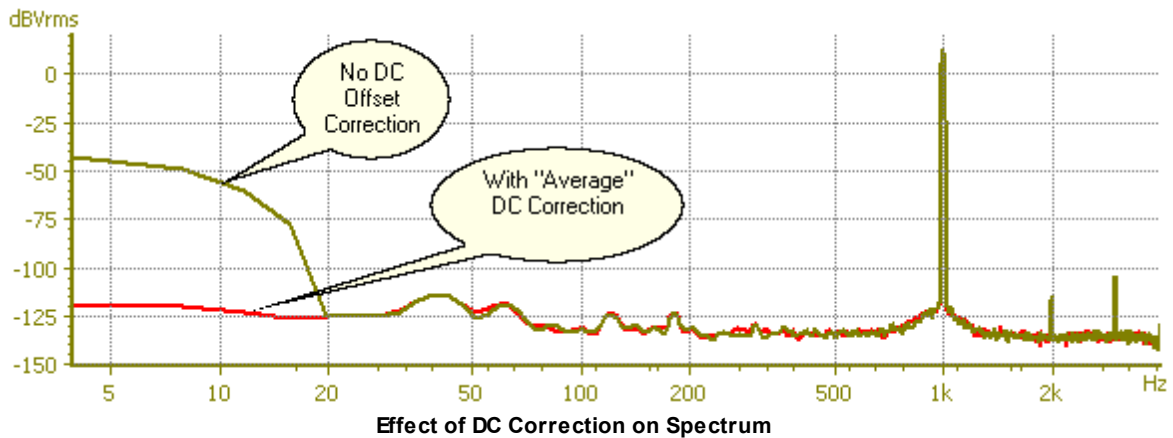

An example of the use of DC correction is shown above. The original spectrum has some DC offset which has "leaked" into adjacent low-frequency bins because of windowing. The red trace shows the same signal with "Average" DC correction applied.

Spectrum Weighting

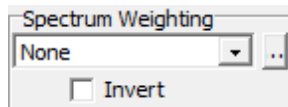

The two spectral outputs of the FFT1 analyzer, the Power Spectrum and Linear Spectrum, can have weighting curves applied to them. Weighting curves are represented by [EQ files](#). The standard [EQ files](#) supplied with SR1 include:

Weighting Filters	
None	No weighting filter is applied.
A-Wt	"A" weighting filter is applied. "A" weighting is specified in ANSI standard S1.4-1983 and is typically used for noise and THD+N measurements with audio applications.
C-Msg Wt	The C-Msg weighting filter, specified in IEEE Std. 743-1995, is intended to be used for noise measurements associated with voice transmission telecommunications.
CCITT	The CCITT weighting filter defined by ITU-T Recommendation O.41 is another telecommunication noise weighting filter.
CCIR (wtd)	Filter defined in CCIR Rec. 468-4 for audio noise measurements. Designed to be used with the Quasi-Peak setting on the Time Domain Detector.
CCIR (unwtd)	Filter defined in CCIR Rec. 468-4 (Annex II) for making unweighted noise measurements.
CCIR (2 kHz)	This filter is identical to the CCIR(wtd) filter except the normalization is changed so that the filter has unity gain at 2 kHz instead of 1 kHz.

Note that the spectral weighting selected with this option is done in the the DSP after FFT computation — the filtering does not affect the dynamic range of the measurement. Checking the "invert" box applies the inverse of the specified weighting to the FFT measurements.

Time Display Interpolation

Near the top of the FFT frequency range of DC to $F_s/2$ there are relative few sampled data points per

cycle in the FFT time record. If the points are plotted by simply connecting adjacent samples a distorted picture of the actual time data may result. When "Time Display Interpolation" is turned on, band-limited interpolation is applied to the time record display to "oversample" the displayed points and produce a more accurate visual representation of the original time-signal. For instance, the graph below on the left shows the time record of a 19.57 kHz sinewave input to the FFT1 with an analyzer sample rate of 64 kHz and with Time Display Interpolation turned off. Turning on Time Display Interpolation, shown below on the right, gives a much more accurate representation of the original signal.

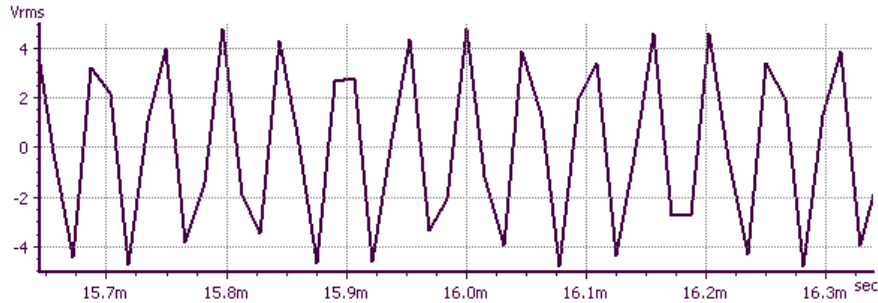

Time Record without Time Domain Interpolation

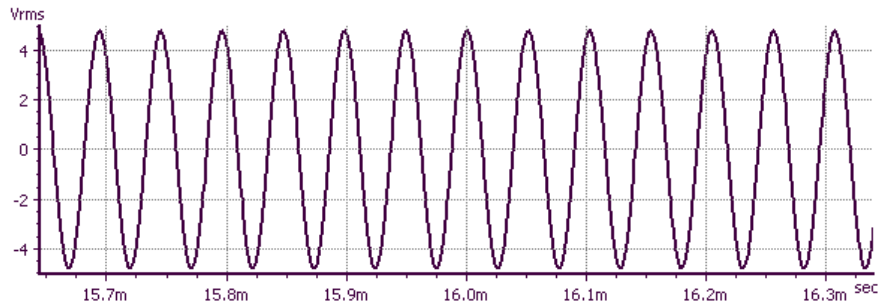

Same Signal with Time Domain Interpolation

Using the FFT1 Analyzer With the FFT Chirp Source

Both the [analog](#) and [digital](#) generators have a FFT chirp source which generates a signal which has equal power in each FFT bin. For the digital chirp the output is flat to within fractions of a mdB, for an analog chirp the signal is typically flat to ± 5 mdB when used with the Hi-Resolution ADC and ± 10 mdB out to the 200 kHz limit of the Hi-Bandwidth ADC. The plots below show FFTs for the analog chirp source for both input converters.

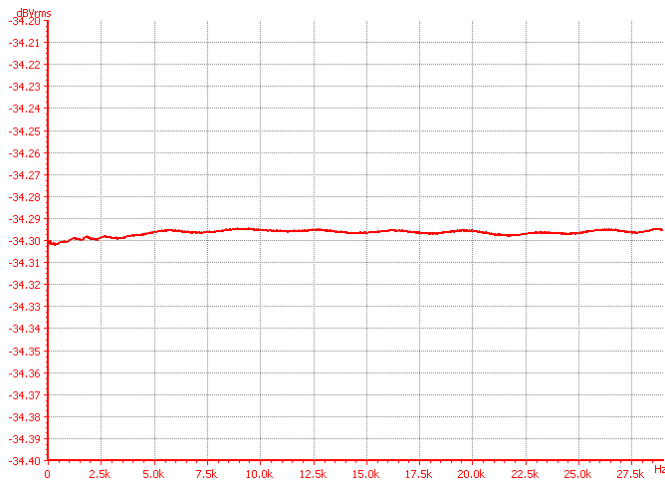

Chirp, Hi-Resolution ADC (Y Scale = 10 mDb/div)

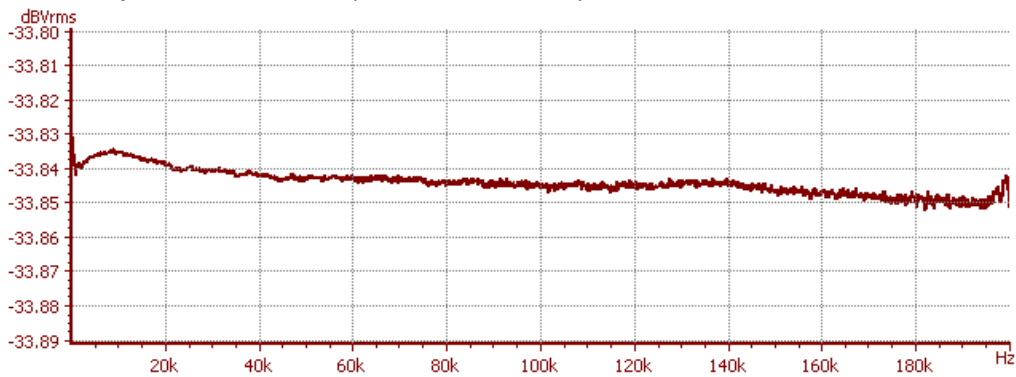

Chirp, Hi-Bandwidth ADC (Y-scale = 10 mdB/div)

The unique property of the synchronous chirp, equal power in each FFT bin, makes it a powerful tool for quickly measuring the frequency response of audio devices. Unlike noise stimulus, which although having a uniform frequency content takes many repeated shots to converge to an accurate result, or swept measurements, which require a separate measurement at each frequency point, the chirp source allows accurate measurement of frequency response in one single FFT acquisition. For instance, the plot at left below shows the single-shot FFT response of the chirp source when passed through a 8-pole 6-zero analog filter with a 5 kHz cutoff frequency.

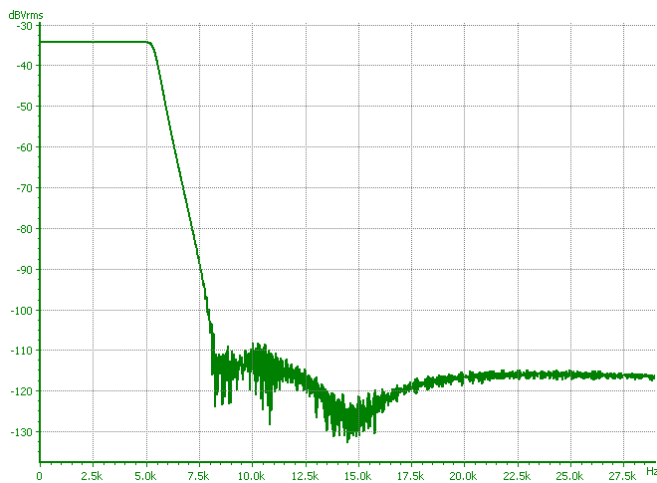

Elliptical Filter (DUT) Output with Chirp Input

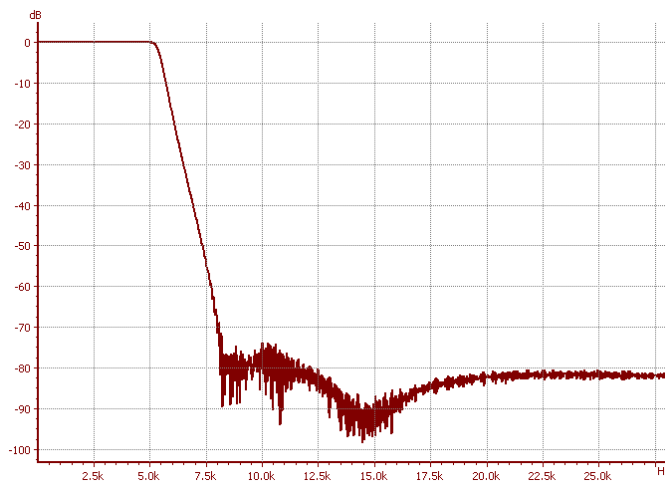

Normalized Frequency Response of Elliptical Filter

If desired, the original chirp signal can be acquired first, without passing it through the DUT, and saved as an offline trace. Then after the spectrum through the DUT is acquired the graph's "Ratio" function can be used to normalize the output to the input producing a true frequency response plot such as the one seen above right.

The same process of acquiring a reference input plot and then normalizing the output to it can be used to measure the phase response of devices in a single FFT shot, however, the process is so much simpler using the dual-channel FFT analyzer (FFT2) that we'll postpone the discussion of phase response until then.



Because the synchronous chirp source has a periodic time-dependent amplitude profile, it may fool the input autoranging control into switching ranges too frequently. Depending on the FFT bandwidth (which determines the chirp length) it may be useful to turn off input autoranging when using the synchronous chirp signal.

For the same reason, be sure to select the "Uniform" window when using the synchronous chirp. Window functions attenuate the beginning and the end of the time record for the FFT analyzers which when using the chirp means that certain frequencies will be attenuated more than others. This destroys the "flat" nature of the synchronous chirp signal.

Using the FFT1 Analyzer With the Time Domain Detector

The FFT1 analyzer can be used together with the [Time Domain Detector](#) to create a powerful tool for analyzing noise and distortion spectra in realtime. The Time Domain Detector outputs a digital signal which represents the input signal with the fundamental notched out and any bandwidth limiting and weighting filters applied. This signal can be routed directly to the input of the FFT analyzer. To implement this setup, select the type of the A0 analyzer as "Time Domain Detector". Set the TDD input to analog Hi-Bandwidth and the TDD function to THD+N Ratio. Now set the type of the A1 analyzer to FFT1 and set its input to "Other Analyzer." The spectrum displayed is the spectrum of the input signal with the fundamental removed by the TDD's notch filter and the remaining noise and distortion amplified by the TDD's post-filter gain.

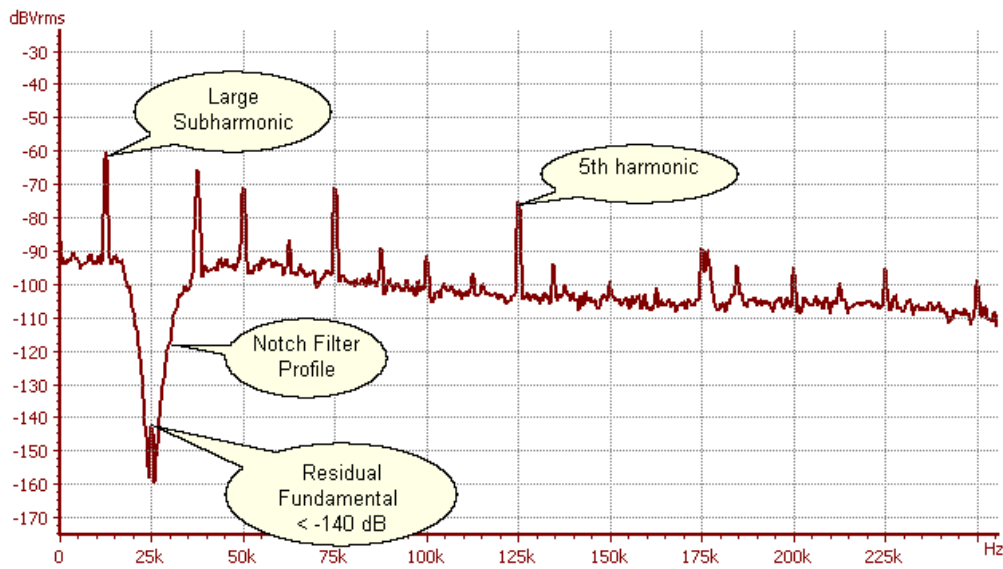

Residual Spectrum of 25 kHz, 1 Vrms Sine from Commercial Function Generator

As an example, the spectrum above shows the residual spectrum from a 25 kHz 1 Vrms sine wave generated by a commercial function generator. The THD+N in a 200 kHz bandwidth as measured by the TDD is -58.6 dB—hardly audio quality, but within the specifications of this function generator. The residual spectrum reveals much more information than the single THD+N value does. The first thing we notice is the profile of the notch filter with the residual fundamental poking through bottom at about -144 dBVrms. The THD+N is clearly dominated by discrete frequencies, rather than noise. In this case, interestingly, the dominant distortion product is not a harmonic, but the 12.5 kHz subharmonic. As it turns out this function generator generates its signals at 1/2 the output frequency and employs a frequency doubler to create the final signal—the subharmonic is the residual of the original pre-doubler signal.

By using the "FFT Cursors" to display the integrated power in the residual spectrum it is possible to directly read out the THD+N due to any part of the residual spectrum between the cursors. This information can be invaluable in deciding which portions of a circuit to optimize.



When using the FFT1 analyzer in combination with the TDD to measure low levels of THD+N be sure the TDD is set to the Hi-Bandwidth converter. Only the Hi-Bandwidth converter signal chain employs the analog notch filter and analog post-filter gain that enables making the most sensitive THD+N measurements.

2.4.4 FFT (Dual Channel)

The Dual-Channel FFT Analyzer (FFT2) computes the frequency spectra of both channels of the selected input domain, analog or digital and additionally computes the magnitude and phase of the dual-channel frequency response function and impulse response. Because the FFT2 analyzer computes frequency response using a *relative* measurement it can make highly accurate measurements of frequency response magnitude and phase without the need for a perfectly flat reference source.

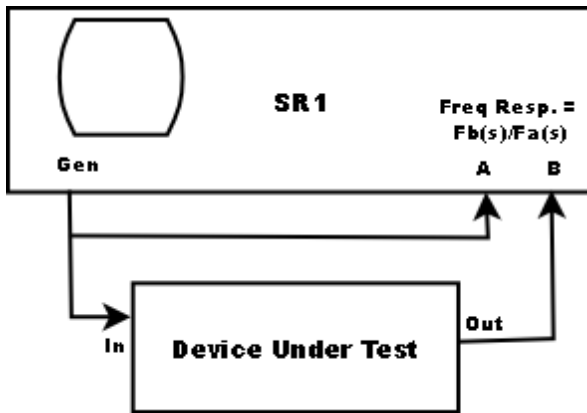

Typical Dual-Channel Response Measurement

The diagram above shows a typical two-channel measurement setup. SR1's Generator provides the stimulus signal which can be a broadband source, such as noise or the FFT chirp signal, or can be narrowband. The generator output is split and sent to both the DUT and the A-channel input of the analyzer. The output of the DUT is sent to the B-channel input of the analyzer. The analyzer then computes the quotient of the two complex FFTs which yields the magnitude and phase of the frequency response.

FFT2 Analyzer Block Diagram

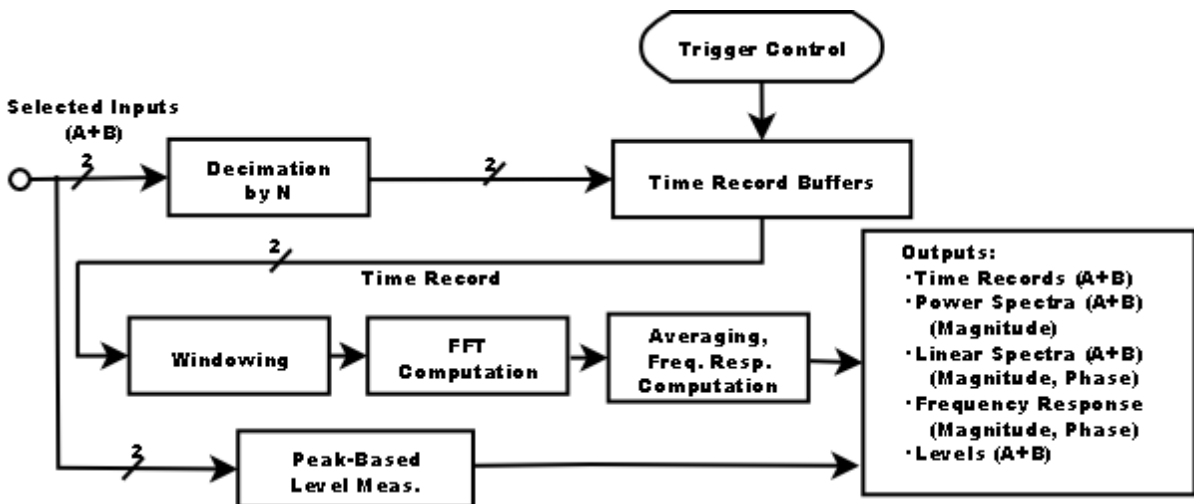

A block diagram of the FFT2 analyzer is shown above. Both input channels of the selected domain are first optionally decimated by up to a factor of 2^{10} depending on the user's bandwidth selection. Each

stage of decimation includes filtering to eliminate alias effects from the discarded portions of the frequency spectrum. The outputs are sent to two buffers which serve as the time records for the FFT2 analyzer. The time records for each channel are synchronized to the occurrence of a trigger. If the [analyzer trigger](#) is not enabled then a trigger is automatically generated as soon as the DSP has finished processing the previous time record. Otherwise, the analyzer waits for a trigger which matches the specified [trigger criteria](#) and begins both time records at the trigger point.

After a trigger occurs and enough time record points have been accumulated to compute a spectrum of the specified resolution, the DSP applies a windowing function to the time-domain data (See [Window Selection](#)). Windowing is necessary due to the finite length of the FFT time record. Unless the input signal happens to be periodic in the time record, discontinuities at the beginning and end of the time record will appear as significant broadening of the true spectrum of the input signal. Typical window functions are large in the middle of the time record and taper off at the beginning and ends, thus minimizing the discontinuities.

After windowing, the DSP computes the FFT of the windowed time records. For a resolution of N lines, $2N$ real time record points are used to compute an FFT of N complex points. Each FFT is then averaged in two different ways. The **Power Spectrum** is computed by computing the power for each spectrum (taking the absolute value of the complex FFT points) and averaging that power into the power computed for previous FFTs. This type of averaging does not reduce the noise floor of the spectrum but it does reduce the variation of the noise floor making it easier to see spectral details on the order of the noise amplitude. Phase information is lost when computing the Power Spectrum. In the example below the unaveraged power spectrum is shown for a signal composed of a 1 kHz sine wave with added white noise. The second spectrum shows averaging on and $N_{avg} = 10$. Note the substantial reduction in the variation of the noise floor and note also that the average value of the noise floor is the same.

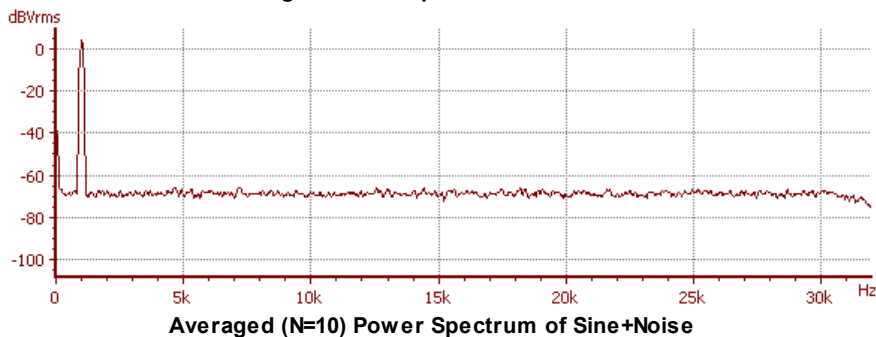
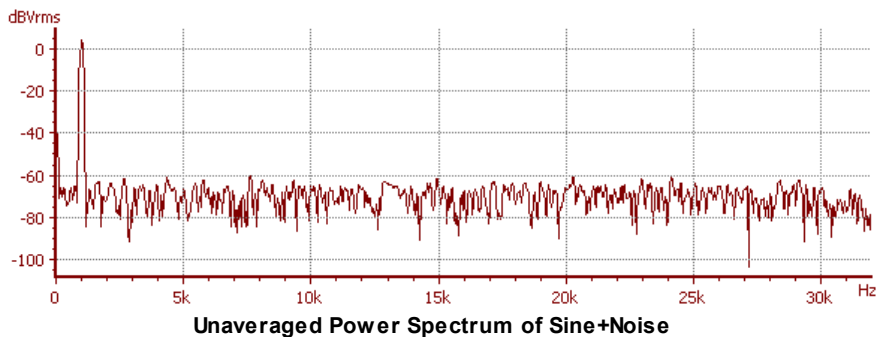

The second spectral output computed by the FFT2 analyzer is the **Linear Spectrum** for each channel. The Linear Spectrum is computed by averaging the real and imaginary parts of each FFT separately. The average of the real and imaginary parts are then used to compute the Linear Spectrum amplitude and phase. In the Linear Spectrum, unlike the Power Spectrum, noise that is uncorrelated to the signal is actually reduced by further averaging. Because of this, use of the Linear Spectrum, unlike the Power Spectrum, requires that the time record be triggered so that the signal waveform will have the same

phase relative to the beginning of the time record for each averaged FFT. Below, the averaged Linear Spectrum (Navg=100) is shown plotted with the averaged Power Spectrum for the same number of averages. Note that averaging the linear spectrum does not reduce the variation in the noise floor, but does reduce the amount of noise. In this case averaging 100 spectra has reduced the noise floor by about 20 dB.

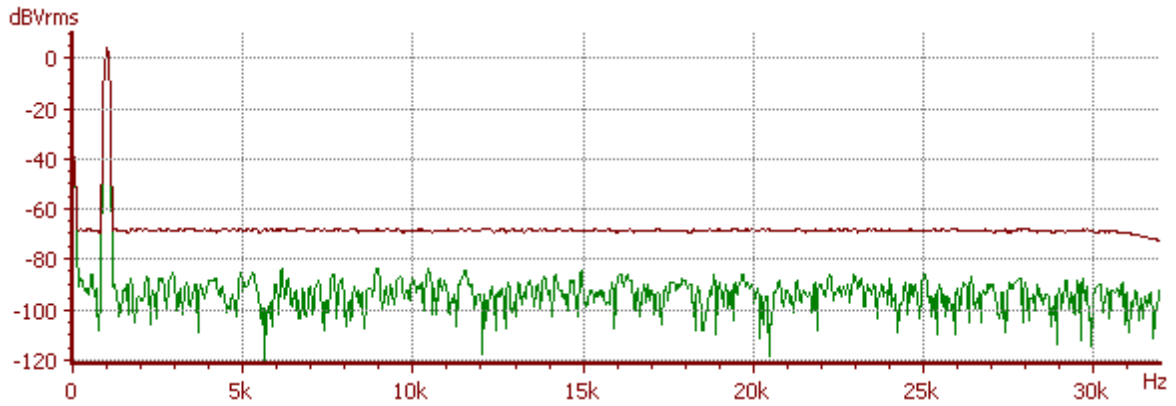

Comparison of Averaged Power Spectrum and Linear Spectrum

Computing the 2-Channel Frequency Response

After computing the Power Spectrum and Linear Spectrum for both channels, DSP computes the Frequency Response. The complex frequency response is defined in terms of the FFTs for the two channels as:

$$T(s) = \frac{F_b(s)}{F_a(s)}$$

is a mathematically "volatile" expression because it diverges when the A-channel input is small. To minimize this volatility SR1 uses a standard technique called the "Tri-Spectral Average" when computing the dual-channel frequency response. If we multiply the numerator and denominator of the equation above by the complex conjugate of the A-channel FFT and average the numerator and denominator separately we get the following expression for the averaged frequency response:

$$\langle T(s) \rangle = \frac{\langle F_b(s) * F_a^*(s) \rangle}{\langle F_a(s) * F_a^*(s) \rangle}$$

The denominator of this expression is simply the Power spectrum of the input channel, which is by definition a positive, real quantity. The numerator, $\langle F_b(s) * F_a^*(s) \rangle$, is a complex quantity known as the cross-spectrum. When SR1 calculates the magnitude and phase of the frequency response it uses the following definitions:

$$Frequency\ Response\ (Mag) = \frac{|Cross\ Spectrum|}{|Power\ Spectrum\ A|}$$

$$Frequency\ Response\ (Phase) = \angle(Cross\ Spectrum)$$

This technique provides a significantly more stable Frequency Response than if SR1 were to simply average the shot by shot frequency response .

Coherence

The FFT2 analyzer also calculates another 2-channel scalar measurement, the coherence. Coherence is measure of the fraction of the output power at a frequency that is phase coherent with the input. A

coherence value of "1" means all of the output is phase coherent with the input, while a value of "0" indicates the output is completely uncorrelated with the input. Because only averaging over several FFTs reveals which portions of the spectrum are phase coherent and which are not, the coherence measurement is valid only when averaging.

Mathematically, the coherence is defined as

$$Coherence = \frac{\langle CrossSpectrum^* \times CrossSpectrum \rangle}{\langle PwrSpecA \rangle \langle PwrSpecB \rangle}$$

As an example consider the spectra below showing the frequency response and coherence of an 8-pole 6-zero elliptical filter with a 5 kHz passband frequency. The spectra were taken with the FFT2 analyzer with the hi-bandwidth ADC, and a 1 Vrms synchronous chirp source outputting equal power into each FFT bin up to 200 kHz. Note that throughout the passband of the filter and into the transition region the coherence is unity. In the stopband however, the output signal is >80 dB below the input and at those small levels there exists enough uncorrelated output noise in the filter output to reduce the coherence to a value below one. At the zeros of the filter, there is virtually no output from the filter and all the SR1 is measuring is uncorrelated noise, hence the zeros of the filter correspond to the regions of lowest coherence.

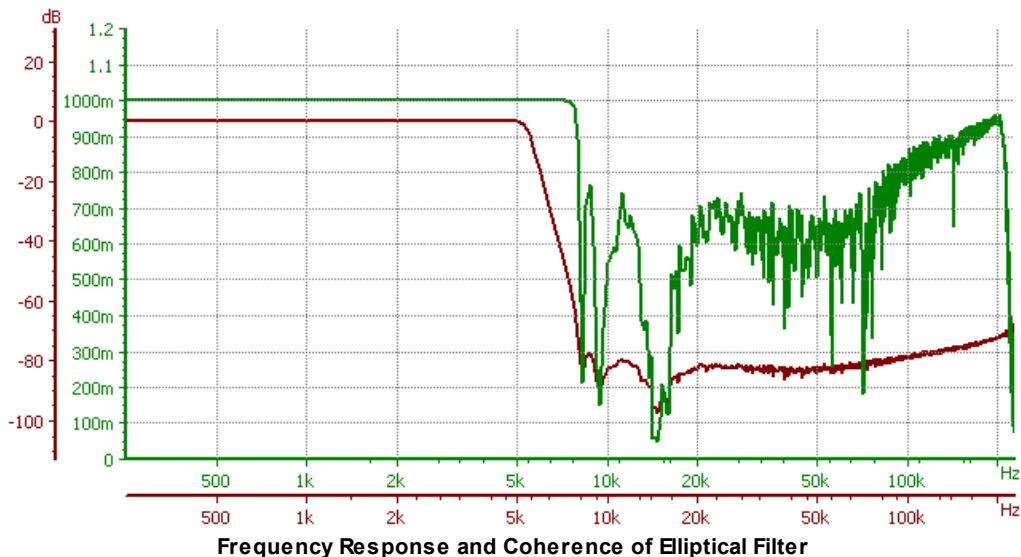

Impulse Response

SR1 computes the impulse response by taking the inverse FFT of the complex (magnitude and phase) frequency response. Only portions of the frequency response which exceed the coherence threshold (See [Coherence](#)) are used when computing the impulse response. Traditionally impulse response measurements have been associated with the use of Maximum Length Sequences as a stimulus. The MLS waveform has several useful properties which simplify the calculation of the impulse response and has a crest factor close to 1 providing good signal to noise. However, because SR1 uses a full dual-channel FFT to calculate impulse response it is not necessary to use MLS waveforms as a stimulus, in fact most broadband sources will work. In particular, noise, MLS, FFT chirp, and log-sine chirp, are all suitable waveforms for impulse response measurements. [Random noise](#) is not a particularly good choice and has a relatively poor crest factor, but is interesting for comparison purposes. The [MLS](#) waveform has a good crest factor and sounds much like random noise, but can produce misleading results in systems with transfer-function nonlinearities. The [FFT chirp](#) waveform has a comparable crest factor to MLS and has the additional advantage of being able to completely tailor the frequency content of the chirp to suit the device under test. (The FFT chirp, however, does sound decidedly "non-random.") Finally, the [log-](#)

[sine](#) chirp stimulus has the fascinating property of being able to temporally separate the response due to the linear and non-linear portions of the DUT transfer functions. (See "Measurement of audio equipment with log-swept sine chirps" by Thomas Kite, *AES Convention Paper 6269 presented at the 117th AES Convention, October 2004* for a succinct summary of the properties and advantages of using the log-sine chirp).

Anechoic Frequency Response

A typical impulse response measurement made with a small room with a microphone and loudspeaker is shown below.

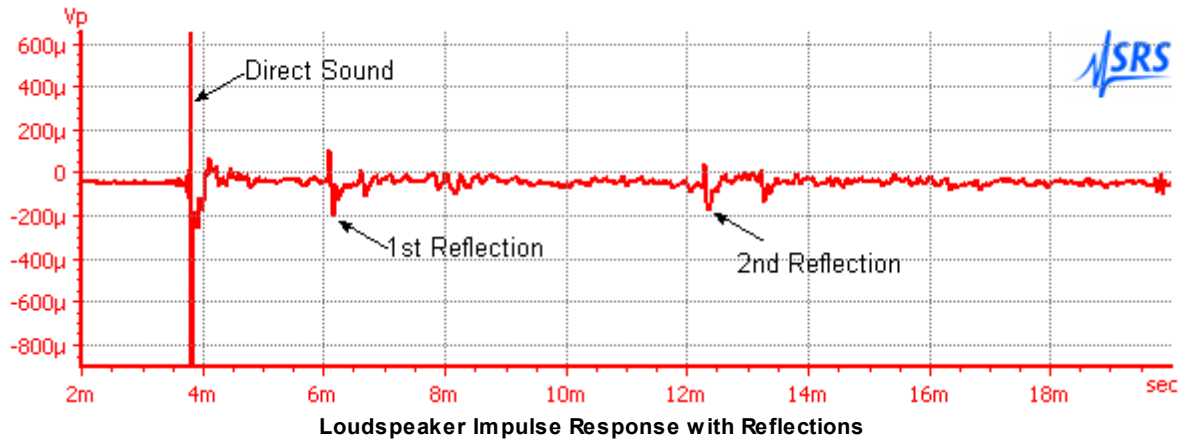

In addition to the response due to the sound directly transmitted from the loudspeaker to the microphone the response includes several reflections from nearby walls. The calculated frequency response, including the direct sound and reflections, is shown below. Interference between the direct paths and the reflected paths cause "oscillations" in the frequency response and obscure the true frequency response of the loudspeaker.

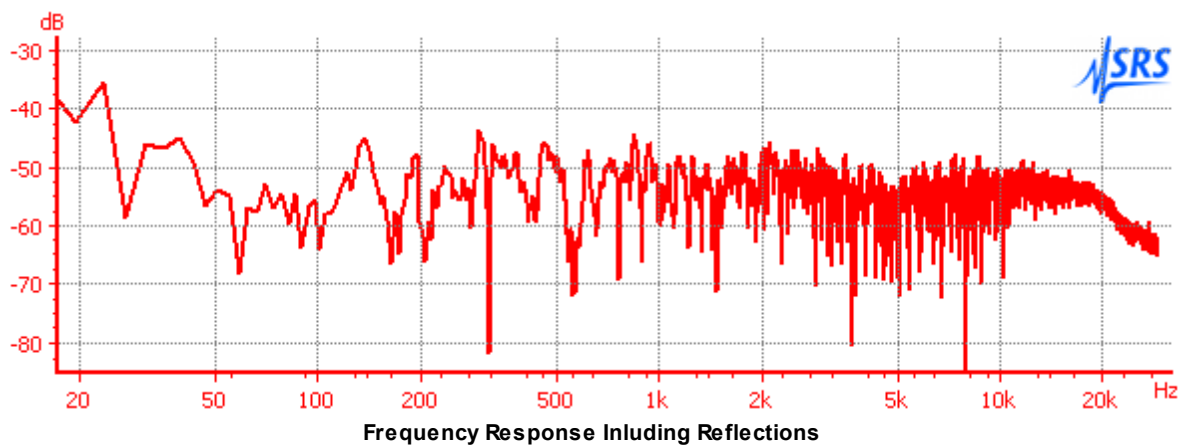

In order to avoid this problem the FFT2 analyzer offers an "Anechoic Frequency Response" measurement. The anechoic frequency response is calculated by transforming only the direct sound portion of the impulse response back to the frequency domain. (The impulse response is suitably windowed to avoid problems with abrupt transitions.) When this is done for the case above the true frequency response emerges much more clearly:

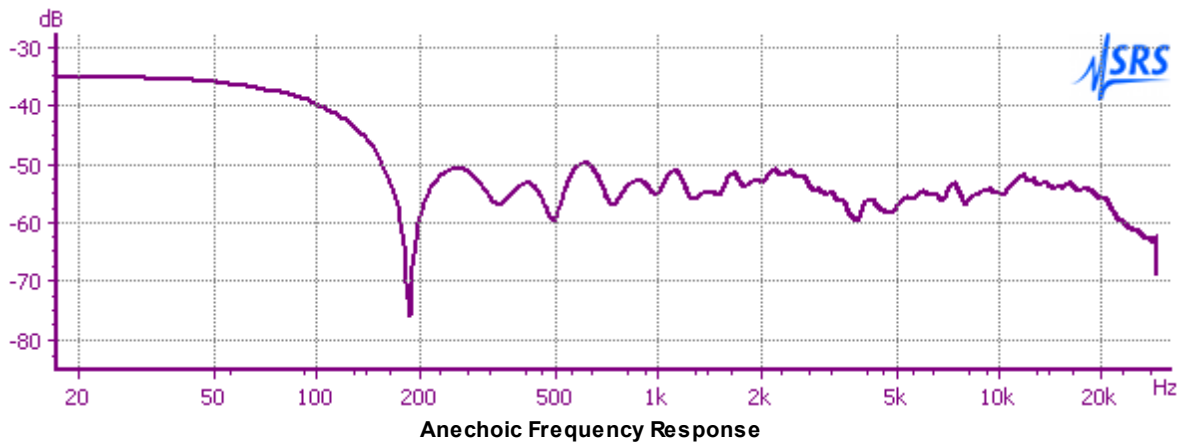

Energy Time Curve

The energy time curve (ETC), is an attempt to find an "envelope" function for the impulse response that attempts to illuminate features of the impulse response that may be obscured by interference effects. For example, the synthesized impulse response shown on the left below consists of a high-amplitude sinusoid with a fast decay time constant mixed with a delayed lower amplitude sign with a slower decay time-constant.

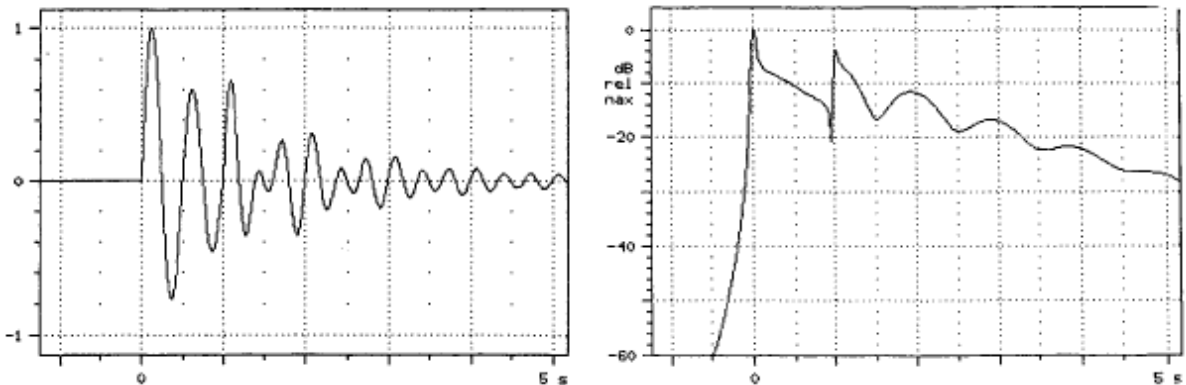

Left: Impulse response consisting of a high amplitude sinusoid with a fast decay time constant and a delayed lower amplitude sine with a slower decay time constant. Right: ETC of the impulse response. (From Andrew Duncan, "The Analytic Impulse", Presented at the 81st AES Convention, November 1986.)

While this may not be immediately obvious from the impulse response graph it is more evident in the computed ETC.

The ETC is calculated by finding an appropriate "imaginary part" for the impulse response in the same way that sine is the appropriate imaginary part for a uniform phasor whose real part is cosine. Technically the imaginary part is found by computing the Hilbert transform of the impulse response. The complex function whose real part is the impulse response and whose imaginary part is its Hilbert transform is known as the analytic impulse response of the system. The ETC is the magnitude of the analytic impulse.

SR1 calculates the ETC from the anechoic frequency response. A frequency-domain window is applied to the anechoic frequency response to reduce alias effects. The result is transformed back to the time-domain to obtain the real part of the analytic impulse response. A phase shifted (Hilbert transformed version) is transformed to obtain the imaginary part of the analytic impulse. The magnitude of the resulting function is the ETC.

Summary of FFT2 Outputs

Measurement	Description
Level A, B	Peak-based levels of both channels of the selected input domain.
Time Record A,B	The underlying time data used to compute spectra. When displayed on a graph this measurement produces an "oscilloscope" type display.
Power Spectrum Amplitude A,B	The amplitude of the power-averaged spectra for each channel.
Linear Spectrum Amplitude A,B	The amplitude of the synchronously averaged spectra. The amplitude of signals that are synchronous with the time record is preserved, other uncorrelated signals average away.
Frequency Response Mag.	The magnitude of the averaged frequency response.
Frequency Response Phase	The phase of the averaged frequency response.
Coherence	2-channel coherence of the A and B signals. Values near one indicate good input/output correlation while values near zero indicate the output consists mostly of uncorrelated noise.
Impulse Response	The Inverse FFT of the Frequency Response. This time-domain signal represents the response of the system to a narrow "impulse" excitation even though it can be measured using any broadband source.
Anechoic Response (Magnitude)	The frequency response magnitude calculated from the time-gated (no reflections) impulse response. Multiple reflection paths introduce can produce interference which obscures the true frequency response of the DUT.
Anechoic Response (Phase)	The frequency response phase calculated from the time-gated (no reflections) impulse response. Multiple reflection paths introduce can produce interference which obscures the true frequency response of the DUT.
Energy-Time Curve	The magnitude of the analytic impulse response, or the "envelope" of the impulse response.

The FFT2 Analyzer Panel

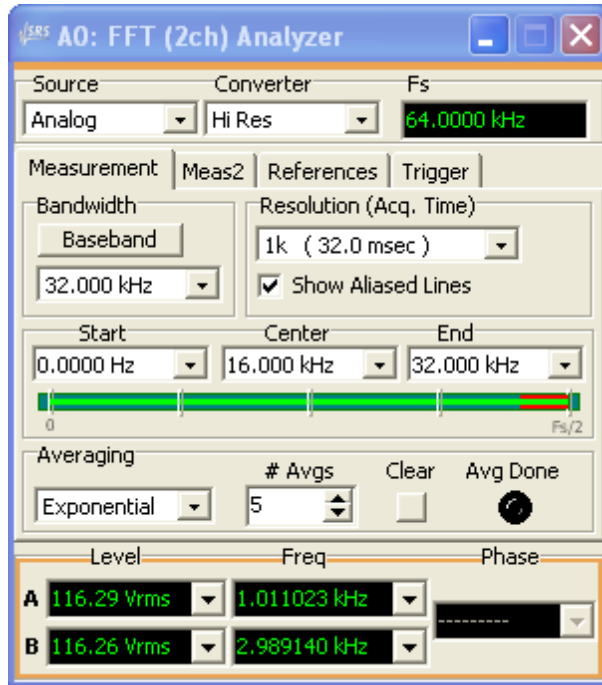

Because both the A and B inputs of the selected input domain are always used by the FFT2 analyzer the Source selection for FFT only offers the choice of "Analog" or "Digital". The "Converter" and "Fs" controls are common to all [analyzers](#). Like the FFT1 analyzer, the levels displayed on the FFT2 analyzer panel are peak-based levels, not RMS levels. (Remember, the [units](#) the levels may be displayed in are independent of the method of computation.) Because the FFT2 analyzer needs to take time to compute FFTs, the continuous input data stream necessary to compute RMS levels is not available. Likewise, the fact that continuous data is unavailable means that the A-B phase computation, which also requires continuous input data, is not available for the FFT2 analyzer. Frequency data is available for analog inputs (which use a hardware-based frequency measurement technique) but not for digital audio inputs.

Bandwidth

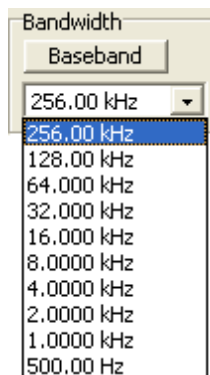

The maximum bandwidth of the FFT is 1/2 of the sampling rate for the selected input source. To instantly switch to full bandwidth, click the "Baseband" button. The "Zoom" feature of the FFT2 analyzer allows selection of narrower bandwidths, in factor of 2 increments, as well. When the bandwidth is decreased, the effective sampling rate is decreased and therefore the amount of time necessary to

acquire a time record of a given length will increase. Therefore the FFT display will update more slowly as the bandwidth is narrowed. Unlike the FFT1 analyzer the FFT2 analyzer has no heterodyne capability so that when the bandwidth is decreased the frequency range always starts at DC.

Aliasing

Aliasing arises in sampled data systems because the real-world filters used to protect A/D converters have finite cutoff slopes. Each of the SR1's A/D converters is protected with either analog or a combination of analog and digital anti-aliasing filtering. For each converter there is some range of frequency below $F_s/2$ that is not fully protected to the level of the ultimate attenuation of the anti-aliasing filter. When using the "zoom" feature of the FFT3 analyzer the analyzer applies digital anti-aliasing filter after each decimation stage to meaning that there is a small region at either end of the analysis range that is not alias-protected to the full attenuation of the digital anti-aliasing filter.

When Show Aliased Lines is checked, the analyzer displays all lines in the full analysis range of the FFT without regard to whether they are fully alias protected. This setting is often perfectly useful for many typical audio measurements. However, when aliasing is potentially a problem the box can be unchecked, in which case only FFT lines that are fully alias-protected are displayed. Areas of the spectrum that are not fully protected are shown in red in the graphical frequency indicator on the FFT panel.

Resolution

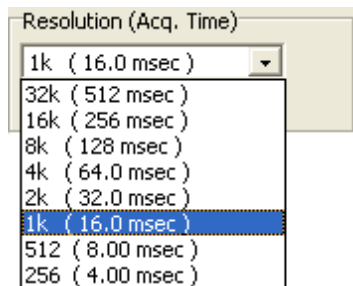

The resolution control determines the number of lines in the computed spectra. Values from 256 lines to 32k lines can be selected. In the resolution control the time to acquire a time record for the selected resolution and current bandwidth selection is shown alongside the number of lines. Obviously, the higher the selected spectral resolution, the longer it will take to acquire the time record for that spectrum.

Averaging

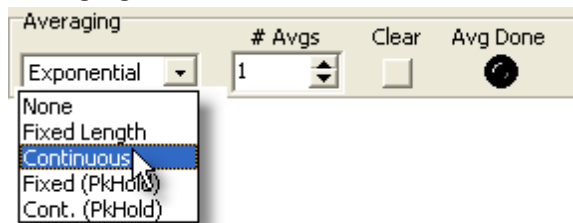

The Power Spectrum, Linear Spectrum, and Frequency Response are all averaged quantities. The amount and type of averaging for both spectra is specified by the controls above. The averaging type controls determines how each of the averaged spectra is averaged. "None" implies that no averaging is performed. In the magnitude of the Power Spectrum and Linear Spectrum are the same and reduce to the magnitude of the last individual FFT. "Fixed Length" averaging means that the analyzer will average the selected number of spectra and then stop. "Continuous" averaging continuously averages the spectra weighting more recent results exponentially more than older spectra. The two "Peak Hold" selections only affect the averaging of the Power Spectra. When Peak Hold is selected instead of

averaging successive power spectra each bin of the new spectrum is compared to the current buffer— if the value in the new spectrum is greater the value in the buffer is replaced. This hold the maximum value in each bin and is useful for detecting unwanted transient events.

The "Clear" button clears the average buffer and re-starts averaging . The "Avg Done" indicator lights when the required number of averages have been accumulated.

The FFT2 Meas2 Panel

This panel contains additional configuration controls for the FFT2 analyzer.

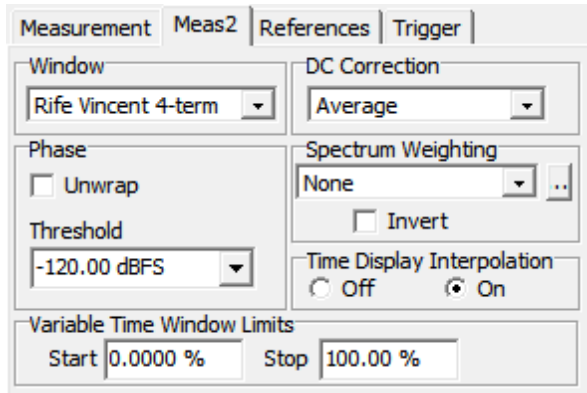

Window Selection

It is well known that the application of a window function is typically necessary to obtain maximum dynamic range for FFT measurements. The discrete Fourier Transform calculated by SR1 calculates a spectrum assuming the time record repeats continuously. Thus, if the signal being analyzed is not perfectly repetitive in the time record interval the the calculated spectrum will include the discontinuities between the beginning and end of the time record which show up in the frequency domain as wide skirts and a high noise floor around the actual spectrum. The first spectrum shown below is the unwindowed spectrum of two sinewaves of arbitrary frequency. The spectrum is completely distorted by the artifacts associated with the time record discontinuities.

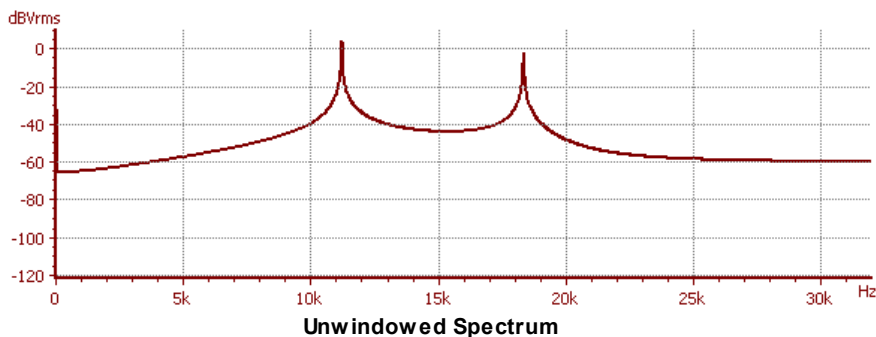

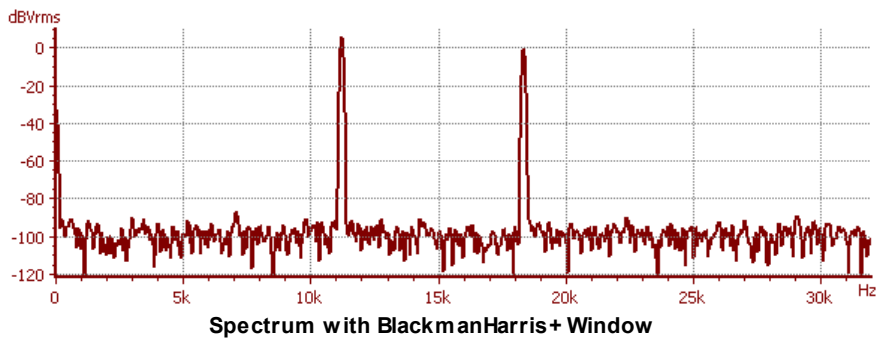

To eliminate the discontinuities between the beginning and end of the time record the time record is typically multiplied by a window function which is large in the middle of the time record and tapers off near the beginning and end of the time record. The second spectrum shows the same two sine waves after application of a window function.

Many window functions have been developed over the years, but few have the >120 dB dynamic range necessary for modern audio measurements. For most measurements with SR1, the Rife Vincent 4-term or the Blackman-Harris+ window are the best windows to use. (The BlackmanHarris+ window is a proprietary improved version of the traditional Blackman Harris window.) These two windows have sufficient dynamic range for most measurements. The other windows are included for historical interest and comparison purposes. The Uniform window should be used when use the FFT chirp, log-sine chirp, or Multitone source is used.

Phase Controls

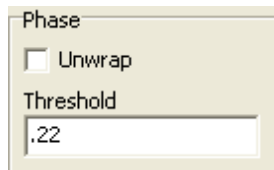

The linear spectrum has phase as well as magnitude associated with it. Checking "Unwrap Phase" instructs SR1 to "unwrap" the phase by adding or subtracting 360° at appropriate break points to create a continuous phase curve.

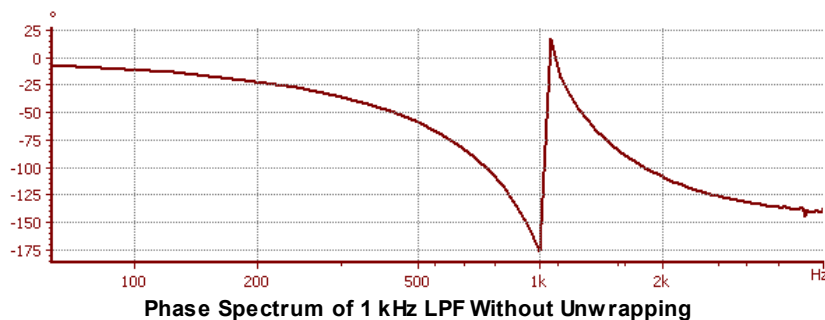

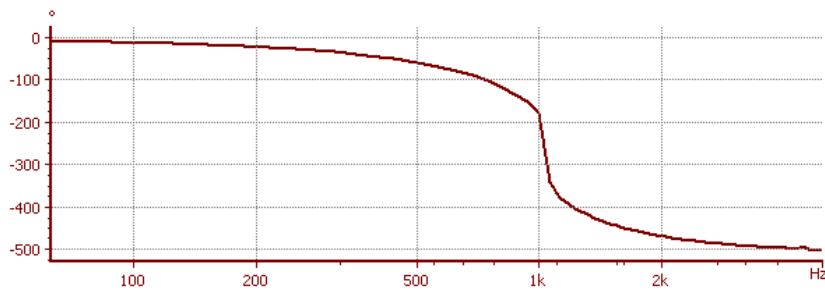

Same Spectrum with Phase Unwrapping On

The FFT2 analyzer uses the [coherence](#) as a threshold value for calculating phase. Coherence is a measure of the phase stability between the input and output channels, thus regions of high coherence will yield stable phase measurements and regions of low coherence will likely yield noisy phase values. Setting a threshold value instructs the FFT2 analyzer to only calculate phase for frequency bins where the coherence exceeds the threshold value. Setting a small threshold can often clean up the phase response spectrum considerably.

DC Correction

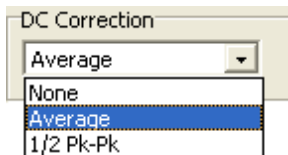

Small amounts of DC in the FFT time record can be removed using the DC Correction control. Selecting Average will subtract the average value of each time record from the time record before taking the FFT. 1/2 Pk-Pk will subtract the average of the maximum and minimum values found in each time record.

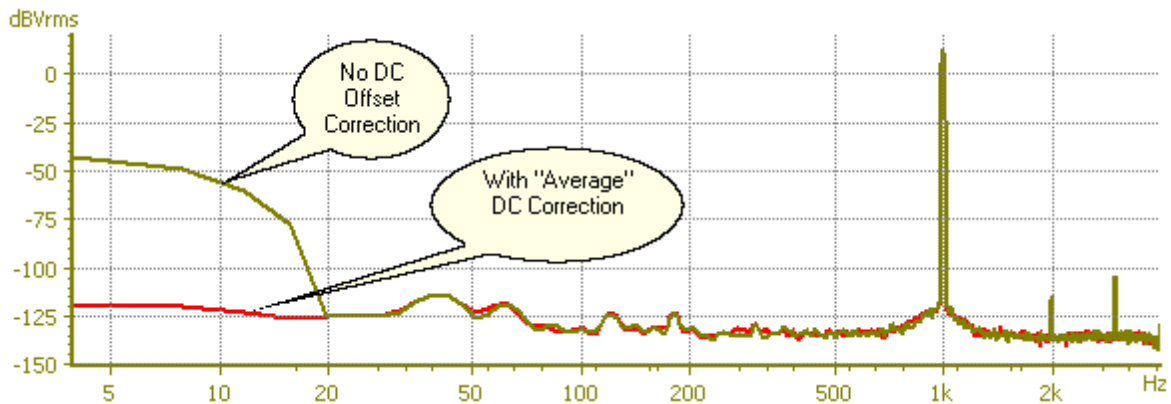

Effect of DC Correction on Spectrum

An example of the use of DC correction is shown above. The original spectrum has some DC offset which has "leaked" into adjacent low-frequency bins because of windowing. The red trace shows the same signal with "Average" DC correction applied.

Spectrum Weighting

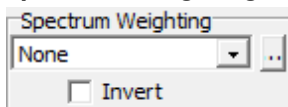

The spectral outputs of the FFT2 analyzer can have weighting curves applied to them. Weighting curves are represented by [EQ files](#). The standard [EQ files](#) supplied with SR1 include:

Weighting Filters	
None	No weighting filter is applied.
A-Wt	"A" weighing filter is applied. "A" weighting is specified in ANSI standard S1.4-1983 and is typically used for noise and THD+N measurements with audio applications.
C-Msg Wt	The C-Msg weighting filter, specified in IEEE Std. 743-1995, is intended to be used for noise measurements associated with voice transmission telecommunications.
CCITT	The CCITT weighting filter defined by ITU-T Recommendation O.41 is another telecommunication noise weighting filter.
CCIR (wtd)	Filter defined in CCIR Rec. 468-4 for audio noise measurements. Designed to be used with the Quasi-Peak setting on the Time Domain Detector.
CCIR (unwtd)	Filter defined in CCIR Rec. 468-4 (Annex II) for making unweighted noise measurements.
CCIR (2 kHz)	This filter is identical to the CCIR(wtd) filter except the normalization is changed so that the filter has unity gain at 2 kHz instead of 1 kHz.

Note that the spectral weighting selected with this option is done in the the DSP after FFT computation — the filtering does not affect the dynamic range of the measurement.

Time Display Interpolation

Near the top of the FFT frequency range of DC to $F_s/2$ there are relative few sampled data points per cycle in the FFT time record. If the points are plotted by simply connecting adjacent samples a distorted picture of the actual time data may result. When "Time Display Interpolation" is turned on, band-limited interpolation is applied to the time record display to "oversample" the displayed points and produce a more accurate visual representation of the original time-signal. For instance, the first graph below shows the time record of a 19.57 kHz sinewave with a FFT analyzer sample rate of 64 kHz with Time Display Interpolation turned off. Turning on Time Display Interpolation, shown in the second graph, gives a much more accurate representation of the original signal.

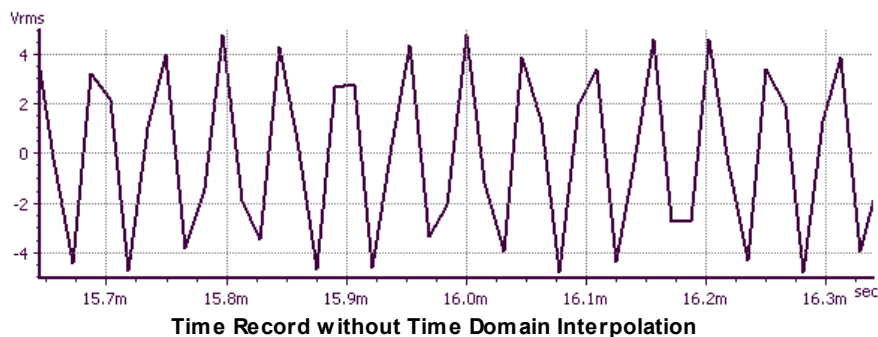

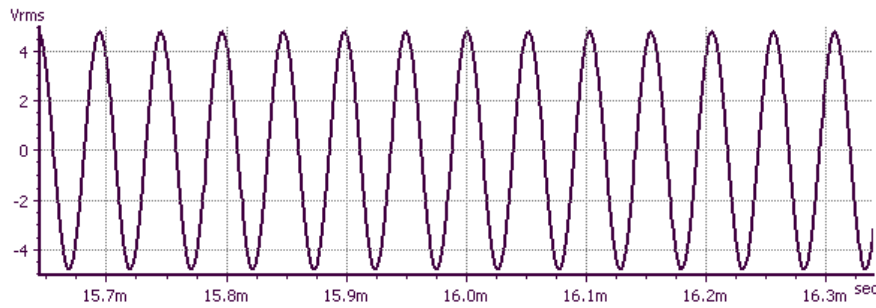

Same Signal with Time Domain Interpolation

The FFT2 Impulse Panel

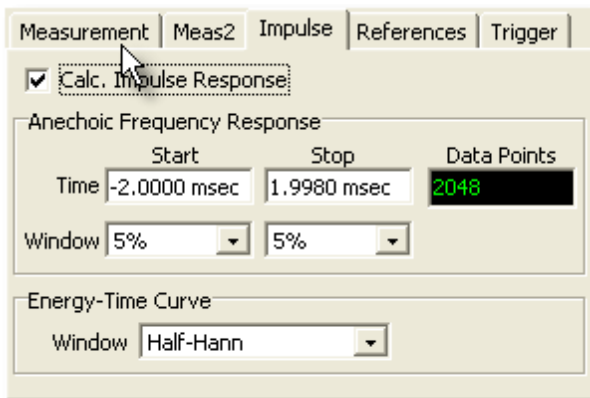

The "Impulse" tab on the FFT2 analyzer panel contains controls governing the computation of the impulse response and related measurements. The "Calc. Impulse Response" checkbox must be checked for SR1 to compute impulse response, anechoic frequency response, and the Energy-Time curve. The calculation of these measurements is time-consuming so the box should be left un-checked to obtain the maximum FFT update rate in situations where they are not needed.

The "Anechoic Frequency Response" controls select the portion of the total impulse response used in the calculation of the anechoic frequency response and energy-time curve. The start value should be set just before the main peak while the stop value should be set to just before the first reflection. The "Data Points" display shows the number of points within the selected range. The two window selections control the width of the raised-cosine window that smooths the transitions to the selected portion of the impulse response. Some experimentation may be necessary to find the settings that produce the best anechoic transfer function.

The Energy-Time Curve window selection controls the window applied in the frequency domain to the anechoic frequency response before obtaining the real and imaginary parts of the analytic impulse response. An excellent discussion of the effects of windowing on the energy-time curve can be found in Lipshitz and Vanderkooy, "Uses and Abuses of the Energy-Time Curve", Journal of the AES, Vol. 38, No. 11, November 1990, pp. 819-836.

None selects no frequency window. This will result in significant aliasing in the ETC, especially if the signal contains energy near the Nyquist frequency.

The Hann windows suppresses both low frequencies and frequencies near the Nyquist frequency and emphasizes frequencies near $F_s/4$. The paper mentioned above contains a detailed discussion of how this window can distort the ETC but it is included for comparison purposes.

The Half-Hann is window recommended by Lipshitz and Vanderkooy which eliminates frequencies near

Nyquist but retains low frequencies.

The 240Hz-8kHz selection removes frequencies below 240Hz and above 8 kHz providing an approximately 5 octave analysis range.

The 120Hz-16kHz selection removes frequencies below 120Hz and above 16 kHz providing an approximately 7 octave analysis range.

Using the FFT2 Analyzer With the FFT Chirp Source

Like the FFT1 analyzer the FFT2 analyzer can be used with SR1's generator "FFT Chirp" waveform which produces a signal with uniform power in each FFT bin. The FFT2 analyzer makes one-shot frequency response measurements using the chirp source even easier— it's not necessary to store a reference input curve for later normalization (as is the case with FFT1) because the FFT2 analyzer normalizes each measurement individually. The magnitude and phase of the frequency response is immediately available with no further computation.

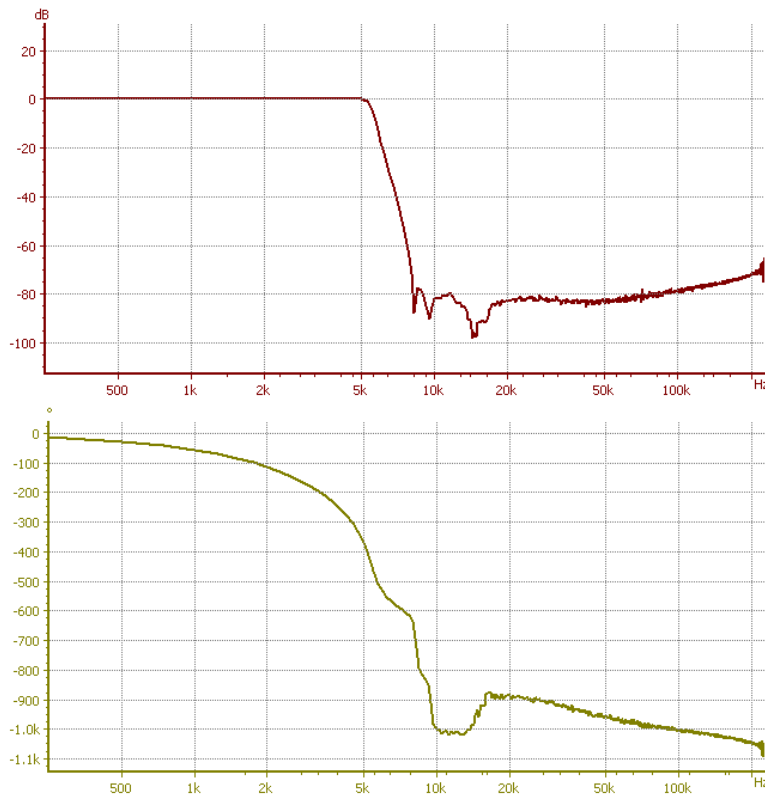

As an example, the 2 plots above show the single-shot magnitude and phase of the frequency response of an 8-pole 6-zero elliptical filter with a 5 kHz pass-band edge. The phase distortion (departure from linear phase) characteristic of elliptical filters near the passband edge is apparent. Using the Graph Calculator's "group delay" function we can directly calculate the group delay from the phase curve.

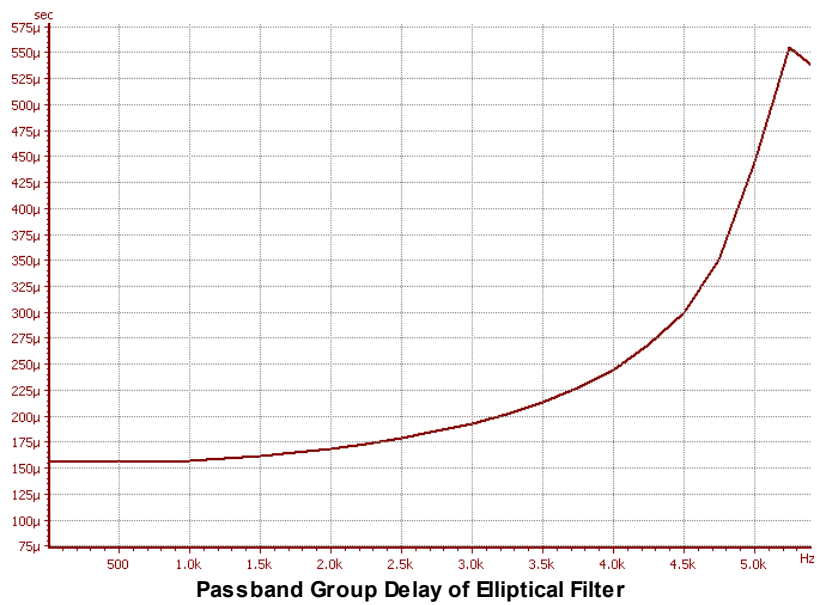

2.4.5 THD Analyzer

The THD (Total Harmonic Distortion) analyzer uses FFT techniques to measure the total or relative amplitude in two groups of user specified group of harmonics. Unlike the Time Domain Detector, which uses time-domain techniques to integrate the total noise+harmonic power outside the fundamental the THD analyzer uses the FFT internally to selectively measure only the amplitudes of harmonics.

The THD Analyzer Panel

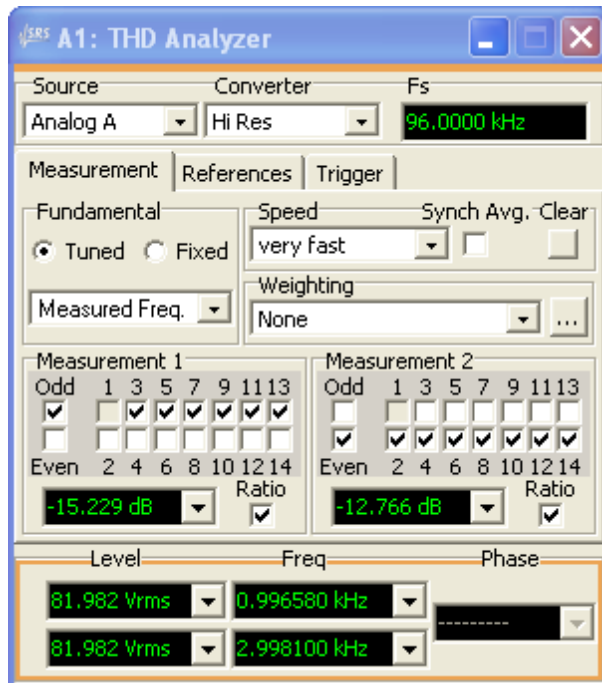

Fundamental Frequency Selection

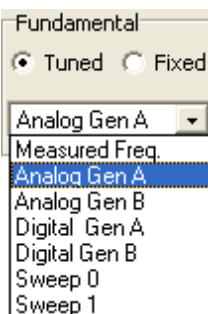

The THD Analyzer computes the power in two sets of harmonics, both relative to the same fundamental frequency. The fundamental can either be a fixed frequency, or it can be "tuned" to any of the choices listed in the tuning control. Selecting "Analog Gen A/B" or "Digital Gen A/B" tune the fundamental the frequency of the selected channel of the specified generator. The Sweep 0/1 selections choose the current sweep frequency of the inner or outer sweep.

Note that when possible, the "Generator" or the "Sweep" settings should be used over the "Measured Freq." setting as they will often result in faster response and better measurement stability.

Harmonic Selection

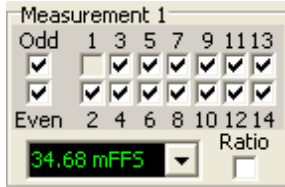

These checkboxes select the set of harmonics included in each measurement. Clicking on the boxes next to the "Odd" and "Even" labels will automatically select (or unselect) all the corresponding odd or even harmonics. Alternatively, the individual harmonic can be selected or unselected by checking or unchecking the corresponding box. The amplitude reported by the measurement is the RMS sum of the harmonic amplitudes for each of the selected harmonics. Note that it is possible to select a harmonic which is outside the frequency range of the selected converter. It is the user's responsibility to ensure that each of the selected harmonics is within the analyzer's frequency range.

If the "Ratio" box is checked the summed amplitude will be divided by the amplitude of the fundamental for the selected channel and the result will be reported as a ratio.



The definitions of THD+N and THD both involve the ratio of distortion products to the amplitude of the fundamental. However most time-domain based analyzers, including SR1's TDD, cannot separately identify the amplitude of the fundamental and instead measure the ratio of the distortion products to the total power in the signal. For small distortion, the difference is insignificant.

The THD Analyzer, which is frequency selective, correctly displays the ration of the sum of the harmonics to the fundamental amplitude. The only exception to this is when the THD analyzer source is set to "Other Analyzer" and the THD analyzer is looking at the notch filtered output of the TDD. In this case the "Ratio" result is divided by the total power in the signal as measured by the TDD. Since the "Other Analyzer" input is only needed when measuring the smallest levels of distortion (<-95 dB), this will not significantly impact the measurement result.

Measurement Speed

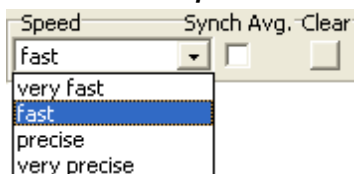

The THD analyzer allows a tradeoff between measurement speed and measurement precision. Internally this is accomplished by varying both the number of FFT averages performed and the resolution of the FFT spectra. When using the precise and very precise settings sweep speeds will be noticeably slower, but the measurement results will exhibit less variability.

Enabling Synchronous Averaging can sometimes be useful when the harmonic amplitudes are close to the noise floor. When Synchronous Averaging is enabled the THD analyzer uses the averaged Linear Spectrum to compute the harmonic amplitudes. As discussed in the FFT Analyzer section, averaging the linear spectrum reduces the amplitude of uncorrelated noise which allows a more accurate measurement of harmonic amplitudes, which are phase correlated to the fundamental and therefore maintain their amplitude in the linear spectrum.

Pressing "Clear" clears the current average buffer. This is useful for reducing the transients caused by,

for instance, changing input ranges.

Weighting

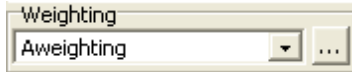

When summing the harmonic amplitudes the analyzer can apply any of the standard weighing filters to the individual harmonic amplitudes. The table below lists the available weighting filter and their typical applications.

Weighting Filters	
None	No weighting filter is applied.
A-Wt	"A" weighting filter is applied. "A" weighting is specified in ANSI standard S1.4-1983 and is typically used for noise and THD+N measurements with audio applications.
C-Msg Wt	The C-Msg weighting filter, specified in IEEE Std. 743-1995, is intended to be used for noise measurements associated with voice transmission telecommunications.
CCITT	The CCITT weighting filter defined by ITU-T Recommendation O.41 is another telecommunication noise weighting filter.
CCIR (wtd)	Filter defined in CCIR Rec. 468-4 for audio noise measurements. Designed to be used with the Quasi-Peak setting on the Time Domain Detector.
CCIR (unwtd)	Filter defined in CCIR Rec. 468-4 (Annex II) for making unweighted noise measurements.
CCIR (2 kHz)	This filter is identical to the CCIR(wtd) filter except the normalization is changed so that the filter has unity gain at 2 kHz instead of 1 kHz.

Vector Harmonic Measurement

In addition to the scalar THD measurement the THD analyzer produces a vector measurement which contains the relative amplitude of all harmonics, regardless of the harmonics selected in the panel.

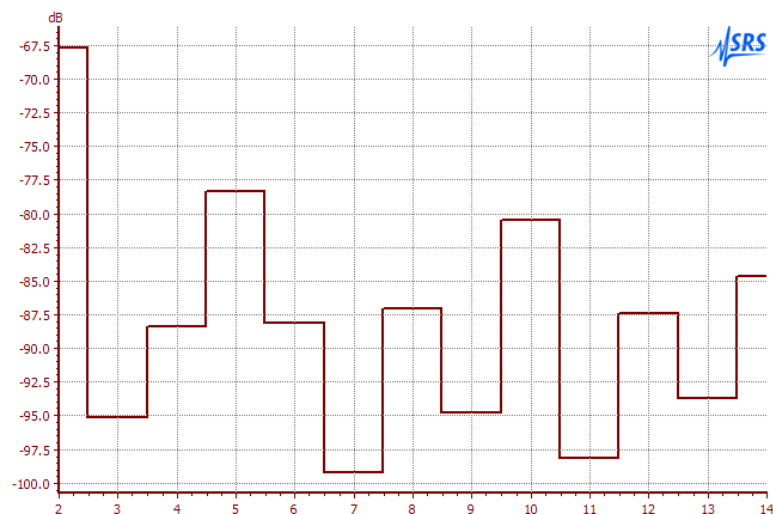

The X-axis for this measurement is simply the harmonic number.

Using the THD Analyzer with the Time Domain Detector

The THD analyzer can be used together with the [Time Domain Detector](#) to make the most precise THD measurements possible. Normally the selected input converter's range must be set large enough to not overload on the the fundamental of the input signal. When using the TDD as an input to the THD Analyzer, the analog notch filter and post filter gain eliminate the fundamental and amplify the remaining distortion products so that the full range of the input converter can be applied to harmonics rather than the fundamental.

To use the THD analyzer with the Time Domain Detector, select the type of one of the analyzers, say A0 to be TDD. Set the input converter of the TDD to Hi-Bandwidth and set the measurement type of the TDD to THD+N in order to enable the notch filter. Set the type of the A1 analyzer to be THD. Set the input of the THD analyzer to "Other Analyzer." The THD will now use as its input the notch filtered signal from the TDD.



When using the THD analyzer in combination with the TDD to measure low levels of THD+N be sure the TDD is set to the Hi-Bandwidth converter. Only the Hi-Bandwidth converter signal chain employs the analog notch filter and an analog post-filter gain that enables making the most sensitive THD measurements.

2.4.6 IMD Analyzer

The IMD Analyzer works in concert with the IMD generator to make three classic audio intermodulation distortion measurements. The SMPTE (Society of Motion Picture and Television Engineers standard RP-120-1994) standard (also similar to the German DIN standard 45403) uses a signal composed of a low frequency sine wave and a higher frequency sinewave at 1/4 (or equal) amplitude. The measured distortion products are the sidebands of the high frequency sine at multiples of the low frequency. Difference frequency distortion (DFD), the subject of an old standard by the CCIF, the predecessor of the ITU-R, consists of applying two equal amplitude high-frequency sines separated by a small frequency difference to the device under test and measuring the nonlinear distortion products at the difference frequency and higher-order combinations of the two frequencies. The modern standard for DFD is IEC 60268-3. Finally, DIM (Dynamic Transient Intermodulation distortion) also known as TIM (Transient Intermodulation Distortion) uses a square wave near 3 kHz and a sine wave near 15 kHz and examines the distortion products at various combinations of the two frequencies.

All of these measurements have a long history and many pages have been written for and against each of them. SR1 can perform all these measurements by first generating the appropriate stimulus using the generator IMD waveform and then selecting the IMD analyzer to perform the measurement.

Summary of IMD Analyzer Outputs

Measurement	Description
Ratio (Selected Ch)	The relative IMD distortion for the selected measurement type and distortion products. Displayed in either percent or dB.
Level A, B	Peak-based level computation for both input channels. Because the IMD Analyzer is internally based on FFT analysis, levels displayed are peak levels. Frequency is calculated for analog, but not digital audio, inputs. Phase is not calculated with this analyzer.

The IMD Analyzer Panel

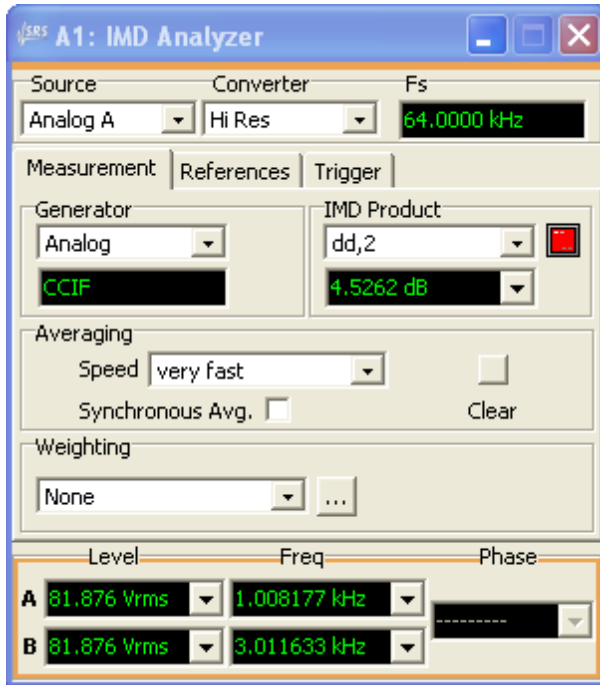

Generator Selection

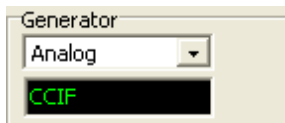

The Generator control selects the generator that will be used for the test. Typically the analog generator will be selected with analog inputs and vice versa, however, cross domain measurements are possible on ADC and DAC devices by selecting a different generator. The selected generator must be using the IMD waveform for the analyzer to function properly. The choice of generator waveform: SMTPE, CCIF, or DIM dictates the analyzer configuration and is displayed in the readout below the generator selection.

IMD Product Selection

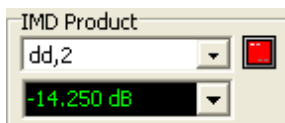

For each type of IMD Measurements the "IMD Product" control determines the particular IMD products that will be included in the measurement. The table below summarizes the available choices:

SMPTE/DIN (f1 = low frequency, f2 = high frequency, U2 = amplitude of high freq. component)		<p> $d_2 = f_2 \pm f_1$ $d_3 = f_2 \pm 2 * f_1$ $d_4 = f_2 \pm 3 * f_1$ </p>
d2	$d_2 = (U_{f_2+f_1} + U_{f_2-f_1})/U_2$	
d2+d3	$d_3 = (U_{f_2+2*f_1} + U_{f_2-2*f_1})/U_2$	
d2+d3+d4	$d_4 = (U_{f_2+3*f_1} + U_{f_2-3*f_1})/U_2$	
CCIF/DFD (fc = center frequency, fd = difference frequency, U = average power of fundamental components)		<p> $d_{d,2} = U_{fd}/U$ $d_{d,3} = (U_{fc+1.5fd} + U_{fc-1.5fd})/U$ </p>
d_{d,2}	$d_{d,2} = U_{fd}/U$	
d_{d,2} + d_{d,3}	$d_{d,3} = (U_{fc+1.5fd} + U_{fc-1.5fd}) / U$	
DIM/TIM (fs = Sine Frequency ~15 kHz, fq = Square Freq. ~ 3.15 kHz)		<p> $U_5 = 5f_q - f_s$ $U_4 = f_s - 4f_q$ </p>
U₅	$U_5 = U_{5f_q-f_s} / U$	
U₅+U₄	$U_4 = U_{f_s-4f_q} / U$	

Note that the listed distortion products are not the complete set of distortion products for each type of measurement. For instance, in the CCIF/DFD measurement there is a second order distortion product at the sum of the input frequencies as well as the difference. However the listed distortion products represent the ones typically measured for each type of IMD measurement.

Averaging

Averaging
 Speed
 Synchronous Avg.

The IMD analyzer implements a user-selectable tradeoff between measurement speed and measurement precision. Internally this is accomplished by varying both the number of FFT averages performed and the resolution of the FFT spectra. When using the precise and very precise settings measurements will be noticeably slower, but the measurement results will exhibit less variability. Pressing "Clear" clears the average buffer and is useful for eliminating the transients caused, for example, by switching input ranges.

Weighting



When summing the harmonic amplitudes the analyzer can apply any of the standard weighting filters to the individual harmonic amplitudes. The table below lists the available weighting filter and their typical applications.

Weighting Filters	
None	No weighting filter is applied.
A-Wt	"A" weighting filter is applied. "A" weighting is specified in ANSI standard S1.4-1983 and is typically used for noise and THD+N measurements with audio applications.
C-Msg Wt	The C-Msg weighting filter, specified in IEEE Std. 743-1995, is intended to be used for noise measurements associated with voice transmission telecommunications.
CCITT	The CCITT weighting filter defined by ITU-T Recommendation O.41 is another telecommunication noise weighting filter.
CCIR (wtd)	Filter defined in CCIR Rec. 468-4 for audio noise measurements. Designed to be used with the Quasi-Peak setting on the Time Domain Detector.
CCIR (unwtd)	Filter defined in CCIR Rec. 468-4 (Annex II) for making unweighted noise measurements.
CCIR (2 kHz)	This filter is identical to the CCIR(wtd) filter except the normalization is changed so that the filter has unity gain at 2 kHz instead of 1 kHz.

2.4.7 Multitone Analyzer

Multitone analysis is a technique whereby a device under test is subject to a stimulus signal containing a number of discrete tones whose frequencies are adjusted to fall exactly on fft bin frequencies of the multitone analyzer. If the analyzer has sufficient resolution relative to the number of tones in the stimulus signal even a single FFT can yield a wealth of audio information by examining the amplitudes in three categories of FFT bins: bins in which a generator tone is present, the amplitudes of which can be used to derive the frequency response of the DUT, bins in which harmonic and intermodulation distortion products of the tones in the stimulus signal are present, which can be used to compute the THD and IMD characteristics of the DUT, and bins in which there are no signal tone or distortion products, whose amplitude represents the noise of the DUT. By carefully examining the amplitudes of these three types of FFT bins it is possible to simultaneously measure Frequency Response, THD+N, THD, IMD, and noise vs. frequency for a device based on a single captured FFT record, measurements that would otherwise take several separate swept measurements.

Multitone Analysis is typically a **synchronous** measurement: tones are generated exactly on bin frequencies and the multitone FFT analyzer is run without a window (uniform window) ensuring that each tone will occupy a single bin in the analyzer spectrum. For this to be true, the device under test cannot shift the frequencies in the stimulus signals. When this condition is met, the multitone analyzer (MTA) can use an interesting technique to measure the noise of the DUT even close to tone and distortion frequencies. When "Noise Analysis" is enabled, the MTA sets the number of lines in the analyzer FFT to twice the length of the stimulus signal. By making the frequency resolution of the received spectrum twice the resolution of the stimulus it is ensured that all tones, harmonics of tones, and IMD products of tones will fall on even bins in the received spectrum while the odd bins will contain only noise.

For some test situations, the signal chain does shift the frequencies. For instance, the multitone stimulus signal can be played back on a tape player with a speed error. In this situation the exact bin frequencies of the stimulus will be smeared over many bins in the received spectra, and the MTA should be operated in **windowed** mode. In windowed mode a window is applied to the received signal to limit the smearing of the tone frequencies and the noise analysis feature described above for synchronous mode is not available. In windowed mode a parameter can be entered which describes the maximum extent of the frequency shift and assists the analyzer in locating regions of tones, distortion, and noise.

Multitone measurements with SR1 first require the configuration of the multitone generator using the [Multitone Configuration Panel](#). The Multitone Configuration Panel contains options for setting the number of tones, tone frequency and phase, and the length of the stimulus signal. Once the generator is configured, the Multitone Analyzer (MTA) can be selected.

Summary of Multitone Analyzer Outputs

The multitone analyzer produces both scalar and vector output measurements which are described below

Measurement	Description
Vector Measurements	
Time Record (A/B)	This is the raw time record received by the MTA. While not useful in and of itself, viewing the time record can be useful in diagnosing measurement setup issues.
Linear Magnitude (A/B)	This vector is the complete FFT of the input signal to the analyzer including all bins.
THD+Noise Bins, (A/B)	This measurement is the vector of all bins that do not contain a tone in the generator signal. The amplitude in these bins represents the sum of noise and distortion products.

Harmonic Distortion Bins, (A/ B)	The vector containing only the bins that represent harmonics of tones present in the generator signal.
IMD Distortion Bins, (A/B)	The vector containing intermodulation products of the tones up to the order specified on the analyzer panel. 2nd order IMD products, for instance, fall at frequencies equal to $f_1 \pm f_2$ where f_1 and f_2 are tones in the generator signal. Note that not all IMD products of a given order may fall within the analysis range.
Noise Bins (A/B)	This vector contains bins that contain no tones or distortion products. If "Noise Analysis" is enabled this vector will contain all the odd bins in the analyzer FFT. If noise analysis is not enabled the analyzer examines each bin and only includes bins in the noise vector that contain no tone, harmonic of a tone, or IMD product of tones.
Total Distortion Bins (A/B)	This vector measurement is only active when "Noise Analysis" is selected. For each non-tone bin pair, the power in the odd bin (noise) is subtracted from the power in the corresponding even bin (noise+distortion). The resulting vector is a good indicator of the total distortion at each frequency.
Frequency Response Mag.(A/ B)	The vector containing the ratio of the received amplitudes at the tone locations relative to the generated tone amplitudes.
Frequency Response Phase (A/B)	The vector containing the phase at the tone locations relative to the phase of each generated tone. For the phase measurement to be meaningful several conditions must be met. First the MTA must be running in synchronous mode. Second, the analyzer must be triggered, so that the analyzer's FFT time record maintains a consistent position with respect to the generator signal. The frequency response phase is calibrated only when using the generator trigger source. Be sure to set the trigger source on the "Trigger" tab of the analyzer to "Generator" and set the "Generator Trigger Source" to either Analog or Digital depending on which generator is being used.
THD+N vs. Freq. (A/ B)	The vector of the ratios of the sum of the harmonics for each tone and the noise amplitude to the received amplitude at the tone frequency. For this measurement it useful to select a tone frequency distribution such as "log prime" or "linear prime" so that harmonics of different tones do not fall on the same frequencies.
THD vs. Freq (A/B)	The vector of the ratios of the sum of the harmonics amplitudes for each tone to the received amplitude at the tone frequency. For this measurement it useful to select a tone frequency distribution such as "log prime" or "linear prime" so that harmonics of different tones do not fall on the same frequencies.
IMD vs. Freq (A/B)	The vector of the ratios of the sum of all IMD products involving a given tone to the received tone amplitude at the tone frequency.
Crosstalk (A/B)	This measurement is only active when the stereo mode is enabled on the Multitone Configuration Panel since it relies on tones being present at different frequencies for the two channels. The Crosstalk vector is the ratio of received amplitudes in bins that do not have tones in the measurement channel to the amplitudes of corresponding bins in the other channel that do have tones.

Freq. Response: Magnitude Ratio B/A	The vector of the ratios of the B channel magnitude response to the A channel magnitude response.
Freq. Response: Phase Delta B-A	The vector of the differences between the B channel phase and the A channel phase.
Scalar Measurements All scalar measurements are taken between the frequency limits specified on the "Scalar Measurements" tab of the Multitone Analyzer panel.	
THD+N Sum (A/B)	The rms sum of all non-tone bins between the the frequency limits. If "noise analysis" is enabled, this includes all odd (noise) bins and all even bins without tones.
THD Sum (A/B)	The rms sum of all bins containing harmonics of tones but not tones.
IMD Sum (A/B)	The rms sum of all bins between the specified frequency limits containing IMD products up to the selected order of all tones.
Total Noise (A/B)	The rms sum of all noise bins between the frequency limits. If "Noise Analysis" is enabled this is simply the sum of all the odd bins within the frequency range.
Total Distortion (A/B)	The rms sum of the total distortion bins between the frequency limits. This measurement is only active when "Noise Analysis" is selected.
Ripple (A/B)	The ratio of the highest amplitude received tone to the lowest amplitude received tone.
Lowest Tone (A/B)	The frequency of the lowest amplitude received tone.
Highest Tone (A/B)	The frequency of the highest amplitude received tone.



Because the multitone source has a periodic time-dependent amplitude profile, it may fool the input autoranging control into switching ranges over the duration of the signal. It may be necessary to turn off input autoranging while using the Multitone Analyzer and manually set the input range.

The Multitone Analyzer Panel

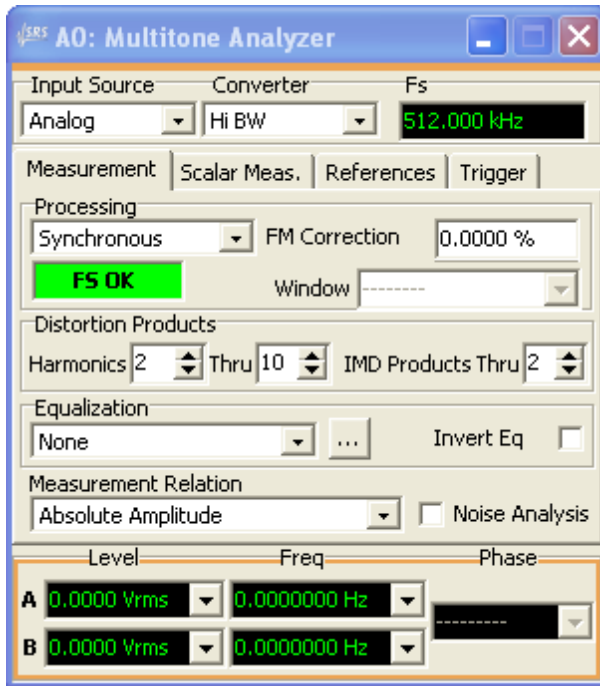

Processing

The MTA has two distinct processing modes: Synchronous and Windowed. Synchronous processing assumes that the DUT does not shift frequencies at all and that therefore all the tone frequencies and harmonics will fall on exact bin frequencies in the received FFT. When operating in the synchronous mode the MTA does not use a window function which would otherwise smear the bin frequency tones over several lines in the received spectrum. When the DUT does shift the frequencies of the multitone generator signal, the MTA must apply a window function to the received signal to limit the smearing of the received tones. In windowed mode certain MTA measurements, such as phase and noise measurement are disabled.

Distortion Products

This panel allows selection of the minimum and maximum harmonics that will be included in measurements like THD and THD+N as well as the maximum order of the intermodulation products that will be included in the IMD measurements.

Equalization

The file selection box allows specification of an EQ file which is then applied as a weighting function to all MTA measurements. EQ files are files which specify a relative response as a function of frequency. EQ files are detailed in the SR1 [File Reference](#). When an EQ file is specified the MTA weights all bins in the received FFT by the frequency response of the EQ file before computing measurements.

Relative Measurements

Certain MTA measurements can be expressed either as an absolute voltage, or relative to various tone amplitudes. The measurements affected by this choice are: THD+N (Bins and Scalar Measurement), THD (Bins and Scalar Measurement), Noise (Bins and Scalar Measurement), Total Distortion (Bins and Scalar Measurement), and IMD (Bins and Scalar Measurement). The allowed relative values are:

Measurement Relation	selects the relative mode for the measurements mentioned above.
Absolute Amplitude	The measurements are expressed as absolute voltages.
Relative to	The absolute voltage for each measurement is divided by the peak voltage of the

Generator	corresponding generator signal.
Relative to Generator (Other Channel)	The absolute voltage for each measurement is divided by the peak voltage of the generator signal for the other channel.
Relative to Tone @ Selected Frequency	The absolute voltage for each channel is divided by the received amplitude of the selected tone in the measurement channel. The "selected" tone is selected on the Edit Multitone Tones panel which can be accessed from the Multitone Configuration panel. The default for the selected tone is the first (lowest frequency) tone.
Relative to Tone @ Selected Frequency (Other Channel)	The absolute voltage for each channel is divided by the received amplitude of the selected tone in the other channel. The "selected" tone is selected on the Edit Multitone Tones panel which can be accessed from the Multitone Configuration panel. The default for the selected tone is the first (lowest frequency) tone.
Relative to RMS Amplitude	The absolute voltage for each measurement is divided by the RMS voltage of the entire received signal.

Noise Analysis

The Noise Analysis checkbox enables noise-related measurements in the MTA. When noise analysis is selected the MTA uses an FFT record which is twice the resolution of the corresponding generator signal length that is selected with the [Multitone Configuration Panel](#). Tones, harmonics of tones, and IMD products of tones will then fall only on even bins in the received FFT while the odd bins will contain only noise. Noise Analysis is only available in the synchronous processing mode since the use of a window function would cause the precise division of the odd and even bins to be lost. The "Noise" and "Total Distortion" measurements are only available when "Noise Analysis" is checked.

The Scalar Measurement Panel

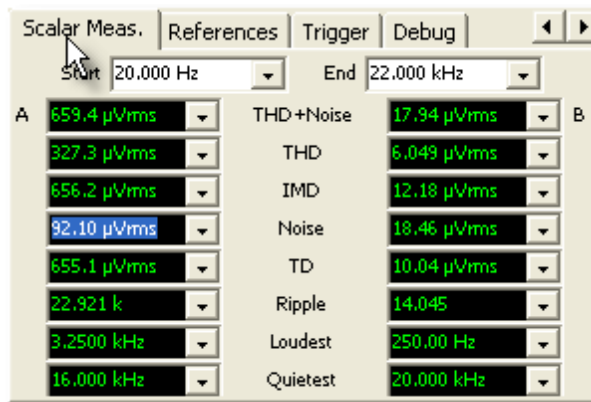

The scalar measurement panel displays the current values of the scalar measurements calculated by the MTA. The controls at the top of the panel select the minimum and maximum frequencies between which the scalar measurements will be calculated

The Multitone Trigger Panel

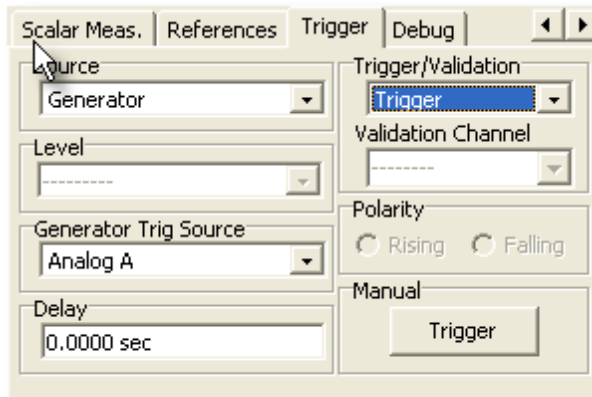

The analyzer trigger is useful in making several different types of multitone measurements. For measurements where the SR1 generator is locally producing the stimulus signal (as opposed to a recorded or broadcast stimulus signal), selecting the Generator Trigger option will maintain a constant time relation between the generated signal and the received FFT frame. This calibrates the MTA's "Frequency Response Phase" measurement which will have zero phase when a wire is connected from the input to the output. When a device is inserted between the input and the output the phase and group delay can be directly read off using the MTA.

For broadcast or recorded multitone stimuli the generator trigger is obviously no longer useful as the SR1's generator no longer has any relation to the actual occurrence of the stimulus signal. Likewise, amplitude triggers may trigger on noise and miss the multitone signal. For these situations the analyzer provides a "validation" option which is a specialized form of analyzer trigger applicable only to the Multitone Analyzer. The validator works by assigning a score to each received FFT based on the ratio of the amplitudes of tone bins to non tone bins. Only received FFTs that score higher than the selected validation criteria (Loose, normal, or tight) will be processed by the analyzer. In general it is best to use the "tightest" validation criteria that still finds the multitone signal as it will generally produce the best measurement results.

2.4.8 Histogram Analyzer

The Histogram Analyzer calculates input amplitude histograms of both channels of the selected input domain. The histogram analyzer divides the input amplitude range into a user specified number of **bins**. The histogram is formed by examining the amplitude of samples of the input data stream, determining the bin the samples belongs in, and incrementing the amplitude of that bin. This process continues for a predetermined number of input samples after which the histogram is displayed and the process repeats. SR1's Histogram Analyzer also has the capability of calculating a real-time gaussian fit to the histogram data and displaying it alongside the histogram.

Histogram Analyzer Outputs

Measurement	Description
Time Record A,B	The sequence of input samples for each input channel.
Histogram A,B	The input amplitude histograms for each input channel.
Probability A,B	The histogram normalized to the total number of bins in the histogram. Each bin amplitude then represents the probability that the input amplitude falls within the limits of that bin.
Fit A, B	The best-fit gaussian to the the probability histograms.
Mean A,B	The Average value of the input samples for each channel.
Sigma A,B	The Standard Deviation of the input samples for each channel.

Example Histograms

The histogram provides a different perspective on audio signals compared FFTs or standard Time Domain techniques. As an example, consider the histograms below:

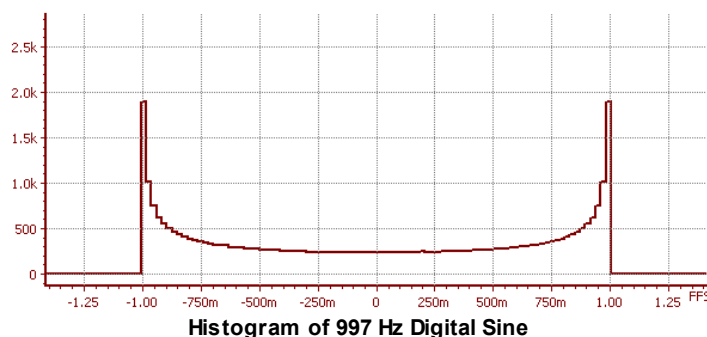

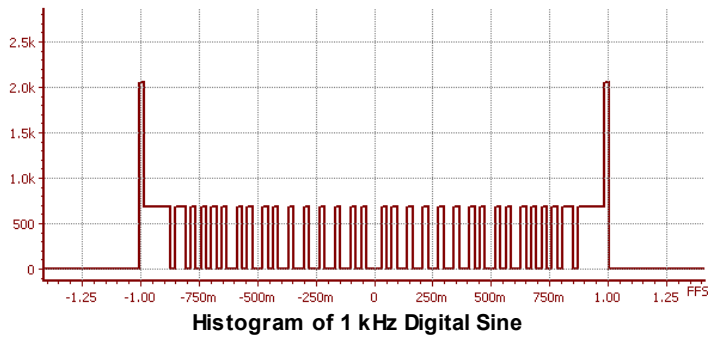

The first histogram shows a 997 Hz digital audio sine wave with a sampling frequency of 48 kHz. Because the sampling frequency is not a multiple of the signal frequency each cycle of the digital audio sine uses slightly different values and the result is a histogram with a smooth continuum of amplitudes between ± 1 FFS. If the sine frequency is shifted slightly to 1 kHz, the histogram changes radically. Now the sampling is a multiple of the signal frequency and each cycle of the sine repeats a finite set of exactly the same values. The "discrete" nature of the 1 kHz sine is easily seen on the histogram even though the two signals would have similar spectra if viewed with the FFT analyzer. In general, the histogram analyzer can reveal details of a signal's quantization that are not apparent with time or frequency domain analysis.

Histogram Analyzer Panel

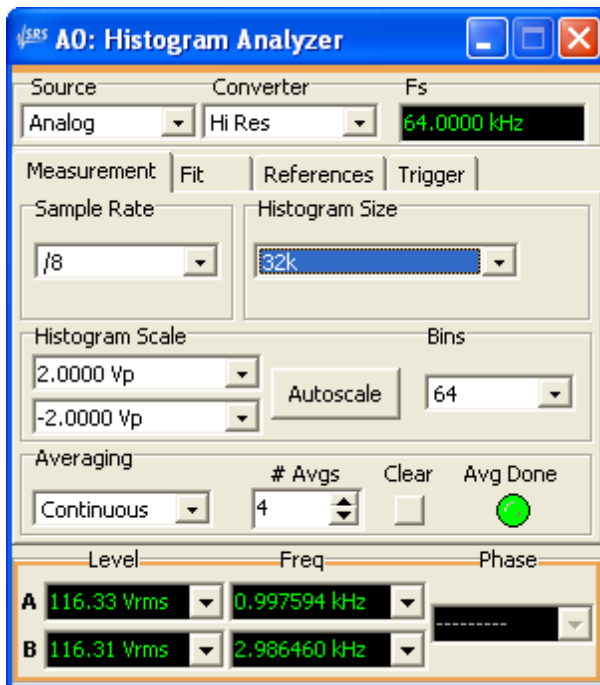

Sample Rate

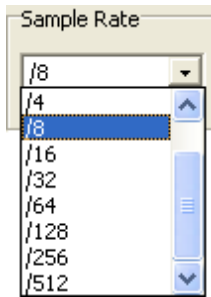

The Histogram Analyzer can examine each sample in the input data stream, or it can examine only every other, every 4th, etc. up to every 512th sample. Use the Sample Rate drop-down to control the fraction of points in the input record which are included in the histogram.

Histogram Size

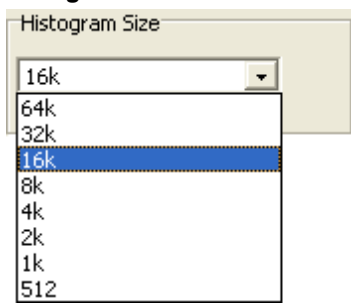

The Histogram Size control determines how many input points are examined for each histogram. This number does not include points which are skipped as a result of the Sample Rate selection. Remember that this control only determines how many input points are looked at— if all the points lie outside of the histogram range the histogram can still have 0 counts in each bin even though the histogram size is set to 16k.

Histogram Scale

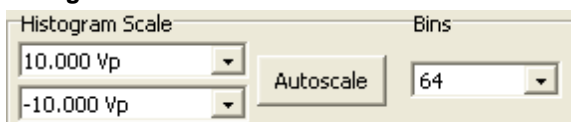

The scale controls determine the upper and lower voltage limit for the histogram. There is no need for the limits to be symmetric. Pressing autoscale automatically sets the upper and lower histogram limits to the current analog input range (if analog inputs are selected). If the selected domain is digital the limits are set to ± 1.414 FFS. The amplitude space between the upper and lower limits is divided into the number of bins selected with the "Bins" drop-down. Values between 16 and 512 bins are allowed.

Histogram Averaging

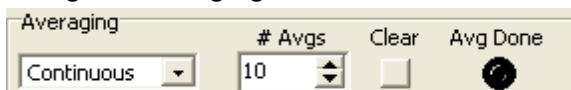

Successive histograms may be averaged. When "Continuous" averaging is selected each new histogram is averaged with the previous results in a manner that weights more recent histograms more strongly than older ones. The averaging process is updated continuously. "Single" averaging averages N histograms all weighted equally (where N is selected with the "# Avgs" control) and then stops acquisition. Press "Clear" at any point to clear the averaging buffer and re-start the averaging process.

Histogram Fit

Do Fit

Channel A	Channel B
Mean 0.0000 Vrms	Mean 0.0000 Vrms
Sigma 0.0000 Vrms	Sigma 0.0000 Vrms

When "Do Fit" is checked the Histogram Analyzer fits a gaussian curve to the to each computed probability histogram. The parameters of the gaussian fit, the mean and standard deviation, are displayed in the panel. The graph below shows the histogram of analog white noise along with the generated gaussian fit.

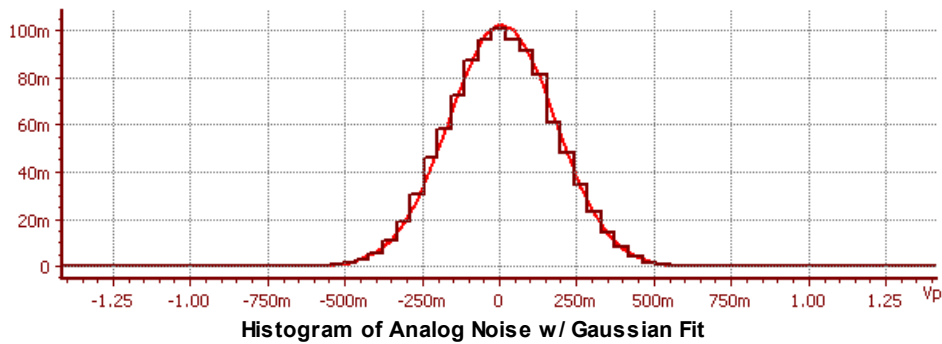

2.4.9 Octave Analyzer

The Octave analyzer (sometimes called an RTA or Real-time analyzer) measures the power present in full octave, 1/3 octave, and 1/12 octave frequency bins from 20 Hz to 20 kHz. The bin centers and shapes follow ANSI Std. S1-11 (2004). In the analog domain, the octave analyzer always uses the [Hi-Resolution](#) converter.

Octave Analyzer Outputs

Measurement	Description
Octave A,B	The fractional octave spectrum for each input channel.
Octave Delta	The difference between the A and B channel octave spectra.

Example Octave Spectra

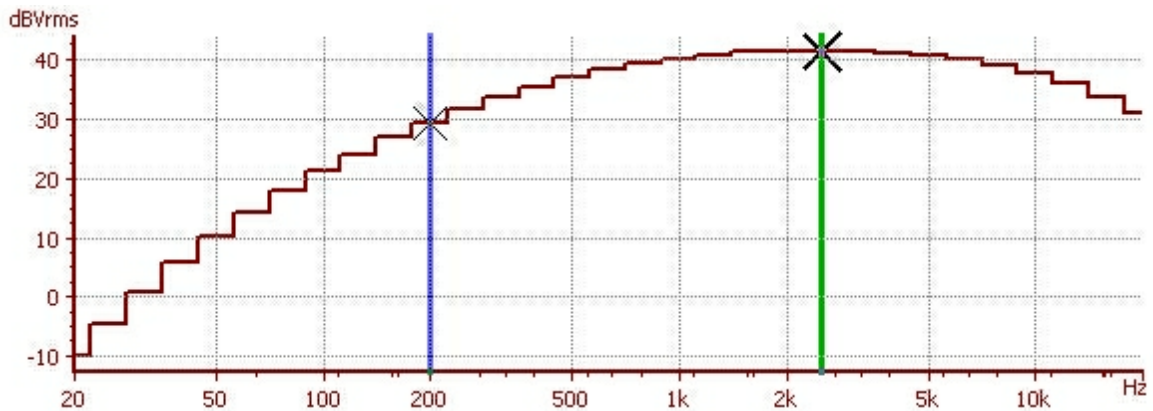

The figure shows a 1/3 octave spectrum of A-weighted white noise.

Octave Analyzer Panel

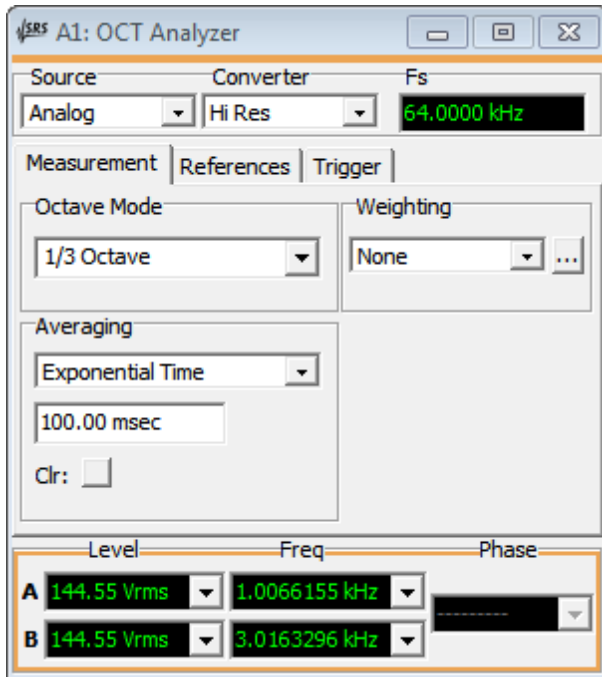

Octave Mode Selection

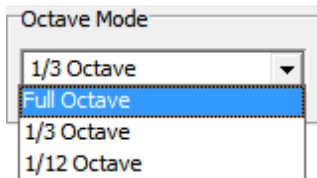

The octave mode selection box determines the fractional octave bands used to measure power. The allowed choices are full-octave, 1/3 octave, and 1/12 octave.

Octave Averaging

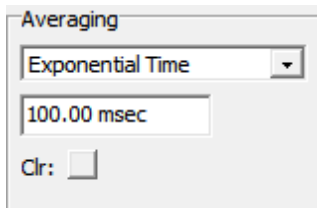

There are two averaging selections available for the octave analyzer, exponential time averaging and peak-hold averaging. Exponential time averaging applies and exponentially-weighted (more recent samples are weighted more highly) moving average filter with the specified time constant to the output of each bin. Peak hold averaging maintains the highest reading obtained for each bin.

2.4.10 Jitter Analyzer

The Jitter analyzer provides realtime detection and analysis of jitter in digital audio carrier and clock signals. The jitter analyzer uses analog Phase Locked Loop hardware to extract the jitter signal from any one of SR1's digital audio inputs. The demodulated jitter signal is digitized and passed to the DSP processor which analyzes the jitter signal either in the time domain or frequency domain depending on the user's selection.

Jitter Analyzer Block Diagram

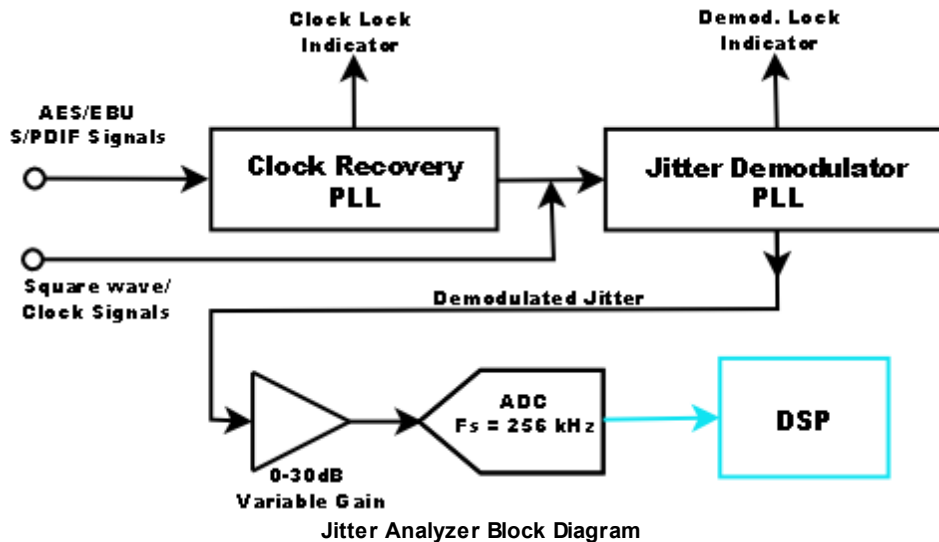

A block diagram of the analog section of the Jitter Analyzer is shown above. If the selected input signal is a professional or consumer digital audio carrier the signal is first passed through a clock-recovery circuit which extracts the underlying clock signal with any accompanying jitter. Clock inputs bypass this stage and are applied directly to the input of a second Phase Locked Loop which extracts the jitter from the clock. Both the clock recovery and jitter demodulator PLLs have corresponding "lock" indicators on the Jitter Analyzer Panel indicating they are locked to their respective input signals. The demodulated jitter signal is amplified and digitized at a sample rate of 256 kHz providing a maximum jitter bandwidth of approximately 113 kHz.

Further processing is done in the DSP processor and depends on the user's selection of "Time Domain" or "Frequency Domain" analysis. When Time Domain analysis is selected the jitter filter is passed successively through 4th order butterworth highpass and lowpass filters to limit the bandwidth of the signal and then through a user selectable weighing filter. (See the discussion of the [Time Domain Detector](#) for details of the available weighting filters.) The resulting signal is then detected with either an RMS or Peak response, much like the [Time Domain Detector](#).

When Frequency Domain analysis is selected, the analyzer works like the single channel FFT analyzer ([FFT1](#)). The Jitter signal is first optionally decimated to reduce the bandwidth and increase the frequency resolution. The output of the decimator is sent to a buffer which stores the incoming data until an [analyzer trigger](#) is received. Upon receipt of a trigger the time record data is multiplied by a [window function](#) which is necessary to attain good dynamic range in the FFT spectrum.

After windowing, the DSP computes the FFT of the jitter time record. For an FFT resolution of N lines, 2N real time record points are needed. Each FFT is then averaged in two different ways. The **Power Spectrum** is computed by computing the power for each spectrum (taking the absolute value of the

complex FFT points) and averaging that power into the power computed for previous FFTs. This type of averaging does not reduce the noise floor of the spectrum but it does reduce the variation of the noise floor making it easier to see spectral details on the order of the noise amplitude. The Jitter Analyzer also computes the **Linear Spectrum**. The Linear Spectrum is computed by averaging the real and imaginary parts of each jitter FFT separately. The average of the real and imaginary parts are then used to compute the Linear Spectrum amplitude and phase. In the Linear Spectrum, unlike the Power Spectrum, noise that is uncorrelated to the signal is actually reduced by further averaging. Because of this, use of the Linear Spectrum, unlike the Power Spectrum, requires that the jitter time record be triggered so that the signal waveform will have the same phase relative to the beginning of the time record for each averaged FFT. As an example, consider the spectra below, both of the same 48k digital audio carrier with 200 mUI of added sine jitter at 10 kHz.

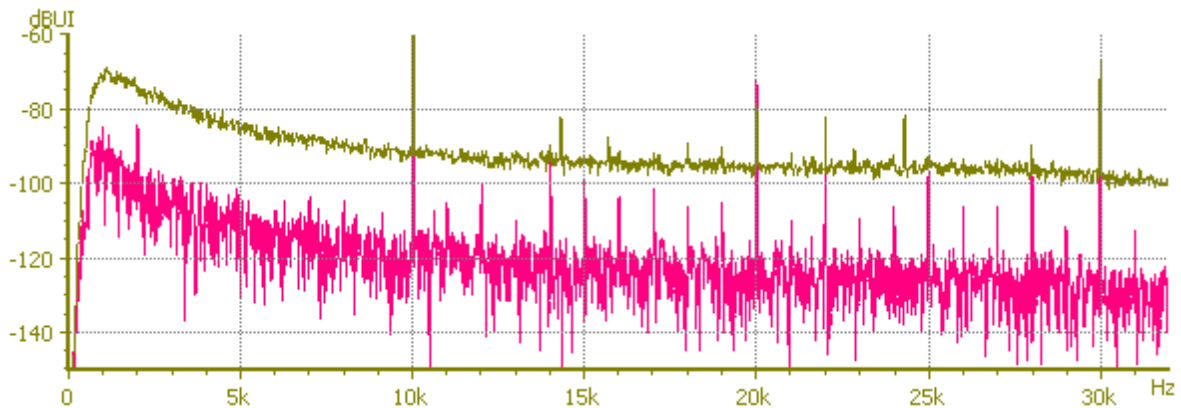

The top trace shows the averaged (N=100) Power Spectrum. The bottom trace is the (N=100) averaged Linear Spectrum (taken with the trigger enabled.) Note the substantial improvement in the noise floor and the additional spectral detail revealed in the linear spectrum.

Highpass, lowpass, and weighting filter selections are available in Frequency Domain analysis but these filters are applied in the frequency domain, after the spectra are computed.

Jitter Analyzer Measurements

Measurement	Description
Time Domain	
Amplitude	The amplitude of the jitter signal calculated from an RMS sum of the jitter input samples. (Though the amplitude is calculated with an RMS sum it is expressed in equivalent <i>peak</i> units of sec or UI.)
Physical Sample Rate	The effective sampling frequency of the input digital audio signal, or in the case of a square wave input, the square wave frequency.
Frequency Domain	
Time Record	The amplitude vs. time record of the jitter signal. When displayed on a graph this produces an "Oscilloscope" type display.
Power Spectrum	The power-averaged FFT of the jitter signal.
Linear Magnitude	The amplitude of the synchronously averaged jitter spectrum. The amplitude of signals that are synchronous with the time record is preserved, other

	uncorrelated signals average away. Note that the signal must either be naturally repetitive within the time-record or a trigger must be used for the linear magnitude spectrum to be meaningful.
Linear Phase	The phase of the synchronously averaged jitter spectrum.
RMS Sum	The amplitude of the jitter signal calculated from an RMS sum of the FFT bins. (Though the amplitude is calculated with an RMS sum it is expressed in equivalent <i>peak</i> units of sec or UI.)
Physical Sample Rate	The effective sampling frequency of the input digital audio signal, or in the case of a square wave input, the square wave frequency.

Jitter Analyzer Input Selection

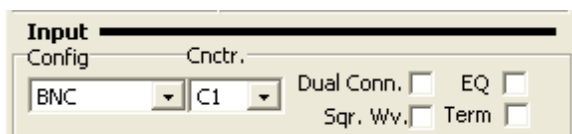

Unlike other SR1 analyzers selection of the input signal for the Jitter Analyzer is done on the Input section of the [Digital I/O](#) panel. Select either the BNC or XLR connectors, optical connector, or the digital audio output monitor. For BNC and XLR connector C1 or C2 must also be specified. Checking "Term" applies the appropriate termination for the selected connector. Selecting "Square Wave" instructs the Jitter Analyzer that the signal at the selected input is not a AES/EBU or consumer digital audio carrier but instead a square-wave, or clock, signal. Clock signals bypass the clock-recovery PLL and are applied directly to the Jitter Demodulator PLL.

The Jitter Analyzer Panel (Common Controls)

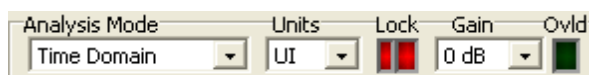

The controls shown above are common to the Time Domain and Frequency Domain analysis modes.

Selection of the Time Domain analysis mode is made using the "Analysis Mode" drop down control. The "Units" control selects whether the Jitter amplitude will be reported in seconds or in Unit Intervals ("UIs"). The Unit Interval is the shortest pulse width found in the digital audio carrier signal and is related to the embedded digital audio sampling rate by:

$$UI \text{ (sec)} = 1.0 / (Fs(\text{Hz}) * 128)$$

The first of the two lock indicators indicate whether the Digital Audio clock recovery phased lock loop is locked to the input digital audio signal. This indicator is absent when the "Square Wave" selection is made on the Digital I/O panel. The second indicates whether the jitter recovery PLL has locked to the recovered clock signal. In general, both indicators should be glowing green for the Jitter Analyzer to produce reliable results. Up to 30 dB of gain is available before the analog jitter signal is digitized. The Gain control should be set to the highest value that does not cause the analyzer to overload.

The Jitter Analyzer Panel (Time Domain Analysis)

Detector	Rate	Reading
RMS	16/s	6.8594 UI
Filters		
Hi Pass <input checked="" type="checkbox"/> On	Lo Pass <input type="checkbox"/> On	Weighting
700.00 Hz	100.00 kHz	None

The Time Domain jitter analyzer has a selectable peak or RMS response which is selected with the "Detector" control. In the RMS mode the analyzer calculates the RMS value of the jitter over an interval whose length is the reciprocal of the specified Measurement Rate. The "Peak" response mode simply chooses the peak value of the Jitter over the same interval as the jitter reading. The rate is adjustable from 1 to 512 measurement intervals per second. Two additional rate settings are available. When the rate is set to "Dig Fs" the measurement interval is set to an integral number of samples of the detected digital audio input sample rate. When the rate is set to "Jitter Gen" the measurement interval is set to an integral number of cycles of the current jitter impairment frequency. The detected jitter amplitude is shown on the "Reading" control.

Three separate filters can be applied to the jitter signal before the amplitude detector. The highpass and lowpass filters are both 4th order butterworth filters. The highpass has an adjustable corner frequency from 50 Hz to 20 kHz. The lowpass filter has a corner frequency between 2 kHz and 100 kHz. The selection of weighting filter is the same as for the Time Domain Analyzer. See the discussion there for details of each filter.

The Jitter Analyzer Panel (Frequency Domain)

Frequency Domain	Trigger		
Resolution	Bandwidth		
4k	128.00 kHz		
	<input checked="" type="checkbox"/> Show Aliased		
Window	Phase Thresh. Unwrap RMS Sum		
Rife Vincent 4	100.00 mUI		
	<input type="checkbox"/> 0.0000 UI		
Filters			
Hi Pass <input checked="" type="checkbox"/> On	Lo Pass <input type="checkbox"/> On		
20.000 kHz	2.0000 kHz		
	Weighting		
	None		
Start	Center	End	
0.0000 Hz	64.000 kHz	128.00 kHz	
Time Display Interpolation	DC Correction		
<input type="radio"/> Off <input checked="" type="radio"/> On	None		
Averaging	# Avgs	Clear	Avg Done
Exponential	1	<input type="checkbox"/>	<input checked="" type="checkbox"/>

Resolution and Bandwidth

The number of lines in the jitter FFT can be set from 256 to 32k lines using the "Resolution control". These lines span the frequency range from DC to the value set in the "Bandwidth" control. The ADC used by the jitter detector, like all of SR1's converters is preceded by an anti-aliasing filter with a finite attenuation slope. As a result, some lines at the upper edge of the frequency range may not be protected against aliases to the full attenuation of the filter. If "Show Aliased Lines" is checked, SR1 will display the entire spectrum up to $F_s/2$ including lines that may not be fully alias-protected. If the control is unchecked only fully alias-protected lines will be displayed and the bandwidths will be adjusted accordingly.

Total Jitter

The RMS Sum control displays the "total" jitter found by RMS summing all the points in the jitter FFT. It will, in general, agree with the "Reading" calculated by the Time Domain jitter analyzer. The sum is performed after all filtering and weighting is applied.

Filtering

Adjustable highpass, lowpass, and weighting filters can be applied to the jitter spectra and the RMS sum calculation. These filters are applied by the DSP after the jitter FFT has been computed. The highpass and lowpass filters are 4th order Butterworth filters. Each filter is enabled or disabled by the corresponding checkbox. The weighting filter choices are same as for the [Time Domain Detector](#). See the discussion there for the types and intended applications of each of the weighting filters.

Averaging

Exponential, or continuous averaging, continuously updates the averaged FFT displays weighting recent spectra more heavily than older spectra. The number of averages in this case is only an approximation of how many spectra are included in the average. Linear averaging averages the specified number of spectra, all equally weighted, and then stops. "None" means that no averaging is applied. In this case the magnitude of the Linear Spectrum and Power Spectrum are the same. The "Clear" button clears the current average buffer and restarts the averaging process. The "Average Done" indicator lights when the required number of averages has been accumulated.

Other Jitter Analyzer Controls

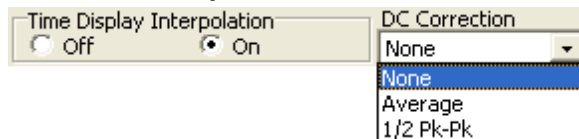

Turning on "Time Domain Interpolation" applies band-limited interpolation to the time record of the Jitter Analyzer. This is useful when looking at the time record display for jitter frequencies near the top of the range where there are only a few samples per cycle. As an example, the plots below show time record displays for a 100 mUI of 75 kHz sinusoidal jitter, with and without time domain interpolation.

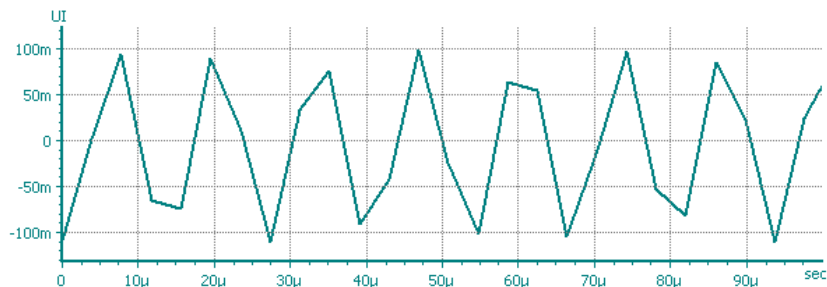

75 kHz Sinusoidal Jitter Recorded without Interpolation...

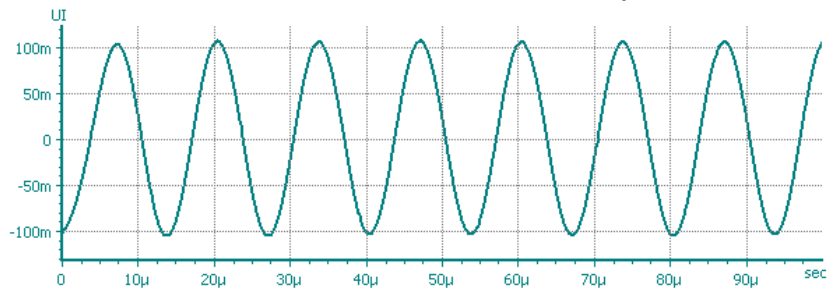

and with Time Domain Interpolation

Selecting one of the DC Correction options, either "Average" or "1/2 Pk-Pk" can reduce the DC offset in the each jitter time-record and reduce the leakage from the DC bin in the spectra which can obscure low-frequency details. Since jitter has intrinsically no DC component, the observed DC components are all due to measurement artifacts.

2.4.11 Digitizer

SR1's optional Digitizer is a sophisticated tool for the analysis of digital audio carrier signals. The Digitizer is designed to complement the real-time measurement capabilities of the [Jitter Analyzer](#) with off-line analysis capable of revealing additional signal details. The Digitizer is designed to work with the [Digitizer Display](#) to produce full-color eye diagrams, histograms of carrier amplitude, jitter amplitude, pulse width and rate, and spectra of both the carrier and the computed jitter signal.

The heart of SR1's digitizer is an 80 MHz 8-bit transient digitizer with an effective analog bandwidth of approximately 20 MHz. The digitizer can store up to 2 Msamples of data in each record. A flexible trigger generator allows synchronization of the digitizer record with a variety of points on the carrier signal as well as external events. After acquiring the record the digitizer analyzes the zero-crossings of the digitized signal, reconstructs the original clock, and then calculates the jitter of the signal relative to the reconstructed clock.

Digitizer Input Selection

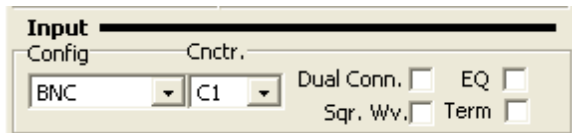

Selection of the input signal for the digitizer is done on the Input section of the [Digital I/O](#) panel. Select either the BNC or XLR connectors, optical connector, or the digital audio output monitor. For BNC and XLR connector C1 or C2 must also be specified. Checking "Term" applies the appropriate termination for the selected connector which can substantially improve the quality of the digitized signal.

Digitizer Acquisition

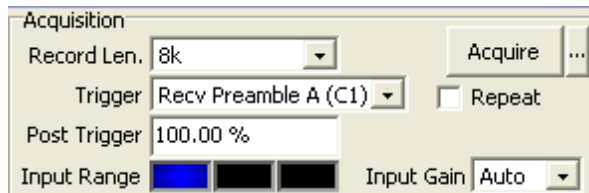

The size of the digitizer record (specified in 80MHz samples) is set with the "Record Length" control. Values from 8 kSamples to 2 MSamples can be selected. To set a scale for the record length recall that the frame rate for a digital audio signal is equivalent to the embedded audio sample rate. So for a 48 kHz sampled digital audio signal each frame takes about 20.8 μ s or about 1.6 kSamples. Thus there are about 4.9 48 kHz frames in an 8 kSample digitizer record and 1258 48 kHz frames in the longest 2M sample record

Each frame contains two sub-frames of 32 bits for a total of 64 bits and each bit cell contains 2 "unit intervals" (UIs) for a total of 128 UIs in each frame. Therefore, at a 48 kHz sample rate each UI contains about 13 digitizer samples. This number grows proportionally larger (26 samples/UI at $F_s = 24$ kHz) at lower sample rates and smaller (3.25 samples/UI at $F_s = 192$ kHz) at higher sample rates. Choosing longer records increases the acquisition and analysis time for each record but provides more frequency resolution in spectral measurements.

Digitizer Input Gain

The digitizer has a selectable front-end gain of x1, x2, and x4. The magnitude of the input relative to the digitizer's full scale is shown by the colored bars at the bottom of the Acquisition box. Blue indicates the signal is below 1/2 of full scale. Green indicates the signal level is optimally adjusted, while red indicates the digitizer is overloaded. Usually setting the input gain to "Auto" will yield the best results.

Occasionally, with signals that have some transient component, it may be necessary to manually set

the gain to one of the three settings.

Digitizer Acquisition

To begin digitizer acquisition press the "Acquire" button on the digitizer panel or the  icon on the

SR1 speedbar. Pressing the  button opens a file dialog allowing the current digitizer record to be saved to disk or to load a previously saved digitizer record. The format of digitizer files is detailed in the [SR1 File Reference](#).

The Digitizer Trigger

Once acquisition has begun the digitizer waits for the specified trigger event to occur. The digitizer trigger can be set to trigger on a variety of events summarized in the table below:

Digitizer Trigger	
Auto	Trigger is generated automatically after "Acquire" is pressed
Receive Preamble A (C1)	Triggers on any channel A subframe preamble (X-preamble) on the C1 input connector.
Receive Preamble B (C1)	Triggers on any channel B subframe preamble (Y-preamble) on the C1 input connector.
Receive Block (C1)	Triggers on any block preamble (Z-preamble) on the C1 input connector.
Receive Error (C1)	Triggers on the occurrence on the C1 input of any of the error conditions listed in the table below.
Receive Preamble A (C2)	Triggers on any channel A subframe preamble (X-preamble) on the C2 input connector.
Receive Preamble B (C2)	Triggers on any channel B subframe preamble (Y-preamble) on the C2 input connector.
Receive Block (C2)	Triggers on any block preamble (Z-preamble) on the C2 input connector.
Receive Error (C2)	Triggers on the occurrence on the C2 input of any of the error conditions listed in the table below.
Receive Preamble A (Ref)	Triggers on any channel A subframe preamble (X-preamble) on the rear-panel reference input connector.
Receive Preamble B (Ref)	Triggers on any channel B subframe preamble (Y-preamble) on the rear-panel reference input connector
Receive Block (Ref)	Triggers on any block preamble (Z-preamble) on the rear-panel reference input.
Receive Error (Ref)	Triggers on the occurrence on the rear-panel reference input of any of the error conditions listed in the table below.
Xmit Preamble A	Triggers on the transmission of a channel A subframe preamble (X-preamble) by the digital audio output generator.
Xmit Preamble B	Triggers on the transmission of a channel B subframe preamble (Y-preamble) by the digital audio output generator.

Xmit Block	Triggers on the transmission of a block preamble (Z-preamble) by the digital audio output generator.
Ref Out Preamble A	Triggers on the transmission of a channel A subframe preamble (X-preamble) at the digital audio reference output.
Ref Out Preamble B	Triggers on the transmission of a channel B subframe preamble (Y-preamble) at the digital audio reference output.
Ref Out Block	Triggers on the transmission of a block preamble (Z-preamble) at the digital audio reference output.
Generator	Triggers on the receipt of a generator trigger. (See the Analog and Digital generator sections)
External (rising)	Triggers on the rising edge of a signal at the rear-panel external trigger in connector.
External (falling)	Triggers on the falling edge of a signal at the rear-panel external trigger in connector.

Error Trigger Conditions

The "Error Trigger" triggers on the receipt of any of the following error conditions detected in their respective input streams:

CRC	For AES/EBU digital audio streams an 8-bit CRC code is generated from the received channel status bits in each block and compared to the value stored in the last byte of the channel status block. A CRC error occurs if these values do not match.
Lock	An error occurs if the digital audio receiver on the given connector cannot lock to the input signal.
Validity	An error occurs if the validity bit is set on either subframe of the received or transmitted signal.
Coding	Bi-phase coding error. The error occurs if the carrier signal remains at the same level for greater than 2 unit intervals (other than during preambles.)
Parity	An error occurs if the computed parity of each subframe does not match the parity bit contained in that subframe.

Post Trigger Length

For all trigger sources except auto trigger, the user can specify the fraction of the total digitizer record that occurs after the occurrence of the trigger. A post trigger fraction of 100% means that the trigger occurs at the very beginning of the record while a fraction of 50% means that the trigger occurs precisely in the middle of the record. This feature enables examination of signal features that occur pre-trigger. For the "Auto" trigger selection, the post-trigger length is always set to 100%.

Digitizer Analysis Controls

Advanced Measure	Jitter Detection	Stable Bits	Re-analyze
	Jit. Rec. Len.	Clock Freq.	RMS Jitter
	82	49.73592 kHz	279.80 psec
Measure Advanced	Fast Interp.	Rise/Fall	Re-analyze
	Display Interp.	Asymmetry	Jitter Fs
	<input checked="" type="checkbox"/>	-29.126 m%	795.7746 kHz

After acquisition, the digitizer examines the input time record and makes a preliminary estimate of the zero-crossing positions and the unit-interval time. For a digital audio signal, all transitions should either

be one, two, or three unit intervals long. If the one-two-three pattern is completely unrecognizable the digitizer will abort processing at this point. If the one-two-three UI pattern is recognized, the digitizer does a more careful measurement of the zero-crossing positions and attempts to recreate the original clock signal by minimizing the jitter at one of three user-selectable points throughout the input record.

Selecting "Preambles" in the Jitter Detection control instructs the Digitizer to reconstruct the clock based on minimizing the jitter at the trailing transition of the 3-UI pulse found in every preamble of the digital audio signal. Because this transition occurs at the end of the longest stable interval in the signal (remember that all pulses in the digital audio signal are one, two or three UIs long and the 3-UI pulses only occur in preambles) pulse pile-up effects due to limited bandwidth are at a minimum at this transition and the "Preambles" selection yields the jitter that is most representative of the intrinsic jitter of the transmitting device rather than cabling effects. Since preambles occur only once every 32 bit-cells in the digital audio signal the "sampling frequency" for the calculated jitter will be 1/32 of the bit-cell rate and the number of calculated jitter points will be equal to the number of preambles in the input record. This implies that the bandwidth for jitter measured with this selection is (1/2 of 1/32) or 1/64th of the original bit cell rate which is equal to the sampling rate of the embedded digital audio signal.

Selecting "All Bits" reconstructs the clock by minimizing the jitter at each bit cell transition. This method has the maximum measurement bandwidth for the calculated jitter signal. The jitter bandwidth will be 1/2 of the bit cell rate or 32 times the embedded digital audio sampling rate. Because the jitter is being sampled at each bit cell transition the calculated jitter will include contributions from both the intrinsic jitter of the transmitter as well as pulse pile-up effects due to bandwidth limiting in the transmission channel. Since during preambles there are bit cell boundaries where no actual transition occurs the digitizer interpolates the position of these "virtual" transitions.

The "Stable Bits" selection is a midpoint between the "Preambles" and "All Bits." The jitter for this setting is calculated at every 4th bit-cell starting from the first transition in the preamble. The jitter bandwidth is thus 1/8th the bit cell rate or 8 times the embedded audio sampling rate.

For non digital audio signals (square waves) the available selections are "Square Rising", "Square Falling", or "Square Both". Square Rising or Falling calculate the jitter on the respective edges of the clock signal. The Jitter bandwidth for these selections is 1/2 the square wave frequency. "Square Both" calculates the jitter on both clock edges leading to a jitter bandwidth equal to the square wave frequency.

After reconstructing the clock, the digitizer calculates the jitter at the user specified points in the input record by comparing the zero-crossing of the reconstructed clock with the actual measured zero crossings in the input record. The total rms jitter and the effective embedded audio sampling rate are calculated and displayed in the "Measure" tab of the Analysis box. The jitter sampling frequency and the number of points at which the jitter is calculated are shown in the "Advanced" tab.

Asymmetry

Several physical processes can lead to a situation where negative going pulses in the carrier signal have systematically different widths from the positive going pulses. For pulses that are roughly trapezoidal in shape an offset in the signal will cause this effect as shown below:

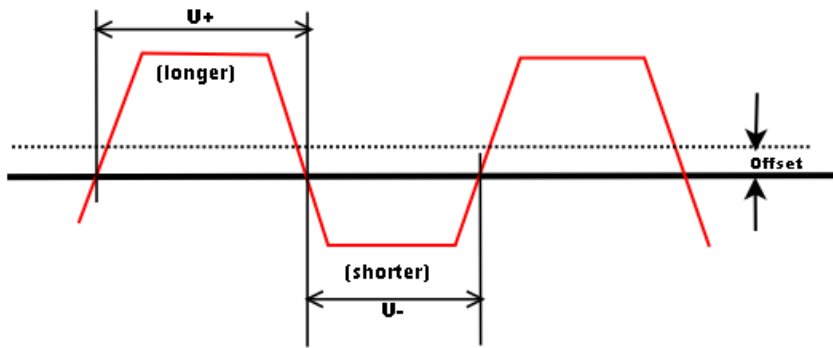

Voltage Offset Leads to Different Positive and Negative Pulse Widths

The same effect can be caused by a transmitter with different time constants for rising and falling edges. On an eye diagram an offset can be detected by observing that the points at which the positive and negative going pulses cross is above the "0 Volts" line. The eye diagram for an actual digital audio signal with a small offset is shown below.

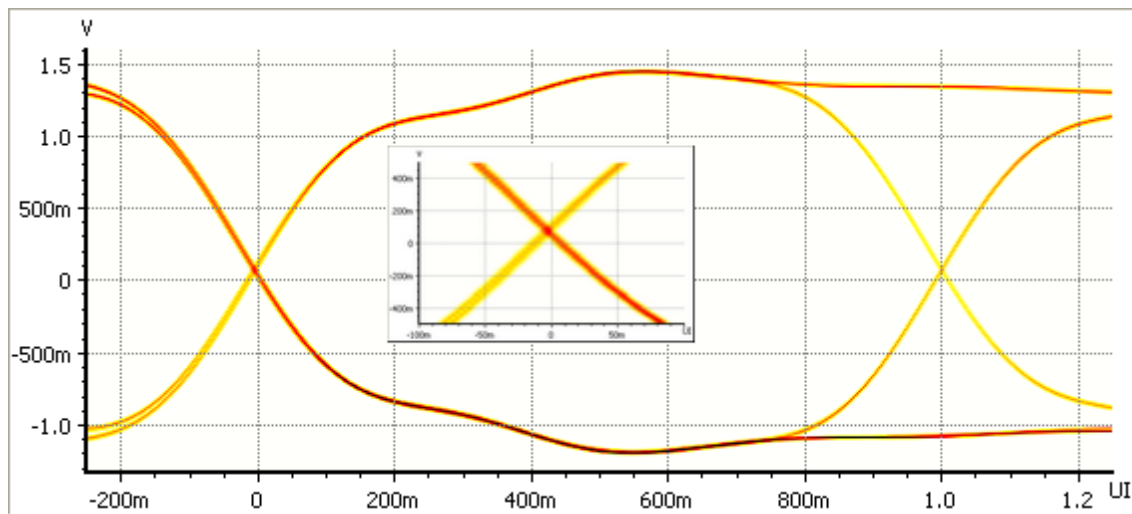

Eye Diagram of Offset Digital Audio Carrier

Another way of observing the effect of asymmetry is to examine the histogram of pulse widths. For an ideal square wave signal there would be a single peak in the histogram of pulse widths corresponding to 1/2 the square wave period. For the digital audio signal above we can see that the 2 UI peak has been split into two peaks—the higher one corresponding to the slightly longer positive going pulses and the peak on the left corresponding to the slightly shorter negative going pulses.

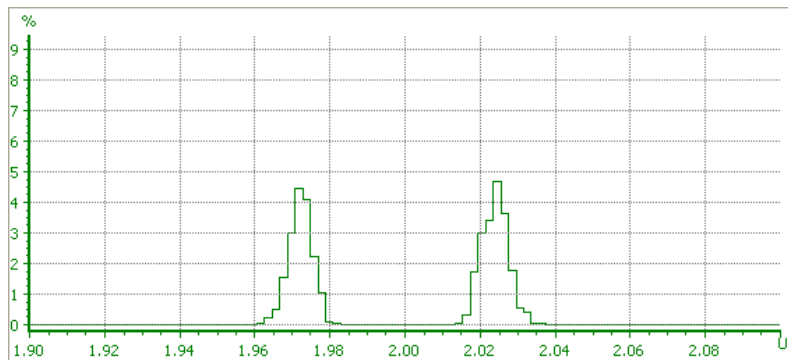

Splitting of 2 UI Peak Caused by Pulse Asymmetry

To account for these processes the digitizer includes an "asymmetry" parameter when reconstructing the original clock. Instead of a single Unit Interval length, the digitizer assumes 2 unit interval lengths, one for positive pulses and one for negative pulses. The difference in the lengths of positive going pulses (U^+), and negative going pulses (U^-), is calculated and displayed as an "asymmetry" parameter defined as:

$$\text{asymmetry} = (U^+ - U^-)/(U^+ + U^-)$$

The asymmetry calculated for each input record is displayed on the "Advanced" tab of the digitizer panel.

If desired, the "peak-splitting" produced by asymmetry in the input record can be removed before calculating the pulse width histogram by checking the "Rise/Fall" checkbox on the "Advanced Measure" tab of the digitizer panel. When the box is checked the digitizer will "correct" the measured pulse widths by the calculated asymmetry before compiling the pulse-width histogram. The histogram above, when recalculated with "Rise/Fall" checked yields the result shown below.

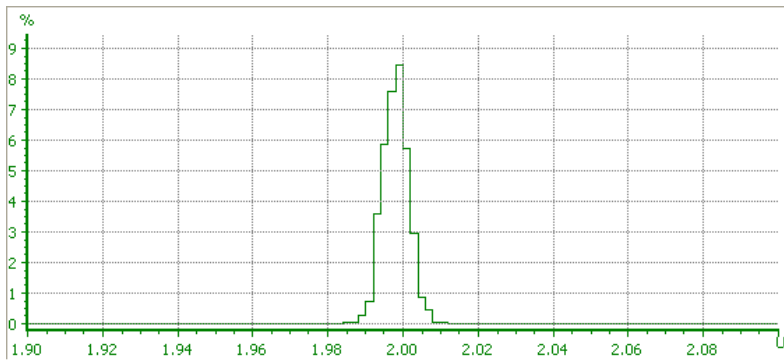

Additional Analysis Controls

The "Re-analyze" button causes the digitizer to reanalyze the current digitizer record, with possibly different analysis settings, without first acquiring a new record. The "Fast Interpolation" check box selects the use a faster, but less accurate interpolation algorithm (spline interpolation) when calculating the zero-crossing positions in the input record. The standard interpolation algorithm (band-limited interpolation) yields the highest accuracy.

Digitizer Measurements

Spectrum			
<input checked="" type="checkbox"/>	Window	Amp. Lines	Jit. Lines
	Blackman-Harris	1024	512
Probability			
<input checked="" type="checkbox"/>	Num. Bins		
	256		
Eye Diagram			
<input checked="" type="checkbox"/>	# UI's	X Res.	Y Res.
	2	512	256

The input amplitude vs. time and jitter amplitude vs. time measurements are always calculated by the digitizer. Optionally three additional sets of measurements can be selected. If these additional measurements are not needed, the corresponding check boxes may be left unchecked to save computation time.

Checking the "Spectrum" box instructs the digitizer to compute the FFT of the input signal and the jitter spectrum. The window function applied before calculating the spectra can be selected from the same list of window functions available in the [FFT analyzers](#). The spectral resolution for the input amplitude spectrum can be selected between 512 and 16k lines. The number of lines in the Jitter spectrum is

adjustable between 256 and 8k lines.

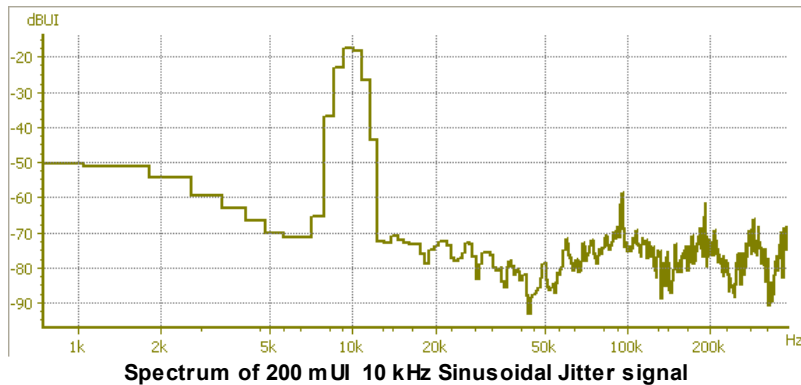

Checking "Probability" computes the histograms of the input amplitude, jitter amplitude, input pulse width and input pulse rate. For a digital audio (or clock) signal, the input amplitude histogram is dominated by two peaks corresponding to the positive and negative voltages of the signal:

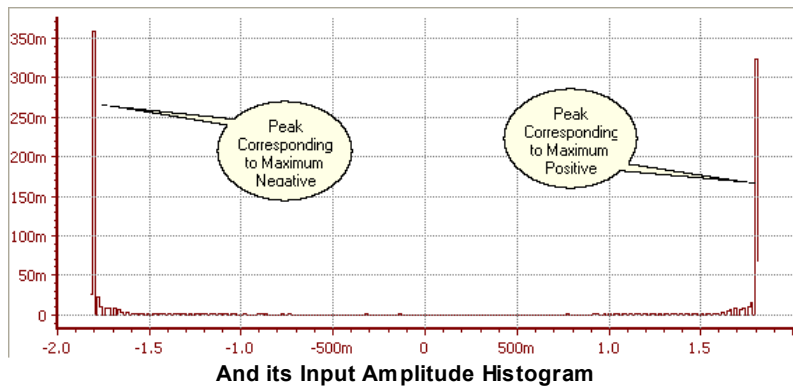
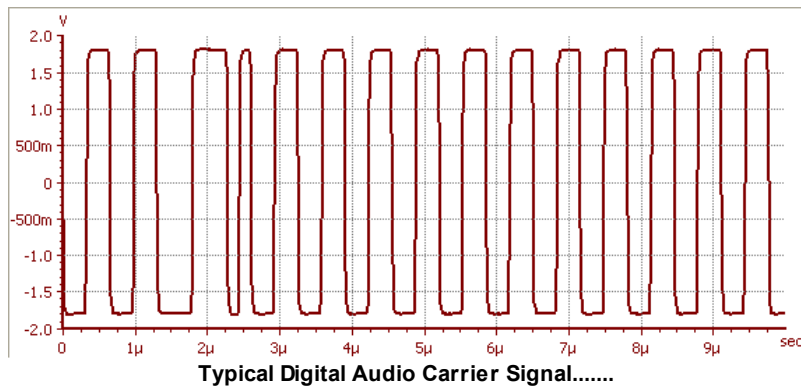

For a digital audio signal the pulse width and pulse rate histogram will show peaks at the one, two, and three UI transition widths that make up a legitimate digital audio carrier:

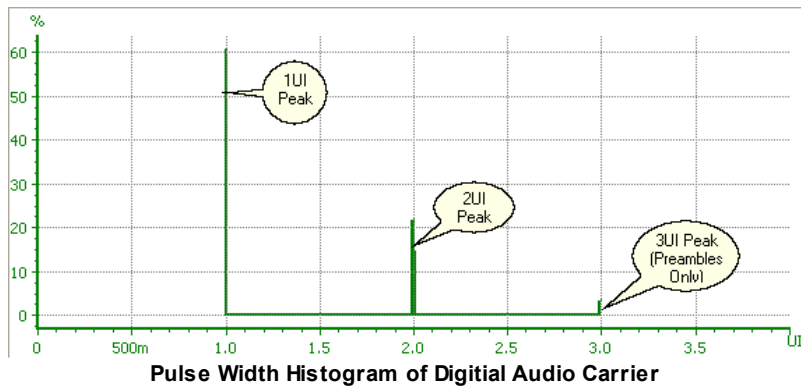

The "Eye Diagram" can be thought of as a two-dimensional histogram. The eye-diagram is constructed by overlaying the transitions corresponding to the selected jitter detection option (preambles, stable bits, or all bits) on a two-dimensional grid. The x-axis of this grid consists of the specified number of UIs binned into the number of bins specified in the "X Resolution" control under the Eye Diagram heading. The y-axis includes the range from the maximum positive to the maximum negative extent of the transitions found. This range is then binned into the number of bins specified in the "Y Resolution" control. The number of points falling into each bin is then mapped into a color indicating the relative probability of that particular voltage-time point. A description of the various color-mapping options is given in the [Digitizer Display](#) section.

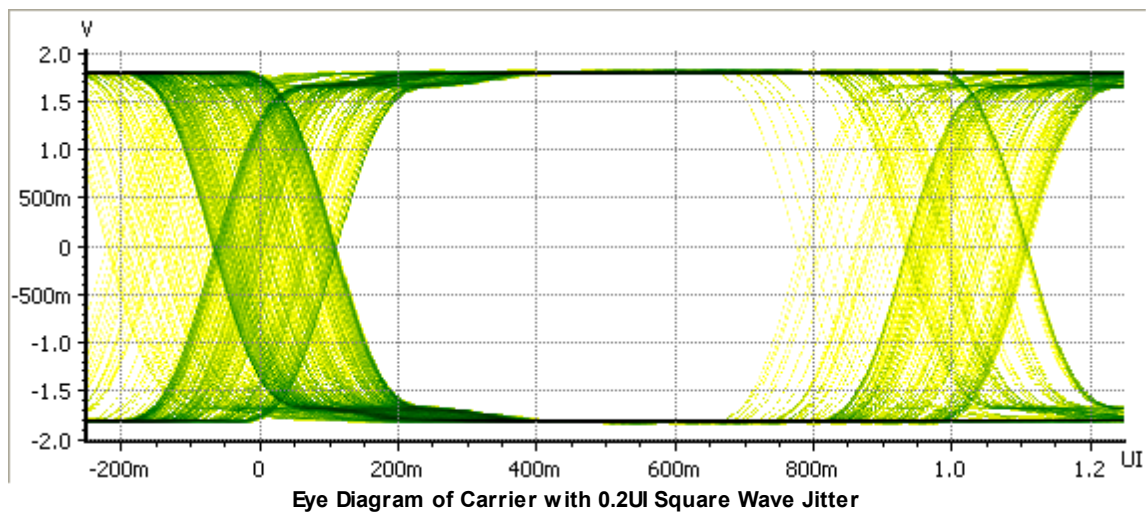

As an example consider the eye diagram above produced by the digitizer looking at SR1's digital audio output with 200 mUI of added square wave jitter. For square wave jitter the pulse edges will occur at one of two times corresponding to the high and low portion of the square wave jitter signal. This is clearly evident in the eye diagram as the lines of high intensity (dark green in this color mapping) are separated by the 200 mUI jitter amplitude.

2.5 Displays Menu

SR1 offers three different types of displays which present visually the measurements made by the various analyzers. The Displays menu offers options for creating and managing the different types of displays used by the instrument.

Graph	Opens a new Graph on the current page.
Bar Chart	Opens a new Bar Chart on the current page.
Digitizer Display	Opens a new digitizer display on the current page.
Other Display Menu Options	Saving and Recalling of displays. Options for managing the page control.

2.5.1 Graph

SR1's graphs are sophisticated tools for displaying and analyzing SR1's measurement results. Any number of graphs with unique content can be placed on different pages of SR1's page control. Each measurement is represented on the graph by a **trace**. Each trace can have its own unique X and Y axis and scaling parameters. Although there is no limit to the number of traces that can be displayed on the graph, only two pairs of X and Y axes, corresponding to the last two selected traces, are shown at once so to avoid cluttering the display. There are four basic types of graph traces: **FFT** type traces show a vector measurement, such as FFT amplitude or phase, with the measurement defining the X-axis. Thus an FFT amplitude trace will be shown with frequency on the X-axis, while an FFT time record trace will be displayed with time on the X-axis. **Stripchart** traces show a scalar measurement, such as THD+N, as a function of time with a scrolling "stripchart" type display. **Sweep** traces show the data from an SR1 sweep with a fixed X-axis that is defined by the sweep and data values that are defined by one of the selected [Sweep Data](#) measurements. Finally, **EQ** traces show the frequency response, magnitude or phase, of an [EQ file](#).

Each trace on the graph is assigned a unique color when it is created (the color may be changed later). The color of the trace data matches the color of the corresponding axes as well as the color of the trace listing in panel on the lower right of the graph. When the cursor is clicked on the trace data, or on the corresponding line in the trace listing panel, the trace becomes the **active trace** and its axis becomes visible (if it had not been previously visible) and the trace listing line is highlighted. The active trace is the trace whose scaling data is shown in the scaling tab at the lower left of the graph and is connected to the cursor display.

Traces on a graph can be **live**, i.e. connected to a currently updating measurement, or **offline**, where the data in the trace is static. Offline traces are useful for storing reference data or for creating **limit** traces, which can be compared to live measurement values and produce a pass/fail type result.

The Graph Display Panel

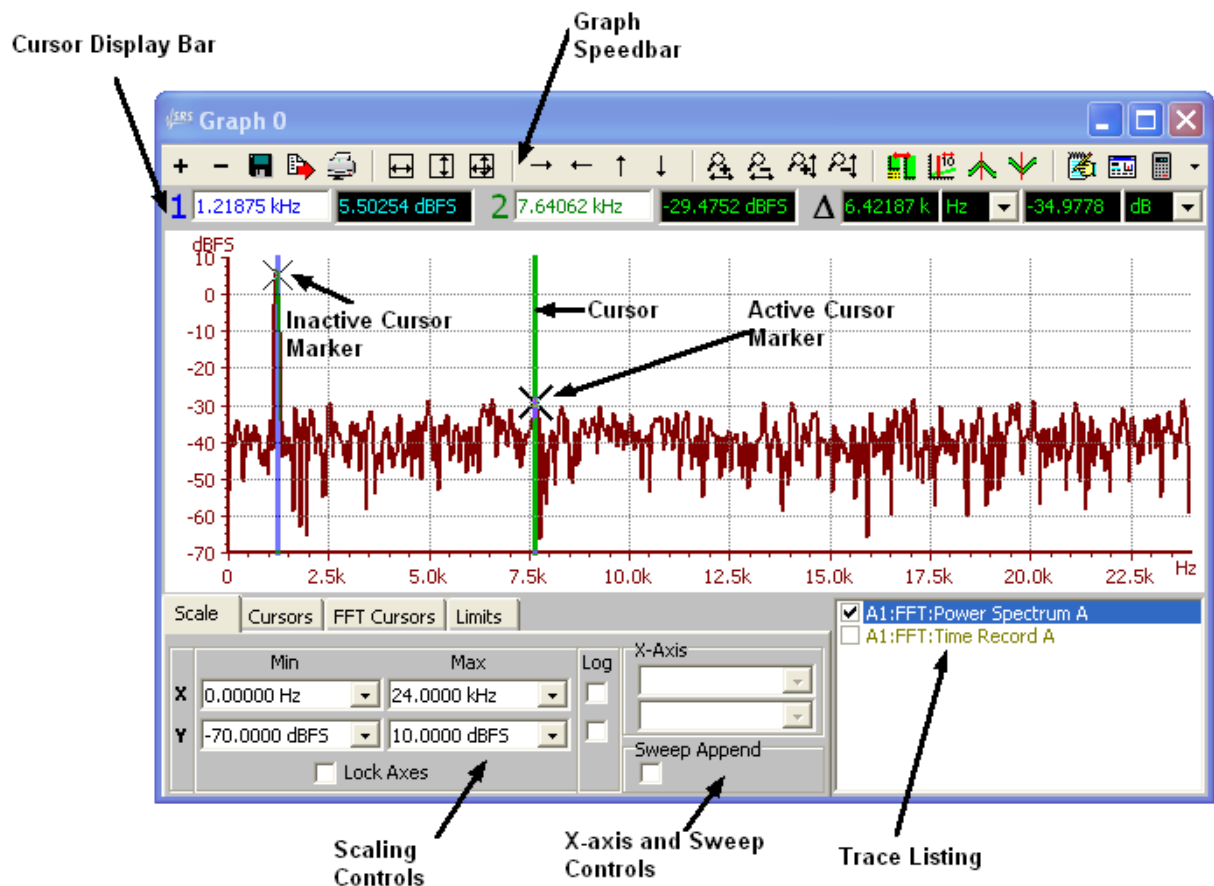

Trace Listing

The panel at the lower right of the graph shows the trace listing. Each trace is represented by a line in the listing such as:

A1:FFT:Power Spectrum A

The color of the line in the trace listing corresponds to the color of the graphed data. The checkbox at the left allows each trace to be separately turned on and off in the graph. The listing shows the source of the measurement, in this case analyzer A1, which is configured as an FFT analyzer, and the measurement, in this case Power Spectrum A. When a trace is offline, as opposed to live, the trace listing display is in italics, e.g.:

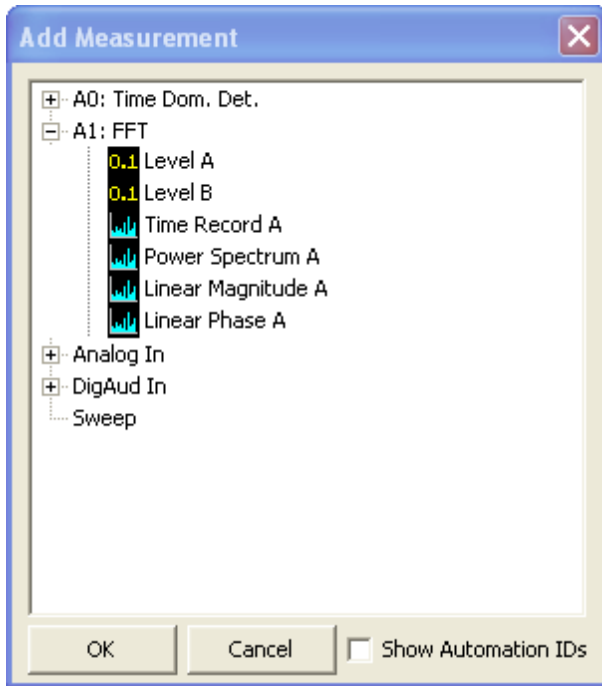

A1:FFT:Power Spectrum A

To add a trace to the graph press the "+" button at the top left of the graph speedbar. After pressing "+" the "Add Measurement" form appears, containing a tree listing all currently available measurements. Double clicking on a measurement creates a trace in the graph corresponding to the selected measurement.



Add Measurement Form

The first two nodes of the tree represent the measurements available from the two analyzers, A0 and A1. The second two nodes of the tree contain measurements related to generic properties of the corresponding input signal: level, frequency and phase. The final tree node, sweep, is only active when a sweep is configured. In that case the node will contain a separate entry for each sweep data that has been selected on the sweep controller panel. Clicking on the sweep trace will produce a trace whose x-axis corresponds to the configured sweep source and y-axis corresponds to the selected sweep data.

Note that measurements accompanied by the  icon are scalar measurements which will be represented by "strip-chart" type traces and measurements shown with the  icon are vector measurements which will be shown on "FFT-type" traces.

Clicking on any line in the Trace Listing makes that trace the active trace which connects it to the cursor and allows control of its scaling.







Right-clicking on the trace listing line brings up a submenu offering the following choices:



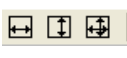
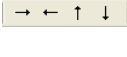
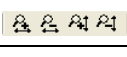

Trace Listing Right Click Menu	
Option	Description
Offline	Makes the trace offline. The current trace data is saved. After being taken offline the trace can still be scaled, renamed, and saved and recalled. Its data, however, is fixed when the trace is taken offline.
Save...	Saves the trace to a disk file. A trace file can be added to any graph by right-clicking in the graph area and selecting "Load Trace" from the submenu.
Cut	Removes the trace from the graph and stores it in memory. The stored trace can be pasted back in the current graph or a different graph by right-clicking in the graph area and selecting "Paste Trace" from the submenu.

Copy	Stores the trace in memory without removing it from the current graph. The stored trace can be pasted back in the current graph or a different graph by right-clicking in the graph area and selecting "Paste Trace" from the submenu.
Copy Offline	Creates a copy of the current trace and makes the copy offline.
Edit...	Opens a window which allows manual editing of the trace data. This is only useful for offline traces as any edits made on live traces will be overwritten when the next measurement is received.
Color...	Opens a color selection dialog which allows selection of a new color for the trace.
Width	Selects the width of the trace: 1, 2, or 3 pixels. For optimum printed output select a width greater than 1 pixel.
Rename..	Allows renaming the trace in the trace listing. "A1:FFT:Power Spectrum A" can be renamed "Reference Amp" or some more descriptive phrase. Only offline traces can be renamed.
Calculate	Provides access to the Trace Calculator. Each calculator option is explained in the trace calculator section.

Graph Speedbar

The speedbar at the top of the graph provides quick access to the following functions:

Graph Speed Bar Functions	
Icon	Description
	Adds a trace to the graph. After pressing the button, the Add Measurement form is displayed showing a tree containing all currently available measurements. Double clicking on a measurement creates a trace in the graph corresponding to the selected measurement.
	Deletes the active trace from the graph. Right-clicking this button displays a submenu allowing fast deletion of all traces, all unused traces (traces that are unchecked in the trace listing) or all sweep traces.
	Saves the graph to a file. The graph can be recalled using the "Load Displays..." option from the Displays selection of the main menu.
	Exports the graph to one of several file formats. Graphical file formats include JPEG (.jpg), bitmap (.bmp), and enhanced windows metafile (.emf). Saving the graph to text (.txt) format saves a comma delimited listing of each trace in X,Y format.
	Prints the graph. After pressing the button a print preview is displayed. The user can select among the installed printers and then press the "print" button to finalize printing. Graphs are always printed in landscape mode.
	Autoscales the active trace. The first button autoscales only the X-axis, the second only the Y-axis. The third button autoscales both the X and Y axes.
	Translates the active trace right, left, up, and down. The direction of translation is adjustable on the Preferences panel.
	Zooms the active trace in and out in the X and Y direction.
	Toggles the graph area between the standard display and a larger graph which covers the

	scaling controls and trace listing.
	Toggles the cursors on and off.
	Moves the active cursor to the next peak right or left.
	Add Annotation. Opens a text window and allows placement of text on the graph area.
	Change Graph Title.
	Access the Trace Calculator. The trace calculator functions are fully described in the trace calculator section.

Scaling Tab

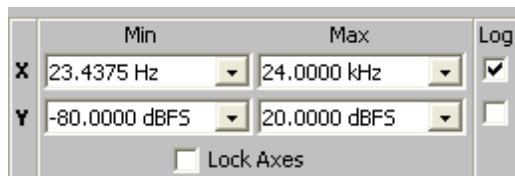

The graph scaling tab controls the scaling and unit selection for the active trace. Each axis can be plotted logarithmically or linearly by clicking the "Log" checkbox for that Axis. Note that when the units for an axis are already intrinsically logarithmic, such as "dBVrms", selecting "Log" will change the units to their corresponding linear value (Vrms) and plot the data on a logarithmic scale.

Some unit selections in the scaling controls depend on analyzer settings. For instance power spectral density units, such as V/vHz, depend on the FFT analyzer's resolution and window settings. When traces with these units are taken offline the units are "frozen" and conversion to other units may be limited.

Lock Axes

Normally, each trace has its own pair of X and Y axes, and each trace can be scaled separately. However, there are times when it is useful to be able to view several traces all plotted with the same scaling on the same axes. Clicking "Lock Axes" causes SR1 to plot all traces that have X and Y axes compatible with the active trace on the same axes as the active trace. Any subsequent scaling operation, such as manually setting the scales or pressing one of the autoscale buttons, will scale *all* the traces with compatible axes rather than just the active trace.

X-Axis and Sweep Controls



The X-axis controls only apply to "strip-chart" type traces. The X-axis for such traces can be plotted as a function of "Index" which is simply a sequential integer label that is applied to each new point, or as a function of real time elapsed since the "Start" button was pressed. If index is selected all the points will appear to have equal spacing even though the actual measurement intervals may vary widely. The index numbering, or the time origin, may always be reset by pressing "Start" (on the speedbar or on the keypad) again.

The second control governs the scaling of strip-chart traces. If "Scale" is selected the graph

automatically autoscales the X-data each time a new point is added to the trace so that the full range of data is always shown on the graph. If "Fixed" is selected the graph scale is not updated automatically so that any new points that are added with X-values exceeding the current range will not be seen. "Pan" maintains the X-axis range until new points reach the right-hand edge of the graph. At that point the maximum X-value "pans" to keep up with the new data while maintaining the total width of the X-axis.

Sweep Append

When sweep traces are present in the graph, the default behavior when a new sweep is started is to clear the data from each sweep trace and fill them with data from the new sweep. When "Sweep Append" is checked, each sweep traces is copied off-line before the sweep traces are zeroed so that data from each iteration of a sweep is maintained in the graph.

Cursor Display Bar



The graph has two independent cursors, cursor 1 (drawn in blue) and cursor 2 (drawn in green). The X and Y values for the two cursors are displayed in the corresponding displays on the Cursor Display Bar. Note that the units of the cursor readout are always the same as the units selected in the scaling tab. The displays to the right of the 'Δ' symbol show the difference between X and Y values of the two cursors.

Moving the Cursors

The two cursors may be moved by grabbing them with the mouse. When the mouse arrow is moved over the cursor the arrow icon changes to "← | →". At this point click the mouse button and drag the cursor to the desired location. The cursors can also be moved by explicitly entering an X-value into either the cursor 1 or cursor 2 X-value control on the cursor display bar. Finally, the active cursor may be moved by turning the knob when the graph has focus. Click on one of the cursors to make it the active cursor or press the <Cursor> key on the keypad to toggle the active cursor.

Cursor Tab



The cursor tab displays statistics for the two cursors. The left side of the tab shows value for cursor 1, the right side for cursor 2. Pressing Start or Stop toggles the collection of statistics. Pressing "Reset" resets the statistical history. The four statistical values collected are: Maximum (Max.), Minimum (Min.), Average (Avg.), and Standard Deviation (SDev). Note that the statistics are calculated in the units of the Y-axis, i.e. the average of a quantity displayed in dB is the average of the dB values, not the average of the underlying value expressed in dB.

Independent Cursors (Ind.)

Normally both cursors are attached to the active trace. Checking "Ind." (Independent Cursors) allows the two cursors to be attached to any of the traces on the graph. Use the two drop-down lists to select the trace attached to each cursor. Checking "Lock X" ensures that the two cursors maintain the same X-value so that the Y values of different traces at the same X-value can be easily compared.

FFT Cursors Tab

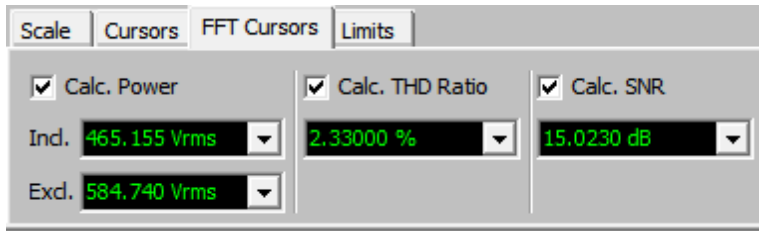

For FFT-type traces, the FFT cursors tab offers some additional cursor measurements. Checking "Calc. Power" displays the RMS integrated power in the spectrum between the two cursors as well as the RMS integrated power *outside* of the two cursors.

Checking "Calc. THD Ratio" calculates the ratio of power in harmonics of the fundamental to the power in the fundamental. The fundamental is marked using the left-most cursor. The maximum harmonic frequency included in the measurement is marked by the right-most cursor. All harmonics, odd and even, up to the maximum frequency are used in calculating the ratio. For a more sophisticated THD measurement that allows the choice of specific harmonics use the [THD Analyzer](#).

Checking "Calc SNR" calculates the Signal-to-noise ratio of the signal. Signal-to-noise is defined as the ratio to the peak signal contained within the cursor region to the integrated power in the cursor region excluding the peak signal.

Limits Tab

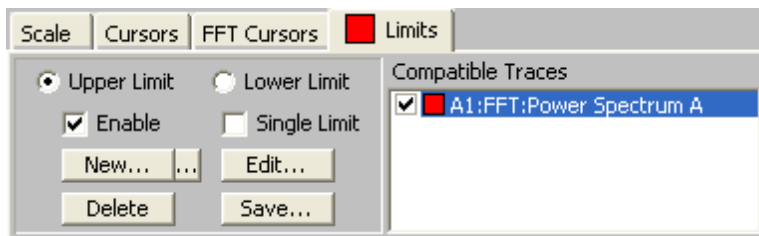

Graphs have the capability to check trace data against predefined upper and lower limits. To create an upper or lower limit, click the appropriate radio button and click on "New...". A dialog appears allowing selection of an existing trace on which to base the limit. The selected trace determines which of the graph traces can be limit-tested; only traces with X and Y axes compatible with the limit trace can be tested. For instance if the trace selected as the limit is an FFT trace then all FFT traces on the graph may be limit tested but a time-record trace cannot be. (The X-axis of the time record is incompatible with the frequency X-axis of the FFT).

Once the trace for the limit has been selected a list of compatible traces appears in the Limit Tab. Each trace can be selected for limit testing by checking the box adjacent to the trace name. Once selected, a green or red box appears indicating whether the trace data passes or fails the limit test. If both an upper and lower limit is present the trace must pass **both** limits in order to pass. The red box on the tab indicates the "AND" of all the pass/fail results for the individual traces.

When first created a limit trace contains identical data to the trace that it was created from. Press "Edit" to change the limit data. (Note that X-values must be in increasing order.)

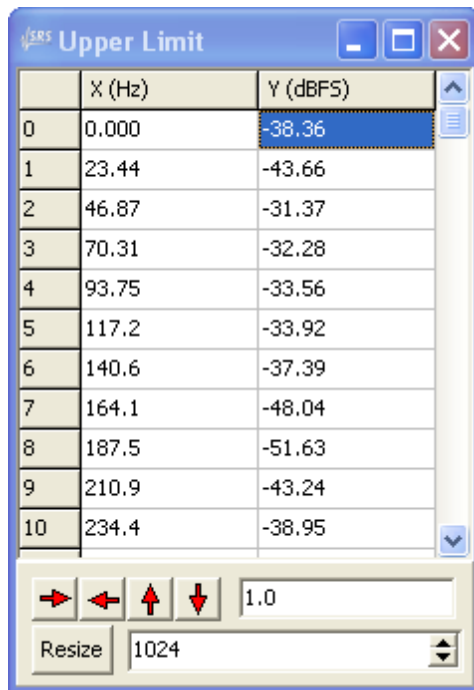

	X (Hz)	Y (dBFS)
0	0.000	-38.36
1	23.44	-43.66
2	46.87	-31.37
3	70.31	-32.28
4	93.75	-33.56
5	117.2	-33.92
6	140.6	-37.39
7	164.1	-48.04
8	187.5	-51.63
9	210.9	-43.24
10	234.4	-38.95

The limit X and Y values can be all moved together with the arrow buttons at the bottom of the panel. This can be useful for creating a limit equal to an existing trace plus some error margin. Individual X and Y values in the limit can be changed as well. If it is not necessary for the limit to have the same number of points as the original trace, the limit can be "resized" by entering the new number of limit points in the up-down control at the bottom of the panel and pressing "Resize". For instance, to create a limit that consists of a single line segment, resize the limit to "2" and then adjust the starting and ending X and Y values for the single limit segment.

Upper or lower limits can be deleted with the "Delete" button on the limit tab, and can be saved to disk with the "Save..." button. To recall a previously saved limit use the "..." button next to the the New button and select the previously saved file from the file dialog.

A limit can be made a "single limit," in which case it has no X-axis and only a single Y-value that is applied to all the points in the trace. A single limit can be thought of as a horizontal line that limits the entire trace. Once a limit has been converted to a "single limit" it cannot be undone.

2.5.1.1 Trace Calculator

Trace Calculator

The trace calculator is a powerful tool for manipulating data contained in graph traces. Each calculator function takes as input one or more input traces and produces a new trace which contains the specified calculator function output. If the function requires a single input the active trace is used by default. If a second trace input is required the user can select from among all available graph traces.

The Trace Calculator can be accessed in two ways: by right-clicking the active trace in the trace listing box or by clicking the calculator icon on the speedbar. After selecting the desired function from the

submenu the corresponding panel appears. For instance, after selecting the "Linearity" function the Linearity panel will be displayed:

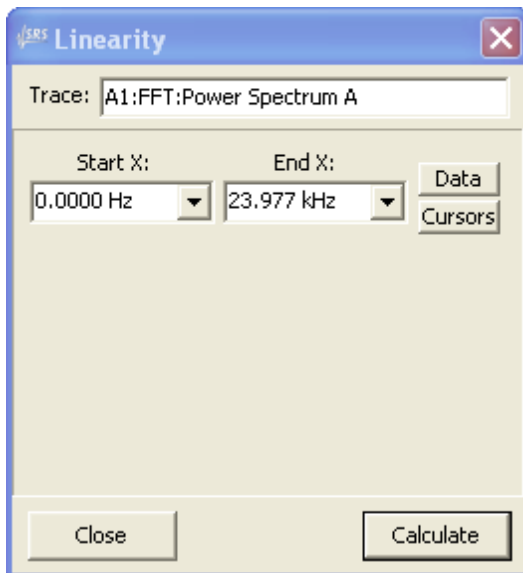

This panel displays several important features common to all the trace calculator functions. The single input trace is displayed at the top of the panel. Because linearity takes only one input argument, no mechanism for selecting the input trace is provided— it is simply the active trace. If the selected function requires a second input trace a drop-down list appears showing the available selections.

The controls below the input trace determine the range of data within the trace on which the calculation will be performed. The default is to operate on the entire data range. However, the user may enter a specific starting and ending X values for the calculation range. Pressing the "Cursors" button sets the starting and ending X-values according to the position of the two cursors.

Pressing "Close" aborts the calculation. Pressing "Calculate" performs the calculation. The result of the calculation will always be a new, offline trace. For instance, after pressing "Calculate" in the example above a new trace appears in the trace listing box as shown below.



Note that the trace calculator does not overwrite existing trace data, a new trace is always created to contain the calculation results.

Trace Calculator Functions

Function	Description
Maximum	Returns a trace containing a constant value equal to the maximum value of the input trace over the input data range.
Minimum	Returns a trace containing a constant value equal to the minimum value of the input trace over the input data range.
Average	Returns a trace containing a constant value equal to the average value of the input trace

	over the input data range. RMS or Linear averaging can be selected. A third option, variance, does not return the average but rather the variance: the RMS average deviation from the mean.
2-sigma	Returns a trace containing a constant value which exceeds 95% (2σ) of the y values within the input data range.
Linearity	Calculates a linear fit to the data within the input range and then returns a trace equal to the difference of the input data and the linear fit.
Smooth	Returns a "smoothed" version of the data in the input range. The smoothing algorithm is selected from the calculator panel.
Invert	Returns a trace containing the "inverted" y-data within the input range. For data displayed in logarithmic units, the y-values are sign-inverted and translated so that the original data and the inverted data have the same value at the "invariant" X-Value selected on the panel. For linearly scaled input data the inverted value is equal to the reciprocal of the ratio of the original y-value to the invariant y-value multiplied by the invariant y-value.
Normalize	After selecting a target X and Y value, this routine returns a scaled version of the input data such that the new trace has the selected Y-value at the selected X-value.
Delta	Returns a trace containing the difference between the two selected input traces over the input data range. If the input data is in dB units, the difference between the dB values is calculated.
Multiply	Returns a trace containing the product of the two selected input traces.
Equalize	Returns a trace containing the input data weighted by the selected EQ file.
Ratio	Returns a trace containing the ratio of the two selected input traces.
Trim	"Trims" the input data to the selected input data range. The returned trace has identical Y-Values to the input trace but only contains points within the specified X-range.
Unwrap	Returns a trace with the "unwrapped" version of the input phase-frequency trace. Unwrapping is done by inserting 360° jumps at appropriate break points in the phase vs. frequency curve.
Group Delay	Returns a trace equal to the Group Delay of the input phase vs. frequency trace. Group delay is defined as the derivative of the radian phase with respect to frequency.
Parametric	Displays a parametric plot of the two selected input traces with their common X-axis as a parameter. Each pair of Y values from the two input traces are used to create an X,Y pair in the returned trace. For instance, if the same trace is selected for both inputs the result will be a straight line with a slope of one whose extent in X and Y is equal to the Y range of the input data. The selected trace Y-values become the Y values for each point, the second trace Y-values furnish the X-values for the displayed points.
MakeEQ	Create and saves an EQ file corresponding to the selected trace. The selected X-value is assigned a value of "1" in the EQ file. All other points are scaled relative to that point.
Make ARB	Creates and saves an ARB file corresponding to the selected trace. The resulting file can be used by the arbitrary waveform generator.

2.5.2 Bar Chart

The Bar Chart is optimized for the display of a single measurement. The chart consists of two main areas: the top portion consists of a large numerical display of the selected measurement and the bottom portion contains a bar chart showing the current value of the measurement along with statistics of the measurement: mean, maximum, minimum, and standard deviation.

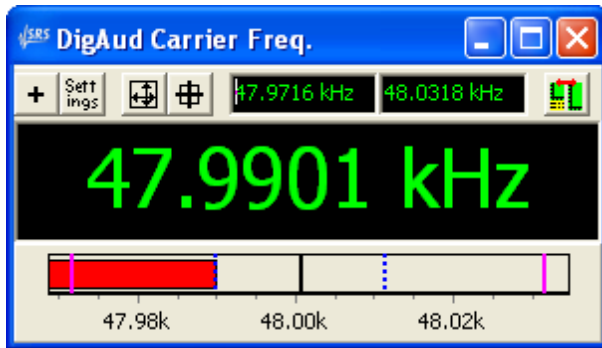

The Barchart Speedbar

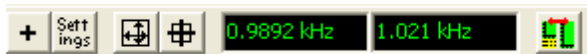



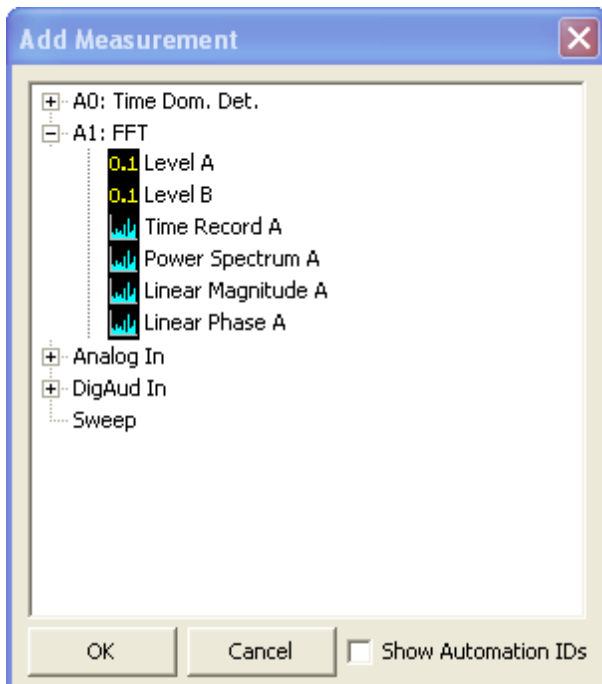

The bar chart speedbar contains the controls necessary to configure the display. The "+" button displays the "Add Measurement" panel which allows selection of the measurement displayed on the bar chart. Note that both scalar and vector measurements can be displayed on the bar chart; for vector measurements additional configuration is necessary on the bar chart settings panel to determine which x-axis point on the vector measurement will be displayed.



The "Add Measurement" panel displays a tree containing all the available measurements. Open the tree

and double-click on a measurement to select it. The "Settings" button displays the bar chart settings panel which contains additional configuration options which will be discussed below.

The  button rescales the bar chart display setting the minimum and maximum of the display to the minimum and maximum observed value of the measurement. The  button resets computation of measurement statistics; maximum, minimum, mean, and standard deviation will be computed from measurements made after the button press. The two displays to the right of the  button can be configured on the bar chart "settings" panel to display the maximum and minimum of the observed measurement, or the mean and standard deviation. Finally the  button toggles the display between numerical display only and the numerical display plus bar chart.

Bar Chart Settings Panel

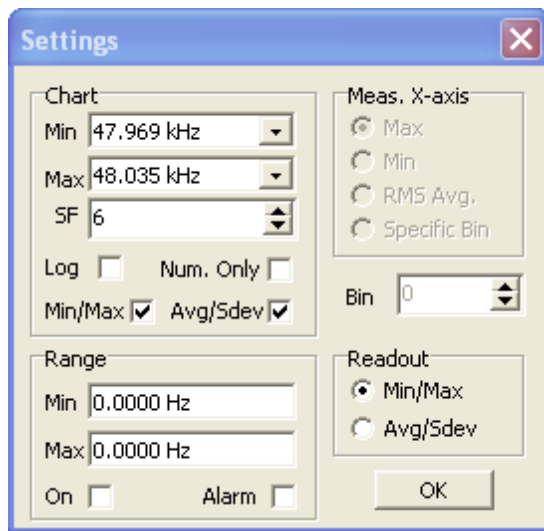

The Minimum and Maximum controls set the bar chart scale, as well as setting the units for both the numerical display and the bar chart. The "SF" (significant figures) control sets the number of significant figures in the numerical display. "Log" sets a logarithmic scale for the bar chart. Selecting "Num. Only" drops the unit string from the numerical display, e.g. instead of 1.043 kHz the display will read "1.043 k".

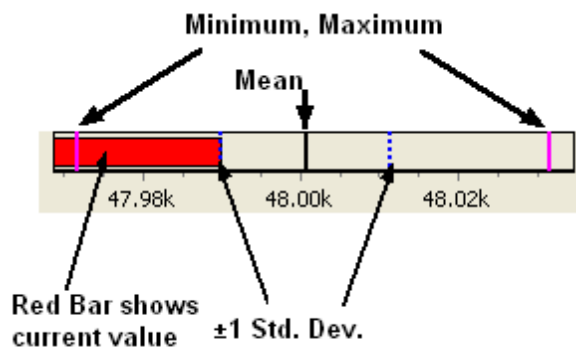

"Min/Max" and "Avg./Sdev" turn on and off the respective markers on the bar chart display. When "Min/

"Max" is selected, the minimum and maximum recorded values of the measurement will be displayed on the bar chart as pink lines. When "Avg/Sdev" is checked, the average value of the measurement (mean) will be displayed as a solid black line with the range of ± 1 standard deviation shown as a dotted blue line. The current value of the measurement is always shown as a red bar.

Alarm Range

The bar chart display has the ability to check if the displayed measurement falls outside a pre-set range. The range is set with the "Min" and "Max" controls in the "Range" box. The "On" box must be checked to enable range checking. Checking "Alarm" will sound a tone each time the measured value is outside the defined range.

Meas. X-Axis

Connecting the bar chart to a scalar measurement, such as frequency, is straightforward, but what does it mean to connect the bar chart to an FFT for instance? The answer is supplied by the selection made in the "Meas. X-Axis" box on the bar chart settings panel. Selecting "Max" or "Min" tells the bar chart to display the maximum or minimum value found in the vector measurement. Selecting "RMS avg." displays the RMS average of all of the vector values. For an FFT, for instance, the displayed value would be the RMS average of each of the FFT bin amplitudes. Finally, "Specific Bin" displays the value from one particular bin of the vector measurement. The "bin" number is simply an integer index into the vector, it is not the actual x-axis value for the vector measurement.

Readout

The "Readout" control determines whether the unit-displays in the speedbar at the top of the bar chart display the maximum and minimum values of the measurement or the mean and standard deviation.

2.5.3 Digitizer Display

The digitizer display is designed to display the measurements calculated by SR1's optional [Digitizer](#). Unlike the [Graph](#), which can display many different traces corresponding to user-selected measurements, the 4 tabs of the Digitizer Display always display the same digitizer measurements. Each digitizer display can be "live", meaning that it is updated each time a new digitizer record is acquired, or it can be "offline" meaning that the displayed measurement results are not updated. Offline Digitizer Displays can be useful for displaying reference data for comparison with live data.

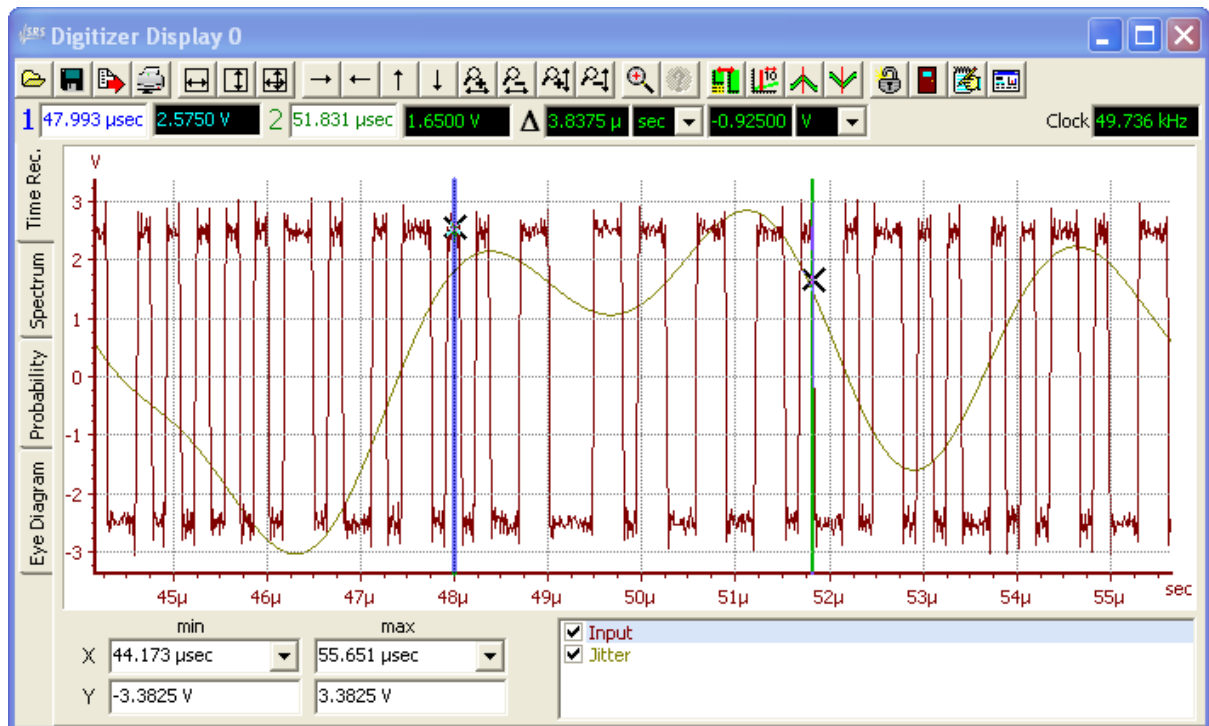













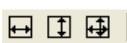
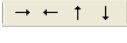
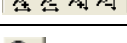

The digitizer display has a similar layout to the Graph. At the top of the display is a speedbar with buttons corresponding to frequently used functions. Below that is a cursor bar with readouts for the two cursors. The calculated effective digital audio sampling frequency is shown at the right-hand edge of the cursor bar. The central portion of the display is a tab-control with 4 tabs each of which displays a different set of digitizer measurements. The "Time Rec." tab show the two measurements which are functions of time: Input Amplitude and Jitter Amplitude. The "Spectrum" tab displays the spectrum of the input signal and the jitter. The "Probability" tab shows amplitude histograms of the input and jitter amplitudes as well as the distribution of pulse widths and pulse rates in the digitizer record. Finally the eye diagram displays probability vs. amplitude and time using a color-coded 2-dimensional plot.

Note that all the traces in a digitizer display reflect measurements computed from the same underlying digitizer record. Therefore, traces may not be copied and pasted between digitizer displays as they may be on the normal graph.

Digitizer Display Speedbar

The speedbar at the top of the Digitizer Display provides quick access to the following functions:

Graph Speed Bar Functions

Icon	Description
	Load a previously saved Digitizer Display.
	Saves the Digitizer Display to a file.
	Exports the currently displayed tab of the Digitizer Display to one of several file formats. The output file can be a text file, a bitmap (.BMP) file, a Windows Enhanced Metafile (.EMF), or a JPEG (.JPG) file.
	Prints the display. After pressing the button a print preview is displayed. The user can select among the installed printers and then press the "print" button to finalizing printing. The currently selected tab (Time Record, Spectrum, Probability, or Eye Diagram) is printed.
	Autoscales the active display. The first button autoscales only the X-axis, the second only the Y-axis. The third button autoscales both the X and Y axes.
	Translates the active display right, left, up, and down. The direction of translation is adjustable on the Preferences panel.
	Zooms the active display in and out in the X and Y direction.
	Toggles the sense of mouse-zooming.
	Shows eye-diagram intensity values as the mouse passes over a point.
	Toggles the graph area between the standard display and a larger graph which covers the scaling controls and trace listing.
	Toggles the cursors on and off.
	Moves the active cursor to the maximum (or minimum) displayed point on the active trace.
	Toggles "Autoscale on Acquire". When unlocked, the display autoscales each time a new digitizer record is acquired. When locked, the current scaling is maintained.
	Toggles online/offline status. When the door is closed the graph is online and new digitizer measurements will be updated to the display. When the door is open, the graph is offline and the display data will not be updated when new digitizer records are taken.
	Add Annotation. Opens a text window and allows placement of text on the graph area.
	Change Graph Title.

Time Record Tab

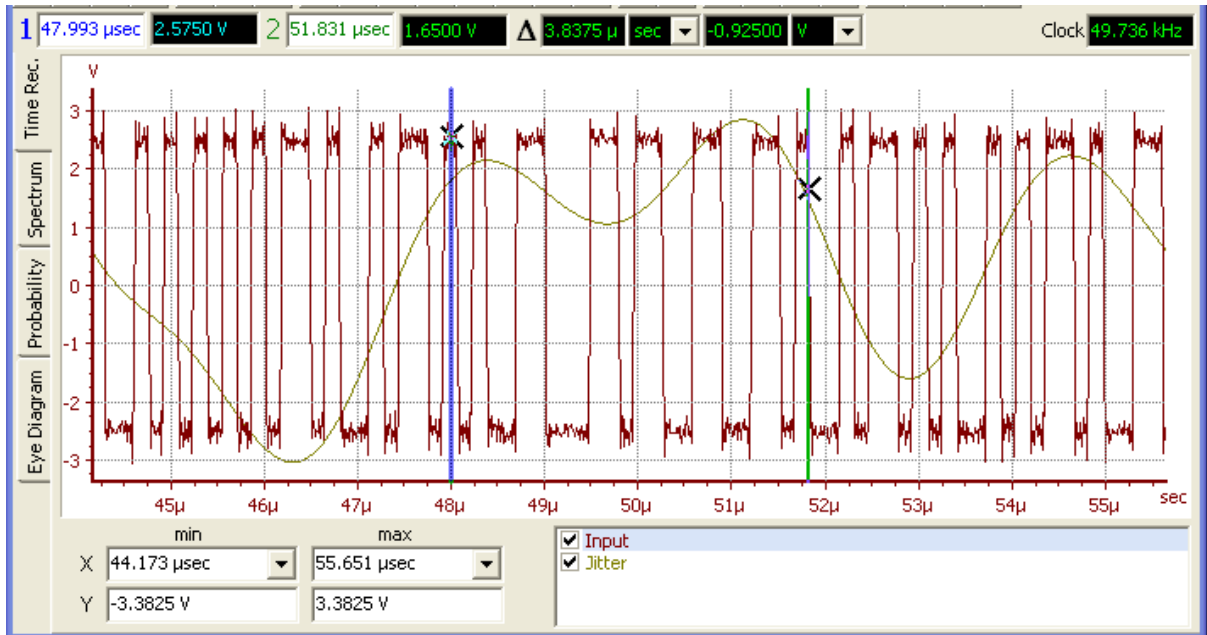

The Time Record tab of the Digitizer Display shows the two amplitude vs. time measurements of the digitizer: input amplitude vs. time, and jitter amplitude vs. time. The input amplitude vs. time trace shows the raw digitizer data i.e. essentially an oscilloscope display of the input signal. The jitter vs. time trace shows the jitter amplitude calculated by the digitizer as a function of time. Jitter amplitude may be displayed in units of seconds or UIs. If either trace is sufficiently zoomed in, the display interpolates points between the actual measured points to provide a smoother visual presentation. The X-axes of the input amplitude and jitter amplitude traces are always the same.

Spectrum Tab

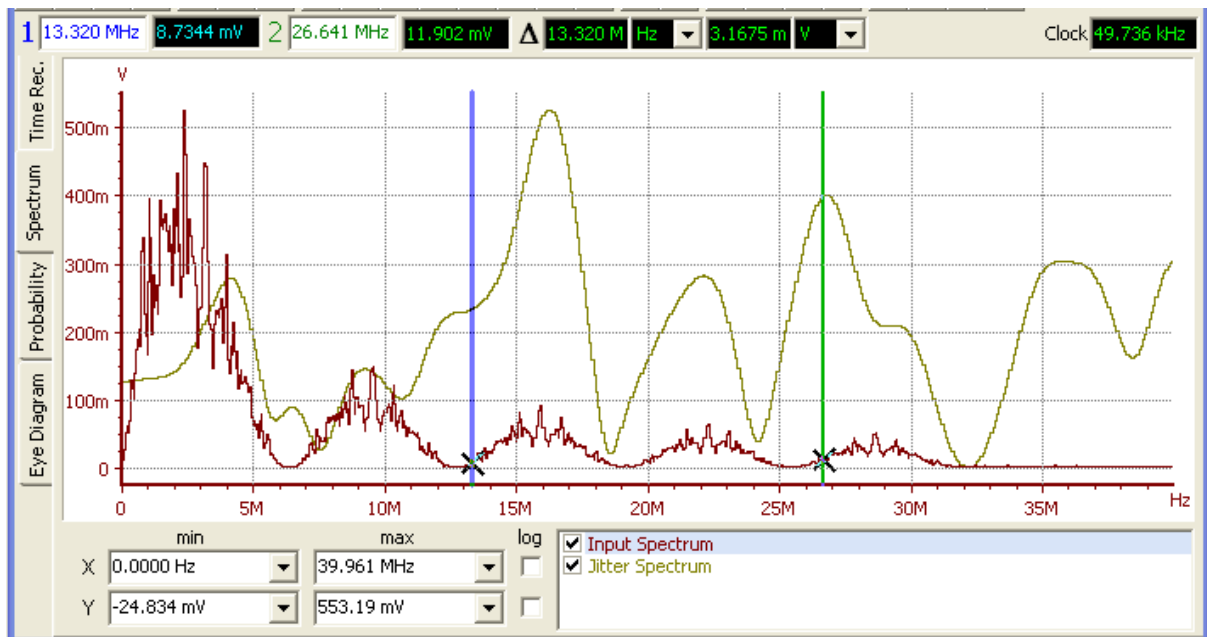

The two traces on the spectrum tab show the FFTs of the input signal and the jitter signal. Each FFT is calculated using all the data in the input or jitter time records. The resolution of these spectra is set on the Spectrum tab of the Digitizer panel. Note that the FFT of the input signal shows the essentially square-wave characteristic of the digital audio carrier signal while the spectrum of the jitter signal will depend on the nature of the detected jitter. If there are fewer jitter data points than FFT lines SR1 will zero-pad the jitter data when computing the jitter FFT spectrum. The jitter record length display on the digitizer panel will be shown in yellow to indicate that insufficient data is available for an accurate jitter FFT spectrum.

Probability Tab

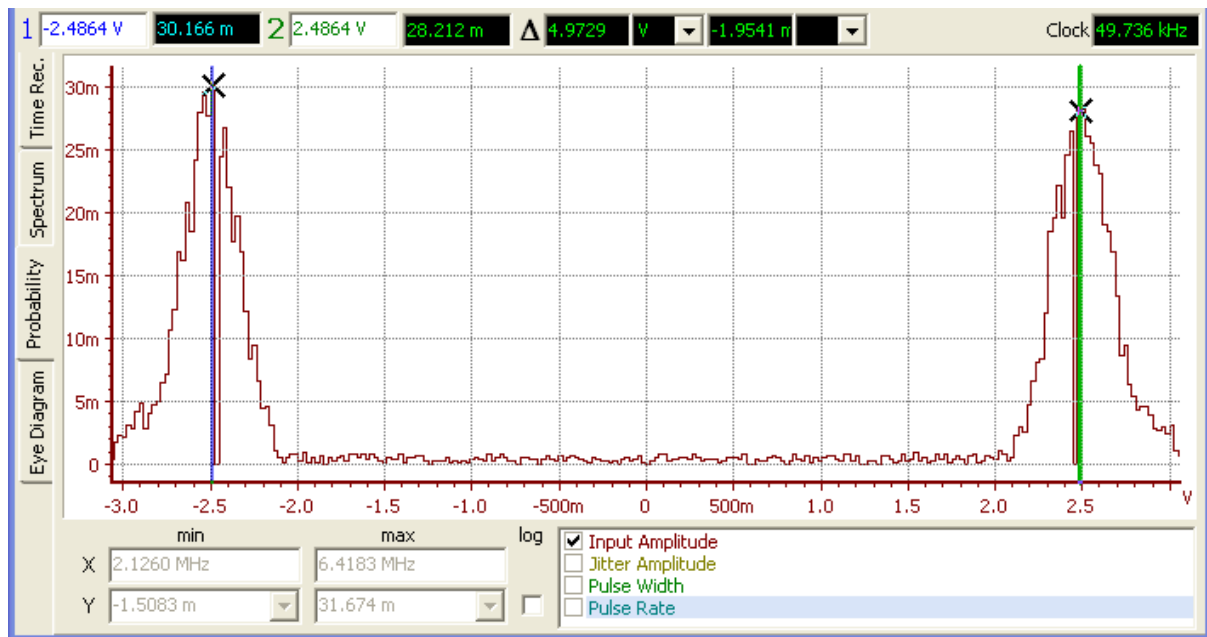

The probability tab shows the histograms for input amplitude, jitter amplitude, pulse width and pulse rate. All 4 histograms are normalized as "probabilities" i.e. the y value for each bin represents the fraction of the total events (amplitude samples or pulses) that fall in that bin. A typical input amplitude histogram, shown above, shows two peaks corresponding to the positive and negative values of the input carrier signal. For a professional or consumer digital audio signal the pulse width histogram typically shows two peaks corresponding to the numerous 1 and 2 UI wide pulses in the signal and a smaller third peak corresponding to the 3 UI pulses found only in the preambles of the digital audio signals. The pulse rate histogram is simply the histogram of the reciprocal of the pulse width values.

Eye Diagram Tab

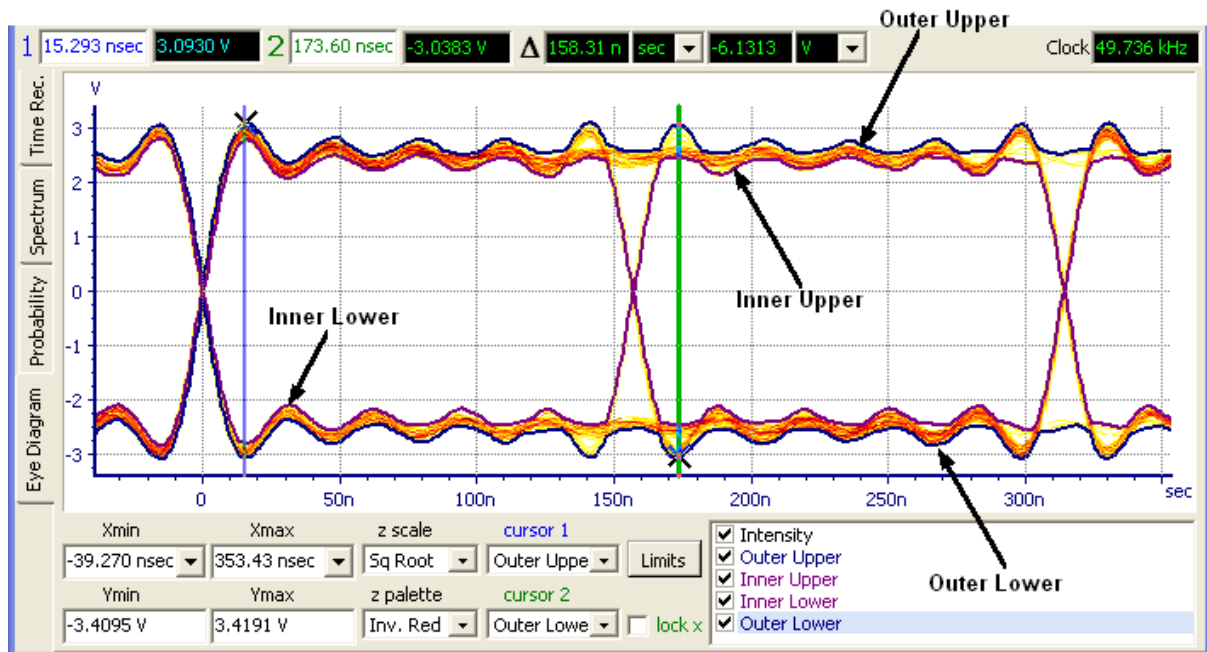

The eye diagram is a plot of probability vs. amplitude and time with probability coded as color. The Digitizer Display assembles overlays the signal transitions corresponding to the "Jitter Detection" selection on the [digitizer](#) panel and calculates the probability of the signal appearing at a given time with a given amplitude. The probability is mapped to a user-selected color palette and an appropriately colored point is plotted on the display. If the  icon is active in the speedbar, the probability can be directly examined by moving the mouse over the desired point.

By examining the probabilities, the Display computes four "envelope" traces corresponding to the inner and outer limits of both the upper and lower portions of each transition. Selecting a trace from the "Cursor 1" or "Cursor 2" control links that cursor to the selected trace. Note that unlike the graph, clicking on a trace in the trace listing window of the Digitizer Display does *not* link the cursor to that trace. Checking "Lock X" locks the X value of the two cursors to the same value so that differences between any of the envelopes can be read off directly on the cursor display bar.

Z-scale and Color Selection

The mapping from probability to color can be selected as linear, square root, or logarithmic with the "Z-Scale" control. Linear mapping tends to produce the most "washed out" color display while logarithmic produces the most intense color. The "Square Root" selection tends to be a good compromise between the two extremes. A range of color palettes are available. Color palettes beginning with "Inverse" display on a white background while the remaining palettes display on a black graph background.

Eye-Limits

The Digitizer Display can test both the width of the eye-opening and the maximum positive and negative voltage of the input signal against pre-determined limits. To enable limit testing press the "Limits" button on the Eye Diagram tab.

There are three sets of limits for the eye diagram. The Outer Limits, (not to be confused with the classic television series of the same name) are two voltage values which specify the maximum positive and negative values of the input signal.

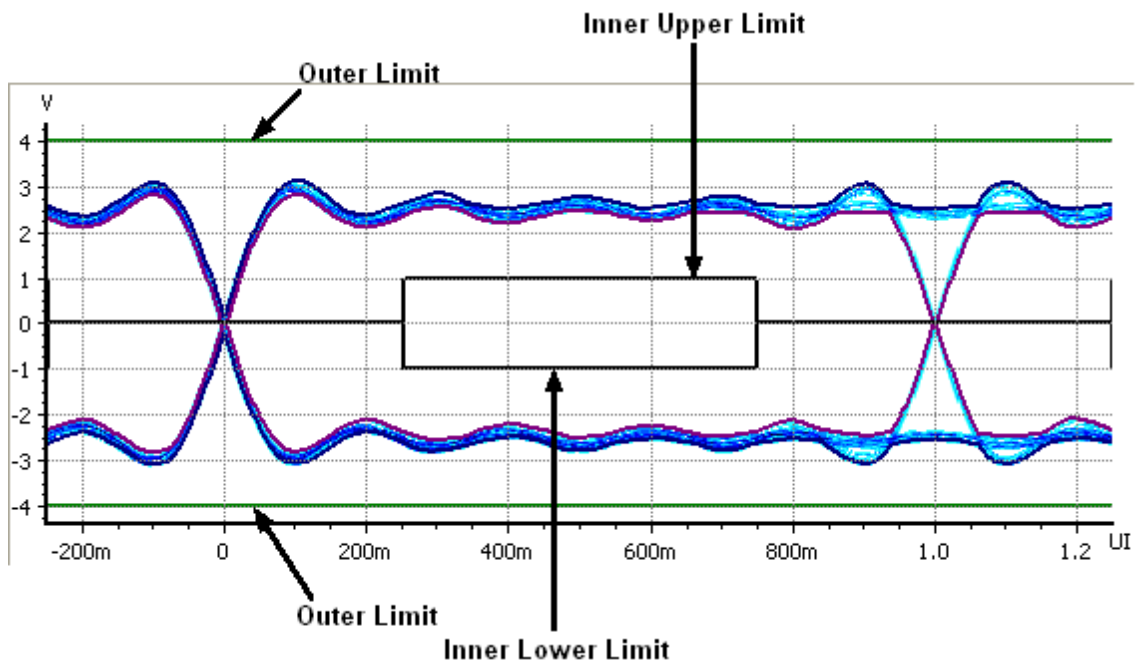

The Inner Upper Limit and Inner Lower Limit determine the minimum width of the eye opening. The limit box can be forced to be symmetrical around the time axis by checking the "Mirror Up/Down" box on the Inner Lower Limit tab. The Inner Upper Limit can be made to be symmetric around the center of the eye opening by checking the "Mirror Left/Right" box on the Inner Upper Limit tab. Arbitrarily complex limit shapes can be created for the Inner limits by entering a sequence of UI and Voltage values into the list on the Inner Limit tabs. The Replace, Add, and Delete buttons can be used to modify the list and the shape of the limit box.

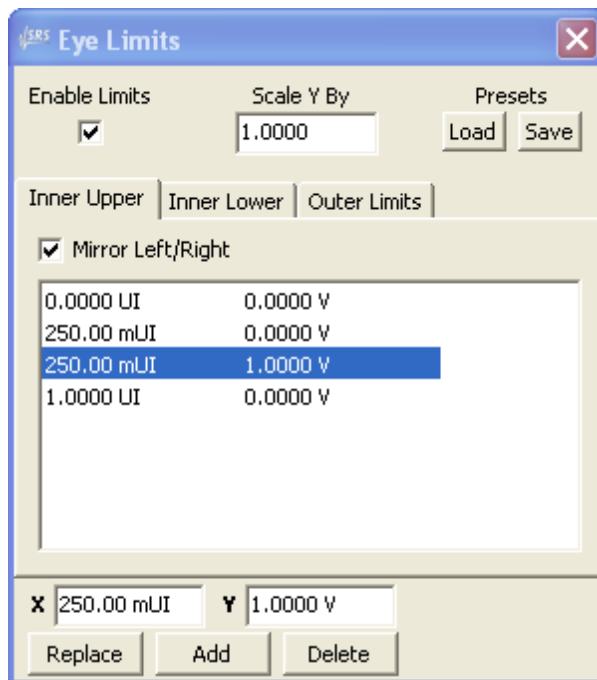

The "Scale Y By" control can be used to scale the Y values of all the limit segments simultaneously so

that the entire limit box can be quickly scaled up or down. Limit settings can be saved to disk and recalled with the "Load" and "Save" buttons on the Eye Limits panel.

When Eye Limit Testing is enabled, the text on the Limits button is drawn in **Red** when the eye diagram plot fails any of the limit tests.

2.5.4 Other Display Menu Options

Save All Displays

Saves all displays (Graphs, Bar Charts, and Digitizer Displays) to an .XML configuration file. When this option is selected a file dialog appears which allows selection of the file and directory. The file dialog contains an additional option which controls whether data is saved with the file, or whether the display is saved as a "placeholder" with all options and scales preserved, but no trace data. "Never Save" saves none of the trace data. "Always Save" saves all of the trace data. "Save if Offline" saves trace data only for offline traces but not for live traces.

Load Displays

Recalls displays saved with either the "Save All Displays" main menu selection or with the "Save" button at the top of the graph speedbar. Recalled displays are placed on the same page and position on the page control that they were originally on when saved.

Delete all Displays

Deletes all displays (Graphs, Bar Charts, and Digitizer Displays) from all tabs of the page control.

Goto Page....

This options selects a new active page on the page control. Select a page from the submenu and the active page will be changed. The same action can be accomplished by simply clicking on the desired page tab at the right of the SR1 screen.

Move Form To Page....

Moves the active panel or graph on the current page to the page selected from the submenu.

Tile Forms

Moves all panels and displays on the active page of the page control to minimize overlap between windows.

2.6 Tools Menu

The Tools menu provides access to options for customizing the operation and appearance of SR1, integrating SR1 into a network environment, and accessing standard Windows computer functionality. The Tools menu options are:

Preferences Panel	Opens the SR1 User Preferences panel
Events Panel	Opens the SR1 Events panel. Links SR1 events with user configurable actions.
Switcher Configuration	Opens the Switcher Configuration panel. Configure networks of I/O switchers.
Hardware Info	Display the status of SR1's hardware.
Networking	Customize the network environment.
Computer Functions	Provides standard Windows computer options: printers, disk ejection, etc.

2.6.1 Preferences Panel

Unlike most SR1 controls, items selected on the preferences panel **retain their value each time SR1 is started**.

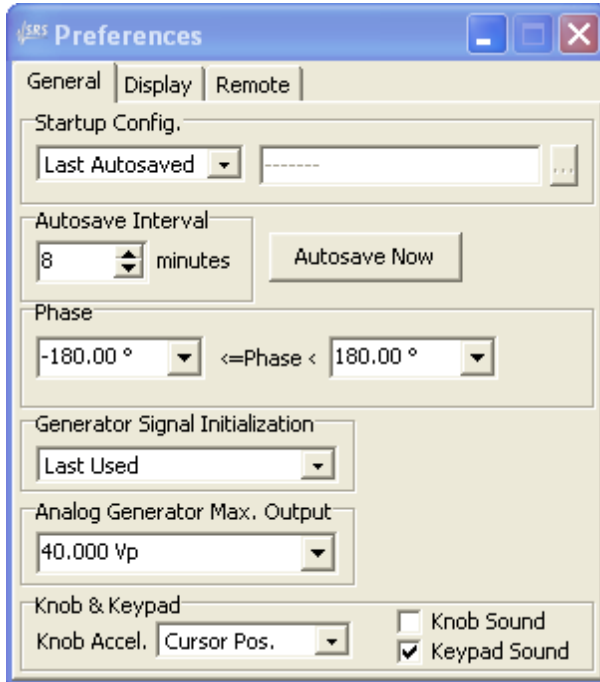

Startup Configuration

The "Startup Configuration" parameter controls SR1's behavior on startup. "SR1 Default" means SR1 will startup in its fixed default configuration each time the instrument is turned on regardless of the configuration when the instrument was last turned off. "User Default" means the instrument will load a user-specified configuration file when the instrument is started. Use the file selection button to select any SR1 configuration file to load at startup. "Last AutoSaved" tells SR1 to use the last Auto-Saved configuration file at startup. SR1 periodically saves a configuration file at the interval specified by "Autosave Interval." If "Last Autosaved" is selected SR1 will load this configuration file ensuring that the instrument starts up in the same state that it was turned off in. The Autosave file can also be used to recreate the instrument's state in the event of a crash. (The autosave configuration file is called "autosave.xml")

Phase

Select any 360° interval. All phase controls and measurements will be shifted into this interval when displayed.

Generator Signal Initialization

This control governs the parameter values for newly selected generator signals for both the analog and digital generators. "SR1 Default" means that all signals will be created with fixed default values for amplitude, frequency etc. Typically the default value for amplitude is "0", and the frequency is "1 kHz." "Last Used" means that signals will be created with the frequency and amplitude values set to the last used values for that particular signal. "Last Used Except Amp" is similar but guarantees that the signal amplitude is set to 0 on creation. "Last Used (signal off)" is again similar, but creates the signal with the "waveform on" box unchecked.

Analog Generator Maximum Output

This selection limits the maximum analog generator peak voltage to the specified value. This can be useful in avoiding accidental over-voltages when the generator is connected to sensitive equipment.

Knob & Keypad

The two checkboxes turn on and off the sounds produced when the knob is turned, or a key on the front-panel keypad is pressed. The "Knob Acceleration" control determines how the selected parameter changes when the knob is turned. "Exponential" and "Power Law" are continuous acceleration profiles which smoothly increase the amount by which the selected parameter changes as the knob turns. When "Cursor Position" is selected turning the knob increments or decrements the digit just to the left of the current cursor position.

Display Preferences Tab

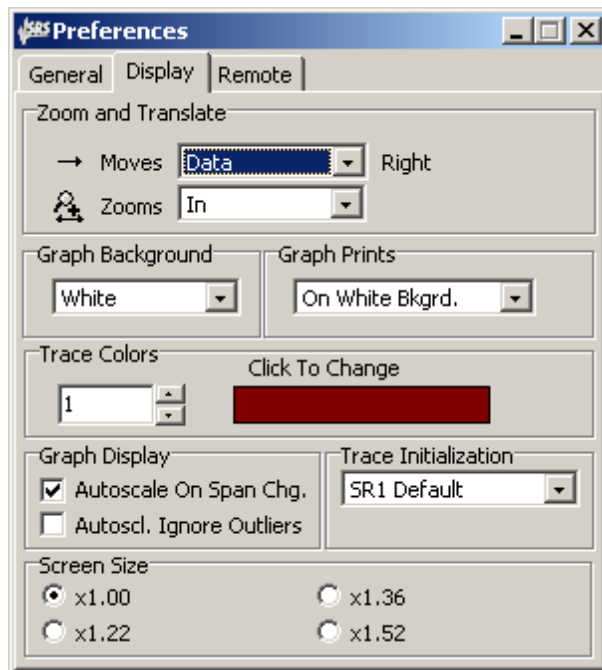

Zoom and Translate

These controls select the sense of the Zoom and Translate controls on both the graph and digitizer graph displays. Depending on which feels more natural the "left arrow" can be selected to move either the data to the left or the axes to the left. Likewise the  icon can be configured to zoom the display in or out.

Graph Background

Select a White or Black background for the graph displays. This selection only affects new graph displays, not displays already on the screen. For printed graphs, the "Graph Prints" control selects whether the printed background is the same as the screen background color or is always white.

Trace Colors

All graph displays use the same set of default colors for each trace. To change the default color for the n th trace, select the desired trace and click on the color bar to bring up a color dialog and choose a new color. Note that the set of default colors is different depending on whether a black or white graph background is chosen. Typically brighter colors work well on the dark background and darker trace colors show up better on the white graph background.

Autoscale Options

When Autoscale on Span Change is selected graph traces that are linked to live FFT measurements will have their X-axis automatically autoscaled to the FFT span whenever the FFT span is changed. Normally, the autoscale algorithm looks at all the points in a trace and chooses a graph scale to include all points. When Autoscale Ignore Outliers is selected the autoscale algorithm ignores points that it considers outliers. This is useful to avoid having a relatively few stray points distort the graph scale.

Trace Initialization

Selecting "SR1 Default" means that each time a new trace is added to a graph, the X and Y-axis units will be set to the SR1 default for that type of trace. For example, an FFT power spectrum trace will always be added with the X-axis in Hz and the Y-axis in Vrms. Selecting "Last Used" means that SR1 will use the most recent user units for the particular type of trace.

Screen Size

When equipped with the optional XGA display the SR1's default panel size may be too small for some users to read comfortably. Changing the screen size allows a uniform magnification of all panels and displays on the screen. Note that the main menu at the top of the screen is unaffected by this setting.

Remote Commands Preferences Tab

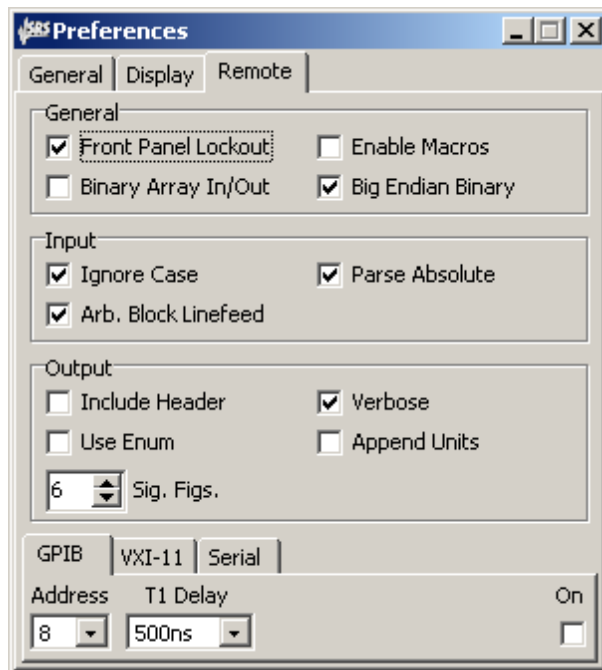

Front Panel Lockout

The IEEE-488 standard specifies that after receipt of a command the instrument is placed in "Remote" state in which the front panel controls are locked out. This can be inconvenient during development. Unchecking this box allows the user to have front panel access without having to press the "Local" key. SR1 never enables the "Local Lockout" state.

Enable Macros

By default, GPIB macros are disabled on startup, as specified in the IEEE-488.2 standard. Selecting this option enables GPIB macros when SR1 starts up.

Binary Array In/Out

By default all remote data interchange with SR1 is done in ASCII format. To maximize transfer rate for large arrays "Binary Array In/Out" can be selected which instructs SR1 to transfer all array data in binary. When selected, integer arrays are transmitted and received as arrays of 32 bit binary values while floating point array data is transmitted and received as arrays of 64 bit double-precision data.

Big Endian Binary

The IEEE-488 standard specifies that binary data is sent in "Big-Endian" format, i.e. most-significant-byte first. However, most PCs natively store floating point data in memory in "little-endian" format, i.e. least-significant-byte first. This would normally then require byte swapping before sending or receiving binary data. Un-checking this box instructs SR1 to send and receive binary arrays in little-endian format. This option has no effect unless "Binary Array In/Out" is selected.

Input Options**Ignore Case**

Checking this box instructs SR1 to ignore the case of incoming remote commands, as specified in the IEEE-488.2 standard. When un-checked, all commands must be sent with the exact case specified in the "SR1 Remote Programming Reference."

Parse Absolute

When checked, SR1 requires that a full path specifier be sent with each command. Un-checked, the object referenced by the previous command will be considered the "default" for the next command. For instance, the command:

```
:AnlgGen:AGenChA:Gain 0.45
```

sets the gain of the Analog Generator channel A to .45. When Parse Absolute is selected this command could be followed, for instance, by the command:

```
:AnlgGen:AGenChA:On 1
```

to turn on the generator channel. Un-checking parse absolute means that the second command could be abbreviated as:

```
On 1
```

All commands subsequent to the first would be understood to point to the `:AnlgGen:AGenChA:` object until another explicit object reference is sent. Although "Parse Absolute" is the IEEE-488.2 standard, it is often more convenient when configuring the instrument, which often requires sending many commands to the same object, to use the abbreviated form.

Arb Block Linefeed

By default, the linefeed character is a required terminator for GPIB arbitrary length block data. When un-checked, the linefeed is not required.

Output Options**Include Header**

Checking this box causes SR1 to include the path header in its response to query commands. For instance, with the box checked, the response to:

```
:AnlgGen:AGenChA:Gain?
```

is

```
:AnlgGen:AGenChA:Gain 0.45
```

while if "Include Header" is off, the response is simply:

0.45

GPIB Options

GPIB			VXI-11	Serial
Address	T1 Delay	On		
8	500ns	<input type="checkbox"/>		

The address control selects the primary GPIB address for the instrument. The T1 delay sets the interval between the time the data lines are set on the bus and the time that "Data Valid" is asserted. The default value of 500 ns is usually sufficient. Checking the "On" box turns on the GPIB interface and enables sending and receiving of remote commands over the GPIB bus.

Serial Port Options

GPIB			VXI-11	Serial		
COM	Baud Rate	Data	Parity	Stop	Handshake	On
2	9600	8	N	1	RTS/CTS	<input checked="" type="checkbox"/>

The rear-panel serial port connector may also be used to communicate with SR1. The COM port selection is only relevant when SR1 is being run in demo mode on a PC. On the instrument all choice will be grayed out except the the port that is actually connected to the rear-panel connector. The other serial port options such as Baud Rate, Data bits, etc. should be set according to the device that will be communicating with SR1. Checking the "On" box enables sending and receiving data over the serial interface.

VXI-11 Options

GPIB			VXI-11	Serial
Core Port	Abort Port	Max Links	Active Links	On
1000	1001	1	0	Security <input checked="" type="checkbox"/>

The Core Port is the main TCP/IP port on which VXI-11 commands are sent and received. The abort port is a secondary port used to send abort commands only to the instrument. SR1 does not respond to commands on the abort port. The core port and abort port must not conflict with other applications on the computer used to communicate with SR1. Any firewall on the communicating computer must open the main port, the abort port, and the Sun RPC port (port 111) for VXI-11 communications to work. Max Links determines the maximum number of simultaneous VXI-11 connections that SR1 will allow. Commands received over multiple connections are processed on a first come-first served basis.

VXI Security Panel

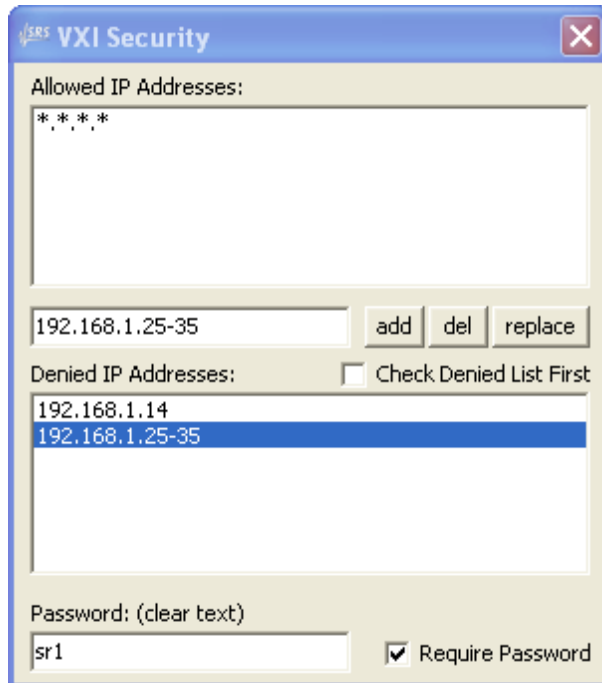

Basic VXI-11 security measures can be configured on the VXI-11 Security Panel, which is accessed from the VXI-11 Options tab by pressing "Security." The panel includes controls for creating a list of IP addresses that will be allowed to connect to SR1 as well as a list of IP addresses that will be denied access to SR1. By default, SR1 checks the allowed list first but if "Check Denied List First" is checked, then SR1 will check the denied list first. The wildcard character (192.168.1.*) as well as explicit ranges of addresses (192.168.1.30-55) are allowed in both lists.

As an example, to allow only a specific range of IP addresses to connect to SR1 one would specify *.*.* in the denied list and the required allowed address range in the allowed range. "Check Denied List First" should remain unchecked in this case. (Otherwise, SR1 would deny access to all IP addresses) Alternatively to allow access to all computers except those in a specific address range one could enter *.*.* in the allowed list and the range of addresses to be denied in the denied list with "Check Denied List First" checked in this case.

The optional password is a clear text message that must be sent via VXI-11 immediately after connecting to SR1. The user has 3 tries to enter the password after connecting before the connection is closed by SR1. SR1 will not response to further VXI-11 commands until the correct password has been entered.

2.6.2 Events Panel

The events panel allows the user to link the occurrence of certain events within SR1 to a variety of user specified actions: file logging, audio alarms, running of scripts, or the firing of COM events. Configuration of the events panel is not necessary during ordinary use of SR1 but can be used to create highly customizable test configurations. The panel shows each of the events that can be tracked, arranged in functional groups. The leftmost checkbox enables tracking of the selected event-this box must be checked for all the other configured actions to occur. The next check box to the right of the event description enables logging of the event to a text file. The "Tone" control allows selection of an audio tone which is played when the selected event occurs. The "..." (ellipsis) button to the right brings up a file dialog allowing selection of a [script](#) which is executed when the event occurs. Finally, the last control on the right allows firing a COM event when the event occurs, which can be trapped and acted upon by a local script or a remote program written in Visual Basic, Microsoft Office, or other COM enabled programming environments.

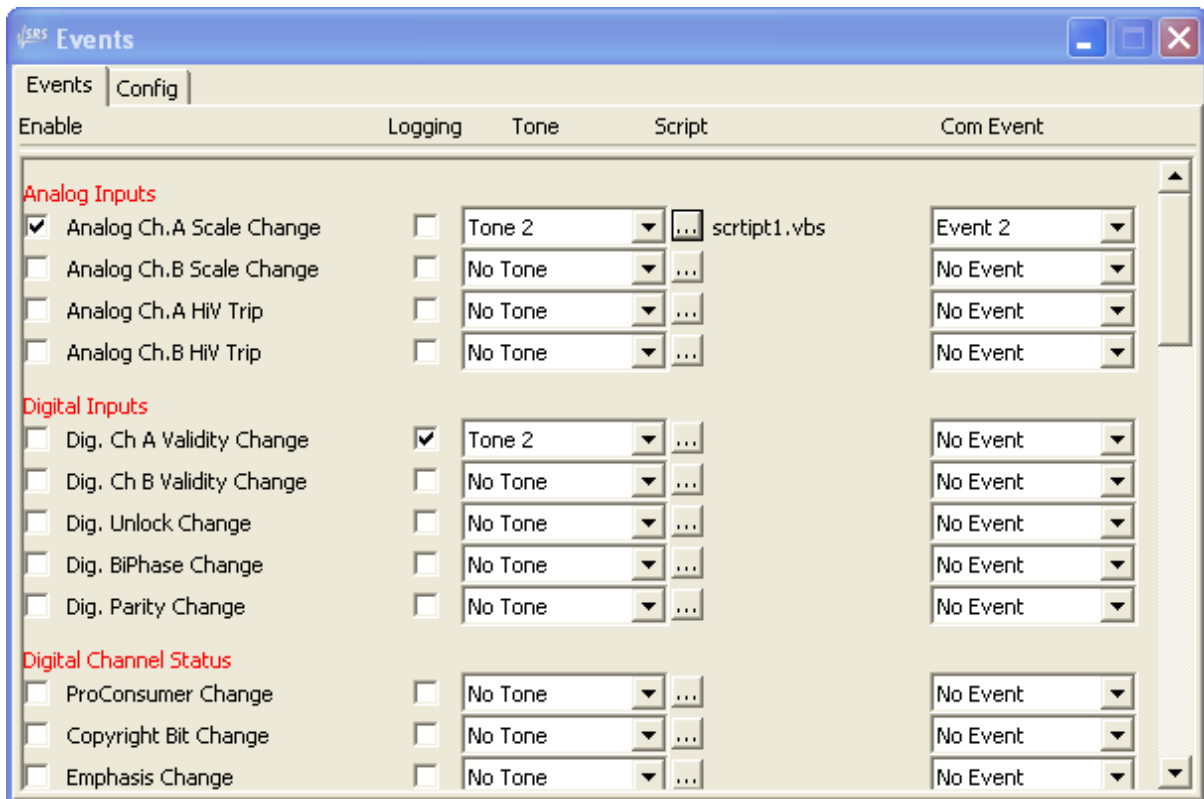

Event Definitions

The following table lists the events shown on the Event Panel along with a description when the event occurs.

Event	Description
Analog Inputs	
Analog Scale Change A,B	Occurs when the input range changes for the specified analog input change. The change can occur as a result of a manual range change or range change due to

	autoranging.
Analog HiV Trip, A,B	Occurs when the analog input High-Voltage protection triggers due to a potentially damaging input voltage on the specified channel. The high-voltage protection will automatically clear itself once the high-voltage is removed.
Digital Inputs	
Validity Change A,B	Occurs when the status of the validity bit for the specified channel of the digital audio input changes.
Unlock Change	Occurs when the " Unlocked " status of the digital audio input changes.
BiPhase Change	Occurs when the " BiPhase Error " status of the digital audio input changes.
Parity Change	Occurs when the " Parity Error " status of the digital audio input changes.
Digital Channel Status	
Pro/Consumer Change	Occurs when the received channel status format changes from Professional to Consumer or vice versa.
Copyright Bit Change	Occurs when there is a change in the status of the Copyright bit in the received consumer channel status.
Emphasis Change	Occurs when there change in the emphasis setting for the received consumer or professional channel status.
CRC Change	Occurs when there is a change in the CRC error status for the received professional channel status.
CSA Byte0-4 Change	Channel status is sent, in both consumer and professional formats in 23 byte blocks. SR1 allows up to 5 bytes to be "watched," i.e. any change in the received channel status in that byte triggers the corresponding event. The watched bytes are configured in the "Config" tab of the channel status panel. These event occurs when there is a change in the received channel status for channel A corresponding to the configured byte.
CSB Byte0-4 Change	Channel status is sent, in both consumer and professional formats in 23 byte blocks. SR1 allows up to 5 bytes to be "watched," i.e. any change in the received channel status in that byte triggers the corresponding event. The watched bytes are configured in the "Config" tab of the channel status panel. These event occurs when there is a change in the received channel status for channel B corresponding to the configured byte.
Ch. A/B User Bit Activity	This event occurs if there is any change in any bit of the the 24 bytes of the received user bits.
Sweep	
Sweep Started	Occurs when a sweep is started.
Sweep New Point Start	Occurs at the beginning of each sweep point, before settled data has been obtained.
Sweep New Point Timeout	Occurs when a sweep point times out due to inability to obtain settled data.
Sweep New Point Done	Occurs at the end of each sweep point after settled data has been acquired.

Sweep Finished	Occurs when the sweep finishes.
Trigger	
A0 Trigger	Occurs when the A0 analyzer is triggered.
A1 Trigger	Occurs when the A1 analyzer is triggered.
New Meas0-4	Up to 5 measurements may be "watched" by the events system. These measurements are configured on the "Config" tab of the events panel. The New Meas0-4 events are triggered when a new value for the corresponding measurements is calculated.
Digitizer Finished Analysis	Occurs when the optional digitizer has finished analyzing a record and creating the digitizer measurements.
Displays	
Bar Limit Exceeded	Occurs when the value displayed in any bar chart exceeds the limits set in the "Range Alarm" settings for that bar chart. The event only occurs if the "Range Alarm" is turned on. The COM event fired by this event includes an argument identifying the particular bar graph which triggered the event.
Graph Limit Exceeded	Occurs when trace limit testing fails for any trace on any graph for which it is enabled. The COM event fired by this event includes an argument identifying the particular graph which triggered the event.
Eye Limit Exceeded	Occurs when the eye diagram limit testing fails on any digitizer display on which it is enabled. The COM event fired by this event includes an argument identifying the particular digitizer display which triggered the event.
Instrument	
Keypad	Occurs when any button on the front panel is pressed. The COM Event which can be fired by this event contains a keycode argument identifying the pressed key.
Knob	Occurs when the front panel knob is turned. The corresponding COM Event includes an argument identifying the direction and amount the knob has turned.
Warning	Occurs whenever SR1 issues a warning. The text of the warning is included as an argument by the corresponding COM event.
Critical Error	Occurs when SR1 encounters a critical error. The text of the error message is included as an argument by the corresponding COM event.
Script timeout	Occurs when the execution of a script times out.
Script Error	Occurs when an error is encountered during the execution of a script.
User Event	The User event only occurs when it triggered programmatically in a script. Use the line: <pre>Call SR1.EventMgr.FireUserEvent ()</pre> to fire the user event.

Event Tab

The events tab on the events panel lists all of the defined events, organized by category. Tracking of each event is enabled by checking the corresponding check box. When being tracked, the occurrence of an event will trigger one or more of the actions configured on the events tab. If a tone is selected in the

"Tone" column, the specified tone will be played when the event occurs. If "Logging" is checked, the occurrence of the event will be recorded with a time stamp in a log file. The logfile can be set and viewed on the "Config" tab of the events panel. An example logfile is shown below for the case where "Sweep Start" and "Sweep Finished" are the events being logged.

```

SR1 Log Opened On: 12/16/2009 9:49:02 AM
12/16/2009 10:34:50 AM Sweep Started
12/16/2009 10:35:03 AM Sweep Finished
12/16/2009 10:41:23 AM Sweep Started
12/16/2009 10:41:36 AM Sweep Finished
12/16/2009 10:41:49 AM Sweep Started
12/16/2009 10:42:01 AM Sweep Finished
12/16/2009 10:42:11 AM Sweep Started
12/16/2009 10:42:21 AM Sweep Finished
12/16/2009 10:42:59 AM Sweep Started
12/16/2009 10:43:12 AM Sweep Finished
12/16/2009 10:43:55 AM Sweep Started
12/16/2009 10:44:09 AM Sweep Finished
12/16/2009 10:47:21 AM Sweep Started
12/16/2009 10:47:32 AM Sweep Finished
12/16/2009 10:47:47 AM Sweep Started
12/16/2009 10:48:01 AM Sweep Finished

```

Events and Scripting

If a script file is configured in the script column, that script will be executed when the event occurs. To associate a script with an event press the ellipsis button (...) in the script column and use the file dialog to navigate to the appropriate script (.vbs) file. To clear a script from an event double-click on the name of the script file. For example, we can write the simple script below, which simply displays a message box with the text "Sweep Done" when it is run.

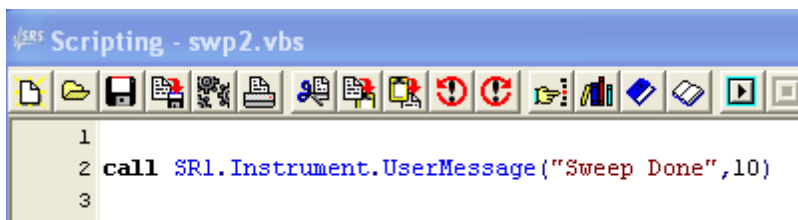

```

1
2 call SR1.Instrument.UserMessage("Sweep Done",10)
3

```

When this script is associated with the "Sweep Finished" event the panel looks like:



Now, each time a sweep is finished, the swp2.vbs script will run and the message "Sweep Done" will be displayed on the SR1 screen.

A Windows COM event may be fired in response to the event. COM events allow local or remote programs to respond to the event, including programs written in Visual Basic, MS Office, or SR1's own local scripting environment. Some events are associated with their own COM Event— for example the Sweep Finished event can fire its own COM Event called, unsurprisingly, "Sweep Finished." Other events can fire one of 5 "generic" COM Events labeled Event1 through Event5. To set up a subroutine in a SR1's scripting environment which traps a COM Event navigate the tree in the right-hand panel in the scripting window to the "Events" node and double click the event to be trapped. A subroutine declaration is started in the script window which marks the routine that will be called when the COM event is fired. For instance in the script below:

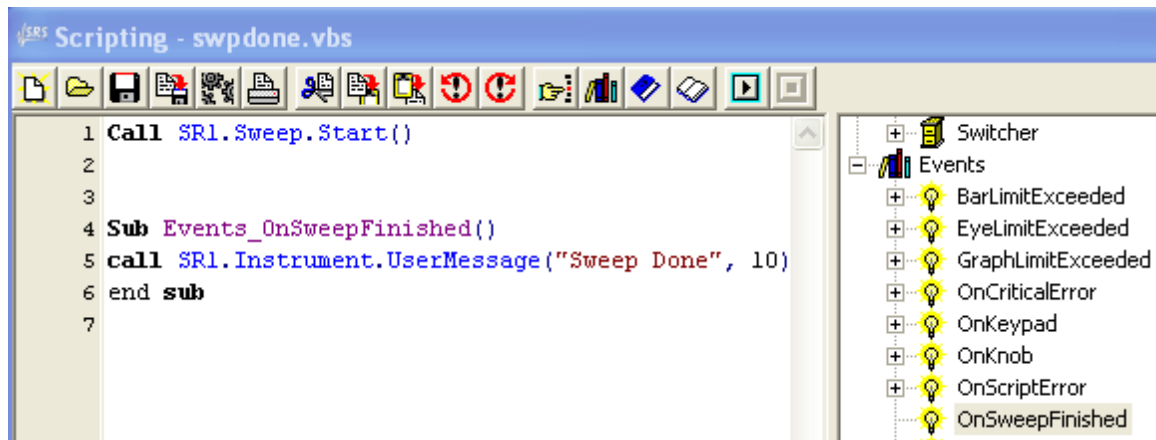

the main program simply starts a sweep. The subroutine "Events_OnSweepFinished()" was created by double clicking the "OnSweepFinished" node in the tree in the right hand panel. It traps the "Sweep

Finished" COM event. The event subroutine continues to trap events until the  button on the scripting panel is pressed. To enable firing of the "Sweep Finished" COM event configure the event panel as shown below:



More details on scripting can be found in the [scripting](#) section of this manual.



Using Events with scripts gives the user a window into the "internals" of SR1 and can offer almost unlimited flexibility if used correctly. However, care must be used when customizing events with scripts. Associating time-consuming scripts with frequently occurring events can adversely affect SR1's response time and even hang the instrument. Be extremely careful when writing event scripts.

Configuration Tab

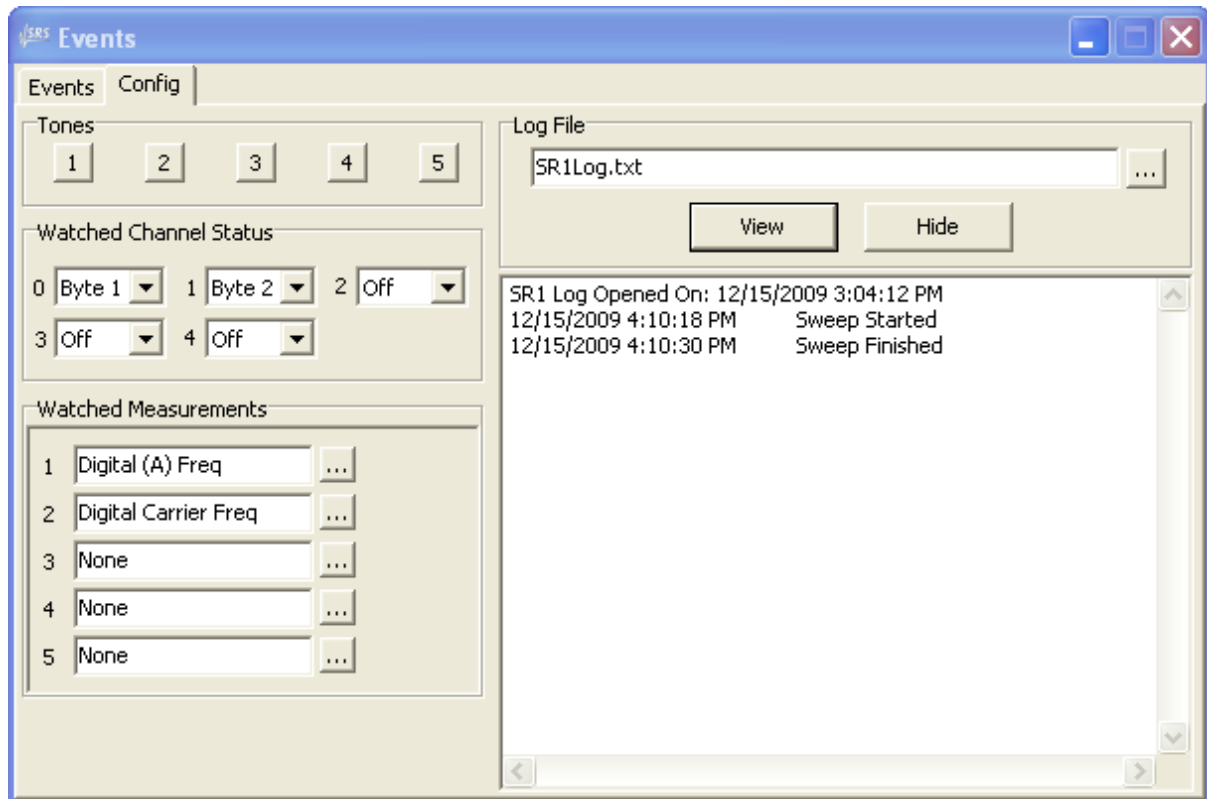

Tones

Pressing the buttons labeled 1-5 previews the tones that can be associated with each event.

Log File

Use the ellipsis button (...) to open a file dialog to select a log file. The default is "SR1Log.txt". Pressing "View" displays the current contents of the file. Note that the form is not updated automatically—pressing "View" displays a new snapshot of the file.

Watched Channel Status

Up to 5 bytes of channel status may be monitored by the events system. There are 5 events for channel A (CSA Byte0-4 Change) and 5 events for channel B (CSB Byte0-4 Change). Each event is associated with one of the bytes in the received channel status by setting the appropriate control to the desired byte. For instance, in the panel shown above, a CSA Byte1 event will be fired every time the received channel status in byte 2 of channel A changes.

Watched Measurements

Up to 5 measurements may be monitored by the events system. The 5 events (New Meas0-4) are fired when SR1 computes a new value for the associated measurement. Use the ellipsis (...) button next to the event and navigate the tree to associate a measurement with one of the 5 events.

2.6.3 Switcher Configuration Panel

SR1 is designed to work with the SR10, SR11, and SR12 switching systems from Stanford Research Systems to provide a flexible system for multiplexing SR1's inputs and outputs, both XLR and BNC. SR10 is an XLR input switcher capable of connecting any two of its twelve XLR inputs to SR1's analog inputs. SR11 is an XLR output switcher capable of routing SR1's two analog output channels to any or all of its 12 XLR output connectors. SR12 is a BNC switcher capable of being configured as either an input or output switcher. All three switchers can be operated in stereo mode (connecting a pair of inputs or outputs to one of 6 pairs of switcher connectors) or mono mode (connecting a single input or output to one of 12 switcher connectors). All three switchers can be controlled using a serial (RS-232) connection or via TCP/IP over ethernet. Up to 16 switchers can be daisy-chained together providing a switching capability of 192 channels.

Using the switchers with SR1 is a two-part process. First, the switcher network must be configured, which involves informing SR1 about the number and type of switchers and how they will be controlled as well as using the web-based control interface of the switchers to assign them unique IP or serial addresses. Details of how to configure the switchers can be found in the user manual for the SR10/11/12, which can be downloaded at www.thinksrs.com.

Once the switch network is configured the switched inputs and/or outputs will have a sequential range of logical channel numbers which identifies each potential input or output connection. It is then possible to configure a sweep over these logical channel numbers in order to repeat measurements over multiple devices connected to the switch network. Instructions for configuring a switcher sweep can be found in the [sweep panel](#) section.

Adding a Switcher to the Network

To configure SR1 with a new switch, press the "New Switch" button at the bottom of the Switcher Configuration panel.

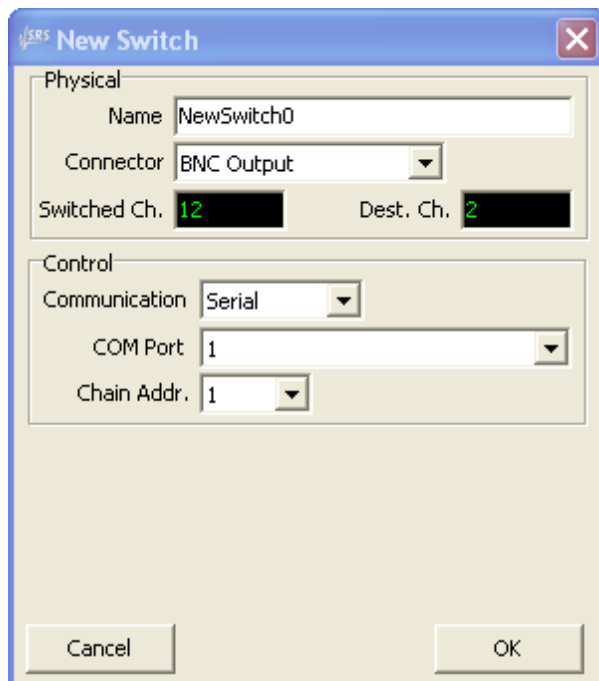

Enter a descriptive name for the new switch, and select the type of switch from the drop down list: BNC Input, BNC Output, XLR Input, or XLR Output. (Note that SR12 BNC Switchers may be used as either BNC Output or Input by setting a jumper on the switch. See the SR12 manuals for details) The number

of switched channels (12) and destination channels (2) is currently fixed— these fields are included for future operation with other switches.

The next set of controls specifies how SR1 will control the switchers: via the serial port (RS-232) or over the ethernet network. If Serial communications is selected then a serial cable must be connected from SR1's rear-panel serial port to the switcher's serial connector. The COM port control will display the available COM port on SR1's internal computer— no user adjustment of this field is necessary. The "Chain Address" identifies individual switches in a daisy chain topology. The chain address entered on the New Switch panel must match the chain address set on the switcher with the rear-panel DIP switch settings. In this configuration the serial cable is connected from SR1 to the "Serial In" port on the first switcher. The "Serial Out" port of the first switcher is connected to the "Serial In" port of the second switcher and so on. Commands are sent from SR1 to the first switch which retransmits the command down the daisy chain until it received by the switch whose chain address matches the destination of the command. (See the SR10/11/12 manual for details on how to set the chain address and how to setup switches in a daisy-chain configuration.)

If TCP/IP operation over ethernet is selected then the switch must be on the same ethernet network as SR1. Enter the IP Address and port that matches the address and port that the switch box was configured with. (The default port for the SR10/11/12 switch boxes is 600). If desired a switch connected to SR1 via ethernet can in turn be daisy-chained via RS-232 with up to 15 additional switchers. The first switch (chain address 0) receives commands from SR1 via TCP/IP and the retransmits the commands via RS-232 down the daisy chain.

Configuring the Switcher Network

The Switcher Configuration Panel displays two different views of the network of attached switchers.

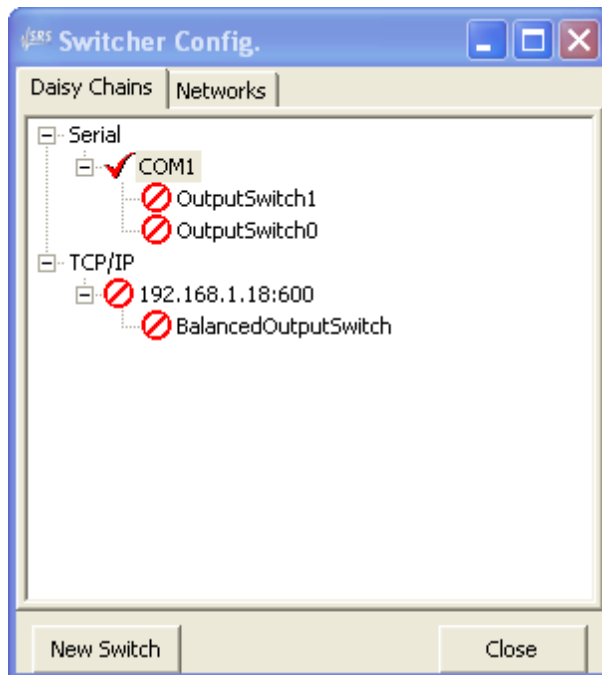

The "Daisy Chain" tab shows the attached switchers organized according to how they are connected to SR1. The "Serial" node of the tree shows all the COM ports found in the instrument and the switchers connected to each COM port. Each switcher must be assigned a unique "chain address" which identifies it. The chain address is assigned by setting DIP switches on the back of each switcher module. The TCP/IP node shows the IP addresses and port assignments of each switcher attached via

the ethernet network. Ethernet addresses and port assignments are configured using the switchers' web interface.

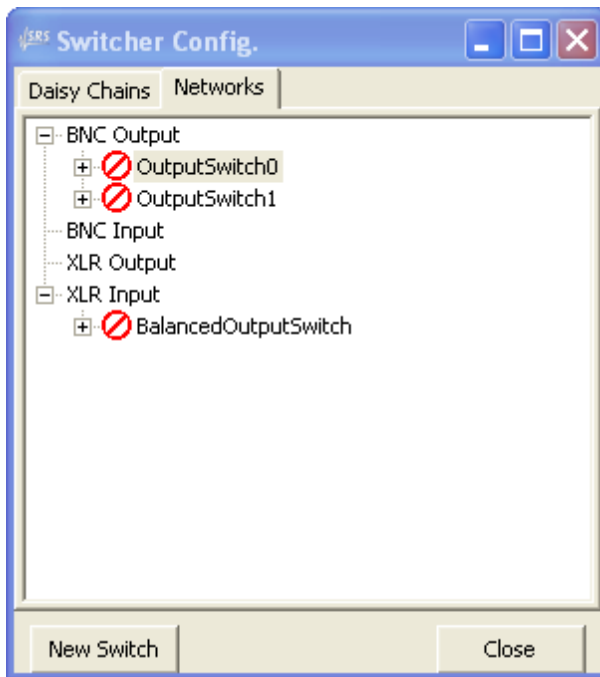

The "Networks" tab of the Switcher Configuration Panel displays the attached switchers by function: BNC output, BNC input, XLR output and XLR input. SR10 switchers are used for XLR inputs and SR11 switchers for XLR outputs while SR12 switchers can be used for BNC inputs and outputs. Opening the node corresponding to one of the switches displays the state of each connector on that switch box:

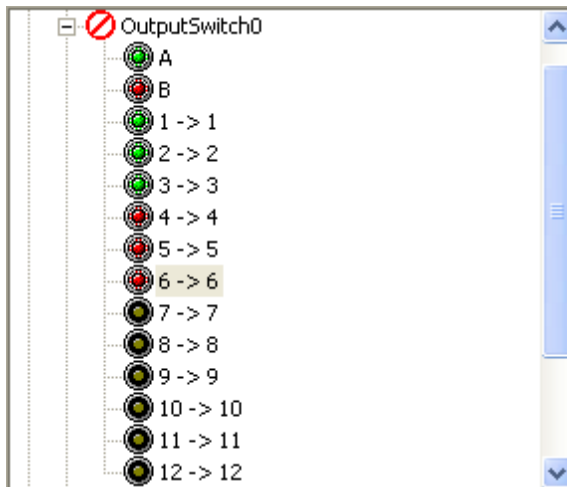

In this output switch example, output A is connected to connectors 1, 2, and 3 and output B is connected to connectors 4, 5, and 6. Double clicking on the one of the connectors toggles its status between no connection (icon is dark), connected to the A output (icon is green) and connected to the B output (icon is red). The connection status can also be set by right-clicking on one of the connector icons. Note that for an output switch the output can be simultaneously connected to several of the switchbox connectors. For an input switcher only one of the connectors can be connected to the input at a time. The numbers to the right of the connector icons identify the physical connector ID for that switch

(the first number) and the logical connector ID assigned to that connector. The physical connector IDs always range from 1-12 whereas the logical IDs can range from 1 to 192 depending on the number of connected switchers. Logical connector IDs are used when setting up a sweep over the switcher inputs or outputs.

Right-clicking on a switch displays the switch options submenu. "Delete" deletes the selected switch from the configuration. "Reset" resets all connectors to their default positions (no connection). "Identify" causes relays to click on the selected switcher so that the physical switch-box can be easily identified. "Edit" displays the Switch Info panel:

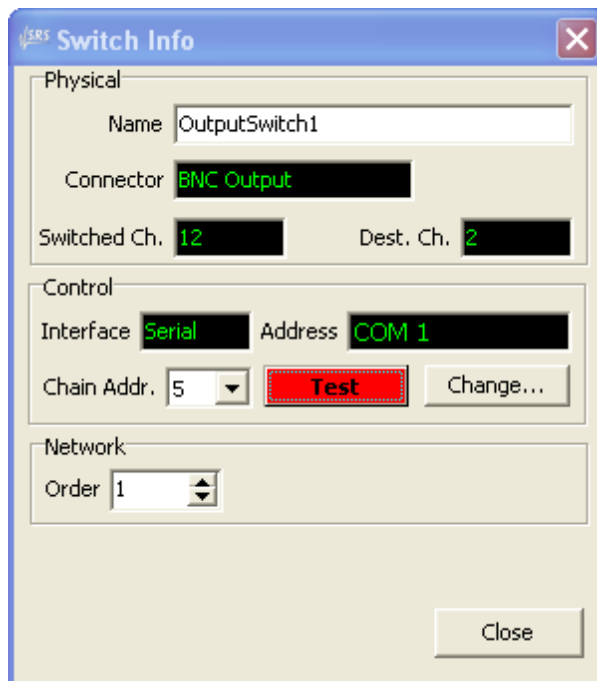

The Switch Info panel allows renaming of the switch and displays the communication parameters for the switch. Pressing "Test" tests communication with the switcher, the button turns green if SR1 successfully communicates with the switch and red if not.

2.6.4 Hardware Status

The Hardware Status panel is a diagnostic panel that is not needed for normal operation of SR1. During normal operation of the instrument, all the status indicators for all of the boards should display green. Should a red indicator appear, indicating a problem with the hardware, contact Stanford Research Systems for technical support and report which items are red in the hardware status panel.

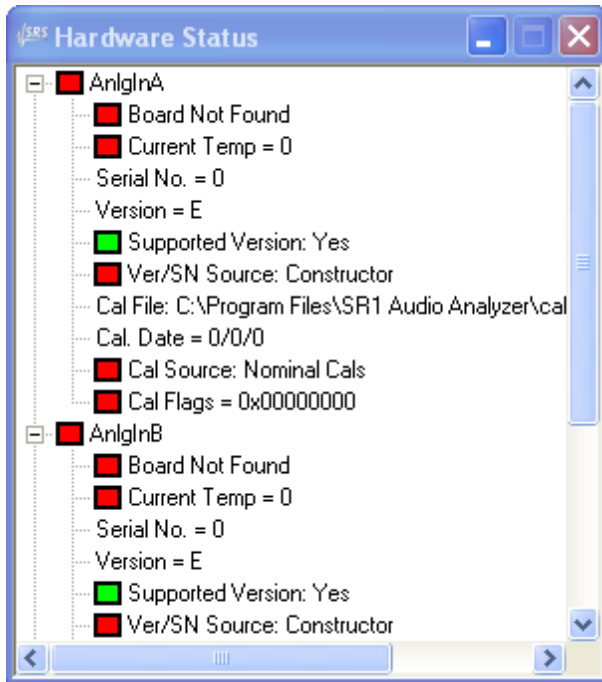

2.6.5 Networking

The following sections describe the controls used to configure operation of SR1 in a networked environment. The controls and dialog boxes described are not unique to SR1— they are from the Windows XP operating system which underlies the instrument. As such, these controls will not be described in complete detail. Only the features relevant to normal use of SR1 will be discussed. The following networking options are available:

Network Setup	Set the instrument's IP address.
Network Places	Display a list of files, folders, and computers on the network.
Map Network Drive	Map a network location to a driver letter.
Remove Network Drive	Remove a mapped network drive.
Share SR1	Allow other users on the network access to a portion of SR1's disk drive.

2.6.5.1 Network Setup

To configure SR1 in a network, select "Network Setup" from the "Networking" option in the "Tools" menu.

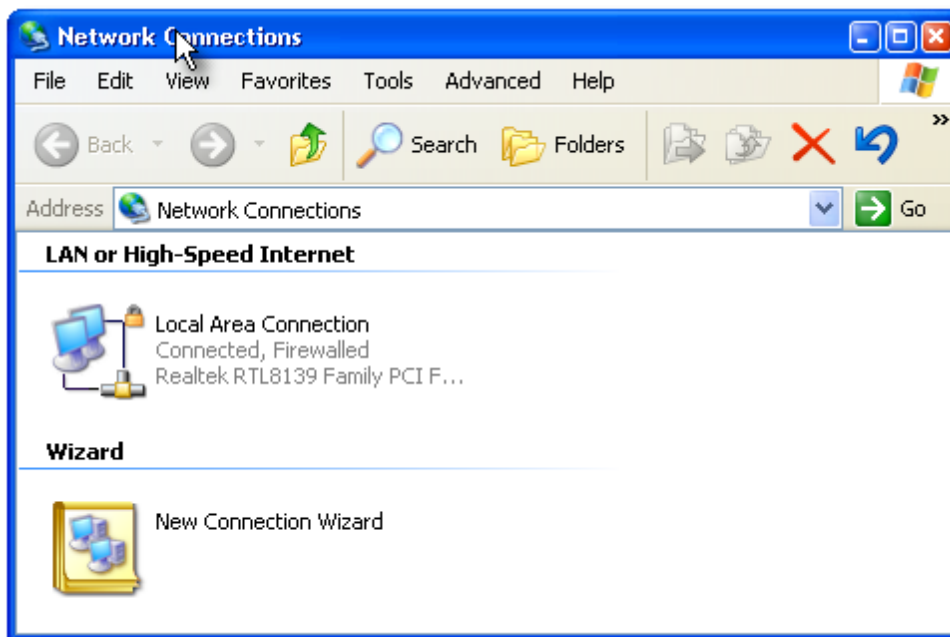

The connection which appears in the "LAN or High-Speed Internet" section corresponds to SR1's rear-panel ethernet connector. To configure this connection, right-click the "Local Area Connection" icon and select "Properties." Scroll down the list of items which appears

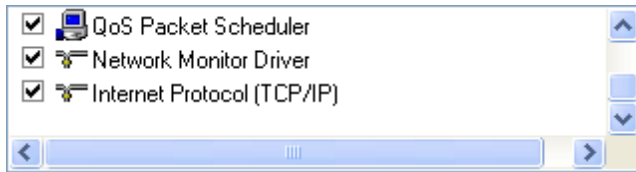

to "Internet Protocol" and right click on Internet Protocol and then click the "Properties" button below the list.

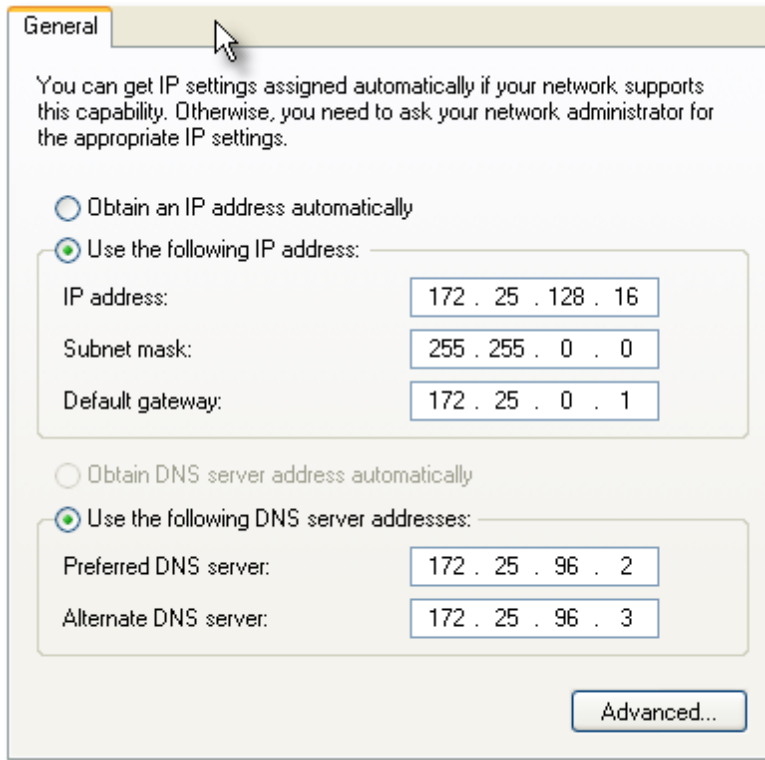

For networks supporting automatic assignment of IP addresses select "Obtain an IP address automatically." Otherwise enter the IP address, subnet mask, gateway, and DNS information manually. If none of this makes any sense contact your network administrator for the correct settings.

2.6.5.2 Network Places

Selecting "Network Places" displays folders, files, and computers located on the network. Click "Add Network Place" to specify new network locations. Select "Entire Network" to browse the entire accessible network.

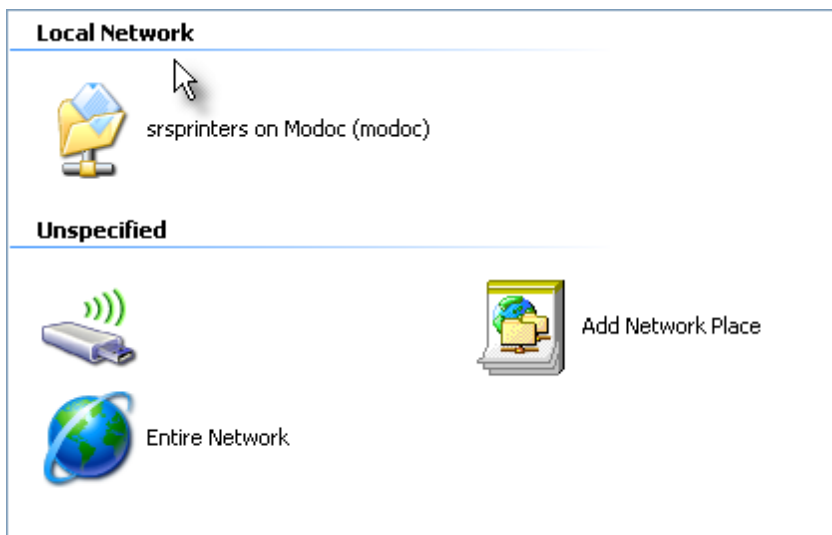

2.6.5.3 Map Network Drive

Select "Map Network Drive" to assign a drive letter to a folder on the network. Enter a drive letter name and browse the network to the desired folder. If "Reconnect at logon" is checked the mapping will be made permanent. Press "Finish" to confirm the drive mapping.

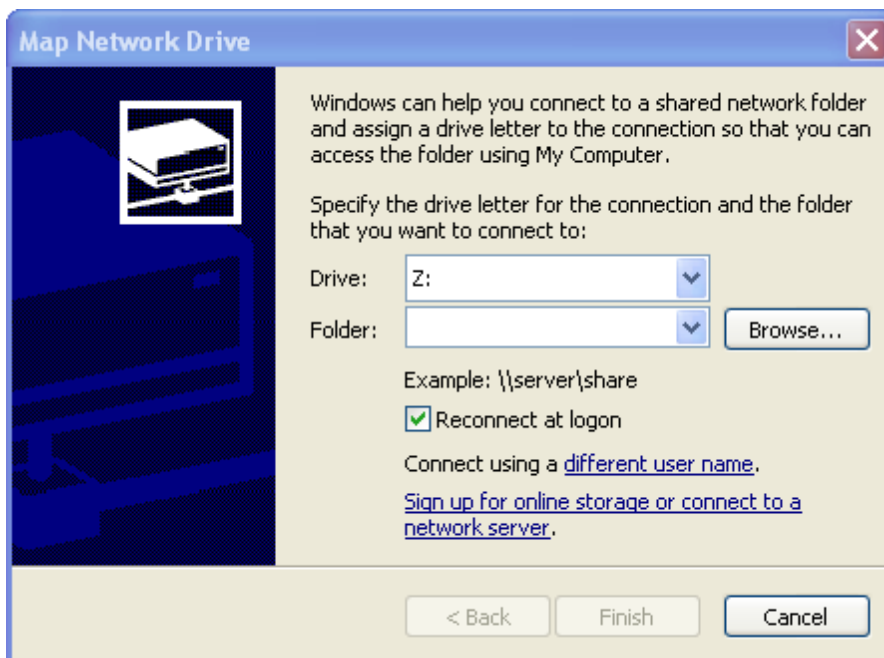

2.6.5.4 Remove Network Drive

Select "Remove Network Drive" to undo a drive mapping. Click on the drive mapping and press "OK" to remove the mapping.

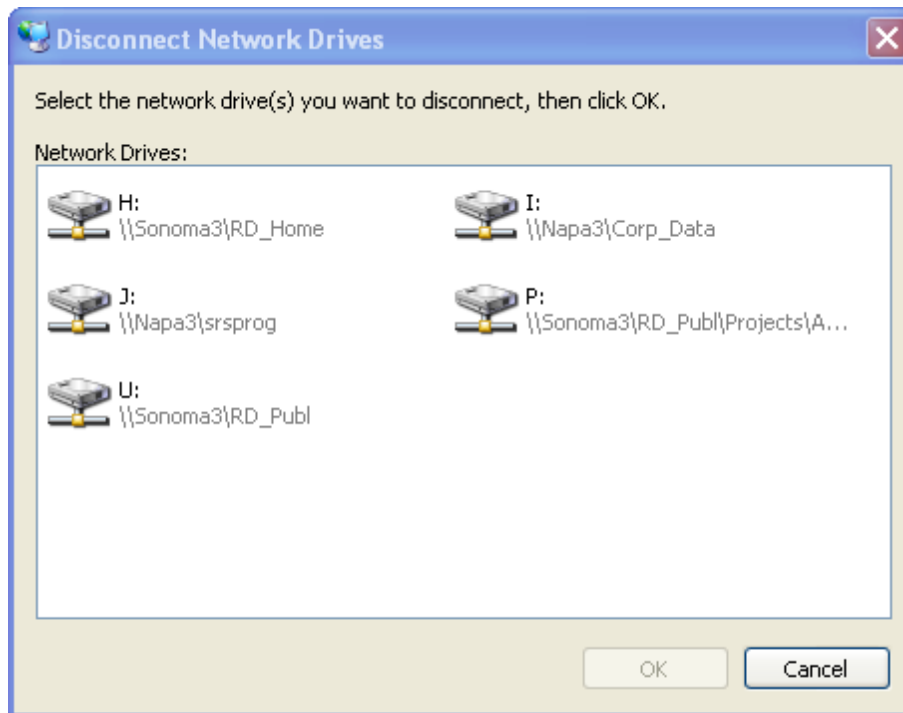

2.6.5.5 Share SR1

Selecting "Share SR1" allows sharing of the "user" folder (and its subfolders) on the SR1 hard disk with other network users. The user folder contains subfolders in which configuration files, EQ files, eye diagram limit specifications and logfiles are stored.

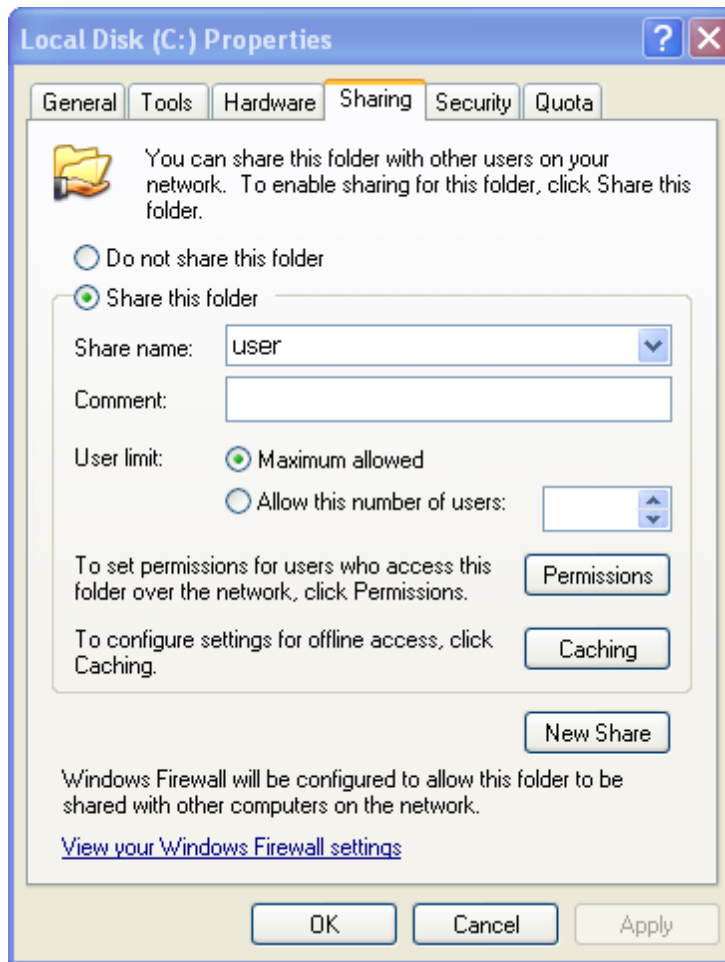

Click "Share this folder" to enable sharing of the folder. Use the Permissions button to set up a list of network users who will be allowed to access SR1.

2.6.6 Computer Functions

The Tools menu contains a number of options related to the configuration of SR1's internal computer. These are:

Printer Panel	Allows configuration of existing printer and adding new printers.
Eject Drive	Safely shuts off removable drives prior to removal.
Power Options	Sets idle time before shutting off the display and hard drive.
Date/Time	Allows setting of the internal clock.
Virtual Keyboard	Brings up the virtual keyboard for text entry without a physical keyboard.
Update SR1	Updates SR1 to the latest version of firmware.

2.6.6.1 Printers Panel

SR1 can print to a USB printer directly connected to the front-panel USB port or to any printer on the network. Click "Add a printer" to configure a new printer.

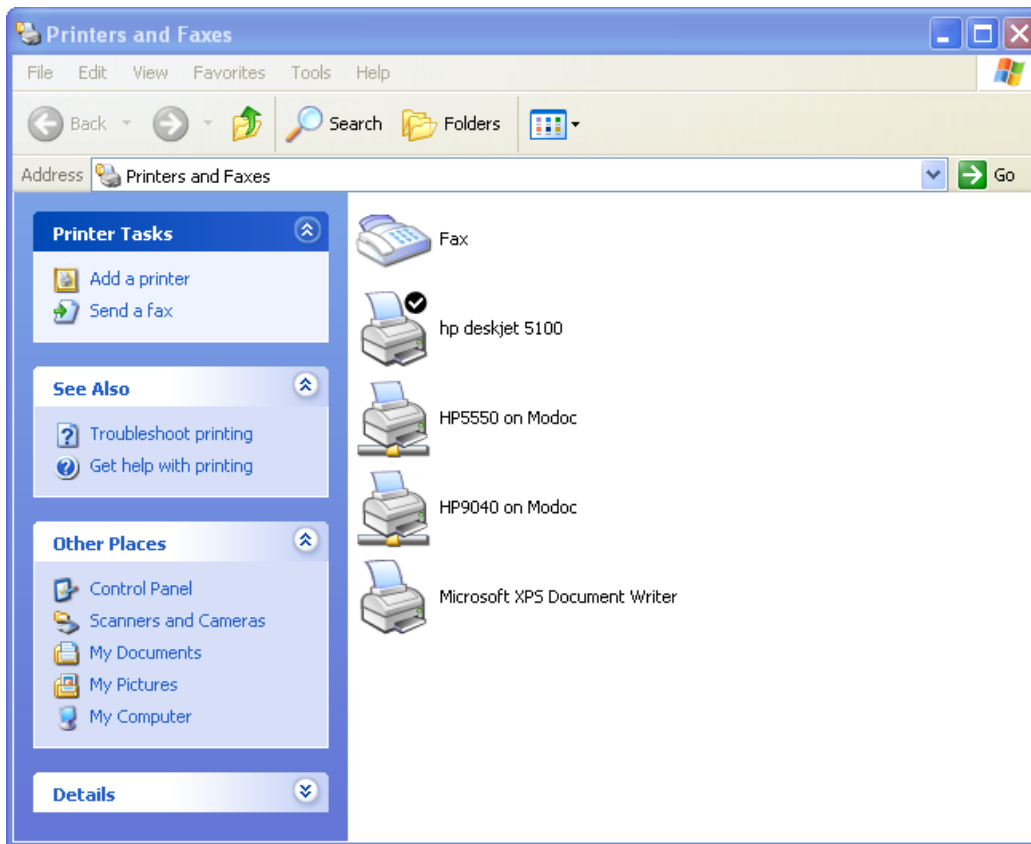

When installing a printer on SR1 the printer driver files must be either in an accessible network location or on a USB drive connected to the instrument.

2.6.6.2 Eject Drive

Select "Eject Drive" to safely shut-down a USB drive connected to SR1 before removing it.

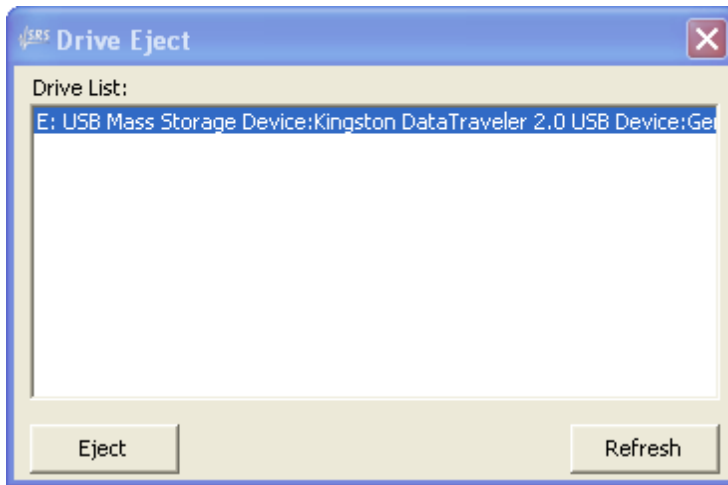

Select the drive to be shut down and press "Eject" before removing the drive.

2.6.6.3 Power Options

Selecting "Power Options" allows setting the idle-time interval before SR1's computer shuts off the monitor or hard disk. Any mouse movement or keyboard activity will turn on the monitor and/or hard drive after they have been turned off.

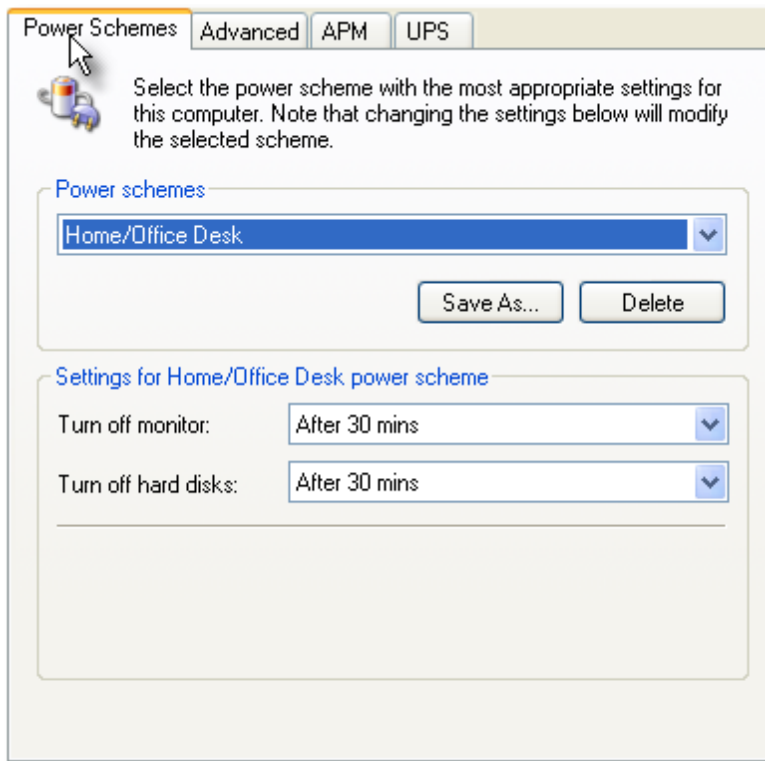

It is recommended that users do not modify any of the other power settings on this panel.

2.6.6.4 Date Time

Select "Date Time" to set the date, time, and time zone for SR1's internal computer.

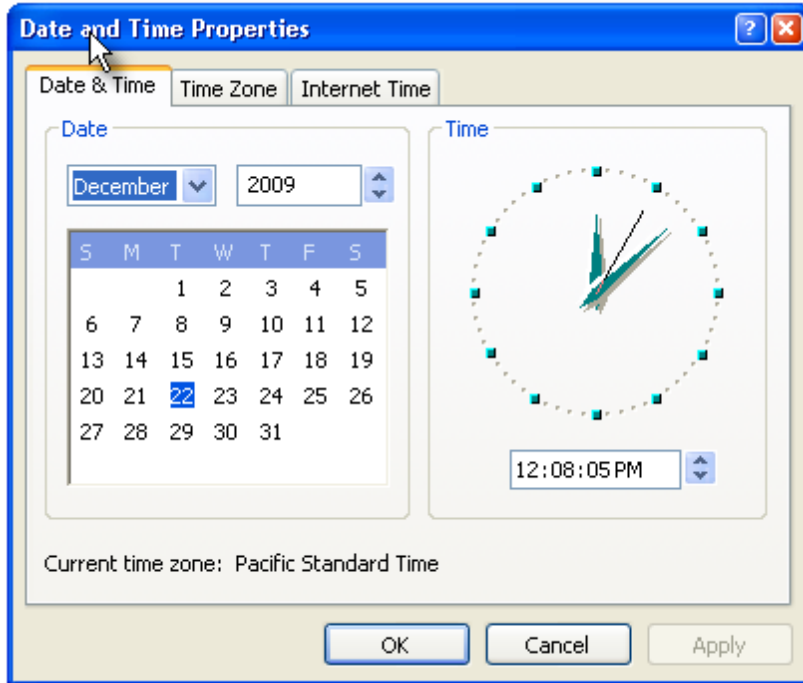

2.6.6.5 Virtual Keyboard

The virtual keyboard provides the functionality of a PC keyboard using only the mouse.



Use the virtual keyboard for text entry (e.g. filenames) in situations where SR1 is not connected to a PC keyboard. The virtual keyboard can be selected via the main menu under the "Tools" category or using the front-panel keypad by pressing <Alt-Alpha>.

2.6.6.6 Updating SR1

Stanford Research Systems is continually updating SR1's firmware to provide new functionality and fix bugs. There are two methods for updating the firmware depending on whether the instrument is

connected directly to the internet, or not. If SR1 is connected to the internet simply select "Update SR1" from the Tools menu and the instrument will automatically contact the update server at Stanford Research Systems.

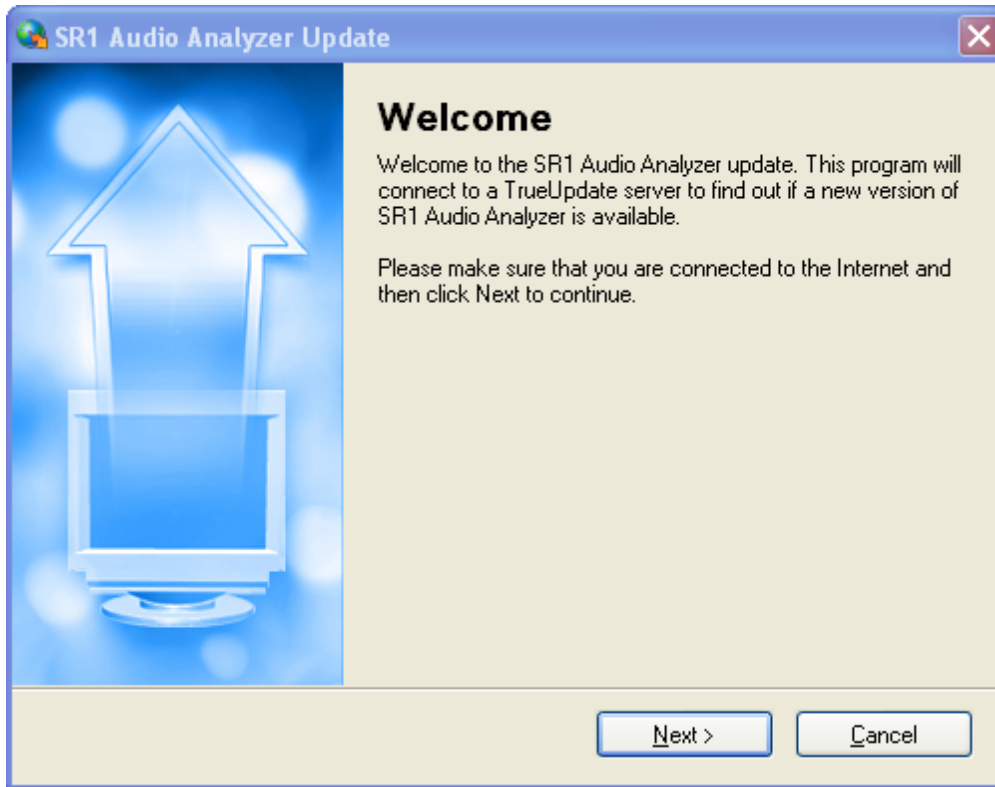

Follow the onscreen directions. The update server will determine if the installed firmware version is the most recent and if necessary, download and install all required files to update the firmware.

If the instrument is not directly connected to the internet, the update files can be downloaded separately, placed on a USB drive, and then executed. To download the required installer file, use a browser to access the URL: <http://sr1update.thinksrs.com>. The server will display a list of patch files:

SR1 Audio Analyzer Software Updates

Version 1.0.14.0 patch [download](#) (12.1MB, 10/30/2009).

This patch updates all earlier versions of SR1 to version 1.0.14.0.

Version 1.0.20.0 patch [download](#) (10.4MB, 12/14/2009).

This patch updates version 1.0.14.0 of SR1 and later to version 1.0.20.0.

Version 1.0.20.0 demo installer [download](#) (30.4MB, 12/14/2009).

For other SRS products, please visit our [main site](#).

Note that separate installers are used to patch the instrument software and install the demo software on a PC. The currently installed firmware version can be determined by selecting "About SR1" from the Help menu. After determining whether a more recent firmware version exists, download the appropriate patch from the website and place the file on a USB drive connected to SR1. To execute the patch open a Windows explorer window and navigate to the USB drive with the patch file. Double click on the patch file to begin the update process. (A windows explorer window can be opened while SR1 is running by using an external keyboard and pressing  -E.

2.7 Automation Menu

Automation refers to controlling the operation of SR1 through some means other than the front-panel interface. There are two basic types of automation, remote and local. Remote automation refers to control of the instrument from a remote computer through one of SR1's 3 physical interface ports: IEEE-488 (GPIB), Serial (RS-232), and ethernet (VXI-11). There are two methods by which the instrument can be controlled remotely: the GPIB command interface and the SR1 Basic command interface. The GPIB command interface consists a set of GPIB commands which are sent as ASCII text strings over one of the three physical interfaces. Arguments to the commands and responses from SR1 are also sent as ASCII text strings.

The SR1 Basic interface (a binary interface based on the Microsoft COM standard) presents the instrument as a set of objects containing properties and actions which can be manipulated by the user. The SR1 Basic interface can only be accessed via the ethernet port and is particularly suited to control by programs written in Visual Basic, Microsoft Office, and other COM enabled languages.

Local Automation, or scripting, refers to control of the instrument via scripts executed locally on the instrument. Scripts interact with the instrument only through the SR1 Basic interface. The Automation Menu provides access to the Scripting Window, a complete development environment for writing and debugging scripts that provides simple, visual access to the SR1 Basic interface.

A complete description of the GPIB command interface is given in the "SR1 GPIB Programming Reference." A complete description of the SR1 Basic interface is given in the "SR1 Basic Programming Reference." Refer to these documents for details of individual commands and functions.

The automation menu contains the following options:

Remote I/c	Opens the remote interface debug panel. This panel allows monitoring of remote commands sent to and by SR1 over each of the remote interfaces.
Run Script...	Allows a script to be run directly without opening the script development window.
Scripting	Opens the script development window.
Scripting Log	Opens a scripting log panel. The scripting log is a form which scripts can write to.
Enable Learning	Starts "Learning Mode". Keypresses will automatically be recorded in the current script.

2.7.1 Remote Interface Panel

The Remote Interface Panel is a valuable tool for developing and debugging remote applications using the GPIB command interface.

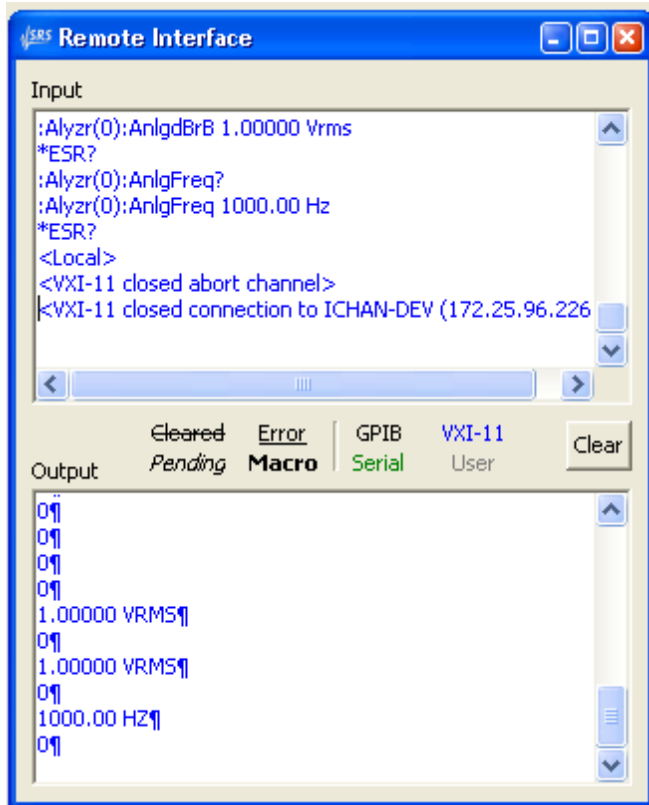

The top portion of the panel records the GPIB commands received over the three physical interfaces. Commands received over the IEEE-488 port are displayed in black, commands received over the ethernet interface in blue, and commands received over the serial port (RS-232) are shown in green. Commands which cannot be parsed by SR1 are underlined to indicate an error. Interface messages, such as <Local> or <Device Clear> are placed in <angle brackets> to differentiate them from literal text.

The bottom window of the panel shows SR1's responses to the received commands. Responses that are queued for sending but have not yet been sent are shown in *italics*— once sent they are shown in normal type. The same color coding for physical interface is used in the output window that is used in the input window.

Press "Clear" to clear both the input and output windows of the Remote Interface Panel.

2.7.2 Scripting Window



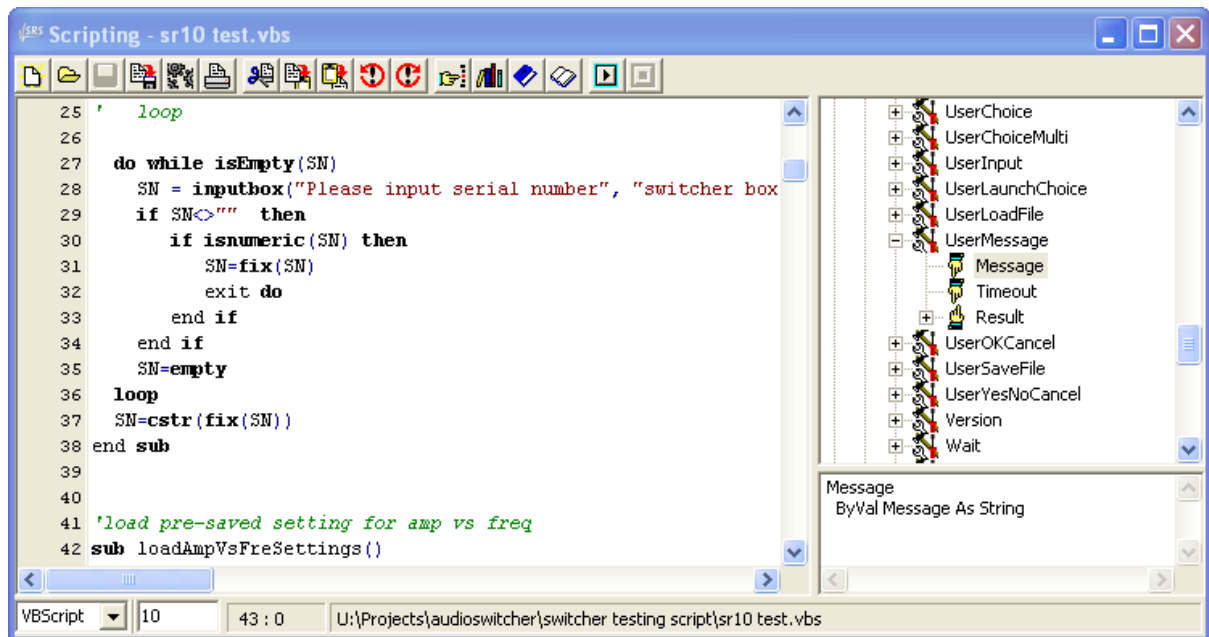





The scripting window provides a complete development environment for writing and debugging SR1 scripts. Scripts are small programs, written either in VBscript or JScript, which can automate small tasks or entire test sequences. Scripts interact with SR1 through the SR1 Basic interface, which divides the instrument into a hierarchical collection of objects, each of which can contain properties that can be set and read and actions which can be performed. A complete description of the SR1 Basic functions can be found in the "SR1 Basic Programming Reference." A good recent introduction to both scripting languages can be found in William R. Stanek's "Microsoft PowerShell, VBScript & JScript Bible" published by Wiley. All examples in this manual will be shown in VBScript.



The scripting window has several sections. At the top is a speedbar providing fast access to commonly used functions. The main window area is used for actually writing the script. Note the line numbers at the left. The two windows to the right show the functions available in the SR1 Basic interface along with a description of function arguments. At the bottom, a status bar shows the currently selected scripting language, the script timeout setting, and the row and column of the current cursor location

The Scripting Window Speedbar



Icon	Description
	Creates a new script. A dialog will prompt to save any existing script before it is cleared.
	Loads a script from a file.
	Saves the current script.
	Save As. Saves the current script to a different file.
	Print Setup. Offers printer and page layout options for printing the script.
	Prints the script.

	Cut, Copy, and Paste. Performs the normal editing options on selected text.
	Undo and Redo. The first button undoes the last action performed. If actions have been undone, the second button will redo the undone action.
	Find. Finds selected text in the script window.
	Replace. Finds selected text in the script window and replaces the text with the user selection.
	Sets a bookmark at the current cursor location. Bookmarks are indicated by the numbered icons  at the left of the main window.
	Go to. Moves the cursor to a given line number and column or to a bookmarked location.
	Begins execution of the script. (This button is also found on the main SR1 speedbar)
	Stops Scripts Events. Disables trapping of any events which have been set up in the current script. (This button is also found on the main SR1 speedbar)

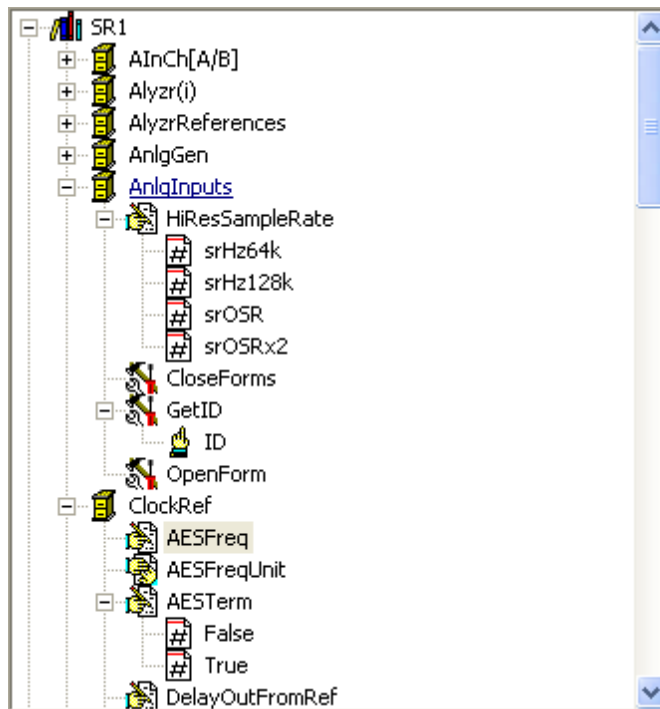
SR1 Basic Interface Window



The right-hand window shows the SR1 Basic interface organized in a tree. The top two branches of the tree are "SR1" and "Events". The "SR1" branch shows the instrument objects and their properties through which the script interacts with SR1. The "Events" branch contains the different events which can be trapped in a script. See the [Events Panel](#) description for a more detailed description how events and scripts interact.

Within the SR1 branch the interface is organized as a hierarchical collection of objects, each denoted by the  icon. Each object may contain several properties, (shown with the  icon), and actions (shown with the  icon). Properties are single values which can be read or set in a script. Actions are more

complex functions which can return values and take multiple arguments. In general, double clicking on any item in the SR1 Basic interface window inserts that text at the cursor location in the main script window.

Properties

Properties are either integer, floating point or "unit-ed" quantities. Integer quantities are read and set as follows:

```
dim intVal
intVal = SR1.AnlgInputs.HiResSampleRate 'read the hi-res sample rate
SR1.AnlgInputs.HiResSampleRate = intVal ' set the hi-res sample rate
```

Some integer properties have "enumerations" associated with them. Enumerations are short mnemonic text strings which can be used in place of integer values. Any enumerations associated with a property are shown underneath the property with the  icon. So for instance the two lines below are interchangeable.

```
SR1.AnlgInputs.HiResSampleRate = 1 ' set to an explicit integer value
SR1.AnlgInputs.HiResSampleRate = srHz128k ' set to the equivalent enumeration
```

These enumerations exist in the SR1 internal scripting environment. To specify these enumerations in VisualBasic, MS Office, or other scripting environments, they must be referred to as "SR1.enumtype.enum" e.g.:

```
SR1.HRSR.srHz128k
```

Enumeration types are found in the file SR1.tlb (SR1 type library)

Unit-ed properties require an additional argument to specify the units the property should be expressed in. For instance:

```
x = SR1.AnlgGen.AGenChA.Gain("db")
```

assigns to the variable x the value of the Analog Generator (channel A) gain in units of db. To set the corresponding property:

```
SR1.AnlgGen.AGenChA.Gain("db") = -10.0
```

To read the value of a unit-ed property in "current units", simply use an empty string for the unit specifier.

```
x = SR1.AnlgGen.AGenChA.Gain("")
```

Unit-ed properties typically have an associated property which reads the current units of the property. For instance:

```
stringvar = SR1.AnlgGen.AGenChA.GainUnit
```

assigns to the variable stringvar the unit-string for the Gain property.

When setting a unit-ed property, the specified units become the current units. For instance

```
SR1.AnlgGen.AGenChA.Gain("%") = 50.0
```

sets percent (%) as the current units of the gain property.

An object can be assigned to a variable using the "set" keyword:

```
set chna = SR1.AnlgGen.AGenChA
chna.Gain("db") = -10.0
x = chna.FreqRdg("")
```

Actions

Actions are functions associated with objects which can return values and take parameters. Parameters are shown underneath the associated action with the 

icon. Return values from actions are denoted by the  icon. Integer parameters, like properties, may have enumerations which are listed underneath the parameter. The syntax for using actions in scripts is similar to that for properties. For instance, the action "LoadTrace" associated with a graph takes a string specifying a trace file and returns an integer which is the id of the new trace. In a script:

```
intMyTraceId = SR1.Graph(graphId).LoadTrace("C:\myTraceFile.xml")
```

One peculiarity of the syntax is the necessity to use the keyword "Call" for actions that have no return values or when the return value is not assigned to a variable. So the example above, if one were not interested in the new trace ID, would be modified to :

```
Call SR1.Graph(graphId).LoadTrace("C:\myTraceFile.xml")
```

The same syntax applies to actions with no return value:

```
Call SR1.Displays.Graph(graphId).AutoScaleX()
```

Input and Output with Scripts

SR1 scripts can interact with the user in a variety of ways. The built-in VBscript function MsgBox displays a message window containing a user specified string and an "OK" button. For instance, the line:

```
MsgBox("MsgBox Argument")
```

produces the following output:



The message window remains up until the user presses either the "OK" button or the "Close Window" button. The "Instrument" section of the SR1 Basic Interface contains several other functions designed to provide flexible input/output from scripts.

UserMessage

The UserMessage function is similar to the built-in MsgBox function except that it contains an additional parameter which specifies a time-out period in seconds. If the user does not press the "OK" or "Close Window" boxes within the time out period the window will disappear and the function returns -1. If the user does take action within the time-out period the function returns 1. For instance:

```
dim x
x = SR1.Instrument.UserMessage("User Message", 5)
if x = -1 then
```

```
Call SR1.Instrument.UserMessage("User Did Not Respond!",10)
end if
```

first displays the message window shown below:

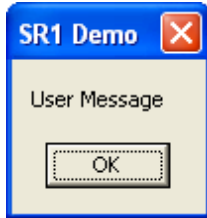

And then displays the second message if the user does not act within the 5 second time-out period.

UserOKCancel

Displays a dialog box with a user message and an "OK" and "Cancel" button. For instance:

```
x = SR1.Instrument.UserOKCancel("Proceed?",10)
```

creates the window:

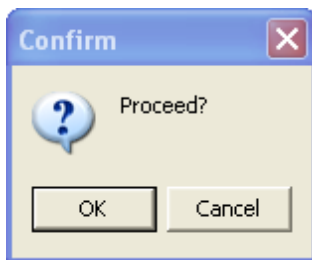

The function returns 1 if OK is pressed, 0 if Cancel is pressed or the window is closed, and -1 if the window times out.

UserChoice

The UserChoice function displays a window with a drop-down box displaying a list of choices:

```
dim x
x = SR1.Instrument.UserChoice("Some Choices...", "A,B,C", 5)
if x = "A" then
    Call SR1.Instrument.UserMessage("User Picked A",10)
elseif x = "B" then
    Call SR1.Instrument.UserMessage("User Picked B",10)
elseif x = "C" then
    Call SR1.Instrument.UserMessage("User Picked C",10)
elseif x = "-timedout-" then
    Call SR1.Instrument.UserMessage("Window Timed Out",10)
```

```
elseif x = "-cancelled-" then
    Call SR1.Instrument.UserMessage("User Cancelled",10)
end if
```

Displays the following window:

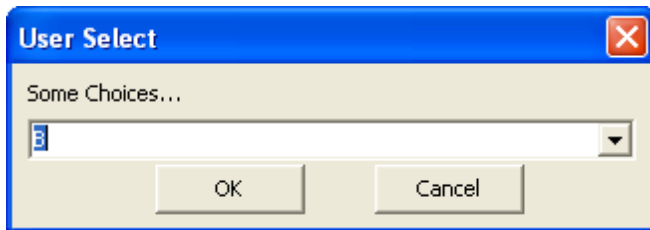

The label above the drop-down box is specified in the first argument. The choices displayed in the drop-down box are given in the second argument as a single string with the choices separated by commas. e. g. "A,B,C" yields:

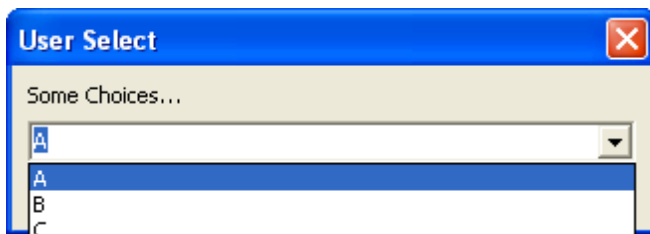

If the user presses "OK" the function returns the string corresponding the selected item, i.e. "A", "B", or "C" in the example. If the window times out the string "-timedout-" is returned. If the user presses "Cancel" the string "-cancelled-" is returned.

UserChoiceMulti

The UserChoiceMulti function also lets the user select among different choices but using a checkbox style selection:

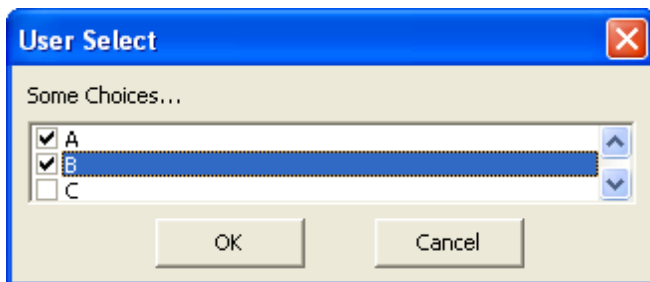

Multiple selections are possible. In the example above, for instance, the function would return the string "A,B". As with UserChoice the function returns "-cancelled-" if cancelled is pressed and "-timedout-" if the timeout limit is reached before the user takes any action.

UserLaunchChoice

Presents a series of buttons with corresponding explanations.

```
x = SR1.Instrument.UserLaunchChoice("Some Choices...", "A,B,C","Performs A,Performs B,
```

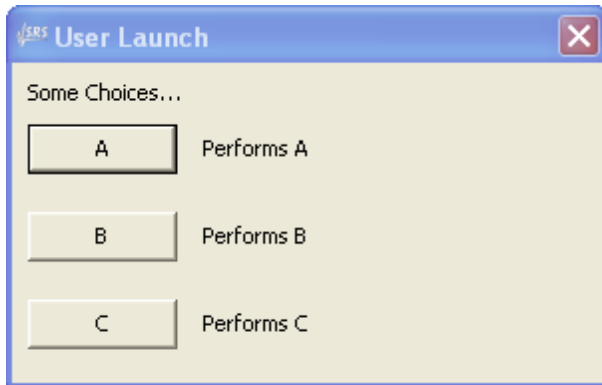



The function returns "A", "B", or "C" if the corresponding button is pressed and "-cancelled-" or "-timedout-" if the window is closed or no action is taken within the timeout interval.

UserLoadFile and UserSaveFile

These functions display the standard Windows Load File and Save File dialogs.

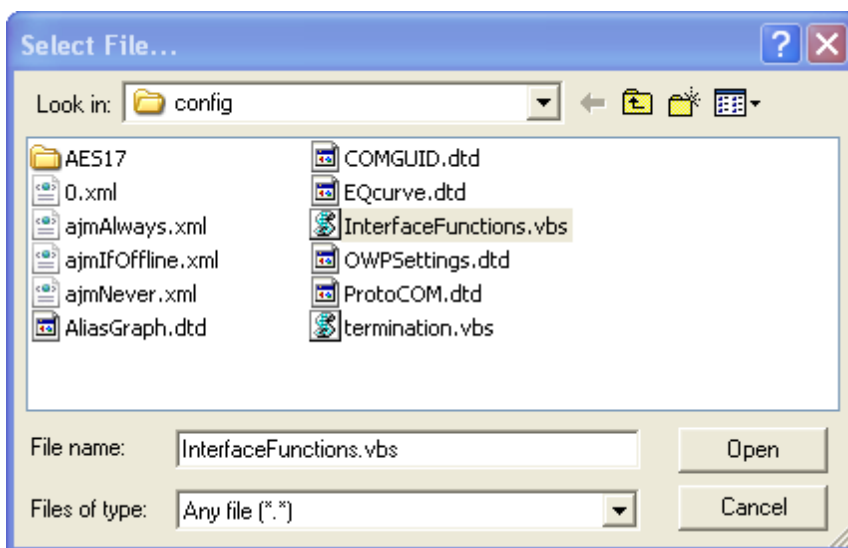
```
x = SR1.Instrument.UserLoadFile("Select File...",200)
```



The return value is the full path-extended filename. In the example above the return value was:

```
"C:\Program Files\SR1 Audio Analyzer\user\config\InterfaceFunctions.vbs"
```

The function also returns "-cancelled-" and "-timedout-" on the occurrence of the corresponding events.

UserInput

The UserInput function displays a simple dialog allowing the user to enter a value. A default value can be shown. For instance,

```
x = SR1.Instrument.UserInput("Input a numeric value...", "122", 25)
```

creates the dialog box:

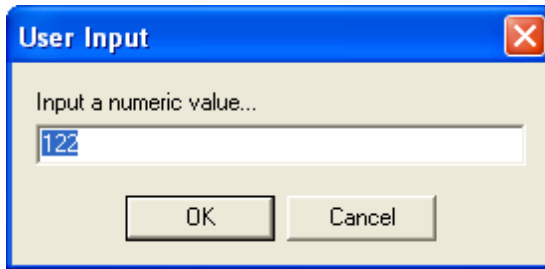

The function returns the string entered in the editbox. The function also returns "-cancelled-" and "-timedout-" on the occurrence of the corresponding events.

Script Logging

The functions described above use dialog boxes to interact with the user. In some situations it is useful to be able to provide output to a form that remains on the screen and does not require user interaction. This can be done using "Script Logging." The script log form can be opened from the "Automation" entry of the SR1 main menu. When opened the log is blank. Scripts can interact with the log using the following functions from the "Scripting" section of the SR1 Basic interface:

SR1.Scripting. OpenScriptLogForm()	Opens the script logging window on the active page of the page control.
SR1.Scripting. OpenScriptLogFormwID()	Opens a script logging window and returns a formID for the opened window. (See the SR1 Basic manual for more information on formIDs.)
SC1.Scripting. CloseScriptLogForm(formID)	Closes the log form with the specified formID.
SR1.Scripting. CloseScriptLogForms()	Closes all script logging windows on all pages of the page control.
SR1.Scripting.ClearLines()	Clears the contents of the scripting window.
SR1.Scripting.WriteLine (Text)	Writes the string specified by the argument to the scripting window.
SR1.Scripting.PrintLog()	Prints the contents of the log.

Using the Bar Chart Display in Scripts

Scripts can use the Bar Chart Display to output messages to users in scripts using the WriteMsg function. The Bar Chart display must be offline, i.e. not displaying a live measurement to do this.

```
dim barId
barId = SR1.Displays.NewBar()
Call SR1.Displays.Bar(barId).GoOffline()
Call SR1.Displays.Bar(barId).WriteMsg("@rHello")
```

The color of the display can be optionally changed by including the escape sequence @ followed by

either r (red) g (green) or y (yellow) at the beginning of the string. These characters are not displayed they only indicate the color of the text.

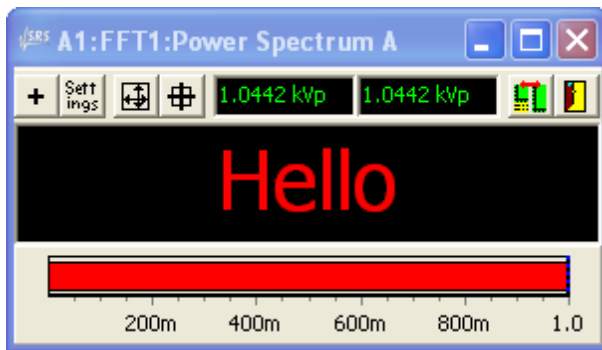

Terminating Scripts

In general, scripts terminate when flow of control reaches the "end" of the script. Since in long complex scripts it may be difficult to provide flow-control to the "end" of the script, the script can be terminated at any time using the VBScript "err.raise" function:

```
call err.raise(errNo (int) , errorSource (string) , errorDescription (string))
```

The SR1 Basic Interface includes a built-in flag, SR1.Scripting.Terminate, which is set true when the user presses the stop () button on the scripting panel. A subroutine can be included in user programs which checks the flag and ends the program:

```
sub checkterm()  
    if SR1.Scripting.Terminate then  
        call err.raise(-1,"checkterm","Manual Program Termination")  
    end if  
end sub
```

By sprinkling calls to "checkterm()" throughout a script, the programmer can ensure that the script will always terminate when the stop button on the scripting panel is pressed.

2.7.3 Learning Mode

SR1 incorporates a "learning mode" to facilitate script development. When learning mode is enabled, if a script is not currently open, a new script will be created. The corresponding scripting commands for all subsequent keypresses, menu selections, panel entries, etc. will then be incorporated into the script window. This lets you do most of the programming by simply making a measurement normally on the instrument. Exit learning mode by selecting "Disable Learning Mode" on the Automation Menu. Scripts generated with Learning Mode may require some manual polishing to be completely reusable, but learning mode can still save considerable time when developing a substantial script.

2.8 Quick Measurement Menu

Most of SR1's panels are "function-centric" in the sense that they group controls related to a single function or feature of the instrument. Thus the analog generator panel contains controls relevant to the operation of the analog generator, the settling panel groups settling controls for all measurements, etc. The **Quick Measurements** menu is different in that it includes a collection of panels that are **measurement-centric** rather than function centric, i.e. each panel contains controls that pertain to a common audio measurement and allows for setup of all the different aspects of the instrument related to that measurement from one convenient location.

Quick Measurements enable the user to quickly setup a measurement with little experience with SR1, but does not expose the full possibilities/power of all of SR1's features and controls.

All Quick Measurements rely on the Quick Measurement Setup Panel which records the basic format for the tests: whether the inputs and outputs are analog or digital, the bandwidth of the measurement, mono or stereo, etc. Based on these settings, each measurement panel then configures the inputs, generators, and analyzers appropriately for the chosen measurement. Most of the Quick Measurements can be run in either free-run mode, in which the measurement result is continuously displayed, or in swept mode, in which the measurement result is recorded as a function of one or two swept parameters. All the necessary controls to configure sweeps and settling are on the Quick Measurement panel.

Sequences of multiple quick measurements can be programmed with the "Automated Measurements" panel. Each of the selected measurements is performed sequentially and the results are included in a formatted report which can be printed or saved as a .PDF or .HTML file.

In the following sections each quick measurement will be described. For each measurement the cabling requirements from SR1 to the EUT will be given, followed by a description of the analyzer and generator configuration for that measurement. Finally, the displays created for each measurement, in both free-run and swept mode, are detailed.

2.8.1 Setup Panel

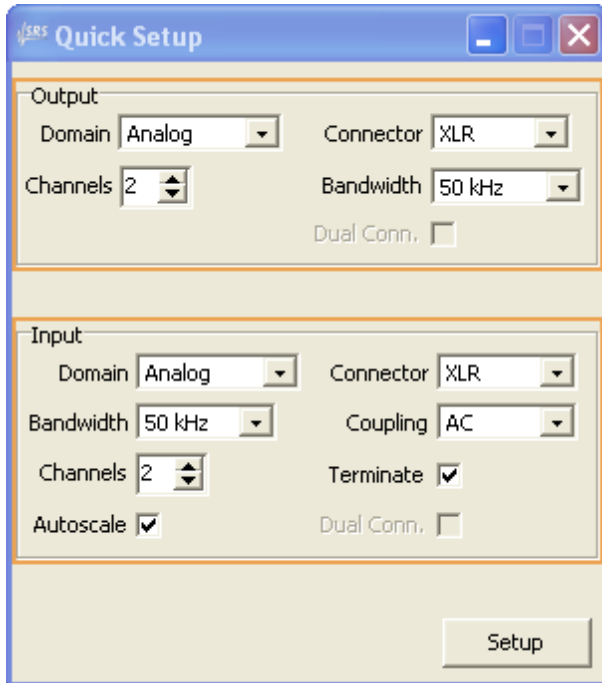

The Setup Panel records basic input and output information for all subsequent quick measurements. First, select the domain (analog or digital) for the measurement input and outputs. The input and output domains do not need to be the same, i.e. cross domain measurements may be made. Next, select the number of input and output channels and the connector (BNC, XLR, or for digital audio signals Optical) for the inputs and outputs. For digital outputs the output sampling rate needs to be configured. For analog inputs and outputs the Bandwidth control dictates which DAC and ADC (high bandwidth or high resolution) will be used in the measurements. Pressing "Setup" performs the configuration.

2.8.2 SNR Panel

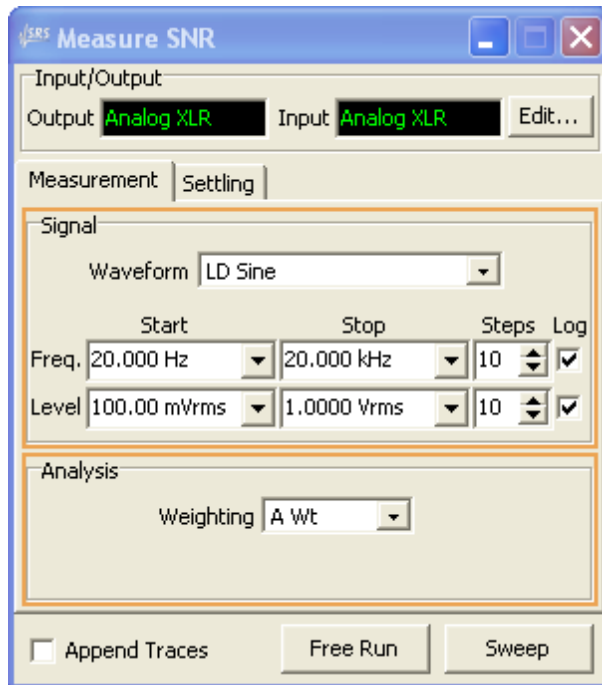

The **SNR (Signal to Noise)** Quick Measurement uses the [Time Domain Detector](#) to measure the Signal to Noise ratio of the EUT. Noise is measured first by measuring the integrated output of the EUT with the generator off. (This effectively puts a resistance equal to the output impedance of the generator across the input of the EUT). The noise value then stored in the dB_r reference for each channel. (If a weighting curve is specified the noise measurement is made with the selected weighting filter in place.) Subsequent measurements are made with the generator on and the results are expressed as a dB Signal-to-Noise ratio.

Cabling Configuration

The output of SR1's analog or digital generator is connected to the EUT's input. The output of the EUT is connected to SR1's analog or digital inputs. The number of inputs and outputs and the connectors used are specified in the [Setup Panel](#).

Generator Configuration

The output waveform is set to either Sine or Low Distortion Sine as specified in the panel. For free-run operation the amplitude and frequency of the generator is set to the frequency and level in the "start" column of the panel. For swept operation the frequency is swept from the start to stop value for each amplitude value specified.

Analyzer Configuration

One or both analyzers (depending on the number of output channels specified in the [Setup Panel](#)) are configured as [Time Domain Detectors](#).

Free Run Configuration

A barchart display is created for each output channel showing the instantaneous SNR.

Sweep Configuration

A [graph](#) will be created for each channel showing a graph of SNR vs. Freq for the selected number of amplitude steps. Log spacing can be selected for both the frequency and amplitude sweeps. The settling parameters of the SNR measurement can be adjusted directly from the "Settling" tab of the panel.

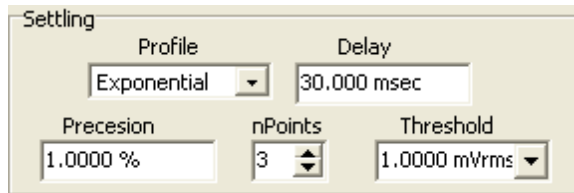

The image shows a software panel titled "Settling" with the following controls:

- Profile:** A dropdown menu set to "Exponential".
- Delay:** A text input field containing "30.000 msec".
- Precision:** A text input field containing "1.0000 %".
- nPoints:** A spin button set to the value "3".
- Threshold:** A dropdown menu set to "1.0000 mVrms".

Refer to the [Settling Panel](#) chapter for a more detailed discussion of what each of the controls means. In general, specifying a smaller precision window and larger value for nPoints will decrease the noise and "glitches" in the sweep at the expense of increasing the time required for the sweep. Some experimentation may be required, depending on the characteristics of the EUT, to find the optimal values of the settling parameters.

2.8.3 Reference Panel

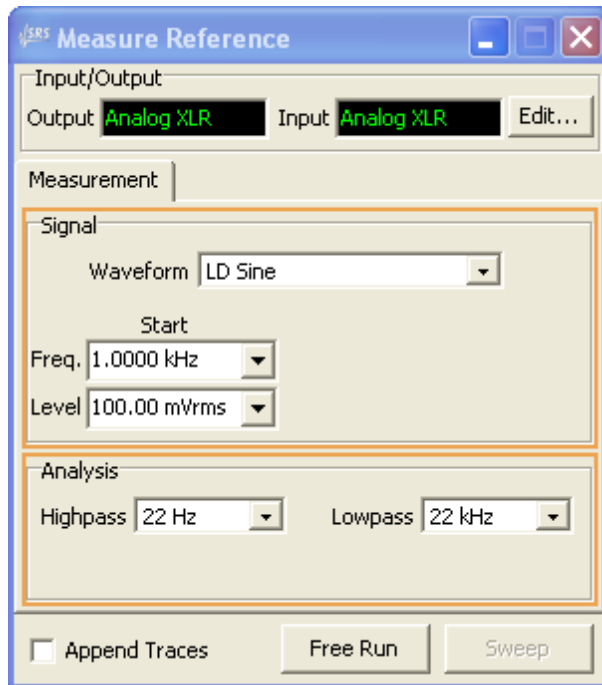

The **Reference** Quick Measurement uses the [Time Domain Detector](#) to measure the output of the EUT at a specified amplitude and frequency and record the result in the dB_r references for each output channel.

Cabling Configuration

The output of SR1's analog or digital generator is connected to the EUT's input. The output of the EUT is connected to SR1's analog or digital inputs. The number of inputs and outputs and the connectors used are specified in the [Setup Panel](#).

Generator Configuration

The output waveform is set to either Sine or Low Distortion Sine as specified in the panel. The amplitude and frequency of the generator is set to the frequency and level.

Analyzer Configuration

One or both analyzers (depending on the number of output channels specified in the [Setup Panel](#)) are configured as [Time Domain Detectors](#). The bandwidth limits for the measurement is selected on the "Analysis" section of the panel.

Free Run Configuration

A bargraph display is created for each output channel showing the instantaneous amplitude for the two inputs. There is no sweep configuration for the Reference measurement.

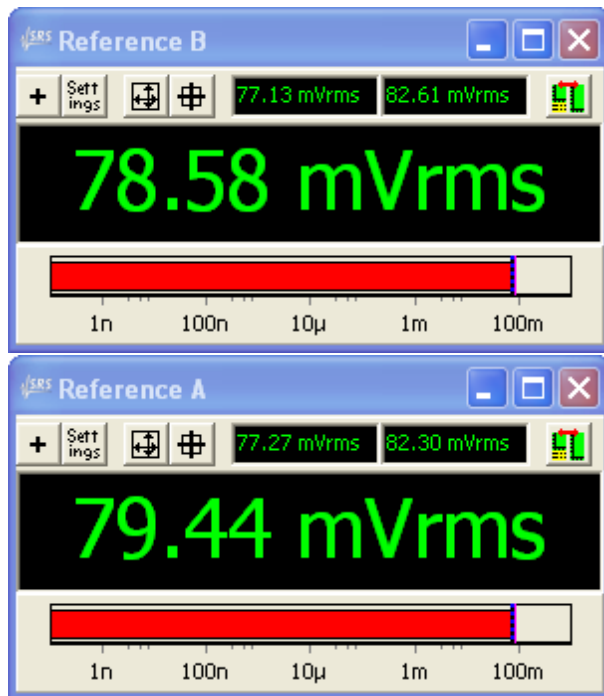

2.8.4 Level Panel

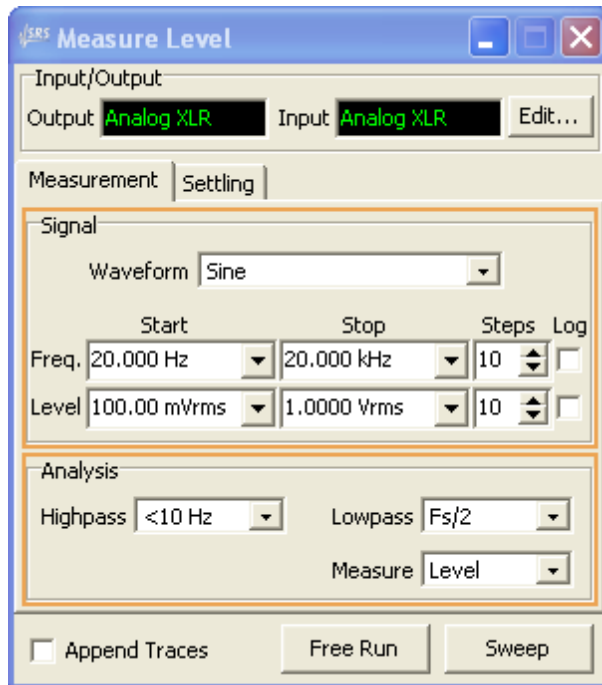

The **Level** quick measurement measures the output level of the EUT either absolutely, or relative to the reference values computed with the "Reference" measurement. The source can be swept over frequency and amplitude to yield the frequency response of the EUT for a range of input amplitudes.

Cabling Configuration

The output of SR1's analog or digital generator is connected to the EUT's input. The output of the EUT is connected to SR1's analog or digital inputs. The number of inputs and outputs and the connectors used are specified in the [Setup Panel](#).

Generator Configuration

The output waveform is set to either Sine or Low Distortion Sine as specified in the panel. For free-run operation the amplitude and frequency of the generator is set to the frequency and level in the "start" column of the panel. For swept operation the frequency is swept from the start to stop value for each amplitude value specified.

Analyzer Configuration

One or both analyzers (depending on the number of output channels specified in the [Setup Panel](#)) are configured as [Time Domain Detectors](#). The upper and lower bandwidth limits are adjustable in the "Analysis" section of the panel.

Free Run Configuration

A barchart display is created for each output channel showing the instantaneous output level of the EUT.

Sweep Configuration

A [graph](#) will be created for each channel showing a graph of output level vs. Freq for the selected number of amplitude steps. Log spacing can be selected for both the frequency and amplitude sweeps. The settling parameters of the Level measurement can be adjusted directly from the "Settling" tab of the panel.

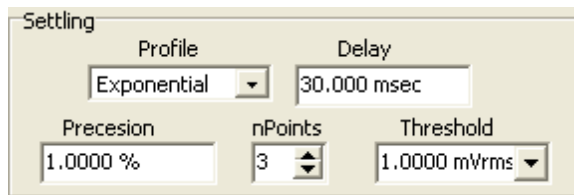

The image shows a software control panel titled "Settling". It contains five main controls:

- Profile:** A dropdown menu currently set to "Exponential".
- Delay:** A text input field containing "30.000 msec".
- Precision:** A text input field containing "1.0000 %".
- nPoints:** A spin button currently set to the value "3".
- Threshold:** A dropdown menu currently set to "1.0000 mVrms".

Refer to the [Settling Panel](#) chapter for a more detailed discussion of what each of the controls means. In general, specifying a smaller precision window and larger value for nPoints will decrease the noise and "glitches" in the sweep at the expense of increasing the time required for the sweep. Some experimentation may be required, depending on the characteristics of the EUT, to find the optimal values of the settling parameters.

2.8.5 THD+N Panel

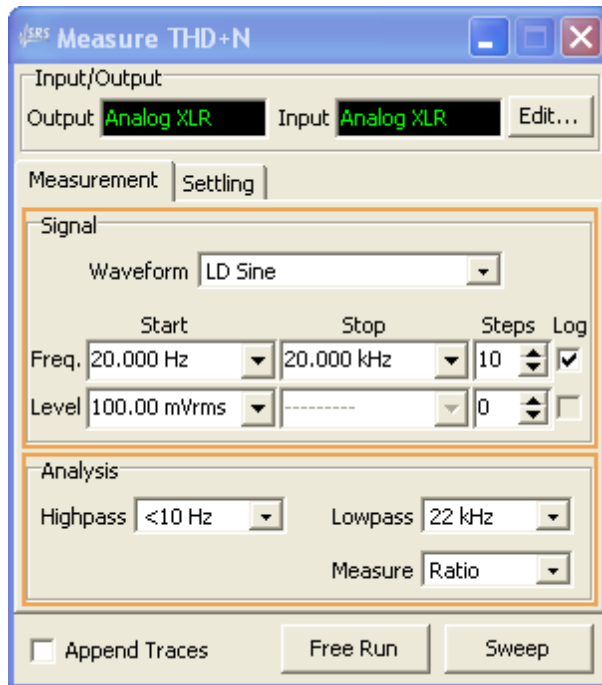

The **THD+N** Quick Measurement panel uses the Time Domain Detector to measure the THD+N (Total Harmonic Distortion plus Noise) of the EUT. In free-run mode the measurement displays the instantaneous THD+N of the EUT at a single frequency and amplitude, in addition the source can be swept over frequency and amplitude to yield the THD+N vs. frequency of the EUT for a range of input amplitudes.

Cabling Configuration

The output of SR1's analog or digital generator is connected to the EUT's input. The output of the EUT is connected to SR1's analog or digital inputs. The number of inputs and outputs and the connectors used are specified in the [Setup Panel](#).

Generator Configuration

The output waveform is set to either Sine or Low Distortion Sine as specified in the panel. For THD+N values below about -90 dB use the Low Distortion sine. For free-run operation the amplitude and frequency of the generator is set to the frequency and level in the "start" column of the panel. For swept operation the frequency is swept from the start to stop value for each amplitude value specified.

Analyzer Configuration

One or both analyzers (depending on the number of output channels specified in the [Setup Panel](#)) are configured as [Time Domain Detectors](#). The upper and lower bandwidth limits are adjustable in the "Analysis" section of the panel. The THD+N can either be displayed as the absolute amplitude of the noise plus distortion, or the

Free Run Configuration

A barchart display is created for each output channel showing the instantaneous THD+N of the EUT.

Sweep Configuration

A [graph](#) will be created for each channel showing a graph of THD+N vs. Freq for the selected range of amplitudes. Log spacing can be selected for both the frequency and amplitude sweeps. The settling parameters of the THD+N measurement can be adjusted directly from the "Settling" tab of the panel.

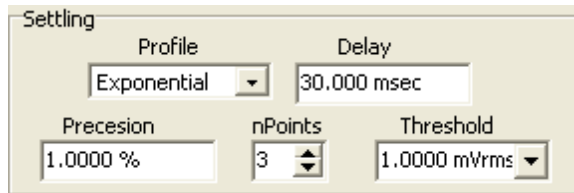

The image shows a software control panel titled "Settling". It contains five controls:

- Profile:** A dropdown menu set to "Exponential".
- Delay:** A text input field containing "30.000 msec".
- Precision:** A text input field containing "1.0000 %".
- nPoints:** A spin button set to the value "3".
- Threshold:** A dropdown menu set to "1.0000 mVrms".

Refer to the [Settling Panel](#) chapter for a more detailed discussion of what each of the controls means. In general, specifying a smaller precision window and larger value for nPoints will decrease the noise and "glitches" in the sweep at the expense of increasing the time required for the sweep. Some experimentation may be required, depending on the characteristics of the EUT, to find the optimal values of the settling parameters.

2.8.6 Frequency Response Panel

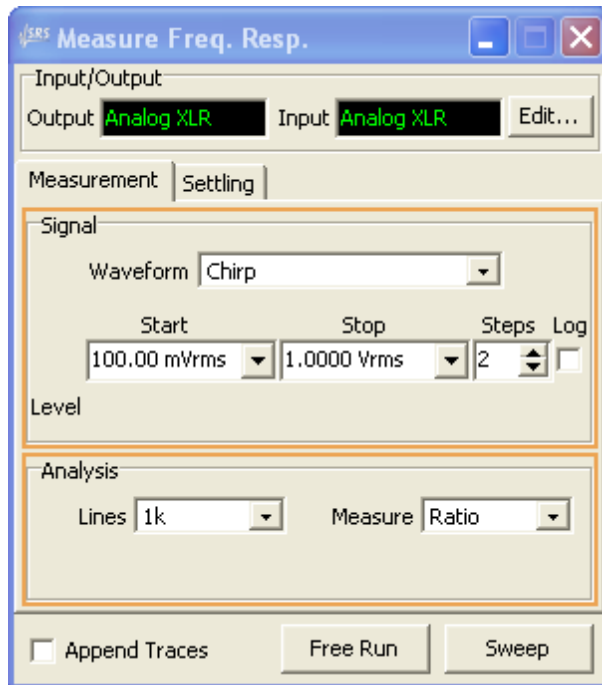

The **Frequency Response** Quick Measurements uses the FFT analyzer and the chirp waveform to rapidly measure the frequency response of the EUT. The [chirp waveform](#) outputs equal power in each FFT bin. Thus, a single FFT using this waveform as a stimulus reveals the frequency response of the EUT.

Cabling Configuration

The output of SR1's analog or digital generator is connected to the EUT's input. The output of the EUT is connected to SR1's analog or digital inputs. The number of inputs and outputs and the connectors used are specified in the [Setup Panel](#).

Generator Configuration

The output waveform is set to Chirp. For free-run operation the amplitude of the generator is set to the value in the "start" column of the panel. For swept operation the amplitude is swept from the start to stop value with the number of steps specified.

Analyzer Configuration

One or both analyzers (depending on the number of output channels specified in the [Setup Panel](#)) are configured as Single Channel [FFT Analyzers](#). If "level" is specified in the Analysis section the results will be displayed as an absolute voltage. If "Ratio" is specified the results are shown relative to the dBrA and dBrB references acquired using the "Reference" quick measurement. The number of lines of resolution is adjustable from 256 to 32k .

Free Run Configuration

A single graph is created with two traces showing the instantaneous frequency response of the EUT.

Sweep Configuration

A [graph](#) will be created for each channel. As the sweep progresses, a trace will be created on each graph for each amplitude value specified in the sweep. The settling parameters of the Frequency Response measurement can be adjusted directly from the "Settling" tab of the panel.

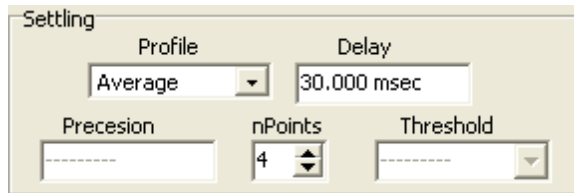

The image shows a software control panel titled "Settling". It contains the following elements:

- Profile:** A dropdown menu currently showing "Average".
- Delay:** A text input field containing "30.000 msec".
- Precesion:** A text input field containing a dashed line "-----".
- nPoints:** A spin box with the number "4" and up/down arrows.
- Threshold:** A dropdown menu containing a dashed line "-----".

Because the frequency response quick measurement is a vector measurement it has different settling options compared to other quick measurements. The only settling profile available for vector measurements is "average." The nPoints control, in this case, dictates how many FFTs will be averaged before the result is displayed. (Refer to the [Settling Panel](#) chapter for a more detailed discussion of settling.)

2.8.7 Distortion Panel

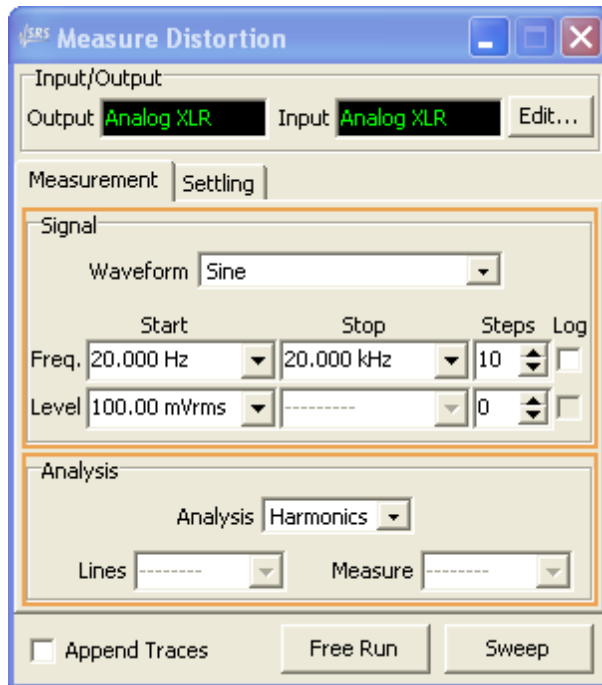

The **Distortion** Quick Measurement panel offers fast access to three distortion-related measurements. THD, Individual Harmonic Amplitude, and an FFT of distortion. THD, measured using the [THD Analyzer](#), expresses the sum of all harmonically related distortion products either as an absolute level or as a ratio to the fundamental. Individual Harmonic Amplitude (Selected in the Analysis window by choosing "Harmonics") displays the amplitude of each individual harmonic as a function of harmonic number. Finally, the Distortion FFT uses the time-domain detector and FFT analyzer in tandem to examine the frequency spectrum of the EUT output with the fundamental notched out.

Cabling Configuration

The output of SR1's analog or digital generator is connected to the EUT's input. The output of the EUT is connected to SR1's analog or digital inputs. The number of inputs and outputs and the connectors used are specified in the [Setup Panel](#).

Generator Configuration

The output waveform is set to Sine or Low-Distortion Sine. For free-run operation the amplitude of the generator is set to the value in the "start" column of the panel. For swept operation the amplitude is swept from the start to stop value with the number of steps specified.

Analyzer Configuration

The analyzer configuration depends on the the Analysis selected. For THD or individual Harmonic Amplitude, one or both analyzers are configured as THD analyzers depending on the number of output channels selected in the setup panel. For this analysis the default is to select all harmonics to be included in the THD measurement. If individual harmonic measurement is required the change must be manually made on the THD analyzer panel.

For Distortion FFT, A0 is set as a Time Domain Detector and A1 is setup as an FFT analyzer. Note that in this configuration only one channel can be analyzed at a time. (Channel A is the default) In order to analyze channel B, the source for the A0 analyzer must be manually changed to "Analog B," or press sweep with no freq or level steps. (This will essentially perform a free-run measurement on both

channels)

Free Run Configuration

For THD analysis, a barchart display is created for each output channel showing the instantaneous THD of the EUT.

For individual harmonic amplitude, a graph is created with a trace for each output channel showing the relative harmonic amplitude as a function of harmonic number:

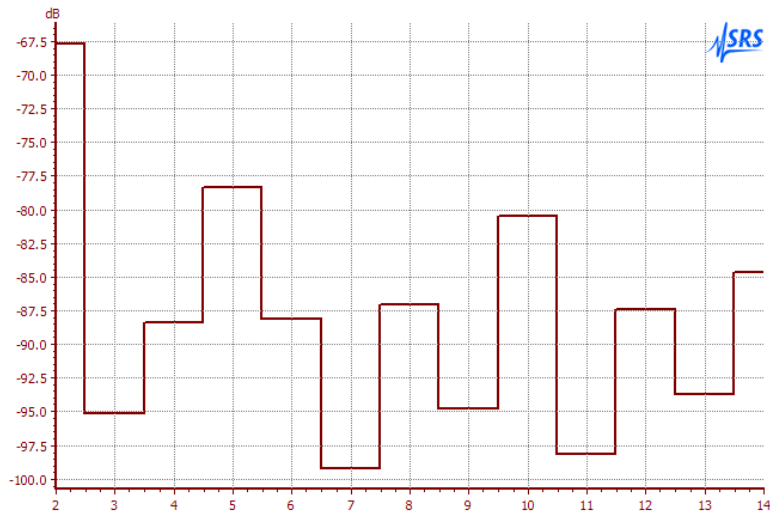

For distortion FFT, a graph is created showing the spectrum of the EUT output with the fundamental removed:

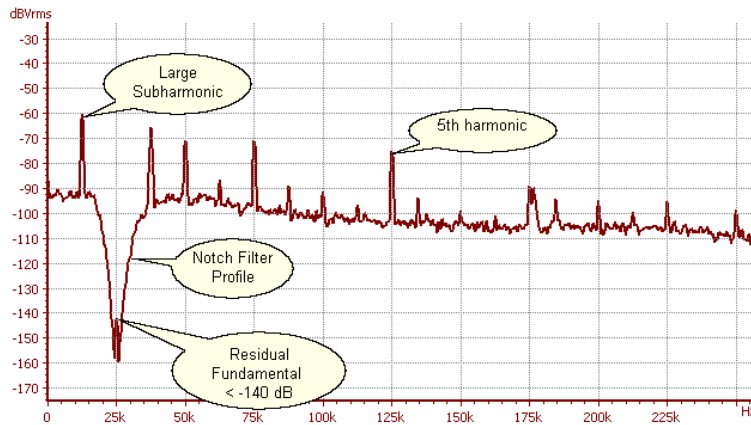

Sweep Configuration

For THD analysis, a graph is created showing THD vs. frequency. A new trace is created for each amplitude specified in the amplitude sweep. For the other analysis modes, graphs similar to the free run graphs are created, the difference being that as the amplitude sweep progresses a new trace is created for each amplitude value in the sweep.

2.8.8 IMD Panel

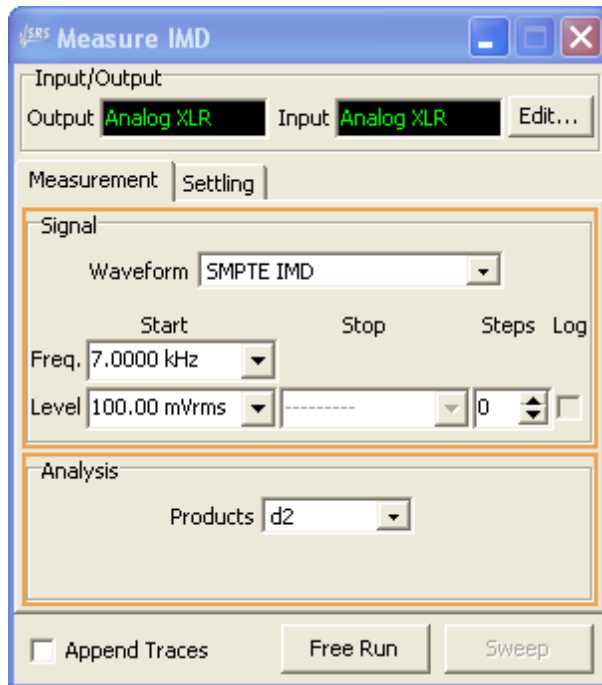

The **IMD** Quick Measurement panel sets up SR1's analyzers, generators, and displays to perform any one of the three standard intermodulation distortion (IMD) measurements: SMPTE, CCIF, and DIM.

Cabling Configuration

The output of SR1's analog or digital generator is connected to the EUT's input. The output of the EUT is connected to SR1's analog or digital inputs. The number of inputs and outputs and the connectors used are specified in the [Setup Panel](#).

Generator Configuration

The output waveform is set to the [IMD](#) waveform of the specified type. For SMPTE measurements the "high frequency" is set to the value entered in the panel while the low frequency defaults to 60 Hz. For CCIF measurements the center frequency is set to the specified value while the difference frequency defaults to 1 kHz. For DIM measurements the tone frequencies are fixed by the standard. The default tone frequencies set up by the quick measurement can always be manually overridden on the appropriate panel.

Analyzer Configuration

One or both analyzers (depending on the number of output channels specified in the [Setup Panel](#)) are configured as [IMD Analyzers](#). The measured distortion products are selectable from the Analysis section of the panel.

Free Run Configuration

A barchart display is created for each output channel showing the instantaneous IMD distortion of the EUT.

Sweep Configuration

A [graph](#) will be created for each channel showing IMD vs. amplitude for the selected range of amplitudes. Log spacing can be selected for both the frequency and amplitude sweeps. The settling parameters of the THD+N measurement can be adjusted directly from the "Settling" tab of the panel.

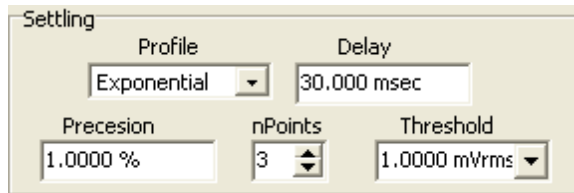

The image shows a software control panel titled "Settling". It contains five main controls:

- Profile:** A dropdown menu currently set to "Exponential".
- Delay:** A text input field containing "30.000 msec".
- Precision:** A text input field containing "1.0000 %".
- nPoints:** A spin button currently set to the value "3".
- Threshold:** A dropdown menu currently set to "1.0000 mVrms".

Refer to the [Settling Panel](#) chapter for a more detailed discussion of what each of the controls means. In general, specifying a smaller precision window and larger value for nPoints will decrease the noise and "glitches" in the sweep at the expense of increasing the time required for the sweep. Some experimentation may be required, depending on the characteristics of the EUT, to find the optimal values of the settling parameters.

2.8.9 Crosstalk Panel

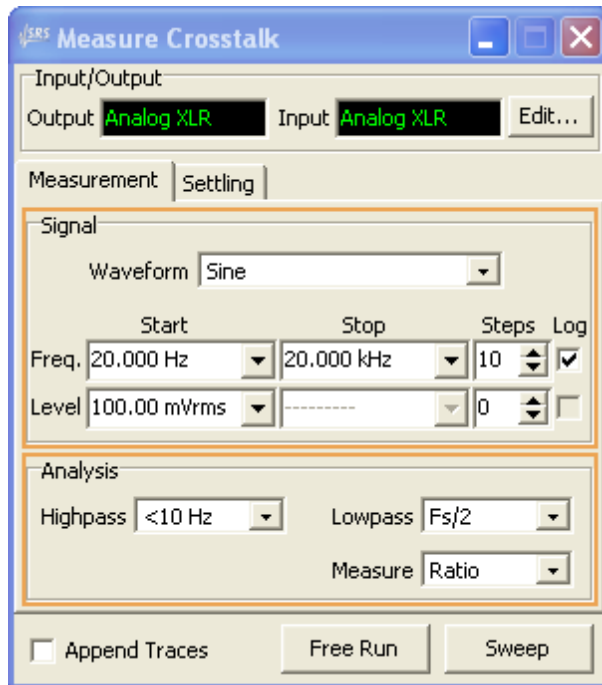

The **Crosstalk** Quick Measurement panel uses the Time Domain Detector (TDD) to measure the crosstalk from one input channel to the other output channel of the EUT. A signal is applied to one input channel of the EUT and the TDD with a bandpass filter is used to measure the output signal from the **other** channel to get the crosstalk amplitude. The final crosstalk measurement is the dB ratio of this amplitude to the output level on the channel to which the input is applied.

Cabling Configuration

The output of SR1's analog or digital generator is connected to the EUT's input. The output of the EUT is connected to SR1's analog or digital inputs. The number of inputs and outputs and the connectors used are specified in the [Setup Panel](#).

Generator Configuration

The output waveform is set to either Sine or Low Distortion Sine as specified in the panel. For free-run operation the amplitude and frequency of the generator is set to the frequency and level in the "start" column of the panel. For swept operation the frequency is swept from the start to stop value for each amplitude value specified.

Analyzer Configuration

One or both analyzers (depending on the number of output channels specified in the [Setup Panel](#)) are configured as [Time Domain Detectors](#). The upper and lower bandwidth limits are adjustable in the "Analysis" section of the panel. Even though both analyzers are configured, only one channel of crosstalk can be measured at a time.

Free Run Configuration

A barchart display is created for each output channel showing the instantaneous Crosstalk ratio.

Sweep Configuration

A [graph](#) will be created for each channel showing a graph of Crosstalk vs. Freq for the selected range of amplitudes. Log spacing can be selected for both the frequency and amplitude sweeps. The settling parameter of the THD+N measurement can be adjusted directly from the "Settling" tab of the panel.

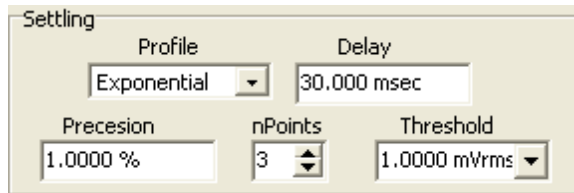

The image shows a software panel titled "Settling" with the following controls:

- Profile:** A dropdown menu set to "Exponential".
- Delay:** A text input field containing "30.000 msec".
- Precision:** A text input field containing "1.0000 %".
- nPoints:** A spin button set to the value "3".
- Threshold:** A dropdown menu set to "1.0000 mVrms".

Refer to the [Settling Panel](#) chapter for a more detailed discussion of what each of the controls means. In general, specifying a smaller precision window and larger value for nPoints will decrease the noise and "glitches" in the sweep at the expense of increasing the time required for the sweep. Some experimentation may be required, depending on the characteristics of the EUT, to find the optimal values of the settling parameters.

2.8.10 Interchannel Phase Panel

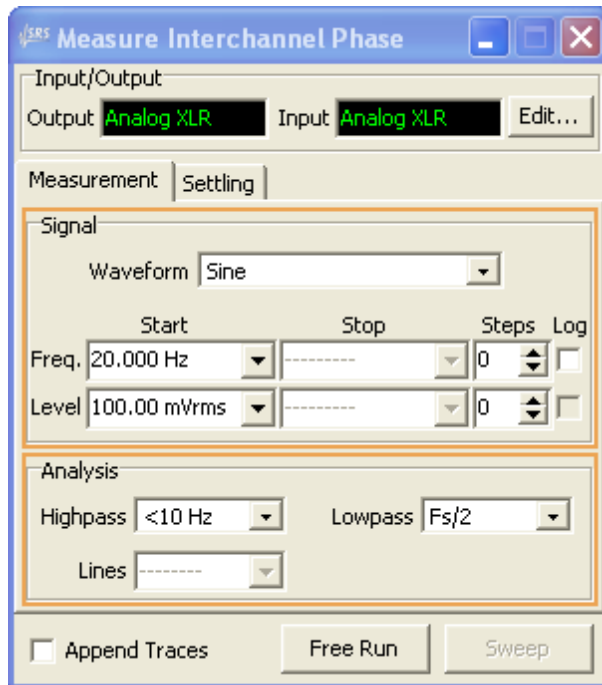

The Interchannel Phase panel configures a measurement of the phase difference between the A and B output channels of the EUT. The phase difference can be measured using either a sinewave at a (sweepable) specific frequency and amplitude or by using the FFT chirp stimulus to provide a complete measurement of phase difference vs. frequency in a single FFT record.

Cabling Configuration

For analog measurements the A channel of the analog generator should be teed and connected to both the A and B inputs of the EUT. For digital measurements simply connect the SR1 generator to the EUT inputs. In both cases the EUT outputs should be connected to the appropriate (analog or digital) inputs of SR1.

Generator Configuration

Depending on the selected stimulus waveform the generator is configured with either a sine or FFT chirp waveform.

Analyzer Configuration

If a sine stimulus is selected the A0 and A1 analyzers are configured as Time Domain Detectors. When a chirp source is selected the A0 analyzer is configured as a Two-Channel FFT analyzer. The two-channel FFT analyzer divides the B channel complex FFT spectrum by the A channel spectrum to get the AB phase vs. frequency response.

Free Run Configuration

For sine stimulus a barchart display is created displaying the interchannel phase at the selected amplitude and frequency. For chirp stimulus a graph is created showing the instantaneous AB phase difference as a function of frequency.

Sweep Configuration

A [graph](#) is created showing the interchannel phase vs. frequency. If the stimulus is sine, the data is obtained by sweeping the sine frequency over the specified limits. If chirp is selected the trace corresponds to a single FFT measurement. In each case, a new trace is created for each point specified

on the amplitude sweep.

2.8.11 In/Out Phase

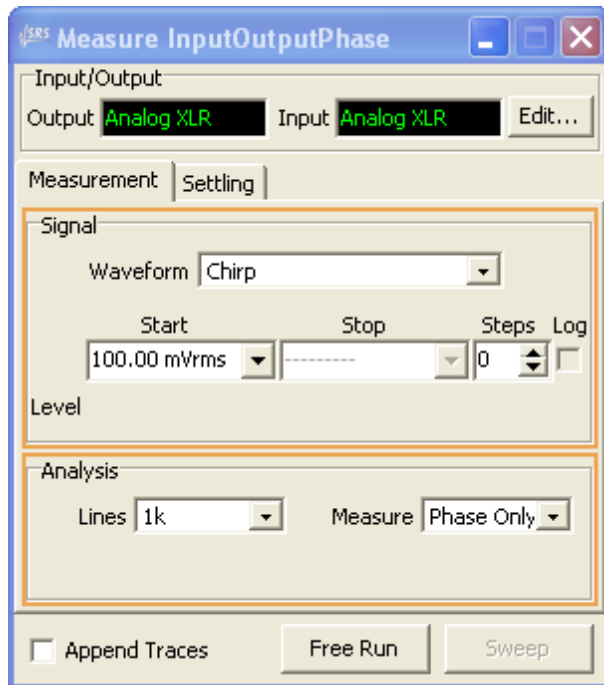

The **In/Out Phase** Measurement panel uses the [FFT analyzer](#) and the [FFT Chirp](#) waveform to measure the input/output phase vs. frequency response of one or both channels of the EUT. The measurement is made in two parts: first, the analyzer inputs are switched to Generator Monitor to generate a "reference phase" curve. Next, the analyzer inputs are switched to measure the phase response of the signal from the EUT. The phase response of the EUT is then generated by taking the difference between the total phase and the reference phase.

Cabling Configuration

The output of SR1's analog or digital generator is connected to the EUT's input. The output of the EUT is connected to SR1's analog or digital inputs. The number of inputs and outputs and the connectors used are specified in the [Setup Panel](#).

Generator Configuration

The output waveform is set to the FFT Chirp waveform. For free-run operation the amplitude the generator is set to the frequency and level in the "start" column of the panel. For swept operation the amplitude is swept from the start to stop value in the number of steps specified.

Analyzer Configuration

One or both analyzers (depending on the number of output channels specified in the [Setup Panel](#)) are configured as FFT (single channel) analyzers. The number of lines of resolution is adjustable in the analysis section of the panel.

Free Run Configuration

A graph is created for each output channel. Traces are created for the reference phase (GenMon phase), the total phase, and the computed phase difference, which is the phase response of the EUT. If the delay calculation is selected an additional trace is created for the group delay measurement. Group delay is calculated by the trace calculator and is the derivative of the phase with respect to frequency.

Sweep Configuration

Same as the free-run configuration except that total phase and phase response traces (and optionally

group delay traces) are added for each amplitude setting in the sweep.

2.8.12 Automated Measurements and Reports

Each time a quick measurement is performed, either in free-run or sweep mode, the results are accumulated in a formatted report. The report includes a header page which details the setup configuration entered in the quick measurement [setup panel](#):

Measurement Report	
	
Signal Setup	
Output	Analog XLR
Channels	2
Impedence	600 ohms
Output BW	200 kHz
Input	Analog XLR
Channels	2
Termination	600 ohm
Coupling	AC
Input BW	200 kHz
Notes	
Example notes for SR1 manual.	

Subsequent pages give information on the results of each test. Free run tests simply record the first value measured. For instance:

Measurement Report

IMD

Waveform	SMPTE
Start Freq.	7.0000 kHz
IM Freq.	60.000 Hz
Start Level	100.00 mVrms
Products	d2
IMD A	-79.34 dB
IMD B	-74.48 dB

Swept measurements record a graph of the measurement in the report:

Self Test 2 Report



Signal Setup

Output	Analog XLR	Output BW	50 kHz
Input	GenMon	Input BW	200 kHz
Notes	Analog Output Board A 30145 Analog Output Board B 30161 Analog Input Board A 20238 Analog Input Board B 20231		

Reference

Waveform	LD Sine	Level	1.0000 Vrms
Freq.	1.0000 kHz	Low Pass	Fs/2
High Pass	< 10 Hz	Reference B	0.99775 Vrms
Reference A	0.99793 Vrms		

Level

Waveform	LD Sine	Stop Freq.	50.000 kHz
Start Freq.	10.000 Hz	Low Pass	Fs/2
Start Level	1.0000 Vrms		
High Pass	< 10 Hz		

Level A&B vs. Frequency

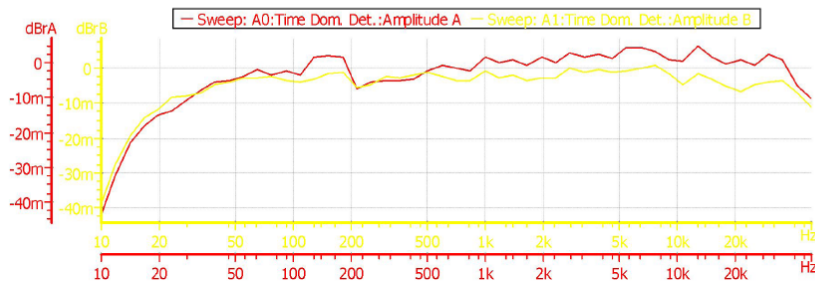

To display the report after measurements have been made, select "Report" from the Quick Measurements menu. The report preview window includes options for page navigation, zooming and scaling, printing, and exporting the report to .PDF or .HTML format.

The Automated Measurement Panel

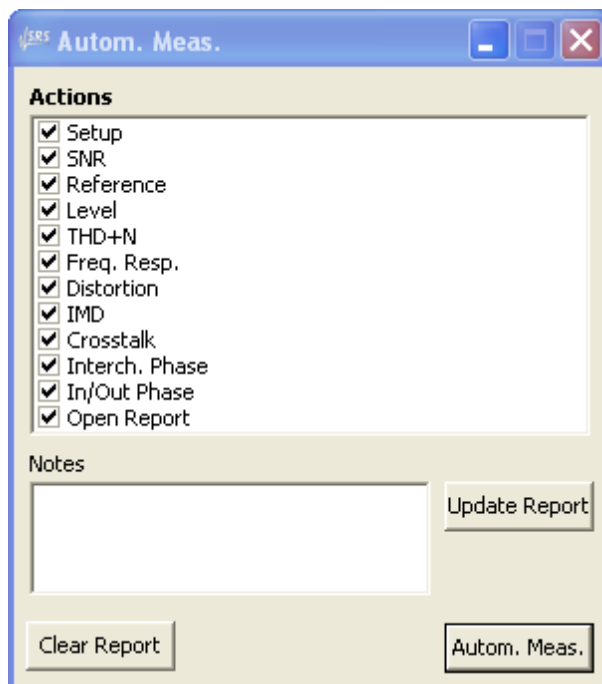

The Automated Measurement Panel allows selection of a group of quick measurements to be performed sequentially. The measurement results for each selected measurement are accumulated in a report. To clear the report in preparation for a new round of measurements press "Clear Report." To include a text note in the report enter the text in the "Notes" field and press "Update Report". To begin the sequence of automated tests press "Autom. Meas."

2.9 Setups Menu

The Setups menu allows SR1 to quickly be configured for many common audio measurements. These pre-programmed setups can be used as a starting point to customize your own configuration files. See [Saving SR1 Configurations](#) for details. The setups are categorized by the domain of the stimulus signal and the domain of the analysis signal, as follows:

Analog-Analog	Measurement setups entirely in the Analog Domain.
Analog-Digital	Measurement setups with an analog stimulus and a digital response. ADC measurements, for example.
Digital-Analog	Measurement setups with a digital stimulus and an analog response. DAC measurements, for example.
Digital-Digital	Measurement setups entirely in the digital signal domain, i.e. a digital effects processor, for instance.
Digital IO	Measurements entirely in the digital carrier domain, i.e. jitter measurements.

2.9.1 Analog-Analog

The Analog-Analog selection lists basic Audio Analyzer measurements in the analog domain. All the Analog-analog setups default the A and B input channels to the BNC inputs, DC coupled, autoranged.

What you'll need to configure for all these setups:

Change the analog input connector and coupling settings on page 1 to match the type of equipment you're using,

28 kHz FFT

This setup configures SR1 for a basic audio band FFT. The Hi-resolution converter is selected for maximum dynamic range. The A0 analyzer is configured as a dual channel FFT analyzer with a span of 28.8 kHz and continuous averaging.. The Analog Generator is loaded with a low-distortion sine waveform set to a default frequency of 1 kHz and an amplitude of 1 Vrms. Page2 contains a graph displaying the A and B channel power spectra while Page 3 contains a graph displaying the A and B channel time records.

What you'll need to configure:

If your'e using the analog generator, adjust the amplitude and frequency of the signal to match your requirements. Otherwise you can turn the analog generator off. The amount of [averaging](#) in the FFT analyzer can be adjusted to suit the noise level of your signal. The FFT resolution is defaulted to 4k points, this can be adjusted.

Frequency Response

This setup configures SR1 for a stereo audio-band frequency response sweep. The Hi-resolution converter is selected for maximum dynamic range. The Time Domain Detector is selected for the A0 analyzer. The Analog Generator is loaded with a sine waveform. Page2 contains a graph displaying the A and B channel frequency response. The sweep controller is programmed to sweep the sine frequency from 20 Hz to 20 kHz in 22 logarithmic steps.

What you'll need to configure:

Adjust the the sine amplitude to match the equipment being tested. The number of points in the sweep can be changed to give faster sweeps or higher resolution sweeps. The [settling parameters](#) can be adjusted to fit the noise levels of the signals being measured.

Wideband FFT

This setup is similar to the audio-band FFT setup described above except that the FFT frequency range is set to the maximum 200 kHz value. The A0 analyzer is configured as a dual channel FFT analyzer with a span of 28.8 kHz and continuous averaging.. The Analog Generator is loaded with a low-distortion sine waveform set to a default frequency of 1 kHz and an amplitude of 1 Vrms. Page2 contains a graph displaying the A and B channel power spectra while Page 3 contains a graph displaying the A and B channel time records.

What you'll need to configure:

If your'e using the analog generator, adjust the amplitude and frequency of the signal to match your requirements. Otherwise you can turn the analog generator off. The amount of [averaging](#) in the FFT analyzer can be adjusted to suit the noise level of your signal. The FFT resolution is defaulted to 4k points, this can be adjusted.

THD+N vs. Amplitude Sweep

Performs a THD+N vs. amplitude stereo sweep. The A0 and A1 analyzers are set to [Time Domain Detector](#) in order to measure THD+N. A low distortion 1 kHz sine waveform is setup with an amplitude sweep range of 50 mVrms to 5 Vrms in 22 logarithmic steps. Page 2 displays a graph of the A and B channel results.

What you'll need to configure:

The default frequency is 1 kHz. This should be adjusted as needed. The [settling parameters](#) can be adjusted to fit the noise levels of the signals being measured. The [bandwidth](#) of TDD can be adjusted to suit the measurement requirements.

THD+N vs. Frequency Sweep

Performs a THD+N vs. frequency stereo sweep. The A0 and A1 analyzers are set to [Time Domain Detector](#) in order to measure THD+N. A low distortion 1 Vrms sine waveform is setup with an frequency sweep range of 20 Hz to 20 kHz in 22 logarithmic steps. Page 2 displays a graph of the A and B channel results.

What you'll need to configure:

The default sine amplitude is 1 Vrms. This should be adjusted as needed.

2.9.2 Analog-Digital

The Analog-Digital selection lists Audio Analyzer measurements with an analog stimulus and a digital response, such as ADC measurements. All the Analog-Digital setups default the digital input to the XLR C1 connector, a sample rate of 48 kHz, and 24 bit resolution. In all of these measurements the sampling rate of the analog generator is set to the digital ISR allowing synchronous cross-domain measurements.

What you'll need to configure for all these setups:

Configure the [Digital IO Input panel](#) to match the sampling rate and resolution of your ADC or other digital output equipment.

FFT

This setup configures SR1 for a basic audio-band FFT. The A0 analyzer is configured as a dual channel FFT analyzer with a span of 28.8 kHz and continuous averaging. The Analog Generator is loaded with a low-distortion sine waveform set to a default frequency of 1 kHz and an amplitude of 1 Vrms. Page2 contains a graph displaying the A and B channel power spectra while Page 3 contains a graph displaying the A and B channel time records.

What you'll need to configure:

Adjust the amplitude and frequency of the analog output signal to match your requirements. The amount of [averaging](#) in the FFT analyzer can be adjusted to suit the noise level of your signal. The FFT resolution is defaulted to 2k points, this can be adjusted.

Frequency Response

This setup configures SR1 for a stereo audio-band frequency response sweep. The Hi-resolution converter is selected for maximum dynamic range. The Time Domain Detector is selected for the A0 analyzer. The Analog Generator is loaded with a sine waveform. Page2 contains a graph displaying the A and B channel frequency response. The sweep controller is programmed to sweep the analog sine frequency from 20 Hz to 20 kHz in 22 logarithmic steps.

What you'll need to configure:

Adjust the the sine amplitude to match the equipment being tested. The number of points in the sweep can be changed to give faster sweeps or higher resolution sweeps. The [settling parameters](#) can be adjusted to fit the noise levels of the signals being measured.

THD+N vs. Amplitude Sweep

Performs a THD+N vs. amplitude sweep. The A0 and A1 analyzers are set to [Time Domain Detector](#) in order to measure THD+N of both channels. A low distortion 1 kHz sine waveform is setup with an amplitude sweep range of 50 mVrms to 5 Vrms in 22 logarithmic steps. Page 2 displays a graph of the A and B channel results.

What you'll need to configure:

The default frequency is 1 kHz. This should be adjusted as needed. The [settling parameters](#) can be adjusted to fit the noise levels of the signals being measured. The [bandwidth](#) of TDD can be adjusted to suit the measurement requirements.

THD+N vs. Frequency Sweep

Performs a THD+N vs. frequency sweep. The A0 and A1 analyzers are set to [Time Domain Detector](#) in order to measure THD+N of both channels. A low distortion 1 Vrms sine waveform is setup with an frequency sweep range of 20 Hz to 20 kHz in 22 logarithmic steps. Page 2 displays a graph of the A and B channel results.

What you'll need to configure:

The default sine amplitude is 1 Vrms. This should be adjusted as needed.

2.9.3 Digital-Analog

The Digital-Analog selection lists basic Audio Analyzer measurements with a digital stimulus and an analog response, i.e. a DAC. The [digital generator](#) is configured with the stimulus signal. The sampling rate of the high-resolution analog converter is set to the digital OSR, so both domains are operating with the same sampling rate.

What you'll need to configure for all these setups:

Change the digital output parameters (connector, sample rate, bit resolution) to match the input of the DACt being tested. Set the [analog inputs](#) to the appropriate connector and input coupling.

FFT

This setup configures SR1 for a basic audio band FFT. The Hi-resolution converter is selected for maximum dynamic range. The frequency range of the FFT is 1/2 the sampling rate of the digital output. The A0 analyzer is configured as a dual channel FFT analyze continuous averaging.. The Digital Generator is loaded with a Isine waveform set to a default frequency of 1 kHz and an amplitude of 1 FFS. Page2 contains a graph displaying the A and B channel power spectra while Page 3 contains a graph displaying the A and B channel time records.

What you'll need to configure:

If your'e using the digital generator, adjust the amplitude and frequency of the signal to match your requirements. Otherwise you can turn the generator off. The amount of [averaging](#) in the FFT analyzer can be adjusted to suit the noise level of your signal. The FFT resolution is defaulted to 4k points, adjust this to obtain the proper balance of update rate vs. frequency resolution

Frequency Response

This setup configures SR1 for a stereo audio-band frequency response sweep. The Hi-resolution converter is selected for maximum input dynamic range. The Time Domain Detector is selected for the A0 analyzer. The Digital Generator is loaded with a sine waveform. Page2 contains a graph displaying the A and B channel frequency response. The sweep controller is programmed to sweep the sine frequency from 20 Hz to 20 kHz in 22 logarithmic steps.

What you'll need to configure:

Adjust the the sine amplitude to match the equipment being tested. The number of points in the sweep can be changed to give faster sweeps or higher resolution sweeps. The [settling parameters](#) can be adjusted to fit the noise levels of the signals being measured.

Wideband FFT

This setup is similar to the audio-band FFT setup described above except that the analog input sampling rate is set to OSRx2 so that the FFT bandwidth is twice as large. The A0 analyzer is configured as a dual channel FFT analyzer with continuous averaging.. The Digital Generator is loaded with a low-distortion sine waveform set to a default frequency of 1 kHz and an amplitude of 1 Vrms. Page2 contains a graph displaying the A and B channel power spectra while Page 3 contains a graph displaying the A and B channel time records.

What you'll need to configure:

If your'e using the digital generator, adjust the amplitude and frequency of the signal to match your requirements. Otherwise you can turn the generator off. The amount of [averaging](#) in the FFT analyzer can

be adjusted to suit the noise level of your signal. The FFT resolution is defaulted to 4k points, adjust this to obtain the proper balance of update rate vs. frequency resolution.

THD+N vs. Amplitude Sweep

Performs a THD+N vs. amplitude stereo sweep. The A0 and A1 analyzers are set to [Time Domain Detector](#) in order to measure THD+N. A 1 kHz digital sine waveform is setup with an amplitude sweep range of 1 mFFS to 1 FFS in 22 logarithmic steps. Page 2 displays a graph of the A and B channel results.

What you'll need to configure:

The default frequency is 1 kHz. This should be adjusted as needed. The [settling parameters](#) can be adjusted to fit the noise levels of the signals being measured. The [bandwidth](#) of TDD can be adjusted to suit the measurement requirements.

THD+N vs. Frequency Sweep

Performs a THD+N vs. frequency stereo sweep. The A0 and A1 analyzers are set to [Time Domain Detector](#) in order to measure THD+N. A low distortion 1 FFS sine waveform is setup with an frequency sweep range of 20 Hz to 20 kHz in 22 logarithmic steps. Page 2 displays a graph of the A and B channel results.

What you'll need to configure:

The default sine amplitude is 1 Vrms. This should be adjusted as needed.

2.9.4 Digital-Digital

The Digital-Digital selection lists measurements with both a digital stimulus and response. The outputs and inputs are set to the XLR connector. The output sampling rate is defaulted to 48 kHz.

What you'll need to configure for all these setups:

Change the digital input and output [settings](#) to match the equipment being tested,

FFT

This setup configures SR1 for a basic audio band FFT. The Hi-resolution converter is selected for maximum dynamic range. The A0 analyzer is configured as a dual channel FFT analyzer with a span of 28.8 kHz and continuous averaging. The Analog Generator is loaded with a low-distortion sine waveform set to a default frequency of 1 kHz and an amplitude of 1 FFS. Page2 contains a graph displaying the A and B channel power spectra while Page 3 contains a graph displaying the A and B channel time records.

What you'll need to configure:

If you're using the digital generator, adjust the amplitude and frequency of the signal to match your requirements. Otherwise you can turn the generator off. The amount of [averaging](#) in the FFT analyzer can be adjusted to suit the noise level of your signal. The FFT resolution is defaulted to 2k points, this can be adjusted.

Frequency Response

This setup configures SR1 for a stereo audio-band frequency response sweep. The Time Domain Detector is selected for the A0 analyzer. The Digital Generator is loaded with a sine waveform. Page2 contains a graph displaying the A and B channel frequency response. The sweep controller is programmed to sweep the sine frequency from 20 Hz to 20 kHz in 22 logarithmic steps and record the A and B channel levels.

What you'll need to configure:

Adjust the the sine amplitude to match the equipment being tested. The number of points in the [sweep](#) can be changed to give faster sweeps or higher resolution sweeps. The [settling parameters](#) can be adjusted to fit the noise levels of the signals being measured.

THD+N vs. Amplitude Sweep

Performs a THD+N vs. amplitude stereo sweep. The A0 and A1 analyzers are set to [Time Domain Detector](#) in order to measure THD+N. A digital 1 kHz sine waveform is setup with an amplitude sweep range of 1 mFFS to 1 FFS in 22 logarithmic steps. Page 2 displays a graph of the A and B channel THD+N vs. Amplitude.

What you'll need to configure:

The default frequency is 1 kHz. This should be adjusted as needed. The [settling parameters](#) can be adjusted to fit the noise levels of the signals being measured. The [bandwidth](#) of TDD can be adjusted to suit the measurement requirements.

THD+N vs. Frequency Sweep

Performs a THD+N vs. frequency stereo sweep. The A0 and A1 analyzers are set to [Time Domain](#)

[Detector](#) in order to measure THD+N. A low distortion 1 FFS sine waveform is setup with an frequency sweep range of 20 Hz to 20 kHz in 22 logarithmic steps. Page 2 displays a graph of the A and B channel THD+N vs. Frequency.

What you'll need to configure:

The default sine amplitude is 1 FFS.. This should be adjusted as needed.

2.9.5 Digital IO

The Digital-IO selection provides 3 measurement setups dealing with jitter measurement.

What you'll need to configure for all these setups:

Change the digital input and output [settings](#) (connector, OSR, bit resolution) to match the equipment being tested,

Jitter Chirp

This measurement uses a jitter "chirp" to measure the jitter transfer function of the equipment being tested. A jitter chirp is a waveform synchronized to the jitter analyzer that contains equal amounts of jitter in each frequency bin. When used as the input to a DUT, the output jitter spectrum is proportional to the jitter transfer function of the DUT. The A0 analyzer is setup as a frequency domain jitter analyzer. Pages 2 and 3 contain the frequency domain and time domain jitter results.

What you'll need to configure:

Adjust the amplitude of the jitter chirp on the [Digital IO Panel](#).

Jitter Sweep

This setup measures jitter amplitude vs. frequency using a sweep. The frequency of a jitter sine is swept from 20 Hz to 100 kHz and the resulting jitter output from the DUT is recorded on Page2.

What you'll need to configure:

Adjust the the sine [amplitude](#) to match the equipment being tested. The number of points in the [sweep](#) can be changed to give faster sweeps or higher resolution sweeps. The [settling parameters](#) can be adjusted to fit the noise levels of the signals being measured.

Jitter

Measures both RMS Jitter and the Jitter spectrum with SR1's jitter generator off. This setup is used to measure the intrinsic jitter output from a DUT. A0 is setup as a time domain jitter analyzer to measure rms jitter while A1 is setup to measure the jitter frequency spectrum.

What you'll need to configure:

The default frequency and amplitude of the digital sine is 1 kHz, 1FFS. This should be adjusted as needed.

2.10 Help Menu

SR1 Help

Opens the help browser containing the SR1 help file. The contents of the helpfile and printed manual are the same.

About SR1

Displays the "About SR1" panel listing the version of instrument software. If the software is running on the instrument (as opposed to demo mode) the serial number of the instrument is also displayed.



Always record the instrument software version and serial number before contacting Stanford Research Systems for technical support.

View Release Notes

Opens a window displaying version information. Each version is listed with features that have been added, improvements to existing features, and bug fixes. The information displayed in this window may be more recent than information contained in the manual or help files.

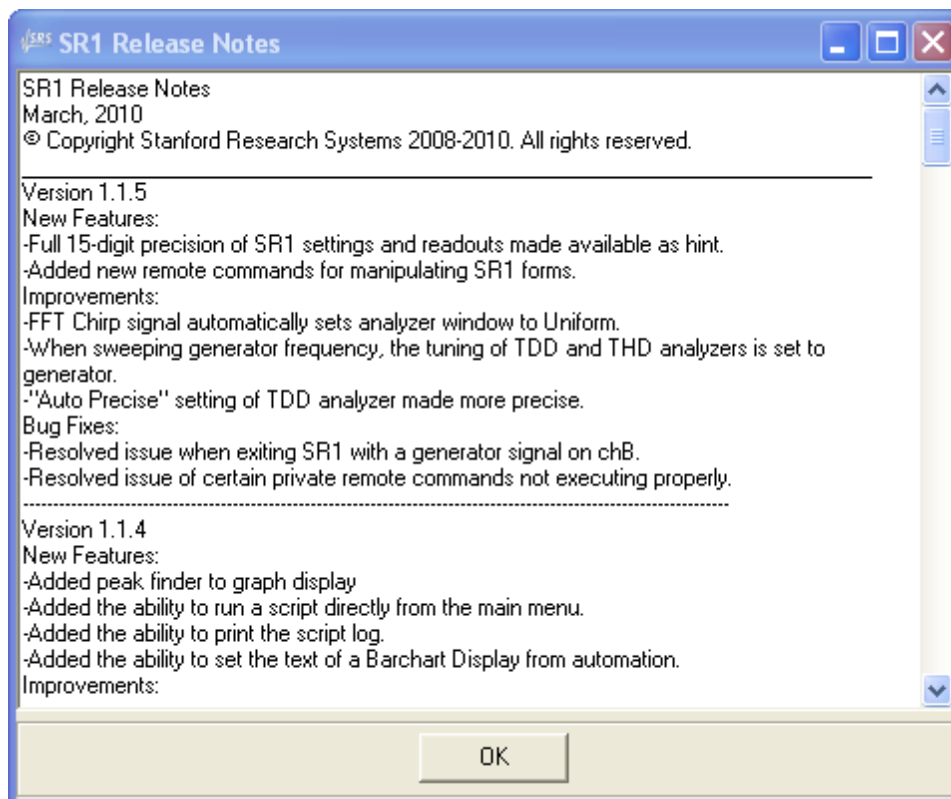

SR1 Reference

Part



3 SR1 Reference

3.1 Front Panel Description

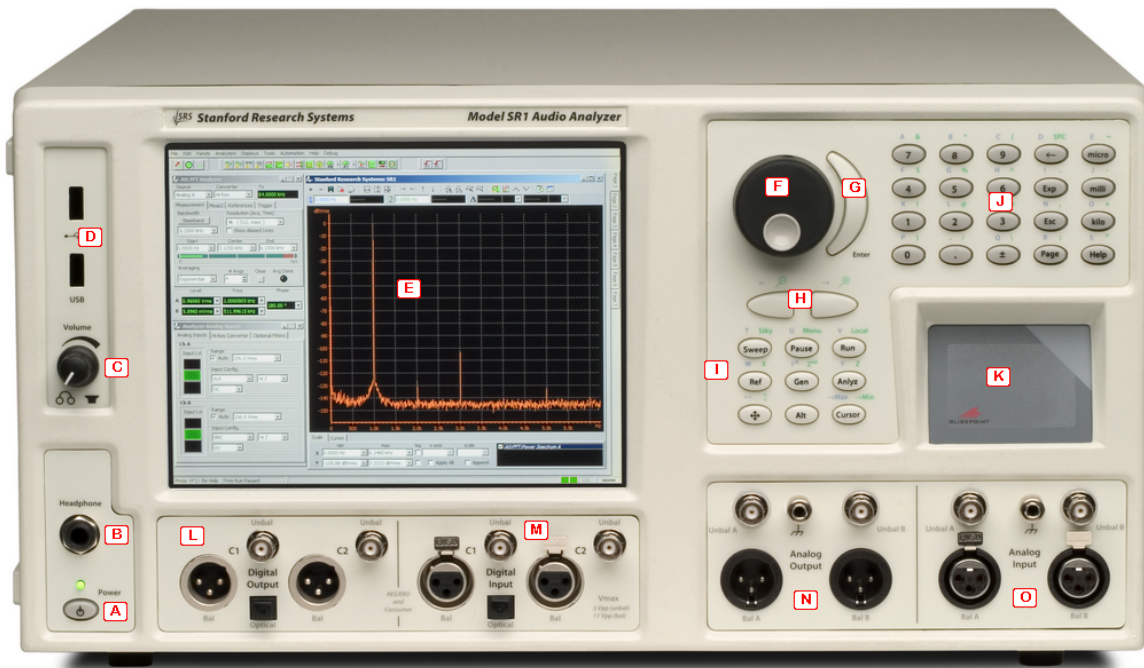

A) Power Button and Indicator

Turns the instrument power on and off. To turn the instrument off, select "Exit" from the file menu. When the screen displays the message "It is now safe to power-off your computer" press the button to turn the power off.

B) Headphone Jack

Standard 1/4" jack accepts all types of headphones. The speaker is muted automatically when headphones are plugged in.

C) Volume Knob

Controls the volume of signals routed to the speaker and headphone using the Monitors Panel. Does not control the volume of "system" sounds generated by the Windows operating system. The Windows sound level is controlled separately on the [Monitors Panel](#), or by the standard Windows volume control.

D) USB Connectors

The two USB connectors may be used to connect a USB drive, a USB printer, or a USB mouse or keyboard.

E) Main Screen

Color LCD screen on which the SR1 software runs. SR1 is sold with two screens, the standard VGA (640x480) display and the optional XGA (1024x768) screen.

F) Knob

Use the knob to modify the value of the screen control which currently has focus. When graphs are

displayed the knob can be used to move the [graph](#) cursor.

G) Enter Key

The Enter key confirms numeric and text entry into controls. See the "[User Interface](#)" chapter for more information on how to use the Enter Key.

H) Tab Keys

The tab keys are used to move focus from one control to another within a window, or to move focus between windows on the screen.

I) Action Keys

These keys are associated with a specific action, such as autoscaling the displays or starting and stopping sweeps. See the "[User Interface](#)" chapter for a detailed descriptions of each key function.

J) Numeric Entry Keys

These keys are used to enter numeric data into controls. See the "[User Interface](#)" chapter for a detailed descriptions of each key function.

K) Touch Pad

The touch pad can be used as a mouse if an external mouse is not connected to the instrument. Drag your finger over the touch pad to move the mouse cursor. To "click" the mouse tap once on the dark grey area. To "double-click," tap twice on the dark grey area. To "right-click" the mouse tap in the lighter grey area at the top right-hand corner of the touch pad.

L) Digital Audio Output Section

Contains connectors for digital audio output. There are two pairs of connectors labeled C1 and C2. Each pair contains a balanced (XLR) connector and an unbalanced (BNC) connector as well as an optical (TOSLINK) connector. Configuration of the output connectors is done on the [Digital I/O](#) panel.

M) Digital Audio Input Section

Contains connectors for digital audio input. There are two pairs of connectors labeled C1 and C2. Each pair contains a balanced (XLR) connector and an unbalanced (BNC) connector as well as an optical (TOSLINK) connector. Configuration of the input connectors is done on the [Digital I/O](#) panel.

N) Analog Output Connectors

Contains the analog output connectors. The two channels of the analog generator can be output either as a balanced signal on the XLR connectors or as an unbalanced signal on either the XLR or BNC connectors. See the [Analog Generator](#) panel description for more details.

O) Analog Input Connectors

Contains the analog input connectors. SR1 accepts analog inputs on either the XLR or BNC connectors. Selection of the input connector as well as other input parameters (coupling, range, etc.) is made on the [Analog Inputs](#) panel.

3.2 Rear Panel Description

The following signals and connectors are found on SR1's rear panel:

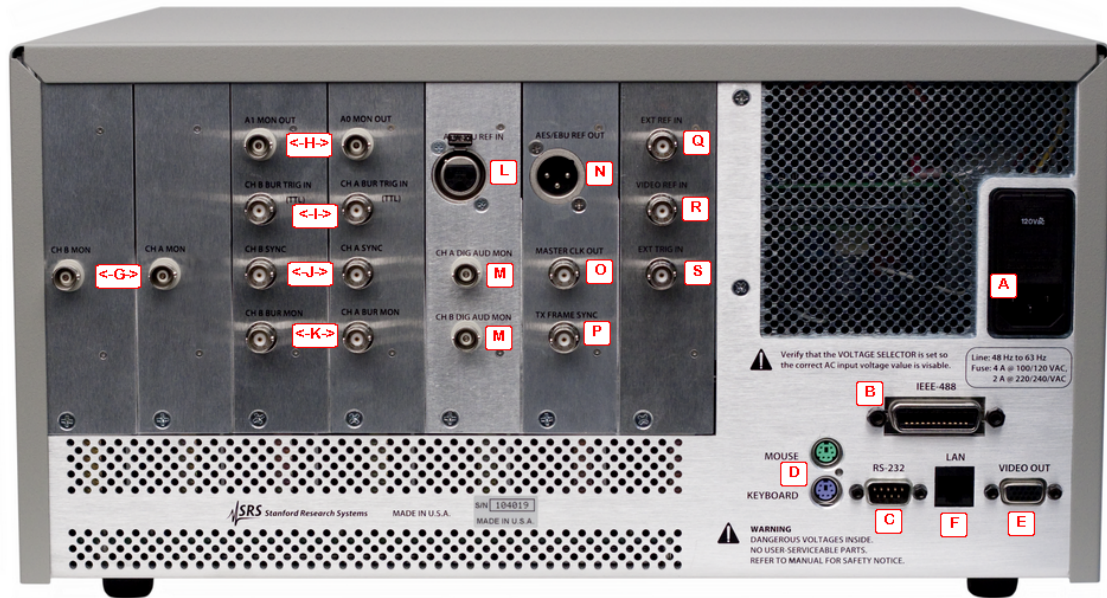

A) Power Entry Module

Connect the supplied power cord to the power entry module to provide AC power to SR1. Make sure that the card on the power entry module shows the correct AC line voltage (100,120,200,240) for your locale.

B) IEEE-488 Connector

The 24 pin IEEE-488 connector allows a host computer to control the SR1 via the IEE-488 (GPIB) instrument bus. The GPIB Address of the unit is set via software on the "Remote" tab of the [Preferences Panel](#).

C) RS-232 Connector

The RS232 serial interface connector is configured as a DCE (transmit on pin 3, receive on pin 20). The Baud Rate, Parity, and Word Length are all configured on the "Remote" tab of the [Preferences Panel](#). To connect the SR1 to a typical PC serial port, usually configured as a DTE, use a straight-through serial cable. The Serial Port can also be used to connect SR1 to a network of SR10/11/12 switching modules. See the section on configuring the switchers for more details.

D) Keyboard and Mouse Port

These connectors accept a standard PS/2-style mouse and keyboard. For the unit to recognize the external mouse and keyboard they must be plugged in before SR1 is powered on.

E) External Video Connector

The external video connector is a VGA style connector which allows connection of an external monitor to SR1. Note that the external video resolution is the same as the resolution used on the SR1's main LCD panel.

F) Ethernet Connector

The standard RJ-11 ethernet connector allows the SR1 to be connected to an ethernet network. Configuration of network parameters (IP address, DNS servers, etc.) is done using the ["Network Setup"](#) option of the ["Tools"](#) menu.

G) Analog Signal Monitor Out (Chs. A and B)

The analog monitors output an amplified version of the input signals found at Analog Inputs A and B. The scaling of these signals is adjustable using the Monitor Panel. The analog monitor signals can also be routed to the speaker or headphone output.

H) Analyzer Monitor Out (A0 and A1)

Certain analyzers have a realtime output signal. For instance, the Time Domain Detector output signal consists of the notch-filtered input signal, i.e. the distortion signal. Like the other monitor outputs, the scaling of the Analyzer monitors can be set using the Monitor Panel.

I) Burst Trigger In (Chs. A and B)

These TTL inputs trigger the corresponding Analog Generator bursts when the generator is configured for either "Gated Burst" or "Triggered Burst". (See the [Analog Generator](#) chapter for details of the SR1's analog generator burst modes.)

J) Sync Out (Chs. A and B)

The sync connectors output a square wave signal with TTL levels that is phase synchronous with the outputs from the Analog Generator. These signals are only meaningful if the Analog Generator Waveform has periodic zero-crossings (i.e. is not noise).

K) Burst Monitor Out (Chs. A and B)

The burst monitors output a TTL high level when the burst of the corresponding Analog Generator channel is in its "high" state, and a TTL low level when the corresponding burst is in a "low" state. These signals are valid for both synchronous bursts and generator bursts. (See the [Analog Generator](#) chapter for details of the SR1's analog generator burst modes.)

L) AES Reference In

Use this input to lock the SR1's internal clock to an external digital audio reference signal (as defined by AES11-2003). Configuration of the clock reference is done on the [Clock Reference](#) panel.

M) Digital Signal Monitor Out (Chs. A and B)

The digital monitors output an amplified version of the digital audio input signal. The scaling of these signals is adjustable using the Monitor Panel. These signals can also be routed to the SR1's internal speaker or to the headphone output.

N) AES Reference Out

This AES-11 (2003) compatible digital-audio reference signal is generated at the frequency specified on the Digital I/O panel.

O) Master Clock Out

The master clock signal is a TTL squarewave whose frequency is related to the digital audio output sampling frequency (OSR) as follows:

OSR	Master Clock Frequency
24 kHz - 56 kHz	OSR x 512
56 kHz - 108 kHz	OSR x 256
108 kHz - 216 kHz	OSR x 128

kHz

If "Master Clock Jitter" is enabled on the Digital I/O panel than the master clock output will be jittered as specified in the Output Impairment tab of the Digital I/O panel. If "Master Clock Jitter" is not selected, the master clock output will reflect the nominal Output Sample Rate regardless of any jitter specified on the Digital I/O panel.

P) Frame Sync Out

This TTL squarewave output signal is high when the digital audio output is outputting the first subframe of each digital audio sample and low when the output is outputting the second subframe of the sample. Thus, it is a squarewave with the same frequency as the digital audio sampling frequency. This signal is unaffected by any jitter selected on the impairment tab of the Digital I/O panel.

Q) Ext Ref In

Use this input to lock the SR1's internal clock to an external square wave reference signal. Configuration of the clock reference is done on the [Clock Reference](#) panel.

R) Video Reference In

Use this input to lock the SR1's internal clock to an external video (NTSC, PAL, or SECAM) signal. Configuration of the clock reference is done on the [Clock Reference](#) panel.

S) Ext. Trigger In

This TTL input triggers any analyzer configured to use "External Trigger." See "[Common Analyzer Features](#)" for a complete description of the SR1's analyzer trigger modes. Note that there is only one input for both analyzers.

3.3 Specifications

Analog Signal Generator

General Characteristics

Amplitude Range (rms)	10 μ V to 28.3 V (balanced) 10 μ V to 14.1 V (unbalanced)
Amplitude Accuracy	$\pm 0.5\%$ (± 0.043 dB) at 1 kHz
Frequency Range	
High BW DAC	10 Hz to 200 kHz
High Res. DAC	10 Hz to 0.45 F_s (F_s : 128 kHz or 64 kHz fixed, 24 kHz to 216 kHz adj.)
Frequency Accuracy	$\pm 0.0005\%$ (5 ppm)
Frequency Resolution	$< F_s / 2^{24}$
Output Configuration	Balanced Ground, Balanced Float, Unbalanced Ground, Unbalanced Float, Common Mode Test
Source Impedance	50 Ω , 150 Ω , 600 Ω (balanced) 25 Ω , 75 Ω , 600 Ω (unbalanced)
Max. Power (600 Ω load)	
Balanced	30.5 dBm
Unbalanced	24.9 dBm
Float Voltage	± 40 V
Crosstalk	
10 Hz to 20 kHz	- 125 dB
>20 kHz	- 100 dB

Waveforms

Low Distortion Sine (Hi BW DAC)

Flatness (rel. 1 kHz)

20 Hz to 20 kHz	± 0.020 dB (typ. ± 0.012 dB)
10 Hz to 64 kHz	± 0.025 dB
10 Hz to 200 kHz	± 0.050 dB

Residual THD+N

0.25 V_{rms} < Amplitude < 4.0 V_{rms}

Hi BW DAC, $F_s = 512$ kHz

1 kHz, 4 V _{rms}	-112 dB (22 kHz BW)
20 Hz to 20 kHz	-105 dB + 1 μ V (22 kHz BW)
	-100.5 dB + 1.7 μ V (80 kHz BW)
	-97 dB + 2.5 μ V (200 kHz BW)
10 Hz to 100 kHz	-89 dB + 2.5 μ V (200 kHz BW)

Hi Res DAC, $F_s = 128$ kHz

1 kHz, 4 V _{rms}	-112 dB (22 kHz BW)
20 Hz to 20 kHz	-106 dB + 1 μ V (22 kHz BW)

20 Hz to 57.6 kHz	-102 dB+ 1.4 μ V (57.6 kHz BW)
<i>Hi Res DAC, Fs = 64 kHz</i>	
1 kHz, 4 Vrms	-112 dB (22 kHz BW)
20 Hz to 20 kHz	-106 dB+ 1 μ V (22 kHz BW)

Normal Sine**Flatness (rel. 1 kHz):****(Amp. \leq 4 Vrms)**

20 Hz to 20 kHz	\pm 0.008 dB (typ. \pm 0.003 dB)
10 Hz to 64 kHz	\pm 0.020 dB
10 Hz to 200 kHz	\pm 0.030 dB

Residual THD+N

(Measured w/ HiBW Analyzer)

Hi BW DAC

1 kHz, 4Vrms	-86 dB (22 kHz BW)
20 Hz to 20 kHz	-85 dB + 1 μ V (22 kHz BW)
	-84.5 dB + 1.7 μ V (80 kHz BW)
	-82 dB +2.5 μ V (200 kHz BW)
10 Hz to 100 kHz	- 93 dB (200 kHz BW)

Hi Res DAC (Fs=128 kHz)

1 kHz, 4Vrms	- 99 dB (22 kHz BW)
20 Hz to 20 kHz	- 98 dB + 1 μ V (22 kHz BW)
10 Hz to 57.6 kHz	- 96.5 dB + 1.4 μ V (57.6 kHz BW)

Hi Res DAC (Fs=64 kHz)

1 kHz, 4Vrms	-106 dB (22 kHz BW)
20 Hz to 20 kHz	-101 dB + 1 μ V (22 kHz BW)

Other Waveforms**Phased Sines**

0 to 360°, 0.001° resolution

IMD

SMPTE/DIN, CCIF/DFD, DIM/TIM

Noise

White, Pink, Filtered White/Pink, USASI

MLSMaximum Length Sequence from 2^8 to 2^{20} samples repetition interval.**Multitone**

1 to 50 tones (individually adjustable in amplitude, phase, and frequency)

FFT Chirp

Equal power in each FFT bin. Frequency response can be modified with an EQ file.

Log-sine Chirp

Swept sine with a logarithmically increasing frequency, Used for impulse response measurements.

Square	10 Hz to 50 kHz frequency range
Ramp	F_s / N frequency range ($N = 20$), adjustable rise/fall fraction
Arbitrary	256 Samples to 136k Samples
Polarity	10 Hz to $F_s / 4$ frequency range
Constant (Offset)	DC to 20 Vp (unbal) / 40 Vp (bal)
Burst Types	Timed, ext. triggered, ext. gated All waveforms can be bursted asynchronously, Sines can be bursted synchronous with sine zero-crossings.

Digital Audio Signal Generator

Digital Audio Carrier Characteristics

Output Amplitude

Balanced

Range	16 mV to 10.24 V (110 Ω load)
Accuracy	$\pm 10\%$ + 80 mV

Unbalanced

Range	4 mV to 2.55 V (75 Ω load)
Accuracy	$\pm 10\%$ + 20 mV

Output Format

Balanced XLR (AES/EBU), dual-connector XLR, unbalanced BNC (SPDIF-EIAJ), dual-connector BNC, Optical (Toslink)

Output Sample Rate 24 kHz to 216 kHz

Sample Rate Accuracy ± 5 ppm

Output Impedance 110 Ω (balanced)
75 Ω (unbalanced)

Digital Audio Waveforms

Sine

Frequency Range	10 Hz to $F_s / 2$
Frequency Resolution	$< F_s / 2^{24}$
Flatness	± 0.001 dB
Harmonic/Spurious	-160 dB

Phased Sine 0 to 360° range, 0.001° resolution

Square 10 Hz to $F_s / 2$ frequency range

IMD	SMPTE/DIN, CCIF/DFD, DIM/TIM
Noise	White, Pink, Filtered White/Pink, USASI
MLS	Maximum Length Sequence from 2^8 to 2^{20} samples repetition interval.
Ramp	F_s/N frequency range (N = 20), adjustable rise/fall fraction
Arbitrary	256 Samples to 136k Samples
FFT Chirp	Equal power in each FFT bin. Frequency response can be modified with an EQ file.
Log-sine Chirp	Swept sine with a logarithmically increasing frequency, Used for impulse response measurements.
Polarity	10 Hz to $F_s / 4$ frequency range
Bursts	All allowed waveforms
Digital Test Waveforms	Digital Constant, Count, Rotating Bits, Staircase, J-Test
Dither	None, triangle and rectangular probability distribution
<i>Digital Audio Carrier Impairments</i>	
Jitter	
Waveforms	Sine, square, uniform noise, BP filtered noise, Chirp
Frequency Range	2 Hz to 200 kHz
Amplitude Range	0 UI to 13 UI
Normal Mode Noise	
Amplitude Range	
Unbalanced	0 to 637 mVpp
Balanced	0 to 2.55 Vpp
Common Mode Sine	
Amplitude Range	0 to 20 Vpp (balanced only)
Frequency Range	10 Hz to 100 kHz
Cable Simulation	Simulates 100 m of digital audio cable
Variable Rise Time	5 ns, 10 ns, 20 ns, 30 ns or variable from 40 ns to 400 ns

Signal Measurements

General Analog Input Characteristics

Amplitude Range (rms)	62.5 mV to 160 V
Input Configuration	XLR, BNC, Generator Monitor, Digital Audio Common Mode
Input Impedance	
Balanced	200 k Ω / 95 pF
Unbalanced	100 k Ω / 185 pF
Input Termination (bal)	300 Ω , 600 Ω , none

Crosstalk

10 Hz to 20 kHz	=- 140 dB
>20 kHz	=- 135 dB

Hi BW ADC

Type	16-bit sigma-delta
Sampling Frequency	512 kHz
Frequency Range	DC to 228 kHz

Hi Resolution ADC

Type	24-bit sigma-delta
Sampling Frequency	128 kHz or 64 kHz (fixed), 24 kHz to 216 kHz (adj.)
Frequency Range	DC to 0.45 Fs

General Digital Input Characteristics

Input Format	Balanced XLR (AES/EBU), dual-connector XLR, unbalanced BNC (SPDIF-EIAJ), dual-connector BNC, Optical (Toslink)
Input Sample Rate	24 kHz to 216 kHz
Input Impedance	Hi Z or 110 Ω (balanced) Hi Z or 75 Ω (unbalanced)

Analog Signal Meters**RMS Level Meter**Accuracy (1 kHz ref) $\pm 0.5\%$ (± 0.043 dB)Flatness (rel. 1 kHz,
Amp. = 4 Vrms)20 Hz to 20 kHz $< \pm 0.008$ dB (typ. $< \pm 0.003$ dB)10 Hz to 64 kHz $< \pm 0.020$ dB10 Hz to 200
kHz $< \pm 0.030$ dB**Frequency Meter**

Range 8 Hz to 300 kHz

Accuracy $\pm(2$ ppm + 10 mHz)**Phase Meter** $\pm 1.0^\circ$ accuracy**Digital Signal Meters****Frequency Meter** 10 Hz to $0.45 F_s$, ± 100 ppm accuracy**Phase Meter** $\pm 0.5^\circ$ accuracy (f = 50 Hz)**Analyzers (Analog and Digital Audio)****Time Domain Analyzer****Measurements** Amplitude, amplitude ratio, THD+N, THD+N ratio, SINAD**Analog Inputs:****Amplitude Accuracy** $\pm 0.5\%$ (± 0.043 dB)**Flatness (1 kHz ref)**50 Hz to 20 kHz $< \pm 0.008$ dB (typ. ± 0.003 dB)20 Hz to 64 kHz $< \pm 0.02$ dB10 Hz to 200 kHz $< \pm 0.05$ dB**Residual Noise** (62.5 mVrms Input Range, Shorted Input)**High Res. ADC ($F_s = 128$
kHz)**22 Hz to 22 kHz -117.5 dBu22 kHz to 57.6 kHz -115 dBuA-Weighted -120 dBu**High BW ADC**22 Hz to 22 kHz -118 dBu22 kHz to 80 kHz -113 dBu10 Hz to 200 kHz -110 dBuA-Weighted -120 dBu**Residual THD+N****High Res. ADC**
($F_s = 128$ kHz)

1 kHz, 4Vrms	-111 dB (22 kHz BW)
20 Hz to 20 kHz	-107 dB + 0.8 μ V (22 kHz BW)
	-101 dB + 1.3 μ V (57.6 kHz BW)

High Res. ADC
(Fs = 64 kHz)

1 kHz, 4Vrms	-111 dB (22 kHz BW)
20 Hz to 20 kHz	-107 dB + 0.8 μ V (22 kHz BW)

High BW ADC

1 kHz, 4 Vrms	-113 dB (22 kHz BW)
20 Hz to 20 kHz	-109 dB + 0.8 μ V (22 kHz BW)
	-102 dB + 1.5 μ V (80 kHz BW)
	-98 dB + 2.5 μ V (200 kHz BW)
10 Hz to 100 kHz	-91 dB (200 kHz BW)

Digital Inputs:

Amplitude Accuracy	± 0.001 dB (at 1 kHz)
Flatness	± 0.001 dB (15 Hz to 22 kHz)
Residual THD+N	≈ -140 dBFS

**Bandwidth Limiting
Filters**

Low Pass Filter 4th order Butterworth, adj. from Fs / 40 to 0.45 Fs, 20 kHz, 40 kHz and 80 kHz fixed elliptical filters per AES17.

High Pass Filter 4th order Butterworth, @ 22 Hz, 100 Hz, and 400 Hz. 20 kHz, 40 kHz and 80 kHz fixed elliptical filters per AES17.

Band Pass Filter

Response

Hi BW ADC	1/3 Octave, Class II (4-pole)
Hi RES ADC	1/3, 1/6, 1/12, 1/24 Octave, Class III (6-pole)
Digital Audio	1/3, 1/6, 1/12, 1/24 Octave, Class III (6-pole)

Tuning Range

Hi BW ADC	10 Hz to 200 kHz
Hi RES ADC	10 Hz to 0.44 Fs
Digital Audio	10 Hz to 0.44 Fs

Tuning Accuracy ± 2.5 %

Amplitude Accuracy ± 0.5 %

weighting Filters A-wt, C-Msg wt, CCITT, CCIR (weighted, unweighted, & 2 kHz norm)

Optional Filters Up to 4 per channel (Hi BW only)

Detector Type RMS, Peak, Quasi-Peak (CCIR-468)

Single-Channel and Dual-Channel FFT Analyzers

Frequency Range

Hi BW ADC	DC to 200 kHz
Hi Res ADC	DC to 0.45 Fs
Digital Audio	DC to Fs / 2

Number of Lines	256, 512, ... 32k
Processing	40-bit floating point
Windows	Blackman Harris, Hanning, Hamming, Equiripple, Flattop, Gaussian, Kaiser, Uniform, Rife Vincent 4, 5 and 10 term
Zoom	Span can be narrowed by up to 512x
Heterodyne	Narrowed span can be centered anywhere in the measurement range. (Single Ch. FFT only)
Averaging	Continuous and fixed length.
Dual-Ch. Measurements	Frequency response, coherence

Other Analyzers

THD Analyzer Measures two independent sets of user-selectable harmonics (2x to 14x)

IMD Analyzer SMPTE/DIN, CCIF/DFD, DIM/TIM

Histogram Analyzer Time vs. amplitude, Histogram, PDF, Gaussian fit to PDF

Multitone Analyzer Level, Frequency Response, THD + N, noise, THD, IMD, Crosstalk

Digital Audio Carrier Measurements

Measurements Carrier amplitude, sample rate, jitter amplitude, jitter spectrum

Sample Rate 24 kHz to 216 kHz

Sample Rate Accuracy ± 5 ppm

Carrier Amplitude Measurements

Balanced (XLR) ± 5 % + 80 mV

Unbalanced (BNC) ± 5 % + 20 mV

Optical Displays voltage of Toslink receiver.

Output to Input Delay Measures delay from Digital Audio Output or AES11 reference output to Digital Audio Input

Range -12.7 UI to $+115.1$ UI in seconds

Resolution 60 ns

Residual Jitter

50 Hz to 100 kHz ≈ 600 ps

Optional Digitizer

Sampling Rate 80 MHz

Acquisition Length 4k, 8k, 16k, 128k, 256k, 512k, 1M, 2M samples

Measurements Input vs. time, jitter vs. time, input spectrum, jitter spectrum, pulse width/rate histograms, jitter probability histogram, eye diagrams

General

Computer Interfaces	GPIB, RS-232, Ethernet, COM. All instrument functions can be controlled.
Reference Input Sources	AES3 (24 Hz to 216 kHz), sine or TTL (8 kHz to 32 MHz), video (NTSC/PAL/SECAM)
Reference Output Format	AES3 (24 Hz to 216 kHz)
Video Out	VGA output for driving external monitor
Power	<275 W, 90 VAC to 264 VAC, 47 Hz to 63 Hz
Dimensions	17 [?] × 8.5 [?] × 20.25 [?] (WHD)
Weight	40 lbs.
Warranty	One year parts and labor on defects in materials and workmanship

3.4 Filter Reference

SR1's analog input boards have provision for the installation of up to 4 optional filters. Each filter can be inserted in the signal chain after the Notch/Bandpass filter and before the postfilter gain elements. (Note that the optional filters only affect Hi Bandwidth analog measurements).

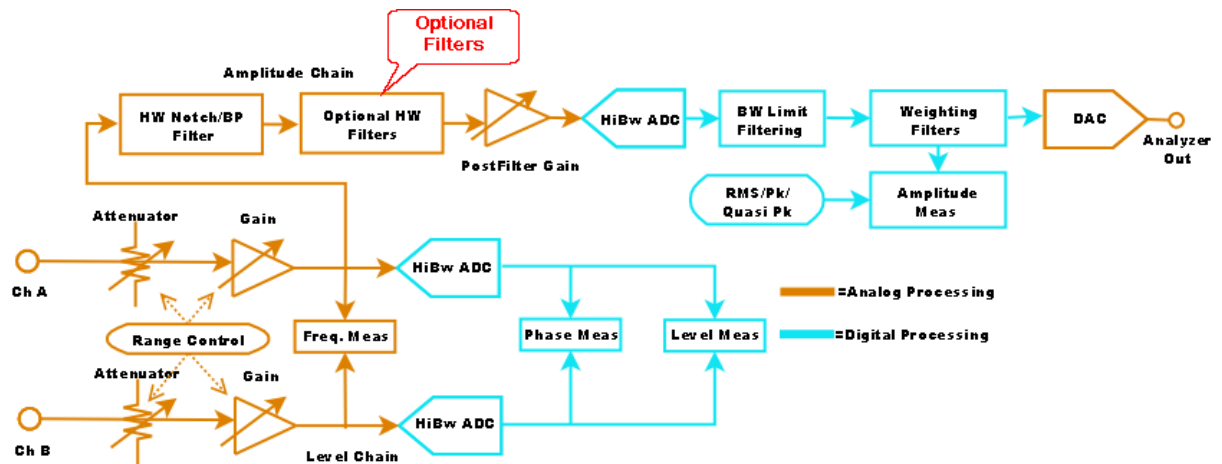

At the current time no optional filters are available. As they are developed detailed information on the response of the optional filters will be included in this section of the manual.

3.5 File Reference

EQ Files (.EQ)

EQ files are XML files that represent a real or complex (magnitude or magnitude and phase) frequency response. There are two types of EQ files, pole-zero files, which contain a set of s-plane poles and zeros which represent a complex frequency response, and sampled EQ files, which contain a set of pairs of frequencies and response values at those frequencies, with other frequency values calculated by interpolation. In the examples below an example of each type of file will be examined and the relevant file options will be explained.

Pole Zero EQ Files

Pole-Zero EQ files contain a list of s-plane poles and zeros which form a complex function of frequency. Thus, pole-zero EQ files have both a magnitude and phase response as a function of frequency.

Consider, for instance, the s-plane transfer function corresponding to the well known A-Weighting function.

$$T_A(s) = \frac{k_A \cdot s^4}{(s + 2\pi \cdot 20.6)^2 (s + 2\pi \cdot 107.7)(s + 2\pi \cdot 737.9)(s + 2\pi \cdot 12200)^2}$$

where $k_A = 7397235900.0$ Note that the function involves an overall constant multiplier, 4 zeros at zero frequency, and 6 real poles

This A-Weighting transfer function is represented by the EQ file shown below:

```
<?xml version="1.0" encoding="UTF-8"?>
<!DOCTYPE EQcurve SYSTEM "EQcurve.dtd">
<EQcurve>
  <MetaData>
    <Source Value="C:\Program Files\Borland\CBuilder5\Projects\Audio_an\EQgen\EQgen.exe"/>
    <DocType Value="EQcurve_XML"/>
    <Version Value="1.0.0"/>
    <Date Value="2005-05-05T15:54:12"/>
  </MetaData>
  <EQdata Name="Style" Type="6" Value="PZmodel"/>
  <EQdata Name="PolesReal" Type="DblArray" Value="20.6,20.6,107.7,737.9,12200,12200"/>
  <EQdata Name="PolesImag" Type="DblArray" Value="0,0,0,0,0,0"/>
  <EQdata Name="ZerosReal" Type="DblArray" Value="0,0,0,0"/>
  <EQdata Name="ZerosImag" Type="DblArray" Value="0,0,0,0"/>
  <EQdata Name="PZmultiplier" Type="3" Value="-6.283185307"/>
  <EQdata Name="Gain" Type="3" Value="7397235900"/>
</EQcurve>
```

The important lines, from the point of view of modifying or synthesizing a new EQ files are:

```
<EQdata Name="Style" Type="6" Value="PZmodel"/>
```

This line indicates that the file is an Pole-Zero EQ file. It must be present, exactly as shown, in all pole-zero EQ files. The next two lines in the file:

```
<EQdata Name="PolesReal" Type="DblArray" Value="20.6,20.6,107.7,737.9,12200,12200"/>
<EQdata Name="PolesImag" Type="DblArray" Value="0,0,0,0,0,0"/>
```

lists the real and the imaginary parts of each of the poles. The two lists must have the same size. Since

the poles in the A-Weighting transfer function are purely real, the imaginary part of each pole in this file is 0. Note that the two repeated poles are simply repeated in the list. Note that the poles in the list are given with values in Hz. Since this is an s-plane transfer function the actual poles should be given in rad/sec. This is handled by the line:

```
<EQdata Name="PZmultiplier" Type="3" Value="-6.283185307"/>
```

This specifies that all pole and zero values should be multiplied by -2π . This converts the Hz values into rad/sec values and also moves poles into the left hand plane, where stable poles are located.

The real and imaginary parts of zeros are specified in a similar manner by:

```
<EQdata Name="ZerosReal" Type="DblArray" Value="0,0,0,0"/>
<EQdata Name="ZerosImag" Type="DblArray" Value="0,0,0,0"/>
```

These two lines give us the 4 zeros at zero frequency specified in the transfer function.

Finally, the last line in the file:

```
<EQdata Name="Gain" Type="3" Value="7397235900"/>
```

Specifies the overall multiplier for this transfer function.

A number of EQ files are supplied with SR1. By examining these files and using the information given above it should be possible to synthesize new EQ files corresponding to any pole-zero type transfer function.

Sampled EQ Files

Sampled EQ files represent a real (magnitude only) frequency response by storing a list of frequencies and responses and using spline interpolation to interpolate the values at other frequency points. The list of y-values in the files may be either pure numbers, or dB ratios. As an example, the same A-Weighting function that was described in pole-zero format above can be represented in sampled format with the file below:

```
<?xml version="1.0" encoding="UTF-8"?>
<!DOCTYPE EQcurve SYSTEM "EQcurve.dtd">
<EQcurve>
  <MetaData>
    <Source Value="C:\Program Files\Borland\CBuilder5\Projects\Audio_an\EQgen\EQgen.exe"/>
    <DocType Value="EQcurve_XML"/>
    <Version Value="1.0.0"/>
    <Date Value="2005-05-05T15:54:12"/>
  </MetaData>
  <EQdata Name="Style" Type="6" Value="Freq Response"/>
  <EQdata Name="Freq" Type="DblArray" Value=
    "0.01,0.02,0.03,0.04,0.05,0.06,0.07,0.08,0.09,0.1,0.2,0.3,0.4,0.5,0.6,0.7,0.8,0.9,
    1,2,3,4,5,6,7,8,9,10,20,30,40,50,60,70,80,90,100,200"/>
  <EQdata Name="Resp" Type="DblArray" Value=
    "0.000300775933872953,0.00302174093251185,0.00932540277740184,0.0187511398949463,
    0.030636637564135,0.0444168356181221,0.0596245322111266,0.075876407055739,0.0928635700095015,
    0.110342389581799,0.286838481522557,0.443881655056602,0.577159672164201,0.688018968891406,
    0.778916516580281,0.852785568914054,0.91256030198955,0.960885423147423,1.00000000003858,
    1.14837827316987,1.15195959556707,1.11740718036267,1.06603938913942,1.00595593739291,
    0.941761216135588,0.876545831584705,0.8124486702114,0.750902168765253,0.341162925654635,
    0.178593707588384,0.107123333734722,0.0707303220476656,0.0499780417068754,0.037110212737056,
    0.0286105664352016,0.0227144341264837,0.01846210568194,0.00466695600216974"/>
</EQcurve>
```

The line:

```
<EQdata Name="Style" Type="6" Value="Freq Response"/>
```

identifies the file as a sampled EQ file with the values given as pure numbers. To specify a file where the values are given in dB use:

```
<EQdata Name="Style" Type="6" Value="Freq Response (dB)"/>
```

The next line:

```
<EQdata Name="Freq" Type="DblArray" Value=
  "0.01,0.02,0.03,0.04,0.05,0.06,0.07,0.08,0.09,0.1,0.2,0.3,0.4,0.5,0.6,0.7,0.8,0.9,
  1,2,3,4,5,6,7,8,9,10,20,30,40,50,60,70,80,90,100,200"/>
```

gives the frequency values for each of the frequency response points. This value must be listed in **kHz**, not Hz.

Finally the y-values corresponding to each of the frequencies listed is described by:

```
<EQdata Name="Resp" Type="DblArray" Value=
  "0.000300775933872953,0.00302174093251185,0.00932540277740184,0.0187511398949463,
  0.030636637564135,0.0444168356181221,0.0596245322111266,0.075876407055739,0.0928635700095015,
  0.110342389581799,0.286838481522557,0.443881655056602,0.577159672164201,0.688018968891406,
  0.778916516580281,0.852785568914054,0.91256030198955,0.960885423147423,1.0000000003858,
  1.14837827316987,1.15195959556707,1.11740718036267,1.06603938913942,1.00595593739291,
  0.941761216135588,0.876545831584705,0.8124486702114,0.750902168765253,0.341162925654635,
  0.178593707588384,0.107123333734722,0.0707303220476656,0.0499780417068754,0.037110212737056,
  0.0286105664352016,0.0227144341264837,0.01846210568194,0.00466695600216974"/>
```

Obviously, the lists of frequency values, and response values must be the same length. When interpolating in a sampled EQ file, if the required frequency is less than the value of the lowest frequency point in the list, the response corresponding to this lowest frequency point is given. Likewise, if the response is required at a value greater than the highest point in the list the value for the highest point in the list is returned.

Digitizer Files (.TXT)

SR1 digitizer files are two-column ASCII text files. The first column displays time, which increases monotonically in intervals of the sampling period. For digitizer files created by SR1's optional digitizer the sampling period is always 12.5 ns (80 MHz). However, it is possible to create files with different sampling rates and import them into the digitizer for display and analysis. The time difference between the first two points is used to compute the sampling interval when a digitizer file is read in.

The second column gives the magnitude of each sample in Volts. Columns are separated by a "Tab" character. When a digitizer file is loaded, the X-axis values in the file are ignored and the Y values are simply loaded as sequential samples. The X-axis is aligned so that the first transition of the type specified in the "Jitter Detection" control on the [Digitizer Panel](#) (Preamble, all bits, etc.) is at time = 0.

A fragment of an example digitizer file is shown below. Users are encouraged to modify digitizer files taken by SR1 or to synthesize their own to experiment with the capabilities of the Digitizer.

```
// SR1 Digitizer Time Record
// X Units = s, Y Units = V
0          0.075
1.25e-08   2.825
2.5e-08    2.375
3.75e-08   2.475
```

5e-08	2.7
6.25e-08	2.35
7.5e-08	2.475
8.75e-08	2.5
1e-07	2.4
1.125e-07	2.65
1.25e-07	2.425
1.375e-07	2.575
1.5e-07	2.575

Arbitrary Waveform Files (.ARB)

SR1 arbitrary waveform files are ASCII text files containing columns of floating point numbers. For instance:

```
0.0000000e+000
0.0001
2.0000000e-004
3.0000000e-004
4.0000000e-004
5.0000000e-004
6.0000000e-004
7.0000000e-004
8.0000000e-004
9.0000000e-004
```

Multiple (tab-separated) columns of values may be present in the file. If so, SR1 will prompt the user for the correct column to use when loading the arbitrary waveform file.

Note that the absolute value of the sample values are disregarded when outputting an arbitrary waveform, only the relative magnitudes of the sample values are important. To arrive at the absolute scaling, SR1 first estimates any overshoot that may occur due to the fact that the file samples may not be band limited. The maximum value of the file waveform (including overshoot) is then scaled to the amplitude value entered on the arbitrary waveform panel. For instance, if the file above was loaded and output with an amplitude of 1 Vp the actual output would show a linear ramp from 0 Vp to 1 Vp.

Configuration and Display Files (.XML)

Configuration and Display files are XML files that specify instrument configuration and display data. Because the data in these files contains multiple settings with many complex interactions it is not recommended or necessary for users to modify configuration or display files.

3.6 Hardware Reference

Using SR1 with an External Monitor

SR1 has a VGA connector on the rear panel which can be used to connect an external monitor. If the SR1 is equipped with the optional XGA (1024x768) display, then the external monitor will run in 1024x768 resolution. If SR1 is equipped with the standard VGA (640x480) display then the external monitor can be run either in VGA mode or in XGA mode. If a VGA SR1 is operated with an external monitor in XGA mode, the front panel LCD display will no longer show the entire screen but instead will show a 640x480 portion of the screen that will pan as the mouse is moved.

To enable operation with an external monitor:

1. Using an external keyboard or the virtual keyboard bring up the windows start menu by pressing the  key.
2. Choose Settings, Control Panel from the Windows start menu.
3. Double-click the "Display" icon and choose the settings tab. Click on the "Advanced Button"
4. Click on the "S3Display" tab. You should see the following panel:

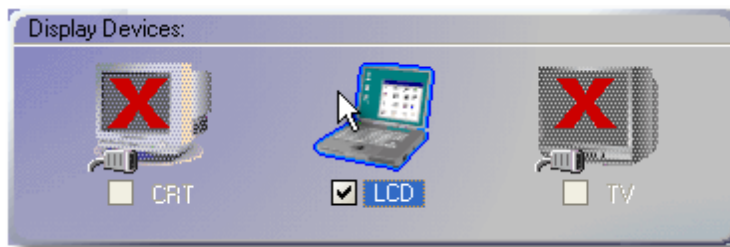

5. Click on the "CRT" box to enable the external monitor.
6. Click OK to return to the Display control panel.

To enable XGA resolution on a VGA SR1:

1. Follow steps 1-6 above.
2. In the "Screen Resolution" control, move the slider to select 1024x768 resolution.

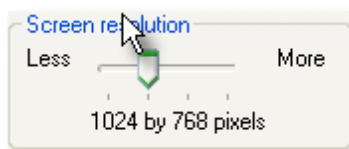

3. The external monitor will now display the entire SR1 screen while the front panel monitor will display a 640x480 portion of it which will "pan" in response to mouse movements.

Rack-mounting SR1

The optional O1RM rack mount kit allow mounting the SR1 audio analyzer in an EIA standard 487 mm (19") rack cabinet.

Two brackets, two handles, two washers and assorted screws are supplied with this kit. When installed, the instrument will occupy 5 U or 5 rack units increments (8.75 in / 222 mm). To install the rack mount kit you will need a #2 Phillips screw driver. Remember that SR1 weighs about 50 lbs, so use caution

when installing it into a rack. See the diagram below for details on installing the rack mount brackets.

1. (Optional) Attach the handles to the rack mount brackets with two 8-32 x 3/8" flat head screws for each bracket.
2. (Optional) Remove the feet and bail from the bottom of the instrument. Turn the instrument onto its left side and remove the 6 screws that attach the feet to the bottom of the instrument. Rotate the instrument back onto its bottom.
3. Remove the front two 10-32 x 3/8" truss head screws on both the left and right side of the instrument.
4. Install one bracket on the right side of the unit using two 10-32 x 1/2" truss head screws. Install the other bracket on the left side of the unit with the washers between the bracket and SR1 using two 10-32 x 1/2" truss head screws.

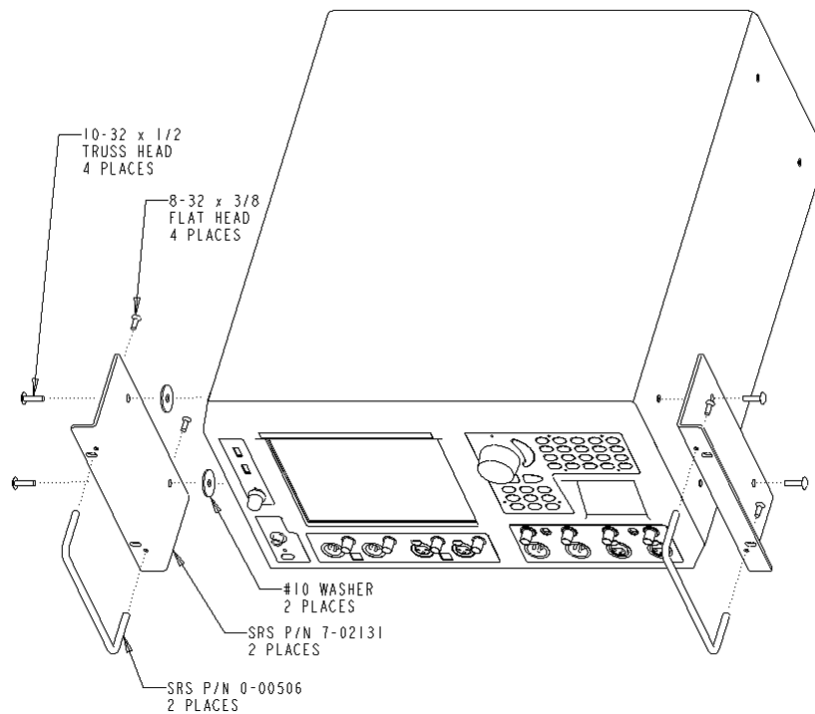

Index

- A -

Arbitrary 49
 About SR1 288
 AES Reference 105, 293
 Amplitude Units 41, 60
 Analog Inputs
 AutoRange 76
 Connector 76
 Coupling 76
 Overload 76
 Overview 9
 Range 76
 Analyzer Monitors 100
 Analyzer Units 110
 Analyzers 107
 Overview 9
 Anechoic frequency response 144
 Arbitrary Waveform 43, 62
 Arbitrary Waveform Files 306
 Automated Measurements 275
 Automation 241, 250

- B -

Bar Chart 202
 BNC Connector 79
 Burst 36, 57
 Burst Modes 36

- C -

Cable Sim 79
 Carrier Level 79
 Carrier Status Tab 79
 CCIF/DFD 62, 161, 267
 Channel Status
 Consumer 87
 Professional 87
 Chirp 43
 Clock 105
 Coding 79
 Coherence 141, 143

Colors
 Analog Colors 35
 Digital Colors 35
 Common Analyzer Features 108
 Common Mode Sine 79
 Computer Functions 236
 Confidence 79
 Configuration Files 28, 29, 30, 31
 Constant (Offset) 43
 Controls
 Unit Display 13
 Unit Entry 13
 Converter 108
 Copyright and Trademarks 8
 CRC 79
 CRC Transmission 87
 Crosstalk 115, 269
 Cursors 197

- D -

Databits Display 79
 Date/Time Settings 238
 Debugging Interface Problems 242
 DeEmphasis 79
 Digital Audio Carrier Measurements 183
 Digital Audio Inputs and Outputs
 Overview 9
 Digital Carrier Amplitude 82
 Digital Input Resolution 80
 Digital Output Connectors 79
 Digital Output Resolution 79
 Digital Test Waveforms
 Digital Constant 62
 Digital Count 62
 Digital Staircase 62
 J-Test 62
 Rotate Bits 62
 Digitizer 183, 205
 Acquisition 183
 Analysis 185
 File Format 306
 Input Gain 183
 Input Selection 183
 Measurements 188
 Overview 9
 Trigger 184
 Digitizer Display

Digitizer Display
 Eye Diagrams 209
 Eye Limits 209
 Probability Tab 208
 Spectrum 207
 Speedbar 205
 Time Record Tab 207

DIM 62

DIM/TIM 161, 267

Displays

 Bar Chart 202
 Digitizer Display 205
 Graphs 192
 Overview 9

Displays Menu 191

Distortion 265

Distortion Spectra 139

Dual Connector 79

- E -

Edit

 Copy 34
 Cut 34
 Delete 34
 Paste 34

Edit Menu 34

Edit Tones 104

Ejecting a USB Drive 237

Energy Time Curve 144

EQ 36, 57

EQ Files 306

Ethernet 218, 241

Events 220

 and Scripting 223
 Configuration 225
 Definitions 220

Example Measurement 19

External Monitor Setup 310

External Reference Input 293

External Sweeps 94

External Trigger Input 293

External Video Connector 293

Eye Diagrams 209

- F -

FFT 127, 141

FFT (Dual Ch.) 141

FFT Analyzer (1 Ch.) 127

FFT Chirp 43, 62

FFT1 Analyzer

 Aliasing 131
 Averaging 132
 Bandwidth 131
 Block Diagram 127
 DC Correction 135
 Phase 134
 Resolution 132
 Weighting 136

FFT2 141

FFT2 Analyzer

 Aliasing 149
 Averaging 149
 Bandwidth 148
 Block Diagram 141
 Coherence 143
 DC Correction 152
 Resolution 149
 Weighting 152
 Windows 150

FFT2 Analyzer

 Phase 151

File Menu 28

File Types 306

Filtered Noise 43, 62

Frame Synch Output 293

Frame-Synch Invert 79

Free-run 91

Frequency Response 263

Frequency Units 41, 60

Front Panel 13

Front Panel Lockout 216

Front Panel Reference 291

Fuse 6

- G -

Generator References 36, 57

Generator Trigger 43, 62

Generator, Analog

Generator, Analog
 Amplitude Controls 36
 Maximum Output Limit 215
 Mono-Stereo Selection 36
 Output Configuration 36
 Panel 36
 Sampling Rate 36
 Units 41
 Waveforms 43

Generator, Digital Audio
 Adding Waveforms 57
 Amplitude Controls 57
 Mono/Stereo Selection 57
 Panel 57
 Units 60
 Waveforms 62

GPIB 218, 241

GPIB Connector 293

Graph

Adding a Trace 193
 Cursor Display Bar 197
 Cursor Tab 197
 FFT Cursors 198
 Limits 198
 Panel 193
 Scaling 196
 Speedbar 195
 Trace Calculator 199
 Trace Listing 193
 X-Axis 196

Graphs 192

- H -

Hardware Status 230
 Harmonic Analyzer 157
 Headphone 100
 Headphone Jack 291
 Help 288
 Hi-Bandwidth 108
 Hi-Res Converter 76
 Hi-Resolution 108
 Histogram Analyzer 171
 Averaging 173
 Bins 173
 Fit 174
 Measurements 171
 Panel 172

Range 173
 Sample Rate 173
 Scaling 173
 Size 173

- I -

IEEE-488 241
 Setting Address 218
 IMD 62
 IMD Analyzer 161
 Averaging 163
 Generator Selection 162
 IMD Products 162
 Panel 162
 Weighting 164
 IMD Distortion 267
 IMD Waveform 43
 Impulse Response 141, 144
 Input Autorange 76
 Input Connectors 76
 Input Impedance 76
 Input Range 76
 Input Sampling Rate 76, 79
 Internal Sweeps 93
 ISR 79

- J -

Jitter Analyzer 177
 Averaging 181
 Bandwidth 181
 Block Diagram 177
 Filtering 181
 Frequency Domain Analysis 180
 Resolution 181
 Time Domain Analysis 180
 Jitter Generation
 Amplitude 79
 EQ 79
 Waveform 79
 Jitter Analyzer
 Input Selection 179
 JScript 243

- K -

Keyboard 13
Keyboard and Mouse Ports 293
Keypad 13
Knob 13, 291

- L -

Limit Testing 198
Line Voltage Selector 6
Load Configuration 31
Load Displays 212
Lock 79
Locking the Clock to an External Source 105
Logging 250
Log-sine chirp 43, 62

- M -

Macros 216
Manual Revision History 8
Mapped Drives 233
Master Clock Output 293
MLS 43, 47, 62
Monitors 100, 293
Mouse 13
Multitone 62, 102
Multitone Analyzer 165
 Distortion Products 168
 Equalization 168
 Measurements 165
 Noise Analysis 169
 Panel 167
 Processing Modes 168
 Trigger Panel 170
 Validation 170

- N -

Network Drives 233
Network Places 232
Network Setup 231
Networking Options 231
Noise 43, 46, 62
Normal Mode Noise 79

- O -

Octave Analyzer
 Panel 175
Octave Analyzer
 Averaging 176
 Mode Selection 176
Optional Filters 76, 305
OSR 79
Output Impairment 79
Overview 9

- P -

Panels 35
Parity 79
Phase 271, 273
Phase Limits 214
Phased Sine 43
Phased Sines 62
Polarity Check 62
Polarity Check Waveform 43
Power Button 291
Power Cord 6
Power Entry Module 293
Power Options 237
Pre-emphasis 79
Preferences 214
 Display Options 215
 Phase Limits 214
 Remote Interfacing 216
 Startup Configuration 214
Print
 Print Screen 32
 Print Setup 33
Printers 236

- Q -

Quick Measurements 253
 Automated Measurements 275
 Crosstalk 269
 Distortion 265
 IMD 267
 In/Out Phase 273
 Level 259

Quick Measurements 253
 Reference 257
 Reports 275
 Setup 254
 SNR 255
 THD+N 261
 Quick Measurements
 Interchannel Phase 271
 Quick Start 19

- R -

Rackmount Setup 310
 Ramp 43, 62
 References 40
 Remote Interface Panel 242
 Remote Interfaces
 Overview 9
 Remote Interfacing 241
 Remove Network Drive 233
 Risetime 79
 RS-232 218, 241
 RS-232 Connector 293

- S -

Safety 6
 Save Configuration 29
 Save Displays 212
 Save Partial Configuration 30
 Scripting Window 243
 Speedbar 243
 SR1 Basic Interface 244
 Scripts 250
 Serial Port 218
 Service 6
 Settling 98
 Settling Options
 Delay 99
 Precision 98
 Profile 98
 Threshold 99
 Sharing SR1 234
 Signal to Noise 255
 Sine 62
 Sine, Low Distortion 43
 Sine, Normal 43

SMPTE/DIN 62, 161, 267
 SNR 255
 Software Updates 238
 Speaker 100
 Specifications 296
 Square Wave 43, 62
 SR1 Basic 244
 Actions 246
 Properties 245
 SR10 226
 SR11 226
 SR12 226
 SRS Contact Information 6
 Startup Configuration 214
 Status Bits 79
 Sweep 91
 Sweep Append 197
 Sweep Axes 91
 Sweep Data 97
 Sweep Settling 98
 Sweep Source 92
 Sweeps and Free-Run
 Overview 9
 Switcher Configuration
 Adding a Switcher 226
 Switcher Sweeps 96
 Switchers 226
 Synchronous Burst Sine 43

- T -

Table Sweeps 93
 TCP/IP 218
 THD 157
 THD Analyzer 157
 Fundamental Selection 157
 Harmonic Selection 158
 Measurement Speed 158
 Weighting 159
 THD Ratio 198
 THD+N 115, 261
 Time Domain Detector 115
 Bandwidth Limiting 124
 Filter 120
 Measurement Rate 119
 Post Filter Gain 126
 Response 119
 Time Sweeps 93

Tools Menu 213
TOSLINK 79
Trace Calculator 199
Trackpad 13

- U -

Units 110
Unpacking 6
Updating SR1 238
USASI Noise 43, 62
User Bits 79
User Interface 13
User Status Bits 90

- V -

Validity 79
VBScript 243
Video Reference 105
Video Reference Input 293
Virtual Keyboard 238
Virtual Keypad 13
Visual Basic 243
Volume Knob 291
VXI-11 218, 241

- W -

Weighting Filters 164

- X -

XLR Connector 79

Endnotes 2... (after index)

Back Cover