

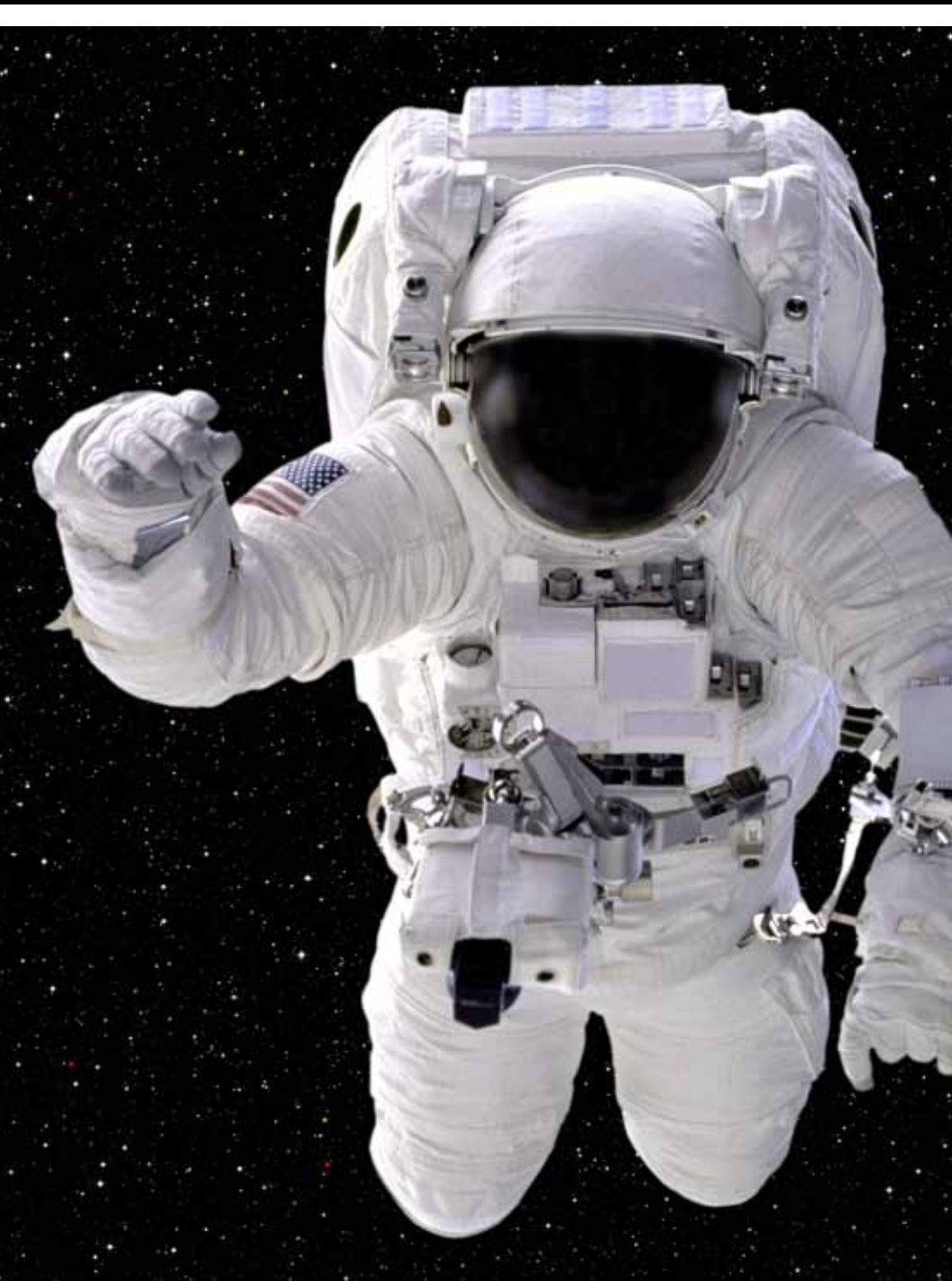



BASICS OF CRYOPUMPING





People who need to create a vacuum would benefit from having access to a satellite and traveling out beyond the Earth's atmosphere. They could create a vacuum by simply opening a valve to space in the chamber in which they want a vacuum created. Then, chamber pressure would drop to the same ultra-high vacuum level as space.

A cryopump has many of the same characteristics of space atmosphere. It operates over a wide range of pressures, provides a clean vacuum and captures gases by freezing them out. As the gases are frozen, they are unable to return to the chamber in which the vacuum is created.

Cryopump Temperature Stages

A typical cryopump consists of a cryogenic refrigerator producing refrigeration at two temperature stages. Each stage in turn cools an extended surface cryopanel onto which the gases will freeze. The **first stage** of the refrigerator, shown at right, usually operates in the range of 50-75 K (Kelvin) and is used to cool the outer cryopanel and louvers across the inlet opening of the cryopump. Water vapor will freeze out onto these panels.

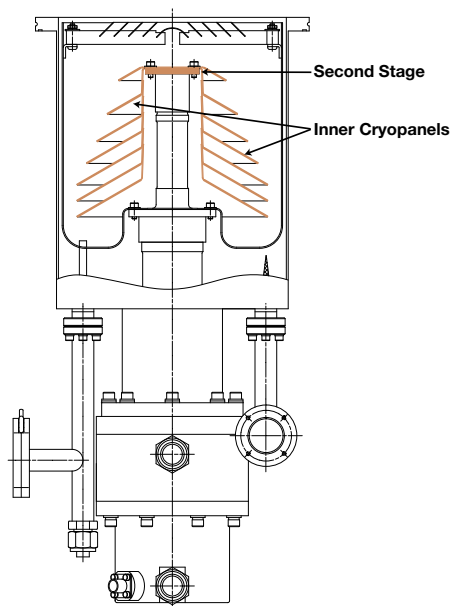
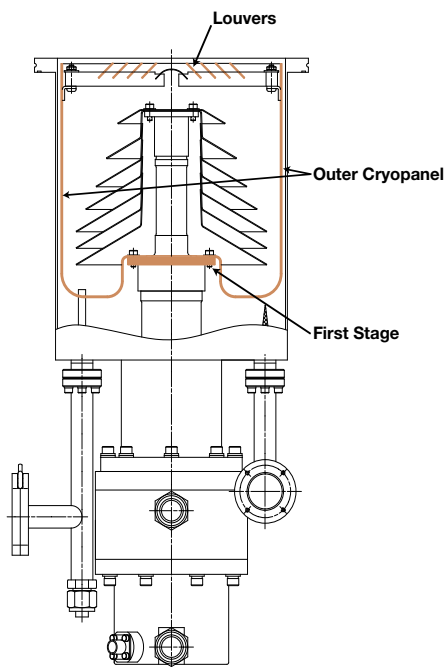

The **second**, or **cold stage**, of the refrigerator, shown at left, usually operates between 10-20 K and is used to cool the inner cryopanel. Gases such as nitrogen, oxygen and argon will freeze onto these panels. Lastly, any gases that have not yet frozen onto a panel will be adsorbed (a process known as **cryosorption**) into charcoal, which is located on the underside of the second stage cryopanel.

Vacuum Pressure

The ability of a cryopump to reduce the pressure in a vacuum chamber to very low levels is shown by the figure at right. It illustrates the relationship between the equilibrium pressure over a layer of cryo-deposit and the temperature of the cryo-deposit.

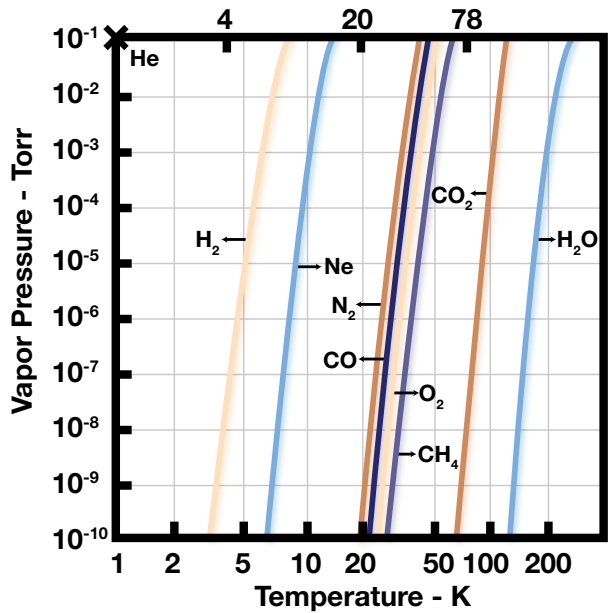

For example, water (which boils at 373 K at 760 torr pressure) has a vapor pressure at its ice temperature of 273 K at 4 torr. If a layer of ice is further cooled to a temperature of 150 K, the equilibrium vapor pressure will be 4×10^{-8} torr. At the operating temperature of the first stage of the refrigerator, the pressure will be off the scale at less than 10^{-10} torr. We also see from this, looking at the curve for nitrogen, that if the cold panel is at 20 K or less the pressure will be less than 10^{-10} torr.

The equilibrium vapor pressure for neon, hydrogen, and helium are too high at 20 K to be cryo-condensed on a bare surface. For that reason, charcoal is used to adsorb these gases.

Charcoal Adsorption

Activated charcoal is used as an adsorbent material because it has a large surface area and also because gases desorb from charcoal quite readily at room temperature. The equilibrium pressure of hydrogen that is adsorbed on charcoal is a function of both the temperature of the charcoal and

the amount of hydrogen that has already been adsorbed by the charcoal. Charcoal has an appreciable capacity for hydrogen, but as the amount of hydrogen that is adsorbed increases, you eventually move from cryosorption to a state whereby the gas is frozen onto the charcoal surface by **cryo-condensation**. Note in the figure above that an increase in the thickness of the layer of gases frozen out does not change the pressure.

Example: If the refrigerator is maintaining one gram of charcoal at 15 K, it can retain 280 SCC of hydrogen at an equilibrium pressure of 10^{-6} torr.

The amount of gas that a cryopump can retain is referred to as its **capacity** for a given species of gas. This capacity is the total volume of gas that can be pumped before the cryopump has to be warmed up and the gas vented (a process known as **regeneration**).

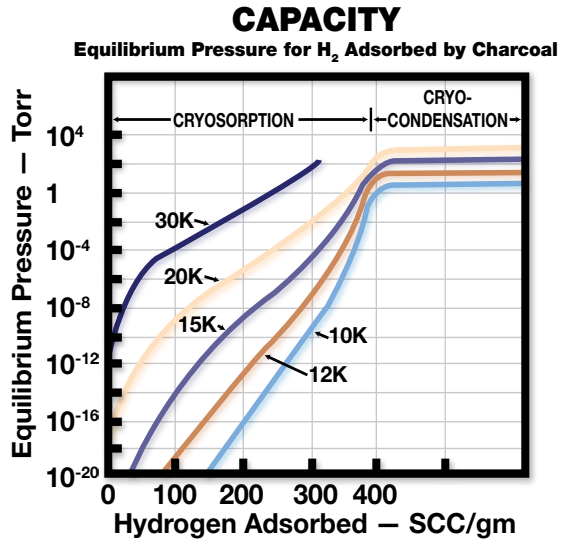

Calculating Cryopumping Speeds

Designers of cryopumps are usually most interested in the **speed** with which a gas can be pumped. Gases flow into a pump as a result of their thermal energy, which is equal to their kinetic energy. This leads to the fact that the average velocity of gas into the port of a pump is equal to the square root of the ideal gas constant, times the temperature, divided

by 2π times the molecular weight of the gas. Therefore, the ideal speed of a cryopump would be equal to the average velocity times the port area into which the gas can flow.

**KINETIC THEORY
IDEAL GAS**

Kinetic Energy = Thermal Energy
 $\frac{1}{2} M V^2 = \frac{3}{2} kT$

Average Velocity into Pump Port
$$\bar{V}_x = \sqrt{\frac{kT}{2\pi M}}$$

Ideal Speed = $\bar{V}_x \times \text{Area}$

Ideal Speed

Since most vacuum systems operate at room temperature, one assumes that the ideal speed is based on room temperature. Thus the

Gas	Molecular Weight	Ideal Speed — ℓ/s per cm^2
H_2	2	44.6
H_2O	18	14.9
N_2	28	11.9

speed of a molecule is a function only of its molecular weight, with the lighter gases having the highest speed.

If all the gas molecules that hit the face area of the pump were to freeze out on the louver, the ideal speed would be achieved. Water comes

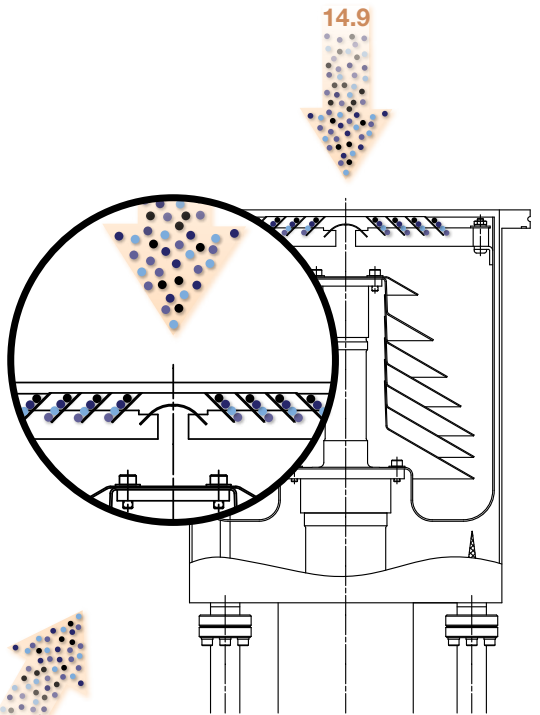

NET SPEED
 $\text{H}_2\text{O} \sim 14.9 \text{ l/s per cm}^2$

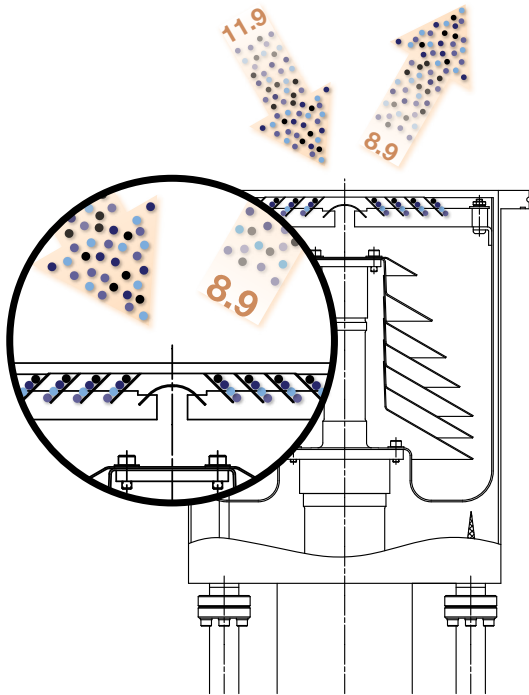

NET SPEED
 $\text{N}_2 \sim 4.8 \text{ l/s per cm}^2$

closest to approaching this perfect value. Almost all of the water molecules that hit the face of the cryopump stick to the surface of the louver without rebounding, as shown above.

Gases such as nitrogen, which have to pass

through the louver to freeze out on the inner cryopanel, have a certain fraction of molecules bounce off the louver prior to reaching the inner panel, as shown at the bottom of the opposite page. A cryopump that has an inlet louver, which is effective in blocking a significant amount of radiant heat from reaching the second stage inner cryopanel, will allow approximately 40%* of the air molecules (oxygen and nitrogen) to flow through it and freeze out on the inner cryopanel. The net speed for nitrogen is thus 40%* of the ideal speed, or 4.8* liters/second per cm^2 .

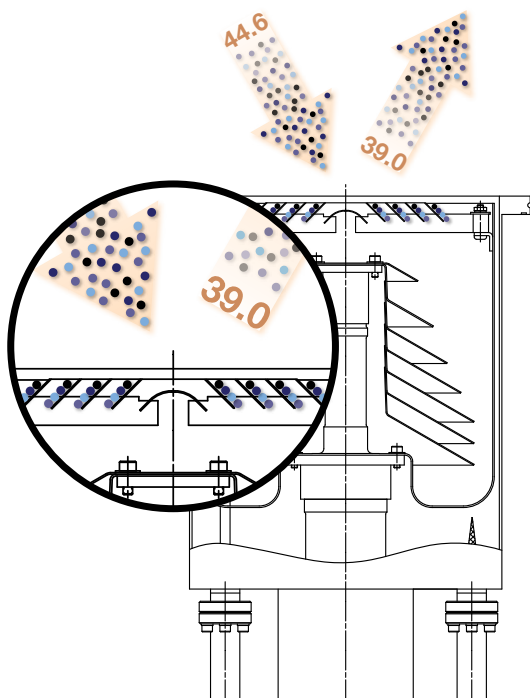

NET SPEED
 $\text{H}_2 \sim 8.9 \text{ l/s per cm}^2$

The net speed for nitrogen is thus 40%* of the ideal speed, or 4.8* liters/second per cm^2 .

Hydrogen, helium and neon have a more tortuous path to travel to reach the charcoal. As a result, only approximately 20%* of the hydrogen molecules that hit the louver of the cryopump will actually end up passing through and being cryosorbed, with the remainder rebounding, as shown above. This results in a net speed for hydrogen that is about 20%* of the ideal speed, or 8.9* liters/second per cm^2 .

*CP-8 rating

Typical Cryopumping Speeds and Capacities

Cryopumps are typically operated in the vacuum range from 1×10^{-3} to 1×10^{-12} torr where gases are in the free molecular flow regime. This means that the molecules usually travel from

one wall to another without hitting each other. In this regime, pumping speeds remain fairly constant. As the cryopump pressure increases into the transition region above 1×10^{-3} torr, it has been observed that pumping speeds increase, as shown above.

MARATHON® CP-8 CRYOPUMP SPEED

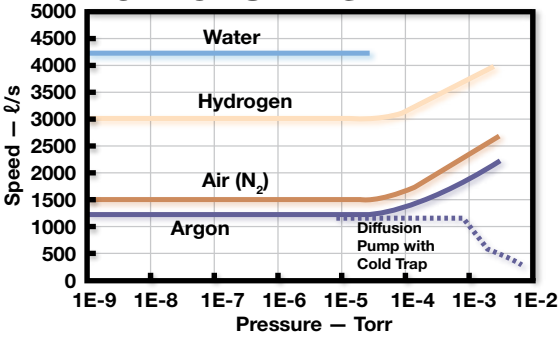

Compared with diffusion pumps, cryopumps have the characteristic of increasing in speed in this pressure region while the speed of diffusion pumps decreases.

MARATHON® CP-8 REFRIGERATOR CAPACITY

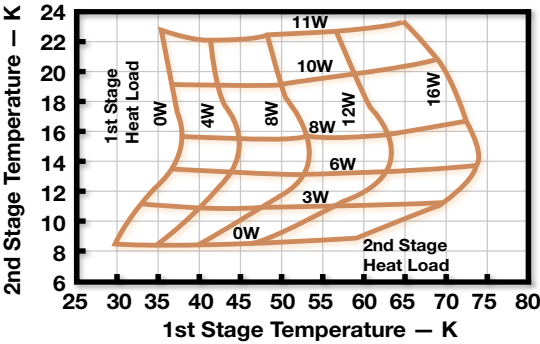

The closed-cycle refrigerators used in cryopumps have a minimum temperature of about 10 K on the cold stage and 35 K on the first stage warm panel, when there is no heat load

applied. As the applied heat load increases, the temperature of each heat station increases. This can be illustrated by looking at a typical operating point for the Marathon[®] CP-8 Cryopump's refrigerator.

Cryopanels are typically sized such that in normal operation, the second stage temperature will be approximately 12 K, and the first stage temperature will be approximately 60 K. The heat load in the refrigerator will be about 5 W on the cold stage and 12 W on the warm stage, as shown at the bottom of the opposite page. This allows a margin of refrigeration for unanticipated radiant heat load from the chamber or additional heat loads due to having gases flow at high rates.

Heat Loads and Insulating Vacuum

Heat loads on a cryopanel typically come from three sources, as illustrated below:

1. Radiant heat from the vacuum chamber
2. The heat of condensation from the gases as they are cooled from room temperature and frozen out at the lower temperature

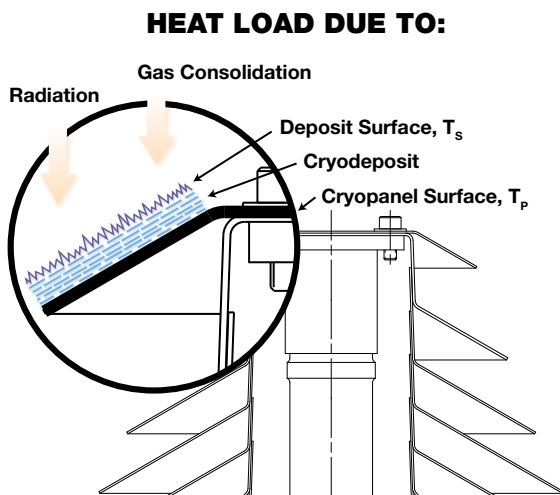

3. Heat conducted from the housing surrounding the cryopanel by the residual gas

The thermal conductivity of air, which is essentially constant above 1 torr pressure, drops dramatically as the pressure is reduced below 1 torr, as shown at right. At pressures below 1×10^{-3} torr, where the gas is in the molecular flow regime, the heat transfer by conduction is essentially negligible. In the cryogenic business, this is said to be an **insulating vacuum**. One can relate this thermal conductivity to the common thermocouple vacuum gauge, which operates on the basis of this change of thermal conductivity in the range from 2×10^{-3} to 1 torr.

THERMAL CONDUCTIVITY AS A FUNCTION OF PRESSURE

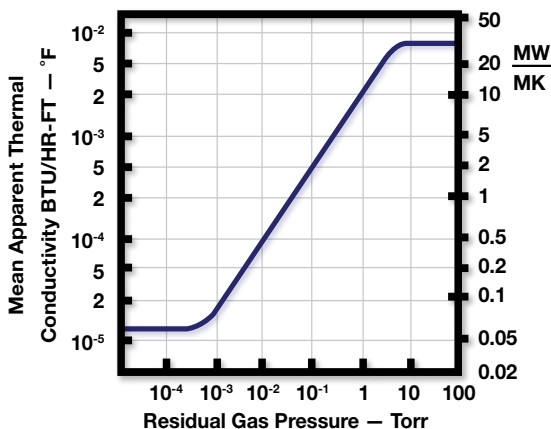

CHEVRON TEMPERATURE VS. WATER LOAD

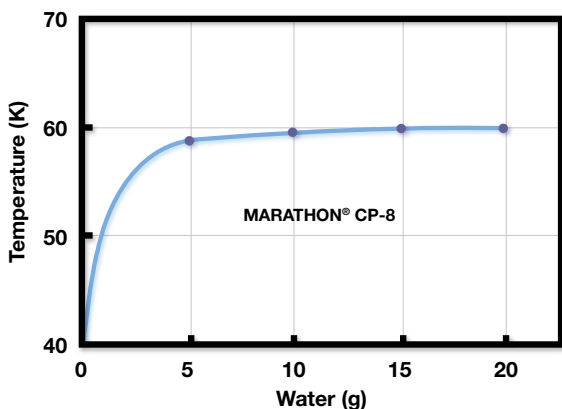

Radiant heat is the primary heat load on a cryopump. For a pump to be heated by radiation, there are two requirements. First, the radiant heat must be emitted from the vacuum chamber and secondly, the cryopump must absorb the radiation that

is incident. Electropolished vacuum chamber walls will typically radiate very little heat on the cryopump. Vacuum chamber walls that have adsorbed water vapor will radiate heat that is approximately equal to black body radiation.

Cryopumps are designed to be able to absorb this radiation. However, since radiant heat is a function of the temperature to the fourth power, if there is a heat source within the vacuum chamber that radiates high temperature heat to the cryopump, it can very easily thermally overload a cryopump. Thus, high temperature sources of heat within a vacuum chamber must be shielded from the cryopump by a water-cooled baffle. Cryopump panels are highly polished and, during cooldown, will reflect radiant heat. However, as the figure at the bottom of the opposite page shows, as soon as a very thin layer of water is frozen out on any cryopump surface, it converts the surface to a thermally black surface that now will absorb the thermal radiation.

Heat loads due to gases freezing out on the cryopumps are usually very small. The exception is the case where the cryopump is being used for pumping argon for sputtering. Most of the heat that is taken out in freezing the argon is removed at the cold stage of the refrigerator. It takes an estimated 0.7 watts of refrigeration to freeze out 1 torr liter/second of argon. As shown in the figure above, as the flow rate of argon

**MARATHON® CP-8 THROUGHPUT
VS. SECOND STAGE TEMPERATURE**

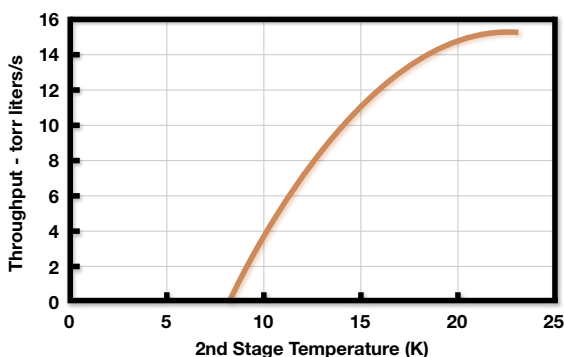

increases, the temperature of the second stage of the refrigerator increases. Since it is usually necessary to simultaneously retain hydrogen on the charcoal, the throughput rating for a cryopump is typically based on the flow it can handle with a cryopanel temperature of 20 K. The pressure at the rated flow rate is usually about 1×10^{-3} torr. If a higher argon pressure is required for a sputtering operation, then a throttle valve is needed ahead of the cryopump to reduce the pressure from the operating pressure to the 10^{-3} torr pressure at the entrance of the cryopump.

Cryopump Capacities

A cryopump will accumulate large amounts of solid water, air, argon, nitrogen, and oxygen before it has to be defrosted, as illustrated at right. Pumping speeds decrease very little while these thick layers of cryodeposits are built up, and the refrigerator's temperature changes very little.

Typically, water can be allowed to accumulate on the louver until approximately half of the louver is blocked. Solid nitrogen and argon can accumulate in layers that are several centimeters thick on the outside of the cold panel. Typically, the thickness is only limited by their coming into contact with a warmer surface. The rated amount of hydrogen that can be adsorbed is usually based on the assumption that the accumulated hydrogen will result

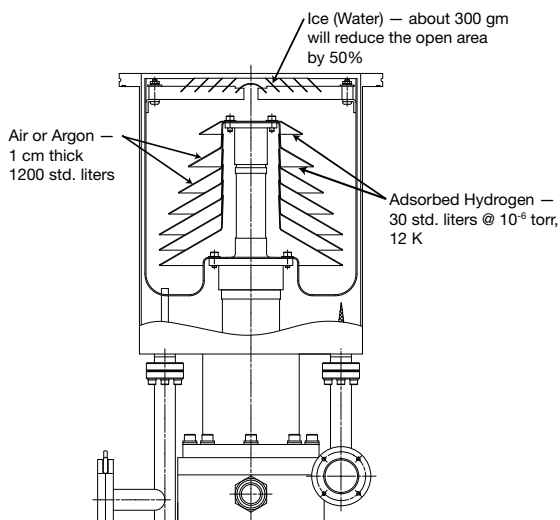

in an equilibrium pressure of 1×10^{-6} torr. At this point, the pumping speed for hydrogen decreases by 50%. When other gases are being pumped and the cryopanel is running at a warmer temperature, the amount of hydrogen that can be adsorbed is reduced.

Cryopump Cooldown

A cryopump is typically attached to a vacuum chamber behind a gate valve so that the cryopump can be isolated and left running while the pressure in the main part of the chamber cycles, as shown at right. In order to cool down a cryopump, it is necessary to establish an insulating vacuum around the cryopump first. It is

usually sufficient to pump down the cryopump housing to a pressure of less than 100 microns (10×10^{-2} torr). A sieve trap between valve V3 and the forepump is recommended.

Since most users do not know what gas species are left in the cryopump, it is necessary to try several starting pressures in order to find out what works best for a particular process. Residual gases will cause the cryopump housing to feel cool and prolong the cooldown. The

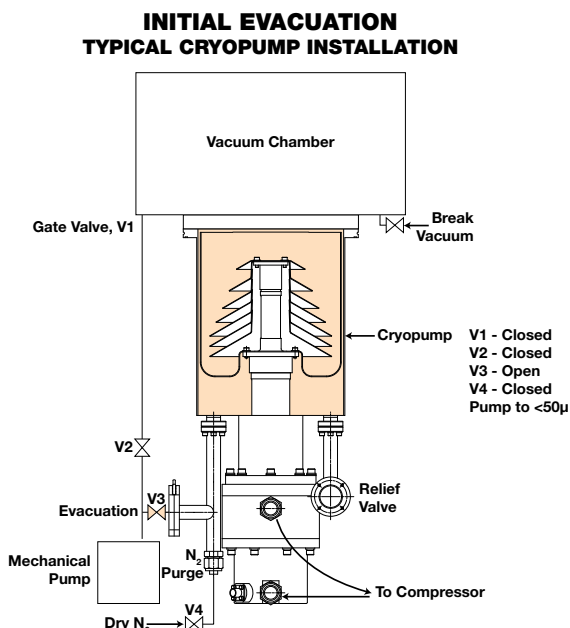

user usually strikes a balance between additional pumping time and additional cooldown time. It is best to favor extended pumping time in order to minimize the loading of the charcoal with the residual gases.

Next, the gate valve (V1) is closed and the cryopump is isolated, as shown at right. As

it cools, the residual gases around it are adsorbed by the charcoal and the pressure is reduced below 1 micron. In this manner an insulating vacuum is established around the cryopump. The amount of gas that is adsorbed by doing this will typically have a negligible effect on the capacity of the charcoal to retain hydrogen when it is cold. The time required for a refrigerator to cool down the cryopanel can range from about 75 minutes for small cryopumps (200 mm/8 in.) to just over 3 hours for the largest units (500 mm/20 in.).

COOLDOWN TYPICAL CRYOPUMP INSTALLATION

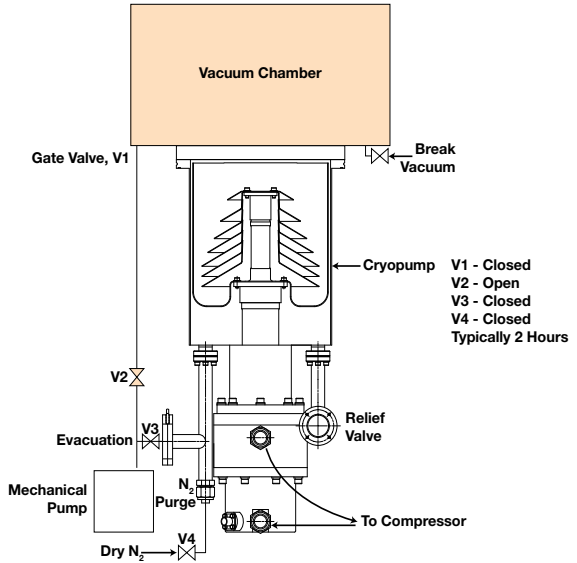

Cryopump Crossover Pressure

A mechanical forepump is typically used to pump down the main vacuum chamber to a pressure called the **crossover** pressure, as shown at the top of the opposite page. This is the pressure at which the forepump is valved out and the main gate valve to the cryopump is opened.

Crossover pressure, which is typically on the order of several hundred microns, is usually high enough that the operator does not have to worry about oil **backstreaming** into the chamber from the mechanical pump. The impulsive gas load that a cryopump can handle when the gate valve is opened, as shown below, is a function of how much gas is pumped,

**ROUGH PUMP TO CROSSOVER PRESSURE
TYPICAL CRYOPUMP INSTALLATION**

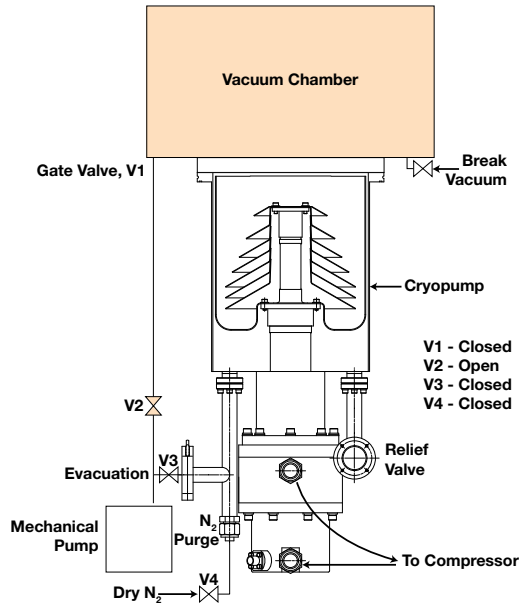

**CROSSOVER PRESSURE
TYPICAL CRYOPUMP INSTALLATION**

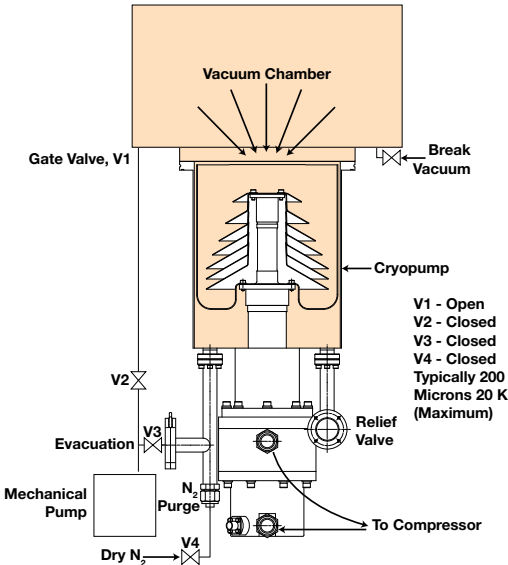

rather than the initial pressure. One can establish the maximum crossover pressure for a cryopump simply by looking at the temperature indicator on the cryopump during crossover, and establishing a pressure such that the second stage temperature does not exceed 20 K immediately after the gate valve is opened. This crossover pressure

can be calculated as shown below for a cryopump that has a rating of 300 torr liters.

$$\text{Crossover pressure} = \frac{\text{Maximum impulsive throughput (torr liters)}}{\text{Chamber volume (liters)}}$$

$$\text{Crossover pressure} = \frac{300 \text{ torr liters}}{200 \text{ liters}} = 1.5 \text{ torr}$$

Mechanical pumps usually evacuate the air from a chamber quite rapidly to a pressure of several hundred microns. Then the pressure decreases slowly as water vapor desorbs from the chamber walls. The optimum crossover

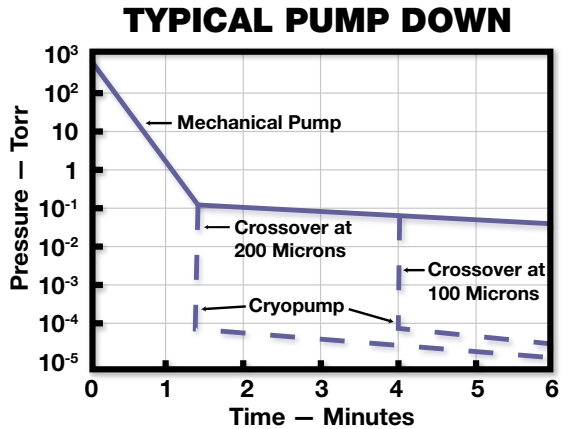

pressure for a cryopump is usually somewhere near the knee of the curve, as shown above. The high speed of the cryopump for air and water results in an almost instantaneous drop in pressure of several decades. The pressure/time relationship after crossover is typically a function of the outgassing rate of a particular chamber and is most often dependent upon the amount of water that has been adsorbed on the chamber walls while it was open to the atmosphere. For work in the high vacuum regime, it is necessary to bake out the chamber walls in order to drive off the water that is adsorbed on them. Minimum pressures of 10^{-8} torr are typically achieved in very clean, unbaked chambers. However, pressures below 10^{-8} torr require special baking procedures and carefully designed enclosures.

Operation During Power Failure

Should there be a power supply interruption, a cryopump usually has enough thermal inertia, and the heat load is low enough (if the cryopump is not handling a high argon throughput), that it can remain cold enough to prevent the gases from coming back off the cryopanel for a period of several minutes, as shown at right. During this time period, the cold panel might warm up to a temperature as high as 30 K. Typically, after the power is restored, the refrigerator will restart and cool the cryopump back down to its normal operating temperature. Processes pumping hazardous gases may require automatic cryopump regeneration following a power failure.

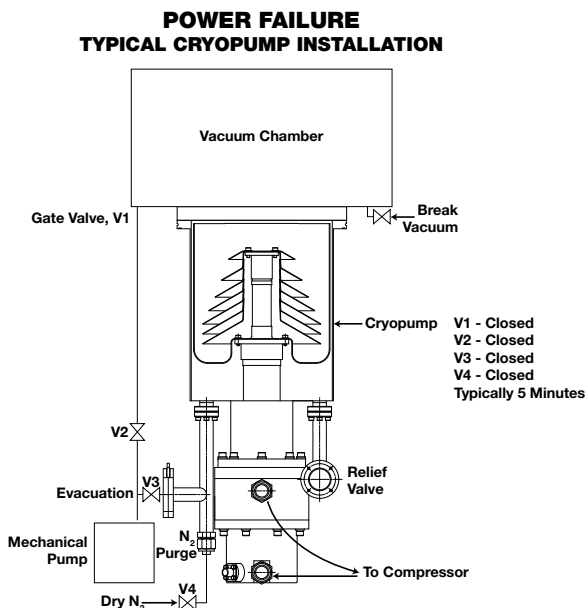

Cryopump Regeneration

In most production applications a cryopump will operate from one to several weeks, depending on the gas load, before having to be warmed up for regeneration. At the time that it is regenerated, the pump is isolated from the vacuum chamber by closing the gate valve and the power to the refrigerator is shut off, as shown on the next page. As the

cryopump warms up, the pressure within the cryopump housing might increase until it reaches a pressure of several PSI above atmospheric pressure. At that time it will vent through a resealing type of relief valve.

The warm up process can be accelerated

by introducing a flow of dry nitrogen gas and heating the cryopump enclosure until the outside of the cryopump housing reaches 40 °C. Nitrogen gas not only facilitates warm up, but it helps purge the adsorbed gases from the charcoal. Nitrogen will dilute any hydrogen and oxygen that might have been pumped and it will also dilute chemically reactive or poisonous-type gases. Reactive or poisonous gases must be vented in a safe fashion to an appropriate site.

The cryopanel should be allowed to warm up to 295-300 K before starting the evacuation process. Stop the nitrogen purge and turn off the heater. Then begin evacuation.

WARM UP / PURGE TYPICAL CRYOPUMP INSTALLATION

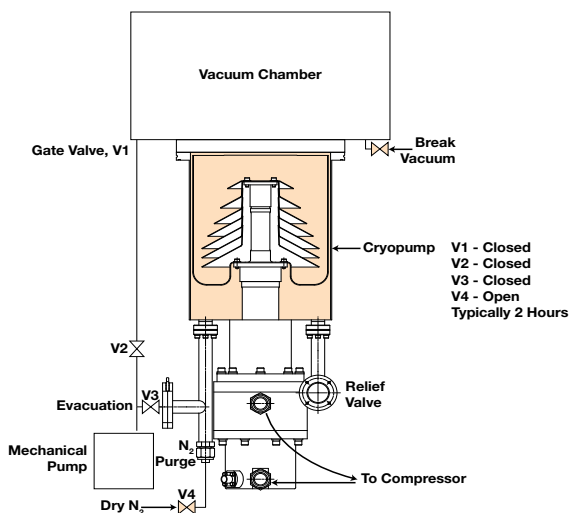

Cryopump Applications and Safety Precautions

Cryopumps are being used in an ever growing variety of industries for a multitude of applications. These include ion implantation systems, UHV systems, sputtering chambers, evaporative coaters, and

molecular beam chambers to name just a few. Because cryopumps have no mechanical parts in the body of the pump, they are relatively insensitive to contaminants and at low temperatures, chemical reactions are retarded as well. Therefore, cryopumps can be used to purge chambers of corrosive or toxic gases that are captured by the freezing process of the refrigerator. Where it is necessary to contain these corrosive or toxic gases, care should be taken during regeneration. The use of a purge to dilute the gases and a safe venting method is generally required.

Cryopumps are capture pumps that operate with a wide range of gases. The gases pumped are retained only while the cryopumps are cold. These gases may be toxic, flammable, or result in high pressures when the pump is warmed up. Therefore, the following safety precautions are recommended:

1. Mount the cryopump behind a gate valve that automatically closes in the event the refrigerator shuts down.
2. Do not block the pressure relief valve.
3. Vent toxic and flammable gases safely.
4. Do not attach an ignition source to the cryopump, such as an ionization gauge or open electric heaters.



Glossary of Terms

Absorption – the process by which a gas or vapor accumulates within a solid or liquid. A solid exposed to vacuum or heat will release or “outgas” atoms with a vapor pressure that is dependent upon the surface temperature of the material.

Adsorption – A process whereby a gas or liquid adheres to the surface of a solid. A solid exposed to vacuum or heat will release or “outgas” atoms with a vapor pressure that is dependent upon the surface temperature of the material.

Backstreaming – This occurs when the fluid in a vacuum pump moves back toward the vacuum chamber being pumped. This can be caused to happen when the chamber being pumped is suddenly vented or exposed to atmosphere.

Base Vacuum – The ultimate level of vacuum achieved.

Capacity – The maximum amount of specific gas a cryopump can retain.

Crossover – A vacuum pressure set point at which pumping is transferred from the mechanical pump to the cryopump.

Cryo-Condensation – The process by which a gas is frozen to the surface of a material.

Cryosorption – The process by which gases, which have not frozen out onto any of the louvers or cryopanel, are adsorbed into charcoal.

First stage – This is the warmer of the two stages in a cryopump and is used to cool the outer cryopanel.

Insulating Vacuum – This is where you have gas in the molecular flow regime (pressures below 1×10^{-3} torr) so that the heat transfer by conduction is essentially negligible.

Micron – A unit of measure of length: 1 micron (μm) = 10^{-6} meter, or a unit of measure of pressure: 1 micron = 10^{-3} torr = 1/760,000 of one atmosphere.

Partial Pressure – Usually determined by an RGA (Residual Gas Analyzer), a partial pressure is the contribution to the total pressure of a vacuum chamber of one component species when the chamber consists of more than one species.

Preventative Maintenance – The procedure by which you maintain equipment based upon the periodic performance of recommended procedures so that the equipment will maintain a higher uptime.

Pumping Speed – This refers to the average speed of the gas entering a cryopump.

Regeneration – The process by which a cryopump is periodically warmed so that it can be purged of the gases it has collected.

Second Stage (Cold Stage) – This is the coldest point on the cryopump. It cools the inner cryopanel.

Throughput – Maximum flow rate of gas into a cryopump as measured in torr liters/second or standard cubic centimeters/second (sccm).

Torr – A unit of pressure whereby 1 torr = 1/760 atmosphere. This is based on atmospheric pressure supporting 760 mm of mercury.

Cryopumps from SHI Cryogenics Group

Marathon® CP Series Cryopumps from SHI Cryogenics Group are specifically designed to meet the needs of high vacuum processes. Applications for these versatile systems range from custom laboratory equipment to industrial-scale tools. Manufacturers of semiconductor devices, flat panel displays, test equipment, solar manufacturing and a wide variety of coating and thermal vacuum systems require efficient, reliable and robust systems that offer a low cost of ownership. The Marathon® CP Series Cryopumps from SHI Cryogenics Group deliver on all fronts.



Marathon® CP Series Cryopumps are offered with standard and low profile enclosures, several flange options, and manual and fully automatic features to ensure that users have modularity and flexibility to choose from when designing their systems. In addition, the optional Marathon® Cryopump Controller (MCC) enables fully-automated regeneration and control of the cryopump system.

All Marathon® CP Series Cryopumps are supported by a worldwide sales and support network. They can be readily maintained without breaking vacuum or removing the cryopump from the chamber for return or replacement. As a result, serviceability maximizes production uptime and lowers the total cost of ownership.

The **SICERA® Cryopump** uses SHI proprietary inverter technology to reduce customer energy costs by 20-30%. The resulting savings and increased production efficiency make SICERA® ideal for high-volume production of semiconductor wafers, flat panel display and other semiconductor-related products.

The complete SICERA® cryopump system includes a compressor and remote controller, which have been thoroughly tested to withstand the most demanding vacuum applications. Through continuous control of both the cryocooler and compressor, SHI Cryogenics Group is able to offer a reliable cryopump system with significant energy savings, as well as excellent temperature and vacuum stability.



United States

Sumitomo (SHI) Cryogenics of America, Inc.
1833 Vultee Street
Allentown, PA 18103
Phone: +1 610-791-6700
Fax: +1 610-791-0440
E-mail: sales@shicryogenics.com

Sumitomo (SHI) Cryogenics of America, Inc.
1500-C Higgins Road
Elk Grove Village, IL 60007
Phone: +1 847-290-5801
Fax: +1 847-290-1984

Sumitomo (SHI) Cryogenics of America, Inc.
1700 Wyatt Drive
Suite 8
Santa Clara, CA 95054
Phone: +1 408-736-4406
Fax: +1 408-736-7325

Asia

Sumitomo Heavy Industries, Ltd.
ThinkPark Tower
Cryogenics Division, Sales Department
1-1, Osaki 2-Chome, Shinagawa-Ku
Tokyo 141-6025, Japan
Phone: +81-3-6737-2550
Fax: +81-3-6866-5114
E-mail: cryo@shi.co.jp

Cryogenics Division, Service Department
2-1-1, Yato-cho, Nishitokyo-city
Tokyo 188-8585, Japan
Phone: +81-42-468-4265
Fax: +81-42-468-4254
E-mail: cryo_service@shi.co.jp

Sumitomo (SHI) Cryogenics Korea Co., Ltd.
Room 619-620, Venture Valley
#958 Goseck-Dong, Kwonsun-Gu
Suwon-City, Gyeonggi-Do, South Korea
Phone: +82-31-278-3050
Fax: +82-31-278-3053
E-mail: Won_Bum_Lee@shi.co.jp

Sumitomo Heavy Industries (Shanghai) Management, Ltd.
10F, SMEG PLAZA
No.1386, Hongqiao Road
Shanghai 200336, P.R. China
Phone: +86-21-3462-7660
Fax: +86-21-3462-7661
Mobile: +86-138-1612-1291
E-mail: ZCryo_ChinaSales@shi.co.jp

Room 107-110, Building 5
No.100, Zixiu Road
Shanghai 201103, P.R. China
Phone: +86-21-6070-5200
Fax: +86-21-6070-5086
E-mail: ZCryo_ChinaService@shi.co.jp

Sumitomo (SHI) Cryogenics Taiwan Co., Ltd.
4th Floor, No. 3
Lane 216, Gongyuan Road
Hsinchu City 300, Taiwan ROC
Phone: +886 3 561 2557
Fax: +886 3 562 3400

Europe

Sumitomo (SHI) Cryogenics of Europe, Ltd.
3 Hamilton Close, Houndmills Industrial Estate
Basingstoke, Hampshire RG21 6YT
United Kingdom
Phone: +44 (0) 1256 853333
Fax: +44 (0) 1256 471507
E-mail: uksales@shicryogenics.co.uk

Sumitomo (SHI) Cryogenics of Europe GmbH
Daimlerweg 5a
Darmstadt D-64293, Germany
Phone: +49 (0) 6151 860 610
Fax: +49 (0) 6151 800 252
E-mail: contact@sumitomocryo.de