

2004 - 2005
TEST AND MEASUREMENT CATALOG

TEGAM

Your Global Source for
Test and Measurement Solutions



TEGAM



Since 1979, TEGAM, Inc. has been your global source for test and measurement solutions.

We enter into our **25th** year confident that we will continue to grow in revenue and reach as a world leader in the test, measurement, & calibration field.

We are proud of our unique, application-specific products, which are used by most of the Fortune 1000, and also of our unprecedented customer service. TEGAM's goal is to create and maintain long-term relationships with our customers. We achieve this goal by our incomparable responsiveness to customer needs and with honest, straightforward communication. Every TEGAM Teammate is empowered and expected to take care of you, our customer.

We have all seen dramatic changes in the electronics industry over the last few years. TEGAM's focus on product development and attention to our customers have resulted in continued growth during these difficult times. Today, TEGAM is launching more new products than any of our competitors. In this catalog, you will find many innovative solutions, including NEW low-cost RF power sensor calibrators, NEW extended frequency range RF power standards, NEW high performance LCR meters, NEW arbitrary waveform generators and voltage amplifiers for MEMS testing applications, and much more. These new products all outperform previous models and cost less to purchase, operate, and maintain.

I sincerely hope that the 2004-2005 TEGAM catalog will be of help to you and your organization. If you have a measurement, production test, or calibration problem that other test equipment manufacturers have not solved, please contact us. We look forward to the opportunity to tackle your challenges.

A circular portrait of Terry A. Gambill, a man with a mustache, wearing a dark suit, white shirt, and patterned tie. The portrait is set against a dark, blurred background and is framed by a soft, white glow.

Terry Gambill

Terry A. Gambill, President
TEGAM, Inc.

TABLE OF CONTENTS

Contact TEGAM

ii

CALIBRATION

A. RF Power Sensor Calibration

Power Sensor Calibrators	1
RF Power Transfer Standards	5
RF Power Level Controller	15
Single Type IV Power Meter	17
Dual Type IV Power Meter	19
RF Mount Temperature Controller	21
Power Sensor Calibration Software	23
Power Sensor Calibration System IIA	25
RF Power Sensor Accessories	27

B. RF Attenuation Measurement

Advanced 30 MHz Receiver	1
Frequency Converter 0.01-18 GHz	3
Frequency Converter 18-40 GHz	5
Attenuator Calibration Software	7
Attenuation Measurement System	9
Attenuation Accessories	12

C. Resistance & Ratio Standards

Standard Resistor	1
Transportable Resistance Standards	3
Resistance Transfer Standard	5
In-Line Decade Resistors	11
Coaxial Resistor Decade Boxes	13
Decade Potentiometer	15
Decade Ratio Transformer Standard	17
Decade Ratio Transformers	19
Automated Precision Ratio Transformer	21
Resistance Accessories	23

D. Temperature Calibrators

Thermocouple Calibrators/Thermometers	1
Thermistor Calibrators/Thermometers	1
RTD Calibrators/Thermometers	1
Ohm Calibrators/Thermometers	1
Temperature Calibration Accessories	2

PRODUCTION TEST

E. Arbitrary Waveform & Function Generators

16-bit True AWG	1
AWG with Extended Memory	3
High Speed AWG	5
Low Cost 16-bit AWG	7
Low Cost AWG with Extended Memory	9
Amplifiers for Waveform Generators	11
Waveform Creation Software	13

F. LCR Meters

General Purpose Programmable LCR Meter	1
42.0 Hz to 5.00 MHz Programmable LCR Meter	3

G. Ohmmeters

High Speed Micro Ohmmeter	1
---------------------------	---

GENERAL TEST

H. Electrical Safety Meters

Safety Voltmeters	1
Voltmeter Accessories	2
Phase Testers	3

I. Digital Thermometers & Temperature Probes

Thermometers	1
Heavy Duty Food Processing Thermometer	2
Thermocouple Thermometers	3
Thermocouple Probes	4
RTD-Thermistor Thermometers	5
Thermistor Probes	6
RTD Probes	7
Probe & Thermometer Accessories	8
Calibrators & Switch Boxes	9

J. Humidity Controllers & Transmitters

RH/Temperature Products	1
-------------------------	---

K. Customer Service and Support

Extended Warranty Plan	1
Calibration Service Plan	2
Total Service Plan	3
Repair and Calibration Services	4
Calibration Certificates & Accreditations	5
Web Resources	6
Index by Model Number	7

A

B

C

D

E

F

G

H

I

J

K

**CONTACT
TEGAM**

**Web
www.tegam.com**

**E-Mail
sales@tegam.com**

**Phone
(440) 466-6100**

**Fax
(440) 466-6110**

**Mail
TEGAM, Inc.
Ten TEGAM Way
Geneva, OH 44041**



**Visit our website
www.tegam.com**

- To see our newest products
- To purchase online or get a quotation
- To learn more about TEGAM and its products, people, & history
- To find a representative in your area
- To download applications notes, specifications, or product data sheets

To get answers to questions about our products:
e-mail us at sales@tegam.com

To talk to our Applications Engineers, Sales Support Staff, and get answers to all your questions about life, TEGAM, and our products:
call us at 1-800-666-1010

Your Global Source for Test and Measurement Solutions

BACK TO CONTENTS

Model 1825

RF CALIBRATION AND MEASUREMENT PRODUCTS

- Calibrates 10 MHz to 18 GHz RF power sensors from Agilent (HP), Anritsu, Boonton, Gigatronix, Rohde & Schwarz, TEGAM and others
- Ideal for labs with annual calibration workloads of 25 RF power sensors or less
- Less than 1/3 the cost of a comparable System IIA
- Can calibrate many popular sensors in 30 minutes or less
- The accuracy and reliability you have come to expect from TEGAM
- No software to learn
- Compact and easy to use
- All connectors are located on the front panel for easy connection
- Rack mount kit available
- Optional A2LA Accredited Calibrations

NOTE: Customer must provide an appropriate RF Signal Source, DVM and an RF Power Meter for the UUT

Economical RF Power Sensor Calibrator

The Model 1825 RF Power Sensor Calibrator is an accurate, economical, and reliable instrument for calibrating RF Power Sensors in the 10MHz to 18 GHz frequency range. This instrument detects the level of RF power being applied to an RF power sensor. Resulting voltage readings are measured by the customer-supplied DVM. Cal factors for the UUT are determined by comparing the readings of the DVM with the readings of the customer-supplied power meter. Cal factors are obtained by performing a few simple calculations. A Microsoft Excel spreadsheet with the formulas inserted is included with the instrument.

The Model 1825 is a low-cost, non-automated version of the popular TEGAM System IIA. No additional software is supplied or required. The Model 1825 offers the same accuracy and reliability as other TEGAM test instruments. The 1825 is not a microprocessor-controlled instrument, but it is simple to operate.

Since measurements are taken with an external DVM, the 1825 could be integrated into an automated workstation depending on the DVM used and the customer's ability to provide the appropriate software.

The Model 1825's built-in Thermistor RF Power Standard is internally temperature controlled, so changes in ambient temperature will not affect power measurements. The Type IV Bridge Circuitry detects RF power by using the DC power substitution method. DC power levels can be measured to within $\pm 0.003\%$.

The Model 1825 is simple to operate. To calibrate a power sensor, the operator connects the output from the customer-supplied RF signal generator to the RF INPUT of the 1825 and the + and - input of the customer-supplied voltmeter to the VOLTMETER red and black binding posts on the 1825. Connect the UUT to a customer-supplied compatible power meter and to the SENSOR port of the 1825 and start taking measurements. The DVM and Power Meter readings are then used in some simple calculations to determine the cal factor of the UUT at the selected frequency. These calculations can be performed by the user or by entering the meter readings into the Microsoft Excel spreadsheet provided by TEGAM. This spreadsheet contains the formulas necessary to calculate cal factor and is provided as a convenience for our customers.



Model 1825

E C O N O M I C A L R F P O W E R S E N S O R C A L I B R A T O R

Specifications

Frequency Range	10 MHz to 18 GHz
Power Range	0.01 to 25 mW (-20 to +14 dBm)
Substitution Bridge Accuracy	±0.003%
Nominal RF Impedance	50 Ohms
VSWR	≤ 1.14
Power Linearity	<0.1% from 1 to 10 mW
Insertion Loss (RF INPUT)	6 dB nominal, 9.5 dB max
Individual calibrations traceable to NIST supplied at the following frequencies:	10 to 100 MHz in 10 MHz increments 100 MHz to 2 GHz in 50 MHz increments 2 GHz to 4 GHz in 100 MHz increments 4 to 12.4 GHz in 200 MHz increments 12.75 to 18 GHz in 250 MHz increments
Calibration Factor Accuracy	+/-1.00% from 0.01 to 10 GHz +/-1.10% from 10 to 18 GHz
Calibration Factor Drift	<0.5% per year
Connectors SENSOR RF IN VOLTMETER	N-type Female SMA Female Binding Post, standard 0.75" spacing for banana plugs
Temperature Operating Storage	+12° to +32° C (+54° to 90° F) -40° to +75° C (-40° to +167° F)
Warm up time	2 hours minimum from instrument power up
Power Requirements	12 Watts, 47 to 420 Hz, 105 to 125 Vac standard or 210 to 250 Vac with a factory installed option.
Weight	17.2 lbs (7.4 kg)
Physical Dimensions Height Width Depth	3.5 in (88.9 mm) 18 in (457.2 mm) 15.4 in (390.7 mm)
Rack Mounting	The Model 1825 can be mounted in a standard 19" rack, with rack mount kit RM-1825
Additional Equipment Required: Signal Generator DVM RF Power Meter	10 MHz to 18GHz Frequency Range, Continuous Wave, 6 dBm minimum power output. DC Volts, 6 1/2-digit minimum. Compatible with the sensor under test.

This data sheet was current when it was produced. However, products are constantly being updated and improved. Because of this some differences may occur between the descriptions herein and the current product. Prices and specifications may be changed without notice.



YOUR GLOBAL SOURCE FOR TEST
AND MEASUREMENT SOLUTIONS

[BACK TO CONTENTS](#)

TEN TEGAM WAY • GENEVA, OHIO 44041
440-466-6100 • FAX 440-466-6110
www.tegam.com • e-mail: sales@tegam.com

Model 1827

RF CALIBRATION AND MEASUREMENT PRODUCTS

- Calibrates 100 kHz to 18 GHz RF power sensors from Agilent (HP), Anritsu, Boonton, Gigatronix, Rohde & Schwarz, TEGAM and others
- The widest frequency range of any commercially available power sensor calibrator
- Less than half the cost of a comparable System IIA
- Two switchable RF inputs
- Ideal for labs with annual calibration workloads of 40 RF power sensors or less
- Can calibrate many popular sensors in 30 minutes or less
- The accuracy and reliability you have come to expect from TEGAM
- No software to learn
- Compact and easy to use
- All connectors are located on the front panel for easy connection
- Rack mount kit available
- Optional A2LA Accredited Calibrations

NOTE: Customer must provide an appropriate RF Signal Source, DVM and an RF Power Meter for the UUT

Economical Wideband RF Power Sensor Calibrator

The Model 1827 RF Power Sensor Calibrator is an accurate, economical, and reliable instrument. The broad frequency range of 100 kHz to 18 GHz makes the Model 1827 an ideal choice for calibrating a wide variety of sensors while keeping annual calibration costs low. Previous calibration systems required two standards to achieve this range, and annual calibration costs were thousands of dollars more. VSWR and accuracy have not been sacrificed to achieve the broad frequency range of this instrument.

The Model 1827 detects the level of RF power being applied to an RF power sensor. Resulting voltage readings are measured by the customer-supplied DVM. Cal factors for the UUT are determined by comparing the readings of the DVM with the readings of the customer-supplied Power Meter. Cal factors are obtained by performing a few simple calculations.

The Model 1827 is a cost effective, non-automated version of the popular TEGAM System IIA. No additional software is supplied or required. The Model 1827 offers the same accuracy and reliability as other TEGAM test instruments. The 1827 is not a microprocessor - controlled instrument,

but it is simple to operate. Since measurements are taken with an external DVM, the 1827 could be integrated into an automated workstation. The Model 1827's built-in Thermistor RF Power Standard is internally temperature controlled, so changes in ambient temperature will not affect power measurements. The Type IV Bridge Circuitry detects RF power by using the DC power substitution method. DC power levels can be measured to within $\pm 0.003\%$.

The Model 1827 has a wider frequency range than any commercially available power sensor calibrator. Because of this wide frequency range, two signal sources may be required. The 1827's two RF Inputs are designed so that the user can change signal sources just by flipping a switch.

This instrument is simple to operate. To calibrate a power sensor, the operator connects the output from the customer-supplied RF signal generator to the one of the RF Inputs of the 1827. Then the + and - input of the customer-supplied voltmeter is connected to the red and black binding posts on the 1827. The operator then connects the UUT to a customer-supplied compatible power meter and to the SENSOR port of the 1827. Measurements can now be taken. The DVM and Power Meter readings are then used to calculate the cal factor of the UUT at the selected frequency. These simple calculations can be performed by the user or by entering the readings into the Microsoft Excel spreadsheet provided by TEGAM. This spreadsheet contains the formulas necessary to calculate cal factor and is provided as a convenience for our customers.



Model 1827

W I D E B A N D P O W E R S E N S O R C A L I B R A T O R

Specifications

Frequency Range	100 kHz to 18 GHz
Power Range	0.01 to 25 mW (-20 to +14 dBm)
Substitution Bridge Accuracy	±0.003%
Nominal RF Impedance	50 Ohms
VSWR	≤ 1.14
Power Linearity	<0.1% from 1 to 10 mW
Insertion Loss (RF INPUT)	6 dB nominal, 10 dB max
Individual calibrations traceable to NIST supplied at the following frequencies:	100, 200, 455 kHz 1, 1.25, 3, 5 MHz 10 to 100 MHz in 10 MHz steps 100 MHz to 2 GHz in 50 MHz steps 2 GHz to 4 GHz in 100 MHz steps 4 to 12.4 GHz in 200 MHz steps 12.75 to 18 GHz in 250 MHz steps
Calibration Factor Accuracy	±0.80% from 0.1 to 10 MHz ±1.00% from 0.01 to 10 GHz ±1.10% from 10 to 18 GHz
Calibration Factor Drift	<0.5% per year
Connectors SENSOR RF IN VOLTMETER	N-type Female SMA Female (X2) Binding Post, standard 0.75" spacing for banana plugs
Temperature Operating Storage	+12° to +32°C (+54° to 90°F) -40° to +75°C (-40° to +167°F)
Warm up time	2 hours
Power Requirements	12 Watts, 47 to 420 Hz, 105 to 125 Vac standard or 210 to 250 Vac with a factory installed option.
Weight	17.7 lbs (8.03 kg)
Physical Dimensions Height Width Depth	3.5 in (88.9 mm) 18 in (457.2 mm) 15.4 in (390.7 mm)
Rack Mounting	The Model 1827 can be mounted in a standard 19" rack, with rack mount kit RM-1825.
Additional Equipment Required: Signal Generator DVM RF Power Meter	100 kHz to 18GHz Frequency Range, Continuous Wave, 6dBm minimum power output. (Two may be required to cover the entire frequency range.) DC Volts, 6 1/2-digit minimum. Compatible with the sensor under test.

This data sheet was current when it was produced. However, products are constantly being updated and improved. Because of this some differences may occur between the descriptions herein and the current product. Prices and specifications may be changed without notice.



YOUR GLOBAL SOURCE FOR TEST
AND MEASUREMENT SOLUTIONS

[BACK TO CONTENTS](#)

TEN TEGAM WAY • GENEVA, OHIO 44041
440-466-6100 • FAX 440-466-6110
www.tegam.com • e-mail: sales@tegam.com

- Used to calibrate RF Power Sensors in the 10 MHz to 18 GHz frequency range
- Standards are directly traceable to NIST
- Thermistor Standards are temperature controlled
- 0.01 mW to 25 mW dynamic range can be extended to 250 mW
- Primary and Working Transfer Standard configurations
- Cased version also available
- Optional A2LA Accredited calibrations

Coaxial RF Power Transfer Standards

TEGAM Temperature Stabilized Coaxial RF Power Transfer Standards enable the precise measurement of microwave power in the 10 MHz to 18 GHz frequency range.

These units are extremely rugged, highly accurate, and stable with time and temperature. They are ideal for use as standards for the transfer of calibration factors to other RF standards and power sensors. Units are supplied with ANSI/NCSL Z540-1-1994 NIST traceable calibration data. A2LA Accredited Calibrations are optional.

These models are designed for use with dc self-balancing bridges such as the TEGAM Model 1806 and 1804 or controllers such as the TEGAM Model 1805B.

System configurations employing instruments of this extreme accuracy typically achieve calibration factor

transfer results normally found only in primary standards laboratories.

The Model F1109 is a feedthrough Thermistor Standard and Power Splitter combination used for the calibration of bolometer, thermocouple and diode terminating power sensors.

The F1109H is a Thermistor Standard, Attenuator, and Power Splitter combination. It is used as a feedthrough standard for the calibration of higher power terminating sensors up to 250 mW. This combination provides broader bandwidth and lower VSWR than other solutions when calibrating 1W to 5W terminating sensors at typical operating power levels.

The Model M1110 is a terminating thermistor Primary Transfer Standard. It is designed to be calibrated directly by a national standards agency such as NIST. The M1110 is used for the calibration of feedthrough devices such as bolometer mount-coupler and bolometer mount-splitter RF Standards, and in other applications requiring direct measurement of RF power.

Both Models feature a Type N RF connector. Bias connectors are binding posts with standard 0.75" spacing for banana plugs. The connector for the internal heater is compatible with the heater control circuit on TEGAM Models 1805B, 1806, and 1820.

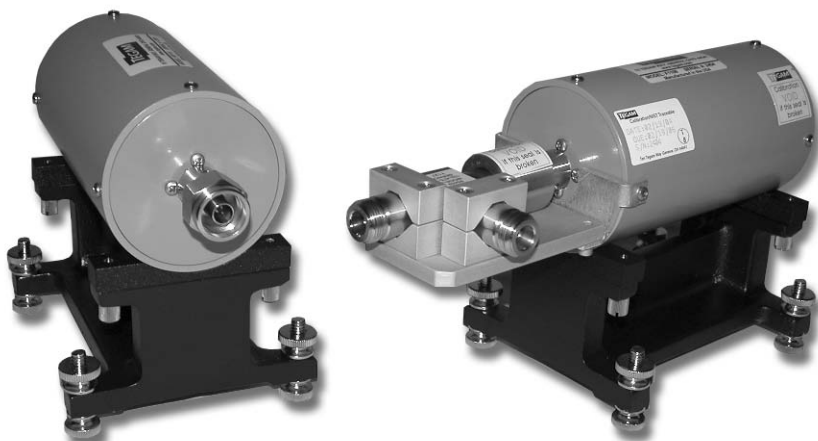

Model F1109/M1110

COAXIAL RF POWER TRANSFER STANDARDS

Specifications

	F1109	M1110
Frequency Range	10 MHz to 18 GHz	10 MHz to 18 GHz
Power Range - F1109H	0.01 to 25 mW (-20 to 14 dBm) 0.1 to 250 mW (-10 to 24 dBm)	0.01 to 25 mW (-20 to 14 dBm)
Nominal Impedance	50 Ohms	50 Ohms
Max VSWR	1.06 from 0.01 to 6 GHz 1.10 from 6 to 15 GHz 1.14 from 15 to 18 GHz	1.50 from 10 to 20 MHz 1.40 from 20 to 50 MHz 1.30 from 50 to 100 MHz 1.20 from 0.1 to 4 GHz 1.30 from 4 to 8 GHz 1.40 from 8 to 18 GHz
Power Linearity - F1109H	<0.1% from 1 to 10 mW <0.1% from 10 to 100 mW	<0.1% from 1 to 10 mW
Insertion Loss - F1109H	6 dB, 8.5 dB max 16 dB, 18.5 dB max	1 dB max
Individual calibrations traceable to NIST supplied at the following frequencies:	10 to 100 MHz in 10 MHz steps 100 MHz to 2 GHz in 50 MHz steps 2 GHz to 4 GHz in 100 MHz steps 4 to 12.4 GHz in 200 MHz steps 12.75 to 18 GHz in 250 MHz steps	10 to 100 MHz in 10 MHz steps 100 MHz to 2 GHz in 50 MHz steps 2 GHz to 4 GHz in 100 MHz steps 4 to 12.4 GHz in 200 MHz steps 12.75 to 18 GHz in 250 MHz steps
Calibration Factor Accuracy	+/-1.00% from 0.01 to 10 GHz +/-1.10% from 10 to 18 GHz	+/-1.20% from 0.01 to 10 GHz +/-1.30% from 10 to 18 GHz
Calibration Factor Drift	<0.5% per year	<0.5% per year
Thermistor DC Bias Power	30 +/- 0.7 mW	30 +/- 0.7 mW
Thermistor Resistance at Bias	200 Ohms	200 Ohms
Thermistor Power Sensitivity	Approximately 13 Ohms/mW	Approximately 13 Ohms/mW
Temperature Operating Storage	+12° to +40°C (+54° to 104°F) -55° to +75°C (-67° to +167°F)	+12° to +40°C (+54° to 104°F) -55° to +75°C (-67° to +167°F)
Warm up time	2 hours	2 hours
Weight	3.25 lbs (1.5 kg)*	2.875 lbs (1.3 kg)
Physical Dimensions		
Height	5.25 in (133.35 mm)*	5.25 in (133.35 mm)
Width	4.00 in (101.6 mm)*	4.00 in (101.6 mm)
Depth	10.21 in (259.33 mm)*	7.45 in (189.23 mm)

*Weight and Physical dimensions will vary for High Power or Case mounted versions.

This data sheet was current when it was produced. However, products are constantly being updated and improved. Because of this some differences may occur between the descriptions herein and the current product. Prices and specifications may be changed without notice.



YOUR GLOBAL SOURCE FOR TEST
AND MEASUREMENT SOLUTIONS

[BACK TO CONTENTS](#)

TEN TEGAM WAY • GENEVA, OHIO 44041
440-466-6100 • FAX 440-466-6110
www.tegam.com • e-mail: sales@tegam.com

Model F1125/M1120

RF CALIBRATION AND MEASUREMENT PRODUCTS

- Used to calibrate RF Power Sensors in the 100 kHz to 4.2 GHz frequency range
- Standards are directly traceable to NIST
- Thermistor Standards are temperature controlled
- 0.01 to 25 mW dynamic range
- Primary and Working Transfer Standard configurations
- Rack mount kit available
- Optional A2LA Accredited calibrations

Coaxial RF Power Transfer Standards

TEGAM Temperature Stabilized Coaxial RF Power Transfer Standards enable the precise measurement of microwave power in the 100 kHz to 4.2 GHz frequency range.

These units are extremely rugged, highly accurate, and stable with time and temperature. They are ideal for use as standards for the transfer of calibration factors to other RF standards and power sensors. Units are supplied with ANSI/NCSL Z540-1-1994 NIST traceable calibration data. A2LA Accredited Calibrations are optional.

These models are designed for use with dc self-balancing bridges such as the TEGAM Model 1806 and 1804, or with controllers such as the TEGAM Model 1805B.

System configurations employing instruments of this extreme accuracy typically achieve calibration factor transfer results normally found only in

primary standards laboratories.

The Model F1125 is a feedthrough Thermistor Standard and Power Splitter combination used for the calibration of bolometer, thermocouple, and diode terminating power sensors.

The Model M1120 is a terminating thermistor Primary Transfer Standard. It is designed to be calibrated directly by a national standards agency such as NIST. The M1120 is used for the calibration of feedthrough devices such as bolometer mount-coupler and bolometer mount-splitter RF Standards. It is also useful in other applications requiring direct measurement of RF power.

Both Models feature a Type N RF connector. Bias connectors are binding posts with standard 0.75" spacing for banana plugs. The internal heater is connected using cables provided with the Models F1125, 1805B, 1806, and 1820.



Model F1125/M1120

COAXIAL RF POWER TRANSFER STANDARDS

Specifications

	F1125	M1120
Frequency Range	100 kHz to 4.2 GHz	100 KHz to 4.2 GHz
Power Range	0.01 to 25 mW (-20 to 14 dBm)	0.01 to 25 mW (-20 to 14 dBm)
Nominal Impedance	50 Ohms	50 Ohms
Max VSWR	1.06 from 100 kHz to 4.2 GHz	1.40 from 100 to 500 KHz 1.20 from 0.5 to 1 MHz 1.10 from 1 to 1000 MHz 1.20 from 1 to 4.2 GHz
Power Linearity	<0.1% from 1 to 10 mW	<0.1% from 1 to 10 mW
Insertion Loss	6 dB, 8.5 dB max	1 dB max
Individual calibrations traceable to NIST supplied at the following frequencies:	100, 200, 455 kHz 1, 1.25, 3, 5 MHz 10 to 100 MHz in 10 MHz steps 0.1 to 2 GHz in 50 MHz steps 2 GHz to 4 GHz in 100 MHz steps 4.2 GHz	100, 200, 455 kHz 1, 1.25, 3, 5 MHz 10 to 100 MHz in 10 MHz steps 0.1 to 2 GHz in 50 MHz steps 2 GHz to 4 GHz in 100 MHz steps 4.2 GHz
Calibration Factor Accuracy	+/-0.80% from 0.01 to 10 MHz +/-0.90% from 10 to 4200 MHz	+/-0.80% from 0.01 to 10 MHz +/-0.90% from 10 to 4200 MHz
Calibration Factor Drift	<0.5% per year	<0.5% per year
Thermistor DC Bias Power	30 +/- 0.7 mW	30 +/- 0.7 mW
Thermistor Resistance at Bias	200 Ohms	200 Ohms
Thermistor Power Sensitivity	Approximately 13 Ohms/mW	Approximately 13 Ohms/mW
Temperature Operating Storage	+12° to +40°C (+54° to 104°F) -55° to +75°C (-67° to +167°F)	+12° to +40°C (+54° to 104°F) -55° to +75°C (-67° to +167°F)
Warm up time	2 hours	2 hours
Weight	5.5 lbs (2.5 kg)	2.875 lbs (1.3 kg)
Physical Dimensions Height Width Depth	3.5 in (88.9 mm) 8.5 in (215.9 mm) 15.4 in (390.7 mm)	2.88 in (73.15 mm) 4.00 in (101.6 mm) 7.45 in (189.23 mm)

This data sheet was current when it was produced. However, products are constantly being updated and improved. Because of this some differences may occur between the descriptions herein and the current product. Prices and specifications may be changed without notice.



YOUR GLOBAL SOURCE FOR TEST
AND MEASUREMENT SOLUTIONS

[BACK TO CONTENTS](#)

TEN TEGAM WAY • GENEVA, OHIO 44041
440-466-6100 • FAX 440-466-6110
www.tegam.com • e-mail: sales@tegam.com

Model F1130/M1130

RF CALIBRATION AND MEASUREMENT PRODUCTS

- Used to calibrate RF Power Sensors in the new wider frequency range of 100 kHz to 18 GHz
- Standards are directly traceable to NIST
- Thermistor Standards are temperature controlled
- 0.01 to 25 mW dynamic range
- Primary and Working Transfer Standard configurations
- Rack mount kit available
- Optional A2LA Accredited calibrations

Coaxial RF Power Transfer Standards

TEGAM Temperature Stabilized Coaxial RF Power Transfer Standards enable the precise measurement of microwave power, now in the 100 kHz to 18 GHz frequency range. With this wider frequency range, the F1130 and M1130 can be used in applications that previously required two standards.

These units are extremely rugged, highly accurate, and stable with time and temperature. They are ideal for use as standards for the transfer of calibration factors to other RF standards and power sensors. Units are supplied with ANSI/NCSL Z540-1-1994 NIST traceable calibration data. A2LA Accredited Calibrations are optional.

These models are designed for use with dc self-balancing bridges such as the TEGAM Model 1806 and 1804, or with controllers such as the TEGAM Model 1805B.

System configurations employing instruments of this extreme accuracy typically achieve calibration factor transfer results normally found only in primary standards laboratories.

The Model F1130 is a feedthrough Thermistor Standard and Power Splitter combination used for the calibration of bolometer, thermocouple, and diode terminating power sensors. The expanded frequency range has been achieved without compromising the VSWR or accuracy specifications.

The Model M1130 is a terminating thermistor Primary Transfer Standard. It is designed to be calibrated directly by a national standards agency such as NIST. The M1130 is used for the calibration of feedthrough devices such as bolometer mount-coupler and bolometer mount-splitter RF Standards. It is also useful in other applications requiring direct measurement of RF power. The VSWR of this model is better than the two standards it replaces and the accuracy is unchanged.

Both models have a wider frequency band than any other thermistor power standard in this range. This reduces the number of standards needed to calibrate power sensors in the 100 kHz to 18 GHz frequency range and lowers annual calibration costs by up to 50%.

Both Models feature a Type N RF connector. Bias connectors are binding posts with standard 0.75" spacing for banana plugs. The internal heater is connected with cables provided with the Models F1130, 1805B, 1806, and 1820.



Prices and specifications subject to change without notice.

[BACK TO CONTENTS](#)

TEGAM®

YOUR GLOBAL SOURCE FOR TEST
AND MEASUREMENT SOLUTIONS

A

Model F1130/M1130

COAXIAL RF POWER TRANSFER STANDARDS

Specifications

	F1130	M1130
Frequency Range	100 kHz to 18 GHz	100 kHz to 18 GHz
Power Range	0.01 to 25 mW (-20 to 14 dBm)	0.01 to 25 mW (-20 to 14 dBm)
Nominal Impedance	50 Ohms	50 Ohms
Max VSWR	1.06 from 100 kHz to 6 GHz 1.10 from 6 to 15 GHz 1.14 from 15 to 18 GHz	1.30 from 100 to 500 kHz 1.10 from 0.5 to 4000 MHz 1.20 from 1 to 4 GHz 1.30 from 4 to 8 GHz 1.40 from 8 to 18 GHz
Power Linearity	<0.1% from 1 to 10 mW	<0.1% from 1 to 10 mW
Insertion Loss	6 dB, 9 dB max	1.5 dB max
Individual calibrations traceable to NIST supplied at the following frequencies:	100, 200, 455 kHz 1, 1.25, 3, 5 MHz 10 to 100 MHz in 10 MHz steps 100 MHz to 2 GHz in 50 MHz steps 2 GHz to 4 GHz in 100 MHz steps 4 to 12.4 GHz in 200 MHz steps 12.75 to 18 GHz in 250 MHz steps	100, 200, 455 kHz 1, 1.25, 3, 5 MHz 10 to 100 MHz in 10 MHz steps 100 MHz to 2 GHz in 50 MHz steps 2 GHz to 4 GHz in 100 MHz steps 4 to 12.4 GHz in 200 MHz steps 12.75 to 18 GHz in 250 MHz steps
Calibration Factor Accuracy	+/-0.80% from 0.1 to 10 MHz +/-1.00% from 0.01 to 10 GHz +/-1.10% from 10 to 18 GHz	+/-0.80% from 0.1 to 10 MHz +/-1.20% from 0.01 to 10 GHz +/-1.30% from 10 to 18 GHz
Calibration Factor Drift	<0.5% per year	<0.5% per year
Thermistor DC Bias Power	30 +/- 0.7 mW	30 +/- 0.7 mW
Thermistor Resistance at Bias	200 Ohms	200 Ohms
Thermistor Power Sensitivity	Approximately 13 Ohms/mW	Approximately 13 Ohms/mW
Temperature		
Operating	+12° to +40°C (+54° to 104°F)	+12° to +40°C (+54° to 104°F)
Storage	-55° to +75°C (-67° to +167°F)	-55° to +75°C (-67° to +167°F)
Warm up time	2 hours	2 hours
Weight	5.5 lbs (2.5 kg)	3.22 lbs (1.46 kg)
Physical Dimensions		
Height	3.5 in (88.9 mm)	2.88 in (73.15 mm)
Width	8.5 in (215.9 mm)	4.00 in (101.6 mm)
Depth	15.4 in (390.7 mm)	9.25 in (234.95 mm)

This data sheet was current when it was produced. However, products are constantly being updated and improved. Because of this some differences may occur between the descriptions herein and the current product. Prices and specifications may be changed without notice.



YOUR GLOBAL SOURCE FOR TEST
AND MEASUREMENT SOLUTIONS

[BACK TO CONTENTS](#)

TEGAM WAY • GENEVA, OHIO 44041
440-466-6100 • FAX 440-466-6110
www.tegam.com • e-mail: sales@tegam.com

Model F1135/M1135

RF CALIBRATION AND MEASUREMENT PRODUCTS

- Used to calibrate RF Power Sensors in the new wider frequency range of 10 MHz to 26.5 GHz
- Standards are directly traceable to NIST
- Thermistor Standards are temperature controlled
- 0.01 to 25 mW dynamic range
- Primary and Working Transfer Standard configurations.
- Rack mount kit available
- Optional A2LA Accredited calibrations

Coaxial RF Power Transfer Standards

TEGAM Temperature Stabilized Coaxial RF Power Transfer Standards enable the precise measurement of microwave power in the 10 MHz to 26.5 GHz frequency range. With this wider frequency range, the F1135 and M1135 can be used in applications that previously required two standards.

These units are extremely rugged, highly accurate, and stable with time and temperature. They are ideal for use as standards for the transfer of calibration factors to other RF standards and power sensors. Units are supplied with ANSI/NC SL Z540-1-1994 NIST traceable calibration data. A2LA Accredited Calibrations are optional.

These models are designed for use with dc self-balancing bridges such as the TEGAM Model 1806 and 1804, or with controllers such as the TEGAM Model 1805B.

System configurations employing instruments of this extreme accuracy typically achieve calibration factor transfer results normally found only in primary standards laboratories.

The Model F1135 is a feedthrough Thermistor Standard and Power Splitter combination used for the calibration of bolometer, thermocouple, and diode terminating power sensors. Its expanded frequency range has been achieved without compromising the accuracy specifications after VSWR correction.

The Model M1135 is a terminating thermistor Primary Transfer Standard. It is designed to be calibrated directly by a national standards agency such as NIST. The M1135 is used for the calibration of feedthrough devices such as bolometer mount-coupler and bolometer mount-splitter RF Standards. It is also useful in other applications requiring direct measurement of RF power. The accuracy specifications are the same as the Models M1110 and M1118. The M1135 has better VSWR from 18 to 26.5GHz.

Both models have the widest frequency band of any thermistor power standard commercially available. This reduces the number of standards needed to calibrate power sensors in the 10 MHz to 26.5 GHz frequency range and lowers annual calibration costs by up to 50%.

The Model F1135 features a 3.5 mm female connector, and the M1135 features a compatible 2.92 mm male connector. Bias connectors are binding posts with standard 0.75" spacing for banana plugs. The internal heater is connected using cables provided with the models F1135, 1805B, 1806, and 1820.



Prices and specifications subject to change without notice.

[BACK TO CONTENTS](#)

TEGAM[®]

YOUR GLOBAL SOURCE FOR TEST
AND MEASUREMENT SOLUTIONS

Model F1135/M1135

COAXIAL RF POWER TRANSFER STANDARDS

Specifications

	F1135	M1135
Frequency Range	10 MHz to 26.5 GHz	10 MHz to 26.5 GHz
Power Range	0.01 to 25 mW (-20 to 14 dBm)	0.01 to 25 mW (-20 to 14 dBm)
Nominal Impedance	50 Ohms	50 Ohms
Max VSWR	1.25 from 0.01 to 18 GHz 1.35 from 18 to 26.5 GHz	1.50 from 10 to 20 MHz 1.40 from 20 to 50 MHz 1.30 from 50 to 100 MHz 1.20 from 0.1 to 4 GHz 1.30 from 4 to 8 GHz 1.40 from 8 to 14 GHz 1.60 from 14 to 26.5 GHz
Power Linearity	<0.1% from 1 to 10 mW	<0.1% from 1 to 10 mW
Insertion Loss	6 dB, 10.5 dB max	2 dB max
Individual calibrations traceable to NIST supplied at the following frequencies:	10 to 100 MHz in 10 MHz steps 100 MHz to 2 GHz in 50 MHz steps 2 GHz to 4 GHz in 100 MHz steps 4 to 12.4 GHz in 200 MHz steps 12.75 to 18 GHz in 250 MHz steps 18 to 26 GHz in 1 GHz steps 26.5 GHz	10 to 100 MHz in 10 MHz steps 100 MHz to 2 GHz in 50 MHz steps 2 GHz to 4 GHz in 100 MHz steps 4 to 12.4 GHz in 200 MHz steps 12.75 to 18 GHz in 250 MHz steps 18 to 26 GHz in 1 GHz steps 26.5 GHz
Calibration Factor Accuracy	+/-1.00% from 0.01 to 10 GHz +/-1.10% from 10 to 18 GHz +/-2.20% from 18 to 26.5 GHz	+/-1.20% from 0.01 to 10 GHz +/-1.30% from 10 to 18 GHz +/-2.30% from 18 to 26.5 GHz
Calibration Factor Drift	<0.5% per year	<0.5% per year
Thermistor DC Bias Power	30 +/- 0.7 mW	30 +/- 0.7 mW
Thermistor Resistance at Bias	200 Ohms	200 Ohms
Thermistor Power Sensitivity	Approximately 13 Ohms/mW	Approximately 13 Ohms/mW
Temperature		
Operating	+12° to +40°C (+54° to 104°F)	+12° to +40°C (+54° to 104°F)
Storage	-55° to +75°C (-67° to +167°F)	-55° to +75°C (-67° to +167°F)
Warm up time	2 hours	2 hours
Weight	6.27 lbs (2.84 kg)	2.875 lbs (1.3 kg)
Physical Dimensions		
Height	3.5 in (88.9 mm)	2.88 in (73.15 mm)
Width	8.5 in (215.9 mm)	4.00 in (101.6 mm)
Depth	15.4 in (390.7 mm)	7.45 in (189.23 mm)

This data sheet was current when it was produced. However, products are constantly being updated and improved. Because of this some differences may occur between the descriptions herein and the current product. Prices and specifications may be changed without notice.



YOUR GLOBAL SOURCE FOR TEST
AND MEASUREMENT SOLUTIONS

[BACK TO CONTENTS](#)

TEN TEGAM WAY • GENEVA, OHIO 44041
440-466-6100 • FAX 440-466-6110
www.tegam.com • e-mail: sales@tegam.com

Model 1107-8

RF CALIBRATION AND MEASUREMENT PRODUCTS

- Used to calibrate RF Power Sensors in the 26.5 to 40 GHz frequency range
- Standards are directly traceable to NIST
- Thermistor Standards are temperature controlled
- 0.01 to 10 mW dynamic range
- Primary and Working Transfer Standard configurations

Waveguide RF Power Transfer Standard

TEGAM Temperature Stabilized Waveguide RF Power Transfer Standards enable the precise measurement of microwave power in the 26.5 to 40 GHz frequency range.

These units are extremely rugged, highly accurate, and stable with time and temperature. They are ideal for use as standards for the transfer of calibration factors to other RF standards and power sensors. Units are supplied with ANSI/NCSL Z540-1-1994 NIST traceable calibration data. A2LA Accredited Calibrations are optional.

These models are designed for use with dc self-balancing bridges such as the TEGAM Model 1806 and 1804.

System configurations employing instruments of this extreme accuracy typically achieve calibration factor transfer results normally found only in primary standards laboratories.

The Model 1107-8 is a Thermistor Standard and Waveguide coupler combination. The Model 1107-8 comes with a waveguide termination. With the termination installed, it is a terminating standard that can be used to calibrate feedthrough type power standards and for other applications requiring direct measurement of RF power. With the termination removed, the Model 1107-8 is a feedthrough standard used for the calibration of bolometer, thermocouple and diode power sensors.

This model features a WR-28 waveguide flange. Bias connectors are binding posts with standard 0.75" spacing for banana plugs. The connector for the internal heater is compatible with the heater control circuit on TEGAM Models 1805B, 1806, and 1820.

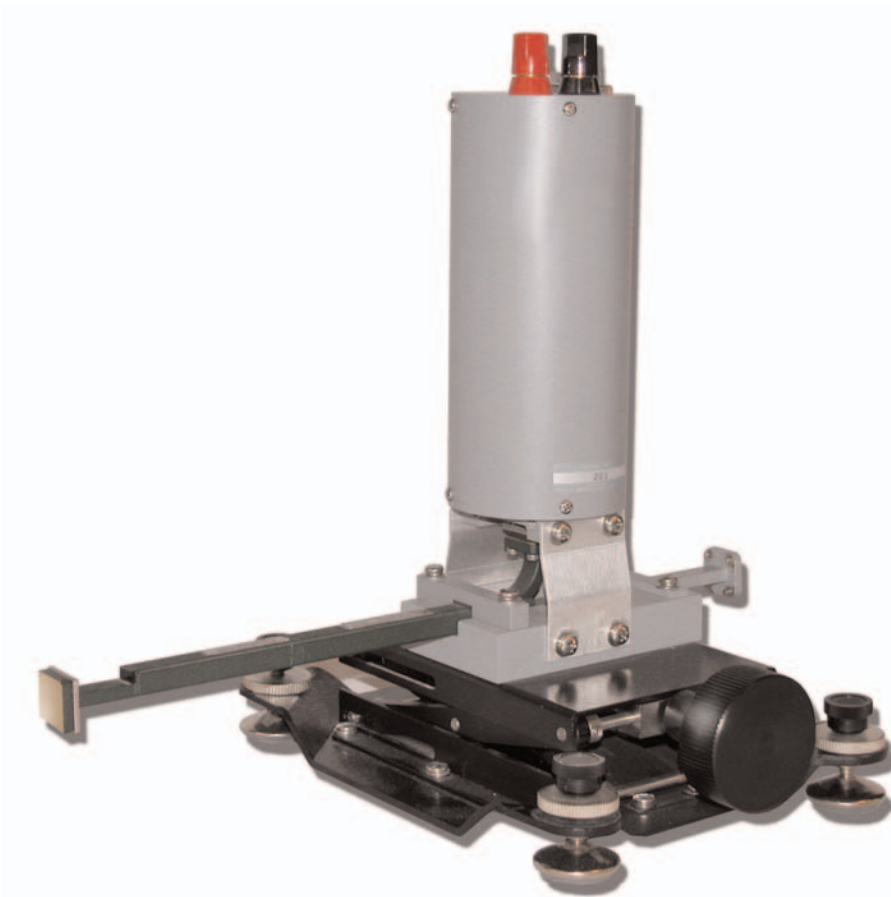

Prices and specifications subject to change without notice.

[BACK TO CONTENTS](#)



YOUR GLOBAL SOURCE FOR TEST
AND MEASUREMENT SOLUTIONS

A

Model 1107-8

WAVEGUIDE RF POWER TRANSFER STANDARD

Specifications

	1107-8 (without termination)	1107-8 (with termination)
Frequency Range	26.5 to 40 GHz	26.5 to 40 GHz
Power Range	0.01 to 10 mW (-20 to 10 dBm)	0.01 to 10 mW (-20 to 10 dBm)
Interface	WR-28 Waveguide Flange	WR-28 Waveguide Flange
Max VSWR	1.20 from 26.5 to 40 GHz	1.20 from 26.5 to 40 GHz
Power Linearity	<0.1% from 1 to 10 mW	<0.1% from 1 to 10 mW
Insertion Loss	3 dB max	6 dB max
Individual calibrations traceable to NIST supplied at the following frequencies:	26.5 GHz 27 to 40 GHz in 1 GHz steps	26.5 GHz 27 to 40 GHz in 1 GHz steps
Calibration Factor Accuracy	$\pm 1.75\%$ from 26.5 to 40 GHz	$\pm 2.1\%$ from 26.5 to 40 GHz
Calibration Factor Drift	<0.5% per year	<0.5% per year
Thermistor DC Bias Power	13 \pm 2 mW	13 \pm 2 mW
Thermistor Resistance at Bias	200 Ohms	200 Ohms
Temperature		
Operating	+12° to +40°C (+54° to 104°F)	+12° to +40°C (+54° to 104°F)
Storage	-55° to +75°C (-67° to +167°F)	-55° to +75°C (-67° to +167°F)
Warm up time	2 hours	2 hours
Weight	5.82 lbs (2.64 kg)	5.86 lbs (2.66 kg)
Physical Dimensions		
Height	11.2 in (285 mm)	11.2 in (285 mm)
Width	9.4 in (239 mm)	9.4 in (239 mm)
Depth	12.4 in (315 mm)	15.4 in (391 mm)

This data sheet was current when it was produced. However, products are constantly being updated and improved. Because of this some differences may occur between the descriptions herein and the current product. Prices and specifications may be changed without notice.



YOUR GLOBAL SOURCE FOR TEST
AND MEASUREMENT SOLUTIONS

[BACK TO CONTENTS](#)

TEN TEGAM WAY • GENEVA, OHIO 44041
440-466-6100 • FAX 440-466-6110
www.tegam.com • e-mail: sales@tegam.com

Model 1805B

RF CALIBRATION AND MEASUREMENT PRODUCTS

- Internal temperature controller
- DC substitution & bias supply
- Automatic DC level control
- Front panel mount error indicator
- One year warranty
- Optional A2LA Accredited Calibrations

Other features of the 1805B are:

• Automatic DC Level Control

To within $\pm 0.1\% +1\mu\text{W}$, with a RF source variation of $\pm 3\text{ dB}$ and an ambient temperature range of $+12$ to $+40^\circ\text{C}$. The dc substitution level is held to an accuracy of $\pm 0.1\% +5\mu\text{W}$.

• DC Substitution and Bias Supply

Maximum accuracy is achieved by using DC power for both bias and substitution signals.

• Quick Visual Indication of Operation and Performance

The unit employs LEDs to inform the user of RF power on/off condition, ac power on/standby, mount error, and remote/listen functions. Easy-to-read meters are used to monitor temperature stability and bridge balance.

RF Power Level Control Unit 0.5 to 10 mW

The 1805B RF Level Control Unit provides fast, reliable, and accurate leveled RF power when used in a closed-loop feedback arrangement. The unit provides automatic dc substitution at 0.5 mW and 1 mW to 10 mW in 1 mW steps using local or IEEE-488 bus control for easy and accurate transfer of calibration factors.

When used with bolometer element RF Power Standards (mounts) such as the TEGAM Model F1109, the 1805B permits the accurate transfer of up to 132 calibration frequencies traceable to NIST from 0.01 to 18.0 GHz. The 1805B is also compatible with other TEGAM System IIA components including all TEGAM RF Power Transfer Standards (refer to applicable data sheets for mount specifications).

An internal temperature controller raises and maintains the temperature of the mount chamber above ambient. This minimizes the effects of changes in ambient temperature for all TEGAM RF

Power Transfer Standards.

The 1805B operates in a closed loop configuration for leveling the RF output of compatible signal sources. These sources are controlled directly using an analog signal applied to a dc coupled AM input connector.

Ultra stable dc high precision metal film resistors provide dc power increments across a TEGAM patented self-balancing bridge. The front panel bridge meter provides visual indication that closed loop stabilization has been achieved and enables rapid system operation. Coarse and fine adjustments are provided to obtain a meter null reading with no RF applied.

In addition to the bridge balance and temperature indicator, the 1805B contains several operational and performance checks. A front panel Mount Error indicator blinks if the voltage across the mount is not within a specified range. This alerts the operator of a mount fault such as open or shorted leads, or improper mount temperature. DC supply voltages are monitored by PCB-mounted LEDs which illuminate with an active power supply.

A standby mode switch allows mount heater circuit operation to maintain mount temperature at all times. This ensures full performance capability and long-term stability of the bolometer mount.



Prices and specifications subject to change without notice.

[BACK TO CONTENTS](#)

TEGAM[®]

YOUR GLOBAL SOURCE FOR TEST
AND MEASUREMENT SOLUTIONS

A

Specifications

DC Power Substitution	
Level Range	0.5, 1 through 10 mW
Accuracy	(@ 30 ± 0.7 mW bias power): ± 0.1% + 5 μW
Bias Power Range	29 - 31 mW, automatic with error indication for out-of-range balance condition.
Power Level Control Range	3 - 23 dB minimum
Leveled RF Power (referenced to DC substituted power) Dynamic Range	± 3 dB
<hr/>	
Unbalanced Detector	
Sensitivity	2 μW/division
Resolution:	0.2 μW
Leveler Loop Gain	80 dB
<hr/>	
Temperature Controller	
Bias Power Temperature Sensitivity	2 μW/°C per hour
Ambient Temperature Dynamic Range	+ 12°C to +40°C (+54° to +104°F)
Mount Warm-up Time	2 hours
Internal Temperature	+60°C (+140°F) nominal
Loop Gain	80 dB minimum
Open Loop Frequency Response	0.1 Hz
Warm-up Drive (saturated)	8-10 V @ 200 mA minimum
Indicator	Voltmeter
<hr/>	
Operating Modes	
Local	Manual front panel control of all unit functions.
Remote	IEEE-488 full function Bus Control RF ON/OFF and substituted DC output power levels (0.5 and 1 - 10 mW in 1 mW steps) using any PC Compatible Controller.
<hr/>	
Temperature Range	
Operating	+10 to +40°C (+50 to +104°F)
Storage	-40°C to +75°C (-40° to +167°F)
<hr/>	
Connectors	Binding Post, standard 0.75" spacing for Banana plugs.
<hr/>	
Power Requirements	110/120/220/240 Vac ±10%, 48 to 62 Hz, 40 Watts
<hr/>	
Weight	Net: 5.9 kg (13 lb)
<hr/>	
Physical Dimensions	
Height	7.57 in (192.2 mm)
Width	8.8 in (223.5 mm)
Depth	17.5 in (444.5 mm)
<hr/>	
Rack Mounting	The Model 1805B is a half rack instrument that can be mounted in any cabinet or rack designed according to EIA RS-310 and MIL-STD-189 using the Rack Adapter Kit (P/N 1919). This kit allows the Model 1805B to be mounted with the Model 1807A or another 1805B in the same rack-mount configuration.

This data sheet was current when it was produced. However, products are constantly being updated and improved. Because of this some differences may occur between the descriptions herein and the current product. Prices and specifications may be changed without notice.



YOUR GLOBAL SOURCE FOR TEST
AND MEASUREMENT SOLUTIONS

[BACK TO CONTENTS](#)

Model 1804

RF CALIBRATION AND MEASUREMENT PRODUCTS

- **Directly traceable to primary voltage and resistance standards**
- **Bias either 100 or 200 ohm mounts**
- **LEDs and Analog Meter are conveniently located on the front panel**
- **Economical, easy to use, compact and light-weight**
- **One-year warranty**
- **Optional A2LA Accredited Calibrations**

Single Type IV RF Power Meter

A

The Model 1804 Single Type IV RF Power Meter is designed for use with bolometer elements and an external DVM to measure high frequency power, microwave power and insertion loss. It can also function as a standard for the calibration of RF detectors, RF voltmeters, and bolometer elements (mounts) manufactured by TEGAM, Weinschel, and Agilent (HP). Mounts easily interface to the 1804's universal front panel binding post connection. Calibration of temperature-compensated mounts can be performed by adding the TEGAM Model 1820 RF Mount Heater.

The exclusive use of 100% DC substituted power eliminates the effect of AC components on the bridge circuit which has been shown to introduce a substantial error in the substituted power due to the short-term time constant of some bolometer elements. Substituted DC power levels ranging from 0.01mW to

30mW can be measured to within $\pm 0.003\%$, which makes this an ideal instrument for insertion loss measurements. Regardless of the application, all measurements can be made directly traceable to primary voltage and resistance standards.

The Model 1804 Type IV RF Power Meter is designed to bias either 100 or 200 ohm mounts and is thus compatible with Agilent (HP) 478A, 486A and 8478A thermistor mounts (when used with cable P/N 138-652) and all TEGAM Thermistor Power Standards (refer to applicable data sheets for mount specifications). A front panel switch selects the operating resistance for the power meter. Each power meter has a bolometer current meter and a fault LED indicator that illuminates under any condition preventing loop balance. Terminals are provided for an external DVM, negative bolometer, and voltage sense.



Model 1804

S I N G L E T Y P E I V R F P O W E R M E T E R

Specifications

Power Range	0.01mW to 30mW
Substitution Bridge Accuracy	±0.003%
Temperature Range	
Operating	+10 to +40°C (+50° to 104°F)
Storage	-40 to +75°C (-40° to +167°F)
Connectors	Binding Post, standard 0.75" spacing for Banana plugs.
Power Requirements	105-125 or 210-250 Vac, 47 to 420 Hz, 12 Watts (factory optional)
Weight	Net 6.20 lbs. (2.82 kg)
Physical Dimension	
Height	3.37 in (85.61 mm)
Width	9.84 in (250.00 mm)
Depth	10.24 in (260.00 mm)
Rack Mounting	The Model 1804 can be shelf mounted in any cabinet or rack designed according to EIA RS-310 and MIL-STD-189

This data sheet was current when it was produced. However, products are constantly being updated and improved. Because of this some differences may occur between the descriptions herein and the current product. Prices and specifications may be changed without notice.



Model 1806

RF CALIBRATION AND MEASUREMENT PRODUCTS

- Internal temperature controller
- Compatible with Agilent Thermistor mounts and all TEGAM Thermistor power standards
- Power meters bias either 100 or 200 ohm mounts
- Fault LED indicator illuminates when loop balance is prevented
- One-year warranty
- Optional A2LA Accredited Calibrations

Dual Type IV Power Meter 0.01 mW to 30 mW

A

The Model 1806 Dual Type IV Power Meter is designed for use with thermistor elements (mounts) to measure high frequency or microwave power. It also functions as a standard for the calibration of bolometer mounts, detectors, RF voltmeters, and for precision insertion loss measurements when used as part of the TEGAM System IIA Automatic Power Meter Calibration System.

The exclusive use of 100% dc substituted power eliminates the effect of ac components on the bridge circuit which has been shown to introduce a substantial error in the substituted power due to the short-term time constant of some bolometer elements. Substituted dc power levels ranging from 0.01 mW to 30 mW can be measured to within $\pm 0.003\%$ which also makes this an ideal instrument for insertion loss measurements.

Regardless of the application, all measurements can be made directly traceable to primary voltage and resistance standards.

The 1806 contains two Type IV Power Meters and two built-in temperature controllers for use with all TEGAM RF Power Transfer Standards (refer to applicable data sheets for mount specifications). The power meters are designed to bias either 100 or 200 ohm mounts. Therefore, they are compatible with Agilent (HP) 478A, 486A, and 8478A thermistor mounts (when used with cable P/N 138-652). Operating resistance for each power meter is selected by a front panel switch. Each power meter has a bolometer current meter and fault LED indicator which illuminates under any condition preventing loop balance. Terminals are provided for an external DVM, positive and negative bolometer, and voltage sense.



Model 1806

DUAL TYPE IV POWER METER

Specifications

Power Range	0.01 mW to 30 mW
Substitution Bridge Accuracy	±0.003%
Temperature Range	
Operating	+10 to +40°C (+25° to 104°F)
Storage	-40 to +75°C (-67° to +167°F)
Temperature Controller	
Bias Power Temperature Sensitivity	2 μ W/°C per hour
Ambient Temperature Dynamic Range	+12°C to +40°C (+54° to 104°F)
Mount Warm-Up Time	2 hours nominal
Internal Temperature	+60°C (+140°F) nominal
Loop Gain	80 dB minimum
Open Loop Frequency Response	0.1 Hz
Warm-Up Drive (saturated)	8-10 V @ 200 mA minimum
Indicator	Voltmeter
Connectors	Binding Post, standard 0.75" spacing for Banana plugs.
Power Requirements	110/120/220/240 Vac \pm 5 -10%, 48 to 62 Hz, 25 Watts
Weight	Net: 16 lbs. (7.26 kg)
Physical Dimensions	
Height	5.2 in (132.1 mm)
Width	17.05 in (433.1 mm)
Depth	18.35 in (466.1 mm)
Rack Mounting	The Model 1806 can be mounted in any cabinet or rack designed according to EIA RS-310 and MIL-STD-189 using the Rack Adapter Kit (P/N 138-606).

This data sheet was current when it was produced. However, products are constantly being updated and improved. Because of this some differences may occur between the descriptions herein and the current product. Prices and specifications may be changed without notice.



YOUR GLOBAL SOURCE FOR TEST
AND MEASUREMENT SOLUTIONS

[BACK TO CONTENTS](#)

Model 1820

RF CALIBRATION AND MEASUREMENT PRODUCTS

- Keeps RF Mounts at operating temperature 24/7
- Reduces system down-time
- Saves you time and money
- Provides constant, regulated temperature control to one or two mounts
- LEDs and Analog Meters are conveniently located on the front panel
- Economical, easy to use, compact and light-weight
- One-year warranty



RF Mount Temperature Controller

A

The Model 1820 RF Mount Temperature Controller provides a stable power source for one or two Precision RF Coaxial Power Standards (mounts). The Model 1820 maintains the mount at operating temperature, reducing warm up time. Simply connect the mounts and in two hours they are temperature stable. Leave the mounts connected and they remain at operating temperature. Connect the mount to your Model 1804, Model 1806 or System II at any time and begin to take measurements.

The 1820 is an economical alternate voltage controller, providing a stable source to the mount's internal thermal

coils which is essential for thermistor temperature elevation. This is critical for RF Mount stability and performance. This unit is compatible with all TEGAM RF Power Standards.

The 1820 is designed to be used on the bench or in a rack. Two mounts can be placed either on top of, behind or beside the unit. Standard equipment includes two 12-inch four-wire temperature control cables with knurled lock collars. An optional three-foot temperature control cable is also available. An easy-to-follow manual provides step-by-step instructions on its operation and maintenance.



Model 1820

RF MOUNT TEMPERATURE CONTROLLER

Specifications

Temperature Controller

Bias Power Temperature Sensitivity	2 μ W/°C per hour
Mount Warm-Up Time	2 hours
Ambient Temperature Dynamic Range	+12°C to +40°C (+54° to 104°F)
Internal Temperature	+60°C (140°F) nominal
Loop Gain	80 dB minimum
Open Loop Frequency Response	0.1 Hz
Warm-Up Drive (saturated)	8-10 V @ 200mA minimum
Indicator	Voltmeter and green LED

Temperature Range

Operating	+10 to +40°C (+50° to 104°F)
Storage	-40 to +75°C (-40° to +167°F)

Connectors

2 x 4 pin microphone (audio) connector.

Power Requirements

105-125 or 210-250 Vac, 47 to 420 Hz, 12 Watts (factory optional)

Weight

Net 6 lbs. (2.72 kg)

Physical Dimensions

Height	85.61 mm (3.37 in)
Width	250.00 mm (9.84 in)
Depth	260.00 mm (10.24 in)

Rack Mounting

The Model 1820 can be shelf mounted in any cabinet or rack designed according to EIA RS-310 and MIL-STD-189

This data sheet was current when it was produced. However, products are constantly being updated and improved. Because of this some differences may occur between the descriptions herein and the current product. Prices and specifications may be changed without notice.



YOUR GLOBAL SOURCE FOR TEST
AND MEASUREMENT SOLUTIONS

[BACK TO CONTENTS](#)

TEN TEGAM WAY • GENEVA, OHIO 44041
440-466-6100 • FAX 440-466-6110
www.tegam.com • e-mail: sales@tegam.com

SYSIIA-SURECAL

AUTOMATED CALIBRATION SOFTWARE

- Permanent data archiving
- Exporting of calibration results
- Streamlined user displays
- Previews of graphical hook-up instructions
- Easier manipulation of data files
- Easier setup of flexible standards
- Display of WORD documents
- Faster selection of calibration procedures
- Sensor procedures can be easily customized

SureCAL was developed by calibration engineers and technicians who are determined to cut the high cost of manually calibrating and maintaining your equipment.

SureCAL is the complete TEGAM solution for all your automated testing needs. SureCAL has TEGAM drivers and procedures, which allow you to streamline your System IIA.

SureCAL Test Manager for Windows lets you navigate easily with your flexible standards, including equipment from Fluke, Hewlett Packard (Agilent), Keithley, TEGAM, and Tektronix.

Hundreds of SureCAL procedures are available to reduce your test time while assuring accuracy.

SureCal Software for RF Power Sensors is included with the System IIA. Additional procedures are also available.

For more information about SureCAL Software, call us at (440) 466-6100 for a FREE demonstration on CD.

SureCAL Calibration Software

A

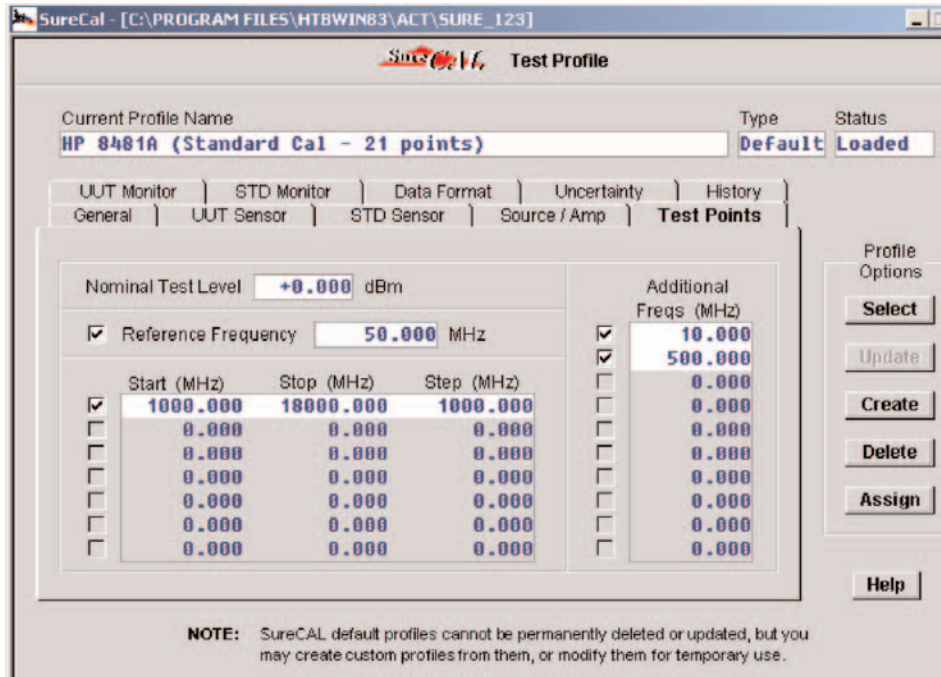

**Upon receipt of the software...
...you can download onto your workstations
and start saving time immediately.**

... And here are some samples of time savings from SureCAL when combined with TEGAM instruments:

System IIA Power Sensor Calibration System

Test Equipment	Manual Test (minutes)	SureCAL Test (minutes)	SAVINGS (minutes)
TEGAM 1807A	471	63	408
TEGAM F1119	371	52	319
TEGAM F1116	371	52	319
TEGAM F1117A	471	63	408

Prices and specifications subject to change without notice.

[BACK TO CONTENTS](#)



YOUR GLOBAL SOURCE FOR TEST AND MEASUREMENT SOLUTIONS

Customers with the most demanding test requirements can now tailor their own calibration profiles using our new flexible **POWER SENSOR RESPONSE TEST PROFILES.**

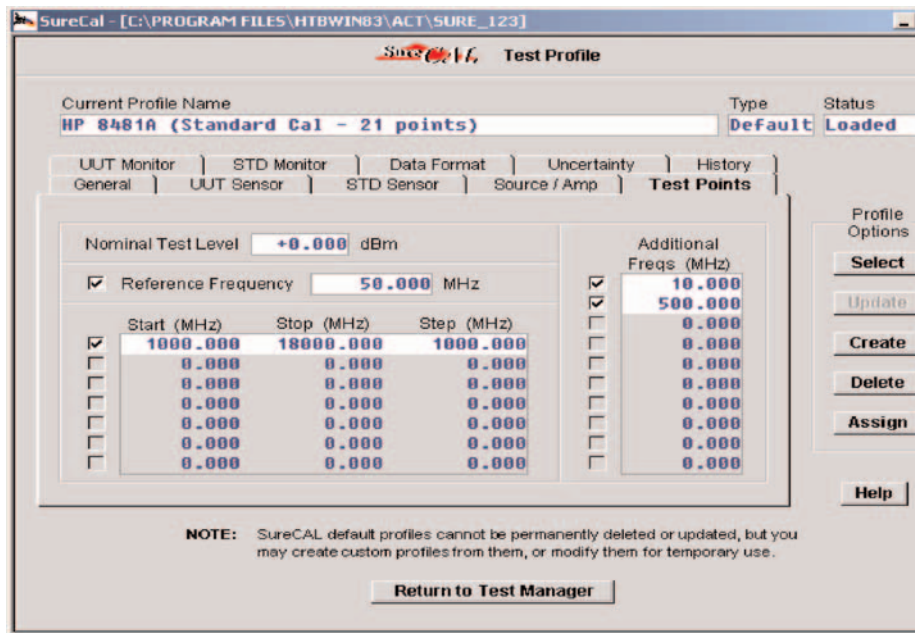

SureCAL Test Manager provides:

- Tool bars for fast access
- Permanent data archiving
- Exporting of calibration results
- Streamlined user displays
- Graphical hook-up instructions
- Easier manipulation of data files
- Easier setup of flexible standards
- Capability to launch Word®, Excel®, Access® and other utilities
- Faster selection of calibration procedures

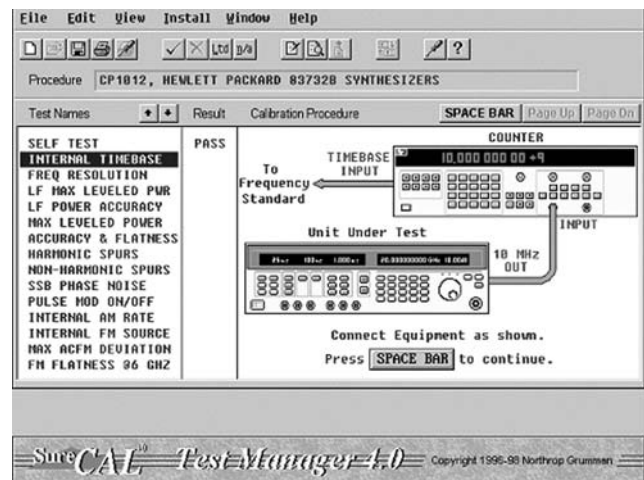

Plus a host of other improvements to simplify its use and improve your productivity.

This data sheet was current when it was produced. However, products are constantly being updated and improved. Because of this some differences may occur between the descriptions herein and the current product. Prices and specifications may be changed without notice.



YOUR GLOBAL SOURCE FOR TEST AND MEASUREMENT SOLUTIONS

BACK TO CONTENTS

TEN TEGAM WAY • GENEVA, OHIO 44041
440-466-6100 • FAX 440-466-6110
www.tegam.com • e-mail: sales@tegam.com

System IIA

RF CALIBRATION AND MEASUREMENT PRODUCTS

A

- Total system accuracy for the transfer of calibration factors 1.2% to 2.5% (RSS) in the 0.01 to 18 GHz range.
- 5 seconds/measurement includes signal averaging and meter settling time.
- Manual or automated operation
- IEEE-488 bus
- SYSIIA-SureCal calibration software included
- Substituted power levels 0.5 mW and 1.0 to 10 mW in 1 mW steps $\pm 0.1\% + 1 \mu\text{W}$.
- Calibration factor transfer repeatability 0.1%
- Calibrates power sensors from 100 kHz to 40 GHz.
- Transfer Standards include NIST traceable calibration data with as many as 141 calibration points.
- Optional A2LA Accredited Calibrations

System IIA is used primarily for the transfer of calibration factors to thermistor, thermocouple, and diode-type RF power meter sensors. Accurate measurement of signal source output level can also be performed. Using power ratio methods, variable & step attenuators and attenuation measuring equipment can be calibrated. Receiver, amplifier, or attenuator linearity can also be measured.

Calibration of RF power sensors is faster and more accurate than any other system with the TEGAM System IIA. This IEEE-488 bus controlled product transforms a slow and costly task into a quick and accurate procedure. The calibration speed of the System IIA is typically 5 seconds per measurement frequency. The settling time of the power sensor/meter under test determines actual speed. Total accuracy is less than 1.2 to 2.5% (RSS). Accuracy is dependent on the frequency and VSWR of the device under test.

Automatic RF Power Sensor Calibration System



The System IIA can be used manually via front panel controls. The task of calibrating power sensors is fully automated by the SureCal calibration software.

Precision RF Power Source

In its most elementary form, System IIA consists of an RF Control Unit (Model 1805B) and a temperature stabilized RF Power Transfer Standard (e.g. Model F1109). Add a customer-supplied RF source and a power meter compatible with the sensor being tested, and you are ready to accurately transfer calibration factors for a wide range of power sensors. Add a customer-supplied PC with GPIB and SureCal software and you have a fast, automatic, precision

power sensor calibration system.

The RF power Transfer Standard permits the accurate transfer of calibration data traceable to NIST. The 1805B uses highly accurate dc power substitution in a precision RF leveling loop. Power levels are established by precision resistor networks at dc, and are verifiable by an accurate dc voltmeter. Use your stable synthesized signal source to step through the calibration frequency points. When used in conjunction with SureCal software, this process is performed automatically via the IEEE-488 bus.

Eleven precision power levels of 0.5, and 1 to 10 mW in 1 mW steps permit the

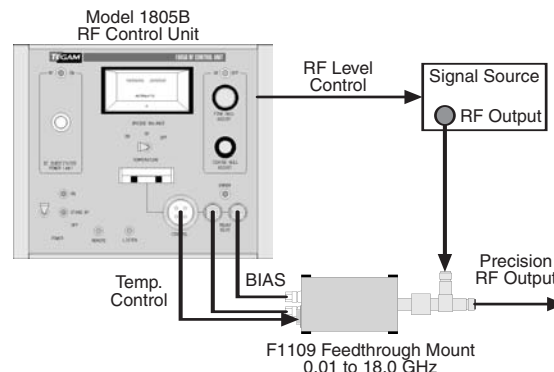

Prices and specifications subject to change without notice.

[BACK TO CONTENTS](#)



YOUR GLOBAL SOURCE FOR TEST AND MEASUREMENT SOLUTIONS

verification and/or calibration of the linearity of measurement devices such as power meters (meter scales), power meter/mount combinations, spectrum analyzers, and receivers (to achieve a 10 mW power level, a signal source with an output of 100 mW is generally necessary).

Precision RF Power Meter

With the addition of a Primary RF Power Transfer Standard (e.g. Model M1110) and a Model 1806 Dual Type IV Power Meter, System IIA capability is expanded so that the working RF Power Transfer Standard can be re-certified on-site. This avoids removing the system from service for recalibration. Also, several working RF Power Transfer Standards can be re-certified using one Primary RF Power Transfer Standard. Re-certification can be accomplished automatically in less than 2 hours. The Model M1110 becomes the certifying element and must be periodically (annual calibration recommended) sent to a calibration facility such as TEGAM, the National Institute of Standards and Technology (NIST), or any equivalent service outside the USA.

The Model 1806 is a Dual Type IV Power Meter and Power Transfer Standard temperature controller combination. Metering circuits indicate the status of both the power meters and the temperature of the Standard. Resistance is front panel switch selectable to accommodate either 100 or 200 ohm thermistor Standards. The 1806

measures dc power levels from 0.01 to 30 mW.

Used in conjunction with a TEGAM RF Power Transfer Standard and an external digital voltmeter, the Model 1806 serves as a precision power meter for measuring RF power levels and for transferring calibration factors between feedthrough Standards or thermistor type sensors. Additionally, the Model 1806 is ideal for performing insertion loss measurements up to 20 dB.

Regardless of the application, all measurements can be directly traced to primary NIST standards. The 1806 can be used with all TEGAM RF Power Transfer Standards and can also be used in place of an HP (Agilent) Model 432 with HP (Agilent) thermistor power sensor Models 478A, 8478A, and 486A (TEGAM cable 138-652 required).

The TEGAM Primary RF Power Transfer Standard is a terminating thermistor mount that can be used to calibrate the reference output found on many power meters which serve thermocouple and diode power sensors.

Operating Flexibility

TEGAM Coaxial RF Power Transfer Standards are available for a wide variety of frequency ranges from 100 KHz to 26.5 GHz. Waveguide RF Power Transfer Standards are available in the 26.5 to 40 GHz range. See the individual Transfer Standards' datasheets for details.

The TEGAM Model 1806 fits a 19-inch rack. It may also be used on the bench. All of the TEGAM feedthrough

RF Power Transfer Standards and the Model 1805B may be used in a bench or rack mount configuration. All of these models are half-rack instruments and can be mounted side-by-side or individually using rack mount kit number 1919.

NIST Traceability

The figure below shows the traceability to NIST of the System IIA. The M1110 is a Primary RF Power Transfer Standard, and the F1109 is a working RF Transfer Standard. The working or feedthrough RF Transfer Standard can be returned to TEGAM for calibration using a NIST-calibrated Primary RF Power Transfer Standard as shown by the path on the right.

To keep the working RF Power Transfer Standard in your lab, a Primary RF Power Transfer Standard can be purchased to re-calibrate it. The Primary RF Power Transfer Standard can be sent directly to NIST for annual calibration as depicted by the path on the right. It can also be sent to TEGAM as depicted by the path on the left. Cost and turnaround times are significantly reduced by sending the Primary RF Power Transfer Standard to TEGAM.

The System IIA comes in a variety of packages. Contact TEGAM for more information.

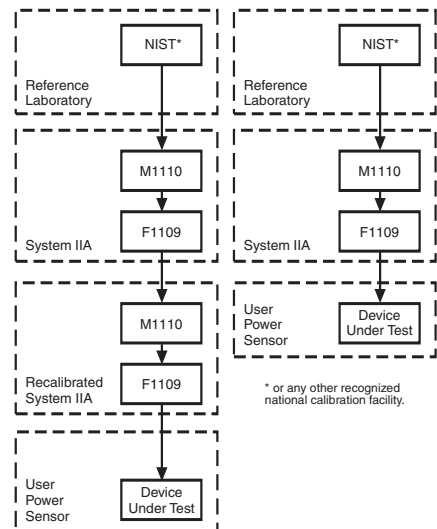
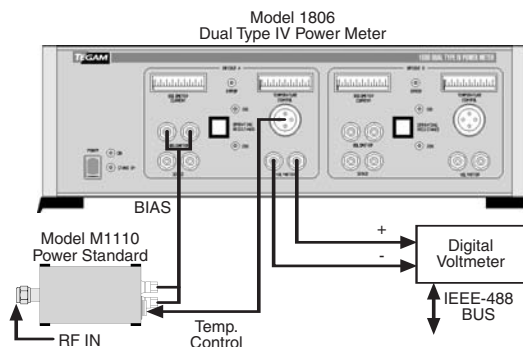

This data sheet was current when it was produced. However, products are constantly being updated and improved. Because of this some differences may occur between the descriptions herein and the current product. Prices and specifications may be changed without notice.



BACK TO CONTENTS

RF Power Sensor Accessories

RF CALIBRATION AND MEASUREMENT PRODUCTS

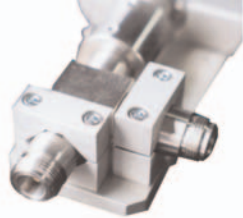

RF Mount Splitter Support



8000 RF Mount Transport Case



1585 Series RF Cables



138-654 Accessory Kit



138-652 Cable

RF Mount Splitter Support Bracket

This sturdy support bracket prevents rotation of Feedthrough Thermistor Mount splitters during use. Rotation of the splitter voids the calibration and can damage the mount.

102-1000 - Fits Models F1109, F1116, and F1119.

102-1000H - Fits Models F1109H and F1119H.

187-4003 SWR Measurement Kit (no photo)

This SWR Measurement Accessory Kit (P/N 187-4003) provides all the items necessary to perform SWR/Return Loss measurements for 0.05-18 GHz using either the TEGAM System IIA or 8850 Attenuation Measurement System. This kit includes SWR Bridges, terminations, adapters and opens to perform SWR measurements on devices having SMA, Type N, or GPC-8 Connectors.

8000 RF Mount Transport Case

This sturdy, well-padded case is designed to protect your power standards during storage or transport. Fits Models F1109, F1109H, F1116, F1117A, F1119, F1119H, M1110, M1111, M1118 and M1120

GPIB (IEEE-488) Cables (no photo)

1583-3 – 1-meter GPIB bus cable

1583-6 – 2-meter GPIB bus cable

1583-9 – 3-meter GPIB bus cable

Three 1583-3 included with all System IIA Power Sensor Packages.

1585 Series RF Cables

1585-1000 – SMA male/SMA male, 36 inches, DC to 18GHz.

1585-1006 – N male/N male, 36 inches, DC to 18GHz

1585-1008 – 3.5mm male/3.5mm male, 36 inches, DC to 26.5GHz

1585-1009 – 2.92mm male/2.29mm male, 36 inches, DC to 40GHz

138-477 or CBL-F1125-48 – Temperature Control Cable (no photo)

Cable is used to connect the heater circuits of the 1805B/1806 to a Thermistor Mount. Included with 1805B and 1806.

138-645 – Accessory Kit

System IIA kit, designed to aid the operator in the calibration of most any type of power sensor and/or meter. The kit includes: 30dB Type N Fixed Attenuator, 30dB 3.5mm Fixed Attenuator, 2 Type N Male to SMA Female Adapters, GPC-7 to Type N Male Adapter, Type N Male to SMA Female Adapter. S-parameter data is supplied on diskette and it all comes in a wooden storage case. Included with all System IIA Power Sensor Packages. A2LA Accredited Calibrations are optional.

138-606 – Rack Mount Kit (no photo)

Rack Mount Kit for the model 1806. (ears only).

1919 - Rack Mount Kit (no photo)

This kit allows the 1805B Power Level Controller and the 1807A, F1119C or F1117AC mounts to be installed in a 19-inch rack. Each unit may be installed separately or any two units may be combined side by side.

138-652 – 1806 or 1804 to HP Thermistor Mount Cable

Cable used to connect HP Temperature Compensated Thermistor Mounts to a TEGAM Type IV Power Meter. The second set of spade lugs are for monitoring the temperature compensation thermistor beads with the second bridge on the 1806 or with a second 1804.

This data sheet was current when it was produced. However, products are constantly being updated and improved. Because of this some differences may occur between the descriptions herein and the current product. Prices and specifications may be changed without notice.



YOUR GLOBAL SOURCE FOR TEST
AND MEASUREMENT SOLUTIONS

[BACK TO CONTENTS](#)

A

Model VM-7

RF ATTENUATION MEASUREMENT

- **Dynamic range in excess of 100 dB (127 dB when using synthesized signal sources)**
- **Rack mount kit available**
- **Resolution down to 0.001 dB**
- **+/- 0.060 dB accuracy**
- **Built-in diagnostic software**
- **Very fast and easy to use**
- **Optional A2LA Accredited Calibrations**

The TEGAM Model VM-7 offers users great flexibility in configuring a measuring system cost-effectively. Since the VM-7 is a 30 MHz receiver, it may be easily adapted to any frequency range with the addition of an appropriate external mixer and local oscillator.

FEATURES INCLUDE:

Advanced Techniques

The Model VM-7 uses advanced digital and analog techniques in a series IF substitution configuration, offering a dynamic range in excess of 100 dB. The unit is also fully bus controllable.

A combination of switched gain and attenuation stages are distributed throughout the receiver. An A/D is used in place of the classic piston attenuator to provide the receiver's unique linearity and accuracy.

The unit is configured as a dual-conversion receiver. A digitally-controlled phase lock loop at the first conversion allows the receiver to deal effectively with less desirable signals, as well as clean, synthesized signals.

Final synchronous detection is handled digitally allowing the receiver to achieve resolution down to 0.001 dB. Variations in signal-to-noise ratio are not handled by injection of noise as in previous receivers of this type. This is now handled in the post detection signal processing using a noise algorithm.

Advanced 30 MHz Receiver

Reliability

The VM-7 has undergone extensive testing on production units so that customers will be ensured excellent reliability in service. Special attention has been paid to cooling requirements, significantly extending component life.

User Friendly

Through the use of "soft key" user interface, the operator is guided through the use of the instrument. A "Help" function provides information on key operation, precluding the need to refer to the manual in most cases.

Performance

The VM-7 offers dynamic range of 127 dB when using the synthesized signal sources. Single step measurements are possible over the full dynamic range because the receiver is not encumbered by mechanically switched range changes. The excellent accuracy built into the receiver translates into an accuracy of ± 0.060 dB for a single-step 100 dB measurement.

Speed of Operation

Advanced digital detection and processing techniques means that measurements are available instantaneously, no matter what the dynamic range or resolution.

Self Calibration

A built-in self calibration routine allows for automatic calibration of the

switched gain and attenuator stages in order to maintain the exceptional accuracy of the instrument.

Diagnostics and Service

Complete diagnostic software has been built into the instrument to allow a technician to easily find a fault. Should repair become necessary, every module can be easily removed through the rear panel.

Rack Mounting

This instrument can be stacked easily with other TEGAM instruments or mounted in any cabinet or rack designed according to MIL-STD-189 or EIA RS-310 using the appropriate rack mounting kit.

System Configuration

The Model VM-7 is easily configured into an attenuation measuring system with the addition of the Model 8852 Frequency Converter and an RF signal source. This system is capable of performing attenuation measurements from 0.01 to 18 GHz. The Frequency range can be extended even further to 40 GHz with the addition of the Model 8853 Frequency Converter. For detailed specifications and a block diagram of such a system refer to the Model 8850 Attenuation Measurement System data sheet.

B



TEGAM[®]

YOUR GLOBAL SOURCE FOR TEST
AND MEASUREMENT SOLUTIONS

Prices and specifications subject to change without notice.

[BACK TO CONTENTS](#)

Model VM-7

ADVANCED 30 MHz RECEIVER

Specifications

Input Frequency	30 +/- 2 MHz	
Sensitivity	-110 dBm wideband	-127 dBm narrow band
Dynamic Range	110 dB wideband	127 dB narrow band
Incremental Accuracy @ 30 MHz	RANGE	ACCURACY*
Wide Band	0 to -90 dBm	±0.02 dB per 10 dB
	-90 to 100 dBm	±0.04 dB per 10 dB
Narrow Band	0 to -100 dBm	±0.02 dB per 10 dB
	-100 to -110 dBm	±0.04 dB per 10 dB
	-110 to -120 dB	±0.12 dB per 10 dB
	* Exclusive of Signal Source effects	
Automatic Frequency Control	Output level ±10 V maximum	
Calibration Source	Internal or External, 30 MHz, at -55 dBm typical	
Int. 10 MHz Reference Oscillator	Frequency Accuracy 0.0025%	
Ext. 10 MHz Reference Oscillator Requirements	Frequency Accuracy 0.0050% (0 dBm Input level)	
Input Connectors	30 MHz Input Type N Female 10 MHz Reference Input/Output BNC Female	
Remote Operation	All front panel functions except powerline operation can be programmed on the IEEE-488 interface bus.	
Power Requirements	100, 120, 220, 240 Vac ±10% @ 50 to 60 Hz	
Power Consumption	90 Watts	
Remote Programmability	Compatible with IEEE-488 STD-1987.1	
EMI	Designed to meet MIL-STD-461 for radiated emission and susceptibility.	
Design and Construction	Designed to meet requirements of MIL-STD-28800D TYPE III, CLASS 5, STYLE E	
Environmental	Operating	0 to 50°C (32° to 122°F)
	Storage	-40 to +75°C (-40° to 167°F)
	Humidity	95 %
Physical Dimensions	Height	5.25 in (133.4 mm)
	Width	16.75 in (425.5 mm)
	Depth	17.5 in (444.5 mm)
	Weight	Net 28 lbs (12.7 kg)

ACCESSORIES

Rack Mounting

This instrument can be rack mounted in any cabinet or rack designed according to MIL-STD-189 or EIA RS-310 using rack mounting kit P/N 187-1007 (adapter ears only) or 187-1008 (contains chassis slides for racks up to 18-24 inches deep).

Maintenance Extender Cards

To make it easier to verify the performance of the VM-7, TEGAM offers two maintenance extender cards as follows:

<u>Part Number</u>	<u>Type</u>
187-1020-000	Digital
187-1021-000	Analog

Spare Module Kit, P/N 187-1030

This kit includes all replaceable module assemblies that can be easily replaced at any location.

Calibration, Attenuation Measurement Lab (CAMLab) Software Program

This system software operates with the Windows™ 3.1 operating environment. The major improvement over other DOS based and HTB programs is that this software provides all the features found in other windows programs such as point and click user operation, dialog boxes for easy instrumentation setup, enhanced measurement data collection, online help and the ability to generate and printout measurement data and graphs from almost any printer. Refer to the CAMLab data sheet for more information.

This data sheet was current when it was produced. However, products are constantly being updated and improved. Because of this some differences may occur between the descriptions herein and the current product. Prices and specifications may be changed without notice.



Certificate no. 2018.01



YOUR GLOBAL SOURCE FOR TEST
AND MEASUREMENT SOLUTIONS

[BACK TO CONTENTS](#)

Model 8852

RF ATTENUATION MEASUREMENT

- Internal or external 10 MHz reference signal
- No adapters needed
- For use with Model VM-7 Advanced 30 MHz Receiver
- Converts 0.01 to 18 GHz signals to a 30 MHz signal
- Rack mount kit available
- Optional A2LA Accredited calibrations

Frequency Converter 0.01 to 18 GHz

Extends Your VM-7 Capabilities to 18 GHz

The Frequency Converter Model 8852 is a device that is intended for use with the TEGAM Model VM-7 Attenuator and Signal Calibrator over the frequency band of .01 to 18 GHz. The 8852 extends the VM-7's capabilities to measure devices at frequencies other than 30 MHz. Other features include:

Aux Output

This RF output supplies a 2 to 18 GHz synthesized continuous wave signal in 2 KHz steps at +7 dBm, which can be used as a signal source for other applications.

IEEE-88 Bus Programmable

The Model 8852 operational parameters are controlled over the IEEE-488 compatible bus using an external controller or an upgraded VM-7 with applicable software.

10 MHz Ref Input/Output

This instrument will either accept or provide a 10 MHz reference signal for system operation.

Rack Mounting

This instrument can be stacked easily with other TEGAM instruments or

mounted in any cabinet or rack designed according to MIL-STD-189 or EIA RS-310 using the appropriate rack mounting kit (P/N 187-1007-1).

Weinschel PLANAR CROWN® Connector System

The use of Weinschel PLANAR CROWN® connectors at the two INPUT connectors provides the Model 8852 user with easy exchange of connector types and eliminates the need for adapters and other devices that would create additional insertion loss. This "Torque Free" type of connector also provides quick replacement of defective connectors. All crowns will mate nondestructively with connectors per MIL-STD-39012 (refer to Weinschel PLANAR CROWN® data sheet for more details).

System Operation

The Model 8852 can be easily configured into an attenuation measuring system with the addition of the TEGAM VM-7 and a signal source. This system is capable of performing attenuation measurements from 0.01 to 18 GHz. For detailed specifications and block diagrams of such a system, refer to the Model 8850 Attenuation Measurement System data sheet. The Frequency range can be extended even further to 40 GHz with the addition of the Model 8853 Frequency Converter.

B



Prices and specifications subject to change without notice.

[BACK TO CONTENTS](#)



YOUR GLOBAL SOURCE FOR TEST
AND MEASUREMENT SOLUTIONS

Model 8852

FREQUENCY CONVERTER

Specifications

Input Frequency Range	Low Band	10 MHz to 2 GHz
	High Band	2 GHz to 18 GHz
Frequency Resolution	1 kHz from .01 to 2 GHz 2 kHz above 2 GHz	
Maximum Input Level	+20 dBm	
Nominal Impedance	50 Ω	
Mixer Compression	+1 dBm (1 dB compression)	
SWR at RF Input Connector	Low Band (0.01-2 GHz)	3.0 maximum
	High Band (2-18 GHz)	3.0 maximum
Conversion Gain (RF IN to 30 MHz)	0 \pm 6 dBm nominal from 0.01 to 18 GHz	
Noise Figure	12 dB maximum	
Output Frequency	30 \pm 2 MHz	
Internal 10 MHz Reference Oscillator	Frequency Stability	\pm 1 ppm @ 0 to 50°C
	Output Level	8 dBm \pm 1 dBm
External 10 MHz Reference Oscillator	Input Impedance	50 Ω
	Input Level	8 dBm \pm 1 dBm
Aux Output	2 to 18 GHz, +7 \pm 2.5 dBm	
Operation	IEEE-488 bus control or VM-7 Local mode (Note: only if the VM-7 I/O card has been upgraded with two bus ports and applicable software)	
Remote Programmability	Compatible with IEEE-488 STD-1987.	
Connectors	RF Inputs	PLANAR CROWN (female Type N)
	10 MHz External Input	female BNC
	10 MHz Output	female BNC
	30 MHz Output	female Type-N
	AUX Output	female SMA
	Digital Interface	24 pin IEEE-488
Input Power Requirements	100, 120, 220, 240 Vac \pm 10% @ 50 to 60 Hz	
Power Consumption	180 Watts	
EMI	Designed to meet MIL-STD-461 for radiated emission and susceptibility.	
Design and Construction	Designed to meet requirements of MIL-STD-28800D TYPE III, CLASS 5, STYLE E	
Environmental	Operating Temperature	0 to 50°C (+32° to +122°F)
	Storage Temperature	-40 to +75°C (-40° to +167°F)
	Humidity	95 %
Physical Dimensions	Height	5.21 in (133.3 mm)
	Width	16.8 in (426.7 mm)
	Depth	24.4 in (619.8 mm)
	Weight	NET: 65 lbs (27.2 kg)

This data sheet was current when it was produced. However, products are constantly being updated and improved. Because of this some differences may occur between the descriptions herein and the current product. Prices and specifications may be changed without notice.



YOUR GLOBAL SOURCE FOR TEST
AND MEASUREMENT SOLUTIONS

[BACK TO CONTENTS](#)

Model 8853

RF ATTENUATION MEASUREMENT

- Used in 8850 to measure attenuation in 18-40 GHz range
- Only requires a 6-13 GHz signal source
- 90 dB dynamic range with +0.04 dB/10 dB accuracy when used in 8850 system.
- SWR < 1.6
- Rack mount kit available

Frequency Converter 18 to 40 GHz

Extends Your VM-7 Capabilities to 40 GHz in Coax

The Model 8853 Frequency Converter is intended for use with any TEGAM Model VM-7 Attenuator/Signal Calibrator to create an 18 to 40 GHz measurement system. This Frequency Converter downconverts the 18 to 40 GHz measurement signal to a 30 MHz IF signal which can be measured by the VM-7. Using the Model 8853 with the Model 8852 Frequency Converter will allow the user to measure attenuation from 0.01 to 40 GHz without the use of an additional LO source. Figure 1 shows a typical Model 8853 Measurement System setup.

When used with the Model 8850 Attenuation Measurement System the Model 8853 does not require any additional signal sources.

This instrument can be easily stacked with other TEGAM instruments or mounted in any cabinet or rack designed according to EIA RS-310 and MIL-STD-189 using the appropriate rack mounting kit.

Weinschel PLANAR CROWN® Connector System

The use of Weinschel PLANAR CROWN® connectors at the INPUT connectors provides the Model 8853 user with easy exchange of connector types and eliminates the need for adapters and other devices that would create additional insertion loss. This “Torque Free” type of connector also provides quick replacement of defective connectors. All crowns will mate nondestructively with connectors per MIL-STD-39012 (refer to Weinschel PLANAR CROWN® data sheet for more details).

B



Specifications

Frequency Range	Signal port	18 to 40 GHz
	RF In	6 to 13.333 GHz
	LO In	5.99 to 13.323 GHz
	IF Out	30 ± 2 MHz
RF Signal Levels	RF Input	+5 dBm nominal, +10 dBm maximum
	LO Input	+7 ± 2 dBm, +10 dBm maximum
	Signal Port	-2 dBm maximum, -10 dBm minimum
Nominal Impedance	50 Ω	
Input Load SWR	<1.6	
Connectors	RF Input	SMA Female
	LO Input	SMA Female
	30 MHz OUTPUT	Type-N Female
	Test Port	PLANAR CROWN 2.92 mm Female
	Signal Port	PLANAR CROWN 2.92 mm Female
Subharmonic	-55 dBm	
Warm-up Period	3 hours minimum	
Input Power Requirements	100, 120, 220, 240 Vac ± 10% @ 50 to 60 Hz	
Power Consumption	180 Watts	
Design and Construction	Designed to meet requirements of MIL-STD-28800D TYPE III, CLASS 5, STYLE E	
Temperature	Operating	+10° to 40°C (+50° to +104°F)
	Storage	-40° to +75°C (-40° to +167°F)
Humidity	95 %	
Physical Dimensions	Height	3.5 in (88.9 mm)
	Width	16.75 in (425 mm) standard rack width
	Depth	20 in (520.7mm)
	Weight	NET: 23.5 lbs (10.66 kg)

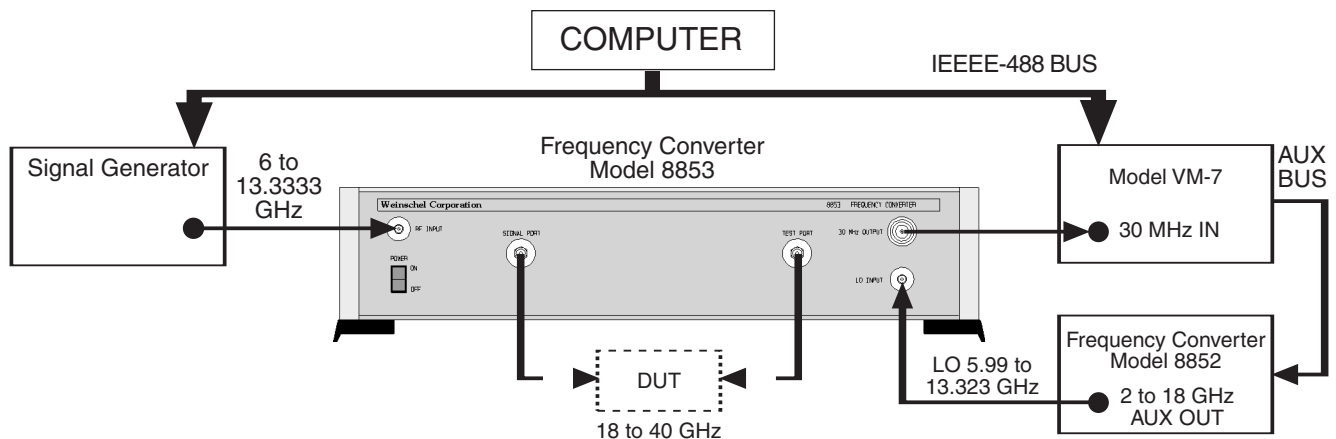

Figure 1. 8850/8853 (18-40 GHz) Measurement System

This data sheet was current when it was produced. However, products are constantly being updated and improved. Because of this some differences may occur between the descriptions herein and the current product. Prices and specifications may be changed without notice.

- Provides automated measurement, data collection, data display, and analysis capability
- User-friendly icons and menus
- User can easily create an RF signal generator driver
- All data is saved in ASCII text format
- Measurements are displayed both graphically and numerically

The TEGAM Calibration and Attenuation Measurement Lab (CAMLab) is application specific software that runs in the Microsoft Windows™ environment on IBM compatible PC's. The CAMLab program significantly enhances the operation of the Model 8850 Attenuation Measurement system by providing the technician with automated measurement, data collection, data display, and analysis capability. The capability to save and recall complicated system instrumentation and test configurations coupled with the graphical environment of Windows™ makes CAMLab easy to use by any level of personnel.

The CAMLab software can be configured to operate and control all system instrumentation to perform automated measurements of fixed, or step attenuators (manual or programmable). Binary attenuators may be measured vertically or horizontally across any number of frequencies. During the measurement process, the data is plotted in real-time in a graph window with attenuation vs. frequency and numerically displayed in a spreadsheet style window (shown). Measurement data and an instrumentation list may be saved in an ASCII text file after completion of a measurement. Multiple data files may be recalled and displayed side by side for

CAMLab for Windows™ Calibration and Attenuation Measurement Lab

comparison of past data. Additionally, past and present calibration data files may be combined either numerically or graphically to allow comparison of attenuator performance. Basic statistical functions are included to help the technician analyze the data and evaluate the performance of the attenuator or device under test.

MENU BAR

Across the top of the CAMLab main window below the title bar and above the toolbar is the menu bar. The menu bar consists of eight (8) drop down menus that are used to select most of the functions necessary to perform measurements and manipulate data. The following is a list of the menu bar captions and their menu item functions.

File - The File menu allows the operator to create new Frequency Files; Edit/Open previously saved data files; and Save a new or updated data file. This menu also contains all of the Printer functions such as Printer Setup, Print Preview, and Print Data.

Edit - This menu contains functions that are common to most Windows™ programs such as the ability to copy selected data from a calibration data grid to the clipboard, Cut/Copy selected fields of data, and the ability to Insert or Append Data from the clipboard into an open Data file Calibration Grid.

Setup - This menu allows the user to create and define a particular System Setup. Once configured this setup can be easily saved to a file and reloaded when needed using this menu.

Measurement - This menu allows the operator to define the measurement parameters and type of measurement run to be performed. The operator can select from two types of measurement runs. Selecting Auto will perform automatic measurement across a selected frequency range. Single Step will stop and prompt the operator before each measurement is performed.

Math - This menu contains all of the CAMLab Math functions to calculate Standard Deviation, Mean, Median, Calibration Deviation, and SWR within a calibration data file.

Preferences - This menu allows the operator to select certain preferences that can be used when operating CAMLab.

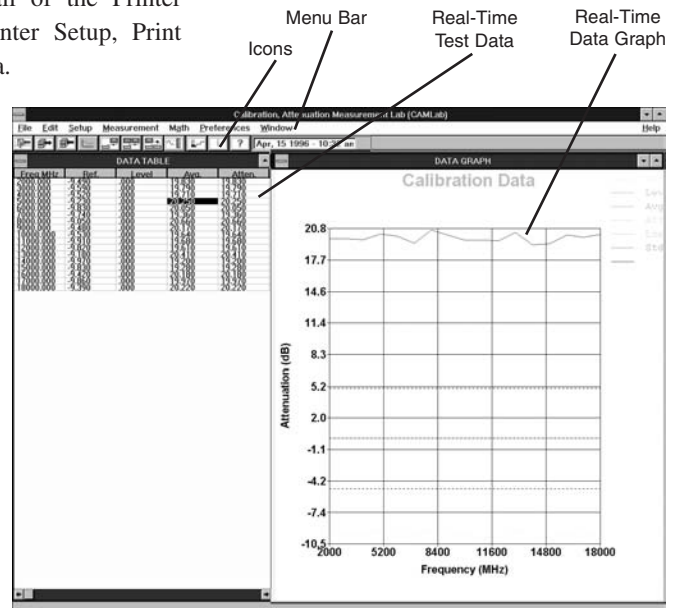

YOUR GLOBAL SOURCE FOR TEST AND MEASUREMENT SOLUTIONS

ICONS

The CAMLab program has a horizontal toolbar that contains the program Icons, this is always present at the top of the main window. The icons in this toolbar are representative of some of the commonly used menu functions such as program information, Help, Open/Save Files, and quick exiting from the program. The CAMLab toolbar also contains program specific Icons, as follows:



Graph calibration data, plots calibration data in a graph window.



VM-7 mode configuration setup for configuring the VM-7 and signal source in a 30 MHz calibration System.



VM-7/8852/8853 mode configuration setup for configuring the VM-7/8852 and signal source for a 0.01-18 GHz calibration System (8850 operation). Allows for the 8853 to be incorporated into the system for measurements between 18.001 to 40 GHz.



VM-7/Mixer mode configuration setup for configuring the VM-7, user selected mixer and two signal sources to perform custom calibrations.



Auto measurement run mode allows the operator to set up and perform automatic measurements across a defined frequency range.



Single Step measurement run mode allows the operator to set up CAMLab to stop before each measurement performed.

The graph window also contains a vertical toolbar which contains the graph window icons. These icons are used to quickly perform such functions as printing the graph, changing the printer setup, copy page/graph to windows clipboard, zoom controls, copy/paste individual plot(s), and change X-Y axis scale of the graph.

This data sheet was current when it was produced. However, products are constantly being updated and improved. Because of this some differences may occur between the descriptions herein and the current product. Prices and specifications may be changed without notice.

Define Generator Drivers Easily

The CAMLab program is capable of automatically controlling the RF generator via the GPIB IEEE-488 interface bus. As with other programs, generator drivers may not work with all makes and models. To combat this problem, CAMLab utilizes an alternative approach. The RF generator drivers are ASCII text files containing a particular RF generator IEEE-488 commands arranged in a specific format. The CAMLab program reads the information from these driver files and builds the IEEE-488 commands necessary to operate the RF generator. Customers now have the advantage of creating their own RF generator drivers for the particular generator being used.

Many Compatible Bus Controllers

CAMLab requires a Windows™ based or compatible computer in addition to a National Instruments GPIB interface. Contact TEGAM for further information on requirements, or to order a compatible computer system.

Use Any Windows™ Compatible Printers

CAMLab makes use of the Windows™ printer functions to select and set up each printer to meet the specific needs of the user. Windows™ is supplied with many printer drivers, but not all are covered. In this case, the user should consult the printer manufacturer for Windows™ drivers specific to a user's make and model of printer.

APPLICATIONS

Attenuation Measurements

The primary function of the Model 8850 and the CAMLab software program is to perform a wide dynamic range attenuation measurements across the 0.01 - 18 GHz frequency band. The addition of a TEGAM Model 8853 Frequency Converter will also allow the Model 8850 to perform measurements over the 18 to 40 GHz frequency range in a coaxial transmission line using this program.

Return Loss (SWR) Measurements

CAMLab can perform these measurements using an SWR bridge or the Weinschel SWR Measurement Kit (P/N 187-4003) with the Model 8850 and the CAMLab Software Program. Once the measurements have been taken, the CAMLab program will display/graph or printout both return loss and the VSWR conversion.

RF Substitution Measurements

The Model 8850 can also perform measurements on attenuators with very high attenuation level (90 dB and above) by using CAMLab's RF substitution capability.

Model 8850

RF ATTENUATION MEASUREMENT

- Dynamic range greater than 100 dB
- 10 MHz to 18 GHz frequency can be extended to 40 GHz
- Fast and accurate
- Easy to use manually or with CAMLab software
- Optional A2LA accredited calibrations

Attenuation Measurement System

The Model 8850 Attenuation Measurement System combines the outstanding accuracy, performance, high sensitivity, and reliability of our Model VM-7 Attenuator and Signal Calibrator with our Model 8852, 0.01 to 18 GHz Frequency Converter.

When combined with a suitable generator, the Model 8850 provides the user with an attenuation calibration system of high accuracy, repeatability and speed. Some other features of this system include:

- **ADVANCED TECHNIQUES** – Advanced digital detection and processing techniques of the VM-7 means that measurements are available instantaneously, no matter what the dynamic range or resolution.

- **SINGLE BAND OPERATION** – The system can be converted to a 0.01 to 18 GHz single port converter. This is accomplished by using the measurement

accessory kit (P/N 187-4001) that is supplied as part of the system. The measurement accessory kit includes low SWR masking attenuators and a power divider to provide a measurement system as shown in Figure 1.

- **DUAL BAND OPERATION** – The RF input frequency range is divided into two bands, 0.01 to 2 GHz, and 2 GHz to 18 GHz. This allows the user direct access to the RF port of either the LOW band or HIGH band mixer to make full use of the VM-7 dynamic range.

- **IEEE-488 BUS PROGRAMMABLE** – Remote programmability over the IEEE-488 bus using an external controller or controlling the system using only the VM-7.

- **AUXILIARY OUTPUT** – An auxiliary output of 2 to 18 GHz synthesized continuous wave signal in 2 KHz steps at +7 dBm is available, which can be used as an RF signal source for other applications.

- **VERSATILE AND USER FRIENDLY** – This measurement system will test all types of attenuators such as fixed, manual, motorized, programmable and other coaxial components. Coaxial components can be quickly and accurately tested using the efficient, user-friendly CAMLab Windows™ software.



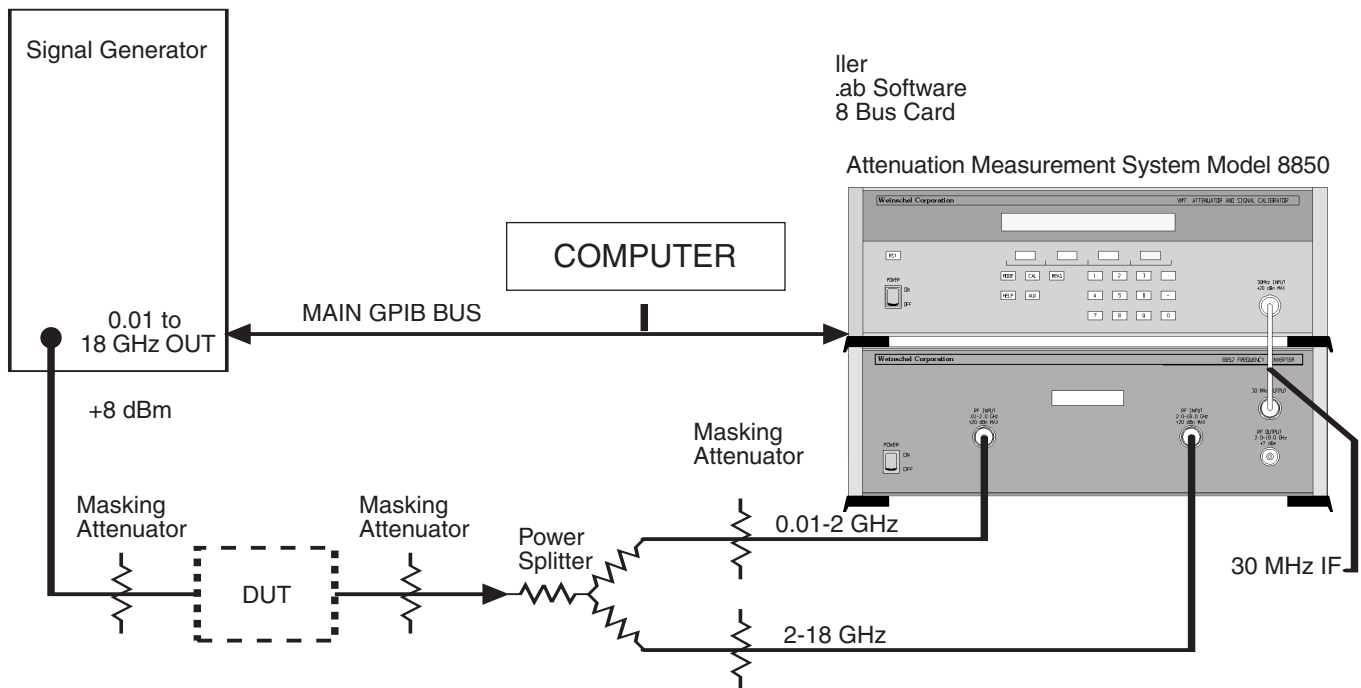

APPLICATIONS

Attenuation Measurements (0.01-18 GHz, extendible to 40 GHz)

The figure above depicts 8850-18. This system is setup for performing component measurements across the 0.01-18 GHz frequency band without changing any connections on the Model 8850 front panel. This setup gives the user the widest measuring frequency range possible. Removing the Power Splitter and connecting the input signal directly to the the desired frequency input allows the user to increase the measurement systems dynamic range with the lowest possible SWR effects. This configuration can perform measurements in either the 0.01-2 GHz band or the 2-18 GHz band, depending on the Model 8850 front panel connection.

Using the Model 8852 as a CW signal source and adding the TEGAM

Model 8853 will allow the Model 8850 to process frequencies up to 40 GHz in coax. Refer to the Model 8853 data sheet for more information and actual configuration diagram. This configuration is available as a system, Model 8850-40.

Return Loss\SWR Measurements

The TEGAM SWR Measurement Kit (P/N 187-4001-1) can be used with the Model 8850 and the CamLab Windows™ Software to perform return loss measurements. The SWR Measurement Kit includes a return loss bridge with an “open” and “short.” Because the Model 8850 operates as a single channel receiver, it can be used as a scalar system. The DUT’s impedance to 50 ohms can be checked as a scalar quantity by measuring return loss. The actual measured return loss can be readily converted into SWR by the system software.

Gain Measurements

Active devices having gain can also be measured by an attenuation measurement system such as the Model 8850. Extra attenuation is required for this application, because the reference level is lower than the measurement level. Depending on the frequency range of the active device, the system can be used in either single or dual band operation. Extra input attenuation will be required to decrease signal level by at least the value of the amplifiers gain so that the Model 8852 remains in its linear region. If the amplifier is to be tested at a particular level, extra attenuation may be inserted at the output of the device to achieve the correct operating levels. Uncertainty values are similar to those for attenuation measurements. However, the distortion of the active device will make measurements level sensitive, adding to the uncertainty.

Model 8850

ATTENUATION MEASUREMENT SYSTEM

Specifications

Input Power Requirements	100,120, 220, 240 Vac $\pm 10\%$ @ 50 to 60 Hz (all Instruments)		
Environmental	Operating Temperature:	0 to 50°C (+32° to 122°F)	
	Storage Temperature:	-40 to +75°C (-40 to +167°F)	
	Humidity:	95 %	
Input Frequency	Low Band:	0.01 to 2 GHz	
	High Band:	2.0 to 18 GHz	
Frequency Resolution	1 kHz from .01 to 2 GHz 2 kHz above 2 GHz		
Maximum Input Level	To prevent damage +20 dBm		
Nominal Impedance	50 Ω at RF input ports		
SWR at RF Input connector	LOW BAND (0.01-2 GHz):	3.0 maximum	
	HIGH BAND (2-18 GHz):	<3.0 maximum	
Dynamic range			
Wide Band	0 to -110 dBm	0.01 to 18 GHz	
Narrow Band	0 to -103 dBm	10 to 300 MHz	
	0 to -112 dBm	300 to 1000 MHz	
	0 to -117 dBm	1000 MHz to 18 GHz	
Linearity Accuracy*	<u>FREQUENCY</u>	<u>ACCURACY</u>	<u>RANGE (dBm)</u>
	10 to 300 MHz	$\pm 0.100/10$ dB ± 0.01 dB	-10 to -20
		$\pm 0.005/10$ dB ± 0.01 dB	-20 to -86
		$\pm 0.100/10$ dB ± 0.01 dB	-100 to -103
	300 MHz to 1 GHz	$\pm 0.100/10$ dB ± 0.01 dB	-10 to -20
		$\pm 0.005/10$ dB ± 0.01 dB	-20 to -95
		$\pm 0.100/10$ dB ± 0.01 dB	-100 to -112
	1 to 18 GHz	$\pm 0.100/10$ dB ± 0.01 dB	-10 to -20
		$\pm 0.005/10$ dB ± 0.01 dB	-20 to -100
		$\pm 0.100/10$ dB ± 0.01 dB	-100 to -117
Attenuation Accuracy*		± 0.015 dB	(System Repeatability)
		$\pm 0.005/10$ dB	0 to 80
		$\pm 0.100/10$ dB	80 to 105
	* Exclusive of SWR effects and connector repeatability (1-18 GHz).		
Operation	Remote using IEEE-488 bus control (Compatible with IEEE-488 STD-1987) or manual using VM-7 Local mode		

B

This data sheet was current when it was produced. However, products are constantly being updated and improved. Because of this some differences may occur between the descriptions herein and the current product. Prices and specifications may be changed without notice.



[BACK TO CONTENTS](#)



YOUR GLOBAL SOURCE FOR TEST AND MEASUREMENT SOLUTIONS



187-4001 Accessory Kit for 8850

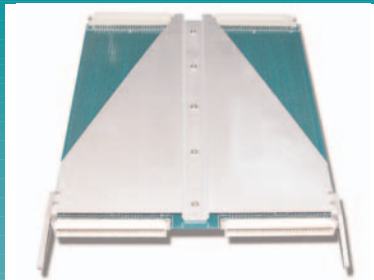

187-1020 VM7 Extender Card



GPIB (IEEE-488) Cables



158-1600 Cable

187-4001 – Attenuation Measurement Accessory Kit (no photo)

Attenuation measurement accessory kit for the 8850 system. This measurement accessory kit is carefully comprised of some of the industry's finest quality components for making RF and Microwave measurements. Included are a selection of masking attenuators, a power divider, a type N adapter and termination, and interconnect cables; all in a wooden storage case. The 8850 includes one 187-4001.

187-4003 – SWR Measurement Accessory Kit (no photo)

This kit provides all the necessary items to perform SWR/Return Loss measurements from 50MHz-18GHz. The kit includes SWR bridges, terminations, adaptors, and opens to perform SWR measurements on devices with SMA, Type N or GPC-7 connectors. The kit includes two wooden storage cases.

187-1007 – Rack Mount Kit (no photo)

Rack Mount Kit for the VM7 (ears only).

187-1020-000 – Maintenance Extender Card, VM7 (no photo)

Used to access digital boards for repair and verification.

187-1021-000 – Maintenance Extender Card, VM7 (no photo)

Used to access analog boards for repair and verification.

187-1009 - I/O Upgrade Kit (VM7/8852) (no photo)

For those customers who own a VM7 with only one bus connector on the I/O card. This printed circuit card upgrade will allow your VM7 to control the 8852 without a bus controller.

GPIB (IEEE-488) Cables

1583-3 – 1-meter GPIB buss cable.

Three each included in 8850-2

1583-6 – 2-meter GPIB buss cable

1583-9 – 3-meter GPIB buss cable

187-1007-1 – Rack Mount Kit (no photo)

Rack Mount Kit for the 8852 (ears only).

187-1008 – Rack Mount Kit (no photo)

Rack Mount Kit and chassis slide kit for the VM7.

1585-1006 - Cable

N male/N male, 36 inches, DC to 18GHz for connecting the 8852 to a signal source.

189-22 – CAMLab Software (no photo)

This program provides the technician with automated measurement, data collection, data display, and analysis capabilities. It saves time by archiving test configurations and test results. With this software, the 8850 system can perform attenuation measurements from 0.01 to 40 GHz. The system can also perform SWR and RF Substitution Measurements.

This data sheet was current when it was produced. However, products are constantly being updated and improved. Because of this some differences may occur between the descriptions herein and the current product. Prices and specifications may be changed without notice.



YOUR GLOBAL SOURCE FOR TEST
AND MEASUREMENT SOLUTIONS

[BACK TO CONTENTS](#)

TEN TEGAM WAY • GENEVA, OHIO 44041
440-466-6100 • FAX 440-466-6110
www.tegam.com • e-mail: sales@tegam.com

Model SR1

RESISTANCE STANDARDS & INSTRUMENTS

- Versatile working standard
- 50 ppm long-term accuracy for most values
- Select from a wide range of values from 0.01Ω to $10M\Omega$
- Accurate, stable, low cost

Standard Resistor

The Model SR1 Standard Resistor is a laboratory standard of high accuracy and stability. The resistance of most values is initially adjusted to an accuracy of 20 ppm of nominal, with long-term accuracy guaranteed to better than 50 ppm. Other values have initial accuracy from 50 ppm to 200 ppm.

Model SR1 has been constructed to meet today's high standards of performance. The resistance wire used is a modern alloy with excellent stability, an extremely low temperature coefficient over a wide range of temperatures, and very low thermal EMF to copper. A unifilar winding on a flat mica card is used to minimize both series inductance and shunt capacitance. The durable aluminum case provides electrostatic

shielding. Gold plated terminals reduce connection errors.

Terminals appear on the top of each unit. They are also brought out the bottom of the case on removable banana plugs. This allows plugging two or more units together in either series or parallel for a wide variety of resistance values. Four-terminal resistance measurements are easily made by using the banana plugs on the bottom of the case as two of the terminals. 0.01 and 0.1Ω values have four terminals on the top and should only be used in four-wire configurations.

For three-terminal or five-terminal guarded measurements, a binding post on top and a banana plug on the bottom provide connections to the case.



Model SR1

STANDARD RESISTOR

Specifications

Standard Values

0.01Ω, 0.1Ω, 1 Ω, 10 Ω, 100 Ω, 1 kΩ, 10 kΩ, 100 kΩ, 1 MΩ, 10 MΩ

Accuracy

See table to the right

Calibration Conditions

23°C, low power, four-terminal measurement

Temperature Coefficient

See Table

Power Coefficient

See Table

Terminal Resistance

Units with 1Ω or higher resistance: Binding posts add 0.1 to 0.2 mΩ to four-terminal resistance value; banana plugs add 2 to 3 mΩ additional resistance

Maximum Ratings

See Table

Breakdown Voltage

1500 V peak to case

Calibration Data

Initial calibration readings are affixed to instrument

Dimensions

Height: 2.1" (5.3 cm)

Width: 3.8" (9.65 cm)

Depth: 2.4" (6.1 cm)

Weight: 8 oz. (227 gm) net

Accuracy				Coefficients		Maximum Ratings		
Value (Ω)	Initial (ppm)	Long Term (ppm)	Calibration (ppm)	Temp. (ppm/°C)	Power (ppm/mW)	Power (mW)	Current (mA)	Voltage (peak V)
0.01	200	500	50	60	20	60	2500	
0.1	100	300	30	40	2.5	250	1600	
1	20	50	10	15	0.3	1000	1000	
10	20	50	10	15	0.3	1000	320	
100	20	50	10	5	0.1	1000	100	
1 k	20	50	10	5	0.1	1000	32	
10 k	20	50	10	5	0.1	1000	10	
100 k	20	50	10	5	0.1	1000	3.2	
1 M	50	100	20	5	0.1	100	0.3	300
10 M	50	100	20	5	0.1	10	0.03	300

Initial Accuracy:

The specifications stated in the TEGAM instrument catalogs and data sheets are intended as acceptance specifications and are guaranteed for 60 days from the date of shipment. They are typically maintained for a much longer period of time.

Long-Term Accuracy:

These specifications are guaranteed for the standard warranty period, and are typically maintained for the life of the instrument. Long-term accuracy is implied when not otherwise stated.

Calibration Accuracy:

Calibration accuracy is the accuracy of TEGAM calibration data relative to the legal units maintained by the U.S. National Institute of Standards and Technology.

Standard Equipment

8234 Instruction Sheet

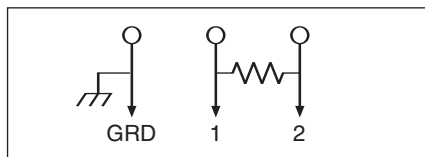

This data sheet was current when it was produced. However, products are constantly being updated and improved. Because of this some differences may occur between the descriptions herein and the current product. Prices and specifications may be changed without notice.



Models SR102, 104

RESISTANCE STANDARDS & INSTRUMENTS

- Highest accuracy and stability
- Lowest temperature coefficients
- Widest selection

Temperature coefficient comparison between a typical TEGAM model and typical 1 ohm standard resistor.

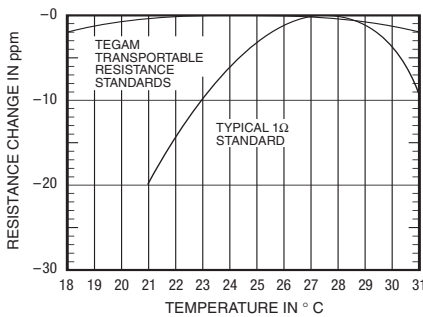

100Ω Standards

These standards were designed to provide an important link between rather odd Quantum Hall resistance values and traditional decade resistance values. 100Ω provides unique reference capability.

10KΩ Standards

This has been the long-standing industry standard for the 10kΩ. This everlasting standard is the benchmark for high accuracy, stability and low temperature coefficients for calibrations requiring NIST traceability.

Transportable Resistance Standards

The TEGAM team of precision Transportable Resistance Standards are oil filled, hermetically sealed, five-terminal resistance standards designed for precision bench top or oil bath applications.

The long-term stability of these resistance standards is typically less than 0.2 ppm per year and temperature coefficients are less than 0.1 ppm per degree Celsius. This excellent long-term stability and low temperature coefficient is achieved by using matched groups of resistors constructed of the alloy Evanohm-R. The resulting low temperature coefficient allows high performance applications of these standards inside or outside an accurately controlled temperature environment.

Maximum accuracy is calculated as a temperature corrected resistance value. This is accomplished by using the

built-in RTD temperature sensor to measure the internal temperature and referencing a temperature correction chart provided with each unit. The measurement accuracy of the built-in RTD thermometer is better than 0.1 degree Celsius.

Very low power coefficients are achieved by using standard resistors constructed with large surface areas like our original Model SR104, 10kΩ standard resistor. The resistors are surrounded by oil to conduct heat generated by the measuring currents out through the stainless steel case.

These characteristics facilitate precise laboratory comparisons without critical environmental controls and are used wherever a need for a very accurate, stable resistor of low temperature coefficient is required.

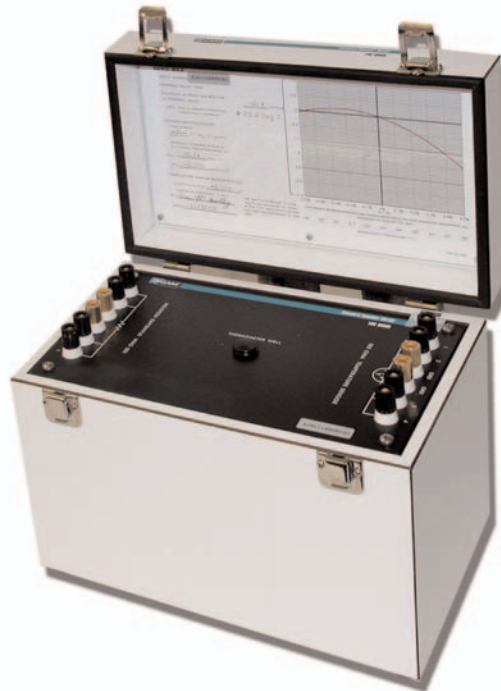

Prices and specifications subject to change without notice.

[BACK TO CONTENTS](#)



YOUR GLOBAL SOURCE FOR TEST AND MEASUREMENT SOLUTIONS

C

Specifications

Stability	±1 ppm/year the first 2 years; ±0.5ppm/year thereafter
Temperature Coefficient	< 0.1 ppm/°C at 23° C
Power Coefficient	Less than 1 ppm/W
Initial Value	
SR102, SR102/DC	±1 ppm
SR104, SR104/DC	±1 ppm
Calibration Uncertainty	
SR102, SR102/DC	0.5 ppm
SR104, SR104/DC	0.25 ppm
Breakdown Voltage	500 Volts peak to case
Power Rating	1 Watt momentary 100W overloads will not cause failure
Insulation Resistance	All terminals maintain a minimum 10 ¹² Ω to ground
AC-DC Difference	Less than ±5 ppm from 0 to 1,592 Hz
Dimensions/Weight	
Bench Top Formica Case	
	Height 10.0 inches Width 8.10 inches Depth 12.25 inches Weight 10.5 lbs. net, 12 lbs. shipping weight
Oil Bath Stainless Steel Case	
	Height 5.0 inches Width 3.5 inches Depth 7.0 inches Weight 4.0 lbs. net, 6.0 lbs. shipping weight

Temperature Coefficient

Alpha (temperature coefficient) less than ±0.1 ppm/° C at 23° C. Beta (1/2 rate of change of temperature coefficient) does not exceed 0.03 ppm/° C² over the temperature range of 18° C to 28° C. This performance is as a passive device without ovens or external power requirements.

Internal Temperature Sensor

The internal temperature sensor is a 1,000 ppm/° C RTD with integral thermowell provided for calibration.

Hermetic Sealing

The resistor is hermetically sealed in oil with metal to glass seals to eliminate the effects of humidity.

Pressure Effects

Normal changes in atmospheric pressure will not effect the value of these resistors. This means that measurements made at NIST in Gaithersburg, MD (sea level) will be consistent with measurements made at NIST in Boulder, CO (5,280 ft. or 1.6 km).

Termination

Five-terminal construction, four-terminal resistor with ground intercept for the standard and temperature sensor. The four resistor binding posts are gold plated tellurium copper to reduce thermal emf. The ground terminals are brass.

Thermal emf

Under normal conditions thermal emf at the terminals does not exceed ±0.1 μV.

Thermal Lagging

Thermal lagging time constant is one hour minimum (1-1/e of total change in one hour).

Dielectric Soakage Effect

The resistance stabilizes to within 0.1 ppm of final value within 5 seconds with 1 V applied to the resistor.

Current Reversal

The resistance value changes less than ±0.1 ppm with reversal of current through the resistor.

Packaging

The bench top versions are mounted in a sturdy formica veneered wooden case having a removable lid and carrying handle. Other versions are packaged in a sturdy stainless steel container.

Ordering Information

Resistance Transfer Standard

SR102	100 Ohm, Bench Top Case
SR102/DC	100 Ohm, Case Deleted
SR104	10,000 Ohm, Bench Top Case
SR104/DC	10,000 Ohm, Case Deleted

Calibration Documentation

Contact TEGAM for OPTION Z540 NIST Traceable Compliance Certificate and Test Data.

Standard Equipment

Each TEGAM Resistance Transfer Standard includes an instruction manual and temperature coefficient chart.

Warranty

One year on materials and workmanship.

Calibration & Technical Services

Contact TEGAM for warranty and remedial repair, calibration services and spare parts, or for additional information on TEGAM sales and service offices around the world.

Contacting TEGAM

For more information, contact TEGAM at:
800-666-1010 (toll-free)
440-466-6100 (phone)
440-466-6110 (fax)
sales@tegam.com (e-mail)
www.tegam.com

This data sheet was current when it was produced. However, products are constantly being updated and improved. Because of this some differences may occur between the descriptions herein and the current product. Prices and specifications may be changed without notice.



YOUR GLOBAL SOURCE FOR TEST AND MEASUREMENT SOLUTIONS

BACK TO CONTENTS

TEN TEGAM WAY • GENEVA, OHIO 44041
440-466-6100 • FAX 440-466-6110
www.tegam.com • e-mail: sales@tegam.com

Model SR1010

RESISTANCE STANDARDS & INSTRUMENTS

- Each device configurable to 10R, 1R, and R/10
- Accuracy of transfer better than 1 ppm
- Six models, decade values from 1 Ω /step to 100k Ω /step
- Establish decade resistances from 0.1 Ω to 1M Ω
- Calibration readings traceable to NIST are provided

Resistance Transfer Standard

The SR1010 meets or exceeds all of the requirements for resistance transfer standards in precision measurement applications. It is easily configured to transfer resistances up or down a decade from their initial resistance value. When used with the connecting networks and shorting bars, it provides 1 ppm transfer accuracies.

Each transfer standard contains twelve equal value precision resistors connected in series by specially designed true 4-terminal junctions. These special junctions assure that a 4-terminal measurement of a series of resistors agrees with the sums of the individual resistors in the series. Accurate parallel connections can be made with the Parallel Compensation Network and the Shorting Bars connected to the junctions.

These standards can be connected to provide three decade values: 10 resistors in series, 10R: 9 resistors in series — parallel, 1R: and 10 resistors in parallel, R/10. The part per million accuracy is assured as the series value is equal to 100 times the parallel value to better than 1 ppm. The series — parallel value relative to either the series value or the parallel value can be found to better than 1 ppm by making a 1:1 comparison with the remaining tenth resistor and a simple calculation.

The accuracy and precision of the individual resistors also make the Model SR1010 ideal for use as a multi-value standard resistor or reference voltage divider.



Model SR1010

RESISTANCE TRANSFER STANDARD

Specifications

Standard Values

1, 10, 100 Ω /step; 1, 10, 100 k Ω /step.

Accuracy

Transfer***	$\pm(1 \text{ ppm} + 0.1\mu\Omega)$ at parallel value for 100:1 transfer $\pm(1 \text{ ppm} + 1\mu\Omega)$ at series-parallel value for 10:1 transfer
Initial	± 20 ppm of nominal value, matched within 10 ppm
Long-Term	± 50 ppm of nominal value
Calibration	± 10 ppm

Calibration Conditions

23°C, low power, four-terminal measurement.

Temperature Coefficient

± 5 ppm/°C, matched within 3 ppm/°C, for 100 Ω and higher.
 ± 1 ppm/°C for 10 Ω .
 ± 15 ppm/°C, matched within 5 ppm/°C, for 1 Ω .

Power Coefficient

± 0.1 ppm/mW per resistor for 100 Ω and higher.
 ± 0.02 ppm/mW per resistor for 10 Ω .
 ± 0.3 ppm/mW per resistor for 1 Ω .

Maximum Power Rating

1W/step or 5 W distributed over 10 resistors.

Breakdown Voltage

1500 V peak to case.

Leakage Resistance

Greater than $10^{12} \Omega$ from terminal to case.

Calibration Data

Initial calibration readings are affixed to instrument.

Dimensions

Height 4.4 in. (11.20 cm).
Width 12.2 in. (31.00 cm).
Depth 4.0 in. (10.15 cm).

Weight

3.25 lb. (1.5 kg).

Standard Equipment

The SR1010 comes with an 8502 instruction manual.

R Value	(Per Step)	1 Ω	10 Ω	100 Ω	1k Ω	10k Ω	100k Ω
One Resistor Alone	max mA	1000	320	100	32	10	3.2
	max V	1	3.2	10	32	100	321
10 Resistors in Parallel R/10	max mA	7100	2300	710	230	71	23
	max V	0.71	2.3	7.1	23	71	230
10 Resistors in Series 10R	max mA	710	230	71	23	7.1	2.3
	max V	7.1	23	71	230	710	2300**

*10 Ω standard is SR1010/LTC

**Do not exceed 1500 V to case

***With Model SB103 and Model PC101 or SPC102

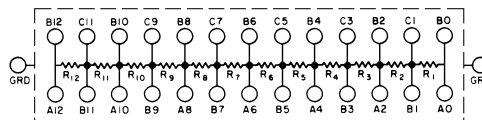

Initial Accuracy:

The specifications stated in the TEGAM instrument catalogs and data sheets are intended as acceptance specifications and are guaranteed for 60 days from the date of shipment. They are typically maintained for a much longer period of time.

Long-Term Accuracy:

These specifications are guaranteed for the standard warranty period, and are typically maintained for the life of the instrument. Long-term accuracy is implied when not otherwise stated.

Calibration Accuracy:

Calibration accuracy is the accuracy of TEGAM calibration data relative to the legal units maintained by the U.S. National Institute of Standards and Technology.

This data sheet was current when it was produced. However, products are constantly being updated and improved. Because of this some differences may occur between the descriptions herein and the current product. Prices and specifications may be changed without notice.



Model SR1030

RESISTANCE STANDARDS & INSTRUMENTS

- **Part-per-million transfers from 100 mΩ to 1 MΩ**
- **Thermally isolated by oil for maximum short-term thermal stability**
- **Excellent long-term stability; ±20 ppm for 6 months**
- **Accuracy calibrated to ±10 ppm**
- **Seven decades of resistance transfer-1, 10, 100, 1 k, 10k and 100kΩ/step**
- **100:1 resistance transfers using series, parallel, series/parallel connection**
- **Calibration readings traceable to the NIST are provided**

Extremely Accurate and Stable

The Model SR1030 provides the part-per-million (ppm) resistance transfer accuracies and the long-term stabilities you need in today's modern metrology and calibration laboratories.

The SR1030 Resistance Transfer Standards are extremely accurate, stable resistance standards that are used on the bench and are light enough to carry with you to remote calibration, repair, production or R&D sites. The SR1030 consists of six transfer standards in decades from 1 Ω to 100 kΩ per step. Each decade standard consists of 12 nominally equal resistors matched initially to within 10 ppm. In addition, each decade standard produces three decade values – 10 resistors in series (10R), 10 resistors in parallel (R/10), and nine of the 10 resistors in series/parallel (R). By making a 1:1 comparison with the tenth resistor, you can resolve a series-parallel value to better than 1 ppm.

Resistance Transfer Standard System

Oil Immersion Provides Thermal Isolation

All standards, except the 100 kΩ/step standard, are immersed in a mineral oil bath. Oil immersion provides thermal isolation to minimize the effects of ambient temperature variations. This means maximum short-term thermal stability for the standards. The SR1030 also exhibits superior long-term stability (±20 ppm of nominal for six months; ±35 ppm for two years; ±50 ppm typical for five years). This gives you longer mean time between calibrations, increasing your calibration throughput.

As an added benefit, the oil speeds the dissipation of heat created in the resistors during calibration. This heat dissipation further contributes to the stability of the standards.

Gaskets seal the SR1030 to keep the work surface and measuring contacts clean. The gaskets also minimize oil aging and contamination to lengthen the time between oil changes.

Since the 100 kΩ standard can be measured at much lower bridge power than the lower value standards, it is not necessary to immerse the standard in oil. However, this standard still benefits from the thermal lagging effects because

it is sealed in a chamber using insulating materials that provide approximately the same temperature lagging effects as oil.

Refining Resistance Technology

TEGAM's experience in design and manufacture of resistance standards has made TEGAM's standards highly respected throughout government and industry. The SR1030 incorporates all the features of the SR1010 Resistance Transfer Standards with the many benefits of a sealed oil bath.

Ideal as a Multi-Value Standard Resistor or Reference Voltage Divider

The high accuracy and precision of the individual resistors make the SR1030 ideal for use as a multi-value standard resistor or reference voltage divider. The superior stability of the SR1030 makes it particularly suitable for calibrating 6-1/2, 7-1/2 and 8-1/2 digit digital multimeters.

Certified Traceable to the NIST

The SR1030 Resistance Transfer Standard System is certified traceable to the National Institute of Standards and Technology. You can use the SR1030 to transfer this traceability to your resistance standards and measuring equipment. Certified calibration data is supplied with every standard.



Model SR1030

RESISTANCE TRANSFER STANDARD SYSTEM

Specifications

Nominal Values (per step)

1, 10, 100, 1 k, 10 k and 100 k Ω

Transfer Accuracy

100:1 $\pm(1 \text{ ppm} + 0.1 \mu\Omega)$ at parallel value, using SB103, PC101, and SPC102 as necessary

10:1 $\pm(1 \text{ ppm} + 0.1 \mu\Omega)$ at series or parallel value, using SB103, PC101, and SPC102 as necessary

Initial Adjustment

± 20 ppm of nominal value matched within 10 ppm

Calibration Accuracy

± 10 ppm, NIST traceable

Calibration Conditions

23 \pm 1 $^{\circ}\text{C}$, low-power, four-terminal measurement, initial calibration readings are provided

Long-Term Resistance Stability

± 20 ppm of nominal for 6 months
 ± 35 ppm for 2 years
 ± 50 ppm for 5 years, typical

Temperature Coefficient

1 Ω ± 15 ppm/ $^{\circ}\text{C}$, matched within 5 ppm/ $^{\circ}\text{C}$
 10 Ω ± 1 ppm/ $^{\circ}\text{C}$
 100 Ω to 100 k Ω ± 5 ppm/ $^{\circ}\text{C}$, matched within 3 ppm/ $^{\circ}\text{C}$

Power Coefficient (typical)

1 Ω ± 0.3 ppm/mW/resistor
 10 Ω ± 0.02 ppm/mW/resistor
 100 Ω to 100 k Ω ± 0.1 ppm/mW/resistor

Maximum Power Rating

Single Step 1W/step
 10 resistors 5W/distributed

Leakage Resistance

1 Ω to 10 k Ω $> 10^{12}$ Ω terminal to case
 100 k Ω $> 10^{13}$ Ω terminal to case

Breakdown Voltage

1500 volts peak to case

Oil Bath

Type Mineral oil, Penreco Drakeol #9, white

Insulation

Resistance Typically 10^{14} Ω cm
 Quantity Approximately 0.5 gallons

Dimensions (with oil)

Height 4.7 in (120 mm)
 Width 4.6 in (117 mm)
 Depth 13.2 in (335 mm)
 Mass Weight 10 lbs (6.35 kg)

Operating Environment

Temperature 22.8 \pm 3.3 $^{\circ}\text{C}$ (73 \pm 6 $^{\circ}\text{F}$)
 Humidity 20 to 50% relative humidity

Safe Operating Environment

Temperature 0 to 50 $^{\circ}\text{C}$ (32 to 126 $^{\circ}\text{F}$)
 Humidity 15 to 80% relative humidity

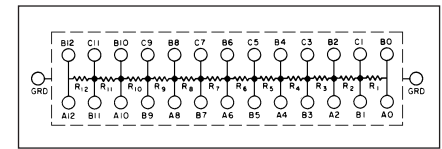

Maximum Current and Voltage Capabilities

SR1030 Resistance Value Per Step	One Resistor Alone Maximum I, V	10 Resistors in Parallel (R/10) Maximum I, V	10 Resistors in Series (R10) Maximum I, V
1 Ω	1.0 A, 1.0 V	7.07 A, 707 mV	707 mA, 7.07 V
10 Ω	316 mA, 3.16 V	2.23 A, 2.23 V	223 mA, 22.3 V
100 Ω	100 mA, 10 V	707 mA, 7.07 V	70.7 mA, 70.7 V
1 k Ω	31.6 mA, 31.6 V	223 mA, 22.3 V	22.3 mA, 233 V
10 k Ω	10 mA, 100 V	70.7 mA, 70.7 V	7.07 mA, 707 V

* Based on the breakdown voltage of 1500 volts peak to case

Combined Option Functional Specifications

Resistor Grouping	Ten Resistors in Parallel	Nine Resistors in Series/Parallel	Ten Resistors in Series
Nominal Value (Relative to Individual Resistor Value R)	0.1R	R	10R
Four-Terminal Measurement	Resistance Added to Value Calculated from Individual Resistor Values (Value and Tolerance in Microhms)		
With SB103 and PC101 or SPC102	0 \pm 0.1 $\mu\Omega$	0 \pm 1 $\mu\Omega$	–
With SB103 Alone	50 \pm 10 $\mu\Omega$	200 \pm 40 $\mu\Omega$	–
With No Accessories	–	–	0 \pm 10 $\mu\Omega$
Two-Terminal Measurement			
With SB103	150 \pm 30 $\mu\Omega$	300 \pm 60 $\mu\Omega$	–
With No Accessories	–	–	300 \pm 60 $\mu\Omega$

This data sheet was current when it was produced. However, products are constantly being updated and improved. Because of this some differences may occur between the descriptions herein and the current product. Prices and specifications may be changed without notice.

Order Information

SR1030 Resistance Transfer

Standard System:

Standard System:	Part No.
1 Ω Resistance Transfer Std.	SR1030-1
10 Ω Resistance Transfer Std.	SR1030-10
100 Ω Resistance Transfer Std.	SR1030-100
1 k Ω Resistance Transfer Std.	SR1030-1 K
10 k Ω Resistance Transfer Std.	SR1030-10 K
100 k Ω Resistance Transfer Std.	SR1030-100 K

Options:

SB103 Shorting Bars	SB103
PC101 Parallel Compensation Network	PC101
SPC102 Series/Parallel Compensation Network	SPC102

Calibration & Technical Services

For warranty and remedial repair, calibration services and spare parts, or for additional information on TEGAM sales and service offices around the world, contact us at **440-466-6100 (ph)** or **440-466-6110 (fx)**.



[BACK TO CONTENTS](#)

Model SR1050

RESISTANCE STANDARDS & INSTRUMENTS

- Resistance transfers from 100kΩ to 110MΩ
- Eleven equal-value precision resistors
- Two models, decade steps 1MΩ to 10MΩ
- Complete control of insulation resistance in resistance transfers

High-Resistance Transfer Standard

Precise transfer measurements up to 110MΩ relative to a single 100kΩ resistance standard can be obtained with the Model SR1050 High-Resistance Transfer Standard. The unit is available in two models: 1MΩ and 10MΩ resistance sections.

Based on a unique method for establishing known ratios, the Model SR1050 standard utilizes a transfer technique that consists of switching resistance sections in parallel, series or series-parallel sections. An outstanding design feature is a structure in which the only insulation leakage paths (other than those within each resistance section) are from the external terminals to ground. This eliminates insulation leakage errors in the transfer of calibration from one resistance level to another using three-terminal measurement techniques.

A specially designed lever switch provides a convenient means of switching into parallel and series-parallel configuration without introducing insulation leakage errors. External shorting or paralleling bars are not necessary. Each resistance section consists of precision wire-wound resistors connected in series. The reduced heat concentration of the series connection improves the thermal characteristics of a resistance element with an already low temperature coefficient.



Model SR1050

HIGH RESISTANCE TRANSFER STANDARD

Specifications

Standard Values	1 and 10M Ω /step
Accuracy	
Transfer	Limited only by short-term repeatability of resistance values. Typical repeatability ± 2 ppm.
Initial	± 25 ppm of nominal value, matched within 10 ppm, for 1M Ω ; ± 30 ppm of nominal value, matched within 10 ppm, for 10M Ω .
Long-Term Calibration	± 50 ppm of nominal value ± 10 ppm for 1M Ω ; 15 ppm for 10M Ω .
Calibration Conditions	23°C, low power, three-terminal measurement
Temperature Coefficient	± 5 ppm/°C, matched within 5 ppm/°C
Power Coefficient	± 0.05 ppm/mW per resistor
Maximum Power Rating	1W/step or 5W distributed over 10 steps, or maximum voltage of 2.5kV where this value does not result in power excess of 1W per resistor.
Breakdown Voltage	3.5kV peak between active terminals and case
Leakage Resistance	Greater than 10 ¹³ Ω from terminals to case
Calibration Data	Initial calibration readings are affixed to instrument
Dimensions	
Height	6.4 in.(16.25 cm)
Width	17 in.(43.2 cm)
Depth	5.6 in.(14.2 cm)
Weight	8.5 lbs. (3.9kg) net
Standard Equipment	Model SR1050 comes with a 6853 instruction manual

Initial Accuracy:

The specifications stated in the TEGAM instrument catalogs and data sheets are intended as acceptance specifications and are guaranteed for 60 days from the date of shipment. They are typically maintained for a much longer period of time.

Long-Term Accuracy:

These specifications are guaranteed for the standard warranty period, and are typically maintained for the life of the instrument. Long-term accuracy is implied when not otherwise stated.

Calibration Accuracy:

Calibration accuracy is the accuracy of TEGAM calibration data relative to the legal units maintained by the U.S. National Institute of Standards and Technology.

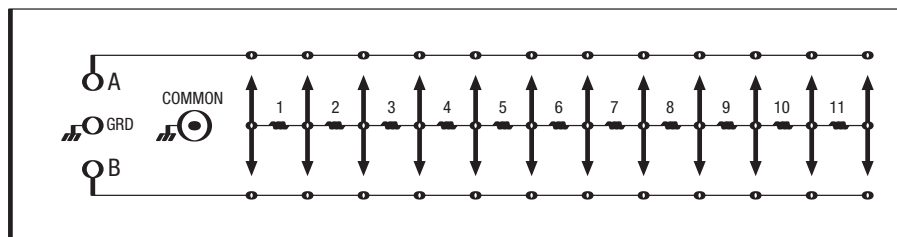

This data sheet was current when it was produced. However, products are constantly being updated and improved. Because of this some differences may occur between the descriptions herein and the current product. Prices and specifications may be changed without notice.



Model DB62

RESISTANCE STANDARDS & INSTRUMENTS

- Four Models each covering six decades
 - 0.01 Ω through 11.1111 k Ω
 - 0.1 Ω through 111.111 k Ω
 - 1 Ω through 1.11111 M Ω
 - 10 Ω through 11.1111 M Ω
- 0.01% Initial Accuracy
- Serves DC through Audio Frequency Applications
- Great Stability due to 5ppm/°C Temperature Coefficient and 0.15 ppm/mW Power Coefficient for values 1 k Ω and up
- Short term switch repeatability ± 0.24 m Ω typical

Dekabox In-Line Decade Resistors

The Model DB62 Dekabox In-Line Decade Resistor provides dependable long-term service in precision DC through audio frequency applications. Six decades of non-inductive, precision, wire-wound fixed resistors are mounted in a low noise shielded aluminum housing.

The DB62 is easy to use. The input terminals and a case connected ground terminal are conveniently located on the front panel. The dials rotate independently through 360 degrees to simplify and speed settings. This allows for a coarse approximation and then

precise finer steps to provide an exact resistance value.

Accuracy over a wide range of ambient conditions is assured by the use of resistors with good temperature and power coefficients. Repeatability is assured by the use of switches that have multiple contacts of solid silver-alloy.

The Dekabox resistance values are easily read from the large-numeral in-line presentation above the knobs. Resistance per step and current ratings of each decade are presented below the knobs for operator convenience and circuit safety.

C



DEKABOX IN-LINE DECADE RESISTORS

Specifications

Model No.	Total Resistance Ω	Smallest Step Ω	Resistance Values (Ω)					
			R1	R2	R3	R4	R5	R6
DB62	Ω	Ω						
	11.1111M	10	1M	100K	10K	1K	100	10
	1.11111M	1	100K	10K	1K	100	10	1
	111.111K	0.1	10K	1K	100	10	1	0.1
	11.1111K	0.01	1K	100	10	1	0.1	0.01

Accuracy Accuracy of resistance increments is given in the table below. Accuracy of resistance change from zero setting is given below.

Initial (60 days) $\pm(0.01\% + 3 \text{ m}\Omega)$
 Long-term $\pm(0.02\% + 6 \text{ m}\Omega)/\text{year}$

Short-Term Switching Repeatability $\pm 0.24 \text{ m}\Omega$ (typical).

Number of Decades Six.

Total Resistance See table above.

Resistance per Decade See table above.

Smallest Step See table above.

Resistance at Zero Setting Approximately $12 \text{ m}\Omega$.

Breakdown Voltage 1,000 V peak to case.

Dimensions

Height 4.3 in. (10.9cm).
 Width 18.0 in. (45.7cm).
 Depth 4.9 in. (12.45 cm).

Weight 4.5 lb. (2.2 kg) net.

Standard Equipment Model DB62 comes with a 7275 instruction manual.

Calibration & Technical Services For warranty and remedial repair, calibration services and spare parts, or for additional information on TEGAM sales and service offices around the world, contact us at **440-466-6100** (ph) or **440-466-6110** (fx).

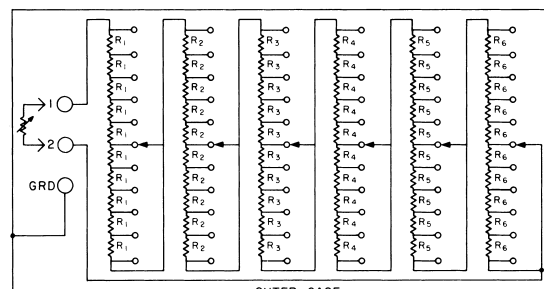

Dekabox Schematic Diagram

Model DB62 ratings per step for each decade

Resistance Per Decade (Ω)	Resistance ¹ Value R (Ω)	Incremental Accuracy		Coefficients		Measurement Duty ² Maximum Ratings		Peak Voltage (V/step)
		Initial (%)	Long-term (%)	Temperature (ppm/ $^{\circ}\text{C}$)	Power (ppm/mW/step)	Power (mW/step)	Current (mA)	
10M	1M	0.01	0.02	5	0.15	100	0.3	300
1M	100k	0.01	0.02	5	0.15	1000	3.2	300
100k	10k	0.01	0.02	5	0.15	1000	10	100
10k	1k	0.01	0.02	5	0.15	1000	32	32
1k	100	0.01	0.02	5	0.15	1000	100	10
100	10	0.012	0.025	15	0.45	1000	320	3.2
10	1	0.03	0.07	20	0.6	1000	1000	1
1	0.1	0.2	0.5	60	3	500	2200	0.2
0.1	0.01	2	5	400	60	160	4000	0.04

¹ Refers to previous table

² Intermittent use such that temperature rise of the resistor will not appreciably exceed that which would occur in free air.

This data sheet was current when it was produced. However, products are constantly being updated and improved. Because of this some differences may occur between the descriptions herein and the current product. Prices and specifications may be changed without notice.



Model DB877

RESISTANCE STANDARDS & INSTRUMENTS

- Resistance range 0.1 Ω through 12 M Ω
- 0.1 Ω resolution
- 0.01% Initial Accuracy
- Serves DC through Audio Frequency Applications
- Great stability due to 5 ppm/ $^{\circ}$ C Temperature Coefficient and 0.3ppm/mW Power Coefficient for values 1 k Ω and up
- Short term switch repeatability ± 1 m Ω typical

Dekabox Coaxial-Dial Decade Resistor

The Model DB877 Dekabox Decade Resistor provides dependable long-term service in precision DC through audio frequency applications. Eight decades of non-inductive, precision, wire-wound fixed resistors are mounted in a low noise shielded metal case that also provides good mechanical protection.

The DB877 is easy to use. It has the input terminals and a case-connected ground terminal conveniently located on the front panel. The dials rotate independently through 360 degrees, and a special detent design facilitates dial

location. This allows for a coarse approximation and then precise finer steps to provide an exact resistance value.

Accuracy over a wide range of ambient conditions is assured by the use of resistors with good temperature and power coefficients. Repeatability is assured by the use of switches that have multiple contacts of solid silver-alloy and silicone treated ceramic wafers.

Resistance per step and current ratings on each decade are presented below the dials for operator convenience and circuit safety.



Model DB877

DEKABOX COAXIAL-DIAL DECADE RESISTOR

Specifications

Accuracy

Initial $\pm(0.01\% + 7\text{m}\Omega)$.
Long-term $\pm(0.02\% + 10\text{m}\Omega)$.

Resistance at Zero Setting

Approximately 40 m Ω .

Breakdown Voltage

1,000 V peak to case.

Short-Term Switching Repeatability

$\pm 1\text{ m}\Omega$ (typical).

Smallest Step

0.1 Ω .

Number of Decades

Eight.

Total Resistance

12 M Ω .

Resistance per Decade

See table.

Dimensions

Height 5.9 in. (15.0 cm).
Width 8.5 in. (21.6 cm).
Depth 6.5 in. (16.5 cm).

Weight

7.5 lb. (3.4 kg) net.

Model DB877 ratings per step for each decade

Resistance Per Decade (Ω)	Smallest Step (Ω)	Incremental Accuracy		Coefficients		Measurement Duty* Maximum Ratings		Peak Voltage (V/step)
		Initial (%)	Long-term (%)	Temperature (ppm/ $^{\circ}$ C)	Power (ppm/mW/step)	Power (mW/step)	Current (mA)	
10M	1M	0.02	0.03	5	0.3	22	0.03	300
1M	100k	0.02	0.03	5	0.3	220	1.5	150
100k	10k	0.02	0.03	5	0.3	500	7	70
10k	1k	0.02	0.03	5	0.3	500	23	23
1k	100	0.02	0.03	5	0.3	500	71	7
100	10	0.03	0.03	15	0.9	500	230	2.3
10	1	0.1	0.12	20	1.2	500	710	0.7
1	0.1	1.0	1.0	60	6	250	1600	1.6

*Intermittent use such that temperature rise of the resistor will not appreciably exceed that which would occur in free air.

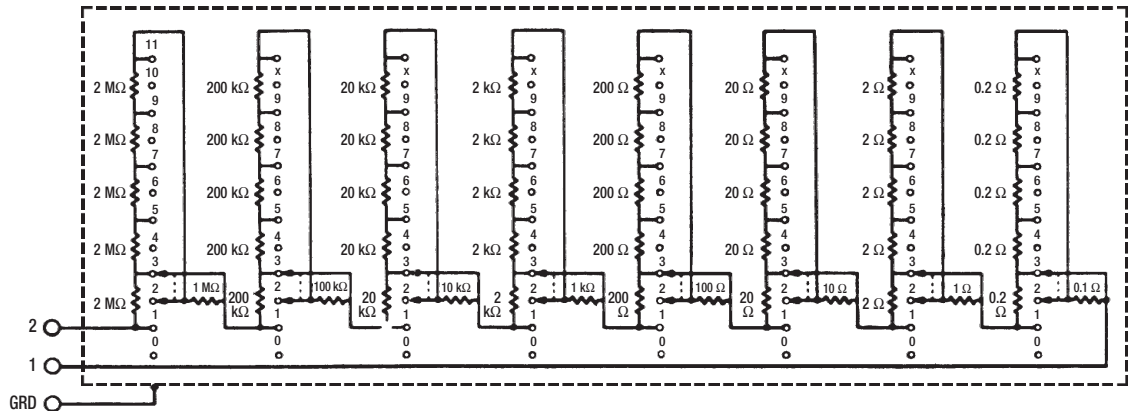

Standard Equipment

Model DB877 comes with a 19199 instruction manual.

Calibration & Technical Services

For warranty and remedial repair, calibration services and spare parts, or for additional information on TEGAM sales and service offices around the world, contact us at 440-466-6100 (ph) or 440-466-6110 (fx).

This data sheet was current when it was produced. However, products are constantly being updated and improved. Because of this some differences may occur between the descriptions herein and the current product. Prices and specifications may be changed without notice.



YOUR GLOBAL SOURCE FOR TEST AND MEASUREMENT SOLUTIONS

[BACK TO CONTENTS](#)

TEN TEGAM WAY • GENEVA, OHIO 44041
440-466-6100 • FAX 440-466-6110
www.tegam.com • e-mail: sales@tegam.com

Models DP 1211, DP 1311

RESISTANCE STANDARDS & INSTRUMENTS

- Kelvin-Varley voltage divider
- Panel-mounting area from 27.1 to 45.2 cm²
- Precision resistors throughout
- Solid silver-alloy switch contacts

Dekapot Coaxial-Dial Decade Potentiometer

These Dekapot potentiometers are precision decade resistive voltage dividers featuring the accuracy, high resolution and constant input impedance of the Kelvin-Varley circuit. They provide known voltage and current ratios for meter calibration, linearity checking, ratio measuring, synchro testing, computer standardization, and many other DC and audio frequency applications.

The stacked dial configuration conserves space without sacrificing operating ease. Each unit occupies less than 45.2 square centimeters of panel space. Convenient in-line reading is

provided by the TEGAM Dekadial coaxial dial.

The DP 1211 offers two decades plus a 100 division potentiometer. The DP 1311 offers three decades plus a 100 division potentiometer.

Exceptional stability and reliability are assured by the use of precision resistive elements. The ceramic switch decks are silicone-treated to improve insulation resistance, and the multiple switch contacts are of solid silver-alloy for long life and low contact resistance. All components are shock-mounted within the sturdy dust cover.



Models DP 1211, DP 1311

DEKAPOT DECADE POTENTIOMETERS

Specifications

DP 1211 Dekapot Decade Potentiometer

Terminal Linearity*	Initial: ± 15 ppm + 0.5 dial division Long-term: ± 20 ppm + 0.5 dial division
*Mid-scale rating. Improves near end-scale settings.	
Coefficients of Linearity	Temperature: ± 2 ppm/ $^{\circ}$ C Power: ± 30 ppm/W for 1k Ω , ± 10 ppm/W for 10k Ω
Calibration Conditions	23 $^{\circ}$ C, low input power
Number of Decades	Two, plus 100-division potentiometer
Resolution	0.003%
Input Resistance	1, 10k Ω (accuracy $\pm 0.01\%$)
Maximum Input Power	5W continuous, 10W intermittent
Breakdown Voltage	750V rms to case
Dimensions	Diameter: 3 in. (7.6cm) Depth: 7.2 in. (18.3cm) Depth (behind panel): 5.9 in. (15cm)
Weight	1.7 lbs (772gm) net

DP 1311 Dekapot Decade Potentiometer

Specifications for the DP 1311 are the same as for the DP 1211 except for the following:

Number of Decades	Three, plus 100-division potentiometer
Dimensions	Diameter: 3 in. (7.6cm) Depth: 8.5 in. (21.6cm) Depth (behind panel): 6.9 in. (17.6cm)
Weight	2.1 lbs (1kg) net

Standard Equipment

Models DP 1211 and DP 1311 come with an 8895 Instruction Sheet.

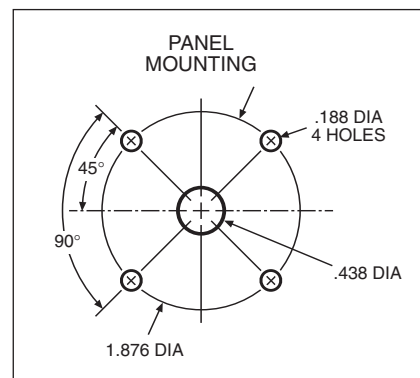
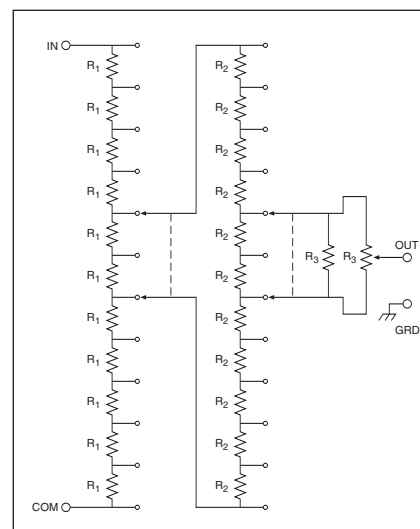

This data sheet was current when it was produced. However, products are constantly being updated and improved. Because of this some differences may occur between the descriptions herein and the current product. Prices and specifications may be changed without notice.



YOUR GLOBAL SOURCE FOR TEST
AND MEASUREMENT SOLUTIONS

[BACK TO CONTENTS](#)

TEN TEGAM WAY • GENEVA, OHIO 44041
440-466-6100 • FAX 440-466-6110
www.tegam.com • e-mail: sales@tegam.com

Model DT72A

AC STANDARDS AND MEASUREMENT INSTRUMENTS

- Resolution 0.1 ppm
- Terminal linearity 0.9 ppm
- Bandwidth 50 Hz to 10 kHz
- Parallel switches reduce contact resistance
- Switch Resistors virtually eliminate switch transients
- Ratio range from -0.0111111 to +1.1111110

Decade Ratio Transformer Standard

Model DT72A is an inductive voltage divider that meets or exceeds all of the requirements for a calibration standard in precision measurement applications. It is easy to integrate into systems for calibration of voltage dividers, transformer standards, synchro/resolver standards, transformers, calibrators, ammeters, and voltmeters. It can also be used to make impedance or capacitance comparisons. The ratio accuracy is traceable to the National Institute of Standards and Technology.

This variable AC voltage divider demonstrates extreme precision for measuring and generating voltage ratios. Seven decades of tapped transformer windings are selected using special low resistance switches providing 0.1 ppm resolution and 0.9 ppm terminal linearity. The key to these standards is extremely stable toroidal transformers, resulting in precision and outstanding long-term

stability over a wide range of environmental conditions. The seven in-line control knobs permit quick, easy setting of the required ratios. The first dial has end stops to prevent accidental switching from zero to full output. The other dials rotate independently through 360° of rotation to simplify the settings. The switch settings are easily read from the large-numeral in-line presentation above the knobs.

Switching transients are virtually eliminated due to a special circuit which couples the adjacent voltage steps through a resistor while the switching is taking place. The range overlap between decades is $\pm 10\%$, permitting accurate voltage ratios from 1.1 to -0.1.

The high input impedance of the DT72A makes it well suited for use in high impedance circuits without causing excessive loading.

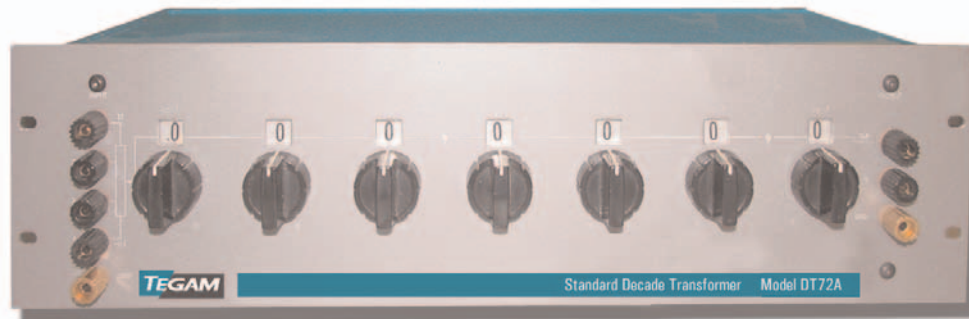

Model DT72A

DECADE RATIO TRANSFORMER STANDARD

Specifications

Characteristic	DT72A Specifications
Frequency Range	50 to 20,000 Hz
Maximum rms Input Voltage	0.35f (f in Hz) or 350 volts, whichever is less.
Ratio Range	
Maximum	1.111111
Minimum	-0.0111111
Maximum Phase Shift	Approx. 0.05 mrad/kHz for settings above 0.1
Resolution	0.00001% (0.1 ppm)
Maximum Input Current	For best performance, no DC current should be permitted. DC input of 20 μ A will decrease AC input voltage about 10% and increase distortion slightly; 200 μ A will cause near saturation of core and serious errors.
Terminal Linearity	50 Hz to 1 kHz: ± 0.9 ppm (referenced to input) for settings 0.1 to 1.0 $[0.9 (10 \times \text{setting})^{1/2} + 0.01]$ ppm for settings 0 to 0.1 Above 1 kHz: multiply by f^2 in kHz Below 50 Hz: Multiply by 50/f(Hz)
Maximum Effective Series Output Impedance	R: approx. 5 ohms maximum L: 30 μ H
Input Impedance at 20 V and 400 Hz	Approximately 500 K ohms minimum
Input Inductance	Approximately 100 to 400 H depending on excitation.
Output Current	1 A maximum
Dimensions	19 in (48.3 cm) wide 5-1/4 in (13.3 cm) high 7.1 in (18 cm) deep
Weight	18 lbs. (8.1 kg) net

Standard Equipment

The model DT72A comes with a 7203 instruction manual.

Calibration & Technical Services

For warranty and remedial repair, calibration services and spare parts, or for additional information on TEGAM sales and service offices around the world, contact us at 440-466-6100 (ph) or 440-466-6110 (fx).

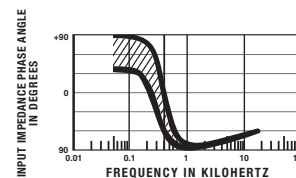
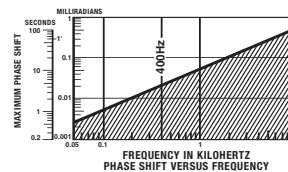
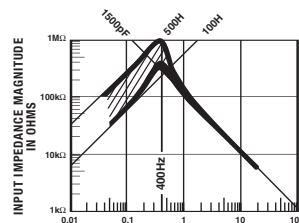
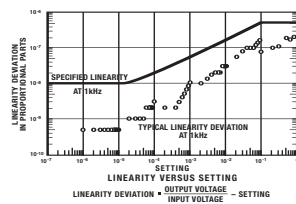
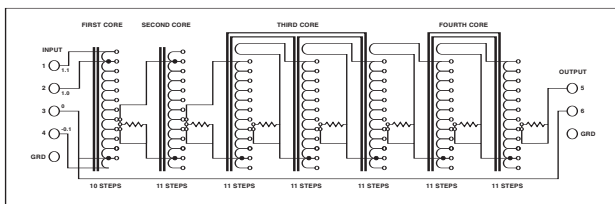

This data sheet was current when it was produced. However, products are constantly being updated and improved. Because of this some differences may occur between the descriptions herein and the current product. Prices and specifications may be changed without notice.



YOUR GLOBAL SOURCE FOR TEST AND MEASUREMENT SOLUTIONS

BACK TO CONTENTS

TEN TEGAM WAY • GENEVA, OHIO 44041
440-466-6100 • FAX 440-466-6110
www.tegam.com • e-mail: sales@tegam.com

Model DT1145

AC STANDARDS AND MEASUREMENT INSTRUMENTS

- **Bench or panel-mounting**
- **Dial arrangement minimizes reading errors**
- **Exceptionally low output impedance**

Dekatron Decade Ratio Transformers

The Dekatron decade ratio transformers are inductive voltage dividers for use at audio frequencies. They feature high input impedance, low output impedance, and low phase shift and are ideal for use as working standards in test setups and calibration laboratories. Applications include voltage and current division, turns-ratio measurement, divider calibration and impedance comparison.

Initial accuracy and long-term stability over a wide range of ambient conditions are assured by the use of gapless toroidal cores of very high permeability. Their inherently stable

characteristics assure permanent calibration over wide ranges of temperature, humidity, vibration and shock. A sturdy metal case provides both mechanical protection and electrical shielding.

The Model DT1145 is for panel mounting and has three decades plus an interpolation potentiometer. It features stacked dials, which results in a configuration that requires less than 7 square inches of panel space.

C

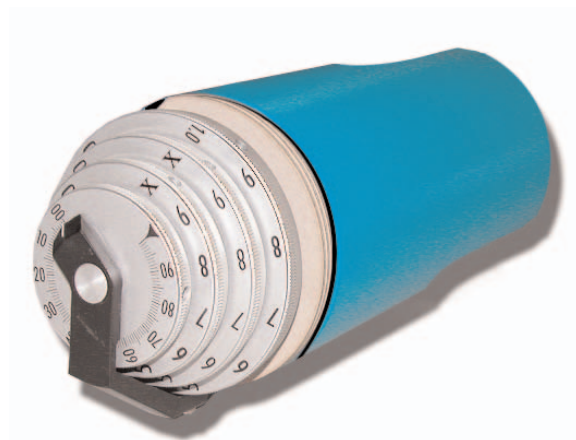

Model DT1145

DEKATRAN DECADE RATIO TRANSFORMERS

Characteristic	DT1145 Specifications
Frequency	50Hz to 5kHz
Terminal Linearity* (Initial & Long-Term)	50 Hz to 1 kHz: ± 10 ppm (referenced to input) Above 1 kHz: multiply by $(1 + 0.1f^2 \text{ in kHz})$ *All setting combinations producing the same nominal output voltage remain with the stated linearity specifications.
Number of Decades	Three, plus interpolating potentiometer
Resolution	Continuous, 0.001% per dial division
Maximum Ratio	1.11100
Maximum Phase Shift	Approximately 0.05mrad/kHz for settings above 0.1
Maximum Input Voltage	0.35VRMS/Hz, 350V maximum
Maximum Input Current (DC)	10 μ A
Input Impedance	High, with no output load. Typical range of measured values for various dial settings and voltages shown in curves.
Input Inductance	Approximately 100 to 300H depending on excitation
Output Current	1A maximum
Output Impedance	Approximately 2.5 Ω maximum in series with 100 μ H
Harmonic Distortion	$(0.0008 \times \text{fkHz})\%$ of output voltage peak to peak for input voltage less than $(0.35 \times f_{\text{Hz}}^{0.11})$ VRMS
Dimensions	Diameter: 3.35 in. (8.5 cm) Depth: 7.2 in. (18.3 cm) Depth: (behind panel) 5.4 in. (13.7 cm)
Weight	2.5 lbs. (1.1kg) net

Standard Equipment

Model DT1145 comes complete with an 8896 Instruction Sheet.

Calibration & Technical Services

For warranty and remedial repair, calibration services and spare parts, or for additional information on TEGAM sales and service offices around the world, contact us at 440-466-6100 (ph) or 440-466-6110 (fx).

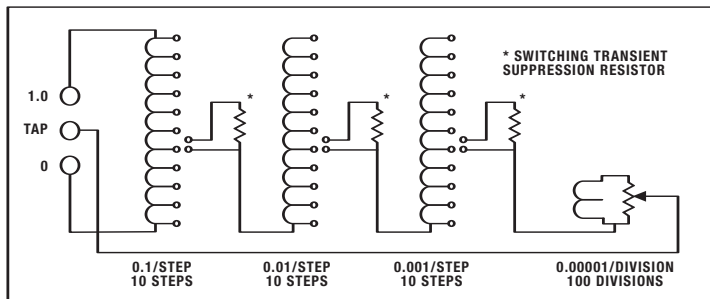
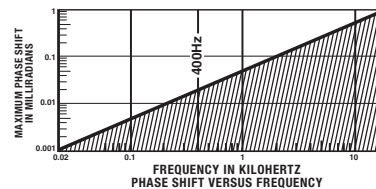
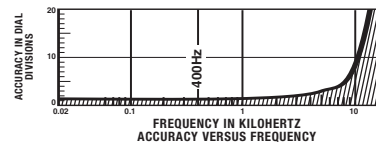
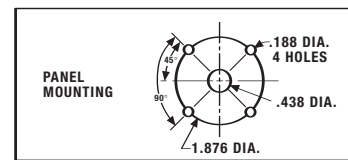
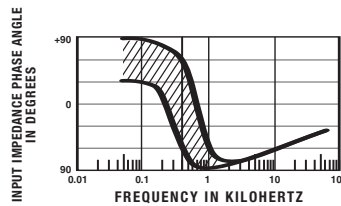
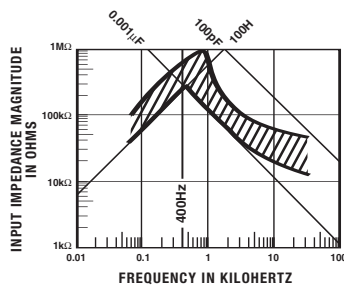

This data sheet was current when it was produced. However, products are constantly being updated and improved. Because of this some differences may occur between the descriptions herein and the current product. Prices and specifications may be changed without notice.



Model PRT-73

AC STANDARDS AND MEASUREMENT INSTRUMENTS

- Remotely programmable via standard IEEE-488 interface
- Standard Resolution to 0.1 ppm
- Optional Resolution to 0.01 ppm
- Terminal Linearity 0.9 ppm
- Wide bandwidth — 10 Hz to 20 kHz
- Standard 0.35 V/Hz, 350 V Max
- Optional 2.5 V/Hz
- Overload protection
- Front panel display for easy set up and operation

Automated Precision Ratio Transformer

The PRT-73 Automated Precision Ratio Transformer meets or exceeds all of the requirements for a calibration standard in precision measurement applications. It is easily integrated into systems for either automated or manual calibration of ratio dividers, transformer standards, synchro/resolver standards, transformers, calibrators, and voltmeters.

The PRT-73 is fully programmable via a standard IEEE-488 interface. Storing calibration procedures in the system controller increases the repeatability of measurements. The PRT-73 increases calibration throughput while maintaining data integrity by allowing measurements to be taken without operator intervention. A local switch allows operators to change from remote programming to front panel operation, providing precise control in delicate null balancing situations. Calibration certificates are easily

printed using data collected from the PRT-73.

A convenient menu mode provides easy access to IEEE-488 address and setup commands. Address and string terminators are displayed on the front panel and are changed using front panel switches.

This seven decade AC voltage divider gives 0.1 ppm resolution for ratio settings from -0.0010000 to 1.0009999, and terminal linearity of 0.9 ppm. It performs over a wide range of frequencies from 50 Hz to 20 kHz with maximum input voltage of 0.35 V/Hz up to 350 V. For greater flexibility, the Low Frequency Option extends voltage capability to 2.5 V/Hz from 10 Hz to 1 kHz. This option expands ratio measurement capabilities to include 150 V at 60 Hz and adds another transformer, improving resolution to 0.01 ppm.



Model PRT-73

AUTOMATED PRECISION RATIO TRANSFORMER

Specifications

Linearity Error (3-Terminal)

0.35 V/Hz Range:

50 Hz to 1.0 kHz: ± 0.9 ppm for settings 0.1 to 1.0000999;

$\pm [0.9 \sqrt{(10 \times \text{setting})} + 0.01 \text{ ppm}]$

For settings 0.01 to 0.1.

200 Hz to 1 kHz:

$\pm [0.9 \sqrt{(10 \times \text{setting})} + 0.01 \text{ ppm}]$

For settings -0.001 to 0.01.

50 Hz to 200 Hz:

$\pm [0.9 \sqrt{(100 \times \text{setting})} + 0.01 \text{ ppm}]$

For settings -0.001 to 0.01.

2.5 V/Hz Range:

50 Hz to 400 Hz:

$\pm (1 \text{ ppm} + 0.9 \text{ ppm} \times \text{Ratio})$

400 Hz to 1 kHz:

Multiply 50 Hz to 400 Hz values by factor of $(f/400)^2$, where f = frequency in Hz.

10 Hz to 50 Hz:

Multiply 50 Hz to 400 kHz values by factor of $50/f$, where f = frequency in kHz.

Linearity errors are given in parts per million (ppm) of input. Verification of linearity errors is traceable to N.I.S.T. uncertainty of 0.5 ppm of input.

Number of Decades

0.35 V/Hz Range: Seven.

2.5 V/Hz Range: Eight.

Resolution

0.35 V/Hz Range: 0.1 ppm of input.

2.5 V/Hz Range: 0.01 ppm of input.

Range

0.35 V/Hz Range:

-0.0010000 to +1.0000999

2.5 V/Hz Range:

-0.00010000 to +1.00009999

Frequency Range

50 Hz to 20 kHz standard.

10 Hz to 1 kHz (2.5 V/Hz).

Maximum Phase Shift

0.35 V/Hz Range:

10 Hz to 100 Hz:

50 μ rad to 5 mrad @ 100 Hz.

100 Hz to 20 kHz:

50 μ rad at 1 kHz to 1 mrad at 20 kHz.

Multiply specifications x 4 for 2.5 V/Hz option.

Maximum Input Voltage

0.35 V RMS/Hz, 350 V maximum.

2.5 V RMS/Hz, 350 V maximum (optional).

Maximum Input Current

For best performance no DC current should be permitted. DC input of 20 μ A will decrease AC input voltage rating about 10% and increase distortion slightly; 200 μ A causes near saturation of core and serious errors.

Input Impedance

0.35 V/Hz Range:

> 40 k Ω , 50 Hz to 1 kHz.

2.5 V/Hz Range:

> 100 k Ω , 10 Hz to 100 Hz.

Above 100 Hz:

100 k Ω decreasing with frequency

Applies for inputs > 10 V RMS.

Input Inductance

0.35 V/Hz: Approx. 100 to 400 H, depending on excitation.

2.5 V/Hz: Approx. 700 H to 2.1 kH depending on excitation.

Output Current

100 mA maximum.

Input Capacitance

0.35 V/Hz Range: 2 nF typical.

2.5 V/Hz Range: 12 nF typical.

Output Series Inductance

0.35 V/Hz Range: 2 μ H to 30 μ H.

2.5 V/Hz Range: 2 μ H to 70 μ H.

Output Series Resistance

0.35 V/Hz Range: 400 m Ω to 7 Ω .

2.5 V/Hz Range: 500 m Ω to 12 Ω .

Dimensions

Height: 5.31 in (135 mm).

Width: 17 in (435 mm).

Depth: 20 in (513 mm).

Weight

13.8 kg (30 lb.).

Environmental

Temperature

Operating: 59°F - 86°F (15°C - 30°C).

Storage: 32°F - 122°F (0°C - 50°C).

Relative Humidity

Operating: 20% - 50% (non-condensing).

Storage: 15% - 80% (non-condensing).

Order Information

Model	Part Number
Precision Ratio Transformer	PRT-73
2.5 V/Hz Option	70161
Rackmount Kit	70192
Rear Panel Terminals Option	70193
Manual	70581

Calibration & Technical Services

For warranty and remedial repair, calibration services and spare parts, or for additional information on TEGAM sales and service offices around the world, contact us at 440-466-6100 (ph) or 440-466-6110 (fx).

This data sheet was current when it was produced. However, products are constantly being updated and improved. Because of this some differences may occur between the descriptions herein and the current product. Prices and specifications may be changed without notice.



YOUR GLOBAL SOURCE FOR TEST
AND MEASUREMENT SOLUTIONS

[BACK TO CONTENTS](#)

TEN TEGAM WAY • GENEVA, OHIO 44041
440-466-6100 • FAX 440-466-6110
www.tegam.com • e-mail: sales@tegam.com



PC101 Parallel Network



SPC102 Series Parallel Network



SB103 Shorting Bars



KK110 Kelvin Klip Leads



KK110 Kelvin Klip Leads with Ground

Model PC101 – Parallel Compensation Network

Used with a pair of SB103 shorting bars for the four-terminal, parallel connection of ten low-value resistors in the Model SR1010 and SR1030 Resistance Transfer Standards.

Model SPC102 – Series Parallel Compensation Network

The Model SPC Series-Parallel Compensation Network is used with a pair of the Model SB103 Shorting Bars for the four-terminal, series-parallel connection of nine low-value resistors in the Model SR1010 and SR1030 Resistance Transfer Standards.

SB103 Shorting Bars

The Model SB103 may be used with either the PC101 or SPC102 Networks to create a series or series-parallel combination of the low value resistors found in the SR1010 and SR1030 Resistance Transfer Standards. Two shorting bars are included in a set.

Model KK110 – Kelvin Klip Leads with Ground

Kelvin Klip assemblies are true four-terminal connections that allow precise measurement by minimizing the affects of lead resistance. Kelvin Klips are particularly useful connecting Transfer Standards to the unit being verified or calibrated. The gold-plated beryllium copper jaws and the gold-plated phosphor bronze spade lugs ensure low contact resistance, low thermal emf to copper, high corrosion resistance, and a long life. The assembly includes a 3 ft. (.9144 m) shielded cable.

KK100 Kelvin Klip Rebuild Kit

Includes all hardware, tape and shrink tubing for the total replacement of 1 set of Kelvin Klips.

This data sheet was current when it was produced. However, products are constantly being updated and improved. Because of this some differences may occur between the descriptions herein and the current product. Prices and specifications may be changed without notice.

Calibrators Feature High Performance Without High Price

Save time, save money, and meet ISO 9000 with the price/performance leader in temperature calibrators.

These meters simulate, source, measure and record 11 Thermocouple types, plus RTD, Thermistor and Ohms signals all in one unit. They out-perform the competition in the lab and on the factory floor with 0.2° accuracy and 0.1° resolution (0.01 ohms). You also get full-featured temperature measurement plus unmatched TEGAM quality all for half the competitors' price.

Save Time

These calibrators increase productivity. They are faster and easier to use than any other calibrator. With 10 memory locations for calibrator setpoints, and a step function, you can easily calibrate controllers, smart transmitters and panel meters. Use the ramp feature to quickly check safety switch and alarm setpoints. Convenient "one-touch" keys select functions for both calibrator and thermometer. Select sensor types, calibrator or thermometer mode, °F or °C, view memory locations, or hold a reading. The 5-digit LCD annunciates all active functions. Programming is a snap. Enter calibrator set points through the calculator style keypad or program them from an outside source. The step function allows one-touch output of programmed values. When turned off, the units retain your programs for quick repeat use. The thermometer mode provides accurate readings and ten memory locations let you record temperature measurements for later review.

Save Money

Now you can calibrate and measure Thermocouples, 100Ω and 1000Ω RTD's, and 2252Ω Thermistors. All of your Temperature problems can be solved with one meter.

MEET ISO 9000

ISO 9000 and other quality programs require precise calibration on the factory floor. TEGAM's meters conform to the tables of the National Institute of Standards and Technology and come with a free statement of traceability to help you meet ISO 9000.

- Choose up to 11 Thermocouple types
- RTD, Ohms and Thermistor functions (850 Series)
- ± 0.2°F (0.1°C) RTD, ± 0.5°F (0.3°C) Thermocouple and Themistor Accuracy
- Calibrator and Thermometer in one unit
- 10 Memory locations
- Step and Ramp Functions
- Free Statement of Traceability
- Shirt-pocket size, Drop-proof, Splash-proof, and Dust-proof case
- Two-year calibration guarantee plus three-year warranty

SPECIFICATIONS

ACCESSORIES SUPPLIED: Statement of Traceability, universal calibration adaptor & cable, integral tilt stand/hanger, wrist strap, 9V battery, manual.

ACCURACY: ± 0.5°F (0.3°C) (rdg > -50°F) K, J, T, E, N. (18° to 28°C ambient)
 ± 0.2°F (0.1°C) (rdg > -50°F) RTD
 ± 0.5°F (0.3°C) Thermistor

RANGE	TYPE K	TYPE J	TYPE T	TYPE E
°F	-328 to 2502	-346 to 1400	-328 to 752	382 to 1832
°C	-200 to 2502	-210 to 760	-200 to 400	-230 to 1000

For other ranges and accuracies see the Calibrator Features Chart at www.tegam.com

DISPLAY: 5-digit LCD

DIMENSIONS: 7.0" x 2.9" x 1.1". Net weight: 12 oz.

ORDERING INFORMATION

MODEL	SENSOR TYPES
840A	K, J, T
845	K, J, T, E, N, B, R, S, G, C, D
850	K, J, T, E, 1000Ω, 100KΩ, 100Ω RTD & Thermistor
855	K, J, T, E, N, B, R, S, G, C, D, 1000Ω, 10KΩ, 100Ω & 1000Ω RTD

This data sheet was current when it was produced. However, products are constantly being updated and improved. Because of this some differences may occur between the descriptions herein and the current product. Prices and specifications may be changed without notice.



D



[BACK TO CONTENTS](#)



YOUR GLOBAL SOURCE FOR TEST AND MEASUREMENT SOLUTIONS

Calibrator Accessories

TEMPERATURE CALIBRATORS/THERMOMETERS

Calibration Kits

TEGAM Calibration Kits are what you need to calibrate temperature devices and check temperatures throughout your plant. No matter what sensor type or connection method, these kits let you calibrate and check temperature controllers, recorders, process monitors, panel meters and transmitters. The heart of each TEGAM Calibration Kit is the 800 Series handheld temperature calibrator (sold separately) that combines bench-meter performance with a data-logging thermometer. Take a look at everything that you get:



KIT #1

K, J, & T Universal Adaptor Kits – each adaptor kit contains a 3' calibration cable with spade lug terminals plus a standard connector and a subminiature connector.
 AC Adaptor/Battery Charger & Rechargeable Battery
 Rubber Boot & Belt Clip
 Type K Wire Temperature Sensor
 Foam-Filled Carrying Case



KIT #5

K, J, T & E Alligator Clip Calibration Cables
 4-Wire RTD/Ohms/Thermistor Alligator Clip Calibration Cable
 2 RTD 4-Pin Connectors
 AC Adaptor/Battery Charger & Rechargeable Battery
 Rubber Boot & Belt Clip
 Type K Wire Temperature Sensor
 Foam-Filled Carrying Case

NOTE: Calibration Kits should be ordered by Kit # along with the calibrator of your choice (not included).

High Impact Carrying Case (as shown in Kit 1 & 5 above)

This case has a foam insert for 840 and 850 Series Calibrators and 819 and 820 Series Thermometers.

ORDERING INFORMATION

MODEL 5000



Rubber Boot and Belt Clip

This rubber boot protects your instrument from everyday bangs and bumps in your toolbox. This boot is designed to protect your calibrator while not interfering with plugging in cables, using the tilt stand or the AC adaptor. Also included is a removable belt clip.

ORDERING INFORMATION

MODEL 8204

EXTENSION CABLES (Not shown)

MODEL NUMBER BY TC TYPE

K	INSULATION	LENGTH
80141	PVC	3'

This data sheet was current when it was produced. However, products are constantly being updated and improved. Because of this some differences may occur between the descriptions herein and the current product. Prices and specifications may be changed without notice.

[BACK TO CONTENTS](#)



YOUR GLOBAL SOURCE FOR TEST
AND MEASUREMENT SOLUTIONS

TEN TEGAM WAY • GENEVA, OHIO 44041
 440-466-6100 • FAX 440-466-6110
 www.tegam.com • e-mail: sales@tegam.com

Model 2411B

ARBITRARY WAVEFORM GENERATORS

- **Very High-Fidelity - 0.005% Waveform Distortion**
- **16-Bit (0.0015%) Resolution**
- **0.1S/s to 2MS/s Adjustable Sample Rate**
- **4 Fully-Programmable Sync Outputs**
- **20 Standard Waveforms**
- **64k Waveform Memory**
- **Stores 100 Custom Waveforms**
- **Summing Input**
- **RS-232C**
- **Options**
 - **1000 Step Sequence Generator**
 - **WaveWorks Pro+™ Waveform Creation Software**
 - **GPIB Communications**
 - **Rack Mount Kit**

Signal Integrity

Waveforms will always be consistent and repeatable because the 2411B is a true arb. It uses the raster scan technique with sequential addressing of waveform memory and a variable sample clock rate to adjust the output frequency. Other generators use phase accumulator-based addressing, which can skip or repeat waveform data points. The typical THD (total harmonic distortion plus noise) of the 2411B is -86 dB making it ideal for applications requiring wide dynamic range signals.

16-Bit True AWG

Comprehensive Features

The 2411B has outstanding performance, offering 16-bit vertical resolution and over 64k of horizontal memory. Standard or arbitrary waveforms are created through the front panel or optional WaveWorks Pro+™ software. The adjustable sample clock ranges from 0.1S/s to 2MS/s. The 2411B's superior fidelity and wide dynamic range make it ideal for applications involving high precision, low voltage or signal amplification. Some applications include micro miniature machine stimulation (MEMS), sensor simulations, sonar, automatic airbag triggering, multi-tone audio signals, cardiac and respiratory device testing.

Function Generator Simplicity

Keypad access to 20 standard waveforms, with adjustable parameters, provides function generator simplicity for general lab applications. For custom signal applications, up to 100 unique waveforms may be defined and stored in waveform memory using the keypad or optional WaveWorks Pro+™ software. All programmed waveforms are available for recall and editing from the front panel, RS-232C, or GPIB (optional) interfaces.

Programmable Synchronous Outputs

Each 2411B is equipped with four independently controlled, synchronous outputs.

Sync outputs allow external instruments, including additional 2411B units, to be hardware triggered by waveform events. Because each output is fully programmable, multiple sync pulses can be defined at any width or location within waveform memory. Hardware sync is more precise than software sync, enhances system performance, and reduces development time.

Facilitates the Design of Complex Test Systems

The RS-232C and optional IEEE-488.2 offer direct, easy, programming. The 2411B has numerous triggering and timing inputs/outputs for precise, multi-phase operation of several instruments. Up to four slave arbs may be triggered by a single master 2411B. With four sync outputs available from each slave (16 total outputs), numerous instruments can be simultaneously triggered by a single waveform event. Further expansion is limited only by propagation delay.

Extensive User Tools

Expand the 2411B's memory up to 30,000 times with the optional sequence generator. Each sequence program can have up to 1,000 steps, which can link to any of the 2411B's 100 user-defined waveforms. Each waveform may be looped up to 1 million times per step. Up to one hundred unique sequence programs may be stored in the sequencer's non-volatile memory.

WaveWorks Pro+™ software (optional) is a total software solution for importing, exporting, creation and editing waveform data in up to seven formats including the common ASCII formats .CSV, and .PRN. See the WaveWorks Pro+™ data sheet for more information.

Warranty

The Model 2411B is backed by a full 3-year warranty and TEGAM's 30-day no risk trial.



Prices and specifications subject to change without notice.

[BACK TO CONTENTS](#)



YOUR GLOBAL SOURCE FOR TEST
AND MEASUREMENT SOLUTIONS

Specifications

Output Waveforms

Up to 100 High-definition custom waveforms, Sine, Square, Triangle, \pm Sawtooth, DC, \pm Pulse, \pm Exponential, AM, SCM, FM, Lin/Log Sweep, Sin x/x (Sinc), Gaussian, Haversine, Circle, Noise.

4 programmable sync signals per waveform.

Sequence Generator (Optional)

Waveform:	Transient-free Loop-and-Link
Repetitions:	Loop: 1,048,575 times Link: 100 waveforms
Program:	1000 Steps total
File:	100 Sequences

Waveform

Storage:	100
Resolution:	Horizontal Points: 65,504 max Vertical Points: 16 bits, 65,536 (+32,767,-32,768)
Sample Rate:	0.1Hz to 2MHz (10s to 500ns) 4-digit resolution \pm 50ppm accuracy
Transition Time:	< 150ns

(Tested with square wave, filter off, 10Vp-p, 50 Ω termination.)

Spectral Purity: (THD + Noise): -86 dB typical

(Tested with 80kHz measurement bandwidth, 2MHz clock, 2 kHz sine wave, 1000 points, filter on, full amplitude, 50 Ω termination.)

Amplitude and Offset

Range	Resolution	Accuracy
\pm 1.00 to 10V	10mV	1% of setting + 20mV
\pm 100mV to 999mV	1mV	3% of setting + 5mV
\pm 10mV to 99.9mV	100 μ V	5% of setting + 1mV

Note: 50 Ω source impedance, measured at open circuit tested with 1 kHz sine wave plus DC offset.

Analog Filter

User-selectable 700kHz 7th order, 40kHz 3rd order

Operational Modes

Continuous, Triggered, Gated, Burst (1 to 1,048,575), Toggled, Hold, RTS (Return to start).

Outputs

Main Output:	Front-panel/50 Ω impedance.
Sync Outputs:	SYNC 1-SYNC; 4 All fully programmable addresses & widths.
SYNC 1 OUT:	Front-panel (TTL)/50 Ω .
SYNC 2 OUT:	Rear panel BNC (TTL).
SYNC 3 OUT:	Rear panel BNC (TTL).
SYNC 4 OUT:	Rear panel BNC (TTL).
CLOCK IN/OUT:	Rear panel sample clock I/O (TTL).
REF IN/OUT:	Rear panel internal or external 10MHz reference (TTL).
Sync Trigger Out:	Rear-panel BNC (TTL) for multiple unit operation.

Inputs

SUM IN:	SUM IN allows external signal to be added to output. Gain = +1 open circuit at 10k Ω input Z.
TRIG IN:	Rear-panel TTL trigger input for triggered, gated, toggled, and burst modes.
CLOCK IN:	Rear-panel sample clock input (TTL, \leq 4MHz).
REF IN:	Rear-panel 10 MHz reference input. The internal crystal-controlled oscillator will phase-lock to the input.
HOLD IN:	Rear-panel TTL input to stop waveform.
RTS IN:	Rear-panel TTL input to initiate RTS mode.

Trigger Sources

Internal Trigger:	0.02 to 10 seconds
Manual Trigger:	Front-panel button
Ext. Trigger Input:	Rear-panel BNC connector

Creation Tools (Internal)

Waveform Editing:	Point Mode, Line Mode, Vertex Mode; Insert Function, Sum Function, Dump Function, Digital Amplitude/Offset, Smooth, Copy/Paste, Waveform Math (A+B, A-B, AxB).
Pointing Device:	Front-panel keys and knob.
Software:	WaveWorks Pro+™ (Optional)

Stored Settings

Setups:	20 instrument settings
---------	------------------------

Computer Interface

RS-232C:	19.2k Baud, max.
GPIO:	IEEE Std. 488.2-1987 (Optional)

General

Temperature Range:	(73.4°F \pm 5.4°F) 23°C \pm 3°C for specified accuracy
Operates:	32°F to 122°F (0°C to +50°C)
Storage:	-4°F to 140°F (-20°C to +60°C)
Dimensions:	10.14" X 4.53" X 11.81" (25.8 X 11.5 X 30 cm) W x H x D
Weight:	11 lbs (5.0kg)
Power:	55VA; 45W (max) 100/120/220/240VAC, +5%, -10%; 48 to 63Hz.

This data sheet was current when it was produced. However, products are constantly being updated and improved. Because of this some differences may occur between the descriptions herein and the current product. Prices and specifications may be changed without notice.

[BACK TO CONTENTS](#)



YOUR GLOBAL SOURCE FOR TEST AND MEASUREMENT SOLUTIONS

TEN TEGAM WAY • GENEVA, OHIO 44041
440-466-6100 • FAX 440-466-6110
www.tegam.com • e-mail: sales@tegam.com

Model 2414B

ARBITRARY WAVEFORM GENERATORS

- Variable Sample Rate – 0.1S/s to 20MS/s
- 12-bit (0.025%) Resolution
- 4 Fully Programmable Sync Outputs
- 20 Standard Waveforms
- 128k Waveform Memory
- Stores 1000 Custom Waveforms
- Summing Input
- 0.06% Waveform Distortion
- RS-232C
- Options
 - 4,096-Step Sequence Generator
 - WaveWorks Pro+™ Waveform Creation Software
 - GPIB Communications
 - Rack Mount Kit

Signal Integrity

Waveforms will always be consistent and repeatable because the 2414B is a true Arbitrary Waveform Generator. It uses the raster scan technique with sequential addressing of waveform memory and a variable sample clock rate to adjust the output frequency. Other generators use phase accumulator-based addressing which compromises waveform integrity by skipping or repeating waveform data points. Phase-shifted and amplitude-varied waveforms used in complicated sequences are easily generated with the 2414B.

AWG with Extended Memory

Comprehensive Features

The 2414B has an independently variable sample clock that ranges from 0.1S/s to 20MS/s. It offers 12-bit vertical resolution and 128k of active waveform memory. Standard or arbitrary waveforms are created through the front panel or optional WaveWorks Pro+™ software. High-quality signal production and true arbitrary waveform generation make the 2414B an ideal solution for high sample rate, precise-signal applications including MEMS actuators and micro engines, bearing failure assessment, I and Q modulation, biofeedback simulation, multi-phase signal generation, conventional signal generation, and much more.

Function Generator Simplicity

Direct front panel access to 20 standard waveforms with user-definable parameters provides function generator simplicity for general lab applications. For test applications where custom signals are required, up to 1,000 unique waveforms may be stored in waveform memory. Once programmed, all waveforms are available for direct recall and editing from the front panel or RS-232C or GPIB (optional) interfaces.

Programmable Synchronous Outputs

Each 2414B is equipped with four independently-controlled synchronous outputs. Sync outputs allow external instruments, including additional 2414B

units, to be hardware triggered by waveform events. Because each output is fully programmable, multiple sync pulses can be defined at any width or location within waveform memory. Hardware sync is more precise than software sync, enhances system performance, and reduces development time. TEGAM is the only manufacturer that offers programmable synchronous outputs.

Extensive User Tools

Expand the 2414B's memory up to 30,000 times with the optional sequence generator. Each sequence program can have up to 4,096 steps, which can link to any of the 2414B's 1,000 user-defined waveforms. Each waveform may be looped up to one million times per step. Up to one hundred unique sequence programs may be stored in the sequencer's non-volatile memory.

WaveWorks Pro+™ software (optional) is a total software solution for importing, exporting, creation and editing waveform data in up to seven formats including the common ASCII formats .CSV, and .PRN. See the WaveWorks Pro+™ data sheet for more information.

Facilitates the Design of Complex Test Systems

The RS-232C and optional IEEE-488.2 offer direct, easy, programming capability. The 2414B has numerous triggering and timing inputs/outputs for precise, multi-phase operation of several instruments. Up to four slave arbs may be triggered by a single master 2414B. With four sync outputs available from each slave (16 total outputs), numerous instruments can be simultaneously triggered by a single waveform event. Further expansion is limited only by propagation delay.

Warranty

The Model 2414B is backed by a full 3-year warranty and TEGAM's 30-day no risk trial.



Prices and specifications subject to change without notice.

[BACK TO CONTENTS](#)

TEGAM®

YOUR GLOBAL SOURCE FOR TEST
AND MEASUREMENT SOLUTIONS

E

Specifications

Output Waveforms

Up to 1,000 custom waveforms, Sine, Square, Triangle, \pm Sawtooth, DC, \pm Pulse, \pm Exponential, AM, SCM, FM, Lin/Log Sweep, Sin x/x (Sinc), Gaussian, Haversine, Circle, Noise.

4 programmable sync signals per waveform.

Sequence Generator (Optional)

Waveform:	Transient-free Loop-and-Link
Repetitions:	Loop: 1,048,575 times Link: 1,000 waveforms
Program:	4,096 Steps total
File:	100 Sequences

Waveform

Storage:	1,000 Waveforms
Resolution:	Horizontal Points: 128k (131,040) max Vertical Points: 12 bits, 4,096 (+2,047, -2,048)
Sample Rate:	0.1Hz to 20MHz (10s to 50ns) 4-1/2 digit resolution \pm 10ppm accuracy
Transition Time:	< 20ns

(Tested with square wave, filter off, 10Vp-p, 50 Ω termination.)

Spectral Purity: (THD + Noise): -65 dB typical
(Tested with 80kHz measurement bandwidth, 20MHz clock, 20 kHz sine wave, 1,000 points, filter on, full amplitude, 50 Ω termination.)

Amplitude and Offset

Range	Resolution	Accuracy
\pm 1.00 to 10V	10mV	1% of setting + 20mV
\pm 100mV to 999mV	1mV	3% of setting + 5mV
\pm 10mV to 99.9mV	100 μ V	5% of setting + 1mV

Note: 50 Ω source impedance, measured at open circuit tested with 1 kHz sine wave plus DC offset.

Analog Filter

User-selectable 7MHz 7th order, low-pass filter.

Operational Modes

Continuous, Triggered, Gated, Burst (1 to 1,048,575), Toggled, Hold, RTS (Return to start).

Outputs

Main Output:	Front-panel/50 Ω impedance.
Sync Outputs:	SYNC 1-SYNC 4; All fully programmable addresses & widths.
SYNC 1 OUT:	Front-panel (TTL)/50 Ω .
SYNC 2 OUT:	Rear panel BNC (TTL).
SYNC 3 OUT:	Rear panel BNC (TTL).
SYNC 4 OUT:	Rear panel BNC (TTL).
CLOCK IN/OUT:	Rear panel sample clock I/O (TTL).
REF IN/OUT:	Rear panel internal or external 10MHz reference (TTL).
Sync Trigger Out:	Rear-panel BNC (TTL) for multiple unit operation.

Inputs

SUM IN:	SUM IN allows external signal to be added to output. Gain = -2 open circuit and -1 with 50 Ω output termination and 50 Ω input Z.
TRIG IN:	Rear-panel TTL trigger input for triggered, gated, toggled, and burst modes.
CLOCK IN:	Rear-panel sample clock input (TTL, \leq 20MHz).
REF IN:	Rear-panel 10 MHz reference input. The internal crystal-controlled oscillator will phase-lock to the input.
HOLD IN:	Rear-panel TTL input to stop waveform.
RTS IN:	Rear-panel TTL input to initiate RTS mode.

Trigger Sources

Internal Trigger:	0.02 to 10 seconds
Manual Trigger:	Front-panel button
Ext. Trigger Input:	Rear-panel BNC connector

Creation Tools (Internal)

Waveform Editing:	Point Mode, Line Mode, Vertex Mode; Insert Function, Sum Function, Dump Function, Digital Amplitude/Offset, Smooth, Copy/Paste, Waveform Math (A+B, A-B, AxB).
Pointing Device:	Front-panel keys and knob.
Software:	WaveWorks Pro TM (Optional)

Stored Settings

Setups:	20 instrument settings
---------	------------------------

Computer Interface

RS-232C:	19.2k Baud, max.
GPIB:	IEEE Std. 488.2-1987 (Optional)

General

Temperature Range:	73.4°F \pm 5.4°F (23°C \pm 3°C) for specified accuracy
Operates:	32°F to 122°F (0°C to +50°C)
Storage:	-4°F to 140°F (-20°C to +60°C)
Dimensions:	10.14" X 4.53" X 11.81" (25.8 X 11.5 X 30 cm) W x H x D
Weight:	11 lbs (5.0kg)
Power:	55VA; 45W (max) 100/120/220/240VAC, +5%, -10%; 48 to 63Hz.

This data sheet was current when it was produced. However, products are constantly being updated and improved. Because of this some differences may occur between the descriptions herein and the current product. Prices and specifications may be changed without notice.



YOUR GLOBAL SOURCE FOR TEST AND MEASUREMENT SOLUTIONS

[BACK TO CONTENTS](#)

TEN TEGAM WAY • GENEVA, OHIO 44041
440-466-6100 • FAX 440-466-6110
www.tegam.com • e-mail: sales@tegam.com

Model 2416A

ARBITRARY WAVEFORM GENERATORS

- High sample rate – 0.01S/s to 100MS/s
- 12-bit (0.025%) Resolution
- 9 Standard Waveforms
- 64k Point Waveform Memory
- Sequence Generator Included
- Direct Frequency Setting
- Standard GPIB Interface
- Options
 - WaveWorks Pro+™ Waveform Creation Software
 - Rack mount kit

High Speed AWG

Comprehensive Features

The 2416B has an independently variable sample clock that ranges from 0.01S/s to 100MS/s. It offers 12-bit vertical resolution and 68k of active waveform memory. Standard or arbitrary waveforms are created through the front panel or optional WaveWorks Pro+™ software. High-quality signal production and true arbitrary waveform generation make the 2416A an ideal solution for high sample rate, precise-signal applications.

Signal Integrity

Waveforms will always be consistent and repeatable because the 2416A is a true Arbitrary Waveform Generator. Other generators use phase accumulator-based addressing which compromises waveform integrity by skipping or repeating waveform data points.

Function Generator Simplicity

Front panel access to nine standard waveforms and their settings provides function generator simplicity for general lab use. For test applications where custom signals are required, up to 99 unique waveforms may be stored in waveform memory.

Unlike most arbs, the 2416A allows a direct frequency setting of the custom waves from the front panel. Once programmed into the 2416A's memory, all waveforms are available for direct recall and editing from the front panel or standard GPIB interface.

Extensive User Tools

The 2416A's memory capabilities are extended by use of its internal sequence generator. Each sequence program can have up to 99 steps, which can link to any of the 2416A's 99 user-defined waveforms. Each waveform may be looped up to 32,767 times per step. Up to nine unique sequence programs may be stored in the sequencer's non-volatile memory.

WaveWorks Pro+™ software (optional) is a total software solution for importing, exporting, creation and editing waveform data in up to seven formats including the common ASCII formats .CSV, and .PRN. See the WaveWorks Pro+™ data sheet for more information.

Warranty

The Model 2416A is backed by a full 1-year warranty and TEGAM's 30-day no risk trial.

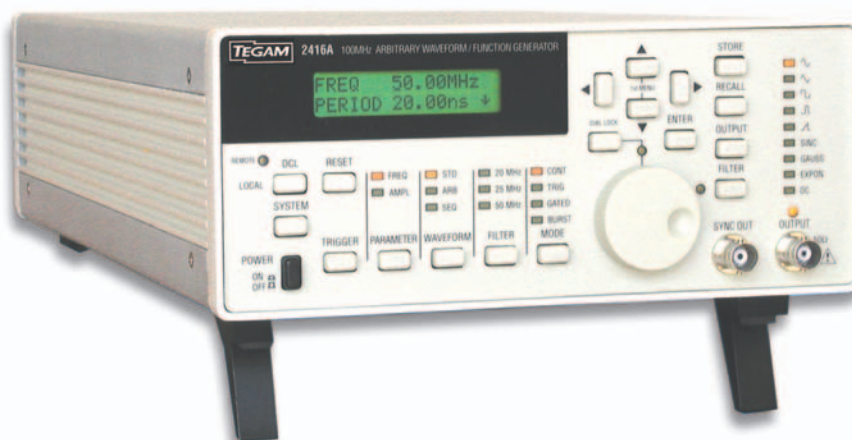

Model 2416A

HIGH SPEED AWG

Output Characteristics

Amplitude: (into 50Ω load)

Range	Resolution	Accuracy
1.00 to 9.99Vp-p	10mV	2%+20mV
100mV to 999mVp-p	1mV	3%+4mV
10mV to 99.9mVp-p	100μV	4%+2mV

Offset: (into 50Ω load)

Range	Window	Accuracy
±0V to 4.50V	±5.0V	2%+1% ampl+20mV
±0V to 450mV	±500mV	3%+1% ampl+5mV
±0V to 45.0mV	±50.0mV	4%+1% ampl+2mV

Filters:

50MHz	7-pole elliptic
25MHz	7-pole elliptic
20MHz	7-pole Gaussian

Squarewave/Pulse:

Rise/fall time: < 5ns. 10% to 90% of amplitude
Aberration: <5%

Synchronous Output:

Front panel TTL, SYNC OUT BNC

Triggering Characteristics

Trigger Input: Rear panel TTL, TRIG IN BNC
Signal: ±10V(max.), width >15ns, pos transition
Sources: Manual, internal, external or bus
Modes: Continuous, triggered, gated, burst (1 to 32,767)
Frequency: External to 10MHz, internal from 20μs to 999s

Internal Synthesizer

Resolution: 4 digits
Accuracy: ± 0.01% of reading
Stability: <100PPM

Functions

Sine: 10 μHz to 50MHz
Distortion: <0.1% below 100kHz
Harmonics: <30 dB below carrier, 100kHz to 50MHz
Flatness: 1% to 1MHz; 5% to 10MHz; 15% to 50MHz
Triangle: 10 μHz to 10MHz, adjustable phase
Square: 10 μHz to 50MHz, adjustable duty cycle
Pulse: 10 μHz to 1MHz, adjustable parameters
Ramp: 10 μHz to 1MHz, adjustable rise/fall times
Sinc (Sin x/x): 10 μHz to 1MHz, 4 to 999 cycles
Gaussian Pulse: 10 μHz to 1MHz, 1000 to 65,535 time constant
Exponential: 10 μHz to 1MHz, 0.01 to 20 time constant
DC: 1% to 100% of amplitude

Arbitrary Waveforms

Memory: 64k points
Wave Segments: 1 to 99
Vertical Resolution: 12 bits (4,096 points)

Sampling Clock

Source: Internal synthesizer, internal reference, external clock
Range: 10mHz to 100MHz
Resolution: 4 digits
Accuracy: 0.01% of reading
Stability: <100PPM

Built-in Utilities

Clear, Fill, Offset, Invert, AM

Sequenced Waveforms

Operation: Loop and Link
Sequences: 1 to 9
Steps: 1 to 99 steps
Repetitions: 0 to 32,767 loops, 99 wave segments

Sampling Clock

Source: Internal synthesizer, internal reference, external clock

Internal Synthesizer

Range: 10mHz to 100MHz
Resolution: 4 digits
Accuracy: 0.01% of reading
Stability: <100PPM

Environmental

Operating Temperature: (32°F to 104°F)
0°C to +40°C, ambient
Specified Accuracy: (68°F to 86°F) +20° to 30°C
Storage Temperature: (-40°F to 86°F)-40° to +60°C
Humidity Range: 80% R.H. non-condensing

Stored Settings

Setups: 10 instrument settings

GPIB Interface IEEE 488.2-1987, SCPI-1993

All front panel controls are accessible via GPIB interface except the power switch.

Subsets: SH1, AH1, T6, TE0, L4, LE0, SR1, RL1, PP2, DC1, DT1, C0

General

Display: 2 line, 16 characters, back-lit LCD
Power: 115/230 Vac, 50/60 Hz, 60 VA max.
Dimensions: 8.3" x 3.5" x 15.4"
(21.1 X 8.89 X 39.1 cm) W x H x D
Weight: Approximately 9 lbs. (4.1 kg)

This data sheet was current when it was produced. However, products are constantly being updated and improved. Because of this some differences may occur between the descriptions herein and the current product. Prices and specifications may be changed without notice.

[BACK TO CONTENTS](#)



YOUR GLOBAL SOURCE FOR TEST
AND MEASUREMENT SOLUTIONS

TEN TEGAM WAY • GENEVA, OHIO 44041
440-466-6100 • FAX 440-466-6110
www.tegam.com • e-mail: sales@tegam.com

Model 2711A

ARBITRARY WAVEFORM GENERATORS

- **Very High-Fidelity - 0.005% Waveform Distortion**
- **16-Bit (0.0015%) Resolution**
- **0.1S/s to 2MS/s Adjustable Sample Rate**
- **Sync Trigger Output for Multi-Phase Operation**
- **Waveform Creation Software Included**
- **10 Standard Waveforms**
- **64k Waveform Memory**
- **Stores 100 Custom Waveforms**
- **RS-232C and GPIB**
- **Options**
 - **100 Step Sequence Generator**
 - **Rack Mount Kit**

Signal Integrity

Waveforms will always be consistent and repeatable because the 2711A is a true AWG. It uses the raster scan technique with sequential addressing of waveform memory and a variable sample clock rate to adjust the output frequency. Other generators use phase accumulator-based addressing, which can skip or repeat waveform data points. The typical THD (total harmonic distortion plus noise) of the 2711A is -86 dB, which makes it ideal for applications sensitive to signal quality. No other arbitrary waveform generator matches the 2711A's price and performance.

Low Cost, 16-Bit AWG

Comprehensive Features

With superior fidelity and wide dynamic range, the 2711A has outstanding performance, offering 16-bit vertical resolution with over 64k of horizontal memory. Standard or arbitrary waveforms are created through the front panel or waveform creation software. The adjustable sample clock ranges from 0.1S/s to 2MS/s. Superior fidelity, low cost, and wide dynamic range make the 2711A ideal for applications involving high precision, low voltage or signal amplification. These include power line harmonics, audio signals, automotive air bags, medical devices and a host of other applications.

Multiple Unit Operation

Each 2711A is equipped with a synchronous trigger output. The synchronous output allows external instruments, including two or more 2711A units, to be hardware triggered by a master 2711A unit. This produces multiple-phase signals with highly accurate phase offsets. Because the 2711A uses the raster scan technique and sequential addressing, there is no need to recalibrate phase offsets every time a frequency change is made. DDS-type generators require this recalibration.

Systems Ready

The Model 2711A is a low cost version of the Model 2411B. It has the same basic performance capabilities but

is designed specifically for systems applications where low cost and performance are valued higher than extended front panel functions. 2711A includes standard RS-232C and GPIB interfaces. WaveWorks™ Jr., wave creation software is also provided at no additional charge. Three multi-phase modes are available to synchronize multiple units for phase sensitive applications.

Function Generator Operation

Direct front panel access to 10 standard waveforms with adjustable parameters provides function generator operation for basic lab use. For test applications where custom signals are required, up to 100 unique waveforms may be stored in waveform memory and recalled via the 2711A's front panel or the included WaveWorks™ Jr. wave creation software.

Effective User Tools

Expand the 2711A's memory capabilities by adding an optional sequence generator. Each sequence program can have up to 100 steps, which can link to any of the 2711A's 100 user-defined waveforms. Each waveform may be looped over one million times per step. Ten unique sequence programs may be stored in the sequencer's non-volatile memory.

WaveWorks™ Jr. is a complete software solution for importing, exporting, creating, and editing waveform data in the common ASCII formats .CSV, and .PRN. Windows™ compatible, it allows full programming access to both the instrument and the sequence generator. WaveWorks Pro+™, advanced wave creation software, is available as an upgrade. See the WaveWorks Pro+™ data sheet for more details.

Warranty

The Model 2711A is backed by a full 3-year warranty and TEGAM's 30-day no risk trial.



Prices and specifications subject to change without notice.

[BACK TO CONTENTS](#)



YOUR GLOBAL SOURCE FOR TEST
AND MEASUREMENT SOLUTIONS

Specifications

Output Waveforms

Up to 100 High-definition custom waveforms, Sine, Square, Triangle, Ramp, DC, Exponential, Haversine, Pulse, Gaussian, Sin x/x (Sinc).

Waveform

Storage: 100 Waveforms
 Resolution: Horizontal Points: 65,500 max
 Vertical Points: 16 bits, 65,536
 (+32,767 to -32,768)
 Sample Rate: 0.1Hz to 2MHz (10s to 500ns)
 4-digit resolution
 ±50ppm accuracy
 Transition Time: < 150ns

(Tested with square wave, filter off, 10Vp-p, 50Ω termination.)

Spectral Purity: (THD + Noise): -86 dB typical

(Tested with 80kHz measurement bandwidth, 2MHz clock, 2 kHz sine wave, 1000 points, filter on, full amplitude, 50Ω termination.)

Amplitude and Offset

Range	Resolution	Accuracy
±1.00 to 10V	10mV	1% of setting + 20mV
±100mV to 999mV	1mV	3% of setting + 5mV
±10mV to 99.9mV	100μV	5% of setting + 1mV

Note: 50Ω source impedance, measured at open circuit tested with 1 kHz sine wave plus DC offset.

Analog Filter

User-selectable 700kHz 7th order, 40kHz 3rd order

Sequence Generator (Optional)

Waveform: Transient-free Loop-and-Link
 Repetitions: Loop: 1,048,575 times
 Link: 100 waveforms
 Program: 100 Steps total
 File: 10 Sequences

Operational Modes

Continuous: Output runs continuously between selected memory address locations.
 Triggered: Output at start point until triggered, then runs once.
 Gated: As triggered except output is continuous until gate signal ends.
 Burst: Each trigger outputs a preprogrammed number of waveforms from 1 to 1,048,575.
 Toggled: Alternate triggers gate the output waveform.
 Master-Slave: For multi-unit operation.
 Cont-Sync: Multiple units run continuously in sync with the master unit.
 Trig-Sync: Multiple units run in sync with the master unit for one cycle when the master unit is triggered.
 Trig-Seq: A tail-chasing mode between the master and the slave unit initiated by triggering the master unit.

Outputs

Main Output: Front-panel/50Ω impedance.
 Sync Output: Front-panel TTL sync output, 50Ω impedance.
 Clock Out: Rear panel AWG waveform sample clock output (TTL). X2 sample clock.
 Reference Out: Rear panel internal 10MHz reference output (TTL).
 Sync Trigger Out: Rear-panel BNC (TTL) for multiple unit operation.

Inputs

TRIG IN: Rear-panel TTL trigger input for triggered, gated, toggled, burst, and master slave modes.
 CLOCK IN: Rear-panel sample clock input (TTL, ≤ 4MHz).
 REF IN: Rear-panel 10 MHz reference input. The internal crystal-controlled oscillator will phase-lock to the input.

Trigger Sources

Manual Trigger: Front-panel button
 Ext. Trigger Input: Rear-panel BNC connector

Creation Tools

WaveWorks™Jr. for Windows™

Operating System: Windows 95, 98, XP, & 2000.
 PC Requirements: 486DX or better with 4MB RAM.
 Interfaces: COM port or National Instruments AT-GPIB card or equivalent.
 Standard Functions: 21
 Math Operation: 6 Operators, 12 Transfer Functions
 Sequence Creation: Optional hardware required
 Waveform Analysis:

Frequency Domain: FFT and IFFT; up to 500th harmonic, graphic display, and tabulation.
 Time Domain: Waveform and digital pattern.
 Edit: Point, Vertex, and Harmonics (FFT and IFFT).

Computer Interface

RS-232C: 19.2k Baud, max.
 GPIB: IEEE Std. 488.2-1987

General

Temperature Range: 73.4°F +/-5.4°F (23°C +/-3°C) for specified accuracy
 Operates: 32°F to 122°F (0°C to +50°C)
 Storage: -4°F to 140°F (-20°C to +60°C)
 Dimensions: 10.14" X 4.53" X 11.81"
 (25.8 X 11.5 X 30 cm) W x H x D
 Weight: 11 lbs (5.0kg)
 Power: 55VA; 45W (max)
 100/120/220/240VAC,
 +5%, -10%; 48 to 63Hz.

This data sheet was current when it was produced. However, products are constantly being updated and improved. Because of this some differences may occur between the descriptions herein and the current product. Prices and specifications may be changed without notice.

[BACK TO CONTENTS](#)



YOUR GLOBAL SOURCE FOR TEST AND MEASUREMENT SOLUTIONS

TEN TEGAM WAY • GENEVA, OHIO 44041
 440-466-6100 • FAX 440-466-6110
 www.tegam.com • e-mail: sales@tegam.com

Model 2714A

ARBITRARY WAVEFORM GENERATORS

- **0.1S/s to 20MS/s Adjustable Sample Rate**
- **12-bit (0.025%) Resolution**
- **Sync Trigger Output for Multi-Phase Operation**
- **Waveform Creation Software Included**
- **10 Standard Waveforms**
- **128k Waveform Memory**
- **Stores 100 Custom Waveforms**
- **0.06% Waveform Distortion**
- **RS-232C and GPIB**
- **Options**
 - **100 Step Sequence Generator**
 - **Rack Mount Kit**

Signal Integrity

Waveforms are always consistent and repeatable because the 2714A is a true arbitrary waveform generator. It uses the raster scan technique with sequential addressing of waveform memory and a variable sample clock rate to adjust the output frequency. Other generators use phase accumulator-based addressing, which can skip or repeat waveform data points. The typical THD (total harmonic distortion plus noise) of the 2714A is -65 dB. No other arbitrary waveform generator matches the 2714A's price and performance.

Low Cost AWG with Extended Memory

Comprehensive Features

High-quality signal production and true arbitrary waveform generation make the 2714A an unmatched combination of price and performance for high sample rate, extended memory applications. The 2714A offers 12-bit vertical resolution with over 128k of horizontal memory. It has a variable sample rate that ranges from 0.1S/s to 20MS/s. This product is ideal for testing I and Q modulation profiles, radar or sonar simulations, complex electromagnetic simulation, ultrasound detector emulation, and a host of other applications.

Multiple Unit Operation

Each 2714A is equipped with a synchronous trigger output. The synchronous output allows external instruments, including two or more 2714A units, to be hardware triggered by a master 2714A unit. This produces multiple-phase signals with highly accurate phase offsets. Because the 2714A uses the raster scan technique and sequential addressing, there is no need to recalibrate phase offsets every time a frequency change is made. DDS-type generators require this recalibration.

Systems Ready

The Model 2714A is a low cost version of the Model 2414B. It has the same basic performance capabilities but is designed specifically

for systems applications where low cost and performance are valued higher than extended front panel functions. 2714A includes standard RS-232C and GPIB interfaces. WaveWorks™ Jr., wave creation software is also provided at no additional charge. Three multi-phase modes are available to synchronize multiple units for phase-sensitive applications.

Function Generator Operation

Direct front panel access to 10 standard waveforms with adjustable parameters provides function generator operation for basic lab use. For test applications where custom signals are required, up to 100 user-defined waveforms may be stored in waveform memory. The waveforms may be recalled via the 2714A's front panel or the included WaveWorks™ Jr. wave creation software.

Effective User Tools

Leverage the 2714A's memory capabilities by adding an optional sequence generator. Each sequence program can have up to 100 steps, which can link to any of the 2714A's 100 user-defined waveforms. Each waveform may be looped over one million times per step. Ten unique programs may be stored in the sequencer's non-volatile memory to produce transient-free output waveforms.

WaveWorks™ Jr. is a complete software solution for importing, exporting, creating, and editing waveform data in the common ASCII formats .CSV, and .PRN. Windows™ compatible, it allows full programming access to both the instrument and the sequence generator. WaveWorks Pro+™, advanced wave creation software, is available as an upgrade. See the WaveWorks Pro+™ data sheet for more details.

Warranty

The Model 2714A is backed by a full 3-year warranty and TEGAM's 30-day no risk trial.



Prices and specifications subject to change without notice.

[BACK TO CONTENTS](#)



YOUR GLOBAL SOURCE FOR TEST
AND MEASUREMENT SOLUTIONS

E

Specifications

Output Waveforms

Up to 100 High-definition custom waveforms, Sine, Square, Triangle, Ramp, DC, Exponential, Haversine, Pulse, Gaussian, Sin x/x (Sinc).

Waveform

Storage:	100 Waveforms
Resolution:	Horizontal Points: 131,036 max Vertical Points: 12 bits, 4,096 (-2,048 to +2,047)
Sample Rate:	0.1Hz to 20MHz (10s to 50ns) 4-digit resolution ±50ppm accuracy
Transition Time:	< 20ns
<i>(Tested with square wave, filter off, 10Vp-p, 50Ω termination.)</i>	
Spectral Purity:	(THD + Noise): -65 dB typical
<i>(Tested with 80kHz measurement bandwidth, 20MHz clock, 20 kHz sine wave, 1000 points, filter on, full amplitude, 50Ω termination.)</i>	

Amplitude and Offset

Range	Resolution	Accuracy
±1.00 to 10V	10mV	1% of setting + 20mV
±100mV to 999mV	1mV	3% of setting + 5mV
±10mV to 99.9mV	100μV	5% of setting + 1mV

Note: 50Ω source impedance, measured at open circuit tested with 1 kHz sine wave plus DC offset.

Analog Filter

User-selectable 7MHz 7th order

Sequence Generator (Optional)

Waveform:	Transient-free Loop-and-Link
Repetitions:	Loop: 1,048,575 times Link: 100 waveforms
Program:	100 Steps total
File:	10 Sequences

Operational Modes

Continuous:	Output runs continuously between selected memory address locations.
Triggered:	Output at start point until triggered, then runs once.
Gated:	As triggered except output is continuous until gate signal ends.
Burst:	Each trigger outputs a preprogrammed number of waveforms from 1 to 1,048,575.
Toggled:	Alternate triggers gate the output waveform.
Master-Slave:	For multi-unit operation.
Cont-Sync:	Multiple units run continuously in sync with the master unit.
Trig-Sync:	Multiple units run in sync with the master unit for one cycle when the master unit is triggered.
Trig-Seq:	A tail-chasing mode between the master and the slave unit initiated by triggering the master unit.

This data sheet was current when it was produced. However, products are constantly being updated and improved. Because of this some differences may occur between the descriptions herein and the current product. Prices and specifications may be changed without notice.

Outputs

Main Output:	Front-panel/50Ω impedance.
Sync Output:	Front-panel TTL sync output, 50Ω impedance.
Clock Out:	Rear panel AWG waveform sample clock output (TTL). X2 sample clock.
Reference Out:	Rear panel internal 10MHz reference output (TTL).
Sync Trigger Out:	Rear-panel BNC (TTL) for multiple unit operation.

Inputs

TRIG IN:	Rear-panel TTL trigger input for triggered, gated, toggled, burst, and master slave modes.
CLOCK IN:	Rear-panel sample clock input (TTL, ≤ 20MHz).
REF IN:	Rear-panel 10 MHz reference input. The internal crystal-controlled oscillator will phase-lock to the input.

Trigger Sources

Manual Trigger:	Front-panel button
Ext. Trigger Input:	Rear-panel BNC connector

Creation Tools

WaveWorks™Jr. for Windows™

Operating System:	Windows 95, 98, XP, & 2000.
PC Requirements:	486DX or better with 4MB RAM.
Interfaces:	COM port or National Instruments AT-GPIB card or equivalent.
Standard Functions:	21
Math Operation:	6 Operators, 12 Transfer Functions
Sequence Creation:	Optional hardware required
Waveform Analysis:	
Frequency Domain:	FFT and IFFT; up to 500th harmonic, graphic display, and tabulation.
Time Domain:	Waveform and digital pattern.
Edit:	Point, Vertex, and Harmonics (FFT and IFFT).

Computer Interface

RS-232C:	19.2k Baud, max.
GPIB:	IEEE Std. 488.2-1987

General

Temperature Range:	73.4°F +/-5.4°F (23°C +/-3°C) for specified accuracy
Operates:	32°F to 122°F (0°C to +50°C)
Storage:	-4°F to 140°F (-20°C to +60°C)
Dimensions:	10.14" X 4.53" X 11.81" (25.8 X 11.5 X 30 cm) W x H x D
Weight:	11 lbs (5.0kg)
Power:	55VA; 45W (max) 100/120/220/240VAC, +5%, -10%; 48 to 63Hz.

[BACK TO CONTENTS](#)



YOUR GLOBAL SOURCE FOR TEST AND MEASUREMENT SOLUTIONS

TEN TEGAM WAY • GENEVA, OHIO 44041
440-466-6100 • FAX 440-466-6110
www.tegam.com • e-mail: sales@tegam.com

Model 2340/2350

ARBITRARY WAVEFORM GENERATORS

- **Precise signal amplification with low distortion**
- **High Voltage Output up to 400Vp-p ($\pm 200V$)**
- **DC-2MHz small signal bandwidth (-3dB)**
- **Full power bandwidth, from DC to 200kHz (-0.1dB)**
- **Single or Dual Channel**
- **Independent 200:1 voltage monitor outputs for each channel**
- **Compatible with all TEGAM Arbitrary Waveform and Function Generators**
- **Compatible with any Signal Generator that can drive a 50 Ω impedance.**
- **Excellent Choice for MEMS, electrostatics, or piezoelectric applications.**

Single/Dual Channel High-Voltage Amplifiers

The Models 2340/2350 are designed for applications that require high-voltage amplification beyond the standard voltage limitations of most waveform, function, or pulse generators.

With a maximum output voltage of 400Vp-p, the Models 2340/2350 come standard with a fixed gain of +50. Gains from 10 to 100 are available by special order.

Each channel is rated for 40mA continuous current with 0.2 Ω output impedance. Each channel has an independent, buffered, voltage monitor output for applications that require a low-level representation of the output signal. The buffers produce a reduction of 200:1 for 50 Ω inputs and 100:1 for 1M Ω and above inputs.

The output current is sensed in both directions by the current limit function. This provides maximum protection to the amplifier during operation. A built-in

power supply monitor protects the power amplifiers by tracking the DC power supply. If a high-voltage DC fault occurs, the monitor will disconnect the power supply from the power amplifiers. Cycling the supply power resets the fault. The amplifiers can drive capacitive loads up to 200pF while maintaining a full power bandwidth exceeding 200kHz.

For maximum user safety, the outputs are grounded to the instrument chassis to prevent accidental voltage loops. A binding post is provided on the front panel for a direct chassis ground connection.

The Models 2340/2350 are cost-effective solutions for specialized applications where low distortion and precise signal amplification is required. These units are particularly suited for high frequency, electrostatic applications that require high voltage.



Model 2340/2350

HIGH VOLTAGE AMPLIFIERS

Specifications

Electrical Specifications

Number of Channels	1 Channel - Model 2340 or 2 Channel - Model 2350
Input Impedance	50Ω Direct Coupled
Output Voltage Range	0 to ± 200V Direct Coupled (400V p-p)
Maximum Output Current	40mA per channel
Output Impedance	< 0.2Ω
Voltage Gain	+50 Fixed (Special Order +10-100)
Sine Wave Distortion (THD)	Refer to Figure 4
Small Signal Bandwidth	DC to 2MHz -Typical (-3dB) - Refer to Figure 1
Full Power	200kHz / 400 Vpp Sine - Typical (-0.1dB) (CL<200pF)
Slew Rate	>250V/uSec
Square Wave Response	< 0.8 μSec for 200 Volt Step
Aberrations	< 2%
50Ω Voltage Monitor Outputs (One for each Channel)	50Ω Input Z (200:1 Ratio) > 1MΩ Input Z (100:1 Ratio)

Safety

Conforms with IEC 61010-1, CE Marked

Environmental

Operating Temperature	0°C to +45°C, (32°F to 113°F) Ambient
Storage Temperature	-20°C to +50°C (-4°F to +122°F)
Humidity Range	< 80% RH Non-Condensing

General

Input Supply Voltage	110/220V 50/60 Hz - Rear Panel Selectable
Power Rating	100VA; 80W
Dimensions: (H x W x L)	4.51" x 10.14" x 11.81" (11.5 x 25.8 x 30.0 cm)
Weight (approximate)	10lbs (4.5kg)

Standard Accessories

User's Manual; 2- BNC to High-Voltage BNC Cables (3ft)

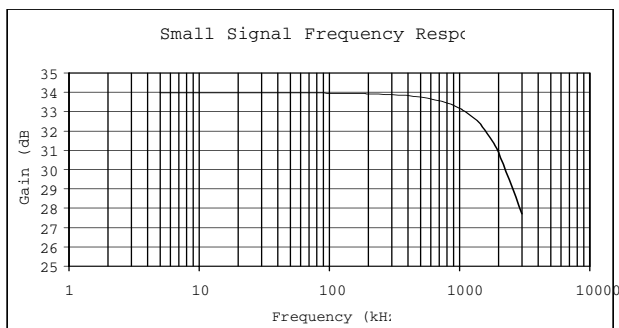

Figure 1: Small Signal Frequency Response (Typical)
Amplifier Gain measured with 900 mV peak-to-peak input. Amplifier Frequency Response (-3 dB) at 2 MHz.

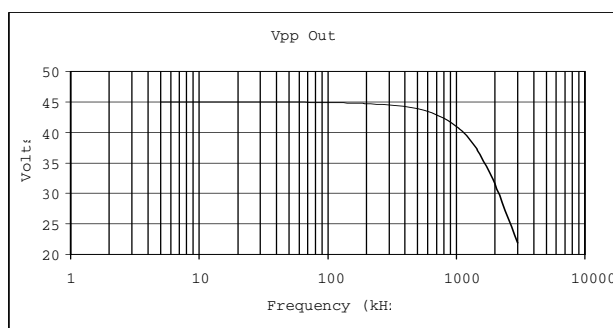

Figure 2: Small Signal Frequency Response (Typical)
Amplifier Gain measured with 900 mV peak-to-peak input. Same as Figure 1 but Y-axis is Volts instead of dB.

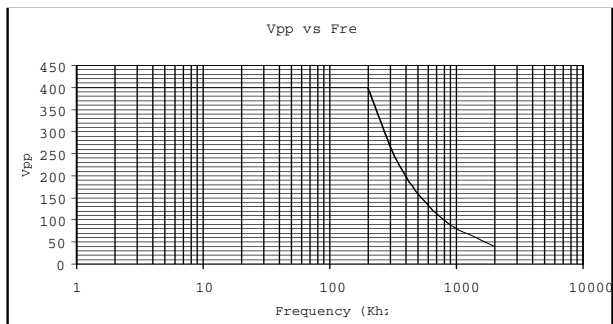

Figure 3: Maximum Vpp vs. Frequency
Amplifier's maximum peak-to-peak output roll off with frequency. This is due to the amplifier's slew rate of 250 V/μSec.

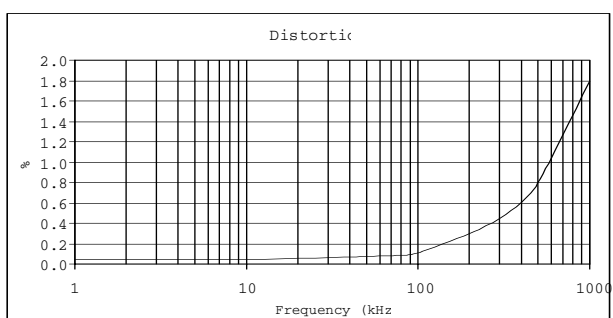

Figure 4: Distortion (Typical)
Distortion measurements were made operating the amplifier at 75% of the maximum Vpp output obtained from Figure 3.

This data sheet was current when it was produced. However, products are constantly being updated and improved. Because of this some differences may occur between the descriptions herein and the current product. Prices and specifications may be changed without notice.



BACK TO CONTENTS

TEN TEGAM WAY • GENEVA, OHIO 44041
440-466-6100 • FAX 440-466-6110
www.tegam.com • e-mail: sales@tegam.com

- Easy to use
- Windows™ Based
- 21 Standard Waveforms
- 12 Math Transfer Functions
- 6 Math Operations
- Sequence Programming
- Digital Patterns
- FFT and IFFT Analysis Tools
- Supports .CSV & .PRN ASCII Data Formats
- Free with purchase of TEGAM 2700 Series Arbs
- GPIB and RS-232C Compatible

Basic Waveform Creation Software for 2700 Series AWGs

Versatile Waveform Solution

WaveWorks™ Jr. is a fundamental software tool used to create, edit, upload, and download arbitrary waveforms to and from your 2700 series arbitrary waveform generators. It turns your computer screen into a virtual waveform palette. WaveWorks™ Jr., with its basic waveform library and complete set of design and editing tools, provides a wide selection of waveforms and waveform sequences. WaveWorks™ Jr. is a basic version of WaveWorks Pro+™ and is included with all 2700 series arbitrary waveform generators at no additional cost.

Comprehensive Waveform Design Tools

In addition to standard waveforms, WaveWorks™ Jr. comes with an array of math operations and transfer functions designed to meet your basic wave shape

requirements. Synthesis in both the time and frequency domain is available by using WaveWorks™ Jr.'s FFT and IFFT routines. A graphical interface is provided for remote operation of your TEGAM 2711A or 2714A, arbitrary waveform generator's controls.

Sequence Programming Capability

One of the features that distinguishes TEGAM arbitrary waveform generators from competitors' models is the programmable sequencer. Sequencing expands an arbitrary waveform generator's memory by linking and looping various waveform segments to produce a continuous waveform output. WaveWorks™ Jr. is used with any of TEGAM's 2700 series arbitrary waveform generators to easily create custom waveform sequences.

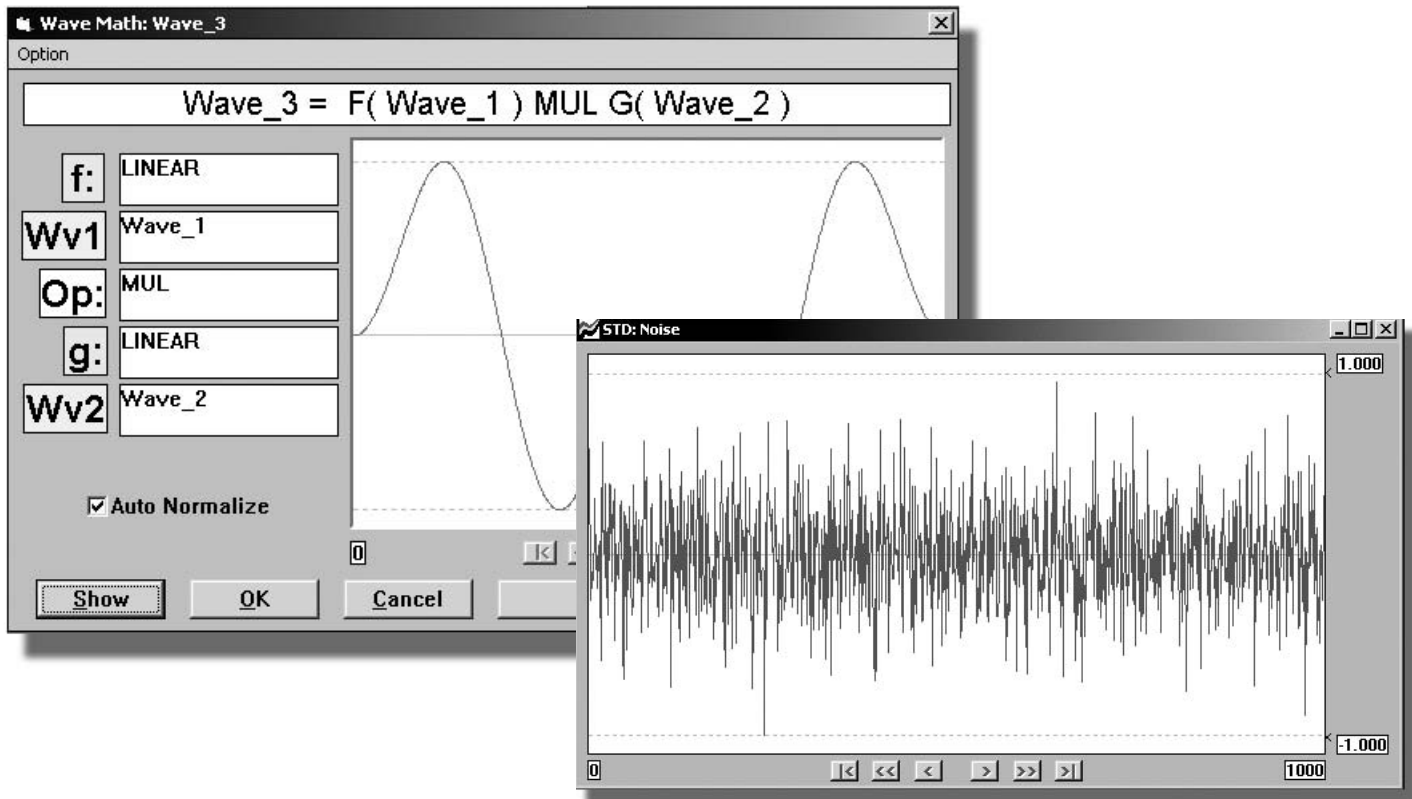

Standard Waveforms

WaveWorks™ Jr. offers 21 standard waveforms with parameter templates to create custom waveforms for your application. The following standard waveform templates are available:

Sine	BPSK	Square	Triangle	DC
Ramp	Squine	Gaussian	Pulse 1	Pulse 2
Digital Noise	Exponential	SinX/X	Continuous Sweep	Steps
AM	FM	PWM	Analog Noise	BFSK
Comb				

Math Transfer Function

12 transfer functions, including integration and differentiation, are available to process waveform data:

Null	Linear	Section	Mirror	DC Cut
Square	Absolute	Polynomial	Rotate	Normalize
Square Root	Log			

Math Operator:

Complex waveforms are readily created by use any of the 6 different math operators:

Addition	Subtraction	Multiplication
Into	Add Into	Cascade

Waveform Analysis/Synthesis

Frequency Domain: FFT and IFFT

- Harmonics: up to 500th harmonic
- Displays: graphic and tabulation
- Entry: tabulation
- Units: Sin-Cos (Ampl), Sin (Ampl-Phase), Cos (Ampl-Phase), Sin (dB-Phase), Cos (dB-Phase)

Other features: random phase entry

Time Domain: Digital Pattern

- Display: graphic
- Edit: mouse

Computer Requirements:

- Operating Systems: Windows 95, 98, XP, and 2000 Operating Systems.
- PC Requirements: 486DX or better processor w/ 4MB RAM
- Interfaces: Serial - COM Port; RS-232C up to 19.2k Baud
GPIB: - National Instruments' AT-GPIB card IEEE standard 488.2-1987

Waveform Generators:

2711A, 2714A

This data sheet was current when it was produced. However, products are constantly being updated and improved. Because of this some differences may occur between the descriptions herein and the current product. Prices and specifications may be changed without notice.

[BACK TO CONTENTS](#)



YOUR GLOBAL SOURCE FOR TEST
AND MEASUREMENT SOLUTIONS

TEN TEGAM WAY • GENEVA, OHIO 44041
440-466-6100 • FAX 440-466-6110
www.tegam.com • e-mail: sales@tegam.com

WaveWorks Pro+™

WAVEFORM CREATION SOFTWARE

- Easy to use
- Windows™ Based
- 33 Standard Waveforms
- 20 Math Transfer Functions
- 13 Math Operations
- Sequence Programming
- Digital Patterns
- FFT and IFFT Analysis Tools
- 8 Data Formats including ASCII (.CSV, .PRN)
- Compatible with TEGAM Arbitrary Waveform Generators
- GPIB and RS-232C Compatible

Advanced Waveform Creation Software for All TEGAM AWGs

Versatile Waveform Solution

WaveWorks Pro+™ is the simplest way to create, edit, upload, download arbitrary waveforms to and from your TEGAM arbitrary waveform generator. It turns your computer screen into a virtual waveform palette. WaveWorks Pro+™, with its extensive waveform library and complete set of design and editing tools, provides unlimited waveforms and waveform sequences when coupled to TEGAM arbitrary waveform generators.

Comprehensive Waveform Design Tools

WaveWorks Pro+™ comes with a comprehensive array of math operations and transfer functions designed to meet your most demanding wave shape requirements. As an added analytical tool, synthesis in both the time and

frequency domain is available by using WaveWorks' FFT and IFFT routines. An instrument interface is also included to allow complete PC operation of your TEGAM arbitrary waveform generator controls via RS-232C or GPIB Interface.

Sequence Programming

TEGAM's arbitrary waveform generators are unique compared to competitor's waveform generators in that they have sequencing capabilities. Sequencing expands an arbitrary waveform generator's memory by linking and looping various waveform segments to produce a continuous waveform output. WaveWorks Pro+™ can be used with any of TEGAM's arbitrary waveform generators to easily create custom waveform sequences.

E

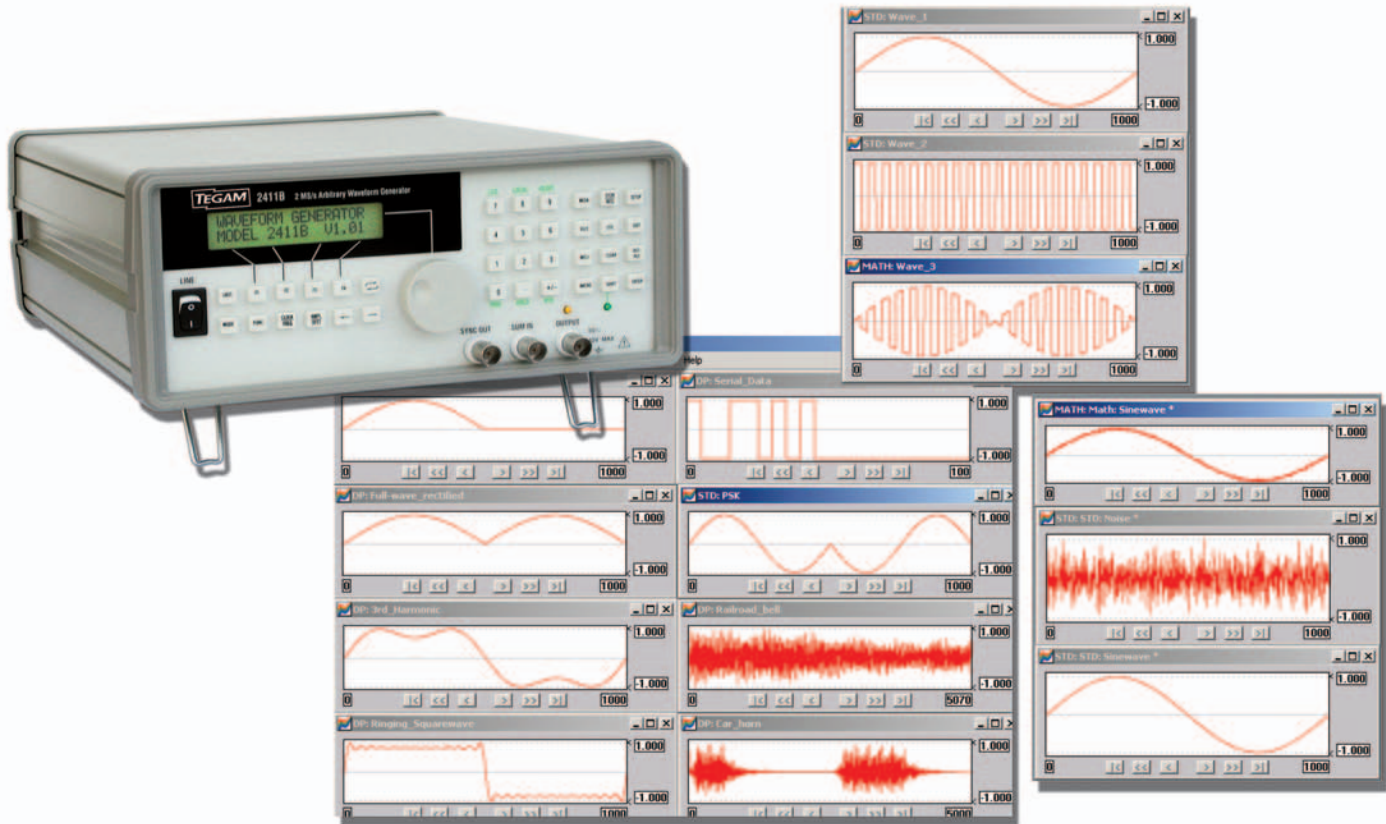

Prices and specifications subject to change without notice.

[BACK TO CONTENTS](#)



YOUR GLOBAL SOURCE FOR TEST AND MEASUREMENT SOLUTIONS

Standard Waveforms

WaveWorks offers 33 standard waveforms that include parameter templates to create custom waveforms for your application. The following standard waveform templates are available:

Sine	Cosine	Square	Triangle	DC
Ramp	Squine	Gaussian	Pulse 1	Pulse 2
VHR Pulse	Exponential	SinX/X	Hanning (SinX/X)	FIR_LPF
AM	FM	PWM	SCM	BFSK
BPSK	Lines	NTSC	PAL	Comb
LPF	Steps	Cardiac	Continuous Sweep	Step Sweep
Burst Sweep	Digital Noise	Analog Noise		

Math Transfer Function

20 transfer functions, including integration and differentiation, are available to process waveform data:

Null	Linear	Section	Mirror	DC Cut
Square	Absolute	Cubic	Band Pass	Normalize
Square Root	Log	Exponential	I-Phase	Rotate
Polynomial	Integration	Differentiation	Q-Phase	I/Q Swap

Math Operator:

Complex waveforms are readily created by use any of the 13 different math operators:

Addition	Subtraction	Multiplication	QAM
Division	Convolution	Cascade	
Into	Add Into	FIR Filter	
AM	PM	FM	

Waveform Analysis/Synthesis

Frequency Domain: FFT and IFFT

- Harmonics: up to 500th harmonic
- Displays: graphic and tabulation
- Entry: tabulation
- Units: Sin-Cos (Ampl), Sin (Ampl-Phase), Cos (Ampl-Phase), Sin (dB-Phase), Cos (dB-Phase)
- Other features: random phase entry

Time Domain: Digital Pattern

- Display: graphic
- Edit: mouse

Computer Requirements:

- Operating Systems: Windows 95, 98, XP, and 2000 Operating Systems.
- PC Requirements: 486DX or better processor w/ 4MB RAM
- Interfaces: Serial - COM Port; RS-232C up to 19.2k Baud
GPIB: - National Instruments' AT-GPIB card IEEE standard 488.2-1987

WaveWorks Pro+ is compatible with the following TEGAM arbitrary waveform generators: 2411A, 2411B, 2414A, 2414B, 2711A, 2714B, 2416A

This data sheet was current when it was produced. However, products are constantly being updated and improved. Because of this some differences may occur between the descriptions herein and the current product. Prices and specifications may be changed without notice.

[BACK TO CONTENTS](#)



YOUR GLOBAL SOURCE FOR TEST AND MEASUREMENT SOLUTIONS

TEN TEGAM WAY • GENEVA, OHIO 44041
440-466-6100 • FAX 440-466-6110
www.tegam.com • e-mail: sales@tegam.com

Model 3525

IMPEDANCE MEASUREMENT INSTRUMENTS

- **0.08% Basic Accuracy**
- **Fast - 15mS Measurement Speed**
- **Compact Size**
- **Easy to Use**
- **Manual or Automated Operation**
- **Better than Agilent at half the price**
- **99 Storable Panel Settings**
- **Built in Comparator Function with External Buzzer**
- **Highly Visible, Dual, 4-1/2 Digit LED Displays**
- **Voltage & Current Monitors**
- **Standard RS-232C & I/O Interfaces**
- **Optional GPIB or BCD Interfaces**
- **3-Year Warranty**

General-Purpose Programmable LCR Meter

The Model 3525 is TEGAM's ultimate solution for applications that require low-cost, high-accuracy impedance parameter testing. Its amazingly flexible design allows it to accommodate a diverse range of testing applications including testing of capacitors, inductors, coils, resistors, materials, thermoelectric cooling devices, piezo-electric sensors and other sensors or components. The instrument is ideal for manual or automated operation.

Nine AC Measurement Parameters

Up to 9 impedance parameters are easily viewed on each of the 3525's two 4-1/2 digit LED displays.

Display A provides accurate and repeatable readings of Inductance (L), Capacitance (C), Resistance (R), or Impedance (|Z|) at a basic accuracy of 0.08%!

Display B indicates measurement values for Dissipation Factor (D or Tan δ), Quality Factor (Q), Phase Angle (θ), Measurement Voltage (V) or Measurement Current (I).

All parameters are selectable from the front panel and may be measured as Series or Parallel equivalents.

Compact

The 3525's compact size is unprecedented and allows side-by-side mounting in standard 19" racks. It measures less than 8" X 4" X 7" (WxHxD) and weighs 5-1/2 pounds. But don't let its size fool you; the 3525 is packed with functionality and value.

Easy to Use

The 3525's user friendliness was implemented as a design specification. Anyone can use this device and begin taking accurate and repeatable readings immediately. The easy-to-use front panel makes instrument operation totally intuitive. There is no need to search hidden submenus to find the instrument's settings. All settings are indicated on the front panel with high visibility LEDs.

Comparator with External Buzzer

A built in GO/NO-GO comparator makes the 3525 an ideal choice for manual verification of component values for QA or manufacturing. An audible beeper increases efficiency by eliminating the need for the user to read the display. Total test time and operator errors are significantly reduced. A front panel lock feature prevents accidental changes of instruments settings.

High Performance at a Low Cost

No other LCR meter has the performance density of the 3525. This innovative solution for cost-sensitive LCR applications is accurate and fast in manual or automated applications. The 3525 performs basic LCR measurements better than Agilent's "most cost effective solution," at less than half its price. The Model 3525 is backed by a full 3-year warranty and TEGAM's 30-day no risk trial. If for any reason you are not satisfied with the performance of the instrument, you can return it for full credit.



Prices and specifications subject to change without notice.

[BACK TO CONTENTS](#)



YOUR GLOBAL SOURCE FOR TEST AND MEASUREMENT SOLUTIONS

F

Model 3525

GENERAL - PURPOSE PROGRAMMABLE LCR METER

Specifications

Comments:

Measurement Parameters

L (Inductance)	L > 1.6000μH - 199.99kH
C (Capacitance)	C > 0.9400pF - 199.99mF
R (Resistance)	R > 0.0100Ω - 199.99MΩ
Z (Impedance)	Z > 0.0100Ω - 199.99MΩ
D (Dissipation Factor / Tan Delta)	D > 0.0001 - 19.999
Q (Quality Factor)	Q > 0.5 - 199.99
θ (Phase Angle)	θ > -180.00° - +180.00°
V (Inter-Terminal Voltage)	V > 0.00V - 1.00V
I (Inter-Terminal Current)	I > 0.00mA - 10.00mA

Measurement Ranges	Ten Programmable Ranges																
Typical Basic Accuracy	0.08%	Dependent Upon Test Variables and Measured Impedance															
Measurement Frequency	1kHz, 120 Hz	±0.01% Frequency Accuracy															
Output Impedance	100Ω ± 10Ω																
Output Amplitude	50mV, 500mV, 1.00V	± (10% ± 10mV) Programmable Test Voltage															
Maximum Short Circuit Current	10mA																
Measurement Ranges	0.1Ω - 100M Ω	10 Ranges - Auto or Manual Modes															
	<i>NOTE: Measurement Ranges are based on Z . Values other than Z are calculated values.</i>																
Measurement Modes	Series or Parallel Equivalent Circuit	Auto or Manually Selected															
Displays	Dual - High Visibility, 4-1/2 Digit LED Displays																
Measurement Speed	<table border="1"> <thead> <tr> <th>MODE</th> <th colspan="2">MEASUREMENT FREQUENCY</th> </tr> <tr> <th></th> <th>120 Hz</th> <th>1kHz</th> </tr> </thead> <tbody> <tr> <td>FAST</td> <td>40mS</td> <td>15mS</td> </tr> <tr> <td>NORMAL</td> <td>90mS</td> <td>50mS</td> </tr> <tr> <td>SLOW</td> <td>360mS</td> <td>250mS</td> </tr> </tbody> </table>	MODE	MEASUREMENT FREQUENCY			120 Hz	1kHz	FAST	40mS	15mS	NORMAL	90mS	50mS	SLOW	360mS	250mS	<i>NOTE: Measurement speed is determined by a number of factors. These are calculated measurement times based on instrument measurement mode and test frequency. There are three user-selectable measurement speeds.</i>
MODE	MEASUREMENT FREQUENCY																
	120 Hz	1kHz															
FAST	40mS	15mS															
NORMAL	90mS	50mS															
SLOW	360mS	250mS															
Trigger	Internal and External Triggering	External Triggering is achieved through the Front Panel, or through rear mounted user interfaces.															
Measurement Terminals	5 Terminal, Kelvin	Configuration: BNC Connectors for Kelvin and a Guard Binding Post															
Zero Offset	Open (>1kΩ) or Short Circuit (<1kΩ) Null																
Comparator	HI-GO-LO	Dual Comparator Functions for A & B Displays															
External Buzzer	Set for PASS/FAIL of Comparator Functions																
Stored Settings	99 Stored instrument Settings	May be stored or recalled through the front panel or remote interface.															
Front Panel Key Lock	User is able to lock the front panel to prevent accidental bumping of the front panel keys.																
User Interfaces	CONTROL I/O Connector RS-232C GPIB (IEEE-488) BCD Interface	Standard Standard Optional PN# 3501 Optional PN# 3502															
Safety	Conforms with IEC 61010-1	CE Marked															
Operating Environment	32° - 104°F (0 - 40°C) @ <80% RH Non-Condensing	Double the measurement errors for conditions outside of this range.															
Storage Environment	14° - 131°F (-10 - 55°C) @ <80% RH Non-Condensing																
Power Requirements - User Selectable	100, 120, 220, & 240 VAC @ 50/60 Hz	Consumption: 20VA ± 10%															
Dimensions	7.88" X 3.94" X 6.70" (20 X 10 X 17 cm)	W X H X D															
Weight	5.5lb (2.5 kg)	Approximate Weight Standard Unit															
Included Accessories	Operation Manual Kelvin Klips Grounded Power Cord	PN # 3525-900-01CD PN # 47454 PN # 161006600															
Options	Radial Lead Adapter Chip Tweezers Chip Test Fixture BCD Interface GPIB (IEEE-488) Interface	PN # 3510 PN # 2005B PN # 3511 PN # 3502 PN # 3501															

This data sheet was current when it was produced. However, products are constantly being updated and improved. Because of this some differences may occur between the descriptions herein and the current product. Prices and specifications may be changed without notice.



Model 3550

IMPEDANCE MEASUREMENT INSTRUMENTS

- **User Selectable Test Frequency from 42.0 Hz to 5.00 MHz.**
- **Fast - 18mS Measurement Speed**
- **0.10% Basic Accuracy**
- **Fully Programmable for Production Line Applications**
- **User Defined Test Voltage and Test Current**
- **16 Measurable Parameters**
- **Absolute or Percentage Comparator**
- **Binning Function Supports 10 Output Bins**
- **Three Highly Visible LED Displays**
- **Standard RS-232C & I/O Interfaces**
- **Optional GPIB or BCD Interfaces**
- **1 - Year Warranty**

42.0 Hz - 5.00 MHz Programmable LCR Meter

The Model 3550 is a fully programmable 42.0 Hz to 5.00 MHz LCR Meter. It is designed for a wide variety of automated or manual testing applications from traditional LCR measurements to frequency characterization of LCR components and materials. All settings are indicated on the front panel with high visibility LEDs. This simplifies setup and programming verification.

Sixteen AC Measurement Parameters

This meter provides accurate and repeatable measurements of 16 different parameters with a basic accuracy of 0.10%. Readings are easily viewed on the three displays.

Display A provides 4½ digit readings of Inductance (L), Capacitance (C), Resistance (R), Impedance (|Z|), or Admittance (|Y|).

Display B indicates 4½-digit measurement values for Dissipation Factor (D or Tan δ), Quality Factor (Q), Equivalent Series Resistance (Rs), Equivalent Parallel Resistance (Rp), Phase Angle (θ), Conductance (G), Reactance (X), or Susceptance (B).

Display C provides a 4-digit reading of the output voltage (V), output current (I) or test frequency (f).

All parameters are easily programmed or selected from the front panel and annunciators clearly indicate the active setting. Measurements can be taken as either series or parallel equivalents.

Designed for Component Testing

With over 4,500 programmable frequency points, accurate frequency characterization of components or materials is straightforward. The three instrument measurement modes (Voltage Mode, Constant Voltage Mode, and Constant Current Mode) allow the user to control the test signal independent of the DUT impedance. A built-in comparator with 10-bin capability makes the 3550 very attractive for binning applications. The user can select either Absolute or Percentage comparator operation and can enable an audible pass/fail buzzer. Changeovers are easy because nine different instrument setups may be stored and recalled from instrument memory and a front panel lock feature prevents accidental changes of instrument settings. RS-232C and I/O connector (TTL) interfaces for handlers or sequencers are standard; a GPIB interface is optional. A wide variety of accessories are available to accommodate various test applications. These include Kelvin Klips, Tweezers for Surface Mount Components, Surface Mount Test Fixtures, Radial/Axial Adapters and more. Programming information and connection instructions are included to simplify integration.

Fast, Accurate and Versatile at a Very Reasonable Price

The 3550 increases production line efficiency because it produces an LCR reading in as little as 18mS. It can measure 16 parameters and produce a reading and a useable comparator output in as little as 40mS. You would expect to pay much more for an LCR meter with this speed and versatility. This unit handles traditional component test, materials characterization, incoming inspection, plus high-frequency profiling applications, too. The 3550 is built with the quality and reliability of all TEGAM products and is backed with a full 1-year warranty.



Prices and specifications subject to change without notice.

[BACK TO CONTENTS](#)



YOUR GLOBAL SOURCE FOR TEST
AND MEASUREMENT SOLUTIONS

F

Model 3550

4 2 . 0 H Z T O 5 . 0 0 M H Z P R O G R A M M A B L E L C R M E T E R

*Depends on the measurement frequency and signal voltage

Specifications

Measurement Parameters

Ls, Lp (Inductance)
Cs, Cp (Capacitance)
Rs, Rp (Resistance)
|Z| (Impedance)
|Y| (Admittance)
G (Conductance)
B (Susceptance)
X (Reactance)
D (Dissipation Factor / Tan Delta)
Q (Quality Factor)
θ (Phase Angle)
V (Inter-Terminal Voltage)
I (Inter-Terminal Current)

Comments:

L > 320nH - 750.0kH
C > 0.160pF - 37.0mF
R > 0.001mΩ - 199.99MΩ*
|Z| > 0.001mΩ - 199.99MΩ*
|Y| > 5.000nS - 100.00S
G > 5.000nS - 100.00S
B > 5.000nS - 100.00S
X > 0.001mΩ - 199.99MΩ*
D > 0.0001 - 9.9999
Q > 0.1 - 1999.9
θ > -180.00° - +180.00°
V > 0.00V - 5.00Vrms
I > 0.00mA - 99.99mA

Measurement Ranges	9 Auto/Manual Ranges	100mΩ, 1Ω, 10Ω, 100Ω, 1kΩ, 10kΩ, 100kΩ, 1MΩ, 10MΩ
Typical Basic Accuracy	0.10%	Dependent Upon Test Variables and Measured Impedance
Measurement Frequency	42.0Hz-5.00MHz	±0.01% Frequency Accuracy
Output Impedance	50Ω ± 10%	
Output Voltage Amplitude	42Hz-1.00MHz: 0.01 - 5.00Vrms 1.01 MHz 5.00MHz: 0.05 - 1.00Vrms	± (10% + 10mV) Programmable Test Voltage ± (20% + 10mV) Programmable Test Voltage
Output Current Amplitude	42Hz-1.00MHz: 0.01 - 99.99mArms 1.01MHz - 5.00MHz: 0.05 - 20.00mArms	± (10% + 10 μA) Programmable Test Current ± (20% + 10 μA) Programmable Test Current
Maximum Short Circuit Current	99.99mA	Open Terminal, Fixed Voltage & Fixed Current Modes
Measurement Modes	Series or Parallel Equivalent Circuit	*Dependent on the measurement frequency Auto or Manually Selected
Displays	Triple - High Visibility, 4½ Digit LED Displays	
Measurement Speed	18mS = Best Measurement Time	<i>NOTE: Measurement speed is determined by a number of factors including RS232, averaging, measurement frequency, auto/manual range, and comparator settings.</i>
Trigger	Internal and External Triggering	External Triggering is achieved by RS232 or GPIB Interface, Front Panel, or Control Connector in Rear of Unit.
Measurement Terminals	5 Terminal, Kelvin	Configuration: BNC Connectors for Kelvin and a Guard Binding Post
Zero Offset	Open (>1kΩ) or Short Circuit (<1kΩ) Null	
Comparator	HI-GO-LO / 10 Sorting Bins	Absolute or % Comparator for Displays A & B
External Buzzer	Set for PASS/FAIL of Comparator Functions	
Stored Settings	9 Stored Instrument Settings	May be stored or recalled through the front panel or remote interface.
Front Panel Key Lock		User is able to lock the front panel to prevent accidental bumping of the front panel keys.
User Interfaces	CONTROL I/O Connector RS-232C GPIB (IEEE-488)	Standard (I/O Port) Standard Optional PN # 3505
Safety	Conforms with IEC 61010-1	CE Marked
Operating Environment	64.4° - 82.4°F (18 - 28°C) @ <80% RH Non-Condensing	Double the measurement errors for conditions outside of this range but within 41.0° - 104°F (5° - 40°C).
Storage Environment	32° - 122°F (0 - 50°C) @ <80% RH Non-Condensing	
Power Requirements - user selectable	100, 120, 220, & 240 VAC ±10% (MAX) 250VAC @ 50/60Hz	Consumption: 40VA MAX
Dimensions	9.85" X 5.83" X 15.75" (250 X 148 X 400 mm)	W X H X D
Weight	15.5lb (7.0 kg) Approximate Weight	
Included Accessories	Operation Manual Power Cord	PN # 3553-9000-1CD PN # 161006600
Options	Chip Tweezers Chip Test Fixture Kelvin Klips Radial Lead Adapter GPIB IEEE-488 Interface	PN # 2005B PN # 3511 PN # 47454 PN # 3510 PN # 3505

This data sheet was current when it was produced. However, products are constantly being updated and improved. Because of this some differences may occur between the descriptions herein and the current product. Prices and specifications may be changed without notice.



[BACK TO CONTENTS](#)

TEN TEGAM WAY • GENEVA, OHIO 44041
440-466-6100 • FAX 440-466-6110
www.tegam.com • e-mail: sales@tegam.com

Model 1750

H I G H S P E E D M I C R O O H M M E T E R

- “TRUE-SPEED” high speed testing capability fast and accurate
- 100 nΩ resolution
- Automatic thermal and electromagnetic noise rejection
- Programmable reference currents
- GPIB, RS-232C & RS-422 compatibility

The TEGAM Model 1750 High Speed Micro Ohmmeter is the first breakthrough in high-speed production test since the laser trimmer. The 1750 is the first fully integrated, multi-mode, bus controllable, high-speed, digital ohmmeter designed to outperform all other ohmmeters and enhance the performance of the world’s fastest laser trimmers and material handlers.

It’s Fast

The 1750 accelerates the high-speed production line with “TRUE-SPEED” performance. In the Fast Mode the 1750 can set-up, zero-out thermal errors, acquire data and make its first reading in less than 12 milliseconds with an accuracy of up to 0.05%! That’s “TRUE-SPEED” performance. Subsequent readings are provided every 10 milliseconds at a true rate of 100 readings per second! “TRUE-SPEED” allows you to maximize the speed of your PLC’s, material handlers and production line machinery.

The 1750 is fast because it provides speed and accuracy while automatically rejecting thermal and line noise. Patented circuitry eliminates thermal and electromagnetic measurement errors caused by contact between device handlers and the device-under-test. The 1750 rejects DC and AC noise offsets while maintaining its high speed test performance. This unique feature is only found on the TEGAM 1750.

It’s High Powered

The 1750’s power is in the user’s ability to quickly configure it through a

High Speed Micro Ohmmeter

selection of standard setup menus. With the 1750 you select your measurement mode, (Resistance, Ohms Comparator or Percentage Comparator), and measurement ranges, (from 2 mΩ to 20 MΩ). You have your choice of reference currents and triggering methods. You can also configure delay times, settling times and automatic thermal and noise rejection.

If you don’t need all this flexibility, just hit the AUTO RANGE button and enjoy the ride!

It’s Easy to Operate

The 1750 is the state-of-the-art programmable ohmmeter that operates via front-panel or over the bus. Clearly labeled multi-function keys provide front panel control of range selection, reading modes, delays, triggers and measurement HOLD. Clear menu driven options provide easy setup for more sophisticated operation, too! The Front panel includes a manual TRIGGER and HOLD function and HI/GO/LO indicators for the open collector TTL output.

It’s Easy to Integrate

The 1750 is unbelievably easy to program. The 1750 contains a full complement of interfaces including IEEE-488, RS-232C and RS-422. To maximize your programming efficiency, each of these interfaces is operated using the same programming command set and front panel indicators to provide continuous status of all operations.

It’s Easy to Calibrate

The 1750 is calibrated using the NIST traceable TEGAM calibration standard Model 17508 and a simple keypad entry procedure. Front panel calibration makes it easy to maintain the 1750 traceability right on the product floor and in less time

than it takes to reload a resistor reel.

It’s Ready for Any Job

The 1750 provides the speed and accuracy desired for automated production test requirements as well as bench top quality control and inspection applications. Not only is the 1750 perfect for high speed production test of low resistance electronic components, but the low current capability and “TRUE-SPEED” performance make the 1750 excellent for dry circuit testing of switches, relays and



G

connector contacts without disturbing the device’s contact surfaces. 1750 fits most resistor, wire, fuse, thermistor and trimmer testing applications.

**For more information contact
TEGAM at 800-666-1010.**

TEGAM[®]

YOUR GLOBAL SOURCE FOR TEST
AND MEASUREMENT SOLUTIONS

Prices and specifications subject to change without notice.

[BACK TO CONTENTS](#)

Model 1750

HIGH SPEED MICRO OHMMETER

TABLE 1:

Full Scale Voltage and Maximum Lead Resistance as a Function of Reference Current

RANGE	RESOLUTION	REFERENCE CURRENT (AVAILABLE SELECTION)							
		1 A	100 mA	10 mA	1 mA	100 μ A	10 μ A	1 μ A	100 nA
2 m Ω	100 n Ω	2 mV							
20 m Ω	1 $\mu\Omega$	20 mV	2 mV						
200 m Ω	10 $\mu\Omega$	200 mV	20 mV						
2 Ω	100 $\mu\Omega$		200 mV	20 mV					
20 Ω	1 m Ω			200 mV	20 mV				
200 Ω	10 m Ω			2 V	200 mV	20 mV			
2 k Ω	100 m Ω				2 V	200 mV			
20 k Ω	1 Ω					2 V	200 mV		
200 k Ω	10 Ω						2 V		
2 M Ω	100 Ω							2 V	
20 M Ω	1 k Ω								2 V

MAX. LEAD RESISTANCE: 500 m Ω 5 Ω 50 Ω 100 Ω 100 Ω 100 Ω 100 Ω 100 Ω

TABLE 2

Delayed Mode Accuracy (In terms of FULL SCALE VOLTAGE)

FULL SCALE VOLTAGE	(\pm) ACCURACY (18-28°C, 1 yr.)
2 mV	0.02% RDG + 5 COUNTS
20 mV	0.02% RDG + 4 COUNTS
200 mV	0.02% RDG + 2 COUNTS
2 V	0.02% RDG + 2 COUNTS
2V (2 M Ω & 20 M Ω ranges)	0.04% RDG + 2 COUNTS

TABLE 3

Temperature Coefficients (In terms of FULL SCALE VOLTAGE)

FULL SCALE VOLTAGE	(\pm) TEMPERATURE COEFFICIENT (0-18°C and 28-50°C)
2 mV	0.004% RDG + 1 COUNT
20 mV	0.004% RDG + 0.5 COUNTS
200 mV	0.002% RDG + 0.1 COUNTS
2V	0.002% RDG + 0.1 COUNTS
2 V (2 M Ω & 20 M Ω RANGES)	0.008% RDG + 0.5 COUNTS

FAST MODE ACCURACY is \pm (0.05% + 5 COUNTS)

Reference Current Modes:

Fast Continuous:

Pulsing reference current (+REF/0), with automatic thermal and noise rejection.

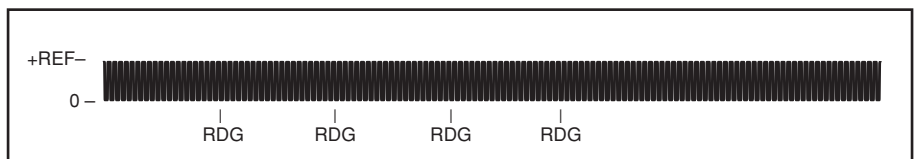

Fast One-Shot:

Triggered single cycle of Fast Continuous Mode.



Delayed Continuous:

Alternating reference current (+REF/-REF) with programmable settling time for reference current and line-cycle digitization.

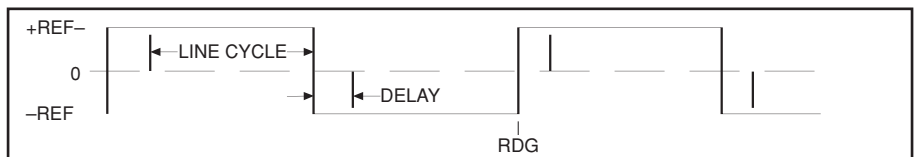

Delayed One-Shot:

Triggered single cycle of Delayed Continuous Mode.

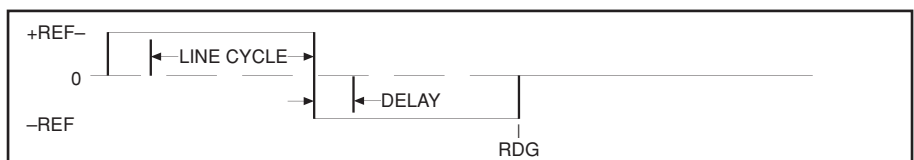

Model 1750

HIGH SPEED MICRO OHMMETER

TABLE 4:

Measurement Times:

FAST MODE v. FULL SCALE VOLTAGE					DELAYED MODE v. FULL SCALE VOLTAGE			
RANGE	2 mV	20 mV	200 mV	2 V	2 mV	20 mV	200 mV	2V
2 mΩ					D			
20 mΩ					D	D		
200 mΩ			10 msec			D	D	
2 Ω			10 msec			D	D	
20 Ω			10 msec			D	D	
200 Ω			10 msec	10 msec		D	D	D
2 kΩ			10 msec	10 msec			D	D
20 kΩ				10 msec			D	D
200 kΩ								D
2 MΩ								D
20 MΩ								D

NOTES:

1. Fast Mode available on range and full scale voltage combinations shown, (10 msec).
2. Delayed Mode available on combinations shown, (D).
3. Delayed Mode Measurement Times = 2x (Line Period + Programmed Delay + 1.7 ms Processing Time). e.g. 60 Hz line frequency and 10 ms delay, Time = 55.0 ms.
4. Delays are programmable from 1 ms to 250 ms in 1 ms increments.

TABLE 5:

Reading Rates:

	MEASUREMENT TIMES	READING RATE	TIME TO FIRST READING
FAST MODE	10 msec	100 rdg/sec	12 msec
DELAYED MODE			
Delay = 1 msec	36 msec	27 rdg/sec	38 msec
Delay = 5 msec	45 msec	22 rdg/sec	47 msec
Delay = 10 msec	55 msec	18 rdg/sec	57 msec

Miscellaneous

- **Display Modes:**
Resistance, Ohms Comparator, % Comparator (Autoranging available in Resistance Mode).
- **Digital Interfaces:**
IEEE-488.1, RS-232C, RS-422, TRIGGER IN and READING DONE via BNC connectors.
- **Display:**
4-1/2 digit alpha numeric readout, 2x16 characters, backlit LCD.
- **Measurement Method:**
4 - terminal connection to the Device-Under-Test, (DUT).
- **Input Connector:**
Heavy duty LEMO type for interface integrity and long life.
- **Input Protection:**
± 15V continuous. ESD protected per IEC-801-2, Level 1.
- **Overload Current:**
Delay Mode: 100% overshoot, <25 μ sec.
Fast Mode: 200% overshoot, <30 μ sec.
- **Noise Rejection:**
60 dB typical at line frequency.

Time to First Reading:

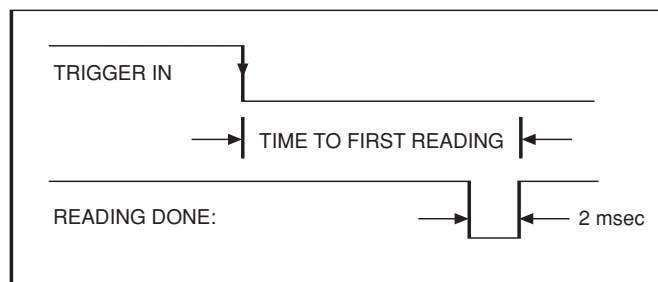

- **Environmental:**
Operating: 0 to 50°C, <80% RH; Storage: -35 to 60°C, <95% RH.
- **EMC:**
CE Class A: EN 55011, IEC; 801-2, IEC801-3.
- **Power:**
<50 VA, 120/240 VAC ± 10%.
- **Dimensions:**
Height, 5.2" (13.3 cm); Width 8.5" (21.7 cm);
Depth, 13.0" (33.0 cm).
- **Weight:**
9 lb. 4 oz. (4.2 kg).
- **Calibration:**
Full front panel calibration requires no internal adjustments and can be easily achieved on the production floor. Recommended calibration equipment is TEGAM Model 17508 Calibration Standard or equivalent. Calibration requires temporary addition of a jumper on internal PC board.

Prices and specifications subject to change without notice.

[BACK TO CONTENTS](#)



YOUR GLOBAL SOURCE FOR TEST AND MEASUREMENT SOLUTIONS

Model 1750

H I G H S P E E D M I C R O O H M M E T E R

Accessories:

17501 Kelvin Klips allow you to make solid four-terminal connections to leaded components. This set is provided as a standard accessory with the 1750 and is particularly useful for hand testing resistors. Four-terminal measurement techniques allow precision measurements by avoiding the effects of lead resistance. Gold-plated, hardened beryllium-copper jaws ensure low contact resistance, low thermal emf to copper, high corrosion resistance and long life.

17502 Spade Lug Adapter is an optional cable set for the 1750. Instead of clips it has spade lugs for connection to binding posts and peripheral equipment.

17503 Sorting Fixture holds components for test while providing four-terminal connection. Its holding clips rotate 90 degrees to accommodate axial and radial leaded components alike. Holders may also be adjusted from 0.75", (1.90cm) to 3.0", (7.62cm) apart allowing use of the fixture with many component sizes and configurations. Terminal contact pressure is also adjustable. Pressure may be reduced for easy insertion of components with small gauge leads. Contacts are gold-plated beryllium-copper.

17504 Kelvin probes allow the measurement of surface resistance. Each probe has two spring loaded pins spaced 1/8" apart. Pins are replaceable.

17505 Male LEMO Connector and Strain Relief is an optional accessory that allows you to interface your existing handlers or probe sets to the new 1750 Resistance Measuring System.

17508 Calibration Standard is a convenient calibration standard that makes calibrating your 1750 quick, easy and accurate. The NIST traceable 17508 provides easy connections and provides a discrete standard for each of the 1750's 11 resistance ranges.

Ordering Information:

- **1750** Resistance Measuring System includes: Model 17509 Operation & Service Manual, 17501 Kelvin Klip Set and NIST Traceable Certificate of Calibration.
- **17501** Kelvin Klip Set
- **17502** Spade Lug Adapter
- **17503** Sorting Fixture
- **17504** Kelvin Probes
- **17505** Male LEMO Connector & Strain Relief
- **17508** Calibration Standard
- **17509** Operation & Service Manual
- **Opt. Z540** Calibration Data Report & NIST Traceable Certificate of Calibration

Call us toll-free at TEGAM at 800-666-1010 for more information on the 1750 or to schedule a FREE 30 Day Evaluation!

This data sheet was current when it was produced. However, products are constantly being updated and improved. Because of this some differences may occur between the descriptions herein and the current product. Prices and specifications may be changed without notice.



Voltmeters Combine Safety with Productivity



These meters automatically test AC and DC volts, null induced voltages, withstand 2,500 volts, and are virtually foolproof. Routine power measurement is never routine. TEGAM's Voltmeters prevent lost-time accidents. Whether you're measuring voltage, locking out equipment, testing or troubleshooting, TEGAM's voltmeters are the safest you can buy. All models have the voltage measuring capabilities of a DMM while fully protecting the user and the instrument against operator errors. There is only one control – an ON/OFF switch. Since there are no functions or ranges to select, the user can't select the wrong one. Testing is fast and easy because the unit automatically checks for AC and DC voltages. When the easy to read display says 000, the line is clear – absolutely. The 36" test leads are permanently secured, yet replaceable. The probes feature unique safety resistors and shock collars. With the best overall protection in the business, TEGAM meters won't blow up or melt down. All models are Underwriters Laboratories approved.

The original Model 110A Safety Voltmeter is designed for voltage troubleshooting. With a range of 1,000 volts, it's more versatile than the Wiggy®, and more accurate than the Simpson 260®. It has 1M ohms of resistance in each lead to protect the user and is designed to take 2,500 volts and keep on working. This meter is ideal for line clearing and TPM and Skills Transfer programs. Customers have reported huge cost savings including thousands of man hours of productivity improvements and reduction of electrical accidents. Meets Category III Overvoltage

protection under UL-3111-1 (IEC-1010-1).

The Voltman eliminates "phantom" voltage readings. This Model 120 represses capacitance effects that occur during utility meter-based checks and other situations where powered and unpowered cables are in close proximity. It verifies line voltages from 0-750 volts while preventing false readings. This boosts productivity of meter installers and repair personnel by eliminating guesswork.

If you need a continuity function or if harmonics are a problem, the Voltman TRMS is for you. Non-sinusoidal waveforms from variable speed motors cause problems for most voltmeters, but the Model 125 provides accurate, dependable readings of distorted waveforms. When there is no voltage present, the unit automatically tests for continuity, ground faults or shorts. Plus, it has all the features of the Model 120.

The Model 122 has the same specifications and functions as the Model 120, but has a continuity tester, a backlit display and audible tone for AC/DC continuity.

All Models also feature:

- Molded-on probes with retractable probe tip covers
- Dual-probe holder with positive lock probe extension for safe, easy, two-hand operation
- Splash proof, dust proof, and withstands 6 ft. drop to concrete
- Auto power off
- Automatic selection ACV or DCV
- One Range – No ranges or functions to select
- Safety and Productivity at an affordable price

SPECIFICATIONS

ACCURACY: ± (0.2% rdg + 1 volt) DC and 50/60 Hz
 RESOLUTION: 1 volt
 ENVIRONMENTAL OPERATING LIMITS: -10°F to +150°F
 DISPLAY: 0.5" LCD, 3 1/2 digits, annunciators for, VAC, VDC, OL, polarity, and low battery
 SIZE, WEIGHT: 6.3" x 2.7" x 1.2", 12 oz.
 WARRANTY: 1 year materials and labor

Wiggy is a registered trademark of Square D Company

Simpson and 260 are registered trademarks of Simpson Electric Co.

ORDERING INFORMATION

MODEL	110A	120	122	125
RANGE VOLTS AC and DC (±):	1,000	750	750	750
MAXIMUM INPUT CONTINUOUS:	1,000	750	750	750
INPUT RESISTANCE:	10MΩ	5KΩ	5KΩ	5KΩ
OVERLOAD TEST VOLTS TRMS (<5 sec.)	2,500	F.S.	F.S.	F.S.
REJECTION OF CAPACITIVE COUPLED INPUTS:	NA	1500pF	1500pF	1500pF
CONTINUITY TEST:	NA	NA	YES	YES

This data sheet was current when it was produced. However, products are constantly being updated and improved. Because of this some differences may occur between the descriptions herein and the current product. Prices and specifications may be changed without notice.



[BACK TO CONTENTS](#)



YOUR GLOBAL SOURCE FOR TEST AND MEASUREMENT SOLUTIONS

Voltmeter Accessories

ELECTRICAL SAFETY METERS



Leather Utility Belt Carrying Case

The 1104 case protects your voltmeter and probes from broken displays and other damages that can occur. This case has a 2" belt loop. It is long lasting, super durable, and is made from top-grain cowhide with riveted seams.

Cordura Nylon lineman's Carrying Case

The 1204 case protects your voltmeter and saves you time because the meter can stay in the case during use. The 1204 features a window to access the ON/OFF switch, a retainer that holds the meter in place, space for probe storage and a 22" shoulder strap. Designed specifically for linemen, the strap can be hung on a nail or unsnapped and put around a pipe or pole, freeing both hands to take measurements. When you have to go out at night, or your meter gets misplaced, the bright yellow cordura nylon case is easy to see. The 1204 case also comes with a belt clip and can be worn on a utility belt.

Overall size is 5 1/2" W x 7 1/2" H x 1 1/2" D.

Probe Adapter Kits

The 12501 probe adapter kit allows you to convert your test leads to alligator clips. The kit includes two screw-on probe adapters and two heavy duty screw in alligator clips with insulating rubber boots. These alligator clips open to 1/2" and fit most terminals and bus bars.

The 12502 probe adapter kit includes two screw-on probe adapters and interchangeable screw-in accessories including two alligator clips with insulating rubber boots, two banana plugs, two needle tips, two spade lugs and two heavy duty tips. With this kit you can adapt your voltmeter to the many different situations you encounter on the job.

ORDERING INFORMATION

MODEL 1104

ORDERING INFORMATION

MODEL 1204

ORDERING INFORMATION

MODEL	DESCRIPTION
12501	Alligator Clip Adapter
12502	Universal Adapter

This data sheet was current when it was produced. However, products are constantly being updated and improved. Because of this some differences may occur between the descriptions herein and the current product. Prices and specifications may be changed without notice.

Electrical Safety Meters

ELECTRICAL SAFETY METERS



SPECIFICATIONS AND ORDERING INFORMATION

MODEL: T-470	RANGE: 115 TO 700V, 400Hz
T-471	115 to 700V, 50/60Hz
MR-1	9V Maximum
DIMENSIONS:	(All PSIs) 1.25" x 1.50" x 2". Net weight 4 oz.
MR-1	2.125" x 3.25" x 1.125". Net weight 4 oz.
LEADS:	24" leads with 1/2" heavy duty test clips
ACCESSORIES SUPPLIED:	Instructions
ACCESSORIES AVAILABLE:	8668 vinyl carrying case

Prevent Costly Damage

TEGAM's Phase Sequence Indicators show installers and servicepeople the correct way to make three-phase connections and prevent costly damage. Working where power is on, TEGAM's Phase Sequence Indicators instantly and clearly identify A/B/C circuits. There's no more guesswork, no more damage to motors, machinery, switchgear or accessories. TEGAM indicators have both an ABC lamp and a BAC lamp. Just connect the Red/White/Blue test leads to the three phase circuit. When correctly connected, the ABC lamp glows. A reversed sequence lights the BAC lamp. An open phase lights both lamps at 200 volts. It's that easy, that fast.

TEGAM's Motor Rotation Indicator prevents costly motor damage by showing rotation direction before connections are made. TEGAM's Motor Rotation Indicator (MR-1) eliminates guessing and the unsafe, damaging practice of "bumping" to determine which way a three-phase motor shaft rotates. Just connect the Motor Rotation Indicator's Red/White/Blue (ABC) test clips to the motor and turn the shaft in the direction you want it to rotate. Push the test button and the ABC or BAC light comes on, showing the correct way to connect the motor to the power source.

- Saves time; no need to disconnect drive shaft couplings
- Eliminates guesswork; protects user and equipment
- Identifies open windings
- Reliable, solid state components
- Test clips open 1/2" to fit most terminals
- Shirt-pocket size
- One-year warranty

This data sheet was current when it was produced. However, products are constantly being updated and improved. Because of this some differences may occur between the descriptions herein and the current product. Prices and specifications may be changed without notice.

[BACK TO CONTENTS](#)

TEGAM[®]

YOUR GLOBAL SOURCE FOR TEST
AND MEASUREMENT SOLUTIONS

Innovative Handheld Digital Thermometers



TEGAM's 820 Series Thermometers are easier to use, more accurate, and provide more functions than any competitive unit at any price, including Fluke's 50 series. Easy to use because every function is controlled by its own accessible front panel key. Easy to understand because the status of every function is shown on the display. Easy to program because one touch of the user friendly keypad changes TC type from K to J to T. One touch changes °F to °C. One touch begins or ends min. max. data recording, views recorded data, or holds the display. It's easy to repeat procedures because the unit retains the functions you've selected even when turned off. The dual input models allow you to view T1, T2, or T1 minus T2, or to continually scan all three modes. Their six data logging registers automatically record the minimum and maximum temperatures of all three modes simultaneously.

These thermometers are more accurate, with accuracies of 0.1% and a resolution of 0.1° full range in °F and °C. You get fast, accurate and repeatable readings, and an unmatched two year

calibration guarantee to prove it.

All models conform to the temperature/voltage tables of the National Institute of Standards and Technology and to IEC 584 standards.

"One-Touch" keys let you:

- Change TC types (K, J, T)
- Change resolution from 0.1° to 1°
- Switch to °F or °C
- Hold display values

"One-Touch" keys on TEGAM's 820/821 also let you:

- View or continuously scan T1, T2 and T1 minus T2
- Record min-max data
- View recorded data
- Scan recorded data

All Models also feature:

- Exceptional accuracy: 0.1% with 0.1° resolution °F and °C
- Repeatability 0.2% typical
- 6 Data logging registers
- Trend indicators on 820/821 show rising, falling, or stable temperature
- Annunciators display status of all functions
- Self-diagnostics show low battery, open TCs, overrange, or internal hardware faults
- Drop-proof, dust-proof, and splash-proof ABS case
- NIST traceable certificate of calibration available upon request
- Two-year calibration guarantee, three-year warranty

These thermometers are extraordinary

ORDERING INFORMATION

MODEL	TC TYPES	INPUTS
819	K, J, T	One
820	K, J	Two
821	K, J, T	Two

SPECIFICATIONS

ACCESSORIES SUPPLIED: Integral tilt stand/handle, wrist strap, 9V battery, manual, two 8712 probes with 820/821 (one 8712 probe with 819).

ACCURACY: ± (0.1% rdg + 0.6°C)

RESOLUTION: 0.1/1°F OR °C

REPEATABILITY: ± 0.2°C (0.36°F) typical

THERMOCOUPLES:	RANGE	TYPE K	TYPE J	TYPE T
	°F	-328 to 2502	-346 to 1400	-328 to 752
	°C	-200 to 1372	-210 to 760	-200 to 400

DISPLAY: 5-digit LCD, 0.4" high

DIMENSIONS: 7" x 2.9" x 1.1". Net weight 10 oz.

This data sheet was current when it was produced. However, products are constantly being updated and improved. Because of this some differences may occur between the descriptions herein and the current product. Prices and specifications may be changed without notice.



[BACK TO CONTENTS](#)



YOUR GLOBAL SOURCE FOR TEST AND MEASUREMENT SOLUTIONS

Thermometers

DIGITAL THERMOMETERS AND PROBES

- Probe features a robust “pistol-grip” ergonomic design
- Accurate, easy to use
- Probe is available in 12”, 18”, and 24” lengths
- Ideal for measuring the temperature of soups, brines, and combo boxes

Heavy Duty Food Processing Thermometer

Temperature quality control in the food-processing environment requires highly rugged thermometers that are accurate and easy-to-use. To address these demands TEGAM introduces the new model 86104 heavy-duty temperature probe and model 874 digital thermometer.

The new 86104 probe features a robust “pistol-grip” ergonomic design and a ruggedized penetration sheath to reduce user fatigue, and increase durability. The 86104 is available in 12”, 18”, and 24” lengths to suit a variety of pro-

cessing plant applications including soups, brines, and especially, combo-box testing.

The 874 digital thermometer is easy to use and provides the durability and accuracy needed for food quality control. The 874 is built with a shock-proof, splash-proof, high-impact ABS case and is available in either °F or °C scales to make a perfect companion for the 86104 series of probes.



Specifications

MODEL	TC TYPE	RANGE	RESOLUTION	ACCURACY
874F	K	°F -40 TO 199.9 °F-120 TO 199.9	0.1° 1°	±(0.5% rdg + 1°F) ±(1% rdg + 2°F)
874C	K	°C-40 TO 199.9 °C-85 TO 1100	0.1° 1°	±(0.5% rdg + 0.5°C) ±(1% rdg + 1°C)

Repeatability:	0.3°F
Dimensions:	6.3” x 2.7 x 1.2”
Display:	3½-digit LCD, .5” high
Net weight:	7.5oz
Available in:	86104-12 K-12” long (Max 700°F) 86104-18 K-18” long 86104-24 K-24” long
Response Time:	0° to 66.6° F in 3 sec.
Description:	304 SS, Pistol Grip, 24: PVC/PVC Cord with male mini TC plug

This data sheet was current when it was produced. However, products are constantly being updated and improved. Because of this some differences may occur between the descriptions herein and the current product. Prices and specifications may be changed without notice.



Thermocouple Thermometers

DIGITAL THERMOMETERS AND PROBES

General Purpose Digital Thermometers

Select a low cost Thermometer in TC type K or J, and get all the accuracy and resolution you need for routine work. We make these easy-to-use thermometers for people whose everyday needs call for basic temperature measurement accuracy and resolution. We build these thermometers with a high-impact ABS case that's shock-proof and splash-proof for tool box durability. We back them with a full one-year warranty. Check the application chart below to see which of these low cost thermometers suits your specific needs.



SPECIFICATIONS

ACCESSORIES SUPPLIED: 9V battery and manual.

MODEL	TC TYPE	RANGE	RESOLUTION	ACCURACY
874F	K	°F-40 to 199.9 °F-120 to 1999	0.1° 1°	± (0.5%rdg + 1.0° F) ± (1%rdg + 2° F)
874C	K	°C-40 to 199.9 °C-85 to 1100	0.1° 1°	± (0.5%rdg + 0.5° C) ± (1%rdg + 1° C)

REPEATABILITY: 0.3°F

DISPLAY: 3½-digit LCD, .5" high

DIMENSIONS: 6.3" x 2.7" x 1.2". Net weight 7.5 oz.

ACCESSORIES AVAILABLE: 8660 tilt stand/belt clip, 8668 vinyl case, 1104 leather case

Accurate Digital Thermometers with Analog Output

TEGAM's 871A/872A, the recognized industry standards, are the only handheld digital thermometers with analog output, plus dual input and easy-to-use rotary switches. These thermometers are the only handhelds whose 1mV per °C analog output can be directly linked to recorders and computers.

- Wide-application accuracy: 0.25% of reading
- Dual thermocouple inputs
- One-hand operation: Upper rotary switch selects °F or °C and 1° or 0.1° resolution; lower rotary switch enables fast comparisons of two temperature points
- Big, bright 3½ - digit LCD display, with low battery and open probe indicators
- 871A accepts type K thermocouples: 872A accepts type J
- Rugged ABS plastic case
- Two-year warranty

ORDERING INFORMATION

MODEL	TC TYPES	INPUTS
871A	K	Two
872A	J	Two



SPECIFICATIONS

ACCESSORIES SUPPLIED: 8712/8722 probe, 9V battery, manual

ACCURACY: ± (0.25% of reading + 1°C)

RESOLUTION: 0.1° to 200°; Full Range

REPEATABILITY: ±0.2° C

THERMOCOUPLES:	RANGE	TYPE K	TYPE J
	°F	-40 to 1999	-40 to 1400
	°C	-40 to 1370	-40 to 760

DISPLAY: 3½ - digit LCD, 0.6" high

DIMENSIONS: 7.0" x 3.1" x 1.6". Net weight 10.6 oz.

ACCESSORIES AVAILABLE: 8668 vinyl carrying case.

This data sheet was current when it was produced. However, products are constantly being updated and improved. Because of this some differences may occur between the descriptions herein and the current product. Prices and specifications may be changed without notice.



[BACK TO CONTENTS](#)



YOUR GLOBAL SOURCE FOR TEST AND MEASUREMENT SOLUTIONS

Thermocouple Probes

DIGITAL THERMOMETERS AND PROBES

Wire Thermocouple Probes: For gas, surface or liquid measurements. These 3-ft. long probes have fiberglass-insulated, 24-ga. wires welded at the tips. (6-ft. long/8712-6). Time constant: 1 sec. Accuracy: $\pm 2.2^{\circ}\text{C}$ or $\pm 0.75\%$

TC TYPE	MAX TEMP	MODEL
K	900° F/480° C	8712
K	900° F/480° C	8712-6

General Purpose Probes: For measuring liquids, gases, or small-area surfaces. Sheath: 304 SS. 3-ft. vinyl-clad straight cord. Time constant: 1 sec. Accuracy: $\pm 2.2^{\circ}\text{C}$ or $\pm 0.75\%$

TC TYPE	MAX TEMP	MODEL
K	1650° F/900° C	8713
J	1400° F/760° C	8723

Penetration Probes: Ideal for measurement of meats, plastics, and other semi-soft materials. Sheath: 304 SS. 1 $\frac{1}{2}$ -ft. (ext. 5-ft.) coil cord with Thermoplastic Rubber jackets. Time constant: 2 sec. Accuracy: $\pm 2.2^{\circ}\text{C}$ or $\pm 0.75\%$

TC TYPE	MAX TEMP	MODEL
K	1650° F/900° C	8714A

Surface Probes: For monitoring hot plates, furnaces, molds and other hot solid surfaces. Exposed thermocouple junction provides quick response upon direct contact. Sheath: 304 SS. 3-ft. vinyl-clad straight cord. Time constant: 3 sec. Accuracy: $\pm 2.2^{\circ}\text{C}$ or $\pm 0.75\%$

TC TYPE	MAX TEMP	MODEL
K	750° F/400° C	8715

Air/Gas Probes: For measuring atmospheres in hoods, ducts and vents. Perforation pattern in shield is designed to prevent radiation-induced tip heating so air/gas temperature measurements are more accurate. Sheath: 304 SS. 3-ft. straight cord. Time constant: 3 sec. Accuracy: $\pm 2.2^{\circ}\text{C}$ or $\pm 0.75\%$

TC TYPE	MAX TEMP	MODEL
K	570° F/300° C	8716

Compact General Purpose/Immersion Probes: Multi-purpose, for measuring air, liquids, soft materials, e.g., water, ice cream, etc. Sheath: 316 SS. TPR coil cord 1 $\frac{1}{2}$ -ft (ext. 5-ft.). Time constant: 1 sec. Accuracy:

TC TYPE	MAX TEMP	MODEL
K	390° F/200° C	8733
T	390° F/200° C	8753

8733 $\pm 2.2^{\circ}\text{C}$ or $\pm 0.75\%$
8753 $\pm 1.0^{\circ}\text{C}$ or $\pm 0.75\%$

Compact Penetration Probes: For measuring semi-soft materials within a restricted temperature range. Sheath: 316 SS. TPR coil cord 1 $\frac{1}{2}$ -ft. (ext. 5-ft.). Time constant: 1 sec. Accuracy: $\pm 2.2^{\circ}\text{C}$ or $\pm 0.75\%$

TC TYPE	MAX TEMP	MODEL
K	390° F/200° C	8734

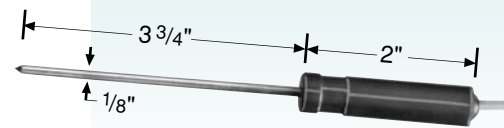
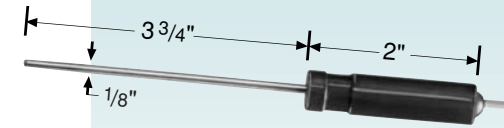
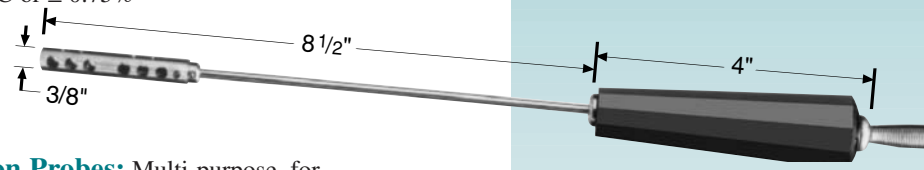
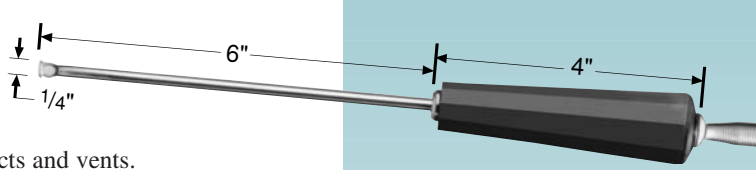
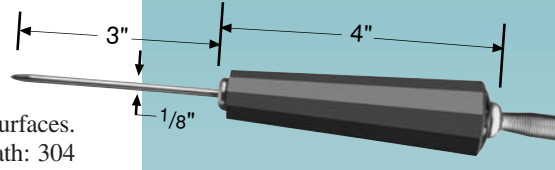
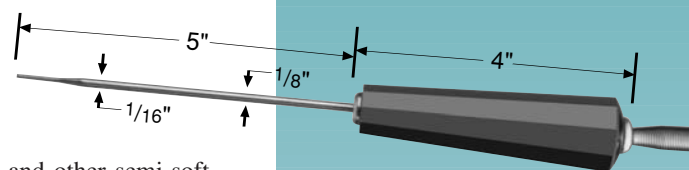

This data sheet was current when it was produced. However, products are constantly being updated and improved. Because of this some differences may occur between the descriptions herein and the current product. Prices and specifications may be changed without notice.

RTD/Thermistor Thermometers

DIGITAL THERMOMETERS AND PROBES



TEGAM's 865/866 2252Ω thermistor thermometers: Your best choice for lab-accurate temperature measurement in a built-tough handheld. TEGAM's thermistor thermometers measure temperatures from -70° F to +300° F (-55° C to +150° C) with precise accuracy: 0.3% of the reading. They're built dust-proof, splash-proof, withstand a six-foot drop and work with all YSI Series 400 probes. Those outstanding qualities—along with their repeatability and long-term stability—make these handheld thermometers ideal for work in the lab or in the field.

- Accuracy: 0.3% of reading
- 1° or 0.1° resolution
- °F or °C scales
- Big, easy-to-read LCD display
- One-year warranty

ORDERING INFORMATION

MODEL	INPUTS	SCALE
865	One	°F
866	One	°C

TEGAM's 868/869 100Ω RTD thermometers, the only handheld RTDs that accept three-wire and four-wire platinum probes, and provide repeatable accuracy of 0.3° C. With exceptional accuracy and the same repeatability and long-term stability of our thermistor units, TEGAM's 868/869 platinum RTD thermometers detect and display temperatures from -360° F to +1100° F. They're ideal for cryogenic and high-temperature research or industrial monitoring. For your flexibility, we provide a mating connector which allows you to use any 100 ohm RTD probe. These units are housed in heavy-duty ABS cases that are dust-proof, splash-proof and drop-proof.

- Accuracy: 0.3° C
- 1° or 0.1° resolution
- °F or °C scales
- Big, easy-to-read LCD display
- One-year warranty

ORDERING INFORMATION

MODEL	INPUTS	SCALE
868	One	°F
869	One	°C

SPECIFICATIONS

ACCESSORIES SUPPLIED: 9V battery and manual.
(spare input connector included with 868/869).

MODEL		RANGE	RESOLUTION	ACCURACY
865	°F	-40 to 199.9	0.1°	± (0.3%rdg + 0.5° F)
	°F	-70 to 300	1°	± (0.3%rdg + 1° F)
866	°C	-40 to 150	0.1°	± (0.3%rdg + 0.3° C)
868	°F	-100 to 199.9	0.1°	± 0.4° F
	°F	-100 to 1100	1°	± 2° F
869	°C	-100 to 199.9	0.1°	± 0.3° C
	°C	-100 to 630	1°	± 1° C

REPEATABILITY: 0.1° C (0.2° F) typical
 DISPLAY: 3½-digit LCD, .5" high
 DIMENSIONS: 6.3" x 2.7" x 1.2". Net weight 7.5 oz.
 ACCESSORIES AVAILABLE: 8660 tilt stand/belt clip, 8668 vinyl case

This data sheet was current when it was produced. However, products are constantly being updated and improved. Because of this some differences may occur between the descriptions herein and the current product. Prices and specifications may be changed without notice.



[BACK TO CONTENTS](#)



YOUR GLOBAL SOURCE FOR TEST
AND MEASUREMENT SOLUTIONS

Thermistor Probes

D I G I T A L T H E R M O M E T E R S A N D P R O B E S



Sensor Probe: Ideal for biological and geophysical testing of gases, liquids and subsoils. This rugged, long probe has stranded 22AWG Teflon-insulated wire. Sheath: 304 SS. Max. temp.: 300° F/150° C.

Time constant: 6 sec.
Accuracy: ± 0.2°C
from 0°C to 70°C

ORDERING INFORMATION

MODEL 8662

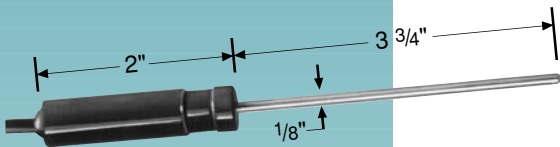

General Purpose Probe: For immersion in liquids and gases. 316 SS sheath. TPR coil cord 1½-ft. (ext. 3-ft.). Max. temp.: 300° F/150° C.

Time constant: 3 sec.
Accuracy: ± 0.2°C
from 0°C to 70°C

ORDERING INFORMATION

MODEL 8663

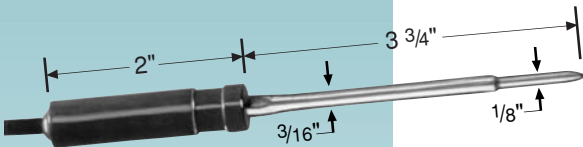

Penetration Probe: Sharp, pointed tip for insertion into semi-soft materials, such as meat and cheeses. Extra heavy duty coil cord expands and retracts thousands of times without breaking.

304 SS sheath; 316 SS tip.
TPR coil cord 1½-ft. (ext. 5-ft.).
Max. Temp.: 300° F/150° C.
Time constant: 3 sec.
Accuracy: ± 0.2°C
from 0°C to 70°C

ORDERING INFORMATION

MODEL 82814

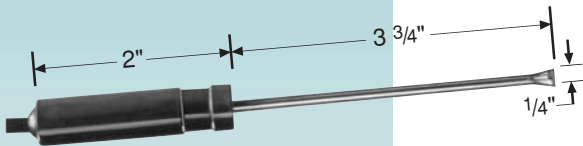

Surface Probe: For fast measurements on flat surfaces. 304 SS sheath. TPR coil cord 1½-ft. (ext. 3-ft.). Max. temp.: 300° F/150° C.

Time constant: 5 sec.
Accuracy: ± 0.2°C
from 0°C to 70°C

ORDERING INFORMATION

MODEL 8665

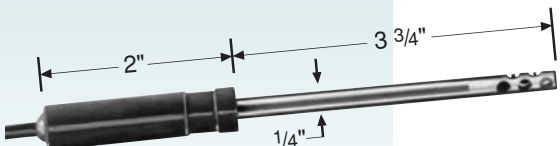

Air/Gas Probe: For measurement of air and gas streams, incubators, etc. Exposed sensing element protected by perforated shield.

304 SS sheath. TPR coil cord 1½-ft. (ext. 3-ft.).
Max. temp.: 300° F/150° C.
Time constant: 10 sec.
Accuracy: ± 0.2°C
from 0°C to 70°C

ORDERING INFORMATION

MODEL 8666

Note: All TEGAM thermistor probes are supplied with YSI Series 400 compatible phone jacks.

This data sheet was current when it was produced. However, products are constantly being updated and improved. Because of this some differences may occur between the descriptions herein and the current product. Prices and specifications may be changed without notice.

TEGAM®

YOUR GLOBAL SOURCE FOR TEST
AND MEASUREMENT SOLUTIONS

BACK TO CONTENTS

TEN TEGAM WAY • GENEVA, OHIO 44041
440-466-6100 • FAX 440-466-6110
www.tegam.com • e-mail: sales@tegam.com

RTD Probes

DIGITAL THERMOMETERS AND PROBES

General Purpose/Immersion Probe: For measuring gases, liquids, soft materials or small-area surfaces, 316 SS sheath. TPR coil cord 1½-ft. (ext. 5-ft.). Range: -200° C to +600° C. Time constant: 10 sec.
Accuracy: ± (0.3°C + 0.5%)

ORDERING INFORMATION

MODEL 8693*

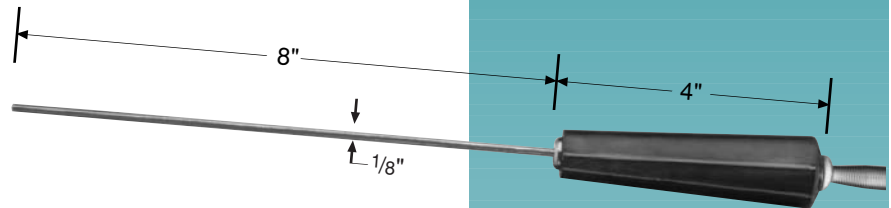

Surface Probe: For measurements on hot or cold flat surfaces. 304 SS sheath. TPR coil cord 1½-ft. (ext. 5-ft.). Range: -50° C to +260° C. Time constant: 3 sec.
Accuracy: (± 0.3°C + 0.5%)

ORDERING INFORMATION

MODEL 8695*

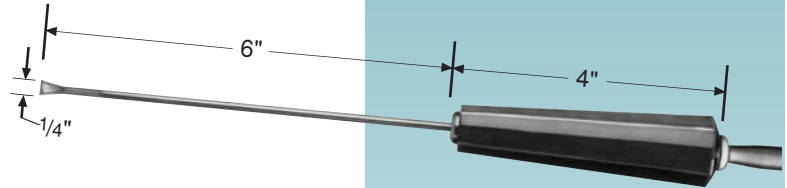

Air/Gas Probe: For measuring air and other gaseous atmospheres. 304 sheath. TPR coil cord 1½-ft. (ext. 5-ft.). Range: -50° C to +260° C. Time constant: 5 sec.
Accuracy: (± 0.3°C + 0.5%)

ORDERING INFORMATION

MODEL 8696*

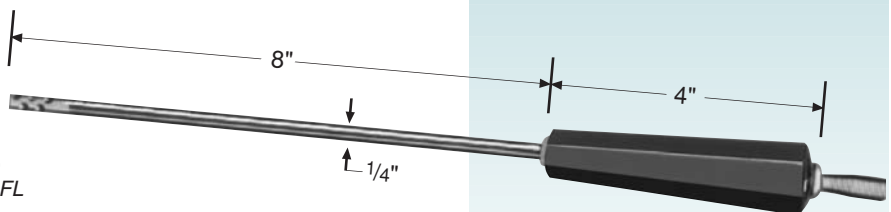

NOTE: All TEGAM 100Ω Platinum RTD probes have 4-wire RTDs and are supplied with a Switchcraft TA4FL (or equivalent) compatible connector.

* Pin 2 - sense (868/9)

This data sheet was current when it was produced. However, products are constantly being updated and improved. Because of this some differences may occur between the descriptions herein and the current product. Prices and specifications may be changed without notice.

[BACK TO CONTENTS](#)

TEGAM®

YOUR GLOBAL SOURCE FOR TEST
AND MEASUREMENT SOLUTIONS

Probes and Thermometer Accessories

DIGITAL THERMOMETERS AND PROBES



Tilt Stand/Probe Holder: Test instrument fits snugly inside holder, providing a tilt stand, belt clip, and probe holder. Detachable temperature probe holder snaps on or off. Tough ABS material provides toolbox durability.

ORDER 8660 WITH THESE TEGAM UNITS

TYPE	FITS MODEL NUMBERS	MODEL
Thermometers	865/866/868/869/874	8660



Padded Case: Foam-padded case can be hung from your work belt. Case includes pocket for storing leads, probes, etc.

ORDER 8668 WITH THESE TEGAM UNITS

8668 CASE	
TYPE	MODEL NUMBERS
Thermometers	819/820/821/865/866/868/869/871A/872A/874

This data sheet was current when it was produced. However, products are constantly being updated and improved. Because of this some differences may occur between the descriptions herein and the current product. Prices and specifications may be changed without notice.

Calibrators and Switchboxes

DIGITAL THERMOMETERS AND PROBES



General Purpose Calibrator: TEGAM's 847, using virtually any digital thermometer as reference, accurately and inexpensively calibrates handheld thermometers, panel meters and thermocouple readout devices. The 847 is compatible with bench or handheld, single or multiple input thermocouple thermometers. TEGAM's 847 simulates K, J, or T thermocouple types. Fine- and coarse-adjustment pots let you quickly dial in -350° to $+2500^{\circ}$ F with a resolution of 0.1° F or $^{\circ}$ C. The 847 is cold-junction compensated to eliminate errors caused by ambient temperature changes and has an accuracy of 0.3%. With an optional extension cable, the 847 becomes a bench unit, complete with rubber feet and built-in tilt feature.

- NIST Traceable Statement of Calibration provided upon request
- Low battery indicated on reference thermometer
- One-year warranty

SPECIFICATIONS

ACCESSORIES SUPPLIED: 840.401 type K TC cable (male sub-miniature connector to spade lugs), 9V battery, instructions
 ACCURACY: $\pm (0.3\% + 1^{\circ}\text{C}) + (\text{accuracy of indicating thermometer})$
 RESOLUTION: 0.1° C/F
 THERMOCOUPLES:

RANGE	TYPE K	TYPE J	TYPE T
$^{\circ}$ F	-328 to 2502	-346 to 1400	-328 to 752
$^{\circ}$ C	-200 to 1372	-210 to 760	-200 to 400

 DIMENSIONS: 5" x 2.8" x 1.5". Net weight 1 lb.
 ACCESSORIES AVAILABLE: 8668 vinyl carrying case, 80141 type K TC extension cable

ORDERING INFORMATION

MODEL 847



Multiprobe Switchbox: TEGAM's 8000 Series switchbox enables you to read six probes in any sequence on your K, J, or T thermometer. Compatible with virtually every bench and handheld digital thermometer, TEGAM multi-probe switchboxes plug directly into any handheld thermometers, including single- and multiple-input units. TEGAM switchboxes can also interface multiple probes with a variety of thermocouple readout devices, including panel meters, process monitors, and analog meters. With an optional extension cable the switchbox becomes a bench unit, complete with rubber feet and built-in tilt feature. You can connect two or more switchboxes together for quick reading of multiple-probe temperatures.

- One-year warranty

SPECIFICATIONS

ACCESSORIES SUPPLIED: Instructions
 DIMENSIONS: 5" x 2.8" x 1.5". Net weight 12 oz.
 ACCESSORIES AVAILABLE: 8668 vinyl carrying case, 80141 type K TC extension cable

ORDERING INFORMATION

MODEL	TC TYPES
8012	K
8022	J
8052	T

This data sheet was current when it was produced. However, products are constantly being updated and improved. Because of this some differences may occur between the descriptions herein and the current product. Prices and specifications may be changed without notice.

[BACK TO CONTENTS](#)



YOUR GLOBAL SOURCE FOR TEST AND MEASUREMENT SOLUTIONS

Humitran

HUMIDITY CONTROLLERS AND TRANSMITTERS

- State-of-the-Art capacitive thin film humidity sensor
- 100 ohm Platinum RTD temperature sensor
- Temperature compensated humidity output
- Factory calibrated
- Low cost

The HUMITRAN series provides a reliable, accurate, and low cost solution for monitoring relative humidity and temperature.

Solid state sensors supply excellent sensitivity, fast response and long-term stability. Simple hookup and linearized output permit interfacing with most display or control devices.

Sensor-Transmitters for Measuring and Controlling Relative Humidity and Temperature



RH/TEMP TRANSMITTER
Model RHT-20C or RHT-10V



RH TRANSMITTER
Model RH-20C or RH-10V



A model RDP temperature duct probe transmitter included

RH/TEMP CONTROLLER
Model CSP-F1, CSP-C1, CSP-F2, CSP-C2

AUTOMOTIVE	MEDICAL	FOOD PROCESSING
Engine Test Cells	Pill Coating	Freeze Drying
Emission Testing	Operating Room	Grain Silos
Paint Spray	Toxicology	Baking
Passenger Environment	Testing	Poultry Industry

MANUFACTURING	STORAGE	ENVIRONMENTAL
Plastics	Food	Heating, Ventilating
Printing	Grain	Air Conditioning
Painting	Paper	Computer Rooms
Adhesives	Tobacco	Museums



HIGH TEMP RH/TEMP PROBE TRANSMITTER
Model HTRH-D or HTRH-W



RH/TEMP DUCT PROBE TRANSMITTER
Model RDP-20C or RDP-10V

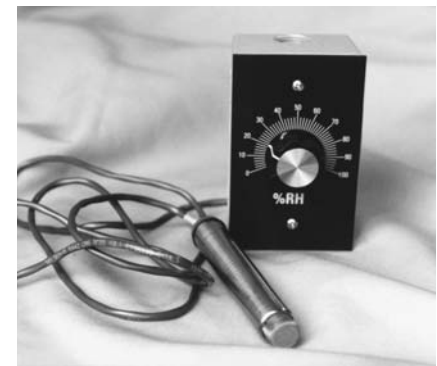

HUMIDITY CONTROLLER
Model RHS-1
Setpoint Controller

Prices and specifications subject to change without notice.

[BACK TO CONTENTS](#)



YOUR GLOBAL SOURCE FOR TEST AND MEASUREMENT SOLUTIONS

J

HUMITRAN-CSP

RH/TEMP CONTROLLER

- **Included Probe may be Thousands of Feet from the Controller**
- **Recorder Outputs**
- **Dual Setpoints, Relay Outputs**
- **Digital Display of Setpoints, Deadbands, and Values**
- **1/8 DIN Metal Enclosure with Panel Mounting Bracket**

Relative Humidity: 3% RH to 95% RH range at $\pm 2\%$ RH accuracy. Temperature compensated -10°F to $+175^{\circ}\text{F}$. 1% RH display resolution.

Temperature: 0°F to 180°F range at $0\pm 1^{\circ}\text{F}$ accuracy, 1° resolution (0°C to 85°C , $\pm 0.6^{\circ}\text{C}$ accuracy for $^{\circ}\text{C}$ version).

Controls: Setpoints: 0%RH to 100% RH, 0°F to 180°F . Deadbands; to $\pm 50\%$ RH, to $\pm 50^{\circ}\text{F}$ ($\pm 40^{\circ}\text{C}$) -all digitally displayed.

Response Time: Under 20 seconds.

Setpoint Outputs: Dual SPDT relays, 5 amp/250VAC contact rating.

Recorder Outputs: 10mV/%RH and 10mV/ $^{\circ}\text{F}$ (10mv/ $^{\circ}\text{C}$). **Display:** 0.56" high-brightness digits. Off-scale indication for open wires. Relay "ON" indicators.

Input Power: 115VAC $\pm 15\%$, 50/60Hz, 5 watts maximum. 230VAC model available.

HUMITRAN-RDP

RH/TEMP DUCT PROBE TRANSMITTER

- **Adjustable, Removable Duct Flange**
- **Wall Mounting Bracket Provided**
- **RDP-20C (4 to 20ma) or RDP-10V (0 to 1V) Outputs**
- **Stainless Steel Housing**

Relative Humidity: 3% RH to 95% RH range at $\pm 2\%$ RH accuracy. Temperature compensated -10°F to $+175^{\circ}\text{F}$.

Temperature: 0°C to 100°C (32°F to 212°F) range at $\pm 0.6^{\circ}\text{C}$ ($\pm 1^{\circ}\text{F}$) accuracy for 4 to 20ma or 0 to 1V output.

RH Output: 4 to 20 ma or 0 to 1V represents 0% to 100% RH. **Input Voltage Range:** 6 to 30VDC, polarity protected for both current and voltage output units.

Response Time: Under 10 seconds

HUMITRAN-RHT & HUMITRAN RH

RH/TEMP TRANSMITTER

- **Compact Wall Mounting**
- **NEMA Housing**
- **RHT-20C (4 to 20ma) or RHT-10V (0 to 1V) Outputs**

RH TRANSMITTER

- **Smallest Size Wall Mount**
- **NEMA Housing**
- **Low Cost**
- **RH-20C (4 to 20ma) or RH-10V (0 to 1V) Outputs**

Relative Humidity: 3% RH to 95% RH range at $\pm 2\%$ RH accuracy. Temperature compensated -10°F to $+175^{\circ}\text{F}$.

Temperature: -20°C to $+75^{\circ}\text{C}$ (-4°F to 167°F), $\pm 0.6^{\circ}\text{C}$ ($\pm 1^{\circ}\text{F}$) accuracy for 4 to 20ma or 0 to 1V output.

Input Voltage Range: 6 to 30VDC, polarity protected for both

current and voltage output units.

RH Output: 4 to 20 ma or 0 to 1V represents 0% to 100% RH.

Response Time: Under 10 seconds

HUMITRAN RHS SERIES

HUMIDITY CONTROLLER

- **Quality relative humidity set point controller**
- **Stainless steel probe (4.7" long x 3/4" diameter)**
- **State-of-the art thin film polymer sensor**
- **Recorder output of 0 to 1V (or 0 to 5V) for 0 to 100% RH input**

Accuracy: 3% RH, from 3% to 95% RH

Operating Temperature Range: Probe -20° to 85°C . Controller 0° to 75°C .

Recorder Output: 10mV/%RH (50mV/%RH with resistor removed).

Controller Output: SPDT (Form "C") Relay; 5AMPS 250 VAC.

Bandwidth Control: ± 0 to $\pm 20\%$ RH, independent of Setpoint setting.

Power: 8VDC to 30 VDC at 125 milliamps maximum.

Probe: Stainless steel, .75" diameter, 4.7" long, 5'2-wire cable with bracket for wall mounting.

Enclosure: Controller mounted in standard metal "T" box (4.5" x 2.75" x 2" deep) screw terminal connectors.

HUMITRAN HT SERIES

HIGH TEMPERATURE RH/TEMP PROBE TRANSMITTER

- **Remote Stainless Steel Probes HTRH-W (2.5" Wall Mounted), HTRH-D (8.5" Duct Mounted)**
- **-40°C to 180°C (-40F to 356°F) Operating Range**
- **2% RH, 0.5°C Accuracies**

Relative Humidity: 3% RH to 95% RH range, $\pm 2\%$ RH

Temperature: -40° to 180°C at $\pm 0.5^{\circ}\text{C}$. Time constant under 4 seconds.

Power Inputs: 7 to 30 VDC polarity protected.

Outputs: 4 to 20 mA, for 0 to 100% RH; 4 to 20mA, for -40°C to 180°C

This data sheet was current when it was produced. However, products are constantly being updated and improved. Because of this some differences may occur between the descriptions herein and the current product. Prices and specifications may be changed without notice.



YOUR GLOBAL SOURCE FOR TEST AND MEASUREMENT SOLUTIONS

[BACK TO CONTENTS](#)

TEN TEGAM WAY • GENEVA, OHIO 44041
440-466-6100 • FAX 440-466-6110
www.tegam.com • e-mail: sales@tegam.com

TEGAM's extended warranty plans provide the assurance that your instrument will continue to function properly, at no additional cost to you, for the life of the program.

This program is offered in three-year and five-year increments.

Extended Warranty Plan

WARRANTY BENEFITS

- Your instrument is returned to full functionality.
- All performance problems, for the entire Extended Warranty Period, are resolved by TEGAM at no additional cost to you.
- The cost of this program is much less than the cost of our standard repair service.
- Your repair costs are paid in advance and will not be subject to future budget cuts.
- You avoid future repair service cost increases.
- This program saves you downtime and money.
- The program eliminates potentially critical delays caused by evaluation, quotation and approval procedures.
- Priority service scheduling is included as part of this plan. Your instrument goes to the head of the line as soon as it arrives at TEGAM.

WARRANTY FEATURES

- Repair and recalibration by trained factory technicians if your instrument stops working or goes out of calibration prematurely (excluding abuse or misuse).
- This includes:
 - Isolation and correction of any faults.
 - Repair/Replacement of defective components.
 - Functionality Verification.
 - A new calibration, if required.
- All Parts and Labor are included at no charge.
- Additional Service:
 - Any new Software and/or Firmware upgrades will be installed.
 - Any new safety and/or reliability enhancements will be installed.
- Available with qualified New Product Purchases.

TO ORDER

EW3-XXXX

(XXXX is the model number of the instrument warranted)

This program offers three full years of repair, starting from the date of shipment.

This extends a standard one-year warranty to three years.

EW5-XXXX

(XXXX is the model number of the instrument warranted)

This program offers five full years of repair, starting from the date of shipment.

This extends a standard one-year warranty to five years.

This data sheet was current when it was produced. However, products are constantly being updated and improved. Because of this some differences may occur between the descriptions herein and the current product. Prices and specifications may be changed without notice.

K

[BACK TO CONTENTS](#)



YOUR GLOBAL SOURCE FOR TEST
AND MEASUREMENT SOLUTIONS

CA3-XXXX/CA5-XXXX

SERVICE PLAN

TEGAM's Calibration Service Program assures that Traceable Calibrations are performed at the TEGAM recommended intervals.

This program is offered in three-year and five-year increments.



Repair and calibration by trained factory technicians

Calibration Service Plan

PLAN FEATURES

- ANSI/NCCL Z540-1-1994 compliant calibration at TEGAM, Inc. recommended intervals.
- This includes:
 - Calibration Records Management.
 - Calibration Due Notification sent in advance of your due date.
 - A Calibration Certificate provided with each calibration.
 - As-Found & As-Left Data provided with each calibration.
- Available for NEW or previously purchased products, (previously purchased products may require a baseline calibration).

PLAN BENEFITS

- Your instrument is regularly calibrated at recommended intervals.
- The cost of this program is much less than the current cost of our standard calibration service.
- You avoid future calibration service cost increases.
- Your calibration is paid in advance and will not be subject to future budget cuts.
- This program saves you downtime and money.
- This program eliminates potentially critical delays caused by quotation and approval procedures.
- Priority service scheduling is included as part of this plan. Your instrument goes to the head of the line as soon as it arrives at TEGAM.

TO ORDER

CA3-XXXX

(XXXX is the model number of the instrument warranted)

This program offers three full years of Calibration services, starting from the date of shipment.

CA5-XXXX

(XXXX is the model number of the instrument warranted)

This program offers five full years of Calibration services, starting from the date of shipment.

This data sheet was current when it was produced. However, products are constantly being updated and improved. Because of this some differences may occur between the descriptions herein and the current product. Prices and specifications may be changed without notice.

TEGAM's Total Service program assures that not only will your instrument continue to function properly, but also that Traceable Calibrations are performed at the TEGAM recommended intervals.

This program is offered in three-year and five-year increments

Total Service Plan

PLAN FEATURES

- Repair and recalibration by trained factory technicians if your instrument stops working or goes out of calibration prematurely (excluding abuse or misuse).
- This includes:
 - Isolation and correction of any faults.
 - Repair/Replacement of defective components.
 - Functionality Verification and a new calibration, if required.
- All Parts and Labor are included at no charge.
- ANSI/NCSL Z540-1-1994 compliant calibration at TEGAM, Inc. recommended intervals.
- This calibration includes:
 - Calibration Records Management
 - Calibration Due Notification sent in advance of your due date.
 - A Calibration Certificate provided with each calibration.
 - As-Found & As-Left Data provided with each calibration.
- Additional Services:
 - Any new Software and/or Firmware upgrades will be installed.
 - Any new safety and/or reliability enhancements will be installed.
- Available with qualified New Product Purchases

PLAN BENEFITS

- Maintains peak instrument performance for up to five years.
- This program allows you to pay in advance for up to five years of TOTAL SUPPORT with PREFERRED STATUS for your new instrument.
- You receive substantial cost reductions from standard calibration and repair fees.
- It simplifies your future budgeting process.
- You can determine your support costs in advance.
- You avoid future price increases for the life of the program.
- This program saves you downtime and money.
- This plan eliminates potentially critical delays caused by evaluation, quotation and approval procedures.
- It's renewable. The TSP is the only plan that gives you the option to renew for an additional three to five years.
- Priority service scheduling is included as part of this plan. Your instrument goes to the head of the line as soon as it arrives at TEGAM.

TO ORDER

TS3-XXXX

(XXXX is the model number of the instrument warranted)

This program offers three full years of calibration and repair services, starting from the date of shipment.

TS5-XXXX

(XXXX is the model number of the instrument warranted)

This program offers five full years of calibration and repair services, starting from the date of shipment.

This data sheet was current when it was produced. However, products are constantly being updated and improved. Because of this some differences may occur between the descriptions herein and the current product. Prices and specifications may be changed without notice.

[BACK TO CONTENTS](#)



YOUR GLOBAL SOURCE FOR TEST AND MEASUREMENT SOLUTIONS



Our customer service team is always ready to help you.

Repair & Calibration Services

Today's fast-paced, technological environment requires that quality, throughput, and cost-effectiveness are maximized in order for your business to thrive. TEGAM realizes that your test instruments are indispensable to your company and directly affect the success and profitability of your business.

Regular evaluation and calibration of instruments with NIST-traceable standards pays dividends. Regular service ensures that your quality level meets or exceeds your customer's expectations, maintains high quality production levels, lowers operating costs, and optimizes the performance of your test instrumentation.

All TEGAM service and calibration services meet or exceed the performance criteria for accuracy and reliability as defined in the MIL45662 and ANSI/NCSL Z540-1-1994 calibration standards. In addition, we are accredited in accordance with ISO/IEC 17025-1999 from A2LA as specified in Certificate Number 2018.01.

Does TEGAM Offer Support for Your Instrument?

TEGAM designs, develops, and manufactures a broad line of test, measurement, and calibration equipment. In addition to providing exceptional repair and calibration service for the products manufactured by TEGAM, TEGAM offers calibration & repair services for a large number of products formerly manufactured by Tektronix, Weinschel, Eaton, Electro Scientific Industries (ESI), Gertsch, Keithley, Pragmatic, and more. To find out whether TEGAM can provide you with the service that you need please go to our Product Support Directory, at www.tegam.com, where you can look up the service & support status of your

instrument by model number. You can also contact TEGAM by phone, 440.466.6100 or complete the online service inquiry form for service information about your product.

Preparation for Shipment to TEGAM

We take pride in our commitment to customer service and product support and wish to provide you with the best quality of service possible. In order to do this, it is necessary to clearly document the nature of service that is required for a particular instrument. There are certain steps that you can take to expedite the repair and/or calibration of your instrument. If these steps are taken, TEGAM can ensure you that we will deliver our product services to you in the most efficient manner possible.

RMA Number

Before shipment to TEGAM, please contact us for an RMA (return material authorization) number. This number is extremely important and is necessary to track your instrument during the service cycle. Either contact TEGAM by phone, 440.466.6100 or complete the online service inquiry form.

Complete an Expedite Service Form (optional)

In addition to the assignment of an RMA number, the handling of your instrument can be optimized by the completion of a Calibration & Repair Service Expedite form. The completion of this quick form is optional, but it can reduce the turnaround time of your instrument significantly by providing our technicians with written instructions by you on the services that you require. There is also space reserved for providing detailed symptoms or special repair instructions.



For more information, visit
www.tegam.com

Calibration Certificates & Accreditations

A2LA Certification

TEGAM, Inc. has always strived toward providing our customers with the highest possible level of quality, service, and reliability. Our accreditation by the American Association for Laboratory Accreditation (A2LA) is representative of these efforts and is yet another visible step in our continual quality improvement process.

TEGAM, Inc. has always sought a method that would accurately reflect our commitment to a quality system that is periodically assessed by our technically competent peers, and that offers demonstrable, nationally recognized evidence of continual compliance.

A2LA has provided the opportunity

for accreditation not only to TEGAM, Inc., but also other calibration laboratories across the nation.

TEGAM, Inc. is now able to provide “A2LA Accredited” calibrations within our Scope of Accreditation as described in our Certificate Number 2018.01 that many of our customers have been seeking. We look forward to serving you now and in the future.

National Association for Proficiency Testing

The National Association for Proficiency Testing (NAPT) is a third party, non-profit organization dedicated to assisting the metrology and testing community in meeting the growing demand for proficiency testing. Proficiency testing is part of the requirement that is being driven by laboratory accreditation to ISO/IEC

17025–1999, “General Requirements for the Competence of Testing and Calibration Laboratories.” Participation in proficiency testing is a valuable quality improvement tool allowing the participant to gain insight into your measurement processes. This translates into improved performance and enhanced measurement quality.

Utilization of NAPT by TEGAM, Inc. allows our organization to receive unbiased analysis of measurement processes to enhance our awareness of our technical competence and data integrity. This very important feedback allows TEGAM, Inc. to provide you, our customer, with the best possible integrity and confidence in our calibration techniques and data.

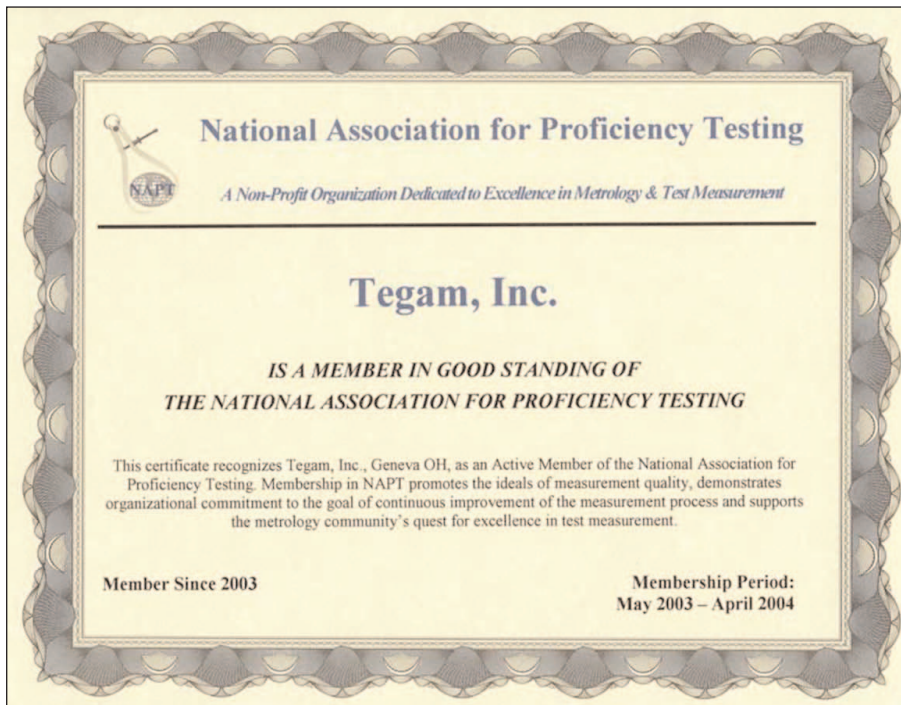

**Please contact
TEGAM
at (440) 466-6100 or
visit our website
at www.tegam.com for...**

**Our Product Support
Directory**

Applications Notes

**Local Sales
Representatives**

Applications Assistance

**Education & Training
Information**

INDEX BY MODEL NUMBER

001-306 National Instruments
 GPIB Interface Card for System
 IIA and 8850Ⓞ

102-373-2 Power Splitter for F1116 ...Ⓞ

102-373-5 Power Splitter for F1119 ...Ⓞ

102-475-1 Power Splitter for F1109 ...Ⓞ

110A Safety VoltmeterH-1

120 Voltman Electrical Service
 VoltmeterH-1

122 Voltman Electrical Service
 Voltmeter with ContinuityH-1

125 Voltman TRMS Electrical
 Service Voltmeter with Continuity
 FunctionH-1

138-606 Rack Mounting Kit for
 1806A-27

138-645 Measurement
 Accessory Kit for System IIAA-27

138-645-1Ⓞ

138-645-2Ⓞ

138-645-4Ⓞ

138-645-5Ⓞ

138-650 Calibrated 50-75 Ohm
 Minimum Loss Matching Pad for
 System IIAⓄ

138-652A-27

187-1007 Rack Mount Kit for VM-7 .B-12

187-1007-1 Rack Mount Kit for
 8852B-12

187-1008 Rack Mount and Chassis
 Slide Kit for VM-7B-12

187-1009 I/O Card Upgrade
 Kit for VM-7B-12

187-1020-000 Digital Extender
 Card for VM-7B-12

187-1021-000 Analog Extender
 Card for VM-7B-12

187-1030 Spare Set of All
 Replaceable Modules for VM-7B-2

187-1800-2 Display Upgrade Kit
 (S/N 0 to 102) for VM-7B-1

187-4001 Attenuation Measurement
 Accessory Kit for 8850B-12

187-4003 SWR Measurement
 Accessory Kit for 8850B-12

189-22 CAMLAB Attenuation
 Measurement SoftwareB-7

230BⓄ

240Ⓞ

240C Kelvin Ratio BridgeⓄ

242BⓄ

242CⓄ

242D Resistance Measuring
 System 10ppmⓄ

242D/SP3632 Resistance
 Measuring System 5ppmⓄ

242E 242D with 801C DC
 Generator DetectorⓄ

250DEⓄ

251Ⓞ

252 LCR Meter, 1KHzⓄ

252/SP2596 Bat. PoweredⓄ

253 LCR Meter, 1KHzⓄ

253/SP2598 Bat. PoweredⓄ

254 LCR Meter, 120HzⓄ

262Ⓞ

263Ⓞ

264Ⓞ

801AⓄ

801B DC Generator Detector for
 Model 242Ⓞ

801C DC Generator Detector for
 Model 242Ⓞ

819 Thermocouple Thermometer,
 Single Input (K, J, &T)I-1

819/RB Model 819 with Rubber
 Boot .I-1

820 Thermocouple Thermometer,
 Dual Input (K & J)I-1

820/RB Model 820 with Rubber
 BootI-1

821 Thermocouple Thermometer,
 Dual Input (K, J, & T)I-1

821/RB Model 821 with Rubber
 BootI-1

840A Calibrator/Thermometer ∞
 C & ∞F (K, J, & T)D-1

845 Calibrator/Thermometer ∞
 C & ∞F (Multi T/Cs)D-1

847 Economical Calibrator ∞
 C & ∞F (K, J, & T)I-9

850 Calibrator/Thermometer ∞C & ∞
 F (K, J, T, & E, Ohms, 100 ohms
 RTD & Thermistor)D-1

855 Calibrator/Thermometer,
 C & ∞F (Multi T/Cs, Ohms, 100
 ohm & 1,000 ohm RTD)D-1

865 Thermistor Thermometer
 (°F)I-5

866 Thermistor Thermometer
 (°C)I-5

868 Platinum RTD Thermometer
 (°F)I-5

869 Platinum RTD Thermometer
 (°C)I-5

871A Thermocouple Thermometer,
 Dual Input w/Analog Output Type K .I-3

872A Thermocouple Thermometer,
 Dual Input w/Analog Output Type J .I-3

874C Economical Thermocouple
 Thermometer (°C) Type KI-3

874F Economical Thermocouple
 Thermometer (°F) Type KI-3

875F Economical Thermocouple
 Thermometer (°F) Type TⓄ

878Ⓞ

879Ⓞ

900A/BⓄ

1104 Utility/Lineman Carrying
 Case (Leather)H-2

1107-7 RF Waveguide Power
 Standard, 18-26.5 GHzⓄ

1107-8 RF Waveguide Power
 Standard, 26.5-40 GHz,A-13

1204 Utility/Lineman Carrying
 Case (Cordura)H-2

1304 Carrying Case & Stand for
 871A & 872AⓄ



Contact TEGAM, Inc. at 440-466-6100 for information

[BACK TO CONTENTS](#)

INDEX BY MODEL NUMBER

1412A	1806 Dual Type IV RF Power Meter	3101 Waveform Generator
1412B Limits Comparator, Accessory for 252, 253, 254A-19	3102 Waveform Generator
1583-3 GPIB/IEEE-488 Cable, 1 Meter Long	1807	3525 General Purpose Programmable LCR Meter
1583-6 GPIB/IEEE-488 Cable, 2 Meters LongF-1
1583-9 GPIB/IEEE-488 Cable, 3 Meters Long	1807A F1109 RF Power Standard in an Enclosure	3550 High Frequency, Programmable LCR Meter
1585-1000 Test Cable with SMA Straight Plug Connectors, DC to 18GHz, 3 Feet LongF-3
1585-1003 Test Cable with SMA Straight Plug Connectors, DC to 18GHz, 1 Foot Long	1820 RF Mount Temperature Controller	5000 Carrying Case for 840 & 850 Series Calibrators, and 819 & 820 Series Thermometers
1585-1006 Test Cable with Type N Straight Plug Connectors, DC to 18 GHz, 3 Feet LongA-21D-2
1585-1008 Low Loss RF Cable with 3.5mm Male Connectors, DC to 26.5GHz, 3 Feet Long	1825 Economical RF Power Sensor Calibrator	5735
1585-1009 Low Loss RF Cable with 2.92mm Male Connectors, DC to 40.0GHz, 3 Ft. LongA-1	5736
1593	1827 Economical Wideband RF Power Sensor Calibrator	5832-1
1700A-3	5832-2
1700/1701B	1919 Half-Rack Mounting Kit for Models 1805B & 1807A	5888-1
1700/1705BA-27	5888-2
1700/SP3779B	2005B 4 Terminal Chip Tweezers for 2150, 2160 (5-ft. Length)	6126
1701B	8000 RF Mount Transport Case
1705B	2005B/SP5132 4 Terminal Chip Tweezers for 252, 253, 254 (5 ft. Length)A-27
1727A Amplifier	8012 6 Input Switch Box T/C Type K
1727A-01 Amplifier	2005C 4 Terminal Chip Tweezers for 2150, 2160 (4 ft. Length)I-9
1750 Micro-Ohmmeter	8022 6 Input Switch Box T/C Type J
1750/17501 Micro Ohmmeter with 3-Foot Kelvin Klip Leads	2150 VideoBridgeI-9
1750/17502 Micro Ohmmeter with 3-Foot Spade Lug Leads	8052 6 Input Switch Box T/C Type T
1804 Single Type IV RF Power Meter	2150/SP5240 VideoBridge with 200V External Bias OptionI-9
1805A	8204 Rubber Boot for 840 & 850 and 819 & 820 Series
1805B RF Power Level Controller	2160 VideoBridge 20Hz to 150KHz, Microcassette DriveD-2
	8660 Tilt Stand, Belt Clip, Probe Holder for 865, 866, 869, & 874
	2160/SP5240 VideoBridge with 200V External Bias OptionI-8
	8662 Temperature Probe, Thermistor, Encapsulated
	2340 Single Channel High Voltage AmplifierI-6
E-11	8663 Temperature Probe, Thermistor, General Purpose/Immersion
	2350 Dual Channel High Voltage AmplifierI-6
E-11	8665 Temperature Probe, Thermistor, Surface
	2400 Shipping Case for Arbitrary Waveform GeneratorsI-6
	8666 Temperature Probe, Thermistor, Air/Gas
	2411B 16-Bit True AWGI-6
E-1	8668 Soft Carrying Case for 819, 820, 821, 865, 866, 868, 869, 871A, 872A, & 874
	2414B AWG with Extended MemoryI-8
E-3	8693 Temperature Probe, 100 ohm, RTD, General Purpose/Immersion
	2416A High Speed AWGI-7
E-5	8695 Temperature Probe, 100 ohm, RTD, Surface
	2600 Digital LCR MeterI-7
	
	2610 Digital LCR Meter with GPIB Interface	
	
	2711A Low Cost 16-Bit AWG	
E-7	
	2714A Low Cost AWG with Extended Memory	
E-9	



Contact TEGAM, Inc. at 440-466-6100 for information

INDEX BY MODEL NUMBER

8696 Temperature Probe, 100 ohm RTD, Air/GasI-7	13325 Sorting Fixture Contact Replacement Kit for 1304, 1717, 17503, and 32001G-4	85115 Replacement Sensor Element for 900 A or BC
8712 Temperature Probe, T/C Type K, Wire, 3 ftI-4	17501 Kelvin Klip Lead Set, 3 Feet Long, for 1750G-4	86104-12 Temperature Probe, T/C Type K, Pistol Grip Penetration, 12"I-2
8712-6 Temperature Probe, T/C Type K, Wire, 6 ftI-4	17502 Spade Lug Lead Set, 3 Feet Long, for 1750G-4	86104-18 Pistol Grip 18"I-2
8713 Temperature Probe, T/C Type K, General PurposeI-4	17503 Sorting Fixture for 1750G-4	86104-24 Pistol Grip 24"I-2
8714A Temperature Probe, T/C Type K, Penetration with Coiled CableI-4	17504 Kelvin Probes for 1750G-4	200020A WaveWorks Pro+ Waveform Creation SoftwareE-15
8715 Temperature Probe, T/C Type K, SurfaceI-4	17505 Male LEMO Connector & Strain Relief for 1750G-4	15030901C
8716 Temperature Probe, T/C Type K, Air/GasI-4	17508 Calibration Standard for 1750G-4	15031001 Comparator Head for CG5011C
8723 Temperature Probe, T/C Type J, General Purpose/ ImmersionI-4	43072 Kelvin Klips for 252, 253, 254 ..C	15061101 Pulse Head for CG5011C
8733 Temperature Probe, T/C Type K, Compact General Purpose/ImmersionI-4	43374 Dust Cover for 252, 253, 254 ..C	67068101 Tunnel Diode PulserC
8734 Temperature Probe, T/C Type K, Compact PenetrationI-4	47422 Tweezer Tip Replacement Kit 12 tips for 2005B, 2005C, & TW2600C	AA5001 Distortion AnalyzerC
8736 Temperature Probe, T/C Type K, Compact Air/GasC	47454 Kelvin Klips, 5 Terminal, 2150, 2160C	AA5001/CCIRC
8737A Temperature Probe, T/C Type K, GriddleC	70161 2.5 V/Hz Option for PRT-73C-22	AM502C
8753 Temperature Probe, T/C Type T, General Purpose/ ImmersionI-4	70192 Rack Mount Kit for PRT-73C-22	AW1012 Control Panel Hinged Window 10" x 12"C
8850 RF Attenuation Measurement SystemB-9	70193 Rear Panel Terminals for PRT-73C-22	AW1418 Control Panel Hinged Window 14" x 18"C
8850-01 8850 with Signal SourceC	80010 AC Adapter/Battery Charger for Model 820 Through 855D-2	AW1418S Control Panel Hinged Window 14" x 18" Stainless SteelC
8850-02 8850 with Signal Source and ComputerC	80135 T/C Type K Velcro Wrap-Around SensorC	AW1822 Control Panel Hinged Window 18" x 22"C
8852 RF Frequency Converter .01 –18GHzB-3	80141 Ext. Cable, T/C Type K, Stranded Wire, 3 FeetD-2	AW1822S Control Panel Hinged Window 18" x 22" Stainless SteelC
8853 RF Frequency Converter 18-40GHzB-5	82814 Temperature Probe, Thermistor, Extra Duty PenetrationI-6	AW2228 Control Panel Hinged Window 22" x 28"C
8861C	83105 Temperature Probe, T/C Type K, High Temperature Right Angle Surface ProbeC	AW2228S Control Panel Hinged Window 22" x 28" Stainless SteelC
12501 Alligator Clip Adaptor for 110A, 120, 122, & 125H-2	83115 Temperature Probe, T/C Type K, High Temperature Surface ProbeC	B9409 Calibrations & Standards DC-40 GHz Reference BookC
12502 Universal Adaptor for 110A, 120, 122, & 125H-2	83804 Temperature Probe, Thermistor, Heavy Duty PenetrationC	CG5011 Programmable Calibration GeneratorC
	85105 Replacement Sensor for 900 A or BC	CRT-12AFC
		CRT-3FC
		CRT-4FC
		CRT-5RC
		DB42C



Contact TEGAM, Inc. at 440-466-6100 for information

[BACK TO CONTENTS](#)

INDEX BY MODEL NUMBER

DB52	DT58	M1000
DB62-11K 11 K ohm Decade ResistorC-11	DT72A Decade Transformer Voltage DividerC-17	M1001
DB62-111K 111 K ohm Decade ResistorC-11	DT1135	M1003
DB62-1M 1 M ohm Decade ResistorC-11	DT1145 Decade Ratio TransformerC-19	M-1011X
B62-11M 11 M ohm Decade ResistorC-11	F1109 RF Power Standard, 0.01-18GHzA-5	M-1012X
DB655A	F1109H RF Power Standard, 0.01-18GHz, High PowerA-5	M1110 RF Power Standard, 0.01-18GHz, N/Male Connector ...A-5
DB877 12 M ohm Decade ResistorC-13	F1116 RF Power Standard, 100KHz-100MHzC	M1111 RF Power Standard, 100KHz-100MHzC
DC5010 Counter/TimerC	F1117A RF Power Standard, 0.05-26.5GHzC	M1118 RF Power Standard, 0.05-26.5GHzC
DC503A	F1117AC F1117A Power Standard Mounted in an EnclosureC	M1120 RF Power Standard, 100KHz-4.2GHzA-7
DM511 Digital MultimeterC	F1119 RF Power Standard, 100KHz-4.2GHzC	M1130 RF Power Standard, 100KHz-18GHzA-9
DM5110 Digital MultimeterC	F1119H RF Power Standard, 100KHz-4.2GHz, High PowerC	M1135 RF Power Standard, 10MHz-26.5GHzA-11
DP1211-1K 1 K ohm Coaxial Dial Decade PotentiometerC-15	F1119C F1119 Power Standard Mounted in an EnclosureC	MR-1 Motor Rotation Indicator ...H-3
DP1211-10K 10 K ohm Coaxial Dial Decade PotentiometerC-15	F1125 RF Power Standard, 100 KHz-4.2 GHzA-7	OCS0550
DP1311-1K 1 K ohm Coaxial Decade PotentiometerC-15	F1130 RF Power Standard, 100kHz-18GHzA-9	OCS0550/DP
DP13110-10K 10 K ohm Coaxial Decade Potentiometer ...C-15	F1135 RF Power Standard, 10MHz-26.5GHzA-11	OCS2500 Oscilloscope Calibration SystemC
DS1463-XX	FG501A 2 MHz Function Generator ...C	PAV w/MF-1
DS1464-XX	FG502 11 MHz Function Generator ...C	PAV w/MF-2
DSB-1524U	FG503 3 MHz Function Generator ...C	PAV w/MF-3
DSRB-5C	FG5010 Programmable 20 MHz Function GeneratorC	PAV w/SF-1
DSRB-5CD	KC-2600 Kelvin Klips for Model 2600 Series LCR MetersC	PAV w/VF-1
DSRB-5CDA-4 Decade Synchro Resolver BridgeC	Kit 1 Calibrator Accessory K (K, J, T, & T/Cs) for 840A & 845 ...D-2	PAV w/VF-2
DSRB-5D	Kit 5 Calibrator Accessory Kit (Multi T/Cs, RTD, Ohms & Thermistor) for 850 & 855D-2	PC101 Parallel Compensation Network for SR1010, 1030, & 1060C-23
DSRS-5	KK100 Kelvin Klip Replacement Kit C-23	PG502
DSRS-5C	KK110 Kelvin Klip Cable, 3 Feet Long, for 242C-23	PG506A
DSRS-5D		PRT-10
DSRS-5DA Decade Synchro Resolver StandardC		PRT-23
DSRS5DA/R Decade Synchro Resolver Standard with Rack MountC		PRT-73 Programmable Precision Ratio TransformerC-21
		PRT-73/2.5 Programmable Precision Ratio Transformer w/2.5 Volt/Hz OptionC-21



Contact TEGAM, Inc. at 440-466-6100 for information

INDEX BY MODEL NUMBER

PS503A Triple Power SupplyⓈ	SR1-0.1 .1 ohm Standard ResistorC-1	SR1030-10K 10 K ohm Resistance Transfer StandardC-7
PS5004 Power SupplyⓈ	SR1-1 1 ohm Standard ResistorC-1	SR1030-100K 100 K ohm Resistance Transfer StandardC-7
PS5010 Power SupplyⓈ	SR1-10 10 ohm Standard Resistor ..C-1	SR1050-1M 1M ohm Resistance Transfer StandardC-9
RS725Ⓢ	SR1-100 100 ohm Standard ResistorC-1	SR1050-10M 10 M ohm Resistance Transfer StandardC-9
RS925Ⓢ	SR1-1K 1K ohm Standard ResistorC-1	ST-200Ⓢ
RS925AⓈ	SR1-10K 10K ohm Standard ResistorC-1	ST-200AⓈ
RS925CⓈ	SR1-100K 100 K ohm Standard ResistorC-1	SYSIIAA-25
RS925D 1.2 M ohm Decade Resistance StandardⓈ	SR1-1M 1 M ohm Standard Resistor C-1	SYSIIA PackagesⓈ
RS-XXⓈ	SR1-10M 10 M ohm Standard ResistorC-1	SYSIIA SureCALA-23
RT-1Ⓢ	SR102 100 ohm Resistance StandardC-3	T-470 Phase Sequence Indicator, 115-700V, 400 HzH-3
RT-5Ⓢ	SR102/DC 100 ohm Resistance Standard, with No Case, for Oil Bath ImmersionC-4	T-471 Phase Sequence Indicator, 115-700V, 50/60 HzH-3
RT-7Ⓢ	SR104 10 K Resistance Standard (0.1PPM T/C)C-3	TG501A GeneratorⓈ
RT-7CⓈ	SR104/DCC-4	TM502A MainframeⓈ
RT-9Ⓢ	SR1010-1 1 ohm Resistance Transfer StandardC-5	TM502A/TB TM502A with Tool Box Plug-InⓈ
RT-18AⓈ	SR1010-10 10 ohm Resistance Transfer StandardC-5	TM503B MainframeⓈ
RT-19AⓈ	SR1010-100 100 ohm Resistance Transfer StandardC-5	TM506A MainframeⓈ
RT-20AⓈ	SR1010-1K 1 K ohm Resistance Transfer StandardC-5	TM5003 MainframeⓈ
RT-23AⓈ	SR1010-10K 10 K ohm Resistance Transfer StandardC-5	TM5003/RI TM5003 with Rear InterfaceⓈ
RT-30AⓈ	SR1010-100K 100 K ohm Resistance Transfer StandardC-5	TM5006A MainframeⓈ
RT-60Ⓢ	SR1030-1 1 ohm Resistance Transfer StandardC-7	TM5006A/R TM5006A with Rack MountⓈ
RV622AⓈ	SR1030-10 10 ohm Resistance Transfer StandardC-7	TM5006A/RI TM5006A with Rear InterfaceⓈ
RV722Ⓢ	SR1030-100 100 ohm Resistance Transfer StandardC-7	TM5006A/R/RI TM5006A with Rack Mount & Rear InterfaceⓈ
SB103 Shorting Bars for SR1010, SR1030, & SR 1060C-23	SR1030-1K 1 K ohm Resistance Transfer StandardC-7	TM5006A/EMC TM5006A with EMC ShieldingⓈ
SC1000Ⓢ	SR1030-10 10 ohm Resistance Transfer StandardC-7	VM-7 Advanced 30 MHz RF ReceiverB-1
SG503Ⓢ	SR1030-100 100 ohm Resistance Transfer StandardC-7	
SG5010 OscillatorⓈ	SR1030-1K 1 K ohm Resistance Transfer StandardC-7	
SG5030 Sine Wave GeneratorⓈ		
SG5050 Sine Wave GeneratorⓈ		
SI5010 ScannerⓈ		
SPC102 Series-Parallel Compensation Network for SR1010, 1030, 1050C-23		
SR1-0.01 .01 ohm Standard ResistorC-1		

 Contact TEGAM, Inc. at 440-466-6100 for information

[BACK TO CONTENTS](#)

K