

INSTRUCTION MANUAL

The Type 84 and 067-0523-00 are electrically similar instruments. The Type designation was changed from 84 to 067-0523-00 at SN 974.

067-0523-00
CALIBRATION
FIXTURE



WARRANTY

All Tektronix instruments are warranted against defective materials and workmanship for one year. Tektronix transformers, manufactured in our own plant, are warranted for the life of the instrument.

Any questions with respect to the warranty mentioned above should be taken up with your Tektronix Field Engineer.

Tektronix repair and replacement-part service is geared directly to the field, therefore all requests for repairs and replacement parts should be directed to the Tektronix Field Office or representative in your area. This procedure will assure you the fastest possible service. Please include the instrument Type and Serial or Model Number with all requests for parts or service.

Specifications and price change privileges reserved.

Copyright © 1963, new material 1967, by Tektronix, Inc., Beaverton, Oregon. Printed in the United States of America. All rights reserved. Contents of this publication may not be reproduced in any form without permission of the copyright owner.



CONTENTS

Section 1	Characteristics
Section 2	Operating Instructions
Section 3	Circuit Description
Section 4	Calibration and Maintenance
Abbreviations and Symbols	
Parts Ordering Information	
Section 5	Electrical Parts List
Section 6	Mechanical Parts List & Diagrams

Abbreviations and symbols used in this manual are based on, or taken directly from, IEEE Standard Symbols for Units", MIL-STD-12B and other standards of the electronics industry. Change information, if any, is located at the rear of this manual.

SEE PARTS LIST FOR SEMICONDUCTOR TYPES

SERIES M MODEL 1, 2, 3



067-0523-00 CALIBRATION FIXTURE

FOR TYPE 580 SERIES

LOAD
LOW HIGH

SERIAL

VERTICAL POSITION

POSITION RANGE ADJ.

CAL. REFERENCE

200 mV

PULSER AMPLITUDE

DISPLAY SELECTOR

PULSER

EXT. INPUT

CAL. (2CM) AND ALT. SYNC

TURN OFF PULSER TO EXTEND MERCURY SWITCH LIFE

OPERATING POSITIONS

UP

POWER LINE

SCOPE AMPL. BALANCE CHECK

PULSER FREQUENCY

EXT. INPUT

TEKTRONIX, INC.

PORTLAND, OREGON, U.S.A.

Fig. 1-1. 067-0523-00 Calibration Fixture.

SECTION 1

CHARACTERISTICS

General

The 067-0523-00 Calibration Fixture is used with Tektronix 580-Series oscilloscopes. The calibration fixture provides a reference signal for setting the oscilloscope vertical amplifier gain, a fast-rise voltage step for adjusting oscilloscope vertical amplifier transient response, and a load bank which loads the oscilloscope power supplies over their full current range. The 067-0523-00 allows a check of the DC balance of the oscilloscope vertical amplifier. It may also be fed external signals which might be used in calibration procedures.

580-Series oscilloscope vertical amplifiers that have been calibrated with the 067-0523-00 have a uniform transient response. The amplitude calibration signal has a long-term amplitude stability. The amplitude signal circuit is driven by the dual-trace alternate sync pulse generated by the oscilloscope. The dual-trace display shows the presence of the sync pulse.

Calibration Reference Signal

A 200-millivolt signal for adjustment of vertical amplifier gain. Signal level is switched by the alternate trace sync pulse from the oscilloscope sweep generator. Signal amplitude can be checked at front-panel jacks.

Pulser

Provides low distortion square-wave pulse with a rise-time considerably less than the response time of the vertical amplifier in a 580-Series Oscilloscope. Pulse amplitude continuously adjustable to either plus or minus 4 centimeters

deflection. Repetition rate adjustable from about 550 to 750 pulses per second. Pulser maintains risetime without need for circuit adjustment.

Scope Amplifier balance check

Connects input leads to oscilloscope vertical amplifier together. The resultant deflection shows any overall DC imbalance of the oscilloscope vertical amplifier.

Power Supply Load

Provides low, normal, and high loading of oscilloscope power supplies. Range corresponds to the range of currents available from power supplies. Allows check of ripple and regulation of each power supply.

Display Selector

A three-position switch which selects the 200 mV calibration signal, pulser, or external input to the oscilloscope.

Power Line Indicator

Lights when line power is present at pins 12 and 13 of the plug-in interconnecting plug.

Mechanical Construction

Aluminum alloy chassis. Aluminum alloy anodized front panel.

SECTION 2

OPERATING INSTRUCTIONS

General

The 067-0523-00 Calibration Fixture is used as an aid to calibration of Tektronix 580-Series Oscilloscopes. Follow the calibration procedure in the instruction manual for the oscilloscope you are calibrating, using the 067-0523-00 for the appropriate steps. The following instructions cover operating the 067-0523-00 only. Steps may be performed individually. The 067-0523-00 is calibrated and ready for use as shipped from the factory.

Preliminary Information

Before inserting the 067-0523-00 in the plug-in compartment, check the setting of the 12.6 V LOAD switch SW135, located on the chassis directly behind the front-panel LOAD switch. Type 581 oscilloscopes before serial number 1531, and Type 585 oscilloscopes before serial number 3763 require extra loading of the 12.6 volt supply because this supply does not drive the vertical amplifier heaters.¹ The 12.6 V LOAD switch should be set toward the rear of the plug-in unit (closed) when calibrating early oscilloscopes. Set the switch toward the front panel (open) on later scopes.

The front-panel LOAD switch must be in the HIGH or NORM position when using the 200 mV calibration signal, external input, or pulser. The LOW position disconnects these circuits, and is for power supply tests only.

Insert the 067-0523-00 into the oscilloscope to be calibrated after any resistance-to-ground measurements have been made on the oscilloscope circuits.

Power Supply Output Voltages

To check the oscilloscope power supply voltages, set the LOAD switch to NORM. Measure the voltages at the power-supply test points called out in the oscilloscope instruction manual.

NOTE

If —150-volt power supply voltage is changed
the oscilloscope will require complete recalibration

Power Supply Regulation and Ripple

To check the oscilloscope power supply regulation and ripple, set the 067-0523-00 LOAD switch to HIGH. Measure the ripple (with a test oscilloscope) of the various supplies with the line voltage at 105 volts (210 volts if the instrument is wired for 234-volt operation). Then set the 067-0523-00 LOAD switch to LOW and again measure the ripple of the various supplies, this time with the line voltage

¹Some early oscilloscopes have been modified to later type. If in doubt, call your Tektronix Field Engineer.

at 125 volts (or 250 volts). Refer to the oscilloscope manual for ripple and voltage limits. Return LOAD switch to NORM.

Oscilloscope Vertical Gain

Set the 067-0523-00 LOAD switch to NORM and the DISPLAY SELECTOR switch to CAL (2 CM) AND ALT SYNC. Free-run the oscilloscope time-base generator at about 1 ms/cm sweep rate; there should be two traces. Adjust the oscilloscope vertical GAIN control for exactly two centimeters vertical distance between the two traces. Make the adjustment with the display centered on the graticule.

Oscilloscope Alternate-Trace Sync Pulse

If the 067-0523-00 produces two traces when operated with the DISPLAY switch at CAL (2 CM) AND ALT SYNC, you know that the oscilloscope time-base generator is producing proper alternate-trace sync pulses for the plug-in unit. If you are calibrating a Type 585, 585A or RM585A, make the same test using Time Base B. Check each sweep rate to be sure the sync pulse is present with sufficient amplitude.

Oscilloscope Vertical Amplifier Balance

Vertical amplifier DC balance is important for optimum linearity. Press the SCOPE AMPL. BALANCE CHECK button to short circuit the grid lines together. See the oscilloscope instruction manual for test procedure, imbalance limits, and methods for balancing the vertical amplifier.

Oscilloscope Vertical Amplifier Transient Response

After completing the oscilloscope calibration procedure steps for vertical amplifier balance and cathode interface checks, you may use the 067-0523-00 for standardizing the transient response of the vertical amplifier.

Set the 067-0523-00 LOAD switch to the NORM position and the DISPLAY SELECTOR to PULSER. Adjust the oscilloscope for 0.05 μ s/cm sweep rate and + INT triggering. Adjust the 067-0523-00 PULSER AMPLITUDE for a 2 centimeter high + pulse. Adjust the PULSER FREQUENCY control for the best display. The best setting of the PULSER FREQUENCY control is that which gives a steady trace.

NOTE

The pulser is sensitive to operating position. In order to use the pulser, the oscilloscope must be positioned so that either of the UP arrows under the OPERATING POSITIONS label is pointing up. If the 067-0523-00 is positioned so that either of these arrows points downward, the pulser will

Operating Instructions—067-0523-00

not operate properly. If the 067-0523-00 has been positioned with an arrow pointed downward, it may take several minutes of pulser operation before the pulser will operate properly because the contacts are overloaded with mercury.

External Input

The 067-0523-00 is provided with an external input connector and a limited bandpass amplifier. The external input is suitable for inserting signals for calibrating the time-base generator(s) of the oscilloscope. To use the external input, connect the signal to the EXT INPUT connector. Set the

LOAD switch to NORM and the DISPLAY SELECTOR to EXT INPUT. Sensitivity is about 0.33 volt/centimeter.

Adjustment of Position Range Adj Control

The POSITION RANGE ADJ control sets the DC balance of the 067-0523-00 amplifier. To adjust it, place the DISPLAY SELECTOR in the EXT INPUT position. Obtain a free-running trace on the CRT. Set PULSER AMPLITUDE at 0 and the VERTICAL POSITION control at midrange. Press the SCOPE AMPL BALANCE CHECK button and note the trace position. Release the button and return the trace to the position noted with the POSITION RANGE ADJ control.

SECTION 3

CIRCUIT DESCRIPTION

General

Fig. 3-1 is a block diagram of the 067-0523-00 Calibration Fixture.

A power supply load circuit allows loading of the oscilloscope power supplies over their output ranges. A front-panel switch sets low, normal, or high loading of the power supplies. In the normal and high loading positions, the circuits of the 067-0523-00 make up a part of the load.

There are two signal generator systems feeding opposite ends of the grid lines of the 580-Series oscilloscope vertical amplifier delay line driver under test. The 580-Series vertical amplifier grid lines have a 186 ohm characteristic impedance between the lines or individually, a 93-ohm characteristic impedance to ground. In the 067-0523-00, the oscilloscope alternate-trace sync pulse drives a bistable multivibrator. Output of the multivibrator drives a cathode-coupled paraphase amplifier to provide the 200-millivolt reference signal. The amplifier is also used for external signal input. The amplifier output is fed to the normally terminated no-signal end of the oscilloscope vertical amplifier grid lines.

The pulser drives the normal signal input end of the oscilloscope vertical amplifier grid lines. The mercury reed switch is a normally-closed switch. When it closes, it propagates a signal down the grid line and completes another 186-ohm termination. A variable current is provided for varying the voltage amplitude and polarity of the pulse displayed. When the pulser is operating, the 067-0523-00 amplifier is disconnected from the grid lines, leaving only the 186-ohm termination. Because of the action of the mercury switch, and the double termination of the grid lines, a very fast-rise pulse is obtained when the contacts close. The fast-rise pulse permits accurate measurement of the oscilloscope vertical amplifier risetime.

When the switch opens, the impedance match is not maintained, and reflections are not damped by the termination.

The pulser polarity, as indicated by the setting of the PULSER AMPLITUDE control, must correspond to the oscilloscope triggering polarity. This allows the oscilloscope to trigger on the voltage step occurring at the close of the reed switch.

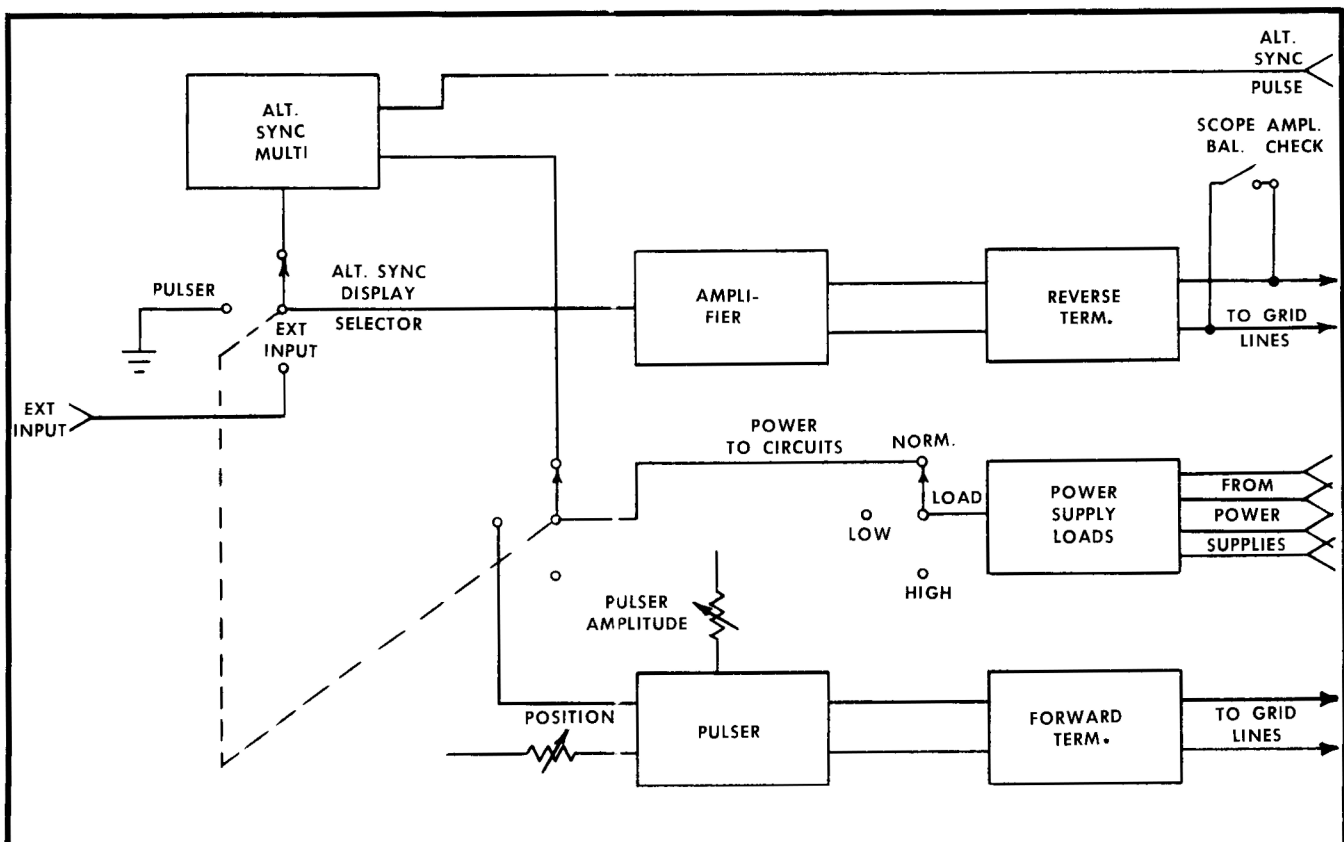

Fig. 3-1. 067-0523-00 Block Diagram.

Circuit Description—067-0523-00

A variable-frequency transformer-coupled multivibrator drives the reed switch coil, allowing the driving frequency to match the reed resonant frequency.

Sync Pulse Multivibrator

The alternate sync multivibrator is a typical Eccles-Jordan bistable circuit, followed by a diode clipper network, which supplies an accurately controlled signal to the amplifier. The multivibrator is driven by a positive pulse fed through terminal 7 of the interconnecting plug. This pulse appears at the end of each sweep. Another pulse (negative) appears at the base of Q74 at the beginning of each sweep, but it is not seen by the multivibrator because Q74 is already reverse biased.

The positive alternate-trace sync pulse forward biases Q74, turning it on, and causing it to draw collector current through either D62 or D72 from the collector of either Q65 or Q75. Assume that Q75 is conducting. Current will be drawn through D62, because the collector at Q65 is at the supply voltage, +12.6 volts. The current drawn through R61 causes a voltage drop, which is coupled through C63 to turn off Q75. When Q75 is turned off, the collector voltage rises, since current is no longer drawn through R71. This voltage change is coupled through C73 to turn on Q65. C63 and C73 assure rapid multivibrator switching. The new voltages at the collectors of Q65 and Q75 hold Q65 in conduction and Q75 turned off. R65 and R75, with R73 and R63 respectively, form voltage dividers setting the steady state voltages at levels which allow bistable operation.

The next positive pulse received at Q74 once again turns on that transistor, draws current through D72, and the circuit reverses with Q65 turned off and Q75 on. D62 and D72 serve to isolate the collector circuits of Q65 and Q75 from each other, and connect the circuit of the "off" transistor to the collector of Q74.

The state of multivibrator transistor Q75 determines whether D49 is forward biased or reverse biased. D49 in turn controls the operation of the diode gate circuit. The clipping circuit is connected to R42 which is one side of resistance network R40, R41, and R42. R40 and R41 alone appear to be a negative voltage source feeding through about 6.1 k Ω . The voltage at the clamp gate end of R42 is shifted between about +7 and +10 volts, causing the voltage at the junction of R40, R41, and R42 to shift between about -100 and +500 millivolts.

When multivibrator transistor Q75 is turned on, its collector drops to about +4 volts, and D49 is forward biased, receiving current through R49. This causes the voltage at the junction of D49, R49, L43, and D44 to be clipped at about 4 volts. D44 is connected to D47, a ten volt zener diode, and this holds D44 reverse-biased. At the junction of R44 and R45, the voltage is about +7 volts. This is fed through D42, clamping the voltage at the junction of D42, R42, and D43 to about +7 volts. This in turn causes the voltage at the junction of R40, R41, and R42 to be about -100 millivolts, which is fed through the DISPLAY SELECTOR switch to the grid of V14A.

When the multivibrator switches, and D75 is turned off, its collector rises to about +12.6 volts. Because D49 becomes connected, through D44, to the clipped +10 volt level, D49 becomes reverse-biased and is turned off. This

+10 volt level, fed through D44, allows D43 to become forward biased. D42 is still connected to the +7 volts, and becomes reverse-biased. D43 allows the voltage at R42 to rise to about +10 volts, causing the voltage at the junction of R40, R41, and R42 to rise to about +500 millivolts.

Amplifier

The amplifier is a cathode-coupled paraphase type, and feeds signals from either the alternate-trace multivibrator or the external input connector to the Type 580-series oscilloscope grid line. The DISPLAY SELECTOR switch, SW29, selects the input to the 067-0523-00 amplifier. In the PULSER position of SW29, the amplifier input is grounded. In the EXT INPUT position, the amplifier is fed signals from the EXT INPUT connector through C1. In the CAL (2 CM) AND ALT SYNC position of the DISPLAY SELECTOR, the signal from the alternate-trace multivibrator is connected to the amplifier. Gain of the amplifier is controlled by CAL REF ADJ control, R18. The 100 volt supply, connected through R30 and R33, provides the required +50 volts for the oscilloscope grid lines.

The +100 volt supply to R30 and R33 is disconnected, allowing D22 and D23 to become reverse-biased. D22 and D23 disconnect the amplifier from the grid lines when the DISPLAY SELECTOR switch is in the PULSER position. The amplifier input grid is grounded, and the amplifier cathode circuit is returned to ground through R21 and the pulser circuit, cutting the amplifier tubes off. Dividers R4-R5 and R14-R15 hold the amplifier output at about +56 volts. The oscilloscope grid line voltage (supplied through R101 and R103 and through the POSITION control R107) falls to about +48 volts, reverse-biasing D22 and D23. When the amplifier is operating, the triodes draw sufficient current to set their plate voltage near 50 volts. Current from the +100 volt supply, through R30 and R33, causes D22 and D32 to conduct.

Center screen position of the 067-0523-00 amplifier is set by the POSITION RANGE CONTROL, R10, which controls the voltage on the grid of V14B.

Pulser

The pulser of the 067-0523-00 is a mercury-wetted reed switch. When the switch is closed, the characteristic impedance of the pulser circuit is 186 ohms, looking in at terminals 9 and 11 of the interconnecting plug. With the switch open, this impedance is approximately 2.5 k Ω . The reed switch shifts the voltage level across grid lines. The PULSER AMPLITUDE control, R10, controls the input voltage to the pulser circuit, and thus the amplitude of the step.

The mercury-wetted reed switch is shown in phantom view in Fig. 3-2. Should the contacts bounce after closing, the mercury maintains circuit continuity. Thus a fast-rise step without electrical transients from relay chatter is obtained. Because the pulse is generated by a mechanical device, the fast-rise characteristic will remain constant over a long period.

The reed lies in the magnetic flux path of a permanent bias magnet. A changing flux is established in the reed by a driving coil. A multivibrator supplies the driving coil with a square wave which switches the flux, moving the reed

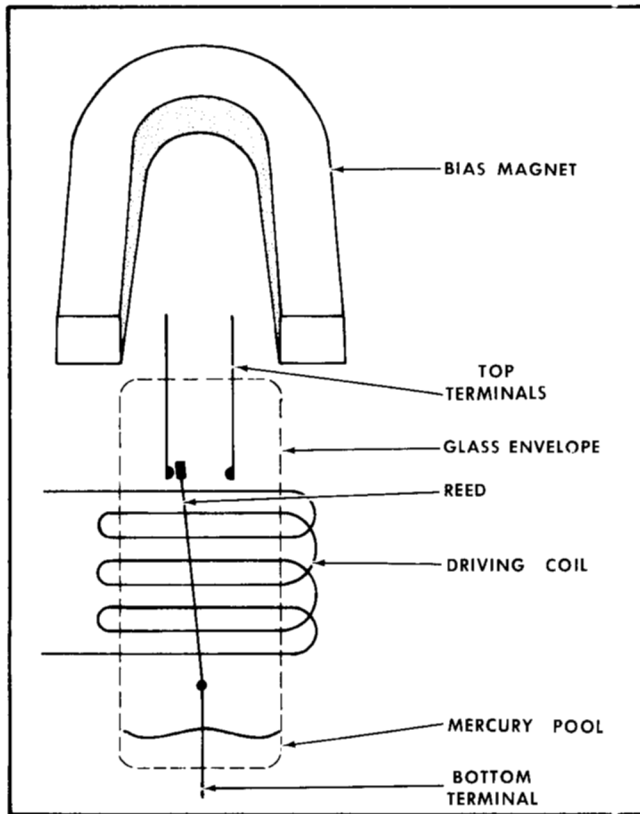

Fig. 3-2. Reed switch assembly, phantom view.

back and forth in the bias field. The bias magnet is physically positioned to bias the reed so it rests normally closed, but will switch back and forth between contacts with drive signal.

Pulser Multivibrator

The driving coil for the pulser reed switch is fed a square wave from a free-running transformer coupled multivibrator, consisting of T91, Q85, and Q95. The transistors are switched back and forth by base signals fed from a feed back winding on T91. Collector current of Q85 and Q95 flows through T91. A low-impedance output winding provides the signal for the driving coil, L119.

The frequency of the pulser multivibrator is variable, controlled by the PULSER FREQUENCY control, R81, which controls the operating bias of Q85 and Q95. The multivibrator frequency is adjustable to allow the reed to be driven at a resonant frequency. Driving the reed at a resonant frequency allows the cleanest display with firm contact action.

SECTION 4

CALIBRATION AND MAINTENANCE

General

The 067-0523-00 Calibration Fixture is stable and does not require frequent recalibration. To insure that the unit is operating properly, we suggest that the calibration be checked every 500 hours of operation or six months, whichever is less.

The Calibration procedure consists of three steps: setting the vertical position range, setting the 200 millivolt calibration reference signal, and adjusting the reed switch bias magnet. The unit should be plugged into an oscilloscope and warmed up for 5 to 10 minutes before calibration.

NOTE

Do not use the 067-0523-00 with a Type 013-0055-00 plug-in extension except to service the unit. Because of the fast rise of the pulser, the plug-in extension may cause considerable ringing of the signal fed to the oscilloscope.

Position Range Adjustment

1. Obtain a free-running sweep on the oscilloscope screen. Set the 067-0523-00 DISPLAY SELECTOR switch to PULSER, and set the PULSER AMPLITUDE control at 0. Center the display on the CRT.

2. Set the DISPLAY SELECTOR switch to EXT INPUT. Ground the EXT INPUT connector, and set the POSITION RANGE ADJ control to center the trace on the CRT.

Cal Reference Adjustment

1. To calibrate the CAL REFERENCE, the following equipment is required.

NOTE

The CAL REFERENCE jacks are elevated 50 volts above ground and have a source impedance of 43.5 k Ω .

a. A differential, AC-coupled oscilloscope with a vertical sensitivity of 10 millivolts per centimeter. A Tektronix Type 530-, 540-, or 550-series oscilloscope with a Type 1A6 plug-in and two P6023 attenuator probes is recommended.

b. An accurate 200-mV reference square-wave source. The source must also have available a 2-volt output square-wave signal. A Tektronix Standard Amplitude Calibrator (Tektronix Part No. 067-0502-00) which has an amplitude accuracy of 1/4% is recommended.

2. Calibrating the CAL REFERENCE.

a. Adjust the test oscilloscope controls:

Mode	Automatic
Slope	+

Coupling	AC
Source	Internal
Time/Div	50 μ s
b. Adjust the Type 1A6 plug-in controls:	
Volts/Cm	1 mVolts
Variable	Cal
Input Selector (both + and - Inputs)	AC

c. Adjust the Type 1A6 Step Atten Balance and Variable Balance controls for no trace movement as the Volts/Cm and Variable (Volts/Cm) controls are rotated throughout their range.

d. Connect a 10 \times attenuator probe to each input connector on the Type 1A6 plug-in.

e. Connect each 10 \times attenuator probe to a common 2-volt square-wave source.

f. Check for minimum vertical deflection, i.e., a single straight line. If a straight line cannot be obtained, the characteristics of the two probes do not match each other well enough.

g. Remove both the probes from the 2-volt square-wave source and connect one of the probes to an accurate 200 mV square-wave source.

h. Adjust the Type 1A6 Volts/Cm and Variable (Volts/Cm) controls to obtain exactly 4 centimeters of square-wave display on the CRT of the test oscilloscope.

i. Disconnect the probe from the 200-mV square-wave source.

j. Set the Type 580-series oscilloscope/067-0523-00 controls:

580-series oscilloscope	
Power	On
Triggering	Free running
Sweep rate	1 ms

067-0523-00	
DISPLAY SELECTOR	CAL (2 CM) AND ALT SYNC

k. Connect a 10 \times attenuator probe from the Type 1A6 plug-in to each CAL REFERENCE jack on the front panel of the 067-0523-00.

l. Observe the display on the CRT of the test oscilloscope. It should be exactly the same height as the 200-mV signal was (4 centimeters).

m. If the Cal Reference signal is not the proper amplitude, remove the left side panel from the Type 580-series oscilloscope and adjust R18, CAL REF ADJ (mounted on the main

chassis of the 067-0523-00) for exactly the same height on the test oscilloscope as was produced by the 200-mV reference square-wave (4 centimeters).

Magnet Adjustment

1. Remove the 067-0523-00 from the oscilloscope and loosen the screws holding the bias magnet until the magnet may be moved for adjustment. Check to be sure that the connections are well soldered to the switch, and that the mercury switch terminals under the bias magnet are about $\frac{1}{32}$ inch from the bias magnet. These terminals also must lie in a plane parallel to the main chassis of the 067-0523-00.

2. Use a plug-in extension, Tektronix part number 013-0055-00 to connect the 067-0523-00 to the oscilloscope. Turn the oscilloscope on and allow it to warm up. Set the oscilloscope sweep rate to $0.05 \mu\text{s}/\text{cm}$. Set the DISPLAY SELECTOR to PULSER and the PULSER FREQUENCY at maximum clockwise. Other settings of 067-0523-00 controls are not important.

3. Listen for the buzz of the reed switch. Slide the magnet until the buzz is at its loudest. There will be a range of loudest buzz, indicating that the reed is hitting both contacts properly. Adjust the oscilloscope time-base for a triggered sweep and check adjustments for a good clean pulse on the CRT. Set the magnet slightly to one side of the center of this range, to be sure that the switch will close when the system is de-energized. Tighten the screws holding the magnet.

4. Turn the PULSER FREQUENCY control through its range and listen to be sure there are no dead spots where the reed does not operate or operates irregularly. The character of the sound will change somewhat as the control is operated, because the reed has resonant modes within the frequency range.

5. Obtain a free running sweep. Move DISPLAY SELECTOR to CAL (2 CM) AND ALT SYNC and check for approximately 2 cm deflection. If approximately 4 cm of deflection is seen (indicating that the reed switch is open) repeat step 3.

6. Remove the plug-in extension. The 067-0523-00 is now ready for use.

Component Replacement

Switches

Switches are supplied as complete assemblies. If one is defective, replace the complete switch. Do not remove the old switch until you are ready to replace it. Note carefully the locations of the leads on the switch to assist when wiring the new switch.

Reed Switch

1. Remove the bias magnet by removing the screws which hold it to the bracket. Set magnet aside.

2. Unsolder the leads to the switch terminals and to the shield foil. Slide switch out of coil.

CAUTION

The reed switch is filled with hydrogen at high pressure. It has a plastic wrapping to prevent injury

from flying glass, should it break. Do not remove the wrapping or damage the envelope of the switch.

3. Orient the new switch so that the end with two terminals will be toward the bias magnet and the terminals lie in the same plane as the chassis. Slide the switch into the coil and position it so that the two terminal pins will be about $\frac{1}{32}$ inch below the bottom of the bias magnet.

4. Solder the connection to the switch terminals and to the shield foil.

5. Replace the bias magnet, tightening the screws until the bias magnet is just held in position, but may be moved.

6. Follow the reed switch bias magnet calibration procedure.

Soldering Precautions

In the production of Tektronix instruments a special silver-bearing solder is used to establish a bond to the ceramic terminal strips. This bond may be broken by repeated use of ordinary tin-lead solder, or by excessive heating of the terminal strip with a soldering iron. Occasional use of ordinary 60-40 solder will not break the bond unless excessive heat is applied.

If you are responsible for the maintenance of Tektronix instruments, it is advisable to have a stock of solder containing about 3% silver. This type of solder is used in printed circuitry, and is generally available locally. It may also be purchased from Tektronix in one-pound rolls; order by part number 251-0154-00.

Because of the shape of the terminals of the ceramic terminal strips, we recommend a wedge-shaped tip on your soldering iron. This type of tip allows heat to be applied directly to the solder in the terminals. It is important to use as little heat as possible while producing a full-flow joint.

The proper technique for soldering components in place requires: (1) the use of long-nose pliers to hold the lead securely between the component and the point where heat is applied, allowing the pliers to serve as a heat sink; (2) the use of a hot iron for a short time; and (3) careful manipulation of the leads to prevent lead breakage. Use a 50- to 70-watt iron when working on ceramic strips.

Ceramic Terminal Strips

Damaged ceramic strips are most easily removed by unsoldering all connections, then knocking the plastic yokes out of the chassis. This can be done by using a plastic or hard-rubber mallet to hit the ends of the yoke protruding through the chassis. If space limitations prohibit use of the mallet directly, a plastic rod can be used between the mallet and the yoke of the strip. When the two yokes supporting the strip have been knocked out of the chassis, the strip and yokes can be removed as a unit. The spacers will probably come out with the yokes; if not, they can be removed separately.

Another way of removing the terminal strip is to cut off the side of the yoke holding the strip with diagonal cutters. This permits the strip to be removed from a difficult area where a mallet cannot be used. The remainder of the yokes and the spacers can be pulled out separately. Since a re-

placement strip is supplied with yokes already attached. The old yokes need not be salvaged. However, the old spacers can probably be used again.

When the damaged strip and yoke assembly has been removed, place the spacers into the holes in the chassis. Then set the ends of the yoke pins into the spacers. Press or tap lightly directly above the yokes to drive the yoke pins down through the spacers. Be certain that the yoke pins are driven completely through the spacers. Then cut off the portion of the yoke pin protruding past the spacers.

TROUBLESHOOTING

There are three tables which will help when troubleshooting the 067-0523-00. Table 4-1 is a list of typical troubles. Table 4-2 is a step-by-step procedure for checking each of the functional blocks for normal operation. If the normal indications are not observed, there is trouble in that circuit block of the unit which was tested. Table 4-3 gives step-by-step procedures for testing in each functional block of the 067-0523-00. Failure to obtain the normal indication in a step indicates that the fault probably lies in one or more of the components listed in the "Components to Check" column.

NOTE

The numbered test points referred to in Tables 4-1, 4-2 and 4-3 are indicated on the circuit diagram by a bracketed number corresponding to the test point number.

Because the 067-0523-00 derives all of its operating voltages from the oscilloscope, and depends on the oscilloscope for its display, you must be sure that the oscilloscope is not the cause of the trouble. Trouble can usually be isolated to either the oscilloscope or plug-in unit by substituting another plug-in for the suspected one and checking for proper operation. Or you can insert the suspected 067-0523-00 in another oscilloscope and check it for proper operation.

If trouble occurs in the 067-0523-00, try to isolate it by quick operational and visual checks. First check the settings of all controls. Then operate the controls to see what effect, if any, they have on the trouble.

After the trouble symptoms are established, look first for simple causes of trouble. Check to see that the pilot light of the oscilloscope is on, feel for any irregularities in the operation of the controls, listen for any unusual sound, see that the tube filaments are lit, and visually check the entire instrument. The type of trouble will generally indicate the checks to make.

Most troubles will be caused by tube or semiconductor failures. Therefore, when trouble has been isolated to a circuit, the tubes and semiconductors in that circuit should be checked (by substitution). Be sure to return tubes and transistors found to be good to their original sockets.

Switches shown in the circuit schematics are coded to indicate the position of the wafer on the switches. The number portion of the code refers to the wafer number on the switch assembly. Wafers are numbered from the front of the switch to the rear. The letters F and R indicate whether the switch contacts are located on the front or the rear of the wafer.

TABLE 4-1
Typical Troubles

Symptom	Probable Causes
1. No display from PULSER, CAL or EXT INPUT POSITION control has little effect.	LOAD switch in LOW position.
2. CAL signal provides about 4 cm deflection. Moving PULSER AMPLITUDE control moves trace.	Reed switch open in CAL position of DISPLAY SELECTOR. Try resetting bias magnet according to calibration procedure.
3. Trace deflected off screen in CAL and EXT INPUT positions. Returns when SCOPE AMPL BALANCE CHECK is pushed.	One side of V14 inoperative, D22 or D23 open.
4. 12.6-volt supply in oscilloscope appears overloaded in HIGH load regulation check.	12.6 V LOAD switch closed when oscilloscope under test has vertical amplifier heaters fed from 12.6 volt supply. Check SN of oscilloscope against numbers given in operating instructions, and check to see if oscilloscope has been modified for DC vertical amplifier heaters.
5. Oscilloscope power supplies do not regulate properly; appear to be normal when checked out.	Open load resistor in 067-0523-00.
6. No pulse from pulser.	Pulser reed switch operating but contact not being broken. Be sure OPERATING POSITION arrows are not pointed down. Check by disconnecting lead to pulser and using jumper to simulate pulser action. Try resetting bias magnet according to calibration procedure.
7. CAL signal not 200 mV, pulser all right.	V14 bad. Also check for about 600 mV peak-to-peak signal at Test Point 1. If voltage is more than 10% high or low, check diodes.

TABLE 4-2
Locating The Faulty Functional Block In The 067-0523-00

Block Under Test	Test Procedure	Normal Indication
1. Amplifier	Obtain trace on oscilloscope screen. Set LOAD at NORM, DISPLAY SELECTOR at EXT INPUT. Apply 1-volt signal from oscilloscope calibrator.	Approximately 3 cm square wave.
2. Alternate sync Flipflop.	Move DISPLAY SELECTOR to CAL. With test oscilloscope, check for 600 mV square wave at Test Point 1.	600 mV square wave. If no square wave, be sure that sync pulse is present at terminal 7 of interconnecting plug.
3. Pulser	Move DISPLAY SELECTOR switch to PULSER.	Buzz of pulser reed switch operating. Buzz will change pitch when PULSER FREQUENCY control is operated.
4. Pulser multivibrator.	Place small magnetic screwdriver about 1/32 inch away from lower reed switch terminal.	A hum will be felt in the screwdriver, the result of the magnetic flux changing in the reed switch driving coil.

TABLE 4-3
Troubleshooting Function Sections

Test	Normal Indication	Components to Check if Abnormal Indication Seen
1. Amplifier		
a. Set the unit for Test 1, Table 4-2. Check DC levels across D22 and D23.	750 mV drop across each diode.	D22, D23, V14, +100 V supply to SW29.
b. Check DC levels at V14 plates to ground.	50 volts from either plate to ground.	If voltage is high: V14, -150 volts through SW29 to junction of R6 and R16, R6, R16, R18. Check R8 through R12, +100-volt supply to these. Grid of V14B should be near ground. If voltage is low: R4, R14, +100 V supply to R4 and R14. Check V14 for grid cathode short.
c. Check DC levels from interconnecting plug pins 14 and 16 to ground.	50 volts to ground at either pin.	If voltage is high, recheck steps a. and b. above. If voltage is low: +100 V supply to SW29, SW29, R30, R33.
d. With test oscilloscope, check for signal at pins 1, 3, 6, 7, and 8, of V14.	150 mV at pin 1, 450 mV at pin 3, 200 mV at pin 6, 0 V at pin 7, 430 mV at pin 8.	V14, Resistors associated with V14, supply voltages. If voltages at pins 1 and 6 of V14 are about 300 and 350 mV, respectively, connect a jumper across the pulser switch terminals. If voltages drop to proper values, check pulser reed switch.
2. Alt. Sync. Multi.		
a. Make Test 1 in Table 4-2.	Amplifier operating properly.	Check amplifier according to Table 4-3 group 1.
b. Set 067-0523-00 for Test 2, Table 4-2. With test oscilloscope, check for signal at Test Point 2. Set test oscilloscope for 10 μs/cm sweep, 5 volts/cm DC coupled vertical sensitivity.	(1) At Test Point 3, a signal waveform similar to Fig. 4-1 with Type 580-series oscilloscope at 2 μs/cm sweep rate. (2) At Test Point 4, (2 points to ground), a signal waveform similar to Fig. 4-2 at either point. (3) At Test Point 5 (2 points to ground) a signal waveform similar to Fig. 4-3.	(1) Q74, D62, D72, and +12.6 volts at junction of R61 and R71, R61, R71. (2) D62, D72, Q65, Q75, R61, R71, R66. (3) Q65, Q75, C73, C63, R63, C65, R75.
c. Check signal at Test Point 1 with test oscilloscope, as in b. above.	600 millivolt square wave, DC level at or near ground.	Check D42, D43, D44, D47, D49. Check for forward/reverse resistance. Check for 10 volts at junction of D47 and R47.

TABLE 4-3 (cont)
Troubleshooting Function Sections

Test	Normal Indication	Components to Check if Abnormal Indication Seen
3. Pulser a. Set 067-0523-00 controls for step 3, Table 4-2.	Buzz of pulser operating, pulse on CRT.	If no buzz, and the test in step 4 of Table 4-2 shows multivibrator is operating, check bias magnet setting, according to calibration procedure. If this does not correct condition, replace reed switch. If reed switch buzzes, but no pulse is seen, disconnect 1 terminal of switch, and open and close circuit across switch with a jumper. If voltage step is seen, replace reed switch. If no voltage step is seen, check D102, +100 V supply to R101, R101, R110, R103, check for ground through SW103 at R103.
4. Pulser Multivibrator a. Set 067-0523-00 controls for step 3, Table 4-2. Check signal at Test Point 6. b. Check waveforms and DC levels between each Test Point 7 and ground.	Signal waveform similar to that of Fig. 4-4. With 0.5 volts/cm vertical sensitivity, the signal should be similar to that of Fig. 4-4 except one-tenth as large in amplitude.	If no signal, or pulse rather than square wave, disconnect L119 and recheck. If signal similar to Fig. 4-4 appears, replace L119. Q85, Q95, R81, R82, R84, R86. Check that +12.6 volt supply is reaching R81 through SW29.

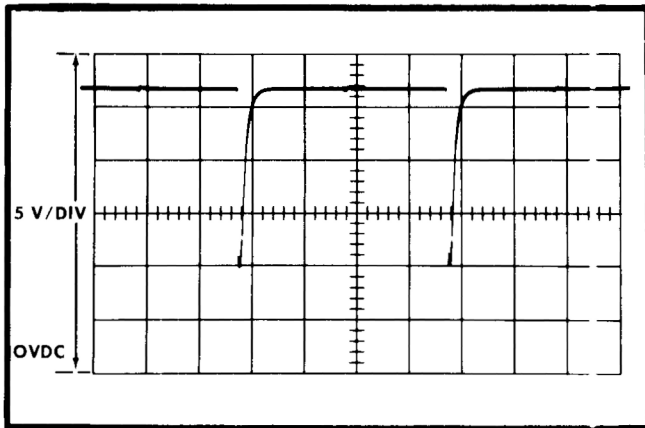

Fig. 4-1. Signal seen at Test Point 3, collector of Q74.

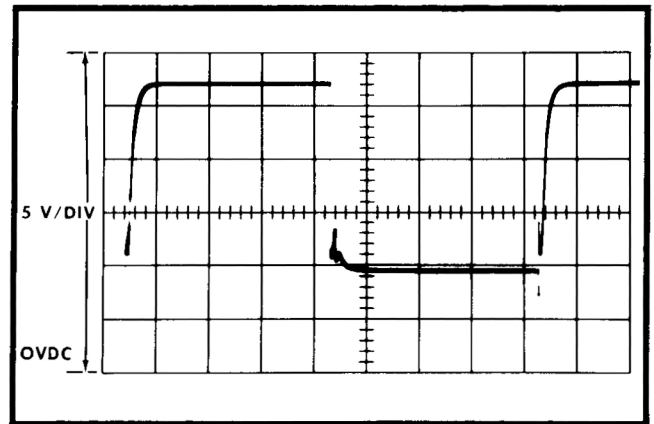

Fig. 4-2. Signal at Test Point 4, collector of Q65 or Q75.

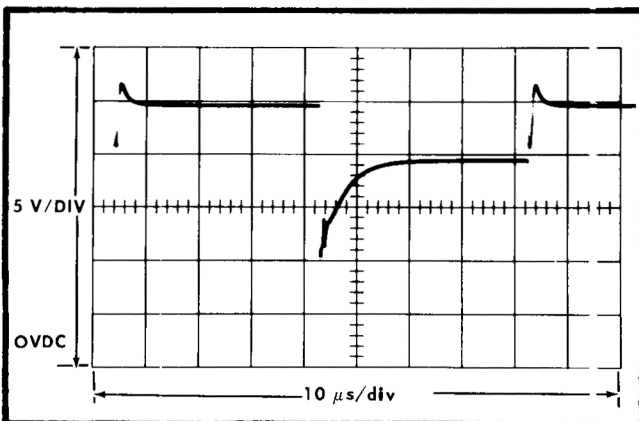

Fig. 4-3. Signal at Test Point 5, base of Q65 or Q75.

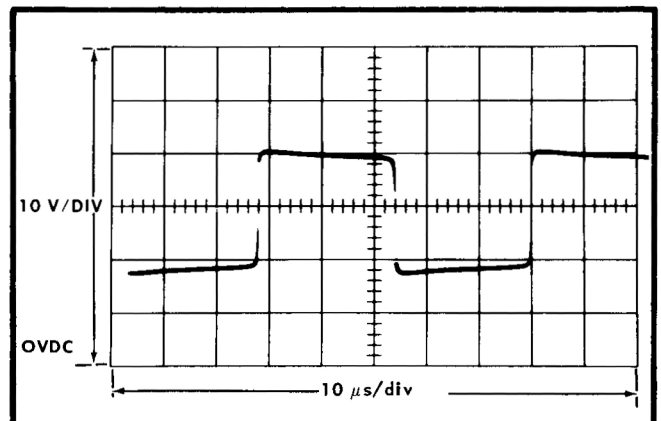

Fig. 4-4. Signal at Test Point 6, collector of Q85 or Q95.

PARTS LIST ABBREVIATIONS

BHB	binding head brass	int	internal
BHS	binding head steel	lg	length or long
cap.	capacitor	met.	metal
cer	ceramic	mtg hdw	mounting hardware
comp	composition	OD	outside diameter
conn	connector	OHB	oval head brass
CRT	cathode-ray tube	OHS	oval head steel
csk	countersunk	P/O	part of
DE	double end	PHB	pan head brass
dia	diameter	PHS	pan head steel
div	division	plstc	plastic
elect.	electrolytic	PMC	paper, metal cased
EMC	electrolytic, metal cased	poly	polystyrene
EMT	electrolytic, metal tubular	prec	precision
ext	external	PT	paper, tubular
F & I	focus and intensity	PTM	paper or plastic, tubular, molded
FHB	flat head brass	RHB	round head brass
FHS	flat head steel	RHS	round head steel
Fil HB	fillister head brass	SE	single end
Fil HS	fillister head steel	SN or S/N	serial number
h	height or high	S or SW	switch
hex.	hexagonal	TC	temperature compensated
HHB	hex head brass	THB	truss head brass
HHS	hex head steel	thk	thick
HSB	hex socket brass	THS	truss head steel
HSS	hex socket steel	tub.	tubular
ID	inside diameter	var	variable
inc	incandescent	w	wide or width
		WW	wire-wound

PARTS ORDERING INFORMATION

Replacement parts are available from or through your local Tektronix, Inc. Field Office or representative.

Changes to Tektronix instruments are sometimes made to accommodate improved components as they become available, and to give you the benefit of the latest circuit improvements developed in our engineering department. It is therefore important, when ordering parts, to include the following information in your order: Part number, instrument type or number, serial or model number, and modification number if applicable.

If a part you have ordered has been replaced with a new or improved part, your local Tektronix, Inc. Field Office or representative will contact you concerning any change in part number.

SPECIAL NOTES AND SYMBOLS

- | | |
|-----------------|--|
| ×000 | Part first added at this serial number |
| 00× | Part removed after this serial number |
| *000-0000-00 | Asterisk preceding Tektronix Part Number indicates manufactured by or for Tektronix, Inc. or reworked or checked components. |
| Use 000-0000-00 | Part number indicated is direct replacement. |

SECTION 5

ELECTRICAL PARTS LIST

Values are fixed unless marked Variable.

Ckt. No.	Tektronix Part No.	Description	S/N Range
Bulbs			
B147	Use 150-027	Neon, NE-23	POWER LINE 101-1029
B147	150-0030-00	Neon, NE-2V	POWER LINE 1030-up

Capacitors

Tolerance $\pm 20\%$ unless otherwise indicated.

Tolerance of all electrolytic capacitors are as follows (with exceptions):

$$3V - 50V = -10\%, +250\%$$

$$51V - 350V = -10\%, +100\%$$

$$351V - 450V = -10\%, +50\%$$

C1	Use *285-0672-00	.1 μ f	PTM	600 v	
C13	Use 283-057	.1 μ f	Disc Type	200 v	
C26	283-002	.01 μ f	Disc Type	500 v	
C63	281-536	.001 μ f	Cer.	500 v	10%
C73	281-536	.001 μ f	Cer.	500 v	10%
C95	Use 283-057	.1 μ f	Disc Type	200 v	
C119	283-026	.2 μ f	Disc Type	25 v	
C122	283-023	.1 μ f	Disc Type	10 v	

Diodes

D22	152-008	Germanium T12G			
D23	152-008	Germanium T12G			
D42	152-008	Germanium T12G			
D43	152-008	Germanium T12G			
D44	152-008	Germanium T12G			
D47	152-064	Zener $\frac{1}{4}$ M10Z10 10 v	$\frac{1}{4}$ w	10%	101-1469
D47	152-0149-00	Zener 1N961B	400 mW, 10 v	5%	1470-up
D49	152-008	Germanium T12G			
D62	152-008	Germanium T12G			
D72	152-008	Germanium T12G			
D102	152-060	Zener 1N3027A 20 v	1 w	10%	101-1469
D102	152-0291-00	Zener 1N3027B	1 w, 20 v	5%	1470-up

Inductors

L119	*108-201	Mercury switch driving coil
------	----------	-----------------------------

Resistors

Resistors are fixed, composition, $\pm 10\%$ unless otherwise indicated

R1	316-105	1 meg	$\frac{1}{4}$ w	
R3	316-101	100 Ω	$\frac{1}{4}$ w	
R4	315-433	43 k	$\frac{1}{4}$ w	5%
R5	315-563	56 k	$\frac{1}{4}$ w	5%
R6	303-303	30 k	1 w	5%

Electrical Parts List—067-0523-00

Resistors (Cont'd)

Ckt. No.	Tektronix Part No.		Description		S/N Range
R8	316-104	100 k	1/4 w		
R9	315-202	2 k	1/4 w		5%
R10	311-016	10 k	2 w	Var.	POSITION RANGE ADJ.
R11	315-202	2 k	1/4 w		5%
R12	316-154	150 k	1/4 w		
R13	316-101	100 k	1/4 w		
R14	315-433	43 k	1/4 w		5%
R15	315-563	56 k	1/4 w		5%
R16	303-303	30 k	1 w		5%
R18	311-003	100 Ω	2 w	Var.	CAL. REF.
R20	306-153	15 k	2 w		
R21	316-474	470 k	1/4 w		
R25	306-103	10 k	2 w		
R26	315-752	7.5 k	1/4 w		5% 101-1569
R26	301-0752-00	7.5 k	1/2 w		5% 1570-up
R27	305-153	15 k	2 w		5%
R30	309-378	10.1 k	1/2 w	Prec.	1%
R31	309-266	93.1 Ω	1/2 w	Prec.	1%
R32	309-266	93.1 Ω	1/2 w	Prec.	1%
R33	309-378	10.1 k	1/2 w	Prec.	1%
R38	319-013	22.6 k	1/4 w	Prec.	
R39	319-013	22.6 k	1/4 w	Prec.	
R40	315-622	6.2 k	1/4 w		5%
R41	301-364	360 k	1/2 w		5%
R42	315-183	18 k	1/4 w		5%
R44	315-511	510 Ω	1/4 w		5%
R45	315-162	1.6 k	1/4 w		5%
R47	304-153	15 k	1 w		
R49	316-104	100 k	1/4 w		
R61	315-911	910 Ω	1/4 w		5%
R63	315-752	7.5 k	1/4 w		5%
R65	315-822	8.2 k	1/4 w		5%
R66	315-391	390 Ω	1/4 w		5%
R71	315-911	910 Ω	1/4 w		5%
R73	315-752	7.5 k	1/4 w		5%
R75	315-822	8.2 k	1/4 w		5%
R78	315-681	680 Ω	1/4 w		5%
R79	316-102	1 k	1/4 w		
R81	311-003	100 Ω	2 w	Var.	PULSER FREQUENCY
R82	316-220	22 Ω	1/4 w		
R84	316-270	27 Ω	1/4 w		
R86	316-102	1 k	1/4 w		
R95	316-820	82 Ω	1/4 w		
R101	308-002	1.5 k	5 w	WW	5%
R102	316-272	2.7 k	1/4 w		
R103	308-002	1.5 k	5 w	WW	5%

Resistors (Cont'd)

Ckt. No.	Tektronix Part No.	Description	S/N Range
R107	311-228	2 x 10 k	
R110	311-228	2 x 10 k	
R114	309-198	3.053 k	
R115	309-198	3.053 k	
R119	307-055	3.9 Ω	
R120	309-159	5 k	
R121	309-159	5 k	
R122	309-058	2 Ω	
R123	309-266	93.1 Ω	
R124	309-266	93.1 Ω	
R125	309-181	2.5 k	
R126	309-181	2.5 k	
R130	308-073	3 k	
R132	306-560	56 Ω	
R133	308-184	7.5 Ω	
R134	308-0204-00	1 Ω	
R134	308-161	3 Ω	
R135	308-184	7.5 Ω	
R136	308-161	3 Ω	
R140	308-065	2 k	
R141	304-473	47 k	
R144	308-024	15 k	
R145	308-041	2.4 k	
R147	316-334	330 k	

Switches

Ckt. No.	Tektronix Part No.	Description	S/N Range
SW29	260-454	Rotary	
SW39	260-247	Push Button	
SW119	Use 260-0282-02	Mercury	
SW135	260-144	Slide	
SW141	260-453	Rotary	

Transformers

T91	*120-279	Toroid TD72	
-----	----------	-------------	--

Transistors

Q65	151-005	2N212	101-1119
Q65	151-0040-00	2N1302	1120-up
Q74	151-005	2N212	101-1119
Q74	151-0040-00	2N1302	1120-up
Q75	151-005	2N212	101-1119
Q75	151-0040-00	2N1302	1120-up
Q85	Use *050-139	Replacement Kit	101-319
Q85	151-0106-00	2N2375	320-1059
Q85	151-0070-00	2N1377	1060-up
Q95	Use *050-139	Replacement Kit	101-319
Q95	151-0106-00	2N2375	320-1059
Q95	151-0070-00	2N1377	1060-up

Electron Tubes

V14	154-0187-00	6DJ8/ECC88	101-739
V14	154-413	8416	740-up

SECTION 6

MECHANICAL PARTS LIST

PARTS ORDERING INFORMATION

Replacement parts are available from or through your local Tektronix Field Office.



Changes to Tektronix instruments are sometimes made to accommodate improved components as they become available, and to give you the benefit of the latest circuit improvements developed in our engineering department. It is therefore important, when ordering parts, to include the following information in your order: Part number including any suffix, instrument type, serial number, and modification number if applicable.

If a part you have ordered has been replaced with a new or improved part, your local Tektronix Field Office will contact you concerning any change in part number.

ABBREVIATIONS AND SYMBOLS

a or amp	amperes	mm	millimeter
BHS	binding head steel	meg or M	megohms or mega (10 ⁶)
C	carbon	met.	metal
cer	ceramic	μ	micro, or 10 ⁻⁶
cm	centimeter	n	nano, or 10 ⁻⁹
comp	composition	Ω	ohm
cps	cycles per second	OD	outside diameter
crt	cathode-ray tube	OHS	oval head steel
CSK	counter sunk	p	pico, or 10 ⁻¹²
dia	diameter	PHS	pan head steel
div	division	piv	peak inverse voltage
EMC	electrolytic, metal cased	plstc	plastic
EMT	electrolytic, metal tubular	PMC	paper, metal cased
ext	external	poly	polystyrene
f	farad	Prec	precision
F & I	focus and intensity	PT	paper tubular
FHS	flat head steel	PTM	paper or plastic, tubular, molded
Fil HS	fillister head steel	RHS	round head steel
g or G	giga, or 10 ⁹	rms	root mean square
Ge	germanium	sec	second
GMV	guaranteed minimum value	Si	silicon
h	henry	S/N	serial number
hex	hexagonal	t or T	tera, or 10 ¹²
HHS	hex head steel	TD	toroid
HSS	hex socket steel	THS	truss head steel
HV	high voltage	tub.	tubular
ID	inside diameter	v or V	volt
incd	incandescent	Var	variable
int	internal	w	watt
k or K	kilohms or kilo (10 ³)	w/	with
kc	kilocycle	w/o	without
m	milli, or 10 ⁻³	WW	wire-wound
mc	megacycle		

SPECIAL NOTES AND SYMBOLS

X000	Part first added at this serial number.
000X	Part removed after this serial number.
*000-000	Asterisk preceding Tektronix Part Number indicates manufactured by or for Tektronix, or reworked or checked components.
Use 000-000	Part number indicated is direct replacement.
	Internal screwdriver adjustment.
	Front-panel adjustment or connector.

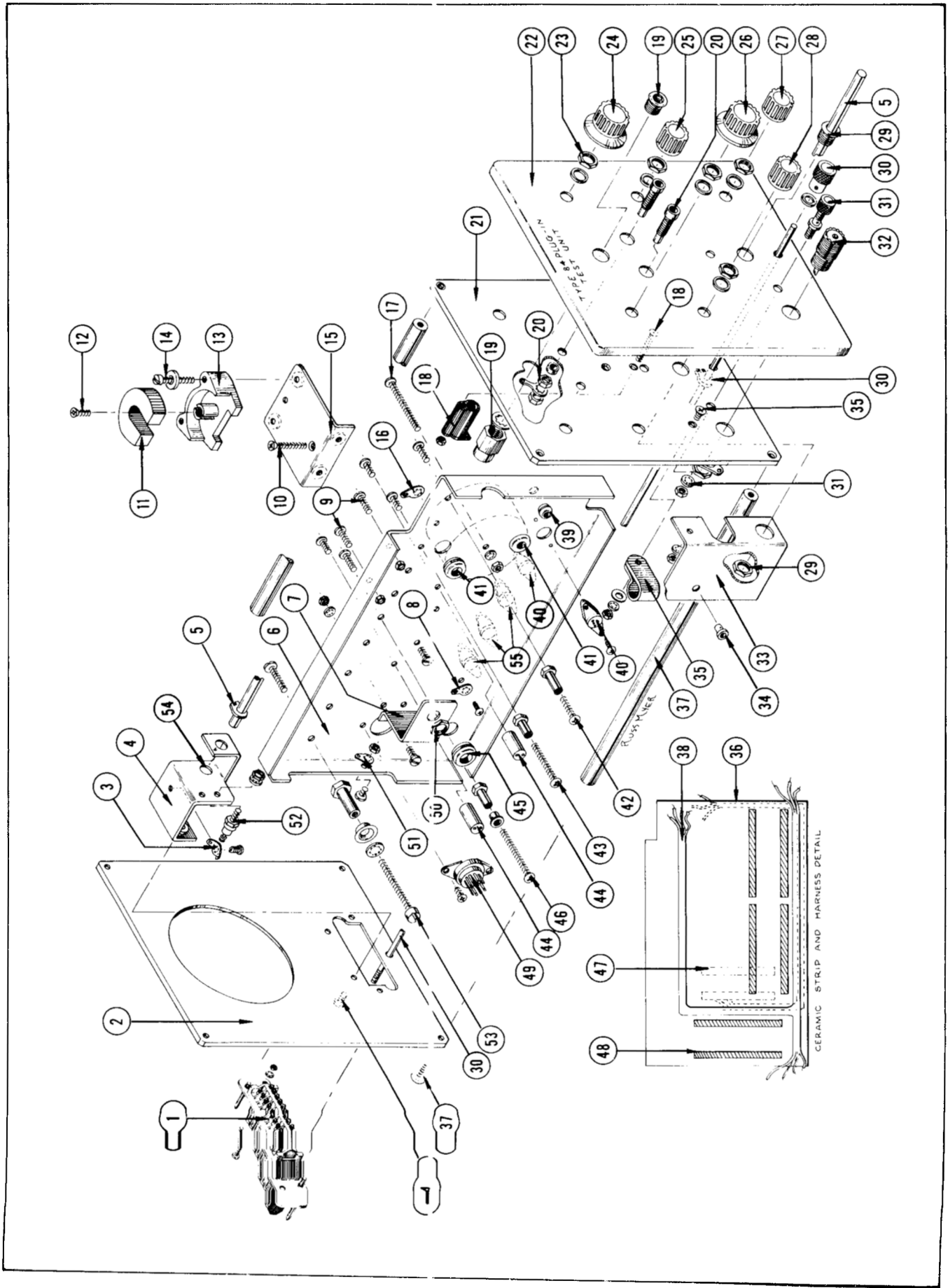

EXPLODED VIEW

REF. NO.	PART NO.	SERIAL/MODEL NO.		QTY.	DESCRIPTION
		EFF.	DISC.		
1	131-0017-00			1	CONNECTOR, chassis mt., 16 contact, male
	- - - - -			-	Mounting Hardware: (not included)
	211-0008-00			2	SCREW, 4-40 x 1/4 BHS
	210-0004-00			1	LOCKWASHER, int. #4
	210-0201-00			1	LUG, solder, SE 4
	210-0406-00			2	NUT, hex, 4-40 x 3/16
2	387-0529-00			1	PLATE, rear
3	210-0204-00			1	LUG, solder, DE 6
	213-0044-00			1	SCREW, thread cutting, 5-32 x 3/16 PHS phillips slot
4	406-0834-00			1	BRACKET, push button switch
	- - - - -			-	Mounting Hardware: (not included)
	211-0504-00			2	SCREW, 6-32 x 1/4 BHS
5	384-0253-00			1	ROD, push button switch
	354-0177-00			1	RING, retaining
6	441-0442-00			1	CHASSIS
	- - - - -			-	Mounting Hardware: (not included)
	211-0504-00			2	SCREW, 6-32 x 1/4 BHS
	211-0538-00			2	SCREW, 6-32 x 3/16 FHS 100° phillips slot
7	406-0841-00			1	BRACKET, pot
	- - - - -			-	Mounting Hardware: (not included)
	211-0507-00			2	SCREW, 6-32 x 5/16 BHS
	210-0006-00			2	LOCKWASHER, int. #6
	210-0407-00			2	NUT, hex, 6-32 x 1/4
8	210-0201-00			5	LUG, solder, SE 4
	213-0044-00			5	SCREW, thread cutting, 5-32 x 3/16 PHS phillips slot
9	211-0008-00			2	SCREW, 4-40 x 1/4 BHS (slide switch mounting)
	210-0406-00			2	NUT, hex, 4-40 x 3/16
10	211-0106-00			2	SCREW, 4-40 x 5/8 FHS (coil mounting)
	210-0004-00			2	LOCKWASHER, int. #4
	210-0406-00			2	NUT, hex, 4-40 x 3/16
11	119-0006-00			1	MAGNET, pocket
12	211-0559-00	101	1539	1	SCREW, 6-32 x 3/8 FHS phillips slot 100°
	211-0512-00	1540		1	SCREW, 6-32 x 1/2 inch, 100° csk, FHS
13	352-0027-00			1	HOLDER, magnet
	- - - - -			-	Mounting Hardware: (not included)
14	211-0532-00			2	SCREW, 6-32 x 3/4 Fil HS
	210-0858-00			2	WASHER, 5/32 ID x 1/2 OD
15	406-0835-00			1	BRACKET, coil and magnet
	- - - - -			-	Mounting Hardware: (not included)
	211-0504-00			2	SCREW, 6-32 x 1/4 BHS
16	210-0202-00			1	LUG, solder, SE 6
17	211-0521-00			1	SCREW, 6-32 x 1 1/2 RHS (transformer mounting)
	210-0912-00			1	WASHER, linenboard (not shown)
	210-0006-00			1	LOCKWASHER, int. #6
	210-0407-00			1	NUT, hex, 6-32 x 1/4
18	352-0008-00	101	1029	1	HOLDER, neon bulb, single, black
	352-0067-00	1030		1	HOLDER, neon bulb, single, gray
	- - - - -			-	Mounting Hardware: (not included)
	211-0031-00	101	1029	1	SCREW, 4-40 x 1 inch FHS
	211-0109-00	1030		1	SCREW, 4-40 x 7/8 inch FHS
	210-0406-00			2	NUT, hex, 4-40 x 3/16
	378-0541-00	X1030		1	FILTER, lens, neon

EXPLODED VIEW (Cont)

REF. NO.	PART NO.	SERIAL/MODEL NO.		QTY.	DESCRIPTION
		EFF.	DISC.		
19	358-0010-00 210-0012-00 210-0494-00			1 1 1	BUSHING, 3/8-32 x 9/16 LOCKWASHER, int, 3/8 x 1/2 NUT, hex, 3/8-32 x 1/2
20	136-0138-00 136-0140-00 210-0895-00 210-0465-00 210-0223-00	101 880	879	2 2 2 4 2	SOCKET, banana jack, black SOCKET, banana jack, charcoal WASHER, insulating NUT, hex, 1/4-32 x 3/8 LUG, solder, 1/4
21	387-0676-00			1	PLATE, front subpanel
22	333-0707-00 333-0707-01	101 974	973	1 1	PANEL, front (Type 84) PANEL, front (Type 067-0523-00)
23	210-0413-00 210-0840-00 210-0012-00			5 5 5	NUT, hex, 3/8-32 x 1/2 WASHER, .390 ID x 9/16 OD LOCKWASHER, int, 3/8 x 1/2
24	366-0028-00 366-0145-00	101 880	879	1 1	KNOB, large black—VERTICAL POSITION KNOB, large charcoal—VERTICAL POSITION
25	366-0033-00 366-0148-00	101 880	879	1 1	KNOB, small black—PULSER AMPLITUDE KNOB, small charcoal—PULSER AMPLITUDE
26	366-0028-00 366-0145-00	101 880	879	1 1	KNOB, large black—LOAD KNOB, large charcoal—LOAD
27	366-0033-00 366-0148-00	101 880	879	1 1	KNOB, small black—PULSER FREQUENCY KNOB, small charcoal—PULSER FREQUENCY
28	366-0033-00 366-0148-00	101 880	879	1 1	KNOB, small black—DISPLAY SELECTOR KNOB, small charcoal—DISPLAY SELECTOR
29	358-0010-00 210-0012-00 210-0413-00			1 1 1	BUSHING, 3/8-32 x 9/16 LOCKWASHER, int, 3/8 x 1/2 NUT, hex, 3/8-32 x 1/2
30	366-0125-00 210-0894-00 384-0510-00 ----- 354-0025-00			1 1 1 -	KNOB, plug-in securing WASHER, poly. .190 ID x 7/16 OD ROD, securing rod includes:
31	129-0035-00 ----- 355-0507-00 200-0103-00 210-0455-00 210-0011-00			1 - 1 1 1 1	RING, retaining POST, binding, assembly Consisting Of: STEM, adapter CAP NUT, hex, 1/4-28 x 3/8 LOCKWASHER, int, 1/4
32	131-0081-00 131-0126-00	101 330	329	1 1	CONNECTOR, coaxial, 1 contact, female CONNECTOR, coaxial, BNC
33	337-0526-00 ----- 210-0407-00 210-0006-00			1 - 1 1	SHIELD, input Mounting Hardware: (not included) NUT, hex, 6-32 x 1/4 LOCKWASHER, int. #6
34	348-0031-00			1	GROMMET, poly. snap-in
35	343-0006-00 ----- 211-0559-00 210-0803-00 210-0006-00 210-0407-00			1 - 1 1 1 1	CLAMP, cable, 1/2" Mounting Hardware: (not included) SCREW, 6-32 x 3/8 FHS 100° phillips slot WASHER, 6L LOCKWASHER, int. #6 NUT, hex, 6-32 x 1/4
36	179-0662-00			1	CABLE, harness, pot
37	384-0508-00 384-0631-00 212-0044-00	101 730	729	4 4 4	ROD, frame, spacing ROD, frame, spacing SCREW 8-32 x 1/2 RHS phillips slot

EXPLODED VIEW (Cont)

REF. NO.	PART NO.	SERIAL/MODEL NO.		QTY.	DESCRIPTION
		EFF.	DISC.		
38	179-0661-00	101	739	1	CABLE, harness, chassis
	179-0960-00	740		1	CABLE, harness, chassis
39	348-0002-00			1	GROMMET, rubber, 1/4"
40	136-0095-00	101	689	2	SOCKET, 4 pin transistor
	136-0181-00	690		2	SOCKET, 3 pin transistor
	- - - - -			-	Mounting Hardware For Each: (not included)
	213-0113-00	101	689	2	SCREW, thread forming, 2-32 x 5/16 inch RHS phillips
	354-0234-00	690		1	RING, transistor socket
41	348-0004-00			2	GROMMET, rubber, 3/8"
42	211-0544-00			2	SCREW, 6-32 x 3/4 Truss HS phillips slot
	210-0478-00			2	NUT, hex, 5-10 W resistor mtg.
	211-0507-00			2	SCREW, 6-32 x 5/16 BHS
43	211-0545-00			1	SCREW, 6-32 x 1 1/4 Truss HS phillips slot
	210-0478-00			1	NUT, hex, 5-10 W resistor mtg.
	211-0507-00			1	SCREW, 6-32 x 5/16 BHS
44	385-0134-00			2	ROD, delrin
	- - - - -			-	Mounting Hardware For Each: (not included)
	213-0041-00			1	SCREW, thread cutting, 6-32 x 3/8 Truss HS phillips
45	348-0005-00			1	GROMMET, rubber, 1/2"
46	211-0553-00			3	SCREW, 6-32 x 1 1/2 RHS phillips slot
	210-0601-00			3	EYELET
	210-0478-00			3	NUT, hex, 5-10 W resistor mounting
	211-0507-00			3	SCREW, 6-32 x 5/16 BHS
47	124-0146-00			2	STRIP, ceramic, 7/16 x 16 notches
	361-0009-00			4	SPACER, nylon, molded
48	124-0154-00			6	STRIP, ceramic, 7/16 x 20 notches
	361-0009-00			12	SPACER, nylon, molded
49	136-0015-00			1	SOCKET, STM9G
	- - - - -			-	Mounting Hardware: (not included)
	213-0044-00			2	SCREW, thread cutting, 5-32 x 3/16 PHS phillips slot
50	210-0413-00			1	NUT, hex, 3/8-32 x 1/2
	210-0840-00			1	WASHER, .390 ID x 7/16 OD
51	210-0202-00			1	LUG, solder, SE 6
	211-0503-00			1	SCREW, 6-32 x 3/16 BHS
	210-0407-00			1	NUT, hex, 6-32 x 1/4
52	129-0006-00			2	POST, connecting, insulating
	- - - - -			-	Mounting Hardware For Each: (not included)
	210-0407-00			1	NUT, hex, 6-32 x 1/4 inch
	210-0006-00			1	LOCKWASHER, int. #6
53	212-0037-00			4	SCREW, 8-32 x 1 3/4 Fil HS
	210-0008-00			4	LOCKWASHER, int. #8
	210-0809-00	101	1479	4	WASHER, centering, resistor, 25 W
	210-0808-00	1480		4	WASHER, centering, resistor
	210-0462-00			4	NUT, hex, 25 W resistor mounting
	212-0004-00			4	SCREW, 8-32 x 5/16 BHS
54	260-0247-00			1	SWITCH, push button—SCOPE AMP BAL CHECK
	- - - - -			-	mounting hardware: (not included w/switch)
	210-0583-00			1	NUT, hex, 1/4-32 x 5/16 inch
	210-0940-00			1	WASHER, 1/4 ID x 3/8 inch OD
55	136-0095-00	101	689	3	SOCKET, 4 pin transistor
	136-0182-00	690		3	SOCKET, 4 pin transistor
	- - - - -			-	mounting hardware for each: (not included w/socket)
	213-0113-00	101	689	2	SCREW, thread forming, 2-32 x 3/16 inch PHS phillips
	354-0234-00	690		1	RING, locking, transistor socket
					STANDARD ACCESSORIES
	070-0345-01			2	MANUAL, instruction (not shown)

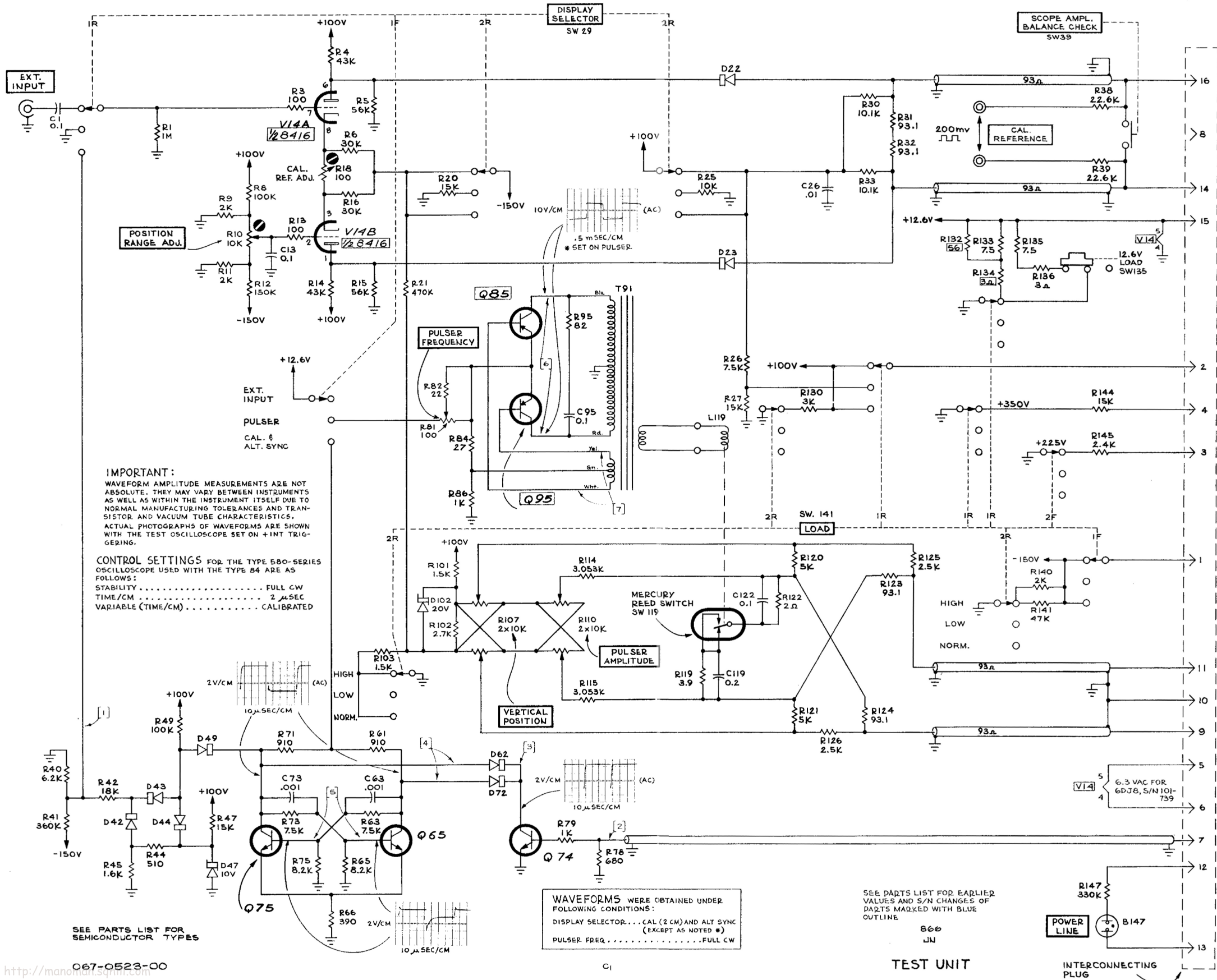

POSITION RANGE ADJ.

DISPLAY SELECTOR SW 29

SCOPE AMPL. BALANCE CHECK SW 39

IMPORTANT:
 WAVEFORM AMPLITUDE MEASUREMENTS ARE NOT ABSOLUTE. THEY MAY VARY BETWEEN INSTRUMENTS AS WELL AS WITHIN THE INSTRUMENT ITSELF DUE TO NORMAL MANUFACTURING TOLERANCES AND TRANSISTOR AND VACUUM TUBE CHARACTERISTICS. ACTUAL PHOTOGRAPHS OF WAVEFORMS ARE SHOWN WITH THE TEST OSCILLOSCOPE SET ON +INT TRIGGERING.

CONTROL SETTINGS FOR THE TYPE 580-SERIES OSCILLOSCOPE USED WITH THE TYPE 84 ARE AS FOLLOWS:
 STABILITY FULL CW
 TIME/CM 2 µSEC
 VARIABLE (TIME/CM) CALIBRATED

WAVEFORMS WERE OBTAINED UNDER FOLLOWING CONDITIONS:
 DISPLAY SELECTOR... CAL (2 CM) AND ALT SYNC (EXCEPT AS NOTED #)
 PULSER FREQ FULL CW

SEE PARTS LIST FOR EARLIER VALUES AND S/N CHANGES OF PARTS MARKED WITH BLUE OUTLINE

SEE PARTS LIST FOR SEMICONDUCTOR TYPES

TEST UNIT

POWER LINE B147

INTERCONNECTING PLUG

MANUAL CHANGE INFORMATION

At Tektronix, we continually strive to keep up with latest electronic developments by adding circuit and component improvements to our instruments as soon as they are developed and tested.

Sometimes, due to printing and shipping requirements, we can't get these changes immediately into printed manuals. Hence, your manual may contain new change information on following pages.

A single change may affect several sections. Sections of the manual are often printed at different times, so some of the information on the change pages may already be in your manual. Since the change information sheets are carried in the manual until ALL changes are permanently entered, some duplication may occur. If no such change pages appear in this section, your manual is correct as printed.

ELECTRICAL PARTS LIST AND SCHEMATIC CORRECTION

CHANGE TO:

R30	322-0605-00	10.1 k Ω	1/4 W	MF	Prec	1%
R33	322-0605-00	10.1 k Ω	1/4 W	MF	Prec	1%
R120	322-0677-00	5 k Ω	1/4 W	MF	Prec	1%
R121	322-0677-00	5 k Ω	1/4 W	MF	Prec	1%

ELECTRICAL PARTS LIST CORRECTION

CHANGE TO:

R31	309-0266-01	93.1 Ω	1/2 W	Prec	1%
R32	309-0266-01	93.1 Ω	1/2 W	Prec	1%
R123	309-0266-01	93.1 Ω	1/2 W	Prec	1%
R124	309-0266-01	93.1 Ω	1/2 W	Prec	1%