

INSTRUCTION MANUAL

Serial Number 1778

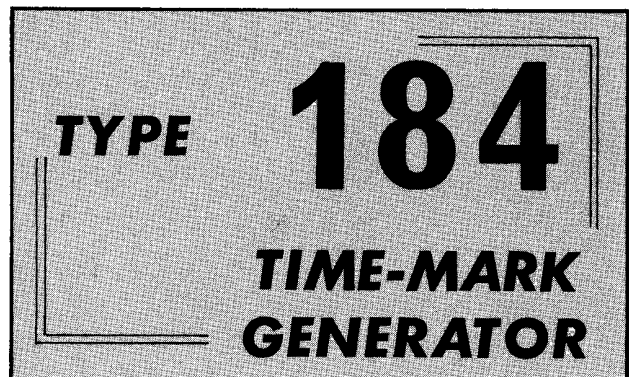

Tektronix, Inc.

S.W. Millikan Way • P. O. Box 500 • Beaverton, Oregon 97005 • Phone 644-0161 • Cables: Tektronix
070-0499-00

1065



WARRANTY

All Tektronix instruments are warranted against defective materials and workmanship for one year. Tektronix transformers, manufactured in our own plant, are warranted for the life of the instrument.

Any questions with respect to the warranty mentioned above should be taken up with your Tektronix Field Engineer.

Tektronix repair and replacement-part service is geared directly to the field, therefore all requests for repairs and replacement parts should be directed to the Tektronix Field Office or Representative in your area. This procedure will assure you the fastest possible service. Please include the instrument Type and Serial number with all requests for parts or service.

Specifications and price change privileges reserved.

Copyright © 1965 by Tektronix, Inc., Beaverton, Oregon. Printed in the United States of America. All rights reserved. Contents of this publication may not be reproduced in any form without permission of the copyright owner.



CONTENTS

| | |
|-----------|------------------------|
| Section 1 | Characteristics |
| Section 2 | Operating Instructions |
| Section 3 | Circuit Description |
| Section 4 | Maintenance |
| Section 5 | Performance Check |
| Section 6 | Calibration |
| Section 7 | Electrical Parts List |
| Section 8 | Mechanical Parts List |
| Section 9 | Diagrams |

A list of abbreviations and symbols used in this manual will be found immediately preceding Section 7. Change information, if any is located at the rear of the manual.

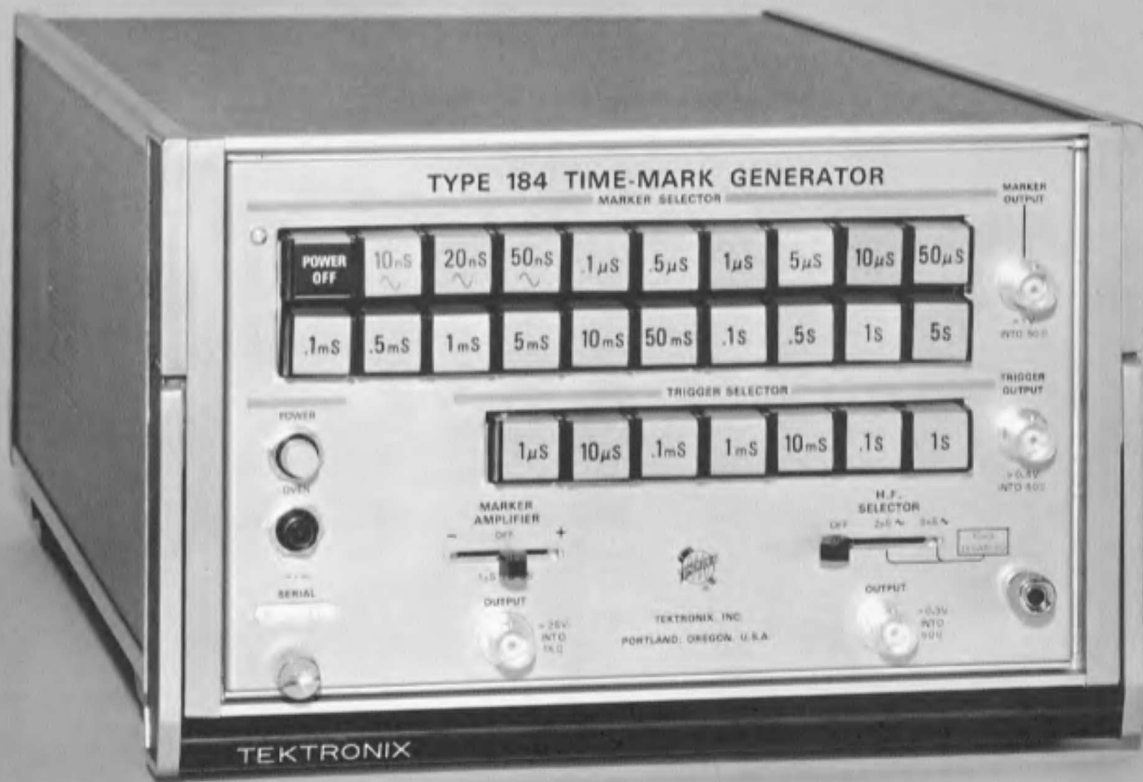

Fig. 1-1. Type 184 Time-Mark Generator

SECTION 1

CHARACTERISTICS

The Type 184 is a compact, precision-built instrument capable of producing accurate time markers for applications in the laboratory, production line or field. Sixteen time-marker selections and five sine-wave marker intervals provide time-marker selections from 2 nanoseconds to 5 seconds. Seven trigger pulse selections provide a triggering pulse rate from 1 μ s to 5 s.

All outputs of the Type 184 are frequency controlled by a stable 10 MHz crystal oscillator.

Operating Data

Marker Output

Provides positive time marks of 1 volt minimum amplitude (into 50 Ω). Marker periods are established by pushbutton MARKER SELECTOR switches.

Marker Periods

Sinusoidal

10, 20 and 50 ns (H.F. SELECTOR must be off for 10 ns markers).

Periodic Pulses

.1, .5, 1, 5, 10, 50 μ s
.1, .5, 1, 5, 10, 50 ms
.1, .5, 1, 5 s

HF Output

Provides 2 ns or 5 ns sine-wave markers of 0.3 V minimum amplitude (into 50 Ω).

Marker Amplifier Output

Provides positive or negative time marks of 25 V minimum amplitude (into 1 k Ω). Marker intervals from 1 μ s to 5 s established by the pushbutton MARKER SELECTOR switches.

Trigger Output

Provides positive triggers of ≥ 0.4 V into 50 Ω or ≥ 2.5 V into open circuit. Period established by pushbutton Trigger

Selector switches. Trigger periods are: 1 and 10 μ s; .1, 1 and 10 ms; .1 and 1 s.

Other Characteristics

| | |
|--------------------|--|
| Crystal Oscillator | Crystal contained in a temperature controlled oven at 75°C. |
| Frequency | 10 MHz $\pm 0.001\%$ (25°C $\pm 5^\circ$ C), 10 MHz $\pm 0.002\%$ (0°C to +50°C) 5 minutes after turn-on if crystal oven is stabilized (instrument connected to power source for 2 hours). |
| Stability | ≤ 3 P/M ¹ in 24 hours (25°C $\pm 5^\circ$ C) after 2 hours continuous operation and after the instrument has accumulated at least 72 hours of total operating time. |
| Power Requirements | 94.5 to 137.5 VAC or 189 to 275 VAC. 50 to 400 Hz. 40 watts approximate. |
| Warm-Up Time | Two hours warm-up time required after the instrument is connected to a power source, to allow crystal oven to stabilize. 5 minutes for rated accuracies at 25°C $\pm 5^\circ$ C (if crystal oven is stabilized). |

Mechanical Specifications

Dimensions: 9 inches wide, 6 inches high and 14 $\frac{3}{4}$ inches long.

Front panel is anodized aluminum. Cabinet is finished in blue vinyl paint.

No special ventilation required.

Accessories

Information on accessories for use with this instrument is included at the rear of the mechanical parts list.

¹Parts per million.

NOTES

Lined area for notes.

SECTION 2

OPERATING INSTRUCTIONS

General

The Type 184 may be operated in any normal environment if protected from moisture, dust or grease. It will operate with line voltages from 93.5 to 135 volts at 115 nominal, or from 187 to 270 volts at 230 nominal line volts. Selection of the two nominal voltages is made by means of the 115-230 Vac switch mounted on the rear panel of the instrument.

Time-marker intervals of $.1 \mu\text{s}$ to 5 s are individually selected or stacked by depressing pushbutton selector switches. Sine-wave marker intervals of 10, 20 and 50 ns may also be selected by pushbutton selector switches.

Frequencies of 200 and 500 MHz which provide marker intervals of 5 and 2 nanoseconds, may be selected by the H.F. SELECTOR switch, and are available at a BNC OUTPUT connector mounted below the H.F. SELECTOR switch.

NOTE

The 10 ns (100 MHz) sine-wave marker is disabled when the 2 or 5 ns markers are in use.

The decade triggers ($1 \mu\text{s}$ to 1 s) are used to trigger external associated test equipment and may be selected by

the TRIGGER SELECTOR pushbuttons. They are available at the TRIGGER OUTPUT connector and are greater than 0.4 volts (into 50 Ω) in amplitude.

High amplitude time markers, ($>25 \text{ V}$ into 1 k Ω) from $1 \mu\text{s}$ to 5 s and either plus or minus polarity, are available at the OUTPUT connector below the MARKER AMPLIFIER switch. These markers are time coincident with the corresponding MARKER OUTPUT signals.

Function of Controls and Connectors

MARKER SELECTOR

Self-cancelling type pushbuttons select the respective individual or collective time marks and apply them to the MARKER OUTPUT connector. Markers up to two decades apart may be stacked by depressing the appropriate pushbuttons simultaneously.

MARKER OUTPUT

The selected time marks are available at the MARKER OUTPUT connector. The amplitude of the markers is greater than 1 volt into 50 Ω .

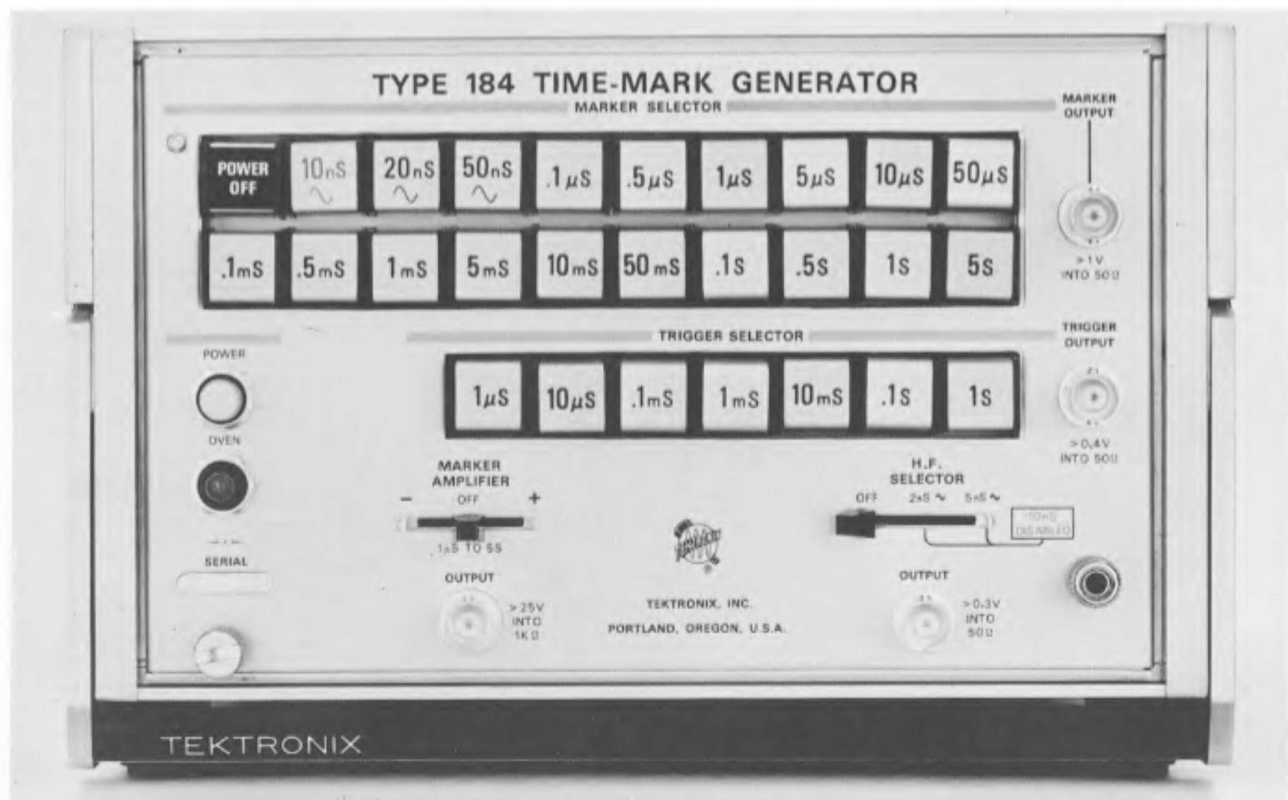

Fig. 2-1. Type 184 front-panel controls.

Operating Instructions—Type 184

TRIGGER SELECTOR Pushbutton selector switches similar to the **MARKER SELECTOR** switch select trigger pulses for external equipment. These selected trigger pulses are in time coincidence with the corresponding decade time markers. They are available at the **TRIGGER OUTPUT** connector as positive-going pulses with a minimum amplitude of 0.4 volts into 50 Ω .

H.F. SELECTOR Selects 2 ns (500 MHz) or 5 ns (200 MHz) sine-wave signal and applies either to the **OUTPUT** connector directly below the **H.F. SELECTOR** switch. Amplitude of these sine-wave time-marker intervals at the **OUTPUT** connector is greater than 0.3 volts into 50 Ω . When the **H.F. SELECTOR** switch is in either of these two positions, the 10 ns marker interval is disabled.

NOTE

In order to obtain a sine-wave signal from the **H.F. SELECTOR**

OUTPUT, a marker button must be pushed in to apply power to the unit.

MARKER AMPLIFIER

Time markers from 1 μ s to 5 s established by the **MARKER SELECTOR** pushbutton switches are available as positive or negative, amplified time markers at the **OUTPUT** connector below the switch. The amplitude of these time markers is greater than 25 volts into 1 k Ω .

POWER Indicator

Power is applied when any one of the **MARKER SELECTOR** switches is pushed in. Power is turned off by the **POWER OFF** switch. A **POWER** indicating light will go on when power is applied.

OVEN Indicator

This indicating light is across the heater windings in the crystal oven and therefore monitors the operation of the thermostat. It indicates when the heater is on. The crystal oven power is independent of the **POWER OFF** switch.

SECTION 3

CIRCUIT DESCRIPTION

Introduction

This section describes the Type 184 circuitry with reference to the block diagram and circuits in Section 9. The reader should follow the diagrams as their description is presented.

Block Diagram

All time-marker intervals are frequency controlled by a stable crystal-controlled oscillator. The basic frequency of 10 MHz from the oscillator is multiplied by frequency doublers and quintuplers to provide timing intervals of 2 through 5 ns. The 2 or 5 ns timing intervals are connected through the H.F. SELECTOR switch to a BNC OUTPUT connector. The 10, 20 and 50 ns intervals are connected to the MARKER SELECTOR switch and applied after selection to the MARKER OUTPUT connector.

The oscillator cathode tank circuit supplies 10 MHz to the first countdown board, which shapes the 10-MHz sine wave into $.1 \mu\text{s}$ time markers and counts down in steps of 2 or 5 to provide time markers from $.1 \mu\text{s}$ through 10 ms.

A second countdown board provides the remaining time markers from 50 ms through 5 s.

Time markers from $.1 \text{ s}$ through 5 s , selected by the MARKER SELECTOR switch, are applied through an emitter follower to the MARKER OUTPUT connector. These markers are also applied to a Marker Amplifier which provides (+) or (-) time-markers with an amplitude greater than 25 volts (into $1 \text{ k}\Omega$).

Positive trigger pulses of $1 \mu\text{s}$, $10 \mu\text{s}$, $.1 \text{ ms}$, 1 ms , 10 ms , $.1 \text{ s}$ and 1 s may be selected by the pushbutton TRIGGER SELECTOR switch. The selected trigger pulse is fed to an emitter follower which provides positive trigger signals of 0.4 volt minimum amplitude (into 50Ω) at the OUTPUT connector.

OSCILLATOR AND MULTIPLIERS

Oscillator

The oscillator V10 is connected as a crystal-controlled grid, tuned-cathode oscillator. The plate tank is tuned to the 5th harmonic, which quintuples the oscillator frequency. Double-tuned tanks in the cathode and plate circuits decrease intermodulation distortion.

A temperature-controlled oven housing the crystal provides frequency stability. Its operation is indicated by a front-panel indicating lamp B504, connected in parallel with the heater element of the oven. Frequency of the oscillator is primarily adjusted to a standard by means of shunt capacitor C11. The slug adjustment L18 in the cathode tank will also affect the oscillator frequency slightly.

Frequency Multipliers and Amplifiers

The multipliers are essentially frequency doublers or amplifiers with the plate tank in each case tuned to the 2nd harmonic of the grid tank. Plate tanks are double tuned, provide high Q and attenuate frequencies other than the

desired output. The output signal is link-coupled to match the load.

50 ns time markers are generated after doubling the 10-MHz oscillator cathode-tank frequency in the plate tank of V20.

20 ns time markers are provided from the plate tank of V30, which operates as an amplifier with both the grid and plate tanks tuned to 50 MHz.

10 ns time markers are derived through the frequency-doubling action of V40. Output from the 100 MHz plate tank is applied by means of the H.F. SELECTOR switch to either the 2 ns or 5 ns time-interval generators or to the MARKER SELECTOR switch.

A separate 200 MHz board employs four diodes, connected as a passive doubler with the tank tuned to 200 MHz. Capacitor C57 in series with the pickoff link is adjusted to match the coupling link circuit to the 50Ω output impedance.

The 2 ns circuit quintuples the 100 MHz from the plate tank of V40. The link-coupled 100 MHz output is selected by the H.F. SELECTOR switch and applied to the grid tank of a push-pull amplifier with the plate tank tuned to 500 MHz, to provide the quintupling action. Output of the plate tank is also link-coupled and applied through the H.F. SELECTOR switch to the OUTPUT connector J70.

Butterfly capacitor C63 is adjusted to tune the grid tank to the input 100 MHz frequency and differential capacitor C64 is adjusted to balance the drive on the grids of the pushbutton multiplier.

The plates of V60 and V70 share a common center-fed high Q quarter-wave line, that is tuned by C70 to a frequency of 500 MHz. The output terminates in a high Q, 500-MHz filter (similar to a re-entry cavity) which decouples any intermodulation signals. C75 tunes the filter to the 500-MHz output frequency.

Each amplifier and multiplier output is selected by either the MARKER SELECTOR switch SW400 or the H.F. SELECTOR switch SW70. The MARKER SELECTOR switch connects the 10, 20 or 50 ns outputs to the MARKER OUTPUT connector or grounds the screen through the output coupling loop.

SHAPER AND COUNTDOWN CIRCUITS

Countdown and shaper circuits for the $.1 \mu\text{s}$ to 10 ms markers are on one etched-wiring board with the remaining countdown circuits and the power supply circuits on another.

The countdown circuits used for the $5 \mu\text{s}$ to the 5 s time-markers are monostable multivibrators with the countdown ratio determined by the multi hold-off time.

$.1 \mu\text{s}$ Amplifier and Shaper

An NPN driving a PNP transistor in a complimentary circuit arrangement provides high gain to shape the input

Circuit Description—Type 184

10 MHz sine wave. This waveform is then differentiated by the coupling networks and appears at the emitter of Q103 as a positive going $.1 \mu\text{s}$ time marker.

$.5 \mu\text{s}$ ($\div 5$) Countdown

Countdown is achieved by the bucket and ladle action of C105 and C107-C108. C105 dumps its charge each $.1 \mu\text{s}$ through Q114 into a pair of capacitors C107 and C108, until enough charge has been built up so that the 5th charge from C105 triggers the blocking oscillator Q120. This occurs each $.5 \mu\text{s}$ and provides the $.5 \mu\text{s}$ time markers.

The voltage step from the $.1 \mu\text{s}$ shaper amplifier is also applied through C105 to the emitter of Q114. The positive $1 \mu\text{s}$ pulse turns Q114 on and dumps a charge into C107 and C108. The negative portion of the input signal reverse biases the emitter-base junction. The junction then acts in the manner of an approximate 6V Zener diode to clamp the negative portion of the input waveform.

These input charges on the ladle capacitor C105, build a staircase ramp voltage across C107 and C108. The amplitude of the ramp is governed by the base-to-emitter bias of Q120 and the size of the bucket capacitors. At approximately 11 volts the emitter-base junction is forward biased and transistor Q120 turns on.

Feedback from transformer T115 drives the transistor to saturation and generates a sharp positive-going pulse. Diode D115 prevents negative voltage excursions at the output of the transformer. The positive output pulse from Q120 is applied through C116 to the base of emitter-follower Q123. The resultant output markers from the emitter of Q123 are delayed approximately 76 ns by delay line L123A to allow stacking with other selected time markers.

$1 \mu\text{s}$ ($\div 2$) Countdown Circuit

Q130, T130 and associated circuitry form a single-shot blocking oscillator with an RC circuit determining the hold-off time of the oscillator. This allows every other $.5 \mu\text{s}$ time-marker input pulse to cycle the oscillator and produce the $1 \mu\text{s}$ markers.

The first $.5 \mu\text{s}$ marker pulse drives Q130 into conduction. Feedback from the transformer T130 drives the transistor to saturation. Capacitor C130 is charged to approximately 10 volts during this on time. When the transformer field collapses and drives Q130 to the off state, the decaying charge on C130 will prevent the second $.5 \mu\text{s}$ time mark from triggering Q130 on. When the third input $.5 \mu\text{s}$ time mark occurs, (C130 will have discharged sufficiently so that Q130 is enabled) Q130 is driven into conduction and the cycle repeats.

The negative pulse generated at the collector of Q130 for every other input pulse is amplified and inverted by Q134, then applied through emitter follower Q133, to the MARKER SELECTOR switch, through an approximate 14 ns delay line L123B. The $1 \mu\text{s}$ markers are also applied to the TRIGGER SELECTOR switch through R136 as $1 \mu\text{s}$ trigger signals. Multiple time-mark signals selected by the MARKER SELECTOR switch are isolated from the Trigger Pickoff and the next countdown stage by diode D137.

$5 \mu\text{s}$ ($\div 5$) Countdown

This circuit (Q145, Q155 and associated circuitry) is a monostable multivibrator that flips with an input trigger pulse and remains in this state until the charge on the collector-to-base coupling capacitor (C143) decreases to the level that will permit the multi to return to its quiescent state. The 5th trigger then starts the cycle again.

In the quiescent state Q155 is conducting, Q145 is off. An input positive signal to the base of Q145 turns Q145 on and Q155 off. The resultant positive signal at the collector of Q155 is an approximate 12 volt square wave, with a duration determined by the time constant of C143, R145 and R146. This time constant allows the $\div 5$ countdown from $1 \mu\text{s}$ to $5 \mu\text{s}$ markers. The output signal at the collector of Q155 is differentiated by C152 and R154, with the negative portion clamped to ground by diode D152. The positive portion of the differentiated signal is applied to both the emitter-follower Q153 and the next countdown circuit. Diode D152 will also protect the base emitter junction of Q153 from breakdown, due to the back voltage developed when C152 is discharged.

$10 \mu\text{s}$ to 10 ms Countdown Circuits

These circuits are identical to the above $5 \mu\text{s}$ countdown circuit with the exception of the countdown time constant that determines the holdoff time of each counter.

50 ms to 5 s Countdown Circuits

These circuits are identical to the previous monostable multivibrators; however, they are mounted on the second board with the power supply circuits and high-amplitude marker amplifier. The 50 ms and 5 s countdown multivibrators contain calibration adjustments to set the holdoff time of the $\div 5$ multivibrators.

The series matching resistors in the time-marker path to the MARKER SELECTOR switch provide current summing in the base of the emitter followers for stacking time markers at the output.

Marker Amplifier

The amplifier provides positive or negative time markers of 25 volts minimum amplitude (into $1 \text{ k}\Omega$).

Marker intervals from $1 \mu\text{s}$ to 5 s selected by the push-button MARKER SELECTOR switch are applied through the first section of polarity switch SW450 to Q454. Q454 is biased to remove the lower portion of the positive input time-marker signal. This together with the speed-up capacitor C452 across limiting resistor R452, provides a narrow time marker at the output.

Inverter amplifier (Q464) emitter bias is such that only the narrow portion of the input pulse turns the transistor on. The positive output time marker from the inverter amplifier or, (if the switch is in the (—) position), the output signal from Q454, is applied to the base of the complimentary emitter-follower stage, Q463 and Q473.

The complimentary emitter-follower stage provides ample current for the added capacitance of most coaxial cables

attached to the output connector and preserves the rise and fall time of the time-marker pulses.

Power Supply

The power supply for the Type 184 consists of three regulated dc voltages. Circuit details for the supplies are shown on the Power Supply schematic.

Power for the dc regulator circuits is supplied from three full-wave bridge rectifier power supplies connected to secondary taps of a single transformer T501. These regulators will maintain a constant regulated output with ac input fluctuations of 94.5 or 137.5 or 189 to 275 volts. The primary of T501 consists of equal windings which may be connected in parallel by SW501 for 115 volt input or in series for 230 volt ac input power. A crystal oven is wired independently to the ON-OFF switch SW400 so power is applied to the heater of the 75°C oven as long as the instrument is connected to a power source. The circuit for the OVEN indicating neon is complete with the thermal switch closed. This neon is therefore an indicating device of proper operation of the crystal oven thermostat. The voltage regulators are mounted on the second countdown board with the exception of the power transistors Q527, Q547 and Q587, which are mounted on the main frame heat sink.

—30 Volt Supply

The —30 volts is the prime supply and the reference voltage for the other dc regulated supplies. The circuit consists of Q583 connected as an emitter follower to drive a series current regulator transistor Q587.

Error sensing is accomplished by the comparator amplifier Q566 and Q576. Reference voltage for the —30 volt supply is established by Zener diode D560 at approximately 9.1 volts at the base of transistor Q566. The bias on the other half of the comparator Q576 is obtained from a voltage divider consisting of R574, R570 and potentiometer R572 (the —30 volt Adjust control). When R572 is properly adjusted the output voltage is exactly —30 volts.

+12 Volt Supply

The —30 volt supply is the reference voltage for the comparator amplifier Q536 and Q546. The output of the comparator amplifier is applied to the base of emitter-follower Q543 which controls the current through the series current regulator transistor Q547.

+125 Volt Supply

The +125 volt regulated supply is similar to the +12 volt regulator except for the differential comparator. Voltage error signals are amplified and applied to the emitter-follower Q523 which controls the current through the series regulator transistor Q527.

Marker and Trigger Selection Switches

Timing frequencies and timing markers are applied through the MARKER SELECTOR switch to the MARKER OUTPUT connector. Trigger signals connect through the TRIGGER SELECTOR switch to the TRIGGER OUTPUT connector. The circuit arrangement is shown in the Marker and Trigger Selector switch schematic in the Diagrams section.

Markers from $.1 \mu\text{s}$ to 5 s, connect through the push-button switch to the base of emitter-follower transistor Q403. The output of this emitter follower at the MARKER OUTPUT connector J405 is greater than 1 volt into 50Ω .

10 ns to 50 ns sine wave frequencies are connected through the MARKER SELECTOR switch, directly to the MARKER OUTPUT connector. $1 \mu\text{s}$ to 5 s markers connect through a polarity switch to the marker amplifier, which provides a time-marker signal of either (+) or (–) polarity and greater than 25 volts in amplitude to the OUTPUT connector.

The TRIGGER SELECTOR switch (SW425) center contacts connect to the output of decade time markers from $1 \mu\text{s}$ to 1 s. Contact is made through pushbutton contacts and applied to emitter-follower transistor Q423. The output is a minimum trigger pulse of 0.4 V into 50Ω termination at the TRIGGER OUTPUT connector J425.

SECTION 4

MAINTENANCE

PREVENTIVE MAINTENANCE

Preventive maintenance consists of cleaning, visual inspection, lubrication, and if needed, recalibration. Preventive maintenance is generally more economical than corrective maintenance, since preventive maintenance can usually be done during idle periods at a time convenient to the user. The preventive maintenance schedule established for the instrument should be based on the amount of use and the environment in which the instrument is used.

Cleaning. Clean the instrument often enough to prevent accumulation of dirt. Dirt on the components acts as a thermal insulating blanket (preventing efficient heat dissipation) and may provide electrical conducting paths.

Clean the instrument by loosening the accumulated dust with a dry, soft paint brush. Remove the loosened dust by vacuum and/or dry, low-pressure compressed air (high-velocity air can damage certain components). Hardened dirt and grease may be removed with a cotton-tipped swab or a soft cloth dampened with water and a mild detergent solution (such as Kelite or Spray White). Abrasive cleaners should not be used.

CAUTION

Do not permit water to get inside controls or shaft bushings.

Lubrication. The life of potentiometers and selector switches is lengthened if these devices are kept properly lubricated. Use a cleaning type lubricant (such as Cramoline) on shaft bushings and switch contacts. Lubricate the switch detents with a heavier grease (Beacon grease No. 325 or equivalent). Do not over-lubricate. The necessary materials and instructions for proper lubrication of Tektronix instruments are contained in a component lubrication kit which may be ordered from Tektronix. Order Tektronix Part No. 003-0342-00.

Visual inspection. After cleaning, the instrument should be carefully inspected for such defects as poor connections, damaged parts, and improperly seated transistors. The remedy for most visible defects is obvious; however, if heat-damaged parts are discovered, determine the cause of over-heating before the damaged parts are replaced. Otherwise, the damage may be repeated.

Tube and Transistor Checks

Periodic preventive maintenance checks on the tubes and transistors used in the instrument are not recommended. The circuits within the instrument generally provide the most satisfactory means of checking tube or transistor usability. Performance of the circuits is thoroughly checked during recalibration, so standard tubes and transistors will usually be detected at that time.

Recalibration

To insure accurate measurements, the instrument calibration

should be checked after each 500 hours of operation, or every six months if used intermittently.

The calibration procedure can be helpful in isolating major troubles in the instrument. Moreover, minor troubles not apparent during regular operation may be revealed and corrected during calibration.

CORRECTIVE MAINTENANCE

Corrective maintenance consists of component replacement and instrument repair. Special techniques or procedures required to replace components in this instrument are described here.

Component identification. The circuit number of each electrical part is shown on the circuit diagrams. Note that a functional group of circuits (such as the power supply) is assigned a particular series of numbers. Switch wafers are identified by counting from the first wafer behind the detent section of the switch towards the last wafer. The letters F and R indicate whether the front or rear of the wafer is used to perform the particular switching function. For example, the designation 2R printed by a switch section on a schematic identifies the switch section as being on the rear side of the second wafer when counting back from the detent section.

Parts replacement. Most of the electronic components in the Type 184 are standard items available locally. The remainder of the electronic components and most of the mechanical parts are manufactured or selected by Tektronix to satisfy particular requirements, or are manufactured for Tektronix to our specifications. However, all parts are obtainable through your Tektronix Field Engineer or Field Office. Before purchasing or ordering, consult the Electrical Parts List to determine the value, tolerance, and ratings required. See Parts Ordering Information and Special Notes and Symbols immediately preceding Section 7.

NOTE

When selecting the replacement parts, remember that the physical size and shape of a component may affect its performance in the circuit. Parts orientation and lead dress should duplicate those of the original part, since many of the components are mounted in a particular way to reduce or control stray capacitance and inductance. After repair, portions of the instrument may require recalibration.

Replacing components on etched-wiring boards. Use ordinary electronic grade 60/40 solder and a 35- to 40-watt pencil soldering iron with a 1/8-inch wide chisel tip. The tip of the iron should be clean and properly tinned for best heat transfer in a short time to the soldered connection. A higher wattage soldering iron, if used and applied for too long a time, ruins the bond between the etched wiring and base material by charring the glass epoxy laminate.

Maintenance—Type 184

The step-by-step technique is as follows:

1. Remove the component by cutting the leads near the body. This frees the leads for individual unsoldering.
2. Grip the lead with needle-nose pliers. Apply the tinned tip of a 40-watt pencil soldering iron to the lead between the pliers and the board; then pull gently.
3. When the solder first begins to melt, the lead will come out, leaving a clean hole. If the hole is not clean, use the soldering iron and a toothpick or a piece of enamel wire to open the terminal hole. Do not attempt to drill the solder out, since the through-hole plating might be destroyed.
4. Clean the leads on the new component and bend them to the correct shape. Carefully insert the leads into the holes from which the defective component was removed.
5. Apply the iron for a short time at each connection on the side of the board opposite the component to properly seat the component.
6. Apply the iron and a little solder to the connections to finish the solder joint.

Ceramic terminal strips. Solder used on the ceramic terminal strips should contain about 3% silver. Ordinary tin-lead solder can be used occasionally without damage to the ceramic terminal strips. Use a 40- to 75-watt soldering iron with $\frac{1}{8}$ -inch wide chisel-shaped tip. If ordinary solder is used repeatedly or if excessive heat is applied, the solder-to-ceramic bond may be broken.

A small roll of 3% silver solder is mounted at the back of the instrument. Silver-bearing solder can be purchased directly from Tektronix in one-pound rolls; order by Tektronix Part No. 251-0514-00.

Observe the following precautions when soldering ceramic terminal strips:

1. Use a hot iron for a short time. Apply only enough heat to make the solder flow freely.
2. Maintain a clean, properly tinned tip.
3. Avoid putting pressure on the ceramic terminal strip.
4. Do not attempt to fill the terminal-strip notch with solder; use only enough solder to cover the wires adequately.
5. Clean the flux from the terminal strip with a flux-remover solvent to maintain good environmental characteristics.

Metal terminals. When soldering metal terminals (e.g., interconnecting plug pins, switch terminals, potentiometers, etc.), ordinary 60/40 solder can be used. The soldering iron should have a 40- to 75-watt rating with a $\frac{1}{8}$ -inch wide chisel-shaped tip.

Observe the following precautions when soldering metal terminals:

1. Apply only enough heat to make the solder flow freely.
2. Apply only enough solder to form a solid connection. Excess solder may impair the function of the part.

3. If a wire extends beyond the solder joint, clip the excess close to the joint.

4. Clean the flux from the solder joint with flux-remover solvent to maintain good environmental characteristics.

Ceramic terminal strip replacement. A complete ceramic terminal strip assembly is shown in Fig. 4-1. Replacement strips (including studs) and spacers are supplied under separate part numbers. The old spacers may be reused if they are not damaged.

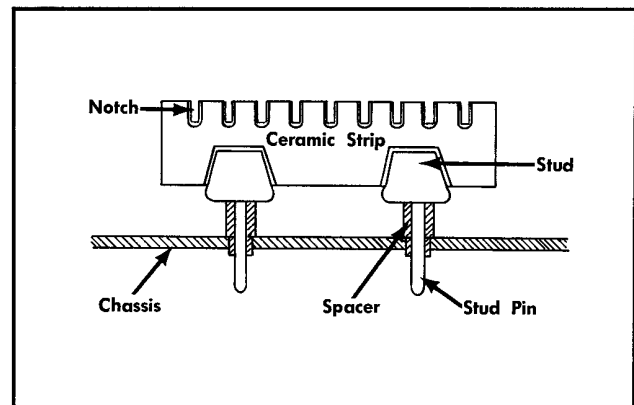

Fig. 4-1. Ceramic terminal strip assembly.

To replace a ceramic terminal strip, first unsolder all connections. Then, the damaged strip can be pried or pulled loose from the chassis. If the spacers come out with the strip, remove them from the stud pins to be used for installation of the new strip.

After the damaged strip has been removed, place the undamaged spacers in the chassis holes. Then, carefully press the studs into the spacers until completely seated. If necessary, use a soft mallet to tap lightly, directly over the stud area of the strip.

Switch Replacement

Individual wafers normally are not replaced in switch assemblies. Replacement switches may be ordered from Tektronix either unwired or with the associated wires and components attached.

When soldering leads to a switch, do not let solder flow around and beyond the terminal rivet as this may destroy the contact spring tension.

Tubes and Transistors

Tubes and transistors should not be replaced unless actually defective. However, temporary substitution is often the fastest and best way to detect a defective tube or transistor. Before substituting a tube or transistor, it is suggested that circuit conditions be checked to be certain that a replacement tube or transistor will not be subject to damage. In some cases, these checks will also show whether or not the tube or transistor is at fault.

When circuit conditions are known to be safe, install a tube or transistor of the same type which is known to be good and check for proper operation. If the original tube or transistor is thus proved acceptable, return it to the socket from which it came to avoid unnecessary recalibration.

Troubleshooting Aids

This manual and the instrument contain many features intended to speed and simplify maintenance. A block diagram which provides an overall picture of instrument operation is included with the diagrams in the back of this manual. The diagrams give the circuit reference number for each electrical component as well as important operating voltages, signals, and conditions for their measurement.

The instrument contains a number of stable metal-film resistors identified by their gray background color and color coding. If a resistor has three significant figures and a multiplier, it will be EIA color coded. If it has four significant figures and a multiplier, the value will be printed on the resistor. For example a 333 kΩ resistor will be color coded, but a 333.5 kΩ resistor will have its value printed on the resistor body. The color coding sequence is shown in Fig. 4-2.

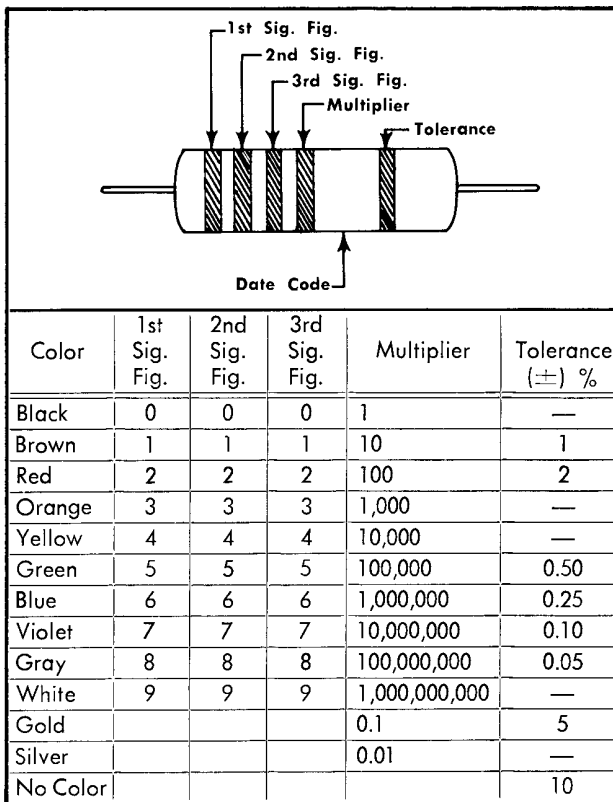

Fig. 4-2. Standard EIA color code for metal-film resistors.

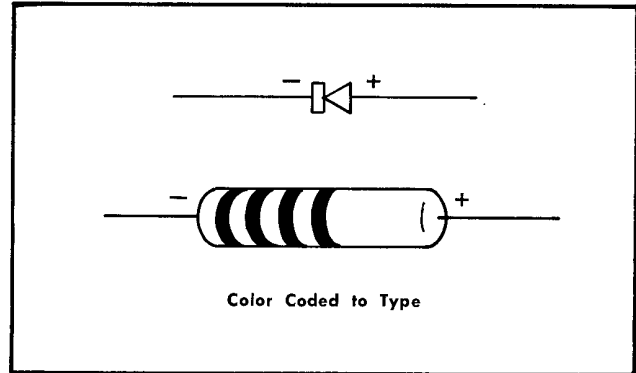

Fig. 4-3. Diode polarity of the glass diodes used in the Type 184.

Fig. 4-3 identifies the polarity of the glass diode types used in Tektronix instruments.

In-circuit diode checks. In-circuit diode checks may be performed with a voltmeter. A comparison check of the voltages on each side of the diode with the typical voltages listed on the diagram will help determine if the diode is faulty. Forward-to-back resistance ratios can be checked by referring to the schematic and pulling appropriate tubes or transistors to remove low resistance loops around the diode.

General Troubleshooting. If the instrument is not operating, attempt to isolate the trouble by a quick operational and visual check. Make sure that any apparent trouble is actually due to a malfunction within the Type 184, and not to improper control settings or a fault in associated equipment.

Operate the front-panel controls to see what effect, if any, they have on the trouble symptoms. The normal or abnormal operation of each particular control helps in establishing the nature of the trouble. The normal function of each control is listed in Section 2 of this manual.

If the trouble cannot be located by means of front-panel checks, remove the instrument from its case and check voltages and waveforms against those shown on the schematics, starting with the power supply connections. Once the trouble is isolated to a particular circuit, refer to the circuit description in Section 3 for an explanation of how the circuit normally operates.

CAUTION

Be careful when making measurements on live circuits. The small size and high density of components used in this instrument result in close spacing. An inadvertent movement of the test probes, or the use of oversized probes, may short between circuits.

Troubleshooting Techniques

This troubleshooting procedure is arranged in an order which checks the simple trouble possibilities before proceeding with extensive troubleshooting. The first few checks assure proper connection, operation and calibration. If the trouble is not located by these checks, the remaining steps

Maintenance—Type 184

aid in locating the defective component. When the defective component is located, it should be replaced following the replacement procedures given in this section.

1. Check associated equipment. Before proceeding with troubleshooting of the Type 184, check that the equipment used with the Type 184 is operating correctly. Check that the signal is properly connected and that the interconnecting cables or probes are not defective. Check the power source.

2. Check control settings. Incorrect control settings can indicate a trouble that does not exist. For example—The 10 ns circuit is disabled when the H.F. SELECTOR switch is not in the OFF position.

3. Check instrument calibration. Check the calibration of the instrument, or the affected circuit if the trouble exists in one circuit. The indicated trouble may only be a result of misadjustment and may be corrected by calibration. Complete instructions are given in the Calibration section of this manual. Individual calibration steps can be performed out of sequence. However, if the circuit affects the calibration of other circuits in the instrument, a more complete calibration will be necessary.

4. Isolate trouble to a circuit. The Type 184 has 15 countdown circuits for time markers and triggers. All countdown circuits are dependent on the preceding circuit to the basic oscillator frequency of 10 MHz (.1 μ s). There are 5 multiplier circuits. Three of these (20, 50 and 100 MHz) are direct multiples of the basic oscillator frequency. The remaining two are multiples of the 100 MHz signal.

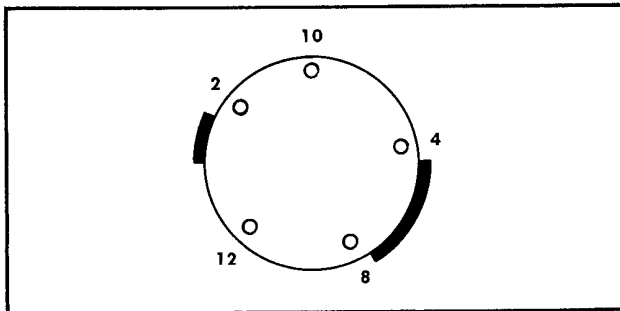

Fig. 4-4. Nuvistor tube pin identification.

Isolate the trouble to the source. For example; failure of the 1 μ s marker circuit could be caused from failure of the preceding countdown circuit, .5 and .1 μ s. Failure of the

5 ns sine-wave marker could be due to failure in the 100 MHz quintupler or basic oscillator.

The pin connections used to connect the etched-wiring boards to the instrument provide a unique method of circuit isolation. For example, a short in the power supply can be isolated to the rectifier circuit or the regulators by disconnecting pin connectors for that voltage at the board.

After the defective circuit has been located, proceed with step 5 through 8 to locate the defective component(s). If the trouble has not been isolated to a circuit using the procedure described here, check voltages and waveforms as explained in step 7 to locate the defective circuit.

5. Check etched-wiring board interconnections. After the trouble has been isolated to a particular circuit, check the pin connectors on the etched-wiring board for correct connection. (See Figs. 4-8 and 4-9). Each electrical component on the boards is identified by its circuit number. The circuit boards are also outlined on the diagrams with a blue line. These pictures used along with the diagrams will aid in locating the components mounted on the etched-wiring boards.

6. Visual check. Visually check the circuit in which the trouble is located. Many troubles can be located by visual indications such as unsoldered connections, broken wires, damaged etched-wiring boards or damaged components.

7. Check voltages and waveforms. Often the defective component can be located by checking for the correct voltage or waveform in the circuit. Typical voltages and waveforms are given on the schematics.

NOTE

Voltages and waveforms given on the diagrams are not absolute and may vary slightly between instruments. To obtain operating conditions similar to those used to make these readings, see the first schematic page.

a. Voltages: Voltage measurements should be taken with a 20,000 ohms/volt dc voltmeter. Accuracy of the voltmeter should be within 3% on all ranges. Be sure that the test prods are well insulated to prevent accidental shorting of components.

b. Waveforms: Use a test oscilloscope(s) which has the following minimum specifications:

Bandwidth: Dc to greater than 500 MHz.

Deflection factor: 0.05 volts/division minimum.

Input impedance: Approximately 10 megohms paralleled by about 10 pF when using a 10 \times probe.

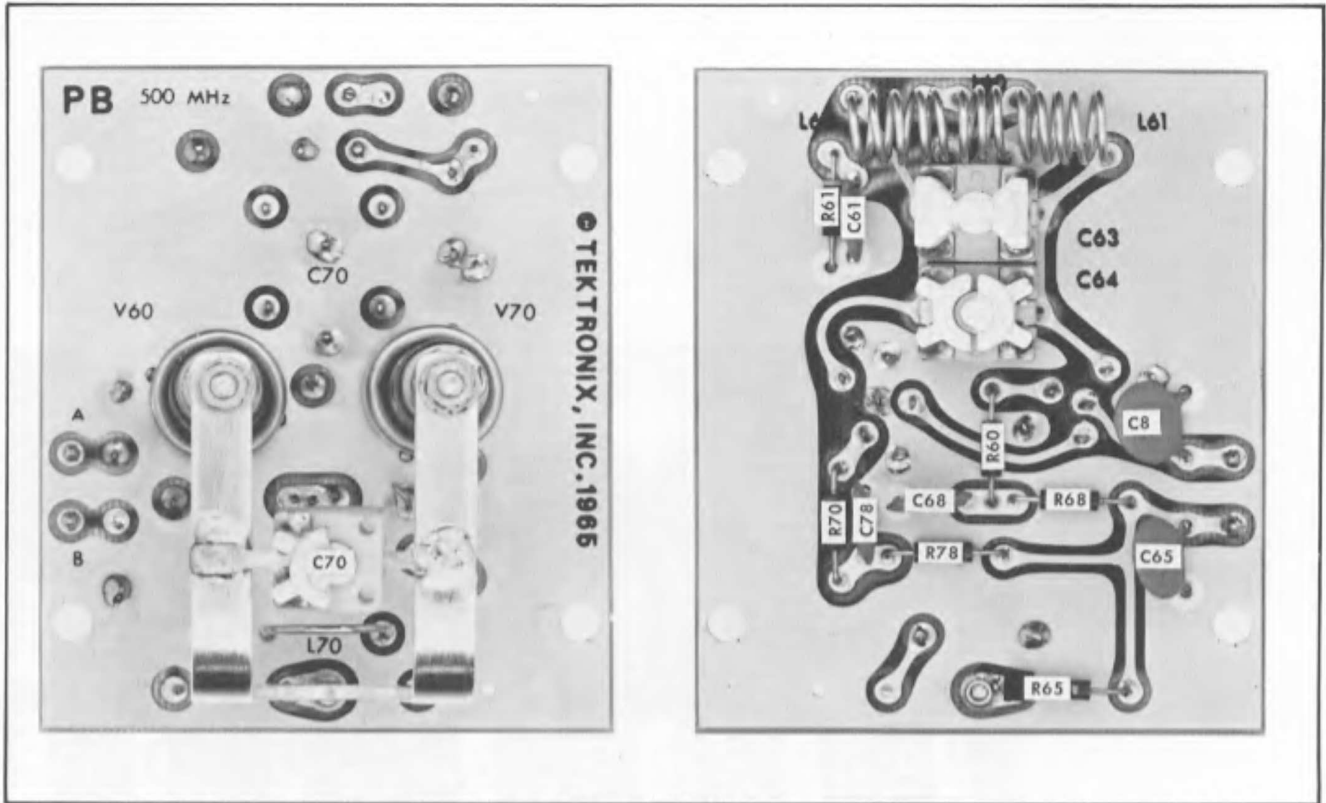

Fig. 4-5. 500 MHz (2 ns) etched-wiring board.



Fig. 4-6. 200 MHz (5 ns) etched-wiring board.

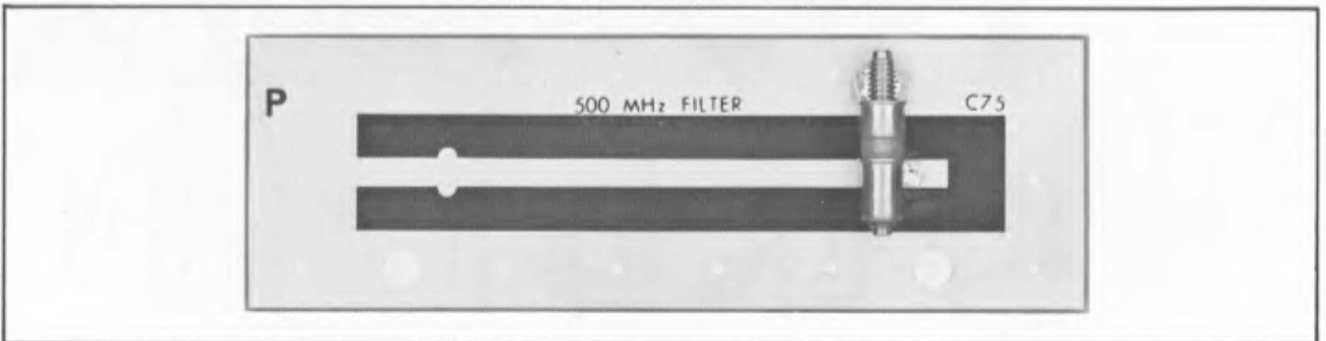

Fig. 4-7. 500 MHz filter etched-wiring board.

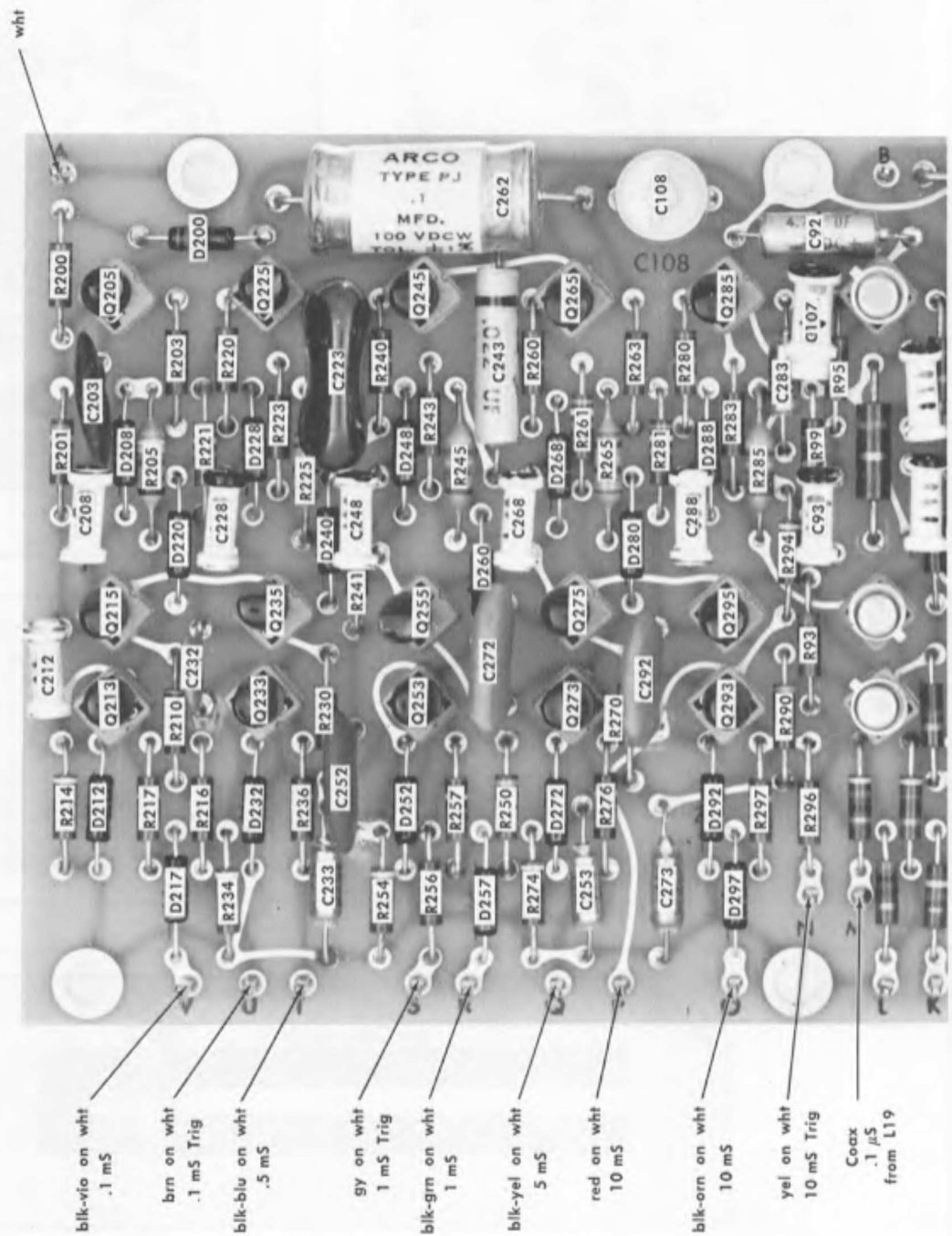

Fig. 4-8a. Upper portion of the .1 μs to 10 ms countdown etched-wiring board.

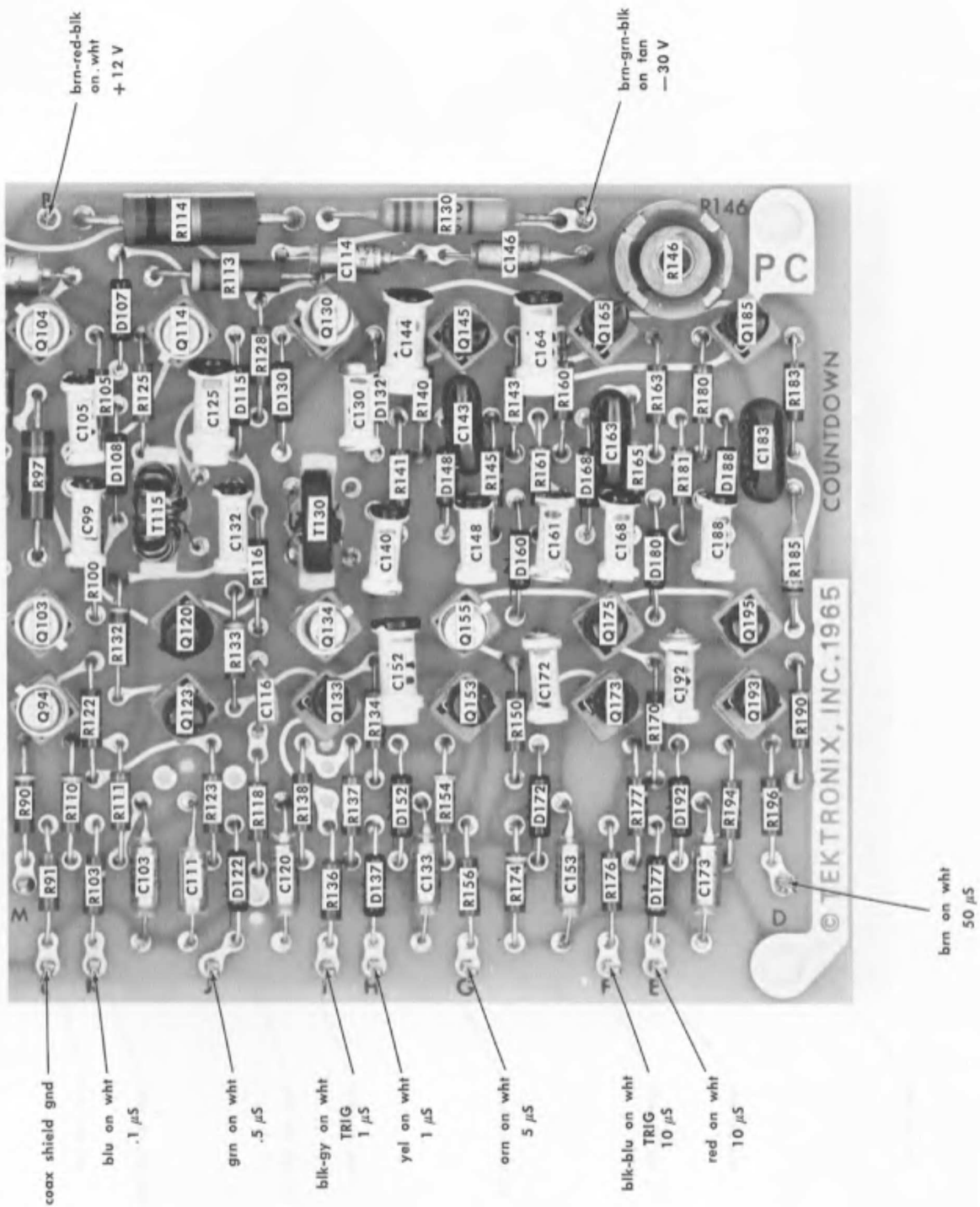

Fig. 4-8b. Lower portion of the .1 μs to 10 ms countdown etched-wiring board.

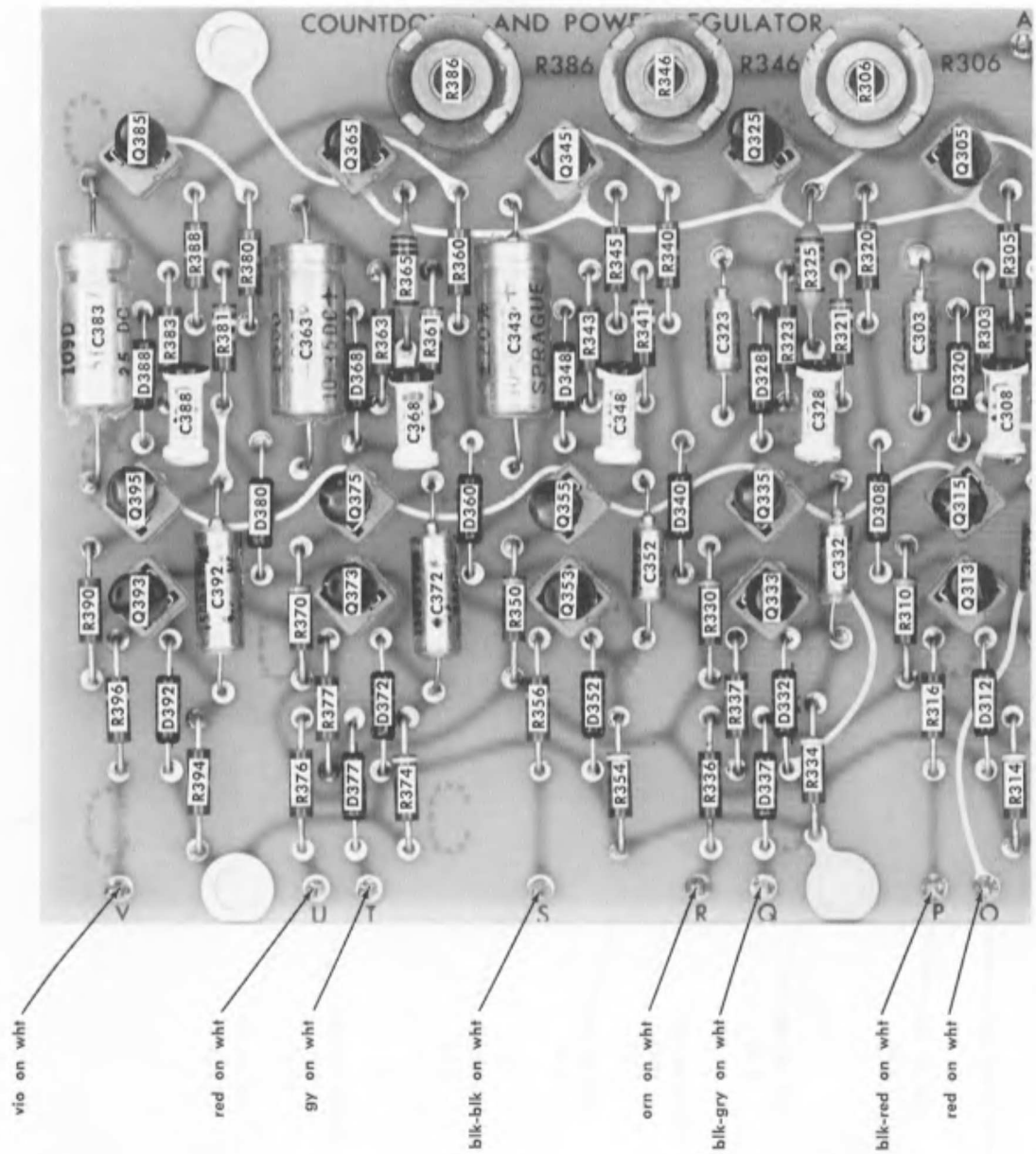

Fig. 4-9a. Lower portion of the 50 ms to 5 s countdown and power regulator etched-wiring board.

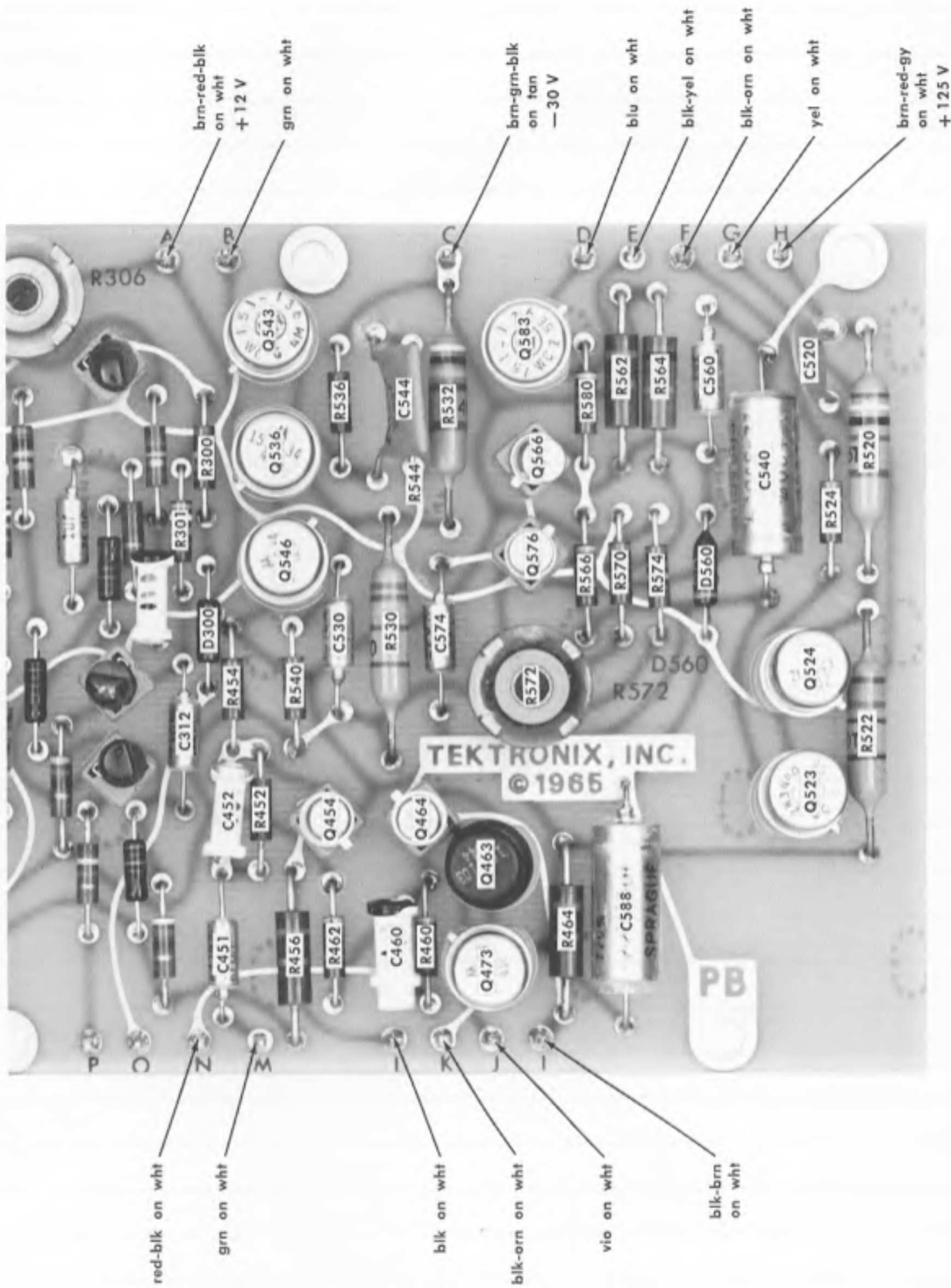

Fig. 4-9b. Upper portion of the 50 ms to 5 s countdown and power regulator etched-wiring board.

SECTION 5

PERFORMANCE CHECK

Introduction

This performance check procedure is provided to check the operation of the Type 184 without removing the cover. This procedure may be used for incoming inspection, instrument familiarization, reliability testing, calibration verification, etc.

Failure to meet the characteristics given in this procedure indicates that the instrument requires internal checks and/or adjustments. See the Calibration section.

Recommended Equipment

The following equipment is recommended for a complete performance check. Specifications given are the minimum necessary to perform this procedure. All equipment is assumed to be calibrated and operating within the original specifications. If equipment is substituted, it must meet or exceed the specifications of the recommended equipment.

For the most accurate and convenient performance check, special calibration fixtures are used in this procedure. These fixtures are available from Tektronix, Inc. Order by part number through your local Tektronix Field Office or representative.

1. Test oscilloscope. Bandpass dc to 30 MHz; 0.05 volts/div deflection factor. Tektronix 540-Series oscilloscope with Type L Plug-In Preamplifier recommended.
2. 1 \times probe with BNC connector. Tektronix P6028 Probe recommended.
3. 10 \times probe with BNC connector. Tektronix P6006 Probe recommended.
4. Test oscilloscope with sampling system. Input impedance 50 Ω , risetime, 0.4 ns maximum. Tektronix 560-Series with Types 3S76 and 3T77 or Tektronix 540-Series with Type 1S1 Plug-In Unit recommended.
5. Electronic Digital Frequency Counter. Frequency measurement dc to 20 MHz. Example: Hewlett Packard 5244L Electronic Counter or equivalent.
6. Termination (one). Impedance 50 Ω ; BNC connectors, Tektronix Part No. 011-0049-00.
7. 5 \times attenuator. Impedance 50 Ω ; GR connectors. Tektronix Part No. 017-0079-00.
8. Adapters, GR to BNC, female. Tektronix Part No. 017-0063-00.
9. Adapter, clip lead to BNC. Tektronix Part No. 013-0076-00.
10. Adapter, BNC to dual binding post. Tektronix Part No. 103-0035-00.
11. Cable (two). Impedance 50 Ω ; type RG58/AU, length 42 inches, BNC connectors. Tektronix Part No. 012-0057-00.
12. Resistor. 1 k Ω , 1/2 watt, 1% tolerance.

General Information

In the following procedure, test equipment connections or control settings should not be changed except when noted. If only a partial check is desired, refer to the preceding step(s) for setup information.

The following procedure uses the recommended equipment. If substitute equipment is used, the user must determine the settings or setup to meet the requirements of the check.

Preliminary Procedure

1. Check fuses for correct value. 115 volt operation: 0.6 amp, slow blow, 3AG. 230 volt operation: 0.3 amp, slow blow, 3AG. Check Line Voltage switch on the back panel for correct operating position (115 or 230 V).
2. Connect the Type 184 to a line voltage within the regulating range of the power supplies. Allow a minimum of 2 hours after the Type 184 is connected to a power source for the crystal to stabilize at 25°C \pm 5° or room ambient temperature. Turn the Type 184 on by depressing any of the MARKER SELECTOR pushbuttons. Allow 5 minutes warm-up time, if the crystal oven has stabilized, before checking the instrument to a given accuracy.

PERFORMANCE CHECK

1. Check Oven Light

Requirement—Oven light should cycle on and off after approximately 5 minutes warm-up time.

Check—Oven light operation.

2. Check Crystal Oscillator Frequency

a. Requirement—Frequency 10 MHz \pm 100 Hz at ambient room temperature. Crystal oven stabilized. (Two hours warm-up time after power is applied before crystal oven is stabilized.)

b. Apply the .1 μ S marker from the MARKER OUTPUT connector through a 50 Ω coaxial cable and 50 Ω termination resistor to the Input connector of a digital frequency counter or equivalent frequency measuring device.

c. Check accuracy of the .1 μ S markers (10 MHz crystal oscillator frequency).







d. Remove the coaxial cable and 50 Ω termination from the frequency measuring device.

3. Check .1 μ S to 5 μ S Marker Timing

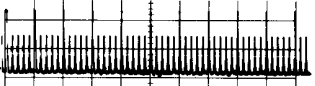
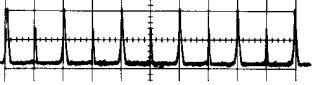
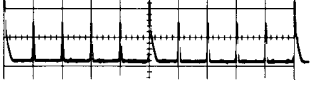
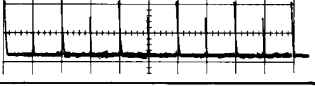
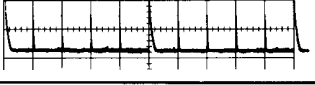
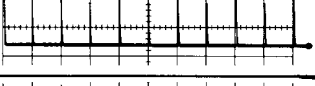
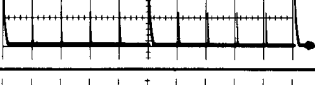
a. Requirement—Marker accuracy dependent on crystal oscillator.

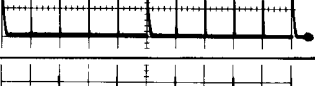
b. Connect the TRIGGER OUTPUT of the Type 184 through a 50 Ω coaxial cable to the external Trigger Input connector of the test oscilloscope (Type 545B).

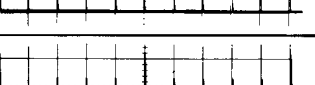
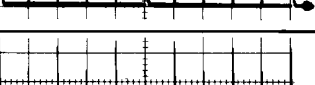
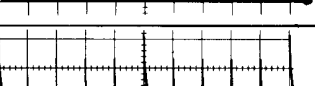
TABLE 5-1

| Type 184 MARKER SELECTOR | Test Oscilloscope Time/Cm | Type 184 TRIGGER SOURCE | Typical Display |
|-----------------------------|------------------------------|----------------------------|---|
| .1 μ S and .5 μ S | .5 μ SEC | 1 μ S |  |
| .5 μ S and 1 μ S | .5 μ SEC | 1 μ S |  |
| 1 μ S and 5 μ S | 1 μ SEC | 10 μ S |  |
| 5 μ S and 10 μ S | 5 μ SEC | 10 μ S |  |
| 10 μ S and 50 μ S | 10 μ SEC | .1 mS |  |
| 50 μ S and .1 mS | 50 μ SEC | .1 mS |  |
| .1 mS and .5 mS | .1 mSEC | 1 mS |  |
| .5 mS and 1 mS | .5 mSEC | 1 mS |  |
| 1 mS and 5 mS | 1 mSEC | 10 mS |  |
| 5 mS and 10 mS | 5 mSEC | 10 mS |  |
| 10 mS and 50 mS | 50 mSEC | .1 S |  |
| 50 mS and .1 S | 10 mSEC | 1 S |  |
| .1 S and .5 S | .1 SEC | 1 S |  |
| .5 S and 1 S | .5 SEC | 1 S |  |
| 1 S and 5 S | 1 SEC | 1 S |  |

c. Connect the output of the MARKER OUTPUT connector on the Type 184 through a 50 Ω coaxial cable and 50 Ω termination resistor to the vertical Input connector of the vertical plug-in unit (Type L) in the test oscilloscope.

d. Set the Type 184 and test oscilloscope controls as follows:

Type 184

| | |
|------------------|-------|
| MARKER SELECTOR | .1 μS |
| TRIGGER SELECTOR | 1 μS |
| MARKER AMPLIFIER | OFF |
| H.F. SELECTOR | OFF |

Test oscilloscope

| | |
|--------------------|---|
| Crt controls | Adjust for well focused display of nominal brightness |
| Horizontal Display | Time Base A |

Time Base A Controls

| | |
|------------------|------------|
| Time/Cm | .1 μSEC |
| Variable | Calibrated |
| Trigger Mode | AC |
| Trigger Slope | +Ext |
| Stability | Preset |
| Triggering Level | Midrange |

Vertical Plug-In Unit (Type L)

| | |
|-------------------|------------|
| Volts/Cm | .5 |
| Variable | Calibrated |
| Input Coupling | DC |
| Vertical Position | Centered |

e. Adjust the Triggering Level control when necessary for a stable display as each step in Table 5-1 is followed.

f. Check the marker timing in accordance with Table 5-1.

4. Check MARKER OUTPUT Amplitude

a. Requirement—Marker amplitude must be greater than 1 volt into 50 ohms.

b. Repeat the steps of Table 5-1, pushing only one MARKER SELECTOR button at a time. Check the amplitude of the time markers.

5. Check Output of MARKER AMPLIFIER

a. Requirements—Positive or negative-going markers with 14 intervals of 1 μs to 5 s in 1-5-10 sequence, 25-V minimum amplitude into 1 kΩ.

b. Connect a BNC to binding post adapter to the MARKER AMPLIFIER OUTPUT connector. Attach a 1 kΩ ½ watt, 1%

resistor across the dual binding post adapter. Connect a clip lead to BNC adapter to the dual binding post adapter (red lead to the red binding post). Connect a 50 Ω coaxial cable between the clip lead to BNC adapter and the Input connector of the vertical plug-in unit in the test oscilloscope. (Fig. 6-13 in Calibration section.)

c. Set the vertical deflection factor (Volts/Cm switch) to 10.

d. Set the Trigger Slope switch of the test oscilloscope to +Int and the Time/Cm switch as listed in Table 5-2.

e. Switch the MARKER AMPLIFIER switch to (+) position and check the amplitude of the MARKER AMPLIFIER output signal for each setting listed in Table 5-2.

f. Change the MARKER AMPLIFIER switch to the (−) position and the test oscilloscope Trigger Slope to (−Int) position.

g. Check the amplitude of the MARKER AMPLIFIER output signal for a minimum −25 volt signal.

h. Remove the adapters and cables from the Type 184 and test oscilloscope.

TABLE 5-2

| Type 184 MARKER SELECTOR | Test Oscilloscope Time/Cm |
|-----------------------------|------------------------------|
| 1 μS | 10 μSEC |
| 5 μS | 10 μSEC |
| 10 μS | .1 mSEC |
| 50 μS | .1 mSEC |
| .1 mS | 1 mSEC |
| .5 mS | 1 mSEC |
| 1 mS | 10 mSEC |
| 5 mS | 10 mSEC |
| 10 mS | 100 mSEC |
| 50 mS | 100 mSEC |
| .1 S | 1 SEC |
| .5 S | 1 SEC |
| 1 S | 1 SEC |
| 5 S | 1 SEC |

6. Check Amplitude and Timing of the TRIGGER OUTPUT

a. Requirement—Positive-going pulses in 1-10 sequence, amplitude ≥0.4V into 50 Ω or ≥2.5V into open circuit.

b. Apply the signal from the TRIGGER OUTPUT connector through a 50 Ω coaxial cable and 50 Ω termination to the vertical Input connector of the vertical plug-in unit (Type L).

c. Set the Volts/Cm switch on the vertical unit to .2.

d. Check the trigger timing and amplitude as listed in Table 5-3.

Performance Check—Type 184

TABLE 5-3

| Type 184 TRIGGER SELECTOR | Test Oscilloscope Time/Cm | Marks/Cm |
|---------------------------|---------------------------|----------|
| 1 μ S | 1 μ SEC | 1 |
| 10 μ S | 10 μ SEC | 1 |
| .1 mS | .1 mSEC | 1 |
| 1 mS | 1 mSEC | 1 |
| 10 mS | 10 mSEC | 1 |
| .1 S | .1 SEC | 1 |
| 1 S | 1 SEC | 1 |

7. Check Sine-wave Marker Timing and Amplitude

a. Requirement—10, 20 and 50 ns sine-wave marker signals at the MARKER OUTPUT connector with 1-V minimum peak-to-peak amplitude into 50 Ω .

b. Apply the signal from the Type 184 MARKER OUTPUT connector through a 50 Ω coaxial cable, a BNC-to-GR adapter and a 5 \times T, 50 Ω , GR attenuator, to the Input (A) connector of the vertical plug-in unit (Type 3S76) for the sampling test oscilloscope.

c. Set the test oscilloscope and plug-in units controls as follows:

| | |
|--------------|---|
| Crt controls | Adjust for well focused display of nominal brightness |
|--------------|---|

Time Base Plug-In Unit (Type 3T77)

| | |
|--------------|---------------------------|
| Time/Div | As indicated in Table 5-5 |
| Sweep Mode | Normal |
| Trigger | +Int |
| Horiz Mag | \times 1 |
| Dots Per Div | 100 |

Vertical Plug-In Unit (Type 3S76)

| | |
|----------------|--------|
| Mv/Div | 100 |
| Input Selector | A Only |

d. Check amplitude and timing of the sine-wave markers in accordance with Table 5-4.

TABLE 5-4

| Type 184 MARKER SELECTOR | Test Oscilloscope Time/Div | Cycle/Div |
|--------------------------|----------------------------|-----------|
| 50 nS | 50 nSEC | 1 |
| 20 nS | 20 nSEC | 1 |
| 10 nS | 10 nSEC | 1 |

e. Remove the 50 Ω coaxial cable from the Type 184 MARKER OUTPUT connector and attach to the H.F. OUTPUT connector.

8. Check Amplitude and Timing of H.F. Sine-wave Markers

a. Requirement—500 MHz (2 ns) and 200 MHz (5 nS) frequencies at the OUTPUT connector with 0.3-V minimum peak-to-peak amplitude into 50 Ω .

b. Set the Type 184 H.F. SELECTOR switch to the 5 nS position.

c. Set the Mv/Div switch on the vertical plug-in unit (Type 3S76) to 50.

d. Check the amplitude and timing of the 2 and 5 nS markers in accordance with Table 5-5.

TABLE 5-5

| Type 184 H.F. SELECTOR | Test Oscilloscope Time/Div | Cycle/Div |
|------------------------|----------------------------|-----------|
| 5 nS | 5 nSEC | 1 |
| 2 nS | 2 nSEC | 1 |

e. Remove all cables, adapters and attenuators from the Type 184 and test oscilloscope.

SECTION 6

CALIBRATION

Introduction

This procedure can be used either as an operational check or to completely calibrate the instrument. The title of each numbered step begins with either "Adjust" ① or "Check", thereby identifying the step as calibration or verification. The steps are identified in this manner so any or all groups of numbered checks can be skipped without disrupting the continuity of the procedure. All "Adjust" steps, however, must be completed in the order given, because some adjustments interact with others. Remember that proper operation is only insured when all steps in the procedure have been completed and all adjustments have been made as accurately as possible.

The location of test points and adjustments is shown in each step. Waveforms which are helpful in determining the correct adjustment or operation are also shown.

Where reference is made to divisions of deflection, the indication will be major divisions.

NOTE

The performance standards described in this section of the manual are provided strictly as guides to calibration of the Type 184 and should not be construed as advertised specifications. If the Type 184 performs within the guide tolerances given in this calibration procedure, it will meet all listed specifications in the Characteristics section of this manual.

EQUIPMENT REQUIRED

The following equipment or its equivalent is required for a complete calibration of the Type 184. Specifications are the minimum necessary for accurate calibration of the instrument. All test equipment is assumed to be calibrated and operating within its specifications. If substitute equipment is used, it must meet or exceed the specifications of the equipment recommended.

Special calibration fixtures are used where necessary. These can be obtained through your local Tektronix Field Office or representative. The part number for the calibration fixture is listed with the description of the part.

1. Test oscilloscope: Bandpass dc to 30 MHz; .05 volts/div deflection factor. Tektronix 540-Series oscilloscope with Type L Plug-In Preamplifier recommended.

2. 1× probe with BNC connector; Tektronix P6028 Probe recommended.

3. 10× probe with BNC connector: Tektronix P6006 Probe recommended.

4. Test oscilloscope with sampling system: Input impedance 50 Ω, risetime 0.4 ns maximum. Tektronix 560-series with Types 3S76 and 3T77 or Tektronix 540-Series with Type 1S1 Plug-In Unit recommended.

5. Variable autotransformer: Variable range 93.5 to 135 Vac or 187 to 270 Vac. If autotransformer does not have an ac voltmeter to monitor the output voltage, an ac voltmeter (rms) with a range of 90 to 270 volts must be used. For example: General Radio W10MT3W Metered Variac Autotransformer.

6. Frequency Standard or Digital Frequency Counter: Frequency 10 MHz, stability 0.3 ppm¹ for short time use, or over 24 hours. A stable communication receiver which can receive the National Bureau of Standards transmitting stations (WWV, WWVB, WWVH) may be used.

7. Dc voltmeter, with sensitivity of 20,000 ohms/volt and calibrated for an accuracy of ±1% at 30 and 125 volts.

8. Termination: Impedance 50 Ω, BNC connectors. Tektronix Part No. 011-0049-00.

9. 5× Attenuator: Impedance 50 Ω, GR connectors. Tektronix Part No. 017-0079-00.

10. Adapter: GR to BNC, female. Tektronix Part No. 017-0063-00.

11. Adapter: clip lead to BNC. Tektronix Part No. 013-0076-00.

12. Adapter: BNC to dual binding post. Tektronix Part No. 103-0035-00.

13. Cables: (2) Impedance 50 Ω, type RG58/AU, length 42 inches, BNC connectors. Tektronix Part No. 012-0057-00.

14. Resistor: 1 kΩ resistor, 1/2 watt, 1% tolerance.

Adjusting Tools (see Fig. 6-2)

| Description | Tektronix Part No. |
|---|--------------------|
| a. Insulated screwdriver, 1½-inch shaft, non-metallic | 003-0000-00 |
| b. Screwdriver, 3-inch shaft | 003-0192-00 |
| c. Tuning rod, 5-inch | 003-0301-00 |

*Parts per million.

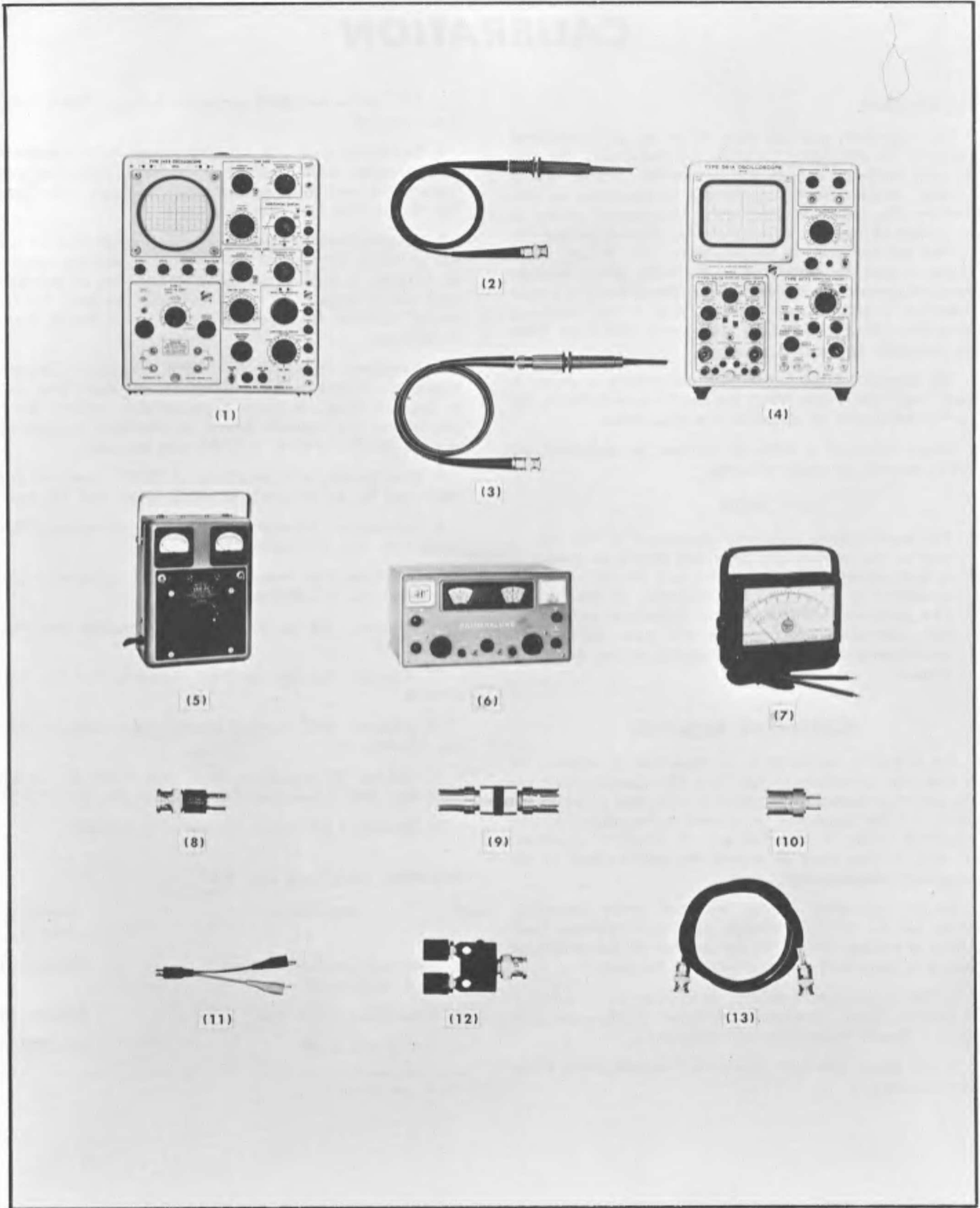

Fig. 6-1. Equipment recommended for calibration.

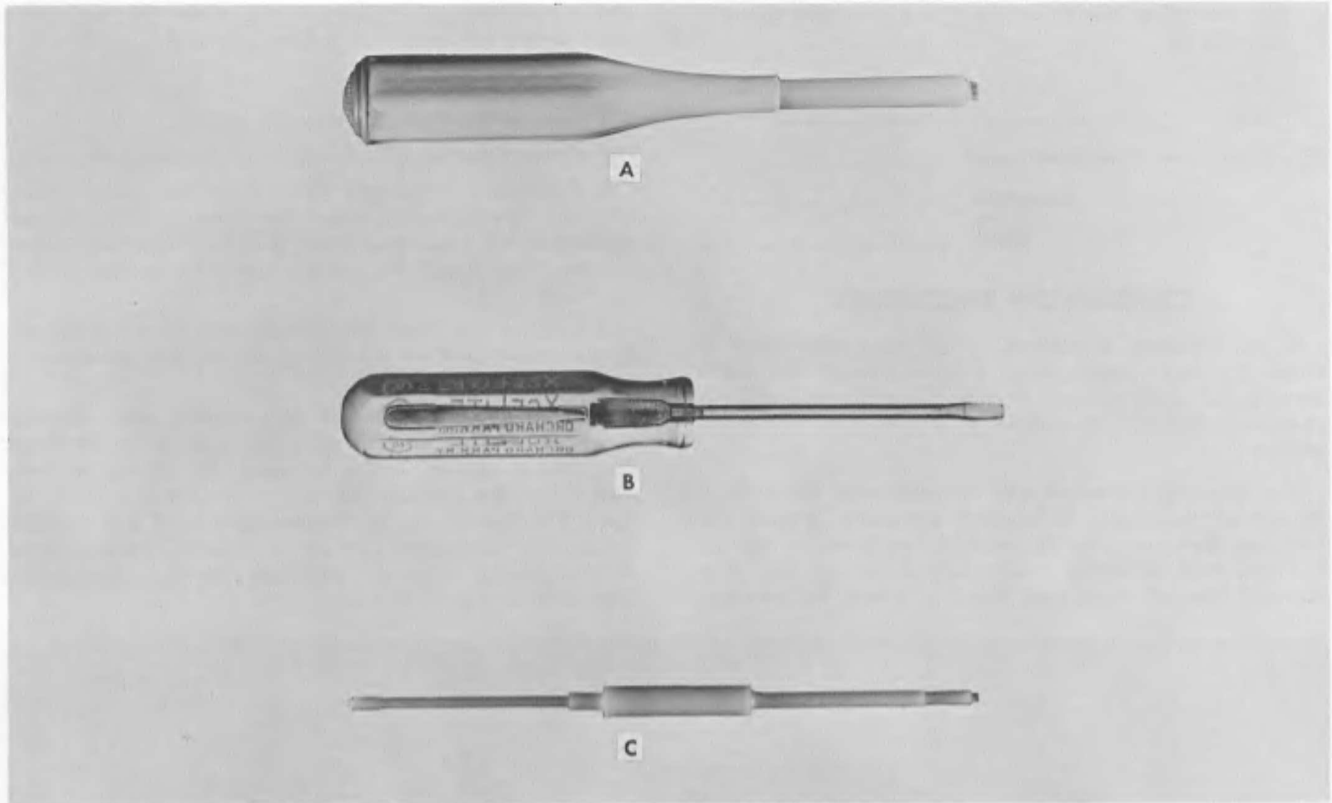

Fig. 6-2. Adjusting tools.

CALIBRATION RECORD AND INDEX

This Abridged Calibration Procedure is provided to aid in checking the operation of the Type 184. It may be used as a calibration guide by the experienced calibrator, or as a calibration record. Since the step numbers and titles used correspond to those in the complete Calibration Procedure, the following procedure serves as an index to locate a step in the complete Calibration Procedure. Characteristics are those listed in the Characteristics section of the Instruction Manual.

Type 184

Instrument Serial No. _____

1. Voltage on -30 volt terminal (pin C) _____
2. Voltage on +12 volt terminal (pin A) _____
3. Voltage on +125 volt terminal (pin H) _____
4. Regulation of -30 volt supply _____ %
5. Marker accuracy and amplitude (1 volt minimum)
 - Crystal oscillator frequency deviation _____ Hz
 - .1 μ S _____
 - .5 μ S _____
 - 1 μ S _____
 - 5 μ S _____
 - 10 μ S _____
 - 50 μ S _____
 - 100 μ S _____

- .5 mS _____
- 1 mS _____
- 5 mS _____
- 10 mS _____
- 100 mS _____
- .5 S _____
- .1 S _____
- 5 S _____

6. Marker Amplifier amplitude (greater than ± 25 V into 1 k Ω at 1 μ S) _____
7. Trigger timing accuracy and amplitude (greater than .4 V)
 - 1 μ S _____
 - 10 μ S _____
 - .1 mS _____
 - 1 mS _____
 - 10 mS _____
 - .1 S _____
 - 1 S _____
8. Sine-wave marker accuracy and amplitude (greater than 1 V)
 - 50 nS _____
 - 20 nS _____
 - 10 nS _____

Calibration—Type 184

9. H.F. sine-wave marker accuracy and amplitude (greater than 0.3 V)

5 nS _____
 2 nS _____

10. Crystal oven thermostat cycles _____

Signature _____

Date _____

CALIBRATION PROCEDURE

In the following procedure, a test equipment setup is shown for each major step. Control settings are listed beneath the setup picture. If only a partial calibration is performed, start with the nearest setup preceding the desired portion.

The following procedure uses the equipment listed under "Equipment Required". If substitute equipment is used, the user must determine that the substitute equipment is equivalent and must determine proper control settings, etc. It is assumed that all equipment listed is within its manufac-

turer's specifications. If there is any doubt, the test equipment should be calibrated before it is used.

Preliminary Procedure

1. Remove the Type 184 from its cabinet.
2. Connect the autotransformer to a suitable power source.
3. Preliminary inspection: Check fuses for correct value. 115 volt operation: 0.6 amp, slow blow, 3 AG; 230 volt operation: 0.3 amp, slow blow, 3 AG. Check Line Switch on the back panel for correct operating position (115 V or 230 V).
4. Connect the Type 184 power cord to the autotransformer output and set the output of the autotransformer to 115 (or 230) volts.
5. Allow 2 hours warm-up time with a room ambient temperature of $25^{\circ}\text{C} \pm 5^{\circ}$ after the Type 184 is connected to a power source. This is necessary for the crystal oven, and hence the oscillator frequency, to stabilize. Turn the Type 184 power on, by depressing any of the MARKER SELECTOR pushbuttons. Allow 5 minutes warm-up time if the crystal oven has stabilized, before checking the instrument to a given accuracy.

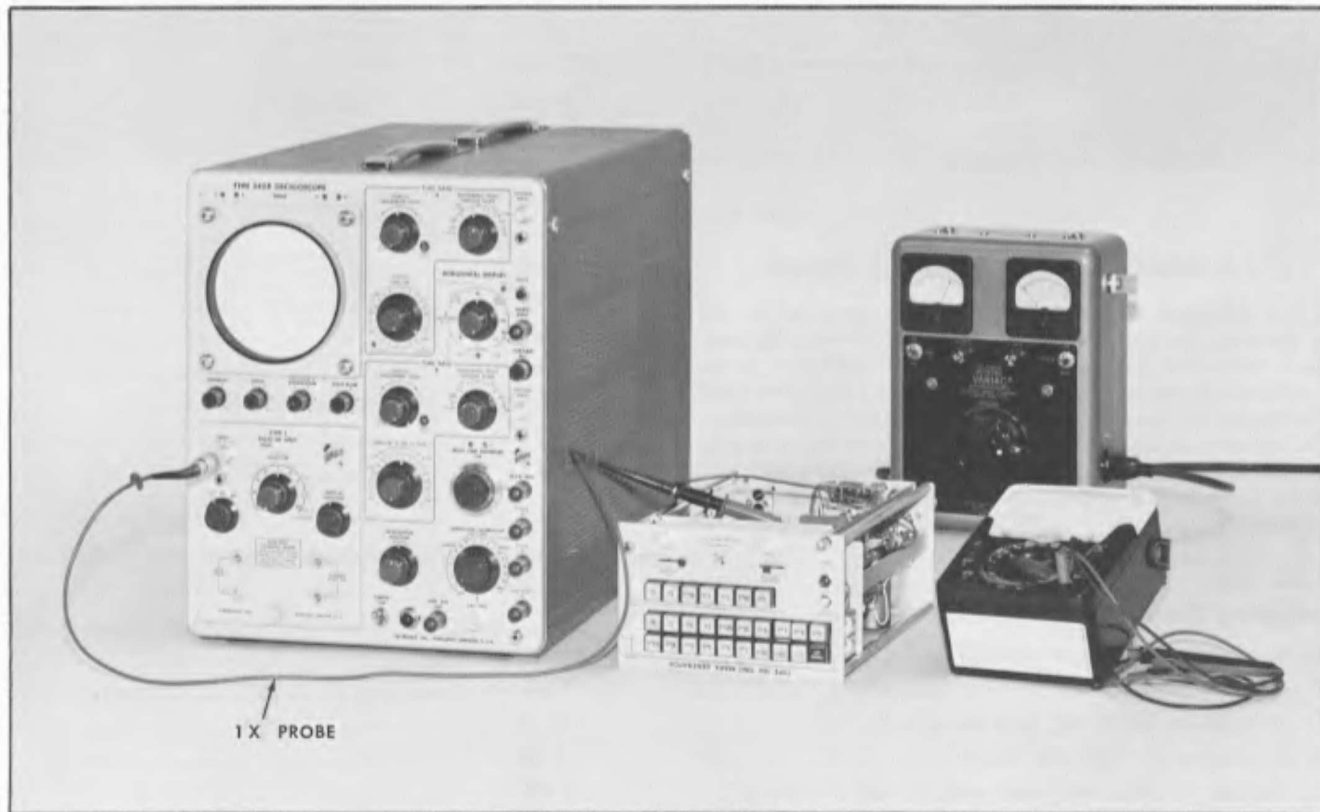

Fig. 6-3. Initial test equipment set-up to check and adjust voltages.

Set controls as follows:

Type 184

| | |
|------------------|------|
| MARKER SELECTOR | 1 mS |
| TRIGGER SELECTOR | None |
| MARKER AMPLIFIER | OFF |
| H.F. SELECTOR | OFF |

Autotransformer

Line Voltage 115 (230) volts

Test Oscilloscope

Crt controls Adjust for well focused display of nominal brightness

| | |
|-----------------------|-------------|
| Horizontal Display | Time Base A |
| Sweep Controls | |
| A Time/Cm | 5 mSEC |
| Variable | Calibrated |
| A Triggering Mode | AC |
| A Trigger Slope | +Line |
| A Stability | Preset |
| A Triggering Level | Midrange |
| Vertical Plug-In Unit | |
| Volts/Div | .05 |
| Variable | Calibrated |
| Input Coupling | AC |
| Vertical Position | Midrange |

TABLE 6-1

| Supply | Typical Regulation Value | Typical maximum Frequency Ripple |
|--------|--------------------------|----------------------------------|
| -30 V | ±3% | 15 mV p-p |
| +12 V | ±3% | 30 mV p-p |
| +125 V | ±3% | 60 mV p-p |



Fig. 6-4. Voltage test points and adjustments.

1. Check Oven Light

- Check oven light operation.
- After 5 minute warm-up time, oven should cycle on and off at approximately 1-2 minute intervals.
- Interaction — None.

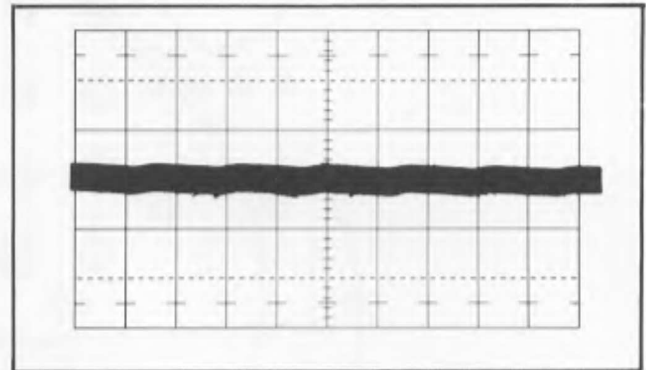

Fig. 6-5. Typical test oscilloscope display of power supply ripple (60-cycle line) vertical deflection, 0.5 volts/div, sweep rate 5 msec/div.

2. Adjust -30 Volt Power Supply

- Test equipment setup is shown in Fig. 6-3.
- Connect the dc voltmeter from the -30 volt supply, pin C on the power board to chassis ground. See Fig. 6-4.
- Adjust R572, the -30 volt adjustment (Fig. 6-4), for -30 volts.
- Interaction — May affect the operation of all circuits within the Time-Mark Generator.

3. Check Power Supply Voltages and Ripple

- Test equipment setup is shown in Fig. 6-3.
- Connect the 1× probe to the test oscilloscope input.
- Check—regulation and ripple of the power supplies while changing the input supply voltage between 94.5 to 137.5 VAC (or 189 to 275 VAC). Power supply test points are shown in Fig. 6-4. Power supply specifications are shown in Table 6-1 and a typical test oscilloscope display of the ripple is shown in Fig. 6-5. Disregard high frequency hash, spikes, transients, etc.
- Return autotransformer output to 115 (230) volts. If the line voltage is approximately 115 (230) volts, the Type 184 may be connected directly to the line for the remainder of the calibration procedure.
- Remove 1× probe.

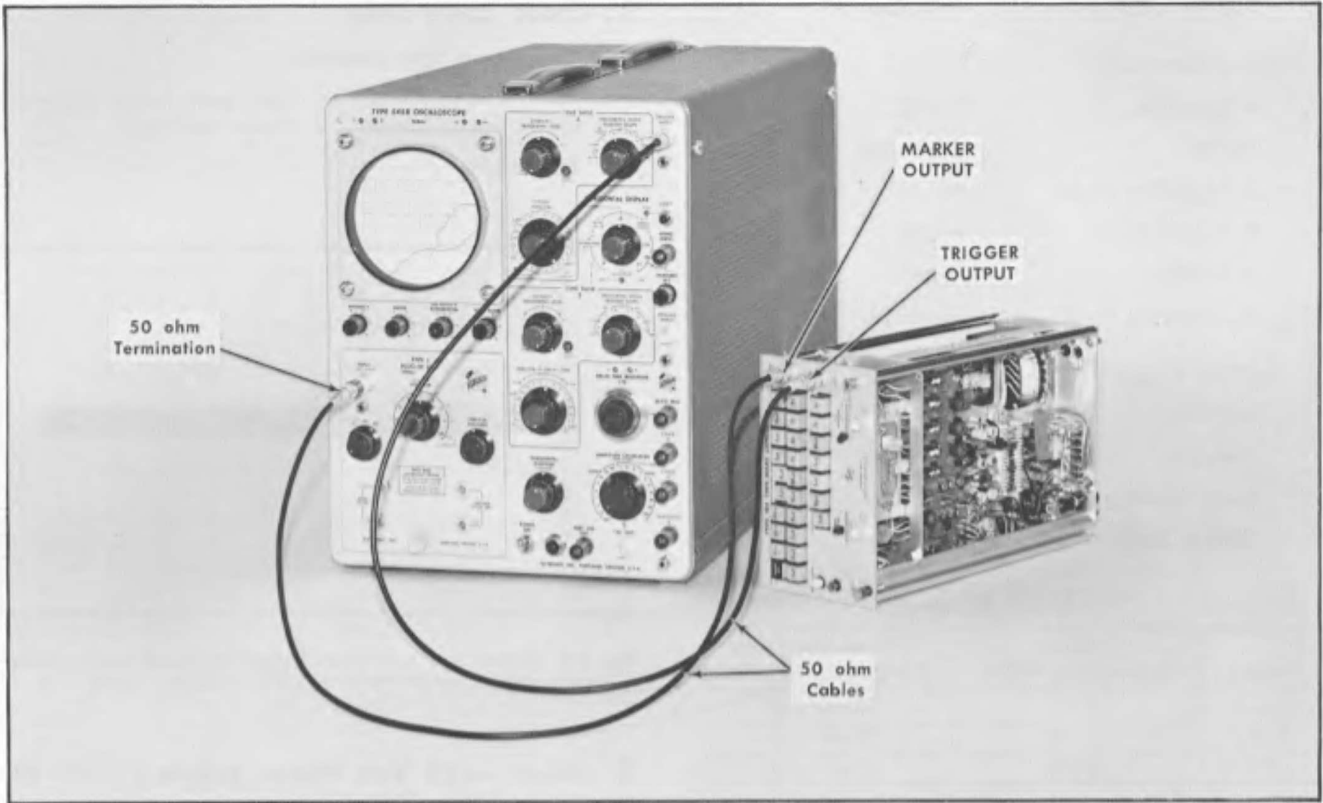

Fig. 6-6. Checking and adjusting .1 μ S and .5 μ S time-markers. Step 4.

Control Settings:

Type 184

| | |
|------------------|------------|
| MARKER SELECTOR | .1 μ S |
| TRIGGER SELECTOR | 1 μ S |
| MARKER AMPLIFIER | OFF |
| H.F. SELECTOR | OFF |

Test Oscilloscope

| | |
|--------------------|---|
| Crt controls | Adjust for well focused display of nominal brightness |
| Horizontal Display | Time Base A |
| Sweep Controls | |
| A Time/Cm | .5 μ SEC |
| Variable | Calibrated |
| A Triggering Mode | AC |
| Trigger Slope | +Int |
| A Stability | Preset |
| A Triggering Level | Midrange |

Vertical Plug-In Unit

| | |
|-------------------|------------|
| Volts/Div | .5 |
| Variable | Calibrated |
| Input Coupling | DC |
| Vertical Position | Midrange |

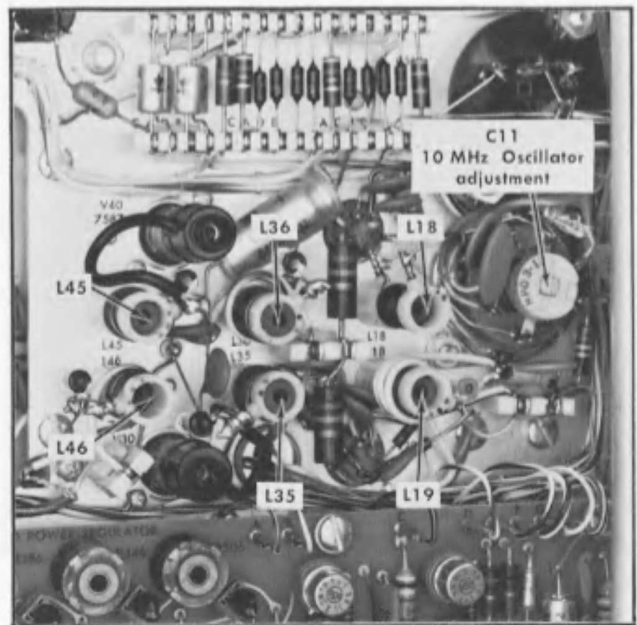

Fig. 6-7. 10 MHz (.1 μ s) 50 MHz (20 ns) and 100 MHz (10 ns) oscillator and multiplier adjustments. Step 4, 10.

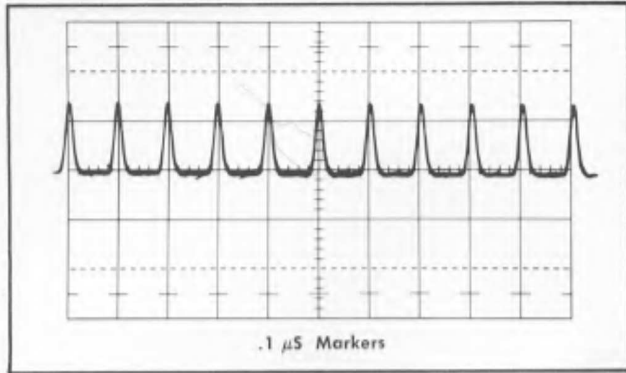

Fig. 6-8a. Typical display of .1 μS markers.

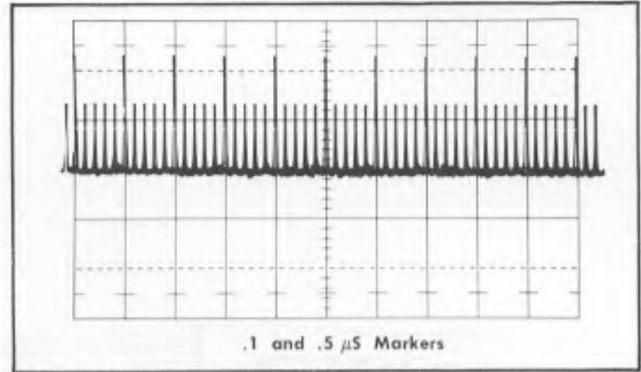

Fig. 6-8b. Typical display of .1 and .5 μS markers. C108 adjusted for accuracy of .5 μS markers. T-18 adjusted for uniformity of the .1 μS markers.

4. Adjust .1 μS and .5 μS Time-Markers

- a. Test equipment setup is shown in Fig. 6-6.
- b. Adjust the A Triggering Level control on the test oscilloscope for a stable display, then center the display on the graticule area with the vertical and horizontal position controls. See Fig. 6-8.
- c. Adjust L18 (Fig. 6-7) midway between the two signal maximum amplitude points.
- d. Change the A Time/Cm switch to .5 μSEC position and adjust L19 (Fig. 6-7) for marker amplitude and uniformity.
- e. Push the Type 184 .1 μS and .5 μS MARKER SELECTOR buttons simultaneously. Set the vertical plug-in unit Volts/Cm switch to 1.
- f. Adjust C108 (Fig. 6-9) for one .5 μS time marker per division.
- g. Adjust L19 and C108 simultaneously for proper count of the .5 μS markers and uniformity of the .1 μS markers. See Fig. 6-8b.
- h. Interaction—Will affect all countdown and multiplier circuits.

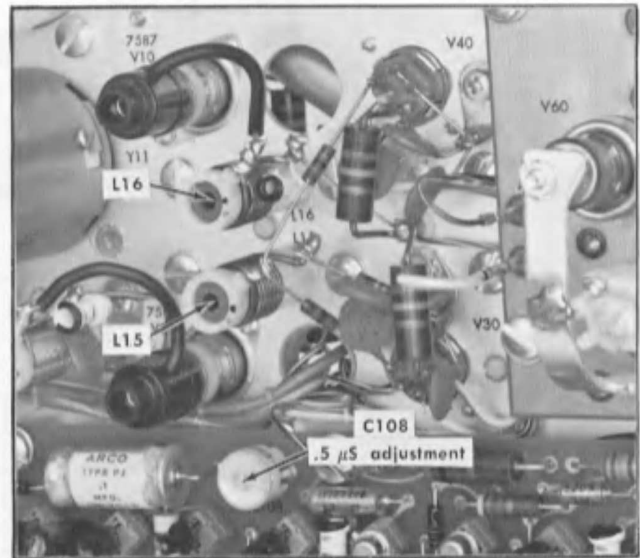

Fig. 6-9. .5 μS marker adjustment C108 and 50 MHz (20 ns) adjustment L16, L15.

NOTES

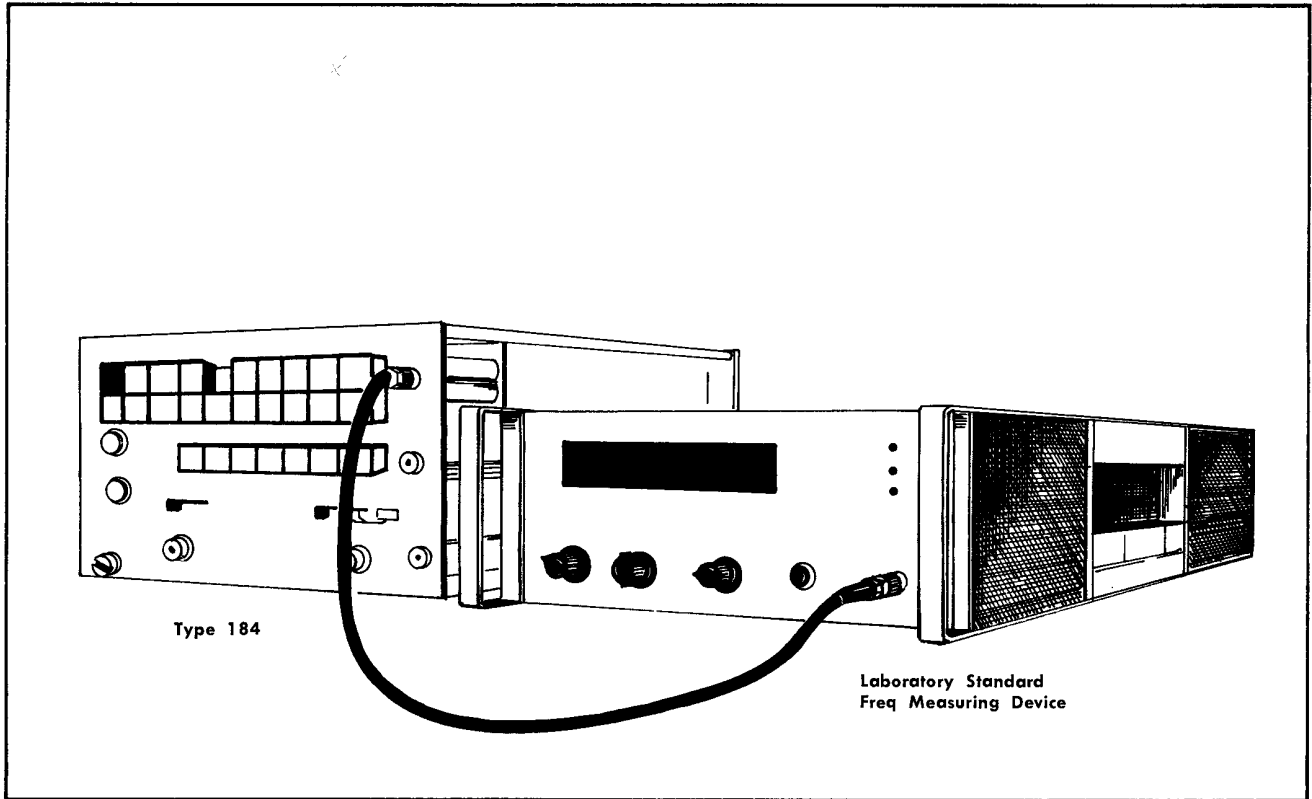

Fig. 6-10a. Suggested setup for adjusting crystal oscillator to laboratory standard. Step 5.

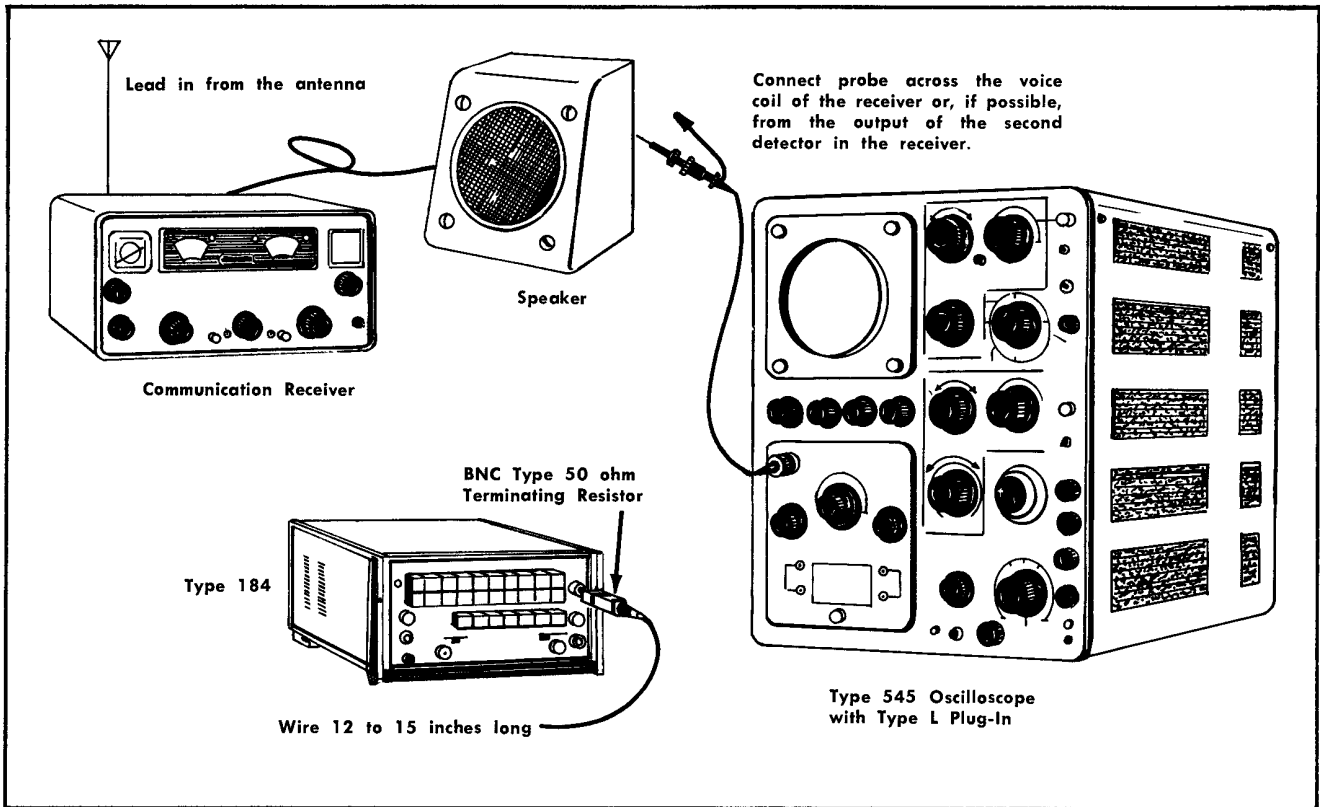

Fig. 6-10b. Suggested setup for adjusting crystal oscillator frequency to National Bureau of Standards. Step 5.

Control settings:

Type 184

| | |
|------------------|------------|
| MARKER SELECTOR | .1 μ S |
| TRIGGER SELECTOR | 1 μ S |
| MARKER AMPLIFIER | OFF |
| H.F. SELECTOR | OFF |

Test Oscilloscope

| | |
|--------------------|---|
| Crt controls | Adjust for well focused display of nominal brightness |
| Horizontal Display | Time Base A |
| Sweep Controls | |
| A Time/Cm | .1 μ SEC |
| Variable | Calibrated |
| A Triggering Mode | AC |
| Trigger Slope | +Int |
| A Stability | Preset |
| A Triggering Level | Midrange |

Vertical Plug-In Unit

| | |
|-------------------|-------------|
| Volts/Div | As required |
| Variable | Calibrated |
| Input Coupling | DC |
| Vertical Position | Midrange |

5. Check or Adjust Crystal Oscillator ①

Adjusting the crystal oscillator frequency requires an accurate 10 MHz frequency standard or frequency measuring device. The National Bureau of Standards through transmitting stations at Boulder, Colorado (WWVB), Washington, D.C. (WWV) or Hawaii (WWVH) provide one means of checking the oscillator. Another method could be direct frequency measurement with an Electronic Digital Frequency Counter. The two methods are described as follows.

NOTE

Allow a minimum warm-up time of 2 hours for the crystal oven to stabilize, before attempting to measure or adjust the oscillator frequency.

Method 1

a. Test equipment setup is shown in Fig. 6-10a.

b. Apply the Type 184 .1 μ S markers from the MARKER OUTPUT connector through a 50 Ω coaxial cable and 50 Ω termination to the Input connector of the Frequency Counter.

c. Adjust C11 on the Type 184 for equal drift in both directions of the frequency as the crystal oven cycles.

d. Remove the cable and termination from the Frequency Counter.

Method 2

a. Test equipment setup is shown in Fig. 6-10b. There is no direct connection between the Type 184 and either the receiver or the test oscilloscope.

b. Trigger the test oscilloscope internally from the signal input to the vertical plug-in unit.

c. The oscillator may be calibrated by beating the frequency of the crystal oscillator against the frequency from National Bureau of Standards broadcasting stations. Tune the receiver to 10 or 20 MHz, whichever is stronger. The signal of the National Bureau of Standards can be recognized by the clicks which occur once each second. During a portion of each minute a 440- or 1000-cycle tone is heard. Adjust the test oscilloscope vertical sensitivity (Volts/Cm switch) during this tone time, for a signal amplitude of approximately 4 cm. Tune the CW or Beat Note Oscillator in the communications receiver. Tune the receiver carefully until only the 440- or 1000-cycle tone can be heard, then turn off the CW or Beat Note Oscillator.

Install a 50- Ω terminating resistor on the MARKER OUTPUT connector of the Type 184 and insert a short (12- to 15-inch) piece of wire in the center conductor of the terminator.

d. Push the .1 μ S MARKER SELECTOR switch on the Type 184. The short wire will act as a radiator for the .1 μ S signal and will be received by the communications receiver. If the signal is too strong from the Type 184, it may block out the signal for the National Bureau of Standards, so if this occurs shorten the radiating wire from the Type 184 until both signals can be heard.

e. During the time the 440- or 1000-cycle tone is not being transmitted from the National Bureau of Standards, adjust C11 in the Type 184 for minimum beat note, or for minimum deflection of the signal on the test oscilloscope.

After the crystal oscillator frequency has been adjusted, do not disturb any of the components in the oscillator circuit. This adjustment of C11 will not affect the adjustment of the other markers since they are timed by this basic frequency and will follow small changes of the oscillator.

f. Disconnect the test equipment setup from the Type 184.

g. Interaction—Will affect accuracy of all marker and trigger signals.

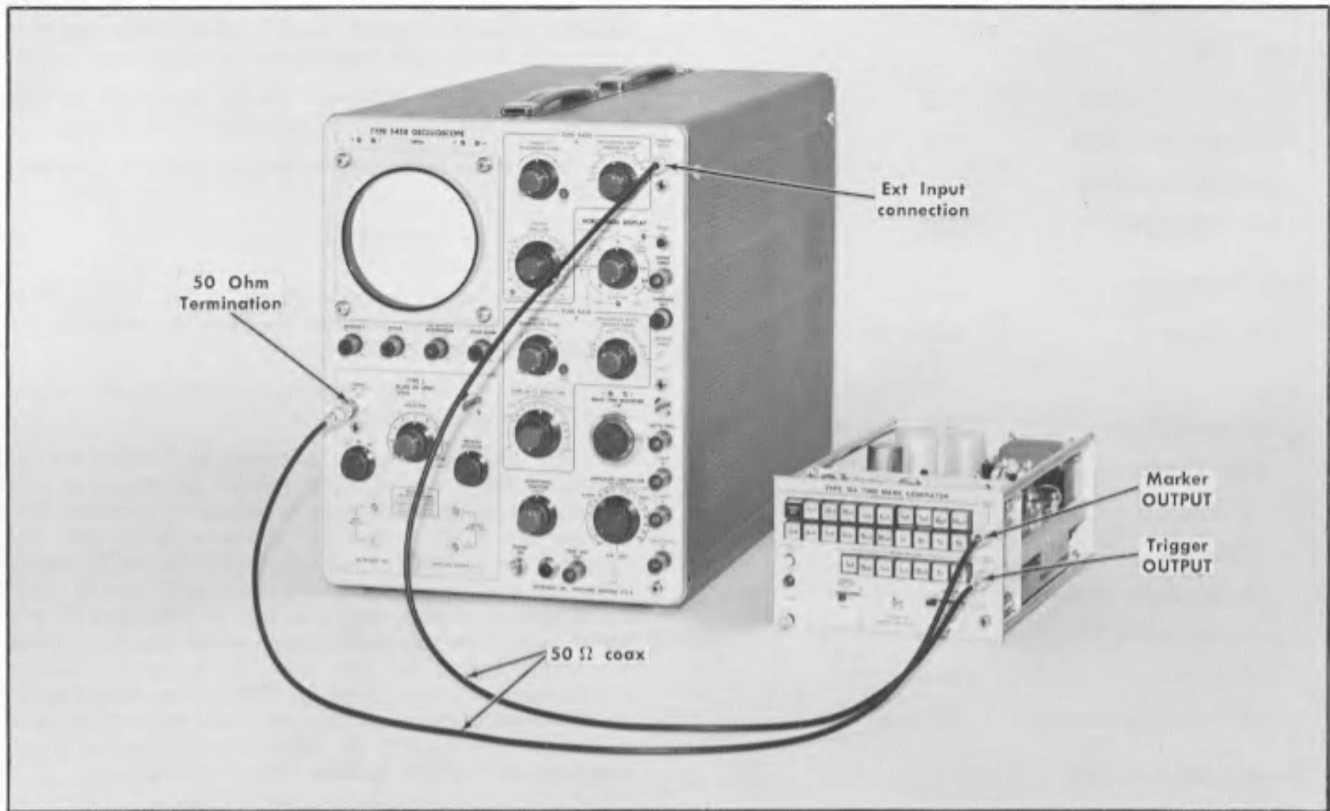

Fig. 6-11. Test equipment setup for checking time-marker accuracy and amplitude. Step 6 and step 7.

Control settings:

Type 184

| | |
|------------------|-----------------------|
| MARKER SELECTOR | As shown in Table 6-2 |
| TRIGGER SELECTOR | As shown in Table 6-2 |
| MARKER AMPLIFIER | OFF |
| H.F. SELECTOR | OFF |

Test Oscilloscope

| | |
|--------------------|---|
| Crt controls | Adjust for well focused display of nominal brightness |
| Horizontal Display | Time Base A |
| Sweep Controls | |
| A Time/Cm | In accordance with Table 6-2 |
| Variable | Calibrated |
| A Triggering Mode | AC |
| Trigger Slope | +Ext |
| A Stability | Preset |
| A Triggering Level | Midrange |

Vertical Plug-In Unit

| | |
|-------------------|------------|
| Volts/Div | 1 |
| Variable | Calibrated |
| Input Coupling | DC |
| Vertical Position | Midrange |

6. Adjust Marker Timing







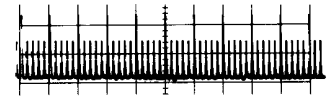
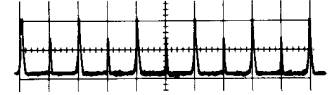
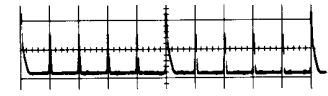
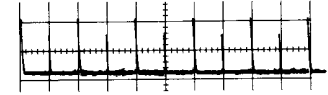
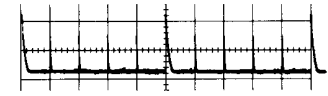
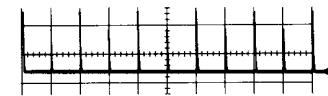

- a. Test equipment setup is shown in Fig. 6-11.
- b. Adjust the Triggering Level control when required, for a stable display as each step in Table 6-2 is followed.
- c. Check and adjust the marker timing according to Table 6-2.

7. Check Marker Amplitude - 1 volt minimum

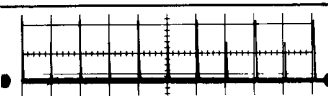
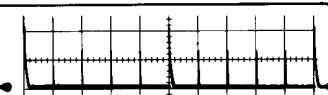
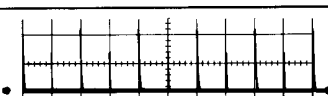
- a. Test equipment setup is shown in Fig. 6-11.
- b. Repeat the steps of Table 6-2 pushing only one MARKER SELECTOR button at a time, measuring the marker amplitude.
- c. Interaction—Because the markers are derived from a previous countdown circuit, there is definite interaction to the successive counters.

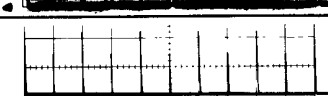
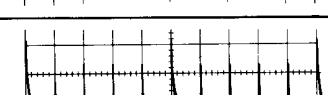
TABLE 6-2

| Type 184 MARKER SELECTOR | Test Oscilloscope Time/Cm | Type 184 TRIGGER SELECTOR | Adjust | Typical Display |
|-----------------------------|------------------------------|------------------------------|-------------------|---|
| .1 μ S and .5 μ S | .5 μ SEC | 1 μ S | C108 (Fig. 6-12a) |  |
| .5 μ S and 1 μ S | .5 μ SEC | 1 μ S | |  |
| 1 μ S and 5 μ S | 1 μ SEC | 10 μ S | R146 (Fig. 6-12a) |  |
| 5 μ S and 10 μ S | 5 μ SEC | 10 μ S | |  |
| 10 μ S and 50 μ S | 10 μ SEC | .1 mS | |  |
| 50 μ S and .1 mS | 50 μ SEC | .1 mS | |  |
| .1 mS and .5 mS | .1 mSEC | 1 mS | |  |
| .5 mS and 1 mS | .5 mSEC | 1 mS | |  |
| 1 mS and 5 mS | 1 mSEC | 10 mS | |  |
| 5 mS and 10 mS | 5 mSEC | .1 S | |  |
| 10 mS and 50 mS | 10 mSEC | .1 S | R306 (Fig. 6-12b) |  |
| 50 mS and .1 S | 50 mSEC | 1 S | |  |
| .1 S and .5 S | .1 SEC | 1 S | R346 (Fig. 6-12b) |  |
| .5 S and 1 S | .5 SEC | 1 S | |  |
| 1 S and 5 S | 1 SEC | 1 S | R386 (Fig. 6-12b) |  |

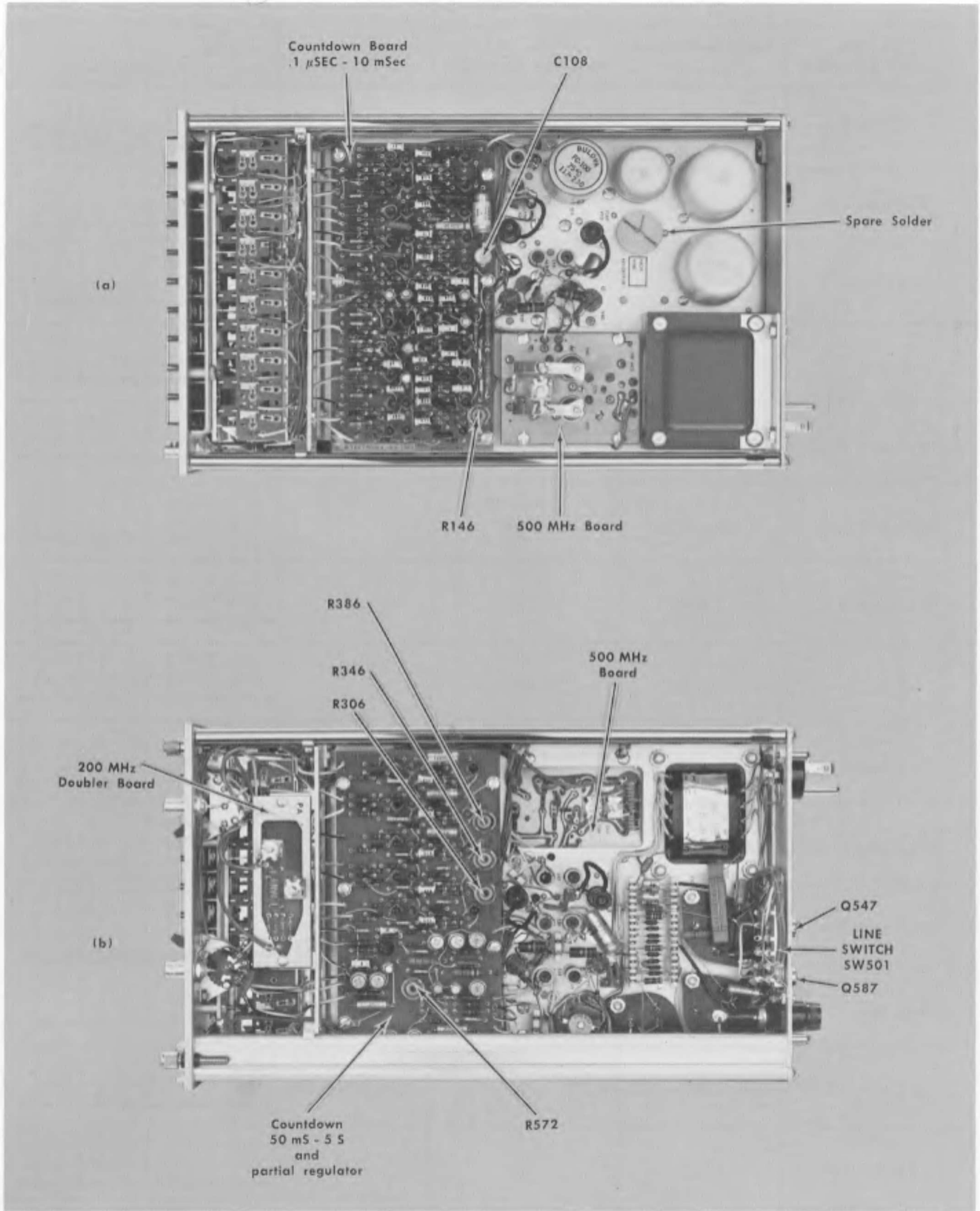

Fig. 6-12. Time Marker timing adjustments. a. Countdown board .1 μ S-10 ms. Step 6. b. Location of R306, R346, R386. Step 6.

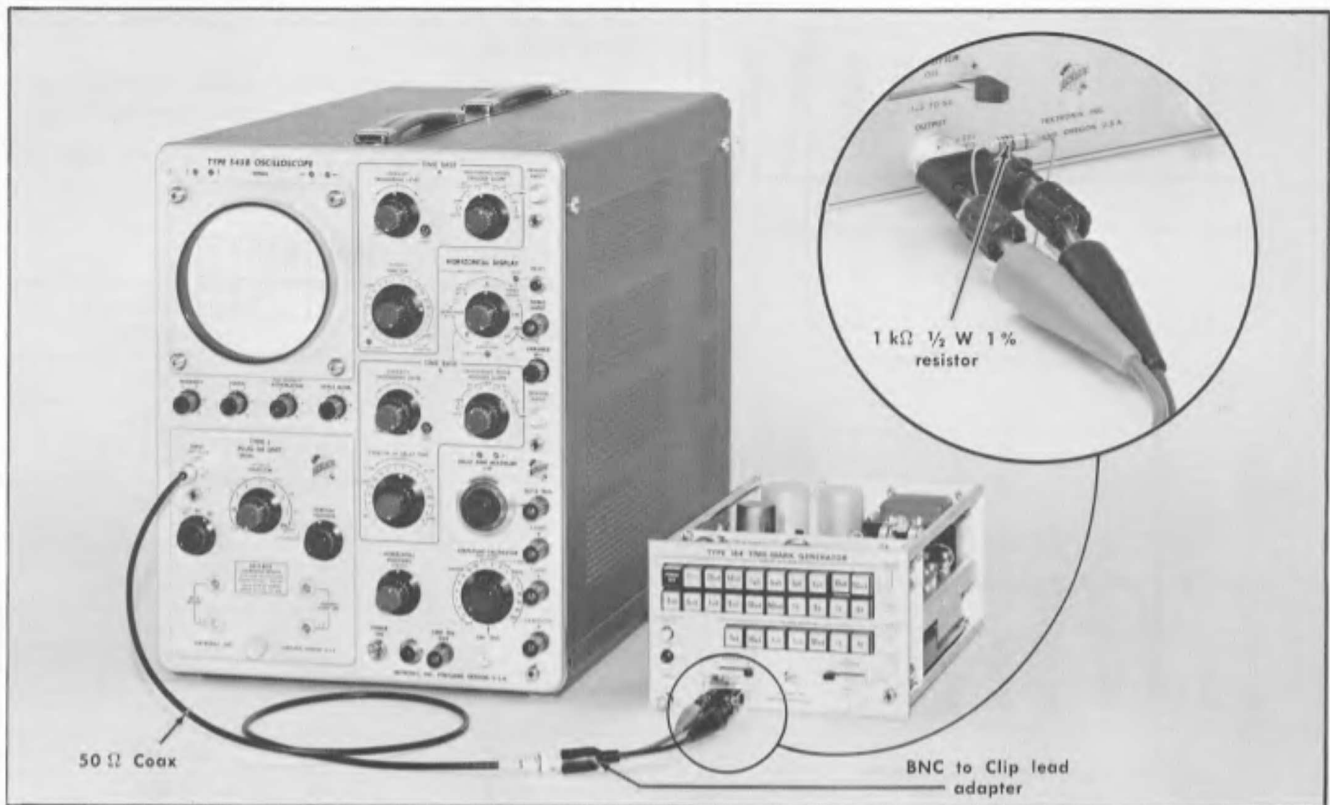

Fig. 6-13. Test equipment setup to measure Marker Amplifier signal amplitude. Step 8.

Control settings:

Type 184

| | |
|------------------|--------------------------|
| MARKER SELECTOR | As directed in Table 6-3 |
| TRIGGER SELECTOR | As directed in Table 6-3 |
| MARKER AMPLIFIER | OFF |
| H.F. SELECTOR | OFF |

Test Oscilloscope

| | |
|--------------------|---|
| Crt controls | Adjust for well focused display of nominal brightness |
| Horizontal Display | Time Base A |
| Sweep Controls | |
| A Time/Cm Variable | As shown in Table 6-3 |
| A Triggering Mode | AC |
| Trigger Slope | +Int |

| | |
|--------------------|----------|
| A Stability | Preset |
| A Triggering Level | Midrange |

Vertical Plug-In Unit

| | |
|-------------------|------------|
| Volts/Div | 10 |
| Variable | Calibrated |
| Input Coupling | DC |
| Vertical Position | Midrange |

8. Check Output of MARKER AMPLIFIER

a. Requirements—Positive or negative-going markers with 14 intervals of 1 μ s to 5 s in 1-5-10 sequence, 25 V minimum amplitude into 1 k Ω .

b. The Marker Amplifier must be terminated into a resistance of 1 k Ω . Test equipment setup is shown in Fig. 6-13.

c. Switch the MARKER AMPLIFIER switch to (+) position. Check the amplitude of the Marker Amplifier output signal for each setting listed in Table 6-3. See Fig. 6-14a.

Calibration—Type 184

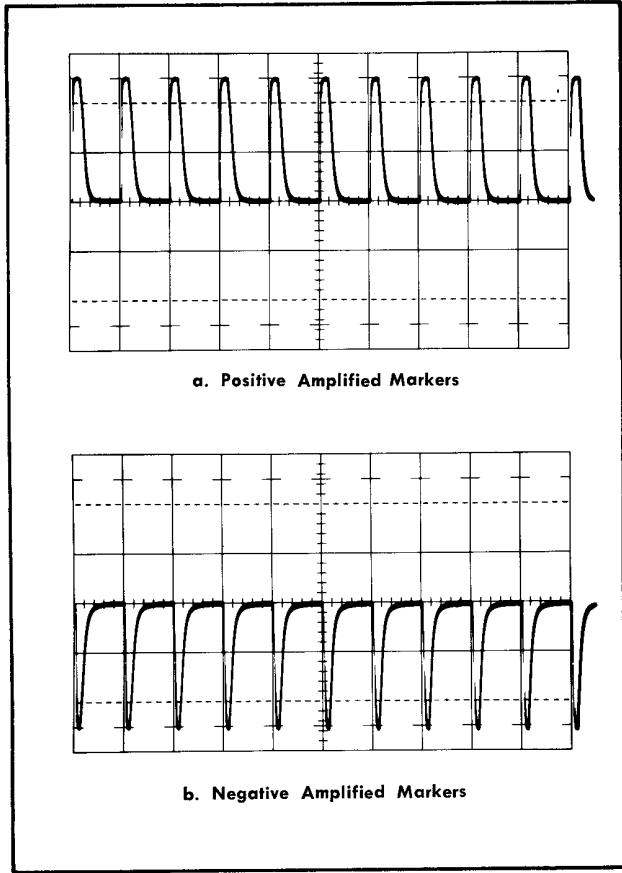

Fig. 6-14. Marker Amplifier Output Signals into 1 k Ω . Volts/cm 10, Time/cm (Table 5-3).

d. Change the MARKER AMPLIFIER switch to the (—) position and the test oscilloscope Trigger Slope switch to (—Int) position.

e. Check the amplitude of the Marker Amplifier output signal for a minimum —25 volt signal. See Fig. 6-14b.

f. Remove the adapters and cables from the Type 184 and test oscilloscope.

TABLE 6-3

| Type 184 MARKER SELECTOR | Test Oscilloscope Time/Cm |
|-----------------------------|------------------------------|
| 1 μ S | 10 μ SEC |
| 5 μ S | 10 μ SEC |
| 10 μ S | .1 mSEC |
| 50 μ S | .1 mSEC |
| .1 mS | 1 mSEC |
| .5 mS | 1 mSEC |
| 1 mS | 10 mSEC |
| 5 mS | 10 mSEC |
| 10 mS | 100 mSEC |
| 50 mS | 100 mSEC |
| .1 S | 1 SEC |
| .5 S | 1 SEC |
| 1 S | 1 SEC |
| 5 S | 1 SEC |

NOTES

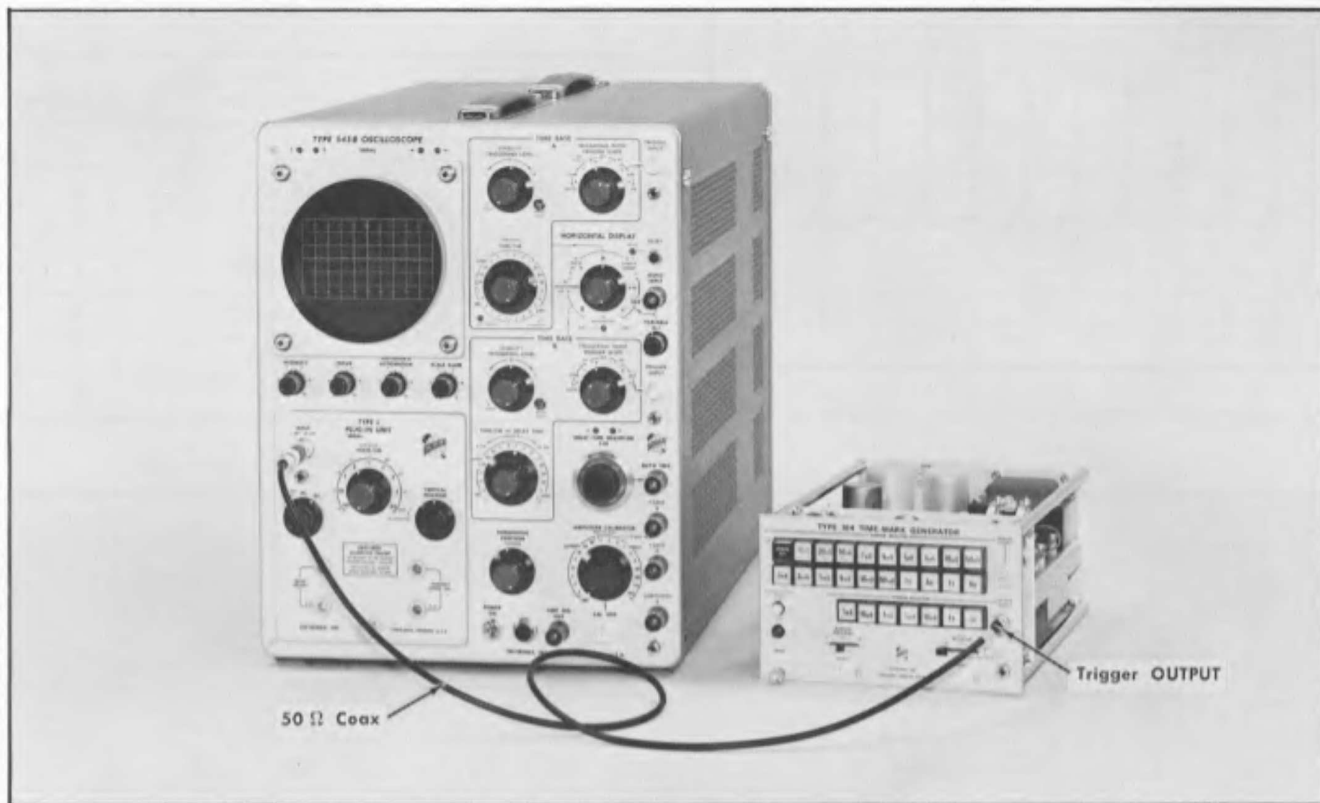

Fig. 6-15. Test equipment setup for checking trigger output amplitude and timing interval. Step 9.

Control Settings:

Type 184

| | |
|------------------|-----------------------|
| MARKER SELECTOR | None |
| TRIGGER SELECTOR | As shown in Table 6-4 |
| MARKER AMPLIFIER | OFF |
| H.F. SELECTOR | OFF |

Test Oscilloscope

| | |
|--------------------|---|
| Crt controls | Adjust for well focused display of nominal brightness |
| Horizontal Display | Time Base A |
| Sweep Controls | |
| A Time/Cm | As shown in Table 6-4 |
| Variable | Calibrated |
| A Triggering Mode | AC |
| Trigger Slope | Int |

| | |
|--------------------|----------|
| A Stability | Preset |
| A Triggering Level | Midrange |

Vertical Plug-In Unit

| | |
|-------------------|------------|
| Volts/Div | .2 |
| Variable | Calibrated |
| Input Coupling | DC |
| Vertical Position | Midrange |

9. Check Amplitude and Timing of the TRIGGER OUTPUT

- a. Requirement—Positive-going pulses with 7 intervals in 1-10 sequence, from 1 μ s to 1 s, and an amplitude ≥ 0.4 V into 50 Ω or ≥ 2.5 V into an open circuit.
- b. Test equipment setup is shown in Fig. 6-15.
- c. Check the trigger timing as listed in Table 6-4.
- d. Check the amplitude of trigger signals. Fig. 6-16.

Calibration—Type 184

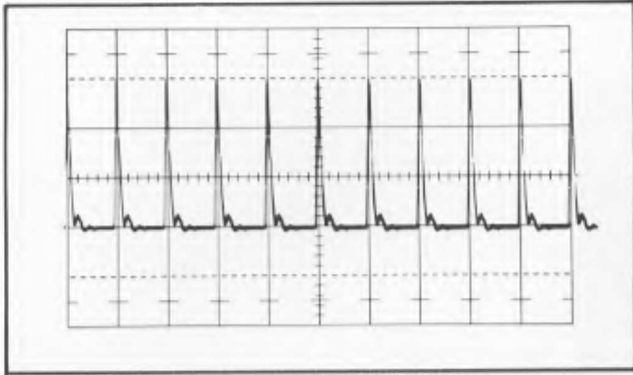

Fig. 6-16. Typical TRIGGER OUTPUT display. Volts/cm .2.

TABLE 6-4

| Type 184 TRIGGER SELECTOR | Test Oscilloscope Time/Cm | Marks/Cm |
|---------------------------|---------------------------|----------|
| 1 μ S | 1 μ SEC | 1 |
| 10 μ S | 10 μ SEC | 1 |
| .1 mS | .1 mSEC | 1 |
| 1 mS | 1 mSEC | 1 |
| 10 mS | 10 mSEC | 1 |
| .1 S | .1 SEC | 1 |
| 1 S | 1 SEC | 1 |

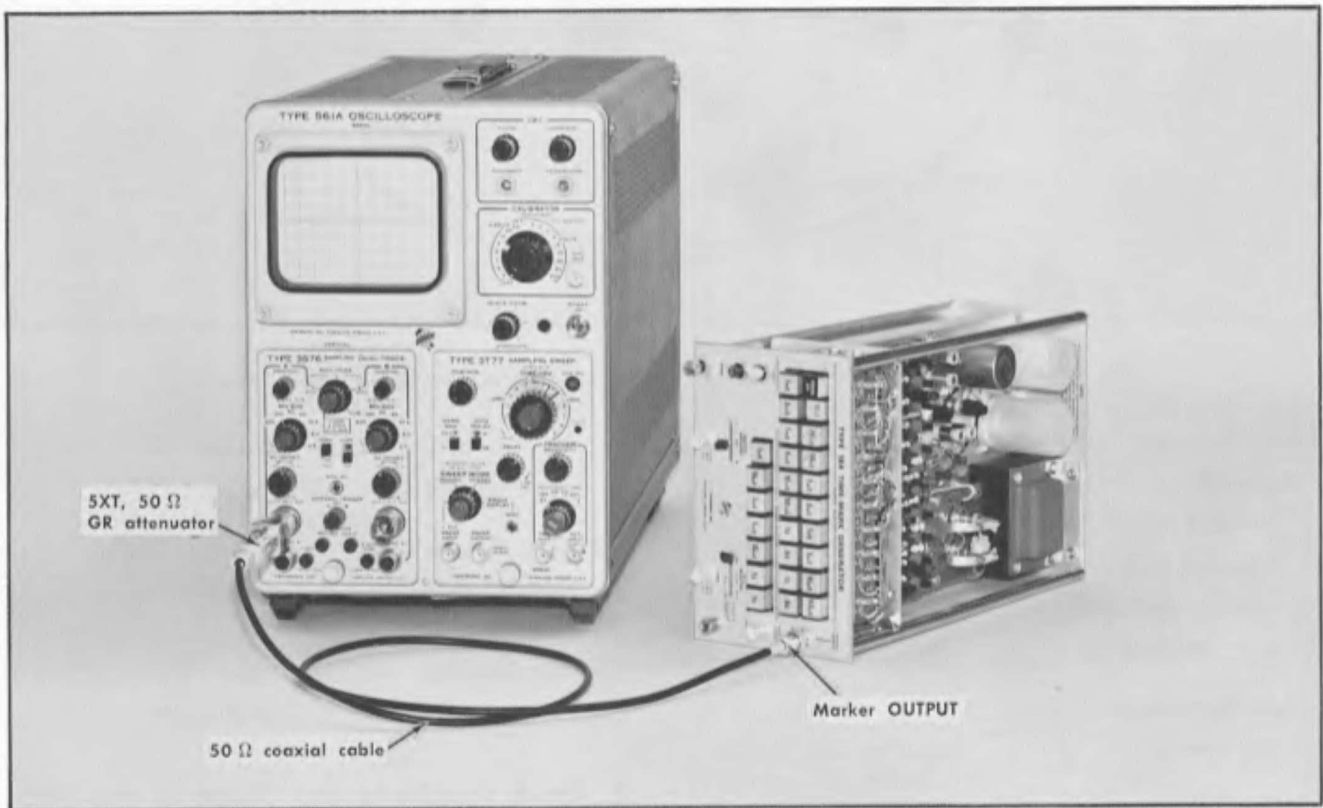

Fig. 6-17. Test equipment setup to check and adjust 10, 20 and 50 ns sine-wave markers. Step 10.

Control Settings:

Type 184

| | |
|------------------|-----------------------|
| MARKER SELECTOR | As shown in Table 6-5 |
| TRIGGER SELECTOR | OFF |
| MARKER AMPLIFIER | OFF |
| H.F. SELECTOR | OFF |

Test Oscilloscope

| | |
|--------------|---|
| Crt controls | Adjust for well focused display of nominal brightness |
|--------------|---|

Time Base Plug-In Unit (Type 3777)

| | |
|--------------|-----------------------|
| Time/Div | As shown in Table 6-5 |
| Sweep Mode | Normal |
| Trigger | +Int |
| Horiz Mag | $\times 1$ |
| Dots Per Div | 100 |

Vertical Plug-In Unit

| | |
|----------------|--------|
| Mv/Div | 100 |
| Input Selector | A Only |

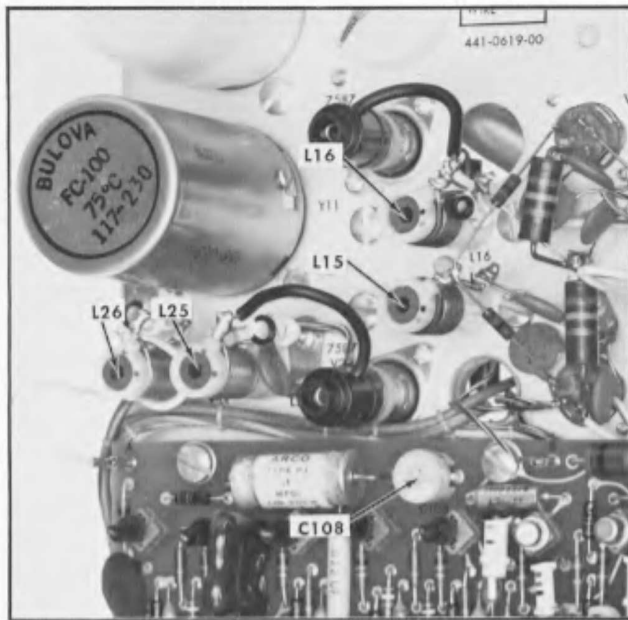

Fig. 6-18. .5 μ s marker adjustment C108 and 50 MHz (20 ns) adjustments L16, L15. Step 10.

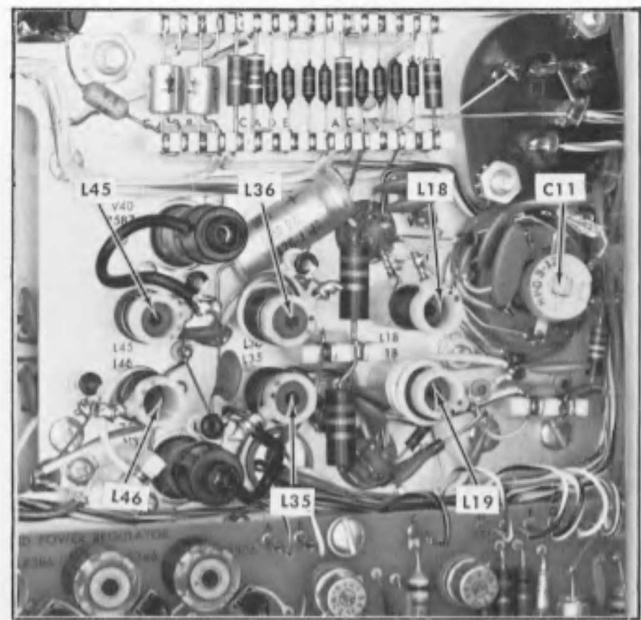

Fig. 6-19. 10 MHz (.1 μ s) 50 MHz (20 ns) and 100 MHz (10 ns) oscillator and multiplier adjustments. Step 4, 10.

**10. Check and Adjust Sine-wave Markers: ①
10, 20, 50 nS and .1 μ S**

- a. Test equipment setup is shown in Fig. 6-17.
- b. Push the 1 μ s pushbutton for the TRIGGER SELECTOR.
- c. Adjust the Time Base Unit, (Type 3T77) Trigger Sensitivity for a stable display.
- d. Measure and adjust the sine-wave markers in accordance with Table 6-5. Minimum marker amplitude is 1 volt peak to peak.
- e. Interaction—Will affect the operation of the 2 and 5 nS sine-wave markers.

TABLE 6-5

| Type 184 MARKER SELECTOR | Test Oscilloscope Time/Div | Adjust for maximum signal amplitude and one marker/div |
|--------------------------|----------------------------|--|
| .1 μ S | .1 μ SEC | Check |
| 50 ns | 50 nSEC | L25, L26 (Fig. 6-17) |
| 20 nS | 20 nSEC | L15, L16, L35, L36 (Figs. 6-17 and 6-18) |
| 10 nS | 10 nSEC | L45, L46 (Fig. 6-18) |

NOTES

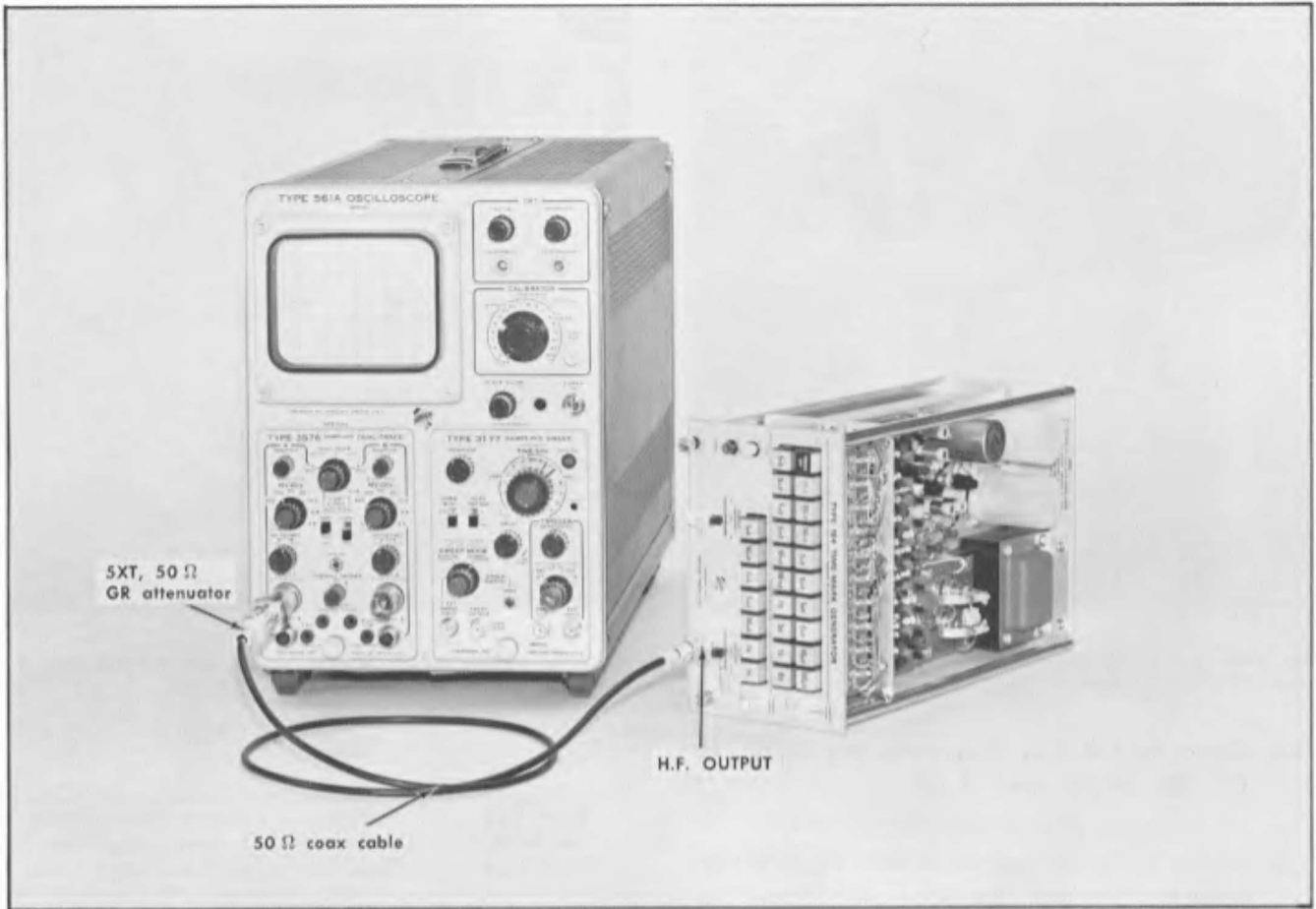

Fig. 6-20. Test equipment setup to check and adjust 2 ns and 5 ns sine-wave markers. Step 11.

Control Settings:

Type 184

| | |
|------------------|-----------------------|
| MARKER SELECTOR | 10 nS |
| TRIGGER SELECTOR | OFF |
| MARKER AMPLIFIER | OFF |
| H.F. SELECTOR | As shown in Table 6-6 |

Test Oscilloscope

| | |
|--------------|---|
| Crt controls | Adjust for well focused display of nominal brightness |
|--------------|---|

Time Base Plug-In Unit (Type 3T77)

| | |
|------------|-----------------------|
| Time/Div | As shown in Table 6-6 |
| Sweep Mode | Normal |

| | |
|--------------|------|
| Trigger | +Int |
| Horiz Mag | ×1 |
| Dots Per Div | 100 |

Vertical Plug-In Unit

| | |
|----------------|--------|
| Mv/Div | 50 |
| Input Selector | A Only |

11. Check and Adjust H.F. Sine-wave Markers: 2 nS and 5 nS

- a. Test equipment setup is shown in Fig. 6-20.
- b. Check amplitude and adjust the sine-wave markers in accordance with Table 6-6. Minimum amplitude 0.3 volt peak to peak.

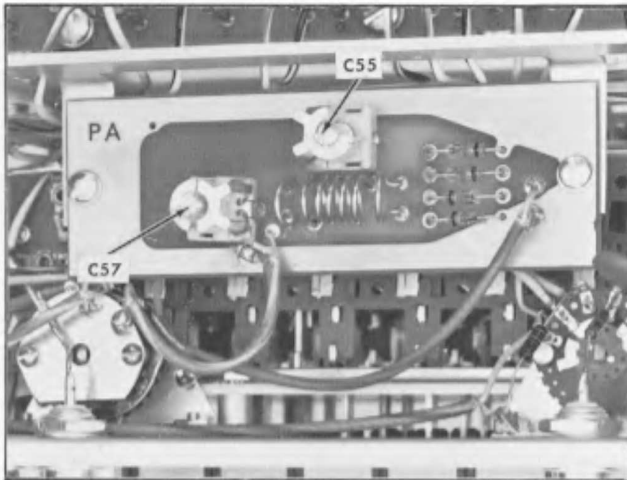

Fig. 6-21. Adjustment C55, C57, 5 nS H.F. oscillator.

TABLE 6-6

| Type 184 H.F. SELECTOR | Test Oscilloscope Time/Div | Adjust for maximum signal amplitude and one marker/div |
|---------------------------|----------------------------------|--|
| 5 nS | 5 nSEC | C55, C57 (Fig. 6-21) |
| 2 nS | 2 nSEC | C63, C64, C70 C75, (Fig. 6-22) |

NOTE

The adjustments for any one sine-wave marker may interact with the other markers. Check and repeat if necessary.

c. Turn the H.F. SELECTOR switch to OFF and disconnect the coaxial cables and adapters from the Type 184 and test oscilloscope.

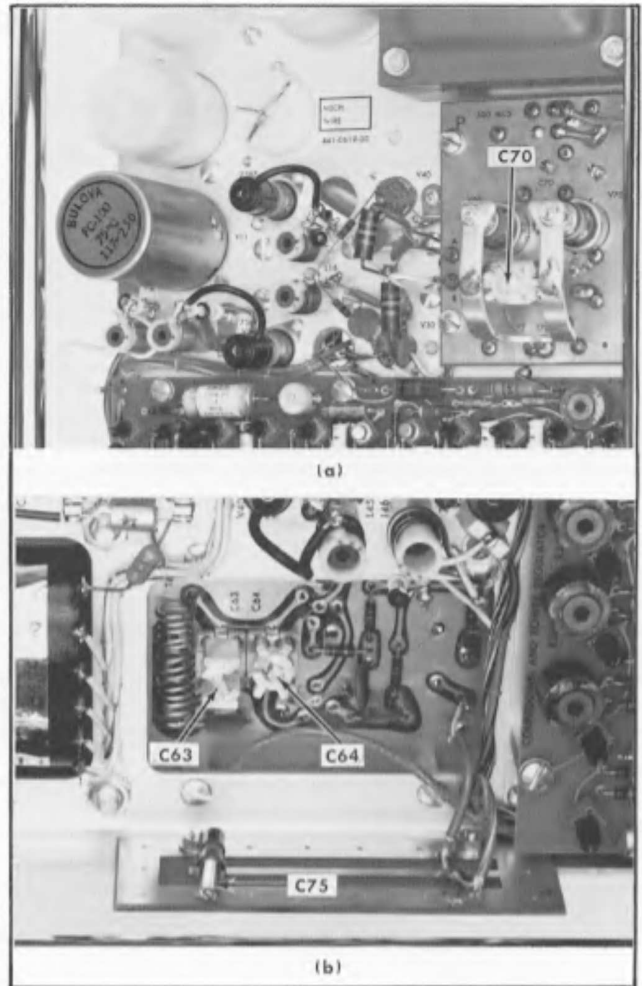

Fig. 6-22. Adjustment C63, C64, C70, C75, 2 nS H.F. oscillator. a. Top of 2 nS multiplier board. b. Bottom of 2 nS multiplier board.

NOTES

ABBREVIATIONS AND SYMBOLS

| | | | |
|--------------|--|-------------------|--|
| A or amp | amperes | L | inductance |
| AC or ac | alternating current | λ | lambda—wavelength |
| AF | audio frequency | \gg | large compared with |
| α | alpha—common-base current amplification factor | $<$ | less than |
| AM | amplitude modulation | LF | low frequency |
| \approx | approximately equal to | lg | length or long |
| β | beta—common-emitter current amplification factor | LV | low voltage |
| BHB | binding head brass | M | mega or 10^6 |
| BHS | binding head steel | m | milli or 10^{-3} |
| BNC | baby series "N" connector | M Ω or meg | megohm |
| X | by or times | μ | micro or 10^{-6} |
| C | carbon | mc | megacycle |
| C | capacitance | met. | metal |
| cap. | capacitor | MHz | megahertz |
| cer | ceramic | mm | millimeter |
| cm | centimeter | ms | millisecond |
| comp | composition | — | minus |
| conn | connector | mtg hdw | mounting hardware |
| \sim | cycle | n | nano or 10^{-9} |
| c/s or cps | cycles per second | no. or # | number |
| CRT | cathode-ray tube | ns | nanosecond |
| csk | countersunk | OD | outside diameter |
| Δ | increment | OHB | oval head brass |
| dB | decibel | OHS | oval head steel |
| dBm | decibel referred to one milliwatt | Ω | ohms |
| DC or dc | direct current | ω | omega—angular frequency |
| DE | double end | p | pico or 10^{-12} |
| $^{\circ}$ | degrees | / | per |
| $^{\circ}$ C | degrees Celsius (degrees centigrade) | % | percent |
| $^{\circ}$ F | degrees Fahrenheit | PHB | pan head brass |
| $^{\circ}$ K | degrees Kelvin | ϕ | phi—phase angle |
| dia | diameter | π | pi—3.1416 |
| \div | divide by | PHS | pan head steel |
| div | division | + | plus |
| EHF | extremely high frequency | \pm | plus or minus |
| elect. | electrolytic | PIV | peak inverse voltage |
| EMC | electrolytic, metal cased | plstc | plastic |
| EMI | electromagnetic interference (see RFI) | PMC | paper, metal cased |
| EMT | electrolytic, metal tubular | poly | polystyrene |
| ϵ | epsilon—2.71828 or % of error | prec | precision |
| \geq | equal to or greater than | PT | paper, tubular |
| \leq | equal to or less than | PTM | paper or plastic, tubular, molded |
| ext | external | pwr | power |
| F or f | farad | Q | figure of merit |
| F & I | focus and intensity | RC | resistance capacitance |
| FHB | flat head brass | RF | radio frequency |
| FHS | flat head steel | RFI | radio frequency interference (see EMI) |
| Fil HB | fillister head brass | RHB | round head brass |
| Fil HS | fillister head steel | ρ | rho—resistivity |
| FM | frequency modulation | RHS | round head steel |
| ft | feet or foot | r/min or rpm | revolutions per minute |
| G | giga or 10^9 | RMS | root mean square |
| g | acceleration due to gravity | s or sec. | second |
| Ge | germanium | SE | single end |
| GHz | gigohertz | Si | silicon |
| GMV | guaranteed minimum value | SN or S/N | serial number |
| GR | General Radio | \ll | small compared with |
| $>$ | greater than | T | tera or 10^{12} |
| H or h | henry | TC | temperature compensated |
| h | height or high | TD | tunnel diode |
| hex. | hexagonal | THB | truss head brass |
| HF | high frequency | θ | theta—angular phase displacement |
| HHB | hex head brass | thk | thick |
| HHS | hex head steel | THS | truss head steel |
| HSB | hex socket brass | tub. | tubular |
| HSS | hex socket steel | UHF | ultra high frequency |
| HV | high voltage | V | volt |
| Hz | hertz (cycles per second) | VAC | volts, alternating current |
| ID | inside diameter | var | variable |
| IF | intermediate frequency | VDC | volts, direct current |
| in. | inch or inches | VHF | very high frequency |
| incd | incandescent | VSWR | voltage standing wave ratio |
| ∞ | infinity | W | watt |
| int | internal | w | wide or width |
| \int | integral | w/ | with |
| k | kilohms or kilo (10^3) | w/o | without |
| k Ω | kilohm | WW | wire-wound |
| kc | kilocycle | xmfr | transformer |
| kHz | kilohertz | | |



PARTS ORDERING INFORMATION

Replacement parts are available from or through your local Tektronix, Inc. Field Office or representative.

Changes to Tektronix instruments are sometimes made to accommodate improved components as they become available, and to give you the benefit of the latest circuit improvements developed in our engineering department. It is therefore important, when ordering parts, to include the following information in your order: Part number, instrument type or number, serial or model number, and modification number if applicable.

If a part you have ordered has been replaced with a new or improved part, your local Tektronix, Inc. Field Office or representative will contact you concerning any change in part number.

SPECIAL NOTES AND SYMBOLS

- ×000 Part first added at this serial number
- 00× Part removed after this serial number
- *000-0000-00 Asterisk preceding Tektronix Part Number indicates manufactured by or for Tektronix, Inc., or reworked or checked components.
- Use 000-0000-00 Part number indicated is direct replacement.
-  Screwdriver adjustment.
-  Control, adjustment or connector.

SECTION 7

ELECTRICAL PARTS LIST

Values are fixed unless marked Variable.

| Ckt. No. | Tektronix Part No. | Description | S/N Range |
|--------------|--------------------|---------------------------------|---------------------|
| Bulbs | | | |
| B504 | Use 150-0056-00 | Neon, Assembly | OVEN |
| B534 | 150-0052-00 | Incandescent w/translucent lens | POWER |
| B534 | 150-0065-00 | Incandescent w/green lens | POWER |
| | | | 100-2199 2200-up |

Capacitors

Tolerance $\pm 20\%$ unless otherwise indicated.

| | | | | | | |
|-----|-------------|---------------|------|-----|-------|-----|
| C1 | 283-0078-00 | 0.001 μ F | Cer | | 500 V | |
| C2 | 283-0078-00 | 0.001 μ F | Cer | | 500 V | |
| C4 | 283-0078-00 | 0.001 μ F | Cer | | 500 V | |
| C5 | 283-0078-00 | 0.001 μ F | Cer | | 500 V | |
| C8 | 283-0078-00 | 0.001 μ F | Cer | | 500 V | |
| C11 | 281-0031-00 | 3-12 pF | Cer | Var | | |
| C13 | 283-0078-00 | 0.001 μ F | Cer | | 500 V | |
| C15 | 283-0078-00 | 0.001 μ F | Cer | | 500 V | |
| C16 | 283-0078-00 | 0.001 μ F | Cer | | 500 V | |
| C17 | 281-0558-00 | 18 pF | Cer | | 500 V | |
| C18 | 281-0509-00 | 15 pF | Cer | | 500 V | 10% |
| C19 | 283-0078-00 | 0.001 μ F | Cer | | 500 V | |
| C23 | 283-0078-00 | 0.001 μ F | Cer | | 500 V | |
| C25 | 283-0078-00 | 0.001 μ F | Cer | | 500 V | |
| C26 | 281-0517-00 | 39 pF | Cer | | 500 V | 10% |
| C29 | 281-0517-00 | 39 pF | Cer | | 500 V | 10% |
| C33 | 283-0078-00 | 0.001 μ F | Cer | | 500 V | |
| C35 | 283-0078-00 | 0.001 μ F | Cer | | 500 V | |
| C36 | 281-0558-00 | 18 pF | Cer | | 500 V | |
| C39 | 281-0511-00 | 22 pF | Cer | | 500 V | 10% |
| C43 | 283-0078-00 | 0.001 μ F | Cer | | 500 V | |
| C45 | 283-0078-00 | 0.001 μ F | Cer | | 500 V | |
| C46 | 281-0505-00 | 12 pF | Cer | | 500 V | 10% |
| C49 | 281-0505-00 | 12 pF | Cer | | 500 V | 10% |
| C55 | 281-0079-00 | 1.5-9.1 pF | Air | Var | | |
| C57 | 281-0081-00 | 1.8-13 pF | Air | Var | | |
| C61 | 283-0078-00 | 0.001 μ F | Cer | | 500 V | |
| C63 | 281-0115-00 | 1.9-8.5 pF | Air | Var | | |
| C64 | 281-0114-00 | 1.3-5.4 pF | Air | Var | | |
| C65 | 283-0078-00 | 0.001 μ F | Cer | | 500 V | |
| C68 | 283-0078-00 | 0.001 μ F | Cer | | 500 V | |
| C70 | 281-0098-00 | 1.2-3.5 pF | Air | Var | | |
| C75 | 281-0027-00 | 0.7-3 pF | Tub. | Var | | |
| C78 | 283-0078-00 | 0.001 μ F | Cer | | 500 V | |
| C92 | 290-0187-00 | 4.7 μ F | EMT | | 35 V | |

Electrical Parts List—Type 184

Capacitors (Cont'd)

| Ckt. No. | Tektronix Part No. | | Description | | | S/N Range |
|----------|--------------------|----------------|-------------|-------|------------|-----------|
| C93 | 281-0511-00 | 22 pF | Cer | 500 V | 10% | |
| C99 | 281-0511-00 | 22 pF | Cer | 500 V | 10% | |
| C103 | 290-0267-00 | 1 μ F | EMT | 35 V | | |
| C105 | 281-0511-00 | 22 pF | Cer | 500 V | 10% | 100-648 |
| C105 | 281-0617-00 | 15 pF | Cer | 200 V | | 649-up |
| C107 | 281-0517-00 | 39 pF | Cer | 500 V | 10% | |
| C108 | 281-0092-00 | 9-35 pF | Cer | | | |
| C111 | 290-0188-00 | 0.1 μ F | EMT | 35 V | 10% | |
| C114 | 290-0267-00 | 1 μ F | EMT | 35 V | | |
| C116 | 283-0000-00 | 0.001 μ F | Cer | 500 V | | |
| C120 | 290-0267-00 | 1 μ F | EMT | 35 V | | |
| C125 | 281-0517-00 | 39 pF | Cer | 500 V | 10% | |
| C130 | 281-0580-00 | 470 pF | Cer | 500 V | 10% | |
| C131 | 281-0501-00 | 4.7 pF | Cer | 500 V | ± 1 pF | X293-up |
| C132 | 281-0511-00 | 22 pF | Cer | 500 V | 10% | |
| C133 | 290-0267-00 | 1 μ F | EMT | 35 V | | |
| C140 | 281-0511-00 | 22 pF | Cer | 500 V | 10% | |
| C143 | 283-0604-00 | 304 pF | Mica | 300 V | 2% | |
| C144 | 281-0517-00 | 39 pF | Cer | 500 V | 10% | |
| C146 | 290-0267-00 | 1 μ F | EMT | 35 V | | |
| C148 | 281-0511-00 | 22 pF | Cer | 500 V | 10% | |
| C152 | 281-0517-00 | 39 pF | Cer | 500 V | 10% | |
| C153 | 290-0267-00 | 1 μ F | EMT | 35 V | | |
| C161 | 281-0572-00 | 6.8 pF | Cer | 500 V | 10% | |
| C163 | 283-0604-00 | 304 pF | Mica | 300 V | 2% | |
| C164 | 281-0517-00 | 39 pF | Cer | 500 V | 10% | |
| C168 | 281-0511-00 | 22 pF | Cer | 500 V | 10% | |
| C172 | 281-0524-00 | 150 pF | Cer | 500 V | | |
| C173 | 290-0267-00 | 1 μ F | EMT | 35 V | | |
| C183 | 283-0594-00 | 0.001 μ F | Mica | 100 V | 1% | |
| C188 | 281-0511-00 | 22 pF | Cer | 500 V | 10% | |
| C192 | 281-0605-00 | 200 pF | Cer | 500 V | | |
| C203 | 283-0104-00 | 2000 pF | Cer | 500 V | 5% | |
| C208 | 281-0511-00 | 22 pF | Cer | 500 V | 10% | |
| C212 | 281-0580-00 | 470 pF | Cer | 500 V | 10% | |
| C223 | 283-0593-00 | 0.01 μ F | Mica | 100 V | 1% | |
| C228 | 281-0511-00 | 22 pF | Cer | 500 V | 10% | |
| C232 | 283-0028-00 | 0.0022 μ F | Cer | 50 V | | |
| C233 | 290-0267-00 | 1 μ F | EMT | 35 V | | |
| C243 | 285-0683-00 | 0.022 μ F | PTM | 100 V | 5% | |
| C248 | 281-0511-00 | 22 pF | Cer | 500 V | 10% | |
| C252 | 283-0083-00 | 0.0047 μ F | Cer | 500 V | 5% | |
| C253 | 290-0267-00 | 1 μ F | EMT | 35 V | | |
| C263 | 285-0595-00 | 0.1 μ F | PTM | 100 V | 1% | |
| C268 | 281-0511-00 | 22 pF | Cer | 500 V | 10% | |
| C272 | 283-0027-00 | 0.02 μ F | Cer | 30 V | | |
| C273 | 290-0267-00 | 1 μ F | EMT | 35 V | | |

Capacitors (Cont'd)

| Ckt. No. | Tektronix Part No. | | Description | | | S/N Range |
|----------|--------------------|----------------|-------------|--------|----------|-----------|
| C283 | 290-0264-00 | 0.22 μ F | EMT | 35 V | 10% | |
| C288 | 281-0511-00 | 22 pF | Cer | 500 V | 10% | |
| C292 | 283-0010-00 | 0.05 μ F | Cer | 50 V | | |
| C303 | 290-0267-00 | 1 μ F | EMT | 35 V | | |
| C308 | 281-0511-00 | 22 pF | Cer | 500 V | 10% | |
| C312 | 290-0264-00 | 0.22 μ F | EMT | 35 V | 10% | |
| C323 | 290-0267-00 | 1 μ F | EMT | 35 V | | 100-2059 |
| C323 | 290-0183-00 | 1 μ F | EMT | 20 V | 10% | 2060-up |
| C328 | 281-0511-00 | 22 pF | Cer | 500 V | 10% | |
| C332 | 290-0244-00 | 0.47 μ F | EMT | 35 V | 5% | |
| C343 | 290-0175-00 | 10 μ F | EMT | 35 V | | 100-2059 |
| C343 | 290-0301-00 | 10 μ F | Elect | 20 V | 10% | 2060-up |
| C348 | 281-0511-00 | 22 pF | Cer | 500 V | 10% | |
| C352 | 290-0136-00 | 2.2 μ F | EMT | 20 V | | |
| C363 | 290-0175-00 | 10 μ F | EMT | 35 V | | |
| C368 | 281-0511-00 | 22 pF | Cer | 500 V | 10% | |
| C372 | 290-0187-00 | 4.7 μ F | EMT | 35 V | | |
| C383 | 290-0158-00 | 50 μ F | EMT | 25 V | +75%—15% | |
| C388 | 281-0511-00 | 22 pF | Cer | 500 V | 10% | |
| C392 | 290-0187-00 | 4.7 μ F | EMT | 35 V | | |
| C451 | 290-0188-00 | 0.1 μ F | EMT | 35 V | 10% | |
| C452 | 281-0580-00 | 470 pF | Cer | 500 V | 10% | |
| C460 | 281-0603-00 | 39 pF | Cer | 500 V | 5% | |
| C468 | 290-0267-00 | 1 μ F | EMT | 35 V | | |
| C501 | 283-0013-00 | 0.01 μ F | Cer | 1000 V | | X870-up |
| C504 | 283-0002-00 | 0.01 μ F | Cer | 500 V | | 100-869 |
| C504 | 283-0044-00 | 0.001 μ F | Cer | 3000 V | | 870-up |
| C505 | 283-0002-00 | 0.01 μ F | Cer | 500 V | | 100-869 |
| C505 | 283-0044-00 | 0.001 μ F | Cer | 3000 V | | 870-up |
| C507 | 283-0013-00 | 0.01 μ F | Cer | 1000 V | | 100-869 |
| C507 | 283-0044-00 | 0.001 μ F | Cer | 3000 V | | 870-up |
| C509 | 283-0002-00 | 0.01 μ F | Cer | 500 V | | 100-869 |
| C509 | 283-0044-00 | 0.001 μ F | Cer | 3000 V | | 870-up |
| C512 | 290-0012-00 | 2 x 40 μ F | EMC | 250 V | | |
| C520 | 283-0003-00 | 0.01 μ F | Cer | 150 V | | |
| C526 | 290-0149-00 | 5 μ F | EMT | 150 V | | |
| C530 | 290-0188-00 | 0.1 μ F | EMT | 35 V | 10% | |
| C532 | 290-0086-00 | 2000 μ F | EMC | 30 V | | |
| C540 | 290-0162-00 | 22 μ F | EMT | 35 V | | |
| C544 | 283-0026-00 | 0.2 μ F | Cer | 25 V | | |
| C546 | 290-0162-00 | 22 μ F | EMT | 35 V | | |
| C552 | 290-0295-00 | 700 μ F | EMC | 75 V | | |
| C560 | 290-0188-00 | 0.1 μ F | EMT | 35 V | 10% | |
| C574 | 290-0267-00 | 1 μ F | EMT | 35 V | | |
| C588 | 290-0162-00 | 22 μ F | EMT | 35 V | | |
| C589 | 290-0162-00 | 22 μ F | EMT | 35 V | | |

Diodes

| | | | | | | |
|------|--------------|-----------|------------------------|--|--|---------|
| D13 | 152-0069-00 | Zener | 1N3041A 1 W, 75 V, 10% | | | X355-up |
| D52 | *152-0075-00 | Germanium | Tek Spec | | | |
| D53 | *152-0075-00 | Germanium | Tek Spec | | | |
| D54 | *152-0075-00 | Germanium | Tek Spec | | | |
| D55 | *152-0075-00 | Germanium | Tek Spec | | | |
| D99 | *152-0185-00 | Silicon | Replaceable by 1N3605 | | | X649-up |
| D105 | *152-0185-00 | Silicon | Replaceable by 1N3605 | | | X649-up |
| D107 | *152-0185-00 | Silicon | Replaceable by 1N3605 | | | |

Electrical Parts List—Type 184

Diodes (Cont'd)

| Ckt. No. | Tektronix Part No. | | Description | S/N Range |
|----------|--------------------|---------|-----------------------|-----------|
| D108 | *152-0185-00 | Silicon | Replaceable by 1N3605 | |
| D115 | *152-0185-00 | Silicon | Replaceable by 1N3605 | |
| D122 | *152-0185-00 | Silicon | Replaceable by 1N3605 | |
| D130 | *152-0185-00 | Silicon | Replaceable by 1N3605 | |
| D132 | *152-0185-00 | Silicon | Replaceable by 1N3605 | |
| D137 | *152-0185-00 | Silicon | Replaceable by 1N3605 | |
| D148 | *152-0185-00 | Silicon | Replaceable by 1N3605 | |
| D152 | *152-0185-00 | Silicon | Replaceable by 1N3605 | |
| D160 | *152-0185-00 | Silicon | Replaceable by 1N3605 | |
| D168 | *152-0185-00 | Silicon | Replaceable by 1N3605 | |
| D172 | *152-0185-00 | Silicon | Replaceable by 1N3605 | |
| D177 | *152-0185-00 | Silicon | Replaceable by 1N3605 | |
| D180 | *152-0185-00 | Silicon | Replaceable by 1N3605 | |
| D188 | *152-0185-00 | Silicon | Replaceable by 1N3605 | |
| D192 | *152-0185-00 | Silicon | Replaceable by 1N3605 | |
| D200 | *152-0185-00 | Silicon | Replaceable by 1N3605 | |
| D208 | *152-0185-00 | Silicon | Replaceable by 1N3605 | |
| D212 | *152-0185-00 | Silicon | Replaceable by 1N3605 | |
| D217 | *152-0185-00 | Silicon | Replaceable by 1N3605 | |
| D220 | *152-0185-00 | Silicon | Replaceable by 1N3605 | |
| D228 | *152-0185-00 | Silicon | Replaceable by 1N3605 | |
| D232 | *152-0185-00 | Silicon | Replaceable by 1N3605 | |
| D240 | *152-0185-00 | Silicon | Replaceable by 1N3605 | |
| D248 | *152-0185-00 | Silicon | Replaceable by 1N3605 | |
| D252 | *152-0185-00 | Silicon | Replaceable by 1N3605 | |
| D257 | *152-0185-00 | Silicon | Replaceable by 1N3605 | |
| D260 | *152-0185-00 | Silicon | Replaceable by 1N3605 | |
| D268 | *152-0185-00 | Silicon | Replaceable by 1N3605 | |
| D272 | *152-0185-00 | Silicon | Replaceable by 1N3605 | |
| D280 | *152-0185-00 | Silicon | Replaceable by 1N3605 | |
| D288 | *152-0185-00 | Silicon | Replaceable by 1N3605 | |
| D292 | *152-0185-00 | Silicon | Replaceable by 1N3605 | |
| D297 | *152-0185-00 | Silicon | Replaceable by 1N3605 | |
| D300 | *152-0185-00 | Silicon | Replaceable by 1N3605 | |
| D308 | *152-0185-00 | Silicon | Replaceable by 1N3605 | |
| D312 | *152-0185-00 | Silicon | Replaceable by 1N3605 | |
| D320 | *152-0185-00 | Silicon | Replaceable by 1N3605 | |
| D328 | *152-0185-00 | Silicon | Replaceable by 1N3605 | |
| D332 | *152-0185-00 | Silicon | Replaceable by 1N3605 | |
| D337 | *152-0185-00 | Silicon | Replaceable by 1N3605 | |
| D340 | *152-0185-00 | Silicon | Replaceable by 1N3605 | |
| D348 | *152-0185-00 | Silicon | Replaceable by 1N3605 | |
| D352 | *152-0185-00 | Silicon | Replaceable by 1N3605 | |
| D360 | *152-0185-00 | Silicon | Replaceable by 1N3605 | |
| D368 | *152-0185-00 | Silicon | Replaceable by 1N3605 | |

Diodes (Cont'd)

| Ckt. No. | Tektronix Part No. | Description | S/N Range |
|----------------|--------------------|-------------|-----------------------|
| D372 | *152-0185-00 | Silicon | Replaceable by 1N3605 |
| D377 | *152-0185-00 | Silicon | Replaceable by 1N3605 |
| D380 | *152-0185-00 | Silicon | Replaceable by 1N3605 |
| D388 | *152-0185-00 | Silicon | Replaceable by 1N3605 |
| D392 | *152-0185-00 | Silicon | Replaceable by 1N3605 |
| D412 | *152-0185-00 | Silicon | Replaceable by 1N3605 |
| D472 | *152-0185-00 | Silicon | Replaceable by 1N3605 |
| D512A,B,C,D(4) | *152-0107-00 | Silicon | Replaceable by 1N647 |
| D532A,B,C,D(4) | 152-0066-00 | Silicon | 1N3194 |
| D552A,B,C,D(4) | *152-0107-00 | Silicon | Replaceable by 1N647 |
| D560 | 152-0212-00 | Zener | 1N936 9 V, 5%, TC |

Fuse

| | | |
|------|-------------|---------------------|
| F502 | 159-0043-00 | 0.6 A, 3AG, Slo-Blo |
|------|-------------|---------------------|

Connectors

| | | | |
|------|--------------|---|---------|
| J70 | 131-0106-00 | Chassis mounted, coaxial, 1 contact, female | |
| J405 | 131-0106-00 | Chassis mounted, coaxial, 1 contact, female | |
| J425 | 131-0106-00 | Chassis mounted, coaxial, 1 contact, female | |
| J470 | 131-0106-00 | Chassis mounted, coaxial, 1 contact, female | |
| J501 | *131-0102-00 | Chassis mounted, motor base, male | 100-219 |
| J501 | *131-0430-00 | Receptacle, electrical | 220-up |

Inductors

| | | | | |
|-----|--------------|-----------------------------|-----|------------------|
| L15 | *114-0172-00 | 0.4-0.65 μ H | Var | Core 276-0511-00 |
| L16 | *114-0172-00 | 0.4-0.65 μ H | Var | Core 276-0511-00 |
| L18 | *114-0113-00 | 6-10 μ H | Var | Core 276-0511-00 |
| L19 | *114-0113-00 | 6-10 μ H | Var | Core 276-0511-00 |
| L25 | *114-0171-00 | 1.4-2 μ H | Var | Core 276-0511-00 |
| L26 | *114-0171-00 | 1.4-2 μ H | Var | Core 276-0511-00 |
| L35 | *114-0172-00 | 0.4-0.65 μ H | Var | Core 276-0511-00 |
| L36 | *114-0172-00 | 0.4-0.65 μ H | Var | Core 276-0511-00 |
| L45 | *114-0173-00 | 0.15-0.23 μ H | Var | Core 276-0511-00 |
| L46 | *114-0173-00 | 0.15-0.23 μ H | Var | Core 276-0511-00 |
| L55 | *108-0348-00 | Coil, 1 turn | | |
| L56 | *108-0347-00 | Coil, 4 $\frac{1}{2}$ turns | | |
| L57 | *108-0348-00 | Coil, 1 turn | | |
| L60 | *108-0346-00 | Coil, 2 $\frac{1}{2}$ turns | | |
| L61 | *108-0347-00 | Coil, 4 $\frac{1}{2}$ turns | | |
| L62 | *108-0347-00 | Coil, 4 $\frac{1}{2}$ turns | | |
| L65 | 276-0507-00 | Core, ferramic suppressor | | |
| L69 | *114-0197-00 | Coil, 1 turn | | |
| L70 | *119-0060-00 | Tank, 500 MHz quintupler | | |

Electrical Parts List—Type 184

Inductors (Cont'd)

| Ckt. No. | Tektronix Part No. | Description | S/N Range |
|----------|--------------------|---------------------------|-----------|
| L121 | 276-0507-00 | Core, ferramic suppressor | |
| L122 | 276-0507-00 | Core, ferramic suppressor | |
| L123A,B | *119-0062-00 | Delay Line Assembly | |
| L131 | 276-0507-00 | Core, ferramic suppressor | |
| L132 | 276-0507-00 | Core, ferramic suppressor | |

Transistors

| | | | |
|------|--------------|-----------------------|---------|
| Q94 | *151-0108-00 | Replaceable by 2N2501 | |
| Q103 | *151-0108-00 | Replaceable by 2N2501 | |
| Q104 | *151-0133-00 | Selected from 2N3251 | |
| Q114 | *151-0133-00 | Selected from 2N3251 | |
| Q120 | *151-0083-00 | Selected from 2N964 | |
| Q123 | *151-0159-00 | Replaceable by 2N918 | |
| Q130 | *151-0108-00 | Replaceable by 2N2501 | |
| Q133 | *151-0159-00 | Replaceable by 2N918 | |
| Q134 | *151-0133-00 | Selected from 2N3251 | |
| Q145 | *151-0159-00 | Replaceable by 2N918 | 100-648 |
| Q145 | *151-0108-00 | Replaceable by 2N2501 | 649-up |
| Q153 | *151-0159-00 | Replaceable by 2N918 | |
| Q155 | *151-0127-00 | Selected from 2N2369 | |
| Q165 | *151-0159-00 | Replaceable by 2N918 | |
| Q173 | *151-0159-00 | Replaceable by 2N918 | |
| Q175 | *151-0159-00 | Replaceable by 2N918 | |
| Q185 | *151-0159-00 | Replaceable by 2N918 | |
| Q193 | *151-0159-00 | Replaceable by 2N918 | |
| Q195 | *151-0159-00 | Replaceable by 2N918 | |
| Q205 | *151-0159-00 | Replaceable by 2N918 | |
| Q213 | *151-0159-00 | Replaceable by 2N918 | |
| Q215 | *151-0159-00 | Replaceable by 2N918 | |
| Q225 | *151-0159-00 | Replaceable by 2N918 | |
| Q233 | *151-0159-00 | Replaceable by 2N918 | |
| Q235 | *151-0159-00 | Replaceable by 2N918 | |
| Q245 | *151-0159-00 | Replaceable by 2N918 | |
| Q253 | *151-0159-00 | Replaceable by 2N918 | |
| Q255 | *151-0159-00 | Replaceable by 2N918 | |
| Q265 | *151-0159-00 | Replaceable by 2N918 | |
| Q273 | *151-0159-00 | Replaceable by 2N918 | |
| Q275 | *151-0159-00 | Replaceable by 2N918 | |
| Q285 | *151-0159-00 | Replaceable by 2N918 | |
| Q293 | *151-0159-00 | Replaceable by 2N918 | |
| Q295 | *151-0159-00 | Replaceable by 2N918 | |
| Q305 | *151-0159-00 | Replaceable by 2N918 | |
| Q313 | *151-0159-00 | Replaceable by 2N918 | |
| Q315 | *151-0154-00 | Replaceable by 2N2924 | |
| Q325 | *151-0159-00 | Replaceable by 2N918 | |
| Q333 | *151-0159-00 | Replaceable by 2N918 | |
| Q335 | *151-0154-00 | Replaceable by 2N2924 | |
| Q345 | *151-0159-00 | Replaceable by 2N918 | |

Transistors (Cont'd)

| Ckt. No. | Tektronix Part No. | Description | S/N Range |
|----------|--------------------|-----------------------|-----------|
| Q353 | *151-0159-00 | Replaceable by 2N918 | |
| Q355 | *151-0154-00 | Replaceable by 2N2924 | |
| Q365 | *151-0159-00 | Replaceable by 2N918 | |
| Q373 | *151-0159-00 | Replaceable by 2N918 | |
| Q375 | *151-0154-00 | Replaceable by 2N2924 | |
| Q385 | *151-0159-00 | Replaceable by 2N918 | |
| Q393 | *151-0159-00 | Replaceable by 2N918 | |
| Q395 | *151-0154-00 | Replaceable by 2N2924 | |
| Q403 | *151-0103-00 | Replaceable by 2N2219 | |
| Q423 | *151-0103-00 | Replaceable by 2N2219 | |
| Q454 | 151-0177-00 | 2N916 | |
| Q463 | *151-0103-00 | Replaceable by 2N2219 | |
| Q464 | *151-0133-00 | Selected from 2N3251 | |
| Q473 | *151-0134-00 | Replaceable by 2N2905 | |
| Q523 | 151-0150-00 | 2N3440 | |
| Q524 | 151-0093-00 | 2N2043 | |
| Q527 | 151-0149-00 | 2N3441 | |
| Q536 | *151-0134-00 | Replaceable by 2N2905 | |
| Q543 | *151-0136-00 | Replaceable by 2N3053 | |
| Q546 | *151-0134-00 | Replaceable by 2N2905 | |
| Q547 | *151-0148-00 | Selected (RCA 40250) | |
| Q566 | *151-0151-00 | Replaceable by 2N930 | |
| Q576 | *151-0151-00 | Replaceable by 2N930 | |
| Q583 | *151-0136-00 | Replaceable by 2N3053 | |
| Q587 | *151-0148-00 | Selected (RCA 40250) | |

Resistors

Resistors are fixed, composition, $\pm 10\%$ unless otherwise indicated.

| | | | | | |
|-----|-------------|-------------|-------|----|----------|
| R11 | 315-0104-00 | 100 k | 1/4 W | 5% | 100-354X |
| R13 | 303-0273-00 | 27 k | 1 W | 5% | |
| R15 | 315-0104-00 | 100 k | 1/4 W | 5% | |
| R19 | 315-0104-00 | 100 k | 1/4 W | 5% | |
| R21 | 315-0270-00 | 27 Ω | 1/4 W | 5% | |
| R23 | 303-0273-00 | 27 k | 1 W | 5% | |
| R31 | 315-0270-00 | 27 Ω | 1/4 W | 5% | |
| R33 | 303-0273-00 | 27 k | 1 W | 5% | |
| R41 | 315-0270-00 | 27 Ω | 1/4 W | 5% | |
| R43 | 303-0273-00 | 27 k | 1 W | 5% | |
| R60 | 315-0680-00 | 68 Ω | 1/4 W | 5% | |
| R61 | 315-0473-00 | 47 k | 1/4 W | 5% | |
| R65 | 315-0470-00 | 47 Ω | 1/4 W | 5% | |
| R68 | 315-0273-00 | 27 k | 1/4 W | 5% | |
| R70 | 315-0680-00 | 68 Ω | 1/4 W | 5% | |

Electrical Parts List—Type 184

Resistors (Cont'd)

| Ckt. No. | Tektronix Part No. | | Description | | S/N Range |
|----------|--------------------|--------|-------------|---------|-----------|
| R78 | 315-0273-00 | 27 k | 1/4 W | 5% | |
| R90 | 315-0470-00 | 47 Ω | 1/4 W | 5% | |
| R91 | 315-0102-00 | 1 k | 1/4 W | 5% | |
| R93 | 315-0102-00 | 1 k | 1/4 W | 5% | |
| R95 | 315-0102-00 | 1 k | 1/4 W | 5% | |
| R97 | 301-0272-00 | 2.7 k | 1/2 W | 5% | |
| R99 | 315-0272-00 | 2.7 k | 1/4 W | 5% | 100-648X |
| R100 | 315-0471-00 | 470 Ω | 1/4 W | 5% | |
| R103 | 315-0241-00 | 240 Ω | 1/4 W | 5% | 100-648 |
| R103 | 315-0201-00 | 200 Ω | 1/4 W | 5% | 649-up |
| R105 | 315-0562-00 | 5.6 k | 1/4 W | 5% | 100-648X |
| R110 | 315-0621-00 | 620 Ω | 1/4 W | 5% | |
| R111 | 315-0472-00 | 4.7 k | 1/4 W | 5% | |
| R113 | 301-0471-00 | 470 Ω | 1/2 W | 5% | |
| R114 | 303-0102-00 | 1 k | 1 W | 5% | |
| R116 | 315-0511-00 | 510 Ω | 1/4 W | 5% | |
| R118 | 315-0102-00 | 1 k | 1/4 W | 5% | |
| R122 | 315-0221-00 | 220 Ω | 1/4 W | 5% | |
| R123 | 315-0101-00 | 100 Ω | 1/4 W | 5% | |
| R125 | 315-0102-00 | 1 k | 1/4 W | 5% | |
| R128 | 315-0102-00 | 1 k | 1/4 W | 5% | |
| R130 | 323-0308-00 | 15.8 k | 1/2 W | Prec 1% | |
| R132 | 315-0472-00 | 4.7 k | 1/4 W | 5% | |
| R133 | 315-0432-00 | 4.3 k | 1/4 W | 5% | 100-1499 |
| R133 | 315-0332-00 | 3.3 k | 1/4 W | 5% | 1500-up |
| R134 | 315-0472-00 | 4.7 k | 1/4 W | 5% | 100-1499 |
| R134 | 315-0562-00 | 5.6 k | 1/4 W | 5% | 1500-up |
| R136 | 315-0100-00 | 10 Ω | 1/4 W | 5% | |
| R137 | 315-0101-00 | 100 Ω | 1/4 W | 5% | |
| R138 | 315-0221-00 | 220 Ω | 1/4 W | 5% | |
| R140 | 315-0103-00 | 10 k | 1/4 W | 5% | |
| R141 | 315-0273-00 | 27 k | 1/4 W | 5% | |
| R143 | 315-0122-00 | 1.2 k | 1/4 W | 5% | |
| R145 | 315-0183-00 | 18 k | 1/4 W | 5% | |
| R146 | 311-0463-00 | 5 k | | | Var |
| R150 | 315-0122-00 | 1.2 k | 1/4 W | 5% | |
| R154 | 315-0912-00 | 9.1 k | 1/4 W | 5% | |
| R156 | 315-0241-00 | 240 Ω | 1/4 W | 5% | |
| R160 | 315-0103-00 | 10 k | 1/4 W | 5% | |
| R161 | 315-0393-00 | 39 k | 1/4 W | 5% | |
| R163 | 315-0222-00 | 2.2 k | 1/4 W | 5% | |
| R165 | 321-0338-00 | 32.4 k | 1/8 W | Prec 1% | |
| R170 | 315-0122-00 | 1.2 k | 1/4 W | 5% | |
| R174 | 315-0432-00 | 4.3 k | 1/4 W | 5% | |
| R176 | 315-0511-00 | 510 Ω | 1/4 W | 5% | |
| R177 | 315-0241-00 | 240 Ω | 1/4 W | 5% | |
| R180 | 315-0103-00 | 10 k | 1/4 W | 5% | |
| R181 | 315-0393-00 | 39 k | 1/4 W | 5% | |

Resistors (Cont'd)

| Ckt. No. | Tektronix Part No. | | Description | | S/N Range |
|----------|--------------------|--------|-------------|------|-----------|
| R183 | 315-0222-00 | 2.2 k | 1/4 W | | 5% |
| R185 | 321-0364-00 | 60.4 k | 1/8 W | Prec | 1% |
| R190 | 315-0302-00 | 3 k | 1/4 W | | 5% |
| R194 | 315-0223-00 | 22 k | 1/4 W | | 5% |
| R196 | 315-0241-00 | 240 Ω | 1/4 W | | 5% |
| R200 | 315-0103-00 | 10 k | 1/4 W | | 5% |
| R201 | 315-0393-00 | 39 k | 1/4 W | | 5% |
| R203 | 315-0222-00 | 2.2 k | 1/4 W | | 5% |
| R205 | 321-0356-00 | 49.9 k | 1/8 W | Prec | 1% |
| R210 | 315-0302-00 | 3 k | 1/4 W | | 5% |
| R214 | 315-0912-00 | 9.1 k | 1/4 W | | 5% |
| R216 | 315-0511-00 | 510 Ω | 1/4 W | | 5% |
| R217 | 315-0241-00 | 240 Ω | 1/4 W | | 5% |
| R217 | 315-0181-00 | 180 Ω | 1/4 W | | 5% |
| R220 | 315-0103-00 | 10 k | 1/4 W | | 5% |
| R221 | 315-0393-00 | 39 k | 1/4 W | | 5% |
| R223 | 315-0222-00 | 2.2 k | 1/4 W | | 5% |
| R225 | 321-0365-00 | 61.9 k | 1/8 W | Prec | 1% |
| R230 | 315-0362-00 | 3.6 k | 1/4 W | | 5% |
| R234 | 315-0912-00 | 9.1 k | 1/4 W | | 5% |
| R236 | 315-0241-00 | 240 Ω | 1/4 W | | 5% |
| R240 | 315-0103-00 | 10 k | 1/4 W | | 5% |
| R241 | 315-0393-00 | 39 k | 1/4 W | | 5% |
| R243 | 315-0222-00 | 2.2 k | 1/4 W | | 5% |
| R245 | 321-0353-00 | 46.4 k | 1/8 W | Prec | 1% |
| R250 | 315-0302-00 | 3 k | 1/4 W | | 5% |
| R254 | 315-0912-00 | 9.1 k | 1/4 W | | 5% |
| R256 | 315-0511-00 | 510 Ω | 1/4 W | | 5% |
| R257 | 315-0241-00 | 240 Ω | 1/4 W | | 5% |
| R260 | 315-0103-00 | 10 k | 1/4 W | | 5% |
| R261 | 315-0393-00 | 39 k | 1/4 W | | 5% |
| R263 | 315-0222-00 | 2.2 k | 1/4 W | | 5% |
| R265 | 321-0365-00 | 61.9 k | 1/8 W | Prec | 1% |
| R270 | 315-0362-00 | 3.6 k | 1/4 W | | 5% |
| R274 | 315-0912-00 | 9.1 k | 1/4 W | | 5% |
| R276 | 315-0241-00 | 240 Ω | 1/4 W | | 5% |
| R280 | 315-0103-00 | 10 k | 1/4 W | | 5% |
| R281 | 315-0393-00 | 39 k | 1/4 W | | 5% |
| R283 | 315-0222-00 | 2.2 k | 1/4 W | | 5% |
| R285 | 321-0353-00 | 46.4 k | 1/8 W | Prec | 1% |
| R290 | 315-0302-00 | 3 k | 1/4 W | | 5% |
| R294 | 315-0912-00 | 9.1 k | 1/4 W | | 5% |
| R296 | 315-0511-00 | 510 Ω | 1/4 W | | 5% |
| R297 | 315-0241-00 | 240 Ω | 1/4 W | | 5% |
| R300 | 315-0103-00 | 10 k | 1/4 W | | 5% |
| R301 | 315-0393-00 | 39 k | 1/4 W | | 5% |

100-1499
1500-up

Electrical Parts List—Type 184

Resistors (Cont'd)

| Ckt. No. | Tektronix Part No. | | Description | | | S/N Range |
|----------|--------------------|--------|-------------|-----|----|-----------|
| R303 | 315-0222-00 | 2.2 k | 1/4 W | | 5% | |
| R305 | 315-0513-00 | 51 k | 1/4 W | | 5% | |
| R306 | 311-0464-00 | 25 k | | Var | | |
| R310 | 315-0362-00 | 3.6 k | 1/4 W | | 5% | |
| R314 | 315-0912-00 | 9.1 k | 1/4 W | | 5% | |
| R316 | 315-0241-00 | 240 Ω | 1/4 W | | 5% | |
| R320 | 315-0103-00 | 10 k | 1/4 W | | 5% | |
| R321 | 315-0393-00 | 39 k | 1/4 W | | 5% | |
| R323 | 315-0222-00 | 2.2 k | 1/4 W | | 5% | |
| R325 | 321-0391-00 | 115 k | 1/8 W | | 1% | 100-2059 |
| R325 | 321-0385-00 | 100 k | 1/8 W | | 1% | 2060-up |
| R330 | 315-0302-00 | 3 k | 1/4 W | | 5% | |
| R334 | 315-0912-00 | 9.1 k | 1/4 W | | 5% | |
| R336 | 315-0511-00 | 510 Ω | 1/4 W | | 5% | |
| R337 | 315-0241-00 | 240 Ω | 1/4 W | | 5% | |
| R340 | 315-0103-00 | 10 k | 1/4 W | | 5% | |
| R341 | 315-0393-00 | 39 k | 1/4 W | | 5% | |
| R343 | 315-0222-00 | 2.2 k | 1/4 W | | 5% | |
| R345 | 315-0513-00 | 51 k | 1/4 W | | 5% | 100-2059 |
| R345 | 323-0357-00 | 51.1 k | 1/2 W | | 1% | 2060-up |
| R346 | 311-0464-00 | 25 k | | Var | | |
| R350 | 315-0362-00 | 3.6 k | 1/4 W | | 5% | |
| R354 | 315-0912-00 | 9.1 k | 1/4 W | | 5% | |
| R356 | 315-0241-00 | 240 Ω | 1/4 W | | 5% | |
| R360 | 315-0103-00 | 10 k | 1/4 W | | 5% | |
| R361 | 315-0393-00 | 39 k | 1/4 W | | 5% | |
| R363 | 315-0222-00 | 2.2 k | 1/4 W | | 5% | |
| R365 | 321-0385-00 | 100 k | 1/8 W | | 1% | |
| R370 | 315-0302-00 | 3 k | 1/4 W | | 5% | |
| R374 | 315-0912-00 | 9.1 k | 1/4 W | | 5% | |
| R376 | 315-0511-00 | 510 Ω | 1/4 W | | 5% | |
| R377 | 315-0241-00 | 240 Ω | 1/4 W | | 5% | |
| R380 | 315-0103-00 | 10 k | 1/4 W | | 5% | |
| R381 | 315-0393-00 | 39 k | 1/4 W | | 5% | |
| R383 | 315-0222-00 | 2.2 k | 1/4 W | | 5% | |
| R385 | 315-0104-00 | 100 k | 1/4 W | | 5% | |
| R386 | 311-0497-00 | 50 k | | Var | | |
| R390 | 315-0123-00 | 12 k | 1/4 W | | 5% | |
| R394 | 315-0203-00 | 20 k | 1/4 W | | 5% | |
| R396 | 315-0241-00 | 240 Ω | 1/4 W | | 5% | 100-1499 |
| R396 | 315-0181-00 | 180 Ω | 1/4 W | | 5% | 1500-up |
| R401 | 301-0510-00 | 51 Ω | 1/2 W | | 5% | |
| R403 | 301-0560-00 | 56 Ω | 1/2 W | | 5% | |
| R405 | 302-0102-00 | 1 k | 1/2 W | | | |
| R408 | 315-0181-00 | 180 Ω | 1/4 W | | 5% | |
| R421 | 302-0103-00 | 10 k | 1/2 W | | | |
| R424 | 301-0391-00 | 390 Ω | 1/2 W | | 5% | |
| R425 | 302-0102-00 | 1 k | 1/2 W | | | |

Resistors (Cont'd)

| Ckt. No. | Tektronix Part No. | | Description | | S/N Range |
|----------|--------------------|--------|-------------|------|-----------|
| R452 | 315-0122-00 | 1.2 k | 1/4 W | | 5% |
| R454 | 315-0102-00 | 1 k | 1/4 W | | 5% |
| R456 | 301-0272-00 | 2.7 k | 1/2 W | | 5% |
| R460 | 315-0472-00 | 4.7 k | 1/4 W | | 5% |
| R462 | 315-0472-00 | 4.7 k | 1/4 W | | 5% |
| R464 | 301-0272-00 | 2.7 k | 1/2 W | | 5% |
| R470 | 315-0101-00 | 100 Ω | 1/4 W | | 5% |
| R504 | 302-0184-00 | 180 k | 1/2 W | | |
| R511 | 307-0023-00 | 4.7 Ω | 1/2 W | | |
| R512 | 302-0124-00 | 120 k | 1/2 W | | |
| R520 | 323-0363-00 | 59 k | 1/2 W | Prec | 1% |
| R522 | 323-0304-00 | 14.3 k | 1/2 W | Prec | 1% |
| R524 | 315-0333-00 | 33 k | 1/4 W | | 5% |
| R527 | 301-0330-00 | 33 Ω | 1/2 W | | 5% |
| R530 | 323-0248-00 | 3.74 k | 1/2 W | Prec | 1% |
| R531 | 308-0245-00 | 0.6 Ω | 2 W | WW | 5% |
| R532 | 323-0285-00 | 9.09 k | 1/2 W | Prec | 1% |
| R534 | 301-0151-00 | 150 Ω | 1/2 W | | 5% |
| R536 | 315-0103-00 | 10 k | 1/4 W | | 5% |
| R540 | 315-0122-00 | 1.2 k | 1/4 W | | 5% |
| R544 | 315-0471-00 | 470 Ω | 1/4 W | | 5% |
| R547 | *308-0087-00 | 0.5 Ω | 1 W | WW | 1% |
| R551 | 307-0023-00 | 4.7 Ω | 1/2 W | | |
| R562 | 301-0272-00 | 2.7 k | 1/2 W | | 5% |
| R564 | 301-0202-00 | 2 k | 1/2 W | | 5% |
| R566 | 315-0472-00 | 4.7 k | 1/4 W | | 5% |
| R570 | 315-0822-00 | 8.2 k | 1/4 W | | 5% |
| R572 | 311-0463-00 | 5 k | | Var | |
| R574 | 315-0183-00 | 18 k | 1/4 W | | 5% |
| R580 | 315-0471-00 | 470 Ω | 1/4 W | | 5% |
| R587 | 301-0270-00 | 27 Ω | 1/2 W | | 5% |

Switches

| | Unwired | Wired | |
|-------|-------------|-------|-------------------------|
| SW70 | 260-0725-00 | | Lever, HF SELECTOR |
| SW400 | 260-0727-00 | | Push, MARKER SELECTOR |
| SW425 | 260-0728-00 | | Push, TRIGGER SELECTOR |
| SW450 | 260-0726-00 | | Lever, MARKER AMPLIFIER |
| SW501 | 260-0747-00 | | Slide, 115 V - 230 V |

Transformers

| | | | |
|------|--------------|----------|---------------------|
| T115 | *120-0410-00 | Toroid | 15 turns, bifilar |
| T130 | *120-0409-00 | Toroid | 2 windings, bifilar |
| T501 | *120-0408-00 | LV Power | |

Electrical Parts List—Type 184

Electron Tubes

| Ckt. No. | Tektronix Part No. | Description | S/N Range |
|----------|--------------------|-------------|-----------|
| V10 | 154-0465-00 | 7587 | |
| V20 | 154-0465-00 | 7587 | |
| V30 | 154-0465-00 | 7587 | |
| V40 | 154-0465-00 | 7587 | |
| V60 | 154-0465-00 | 7587 | |
| V70 | 154-0465-00 | 7587 | |

Crystal

| | | | |
|-----|-------------|--------------------------|----------|
| Y11 | 158-0023-00 | Crystal Assembly, 10 MHz | 100-1509 |
| Y11 | 158-0023-01 | Crystal Assembly, 10 MHz | 1510-up |

SECTION 8

MECHANICAL PARTS LIST

A list of abbreviations and special symbols in use throughout this manual will be found immediately preceding the Electrical Parts List, Section 7. Abbreviations and symbols used in this manual are based on or taken directly from IEEE Standard 260 "Standard Symbols for Units", MIL-STD-12B and other standards of the electronics industry. Parts ordering information is also located immediately preceding Section 7.

Mechanical Parts List—Type 184

FRONT

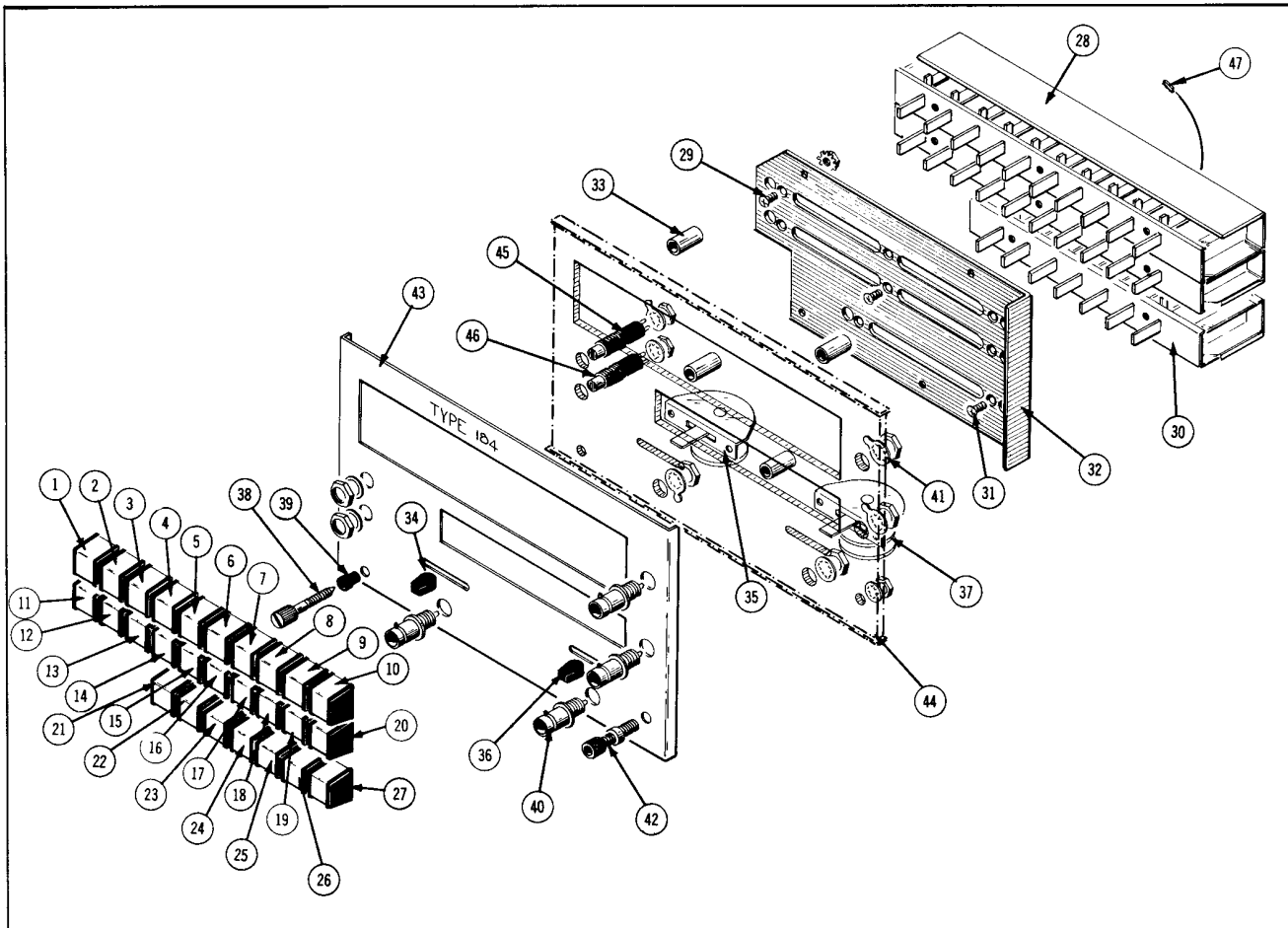

| REF. NO. | PART NO. | SERIAL/MODEL NO. | | QTY. | DESCRIPTION |
|----------|-------------|------------------|-------|------|-----------------------------|
| | | EFF. | DISC. | | |
| 1 | 366-0343-03 | | | 1 | KNOB, pushbutton, POWER OFF |
| 2 | 366-0298-00 | | | 1 | KNOB, pushbutton, 10 nS |
| 3 | 366-0299-00 | | | 1 | KNOB, pushbutton, 20 nS |
| 4 | 366-0300-00 | | | 1 | KNOB, pushbutton, 50 nS |
| 5 | 366-0301-00 | | | 1 | KNOB, pushbutton, .1 μS |
| 6 | 366-0302-00 | | | 1 | KNOB, pushbutton, .5 μS |
| 7 | 366-0303-00 | | | 1 | KNOB, pushbutton, 1 μS |
| 8 | 366-0304-00 | | | 1 | KNOB, pushbutton, 5 μS |
| 9 | 366-0305-00 | | | 1 | KNOB, pushbutton, 10 μS |
| 10 | 366-0306-00 | | | 1 | KNOB, pushbutton, 50 μS |
| 11 | 366-0307-00 | | | 1 | KNOB, pushbutton, .1 mS |
| 12 | 366-0308-00 | | | 1 | KNOB, pushbutton, .5 mS |
| 13 | 366-0309-00 | | | 1 | KNOB, pushbutton, 1 mS |
| 14 | 366-0310-00 | | | 1 | KNOB, pushbutton, 5 mS |
| 15 | 366-0311-00 | | | 1 | KNOB, pushbutton, 10 mS |
| 16 | 366-0312-00 | | | 1 | KNOB, pushbutton, 50 mS |
| 17 | 366-0313-00 | | | 1 | KNOB, pushbutton, .1 S |
| 18 | 366-0314-00 | | | 1 | KNOB, pushbutton, .5 S |
| 19 | 366-0315-00 | | | 1 | KNOB, pushbutton, 1 S |
| 20 | 366-0316-00 | | | 1 | KNOB, pushbutton, 5 S |
| 21 | 366-0303-00 | | | 1 | KNOB, pushbutton, 1 μS |
| 22 | 366-0305-00 | | | 1 | KNOB, pushbutton, 10 μS |

FRONT (Cont'd)

| REF. NO. | PART NO. | SERIAL/MODEL NO. | | QTY. | DESCRIPTION |
|----------|-------------|------------------|-------|------|---|
| | | EFF. | DISC. | | |
| 23 | 366-0307-00 | | | 1 | KNOB, pushbutton, .1 mS |
| 24 | 366-0309-00 | | | 1 | KNOB, pushbutton, 1 mS |
| 25 | 366-0311-00 | | | 1 | KNOB, pushbutton, 10 mS |
| 26 | 366-0313-00 | | | 1 | KNOB, pushbutton, .1 S |
| 27 | 366-0315-00 | | | 1 | KNOB, pushbutton, 1 S |
| 28 | 260-0727-00 | | | 1 | SWITCH, unwired, MARKER SELECTOR |
| | - - - - - | | | - | mounting hardware: (not included w/switch) |
| 29 | 211-0541-00 | | | 6 | SCREW, 6-32 x 1/4 inch, 100° CSK, FHS, phillips |
| | 210-0802-00 | | | 6 | WASHER, 6S x 5/16 inch |
| 30 | 260-0728-00 | | | 1 | SWITCH, unwired, TRIGGER SELECTOR |
| | - - - - - | | | - | mounting hardware: (not included w/switch) |
| 31 | 211-0541-00 | | | 2 | SCREW, 6-32 x 1/4 inch, 100° CSK, FHS, phillips |
| | 210-0802-00 | | | 2 | WASHER, 6S x 5/16 inch |
| 32 | 407-0136-00 | | | 1 | BRACKET, switch |
| | - - - - - | | | - | mounting hardware: (not included w/bracket) |
| 33 | 361-0104-00 | | | 4 | SPACER, sleeve |
| | 210-0457-00 | | | 4 | NUT, keps, 6-32 x 5/16 inch |
| 34 | 366-0215-01 | | | 1 | KNOB, lever, MARKER AMPLIFIER |
| 35 | 260-0726-00 | | | 1 | SWITCH, lever, MARKER AMPLIFIER |
| | - - - - - | | | - | mounting hardware: (not included w/switch) |
| | 210-0586-00 | | | 2 | NUT, keps, 4-40 x 1/4 inch |
| 36 | 366-0215-01 | | | 1 | KNOB, lever, H.F. SELECTOR |
| 37 | 260-0725-00 | | | 1 | SWITCH, lever, H.F. SELECTOR |
| | - - - - - | | | - | mounting hardware: (not included w/switch) |
| | 210-0586-00 | | | 2 | NUT, keps, 4-40 x 1/4 inch |
| 38 | 214-0553-00 | | | 1 | SCREW, latch |
| 39 | 358-0255-00 | | | 1 | BUSHING, latch |
| 40 | 131-0106-00 | | | 4 | CONNECTOR, coaxial, 1-contact female (w/hardware) |
| 41 | 210-0255-00 | | | 3 | LUG, solder, pot |
| 42 | 129-0103-00 | | | 1 | ASSEMBLY, binding post |
| | - - - - - | | | - | assembly includes: |
| | 200-0103-00 | | | 1 | CAP, binding post |
| | 129-0077-00 | | | 1 | POST, binding, stud |
| | - - - - - | | | - | mounting hardware: (not included w/assembly) |
| | 210-0455-00 | | | 1 | NUT, 1/4-28 x 3/8 x 3/32 inch |
| | 210-0046-00 | | | 1 | LOCKWASHER, steel, shakeproof |
| 43 | 333-0888-00 | | | 1 | PANEL, front |
| 44 | 386-0154-00 | | | 1 | PLATE, sub-panel, front |

Mechanical Parts List—Type 184

FRONT (Cont'd)

| REF. NO. | PART NO. | SERIAL/MODEL NO. | | QTY. | DESCRIPTION |
|----------|-------------|------------------|-------|------|--|
| | | EFF. | DISC. | | |
| 45 | 136-0164-00 | | | 1 | SOCKET, lamp |
| | - - - - - | | | - | mounting hardware: (not included w/socket) |
| | 210-0590-00 | | | 1 | NUT, hex., $\frac{3}{8}$ -32 x $\frac{7}{16}$ inch |
| | 210-0978-00 | | | 1 | WASHER, $\frac{3}{8}$ ID x $\frac{1}{2}$ inch OD |
| | 210-0255-00 | | | 1 | LUG, solder, pot |
| | 210-0413-00 | | | 1 | NUT, hex, $\frac{3}{8}$ -32 x $\frac{1}{2}$ inch |
| 46 | - - - - - | | | - | LIGHT, neon, amber |
| | - - - - - | | | - | mounting hardware: (not included w/light) |
| | 210-0590-00 | | | 1 | NUT, hex., $\frac{3}{8}$ -32 x $\frac{7}{16}$ inch |
| | 210-0978-00 | | | 1 | WASHER, $\frac{3}{8}$ ID x $\frac{1}{2}$ inch OD |
| | 210-0012-00 | | | 1 | LOCKWASHER, internal, $\frac{3}{8}$ x $\frac{1}{2}$ inch |
| | 210-0413-00 | | | 1 | NUT, hex, $\frac{3}{8}$ -32 x $\frac{1}{2}$ inch |
| 47 | 131-0371-00 | | | 23 | CONNECTOR, single contact |

CHASSIS

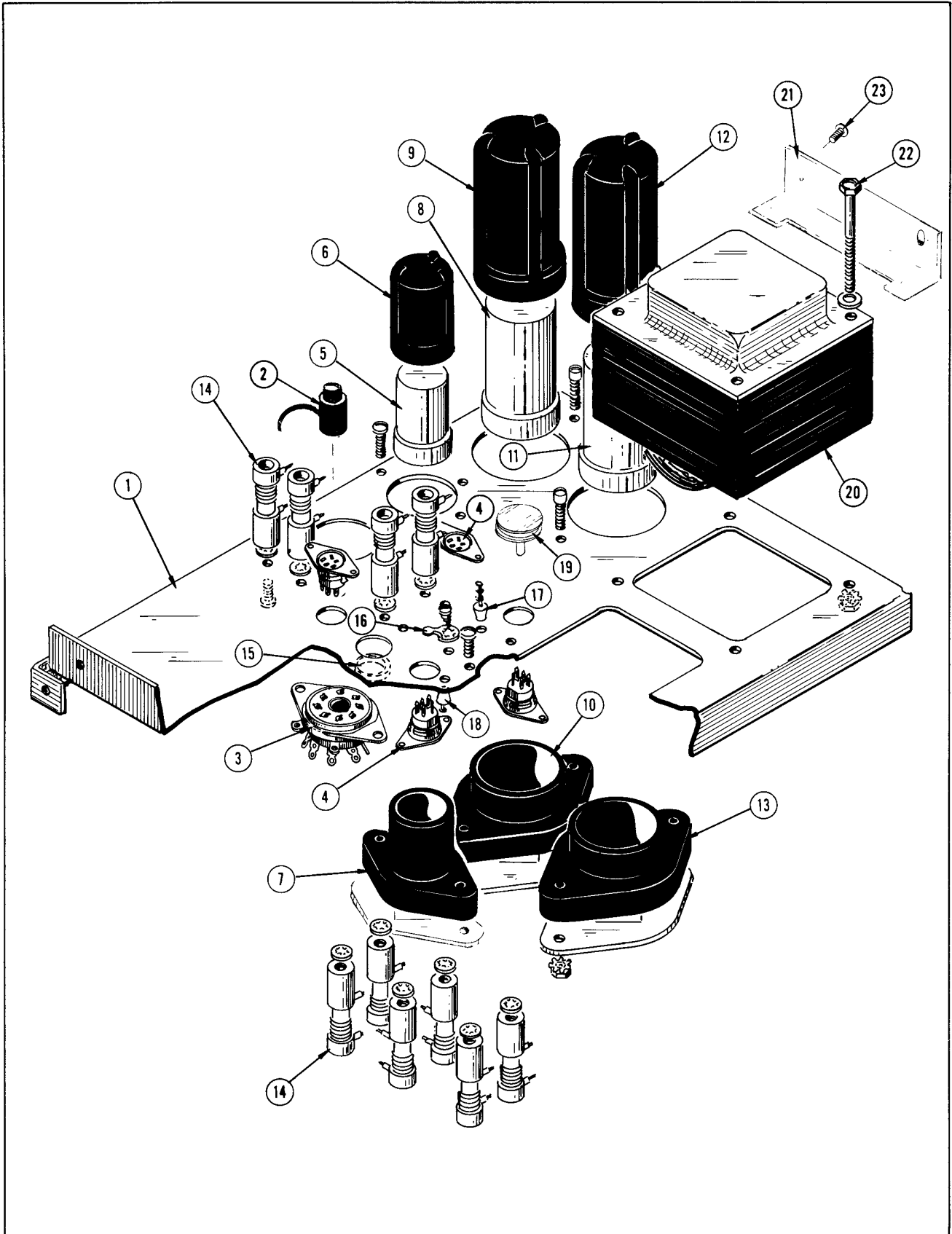

Mechanical Parts List—Type 184

CHASSIS

| REF. NO. | PART NO. | SERIAL/MODEL NO. | | QTY. | DESCRIPTION |
|----------|---|--|-------------------|---|---|
| | | EFF. | DISC. | | |
| 1 | 441-0619-00 ----- 211-0504-00 211-0565-00 | | | 1 - 5 5 | CHASSIS mounting hardware: (not included w/chassis) SCREW, 6-32 x 1/4 inch, PHS phillips SCREW, 6-32 x 3/8 inch, THS, phillips |
| 2 | 131-0142-00 | | | 4 | CONNECTOR, cable end |
| 3 | 136-0011-00 ----- 213-0044-00 | | | 1 - 2 | SOCKET, 8 pin mounting hardware: (not included w/socket) SCREW, thread forming, 5-32 x 3/16 inch, PHS, phillips |
| 4 | 136-0101-00 ----- 213-0055-00 | | | 4 - 2 | SOCKET, nuvistor mounting hardware for each: (not included w/socket) SCREW, thread forming, 2-56 x 3/16 inch, PHS, phillips |
| 5 | ----- | | | 1 | CAPACITOR |
| 6 | 200-0533-00 | | | 1 | COVER, capacitor |
| 7 | 432-0047-00 386-0252-00 ----- 211-0516-00 210-0457-00 | | | 1 1 1 - 2 2 | BASE, capacitor mounting PLATE, fiber mounting hardware: (not included w/plate) SCREW, 6-32 x 7/8 inch, PHS, phillips NUT, keps, 6-32 x 5/16 inch |
| 8 | ----- | | | 1 | CAPACITOR |
| 9 | 200-0260-00 | 100 | 239 | 1 | COVER, capacitor |
| | 200-0538-00 | 240 | | 1 | COVER, capacitor |
| 10 | 432-0044-00 432-0048-00 386-0254-00 ----- 211-0532-00 211-0516-00 210-0457-00 | 100 240 240 ----- 100 240 | 239 239 239 | 1 1 1 1 1 - 2 2 2 | BASE, capacitor mounting BASE, capacitor mounting PLATE, fiber mounting hardware: (not included w/plate) SCREW, 6-32 x 3/4 inch, Fil HS, phillips SCREW, 6-32 x 7/8 inch, PHS NUT, keps, 6-32 x 5/16 inch |
| 11 | ----- | | | 1 | CAPACITOR |
| 12 | 200-0260-00 | 100 | 239 | 1 | COVER, capacitor |
| | 200-0538-00 | 240 | | 1 | COVER, capacitor |
| 13 | 386-0254-00 432-0044-00 432-0048-00 ----- 211-0532-00 211-0516-00 210-0457-00 | 100 240 240 ----- 100 240 | 239 239 239 | 1 1 1 1 - 2 2 2 | PLATE, fiber BASE, capacitor mounting BASE, capacitor mounting mounting hardware: (not included w/plate) SCREW, 6-32 x 3/4 inch, Fil HS, phillips SCREW, 6-32 x 7/8 inch, PHS NUT, keps, 6-32 x 5/16 inch |
| 14 | ----- ----- 211-0510-00 210-0006-00 | | | 10 - 1 1 | COIL mounting hardware for each: (not included w/coil) SCREW, 6-32 x 3/8 inch, PHS LOCKWASHER, internal, #6 |

CHASSIS (Cont'd)

| REF. NO. | PART NO. | SERIAL/MODEL NO. | | QTY. | DESCRIPTION |
|----------|-------------|------------------|-------|------|--|
| | | EFF. | DISC. | | |
| 15 | 348-0063-00 | | | 1 | GROMMET, plastic, .485 ID x 1/2 inch OD |
| 16 | 210-0201-00 | | | 9 | LUG, solder, SE #4 |
| | ----- | | | - | mounting hardware for each: (not included w/lug) |
| | 213-0044-00 | | | 1 | SCREW, thread forming, 5-32 x 3/16 inch, PHS, phillips |
| 17 | 131-0359-00 | | | 1 | CONNECTOR, feed through |
| | ----- | | | - | mounting hardware for each: (not included w/connector) |
| | 358-0176-00 | | | 1 | BUSHING, plastic |
| 18 | 131-0227-00 | 100 | 109 | 1 | CONNECTOR, stand off |
| | 131-0227-00 | 110 | | 2 | CONNECTOR, stand off |
| | ----- | | | - | mounting hardware: (not included w/connector) |
| | 358-0176-00 | | | 1 | BUSHING, plastic |
| 19 | 214-0210-00 | | | 1 | SPOOL, solder, w/solder |
| | ----- | | | - | spool includes: |
| | 214-0209-00 | | | 1 | SPOOL, solder |
| | ----- | | | - | mounting hardware: (not included w/spool) |
| | 361-0007-00 | | | 1 | SPACER, nylon |
| 20 | ----- | | | 1 | TRANSFORMER |
| | ----- | | | - | transformer includes: |
| 21 | 407-0204-00 | | | 1 | BRACKET, transformer support |
| 22 | 212-0517-00 | | | 4 | SCREW, 10-32 x 1 3/4 inches, HHS |
| | 210-0812-00 | | | 4 | WASHER, fiber, #10 |
| | 220-0410-00 | | | 4 | NUT, keps, 10-32 x 3/8 inch |
| 23 | ----- | | | - | mounting hardware: (not included w/transformer) |
| | 211-0507-00 | | | 2 | SCREW, 6-32 x 5/16 inch, PHS, phillips |
| | 210-0457-00 | | | 2 | NUT, keps, 6-32 x 5/16 inch |

BOARDS & REAR

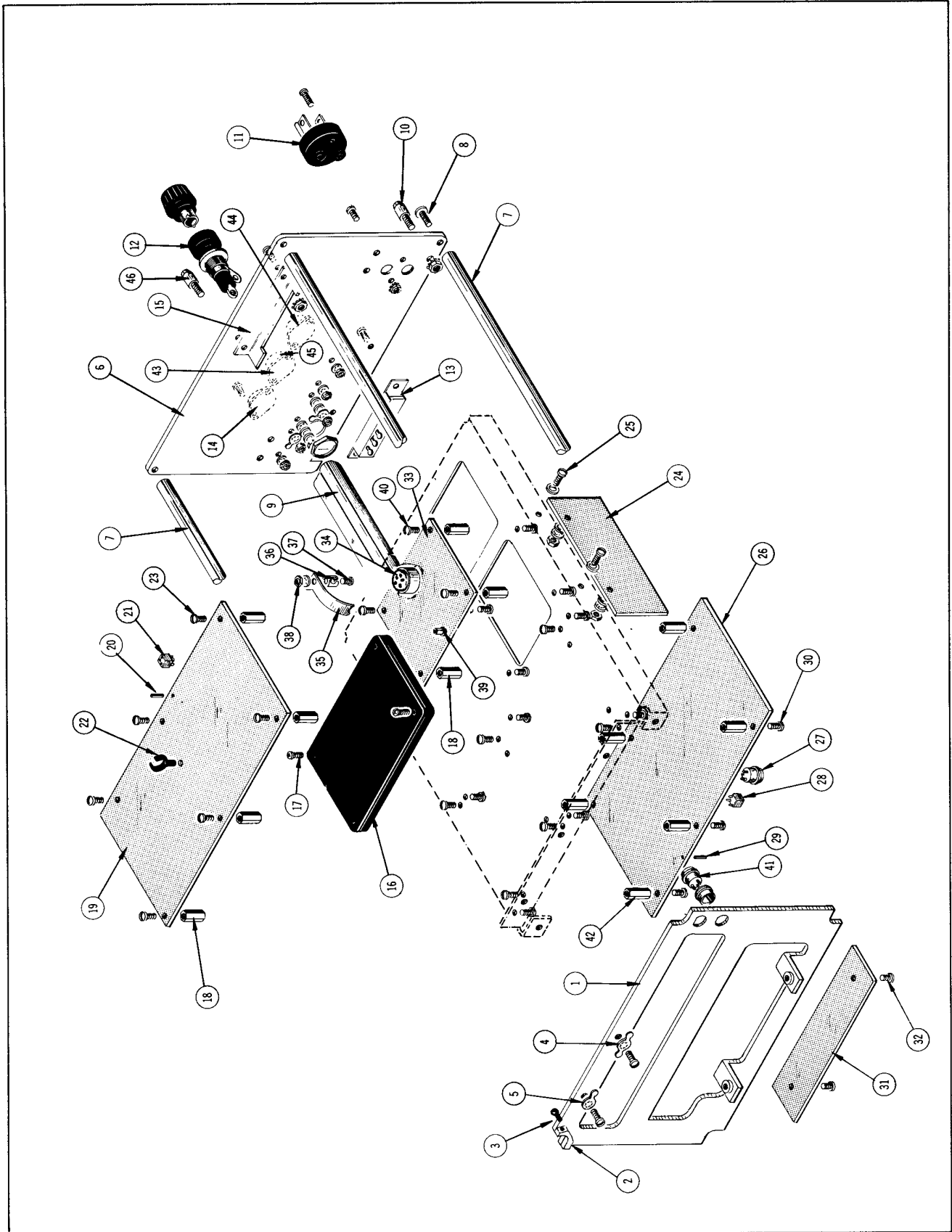

BOARDS & REAR

| REF. NO. | PART NO. | SERIAL/MODEL NO. | | QTY. | DESCRIPTION |
|----------|-------------|------------------|-------|------|--|
| | | EFF. | DISC. | | |
| 1 | 386-0153-00 | | | 1 | PLATE, bulkhead |
| | - - - - - | | | - | plate includes: |
| 2 | - - - - - | | | 4 | CLAMP |
| 3 | 211-0094-00 | | | 4 | SCREW, 6-32 x 1/4 inch, THS, phillips |
| 4 | 210-0204-00 | | | 1 | LUG, solder, DE #6 |
| | - - - - - | | | - | mounting hardware: (not included w/lug) |
| | 211-0503-00 | | | 1 | SCREW, 6-32 x 3/16 inch, PHS, phillips |
| 5 | 210-0202-00 | | | 1 | LUG, solder, SE #6 |
| | - - - - - | | | - | mounting hardware: (not included w/lug) |
| | 211-0503-00 | | | 1 | SCREW, 6-32 x 3/16 inch, PHS, phillips |
| 6 | 386-0155-00 | | | 1 | PLATE, rear |
| 7 | 384-0615-00 | | | 3 | ROD, spacing |
| 8 | 212-0044-00 | | | 4 | SCREW, 8-32 x 1/2 inch, RHS, phillips |
| 9 | 351-0096-00 | | | 1 | GUIDE, slide |
| | - - - - - | | | - | mounting hardware: (not included w/guide) |
| | 211-0538-00 | | | 2 | SCREW, 6-32 x 5/16 inch, FHS, phillips |
| 10 | 214-0680-00 | | | 1 | PIN, locating |
| | - - - - - | | | - | mounting hardware: (not included w/pin) |
| | 210-0457-00 | | | 1 | NUT, keps, 6-32 x 5/16 inch |
| 11 | 131-0430-00 | 100 | 1041 | 1 | CONNECTOR, motor base |
| | 131-0430-01 | 1042 | | 1 | CONNECTOR, motor base |
| | - - - - - | | | - | connector includes: |
| | 386-1044-00 | | | 1 | PLATE, mounting |
| | 200-0185-00 | 100 | 1041 | 1 | COVER, plastic. |
| | 200-0185-01 | 1042 | | 1 | COVER, plastic |
| | 377-0041-00 | 100 | 1041 | 1 | INSERT, plastic |
| | 377-0051-00 | 1042 | | 1 | INSERT, plastic |
| | 214-0078-00 | | | 1 | PIN, connecting |
| | 129-0041-00 | 100 | 1041 | 2 | PIN, connecting |
| | 129-0041-01 | 1042 | | 1 | POST, ground |
| | 211-0015-00 | 100 | 1041 | 1 | POST, ground |
| | 213-0088-00 | 1042 | | 1 | SCREW, 4-40 x 1/2 inch, RHS, phillips |
| | 210-0586-00 | 100 | 1041X | 1 | SCREW, thread forming, 4-40 x 1/4 inch, PHS |
| | 211-0132-00 | X1042 | | 2 | NUT, keps, 4-40 x 1/4 inch |
| | | | | 1 | SCREW, sems, 4-40 x 1/2 inch, PHS |
| 12 | 352-0002-00 | | | 1 | ASSEMBLY, fuse holder |
| | - - - - - | | | - | assembly includes: |
| | 352-0010-00 | | | 1 | HOLDER, fuse (with nut) |
| | 210-0873-00 | | | 1 | WASHER, rubber |
| | 200-0582-00 | | | 1 | CAP, fuse |
| 13 | 260-0747-00 | | | 1 | SWITCH, slide 115 V-230 V |
| | - - - - - | | | - | mounting hardware: (not included w/switch) |
| | 211-0008-00 | | | 2 | SCREW, 4-40 x 1/4 inch, PHS, phillips |
| | 210-0406-00 | | | 2 | NUT, hex., 4-40 x 3/16 inch |
| 14 | - - - - - | | | 1 | TRANSISTOR |
| | - - - - - | | | - | mounting hardware: (not included w/transistor) |
| | 211-0507-00 | | | 2 | SCREW, 6-32 x 5/16 inch, PHS |
| | 210-0006-00 | | | 1 | LOCKWASHER, internal #6 |
| | 210-0202-00 | | | 1 | LUG, solder, SE #6 |
| | 210-0407-00 | | | 2 | NUT, hex, 6-32 x 1/4 inch |

BOARDS & REAR (Cont'd)

| REF. NO. | PART NO. | SERIAL/MODEL NO. | | QTY. | DESCRIPTION |
|----------|-------------|------------------|-------|------|--|
| | | EFF. | DISC. | | |
| 15 | - - - - - | | | - | SUB-PART OF TRANSFORMER (see chassis view) |
| 16 | 119-0062-00 | | | 1 | ASSEMBLY, DELAY LINE |
| | - - - - - | | | - | mounting hardware: (not included w/assembly) |
| 17 | 211-0014-00 | | | 2 | SCREW, 4-40 x 1/2 inch, PHS, phillips |
| | 210-0586-00 | | | 2 | NUT, keps, 4-40 x 1/4 inch |
| 18 | 385-0080-00 | | | 10 | ROD, hex., 1/4 x 7/16 inch |
| | - - - - - | | | - | mounting hardware for each: (not included w/rod) |
| | 211-0507-00 | 100 | 219 | 1 | SCREW, 6-32 x 5/16 inch, PHS, phillips |
| | 211-0504-00 | 220 | | 1 | SCREW, 6-32 x 1/4 inch, PHS, phillips |
| | 210-0006-00 | | | 1 | LOCKWASHER, internal #6 |
| 19 | 670-0207-00 | | | 1 | ASSEMBLY, etched board, COUNTDOWN |
| | - - - - - | | | - | assembly includes: |
| | 388-0629-00 | | | 1 | BOARD, etched |
| | - - - - - | | | - | board includes: |
| 20 | 214-0506-00 | | | 22 | PIN, connector, straight |
| 21 | 136-0220-00 | | | 33 | SOCKET, transistor |
| 22 | 426-0121-00 | | | 2 | MOUNT, toroid |
| | 361-0007-00 | | | 2 | SPACER |
| | - - - - - | | | - | mounting hardware: (not included) |
| 23 | 211-0601-00 | | | 6 | SCREW, 6-32 x 5/16 inch, PHS, w/lockwasher |
| 24 | 670-0206-00 | | | 1 | ASSEMBLY, etched-wiring board, 500 MHz FILTER |
| | - - - - - | | | - | board includes: |
| | 388-0674-00 | | | 1 | BOARD, etched-wiring, unwired |
| | - - - - - | | | - | mounting hardware: (not included w/board) |
| 25 | 211-0507-00 | | | 2 | SCREW, 6-32 x 5/16 inch, PHS |
| | 210-0006-00 | | | 2 | LOCKWASHER, internal #6 |
| | 210-0802-00 | | | 2 | WASHER, 6S |
| | 210-0407-00 | | | 2 | NUT, hex, 6-32 x 1/4 inch |
| 26 | 670-0208-00 | | | 1 | ASSEMBLY, etched-wiring board, COUNTDOWN & POWER REGULATOR |
| | - - - - - | | | - | board includes: |
| 27 | 136-0183-00 | | | 8 | SOCKET, transistor |
| 28 | 136-0220-00 | | | 19 | SOCKET, transistor |
| | 388-0628-00 | | | 1 | BOARD, etched |
| | - - - - - | | | - | board includes: |
| 29 | 214-0506-00 | | | 22 | PIN, connector |
| | - - - - - | | | - | mounting hardware: (not included w/board) |
| 30 | 211-0601-00 | | | 6 | SCREW, assembly washer, 6-32 x .313 inch, PHB |
| 31 | 670-0204-00 | | | 1 | ASSEMBLY, etched-wiring board, 200 MHz |
| | - - - - - | | | - | board includes: |
| | 388-0631-00 | | | 1 | BOARD, etched-wiring, unwired |
| | - - - - - | | | - | mounting hardware: (not included w/board) |
| 32 | 211-0116-00 | | | 2 | SCREW, sems, 4-40 x 5/16 inch PHS phillips |

BOARDS & REAR (Cont'd)

| REF. NO. | PART NO. | SERIAL/ MODEL NO. | | QTY. | DESCRIPTION |
|----------|-------------|-------------------|-------|------|--|
| | | EFF. | DISC. | | |
| 33 | 670-0205-00 | | | 1 | ASSEMBLY, etched board, 500 MHz MULTIPLIER |
| | - - - - - | | | - | assembly includes: |
| | 388-0630-00 | | | 1 | BOARD, etched |
| | 214-0506-00 | | | 2 | PIN, connector, straight |
| 34 | 136-0125-00 | | | 2 | SOCKET, nuvistor, with ring |
| 35 | - - - - - | | | 1 | TANK, tuned, 2 ns |
| 36 | 344-0125-00 | | | 2 | CLIP, electrical |
| | - - - - - | | | - | mounting hardware for each: (not included w/cap) |
| 37 | 211-0008-00 | | | 1 | SCREW, 4-40 x 1/4 inch, PHS |
| | 210-0004-00 | | | 1 | LOCKWASHER, internal #4 |
| 38 | 210-0406-00 | | | 1 | NUT, hex., 4-40 x 3/16 inch |
| 39 | 131-0427-00 | | | 1 | CONNECTOR |
| | - - - - - | | | - | mounting hardware: (not included w/board) |
| 40 | 211-0601-00 | | | 4 | SCREW, 6-32 x 5/16 inch, PHS, w/lockwasher |
| 41 | 136-0181-00 | | | 2 | SOCKET, transistor |
| | 354-0234-00 | | | 2 | RING, transistor socket, mounting |
| 42 | 385-0146-00 | | | 6 | ROD, hex., 1/4 x 1 1/16 inch |
| | - - - - - | | | - | mounting hardware for each: (not included w/rod) |
| | 211-0507-00 | 100 | 219 | 1 | SCREW, 6-32 x 5/16 inch, PHS |
| | 211-0504-00 | 220 | | 1 | SCREW, 6-32 x 1/4 inch, PHS |
| | 210-0006-00 | | | 1 | LOCKWASHER, internal #6 |
| 43 | - - - - - | | | 1 | TRANSISTOR |
| | - - - - - | | | - | mounting hardware: (not included w/transistor) |
| | 386-0143-00 | | | 1 | PLATE, mica |
| | 210-0811-00 | | | 2 | WASHER, fiber, shouldered |
| | 210-0802-00 | | | 2 | WASHER, 6S x 5/16 inch |
| | 210-0006-00 | | | 1 | LOCKWASHER, internal #6 |
| | 210-0202-00 | | | 1 | LUG, solder, SE #6 |
| | 210-0407-00 | | | 2 | NUT, hex., 6-32 x 1/4 inch |
| | 211-0510-00 | | | 1 | SCREW, 6-32 x 3/8 inch, PHS |
| | 211-0511-00 | | | 1 | SCREW, 6-32 x 1/2 inch, PHS |
| 44 | - - - - - | | | 1 | TRANSISTOR |
| | - - - - - | | | - | mounting hardware: (not included w/transistor) |
| | 210-0006-00 | | | 2 | LOCKWASHER, internal #6 |
| | 210-0407-00 | | | 2 | NUT, hex., 6-32 x 1/4 inch |
| | 211-0507-00 | | | 2 | SCREW, 6-32 x 5/16 inch, PHS |
| 45 | 200-0669-00 | X160 | | 1 | COVER, transistor |
| 46 | 214-0680-00 | | | 1 | PIN, locating |

CERAMIC STRIPS & CABLE HARNESES

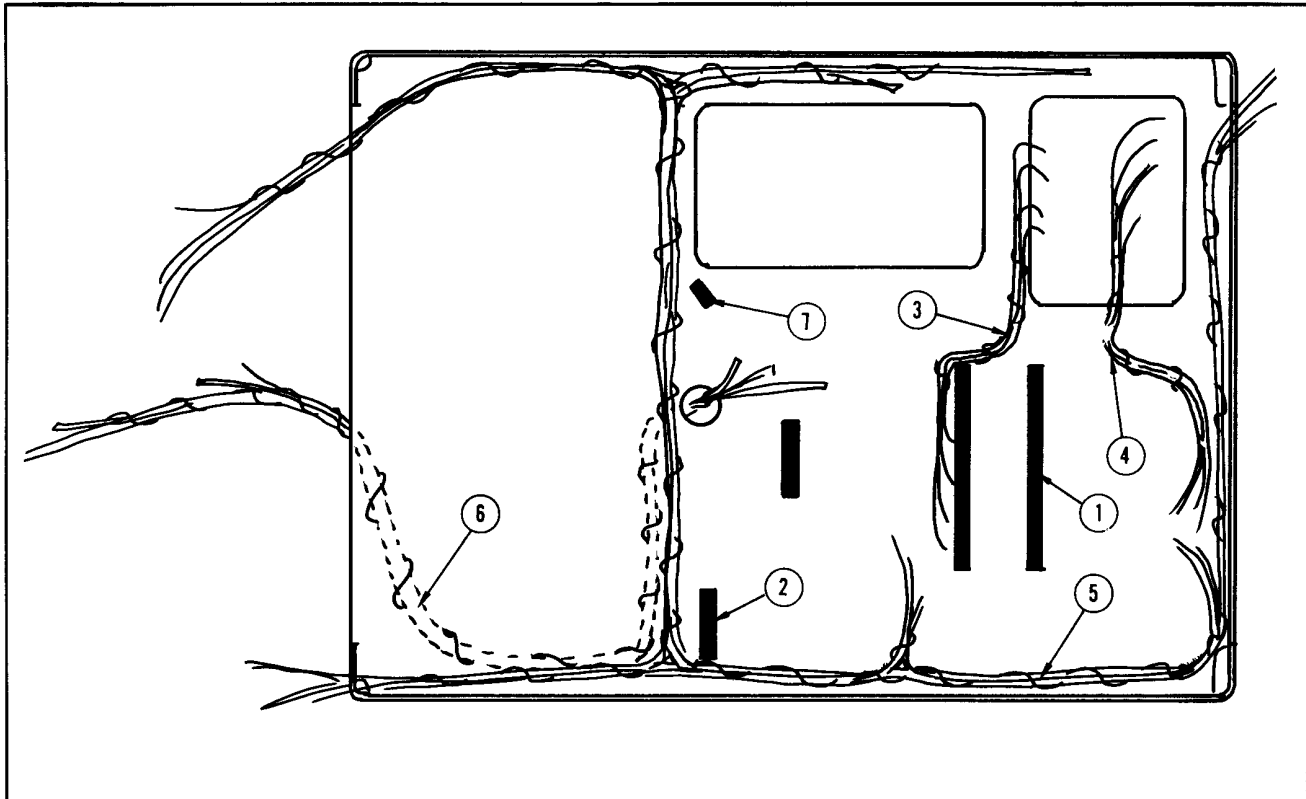

| REF. NO. | PART NO. | SERIAL/MODEL NO. | | QTY. | DESCRIPTION |
|----------|-------------|------------------|-------|------|--|
| | | EFF. | DISC. | | |
| 1 | 124-0146-00 | | | 2 | STRIP, ceramic, 16 notch |
| | ----- | | | - | each strip includes: |
| | 355-0046-00 | | | 2 | STUD, plastic |
| | ----- | | | - | mounting hardware for each: (not included w/strip) |
| | 361-0008-00 | | | 2 | SPACER, plastic |
| 2 | 124-0119-00 | | | 2 | STRIP, ceramic, 2 notch |
| | ----- | | | - | each strip includes: |
| | 355-0046-00 | | | 1 | STUD, plastic |
| | ----- | | | - | mounting hardware for each: (not included w/strip) |
| | 361-0008-00 | | | 1 | SPACER, plastic |
| 3 | 179-1005-00 | | | 1 | CABLE HARNESS, transformer |
| 4 | 179-1003-00 | | | 1 | CABLE HARNESS, power II |
| 5 | 179-1002-00 | | | 1 | CABLE HARNESS, power I |
| | ----- | | | - | cable harness includes: |
| | 131-0371-00 | | | - | CONNECTOR, single contact |
| 6 | 179-1004-00 | | | 1 | CABLE HARNESS, switch |
| | ----- | | | - | cable harness includes: |
| | 131-0371-00 | | | - | CONNECTOR, single contact |
| 7 | 124-0118-00 | 100 | 109X | 1 | STRIP, ceramic, 1 notch |
| | ----- | | | - | strip includes: |
| | 355-0046-00 | | | 1 | STUD, plastic |
| | ----- | | | - | mounting hardware: (not included w/strip) |
| | 361-0008-00 | | | 1 | SPACER, plastic |

CABINET

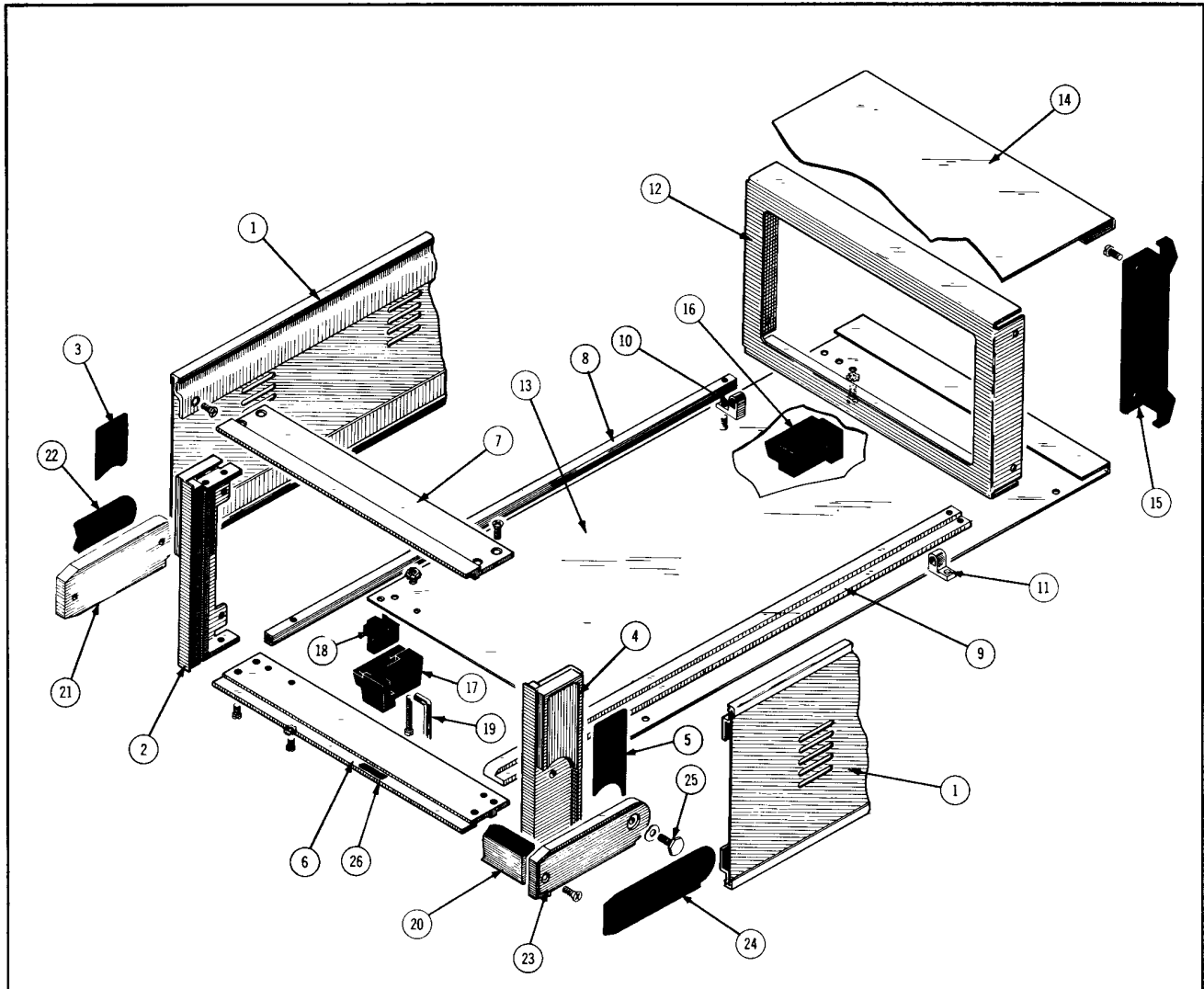

| REF. NO. | PART NO. | SERIAL/MODEL NO. | | QTY. | DESCRIPTION |
|----------|-------------|------------------|-------|------|---|
| | | EFF. | DISC. | | |
| - | 437-0078-00 | | | 1 | ASSEMBLY, cabinet assembly includes: |
| 1 | 386-0141-00 | | | 2 | PLATE, side |
| 2 | 426-0253-00 | | | 1 | FRAME, front left |
| 3 | 377-0121-00 | | | 1 | INSERT, decorative, left |
| 4 | 426-0252-00 | | | 1 | FRAME, front right |
| 5 | 377-0120-00 | | | 1 | INSERT, decorative, right |
| 6 | 426-0254-00 | | | 1 | FRAME, front bottom |
| | | | | - | mounting hardware: (not included w/frame) |
| | 212-0004-00 | | | 2 | SCREW, 8-32 x 5/16 inch, PHS, phillips |
| | 212-0002-00 | | | 2 | SCREW, 8-32 x 1/4 inch, FHS, phillips |
| 7 | 426-0255-00 | | | 1 | FRAME, front top |
| | | | | - | mounting hardware: (not included w/frame) |
| | 212-0002-00 | | | 4 | SCREW, 8-32 x 1/4 inch 100°, CSK, FHS, phillips |
| 8 | 351-0093-00 | | | 1 | GUIDE, left |
| | | | | - | mounting hardware: (not included w/guide) |
| | 212-0023-00 | | | 1 | SCREW, 8-32 x 3/8 inch, PHS, phillips |
| | 210-0007-00 | | | 1 | LOCKWASHER, external #8 |

CABINET (Cont'd)

| REF. NO. | PART NO. | SERIAL/MODEL NO. | | QTY. | DESCRIPTION |
|----------|-------------|------------------|-------|------|--|
| | | EFF. | DISC. | | |
| 9 | 351-0092-00 | | | 1 | GUIDE, right |
| 10 | 358-0293-01 | | | 1 | BUSHING, plug-in securing, left |
| | - - - - - | | | - | mounting hardware: (not included w/bushing) |
| | 211-0510-00 | | | 1 | SCREW, 6-32 x 3/8 inch, PHS, phillips |
| | 210-0005-00 | | | 1 | LOCKWASHER, external #6 |
| | 210-0457-00 | | | 1 | NUT, keps, 6-32 x 5/16 inch |
| | 212-0001-00 | | | 1 | SCREW, 8-32 x 1/4 inch, PHS, phillips |
| | 210-0007-00 | | | 1 | LOCKWASHER, external #8 |
| 11 | 358-0294-01 | | | 1 | BUSHING, plug-in securing, right |
| | - - - - - | | | - | mounting hardware: (not included w/bushing) |
| | 211-0510-00 | | | 1 | SCREW, 6-32 x 3/8 inch, PHS, phillips |
| | 210-0005-00 | | | 1 | LOCKWASHER, external #6 |
| | 212-0001-00 | | | 1 | SCREW, 8-32 x 1/4 inch, PHS, phillips |
| | 210-0007-00 | | | 1 | LOCKWASHER, external #8 |
| 12 | 386-0139-00 | | | 1 | PLATE, rear |
| 13 | 386-0140-00 | | | 1 | PLATE, bottom |
| 14 | 386-0138-00 | | | 1 | PLATE, top |
| 15 | 348-0075-00 | | | 2 | FOOT, rear guard |
| | - - - - - | | | - | mounting hardware for each: (not included w/foot) |
| | 212-0004-00 | | | 2 | SCREW, 8-32 x 5/16 inch, PHS, phillips |
| 16 | 348-0074-00 | | | 2 | FOOT, bail limiting, left rear-right front |
| | - - - - - | | | - | mounting hardware for foot, left rear: (not included w/foot) |
| | 211-0532-00 | | | 2 | SCREW, 6-32 x 3/4 inch, Fil HS, phillips |
| | 210-0457-00 | | | 1 | NUT, keps, 6-32 x 5/16 inch |
| | - - - - - | | | - | mounting hardware for foot, right front: (not included w/foot) |
| | 211-0532-00 | | | 2 | SCREW, 6-32 x 3/4 inch, Fil HS, phillips |
| 17 | 348-0073-00 | | | 2 | FOOT, bail limiting, right rear-left front |
| | - - - - - | | | - | mounting hardware for foot, right rear: (not included w/foot) |
| | 211-0532-00 | | | 2 | SCREW, 6-32 x 3/4 inch, Fil HS, phillips |
| | 210-0457-00 | | | 1 | NUT, keps, 6-32 x 5/16 inch |
| | - - - - - | | | - | mounting hardware for foot, left front: (not included w/foot) |
| | 211-0532-00 | | | 2 | SCREW, 6-32 x 3/4 inch, Fil HS, phillips |
| 18 | 377-0119-00 | | | 4 | INSERT, foot |
| 19 | 348-0072-00 | | | 1 | FOOT, flip stand bail |
| 20 | 367-0052-00 | | | 1 | HANDLE |
| | - - - - - | | | - | mounting hardware: (not included w/handle) |
| | 212-0040-00 | | | 2 | SCREW, 8-32 x 3/8 inch, 100°, CSK, FHS, phillips |
| 21 | 367-0051-00 | | | 1 | HANDLE, pivot, left |
| 22 | 377-0123-00 | | | 1 | INSERT, decorative, pivot, left |
| 23 | 367-0050-00 | | | 1 | HANDLE, pivot, right |
| 24 | 377-0122-00 | | | 1 | INSERT, decorative, pivot, right |
| 25 | 214-0554-00 | | | 2 | BOLT, hinge |
| | 214-0558-00 | | | 2 | WASHER, thrust |
| 26 | 334-1016-00 | | | 1 | TAG, identification |

STANDARD ACCESSORIES

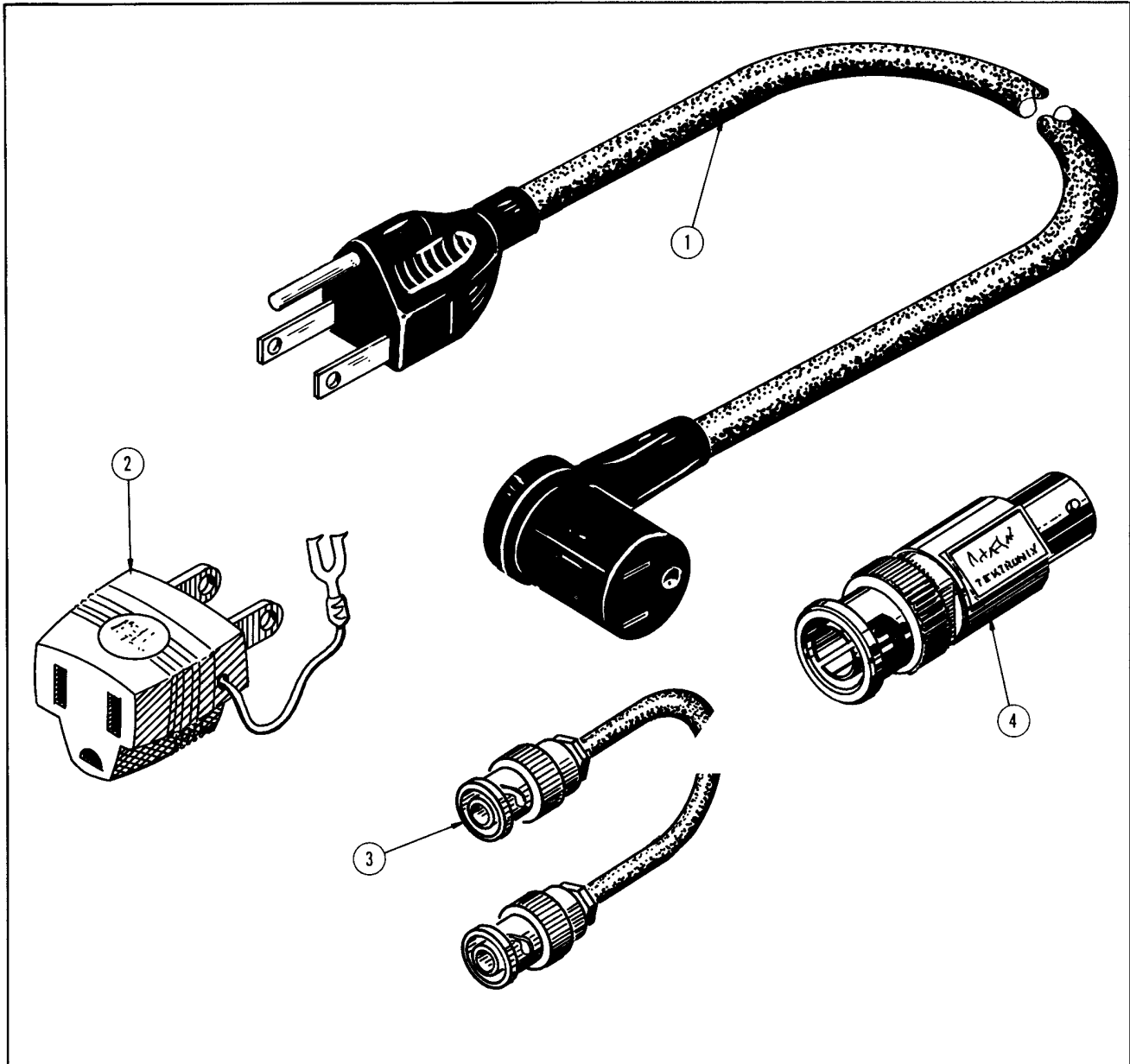

| REF. NO. | PART NO. | SERIAL/MODEL NO. | | QTY. | DESCRIPTION |
|----------|-------------|------------------|-------|------|---------------------------------|
| | | EFF. | DISC. | | |
| 1 | 161-0024-00 | 100 | 1999 | 1 | CORD, power |
| | 161-0024-01 | 2000 | | 1 | CORD, power |
| 2 | 103-0013-00 | | | 1 | ADAPTER, 3- to 2-wire |
| 3 | 012-0057-00 | 100 | 823 | 2 | CABLE, BNC |
| | 012-0057-01 | 824 | | 2 | CABLE, BNC |
| 4 | 011-0049-00 | | | 1 | TERMINATION, 50 Ω, BNC |
| | 070-0499-00 | | | 2 | MANUAL, instruction (not shown) |

VOLTAGE AND WAVEFORM CONDITIONS

Voltage readings were taken with a 20,000 ohms/volt VOM. All readings in volts. Voltages are measured with respect to chassis ground unless otherwise noted.

Waveforms shown are actual photographs taken with a Tektronix Oscilloscope Camera and Projected Graticule.







Voltages and waveforms on the schematics are not absolute and may vary between instruments. Any apparent difference between voltage levels measured with the voltmeter and those shown on the waveform are due to circuit loading by the voltmeter.

Waveforms for the high frequency circuits (10 MHz to 500 MHz) were taken with a sampling type test oscilloscope. The OUTPUT was terminated into 50 ohms. Waveforms for the .1 μ s to 5 s countdown circuits were taken with a real time test oscilloscope.

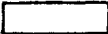
To indicate true time relationship between signals, the test oscilloscope was externally triggered.

Schematic Symbols

The following are used on the schematics:

| | |
|---|---|
|  | Screwdriver adjustment |
|  | Front-panel control or connector. |
|  | Clockwise control rotation in direction of arrow. |
|  | Connection made at indicated pin on etched-wiring board. |
|  | Connection soldered to etched-wiring board. |
|  | Blue line encloses components located on etched-wiring board. |
|  | Input from, or output to indicated schematic. |

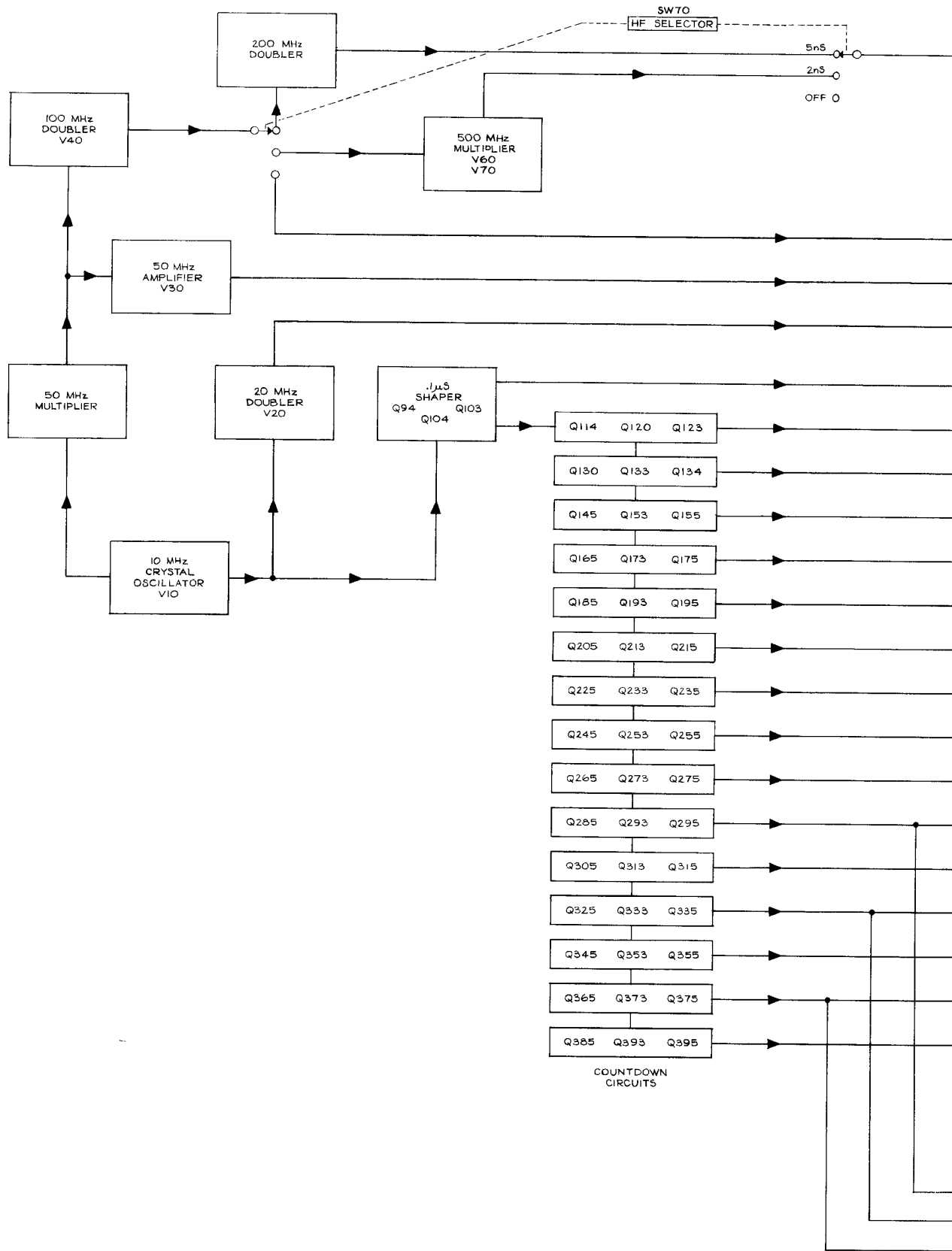

TYPE 184 TIME MARK GENERATOR

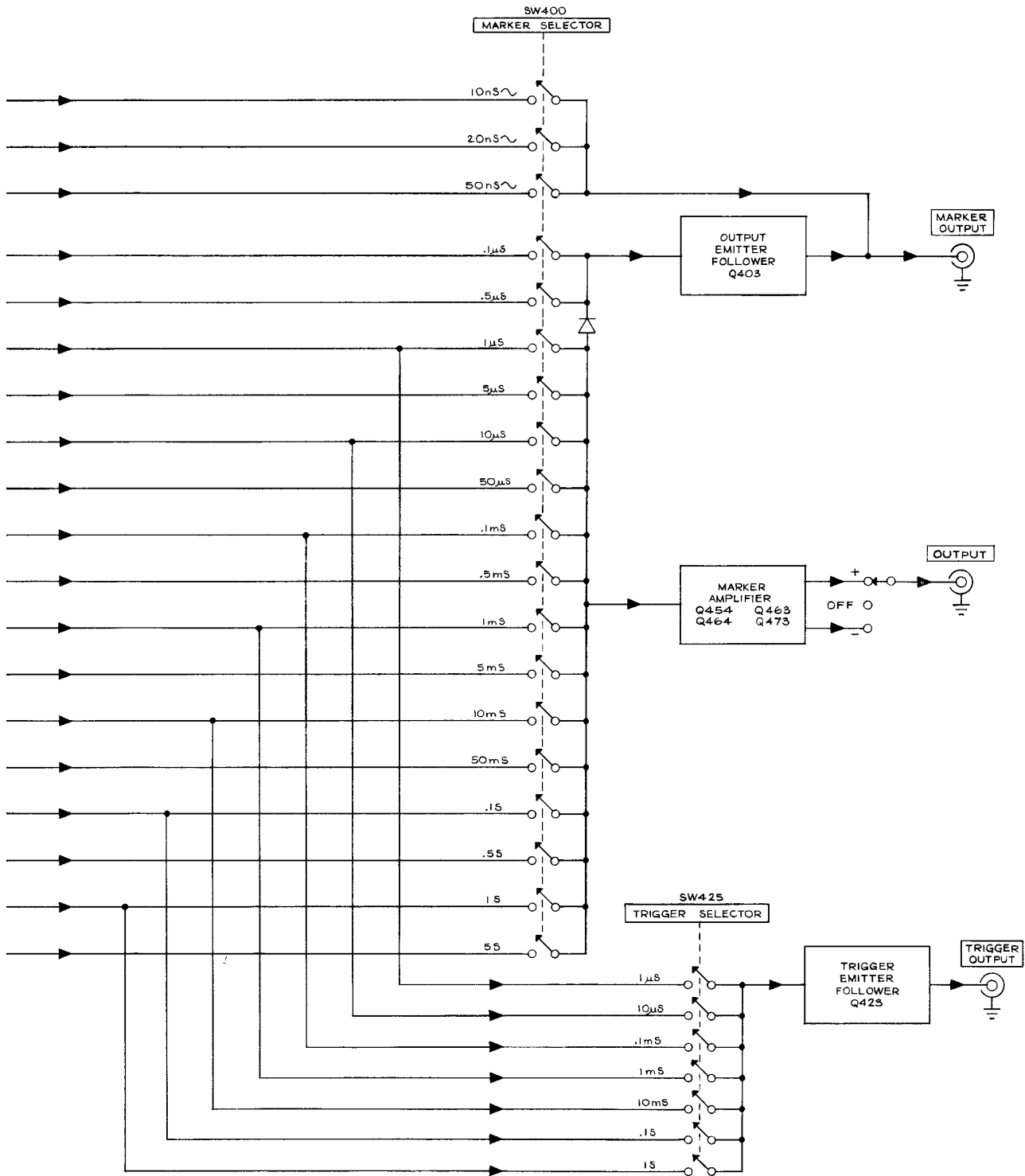
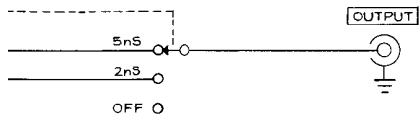

6N
965

BLOCK DIAGRAM

VOLTAGE & WAVEFORM CONDITIONS
←

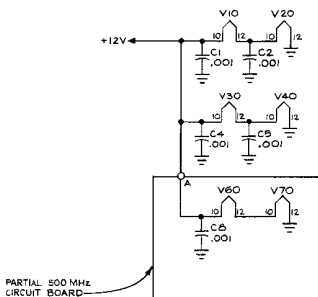

PARTIAL 500 MHz CIRCUIT BOARD



VOLTAGES obtained under conditions given on left side of this diagram.

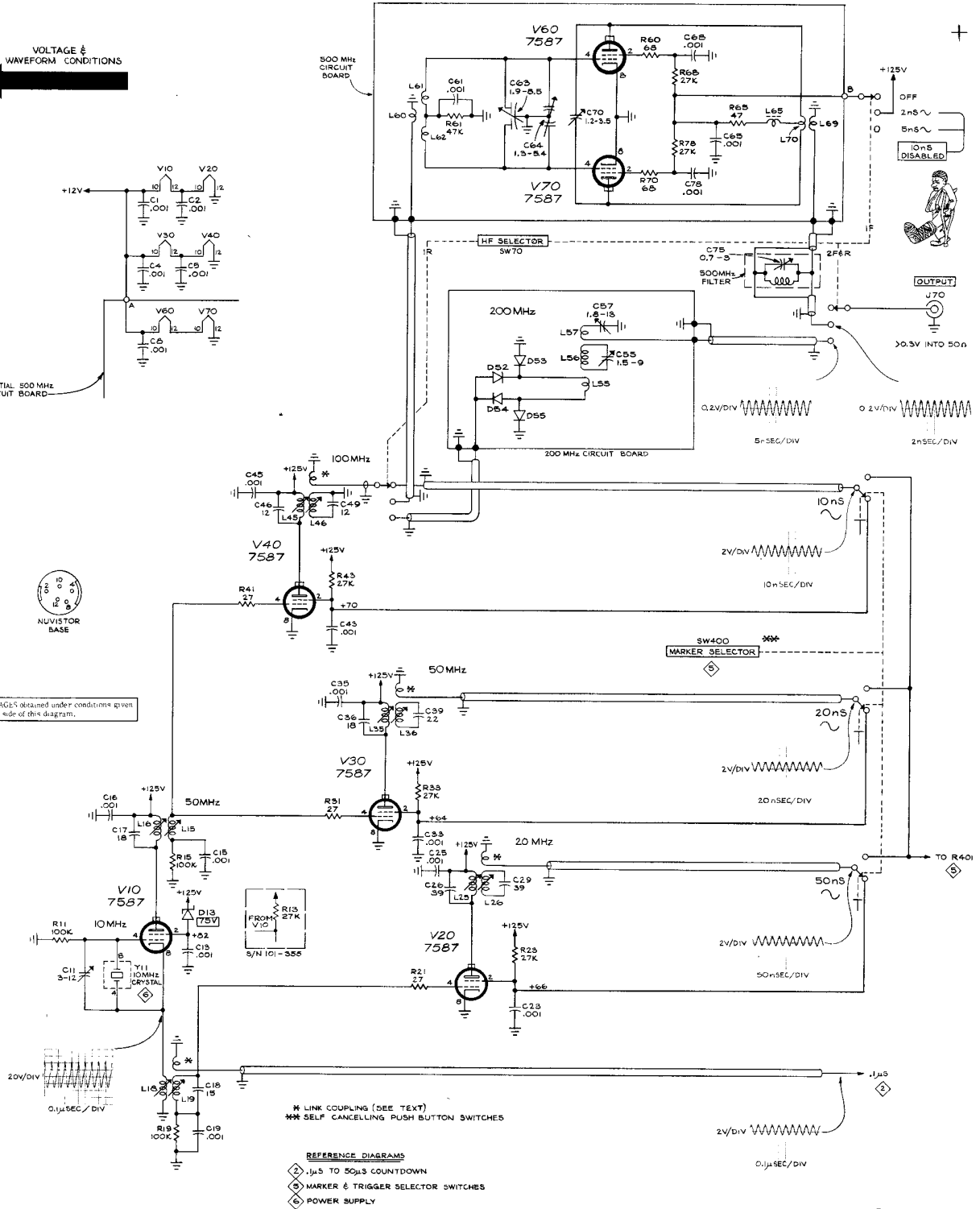

- * LINK COUPLING (SEE TEXT)
 ** SELF CANCELLING PUSH BUTTON SWITCHES
- REFERENCE DIAGRAMS
 ② 1µs TO 50µs COUNTDOWN
 ③ MARKER & TRIGGER SELECTOR SWITCHES
 ④ POWER SUPPLY

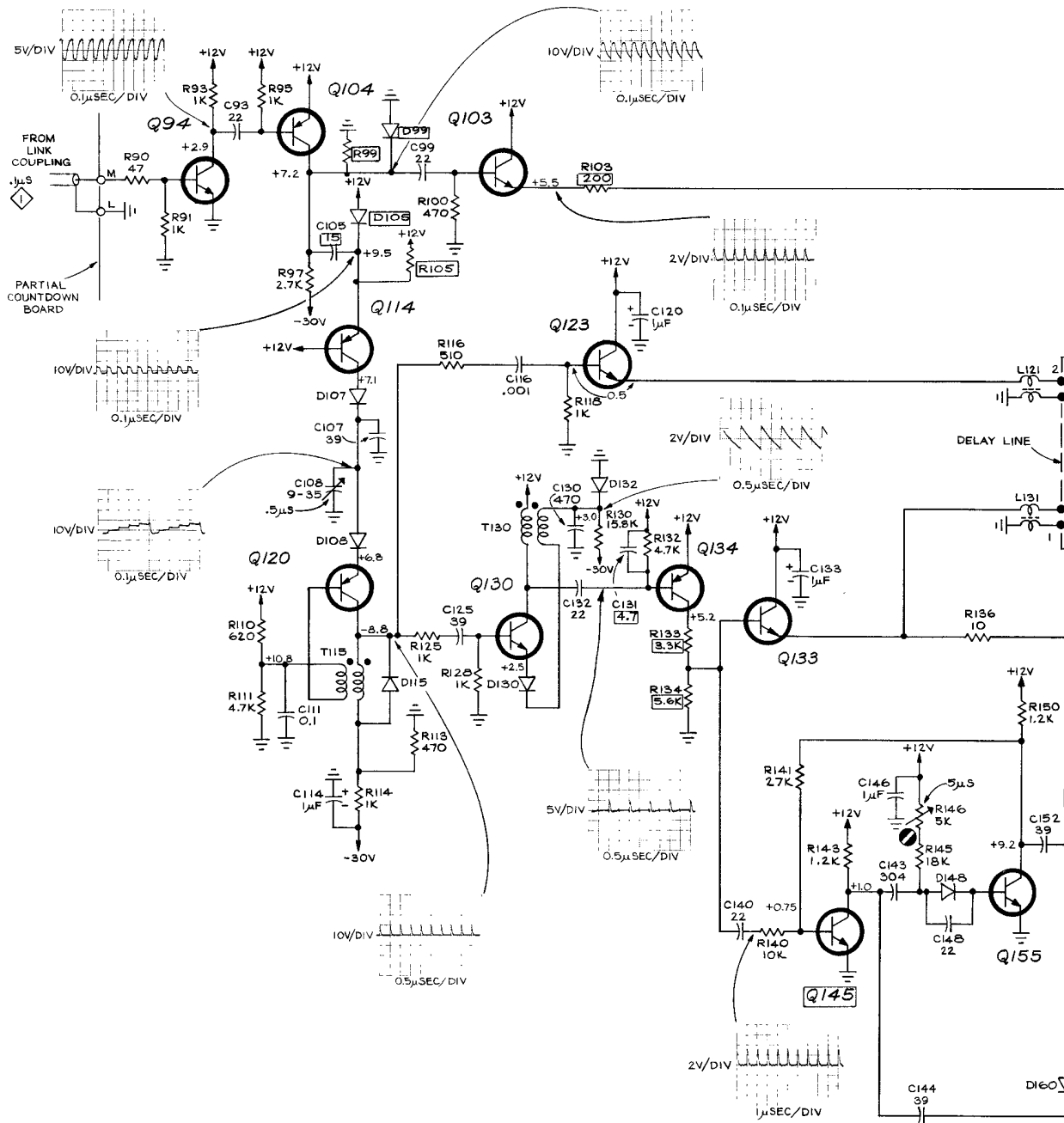

REFERENCE DIAGRAMS

- ① OSCILLATOR & MULTIPLIERS
- ③ .1ms TO 10ms COUNTDOWN
- ⑤ MARKER & TRIGGER SELECTOR SWITCHES

SEE PARTS LIST FOR SEMICONDUCTOR TYPES

*COLORED LEADS CONNECT THROUGH FERRITE BEAD TO GROUND

VOLTAGES obtained under conditions given on diagram ①.

SEE PARTS LIST FOR EARLIER VALUES AND SERIAL NUMBER RANGES OF PARTS MARKED WITH BLUE OUTLINE.

TYPE 184 TIME MARK GENERATOR

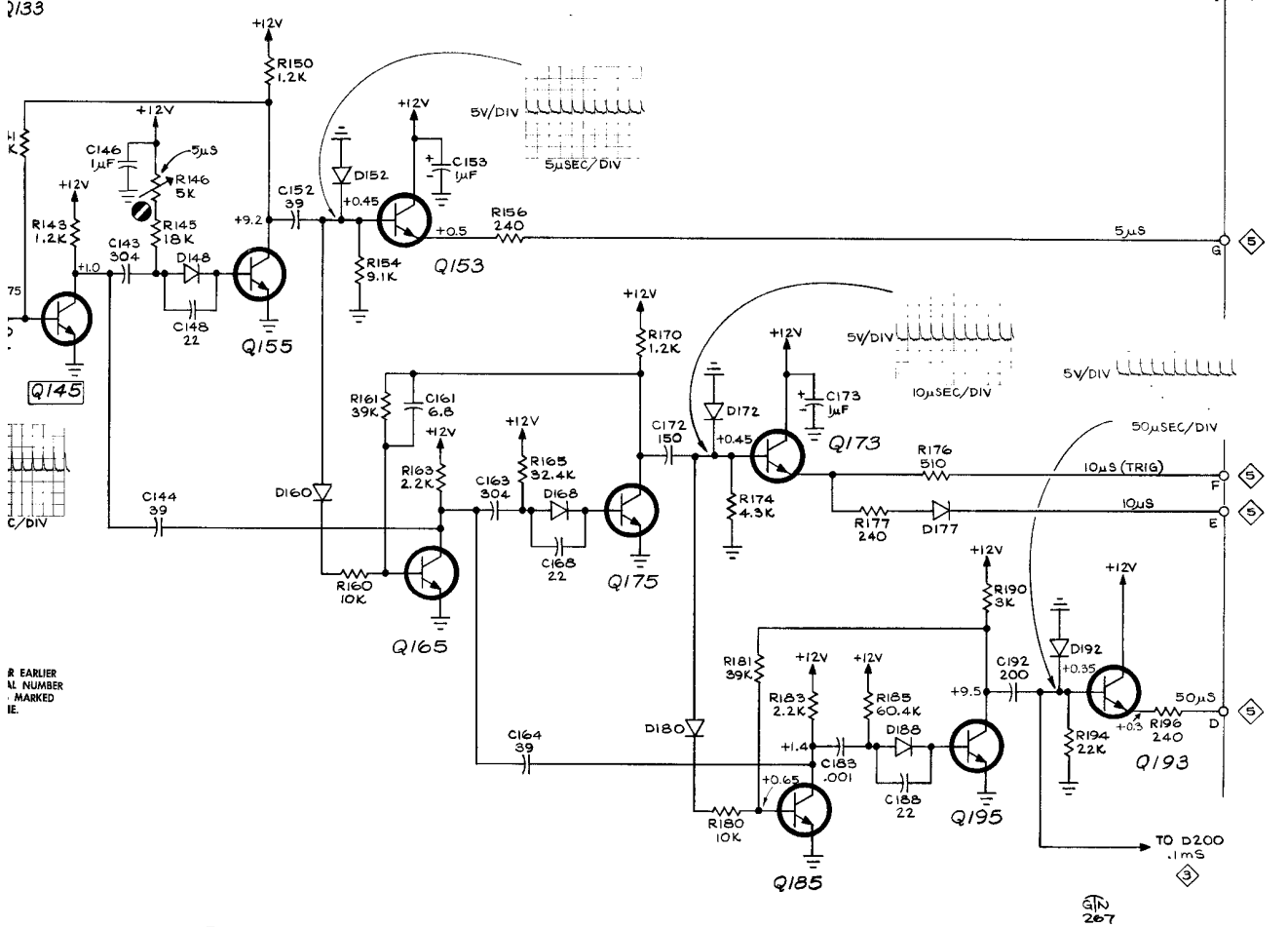
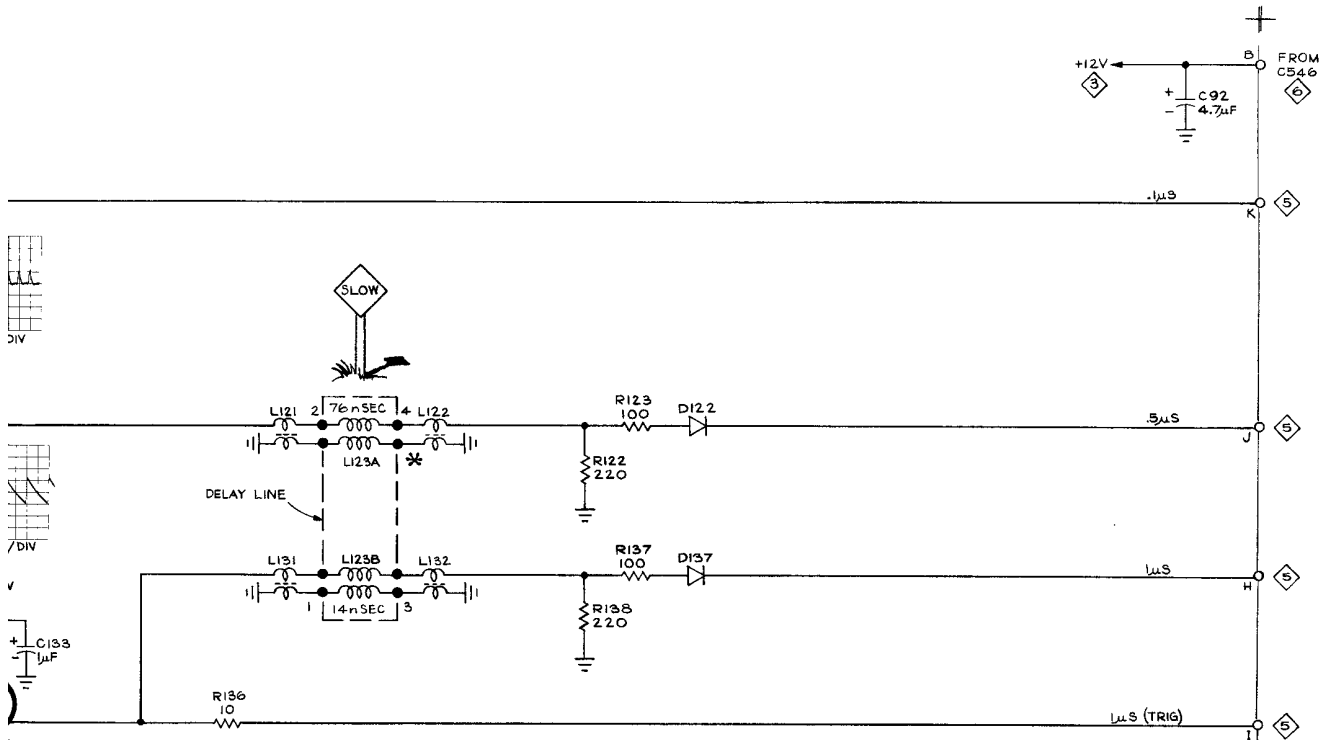

R EARLIER
 NUMBER
 MARKED
 IE.

.1μs TO 50μs COUNTDOWN 2

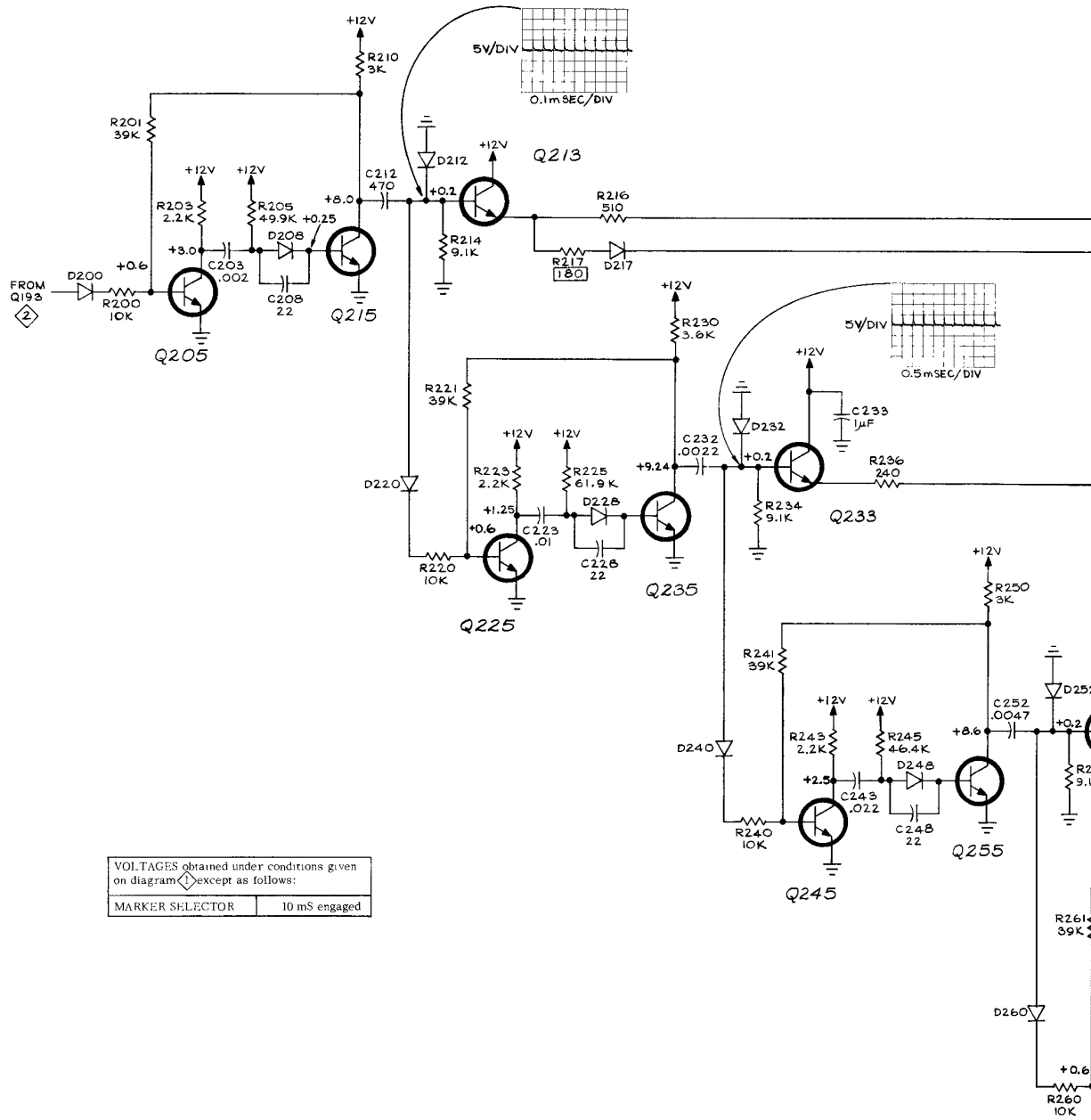

VOLTAGES obtained under conditions given on diagram ◊ except as follows:

| | |
|-----------------|---------------|
| MARKER SELECTOR | 10 mS engaged |
|-----------------|---------------|

REFERENCE DIAGRAMS

- ◊ 2 .1μS TO 50μS COUNTDOWN
- ◊ 4 50mS TO 5S COUNTDOWN
- ◊ 5 MARKER & TRIGGER SELECTOR SWITCHES

SEE PARTS LIST FOR SEMICONDUCTOR TYPES

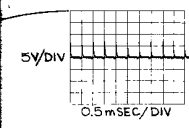
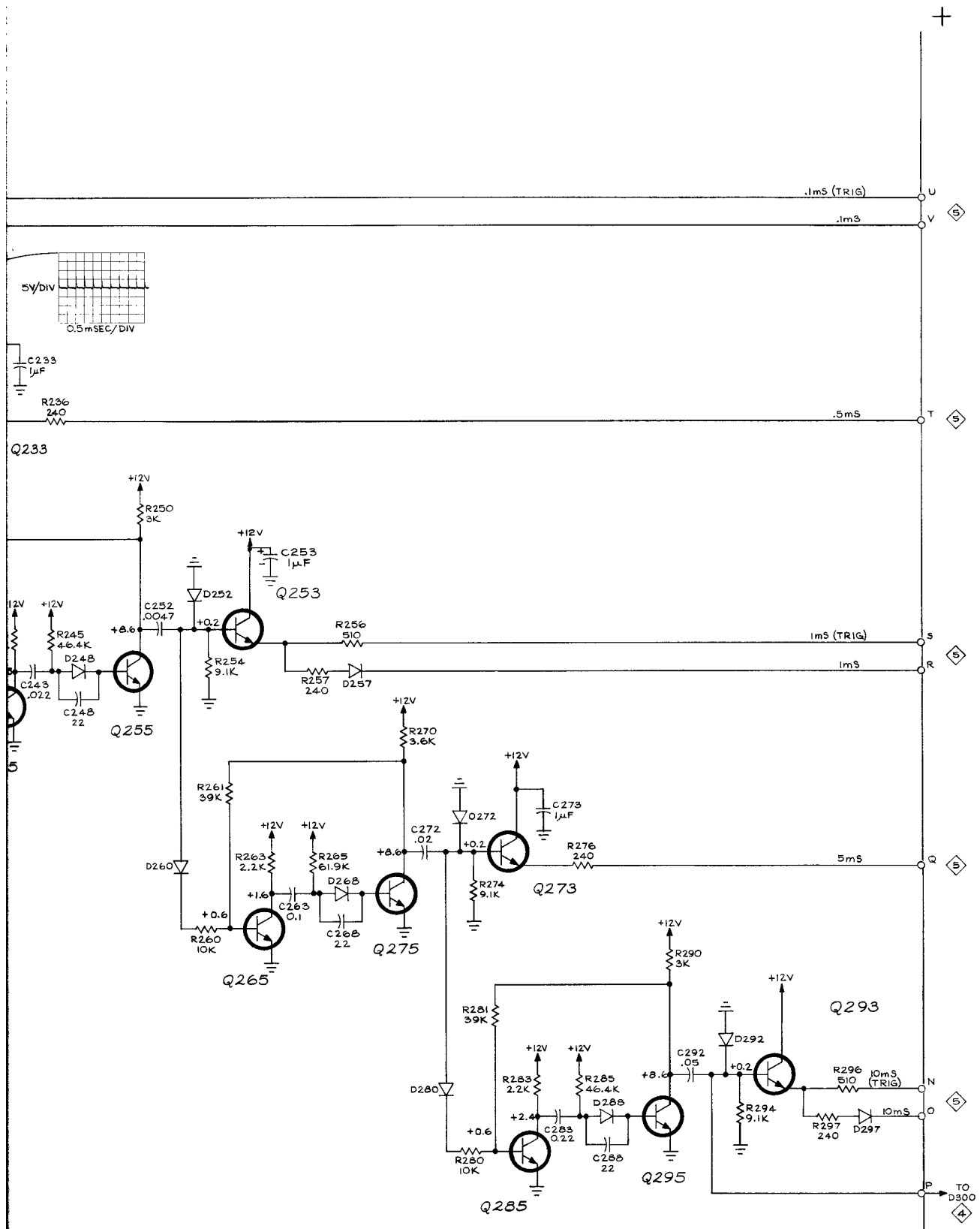

Q233

1mS TO 10mS COUNTDOWN

B

267

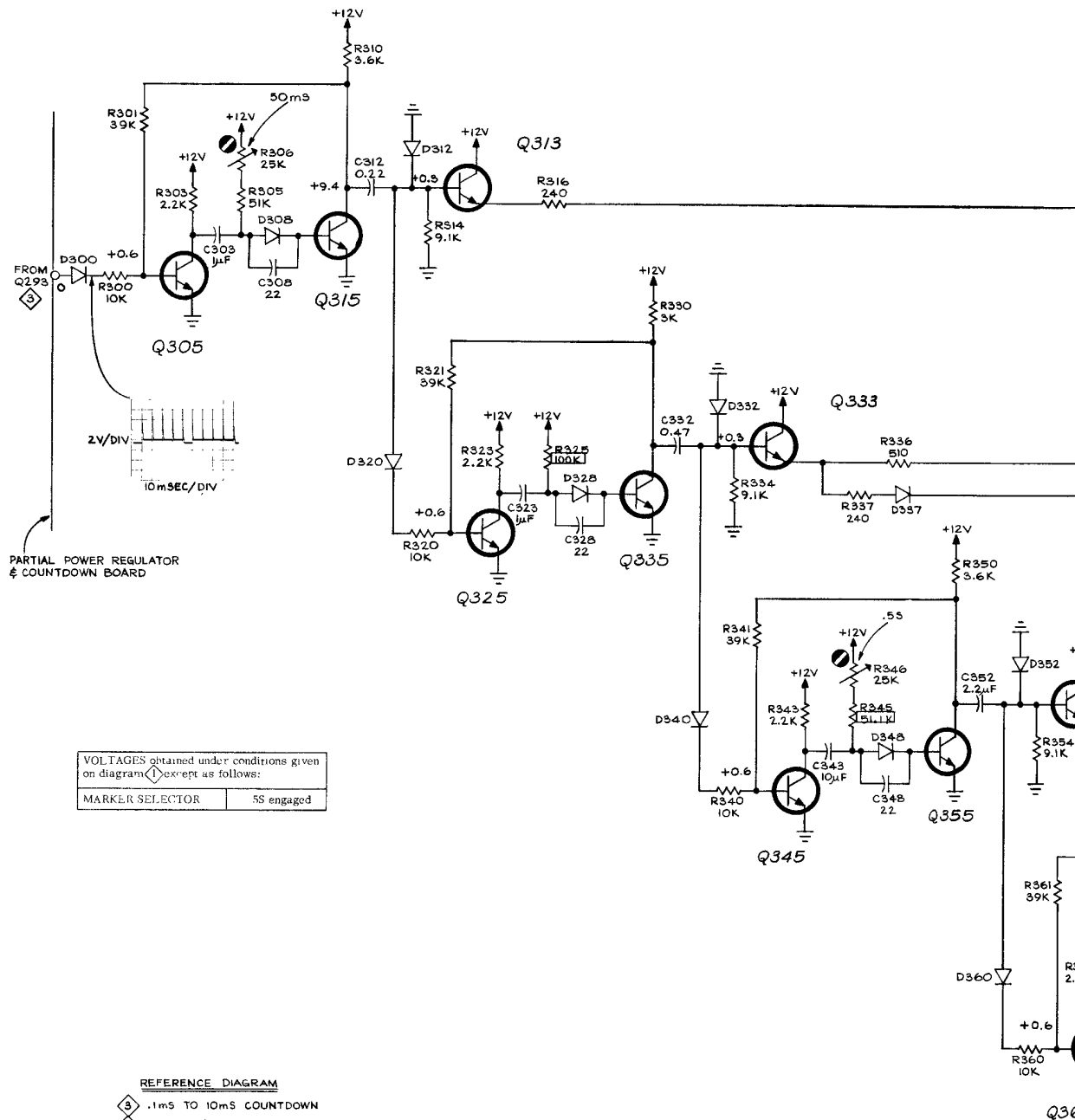

REFERENCE DIAGRAM
 3 .1ms TO 10ms COUNTDOWN
 5 MARKER & TRIGGER SELECTOR SWITCHES

SEE PARTS LIST FOR SEMICONDUCTOR TYPES

SEE PARTS LIST FOR EARLIER VALUES AND SERIAL NUMBER RANGES OF PARTS MARKED WITH BLUE OUTLINE.

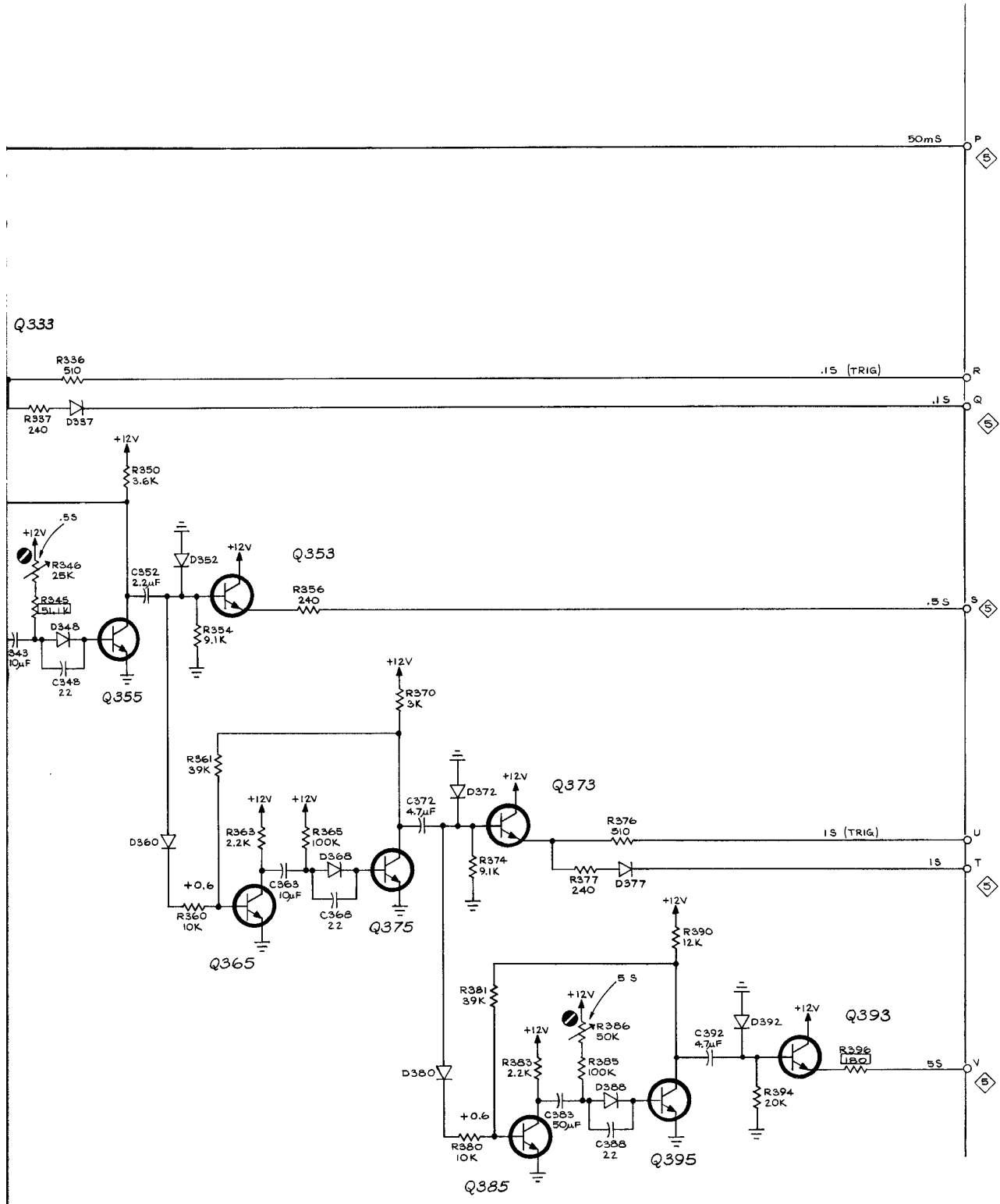

Q 333

50mS TO 5 S

COUNTDOWN 4

c

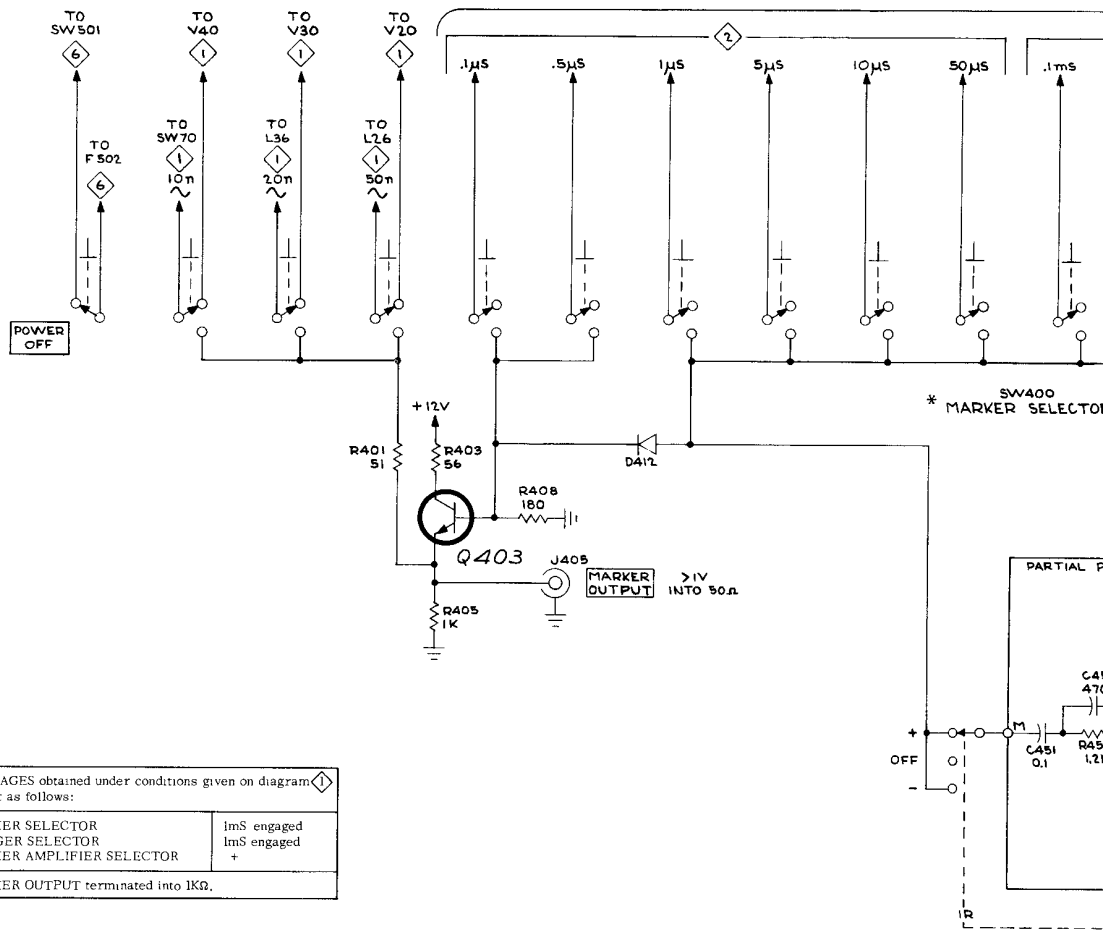

VOLTAGES obtained under conditions given on diagram (1) except as follows:

| | |
|---------------------------|-------------|
| MARKER SELECTOR | 1mS engaged |
| TRIGGER SELECTOR | 1mS engaged |
| MARKER AMPLIFIER SELECTOR | + |

MARKER OUTPUT terminated into 1KΩ.

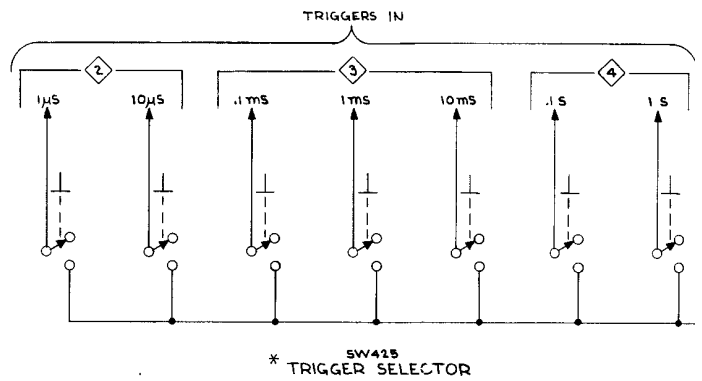

SEE PARTS LIST FOR SEMICONDUCTOR TYPES

* SELF CANCELLING PUSH BUTTON SWITCHES

+

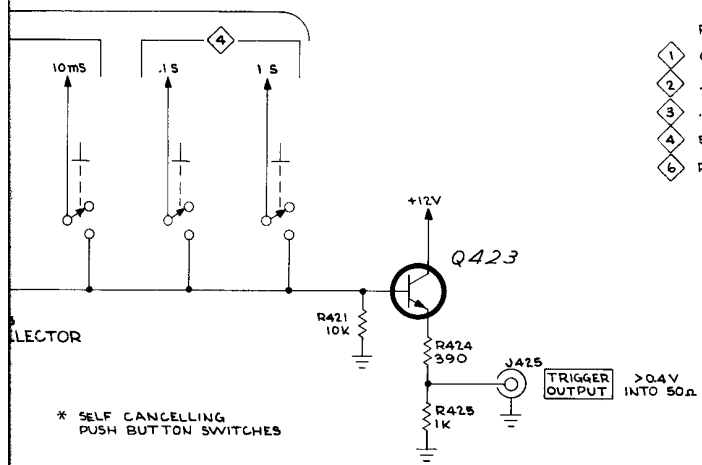
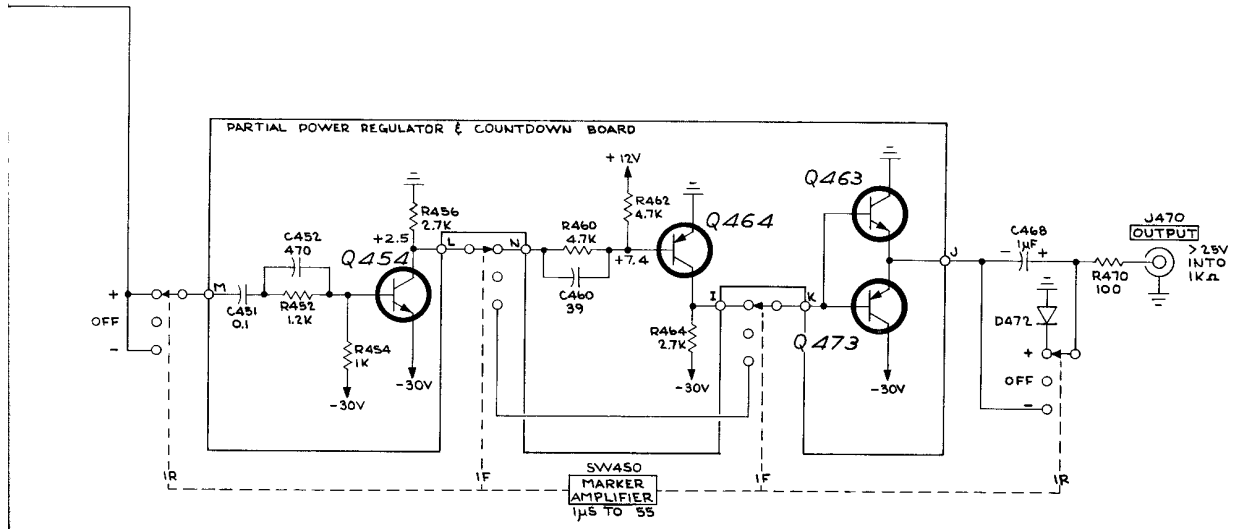
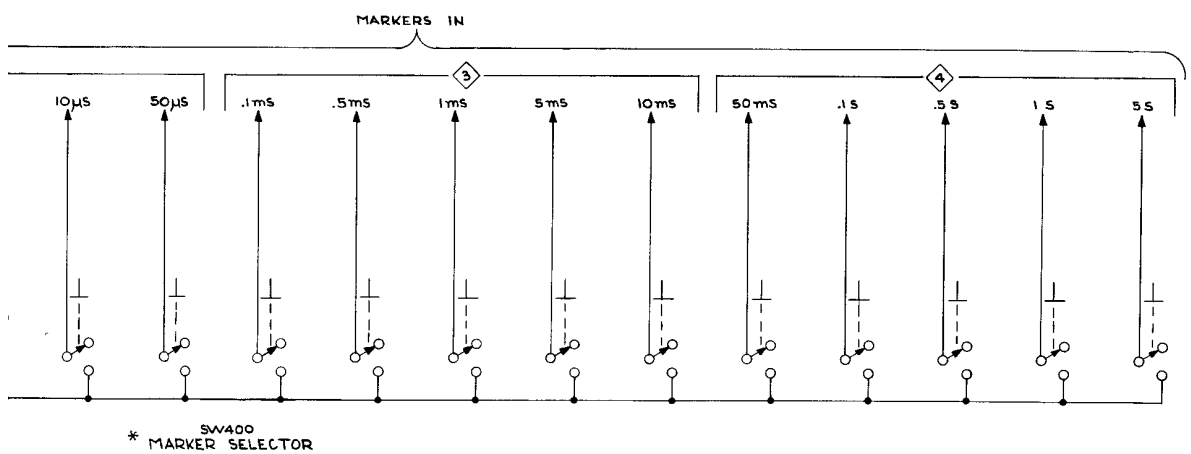

- REFERENCE DIAGRAMS
- 1 OSCILLATOR & MULTIPLIERS
 - 2 .1µs TO 50µs COUNTDOWN
 - 3 .1ms TO 10ms COUNTDOWN
 - 4 50ms TO 5s COUNTDOWN
 - 6 POWER SUPPLY

865
MARKER AMPLIFIER
MARKER AND TRIGGER SELECTOR SWITCHES

A₁

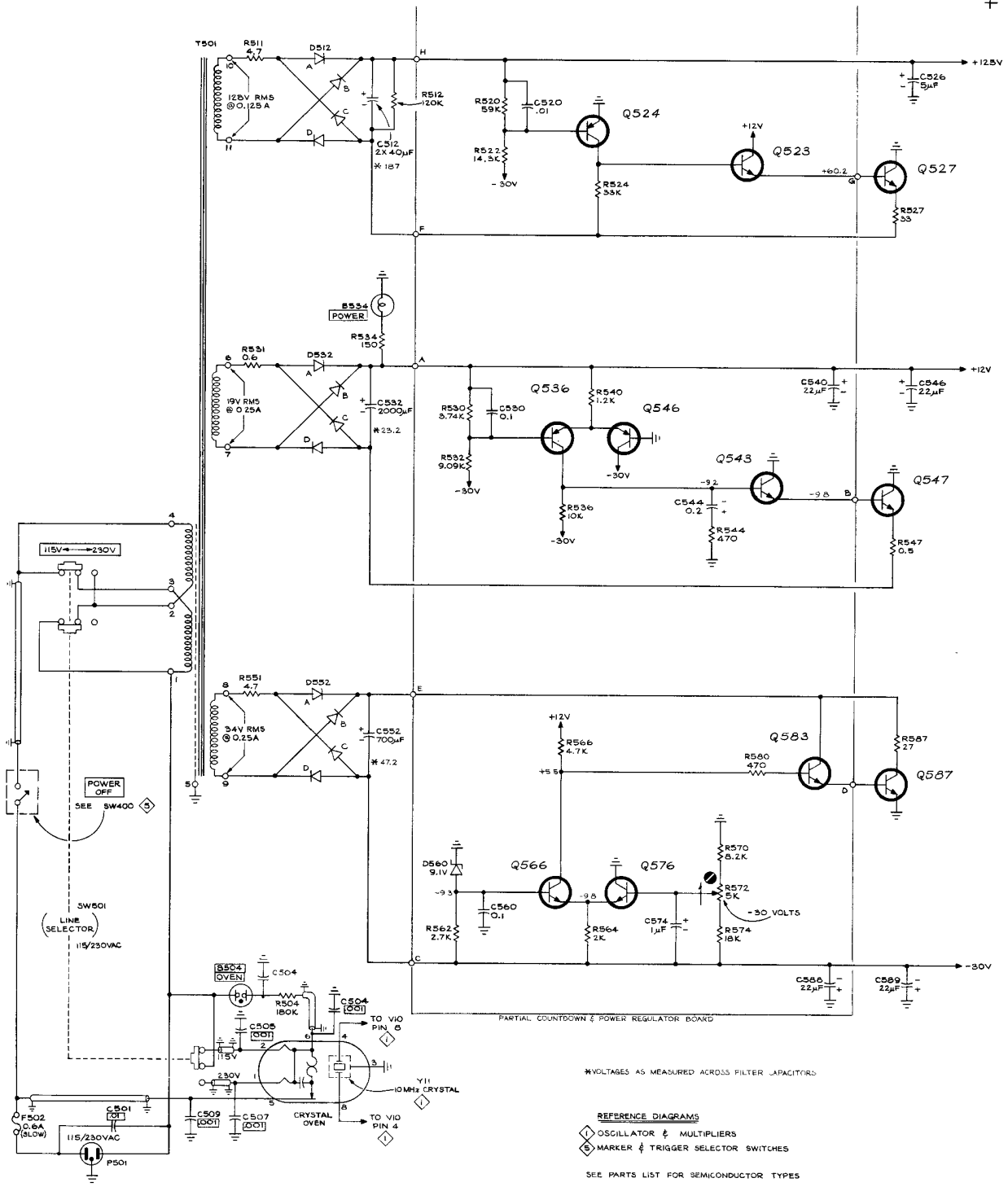

PARTIAL COUNTDOWN & POWER REGULATOR BOARD

*VOLTAGES AS MEASURED ACROSS FILTER CAPACITORS

REFERENCE DIAGRAMS
 ◇ OSCILLATOR & MULTIPLIERS
 ◇ MARKER & TRIGGER SELECTOR SWITCHES
 SEE PARTS LIST FOR SEMICONDUCTOR TYPES

Vol. 1, GTS, guaranteed under conditions shown on diagram

TYPE 104 TIME MARK GENERATOR

POWER SUPPLY

MANUAL CHANGE INFORMATION

At Tektronix, we continually strive to keep up with latest electronic developments by adding circuit and component improvements to our instruments as soon as they are developed and tested.

Sometimes, due to printing and shipping requirements, we can't get these changes immediately into printed manuals. Hence, your manual may contain new change information on following pages. If it does not, your manual is correct as printed.

TEXT CORRECTION

SECTION 1 CHARACTERISTICS

Page 1-1, column 2

Trigger Output

Amplitude ≥ 0.4 V into 50 Ω or ≥ 2.5 V into open circuit.

Other Characteristics

Crystal Oscillator Crystal contained in a temperature controlled oven at 75°C.

Frequency 10 MHz $\pm 0.001\%$ (25°C $\pm 5^\circ\text{C}$), 10 MHz $\pm 0.002\%$ (0°C to +50°C) 5 minutes after turn-on if crystal oven is stabilized (instrument connected to power source for 2 hours).

Stability ≤ 3 P/M in 24 hours (25°C $\pm 5^\circ\text{C}$) after 2 hours continuous operation and 72 hours initial operation.

Power Requirements 94.5 to 137.5 VAC or 189 to 275 VAC. 50 to 400 Hz. 40 watts approximate.

Warm-up Time Two hours warm-up time required after the instrument is connected to a power source, to allow crystal oven to stabilize. 5 minutes for rated accuracies at 25°C $\pm 5^\circ\text{C}$ (if crystal oven is stabilized).

SECTION 5 PERFORMANCE CHECK

Page 5-1, column 2

Step 2 a

Change: Requirement—Frequency 10 MHz ± 100 Hz at ambient room temperature.

Page 5-3, column 2

Step 6 a

Change: Requirement—Positive-going pulses in 1-10 sequence, amplitude ≥ 0.4 V into 50 Ω or ≥ 2.5 V into open circuit.

SECTION 6 CALIBRATION

Page 6-5, column 2

Step 3 c

Change: Check—regulation and ripple of the power supplies while changing the input supply voltage between 94.5 to 137.5 VAC (or 189 to 275 VAC).
Power supply.....

Page 6-15, column 2

Step 9 a

Change: Requirement—Positive-going pulses with 7 intervals in 1 to 10 sequence, from 1 μ s to 1 s, and an amplitude ≥ 0.4 V into 50 Ω or ≥ 2.5 V into an open circuit.

TYPE 184

TEXT CORRECTION

Section 1 Characteristics

Page 1-1 column 2

CHANGE: Other Characteristics to read:

Stability Frequency drift ≤ 3 P/M in 24 hours (25°C $\pm 5^\circ\text{C}$)
after 2 hours continuous operation and 72 hours
initial operation.

Section 5 Performance Check

Page 5-3 column 2

CHANGE: Step 6 a to read:

Requirement-- Positive-going pulses in 1-10 sequence,
amplitude ≥ 0.4 V into 50 Ω or ≥ 2.5 V into open circuit.

C2/867

TYPE 184

TENT SN 2200

PARTS LIST CORRECTION

CHANGE TO:

B534

150-0065-00

Incandescent, 10 V, 40 mA

TYPE 184

TENT SN 2060

PARTS LIST CORRECTION

CHANGE TO:

| | | | | |
|------|-------------|------------|-------|------------|
| R325 | 321-0385-00 | 100 k | 1/8 W | 1 % |
| R345 | 323-0357-00 | 51.1 k | 1/2 W | 1 % |
| C323 | 290-0183-00 | 1 μ F | 20 V | \pm 10 % |
| C343 | 290-0301-00 | 10 μ F | 20 V | \pm 10 % |