

INSTRUCTION MANUAL

Serial Number _____

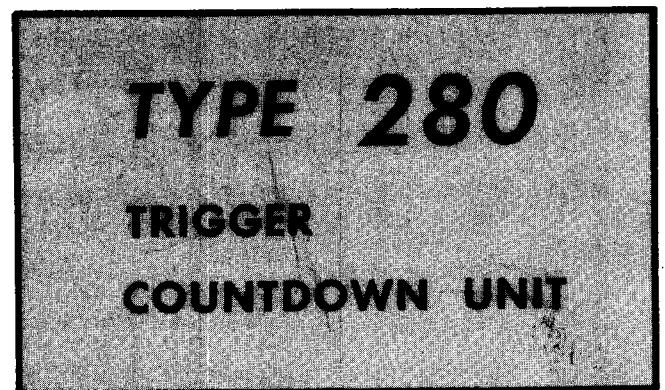

Tektronix, Inc.

S.W. Millikan Way ● P. O. Box 500 ● Beaverton, Oregon ● Phone MI 4-0161 ● Cables: Tektronix

Tektronix International A.G.

Terrassenweg 1A ● Zug, Switzerland ● PH. 042-49192 ● Cable: Tekintag, Zug Switzerland ● Telex 53.574

K4XL's BAMA

This manual is provided **FREE OF CHARGE** from the "BoatAnchor Manual Archive" as a service to the Boatanchor community.

It was uploaded by someone who wanted to help you repair and maintain your equipment.

If you paid anyone other than BAMA for this manual, you paid someone who is making a profit from the free labor of others without asking their permission.

You may pass on copies of this manual to anyone who needs it. But do it without charge.

Thousands of files are available without charge from BAMA. Visit us at <http://bama.sbc.edu>

Uploaded By:
Jerry J. Ingordo
W2JI



WARRANTY

All Tektronix instruments are warranted against defective materials and workmanship for one year. Tektronix transformers, manufactured in our own plant, are warranted for the life of the instrument.

Any questions with respect to the warranty mentioned above should be taken up with your Tektronix Field Engineer.

Tektronix repair and replacement-part service is geared directly to the field, therefore all requests for repairs and replacement parts should be directed to the Tektronix Field Office or Representative in your area. This procedure will assure you the fastest possible service. Please include the instrument Type and Serial number with all requests for parts or service.

Specifications and price change privileges reserved.



CONTENTS

Warranty

- Section 1 Characteristics
- Section 2 Operating Instructions
- Section 3 Circuit Description
- Section 4 Calibration and Maintenance
- Section 5 Parts List and Schematics

Copyright © 1963 by Tektronix, Inc.,
Beaverton, Oregon. Printed in the United
States of America. All rights reserved.
Contents of this publication may not be re-
produced in any form without permission
of the copyright owner.

TYPE 280
TRIGGER COUNTDOWN
UNIT

SERIAL



COARSE

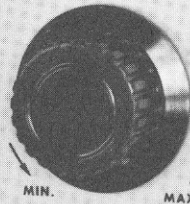

OUTPUT
REPETITION
RATE

USE HIGHEST PERMISSIBLE
OUTPUT REPETITION RATE
FOR LEAST JITTER

FINE

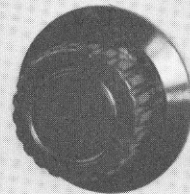

POWER
ON



PWR. ● FUSE ●

TEKTRONIX, INC., PORTLAND, OREGON, U.S.A.

SECTION 1

CHARACTERISTICS

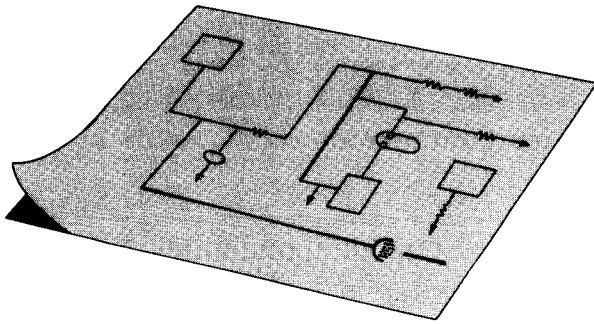

Introduction

The Type 280 Trigger Countdown Unit is designed primarily for use with Tektronix sampling time-base systems. It can also be used with Tektronix Type 530, 540, 550, and 580 Series Oscilloscopes. The Type 280 will synchronize the trigger circuits in the sampling time-base units at frequencies up to 5 gigacycles (5×10^9 cycles per second).

The instrument counts down from the frequency of the input signal and supplies a 15- to 45-megacycle output frequency to trigger the time-base units. This permits the trigger circuit of the sampling system or conventional oscilloscopes to lock in solidly with a much higher input signal frequency.

The Type 280 is shielded to permit operation in areas that have significant rf radiation levels.

Characteristics

Input Impedance

About 50 ohms.

Output Impedance

Both outputs drive 50-ohm loads. FAST RISE TRIGGER OUTPUT is reverse terminated in 50 ohms.

Input Signal Requirements

Amplitude: 50 millivolts to 4 volts, peak-to-peak.

Frequency: 30 megacycles to 5 gigacycles.

Maximum dc input: ± 2 volts.

Output Frequency

Continuously variable from 15 megacycles to 45 megacycles.

Output Signal Amplitude

At LARGE AMPLITUDE TRIGGER OUTPUT connector: 1.5 volts minimum into 50 ohms, peak, with a risetime not exceeding 4 nanoseconds (for use with Tektronix Type N Sampling Plug-In Unit or Type 530, 540, 550, or 580 Series Oscilloscopes).

At FAST RISE TRIGGER OUTPUT connector: 150 millivolts minimum into 50 ohms, peak, with a risetime not

exceeding 0.4 nanoseconds (for use with the Type 3T77 Sampling Sweep Plug-In Units or Type 5T1 Timing Unit).

Amplitude of Trigger Output Seen at Input Connector

100 millivolts peak-to-peak (maximum)*.

Line Power Requirements

Line Voltage: 117 or 234 volts (instrument may be wired for either voltage).

Frequency: 60 to 800 cps.

Nominal Wattage: 10 watts.

Power Supply Regulation

When wired for 117-volt operation, the Type 280 will regulate properly on line voltages from 105 to 125 volts. When wired for 234-volt operation, the instrument will regulate properly on line voltages from 210 to 250 volts.

Line Fuse

0.1-ampere, slow-blowing type fuse for either 117- or 234-volt operation.

Dimensions

7" x 6" x 4".

Weight

4.5 pounds.

Construction

Aluminum chassis and housing.

Front-panel is photo-etched, anodized aluminum.

Accessories

	Tektronix Part Number
1 — 3-wire power adapter	103-013
1 — Power cord	161-015
2 — Instruction manuals	070-350

* 175 millivolts for instruments below SN 230.

SECTION 2

OPERATING INSTRUCTIONS

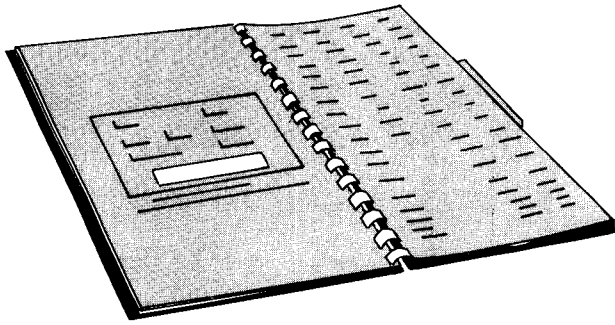

General

This section of the manual describes operating considerations for the Type 280, including conversion of the line transformer to either 117- or 234-volt operation, cable considerations, proper hookup, and front-panel operation with the various types of Tektronix instruments.

The Type 280 is a frequency countdown device that is responsive to input signal frequencies from 30 megacycles to 5 gigacycles. The counted down output signal of the Type 280 is intended as a triggering pulse for oscilloscope time-base trigger circuits.

Line Voltage

A metal tag or silk screen near the power receptacle indicates the proper operating voltage of your Type 280. However, the operating voltage of the instrument can be converted to 117-volt or 234-volt operation by changing the wiring on the line transformer. The power transformer has two 117-volt primary windings connected in parallel for 117-volt operation and in series for 234-volt operation. To convert the line transformer from 117-volt to 234-volt operation, remove the jumper wires between pins 1 and 2 and between 3 and 4 on the transformer. Reconnect

one of the jumper wires between pins 2 and 3. Connect the yellow wire with a brown stripe to pin 4 and the two yellow wires with brown and green stripes to pin 1 (see Fig. 2-1). The transformer is now wired for 234-volt operation; however, the male plug of the Type 280 power cord will probably have to be replaced with one that mates with a 234-volt type of receptacle.

To convert the line transformer from 234-volt to 117-volt operation, remove the jumper wire between pins 2 and 3 on the line transformer. Then connect a jumper wire between pins 1 and 2 and another jumper between pins 3 and 4. Connect the two yellow wires with brown and green stripes to pin 1 and the yellow wire with a brown stripe to pin 4 (see Fig. 2-1).

Cable Considerations

Make all connections to and from the Type 280 Trigger Countdown Unit through short lengths of low-loss coaxial cable. This is especially important when coupling high frequencies to the SYNC INPUT connector.

The Type 280 Input and Output Connectors have an impedance of 50 ohms. Therefore, it is advisable to use coaxial cables or suitable devices that match the 50-ohm connector impedance.

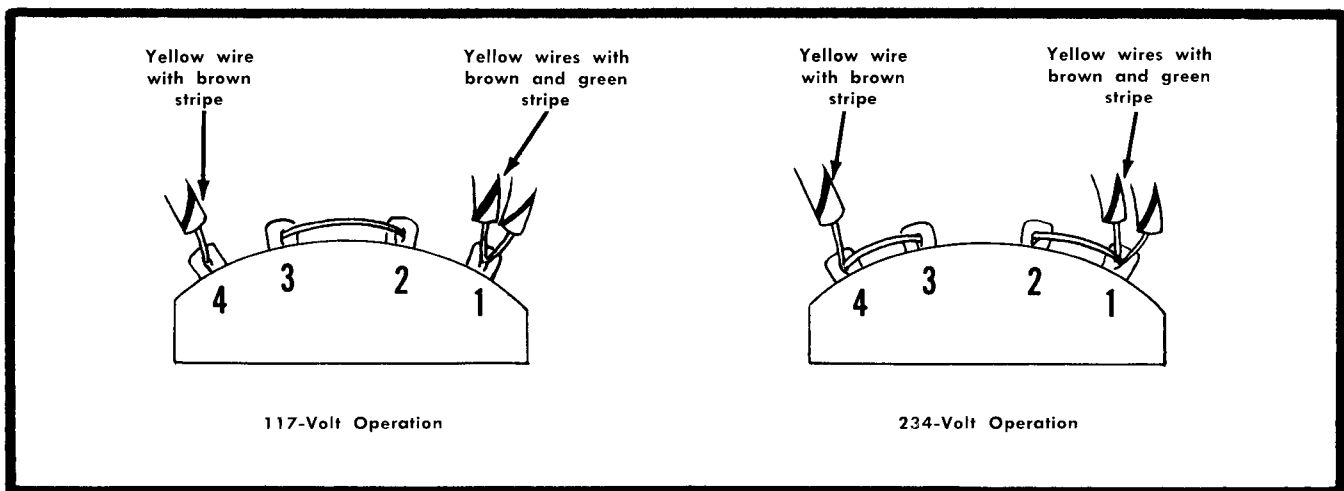

Fig. 2-1. Line transformer connections for 117- and 234-volt operation.

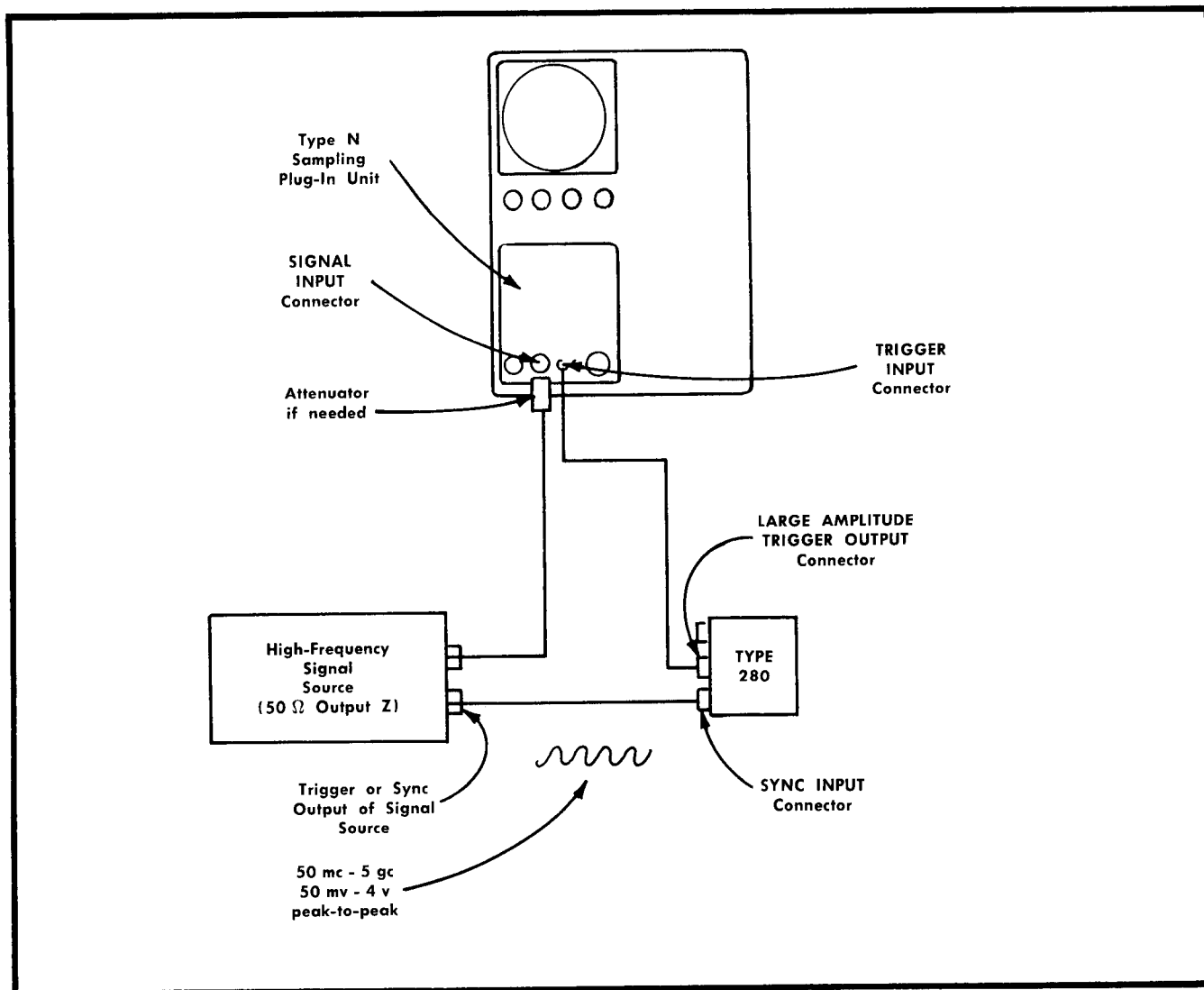

Fig. 2-2. The Type 280 Trigger Countdown Unit connected for use with Tektronix Type N Sampling Plug-In Unit.

Signal and Sync Connections

Figs. 2-2 through 2-7 show various connection techniques employing the Type 280 with several other Tektronix instruments. Do not make connections to the Type 280 other than those shown. Otherwise, improper synchronization may result.

Fig. 2-2 illustrates the proper connections to use with the Tektronix Type N Sampling Plug-In Unit. The Type N Unit requires at least a 0.5-volt trigger signal at its TRIGGER INPUT connector. Other Tektronix sampling systems trigger on the lower amplitude signal present at the Type 280 FAST RISE TRIGGER OUTPUT connector. Signal delay cable is not necessary with the Type N at high repetition signals (above 100 mc).

Fig. 2-3 illustrates one method for connecting the Type 280 to the Tektronix Type 3S76/3T77 sampling system. The

attenuator shown in the line between the signal source and the input of the vertical sampling plug-in unit is only required for the signal amplitudes above about 1.6 volts, peak-to-peak. Also, in cases where the trigger or sync signal from the signal source exceeds 4 volts, peak-to-peak, an appropriate attenuator must be added to the Type 280 SYNC INPUT connector. However, because of the high sensitivity of the Type 280, an attenuator will improve termination accuracy and reduce the amount of trigger kick-back voltage from the SYNC INPUT connector even when the sync signal is less than 4 volts.

Fig. 2-4 shows a second connection method that may be used with both the Type 3S76/3T77 and the Type 4S1/5T1 dual-trace sampling systems. If knowing whether there is stable triggering in the sampling system is important, this method works well. However, the method shown in Fig. 2-3 offers a slightly better triggering environment.

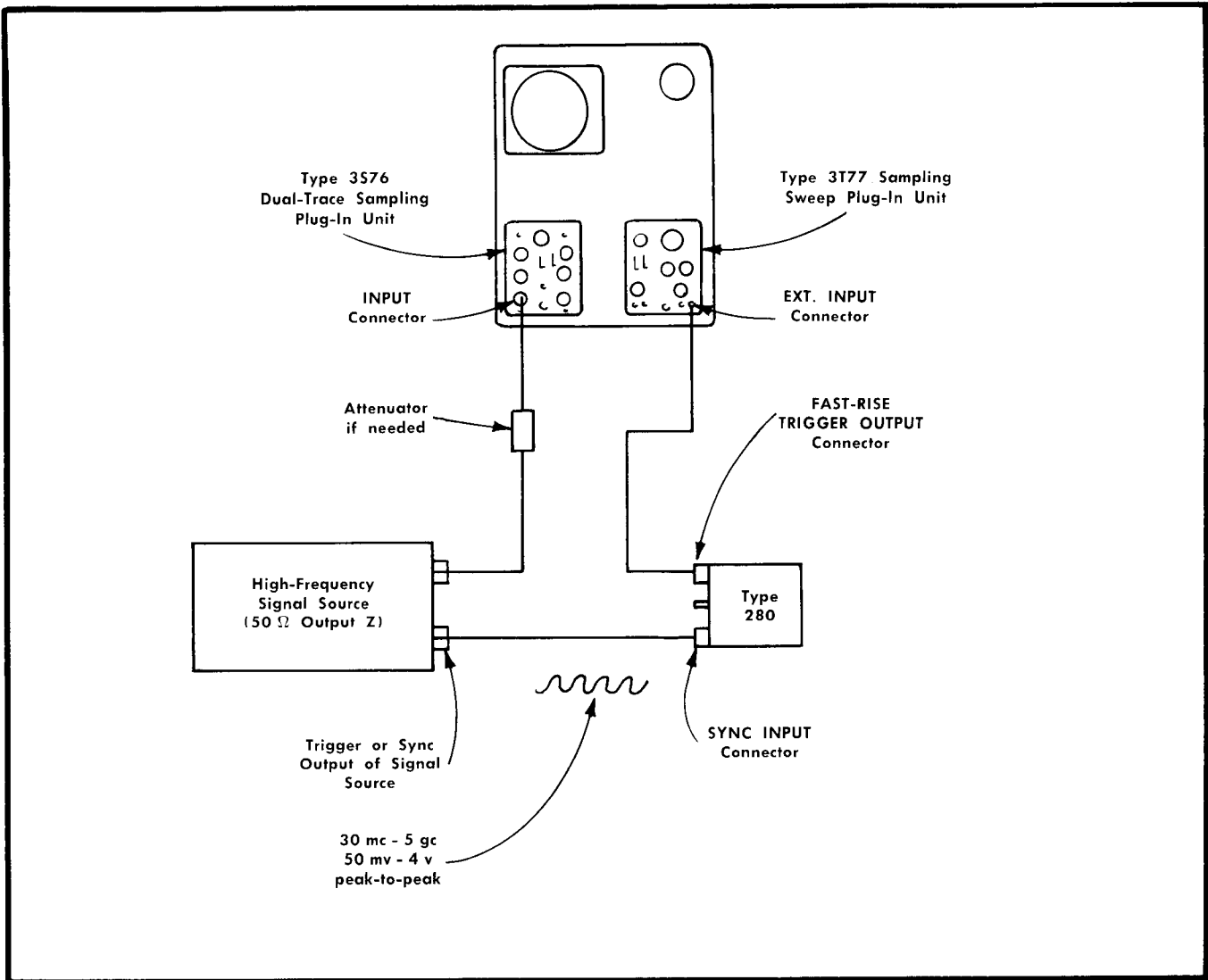

Fig. 2-3. The Type 280 Trigger Countdown Unit connected for use with the Tektronix Type 3576/3T77 Sampling System.

Fig. 2-5 shows the Type 280 connected for operation with the Type 4S1 or 4S2/5T1 dual-trace sampling system. This method involves the same general principles as described previously for Fig. 2-3.

In Fig. 2-6 the Type 280 is shown connected for operation with a conventional, real time oscilloscope. This system is limited in its vertical frequency response and trigger circuit response. Therefore, the COARSE OUTPUT REPETITION RATE control should be kept near the counterclockwise (MIN.) end of its range to keep from exceeding the upper frequency limit of the trigger circuit.

In situations where the signal source does not have a separate trigger or sync signal output, you may use the coupling network shown in Fig. 2-7. However, consider the following before using this network.

When using the "T" connector, the signal source works into an impedance of 25 ohms, or one half of the nominal

impedance. This causes reflections to appear back at the signal source. In some cases, this has a negligible effect (depending on the type of source). In other cases, the reflections produced may overload the source and cause it to operate abnormally, or set up standing waves that reduce the signal available to the "T" connector. An attenuator in the coupling between the source and the "T" connector will reduce reflections. If enough signal amplitude is available, attenuators used in each leg of the "T" connector will further reduce reflections.

Another consideration is the trigger "kickback" from the Type 280 which may appear on the display. This kickback signal is actually an attenuated version of the same signal that appears at the FAST RISE TRIGGER OUTPUT connector. This signal occurs each time the Type 280 produces a counted down trigger pulse. The amplitude of the "kick-back" is about 50 millivolts, peak, and will not be very

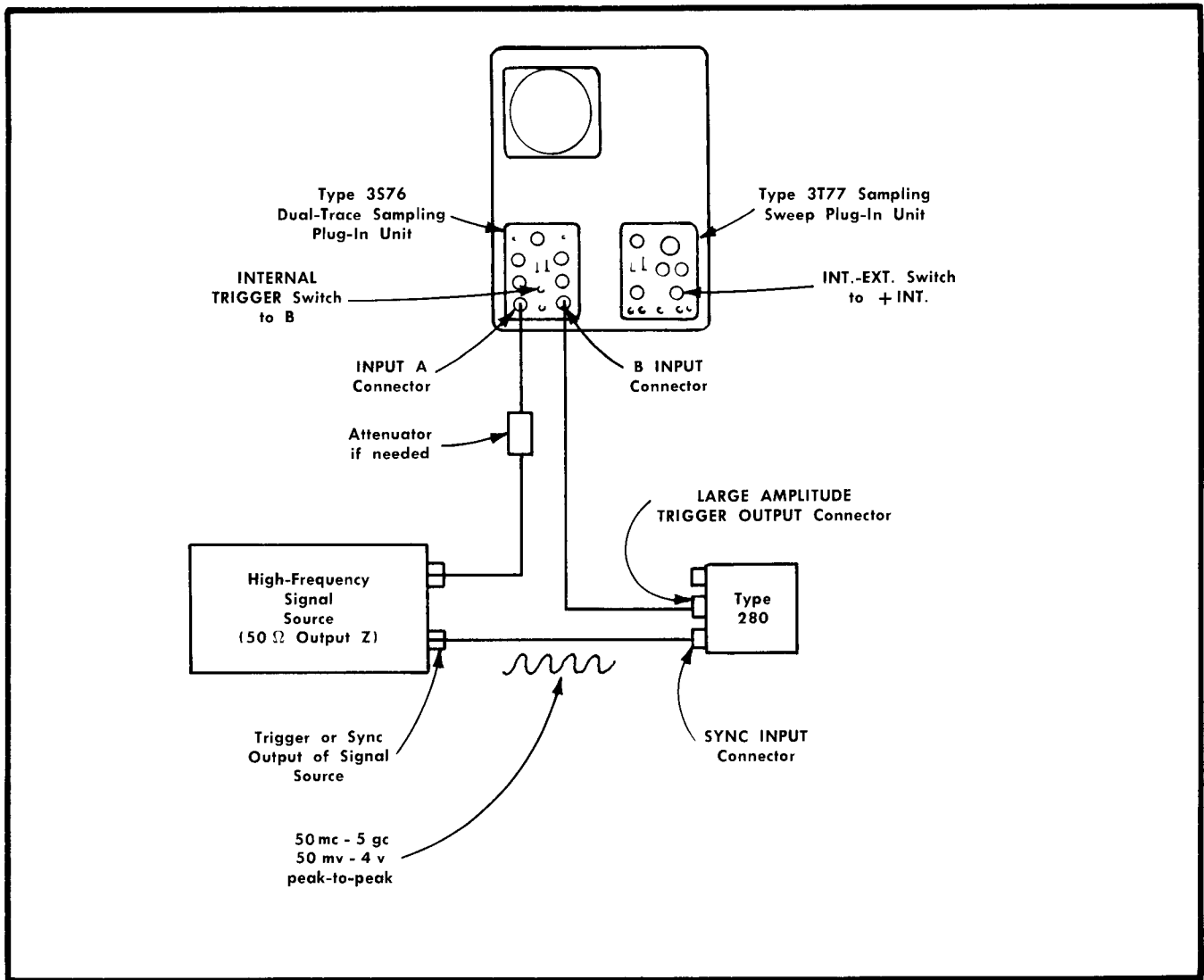

Fig. 2-4. An alternative connection method for the Type 280 with dual-trace sampling systems. This method utilizes the internal trigger network of the sampling system.

apparent when working with high amplitude (in comparison) input signals. On low amplitude signals the kickback will be more obvious. Since the kickback signal is lower in frequency than the signal being observed, set the sampling system delay to observe a portion of the input signal occurring between trigger "kickback" pulses. An attenuator in each leg of the "T" connector will help reduce kickback and reflections.

There are commercially available devices, such as matched power dividers, that attenuate voltage by a factor of two, but do not introduce the mismatch of the ordinary "T" connector.

Function of OUTPUT REPETITION RATE Controls

The Type 280 continually produces an output signal once it is turned on. This is true regardless of the settings of the

OUTPUT REPETITION RATE controls and whether or not a sync signal is applied.

COARSE control varies the output repetition rate from below 15 megacycles (fully counterclockwise) to above 45 megacycles (fully clockwise). The COARSE control has a range of ten turns.

The FINE control provides vernier repetition rate adjustment at any setting of the COARSE control. Since the FINE control varies the repetition rate over a small range, it is chiefly used when counting down from frequencies near the upper limit of the Type 280.

Obtaining a Stable Display

The Type 280 can be synchronized with the least time jitter between SYNC INPUT and TRIGGER OUTPUT when

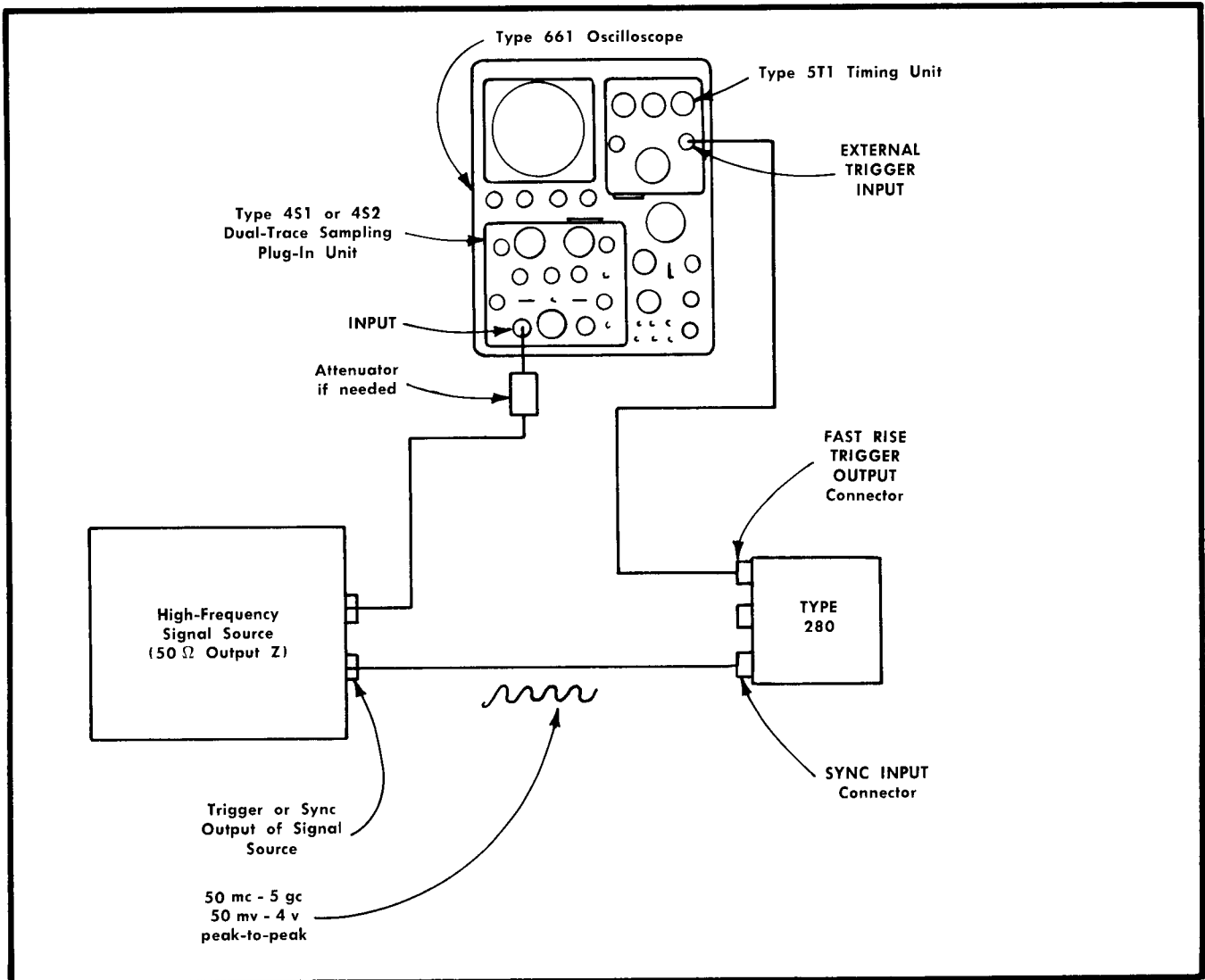

Fig. 2-5. The Type 280 Trigger Countdown Unit connected for use with the Tektronix Type 451 or 452/5T1 Sampling System.

it operates at its highest repetition rate. Jitter becomes more apparent as the signal amplitude to the SYNC INPUT connector is reduced. To assure minimum jitter, use the maximum repetition rate consistent with the signal at the SYNC INPUT connector. This applies to sampling oscilloscopes that can resolve time jitter in the picosecond range. With conventional, real time oscilloscopes, keep the counted down output low in frequency due to the lower frequency response of the triggering circuits.

Connect the Type 280 as described in "Signal and Sync Connections", then obtain a stable display by properly triggering the sampling system with the output signal from the Type 280. To do this, set the COARSE control fully clockwise and set the TRIGGER SENSITIVITY or THRESHOLD control just clockwise past the point where a trace first appears. (With conventional real time oscilloscopes, the

COARSE control should be set fully counterclockwise.) To make sure the type 280 has control of the sampling system trigger circuits, momentarily turn off the Type 280 POWER switch. The trace on the sampling oscilloscope crt should disappear. If not, the sampling system is free-running and the TRIGGER SENSITIVITY or THRESHOLD control has been advanced too far clockwise. In this case, check all connections and front-panel settings; then repeat the above procedure.

If you use the alternative connection method shown in Fig. 2-4, you can recognize proper triggering on the sampling oscilloscope crt as follows: With the Type 280 connected as shown in Fig. 2-4, set the vertical sampling plug-in unit for dual-trace operation. Set the sampling system for internal triggering from the channel displaying the Type 280 large amplitude signal. Adjust the TRIGGER SENSITIVITY

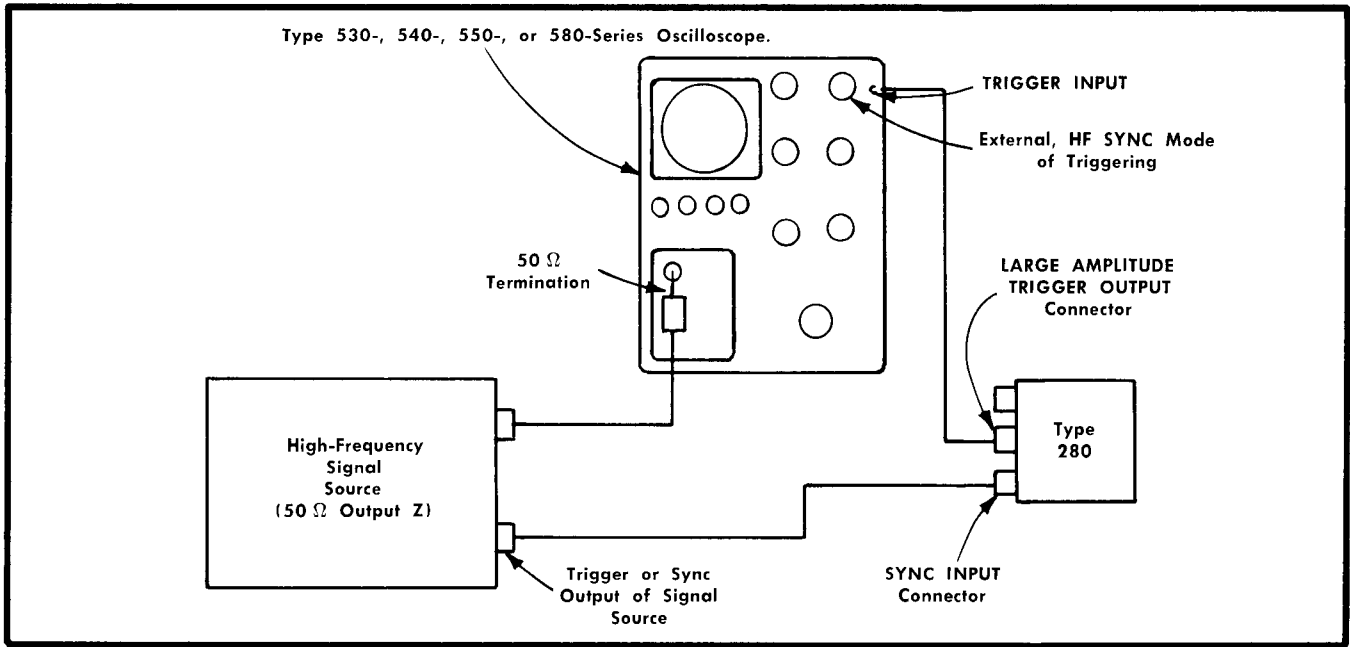

Fig. 2-6. The Type 280 Trigger Countdown Unit connected for use with Tektronix 530-, 540-, 550-, or 580-Series Oscilloscope.

or THRESHOLD control for a stable display of the Type 280 signal. For the moment, disregard the input signal you wish to observe.

The second and final step in obtaining a stable display is to synchronize the Type 280 with the high-frequency input signal you wish to observe. This is done only with the Type 280 OUTPUT REPETITION RATE controls and not with the triggering controls of the sampling system. To synchronize the Type 280 with the input signal, slowly turn the COARSE control counterclockwise until you reach a point where the input signal is almost stable on the crt. Next, slowly turn the FINE control back and forth until the input signal locks in. If the signal does not lock in, the COARSE control requires a more exact adjustment; closer to the point where the signal locks in. At this point, set the recovery time of the sampling system to help lock in the display.

Control settings are more critical as the SYNC INPUT signal frequency exceeds 1 gigacycle and as the amplitude nears 50 millivolts. Also, due to the input vswr, there is a possibility that at certain frequencies a current minimum may occur at the tunnel diode, D12. If this occurs, more sync amplitude may be required to obtain satisfactory synchronization. Since the transistors in the Type 280 stabilize after a warm-up period, it may be necessary to reset the controls after the transistors reach normal operating temperature.

At frequencies above 1 gigacycle kickback may be reduced by connecting a 50 pf capacitor in series with the SYNC INPUT connector. This offers a relatively low impedance to the synchronizing signal, yet offers a fairly high impedance to the kickback signal. Remember, that this is not satisfactory for signals below 1 gigacycle.

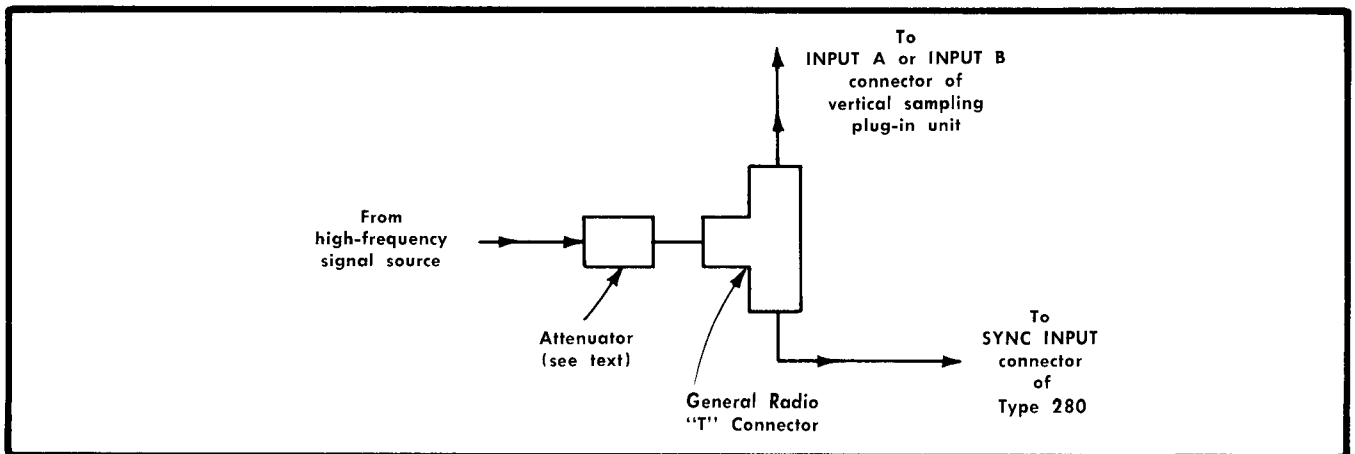
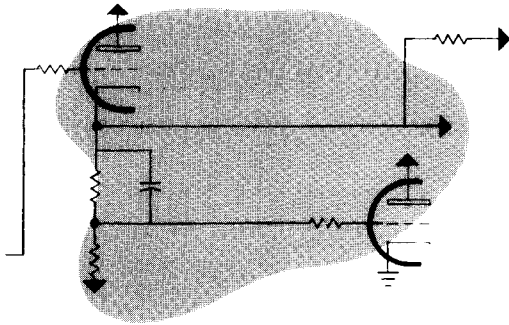

Fig. 2-7. Method of obtaining a sync signal when none is available at source. See text for limitations of this network.

SECTION 3

CIRCUIT DESCRIPTION



General Description

The Type 280 Trigger Countdown Unit contains a two-part chassis with the high-frequency circuitry mounted on an etched-circuit board separate from the power supply.

The Type 280 circuitry includes a variable-frequency multivibrator and a 6-volt power supply. The multivibrator is synchronized by a signal applied to the SYNC INPUT connector, J1.

Power Supply

The power supply of the Type 280 is a full wave, series regulated supply with a Zener diode voltage reference.

The primary circuit of the line transformer contains a filtering network to isolate the Type 280 from high-frequency line transients. A neon glow lamp is connected across the line fuse (F601) and lights when the fuse is blown. A second neon glow lamp is connected across the line and lights when the POWER switch is placed to ON.

The two primary windings of the power transformer are 117-volt windings connected in parallel for 117-volt operation or in series for 234-volt operation.

The secondary winding of the line transformer has about a 13-volt (rms) output at the nominal line voltage. The secondary winding connects to a full-wave bridge rectifier.

Q616 and Q617 are connected for voltage regulation. Q617 is effectively in series with the load and acts as a variable resistance to maintain a fixed voltage drop across the load. To understand the operation of the series regulator, suppose the load on the power supply increases and draws more current through R612 and Q617. This would tend to make the voltage at the emitter of Q614 more negative. The base of Q614 is at a constant voltage (about 6.2 volts) supplied by Zener diode D613. With the base of Q614 constant and its emitter voltage trying to go negative, Q614 conducts more current and its collector and the base of Q617 move in the negative direction. This decreases the drop across Q617 which, in turn, causes a corrective increase in the voltage across the load. If the voltage across the load attempts to increase, the circuit would reverse the operation described above and cause a corrective decrease in the voltage across the load. The circuit also acts in a similar manner to decrease 120-cycle ripple from the bridge rectifier, and the effect of line voltage variations.

High-Frequency Circuitry

The etched-circuit board in the Type 280 contains all the fast-switching and high-frequency circuitry. Power for all of the components on the etched-circuit board is supplied through the power connector P602.

The etched-circuit board includes a fast-switching multivibrator and a one-transistor amplifier that provides a signal to the LARGE AMPLITUDE TRIGGER OUTPUT connector.

Unsynchronized operation of the multivibrator is as follows: First, assume tunnel diode D12 has just switched to its "high voltage" state (about 450 millivolts). This places a more positive bias on the base of Q24, forcing it to conduct harder. This drops the collector voltage of Q24 and hence, the base voltage of Q33 to near ground potential. The emitter of Q33, however, can only fall toward ground at an exponential rate due to the charge on C34. The discharge time constant of C34 is determined by R33, R34, R36, R37, and the base impedance of Q43. R34 and R37 are variable to provide front-panel frequency control.

As the emitter voltage of Q33 drops, so does the base and emitter of Q43. This reduces the current through R43 until the valley current of D12 is reached. At this point, D12 switches to its "low voltage" state (about 50 millivolts). This decreases the base bias current of Q24 and allows its collector and the base of Q33 to rise quickly toward +6 volts, at a rate limited by stray capacitance and the current available from R24.

As the base voltage of Q33 increases, a high charging current flows into C34 and quickly raises the base and emitter voltage of Q43. This increases current through R43 until the peak current of the tunnel diode D12 is reached. At this time, the tunnel diode switches again to its "high voltage" state and a cycle is completed.

The multivibrator can be synchronized by a frequency near some multiple of the free-running frequency by injecting sync current into the tunnel diode D12. The sync current influences both the time when the tunnel diode switches to its "high voltage" state and when it switches back to its "low voltage" state.

Diode D8 reduces the amount of trigger signal "kickback" that would normally appear at the SYNC INPUT connector. Resistors R6 and R7 set the proper forward bias on D8 for optimum attenuation of the trigger signal "kickback". Decreasing the bias on D8 would decrease the amplitude of the trigger signal "kickback" but instrument sensi-

Circuit Description — Type 280

tivity would also decrease. The "ring shield" reduces the effective end-to-end capacity of D8 (see Fig. 3-1) and thus reduces capacitive coupling through D8.

The Q54 circuit amplifies the trigger signal to 1.5 volts at a source impedance of about 50 ohms for use with the Tektronix Type N Sampling Plug-In Unit.

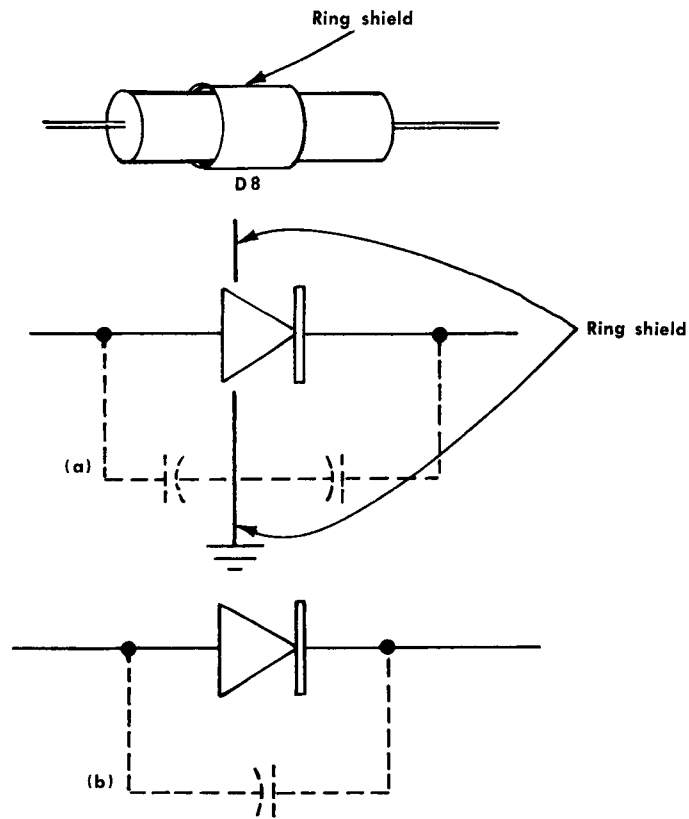
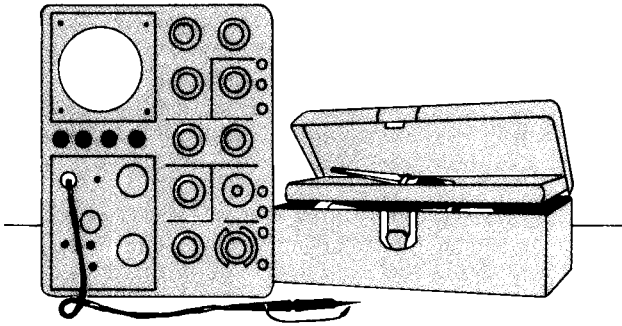

Fig. 3-1. Illustration of D8 end-to-end capacity with (a) and without (b) ring shield.

SECTION 4

MAINTENANCE



Access to Interior

WARNING

Remove the power plug from the Type 280 before dismantling.

To gain access to the interior of the Type 280, remove the two set screws in the bottom panel (side opposite the front panel) of the instrument—it is not necessary to remove the screws that secure the rubber feet.

After removing the screws, pry the front and rear panels out of the wrap-around housing. (NOTE: It is desirable that the panels fit snugly and make good metal-to-metal contact in the wrap-around housing for best rf shielding.)

Removal and Replacement of Parts

The method for removing most of the parts in the Type 280 is obvious and requires no detailed instruction. However, in the case of ceramic strips and etched-circuit boards, some additional information may be helpful. This information appears in the following paragraphs.

Soldering Precautions

In the production of the Type 280, a silver-bearing solder is used for soldering to the ceramic terminal strips. This is necessary to maintain a good solder-to-ceramic bond. In all repair work, solder used for the ceramic strips should contain about 3% silver. If this type of solder is not available locally, it may be purchased directly from Tektronix in one-pound rolls; order by part number 251-514. (Occasional use of ordinary tin-lead solder is permissible if low heat is applied.)

A wedge shaped tip on the soldering iron is best for soldering or unsoldering parts on the ceramic strip. This type of tip allows you to apply heat directly to the solder-slot in the strip, thus reducing the overall heating effect. Use as little heat as possible to establish a good solder bond.

To properly solder and unsolder the short-lead components in the Type 280, the following procedure is recommended. (1) Use long-nose pliers for a heat sink. Attach the pliers between the component and the point where the heat is applied. (2) Use a hot soldering iron for a short time. (3) Carefully manipulate the leads to prevent lead or insulation damage. (4) Use only a small amount of solder; just enough to make a good bond.

Mounting Components

Many components in the Type 280 are mounted in a particular way to reduce stray inductance and capacitance. Therefore, carefully install replacement components to duplicate lead length, lead dress, and location of the original component.

Replacement of Ceramic Terminal Strips

To remove a ceramic terminal strip, first unsolder all connections. Then pry the strip, with yokes attached, out of the chassis. Another way to remove a strip is to use diagonal cutters to cut off one side of each yoke to free the strip. Be careful not to damage the spacers since they can be reused. With the strip removed, the remainder of each yoke can be pulled from the chassis with a pair of pliers. The yokes need not be salvaged since new yokes are furnished with each ceramic strip.

After the old strip and yokes have been removed, insert the new strip, with yokes attached, into the spacers located in the holes of the chassis. With a soft-faced mallet, lightly tap the yoke pins into the spacers. Make sure the pins are seated properly in the spacers.

TROUBLESHOOTING

Visual Inspection

Some troubles that may occur in the Type 280 can be found by a visual inspection of the instrument. As a general rule, if trouble develops, make a visual inspection first.

Visual defects may include loose or broken connections, frayed or broken cables, damaged connectors, burned components, broken terminal strips, etc. The remedy for all of these troubles is obvious except in the case of a burned or over-heated component. A heat-damaged component is usually the result of some other, less apparent, trouble in the circuit. Before replacing a heat-damaged component, find the actual cause of trouble. Otherwise, the damage may be repeated.

Checking Semiconductors

Trouble in the Type 280 could be due to semiconductor failure. Once detailed troubleshooting is started, check for possible semiconductor failure first. Since they are accessible, semiconductors can easily be replaced with one of the same type you know is good.

Circuit Description — Type 280

With the exception of tunnel diode D12, semiconductors can be checked with an ohmmeter if no other method is available. However, resistance readings of semiconductors of the same type vary widely. Therefore, resistance readings are valid only when checking for front-to-back resistance, opens, and shorts.

Voltage Checks

Voltage checks should be considered as another method of isolating a trouble in the instrument. Several voltages at key points in the circuit are shown on the circuit diagram. When taking voltage measurements, make sure the circuit conditions are as close as possible to those described on the circuit diagram. Otherwise, some of the voltages will not be as shown. The voltages shown, however, are not absolute and may vary somewhat from instrument to instrument.

Checkout Procedure

The following is a step-by-step checkout procedure for the instrument. It will be effective for most of the troubles that may occur in the Type 280 Trigger Countdown Unit. Start with step 1, then go to step 2, and so on, until the trouble is isolated.

1. With an ac voltmeter, check for 105 to 125 volts across pins 1 and 4 of the primary winding of the line transformer. If the voltage at this point is not proper, the trouble may be improper line voltage, faulty power cord, blown fuse (F601), shorted capacitor or feed-through filter, faulty POWER switch, or a poor connection in the Power Connector (J602/P602).

2. With a dc voltmeter, check for +6 volts at pin 7 of the Power Connector. If the voltage is significantly higher than 6 volts the regulator circuit is probably not functioning properly. If the voltage is significantly lower than 6 volts the trouble is probably excessive loading on the supply. However, in either case, the regulator circuit (Q614/Q617) or the bridge rectifier D612 may be at fault.

3. With a test oscilloscope (ac-coupled with sensitivity at 1 mv/div.) check 120-cycle ripple at pin 7 with COARSE control turned fully clockwise; maximum ripple should be 1 millivolt, peak-to-peak. Turn COARSE control fully counter-clockwise and check for oscillation in the +6-volt supply; disregard the voltage variation caused by the normal switching action of the Type 280. If there is oscillation, replace Q617.

4. With a sampling oscilloscope, check the signal at both the FAST RISE TRIGGER OUTPUT and LARGE AMPLITUDE TRIGGER. If there is no signal at either of these, the trouble is in the multivibrator circuit (Q24, Q33, Q43, or D12). If the signal is present only at the FAST RISE TRIGGER OUTPUT connector, the trouble is in the Q54 circuit.

5. While monitoring the signal at the FAST RISE TRIGGER OUTPUT connector, vary the COARSE Output Repetition Rate control throughout its range. The frequency of the output signal should vary between 15 and 45 megacycles. If not, Q43, Q33, or Q24 may be at fault.

6. With the sampling oscilloscope, check for a signal at the SYNC INPUT connector. The signal at this point should be an attenuated version of the signal at the FAST RISE TRIGGER OUTPUT connector. Amplitude of the signal should be no more than 100 millivolts peak-to-peak*. If the signal is appreciably higher or lower than 100 millivolts, D8 may be faulty.

7. Set the sampling oscilloscope for external triggering and apply the signal from the FAST RISE TRIGGER OUTPUT connector to the sampling oscilloscope external trigger input. (If the sampling system is a Tektronix Type N Sampling Plug-In Unit, apply the signal from the LARGE AMPLITUDE TRIGGER OUTPUT connector to the TRIGGER INPUT connector of the Type N Unit.) Apply the signal from the unused Type 280 Output connector to the sampling system input (through an attenuator, if needed). Set the TRIGGER SENSITIVITY or THRESHOLD control of the sampling system for a stable display of the output pulse from the Type 280. This step verifies that the sampling system can be properly triggered by the Type 280. Leave the TRIGGER SENSITIVITY or THRESHOLD control at this setting for the next step.

8. Disconnect the signal applied to the sampling system input. Leave the connection to the sampling oscilloscope external trigger input. Connect a high-frequency signal to the sampling system and the Type 280 as shown in Figs. 2-2 through 2-6. Adjust the Type 280 REPETITION RATE controls for a stable sampling oscilloscope display of the high-frequency signal. (NOTE: The most stable display occurs when the COARSE control is set near its fully clockwise position.) If a stable display cannot be obtained, make sure the sync signal meets the requirements described in Section 1 of this manual under "Input Signal Requirements". Also, see "Obtaining a Stable Display" in Section 2. If the sync signal is normal, the trouble is probably in the input circuitry of the Type 280; check D8, C6, D12, etc.

* Instruments with SN's below 230 should be no more than 175 millivolts peak-to-peak and the signal should not be appreciably higher or lower than 50 millivolts.

SECTION 5

PARTS LIST AND SCHEMATICS

PARTS ORDERING INFORMATION

Replacement parts are available from or through your local Tektronix Field Office.



Changes to Tektronix instruments are sometimes made to accommodate improved components as they become available, and to give you the benefit of the latest circuit improvements developed in our engineering department. It is therefore important, when ordering parts, to include the following information in your order: Part number including any suffix, instrument type, serial number, and modification number if applicable.

If a part you have ordered has been replaced with a new or improved part, your local Tektronix Field Office will contact you concerning any change in part number.

ABBREVIATIONS AND SYMBOLS

a or amp	amperes	mm	millimeter
BHS	binding head steel	meg or M	megohms or mega (10 ⁶)
C	carbon	met.	metal
cer	ceramic	μ	micro, or 10 ⁻⁶
cm	centimeter	n	nano, or 10 ⁻⁹
comp	composition	Ω	ohm
cps	cycles per second	OD	outside diameter
crt	cathode-ray tube	OHS	oval head steel
CSK	counter sunk	p	pico, or 10 ⁻¹²
dia	diameter	PHS	pan head steel
div	division	piv	peak inverse voltage
EMC	electrolytic, metal cased	plstc	plastic
EMT	electrolytic, metal tubular	PMC	paper, metal cased
ext	external	poly	polystyrene
f	farad	Prec	precision
F & I	focus and intensity	PT	paper tubular
FHS	flat head steel	PTM	paper or plastic, tubular, molded
Fil HS	fillister head steel	RHS	round head steel
g or G	giga, or 10 ⁹	rms	root mean square
Ge	germanium	sec	second
GMV	guaranteed minimum value	Si	silicon
h	henry	S/N	serial number
hex	hexagonal	t or T	tera, or 10 ¹²
HHS	hex head steel	TD	toroid
HSS	hex socket steel	THS	truss head steel
HV	high voltage	tub.	tubular
ID	inside diameter	v or V	volt
incd	incandescent	Var	variable
int	internal	w	watt
k or K	kilohms or kilo (10 ³)	w/	with
kc	kilocycle	w/o	without
m	milli, or 10 ⁻³	WW	wire-wound
mc	megacycle		

SPECIAL NOTES AND SYMBOLS

X000	Part first added at this serial number.
000X	Part removed after this serial number.
*000-000	Asterisk preceding Tektronix Part Number indicates manufactured by or for Tektronix, or reworked or checked components.
Use 000-000	Part number indicated is direct replacement.
	Internal screwdriver adjustment.
	Front-panel adjustment or connector.

FRONT GROUP

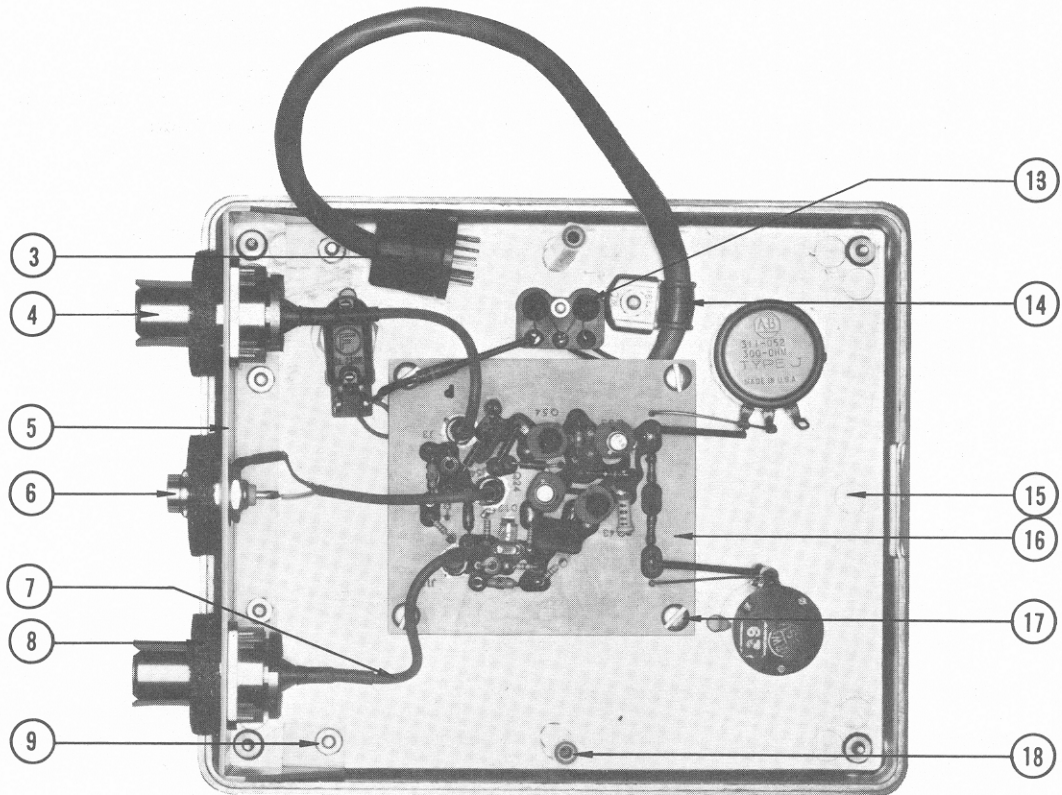

FRONT GROUP

REF. NO.	PART NO.	SERIAL NO.		QTY.	DESCRIPTION
		EFF.	DISC.		
1.	333-730			1	PANEL, front
2.	260-134			1	SWITCH, raw, toggle, 1 pole, 1 throw, molded
	210-473			1	Mounting hardware:
	210-902			1	NUT, switch, brass, $1\frac{5}{32}$ -32 x $\frac{5}{64}$ in. 12 sided
	354-055			1	WASHER, steel, flat
	210-414			1	RING, locking switch, $\frac{23}{32}$ OD x $\frac{15}{32}$ ID
				1	NUT, hex, brass, $1\frac{5}{32}$ -32 x $\frac{9}{16}$ in.
3.	136-099			1	SOCKET, cable end, 9 pin
	200-249			1	COVER, cable socket, 9 pin, black, plastic
4.	132-001			2	NUT, coupling
	132-002			2	SLEEVE, conductor, outer
	132-007			2	RING, snap
	132-016			2	NUT, retaining
	132-026			2	OUTER TRANSITION, piece
	132-027			2	INNER TRANSITION, piece
	132-028			2	INSULATOR
	132-029			2	CONDUCTOR, inner
	166-221			2	TUBE, ferrule alum.
	132-040			2	ADAPTER, zamak #5, bright cad plate
	211-038			8	SCREW, 4-40 x $\frac{5}{16}$ in. FHS, phillips slot
5.	406-862			1	BRACKET, GR and BNC connector
6.	131-106			1	CONNECTOR, chassis mount, coax, 1 contact
	337-547			1	SHIELD, BNC connector
	210-207			1	LUG, solder, pot, plain, $\frac{3}{8}$ in.
7.	131-155			3	CONNECTOR, coax, miniature, 50 Ω impedance
8.	337-549			3	SHIELD, gasket filter
9.	210-407			4	NUT, hex, brass, 6-32 x $\frac{1}{4}$ in.
	210-006			4	LOCKWASHER, steel, internal #6
10.	366-201			1	KNOB, charcoal (without dot)
11.	366-145			1	KNOB, charcoal
12.	211-071			4	SCREW, 4-40 x $\frac{3}{8}$ in. PHS, phillips slot
13.	352-006			1	HOLDER, neon, melamine, double, molded
	211-031			1	Mounting hardware:
	210-406			2	SCREW, 4-40 x 1 in. FHS
				2	NUT, hex, brass, 4-40 x $\frac{3}{16}$ in.
14.	343-003			1	CLAMP, cable, $\frac{1}{4}$ in. plastic
	210-863			1	Mounting hardware:
	210-407			1	WASHER, steel "D" type for #10 screw
				1	NUT, hex, brass, 6-32 x $\frac{1}{4}$ in.
15.	200-420			1	COVER, front casting
16.	388-544			1	BOARD, etched circuit assembly
	388-528			1	Consisting of:
	136-062			1	Board, etched circuit
	131-156			4	SOCKET, 4 pin tube for $\frac{1}{8}$ in. etched circuit
	352-041			3	CONNECTOR, coax, miniature, 50 Ω impedance, chassis mount
	346-026			1	HOLDER, tunnel diode, copper
				1	STRAP, diode holder
17.	211-504			4	SCREW, 6-32 x $\frac{1}{4}$ in. BHS
	385-080			4	ROD, alum. hex, $\frac{1}{4}$ x $\frac{7}{16}$ in.
	210-006			4	LOCKWASHER, steel, internal #6
18.	385-167			2	ROD, spacer, hex, alum. 3.535 long
	210-006			2	LOCKWASHER, steel, internal #6

REAR GROUP AND POWER CHASSIS

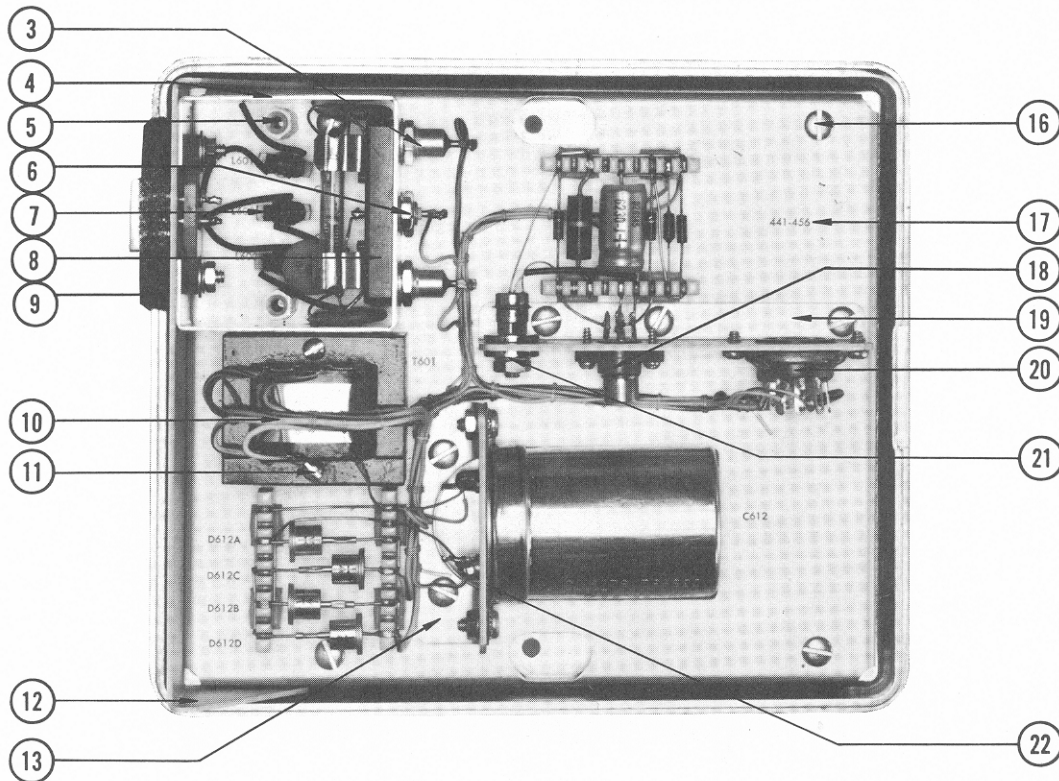
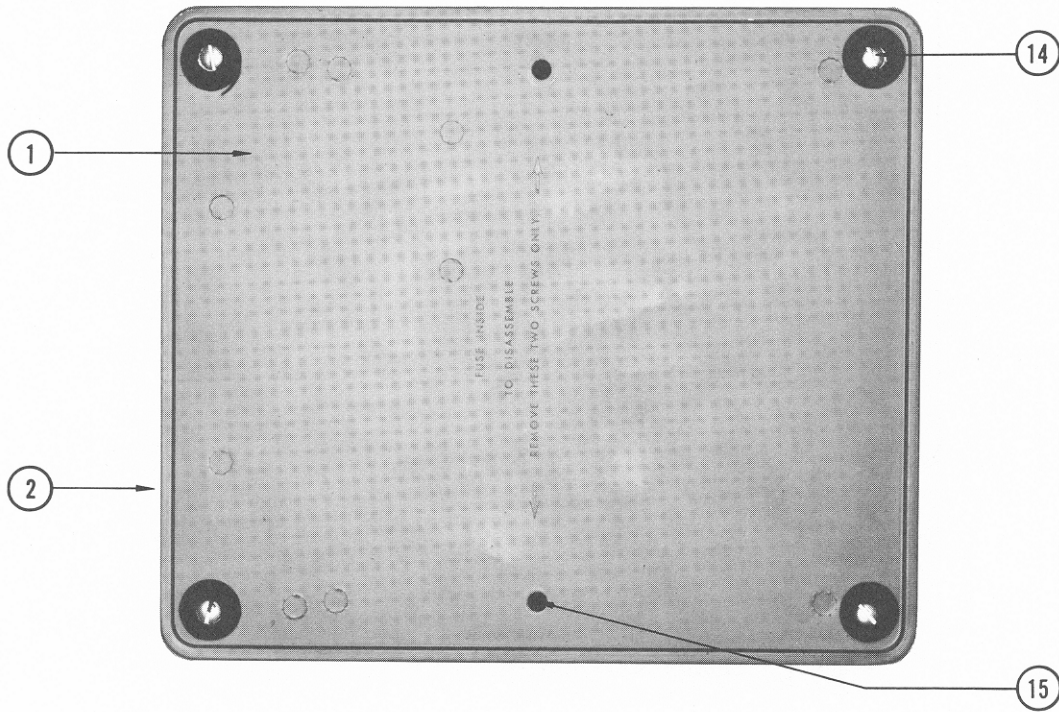

REAR GROUP AND POWER CHASSIS

REF. NO.	PART NO.	SERIAL NO.		QTY.	DESCRIPTION
		EFF.	DISC.		
1.	200-421			1	COVER, rear
2.	136-144			1	SOCKET, assembly, 3 pin
	380-047			1	HOUSING, pin socket Mounting hardware:
	211-522			2	SCREW, 6-32 x 5/8 in. FHS, 100° phillips slotted
	210-803			2	WASHER, steel, 6L x 3/8 in.
	210-006			2	LOCKWASHER, steel, internal #6
	210-407			2	NUT, hex, brass, 6-32 x 1/4 in.
3.	210-580			2	NUT, brass, 5/16-24 x 3/8 in. hex
	210-048			2	LOCKWASHER, steel, 5/16 in. internal
4.	441-455			1	CHASSIS, AC filter
5.	385-168			2	ROD, hex, spacer, 1.168 in. long Mounting hardware:
	211-507			2	SCREW, 6-32 x 5/16 in. BHS
	210-803			2	WASHER, steel, 6L x 3/8 in.
	210-006			2	LOCKWASHER, steel, internal #6
6.	210-465			1	NUT, hex, brass, 1/4-32 x 3/8 x 3/32 in.
	210-046			1	LOCKWASHER, steel, shakeproof
7.	426-121			3	MOUNT, toroid, nylon, 1 5/32 x 1/8 x 9/64 in.
8.	352-031			1	HOLDER, fuse, single, 3AG Mounting hardware:
	211-507			1	SCREW, 6-32 x 5/16 in. BHS
	210-006			1	LOCKWASHER, steel, internal #6
	210-407			1	NUT, hex, brass, 6-32 x 1/4 in.
9.	337-548			1	SHIELD, gasket filter
10.	179-680			1	CABLE harness, power
11.	211-019			2	SCREW, 4-40 x 1 in. RHS
	210-017			2	LOCKWASHER, steel, #5 cad plated spring
	210-004			2	LOCKWASHER, steel, internal #4
	210-406			2	NUT, hex, brass, 4-40 x 3/16 in.
12.	406-863			1	BRACKET, power receptacle Mounting hardware:
	210-006			4	LOCKWASHER, steel, internal #6
	210-407			4	NUT, hex, brass, 6-32 x 1/4 in.
13.	406-865			1	BRACKET, capacitor Mounting hardware:
	211-504			2	SCREW, 6-32 x 1/4 in. BHS
	385-080			2	ROD, alum. hex, 1/4 x 7/16 in.
	210-006			2	LOCKWASHER, steel, internal #6
14.	348-037			4	FOOT, rubber, black, 1/2 in. dia. x 3/16 in. high Mounting hardware:
	211-011			4	SCREW, 4-40 x 5/16 in. BHS
15.	211-507			2	SCREW, 6-32 x 5/16 in. BHS (not shown)
16.	211-504			4	SCREW, 6-32 x 1/4 in. BHS
	385-080			4	ROD, alum. hex, 1/4 x 7/16 in.
	210-006			4	LOCKWASHER, steel, internal #6
17.	441-456			1	CHASSIS, power
18.	136-095			1	SOCKET, transistor, 4 pin, mica filled phenolic Mounting hardware:
	213-113			2	SCREW, 2-32 x 5/16 in. RHS, thread forming, phillips

REAR GROUP AND POWER CHASSIS (continued)

REF. NO.	PART NO.	SERIAL NO.		QTY.	DESCRIPTION
		EFF.	DISC.		
19.	406-864			1	BRACKET, interlock
	211-504			3	Mounting hardware: SCREW, 6-32 x 1/4 in. BHS
20.	136-015			1	SOCKET, STM9G
	213-044			2	Mounting hardware: SCREW, 5-32 x 3/16 in. Pan H steel, thread cutting
21.	210-409			1	NUT, hex, brass, 8-32 x 5/16 in.
	210-008			1	LOCKWASHER, steel, internal #8
	210-858			2	WASHER, brass, 5/32 ID x 1/2 OD
	210-933			2	WASHER, mica with hole for #8 screw
	210-948			2	WASHER, teflon
22.	386-255			1	PLATE, metal capacitor mounting
	211-534			2	Mounting hardware: SCREW, 6-32 x 5/16 in. PHS, with lockwasher
	210-006			2	LOCKWASHER, steel, internal #6
	210-407			2	NUT, hex, brass, 6-32 x 1/4 in.

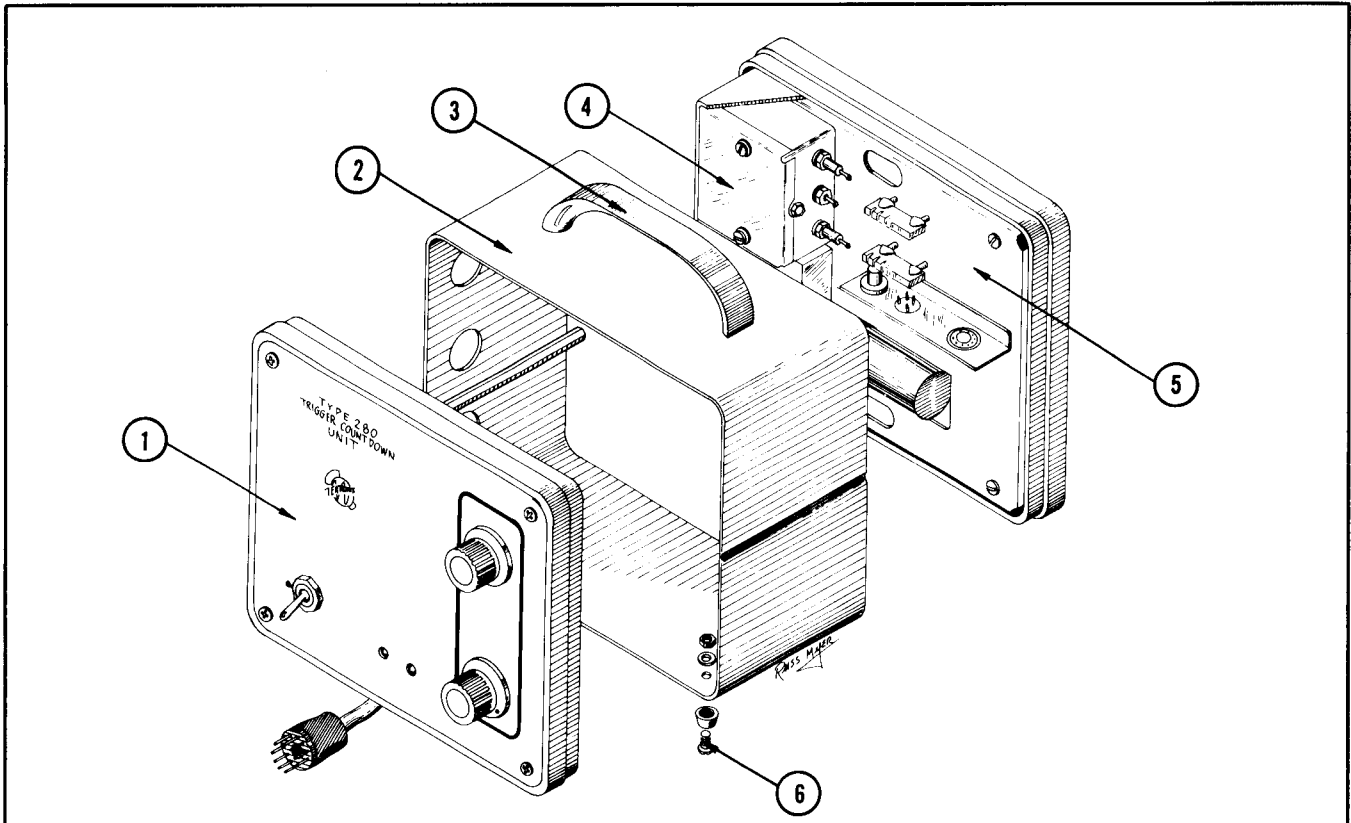

EXPLODED VIEW





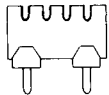
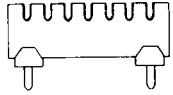
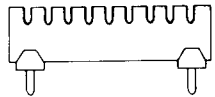
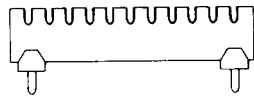

REF. NO.	PART NO.	SERIAL NO.		QTY.	DESCRIPTION
		EFF.	DISC.		
1.	Pg.				Subpanel Group
2.	380-040			1	HOUSING, wrap-around
3.	367-007			1	HANDLE, drawer
	212-004			2	Mounting hardware: SCREW, 8-32 x 5/16 in. BHS
4.	337-546			1	SHIELD, AC filter
	211-504			2	Mounting hardware: SCREW, 6-32 x 1/4 in. BHS
	210-803			2	WASHER, steel, 6L x 3/8 in.
5.	Pg.				Power Chassis Group
6.	348-037			4	FOOT, rubber, black, 1/2 in. dia. x 3/16 in. hi
	211-008			4	Mounting hardware: SCREW, 4-40 x 1/4 in. BHS
	210-004			4	LOCKWASHER, steel, internal #4
	210-406			4	NUT, hex, brass, 4-40 x 3/16 in.

CERAMIC STRIPS AND MOUNTINGS

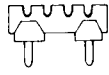
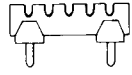
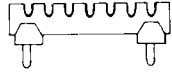

3/4 inch

	1 notch	124-100
	2 notch	124-086
	3 notch	124-087
	4 notch	124-088
	7 notch	124-089
	9 notch	124-090
	11 notch	124-091

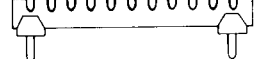
7/16 inch

	1 notch	124-118
	2 notch	124-119
	3 notch	124-092
	4 notch	124-120
	5 notch	124-093
	7 notch	124-094
	9 notch	124-095
	11 notch	124-106

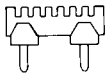
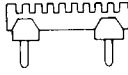
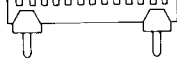



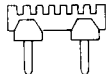
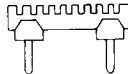
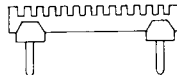
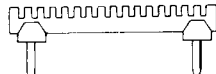
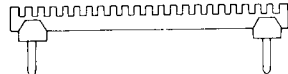

7/16 inch SMALL NOTCH —Short Stud

	7 notch	124-149
	9 notch	124-148
	13 notch	124-147
	16 notch	124-146
	20 notch	124-145

7/16 inch SMALL NOTCH —Tall Stud

	7 notch	124-158
	9 notch	124-157
	13 notch	124-156
	16 notch	124-155
	20 notch	124-154

MOUNTINGS

	Stud, nylon, short	355-046
	Stud, nylon, tall	355-082
	Spacer, 1 ¹ / ₃₂ inch	361-039
	Spacer, 3/8 inch	361-009
	Spacer, 1/4 inch	361-008
	Spacer, 5/32 inch	361-007

Ceramic strips include studs, but spacers must be ordered separately by part no.

ACCESSORIES

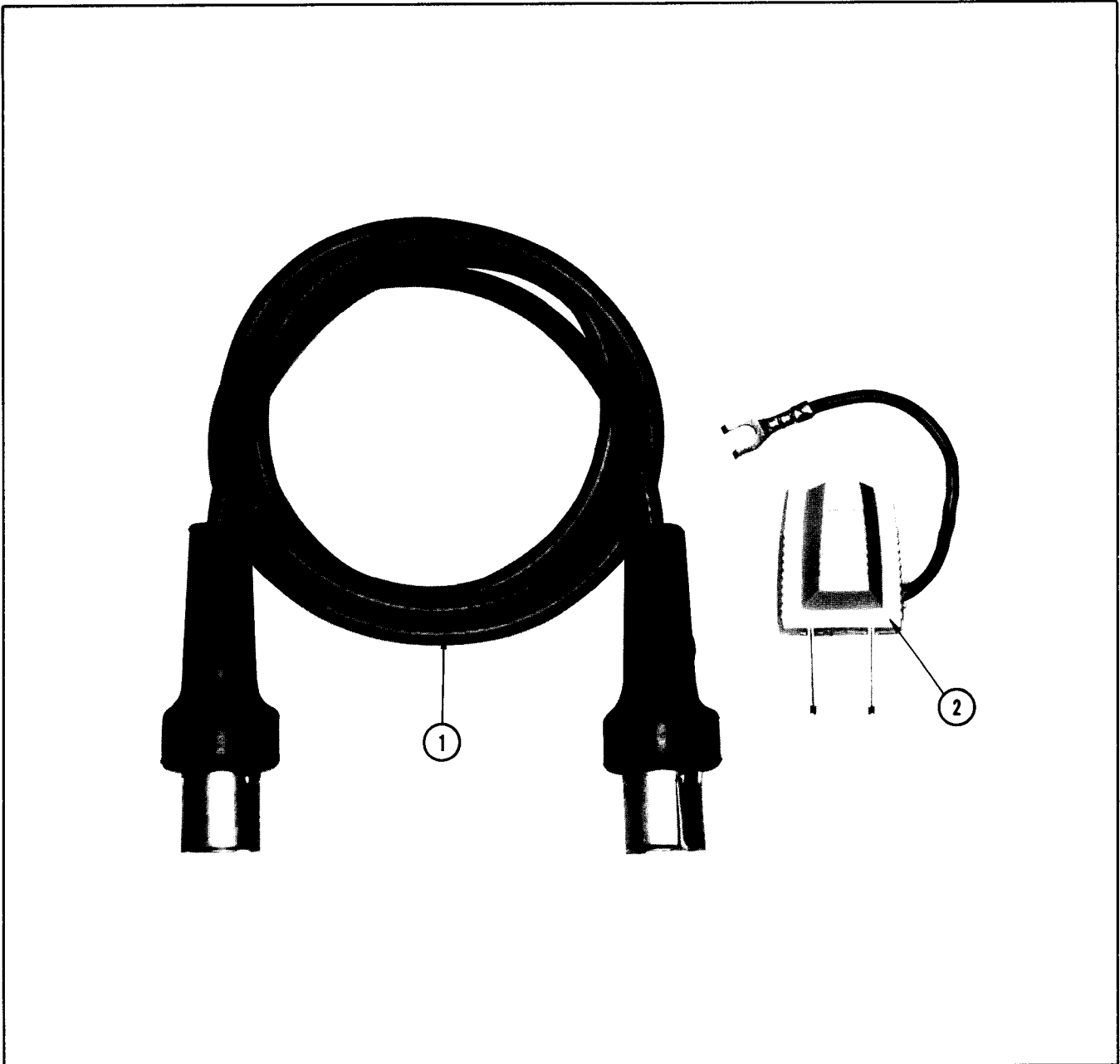

REF. NO.	PART NO	SERIAL NO.		QTY.	DESCRIPTION
		EFF.	DISC.		
1.	017-512			1	CABLE, 50 Ω , 5 nsec
2.	103-013			1	ADAPTER, power cord, 3 wire to 2 wire

Blank Page

SECTION 5

PARTS LIST AND SCHEMATICS

Values are fixed unless marked Variable.

Ckt. No.	Tektronix Part Number	Description	S/N Range
----------	--------------------------	-------------	-----------

BULBS

B601	150-002	Neon NE-2	
B602	150-002	Neon NE-2	

CAPACITORS

Tolerance $\pm 20\%$ unless otherwise indicated.

Tolerance of all electrolytic capacitors are as follows (with exceptions):

3 V — 50 V = -10% , $+250\%$
 51 V — 350 V = -10% , $+100\%$
 351 V — 450 V = -10% , $+50\%$

C3	281-516	39 pf	Cer.	500 v	
C6	283-024	.1 μ f	Disc Type	30 v	
C12	281-516	39 pf	Cer.	500 v	10%
C34	281-523	100 pf	Cer.	350 v	
C42	283-024	.1 μ f	Disc Type	30 v	
C600	283-006	.02 μ f	Disc Type	600 v	
C601	283-006	.02 μ f	Disc Type	600 v	
C602	281-598	.001 μ f	Cer.	500 v	
C603	281-597	.0025 μ f	Cer.	500 v	
C604	281-597	.0025 μ f	Cer.	500 v	
C605	283-001	.005 μ f	Disc Type	500 v	
C612A,B	290-170	2 x 500 μ f	EMC	25 v	
C613	290-105	100 μ f	Littl-Lytics	6 v	

DIODES

D8	152-065	Silicon	HD5000
D12	152-099	Tunnel	50 MA
D612A,B,C,D	152-047	Silicon	1N2862 (or equivalent)
D613	152-034	Zener	1N753 6.2 v

FUSES

F601	159-048	.1 Amp 3AG Slo-Blo
------	---------	--------------------

Parts List — Type 280

INDUCTORS

Ckt. No.	Tektronix Part Number	Description	S/N Range
L3	Use *108-260	.1 μ h	
L15	Use *108-260	.1 μ h	
LR31	*108-257	.1 μ h (on 27 Ω , 1/10 w, 5% resistor)	
L600	*120-291	Toroid 15T TD81	
L601	*120-291	Toroid 15T TD81	
L602	*120-291	Toroid 15T TD81	
L614	276-507	Ferramic Suppressor	

RESISTORS

Resistors are fixed, composition, $\pm 10\%$ unless otherwise indicated.

R3	317-470	47 Ω	1/10 w			5%
R6	Use 315-391	390 Ω	1/4 w			5%
R7	317-680	68 Ω	1/10 w			5%
R12	Use 317-620	68 Ω	1/10 w			5%
R15	317-470	47 Ω	1/10 w			5%
R20	317-270	27 Ω	1/10 w			5%
R24	316-391	390 Ω	1/4 w			
R33	318-092	40.9 Ω	1/8 w			
R34	311-332	500 Ω		Var.	Prec. WW	1/2% COURSE (Rep. Rate)
R36	318-071	1.16 k	1/8 w		Prec.	1%
R37	311-052	300 Ω		Var.		FINE (Rep. Rate)
R43	317-270	27 Ω	1/10 w			5%
R44	317-270	27 Ω	1/10 w			5%
R54	315-510	51 Ω	1/4 w			5%
R55	315-201	200 Ω	1/4 w			5%
R601	316-224	220 k	1/4 w			
R602	301-224	220 k	1/2 w			5%
R612	303-270	27 Ω	1 w			5%
R613	315-561	560 Ω	1/4 w			5%
R614	315-331	330 Ω	1/4 w			5%
R615	315-102	1 k	1/4 w			5%

SWITCHES

	Unwired	Wired		
SW601	260-290		Toggle	POWER ON

TRANSFORMERS

T601	*120-290	Power
------	----------	-------

TRANSISTORS

Ckt. No.	Tektronix Part Number	Description	S/N Range
Q24	151-097	2N955	
Q33	151-097	2N955	
Q43	151-094	2N835	
Q54	151-083	2N964	
Q614	151-040	2N1302	
Q617	151-036	2N601	

WAVEFORMS & VOLTAGE READINGS
WERE OBTAINED UNDER FOLLOWING
CONDITIONS:

COARSE.....CENTERED

280 A TRIGGER COUNTDOWN UNIT

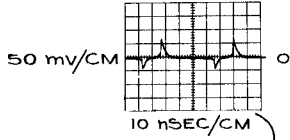

SYNC INPUT
30MC TO 5GC
50 mV TO 4V
PEAK TO PEAK

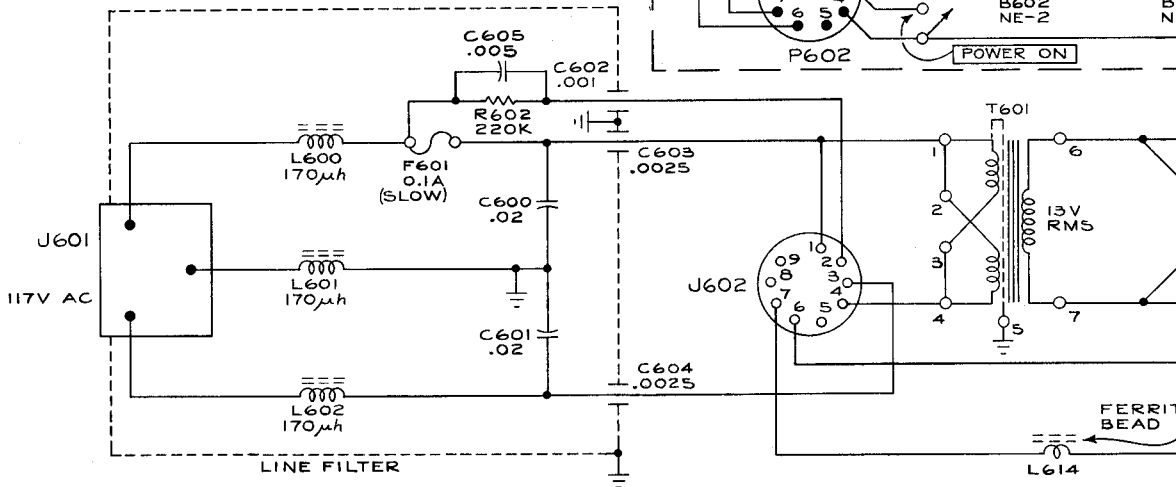
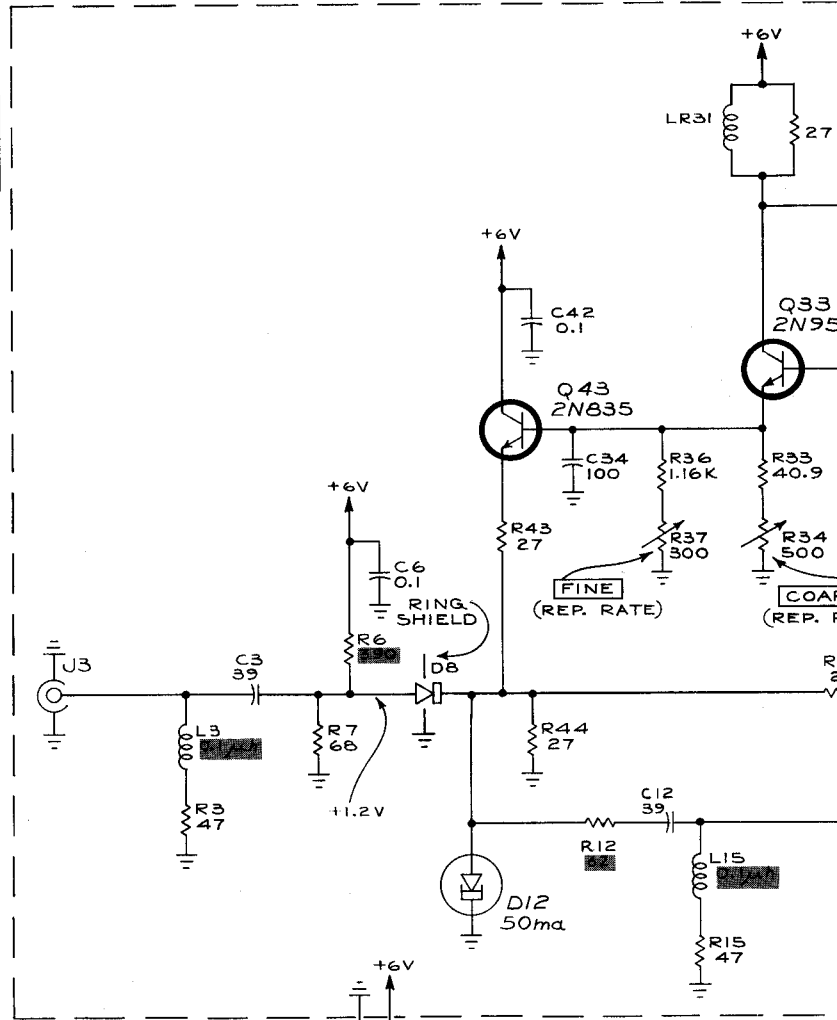
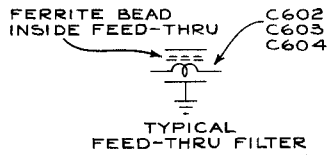

+

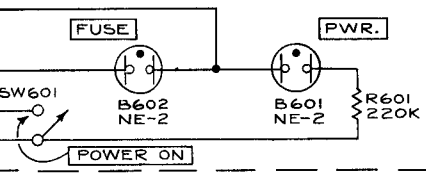
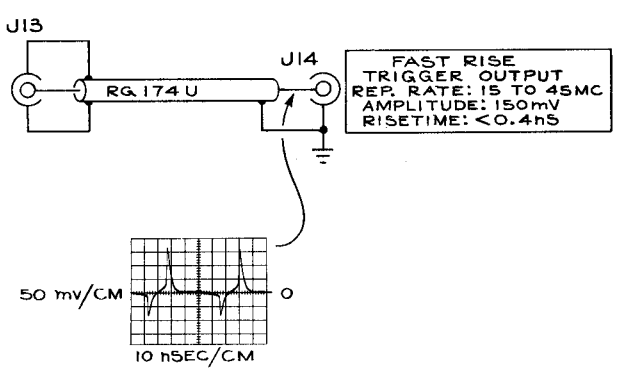
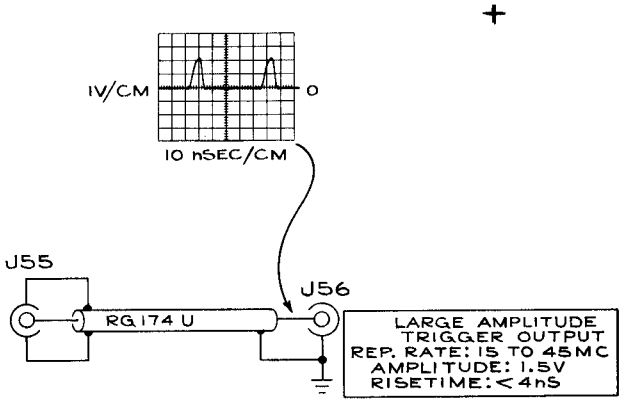
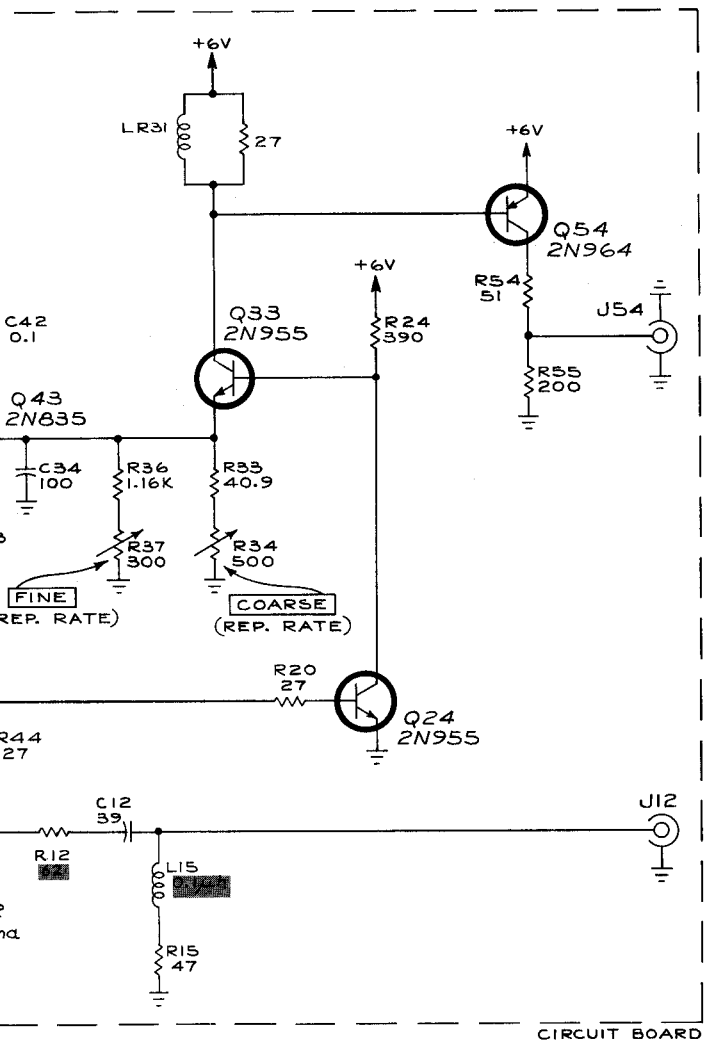

COUNTDOWN SUPPLY

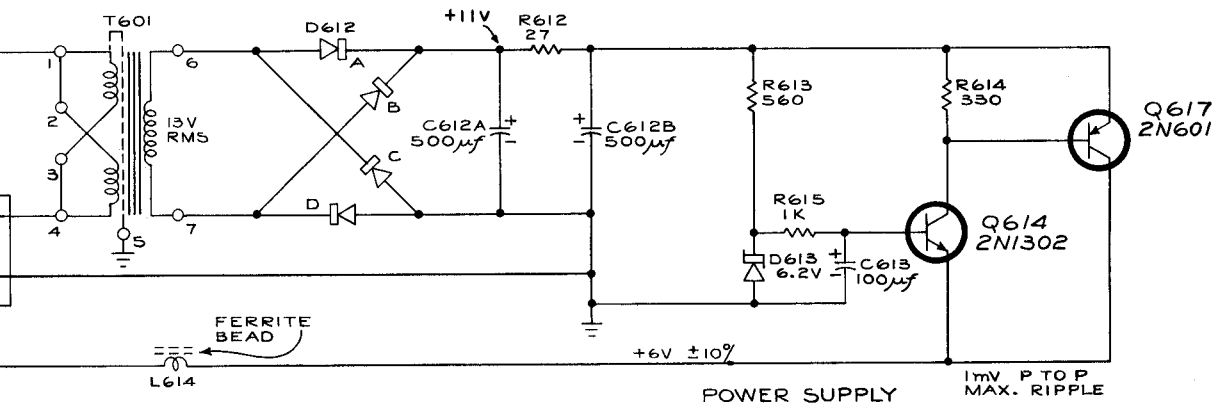

POWER SUPPLY

SEE PARTS LIST FOR EARLIER VALUES AND S/N CHANGES OF PARTS MARKED WITH RED TINT BLOCKS

TRIGGER COUNTDOWN UNIT

MANUAL CHANGE INFORMATION

At Tektronix, we continually strive to keep up with latest electronic developments by adding circuit and component improvements to our instruments as soon as they are developed and tested.

Sometimes, due to printing and shipping requirements, we can't get these changes immediately into printed manuals. Hence, your manual may contain new change information on following pages. If it does not, your manual is correct as printed.