



**INSTRUCTION
MANUAL**

CATHODE-RAY OSCILLOSCOPE

TYPE 535

TYPE 545

MODIFICATION & REPAIR, CALIBRATE
MARCH/1965

CATHODE RAY OSCILLOSCOPE TYPE 535/545

INSTRUCTION MANUAL



TEKTRONIX, INC.
MANUFACTURERS OF CATHODE-RAY AND VIDEO TEST INSTRUMENTS

P. O. Box 500 ● Beaverton, Oregon, U.S.A Phone: Mitchell 4-0161 ● Cables: Tektronix

070-198

Type 535/545 SERIAL NUMBER 380

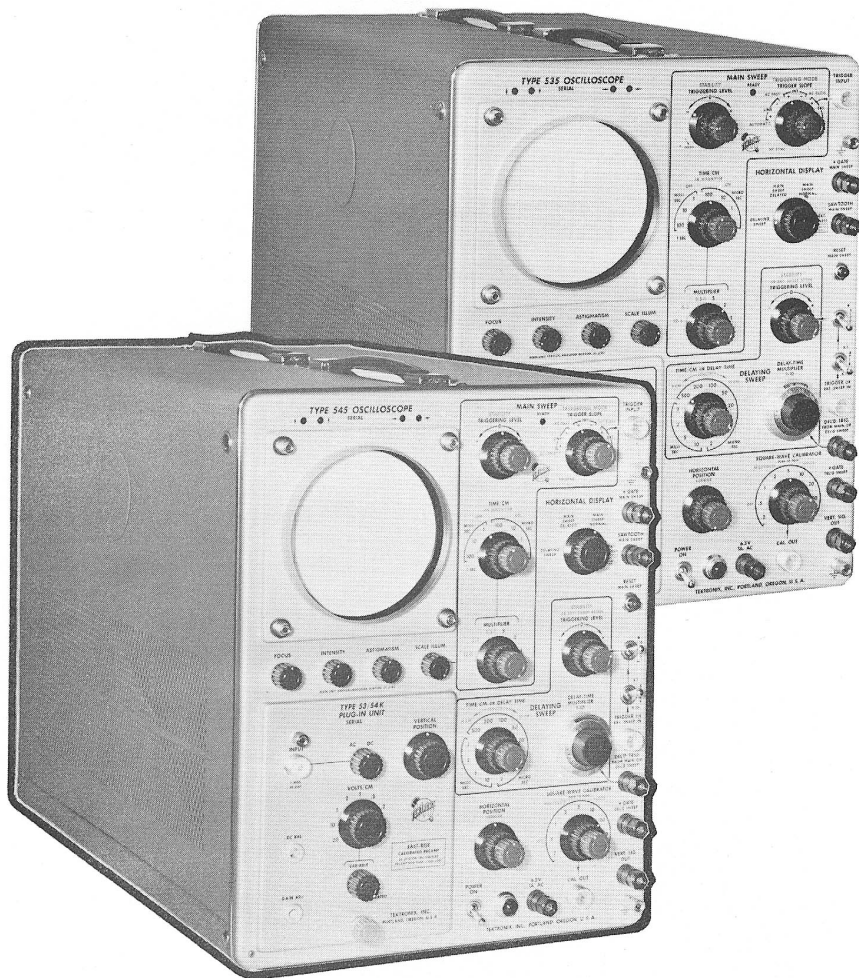

Type 535/545 Oscilloscopes

A-A



NOTE

This instruction manual has been prepared to cover TEKTRONIX Type 535/545 Oscilloscopes of all serial number ranges. Text, diagrams, and parts lists have been expanded to incorporate all circuit modifications adopted during the course of manufacture. The serial ranges of instruments to which various modifications were applied before shipping from the factory have been noted wherever necessary.

However, because many instruments have been modified in the field and out of serial sequence, component values and circuitry of a given instrument may differ considerably from those indicated in this manual for its serial number. The user is urged, therefore, to enter whatever changes may be necessary to bring this manual into agreement with the present circuitry of his oscilloscope.

When ordering parts, always include the following information:

1. Instrument Type (535/545).
2. Instrument Serial Number (as, S/N 9999).
3. Part Circuit Number (as, R999).
4. Part Description (value, type, rating, tolerance, etc.).
5. The 6-digit TEKTRONIX part number (as, 999-999).

SAFETY NOTICE

This oscilloscope employs dangerously high voltages. Since some maintenance must of necessity be performed with the case removed, great care should be taken. Use only insulated tools, stand on a dry floor and if possible keep one hand in your pocket. Care should also be used in making any connections to the deflection plates of the cathode-ray tube through the access panel. It is advised that the access panel never be removed until the power has first been turned off. The instrument should not be operated with this protective cover removed.



CONTENTS

GENERAL DESCRIPTION

SECTION 1

Characteristics. Functions of Front-Panel Controls and Connectors.

OPERATING INSTRUCTIONS

SECTION 2

First-Time Operation. Triggering Instructions. Sweep Operation. Auxiliary Functions. Functional Block Diagram. Simplified Sweep Diagrams.

CIRCUIT DESCRIPTION

SECTION 3

Block Diagram. Vertical-Deflection System. Horizontal-Deflection System. Delaying-Sweep Circuits. Sweep Amplifier. Power Supply. CRT Circuit.

MAINTENANCE

SECTION 4

General Information. Recalibration.

PARTS LIST

SECTION 5



SECTION I

GENERAL DESCRIPTION

The Type 535 and 545 are high-speed laboratory oscilloscopes. Their fast risetime coupled with wide sweep-speed range and 10-kilovolt accelerating voltage opens the way to faster, easier analyses of fast-rising waveforms. Additional adaptability is provided by plug-in preamplifiers which extend their use to almost all laboratory-oscilloscope applications. Accurately calibrated sweep speeds and vertical-deflection sensitivity permit quantitative time and amplitude measurements to be made. Accurately-delayed trigger sweeps make possible the selection and detailed observation of minute portions of voltage waves.

CHARACTERISTICS

Cathode-Ray Tube

A Tektronix 5-inch post-deflection acceleration cathode-ray tube is furnished with the instrument. With 10-kv acceleration potential the trace is bright enough that a single sweep can be photographed with a P11 screen even at the fastest sweep speeds. A P-2 phosphor is furnished unless other phosphors are specially requested.

Vertical-Deflection System

A dc-coupled vertical amplifier in the main unit is adjusted for optimum transient response and wide pass band. A plug-in channel-switching unit provides a dual-trace presentation for repetitive signals. Input to the vertical-deflection system must be made through one of the available types of plug-in units.

Horizontal-Deflection System

The two linear sweep generators are Miller runup circuits with excellent linearity. The main sweep has the extremely wide speed range from .02 microseconds per centimeter to 12 seconds per centimeter, and 24 fixed, calibrated sweep speeds accurate within 3 per cent. The main-sweep control has eight positions, .1, 1, 10, and 100 microseconds per centimeter, 1, 10, 100, milliseconds per centimeter, and 1 second per centimeter. The main-sweep multiplier control has three positions giving multiplications of 1, 2 and 5 times, to provide the 24 fixed speeds. Three additional positions of the multiplier give continuously-adjustable multipliers of 1-to-2.5, 2-to-5, and 5-to-12 times, so that the above range of fixed speeds is also covered continuously. The 5X magnifier increases the maximum speed to

.02 microseconds per centimeter.

5X Magnifier

Sweep magnification is produced by increasing the sweep output amplifier gain five times. The center two-centimeter portion of the trace is expanded to ten centimeters. Any one-fifth of the sweep so magnified can be positioned to show on the screen by means of the horizontal positioning control.

DC-Coupled Unblinking

The unblinking square wave is dc coupled to the grid of the cathode-ray tube to assure uniform unblinking bias for all sweep times and repetition rates.

Triggering System

The sweep can be triggered by a wide range of triggering voltages, either derived internally from the signal to be displayed, derived internally from the delayed-sweep trigger generator, through a front-panel connector from an external source, or 60 cycles. The circuit permits the sweep to be triggered from any selected point along the triggering waveform. A recurrent triggering arrangement which runs at a 60-cycle rate will synchronize with repetitive trigger signals from 60 cycles to 2 megacycles.

Delaying Sweep

The delaying-sweep generator is a second Miller runup, also with excellent linearity, but with more limited speed range, 2 microseconds per centimeter to 10 milliseconds per centimeter



in 12 fixed steps. A front-panel connector provides the means for connecting triggering signals. A 10-to-1 attenuator and a trigger inverter can be switched in if desired. The delaying sweep can be used either to deflect the beam or to produce a delayed trigger for the main sweep. The delayed trigger can be timed to occur at any point along the sawtooth by means of a 10-turn delay control, calibrated in centimeters of delay.

Delayed Sweeps

Delayed sweeps can be initiated either by a delayed trigger generated by the delaying sweep, or by a selected trigger which is selected by excluding all triggers until a prescribed interval has passed. The prescribed interval is determined by the setting of the delay control.

Horizontal-Deflection Amplifier

A dc-coupled horizontal-deflection amplifier provides horizontal sensitivity of 0.2 volts per centimeter, continuously adjustable to approximately 15 volts per centimeter. Sensitivity is controlled by a 10-to-1 frequency-compensated fixed attenuator, and a continuously adjustable amplifier gain control.

Because this amplifier was designed for optimum performance with a sweep sawtooth, its performance with sine waves is limited. This sine-wave limitation can best be defined by an amplitude-frequency product, which can be exceeded only at the expense of considerable distortion. The amplitude-frequency product is 2.4 centimeter-megacycles. Thus a full 10 centimeters of deflection can be used at 240 kc, and a 2.4-mc sine wave can be viewed if the amplitude is one centimeter peak-to-peak or less. The amplifier frequency response to a sine wave is down less than 30% at 800 kc when the amplitude is within this limitation.

Output Waveforms Available

Front-panel connectors provide a 150-volt

positive-going sawtooth and a 20-volt plus gate, synchronized with the main sweep, a 20-volt plus gate synchronized with the delaying sweep, a 5-volt delayed trigger derived either from the main or delaying sweep and a sample of the vertical-deflection signal through a cathode follower, with a voltage of about 2 volts per centimeter of deflection. Bandwidth of this circuit with a Type 5354A preamplifier is about 6 megacycles. The calibrator provides an adjustable amplitude symmetrical square wave with a repetition rate of about 1000 cycles, and a rise-time in the order of a microsecond. The amplitude is adjustable in 18 fixed steps from 0.2 millivolts to 100 volts, peak-to-peak, accurate within 3 per cent.

Power Supply

All dc voltages are regulated to accommodate line-voltage variations between 105 and 125 volts, or 210 and 250 volts, 50 to 60 cycles ac, and for the differences in dc loads imposed by the different plug-in units. Regulated dc is provided for the plug-in preamplifier heaters.

Power Consumption

At 117 or 234 volts, 535 watts with the 5354C plug-in unit in place.

Cooling

Safe operating temperature is maintained with filtered, forced-air ventilation. A thermal disconnect device turns off ac power in the event the fan fails or the air intake becomes blocked.

Mechanical Description

Front-panel dimensions, 13" wide, 16-3/4" high, case 24" deep. Weight, 65 lbs. The instrument is constructed of electrically-welded aluminum alloy, with photo-engraved anodized front panel and wrinkle-enamel cabinet.

FUNCTIONS OF FRONT-PANEL CONTROLS AND CONNECTORS

HORIZONTAL DISPLAY--Four-position switch arranges sweep circuits for kinds of displays: MAIN SWEEP NORMAL, DELAYING SWEEP, MAIN SWEEP DELAYED and EXT. SWEEP.

Main Sweep

TRIGGERING MODE (red knob)--Five-position switch arranges trigger circuits for four kinds of triggering: AUTOMATIC, AC



FAST, AC SLOW and DC, and for synchronized sweeps, HF SYNC. For Type 535 below S/N7553, and Type 545 below S/N5947, AUTOMATIC is labeled AC AUTO. Type 535 below S/N1059 has no HF SYNC position.

TRIGGER SLOPE--Six-position switch selects source of trigger signal and converts to negative-going output, either negative-going or positive-going input.

TRIGGER INPUT--UHF coax connector to triggering circuits through EXT positions of TRIGGER SLOPE switch.

STABILITY (red knob)--Control for adjusting the stability of the sweep circuits for a stable display. The control has a PRESET position suitable for most triggering applications. For Type 535 below S/N7553, and Type 545 below S/N7401, there is no PRESET position on the STABILITY control.

TRIGGERING LEVEL--Potentiometer determines part of triggering waveform where sweep triggers.

TIME/CM--Eight-position switch selects timing capacitors to determine sweep speeds, and determine duration of trigger holdoff period.

MULTIPLIER--Six-position switch. Three positions place precision charging resistors in series with timing capacitors to determine sweep speeds in conjunction with selected timing capacitor. Three positions, marked in red, place adjustable charging voltages in series with timing capacitors for continuous control of sweep speeds.

5X MAGNIFIER (red knob)--Two-position switch removes or inserts feedback in sweep amplifier to change sweep speeds by a factor of five.

+GATE--Connector supplying 20-volt positive pulse via cathode follower synchronized with main sweep, duration same as sweep.

SAWTOOTH--Connector supplying 150-volt positive-going sawtooth via cathode follower synchronized with main sweep.

Delaying Sweep

STABILITY (red knob)--Adjustment of multi-

vibrator bias in region for recurrent or triggered sweeps.

TRIGGERING LEVEL--Potentiometer determines part of triggering waveform where sweep triggers.

TIME/CM--Twelve-position switch selects twelve fixed sweep speeds.

LENGTH (red knob)--Sweep-length control permits delaying sweep to be reverted immediately after delayed main sweep is triggered to increase possible duty cycle. Normally will be left at 10 cm.

DELAY-TIME MULTIPLIER--Ten-turn helical resistor adjusts pickoff voltage on sawtooth-voltage comparator to determine timing of delayed trigger. For Type 535 below S/N1059, this control is labeled CM OF DELAY.

RESET MAIN SWEEP--Pushbutton arms main-sweep triggering circuit to accept trigger for MAIN SWEEP DELAYED circuit.

DEL'D TRIGGER--Connector from cathode follower supplies delayed trigger from main sweep or from delaying sweep.

+GATE--Connector via cathode follower supplies 20-volt positive pulse synchronized with delaying sweep.

SLOPE + or --- Toggle switch selects inverted or in-phase output from trigger inverter for triggering sweep-gating multivibrator, or selects polarity for external sweeps.

ATTEN, X1, X10--Toggle switch inserts or bypasses 10-to-1 compensated attenuator in delaying-sweep trigger-input circuit, or external sweep circuit.

EXT SWEEP--Continuously adjustable gain control for horizontal amplifier. Switched out of circuit for internal sweeps.

EXTERNAL SWEEP IN--Front-panel connector to horizontal amplifier through HORIZONTAL DISPLAY switch. Magnifier must be switched to ON for undistorted 10-cm deflection.

HORIZONTAL POSITION--Positions trace along



horizontal axis.

VERNIER (red knob)--Fine adjustments of horizontal positioning, with 5 times the resolution of the coarse adjustment.

Other Output Waveforms

SQUARE-WAVE CALIBRATOR (red knob)--Three-position switch turns on calibrator plate voltage and switches in or out 1000-to-1 voltage divider to give either volts or millivolts output.

(Black knob)--Nine-position switch selects nine taps on precision voltage divider in calibrator circuit. Provides accurate peak-to-peak voltages of .2, .5, 1, 2, 5, 10, 20, 50, and 100 volts in VOLTS position, or millivolts in the MILLIVOLTS position of the red concentric control knob.

VERT. SIG. OUT--Connector via cathode follower supplies a sample of the vertical-deflection signal. For Type 535, below S/N 1059, this control is labeled INT. TRIG. OUT.

CAL OUT--UHF coax front-panel connector from the calibrator.

Auxiliary Controls

POWER--On-off switch in primary of power transformer and ventilating-fan lead.

FOCUS--Adjustable voltage for the cathode-ray tube focusing grid.

INTENSITY--Bias adjustment to cathode-ray tube control grid.

ASTIGMATISM--Adjustable voltage for the astigmatism grid of the cathode-ray tube.

SCALE ILLUM--Adjustable series resistor controls current through graticule lights.

Beam-position indicators, unlabeled, marked with arrows. The arrow nearest the illuminated indicator shows which way the beam is off the screen if it cannot be seen.

Rear of Cabinet

CRT CATHODE--Binding post connects to crt cathode through high-voltage capacitor. Input impedance 8 k to 15 k. Discharge time constant about 15 milliseconds. There is no CRT CATHODE connector on Type 535 below S/N 1059.



SECTION 2

OPERATING INSTRUCTIONS

FIRST-TIME OPERATION

Control Settings

First get a trace on the screen with the main sweep by the simplest method, and then proceed with the presentation you want after you get an idea of the functions of the controls. To get a simple trace on the screen, insert a preamplifier, for example the 53/54K, and proceed as follows:

Turn the POWER switch to OFF. Connect the power cord to a source of 117-volt, 60-cycle power. Then set the front-panel controls as follows:

INTENSITY Counterclockwise (CCW)
 FOCUS Center
 ASTIGMATISM Center
 POWER ON

Main Sweep

TRIGGERING LEVEL CCW
 STABILITY (red knob) PRESET
 or CCW
 TRIGGER SLOPE +INT
 TRIGGERING MODE (red) AUTOMATIC
 or AC AUTO
 TIME/CM 100 MICROSEC
 MULTIPLIER 2
 HORIZONTAL DISPLAY
 MAIN SWEEP NORMAL

Delaying Sweep

TRIGGERING LEVEL Center
 STABILITY CCW

HORIZONTAL POSITION Center

SQUARE-WAVE CALIBRATOR 5

VOLTS, MILLIVOLTS, OFF VOLTS

Connect a lead between the CAL. OUT terminal and the INPUT terminal of the 53/54K unit. Set the controls of the 53/54K unit as follows:

INPUT SELECTOR INPUT A, AC
 VOLTS/CM 2
 VARIABLE (red) Clockwise
 VERTICAL POSITION Center

When the POWER switch has been turned on for about one minute, turn the INTENSITY control clockwise until you can see a trace on the screen. With the calibrator waveform displayed, you can set the FOCUS, INTENSITY and ASTIGMATISM controls for a sharp line, and position the trace near the screen center with the HORIZONTAL POSITION and VERTICAL POSITION controls.

If your instrument is a Type 535 below SN 7553, or a Type 545 below SN7401, procedure for obtaining a trace is as follows: After the power has been on for about one minute, turn the INTENSITY control clockwise until you can see the spot at the left of the screen, and then back the control off until the spot is barely visible.

Now advance the red STABILITY knob at the top center of the oscilloscope until you get a trace. If the trace is not stable, back the control off counterclockwise slightly until the trace is stable. Then you can adjust FOCUS, INTENSITY and ASTIGMATISM controls for a sharp line, and center the trace with HORIZONTAL POSITION and VERTICAL POSITION controls.



Triggering Modes

1. Automatic

The triggering method just described is the AUTOMATIC mode of triggering. This is about the simplest mode of triggering. It is useful for general-purpose viewing, and will operate satisfactorily for a wide variety of trigger signals whose repetition rates are between sixty cycles and about two megacycles.

2. AC Slow

When you have a good, well focused trace of the calibrating waveform by the AUTOMATIC mode of triggering, try the other four TRIGGERING MODE switch positions. Turn the switch to the AC SLOW position. Advance the TRIGGERING LEVEL control to the right until you get a stable trace. There may be a considerable range of the TRIGGERING LEVEL control over which you can get a stable trace, and the start of the trace will move up and down the edge of the square wave within this range. Notice that the trace starts on the upgoing part of the calibrator square wave.

Now turn the TRIGGER SLOPE switch to the -INT position, and readjust the TRIGGERING LEVEL to obtain a stable trace again. Notice now that the trace starts on the down-going portion of the trace and that the position of the start can again be changed somewhat with the LEVEL control.

3. DC Triggering

Now turn the TRIGGERING MODE switch to DC. Adjust the LEVEL control for stable triggering, and then position the trace with the vertical positioning control. You will notice that triggering occurs at a vertical level on the screen selected by the LEVEL control, and that the triggering point changes relative to the waveform as the waveform is positioned vertically. This effect will be more noticeable if you look at a low-frequency sine wave.

4. AC Fast

In the AC FAST position of the TRIGGERING MODE switch, the circuit is quite similar to

that in the AC SLOW position, and you will notice no difference when displaying the calibrator waveform. The only difference is that an rc filter is inserted in the circuit, making it insensitive to low frequencies, and allowing it to recover quickly from dc level changes. This is the position to use when there is no hum present. This is also the best position to use with the alternate sweep feature of the 53/54C unit if you use INTERNAL triggering with signals having frequency components above 10 kc.

5. HF Sync

The HF SYNC position of the TRIGGERING MODE switch is primarily for signals having a repetition rate in excess of ten megacycles. In this position the sweep will trigger poorly, if at all, on the calibrator waveform. To trigger on a high-frequency signal, simply advance the STABILITY control until a stable trace is obtained. The LEVEL control is not used in this position. Type 535 oscilloscopes below SN 1059 do not have an HF SYNC triggering mode.

TRIGGERING INSTRUCTIONS

General

The Type 535/545 triggering system is very flexible and stable. However, if you are not familiar with the TRIGGERING LEVEL control used on these instruments, you will need to distinguish between its operation and that of the trigger amplitude control used on some other Tektronix oscilloscopes.

Triggering Level

The TRIGGERING LEVEL control selects the point on the triggering waveform at which triggering will occur. To trigger on small signals this control must be set near 0, or near the dc level with dc triggering. The levels are indicated on the panel as positive to the right and negative to the left. Negative positions of the LEVEL control cause triggering to occur during negative level of the triggering waveform and positive positions cause triggering during positive levels. This control is not used in the AUTOMATIC and HF SYNC positions of the TRIGGERING MODE switch.



Trigger Slope

The + positions of the TRIGGER SLOPE switch (black knob) cause triggering to occur during the rising portion of the triggering waveform. The level may be either negative or positive. The - positions cause triggering to occur during the falling portion of the waveform. Thus for slow rising waveforms such as sine waves, the triggering point can be caused to occur at almost any point in the waveform.

An additional function of the TRIGGER SLOPE switch selects the source of trigger signals. For each of the available signal sources, the switch provides a choice of positive or negative slope.

Triggering Mode

The TRIGGERING MODE switch arranges the circuits to provide the kind of triggering you need. This is the red knob and the positions it selects are labeled in red on the panel.

Slowly changing waveforms work best on the AC SLOW and DC positions. In the AC SLOW position, a capacitor removes the dc component of the triggering waveform and makes triggering on the vertical signal independent of trace position. This position is suitable for signals from twenty cycles up to about five or ten megacycles. The DC position is the same except that it responds to dc as well. In the AC FAST position, the circuit includes an rc filter, useful for preventing 60-cycle, or other low-frequency components, from triggering the sweep when both high- and low-frequency components are present in the triggering waveform. The low-frequency limit is about two kilocycles. In these three positions, if the STABILITY control is properly set, the sweep will not run unless triggered by a signal.

The AUTOMATIC and the HF SYNC switch positions both arrange synchronizing circuits, rather than strictly triggering circuits. The AUTOMATIC circuit provides a free-running multivibrator having a normal repetition rate of about 50 cycles. This locks in, and runs synchronously with, recurrent triggering waveforms from 60 cycles to about 2 megacycles. The synchronized multivibrator then triggers the sweep-gating multivibrator.

The HF SYNC switch setting arranges a circuit which connects the triggering source direct-

ly to the sweep-gating multivibrator so that it can synchronize with the triggering waveform. The sweep-gating multivibrator must be free-running for this type of operation. It free-runs at advanced settings of the STABILITY control. It will synchronize with signals whose frequencies are as high as 30 megacycles, at a sweep-repetition rate up to 200 kilocycles.

Stability

The STABILITY control adjusts bias level on the sweep-gating multivibrator near the level at which it will free-run. Three principal settings of the STABILITY control are used; the first setting is with the control advanced to the right, just past the point where the sweep-gating multivibrator free-runs, second, retarded to the left about 5 or 10 degrees left of the point where free-running ceases; and third, retarded all the way left, to make the multivibrator inoperative.

For synchronized operation of the sweep-gating multivibrator, that is, with the HF SYNC switch position, set the STABILITY control to the advanced position so that the sweep just free-runs, and keep it to the right of this point while adjusting its position to synchronize the sweep.

For all triggered modes of operation, except AUTOMATIC, the STABILITY control should be retarded 5 to 10 degrees to the left of the free-run point. In the AUTOMATIC mode and when the STABILITY control is turned to the PRESET position, the STABILITY control is replaced by an internal control which has been preset to give reliable triggering for most triggering applications.

For Type 535 below SN7553 and Type 545 below S/N7401 the STABILITY control has no PRESET position. In these instruments with TRIGGERING MODE in AC AUTO or AUTOMATIC position, the sweep-gating multivibrator is triggered, and a retarded position of the STABILITY control is required.

SWEEP OPERATION

The four positions of the HORIZONTAL DISPLAY SELECTOR arrange for the horizontal deflection of the beam by the main sweep, the delaying sweep, the main sweep delayed, or by an external sweep signal.



Main Sweep Normal

For the MAIN SWEEP NORMAL position of the HORIZONTAL DISPLAY SELECTOR only the main-sweep is displayed. Triggering can be produced from the displayed signal internally, or external trigger signals can be connected to the upper TRIGGER INPUT connector.

Delaying Sweep

In the DELAYING SWEEP position, the sawtooth that is normally used to delay the main sweep is connected to the horizontal amplifier to provide the sweep. This delaying sweep can only be triggered by applying a trigger to the TRIGGER connector near the delaying sweep controls. This trigger signal can be obtained from an external source or a test lead can be connected from the TRIGGER connector to the VERT. SIG. OUT connector to trigger the delaying sweep on the vertical signal. The SLOPE, +, -, switch selects the desired slope and the ATTEN X10 toggle switch provides attenuation if desired. Other triggering adjustments operate the same as for the main sweep.

Main Sweep Delayed

Display the waveform you want to observe with the delaying sweep. Set the DELAY-TIME MULTIPLIER control to 2 or 3 centimeters and set the main-sweep TIME/CM several times faster than the delaying sweep time. Switch to MAIN SWEEP DELAYED and adjust the main sweep triggering circuits until the main sweep runs recurrently, and switch back again to the delaying sweep. When the main sweep operates it brightens the trace while it runs.

The brightening helps determine what part of the waveform displayed by the delaying sweep will be displayed by the delayed main sweep. Increasing the main-sweep speed narrows the brightened portion, and increasing the DELAY-TIME MULTIPLIER control clockwise moves the brightened portion to the right. If desirable, adjust the delaying-sweep LENGTH control until the delaying sawtooth stops just after it passes the brightened portion of the trace. This causes the delaying sawtooth to revert after the main-sweep sawtooth reverts, and also increases the possible duty cycle of the main sweep.

Triggered Delayed Sweeps

Now if you back the STABILITY control to the left a little more the delay trigger signal will not trigger the main sweep, but will arm it for trigger signals connected into the main-sweep trigger input circuit, and permit you to display delayed signals without jitter, even if the signal itself does jitter.

Single Sweeps (Reset Main-Sweep Control)

The RESET button provides a means of obtaining a single sweep. Depending on the setting of the main-sweep STABILITY control, this sweep can occur immediately when the button is depressed or the sweep will wait until it is triggered, at which time only one sweep will occur.

Turn the delaying-sweep STABILITY control counterclockwise and leave the other controls as set for main-sweep-delayed operation. Depress the RESET button. If the main-sweep STABILITY control is set to the position where it requires no trigger, there will be a single trace. If it is backed off to the position where it requires a trigger the READY indicator will light, indicating that the trigger circuit is armed and waiting for a trigger. Upon the occurrence of a trigger, there will be a single sweep and the ready light will go out.

External Sweep

Switch the HORIZONTAL DISPLAY control to EXT SWEEP and turn the 5X MAGNIFIER to ON. Connect the source of external horizontal signal to the EXT SWEEP IN connector. The signal can then be attenuated by the 10X attenuator and inverted by the SLOPE switch, or continuously adjusted by the EXT SWEEP ATTEN control. There should be no dc component to the external sweep signal. If there is, the continuous gain adjustment will also position the trace horizontally, and may move the signal out of range of the HORIZONTAL POSITION control.

When sinusoidal signals above 240 kc are applied to the horizontal amplifier, it is necessary to limit the maximum deflection to prevent distortion. The amplitude-frequency product should not exceed 2.4 centimeter-megacycles. For example, for a 400-kc sine wave, the maximum deflection that can be obtained



without noticeable distortion is 6 centimeters peak-to-peak.

Sweep Controls

Main-Sweep Time/CM and Multiplier

These controls determine the speed of the horizontal trace. The time per centimeter of horizontal deflection is equal to the product of the MULTIPLIER setting and the TIME/CM setting. Times per centimeter from .1 microsecond to 1 second in steps of 10 can be selected with the TIME/CM switch, and accurate fixed multipliers of 1, 2, and 5 times can be selected with the MULTIPLIER switch. The sweep times so selected can be depended on within three per cent of their indicated value. The variable sweep time positions can be checked at the limits of the 2.5-to-1 times, and 5-to-2 times positions against the accurate fixed multipliers, to improve their accuracy.

Magnifier

This control inserts or removes a feedback network in the sweep amplifier that changes the gain five times. The linearity of the amplifier is somewhat better when the feedback circuit is included. The center one fifth of the trace is expanded to fill the graticule when the magnifier is switched on. When you use the sweep magnifier to realize the fastest sweep time, .02 microseconds per centimeter, the linearity is reduced from three per cent to about five per cent.

Whenever the HORIZONTAL DISPLAY control is set at EXT. SWEEP, the 5X MAG control must be ON to keep the input amplifier within its linear range. This is true whether you have the 10X ATTEN. in or out.

Delaying-Sweep Time/cm

The delaying-sweep TIME/CM control provides twelve fixed sweep speeds. The LENGTH control provides a means of adjusting the sweep length from four to ten centimeters. If it is desired to measure the time between two points on the trace, this time can normally be read directly from the graticule. However, if slightly greater accuracy is required, you can use the DELAY TIME MULTIPLIER dial. Set the main sweep to run several times faster than the de-

laying sweep and advance the main-sweep STABILITY control so it is triggered by the delaying sweep. When start of the brightened portion of the delaying sweep trace corresponds with the point you wish to measure, the DELAY TIME and DELAY TIME MULTIPLIER dials will read the time from the start of the trace to the point you wish to measure.

The accuracy of any particular range can be maximized by adjusting the DELAY START and DELAY STOP controls on that range as explained in the maintenance section of this manual.

AUXILIARY FUNCTIONS

Square-Wave Calibrator

Accuracy of the open-circuit voltage of the calibrator is within 3 per cent of the indicated voltage. However, since the output impedance at the CAL OUT terminal varies with the setting of the voltage-selector switch, you must be careful that the load impedance you connect it to does not change the output voltage. The output impedance varies between about 100 ohms over the millivolt range to about 5000 ohms at the 50-volt tap. Except at the 100-volt tap, the output voltage depends on the division ratio of a voltage divider. Any appreciable change in impedance of the shunt leg of the divider will therefore reduce the output approximately in proportion to the reduction of impedance. The 1-megohm input impedance of the oscilloscope will cause no appreciable change in voltage at any setting of the selector switch. At the 100-volt tap, the output impedance is that of the cathode follower, about 250 ohms.

The rising portion of the calibrator waveform follows an rc charge curve with a time constant such that it requires about 1 microsecond to reach 90 per cent of peak. Millivolt settings provide a slightly better risetime of about 0.7 microseconds, and the worst case is the 50-volt setting with about 1.5 microseconds to the 90 per cent point. Reactive loads will affect these times.

The frequency of the calibrator multivibrator is nominally 1000 cycles, but may vary 30 per cent either way. Do not use it for more than a rough check of sweep-timing accuracy.



Trigger Rate Generator

The delaying-sweep generator can be used as a trigger-rate generator by advancing the STABILITY control to the free-run position and using the +GATE from the delaying sweep as the trigger output. The trigger rate can be varied from 10 cps to 40 kc by the delaying-sweep TIME/CM and LENGTH controls.

Trace-Brightness Modulation

To couple time markers into the cathode circuit for brightness modulation, disconnect the ground strap at the rear of the instrument and connect the source of modulating voltage to the CRT CATHODE post. A peak-to-peak voltage of about 50 volts is required to turn the beam on and off. Input impedance is 8 k to 15 k, depending on the INTENSITY control setting. The circuit is ac coupled through a high-voltage capacitor, discharge time constant about 15 milliseconds.

Direct Connection to Deflection Plates

A plastic plate and mounting bracket are available from the factory for making direct connections to the crt vertical-deflection plates. The mounting bracket is designed to clamp around the neck of the crt shield, adjacent to the deflection-plate connections. When mounted correctly, the plate will be accessible through the crt deflection-plate access hole in the left side-panel. The bracket and plate may be ordered with or without the necessary parts for vertical-positioning voltages. Specify part number 013-008 for the unwired unit, or part number 013-007 for the wired unit. Holes can be drilled in this plate for wire guides or for mounting coaxial connectors. The two pins on the left-hand side of the crt neck are the vertical deflection plates.

To avoid distortion the average dc potential on these plates should be 300 volts. If you use a different voltage the distortion can be minimized by adjusting the GEOM. ADJ. control at the rear of the sweep chassis.

Unless dc coupling is required, connect coupling capacitors in series with the leads to the deflection plates and connect one-megohm resistors from the deflection plates to the leads from the vertical amplifier. With this connection the plates are maintained at the proper operating potential and positioning control is retained by

the front-panel controls.

Vertical Signal Out

The signal applied to the vertical amplifier is available at the front-panel VERT. SIG. OUT binding post. A signal which will cause one centimeter of deflection will produce a signal of about two volts, peak-to-peak, at the binding post. The signal is applied to the binding post at a relatively low impedance from a cathode follower. The passband is dependent on the external load. With a one megohm resistor shunted by a 50 μmf capacitor as a load, it extends from about 20 cycles to 4.5 megacycles at the 3-db points. Without the capacitive load the high-frequency 3-db point is extended to about 6 megacycles.

FUNCTIONAL BLOCK DIAGRAM

General

The functional block diagram shows the functional relationships of the basic elements of the sweep system. A four-position switch in the center of the diagram, labeled HORIZONTAL DISPLAY, sets up the circuits for the four kinds of sweep operation. The four positions of the switch are labeled MAIN SWEEP NORMAL, MAIN SWEEP DELAYED, DELAYING SWEEP, and EXT. SWEEP.

Horizontal Display Selector

When the HORIZONTAL DISPLAY switch is in the MAIN SWEEP NORMAL position, the triggered main sweep circuit shown in the upper half of the diagram, moves the cathode-ray spot across the screen in the normal manner.

When the switch is in the DELAYING SWEEP position, the triggered delaying sweep circuit, shown in the lower half of the diagram, moves the cathode-ray spot across the screen in the same manner as the main sweep.

When the switch is in the MAIN SWEEP DELAYED position both the main sweep circuit and the delaying sweep circuits run. The delaying sweep starts first and starts the main sweep later. There are two modes of operation in which the main sweep is delayed.



Delayed Sweeps

In one mode the delaying sweep receives the external trigger signal while the main sweep receives its trigger signal later from the delaying sweep, and the main sweep then moves the cathode-ray beam across the screen. The trigger signal for the main sweep in this mode is derived from the delaying sweep at the instant the delaying-sweep sawtooth reaches a level determined by the adjustment of the delay-pickoff circuit.

In the second mode of delayed-sweep operation, both the main sweep and the delaying sweep run, as in the first mode, but in this mode the main sweep is triggered by a selected external trigger signal. All trigger signals except the desired one are locked out until a signal from the delaying sweep opens the trigger circuit into the main sweep. Then the next external trigger signal that comes along will trigger the main sweep. The circuit into the main sweep is completed when the gating circuit is opened by the delay-pickoff signal. The delay-pickoff signal originates when the delaying-sweep sawtooth reaches the level determined by the adjustment of the delay-pickoff circuit.

Trace Brightening

The cathode-ray beam is kept turned off when a sweep is not moving the beam across the screen. When a sweep is in process the beam is turned on by an unblanking signal that lasts only as long as the sweep and then turns the beam back off after the sweep is completed. If both sweeps are running, each produces its own unblanking signal and both unblanking signals help to turn on the beam. The main-sweep unblanking pulse makes a brighter trace than the delaying-sweep pulse.

The difference in brightness for the two pulses is useful for finding out where to set the delay-pickoff circuit to display the part of a signal you want to examine. To make use of this characteristic, display the signal with the delaying sweep and adjust the delay-pickoff circuit so that the brightening that occurs brightens the place on the trace you want to examine. Then adjust the speed of the main sweep so that the brightening covers the amount of the trace you want to examine, and display the signal with the main sweep delayed. The part of the trace you have brightened will then be spread clear

across the screen.

External Sweeps

When the HORIZONTAL DISPLAY switch is in the EXT. SWEEP position, any signal connected to the TRIGGER binding post will move the cathode-ray spot back and forth across the screen. There is a continuous unblanking signal with this switch setting so that the spot is visible all the time. The arrangement is useful for displaying Lissajous figures and for similar applications not requiring a linear sweep.

SIMPLIFIED SWEEP DIAGRAMS

Main Sweep Simplified Diagram

The trigger signal is normally coupled to the multivibrator by way of the main-sweep trigger amplifier. The trigger signal trips the multivibrator, which sends a negative gate through the disconnect diodes to two points on the sweep generator. The sweep generator makes a positive-going sawtooth that is amplified and used to sweep the beam across the cathode-ray tube.

The speed of the sawtooth depends on the capacitance of the timing capacitor and the resistance of the charging resistor. The height of the sawtooth depends on the setting of the sweep length adjustment. A portion of the sawtooth voltage is coupled back to the multivibrator control grid via the sweep-length and holdoff tubes, where it reverts the multivibrator and turns the sawtooth generator off.

Quiescent bias on the multivibrator is determined by the dc level of the stability cathode follower, which depends on the STABILITY control setting. The purpose of this control is to set the multivibrator bias near enough to triggering that the input trigger will trigger it. If the bias is lowered still further, the multivibrator will trigger itself again as soon as it is reverted, and run recurrently.

When used in delayed-trigger operation, the stability tube is combined with a second tube to form a bistable gate generator which can either trigger the multivibrator or place it near the point of triggering during its second stable state. The bistable gate generator is triggered by the delayed trigger to the second stable state



where it remains until the main sweep reverts it and itself at the same time.

With low settings of the STABILITY control, during this period, the multivibrator will respond to trigger signals from the main-sweep trigger amplifier, but will not respond during the previous period when it is in the first stable state. Triggering of the main sweep is therefore held off until the delay trigger arrives and arms the main sweep.

Delaying Sweep Simplified Diagram

The delaying-sweep circuit is similar to the main-sweep circuit. The trigger signal to the multivibrator control grid is coupled through the stability cathode follower. The sweep-length cathode follower operates in parallel with the stability tube, and is cut off until the sawtooth

reaches the grid voltage of the stability tube. The sweep-length control determines the amplitude and dc level of the sawtooth voltage at the grid of the sweep-length tube. This control is the red knob concentric with the TIME/CM switch, labeled LENGTH in red on the front panel.

Delay-Pickoff Simplified Diagram

The delay pickoff generates a trigger when the delaying-sweep sawtooth reaches a prescribed level, determined by the DELAY TIME control setting. The delay comparator has the pentode section conducting until the sawtooth raises the triode grid above the pentode grid. The positive plate pulse, generated when the pentode cuts off, triggers the delay-trigger shaper. The DELAY TIME control can adjust the bias of the comparator over the same range as the delay sawtooth.



SECTION 3

CIRCUIT DESCRIPTION

BLOCK DIAGRAM

The Block Diagram shows interconnections of the functional parts of the oscilloscope, except the power supplies. Functions of the switches are shown instead of their actual connections.

Vertical Amplifier

Plug-In Preamplifiers

In the upper left of the Block Diagram is shown the vertical-deflection system. The block labeled "Plug-ins" represents one of the several plug-in preamplifiers available. Units are available with a wide pass band, with reduced pass-band and higher sensitivity, with differential input, with channel switching for alternate trace presentation, etc. These units have calibrated gain controls and the vertical-position controls. Connections for power in and signal out are made through a multiple-contact mating plug and socket. Output from these units is push-pull at low impedance.

Main Unit

The main unit contains all portions of the oscilloscope except the vertical-deflection preamplifiers. This includes the high-level vertical deflection system, the calibrator, the two sweep circuits, all power supplies, and the cathode-ray tube.

The main-unit vertical-deflection system begins with the delay-line driver stage. This stage feeds the vertical-deflection signal to the 1/4-microsecond delay line and to the trigger-pickoff circuit used to trip the sweep from the observed signal.

Delay Line

The Type 535 Oscilloscope has a balanced 24-section lumped-section delay line which adds 1/4 microsecond of delay to the signal. The Type 545 has a balanced 50-section delay line which adds .2 microseconds of signal delay. This delay is added so that the sweep circuits will

have time to get the cathode-ray spot unblanked and sweeping before the signal reaches the vertical deflection plates.

Trigger Cathode Followers

The trigger signal from the main-unit amplifier passes through two cathode followers. The first applies the signal at low impedance to the trigger amplifier and the second connects to the front-panel VERT. SIG. OUT binding post.

Main Sweep

Trigger Phase Inverter

This stage provides either in-phase or inverted output so as to provide negative-going output for either negative-going or positive-going input signals.

Trigger Shaper

The trigger-shaper makes a sharp pulse from the trigger signal at a time during the sloping part of the trigger signal determined by the setting of the triggering-level control. A sharpened negative-going pulse triggers the multivibrator.

Multivibrator

The multivibrator turns on the sweep generator and generates the crt-tube unblanking pulse when it is switched from its quiescent state. The sharp negative-going trigger signal from the trigger-shaper circuit trips the multivibrator, which thereafter stays in the second state until the sweep generator reverts it to its quiescent state.

Stability and Delayed-Trigger CF

When the main-sweep-normal function is in operation this circuit adjusts the dc level of the input grid of the gating multivibrator. When the delayed-trigger function is in operation the circuit sets the dc level and also amplifies the delayed trigger to trigger the multivibrator or sets a dc pedestal that places the multivibrator input grid within range of the main-sweep trigger signals.



Sweep Generator

The sweep generator is a Miller integrator that produces a positive-going sawtooth about 150 volts peak-to-peak. The sweep generator turns itself off when it reaches a prescribed level determined by the sweep-length control, by transmitting a signal through the trigger-holdoff circuits to the multivibrator.

Trigger Holdoff

The trigger-holdoff circuit transmits the sweep turn-off signal to the multivibrator but briefly holds off subsequent trigger signals from starting the sweep again until all parts of the circuit have reached their quiescent states.

Sweep Amplifier

The sweep amplifier converts the sawtooth output of the sweep generator into push-pull output at low impedance at the level required to sweep the beam across the crt-tube screen. The amplifier gain can be increased by a factor of five for sweep magnification. The horizontal-positioning control operates on this stage.

Delaying Sweep

The delaying sweep has essentially the same circuit elements as the main sweep. The phase inverter selects in-phase or inverted signals by means of a toggle switch. The trigger-shaper

stage makes sharp pulses that trigger the multivibrator. The multivibrator turns on the sweep generator and is reverted by the sweep generator through a holdoff circuit.

Unblanking

Each multivibrator generates a positive unblanking pulse at the same time that it turns on the sweep generator. The main-sweep pulse is several volts higher than the delaying-sweep pulse and therefore brightens the trace more than the delaying sweep pulse. The pulses are transmitted to the crt grid by separate cathode followers with the same cathode resistor.

External Sweep Amplifier

The external-sweep amplifier uses the same tubes as the delayed-sweep trigger-inverter stage. One position of the HORIZONTAL DISPLAY SWITCH arranges the circuits so the amplified signal is connected to the sweep-output amplifier. A ten-to-one fixed attenuator and a continuous control of amplifier gain provide 100-to-1 adjustment of horizontal-deflection sensitivity.

Calibrator

The calibrator has no internal connection to the vertical amplifier system. It consists of a symmetrical multivibrator with a cathode-follower output tube whose cathode resistor is a calibrated voltage divider.

VERTICAL DEFLECTION SYSTEM

The circuitry found in the Type 535 Vertical Deflection system is basically different from that in the Type 545. Also, extensive changes were made in the Vertical systems at SN 8628 in the Type 535, and at SN 9292 in the Type 545. Therefore, it will be necessary to compare the serial number and type of your instrument against the proper Vertical Deflection subheading in the material to follow.

GENERAL

Vertical amplifiers in all Type 535/545 oscilloscopes have separate input-amplifier units that can be plugged into the main unit. The various plug-in units provide a variety of pass bands and sensitivities, a differential amplifier, and a channel-switching unit to provide dual-

trace presentations.

The plug-in units develop balanced push-pull output which is maintained push-pull throughout the remainder of the amplifier. The units contain input selector switches, sensitivity adjust-



ments, and vertical positioning controls.

Signal connections to the vertical amplifier in the main unit are made by means of terminals in a mating multiple-contact plug and socket. Power connections from the main unit are made through other connectors on the same plug-and-socket assembly.

Main Unit Vertical Amplifier Input Stage Type 535, S/N 101-8627

In Type 535 instruments, Serial Numbers 101 through 8627, signal input from the plug-in units is connected through terminals 1 and 3 to the grids of input amplifiers V508 and V509. The cathodes of these two tubes are connected through a degenerative rc network, R502, R503, R504 and C503. This network lowers the amplifier gain about two per cent except during the first 1/4-microsecond for a step signal, to compensate for a response characteristic of cathode followers used elsewhere in the vertical amplifier system. Push-pull neutralization through C500 and C501 reduces input capacitance at the grids.

Delay Line

Plate output from V508 and V509 is connected to the delay line. The 24-section, 1/4-microsecond delay line introduces an additional 1/4-microsecond of signal delay to permit the sweep generator and unblanking circuits to get going before the triggering signal gets to the deflection plates, so that the leading edge of the signal can be observed. The triggering signal is taken push-pull from the midpoint of the first delay-line section so that the capacitance of the grids of trigger amplifiers V527A and V524B can be part of the delay-line shunt capacitance.

The line is terminated by R938 and R940, with C938 and C940 to correct the phase angle of the terminating impedance. Output is taken from the midpoint of the last delay-line section so that the input capacitance of cathode followers V558A and V558B can be part of the line shunt capacitance.

Delay-Line Output Cathode Followers

Cathode output from V558A and V558B is connected through peaking coils L557 and L558 to the grids of V570 and V580. Gain of this stage can be adjusted over a small range by an internal

screwdriver adjustment, R574 labeled AMPL GAIN, which adjusts the amount of degeneration in the common-cathode circuit. L570 and L580 are adjustable peaking coils.

DC-Shift Compensation

A long-time-constant change in gain which is characteristic in high-conductance stages is compensated for by an rc network, R595, R596, R597, C595A and C595B. A screwdriver adjustment on R596, labeled DC SHIFT COMP permits the amount of compensation to be adjusted to accommodate tube differences.

Output Cathode Followers

Plate output from V570 and V580 is applied to the vertical-deflection plates of the cathode-ray tube through cathode followers V606A and V606B, and through peaking coils L634 and L635 and damping resistors R634 and R635.

Off-Screen Trace Indicator

Neon glow lamps NE628 and NE629 are connected between cathodes and +225 volts. The cathodes are somewhat higher than +225 volts when the spot is centered. If the cathode of either tube rises much above this voltage so that the spot is not visible on the screen, the neon glow lamp at that cathode will glow and show which direction off the screen it is positioned.

Internal-Trigger Pickoff

Internally derived triggering voltage is taken from the vertical-deflection signal through V527A and V527B, which are connected in order to produce single-ended output from push-pull input. Cathode follower V535 supplies the signal to the INT. positions of the TRIGGER SLOPE switch, SW1.

Vertical-Signal Output

The second half of cathode-follower V535 connects through C540 to a front-panel connector labeled VERT. SIG. OUT. Output level is approximately 2 volts per centimeter of vertical deflection. Bandwidth at the terminal with no external load is about 6 megacycles at the 3-db point. A capacitive load of 50 μf will reduce this bandwidth to about 4.5 megacycles. Low-frequency cutoff is about 20 cycles into a 1-megohm load.



Type 535, S/N 8628 and up
Vertical-Deflection System
The Amplifier Circuit

The vertical-deflection system in the Type 535 was considerably changed starting at Serial Number 8628. In instruments above that serial number, the signal input from the plug-in unit is coupled through terminals 1 and 3 of the interconnecting plug to the grids of the Input Amplifier stage. The plate circuit of this stage is compensated for both high-frequency attenuation and dc shift.

High-frequency compensation is provided by the series-shunt peaking coils L506 and L523. These coils extend the bandwidth of the amplifier by reducing the high-frequency attenuation caused by the stray capacitance in the circuit.

DC shift in the amplifier tubes--a condition whereby the dc (and extremely low-frequency) transconductance is less than at mid-frequencies--is compensated for by a dc "boost" network. R507 and C507A, in the plate circuit of V504, and R524 and C507B, in the plate circuit of V524, shunt the plate-load resistors in each circuit. The extremely long time constant of the circuit is such that the plate-load resistance remains 1.8 kilohms in the range from dc to a fraction of a cycle, but reduces in value to a minimum of 1.77 kilohms for frequencies above this range. The slightly higher plate-load resistance, in the range from dc to a fraction of a cycle, compensates for the slightly reduced transconductance of the tubes in this range, so that the gain remains substantially constant from dc to the upper limit of the amplifier.

The Input Amplifier is coupled to the Output stage by the Driver C.F. stage V533B and V543B. This cathode-follower stage provides the necessary low impedance to drive the Output Amplifier. The Output Amplifier is the driving source for the Delay Line and the vertical deflection plates in the crt. The gain of this stage is adjusted by means of R570, the GAIN ADJ., which varies the degeneration in the cathode circuit. This control is adjusted so that the vertical deflection on the crt agrees with the plug-in unit's VOLTS/CM calibration when the VARIABLE control is set to the CALIBRATED position. R553 and R563 are the terminating resistors for the Delay Line; they are also the plate-load resistors for the Output Amplifier.

Beam Position Indicators

The beam-position indicators B536 and B546, located on the front panel above the crt, indicate the relative vertical position of the trace with respect to the center of the graticule. When the beam is centered vertically, the potential across either neon is insufficient to light it. As the beam is positioned up or down the screen, however, the grid voltage for the Indicator Amplifiers, obtained from a tap on the Delay Line terminating resistors, will change. The current through one amplifier will increase, and the current through the other will decrease. Hence, the voltage across one neon will increase, causing it to light, and the voltage across the other will decrease, causing it to remain extinguished. The neon that lights will indicate the direction in which the beam has been moved.

Trigger Pickoff

When internal triggering of the Time Base Generator is employed (black TRIGGER SLOPE knob in either the +or-INT. position), a "sample" of the vertical signal is used to develop the triggering pulse. This "sample", obtained from the Driver C.F. stage, is amplified by the Trigger Pickoff Amplifier and coupled through the Trigger C.F. to the Time Base Trigger circuit.

This "sample" of the vertical signal is also a-c coupled, through V593B and C599, to a front-panel jack labeled VERT. SIG. OUT.

Delay Line

The output signal from the Vertical Amplifier is coupled through the Balanced Delay Line to the vertical deflection plates of the crt. The function of the line is to delay the arrival of the waveform at the deflection plates until the crt has been unblanked and the horizontal sweep started. This delay insures that the very "front" of fast vertical signals can be observed. The line is adjusted, by means of the variable capacitors connected across the line, for optimum transient response.

Type 545, S/N 101-9291
Main-Unit Input Stage

In Type 545 oscilloscopes from serial number 101 through 9291, signal input from the preamp is connected through terminals 1 and 3 to the



grids of input amplifiers V1025B and V1040B. The cathodes of these two tubes are connected together through the degenerative network, R1026, R1027, and R1028. R1027, labeled GAIN ADJ., is variable to allow the amplifier gain to be varied over a small range. L1022 and L1041 provide series peaking and L1021 and L1042 provide shunt peaking for the stage. Triodes V1050A and V1052A provide the low impedance necessary for driving the distributed-amplifier grid line.

Beam-Position Indicators

Triodes V1025A and V1040A have as their plate loads neon glow lamps B1010 and B1014 across 1-megohm resistors. When the trace is centered, the plate current is insufficient to ignite these lamps, but as the trace is positioned off the screen vertically the current through one triode will increase causing the corresponding lamp to glow showing which way the trace is off the screen.

Trigger Pickoff

The trigger pickoff tubes, V1060 and V1066 convert the push-pull vertical signal on the distributed-amplifier grid lines to single ended output without disrupting the balanced configuration of the grid lines. The trigger cathode follower supplies the amplified vertical signal at low impedance to the oscilloscope trigger circuits and to the vertical-signal-out cathode follower. This cathode follower applies a sample of the vertical signal, somewhat limited in pass band, to the front-panel binding post labeled VERT. SIG. OUT.

DC-Shift Compensation

DC-shift compensation is accomplished in two ways and corrects for two different time constants. The series combination of R1080 and C1045B on plate line L1080, and R1084 and C1050B on plate line L1083, lowers the termination resistance of these lines to all but the very low frequencies. They provide a time constant which corrects for the initial dc shift in the amplifier. The second time constant is corrected by R1045 and C1045A and R1050 and C1050A. These rc networks have a negligible loading effect on the distributed-amplifier plate lines, but provide low-frequency positive feedback to the input-amplifier plates. This feedback corrects for the longer-time-constant dc shift.

R1059, labeled DC SHIFT COMP. permits the amount of compensation to be adjusted to accommodate tube differences.

Distributed Amplifier

The output amplifier is a six-section, balanced, distributed amplifier. The grid lines are driven by V1050A and V1052A through rc frequency-compensating networks. The plate lines, L1080 and L1083, drive the delay line directly. Each section of the plate lines is tuned for optimum response to a square wave by trimmers connected line to line.

Termination Network

Unless the plate lines are terminated at the reverse end with a resistance equal to their characteristic impedance, signals traveling the reverse direction down the line will be reflected and appear in the output. Since resistors are not available, in a suitable power rating, which appear resistive over the wide pass band of the Type 545, and adjustable terminating network is used. The coils, L1070, and L1071, are wound with resistance wire and have a total resistance of 595 ohms. Each section has a characteristic impedance which is approximately equal to the impedance of the plate lines less the series dc resistance between it and the plate lines.

Type 545, S/N 9292 and up Main Unit Input Circuit

The signal input from the Plug-in unit is coupled through terminals 1 and 3 of the interconnecting plug to the grids of the Input Amplifier stage. R1027 varies the cathode degeneration, and thus sets the gain of the stage to agree with the Preamplifier's front-panel calibration when the VARIABLE knob is in the CALIBRATED position.

The Input Amplifier is coupled to the Distributed Amplifier by the cathode followers V1033 and V1043. The cathode followers isolate the Distributed Amplifier from the Input Amplifier, and provide the necessary low-impedance drive for the Distributed Amplifier's grid line.

High-frequency compensation for the Input Amplifier is provided by the variable peaking coils L1014 and L1024. Variable inductors L1036 and L1046 provide additional peaking at



the very high frequencies.

Output Stage

The output stage is a 6-section Distributed Amplifier. The tapped inductors in the transmission line, between each grid and between each plate, isolate each section from the capacitance of the adjacent sections.

The input signal for each tube is obtained from the grid line, which is driven by the cathode followers V1033 and V1043. The amplified signal at each plate, fed to the plate line, becomes an integral part of the wave traveling down the line toward the deflection plates.

The vertical signal is delayed 0.2 microsecond between the input to the grid line and the vertical deflection plates. This delay insures that the very "front" of fast vertical signals can be observed. About 0.015 microsecond of the total delay time occurs in the Distributed Amplifier; the remaining 0.185 microsecond occurs in the Delay Line.

The tapped inductors between each section of Distributed Amplifier provide about 0.003 microsecond of delay. By making the delay time in the grid and plate lines equal, the signal arriving at each plate, through the electron stream of the tube, will be synchronous with the signal moving down the plate line from the preceding sections.

DC Shift Compensation

DC shift in the amplifier--a condition whereby the dc and very low-frequency transconductance is less than at mid-frequencies--is compensated for in two ways. R1090 and C1093B, in plate line L1104 and R1095 and C1093D in plate line L1114, form a low-frequency boost network; the time constant of this network is such that the termination resistance of the line is increased in the range from very low frequencies to dc. A longer time constant, for extremely low-frequency and dc compensation, is provided by R1092, R1094, and C1093A, in one plate line, and by R1097, R1099 and C1093C in the other, which provide a small amount of positive feedback from the plate lines to the plate circuits of the Input Amplifier. A variable resistor R1091, the DC SHIFT COMP. control is connected between the two networks to adjust for the proper amount of

compensation.

Beam-Position Indicators

The beam-position indicators B1083 and B1087, located on the front panel above the crt, indicate the relative vertical position of the trace with respect to the center of the graticule. When the beam is positioned up or down the screen, however, the current through the Indicator Amplifiers, and hence the voltage across the neons, will change. One neon will increase, causing it to light, and the voltage across the other will decrease, causing it to remain extinguished. The neon that lights will indicate the direction in which the beam has been moved.

Trigger Pickoff

When internal triggering of the Time Base Generator is desired (black TRIGGER SLOPE knob in either the +or-INT. position), a "sample" of the vertical signal is used to develop the triggering pulse. This "sample" is obtained from the trigger pickoff circuit consisting of the Trigger Pickoff Amplifier V1054 and V1064, and Trigger Pickoff C.F. V1223B.

This "sample" of the vertical signal is also ac-coupled, through V1223A and C1228, to a front-panel jack labeled VERT. SIG. OUT

Delay Line

The output signal from the Vertical Amplifier is coupled through the balanced Delay Line to the vertical deflection plates of the crt. The function of the Delay Line is to retard the arrival of the waveform at the deflection plates until the crt has been unblanked and the horizontal sweep started. This delay, as mentioned previously, insures that the very "front" of fast vertical signals can be observed. The line is adjusted, by means of the variable capacitors connected across the line, for optimum transient response.

The entire Delay Line, which includes the plate line in the Distributed Amplifier, is reverse-terminated in its characteristic impedance. The Termination Network, shown on the Vertical Amplifier diagram, is designed to dissipate both the dc and signal energy in the line by presenting a constant resistance over the frequency range of the amplifier. The terminating resistors R1071 and R1073 are especially made,



wirewound, noninductive, distributed resistors. The 600 ohms total resistance in each is "tapered", or distributed, in steps. The largest segment of the terminating resistance appears nearest the line; the smallest segment appears at the opposite end. Each step of the resistance is then tuned, by means of the variable capacitors, so that the network will present an optimum load to the line.

Calibrator

The calibrator is a symmetrical multivibrator with V670A and V670B connected in order to turn cathode follower V262A on and off as it oscillates. During the negative pulse at multivibrator V670A, the grid of the cathode follower is driven well below cutoff, so the cathode is at ground voltage. During the positive pulse at the multivibrator the plate is cut off and rests slightly below +100 volts. The voltage of the plate during cutoff is determined by the setting of R679, part of a divider between +100 volts and ground. R679 is a screwdriver adjustment labeled CAL. ADJ. Cathodes of the multivibrator are returned to -150 volts. The multivibrator frequency is about one kilocycle.

Cathode follower V246A has a tapped calibrated voltage divider for its cathode resistor. When the CAL. ADJ control is properly set, the cathode-follower cathode is at +100 volts when V670A is cut off. Taps on the divider divide the 100 volts down to 50, 20, 10, 5, 2, 1, .5 and .2 volts. A second divider with a division ratio of 1000 to 1, can be switched in if desired to divide these voltages into millivolts. C682 from the cathode to ground corrects a slight overshoot. No internal connection from the calibrator to the vertical-deflection circuits is provided.

Main Sweep

Trigger Amplifier

The TRIGGER SLOPE switch selects the source of triggering voltage and arranges the trigger-amplifier input circuit to produce negative-going output for either negative-going or positive-going portions of the input signal.

Trigger amplifier V8 is a cathode-coupled phase inverter. A capacitor, C3, can be switched into the grid circuit to remove the dc component of the trigger signal. Output is always taken from

the A-section plate, but the TRIGGER SLOPE selector connects either the A-section grid or the B-section grid to the input signal source. For positive-going signals connection is made to the A-section grid, and for negative-going signals connection is made to the B-section grid, and in each case the opposite grid is connected to an adjustable dc bias source, adjustable by means of the TRIGGERING LEVEL control, R14. This control adjusts the dc level of the A-section plate output. The dc level of the plate output is important to the circuit operation in three of the positions of the TRIGGERING MODE switch because in these three switch positions the input grid to the trigger shaper stage, V20A, is dc coupled to the plate of V8. The effect of the dc level is shown in a later paragraph.

Triggering Mode Switch

The TRIGGERING MODE switch, SW5, has five positions marked in red in the upper right-hand corner of the instrument panel: DC, AC SLOW, AC FAST, AUTOMATIC, and HF SYNC. (Type 535, S/N101-1058 has no HF SYNC position. Type 535, S/N 101-6044 and Type 545, S/N101-6889 have the AUTOMATIC position indicated as AC AUTO.) This switch arranges the circuits of the trigger-amplifier and trigger-shaping stages to accommodate all types of triggering.

DC, AC Slow and AC Fast

When the TRIGGERING MODE switch is in the DC position, the triggering signal is direct coupled through the trigger amplifier so that the dc component of the signal is applied to the trigger shaper. In the AC SLOW position, C3 removes the dc component of the signal, and in the AC FAST position, C4 and R6 form an rc filter to remove the low-frequency component of the triggering signal and allow fast recovery of the trigger circuits in the presence of dc level changes.

In these three positions, the trigger shaper, V20, is connected as a bistable multivibrator. In the quiescent state between triggers, the pentode section is conducting and its plate is therefore down. The grid of the triode section is dc coupled to the pentode-section plate through divider, R34, R35, R36, which holds the triode-section grid below plate-current cutoff.



The negative-going trigger signal at the pentode grid raises the pentode plate which carries the triode grid positive into plate-current conduction. This also raises the triode cathode which is coupled to the pentode cathode through C28, R28, so that current is further reduced in the pentode, and the pentode cuts off. The transition is made very rapidly, regardless of how slowly the pentode grid signal falls. R28, connected between the two cathodes, is adjustable so that the trigger sensitivity can be adjusted. This is a screwdriver control marked SENSITIVITY on the chassis. No cathode current flows from the cathode not conducting through R28 when the trigger shaper is in either stable condition, so its effect is to lower the cathode voltage of the tube not conducting. For example, when the triode section is not conducting and its grid is below its cathode by the amount determined by plate current through R24, its cathode is below the cathode of the pentode section. R28, R27 form a voltage divider that places the triode cathode about two volts lower than the pentode cathode. This places the triode grid and cathode two volts closer together. The larger R28 becomes, the closer to conduction the triode will be. Increasing R28 therefore increases trigger sensitivity.

The steep negative-going step at the plate of the triode section is differentiated in an rc circuit, including C58 shown in the sweep diagram, with a time constant of about a tenth microsecond, and the sharpened pulse trips the multivibrator. The circuit will respond to trigger signals with a frequency up to 2 mc.

The TRIGGERING LEVEL control, R14, adds a bias to the plate-output signal of the inverter stage, V8. This changes the level of the cathode of the shaper stage, V20, and therefore changes the level on the triggering signal that must be reached to return the shaper-stage cathode to the transition point.

For example, to adjust the triggering level so that triggering will occur at a point four volts positive on the positive-going portion of a 10-volt peak-to-peak trigger-input signal, the triggering-level bias would be set about four volts above the zero level. The dc level of the plate of the inverter stage would therefore rise about twenty volts. Positive-going input would become negative-going output, which, starting twenty volts higher than zero level, would need to drop twenty volts to return to the transition

point and trigger the shaper stage.

Automatic

In the AUTOMATIC position of the TRIGGERING MODE switch, the plate of the pentode section of trigger-shaper V20, drives the grid of the triode section just as it does in the AC SLOW position. But in addition, it also drives its own grid through R30, a high resistance of several megohms.

When the transition takes place and the plate of the pentode rises, for example, the triode grid also rises carrying with it the right-hand end of R30. The left-hand end of R30 is connected to the pentode grid through R21. The time constant of the rc circuit between the triode grid and ac ground through C20, R30 and R21, is of such length that it takes about .01 seconds for the pentode grid to rise exponentially from its starting point below cutoff to a point where plate current can flow. During the .01-second period, the pentode grid rises, but the triode grid remains at a constant voltage until the next transition, when pentode plate current begins to flow.

When pentode plate current flows, the pentode plate drops, forcing the triode grid down, and thus the right-hand end of R30 is forced down. The left-hand end of R30 and the pentode grid immediately begin to drop exponentially toward pentode cutoff. When the pentode grid reaches cutoff again it has completed one cycle of the approximately 50-cycle sawtooth. The range of pentode grid voltage between pentode cutoff and triode cutoff is about six volts for the AUTOMATIC circuit. This is increased from about 1/4 volt for the DC and AC SLOW circuit connections by addition of R23 to the plate load of the pentode.

Since the pentode grid is never more than six volts from cutoff, a trigger signal with a peak-to-peak voltage of six volts or more can drive the grid to cutoff at any time during the negative-going excursion and produce a trigger output. Smaller trigger signals can also trigger the shaper but only if they occur at a time when the grid is within their peak voltage of cutoff. The duty cycles of operation of the sweep is somewhat reduced therefore with smaller trigger signals.

This circuit configuration is useful because



with it the sweep can be synchronized with repetitive signals over a wide range of frequencies without readjustment. When not triggered externally, the sweep continues at a fifty-cycle rate, and in the absence of any vertical signal, generates a base line that shows that the oscilloscope is adjusted in order to display any signal that might be connected to the vertical-deflection system.

HF Sync

When the TRIGGERING MODE switch is in the HF SYNC position, the trigger-amplifier and trigger-shaper stages are bypassed and the trigger signal is applied directly to the sweep multivibrator. In this position the STABILITY control is set so the sweep multivibrator free runs. The trigger signal is superimposed on the negative-going trigger-holdoff waveform at the grid of V58A and will cause the multivibrator to synchronize at a submultiple of the triggering-signal frequency. This circuit is suitable for signals in excess of five megacycles.

Multivibrator

The dc-coupled multivibrator, shown in the sweep generator diagram, turns on the sweep generator upon receipt of a negative trigger from the trigger shaper, and holds off subsequent trigger signals until after the sweep is completed. The multivibrator consists of V58 and V70 with both common-cathode and plate-to-grid coupling. Plate-to-grid coupling is by means of a cathode follower. V58 is the positive-going half of the multivibrator, which in the quiescent state is conducting. V70 is the negative-going half of the multivibrator which in the quiescent state is cut off.

In the quiescent state V58A is conducting and its plate is down. Cathode-follower V58B holds the grid of V70 below cutoff through voltage divider R65, R66. The plate load of V58A includes L61 to speed the rise of plate voltage, and R62 which raises the plate voltage a few volts

above +100 when the plate is cut off. The use of cathode-follower V58B, between V58A plate and V70 grid, isolates the positive-going plate from the capacitances of the various loads that require a positive-going pulse and thereby permits a steeper positive step. The voltage divider in the cathode of the cathode follower is compensated by C65 for the shunt capacitance to ground of the grid of V70.

While V70 is cut off its plate rests at -3.2 volts, because of diode current in V80A and V80B, which flows through R69. When the negative trigger pulse from the trigger-shaper stage reaches the grid of V58A, an amplified positive pulse at V58A plate is coupled through cathode follower V58B to the grid of V70. This raises the grid of V70 above cutoff and plate current raises the common-cathode voltage which further raises the plate voltage of V58A. The biases and plate loads are adjusted so that when V58A is conducting, the grid of V70 is held below cutoff, and when V70 is conducting, the cathode of V58A is held above cutoff.

There are thus two stable states, in either of which the multivibrator will remain until a signal of the proper polarity and amplitude at the grid of V58A switches it to the other state. To return the multivibrator back to the quiescent state with V58A conducting, a positive voltage is required at the grid of V58A which is high enough to cause plate current to flow. The positive pulse for returning the multivibrator to its quiescent state is supplied from the sweep generator when it has completed its sweep.

Stability Cathode Follower

The STABILITY control, R43, adjusts the grid voltage of cathode follower V43A, which in turn determines the quiescent grid voltage of positive multivibrator V58A at about -40 volts, just above the threshold of triggering. Holdoff cathode follower V54A, and delay trigger cathode follower V37B, are normally cut off and do not contribute to the quiescent level of V58A grid.

HORIZONTAL DEFLECTION SYSTEM

Sweep Generator

The sweep generator is a Miller integrator circuit. The circuit includes disconnect diodes V80A and V80B, cathode-follower coupler V85, timing capacitor C99, and the Miller tube, V90.

In the quiescent state between sweeps, the plates of diodes V80A and V80B rest at -3.2 volts. Very little current flows through V80A to the grid circuit of V90, and V90 grid therefore rests at about -3.3 volts. More current flows through V80B so that its cathode is at about -5 volts.



sweep amplifier and unblanking circuits, and connect the delayed trigger to the main-sweep circuits.

In the MAIN SWEEP NORMAL position, this switch connects the main-sweep generator to the sweep amplifier, grounds the grid of the delaying-sweep unblanking cathode follower and supplies main-sweep sawtooth to the delay pickoff.

In the DELAYING SWEEP position the switch connects the delaying-sweep generator to the sweep amplifier and to the delay-pickoff comparator circuit, V195B, and connects the delaying-sweep gate to the unblanking mixer. Both the main- and the delaying-sweep unblanking signals unblank the cathode-ray tube.

In the MAIN SWEEP DELAYED position of the switch the delaying-sweep is disconnected from the sweep amplifier, its unblanking mixer grid is grounded, the main-sweep generator is connected to the sweep amplifier and unblanking mixer, and the main-sweep trigger input is connected to the delay pickoff.

In the EXT. SWEEP position the switch rearranges the delaying-sweep trigger shaper into a cathode follower and connects its output to the sweep-amplifier input. It also biases off the delay-trigger circuit and the delaying-sweep multivibrator, and supplies a positive dc bias to the unblanking circuit to hold the cathode-ray tube unblanked.

DELAYING-SWEEP CIRCUITS

Delayed-Trigger Amplifier

The delayed-trigger from the delay-pickoff circuit, described in a later paragraph, is amplified in V37A, and applied to the grid of delayed-trigger cathode follower V37B through compensated voltage-divider C50, R50, R51. The cathode voltage of V37B is determined by current through R53 which is returned to -150 volts.

Current through R53 can be contributed by cathode current through any of three cathode followers, V43A, the stability tube; V54A, the holdoff tube; or V37B, the delayed-trigger tube, depending on the position of the HORIZONTAL DISPLAY switch, the setting of the STABILITY control, and the stage of the trigger-and-sweep sequence.

With the MAIN SWEEP NORMAL position the plates of V37A and V43A are disconnected and screen current furnishes the cathode current of V43A. With the switch in the MAIN SWEEP DELAYED and the DELAYING SWEEP positions plate voltage is connected both to V37A and V43A. The plate of V43A is connected to the grid of V37B through compensated voltage divider C50, R50, R51, in such a way that V43A and V37B become a bistable multivibrator.

In the quiescent state V37B conducts and holds the common-cathode voltage so high V43A is cut off. A positive pulse at the grid of V37A will therefore become a negative pulse at its plate.

The negative pulse drives the grid of V37B down below cutoff, and the multivibrator assumes the second stable state in which V43A conducts and V37B is cut off. The cathode level in this state can be set by means of the bias voltage determined by the setting of the STABILITY control.

By setting the cathode level past the threshold of triggering for the sweep-gating multivibrator, a sweep will not be triggered, but the grid will be placed close enough to triggering that a negative trigger pulse from the main-sweep trigger circuit will trigger a sweep.

Two methods of delayed triggering are thus available. The first method in which the delayed trigger actually triggers the sweep is the ordinary system. The second method permits the sweep to be triggered actually from the delayed pulse you want to observe. The delayed trigger opens up the normal trigger channel that has been closed up to that time in order to hold off undesired triggers.

Delay Pickoff

The delay pickoff circuit is a sawtooth comparator circuit arranged to produce a positive output voltage at the time of pickoff. Before the pickoff time, V195 is cut off. Its cathode is tied to the cathode of V196 which is conducting and therefore determining the common-cathode voltage.



The common-cathode voltage is adjustable by means of R209, a 10-turn helical resistor, labeled DELAY-TIME MULTIPLIER on the front panel. V228A is a constant-current pentode supplying cathode current to the comparators from the -150-volt supply. This arrangement permits the cathode of V196 to follow its grid over a wide range with very little variation of cathode voltage.

Plate current through R205 therefore also remains very nearly constant while V196 is conducting, no matter at what voltage the grid is set by the DELAY-TIME MULTIPLIER control, R209. This is important because the plate voltage of V196 is required to hold the grid voltage of the shaper stage, V216A, near the triggering.

The positive-going delaying-sweep sawtooth raises the grid of non-conducting V195B toward its cathode voltage. When the grid rises past the cathode voltage set by the DELAY-TIME MULTIPLIER control, V195 conducts and V196 cuts off.

Delayed-Trigger Shaper

When V196 cuts off, because of conduction in V195, its plate rises carrying the grid of trigger shaper V216A positive past its transition point. The trigger-shaper stage is regenerative so as to produce a fast transition, and the resulting positive step at the plate of V216B is differentiated through C228 and used to arm or to trigger the main-sweep circuits. The sharp differentiated pulse is transmitted to the succeeding circuits through cathode follower V228B.

Two internal screwdriver controls accessible from the right side through holes in the cabinet permit you to adjust the delay time more accurately if necessary so you can read centimeters of delay within a fraction of one per cent directly from the micrometer dial of the 10-turn DELAY-TIME MULTIPLIER control. R208 adjusts the total dc voltage across R209 so that each of the ten turns of this resistor positions the point of delay pickoff one centimeter of horizontal beam displacement. R195 sets the dc level of the delay sawtooth accurately so that the zero setting of the DELAY-TIME MULTIPLIER control corresponds to the start of the delaying sawtooth.

Reset Button

The main-sweep circuits can be adjusted to perform a single sweep when triggered and then be unresponsive to any further triggers. This circuitry is set up when the HORIZONTAL DISPLAY switch is in the MAIN SWEEP DELAYED position, and the delaying sweep is deactivated by turning the delaying-sweep STABILITY control counterclockwise.

The main-sweep multivibrator STABILITY control is set at the level where it would normally be for main-sweep-triggered operation, and the desired trigger-signal source is connected to the main-sweep triggering circuits.

With the MAIN SWEEP DELAYED setting of the switch, V43A and V37B form a bistable multivibrator when the main-sweep STABILITY control is adjusted as described in the previous paragraph. In the stable state that exists after completion of one sweep and before the RESET button is pressed, V37B is conducting and thereby determining the voltage level of the common-cathode circuits. This level is high enough to hold off V58A from triggering. The RESET control, SW235, shown on the delay-pickoff diagram, applies a negative pulse to V37B and turns it off, thereby switching multivibrator V43A, V37B, to its second stable state with V43A controlling the common cathode level. This level is lower and it places the grid of V58A within the region where it will trigger, if the STABILITY control has been properly set, and the next trigger signal will initiate a sweep. At the end of the sweep, holdoff cathode-follower V54A raises the common-cathode level up momentarily, thereby switching V37B on and V43A off again, and the circuit returns to its first stable state.

Ready Light

The ready light, B42, shows whether V43A is conducting. When V43A conducts it pulls down the grid of V43B and thereby raises the plate high enough to light the neon glow lamp.

When the ready light is glowing a single negative pulse at the main-sweep multivibrator grid, V58A, will trigger a single sweep and the circuit will thereafter be disarmed for subsequent triggers.



SWEEP AMPLIFIER

Amplifier

Input to the amplifier is selected by one of the positions of the HORIZONTAL DISPLAY switch, SW200. A cathode follower, V240B, feeds the selected signal to a second cathode follower, V240A, which in turn feeds a common-cathode, grounded-grid phase inverter, V265A and V272A. Gain of the phase-inverter stage can be adjusted by adjusting R226 and R270, labeled SWP. CAL. and MAG. GAIN on the chassis, which determine the degree of coupling between the two cathodes. Output from the phase-inverter stage is applied to the horizontal-deflection plates of the cathode-ray tube through cathode followers V265B and V272B.

Magnifier

A negative voltage feedback network, made up of R259 and the parallel resistance of R260 and R254, accurately determines the gain of the sweep amplifier. This negative feedback can be disconnected by means of SW254A, labeled 5X MAGNIFIER, ON and OFF, in red on the front panel. When the feedback is removed, the gain of the amplifier is increased by a factor of five for the magnified sweep. R266 and R270 between cathodes of the phase-inverter stage V265A and V272A are also switched by the 5X MAGNIFIER switch, to permit the gains to be individually adjusted in order to keep the ratio of gains exactly five times for the two positions while permitting the spot speeds to be accommodated to the graticule. An internal screw-driver adjustment, R262, labeled SWEEP/MAG REGIS. adjusts the bias of the degeneration cathode follower so that it is the same for both switch positions. This permits the magnified and normal sweep traces to be kept in accurate register, so that the center portion of the normal sweep will be centered when magnified.

Gated CF Current Booster

Cathode current for cathode follower V265B which drives the negative-going, left-hand plate of the crt, is determined by the plate current of pentode V282. The pentode is used because its plate current remains nearly constant over a large range of plate voltage, so that the cathode-follower current is kept nearly constant even

though its cathode voltage drops through a range of about 150 volts. For the fastest sweeps, the maximum permissible continuous current through these tubes is too small to discharge the capacitance of the crt deflection plate and its associated wiring at the required rate. To increase the current through these tubes to the required value, a positive, flat-topped pulse is applied to the grid of the pentode during the period of the sweep. The positive pulse is derived by differentiating the positive-going sawtooth, through an rc network. Its amplitude is thus proportional to sweep speed. For the fastest sweep, the tube current is several times normal, but at the reduced duty cycle of the sweep, is well within the average dissipation limit of the tubes.

Beam-Position Indicators

Two neon glow lamps, B292 and B293, connected across the deflection plates and biased slightly below the average dc voltage of the plates, indicate which direction the spot is off the screen if it cannot be seen. If either plate assumes a voltage much higher than the average voltage, the glow lamp connected to that plate will glow.

Positioning

Horizontal positioning of the trace is adjustable through cathode follower V246B which sets the dc grid voltage of input cathode follower V240B. The grid voltage of the positioning cathode follower is determined by potentiometer R250, labeled HORIZONTAL POSITION on the front panel, and by R248, labeled VERNIER in red on the front panel, which will move the spot about one-fifth as far as R250.

External Sweep Amplifier

When the HORIZONTAL DISPLAY switch, SW200, is in the EXT. SWEEP position, the EXT. SWEEP connector connects to an auxiliary amplifier which uses the tubes and circuits

External-sweep signals are applied either to the grid of V113A or V113B, depending on the setting of SLOPE switch, SW113. For in-phase amplification the SLOPE switch should be switched to -, and the signal will be connected to V113A.



The signal applied to V113A grid is cathode coupled to V120A, which, with V120B, is a cathode-coupled, grounded-grid amplifier. Gain of this amplifier can be adjusted by varying R122 which determines the amount of cathode coupling. The two cathodes must be at the same dc voltage, or variation of R122 will change the dc level. R114 labeled EXT. AMPL. DC BAL. on the chassis can be adjusted so that the cathodes of V120A and V120B are at the same voltage.

Plate output from V120B is connected to the sweep amplifier through cathode follower V130A in the EXT. SWEEP position of the HORIZONTAL DISPLAY switch.

Note that the external sweep signal must not have a dc component of its own or the dc balance will be upset, and adjustment of the 10-1 gain control will position the trace horizontally.

POWER SUPPLY

Transformer

Plate and heater power for the main unit and the plug-ins is provided by a single power transformer, T700. The primary is wound with two equal 117-volt windings that can be connected either in parallel for 117-volt operation, or in series for 234-volt operation. The power supply will operate satisfactorily over the voltage ranges 105 to 125 volts and 210 to 250 volts, 50 to 60 cycles. The secondary contains five separate high-voltage windings and seven separate heater windings.

Rectifiers

The ac voltage from the high-voltage windings is rectified by bridge-connected full-wave dry-disk selenium rectifiers.

Regulation, -150-Volt Supply

All dc voltages furnished by the power supply are regulated either in the power supply or in the circuit it supplies. Reference voltage for the regulators is established by means of a gas-diode voltage stabilizer that determines the grid potential of a comparator amplifier, V712, in the -150-volt supply. The grid potential of V712A established by the gas diode is compared against the grid voltage of V712B. The grid voltage of V712B is obtained from a divider, R715, R716, R718, which divides down the voltage of the -150-volt bus being regulated. R716, labeled -150 ADJ on the chassis, is a screwdriver adjustment which determines the percentage of voltage division that appears at V712B, and thereby determines the total voltage across the divider.

The voltage difference between the two grids of V712 appears as an amplified error signal at

V712B plate. The amplified error signal is further amplified in V700, which is dc connected to V712B plate and to the grids of series tubes, V725, V726, and V727.

The series tubes change their plate-to-cathode resistance according to their grid-to-cathode voltage. The dc-coupled amplified error signal at their grids controls their plate resistance in order to introduce a change of drop through the tubes in the right direction to correct any difference in voltage between the two grids of the comparator tube. C707 and C717 bypassing the dc-coupled dividers, increase the ac gain of the feedback loop and thereby reduce ripple.

C115 connected between the -150-volt bus and ground keeps the output impedance down at frequencies above cutoff for the regulator feedback amplifiers. The screen of V700 has a small amount of the ripple that exists ahead of the regulators connected to it through R278. The phase of the amplified ripple voltage that appears at the plate of V700 is such as to out-phase most of the ripple at the -150-volt bus. R724 bypassing the series tubes reduces the amount of load current through them.

+100-Volt Supply

The comparator tube in the +100-volt supply, V742, compares its grounded cathode to the tapped-down voltage of divider, R750, R751 connected between the -150-volt bus as a reference voltage and the +100-volt bus to be regulated. The tapped-down point is a volt or so below ground. The screen of V742 receives a sample of the ripple signal through R744 to provide an out-phasing signal that reduces the output ripple at the +100-volt bus. High-frequency gain of the feedback loop is increased by C750, and C751A reduces the high-frequency output impedance.



+ 225-Volt Supply

Rectified ac from terminals 7 and 14 is added to the unregulated dc of the +100-volt supply to provide about 320 volts to the plate of series tube V748A. The comparator tube is V765 and an additional gain stage with V757 increases the feedback-loop gain. C770 and C763 increase the ac gain, and C751B provides low output impedance at high frequencies. Unregulated voltage taken from a point ahead of the series tube supplies the regulator for the cathode-ray tube supply. R762 reduces the load current through the series tube.

+ 350-Volt Supply

Rectified ac from terminals 5 and 10 of transformer T700 is added to the unregulated input to the +225-volt series tube, and applied to the plate of series tube V784. The comparator tube is V782. Screen injection of ripple voltage is used. C787 increases ac gain and C751C lowers high-frequency output impedance. R785 reduces load current through the series tube.

+ 500-Volt Supply

Rectified ac from terminals 20 and 21 of transformer T700 is added to the regulated side of the +350 supply, and applied to the plate of series tube V794. The comparator tube is V791 with screen injection of ripple. C797 increases ac loop gain, and C790B in series with C751C to ground, reduces output impedance at high frequencies. C795 reduces load current through the series tube.

Time-Delay Relay

A thermal-delay relay, K700, delays application of high voltage to the external circuits for about 25 seconds so that the heaters have time to get up to temperature. The dc current to the heaters of the plug-in units bypasses the regula-

tor tube, V748B, through R749 during this period. If the ac circuit is momentarily broken the thermal-delay relay operates and again waits for 25 seconds after reapplication of the ac before completing the dc high-voltage circuit connection.

High-Voltage Supply

Accelerating voltages for the cathode-ray tube are obtained by rectifying a 60-kc high ac voltage produced by a vacuum-tube oscillator. V803 is the oscillator tube connected as a Hartley oscillator with the primary of transformer T801 as the tapped inductor, and C806 as the capacitor.

A voltage-tripler rectifier, consisting of V821, V822, V823, C821, C822, and C823, supplies about 8650 volts positive for the post-deflection accelerating anode of the cathode-ray tube.

High-Voltage Regulator

A sample of the cathode voltage is tapped off by means of R814, R812, and adjustable R811, and applied to the grid of comparator tube V810A. The cathode of V810A is connected to -150 volts, and the grid is compared to that voltage. The difference voltage is amplified in the comparator tube and amplified again in shunt-regulator tube V810B, whose plate voltage determines the screen voltage of oscillator V803.

If, for example, the high voltage should become too high, it would make the grid of the comparator tube more negative with respect to its cathode. When the grid drops, the plate rises, thereby raising the grid of V810B. When its grid rises its plate drops, thereby dropping the screen voltage of the oscillator tube, and reducing the amplitude of oscillation. The reduction of primary voltage of T801 reduces the high voltage, thereby correcting the original departure. C814 at V810A grid reduces noise and hum.

CRT CIRCUIT

Unblanking

The control-grid voltage is produced by a winding and rectifier, V824, similar to the cathode supply, but insulated from it. The positive end of the control-grid supply is connected to the cathode of unblanking cathode-follower V54A,

and the negative end at -1450 volts is connected to the control grid through potentiometer R831, labeled INTENSITY on the front panel. When the unblanking pulse is produced at the cathode of the unblanking cathode follower, it drives the whole grid-voltage supply with it, winding, filter, potentiometer, so that the same pulse appears at



the cathode-ray tube grid 1550 volts below. Since this is a dc connection, the unblanking pulse may have any duration with no change in grid voltage. C834 transmits the leading edge of the unblanking pulse to reduce unblanking time for fast sweeps, and R834, R835, and R830, provide the right time constant to prevent overshoot.

CRT Geometry Adjust

The second-anode voltage required for best linearity at the extremes of deflection may vary somewhat between tubes. R861, a screwdriver control, labeled GEOM. ADJ. on the chassis, permits this voltage to be adjusted.



SECTION 4 MAINTENANCE

Replacement of Components

Tektronix will supply replacement components at current net prices. However, since most of the components are standard electronic and radio parts we suggest you get them from your local dealer if you can. Be sure to consult your instruction manual first to see what tolerances are required.

We specially select some of the components, whose values must fall within prescribed limits, by sorting through our regular stocks. The components so selected will have standard RETMA color-code marks showing the values and tolerances of the stock they were selected from, but they will not in general be replaceable from dealers stocks.

Such selected parts, as well as the parts we manufacture at Tektronix, are identified in the parts list either by notes or by our own stock numbers. Order these parts from the Tektronix factory in Portland, Oregon.

Parts-Ordering Information

You will find a serial number on the front-piece of this manual. This is the serial number of the instrument the manual was prepared for. Be sure the manual number matches the number of the instrument when you order parts.

A Tektronix instruction manual usually contains hand-made changes to diagrams and parts lists, and sometimes text. These changes are in general only appropriate to the instrument the manual was prepared for, the instrument whose serial number appears on the manual front-piece. The hand-made changes show changes to the instrument that have been made after the printing of the manual.

We make some of the instrument changes during the factory test procedure. Our technicians hand-tailor the circuits, if it seems appropriate, to provide the widest possible latitude of operation. Other changes are made to include the latest circuit improvements as they are developed in our engineering department, or when improved components become available. In any event, the changes are to your benefit. We have

tried to give you the best instrument we can.

Soldering Precaution

The solder used on the ceramic terminals in this instrument must contain a small percentage of silver. If for any reason you resolder, be sure the solder you use contains silver. Silver-bearing solder is used in printed-circuit techniques, and is therefore available from all solder manufacturers. Repeated use of ordinary tin-lead solder will dissolve the fused bond of silver that makes the solder adhere to the porcelain, especially if the soldering iron is quite hot.

Color Coding

We use color-coded wires in this instrument to help you identify the various circuits. The ac power leads are yellow and coded 1-1-0 (brown-brown-brown) following the RETMA resistor color code. The +350-volt bus is white and coded 3-5-0 (orange-green-brown, beginning with the widest stripe). The heater leads are coded 6-1, 6-2, etc., not to indicate that the voltages are different but to differentiate between the leads. All signal leads have a single stripe. A few wire colors are indicated by small, lower-case letters on the diagrams.

Air Filter

The Type 535/545 Oscilloscope is cooled by filtered, forced air. If the filter gets too dirty it will restrict the flow of cooling air and may cause the instrument to overheat. The filter should be inspected every three or four months and cleaned or replaced if necessary.

Two types of air filters can be used with your Tektronix equipment. A washable air filter constructed of aluminum wool coated with an adhesive is usually supplied with your instrument. A disposable glass-wool filter is available through your local Tektronix field office or direct from the factory. If you are replacing an aluminum-type filter with the disposable glass-wool type, it is best to order No. 378-009, which includes two back-up screens that help to prevent damage to the filter. For future replacements of the



glass-wool filter only, order No. 378-012.

To clean the aluminum filter, run hot water through it from the side that was inside. Or slosh it around in hot soapy water and rinse it in clear water. Then dry it thoroughly and coat it with new adhesive. When new, the filter is coated with "Filter Coat", a product of the Research Products Corporation. Pint cans are available under the name "Handi-Koter" from some air-conditioner suppliers. Other adhesive materials are no doubt satisfactory.

Fan Motor

The fan motor bearings will require oiling every few months or every thousand hours of operation. Use a good grade of light machine oil, and apply only a drop or two.

Trouble Shooting

If the instrument fails to operate at all, including the fan and the pilot light, check the source of power and determine that the power cord plug is firmly in place. Then check the fuse at the back of the instrument near the power receptacle. If the instrument has been operating but has just stopped, it may have overheated and tripped the thermal cutout. The thermal cutout will reset itself when the instrument cools down enough. Possible causes of overheating are fan stoppage, restriction of air circulation or high room temperature. Be sure the air filter is clean.

If the fan and pilot light operate but there is no spot visible, there is a possibility that the spot is positioned off the screen for some reason. Check whether the beam-position-indicator lights are operating and if the positioning controls produce any effect. Advance the INTENSITY control and see if there is some unfocused glow on the screen to indicate the presence of beam current. If there is an indication that there is a beam positioned off the screen, look for a dc component in one of the input signals.

This is a complex electronic instrument. There is no simple way of locating troubles. An understanding of the functions of the circuits is the best help. With an understanding of the circuits, you will be able to make a good guess at the general source of troubles from their symptoms. Be doubly sure that the difficulty you are having is not caused by some misad-

justment of the front-panel controls. If not, you will need to take the panels off for further checks.

Each side panel and the bottom panel are individually removable when service becomes necessary. To remove a side panel, release the fasteners near the front and back and swing the top of the panel out until the bottom hinge releases. To remove the bottom panel release the four fasteners and lift the panel off.

To replace the panels, reverse the process above. Each fastener is designed so that the first one-quarter turn engages an ear on the fastener with the oscilloscope frame. Further turning of the screw locks the ear in place.

WARNING: When you have the panels off the instrument, be careful of high voltages. The lower-voltage busses are potentially more dangerous than the crt accelerating voltage because of the high current capabilities and rather large filter capacitors in these supplies. When you reach into the instrument while it is turned on, do not hold the metal frame with the other hand. If possible, stand on an insulated floor and use insulated tools.

Troubles are usually caused by tube failure, and you can frequently correct them by finding the bad tube and replacing it with a good one. However, sometimes a tube burns up resistors or overstresses capacitors when it fails, and in these cases you will also have to find the bad components. Sometimes you can find them by visual inspection. One way to find bad tubes is to try replacing suspected tubes with good ones. If possible, replace all suspected tubes at one time, and if the trouble is helped, return the old ones one at a time until the offending one is discovered.

Tube failure will often show up in the voltage readings of the power supply. So another early step to take when you look for troubles is to check voltages and currents from the regulated power supplies. The voltages can be checked from the top or right side of the instrument on a ceramic terminal strip near the rear of the instrument. The voltages are marked on the chassis. The -150-volt terminal should read within one per cent of 150 volts. The remainder of the voltages should be within about five per cent of their indicated voltages. Keep in mind that these are quite close tolerances, especially



the 150-volt tolerance. Very few portable voltmeters have comparable accuracy, so be sure that any small discrepancy you may find is not due to voltmeter error.

All four positive voltage supplies refer to -150 volts for their control. If this voltage is off, all other voltages will also be off. Be especially sure of your -150-volt measurement before you draw any conclusions from other voltage measurements. The -150-volt supply can be adjusted by means of a screwdriver control marked -150 ADJ. on the right near the bottom of the instrument. The remaining supplies cannot be adjusted, and any large discrepancy you find in them will probably be caused by tube deterioration, or by unusual loads in the rest of the

instrument.

Total current from each supply can be measured roughly by measuring the voltage drop across the protective resistors, R732, R740, R756, R780, and R790. Current indication is 200 ma per volt on R732 and R780; 100 ma per volt on all the others. The resistors are conveniently mounted on the under side of the instrument. R790 in the 500-volt supply is nearest the front panel, and the others follow in order of their voltage. These resistors are located on the unregulated side of the supplies, and their voltage to ground will depend on line voltage. Toward the back of the instrument from each resistor is a bare bus across the terminal strip. These have the regulated voltages on them.

RECALIBRATION PROCEDURE

Vertical Amplifier, Type 535

Before changing any adjustments in the vertical amplifier check whether the tubes have deteriorated. You can make a satisfactory check by determining the approximate gain of each stage and how nearly balanced the two halves of each push-pull stage are. First check the balance of each stage. This can be done by connecting together the plates of the two halves of each stage, or the cathodes for cathode followers, and finding how far the trace is deflected from its position with the deflection plates shorted together.

Check Balance

First, short the vertical-deflection plates together and note where the trace lies. Then position the trace with the VERTICAL POSITION control to the same spot with the short removed, and short together pins 2 and 7 of V606, the output cathode followers in S/N 101 through 8627, or pins 2 of V554 and V564, output amplifiers in S/N 8628 and up. The spot should not move more than .75 centimeter. If it does, try exchanging tubes until you achieve a better balance.

Repeat the procedure with V533A and V543A in instruments above S/N 8627, or with V570 and V580 in instruments below S/N 8627, in either case connecting pins 2 together. Replace or interchange these tubes if there is more than two centimeters unbalance. Repeat with the input amplifiers, V504 and V524 in instruments with

serial numbers above 8627, connecting pins 2 together. If your instrument has a serial number between 101 and 8627, connect pins 2 or 9 of V508 and V509. In either case, replace if unbalance is more than three centimeters.

Check Gain

First check the high voltage at the left end of the ceramic terminal near the crt socket. Adjust to -1350 volts if necessary with the H.F. ADJ control at the right side of the instrument near the rear.

Connect an EP53A Gain Set Adapter between the output of the plug-in and the plug-in connector. Connect .2 volts from the square wave calibrator to the gain set adapter and adjust the GAIN ADJ. control in the center of the vertical amplifier chassis for 2 cm deflection. Remove the Gain set Adapter after adjusting the vertical amplifier gain.

DC Shift Compensation

Set the sweep speed at a slow speed, say 1 millisecond per centimeter and set the vertical sensitivity to .5 VOLTS/CM, DC. Connect the negative terminal of a 1-1/2-volt or 2-volt battery to the oscilloscope ground and touch a lead from the positive terminal to the vertical input. Look for an overshoot or rounding at the start of the step of voltage with a time constant in the neighborhood of 1 or 2 seconds. If



necessary, adjust R596, labeled DC SHIFT COMP, accessible from the left of the instrument near the center of the left side so the spot comes immediately to the final level without overshooting.

The DC SHIFT COMP. control is found in Type 535 instruments only below S/N8628. In serial numbered instruments above that number, DC Shift is adequately compensated by fixed components and no adjustment is necessary.

Vertical-Amplifier High-Frequency Compensation

High-frequency compensation is adjustable in Type 535 oscilloscopes S/N8628 and above by means of inductors L506 and L523 in the plate loads of V504 and V524, and by means of inductors L553 and L563 in the plate loads of V554 and V564. In Type 535 instruments, S/N101 through 8627, high-frequency compensation is adjustable by means of inductors L570 and L580 in the plate loads of V570 and V580.

Other peaking inductors in the circuit have fixed values that produce a response characteristic that can be accurately compensated by a single pair of adjustable inductors to take care of variations in vacuum tubes.

The adjustment of these inductors can best be made with square waves whose risetime is faster than the response time of the Type 531 which is about .035 microseconds with the Type 53/54A Preamp in place. The Type 104 or Type 105 is used in factory alignment. The waveform of the built-in calibrator of the oscilloscope has fast enough risetime for some adjustments but not for high-frequency compensation.

Insert a wide-band plug-in preamplifier, for example, the Type 53/54A. Connect the Tektronix Type 105 Square-Wave Generator to either one of the 53/54A inputs and set the frequency to 400 kc. Set the 53/54A to .05 VOLTS/CM and the TIME/CM switch of the oscilloscope to 1 MICROSEC/CM. Obtain a stable, triggered trace of the square wave.

Examine the square wave display on the crt. If one portion seems to be worse than the remainder examine the coils in the vertical amplifier visually. If one coil is set to a physical position quite different than the other coil try changing its position while watching the square

wave display.

The delay-line affects only the first half microsecond of the square wave. If the first part of the square wave shows slight wrinkles try touching the metal blade of the alignment tool to various trimmers until the trimmer which affects the wrinkle is seen. Only a slight adjustment of the trimmer should be necessary to remove the wrinkle. If more than one bump is seen in the first part of the square wave adjust the trimmers in turn, taking care to make only a slight readjustment each time, until the wrinkles are reduced. The trimmers are all more or less interacting so that the technique of adjustment requires considerable practice.

When the slight wrinkles have been removed from the delay-line you may find that the leading edge of the square wave has a slightly rounded appearance. Adjustment of the compensating coils in the vertical amplifier should prove helpful in correcting this. When the front corner of the waveform is correct you may find that the two compensating coils in the plate circuit of the output amplifiers are set to physically different positions.

The coils at the termination of the delay-line, next to the crt, affect the termination of the line. The action of these coils will appear half way across the top of the square wave. Normally, a slight termination bump will be evident at this point. The two coils at the termination of the line should be adjusted to bring this bump to a minimum.

In general, if you seriously suspect delay-line trouble we recommend that you get in touch with your nearest representative, or the factory at Portland, Oregon for more detailed instruction, or help.

Type 545 Vertical-Amplifier Adjustments

1. Gain Adjustment

The main unit sensitivity is standardized at 0.1 volt per centimeter so that the calibrated gain controls of all plug-in units will be correct. Since this sensitivity is affected by the crt accelerating voltage, first check the voltage at the left end of the ceramic terminal strip near the crt socket. Adjust to -1350 volts if necessary with the H.V. ADJ. control at the right side of the instrument near the rear.



Now connect a voltmeter between pins 1 and 3 on the interconnecting plug. Position the trace two centimeters above and below center with the VERTICAL POSITION control and adjust the main amplifier GAIN ADJ. control, R1027, until there is a total voltage change of .4 volts.

As an alternate method a plug-in unit can be used that is known to have the correct gain. Apply a signal from the oscilloscope square-wave calibrator and adjust the main amplifier GAIN ADJ. control to obtain the correct sensitivity.

2. DC Shift Compensation

The DC SHIFT COMP. control compensates for a relatively slow drift in the vertical amplifier when a dc voltage is applied. To make this adjustment, free run the sweep at about 2 seconds per centimeter. Intermittently apply the probe to the +100 bus, or other regulated dc supply, and set the vertical sensitivity to obtain about 3 cm deflection. Look for an overshoot or rounding at the start of the step with a time constant of one or two seconds. If necessary, adjust the DC SHIFT COMP. control until the spot comes immediately to the final level without overshooting.

3. Distributed Amplifier and Delay Line

The adjustments of the trimmers in the distributed amplifier and delay line should be quite stable. Minor adjustments may be required as tubes are changed, however.

These adjustments are best made with a pulser which has a risetime of 5 millimicroseconds or better and is free of overshoot. The Tektronix Type 105 Square-Wave Generator can be used but care must be exercised to avoid overcompensation because of its slower risetime.

Connect the pulser to the INPUT connector of the 53/54K unit and observe the pulse with about three centimeters deflection. Use a sweep speed of about .1 microsecond per centimeter to observe wrinkles and about 1 microsecond per centimeter to observe the level or slope of the pulse. If there is considerable rounding of the leading edge or many wrinkles, be sure that the tubes are not at fault before making any adjustments.

The waveform, starting at the leading edge

and extending for about .4 microseconds along the pulse, is affected by the trimmers beginning at the crt deflection plates and extending back through the termination network. The location of any trimmer causing a wrinkle can be determined by touching the tuning tool to the trimmers until the resulting wrinkle coincides with the wrinkle in question. It can then be removed by a slight adjustment of the trimmer. If several trimmers need adjustment, switch the sweep speed to 1 microsecond per centimeter periodically to check the level of the section being adjusted.

CRT Geometry Adjustment

The second-anode voltage required for best linearity at the extremes of deflection may vary somewhat between tubes. Apply a 60-cycle sine wave to the vertical amplifier and free-run the sweep so there is a solid raster 10 cm wide and 4 cm high on the face of the crt. Adjust R861, a screwdriver control labeled GEOM. ADJ., so that the top, bottom and sides of the rectangular raster are as straight as possible.

Trigger-Circuit Adjustments

The screwdriver adjustable controls referred to in the following discussion are located at the top and to the front of the instrument and are accessible when the cabinet is removed or slid back about half way.

1. Triggering Level Centering

This control sets the level of the trigger shaper stage so that no readjustment of the TRIGGERING LEVEL control is required as the TRIGGER SLOPE switch is changed from + to -slope.

- a. Set the TRIGGERING MODE switch to AC SLOW and the TRIGGER SLOPE switch to +INT.
- b. Display the calibrator waveform with 2 to 4 mm amplitude.
- c. Turn the TRIGGER SLOPE switch back and forth from +INT to -INT. Simultaneously adjust the TRIGGERING LEVEL CENTERING control and the TRIGGERING LEVEL control until no change of either control is required as the SLOPE switch is changed from +INT to -INT.



2. Internal Trigger DC Level

This control sets the triggering level in the DC position of the TRIGGERING MODE switch. It is set so the sweep will trigger near 0 on the TRIGGERING LEVEL control when the trace is centered vertically.

- a. Display the calibrator waveform with 1 cm amplitude and the trace centered.
- b. Turn the TRIGGERING MODE to DC.
- c. Turn the TRIGGERING LEVEL control to 0.
- d. Adjust the INT. TRIG. DC LEVEL ADJ. control so the sweep will trigger on either + or -INT without readjustment of the TRIGGERING LEVEL control.

3. Trigger Sensitivity

This control adjusts the sensitivity of the trigger shaper stage. If the sweep triggers erratically or on the wrong slope it may indicate that this adjustment is incorrect.

- a. Remove the vertical signal.
- b. Turn the TRIGGER SLOPE switch to + LINE.
- c. Set the sweep controls to 100 μ sec/cm and trigger from the line.
- d. Turn the TRIG. SENS. control clockwise until the trace brightens abruptly. This indicates that the trigger circuit is oscillating. Now back the control off about 45 degrees.

4. Preset Stability

This control sets the trigger shaper circuit to the optimum point for triggering in the AUTOMATIC mode.

- a. Remove the vertical signal.
- b. Set the TIME/CM switch to 100 MICROSEC and the TRIGGERING MODE switch to AUTOMATIC.
- c. Turn the PRESET STABILITY control, R49, full right, then back it off until the trace dims. Continue turning left until trace disappears.

- d. Adjust the PRESET STABILITY control to the center of the range between the point where trace dims and trace disappears.

The Preset Stability Control is found only on Type 535 oscilloscopes S/N7553 and up, and on Type 545, S/N7401 and up.

Sweep-Circuit Adjustments

The sweep circuits are quite stable and should not require frequent readjustments. The need for readjustment can be determined quickly by checking the time-base calibration with an accurate time-mark generator. Often only a single adjustment need be made.

We check our sweep timing with a Tektronix Type 180 or 181 Time-Mark Generator. However, you can use any other frequency generator accurate to one per cent or better. Because the small amount of non-linearity present in the sweep is concentrated in the first and last centimeters, we adjust the timing over the center 8 centimeters of the display. In this way the errors are minimized and the accuracy over the center portion can approach a value limited principally to the spot size.

The following procedure is based on that used in our test department. This sequence should be followed.

1. C240 Adjustment

This adjustment provides high-frequency compensation for a voltage divider in the sweep amplifier.

- a. Connect the calibrator signal to both the EXT. SWEEP INPUT and the TRIGGER INPUT.

- b. Set the controls as follows:

Trigger Controls-AC SLOW, +EXT.
VOLTS/CM-10
TIME/CM-500 MICROSEC/CM
HORIZONTAL DISPLAY-EXT. SWEEP
MAGNIFIER-ON

- c. Connect the SAWTOOTH OUT to the vertical input.



d. Obtain a stable vertical sweep with the STABILITY and TRIGGERING LEVEL controls.

e. Adjust C240, located on the top of the sweep chassis to the right of V240, for a square-topped signal with no overshoot.

2. Swp. Cal. Adjustment

The SWP. CAL. control adjusts the gain of the sweep amplifier to calibrate the low- and medium-speed sweeps.

a. Set the HORIZONTAL DISPLAY switch to DELAYING SWEEP.

b. Set the delaying sweep TIME/CM control to 1 MILLISEC/CM.

c. Display 1-millisecond markers from a time-mark generator.

d. Adjust the SWP. CAL. control, located in the top row of controls, so the markers correspond with the graticule.

3. Mag. Gain Adjustment

The MAG. GAIN control adjusts the gain of the sweep amplifier when the MAGNIFIER is turned on.

a. Set the TIME/CM controls at 1 MILLI-SEC/CM.

b. Display 100-microsecond markers.

c. Turn the MAGNIFIER switch to ON.

d. Adjust the MAG. GAIN control, located in the row of controls, so every second marker corresponds with a graticule line.

4. Swp./Mag. Regis.

The SWP./MAG. REGIS. control adjusts the voltage on the feedback attenuator so the magnifier expands the trace both ways from the screen center.

a. Back the STABILITY control off to stop the sweep.

b. Turn up the INTENSITY control so the spot is visible.

c. Turn the MAGNIFIER on and center the spot behind the center graticule line with the HORIZONTAL POSITION control.

d. Turn the MAGNIFIER off and adjust the SWP./MAG. REGIS. control, located in the row of controls, so that the spot is still centered.

5. Main-Sweep Vernier Adjustment

The MAIN-SWEEP VERNIER control, R99M, allows the speed of the main-sweep speed to be varied slightly to agree exactly with the delaying sweep.

a. Set the HORIZONTAL DISPLAY switch to MAIN SWEEP NORMAL.

b. Set the main-sweep controls to 2 MILLI-SEC/CM.

c. Display 1-millisecond markers.

d. Adjust R99M, located on the bracket between the VOLTS/CM and MULTIPLIER switches, so every other marker corresponds with a graticule line.

6. Sweep Length Adjustment

The SWP. LENGTH control sets the sweep length so it fills the graticule without hitting the sides of the crt with attendant electron scattering.

a. With the HORIZONTAL DISPLAY switch set to MAIN SWEEP NORMAL, free run the sweep by advancing the stability control.

b. Set the SWP. LENGTH control, located in the top row of controls, so the sweep is about 10 1/2 centimeters long.

7. 10 Microsec/cm Main-Sweep Adjust

A trimmer across the timing capacitor adjusts the sweep speed in this range.

a. Display 10-microsecond markers with the main sweep set at 10-MICROSEC/CM.

b. Adjust C99F, the trimmer nearest the panel on the right of the main-sweep switch, so the markers correspond with the graticule.



8. 1 Microsec/cm Main-Sweep Adjust

A trimmer across the timing capacitor adjusts the sweep speed in this range.

- a. Display 1-microsecond markers with the main sweep set at 1-MICROSEC/CM.
- b. Adjust C99H, the trimmer toward the rear of the TIME/CM switch, so the markers correspond with the graticule.

9. .1 Microsec/cm Main-Sweep Adjust

A trimmer serves as an adjustable timing capacitor in this range.

- a. Display 1-microsecond markers with the main sweep speed set at .5 MICROSEC/CM.
- b. Adjust C99J so the markers correspond with every other graticule line.

10. .1 Microsec/cm Linearity Adjust

Two capacitors are adjusted for best linearity at this speed.

- a. Display a 10-mc sine wave with the sweep set at .1 MICROSEC/CM.
- b. Adjust C254, located at the top rear of the sweep chassis, for the correct timing of the last half of the sweep.
- c. Adjust C267, located between the last two controls at the left of the chassis for linearity and correct timing of the start of the trace.
- d. Repeat steps b. and c. until interaction is overcome.

11. .02 Microsec/cm Main-Sweep Adjust

This adjustment provides high-speed compensation for the sweep so that the sweep speed is correct when the trace is centered. For best results this adjustment requires the use of a Tektronix Type 180 Time-Mark Generator as described in the following procedure. However, an alternate procedure is also given requiring only an accurate frequency generator.

- a. Connect the 50-mc output of the Type

180 to the vertical input.

- b. Trigger the sweep externally with the 100 kc trigger from the Type 180.
- c. Set the sweep speed to .1 MICROSEC/CM.
- d. Obtain a stable display with the trace centered and turn the MAGNIFIER to ON.
- e. Preset C278 and C286 to minimum capacitance (lettering toward mounting holes).
- f. Without changing the horizontal positioning more than one centimeter, turn C278 and C286 in equal increments to increase the sweep speed until the waveform is aligned with the graticule.
- g. Recheck the .1 Microsec/cm Linearity Adjustment (Paragraph 10). There is some interaction between these two adjustments.

Alternate Procedure

- a. If you don't have a Type 180, connect a 10-mc sine wave from an accurate (at least 1%) frequency generator to the vertical input.
- b. Obtain a stable trace with full-screen vertical deflection.
- c. Set the sweep speed to .1 MICROSEC/CM and turn the MAGNIFIER to ON. Do not change the horizontal position more than two centimeters.
- d. Preset C278 and C286 to minimum capacitance (lettering toward mounting holes).
- e. Turn C278 and C286 in equal increments to increase the sweep speed until one cycle fills five centimeters. For best accuracy observe the waveform at the center line where the slope is the greatest.
- f. Recheck the .1 Microsec/cm Linearity Adjustment (Paragraph 10).

12. Delay Start, Stop Adjust

The DELAY START and DELAY STOP adjustments calibrate the readings of the DELAY TIME MULTIPLIER control. These screwdriver



adjustments are accessible when the right side panel is removed.

- a. Turn the HORIZONTAL DISPLAY switch to DELAYING SWEEP.
- b. Set the delaying sweep TIME/CM switch to 1 MILLISEC/CM.
- c. Display 1-millisecond markers using external trigger, +SLOPE.
- d. Turn the HORIZONTAL DISPLAY switch to MAIN SWEEP DELAYED.
- e. Set the MAIN SWEEP to 10 MICROSEC/CM.
- f. Turn the STABILITY control completely clockwise and turn the TRIGGER SLOPE to EXT.
- g. Set the DELAY-TIME MULTIPLIER to 1.00 and adjust the DELAY START ADJ. so that the leading edge of the second marker occurs at the start of the sweep. You can check which marker is on the sweep by switching back to DELAYING SWEEP and observing which marker is brightened.
- h. Turn the DELAY-TIME MULTIPLIER dial to 9.00 and adjust the DELAY STOP ADJ. until the leading edge of the 10th marker occurs at the start of the sweep. Repeat steps g. and h. until the interaction is eliminated.

13. 100 Microsec/cm Delaying Sweep Adjust

A trimmer across the timing capacitor adjusts the sweep speed in this range.

- a. Set the delaying-sweep speed to 100 MICROSEC/CM and display 100-microsecond markers.
- b. Set the main sweep at 1 MICROSEC/CM.
- c. Switch the HORIZONTAL DISPLAY switch to MAIN SWEEP DELAYED.
- d. Set the DELAY-TIME MULTIPLIER dial so the leading edge of the second marker occurs at the start of the sweep and note the dial reading.

- e. Set the dial so it reads 8.00 plus this original reading and adjust C190D, the lower trimmer capacitor on the delaying sweep TIME/CM switch, so the leading edge of the 10th marker occurs at the start of the sweep. If a change is made there may be some change in the reading at d. and the step should be repeated.

14. 10 Microsec/cm Delaying Sweep Adjust

A trimmer across the timing capacitor adjusts the sweep speed in this range.

- a. Display 10-microsecond markers with the delaying sweep set to 10 MICROSEC/CM.
- b. Set the DELAY-TIME MULTIPLIER dial so the leading edge of the second marker occurs at the start of the sweep and note the dial reading.
- c. Set the dial so it reads 8.00 plus the original reading and adjust C190F, the upper trimmer on the delaying sweep TIME/CM switch, so the leading edge of the 10th marker occurs at the start of the sweep. Repeat the adjustment procedure if necessary.

15. Multi. Bal. Adjustment

The MULTI. BAL control, R64, adjusts the sensitivity of the sweep multivibrator so that it cannot be triggered while it is being held off by the trigger gate generator.

- a. Remove any vertical signal or triggering signal.
- b. Set the controls as follows:

HORIZONTAL DISPLAY
DELAYING SWEEP

Delaying-Sweep STABILITY
CCW

Main-Sweep STABILITY
CW

MULTI. BAL., R64
CW

(located about half way back on top chassis)



- c. Connect a voltmeter from ground to pin 8 of V37, located just behind the TRIGGERING MODE switch.
- d. Note the voltmeter reading--it should be about -40 volts.
- e. Back the main-sweep STABILITY control all the way counterclockwise then advance it clockwise while watching the voltmeter until the reading is 10 volts more negative than the reading obtained in step d (about -50 volts).
- f. Slowly turn the MULTI BAL control, R64, counterclockwise until the voltmeter reading drops suddenly to a lower reading. This provides a holdoff voltage of 10 volts.

External Sweep DC Balance

Turn the HORIZONTAL DISPLAY switch to EXT. SWEEP and the 5X MAGNIFIER to ON. Position the spot onto the screen and turn the EXT. SWEEP ATTEN. back and forth. If the spot moves horizontally as the EXT. SWEEP

ATTEN. control is turned, adjust the EXT. SWEEP AMPL. DC BAL. control until the spot remains stationary. The EXT. SWEEP AMPL. DC BAL. control is located at the front of the vertically-mounted chassis at the right side of the instrument.

Calibrator Adjustment

When the CALIBRATOR switch is turned to OFF the calibrator cathode follower, V246A, remains conducting at the current required to develop 100 volts across the voltage divider. To check the calibrator, turn the instrument on its side, and measure the cathode voltage at V246 cathode. This voltage appears at the pin jack labeled CAL. TEST POINT on the side of the chassis to the rear of the CALIBRATOR switch. If necessary, adjust R679, a screw-driver control labeled CAL. ADJ., accessible at the underside of the bottom chassis near the CALIBRATOR switch, so the cathode voltage measures 100 volts. Be sure of the accuracy of your test meter. Test meters are likely to be less accurate than the calibrator, which should be within about one per cent at this point.



REPLACEMENT OF COMPONENTS

Due to procurement difficulties, some of the components in any particular instrument may vary slightly from the values shown in this manual. In some cases two or more parts were substituted for one. These substitutions were made to allow earlier shipment when the instrument was constructed. They do not affect the performance of the instrument. In case replacement is necessary, either these values or the ones shown in the manual may be used.

Circuit numbers marked with a double asterisk (***) refer to parts that are not listed by Tektronix part number. These parts may be replaced by purchasing replacements locally, matching physical dimensions and electrical characteristics.

ABBREVIATIONS

Cer.	Ceramic	m	milli or 10^{-3}
Comp.	Composition	Ω	ohm
EMC	Electrolytic, metal-cased	PBT	Paper, "Bathtub"
f	Farad	PMC	Paper, metal-cased
GMV	Guaranteed minimum value	Poly	Polystyrene
h	Henry	Prec.	Precision
k	Kilohm or 10^3 ohms	PT	Paper
M/Cer.	Mica or Ceramic	v	Working volts DC
meg	Megohm or 10^6 ohms	Var.	Variable
μ	Micro. or 10^{-6}	w	Watt
μu	Micromicro or 10^{-12}	WW	Wire-wound

SPECIAL NOTES AND SYMBOLS

+	and up
X000	Part first added after this serial number
000X	Part removed at this serial number
(Mod. w/)	Simple replacement not recommended. Modify to value for later instruments and change other listed parts to match.

Where no type or serial number is indicated, the part is in both instruments, S/N 101 and up.



SECTION 5 PARTS LIST

BULBS

Ckt. No.	Instr.	S/N Range	Description	Part No.
NE42 B42	535	101-6044	Type NE-2, 65-75 v, 1/25 w	Use 150-002
		6045-7626	Type NE-2, 65-75 v, 1/25 w	Use 150-002
		7627 - up	Type NE-2, 50-75 v, 1/25 w	150-002
NE42 B42	545	101-5000	Type NE-2, 65-75 v, 1/25 w	Use 150-002
		5001-7754	Type NE-2, 65-75 v, 1/25 w	Use 150-002
		7755 - up	Type NE-2, 50-75 v, 1/25 w	150-002
NE95 B95	535	101-5000	Type NE-2, 55 v, 1/25 w	150-009
		5001-7626	Type NE-2, 55 v, 1/25 w	150-009
		7627 - up	Type NE-2, 50-75 v	150-009
NE95 B95	545	101-5000	Type NE-2, 55 v, 1/25 w	150-009
		5001-7754	Type NE-2, 55 v, 1/25 w	150-009
		7755 - up	Type NE-2, 50-75 v, 1/25 w	150-002
NE96 B96	535	101-5000	Type NE-2, 65 v, 1/25 w	150-011
		5001-7626	Type NE-2, 65 v, 1/25 w	150-011
		7627 - up	Type NE-2, 50-75 v, 1/25 w	150-002
NE96	545	101-5000	Type NE-2, 65 v, 1/25 w	150-011
		5001-7754	Type NE-2, 65 v, 1/25 w	150-011
		7755 - up	Type NE-2, 50-75 v, 1/25 w	150-002
NE180 B180	535	101-5000	Type NE-2, 65 v, 1/25 w	150-011
		5001-7610	Type NE-2, 65 v, 1/25 w	150-011
		7611 - up	Type NE-2, 50-75 v, 1/25 w	150-002
NE180 B180	545	101-5000	Type NE-2, 65 v, 1/25 w	150-011
		5001-7754	Type NE-2, 65 v, 1/25 w	150-011
		7755 - up	Type NE-2, 50-75 v, 1/25 w	150-002
NE187 B187	535	101-5000	Type NE-2, 55 v, 1/25 w	150-009
		5001-7610	Type NE-2, 55 v, 1/25 w	150-009
		7611 - up	Type NE-2, 50-75 v, 1/25 w	150-002
NE187 B187	545	101-5000	Type NE-2, 55 v, 1/25 w	150-009
		5001-7754	Type NE-2, 55 v, 1/25 w	150-009
		7755 - up	Type NE-2, 50-75 v, 1/25 w	150-002
NE287 B287	535	101-5000	Type NE-2, 55-70 v, 1/25 w	Use 150-002
		5001-7626	Type NE-2, 55-70 v, 1/25 w	Use 150-002
		7627 - up	Type NE-2, 50-75 v, 1/25 w	150-002
NE287 B287	545	101-5000	Type NE-2, 55-70 v, 1/25 w	Use 150-002
		5001-7754	Type NE-2, 55-70 v, 1/25 w	Use 150-002
		7755 - up	Type NE-2, 50-75 v, 1/25 w	150-002
NE292 B292	535	101-5000	Type NE-2, 65-75 v, 1/25 w	Use 150-014
		5001-8627	Type NE-2, 65-75 v, 1/25 w	Use 150-014
		8628 - up	Type NE-2, 50-75 v, 1/25 w	150-002
NE292	545	101-5000	Type NE-2, 65-75 v, 1/25 w	Use 150-014



B292	545	5001-9291 9292 - up	Type NE-2, 65-75 v, 1/25 w Type NE-2, 50-75 v	Use	150-014 150-002
NE293 B293	535	101-5000 5001-8627 8628 - up	Type NE-2, 75 v, 1/25 w Type NE-2, 75 v, 1/25 w Type NE-2, 50-75 v, 1/25 w	Use Use	150-014 150-014 150-002
NE293 B293	545	101-5000 5001-9291 9292 - up	Type NE-2, 75 v, 1/25 w Type NE-2, 75 v, 1/25 w Type NE-2, 50-75 v, 1/25 w	Use Use	150-014 150-014 150-002
B730			#47, Incandescent		150-001
B731			#47, Incandescent		150-001
B732			#47, Incandescent		150-001

CAPACITORS

C1			4.7 μ f Cer.	Fixed 500 v	+or-1 μ f	281-501
C3			.001 μ f PT	Fixed 600 v	20%	285-501
C4			100 μ f Cer.	Fixed 350 v	20%	281-523
C7			.001 μ f Cer.	Fixed 500 v	GMV	283-000
C9			47 μ f Cer.	Fixed 500 v	20%	281-518
C17			.001 μ f Cer.	Fixed 500 v	GMV	283-000
C20			.01 μ f PT	Fixed 400 v	20%	285-510
C22	535 545	X10016 - up X9403 - up	.01 μ f Cer. .01 μ f Cer.	Fixed 500 v Fixed 500 v	GMV GMV	283-002 283-002
C28			.005 μ f Cer.	Fixed 500 v	GMV	283-001
C34			22 μ f Cer.	Fixed 500 v	20%	281-510
C37			.001 μ f Cer.	Fixed 500 v	GMV	283-000
C40			.005 μ f Cer.	Fixed 500 v	GMV	283-001
C41			.005 μ f Cer.	Fixed 500 v	GMV	283-001
C45			.001 μ f Cer.	Fixed 500 v	GMV	283-000
C50			8 μ f Cer.	Fixed 500 v	+or-0.5 μ f	281-503
C54A			.22 μ f PT	Fixed 400 v	20%	285-533
C54B			.022 μ f PT	Fixed 400 v	20%	285-515
C54C			.0022 μ f PT	Fixed 400 v	20%	285-543
C54D			220 μ f Mica	Fixed 500 v	10%	283-536



C56			39 μmf	Cer.	Fixed	500 v	10%	281-516
C58	535/545	101-5000	27 μmf	Cer.	Fixed	500 v	5%	281-515
		5001 - up	27 μmf	Cer.	Fixed	500 v	20%	281-513
C65			12 μmf	Cer.	Fixed	500 v	10%	281-506
C71			82 μmf	Cer.	Fixed	500 v	10%	281-528
C72	535/545	X5118 - up	.005 μf	Cer.	Fixed	500 v	GMV	283-001
C73			12 μmf	Cer.	Fixed	500 v	10%	281-506
C76	535	X1439 - up	.005 μf	Cer.	Fixed	500 v	GMV	283-001
		101 - up	.005 μf	Cer.	Fixed	500 v	GMV	283-001
C78	535	X613 - up	.005 μf	Cer.	Fixed	500 v	GMV	283-001
		101 - up	.005 μf	Cer.	Fixed	500 v	GMV	283-001
C81			.001 μf	Cer.	Fixed	500 v	GMV	283-000
C95			.001 μf	Cer.	Fixed	500 v	GMV	283-000
C96			82 μmf	Cer.	Fixed	500 v	10%	281-528
C99A			1.0 μf)					
C99B			0.1 μf)					
C99C			.01 μf)					
				Special timing series mfd. by Tektronix. 291-007A or				
				Order replacements from factory.				291-007B
C99D*			.001 μf	Special				291-008A or B

*This .001 μf capacitor may be ordered separately. Note color band on end; if white, order 291-008A; if black, order 291-008B.

C99E			82 μmf	Mica	Fixed	500 v	5%	283-534
C99F	535	101-8628	5-20 μmf	Cer.	Var.	500 v		Use 281-010
		8629 - up	4.5-25 μmf	Cer.	Var.	500 v	20%	281-010
	545	101-7400	5-20 μmf	Cer.	Var.	500 v		Use 281-010
		7401 - up	4.5-25 μmf	Cer.	Var.	500 v	20%	281-010
C99G			82 μmf	Mica	Fixed	500 v	5%	283-534
C99H	535	101-8627	4.5-25 μmf	Cer.	Var.	500 v		Use 281-010
		8628 - up	5-20 μmf	Cer.	Var.	500 v	20%	281-010
	545	101-7400	4.5-25 μmf	Cer.	Var.	500 v		Use 281-010
		7401 - up	5-20 μmf	Cer.	Var.	500 v	20%	281-010
C99J			3-12 μmf	Cer.	Var.	500 v	20%	281-007
C100	535	101-7494	5-25 μmf	Cer.	Var.	500 v		281-011
		7495 - up	8-50 μmf	Cer.	Var.	500 v		281-013
	545	101-7329	5-25 μmf	Cer.	Var.	500 v		281-011
		7330 - up	8-50 μmf	Cer.	Var.	500 v		281-013
C101			5-25 μmf	Cer.	Var.	500 v	281-011	



C102			100 $\mu\mu\text{f}$	Cer.	Fixed	500 v	10%	281-530
C108			.001 μf	Cer.	Fixed	500 v	GMV	283-000
C110			5-25 $\mu\mu\text{f}$	Cer.	Var.	500 v		281-011
C132			22 $\mu\mu\text{f}$	Cer.	Fixed	500 v	20%	281-510
C146			47 $\mu\mu\text{f}$	Cer.	Fixed	500 v	20%	281-518
C148A			.047 μf	PT	Fixed	400 v	20%	285-519
C148B			.0047 μf	PT	Fixed	400 v	20%	285-506
C148C			470 $\mu\mu\text{f}$	Cer.	Fixed	500 v	20%	281-525
C148D	535	101-1545X	47 $\mu\mu\text{f}$	Cer.	Fixed	500 v	20%	281-518
		X5105 - up	22 $\mu\mu\text{f}$	Cer.	Fixed	500 v	20%	281-510
	545	X5138 - up	22 $\mu\mu\text{f}$	Cer.	Fixed	500 v	20%	281-510
C158			12 $\mu\mu\text{f}$	Cer.	Fixed	500 v	10%	281-506
C170			39 $\mu\mu\text{f}$	Cer.	Fixed	500 v	10%	281-516
C172			12 $\mu\mu\text{f}$	Cer.	Fixed	500 v	10%	281-506
C187			.001 μf	Cer.	Fixed	500 v	GMV	283-000
C190A			.0505 μf	Special)				
C190B			.00505 μf	Special)	Timing Series			291-006
C190C			450-475 $\mu\mu\text{f}$	Special)				
C190D	535	101-7860	8-50 $\mu\mu\text{f}$	Cer.	Var.	500 v		281-013
		7861 - up	7-45 $\mu\mu\text{f}$	Cer.	Var.	500 v		281-012
	545	101-8179	8-50 $\mu\mu\text{f}$	Cer.	Var.	500 v		281-013
		8180 - up	7-45 $\mu\mu\text{f}$	Cer.	Var.	500 v		281-012
C190E			39 $\mu\mu\text{f}$	Mica	Fixed	500 v	5%	283-533
C190F	535	101-7860	3-12 $\mu\mu\text{f}$	Cer.	Var.	500 v		281-009
		7861 - up	3-12 $\mu\mu\text{f}$	Cer.	Var.	500 v		281-007
	545	101-8179	3-12 $\mu\mu\text{f}$	Cer.	Var.	500 v		281-009
		8180 - up	3-12 $\mu\mu\text{f}$	Cer.	Var.	500 v		281-007
C191			.01 μf	PT	Fixed	400 v	20%	285-510
C197			220 $\mu\mu\text{f}$	Mica	Fixed	500 v	10%	283-536
C209			.01 μf	Cer.	Fixed	500 v	20%	283-002
C218			22 $\mu\mu\text{f}$	Cer.	Fixed	500 v	20%	281-510
C228			47 $\mu\mu\text{f}$	Cer.	Fixed	500 v	20%	281-518
C232	535	X5084 - up	.005 μf	Cer.	Fixed	500 v	GMV	283-001
	545	X5125 - up	.005 μf	Cer.	Fixed	500 v	GMV	283-001



C235	535	101-2419	12 $\mu\mu\text{f}$	Cer.	Fixed	500 v		Use	281-510
		2420 - up	22 $\mu\mu\text{f}$	Cer.	Fixed	500 v	20%		281-510
	545	101-618	12 $\mu\mu\text{f}$	Cer.	Fixed	500 v		Use	281-510
		619 - up	22 $\mu\mu\text{f}$	Cer.	Fixed	500 v	20%		281-510
C236			.001 $\mu\mu\text{f}$	Cer.	Fixed	500 v	GMV		283-000
C240	535	101-10921	3-12 $\mu\mu\text{f}$	Cer.	Var.	500 v		Use	281-010
		10922 - up	4.5-25 $\mu\mu\text{f}$	Cer.	Var.	500 v			281-010
	545	101-14543	3-12 $\mu\mu\text{f}$	Cer.	Var.	500 v		Use	281-010
		14544 - up	4.5-25 $\mu\mu\text{f}$	Cer.	Var.	500 v			281-010
C241			4.7 $\mu\mu\text{f}$	Cer.	Fixed	500 v	+or-1 $\mu\mu\text{f}$		281-501
C245	535	X10702 - up	.68 μf	Cer.	Fixed	500 v	+or-.136 $\mu\mu\text{f}$		281-537
	545	X14223 - up	.68 μf	Cer.	Fixed	500 v	+or-.136 $\mu\mu\text{f}$		281-537
C249	535	101-10015X	.01 μf	PT	Fixed	400 v	20%		285-510
	545	101-13343X	.01 μf	PT	Fixed	400 v	20%		285-510
C254	535	101-409	1.5-7 $\mu\mu\text{f}$	Cer.	Var.	500 v			281-005
		401-612	.5-5 $\mu\mu\text{f}$	Poly.	Var.	500 v			281-002
		613 - up	3-12 $\mu\mu\text{f}$	Cer.	Var.	500 v			281-007
	545	101 - up	3-12 $\mu\mu\text{f}$	Cer.	Var.	500 v			281-007
C258	535	X613 - up	1.5 $\mu\mu\text{f}$	Cer.	Fixed	500 v	+or-1/2 $\mu\mu\text{f}$		281-526
	545	101 - up	1.5 $\mu\mu\text{f}$	Cer.	Fixed	500 v	+or-1/2 $\mu\mu\text{f}$		281-526
C266	535	101-612X	47 $\mu\mu\text{f}$	Cer.	Fixed	500 v	20%		281-518
C267	535	101-612	8-50 $\mu\mu\text{f}$	Cer.	Var.	500 v			281-013
		613 - up	9-180 $\mu\mu\text{f}$	Mica	Var.	500 v			281-023
	545	101 - up	9-180 $\mu\mu\text{f}$	Mica	Var.	500 v			281-023
C273			6-25 $\mu\mu\text{f}$	EMC	Fixed	300 v	-20+ 50%		290-000
C278	535	X613 - up	3-12 $\mu\mu\text{f}$	Cer.	Var.	500 v			281-009
	545	101 - up	3-12 $\mu\mu\text{f}$	Cer.	Var.	500 v			281-009
C282			.047 μf	PT	Fixed	400 v	20%		285-519
C284	535	101-1125	8 $\mu\mu\text{f}$	Cer.	Fixed	500 v	+or-1/2 $\mu\mu\text{f}$		281-503
		1126 - up	4.7 $\mu\mu\text{f}$	Cer.	Fixed	500 v	+or-1 $\mu\mu\text{f}$		281-501
	545	101 - up	4.7 $\mu\mu\text{f}$	Cer.	Fixed	500 v	+or-1 $\mu\mu\text{f}$		281-501
C286	535	X613 - up	3-12 $\mu\mu\text{f}$	Cer.	Var.	500 v			281-009
	545	101 - up	3-12 $\mu\mu\text{f}$	Cer.	Var.	500 v			281-009
C292	535	X10016 - up	.005 μf	Cer.	Fixed	500 v			283-001
	545	X13344 - up	.005 μf	Cer.	Fixed	500 v			283-001
C672			330 $\mu\mu\text{f}$	Mica	Fixed	500 v	10%		283-518
C673			330 $\mu\mu\text{f}$	Mica	Fixed	500 v	10%		283-518
C682			27 $\mu\mu\text{f}$	Cer.	Fixed	500 v	20%		281-513



C695			.001 μ f	Cer.	Fixed	500 v	GMV	283-000
C700			.02 μ f	Cer.	Fixed	250 v	GMV	283-004
C707			.01 μ f	PT	Fixed	400 v	20%	285-510
C711			.01 μ f	PT	Fixed	400 v	20%	285-510
C715	535	101-1058	2x40 μ f	EMC	Fixed	250 v	-20+ 50%	290-012
		1059 - up	2x40 μ f	EMC	Fixed	250 v	-20+ 50%	290-040
	545	101 - up	2x40 μ f	EMC	Fixed	250 v	-20+ 50%	290-040
C717			.01 μ f	PT	Fixed	400 v	20%	285-510
C720	535	X5403 - up	.01 μ f	Cer.	Fixed	500 v	GMV	283-002
	545	X5448 - up	.01 μ f	Cer.	Fixed	500 v	GMV	283-002
C732			125 μ f	EMC	Fixed	350 v	-20+ 50%	290-044
C740			150 μ f	EMC	Fixed	250 v	-20+ 50%	290-048
C741			150 μ f	EMC	Fixed	250 v	-20+ 50%	290-048
C750			.01 μ f	PT	Fixed	400 v	20%	285-510
C751			3x10 μ f	EMC	Fixed	450 v	-20+ 50%	290-033
C756			125 μ f	EMC	Fixed	450 v	-20+ 50%	290-045
C763			.01 μ f	PT	Fixed	400 v	20%	285-510
C770			.01 μ f	PT	Fixed	400 v	20%	285-510
C780			125 μ f	EMC	Fixed	350 v	-20+ 50%	290-044
C787			.01 μ f	PT	Fixed	400 v	20%	285-510
C790A,B			2x40 μ f	EMC	Fixed	450 v	-20+ 50%	290-042
C797			.01 μ f	PT	Fixed	400 v	20%	285-510
C800			.047 μ f	PT	Fixed	400 v	20%	285-519
C803			.001 μ f	PT	Fixed	600 v	20%	285-501
C805			.01 μ f	PT	Fixed	400 v	20%	285-510
C806			.001 μ f	PT	Fixed	600 v	20%	285-501
C807			2x20 μ f	EMC	Fixed	450 v	-20+ 50%	290-037
C814			.0068 μ f	PT	Fixed	3000 v	20%	285-508
C815			.01 μ f	Cer.	Fixed	500 v	GMV	283-002
C820			.0068 μ f	PT	Fixed	3000 v	20%	285-508



C821			.0068 μ f	PT	Fixed 5000 v	20%	285-509
C822			500 μ f	Cer.	Fixed 10,000 v		281-556
C823			500 μ f	Cer.	Fixed 10,000 v		281-556
C830			.0068 μ f	PT	Fixed 3000 v	20%	285-508
C832			.015 μ f	PT	Fixed 3000 v	20%	285-513
C834			.015 μ f	PT	Fixed 3000 v	20%	285-513
C841	535	X1439 - up	.005 μ f	Cer.	Fixed 500 v	GMV	283-001
	545	101 - up	.005 μ f	Cer.	Fixed 500 v	GMV	283-001
C855			.015 μ f	PT	Fixed 3000 v	20%	285-513
C857			.015 μ f	PT	Fixed 3000 v	20%	285-513

FUSES

F701			6 amp, 3 AG, Fast-Blo, 117 v, 60 cycle				159-013
F701			3 amp, 3 AG, Slo-Blo, 234 v, 50 cycle				159-005
F730	535	X1621-2076	#24 copper wire, coiled			Use	302-101
		2077-8893X	#33 magnet wire, coiled			Use	302-101
	545	101-9838X	#33 magnet wire, coiled			Use	302-101

INDUCTORS

L61			88 μ h	Fixed			108-022
LR72			#40 wire, 450 turns on 3.3 k, 1 w resistor				108-058
LR72							

RECTIFIERS

SR650	535	X1059-8627X	1-500 ma plates/leg			106-016
SR732			5-250 ma plates/leg			106-012
SR740			5-500 ma plates/leg			106-013
SR756	535	101-8627	4-250 ma plates/leg			106-014
		8628 - up	4-500 ma plates/leg			106-019
	545	101 - up	4-500 ma plates/leg			106-019
SR780			4-250 ma plates/leg			106-014
SR790			5-125 ma plates/leg			106-015

RELAYS

K700			45 sec, Thermal Time-Delay			148-002
K701	535	101-1703	4P2T, 6 v order Mod Kit K535-1107, 040-085			
		1704 - up	4P2T, 6 v			148-004
	545	101 - up	4P2T, 6 v			148-004



RESISTORS

R1			1 meg	1/2 w	Fixed	Comp.	5%	301-105
R2			390 k	1/2 w	Fixed	Comp.	5%	301-394
R3			50 k	2 w	Var.	Comp.	20%	311-023
R4			100 k	1/2 w	Fixed	Comp.	10%	302-104
R5			1 meg	1/2 w	Fixed	Comp.	10%	302-105
R6			100 k	1/2 w	Fixed	Comp.	10%	302-104
R7			470 k	1/2 w	Fixed	Comp.	10%	302-474
R8			47 Ω	1/2 w	Fixed	Comp.	10%	302-470
R9			4.7 k	1 w	Fixed	Comp.	10%	304-472
R10			4.7 k	1 w	Fixed	Comp.	10%	304-472
R11			47 Ω	1/2 w	Fixed	Comp.	10%	302-470
R12			33 k	2 w	Fixed	Comp.	10%	306-333
R13			39 k	2 w	Fixed	Comp.	10%	306-393
R14	535	101-7552	2x100 k	1/2 w	Var.	Comp.	20%	311-030*
		7553 - up	100 k	1/2 w	Var.	Comp.	20%	311-096**
	545	101-7400	2x100 k	1/2 w	Var.	Comp.	20%	311-030*
		7401 - up	100 k	1/2 w	Var.	Comp.	20%	311-096**
*Furnished as a unit with R43.								
**Furnished as a unit with R43 and SW43.								
R15			22 k	1/2 w	Fixed	Comp.	10%	302-223
R16			470 k	1/2 w	Fixed	Comp.	10%	302-474
R17			470 k	1/2 w	Fixed	Comp.	10%	302-474
R19			56 k	1/2 w	Fixed	Comp.	10%	302-563
R20			47 k	1/2 w	Fixed	Comp.	10%	302-473
R21			47 k	1/2 w	Fixed	Comp.	10%	302-473
R22			47 Ω	1/2 w	Fixed	Comp.	10%	302-470
R23	535	101-10015	1 k	1/2 w	Fixed	Comp.	10%	302-102
		10016 - up	680 Ω	1/2 w	Fixed	Comp.	10%	302-681
	545	101-13343	1 k	1/2 w	Fixed	Comp.	10%	302-102
		13344 - up	680 Ω	1/2 w	Fixed	Comp.	10%	302-681



R24	535	101-10015	2.7 k	1/2 w	Fixed	Comp.	10%	302-272
		10016 - up	1.5 k	1/2 w	Fixed	Comp.	10%	302-152
	545	101-13343	2.7 k	1/2 w	Fixed	Comp.	10%	302-272
		13344 - up	1.5 k	1/2 w	Fixed	Comp.	10%	302-152
R27			22 k	2 w	Fixed	Comp.	10%	306-223
R28			500 Ω	2 w	Var.	Comp.	20%	311-005
R29			22 k	2 w	Fixed	Comp.	10%	306-223
R30			2.7 meg	1/2 w	Fixed	Comp.	10%	302-275
R32	535	101-894	1.5 k	1/2 w	Fixed	Comp.	10%	302-152
		895 - up	820 Ω	1/2 w	Fixed	Comp.	10%	302-821
	545	101 - up	820 Ω	1/2 w	Fixed	Comp.	10%	302-821
R33			47 Ω	1/2 w	Fixed	Comp.	10%	302-470
R34			100 k	1/2 w	Fixed	Comp.	10%	302-104
R35			100 k	1/2 w	Fixed	Comp.	10%	302-104
R36			100 k	2 w	Var.	Comp.	20%	311-026
R37			470 k	1/2 w	Fixed	Comp.	10%	302-474
R38			1 meg	1/2 w	Fixed	Comp.	10%	302-105
R39			100 Ω	1/2 w	Fixed	Comp.	10%	302-101
R40			220 k	1/2 w	Fixed	Comp.	10%	302-224
R41			10 k	1/2 w	Fixed	Comp.	10%	302-103
R42			470 k	1/2 w	Fixed	Comp.	10%	302-474
R43	535	101-7552	2x100 k	1/2 w	Var.	Comp.	20%	311-030*
		7553 - up	100 k	1/2 w	Var.	Comp.	20%	311-096**
	545	101-7400	2x100 k	1/2 w	Var.	Comp.	20%	311-030*
		7401 - up	100 k	1/2 w	Var.	Comp.	20%	311-096**
*R14 and R43 are concentric.								
**R43 is concentric with R14 and SW43.								
R44			100 k	1/2 w	Fixed	Comp.	5%	301-104
R45			200 k	1/2	Fixed	Comp.	5%	301-204
R46			100 Ω	1/2 w	Fixed	Comp.	10%	302-101
R47	535	101-415	470 k	1/2 w	Fixed	Comp.		Use 301-474
		416 - up	470 k	1/2 w	Fixed	Comp.	5%	301-474
	545	101 - up	470 k	1/2 w	Fixed	Comp.	5%	301-474
R48			47 k	1 w	Fixed	Comp.	10%	304-473



R49	535	X6045 - up	100 k	2 w	Var.	Comp.	20%	311-026	
	545	X5946 - up	100 k	2 w	Var.	Comp.	20%	311-026	
R50			95 k	1/2 w	Fixed	Prec.	1%	309-044	
R51			220 k	1/2 w	Fixed	Prec.	1%	309-052	
R52			100 Ω	1/2 w	Fixed	Comp.	10%	302-101	
R53			22 k	2 w	Fixed	Comp.	10%	306-223	
R54			100 Ω	1/2 w	Fixed	Comp.	10%	302-101	
R55A			4.7 meg	1/2 w	Fixed	Comp.	10%	302-475	
R55B			470 k	1/2 w	Fixed	Comp.	10%	302-474	
R57			4.7 meg	1/2 w	Fixed	Comp.	10%	302-475	
R58			1 k	1/2 w	Fixed	Comp.	10%	302-102	
R59			47 Ω	1/2 w	Fixed	Comp.	10%	302-470	
R60			2.7 k	1 w	Fixed	Comp.	Selected)		
R61			3.3 k	1 w	Fixed	Comp.	Selected)	312-569	
Note: R60 and R61 selected to total 6 k, +or-2 1/2%. Furnished as a unit.									
R62			56 k	1 w	Fixed	Comp.	5%	303-563	
R63			47 Ω	1/2 w	Fixed	Comp.	10%	302-470	
R64	535	X895 - up	2.5 k	1/10 w	Var.	Comp.	20%	311-010	
	545	101 - up	2.5 k	1/10 w	Var.	Comp.	20%	311-010	
R65			39 k	1 w	Fixed	Comp.	Selected*)		
R66			33 k	1 w	Fixed	Comp.	Selected*)	312-570	
*Selected with ratio 39/33 +or-2 1/2%. Furnished as a unit.									
R67			100 Ω	1/2 w	Fixed	Comp.	10%	302-101	
R68			8 k	5 w	Fixed	WW	5%	308-053	
R69	535	101-1125	1 k	1/2 w	Fixed	Comp.	10%	302-102	
		1126-1219	1.5 k	1/2 w	Fixed	Comp.	10%	302-152	
		1220 - up	1 k	1/2 w	Fixed	Comp.	10%	302-102	
	545	101 - up	1 k	1/2 w	Fixed	Comp.	10%	302-102	
R70	535	101-1125	47 k	1/2 w	Fixed	Comp.	10%	302-473	
		1126-1219	33 k	1 w	Fixed	Comp.	10%	304-333	
		1220 - up	47 k	1/2 w	Fixed	Comp.	10%	302-473	
	545	101 - up	47 k	1/2 w	Fixed	Comp.	10%	302-473	



R71			270 Ω	1/2 w	Fixed Comp.	10%		302-271
R72	535	101-5117	3.3 k	1 w	Fixed Comp.	10%	Part of L72	
		5118 - up	47 Ω	1/2 w	Fixed Comp.	10%		302-470
	545	X4117 - up	47 Ω	1/2 w	Fixed Comp.	10%		302-470
R73			47 k	1/2 w	Fixed Comp.	10%		302-473
R74			100 k	1/2 w	Fixed Comp.	10%		302-104
R75			100 Ω	1/2 w	Fixed Comp.	10%		302-101
R76	535	X1439 - up	47 Ω	1/2 w	Fixed Comp.	10%		302-470
	545	101 - up	47 Ω	1/2 w	Fixed Comp.	10%		302-470
R77			4.7 k	1 w	Fixed Comp.	10%		304-472
R78	535	101-8744	47 k	1 w	Fixed Comp.		Use	301-363
		8745 - up	36 k	1/2 w	Fixed Comp.	5%		301-363
	545	101-9860	47 k	1 w	Fixed Comp.		Use	301-363
		9861 - up	36 k	1/2 w	Fixed Comp.	5%		301-363
R79			1 meg	1/2 w	Fixed Comp.	10%		302-105
R80			10 k	1/2 w	Fixed Comp.	10%		302-103
R81			100 k	1/2 w	Fixed Comp.	10%		302-104
R82			1 meg	1/2 w	Fixed Comp.	10%		302-105
R83			1.8 meg	1/2 w	Fixed Comp.	10%		302-185
R84			100 k	1 w	Fixed Comp.	10%		304-104
R85			47 Ω	1/2 w	Fixed Comp.	10%		302-470
R86			470 Ω	1/2 w	Fixed Comp.	10%		302-471
R87			8 k	5 w	Fixed WW	5%		308-053
R88			2 k	2 w	Var. Comp.	20%		311-008
R89			4 k	5 w	Fixed WW	5%		308-051
R90			47 Ω	1/2 w	Fixed Comp.	10%		302-470
R91			22 k	2 w	Fixed Comp.	10%		306-223
R92			22 k	2 w	Fixed Comp.	10%		306-223
R93			22 k	2 w	Fixed Comp.	10%		306-223
R95			47 k	1/2 w	Fixed Comp.	10%		302-473
R96			1.5 meg	1/2 w	Fixed Comp.	10%		302-155
R97	535	101-3509X	100 Ω	1/2 w	Fixed Comp.	10%		302-101
	545	101-1303X	100 Ω	1/2 w	Fixed Comp.	10%		302-101



R99A			30 meg	2 w	Fixed Prec.	1%		310-505	
R99B			10 meg	1 w	Fixed Prec.	1%		310-107	
R99C			10 meg	1 w	Fixed Prec.	1%		310-107	
R99D			3 meg	1/2 w	Fixed Prec.	1%		309-026	
R99E			1 meg	1/2 w	Fixed Prec.	1%		309-014	
R99F			1 meg	1/2 w	Fixed Prec.	1%		309-014	
R99G			300 k	1/2 w	Fixed Prec.	1%		309-125	
R99H			100 k	1/2 w	Fixed Prec.	1%		309-045	
R99J			100 k	1/2 w	Fixed Prec.	1%		309-045	
R99K	535	101-3935	10 k	1/2 w	Fixed Comp.	10%		302-103	
		3936 - up	6.8 k	1 w	Fixed Comp.	10%		304-682	
	545	101-1683	10 k	1/2 w	Fixed Comp.	10%		302-103	
		1684 - up	6.8 k	1 w	Fixed Comp.	10%		304-682	
R99L	535	101-3935	20 k	2 w	Var. Comp.	20%		311-018	
		3936 - up	15 k	2 w	Var. Comp.	20%		311-045	
	545	101-1683	20 k	2 w	Var. Comp.	20%		311-018	
		1684 - up	15 k	2 w	Var. Comp.	10%		311-045	
R99M	535	101-1742	Selected for individual instrument. Use						311-056
		1743 - up	500 Ω	1/10 w	Var. Comp.	20%		311-056	
	545	101-198	Selected for individual instrument. Use						311-056
		199 - up	500 Ω	1/10 w	Var. Comp.	20%		311-056	
R101			900 k	1/2 w	Fixed Prec.	1%		309-111	
R102			111 k	1/2 w	Fixed Prec.	1%		309-046	
R105			100 k	1/2 w	Var. Comp.	20%		311-046*	
*R105, R122 and R140 are furnished as a unit.									
R106			22 k	1/2 w	Fixed Comp.	10%		302-223	
R107			1 meg	1/2 w	Fixed Comp.	10%		302-105	
R108			100 k	1/2 w	Fixed Comp.	10%		302-104	
R109	535	X5564 - up	47 Ω	1/2 w	Fixed Comp.	10%		302-470	
	545	X5646 - up	47 Ω	1/2 w	Fixed Comp.	10%		302-470	
R110			1 meg	1/2 w	Fixed Prec.	1%		309-014	
R113	535	101-7912	47 k	1 w	Fixed Comp.	10%		304-473	
		7913 - up	33 k	1 w	Fixed Comp.	10%		304-333	
	545	101-8299	47 k	1 w	Fixed Comp.	10%		304-473	
		8300 - up	33 k	1 w	Fixed Comp.	10%		304-333	



R114	50 k	2 w	Var. Comp.	20%	311-023
R115	47 k	1 w	Fixed Comp.	10%	304-473
R120	100 Ω	1/2 w	Fixed Comp.	10%	302-101
R121	47 k	1 w	Fixed Comp.	10%	304-473
R122	15 k	2 w	Var. Comp.	20%	311-046*
R123	47 k	1 w	Fixed Comp.	10%	304-473
R124	33 k	2 w	Fixed Comp.	10%	306-333
R130	100 Ω	1/2 w	Fixed Comp.	10%	302-101
R131	3.3 k	1/2 w	Fixed Comp.	10%	302-332
R132	100 k	1/2 w	Fixed Comp.	10%	302-104
R133	270 k	1/2 w	Fixed Comp.	10%	302-274
R134	100 Ω	1/2 w	Fixed Comp.	10%	302-101
R135	33 k	2 w	Fixed Comp.	10%	306-333
R136	2.2 k	1/2 w	Fixed Comp.	10%	302-222
R140	100 k	1/2 w	Var. Comp.	20%	311-046*
*R105, R122 and R140 furnished as a unit.					
R141	100 k	1/2 w	Fixed Comp.	10%	302-104
R142	27 k	1/2 w	Fixed Comp.	10%	302-273
R143	47 k	1/2 w	Fixed Comp.	10%	302-473
R146	100 Ω	1/2 w	Fixed Comp.	10%	302-101
R147	22 k	1 w	Fixed Comp.	10%	304-223
R148	100 Ω	1/2 w	Fixed Comp.	10%	302-101
R150	1 meg	1/2 w	Fixed Comp.	10%	302-105
R151	1 k	1/2 w	Fixed Comp.	10%	302-102
R155	100 Ω	1/2 w	Fixed Comp.	10%	302-101
R156	10 k	1 w	Fixed Comp.	5%	303-103
R157	100 Ω	1/2 w	Fixed Comp.	10%	302-101
R158	39 k	1 w	Fixed Comp.	5%	303-393
R159	33 k	1 w	Fixed Comp.	5%	303-333



R160	15 k	2 w	Fixed Comp.	5%	305-153
R163	100 Ω	1/2 w	Fixed Comp.	10%	302-101
R164	2.2 k	1/2 w	Fixed Comp.	10%	302-222
R165	47 k	1/2 w	Fixed Comp.	10%	302-473
R170	2.7 k	1/2 w	Fixed Comp.	10%	302-272
R172	47 k	1/2 w	Fixed Comp.	10%	302-473
R173	100 k	1/2 w	Fixed Comp.	10%	302-104
R174	100 Ω	1/2 w	Fixed Comp.	10%	302-101
R177	10 k	1/2 w	Fixed Comp.	10%	302-103
R180	15 k	2 w	Fixed Comp.	10%	306-153
R181A	10 k	2 w	Var. Comp.	20%	311-016
R181B**	15-47 k	1/2 w	Fixed Comp.	Selected	
R182A	12 k	2 w	Fixed Comp.	10%	306-123
R182B**	15-47 k	1/2 w	Fixed Comp.	Selected	

**Selected to adjust range of DELAYING SWEEP LENGTH control.

R185	100 Ω	1/2 w	Fixed Comp.	10%	302-101
R186	220 k	2 w	Fixed Comp.	10%	306-224
R187	100 k	1/2 w	Fixed Comp.	10%	302-104
R188	1.5 meg	1/2 w	Fixed Comp.	10%	302-155
R190A	404 k	1/2 w	Fixed Prec.	+or-1/4%	312-567*
R190B	606 k	1/2 w	Fixed Prec.	+or-1/4%	312-568*
R190C	1.01 meg	1/2 w	Fixed Prec.	+or-1/4%	312-571*

*These resistors may be ordered individually and the customer will get the correct value.
Checked within 1/4% of ratio:4/6/10.

R195	100 k	2 w	Var. Comp.	20%	311-026
R196	470 k	1/2 w	Fixed Comp.	10%	302-474
R197	6.8 k	1/2 w	Fixed Comp.	10%	302-682
R198	100 Ω	1/2 w	Fixed Comp.	10%	302-101
R200	100 k	1/2 w	Fixed Comp.	10%	302-104



R201			47 k	1/2 w	Fixed Comp.	10%	302-473
R202			10 k	1/2 w	Fixed Comp.	10%	302-103
R205			15 k	1/2 w	Fixed Comp.	10%	302-153
R206			100 Ω	1/2 w	Fixed Comp.	10%	302-101
R207			10 k	5 w	Fixed WW	5%	308-054
R208			10 k	2 w	Var. WW	20%	311-015
R209			30 k	3 w	Var. Helipot	.1%	311-022
R216			100 Ω	1/2 w	Fixed Comp.	10%	302-101
R217			3.9 k	1/2 w	Fixed Comp.	10%	302-392
R218			95 k	1/2 w	Fixed Prec.	1%	309-044
R219			150 k	1/2 w	Fixed Prec.	1%	309-049
R220			100 Ω	1/2 w	Fixed Comp.	10%	302-101
R223			39 k	2 w	Fixed Comp.	10%	306-393
R224	535	101-6030	4.7 k	1/2 w	Fixed Comp.	10%	302-472
		6031 - up	5.6 k	1/2 w	Fixed Comp.	10%	302-562
	545	101-6026	4.7 k	1/2 w	Fixed Comp.	10%	302-472
		6027 - up	5.6 k	1/2 w	Fixed Comp.	10%	302-562
R228			10 k	1/2 w	Fixed Comp.	10%	302-103
R229			270 k	1/2 w	Fixed Comp.	10%	302-274
R230			100 Ω	1/2 w	Fixed Comp.	10%	302-101
R231			1 k	1/2 w	Fixed Comp.	10%	302-102
R232	535	X5084 - up	47 Ω	1/2 w	Fixed Comp.	10%	302-470
	545	X5125 - up	47 Ω	1/2 w	Fixed Comp.	10%	302-470
R235			22 k	1/2 w	Fixed Comp.	10%	302-223
R236			22 meg	1/2 w	Fixed Comp.	10%	302-226
R240	535	101-10015	1 meg	1/2 w	Fixed Prec.	1%	309-014
		10016-10701	1.94 meg	1/2 w	Fixed Prec.	1%	309-022
		10702 - up	1.75 meg	1/2 w	Fixed Prec.	1%	309-019
	545	101-13343	1 meg	1/2 w	Fixed Prec.	1%	309-014
		13344-up	1.94 meg	1/2 w	Fixed Prec.	1%	309-022
		14223 - up	1.75 meg	1/2 w	Fixed Prec.	1%	309-019
R241	535	101-10015	1.23 meg	1/2 w	Fixed Prec.	1%	309-016
		10016 - up	3.1 meg	1/2 w	Fixed Prec.	1%	309-027
	545	101-13343	1.23 meg	1/2 w	Fixed Prec.	1%	309-016



R241 (cont.)		13344 - up	3.1 meg	1/2 w	Fixed	Prec.	1%	309-027
R242			100 Ω	1/2 w	Fixed	Comp.	10%	302-101
R243			100 k	1 w	Fixed	Comp.	10%	304-104
R244	535	X1439 - up	2.2 k	1/2 w	Fixed	Comp.	10%	302-222
	545	101 - up	2.2 k	1/2 w	Fixed	Comp.	10%	302-222
R245	535	X10702 - up	22 meg	1/2 w	Fixed	Comp.	10%	302-226
	545	X14223 - up	22 meg	1/2 w	Fixed	Comp.	10%	302-226
R246	535	101-10015	470 k	1/2 w	Fixed	Comp.	10%	302-474
		10016 - up	100 k	2 w	Var.	Comp.	10%	311-030
		Furnished with R248 (311-030).						
	545	101-13343	470 k	1/2 w	Fixed	Comp.	10%	302-474
		13343 - up	100 k	2 w	Var.	Comp.	10%	311-030
		Furnished with R248 (311-030).						
R247	535	101-10015	4.7 meg	1/2 w	Fixed	Comp.	10%	302-475
		10016 - up	9 meg	1/2 w	Fixed	Prec.	2%	309-232
	545	101-13343	4.7 meg	1/2 w	Fixed	Comp.	10%	302-475
		13344 - up	9 meg	1/2 w	Fixed	Prec.	2%	309-232
R248	535	101-10015	500 k	2 w	Var.	Comp.	20%	311-048
		Furnished with R250 (311-048).						
		10016 - up	100 k	2 w	Var.	Comp.	20%	311-030
		Furnished with R246 (311-030).						
	545	101-13343	500 k		Var.	Comp.	20%	311-048
		Furnished with R248 (311-048).						
		13344 - up	100 k	2 w	Var.	Comp.	20%	311-030
		Furnished with R246 (311-030).						
R249	535	101-10015	560 k	1/2 w	Fixed	Comp.	10%	302-564
		10016 - up	33 k	1/2 w	Fixed	Comp.	10%	302-333
	545	101-13343	560 k	1/2 w	Fixed	Comp.	10%	302-564
		13344 - up	33 k	1/2 w	Fixed	Comp.	10%	302-333
R250	535	101-10015X	500 k		Var.	Comp.	20%	311-048
		Furnished with R248 (311-048).						
		X10702 - up	47 k	1/2 w	Fixed	Comp.	10%	302-473
	545	101-13343X	500 k		Var.	Comp.	20%	311-048
		Furnished with R248 (311-048).						
		X14223 - up	47 k	1/2 w	Fixed	Comp.	10%	302-473
R253	535	101-10015X	100 Ω	1/2 w	Fixed	Comp.	10%	302-101
	545	101-13343X	100 Ω	1/2 w	Fixed	Comp.	10%	302-101
R254			111 k	1/2 w	Fixed	Prec.	1%	309-046
R255			100 Ω	1/2 w	Fixed	Comp.	10%	302-101
R256			100 k	1 w	Fixed	Comp.	10%	304-104
R259			400 k	1 w	Fixed	Prec.	1%	310-094



R260			400 k	1 w	Fixed Prec.	1%	310-094
R261			22 k	1/2 w	Fixed Comp.	10%	302-223
R262			20 k	2 w	Var. Comp.	20%	311-018
R265			47 Ω	1/2 w	Fixed Comp.	10%	302-470
R266	535	101-612	5 k	2 w	Var. Comp.	20%	311-011
		613 - up	10 k	2 w	Var. Comp.	20%	311-016
	545	101 - up	10 k	2 w	Var. Comp.	20%	311-016
R267			2.2 k	1 w	Fixed Comp.	10%	304-222
R268			6 k	5 w	Fixed WW	5%	308-052
R269			2.2 k	1 w	Fixed Comp.	10%	304-222
R270	535	101-612	1 k	2 w	Var. Comp.	20%	311-006
		613 - up	2 k	2 w	Var. Comp.	20%	311-008
	545	101 - up	2 k	2 w	Var. Comp.	20%	311-008
R272			47 Ω	1/2 w	Fixed Comp.	10%	302-470
R273			100 Ω	1/2 w	Fixed Comp.	10%	302-101
R278	535	101-612	25 k	5 w	Mica plate	1%	310-503
		613 - up	6-25 k	5 w	Mica plate	1%	310-506
	545	101 - up	6-25 k	5 w	Mica plate	1%	310-506
R279			47 Ω	1/2 w	Fixed Comp.	10%	302-470
R282			390 Ω	1/2 w	Fixed Comp.	10%	302-391
R283			47 Ω	1/2 w	Fixed Comp.	10%	302-470
R284			2.2 k	1/2 w	Fixed Comp.	10%	302-222
R286	535	101-612	30 k	5 w	Mica plate	1%	310-504
		613 - up	6-30 k	5 w	Mica plate	1%	310-507
	545	101 - up	6-30 k	5 w	Mica plate	1%	310-507
R287			100 Ω	1/2 w	Fixed Comp.	10%	302-101
R288			39 k	2 w	Fixed Comp.	10%	306-393
R289			39 k	2 w	Fixed Comp.	10%	306-393
R292			470 k	1/2 w	Fixed Comp.	10%	302-474
R293			470 k	1/2 w	Fixed Comp.	10%	302-474
R294	535	101-8553	470 k	1/2 w	Fixed Comp.	10%	302-474
		8554 - up	820 k	1/2 w	Fixed Comp.	10%	302-824
	545	101-9406	470 k	1/2 w	Fixed Comp.	10%	302-474
		9407 - up	820 k	1/2 w	Fixed Comp.	10%	302-824



R295	535	101-8553	470 k	1/2 w	Fixed Comp.	10%	302-474
		8554 - up	820 k	1/2 w	Fixed Comp.	10%	302-824
	545	101-9406	470 k	1/2 w	Fixed Comp.	10%	302-474
		9407 - up	820 k	1/2 w	Fixed Comp.	10%	302-824
R670			150 k	1/2 w	Fixed Comp.	10%	302-154
R671			1 k	1/2 w	Fixed Comp.	10%	302-102
R672	535	101-10015	3.3 meg	1/2 w	Fixed Comp.	10%	302-335
		10016 - up	3.9 meg	1/2 w	Fixed Comp.	10%	302-395
	545	101-13343	3.3 meg	1/2 w	Fixed Comp.	10%	302-335
		13344 - up	3.9 meg	1/2 w	Fixed Comp.	10%	302-395
R673			2.7 meg	1/2 w	Fixed Comp.	10%	302-275
R674			1 k	1/2 w	Fixed Comp.	10%	302-102
R675			68 k	1/2 w	Fixed Comp.	10%	302-683
R676			33 k	1 w	Fixed Comp.	10%	304-333
R679			10 k	2 w	Var. Comp.	20%	311-016
R680	535	101-10433	100 k	1/2 w	Fixed Comp.	10%	302-104
		10434 - up	68 k	1/2 w	Fixed Comp.	10%	302-683
	545	101-13821	100 k	1/2 w	Fixed Comp.	10%	302-104
		13822 - up	68 k	1/2 w	Fixed Comp.	10%	302-683
R681			1.5 meg	1/2 w	Fixed Comp.	10%	302-155
R682			100 Ω	1/2 w	Fixed Comp.	10%	302-101
R683			9.5 k	1/2 w	Fixed Prec.	1%	309-121
R684			6.375 k	1/2 w	Fixed Prec.	1%	309-119
R685			2.1 k	1/2 w	Fixed Prec.	1%	309-117
R686			1.025 k	1/2 w	Fixed Prec.	1%	309-116
R687			610 Ω	1/2 w	Fixed Prec.	1%	309-113
R688			200 Ω	1/2 w	Fixed Prec.	1%	309-073
R689			100 Ω	1/2 w	Fixed Prec.	1%	309-112
R690			60 Ω	1/2 w	Fixed Prec.	1%	309-067
R691			40 Ω	1/2 w	Fixed Prec.	1%	309-066
R694			100 k	1/2 w	Fixed Prec.	1%	309-045
R695			100 Ω	1/2 w	Fixed Prec.	1%	309-112
R698	535/545	X5001 - up	.25 Ω	1/2 w	Fixed WW	10%	308-090



R699			100 Ω	1/2 w	Fixed Comp.	10%		302-101
R700			15 k	1 w	Fixed Comp.	10%		304-153
R701			15 k	1 w	Fixed Comp.	10%		304-153
R703			68 k	1/2 w	Fixed Comp.	10%		302-683
R704			27 k	1/2 w	Fixed Comp.	10%		302-273
R706			2.7 meg	1/2 w	Fixed Comp.	10%		302-275
R707			2.7 meg	1/2 w	Fixed Comp.	10%		302-275
R708	535	X1283 - up	12 Ω	1 w	Fixed Comp.	10%		304-120
	545	101 - up	12 Ω	1 w	Fixed Comp.	10%		304-120
R710			33 k	1/2 w	Fixed Comp.	10%		302-333
R711			100 k	1/2 w	Fixed Comp.	10%		302-104
R712			100 k	1/2 w	Fixed Comp.	10%		302-104
R713	535	X2035 - up	1 k	1/2 w	Fixed Comp.	10%		302-102
	545	X401 - up	1 k	1/2 w	Fixed Comp.	10%		302-102
R715	535	101-3324	50 k	1/2 w	Fixed Comp.		Use	310-086
		3325 - up	50 k	1 w	Fixed Comp.	1%		310-086
	545	101-1186	50 k	1/2 w	Fixed Prec.		Use	310-086
		1187 - up	50 k	1 w	Fixed Prec.	1%		310-086
R716			10 k	2 w	Var. WW	20%		311-015
R717			100 k	1/2 w	Fixed Comp.	10%		302-104
R718	535	101-3324	68 k	1/2 w	Fixed Prec.		Use	310-054
		3325 - up	68 k	1 w	Fixed Prec.	1%		310-054
	545	101-1186	68 k	1/2 w	Fixed Prec.		Use	310-054
		1506 - up	68 k	1 w	Fixed Prec.	1%		310-054
R719			470 k	1/2 w	Fixed Comp.	10%		302-474
R720	535	X5403 - up	10 Ω	1/2 w	Fixed Comp.	10%		302-100
	545	X5448 - up	10 Ω	1/2 w	Fixed Comp.	10%		302-100
R724	535	X1777 - up	1 k	25 w	Fixed WW	5%		308-037
		R724 was called R725, S/N 101-1776.						
R725	535	101-1776X	1 k	25 w	Fixed WW	5%		308-037
		X5380 - up	10 k	2 w	Fixed Comp.	10%		306-103
	545	101-220X	1 k	25 w	Fixed WW	5%		308-037
		X5368 - up	10 k	2 w	Fixed Comp.	10%		306-103
R726			1 k	1/2 w	Fixed Comp.	10%		302-102
R727			1 k	1/2 w	Fixed Comp.	10%		302-102



R728			150 k	1/2 w	Fixed Comp.	10%		302-154
R729			1 meg	1/2 w	Fixed Comp.	10%		302-105
R730	535	X8894 - up	100 Ω	1/2 w	Fixed Comp.	10%		302-101
	545	X9839 - up	100 Ω	1/2 w	Fixed Comp.	10%		302-101
R732	535	101-695	10 Ω	2 w	Fixed Comp.	10%		306-100
		696-5379	10 Ω	1 w	Fixed Comp.	10%	(2)	304-100
		5380 - up	10 Ω	1 w	Fixed Comp.	10%		304-100
	545	101-5367	10 Ω	1 w	Fixed Comp.	10%	(2)	304-100
		5368 - up	10 Ω	1 w	Fixed Comp.	10%		304-100
R733	535	X5380 - up	10 Ω	1 w	Fixed Comp.	10%		304-100
	545	X5368 - up	10 Ω	1 w	Fixed Comp.	10%		304-100
R735			100 k	1/2 w	Fixed Comp.	10%		302-104
R736			50 Ω	2 w	Var. WW	20%		311-055
R740	535	101-695	10 Ω	1/2 w	Fixed Comp.	10%		302-100
		696 - up	10 Ω	1 w	Fixed Comp.	10%		304-100
	545	101 - up	10 Ω	1 w	Fixed Comp.	10%		304-100
R742			47 k	1/2 w	Fixed Comp.	10%		302-473
R743			39 k	1/2 w	Fixed Comp.	10%		302-393
R744			680 k	1/2 w	Fixed Comp.	10%		302-684
R747			1.5 meg	1/2 w	Fixed Comp.	10%		302-155
R748	535		3 k	10 w	Fixed WW	5%		308-020
	545		30 k	10 w	Fixed WW	5%		308-027
R749			750 Ω	10 w	Fixed WW	5%		308-016
R750	535	101-3697	333 k	1/2 w	Fixed Prec.		Use	310-056
		3698 - up	333 k	1 w	Fixed Prec.	1%		310-056
	545	101-1505	333 k	1/2 w	Fixed Prec.		Use	310-056
		1506 - up	333 k	1 w	Fixed Prec.	1%		310-056
R751	535	101-3697	490k	1/2 w	Fixed Prec.		Use	310-057
		3698 - up	490 k	1 w	Fixed Prec.	1%		310-057
	545	101-1505	490 k	1/2 w	Fixed Prec.		Use	310-057
		1506 - up	490 k	1 w	Fixed Prec.	1%		310-057
R756			10 Ω	2 w	Fixed Comp.	10%		306-100
R757			270 k	1/2 w	Fixed Comp.	10%		302-274
R758			56 k	1/2 w	Fixed Comp.	10%		302-563
R760			1.5 meg	1/2 w	Fixed Comp.	10%		302-155



R761	535	101-1776X	2 k	10 w	Fixed	WW	5%		308-017
	545	101-220X	2 k	10 w	Fixed	WW	5%		308-017
R762	535	X1777 - up	2 k	10 w	Fixed	WW	5%		308-017
	545	X221 - up	2 k	10 w	Fixed	WW	5%		308-017
		(In 545, R762 was called R761, SNs 101-220)							
R763			1.5 meg	1/2 w	Fixed	Comp.	10%		302-155
R764			2.2 meg	1/2 w	Fixed	Comp.	10%		302-225
R765			180 k	1/2 w	Fixed	Comp.	10%		302-184
R766			82 k	1 w	Fixed	Comp.	10%		304-823
R767	535	X2035 - up	1 k	1/2 w	Fixed	Comp.	10%		302-102
	545	X401 - up	1 k	1/2 w	Fixed	Comp.	10%		302-102
R770			2.2 meg	1/2 w	Fixed	Comp.	10%		302-225
R771	535	101-3697	220 k	1/2 w	Fixed	Prec.		Use	310-055
		3698 - up	220 k	1 w	Fixed	Prec.	1%		310-055
	545	101-1505	220 k	1/2 w	Fixed	Prec.		Use	310-055
		1506 - up	220 k	1 w	Fixed	Prec.	1%		310-055
R772	535	101-3697	333 k	1/2 w	Fixed	Prec.		Use	310-056
		3698 - up	333 k	1 w	Fixed	Prec.	1%		310-056
	545	101-1505	333 k	1/2 w	Fixed	Prec.		Use	310-056
		1506 - up	333 k	1 w	Fixed	Prec.	1%		310-056
R777	535	X5380 - up	10 Ω	1 w	Fixed	Comp.	10%		304-100
	545	X5368 - up	10 Ω	1 w	Fixed	Comp.	10%		304-100
R778			82 k	2 w	Fixed	Comp.	10%		306-823
R779			2.2 meg	1/2 w	Fixed	Comp.	10%		302-225
R780	535	101-5379	2x10 Ω	1 w	Fixed	Comp.	10%	(2)	304-100
		5380 - up	10 Ω	1 w	Fixed	Comp.	10%		304-100
	545	101-5367	10 Ω	1 w	Fixed	Comp.	10%	(2)	304-100
		5368 - up	10 Ω	1 w	Fixed	Comp.	10%		304-100
R781	535	101-8217	1.5 meg	1/2 w	Fixed	Comp.	10%		302-155
		8218 - up	1.0 meg	1/2 w	Fixed	Comp.	10%		302-105
	545	101-9291	1.5 meg	1/2 w	Fixed	Comp.	10%		302-155
		9292 - up	1.0 meg	1/2 w	Fixed	Comp.	10%		302-105
R782	535	101-8217	390 k	1/2 w	Fixed	Comp.	10%		302-394
		8218 - up	560 k	1/2 w	Fixed	Comp.	10%		302-564
	545	101-9291	390 k	1/2 w	Fixed	Comp.	10%		302-394
		9292 - up	560 k	1/2 w	Fixed	Comp.	10%		302-564
R783			47 k	1/2 w	Fixed	Comp.	10%		302-473
R784			1.5 meg	1/2 w	Fixed	Comp.	10%		302-155



R785	535	X177-8217	2 k	20 w	Fixed	WW	5%	308-031
		8218 - up	2.4 k	20 w	Fixed	WW	5%	308-068
	545	X221-5367	2 k	20 w	Fixed	WW	5%	(2) 308-031
		5368-9291	2 k	20 w	Fixed	WW	5%	308-031
		9292 - up	1.5 k	25 w	Fixed	WW	5%	308-040
R786	535	101-1776X	2 k	20 w	Fixed	WW	5%	308-031
		X8218 - up	2.4 k	20 w	Fixed	WW	5%	308-068
	545	101-220X	2 k	20 w	Fixed	WW	5%	(2) 308-031
		X5368-9291	2 k	20 w	Fixed	WW	5%	308-031
		9292 - up	1.5 k	25 w	Fixed	WW	5%	308-040
R787	535	101-3697	1.84 meg	1/2 w	Fixed	Prec.		Use*
		3698 - up	236 k	1 w	Fixed	WW	1%	308-083
	545	101-1505	1.84 meg	1/2 w	Fixed	Prec.		Use*
		1506 - up	236 k	1 w	Fixed	WW	1%	308-083
R788	535	101-3697	780 k	1/2 w	Fixed	Prec.		Use*
		3698 - up	100 k	1/2 w	Fixed	WW	1%	Use*
	545	101-1505	780 k	1/2 w	Fixed	Prec.		Use*
		1506 - up	100 k	1/2 w	Fixed	WW	1%	308-084
*For initial replacement, replace R787 and R788 at the same time.								
R789			1 k	1/2 w	Fixed	Comp.	10%	302-102
R790			10 Ω	1/2 w	Fixed	Comp.	10%	302-100
R791			150 k	1/2 w	Fixed	Comp.	10%	302-154
R792			120 k	1/2 w	Fixed	Comp.	10%	302-124
R793			27 k	1/2 w	Fixed	Comp.	10%	302-273
R794			1 meg	1/2 w	Fixed	Comp.	10%	302-105
R795	535	X1777-8627	2 k	10 w	Fixed	WW	5%	308-017
		8628 - up	4.5 k	5 w	Fixed	WW	5%	308-066
	545	X221 - up	3 k	10 w	Fixed	WW	5%	308-020
		(SNs 101-220, this resistor was called R796.)						
R796	535	101-1776X	2 k	10 w	Fixed	WW	5%	308-017
	545	101-220X	3 k	10 w	Fixed	WW	5%	308-020
R797	535	101-3697	220 k	1/2 w	Fixed	Prec.		Use
		3698 - up	220 k	1 w	Fixed	Prec.	1%	310-055
	545	101-1505	220 k	1/2 w	Fixed	Prec.		Use
		1506 - up	220 k	1 w	Fixed	Prec.	1%	310-055
R798	535	101-3697	720 k	1/2 w	Fixed	Prec.		Use
		3698 - up	720 k	1 w	Fixed	Prec.	1%	310-059
	545	101-1505	720 k	1/2 w	Fixed	Prec.		Use
		1506 - up	720 k	1 w	Fixed	Prec.	1%	310-059
R800			1 k	1/2 w	Fixed	Comp.	10%	302-102



R803			56 k	2 w	Fixed Comp.	10%	306-563
R804			100 k	1/2 w	Fixed Comp.	10%	302-104
R805			1 k	1/2 w	Fixed Comp.	10%	302-102
R807			390 Ω	2 w	Fixed Comp.	10%	306-391
R810			470 k	1/2 w	Fixed Comp.	10%	302-474
R811			2 meg	2 w	Var. Comp.	20%	311-042
R812			2.2 meg	1/2 w	Fixed Comp.	10%	302-225
R813			4.7 meg	1/2 w	Fixed Comp.	10%	302-475
R814			4.7 meg	1/2 w	Fixed Comp.	10%	302-475
R815			4.7 meg	1/2 w	Fixed Comp.	10%	302-475
R829	535	X10300 - up	33 k	1/2 w	Fixed Comp.	10%	302-333
R830			47 k	1/2 w	Fixed Comp.	10%	302-473
R831			1 meg	1/2 w	Var. Comp.	20%	311-041
R832			4.7 meg	2 w	Fixed Comp.	10%	306-475
R833			4.7 meg	2 w	Fixed Comp.	10%	306-475
R834			100 k	1/2 w	Fixed Comp.	10%	302-104
R835			1 meg	1/2 w	Fixed Comp.	10%	302-105
R837	535	X5380 - up	4.7 meg	1/2 w	Fixed Comp.	10%	302-475
	545	101 - up	4.7 meg	1/2 w	Fixed Comp.	10%	302-475
R838			1 k	1/2 w	Fixed Comp.	10%	302-102
R839			100 Ω	1/2 w	Fixed Comp.	10%	302-101
R840			68 k	2 w	Fixed Comp.	10%	306-683
R841	535	X1439 - up	47 Ω	1/2 w	Fixed Comp.	10%	302-470
	545	101 - up	47 Ω	1/2 w	Fixed Comp.	10%	302-470
R850			2.2 meg	2 w	Fixed Comp.	10%	306-225
R851			2.2 meg	2 w	Fixed Comp.	10%	306-225
R852			2 meg	1/2 w	Var. Comp.	20%	311-043
R853			1 meg	2 w	Fixed Comp.	10%	306-105
R855			10 k	1/2 w	Fixed Comp.	10%	302-103



R856			27 k	1/2 w	Fixed Comp.	10%	302-273
R857			1 meg	1/2 w	Fixed Comp.	10%	302-105
R860			50 k	2 w	Var. Comp.	20%	311-023
R861			100 k	2 w	Var. Comp.	20%	311-026
R863	545	101 - up	100 k	1/2 w	Fixed Comp.	10%	302-104
R864	545	101 - up	150 k	1/2 w	Fixed Comp.	10%	302-154

SWITCHES

					Unwired	Wired
SW1*	535	101-10015	TRIGGER SLOPE		260-099	262-080
		10016 - up	TRIGGER SLOPE		260-099	262-183
	545	101 - up	TRIGGER SLOPE		260-099	262-080
SW5*	535	101-10015	TRIGGER MODE		260-099	262-080
		10016 - up	TRIGGER MODE		260-099	262-183
	545	101-13343	TRIGGER MODE		260-099	262-080
		13344 - up	TRIGGER MODE		260-099	262-183
SW1 and SW5 shafts are concentric. Furnished as a unit.						
SW43	535	X7553 - up	Furnished with R14 and R43.			311-096
	545	X7401 and up	Furnished with R14 and R43.			311-096
SW55*			TIME/CM		260-010	262-063
SW90			MULTIPLIER		260-011	262-064
SW100			ATTEN		260-014	
SW113			SLOPE		260-014	
SW190			TIME/CM		260-009	262-060
SW200			HORIZONTAL DISPLAY		260-007	262-061
SW235			RESET, MAIN SWEEP		260-017	
SW254*			5X MAGNIFIER		260-010	262-063
*SW254 and SW55 are concentric. Furnished as a unit.						
SW670	535	101-7893	VOLTS, MILLIVOLTS, OFF) USE			262-132
		7894 - up	VOLTS, MILLIVOLTS, OFF) USE		260-177	262-132
	545	101-8266	VOLTS, MILLIVOLTS, OFF) USE			262-132
		8267 - up	VOLTS, MILLIVOLTS, OFF) USE		260-177	262-132
SW680	535	101-7893	SQUARE-WAVE CALIBRATOR)	USE		262-132
		7894 - up	SQUARE-WAVE CALIBRATOR)	260-177		262-132
	545	101-8266	SQUARE-WAVE CALIBRATOR)	USE		262-132
		8267 up	SQUARE-WAVE CALIBRATOR)	260-177		262-132
SW670 and SW680 shafts are concentric. Furnished as a unit.						



SW701	535	101-5000	POWER ON	260-066	260-066
		5001 - up	POWER ON	260-134	260-134
	545	101 - up	POWER ON	260-134	260-134

THERMAL CUT-OUTS

TK701			Type SE11, 128 degrees F.		260-070
-------	--	--	---------------------------	--	---------

TRANSFORMERS

T700			Plate and Heater Supply, Power		120-037
T700			Power, for export (all serial numbers)		120-086
T801			CRT Supply		120-036

VACUUM TUBES

V8	535	101-10015	6BQ7A	Trigger Amplifier	154-028
		10016 - up	6DJ8	Trigger Amplifier	154-187
	545	101-13343	6BQ7A	Trigger Amplifier	154-028
		13344 - up	6DJ8	Trigger Amplifier	154-187
V20	535	101-10015	6U8	Trigger Shaper	154-033
		10016 - up	6DJ8	Trigger Shaper	154-187
	545	101-13343	6U8	Trigger Shaper	154-033
		13344 - up	6DJ8	Trigger Shaper	154-187
V37A,B		6U8	Delayed Trigger Amplifier and + Multivibrator Trig. Gate Generator	154-033	
V43A,B		6U8	-Multivibrator, Trig. Gate Generator and Ready Indicator	154-033	
V54A,B	535	101-10015	6BQ7A	Sweep Holdoff Cathode Follower	154-028
		10016 - up	6DJ8	Sweep Holdoff Cathode Follower	154-187
	545	101-13343	6BQ7A	Sweep Holdoff Cathode Follower	154-028
		13344 - up	6DJ8	Sweep Holdoff Cathode Follower	154-187
V58A,B	535	101-10015	6BQ7A	+ Multivibrator and Mult. C.F.	154-028
		10016 - up	6DJ8	+ Multivibrator and Mult. C.F.	154-187
	545	101-13343	6BQ7A	+ Multivibrator and Mult. C.F.	154-028
		13344 - up	6DJ8	+ Multivibrator and Mult. C.F.	154-187
V70	535	101-1125	12BY7	-Multivibrator	154-047
		1126-1219	6CL6	-Multivibrator	154-031
	545	1220 - up	12BY7	-Multivibrator	154-047
		101 - up	12BY7	-Multivibrator	154-047
V73A,B	535	101-10015	6BQ7A	Sweep-out and Gate-out C.F.	154-028
		10016 - up	6DJ8	Sweep-out and Gate-out C.F.	154-187
	545	101-13343	6BQ7A	Sweep-out and Gate-out C.F.	154-028
		13344 - up	6DJ8	Sweep-out and Gate-out C.F.	154-187
V78		6AU6	Multi-Trace Units Sync Amplifier	154-022	
V80		6AL5	Disconnect Diodes	154-016	



V85	535	101-10015	6BQ7A	Sweep-generator C.F.	154-028
		10016 - up	6DJ8	Sweep-generator C.F.	154-187
	545	101-13343	6BQ7A	Sweep-generator C.F.	154-028
		13344 - up	6DJ8	Sweep-generator C.F.	154-187
V90			6CL6	Sweep Generator	154-031
V113			12AU7	Trigger Amplifier Cathode Follower	154-041
V120	535	101-10015	6BQ7A	Trigger Amplifier	154-028
		10016 - up	6DJ8	Trigger Amplifier	154-187
	545	101-13343	6BQ7A	Trigger Amplifier	154-028
		13344 - up	6DJ8	Trigger Amplifier	154-187
V130			6U8	Trigger Shaper Ext. Sweep C.F.	154-033
V140	535	101-10015	6BQ7A	Comparator	154-028
		10016 - up	6DJ8	Comparator	154-187
	545	101-13343	6BQ7A	Comparator	154-028
		13344 - up	6DJ8	Comparator	154-187
V150A,B	535	101-10015	6BQ7A	Holdoff C.F. and Swp. Gen. C.F.	154-028
		10016 - up	6DJ8	Holdoff C.F. and Swp. Gen. C.F.	154-187
	545	101-13343	6BQ7A	Holdoff C.F. and Swp. Gen. C.F.	154-028
		13344 - up	6DJ8	Holdoff C.F. and Swp. Gen. C.F.	154-187
V155A,B			6U8	-Multivibrator and + Multivibrator	154-033
V172A,B	535	101-10015	6BQ7A	Gate-out C.F. and Mult. C.F.	154-028
		10016 - up	6DJ8	Gate-out C.F. and Mult. C.F.	154-187
	545	101-13343	6BQ7A	Gate-out C.F. and Mult. C.F.	154-028
		13344 - up	6DJ8	Gate-out C.F. and Mult. C.F.	154-187
V180			12AL5	Disconnect Diodes	154-038
V190			12AU6	Sweep Generator	154-040
V195	535	101-7009	6U8	Delay Pickoff	154-033
		7010 - up	6AU6	Delay Pickoff	154-022
	545	101-6889	6U8	Delay Pickoff	154-033
		6890 - up	6AU6	Delay Pickoff	154-022
V196	535	X7010 - up	6AU6	Delay Pickoff	154-022
	545	X6890 - up	6AU6	Delay Pickoff	154-022
V216			6U8	Delay Trigger Shaper	154-033
V228A,B			6U8	Constant Current Tube and Delayed Trigger Cathode Follower	154-033
V240A,B	535	101-10015	6BQ7A	Driver C.F. and Input C.F.	154-028
		10016 - up	6DJ8	Driver C.F. and Input C.F.	154-187
	545	101-13343	6BQ7A	Driver C.F. and Input C.F.	154-028
		13344 - up	6DJ8	Driver C.F. and Input C.F.	154-187
V246A,B	535	101-10015	6BQ7A	Cal. C.F. and Horiz. Position C.F.	154-028
		10016 - up	12AU7	Cal. C.F. and Horiz. Position C.F.	154-041
	545	101-13343	6BQ7A	Cal. C.F. and Horiz. Position C.F.	154-028



V246A,B	545	13344 - up	12AU7	Cal. C.F. and Horiz. Position C.F.		154-041
V265A,B	535	101-10015	6BQ7A	Sweep Amp. and Swp. C.F.	Use	157-022
		10016 - up	6DJ8	Sweep Amp. and Swp. C.F.		154-187
	545	101-13343	6BQ7A	Sweep Amp. and Swp. C.F.	Use	157-022
		13344 - up	6DJ8	Sweep Amp. and Swp. C.F.		154-187
V272A,B	535	101-10015	6BQ7A	+ Sweep Amp. and +Swp. C.F.	Use	157-022
		10016 - up	6DJ8	+ Sweep Amp. and +Swp. C.F.		154-187
	545	101-13343	6BQ7A	+ Sweep Amp. and +Swp. C.F.	Use	157-022
		13344 - up	6DJ8	+ Sweep Amp. and +Swp. C.F.		154-187
V282	535	101-1125	12BY7	Sawtooth Corrector		154-047
		1126 - up	6CL6	Sawtooth Corrector		154-047
	545	101 - up	6CL6	Gated C.F. Current Booster		154-031
V670	535	101-10015	6U8	Calibrator Multivibrator		154-033
		10016 - up	6AU6	Calibrator Multivibrator		154-022
	545	101-13343	6U8	Calibrator Multivibrator		154-033
		13344 - up	6AU6	Calibrator Multivibrator		154-022
V700			6AU6	-150 v DC Amplifier		154-022
V710			5651	Voltage Reference		154-052
V712			12AX7	-150 v Comparator		154-043
V725			12B4	-150 v Series Regulator		154-044
V726			12B4	-150 v Series Regulator		154-044
V727			12B4	-150 v Series Regulator		154-044
V742			6AU6	+ 100 v Comparator		154-022
V748A,B			6080	+ 225 and + 100 v Series Regulators		154-056
V757			6AU6	+ 225 v DC Amplifier		154-022
V765			12AX7	+ 225 v Comparator		154-043
V782			6AU6	+ 350 v Comparator		154-022
V784			6080	+ 350 v Series Regulator		154-056
V791			6AU6	+ 500 v Comparator		154-022
V794			12B4	+ 500 v Series Regulator		154-044
V803			6AU5	Oscillator		154-021
V810A,B			12AU7	DC Comparator and Shunt Comparator		154-041
V820			5642	-1350 v Rectifier		154-051
V821			5642	+ 8650 v Voltage Tripler		154-051



V822			5642	+ 8650 v Voltage Tripler		154-051
V823			5642	+ 8650 v Voltage Tripler		154-051
V824			5642	-1450 v Rectifier		154-051
V840	535	101-10015	6BQ7A	Unblanking Mixer		154-028
		10016 - up	6DJ8	Unblanking Mixer		154-187
	545	101-13343	6BQ7A	Unblanking Mixer		154-028
		13344 - up	6DJ8	Unblanking Mixer		154-187
V859	535		T51P2A/5BGP2		CRT	*154-081
	545		T54P2/5BHP2		CRT	*154-098

535 VERTICAL AMPLIFIER

CAPACITORS

B536	X8628 - up	Type NE-2, 50-75 v, 1/25 w	150-002
B546	X8628 - up	Type NE-2, 50-75 v, 1/25 w	150-002
B628	101-8627X	Type NE-2, 65-75 v, 1/25 w	150-014
B629	101-8627X	Type NE-2, 65-75 v, 1/25 w	150-014

BULBS

C500	101-1058X	2.2 μ f	Cer.	Fixed	500 v	+ or -0.5 μ f	281-500
C501	101-1058X	2.2 μ f	Cer.	Fixed	500 v	+ or -0.5 μ f	281-500
C503	101-8627X	.047 μ f	PT	Fixed	400 v	20%	285-519
C504	X8628 - up	.005 μ f	Cer.	Fixed	500 v	GMV	283-001
C505	X8628 - up	.005 μ f	Cer.	Fixed	500 v	GMV	283-001
C507A,B	X8628 - up	2x10 μ f	EMC	Fixed	250 v		290-076
C510	X2770-8627	.01 μ f	Cer.	Fixed	500 v	GMV	283-002
	8628 - up	.005 μ f	Cer.	Fixed	500 v	GMV	283-001
C513	X1059-8627X	.001 μ f	Cer.	Fixed	500 v	GMV	283-000
C515	101-8627X	150 μ f	EMC	Fixed	250 v	-20+ 50%	290-048
C516	101-8627X	150 μ f	EMC	Fixed	250 v	-20+ 50%	290-048
C517	X8628 - up	.001 μ f	Cer.	Fixed	500 v	GMV	283-000
C517A,B	101-8627X	2x40 μ f	EMC	Fixed	450 v	-20+ 50%	290-043
C520	101-581	.01 μ f	Cer.	Fixed	500 v	Use	283-002
	582-8627X	.01 μ f	Cer.	Fixed	500 v		283-002
C532	X858-8627X	.005 μ f	Cer.	Fixed	500 v	GMV	283-001
C537	X8628 - up	.005 μ f	Cer.	Fixed	500 v	GMV	283-001



C538	X5513-8627X	.005 μ f	Cer.	Fixed 500 v	GMV		283-001
C540	101-3209 3210-8627X	.022 μ f	PTM	Fixed 400 v		Use	285-517
		.022 μ f	PTM	Fixed 600 v	20%		285-517
C543	X8628 - up	.005 μ f	Cer.	Fixed 500 v	GMV		283-001
C547	X8628 - up	.005 μ f	Cer.	Fixed 500 v	GMV		283-001
C550	X8628 - up	.005 μ f	Cer.	Fixed 500 v	GMV		283-001
C556	X8628 - up	.001 μ f	Cer.	Fixed 500 v	GMV		283-000
		.01 μ f	Cer.	Fixed 500 v	GMV		283-002
C560	X6321-8627 8628 - up	.001 μ f	Cer.	Fixed 500 v	GMV		283-000
		.01 μ f	Cer.	Fixed 500 v	GMV		283-002
C566	X8628 - up	.001 μ f	Cer.	Fixed 500 v	GMV		283-000
C571	101-8627X	.005 μ f	Cer.	Fixed 500 v	GMV		283-001
C579	101-8627X	.005 μ f	Cer.	Fixed 500 v	GMV		283-001
C582	X8628 - up	.005 μ f	Cer.	Fixed 500 v	GMV		283-001
C586	X8628 - up	1.5 μ f	Cer.	Fixed 500 v	+or-0.5 μ f		281-526
C595A,B	101-8627X	2x40 μ f	EMC	Fixed 150 v	-20+50%		290-039
C596	X8628 - up	.005 μ f	Cer.	Fixed 500 v	GMV		283-001
C599	X8628 - up	.022 μ f	PTM	Fixed 600 v	20%		285-517
C603	X8628 - up	2x40 μ f	EMC	Fixed 250 v			290-040
C605A,B,C	X8628 - up	10x20x40 μ f	EMC	Fixed 475 v			290-063
C650	X1059-8627X	2x1000 μ f	EMC	Fixed 15 v	-20+50%		290-051

INDUCTORS

L506	X8628 - up	21-40 μ h	Var.	Core	276-503		114-082
L523	X8628 - up	21-40 μ h	Var.	Core	276-503		114-082
L527	101-8627X	29 μ h	Fixed				108-016
L536	X1208-8627X	1.1 μ h	Fixed				108-078
L551	X8628 - up	.75 μ h	Fixed				108-072
L553	X8628-8850 8851 - up	26-45 μ h	Var.	Core	276-503		114-081
		17-48 μ h	Var.	Core	276-511		114-103
L557	101-8627X	1.2 μ h	Fixed				108-056



L560	101-8627X	1.2 μ h	Fixed				108-056
L561	X8628 - up	.75 μ h	Fixed				108-072
L563	X8628-8850 8851-up	26-45 μ h 17-48 μ h	Var. Var.	Core Core	276-503 276-511		114-081 114-103
L570	101-8627X	17-30 μ h	Var.	Core	276-503		114-004
L580	101-8627X	17-30 μ h	Var.	Core	276-503		114-004
L582	X8628 - up	18 μ h	Fixed	(wound on 1w, 10M resistor)			108-129
L634	101-584 585-695 696-8627X	8.8 μ h 9.3 μ h 8.8 μ h	Fixed Fixed Fixed		Use		108-057 108-057 108-057
L635	101-584 585-695 696-8627X	8.8 μ h 9.3 μ h 8.8 μ h	Fixed Fixed Fixed		Use		108-057 108-057 108-057

RESISTORS

R500	101-8627X	4 k	5 w	Fixed	WW	5%	308-051
R501	101-1058 1059-8627X	20 k 15 k	8 w 10 w	Fixed Fixed	WW WW	5% 5%	308-011 308-024
R502	101-8627 8628 - up	10 Ω 27 Ω	1/2 w 1/2 w	Fixed Fixed	Comp. Comp.	10% 10%	302-100 302-270
R503	101-581 582-8627X	5.6 Ω 3.9 Ω	1 w 1 w	Fixed Fixed	Comp. Comp.	10% 5%	307-002 307-004
R504	101-8627 8628 - up	10 Ω 150 k	1/2 w 1/2 w	Fixed Fixed	Comp. Comp.	10% 10%	302-100 302-154
R505	X8628 - up	620 Ω	2 w	Fixed	Comp.	5%	305-621
R506	X8628 - up	1.8 k	1/2 w	Fixed	Prec.	1%	310-533
R507	101-1058X X8628 - up	10 Ω 100 k	1/2 w 1/2 w	Fixed Fixed	Comp. Comp.	10% 10%	302-100 302-104
R508	101-1058X	10 Ω	1/2 w	Fixed	Comp.	10%	302-100
R509	101-1058X	10 Ω	1/2 w	Fixed	Comp.	10%	302-100
R510	101-1058X X8628 - up	10 Ω 6.8 k	1/2 w 1 w	Fixed Fixed	Comp. Comp.	10% 10%	302-100 304-682
R511	X1059-8627X	10 k	1 w	Fixed	Comp.	10%	304-103
R512	X1059-8627X	39 k	1/2 w	Fixed	Comp.	10%	302-393
R513	X1059-8627 8628 - up	1 meg 4 k	1/2 w 5 w	Fixed Fixed	Comp. WW	10% 5%	302-105 308-051



R514	X8628 - up	15 k	5 w	Fixed	WW	5%		308-108
R515	101-414 415-8627X	100 Ω 100 Ω	1/2 w 1 w	Fixed Fixed	Comp. Comp.		10%	304-101 304-101
R516	101-414 415-8627X	100 Ω 100 Ω	1/2 w 1 w	Fixed Fixed	Comp. Comp.		10%	Use 304-101 304-101
R517	101-8627 8628 - up	100 Ω 470 k	1 w 1/2 w	Fixed Fixed	Comp. Comp.	10% 10%		304-101 302-474
R518	101-414 415-8627X	100 Ω 100 Ω	1/2 w 1 w	Fixed Fixed	Comp. Comp.		10%	Use 304-101 304-101
R520	101-8627 8628 -up	120 k 27 Ω	1/2 w 1/2 w	Fixed Fixed	Comp. Comp.	10% 10%		302-124 302-270
R521	101-8627X	150 k	1/2 w	Fixed	Comp.	10%		302-154
R523	X8628 - up	1.8 k	1/2 w	Mica Plate		1%		310-533
R524	X8628 - up	100 k	1/2 w	Fixed	Comp.	10%		302-104
R526	X8628 - up	47 Ω	1/2 w	Fixed	Comp.	10%		302-470
R527	101-8627X	4.7 k	1 w	Fixed	Comp.	10%		304-472
R528	101-581 582-1064 1065-8627X	1 k 47 Ω 150 Ω	1/2 w 1/2 w 1/2 w	Fixed Fixed Fixed	Comp. Comp. Comp.	10% 10% 10%		302-102 302-470 302-151
R529	101-8627 8628 -up	15 k 8.2 k	2 w 2 w	Fixed Fixed	Comp. Comp.	10% 5%		306-153 305-822
R530	101-8627 8628 - up	470 Ω 8.2 k	1/2 w 2 w	Fixed Fixed	Comp. Comp.	10% 5%		302-471 305-822
R531	101-8627X	18 k	1 w	Fixed	Comp.	10%		304-183
R532	101-581 582-1064 1065-8627X	1 k 47 Ω 150 Ω	1/2 w 1/2 w 1/2 w	Fixed Fixed Fixed	Comp. Comp. Comp.	10% 10% 10%		302-102 302-470 302-151
R533	X8628 - up	150 k	1/2 w	Fixed	Comp.	10%		302-154
R534	X833-8627 8628 - up	47 Ω 330 k	1/2 w 1/2 w	Fixed Fixed	Comp. Comp.	10% 10%		302-470 302-334
R535	101-8627X	47 Ω	1/2 w	Fixed	Comp.	10%		302-470
R536	101-8627 8628 - up	15 k 330 k	2 w 1/2 w	Fixed Fixed	Comp. Comp.	10% 10%		306-153 302-334
R537	X8628 - up	1 meg	1/2 w	Fixed	Comp.	10%		302-105
R538	101-8627X	47 Ω	1/2 w	Fixed	Comp.	10%		302-470



R539	101-8627 8628 - up	15 k 680 k	2 w 1/2 w	Fixed Comp. Fixed Comp.	10% 10%	306-153 302-684
R540	101-8627X	1 meg	1/2 w	Fixed Comp.	10%	302-105
R541	X8628 - up	47 Ω	1/2 w	Fixed Comp.	10%	302-470
R546	X8628 - up	330 k	1/2 w	Fixed Comp.	10%	302-334
R547	X8628 - up	1 meg	1/2 w	Fixed Comp.	10%	302-105
R550	X8628 - up	1 k	5 w	Fixed WW	5%	308-106
R551	X8628 - up	47 Ω	1/2 w	Fixed Comp.	10%	302-470
R553	X8628 - up	1.8 k	3 w	Mica Plate	1%	310-534
R556	101-8627 8628 - up	47 Ω 100 k	1/2 w 1/2 w	Fixed Comp. Fixed Comp.	10% 10%	302-470 302-104
R557	101-8627X	10 Ω	1/2 w	Fixed Comp.	10%	302-100
R558	101-8627 8628 - up	8.2 k 27 Ω	2 w 1/2 w	Fixed Comp. Fixed Comp.	10% 10%	306-822 302-270
R559	101-8627X	8.2 k	2 w	Fixed Comp.	10%	306-822
R560	101-8627X	10 Ω	1/2 w	Fixed Comp.	10%	302-100
R561	X8628 - up	47 Ω	1/2 w	Fixed Comp.	10%	302-470
R563	X8628 - up	1.8 k	3 w	Mica Plate	1%	310-534
R566	X8628 - up	100 k	1/2 w	Fixed Comp.	10%	302-104
R568	X8628 - up	27 Ω	1/2 w	Fixed Comp.	10%	302-270
R570	101-8627 8628 - up	3 k 500 Ω	4 w 2 w	Mica Plate Var. Comp.	1%	310-502 311-005
R571	101-8627X	1 meg	1/2 w	Fixed Comp.	10%	302-105
R573	101-8627 8628 - up	4 k 2.5 k	5 w 5 w	Fixed WW Fixed WW	5% 1%	308-051 308-103
R574	101-8627 8628 - up	100 Ω 2.5 k	2 w 5 w	Var. Comp. Fixed WW	20% 1%	311-003 308-103
R575	101-8627X	4 k	5 w	Fixed WW	5%	308-051
R577	101-8627 8628 - up	2.7 k 100 Ω	1 w 1/2 w	Fixed Comp. Fixed Comp.	10% 10%	304-272 302-101
R579	101-8627X	1 meg	1/2 w	Fixed Comp.	10%	302-105



R580	101-8627 8628 - up	3 k 100 Ω	4 w 1/2 w	Mica Plate Fixed Comp.	1% 10%	310-502 302-101
R582	X8628 - up	3 k	2 w	Fixed Comp.	5%	305-302
R583	X8628 - up	3.6 k	1 w	Fixed Comp.	5%	303-362
R585	X8628 - up	12 k	2 w	Fixed Comp.	5%	305-123
R586	X8628 - up	1.6 k	1/2 w	Fixed Comp.	5%	301-162
R587	X8628 - up	12 k	2 w	Fixed Comp.	5%	305-123
R590	X8628 - up	47 Ω	1/2 w	Fixed Comp.	10%	302-470
R593	X8628 - up	30 k	10 w	Fixed WW	5%	308-027
R595	101-2297 2298-8627 8628 - up	39 k 27 k 47 Ω	1/2 w 1/2 w 1/2 w	Fixed Comp. Fixed Comp. Fixed Comp.	5% 10% 10%	301-393 302-273 302-470
R596	101-8627 8628 - up	1 meg 47 Ω	2 w 1/2 w	Var. Comp. Fixed Comp.	20% 10%	311-039 302-470
R597	101-2297 2298-8627X	39 k 27 k	1/2 w 1/2 w	Fixed Comp. Fixed Comp.	10% 10%	302-393 302-273
R598	X8628 - up	22 k	2 w	Fixed Comp.	10%	306-223
R599	X8628 - up	1 meg	1/2 w	Fixed Comp.	10%	302-105
R603	X8628 - up	100 Ω	1 w	Fixed Comp.	10%	304-101
R605	X8628 - up	100 Ω	1/2 w	Fixed Comp.	10%	302-101
R606	101-8627X	10 Ω	1/2 w	Fixed Comp.	10%	302-100
R607	101-8627 8628 - up	1.2 k 47 Ω	2 w 1/2 w	Fixed Comp. Fixed Comp.	10% 10%	306-122 302-470
R608	101-8627X	47 Ω	1/2 w	Fixed Comp.	10%	302-470
R609	101-8627 8628 - up	5.6 k 100 Ω	2 w 1/2 w	Fixed Comp. Fixed Comp.	10% 10%	306-562 302-101
R610	101-8627X	8 k	5 w	Fixed WW	5%	308-007
R612	101-8627X	8 k	5 w	Fixed WW	5%	308-007
R613	101-8627X	5.6 k	2 w	Fixed Comp.	10%	306-562
R615	101-8627X	10 Ω	1/2 w	Fixed Comp.	10%	302-100
R627	X1514-8627X	1 k	1/2 w	Fixed Comp.	10%	302-102
R628	101-8627X	100 k	1/2 w	Fixed Comp.	10%	302-104



R629	101-8627X	100 k	1/2 w	Fixed Comp.	10%		302-104
R634	101-969 970-8627X	820 Ω 820 Ω	1/2 w 1/2 w	Fixed Comp. Fixed Comp.		Use	301-821 301-821
R635	101-969 970-8627X	820 Ω 820 Ω	1/2 w 1/2 w	Fixed Comp. Fixed Comp.		Use	301-821 301-821
R650	X1059-1280 1281-8627X	180 Ω 220 Ω	2 w 2 w	Fixed Comp. Fixed Comp.	10% 10%		306-181 306-221

VACUUM TUBES

V504	X8628 - up	12BY7A	Input Amplifier				157-053*
V508	101-1058 1059-8627X	6BQ7A 6CL6	Delay Line Input	Selected			157-016* 157-021*
V509	101-1058 1059-8627X	6BQ7A 6CL6	Delay Line Input	Selected			157-016* 157-021*
V524	X8628 - up	12BQ7A	Input Amplifier				157-053*

*These tubes are checked but not paired. They are used in symmetrical circuitry and both tubes should be replaced at the same time with the same group number. Tek number covers only one tube; order in groups of two. V508 and V509 must be replaced at the same time.

V527	101-8627X	6U8	Int. Trigger Amp.				154-033
V533	X8628 - up	6BQ7A	Indicator Amp. and Driver				154-028
V535	101-8627X	6BQ7A	Int. Trigger Cathode Follower				154-028
V543	X8628 - up	6BQ7A	Indicator Amp. and Driver				154-028
V554	X8628 - up	6197	Output Amplifier				154-146
V558	101-8627X	6BQ7A	Delay Line Output C.F.				154-028
V564	X8628 - up	6197	Output Amplifier				154-146
V570	101-8627X	12BY7	Output Amplifier				154-047
V580	101-8627X	12BY7	Output Amplifier				154-047
V584	X8628 - up	6U8	Trigger Pickoff Amplifier				154-033
V593	X8628 - up	6BQ7A	Vertical Signal Output C.F.				154-028
V606	101-8627X	6BQ7A	Vertical Signal Output C.F.				154-028

535 DELAY LINE

CAPACITORS

C900	101-8627X	1.5-7 μmf Cer.	Var.	500 v	Use	295-057
------	-----------	----------------	------	-------	-----	---------



C901	101-581X	1.5 μmf	Cer.	Fixed	500 v	+or-0.5 μmf	281-526
C902-909	101-8627X	1.5-7 μmf	Cer.	Var.	500 v	Use	295-057
C903-920	X8628 - up	.7-3 μmf	Tub.	Var.			281-027
C920-928	101-8627X	1.5-7 μmf	Cer.	Var.	500 v	Use	295-057
C930-935	101-8627X	1.5-7 μmf	Cer.	Var.	500 v	Use	295-057
C930-940	X8628 - up	.7-3 μmf	Tub.	Var.			281-027
C938	101-3198 3199-8627X	1.5 μmf 1 μmf	Cer. Cer.	Fixed Fixed	500 v 500 v	+or-0.5 μmf +or-0.2 μmf	281-526 281-538
C939	101-8627X	.001 μf	Cer.	Fixed	500 v	GMV	283-000
C940	101-3198 3199-8627X	1.5 μmf 1 μmf	Cer. Cer.	Fixed Fixed	500 v 500 v	+or-0.5 μmf +or-0.2 μmf	281-526 281-538

INDUCTORS

L900	101-996 997 - up	5.6 μh	Fixed, 9 section Fixed, 9 section			Use	108-117 108-059
L900A	X997-8627X	2.8-5.0 μh		Var.	Core	276-032	114-012
L901	101-996 997 - up		Fixed, 9 section Fixed, 9 section			Use	108-117 108-059
L901A	X997-8627X	2.8-5.0 μh		Var.	Core	276-032	114-012
L905	X8628 - up		Fixed, 18 section				108-130
L906	X8628 - up		Fixed, 18 section				108-130
L920	101-8627X		Fixed, 9 section				108-060
L921	101-8627X		Fixed, 9 section				108-060
L925	X8628 - up	2.5 μh	Fixed				108-103
L926	X8628 - up	2.5 μh	Fixed				108-103
L930	101-8627X		Fixed, 6 section				108-061
L931	101-8627X		Fixed, 6 section				108-061
L935	X8628 - up		Fixed, 11 section				108-131
L936	X8628 - up		Fixed, 11 section				108-131
L955	X8628 - up	7.5-15 μh		Var.	Core	276-506	114-083
L956	X8628 - up	7.5-15 μh		Var.	Core	276-506	114-083



RESISTORS

R936	101-8627X	10 Ω	1/2 w	Fixed Comp.	10%	302-100
R937	101-8627X	10 Ω	1/2 w	Fixed Comp.	10%	302-100
R938	101-8627X	775 Ω	1/2 w	Fixed Prec.	1%	309-114
R939	101-8627X	470 Ω	1 w	Fixed Comp.	10%	304-471
R940	101-8627X	775 Ω	1/2 w	Fixed Prec.	1%	309-114

545 VERTICAL AMPLIFIER

BULBS

NE1010	101-1371	Type NE-2, 65-75 v	Use	150-002
B1010	1372-9291X	Type NE-2, 50-75 v		150-002
NE1014	101-1371	Type NE-2, 65-75 v	Use	150-002
B1014	1372-9291X	Type NE-2, 50-75 v		150-002
B1083	X9292 - up	Type NE-2, 50-75 v		150-002
B1087	X9292 - up	Type NE-2, 50-75 v		150-002

CAPACITORS

C1003	X9292 - up	2x20 μ f	EMC	Fixed	450 v		290-036
C1005A	X9299 - up	40 μ f)					
C1005B	X9292 - up	20 μ f)	EMC	Fixed	475 v		290-063
C1005C	X9292 - up	10 μ f)					
C1007	X9292 - up	.1 μ f	PTM	Fixed	400 v	20%	285-526
C1010	101-9291X	.005 μ f	Cer.	Fixed	500 v	GMV	283-001
C1013	X9292 - up	.005 μ f	Cer.	Fixed	500 v	GMV	283-001
C1014	101-9291X	.005 μ f	Cer.	Fixed	500 v	GMV	283-001
C1015	X9292 - up	.005 μ f	Cer.	Fixed	500 v	GMV	283-001
C1020	101-9291X	.005 μ f	Cer.	Fixed	500 v	GMV	283-001
C1029	X9292 - up	.001 μ f	Cer.	Fixed	500 v	GMV	283-000
C1030	X9292 - up	.005 μ f	Cer.	Fixed	500 v	GMV	283-001
C1031	X9292 - up	.005 μ f	Cer.	Fixed	500 v	GMV	283-001
C1033	X9292 - up	.005 μ f	Cer.	Fixed	500 v	GMV	283-001
C1035	101-9291X	.005 μ f	Cer.	Fixed	500 v	GMV	283-001
C1039	X9292 - up	.001 μ f	Cer.	Fixed	500 v	10%	281-536



C1045	101-9291X	2x75 μf	EMC	Fixed	150 v	-20+ 50%	290-053
C1049	X9292 - up	.001 μf	Cer.	Fixed	500 v	10%	281-536
C1050	101-9291X	2x75 μf	EMC	Fixed	150 v	-20+ 50%	290-053
C1051	101-9291X	.005 μf	Cer.	Fixed	500 v	GMV	283-001
C1052	101-9291 9292 - up	.001 μf .001 μf	Cer. Cer.	Fixed Fixed	500 v 500 v	10% GMV	281-536 283-000
C1054	101-9291 9292 - up	.001 μf .005 μf	Cer. Cer.	Fixed Fixed	500 v 500 v	10% GMV	281-536 283-001
C1055	101-1077 1078-9291X	.022 μf .022 μf	PTM PT	Fixed Fixed	400 v 600 v	Use 20%	285-517 285-517
C1056	X9292 - up	150 $\mu\mu f$	Cer.	Fixed	500 v	20%	281-524
C1057	101-9291X	.001 μf	Cer.	Fixed	500 v	GMV	283-000
C1060	101-9291X	.001 μf	Cer.	Fixed	500 v	GMV	283-000
C1062	101-9291 9292 - up	150 $\mu\mu f$.001 μf	Cer. Cer.	Fixed Fixed	500 v 500 v	20% GMV	281-524 283-000
C1064	101-9291X	.005 μf	Cer.	Fixed	500 v	GMV	283-001
C1066	101-9291X	.001 μf	Cer.	Fixed	500 v	GMV	283-000
C1070	101-9291X	100 $\mu\mu f$	Cer.	Fixed	350 v	20%	281-523
C1072	101-9291X	12 $\mu\mu f$	Cer.	Fixed	500 v	10%	281-506
C1073	101-9291X	1-8 $\mu\mu f$	Tub.	Var.	500 v		281-003
C1074	101-354 355-9291X	10 $\mu\mu f$ 4.7 $\mu\mu f$	Cer. Cer.	Fixed Fixed	500 v 500 v	10% 10%	281-504 281-501
C1075	101-9291 9292 - up	1-8 $\mu\mu f$ 8-50 $\mu\mu f$	Tub. Cer.	Var. Var.	500 v		281-003 281-022
C1076	101-9291X	1-8 $\mu\mu f$	Tub.	Var.	500 v		281-003
C1077	101-9291 9292 - up	1-8 $\mu\mu f$ 8-50 $\mu\mu f$	Tub. Cer.	Var. Var.	500 v		281-003 281-022
C1078	X355-9291 9292 - up	2.2 $\mu\mu f$.7-3 $\mu\mu f$	Cer. Tub.	Fixed Var.	500 v	+ or -1/2 $\mu\mu f$	281-500 281-027
C1081	101-9291X	.001 μf	Cer.	Fixed	500 v	GMV	283-000
C1082	101-9291X	150 $\mu\mu f$	Cer.	Fixed	500 v	20%	281-524
C1083	101-9291X	.001 μf	Cer.	Fixed	500 v	GMV	283-000



C1084	101-9291X	.7-3 $\mu\mu f$	Tub.	Var.	500 v		281-027
C1085	X9292 - up	.005 μf	Cer.	Fixed	500 v	GMV	283-001
C1089	X9292 - up	.005 μf	Cer.	Fixed	500 v	GMV	283-001
C1090	101-9291X	.001 μf	Cer.	Fixed	500 v	GMV	283-000
C1091	101-9291X	150 $\mu\mu f$	Cer.	Fixed	500 v	20%	281-524
C1092	101-9291X	.001 $\mu\mu f$	Cer.	Fixed	500 v	GMV	283-000
C1093	101-9291X	.7-3 $\mu\mu f$	Tub.	Var.	500 v		281-027
C1093A, B, C, D	X9292 - up	4x75 μf	EMC	Fixed	150 v		290-071
C1100	101-9291X	.001 μf	Cer.	Fixed	500 v	GMV	283-000
C1101	101-9291X	150 $\mu\mu f$	Cer.	Fixed	500 v	20%	281-524
C1102		.001 μf	Cer.	Fixed	500 v	GMV	283-000
C1103	101-9291X	.7-3 $\mu\mu f$	Tub.	Var.	500 v		281-027
C1104	X9292 - up	.7-3 $\mu\mu f$	Tub.	Var.	500 v		281-027
C1105	X9292 - up	150 $\mu\mu f$	Cer.	Fixed	500 v	20%	281-524
C1106	X9292 - up	150 $\mu\mu f$	Cer.	Fixed	500 v	20%	281-524
C1110	101-9291X	.001 μf	Cer.	Fixed	500 v	GMV	283-000
C1111	101-9291X	150 $\mu\mu f$	Cer.	Fixed	500 v	20%	281-524
C1112		.001 μf	Cer.	Fixed	500 v	GMV	283-000
C1113	101-9291X	.7-3 $\mu\mu f$	Tub.	Var.	500 v		281-027
C1120	101-9291X	.001 μf	Cer.	Fixed	500 v	GMV	283-000
C1121	101-9291X	150 $\mu\mu f$	Cer.	Fixed	500 v	20%	281-524
C1122		.001 μf	Cer.	Fixed	500 v	GMV	283-000
C1123	101-9291X	.7-3 $\mu\mu f$	Tub.	Var.	500 v		281-027
C1124	X9292 - up	.7-3 $\mu\mu f$	Tub.	Var.	500 v		281-027
C1126	X9292 - up	150 $\mu\mu f$	Cer.	Fixed	500 v	20%	281-524
C1130	101-9291X	.001 μf	Cer.	Fixed	500 v	GMV	283-000
C1132		.001 μf	Cer.	Fixed	500 v	GMV	283-000



C1133	101-9291X	.7-3 $\mu\mu f$	Tub.	Var.	500 v		281-027
C1141	101-9291X	.005 μf	Cer.	Fixed	500 v	GMV	283-001
C1142	X9292 - up	.001 μf	Cer.	Fixed	500 v	GMV	283-000
C1144	X9292 - up	.7-3 $\mu\mu f$	Tub.	Var.			281-027
C1146	X9292 - up	150 $\mu\mu f$	Cer.	Fixed	500 v	20%	281-524
C1150	101-9291X	2x20 μf	EMC	Fixed	450 v	-20+50%	290-037
C1151	101-9291X	2x20 μf	EMC	Fixed	450 v	-20+50%	290-037
C1152	101-5000	.005 μf	Cer.	Fixed	500 v	GMV	283-001
	5001-9291	.1 μf	PTM	Fixed	400 v	20%	285-526
	9292 - up	.001 μf	Cer.	Fixed	500 v	GMV	283-000
C1153	101-9291X	2x20 μf	EMC	Fixed	450 v	-20+50%	290-037
C1155	101-9291X	.005 μf	Cer.	Fixed	500 v	GMV	283-001
C1161	101-9291X	.005 μf	Cer.	Fixed	500 v	GMV	283-001
C1162	X9292 - up	.001 μf	Cer.	Fixed	500 v	GMV	283-000
C1164	X9292 - up	.7-3 $\mu\mu f$	Tub.	Var.			281-027
C1166	X9292 - up	150 $\mu\mu f$	Cer.	Fixed	500 v	20%	281-524
C1172	X9292 - up	.001 μf	Cer.	Fixed	500 v	GMV	283-000
C1182	X9292 - up	.001 μf	Cer.	Fixed	500 v	GMV	283-000
C1184	X9292 - up	.7-3 $\mu\mu f$	Tub.	Var.	500 v		281-027
C1186	X9292 - up	150 $\mu\mu f$	Cer.	Fixed	500 v	20%	281-524
C1192	X9292 - up	.001 μf	Cer.	Fixed	500 v	GMV	283-000
C1202	X9292 - up	.001 μf	Cer.	Fixed	500 v	GMV	283-000
C1204	X9292 - up	.7-3 $\mu\mu f$	Tub.	Var.			281-027
C1205	X9292 - up	150 $\mu\mu f$	Cer.	Fixed	500 v	20%	281-524
C1208	X9292 - up	.005 μf	Cer.	Fixed	500 v	GMV	283-001
C1212	X9292 - up	.001 μf	Cer.	Fixed	500 v	GMV	283-000
C1220	X9292 - up	.005 μf	Cer.	Fixed	500 v	GMV	283-001
C1223	X9292 - up	.001 μf	Cer.	Fixed	500 v	GMV	283-000
C1228	X9292 - up	.022 μf	PTM	Fixed	600 v	20%	285-517



INDUCTORS

L1014	X9292-11904 11905 - up	1.7-3.7 μ h 1.8-3.9 μ h	Var. Var.	Core Core	276-506 276-032	114-088 114-112
L1021	101-210 211-9291X	.79-1.5 μ h .3-5 μ h	Var. Var.	Core Core	276-032 276-032	114-025 114-037
LR1022	101-210	2.5 μ h, on 4.7 k, 1/2 w, 10% comp. res.			Use	108-103
L1022	211-312 313-8397 8398-9291X	3.2 μ h 2.5 μ h 1.8-3.9 μ h	Fixed Fixed Var.		Use	108-103 108-103 114-079
L1024	X9292-11904 11905 - up	1.7-3.7 μ h 1.8-3.9 μ h	Var. Var.	Core Core	276-506 276-506	114-088 114-112
L1036	X9292-11904 11905 - up	.5-1 μ h 0.3-0.55 μ h	Var. Var.	Core Core	276-506 276-506	114-087 114-111
LR1041	101-210	2.5 μ h, on 4.7k, 1/2 w, 10% comp. res.			Use	108-103
L1041	211-312 313-8397 8398-9291X	3.2 μ h 2.5 μ h 1.8-3.7 μ h	Fixed Fixed Var.		Use	108-103 108-103 114-079
LR1042	101-210 211-9291X	.79-1.5 μ h .3-.5 μ h	Var. Var.	Core Core	276-032 276-032	114-025 114-037
L1046	X9292-11904 11905 - up	.5-1 μ h 0.3-.55 μ h	Var. Var.	Core Core	276-506 276-506	114-087 114-111
L1064	X9292-14733 14734 - up	14 μ h 8.4 μ h	Fixed Fixed		+ or -5%	108-134 108-157
L1067	101-9291X	12 μ h	Fixed			108-005
L1070	101-9291X	Terminating line, 5 section				108-081
L1071	101-9291 9292-10119 10120 - up	Terminating line, 5 section .9-1.6 μ h .3-.5 μ h	Var. Var.	Core Core	276-506 276-506	108-081 114-038 114-092
L1073	X9292-10119 10120 - up	.9-1.6 μ h .3-.5 μ h	Var. Var.	Core Core	276-506 276-506	114-038 114-092
L1080	101-9291X	Plate line, 7 section				108-096
L1081	101-9291X	Grid line, 7 section				108-080
L1082	101-9291X	Grid line, 7 section				108-080
L1083	101-9291X	Plate line, 7 section				108-096
L1103	X9292-10119 10120 - up	Grid line, 7 section Grid line, 6 section		Use		108-145 108-145



L1104	X9292-10119 10120 - up	Plate line, 6 section Plate line, 7 section				108-135 108-139
L1113	X9292-10119 10120 - up	Grid line, 7 section Grid line, 6 section	Use			108-145 108-145
L1114	X9292-10119 10120 - up	Plate line, 6 section Plate line, 7 section				108-135 108-139

RESISTORS

R1003	X9292 - up	100 Ω	1 w	Fixed Comp.	10%	304-101
R1005	X9292 - up	100 Ω	1 w	Fixed Comp.	10%	304-101
R1007	X9292 - up	47 Ω	1/2 w	Fixed Comp.	10%	302-470
R1008	X9292 - up	47 Ω	1/2 w	Fixed Comp.	10%	302-470
R1009	X9292 - up	100 Ω	1 w	Fixed Comp.	10%	304-101
R1010	101-9291X	1 meg	1/2 w	Fixed Comp.	10%	302-105
R1011	101-5805 5806-9291 9292 - up	1 meg 100 k 27 Ω	1/2 w 1/2 w 1/2 w	Fixed Comp. Fixed Comp. Fixed Comp.	10% 10% 10%	302-105 302-104 302-270
R1012	101-9291X	470 k	1/2 w	Fixed Comp.	10%	302-474
R1013	101-5805 5806-9291 9292 - up	1 meg 100 k 910 Ω	1/2 w 1/2 w 2 w	Fixed Comp. Fixed Comp. Fixed Comp.	10% 10% 5%	302-105 302-104 305-911
R1014	101-9291 9292 - up	1 meg 500 v	1/2 w 1/2 w	Fixed Comp. Mica Plate	10% 2%	302-105 310-515
R1015	101-9291 9292 - up	1 k 150 k	1/2 w 1/2 w	Fixed Comp. Fixed Comp.	10% 10%	302-102 302-154
R1016	X9292-11691 11692 - up	4 k 3 k	5 w 5 w	Fixed WW Fixed WW	5% 5%	308-051 308-062
R1017	X9292-11691 11692 - up	12 k 10 k	8 w 8w	Fixed WW Fixed WW	5% 5%	308-069 308-126
R1018	X9292 - up	330 Ω	1/2 w	Fixed Comp.	10%	302-331
R1019	X9292 - up	470 k	1/2 w	Fixed Comp.	10%	302-474



R1020	101-8667 8668-9291X	1.2 k 1.2 k	2 w 2 w	Fixed Comp. 10% Fixed Comp. 5%		306-122 305-122
R1021	101-9291 9292 - up	650 Ω 27 Ω	1/2 w 1/2 w	Fixed Mica plate Fixed Comp. 10%		310-513 302-270
R1022	101-9291X	100 Ω	1/2 w	Fixed Comp. 10%		302-101
R1023	101-9291X	68 k	1/10 w	Fixed Comp. 10%		307-006
R1024	X9292 - up	500 Ω	1/2 w	Fixed Mica plate		310-515
R1025	101-9291X	27 Ω	1/2 w	Fixed Comp. 10%		302-270
R1026		330 Ω	1/2 w	Fixed Comp. 10%		302-331
R1027		200 Ω	2 w	Var. Comp.		311-004
R1028	101-9291X	330 Ω	1/2 w	Fixed Comp. 10%		302-331
R1029	X9292 - up	470 k	1/2 w	Fixed Comp. 10%		302-474
R1030	101-9291X	4 k	5 w	Fixed WW 5%		308-051
R1031	101-9291 9291-11691 11692 - up	15 k 4.7 k 2.2 k	10 w 1 w 1 w	Fixed WW 5% Fixed Comp. 10% Fixed Comp. 10%		308-024 304-472 304-222
R1033	X9292-11904 11905 - up	1.5 k 2.5 k	5 w 5 w	Fixed WW 5% Fixed WW 5%		308-061 308-127
R1035	101-9291X	10 k	1 w	Fixed Comp. 10%		304-103
R1036	X9292 - up	27 k	2 w	Fixed Comp. 10%		306-273
R1039	X9292-11904 11905 - up	39 Ω 33 Ω	1/2 w 1/2 w	Fixed Comp. 10% Fixed Comp. 10%		302-390 302-330
R1040	101-9291X	27 Ω	1/2 w	Fixed Comp. 10%		302-270
R1041	101-9291X	100 Ω	1/2 w	Fixed Comp. 10%		302-101
R1042	101-9291X	650 Ω	1/2 w	Fixed Mica plate		310-513
R1043	101-9291X	68 k	1/10 w	Fixed Comp. 10%		307-006
R1045	101-9291X	47 k	1/2 w	Fixed Comp. 10%		302-473
R1046*	101-9291 9292 - up	100 Ω 27 k	1/2 w 2 w	Fixed Comp. 10% Fixed Comp. 10%		302-101 306-273
R1047*	101-9291X	100 Ω	1/2 w	Fixed Comp. 10%		302-101
	*Note: In some manuals, R1046 and R1047 were R1052 and R1054.					
R1049	X9292-11904 11905 -up	39 Ω 33 Ω	1/2 w 1/2 w	Fixed Comp. 10% Fixed Comp. 10%		302-390 302-330



R1050	101-9291X	47 k	1/2 w	Fixed Comp.	10%		302-473
R1051	101-9291X	2.2 k	1 w	Fixed Comp.	10%		304-222
R1052	101-5000	100 Ω	1/2 w	Fixed Comp.	10%		302-101
	5001-9291	47 Ω	1/2 w	Fixed Comp.	10%		302-470
	9292 - up	470 k	1/2 w	Fixed Comp.	10%		302-474
R1053	101-9291X	30 k	10 w	Fixed WW	5%		308-027
R1054	101-5000	100 Ω	1/2 w	Fixed Comp.	10%		302-101
	5001-9291	47 Ω	1/2 w	Fixed Comp.	10%		302-470
	9292 - up	167 Ω	5 w	Fixed WW	5%		308-104
R1055	101-9291	15 k	2 w	Fixed Comp.	10%		306-153
	9292 - up	4.5 k	5 w	Fixed WW	5%		308-066
R1056	101-9291X	1 meg	1/2 w	Fixed Comp.	10%		302-105
R1057	101-9291X	2.7 k	2 w	Fixed Comp.	10%		306-272
R1059	101-9291X	250 k	2 w	Var. Comp.	20%		311-061
R1060	101-9291X	470 k	1/2 w	Fixed Comp.	10%		302-474
R1062	101-9291	4.5 k	5 w	Fixed WW	5%		308-066
	9292 - up	470 k	1/2 w	Fixed Comp.	10%		302-474
R1064	101-9291	167 Ω	5 w	Fixed WW	5%		308-045
	9292-14733X	2 k	1 w	Fixed Comp.	5%		303-202
R1066	101-9291X	470 k	1/2 w	Fixed Comp.	10%		302-474
R1067	101-210	2k	1 w	Fixed Comp.		Use	303-202
	211-9291X	2 k	1 w	Fixed Comp.	5%		303-202
R1071	X6890-9719	600 Ω	5 w	Mica plate		Use	312-587
	9720 - up	600 Ω	5 w	Fixed Mica plate			312-587
R1073	X6890-9719	600 Ω	5 w	Fixed Prec.		Use	312-587
	9720 - up	600 Ω	5 w	Fixed Mica plate			312-587
NOTE: R1071 and R1073 are 1 pair, matched within 1/2% of each other.							
R1075	X9292 - up	220 Ω	1/4 w	Fixed Comp.	10%		316-221
R1077	X9292 - up	47 Ω	1/4 w	Fixed Comp.	10%		316-470
R1078	X9292 - up	150 Ω	1/4 w	Fixed Comp.	10%		316-151
R1080	101-9291	8.2 k	1/2 w	Fixed Comp.	10%		302-822
	9292 - up	150 k	1/2 w	Fixed Comp.	10%		302-154
R1081	101-9291	470 k	1/2 w	Fixed Comp.	10%		302-474
	9292 - up	330 k	1/2 w	Fixed Comp.	10%		302-334
R1082	101-9291X	4.5 k	5 w	Fixed WW	5%		308-066



R1083	101-9291	470 k	1/2 w	Fixed	Comp.	10%	302-474
	9292-10247	330 k	1/2 w	Fixed	Comp.	10%	302-334
	10248 - up	390 k	1/2 w	Fixed	Comp.	10%	302-394
R1084	101-9291	8.2 k	1/2 w	Fixed	Comp.	10%	302-822
	9292 - up	680 k	1/2 w	Fixed	Comp.	10%	302-684
R1085	X9292 - up	1 meg	1/4 w	Fixed	Comp.	10%	316-105
R1087	X9292-10247	330 k	1/2 w	Fixed	Comp.	10%	302-334
	10248 - up	390 k	1/2 w	Fixed	Comp.	10%	302-394
R1089	X9292 - up	1 meg	1/4 w	Fixed	Comp.	10%	316-105
R1090	101-9291	470 k	1/2 w	Fixed	Comp.	10%	302-474
	9292 - up	8.2 k	1/4 w	Fixed	Comp.	10%	316-822
R1091	101-9291	4.5 k	5 w	Fixed	WW	5%	308-066
	9292 - up	250 k	2 w	Var.	Comp.		311-061
R1092	101-9291	470 k	1/2 w	Fixed	Comp.	10%	302-474
	9292 - up	47 k	1/2 w	Fixed	Comp.	10%	302-473
R1093	X9292-9596X	15 k	1/2 w	Fixed	Comp.	10%	302-153
R1094	X9292 - up	68 k	.1 w	Fixed	Comp.	10%	307-006
R1095	X9292 - up	8.2 k	1/4 w	Fixed	Comp.	10%	316-822
R1097	X9292 up	47 k	1/2 w	Fixed	Comp.	10%	302-473
R1098	X9292-9596X	15 k	1/2 w	Fixed	Comp.	10%	302-153
R1099	X9292 - up	68 k	.1 w	Fixed	Comp.	10%	307-006
R1100	101-9291X	470 k	1/2 w	Fixed	Comp.	10%	302-474
R1101	101-9291X	4.5 k	5 w	Fixed	WW	5%	308-066
R1102		470 k	1/2 w	Fixed	Comp.	10%	302-474
R1105	X9292 - up	4.5 k	5 w	Fixed	WW	5%	308-066
R1110	101-9291X	470 k	1/2 w	Fixed	Comp.	10%	302-474
R1111	101-9291X	4.5 k	5 w	Fixed	WW	5%	308-066
R1112		470 k	1/2 w	Fixed	Comp.	10%	302-474
R1120	101-9291X	470 k	1/2 w	Fixed	Comp.	10%	302-474
R1121	101-9291X	4.5 k	5 w	Fixed	WW	5%	308-066
R1122		470 k	1/2 w	Fixed	Comp.	10%	302-474
R1125	X9292 - up	4.5 k	5 w	Fixed	WW	5%	308-066



R1130	101-9291X	470 k	1/2 w	Fixed Comp.	10%	302-474	
R1131	101-9291X	4.5 k	5 w	Fixed WW	5%	308-066	
R1132		470 k	1/2 w	Fixed Comp.	10%	302-474	
R1140	101-9291X	390 Ω	1/2 w	Fixed Comp.	5%	301-391	
R1141	101-266	10 k	5 w	Fixed WW	5%	308-008	
		in series with 1.8 k, 1 w, fixed, comp., 10% res.					304-182
	267-9291X	12 k	8 w	Fixed WW	5%	308-069	
R1142	101-8667	1.2 k	5 w	Fixed WW	5%	308-063	
	8668-9291	1.0 k	5 w	Fixed WW	5%	308-106	
	9292 - up	470 k	1/2 w	Fixed Comp.	10%	302-474	
R1143	101-9291X	390 Ω	1/2 w	Fixed Comp.	5%	301-391	
R1145	X9292 - up	4.5 k	5 w	Fixed WW	5%	308-066	
R1150	101-9291X	100 Ω	1 w	Fixed Comp.	10%	304-101	
R1151	101-9291X	100 Ω	1 w	Fixed Comp.	10%	304-101	
R1152	101-9291	47 Ω	1/2 w	Fixed Comp.	10%	302-470	
	9292 - up	470 k	1/2 w	Fixed Comp.	10%	302-474	
R1153	101-9291X	47 Ω	1/2 w	Fixed Comp.	10%	302-470	
R1154	101-9291X	100 Ω	1 w	Fixed Comp.	10%	304-101	
R1155		150 k	1/2 w	Fixed Comp.	10%	302-154	
	Note: R1155 was called R1156 in some manuals.						
R1162	X9292 - up	470 k	1/2 w	Fixed Comp.	10%	302-474	
R1165	X9292 - up	4.5 k	5 w	Fixed WW	5%	308-066	
R1172	X9292 - up	470 k	1/2 w	Fixed Comp.	10%	302-474	
R1182	X9292 - up	470 k	1/2 w	Fixed Comp.	10%	302-474	
R1185	X9292 - up	4.5 k	5 w	Fixed WW	5%	308-066	
R1192	X9292 - up	470 k	1/2 w	Fixed Comp.	10%	302-474	
R1212	X9292 - up	470 k	1/2 w	Fixed Comp.	10%	302-474	
R1216	X9292 - up	360 Ω	1/2 w	Fixed Comp.	5%	301-361	
R1218	X9292 - up	1 k	5 w	Fixed WW	5%	308-106	
R1221	X9292 - up	100 Ω	1/2 w	Fixed Comp.	10%	302-101	
R1223	X9292-11904	2.7 k	2 w	Fixed Comp.	10%	306-272	
	11905 - up	4.7 k	2 w	Fixed Comp.	10%	306-472	



R1224	X9292 - up	30 k	10 w	Fixed WW	5%	308-027
R1226	X9292 - up	100 Ω	1/2 w	Fixed Comp.	10%	302-101
R1227	X9292 - up	15 k	2 w	Fixed Comp.	10%	306-153
R1228	X9292 - up	1 meg	1/2 w	Fixed Comp.	10%	302-105

VACUUM TUBES

V1014	X9292 - up	12BY7A	Input Amplifier			157-053
V1024	X9292 - up	12BY7A	Input Amplifier			157-053
V1025A,B						
	101-1464	6AW8	Indicator Amp. and Input Amp.	Selected		157-039
	1465-9291X	6AW8	Indicator Amp. and Input Amp.	Selected	Use*	157-039
V1033	X9292-11904	6BQ7A	Grid-Line Driver			154-028
	11905 - up	6DJ8	Grid-Line Driver			154-187
V1040A,B						
	101-1464	6AW8	Indicator Amp. and Input Amp.			154-095
	1465-9291X	6AW8	Indicator Amp. and Input Amp.			157-039
V1043	X9292-11904	6BQ7A	Grid-Line Driver			154-028
	11905-up	6DJ8	Grid-Line Driver			154-187
V1050A,B						
	101-9291X	6BQ7A	Driver C.F. and Internal Trig. C.F.			154-028
V1052A,B						
	101-9291X	6BQ7A	Driver C.F. and Vert. Sig. Out C.F.			154-028
V1054	X9292 - up	6DK6	Trigger-Pickoff Amplifier			154-149
V1060	101-972	6CB6	Balance Amplifier			154-030
	973-9291X	6CB6	Balance Amplifier			157-030
V1064	X9292 - up	6DK6	Trigger-Pickoff Amplifier			154-149
V1066	101-972	6CB6	Internal Trigger Amplifier	} Selected		154-037
	973-9291X	6CB6	Internal Trigger Amplifier			157-037
V1080-1132						
	101-972	6CB6	Output Amplifiers (12 tubes)	} Selected		157-037
	973-9291X	6CB6	Output Amplifiers (12 tubes)			
V1084	X9292 - up	12AU7	Indicator Amplifier			154-041
V1104-1214						
	X9292 - up	6DK6	Distributed Amplifiers (12 tubes)			154-149
V1223	X9292-11904	6BQ7A	Vertical-Signal Output C.F.			154-028
	11905-up	6DJ8	Vertical-Signal Output C.F.			154-187



545 DELAY LINE

CAPACITORS

C1201-1250	101-9291X	.7-3 μmf Tub.	Var.	500 v		281-027
C1260-1275	101-9117 9118-9291X	3.3 μmf Cer. 1.5 μmf Cer.	Fixed	500 v	+ or -1/4 μmf $\pm 1/4\mu\text{mf}$	281-534 281-529
C1280	101-9291X	.68 μmf Cer.	Fixed	500 v	20%	281-537
C1281	101-582X X9118-9291X	.68 μmf Cer. .68 μmf Cer.	Fixed	500 v	20%	281-537 281-537
C1282	101-9291X	1 μmf Cer.	Fixed	500 v	20%	281-538
C1301-1350	X9292 - up	.7-3 μmf Tub.	Var.			281-027
C1360-1375	X9292 - up	1.5 μmf Cer.	Fixed	500 v	+ or -0.5 μmf	281-526
C1380	X9292 - up	.68 μmf Cer.	Fixed	500 v	20%	281-537
C1381	X9292 - up	.68 μmf Cer.	Fixed	500 v	20%	281-537
C1382	X9292 - up	1 μmf Cer.	Fixed	500 v	20%	281-538
C1384	X9534 - up	.68 μmf Cer.	Fixed	500 v	20%	281-537
C1385	X9534 - up	.68 μmf Cer.	Fixed	500 v	20%	281-537

INDUCTORS

L1204	101-9117 9118-9291X	30 section 30 section				108-094 108-133
L1205	101-9117 9118-9291X	30 section 30 section				108-094 108-133
L1234	101-9117 9118-9291X	20 section 20 section				108-093 108-132
L1235	101-9117 9118-9291X	20 section 20 section				108-093 108-132
L1304	X9292 - up	30 section				108-133
L1305	X9292 - up	30 section				108-133
L1334	X9292 - up	20 section				108-132
L1335	X9292 - up	20 section				108-132
L1254	101-9291X	0.9-1.6 μh Var.	Core		276-506	114-038
L1255	101-9291X	0.9-1.6 μh Var.	Core		276-506	114-038



L1354	X9292 - up	0.9-1.6 μ h Var.	Core	276-506	114-038
L1355	X9292 - up	0.9-1.6 μ h Var.	Core	276-506	114-038

RESISTORS

R1201	101-9117	680 Ω	1/2 w	Fixed	Comp.	10%	302-681
	9118-9291X	1 k	1/2 w	Fixed	Comp.	10%	302-102
R1202	101-9117	680 Ω	1/2 w	Fixed	Comp.	10%	302-681
	9118-9291	1 k	1/2 w	Fixed	Comp.	10%	302-102
	9292 - up	470 k	1/2 w	Fixed	Comp.	10%	302-474
R1203	101-9117	680 Ω	1/2 w	Fixed	Comp.	10%	302-681
	9118-9291X	1 k	1/2 w	Fixed	Comp.	10%	302-102
R1204	101-9117	680 Ω	1/2 w	Fixed	Comp.	10%	302-681
	9118-9291X	1 k	1/2 w	Fixed	Comp.	10%	302-102
R1205	101-9117	680 Ω	1/2 w	Fixed	Comp.	10%	302-681
	9118-9291	1 k	1/2 w	Fixed	Comp.	10%	302-102
	9292 - up	4.5 k	5 w	Fixed	WW	5%	308-066
R1206	101-9117	680 Ω	1/2 w	Fixed	Comp.	10%	302-681
	9118-9291	1 k	1/2 w	Fixed	Comp.	10%	302-102
	9292 - up	360 k	1/2 w	Fixed	Comp.	5%	301-361
R1207	101-9117	680 Ω	1/2 w	Fixed	Comp.	10%	302-681
	9118-9291X	1 k	1/2 w	Fixed	Comp.	10%	302-102
R1208	101-9117	680 Ω	1/2 w	Fixed	Comp.	10%	302-681
	9118-9291	1k	1/2w	Fixed	Comp	10%	302-102
	9292 - up	12 k	8 w	Fixed	WW	5%	308-069
R1301-1308	X9292 - up	1 k	1/2 w	Fixed	Comp.	10%	302-102



+

V246A

CALIBRATOR
CATHODE FOLLOWER

V670

CALIBRATOR MULTIVIBRATOR

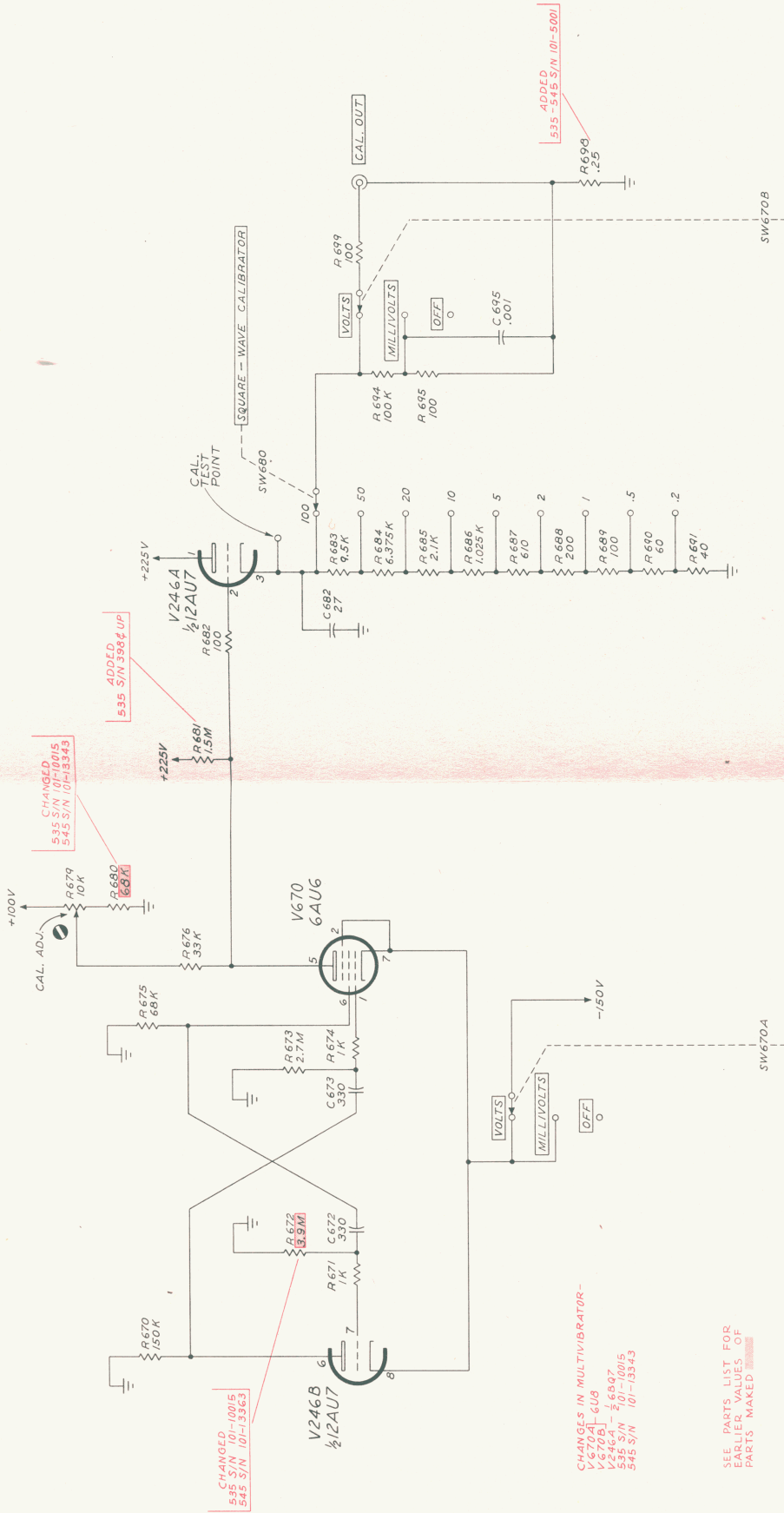

CHANGED - 10015
535 S/N 101-10015
545 S/N 101-3343

ADDED
535 S/N 3884 UP

CHANGED - 10015
535 S/N 101-10015
545 S/N 101-3343

ADDED
535-545 S/N 101-5001

CHANGES IN MULTIVIBRATOR -
V670B - 6U8
V670A - 6E9Q7
V246A - 2E9Q7
535 S/N 101-10015
545 S/N 101-3343

SEE PARTS LIST FOR
EARLIER VALUES OF
PARTS MADE

4-10-59
KF

CALIBRATOR

A A

T TYPE 535-545 OSCILLOSCOPE

+

V840
UNBLANKING MIXER

V820, V821, V822, V823, V824
RECTIFIERS

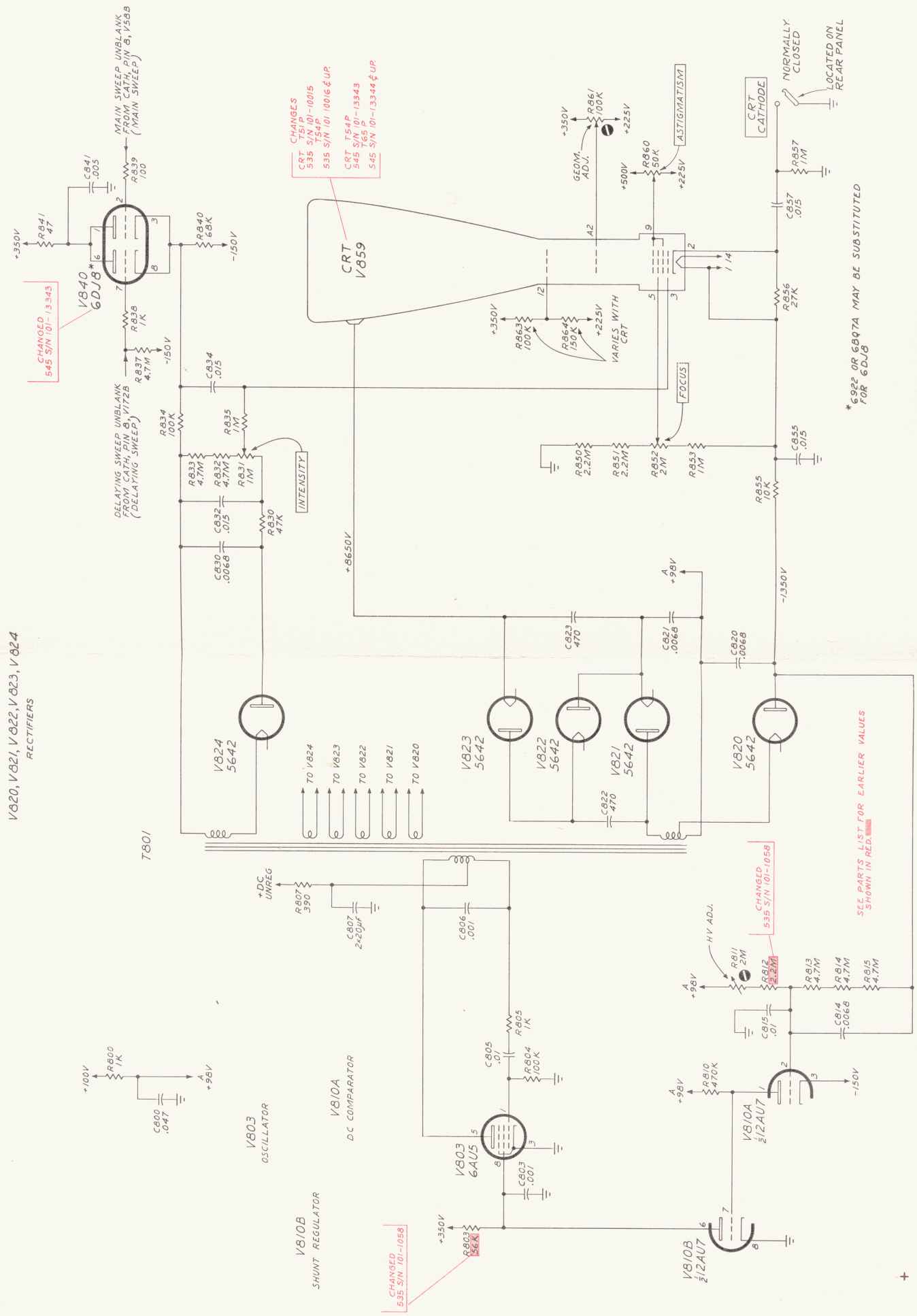

CHANGED
545 S/N 101-13343

CHANGES
CRT T510P
535 S/N 101-10015
T54P
535 S/N 101-10016 & UP
CRT T544P
545 S/N 101-13343
T65 P
545 S/N 101-13344 & UP

CHANGED
535 S/N 101-1058

SEE PARTS LIST FOR EARLIER VALUES
SHOWN IN RED

*6922 OR 6B07A MAY BE SUBSTITUTED
FOR 6DJ8

CRT CATHODE
NORMALLY CLOSED
LOCATED ON REAR PANEL

+

V228B
DELAYED TRIGGER C.F.

V216A
V216B
DELAY TRIGGER SHAPER

V195
V196
DELAY PICKOFF

V228A
CONSTANT CURRENT TUBE

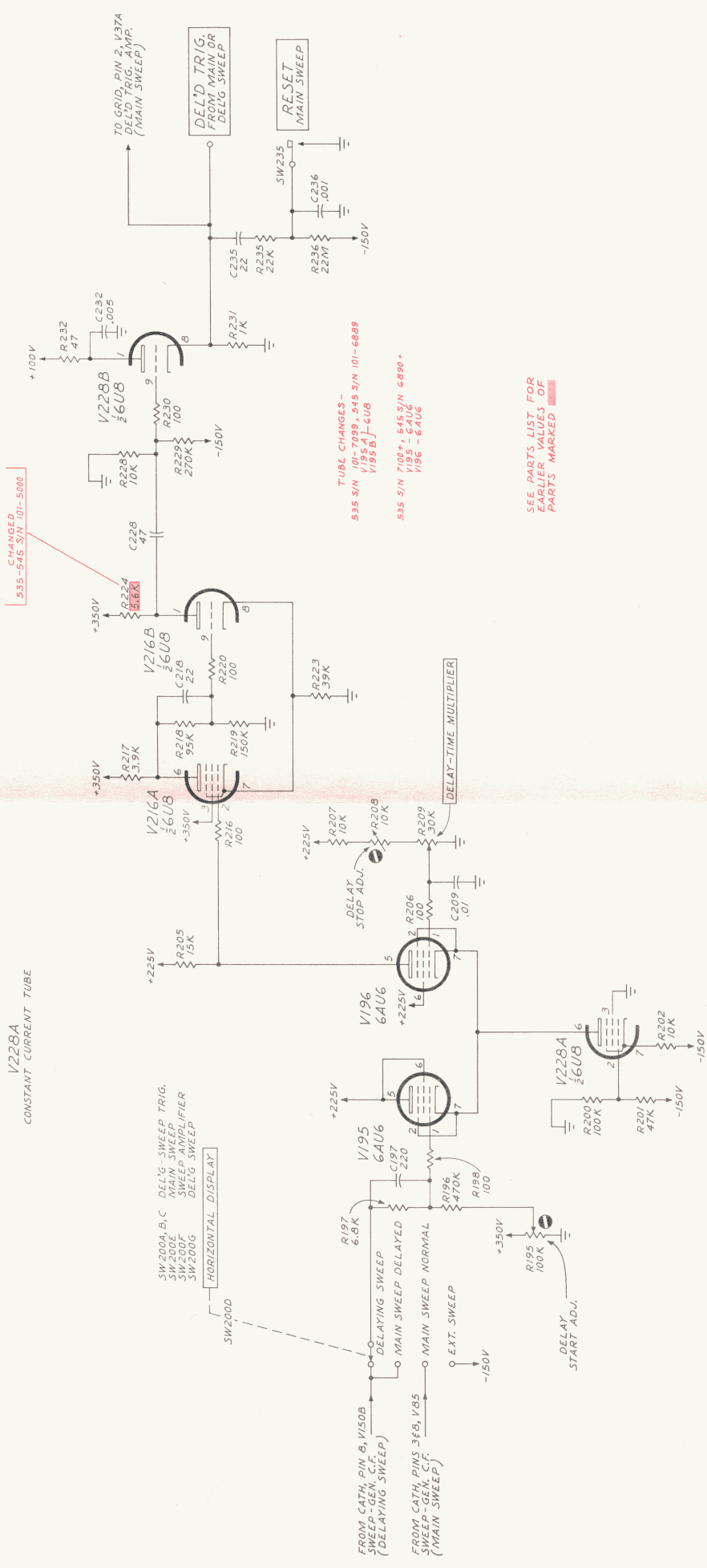

CHANGED
535-545 S/N 101-5000

TUBE CHANGES -
535 S/N 101-7099, 545 S/N 101-6889
V195 A1-CUB
V196 -64UG

535 S/N 7100+, 545 S/N 6890+
V196 -64UG

SEE PARTS LIST FOR
EARLIER VALUES OF
PARTS MARKED

4-18-57
KF

DELAY PICKOFF

A A

TYPE 535-545 OSCILLOSCOPE

+

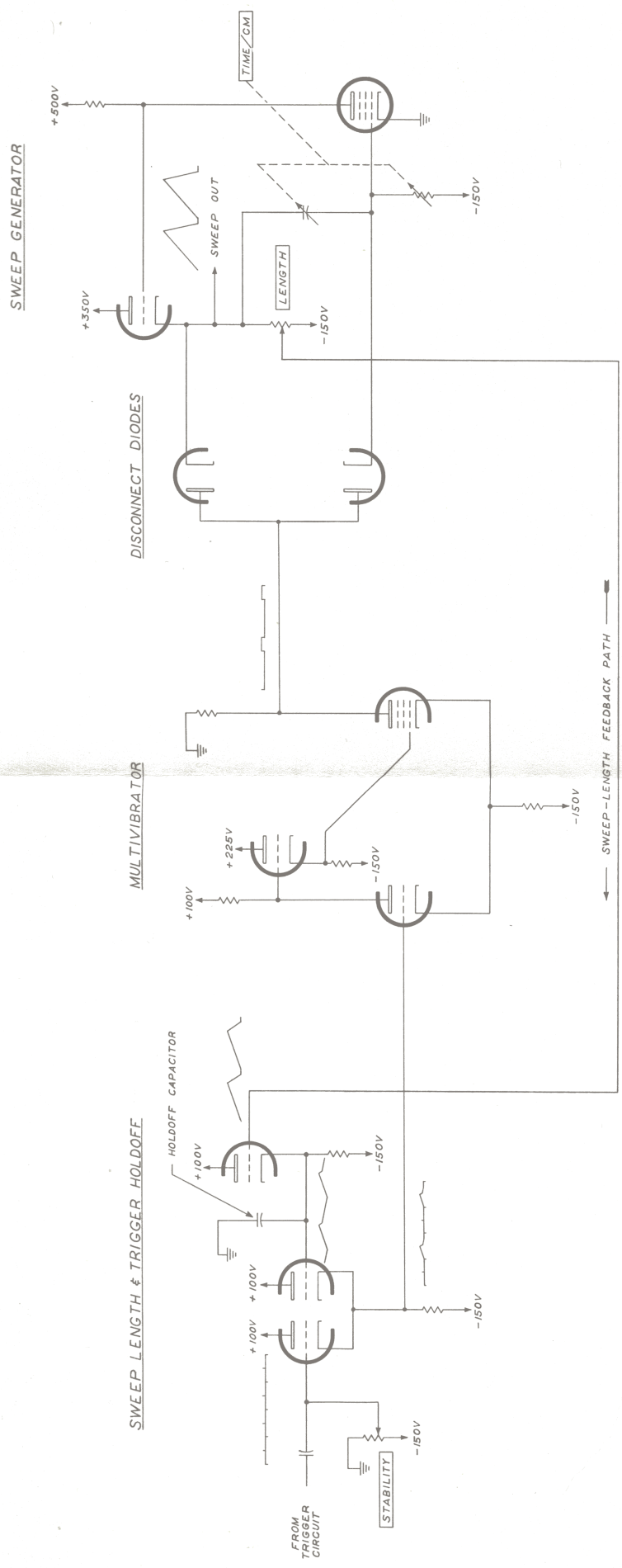

3-15-54
KF

SIMPLIFIED DIAGRAM
DELAYING-SWEEP GENERATOR

TYPE 535 OSCILLOSCOPE

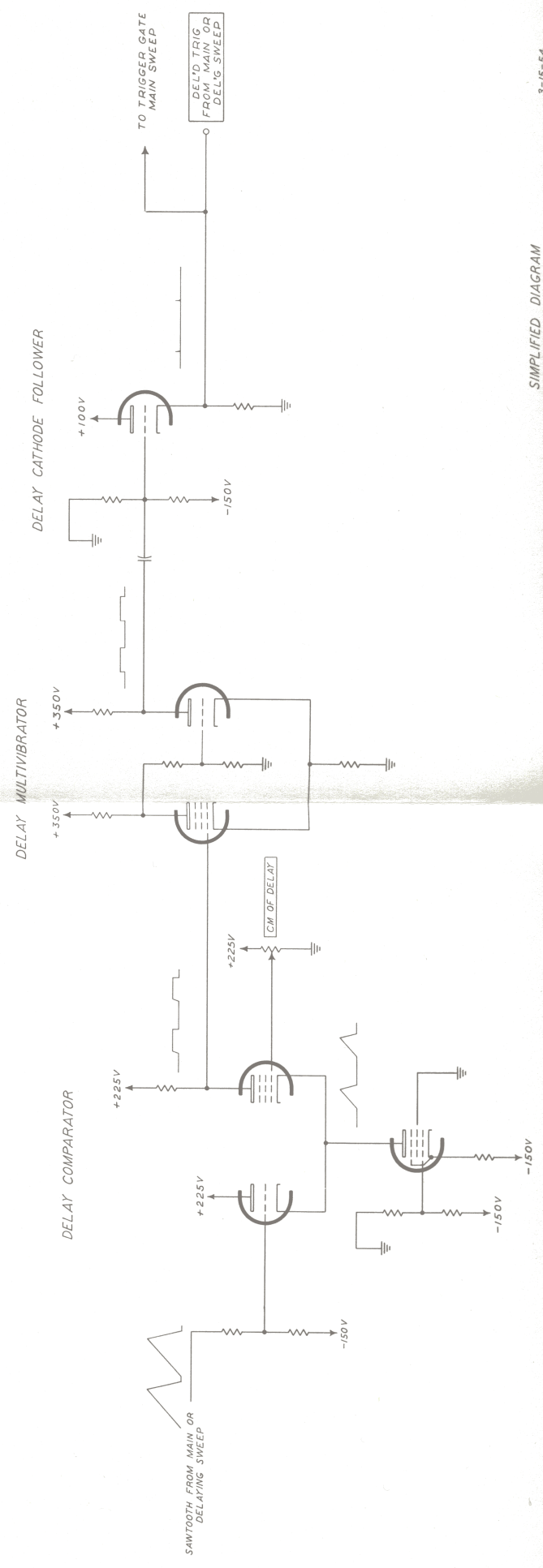

SIMPLIFIED DIAGRAM
DELAY PICKOFF

3-15-54
KF

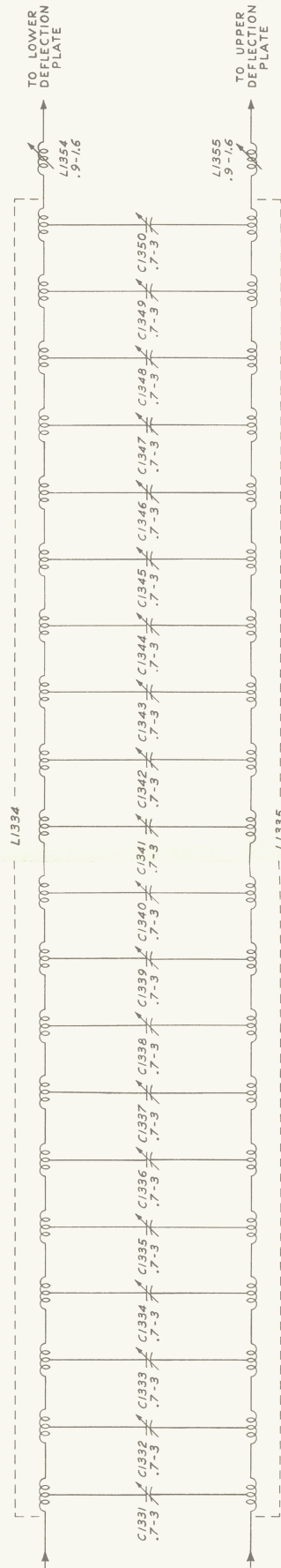
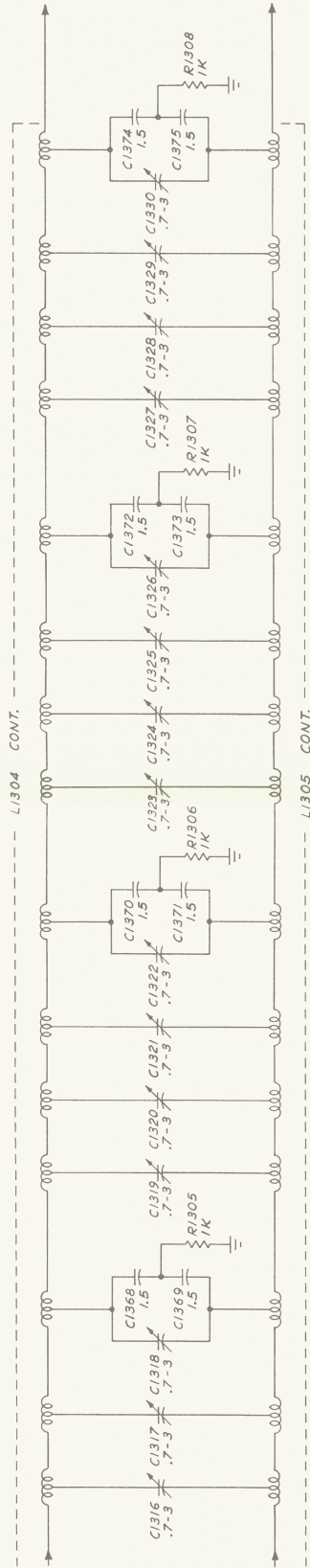
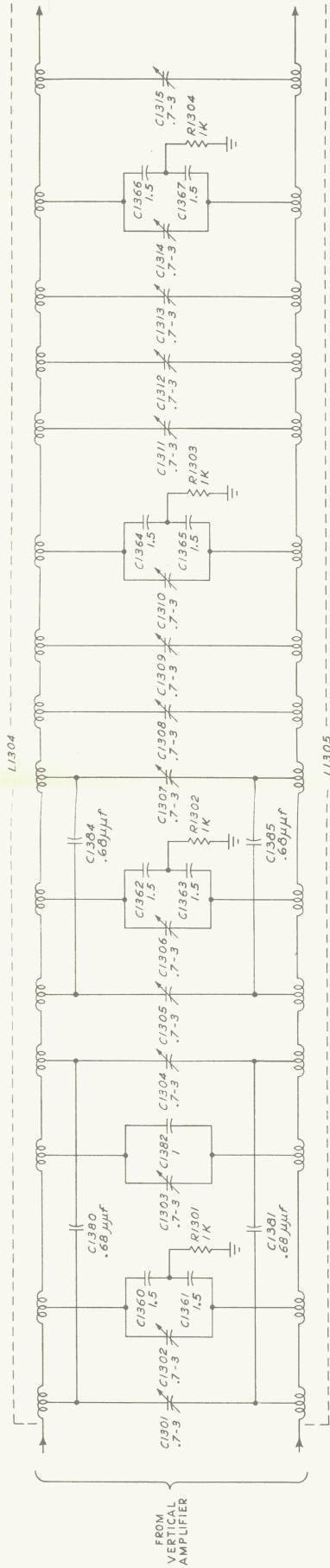

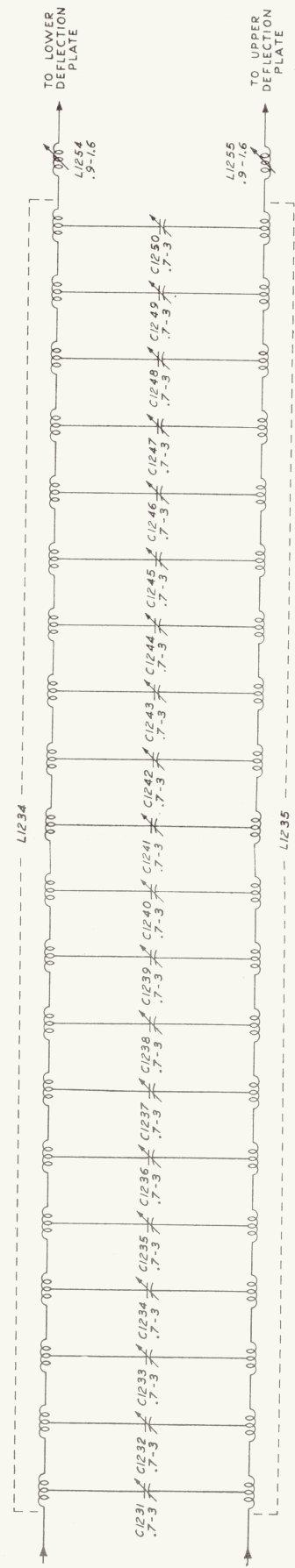
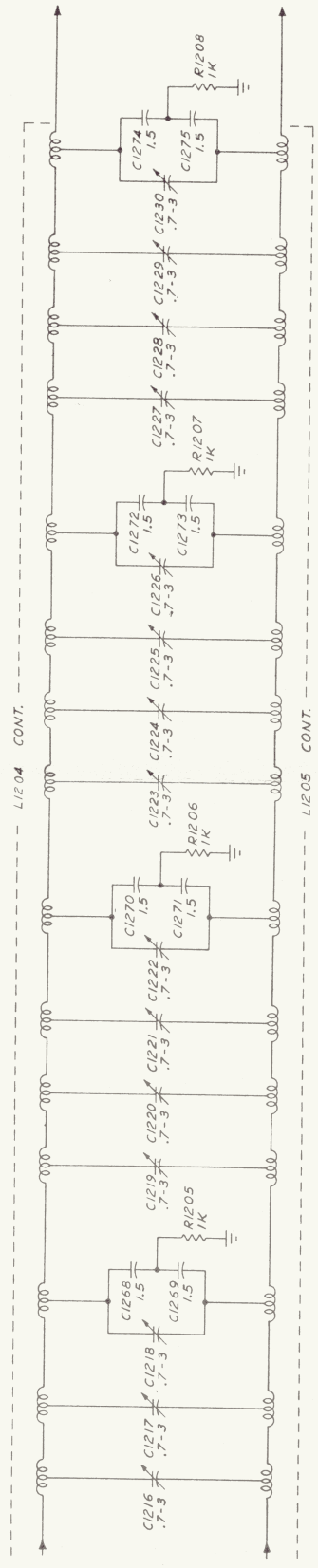
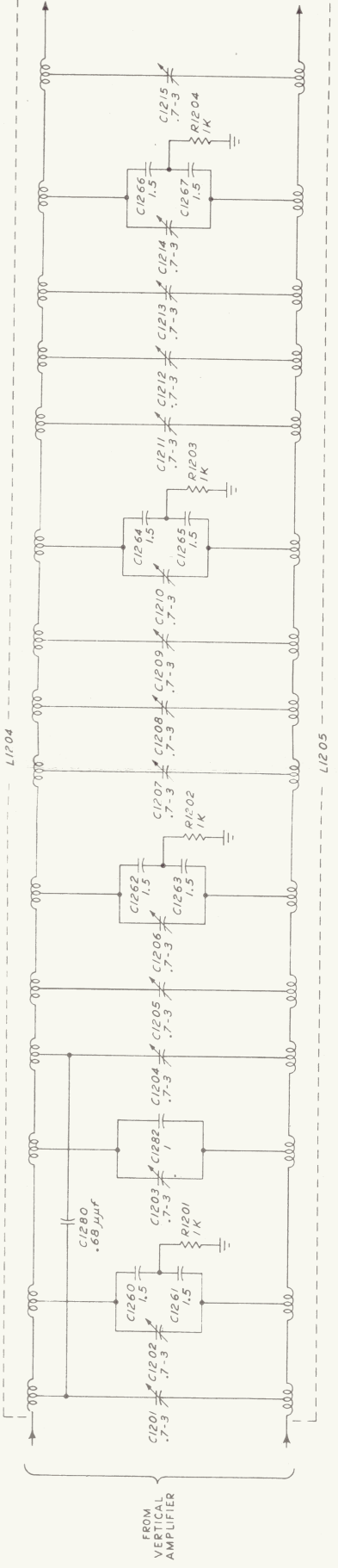

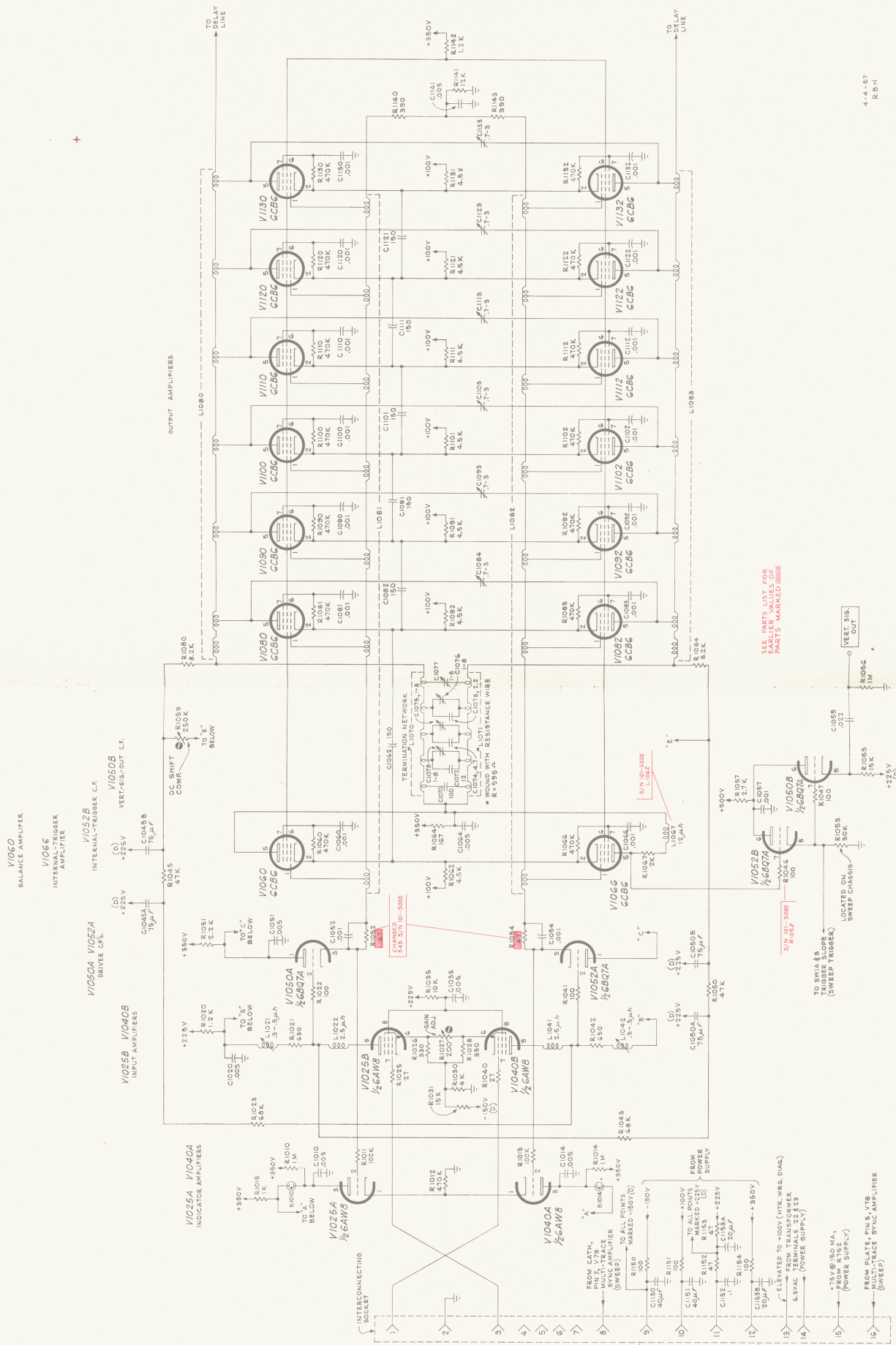

SEE PARTS LIST FOR EARLIER VALUES OF PARTS MARKED WITH

4-4-57 R9H

VERTICAL AMPLIFIER

A A

TYPE 545 OSCILLOSCOPE 57N (01-329)

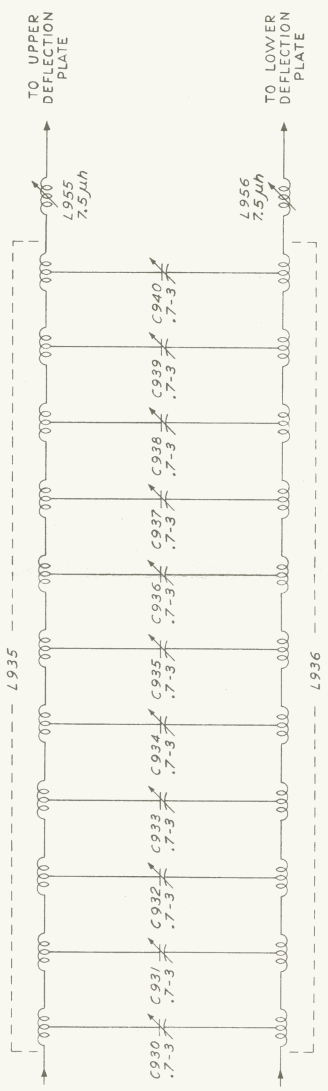
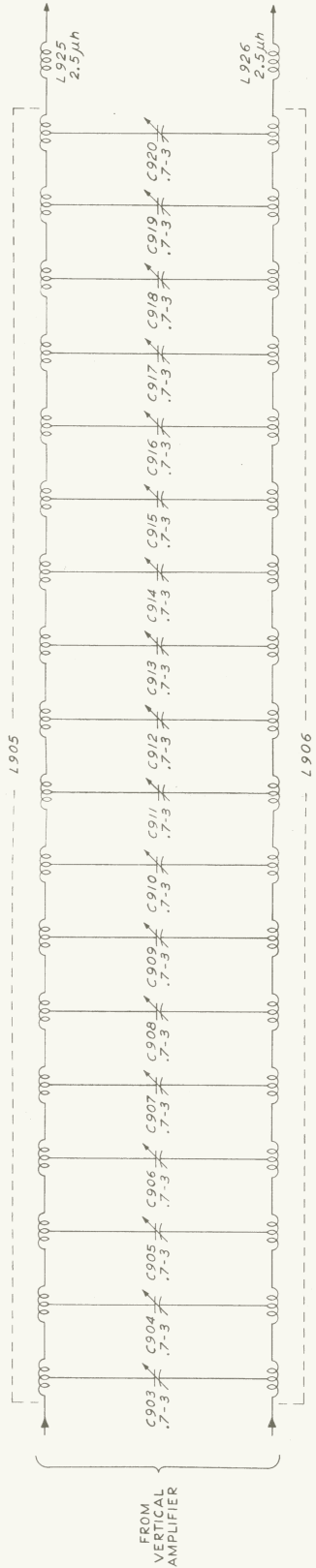

11-29-57 JR

DELAY LINE NETWORK

AA

TYPE 535 OSCILLOSCOPE
S/N 8628 & UP

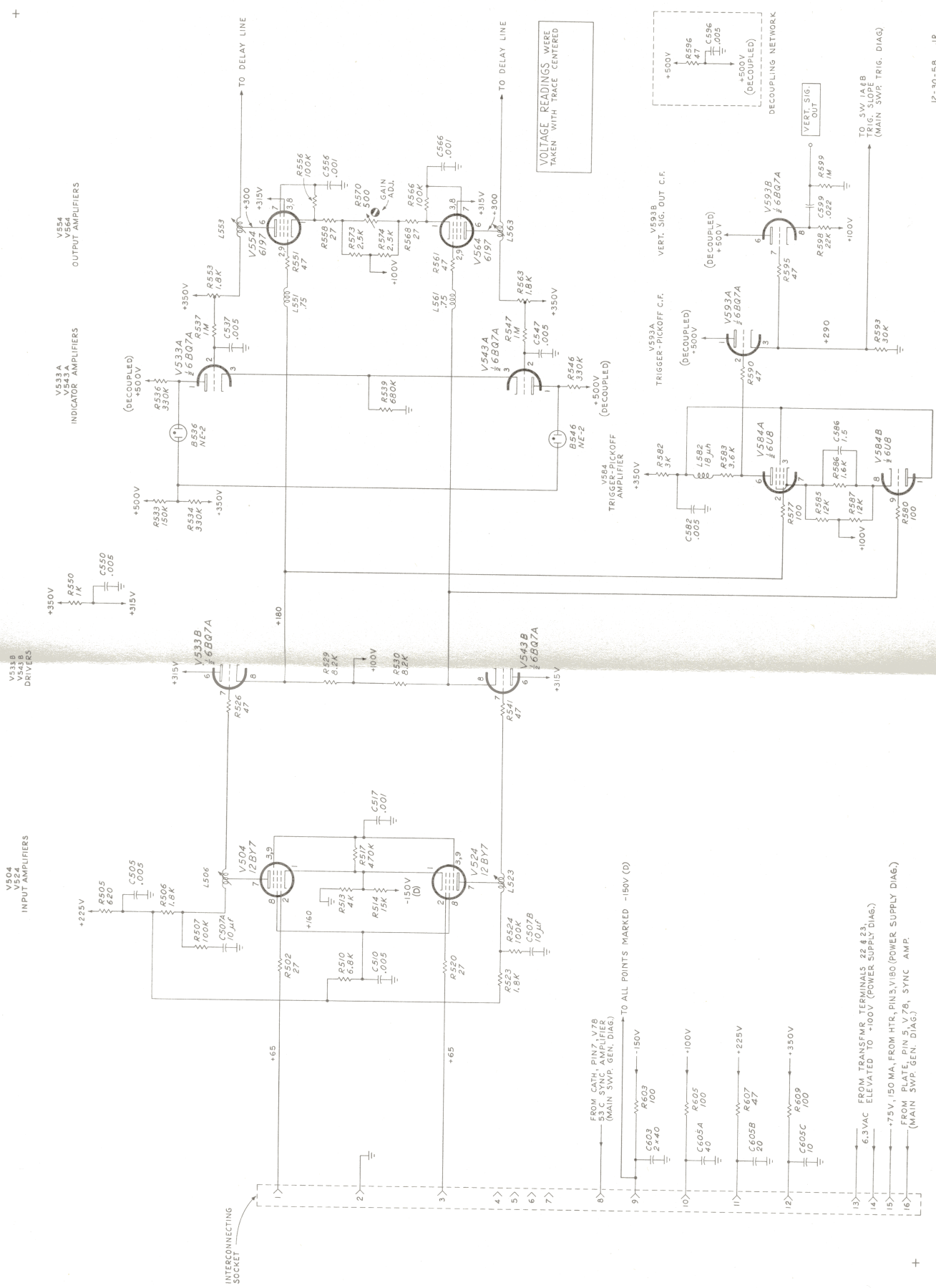

VERTICAL AMPLIFIER

12-30-58 JR

A A

TYPE 535 OSCILLOSCOPE S/N 9628 & UP

VOLTAGE READINGS WERE TAKEN WITH TRACE CENTERED

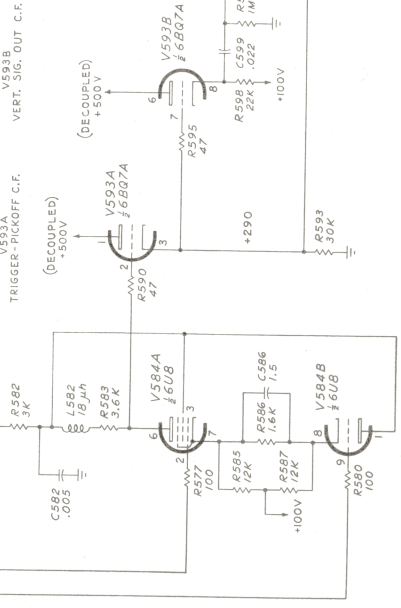
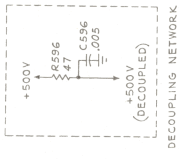

+

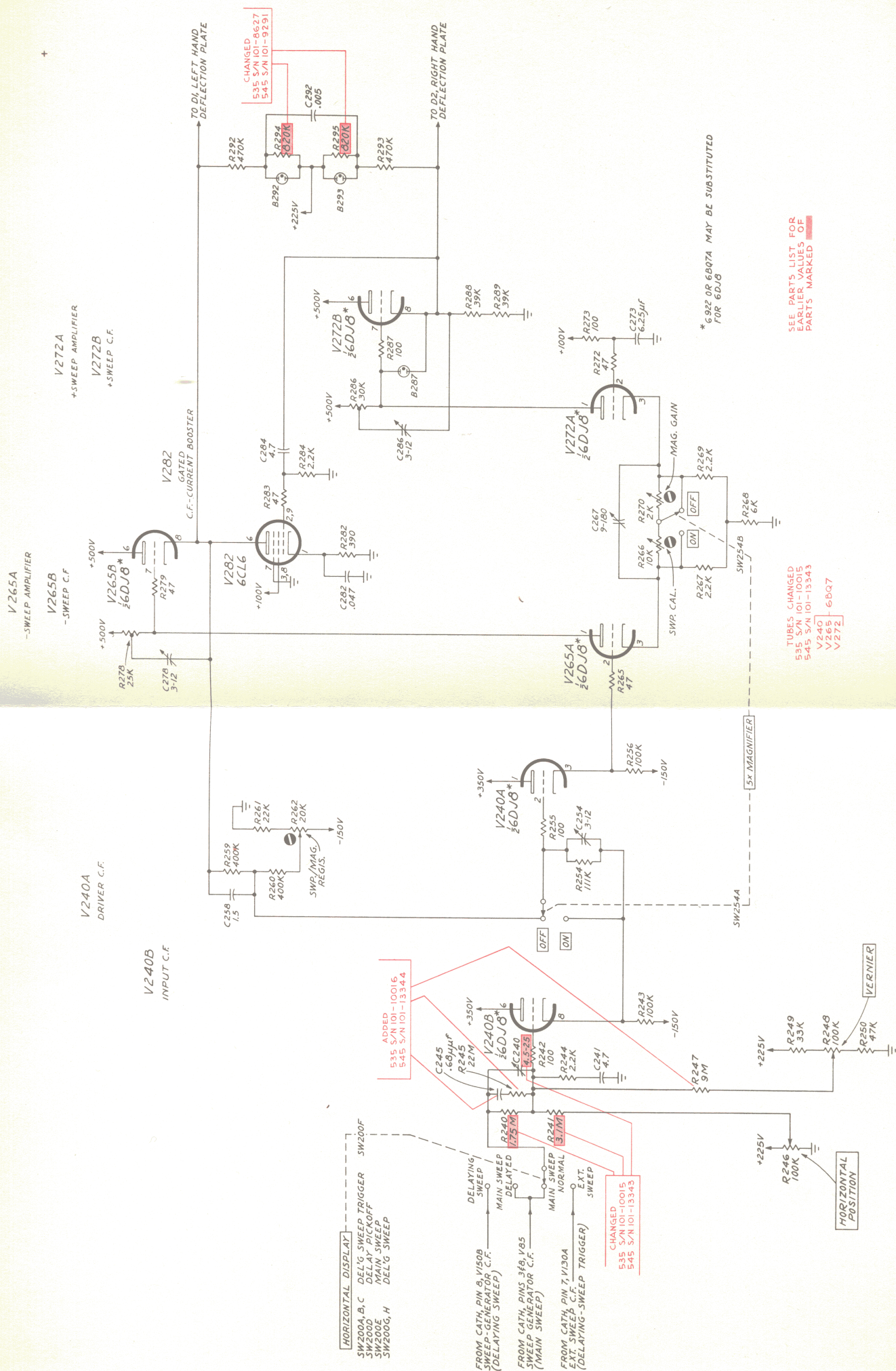

CHANGED
535 S/N 101-8627
545 S/N 101-9291

ADDED
535 S/N 101-10016
545 S/N 101-13344

CHANGED
535 S/N 101-10015
545 S/N 101-13343

TUBES CHANGED
535 S/N 101-10015
545 S/N 101-13343
V240 6DQ7
V265 6DQ7
V272 6DQ7

* 6922 OR 6BQ7A MAY BE SUBSTITUTED FOR 6DQ7

HORIZONTAL POSITION

VERNIER

HORIZONTAL DISPLAY
SW200A, B, C DELG SWEEP TRIGGER
SW200B DELAY OFF
SW200C DELG SWEEP
SW200G, H

FROM CATH. PIN 9, V150B (DELAYING SWEEP)
FROM CATH. PINS 3, 8, V165 SWEEP GENERATOR C.F. (MAIN SWEEP)
FROM CATH. PIN 7, V150A EXT. SWEEP C.F. (DELAYING-SWEEP TRIGGER)

DELAYING-SWEEP TIMING SWITCH

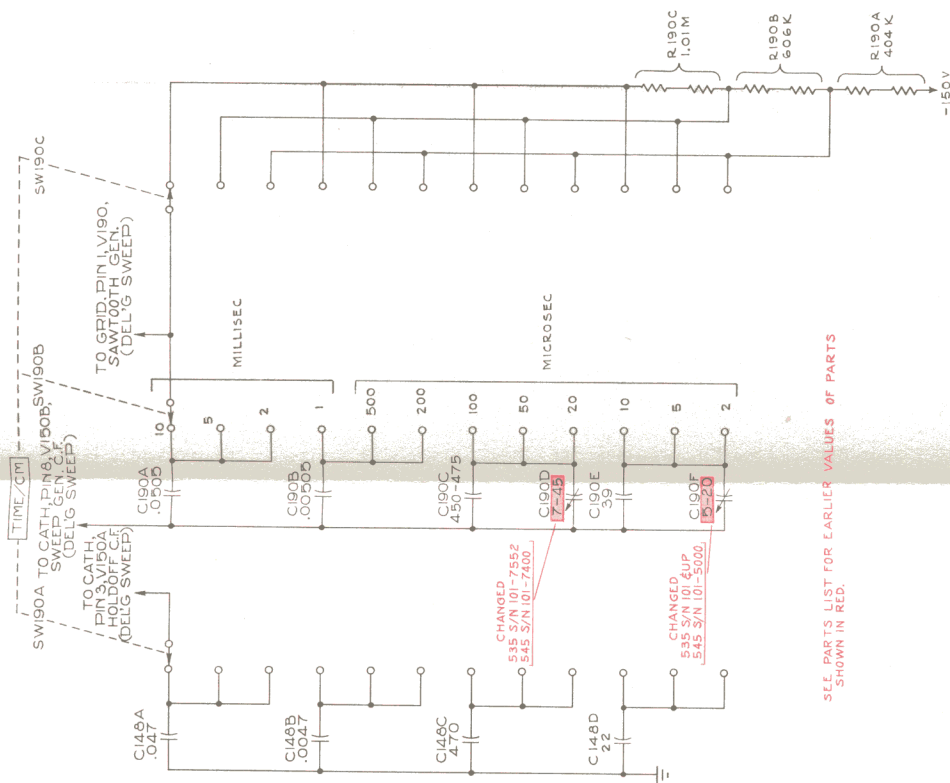

SEE PARTS LIST FOR EARLIER VALUES OF PARTS SHOWN IN RED.

FIG. 8-12-57

DELAYING - SWEEP TIMING - SWITCH

TYPE 535-545 OSCILLOSCOPE

A A

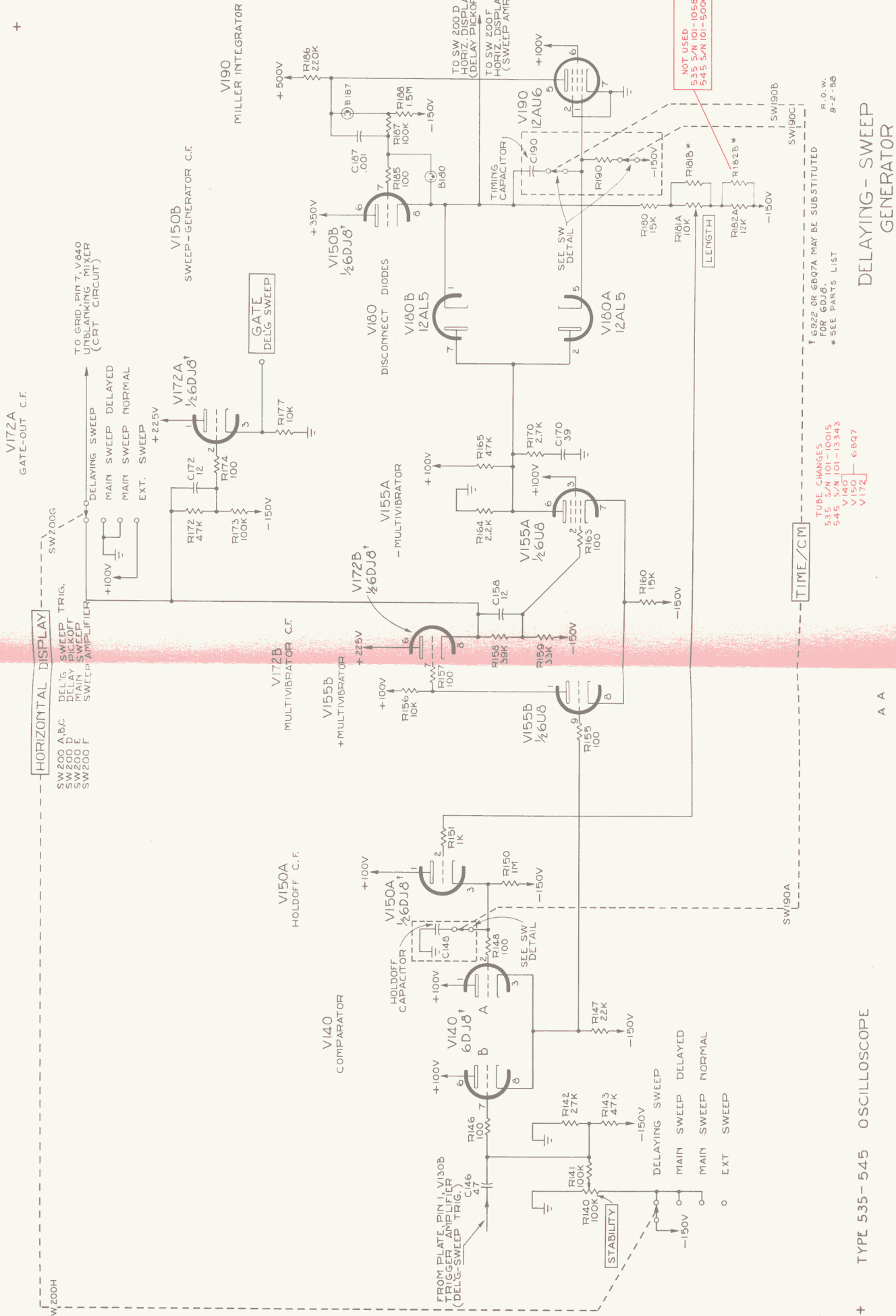

† 6922 OR 6BQ7A MAY BE SUBSTITUTED FOR 6DJ6.
 * SEE PARTS LIST

TUBE CHANGES
 535 S/N 101-10015
 545 S/N 101-13343
 V140 68Q7
 V172 68Q7

DELAYING-SWEEP GENERATOR

TYPE 535-545 OSCILLOSCOPE

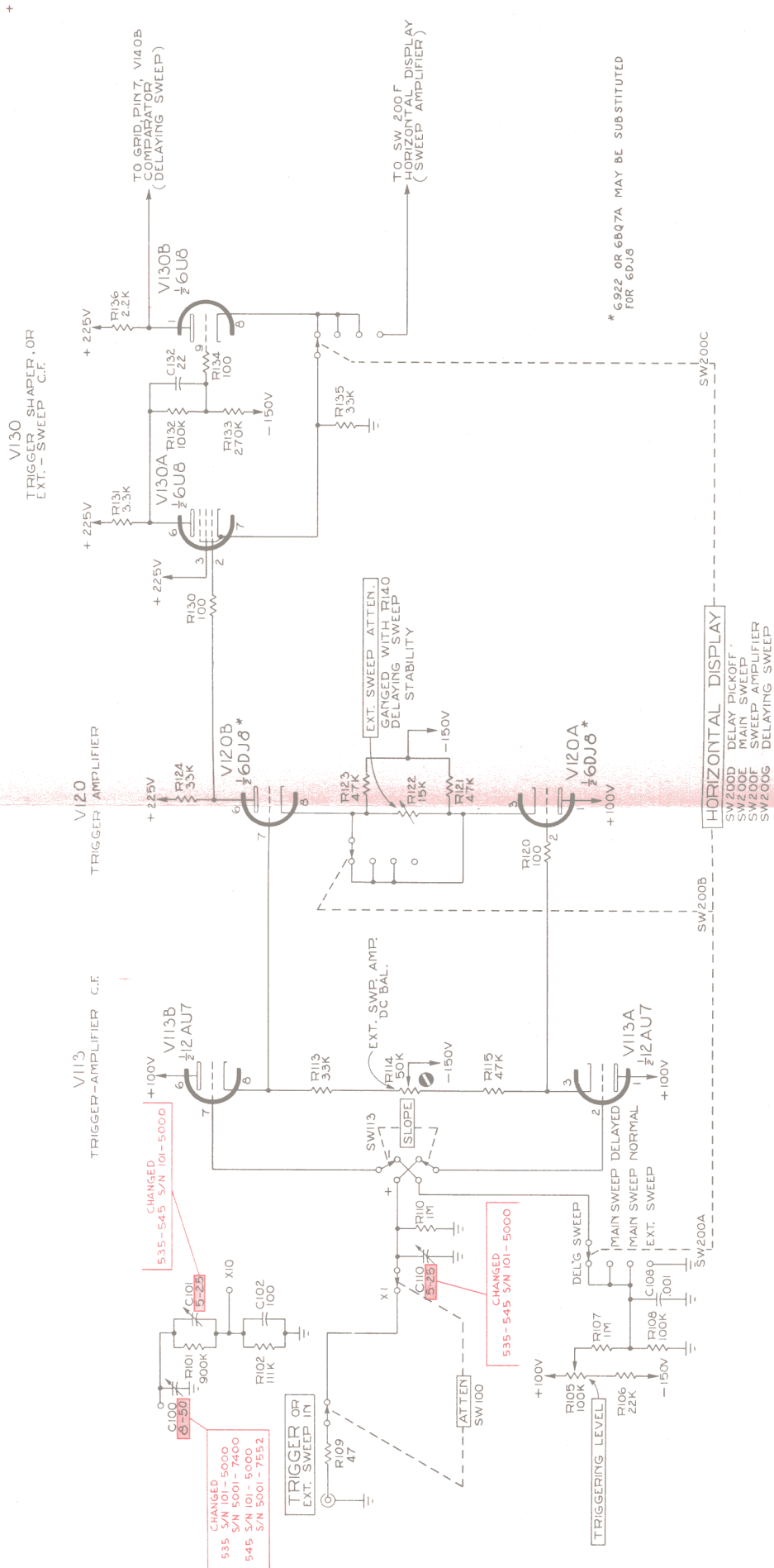

SEE PARTS LIST FOR EARLIER VALUES OF PARTS MARKED

TUBE CHANGES 535 S/N 101-10015, 545 S/N 101-13343 V120-68J7

P.O.W. 4-26-58

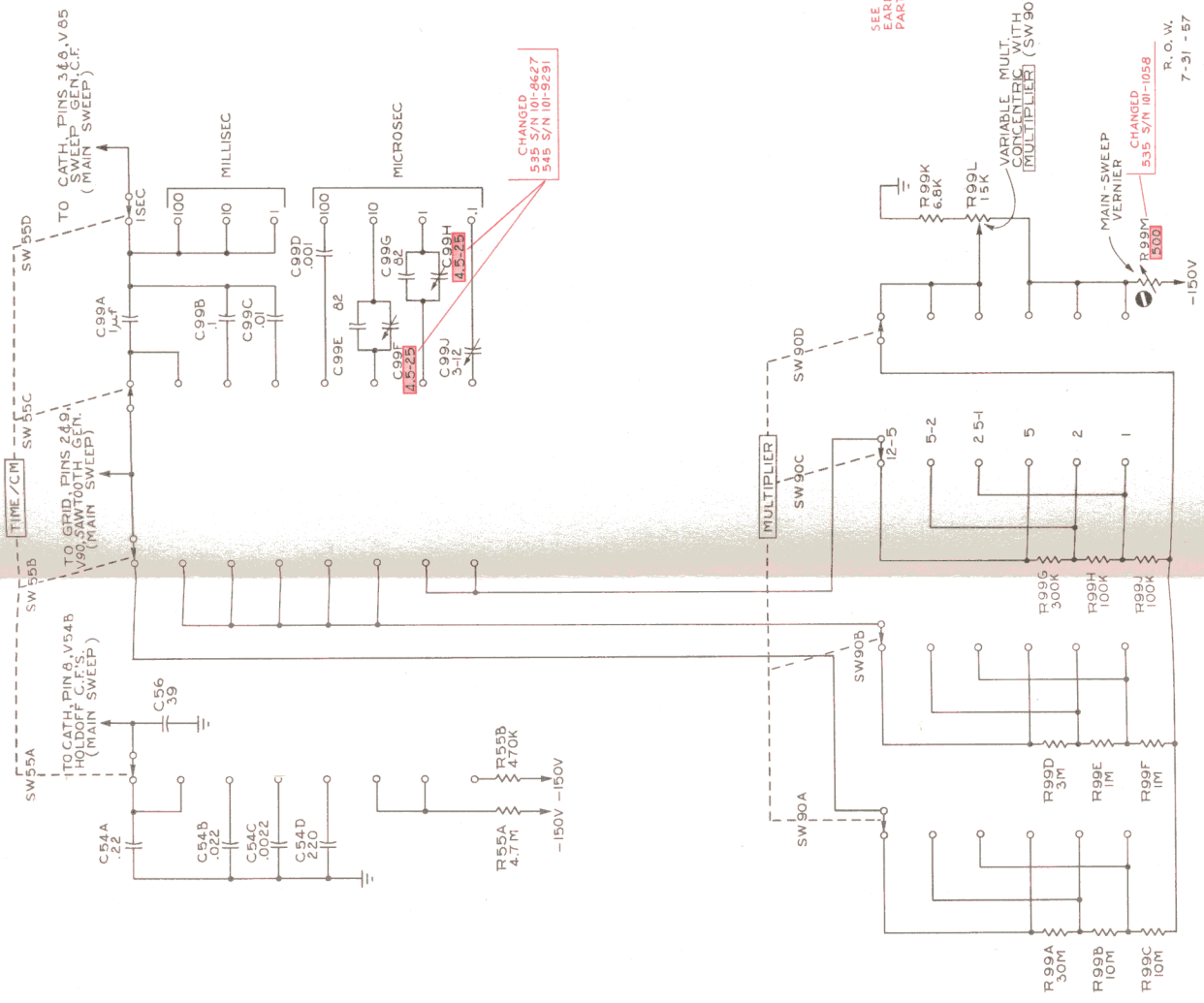

CHANGED
535 S/N 101-927
535 S/N 101-929

SEE PARTS LIST FOR
EARLIER VALUES OF
PARTS MARKED

VARIABLE MULT.
MULTIPLIER (SW 90)

MAIN-SWEEP
VERNIER

CHANGED
535 S/N 101-1058

R. O. W.
7-31-57

MAIN - SWEEP TIMING SWITCH

TYPE 535 - 545 OSCILLOSCOPE

A A

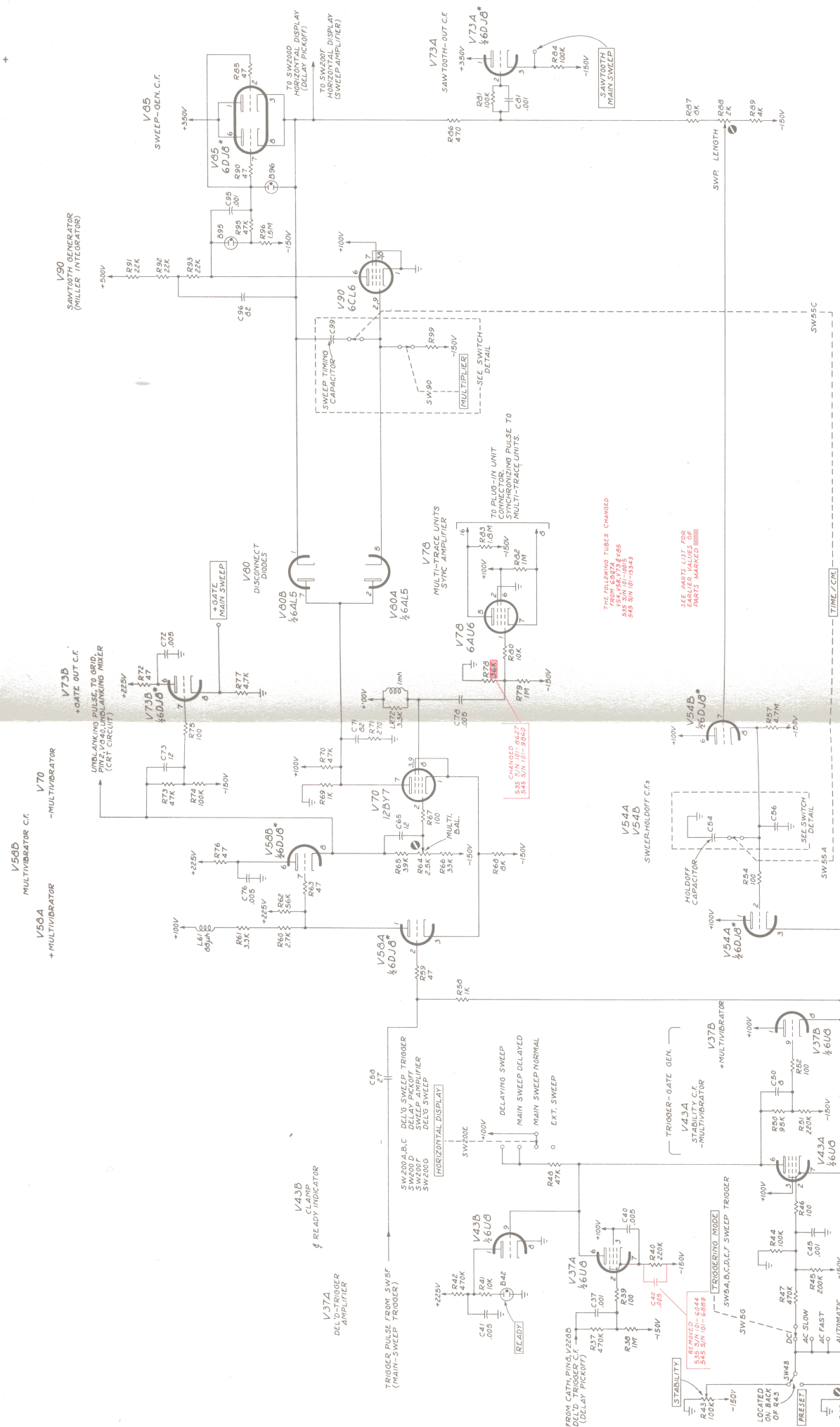

THE FOLLOWING TUBES CHANGED
 535 S/N 10-8627
 535 S/N 10-3502

SEE PARTS LIST FOR
 TABLE VALUES OF
 PARTS MARKED

892 OR 8902A MAY BE SUBSTITUTED
 FOR 892

TYPE 535-545 OSCILLOSCOPE

A A

MAIN SWEEP GENERATOR

P. 3-55

+

V20 TRIGGER SHAPER

V8 TRIGGER AMPLIFIER

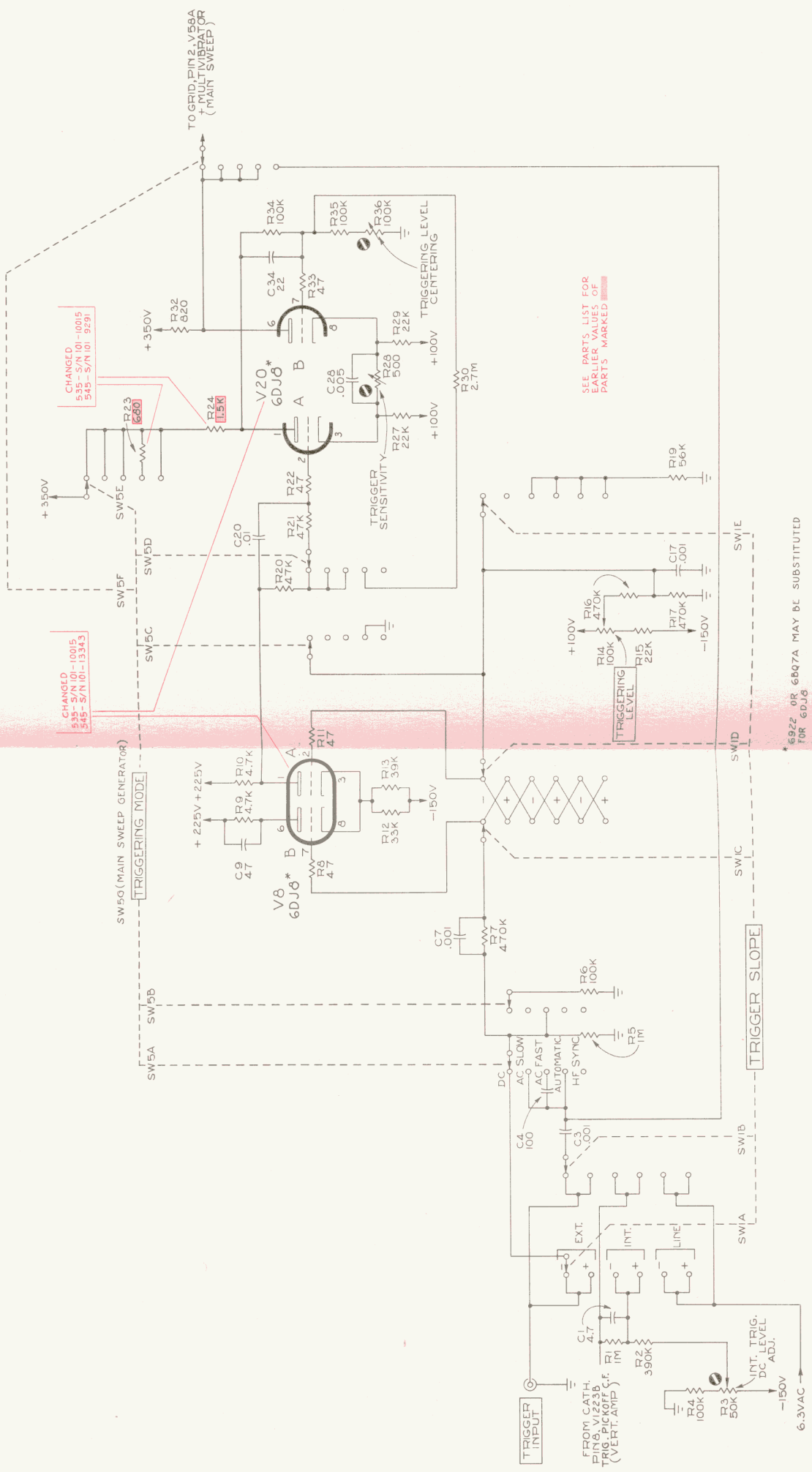

B.O.W.
10-27-56

MAIN SWEEP TRIGGER

AA

+ TYPE 535 - 545 OSCILLOSCOPE

SWEEP GENERATOR

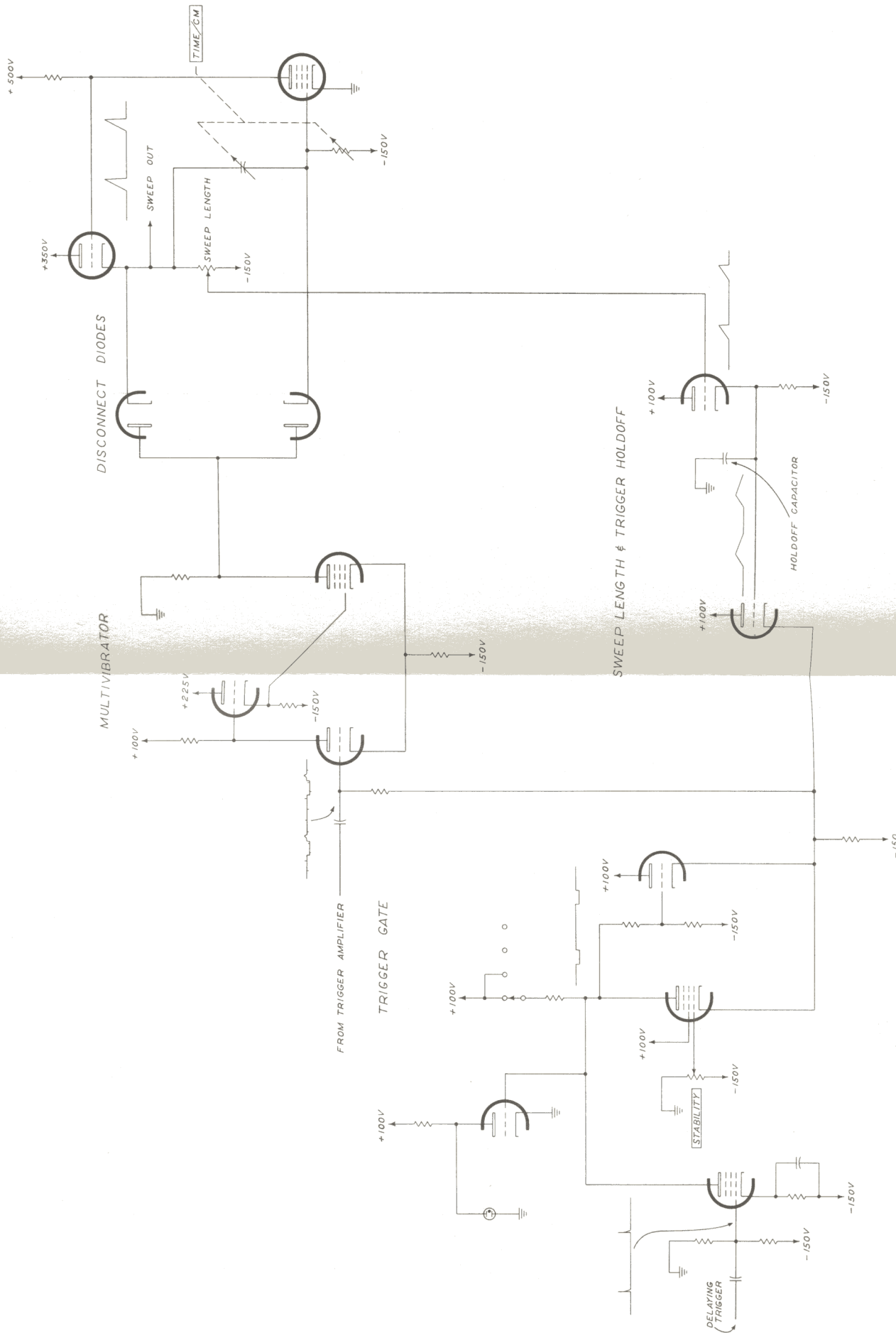

SIMPLIFIED DIAGRAM
SWEEP GENERATOR

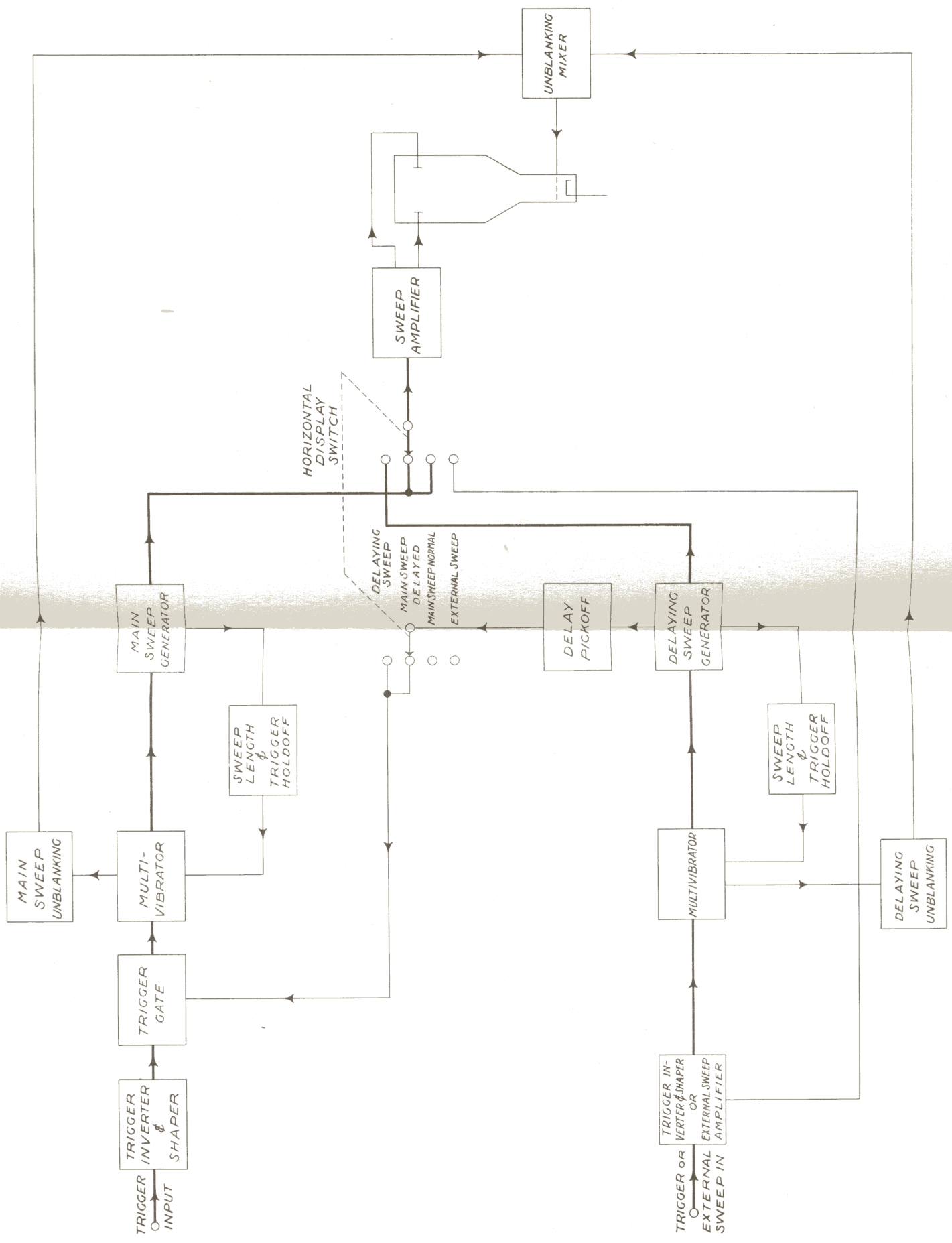

FUNCTIONAL BLOCK DIAGRAM

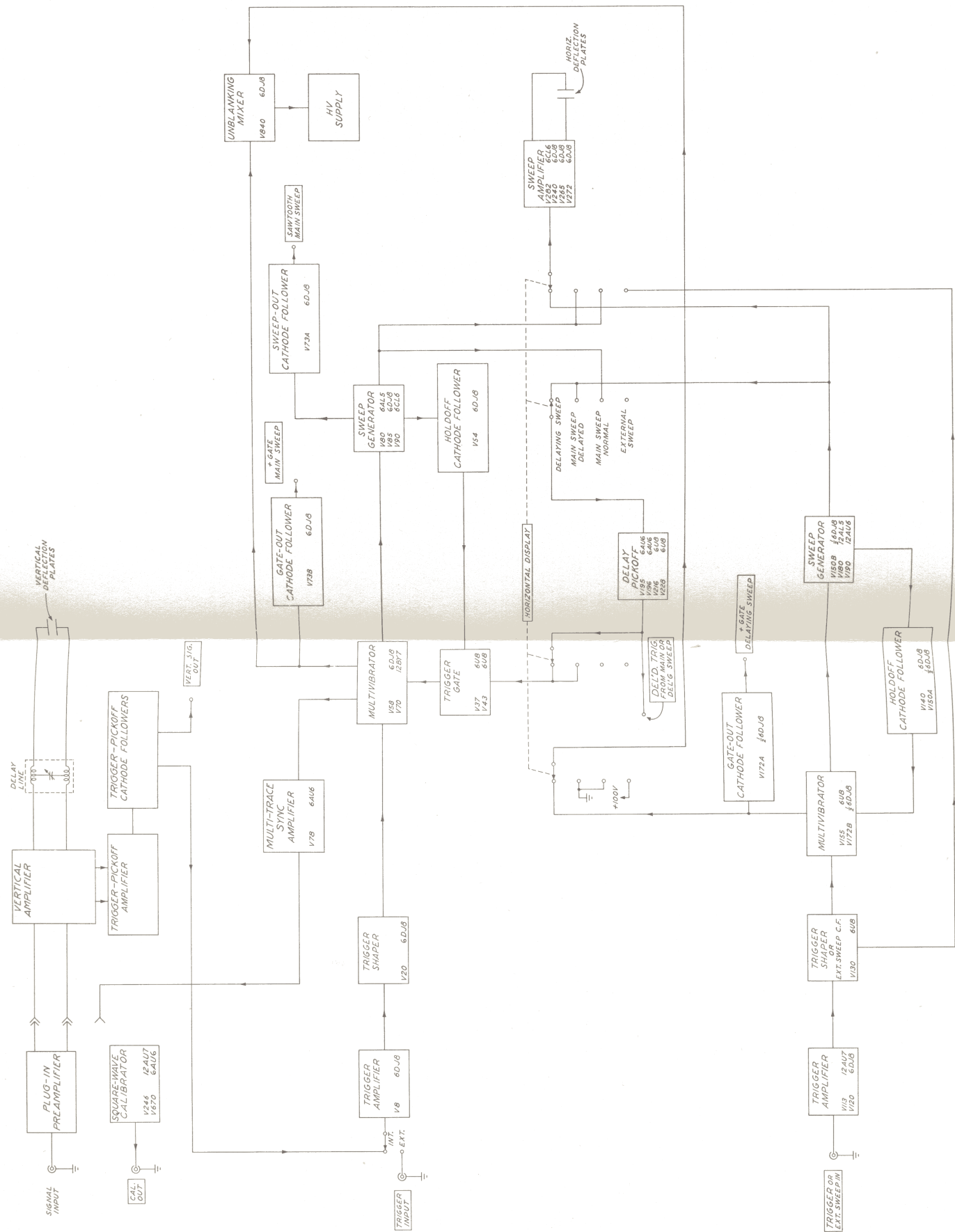

K4XL's **BAMA**

This manual is provided **FREE OF CHARGE** from the "BoatAnchor Manual Archive" as a service to the Boatanchor community.

It was uploaded by someone who wanted to help you repair and maintain your equipment.

If you paid anyone other than BAMA for this manual, you paid someone who is making a profit from the free labor of others without asking their permission.

You may pass on copies of this manual to anyone who needs it. But do it without charge.

Thousands of files are available without charge from BAMA. Visit us at <http://bama.sbc.edu>