

INSTRUCTION MANUAL

Serial Number _____

TYPE 567
READOUT
OSCILLOSCOPE

Tektronix, Inc.

S.W. Millikan Way ● P. O. Box 500 ● Beaverton, Oregon 97005 ● Phone 644-0161 ● Cables: Tektronix

070-0322-01

965



WARRANTY

All Tektronix instruments are warranted against defective materials and workmanship for one year. Tektronix transformers, manufactured in our own plant, are warranted for the life of the instrument.

Any questions with respect to the warranty mentioned above should be taken up with your Tektronix Field Engineer.

Tektronix repair and replacement-part service is geared directly to the field, therefore all requests for repairs and replacement parts should be directed to the Tektronix Field Office or Representative in your area. This procedure will assure you the fastest possible service. Please include the instrument Type and Serial number with all requests for parts or service.

Specifications and price change privileges reserved.

Copyright © 1962, new material copyright 1965 by Tektronix, Inc., Beaverton, Oregon. Printed in the United States of America. All rights reserved. Contents of this publication may not be reproduced in any form without permission of the copyright owner.



CONTENTS

Warranty

- Section 1 Characteristics
- Section 2 Operating Instructions
- Section 3 Circuit Description
- Section 4 Maintenance
- Section 5 Calibration
- Section 6 Parts List and Diagrams

A list of abbreviations and symbols used in this manual will be found on page 6-1. Change information, if any, is located at the rear of the manual.

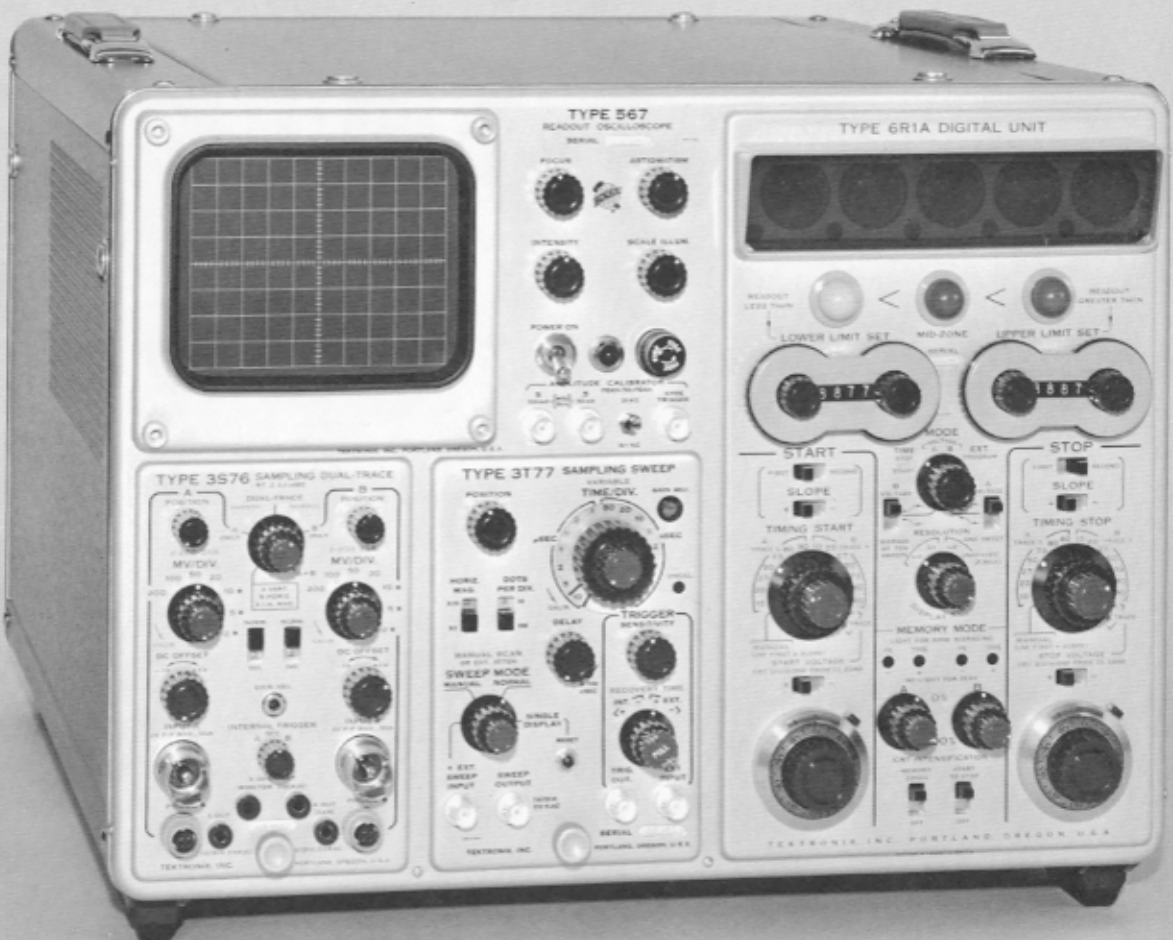

Type 567 Readout Oscilloscope including the Type 3S76 Sampling Dual-Trace Unit, the Type 3T77 Sampling Sweep Unit, and the Type 6R1A Digital Unit.

Type 567

SECTION 1

CHARACTERISTICS

General Information

The Tektronix Type 567 Readout Oscilloscope is the power supply and indicator unit for a complete system that provides digital readout of signal information. The two smaller plug-in cells accept any of the Tektronix 2 or 3 Series plug-in units. The large plug-in cell accepts the Tektronix 6 Series digital units. The digital units are compatible with some (but not all) of the 2 or 3 Series units. See your Tektronix Field Engineer for details. Without the digital unit, the Type 567 will operate in the normal oscilloscope manner. With the digital unit, the system can readout its own display of risetime, amplitude or time difference for either conventional voltage-time displays or sampling equivalent-time displays. The system provides "go, no-go" signals, and can be programmed automatically using up to three Tektronix Type 262 Programmers.

ELECTRICAL CHARACTERISTICS

Power Supplies

Electronically regulated for stable operation with widely varying line voltages and loads.

Line voltage requirements—105 to 125 volts, or 210 to 250 volts, rms, 50 to 60 cps, single-phase ac.

Power—Approximately 400 watts when using the Type 3S76, 3T77 and 6R1A Plug-In Units.

Fuse—4 Amp Fast-Blow for 117 volts, 2 Amp Fast-Blow for 234 volts.

Cathode-Ray Tube

Type—T5032-2-1 (S/N 1999-up)
T5610-31 (S/N 750-1998)
T5031-2 (S/N 101-749)

Phosphors—Standard phosphors as listed above, others available as listed with accessories at end of this section.

Unblanking—Deflection type, dc coupled.

Accelerating potential—Approximately 3.5 kv.

Usable viewing area—8 divisions vertical by 10 divisions horizontal.

Deflection plate deflection factors (nominal at 3.5 kv)

(S/N 1999-up) (S/N 101-1998)

Vertical— 19.5 volts/div 22.8 volts/div

Horizontal—18.4 volts/div 18.4 volts/div

Graticule

Internal within crt (S/N 1999-up)

External plastic (S/N 101-1998)

Illumination—Variable edge lighting.

Markings—Marked in 8 vertical and 10 horizontal 1-centimeter divisions with 2-millimeter markings on the centerlines.

Amplitude Calibrator

(S/N 2060-up). A square wave with accurate time duration and amplitude; intended for use when setting the vertical and horizontal plug-in units front-panel calibrate controls. Two output frequencies, an accurate 20 kc and an approximate 1 kc. The 1-kc square wave is valuable when adjusting low-frequency attenuator probes.

Output Voltage—Separate BNC connectors produce ground-referenced 0.5 and 5 volts peak to peak when loaded (one or both at the same time) by 100 k or greater. Same connectors provide 50 and 500 mv peak to peak when loaded (one at a time) by 50 ohms.

Accuracy—Voltage accurate to $\pm 2\%$ peak to peak into 100 k or greater loads. Voltage accuracy into 50 Ω depends on load resistor: $\pm 2\%$ peak to peak when 50 Ω is within 1% at one output connector at a time.

Frequency of 20-kc square wave is within 0.1% when the 1-kc square wave is within $+80\%$ and -40% ; symmetry not specified for either frequency.

+Pre Trigger—A short-duration, ground-referenced, positive pulse at least 600 mv peak to peak into 100 k or greater, that occurs approximately $\frac{1}{4}$ cycle ahead of each plus rise of square-wave signal. Amplitude is reduced by 50 Ω load, but +Pre Trigger signal is intended for externally triggering the time-base units of sampling systems not employing an internal trigger pickoff.

All three output connectors of the Amplitude Calibrator are short-circuit proof. External short circuits will not damage the calibrator circuits.

(S/N 101-299). Waveform—Square waves at line frequency.

Output Voltage—0.05, 0.5, 5 and 50 volts, peak to peak into 1 meg or greater load, one at a time.

Accuracy—Peak-to-peak amplitude of square waves within 3% of indicated voltage.

(S/N 300-2059). Above characteristics plus 100-mv peak-to-peak square wave available from 0.5 jack when loaded with $\pm 1\%$ 50 Ω .

Ventilation

Forced, filtered air. A thermal relay interrupts instrument power in the event of overheating. Fan remains on if thermal relay opens during 117-volt operation. Fan turns off if thermal relay opens during 234-volt operation. Temperature of the thermal relay must drop about 15° F before power will be restored.

Characteristics—Type 567

MECHANICAL CHARACTERISTICS

The Type 567 is constructed with aluminum-alloy chassis and cabinet. Cabinet is finished with a durable blue vinyl plastic. The unit sits on short anti-slide neoprene feet.

Cabinet dimensions—Height $13\frac{5}{8}$ " , width 17" , depth 23" .

Accessories

Information on accessories for use with this instrument is included at the rear of the mechanical parts list.

SECTION 2

OPERATING INSTRUCTIONS

General Information

The Type 567 is a specially designed oscilloscope for producing digital display of information which can be obtained only from the crt on an ordinary oscilloscope. The digital readout system can be made to display either voltage or time, and may be used for such applications as measuring the peak-to-peak amplitude of a waveform, or its risetime. If dual-trace plug-in units are used with the Type 567, the digital readout system can be used to obtain both voltage and time measurements on either trace. In addition, the digital readout system will make time measurements between signals displayed on one trace and signals displayed on the other.

The Type 567 and associated units are relatively easy to operate once the basic operating procedures are understood. It is the purpose of this section and similar sections in the plug-in unit manuals to establish the proper operating techniques. This manual covers instructions for the Type 567 only. For operating instructions for the plug-in units, refer to the applicable instruction manuals.

Preliminary Instructions

Before operating the Type 567, a suitable location for the instrument must be chosen. The location should provide a stable support for the instrument. Care should be taken that adequate air circulation is permitted through the instrument by keeping it away from walls, or from other equipment which might block the air intake through the filter or the exhaust passages in the cabinet. If the flow of air over the components in the unit is interrupted, overheating of the instrument may cause a thermal relay in the instrument to open, shutting down the instrument.

The Type 567 Oscilloscope can be operated from 110, 117, or 124 volts, or 220, 234, or 248 volts. The only changes necessary to convert from one operating voltage to another are in the wiring of the power transformer primary and the fan motor. The power transformer used in the Type 567 uses two separate primary windings plus two 6% boost-buck windings. The primary windings are connected in parallel for 117-volt operation and in series for 234-volt operation. Proper connections for each line voltage are shown on the side of the power transformer and on the Power Supply schematic.

A small metal tag near the power receptacle at the rear of the instrument indicates the line voltage for which the instrument was wired at the factory. If wired for 117 volts, the instrument will operate properly with line voltages between approximately 105 and 125 volts. If wired for 234 volts, the instrument will operate properly from approximately 210 to 250 volts.

To change the power transformer connections for operation on another line voltage, change the location of the bare wire straps at the primary terminals. It is not necessary to move any of the plastic insulated wires. Place the new straps in accordance with the markings on the tag located on the power transformer side.

When a suitable location has been chosen, set the POWER ON switch to the off position and connect the instrument to an appropriate source of power. Place the desired vertical plug-in unit (for example, the Type 3A2 or 3S76) in the left plug-in compartment of the oscilloscope (see Fig. 2-1). Place the horizontal plug-in unit (for example, the Type 3B2 or 3T77) in the center compartment. Finally, place the desired digital unit (for example, the Type 6R1 or 6R1A) in the right compartment of the oscilloscope. Make certain all units are properly inserted and locked in place before turning on the oscilloscope power. The horizontal and vertical plug-in units are locked in place by turning the front-panel knurled aluminum locking knobs clockwise. The digital unit is locked in place by removing the right side panel and tightening the two fasteners at the rear of the compartment.

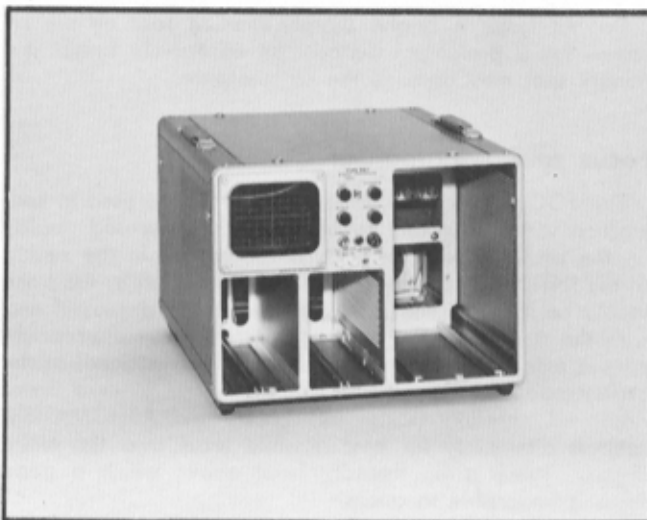

Fig. 2-1. Type 567 plug-in compartments.

Checking Plug-In Unit Accuracy

Each vertical, horizontal and digital plug-in unit must be calibrated within the particular oscilloscope in which it is to be operated. Units purchased as a system (oscilloscope and three plug-ins) are calibrated together as a system at the factory. Units purchased separately, or calibrated separately, must have their basic gain adjustments made when they are installed.

Individual oscilloscope crt deflection factors differ within normal limits. The vertical and horizontal units have front-panel Calib controls so the particular amplifier gain can be set to that needed by the crt. Some sampling plug-in units have internal digital gain controls that must be correctly adjusted. See the individual plug-in unit instruction manual calibration procedure for details.

The digital unit is sensitive to the oscilloscope power-supply voltages. Digital readout accuracy is closely related to power-supply voltage accuracy. Since it is impossible to

Operating Instructions—Type 567

make all Type 567 Oscilloscope power supplies to have exactly the same voltage accuracy, the digital unit must be calibrated in the oscilloscope in which it is used. If a calibrated digital unit (either Type 6R1 or 6R1A) is placed into another Type 567 Oscilloscope, check the accuracy of the start and stop voltages and the rate of rise of the voltmeter ramp before relying on either time or voltage readout. See the digital unit instruction manual calibration procedure (Type 6R1A steps 5 and 6; Type 6R1 steps 15 and 17) for details.

Intensity Control

The INTENSITY control is used to adjust the brightness of the oscilloscope display. Begin with INTENSITY control counterclockwise, because some plug-ins permit a bright spot during warm up. After turning on the instrument and waiting a few minutes for warm up, free run the oscilloscope sweep by setting the TRIGGER SENSITIVITY or LEVEL control fully clockwise. Adjust the INTENSITY control for a suitable trace intensity.

Do not leave a bright, sharply focused spot on the crt screen for a prolonged period. An excessively bright stationary spot may damage the crt phosphor.

Focus and Astigmatism Controls

The FOCUS and ASTIGMATISM controls are used in conjunction with each other to produce a well-focused display on the oscilloscope screen. Because changes in the setting of the INTENSITY control may affect focus slightly, the trace should be focused with the actual waveform displayed and with the desired intensity setting. Refer to the appropriate plug-in manuals for instructions for applying a signal to the oscilloscope and obtaining a stable display. With a signal displayed, carefully adjust the FOCUS and ASTIGMATISM controls alternately for best possible focus over the entire display. There is an intensity level above which a good focus is impossible to attain.

Scale Illumination Control

The crt graticule is edge-lighted by two small lamps at the bottom. The lighting can be adjusted to suit the ambient light conditions by means of the SCALE ILLUM control. Rotating the control clockwise increases the brightness of the graticule scale markings. The graticule is marked with eight 1-centimeter divisions vertically and ten 1-centimeter divisions horizontally, with 2-millimeter markings on the centerlines.

Changing Plug-In Units

Horizontal and vertical plug-in units used in the Type 567 may be changed at any time. However, it is recommended that the instrument be turned off while a change is made. This affords maximum protection to the oscilloscope and other plug-in units against sudden transients and load changes.

Whenever a horizontal or vertical plug-in unit is changed, it is important that you check both the gain and timing of the oscilloscope. This will ensure accurate measurements.

Amplitude Calibrator (SN 2060-up)

The Amplitude Calibrator provides a choice of four square-wave voltages with amplitude tolerance of $\pm 2\%$. 0.5 and 5 volts peak to peak when loaded (one or both at the same time) by 100 k or greater, and 50 and 500 mv when loaded (one at a time) by $50 \Omega \pm 1\%$. Two frequencies are available: crystal-controlled 20-kc ($\pm 0.1\%$) square waves, and 1-kc ($\pm 20\%$) square waves. The two frequencies are selectable by a front-panel 20 KC \approx 1 KC toggle switch. The voltage accuracy of any one of the four output voltages may be adjusted to within $\pm 1/2\%$ by special calibration.

The Amplitude Calibrator is valuable for adjusting the front-panel Calib controls of both vertical and horizontal real-time or sampling plug-in units. The 20-kc frequency (and the ability to make one of the output voltages very accurate) permits checking the system operation including digital unit time and voltage readout. The 1-kc frequency is valuable for compensating low-frequency attenuator probes.

Front-panel BNC connectors permit convenient 50Ω cable connection of calibrator signals to the plug-in unit input terminals, or to external equipment. If the vertical plug-in unit has a high-impedance input, the two higher square-wave voltages will apply. Addition of an external 50Ω termination (Tektronix Part No. 011-0049-00) at the plug-in input connector will provide the two lower voltages. If the plug-in unit has an internal 50Ω termination, do not add the external termination when accurate voltages are desired. (Actually, the Amplitude Calibrator is short-circuit proof, so any load is permissible, but accurate voltages are obtainable only as above.)

The +Pre Trigger connector delivers a positive pulse approximately $1/4$ cycle before each positive step of both the 20-kc and 1-kc square-wave signals. Sampling plug-in time-base units can effectively use the +Pre Trigger signal (at 20 kc) for external triggering. A positive step will then appear near the beginning of the display, produced without external delay cable in the pretrigger signal path.

(S/N 300-2059)

The Amplitude Calibrator provides a choice of four square-wave signals with peak-to-peak voltages of 0.05, 0.5, 5 and 50 volts $\pm 3\%$ when loaded by 1 megohm or greater. In addition, a signal of 100 mv peak to peak $\pm 3\%$ into a $50 \Omega (\pm 1\%)$ resistance is provided from the 0.5 jack. This voltage is valuable for checking the vertical calibration of sampling plug-in units. Frequency of the square wave is that of the power line.

(S/N 101-299)

The Amplitude Calibrator provides a choice of four square-wave signals with peak-to-peak voltages of 0.05, 0.5 and 5 and 50 volts $\pm 3\%$ when loaded by 1 megohm or greater. Frequency of the square wave is that of the power line. The Amplitude Calibrator is valuable for checking real-time plug-in unit calibration and the compensation of attenuator probes. It is also valuable as a time reference for adjusting the horizontal unit calibration; three complete cycles at 60 cps line frequency occur in 50 milliseconds (2 cycles at 50 cps line frequency occur in 40 milliseconds).

TABLE 2-1

Type 567 Power Supply Current Capabilities For X and Y Plug-In Units

Supply	Max. Total Current	Connector Terminals
Reg. -100 vdc	130 ma	23- to 9 ground
Reg. -12.2 vdc	1.5 amps	16- to 5 ground
Reg. +125 vdc	150 ma	15+ to 9 ground
Reg +300 vdc	150 ma	10+ to 9 ground
Unreg. 6.3 vac	5 amps per plug-in	1-2

+210 volts dc to permit proper focus and astigmatism control.

The limit of the amount of power which can be dissipated in one plug-in unit is based primarily upon the ambient temperature and amount of ventilation supplied. Vacuum tubes should not be operated with envelope temperatures above 150° C when the ambient temperature is at 25° C, or above 175° C when the ambient temperature is at 50° C. The Type 567 indicator unit can be operated in ambient temperatures up to 45° C.

Separate terminals are provided for the ground return of the -12.2-volt regulated heater supply. When using this supply in your own plug-in design, it is best to run two leads to the heater terminals so that the ground lead can be connected directly to terminal 5, thus eliminating ground currents.

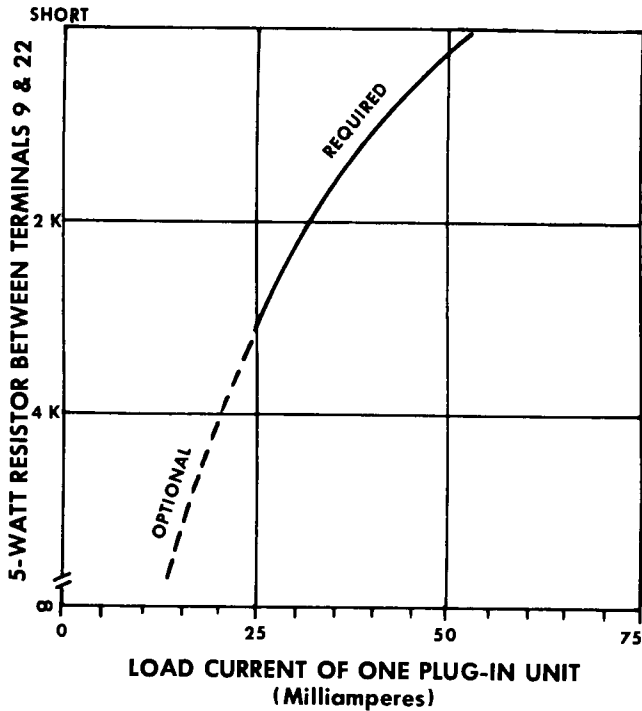

Fig. 2-2. -100-volt supply shunt.

Skeleton Plug-In Units

Skeleton plug-in units for the vertical and horizontal sections are available for all of the Tektronix Type 560 Series oscilloscopes, including the Type 567. None are available for the large plug-in area used for digital readout. These skeleton units permit you to build your own plug-in circuitry for use in the Type 567. If you use your own circuitry, provision may be made for operating the digital readout circuits, although this is not necessary. Order the skeleton chassis as Modification Kit number 040-0245-00 from your local Tektronix Field Office.

A dummy cover is available for the digital cell. Order by Tektronix Part No. 016-0051-00.

Power Supply Capabilities

The total dc power available for vertical and horizontal plug-in use is 85 watts divided between four regulated supplies. The remaining power available must be reserved for the digital units. Use of current from any of the unregulated dc supply leads is not recommended.

The four regulated dc supplies listed in Table 2-1 are employed by the X and Y axis amplifiers.

Since the Type 567 indicator unit employs two plug-in units to operate the X and Y axes of the crt, currents listed in Table 2-1 are normally divided between them. However, a single plug-in alone can be used, such as a vertical amplifier, with moving-film recording used instead of a horizontal sweep. In such a case, it will be necessary to elevate the crt horizontal deflection plates to approximately +180 to

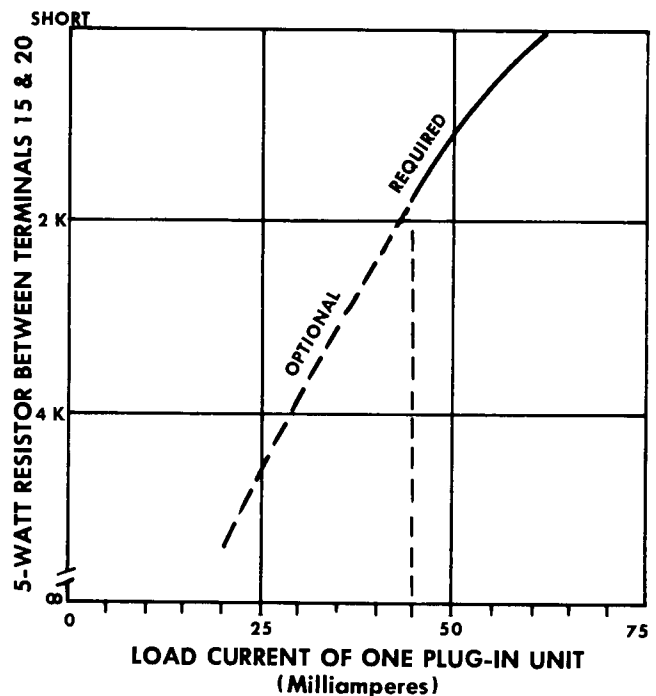

Fig. 2-3. +125-volt supply shunt.

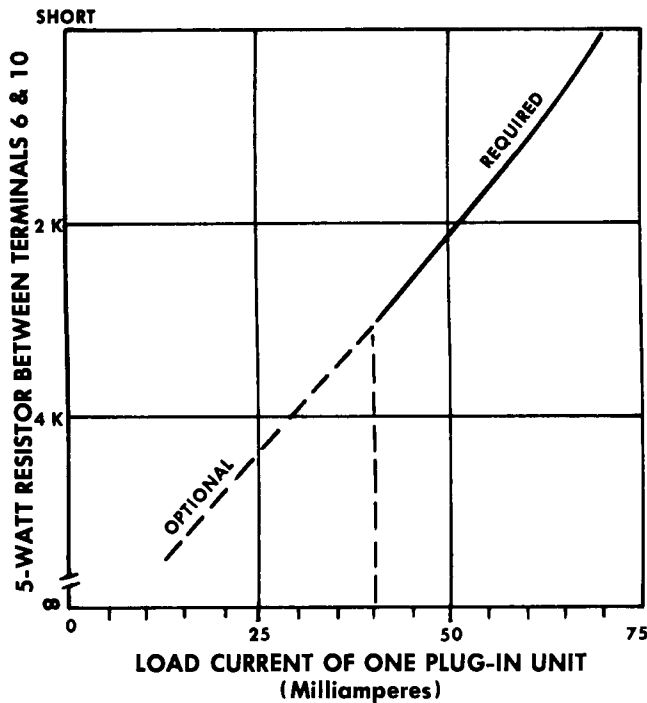

Fig. 2-4. +300-volt supply shunt.

above 150° C when the ambient temperature is at 25° C, or above 175° C when the ambient temperature is at 50° C. The Type 567 indicator unit can be operated in ambient temperatures up to 45° C.

Separate terminals are provided for the ground return of the -12.2-volt regulated heater supply. When using this supply in your own plug-in design, it is best to run two leads to the heater terminals so that the ground lead can be connected directly to terminal 5, thus eliminating ground currents.

TABLE 2-2
Recommended Type 567 Regulated Power-Supply Shunt Resistors¹

Shunt Resistor Values	-100 v	+125 v	+300 v
No Shunt	0 to 25 ma	0 to 45 ma	0 to 40 ma
2000 Ω, 5 w between proper terminals of power connector.	20 to 45 ma	25 to 60 ma	35 to 67 ma
SHORT, between proper terminals of power connector.	40 to 65 ma	50 to 75 ma	65 to 75 ma

¹Currents listed are one-half total available, based on two plug-in units being used.

Suggested Power-Supply Shunt Resistor Values

To make efficient special use of the Type 567 indicator unit power supply, the load currents and maximum or minimum load values must be known.

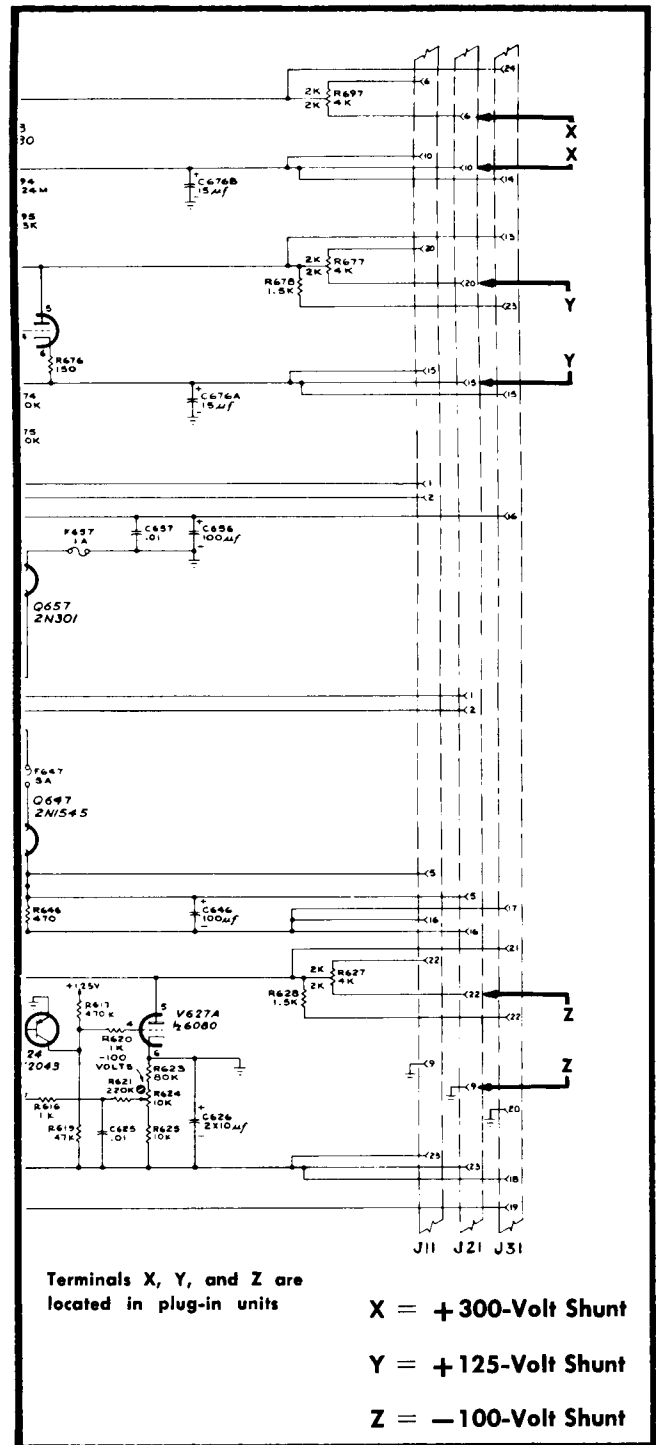

Fig. 2-5. Power-supply shunt resistor connections.

The nature of series-regulated power supplies permits obtaining more current from them than can normally be handled by the series tube alone (providing the power transformer and rectifiers can supply more current). By placing a shunt resistor of appropriate value across the series regulator tube, additional current can be made available for the load. The correct value shunt resistor must be chosen to permit the regulator system to deliver current with low ripple, and the

Use of shunt-resistor values suggested in Table 2-2 will lead to a minimum of total power required, and give lowest plug-in temperature. It is the simplest method that will not overtax supplies, either for regulation or temperature. However, if Table 2-2 does not meet your design needs, refer to the curves of Figs. 2-2, 2-3, or 2-4 to aid your choice of individual power-supply shunt resistors. Always plan the shunt to permit lowest plate dissipation in the series regulator tube consistent with proper regulation and ripple values.

A portion of the power-supply schematic has been reproduced in Fig. 2-5, identifying interconnecting plug terminals specified in Table 2-3. J11 and J21 are the horizontally-mounted interconnecting plugs at the rear of the vertical and

horizontal plug-in cells, respectively. Do not use shunt resistors in the digital cell at J31.

TABLE 2-3

**Plug-In Interconnecting Plug Terminals
For Regulated Supply Shunt Resistors
In X and Y Amplifiers**

Supply	Terminals
-100	22-9 return
+125	20-15 return
+300	6-10 return

SECTION 3

CIRCUIT DESCRIPTION

General Information

The Type 567 Oscilloscope consists of three major parts: the low-voltage power supplies, the crt circuits, and the Amplitude Calibrator. The oscilloscope is essentially an indicator and power supply for the plug-in units used with the instrument. Vertical and horizontal plug-in units drive the deflection plates of the crt directly, and also drive the digital unit.

The low-voltage power supplies provide outputs of -100 , -12.2 , $+20$, $+125$, and $+300$ volts.

The crt circuits contain the high-voltage power supply and crt. The high-voltage supply provides regulated 3.3-kv potential to the crt cathode.

The Amplitude Calibrator generates square waves with calibrated amplitudes at either 20 kc or 1 kc. The calibrator square waves are used as a convenient signal source to verify the calibration of the vertical, horizontal, and digital plug-in units.

Low-Voltage Power Supplies

Low-voltage power supplies of the Type 567 supply all the power to the high-voltage power supply, the Amplitude Calibrator, and the three plug-in units. Each regulated output voltage is stable over the line voltage range of 105 to 125 volts rms, or 210 to 250 volts rms, centered at either 117 or 234 volts 50 to 60 cps. The supplies will remain within regulation for line-voltage distortion up to about 5%.

All regulated power supplies are referenced to V609 of the -100 -volt supply; the output voltage of the -100 -volt supply is the reference voltage for all other regulated supplies.

Vertical and horizontal plug-in units use power from all but the $+20$ -volt supply. The $+20$ -volt supply is used by the digital unit and can be used externally through the digital unit (Type 6R1 or 6R1A J34-G) at currents up to 500 ma.

Three of the power supplies include shunt resistors that allow more current to be drawn than can be handled by the series regulators alone. A discussion of power-supply loads and shunts is included in the section on Operating Instructions.

-100 -Volt Power Supply

Line voltage is applied through fuse F601 and the thermal cutout relay TK601 to the primary windings of T601. This energizes the secondary windings of T601. Terminals 19 and 20 of T601 apply power to a full-wave bridge rectifier consisting of D602A, B, C, and D. The unregulated output of the rectifier circuit is applied to the -100 -volt regulator circuit and through the interconnecting plugs to the plug-in units.

Voltage regulator tube V609 maintains the grid of V616B at approximately -85 volts. The voltage at the grid of V616A is obtained from a divider between ground and the -100 -volt output of the regulator. V616 is a cathode-coupled difference amplifier which compares the voltage at the grid of V616A against the fixed -85 volts at the grid of V616B. Potentiometer R624 sets the output of the power supply at -100 volts.

If the output voltage tends to change from -100 volts, a sample of the change is applied through the divider to the grid of V616A. This error signal is amplified and inverted by V616A and applied to the base of Q624. Q624 amplifies and inverts the error signal and applies it to the grid of series regulator V627A. The change in grid voltage of V627A changes the voltage drop across the tube and causes the output voltage to return to normal.

Capacitor C625 increases the ac loop gain of the regulator circuit. Its function is to quickly compensate for rapid changes in the output voltage. The higher ac loop gain provided by C625 also reduces ripple at the output of the regulator. C626 aids in reducing the ac output impedance of the -100 -volt supply.

$+125$ -Volt Power Supply

A full-wave bridge rectifier circuit from terminals 33 and 34 of T601 supplies power to the $+125$ -volt regulator circuit and to the plug-in units through the interconnecting plugs. The $+125$ -volt supply compares its own output voltage with the -100 -volt supply through the resistive voltage divider R674-R675. The divider supplies a voltage near ground to the grid of V664. If the output voltage from the regulator changes, a portion of this change is applied through the divider to the grid of error amplifier V664. The error signal is amplified by V664 and applied to the grids of series regulator V677. The change in voltage at the grids of V677 changes the voltage drop across V677 and compensates for the change in output voltage.

The screen supply for V664 is obtained primarily from the output of the regulator circuit. R665 applies ripple from the unregulated bus to the screen as a signal voltage. The ripple is amplified and helps to reduce ripple appearing on the output.

Capacitor C674 is used to increase the ac loop gain of the regulator circuit. This allows the circuit to recover rapidly from sudden changes in output voltage. The increased ac loop gain also helps to reduce the ripple at the output of the regulator. C676A reduces the ac impedance of the $+125$ -volt supply. Resistors R671 and R676 in the cathodes of the series regulator V677 tend to balance the current through the two sections of the tube.

On all Type 567s S/N 300-up, the $+125$ -volt supply is adjustable by R667 and R668. The -100 -volt supply must be adjusted to the correct voltage before adjusting R668 to set the $+125$ -volt supply to the correct value.

Circuit Description—Type 567

+300-Volt Power Supply

A full-wave bridge rectifier circuit from terminals 31 and 32 of T601 supplies +165 unregulated dc volts that are added to the unregulated +235 volts (of the +125-volt regulated supply) to provide a total of +400 volts to the +300-volt regulator and to the crt circuit. A voltage divider between the regulator output and -100 volts, supplies a voltage near ground to the grid of V684. If the output voltage from the regulator changes, a portion of this change is applied through the divider and C694 to the grid of error amplifier V684. The error signal is amplified and inverted and applied to the grid of series regulator V627B. The change in voltage at V627B grid changes V627B conduction and compensates for the change in output voltage.

The screen supply for V684 is obtained from both the +400-volt unregulated lead and from the regulated +300 volts. R685 applies ripple voltage from the unregulated lead as a signal to V684 screen to help reduce ripple voltage appearing in the regulated output.

Capacitor C694 supplies fast changes in output voltage to the grid of error amplifier V684, reducing the ac output impedance of the regulator circuit. C676B also aids to reduce the ac impedance of the +300-volt supply.

On all Type 567s S/N 300-up, the +300-volt power supply is adjustable by R696 and R698. Both the -100- and +125-volt power supplies must be adjusted before calibrating R698.

-12.2-Volt Power Supply

The -12.2-volt regulator is similar to the -100-volt regulator except that it uses transistors instead of tubes. A full-wave rectifier consisting of D632A and B provides unregulated dc voltage to the regulator. A divider between -100 volts and ground is used to provide a constant -12 volts for the base of Q634. The output voltage of the regulator, appearing at the emitter of Q634, is compared to the voltage at the base. Because of this circuit arrangement, the voltage at the base of Q634 sets the output voltage of the supply.

Normally, the voltage at the emitter and base of Q634 will be nearly the same. If the voltage at the emitter changes because of a change in the supply output voltage, this changes the current through the transistor. This in turn produces a change in the collector voltage of Q634 and in the base voltage of Q644. The change at the base of Q644 is amplified at the collector and applied to the base of the series regulator transistor Q647. The change in base voltage of Q647 changes the voltage drop across Q647 in such a direction as to compensate for the change in output voltage, and the output then returns to normal.

As an example, if the output of the supply starts to go more negative, this causes Q634 to conduct more heavily. This produces a drop in the voltage at the collector of Q634 and at the base of Q644. The drop in voltage at the base of Q644 also causes this transistor to conduct more heavily, causing its collector voltage to change in the positive direction. The more positive voltage at the base of Q647 increases the voltage drop across Q647, thereby decreasing the output voltage of the supply to normal.

Fuse F647 is used to protect Q647 in the event the output is accidentally overloaded. Capacitor C646 reduces ripple voltage at the output of the regulator circuit.

On all Type 567s S/N 300-up, the -12.2-volt supply is adjustable by R630, R631, and R632. Both the -100- and +125-volt power supplies must be adjusted before calibrating R631.

+20-Volt Power Supply

Full-wave bridge rectifier D652A, B, C, and D rectifies voltage from terminals 11 and 12 of T601 and supplies power to the +20-volt regulator circuit. A voltage divider between +125 volts and ground sets the base of Q654 near +20 volts. The output voltage of the supply, appearing at the emitter of Q654, is compared to the voltage at the base.

If the supply voltage changes, the bias and conduction of Q654 is changed. Supply voltage changes are then amplified and inverted and applied to the base of emitter-follower Q653. Q653 provides current gain to the correcting signal and drives the base of Q657 to change its conduction and bring the output voltage back to normal. C654 provides a low ac impedance to Q654 base, reducing the supply ac output impedance. C656 and C657 also aid to reduce the supply ac output impedance.

Fuse F657 protects Q657 in the event the output is accidentally overloaded.

On all Type 567s S/N 300-up, the +20-volt supply is adjustable by R650 and R651. R650 is connected between the -12.2- and the output of the +20-volt supply. Thus, the -12.2- and +125-volt power supplies must both be adjusted to the correct voltage before adjusting R650 to set the +20-volt supply to the correct value.

High-Voltage Power Supply

Unregulated +400 volts from the +300-volt power supply is applied to the high-voltage oscillator, V800. V800 and its associated circuitry is a modified Hartley oscillator. C802 and the primary winding of T801 form the tuned circuit in the plate of V800. The oscillator operates at approximately 35 kc. High-voltage transformer T801 provides the high voltages and heater voltages for the rectifiers.

One secondary winding of T801 and rectifier V822 form a half-wave rectifier circuit which supplies approximately -3.3 kv to the cathode of the crt. A separate secondary winding of T801 and V832 supply a floating negative voltage for the control grid of the crt.

A voltage divider between the -3.3-kv output of V822 and +300 volts supplies voltage to the focusing grid of the crt and also applies a sample of the power-supply output to the high-voltage regulator circuit. Potentiometer R841 sets the high voltage. If the output voltage changes from this set value, a portion of the change appears at the grid of V814B as an error signal. The error signal is amplified by V814B and V814A and applied to the screen grid of the High Voltage Oscillator V800. The change in screen voltage on the oscillator causes either an increase or a decrease in the amplitude of the oscillations. The change in amplitude of the oscillations is always in a direction to compensate for the error in the output voltage.

The output voltage from V832 is not regulated directly, but is regulated indirectly by the operation of the V800 screen grid regulator loop.

Capacitor C842 greatly increases the ac loop gain of the high-voltage regulator circuit. This permits the regulator to quickly compensate for rapid changes in the output voltage.

Crt Circuits

Voltage for the control grid of the crt is obtained from R834 and R833 at the output of the control grid power supply. By varying the setting of the INTENSITY control R834, the voltage at the control grid relative to the cathode can be changed to provide the desired display brightness. Beginning with S/N 249, neon glow tubes B852-B853 were added. The bulbs ignite only when the INTENSITY control is fully counterclockwise. Thus, both the grid and cathode of the crt are protected from arcing.

Voltage for the focus grid of the crt is obtained from potentiometer R845. The Astigmatism element receives its voltage from potentiometer R864. Varying both R845 and R864 affects the crt spot size.

The presence and intensity of the crt beam is controlled by signals from each of the three plug-in units used with the Type 567. The oscilloscope uses deflection unblanking during the sweep interval. In this method an additional pair of deflection plates in the crt electron gun deflects the beam off the screen except during the sweep. When the horizontal sweep is triggered, the unblanking signal is applied from the time-base unit through terminal 13 of J21 to one of the unblanking deflection plates. The unblanking signal then moves the electron beam rapidly on screen for the duration of the sweep. The beam is then deflected off screen again until time for the next sweep.

Chopped mode blanking signals from a multi-trace vertical plug-in unit are applied through terminal 24 of J11 to the cathode of the crt. These blanking signals are used to blank switching transients which result when the plug-in unit is operated in the chopped mode. Chopped blanking prevents the chopping transients from being displayed on the crt at normal intensity.

Intensity brightening of the crt trace by either the digital unit or a two-sweep time-base unit is accomplished by coupling brightening signals to the reference voltage for the crt grid-voltage supply. The brightening signal from the digital unit changes the overall grid supply voltage through terminal 15 of J32. The brightening signal from the two-sweep timing unit changes the overall grid supply voltage through terminal 14 of J21. Two diodes, D836 and D837, provide a low-impedance return for the crt grid circuit, reducing intensity modulation caused by any normal power-supply ripple. Diode D835 disconnects +125 volts applied to terminal 14 of J21 by some plug-in units.

Sharply differentiated blanking pulses from the vertical sampling unit are applied to the crt cathode through terminal 24 of J11 to turn off the crt beam between sampling dots. Thus, the crt beam is blanked between dots, avoiding possible display confusion.

A beam rotator coil around the crt is used to align the oscilloscope trace with the horizontal graticule markings.

The magnetic field set up by the coil deflects the electron beam up on one side of the crt and down on the other. By varying the strength and direction of the field with the CRT BEAM ROTATOR control, the trace can be aligned with the graticule markings.

Amplitude Calibrator (S/N 2060-up)

The Amplitude Calibrator is a two-frequency signal source that is crystal controlled at 20 kc and rc time-constant controlled at approximately 1 kc. An astable multivibrator drives both a divide-by-two bistable multivibrator and a positive slope differentiator circuit. Square waves of known amplitude at the front-panel connectors come from the $\div 2$ circuit, and positive pretrigger pulses come from the differentiator circuit. The $\div 2$ circuit clamps off the differentiator every other astable cycle. Thus, the positive pretrigger pulse is generated approximately $\frac{1}{4}$ cycle before each positive portion of the output square wave.

Selection of output frequency is by a front-panel 20 KC \approx 1 KC toggle switch. The switch is open for 20-kc operation, but is closed for 1-kc operation. 20-kc operation places a series-mode 40-kc crystal in the feedback path. 1-kc operation places a 0.0033 μ f capacitor across the crystal, making feedback capacitive and the frequency rc controlled.

Astable Oscillator. Q900 and Q914 form a common-emitter astable multivibrator. The regenerative feedback circuit consists of the common connection of the two transistor emitters, and the crystal (Y905) from Q900 collector to Q914 base for 20-kc operation, or C904-D904 in parallel with the crystal for 1-kc operation. D904 is reverse biased (for 20-kc operation) by the voltage divider R912-R914; thus C904 is effectively switched out of the circuit. D904 is forward biased when SW915 connects R915 in parallel with R912, connecting C904 in parallel with Y905. Both circuit conditions are shown in simplified form in Fig. 3-1.

Fig. 3-1a shows the active circuit elements for 20-kc operation. Note the parallel resistance value with equivalent voltage source for R908 and R909. The +21 volts is the value of divider voltage when no current is drawn through either R905 or R906. If either base draws current through its 20-k resistor, the +21 volts acts as if it has a 16.6-k source resistance. Fig. 3-1b shows the active circuit elements for 1-kc operation. D904 is a low resistance when it is forward biased placing C904 in parallel with Y905.

Fig. 3-2 shows four astable circuit waveforms during 1-kc operation. D904 and C904 are drawn between waveforms for study purposes. Note that D904 is forward biased when Q900 collector is positive, but reverse biased when Q900 collector is near ground; C904 receives a charge while Q900 collector is positive, but loses its charge when Q900 collector is near ground.

A 2-kc operation cycle is as follows: Assume Q900 collector has just gone positive. D904 connects C904 from Q900 collector to Q914 base. Q914 base is taken about 12.6 volts more positive (due to previous C904 18-volt charge) cutting Q914 off. Q900 collector low resistance connects C904 between +15 volts and +32.6 volts at the junction of Q914 base and R905. Q914 base draws no current, so C904 begins to discharge through R905 and Q900 collector. Point #1 of Fig. 3-2 has just been reached. As Q914 base wave-

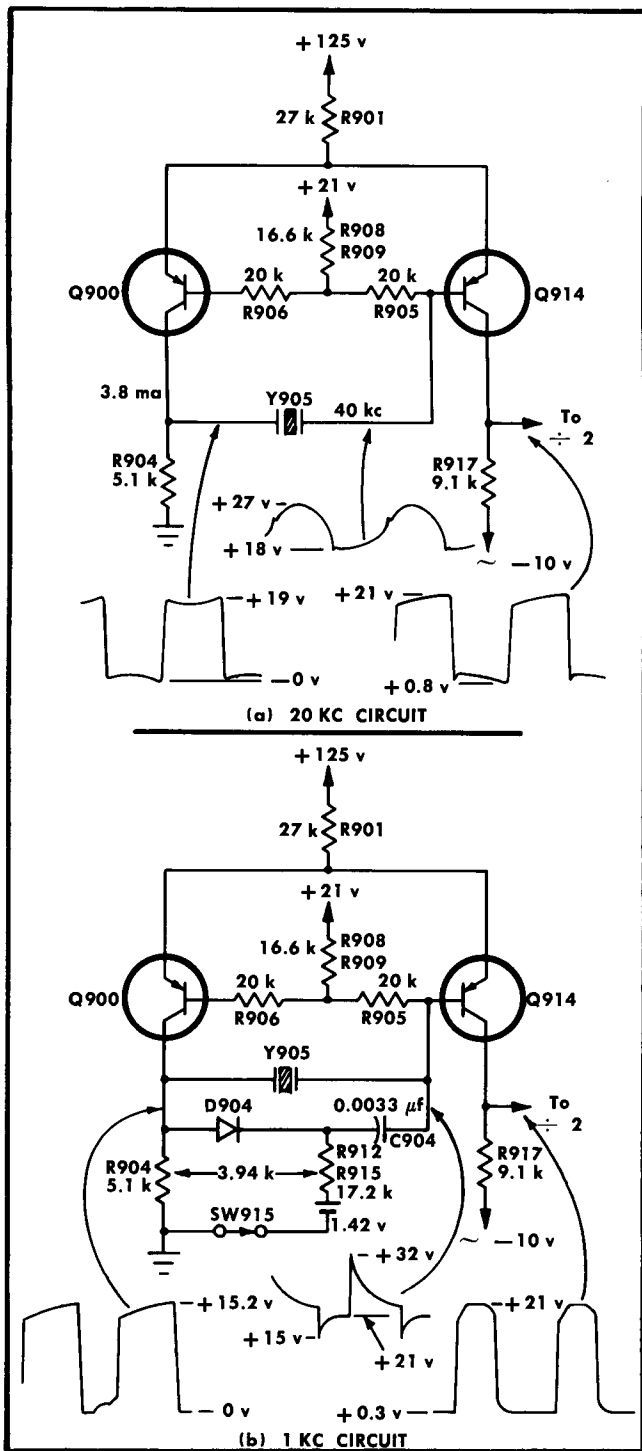

Fig. 3-1. Simplified Amplitude Calibrator astable circuits.

form drops toward +21 volts, Q900 collector voltage is prevented from quite reaching +15.2 volts. The fast drop of Q914 base waveform and slow rise of Q900 collector waveform are due to C904 discharge. As the base of Q914 reaches +22.5 volts (point #2 of Fig. 3-2) Q914 begins to conduct, adding to the current of common emitter resistor R901. Regenerative action follows immediately as Q914 emitter carries Q900 emitter toward reverse bias. Q900 col-

lector falls as its emitter is taken negative, disconnecting D904 from C904. C904 is now connected at one end to about +1.42 volts through the equivalent resistance of 17.2 k (parallel resistance value of R912 and R915), and to the base of Q914 at the other end. The charge on C904 limits its fall at D904 cathode to about +8 volts because Q914 base begins to draw current when the base reaches +15 volts. The parallel resistance of R912-R915 and the base current of Q914 recharge C904. As the current through R912-R915 decreases (nearing point #3 of Fig. 3-2) the current through Q914 decreases letting the common emitter voltage go positive, causing Q900 to again conduct. Q900 conduction begins and its collector rises about 2.5 volts before D904 again connects the regenerative feedback circuit so the astable will flip. As D904 conducts, fast regenerative action turns Q914 off and Q900 on. The cycle is complete and C904 begins to discharge to repeat the process.

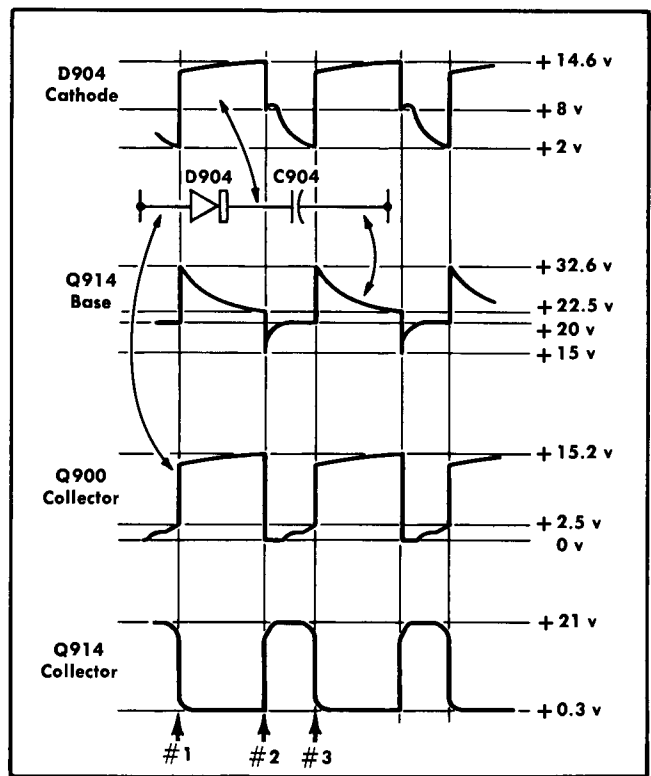

Fig. 3-2. Astable multivibrator waveforms during 1-kc operation.

A 40-kc operation cycle follows the same sequence of events, except that Y905 is the feedback element between Q900 collector and Q914 base and D904 is reverse biased all the time. Y905 is an open circuit at all frequencies other than its series resonant frequency of 40 kc. The waveform at the base of Q914 in Fig. 3-1a shows the crystal sine wave nature when Q914 is cut off. Base current of Q914 flattens off the waveform bottom as Y905 provides turn-on base current during the time Q914 conducts.

Once 40-kc oscillation is established, the crystal assumes a mechanical vibration at the rate of oscillation. At the time the operator switches from 20-kc to 1-kc operation the crystal mechanical vibration is seen to die out during the first few

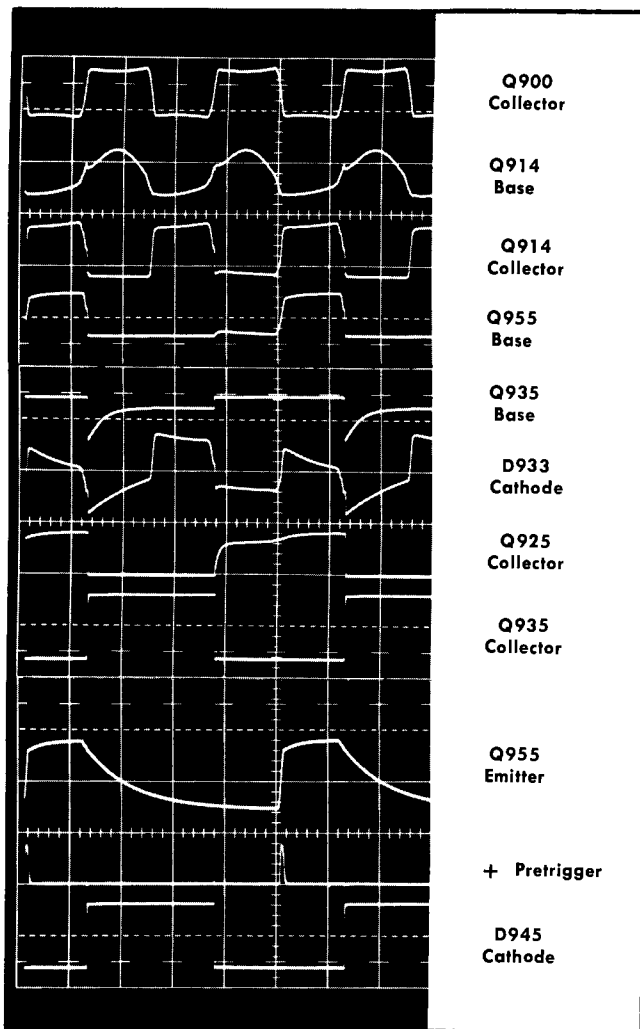

Fig. 3-3. Amplitude Calibrator time diagram. Operation at 20 kc (partial graticule shown).

moments of 1-kc operation. Actually, the crystal aids in coupling energy when the astable is operating at 2 kc because the rapid voltage changes at each switching time contain high frequencies. The crystal then "locks in" the 2-kc oscillations causing the 1-kc output signal to be very stable. The actual frequency of 1-kc output cannot be specified tightly because the crystal's ability to lock-in 2-kc oscillations is dependent upon transistor beta and other variables.

$\div 2$ Multivibrator. Q925 and Q935 form a triggerable bistable multivibrator that divides the astable output frequency by two. It drives the output voltage divider and controls the +Pre Trigger emitter-follower Q955. The time relationships of several points throughout the whole Amplitude Calibrator are shown in Figs. 3-3 and 3-4. Each figure is made up of three multiple-exposure photographs made by externally triggering the test oscilloscope to guarantee time coincidence of each waveform; voltage amplitudes are uncalibrated.

Assume Q925 is conducting and is saturated so its collector voltage is less than a volt positive. Voltage divider

R925-R937 from Q925 collector to Q935 base sets Q935 base at about -1.5 volts, assuring that Q935 is completely cut off. D935 in Q935 collector circuit permits the output voltage divider to disconnect from R934-R935. D935 anode voltage is about $+5.5$ volts and its cathode and Q935 collector are at about $+20.2$ volts. Q935 collector voltage is set by the output voltage divider. Thus, D935 assures that the output voltage divider will not be loaded by the $\div 2$ circuit during the positive portion of the output signal. The output voltage is adjusted by R943, and is completely independent of the $\div 2$ circuit.

Q925 conduction draws current through both its normal collector load R924, and through R952-D953-D954-R954 to bias D951 and Q955 to cutoff. When D951 is cut off, Q955 cannot receive positive pulses from the astable circuit.

The $\div 2$ multivibrator switches states whenever the astable output goes negative. R922 holds D923 cathode slightly negative in respect to its anode, but not conducting. As the astable output goes negative, C923 couples a turn-off pulse through D923 to the base of Q925. (D933 was held about 7 volts reverse biased with Q935 cut off.) As Q925 starts

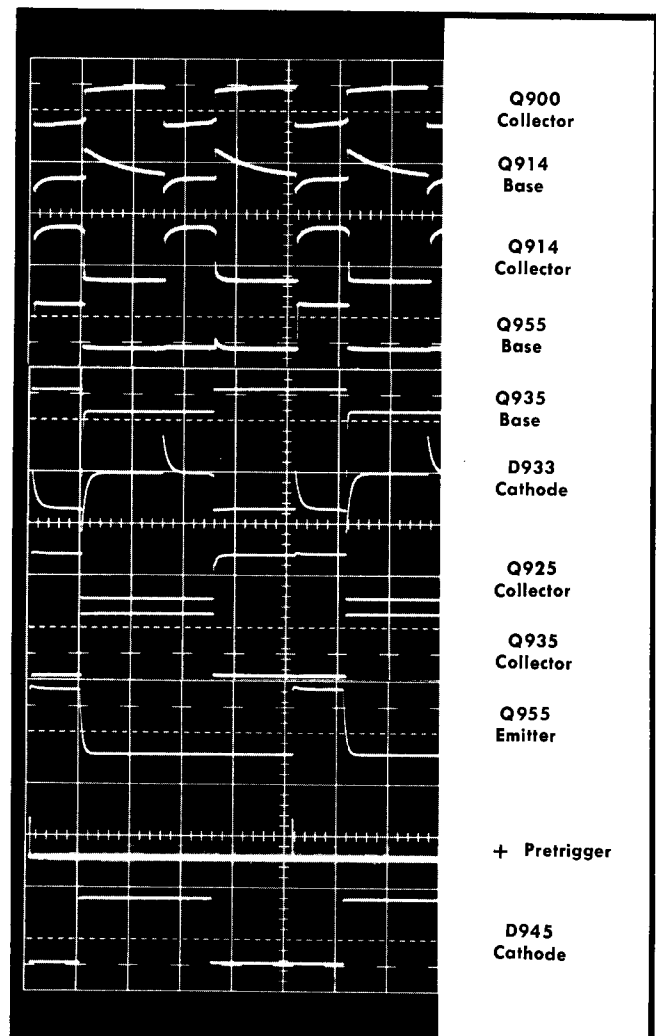

Fig. 3-4. Amplitude Calibrator time diagram. Operation at 1 kc (partial graticule shown).

Circuit Description—Type 567

to turn off, its collector voltage rises positive, C925 applies turn-on bias to Q935 base and the $\div 2$ circuit switches. Regenerative feedback is applied to Q925 base by Q935 collector and C935.

Q935 collector now rests at less than +0.2 volt, close enough to ground that D945 of the output divider carries no current. Q935 collector current passes through both its normal collector load R934 and the series resistance of R940-R941-R943.

Q925 is cut off and its collector rests at +5 volts. The $\div 2$ circuit will change states the next time the astable output goes negative and the cycle will repeat.

+Pre Trigger circuit. The +Pre Trigger circuit is an emitter-follower and differentiator circuit that responds to positive signals from the astable circuit if Q925 is cut off. When Q925 is conducting, D951 anode is held at about +1.5 volts preventing any positive signal from being applied to the base of Q955. Thus it is that a +Pre Trigger pulse is formed only when the output signal is at ground and Q925 is cut off. D954 allows Q925 collector to rise for rapid switching of the $\div 2$ circuit. C954 serves as a low impedance so any stored charge in D954 will not be applied to Q955 base. C954 also releases Q955 base slowly as R954 charges C954 so Q925 positive change does not reach Q955 base as a signal. D953 disconnects C954 from Q955 base so signals can couple through D951 and turn on the emitter-follower. Q955 emitter faithfully follows every other positive astable output pulse. C957 differentiates Q955 emitter signal and D959 couples only the positive pulse to the output. Any negative change at Q955 emitter, from either the astable

signal drop or from Q925 collector pulling down, is stopped from reaching the output by D959.

Amplitude Calibrator (S/N 101-299)

The calibrator consists of a bistable multivibrator, V884A and V884B, which is triggered at the line frequency by a 6.3-volt ac signal applied to the cathode of V884A. The signal at the cathode of V884A switches the multivibrator between its two states. When V884A is conducting, the low voltage at its plate cuts off V884B. Or, when V884B is conducting, its low plate voltage lowers the grid voltage of V884A sufficiently to cut V884A off. Thus, both tubes do not conduct at the same time.

When V884A is cut off, the voltage at the control grid and cathode of V884B is determined by the setting of the CAL AMPL control, R871. This determines the maximum voltage level reached by the square-wave output. The square waves start at ground at the time V884B is cut off and reach the maximum amplitude established by R871 when V884A is cut off. The CAL AMPL control is adjusted to give the appropriate output square-wave amplitudes via the output divider R885 through R889.

Amplitude Calibrator (S/N 300-2049)

R890 was added at S/N 300 so the 0.5 output jack will provide a 100-mv peak-to-peak signal into 50 ohms. No other alterations were made and the circuit description is the same as above.

SECTION 4

MAINTENANCE

Visual Inspection

If trouble occurs in the Type 567, make sure the associated equipment is operating and the controls are properly set. If it is determined that the trouble is definitely in the Type 567, a visual check may reveal the cause. Defects such as loose or broken connections, frayed or broken cables, damaged connectors, and burned components can generally be detected by a visual inspection. Except for heat-damaged components the remedy for such defects is obvious. Overheating of components is usually a symptom of other, less apparent troubles in the circuit. For this reason, it is essential to determine the actual cause of overheating before the damaged parts are replaced; otherwise, the damage may be repeated.

Parts Removal and Replacement

Whenever a part is replaced, check and adjust the instrument calibration as necessary. Most parts in the Type 567 can be replaced without detailed instructions. Some, however, are best removed and replaced by using definite procedures contained in the following paragraphs. (Parts ordering information is included in the Parts List section of this manual.)

CAUTION

Turn ac power off before removing tubes or transistors from their sockets.

Transistor Replacement. Transistors should not be replaced unless they are actually defective. Transistor defects usually take the form of the transistor opening, shorting, or developing excessive leakage. To check a transistor for these and other defects, use a transistor curve display instrument such as a Tektronix Type 575. However, if a good transistor checker is not readily available, a defective

transistor can be found by signal-tracing, by making in-circuit voltage checks, by measuring the transistor forward-to-back resistance using proper ohmmeter resistances, or by using the substitution method. The location of all transistors is silk-screened on the chassis next to each socket.

To check transistors using a voltmeter, measure the emitter-to-base and emitter-to-collector voltages and determine if the voltages are consistent with the normal resistances and currents in the circuit (see Fig. 4-1).

To check a transistor using an ohmmeter, know your ohmmeter ranges, the currents they deliver, and the internal battery voltage(s). If your ohmmeter does not have sufficient resistance in series with its internal voltage source, excessive current will flow through the transistor under test. Excessive current and/or high internal ohmmeter source voltage may permanently damage the transistor.

NOTE

As a general rule, use the $R \times 1 \text{ k}$ range where the current is usually limited to less than 2 ma and the internal voltage is usually $1\frac{1}{2}$ volts. You can quickly check the current and voltage by inserting a multimeter between the ohmmeter leads and measuring the current and voltage for the range you intend to use.

When you know which ohmmeter ranges will not harm the transistor, then use those ranges to measure the resistance with the ohmmeter connected both ways as given in Table 4-1.

TABLE 4-1
Transistor Resistance Checks

Ohmmeter Connections ¹	Resistance Readings That Can Be Expected Using the $R \times 1 \text{ k}$ Range
Emitter-Collector	High readings both ways (about 60 k to around 500 k).
Emitter-Base	High reading one way (about 200 k or more). Low reading the other way (about 400 Ω to 2.5 k).
Base-Collector	High reading one way (about 500 k or more). Low reading the other way (about 400 Ω to 2.5 k).

¹Test prods from the ohmmeter are first connected one way to the transistor leads and then the test prods are reversed (connected the other way). Thus, the effects of the polarity reversal of the voltage applied from the ohmmeter to the transistor can be observed.

If there is doubt about whether the transistor is good or not, substitute a new transistor, but first be certain the circuit voltages applied to the transistor are correct before making the substitution.

When checking transistors by substitution, be sure that the voltages and loads on the transistor are normal before making the substitution. If a transistor is substituted without first checking out the circuit, the new transistor may immediately be damaged by some defect in the circuit.

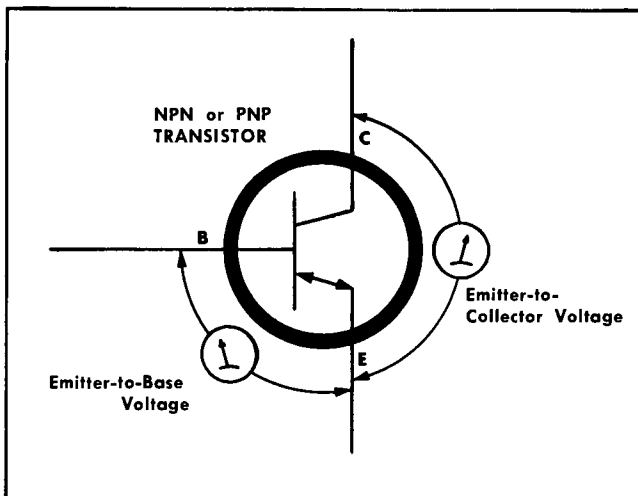

Fig. 4-1. In-circuit voltage checks NPN or PNP transistors.

Maintenance—Type 567

Tube Replacement. Tester checks on tubes used in the Type 567 are not recommended. Tube testers sometimes indicate a tube to be defective when that tube is operating satisfactorily in a circuit, or they may fail to indicate tube defects which affect the performance of the circuits. The criterion for the usability of a tube is whether or not it works properly in the circuit. If it does not, it should be replaced. Unnecessary replacement is not only expensive but may also require needless recalibration of the instrument.

Lamp Replacement. The graticule illumination lamps are bayonet Type 44, 6-8 volt bulbs. Remove the four bezel nuts, lift away the bezel and graticule eyebrow, and replace the lamps in the normal manner.

Air Filter

The Type 567 Oscilloscope is cooled by air drawn through a plastic disposable filter located at the rear of the instrument. If the filter becomes excessively dirty, it will restrict the flow of air and may cause overheating. High internal temperatures will not only reduce the lifetime of the instrument components, but may also cause the thermal cutout to open at inconvenient times. If the oscilloscope is wired for 117 volts, the fan motor continues to run when the thermal cutout opens but all other power in the instrument is disconnected. If the instrument is wired for 234 volts, all power in the instrument including the fan is disconnected when the cutout opens. Any time that the thermal cutout opens, the filter should be checked immediately. When the interior temperature of the instrument has returned to the safe level, the thermal cutout will close to reapply power to the instrument.

The filter should be visually checked every few weeks. It should be replaced at least every three or four months, and more often if required.

Fan Motor

Fan motor bearings have been lubricated at the factory and should not require further lubrication more often than about every six months. One or two drops of light machine oil on the bearings is adequate.

Removal of Panels

The side, top, and bottom panels of the Type 567 can be removed separately for maintenance work. All panels are held in place by small coin-slot fasteners. To remove the panels, use a screwdriver or coin to rotate the fastener approximately two turns counterclockwise. Pull the upper portion of the side panels outward from the top. After first releasing the fasteners, the top and bottom panels can be lifted off. Panels can be replaced by reversing the order of their removal.

Cleaning

The Type 567 should be cleaned as often as operating conditions require. Accumulation of dirt in the instrument can cause overheating and component breakdown. Dirt on components acts as an insulating blanket and prevents efficient heat dissipation. It also provides a possible electrical conduction path.

Loose dust accumulated on the outside of the Type 567 can be removed with a cloth or small paint brush. The paint brush is particularly useful for dislodging dust on and around the front-panel controls. Dirt which remains can be removed with a soft cloth dampened in a mild solution of water and detergent. Abrasive cleaners should not be used.

The high-voltage circuits, including parts located under the high-voltage shield, should receive special attention. Excessive dust and dirt in these areas may cause high-voltage arcing and result in improper instrument operation.

CAUTION

Avoid the use of chemical cleaning agents which might damage the plastics used in this instrument. Some chemicals to avoid are benzene, toluene, zylene, acetone, or similar solvents.

To clean the crt protector plate and the face of the crt, first remove the four bezel mounting nuts. Then, remove the bezel and the protector plate. Clean all surfaces with a soft, lint-free cloth dampened with mild detergent and water. Repeat with a cloth dampened with water only.

Recalibration

To assure accurate measurements check the calibration of this instrument after each 500 hours of operation or every six months if used intermittently. Complete calibration instructions are given in Section 5.

The calibration procedure can also be helpful in localizing certain troubles in the instrument. In some cases, minor troubles, not apparent during normal use, may be revealed and/or corrected by recalibration.

Resistor Coding

The Type 567 uses a number of very stable metal film resistors identified by their gray background color and color coding.

If the resistor has three significant figures with a multiplier, the resistor will be EIA color coded. If it has four significant figures with a multiplier, the value will be printed on the resistor. For example, a 333-k resistor will be color coded, but a 333.5-k resistor will have its value printed on the resistor body.

The color-coding sequence is shown in Fig. 4-2, and Table 4-2.

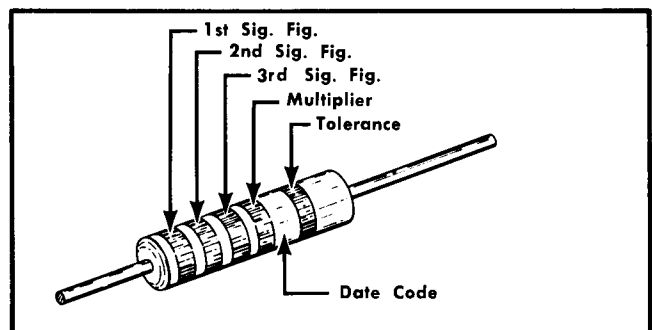

Fig. 4-2. Standard EIA color code for metal film resistors.

TABLE 4-2
Color Code Sequence

Color	1st Sig. Fig.	2nd Sig. Fig.	3rd Sig. Fig.	Multiplier	(±) % Tolerance
Black	0	0	0	1	-
Brown	1	1	1	10	1
Red	2	2	2	100	2
Orange	3	3	3	1,000	-
Yellow	4	4	4	10,000	-
Green	5	5	5	100,000	0.50
Blue	6	6	6	1,000,000	0.25
Violet	7	7	7	10,000,000	0.10
Gray	8	8	8	100,000,000	0.05
White	9	9	9	1,000,000,000	-
Gold	-	-	-	0.1	5
Silver	-	-	-	0.01	-
No Color	-	-	-	-	10

Ceramic Terminal Strip Replacement

A complete ceramic terminal strip assembly is shown in Fig. 4-3. Replacement strips (including studs) and spacers are supplied under separate part numbers. The old spacers may be reused unless they are damaged.

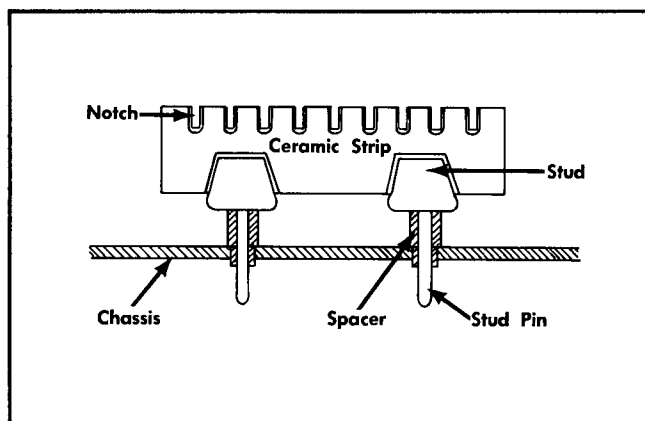

Fig. 4-3. Ceramic terminal strip assembly.

After the damaged strip has been removed, place the undamaged spacers in the chassis holes. Then, carefully press the studs into the spacers until they are completely seated. If necessary, use a soft mallet and tap lightly directly over the stud area of the strip.

Soldering

Ceramic Terminal Strips. Solder used on the ceramic terminal strips should contain about 3% silver. Ordinary 60/40 solder can be used occasionally without damage to the ceramic terminal strips. Use a 40- to 75-watt soldering iron with a 1/8" wide chisel-shaped tip. If ordinary solder is used repeatedly or if excessive heat is applied, the solder-to-ceramic bond can be broken.

A small supply of solder containing about 3% silver is included on a spool mounted inside the instrument near top center, just behind the Amplitude Calibrator. Additional solder should be available locally, or it can be purchased from Tektronix in one-pound rolls; order by Tektronix Part No. 251-0514-00.

Observe the following precautions when soldering ceramic terminal strips:

1. Use a hot iron for a short time. Apply only enough heat to make the solder flow freely.
2. Maintain a clean, properly tinned tip.
3. Avoid putting pressure on the ceramic terminal strip.
4. Do not attempt to fill the terminal-strip notch with solder; use only enough solder to cover the wires adequately.

Metal Terminals. When soldering metal terminals (e.g., switch terminals, potentiometers, etc.), ordinary 60/40 solder can be used. The soldering iron should have a 40- to 75-watt rating with a 1/8" wide chisel-shaped tip.

Observe the following precautions when soldering metal terminals.

1. Apply only enough heat to make the solder flow freely.
2. If a wire extends beyond the solder joint, clip the excess close to the joint.
3. Apply only enough solder to form a solid connection. Excess solder may impair the function of the part.

Cathode-Ray Tube

Use the following procedure for removal and replacement of the crt:

WARNING

Use care when handling a crt. Avoid striking it on any object that might cause it to crack and implode. Flying glass from an imploding crt can cause serious injury. Wear safety glasses or a plastic face mask.

1. Disconnect the instrument power.
2. Place the instrument on a level workbench.
3. Remove the crt bezel. Note the faceplate position.
4. Carefully remove the four neck-leads. Use long-nose pliers and slowly pull each clip off its neck pin.
5. Loosen the 10-32 bolt in the white plastic crt rear neck clamp.
6. Place one hand over the crt face. With the other hand push gently on the crt socket until the tube moves slightly forward. Remove the socket and push on the center of the crt base. Carefully guide the tube out the front, so as not to touch the magnetic shield with the neck pins.

To install a new crt:

1. Position the tube with two neck pins at both the left side and top.
2. Carefully insert the tube into the magnetic shield, being careful not to touch the shield with the neck pins.

Maintenance—Type 567

3. Extend the finger of one hand into the rear end of the shield to help guide the base into place. Push the crt into place so the front of the tube is correctly positioned as noted above.

4. Tighten the 10-32 bolt in the plastic clamp until the crt neck is held firmly. DO NOT OVERTIGHTEN.

5. Use long-nose pliers and carefully install the neck clips to the neck pins; observe the color code as marked on the shield near each opening.

6. If the crt face is not parallel with the front panel, use a $\frac{7}{64}$ " allen wrench to loosen the two blued bolts at the mounting clamp. Raise, lower, or otherwise position the crt socket so the face is correctly positioned. Tighten the blued bolts and check that the neck pins are not grounded.

7. Reinstall the bezel and recalibrate the instrument per the Calibration Procedure.

Troubleshooting

In the event of trouble, help with the particular problem may be obtained by reading the circuit description. Voltage checks and normal troubleshooting procedures will lead to the trouble and its correction.

When a trouble occurs in the instrument, an attempt should be made to isolate the trouble by quick operational and visual checks. You should first recheck the settings of all controls on the oscilloscope and plug-in units. Then, operate the front-panel controls to see what effect, if any, they have on the trouble. The normal or abnormal operation of the various controls will allow you to firmly establish the trouble symptoms.

Many troubles occurring will likely be located in one of the three plug-in units used with the Type 567. The first step required in troubleshooting the system is to determine if the trouble is in the Type 567 or in one of the plug-in units. The fastest and best way to determine this is by substituting other plug-in units in the oscilloscope. If other plug-in units are not available, a quick check can be made by measuring the output and ripple voltages of each regulated power supply and by checking the operation of the crt circuit. If the regulated power supplies and the crt circuit appear to be working properly, the trouble is probably located in one of the plug-in units. In this case, refer to the appropriate plug-in unit instruction manual for troubleshooting information. If the regulated power supplies or the crt circuit are not operating correctly, the trouble is probably in the Type 567.

Most troubles occurring in Tektronix instruments result from the failure of vacuum tubes or transistors. Therefore, if trouble occurs, tubes and transistors should be checked as one of the first steps. It is preferable to check them by substitution rather than with a tester since testers frequently fail to indicate certain troubles which can affect oscilloscope performance. When a tube develops shorted elements, associated components can be damaged. Look for burned resistors, etc., when replacing defective tubes.

To aid in troubleshooting the Type 567, typical circuit voltages are indicated on the circuit diagrams. These voltages may vary slightly from instrument to instrument, but should be quite close to the indicated values.

All wiring used in the Type 567 is color coded to facilitate circuit tracing. In addition, all regulated power-supply leads are coded with specific color combinations for easy identification. In general, three stripes are placed on the wires of the regulated supplies. The first color (widest stripe) indicates the first number in the voltage on that lead, using the standard EIA number-color equivalencies. The second color indicates the second number in the lead voltage and the third color is a multiplier. The method is similar to the color coding of resistors. Thus, the -100-volt leads are coded brown, black, brown. The voltage is positive if the main color of the wire is white and negative if the main color of the wire is black. Four colors would be required to give all the digits plus a multiplier for the +125-volt leads. To avoid this, the +125 leads are coded as +120; brown, red, brown on a white base.

Reference voltages for most of the low-voltage power supplies are obtained from the -100-volt supply. Therefore, if the -100-volt supply is not operating properly, operation of the other low-voltage supplies will be affected. For this reason, it is important, when trouble is detected in the low-voltage power supply, that the -100-volt supply be checked first. If the output of the -100-volt supply is normal, then troubleshoot the power supply where the trouble was first evident.

If the instrument is not operating, check the obvious things first. Check that the instrument is plugged in and that there is power at the socket. Check that the pilot lamp and tube heaters are lit. If necessary check the line fuse. When the obvious indications and troubles have been checked, proceed to a more detailed analysis of the trouble.

Once it has been determined that the Type 567 contains the trouble, turn off the power and remove all three plug-in

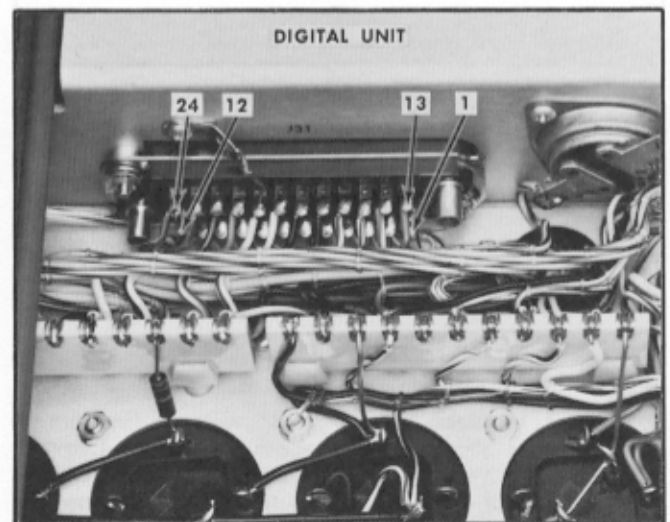

Fig. 4-4. Rear view of J31.

units. Measure power-supply resistances given in Table 4-3. Resistance is measured from the chassis to the low-voltage power-supply test points on J31 shown in Fig. 4-4. (J31 is the top connector right behind the digital unit plug-in cell. The pins numbered in Fig. 4-4 are the top row of pins, most easily reached with the leads of an ohmmeter.) If any resistance values are significantly lower than stated in Table 4-3, complete your circuit tracing using the diagrams at the back of this manual.

In the event of problems in the Amplitude Calibrator, detailed voltages and waveforms appear on the schematic diagram at the back of this manual. A voltmeter and/or a test oscilloscope, with attention to the information on the diagram and in the circuit description, should prove adequate for troubleshooting in the calibrator circuit. The location of all Amplitude Calibrator components is shown in Fig. 4-5.

TABLE 4-3
Power-Supply Resistances to Ground

General	Pin	Circuit	Approx. Res.
J31	18	−100-V regulated	9 k
J31	17	−12.2-V regulated	110 Ω
J31	16	+20-V regulated	900 Ω
J31	15	+125-V regulated	10 k
J31	14	+300-V regulated	55 k
J31	22	+75-V unregulated	20 k
J31	23	+22-V unregulated	4 k
J31	24	+380-V unregulated	30 k
C632	+ pin	+4-V unregulated	55 Ω
C562	shell	−5-V unregulated	120 Ω

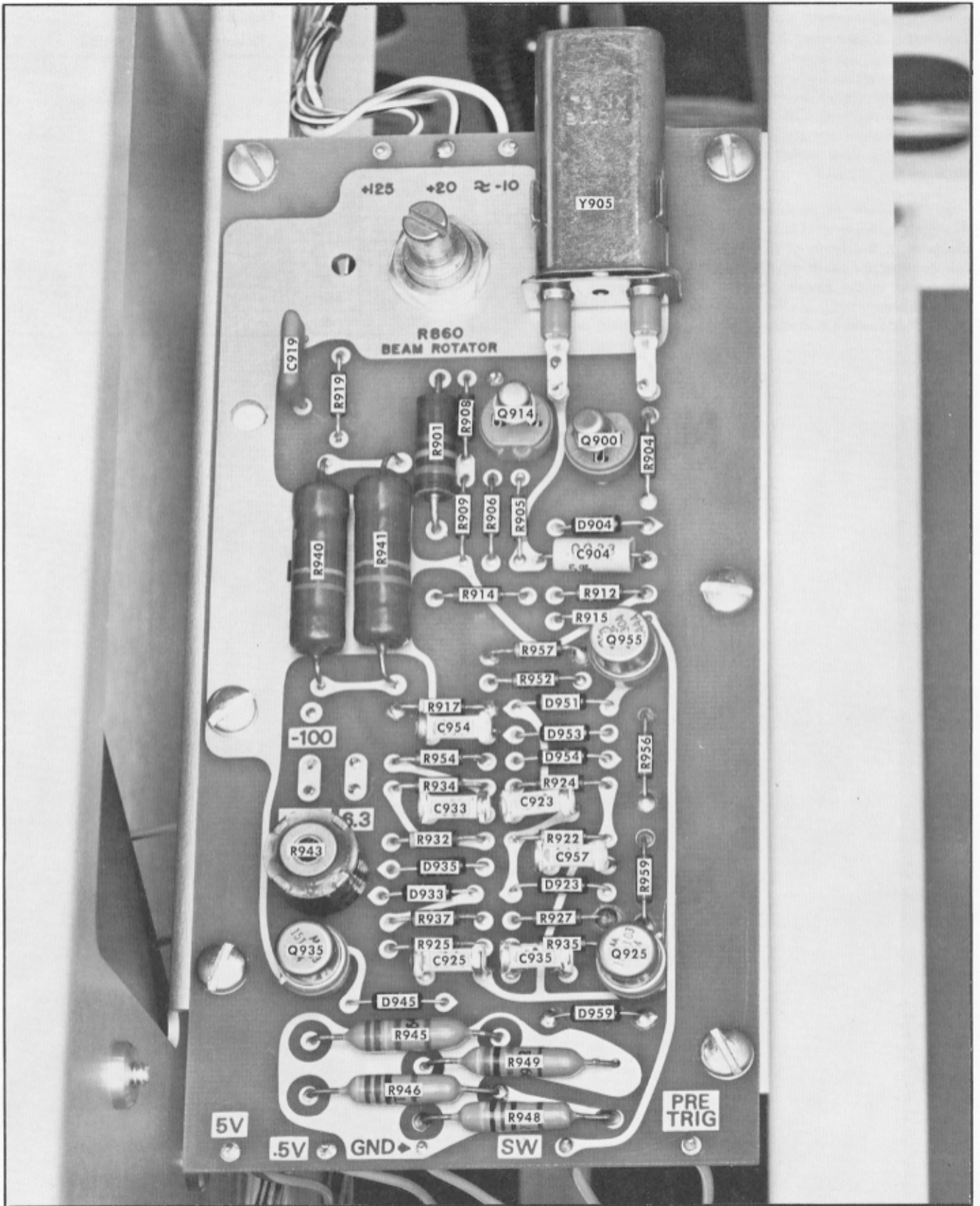

Fig. 4-5. Location of electrical components in Amplitude Calibrator.

SECTION 5

CALIBRATION

Introduction

The information in this section of the manual will enable you to calibrate and check the operation of the Type 567 Oscilloscope. This section may also be used as an aid in isolating troubles occurring within the unit.

Since the number of adjustment controls in the Type 567 is small, only a short time is required to calibrate the instrument.

Care should be taken in adjusting all power-supply voltages. The output of the —100-volt supply affects the output of the other supplies. Changes in power-supply voltages may require additional adjustments in the Type 567 and associated plug-in units to bring the system into proper calibration. Do not adjust the —100 VOLTS control unless the supply output is other than —100 volts.

Changes in high voltage will cause a change in the deflection factors of the crt. This will in turn affect display gain and timing adjustments. Therefore, unless the high voltage is more than 4% from its nominal level, no adjustment of the HIGH VOLTAGE control should be made. An exception is when a complete calibration of the Type 567 and plug-in units is to be made.

This procedure is correct for the Type 567 S/N 2060-up. Notes regarding calibration for earlier instruments follow the main procedure.

TEST EQUIPMENT REQUIRED

The following equipment, or its equivalent, is required to calibrate and check the operation of the Type 567.

(1) Test oscilloscope with a minimum deflection factor of 5 mv/div, such as the Tektronix Type 545B with Type H Plug-In Unit.

(2) 1× passive probe, such as Tektronix P6028, 3.5 foot with BNC connector. Tektronix Part No. 010-0120-00.

(3) Vertical plug-in unit, such as the Type 3A1 or Type 3S76. Use a plug-in that is normally used in the Type 567.

(4) Horizontal plug-in unit, such as the Type 2B67 or Type 3T77. Use a plug-in that is normally used in the Type 567.

(5) Digital unit, such as the Type 6R1A.

(6) Variable autotransformer. Should vary the line voltage from 105 to 125 volts ac (or 210 to 234 volts ac), minimum of 500-watt rating.

(7) Precision dc voltmeter capable of measuring 50 millivolts to 300 volts. Meter accuracy: ±0.2% or better. Minimum meter resistance of 20,000 Ω/v. Example: Fluke Type 801 Differential Voltmeter.

(8) Dc voltmeter capable of measuring —3.3 kv, ±4%. Minimum meter resistance of 20,000 Ω/v.

(9) Optional square-wave generator capable of delivering 100-kc positive-going square-wave signal between 50 and 100 volts peak to peak. Example: Tektronix Type 105 Square Wave Generator. Must use output inverter Tektronix Type TU-5/105 Adapter, Tektronix Part No. 013-0075-00.¹

(10) Optional special Tektronix 067-0500-00 Crt Deflection Capacitance Normalizer for 560 Series Oscilloscopes. Tektronix Part No. 067-0500-00.¹

(11) Two optional BNC 10× attenuators, Tektronix Part No. 011-0059-00.¹

(12) Optional 1% BNC 50 Ω termination, Tektronix Part No. 011-0049-00.¹

(13) Accurate time-mark generator capable of producing 100 μsec, 1 msec and 1 sec markers about 3 volts peak to peak, ±0.001% time accuracy. Example: Tektronix Type 180A Time-Mark Generator.

(14) Two 50 Ω coax cables with BNC connectors, 42-inch cable, such as Tektronix Part No. 012-0057-00. (A third cable will be needed in step 12e if sampling plug-in units are used.)

(15) A small screwdriver with insulated handle.

(16) Special low-capacitance tool, for adjusting crt deflection-plate capacitance.

**Tektronix
Part No.**

Handle, Nylon 003-0305-00

Adjusting Insert, Nylon 003-0304-00

PRELIMINARY PROCEDURE S/N 2060-UP

Install the type of plug-in units most used in the Type 567. If sampling units are sometimes used, install them; install the Type 6R1A Digital Unit. Connect the Type 567 power cord to the variable autotransformer and set the output voltage to 117 (234) volts. Switch on the Type 567 power and turn the INTENSITY control fully counterclockwise. Let the instrument warm up for 10 to 15 minutes and then remove the side and top panels.

SHORT FORM PROCEDURE

- 1. (Pg. 5-4) Check/Adjust —100-Volt Supply Voltage.
Real-time Plug-In Units: —99 to —101 volts.
Sampling Plug-In Units: —99.5 to —100.5 volts.
Final Value: _____ Volts.
- 2. (Pg. 5-4) Check/Adjust +125-Volt Supply Voltage.
Real-time Plug-In Units: +123.75 to +126.25 volts.
Sampling Plug-In Units: +124.37 to +125.63 volts.
Final Value: _____ Volts.
- 3. (Pg. 5-5) Check/Adjust +300-Volt Supply Voltage.
Real-time Plug-In Units: +297 to +303 volts.
Sampling Plug-In Units: +298.5 to +301.5 volts.
Final Value: _____ Volts.

¹Optional items required only if step 9 is performed. See note, page 5-12.

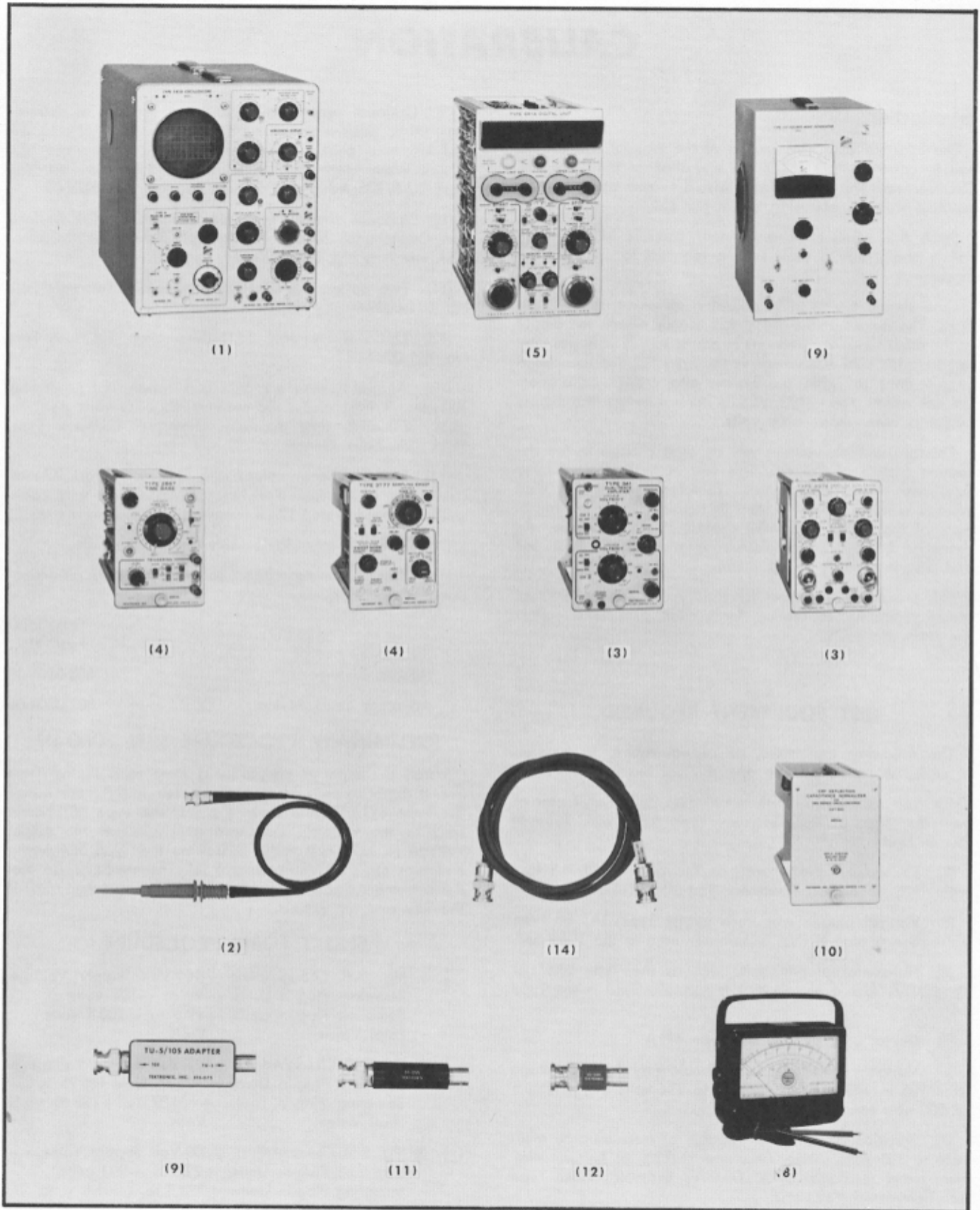

Fig. 5-1A. Recommended test equipment for calibrating the Type 567.

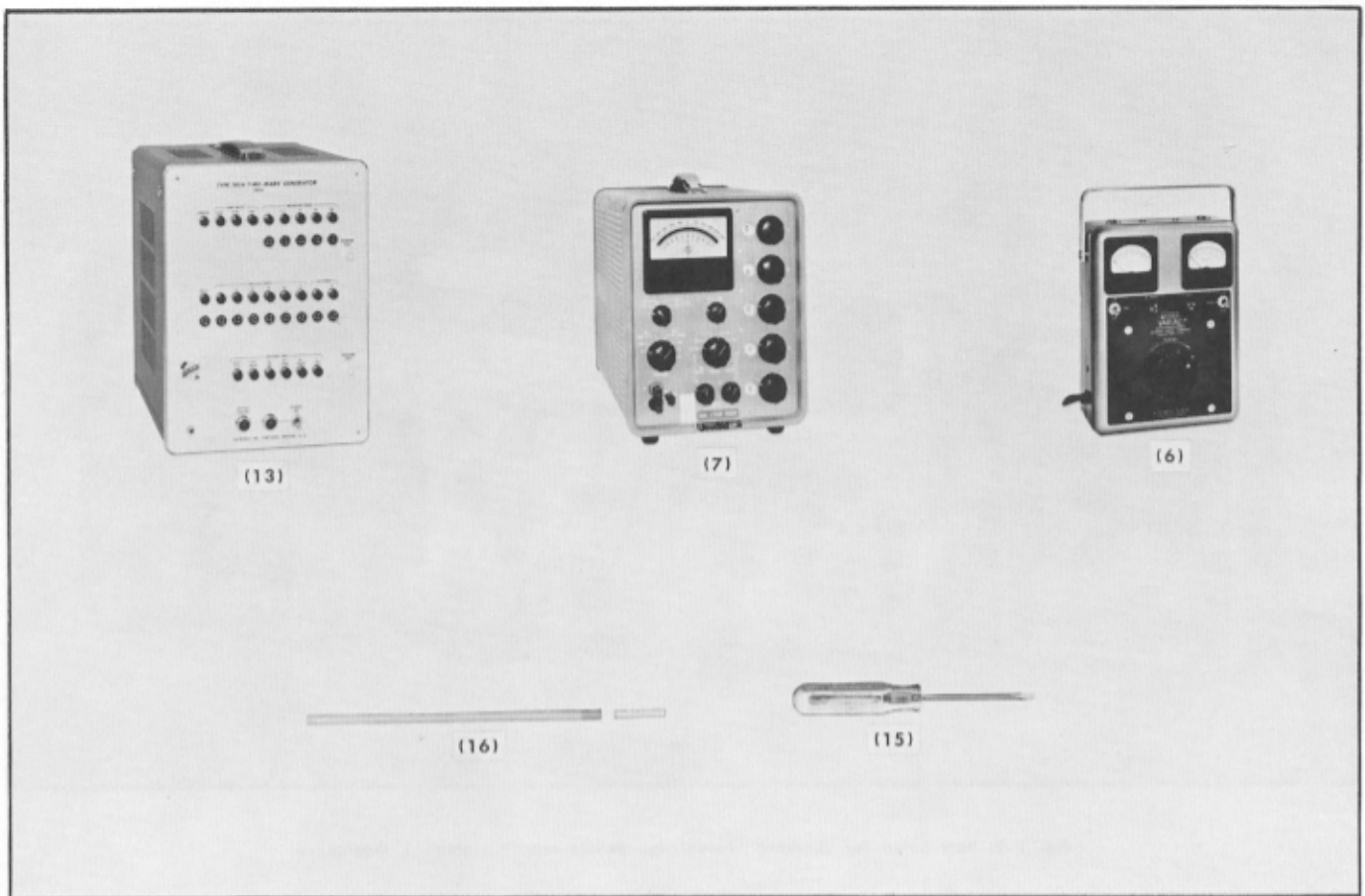

Fig. 5-1B. Recommended test equipment for calibrating the Type 567.

4. (Pg. 5-5) Check/Adjust -12.2-Volt Supply Voltage.
Limits: -12.078 to -12.322 volts.
Final Value: _____ Volts.
5. (Pg. 5-5) Check/Adjust +20-Volt Supply Voltage.
Limits: +19.8 to +20.2 volts.
Final Value: _____ Volts.
6. (Pg. 5-6) Check Low-Voltage Power Supply Ripple.
See Table 5-1.
- | | |
|-----------------|------------------|
| -100: _____ mv. | -12.2: _____ mv. |
| +125: _____ mv. | +20: _____ mv. |
| +300: _____ mv. | |
7. (Pg. 5-8) Check/Adjust -3300-Volt Supply Voltage.
Limits: -3268 to -3432 volts.
Final Value: _____ Volts.
8. (Pg. 5-10) Check Crt Deflection Factors.
Limits: Vertical 148.4 to 162.4 volts/8 div.
Horizontal 175 to 193 volts/10 div.
Final Value: Vert.: _____, Horiz.: _____
9. (Pg. 5-12)
Or
10. (Pg. 5-16) Check/Adjust Crt Deflection-Plate capacitance.

- Vertical Horizontal
11. (Pg. 5-20) Adjust Crt Beam Rotator, R860.
12. (Pg. 5-22) Check/Adjust Amplitude Calibrator.
- | |
|---|
| <input type="checkbox"/> Frequency, $\pm 0.1\%$. |
| <input type="checkbox"/> CAL AMPL Control, R943. |
| <input type="checkbox"/> Terminated output. |
| <input type="checkbox"/> +PRE TRIGGER Amplitude. |

ADJUSTMENT PROCEDURE

The following steps are given in the sequence required for proper calibration of the Type 567. Adjust only those controls that are out of tolerance. The digital system accuracy is dependent upon power-supply voltage accuracy. Adjustments of the -100-volt supply will usually require adjustment of the remaining low-voltage power supplies. All low-voltage supplies have a $\pm 1\%$ voltage tolerance, but all of them are capable of closer adjustment providing the test voltmeter is sufficiently accurate. Adjustment of any supply in the Type 567 will require some recalibration of the plug-in unit system. When using sampling plug-in units, it is desirable to adjust the -100-, +125- and +300-volt low-voltage supplies to within 0.5%.

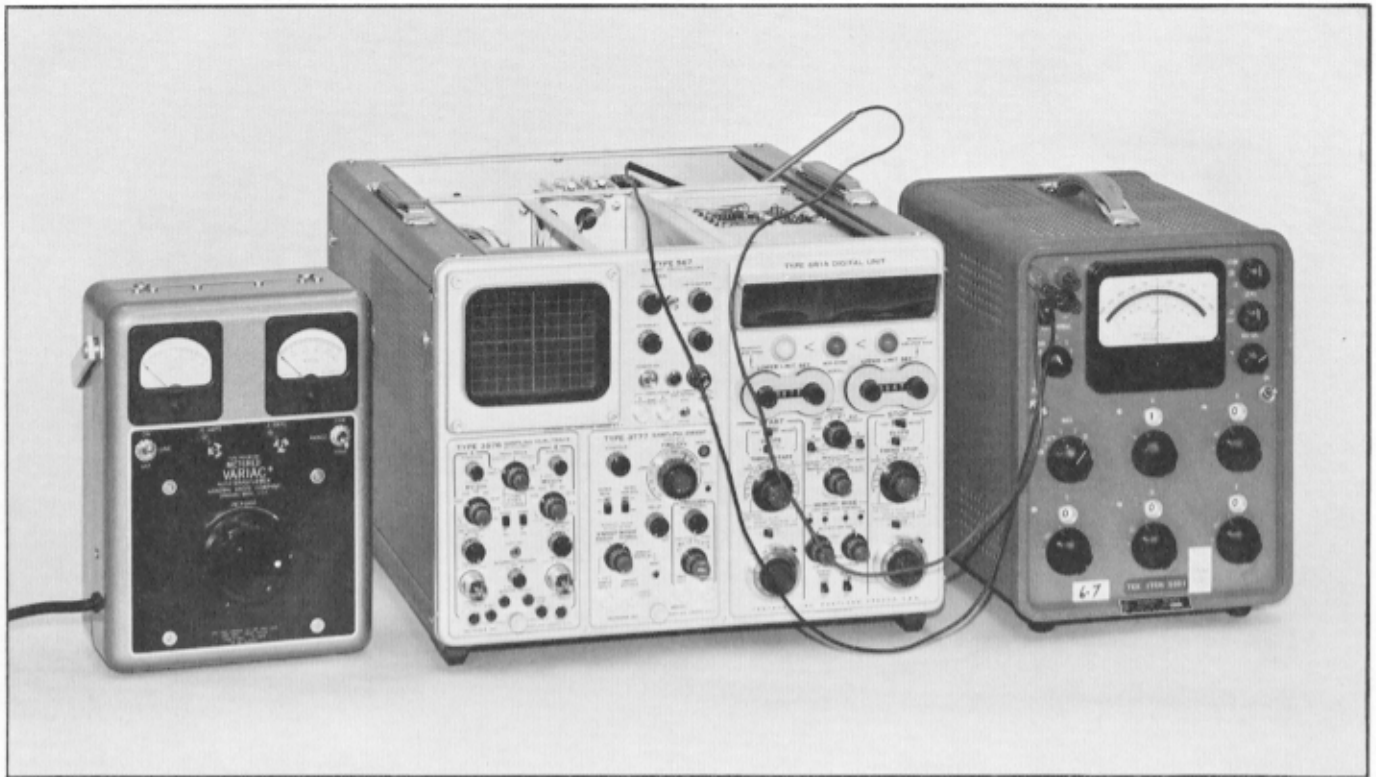

Fig. 5-2. Test setup for checking low-voltage power supplies, steps 1 through 5.

CONTROL SETTINGS

Type 567	
INTENSITY	Fully counterclockwise
Vertical Unit	
Position control(s)	Midrange
Mode	Channel A
Other controls	Optional
Horizontal Unit	
Position control	Midrange
No sweep	
Digital Unit	
All controls	Optional

1. Check/Adjust -100-Volt Supply Voltage

a. Set the autotransformer output to 117 volts (234 volts). Connect the precision voltmeter between the -100-volt test point and ground (see Fig. 5-3). If the voltage is outside the limits of -99 to -101 volts, adjust the -100 VOLTS control, R621 (see Fig. 5-4).

b. Slowly change the output of the variable autotransformer through the range of 105 to 125 volts (210 to 250 volts) and watch the precision voltmeter. The -100 volts should not change more than $\pm 1\%$ of the value read in the preceding paragraph when the autotransformer output was 117 volts (234 volts). As an example, if the 117-volt line value of the -100-volt supply was -99 volts, the voltage must not change outside the limits of -98.01 to -99.99 volts as the line voltage is varied from 105 to 125 volts.

If the supply changes more than $\pm 1\%$ as the line voltage is varied from 105 to 125 volts, the most probable cause is a defective regulator tube. Turn off the instrument and change V627. Repeat steps 1a and 1b.

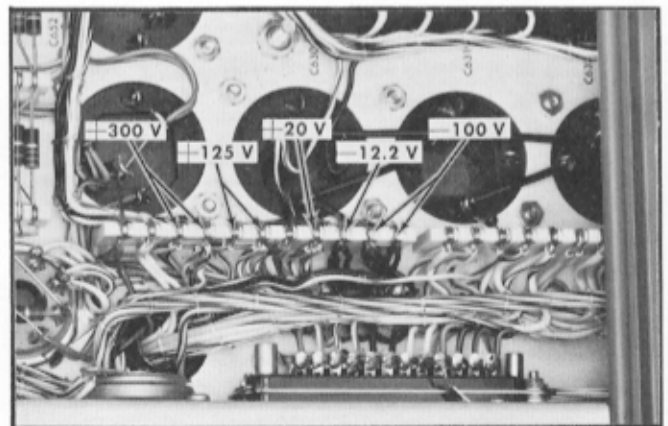

Fig. 5-3. Low-voltage power supply test points, steps 1 through 5.

2. Check/Adjust +125-Volt Supply Voltage

a. Set the autotransformer output to 117 volts (234 volts). Connect the precision voltmeter between the +125-volt test point and ground (see Fig. 5-3). If the voltage is outside the limits of +123.75 to +126.25 volts, adjust the +125 VOLTS control, R668 (see Fig. 5-4).

b. Slowly change the output of the variable autotransformer through the range of 105 to 125 volts (210 to 250 volts) and watch the precision voltmeter. The +125 volts should not change more than $\pm 1\%$ of the value read in the preceding paragraph when the autotransformer output was 117 volts (234 volts). As an example, if the 117-volt line value of the +125-volt supply was +125.5 volts, the voltage must not change outside the limits of +124.245 to +126.755 as the line voltage is varied from 105 to 125 volts.

If the supply changes more than $\pm 1\%$ as the line voltage is varied from 105 to 125 volts, the most likely cause is a defective regulator tube. Turn off the instrument and change V677. Repeat steps 2a and 2b. (The +125-volt supply can be caused to vary more than $\pm 1\%$ if the -100-volt supply varies more than $\pm 1\%$.)

3. Check/Adjust +300-Volt Supply Voltage

a. Set the autotransformer output to 117 volts (234 volts). Connect the precision voltmeter between the +300-volt test point and ground (see Fig. 5-3). If the voltage is outside the

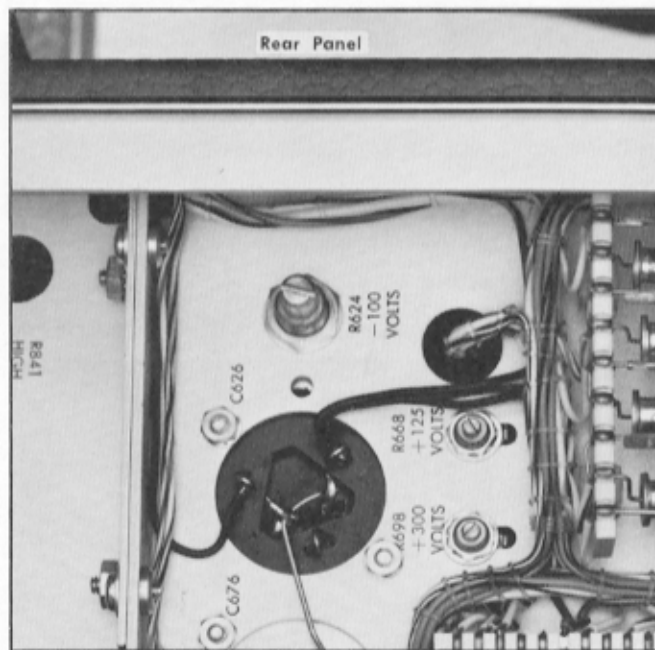

Fig. 5-4. Upper chassis low-voltage power supply adjustment locations.

limits of +297 to +303 volts, adjust the +300 VOLTS control, R698 (see Fig. 5-4).

b. Slowly change the output of the variable autotransformer through the range of 105 to 125 volts (210 to 250 volts) and watch the precision voltmeter. The +300 volts should not change more than $\pm 1\%$ of the value read in the preceding paragraph when the autotransformer output was 117 volts (234 volts). As an example, if the 117-volt line value of the +300-volt supply was +301.6 volts, the voltage must not change outside the limits of +297.584 to +304.616 volts as the line voltage is varied from 105 to 125 volts.

If the supply changes more than $\pm 1\%$ as the line voltage is varied from 105 to 125 volts, the most likely cause is a defective regulator tube. Turn off the instrument and change

V677. Repeat steps 3a and 3b. (The +300-volt supply can be caused to vary more than $\pm 1\%$ if the -100-volt supply varies more than $\pm 1\%$.)

4. Check/Adjust -12.2-Volt Supply Voltage

a. Connect the precision voltmeter between the -12.2-volt test point and ground (see Fig. 5-3). If the voltage is outside the limits of -12.078 to -12.322 volts, adjust the -12.2 VOLTS control R631 (see Fig. 5-5).

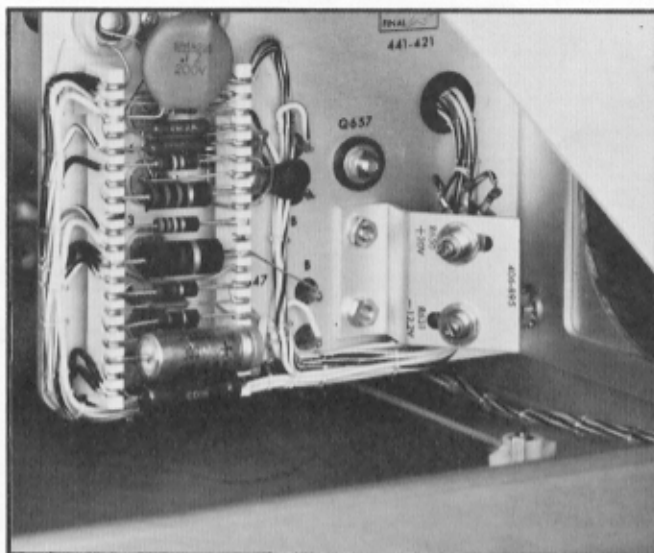

Fig. 5-5. Right side low-voltage power supply adjustment locations.

b. Slowly change the output of the variable autotransformer through the range of 105 to 125 volts (210 to 250 volts) and watch the precision voltmeter. The -12.2 volts should not change more than $\pm 1\%$ of the value read in the preceding paragraph when the autotransformer output was 117 volts (234 volts).

If the supply changes more than $\pm 1\%$ as the line voltage is varied from 105 to 125 volts, a possible cause is reduced capacitance of C630, C631 or C632.

5. Check/Adjust +20-Volt Supply Voltage

a. Set the autotransformer output to 117 volts (234 volts). Connect the precision voltmeter between the -20-volt test point and ground (see Fig. 5-3). If the voltage is outside the limits of +19.80 and +20.20 volts, adjust the +20 VOLTS control, R650 (see Fig. 5-5).

b. Slowly change the output of the variable autotransformer through the range of 105 to 125 volts (210 to 250 volts) and watch the precision voltmeter. The +20 volts should not change more than $\pm 1\%$ of the value read in the preceding paragraph when the autotransformer output was 117 volts (234 volts).

If the supply changes more than $\pm 1\%$ as the line voltage is varied from 105 to 125 volts, check to see if either the -100- or +125-volt supplies are also changing more than $\pm 1\%$.

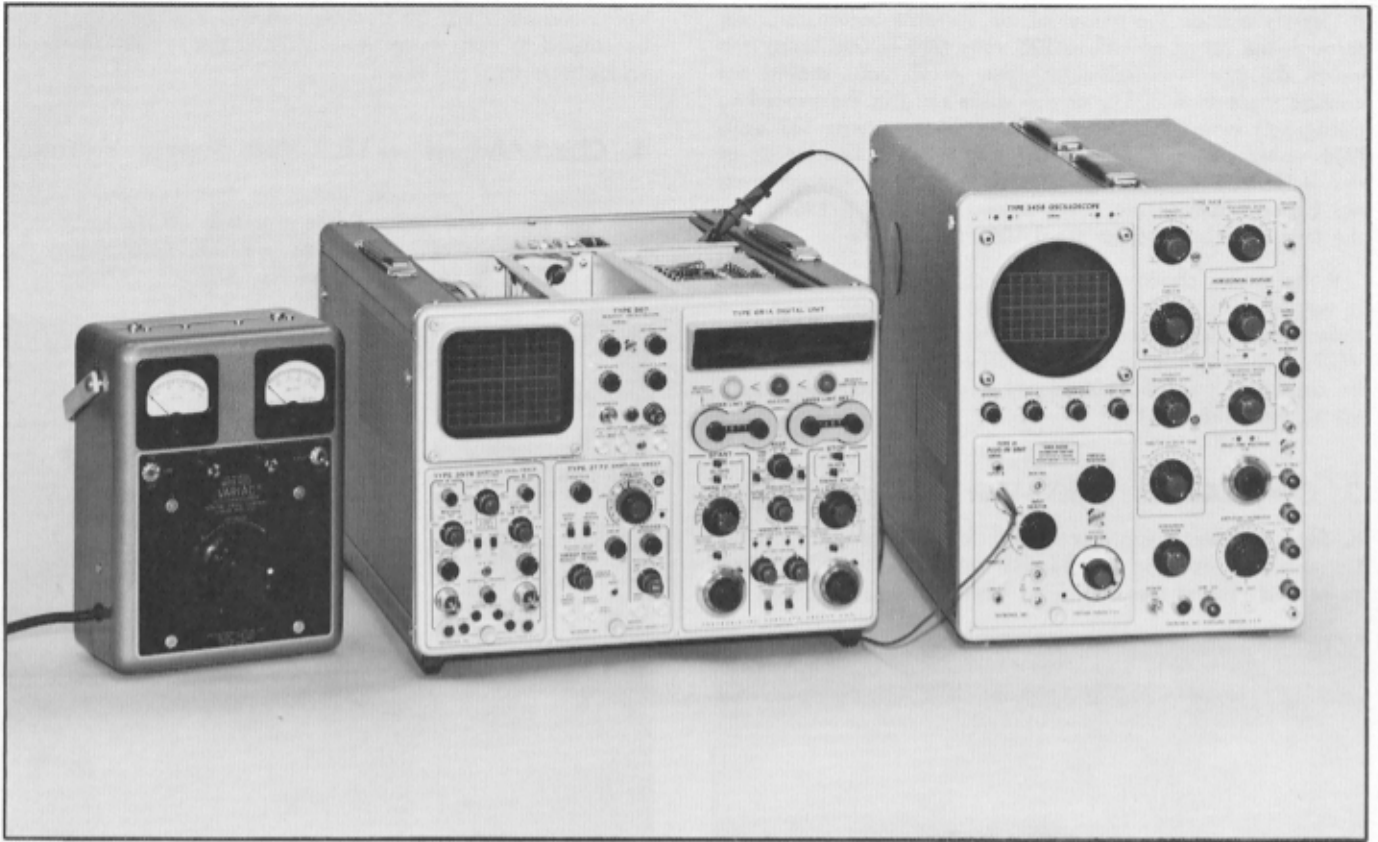

Fig. 5-6. Low-voltage power supply ripple test setup, step 6.

CONTROL SETTINGS

Type 567 controls: Set as for voltage measurements. No sweep.

Test Oscilloscope controls:

Vertical Unit

Volts/Cm	.005
Input Selector	AC

Horizontal

Horizontal Display	A
Triggering Mode	AC
Triggering Slope	+LINE
Stability	PRESET
Time/Cm	5 mSEC
Intensity	Normal trace brightness
Other controls	Optional

The above is for a Type 545B/Type H system. For other test oscilloscopes, set the controls to obtain the same operation.

6. Check Low-Voltage Power-Supply Ripple

a. Connect the test oscilloscope 1X probe tip to the —100-volt test point, and the ground clip to ground as in Figs.

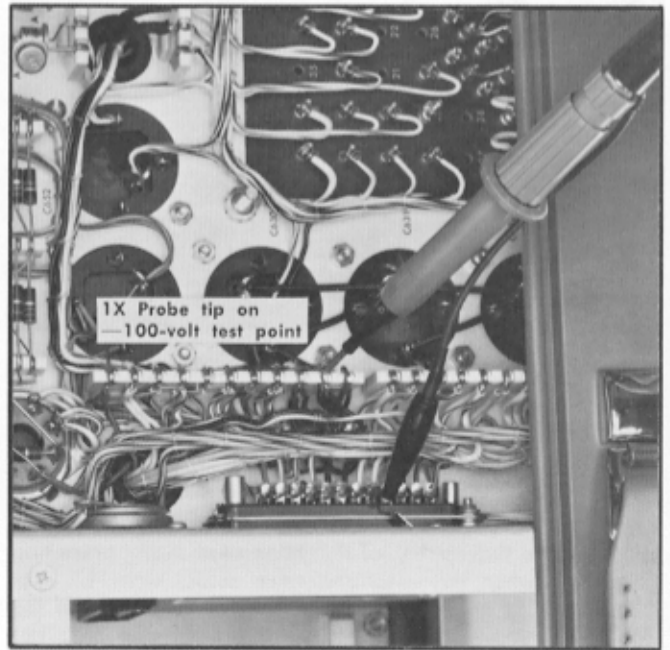

Fig. 5-7. Low-voltage power supply test points, step 6.

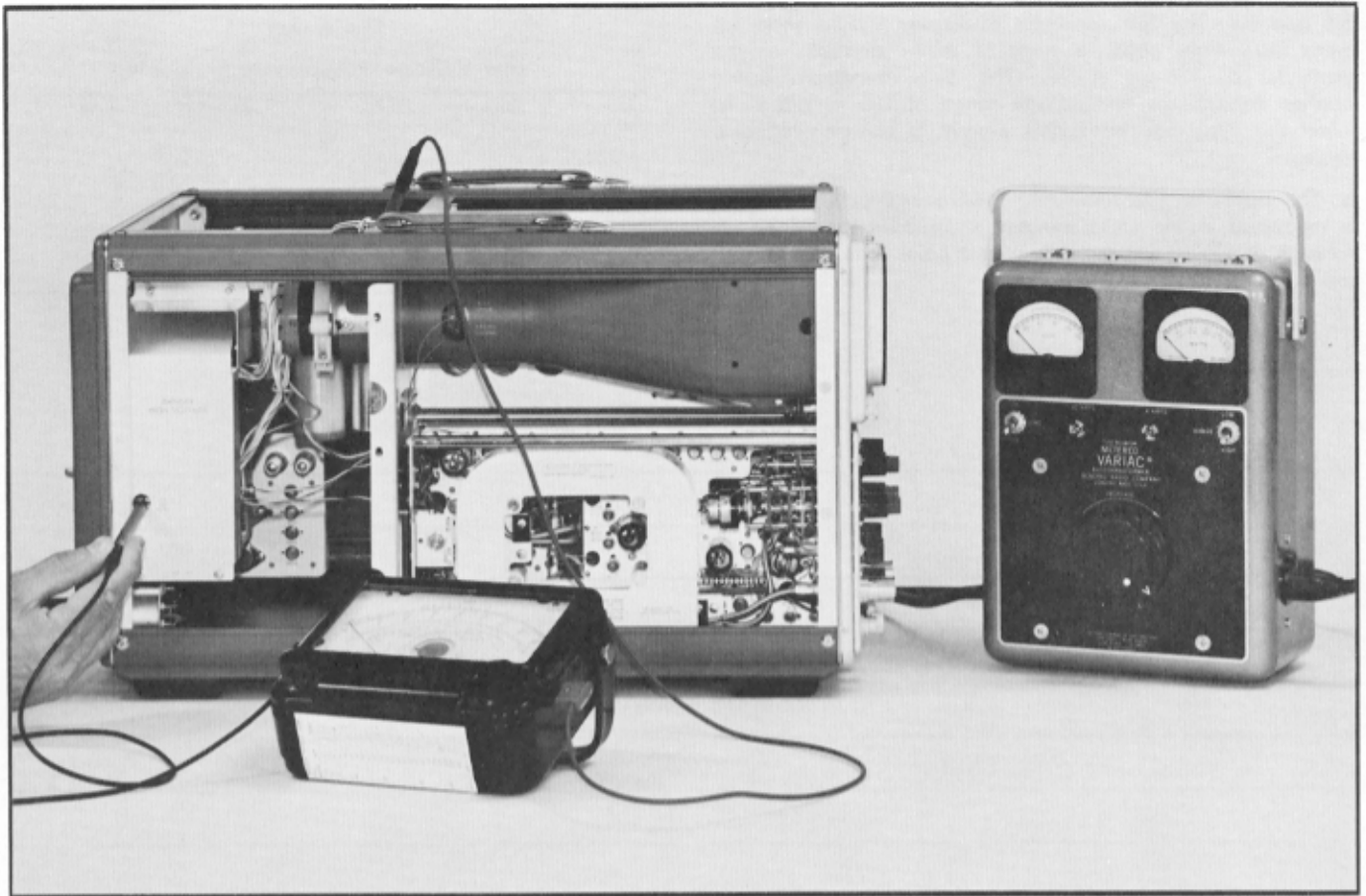

Fig. 5-8. High-voltage power supply test setup, step 7.

CONTROL SETTINGS

Real-Time Vertical Unit	
Position control(s)	Fully clockwise
Mode	Channel A
Other controls	Optional
Real-Time Horizontal Unit	
Position control	Fully counterclockwise
No sweep	
Type 567	
INTENSITY	Fully counterclockwise
Sampling Vertical Unit	
Position control(s)	Midrange
Mode	Channel A
Other controls	Optional
Sampling Horizontal Unit	
Position control	Midrange
No sweep	

7. Check/Adjust —3300-Volt Supply Voltage

a. Set the autotransformer output to 117 volts (234 volts). Connect the high-voltage 20,000 Ω/v meter between the —3300-volt HV TEST POINT (see Fig. 5-9) and ground. If the voltage is outside the $\pm 4\%$ limits of —3268 to —3432 volts, adjust HIGH VOLTAGE control, R841 (see Fig. 5-10).

b. Turn the Type 567 INTENSITY control fully clockwise. (There will be no spot if controls are set as called out for Fig 5-8.) Watch the voltmeter while slowly changing the variable autotransformer through the range of 105 to 125 volts (210 to 250 volts). The high voltage should not change more than 4% from the value noted in the preceding paragraph.

c. Turn the Type 567 INTENSITY control fully counterclockwise while looking into the HV TEST POINT opening. As the control nears its counterclockwise end of rotation, a neon glow should be noted inside the high-voltage protection cover. If, after close inspection, no glow can be seen, turn off the Type 567 power and remove the high-voltage cover. Repeat the test; B852 and B853 should both ignite when the INTENSITY control is fully counterclockwise. If they do not, change both bulbs. Replace the high-voltage cover and repeat steps 7a and 7b.

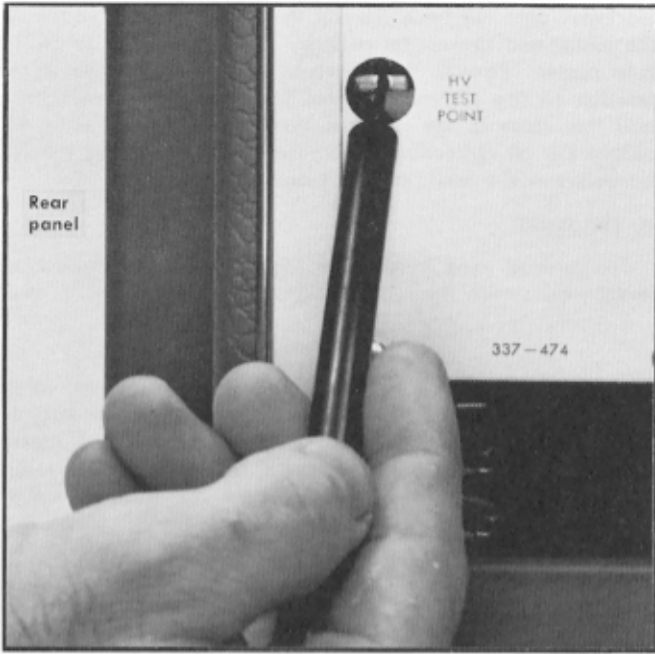

Fig. 5-9. High-voltage power supply test point, step 7.

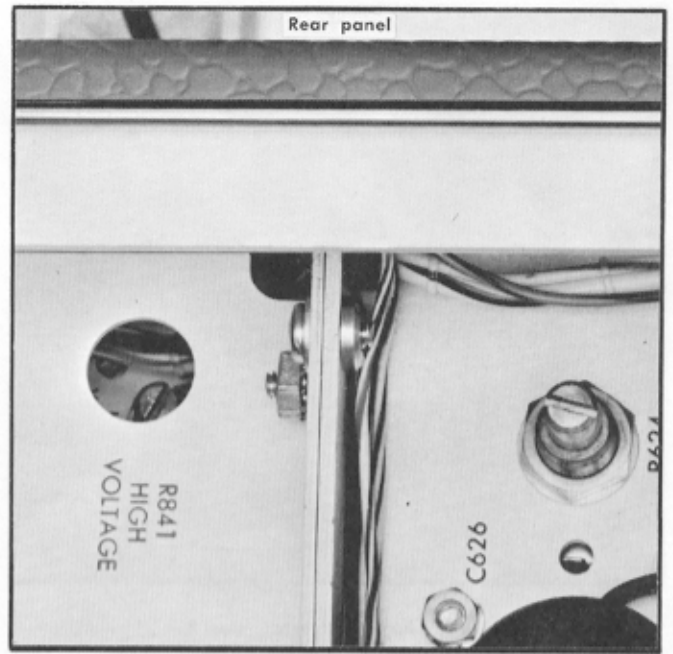

Fig. 5-10. High-voltage power supply adjustment location, step 7.

NOTES

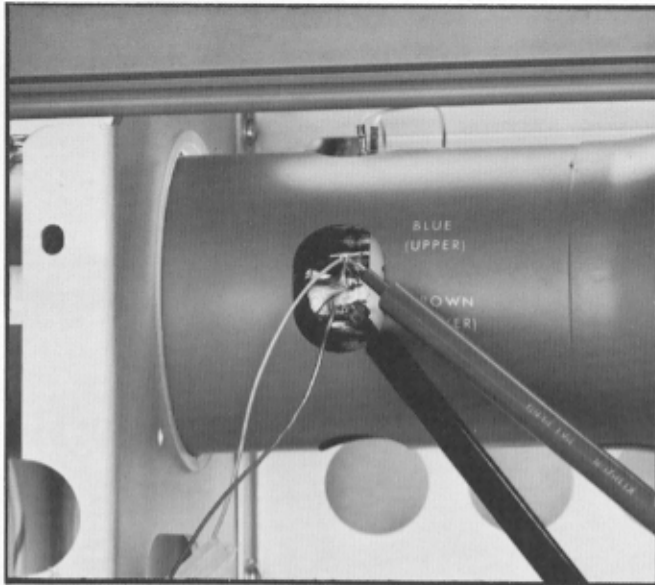

Fig. 5-11. Crt deflection factor test setup, step 8.

NOTE

Step 8 should be performed only when new crt is installed.

CONTROL SETTINGS

Vertical Unit	
Position control(s)	Midrange (trace centered)
Mode	Channel A

Horizontal Unit
Free run to present a steady trace.

Type 567
INTENSITY and FOCUS controls set for normal intensity trace.

8. Check Crt Deflection Factors

a. Vertical.

Set the 20,000 Ω/v meter to a dc scale with a full scale value of 100 to 200 volts. Place the meter leads carefully on the crt vertical deflection plate pins, minus lead on upper plate (see Fig. 5-11). Turn the vertical unit Position control

clockwise until the trace rests at the top graticule line. Read the meter and record the voltage. Return the trace to graticule center. Reverse the meter leads and adjust the trace position to the graticule bottom line. Read the meter and add this value to the previous reading. Divide by eight to obtain the crt deflection factor. Total voltage swing should be between the limits of 148.4 and 162.4 volts.

b. Horizontal.

The method used to measure the crt horizontal deflection factor varies with the type of horizontal plug-in unit in use.

Real Time

Operate the sweep at any convenient free-run rate. Adjust the horizontal Position control so the trace begins at the far left graticule line. Stop the sweep and place the voltmeter leads on the horizontal deflection-plate pins at the top side of the crt neck; connect the positive meter lead to the red lead. Record the voltage.

Set the Time/Div control at 1 SEC and the Variable control fully counterclockwise. Start a sweep by turning the triggering Level control through its range. The voltmeter indication will begin to drop. As the spot passes the graticule center, reverse the meter polarity and record the voltage at the time the spot reaches the far right graticule line. (Since the spot is moving slowly, it may be necessary to do this two or three times, in order to get a reading within ± 2 volts of the actual voltage.) Record the reading.

Add the two readings. Total voltage swing should be between the limits of 175 and 193 volts.

Sampling

Free run the sampling time-base unit at any sweep rate, and set the horizontal Position control so the trace begins just to the left of the far left graticule line. Switch operation to Manual, reducing the crt intensity if necessary, and position the spot with the Manual Scan control to the far left graticule line. Place the voltmeter leads on the horizontal deflection-plate pins at the top side of the crt neck; connect the positive meter lead to the red lead. Record the voltage.

Remove the meter leads and position the spot with the Manual Scan control to the far right graticule line. Reverse the meter leads and record the voltage.

Add the two readings. Total voltage swing should be between the limits of 175 and 193 volts.

NOTES

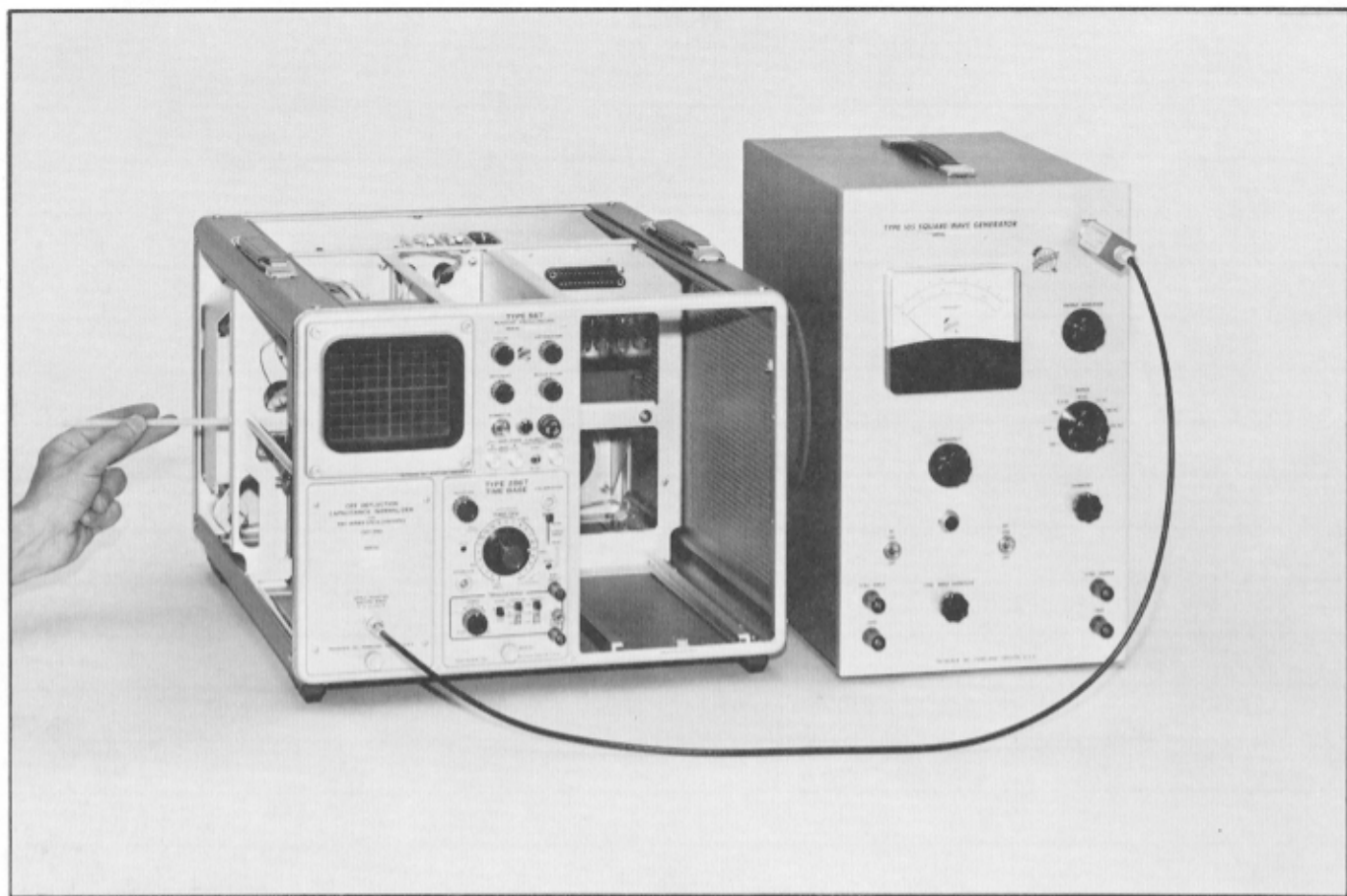

Fig. 5-12. Step 9a test setup.

CONTROL SETTINGS

Crt Deflection Capacitance Normalizer
No controls

Horizontal Unit (such as Type 2B67)

Time/Div	20 μ SEC
Triggering	Internal AC

Type 105

Range	100 KC
Frequency	Set for full scale meter reading
Output Amplitude	About 1 or 2 o'clock

CONNECTIONS

Install Type TU-5/105 Adapter to Type 105 Output connector while the Type 105 DC power is Off. (If Type 105 has UHF connector, use UHF to BNC adapter.) Connect a 50-ohm coax cable between the Type TU-5/105 Adapter and the Capacitance Normalizer input. (Type TU-5/105 Adapter is required to invert the Type 105 negative output. The adapter contains two diodes and an electrolytic capacitor in a clamped inverter circuit.)

9. Check/Adjust Crt Deflection-Plate Capacitance (Using Capacitance Normalizer)

NOTE

The following crt deflection-plate capacitance compensation (steps 9 and 10) can be ignored if the Type 567 is used for sampling only, or real-time displays under 3 or 4 megacycles only. The capacitance adjustments are to be made only after changing the crt if real-time displays up to 10 megacycles are required. Step 9 uses the special Tektronix 067-0500-00 Crt Capacitance Normalizer as a calibration aid. Step 10 uses a 10-mc bandwidth plug-in unit. Adjustment accuracy and resolution are best when using the Capacitance Normalizer.

a. Vertical Deflection Plates, C760

Set up the equipment and display as shown in Fig. 5-12.

Use the low-capacitance tool (item 16) to adjust C760 for best flat-topped square-wave display. C760 is shown in Figs. 5-13 and 5-14. Proper compensation is shown in Fig. 5-15. It may be necessary to position the leads to the deflection plates to aid in obtaining a good square-wave

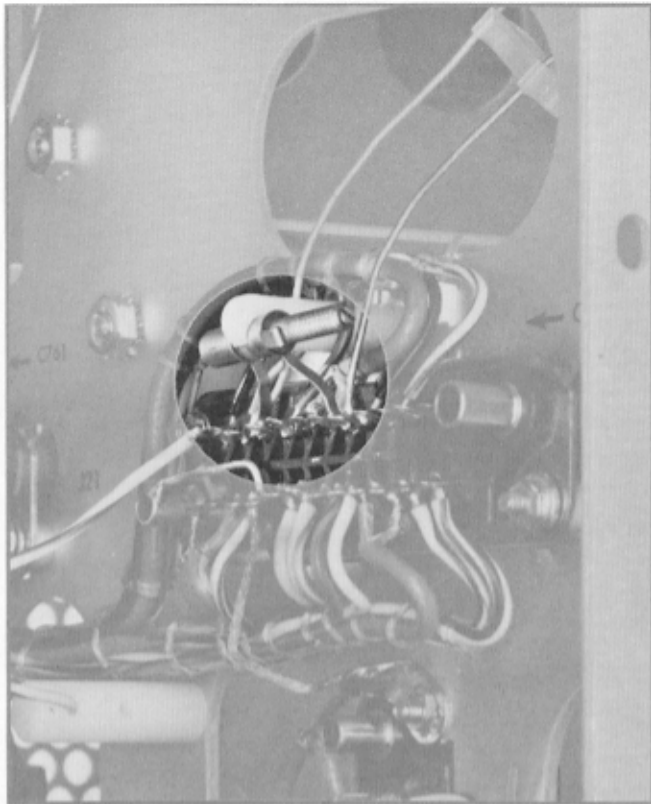

Fig. 5-13. Normal location of C760, step 9a.

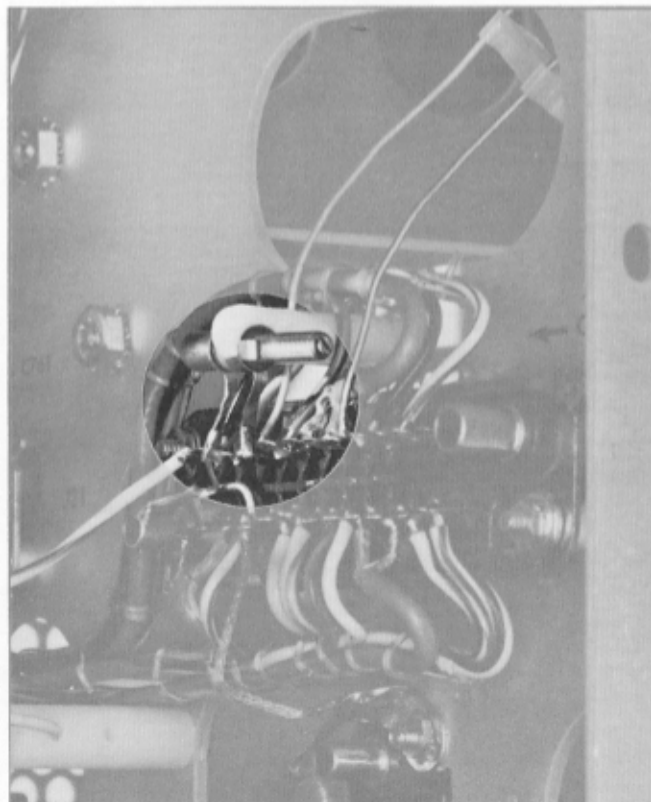
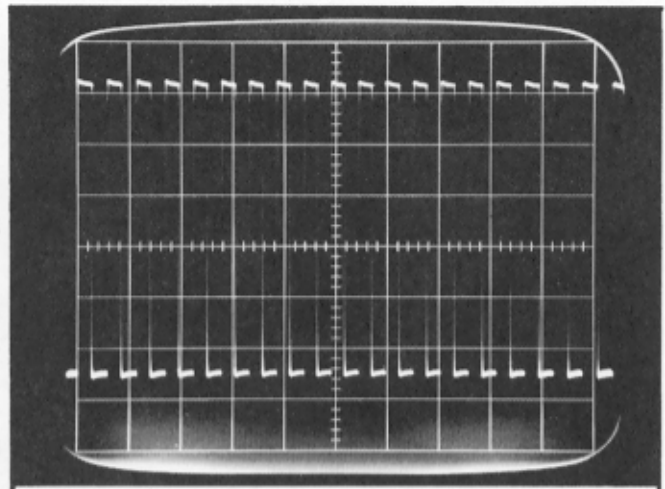
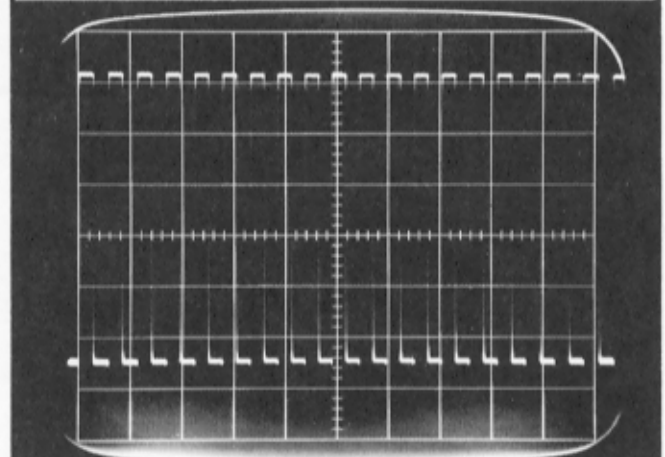

Fig. 5-14. Alternate location of C760, step 9a.

display. C760 is to be located as in Fig. 5-13 unless correct compensation is impossible; then move it to the position between terminal 21 and chassis as shown in Fig. 5-14.



C760 capacitance is low.



C760 capacitance is correct

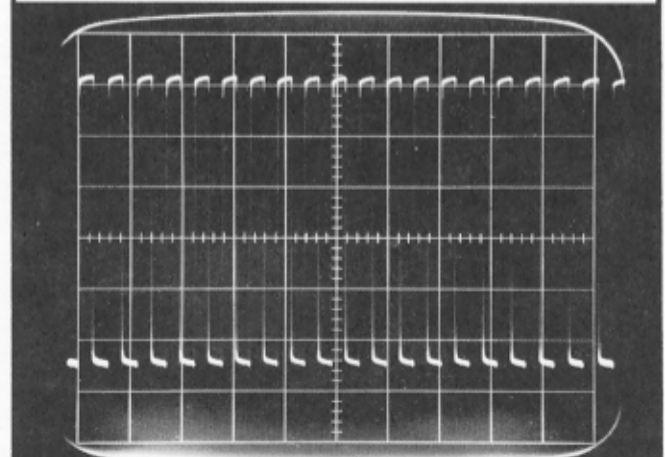

C760 capacitance is high.

Fig. 5-15. Waveforms for step 9a.

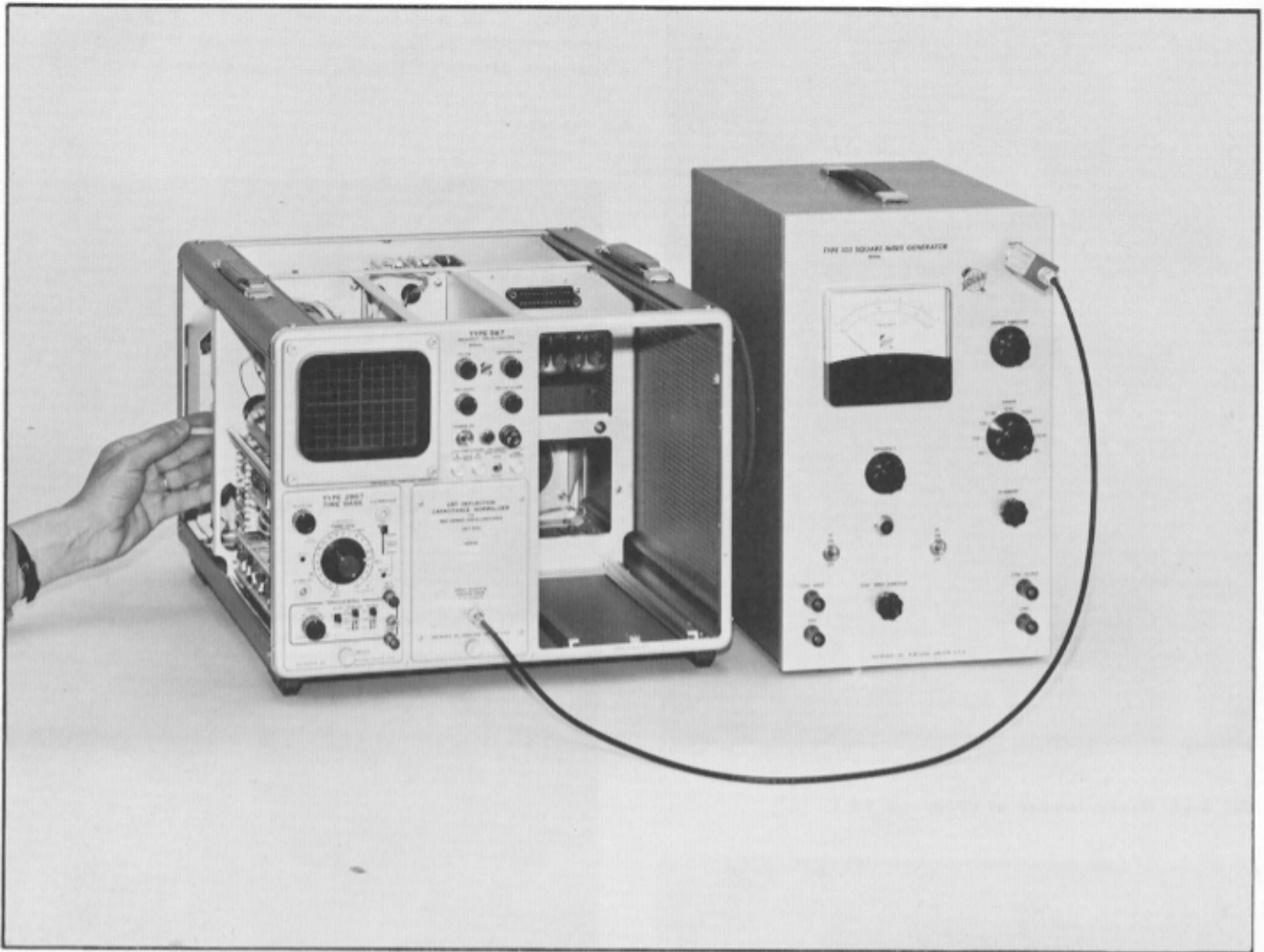

Fig. 5-16. Step 9b test setup.

b. Horizontal Deflection Plates, C761

Control settings and connections are the same as for step 9a, except that the Capacitance Normalizer and timing unit positions are exchanged.

Set up the equipment and display as shown in Fig. 5-16.

Use the low-capacitance tool (item 16) to adjust C761 for best flat-topped square-wave display. (C761 is shown in Fig. 5-17.) Proper compensation is shown in Fig. 5-18. It may be necessary to position the leads to the deflection plates to aid in obtaining a good square-wave display.

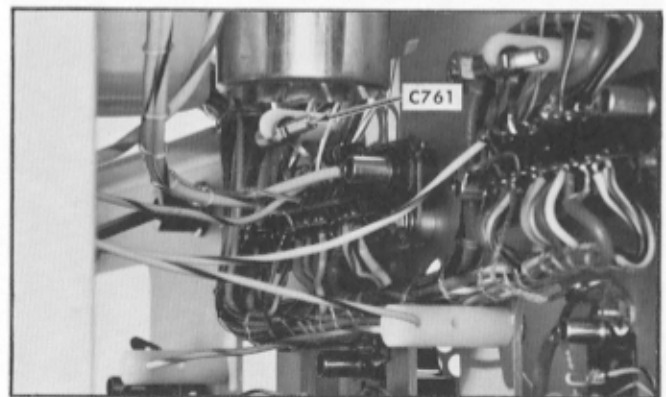

Fig. 5-17. Location of C761, step 9b.

NOTES

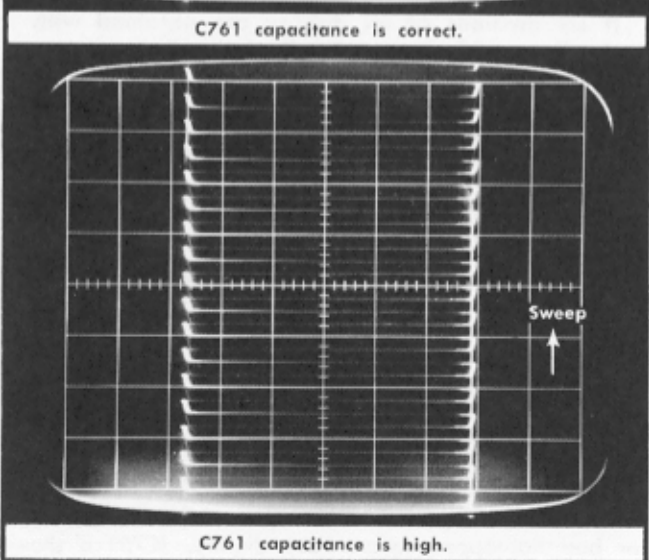
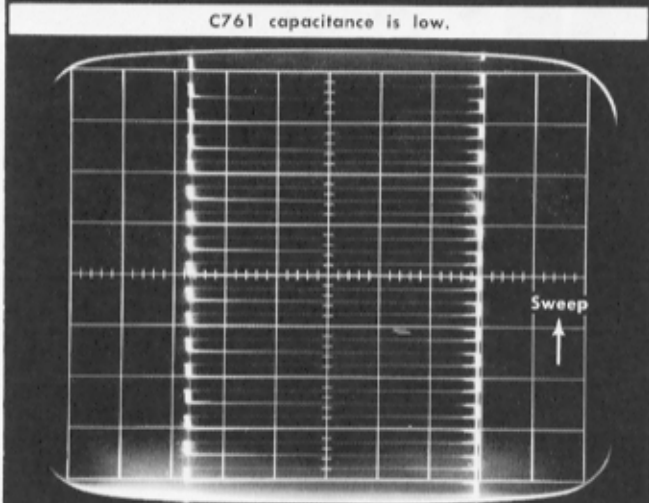
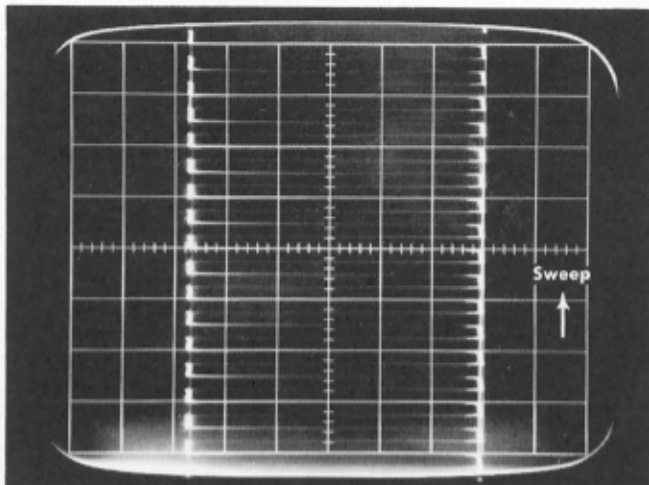

Fig. 5-18. Waveforms for step 9b.

Notes section with horizontal lines for writing.

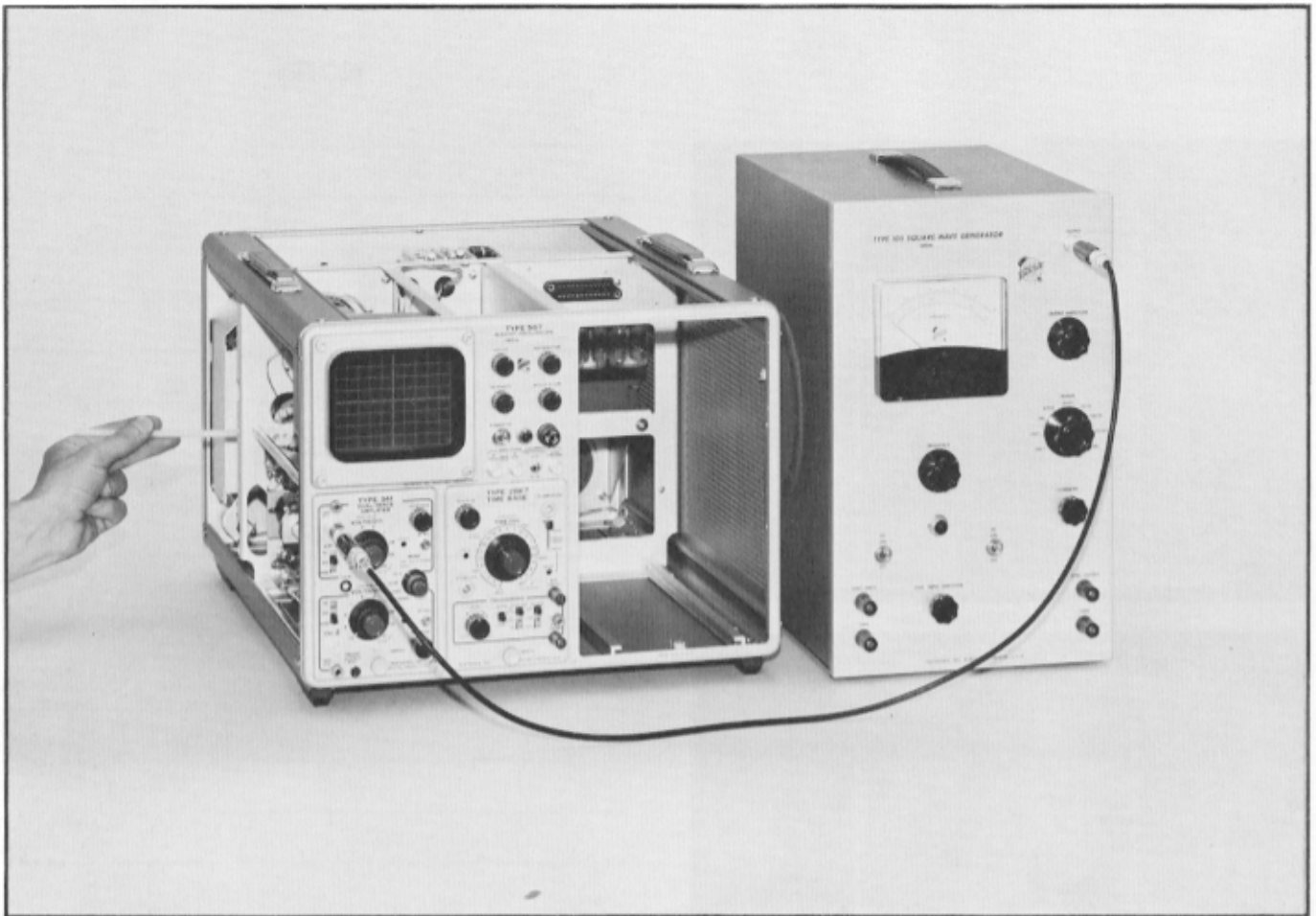

Fig. 5-19. Step 10a test setup.

CONTROL SETTINGS

Vertical Unit (such as Type 3A1)	
Volts/Div	.01 (max. sensitivity)
Mode	Channel 1
Input	DC Coupled
Horizontal Unit (such as Type 2B67)	
Time/Div	1 μ SEC
Triggering	Internal AC
Type 105	
Range	100 KC
Frequency	Set for full scale meter reading
Output Amplitude	Clockwise past 10 o'clock for over 5 div display

CONNECTIONS

10 \times attenuator at Type 105 Output connector. 50 Ω coax cable to a second 10 \times attenuator. 50 Ω termination between second 10 \times attenuator and vertical unit channel 1 input connector.

NOTE

If six divisions of crt display are obtained with the Type 105 Output Amplitude control counterclockwise from 10 o'clock, add more attenuation in the line to the vertical unit. The Type 105 rise-time is degraded when the Output Amplitude control is counterclockwise from about a 10 o'clock position.

10. Check/Adjust Crt Deflection-Plate Capacitance (Using Type 3A1 or other 10-mc vertical unit)

(Do only after installing new crt.)

a. Vertical Deflection Plates, C760

Set up the equipment and display as shown in Fig. 5-19.

Use the low-capacitance tool (item 16) to adjust C760 for best flat-topped square-wave display. (C760 is shown in Figs. 5-20 and 5-21.) Proper compensation is shown in Fig. 5-22. It may be necessary to position the leads to the deflection plates to aid in obtaining a good square-wave

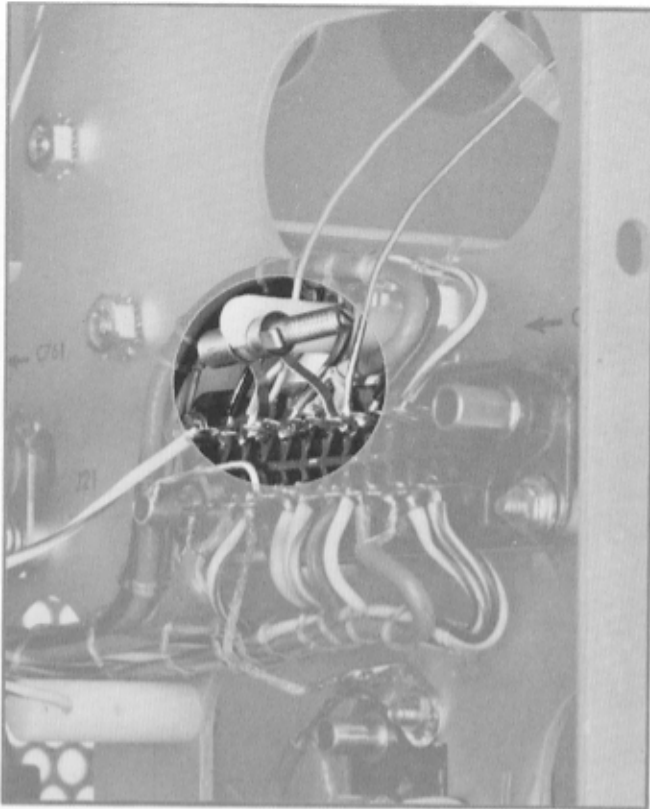

Fig. 5-20. Normal location of C760, step 10a.

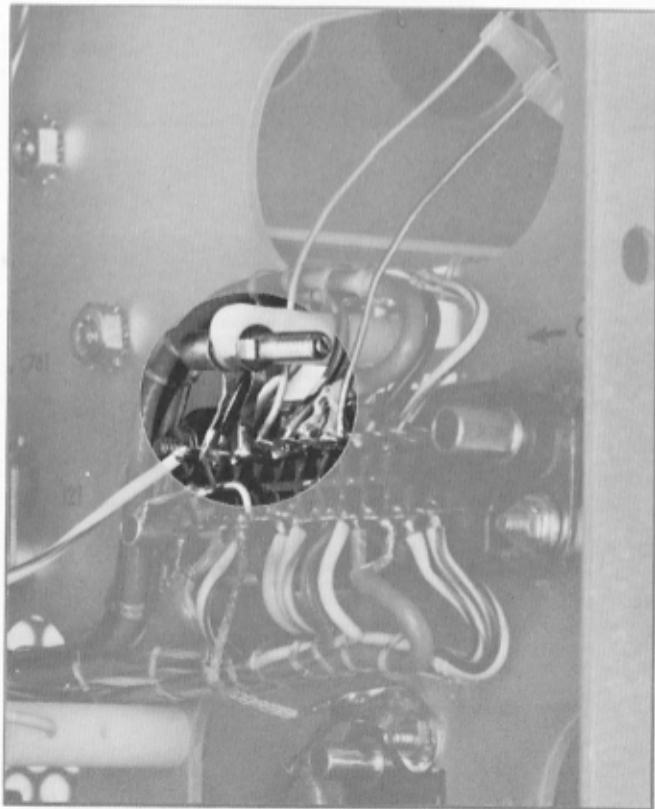

Fig. 5-21. Alternate location of C760, step 10a.

display. C760 is to be located as in Fig. 5-20 unless correct compensation is impossible; then move it to the position between terminal 21 and chassis as shown in Fig. 5-21.

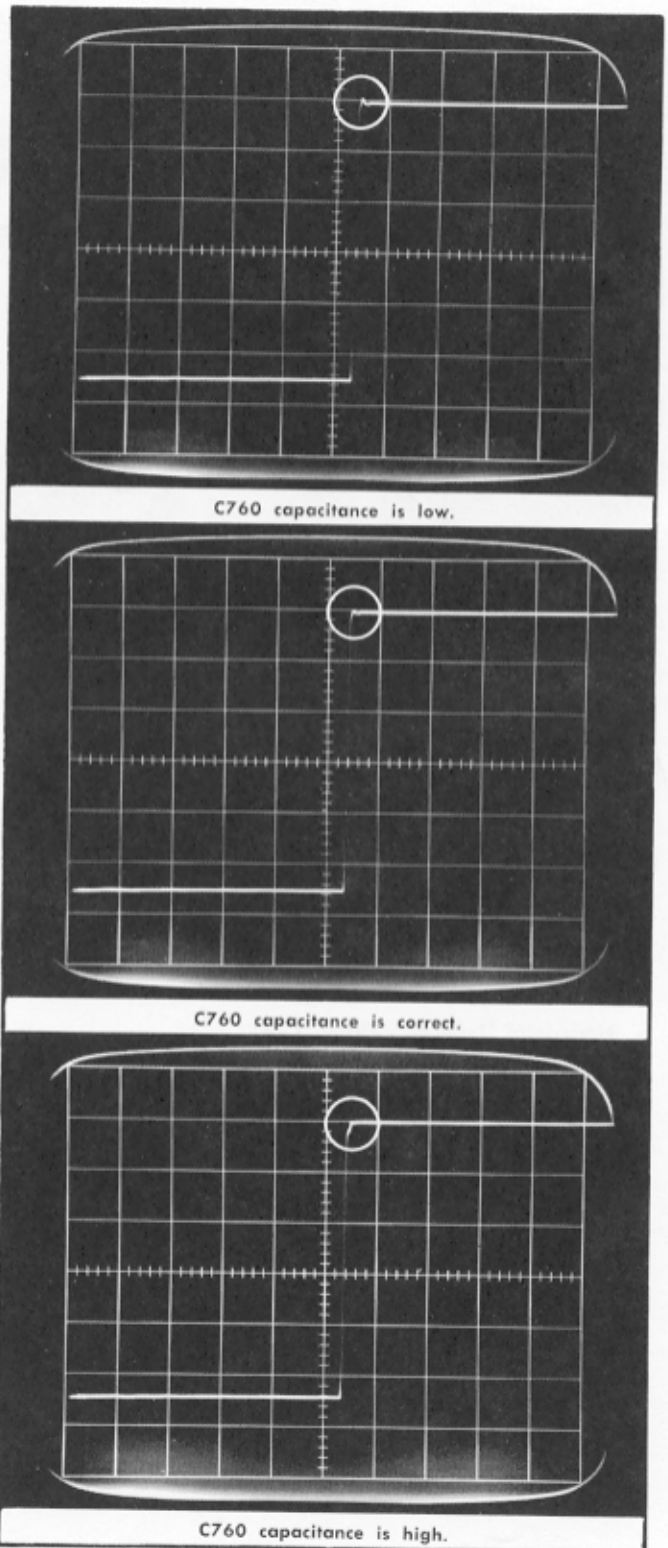

Fig. 5-22. Waveforms for step 10a.

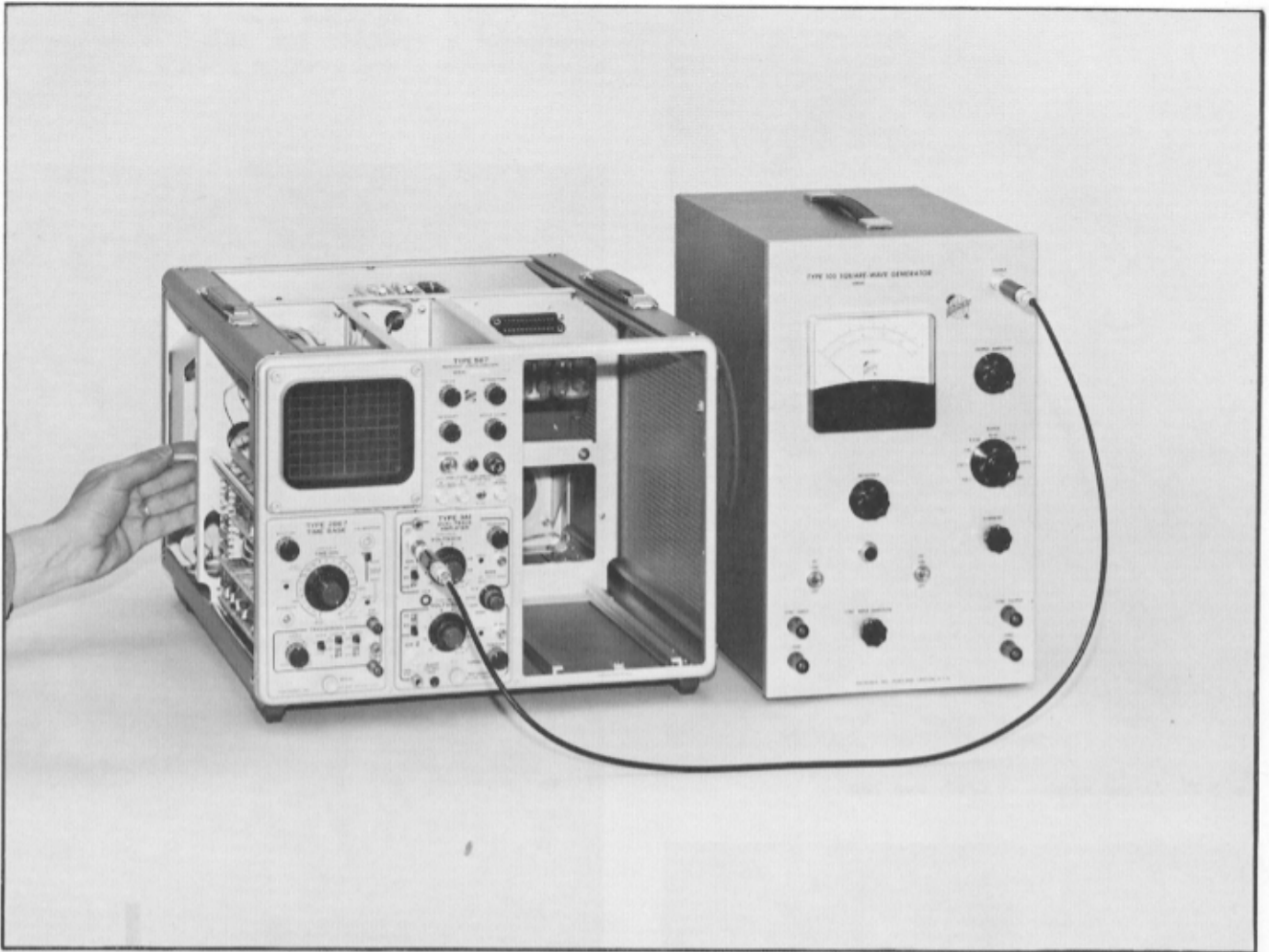

Fig. 5-23. Step 10b test setup.

b. Horizontal Deflection Plates, C761

Control settings and connections are the same as for step 10a, but with the Type 3A1 and Type 2B67 positions exchanged.

Set up the equipment and display as shown in Fig. 5-23.

Use the low-capacitance tool (item 16) to adjust C761 for best flat-topped square-wave display. (C761 location is shown in Fig. 5-24.) Proper compensation is shown in Fig. 5-25. It may be necessary to position the leads to the deflection plates to aid in obtaining a good square-wave display. (C761 does not have an alternate location as does C760.)

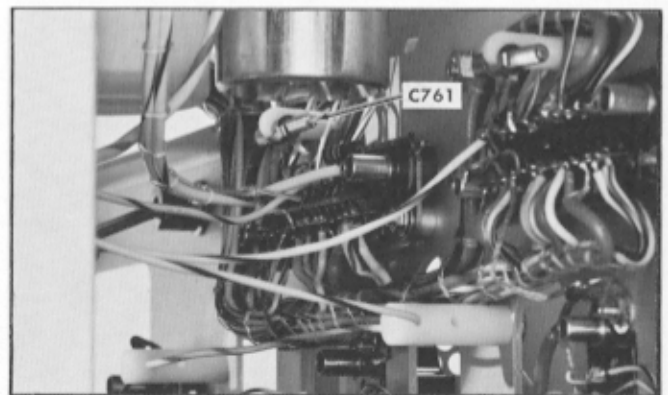

Fig. 5-24. Location of C761, step 10b.

NOTES

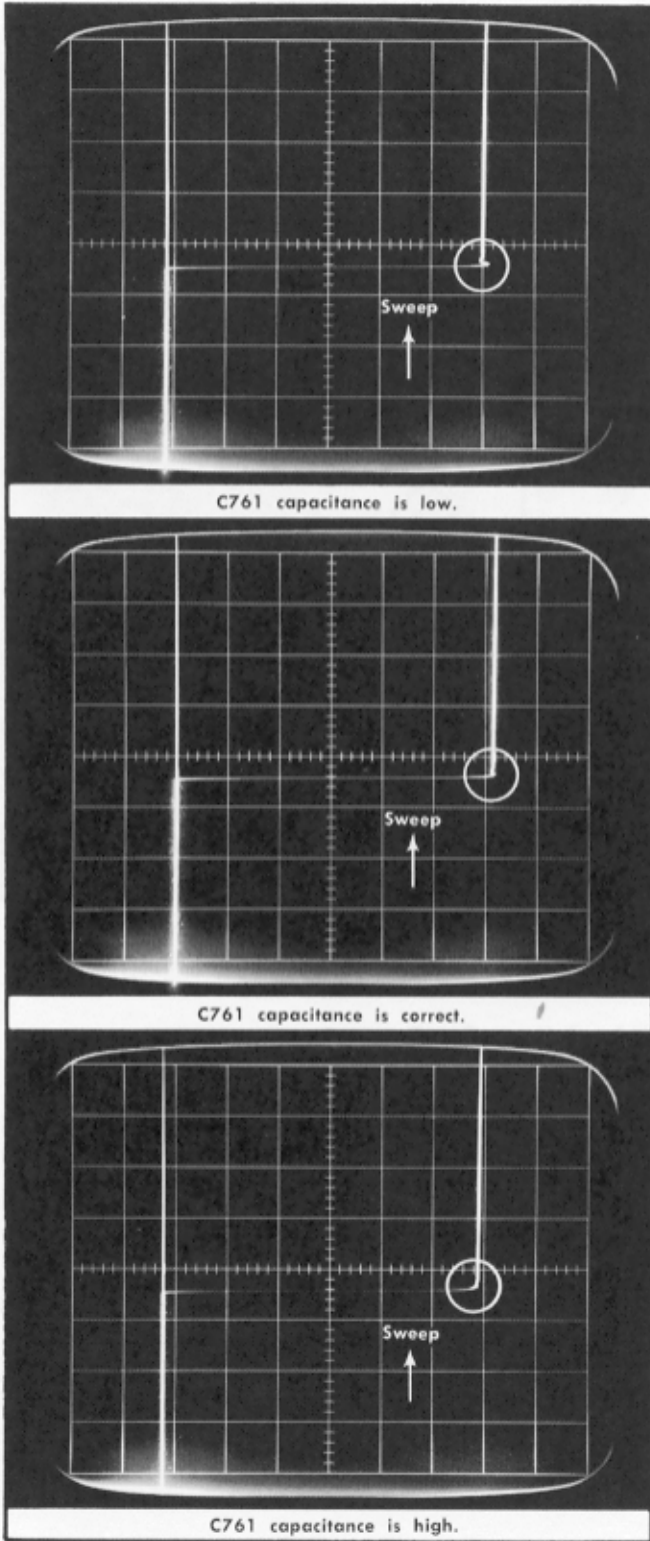

Fig. 5-25. Waveforms for step 10b.

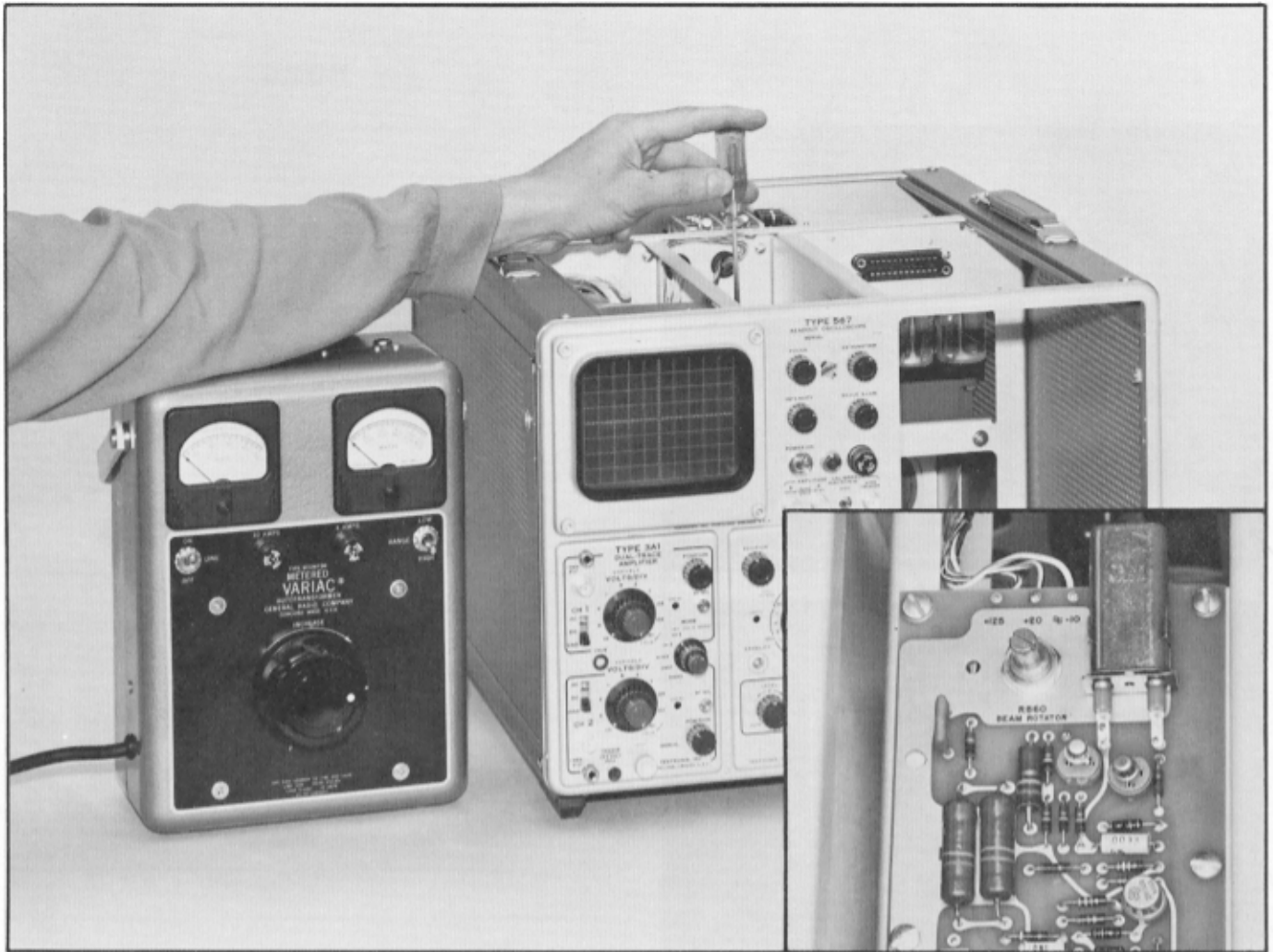

Fig. 5-26. Crt beam rotator adjustment setup for step 11.

CONTROL SETTINGS

Vertical Unit

Input	Grounded
Volts/Div	Insensitive
Position	Trace centered

Horizontal Unit

Time/Div (real time)	1 mSEC or higher
Time/Div (sampling)	Optional
Triggering	Free-running trace

11. Adjust Crt Beam Rotator, R860

NOTE

The crt beam trace level is affected by small magnetic fields. The trace level changes with change of operating position of the Type 567. Align the crt beam rotator with the instrument in the exact position of operation.

Obtain a free-running trace as shown in Fig. 5-26. Set the vertical unit Position control so the trace intersects the horizontal graticule centerline.

Adjust R860, the CRT BEAM ROTATOR control, until the trace lines up with the graticule line. (R860 is shown as an insert in Fig. 5-26.)

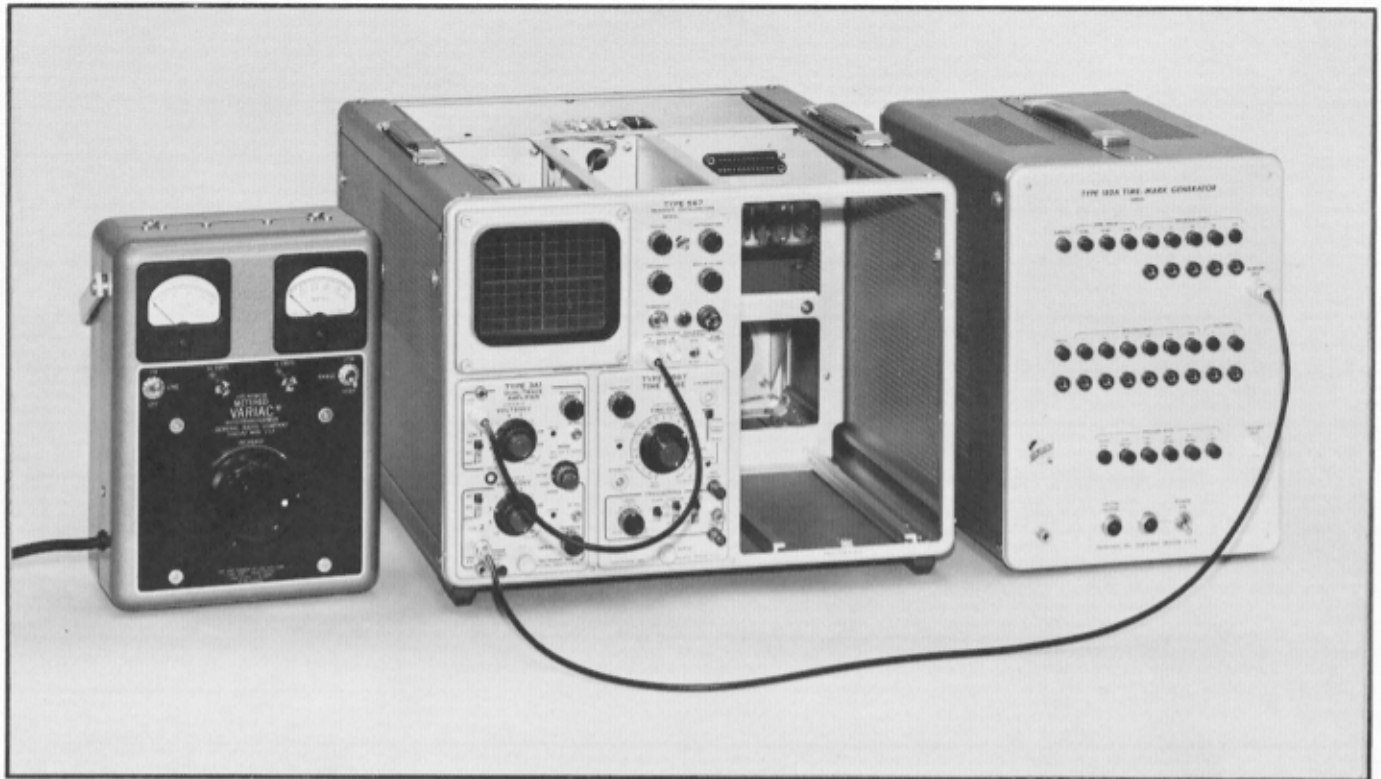

Fig. 5-27. Step 12a test setup.

CONTROL SETTINGS

Type 3A1 Vertical Unit	
Mode	ALTER
Volts/Div (both channels)	2
Trigger	CH 1 ONLY PULL
or	
Type 3A2 Vertical Unit	
Mode	ALTER
Volts/Div (both channels)	2
Trig Source	CH 1
Polarity (both channels)	NORM
Time-Base Horizontal Unit	
Time/Div	.1 mSEC
Triggering	Internal +AC
Type 180A Time-Mark Generator	
Buttons pushed	100 MICROSECONDS and 1 SECOND
Type 567	
Amplitude Calibrator	20 KC

CONNECTIONS

A 50 Ω coax cable from the Type 180A Marker Out connector to the vertical unit channel 2 input connector.

A 50 Ω coax cable from the Type 567 Amplitude Calibrator 5-volt connector to the vertical unit channel 1 input.

NOTE

If you have only sampling plug-in units for the Type 567 the test oscilloscope may be used for the display required, providing a dual-channel plug-in unit is used. Use step 12b instead of 12a.

12. Check/Adjust Amplitude Calibrator

a. 20-kc Frequency Check (using real-time plug-in units in Type 567).

Set up the equipment as shown in Fig. 5-27 and obtain a display that is triggered from the channel 1 calibrator signal. Note that the Amplitude Calibrator signal remains as a fixed display, but the time marks drift to the right or to the left.

The drift is an indication of frequency difference between the Amplitude Calibrator crystal and the reference oscillator of the Time-Mark Generator. If the time marks drift to the left, the Amplitude Calibrator frequency is higher than the Time-Mark Generator frequency. If the time marks drift to the right, the Amplitude Calibrator frequency is lower than the Time-Mark Generator frequency (see Fig. 5-28). Make the measurement in the following manner.

1. Watch the time-mark display. Note the regular occurrence of the 1-second marker flashing through the 100-μsecond markers.

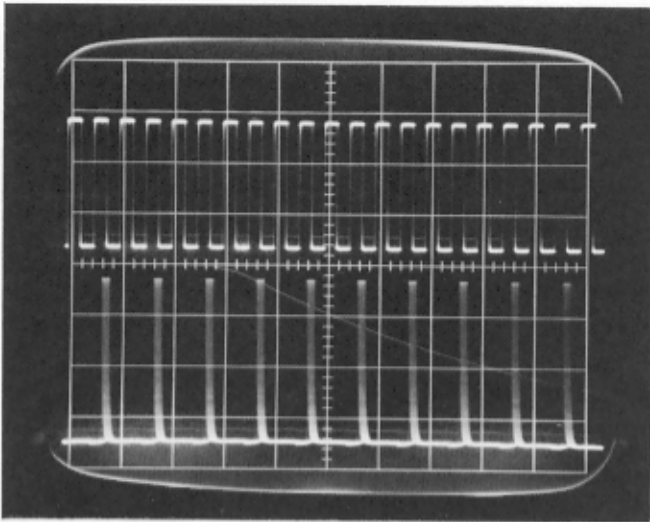

Fig. 5-28. Step 12a waveforms. 1 second time exposure. Note 1 second marker at slant through 100 msec markers.

2. Choose any one 100- μ second marker and follow it across the crt for a count of ten seconds. Start the mark

count as the chosen marker coincides with a vertical graticule line, and note the position of the same marker at the end of the tenth second. The number of divisions traveled in 10 seconds, and the time per division permits a direct measure of the frequency difference of the two oscillators.

3. With the horizontal unit Time/Div control set to .1 mSEC, if the chosen marker travels 8 divisions in 10 seconds, the time displacement is 0.08 msec each second, or 80 μ sec each second. Each cycle of the Amplitude Calibrator takes 50 μ sec; after 20,000 cycles the example error is 80 μ sec or 1.6 cycles error out of 20,000 cycles per second. Thus, the percentage error is:

$$1.6/20,000 \times 100 = 0.008\%$$

Therefore, at 0.1 msec/div, 10 divisions travel in 10 seconds indicates 0.01% error.

4. If the chosen marker travels off screen in less than 10 seconds, change the horizontal unit Time/Div control to 1 mSEC and the Time-Mark Generator push buttons to 1 MIL- LISECONDS and 1 SECONDS. Using the principle described in 3, each division of travel per second of the chosen marker is 0.01% error, and 10 divisions travel in 10 seconds is 0.1% error. Maximum error, $\pm 0.1\%$.

NOTES

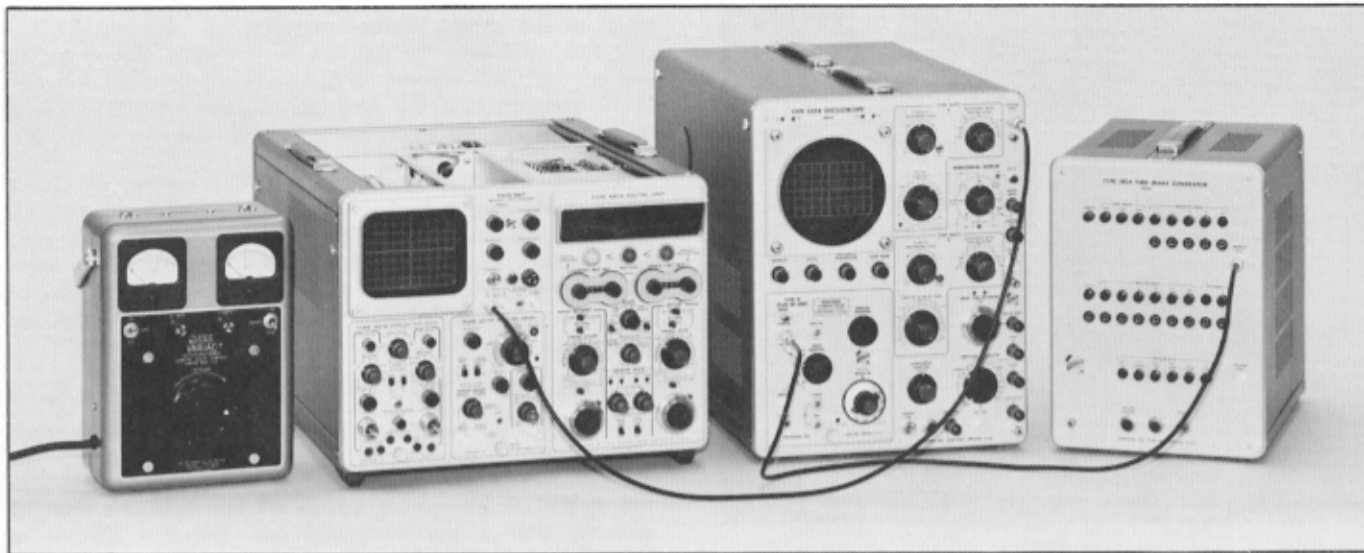

Fig. 5-29. Step 12b test setup. (6R1A not required to be installed.)

CONTROL SETTINGS

Test Oscilloscope	
Triggering	EXT AC AUTO
Time/Div	.1 mSEC
Vertical Unit	
Volts/Div	2
Type 180A Time-Mark Generator	
Buttons pushed	100 MICROSECONDS and 1 SECONDS

CONNECTIONS

50 Ω coax cable from Type 180A Marker Out connector to test oscilloscope vertical unit input. 50 Ω coax cable from Type 567 Amplitude Calibrator 5-volt connector to the test oscilloscope Trigger Input connector.

b. 20-kc Frequency Check (when only sampling plug-in units are in Type 567).

Set up the equipment as shown in Fig. 5-29 and obtain a display that is externally triggered by the Type 567 Amplitude Calibrator signal. The display is that of the time marks that drift to the right or to the left. The drift is an indication of frequency difference between the Amplitude Calibrator crystal and the reference oscillator of the Time-Mark Generator. If the time marks drift to the left, the Amplitude Calibrator frequency is higher than the Time-Mark Generator frequency. If the time marks drift to the right, the Amplitude Calibrator frequency is lower than the Time-Mark Generator frequency (see Fig. 5-30).

Make the measurement in the following manner:

1. Watch the time-mark display. Note the regular occurrence of the 1-second marker flashing through the 100-μsecond markers.

2. Choose any one 100-μsecond marker and follow it across the crt for a count of ten seconds. Start the mark

count as the chosen marker coincides with a vertical graticule line, and note the position of the same marker at the end of the tenth second. The number of divisions traveled in 10 seconds, and the time per division permits a direct measure of the frequency difference of the two oscillators.

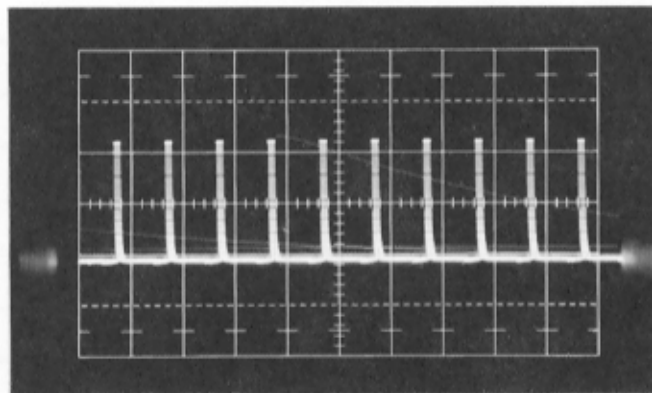

Fig. 5-30. Step 12b waveform. 1 second time exposure. Note 1 second marker at slant through 100 μsec markers.

3. With the horizontal Time/Div control set to 1 mSEC, if the chosen marker travels 8 divisions in 10 seconds, the time displacement is 0.08 msec each second, or 80 μsec each second. Each cycle of the Amplitude Calibrator takes 50 μsec; so after 20,000 cycles the example error is 80 μsec or 1.6 cycles error out of 20,000 cycles per second. Thus, the percentage error is:

$$1.6/20,000 \times 100 = 0.008\%$$

Therefore, at 0.1 msec/div, 10 divisions of travel in 10 seconds indicates 0.01% error.

4. If the chosen marker travels off screen in less than 10 seconds, change the test oscilloscope Time/Div control to 1mSEC and the Time-Mark Generator push buttons to 1 MILLISECONDS and 1 SECOND. Using the principle described in 3, each division of travel per second of the chosen marker is 0.01% error, and 10 divisions travel in 10 seconds is 0.1% error.

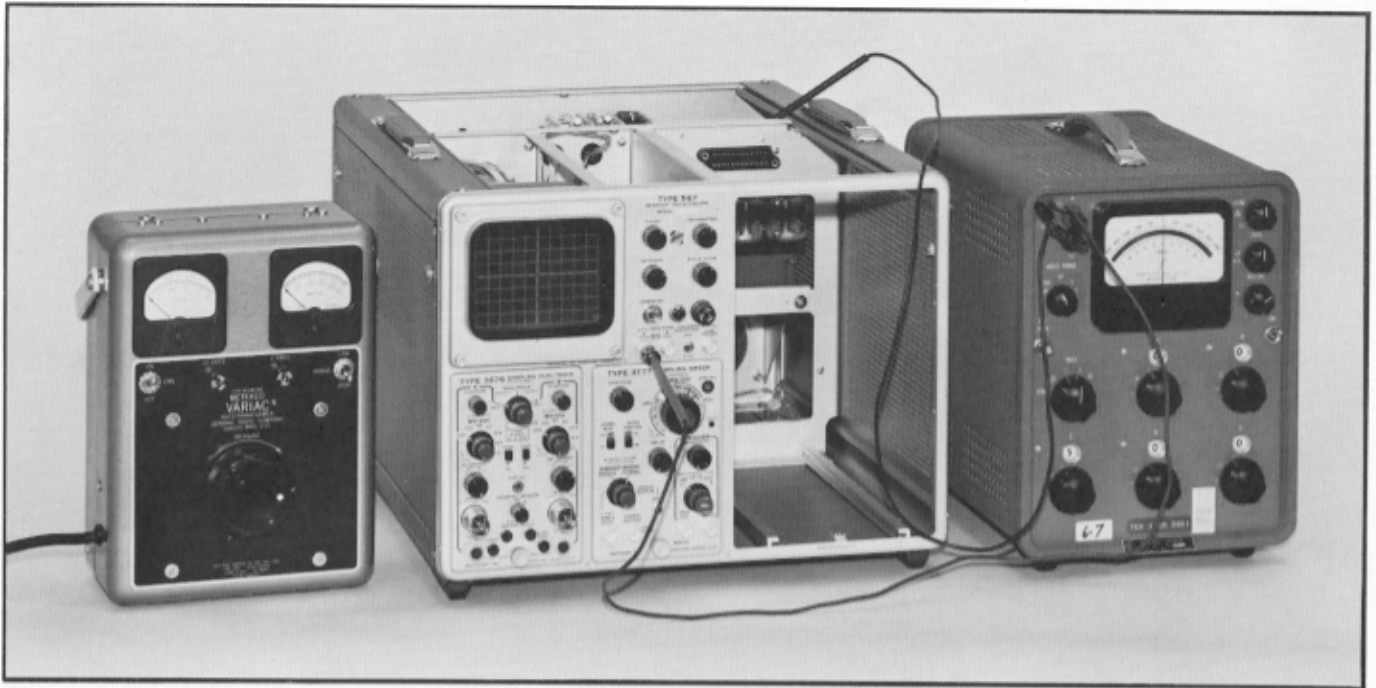

Fig. 5-31. Dc voltmeter test setup for step 12c.

CONTROL SETTINGS

Vertical Unit
Any position

Horizontal Unit
Any position

Dc Voltmeter
Set to read 5.00 volts

Type 567

Pull Q935 out of its socket (located on Amplitude Calibrator board and shown in Fig. 5-32). This places a steady dc voltage at the two calibrator output terminals equal to the +peak of the square-wave signal.

CONNECTIONS

Connect the minus lead of the voltmeter to the Type 567 chassis, and the plus lead to the Amplitude Calibrator 5-volt connector.

c. Set CAL AMPL control, R943.

Set up the equipment as shown in Fig. 5-31 and measure the dc voltage at the 5 V/500 mV connector of the Amplitude Calibrator. Adjust R943 (Fig. 5-32) so the voltage is as close to 5 volts as possible.

Move the voltmeter plus lead to the .5 V/50 mV connector of the Amplitude Calibrator and measure the voltage. The voltage must be within the limits of +0.49 to +0.51 volts. If the voltage is out of tolerance, readjust R943 to just bring the voltage within tolerance. Recheck the 5-volt value which must be within the limits of +4.90 to +5.10 volts. If both voltages are at the borderline of tolerance; one above normal value, and the other below normal value; it may be good preventive maintenance to check and change one or more divider resistors R945, R946, and R949.

Install a 50 Ω resistor of known $\pm 1\%$ accuracy (such as the 50 Ω termination, item 12 of equipment required) on the Amplitude Calibrator 5 V/500 mV connector. Set the voltmeter to read 500 millivolts. The voltage must be within the limits of +0.49 to +0.51 volts.

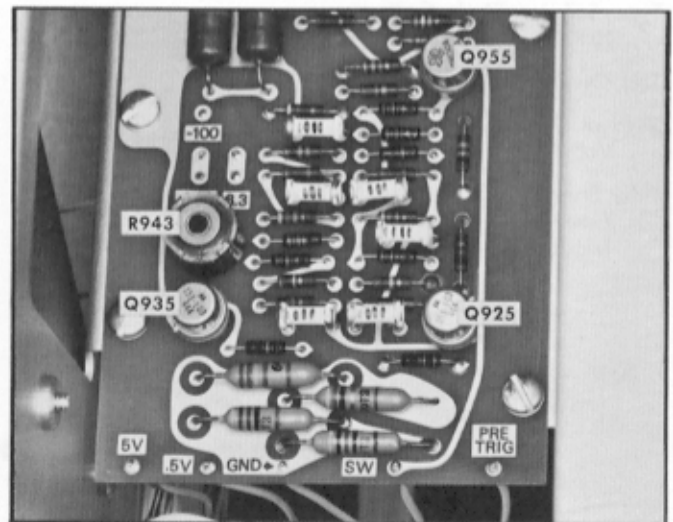

Fig. 5-32. Top view Amplitude Calibrator circuit board.

Move the 50 Ω termination and voltmeter lead to the .5 V/50 mV connector and check for an output voltage between the limits of 49 to 51 millivolts. If the voltage is out of tolerance, check and if necessary change, R948.

Replace Q935 in its socket and check for proper square waves out of the Amplitude Calibrator, at 20 KC and at about 1 KC.



Fig. 5-33. Step 12d test setup.

CONTROL SETTINGS

Type 567 Amplitude Calibrator	
20 KC \approx 1 KC switch	20 KC
Test Oscilloscope	
Vertical Unit	
Volts/Div	.2
Time Base	
Time/Div	5 μ SEC
Triggering	+Internal AC

CONNECTIONS

50 Ω coax cable from Type 567 Amplitude Calibrator

+PRE TRIGGER connector to the test oscilloscope vertical unit input connector.

d. +PRE TRIGGER Amplitude into 100 k or greater.

Set up the equipment as in Fig. 5-33. The peak-to-peak amplitude of the +PRE TRIGGER signal must be greater than 3 major divisions on the test oscilloscope graticule.

NOTE

The +PRE TRIGGER voltage rating into 100 k or greater includes the Type 353 and its Type P6038 Probes. The same test (as above) can be made using a Type 353 and a Type P6038 Probe placed directly into the +PRE TRIGGER connector.

NOTES

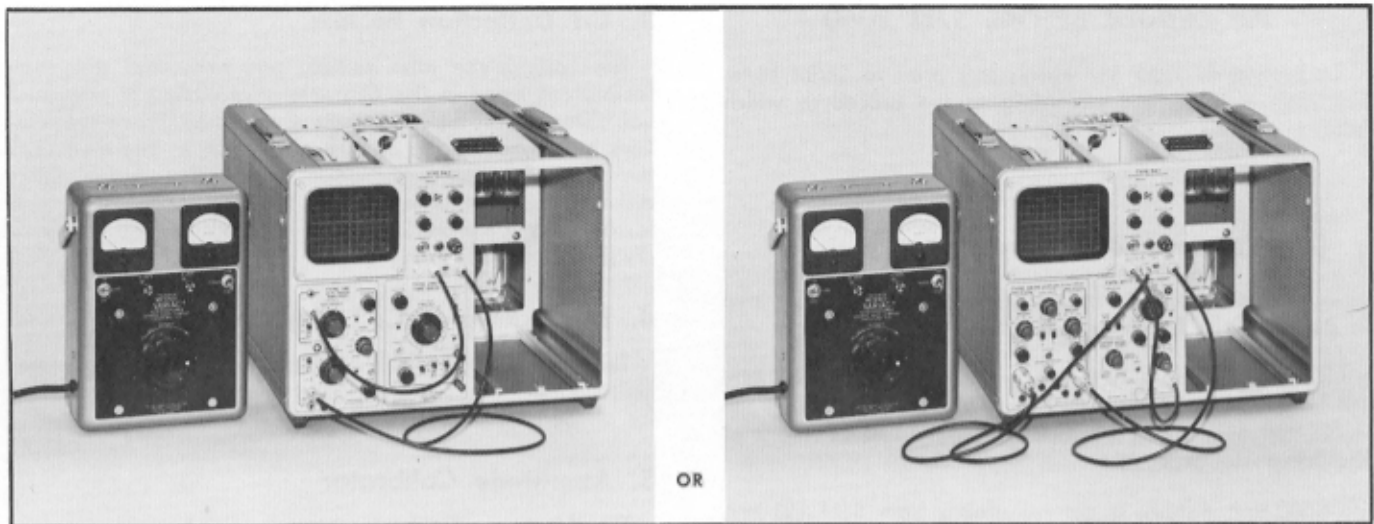

Fig. 5-34. Test setup for step 12e.

CONTROL SETTINGS

Real Time (high impedance)

Vertical Unit	
Volts/Div (both channels)	.2
Mode	ADDED
Trigger	CH 1 ONLY
Horizontal Unit	
Time/Div	10 μ SEC
Triggering	+Internal AC

(If vertical unit cannot provide CH 1 ONLY triggering, externally trigger horizontal unit from 5 V connector of Amplitude Calibrator.)

CONNECTIONS

Real Time. 50 Ω coax cable or BNC to BNC patch cord from Amplitude Calibrator .5 V connector to vertical unit channel A input connector. 50 Ω coax cable or BNC to BNC patch cord from Amplitude Calibrator +PRE TRIGGER connector to vertical unit channel B input connector.

CONTROL SETTINGS

Sampling (50 Ω impedance)

Vertical Unit	
Mv/Div	50
Mode	A + B
Internal Trigger	A
Horizontal Unit	
Time/Div	10 μ SEC
Triggering	+Internal
Type 567	
20 KC \approx 1 KC switch	20 KC
Intensity	For normal display brilliance

CONNECTIONS

Sampling. 50 Ω coax cable from Amplitude Calibrator .5 V/50 mV connector to vertical unit channel A input connector through a BNC to GR adapter. 50 Ω coax cable from Amplitude Calibrator +PRE TRIGGER connector to vertical unit channel B input connector through a BNC to GR adapter. 50 Ω coax cable from Amplitude Calibrator 5 V/500 mV connector to horizontal unit external trigger input connector.

e. +PRE TRIGGER Time Check.

Set up the equipment as shown in Fig. 5-34 and obtain the display shown in Fig. 5-35. The time between the rise of the +pre trigger waveform and the following rise of the square wave must be 12.5 μ sec \pm 5 μ sec.

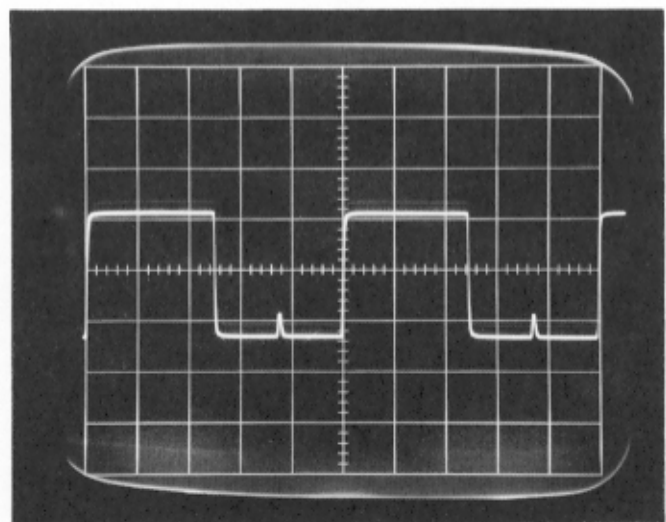

Fig. 5-35. Step 12e waveform.

PROCEDURE BEFORE S/N 2060

Calibration of Type 567 instruments prior to Serial Number 2060 is performed according to the procedure which follows:

1. Low-Voltage Power Supplies

- a. -100-Volt Supply is calibrated in the manner described in step 1 of the foregoing procedure.
- b. +125-Volt Supply is not adjustable in instruments S/N 101-299, and its tolerance is $\pm 3\%$. Adjustment of the +125-Volt Supply for S/N 300-up is described in step 2 of the foregoing procedure.
- c. +300-Volt Supply is not adjustable from S/N 101-299, and its tolerance is $\pm 3\%$. Step 3 of the foregoing procedure describes checking and adjustment of the +300-Volt Supply in Type 567 S/N 300-up.
- d. -12.2-Volt Supply is not adjustable from S/N 101-299, and its tolerance is $\pm 3\%$. Checking and adjustment of the -12.2-Volt Supply in Type 567 S/N 300-up is described in step 4 of the foregoing procedure.
- e. +20-Volt Supply is not adjustable for S/N 101-2004. Its tolerance for this serial range is $\pm 3\%$. For S/N 2005-up the +20-Volt Supply is adjustable, with procedure and limits as in step 5 of the preceding procedure.

2. High-Voltage Power Supply

The high-voltage power supply limits and adjustment have remained the same from S/N 101-up.

3. Crt Deflection Factors

The cathode-ray tube vertical and horizontal deflection factors are listed in the Characteristics section of this manual. Step 8 of the preceding Calibration Procedure outlines how to check the crt deflection factors. The method is the same for earlier instruments, only the vertical limits differ. In instruments below S/N 1999, the vertical deflection factor limits are from 21.7 to 24.1 volts per major graticule division, or a total swing of from 173.6 to 192.8 volts.

4. Beam Rotator Coil Adjustment

There is no change in the adjustment of the beam rotator coil, and the procedure included in this manual will apply for all Serial Number instruments.

5. Amplitude Calibrator

The Amplitude Calibrator provides line-frequency square waves with $\pm 3\%$ voltage accuracy into 1 megohm or greater for S/N 101-299. The output voltages are 0.05, 0.5, 5 and 50 volts. At S/N 300, R890 was added so the 0.5-volt output jack would provide 50 mv $\pm 3\%$ into 50 ohms.

The CAL AMPL control R871 can be properly adjusted using the following procedure:

Use a jumper lead and ground pin 8 (cathode) of V884A. The multivibrator is now held in a steady state so all the output jacks present a dc voltage rather than a square-wave voltage.

Connect a 1%, 20,000 Ω/v voltmeter between pin 7 (cathode) of V884B and ground. Adjust the CAL AMPL control R871 for a reading of 100 volts. Check the voltage at each front-panel jack to be within 3%.

S/N 300-up. Connect a 50 Ω (1%) resistor from the 0.5-volt jack to ground. You should measure 100 mv, $\pm 3\%$. Remove the jumper lead and the voltmeter.

SECTION 6

PARTS LIST AND DIAGRAMS

PARTS ORDERING INFORMATION

Replacement parts are available from or through your local Tektronix Field Office.



Changes to Tektronix instruments are sometimes made to accommodate improved components as they become available, and to give you the benefit of the latest circuit improvements developed in our engineering department. It is therefore important, when ordering parts, to include the following information in your order: Part number including any suffix, instrument type, serial number, and modification number if applicable.

If a part you have ordered has been replaced with a new or improved part, your local Tektronix Field Office will contact you concerning any change in part number.

ABBREVIATIONS AND SYMBOLS

a or amp	amperes	mm	millimeter
BHS	binding head steel	meg or M	megohms or mega (10 ⁶)
C	carbon	met.	metal
cer	ceramic	μ	micro, or 10 ⁻⁶
cm	centimeter	n	nano, or 10 ⁻⁹
comp	composition	Ω	ohm
cps	cycles per second	OD	outside diameter
crt	cathode-ray tube	OHS	oval head steel
CSK	counter sunk	p	pico, or 10 ⁻¹²
dia	diameter	PHS	pan head steel
div	division	piv	peak inverse voltage
EMC	electrolytic, metal cased	plstc	plastic
EMT	electrolytic, metal tubular	PMC	paper, metal cased
ext	external	poly	polystyrene
f	farad	Prec	precision
F & I	focus and intensity	PT	paper tubular
FHS	flat head steel	PTM	paper or plastic, tubular, molded
Fil HS	fillister head steel	RHS	round head steel
g or G	giga, or 10 ⁹	rms	root mean square
Ge	germanium	sec	second
GMV	guaranteed minimum value	Si	silicon
h	henry	S/N	serial number
hex	hexagonal	t or T	tera, or 10 ¹²
HHS	hex head steel	TD	toroid
HSS	hex socket steel	THS	truss head steel
HV	high voltage	tub.	tubular
ID	inside diameter	v or V	volt
incd	incandescent	Var	variable
int	internal	w	watt
k or K	kilohms or kilo (10 ³)	w/	with
kc	kilocycle	w/o	without
m	milli, or 10 ⁻³	WW	wire-wound
mc	megacycle		

SPECIAL NOTES AND SYMBOLS

X000	Part first added at this serial number.
000X	Part removed after this serial number.
*000-000	Asterisk preceding Tektronix Part Number indicates manufactured by or for Tektronix, or reworked or checked components.
Use 000-000	Part number indicated is direct replacement.
	Internal screwdriver adjustment.
	Front-panel adjustment or connector.

FRONT

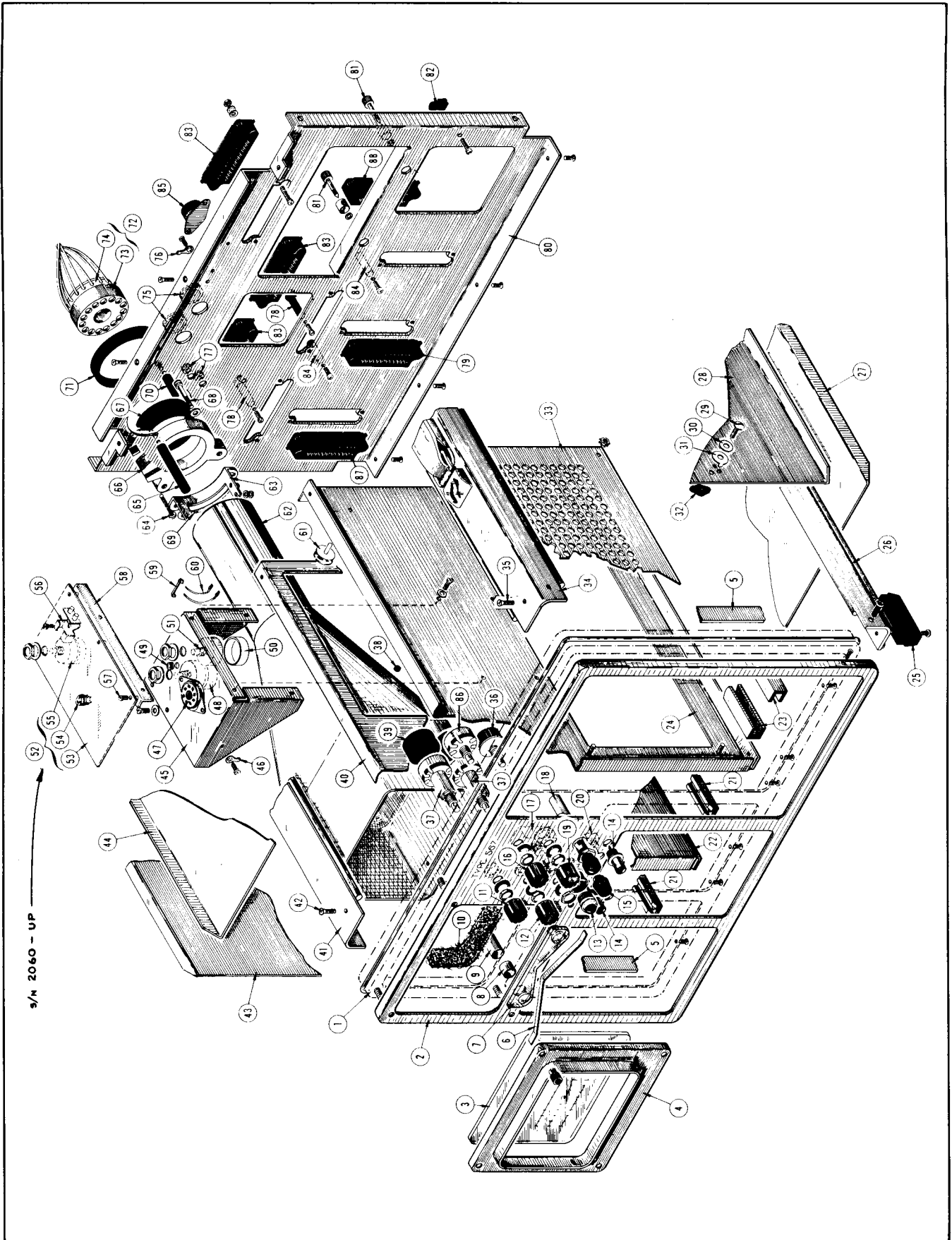

FRONT

REF. NO.	PART NO.	SERIAL/MODEL NO.		QTY.	DESCRIPTION
		EFF.	DISC.		
1	387-0493-00	101	2059	1	PLATE, front sub-panel
	387-0991-00	2060		1	PLATE, front sub-panel
	- - - - -			-	plate includes:
	354-0156-00			1	RING, ornamental
2	333-0682-00	101	2059	1	PANEL, front
	333-0868-00	2060		1	PANEL, front
	- - - - -			-	mounting hardware: (not included w/panel)
	213-0055-00			6	SCREW, thread forming, 2-32 xx $\frac{3}{16}$ inch PHS
3	331-0076-00	101	1998X	1	GRATICULE
4	200-0272-00	101	352	1	COVER, graticule
	200-0409-00	353	1998	1	COVER, trim & graticule assembly
	200-0426-00	1999		1	COVER, trim & graticule assembly
	- - - - -			-	cover includes:
	101-0005-00	X353	1998	1	TRIM, graticule cover
	101-0006-00	1999		1	TRIM, graticule cover
	- - - - -			-	mounting hardware: (not included w/cover)
	210-0434-00	101	352	4	NUT, graticule
	210-0571-00	353		4	NUT, graticule
	210-0864-00			4	WASHER, $\frac{3}{16}$ ID x $\frac{3}{8}$ inch OD
210-0844-00			8	WASHER, neoprene, $\frac{7}{32}$ ID x $\frac{3}{8}$ inch OD	
5	381-0196-00			2	BAR, stiffener
	- - - - -			-	mounting hardware for each: (not included w/bar)
	212-0002-00			2	SCREW, 8-32 x $\frac{1}{4}$ inch FHS
6	214-0442-00	X1999		1	SPRING, light reflector
7	387-0934-00	X1999		1	PLATE, light reflector
8	377-0064-00	101	1998X	2	INSERT, graticule light
9	136-0035-00			2	SOCKET, graticule light
	- - - - -			-	mounting hardware for each: (not included w/socket)
	211-0534-00			1	SCREW, 6-32 x $\frac{5}{16}$ inch PHS w/lockwasher
	210-0803-00			1	WASHER, 6L x $\frac{3}{8}$ inch
	210-0457-00			1	NUT, keps, 6-32 x $\frac{5}{16}$ inch
10	124-0142-00	101	1998	1	STRIP, felt
	124-0167-00	1999	2599	1	STRIP, felt
	348-0090-00	2600		4	CUSHION, sponge, CRT
11	366-0148-00			1	KNOB, small charcoal—FOCUS
	- - - - -			-	knob includes:
	213-0004-00			1	SCREW, set, 6-32 x $\frac{3}{16}$ inch HSS
12	366-0148-00			1	KNOB, small charcoal—INTENSITY
	- - - - -			-	knob includes:
	213-0004-00			1	SCREW, set, 6-32 x $\frac{3}{16}$ inch HSS
13	136-0031-00	101	3089	1	SOCKET, light, red
	136-0031-01	3090		1	SOCKET, light, green

FRONT (Cont'd)

REF. NO.	PART NO.	SERIAL/MODEL NO.		QTY.	DESCRIPTION
		EFF.	DISC.		
14	136-0140-00 ----- 210-0895-00 210-0465-00 210-0223-00	101	2059	3 - 1 2 1	SOCKET, banana jack mounting hardware for each: (not included w/socket) WASHER, insulating NUT, hex, 1/4-32 x 3/8 inch LUG, solder, 1/4 inch
15	131-0352-00 352-0002-00 ----- 352-0010-00 200-0582-00 210-0873-00 -----	2060		3 1 - 1 1 1 1	CONNECTOR, female, BNC ASSEMBLY, fuse holder assembly includes: HOLDER, fuse CAP, fuse WASHER, rubber, 1/2 ID x 1 1/16 inch OD NUT, hex, fuse holder
16	366-0148-00 ----- 213-0004-00			1 - 1	KNOB, small charcoal—ASTIGMATISM knob includes: SCREW, set, 6-32 x 3/16 inch HSS
17	260-0014-00 ----- 210-0414-00 354-0055-00 210-0902-00 210-0473-00			1 - 1 1 1 1	SWITCH, toggle—POWER ON mounting hardware: (not included w/switch) NUT, hex, 15/32-32 x 9/16 inch RING, locking, switch WASHER, .470 ID x 2 1/32 inch OD NUT, switch, 15/32-32 x 5/64 inch, 12 sided
18	200-0237-00	101	669X	1	COVER, insulation, fuse holder
19	366-0148-00 ----- 213-0004-00			1 - 1	KNOB, small charcoal—SCALE ILLUM. knob includes: SCREW, set, 6-32 x 3/16 inch HSS
20	136-0140-00 ----- 210-0895-00 210-0465-00 210-0223-00	101	2059	1 - 1 1 1	SOCKET, banana jack mounting hardware: (not included w/socket) WASHER, insulating NUT, hex, 1/4-32 x 3/8 inch LUG, solder, 1/4 inch
	260-0613-00 ----- 210-0940-00 210-0562-00 210-0223-00 210-0255-00	2060 2060 2160	 2159	1 - 1 2 1 1	SWITCH, toggle—20 KC-1 KC mounting hardware: (not included w/switch) WASHER, 1/4 ID x 3/8 inch OD NUT, hex, 1/4-40 x 5/16 inch LUG, solder, 1/4 inch LUG, solder, 3/8 inch
21	351-0038-00 ----- 211-0541-00			2 - 2	GUIDE, rail track, plug-in mounting hardware for each: (not included w/guide) SCREW, 6-32 x 1/4 inch FHS phillips
22	387-0489-00 ----- 211-0507-00 211-0538-00 210-0457-00			1 - 2 5 7	PLATE, frame, plug-in housing mounting hardware: (not included w/plate) SCREW, 6-32 x 5/16 inch BHS SCREW, 6-32 x 5/16 inch FHS phillips NUT, keps, 6-32 x 5/16 inch

FRONT (Cont'd)

REF. NO.	PART NO.	SERIAL/MODEL NO.		QTY.	DESCRIPTION
		EFF.	DISC.		
23	351-0048-00 ----- 211-0541-00			2 - 2	GUIDE, rail track, large plug-in mounting hardware for each: (not included w/guide) SCREW, 6-32 x 1/4 inch FHS phillips
24	387-0494-00 387-0704-00 387-0987-00 ----- 211-0538-00 211-0507-00 210-0803-00 210-0457-00	101 340 2060 	339 2059 	1 1 1 - 8 4 4 12	PLATE, frame, plug-in housing PLATE, frame, plug-in housing PLATE, frame, plug-in housing mounting hardware: (not included w/plate) SCREW, 6-32 x 5/16 inch FHS phillips SCREW, 6-32 x 5/16 inch BHS WASHER, 6L x 3/8 inch NUT, keps, 6-32 x 5/16 inch
25	348-0042-00 348-0052-00 ----- 212-0071-00 210-0458-00	101 2020 	2019 	4 4 - 2 2	FOOT, gray FOOT, anti-slide mounting hardware for each: (not included w/foot) SCREW, 8-32 x 1 inch FHS NUT, keps, 8-32 x 11/32 inch
26	122-0101-00 ----- 212-0039-00 210-0458-00 210-0804-00			2 - 5 4 1	ANGLE, rail, bottom mounting hardware for each: (not included w/angle) SCREW, 8-32 x 3/8 inch THS phillips NUT, keps, 8-32 x 11/32 inch WASHER, 8S x 3/8 inch
27	387-0490-00 ----- 105-0007-00 210-0480-00 210-0847-00 213-0114-00			1 - 4 4 4 4	PLATE, cabinet bottom plate includes: STOP, steel NUT, latch, nylon, cabinet fastener WASHER, nylon, .164 ID x .500 inch OD SCREW, cabinet latch, 8-32 x .437 inch
28	387-0485-00 -----			1 -	PLATE, cabinet side, right plate includes:
29	213-0114-00			2	SCREW, cabinet latch, 8-32 x .437 inch
30	210-0847-00			2	WASHER, nylon, .164 ID x .500 inch OD
31	105-0007-00			2	STOP, steel
32	210-0480-00			2	NUT, latch, nylon, cabinet fastener
33	387-0705-00 387-0993-00 ----- 210-0457-00 211-0538-00	X340 2060 X340 2060	2059 2059	1 1 - 6 3	PLATE, access, plug-in PLATE, access, plug-in mounting hardware: (not included w/plate) NUT, keps, 6-32 x 5/16 inch SCREW, 6-32 x 5/16 inch FHS phillips

FRONT (Cont'd)

REF. NO.	PART NO.	SERIAL/MODEL NO.		QTY.	DESCRIPTION
		EFF.	DISC.		
34	381-0194-00			1	BAR, rail, top right
	- - - - -			-	bar includes:
	367-0040-00			1	ASSEMBLY, handle
	- - - - -			-	assembly includes:
	367-0011-00			1	HANDLE
	343-0073-00			2	CLAMP, handle
	211-0507-00			6	SCREW, 6-32 x 5/16 inch BHS
	210-0457-00			6	NUT, keps, 6-32 x 5/16 inch
35	- - - - -				mounting hardware: (not included w/bar)
	212-0039-00			4	SCREW, 8-32 x 3/8 inch THS
	210-0458-00			4	NUT, keps, 8-32 x 1 1/32 inch
	210-0804-00			1	WASHER, 8S x 3/8 inch
36	- - - - -			1	POT
	- - - - -			-	mounting hardware: (not included w/pot)
	210-0590-00			1	NUT, hex., 3/8-32 x 7/16 inch
	210-0012-00			1	LOCKWASHER, internal, 3/8 x 1/2 inch
	210-0840-00			1	WASHER, .390 ID x 9/16 inch OD
	210-0413-00			1	NUT, hex, 3/8-32 x 1/2 inch
37	- - - - -			2	POT
	- - - - -			-	mounting hardware for each: (not included w/pot)
	210-0013-00			1	LOCKWASHER, internal, 3/8 x 1 1/16 inch
	210-0840-00			1	WASHER, .390 ID x 9/16 inch OD
	210-0413-00			1	NUT, hex, 3/8-32 x 1/2 inch
38	348-0031-00			4	GROMMET, plastic, 3/32 inch
39	200-0269-00	101	3139	2	COVER, pot
	200-0745-00	3140		2	COVER, pot
40	406-0737-00	101	2059	1	BRACKET, crt shield
	407-0071-00	2060		1	BRACKET, crt shield
	- - - - -			-	mounting hardware: (not included w/bracket)
	211-0507-00			2	SCREW, 6-32 x 5/16 inch BHS
	211-0538-00			4	SCREW, 6-32 x 5/16 inch FHS
	210-0803-00			6	WASHER, 6L x 3/8 inch
	210-0457-00			6	NUT, keps, 6-32 x 5/16 inch
41	381-0195-00			1	BAR, rail, top left
	- - - - -			-	bar includes:
	367-0040-00			1	ASSEMBLY, handle
	- - - - -			-	assembly includes:
	367-0011-00			1	HANDLE
	343-0073-00			2	CLAMP, handle
	211-0507-00			6	SCREW, 6-32 x 5/16 inch BHS
	210-0457-00			6	NUT, keps, 6-32 x 5/16 inch
42	- - - - -			-	mounting hardware: (not included w/bar)
	212-0039-00			4	SCREW, 8-32 x 3/8 inch THS
	210-0458-00			4	NUT, keps, 8-32 x 1 1/32 inch
	210-0804-00			1	WASHER, 8S x 3/8 inch

FRONT (Cont'd)

REF. NO.	PART NO.	SERIAL/MODEL NO.		QTY.	DESCRIPTION
		EFF.	DISC.		
43	387-0486-00			1	PLATE, cabinet side, left
	- - - - -			-	plate includes:
	105-0007-00			2	STOP, steel
	210-0480-00			2	NUT, latch, nylon, cabinet fastener
	210-0847-00			2	WASHER, nylon, .164 ID x .500 inch OD
	213-0114-00			2	SCREW, cabinet latch, 8-32 x .437 inch
44	387-0491-00			1	PLATE, cabinet top
	- - - - -			-	plate includes:
	105-0007-00			4	STOP, steel
	210-0480-00			4	NUT, latch, nylon, cabinet fastener
	210-0847-00			4	WASHER, nylon, .164 ID x .500 inch OD
	213-0114-00			4	SCREW, cabinet latch, 8-32 x .437 inch
45	441-0405-00	101	2059X	1	CHASSIS, calibrator
	- - - - -			-	mounting hardware: (not included w/chassis)
	211-0507-00			6	SCREW, 6-32 x 5/16 inch BHS
	210-0803-00			6	WASHER, 6L x 3/8 inch
46	210-0201-00	101	2059X	1	LUG, solder, SE #4
	- - - - -			-	mounting hardware: (not included w/lug)
	213-0044-00			1	SCREW, thread cutting, 5-32 x 3/16 inch PHS phillips
47	136-0015-00	101	2059X	1	SOCKET, STM9G
	- - - - -			-	mounting hardware: (not included w/socket)
	213-0044-00			2	SCREW, thread cutting, 5-32 x 3/16 inch PHS phillips
48	- - - - -	101	2059X	1	POT
	- - - - -			-	mounting hardware: (not included w/pot)
	210-0207-00			1	LUG, solder, 3/8 inch
	210-0012-00			1	LOCKWASHER, internal, 3/8 x 1/2 inch
	210-0840-00			1	WASHER, .390 ID x 9/16 inch OD
	210-0413-00			1	NUT, hex, 3/8-32 x 1/2 inch
49	348-0004-00	101	2059X	1	GROMMET, 3/8 inch
50	200-0247-00	101	489X	1	CAP, pot
51	- - - - -	101	2059X	1	POT
	- - - - -			-	mounting hardware: (not included w/pot)
	210-0840-00	X490	2059X	1	WASHER, .390 ID x 9/16 inch OD
	210-0413-00	X490	2059X	1	NUT, hex, 3/8-32 x 1/2 inch

FRONT (Cont'd)

REF. NO.	PART NO.	SERIAL/MODEL NO.		QTY.	DESCRIPTION
		EFF.	DISC.		
52	670-0403-00	X2060		1	ASSEMBLY, CIRCUIT BOARD, CALIBRATOR (See Ref #57)
	- - - - -			-	assembly includes:
53	388-0622-00	X2060		1	BOARD, etched circuit, calibrator
54	136-0150-00	X2060		5	SOCKET, 3-pin transistor
55	- - - - -	X2060		1	POT
	- - - - -			-	mounting hardware: (not included w/pot alone)
	210-0207-00			1	LUG, solder, 3/8 inch
	210-0012-00			1	LOCKWASHER, internal, 3/8 x 1/2 inch
	210-0840-00			1	WASHER, .390 ID x 9/16 inch OD
	210-0413-00			1	NUT, hex, 3/8-32 x 1/2 inch
56	136-0153-00	X2060		1	SOCKET, crystal
	- - - - -			-	mounting hardware: (not included w/socket alone)
	211-0022-00			2	SCREW, 2-56 x 3/16 inch RHS
	210-0001-00			2	LOCKWASHER, internal, #2
	210-0405-00			2	NUT, hex, 2-56 x 3/16 inch
57	- - - - -			-	mounting hardware: (not included w/assembly)
	211-0507-00	2060	2289	6	SCREW, 6-32 x 5/16 inch BHS
	211-0601-00	2290		6	SCREW, sems, 6-32 x 5/16 inch PHB, phillips
58	407-0070-00	X2060		1	BRACKET, calibrator
	- - - - -			-	mounting hardware: (not included w/bracket)
	211-0507-00			2	SCREW, 6-32 x 5/16 inch BHS
	210-0803-00			2	WASHER, 6L x 3/8 inch
59	344-0111-00	X2020		1	CLIP, deflection lead
60	175-0582-00	101	409	1	WIRE, crt lead, .458 foot, striped brown, w/connector
	175-0641-00	410		1	WIRE, crt lead, .833 foot, brown, w/connector
	175-0583-00			1	WIRE, crt lead, 11 1/2 inches, striped red, w/connector
	175-0584-00			1	WIRE, crt lead, 11 1/2 inches, striped green, w/connector
	175-0596-00	101	409	1	WIRE, crt lead, .417 foot, striped blue, w/connector
	175-0642-00	410		1	WIRE, crt lead, .833 foot, blue, w/connector
61	214-0210-00			1	ASSEMBLY, solder
	- - - - -			-	assembly includes:
	214-0209-00			1	SPOOL, solder
	- - - - -			-	mounting hardware: (not included w/spool)
	361-0007-00			1	SPACER, nylon, .063 inch
62	337-0495-00			1	SHIELD, crt
	- - - - -			-	mounting hardware: (not included w/shield)
	211-0504-00			4	SCREW, 6-32 x 1/4 inch BHS
	211-0503-00			2	SCREW, 6-32 x 3/16 inch BHS
63	406-0730-00			1	BRACKET, adjustment
	- - - - -			-	mounting hardware: (not included w/bracket)
	211-0534-00			4	SCREW, 6-32 x 5/16 inch PHS w/lockwasher
	210-0803-00			4	WASHER, 6L x 3/8 inch
	210-0457-00			4	NUT, keps, 6-32 x 5/16 inch

FRONT (Cont'd)

REF. NO.	PART NO.	SERIAL/MODEL NO.		QTY.	DESCRIPTION
		EFF.	DISC.		
64	211-0560-00			1	SCREW, 6-32 x 1 inch RHS
	210-0407-00	101	718	1	NUT, hex., 6-32 x 1/4 inch
	220-0419-00	719		1	NUT, square, 6-32 x 5/16 inch
65	385-0137-00	101	409X	1	ROD, delrin, 2 1/4 inches
	- - - - -			-	mounting hardware: (not included w/rod)
	213-0041-00			1	SCREW, thread cutting, 6-32 x 3/8 inch THS phillips
66	354-0147-00	101	609	1	RING, clamping (See Ref #68 & 69)
	354-0212-00	610		1	RING, clamping (See Ref #68 & 69)
	- - - - -			-	ring includes:
67	124-0160-00	X610		1	STRIP, liner, crt clamp
	- - - - -			-	mounting hardware: (not included w/ring)
68	211-0576-00			2	SCREW, 6-32 x 7/8 inch socket head cap
	210-0858-00			2	WASHER, 5/32 ID x 1/2 inch OD
69	214-0207-00			1	NUT, adjustment, securing
70	385-0137-00			1	ROD, delrin, 2 1/4 inches
	- - - - -			-	mounting hardware: (not included w/rod)
	213-0041-00			1	SCREW, thread cutting, 6-32 x 3/8 inch THS phillips
71	348-0041-00			1	CUSHION, rubber
72	179-0596-00			1	CABLE HARNESS, crt socket
	- - - - -			-	cable harness includes:
	136-0124-00	101	649	1	SOCKET, crt, wired
	136-0175-00	650		1	SOCKET, crt, wired
	- - - - -			-	socket includes:
73	136-0117-00			1	SOCKET, crt w/o leads
	131-0178-00			9	CONNECTOR, cable end, crt
74	387-0393-00			1	PLATE, back, crt socket
	- - - - -			-	mounting hardware: (not included w/plate alone)
	213-0086-00			2	SCREW, thread cutting, 2-32 x 7/16 inch PHS
75	348-0012-00			2	GROMMET, 5/8 inch
76	210-0201-00			2	LUG, solder, SE #4
	- - - - -			-	mounting hardware for each: (not included w/lug)
	213-0044-00			1	SCREW, thread cutting, 5-32 x 3/16 inch PHS phillips
77	348-0002-00			2	GROMMET, 1/4 inch
78	352-0015-00	101	2229X	2	HOLDER, nylon, coil form
	- - - - -			-	mounting hardware for each: (not included w/holder)
	213-0045-00			1	SCREW, self-tapping, 4-40 x 3/16 inch PHS phillips
79	131-0148-00			1	CONNECTOR, 24-contact, female
	- - - - -			-	mounting hardware: (not included w/connector)
	211-0012-00			2	SCREW, 4-40 x 3/8 inch BHS
	210-0004-00			1	LOCKWASHER, internal, #4
	210-0201-00			1	LUG, solder, SE #4
	210-0406-00			2	NUT, hex, 4-40 x 3/16 inch

Parts List—Type 567

FRONT (Cont'd)

REF. NO.	PART NO.	SERIAL/MODEL NO.		QTY.	DESCRIPTION
		EFF.	DISC.		
80	387-0492-00	101	2059	1	PLATE, bulkhead
	387-0990-00	2060		1	PLATE, bulkhead
81	214-0226-00			-	plate includes:
	358-0182-00			2	FASTENER, screw, 10-24 x 1 ³ / ₈ inches
	354-0171-00			2	BUSHING, stand-off
82	343-0003-00			2	RING, retaining
				1	CLAMP, cable, 1/4 inch
				-	mounting hardware: (not included w/clamp)
	211-0510-00			1	SCREW, 6-32 x 3/8 inch BHS
	210-0803-00			1	WASHER, 6L x 3/8 inch
	210-0457-00			1	NUT, keps, 6-32 x 5/16 inch
83	131-0148-00			3	CONNECTOR, 24-contact, female
				-	mounting hardware for each: (not included w/connector)
	211-0014-00			2	SCREW, 4-40 x 1/2 inch BHS
	166-0029-00			2	TUBE, spacer
	210-0004-00			2	LOCKWASHER, internal, #4
	210-0406-00			2	NUT, hex, 4-40 x 3/16 inch
84	385-0135-00			2	ROD, delrin, 1 ⁵ / ₁₆ inch
				-	mounting hardware for each: (not included w/rod)
	213-0041-00			1	SCREW, thread cutting, 6-32 x 3/8 inch THS phillips
85	260-0246-00			1	SWITCH, thermal cutout
				-	mounting hardware: (not included w/switch)
	211-0507-00			2	SCREW, 6-32 x 5/16 inch BHS
	210-0803-00			2	WASHER, 6L x 3/8 inch
	210-0006-00			2	LOCKWASHER, internal, #6
	210-0407-00			2	NUT, hex, 6-32 x 1/4 inch
86				1	POT
				-	mounting hardware: (not included w/pot)
	210-0012-00			1	LOCKWASHER, internal, 3/8 x 1/2 inch
	210-0207-00			1	LUG, solder, 3/8 inch
	210-0840-00			1	WASHER, .390 ID x 9/16 inch OD
	210-0413-00			1	NUT, hex, 3/8-32 x 1/2 inch
87	131-0148-00			1	CONNECTOR, 24-contact, female
				-	mounting hardware: (not included w/connector)
	211-0012-00			2	SCREW, 4-40 x 3/8 inch BHS
	210-0201-00			2	LUG, solder, SE #4
	210-0406-00			2	NUT, hex, 4-40 x 3/16 inch

FRONT (Cont'd)

REF. NO.	PART NO.	SERIAL/MODEL NO.		QTY.	DESCRIPTION
		EFF.	DISC.		
88	131-0148-00			1	CONNECTOR, 24-contact, female
	-----			-	mounting hardware: (not included w/connector)
	211-0014-00			2	SCREW, 4-40 x 1/2 inch BHS
	166-0029-00			2	TUBE, spacer
	210-0004-00			1	LOCKWASHER, internal, #4
	210-0201-00			1	LUG, solder, SE #4
	210-0406-00			2	NUT, hex, 4-40 x 3/16 inch

REAR

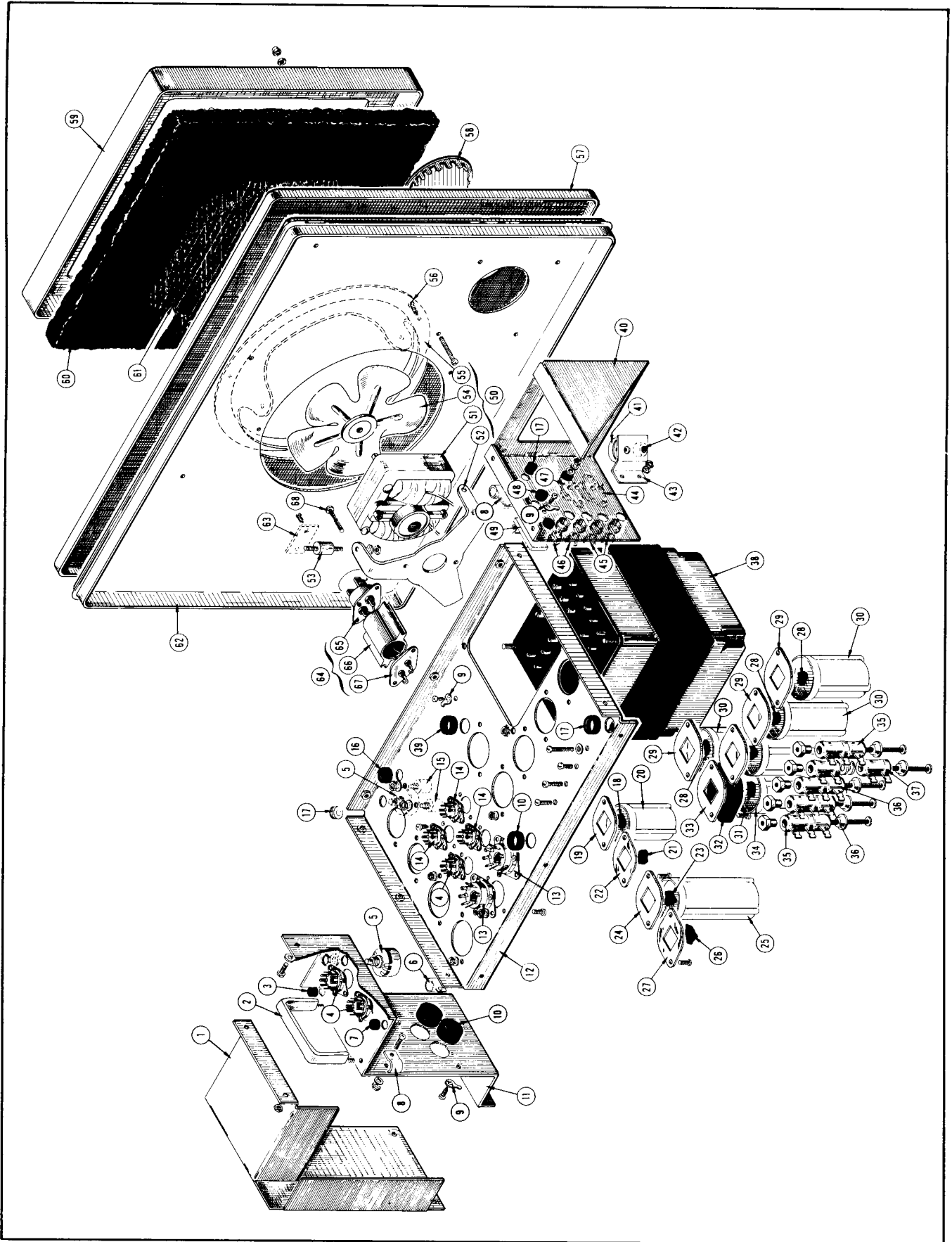

REAR

REF. NO.	PART NO.	SERIAL/MODEL NO.		QTY.	DESCRIPTION
		EFF.	DISC.		
1	337-0474-00 - - - - - 211-0504-00 210-0457-00			1 - 2 2	SHIELD, high-voltage - mounting hardware: (not included w/shield) SCREW, 6-32 x 1/4 inch BHS NUT, keps, 6-32 x 5/16 inch
2	346-0001-00 - - - - - 210-0004-00 210-0406-00			1 - 2 2	STRAP, mounting, high-voltage transformer - mounting hardware: (not included w/strap) LOCKWASHER, internal, #4 NUT, hex, 4-40 x 3/16 inch
3	348-0003-00			1	GROMMET, 5/16 inch
4	136-0015-00 - - - - - 213-0044-00			3 - 2	SOCKET, STM9G - mounting hardware for each: (not included w/socket) SCREW, thread cutting, 5-32 x 3/16 inch PHS phillips
5	- - - - - - - - - - 210-0840-00 210-0413-00			2 - 1 1	POT - mounting hardware for each: (not included w/pot) WASHER, .390 ID x 9/16 inch OD NUT, hex, 3/8-32 x 1/2 inch
6	343-0004-00 - - - - - 211-0510-00 210-0803-00 210-0457-00			1 - 1 1 1	CLAMP, cable, 5/16 inch - mounting hardware: (not included w/clamp) SCREW, 6-32 x 3/8 inch BHS WASHER, 6L x 3/8 inch NUT, keps, 6-32 x 5/16 inch
7	348-0002-00			1	GROMMET, 1/4 inch
8	343-0042-00 - - - - - 211-0507-00 210-0803-00 210-0006-00 210-0407-00			2 - 1 1 1 1	CLAMP, cable, 5/16 inch (half) - mounting hardware for each: (not included w/clamp) SCREW, 6-32 x 5/16 inch BHS WASHER, 6L x 3/8 inch LOCKWASHER, internal, #6 NUT, hex, 6-32 x 1/4 inch
9	210-0201-00 - - - - - 213-0044-00			4 - 1	LUG, solder, SE #4 - mounting hardware for each: (not included w/lug) SCREW, thread cutting, 5-32 x 3/16 inch PHS phillips
10	348-0006-00			3	GROMMET, 3/4 inch
11	441-0406-00 - - - - - 211-0507-00 210-0803-00 211-0538-00			1 - 2 2 5	CHASSIS, high-voltage/focus & intensity - mounting hardware: (not included w/chassis) SCREW, 6-32 x 5/16 inch BHS WASHER, 6L x 3/8 inch SCREW, 6-32 x 5/16 inch FHS phillips
12	441-0407-00 - - - - - 212-0004-00 210-0804-00 210-0458-00 212-0040-00			1 - 3 4 1 5	CHASSIS, power - mounting hardware: (not included w/chassis) SCREW, 8-32 x 5/16 inch BHS WASHER, 8S x 3/8 inch NUT, keps, 8-32 x 11/32 inch SCREW, 8-32 x 3/8 inch FHS phillips

Parts List—Type 567

REAR (Cont'd)

REF. NO.	PART NO.	SERIAL/MODEL NO.		QTY.	DESCRIPTION
		EFF.	DISC.		
13	136-0011-00 ----- 211-0538-00 210-0006-00 210-0407-00			2 - 2 2 2	SOCKET, STM8G mounting hardware for each: (not included w/socket) SCREW, 6-32 x 5/16 inch FHS phillips LOCKWASHER, internal, #6 NUT, hex, 6-32 x 1/4 inch
14	136-0008-00 ----- 213-0044-00			3 - 2	SOCKET, STM7G mounting hardware for each: (not included w/socket) SCREW, thread cutting, 5-32 x 3/16 inch PHS phillips
15	----- ----- 210-0046-00 210-0583-00			2 - 1 1	POT mounting hardware for each: (not included w/pot) LOCKWASHER, internal, .400 OD x .261 inch ID NUT, hex, 1/4-32 x 5/16 inch
16	348-0004-00			1	GROMMET, 3/8 inch
17	348-0005-00			3	GROMMET, 1/2 inch
18	----- -----			1 -	CAPACITOR capacitor includes:
19	386-0252-00			1	PLATE, fiber, small capacitor
20	200-0256-00 ----- 211-0534-00 210-0006-00 210-0407-00			1 - 2 2 2	COVER, capacitor mounting hardware: (not included w/capacitor) SCREW, 6-32 x 5/16 inch PHS w/lockwasher LOCKWASHER, internal, #6 NUT, hex, 6-32 x 1/4 inch
21	----- -----			1 -	CAPACITOR capacitor includes:
22	386-0253-00 ----- 211-0534-00 210-0006-00 210-0407-00			1 - 2 2 2	PLATE, metal, small capacitor mounting hardware: (not included w/capacitor) SCREW, 6-32 x 5/16 inch PHS w/lockwasher LOCKWASHER, internal, #6 NUT, hex, 6-32 x 1/4 inch
23	----- -----			1 -	CAPACITOR capacitor includes:
24	386-0254-00			1	PLATE, fiber, large capacitor
25	200-0261-00 ----- 211-0543-00 210-0006-00 210-0407-00			1 - 2 2 2	COVER, capacitor mounting hardware: (not included w/capacitor) SCREW, 6-32 x 5/16 inch RHS LOCKWASHER, internal, #6 NUT, hex, 6-32 x 1/4 inch
26	----- -----			1 -	CAPACITOR capacitor includes:
27	386-0255-00 ----- 211-0534-00 210-0006-00 210-0407-00			1 - 2 2 2	PLATE, metal, large capacitor mounting hardware: (not included w/capacitor) SCREW, 6-32 x 5/16 inch PHS w/lockwasher LOCKWASHER, internal, #6 NUT, hex, 6-32 x 1/4 inch

REAR (Cont'd)

REF. NO.	PART NO.	SERIAL/MODEL NO.		QTY.	DESCRIPTION
		EFF.	DISC.		
28	- - - - -			4	CAPACITOR
	- - - - -			-	each capacitor includes:
29	386-0254-00			1	PLATE, fiber, large capacitor
30	200-0293-00			1	COVER, capacitor
	- - - - -			-	mounting hardware for each: (not included w/capacitor)
	211-0543-00			2	SCREW, 6-32 x 5/16 inch RHS
	210-0006-00			2	LOCKWASHER, internal, #6
	210-0407-00			2	NUT, hex, 6-32 x 1/4 inch
31	- - - - -			1	CAPACITOR
	- - - - -			-	mounting hardware: (not included w/capacitor)
32	432-0044-00	X360	2279X	1	BASE, capacitor mounting
33	386-0254-00			1	PLATE, fiber, large capacitor
	211-0543-00	101	359	2	SCREW, 6-32 x 5/16 inch RHS
	211-0514-00	360	2279	2	SCREW, 6-32 x 3/4 inch BHS
	211-0543-00	2280		2	SCREW, 6-32 x 5/16 inch RHS
	210-0006-00			2	LOCKWASHER, internal, #6
	210-0407-00			2	NUT, hex, 6-32 x 1/4 inch
34	200-0261-00	101	359	1	COVER, capacitor, 4 1/16 inches
	200-0259-00	360	2109	1	COVER, capacitor, 3 3/16 inches
	200-0293-00	2110	2279	1	COVER, capacitor, 2 9/16 inches
	200-0258-00	2280		1	COVER, capacitor, 3 1/32 inches
35	- - - - -			2	RESISTOR
	- - - - -			-	mounting hardware for each: (not included w/resistor)
	212-0037-00			1	SCREW, 8-32 x 1 3/4 inches Fil HS
	210-0008-00			1	LOCKWASHER, internal, #8
	210-0809-00	101	3189	1	WASHER, resistor centering
	210-0808-00	3190		1	WASHER, resistor centering
	210-0462-00			1	NUT, hex, resistor mounting
	212-0004-00			1	SCREW, 8-32 x 5/16 inch BHS
36	- - - - -			2	RESISTOR
	- - - - -			-	mounting hardware for each: (not included w/resistor)
	212-0037-00			1	SCREW, 8-32 x 1 3/4 inches Fil HS
	210-0808-00			1	WASHER, resistor centering
	210-0462-00			1	NUT, hex, resistor mounting
	212-0004-00			1	SCREW, 8-32 x 5/16 inch BHS
37	- - - - -	101	2004	1	RESISTOR
	- - - - -	2005		2	RESISTOR (stacked on top of each other)
	- - - - -			-	mounting hardware: (not included w/resistor)
	212-0037-00	101	2004	1	SCREW, 8-32 x 1 3/4 inches Fil HS
	211-0552-00	2005		1	SCREW, 6-32 x 2 inches BHS
	210-0808-00	101	2004	1	WASHER, resistor centering
	210-0886-00	2005		3	WASHER, centering
	210-0803-00	X2005		1	WASHER, 6L x 3/8 inch
	210-0805-00	X2005		1	WASHER, 10S x 7/16 inch
	210-0462-00	101	2004	1	NUT, hex, resistor mounting
	210-0478-00	2005		1	NUT, hex, resistor mounting
	212-0004-00	101	2004	1	SCREW, 8-32 x 5/16 inch BHS
	211-0510-00	2005		1	SCREW, 6-32 x 3/8 inch BHS

REAR (Cont'd)

REF. NO.	PART NO.	SERIAL/MODEL NO.		QTY.	DESCRIPTION
		EFF.	DISC.		
38	- - - - -			1	TRANSFORMER
	- - - - -			-	transformer includes: (mounting hardware)
	212-0546-00			4	SCREW, 10-32 x 4 1/2 inches HHS
	210-0812-00			4	WASHER, fiber, #10
	220-0410-00			4	NUT, keps, 10-32 x 3/8 inch
39	348-0012-00			1	GROMMET, 5/8 inch
40	441-0421-00			1	CHASSIS, regulator & transformer support
	- - - - -			-	mounting hardware: (not included w/chassis)
	212-0040-00			4	SCREW, 8-32 x 3/8 inch FHS phillips
	210-0804-00			8	WASHER, 8S x 3/8 inch
	210-0458-00			8	NUT, keps, 8-32 x 1 1/32 inch
41	- - - - -	X2005		1	POT
	- - - - -			-	mounting hardware: (not included w/pot)
	210-0046-00			1	LOCKWASHER, internal, .400 OD x .261 inch ID
	210-0583-00			1	NUT, hex, 1/4-32 x 5/16 inch
42	- - - - -	X408		1	POT
	- - - - -			-	mounting hardware: (not included w/pot)
	210-0046-00			1	LOCKWASHER, internal, .400 OD x .261 inch ID
	210-0583-00			1	NUT, hex, 1/4-32 x 5/16 inch
43	406-0895-00	X408		1	BRACKET, pot
	- - - - -			-	mounting hardware: (not included w/bracket)
	211-0507-00			2	SCREW, 6-32 x 5/16 inch BHS
	210-0006-00			2	LOCKWASHER, internal, #6
	210-0407-00			2	NUT, hex, 6-32 x 1/4 inch
44	- - - - -			1	TRANSISTOR
	- - - - -			-	mounting hardware: (not included w/transistor)
	211-0510-00			2	SCREW, 6-32 x 3/8 inch BHS
	210-0006-00			1	LOCKWASHER, internal, #6
	210-0202-00			1	LUG, solder, SE #6
	210-0407-00			2	NUT, hex, 6-32 x 1/4 inch
45	136-0095-00	101	2019	2	SOCKET, 4-pin transistor
	136-0181-00	2020		2	SOCKET, 3-pin transistor
	- - - - -			-	mounting hardware for each: (not included w/socket)
	213-0113-00	101	2019	2	SCREW, thread forming, 2-32 x 5/16 inch RHS phillips
	354-0234-00	2020		1	RING, transistor socket
46	136-0095-00	101	2019	2	SOCKET, 4-pin transistor
	136-0182-00	2020		2	SOCKET, 4-pin transistor
	- - - - -			-	mounting hardware for each: (not included w/socket)
	213-0113-00	101	2019	2	SCREW, thread forming, 2-32 x 5/16 inch RHS phillips
	354-0234-00	2020		1	RING, transistor socket

REAR (Cont'd)

REF. NO.	PART NO.	SERIAL/MODEL NO.		QTY.	DESCRIPTION
		EFF.	DISC.		
47	- - - - -			1	TRANSISTOR
	- - - - -			-	mounting hardware: (not included w/transistor)
	129-0049-00	101	649	2	POST, terminal
	211-0511-00	650		2	SCREW, 6-32 x 1/2 inch BHS
	210-0409-00	101	649	2	NUT, hex, 8-32 x 5/16 inch
	210-0407-00			2	NUT, hex, 6-32 x 1/4 inch
	210-0008-00	101	649	2	LOCKWASHER, internal, #8
	210-0006-00	101	649	2	LOCKWASHER, internal, #6
	210-0006-00	650		1	LOCKWASHER, internal, #6
	210-0202-00	650		1	LUG, solder, SE #6
	210-0804-00	101	649	2	WASHER, 8S x 3/8 inch
	210-0803-00	650		2	WASHER, 6L x 3/8 inch
	210-0900-00			2	WASHER, bakelite
	387-0345-00			1	PLATE, insulator
48	354-0068-00	101	2168	2	RING, securing
	354-0068-00	2169		1	RING, securing
49	352-0025-00			1	HOLDER, fuse, dual
	- - - - -			-	mounting hardware: (not included w/holder)
	211-0511-00			2	SCREW, 6-32 x 1/2 inch BHS
	210-0006-00			2	LOCKWASHER, internal, #6
	210-0407-00			2	NUT, hex, 6-32 x 1/4 inch
50	635-0409-00			1	ASSEMBLY, FAN MOTOR (See Ref #56)
	- - - - -			-	assembly includes:
51	147-0001-00			1	MOTOR
	- - - - -			-	mounting hardware: (not included w/motor alone)
	355-0044-00			2	STUD, 10-32 x 27/16 inches
	210-0010-00			6	LOCKWASHER, internal, #10
	210-0410-00			4	NUT, hex, 10-32 x 5/16 inch
52	426-0047-00			1	MOUNT, fan motor
	- - - - -			-	mounting hardware: (not included w/mount alone)
53	348-0008-00			3	SHOCKMOUNT, rubber
	210-0008-00			6	LOCKWASHER, internal, #8
	210-0409-00			6	NUT, hex, 8-32 x 5/16 inch
54	369-0007-00			1	BLADE, fan, 7 inches
55	354-0053-00			1	RING, fan
56	- - - - -			-	mounting hardware: (not included w/assembly)
	213-0104-00			6	SCREW, thread forming, 6-32 x 3/8 inch THS phillips
57	387-0488-00			1	PLATE, rear overlay
	- - - - -			-	plate includes:
58	134-0028-00			1	PLUG, steel
	- - - - -			-	mounting hardware: (not included w/plate)
	213-0104-00			3	SCREW, thread forming, 6-32 x 3/8 inch THS phillips

Parts List—Type 567

REAR (Cont'd)

REF. NO.	PART NO.	SERIAL/MODEL NO.		QTY.	DESCRIPTION
		EFF.	DISC.		
59	380-0018-00			1	HOUSING, air filter
	- - - - -			-	mounting hardware: (not included w/housing)
	212-0031-00			2	SCREW, 8-32 x 1 1/4 inches RHS
	210-0458-00			2	NUT, keps, 8-32 x 1 1/32 inch
	210-0402-00			2	NUT, cap, hex, 8-32 x 5/16 inch
60	378-0011-00	101	749	1	FILTER, air
	378-0023-00	750		1	FILTER, air
61	378-0762-00	X750		1	SCREEN, air filter
62	387-0487-00			1	PLATE, rear sub-panel
	- - - - -			-	plate includes:
	354-0156-00			1	RING, ornamental
63	334-0649-00			1	TAG, voltage rating
	- - - - -			-	mounting hardware: (not included w/tag)
	213-0088-00			2	SCREW, thread forming, 4-40 x 1/4 inch PHS phillips
64	650-0204-00			1	ASSEMBLY, A.C. LINE FILTER (See Ref # 68)
	- - - - -			-	assembly includes:
65	131-0102-00	101	2739	1	CONNECTOR, 3-wire, motor base
	131-0102-01	2740		1	CONNECTOR, 3-wire, motor base
	- - - - -			-	connector includes:
	129-0041-00	101	2739	1	POST, ground
	129-0041-01	2740		1	POST, ground
	200-0185-00	101	2739	1	COVER, motor base
	200-0185-01	2740		1	COVER, motor base
	210-0003-00	101	2739X	2	LOCKWASHER, external, #4
	210-0551-00	101	2739X	2	NUT, hex, 4-40 x 1/4 inch
	211-0132-00	X2740		1	SCREW, sems, 4-40 x 1/2 inch, PHS
	211-0015-00	101	2739	1	SCREW, 4-40 x 1/2 inch RHS
	213-0088-00	2740		1	SCREW, thread forming, 4-40 x 1/4 inch, PHS
	214-0078-00			2	PIN, connecting
	377-0041-00	101	2739	1	INSERT, black urea
	377-0051-00	2740		1	INSERT, black urea
	386-0933-00			1	PLATE, motor base
66	361-0015-00			1	SPACER, line filter
67	387-0025-00			1	PLATE, line filter cap
68	- - - - -			-	mounting hardware: (not included w/assembly)
	211-0552-00			2	SCREW, 6-32 x 2 inches BHS
	210-0457-00			2	NUT, keps, 6-32 x 5/16 inch

CABLE HARNESS & CERAMIC STRIP DETAIL

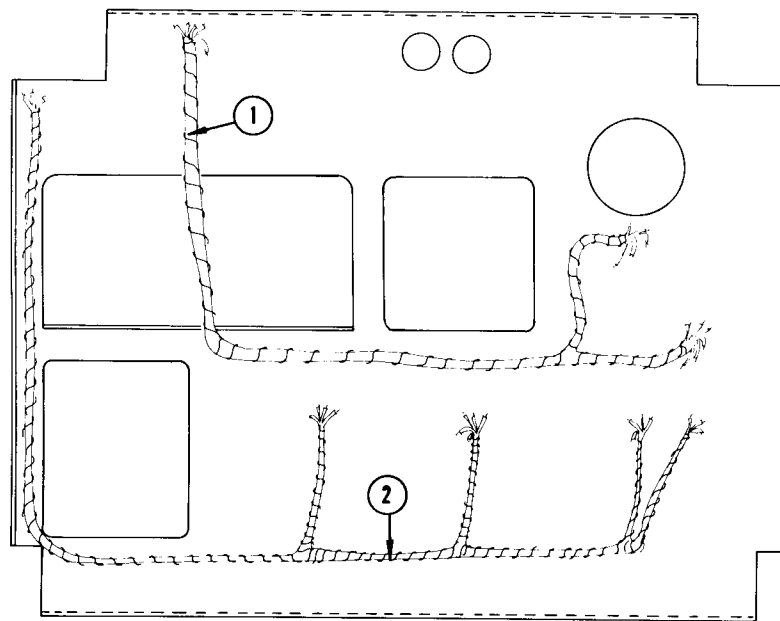

BULKHEAD

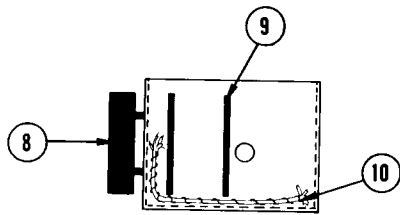

CALIBRATOR CHASSIS

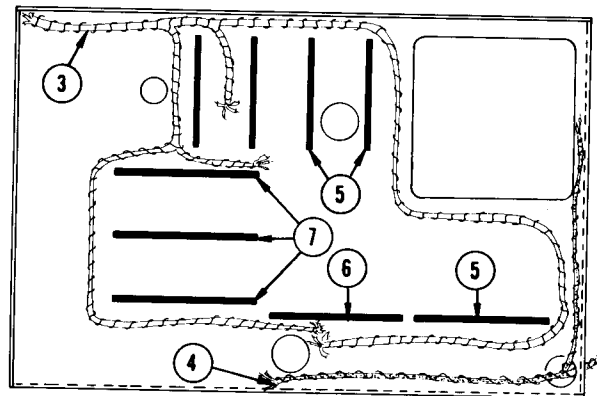

POWER CHASSIS

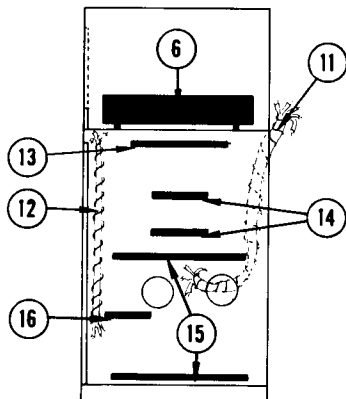

HIGH VOLTAGE / FOCUS AND INTENSITY CHASSIS

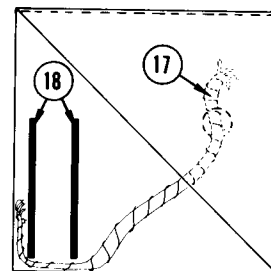

REGULATOR & TRANSFORMER SUPPORT CHASSIS

CABLE HARNESS AND CERAMIC STRIP DETAIL

REF. NO.	PART NO.	SERIAL/MODEL NO.		QTY.	DESCRIPTION	
		EFF.	DISC.			
1	179-0574-00	101	649	1	CABLE HARNESS, bulkhead #1	
	179-0858-00	650		1	CABLE HARNESS, bulkhead #1	
2	179-0575-00	101	407	1	CABLE HARNESS, bulkhead #2	
	179-0573-00			408	1	CABLE HARNESS, power
4	179-0721-00	101	407	1	CABLE HARNESS, power	
	179-0578-00			408	1	CABLE HARNESS, 110-volt
5	124-0090-00	101	407	5	STRIP, ceramic, 3/4 inch x 9 notches	
	-			-	-	each strip includes:
	-			-	-	STUD, nylon
	-			-	-	mounting hardware for each: (not included w/strip)
	355-0046-00			-	-	2
361-0009-00	-	-	2			
6	124-0091-00	101	407	3	STRIP, ceramic, 3/4 inch x 11 notches	
	-			-	-	each strip includes:
	-			-	-	STUD, nylon
	-			-	-	mounting hardware for each: (not included w/strip)
355-0046-00	-	-	2	SPACER, nylon, .313 inch		
361-0009-00	-	-	2			
7	124-0145-00	101	407	3	STRIP, ceramic, 7/16 inch x 20 notches	
	-			-	-	each strip includes:
	-			-	-	STUD, nylon
	-			-	-	mounting hardware for each: (not included w/strip)
355-0046-00	-	-	2	SPACER, nylon, .313 inch		
361-0009-00	-	-	2			
8	124-0094-00	101	2059X	1	STRIP, ceramic, 7/16 inch x 7 notches	
	-			-	-	strip includes:
	-			-	-	STUD, nylon
	-			-	-	mounting hardware: (not included w/strip)
355-0046-00	-	-	2	SPACER, nylon, .188 inch		
361-0008-00	-	-	2			
9	124-0090-00	101	2059X	2	STRIP, ceramic, 3/4 inch x 9 notches	
	-			-	-	each strip includes:
	-			-	-	STUD, nylon
	-			-	-	mounting hardware for each: (not included w/strip)
355-0046-00	-	-	2	SPACER, nylon, .313 inch		
361-0009-00	-	-	2			
10	179-0579-00	101	2059	1	CABLE HARNESS, calibrator chassis	
	179-0966-00	2060	2059	1	CABLE HARNESS, calibrator chassis	
11	179-0576-00	101	2059	1	CABLE HARNESS, focus & intensity	
	179-0965-00	2060	2059	1	CABLE HARNESS, focus & intensity	
12	179-0577-00	101	2059	1	CABLE HARNESS, high-voltage	
13	124-0094-00	101	2059X	1	STRIP, ceramic, 7/16 inch x 7 notches	
	-			-	-	strip includes:
	-			-	-	STUD, nylon
	-			-	-	mounting hardware: (not included w/strip)
355-0046-00	-	-	2	SPACER, nylon, .313 inch		
361-0009-00	-	-	2			

CABLE HARNESS AND CERAMIC STRIP DETAIL (Cont'd)

REF. NO.	PART NO.	SERIAL/MODEL NO.		QTY.	DESCRIPTION
		EFF.	DISC.		
14	124-0092-00	101	101	1	STRIP, ceramic, $\frac{7}{16}$ inch x 3 notches
	- - - - -			-	strip includes:
	355-0046-00			1	STUD, nylon
	- - - - -	-	mounting hardware: (not included w/strip)		
	361-0009-00	1	SPACER, nylon, .313 inch		
	- - - - -	-			
14	124-0120-00	102		2	STRIP, ceramic, $\frac{7}{16}$ inch x 4 notches
	- - - - -			-	each strip includes:
	355-0046-00			2	STUD, nylon
	- - - - -			-	mounting hardware for each: (not included w/strip)
361-0009-00	2	SPACER, nylon, .313 inch			
- - - - -	-				
15	124-0106-00			2	STRIP, ceramic, $\frac{7}{16}$ inch x 11 notches
	- - - - -			-	each strip includes:
	355-0046-00			2	STUD, nylon
	- - - - -			-	mounting hardware for each: (not included w/strip)
361-0009-00	2	SPACER, nylon, .313 inch			
- - - - -	-				
16	124-0092-00			1	STRIP, ceramic, $\frac{7}{16}$ inch x 3 notches
	- - - - -			-	strip includes:
	355-0046-00			1	STUD, nylon
	- - - - -			-	mounting hardware: (not included w/strip)
361-0009-00	1	SPACER, nylon, .313 inch			
- - - - -	-				
17	179-0604-00	101	407	1	CABLE HARNESS, regulator
	179-0722-00			1	CABLE HARNESS, regulator
18	124-0145-00			2	STRIP, ceramic, $\frac{7}{16}$ inch x 20 notches
	- - - - -			-	each strip includes:
	355-0046-00			2	STUD, nylon
	- - - - -			-	mounting hardware for each: (not included w/strip)
361-0008-00	2	SPACER, nylon, .188 inch			
- - - - -	-				

STANDARD ACCESSORIES

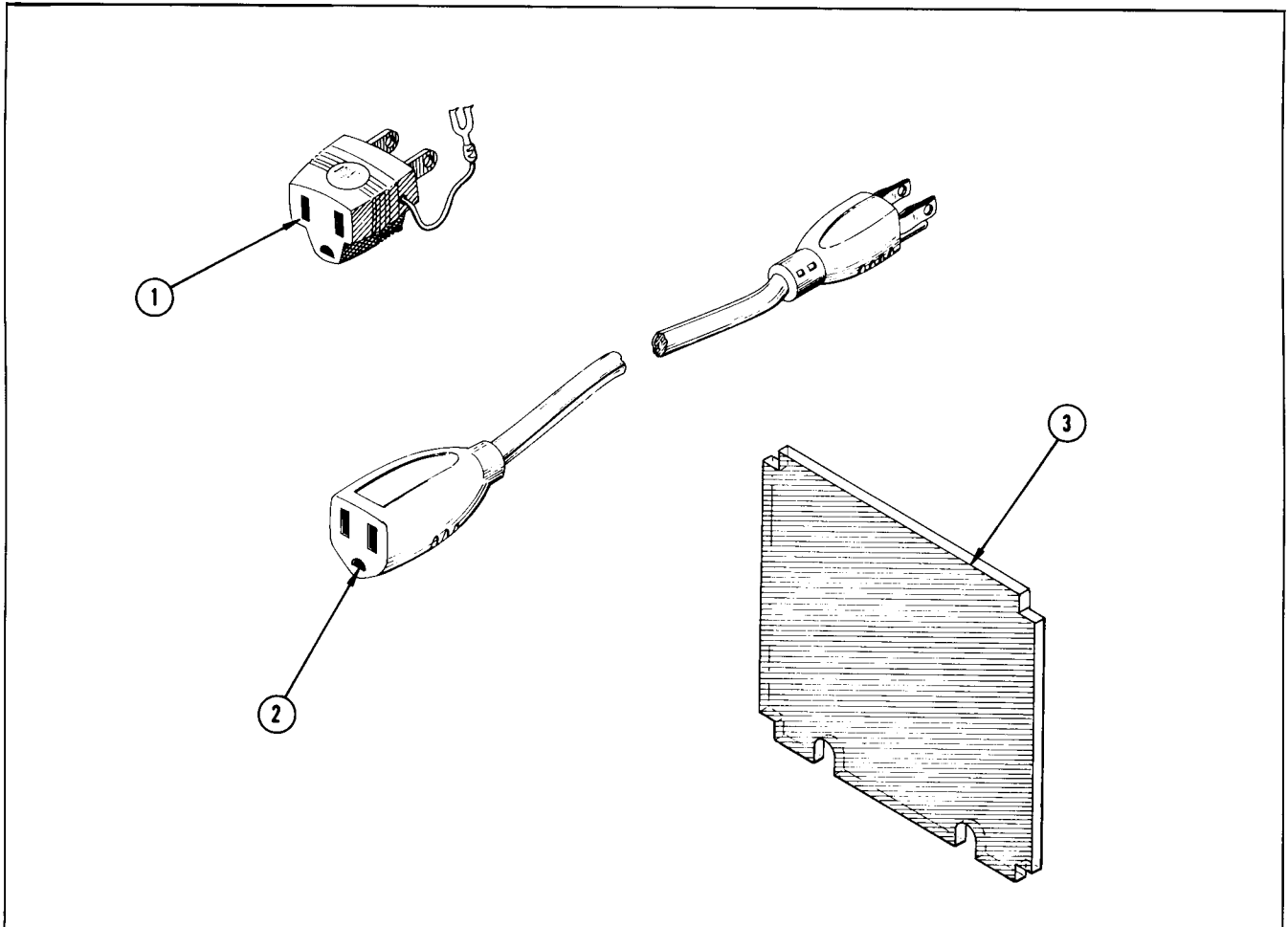

REF. NO.	PART NO.	SERIAL/MODEL NO.		QTY.	DESCRIPTION
		EFF.	DISC.		
1	103-0013-00			1	ADAPTER, power cord
2	161-0010-00	101	2849	1	CORD, power
	161-0010-03	2850		1	CORD, power
3	378-0525-00	X400	1998	1	FILTER, light
	378-0544-00	1999	2168	1	FILTER, light, smoke gray (installed)
	378-0560-00	2169		1	FILTER, light, smoke gray (installed)
	387-0935-00	X1999		1	PLATE, protector
--	070-0322-01			2	MANUAL, instruction (not shown)

ELECTRICAL PARTS LIST

Values are fixed unless marked Variable.

				Bulbs		
Ckt. No.	Tektronix Part No.	Description		S/N Range		
B603	150-004	Incandescent, G.E. #328				
B604	150-001	Incandescent, G.E. #47, Graticule Light		101-1998		
B604	150-031	Incandescent #44 Graticule Light		1999-up		
B605	150-001	Incandescent, G.E. #47, Graticule Light		101-1998		
B605	150-031	Incandescent #44 Graticule Light		1999-up		
B852 } B853 }	150-009	Bulb, Neon NE-2 —55 v		X249-up		

Capacitors

Tolerance $\pm 20\%$ unless otherwise indicated.Tolerance of all electrolytic capacitors are as follows:
(with exceptions)

3 V — 50 V = -10%, + 250%
 51 V — 350 V = -10%, + 100%
 351 V — 450 V = -10%, + 50%

C600A	281-559	.0015 μ f	Cer.	500 v	
C600B	281-559	.0015 μ f	Cer.	500 v	
C602	Use 290-078	2 x 200 μ f	EMC	250 v	
C608	285-569	.01 μ f	PTM	200 v	
C625	285-569	.01 μ f	PTM	200 v	
C626	Use 290-075	2 x 10 μ f	EMC	250 v	
C630	Use 290-086	2000 μ f	EMC	30 v	
C631	Use 290-086	2000 μ f	EMC	30 v	
C632	Use 290-086	2000 μ f	EMC	30 v	
C633	Use 290-201	100 μ f	EMT	15 v	
C638	283-0000-00	.001 μ f	Disc. Type	500 v	X410-up
C640	283-026	.2 μ f	Disc Type	25 v	X3100-up
C640	283-0079-00	.01 μ f	Cer.	250 v	101-2119 2120-up
C646	Use 290-0137-00	100 μ f	EMT	30 v	+75%—15% 101-3099
C646	290-0248-01	150 μ f	EMT	15 v	3100-up
C652	Use 290-086	2000 μ f	EMC	30 v	
C653	283-004	.02 μ f	Disc Type	150 v	X506-up
C654	Use 283-057	.1 μ f	Disc Type	200 v	
C656	290-015	100 μ f	EMT	25 v	
C657	283-003	.01 μ f	Disc Type	150 v	
C662	Use 290-130	2 x 125 μ f	EMC	350 v	
C674	285-604	.01 μ f	PTM	400 v	
C676A,B	Use 290-007	2 x 15 μ f	EMC	450 v	
C682	Use 290-130	2 x 125 μ f	EMC	350 v	
C694	285-604	.01 μ f	PTM	400 v	
C760	281-027	.7-3 pf	Tub.		Var.
C761	281-027	.7-3 pf	Tub.		Var.
C801	283-006	.02 μ f	Disc Type	600 v	
C802	283-538	.003 μ f	Mica	500 v	10%
C803	283-000	.001 μ f	Disc Type	500 v	
C807	285-501	.001 μ f	PTM	600 v	
C816	290-149	5 μ f	EMT	150 v	
C822	283-036	.0025 μ f	Disc Type	6000 v	
C824	283-036	.0025 μ f	Disc Type	6000 v	
C825	283-036	.0025 μ f	Disc Type	6000 v	
C837	283-036	.0025 μ f	Disc Type	6000 v	
C841	283-006	.02 μ f	Disc Type	600 v	
C842	283-034	.005 μ f	Disc Type	4000 v	
C854	283-036	.0025 μ f	Disc Type	6000 v	
C876	290-025	6.25 μ f	EMT	200 v	101-2059X

Parts List — Type 567

Capacitors (continued)

Ckt. No.	Tektronix Part No.		Description			S/N Range
C878	281-523	100 pf	Cer.	350 v		101-2059X
C884	281-524	150 pf	Cer.	500 v		101-2059X
C904	285-0627-00	.0033 μ f	PTM	100 v		X2060-up
C919	283-0059-00	1 μ f	Cer.	25 v		X2060-up
C923	281-0543-00	270 pf	Cer.	500 v	10%	X2060-up
C925	281-0550-00	120 pf	Cer.	500 v	10%	X2060-up
C933	281-0543-00	270 pf	Cer.	500 v	10%	X2060-up
C935	281-0550-00	120 pf	Cer.	500 v	10%	X2060-up
C954	281-0536-00	1000 pf	Cer.	500 v	10%	X2060-up
C957	281-0536-00	1000 pf	Cer.	500 v	10%	X2060-up

Diodes

D602A,B,C,D	*152-047	Silicon	Replaceable by 1N2862			101-2629
D602A,B,C,D	152-0066-00	Silicon	1N3194			2630-up
D632 A,B	152-035	Silicon	1N1563A			
D652A,B,C,D	*152-047	Silicon	Replaceable by 1N2862			101-2629
D652A,B,C,D	152-0066-00	Silicon	1N3194			2630-up
D662A,B,C,D	*152-047	Silicon	Replaceable by 1N2862			101-2629
D662A,B,C,D	152-0066-00	Silicon	1N3194			2630-up
D682 A,B,C,D	*152-047	Silicon	Replaceable by 1N2862			101-2629
D682A,B,C,D	152-0066-00	Silicon	1N3194			2630-up
D835	Use *152-047	Silicon	Replaceable by 1N2862			101-2629
D835	152-0066-00	Silicon	1N3194			2630-up
D836	Use *152-047	Silicon	Replaceable by 1N2862			101-2629
D836	152-0066-00	Silicon	1N3194			2630-up
D837	Use *152-047	Silicon	Replaceable by 1N2862			101-2629
D837	152-0066-00	Silicon	1N3194			2630-up
D852	*152-061	Silicon	Tek Spec			101-316X
D904	*152-0185-00	Silicon	Replaceable by 1N1452			X2060-up
D923	*152-0185-00	Silicon	Replaceable by 1N1452			X2060-up
D933	*152-0185-00	Silicon	Replaceable by 1N1452			X2060-up
D935	*152-0185-00	Silicon	Replaceable by 1N1452			X2060-up
D945	*152-0185-00	Silicon	Replaceable by 1N1452			X2060-up
D951	*152-0185-00	Silicon	Replaceable by 1N1452			X2060-up
D953	*152-0185-00	Silicon	Replaceable by 1N1452			X2060-up
D954	*152-0185-00	Silicon	Replaceable by 1N1452			X2060-up
D959	*152-0185-00	Silicon	Replaceable by 1N1452			X2060-up

Fuses

F601	{ 159-017	4 Amp.	3 AG Fast Blo	117 v oper		
	{ 159-021	2 Amp.	3 AG Fast Blo	234 v oper		
F647	159-014	5 Amp.	3 AG Fast Blo			101-2819
F647	159-0015-00	3 Amp.	3 AG Fast Blo			2820-up
F657	159-022	1 Amp.	3 AG Fast Blo			

Inductors

L860	*108-228	Beam Rotator on 276-063
------	----------	-------------------------

Resistors

Resistors are fixed, composition, $\pm 10\%$ unless otherwise indicated.

R600	304-100	10 Ω	1 w				101-407
R600	306-100	10 Ω	2 w				408-up
R603	304-330	33 Ω	1 w				
R604	311-055	50 Ω		Var.	WW	SCALE ILLUM.	101-1998
R604	311-377	25 Ω		Var.	WW	SCALE ILLUM.	1999-up
R605	308-142	30 Ω	3 w		WW	5%	101-1998X

Resistors (continued)

Ckt. No.	Tektronix Part No.	Description			S/N Range
R608	302-104	100 k	1/2 w		
R609	302-222	2.2 k	1/2 w		
R610	302-106	10 meg	1/2 w		
R611	302-102	1 k	1/2 w		
R614	302-473	47 k	1/2 w		
R616	302-102	1 k	1/2 w		
R617	302-474	470 k	1/2 w		
R619	302-473	47 k	1/2 w		
R620	302-102	1 k	1/2 w		
R621	302-224	220 k	1/2 w		
R623	308-186	80 k	1/2 w	WW	1% 101-2539
R623	308-0186-01	80 k	1 w	WW	1% 2540-up
R624	311-015	10 k		Var.	
R625	308-226	10 k	1/2 w	WW	—100 VOLTS 1%
R627	308-176	4 k	20 w	WW	5%
R628	308-040	1.5 k	25 w	WW	5%
R630	302-823	82 k	1/2 w		
R631	311-361	500 k	1/2 w	Var.	—12.2 V ADJ. X408-up
R632	301-394	390 k	1/2 w		5% X408-up
R633	309-104	2.05 k	1/2 w	Prec.	1%
R634	310-115	15 k	1 w	Prec.	1%
R637	302-334	330 k	1/2 w		
R638	302-272	2.7 k	1/2 w		
R640	302-151	150 Ω	1/2 w		101-2119
R640	301-0122-00	1.2 k	1/2 w		5% 2120-up
R644	306-221	220 Ω	2 w		
R646	302-471	470 Ω	1/2 w		
R650	311-125	50 k	2 w	Var.	+20 v ADJ. X2005-up
R651	301-434	430 k	1/2 w		5% X2005-up
R652	302-151	150 Ω	1/2 w		X506-up
R653	309-161	106 k	1/2 w	Prec.	1%
R654	309-331	20.2 k	1/2 w	Prec.	1%
R655	302-154	150 k	1/2 w		
R656	304-183	18 k	1 w		
R657	302-222	2.2 k	1/2 w		X310-up
R660	304-100	10 Ω	1 w		101-407
R660	306-100	10 Ω	2 w		408-up
R661	304-100	10 Ω	1 w		101-407
R661	306-100	10 Ω	2 w		408-up
R663	302-273	27 k	1/2 w		
R664	302-333	33 k	1/2 w		
R665	302-684	680 k	1/2 w		101-407
	301-124	120 k	1/2 w		5% 408-up
R666	302-474	470 k	1/2 w		
R667	302-565	5.6 meg	1/2 w		
R668	311-361	500 k	1/2 w	Var.	+125 V ADJ. X408-up
R669	302-102	1 k	1/2 w		X408-up
R671	308-218	150 Ω	3 w		
R672	302-102	1 k	1/2 w		
R673	302-474	470 k	1/2 w		
R674	309-101	330 k	1/2 w	Prec.	1%
R675	309-109	250 k	1/2 w	Prec.	1%
R676	308-218	150 Ω	3 w	WW	5%
R677	308-176	4 k	20 w	WW	5% 101-2004
R677	308-113	3 k	8 w	WW	5% 2005-up
R678	308-040	1.5 k	25 w	WW	5% 101-2004
R678	308-037	1 k	25 w	WW	5% 2005-up

Parts List — Type 567

Resistors (continued)

Ckt. No.	Tektronix Part No.	Description				S/N Range
R679	308-113	3 k	8 w		WW	2005-up
R680	304-100	10 Ω	1 w			
R681	304-100	10 Ω	1 w			X408-up
R682	301-473	47 k	1/2 w			X506-up
R683	302-394	390 k	1/2 w		5%	
R694	302-333	33 k	1/2 w			
R685	302-224	220 k	1/2 w			101-407
R685	301-134	130 k	1/2 w		5%	408-505
R685	303-823	82 k	1 w		5%	506-up
R686	302-105	1 meg	1/2 w			101-407
R686	301-185	1.8 meg	1/2 w		5%	408-up
R689	302-102	1 k	1/2 w			
R690	302-102	1 k	1/2 w			
R692	302-474	470 k	1/2 w			X408-up
R694	309-156	1.024 meg	1/2 w		Prec.	
R695	309-139	333 k	1/2 w		Prec.	
R696	302-825	8.2 meg	1/2 w			X408-up
R697	308-176	4 k	20 w		WW	
R698	311-361	500 k	1/2 w	Var.	5%	
R699	302-104	100 k	1/2 w		+300 V ADJ.	X408-up
R770	302-564	560 k	1/2 w			
R801	304-337	330 Ω	1 w			
R802	302-562	5.6 k	1/2 w			X330-up
R803	306-333	33 k	2 w			101-329
R803	306-273	27 k	2 w			330-up
R804	302-101	100 Ω	1/2 w			
R806	302-563	56 k	1/2 w			
R807	302-392	3.9 k	1/2 w			
R815	302-474	470 k	1/2 w			
R816	302-222	2.2 k	1/2 w			
R825	302-104	100 k	1/2 w			
R828	302-563	56 k	1/2 w			
R829	302-471	470 Ω	1/2 w			X379-up
R831	Use *050-143		Replacement Kit			101-649
R831†	(3) 305-565	5.6 meg	2 w		5%	650-up
	(2) 305-685	6.8 meg	2 w		5%	650-up
R833	302-105	1 meg	1/2 w			
R834	311-043	2 meg		Var.	INTENSITY	101-3139
R834	311-0043-02	2 meg		Var.	INTENSITY	3140-up
R835	301-683	68 k	1/2 w		5%	
R836	301-242	2.4 k	1/2 w		5%	
R837	301-242	2.4 k	1/2 w		5%	
R838	301-104	100 k	1/2 w		5%	
R839	301-122	1.2 k	1/2 w		5%	
R840	309-025	2.5 meg	1/2 w		Prec.	
R841	311-042	2 meg		Var.	HIGH VOLTAGE	
R843	Use *050-145		Replacement Kit			101-649
R843††	(3) 305-565	5.6 meg	2 w		5%	650-up
R845	311-121	5 meg		Var.	FOCUS	101-3139
R845	311-0121-01	5 meg		Var.	FOCUS	3140-up
R847	310-103	4 meg	1 w		Prec.	
R849	302-223	22 k	1/2 w		1%	

† S/N 650-up. *050-143 may be used.

†† S/N 650-up. *050-145 may be used.

Resistors (Cont'd)

Ckt. No.	Tektronix Part No.	Description	S/N Range
R852	Use 302-273	27 k $\frac{1}{2}$ w	
R853	302-104	100 k $\frac{1}{2}$ w	
R854	302-225	2.2 meg $\frac{1}{2}$ w	
R855	302-471	470 Ω $\frac{1}{2}$ w	
R860	311-007	2 x 1 k	X379-up CRT BEAM ROTATOR
R861	302-680	68 Ω $\frac{1}{2}$ w	
R862	302-224	220 k $\frac{1}{2}$ w	
R863	302-104	100 k $\frac{1}{2}$ w	
R864	311-032	250 k 2 w	Var. ASTIGMATISM
R870	301-393	39 k $\frac{1}{2}$ w	5% 101-2059X
R871	Use 311-364	20 k	Var. CAL. AMPL. 101-2059X
R872	301-154	150 k $\frac{1}{2}$ w	5% 101-2059X
R873	301-103	10 k $\frac{1}{2}$ w	5% 101-2059X
R876	301-153	15 k $\frac{1}{2}$ w	5% 101-2059X
R877	301-183	18 k $\frac{1}{2}$ w	5% 101-2059X
R878	301-564	560 k $\frac{1}{2}$ w	5% 101-2059X
R879	Use 301-114	110 k $\frac{1}{2}$ w	5% 101-2059X
R880	316-101	100 Ω $\frac{1}{4}$ w	101-2059X
R883	305-223	22 k 2 w	5% 101-2059X
R885	309-100	10 k $\frac{1}{2}$ w	Prec. 1% 101-2059X
R886	309-235	9 k $\frac{1}{2}$ w	Prec. 1% 101-2059X
R887	309-236	900 Ω $\frac{1}{2}$ w	Prec. 1% 101-2059X
R888	309-238	90 Ω $\frac{1}{2}$ w	Prec. 1% 101-2059X
R889	318-052	10 Ω $\frac{1}{8}$ w	Prec. 1% 101-2059X
R890	309-112	100 Ω $\frac{1}{2}$ w	Prec. 1% X300-2059X
R901	303-0273-00	27 k 1 w	5% X2060-up
R904	315-0512-00	5.1 k $\frac{1}{4}$ w	5% X2060-up
R905	315-0203-00	20 k $\frac{1}{4}$ w	5% X2060-up
R906	315-0203-00	20 k $\frac{1}{4}$ w	5% X2060-up
R908	315-0104-00	100 k $\frac{1}{4}$ w	5% X2060-up
R909	315-0203-00	20 k $\frac{1}{4}$ w	5% X2060-up
R912	315-0394-00	390 k $\frac{1}{4}$ w	5% X2060-up
R914	315-0155-00	1.5 meg $\frac{1}{4}$ w	5% X2060-up
R915	315-0183-00	18 k $\frac{1}{4}$ w	5% X2060-up
R917	315-0912-00	9.1 k $\frac{1}{4}$ w	5% X2060-up
R919	315-0100-00	10 Ω $\frac{1}{4}$ w	5% X2060-up
R922	315-0473-00	47 k $\frac{1}{4}$ w	5% X2060-up
R924	315-0752-00	7.5 k $\frac{1}{4}$ w	5% X2060-up
R925	315-0203-00	20 k $\frac{1}{4}$ w	5% X2060-up
R927	315-0124-00	120 k $\frac{1}{4}$ w	5% X2060-up
R932	315-0473-00	47 k $\frac{1}{4}$ w	5% X2060-up
R934	315-0752-00	7.5 k $\frac{1}{4}$ w	5% X2060-up
R935	315-0203-00	20 k $\frac{1}{4}$ w	5% X2060-up
R937	315-0124-00	120 k $\frac{1}{4}$ w	5% X2060-up
R940	324-0313-00	17.8 k 1 w	Prec 1% X2060-up
R941	324-0313-00	17.8 k 1 w	Prec 1% X2060-up
R943	311-0462-00	1 k	Var. CAL AMPL X2060-up
R945	323-0216-00	1.74 k $\frac{1}{2}$ w	Prec 1% X2060-up
R946	323-0690-00	422 Ω $\frac{1}{2}$ w	Prec $\frac{1}{2}$ % X2060-up
R948	323-0689-00	402 Ω $\frac{1}{2}$ w	Prec $\frac{1}{2}$ % X2060-up
R949	323-0688-00	47 Ω $\frac{1}{2}$ w	Prec $\frac{1}{2}$ % X2060-up
R952	315-0153-00	15 k $\frac{1}{4}$ w	5% X2060-up
R954	315-0103-00	10 k $\frac{1}{4}$ w	5% X2060-up
R956	315-0103-00	10 k $\frac{1}{4}$ w	5% X2060-up
R957	315-0333-00	33 k $\frac{1}{4}$ w	5% X2060-up

Parts List—Type 567

Resistors (Cont'd)

Ckt. No.	Tektronix Part No.	Description		S/N Range
R959	315-0101-00	100 Ω	1/4 w	5% X2060-2819
R959	315-0391-00	390 Ω	1/4 w	5% 2820-up
R960	302-0102-00	1 k	1/2 w	X2060-up

Switches

	Unwired	Wired	Description	S/N Range
SW601	260-014		Toggle POWER ON	
TK601	260-246		Thermal Cutout 123°	
SW915	260-0613-00		Toggle	X2060-up

Transformers

T600	*120-164	Toroid 3T TD #12
T601	*120-232	Low Voltage
T801	Use *120-292	High Voltage

Transistors

Q624	151-093	2N2043	
Q634	151-040	2N1302	
Q644	151-042	2N1378	
Q647	151-060	2N1545	101-2119
Q647	151-0165-00	2N3614	2120-up
Q653	151-007	2N270	
Q654	151-007	2N270	101-2004
Q654	*151-133	Selected from 2N3251	2005-up
Q657	Use 151-137	2N2148	
Q900	*151-0133-00	Selected from 2N3251	X2060-up
Q914	*151-0133-00	Selected from 2N3251	X2060-up
Q925	*151-0103-00	Replaceable by 2N2219	X2060-up
Q935	*151-0103-00	Replaceable by 2N2219	X2060-up
Q955	151-0069-00	2N1304	X2060-up

Electron Tubes

V609	154-291	OG3	
V616	154-187	6DJ8	
V627	154-056	6080	
V664	154-022	6AU6	
V677	154-056	6080	
V684	154-022	6AU6	
V800	154-167	6CZ5	
V814	154-046	12BH7	
V822	154-051	5642	
V832	154-051	5642	
V859	Use *154-376	T5032-31 CRT Standard Phosphor	101-1998
V859	*154-454	T5032-2-1 CRT Standard Phosphor	1999-3195
V859	*154-0613-01	T5611-2-1 CRT Standard Phosphor	3196-up
V884	154-278	6BL8	101-2059X

Crystal

Y905	158-0016-00	40 KC	X2060-up
------	-------------	-------	----------

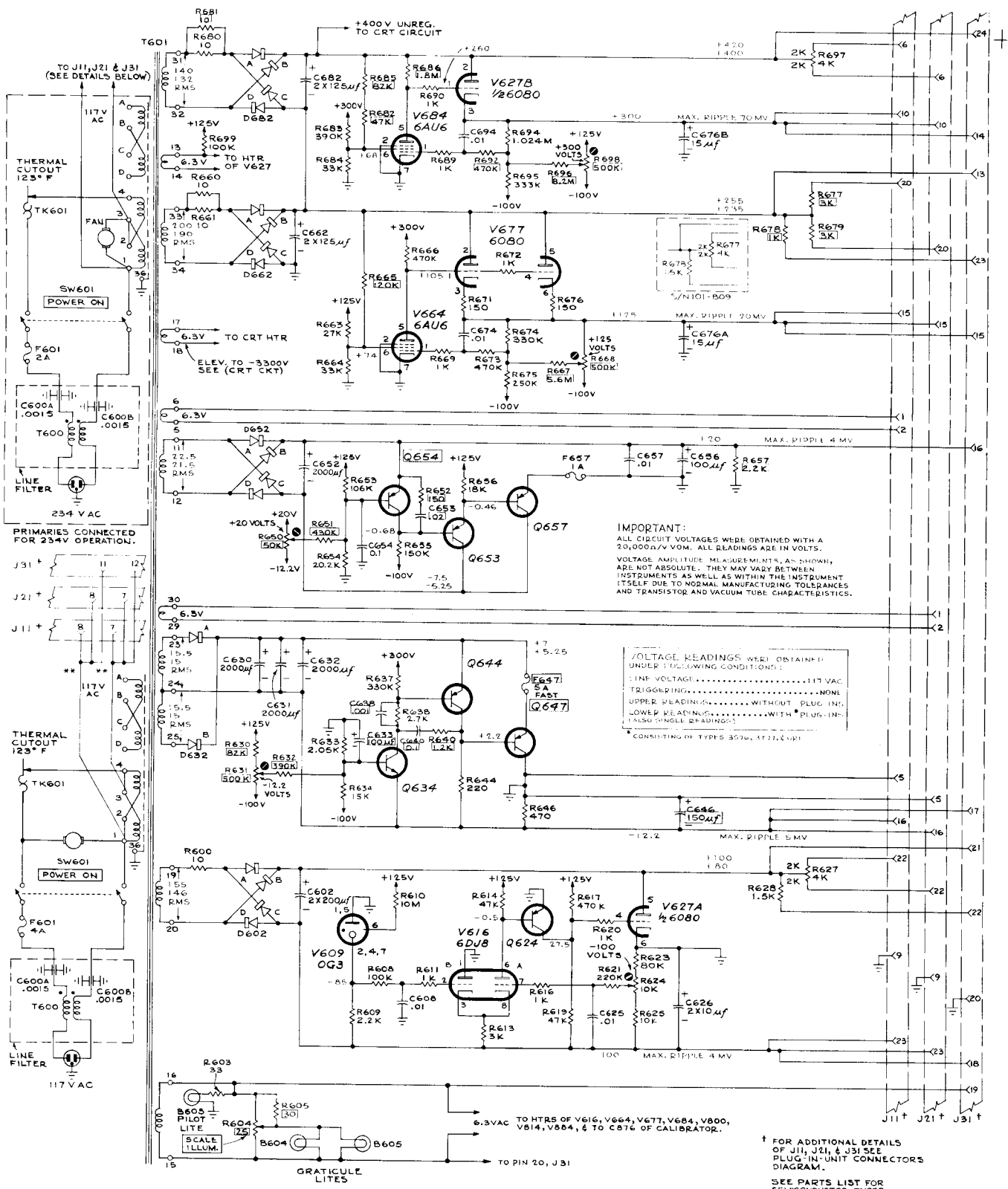

IMPORTANT:
 ALL CIRCUIT VOLTAGES WERE OBTAINED WITH A 20,000 Ω /V VOM. ALL READINGS ARE IN VOLTS. VOLTAGE AMPLITUDE MEASUREMENTS, AS SHOWN, ARE NOT ABSOLUTE. THEY MAY VARY BETWEEN INSTRUMENTS AS WELL AS WITHIN THE INSTRUMENT ITSELF DUE TO NORMAL MANUFACTURING TOLERANCES AND TRANSISTOR AND VACUUM TUBE CHARACTERISTICS.

VOLTAGE READINGS WERE OBTAINED UNDER FOLLOWING CONDITIONS:
 LINE VOLTAGE.....117 VAC
 TRIGGERING.....NONE
 UPPER READINGS.....WITHOUT PLUG INS
 LOWER READINGS.....WITH PLUG INS
 (ALSO SINGLE READINGS)
 *CONSISTING OF TYPES 807A, 1771, 6081

TYPE 567 READOUT OSCILLOSCOPE

POWER SUPPLY

SEE PARTS LIST FOR EARLIER VALUES AND S/N CHANGES OF PARTS MARKED WITH BLUE OUTLINE.
 ** DENOTES CONNECTIONS REMOVED AT 5N3060 & 1P

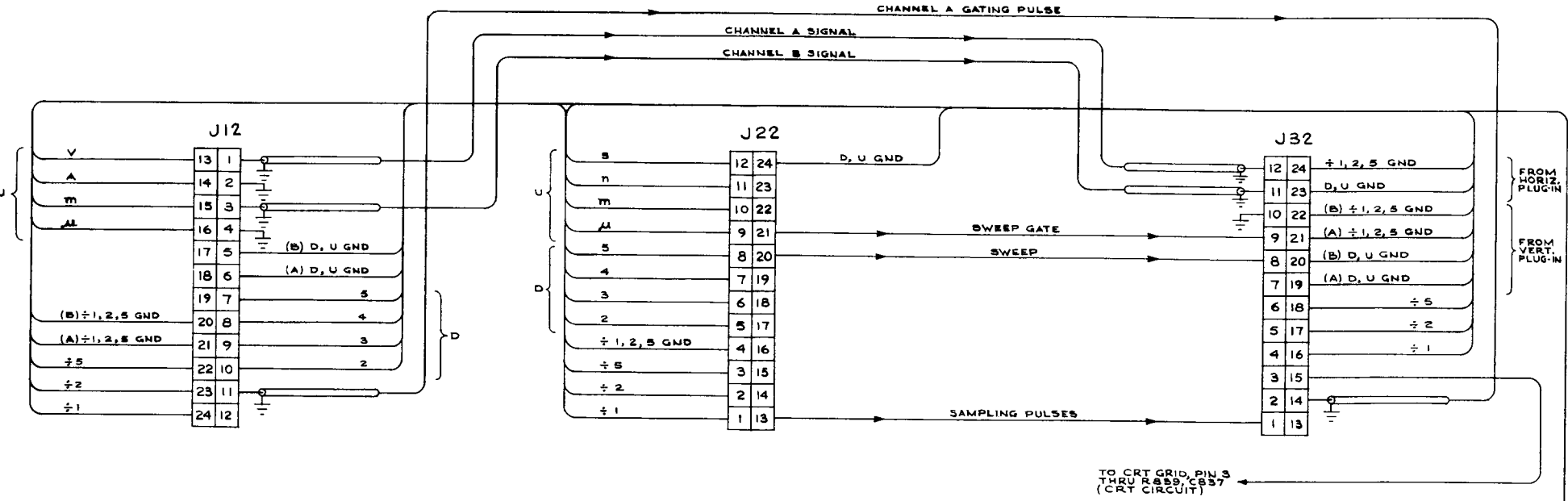

TO CRT GRID, PIN 3
THRU R559, C637
(CRT CIRCUIT)

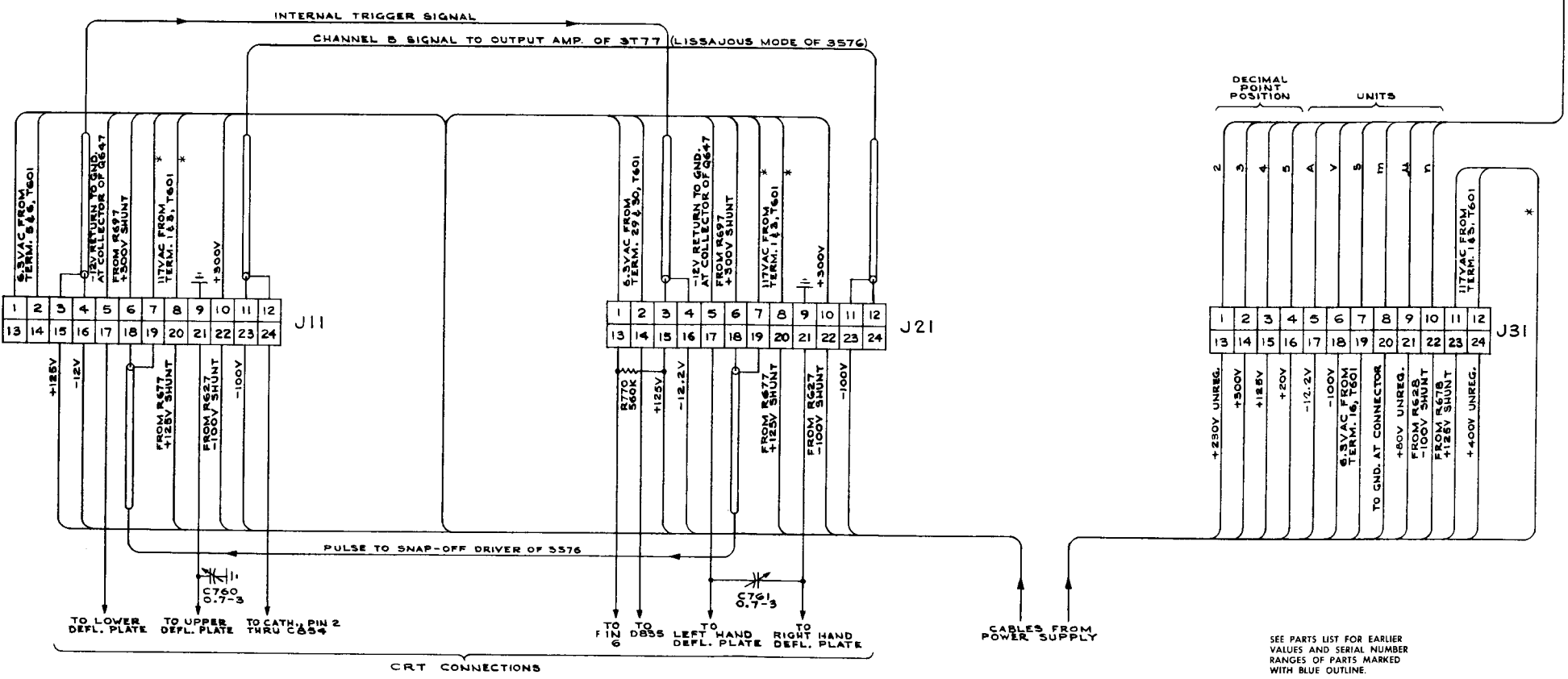

TO LOWER DEFL. PLATE
TO UPPER DEFL. PLATE
TO CATH. PIN 2
THRU C654

CRT CONNECTIONS

TO FIN 6
TO D655
TO LEFT HAND DEFL. PLATE
TO RIGHT HAND DEFL. PLATE

CABLES FROM POWER SUPPLY

SEE PARTS LIST FOR EARLIER VALUES AND SERIAL NUMBER RANGES OF PARTS MARKED WITH BLUE OUTLINE.

* DENOTES CONNECTIONS REMOVED AT S/N 3060 & UP

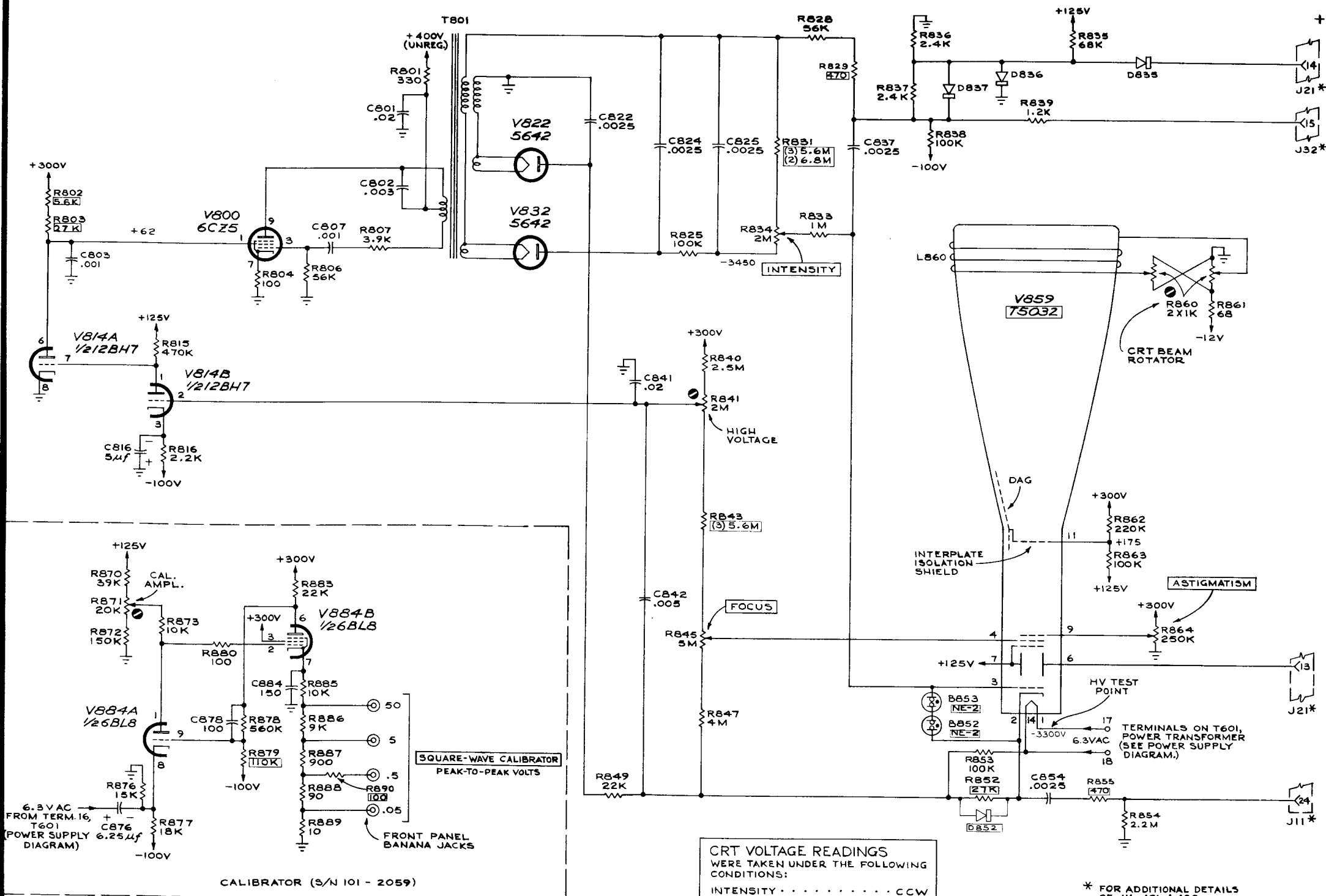

CALIBRATOR (S/N 101 - 2059)

CRT VOLTAGE READINGS
 WERE TAKEN UNDER THE FOLLOWING
 CONDITIONS:
 INTENSITY CCW

* FOR ADDITIONAL DETAILS
 OF J11, J21, & J32
 SEE PLUG-IN-UNIT
 CONNECTORS DIAGRAM.

ALSO SEE IMPORTANT NOTE ON PWR. SPLY. DIAG.

SEE PARTS LIST FOR EARLIER
 VALUES AND S/N CHANGES OF

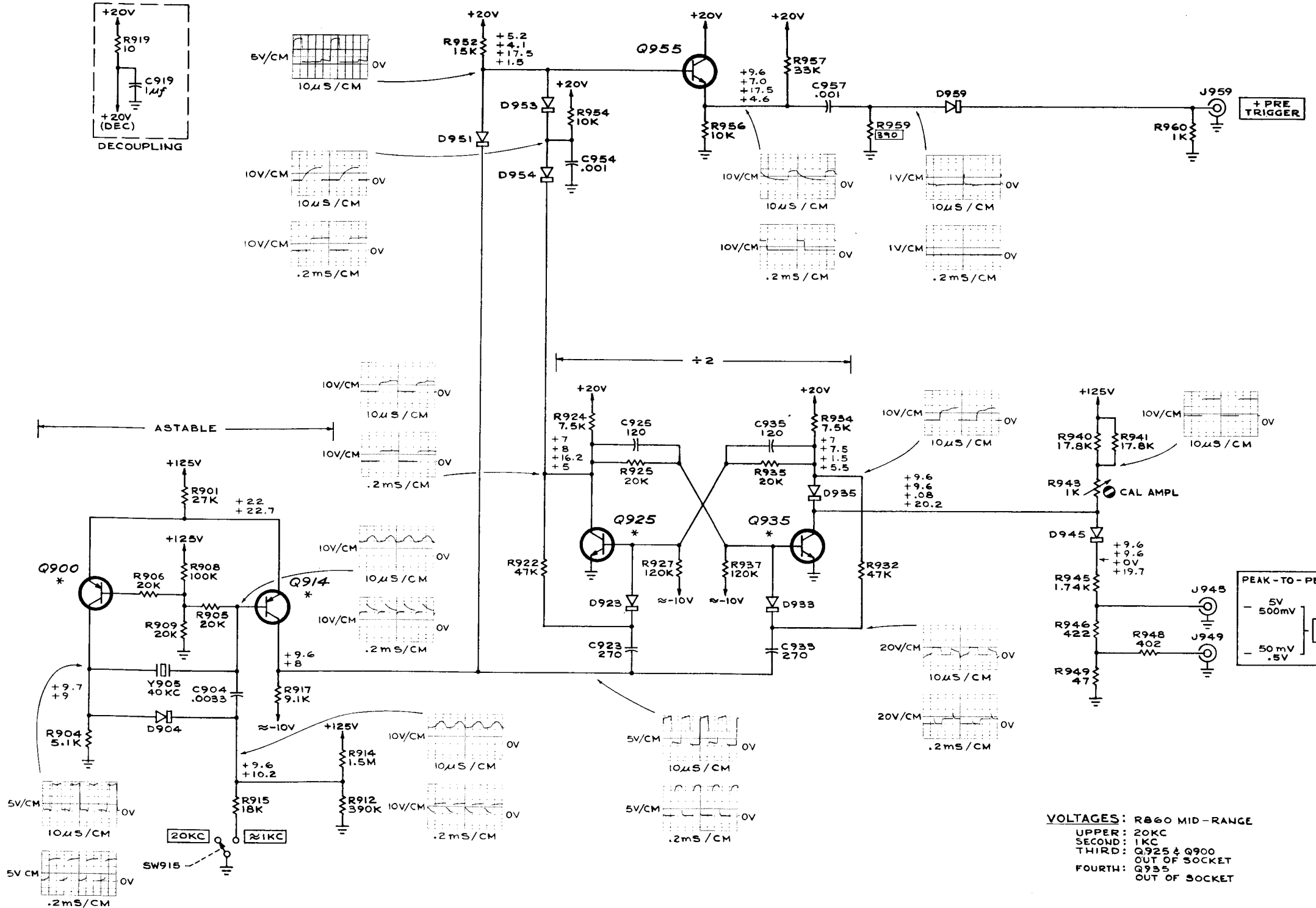
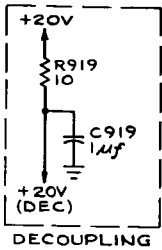

TYPE 567

ELECTRICAL PARTS LIST CORRECTION

CHANGE:

V859

154-0613-01

T5611-2-1

CRT Standard Phosphor

M14,439/169

**INSTRUCTIONS FOR REPLACING GLASS CRT'S
WITH ONE OF THE FOLLOWING CERAMIC CRT'S:**

Part No. 154-0613-00/02/03, 154-0614-00/02/03

TYPE T5032 CRT REPLACEMENT

For the following Tektronix Oscilloscopes:

<u>Type</u>	<u>Serial Number</u>
561A	5001-12399*
561A	12400-up
RM561A	101-105: 5001-6885*
RM561A	6886-up
567	101-749
567	1999-3195
RM567	101-228
RM567	1999-up
568/R568	B010100-B130589

*This is applicable in the above indicated SN range of instruments if 050-0214-00, 050-0214-01, 050-0214-02 or 050-0214-03 has been installed.

This provides instructions for replacing the old style T5032 glass CRT (either internal or external graticule) with the style T5611 ceramic CRT. See the list below for the proper replacement CRT part number:

<u>Type T5032 Glass CRT</u>	<u>New Type T5611 Ceramic CRT</u>
154-0454-00	154-0613-00
154-0455-00	154-0613-02
154-0456-00	154-0613-03
154-0449-00	154-0613-00
154-0373-00	154-0614-00
154-0374-00	154-0614-02
154-0375-00	154-0614-03
154-0376-00	154-0614-00

NOTE 1: If the serial number of the instrument is above those listed, or if this has been installed, disregard the instructions as the T5611 CRT is a direct replacement.



INSTALLATION INSTRUCTIONS.

- () 1. Remove the four graticule nuts, graticule cover (or Bezel if present) light filter (if used) light guide and retainer spring (if present).
- () 2. Disconnect the deflection plate connectors from the neck pins on the CRT.
- () 3. Remove the CRT socket connector and loosen the clamp at the base of the CRT.
- () 4. Remove the CRT.
- () 5. Remove the CRT cushions, 4 (for Type 561A, RM561A, 567, RM567) or 6 (Type 568, R568) from the inside of the CRT shield.
- () 6. Install the new CRT. Complete the installation by performing steps 1, 2 and 3 in reverse order.

THIS COMPLETES THE INSTALLATION.

- () Recalibrate your instrument according to the Calibration Section of your Instruction Manual.
- () Please put this information in your Instruction Manual for future reference.

K4XL's **BAMA**

This manual is provided **FREE OF CHARGE** from the "BoatAnchor Manual Archive" as a service to the Boatanchor community.

It was uploaded by someone who wanted to help you repair and maintain your equipment.

If you paid anyone other than BAMA for this manual, you paid someone who is making a profit from the free labor of others without asking their permission.

You may pass on copies of this manual to anyone who needs it. But do it without charge.

Thousands of files are available without charge from BAMA. Visit us at <http://bama.sbc.edu>