



**PLEASE CHECK FOR CHANGE INFORMATION  
AT THE REAR OF THIS MANUAL.**

**7D15  
UNIVERSAL  
COUNTER/TIMER**

**INSTRUCTION MANUAL**

**Tektronix, Inc.  
P.O. Box 500  
Beaverton, Oregon 97077**

070-1433-00  
Product Group 42

Serial Number \_\_\_\_\_

First Printing SEP 1974  
Revised APR 1985

Copyright © 1974 Tektronix, Inc. All rights reserved.  
Contents of this publication may not be reproduced in any  
form without the written permission of Tektronix, Inc.

Products of Tektronix, Inc. and its subsidiaries are covered  
by U.S. and foreign patents and/or pending patents.

TEKTRONIX, TEK, SCOPE-MOBILE, and  are  
registered trademarks of Tektronix, Inc. TELEQUIPMENT  
is a registered trademark of Tektronix U.K. Limited.

Printed in U.S.A. Specification and price change privileges  
are reserved.

#### **INSTRUMENT SERIAL NUMBERS**

Each instrument has a serial number on a panel insert, tag,  
or stamped on the chassis. The first number or letter  
designates the country of manufacture. The last five digits  
of the serial number are assigned sequentially and are  
unique to each instrument. Those manufactured in the  
United States have six unique digits. The country of  
manufacture is identified as follows:

B000000	Tektronix, Inc., Beaverton, Oregon, USA
100000	Tektronix Guernsey, Ltd., Channel Islands
200000	Tektronix United Kingdom, Ltd., London
300000	Sony/Tektronix, Japan
700000	Tektronix Holland, NV, Heerenveen, The Netherlands

# TABLE OF CONTENTS

	Page		Page
<b>Section 1 SPECIFICATION</b>		<b>Section 3 CIRCUIT DESCRIPTION (Cont'd)</b>	
Introduction . . . . .	1-1	Readout Theory . . . . .	3-10
Electrical Characteristics . . . . .	1-1	General . . . . .	3-10
Environmental Characteristics . . . . .	1-7	CH 1 Column and Row Data . . . . .	3-10
Physical Characteristics . . . . .	1-7	CH 2 Column and Row Date . . . . .	3-12
		Overflow . . . . .	3-13
<b>Section 2 OPERATING INSTRUCTIONS</b>		-5 V Supply . . . . .	3-14
Installation . . . . .	2-1	<b>Section 4 MAINTENANCE</b>	
Front Panel Controls and Connectors . . . . .	2-2	Introduction . . . . .	4-1
Modes of Operation . . . . .	2-7	Preventive Maintenance . . . . .	4-1
Operation and Checkout . . . . .	2-10	Troubleshooting . . . . .	4-1
		Corrective Maintenance . . . . .	4-3
		Component Replacement . . . . .	4-4
		Recalibration After Repair . . . . .	4-4
		Repackaging for Shipment . . . . .	4-4
		<b>Section 5 CALIBRATION</b>	
		Recalibration Interval . . . . .	5-1
		Test Equipment Required . . . . .	5-1
		Calibration Procedure . . . . .	5-4
		Index to Calibration Procedure . . . . .	5-5
		<b>Section 6 INSTRUMENT OPTIONS</b>	6-1
		<b>Section 7 ELECTRICAL PARTS LIST</b>	
		Abbreviations and Symbols	
		<b>Section 8 DIAGRAMS AND CIRCUIT BOARD ILLUSTRATIONS</b>	
		Symbols and Reference Designators	
		<b>Section 9 MECHANICAL PARTS LIST</b>	
		<b>CHANGE INFORMATION</b>	

**WARNING**

*THE FOLLOWING SERVICING INSTRUCTIONS ARE FOR USE BY QUALIFIED PERSONNEL ONLY. TO AVOID PERSONAL INJURY, DO NOT PERFORM ANY SERVICING OTHER THAN THAT CONTAINED IN OPERATING INSTRUCTIONS UNLESS YOU ARE QUALIFIED TO DO SO.*

# OPERATORS SAFETY SUMMARY

The general safety information in this part of the summary is for both operating and servicing personnel. Specific warnings and cautions will be found throughout the manual where they apply, but may not appear in this summary.

## Terms In This Manual

**CAUTION** statements identify conditions or practices that could result in damage to the equipment or other property.

**WARNING** statements identify conditions or practices that could result in personal injury or loss of life.

## Terms As Marked on Equipment

**CAUTION** indicates a personal injury hazard not immediately accessible as one reads the marking, or a hazard to property including the equipment itself.

**DANGER** indicates a personal injury hazard immediately accessible as one reads the marking.

## Symbols In This Manual



This symbol indicates where applicable cautionary or other information is to be found.

## Symbols As Marked on Equipment



**DANGER** — High voltage.



Protective ground (earth) terminal.



**ATTENTION** — refer to manual.

## Power Source

This product is intended to operate from a power source that will not apply more than 250 volts rms between the supply conductors or between either supply conductor and ground. A protective ground connection by way of the grounding conductor in the power cord is essential for safe operation.

## Grounding the Product

This product is grounded through the grounding conductor of the power cord. To avoid electrical shock, plug the power cord into a properly wired receptacle before connecting to the product input or output terminals. A protective ground connection by way of the grounding conductor in the power cord is essential for safe operation.

## Danger Arising From Loss of Ground

Upon loss of the protective-ground connection, all accessible conductive parts (including knobs and controls that may appear to be insulating) can render an electric shock.

## Use the Proper Power Cord

Use only the power cord and connector specified for your product.

Use only a power cord that is in good condition.

For detailed information on power cords and connectors, see maintenance section.

Refer cord and connector changes to qualified service personnel.

## Use the Proper Fuse

To avoid fire hazard, use only the fuse of correct type, voltage rating and current rating as specified in the parts list for your product.

Refer fuse replacement to qualified service personnel.

## Do Not Operate in Explosive Atmospheres

To avoid explosion, do not operate this product in an explosive atmosphere unless it has been specifically certified for such operation.

## Do Not Remove Covers or Panels

To avoid personal injury, do not remove the product covers or panels. Do not operate the product without the covers and panels properly installed.

# **SERVICE SAFETY SUMMARY**

## **FOR QUALIFIED SERVICE PERSONNEL ONLY**

*Refer also to the preceding Operators Safety Summary.*

### **Do Not Service Alone**

Do not perform internal service or adjustment of this product unless another person capable of rendering first aid and resuscitation is present.

### **Use Care When Servicing With Power On**

Dangerous voltages exist at several points in this product. To avoid personal injury, do not touch exposed connections and components while power is on.

Disconnect power before removing protective panels, soldering, or replacing components.

### **Power Source**

This product is intended to operate from a power source that will not apply more than 250 volts rms between the supply conductors or between either supply conductor and ground. A protective ground connection by way of the grounding conductor in the power cord is essential for safe operation.

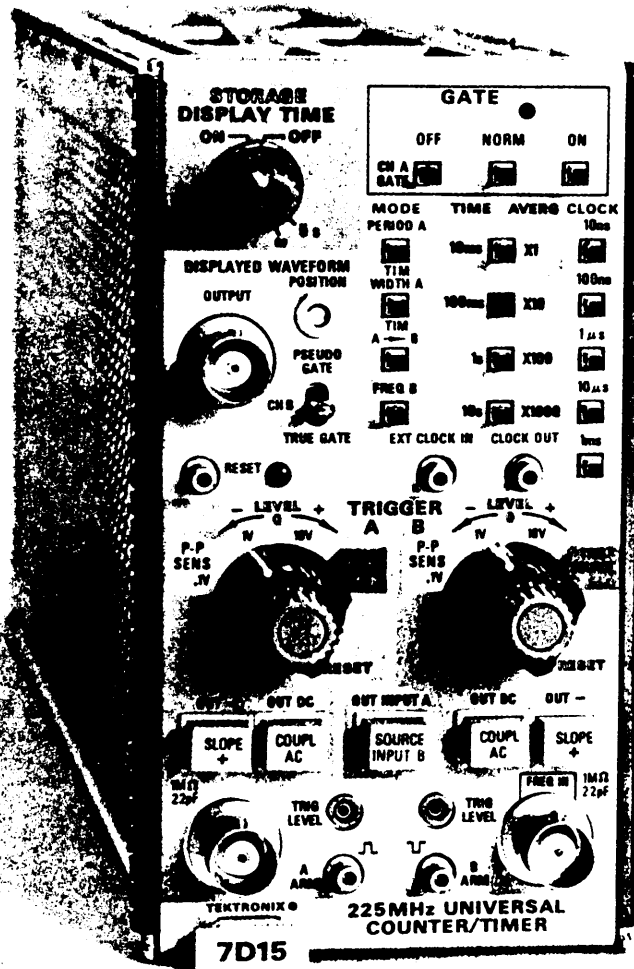

Fig. 1-1. 7D15 Universal Counter/Timer.

# SPECIFICATIONS

## Introduction

The 7D15 is a digital counter plug-in designed for use with all readout-equipped 7000-Series Oscilloscope mainframes. It will function in any plug-in compartment; however, in the vertical compartment, a selectable display is internally connected to the oscilloscope. When used in the horizontal compartment, mainframe triggers are available to the 7D15.

The 7D15 has eight modes of operation: Frequency—DC to 225 MHz direct, Frequency Ratio—0 to  $10^5:1$ , Period—10 ns to  $10^5$  s, Period Averaging—10 ps resolution, TIM—10 ns to  $10^5$  s, TIM Averaging—1 ns accuracy, Totalize—1 to  $10^8$  events, Manual Stop Watch—to  $10^5$  s.

The electrical specifications listed in the Performance Requirement column are valid over the stated environmental range for instruments calibrated at an ambient temperature of  $+20^\circ\text{C}$  to  $+30^\circ\text{C}$  and after a five minute warmup unless otherwise noted. The information listed in the Supplemental Information column indicates typical instrument operation and is not to be construed as a requirement for proper instrument operation.

TABLE 1-1  
ELECTRICAL CHARACTERISTICS

Characteristics	Performance Requirement
<b>MEASUREMENT MODES</b>	
<b>Frequency Mode</b>	
Range	DC to 225 megahertz
Resolution	0.1 hertz minimum
<sup>1</sup> Accuracy	$E_{\text{freq}} \text{ (hertz)} = \pm TB \times F_{\text{in}} \pm 1/T$ $E_{\text{freq}} \text{ (%) } = 100\% \left[ \pm TB \pm \frac{1}{T \times F_{\text{in}}} \right]$
<b>Period Mode</b>	
Range	10 nanoseconds to $10^5$ seconds with averaging times of X1 to X1000 in decade steps.
Resolution	10 picoseconds maximum.
<sup>1</sup> Accuracy	$E_{\text{per}} \text{ (sec)} = \pm TB \times P_{\text{in}} \pm \frac{1 \times 10^{-9} \pm K \pm P_{\text{ck}}}{M}$ $E_{\text{per}} \text{ (%) } = 100\% \left[ \pm TB \pm \frac{\pm 1 \times 10^{-9} \pm K \pm P_{\text{ck}}}{P_{\text{in}} \times M} \right]$
<b>Time Interval Mode</b>	
Range	6 nanoseconds to $10^5$ seconds with averaging times of X1 to X1000.
Resolution	0.1 nanosecond usable.
<sup>1</sup> Accuracy (nominal)	$E_{\text{TI}} \text{ (sec)} = TB \times P_{\text{in}} \pm (P_{\text{ck}}/\sqrt{M}) \pm 10^{-9} \pm K$ $E_{\text{TI}} \text{ (%) } = 100\% \pm TB \pm \frac{(P_{\text{ck}}/\sqrt{M}) \pm 10^{-9} \pm K}{P_{\text{in}}}$
	The complete expression for Time Interval averaging depends on signal to noise ratio and statistical distribution factors.

<sup>1</sup> Refer to Figs. 1-2 through 1-7 at the rear of this section for additional accuracy information.

TABLE 1-1 (cont)

Characteristics	Performance Requirement
Frequency Ratio CH B/EXT clock  Range	10 <sup>-7</sup> to 10 <sup>4</sup>
Totalize, CH B:  Range	0 to 10 <sup>8</sup> counts (Manual ON-OFF control or electrical control from CH A.)
Manual Stop Watch  Range	0 to 10 <sup>5</sup> seconds

NOTE

Formulas given where TB (dec %) is the time base accuracy;  $P_{in}$  is the period or time interval of the unknown signal (whichever is applicable);  $M$  is the number of averages taken;  $P_{ck}$  is the measurement clock period;  $T$  is the gate time;  $F_{in}$  is the frequency of the unknown signal;  $E_{npk}$  is equal to the peak noise amplitude at the input to the counter gate circuit;  $dv/dt$  is the signal slope at the input to the gate;  $K$  is equal to  $2E_{npk}/dv/dt$ .

Characteristics	Performance Requirements	Supplemental Information
INPUT SIGNALS CH A & B		
Frequency Range (CH B only)		
DC Coupled	DC to 225 megahertz	
AC Coupled	5 hertz to 225 megahertz	
Sensitivity		
CH A & B Inputs	100 millivolts peak-to-peak	
TRIG SOURCE	Vertical deflection of: 0.5 divisions to 50 MHz 1.0 divisions to 225 MHz or to the vertical system bandwidth, whichever is less.	
Input Resistance and Capacitance	Approximately 1 megohm, 22 picofarads	
Minimum Pulse Width	5 nanoseconds	
Minimum gate "OFF" time Between Samples During TIM Averaging Operation	10 nanoseconds	
Maximum Input Voltage	200 volts DC linearly derated to 20 volts at 200 megahertz	$E_{max} = 20 + 180 (1 - F_{in}(\text{MHz})/200)$



TABLE 1-1 (cont)

Characteristics	Performance Requirements	Supplemental Information
Minimum Signal Period in "PER" Mode	10 nanoseconds	
Minimum CH A Input Pulse Width in "FREQ B-CH A Gate" Mode		10 nanoseconds
<b>Triggering</b>		
Preset Position	Automatically triggers at 0 volts	
Level Control		
Range: (CH A and CH B)	.1 V, $\pm 500$ millivolts; 1 V, $\pm 5$ volts; 10 V, $\pm 50$ volts	
Range: TRIG SOURCE	Approximately $\pm 2.5$ divisions	
<b>Arming Inputs</b>		
Input R and C	Approximately 10 kilohm, 20 picofarads	
Lead Time for Pulse to become effective	5 nanoseconds	
Lead Time to Negate effect of "ARM"	5 nanoseconds	
Minimum rise and fall rate	$dv/dt \geq 10$ Volts per microsecond	
Sensitivity A ARM	A logical "1" occurs with either no signal applied or with +0.5 volt or greater. A logical "0" occurs with less than +0.2 volt @ I sink $\leq 0.2$ milliamperes	
B ARM	Logic "1" $\leq 0.2$ volt or no signal applied Logic "0" $\geq +0.5$ volt	
Maximum Operating Voltage	+10 volts to -5 volts	
Maximum Input Voltage	$\pm 15$ volts	
<b>External Clock In</b>		
Input Requirements	Internal switch selectable	
Minimum Amplitude	0.8 volt peak-to-peak sine wave or pulse with 30% to 70% duty cycle	
Coupling	AC	

TABLE 1-1 (cont)

Characteristics	Performance Requirements	Supplemental Information
Maximum Input Voltage	±50 volts DC, 20 volts peak-to-peak	
Frequency Range	1 megahertz ±5%; Phase Lock Operational. 10 nanoseconds, 100 nanoseconds clock available.  20 hertz to 5 megahertz; Phase Lock Nonoperational.	
RESET—Front Panel	Reset initializes the instrument. All counters are affected, including averaging circuits.	
Input R and C	Approximately 10 kilohms, 30 picofarads	
Input Requirements		
Amplitude	Logic "1" + 2 volts or greater  Logic "0" + 0.5 volt or less	
Pulse Width	≥ 500 nanoseconds	
Maximum Operating Input Voltage	+10 volts to -10 volts	
Rise and Falltime	100 nanoseconds or less	
Maximum Input Voltage	± 15 volts	
Reset (located on Rear Interface B13)		Negative-going transition TTL compatible pulse
Rise and Falltime		≤ 100 nanoseconds
Width		≥ 500 nanoseconds
Hold Signal (located on Rear Interface B22)		TTL compatible, negative-logic signal
Rise and Falltime		≤ 200 nanoseconds
Propagation Delay for Signal to become effective or ineffective		≤ 100 nanoseconds

TABLE 1-1 (cont)

Characteristics	Performance Requirements	Supplemental Information
<b>INTERNAL TIME BASE</b>		
Crystal Oscillator		
Frequency		5 megahertz
Accuracy 0°C to +50°C	Within 0.5 part per million	
Long Term Drift	1 part or less in 10 <sup>7</sup> per month	
<b>OUTPUT SIGNALS</b>		
Monitor Signals		
Clock Out	Logic "1" = +0.5 volt ±10% into 50 ohms  Logic "0" ≤ 0 volt into 50 ohms. TTL compatible without 50 ohm load (1.6 milliamp current capacity)	Z <sub>out</sub> 430 ohms
A and B Trigger Level	Z <sub>out</sub> ≈ 1 kilohm  V <sub>out</sub> = ±0.5 volt into 1 megohm  (10X scaling)	
Externally Programable with ±5 volt Signal maximum and in the Preset Position		
Analog Display (Internally Connected)	Front panel switch selects either "True Gate" signal, "Pseudo Gate", or "Channel "B" out	The Pseudo Gate signal is a high-speed representation of the 7D15 gate signal
Position	Controlled by front panel screwdriver control	
Amplitude	1.0 division. Can be set from 0.2 to 1 div ±20%.	Changed by resistor alteration
Rise and Faltime	Less than 2 nanoseconds	
Propagation delay: Input BNC's to plug-in interface		True Gate: ≈ 20 nanoseconds Pseudo Gate: ≈ 18 nanoseconds CH B: ≈ 16 nanoseconds

TABLE 1-1 (cont)

Characteristics	Performance Requirements	Supplemental Information
<p>Displayed gate width to "effective" gate width</p> <p>In "Freq" or "events": operation, lead time required of gate display over CH B display to guarantee proper accumulation or non-accumulation of count.</p>		<p>Matches to within 1 nanosecond; depends on correct calibration of horizontal time base used</p> <p>≥ 1 nanosecond</p>
<p>External Display</p>	<p>Located on front panel, same as "analog display" except position and amplitude controls have no effect</p>	
<p>Amplitude</p>	<p>Logic "1" = +0.5 volt ±10% into 50 ohms.</p> <p>Logic "0" ≤ 0 volt into 50 ohm TTL compatible without 50 ohm load (1.6 milliamper current capability)</p>	
<p>Rise and Faltime</p>	<p>≥ 1.5 nanoseconds with 50 ohm load</p>	
<p>Propagation delay from input BNC's to display</p>		<p>True Gate: ≈ 21 nanoseconds Pseudo Gate: ≈ 19 nanoseconds CH B ≈ 17 nanoseconds</p>
<p>"True Gate" &amp; "Pseudo Gate" output pulse width to "Effective Gate"</p>		<p>Matches to within 1 nanosecond</p>
<p>Busy Signal (located on Rear Interface A22)</p> <p>Rise and Faltime</p> <p>Delay After Reset Command</p>		<p>Nominally TTL compatibility, positive logic</p> <p>100 nanoseconds maximum</p> <p>150 nanoseconds maximum</p>
<p>DISPLAYS</p> <p>Gate Indicator</p>		<p>A LED lamp indicates internal gate condition</p>
<p>Display Mode Switch</p> <p>Display Time Control</p>	<p>Front panel switch allows selection of readout "follow or store"</p>	<p>Continuously variable from 0.1 second or less to approximately 5 seconds. With control in maximum clockwise position, the display is held indefinitely</p>

TABLE 1-1 (cont)

Characteristics	Performance Requirements	Supplemental Information
Readout	8 digits of display, the four most significant digits have zero suppression. Overflow by ">" arrow. Legend located on Channel 2 of readout system	
Resolution, Minimum		
Frequency	0.1 hertz	
Per, TIM	10 nanoseconds	
Multi-per	10 picoseconds	
Multi-TIM	100 picoseconds (limited)	

TABLE 1-2

## ENVIRONMENTAL CHARACTERISTICS

Refer to the specification for the associated oscilloscope.

TABLE 1-3

## PHYSICAL CHARACTERISTICS

Size	Fits all 7000-Series plug-in compartments.
Weight	3.1 Pounds (1.4 kilograms)

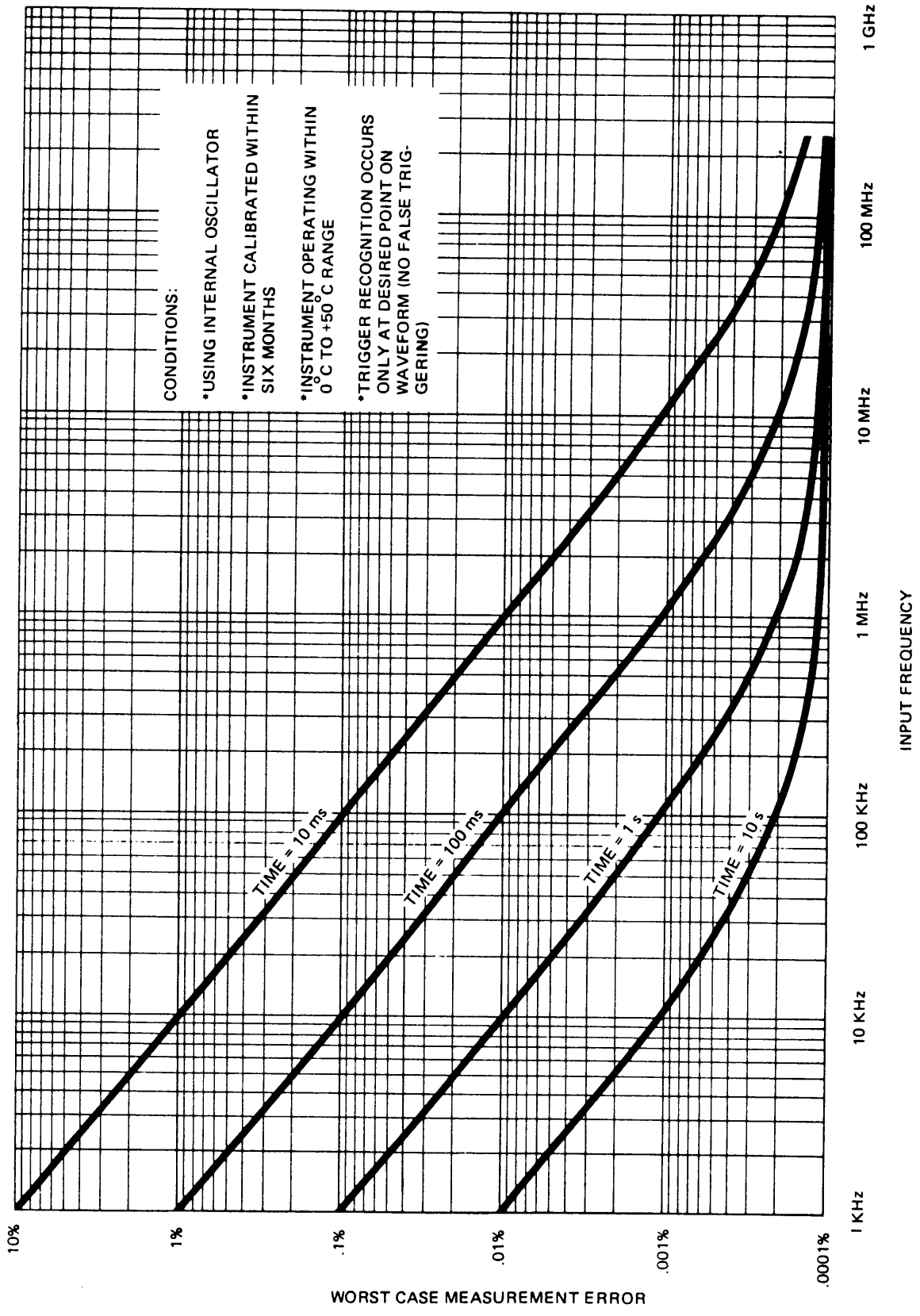

Fig. 1-2. 7D15 Frequency mode accuracy stated in percent.

1432-2

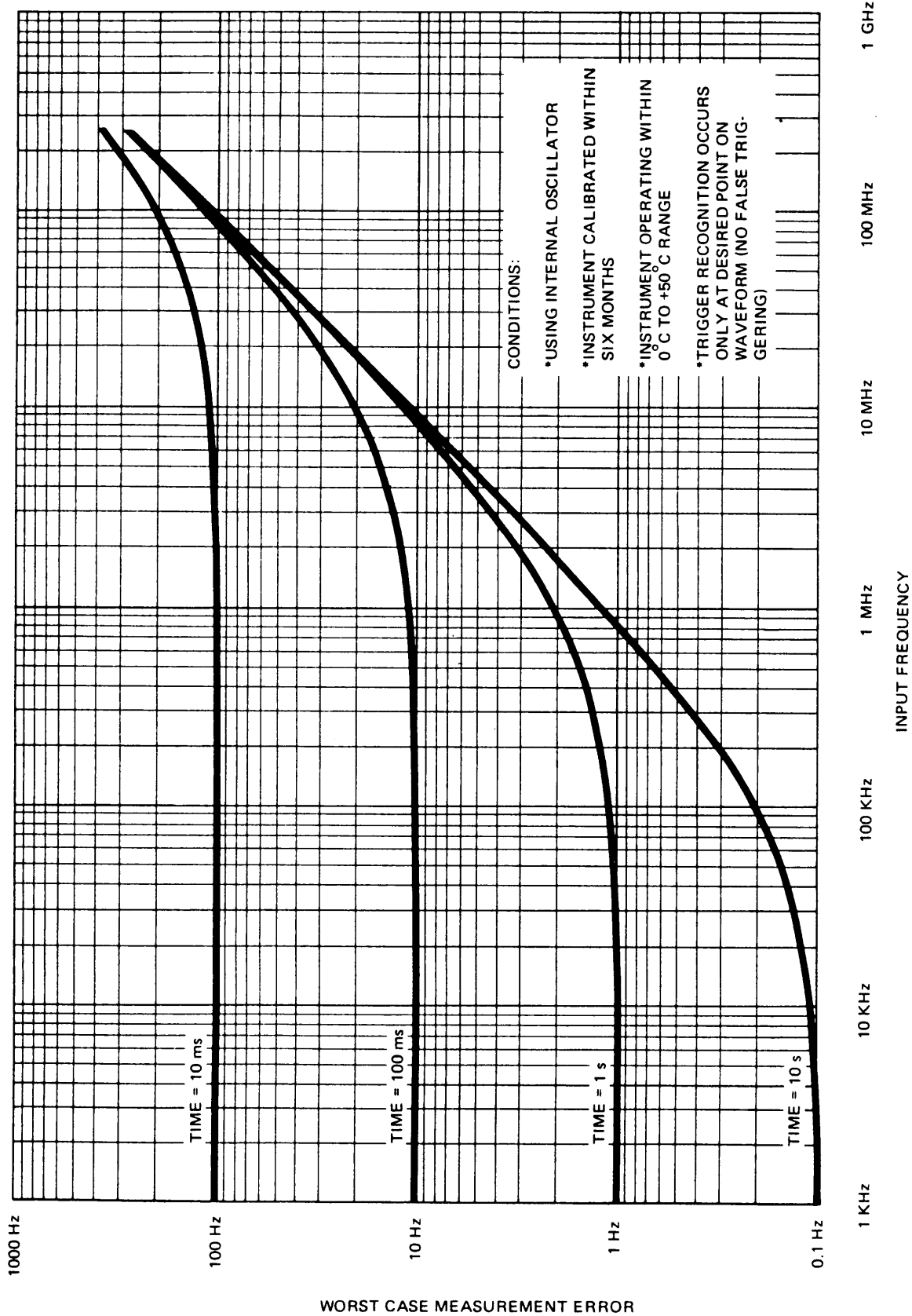

Fig. 1-3. 7D15 Frequency mode accuracy stated in hertz.

1432-3

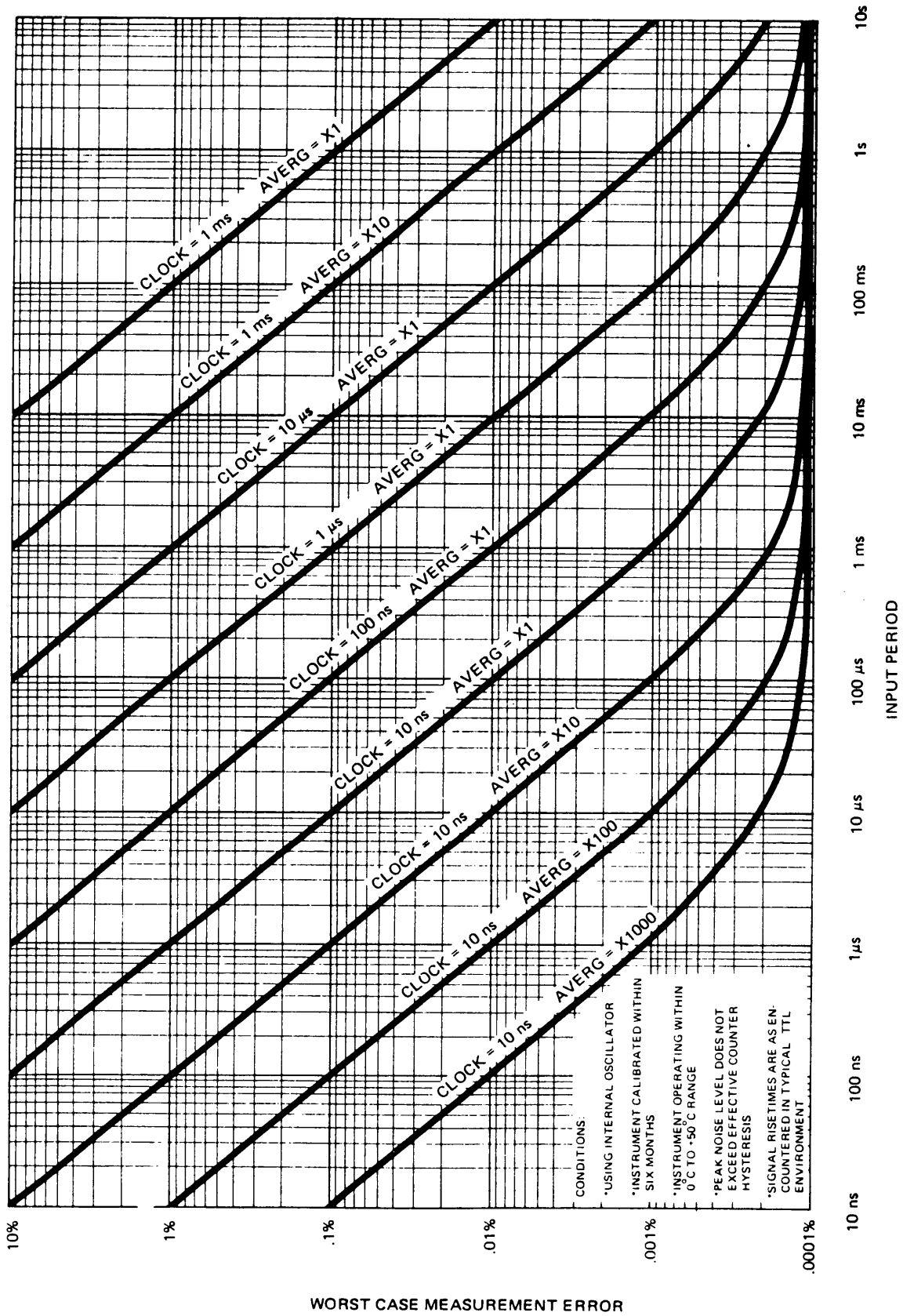

Fig. 1-4. 7D15 Period mode accuracy stated in percent.



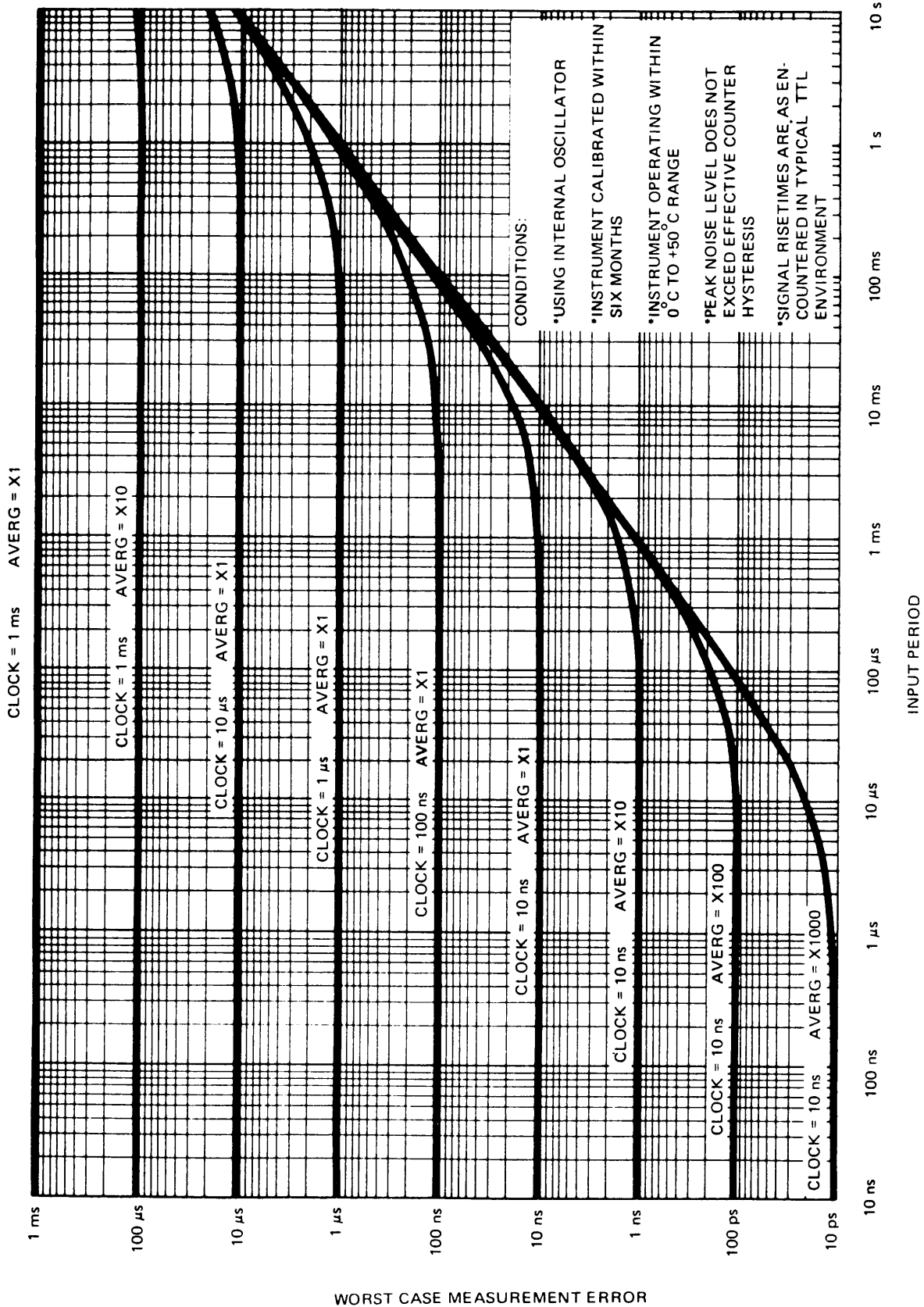

Fig. 1-5. 7D15 Period mode accuracy stated in time.

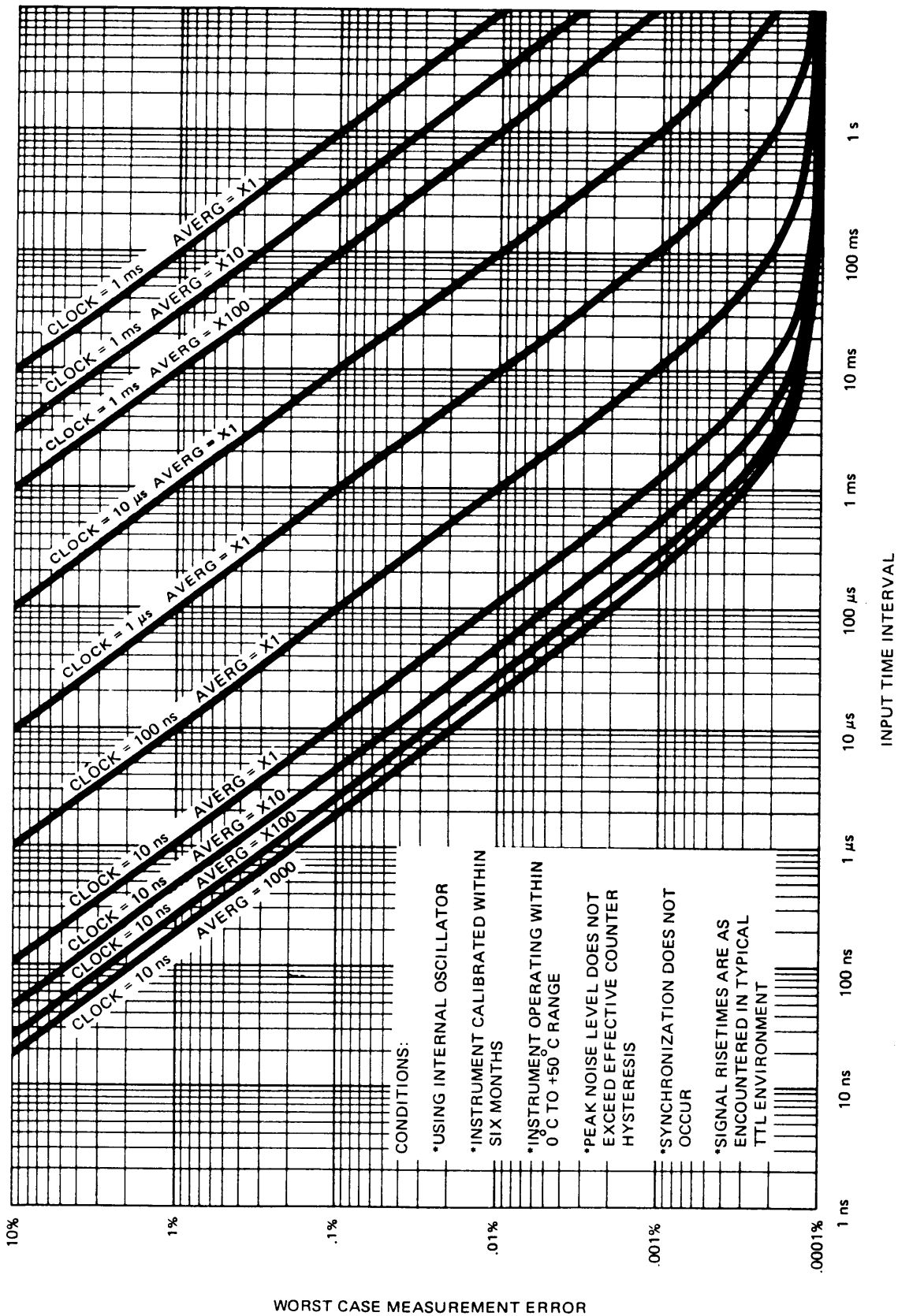

Fig. 1-6. 7D15 Time Interval mode accuracy stated in present.

1432-6

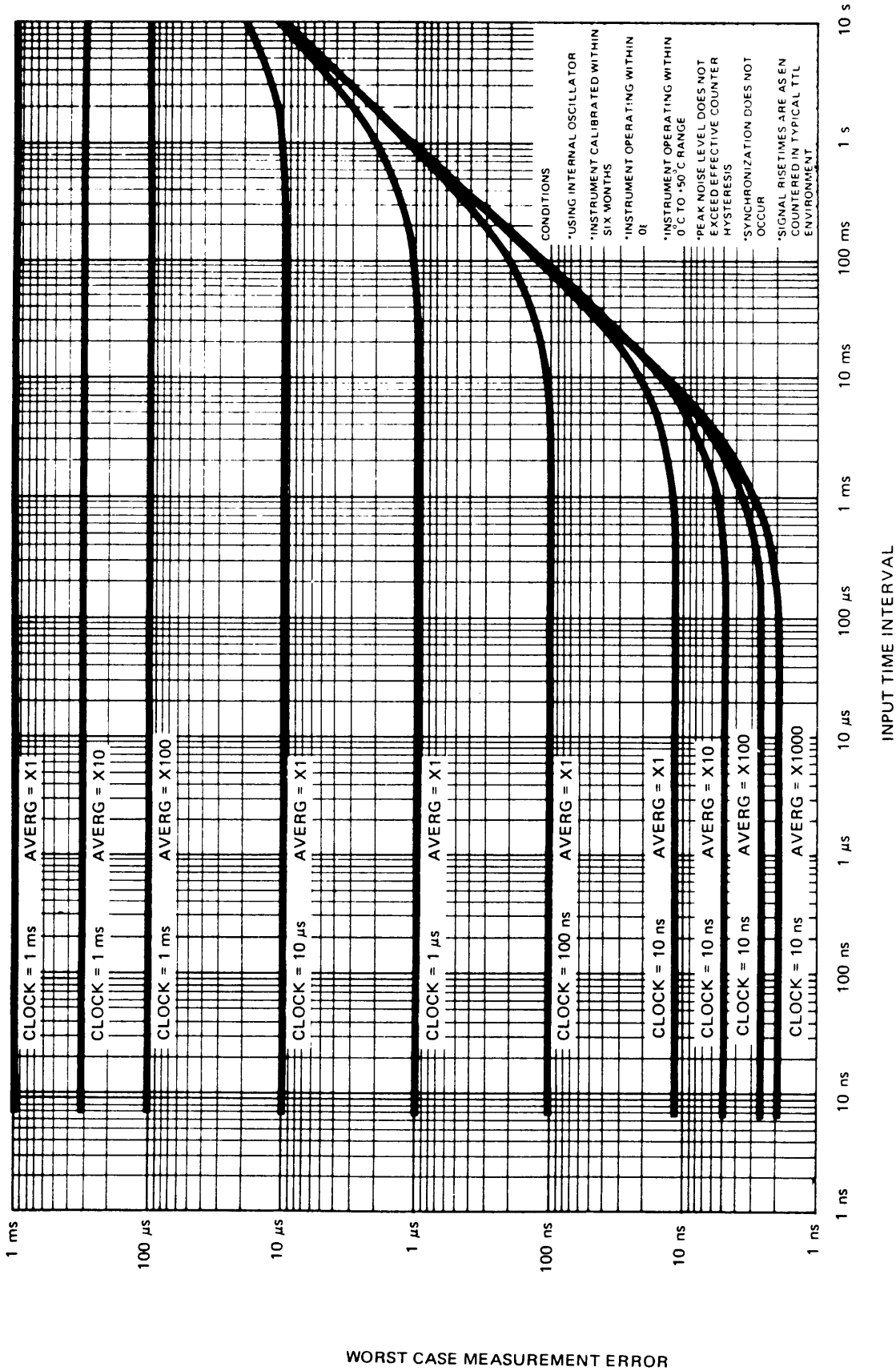
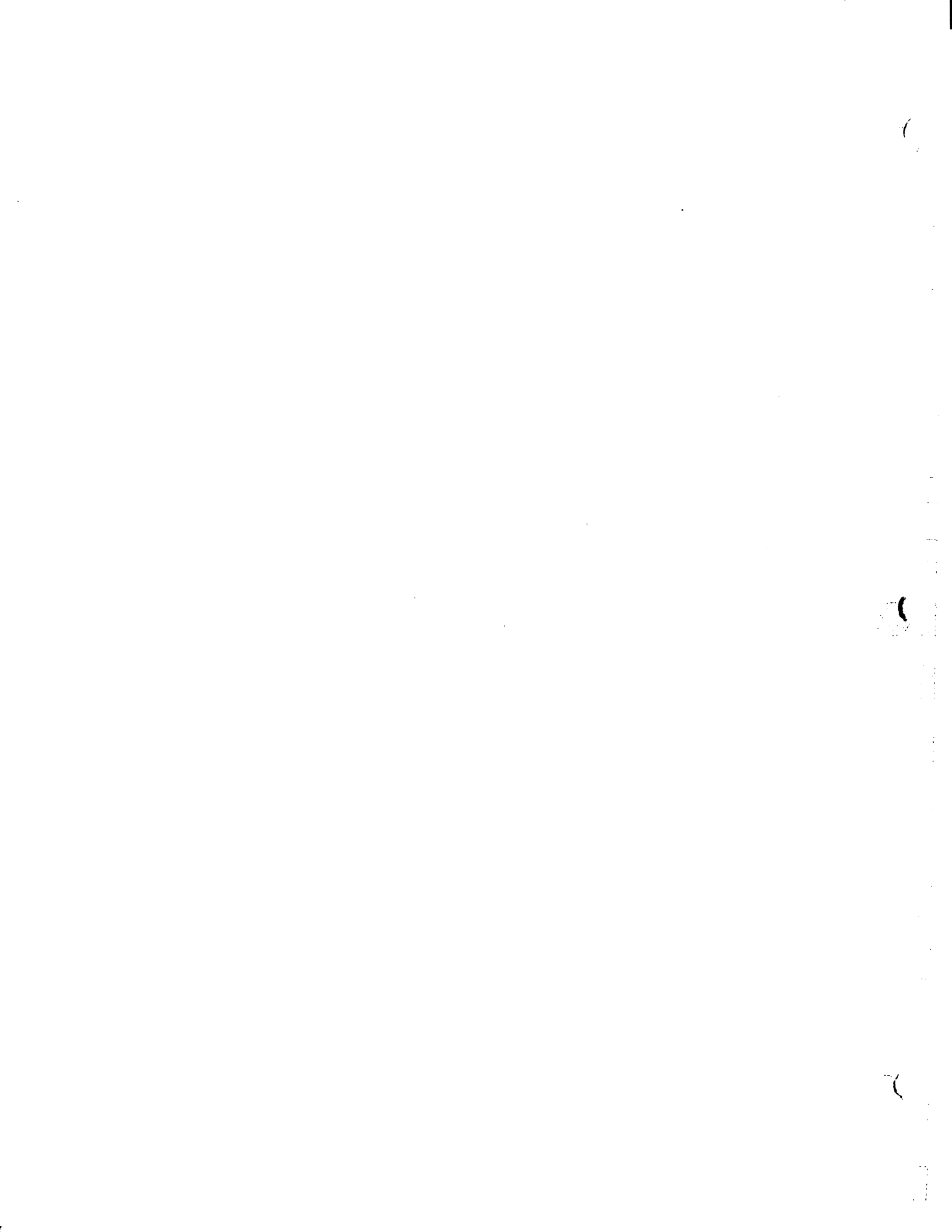

Fig. 1-7. 7D15 Time Interval mode accuracy stated in time.

WORST CASE MEASUREMENT ERROR

1432-7



# OPERATING INSTRUCTIONS

## GENERAL

The 7D15 Universal Counter/Timer plug-in unit operates with the readout system of Tektronix 7000-series Oscilloscopes to measure frequency or frequency ratio, period, time interval, and to totalize (count number of events).

To effectively use the 7D15, the operation and capabilities of the instrument must be known. This section describes front-panel control functions and general information on signal input connections.

## Installation

The 7D15 is calibrated and ready for use as received. It can be installed in any compartment of Tektronix 7000-Series Oscilloscopes; however, if a displayed waveform is desired, it should be used in one of the vertical compartments. Mainframe triggers are furnished the 7D15 when installed in a horizontal compartment.

To install, align the upper and lower rails of the 7D15 with the oscilloscope tracks and slide it in. The front panel will be flush with the front of the oscilloscope and the latch at the bottom left corner will be in place against the front panel when the 7D15 is fully installed. To remove, pull on the latch (inscribed with the unit identification "7D15") and the 7D15 will unlatch. Continue pulling to slide the 7D15 out of the oscilloscope.

FRONT PANEL CONTROLS AND CONNECTORS

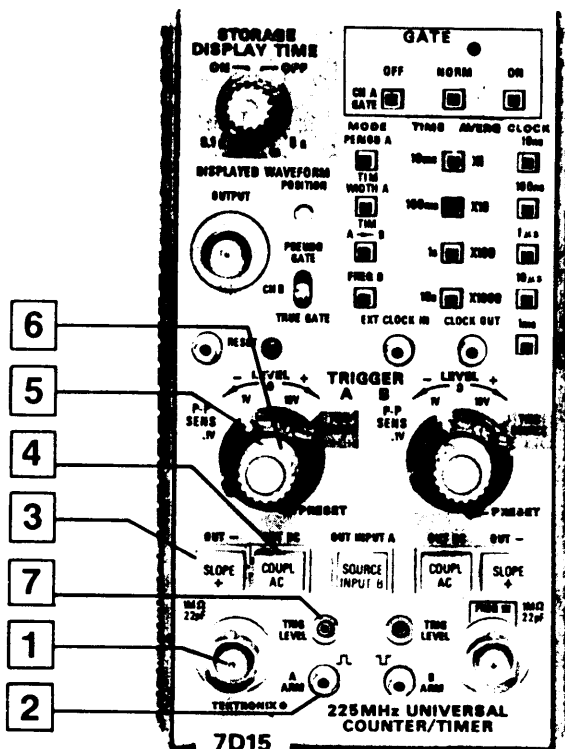

A TRIGGER

- 1** A Input Connector: When selected, provides a means for connecting the trigger signal.
- 2** A ARM Jack: Gates the A Input. A logical Lo gates the A Input off and a logical Hi gates the A Input on.
- 3** SLOPE Switch: Selects whether the positive- or negative-going slope of the signal is to be used as a trigger. The inward position of the SLOPE switch selects the positive slope and the outward position of the SLOPE switch selects the negative slope.
- 4** COUPL Switch: Selects the input coupling to be used. The outward position of the COUPL switch connects both the DC and AC component of the A Input to the attenuator. The inward position allows only frequencies above approximately 5 Hz to pass.
- 5** P-P SENS  
 .1V, 1V, 10V Positions: Selects the sensitivity of channel A trigger amplifier.  
 TRIG SOURCE Position: Selects the internal vertical amplifier trigger signal when installed in the horizontal compartment.
- 6** LEVEL Control: Controls the DC trigger level of the channel A trigger amplifier. The PRESET position (LEVEL control fully clockwise) sets the DC trigger level to 0 volts.
- 7** TRIG LEVEL Jack: May be used to monitor the DC trigger level or, when the LEVEL control is in the PRESET position, the TRIG LEVEL jack can be used to externally set the DC trigger level.

Figure 2-1

1432-8

FRONT PANEL CONTROLS AND CONNECTORS

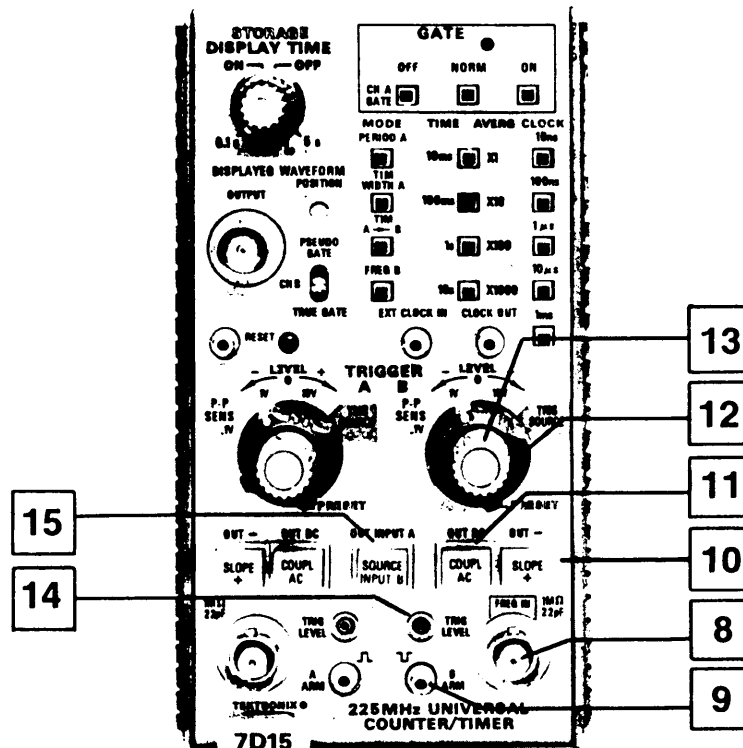

B TRIGGER

- 8** B Input Connector: When selected, provides a means for connecting the trigger signal.
- 9** B ARM Jack: Lo gates the B Input on. A logical Hi gates the B Input off and a logical Lo gates the B Input on.
- 10** SLOPE Switch: Selects whether the positive- or negative-going slope of the signal is to be used as a trigger. The inward position of the SLOPE switch selects the positive slope and the outward position of the SLOPE switch selects the negative slope.
- 11** COUPL Switch: Selects the input coupling to be used. The outward position of the COUPL switch connects both the DC and AC component of the B Input to the attenuator. The inward position allows only frequencies above approximately 5 Hz to pass.
- 12** P-P SENS  
.1 V, 1 V, 10 V Positions: Select the sensitivity of channel B trigger amplifier.  
TRIG SOURCE Position: Selects the internal vertical amplifier trigger signal when installed in a horizontal compartment.
- 13** LEVEL Control: Controls the DC level of the channel B trigger amplifier. The PRESET Position (LEVEL control fully clockwise) sets the DC trigger level to 0 volts.
- 14** TRIG LEVEL Jack: May be used to monitor the DC trigger level or, when the LEVEL control is in the PRESET position, the TRIG LEVEL jack can be used to externally set the DC trigger level.
- 15** SOURCE Switch: The outward position of the SOURCE pushbutton switch internally connects the signal at A Input to both A trigger amplifier and B trigger amplifier. The inward position of the SOURCE switch connects the B Input to the B trigger amplifier. The A Input remains connected to the A trigger amplifier.

1432-9A

Figure 2-2

FRONT PANEL CONTROLS AND CONNECTORS

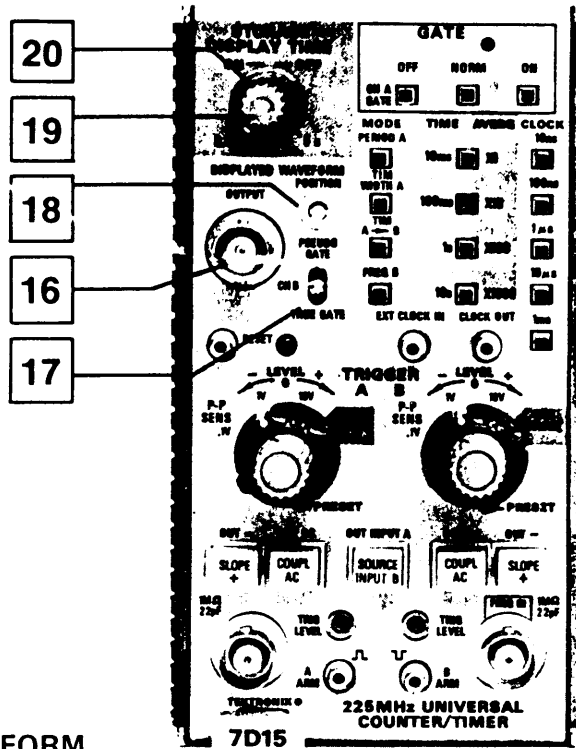

DISPLAYED WAVEFORM

- 16** OUTPUT Connector: Provides an output for monitoring the PSEUDO GATE, CH B signal or, TRUE GATE.
- 17** Displayed Waveform Selector.  
 TRUE GATE: The main gate waveform. The repetition rate of the TRUE GATE is a function of the DISPLAY TIME setting.  
 CH B: The conditioned signal derived from the output of the channel B shaper circuit.  
 PSEUDO GATE: A high repetition-rate replica of the TRUE GATE.

NOTE

These signals may be displayed on the CRT when the 7D15 is used in a mainframe vertical compartment.

- 18** POSITION Screwdriver Control: Sets the position of the signal displayed on the CRT.

STORAGE and DISPLAY TIME

- 19** STORAGE Switch  
 ON: The 7D15 stores the digital display of the previous measurement until the end of the next measurement and then updates the display.  
 OFF: The 7D15 provides a continuous display during the counting process.
- 20** DISPLAY Control: The display time variable control holds the displayed digital reading for a period of 0.1 s to 5 s. In the fully clockwise position ( $\infty$ ), the display is held indefinitely.

1432-10

Figure 2-3



FRONT PANEL CONTROLS AND CONNECTORS

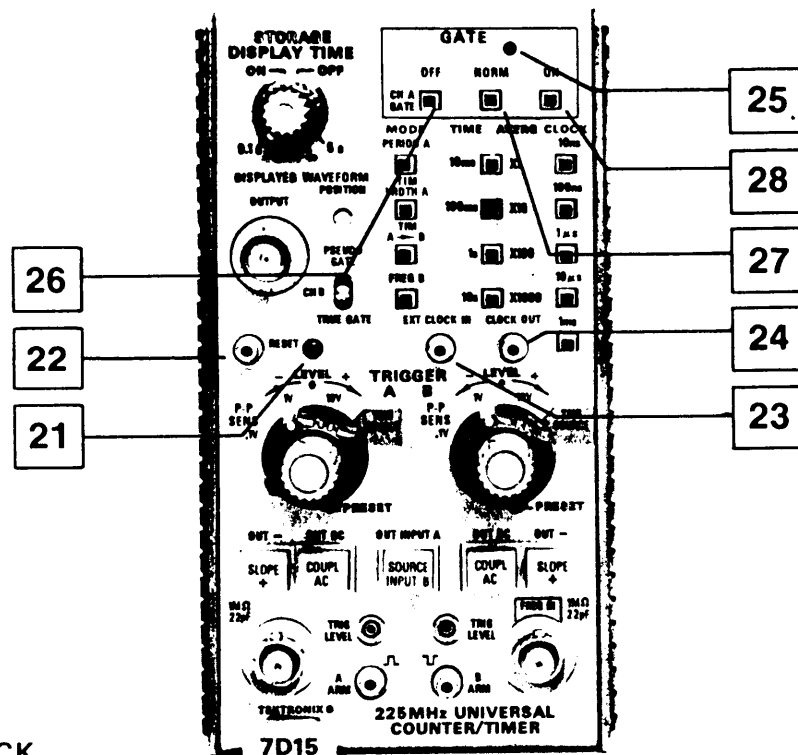

RESET and CLOCK

- 21** RESET Pushbutton: The momentary pushbutton switch initializes the instrument. All counters are affected including the averaging circuits.
- 22** RESET Connector: Provides a means for remotely resetting the 7D15. A logical Hi causes the 7D15 to initialize.
- 23** EXT CLOCK IN Connector: Provides a means for connecting an external clock (an "in-house" standard) or to obtain a different measurement interval for FREQ measurements. To apply an external clock, an internal slide switch (located on the right side of the 7D15) must be switched to the Ext. position (towards the rear).
- 24** CLOCK OUT Connector: Provides a means for monitoring the internal oscillator as selected by the CLOCK pushbuttons.

GATE

- 25** LIGHT: The light indicates the state of the main gate. When lit, the main gate is on (7D15 is in the process of making a measurement). When the light is extinguished the main gate is off.
- 26** OFF Pushbutton: With this button depressed, the 7D15 main gate is held off. When the MODE switch is in the FREQ position, however, the A Input is used to turn the main gate on and off.
- 27** NORM Pushbutton: When this button is depressed, the MODE switches control the main gate in the normal manner.
- 28** ON Pushbutton: When this button is depressed, the 7D15 main gate is held on. When in the PERIOD A, TIM WIDTH, or TIM A B Mode; the 7D15 counts at the rate selected by the CLOCK switch. When in the FREQ mode, the 7D15 counts events present at the B Input connector.

1432-11

Figure 2-4

FRONT PANEL CONTROLS AND CONNECTORS

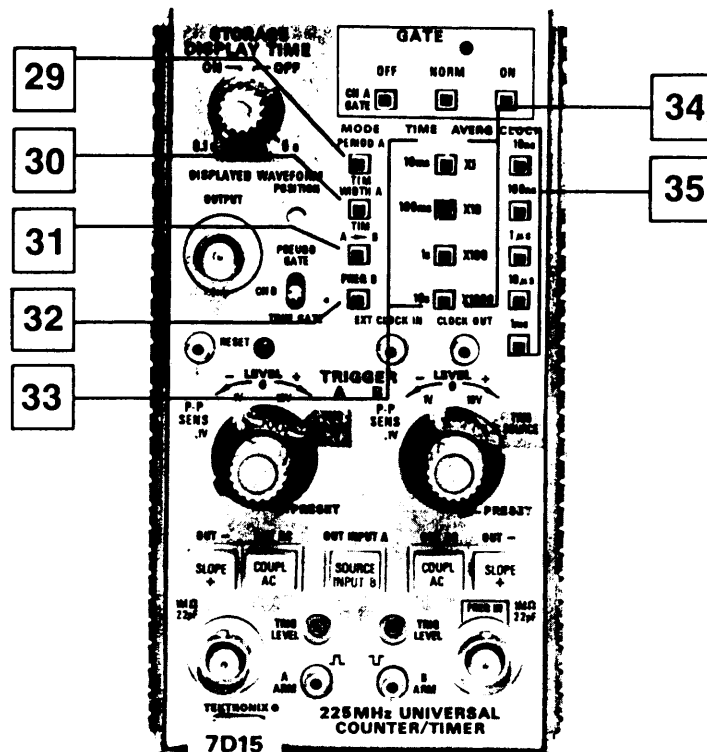

MODE

- 29** PERIOD A: The 7D15 triggers on the slope and level selected by the A TRIGGER section to measure periods of 10 ns to 10<sup>5</sup> s.
- 30** TIM WIDTH A: The 7D15 starts on the slope and level selected by the A TRIGGER section and stops at nearly the same level, but the other slope. The B TRIGGER section does not function in this mode.
- 31** TIM A B: The 7D15 starts on the slope and level selected by the A TRIGGER section and stops on the slope and level selected by the B TRIGGER section. Two completely separate signals may be used, or for a single signal source, use the A Input and the SOURCE switch.
- 32** FREQ B: The 7D15 measures frequency directly from DC to 225 MHz. Signal connection is made via the B Input connector.

TIME – AVERAGE

- 33** 10 ms, 100 ms, 1 s, 10 s Pushbuttons: These switch positions are used in conjunction with the FREQ mode to select the measurement interval.
- 34** X1, X10, X100, X1000 Pushbuttons: These switch positions are used in conjunction with the PERIOD A, TIM WIDTH A, and TIM A B modes to select the number of measurements to be averaged.

CLOCK

- 35** 10 ns, 100 ns, 1 μs, 10 μs, 1 ms Pushbuttons: Selects the clock rates to be used.

1432-12

Figure 2-5

## MODES OF OPERATION

### Manual Stop Watch

This mode uses the GATE ON OFF switches to manually turn the counter main gate on and off. The counting rate is determined by the CLOCK switches. Times of up to  $10^5$  s can be measured in this mode.

### Event Counter

In the EVENTS mode, the 7D15 counters accept information from the B Input connector. The B TRIGGER controls select the counter triggering point. From 1 to  $10^8$  events can be counted in this mode.

### Frequency Measurements

The 7D15 can measure frequencies directly from dc to 225 MHz when used in the FREQ mode. To obtain greater resolution of low-frequency measurements, measure the period of the waveform and calculate frequency (Frequency = 1/Period).

### Frequency Ratio Measurements

The ratio of one signal to another can be compared with a range of up to  $10^4:1$  and, depending on the range, a resolution of up to  $10^{-7}$ . In the Frequency Ratio mode, the "standard" or reference signal is usually connected to the EXT CLOCK IN and the signal to be compared is connected to the B Input connector.

## Time Interval Measurements (TIM)

Two basic modes of time interval measurements can be selected, TIM WIDTH, and TIM A → B. The TIM WIDTH mode measures the time between two points on a waveform. These points are selected by the A TRIGGER controls such that the counter main gate turns on at the point on the waveform selected by the A SLOPE and LEVEL controls and turns off at the same level but on the other slope. See Fig. 2-6c.

The TIM A → B mode, like the TIM WIDTH mode, measures the time between two points on a waveform. These two points are controlled individually, such that the A TRIGGER controls select the point on the waveform that turns the main gate on, and the B TRIGGER controls select the point on the waveform that turns the main gate off. See Fig. 2-6d.

## Period Measurements and Period Averaging

The 7D15 measures periods from 10 ns to  $10^5$  s. Up to 1000 periods can be averaged to obtain a resolution of up to 10 ps.

The period mode measures the time between two points on a waveform. These two points are selected by the A TRIGGER controls such that the counter main gate turns on and off at the point selected by the level and slope controls, see Fig. 2-6A. The period averaging mode holds

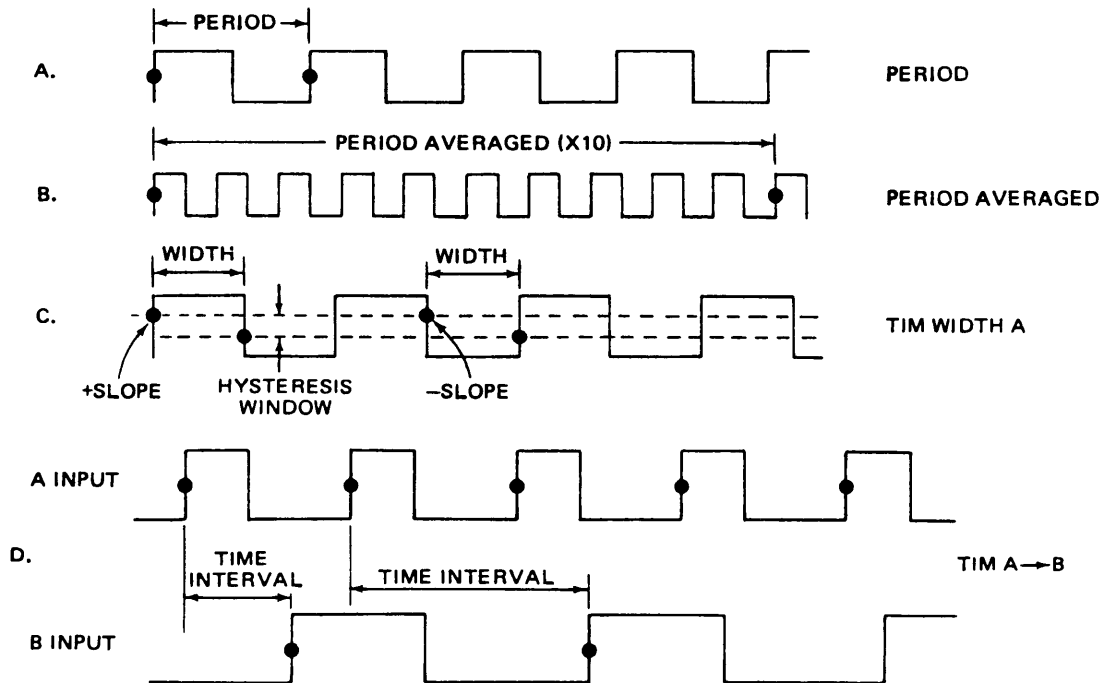

Fig. 2-6. Measurement intervals.

1432-13

the counter main gate on until 1, 10, 100 or 1000 periods are counted (see Fig. 2-6B).

### Time Interval Averaging

Averaging makes possible time interval measurement as short as six nanoseconds with a usable resolution up to 0.1 nanosecond. This increased resolution is achieved by statistically reducing the  $\pm 1$  count error inherent in single shot time interval measurements. The probability of obtaining the true value increases with the number of intervals averaged.

Time interval averaging can be used whenever several repetitive intervals are available. The number of averages selected (10, 100, or 1000) is largely determined by the number of intervals available. Overflowing the counter registers is another consideration for selecting the number of averages.

Time interval averaging should not be used when the interval being measured might vary during the measurement cycle (a non-repetitive signal), or when signal repetition rate is synchronized with the counter clock rate. The problems of synchronization are discussed later.

Unlike period averaging (which turns the counter main gate on for a certain length of time), time interval averaging makes a predetermined number of discrete measurements, then averages these measurements to obtain the final answer. For instance, for 1000 averages, the counter main gate is turned on and off 1000 times before the final answer is ready.

With a ten nanosecond clock, it is possible to obtain accuracies of one nanosecond. For example, assume that the time interval to be measured is 11 nanoseconds. The measurement is made and the results are totaled 1000 times. In this case, a ten nanosecond clock is used. 1.1 pulses of the clock will occur during the measurement interval, so 1100 counts would be expected to occur during 1000 measurements. Since the counter cannot record a fractional count, sometimes it registers one count and sometimes two counts, depending on the timing between the clock and the repetition rate of the interval to be measured. Assuming a uniform random distribution of timing coincidence, two counts are recorded 10% of the time and one count 90% of the time. Figure 2-7 shows the graphical representation of this example.

While time interval averaging reduces inaccuracies, the amount is often difficult to determine. The period of the interval to be measured is one variable in calculating the

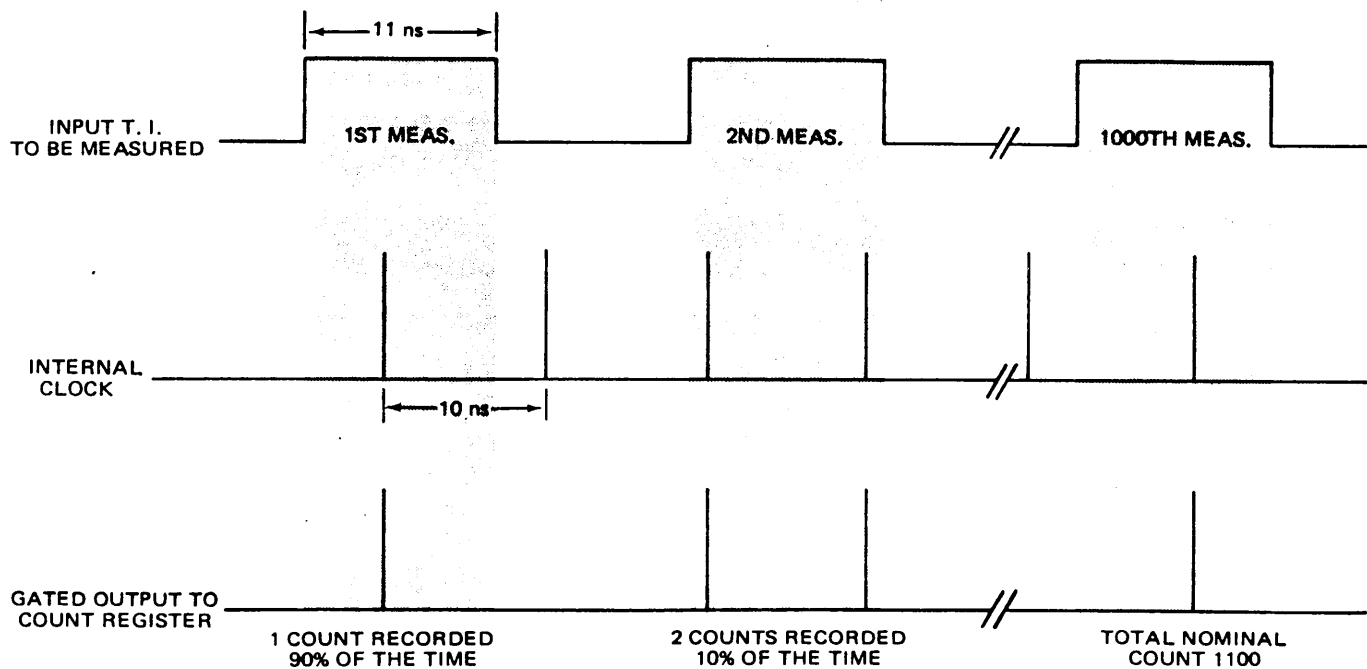

EXAMPLE ASSUMES UNIFORM RANDOM DISTRIBUTION OF TIMING COINCIDENCE.

1432-14

Fig. 2-7. Graphical representation of time interval averaging.

standard deviation. A probability distribution graph for the previous example, where the time interval is 11 ns, is shown in Figure 2-8. Compare this graph with the probability distribution graphs for 10.1 ns and 15 ns. The probability range for a time interval of 10.1 ns is narrower than for a time interval of 11 ns or 15 ns. Readings in the shaded area of the graph represent the range of answers that may be given 50% of the time.

Another variable that can change the shape of the distribution curve is the number of averages taken. The graphs shown in Figure 2-9 represent the probability curve of an 11 ns time interval that is averaged 10, 100, and 1000 times. The graphs show that the probability of obtaining an answer near 11 ns increases with the number of averages taken.

It should be noted that the previous examples assume a uniform random distribution of time coincidence. If the input time interval and clock is synchronized an erroneous answer may be given; see Figure 2-10. The answer does not vary, but is wrong. Anything short of pure synchronization is usually acceptable.

If synchronization is suspected, a check can be made by comparing the repetition rate of the time interval to be measured with the 7D15 clock rate. This can be done by triggering the oscilloscope with the 7D15 PSEUDO GATE and observing the CLOCK OUT signal. Since all the 7D15 Clock positions are synchronized with each other, for the purpose of display, a lower clock rate position can be used. Synchronization is indicated by a display with little or no drift.

The amount of acceptable drift can be determined first, by calculating the time needed to make a time interval average measurement ( $T_{meas}$ ) by the following:

$$T_{meas} = \frac{\text{Number of averages}}{\text{Repetition rate of measured time interval}}$$

Second, observe the waveform and measure the time of one cycle of drift. Correct for the time interval actually used.

Generally, synchronization will not occur if this figure is less than  $T_{meas}$ .

Example: A time interval with a repetition rate of 100 kHz is being measured and averaged 1000 times, using a clock of 10 ns.

$$T_{meas} = \frac{1000}{100 \text{ kHz}} = 10 \text{ ms}$$

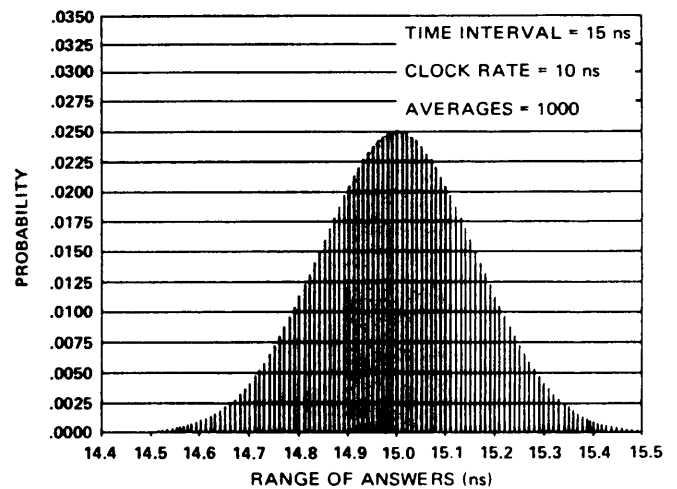
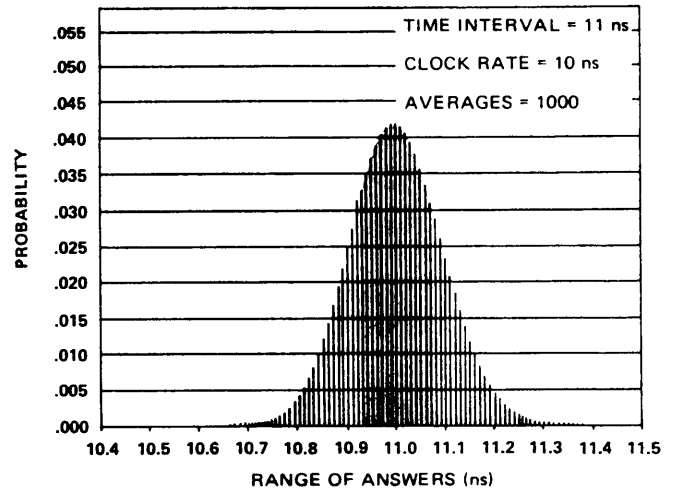
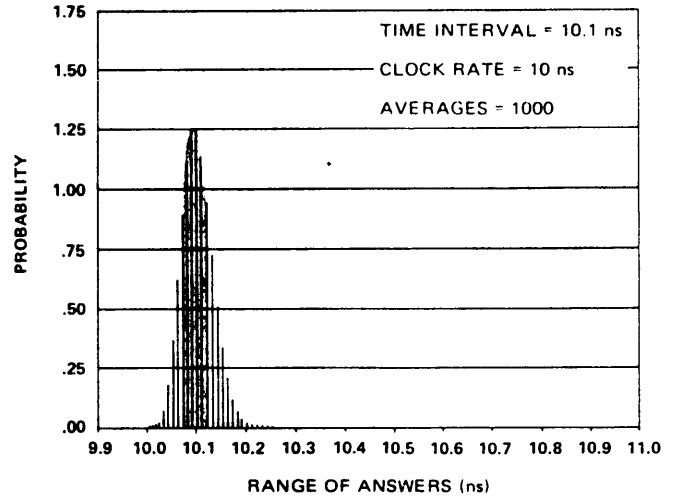

THE ABOVE EXAMPLES ASSUME A UNIFORMLY RANDOM DISTRIBUTION OF TIMING COINCIDENCE.

1432-15

Fig. 2-8. Probability versus time interval.

## Operating Instructions—7D15

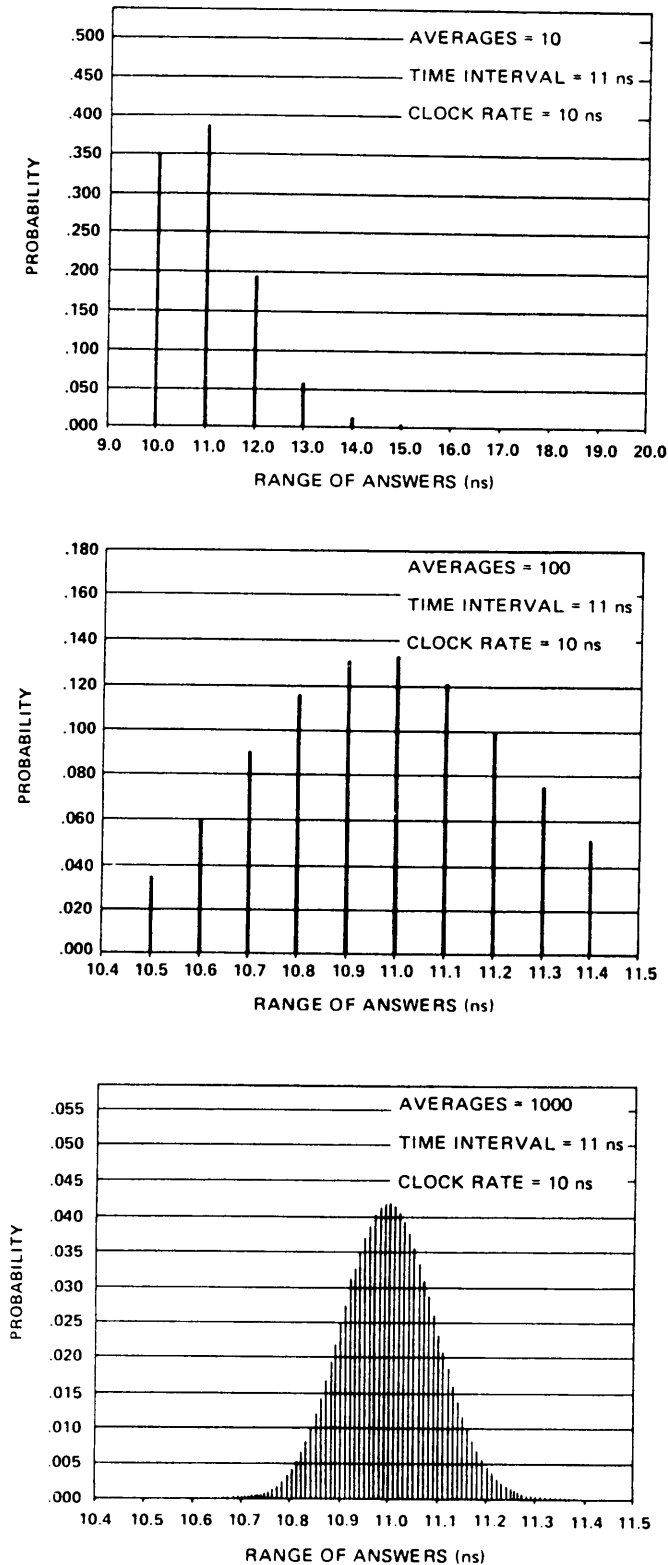

THE ABOVE EXAMPLES ASSUME A UNIFORMLY RANDOM DISTRIBUTION OF TIMING COINCIDENCE.

1432-16

Fig. 2-9. Probability versus number of averages.

The CLOCK OUT signal is viewed on the oscilloscope, using an amplifier plug-in unit. The display is triggered with the PSEUDO GATE. To present a usable display, the 7D15 clock rate is changed to 10  $\mu$ s. A drift of 1.5 seconds per cycle is noted. This drift rate is corrected by:

$$\frac{10 \text{ ns}}{10 \mu\text{s}} \times 1.5 \text{ seconds} = 1.5 \text{ ms}$$

Since  $T_{\text{meas}}$  (10 ms) is greater than the drift rate (1.5 ms), synchronization is not a problem.

To eliminate a synchronous relationship, change the input signal repetition rate, introduce some type of phase instability to the input signal, or alter the 7D15 clock frequency (two or three ppm is usually adequate). Any of these methods allow the counter to seek a true random distribution of time coincidence.

### Selective Time Interval Measurements

Selective time interval measurements are made possible by using the 7D15 A ARM and B ARM gates. The oscilloscope delayed gate can be used in conjunction with the ARM gates to choose the portion of a waveform to be measured. Refer to the oscilloscope and time base manuals for complete information concerning gate outputs available.

## OPERATION AND CHECKOUT

### Introduction

These procedures demonstrate the use of the connectors and controls of the 7D15, and also provide a means of checking the basic operation of the instrument.

### Preliminary Setup

Install the 7D15 into a vertical compartment of any 7000-Series, readout-equipped, oscilloscope. Set the oscilloscope Vertical Mode and Trigger Source switches to the proper settings.

Install a 7B-Series time-base unit into a horizontal compartment and set the oscilloscope Horizontal Mode switch to the proper setting. Adjust the time-base unit throughout the procedures to obtain an optimum triggered display.

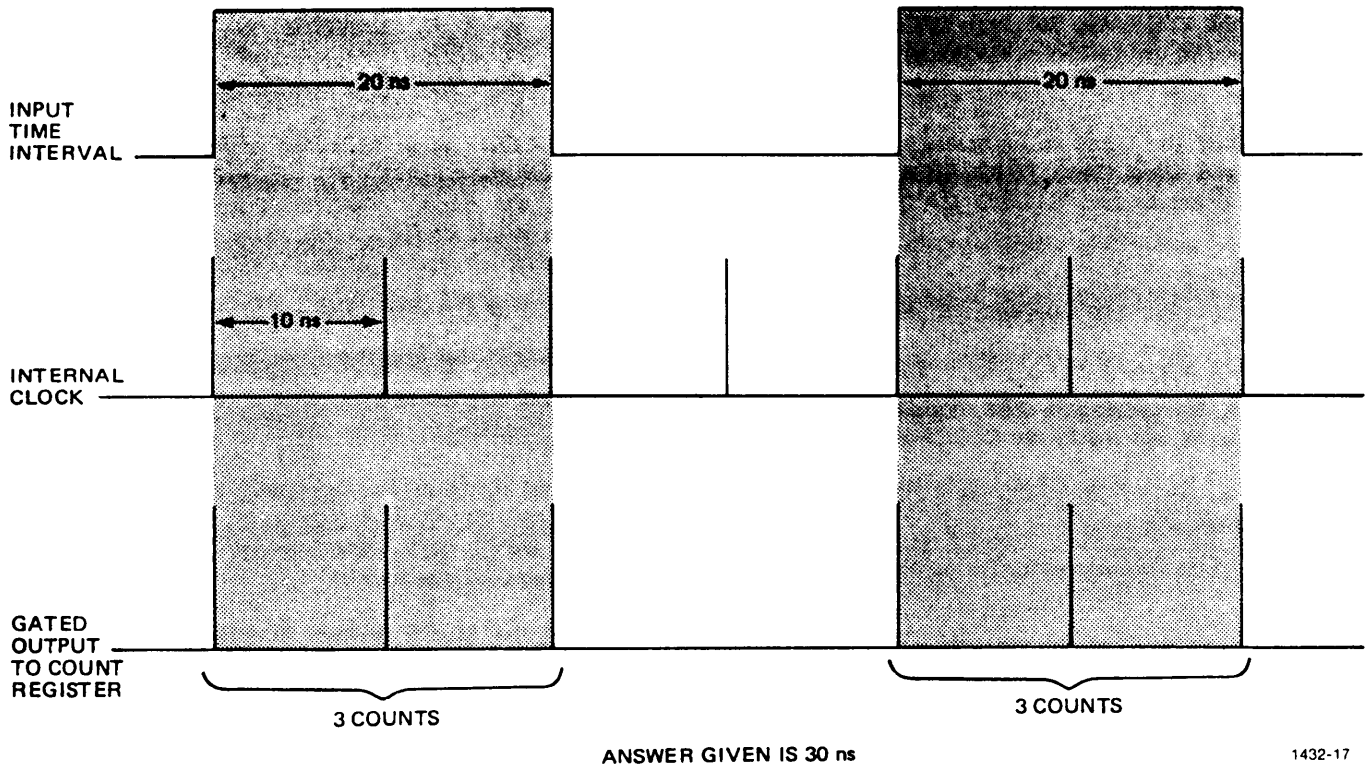

Fig. 2-10. Results of pure synchronization between the clock rate and input time interval.

Set the 7D15 controls as follows:

A and B TRIGGER

SLOPE	+
COUPL	DC
SENS	.1 V
LEVEL	PRESET
SOURCE	INPUT B

DISPLAYED WAVEFORM

Switch	PSEUDO GATE
--------	-------------

### Manual Stop Watch

1. Set the 7D15 GATE switch to OFF and set the MODE switch to PERIOD A.
2. Select the desired counting interval (a counting interval of 1 ms can be observed easily).
3. Turn the STORAGE switch to OFF and the DISPLAY control to ∞.
4. The 7D15 is ready to count. Use the GATE ON OFF switch to start and stop the counter. Push the RESET button to reset the counter.

### NOTE

*To obtain the total time of a number of time measurements, do not reset counter.*

### Event Counter

1. Set the 7D15 GATE switch to OFF and set the MODE switch to FREQ B.
2. Turn the STORAGE switch to OFF and connect the signal to be counted to the B Input connector (a 0.4 V, 1 kHz oscilloscope calibrator signal may be used to show operation).
3. Use the GATE ON OFF switch to start and stop the event counter. If necessary, adjust the B TRIGGER controls to obtain proper triggering. The DISPLAY control determines the length of time that the digital display is shown on the CRT before the counter resets.

### Period Measurements

1. Set the 7D15 MODE switch to PERIOD A, the AVERG switch to X1, the GATE switch to NORM, and the CLOCK switch to the desired resolution.

## Operating Instructions—7D15

2. Set the STORAGE switch to ON and the DISPLAY TIME control to the desired repetition rate.

3. Connect the signal to be measured to the A Input connector and adjust the A TRIGGER controls for proper triggering. Observe the PSEUDO GATE display on the CRT.

### NOTE

*The CLOCK OUT signal may be used as the A Input Signal to show operation. The period of the CLOCK OUT signal is selected by the CLOCK switch.*

### Period Averaging

1. Follow the procedures for Period Measurements.
2. Set the AVERG switch to the number of averages desired, i.e., with the CLOCK OUT signal connected through a 50 ohm terminator to the A Input, the CLOCK switch set to 10 ns, and the AVERG switch set to X1000, the 7D15 digital display will be "10.00 ns 1000X"  $\pm 1$  count.

### Frequency Measurements

1. Set the 7D15 MODE switch to FREQ, the GATE switch to NORM, and the TIME switch to the desired measurement interval.
2. Set the STORAGE switch to ON and the DISPLAY TIME switch to the desired repetition rate.
3. Connect the signal to be measured to the B Input connector and adjust the B TRIGGER controls for proper triggering.

### NOTE

*The CLOCK OUT signal may be used as the B Input signal to show operation. The frequency of the CLOCK OUT signal is selected by the CLOCK switch, i.e., with the CLOCK OUT signal connected to the B Input, the CLOCK switch set to 100 ns, and the TIME switch set for a 1 second measurement interval the 7D15 will read "10000.000 kHz 1000 ms".*

### Frequency Ratio Measurements

1. Apply one of the signals to be compared to the EXT CLOCK IN connector using one of the cables supplied with the 7D15. This signal is usually a standard to which the other signal is compared. Move the internal Clock switch toward the rear of the plug-in to the External clock position, see Fig. 2-11. *Refer internal Clock switch changes to qualified service personnel.*
2. Set the MODE switch to FREQ and the TIME AVERG switch to X1.
3. Connect the second signal (the signal to be compared) to the B Input connector. Adjust the B TRIGGER controls for proper triggering.
4. The numerical readout located on the upper portion of the CRT indicates the ratio of the B Input signal to the EXT CLOCK IN signal.
5. To obtain greater resolution, the TIME AVERG switch can be used to divide the EXT CLOCK IN signal by 10, 100, or 1000. However, the decimal point for these switch positions will be incorrect. To obtain the correct answer, multiply the CRT readout by the correction factor given in Table 2-1. For example, the CRT reads 10000.00 and the TIME AVERG switch is set to X10. The corrected readout is 10.00000:1.

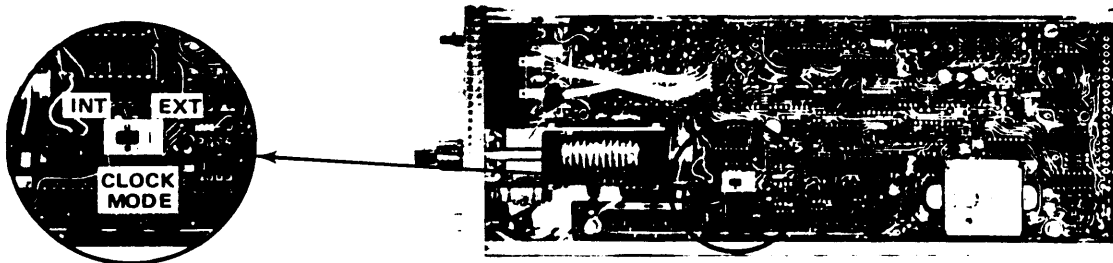

1432-18

Fig. 2-11. Internal/External clock switch.



TABLE 2-1

Frequency Ratio Decimal Point Chart

TIME AVERG Switch Position	7D15 Readout	Correction Factor	Corrected Readout
X1	0.0000	X10 <sup>1</sup>	0.0000 : 1
X10	00.00	X10 <sup>3</sup>	000.00 : 1
X100	0.000	X10 <sup>3</sup>	000.000 : 1
X1000	0.0000	X10 <sup>3</sup>	000.0000 : 1

**TIM WIDTH and TIM WIDTH Averaging Measurements**

1. Set the 7D15 MODE switch to TIM WIDTH A, and AVERG switch to the desired number of measurements to be averaged. Set the GATE switch to NORM and the CLOCK switch to the desired resolution.

2. Set the STORAGE switch to ON and the DISPLAY TIME control to the desired repetition rate.

**NOTE**

The oscilloscope Calibrator may be used as the A and B Inputs to show operation, i.e., connect a 1 kHz, 0.4 V Calibrator signal to the A Input and set the SOURCE switch to the outward position. With the CLOCK set to 10 ns and the AVERG switch set to X10, the 7D15 digital display will be "1000.000 μs 10X" ± calibrator accuracy.

**APPLICATIONS**

Your 7D15 and 7000 Series Oscilloscope provide a flexible and accurate measurement system. The capabilities of the system depend upon the mainframe and other plug-in units selected. Specific applications are also described in the manuals of the mainframe and other plug-in units. The overall system can also be used for many applications not described in these manuals. Contact your Tektronix Field Office or Representative for assistance in making specific measurements with this instrument.

**TIMING MEASUREMENT**

**Pulse Width**

The TIM WIDTH A mode pushbutton on the 7D15 allows you to measure pulse width directly. Only the channel A triggering circuit is used in this measurement. Figure 2-12 shows the equipment setup to measure the width of a TTL clock pulse. The 10 ns clock rate and X1000 measurement average provides maximum accuracy and resolution. The display of the PSEUDO GATE indicates the measurement interval.

Width measurements are generally made at the 50% amplitude of the pulse. For an exact measurement of pulse width at any amplitude level, set the trigger level by monitoring the channel A TRIG LEVEL jack with a DVM. This pulse has a 5 V amplitude. With the P-P SENS control set to 1 V, the trigger level should be set for an output at the A TRIG LEVEL jack of +0.25 V.

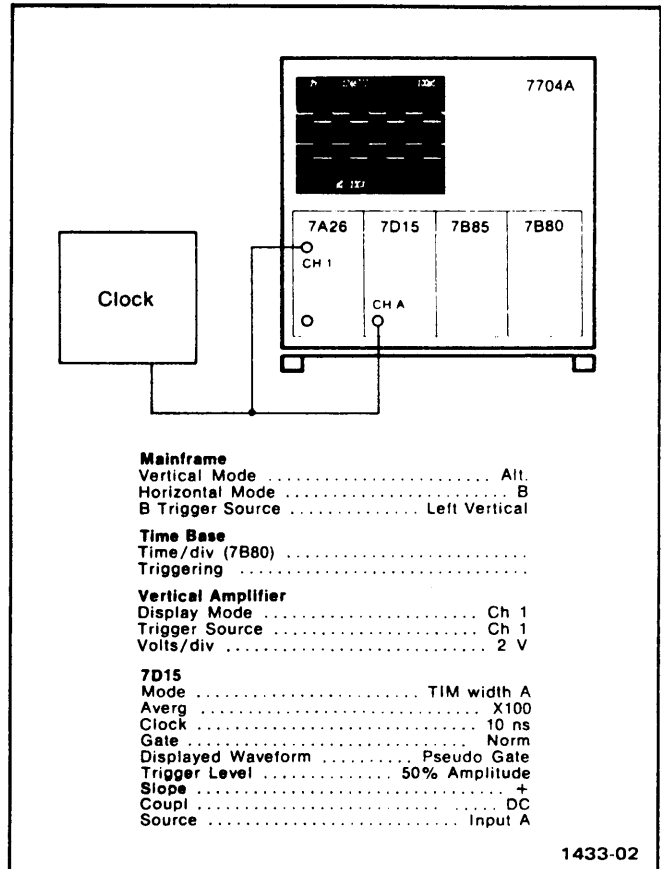

Fig. 2-12. Equipment setup for typical width measurement.

Figure 2-13 shows the equipment setup to measure the width of a noise spike that is appearing in a logic signal. Using trigger arming, the 7D15 is set to make the width measurement only after the logic signal has gone low.

Connect the delayed sweep output to the A ARM connector of the 7D15. The Delay Time Multiplier and the Variable Time/DIV control can now be used to position the beginning of the arming gate after the falling edge of the logic signal and to keep the trigger circuit armed for the duration of the low level. The intensified zone indicates the position and width of the arming gate. With this setup, the 7D15 will capture and measure the width of the first positive-going transition that occurs after it is armed.

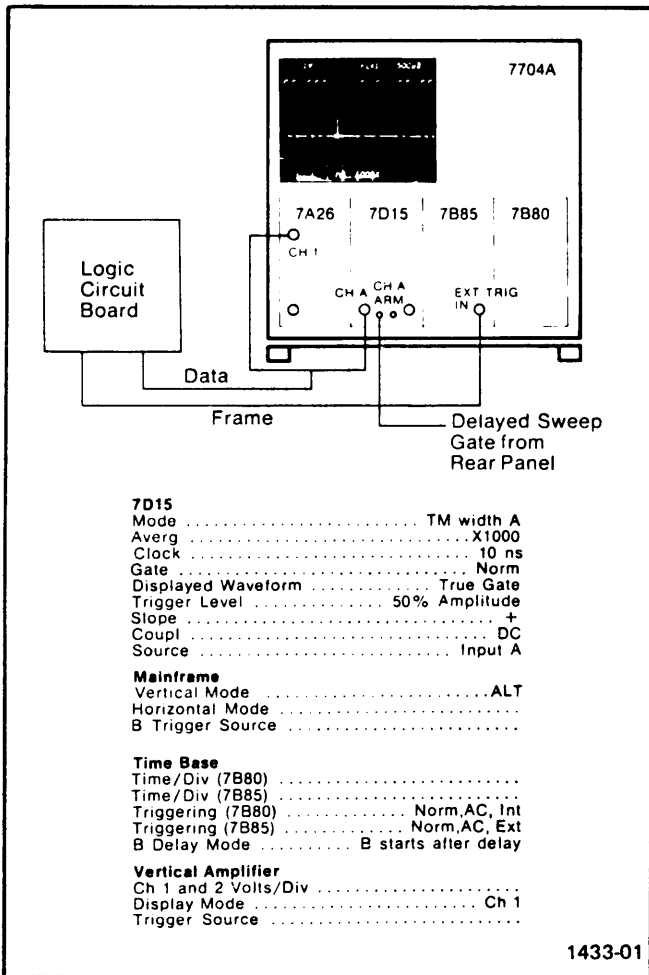

Fig. 2-13. Equipment set up for transient measurement.

The 7D15 can also measure the width of single-shot events. Figure 2-14 shows the waveform photograph of destruction test made with a storage oscilloscope and the 7D15. The width of this displayed pulse was measured simultaneously with the storage of the display. Since the event occurred once, the arming gate was not required.

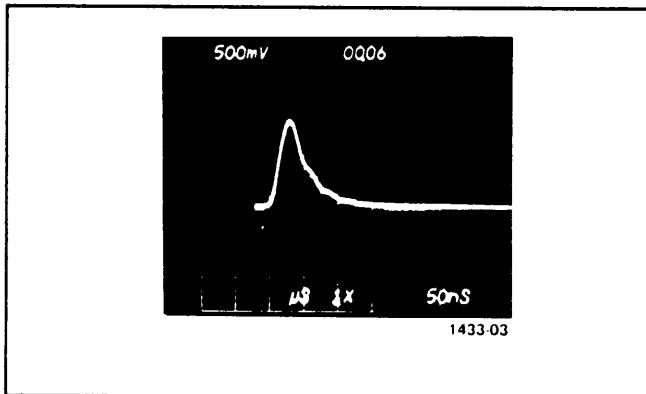

Fig. 2-14. Waveform and width measurement readout for destruction test.

### Pulse Period

Using the same setup as shown in Fig. 2-12, press the PERIOD A MODE pushbutton. The period measurement is now read out on the CRT. Merely set the A TRIGGER controls to trigger the counter either on the leading or falling edge of the pulse. The trigger level can be adjusted to meet your specific measurement requirement.

Since the signal being measured is repetitive, X1000 measurement averaging is selected to obtain maximum accuracy and resolution.

As with pulse width measurements, trigger arming is not necessary to measure the period of a signal. Arming is useful though when looking at data pulse trains or other signals where a pulse may or may not be present during a given clock cycle.

### Time Between Non-adjacent Events

The ability to select a particular pulse in a pulse train for measurement, as was previously illustrated by the pulse width measurement of a noise spike, can also be applied to the measurement of the time between non-adjacent events.

Figure 2-15 shows the equipment setup for a time interval measurement on a serial word train from a disk memory device. The origin pulse in this case is used to trigger the A time base. The delayed sweep gate is again used to arm the counter's trigger circuits. In this case, the delayed sweep gate is connected to both the A ARM and B ARM connectors because the TIM A—B mode is being used.

Once a stable display is obtained, measurements can be made between any two points on the waveform merely by adjusting the trigger levels and slopes, and by adjusting the position and width of the intensified zone (the delayed sweep gate). The Delay Time Multiplier control determines the position of the leading edge of the delayed sweep gate and thus the point of arming the A TRIGGER circuit. The time base Variable Time/Division control sets the width of the delayed sweep gate and thus the position of the falling edge of the gate, or the point of arming for the B TRIGGER circuit. The delayed sweep gate is applied to the A and B ARM inputs, A trigger is armed during the time B trigger is disarmed, and vice versa.

When making adjustments to your circuitry, you can resolve small changes in risetime easily. However, the 7D15 is not recommended for measuring risetimes faster than 125 ns.

The two separate trigger circuits of the 7D15 and the ability to set exact trigger levels through the two TRIG LEVEL jacks allows you to make very accurate risetime measurements with the unit. Again, trigger arming can be used to select a particular pulse in non-repetitive pulse trains.

Figure 2-16 shows the equipment setup for measuring the risetime of a clock pulse as it is input into a flip-flop. This is a flip-flop which requires a clock pulse risetime of 150 ns from the 0.6 V level to the 5.4 V level.

The TRIGGER SLOPE controls in this measurement are both set to (+). To set the TRIGGER LEVEL controls, connect a DVM to one TRIG LEVEL jack at a time, and set the A trigger level for 0.6 V and B trigger level for 5.4 V. With the TIM A→B MODE pushbutton pressed the risetime is read directly on the CRT.

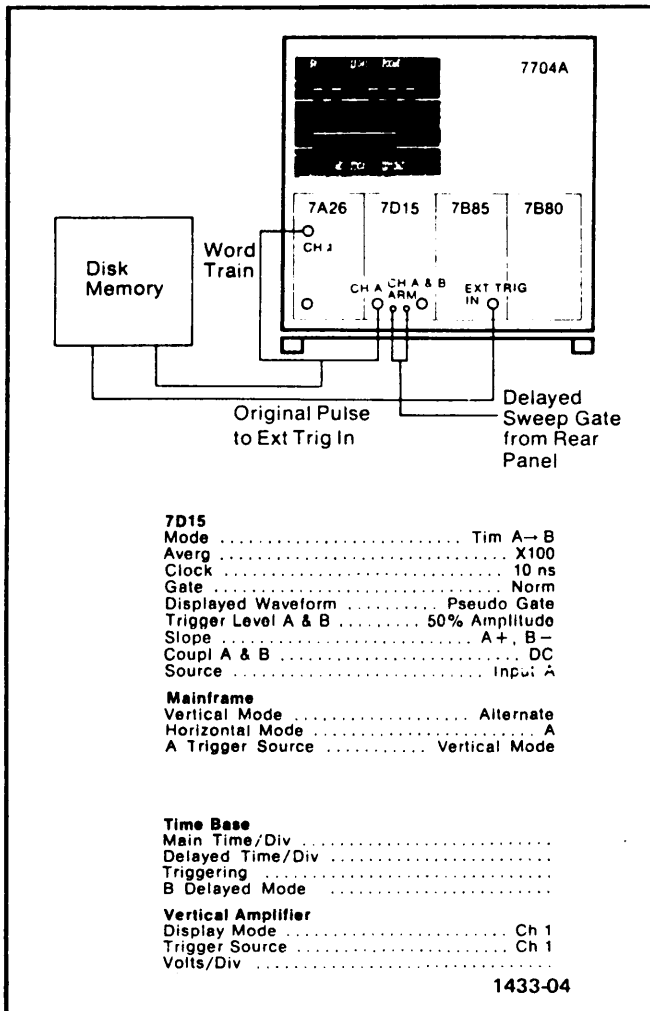

Fig. 2-15. Equipment setup for measurement of time between non-adjacent events.

In this example, the counter arming gate is set to measure the time between the falling edge of the first pulse in the display and the leading edge of the last pulse. The waveform photo in Fig. 2-15 shows the analog waveform display (upper trace), the PSEUDO GATE display of the counter's actual measurement period (lower trace), and the readout of the actual measurement. The 100X measurement averaging improves the accuracy and resolution of the measurement. The accuracy in this case is within 4 ns (0.00036%).

### Time Between Two Voltage Levels

Risetime, the time between the 10% and 90% pulse levels, or the time required for a transducer to rise from one level to another, can easily be acquired from the 7D15 TIM A→B mode. For example, if you are making a series of risetime measurements where the 10% and 90% levels are not changing, each risetime is digitally read out on the CRT; this eliminates the need to carefully position the waveform, and then count divisions on the CRT.

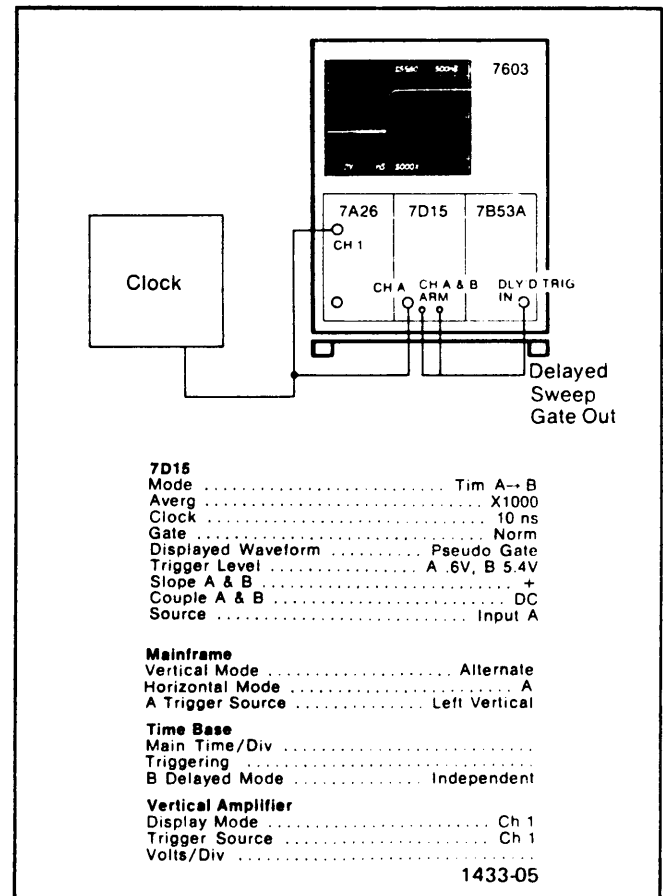

Fig. 2-16. Equipment setup for risetime measurement.

## Operating Instructions—7D15

In this case the risetime measurement is 155.60 ns. The accuracy is within 2 ns or 1.3%.

This method can be easily used for measuring rise and fall times slower than 125 ns. The trigger arming gate (the delayed sweep gate) must be connected to both the A ARM and B ARM connectors. Set the A trigger level control to trigger at the 10% point and the B trigger level control for the 90% point. Now a typical time interval measurement (TIM A—B) can be done by moving the intensified zone from one risetime to the other.

### Propagation Delay

The two signal inputs to the 7D15 trigger circuits allow you to make propagation delay measurements quickly and easily. Figure 2-17 shows the equipment setup required to measure the propagation delay of a clock signal as it passes through seven TTL gates.

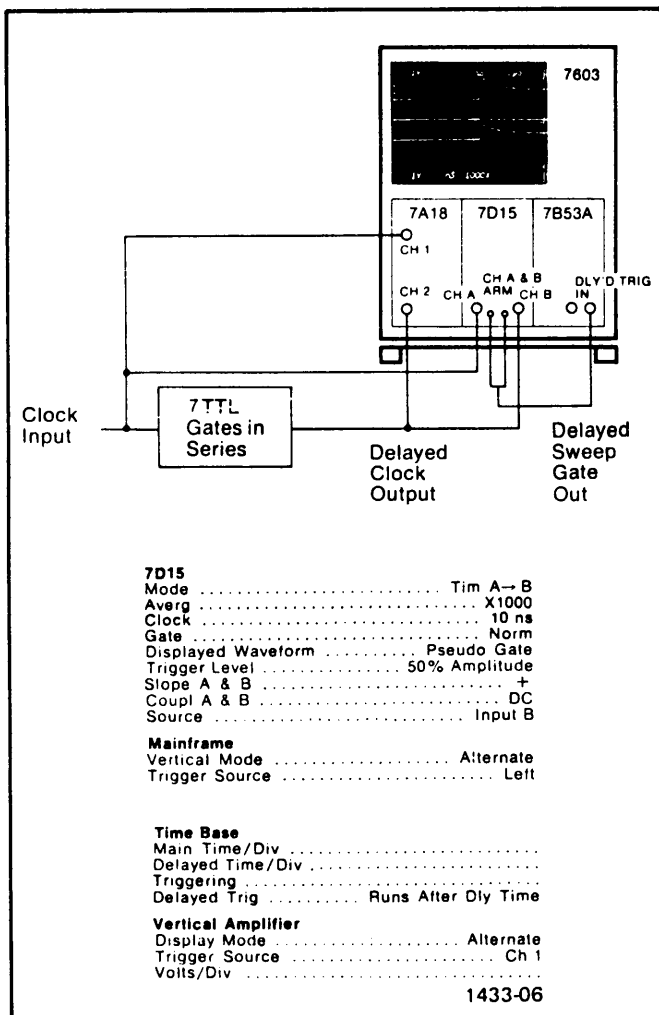

Fig. 2-17. Equipment setup for propagation delay measurement.

In this setup, the undelayed pulse is connected to both channel 1 of the vertical amplifier and channel A of the 7D15; the delayed pulse is connected to channel 2 of the vertical amplifier and channel B of the 7D15. The 7D15's SOURCE INPUT B pushbutton determines the source of the trigger signal for channel B. When out, it receives its signal from the channel A input (in the TIM A—B mode). When in, each trigger circuit receives its trigger signal from its respective input connector.

Trigger arming is required for this measurement, because channel B must know which pulse to trigger on with respect to the undelayed pulse. Connect the delayed sweep gate to both trigger arming input jacks.

With the oscilloscope vertical mode set for alternate trace sweeps, trigger on the undelayed pulse (channel 1). Now adjust the intensified zone so that it begins before the rise of the undelayed pulse and ends before the rise of the undelayed pulse. The propagation delay is then read out on the CRT. The measurement in this case is 76.60 ns.

For maximum accuracy, both the TRIGGER LEVEL controls should be set for the same voltage level. This can be obtained either by measuring the voltage levels through the TRIG LEVEL jacks with a DVM or by applying the desired voltage to each jack.

### Phase Shift

To determine phase, the time between the same voltage level on the leading and lagging signals is measured and divided by a conversion factor (Time/Degree). For example, if the period of the signal (as measured with 7D15) is 2  $\mu$ s (5 MHz), the Time/Degree conversion factor is: 2  $\mu$ s/360° = 5.55 ns/degree. If the time interval between the two phases is measured as 50 ns, the phase difference is thus: 50 ns/5.55 ns/degree = 9.09° of phase shift.

Figure 2-18 shows the equipment setup for the measurement of the phase shift of a 5 MHz signal. Like the previous propagation delay measurement, one signal is applied to each trigger input of the 7D15. Again, the SOURCE INPUT B pushbutton is pressed to enable both input connectors. Both the channel A and B TRIGGER LEVEL controls are set to preset, which means the trigger circuits will trigger on the zero crossover point.

Trigger arming is not required for this measurement. Merely trigger the scope on the negative-going slope of channel 1. This assures that the pseudo gate display is on the CRT. The pseudo gate display indicates that the measurement is being made between the two zero crossover points. In this case, the time measured is 75.60 ns for phase shift of 75.6 ns/5.55 ns/degree = 13.8°.

This method of measuring phase shift can be used for single-shot or repetitive signals, with accuracies of 0.125° and 0.075°, respectively, at 35 kHz. Several factors affect this accuracy:

1. Amplitude of the two signals—it is more difficult for the 7D15 to detect the zero crossover point on low amplitude signals.
2. Relative amplitude of the two signals—ideally both signals should be the same amplitude.
3. Noise on the signals—noise may fire the trigger circuits prematurely causing jitter in the measurement, ultimately affecting the resolution of the readout.
4. Frequency of the signals—the frequency range, for best results, is 60 Hz to 50 MHz.

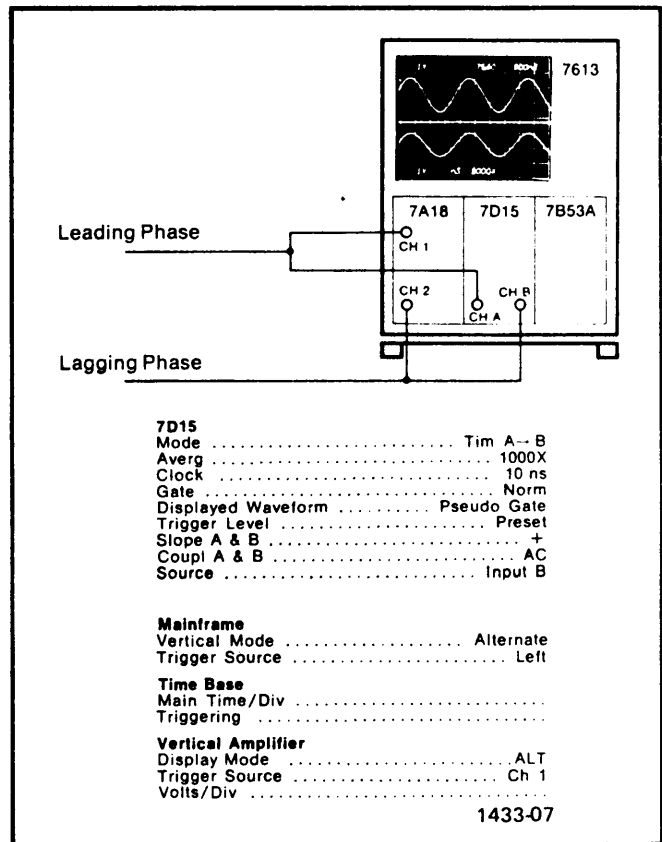

Fig. 2-18. Equipment setup for phase shift measurement.

