

User Manual

TDS3FFT
FFT Application Module
071-0349-01



071034901

Copyright © Tektronix, Inc. All rights reserved.

Tektronix products are covered by U.S. and foreign patents, issued and pending. Information in this publication supercedes that in all previously published material. Specifications and price change privileges reserved.

Tektronix, Inc., P.O. Box 500, Beaverton, OR 97077

TEKTRONIX, TEK, TEKPROBE, and Tek Secure are registered trademarks of Tektronix, Inc.

DPX, WaveAlert, and e*Scope are trademarks of Tektronix, Inc.

WARRANTY SUMMARY

Tektronix warrants that the products that it manufactures and sells will be free from defects in materials and workmanship for a period of one (1) year from the date of shipment from an authorized Tektronix distributor. If a product proves defective within the respective period, Tektronix will provide repair or replacement as described in the complete warranty statement.

To arrange for service or obtain a copy of the complete warranty statement, please contact your nearest Tektronix sales and service office.

EXCEPT AS PROVIDED IN THIS SUMMARY OR THE APPLICABLE WARRANTY STATEMENT, TEKTRONIX MAKES NO WARRANTY OF ANY KIND, EXPRESS OR IMPLIED, INCLUDING WITHOUT LIMITATION THE IMPLIED WARRANTIES OF MERCHANTABILITY AND FITNESS FOR A PARTICULAR PURPOSE. IN NO EVENT SHALL TEKTRONIX BE LIABLE FOR INDIRECT, SPECIAL OR CONSEQUENTIAL DAMAGES.

Contacting Tektronix

Product Support For questions about using Tektronix measurement products, call toll free in North America:
1-800-833-9200
6:00 a.m. – 5:00 p.m. Pacific time

Or contact us by e-mail:
support@tektronix.com

For product support outside of North America, contact your local Tektronix distributor or sales office.

Service Support Tektronix offers a range of services, including Extended Warranty Repair and Calibration services. Contact your local Tektronix distributor or sales office for details.

For a listing of worldwide service centers, visit our web site.

Toll-free Number In North America:
1-800-833-9200
An operator can direct your call.

Postal Address Tektronix, Inc.
Department or name (if known)
P.O. Box 500
Beaverton, OR 97077
USA

Web Site www.tektronix.com

Contents

Safety Summary	2
Installing the TDS3FFT Application Module	5
Introduction	5
FFT Features	6
Displaying an FFT Waveform	7
FFT Math Menu	8
FFT Windows	12
Aliasing	14
FFT Examples	16

Safety Summary

To avoid potential hazards, use this product only as specified. While using this product, you may need to access other parts of the system. Read the *General Safety Summary* in other system manuals for warnings and cautions related to operating the system.

Preventing Electrostatic Damage

 **CAUTION.** *Electrostatic discharge (ESD) can damage components in the oscilloscope and its accessories. To prevent ESD, observe these precautions when directed to do so.*

Use a Ground Strap. Wear a grounded antistatic wrist strap to discharge the static voltage from your body while installing or removing sensitive components.

Use a Safe Work Area. Do not use any devices capable of generating or holding a static charge in the work area where you install or remove sensitive components. Avoid handling sensitive components in areas that have a floor or benchtop surface capable of generating a static charge.

Handle Components Carefully. Do not slide sensitive components over any surface. Do not touch exposed connector pins. Handle sensitive components as little as possible.

Transport and Store Carefully. Transport and store sensitive components in a static-protected bag or container.

Manual Storage

The oscilloscope front cover has a convenient place to store this manual.

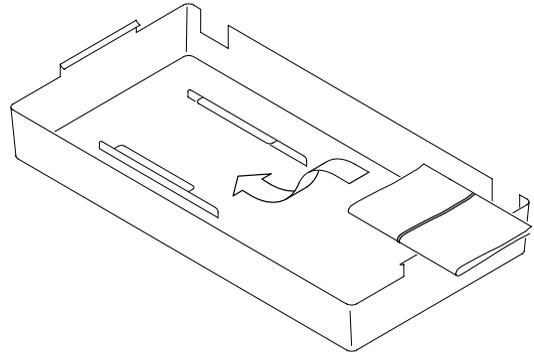

Installing the TDS3FFT Application Module

Refer to the *TDS3000 & TDS3000B Series Application Module Installation Instructions* for instructions on installing and testing the application module.

Introduction

The FFT application module adds FFT (Fast Fourier Transform) measurement capabilities to your oscilloscope. The FFT process mathematically converts the standard time-domain signal (repetitive or single-shot acquisition) into its frequency components, providing spectrum analysis capabilities.

Being able to quickly look at a signal's frequency components and spectrum shape is a powerful research and analysis tool. FFT is an excellent troubleshooting aid for:

- Testing impulse response of filters and systems
- Measuring harmonic content and distortion in systems
- Identifying and locating noise and interference sources
- Analyzing vibration
- Analyzing harmonics in 50 and 60 Hz power lines

FFT Features

The FFT application module provides the following features:

FFT Windows

Four FFT windows (Rectangular, Hamming, Hanning, and Blackman-Harris) let you match the optimum window to the signal you are analyzing. The Rectangular window is best for nonperiodic events such as transients, pulses, and one-shot acquisitions. The Hamming, Hanning, and Blackman-Harris windows are better for periodic signals.

Analyze Repetitive, Single-Shot, and Stored Waveforms

You can display an FFT waveform on any actively-acquired signal (periodic or one-shot), the last acquired signal, or any signal stored in reference memory.

dB or Linear RMS Scales

The FFT vertical graticule can be set to either dB or Linear RMS. A dB scale is useful when the frequency component magnitudes cover a wide dynamic range, letting you show both lesser and greater- magnitude frequency components on the same display. A Linear scale is useful when the frequency component magnitudes are all close in value, allowing direct comparison of their magnitudes.

Time Signals and FFT Waveforms Displayed Together

The time signals and FFT waveforms can be shown together on the display. The time signal highlights the problem; the FFT waveform helps you determine the cause of the problem.

Displaying an FFT Waveform

1. Set the source signal Vertical **SCALE** so that the signal peaks do not go off screen. Off-screen signal peaks can result in FFT waveform errors.
2. Set the Horizontal **SCALE** control to show five or more cycles of the source signal. Showing more cycles means the FFT waveform shows more frequency components, provides better frequency resolution, and reduces aliasing.
If the signal is a single-shot (transient) signal, make sure that the entire signal (transient event and ringing or noise) is displayed and centered on the screen.
3. Push the Vertical **MATH** button to show the math menu.
4. Push the **FFT** screen button to show the FFT side menu.
5. Select a signal source. You can do an FFT on any channel or any stored reference waveform.
6. Select the appropriate vertical scale and FFT window.
7. Use zoom controls and the cursors to magnify and measure the FFT waveform.

FFT Math Menu

Bottom	Side	Description
FFT	Set FFT Source to	Sets the FFT signal source. Valid input sources are Ch 1 and Ch 2 (2-channel instruments), Ch 1 through Ch 4 (4-channel instruments), and Ref 1 through Ref 4 (all instruments).
	Set FFT Vert Scale to	Sets the display vertical scale units. Available scales are dBV RMS and Linear RMS.
	Set FFT Window to	Sets which window function (Hanning, Hamming, Blackman-Harris, or Rectangular) to apply to the source signal. Refer to page 12 for more FFT window information.

FFT Source Key Points

- Push the side menu button to select the source.
- Using FFT slows down the oscilloscope's response time in Normal acquisition mode (10k record length).
- A waveform acquired in Normal acquisition mode has a lower noise floor and better frequency resolution than a waveform acquired in Fast Trigger mode.

- Signals that have a DC component or offset can cause incorrect FFT waveform component magnitude values. To minimize the DC component, choose AC Coupling on the source signal.
- To reduce random noise and aliased components in repetitive or single-shot events, set the oscilloscope acquisition mode to average over 16 or more samples. Average mode attenuates signals not synchronized with the trigger.
- Do not use the Average acquisition mode if the source signal contains frequencies of interest that are not synchronized with the trigger rate.
- Do not use Peak Detect and Envelope modes with FFT. Peak Detect and Envelope modes can add significant distortion to the FFT results.
- For transient (impulse, one-shot) signals, set the oscilloscope to trigger on the transient pulse in order to center the pulse information in the waveform record.

FFT Vertical Scale Key Points

- Push the side menu button to select a scale. Available scales are dBV RMS and Linear RMS.
- Use the Vertical POSITION and SCALE knobs to vertically move and rescale the FFT waveform.
- To display FFT waveforms with a large dynamic range, use the dBV RMS scale. The dBV scale displays component magnitudes using a log scale, expressed in dB relative to $1 V_{RMS}$, where $0 \text{ dB} = 1 V_{RMS}$, or in source waveform units (such as amps for current measurements).
- To display FFT waveforms with a small dynamic range, use the Linear RMS scale. The Linear RMS scale lets you display and directly compare components with similar magnitude values.

Nyquist Frequency Key Point

- To determine the Nyquist frequency, push the ACQUIRE menu button. This displays the current sample rate on the bottom right area of the screen. The Nyquist frequency is one-half of the sample rate. For example, if the sample rate is 25.0 MS/s, then the Nyquist frequency is 12.5 MHz.

Zooming an FFT Display. Use the Zoom button  , along with horizontal POSITION and SCALE controls, to magnify FFT waveforms. When you change the zoom factor, the FFT waveform is horizontally magnified about the center vertical graticule, and vertically magnified about the math waveform marker. Zooming does not affect the actual time base or trigger position settings.

NOTE. *FFT waveforms are calculated using the entire source waveform record. Zooming in on a region of either the source or FFT waveform will not recalculate the FFT waveform for that region.*

Measuring FFT Waveforms Using Cursors. You can use cursors to take two measurements on FFT waveforms: magnitude (in dB or signal source units) and frequency (in Hz). dB magnitude is referenced to 0 dB, where 0 dB equals $1 V_{RMS}$. Use horizontal cursors (H Bars) to measure magnitude and vertical cursors (V Bars) to measure frequency.

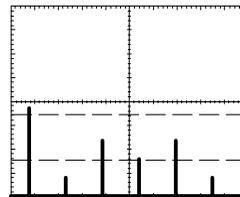

Magnitude cursors

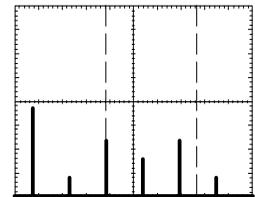

Frequency cursors

FFT Windows

Applying a window function to the source waveform record changes the waveform so that the start and stop values are close to each other, reducing FFT waveform discontinuities. This results in an FFT waveform that more accurately represents the source signal frequency components. The 'shape' of the window determines how well it resolves frequency or magnitude information.

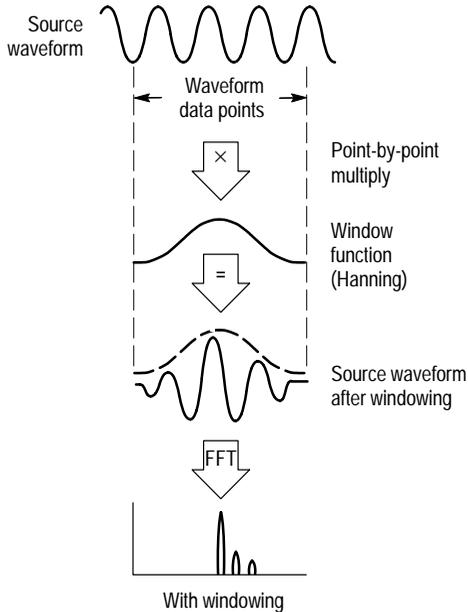

FFT Window	Characteristics	Best for measuring
Blackman-Harris	Best magnitude, worst at resolving frequencies.	Predominantly single frequency waveforms to look for higher order harmonics.
Hamming, Hanning	Better frequency, poorer magnitude accuracy than Rectangular. Hamming has slightly better frequency resolution than Hanning.	Sine, periodic, and narrow-band random noise. Transients or bursts where the signal levels before and after the event are significantly different.
Rectangular	Best frequency, worst magnitude resolution. This is essentially the same as no window.	Transients or bursts where the signal levels before and after the event are nearly equal. Equal-amplitude sine waves with frequencies that are very close. Broad-band random noise with a relatively slow varying spectrum.

Aliasing

Problems occur when the oscilloscope acquires a signal containing frequency components that are greater than the Nyquist frequency ($1/2$ the sample rate). The frequency components that are above the Nyquist frequency are undersampled and appear to “fold back” around the right edge of the graticule, showing as lower frequency components in the FFT waveform. These incorrect components are called aliases.

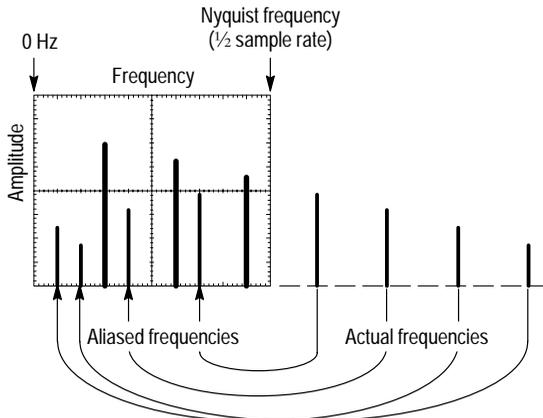

Use the following methods to eliminate aliases:

- Increase the sample rate by adjusting the Horizontal SCALE to a faster frequency setting. Since you increase the Nyquist frequency as you increase the horizontal frequency, the aliased frequency components should appear at their proper frequency.

If the increased number of frequency components shown on the screen makes it difficult to measure individual components, use the Zoom button to magnify the FFT waveform.

- Use a filter on the source signal to bandwidth limit the signal to frequencies below that of the Nyquist frequency. If the components you are interested in are below the built-in bandwidth settings (20 MHz bandwidth for all oscilloscopes, 150 MHz bandwidth for 300 MHz and 500 MHz oscilloscopes), set the source signal bandwidth to the appropriate value. Push the Vertical MENU button to access the source channel bandwidth menu.

FFT Examples

FFT Example 1

A pure sine wave can be input into an amplifier to measure distortion; any amplifier distortion will introduce harmonics in the amplifier output. Viewing the FFT of the output can determine if low-level distortion is present.

You are using a 20 MHz signal as the amplifier test signal. You would set the oscilloscope and FFT parameters as listed in the table:

FFT Example 1 Settings

Control	Setting
CH 1 Coupling	AC
Acquisition Mode	Average 16
Horizontal Resolution	Normal (10k points)
Horizontal SCALE	100 ns
FFT Source	Ch 1
FFT Vert Scale	dBV
FFT Window	Blackman-Harris

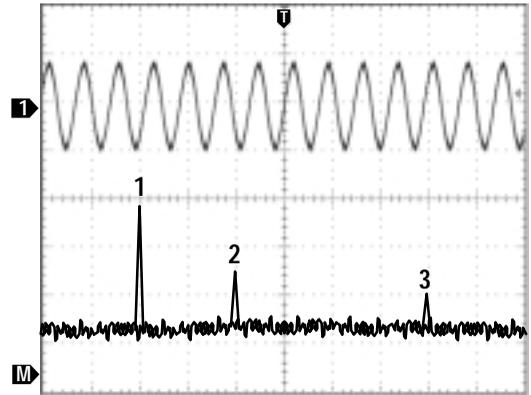

The first component at 20 MHz (figure label 1) is the source signal fundamental frequency. The FFT waveform also shows a second-order harmonic at 40 MHz (2) and a fourth-order harmonic at 80 MHz (3). The presence of components 2 and 3 indicate that the system is distorting the signal. The even harmonics suggest a possible difference in signal gain on half of the signal cycle.

FFT Example 2

Noise in mixed digital/analog circuits can be easily observed with an oscilloscope. However, identifying the sources of the observed noise can be difficult.

The FFT waveform displays the frequency content of the noise; you may then be able to associate those frequencies with known system frequencies, such as system clocks, oscillators, read/write strobes, display signals, or switching power supplies.

The highest frequency on the example system is 40 MHz. To analyze the example signal you would set the oscilloscope and FFT parameters as listed in the following table:

FFT Example 2 Settings

Control	Setting
CH 1 Coupling	AC
Acquisition Mode	Sample
Horizontal Resolution	Normal (10k points)
Horizontal SCALE	4.00 μ s
Bandwidth	150 MHz
FFT Source	Ch 1
FFT Vert Scale	dBV
FFT Window	Hanning

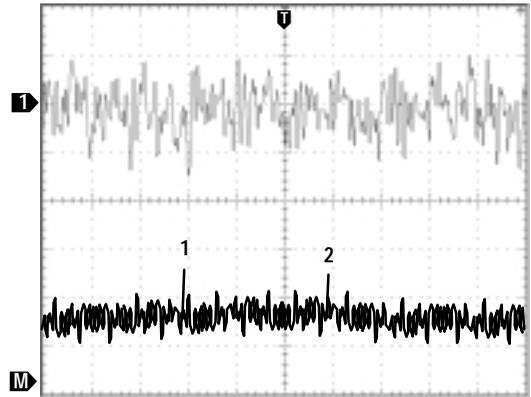

Note the component at 31 MHz (figure label 1); this coincides with a 31 MHz memory strobe signal in the example system. There is also a frequency component at 62 MHz (figure label 2), which is the second harmonic of the strobe signal.

