

Introducing the 11401 and 11402 Digitizing Oscilloscopes

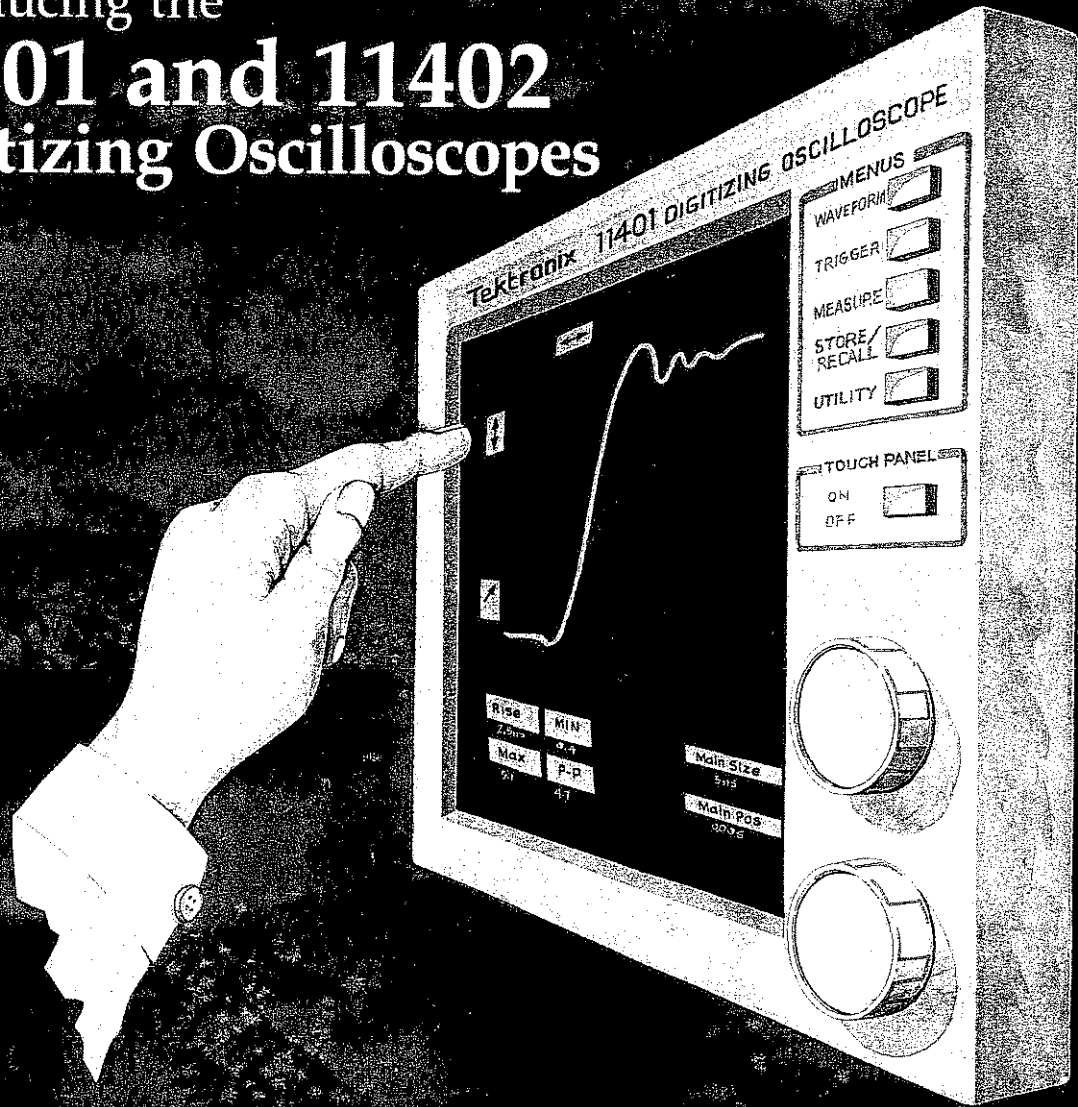

Introducing the
11401 and 11402
Digitizing Oscilloscopes

INSTRUMENT SERIAL NUMBERS

Each instrument has a serial number on a panel insert, tag, or stamped on the chassis. The first number or letter designates the country of manufacture. The last five digits of the serial number are assigned sequentially and are unique to each instrument. Those manufactured in the United States have six unique digits. The country of manufacture is identified as follows:

B000000	Tektronix, Inc., Beaverton, Oregon, USA
100000	Tektronix Guernsey, Ltd., Channel Islands
200000	Tektronix United Kingdom, Ltd., London
300000	Sony/Tektronix, Japan
700000	Tektronix Holland, NV, Heerenveen, The Netherlands

Copyright © Tektronix, Inc., 1986. All rights reserved. Tektronix products are covered by U.S. and foreign patents, issued and pending. TEKTRONIX, INC, SCOPEMOBILE and  are registered trademarks. Printed in U.S.A.

IBM® is a registered trademark of International Business Machines Corporation.

GPIB-PC is a trademark of National Instruments Corporation.

Centronics® is a registered trademark of Data Computer Corporation.

First Printing July 1986

Introducing a New Family of Laboratory Oscilloscopes From the World Leader in Oscilloscope Technology

The 11401/11402 Digitizing Oscilloscopes are the first of a new family of laboratory oscilloscopes from Tektronix. These versatile instruments feature precise signal-acquisition circuitry, a high-resolution digitizer, and local intelligence. This powerful combination gives you the accuracy of a conventional Tektronix oscilloscope, plus the convenience and measurement-repeatability of a digitizing system.

With one of these oscilloscopes, you can perform both common-place and complex measurements faster and easier. The digitizer lets you measure a wide variety of pulse and signal parameters automatically. The internal processor allows you to perform sophisticated signal analysis using such techniques as signal averaging and waveform transformations.

A touch-screen human interface gives you easy access to these advanced measurement capabilities. The touch screen lets you quickly set up waveforms and measurements, simply by touching on-screen icons and menu items.

The oscilloscopes also provide both RS-232-C and IEEE-488 General Purpose Interface Bus (GPIB) interfaces. These interfaces and a comprehensive command set let you remotely access all of the instruments' waveform setup and measurement facilities.

Some of the 11401/11402's more important capabilities are:

- Up to 1 GHz bandwidth with the 11402 and up to 500 MHz bandwidth with the 11401, depending on the configuration.
- Up to 8 signal-input channels, acquired and displayed simultaneously.
- 10-bit vertical resolution.
- Vertical accuracy of $\leq 2\%$ of the volts/division setting, depending on enhanced accuracy status and plug-in configuration.
- Time-base accuracy to within 100 ps + 0.002% of measurement interval.
- Plug-in reconfigurability.
- On-board pulse parameter measurements and waveform processing.
- Single-button automatic scope set-ups with AUTOSET.
- Waveform Record lengths to 10,240 points; total storage to 102,400 points.
- Built-in, dual time-bases with 10 psec resolution.
- High-resolution time A-B measurements.
- GPIB and RS-232-C industry-standard remote-control interfaces.
- Command set provides full remote access to all waveform setup and measurement features.
- Self-calibration and extensive internal diagnostics.

About this Book

This manual introduces you to the wide range of test and measurement features that the 11401/11402 Digitizing Oscilloscopes have to offer. Included is a demonstration of these instruments' versatile human interface and their powerful measurement capabilities. The GPIB and RS-232-C interfaces are also described. A summary of the product specifications is given at the end of this manual. Refer to the 11401/11402 User's Reference Manual for more comprehensive operating information.

You can use this manual with an instrument or as a means of familiarizing yourself with the instrument when one is not available.

Contents

1 Basic Operation

Getting Started

Easy Waveform Setup, Automatic Measurement of Pulse Parameters

Touch Screen Operating Concepts

Introducing the 11401/11402's Versatile, User-friendly Human Interface

2 Measurements and Calculations

Seven Examples showing the Power of the 11401/11402 in Handling a Wide Spectrum of Waveform Measurements

3 GPIB and RS-232-C

Overview of how the 11401/11402's remote interfaces and command set can be used for automated test and measurement.

4 General Information

List of Reference Manuals and Specification Summary

Safety Summary

The following general safety information applies to all operators and service personnel.

Terms

In Manuals

CAUTION statements identify conditions or practices that could result in damage to the equipment or other property.

WARNING statements identify conditions or practices that could result in personal injury or loss of life.

As Marked On Equipment

CAUTION indicates a personal injury hazard not immediately accessible as one reads the marking, or a hazard to property including the equipment itself.

DANGER indicates a personal injury hazard immediately accessible as one reads the marking.

Symbols

In Manuals

 Static-Sensitive Devices

As Marked On Equipment

 DANGER—High voltage.

 Protective ground (earth) terminal.

 ATTENTION—Refer to manual.

Warnings

Power Source

This product is intended to operate from a power source that will not apply more than 250 volts rms between the supply conductors or between either supply conductor and ground. A protective ground connection, by way of the grounding conductor in the power cord, is essential for safe operation.

Grounding the Instrument

The 11401 and 11402 are grounded through the grounding conductor of the power cord. To avoid electrical shock, plug the power cord into a properly wired receptacle, where earth ground has been verified by a qualified service person, before making connections to the input or output terminals of the instrument. A protective-ground connection, by way of the grounding conductor in the power cord, is essential for safe operation.

Danger Arising from Loss of Ground

Upon loss of the protective-ground connection, all accessible conductive parts (including knobs and controls that may appear to be insulating), can render an electric shock.

Use the Proper Fuse

To avoid fire hazard, use only the fuse specified in the parts list for your product, and which is identical in type, voltage rating, and current rating.

Do Not Operate in Explosive Atmosphere

To avoid explosion, do not operate this instrument in an atmosphere of explosive gases.

Do Not Remove Panels or Covers

To avoid personal injury, do not remove the protective cabinet panels or covers. Do not operate this instrument without the panels or covers properly installed.

Basic Operation

1



Contents

Getting Started	1-3
Initializing the 11401/11402	1-4
Displaying a Waveform	1-6
Adjusting Vertical Size and Position	1-7
Adjusting Horizontal Size and Position	1-8
Performing Measurements	1-9
Hardcopy	1-12
Touch Screen Operating Concepts	1-13
Control Panel Layout	1-14
Menus	1-16
Icons	1-19
Windows	1-20
Summary	1-22

Basic Operation

The 11401/11402's touch-screen interface makes these oscilloscopes both simple to use and simple to learn. The following tutorial gives you a quick introduction to the 11401/11402's basic operation and to some of their measurement capabilities.

In the few minutes this tutorial takes, you will learn:

- How to display a waveform.
- How to measure a variety of pulse parameters, automatically.
- How to make a hard copy of your waveform and measurement results.

Following the tutorial is a brief introduction to the operation of the 11401/11402's touch screen.

With the information contained in this Basic Operation section, you can begin to explore the many new measurement possibilities that these instruments have to offer.

Getting Started

(If an 11401 or 11402 is not available skip to "Displaying a Waveform" on page 1-6.)

Install a Tektronix 11000-Series vertical amplifier plug-in with at least two signal-input channels in the left slot of the 11401 or 11402. Additional plug-ins may also be installed at this time.

Connect the oscilloscope to a proper power source and set the rear-panel **PRINCIPAL POWER SWITCH** to ON. (If you are unsure of the suitability of your power source, refer to the Installation section of the 11401/11402 User's Reference Manual.)

Connect a dot-matrix printer with a Centronics-compatible interface (such as a Tektronix 4644) to the **PRINTER** port on the oscilloscope's rear panel.

Set the front-panel **ON/STANDBY** pushbutton to ON.

The oscilloscope performs a sequential self-test. When the self-test is finished the crt will display a message, **SELF-TEST PASSED** to show that the instrument is working correctly.

(The clicking sound that the oscilloscope makes during power-up comes from the relays in the plug-in units, which are stepped through their attenuation range.)

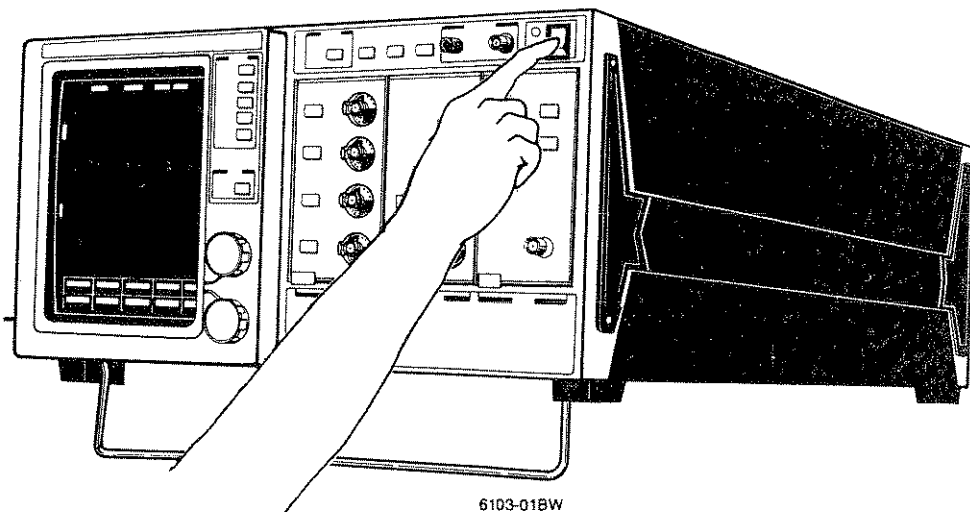
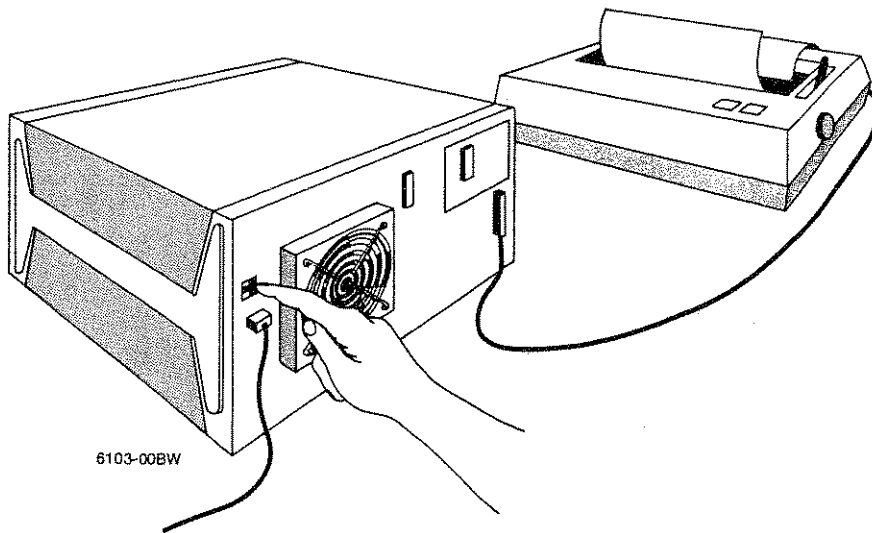

Initializing the 11401/11402

After the self-test, the oscilloscope settings are returned to the state they were in when the power was last turned off.

Often you will want to reset the oscilloscope settings to a base state. This can be done with the initialize function, which automatically resets the oscilloscope to factory-preset settings.

To initialize the oscilloscope, first press the **UTILITY** pushbutton, located in the **MENUS** selection area next to the display screen.

A Utility menu is displayed in the menu/status area at the bottom of the screen.

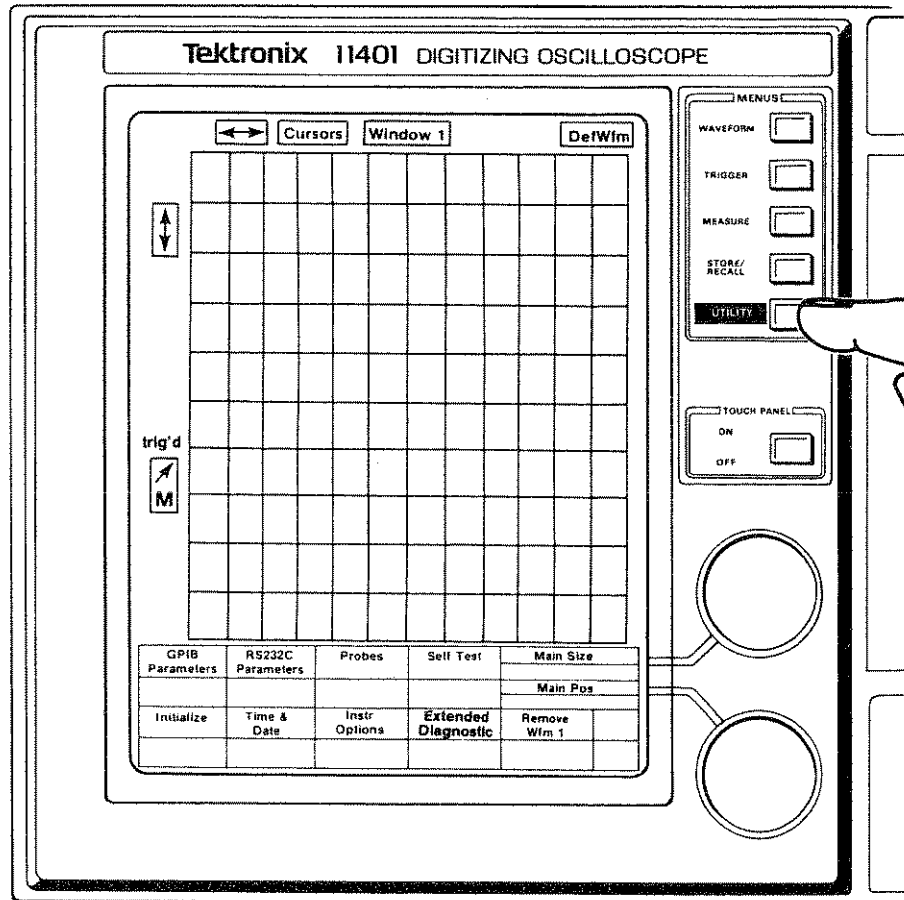

6103-02BW

Initializing the 11401/11402 (cont)

Next, touch the **Initialize** label in the Utility menu.

The oscilloscope functions are reset to factory preset settings.

If you get lost in any of the procedures given in this book, the initialize function provides you with a convenient method of starting over.

(When you touch the screen, the oscilloscope displays a box indicating the selected menu label. The box follows your finger around the screen. When you remove your finger, the box disappears and the last menu label selected is implemented.)

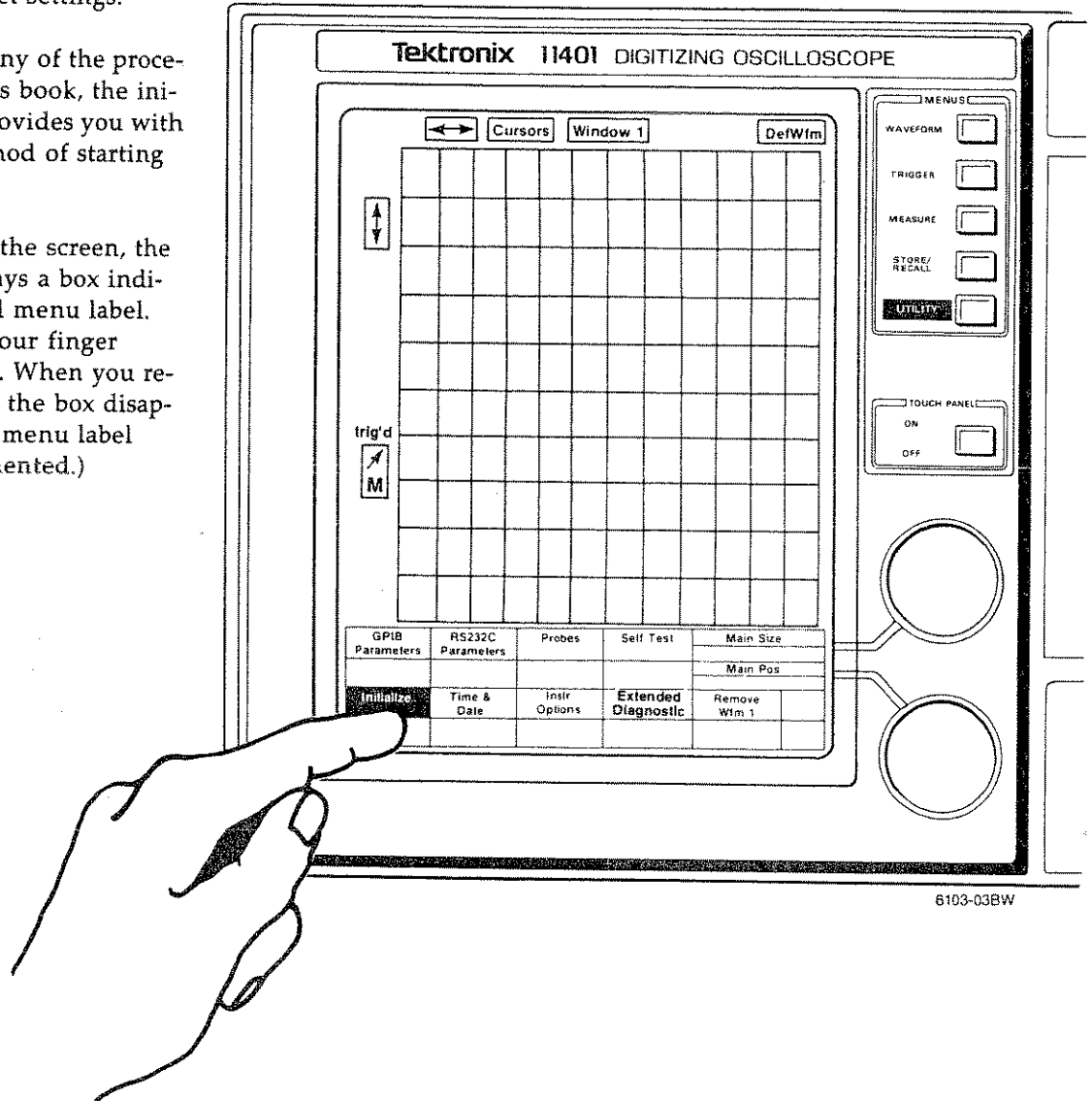

Displaying a Waveform

There are several ways to display waveforms with the 11401/11402. You can select a signal, then adjust the volts/division, time/division, and triggering, just as you would with a conventional oscilloscope. Or, you can let the 11401/11402 select all these settings for you, using the Autoset feature.

To use the Autoset feature, connect a probe to a signal and press the channel selection pushbutton for the probe or the probe ID button to get a trace on the display screen graticule.

(The graticule is also referred to in this manual as the axes.)

Now, to obtain a waveform display, press the **AUTOSET** pushbutton.

The **AUTOSET** function automatically chooses a setup that provides a stable display of the signal.

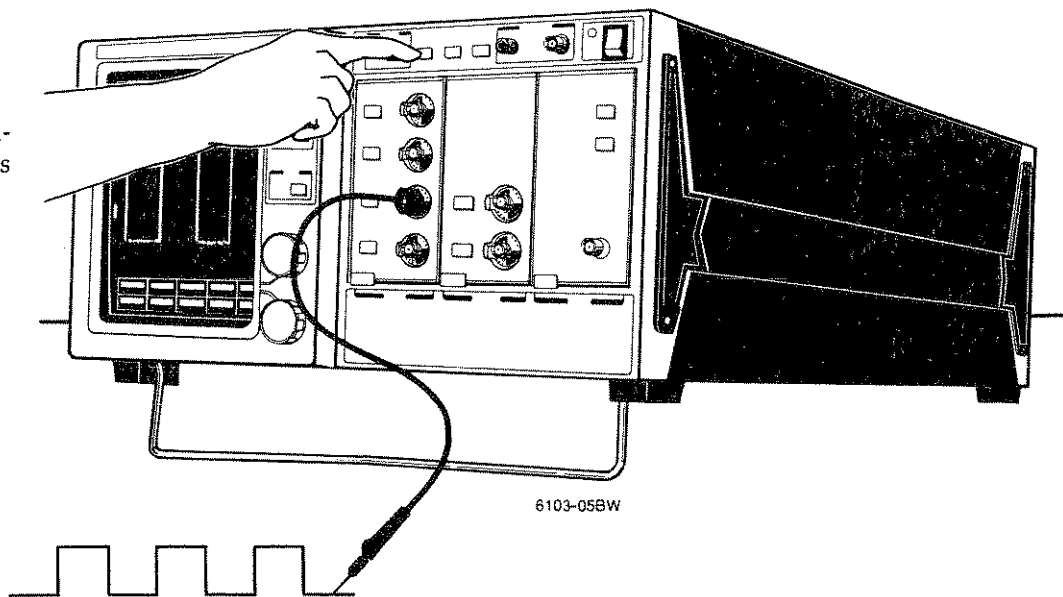
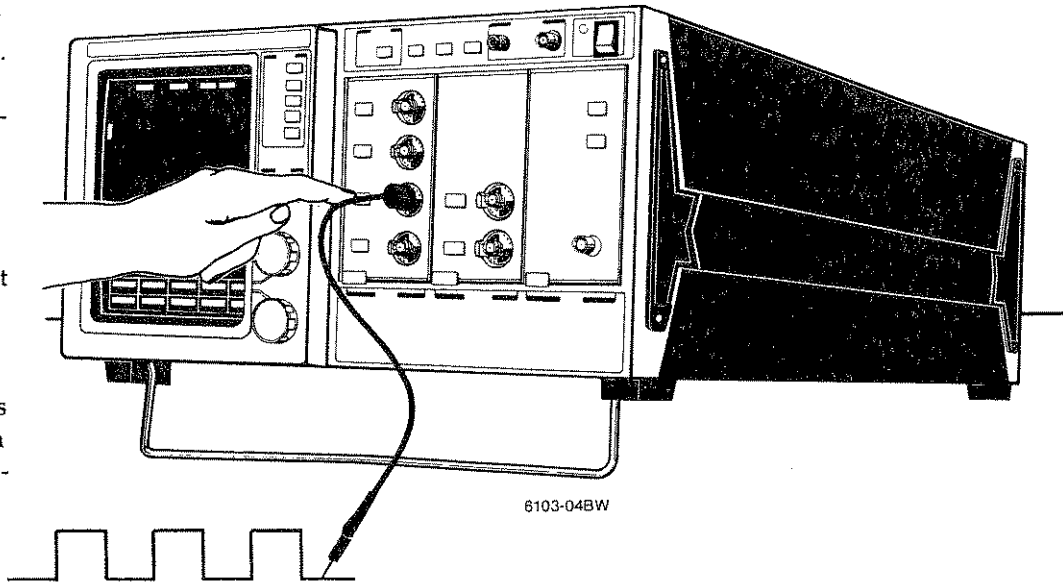

Adjusting Vertical Size and Position

If you wish to change the waveform's vertical size or position, touch the  icon to activate it. This operation assigns the volts/division (Vert Gain) and vertical offset (Vert Offset) functions for the selected channel to the Control knobs.

Turn these knobs to adjust the vertical size and position of the waveform.

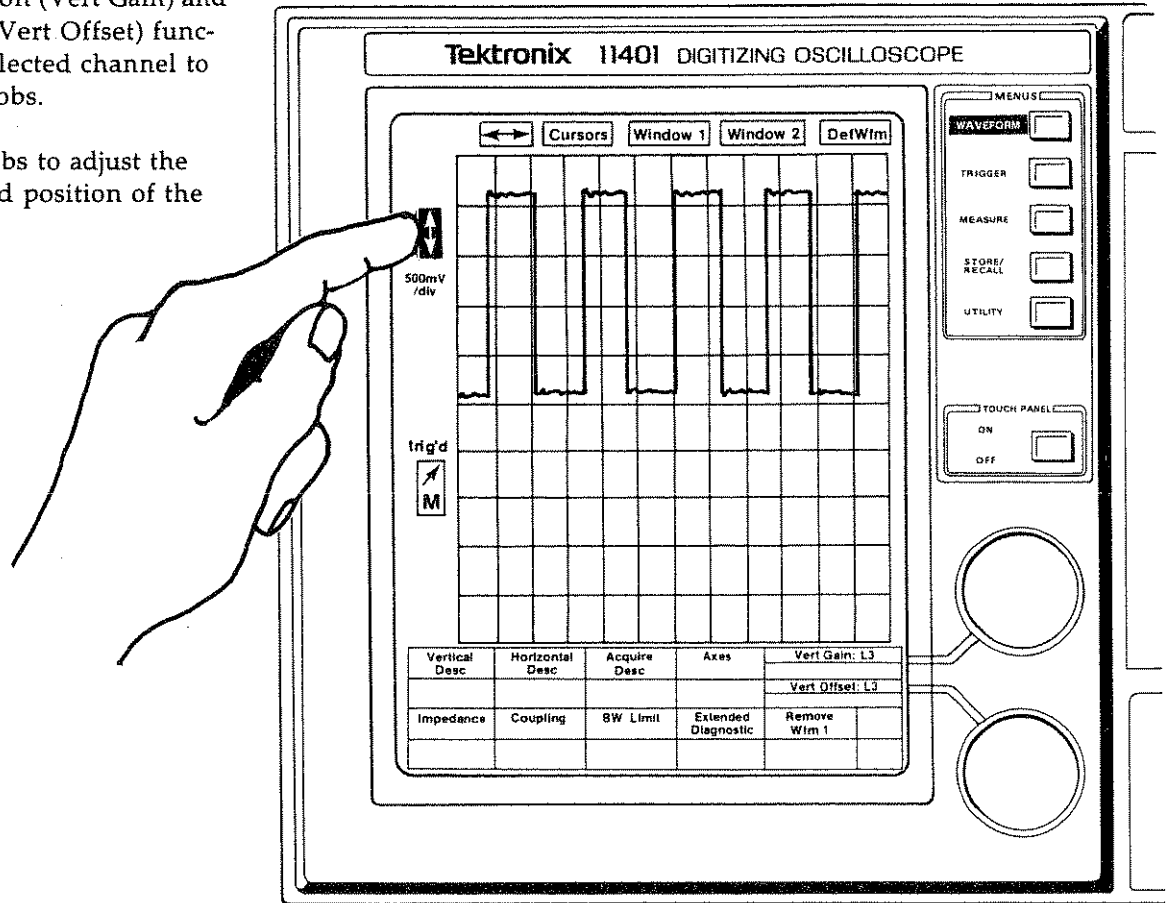

6103-06BW

Adjusting Horizontal Size and Position

To change the waveform's horizontal size or position, touch the  icon to activate it. The main time-base time/division (Main Size) and position (Main Pos) functions are assigned to the Control knobs.

Turn these knobs to adjust the horizontal size and position of the waveform.

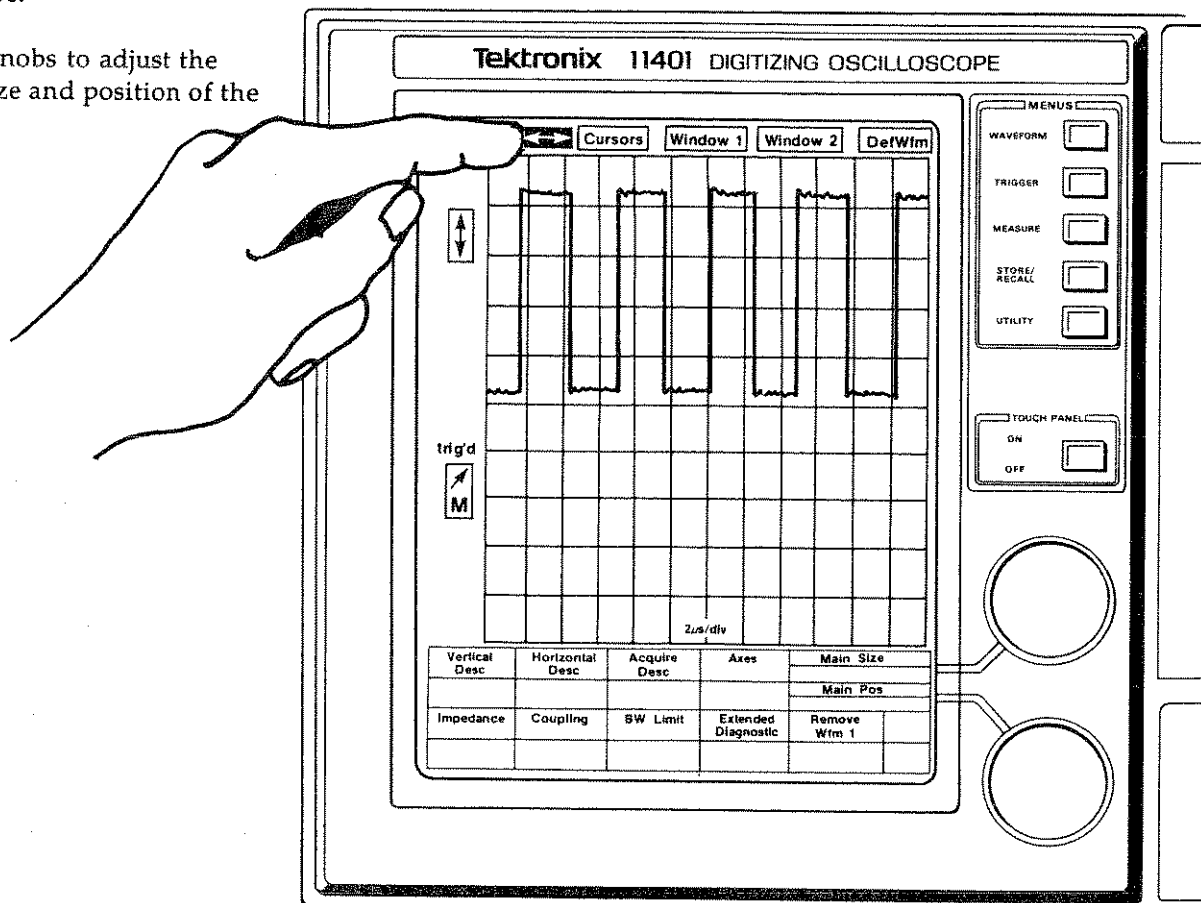

6103-07BW

Performing Measurements

Measurements are the real reason people buy oscilloscopes. The ability to automatically measure a wide variety of waveform parameters is thus one of 11401/11402's most important features.

To measure parameters of the waveform you just displayed, press the **MEASURE** pushbutton.

The Measure menu is displayed in the menu/status area of the screen and the Measurements pop-up menu is displayed over the waveform.

This menu shows all the measurement functions that the oscilloscope can perform automatically.

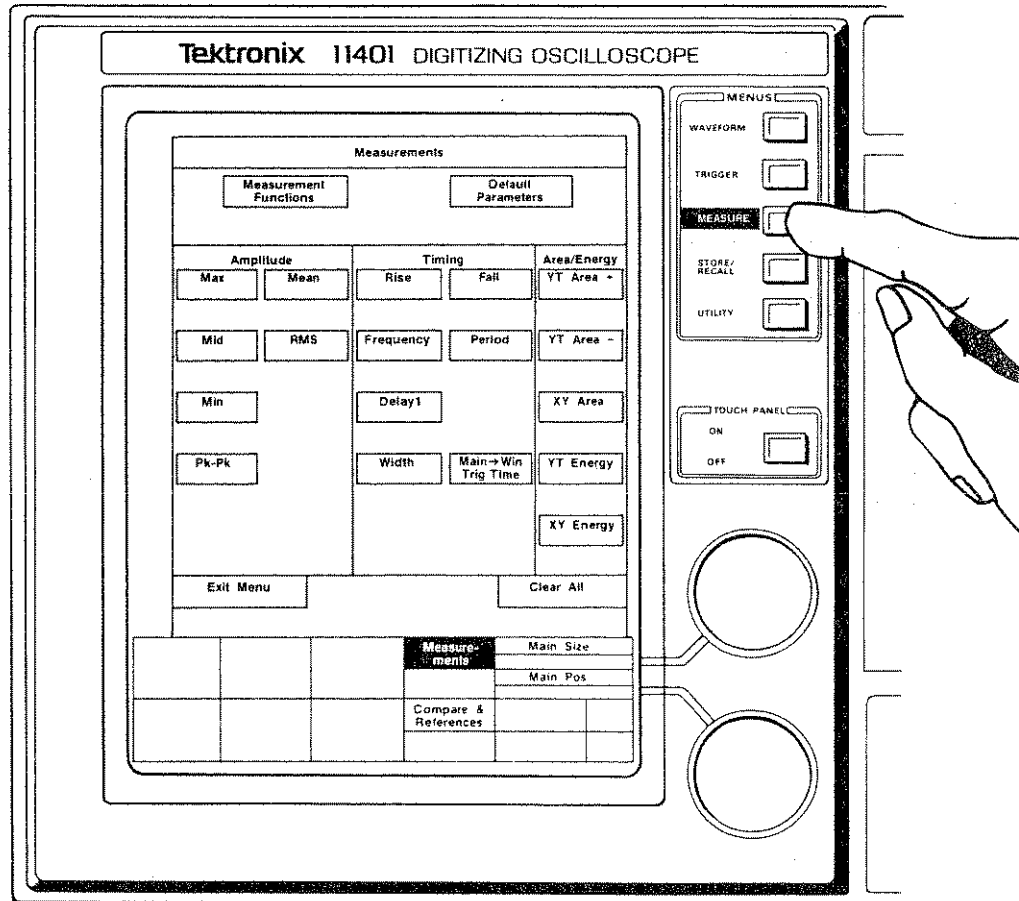

6103-08BW

Performing Measurements (cont)

Touch the following labels in the Measurements pop-up menu:

, , ,
 , , and
 . (Up to six measurement functions can be selected at a time.)

As each measurement function is selected, a label for it appears in the Measure menu at the bottom of the screen. The execution of the measurement begins as soon as the measurement function is selected, and the measurement results are shown in the status area below its function label.

When you have finished selecting measurement functions, touch the label to remove the pop-up menu.

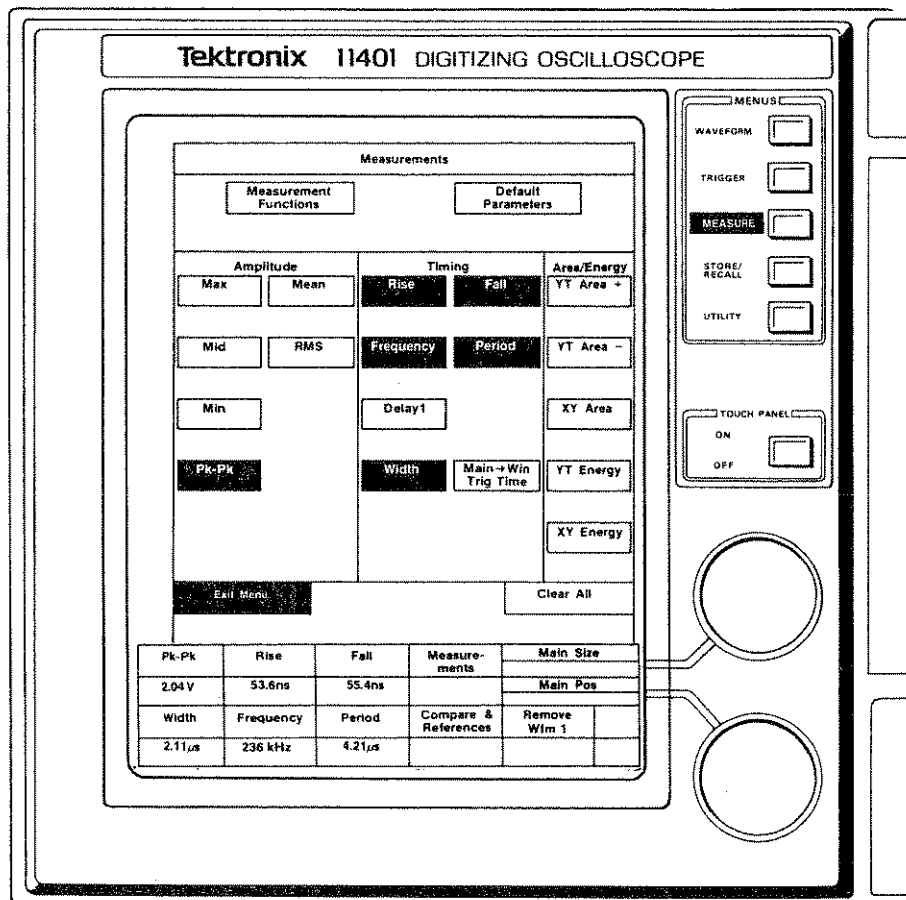

6103-09BW

Performing Measurements (cont)

After the pop-up menu disappears, the entire waveform being measured is again displayed. The measurement results continue to be displayed below the respective measurement labels and will change to reflect changes in the waveform.

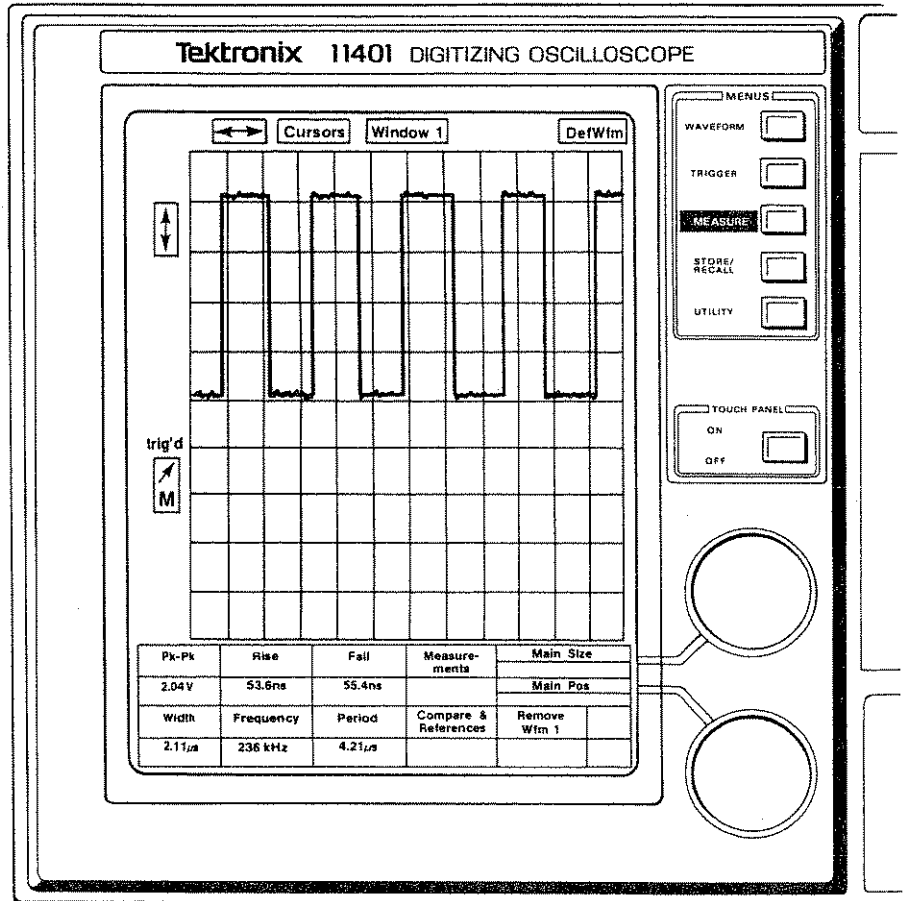

6103-10BW

Hardcopy

To get a hardcopy of the displayed waveform and measurement results, press the **HARDCOPY** pushbutton.

A paper copy of the information on the display screen is then printed.

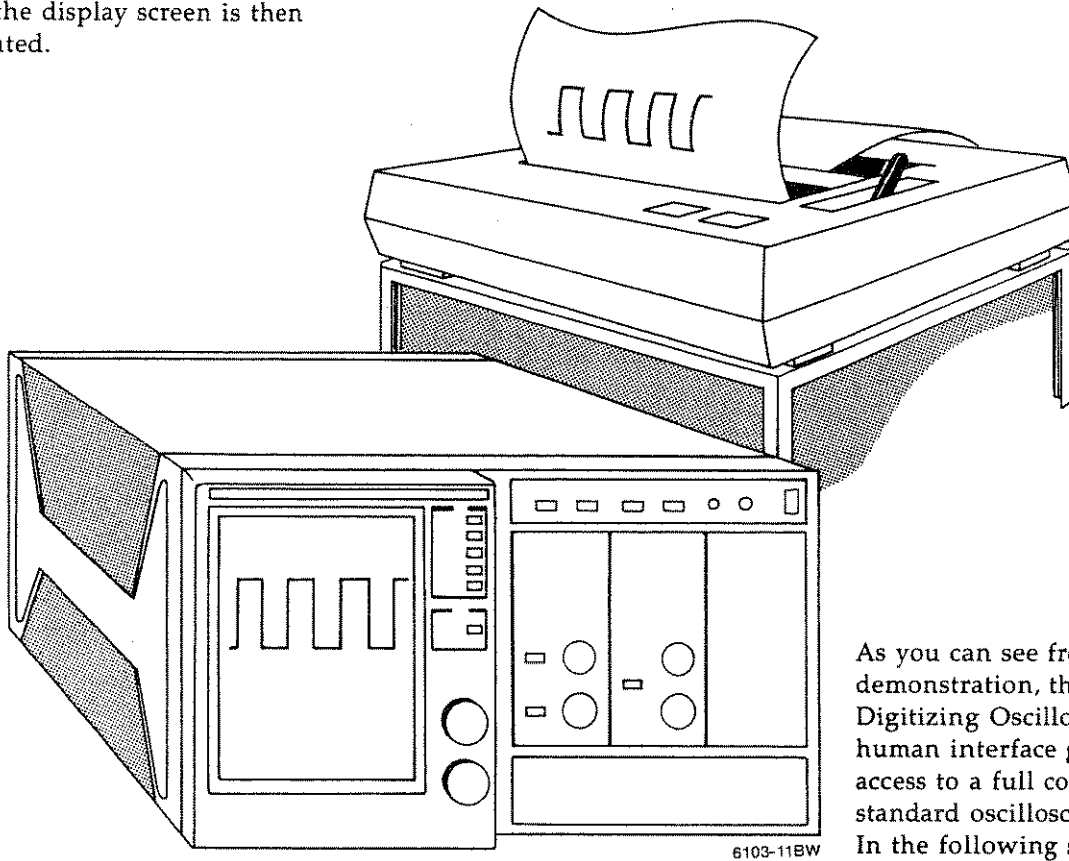

6103-11BW

As you can see from this short demonstration, the 11401/11402 Digitizing Oscilloscopes' versatile human interface gives you easy access to a full complement of standard oscilloscope functions. In the following sections of this manual you will learn more detailed information about how to use this interface to tap the powerful measurement capabilities of the 11401/11402.

Touch Screen Operating Concepts

Now that you've had some experience with the oscilloscope, let's take a closer look at its human interface.

The front-panel pushbuttons and touch screen of the 11401/11402 have been designed to make a wide selection of measurement functions easily accessible to the user.

The touch screen is the focal point of oscilloscope operation. It can be thought of as a reconfigurable control panel.

Control functions and menu selections are indicated on the screen either with labels or icons. A grid of infrared beams and sensors overlaying the crt screen detects when one of the labels or icons is touched. This touch concept is also used to select traces on the screen.

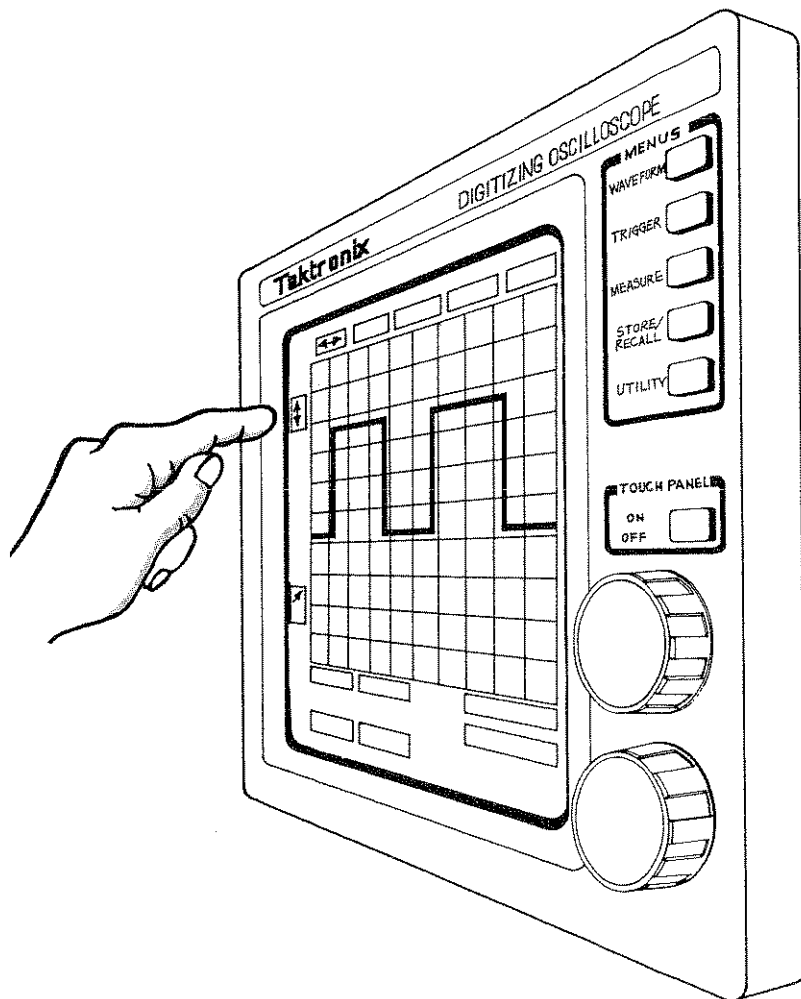

6103-12BW

Control Panel Layout

The 11401/11402 provide four devices to assist you in setting up and measuring waveforms:

- Menu pushbuttons
- Menus
- Icons
- Control knobs

The menu pushbuttons select menus, which are displayed in the menu/status area at the bottom of the screen. These menus are called major menus.

If you have an oscilloscope available, press several of the menu pushbuttons and look at the selection of major menus.

Each major menu permits you to set specific waveform setup and measurement functions.

Pop-up menus, which you access from major menus, let you select additional setup and measurement functions.

The icons are always active on the screen. They select often used oscilloscope controls like vertical and horizontal sensitivity and triggering. One of their uses is to change the functions of the Control knobs.

Regardless of which menu you are using, you can always touch an icon and change the functions of the Control knobs.

The Control knobs allow you to adjust the waveform display or triggering parameters. They act only on the selected trace, which is brighter than the other traces. (A trace is selected and highlighted when initially acquired or when touched on the display.)

The functions assigned to the Control knobs change depending on the setup or measurement function you are using. Labels at the right of the menu/status area show the functions currently assigned to the Control knobs.

Control Panel Layout (cont)

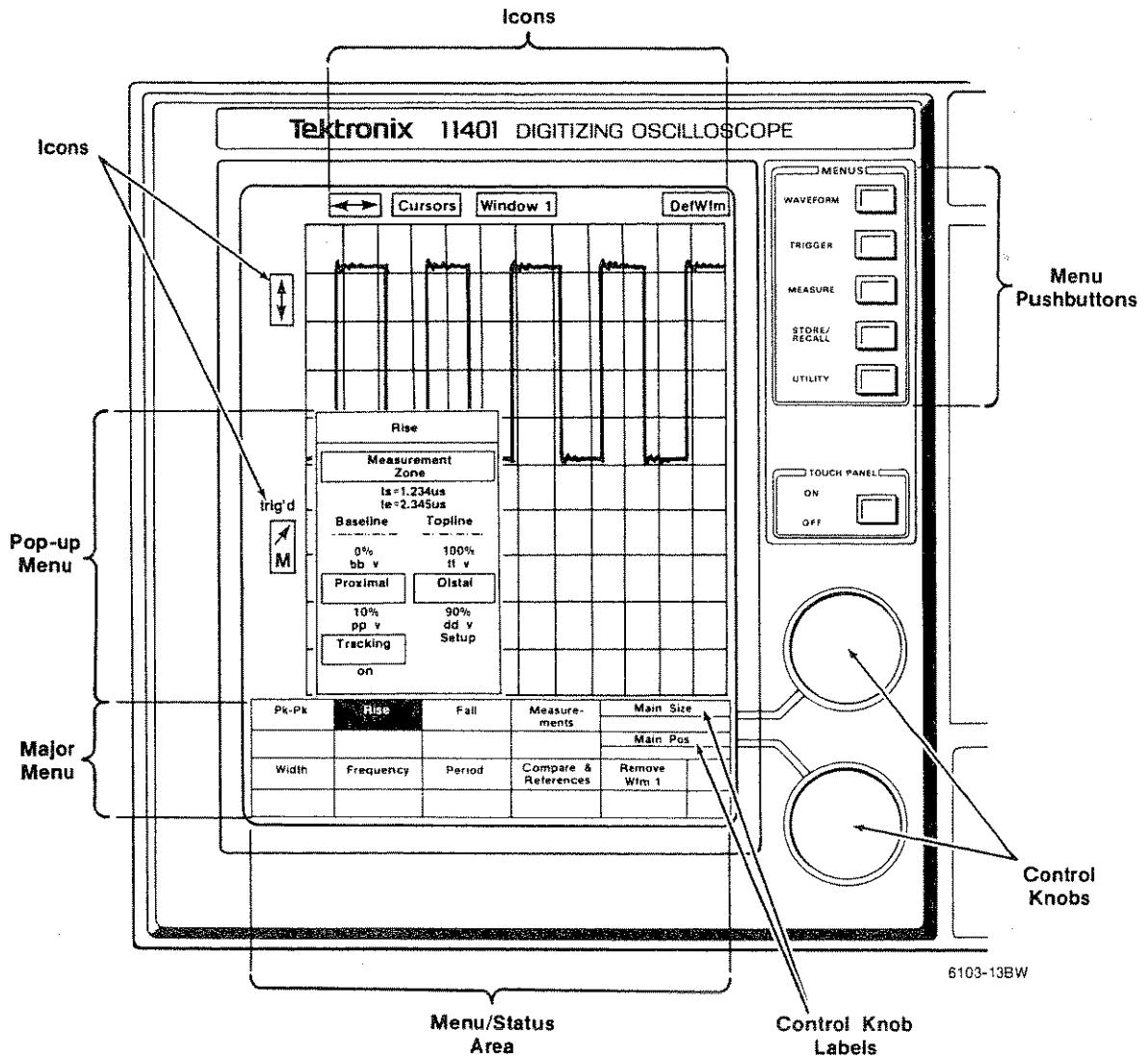

Menus

Nearly all the instrument's waveform setup and measurement functions are selected through the major menus, which you select with the menu pushbuttons. Each major menu can be thought of as a section of a large, electronically-controlled front panel.

Each major menu has several pop-up menus, which are displayed when a particular function is selected. These pop-up menus allow additional functions to be selected.

Pop-up menus are displayed over the waveform display. When you exit a pop-up menu, the waveform display is restored.

(Pressing any of the menu pushbuttons, automatically overrides the function menu and any pop-up menu currently being displayed.)

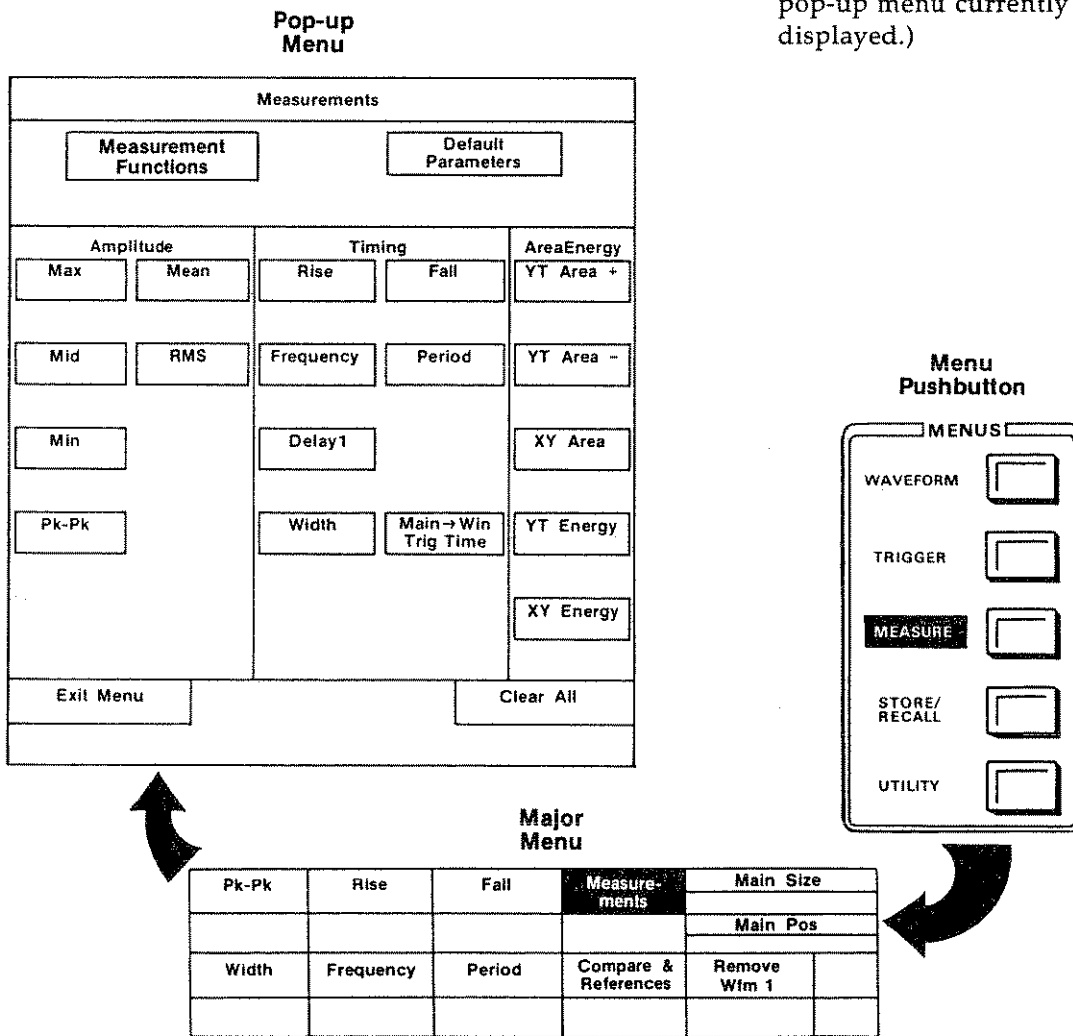

6103-14BW

Menus (cont)

To demonstrate the touch-screen operation and the menu organization, let's look at how triggering functions are selected.

Pressing the **TRIGGER** pushbutton causes the Trigger menu to be displayed in the menu/status area.

Each of the labels in the Trigger menu allows you to set a particular waveform function by

- toggling it,
- assigning the Control knobs to control it,
- or, displaying a list of options in a pop-up menu.

The status of the function is displayed below the label in the status area.

For example, touching the **Slope** label causes the trigger slope to toggle between + and -.

Touching the **Level** label assigns the Level and Time Holdoff functions to the Control knobs.

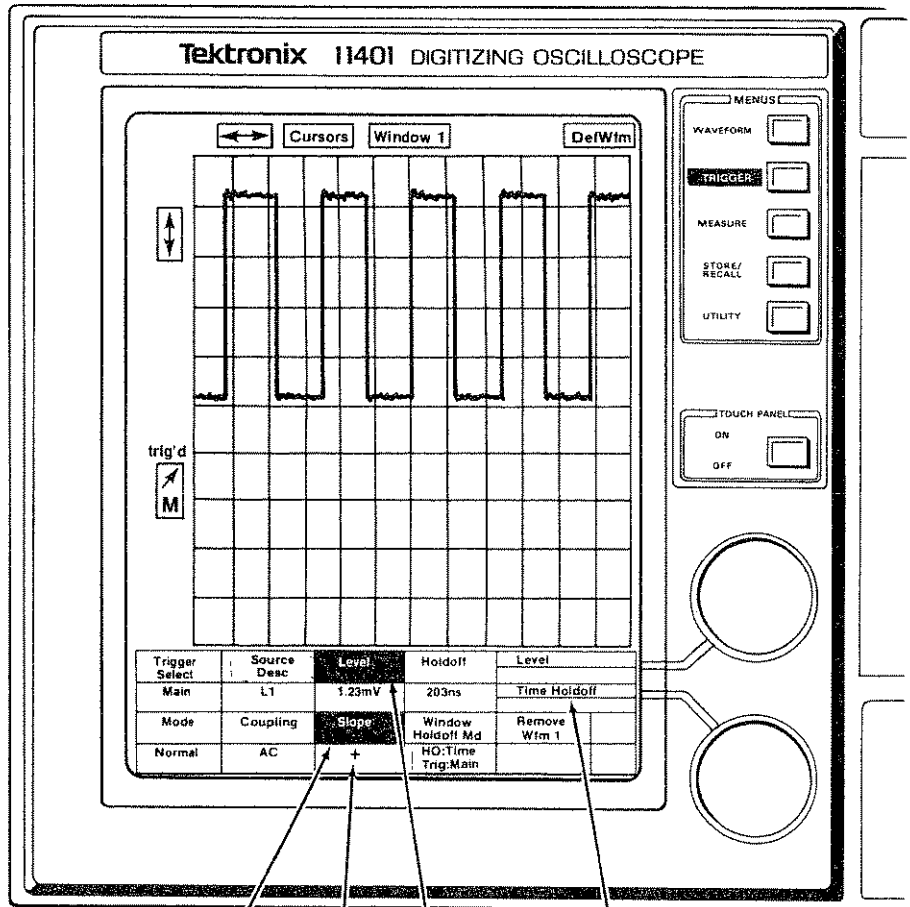

6103-15BW

Slope Label

Slope Status

Level Label

Control Knob Functions

Menus (cont)

Touching the **Source Desc** label causes a pop-up menu of trigger source alternatives to be displayed. (The **Back Space** label allows you to correct a mistake in selection.)

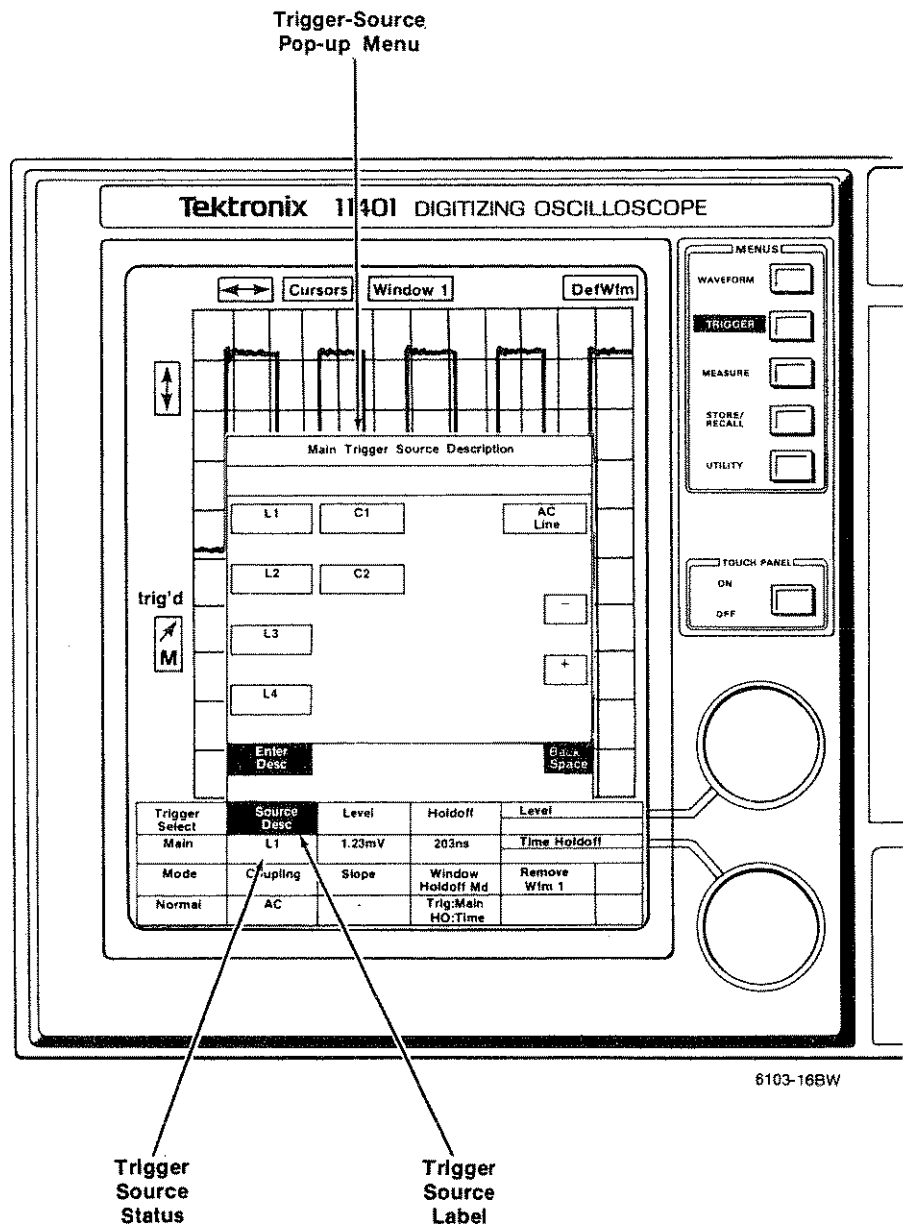

After selecting a trigger source, touching the **Enter Desc** label removes the pop-up menu from the display. The trigger source status is then updated below the **Source Desc** label.

This process for using the Trigger menu functions is typical of all the menus that the instrument provides.



Icons

The icons on the left side and top of the screen give you direct access to often used oscilloscope functions.

For example, the  and  icons change the functions of the Control knobs. When the  icon is touched, the Control knobs control the vertical gain (volts/division) and vertical offset (positioning).

When the  icon is touched, the Control knobs control the horizontal size (time/division) and horizontal positioning.

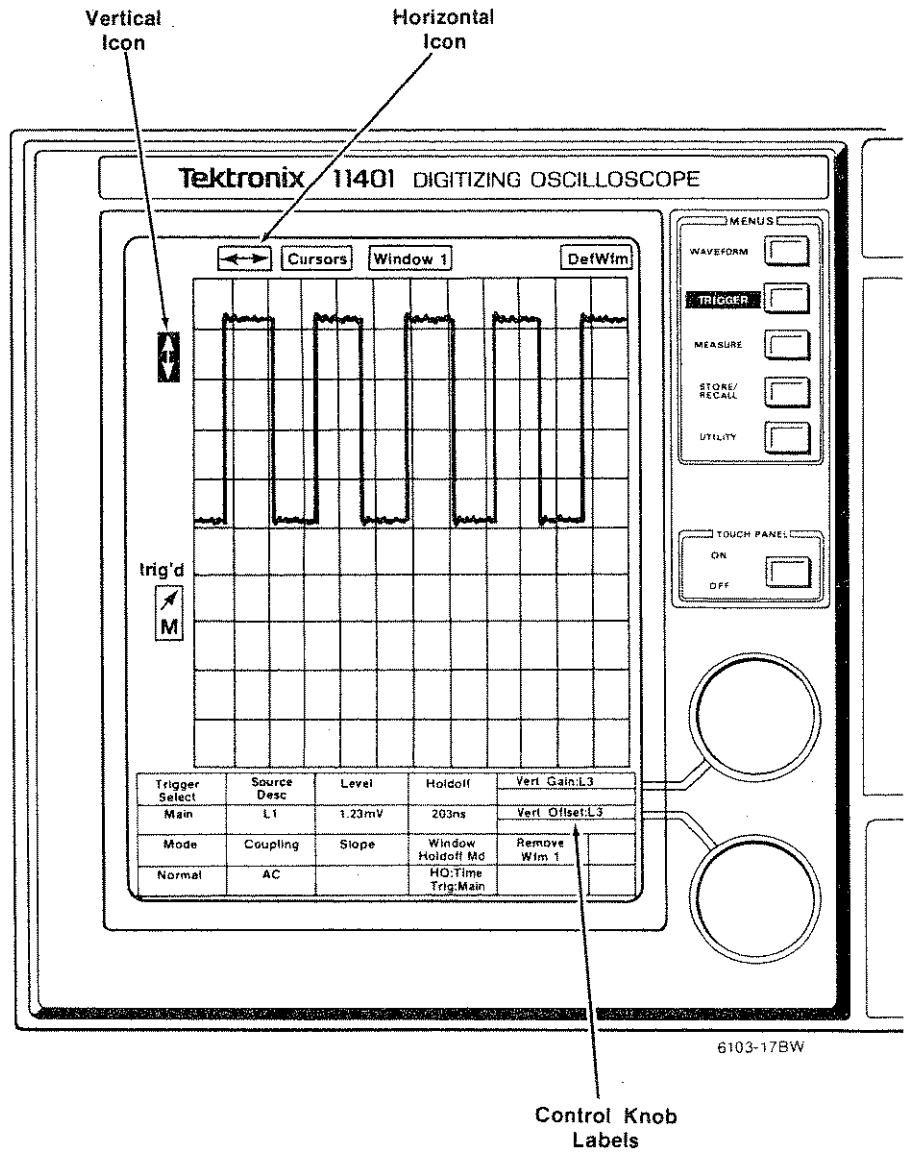

Windows

The window icons (Window 1 and Window 2) control another important function of the oscilloscope. They select the dual time-base display.

Touching the Window 1 icon causes two graticules (or axes) to be displayed and a second time base, called the Window time base, to become active in the lower axes. (A waveform must be present for the Window 1 icon to become active.)

The lower axes provides an area for viewing a selected portion of the main waveform record in the upper axes in greater detail. These selected views of the main waveform are called windows.

Two windows (window 1 and window 2) can be displayed in the lower axes at one time. Windows are like delayed sweeps in an analog oscilloscope. They are a subset of the main waveform shown in the upper axes. Their position and size relative to the main waveform are displayed as intensified zones on the main waveform.

When more than one waveform is displayed, the Control knobs, icons, and menu selections are assigned to the selected (brighter) waveform. To make another waveform the selected waveform, simply touch it. The selected trace is then brightened and the axes labels are changed to describe the newly selected waveform.

The Window 2 icon allows a second waveform to be displayed in the lower axes (not shown), allowing you to view two different portions of the main waveform in the upper axes. (The Window 2 icon becomes available only after a waveform has been displayed with the Window 1 icon.)

This dual-axes display greatly facilitates delay-time and dual time-base measurements. It lets you zoom in on signal details and improves measurement resolution and accuracy.

Windows (cont)

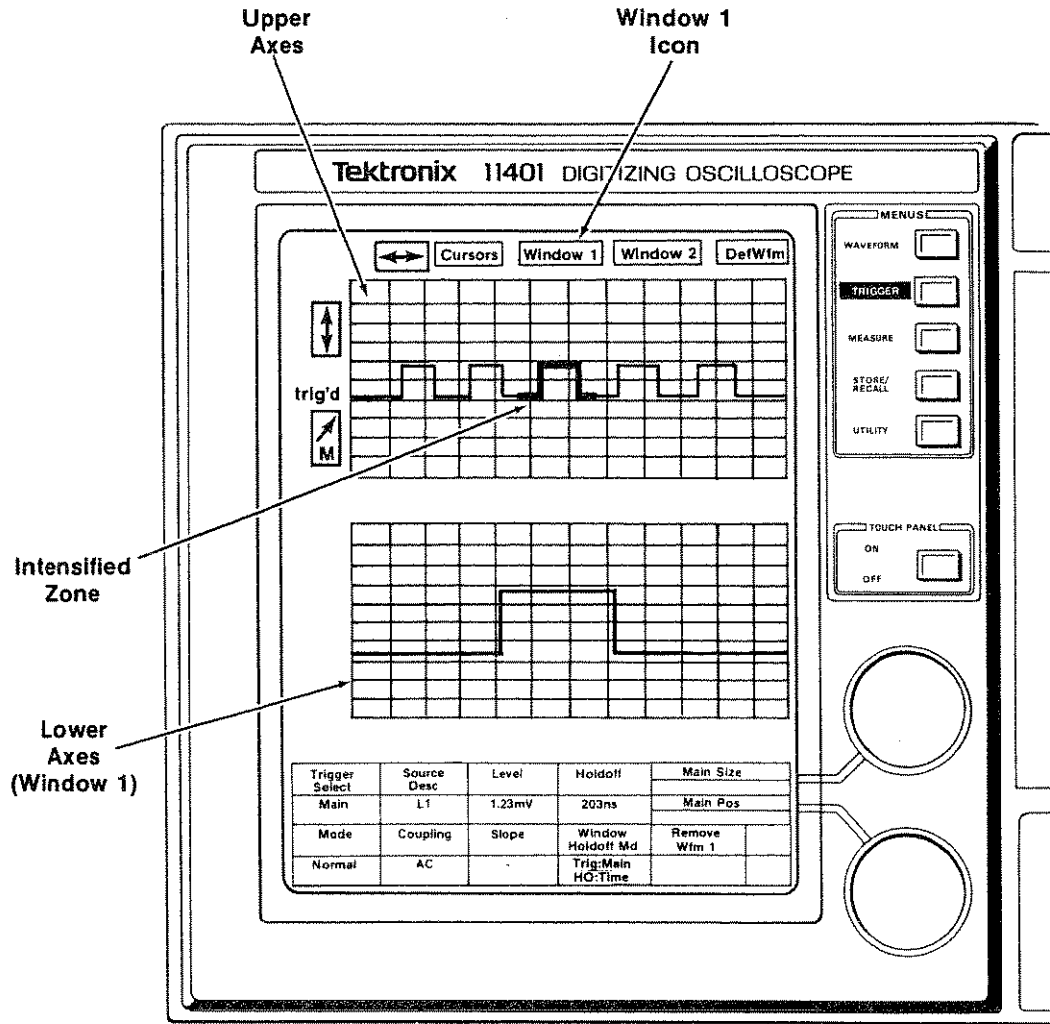

6103-18BW

Summary

As the preceding demonstration and discussion in this section have illustrated, the human interface for the 11401/11402 performs two important functions.

- It makes the full range of 11401/11402 oscilloscope functions easily accessible.
- It simplifies the process of setting up and measuring waveforms.

In the next section of this manual, we will demonstrate some of the unique measurement capabilities of the 11401/11402.

Measurements and Calculations

2

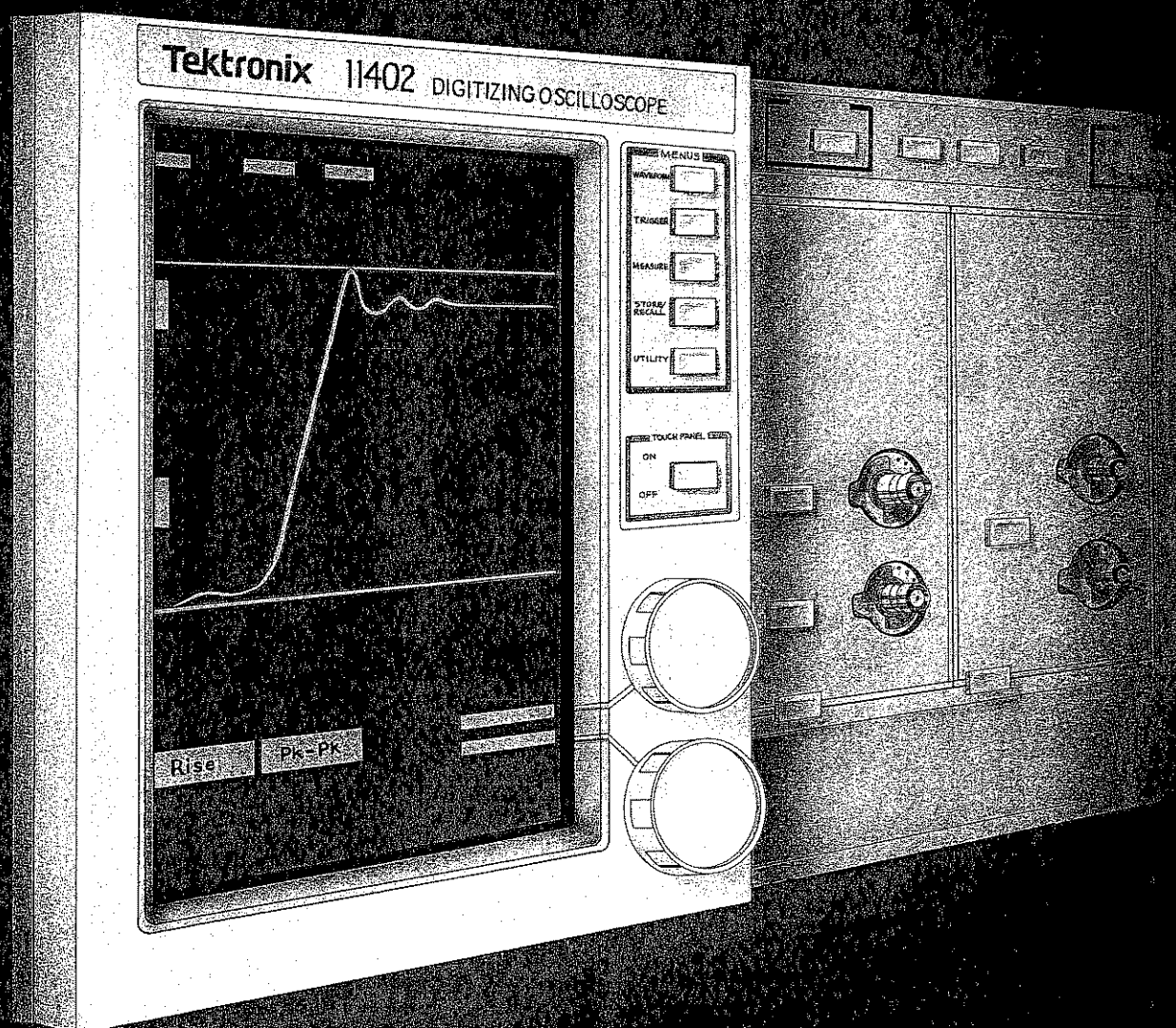

6

6

6

Contents

Example 1—Measurement Annotation.....	2-3
Example 2—Comparing Two Waveforms	2-8
Example 3—Making Precise Measurements in Noisy Environments	2-11
Power Supply Ripple Measurement Using the Average Function	2-12
Power Supply Noise Measurement Using the Envelope Function	2-14
Example 4—Storing Waveforms	2-16
Example 5—High-Accuracy Time Measurements.....	2-22
Example 6—Pulse Jitter Measurements	2-25
Example 7—Using Measurement Zones Delimiters.....	2-27
Summary	2-29

Measurements and Calculations

Two features that have made Tektronix laboratory oscilloscopes stand out over the years are the precision of their signal acquisition circuitry and their measurement accuracy.

Building on this firm foundation, the 11401/11402 Digitizing Oscilloscopes offer many new features aimed at

- improving measurement accuracy,
- speeding up the measurement process,
- and providing greater measurement repeatability.

The following examples illustrate the 11401/11402's ability to make common oscilloscope measurements quickly and accurately and to simplify complex measurements.

Example 1 – Measurement Annotation

The 11401/11402's high-resolution digitizer and waveform analysis circuitry simplify the measurement of common pulse parameters like risetime, falltime, amplitude, frequency, period, and delay.

This example shows how easily a risetime measurement can be made on a signal going through a gate.

Here, annotation lines will be used to enhance the measurement. Annotation lines show the area of the waveform where a particular measurement is being made. The 11401/11402 provide the ability to move these annotation lines to change the nature of the measurement.

Connect the channel 1 and channel 2 probes to the input and output of the gate, respectively.

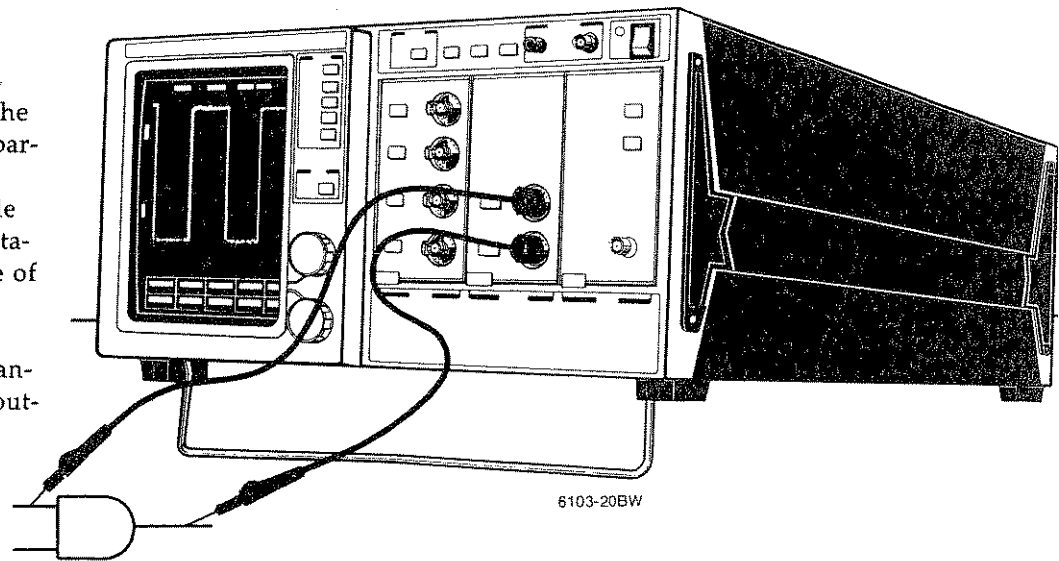

Example 1 (cont)

Acquire a display of both input signals. (A quick way to acquire a display is to press the **CH1** button on the plug-in and the **AUTOSET** pushbutton to obtain a triggered display of the channel 1 signal. Then press the **CH2** pushbutton on the plug-in unit to add the channel 2 signal to the display.)

Adjust the horizontal and vertical size and positioning so that the leading edges of both signals are displayed. The vertical controls operate on the selected (intensified) trace, which you select by touching the trace. The horizontal controls operate on both traces.

Touch the channel 1 waveform (the input signal to the gate) to select it.

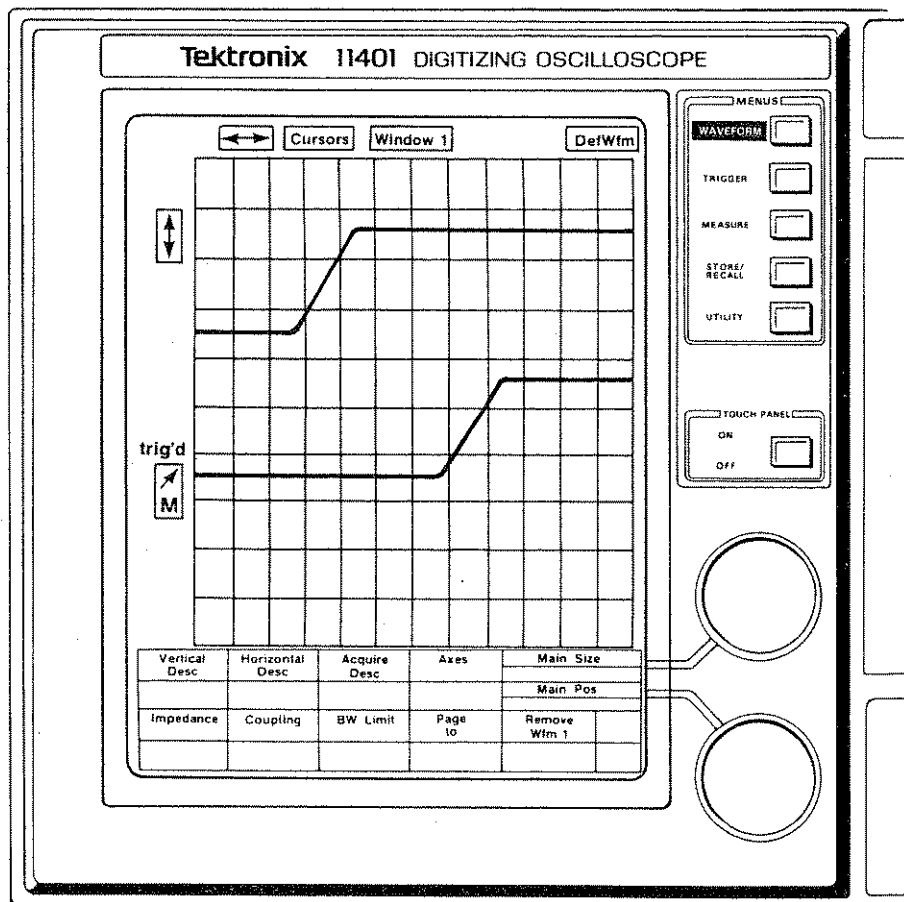

6103-21BW

Example 1 (cont)

Press the **MEASURE** pushbutton to select the Measure major menu.

Touch the **Measurements** label to display the Measurements pop-up menu.

Touch the **Rise** label in the pop-up menu to select the risetime measurement. The **Rise** label should then be displayed in the menu/status area. The value below the **Rise** label is the risetime of the selected waveform, which in this case is the channel 1 waveform.

Touch the **Exit Menu** label to exit the pop-up menu.

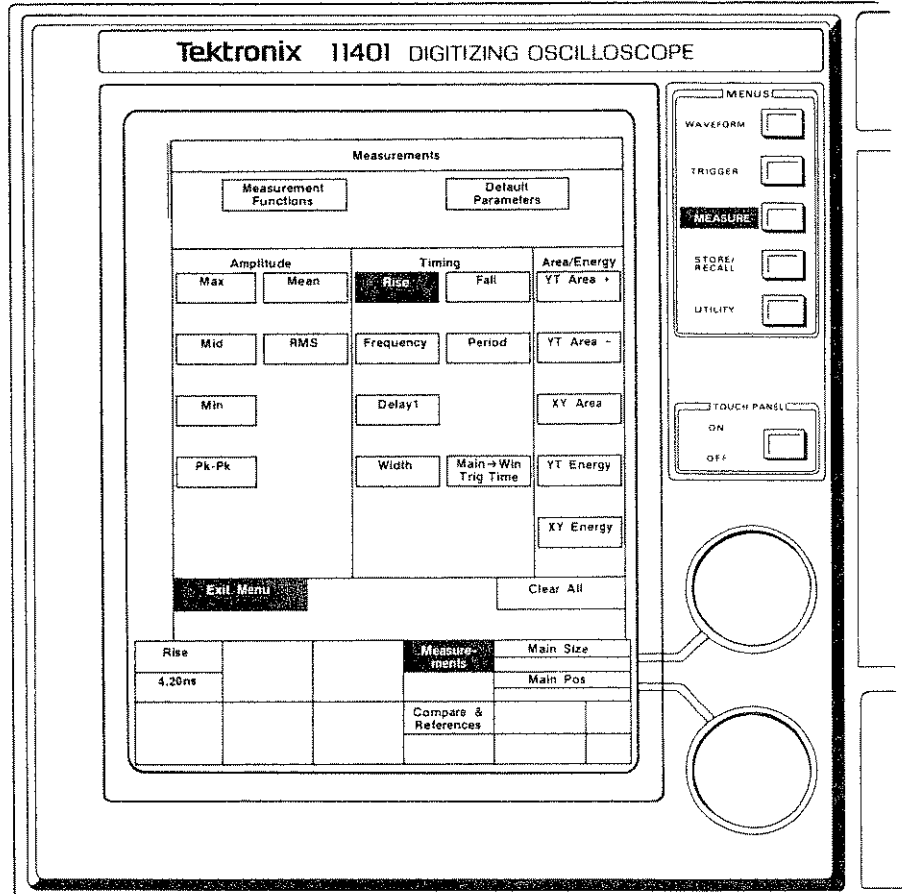

6103-538W

Example 1 (cont)

Now, touch the **Rise** label.

Annotation lines are displayed to show the 10% and 90% amplitude levels (called the proximal and distal levels) between which the risetime measurement is being made. Also shown are the topline and baseline on the waveform.

A pop-up menu is also displayed that shows the percentage of the pulse amplitude that the measurement levels are set for. For example, the default values for the proximal and distal levels are 10% and 90%, respectively.

To change the risetime measurement levels, touch the **Proximal** and **Distal** labels. The Control knobs can now be used to set the Proximal and Distal levels.

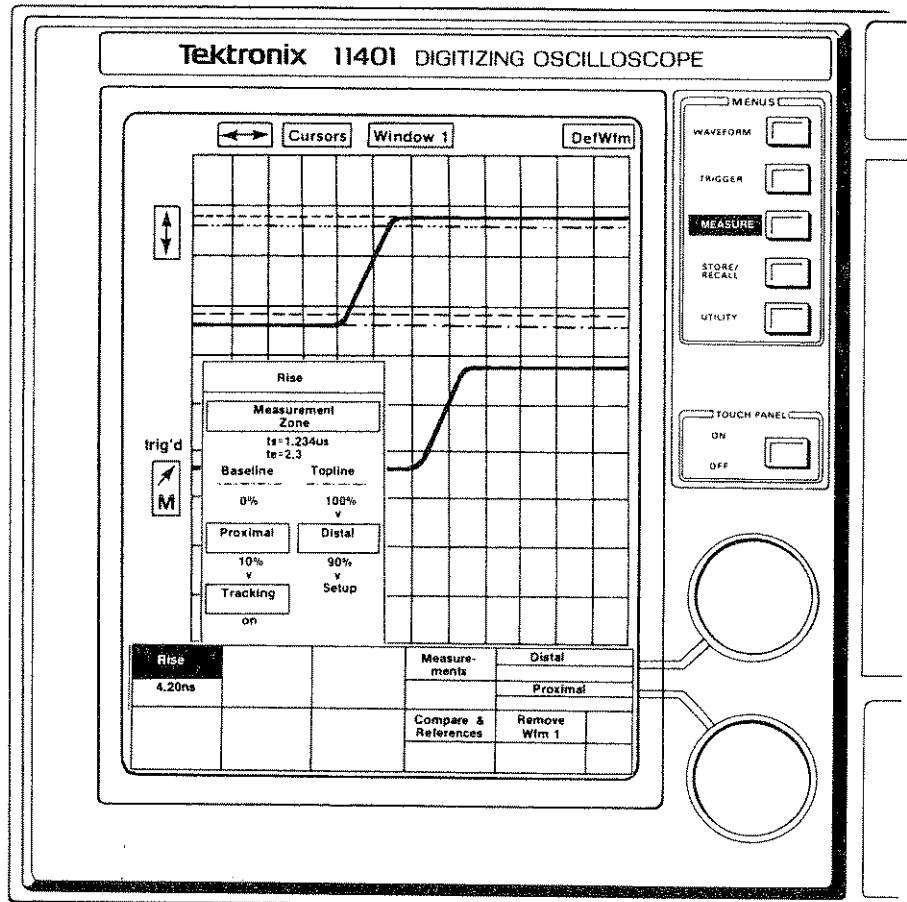



6103-54BW

Example 1 (cont)

To remove the pop-up menu but keep the annotation lines, touch the **Rise** label.

The intensified zone on the leading edge of the pulse shows the part of the pulse included in the risetime measurement. Turn the Control knobs to change the start and stop points of the measurement.

To turn off the annotation, touch the  or  icon.

Try some of the other timing measurements in the Measurements pop-up menu. For each measurement, turn on the annotation (by touching the measurement label in the menu/status area) to see where the measurements are being made.

You can use the 11401/11402's automatic measurement functions to examine and analyze the operation of both logic devices and linear amplifiers.

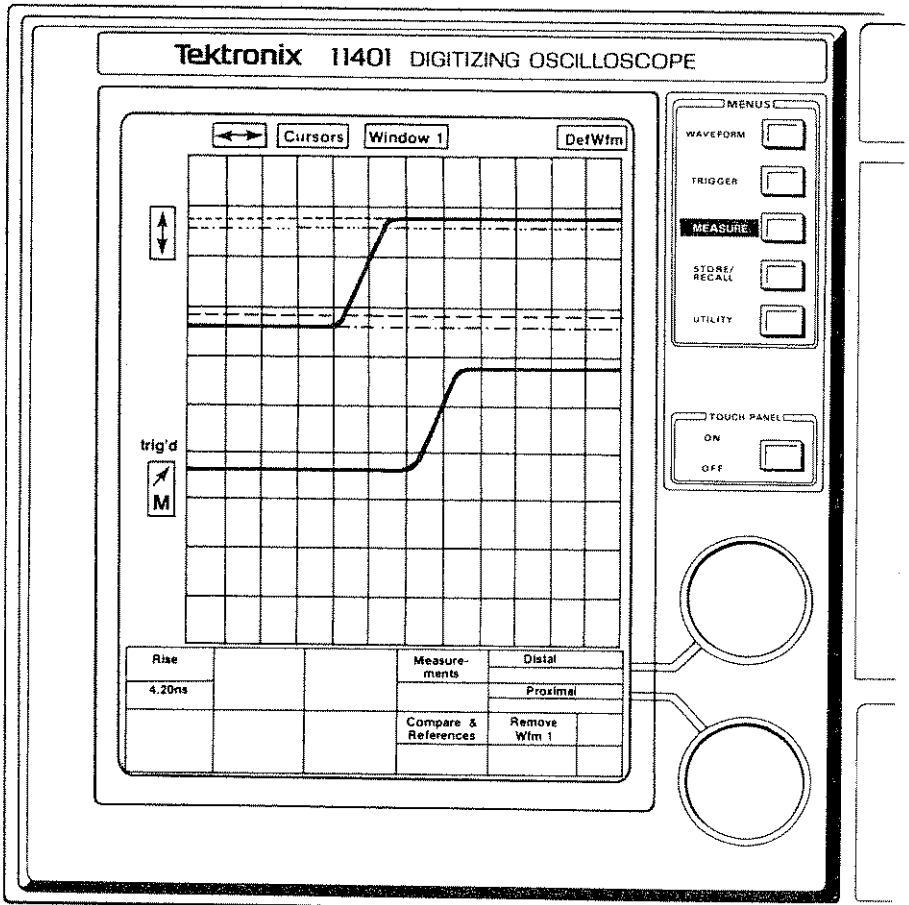

6103-55BW

Example 2 – Comparing Two Waveforms

The 11401/11402 provide a simple mechanism for storing waveform measurement results for comparison with other waveform measurements.

To illustrate this technique, display the two waveforms that were used in Example 1.

Touch the channel 1 waveform to select it. Then select the Rise measurement using the following steps:

- Press the **MEASURE** push-button.
- Touch the **Measurements** label in the Measure major menu.
- Touch the **Rise** label in the Measurements pop-up menu.
- Touch the **Exit Menu** label in the Measurements pop-up menu.

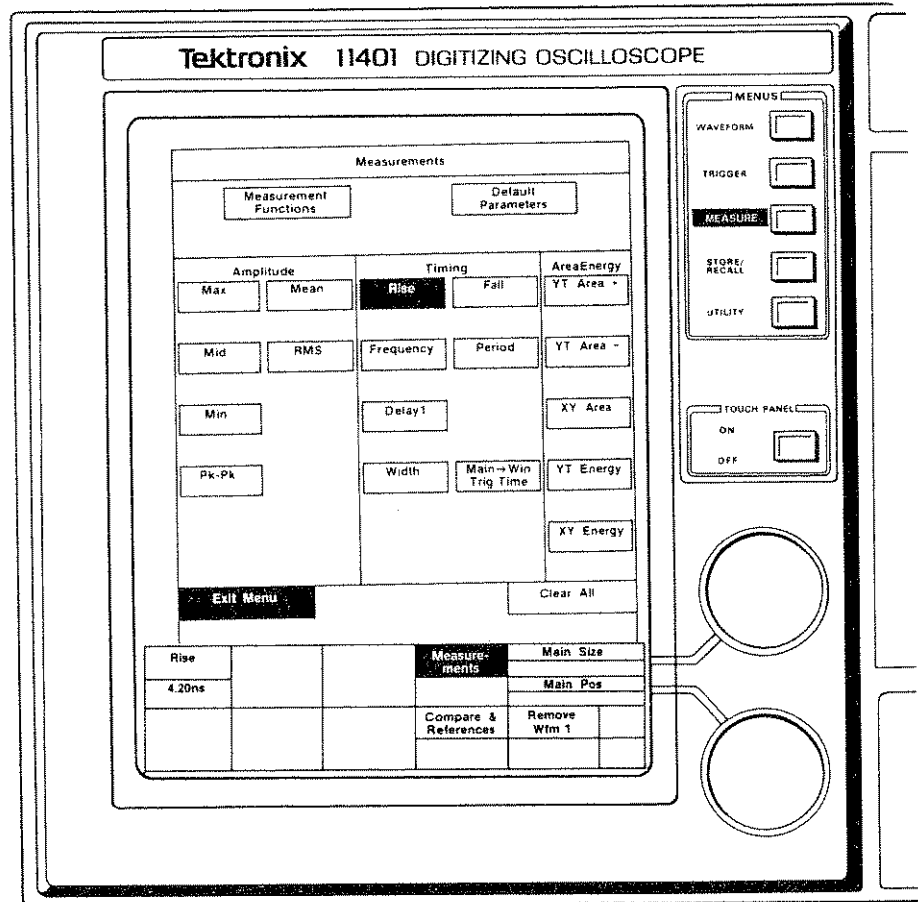

6103-26BW

Example 2 (cont)

Now, touch the **Compare & References** label in the Measure major menu to display the Compare and Reference Values pop-up menu.

Touch the **Save Current Meas Values as References** label in the pop-up menu. The risetime of the selected waveform (and any other measurement results that may be selected) is saved.

Next, touch the **Compare** label to toggle the compare function on.

The risetime measurement shown below the **Rise** label in the major Measure menu is now a comparison delta value. This value is the difference between the value you just stored and the current value. Since you are still measuring the channel 1 signal, this comparison should be approximately zero.

Touch the **Compare & References** label in the Measure major menu to exit the pop-up menu.

Compare and Reference Values				
Compare		Save Current Meas Values as References		
On				

Adjust References				
Delay2 Ref		Rise Ref		
148ns		45ns		
Δ Rise			Measurements	Main Size
0.02ns				Main Pos
			Compare & References	Remove Wfm 1

6103-27BW

Example 2 (cont)

Touch the channel 2 waveform to select it.

The value below the **Rise** label now is a measurement of the difference between the risetime of the channel 1 waveform (the stored reference value) and the risetime of the channel 2 waveform.

This technique can be used to compare any of the signal and pulse parameter measurements available in the Measurements pop-up menu. You can also compare the measurements of several different pulse parameters at a time.

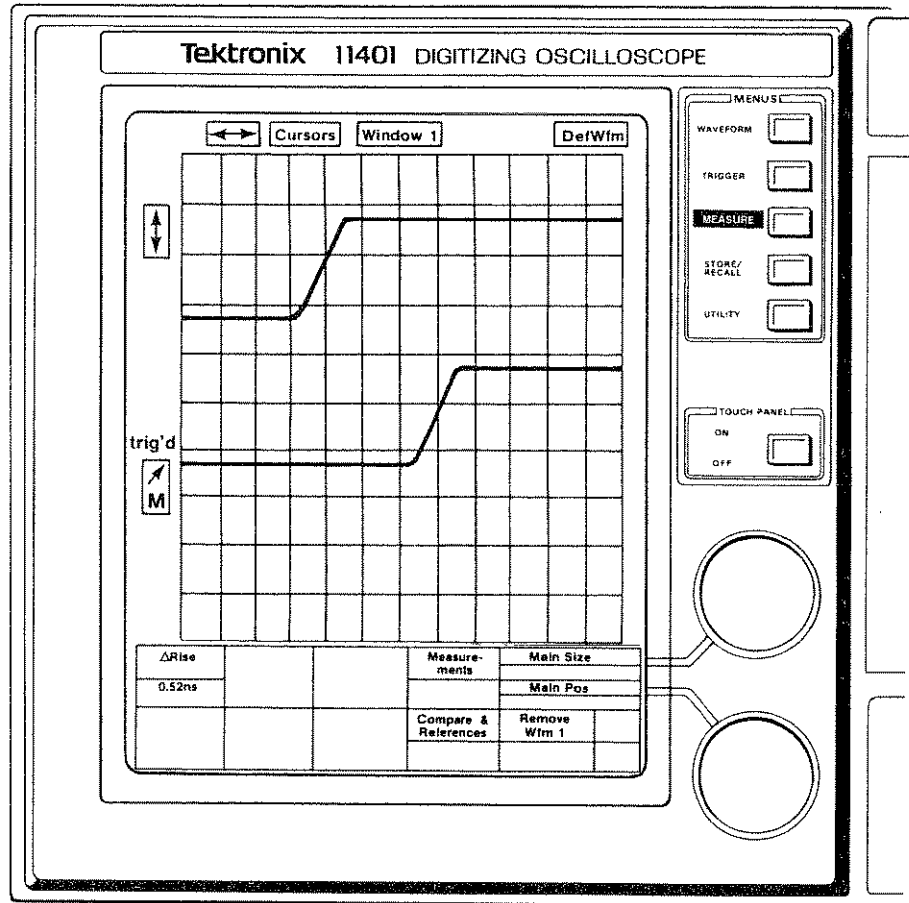

6103-288W

Example 3 – Making Precise Measurements in Noisy Environments

The 11401/11402 greatly improve the accuracy of measurements made in noisy environments by allowing you to use signal averaging to remove random noise.

The following example shows how you can measure power-supply ripple to a resolution of 14 bits, using signal averaging.

Here, a differential plug-in is used. Connect a pair of probes across the load of a power supply. The differential measurement cancels any measurement inaccuracies due to ground current. (If the differential plug-in is not available, connect one probe from a normal vertical plug-in to the non-ground side of the power-supply load.)

Obtain a display of the power supply ripple.

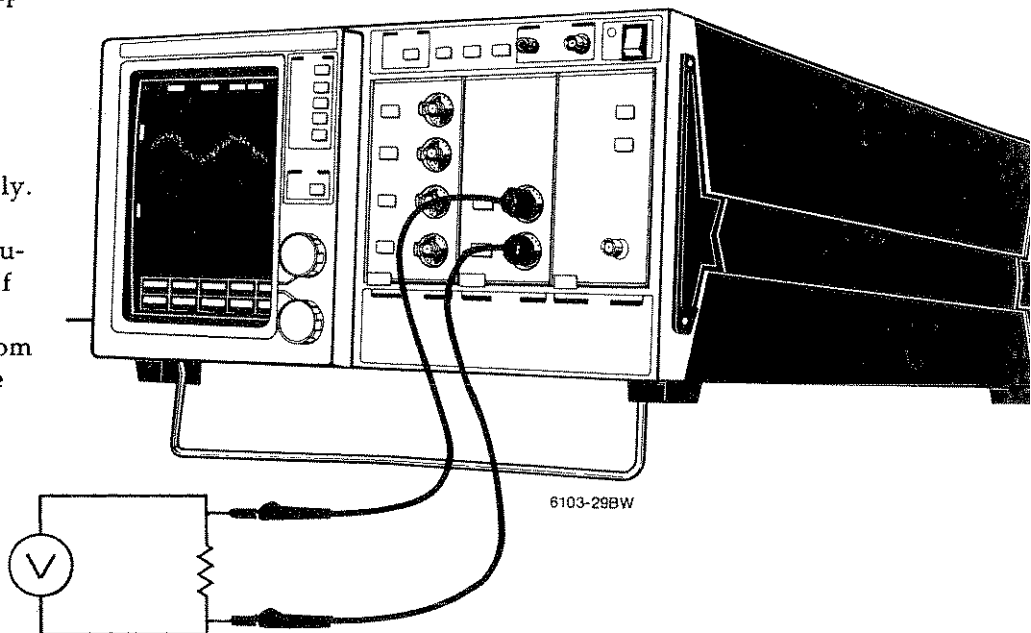

Power Supply Ripple Measurement Using the Average Function

To obtain an accurate measurement of the power supply ripple, you can use the oscilloscope to average out the noise. If the noise is random, it should go to zero, leaving a clear display of the ripple.

Press the **WAVEFORM** pushbutton to display the Waveform major menu and touch the **Acquire Desc** label in this menu. The Acquire Description pop-up menu is displayed.

Touch the **Average N** label in this menu to select signal averaging.

Acquire Description		
Average N On	Stop Acquisition On	
	% Fill Complete	Set % 99%
	Set Avg N 32	Average Complete
	Envelope N Off	Both Avg & Env
Set EnvN 34	Single Trigger	Trigger Select Main
Run Acquisition Continuous		

Vertical Desc	Horizontal Desc	Acquire Desc	Axes	Number of Avg	
				Number of Avg	
Impedance	Coupling	BW Limit	Extended Diagnostic	Remove Wfm 1	

6103-30BW

Example 3 (cont)

The pop-up menu is removed and the waveform is now an average of many acquisitions of the input signal. You can select the number of acquisitions in each average with either of the Control knobs.

The signal-to-noise ratio is improved by a factor equal to the square root of the number of acquisitions that are averaged. Thus, the higher the number of acquisitions, the greater the noise reduction.

To measure the peak-to-peak voltage of this averaged waveform, press the **MEASURE** pushbutton to obtain the Measure major menu, then touch the **Measurements** label in this menu to obtain the Measurements pop-up menu. Touch the **Pk-Pk** label in the Measurements pop-up menu, then touch the **Measurements** label again in the menu/status area to remove the pop-up menu.

The peak-to-peak voltage of the power supply ripple is shown below the **Pk-Pk** label.

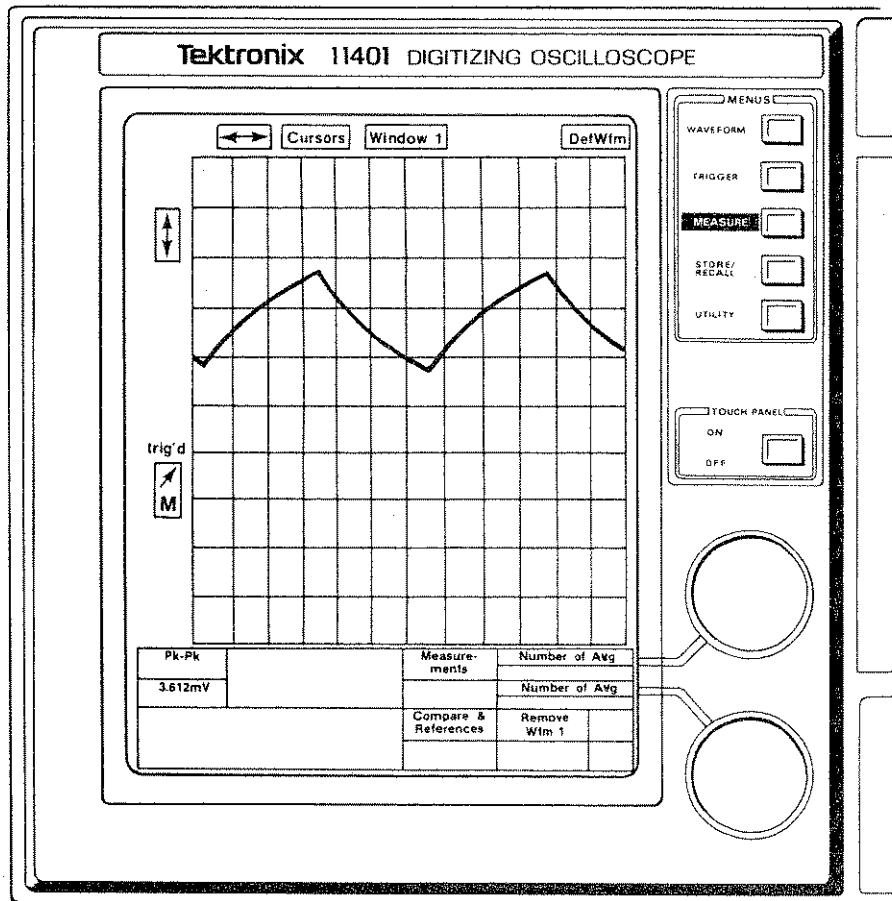

6103-31BW

Power Supply Noise Measurement Using the Envelope Function

The Acquire Description pop-up menu also provides a convenient means of setting up a peak-to-peak measurement of the noise component of the power-supply ripple.

Press the **WAVEFORM** pushbutton to display the Waveform major menu. Then, touch the **Acquire Desc** label again in the Waveform major menu.

Touch the **Envelope N** label in the Acquire Description pop-up menu.

Acquire Description					
Average N		Stop Acquisition On			
On		% Fill Complete	Set %		
32		Average Complete	99%		
Envelope N		Envelope Complete		Both Avg & Env	
Off					
Set EnvN		Single Trigger	Trigger Select		
34		Main			
Run Acquisition					
Continuous					
Vertical Desc	Horizontal Desc	Acquire Desc	Axes	Number of Env	
				Number of Env	
Impedance	Coupling	BW Limit	Extended Diagnostic	Remove Wfm 1	

6103-32BW

Example 3 (cont)

The pop-up menu is removed and the waveform is now an envelope of the noise on the power supply signal. Like the signal averaging function, the envelope is obtained from many acquisitions of the input signal. You can use either of the Control knobs to select the number of acquisitions in the envelope.

Touch the **Cursors** icon.

Using the Control knobs, you can now move the to cursors to precisely measure the peak-to-peak voltage of the noise by measuring the separation of the envelope waveform. Adjust the cursors so that there is one time unit difference between them (the Δ value should be equal to one unit of cursor sensitivity). The Δv value then gives the peak-to-peak voltage of the noise.

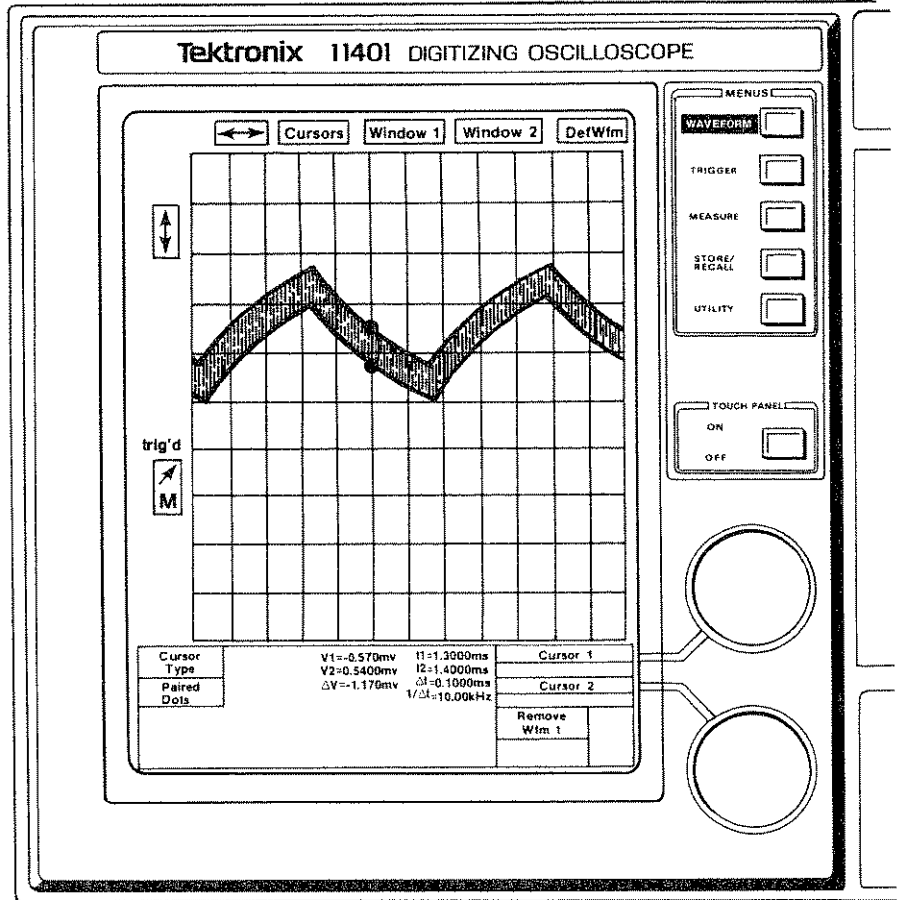

6103-33BW

Example 4 – Storing Waveforms

The 11401/11402 will store multiple waveform records and up to 10 sets of control settings. Stored waveforms can then be used for analysis or comparison with newly acquired waveforms. Control settings are stored in nonvolatile memory so that often used setups can be quickly recalled at any time.

Acquire a signal through channel 1 and adjust the waveform so that at least two pulses are displayed.

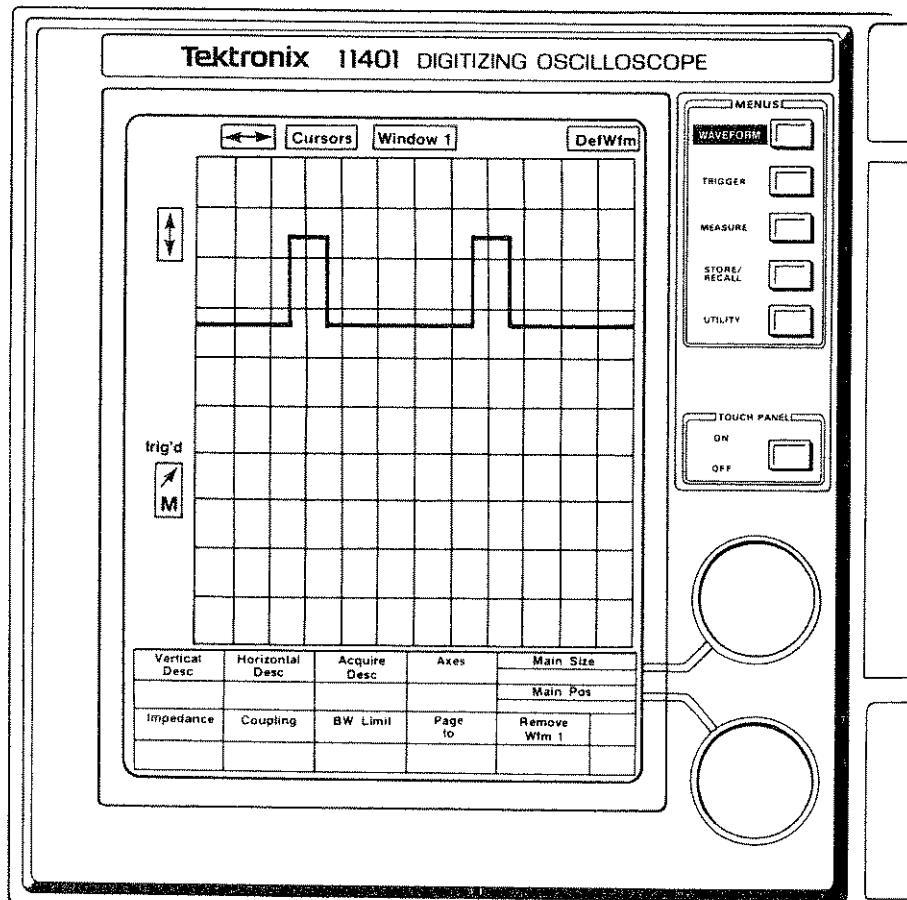

6103-348W

Example 4 (cont)

Touch the **Window 1** icon to create a dual-axes display.

The waveform displayed in the lower axes is an expanded version of the waveform in the upper axes. You are using the lower axes as a window to get a higher resolution look at the waveform in the upper axes.

Adjust the horizontal size and position of the waveform in the lower axes so that you are looking at the first pulse of the waveform in the upper axes. The intensified portion of the waveform in the upper axes shows the part of that waveform being displayed in the lower axes.

One of the benefits of using windows is that they allow high resolution analysis of waveforms.

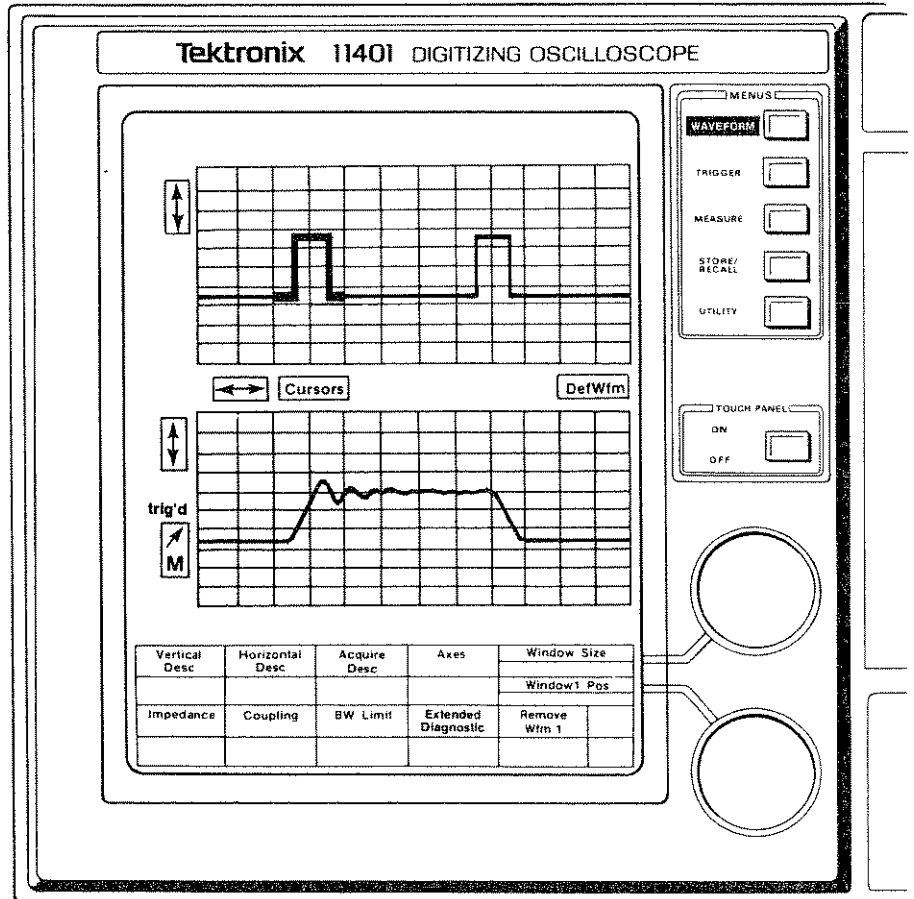

6103-35BW

Example 4 (cont)

Select the waveform in the upper axis, then select the **Window 2** icon. A second trace is then displayed in the lower axes. This trace represents a second window with which to view the waveform in the upper axes.

Again, you can use the horizontal size and position controls and the intensified zone in the upper axes to position this second window to view a different part of the waveform in the upper axes. (You might also wish to use the vertical positioning to separate the two traces in the lower axes for easier viewing.

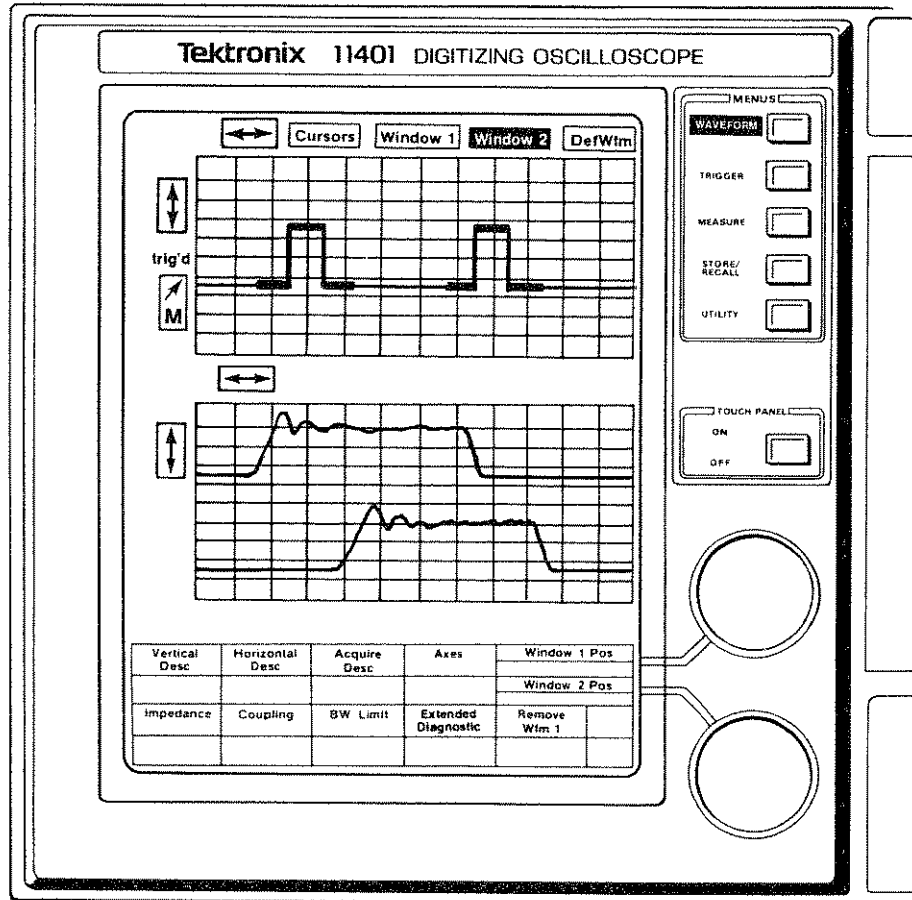

6103-36BW

Example 4 (cont)

Press the **STORE/RECALL** push-button to display the Store/Recall major menu.

Touch the **Store Waveform** label to display the Store Waveform pop-up menu.

With this menu, you can store any of the waveforms currently displayed on the crt, or touch the Store All label to store all three.

Touch the **L1 Window 2** label to store the currently selected waveform.

(The Store Setting label operates the same way, allowing you to store the current control settings.)

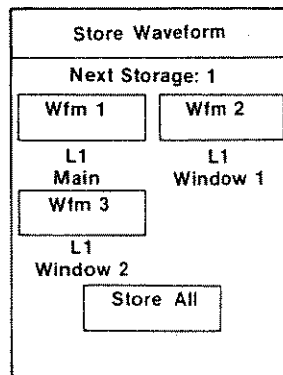

Store Waveform	Recall Waveform	Clear Waveform	Delete Waveform	Window 1 Pos	
				Window 2 Pos	
Store Setting	Recall Setting	Sequence Setting	Delete Setting	Remove Wfm 1	

6103-37BW

Example 4 (cont)

To illustrate how a stored waveform can be recalled, perform the following operation to reduce the display to one axes and remove all the waveforms from the display.

Press the **WAVEFORM** pushbutton to display the Waveform major menu and touch the **Lower Axes** label in this menu. From the Lower Axes pop-up menu, touch the **Reduce to One Axes** label.

All the waveforms are now displayed on one axes.

Now, touch the **Remove Wfm 1** label in the menu/status area three times to remove all the currently displayed waveforms.

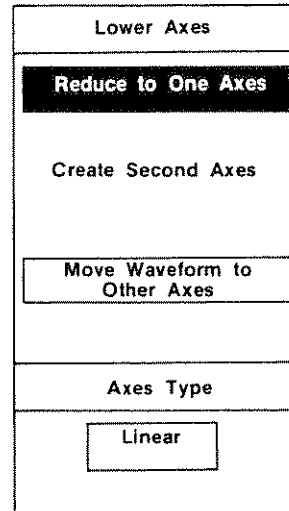

Vertical Desc	Horizontal Desc	Acquire Desc	Lower Axes	Main Size
				Main Pos
Impedance	Coupling	BW Limit	Page to	Remove Wfm 1

6103-38BW

Example 4 (cont)

To display the stored waveform, press the **STORE/RECALL** push-button to display the Store/Recall major menu. Then touch the **Recall Waveform** label to display the pop-up menu of all the stored waveforms.

Touch the **Stored 1** label. The stored waveform is displayed.

This waveform can now be compared with other waveforms.

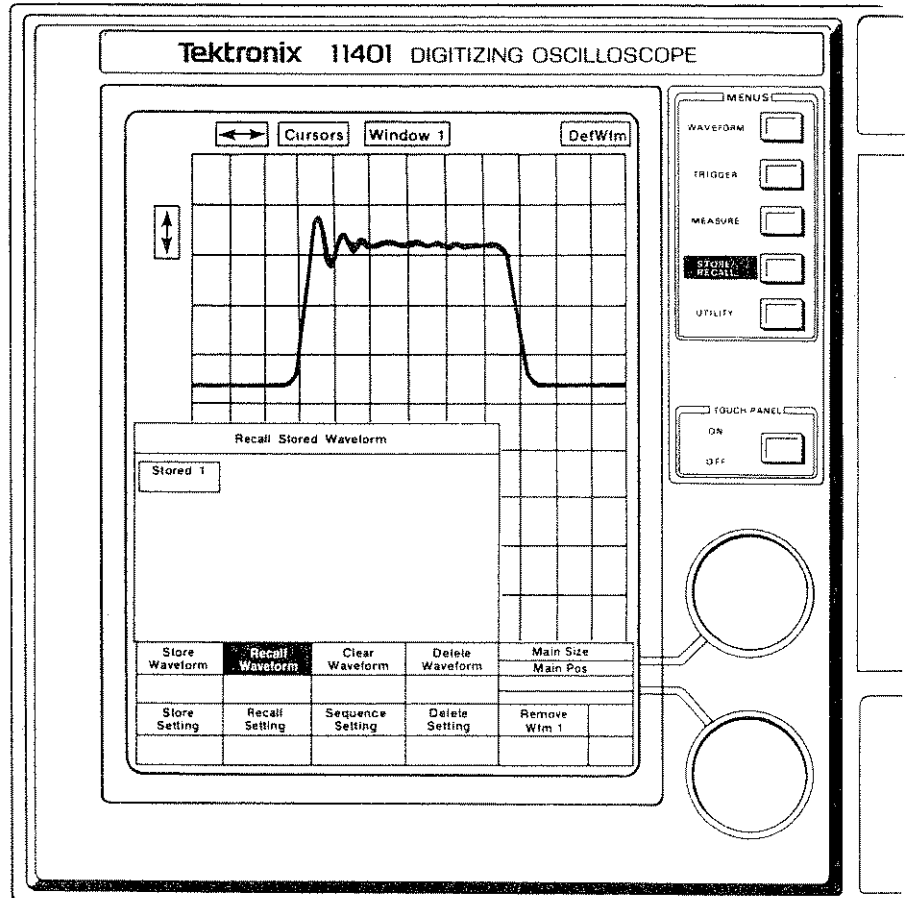

6103-39BW

Example 5 – High-Accuracy Time Measurements

The 11401/11402 permits you to use the dual time bases in a unique way to increase the precision of time measurements.

Interpolation hardware lets you make time measurements between the main time-base trigger event and the window time-base trigger event with 50 picosecond or better timing resolution. This mode can be used just like Time A-B mode on a counter/timer, to measure pulse width propagation on delay, and many other common timing parameters. The advantage of using this trigger-to-trigger mode over counter/timer A-B mode is that signals can be conditioned by plug-in amplifiers.

Self-calibration and probe deskewing functions ensure that these measurements are made very accurately.

Probe deskewing matches the propagation delays of the vertical systems. To deskew the probes, connect them to the calibrator output of the oscilloscope.

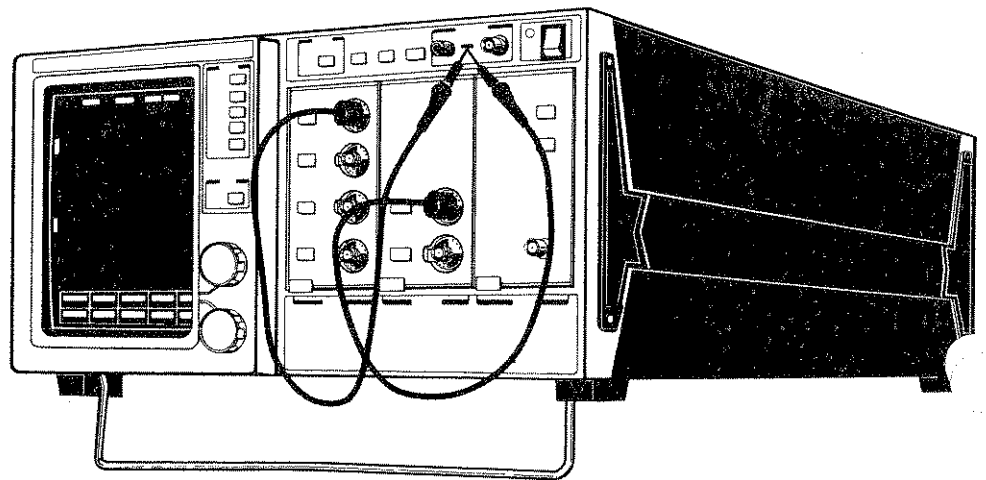

6103-40BW

Example 5 (cont)

Press the **UTILITY** pushbutton, then touch the **Probes** label in the Utility major menu.

Select the probe to be deskewed by touching the label for the probe channel in the Probes pop-up menu. For example, if the probe is connected to channel 1 of the left plug-in touch the **L1** label.

Then touch the **Time Deskew** label. The probe is deskewed automatically.

Repeat this deskewing procedure for the probe connected to the other channel.

Probes

Probe ID Function

Waveform Select /New Wfm	Wfm Select New Wfm & AutoSet	Sequence Settings
--------------------------	------------------------------	-------------------

<p style="text-align: center;">Channels</p> <table style="width: 100%;"> <tr> <td style="background-color: black; color: white; text-align: center; padding: 5px;">L1</td> <td style="background-color: black; color: white; text-align: center; padding: 5px;">C1</td> </tr> <tr> <td style="text-align: center; padding: 5px;">L 2</td> <td style="text-align: center; padding: 5px;">C 2</td> </tr> <tr> <td style="text-align: center; padding: 5px;">L 3</td> <td></td> </tr> <tr> <td style="text-align: center; padding: 5px;">L 4</td> <td></td> </tr> </table>	L1	C1	L 2	C 2	L 3		L 4		<p style="text-align: center;">Probe Function</p> <table style="width: 100%;"> <tr> <td style="text-align: center; padding: 5px;">Calibrate and Compensate</td> </tr> <tr> <td style="background-color: black; color: white; text-align: center; padding: 5px;">Time Deskew</td> </tr> <tr> <td style="text-align: center; padding: 5px;">Use Previous Cal/Skew Const</td> </tr> </table>	Calibrate and Compensate	Time Deskew	Use Previous Cal/Skew Const
L1	C1											
L 2	C 2											
L 3												
L 4												
Calibrate and Compensate												
Time Deskew												
Use Previous Cal/Skew Const												

GPIB Parameters	RS232C Parameters	Probes	Self Test	Main Size	
TalkListen 17	9600Bd			Main Pos	
Initialize	Time & Date	Instr Options	Extended Diagnostics	Remove Waveform	
	15:32.27 02/15/86			L1,M	

6103-41BW

Example 5 (cont)

Precise propagation delay measurements can now be made between two signals as follows.

Connect the probes to the two signals to be measured.

Press the **TRIGGER** pushbutton, then setup the Main time-base Trigger Coupling, Source, and Level for DC, L1, and 2 V, respectively.

Next, set the Window triggering for DC, C1, and 2 V.

Now press the **MEASURE** pushbutton and touch the **Measurements** label. From the Measurements pop-up menu, select the **Main-Win Trig Time** function.

The time between the two trigger events is then measured and displayed in the status area below the **Main-Win Trig Time** label.

Since this is a trigger-to-trigger measurement, the measurement can be made without fully digitizing the waveform. In fact, the signals being measured do not need to be displayed on the crt at all.

This measurement technique can improve measurement throughput on repetitive signals and even be used to make single-shot A-B time measurements.

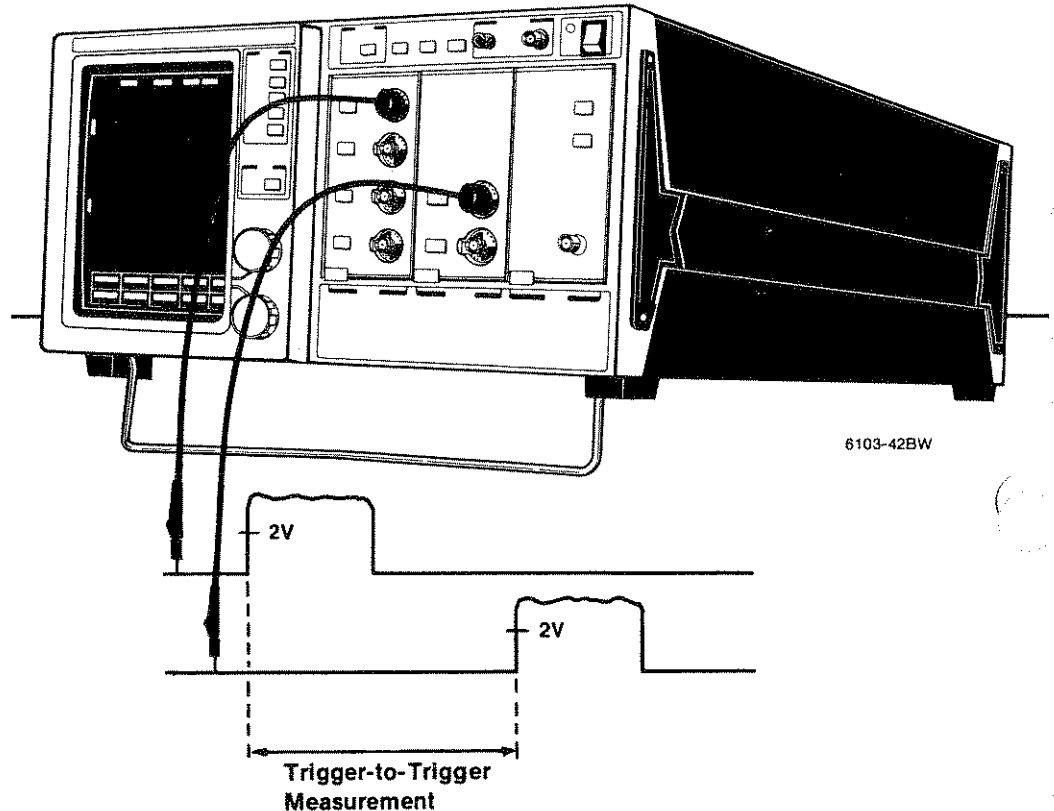

Example 6 – Pulse Jitter Measurements

The Point Accumulate function lets you view the range over which a signal varies in voltage and time. The waveform display using the Point Accumulation function is similar to that obtained from a crt storage scope using variable persistence storage, except with the 11401 or 11402, there is no fading or blooming.

The relative density of the dots gives you a statistical view of the jitter distribution.

To demonstrate the Point Accumulate function, obtain a display of a pulse with risetime jitter.

Select the **Horizontal Desc** label from the Waveform major menu. Touch the **Point Accumulate** label in the Horizontal Description pop-up menu.

The range of the pulse jitter is then shown with the accumulation of dots.

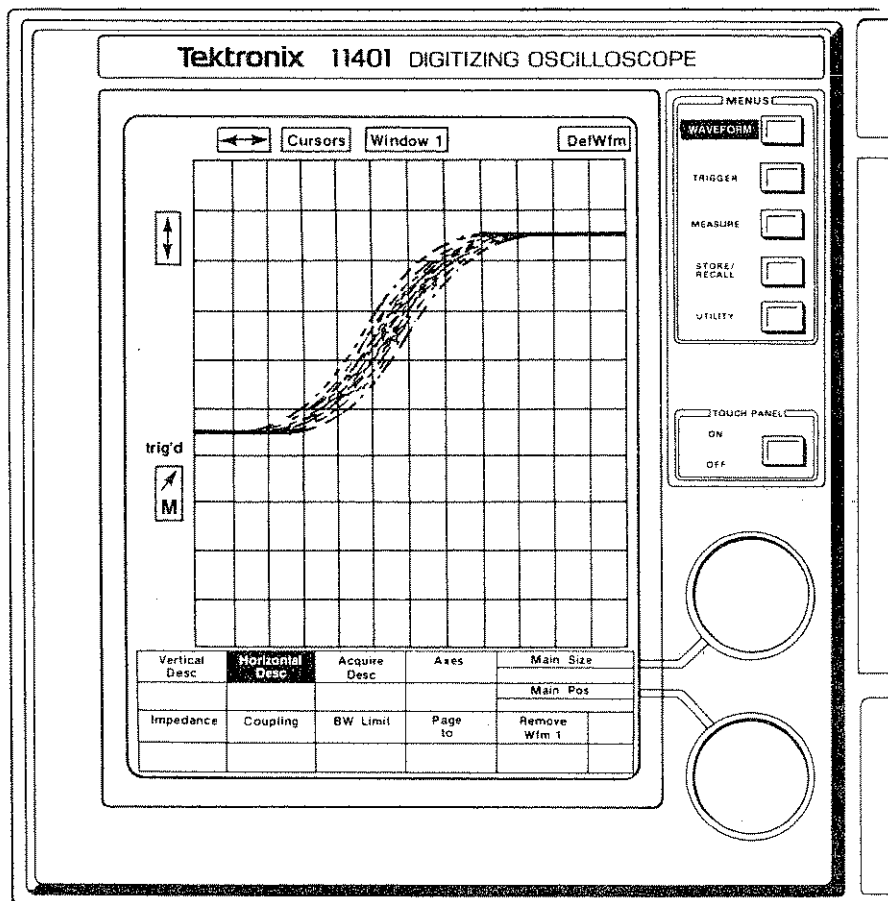

6103-438W

Example 6 (cont)

To measure the jitter, touch the **Cursors** icon, then touch the **Cursor Type** label to display the Cursor Type pop-up menu. From this menu, select the **Vert Bars** cursors.

Using the Control knobs, you can adjust the vertical bar cursors to define the scope of the measurement. The jitter width is then displayed as a delta-time measurement.

The Point Accumulate function and bar cursors allow pulse jitter to be measured accurately and repeatedly.

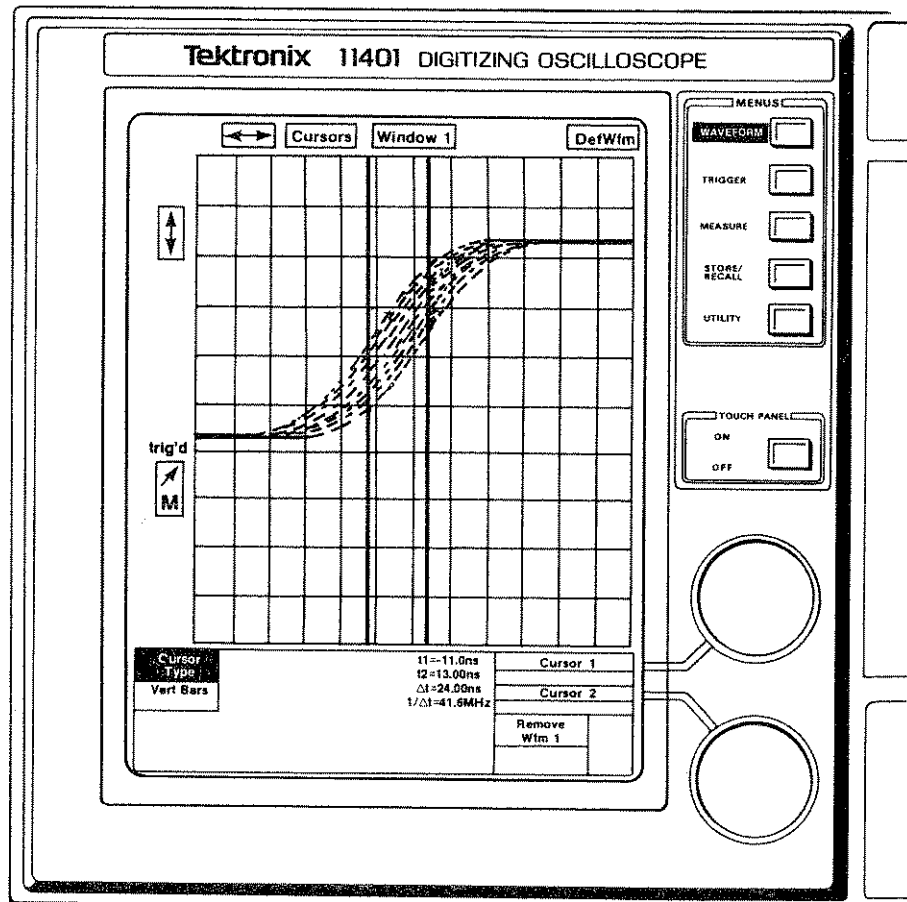

6103-44BW

Example 7 – Using Measurement Zone Delimiters

Measurement zone delimiters let you measure specific signal details while still viewing the entire waveform.

For example, obtain a display of a pair of pulses with ringing on the pulse tops.

Next, press the **MEASURE** push-button to display the Measure major menu and the **Measurements** label in this menu. Then touch the **Frequency** label in the Measurements pop-up menu and the **Exit Menu** label.

The frequency of the first cycle of the input signal is displayed below the Frequency label.

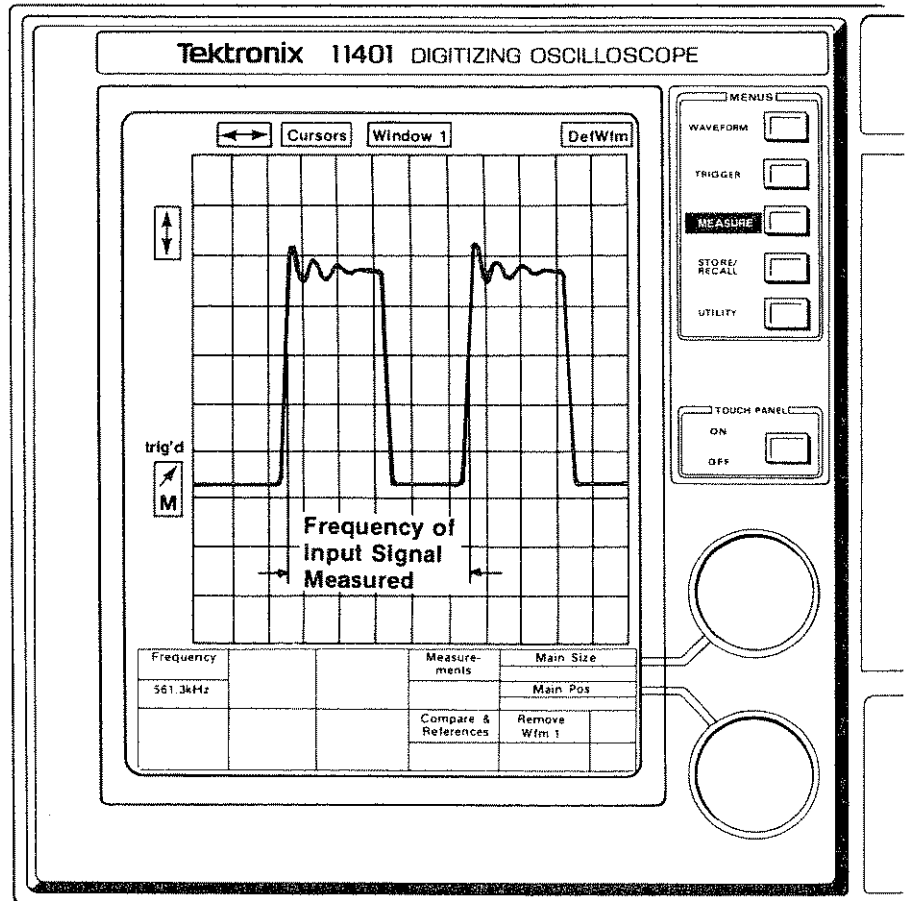

6103-45BW

Example 7 (cont)

Using the measurement zone delimiters, you can restrict the frequency measurement to the ringing on the pulse top.

Touch the **Frequency** label in the menu/status area to obtain the Frequency pop-up menu. In this menu, touch the **Measurement Zone** label.

A pair of bar cursors is displayed. Using the Control knobs, you can position these cursors to limit the frequency measurement to the pulse top.

Measurement zone delimiters are available with most of the measurement functions in the Measurement pop-up menu, allowing you to measure waveform conditions at specific parts of a waveform display.

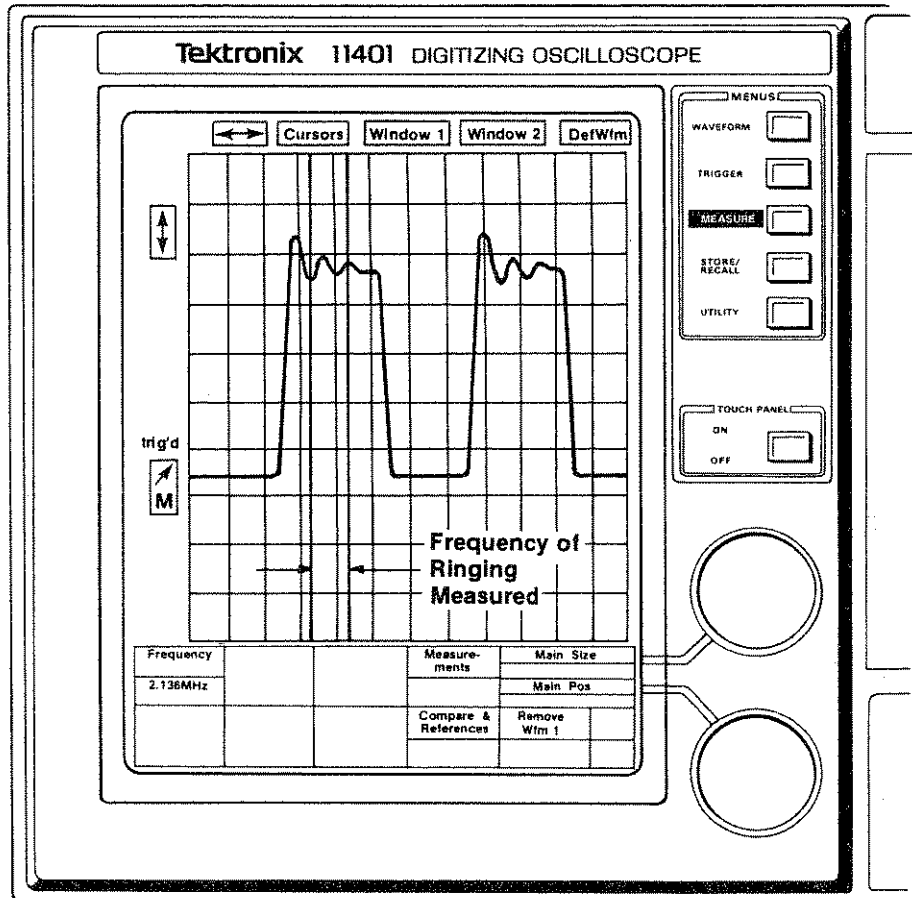

6103-46BW

Summary

The preceding demonstrations give only a few examples of the measurement and analysis power available with the 11401/11402. As you have seen all of these functions are easily accessible through the touch screen menus.

These features can also be accessed remotely through either the GPIB or the RS-232-C ports. These interfaces are described in the next section of this manual.

(

C

C

GPIB and RS-232-C

3

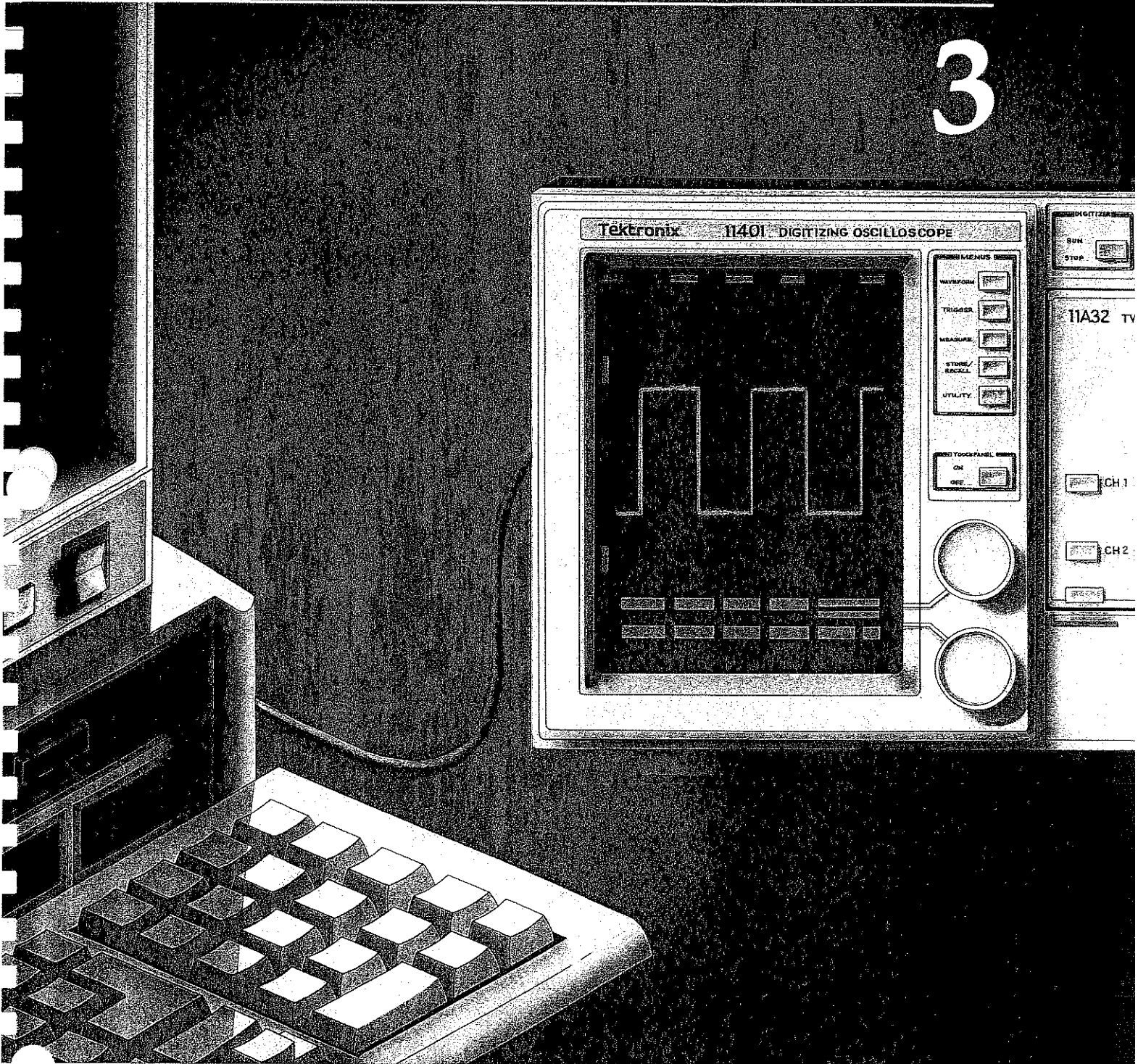

6

6

6

Contents

A Quick Look at the GPIB and RS-232-C Interfaces	3-3
RS-232-C Interface Features	3-4
GPIB Interface Features	3-5
Setting Up the Interface	3-6
RS-232-C Setup	3-6
GPIB Setup	3-7
Communicating Remotely with the 11401/11402	3-8

GPIB and RS-232-C

The 11401/11402 oscilloscopes provide an IEEE-488 standard General Purpose Interface Bus (GPIB) interface and an RS-232-C interface. These interfaces allow virtually all the oscilloscopes' waveform setup and measurement functions to be remotely controlled from a personal computer, minicomputer, mainframe computer, or automated test-equipment (ATE) controller.

This remote control capability provides two benefits. First, if you are involved in research or development projects, you can perform complicated test setups and measurements automatically. Measurement results are returned in an easy-to-interpret format, which can be fed conveniently into a computer program for further analysis.

Second, if you are performing automated testing, the 11401/11402 provide the basis for a powerful ATE system. Using the oscilloscopes' simple command language, you can write comprehensive test suites, which a test technician can perform from a controller console.

This section describes the major features the GPIB and the RS-232-C interfaces and how they may be used for data transfer and instrument control. Detailed instructions for using these interfaces can be found in the 11401/11402 User's Reference manual.

A Quick Look at the GPIB and RS-232-C Interfaces

The GPIB and RS-232-C interfaces represent the two most popular, industry standards for remote communication with test equipment. The 11401/11402 support both of these standards.

Each interface accesses the same set of oscilloscope functions. So, which interface you choose depends on your application and on the type of control equipment available to you.

Some of the factors you need to consider when deciding which interface to use are:

- Will a single or multiple device system be required?
- What are the computer, controller, and software constraints?
- How fast will the data-transfer rates have to be?
- What are the interrupt handling requirements?

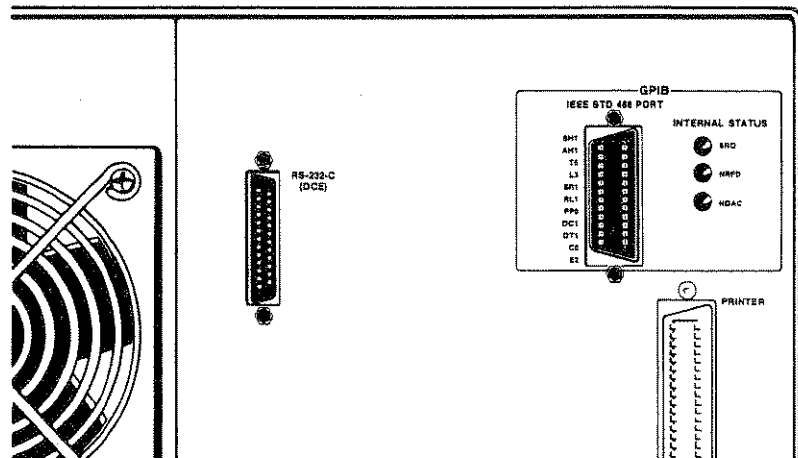

6103-47BW

RS-232-C Interface Features

The RS-232-C interface offers the benefit of simplicity when all you need is a direct connection between a computer (or terminal) and the 11401/11402.

This interface supports standard full-duplex communication of serial data at baud rates of up to 9600 baud.

A convenient setup menu allows you to quickly select the communication parameters such as parity, stop bits, or data encoding that your equipment requires.

The 11401/11402 are configured as DCE (Data Communication Equipment) devices. This means that they can be connected directly to a computer or terminal that is configured as a DTE (Data Terminal Equipment) device. On the other hand, if the computer is configured as a DCE device, a special "null modem" cable is required to connect the two instruments together.

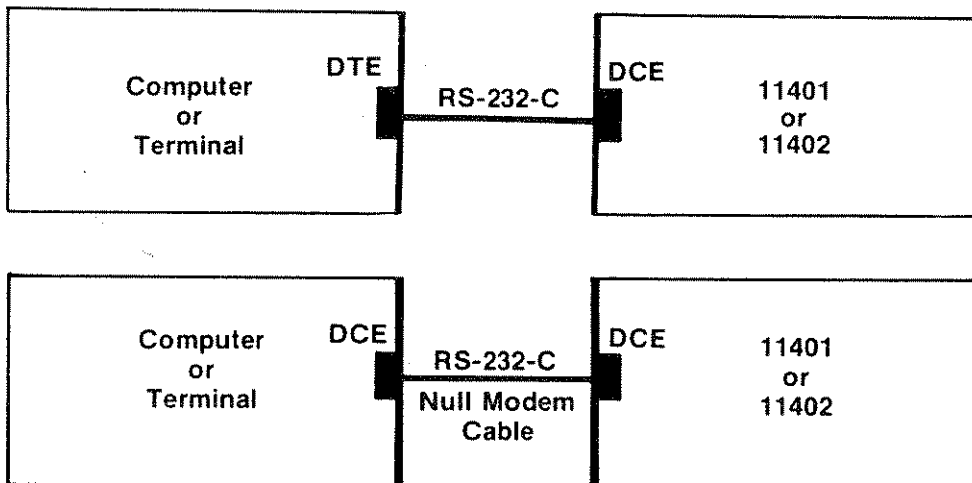

6103-48BW

GPIB Interface Features

The GPIB interface allows you to operate an 11401/11402 in a multiple-device environment, in which several measurement and test instruments, and peripherals, are interconnected through a common communications bus.

This parallel interface features reliable, bidirectional data transfer. A setup menu is also provided for this interface that allows you to quickly select interface parameters such as communications mode, address, and data encoding.

A GPIB-based system can be interconnected in two configurations: star and linear. A combination of the two configurations can also be used.

Providing that the standard GPIB rules for cable lengths and device loads are followed, up to 15 devices (including the controller) can be supported on a single GPIB bus. You can thus create a sophisticated automated test environment, with the option of operating multiple test stations from a single controller.

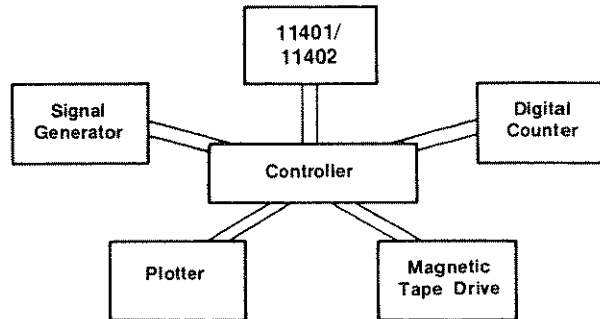

Star Configuration

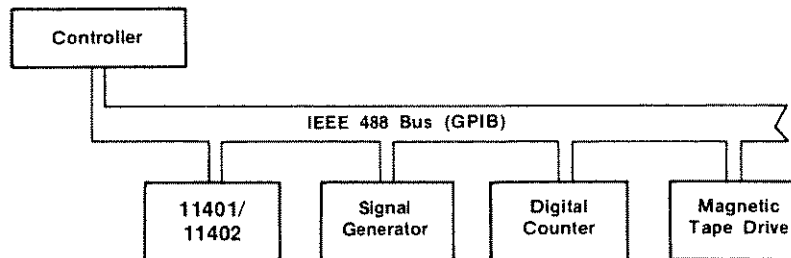

Linear Configuration

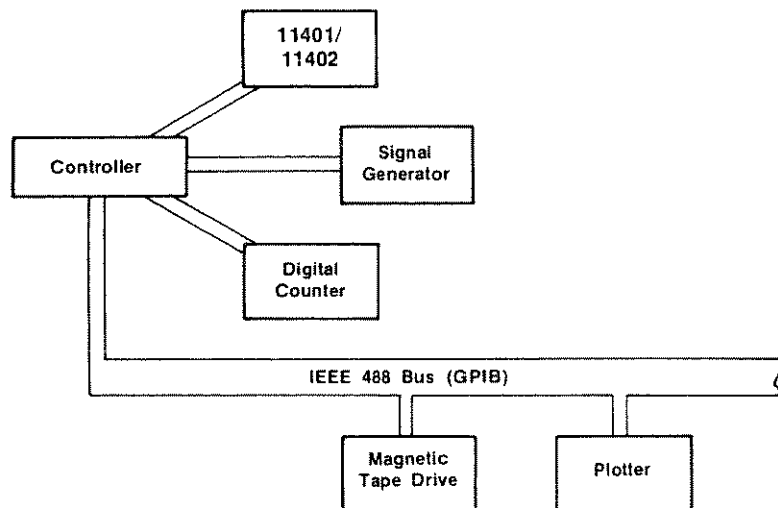

Combined Configuration

6103-49BW

Setting Up the Interfaces

RS-232-C Setup

The 11401/11402 provide an industry-standard, 25-pin, female D-connector on the rear panel. Through this connector, the oscilloscopes can be connected to a modem or directly to a computer or controller. For direct connections, the interconnect cable can be up to 15 meters (50 feet) long.

The Utility major menu provides a pop-up menu that lets you select RS-232-C parameters to match the data sending and receiving parameters that the computer or controller are using. The following parameters can be set from this menu:

- Baud Rate
- Echo
- Stop Bits
- Parity

- Delay (Query Response Time)
- Flagging (Handshaking Protocol)
- Verbose Mode
- EOL String (End-Of-Line Terminator)
- Data Encoding

The 11401/11402 User's Reference manual provides detailed information on setting up the RS-232-C interface.

RS232C Parameters					
Baud Rate		Echo		Stop Bits	
9600Bd		On/Off		Bits	
Parity		Flagging		Delay	
None		Soft		0.010s	
EOL String		Verbose		Debug	
CR/LF		On		Off	
GPIB Parameters	RS232C Parameters	Probes	Self Test	Main Size	
	9600Bd			Main Pos	
Initialize	Time & Date	Instr Options	Extended Diagnostic	Remove Wfm 1	

6103-50BW

GPIB Setup

A standard IEEE-488 connector is provided on the 11401/11402 rear panel. Adjacent to this connector are LEDs that indicate the internal status of the interface when being remotely operated.

When distributing test equipment and peripherals along a GPIB bus, the following rules must be adhered to:

- No more than 15 devices (including the controller) can be included on a single bus.
- The total cable length cannot exceed 20 meters (65 feet).
- To maintain bus electrical characteristics, one device load must be connected for every 2 meters (6 feet) of cable. (Generally each instrument or peripheral represents one device load to the bus.)
- At least one half of the device loads must be powered on at one time.

A pop-up menu for selecting GPIB parameters is also available from the Utility major menu. The following parameters can be set from this menu:

- Mode (Talk/Listen, Off Bus)
- Address (Bus Address)
- Terminator (End of Transmission Terminator)
- Debug

The 11401/11402 User's Reference manuals provide detailed information on setting up the GPIB interface.

GPIB Parameters
C&F V81.1
Mode
Talk/Listen
Address
17
Terminator
EOI
Debug
On

GPIB Parameters	RS232C Parameters	Probes	Self Test	Main Size	
TalkListen				Main Pos	
17					
Initialize	Time & Date	Instr Options	Extended Diagnostic	Remove Wfm 1	

6103-51BW

Communicating Remotely with the 11401/11402

The 11401/11402 oscilloscopes recognize a set of ASCII commands that provide access to all of their waveform setup and measurement functions. These commands (called device-dependent messages) can be included in application programs and sent to the oscilloscopes through the GPIB and RS-232-C interfaces. The command set allows complete remote control of the oscilloscopes.

The commands consists of straightforward, English-language statements. There are two types of commands:

- set commands, which change or modify internal oscilloscope control-settings and do not elicit a response, and
- query commands, which request the oscilloscopes to send measurements, waveforms, control settings, or status back to the computer or controller.

These commands can be included in any programming language such as BASIC, FORTRAN, Pascal, C, or assembly language. The only requirement is that the compiler, interpreter, or assembler provides the facilities to send ASCII character strings to a port and receive ASCII replies from the port.

The following examples show two excerpts from a BASIC application program, written for an IBM PC/XT/AT. The first excerpt shows how set and query commands are sent to the oscilloscope through the RS-232-C interface.

```
PRINT #1, "CHC1 COUPLING:DC"  
PRINT #1, "CHC1? COUPLING"  
LINE INPUT #1, RD$
```

The second excerpt shows how commands are sent through the GPIB interface. Here, it is assumed that the IBM PC is equipped with a National GPIB-PC interface card.

```
WRT$ = "CHC1 COUPLING:DC"  
CALL IBWRT(ET%,WRT$)  
  
WRT$ = "CHC1? COUPLING"  
CALL IBWRT(ET%,WRT$)  
CALL IBRD(ET%,RD$)
```

In both these examples, a set command changes the channel 1 coupling to dc for the center plug-in. A query command then asks that the current setting of the center, channel 1 coupling be sent back to the computer for verification.

This remote control capability serves two important functions. First, it provides a simple and flexible method of setting up measurements and recording measurement results.

Second, it provides a powerful tool for developing and running automated test suites. If you are using an interpreter-based language like BASIC, you can create test programs interactively with an 11401/11402 and its associated test gear. Updating programs is just as simple.

The 11401/11402 User's Reference Manual provides detailed information on the operation of both the GPIB and RS-232-C interfaces. It describes each device-dependent message in the command set and provides comprehensive instructions for writing test and measurement programs.

General Information

4

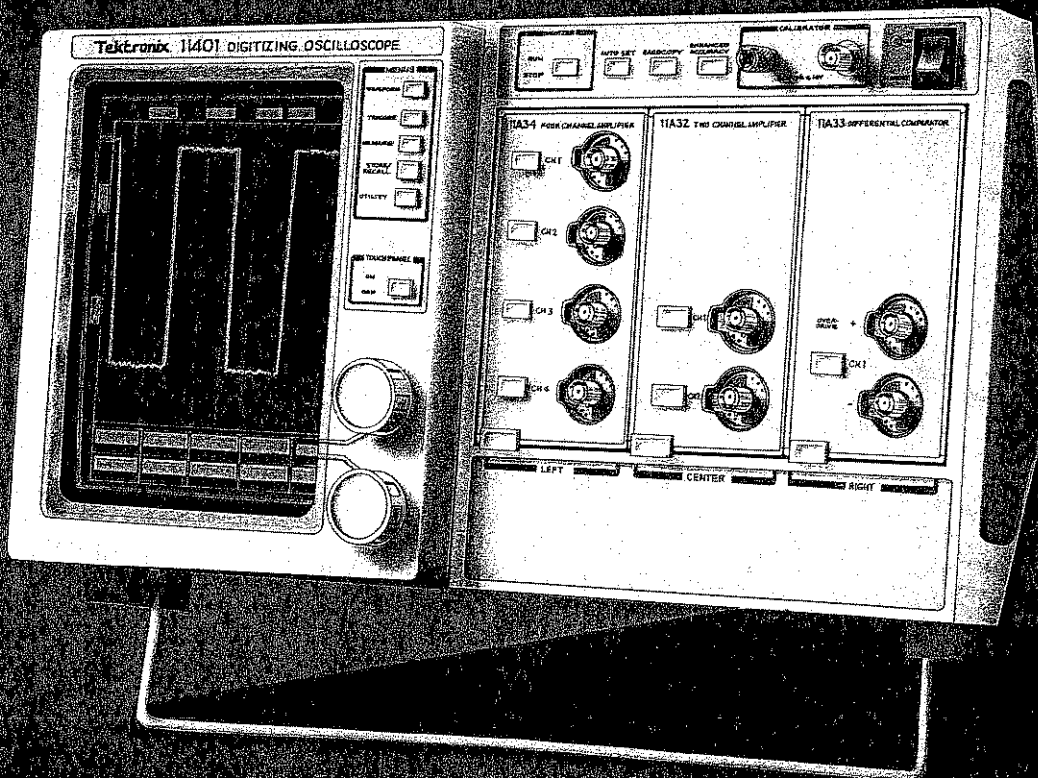

6

6

6

Contents

Manual Set	4-3
Specification Summary	4-4
Vertical System	4-4
Digitizer	4-4
Time Base	4-4
Trigger	4-5
Waveform Processing	4-5
Display	4-6
Electrical Outputs	4-6
Remote Interfaces	4-6
AC Line Power	4-7
Options	4-7

General Information

The 11401/11402 is backed with the same kind of comprehensive user manuals and customer service that you have come to expect from a Tektronix Laboratory Instrument Division product.

This section shows the user and service manuals available with the 11401/11402.

It also gives you a summary of 11401/11402's more important specifications. A list of options are given at the end of the specification section.

Manual Set

Three operator's manuals are furnished as standard accessories with the 11401/11402. Three service manuals are also available. These manuals are described below.

Operating Manuals

 070-6255-00
A quick recall of operations discussed in the User's Reference Manual

 070-6103-00
Explains operating concepts

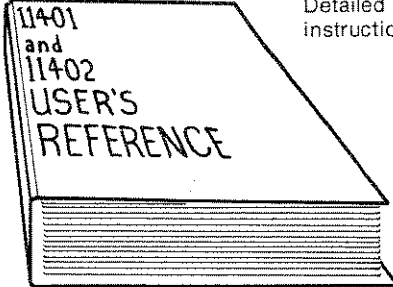
 070-5791-00
Detailed operating instructions

Service Manuals

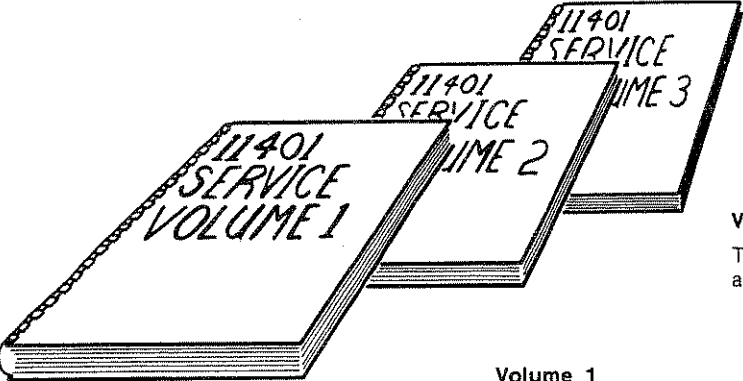
Volume 1
General Information, Theory of Operation, Checks and Adjustments, and Maintenance

Volume 2
Troubleshooting and Diagnostics

Volume 3
Diagrams and Circuit Board Illustrations

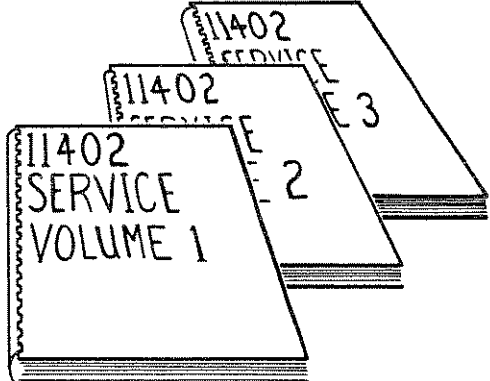
Volume 2
Troubleshooting and Diagnostics

Volume 3
Diagrams and Circuit Board Illustrations

Specification Summary

These specifications are condensed from a more complete list located in Section 4 of the 11401/11402 User's Reference Manual.

Vertical System

Accuracy	≤2% of full screen, depending on plug-in and probe combination and status of ENHANCED ACCURACY.
Maximum System Bandwidth (Equivalent Time)	
11401	Up to 500 MHz, depending on plug-in and probe combination.
11402	Up to 1 GHz, depending on the plug-in and probe combination.
Equivalent Time Step Response—Risetime (System)	Depends upon plug-in; refer to Tektronix Products Catalog or 11401/11402 User's Reference Manual.

Digitizer

Digitizer	10 bits; effective resolution can be extended to approximately 14 bits with averaging.
Sampling Rate	20 megasamples/s maximum.

Time Base

Record Interval (Effective Sample Interval)	10 ps to 2 s (as determined by Record Duration and Record Length) in a 1-2-5 sequence.
Record Length	512, 1024, 2048, 4096, 5120, 8192, 10240 points.
Record Duration	5.12 ns to 1024 s. Time per division is 0.5 ns to 100 s, selectable in a 1-2-5 sequence.
Accuracy	100 ps + 0.002% of measurement interval.

Trigger

Range	\pm full screen.
Trigger Level Accuracy	Within 1% of full screen (10 LSB's).
Trigger Coupling Modes	AC, DC, High-frequency Reject, Low-frequency Reject, Noise Reject.
Holdoff	10 s maximum.
Window Record Positioning	
Window Position Accuracy, Positioned from Main Trigger	100 ps + 0.002% of record duration.
Window Position Accuracy, Positioned from Window Trigger	100 ps + 0.002% of record duration.
Window Position Jitter, Positioned from Window Trigger	100 ps or less.
Maximum Event Frequency, Positioned by Events	200 MHz.

Waveform Processing

Waveform Parameters Measured

Amplitude	Max, Min, Peak-to-Peak, RMS, Mean, Mid.
Timing	Risetime, Falltime, Width, Delay1, Delay2, Frequency, Period,
Area/Energy	YT Area, XY Area, YT Energy, XY Energy.
Waveform Functions	Average, Envelope, Differentiate, Integrate, Interpolate (Linear), Smooth, Log, Natural Log, Exponential, Square Root, Absolute Value, Signum.

Display

Crt	9 inch diagonal.
Overall Screen	552 x 704 pixels.
Waveform Area	512 x 512 pixels, up to 8 waveforms, one or two axes.
Text	209-symbol character set; 10 x 16 pixel character cell; 55 characters per line; 44 lines.

Electrical Outputs

Calibrator Output

Frequency and Amplitude	Determined by instrument sensing needs, with or without probes.
-------------------------	---

Remote Interfaces

GPIB	IEEE-488 1978.
RS-232-C	DCE type, with baud rates up to 9600 baud.
PRINTER	Centronics® compatible, parallel.

AC Line Power

Ranges	90 V to 132 V rms, and 180 V to 250 V rms.
Line Frequency	48 Hz to 400 Hz.
Power Consumption	330 W maximum.
Line Current (max)	5.5 A rms at 50 Hz, 90 V line, with 5% clipping.
Fuse Rating	6 A, 250 V.
Dimensions (Bench Version)	17.5 x 23.6 x 9.3 in (44.5 x 60.0 x 23.7 cm).
Weight	41.6 lb. (18.9 kg).

Options

Option 2D	Memory Expansion.
Option 1R	Rack Mount.
Option 1C	Loop-through BNC's.
Option 4D	DMA Controller.
Option B1	Service Manual Set.
Options A1 through A5	For various international Power Cord requirements.

