

11A52 Two Channel Amplifier

Serial Number _____

Please check for CHANGE INFORMATION at the rear of this manual.

INSTRUMENT SERIAL NUMBERS

Each instrument has a serial number on a panel insert, tag, or stamped on the chassis. The first number or letter designates the country of manufacture. The last five digits of the serial number are assigned sequentially and are unique to each instrument. Those manufactured in the United States have six unique digits. The country of manufacture is identified as follows:

B000000	Tektronix, Inc., Beaverton, Oregon, USA
100000	Tektronix Guernsey, Ltd., Channel Islands
200000	Tektronix United Kingdom, Ltd., London
300000	Sony/Tektronix, Japan
700000	Tektronix Holland, NV, Heerenveen, The Netherlands

Copyright© Tektronix, Inc., 1987–1988. All rights reserved. Tektronix products are covered by U.S. and foreign patents, issued and pending. TEKTRONIX, INC. SCOPEMOBILE and  are registered trademarks. Printed in U.S.A.

11A52 Features and Functions

Features

- DC to 600 MHz bandwidth (in 11402)
- Dual trace
- Calibrated sensitivities from 1 mV to 10 V/division
- 50 Ω input impedance
- High-resolution, calibrated DC offset (0.25 division/increment, coarse; 0.025 division/increment, fine)
- Fast overdrive recovery

Functions

Signals applied to the CH 1 and CH 2 input connectors can be displayed or removed from the display by pressing the display on/off buttons adjacent to the input connectors.

All other 11A52 functions are controlled through the host mainframe. Such mainframe-controlled functions are:

- Sensitivity, Coarse and Fine, over a range of 1 mV to 10 V/division.
- Vertical Offset.
- Coupling: AC, DC, or Off.
- Bandwidth Limit: 100 MHz or 20 MHz.
- Display Polarity: normal or inverted.
- Trigger Polarity: normal or inverted.
- Combination of Display Channels: See *Operating Information* section of mainframe User Reference manual.
- Combination of Trigger Channels: same as Display Channels; see *Operating Information* section of mainframe User Reference manual.

Contents

Section 1—General Information

Contents of this Supplement	1-1
11A52 Service Manual	1-2
Plug-in to Mainframe Compatibility	1-2
Initial Inspection	1-3
Operating Temperature	1-3
Installing and Removing the 11A52	1-4
Instrument Options	1-6
Packaging for Shipment	1-6

Section 2—Operating the 11A52 in 11300-series Mainframes

Display On/Off	2-1
Selecting Coupling, HF Limit, and Impedance	2-1
Other Functions	2-2
Position and Offset	2-2
HF Limit	2-3
DC Circuit Loading	2-4
Adding Waveforms	2-5
Overdrive Recovery	2-6
50 Ω Overload	2-7
Active Probes	2-7
Probe ID	2-7
Front-Panel Error Messages	2-8
GPIB and RS-232-C Commands and Syntax	2-9

Section 3—Operating the 11A52 in 11400-series Mainframes

Display On/Off	3-1
Other Functions	3-1
Vertical Offset	3-2
BW Limit	3-2
DC Circuit Loading	3-3
Adding and Subtracting Waveforms	3-5
Overdrive Recovery	3-6
50 Ω Overload	3-7
Active Probes	3-7
Probe ID	3-7
Front-Panel Error Messages	3-9
GPIB and RS-232-C Commands and Syntax	3-10

Section 4—Specification

Performance Conditions	4-1
Electrical Characteristics	4-1
Environmental Characteristics	4-6
Physical Characteristics	4-7
Recommended Probes	4-7

Appendix A—Glossary

Appendix B—Instrument Documentation

Illustrations

1-1	Installing a plug-in unit in a mainframe oscilloscope.....	1-5
2-1	Location of AC coupling capacitors in plug-in amplifiers	2-4
3-1	Location of AC coupling capacitors in plug-in amplifiers	3-4
3-2	Sequence of decisions used to select a new waveform in response to probe ID button	3-8
4-1	Dimensions of 11A52	4-8

Tables

2-1	Functions and Where They are Described	2-2
2-2	Channel Parameter Commands (for 11300-series oscilloscopes)	2-9
3-1	Functions and Where They are Described	3-1
3-2	Channel Parameter Commands (for 11400-series oscilloscopes)	3-10
4-1	Electrical Characteristics	4-1
4-2	Environmental Characteristics	4-6
4-3	Physical Characteristics	4-7

Section 1

General Information

This Supplement to the mainframe User Reference manual and the Incoming Inspection Procedure manual are standard accessories to the 11A52. For a list of related manuals, see Appendix B.

Contents of this Supplement

This Supplement contains the following four sections:

Section 1—GENERAL INFORMATION, describes mainframe to plug-in unit compatibility, explains how to install and remove the 11A52 from a mainframe, outlines any options available for the 11A52, and gives details about packaging for shipment.

Most 11A52 functions, and their use, are described in the *Operating Information* section of the mainframe User Reference manuals. These functions are those common to all amplifier plug-in units. Examples of common functions are offset, sensitivity, input impedance (where selectable), coupling, and bandwidth limit. Only functions unique to the 11A52-11300-series or 11A52-11400-series combinations are explained in the following sections.

Section 2—OPERATING THE 11A52 IN 11300-SERIES MAINFRAMES, explains how to operate those 11A52 functions not covered in the *11301 and 11302 User Reference Manual*, or the *11301A and 11302A User Reference Manual*.

Section 3—OPERATING THE 11A52 IN 11400-SERIES MAINFRAMES, explains how to operate those 11A52 functions not covered in the *11401 and 11402 User Reference Manual*.

Section 4—SPECIFICATION, gives detailed specifications of all 11A52 mainframe oscilloscope combinations.

11A52 Service Manual

WARNING

The 11A52 Service manual is for use by qualified service personnel only. To avoid personal injury, do not perform any service other than that contained in the Operator's manual unless you are qualified to do so. Refer to the Operators Safety Summary and Service Safety Summary before performing any service.

The 11A52 Service Manual contains the following information:

Section 1—GENERAL INFORMATION.

Section 2—THEORY OF OPERATION.

Section 3—MAINTENANCE AND DIAGNOSTICS.

Section 4—PERFORMANCE VERIFICATION AND ADJUSTMENT.

Section 5—INSTRUMENT OPTIONS.

Section 6—REPLACEABLE ELECTRICAL PARTS.

Section 7—SCHEMATIC DIAGRAMS & CIRCUIT BOARD ILLUSTRATIONS.

Section 8—REPLACEABLE MECHANICAL PARTS.

Plug-in to Mainframe Compatibility

The 11A52 is designed for use in the 11301, 11301A, 11302, 11302A, 11401, 11402 and future 11000-series plug-in mainframes. 11A52 bandwidth varies depending on the host mainframe. Details about bandwidth are included in Section 4, *Specification*, of this supplement, and in the Tektronix Corporate Catalog. Refer to the Tektronix Corporate Catalog for complete compatibility information.

Initial Inspection

This instrument was inspected mechanically and electrically before shipment, and should meet all electrical specifications. First, inspect the 11A52 for physical damage incurred in transit. Secondly, to verify that the instrument is functioning properly, perform the *Functional Test Procedure*, shipped with the instrument. This brief procedure verifies most instrument functions and checks the internal auto-calibration references. If you find instrument damage or deficiency, contact your local Tektronix Field Office or representative.

Operating Temperature

The 11A52 can be operated where the ambient air temperature is between 0° and +50° C and can be stored in ambient temperatures from -40° to +75° C. After storage at temperatures outside the operating limits, allow the chassis to reach operating temperature limits before applying power.

Installing and Removing the 11A52



To avoid instrument damage set the mainframe ON/STANDBY switch to STANDBY before installing or removing the 11A52.

If the green indicator light remains ON, when the STANDBY position is selected, the switch has been internally disabled.

To remove or reinstall plug-in units, use the mainframe PRINCIPAL POWER SWITCH (rear panel) to shut OFF the power. This will prevent damage to either the plug-in or the mainframe.

To once again enable the ON/STANDBY switch, refer the instrument to qualified service personnel.

When installed in any 11401 or 11402 plug-in compartment, or in the 11301, 11301A, 11302 or 11302A left or center plug-in compartment, the 11A52 will provide a conventional display.

When installed in the center or right plug-in compartment of the 11301, 11301A, 11302 or 11302A, the 11A52 will also provide the X (horizontal) part of an X-Y display, or provide a trigger signal for the mainframe time base.

To install the 11A52 in any 11000-series oscilloscope mainframe, set the mainframe ON/STANDBY switch to STANDBY. Align the grooves in the top and bottom of the 11A52 with the guides in the mainframe plug-in compartment, then insert the 11A52 into the mainframe until its front panel is flush with the front panel of the mainframe.

To remove the 11A52 from a mainframe, set the mainframe ON-STANDBY switch to STANDBY. Then pull the release latch (see Figure 1-1) to disengage the unit from the mainframe, and pull the 11A52 straight out of the plug-in compartment.

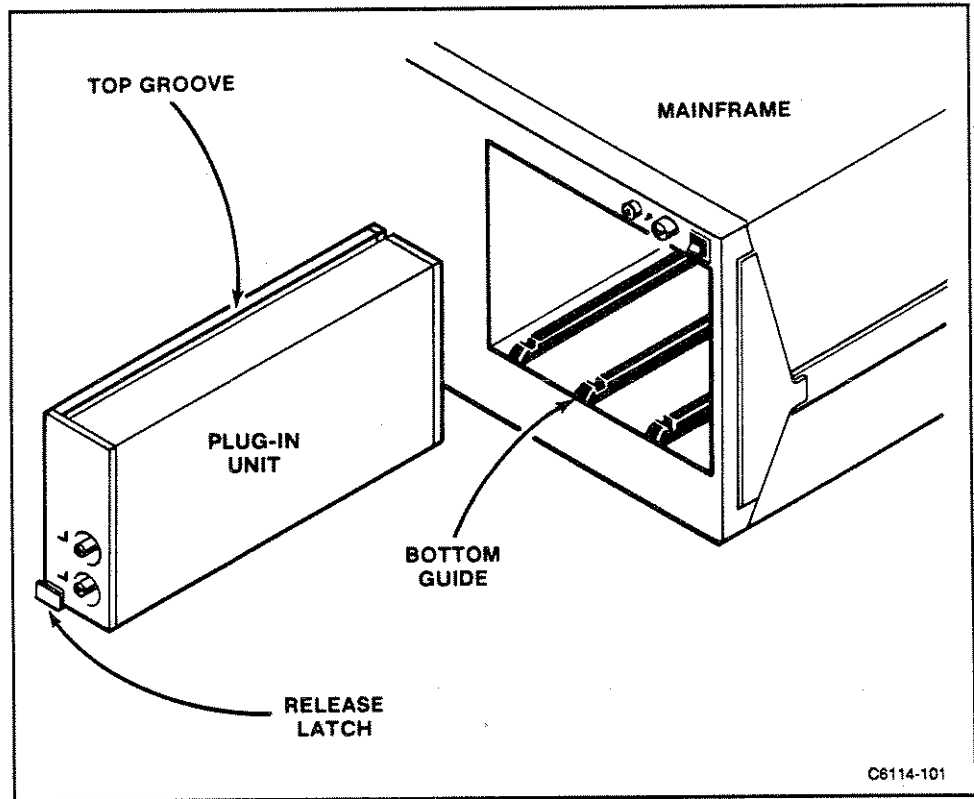

Figure 1-1. Installing a plug-in unit in a mainframe oscilloscope.

Instrument Options

Option 25 includes two P6231 probes.

Packaging for Shipment

If this instrument is to be shipped by commercial transportation, we recommend that it be packaged in the original manner. The original carton and packaging material should be saved and reused for this purpose.

NOTE

Package and ship plug-in units and mainframes separately.

If the 11A52 is to be shipped to a Tektronix Service Center for service or repair, attach a tag to the instrument. On the tag, include the following information:

- Name and address of the instrument owner;
- Name of a person at your firm who can be contacted about the instrument;
- Complete instrument type and serial number; and
- A description of the service required.

If the original package is not available or is not fit for use, package the 11A52 as follows:

1. Obtain a corrugated cardboard carton with inside dimensions at least six inches greater than the instrument dimensions. Use a carton with a test strength of at least 200 pounds.
2. Fully wrap the 11A52 with anti-static sheeting, or its equivalent, to protect the finish.
3. Cushion the 11A52 on all sides by tightly packing dunnage or urethane foam between the carton and the instrument. Allow three inches of packing on each side.
4. Seal the carton with shipping tape or with industrial staples.
5. Mark the address of the Tektronix Service Center and your return address on the carton in one or more prominent places.

Section 2

Operating the 11A52 in 11300-series Mainframes

Display On/Off

The 11A52 has only two front-panel controls—the display on/off buttons. Pressing a display on/off button will cause its channel, and signal, to be displayed or removed from the display (the function toggles). When a channel is displayed, its label (CH 1 or CH 2) will be lighted.

Selecting Coupling, HF Limit, and Impedance

To select the desired setting for Coupling, HF Limit, or Impedance, proceed as follows:

- 1a. If no trace is displayed, press any plug-in display on/off button to create a trace.
- 1b. If several traces are displayed, select a channel by touching the desired trace description at the top of the CRT.
2. On the 11301 and 11302 oscilloscopes press any VERTICAL button once—OFFSET, SIZE, or POS. On the 11301A and 11302A oscilloscopes press any VERTICAL button twice. This will cause the Control Menu to be displayed.
3. Touch the desired function's label. Successive touches will change its state.

Other Functions

Other 11A52 functions are controlled within the 11300-series mainframe, and their operation is described in detail in Section 2, *Operating Information*, of the *11301 and 11302 User Reference Manual*, and the *11301A and 11302A User Reference Manual*. Table 2-1 shows where to find information about operating the 11A52.

TABLE 2-1
Functions and Where They are Described

Function	Described Under Heading
Offset, Size (V/div)	Waveform Acquisition: Vertical Menu; or for X-Y Display: Horizontal Menu.
Display \pm Ch 1, \pm Ch 2	Waveform Acquisition: Vertical Menu.
Polarity	Waveform Acquisition: Waveform Menu.
Trigger Selection and Polarity	Trigger Source Major Menu.

Position and Offset

All 11300-series oscilloscopes assign position control to the Left Control knob by pressing the VERTICAL POSition button once. The Vertical Position control moves the trace as a user convenience. For example, when displaying multiple channels it may be desirable to set ground references for each trace on separate graticule lines. Position is a screen-related function; its units are divisions.

The offset function, accessed by pressing the VERTICAL OFFSET button, subtracts a precision voltage from the input signal. Changing offset moves the trace just as does the position control. However, if the deflection factor is subsequently changed, the effect is different.

Changing the sensitivity will increase or decrease the size of the display around some screen level (e.g., two divisions above graticule center) set by the Position control. When using a sensitivity that makes the displayed waveform larger than the screen, the Offset control is used to bring the waveform area of interest to the screen location established by the Position control.

The Position control has a range of plus and minus four divisions from graticule center, but the Offset control has a range defined in volts. Offset can be as much as 1000 divisions at 1 mV/division. The Offset control range is one volt for all sensitivities from 1 mV to 99.5 mV/division, but increases to 10 volts for sensitivities from 100 mV to 995 mV/division. For sensitivities from 1 volt to 10 volts/division, Offset control range increases to 100 volts.

The 11A52 attempts to maintain the user-selected offset voltage even though the offset range changes due to a change in sensitivity. An offset voltage of less than one volt will be maintained as the sensitivity is changed over the entire range of 1 mV/division to 10 V/division. A selected offset of greater than one volt is beyond the offset range for the most sensitive settings and will be reset to one volt when the sensitivity is increased to any value between 99.5 mV and 1 mV/division.

HF Limit

Two four-pole (24 dB/octave) bandwidth limit (low-pass) filters are available for each 11A52 channel. The purpose of these filters is to reduce the amplitude of unwanted noise or interference occurring at frequencies above the frequency of the signal of interest. The user has a choice of cut-off (-3 dB) frequencies, either 20 MHz or 100 MHz, independently for each channel. The trigger, auxiliary trigger, and display signal bandwidths for a channel are always the same. The auxiliary trigger is the signal sent to the right plug-in compartment.

DC Circuit Loading

AC coupling capacitors are connected differently in the 11A52 and 11A71 than in the 11A32 and 11A34. Figure 2-1 shows this difference.

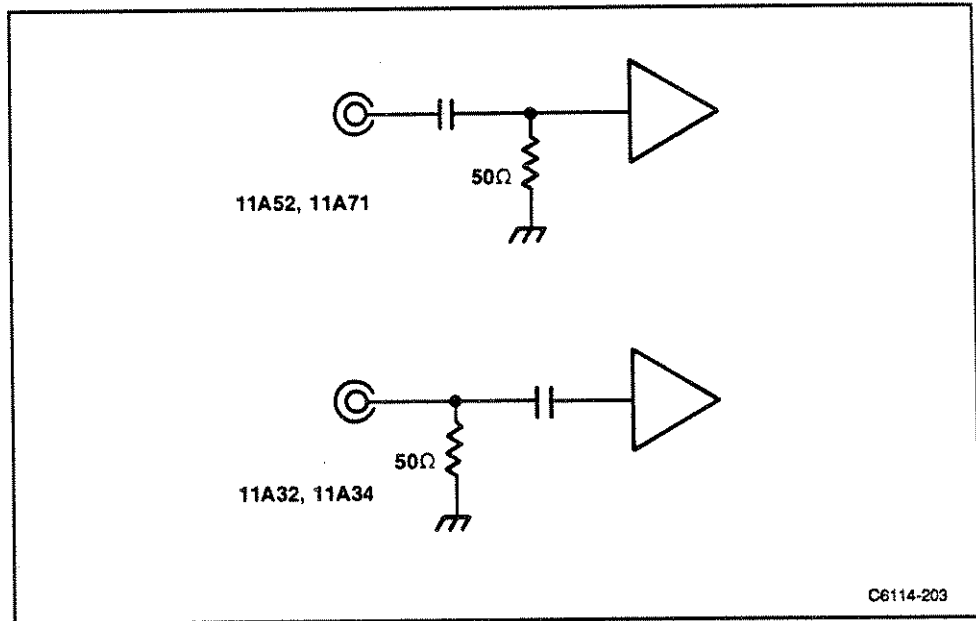

Figure 2-1. Location of AC coupling capacitors in plug-in amplifiers.

In the 11A52 and 11A71, the coupling capacitor isolates both the input termination and the amplifier from external DC voltages. Avoid inadvertently selecting DC Coupling if your circuit will be damaged by the resulting 50 Ω termination to ground. See Caution below. The coupling capacitor in the 11A32 and 11A34 does not isolate the input termination from external DC voltages.

When AC Coupling is selected, the 11A52 coupling capacitor allows the user to test low-impedance circuits that are elevated in potential by up to 100 volts DC without loading the circuit at DC. Passive attenuating probes such as the P6056 or P6057 eliminate the DC loading and lower the low-frequency -3 dB point.

In the Off coupling mode the AC coupling capacitor precharges in about three seconds to the average DC voltage of the circuit being tested. Always use the Off mode when connecting the 11A52 input to a circuit that may have more than 25 volts (the 11A52 peak input voltage rating) present. This will precharge the coupling capacitor. Wait a few seconds before selecting AC coupling.

The coupling capacitor is discharged upon removal of the external circuit.

CAUTION

Always use caution when working with voltages in excess of 25 volts.

When the input coupling is set to DC a 50 Ω termination resistance is connected directly from the 11A52 input connector to ground. Take care that the circuit connected to the 11A52 input will not be damaged by the 50 Ω load.

Two ways of unintentionally invoking DC Coupling in the 11A52 are:

- 1. Invoking Autoset, because the Autoset process starts by searching for a DC voltage, and*
- 2. Recalling a stored control setting that dictates DC Coupling.*

Switching coupling to Dc when more than 25 V is present at the 11A52 input will exceed the peak input voltage specification, and may damage the 11A52 input relay. A damaged relay could cause an error in calibration.

Adding Waveforms

NOTE

Before adding waveforms, check that each channel's display is independently on screen.

The 11300-series oscilloscopes allow the addition of any two channels. That is, one channel may be added to a channel from another plug-in unit. A simple restriction applies. Each channel must be in its linear operating range. This is assured if each channel separately is within the screen area before addition.

Those portions of a trace which are off screen will not be valid when brought back on screen using another channel's input signal or Offset control. This general restriction applies to any dual-channel oscilloscope.

Overdrive Recovery

Overdrive occurs when any 11A52 channel is driven out of its linear range of approximately ± 15 divisions.

The 11A52 has extraordinarily good overdrive recovery, and this feature may be used to greatly extend measurement resolution. For example, suppose a signal changes from -1.7 V to $+0.8$ V in 1 ns. The 11A52 could be used to determine if the signal stabilized immediately at $+0.8$ V or if perhaps had some small aberration following the transition. By setting the 11A52 offset to $+0.8$ V and the sensitivity to 1 mV/division, aberrations of just 0.1% of the original transition will be 2.5 divisions in amplitude (0.1% of 2.5 V is 2.5 mV or 2.5 divisions at 1 mV/division).

Any amplifier will ultimately reach an equilibrium value after an input step (although its accuracy will determine how far that equilibrium value is from the correct value). The 11A52's ability to settle quickly to within a very small fraction of its equilibrium value is exceptional. The time it takes the 11A52 to settle to within a stated fraction of the equilibrium value is its overdrive recovery time.

Measuring the overdrive recovery time of an 11A52 takes some care and can lead to some surprising results. An interesting experiment is to use a very flat pulse generator, such as the Tektronix PG 506, to pulse the 11A52. Connect the generator's fast-rise output to the 11A52 input through a short (one foot or less) coaxial cable. Adjust the pulse amplitude to 1 volt. Set the 11A52 sensitivity to 1 mV/division. Each division now represents 0.1% of the input signal. Trigger the oscilloscope and observe the recovery of the 11A52 using 50 ns/division sweep rate. Now increase the cable length by about three feet (for example, use a 42-inch length of RG-58 cable, Tektronix part 012-0057-01) and observe the new waveform.

The waveform change is due to skin effect loss in the longer cable. What is surprising is that the skin effect loss persists for over 200 ns even though the total cable delay is only 5 ns. At 400 ns the loss is still 0.02%. The only way to eliminate all skin effect loss is to connect the PG506 directly to an 11A52 input connector.

This experiment shows the importance of using a short cable to test overdrive recovery.

50 Ω Overload

When the input voltage substantially exceeds 5 Vrms, the 11A52 will sense the overload and disconnect the 50 Ω input termination. The mainframe will display the message:

Input channel N overload on LEFT/CENTER/RIGHT plug-in

where N = 1 or 2.

To reconnect the 50 Ω input termination, first correct the overload condition, then select AC or DC from the Coupling menu.

Active Probes

Using an active probe, such as the P6231, eliminates the possibility of AC Coupling. Coupling options available when using such a probe are Off and DC.

Probe ID

The Probe ID section of the Utility Menu is the means of selecting how any 11300-series oscilloscope responds to an ID button-push of recommended probes. All, or some combination of the following operations may be set to start in response to probe ID buttons. To display the Utility Menu, press the front-panel UTILITY button (once on 11301 or 11302 oscilloscopes, twice on 11301A or 11302A oscilloscopes). For details, see the *Probe ID* section of the *Waveform Acquisition* subsection in the mainframe User Reference manual.

Pressing the probe ID button can initiate one or more of the following operations:

1. **Present a new display, or if that channel is already displayed, select the existing trace.** Pressing the ID button of a probe connected to an undisplayed left or center compartment channel will cause that channel to be displayed, unless doing so would exceed the maximum number of traces. Unlike the 11A52 display on/off button, pressing the probe ID button a second time will not remove the display.

Probe ID button-presses for displayed channels will do two things: a) select the trace(s) using this channel, and b) momentarily brighten all traces using this channel.

2. **Stored settings can be sequentially recalled.** Pressing the probe ID button can cause a sequential recall of stored settings. The stored settings feature must be enabled using the Probe ID Utility menu. Settings must be stored as explained under *STORE/RECALL Major Menu* in the *11301 and 11302 User Reference Manual*, or the *11301A and 11302A User Reference Manual*.
3. **The mainframe can Autoset to accommodate the input signal introduced by the probe.** The Autoset feature can be enabled or disabled using the Probe ID Utility menu. Autoset is the automatic setup of vertical deflection factor, triggering, and sweep speed to produce a meaningful display, e.g., two to five divisions of vertical deflection and two to five repetitions of the input signal. For more information, refer to *Autoset* in the *11301 and 11302 User Reference Manual*, or the *11301A and 11302A User Reference Manual*.
4. **The mainframe can automatically measure the selected trace.** Automatic measurements of the selected trace can be initiated by pressing a probe ID button. The Automatic Measurements feature can be enabled or disabled using the Probe ID Utility menu. Such measurements are peak-to-peak, maximum, middle, and minimum voltages; frequency, period, pulse width, and duty cycle. For full information about automatic measurements, see *Measure* in the *11301 and 11302 User Reference Manual*, or the *11301A and 11302A User Reference Manual*.
5. **An interrupt to the GPIB and RS-232-C can be generated.** Pressing a probe ID button will cause the mainframe to produce an SRQ to the GPIB and RS-232-C. For more information, refer to the *GPIB/RS-232-C* section of the *11301 and 11302 User Reference Manual*, or the *11301A and 11302A User Reference Manual*.

Front-Panel Error Messages

- Message:** Internal DAC overflow on channel N of LEFT, CENTER, or RIGHT plug-in unit, where N = 1 or 2.
- Cause:** Some plug-in unit detected that a requested setting overflowed an internal DAC. Such overflow usually indicates defective hardware. In this situation, the plug-in unit sets the DAC to the limit nearer the requested setting.
- Message:** Bad Level 2 probe checksum on channel N of LEFT, CENTER, or RIGHT plug-in unit, where N = 1 or 2.
- Cause:** Some plug-in unit detected that a Level 2 TEKPROBE had failed or been improperly connected.
- Message:** Requested Coupling not available on Channel N of LEFT, CENTER, or RIGHT plug-in unit, where N = 1 or 2.
- Cause:** Some plug-in unit had a Level 2 probe, capable of offset, connected when either Autoset or Probe Cal was invoked.

GPIB and RS-232-C Commands and Syntax

The following commands set parameters of a specified channel.

TABLE 2-2
Channel Parameter Commands
(for 11300-series Oscilloscopes)

Header	Link	Argument		
CH<L1, L2, C1, C2, R1 or R2>	COUPLING:	AC DC OFF		
	OFFSET: ¹	<NR>		
	Volts/div	Offset Range	Resolution via RS-232-C, GPIB, or Numeric Entry	Step Size via front-panel Control knob
	1 mV to 99.5 mV 100 mV to 995 mV 1 V to 10 V	±1 V ±10 V ±100 V	25E-6 250E-6 2.5E-3	Coarse: 0.25 div. Fine: 0.025 div.
	BWHI:	<NR> ≤24E6 >24E6 to ≤120E6 >120E6	HF Limit 20E6 100E6 350E6, 11301 400E6, 11302	
	IMPEDANCE:	<NR> <1E3	Impedance 50	
	SENSITIVITY: ¹	Sensitivity 1E-3 to 1.99E-3 2E-3 to 4.98E-3 5E-3 to 9.95E-3 10E-3 to 19.9E-3 20E-3 to 49.8E-3 50E-3 to 99.5E-3 100E-3 to 199E-3 200E-3 to 498E-3 500E-3 to 995E-3 1 to 1.99 2 to 4.98 5 to 10	Resolution (step size) 10E-6 20E-6 50E-6 100E-6 200E-6 500E-6 1E-3 2E-3 5E-3 10E-3 20E-3 50E-3	
	UNITS:	<qstring> (query only) The 11A52 answers a Units query with a units status message, which indicates the units of conversion of a probe connected to its Ch N input.		

¹ The numbers listed are those available at the input connectors. Connecting an attenuating probe will change the value by the probe attenuating factor (e.g., a 10X probe will change the value ±10 to ±100).

Table 2-2 (cont)
Chanel Parameter Commands
(for 11300-series Oscilloscopes)

Header	Link	Argument
CH<L1, L2, C1, C2, R1 or R2> (cont)	PROBE:	<p><qstring> (query only)</p> <p>This query-only link returns a quoted string indicating what type of probe is connected to the input. If a Level 1 TEKPROBE is connected, the query response is "Level 1." If a Level 2 TEKPROBE is connected, the query response is "Level 2/<probe_type>/ <serial_number>." When neither Level 1 nor Level 2 TEKPROBE is connected, the query response is "NONE."</p>

Legend

CH<L1, L2, C1, C2, R1 or R2>	L, C, and R mean Left, Center, and Right plug-in compartments; 1 and 2 mean Channel 1 and Channel 2, respectively.
COUPLING	Sets the specified channel input coupling.
OFFSET	Sets the specified channel offset.
BWHI	Sets the HF Limit (bandwidth) of the specified channel.
NRx	Numeric representation.
IMPEDANCE	Sets the input impedance of the specified channel.
SENSITIVITY	Sets the deflection factor of the specified channel. Sensitivity is a channel-specific command which does not apply to compound waveforms.
qstring	Quoted string data.

Section 3

Operating the 11A52 in 11400-series Mainframes

Display On/Off

The 11A52 has only two front-panel controls—the display on/off buttons. Pressing a display on/off button will cause its channel, and signal, to be displayed or removed from the display (the function toggles). When a channel is displayed, its label (CH 1 or CH 2) will be lighted.

Other Functions

All other 11A52 functions are controlled within the 11401 or 11402 oscilloscope, and their operation is described in the *11401 and 11402 User Reference manual*. Table 3-1 shows where to find information about operating the 11A52.

TABLE 3-1
Functions and Where They are Described

Function	Described under Heading ¹
Vertical Offset	Vertical Size and Position.
Vertical Size (sensitivity)	Vertical Size and Position.
Coupling (AC, DC, Off)	Selecting Channel Coupling.
Select 11A52 Channel	Displaying Waveforms (an alternative to pressing the 11A52 display on/off button).
Input Impedance	Selecting Channel Input Impedance.
Offset	Vertical Position.
BW Limit	Selecting Channel Bandwidth Limit.
Display Polarity	Vertical Description.

¹Under Waveform Control in Section 2, *Operating Information*.

Vertical Offset

The 11401 and 11402 oscilloscopes use offset to position the trace on the screen. In YT (signal vs. time) mode offset determines vertical position, but when a plug-in unit provides the X component of an XY display, offset controls horizontal position.

Offset is an input-signal-related-control, and its units are those of the input signal—usually volts.

Offset subtracts a precision voltage from the input signal. To access the offset function, touch the double-ended arrow at the left edge of the screen. Control of offset is then assigned to the Lower Control knob.

In the 11401 and 11402, changing the vertical deflection factor magnifies or compresses the displayed signal about screen center. Therefore, to examine a portion of the input signal in greater detail, use Vert Offset (the Lower Control knob) to position the area of interest to screen center. Next, use the Vert Size (the Upper Control knob) to adjust the display to the size needed for detailed examination.

BW Limit

Two four-pole (24 dB/octave) bandwidth limit (low-pass) filters are available for each 11A52 channel. The purpose of these filters is to reduce the amplitude of unwanted noise or interference occurring at frequencies above the frequency of the signal of interest. The user has a choice of cut-off (-3 dB) frequencies, either 20 MHz or 100 MHz, independently for each channel. The trigger, auxiliary trigger, and display signal bandwidths for a channel are always the same. The auxiliary trigger is the signal sent to the right plug-in compartment.

DC Circuit Loading

AC coupling capacitors are connected differently in the 11A52 and 11A71 than in the 11A32 and 11A34. Figure 3-1 shows this difference.

In the 11A52 and 11A71, the coupling capacitor isolates both the input termination and the amplifier from external DC voltages. Avoid inadvertently selecting DC coupling if your circuit will be damaged by the resulting 50 Ω termination to ground. See Caution below. The coupling capacitor in the 11A32 and 11A34 does not isolate the input termination from external DC voltages.

When AC Coupling is selected, the 11A52 coupling capacitor allows the user to test low-impedance circuits that are elevated in potential by up to 100 volts DC without loading the circuit at DC. Passive attenuating probes such as the P6056, or P6057 eliminate the DC loading and lower the low-frequency -3 dB point.

In the Off Coupling mode the AC coupling capacitor precharges in about three seconds to the average DC voltage of the circuit being tested. Always use the Off mode when connecting the 11A52 input to a circuit that may have more than 25 volts (the 11A52 peak input voltage rating) present. This will precharge the coupling capacitor. Wait a few seconds before selecting AC Coupling.

The coupling capacitor is discharged upon removal of the external circuit.

CAUTION

Always use caution when working with voltages in excess of 25 volts.

When the input coupling is set to DC, a 50 Ω termination resistance is connected directly from the 11A52 input connector to ground. Take care that the circuit connected to the 11A52 input will not be damaged by the 50 Ω load.

Two ways of unintentionally invoking DC coupling in the 11A52 are:

- 1. Invoking Autoset, because the Autoset process starts by searching for a DC voltage, and*
- 2. Recalling a stored control setting that dictates DC Coupling.*

Switching coupling to DC when more than 25 V is present at the 11A52 input will exceed the peak input voltage specification, and may damage the 11A52 input relay. A damaged relay could cause an error in calibration.

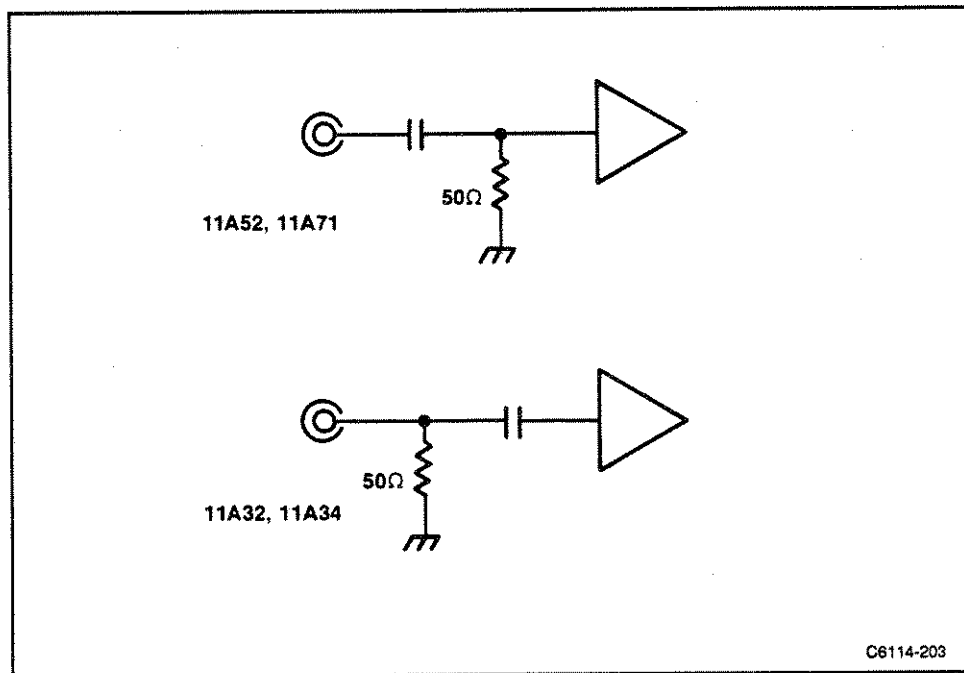

Figure 3-1. Location of AC coupling capacitors in plug-in amplifiers.

Adding and Subtracting Waveforms

The 11401 and 11402 mainframes do not allow the addition or subtraction of live waveforms without restriction. The reason for this lies in the manner in which samples are taken and used by the mainframe. Each plug-in compartment has an associated sampler in the 11401 or 11402. Samples are taken simultaneously by each sampler. A channel from one plug-in unit may be added to or subtracted from that of another plug-in unit accurately by virtue of this simultaneity. Thus noise and other signals unrelated to the trigger will be canceled when channels in different plug-in units are subtracted.

Signals from different channels within a plug-in unit are sampled at different times. Signals that are entirely repetitive and related to the trigger signal may be successfully added or subtracted in spite of this. However, signals that are not repetitive or related to the trigger will not be sampled at the same time, and may not be displayed correctly. Therefore it is preferable that signals to be added or subtracted be selected from different plug-in compartments.

The best common-mode rejection is obtained with a differential amplifier plug-in unit because its hardware subtracts the signals at its two inputs, passing only the result to the mainframe.

Even when using channels from different plug-in compartments, the following two problems limit the accuracy of sums or differences:

1. Each waveform in memory is constantly being updated, and therefore consists of some points that are older than others. Although samples may be taken simultaneously, there is a chance that a correct sample may be replaced in memory with a newer value before the waveform is processed and displayed.
2. Delay differences between channels of different plug-in units due to probe cable length differences are normally removed by deskewing the probes and the associated amplifier channel. Samples are still taken simultaneously, but the display is manipulated to remove time differences. Signals correlated to the trigger signal are correctly restored to their proper time relationship, but there is no way for signals unrelated to the trigger to be corrected with this deskewing technique. High-frequency rejection of signals unrelated to the trigger is not improved by deskewing.

The solution to both problems is to invoke averaging. The averaging process suppresses all signals and noise unrelated to the trigger.

Overdrive Recovery

Overdrive occurs when any 11A52 channel is driven out of its linear range of approximately ± 15 divisions.

The 11A52 has extraordinarily good overdrive recovery, and this feature may be used to greatly extend measurement resolution. For example, suppose a signal changes from -1.7 V to $+0.8$ V in 1 ns. The 11A52 could be used to determine if the signal stabilized immediately at $+0.8$ V or if perhaps had some small aberration following the transition. By setting the 11A52 offset to $+0.8$ V and the sensitivity to 1 mV/division, aberrations of just 0.1% of the original transition will be 2.5 divisions in amplitude (0.1% of 2.5 V is 2.5 mV or 2.5 divisions at 1 mV/division).

Any amplifier will ultimately reach an equilibrium value after an input step (although its accuracy will determine how far that equilibrium value is from the correct value). The 11A52's ability to settle quickly to within a very small fraction of its equilibrium value is exceptional. The time it takes the 11A52 to settle to within a stated fraction of the equilibrium value is its overdrive recovery time.

Measuring the overdrive recovery time of an 11A52 takes some care and can lead to some surprising results. An interesting experiment is to use a very flat pulse generator, such as the Tektronix PG 506, to pulse the 11A52. Connect the generator's fast-rise output to the 11A52 input through a short (one foot or less) coaxial cable. Adjust the pulse amplitude to 1 volt. Set the 11A52 sensitivity to 1 mV/division. Each division now represents 0.1% of the input signal. Trigger the oscilloscope and observe the recovery of the 11A52 using 50 ns/division sweep rate. Now increase the cable length by about three feet (for example, use a 42-inch length of RG-58 cable, Tektronix part 012-0057-01) and observe the new waveform.

The waveform change is due to skin effect loss in the longer cable. What is surprising is that the skin effect loss persists for over 200 ns even though the total cable delay is only 5 ns. At 400 ns the loss is still 0.02%.

This experiment shows the importance of using a short cable to test overdrive recovery.

50 Ω Overload

When the input voltage substantially exceeds 5 Vrms, the 11A52 will sense the overload and disconnect the 50 Ω input termination. The mainframe will display the message:

Input channel N overload on LEFT/CENTER/RIGHT plug-in

where N = 1 or 2.

To reconnect the 50 Ω input termination, first correct the overload condition, then select AC or DC from the Coupling menu.

Active Probes

Using an active probe, such as the P6231, eliminates the possibility of AC Coupling. Coupling options available when using such a probe are Off and DC.

Probe ID

The **Probe ID function** is the means of selecting how the 11401 or 11402 responds to an ID button-push of recommended probes. (The **Probe ID Function** is part of the **Probes** pop-up menu, which is selected from the Utilities major menu.) All, or some combination of the following operations may be set to start in response to probe ID buttons. To display the Utility major menu, press the front-panel UTILITY button. For details, see the *Probe Calibration and ID Function* section of the Utilities subsection in the *11401 and 11402 User Reference Manual*.

Pressing the probe ID button can initiate one of the following operations:

1. If the **Probe ID function** (in the **Probes** pop-up menu of the Utility major menu) is set to **Sequence Settings**, the next front-panel setting will be recalled. If the **Probe ID Function** is not set to **Sequence Settings**, then operation 2 or 3, which involve a new waveform and waveform selection, will occur.

If the Sequence Settings option is enabled, front-panel settings can be sequentially recalled via the Probe ID function. The settings must be stored as explained under *Storing and Recalling Waveforms* in the *11401 and 11402 User Reference Manual*.

2. If the **Probe ID Function** (in the **Probes** pop-up menu of the Utility major menu) is set to **Waveform Select/New Wfm**, a waveform will be selected. Figure 3-2 shows the sequence of decisions used to select a new waveform.
3. If the Probe ID Function is set to **Wfm Select/New Wfm & AutoSet**, then the decisions shown in Figure 3-2 will be made, and the resulting selected waveform is autoselected.

Events 1, 2, and 3 are mutually exclusive. Event 4 may be combined with any one of them.

4. If the IDPROBE SRQMASK is enabled, an appropriate event will be returned to the GPIB and RS-232-C ports.

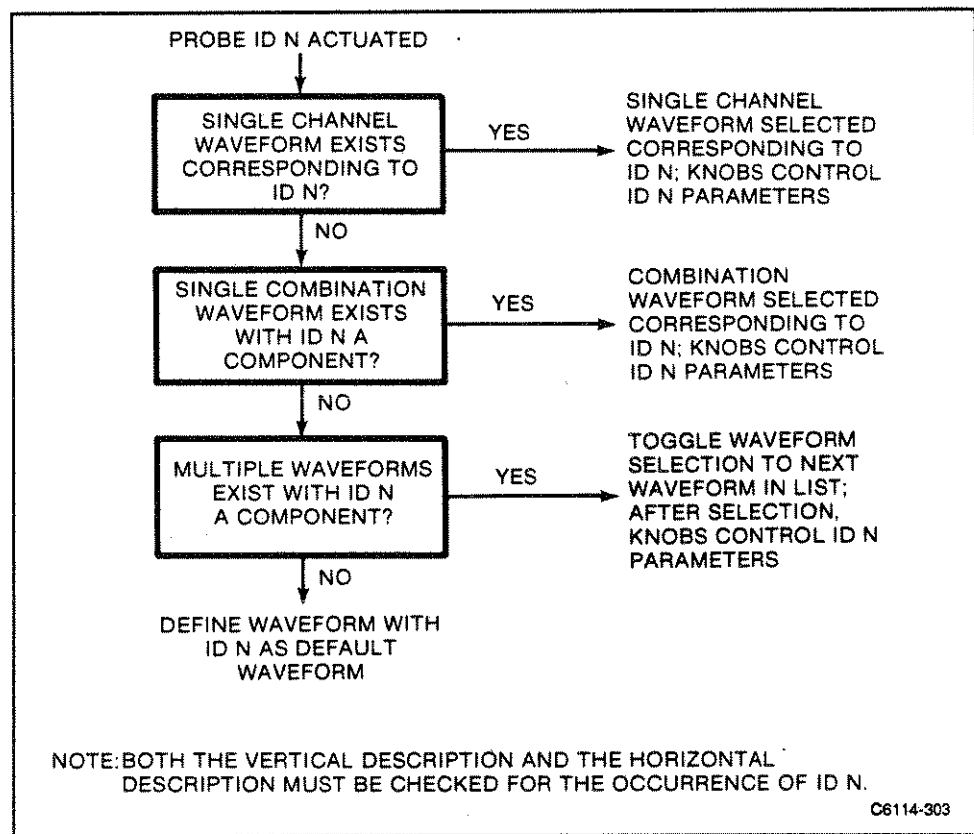

Figure 3-2. Sequence of decisions used to select a new waveform in response to probe ID button.

Front-Panel Error Messages

Message: Internal DAC overflow on channel N of LEFT, CENTER, or RIGHT plug-in unit, where N = 1 or 2.

Cause: Some plug-in unit detected that a requested setting overflowed an internal DAC. Such overflow usually indicates defective hardware. In this situation, the plug-in unit sets the DAC to the limit nearer the requested setting.

Message: Bad Level 2 probe checksum on channel N of LEFT, CENTER, or RIGHT plug-in unit, where N = 1 or 2.

Cause: Some plug-in unit detected that a Level 2 TEKPROBE had failed or been improperly connected.

GPIB and RS-232-C Commands and Syntax

The following commands set parameters of a specified channel.

Table 3-2
Channel Parameter Commands
(for 11400-series Oscilloscopes)

Header	Link	Argument		
CH<L1, L2, C1, C2,R1, or R2>	COUPLING:	AC DC OFF		
	OFFSET: ¹	<NRx>		
	Volts/div	Offset Range	Resolution via RS-232-C, GPIB, or Numeric Entry	Step Size via front-panel Control knob
	1 mV to 99.5 mV 100 mV to 995 mV 1 V to 10 V	±1 V ±10 V ±100 V	25E-6 250E-6 2.5E-3	Coarse: 0.25 div. Fine: 0.025 div.
	BW:	<NRx> ≤24E6 >24E6 to ≤120E6 >120E6	Bandwidth 20E6 100E6 500E6, 11401 600E6, 11402	
	IMPEDANCE:	<NRx> <1E3	Impedance 50	
	SENSITIVITY: ¹	Sensitivity 1E-3 to 1.99E-3 2E-3 to 4.98E-3 5E-3 to 9.95E-3 10E-3 to 19.9E-3 20E-3 to 49.8E-3 50E-3 to 99.5E-3 100E-3 to 199E-3 200E-3 to 498E-3 500E-3 to 995E-3 1 to 1.99 2 to 4.98 5 to 10	Resolution (step size) 10E-6 20E-6 50E-6 100E-6 200E-6 500E-6 1E-3 2E-3 5E-3 10E-3 20E-3 50E-3	
	UNITS:	<qstring> (query only) The 11A52 answers a Units query with a units status message, which indicates the units of conversion of a probe connected to its Ch N input.		

¹The numbers listed are those available at the input connectors. Connecting an attenuating probe will change the value by the probe attenuating factor (e.g., a 10X probe will change the value ±10 to ±100).

Table 3-2 (cont)
Channel Parameter Commands
(for 11400-series Oscilloscopes)

Header	Link	Argument
CH<L1, L2, C1, C2, R1, or R2>	PROBE:	<qstring> (query only) This query-only link returns a quoted string indicating what type of probe is connected to the input. If a Level 1 TEKPROBE is connected, the query response is "Level 1." If a Level 2 TEKPROBE is connected, the query response is "Level 2/<probe_type>/ <serial_number>." When neither Level 1 nor Level 2 TEKPROBE is connected, the query response is "NONE."

Legend

CH<L1, L2, C1, C2, R1 or R2>	L, C, and R mean Left, Center, and Right plug-in compartments; 1 and 2 mean Channel 1 and Channel 2.
COUPLING	Sets the specified channel input coupling.
OFFSET	Sets the specified channel offset.
BW	Sets the HF Limit (bandwidth) of the specified channel.
NRx	Numeric representation.
IMPEDANCE	Sets the input impedance of the specified channel.
SENSITIVITY	Sets the deflection factor of the specified channel. Sensitivity is a channel-specific command which does not apply to compound waveforms.
qstring	Quoted string data.

Section 4

Specification

Performance Conditions

The specifications that follow apply when the instrument is in the condition of Enhanced Accuracy. Enhanced Accuracy is initiated by pushing the E A button on the specific host mainframe after the system has reached thermal equilibrium, which requires 20 minutes warmup. Enhanced Accuracy is indicated on the CRT display and remains in effect as long as the mainframe internal temperature change is less than 5° C from the temperature at which the calibration was performed. When the 5° C change does occur the accuracy condition becomes Not-Enhanced. In the Not-Enhanced condition those Characteristics that are temperature sensitive may not remain within the limits of these specifications. The instrument specifications are valid at an ambient temperature of 0° to 50° C, unless otherwise stated.

TABLE 4-1
Electrical Characteristics

Circuit	Characteristic	Performance Requirement																	
Display Deflection Factor (Sensitivity)	Calibrated Range	1 mV to 10 V/div.																	
	Enhanced DC Accuracy ¹ , either polarity, any HF Limit of 11A52 in 11300-series Mainframes, with on-screen cursors.																		
	Without Probes																		
	<table border="1"> <thead> <tr> <th>Volts/Div</th> <th>ΔV DC Acc.</th> <th>DC Balance</th> <th>DC Offset Acc.</th> </tr> </thead> <tbody> <tr> <td>1 mV to 99.5 mV</td> <td>$\pm(1.0\% + 0.04 \text{ div})$</td> <td>$\pm(0.20 \text{ mV} + 0.13 \text{ div})$</td> <td>$\pm(0.15\% + 0.4 \text{ mV})$</td> </tr> <tr> <td>100 mV to 995 mV</td> <td>$\pm(1.0\% + 0.04 \text{ div})$</td> <td>$\pm(2 \text{ mV} + 0.13 \text{ div})$</td> <td>$\pm(0.20\% + 4 \text{ mV})$</td> </tr> <tr> <td>1 V to 10 V</td> <td>$\pm(1.0\% + 0.04 \text{ div})$</td> <td>$\pm(20 \text{ mV} + 0.13 \text{ div})$</td> <td>$\pm(0.20\% + 40 \text{ mV})$</td> </tr> </tbody> </table>	Volts/Div	ΔV DC Acc.	DC Balance	DC Offset Acc.	1 mV to 99.5 mV	$\pm(1.0\% + 0.04 \text{ div})$	$\pm(0.20 \text{ mV} + 0.13 \text{ div})$	$\pm(0.15\% + 0.4 \text{ mV})$	100 mV to 995 mV	$\pm(1.0\% + 0.04 \text{ div})$	$\pm(2 \text{ mV} + 0.13 \text{ div})$	$\pm(0.20\% + 4 \text{ mV})$	1 V to 10 V	$\pm(1.0\% + 0.04 \text{ div})$	$\pm(20 \text{ mV} + 0.13 \text{ div})$	$\pm(0.20\% + 40 \text{ mV})$		
	Volts/Div	ΔV DC Acc.	DC Balance	DC Offset Acc.															
1 mV to 99.5 mV	$\pm(1.0\% + 0.04 \text{ div})$	$\pm(0.20 \text{ mV} + 0.13 \text{ div})$	$\pm(0.15\% + 0.4 \text{ mV})$																
100 mV to 995 mV	$\pm(1.0\% + 0.04 \text{ div})$	$\pm(2 \text{ mV} + 0.13 \text{ div})$	$\pm(0.20\% + 4 \text{ mV})$																
1 V to 10 V	$\pm(1.0\% + 0.04 \text{ div})$	$\pm(20 \text{ mV} + 0.13 \text{ div})$	$\pm(0.20\% + 40 \text{ mV})$																
With P6231 Probe calibrated from 11300-series Calibrator output																			
<table border="1"> <thead> <tr> <th>Volts/Div</th> <th>ΔV DC Acc.</th> <th>DC Balance</th> <th>DC Offset Acc.</th> </tr> </thead> <tbody> <tr> <td>10 mV to 995 mV</td> <td>$\pm(1.1\% + 0.04 \text{ div})$</td> <td>$\pm(2 \text{ mV} + 0.13 \text{ div})$</td> <td>$\pm(0.15\% + 2 \text{ mV})$</td> </tr> <tr> <td>$\geq 1 \text{ V}$</td> <td>$\pm(1.2\% + 0.04 \text{ div})$</td> <td>$\pm(20 \text{ mV} + 0.13 \text{ div})$</td> <td>$\pm(0.15\% + 2 \text{ mV})$</td> </tr> <tr> <td>Probe Tip TC term</td> <td>100 ppm/° C</td> <td></td> <td></td> </tr> </tbody> </table>	Volts/Div	ΔV DC Acc.	DC Balance	DC Offset Acc.	10 mV to 995 mV	$\pm(1.1\% + 0.04 \text{ div})$	$\pm(2 \text{ mV} + 0.13 \text{ div})$	$\pm(0.15\% + 2 \text{ mV})$	$\geq 1 \text{ V}$	$\pm(1.2\% + 0.04 \text{ div})$	$\pm(20 \text{ mV} + 0.13 \text{ div})$	$\pm(0.15\% + 2 \text{ mV})$	Probe Tip TC term	100 ppm/° C					
Volts/Div	ΔV DC Acc.	DC Balance	DC Offset Acc.																
10 mV to 995 mV	$\pm(1.1\% + 0.04 \text{ div})$	$\pm(2 \text{ mV} + 0.13 \text{ div})$	$\pm(0.15\% + 2 \text{ mV})$																
$\geq 1 \text{ V}$	$\pm(1.2\% + 0.04 \text{ div})$	$\pm(20 \text{ mV} + 0.13 \text{ div})$	$\pm(0.15\% + 2 \text{ mV})$																
Probe Tip TC term	100 ppm/° C																		

¹ For absolute DC accuracy of single-point measurements using Offset, and the DC Offset Accuracy, DC Balance and ΔV DC Accuracy terms. Apply the ΔV DC Accuracy only to the difference between the Vertical Position setting and the measurement point.

TABLE 4-1 (cont.)
Electrical Characteristics

Circuit	Characteristic	Performance Requirement		
Display Deflection Factor (Sensitivity) (Cont)	Enhanced DC Accuracy ¹ , either polarity, any BW Limit, of 11A52 in 11401/11402 Mainframes.			
	Without Probes			
	Volts/Div	ΔV DC Acc.	DC Balance	DC Offset Acc.
	1 mV to 99.5 mV	$\pm(0.8\% + 0.01 \text{ div})$	$\pm(0.2 \text{ mV} + 0.10 \text{ div})$	$\pm(0.15\% + 0.4 \text{ mV})$
	100 mV to 995 mV	$\pm(0.8\% + 0.01 \text{ div})$	$\pm(2 \text{ mV} + 0.10 \text{ div})$	$\pm(0.20\% + 4 \text{ mV})$
	1 V to 10 V	$\pm(0.8\% + 0.01 \text{ div})$	$\pm(20 \text{ mV} + 0.10 \text{ div})$	$\pm(0.20\% + 40 \text{ mV})$
With P6231 Probe calibrated from 11401/11402 Calibrator output				
Volts/Div	ΔV DC Acc.	DC Balance	DC Offset Acc.	
10 mV to 995 mV	$\pm(0.9\% + 0.01 \text{ div})$	$\pm(2 \text{ mV} + 0.10 \text{ div})$	$\pm(0.15\% + 2 \text{ mV})$	
$\geq 1 \text{ V}$	$\pm(1.0\% + 0.01 \text{ div})$	$\pm(20 \text{ mV} + 0.10 \text{ div})$	$\pm(0.15\% + 2 \text{ mV})$	
Probe Tip TC term	100 ppm/ $^{\circ}$ C			
Coarse Resolution	1, 2, 5 sequence.			
Fine Resolution	Depends on Deflection Factor, as follows: Rotating the Fine control one increment will change the Deflection Factor by 1% of the next more-sensitive Coarse setting. For example, with deflection factor set to 198 mV, rotating the Fine control counterclockwise will cause this sequence of sensitivities: 199 mV, 200 mV, 202 mV, etc. Rotating the Fine control clockwise from 204 mV/div will cause the reverse sequence (202 mV, 200 mV, 199 mV, etc.).			

¹ For absolute DC accuracy of single-point measurements using Offset, and the DC Offset Accuracy, DC Balance and ΔV DC Accuracy terms. Apply the ΔV DC Accuracy only to the difference between the Vertical Position setting and the measurement point.

TABLE 4-1 (cont.)
Electrical Characteristics

Circuit	Characteristic	Performance Requirement				
Display Offset	Accuracy	See <i>Deflection Factor Accuracy</i> , which precedes this characteristic.				
	Range, Resolution depend on Deflection Factor, as follows:					
	Between 1 mV and 99.5 mV/div.	±1 V. Coarse and fine resolution are 0.25 div. (250 μV) and 0.025 div. (25 μV), respectively.				
	Between 0.1 V and 0.995 V/div.	±10 V. Coarse and fine resolution are 0.25 div. (2.5 mV) and 0.025 div. (250 μV), respectively.				
	Between 1 V and ±10.0 V/div.	±100 V. Coarse and fine resolution are 0.25 div. (25 mV) and 0.025 div. (2.5 mV) respectively.				
Display Frequency Response (0° to + 35° C)	High Frequency Limit, (-3 dB point) and Calculated Rise Time of Display, Auxiliary, & Trig signals	Type of Mainframe				
		Volts/Division	11301(A)	11302(A)	11401	11402
		≥10 mV	350 MHz 1.0 ns	400 MHz 0.9 ns	500 MHz 0.7 ns	600 MHz 0.6 ns
		5 mV-9.95 mV	300 MHz 1.2 ns	350 MHz 1.0 ns	350 MHz 1.0 ns	400 MHz 0.9 ns
		2 mV-4.98 mV	250 MHz 1.4 ns	250 MHz 1.4 ns	250 MHz 1.4 ns	250 MHz 1.4 ns
		1 mV-1.99 mV	200 MHz 1.8 ns	200 MHz 1.8 ns	200 MHz 1.8 ns	200 MHz 1.8 ns
		High Frequency -3 dB				
		100 MHz Limit	100 MHz ±30%.			
	20 MHz Limit	20 MHz ±30%.				
	Low Frequency -3 dB point	1 kHz maximum from 50 Ω source (VDC <20 V).				

TABLE 4-1 (cont.)
Electrical Characteristics

Circuit	Characteristic	Performance Requirement
Display Step Response (0° to 35° C)	Overdrive Recovery Time¹	
	1 mV to 99.5 mV/div. (for signals up to ±2 V peak)	<20 ns to within (0.1% of signal +0.2 division).
	100 mV to 995 mV/div. (for signals up to ±20 V peak)	<20 ns to within (0.1% of signal +0.2 division).
Input	Maximum Input Voltage, AC or DC Coupled	5 Vrms (0.5 W) or 0.25 watt-second pulses not exceeding 25 V peak.
	Maximum DC Input Voltage, AC Coupled	≤100 V (DC+peak AC).
	 <i>Signals of more than 25 V peak amplitude must be connected with the input coupling set to OFF so that the input coupling capacitor is precharged.</i>	
	Input Disconnect Threshold	4 Vrms minimum to 6 V rms maximum.
	Power-Down Condition	50 Ω terminations disconnect when 11A52 is powered down.
	Impedance (DC coupled)	50 Ω within 0.5%, VSWR < 1.25:1 from DC to 500 MHz.
	Impedance (AC coupled)	50Ω ±1% in series with nominally 2.2 μF, with 500 kΩ to ground. VSWR < 1.25:1 from 100 kHz to 500 MHz.
	Input Bias Current	4.0 μA maximum.

¹Cable losses greatly increase the overdrive recovery time as cables are lengthened. See the discussion on pages 2-6 and 3-6.

TABLE 4-1 (cont.)
Electrical Characteristics

Circuit	Characteristic	Performance Requirement
Miscellaneous	Typical Noise	
	1.0 mV to 1.99 mV/div	0.087 div, rms.
	2.0 mV to 4.98 mV/div	0.04 div, rms.
	5.0 mV to 9.95 mV/div	0.02 div, rms.
	10.0 mV to 99.5 mV/div	0.015 div, rms.
	100 mV to 995 mV/div	0.015 div, rms.
	1.0 V to 10.0 V/div	0.015 div, rms.
	DC Drift with Temperature	20 $\mu\text{V}/^\circ\text{C}$, or less, at any sensitivity. ¹
	Channel Isolation	At least 50:1 display ratio ² , any Coarse volts/div setting, DC- 600 MHz.
	Common Mode Rejection Ratio	At least 20:1, DC to 50 MHz, 10-div. reference signal on each input.
	Probe Compatibility	The 11A52 is compatible with Level 1 and 2 TEKPROBES. ³

¹DC drift can be calibrated out by invoking a calibration (Enhanced Accuracy) at any specific operating temperature.

$$^2\text{Display ratio} = \frac{\text{Amplitude (div)} \times \text{V/div (driven channel)}}{\text{Error amplitude (div)} \times \text{V/div (undriven channel)}}$$

³TEKPROBE is Tektronix' name for the interface used with probes designed for the 11000-series of oscilloscopes and plug-in units. TEKPROBES have output connectors with one or more spring loaded coding pins. Two categories of TEKPROBES are:

Level 1

A level 1 probe uses analog encoding to indicate the probe's scale factor to the plug-in unit.

Level 2

A level 2 probe uses an EEPROM to store data about the the probe's transfer units, scale factor, and output voltage scale factor. Such data are serially encoded, then stored in the EEPROM. The probe data is intended to be read once at instrument power-up or when the probe is first connected to a plug-in unit (that is, at probe power-up).

TABLE 4-2
Environmental Characteristics

Characteristic	Information
Ambient temperature (External to main frame)	
Operating within specs.	0° to +50° C., mainframe ambient.
Nonoperating	-40° to +75° C.
Humidity, Operating and Nonoperating	Five days, per MIL-T-28800C, Type III, class 5 as described in 3.9.2.2 and 4.5.5.1.2.2.
Altitude	
Operating	To 4,570 m (15,000 ft.).
Nonoperating	To 15,200 m (50,000 ft.).
Vibration	
Operating, installed on Flexible Extender	MIL-T-28800C, Sec. 4.5.5.3.1, type III, class 5.
Shock, Nonoperating (not installed in mainframe)	MIL-T-28800C, Sec. 4.5.5.4.1, type III, class 5.
Bench Handling (operating and nonoperating)	MIL-T-28800C, Sec. 4.5.5.4.3, type III, class 5.
Packaged Product Vibration and Shock	
Vibration and Bounce of Packaged Product	Meets ASTM D999-75, Method A (NSTA Project 1A-B-1).
Drop of Packaged Product	Meets ASTM D775-61, Paragraph 5 (NSTA Project 1A-B-2).
Electromagnetic Compatibility	MIL. STD. 461B. FCC Part 15, Subpart J, Class A. VDE 0871/6.78, Class B.

Table 4-3
Physical Characteristics

Characteristic	Information
Weight (max)	1 lb. 14 oz. (851 grams).
Weight of Packaged Product (max)	4 lb. 12 oz. (2.2 kg).
Dimensions (max)	Refer to Figure 4-1.

Recommended Probes

Tektronix recommends the P6231 Probe for use with the 11A52. It has the following characteristics:

P6231 Low Impedance Subminiature 10X Active Probe. The P6231 has a bandwidth of 1.5 GHz, input impedance of 450 Ω , and DC offset of ± 5 V controlled by the 11A52. The P6231 is a Level 2 probe.

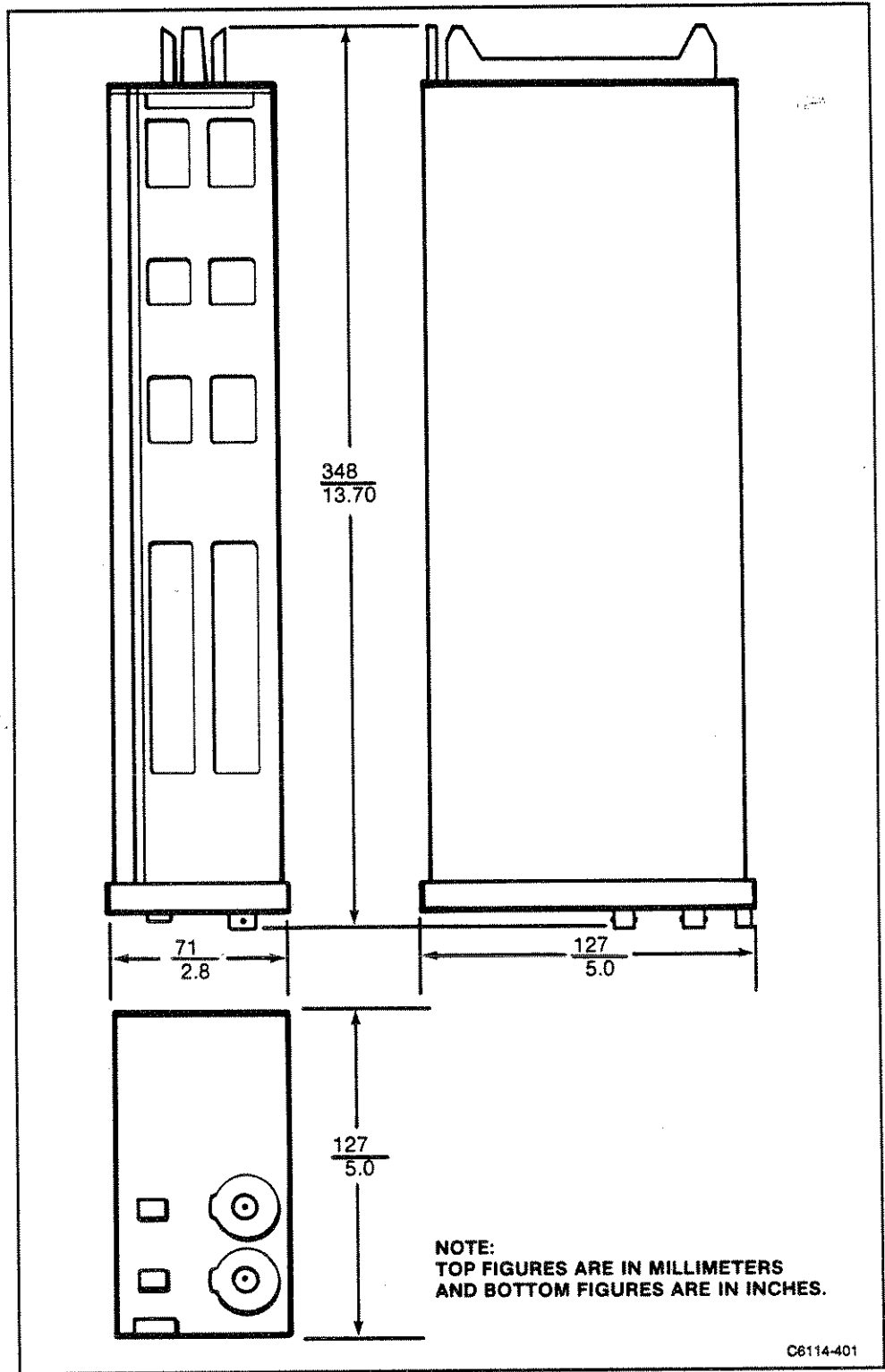

Figure 4-1. Dimensions of 11A52.

Appendix A—Glossary

Deflection factor	The ratio of input signal to response in the 11000 system. The reciprocal of sensitivity.
Display on/off button	The front-panel, plug-in button that designates a channel for display, or removes a channel from the display.
Mainframe	Any 11000-series oscilloscope exclusive of plug-in units.
Offset	A control that allows the user to subtract a precision voltage from the input signal to vary the position of the displayed signal.
ON/STANDBY	The front-panel power control on 11000-series mainframes. When set to ON, applies operating power to all circuits. When set to STANDBY, the mainframe DC power supply supplies power to the counter-timer crystal oven (Option 1T).
Overdrive	A condition in which amplifiers are driven into a non-linear operating range. Typically many divisions off screen.
Overload	The condition existing when a potentially damaging voltage is applied to the input connector.
Toggle	To switch alternately between two functions (e.g., on and off).

Appendix B—Instrument Documentation

- *Introducing the 11301 and 11302 Programmable Oscilloscopes.* This book helps the new user learn the concepts and operation of the 11301 and 11302 programmable oscilloscopes.

or

Introducing the 11301A and 11302A Counter/Timer Oscilloscopes. This book helps the new user learn the concepts and operation of the 11301A and 11302A counter/timer oscilloscopes.

- *Introducing the 11401 and 11402 Digitizing Oscilloscopes.* Intended for new users, this book explains the concepts and operation of the 11401 and 11402 digitizing oscilloscopes.
- *The 11301 and 11302 User Reference Manual* contains detailed information about measurements the instruments can make, and instructions about how to set the oscilloscope to perform such measurements. Also, installation instructions, specifications, description of options, and details about using the 11301 and 11302 with the GPIB and RS-232-C interfaces are included here.

or

The 11301A and 11302A User Reference Manual contains detailed information about measurements the instruments can make, and instructions about how to set the oscilloscope to perform such measurements. Also, installation instructions, specifications, description of options, and details about using the 11301A and 11302A with the GPIB and RS-232-C interfaces are included here.

- *The 11401 and 11402 User Reference Manual* contains detailed information about measurements the instruments can make, and instructions about how to set the oscilloscope to perform such measurements. Also, installation instructions, specifications, description of options, and details about using the 11401 and 11402 with the GPIB and RS-232-C interfaces are included here.
- *The 11301 and 11302 Pocket Reference* is a short-form reference. The Pocket Reference gives menus and a brief description of functions selected. External interface commands are listed with their basic syntax, and a list of error and warning messages is included.

or

The 11301A and 11302A Pocket Reference is a short-form reference. The Pocket Reference gives menus and a brief description of functions selected. External interface commands are listed with their basic syntax, and a list of error and warning messages is included.

- *The 11A52 Service Manual* includes information needed to check and adjust, perform diagnostic troubleshooting, repair, and otherwise service your instrument.
- *The 11A52 Functional Test Procedure* manual verifies that the instrument is functioning properly.



MANUAL CHANGE INFORMATION

At Tektronix, we continually strive to keep up with latest electronic developments by adding circuit and component improvements to our instruments as soon as they are developed and tested.

Sometimes, due to printing and shipping requirements, we can't get these changes immediately into printed manuals. Hence, your manual may contain new change information on following pages.

A single change may affect several sections. Since the change information sheets are carried in the manual until all changes are permanently entered, some duplication may occur. If no such change pages appear following this page, your manual is correct as printed.

SEND TO: TEKTRONIX, INC.
LAB INSTRUMENTS MARKETING SUPPORT
P.O. BOX 500, DEL STA 39-327
BEAVERTON, OREGON 97077

11000-SERIES OSCILLOSCOPE PROBLEM REPORT

A INSTRUMENT CONFIGURATION:

Instrument	Section	ROM (Version)	ID # (Serial Number)

Option Information

COMPANY NAME: _____
USER: _____
B ADDRESS: _____
CITY: _____ STATE: _____ ZIP: _____
PHONE: _____ EXTENSION: _____

REASON FOR REPORT

- Hardware/Mechanical Problem
- Software/Firmware Problem
- Documentation Problem
- Suggested Enhancement C

SUBMITTED BY: _____ DATE: _____

IS THE PROBLEM REPRODUCIBLE?

- Yes
- No
- Intermittent

SYSTEM DESCRIPTION: (Hardware, software, firmware and host related to the problem)

D

DESCRIPTION OF PROBLEM:

E

LIST ENCLOSURES:

Tektronix
COMMITTED TO EXCELLENCE

Instructions For Completing The Problem Report

- I. Please type or print clearly. Use a separate Problem Report (PR) for each problem.
- II. **SECTION A**
Fill in the instrument configuration table, including all plug-in units, modules, and probes installed in the oscilloscope. The information can be found in one of the menus under the UTILITY major menu.
Instrument: Write the instrument name (e.g., 11301, 11401, 11A32, etc.).
Section (Microprocessor Subsystem): If the instrument has more than one section write the section name. For plug-ins, write in which mainframe slot they are located (e.g., left, center, right).
ROM (Version): Write the rom version number for each instrument and section. Instruments with more than one section will have more than one version number.
ID# (Serial Number): Write the serial number for each instrument. At the factory the ID number is programmed to be the instrument's serial number. If this value has been changed, please write the serial number physically attached to the instrument (mainframes: front panel, plug-in units: top rail).
- III. **SECTION B**
Use the complete company mailing address. Include the name and phone number of the person reporting the error. Also, be sure to fill in the name of the person submitting the PR.
- IV. **SECTION C**
Check the reason for the report and whether the problem is reproducible. We cannot fix a problem when we cannot reproduce the problem condition.
- V. **SECTION D**
Give a complete description of the system configuration on which the problem occurred. Include related peripherals, interfaces, options, special switch and/or strap settings and operating system.
- VI. **SECTION E**
Describe the problem completely. Include any information which might help in evaluating the error with the PR. If you have determined a procedure to avoid the error condition, please include this procedure. If this problem prevents you from accomplishing any useful work with the product, please state this fact. Be sure to include with the PR any information (programs, listings, hard copies, etc.) which will help us duplicate your problem.
- VII. **SECTION F**
This section is for use by Tektronix Lab Instruments Marketing Support personnel. **DO NOT WRITE IN THIS SPACE.**
- VIII. Mail **all** copies of the Problem Report to:
TEKTRONIX, INC.
LAB INSTRUMENTS MARKETING SUPPORT
P.O. BOX 500, DEL STA 39-327
BEAVERTON, OREGON 97077

INTERNAL USE ONLY
(DO NOT WRITE BELOW THIS LINE)

F

DATE RECEIVED
IR #