

2205 OSCILLOSCOPE

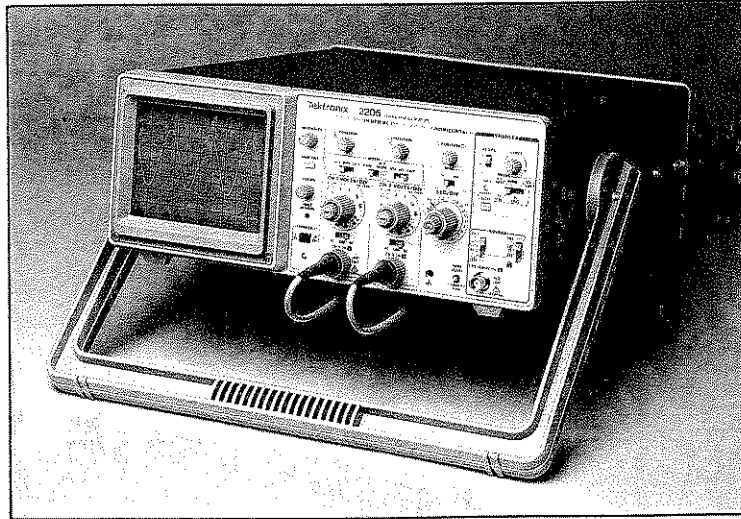

TEK

070-6717-00
PRODUCT GROUP 46

2205 OSCILLOSCOPE

OPERATOR'S MANUAL

First Printing October 1987

Tektronix[®]
COMMITTED TO EXCELLENCE

Copyright © 1987 Tektronix, Inc. All rights reserved. Contents of this publication may not be reproduced in any form without the written permission of Tektronix, Inc.

Products of Tektronix, Inc. and its subsidiaries are covered by U.S. and foreign patents issued and pending.

Information in this publication supersedes that in all previously published material. Specification and price change privileges reserved. TEKTRONIX, TEK, PLOT 10, TEKTEST, SCOPE-MOBILE, and  are registered trademarks. For further information, contact Tektronix, Inc. Corporate Offices, P.O. Box 500, Beaverton, OR 97077. Phone: (503) 627-7111; TWX: (910)467-8708; TLX: 151754. Subsidiaries and distributors worldwide.

Printed in Hong Kong.

INSTRUMENT SERIAL NUMBERS

Each instrument has a serial number on a panel insert, tag, or stamped on the chassis. The first number or letter designates the country of manufacture. The last five digits of the serial number are assigned sequentially and are unique to each instrument. Those manufactured in the United States have six unique digits.

B010000 Tektronix, Inc., Beaverton, Oregon, U.S.A.

HK00000 Hong Kong

E200000 Tektronix United Kingdom, Ltd., London

J300000 Sony/Tektronix, Japan

H700000 Tektronix Holland, NV, Heerenveen,
The Netherlands

NOTICE to the user/operator:

The German Postal Service requires that Systems assembled by the operator/user of this instrument must also comply with Postal Regulation, Vfg. 1046/1984, Par. 2, Sect. 1.

HINWEIS für den Benutzer/Betreiber:

Die vom Betreiber zusammengestellte Anlage, innerhalb derer dies Gerät eingesetzt wird, muß ebenfalls den Voraussetzungen nach Par. 2, Ziff. 1 der Vfg. 1046/1984 genügen.

NOTICE to the user/operator:

The German Postal Service requires that this equipment, when used in a test setup, may only be operated if the requirements of Postal Regulation, Vfg. 1046/1984, Par. 2, Sect. 1.7.1 are complied with.

HINWEIS für den Benutzer/Betreiber:

Dies Gerät darf in Meßaufbauten nur betrieben werden, wenn die Voraussetzungen des Par. 2, Ziff. 1.7.1 der Vfg. 1046/1984 eingehalten werden.

Certificate of the Manufacturer/Importer

We hereby certify that the 2205 OSCILLOSCOPE

AND ALL INSTALLED OPTIONS

complies with the RF Interference Suppression requirements of
Amtsbl.-Vfg 1046/1984.

The German Postal Service was notified that the equipment is being
marketed.

The German Postal Service has the right to re-test the series and to
verify that it complies.

TEKTRONIX

Bescheinigung des Herstellers/Importeurs

Hiermit wird bescheinigt, daß der/die/das 2205 OSCILLOSCOPE

AND ALL INSTALLED OPTIONS

in Übereinstimmung mit den Bestimmungen der Amtsblatt-Verfügung
1046/1984 funktentstört ist.

Der Deutschen Bundespost wurde das Inverkehrbringen dieses Gerätes
angezeigt und die Berechtigung zur Überprüfung der Serie auf Einhalten
der Bestimmungen eingeräumt.

TEKTRONIX

CONTENTS

	Page
Operator's Safety Summary	iv
The 2205 Oscilloscope	vii
 SECTION 1—PREPARATION FOR USE	
Safety	1-1
Line Voltage Selection	1-1
Line Fuse	1-4
Power Cord	1-4
Instrument Cooling	1-4
Initial Start-Up	1-5
 SECTION 2—OPERATION	
Front Panel Organization	2-1
Controls, Connectors, and Indicators	2-1
Learning the Controls	2-6
Display Controls	2-8
Vertical Controls	2-8
Input Coupling	2-8
Channel Selection	2-9
Add and Invert	2-9
Chop or Alt?	2-9
Horizontal Controls	2-10
Sweep Speed Selection	2-10
Magnifying Waveform Details	2-10

SECTION 2—OPERATION (CONTINUED)

Trigger Controls	2-10
Which Mode to Use	2-11
Source	2-12
Slope	2-12
Level	2-12
Connecting Signals	2-12
Waveform Fidelity and Probe Grounds	2-13
Probe Compensation	2-13
Probe Handling	2-13
Coaxial Cables	2-14

SECTION 3—APPLICATIONS

Amplitude Measurements	3-1
Peak-to-peak Voltage	3-1
Instantaneous Voltage	3-3
Algebraic Addition	3-5
Common-mode Rejection	3-6
Amplitude Comparison (Ratio)	3-7
Time Measurements	3-8
Time Duration	3-8
Period and Frequency	3-10
Rise Time	3-10
Time Difference Between Pulses on Time-Related Signals	3-12
Phase Difference	3-14
Television Displays	3-17
TV Field Signals	3-17
TV Line Signals	3-18
Z-Modulation	3-18

SECTION 4—CHECKS AND ADJUSTMENTS

Trace Rotation	4-1
Probe Compensation	4-1

SECTION 5—PERFORMANCE CHARACTERISTICS

SECTION 6—OPTIONS AND ACCESSORIES

Standard Accessories	6-1
Options	6-1
Optional Accessories	6-4

APPENDIX A - Magnified Sweep Speeds

APPENDIX B - Repackaging for Shipment

APPENDIX C - Glossary

OPERATOR'S SAFETY SUMMARY

The general safety information in this summary is for both operating and servicing personnel. Specific warnings and cautions — found throughout the manual where they apply — do not appear in this summary.

Terms

In This Manual

CAUTION statements identify conditions or practices that could result in damage to the equipment or the property.

WARNING statements identify conditions or practices that could result in personal injury or loss of life.

As Marked on Equipment

CAUTION indicates a personal-injury hazard that is not immediately accessible as one reads the markings, or a hazard to property, including the equipment itself.

DANGER indicates a personal-injury hazard that is immediately accessible as one reads the marking.

Symbols

In This Manual



This symbol indicates applicable cautionary or other information. For maximum input voltage see Table 5-1.

As Marked on Equipment



DANGER—High voltage.



Protective ground (earth) terminal.



ATTENTION—Refer to manual.

Power Source

This product is intended to operate from a power source that does not apply more than 250 V rms between the supply conductors or between either supply conductor and ground. A protective ground connection, by way of the grounding conductor in the power cord, is essential for safe operation.

Grounding the Product

This product is grounded through the grounding conductor of the power cord. To avoid electrical shock, plug the power cord into a properly wired receptacle before making any connections to the product input or output terminals. A protective ground connection, by way of the grounding conductor in the power cord, is essential for safe operation.

Danger Arising From Loss of Ground

Upon loss of the protective-ground connection, all accessible conductive parts, including knobs and controls that may appear to be insulating, can render an electric shock.

Use the Proper Power Cord

Use only the power cord and connector specified for your product.

The power cord must be in good condition.

Read Section 1 for power-cord and connector information.

Use the Proper Fuse

To avoid fire hazard, use only a fuse of the correct type, voltage rating and current rating as specified on the back of your product and in Table 6-1.

Do Not Operate in an Explosive Atmosphere

To avoid explosion, do not operate this product in an explosive atmosphere.

Do Not Remove Covers or Panels

To avoid personal injury, do not remove the product covers or panels. Do not operate the product without the covers and panels properly installed.

THE 2205 OSCILLOSCOPE

The TEKTRONIX 2205 Oscilloscope is a rugged, lightweight, dual-channel, 20 MHz instrument that features a bright, sharply defined trace on an 80 by 100 mm cathode-ray tube (crt).

Its low-noise vertical system supplies calibrated deflection factors from 5 mV to 5 V per division at full bandwidth.

Stable triggering is achieved over the full bandwidth of the vertical system. The flexibility and high sensitivity of the trigger system provides a range of conveniences such as hands-free triggering with the peak-to-peak automatic mode, normal trigger mode, independent selection of TV line and TV field triggering at any sweep speed, and single-sweep triggering. The trigger signal is dc coupled. An external triggering signal or an external Z-axis modulation signal can be applied via a front-panel connector and the source-selector switches.

The horizontal system provides calibrated sweep speeds from 0.5 s to 100 ns per division. For greater measurement accuracy, a X10 magnifier circuit extends the maximum sweep speed to 10 ns per division.

Accessories

The instrument is shipped with the following accessories: operator's manual, two signal adapters, a power cord, and a power-cord clamp. Part numbers for these standard accessories, as well as for other optional accessories, are located in Section 6, *Options and Accessories*. The voltage-sensing signal adapters were designed specifically to complement the performance of your 2205.

For More Information

Should you need additional information about your 2205 Oscilloscope or about other Tektronix products; contact the nearest Tektronix Sales Office or Distributor, consult the Tektronix product catalog, or, in the U.S., call the Tektronix National Marketing Center, toll free at 1-800-426-2200.

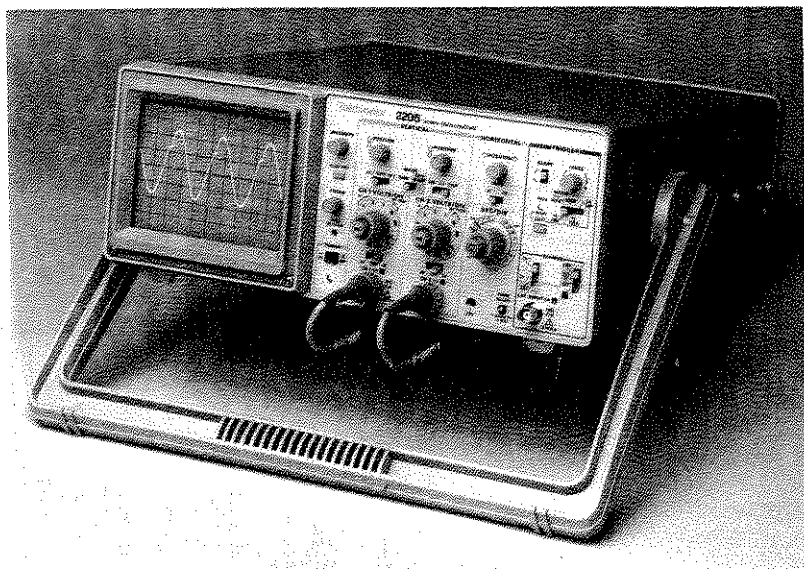

The 2205 Oscilloscope.

SECTION 1

**PREPARATION
FOR USE**



1

Handwritten text on the right margin, possibly bleed-through from the reverse side of the page.

This section gives you important safety information and tells you how to proceed with initial start-up of the TEKTRONIX 2205 Oscilloscope.

SAFETY

Before connecting the 2205 Oscilloscope to a power source, read this entire section. Also refer to the Safety Summary at the front of this manual for power source, grounding, and other safety considerations pertaining to the use of the instrument. Be sure that you have the training required to safely connect the 2205 to the signals you want to measure.

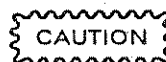





This instrument may be damaged if operated with the LINE VOLTAGE SELECTOR (on the rear panel) set for the wrong applied ac source voltage or if a wrong line fuse is installed.

LINE VOLTAGE SELECTION

The 2205 operates from either a 115-V or a 230-V nominal ac power line with any frequency from 48 Hz to 440 Hz. Before connecting the power cord to a power source, verify that the LINE VOLTAGE SELECTOR, located on the rear panel, is set correctly and that the proper line fuse is installed. Refer to Table 1-1, Figure 1-1, and the instrument rear panel.

To convert the 2205 for operation on the other line-voltage range, first check that the power cord is not connected to any power source. Then use a flat-bladed screwdriver to move the LINE VOLTAGE SELECTOR to the required position and install the appropriate fuse (listed on the rear panel and in Table 6-1).

Table 1-1
Power Plugs and Line Voltage Selection

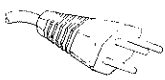
Plug Configuration	Power Option	Plug Type	Line Voltage Selector	Reference Standards ^b
	Std	United States 120 V	115V	ANSI C73.11 NEMA 5-15-P IEC 83 UL 198.6
	A1	Europe 220 V	230V	CEE (7), II, IV, VII IEC83 IEC 127
	A2	United Kingdom 240 V	230V ^a	BS 1363 IEC 83 IEC 127
	A3	Australia 240 V	230V	AS C112 IEC 127
	A4	North America 240 V	230V	ANSI C73.20 NEMA 6-15-P IEC 83 UL 198.6
	A5	Switzerland 220 V	230V	SEV IEC 127

^aA 5 A, Type C fuse is installed inside the plug of the Option A2 power cord.

^bReference Standards Abbreviations:

- ANSI — American National Standards Institute
- AS — Standards Association of Australia
- BS — British Standards Institution
- CEE — International Commission on Rules for the Approval of Electric Equipment
- IEC — International Electrotechnical Commission
- NEMA — National Electrical Manufacturer's Association
- SEV — Schweizerischer Elektrotechnischer Verein
- UL — Underwriters Laboratories Inc.

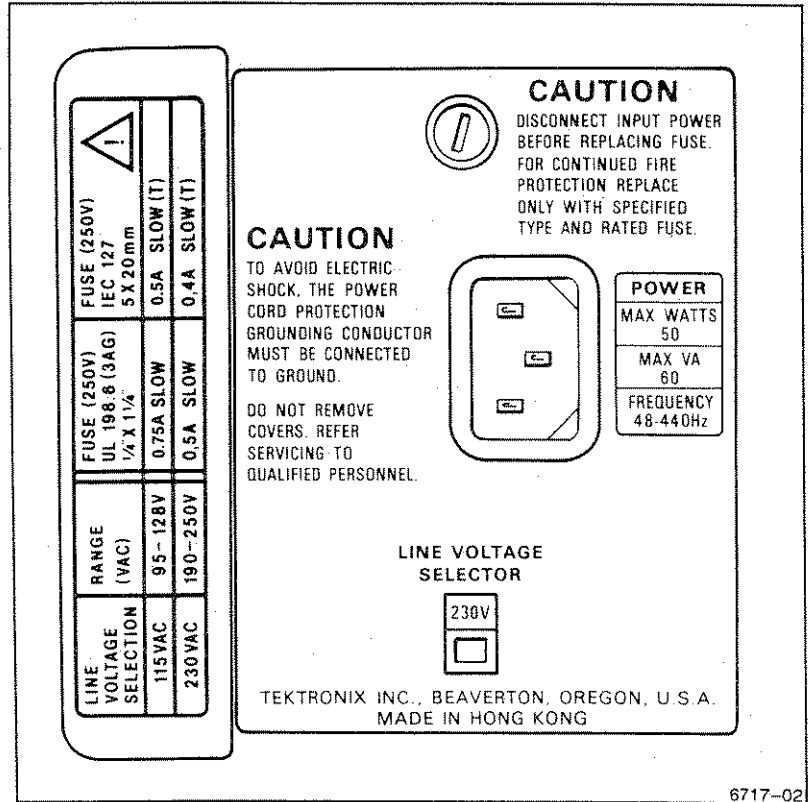

Figure 1-1. Voltage selector switch, fuse, and power-cord receptacle.

1

LINE FUSE

The fuse holder is located on the rear panel and contains the line (mains) fuse. Use the following procedure to verify that the proper fuse is installed or to install a replacement fuse.

1. Unplug the power cord from the power source (if applicable).
2. Use a screwdriver to press in and slightly rotate the fuse-holder cap counterclockwise to release it.
3. Pull the cap (with the fuse) out of the fuse holder.
4. Verify that the fuse is the same type listed on the back of the instrument. The two type of fuses listed are not directly interchangeable; they require different types of fuse caps.
5. Reinstall the fuse (or replacement fuse) in the fuse-holder cap.
6. Replace the fuse holder and cap.

POWER CORD

This instrument has a detachable, three-wire power cord with a three-contact plug for connection to both the power source and protective ground. The ground contact on the plug connects through the power-cord to the external metal parts of the instrument. For electrical shock protection, insert this plug only into a power source outlet that has a properly grounded protective-ground contact.

Instruments are shipped with the required power cord as ordered by the customer. Power cord plug information is presented in Table 1-1, and part numbers are listed in Table 6-1.

INSTRUMENT COOLING

Maintain adequate airflow to prevent instrument damage from internally generated heat. Before turning on the power, check that the spaces around the air-intake holes on the sides of the cabinet are free of any obstruction to airflow.

INITIAL START-UP

Up to now, you should have made the following preparation:

1. Read the safety information.
2. Verified that the LINE VOLTAGE SELECTOR is set for the source voltage to be used.
3. Verified the fuse.
4. Attached the power cord.
5. Ensured adequate ventilation around the instrument.
6. Plugged the power cord into the appropriate power source outlet.

Now turn on your oscilloscope by pressing in the POWER button. Observe that the Power-On indicator, located below the button, illuminates.

THE UNIVERSITY OF CHICAGO

PHYSICS DEPARTMENT
5720 S. UNIVERSITY AVE.
CHICAGO, ILL. 60637
TEL: 773-936-3700
WWW.PHYSICS.UCHICAGO.EDU

PHYSICS 435

PHYSICS 435

PHYSICS 435

SECTION 2

OPERATION

2

NOTE: Numbers on the instrument are keyed to Table 2-1.

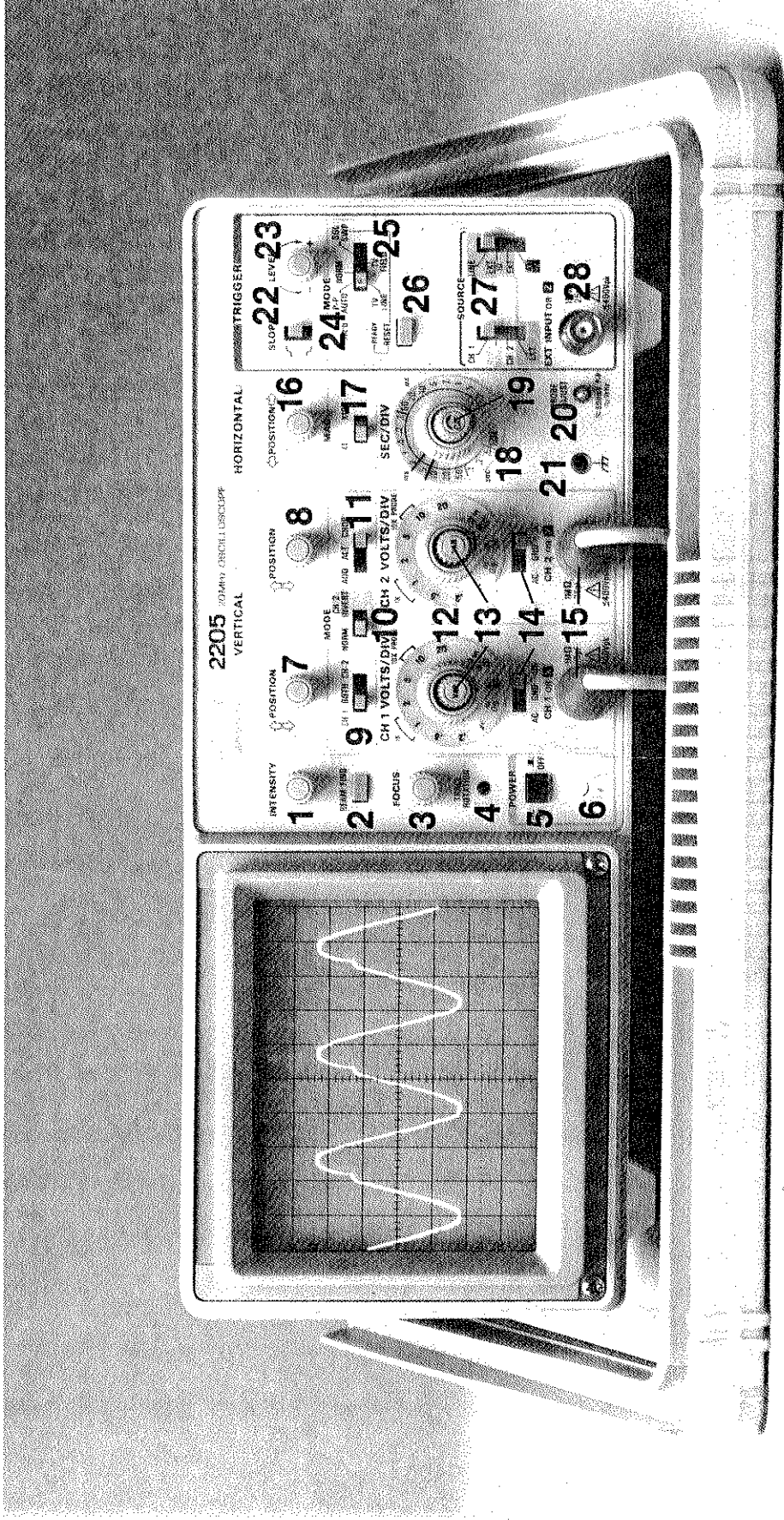

FRONT PANEL ORGANIZATION

The 2205 front panel is organized to make it easy for you to display signals and make measurements. Referring to the fold-out illustration, Figure 2-1, or to the oscilloscope itself, notice that the front panel is partitioned into four major control sections - Display, VERTICAL, HORIZONTAL, and TRIGGER.

Just to the right of the cathode-ray tube (crt) screen are the Display controls. Display controls affect the display, but not the waveform. These controls adjust brightness and focus of the trace, align the trace with the graticule, and help you quickly find off-screen signals.

Like any oscilloscope, the 2205 draws a graph of voltage as a function of time. The VERTICAL section, enclosed within shaded gray lines, contains the controls that define the voltage (or vertical) axis of the display. Also a part of this section are the two BNC input connectors, through which you apply the signals that you want to view.

The HORIZONTAL controls are to the right of the VERTICAL section. Horizontal controls set and move the time (or horizontal) axis for the displayed traces.

On the extreme right of the front panel, enclosed within shaded green lines, is the TRIGGER section. Trigger controls define the signals and the conditions needed to initiate (or trigger) every sweep across the time axis. An indicator light (TRIG'D) comes on when the sweep is triggered. A BNC input connector at the bottom of the TRIGGER section lets you apply either an external trigger signal or an external Z-axis (display intensity) control signal.

CONTROLS, CONNECTORS, AND INDICATORS

Table 2-1 lists all the controls, connectors, and indicators on your 2205 Oscilloscope. Following Table 2-1, a short procedure describes how to get a display. The remainder of this section offers suggestions and tips for using the controls to obtain the most effective displays and to make the most accurate measurements.

Table 2-1
Summary of Controls, Connectors, and Indicators

No.	Title	Function	Recommended Use
1	INTENSITY	Adjusts trace brightness.	Compensate for ambient lighting, trace speed, trigger frequency.
2	BEAM FIND	Compresses display to within CRT limits	Locate off-screen phenomena.
3	FOCUS	Adjusts for finest trace thickness.	Optimize display definition.
4	TRACE ROTATION	Adjusts trace parallel to center-line.	Compensate for earth's magnetic field.
5	POWER	Turns power on and off.	Control power to the instrument.
6	Power Indicator	Illuminates when power is turned on.	Determine power condition.
7, 8	VERTICAL POSITION	Moves trace up or down on screen.	Position trace vertically and compensate for dc component of signal.
9	CH 1-BOTH-CH 2	Selects signal inputs for display.	View either channel independently or both channels simultaneously.
10	NORM-INVERT	Inverts the Channel 2 signal display.	Provide for differential (CH 1-CH 2) or summed (CH 1+CH 2) signals when ADD is selected.
11	ADD-ALT-CHOP	ADD shows algebraic sum of CH 1 and CH 2 signals. ALT displays each channel alternately. CHOP switches between CH 1 and CH 2 signals during the sweep at 500 kHz rate.	Display summed or individual signals.
12	VOLTS/DIV	Selects vertical sensitivity.	Adjust vertical signal to suitable size.

2

Table 2-1 (cont'd)

No.	Title	Function	Recommended Use
13	Variable (CAL)	Provides continuously variable deflection factors between calibrated positions of the VOLTS/DIV switch. Reduces gain by at least 2.5:1.	Match signals for common-mode readings. Adjust height of pulse for rise-time calculations.
14	AC-GND-DC	In AC, blocks dc component of signal. In GND, gives reference point and allows precharging of input-coupling capacitor. In DC, couples all components of signal.	Select method of coupling input signals to the vertical deflection system.
15	CH 1 OR X CH 2 OR Y	Provides for input signal connections. CH 1 gives horizontal deflection when SEC/DIV is in X-Y; CH 2 provides vertical deflection.	Apply signals to the vertical deflection system.
16	HORIZONTAL POSITION	POSITION moves traces horizontally.	Control trace positioning in horizontal direction.
17	MAG (X1-X10)	Selects degree of horizontal magnification.	Examine small phenomena in detail. Extends sweep speed to 10 ns/div.
18	SEC/DIV	Selects time-base speed.	Set horizontal speed most suited to requirements.
19	Variable (CAL)	Provides continuously variable uncalibrated sweep speeds to at least 2.5 times the calibrated setting.	Extend the slowest speed to at least 1.25 s/div.

Table 2-1 (cont'd)

No.	Title	Function	Recommended Use
20	PROBE ADJUST	Provides approximately 0.5-V, 1-kHz square wave.	Allows user to adjust compensation of 10X probe. This source may be used to check the basic functioning of vertical and horizontal circuits but is not intended to check their accuracy.
21	h (Ground Receptacle)	Provides safety ground and direct connection to signal source.	Chassis ground connection.
22	SLOPE	Selects the slope of the signal that triggers the sweep.	Provide ability to trigger from positive-going or negative-going signals.
23	LEVEL	Select trigger-signal amplitude point.	Select actual point of trigger.
24	TRIG'D READY	Indicator lights when sweep is triggered in P-P AUTO, NORM, or TV FIELD. In Single Sweep mode, indicates trigger is armed.	Indicate trigger state.
25	MODE	P-P AUTO/TV LINE triggers from waveforms and television lines having repetition rates of at least 20 Hz. NORM triggers from adequate signal, with no trace in absence of trigger signal. TV FIELD triggers from TV field signals; trigger polarity must be observed. SGL SWP triggers sweep only once when armed by RESET button; used for displaying or photographing nonrepetitive or unstable signals.	Select trigger mode.

2

Table 2-1 (cont'd)

No.	Title	Function	Recommended Use
26	RESET	Arms trigger circuit for SGL SWP.	
27	SOURCE	CH 1, CH 2, LINE, and EXT trigger signals are selected directly. In VERT MODE, trigger source is determined by the VERTICAL MODE selectors as follows: CH 1: trigger comes from Channel 1 signal. CH 2: trigger comes from Channel 2 signal. BOTH-ADD and BOTH-CHOP: trigger is algebraic sum of Channel 1 and Channel 2 signals. BOTH-ALT: trigger comes from Channel 1 and Channel 2 on alternate sweeps.	Select source of signal that is coupled to the trigger circuit.
28	EXT INPUT	Connection for applying external signal for use as a trigger.	Trigger from a source other than vertical signal. Also used for single-shot application.
		Connection for applying external signal for intensity modulation. To intensity modulate the display, set the right TRIGGER SOURCE control to EXT=Z.	Provide intensity modulation from independent source.

LEARNING THE CONTROLS

If you have not read Section 1 yet, you should do so now. Then, after turning the power on, let the oscilloscope warm up for a few minutes before starting this procedure.

1. Set instrument controls as follows:

Display

INTENSITY	Midrange
FOCUS	Set for clearly defined trace

Vertical (both channels)

POSITION	Midrange
MODE	CH 1
VOLTS/DIV	.1 V (1X)
VOLTS/DIV Variable	CAL detent (fully clockwise)
Input Coupling	AC

Horizontal

POSITION	Midrange
MODE	X1
SEC/DIV	0.2 ms
SEC/DIV Variable	CAL detent (fully clockwise)

Trigger

SLOPE	
LEVEL	Midrange
MODE	P-P AUTO
SOURCE	CH 1

2. Connect a signal adapter to the Channel 1 input BNC connector (labeled CH 1 or X). Attach the ground lead to the collar of the EXT INPUT connector and apply the signal adapter tip to the PROBE ADJUST terminal. If necessary, adjust the TRIGGER LEVEL control to get a stable display.
3. Change the Channel 1 input coupling to GND and use the Channel 1 POSITION control to align the baseline trace to the

center horizontal graticule line. This sets the zero reference for the display.

- Return the Channel 1 input coupling to AC. Notice that the square wave is centered vertically on the screen. Now set the input coupling to DC and observe what happens to the waveform. The zero reference is maintained at the center horizontal graticule line.

NOTE

More information about using the controls is contained at the end of this procedure. Refer to it when needed while learning the front-panel controls.

- Use the following controls and notice the effect each has on the displayed waveform as the settings are changed.

Each POSITION control
CH 1 VOLTS/DIV
CH 1 VOLTS/DIV Variable (CAL)
SEC/DIV Variable (CAL)
HORIZONTAL MODE
HORIZONTAL MAG
TRIGGER SLOPE

- At this point, connect the second signal adapter to the CH2 or Y input connector. Set the VERTICAL MODE selector to CH 2 and TRIGGER SOURCE to CH 2, then follow steps 2 through 5 again, using the Channel 2 controls.
- Now set the VERTICAL MODE selectors to BOTH-NORM-ALT and return both VOLTS/DIV controls to .2 V (1X). Rotate all variable controls clockwise to their CAL detents. Set the TRIGGER SOURCE switch to CH 1. Then use the VERTICAL POSITION controls to position the two traces to convenient locations on the screen.
- While watching the Channel 2 waveforms, set the middle VERTICAL MODE control to CH 2 INVERT and notice the effect. Then set the right MODE to ADD. What happens to the control waveforms? Finally, return the middle MODE control to NORM. What waveform is displayed now?

Congratulations! You now know how to use the 2205 front-panel controls to display signals and move them about on the screen. The remainder of this section gives you more information about the controls and offers suggestions for their use. Section 3 explains how to make specific types of measurements and how to use the other controls not covered in the preceding exercise.

DISPLAY CONTROLS

Set the INTENSITY control for comfortable viewing, but not brighter than you need. Use high-intensity settings to observe low-repetition-rate signals, narrow pulses in long time intervals, or occasional variations in fast signals.

VERTICAL CONTROLS

When making voltage measurements, rotate the VOLTS/DIV CAL control fully clockwise (in detent). Best accuracy is achieved by setting the VOLTS/DIV control for the largest display possible.

When a cable or a signal adapter is used to connect a signal, the number in the 1X front-panel area indicates sensitivity. When using a 10X probe, the number in the 10X PROBE front-panel area indicates sensitivity. For example, the setting of 1 V/div with a cable or signal adapter would be 10 V/div with a 10X probe. And, although the knob skirt is not marked, 5 V/div at 1X would be 50 V/div if a 10X probe were used.

Input Coupling

For most applications, use DC input coupling. This mode is compatible with the standard accessory signal adapters and it displays logic levels and DC levels of static signals.

Use GND input coupling to show where the zero-volt level will be located when you shift to DC or AC coupling.

Use AC coupling for the special cases where you need to see small signals on large DC voltage levels.

Channel Selection

With the three VERTICAL MODE selectors, you can display combinations of the two vertical channels. When Channel 1 is selected, the other two MODE switches are not active. When CH 2 is selected, the middle MODE switch (NORM/CH 2 INVERT) becomes active. And when BOTH channels are selected for display, all three MODE selectors are active.

ADD and INVERT

Select ADD mode to display the algebraic sum of the CH1 and CH 2 signals. When you use ADD, the CH 1 and CH 2 VOLTS/DIV settings should be equal.

Selecting CH 2 INVERT causes the polarity of the CH 2 waveform to be inverted. This allows you to see the difference between CH 1 and CH 2 signals on the ADD trace.

CHOP or ALT?

When BOTH channels are selected, the display is time-shared. The CHOP mode displays each channel for a short time and multiplexes during the sweep to give the appearance of displaying both channels at once. This mode (CHOP) works better than ALT for sweep speeds slower than 1 ms per division and for low-repetition-rate signals that make the display flicker (up to 2 μ s/division).

The ALT mode displays each channel for the duration of a complete sweep. It gives a cleaner display of multiple channels than CHOP does and is usually preferred at moderate to high sweep speeds.

Certain trigger conditions, including composite trigger selection, can cause a display that implies a phase relationship or even synchronization of independent waveforms. If in doubt about the relative timing of CH 1 and CH 2 signals, experienced operators set the TRIGGER SOURCE to either CH 1 or CH 2.

2

HORIZONTAL CONTROLS

Sweep-Speed Selection

The unmagnified sweep (MAG set to X1) is the horizontal function needed for most applications. Best measurement accuracy is achieved by setting the SEC/DIV control for the fastest sweep that will display the interval of interest. The variable control (CAL) should be in its detent (fully clockwise).

Magnifying Waveform Details

The X10 MAG mode expands the unmagnified trace. A magnified trace is useful for observing specific portions of a waveform when you are making accurate timing measurements or looking at waveform details.

When selected, X10 MAG mode lets you examine details, such as the entire leading edge of a pulse's second repetition, of a trace up to 10 screen lengths from the trigger point.

Appendix A lists the sweep speeds for 10X magnification at every SEC/DIV control setting.

The one-division segment of the unmagnified trace centered on the middle vertical graticule line is expanded and displayed as the magnified trace. With the center vertical graticule line as the reference, the investigation of waveform details around any point on the unmagnified trace, as well as the measurement of time with greater accuracy, become easy tasks.

TRIGGER CONTROL

For most signals, the trigger-control settings that will yield hands-off triggering are:

MODE	P-P AUTO
SOURCE	VERT MODE

Which Mode to Use

P-P AUTO/TV LINE—With this mode set, the range of the LEVEL control is confined to the values between the triggering-signal peaks. For example, selecting P-P AUTO and rotating the LEVEL control to the center of its range establishes a trigger point about midway between the peaks of the triggering signal.

In this mode, the absence of a triggering signal causes the sweep to free-run. And with signals below 20 Hz, the P-P AUTO circuit may not find the correct level.

Whenever TRIGGER SOURCE is set to VERT MODE, the triggering signal is supplied by the channel being displayed – or as shown in Table 2-1.

The P-P AUTO mode is effective for monitoring logic signals and television lines having at least 20 Hz repetition rate. Selecting P-P AUTO at the instrument front panel also sets the TV LINE triggering mode.

NORM – This mode produces a sweep only when the triggering signal meets the criteria set by the LEVEL and SLOPE controls. With NORM mode selected, range of the LEVEL control is sufficient to set any voltage threshold that can be displayed by the instrument. In the absence of a triggering signal, no sweep occurs.

Use the NORM mode for viewing infrequent events and erratic signals.

SGL SWP – When this mode is selected, the sweep is triggered only once. Press the RESET button once to arm the trigger circuit and illuminate the READY indicator. When a trigger event occurs, the sweep runs once and the READY light extinguishes.

Use the SGL SWP mode to display or photograph nonrepetitive or unstable signals.

TV FIELD – This mode triggers the sweep at the beginning of a television field. To change the TV field being displayed, you must interrupt the trigger signal by setting the input coupling switch momentarily to GND then back either DC or AC until the desired field is displayed.

To display Field 1 and Field 2 at the same time, connect the same television signal to both the CH 1 and CH 2 inputs; set VERTICAL MODE to BOTH and ALT; and set the SEC/DIV control to 0.5 ms or faster sweep speed.

If you magnify the vertical display beyond the graticule, the trigger may be degraded. To avoid trigger overload, use either CH 1 or CH 2 for display and use the EXT INPUT channel with an appropriate video signal as the trigger source. A composite sync signal can be used for the trigger source as well as composite video.

2

Source

Choose a single channel as the trigger source to correctly display the timing relationships between two channels. Choose the channel with the lowest frequency signal to avoid ambiguous displays.

With TRIGGER SOURCE set to VERT MODE and VERTICAL MODE set to ADD or CHOP, the triggering signal is the algebraic sum of the Channel 1 and Channel 2 input signals.

Use a composite trigger source only to view asynchronous signals simultaneously. To generate a composite trigger: select VERT MODE TRIGGER SOURCE and BOTH-ALT VERTICAL MODE.

Slope

Use the SLOPE control to select either the rising (\nearrow) or the falling (\searrow) edge of the signal to trigger the sweep.

Level

The LEVEL control gives you complete freedom to choose the most appropriate threshold voltage on a signal to initiate sweeps whenever any trigger mode except P-P AUTO is selected.

CONNECTING SIGNALS

The signal adapter supplied with the instrument is usually the most convenient way to connect a signal to the 2205. These signal adapters are shielded to prevent pickup of electromagnetic interference. When connected to the 2205 input, a signal

adapter presents 1 M Ω and about 100 pF impedance to the circuit under test. If this capacitance is disruptive to the circuit being tested, use the optional 10X probe.

Waveform Fidelity and Probe Grounds

When using a probe, its ground lead must be used for accurate measurements and observations. Use the shortest ground connection possible for best waveform fidelity.

In some cases, a separate ground from the unit under test to the ground receptacle on the oscilloscope front panel can reduce interference from low-frequency hum and noise. For rough checks of larger signals, such as 5 V logic, a ground lead separate from the probe – or even the safety ground connection, which is shared with the unit under test – may work for a signal ground. Fast signal transitions will be highly distorted, and extraneous noise will be induced without the probe ground connection, and/or with extra ground connections from the 2205 to the circuit being tested.

Probe Compensation (Optional 10X Probe)

Misadjustment of probe compensation is a common source of measurement error. Due to variations in oscilloscope input characteristics, probe compensation should be checked whenever a 10X probe is moved from one oscilloscope to another or from one channel to another on the same oscilloscope. Always compensate the probe to the channel on which it will be used. See the procedure in Section 4, *Checks and Adjustments*.

Probe Handling (Optional 10X Probe)

Both the probe and the probe accessories should be handled carefully to prevent damage. Striking a hard surface can damage both the probe body and the probe tip. Exercise care to prevent the cable from being crushed, kinked, or excessively strained.

Coaxial Cables

To maintain good waveform fidelity and accuracy, use only high-quality, low-loss coaxial cables. When you use 50 Ω or 75 Ω coaxial cable, attach a matching external terminator. Some high frequency response will be lost without external termination.

SECTION 3

APPLICATIONS

This section describes how to make specific types of measurements with your 2205 Oscilloscope. Before performing any procedure, be sure you are familiar with the information contained in the *Operator's Safety Summary* and in Section 1. Preset the instrument front-panel controls, using the setup in Learning the Controls in Section 2, as a guideline, and then turn on the power. For maximum measurement accuracy, allow a 20-minute warm-up period.

AMPLITUDE MEASUREMENTS

Peak-to-Peak Voltage

This procedure may be used to make peak-to-peak voltage measurements between any two points on the waveform.

1. Apply the signal to either the CH1 or the CH2 input connector and set the VERTICAL MODE selector to display the channel used.
2. Set the appropriate VOLTS/DIV control to display about 5 divisions of the waveform and ensure that the VOLTS/DIV variable control is in the CAL detent.
3. Adjust the TRIGGER LEVEL control to obtain a stable display.
4. Rotate the SEC/DIV control to a setting that displays at least one cycle of the waveform.
5. Vertically position the display so that the negative peak of the waveform coincides with one of the horizontal graticule lines (see Figure 3-1, Point A).
6. Horizontally position the display so that one of the positive peaks coincides with the center vertical graticule line (Figure 3-1, Point B).
7. Measure the divisions of vertical deflection from peak-to-peak (Figure 3-1, Point A to Point B).

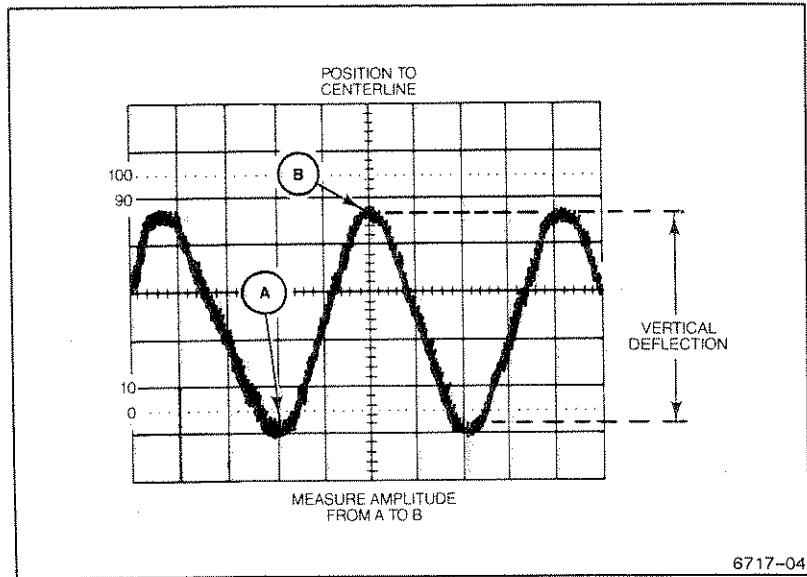

3

Figure 3-1. Measuring peak-to-peak voltage of a waveform.

NOTE

If the amplitude measurement is critical or if the trace is thick (because of hum or noise on the signal), a more accurate result can be obtained by measuring from the top of a peak to the top of a valley. This will eliminate trace width from the measurement.

8. Calculate the peak-to-peak voltage, using the following formula:

$$V_{p-p} = \frac{\text{vertical deflection (divisions)}}{\text{setting (10X Probe)*}} \times \text{VOLTS/DIV}$$

**If a 1X probe is being used for the measurement, use the 1X VOLTS/DIV setting.*

EXAMPLE. In Figure 3-1, the measured peak-to-peak vertical deflection is 4.4 divisions using a 10X attenuator probe with the VOLTS/DIV switch set to 5V (10X PROBE).

Substituting the given values:

$$V_{p-p} = 4.4 \text{ div} \times 5 \text{ V/div} = 22 \text{ V.}$$

Instantaneous Voltage

To measure the instantaneous voltage level at a given point on a waveform, referred to ground, use the following procedure:

1. Apply the signal to either the CH1 or the CH2 input connector and set the VERTICAL MODE selector to the channel used.
2. Verify that the VOLTS/DIV variable control is in the CAL detent and set input coupling to GND.
3. Vertically position the trace to the center horizontal graticule line. This establishes the ground reference location.

NOTE

If the measurements are to be made relative to a voltage level other than ground, set the input coupling switch to DC and apply the reference voltage to the input connector. Then position the trace to the horizontal reference line.

4. Set the input coupling control to DC. Points on the waveform above the ground reference location are positive; points below are negative.

NOTE

If using Channel 2, ensure that the center VERTICAL MODE selector (NORM, CH 2 INVERT), is set to NORM.

5. If necessary, repeat Step 3 using a different horizontal ground reference line that allows the waveform in Step 4 to be displayed on screen.

6. Adjust the TRIGGER LEVEL control to obtain a stable display.
7. Set the SEC/DIV control to a position that displays at least one cycle of the signal.
8. Measure the divisions of vertical deflection between the ground reference line and the point on the waveform at which the level is to be determined (see Figure 3-2).

3

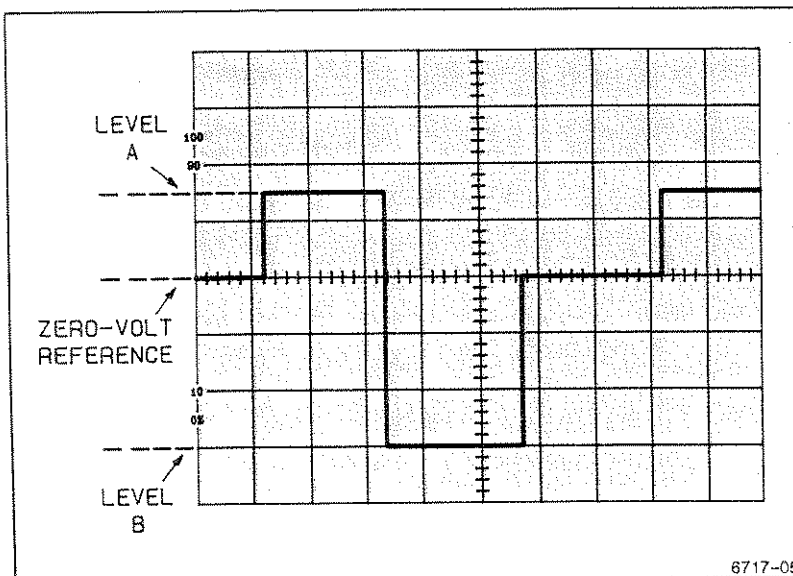

Figure 3-2. Instantaneous voltage measurement.

9. Calculate the instantaneous voltage, using the following formula:

$$\text{Instantaneous Voltage} = \text{vertical deflection (divisions)} \times \text{polarity (+ or -)} \times \text{VOLTS/DIV setting (10X Probe)*}$$

**If the signal adapter is being used for the measurement, use the 1X VOLTS/DIV setting.*

EXAMPLE. In Figure 3-2, the zero-volt reference is as shown at the center vertical graticule line, a 10X attenuation probe is being used, and VOLTS/DIV is set to 2 V (10X PROBE). Two unknown voltage levels, A and B, are marked on the waveform. A is 1.5 divisions above the zero-volt reference level, and B is three divisions below the zero-volt reference level. What are the respective voltages of levels A and B?

Substituting the given values:

$$\begin{aligned}\text{Instantaneous Voltage A} &= 1.5 \text{ div} \times (+1) \times 2 \text{ V/div} = 3.0 \text{ V.} \\ \text{Instantaneous Voltage B} &= 3.0 \text{ div} \times (-1) \times 2 \text{ V/div} = -6.0 \text{ V.}\end{aligned}$$

Algebraic Addition

With the three VERTICAL MODE selectors set to BOTH-NORM-ADD, the waveform displayed is the algebraic sum of the signals applied to the Channel 1 and Channel 2 inputs (CH1 + CH2). If the middle MODE selector is then set to CH2 INVERT, the waveform displayed is the difference between the signals applied to the Channel 1 and Channel 2 inputs (CH1 - CH2). When both VOLTS/DIV controls are set to the same deflection factor, the deflection factor of the ADD trace is equal to the deflection factor indicated by either VOLTS/DIV control.

The following general precautions should be observed when using ADD VERTICAL MODE.

1. Do not exceed the input voltage rating of the oscilloscope.
2. Do not apply signals whose peaks exceed the equivalent of about ± 8 times the VOLTS/DIV settings, because large voltages may distort the display. For example, with a VOLTS/DIV setting of 0.5 V, the voltage applied to that channel should not exceed approximately 4 V.
3. Position the Channel 1 and Channel 2 waveforms near center screen, when viewed separately. This ensures the greatest dynamic range for ADD mode operation.
4. To attain similar responses from both channels, set the Channel 1 and Channel 2 input coupling selectors to the same position.

Common-Mode Rejection

The following procedure shows how to eliminate unwanted AC line frequency components. Similar methods could be used to eliminate other unwanted frequency components or to provide a DC offset.

1. Apply the signal containing the unwanted line-frequency components to the CH1 input connector.
2. Apply a line-frequency signal to the CH2 input connector. To maximize cancellation, the signal applied to Channel 2 must be in phase with the unwanted line frequency component of the Channel 1 input.
3. Set the three VERTICAL MODE selectors to BOTH-NORM-ALT; set both VOLTS/DIV controls equally to produce displays of approximately four or five divisions amplitude.
4. Adjust the CH2 VOLTS/DIV and Variable (CAL) controls so that the Channel 2 display is approximately the same amplitude as the undesired portion of the Channel 1 display (see Figure 3-3 top).
5. Now set the middle and right VERTICAL MODE selectors to CH2 INVERT and ADD. Slightly readjust the CH2 VOLTS/DIV variable control for maximum cancellation of the undesired signal component (Figure 3-3 bottom).

Amplitude Comparison (Ratio)

In some applications, it may be necessary to establish a set of deflection factors between step settings of the VOLTS/DIV controls. This is useful for comparing unknown signals to a reference signal of known amplitude.

To accomplish this, a reference signal of known amplitude is first set to an exact number of vertical divisions by adjusting the VOLTS/DIV and VOLTS/DIV Variable (CAL) controls. Unknown signals can then be quickly and accurately compared to the reference signal without disturbing the setting of the VOLTS/DIV Variable controls.

1. Apply the reference signal to either the CH1 or the CH2 input connector and set the left VERTICAL MODE selector to display the channel used.

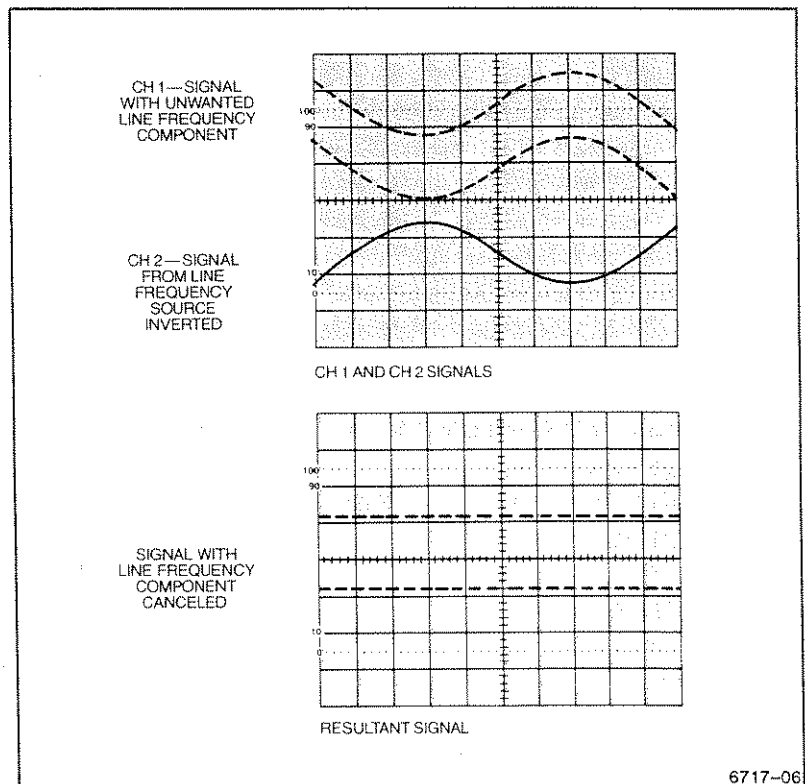

Figure 3-3. Common-mode rejection.

2. Set the amplitude of the reference signal to 5 vertical divisions by adjusting the VOLTS/DIV and VOLTS/DIV Variable (CAL) controls.
3. Disconnect the reference signal and apply the unknown signal to the same channel input. Adjust the vertical position of the waveform so that its bottom edge just touches the 0% line on the crt.
4. Horizontally position the waveform so that its topmost features cross the center vertical graticule line (see Figure 3-4).

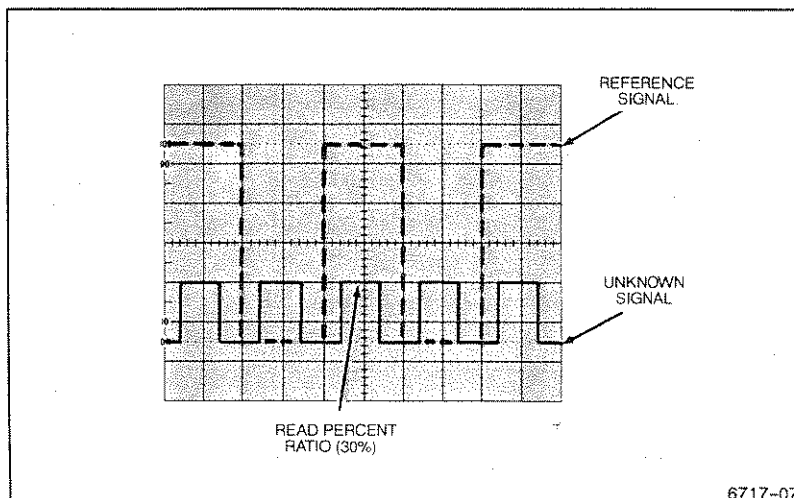

Figure 3-4. Determining voltage ratio.

3

5. Read the percent ratio directly from the graduations on the vertical centerline, referring to the 0% and 100% percentage marks on the left edge of the graticule (1 minor division equals 4% for a 5-division display).

TIME MEASUREMENTS

Time Duration

To measure time between two points on a waveform, use the following procedure:

1. Apply the signal to either the CH1 or the CH2 input connector and set the VERTICAL MODE selector to display the channel used.
2. Adjust the TRIGGER LEVEL control to obtain a stable display.
3. Set the SEC/DIV control to display between one and two complete repetitions of the waveform. Check that the SEC/DIV variable control is in the CAL detent.

- Position the display to place the time-measurement points on the center horizontal graticule line (see Figure 3-5).

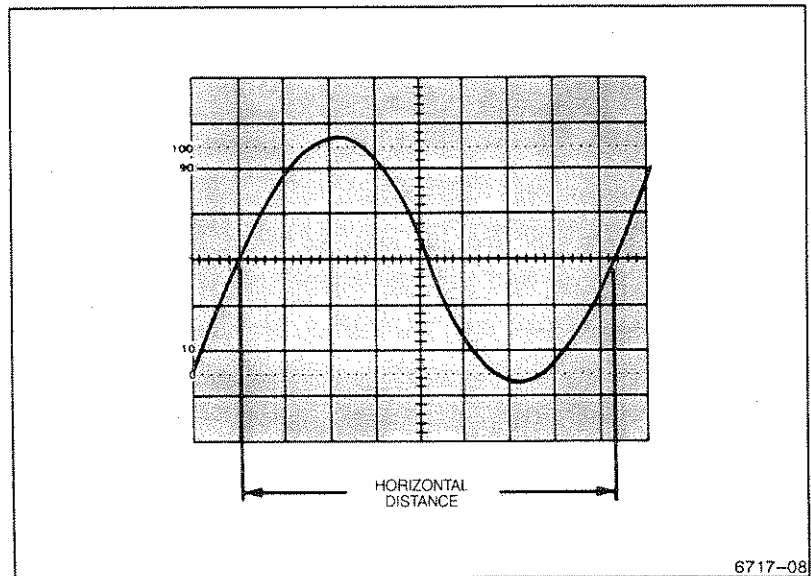

Figure 3-5. Measuring time duration.

- Measure the horizontal distance between the time measurement points.
- Calculate time duration using the following formula:

$$\text{Time Duration} = \frac{\text{horizontal distance (divisions)} \times \text{SEC/DIV control setting}}{\text{magnification factor}}$$

EXAMPLE. In Figure 3-5, the distance between the time measurement points is 8.3 divisions, and the SEC/DIV setting is 2 ms per division, HORIZONTAL MAG is set to X1.

Substituting the given values:

$$\text{Time Duration} = 8.3 \text{ div} \times 2 \text{ ms/div} = 16.6 \text{ ms}$$

Period and Frequency

In the preceding example, you measured the time duration of one complete waveform cycle. This particular measurement is called the waveform period (T). The frequency (f) of a recurrent signal can be determined from its period as follows:

1. Measure the time duration of one waveform cycle (period) using the preceding time-duration measurement procedure.
2. Calculate the reciprocal of the period to determine the waveform frequency.

EXAMPLE. The signal in Figure 3-5 has a period (T) of 16.6 ms. Calculating frequency (f):

$$f = \frac{1}{T} = \frac{1}{16.6 \times 10^{-3}\text{s}} = 60 \text{ Hz}$$

Rise Time

Rise time measurements use the same methods as time duration, except that the measurements are made between the 10% and 90% points on the low-to-high transition of the selected waveform. Fall time is measured between the 90% and 10% points of the high-to-low transition of the waveform.

1. Apply a signal to either the CH1 or the CH2 input connector and set the VERTICAL MODE selector to display the channel used.
2. Set the appropriate VOLTS/DIV and VOLTS/DIV Variable (CAL) control for an exact 5-division display.
3. Vertically position the traces so that the zero reference of the waveform touches the 0% graticule line and the top of the waveform touches the 100% graticule line.
4. Horizontally position the display so the 10% point on the waveform intersects the second vertical graticule line (Figure 3-6, Point A).

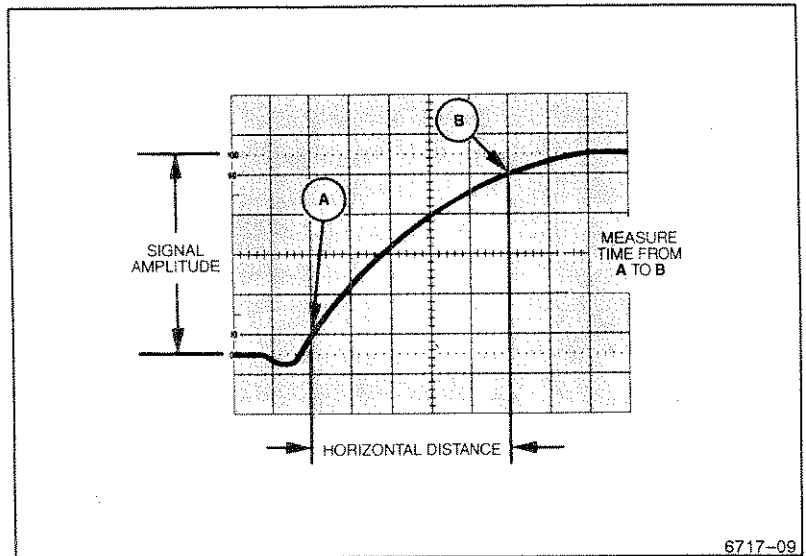

Figure 3-6. Measuring rise time.

NOTE

You can achieve better accuracy by using the SEC/DIV control, or horizontal magnification, to expand the waveform transition so that it occupies from four to six horizontal divisions between the 10% and 90% amplitude points.

5. Measure the horizontal distance between the 10% and 90% points (Figure 3-6, Points A and B) and calculate time duration using the following formula:

$$\text{Rise Time} = \frac{\text{horizontal distance (divisions)} \times \text{SEC/DIV control setting}}{\text{magnification factor}}$$

EXAMPLE. In Figure 3-6, the horizontal distance between the 10% and 90% amplitude points is 5 divisions, and the SEC/DIV switch is set to 1 μs per division. HORIZONTAL MAG is set to X1.

Applications

Substituting given values in the formula:

$$\text{Rise Time} = \frac{5 \text{ div} \times 1 \text{ } \mu\text{s/div}}{1} = 5 \text{ } \mu\text{s}$$

Time Difference Between Pulses on Time-Related Signals

The calibrated sweep speed and dual-trace features of the 2205 allow measurement of the time difference between two separate events. To measure time difference, use the following procedure:

1. Set the TRIGGER SOURCE to CH1.
2. Set both input coupling controls to the same position.
3. Using probes or cables with equal time delays, apply a known reference signal to the CH1 input connector and apply the comparison signal to the CH2 input.
4. Set both VOLTS/DIV controls for a display of about five divisions.
5. Set VERTICAL MODE to BOTH; then select either ALT or CHOP, depending on the frequency of the input signals.
6. If the two signals are opposite in polarity, set the middle VERTICAL MODE selector to CH2 INVERT to invert the Channel 2 display.
7. Adjust the TRIGGER LEVEL control for a stable display.
8. Set the SEC/DIV control to a sweep speed that provides three or more divisions of horizontal separation between measurement points on the two displays. Center each of the displays vertically (see Figure 3-7).

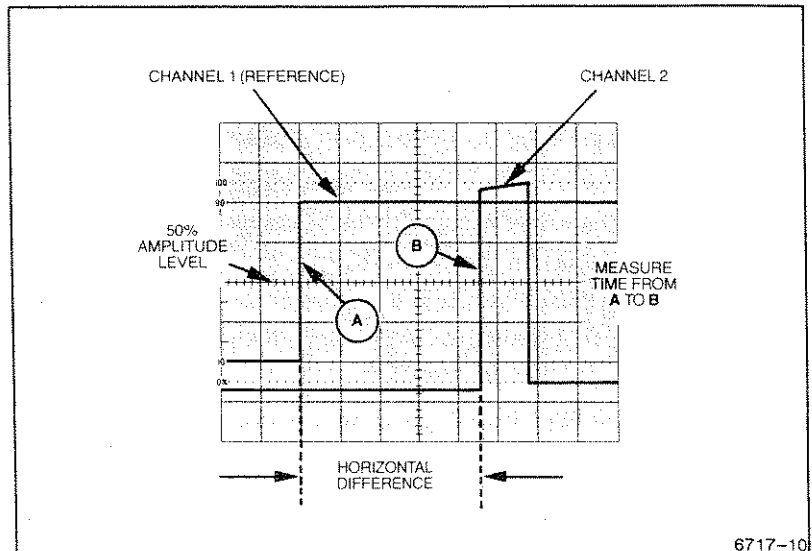

Figure 3-7. Time difference between pulses on time-related signals.

9. Determine the horizontal difference between the two signal measurement points and calculate the time difference using the following formula:

$$\text{Time Difference} = \frac{\text{horizontal difference (divisions)} \times \text{SEC/DIV control setting}}{\text{magnification factor}}$$

EXAMPLE. In Figure 3-7, the SEC/DIV control is set to 50 μs per division and HORIZONTAL MAG is set to X10. The horizontal difference between waveform measurement points is 4.5 divisions.

$$\text{Time Difference} = \frac{50 \mu\text{s/div} \times 4.5 \text{ div}}{10} = 22.5 \mu\text{s}$$

Phase Difference

In a similar manner to the preceding measurement, you can make a phase comparison between two signals of the same frequency using the dual-trace feature of the 2205. This method of phase-difference measurement can be used for signals with frequencies up to the limit of the vertical deflection system. To make a phase comparison, use the following procedure:

1. Set the TRIGGER SOURCE selector to CH1.
2. Set both input coupling controls to the same position, depending on the type of input coupling desired.
3. Using probes or cables with equal time delays, apply a known reference signal to the CH1 input connector and apply the unknown signal to the CH2 input.
4. Set VERTICAL MODE to BOTH; then select either ALT or CHOP, depending on the frequency of the input signals. The reference signal should precede the comparison signal in time.
5. If the two signals are opposite in polarity, set the middle VERTICAL MODE switch to CH2 INVERT to invert the Channel 2 display.
6. Set both VOLTS/DIV and VOLTS/DIV Variable (CAL) controls to display equal-amplitude waveforms.
7. Adjust the TRIGGER LEVEL control for a stable display and center the display vertically.
8. Set the SEC/DIV control to a sweep speed that displays about one full cycle of the waveforms.
9. Position the displays and adjust the SEC/DIV Variable (CAL) control so that one cycle of the reference signal occupies exactly eight horizontal graticule divisions at the 50% rise-time points (see Figure 3-8). Each horizontal division of the graticule now represents 45° of the cycle (360° divided by 8 divisions), and the horizontal graticule calibration can be stated as 45° per division.

10. Measure the horizontal difference between corresponding points on the two waveforms at the 50% rise-time points and calculate the phase difference using the following formula:

$$\text{Phase Difference} = \frac{\text{horizontal difference (divisions)}}{\text{graticule calibration (deg/div)}}$$

EXAMPLE. In Figure 3-8, the horizontal difference is 0.6 division with a graticule calibration of 45° per division.

Substituting the given values into the phase-difference formula:

$$\text{Phase Difference} = 0.6 \text{ div} \times 45^\circ/\text{div} = 27^\circ.$$

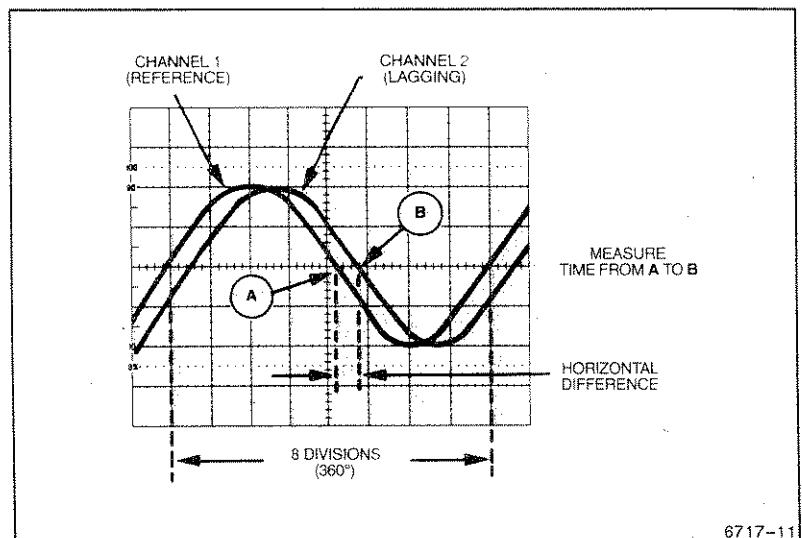

Figure 3-8. Phase difference.

More accurate phase measurements can be made by using the horizontal magnifier function to increase the sweep speed without changing the SEC/DIV variable control setting. To do this, set the HORIZONTAL MAG to X10.

With the sweep speed increased 10 times (MAG set to X10), the magnified horizontal graticule calibration will be 4.5° per division ($45^\circ/\text{division}$ divided by 10). Figure 3-9 shows the same signals illustrated in Figure 3-8, but horizontally magnified by a factor of 10.

EXAMPLE. In Figure 3-9, the 10X magnified display results in a horizontal difference of six divisions between the two signals.

Substituting the given values into the phase difference formula:

$$\text{Phase Difference} = 6 \text{ div} \times 4.5^\circ/\text{div} = 27^\circ.$$

3

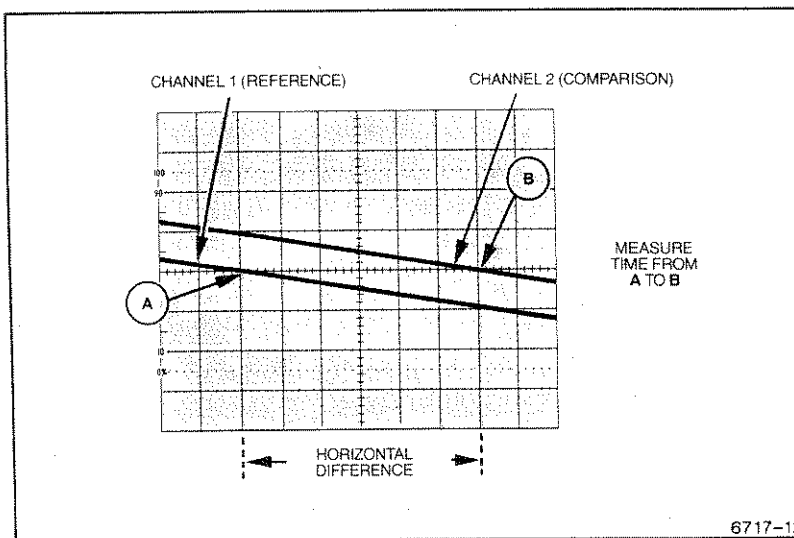

Figure 3-9. High-resolution phase difference.

TELEVISION DISPLAYS

TV Field Signals

The 2205 television feature can be used to display TV field signals. To do so, proceed as follows:

1. Set the TRIGGER MODE selector to TV FIELD and set the SEC/DIV control to 2 ms.
2. Apply the television signal to either the CH1 or the CH2 input connector and set the VERTICAL MODE selector to display the channel used.
3. For positive-going TV signal sync pulses, set the TRIGGER SLOPE to \swarrow and rotate the LEVEL control fully counterwise. (Sometimes it may be necessary to move the LEVEL control slightly clockwise to obtain stable triggering.)
4. Set the appropriate VOLTS/DIV control to display one division or more of composite video signal.
5. To change the TV field being displayed, momentarily interrupt the trigger signal by setting the input coupling to GND, then back to DC or AC until the desired field is displayed.

NOTE

To examine a TV Field signal in more detail, set HORIZONTAL MAG to X10.

6. To display either Field 1 or Field 2 individually, connect the television signal to both the CH1 and CH2 input connectors and select BOTH and ALT VERTICAL MODE. Set the SEC/DIV control to 0.5 ms or faster sweep speed (displays less than one full field). This will synchronize the Channel 1 display to one field and the Channel 2 display to the other field.

TV Line Signals

The following procedure is used to display a TV Line signal.

1. Verify that TRIGGER MODE is set to P-P AUTO/TV LINE.
2. Apply the Television signal to either the CH1 or the CH2 input connector and set the VERTICAL MODE selector to display the channel used.
3. Set the SEC/DIV control to 10 μ s.
4. For positive-going TV signal sync pulses, set the TRIGGER SLOPE to \nearrow and rotate the LEVEL control fully clockwise. For negative-going sync pulses, set the TRIGGER SLOPE to \searrow and rotate the LEVEL control fully counterclockwise. (Sometimes it may be necessary to move the LEVEL control slightly clockwise to obtain stable triggering.)
5. Set the appropriate VOLTS/DIV control to display one division or more of composite sync signal.

NOTE

To examine a TV Line signal in more detail, set HORIZONTAL MAG to X10.

6. To display a selected TV Line pulse, first trigger the sweep on a TV Field sync pulse. Use the HORIZONTAL POSITION control to select the desired line pulse, then set HORIZONTAL MAG to X10.

Z-MODULATION

The Z-modulation system can be used to display time markers, because it depends entirely upon the accuracy of the signal source. It can also be used in any situation where external control of the brightness of some or all of the trace is required.

The Z, or intensity, modulation feature is operated in the following manner:

1. Set the left and right TRIGGER SOURCE controls to EXT and EXT=Z, respectively.
2. Apply a signal to either the CH1 or the CH2 connector and set the VERTICAL MODE selector to display the channel used.
3. Apply the Z-modulation signal to the connector labeled EXT INPUT or Z.

When the Z-modulation and the vertical-input signals are synchronized, Z-modulation is seen as gaps in the trace at the modulation frequency. The size of the gap depends upon the mark-to-space ratio of the Z-modulation signal. The positive-going portion of the Z-modulation signal decreases display brightness.

SECTION 4

**CHECKS AND
ADJUSTMENTS**

Performing the operator checks and adjustments in this section will eliminate significant sources of measurement error and will improve measurement confidence. If adjustments are required beyond the scope of this section, refer the instrument to a qualified service technician.

A complete performance check should be made after every 2000 hours of operation or once a year if the instrument is used infrequently. A shorter interval may be necessary if your instrument is subjected to harsh environments or severe usage.

TRACE ROTATION

Normally, the horizontal axis of a waveform display will be parallel to the center horizontal graticule line. To check horizontal alignment and to adjust it if necessary, perform the following procedure. A probe is not needed for this adjustment.

1. Preset instrument controls (see Learning the Controls in Section 2) and obtain a baseline trace.
2. Use the Channel 1 POSITION control to move the baseline trace to the center horizontal graticule line.
3. The trace should be parallel to the center horizontal graticule line. If it is not, use a small flat-bit screwdriver to adjust the TRACE ROTATION control on the front panel so that the trace aligns with the center horizontal graticule line.

PROBE COMPENSATION (Optional 10X Probe)

Misadjustment of probe low-frequency compensation is a common source of measurement error. Most attenuator probes are equipped with compensation adjustments. To ensure optimum measurement accuracy, always compensate the oscilloscope probes before making measurements. Probe compensation is accomplished as follows:

1. Preset instrument controls (as given in Learning the Controls, in Section 2, Operation) and obtain a baseline trace.
2. Attach the two optional X10 probes to the CH1 and CH2 input connectors.

3. Set both VOLTS/DIV controls to .1 V (X10 probe), set both input coupling controls to DC, and select CH1 VERTICAL MODE.
4. Place the tip of the Channel 1 probe on the PROBE ADJUST terminal.
5. Using the approximately 1 kHz Probe Adjust signal, obtain a 5-division display.
6. Set the SEC/DIV control to display several cycles of the signal. Use the Channel 1 POSITION control to vertically center the display.
7. Check the waveform presentation for overshoot and rolloff (see Figure 4-1). If necessary, perform step 8 to adjust the probe low-frequency compensation. Otherwise, proceed to step 9.
8. Rotate the sleeve on the probe head to expose the LF COMP adjustment capacitor (see Figure 4-2). Use a low-reactance alignment tool to adjust LF COMP and obtain a square, or nearly square, front corner on the waveform tops (Figure 4-1, top trace).

4

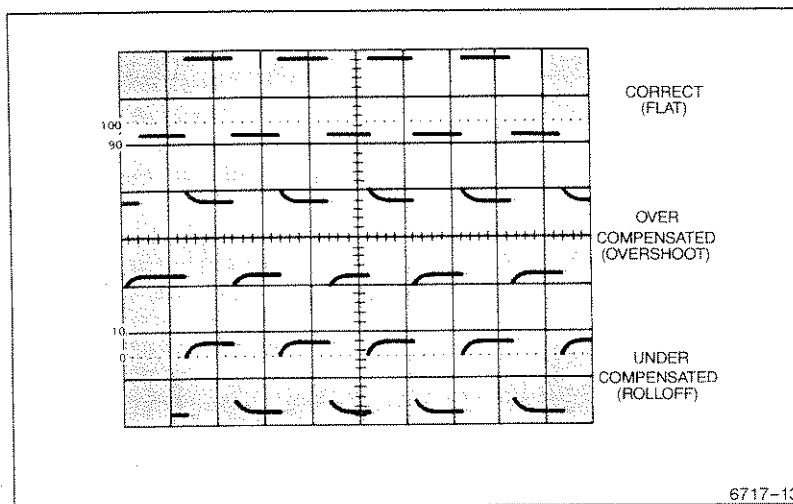

Figure 4-1. Probe compensation.

9. Select CH2 VERTICAL MODE. Disconnect the Channel 1 probe tip and attach the Channel 2 probe tip to the PROBE ADJUST output terminal.
10. Obtain a 5-division signal display and vertically center the trace.
11. Repeat step 7 for the Channel 2 probe.

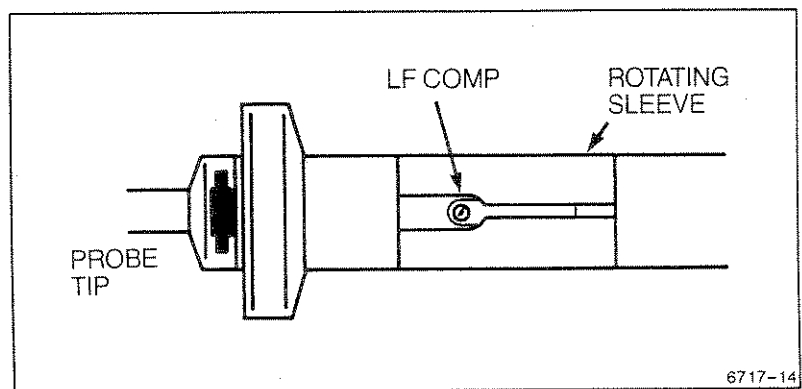

Figure 4-2. Locating the low-frequency compensation adjustment.



SECTION 5

**PERFORMANCE
CHARACTERISTICS**

The 2205 electrical characteristics listed in Table 5-1 are valid when it has been adjusted at an ambient temperature between +20°C and +30°C, has had a warm-up period of at least 20 minutes, and is operating at an ambient temperature between 0°C and +40°C (unless otherwise noted).

Environmental characteristics are given in Table 5-2. The 2205 meets the requirements of MIL-T-28800C, paragraphs 4.5.5.5.1.3, 4.5.5.1.4, and 4.5.5.1.2.2 for Type III, Class 5 equipment, except where otherwise noted.

Mechanical characteristics of the instrument are listed in Table 5-3.

TABLE 5-1
Electrical Characteristics

Characteristics	Performance Requirements
VERTICAL DEFLECTION SYSTEM	
Deflection Factor	
Range	5 mV per division to 5 V per division in a 1-2-5 sequence of 9 steps.
Accuracy	± 3%.
Variable Control Range	Continuously variable and uncalibrated between step settings. Increases deflection factor by at least 2.5 to 1.
Step Response (Rise Time)	Applicable from 5 mV per division to 5 V per division. Rise times calculated from: $t_r = \frac{0.35}{BW}$
+5°C to +35°C	17.5 ns or less.
0°C to +5°C and +35°C to +40°C	23.3 ns or less.

TABLE 5-1 (cont'd)

Characteristics	Performance Requirements
VERTICAL DEFLECTION SYSTEM (cont'd)	
Bandwidth (-3 dB) +5 °C to +35 °C	20 MHz or more.
0 °C to +5 °C and +35 °C to +40 °C	15 MHz or more.
AC Coupled Lower Cutoff Frequency	10 Hz or less at -3 dB.
CHOP Mode Switching Rate	500 kHz \pm 30%.
Input Characteristics	
Resistance	1 M Ω \pm 2%.
Capacitance	25 pF \pm 2 pF.
Maximum Safe Input Voltage (DC or AC Coupled)	400 V (dc + peak ac) or 800 V ac p-p to 10 kHz or less.
Common-Mode Rejection Ratio (CMRR)	At least 10 to 1 at 20 MHz.
Trace Shift	
With VOLTS/DIV Switch Rotation	0.75 division or less (Variable control in CAL detent).
With VOLTS/DIV Variable Control Rotation	1.0 division or less.
With Channel 2 Inverted	1.5 divisions or less.
Channel Isolation	Greater than 100 to 1 at 10 MHz.

TABLE 5-1 (cont'd)

Characteristics	Performance Requirements	
TRIGGER SYSTEM		
Trigger Sensitivity		
P-P AUTO/TV LINE and NORM Modes	5 MHz	30 MHz
Internal Signal	0.3 div	1.0 div
External Signal	40 mV	150 mV
Lowest Usable Frequency in P-P AUTO Mode	≥ 20 Hz	
TV FIELD Mode	1.0 division of composite sync.	
External Input		
Resistance	$1 \text{ M}\Omega \pm 10\%$	
Capacitance	$25 \text{ pF} \pm 2.5 \text{ pF}$	
Maximum Voltage	400 V (dc + peak ac) or 800 V ac p-p at 10 kHz or less.	
Trigger Level Range		
NORM Mode	± 15 divisions referred to the appropriate vertical input.	
EXT Source	At least $\pm 1.6 \text{ V}$, 3.2 V p-p.	
EXT/10 Source	At least $\pm 16 \text{ V}$, 32 V p-p.	

TABLE 5-1 (cont'd)

Characteristics	Performance Requirements	
HORIZONTAL DEFLECTION SYSTEM		
Sweep Rate		
Calibrated Range	0.5 s per division to 0.1 μ s per division in a 1-2-5 sequence. Magnification extends maximum usable sweep speed to 10 ns per division.	
Accuracy	Magnified	
	X1	X10
+15°C to +35°C	$\pm 3\%$	$\pm 4\%$
0°C to +40°C	$\pm 4\%$	$\pm 5\%$
Variable Control Range	Continuously variable and uncalibrated between calibrated step settings. Decreases calibrated sweep speeds at least by a factor of 2.5.	
Sweep Linearity	Magnified	
	X1	X10
	$\pm 5\%$	$\pm 7\%$
Position Control Range	Start of sweep, to 10th division in X1 and to 100th division in X10, will position past the center vertical graticule line.	
Registration of Unmagnified and Magnified Traces	0.2 division or less, aligned to central vertical graticule line.	

TABLE 5-1 (cont'd)

Characteristics	Performance Requirements
Z-MODULATION	
Sensitivity	5 V causes noticeable modulation. Positive-going input decreases intensity.
Usable Frequency Range	Dc to 5 MHz.
Maximum Safe Input Voltage	400 V (dc + peak ac) or 800 V ac p-p to 10 kHz or less.
X-Y OPERATION (X1 MODE)	
Deflection Factors	Same as Vertical Deflection System with Variable controls in CAL detents.
Accuracy	
X-Axis	$\pm 5\%$
Y-Axis	Same as Vertical Deflection System.
Bandwidth (-3 dB)	
X-Axis	Dc to at least 1 MHz.
Y-Axis	Same as Vertical Deflection System.
Phase Difference Between X- and Y-Axis Amplifiers	$\pm 3^\circ$ from dc to 50 kHz.
PROBE ADJUSTMENT SIGNAL OUTPUT	
Voltage into 1 M Ω Load	0.5 V $\pm 5\%$.
Repetition Rate	1 kHz $\pm 20\%$.

TABLE 5-1 (cont'd)

Characteristics	Performance Requirements
POWER REQUIREMENTS	
Line Voltage Ranges	
115 V Setting	95 V ac to 128 V ac.
230 V Setting	185 V ac to 250 V ac.
Line Frequency	48 Hz to 440 Hz.
Maximum Power Consumption	40 W (60 VA).
Line Fuse	UL198.6, 3AG (1/4 x 1 1/4 inch)
115 V Setting	0.75 A Slow
230 V Setting	0.5 A, Slow
CATHODE-RAY TUBE	
Display Area	80 by 100 mm.
Standard Phosphor	GH (P31).
Nominal Accelerating Voltage	1800 V \pm 10%.



**Table 5-2
Environmental Characteristics**

Characteristics	Performance Requirements
Temperature Operating	0°C to +40°C (+32°F to +104°F).
Nonoperating	-55°C to +75°C (-67°F to +167°F).
Altitude Operating	To 4500 m (15,000 ft.). Maximum operating temperature decreases 1°C per 300 m (1,000 ft.) above 1,500 m (5,000 ft.).
Nonoperating	To 15,250 m (50,000 ft.).
Relative Humidity Operating (+30°C to +40°C)	85% +0%, -5%
Nonoperating (+30°C to +60°C)	85% +0%, -5%
Vibration (Operating)	15 minutes along each of three major axes at a total displacement of 0.015 inch p-p (2.4 g at 55 Hz) with frequency varied from 10 Hz to 55 Hz to 10 Hz in one-minute sweeps. Hold for 10 minutes at 55 Hz in each of three major axes. All major resonances must be above 55 Hz.
Shock (Operating and Nonoperating)	30 g, half-sine, 11-ms duration, three shocks per axis each direction, for a total of 18 shocks.
Radiated and Conducted Emission Requirements	Meets VDE 0871 Class B.

Performance Characteristics

Table 5-3
Mechanical Characteristics

Characteristics	Performance Requirements
Weight With Power Cord	8.25 kg (13.7 lbs) or less.
Domestic Shipping Weight	9.1 kg (20.0 lbs) or less.
Height	138 mm (5.4 in).
Width	
With Handle	379 mm (14.9 in).
Without Handle	327 mm (12.9 in).
Depth	
Without Front Cover	441 mm (17.4 in).
With Optional Front Cover	455 mm (17.9 in).
With Handle Extended	516 mm (20.3 in).

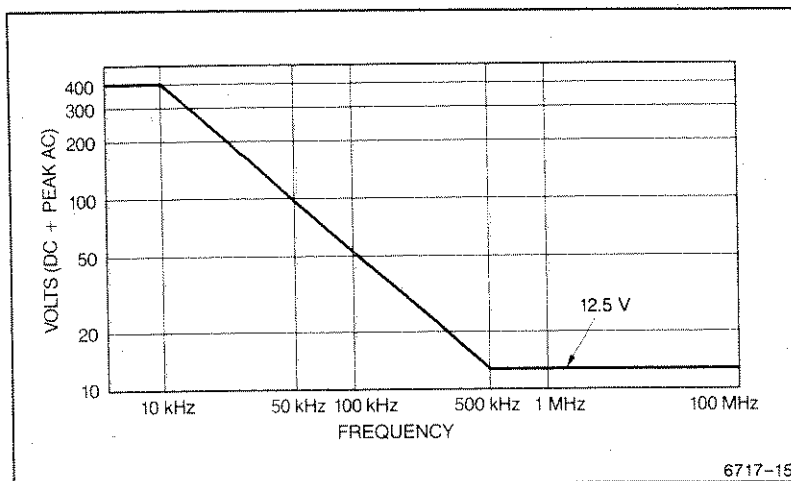

Figure 5-1. Maximum input voltage versus frequency derating curve for CH 1 OR X, CH 2 OR Y, and EXT INPUT connectors.

5

SECTION 6

**OPTIONS AND
ACCESSORIES**

This section lists the standard accessories (including Tektronix part numbers) that are shipped with each instrument. It also briefly describes the options that can be included with the original instrument order. If you wish to obtain any of these options after receiving your instrument, use the accessories list contained in Tables 6-1 and 6-2. For additional information about instrument options and other optional accessories, consult the current Tektronix Product Catalog or contact your local Tektronix Sales Office or distributor.

STANDARD ACCESSORIES

Each instrument is shipped with the following standard accessories.

Quantity	Description	Part Number
2	Signal Adapters	103-0275-00
1	Operator's Manual	070-6717-00
1	Power Cord and Fuse	Per option ordered; see Table 6-1
1	Power Cord Clamp	343-0003-00
1	Screw	213-0882-00
1	Washer	210-0803-00

OPTIONS

Option 02

This option is intended for users who need added front-panel protection and accessories-carrying ease demanded by frequent travel to remote service sites. It includes a protective front panel cover and an accessories pouch that attaches to the top of the instrument.

Option 1C

An oscilloscope camera is useful for capturing single events and documenting measurement results; it helps communicate

results with clarity and credibility. Option 1C provides the Tektronix C-5C Option 04 Low-cost Camera for use with your oscilloscope.

Option 1K

When this option is specified, a K212 Portable Instrument Cart is included in the shipment. The cart provides a stable yet movable platform that is well suited for on-site instrument mobility in a variety of work areas.

Option 1R

When the oscilloscope is ordered with Option 1R, it is shipped in a configuration that permits easy installation into virtually any 19 inch wide electronic equipment rack. All hardware is supplied for mounting the instrument into the main frame.

Complete rack mounting instructions are provided in a separate document. These instructions also contain the procedures for converting a standard instrument into the Option 1R configuration by using the separately orderable rack-mounting conversion kit.

Option 1T

Adds Transit Case for 2205.

Option 22

Adds 24 Signal Adapters (016-0921-00).

Option 23

Two P6103, dc to 50 MHz, 10X Modular Probes are provided.

Option 24

Two P6062B 1X-10X Selectable-Attenuation Probes are added.

Power Cords

Instruments are shipped with the detachable power cord and fuse configuration ordered by the customer. Table 6-1 identifies the Tektronix part numbers for international power cords and associated fuses. Additional information about power cord options is contained in Section 1, *Preparation for Use*.

TABLE 6-1
Power Cords and Fuses

Description	Part Number
Standard (United States)	
Power Cord, 2.5 m	161-0104-00
Fuse, 0.75 A, 250 V, 3AG, 1/4" x 1 1/4", Slow	159-0042-00
Option A1 (Universal Europe)	
Power Cord, 2.5 m	161-0104-06
Fuse, 0.5 A, 250 V, 3AG, 1/4" x 1 1/4", Slow	159-0032-00
Option A2 (United Kingdom)	
Power Cord, 2.5 m	161-0104-07
Fuse, 0.5 A, 250 V, 3AG, 1/4" x 1 1/4", Slow	159-0032-00
Option A3 (Australia)	
Power Cord, 2.5 m	161-0104-05
Fuse, 0.5 A, 250 V, 3AG, 1/4" x 1 1/4", Slow	159-0032-00
Option A4 (North America)	
Power Cord, 2.5 m	161-0104-08
Fuse, 0.5 A, 250 V, 3AG, 1/4" x 1 1/4", Slow	159-0032-00
Option A5 (Switzerland)	
Power Cord, 2.5 m	161-0167-00
Fuse, 0.5 A, 250 V, 3AG, 1/4" x 1 1/4", Slow	159-0032-00

OPTIONAL ACCESSORIES

Table 6-2 lists recommended optional accessories for your instrument.

TABLE 6-2
Optional Accessories

Description	Part Number
Front Panel Protective Cover	200-3397-00
Accessory Pouch	016-0677-02
Front Panel Protective Cover and Accessory Pouch	020-1514-00
Hand Carrying Case	016-0792-01
CRT Light Filter, Clear	337-2775-02
Rack Mount Conversion Kit	016-0819-02
Viewing Hoods	
Collapsible	016-0592-00
Polarized	016-0180-00
Binocular	016-0566-00
Probe, 10X, 2 m, with accessories	P6103
Alternative Power Cords	
European	020-0859-00
United Kingdom	020-0860-00
Australian	020-0861-00
North American	020-0862-00
Switzerland	020-0863-00

TABLE 6-2 (cont)

Description	Part Number
Attenuator Voltage Probes	
10X Standard	P6103
10X Subminiature	P6130
10X Environmental	P6008
1X-10X Selectable	P6062B
100X High Voltage	P6009
1000X High Voltage	P6015
Current Probes	P6021, P6022 A6302/AM503, A6303/AM503
Current-Probe Amplifier	134
Active Probe, 10X FET	P6202A
Active-probe Power Supply	1101A
Ground Isolation Monitor	A6901
Isolator (for multiple, independently referenced, differential measurements)	A6902B
DC Inverter	1107
DC Inverter Mounting Kit	016-0785-00
Portable Power Supply	1105
Battery Pack	1106
Oscilloscope Cameras	
Low-cost	C-5C Option 04
Motorized	C-7 Option 03 and Option 30
Portable Instrument Cart	K212
2205 Service Manual	070-6716-00

APPENDIX A

Magnified Sweep Speeds

SEC/DIV Setting	Magnified Sweep Speed (Time/Division)
	X10
0.5 s	50 ms
0.2 s	20 ms
0.1 s	10 ms
50 ms	5 ms
20 ms	2 ms
10 ms	1 ms
5 ms	.5 ms
2 ms	.2 ms
1 ms	.1 ms
.5 ms	50 μ s
.2 ms	20 μ s
.1 ms	10 μ s
50 μ s	5 μ s
20 μ s	2 μ s
10 μ s	1 μ s
5 μ s	.5 μ s
2 μ s	.2 μ s
1 μ s	.1 μ s
.5 μ s	50 ns
.2 μ s	20 ns
.1 μ s	10 ns

APPENDIX B

Repackaging For Shipment

If this instrument is to be shipped by commercial transportation, it should be packaged in the original manner. The carton and packaging material in which your instrument was shipped to you may be retained for this purpose.

If the original packaging is unfit for use or is not available, repackage the instrument as follows:

1. Obtain a corrugated cardboard shipping carton having inside dimensions at least six inches greater than the instrument dimensions and having a carton test strength of at least 275 pounds.
2. If it is to be shipped to a Tektronix Service Center for service or repair, attach a tag to the instrument showing the following: Owner (with address), name of the person at your firm who can be contacted, complete instrument type and serial number, and a description of the service required.
3. Wrap the instrument with polyethylene sheeting or equivalent to protect the outside finish and to prevent entry of packing materials.
4. Cushion the instrument on all sides by tightly packing dunnage or urethane foam between the carton and the instrument, allowing three inches on each side.
5. Seal the carton with shipping tape or with an industrial stapler.
6. Mark the address of the Tektronix Service Center and your return address on the carton in one or more prominent locations.

APPENDIX C

GLOSSARY

DISPLAY CONTROLS

BEAM FIND—Finds the beam when it is off the screen.

FOCUS—Adjusts the trace for optimum focus.

INTENSITY—Adjusts the brightness of the trace.

POWER (ON-OFF)—Turns on AC power to the power supply. When the light is on the instrument operates; when the light is off the instrument is off.

TRACE ROTATION—Adjusts the trace to be parallel with the fixed graticule. (See OTHERS for graticule).

VERTICAL CONTROLS

ADD—Combines Channel 1 and Channel 2 algebraically.

ALTERNATE (ALT)—Shows CH 1 and CH 2 alternately; first one sweep of Channel 1 then one sweep of Channel 2.

Alternating Coupling (AC)—Static signal components are blocked and only the alternating components of the input signal reach the channel.

BOTH—Displays CH 1 and CH 2 in ALT, CHOP, or ADD mode.

CAL—Changes the variable scale factor up to 2.5 times the VOLTS/DIV setting.

Channel 1 (CH 1)—Displays only Ch 1 on the screen.

Channel 2 (CH 2)—Displays only Ch 2 on the screen.

Channel 2 Invert (CH 2 INVERT)—Inverts the polarity of CH 2. (See OTHERS for polarity.)

CHOP—The scope will draw part of CH 1, then part of CH 2 by switching back and forth.

Channel 1 Volts/Division (CH 1 VOLTS/DIV)—This switch is the scale factor for CH 1.

Channel 2 Volts/Division (CH 2 VOLTS/DIV)—This switch is the scale factor for CH 2.

Direct Coupling (DC)—All components of the input signal reach the input channel.

GROUND (*⏏*)—Shows where the zero level will be located when shifted to AC or DC.

Normal (NORM)—CH 1 and Ch 2 both have the same polarity when set to NORM. (See OTHERS for polarity.)

POSITION—Moves the trace vertically on the screen.

HORIZONTAL CONTROLS

CAL—Reduces the SEC/DIV by up to 2.5:1.

Ground receptacle—Provides safety earth connection to signal source.

Magnified times 1 (MAG X1)—Magnifies the SEC/DIV by 1.

Magnified times 10 (MAG X10)—Magnifies the SEC/DIV by 10.

POSITION—Moves the trace horizontally on the screen.

PROBE ADJUST—Provides a square wave for use as a reference when adjusting compensation on 10X probes.

Seconds/Division (SEC/DIV)—Lets you select the rate at which the beam sweeps across the screen.

TRIGGER CONTROLS

Channel 1 (CH 1)—Selects CH 1 signals to trigger the time base.

Channel 2 (CH 2)—Selects CH 2 signals to trigger the time base.

External (EXT)—Selects external signals to trigger the time base.

External 10 (EXT/10)—Selects external signal, divides it by 10, and connects it to the trigger circuit.

LEVEL—Determines signal level at which the trigger will occur.

LINE—Another trigger source (the power line).

Normal (NORM)—Allows selection of any TRIGGER LEVEL within approximately ± 15 divisions.

Peak to Peak Automatic (P-P AUTO)—Limits TRIGGER LEVEL to a range determined by peaks of signal. If no signal appears in about 5 ms, the sweep starts on its own to show a "baseline."

RESET—This button is used only in SGL SWP Mode to reset the sweep. (See TRIGGER for single sweep.)

Single Sweep (SGL SWP)—A mode in which, when a trigger occurs, only one sweep will run.

SLOPE—Determines whether the trigger point will occur on the raising or falling edge of the signal.

Trigger Ready (TRIG'D)—Lights when the sweep is triggered.

Television Field (TV FIELD)—Trigger on tv fields.

Television Line (TV LINE)—Trigger on tv lines.

Vertical Mode (VERT MODE)—Trigger source is determined by the Vertical Mode.

OTHERS

Alternation—A change in polarity, like a positive (+) changing directions to a negative (-) and back again.

Cathode-Ray Tube (CRT)—The picture tube.

Divisions—The lines that divide CRT display area units into X and Y components.

Graticule—The square boxes formed by lines on the CRT face.

Hertz—The basic unit of frequency.

Ohm (Ω)—The basic unit of resistance.

Polarity—The positive (+) or negative (-) direction of voltage or current.

