

User Manual

Tektronix

2232
Digital Storage Oscilloscope

070-7066-01

**Please check for change information at
the rear of this manual.**

First Printing MAY 1992
Revised AUGUST 1992

Instrument Serial Numbers

Each instrument manufactured by Tektronix has a serial number on a panel insert or tag, or stamped on the chassis. The first letter in the serial number designates the country of manufacture. The last five digits of the serial number are assigned sequentially and are unique to each instrument. Those manufactured in the United States have six unique digits. The country of manufacture is identified as follows:

B010000	Tektronix, Inc., Beaverton, Oregon, USA
E200000	Tektronix United Kingdom, Ltd., London
J300000	Sony/Tektronix, Japan
H700000	Tektronix Holland, NV, Heerenveen, The Netherlands

Instruments manufactured for Tektronix by external vendors outside the United States are assigned a two digit alpha code to identify the country of manufacture (e.g., JP for Japan, HK for Hong Kong, IL for Israel, etc.).

Tektronix, Inc., P.O. Box 500, Beaverton, OR 97077

Printed in U.S.A.

Copyright © Tektronix, Inc., 1992. All rights reserved. Tektronix products are covered by U.S. and foreign patents, issued and pending. The following are registered trademarks: TEKTRONIX, TEK, TEKPROBE, and SCOPE-MOBILE.

WARRANTY

Tektronix warrants that this product will be free from defects in materials and workmanship for a period of three (3) years from the date of shipment. If any such product proves defective during this warranty period, Tektronix, at its option, either will repair the defective product without charge for parts and labor, or will provide a replacement in exchange for the defective product.

In order to obtain service under this warranty, Customer must notify Tektronix of the defect before the expiration of the warranty period and make suitable arrangements for the performance of service. Customer shall be responsible for packaging and shipping the defective product to the service center designated by Tektronix, with shipping charges prepaid. Tektronix shall pay for the return of the product to Customer if the shipment is to a location within the country in which the Tektronix service center is located. Customer shall be responsible for paying all shipping charges, duties, taxes, and any other charges for products returned to any other locations.

This warranty shall not apply to any defect, failure or damage caused by improper use or improper or inadequate maintenance and care. Tektronix shall not be obligated to furnish service under this warranty a) to repair damage resulting from attempts by personnel other than Tektronix representatives to install, repair or service the product; b) to repair damage resulting from improper use or connection to incompatible equipment; or c) to service a product that has been modified or integrated with other products when the effect of such modification or integration increases the time or difficulty of servicing the product.

THIS WARRANTY IS GIVEN BY TEKTRONIX WITH RESPECT TO THIS PRODUCT IN LIEU OF ANY OTHER WARRANTIES, EXPRESSED OR IMPLIED. TEKTRONIX AND ITS VENDORS DISCLAIM ANY IMPLIED WARRANTIES OF MERCHANTABILITY OR FITNESS FOR A PARTICULAR PURPOSE. TEKTRONIX' RESPONSIBILITY TO REPAIR OR REPLACE DEFECTIVE PRODUCTS IS THE SOLE AND EXCLUSIVE REMEDY PROVIDED TO THE CUSTOMER FOR BREACH OF THIS WARRANTY. TEKTRONIX AND ITS VENDORS WILL NOT BE LIABLE FOR ANY INDIRECT, SPECIAL, INCIDENTAL, OR CONSEQUENTIAL DAMAGES IRRESPECTIVE OF WHETHER TEKTRONIX OR THE VENDOR HAS ADVANCE NOTICE OF THE POSSIBILITY OF SUCH DAMAGES.



This manual is designed to familiarize you with the features and operation of the 2232 Digital Storage Oscilloscope.

The *Before You Begin* section contains important safety information as well as instructions on preparing the instrument for use.

Use the *At a Glance* section to learn about each of the front-panel controls and menus.

With the *In Detail* section you can begin exploring the various ways of using the oscilloscope to display, measure, and store waveforms.

Related Manuals

Tektronix also provides the following documentation for the 2232 Digital Storage Oscilloscope:

- The *2232 Service Manual* contains extended service information; including circuit description, schematics, and a complete electrical parts list. There are two service manuals: part number 070-7067-01 documents instruments with serial numbers B010100 to B029999; and part number 070-8548-00 is for serial numbers B030000 and above.
- The *2221A, 2224, & 2232 Optional GPIB & RS-232-C Interfaces User Manual* (070-8159-01) shows how to connect, program, and use the optional GPIB and RS-232-C communication interfaces.
- The *QuickStart* package (020-1812-04 for the U.S. and 020-1812-06 for international) includes a video tape and exercises along with a signal board to provide you with practical instruction.

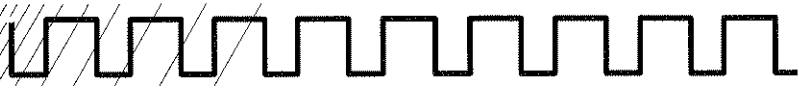

Contents

Welcome	i
Product Description	vii

Before You Begin

Safety	1-1
Symbols and Terms	1-1
Specific Precautions	1-2
Start Up	1-3
Installation & Power On	1-3
Initial Setup	1-4
Setting Up the Display	1-4
Adjusting Trace Rotation	1-5
Checking the Probe Compensation	1-6
Installing the Accessory Pouch	1-7
Using the Power Cord Wrap	1-8

At a Glance

Front Panel	2-1
Power Switch	2-4
CRT Display	2-5
Display Mode	2-6
CRT Display Controls	2-8
Vertical Controls and Connections	2-10
Horizontal Controls	2-14
Trigger Controls	2-16
Cursor Controls	2-20
Acquisition Controls	2-21
Save Reference Memory Buttons	2-22
Setup Menus	2-25
Acquisition Menu	2-26
Display Menu	2-28
Format Reference Menu	2-29
NVmem Reference Menu	2-30
Plot Menu	2-31
Advanced Functions Menu	2-33

Displaying Signals	3-1
Applying Signals to the Vertical Inputs	3-1
Connecting Signals	3-1
Coupling Signals	3-2
Precharging the Signal Input	3-2
Building a Basic Display	3-3
Presetting the Controls	3-3
Selecting the Display Mode (STORE/NON-STORE)	3-3
Selecting the Trigger Mode	3-4
Selecting the Horizontal Mode and Scale	3-4
Selecting the Vertical Mode and Scale	3-5
Setting the Display Intensity and Focus	3-6
Finding "Lost" Displays	3-7
Digitizing Signals	3-8
Selecting the Acquisition Mode	3-9
Selecting the High-Speed Storage Mode	3-9
Selecting Slow-Speed Storage Modes	3-9
Viewing Slowly Occurring Events	3-10
Capturing Random Events	3-12
Accumulating Signal Peaks (ACCPEAK)	3-13
Detecting Signal Glitches	3-13
Averaging Signals	3-14
Sampling Signals	3-14
Clocking Acquisitions	3-15
Selecting the Acquisition Record Length (1K/4K)	3-15
Compressing the Acquisition Record Length (4K Compress)	3-16
Positioning the Acquisition Record	3-17
Preventing Signal Aliases	3-18
Displaying Magnified Sweeps	3-19
Using the X10 Magnifier	3-19
Displaying Two Channels	3-20
Comparing Two Signals	3-20
Adding Two Signals	3-20
Subtracting Signals or Signal Components (Common Mode Rejection)	3-20
Displaying Two Sweeps	3-22
Using RUNS AFTER DELAY	3-22
Displaying X-Y Patterns	3-23
Limiting Bandwidth	3-25
Modulating the Display Intensity	3-25
Triggering on Signals	3-26
Triggering on Repetitive Signals	3-26
Triggering on Low-Frequency Signals	3-27
Triggering on Random or Infrequent Events	3-27
Triggering on Complex or Non-Repetitive Signals	3-28

Triggering on Line Frequency	3-29
Triggering with an External Signal	3-29
Triggering on TV Signals	3-29
Removing Unwanted Trigger Signal Components	3-31
Measuring Signals	3-33
Measuring with the Graticule	3-33
Measuring with STORE Mode Cursors	3-33
Positioning the Cursors	3-34
Measuring Voltage	3-34
Measuring Voltages in Reference to Ground	3-35
Measuring Time with the Graticule or Cursors	3-37
Measuring Time Using the Delay Time Readout	3-38
Measuring Frequency	3-39
Measuring Rise Time and Fall Time	3-40
Measuring Trigger Level	3-42
Measuring Phase Difference	3-42
Saving Waveforms and Setups	3-45
Saving and Recalling Waveforms	3-45
Saving the Current Acquisition	3-45
Saving Waveforms in SAVE REF Memory	3-45
Recalling a Waveform from SAVE REF	3-46
Comparing Saved Waveforms	3-46
Formatting Saved Waveforms	3-46
Saving Waveforms in Long-Term Memory	3-47
Saving and Recalling Setups	3-49
Saving a Setup	3-49
Recalling a Setup from Memory	3-49
Recalling a Power Up State	3-49
Transmitting Waveforms	3-51
Communicating via Interface Options	3-51
Plotting or Printing a Waveform	3-52

Appendices

Appendix A: Options and Accessories	A-1
Options	A-1
Standard Accessories	A-2
Other Accessories	A-3
Appendix B: Specification	A-5
General Product Description	A-5
Options and Accessories	A-7
Performance Conditions	A-7
Characteristic Tables	A-8
Appendix C: Performance Verification	A-25

General Information	A-25
Purpose	A-25
Performance Check Interval	A-25
Structure	A-25
Limits and Tolerances	A-25
Test Equipment Required	A-26
Procedures	A-28
Initial Setup Procedure	A-28
Vertical System Checks	A-28
Horizontal System Checks	A-37
Trigger System Checks	A-45
External Z-Axis, Probe Adjust, External Clock, and X-Y Plotter Checks	A-51
Appendix D: Storage Modes	A-55

Glossary and Index

Glossary	G-1
Index	I-1

Change Information

Product Description

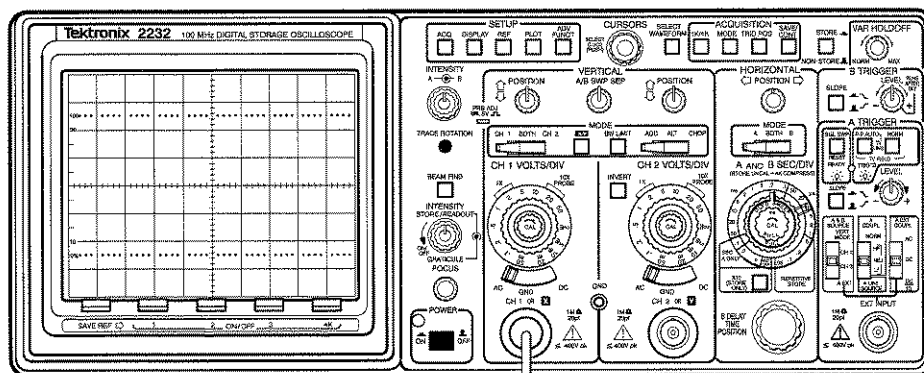

Your Tektronix 2232 Digital Storage Oscilloscope is a superb tool for displaying, measuring and saving waveforms. Its performance addresses the needs of both benchtop lab and portable applications:

- Combination analog and digital oscilloscope
- 100 MHz maximum analog bandwidth
- 100 Megasamples/sec digital sampling rate
- Multiple storage acquisition modes including glitch capture as narrow as 10 ns
- Cursor measurement and digital readouts
- Delayed time base
- Waveform storage and retrieval
- X-Y Plotter output
- Optional RS-232 or GPIB communication interfaces

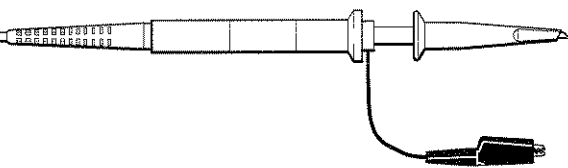



Safety

Please take a moment to review these safety precautions. They are provided for your protection and to prevent damage to the oscilloscope. This safety information applies to all operators.

Symbols and Terms

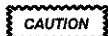
These two terms appear in manuals:

-  statements identify conditions or practices that could result in damage to the equipment or other property.
-  statements identify conditions or practices that could result in personal injury or loss of life.

These two terms appear on equipment:

- *CAUTION* indicates a personal injury hazard not immediately accessible as one reads the marking, or a hazard to property including the equipment itself.
- *DANGER* indicates a personal injury hazard immediately accessible as one reads the marking.

This symbol appears in manuals:



Static-Sensitive Devices

These symbols appear on equipment:



DANGER
High Voltage



Protective
ground (earth)
terminal



ATTENTION
Refer to
manual

Specific Precautions

Observe all the following precautions to ensure your personal safety and to prevent damage to either the 2232 or equipment connected to it.

Power Source

The 2232 is intended to operate from a power source that will not apply more than 250 V_{rms} between the supply conductors or between either supply conductor and ground. A protective ground connection, through the grounding conductor in the power cord, is essential for safe system operation.

Grounding the Oscilloscope

The 2232 oscilloscope is grounded through the power cord. To avoid electric shock or possible damage to instrument, plug the power cord into a properly wired receptacle where earth ground has been verified by a qualified service person. Do this before making connections to the input or output terminals of the oscilloscope.

Without the protective ground connection, all parts of the 2232 are potential shock hazards. This includes knobs and controls that may appear to be insulators.

Use the Proper Power Cord

Use only the power cord specified for your product. Use only a power cord that is in good condition.

Use the Proper Fuse

To avoid fire hazard, use only the fuse specified in the parts list for your product, and which is identical in type, voltage rating, and current rating.

Do Not Remove Covers or Panels

To avoid personal injury, do not operate the 2232 without the panels or covers.

Do Not Operate in Explosive Atmospheres

The 2232 provides no explosion protection from static discharges or arcing components. Do not operate the 2232 in an atmosphere of explosive gasses.

Electric Overload

Never apply a voltage to a connection on the 2232 that is outside the range specified for that connection. Do not attempt to operate the oscilloscope without a proper ground connection.

Start Up

Before you use the 2232 Digital Storage Oscilloscope, ensure that it is properly installed and powered on.

Installation & Power On

To install and power on the 2232 Digital Storage Oscilloscope, perform the following steps:

- Step 1:** Connect the proper power cord to the back of the instrument as shown below in Figure 1-1.

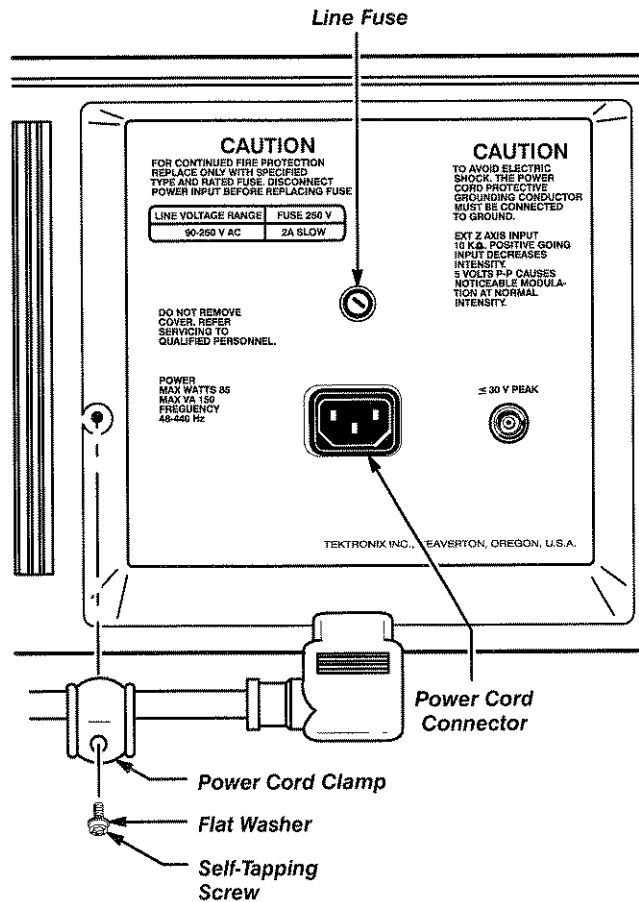
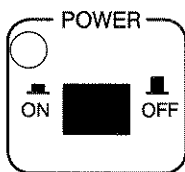

Figure 1-1: Installing the Power Cord

- Step 2:** Check that you have the proper power supply for the instrument. The 2232 requires a line source that is 90 to 250 VAC with a frequency of 48 Hz to 440 Hz.

- Step 3:** Check the fuse to be sure it is the proper type and rating. The 2232 is shipped with the UL® approved fuse installed.
- Step 4:** Be sure you have the appropriate operating environment. Specifications for temperature, relative humidity, altitude, vibrations, and emissions are included in the *Specifications* appendix of this manual.
- Step 5:** Leave space for cooling. Do this by verifying that there are no airflow obstructions within 2 inches (5.1 cm) of the air-intake on the sides of the cabinet and exhaust holes on the rear of the cabinet (where the fan operates).
- Step 6:** Connect the power cord from the rear-panel power connector to the power system.
- Step 7:** Push the **POWER** button in to turn on the instrument. A green light indicates the power is on.



The instrument automatically runs a complete diagnostic check of the digital system. If any diagnostic failures occur they will appear on screen. Contact your service representative if you encounter a problem.

Pressing the **POWER** button again toggles the switch and turns off the power.

Initial Setup

This section will help you set up the oscilloscope for use and allow you to become familiar with some of the controls.

Setting Up the Display

Table 1-1 gives a setup for a basic analog display. Use the setup for the trace rotation and probe compensation adjustments that follow.

Table 1-1: Basic Analog Display Setup

Title	Title	Title
Display Controls	A and B INTENSITY	Midrange
	STORE/READOUT	Midrange
	FOCUS	Midrange
Vertical Controls	POSITION	Midrange
	MODE	CH 1
	X-Y	Off (button out)
	BW LIMIT	Off (button out)
	VOLTS/DIV	10 mV
	VOLTS/DIV Variable	CAL detent
	INVERT	Off (button out)
	AC-GND-DC	DC

Table 1-1: Basic Analog Display Setup (Cont.)

Title	Title	Title
Horizontal Controls	POSITION MODE A SEC/DIV SEC/DIV Variable X10 Magnifier	Midrange A .2 ms CAL detent Off (knob in)
A Trigger Controls	VAR HOLDOFF Mode SLOPE LEVEL A & B SOURCE A COUPL	NORM P-P AUTO Out (positive) Midrange VERT MODE NORM
Display Mode Control	STORE/NON-STORE	NON-STORE (button out)

Adjusting Trace Rotation

Using the previous setup, Figure 1-2 shows how the display should now appear.

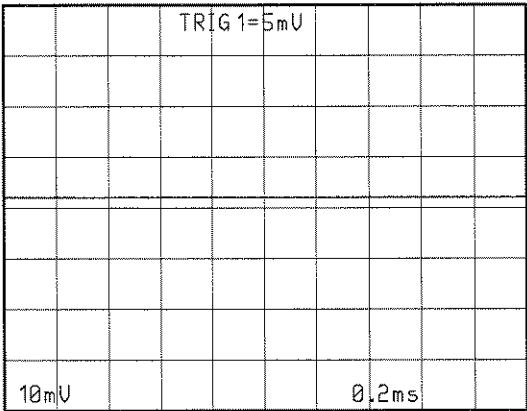

Figure 1-2: Initial Setup Display

Use the following procedure to align the baseline trace parallel with the center horizontal graticule line:

- Step 1:** Turn the Channel 1 **POSITION** control to position the trace on the center horizontal graticule line.
- Step 2:** Using a small-blade screwdriver, adjust the recessed **TRACE ROTATION** control to align the trace with the graticule line.

You may need to make this adjustment again if you move or orient the oscilloscope in a different direction.

Checking the Probe Compensation

NOTE

Always compensate a probe for the particular channel that you use it with.

Use the following procedure to check the probe compensation:

- Step 1:** Set the instrument controls as described in *Setting up the Display*.
- Step 2:** Connect the probe to the channel you intend to use it for.
(If the probe is properly "coded" the volts-per-division readout for the channel will change to match the attenuation factor of the probe. The 10X probes supplied with the oscilloscope already have the proper coding.)
- Step 3:** Clip the probe tip to the **PRB ADJ** connector.
- Step 4:** Use the **VOLTS/DIV** control to display about 5 divisions of the waveform.
- Step 5:** Use the **VERTICAL POSITION** and **HORIZONTAL POSITION** controls to center the display.
- Step 6:** Check the waveform against Figure 1-3 to see if the probe is correctly compensated.

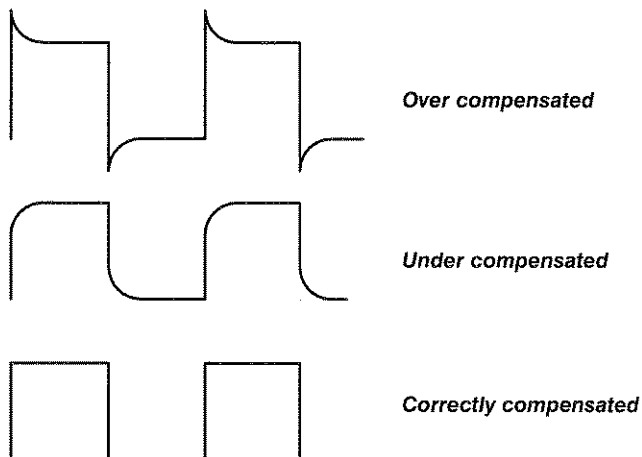

Figure 1-3: Checking Probe Compensation

- Step 7:** Adjust the compensation if necessary.

NOTE

The instruction manual supplied with the probe provides complete information about the probe and probe compensation.

**Installing the
Accessory Pouch**

Figure 1-4 shows the correct method of installing the accessory pouch on the instrument.

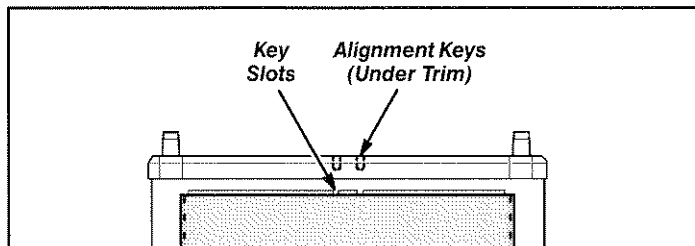

A. Center the Pouch Plate to Align the Key Slots.

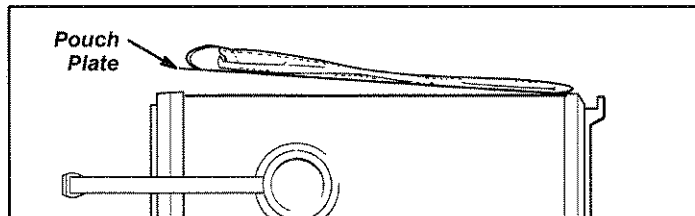

B. Push the Pouch Plate into the Rear Trim Gap.

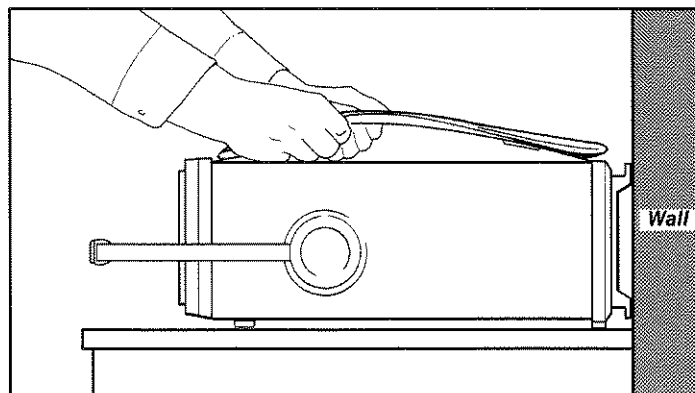

C. Bow the Plate and Slide it into the Front Trim Gap.

Figure 1-4: Installing the Accessory Pouch

Using the Power Cord Wrap

Figure 1-5 shows how to wrap the power cord on the back when you transport or store the instrument.

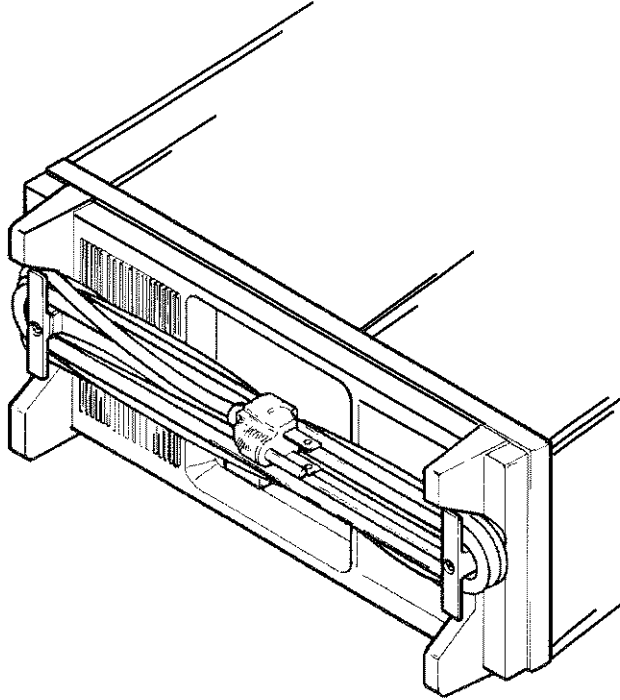

Figure 1-5: Using the Power Cord Wrap

Front Panel

The controls and other features on the front panel of the 2232 Digital Storage Oscilloscope are divided into functional sections. Each functional section is highlighted in (Figure 2-1):

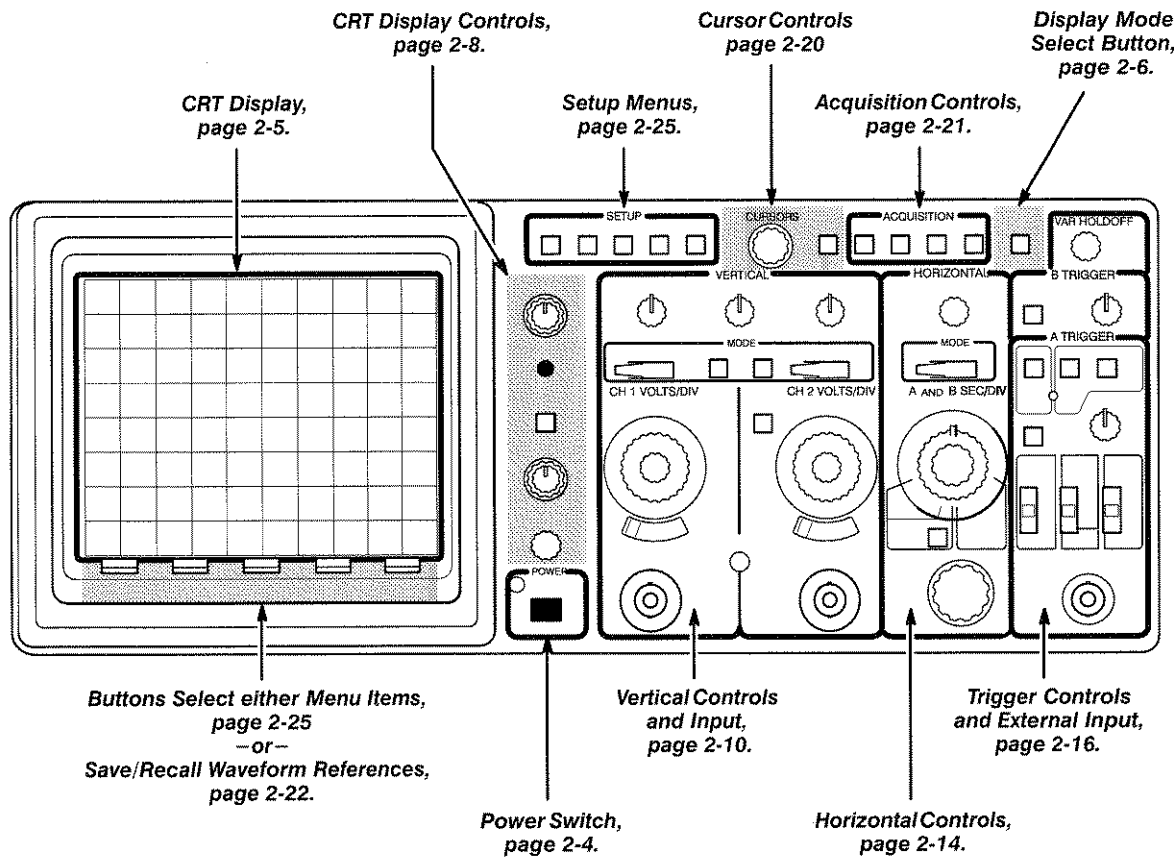

Figure 2-1: Front Panel Control Sections

Figures 2-2 and 2-3 show the front panel of the oscilloscope in greater detail.

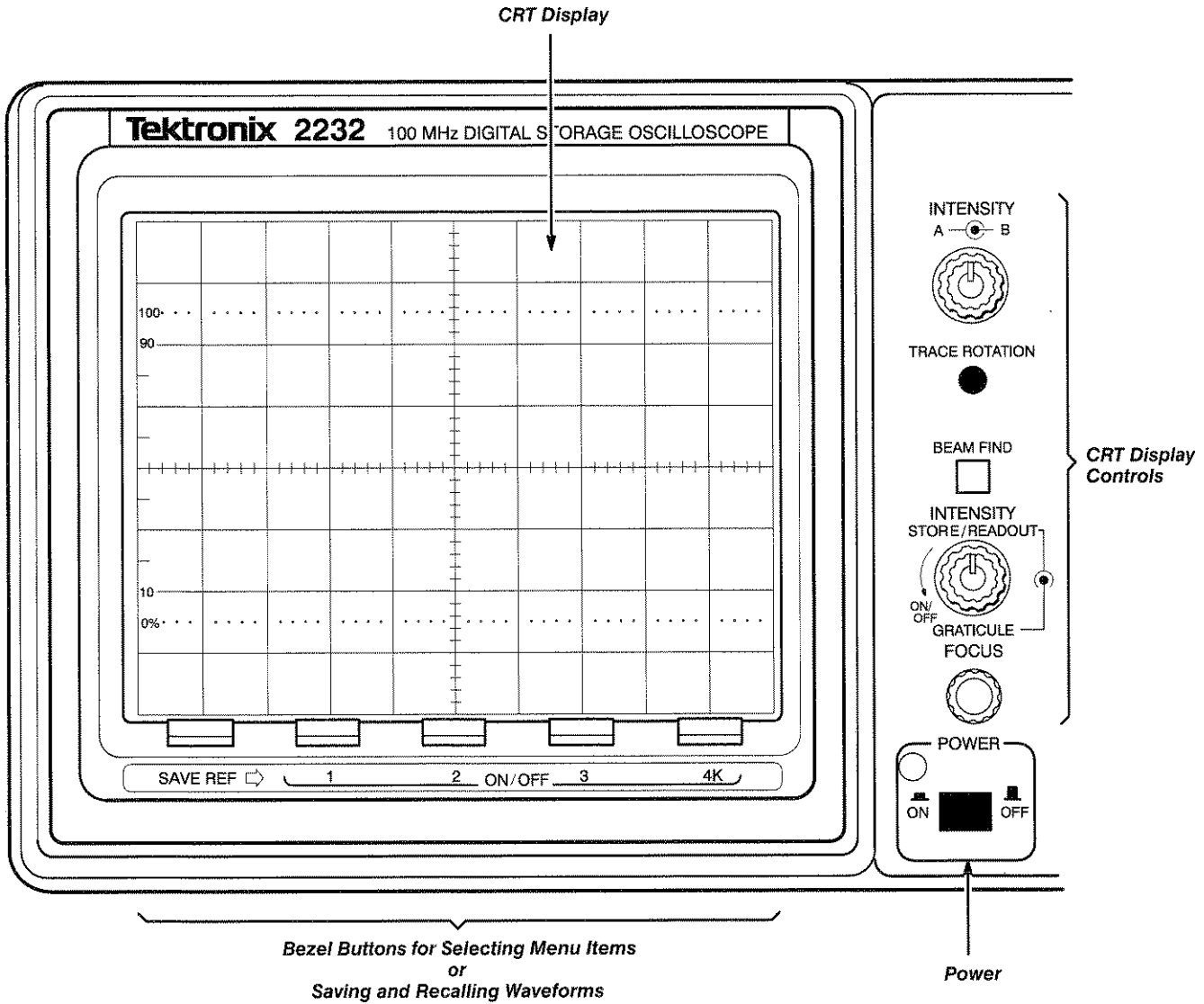

Figure 2-2: Front Panel View — Left Side

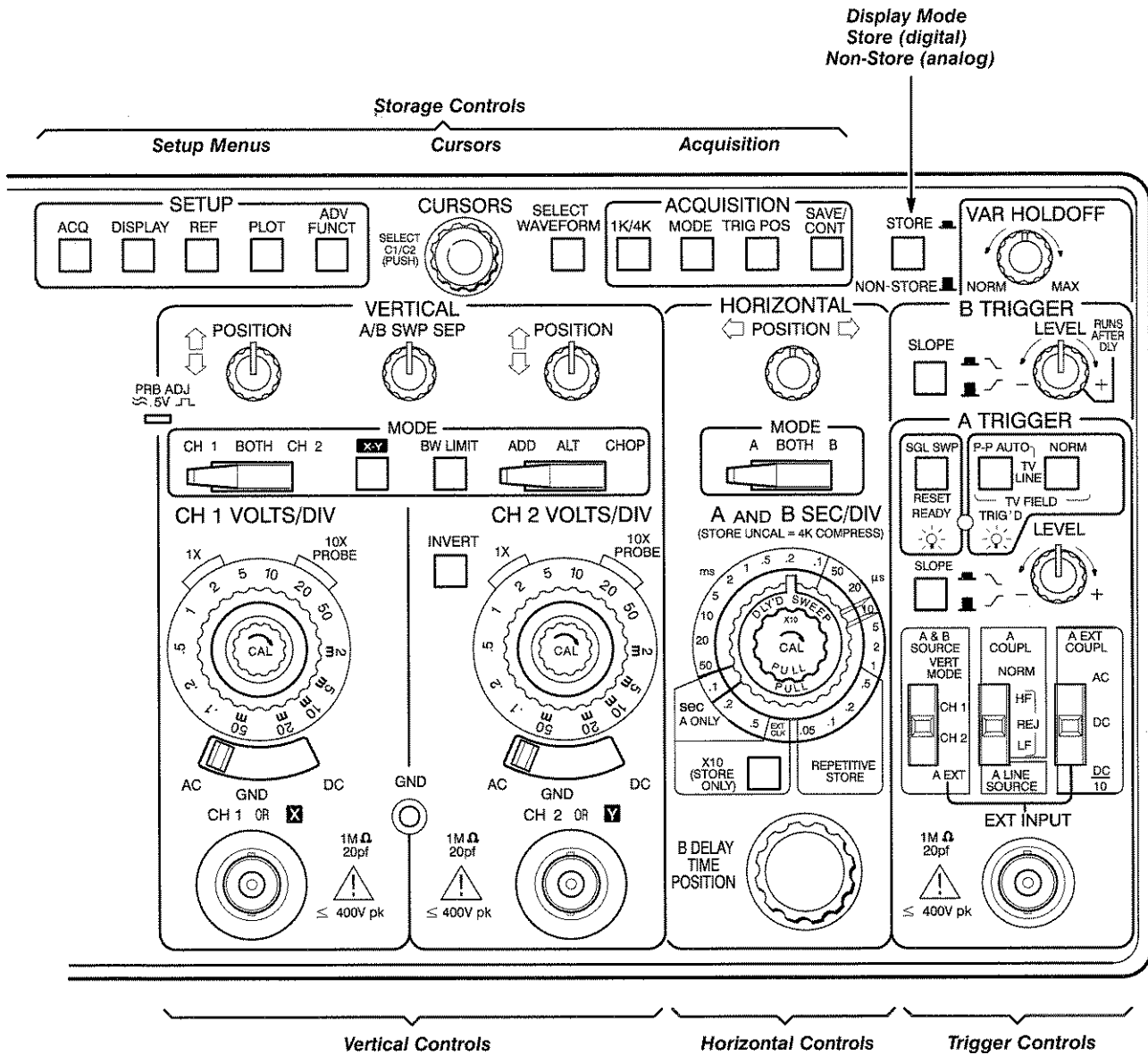
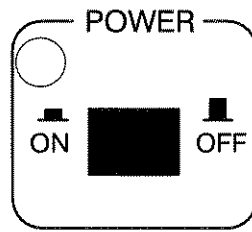
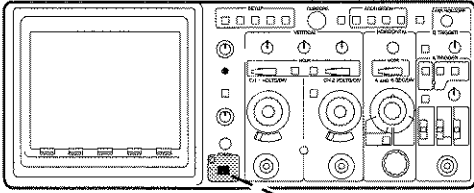

Figure 2-3: Front Panel View — Right Side

Power Switch



POWER

The push-button switch turns the power on and off. A green light indicates the power is on.

CRT Display

The CRT graticule area is divided into eight vertical divisions for amplitude (volts/division) measurements and ten horizontal divisions for time (seconds/division) measurements. The settings of the volts/division and seconds/division controls determine the scale of the graticule.

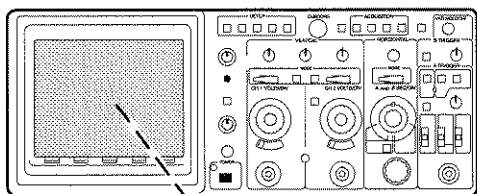

Percent Markings are for rise time measurements.

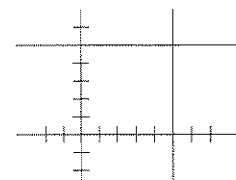
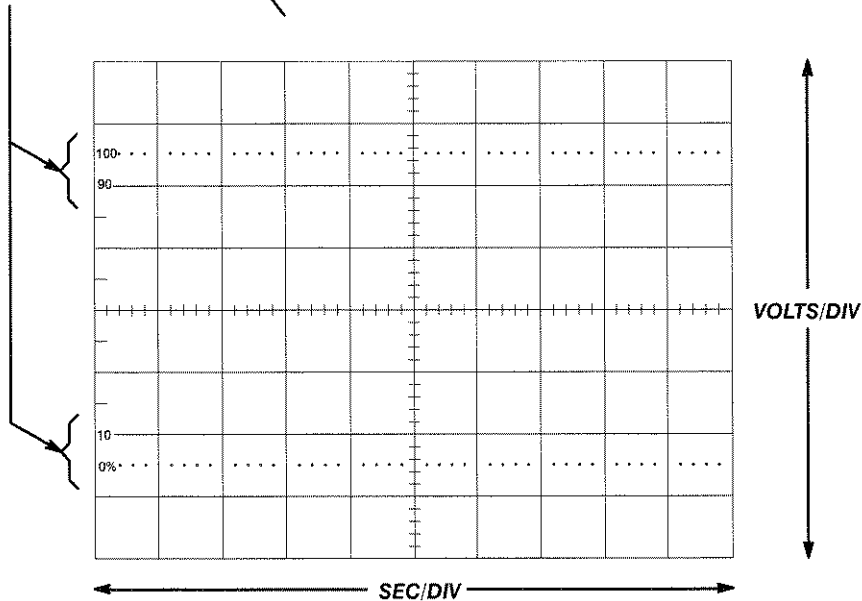

Each major division is split into 5 minor divisions. One minor division equals two-tenths (.2) of a major division.

Display Mode

There are two separate display modes: the analog **NON-STORE** mode (Figure 2-4) and the digital **STORE** mode (Figure 2-5). The **STORE/NON-STORE** button selects the display mode.

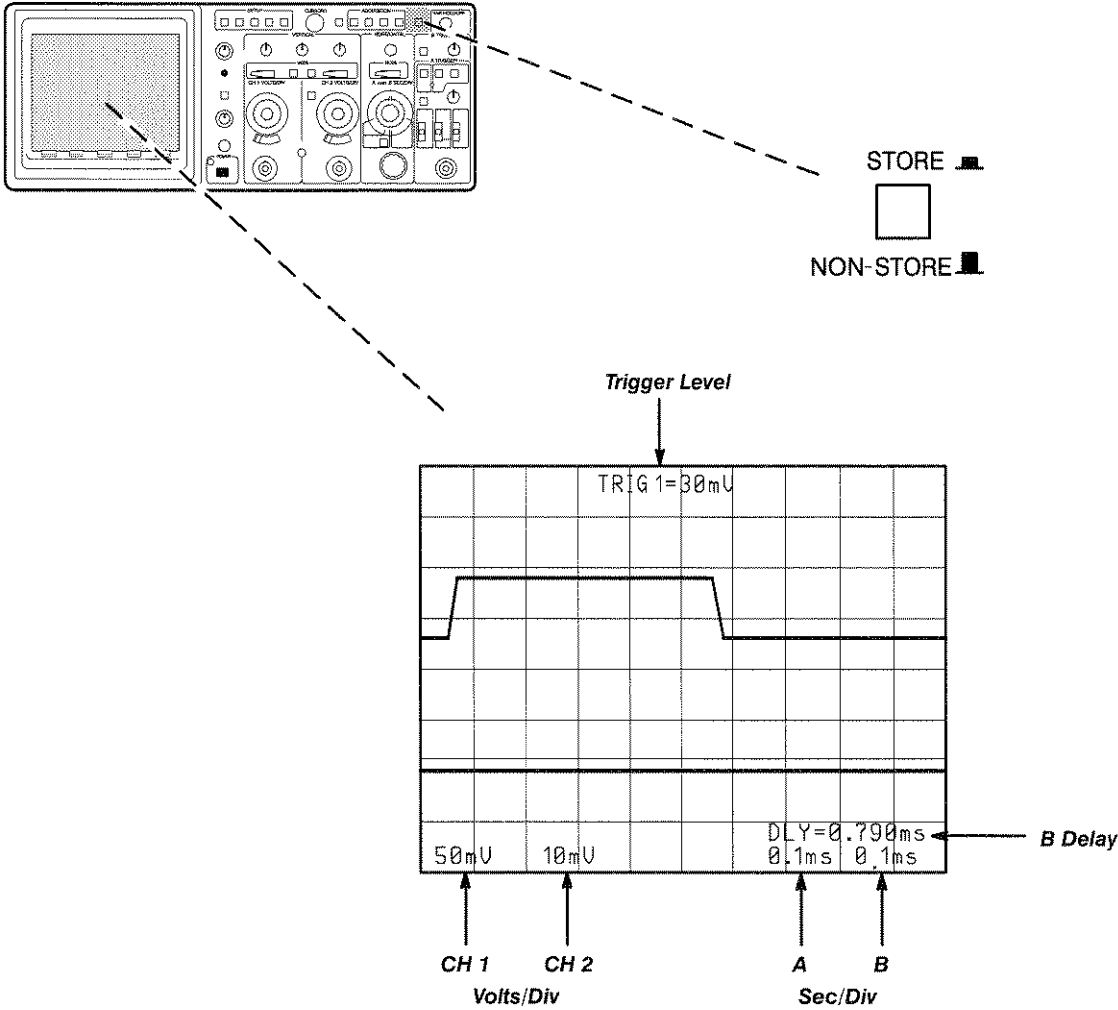

Figure 2-4: Analog (NON-STORE) Mode Display

The readouts displayed in the analog mode also appear in the digital mode.

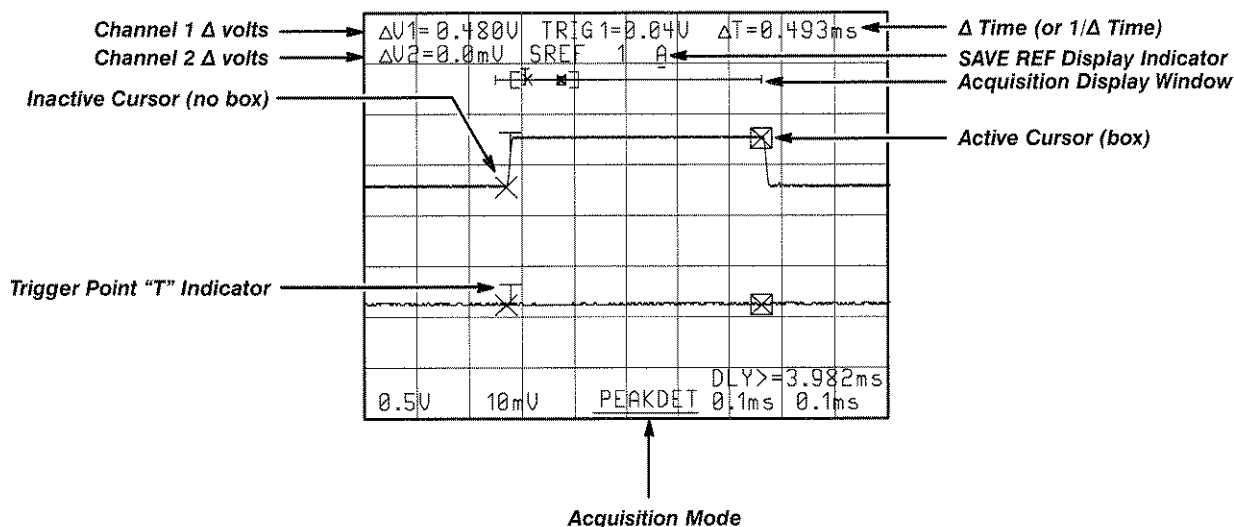

Figure 2-5: Digital (STORE) Mode Display

Other Readout Symbols

- > Indicates uncalibrated volts/division or seconds/division switch settings.
- ↓ Appears before the Channel 2 volts/division readout when **INVERT** is on.
- $\frac{B}{W}$
L Appears next to the volts/division readouts when the **BW LIMIT** switch is on.
- ~ Appears above the volts/division readout volts symbol (**V**) if input coupling is set to **AC**. Also appears above the A Trigger Level volts symbol when the **A COUPL** switch is set to **LF REJ** or when input coupling is set to **AC**.
- ⌋ Precedes the volts/division readout if the input coupling is set to **GND**. Replaces the **Δ** symbol in the **Δ volts** readout when making ground-referenced voltage measurements.
- c Indicates a compressed 4K record.
- % Replaces the volts symbol (**V**) whenever the volts/division variable (**CAL**) is in the uncalibrated position.
- Appears on the top graticule line below the **SRQ**, **ADDR** or **PLOT** markings to indicate the status of the communications option (GPIB or RS-232). A similar symbol under the **SREF** readouts **1**, **2**, **3**, **4K** (reference memories) or **A** (current acquisition) indicates which of these waveform displays is currently selected for cursor measurement.

CRT Display Controls

The CRT display controls adjust the alignment, intensity and focus of the waveform displays and readout information.

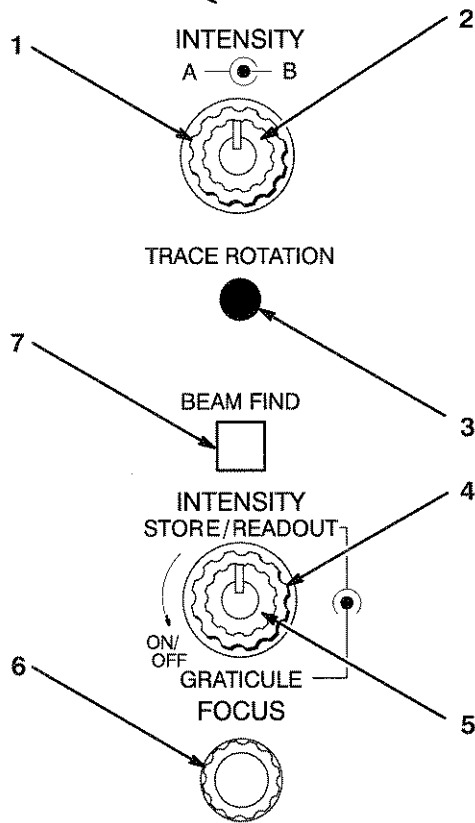
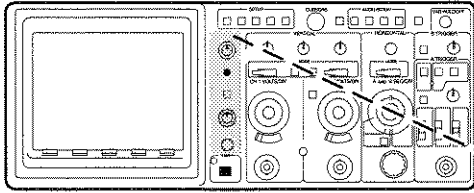

- 1 INTENSITY A**
Adjusts the intensity of **A NON-STORE** sweep.
- 2 INTENSITY B**
Adjusts the intensity of **B NON-STORE** sweep.
- 3 TRACE ROTATION**
Aligns baseline trace with the horizontal graticule. (Use a small screwdriver to adjust the recessed control.)
- 4 INTENSITY STORE/READOUT**
Adjusts the intensity of the entire **STORE** display as well as **NON-STORE** readouts.
- 5 GRATICULE**
Controls graticule illumination.
- 6 FOCUS**
Focuses the display.
- 7 BEAM FIND**
Locates dim or off-screen displays.

Vertical Controls and Connections

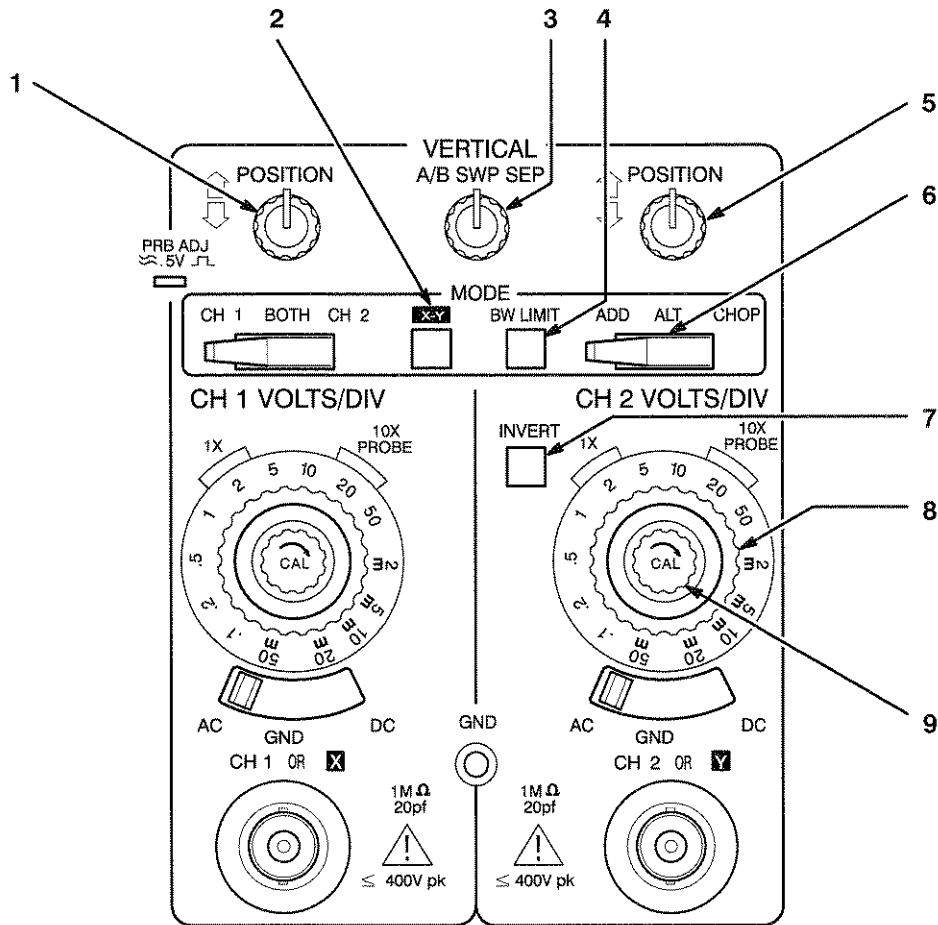
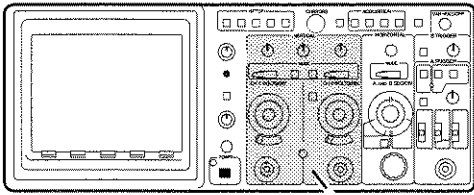

- 1 POSITION (Channel 1)**

Vertically positions the signal displayed in Channel 1.
- 2 X-Y**

Displays simultaneous phase and amplitude relationships between signals connected to Channel 1 and Channel 2 (Lissajous figures). The signal in Channel 1 drives the horizontal (X) axis and the signal in Channel 2 drives the vertical (Y) axis.
- 3 A/B SWP SEP**

(A and B Sweep Separation) — Vertically separates the B sweep from A sweep in the **NON-STORE** mode.
- 4 BW LIMIT**

(Bandwidth Limit) — Reduces or eliminates unwanted high-frequency noise on the input signal by limiting the bandwidth of the oscilloscope to 20 MHz.
- 5 POSITION (Channel 2)**

Vertically positions the signal displayed in Channel 2.
- 6 ADD ALT CHOP**

(This switch is activated when the **CH 1 BOTH CH 2** switch is in **BOTH**.)

ADD — Displays the sum of Channel 1 and Channel 2 signals. (Displays the difference between Channel 1 and Channel 2 with Channel 2 **INVERT** pushed in.)

ALT (Alternate) — Alternates the sweep between Channel 1 and Channel 2 display.

CHOP — Electronically switches the sweep display between Channel 1 and Channel 2 at a rate of 500 kHz.
- 7 INVERT**

Vertically inverts the Channel 2 signal.
- 8 VOLTS/DIV (Channel 2)**

(Volts per division) — Selects the vertical scale factor for Channel 2. Also vertically expands or compresses Channel 2 saved waveforms.
- 9 CAL (Channel 2)**

(Calibrated) — The clockwise position provides calibrated volts/division settings. Rotating the control counterclockwise variably increases the attenuation of the settings, thereby reducing signal amplitude. (Variable settings are not calibrated.)

Vertical Controls and Connections (Cont.)

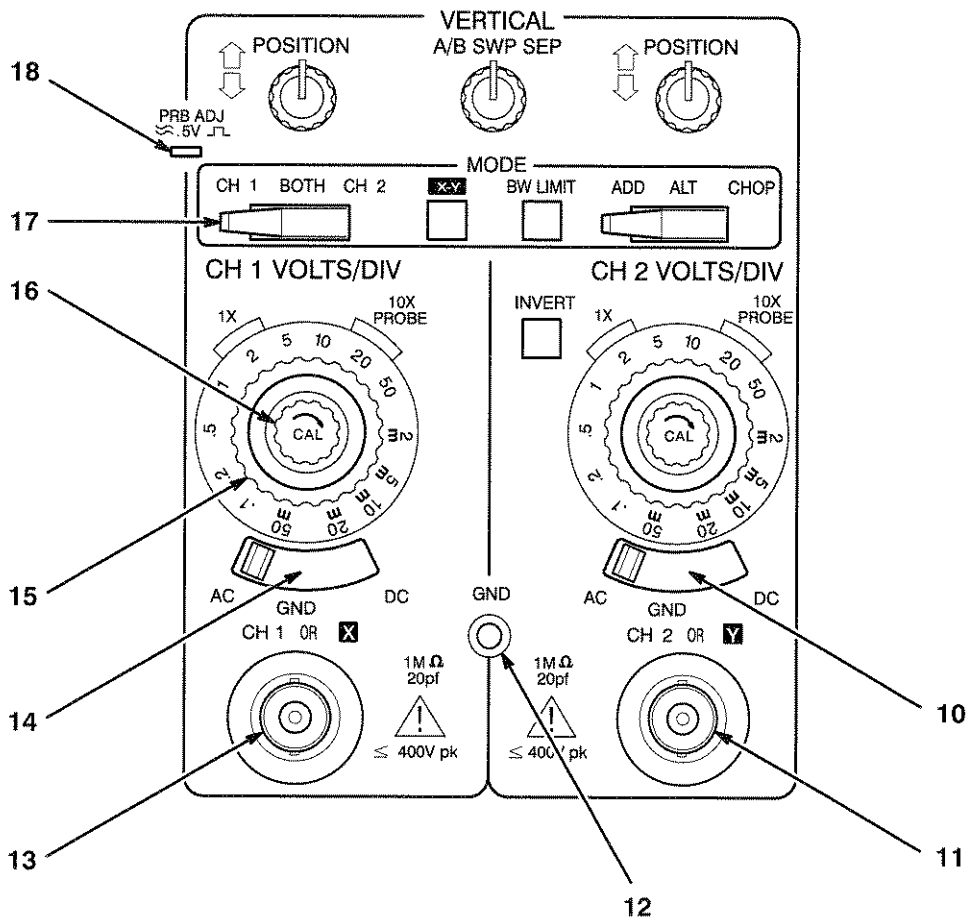
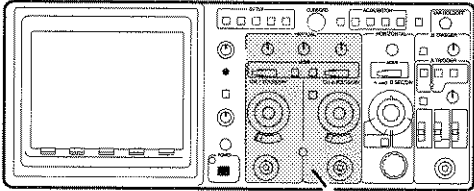

- 10 COUPLING (Channel 2)**
AC — Capacitively couples the signal input. Blocks DC to 10 Hz signals.
GND (Ground) — Decouples the signal input and connects the vertical system to ground reference.
DC — Passes all signal components to the vertical and acquisition systems.
- 11 Input Connection (Channel 2)**
Provides the Channel 2 signal input connection for probes or coaxial cables.
- 12 GND Connection**
The “Banana” jack receptacle provides a connection to the instrument ground.
- 13 Input Connection (Channel 1)**
Provides the Channel 1 signal input connection for probes or coaxial cables.
- 14 COUPLING (Channel 1)**
AC — Capacitively couples the signal input. Blocks DC to 10 Hz signals.
GND (Ground) — Decouples the signal input and connects the vertical system to ground reference.
DC — Passes all signal components to the vertical and acquisition systems.
- 15 VOLTS/DIV (Channel 1)**
(Volts per division) — Selects the vertical scale factor for Channel 1. Also vertically expands or compresses Channel 1 saved waveforms.
- 16 CAL (Channel 1)**
(Calibrated) — The clockwise position provides calibrated volts/division settings. Rotating the control counterclockwise variably increases the attenuation of the settings, thereby reducing signal amplitude. (Variable settings are not calibrated.)
- 17 CH 1 BOTH CH 2**
Selects either a single-channel display or a two-channel display:
CH 1 — Displays Channel 1 only.
BOTH — Activates the **ADD ALT CHOP** switch for two-channel displays.
CH 2 — Displays Channel 2 only.
- 18 PRB ADJ**
(Probe Adjust) — Provides a 0.5 V square wave signal to compensate X10 probes.

Horizontal Controls

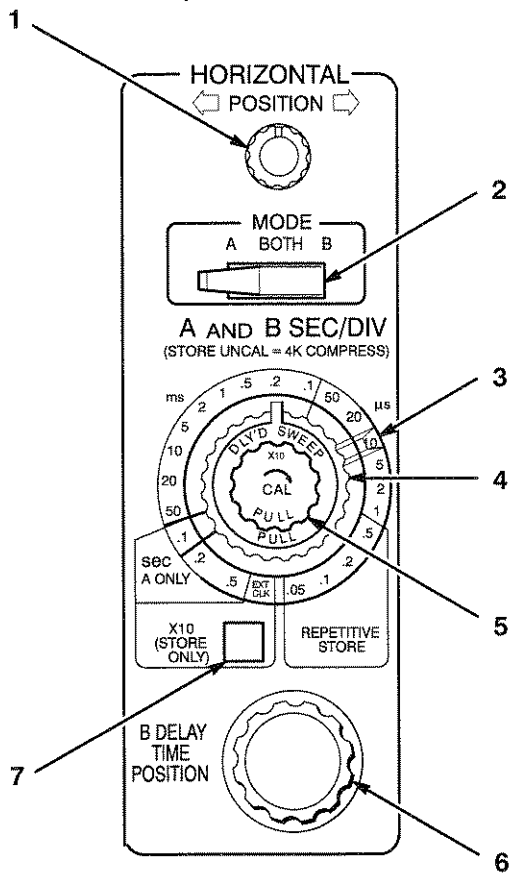
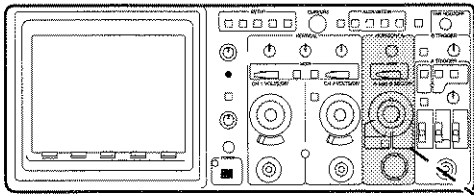

- 1 POSITION**

Horizontally positions signal displays in both **STORE** and **NON-STORE** modes.
- 2 A BOTH B**

Selects the desired horizontal mode:

A — Displays only the main or “A” (non-delayed) sweep.

BOTH — Simultaneously displays both **A** (intensified) and **B** sweeps in the **NON-STORE** mode. (In the **STORE** mode only the **A** intensified sweep is displayed.) The intensified portion of **A** sweep indicates where the **B** delayed sweep begins and ends.

B — Displays only the delayed or “B” sweep.
- 3 A SEC/DIV**

Selects the horizontal seconds-per-division scale for **A** sweep. To lock the **A** and **B** controls together, align the control indicators.
- 4 B SEC/DIV**

Selects the horizontal seconds-per-division scale for **B** sweep. Pull the knob out and turn it clockwise to select faster “delayed” sweep speeds.
- 5 X10 PULL**

In **NON-STORE**, pulling the knob out horizontally magnifies (by ten times) the center one division of the display.

In **STORE**, pulling the knob out horizontally magnifies (by ten times) one division area of the display centered around the active cursor.

CAL

In **NON-STORE**, rotating the control counterclockwise variably decreases the sweep speed. The clockwise position selects calibrated settings.

In **STORE**, rotating the control counterclockwise horizontally compresses 4K acquisitions to 1K.
- 6 B DELAY TIME POSITION**

Selects the point where **B** (delayed) sweep starts in relation to **A** sweep.
- 7 X10 (STORE ONLY)**

Slows the **STORE** sweep speeds of 0.1, 0.2, and 0.5 seconds to 1, 2, and 5 seconds respectively.

Trigger Controls

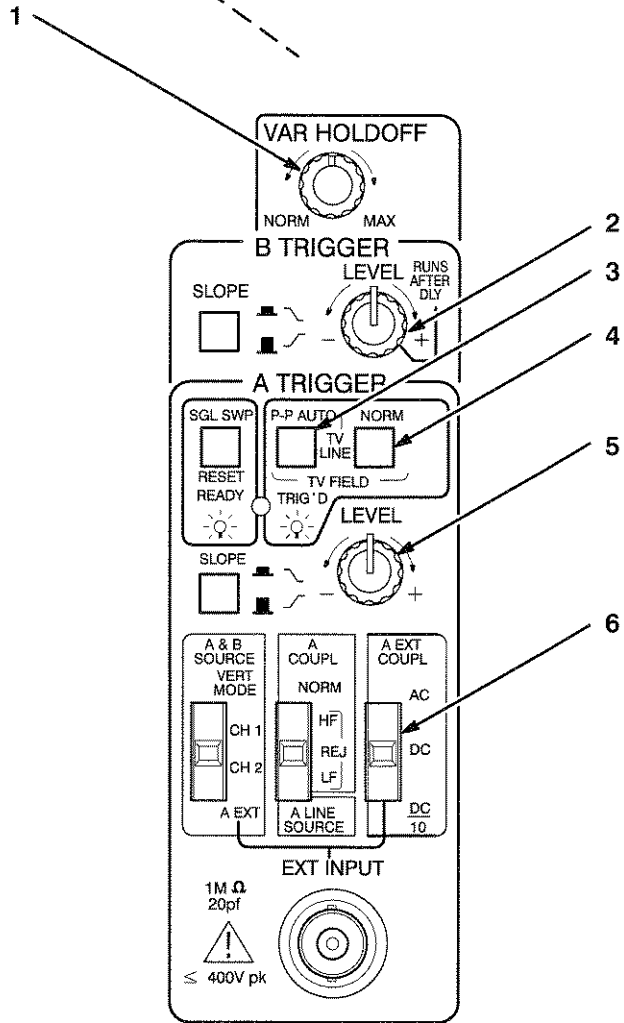
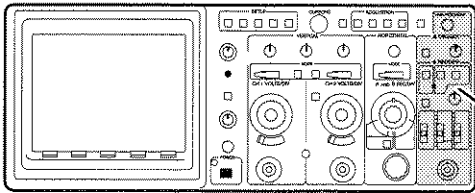

1 VAR HOLDOFF

(Variable Holdoff) — Varies the amount of time the horizontal system waits before beginning another sweep. This helps stabilize the display of some waveforms.

The holdoff time in the **MAX** position is at least 10 times greater than **NORM**.

2 SLOPE (B Trigger)

Selects either the positive (button out) or negative (button in) signal transition to trigger B sweep.

3 P-P AUTO/TV LINE

Automatically determines the trigger level on repetitive signals of 20 Hz and higher in **NON-STORE** and 500 Hz and higher in **STORE**. Initiates a base-line reference trace in the absence of an adequate trigger signal.

If a TV signal is applied, the oscilloscope will trigger on the TV line information.

4 NORM

(Normal Triggering Mode) — In **NON-STORE**, the **A TRIGGER LEVEL** control sets the trigger point regardless of the trigger signal amplitude. The oscilloscope does not automatically sweep without an adequate trigger signal. This mode is useful for low frequency or low repetition rate signals.

In **STORE**, the last signal acquired is displayed until the next trigger occurs.

TV FIELD — (Press **P-P AUTO** and **NORM** in at the same time.) This mode sets the oscilloscope to trigger on television field (vertical sync) signals. The A sweep will occur automatically in the absence of a trigger signal.

5 LEVEL (A Trigger)

Selects the voltage level on the positive (or negative) signal transition) at which the A trigger will occur.

6 A EXT COUPL

Selects the method of coupling the **EXT INPUT** signal:

AC — Capacitively couples (and blocks DC components) of the signal.

DC — Couples DC and all other signal components.

DC/10 — Couples all signal components and attenuates the external input signal by a factor of 10.

Trigger Controls (Cont.)

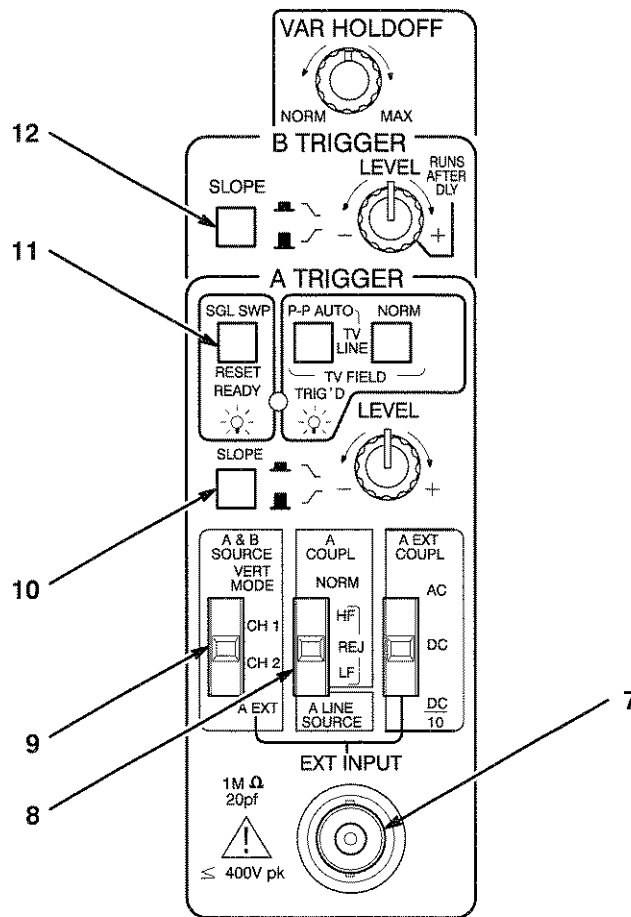
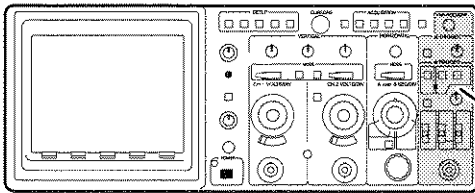

- 7 EXT INPUT**
Input connection for an external trigger signal.
- 8 A COUPL**
Selects the method of coupling the **A** trigger source:
- NORM** (Normal Coupling) — Couples all frequency components of the trigger signal.
- HF REJ** (High-frequency Reject) — Attenuates AC components of the trigger signal above 40 kHz.
- LF REJ** (Low-frequency Reject) — Attenuates AC components of the trigger signal below 40 kHz.
- A LINE SOURCE** — Uses a signal derived from the AC power line to trigger the A sweep.
- 9 A&B SOURCE**
Selects the trigger signal source for both **A** and **B** Triggers:
- VERT MODE** (Vertical Mode) — The selected vertical mode automatically supplies the trigger signal. In **ADD** or **CHOP**, the trigger source is the algebraic sum of the Channel 1 and Channel 2. In **ALT**, the trigger source alternates between the channels in sync with the display.
- CH 1** — Selects only the signal in channel 1 as the trigger source regardless of the vertical mode selected.
- CH 2** — Selects only the signal in channel 2 as the trigger source.
- A EXT** (A External) — Uses the signal applied to the **EXT INPUT** connector as the trigger signal for the A trigger circuit.
- 10 SLOPE (A Trigger)**
Selects either the positive (button out) or the negative (button in) signal transition for triggering the next A sweep or acquisition.
- 11 LEVEL (B Trigger)**
Sets the point in the signal transition at which the B sweep trigger occurs. If the control is set to **RUNS AFTER DELAY**, **B DELAY TIME POSITION** will control the amount of time delay from the start of A sweep to start of B sweep. (The A sweep, and not B sweep, is triggered in **RUNS AFTER DELAY** mode.)
- 12 SGL SWP**
(Single Sweep) — Sets the oscilloscope to trigger a single sweep in the **NON-STORE** mode. In the **STORE** mode, single-shot events are captured and displayed.

Cursor Controls

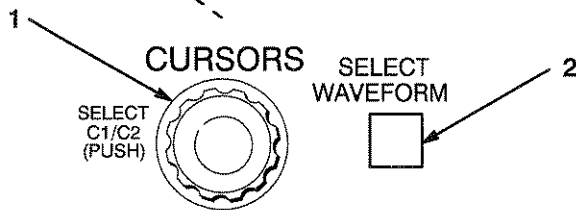
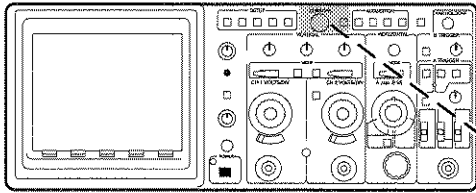

1 CURSORS

Rotating the **CURSORS** knob moves the selected cursor. The 1K window of a 4K acquisition will move with the selected cursor to view the entire record.

(The **CURSORS** control can also make item selections or change item values in the **ACQ** and **REF** Setup menus.)

SELECT C1/C2 (PUSH) — Pushing the **CURSORS** knob selects the cursor to position. The cursor is enclosed by a box when selected.

2 SELECT WAVEFORM

Selects the waveform on which the cursors appear if one or more reference memories are displayed. The “—” symbol under the “SREF” location read-out indicates that the cursors are on this particular reference memory display. (The “A” stands for the current acquisition display.)

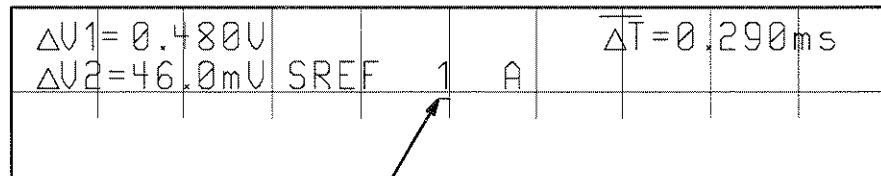

Underscore indicates the cursors are on reference memory "1"

Acquisition Controls

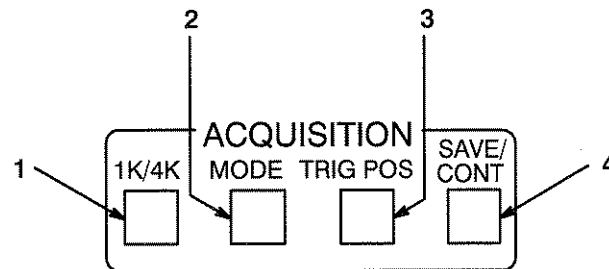
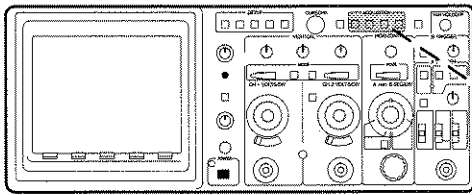

- 1** **1K/4K**

Selects an acquisition record length of either 1K (one-thousand bytes, one screen) or 4K (four-thousand bytes, four screens).
- 2** **MODE**

Selects the desired acquisition mode directly without using the acquisition menu. (Refer to *Digitizing Signals*, page 3-8.)
- 3** **TRIG POS**

(Trigger Position) — Selects the acquisition record displayed relative to the trigger position (indicated by a “T”) on the waveform; pretrigger, midtrigger, or posttrigger.
- 4** **SAVE/CONT**

(Save or continue) — SAVE temporarily freezes and displays the current acquisition record.

CONT (continue) starts another acquisition.

Save Reference Memory Buttons

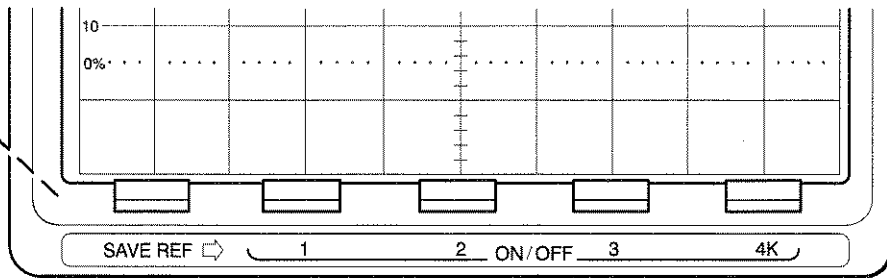
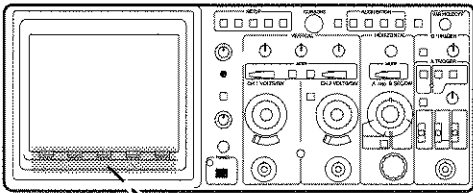

SAVE REF 1, 2, 3 or SAVE REF 4K — When waveforms are displayed in the **STORE** mode, you can use the buttons to save up to three separate displays acquired in the 1K mode (memory locations 1, 2 or 3) or one display acquired in 4K mode (memory location 4K).

To save a waveform display, press the **SAVE REF** button first and then one of the memory location buttons within five seconds. The waveform display will be saved to that memory location.

To turn the reference memory display on or off press only the numbered menu button.

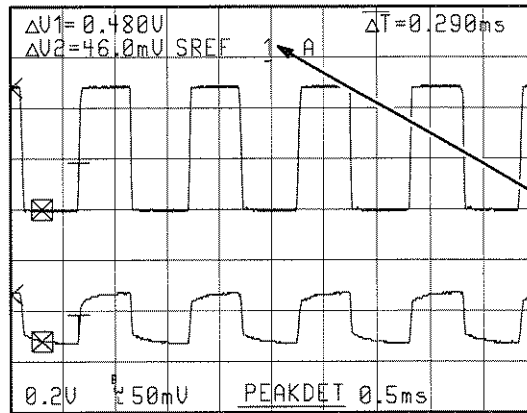

Indicates SAVE REF Memory location 1.

The "1" underneath 1 indicates the cursors are on this memory display.

1K Two-Channel Acquisition Saved in Memory Location 1.

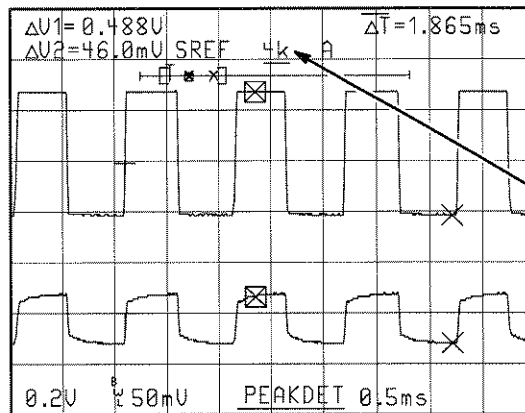

Indicates SAVE REF Memory location 4K.

4K Two-Channel Acquisition Saved in Memory Location 4K.

Setup Menus

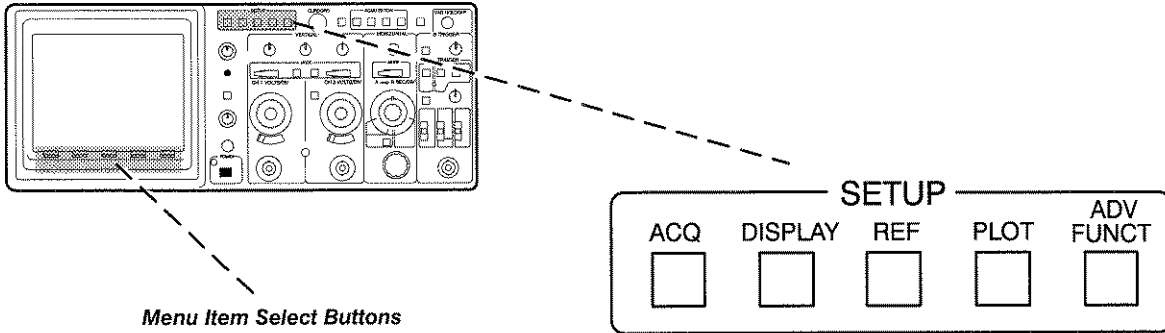

Menu Item Select Buttons

Pressing one of the five Setup buttons displays a corresponding menu on the CRT. Pressing the same button again returns to normal operation.

- **ACQ** — Acquisition Menu
- **DISPLAY** — Display Menu
- **REF** — Waveform Reference Menu
- **PLOT** — Plot Menu
- **ADV FUNCT** — Advanced Functions Menu

Menu Item Select Buttons — When a Setup menu is displayed, each bezel button (located underneath the displayed menu) moves a “box” to select from the menu items that appear directly above the button.

For example, pressing the **DISPLAY** setup button brings up the Display Menu (Figure 2-6). Pressing the button underneath **ΔT Display** selects either **ΔT** or **1 / ΔT** .

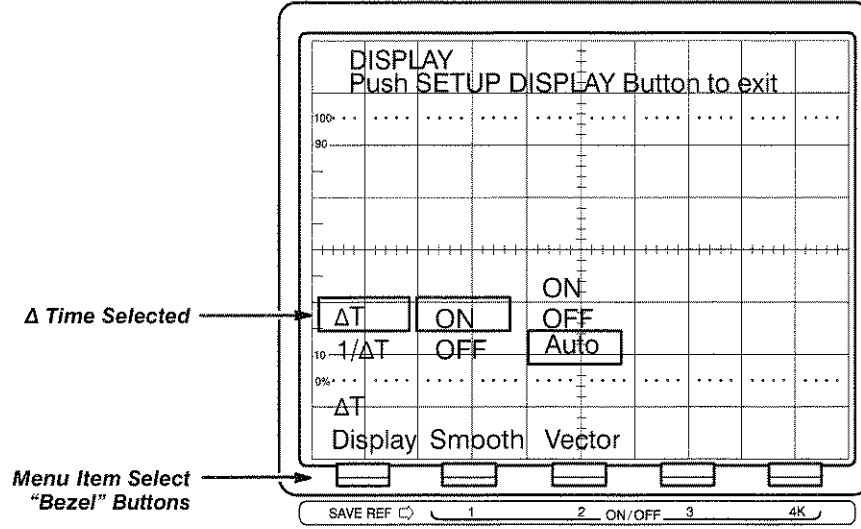

Figure 2-6: Setup Menu Example (Display)

Acquisition Menu

The Acquisition menu (Figure 2-7) allows you to configure the acquisition system to your particular application.

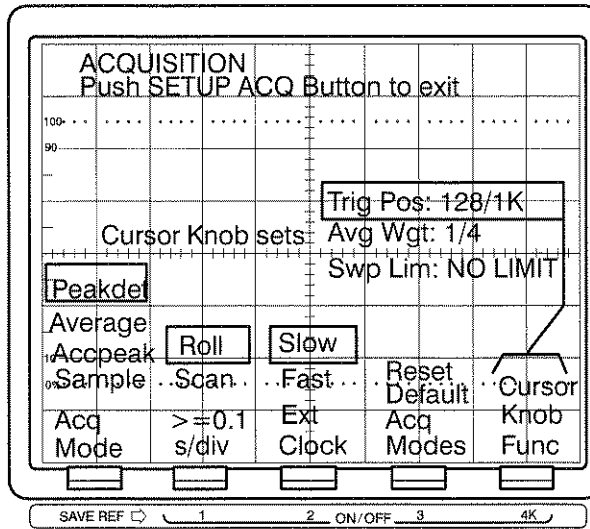

Figure 2-7: Acquisition Menu

Acq Mode

Peakdet (Peak Detect) — Detects spikes or “glitches” in the acquired signals.

Average — Reduces the amount random signal noise displayed by weighted average of signal samples.

Accpeak (Accumulate Peak) — Accumulates signal peaks over multiple acquisitions.

Sample — Samples the signal at 100 Ms/sec (megasamples per second) but, unlike the other acquisition modes, does not do any digital signal processing.

Roll / Scan

Roll — Continuously acquires and displays waveform data. The acquisition appears to “roll” from right to left across the display. (Roll is only available for settings of 0.1 s to 5 s.)

Scan — Updates the acquisition record left to right across the display at the rate set by the seconds/division control. (Scan is only available for settings of 0.1 s to 5 s.)

Ext Clock

(External Clock) — Selects the slow (Roll/Scan) mode or Fast (Record) mode for an external (acquisition) clock signal applied to the auxiliary connector on the left side of the instrument.

Reset Default Acq Modes

(Reset Default Acquisition Modes) — Resets the Acquisition Menu selections to factory default conditions.

Cursor Knob Func

(Cursor Knob Function) — Selects the menu item value to set with the **CURSORS** control.

Trig POS (Trigger Position) — Sets the number of points acquired prior to the trigger.

Avg Wgt (Average Weight) — Weights the last sample in the Average acquisition mode from 1/1 to 1/256.

Swp Lim (Sweep Limit) — Selects the number of acquisitions to make before halting; 1 to 999,000 or NO LIMIT.

Display Menu

The Display menu allows you to configure cursor time readout, smoothing and vectors (Figure 2-8).

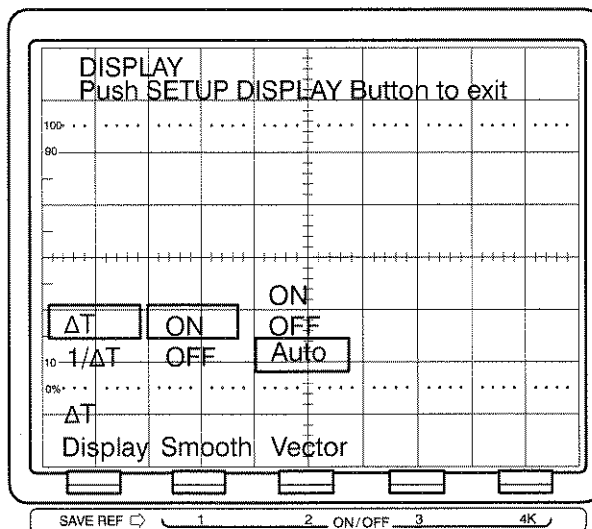

Figure 2-8: Display Menu

ΔT Display

ΔT — Display time or period measurement.

$1/\Delta T$ — Display frequency measurement.

Smooth

Uses a digital process to smooth the waveform display, yet retain the glitch-catching capabilities of Peak Detect or Accumulate Peak acquisition modes. (Smooth applies only to the Peak Detect or Accumulate Peak modes.)

Vector

ON — Connects data points together with vector lines in all acquisition modes.

OFF — Displays only the data points in all acquisition modes.

Auto — Displays vector lines at all seconds/division acquisition settings except repetitive store (0.5 μ s to 0.05 μ s) and X-Y.

Format Reference Menu

Use the **Save Ref** (Save Reference) button to toggle between the reference menus **NVmem** (non-volatile memory, Figure 2-10) and **Format** (Figure 2-9).

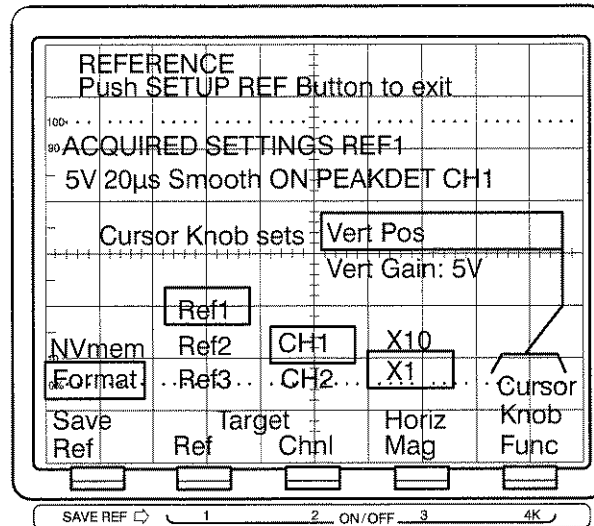

Figure 2-9: Format Reference Menu

Format

The Format reference menu allows you to select a **SAVE REF** memory and change its vertical and horizontal format.

Target

Ref (Reference) — Selects the contents of one of the three reference memories (**Ref1**, **Ref2** or **Ref3**) to format.

Chnl (Channel) — Selects which of the channels (**CH1** or **CH2**) of the reference memory to format.

Horiz Mag

(Horizontal Magnification) — Magnifies the selected memory by ten times (**X10**) or by the acquired (**X1**) magnification.

Cursor Knob Func

(Cursor Knob Function) — Selects which vertical aspect of the saved waveform to adjust with the **CURSORS** knob.

Vert Pos (Vertical Position) — Adjusts the vertical position of the saved waveform display.

Vert Gain (Vertical Gain) — Adjusts the vertical scale of the saved waveform to a maximum of three settings higher, or lower, than the setting it was originally saved at.

NVmem Reference Menu

Use the **Save Ref** (Save Reference) button to toggle between the reference menus **NVmem** (non-volatile memory, Figure 2-10) and **Format** (Figure 2-9).

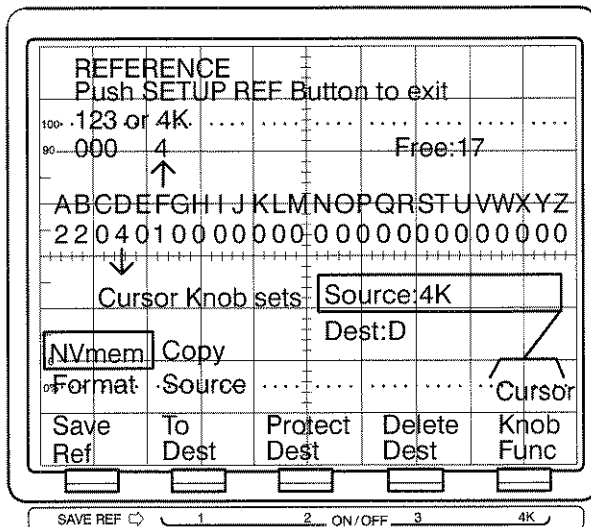

Figure 2-10: NVmem Reference Menu

NVmem

This reference menu allows you to copy to or from any of the **SAVE REF** memory locations and NVmem locations. The non-volatile memory is divided into locations labeled A through Z. (However, the number of actual waveforms that you can store depends on their individual record length and mode of acquisition.) The number under each memory location indicates the size in kilobytes of the contents.

Copy Source To Dest

(Copy Source to Destination) — Copies the indicated source (↓) to the indicated destination (↑).

Protect Dest

(Protect Destination) — Protects the indicated destination (↑). Destination memories can not be overwritten or deleted when protected. The numeral underneath the memory location intensifies to show when that location is protected.

Delete Dest

(Delete Destination) — Deletes the indicated destination (↑) if it is not protected.

Cursor Knob Func

(Cursor Knob Function)

Source — Activates the source arrow (↓) indicator. Use the **CURSORS** knob to position the arrow at the desired memory source.

Dest (Destination) — Activates the destination arrow (↑) indicator. Use the **CURSORS** knob to position the arrow at the desired memory destination.

Plot Menu

The Plot menu (Figure 2-11) controls the plotting parameters.

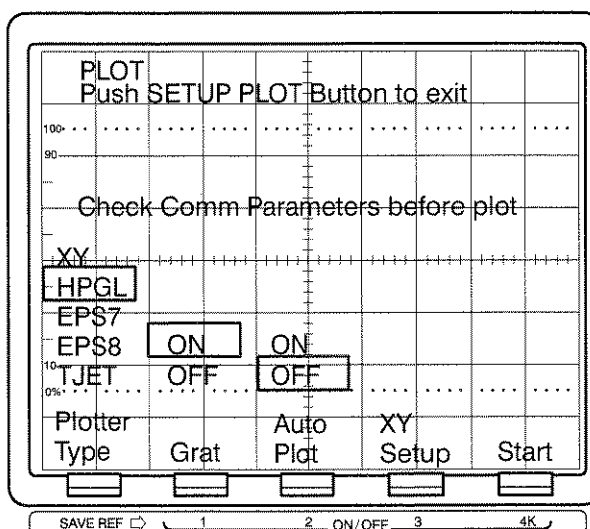

Figure 2-11: Plot Menu

Plotter Type

Selects the analog X-Y Plotter or digital plotter output format. The digital output format requires a GPIB or RS-232 option.

XY — Analog X-Y plotter

HPGL — Hewlett-Packard® Graphics Language

EPS7 — Epson® low-speed

EPS8 — Epson® high-speed double-density

TJET — Hewlett-Packard® ThinkJet™

Grat

ON — Plots graticule lines.

OFF — Suppresses graticule lines.

Auto Plot

ON — Automatically plots acquisitions. The graticule and readouts are plotted on the first acquisition only. The oscilloscope will wait for each plot to finish before beginning another acquisition.

OFF — Disables Auto Plot.

XY Setup

Generates a pattern for calibrating analog X-Y plotter gain and offset.

Start

Initiates transmission of the waveform display over the X-Y plotter or communications option.

Advanced Functions Menu

The Advanced Functions menu (Figure 2-12) provides access to various other diagnostics and setup functions.

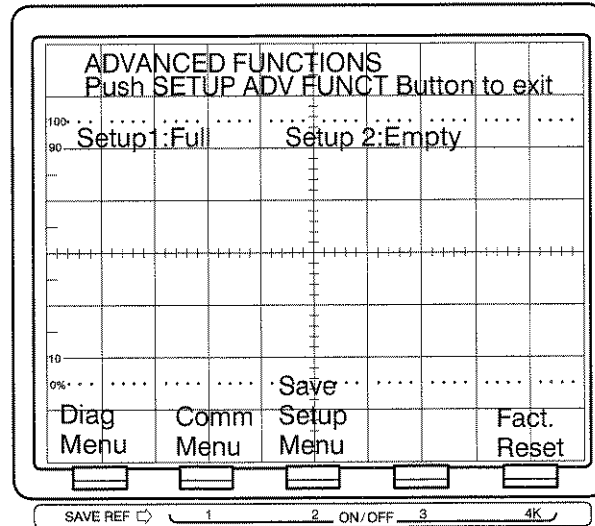

Figure 2-12: Advanced Functions Menu

Diag Menu

(Diagnostic Menu) — Selects diagnostic tests and calibration aids used to service the instrument. Detailed menu information is contained in the 2232 service manual.

Comm Menu

(Communications Menu) — Sets stop-bit and flow parameters for the RS-232 option.

Factory Reset

Resets the factory default acquisition, processing, and display modes for all sweep speeds.

Save Setup Menu

The Saved Setups Menu (Figure 2-13) allows you to save acquisition and other menu settings as well as select what default or saved settings the oscilloscope will recall when the power is turned on.

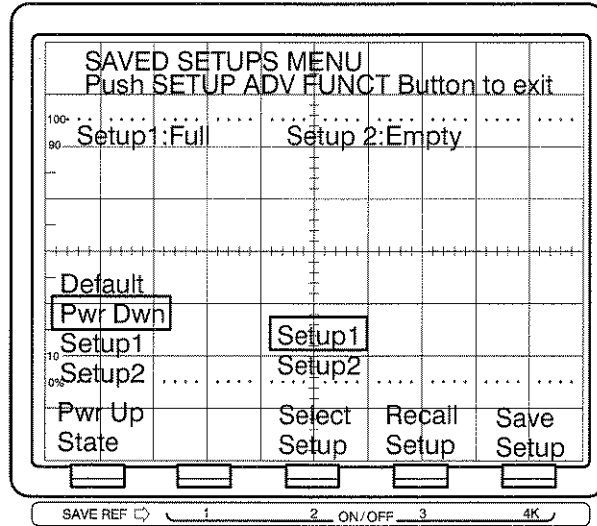

Figure 2-13: Save Setup Menu

Pwr Up State

(Power Up State) — Selects one of the following settings for the oscilloscope when the power is turned on:

Default — The oscilloscope uses the factory default settings at power up.

Pwr Dwn (Power Down) — The oscilloscope automatically saves the acquisition and menu settings when the power is turned off. The instrument will return to these settings when the power is turned back on.

Setup1 — The oscilloscope uses the settings saved under “Setup1” at power up.

Setup2 — The oscilloscope uses the settings saved under “Setup2” at power up.

Select Setup

Setup1 — Selects “Setup1” to save to, or recall from, memory.

Setup2 — Selects “Setup2” to save to, or recall from, memory.

Recall Setup

Recalls the indicated Select Setup memory.

Save Setup

Saves the current software-controlled settings to the indicated Select Setup memory.

Setup Menus

Displaying Signals

Displaying Signals describes the basic tasks involved in using the 2232 Digital Storage Oscilloscope to reveal the waveform characteristics of electrical signals. In particular, *Building a Basic Display*, provides an overview of the control sections and is a good starting point for anyone unfamiliar with oscilloscopes.

Applying Signals to the Vertical Inputs

There are two vertical channels on the oscilloscope. Each channel has an input connection and an input coupling switch (Figure 3-1).

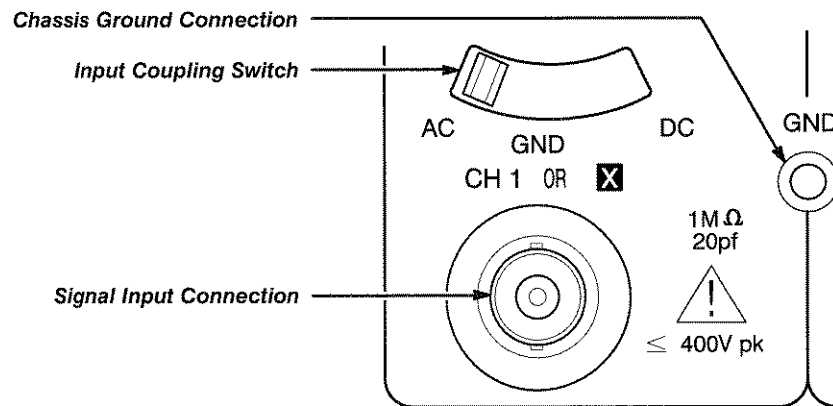

Figure 3-1: Input Connection and Coupling Switch

Connecting Signals

Use either a probe or coaxial cable to connect a signal to a vertical input.



Be careful to observe the maximum input voltage rating ($\leq 400 V_{peak}$). Use a high-voltage probe if necessary.

For AC signals that have a DC level higher than ten times the volts/division setting, use the precharging technique described below.

Connecting the Standard Probes — Use the standard accessory 10X probes supplied with the instrument for most circuit-to-input connections. The 10X attenuation factor provides a high input impedance that minimizes

signal loading in the circuitry under test. The connector ends of the accessory 10X probes are coded to change the readout by the appropriate scale factor.

- Step 1:** Gently twist the probe connector clockwise onto the input BNC until it locks.
- Step 2:** Make sure the probe is properly compensated. Refer to *Checking the Probe Compensation*, page 1-6.
- Step 3:** Connect the ground clip on the probe to the ground connection of the circuit. This will reduce signal noise and provide a common ground reference for DC measurements.

Probe Accessories — Tektronix also supplies many other types of probes and probe accessories to meet your measurement needs. Your Tektronix representative, local Tektronix Field Office, or Tektronix products catalog can also provide additional information on accessories.

Coaxial Cables — Use a coaxial cable to connect a BNC output or other terminated signal source to the oscilloscope input. If necessary, use a termination (usually 50 Ω) on the signal input to match the characteristic impedance and preserve the fidelity of the signal. Tektronix also carries a variety of coaxial cable and cabling accessories for various applications.

Coupling Signals

Use the **AC-GND-DC** switch to select the desired input coupling mode (Figure 3-1).

AC — Capacitively couples the input and blocks DC to 10 Hz signals.

GND — Decouples the signal from the input and connects the input circuit to ground reference.

DC — Passes all signal components (AC and DC) to the vertical system.

Precharging the Signal Input

Use the procedure below when coupling AC signals that have a high DC voltage level or when probing between signals that differ greatly in DC levels. This procedure becomes especially useful if the difference in DC level is more than ten times the volts/division switch setting or if the circuit is sensitive to the charging, or discharging, of the internal AC coupling capacitor.

- Step 1:** Set the input coupling switch to **GND** before connecting the probe tip to a signal source.
- Step 2:** Touch the probe tip to the oscilloscope chassis ground (**GND**) connector.
- Step 3:** Wait several seconds for the input-coupling capacitor to discharge.

- Step 4:** Connect the probe tip to the signal source.
- Step 5:** Wait several seconds for the input-coupling capacitor to charge to the DC level of the signal source.
- Step 6:** Set the input coupling switch to **AC**. Position the AC signal within the graticule area.

Building a Basic Display

Displaying a simple, repetitive signal is one of the most common tasks encountered when using an oscilloscope. To properly display a signal you must make the appropriate control settings in four different sections of the front panel:

- CRT Display
- Vertical
- Horizontal
- Trigger

These control sections are arranged left to right across the front panel of the 2232 Digital Storage Oscilloscope.

Presetting the Controls

It is often helpful to preset the front panel controls to get a sweep on the screen before you try to apply a signal. With a simple “trace” on screen you can adjust the display intensity and focus before you make any other settings.

If you are unfamiliar with oscilloscopes you may want to begin with the basic analog setup given in *Start Up*, page 1-4. In addition, the following sections describe the basic controls and a general approach to setting them:

- *Selecting the Display Mode (STORE/NON-STORE)*
- *Selecting the Trigger Mode*
- *Selecting the Horizontal Mode and Scale*
- *Selecting the Vertical Mode and Scale*
- *Setting the Display Intensity and Focus*
- *Finding “Lost” Displays*

Selecting the Display Mode (STORE/NON-STORE)

Toggle the **STORE/NON-STORE** button to display signals in either the digital (**STORE**) or analog (**NON-STORE**) mode. You may find it helpful to set up the signal display in the analog mode first before switching to the **STORE** mode.

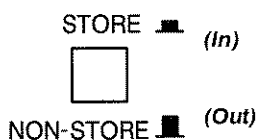

As soon as you enter the **STORE** mode the oscilloscope digitally acquires the signal and actively displays it on the screen. Acquisition modes for different sweep speeds are determined by default but they may be changed. (Refer to *Digitizing Signals*, page 3-8.) The front panel controls that govern the analog display in **NON-STORE** also govern the storage display. The **STORE** mode, however, gives you the additional capabilities of digital processing, cursor measurements, and waveform storage and retrieval.

Selecting the Trigger Mode

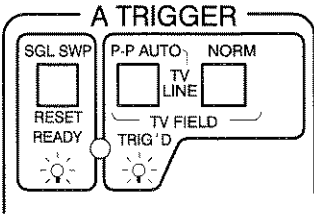

Set the trigger mode to **P-P AUTO** for most routine displays. This mode automatically adjusts the range of the trigger-level control for repetitive signals above 20 Hz and automatically generates a sweep in the absence of an adequate trigger signal.

There are many other ways to trigger a signal. Refer to the section entitled *Triggering on Signals*, page 3-26, for a complete discussion.

Selecting the Horizontal Mode and Scale

Using the horizontal controls (Figure 3-2) you can display and horizontally scale a signal applied to the oscilloscope. There are also two separate time base modes that you can use separately or in combination.

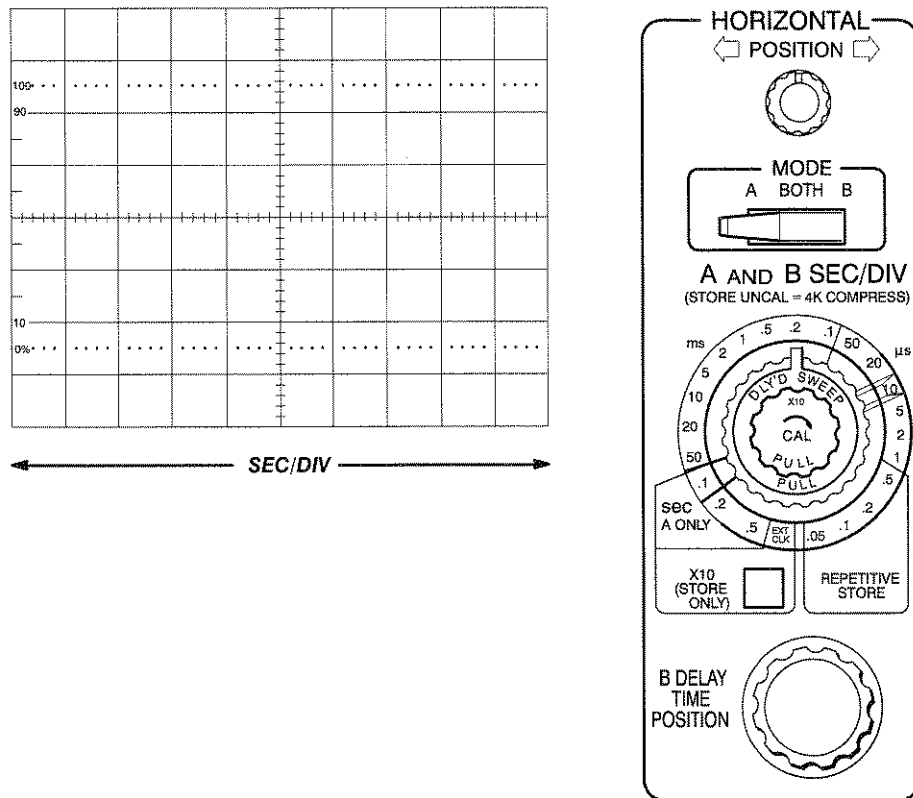

Figure 3-2: Horizontal Display Controls

- Step 1:** Select the time base mode with the horizontal **MODE** switch:

A — Selects the **A** sweep mode. Use this mode for basic displays that require only one sweep.

BOTH — Simultaneously displays both **A** (intensified) and **B** sweeps in the **NON-STORE** mode. (In the **STORE** mode only the **A** intensified sweep is displayed.) The intensified portion of **A** sweep indicates where the **B** delayed sweep begins and ends. Refer to *Displaying Two Sweeps*, page 3-22.

B — Displays **B** sweep only. Refer to *Displaying Two Sweeps*, page 3-22.

- Step 2:** Use the **A AND B SEC/DIV** controls to select the horizontal scale factor for the selected mode(s).

A SEC/DIV — Selects the **A** sweep speed by turning both **A AND B SEC/DIV** controls together. The gray **DLY'D SWEEP (B SEC/DIV)** knob will lock together with the clear plastic **A SEC/DIV** skirt when you align the indicators.

B SEC/DIV (DLY'D SWEEP) — Selects the **B** sweep speed by turning the gray **DLY'D SWEEP (B SEC/DIV)** knob. Pull and turn the **DLY'D SWEEP** knob clockwise to select faster sweep speeds for the **B SEC/DIV** time-base only.

- Step 3:** Adjust the horizontal **POSITION** control as necessary.

Selecting the Vertical Mode and Scale

The vertical display controls allow you to adjust the vertical scale, position, and mode.

- Step 1:** Select the channel you want with the **CH1 BOTH CH2** switch:

CH 1 — Displays Channel 1 only.

BOTH — Activates the **ADD ALT CHOP** switch for two-channel displays.

CH 2 — Displays Channel 2 only.

- Step 2:** Preset the input coupling for that channel to ground (**GND**). (Also refer to *Precharging the Signal Input*, page 3-2.)

- Step 3:** Set the vertical scale (or attenuation factor) for the display by turning the volts/division knob of the selected channel (Figure 3-3). Choose a setting that is several times higher than the amplitude of the signal. This will keep the display from going off screen.

Note the 1X and 10X nomenclature next to the **VOLTS/DIV** control. Vertical scale factors range from 2 mV to 5 V per division for a X1 probe and 20 mV to 50 V per division for a 10X probe. (Probes with higher factors of attenuation are also available from Tektronix.) If a probe is properly coded, the display readout of the channel it is connected to will change by the appropriate scale factor.

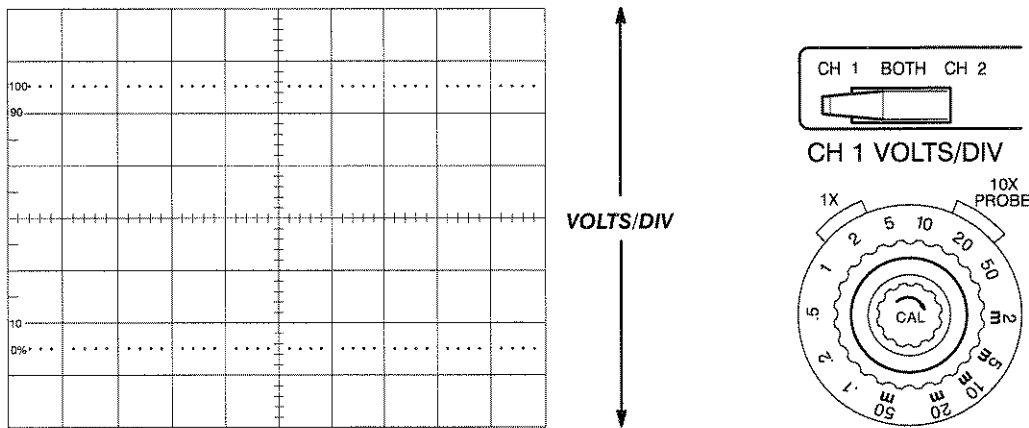

Figure 3-3: Vertical Display Controls

- Step 4:** Apply the signal to the input and move the coupling switch to **AC** (or **DC**). (Refer to *Applying a Signals to the Vertical Inputs*, page 3-1.)
- Step 5:** Adjust the vertical position control for the selected channel as necessary.

Setting the Display Intensity and Focus

Once you have a simple trace or signal displayed on the screen, use the **FOCUS** and **INTENSITY** knobs to control the CRT display (Figure 3-4).

The larger (outer) knob of the **A** and **B INTENSITY** controls adjusts the intensity of **A NON-STORE** sweep. The smaller (inner) control adjusts the intensity of **B NON-STORE** sweep and the intensified portion of the **A NON-STORE** sweep.

Displaying Signals

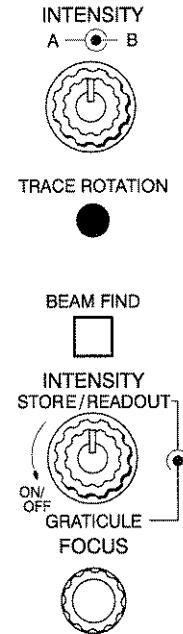
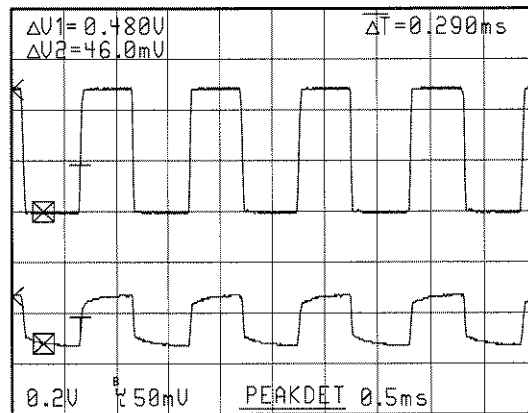

Figure 3-4: CRT Display Controls

The **INTENSITY STORE/READOUT** control sets the brightness of the readouts in the **NON-STORE** mode as well as the intensity of the entire **STORE** display. You can also toggle the readouts on and off by turning the larger (outer) control fully counterclockwise and then back to the normal level.

Some readouts do not appear in both **STORE** and **NON-STORE** modes. Refer to *Display Mode*, page 2-6.

The **FOCUS** control adjusts the clarity of the display.

Finding “Lost” Displays

Because of signal variances or misadjusted front panel settings it is not uncommon to “lose” a signal display. When this happens, use the following procedure:

- Step 1:** Note which channel the signal is applied to and make sure the vertical mode is set for that channel.
- Step 2:** Set the oscilloscope in the **NON-STORE** mode.
- Step 3:** Press the **BEAM FIND** button and hold it in. The beam of the CRT is now intensified and compressed into the viewing area (Figure 3-5).

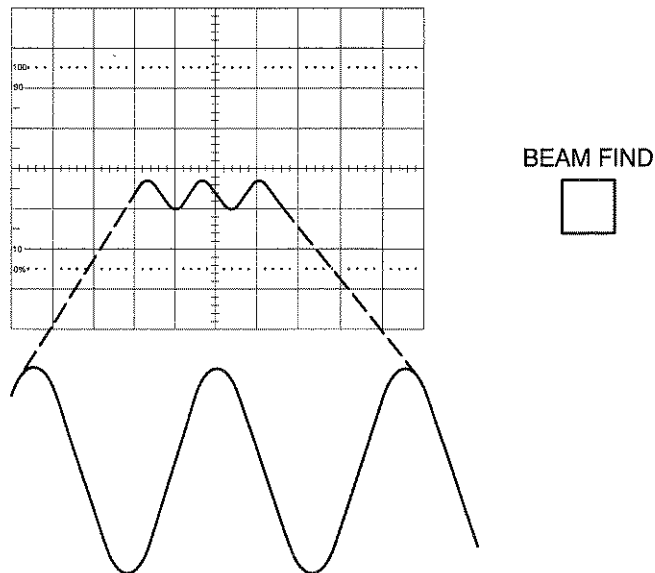

Figure 3-5: Beam Find

If the beam appears to be stuck on some portion of the display, check the trigger mode settings. Setting the Horizontal mode to **A** and the trigger mode to **P-P AUTO** will give you a sweep in the absence of a trigger signal. Also check to be sure the **X-Y** button is not pushed in and the seconds/division is not set too fast or too slow for the signal you are trying to display.

- Step 4:** Adjust the horizontal and vertical position control(s) to center the signal display within the compressed area and then release the **BEAM FIND** button.
- Step 5:** Adjust the **A** and **B INTENSITY** control to a normal level and adjust the vertical and horizontal scale with the **VOLTS/DIV** and **SEC/DIV** controls.

If you fail to locate the sweep using this procedure you may want to use the basic analog setup given in the *Start Up*, page 1-4 and try reapplying the signal to the input.

Digitizing Signals

There are four different acquisition modes to choose from when you digitize a signal in the **STORE** mode:

- **Accumulate Peak** mode finds the highest and lowest record points over many acquisitions. It reveals variations in the signal over time.
- **Average** mode calculates the average value for each record point over many acquisitions. It reduces apparent noise in a repetitive signal.
- **Sample** mode records the first sample in every acquisition interval and presents more of a "real-time" view of the signal.

- **Peak Detect** mode uses the highest and lowest samples in two intervals. It reveals glitches and is relatively immune to waveform aliasing. (For further discussion of aliasing refer to *Preventing Signal Aliases*, page 3-18.)

Each sweep speed has a “default” setting for the acquisition mode. You can reset to these default modes anytime by selecting **Factory Reset** in the Advanced Functions menu. You can also set the oscilloscope to return to the default settings every time you power up the instrument. (See *Saving and Recalling Setups*, page 3-49)

Not all acquisition modes are available at all sweep speeds. The SEC/DIV and trigger mode settings determine the storage mode and corresponding set of available acquisition modes. Refer to Appendix D.

Selecting the Acquisition Mode

There are two ways to select the acquisition mode:

1. **Acquisition Menu** — Push the **ACQ** button under **SETUP** and press the menu button labeled **Acq Mode**.
2. **Front-Panel Acquisition Controls** — Push the **MODE** button on the front-panel bank of **ACQUISITION** switches.

Selecting the High-Speed Storage Mode

The “Repetitive Store” mode is indicated on the front panel for time base settings of 0.5 μ s and faster. Because of the sampling rate (100 Ms/s) the oscilloscope must make numerous acquisitions at these speeds to complete a waveform record. The Repetitive Store mode, therefore, should only be used when acquiring repetitive signals.

Selecting Slow-Speed Storage Modes

For time base settings 0.1 s and slower, both the trigger mode and the roll or scan selection from the Acquisition Menu configures one of the following storage modes:

Scan:

- **Untriggered Scan** — (**P-P AUTO**) Each acquisition record appears left to right across the display and continually overwrites the previous record at the rate set by the **SEC/DIV** control. Untriggered Scan Mode is useful for viewing *single*, slowly occurring events that you do not want to trigger the oscilloscope on.
- **Triggered Scan** — (**NORM**) The acquisition record appears left to right across the display with every trigger. The oscilloscope overwrites the record left to right with new data only when there is another trigger. Triggered Scan Mode is useful for capturing *single*, slowly occurring events coincident with a trigger.

- **Scan-roll-scan** — (**SGL SWP** and **Scan**) A new record appears across the screen from left to right until it reaches the trigger point and then rolls right to left from the trigger point until a trigger occurs. When a trigger occurs, the oscilloscope scans left to right until the record is filled and then freezes the display. (Selecting either **Average** or **Accpeak** acquisition switches the storage mode to the equivalent of Triggered Scan, but only allows one acquisition or “single sweep.”) Scan-roll-scan (or single-sweep scan) is useful for capturing an intermittent event and saving it on screen until the trigger is manually rearmed.

Roll:

- **Untriggered Roll** — (**P-P AUTO** or **NORM**) The waveform moves continuously across the screen from right to left like a chart recorder. Untriggered Roll mode is useful for viewing a *series* of events or slowly occurring, *continuous* events when no trigger is desired.
- **Triggered Roll** — (**SGL SWP**) The record moves across the screen continuously from right to left. When the trigger event occurs, the oscilloscope retains the waveform on screen and disables further acquisitions. Triggered Roll is useful for capturing an intermittent event and saving it on screen until the trigger is manually rearmed.

Refer to the following sections entitled *Viewing Slowly Occurring Events* and *Capturing Random Events* for further instructions on how to use the slow-speed storage modes.

Viewing Slowly Occurring Events

Untriggered Scan Mode:

View *single*, slowly occurring events that you *do not* want to trigger on.

- Step 1:** Set the **A** Trigger Mode to **P-P AUTO**.
- Step 2:** Press the Setup **ACQ** button to call up the Acquisition Menu.
- Step 3:** Select **Scan** and press the **ACQ** menu button again to exit the menu.
- Step 4:** Note that the acquisition record appears across the screen from left to right, then repeatedly overwrites the previous record with new data (Figure 3-6).

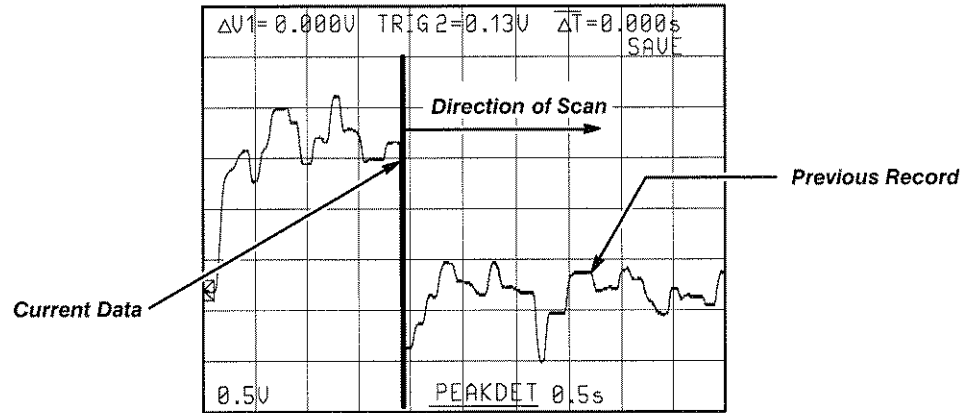

Figure 3-6: Scan Mode

Triggered Scan Mode:

View *single*, slowly occurring events that you *want* to redisplay coincident with a new trigger.

- Step 1:** Set the **A** Trigger Mode to **NORM**.
- Step 2:** Press the Setup **ACQ** button to call up the Acquisition Menu.
- Step 3:** Select **Scan** and press the **ACQ** menu button again to exit the menu.
- Step 4:** Note that a waveform record is acquired left to right with a trigger event. Each new trigger event then causes the acquisition to overwrite the previous record from left to right.

Untriggered Roll Mode:

View a *series* of events or slowly occurring, *continuous* events.

- Step 1:** Set the **A** Trigger Mode to **P-P AUTO** or **NORM**
- Step 2:** Press the Setup **ACQ** button to call up the Acquisition Menu.
- Step 3:** Select **Roll** and press the **ACQ** menu button again to exit the menu.
- Step 4:** Note that the trace “rolls” across the screen from right to left (Figure 3-7) and does not permit any trigger event to interrupt the display.

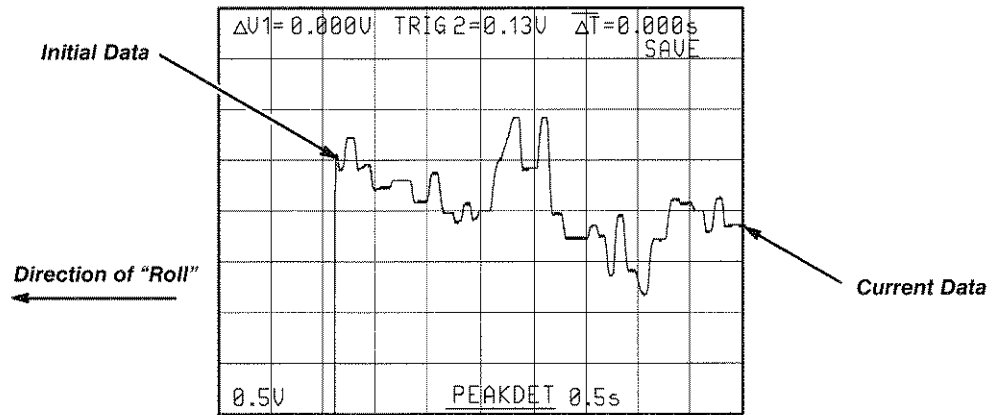

Figure 3-7: Roll Mode

Capturing Random Events

Infrequent or random events can be “captured” by using the single-sweep trigger mode in combination with either the Scan or the Roll mode. These two modes are called “Scan-roll-scan” and “Triggered Roll” respectively. These two modes are only available at sweep speeds of 0.1 ms and slower.

Triggered Roll:

- Step 1:** Set the **A** Trigger Mode to **P-P AUTO**.
- Step 2:** Press the Acquisition **TRIG POS** button to select the position on the screen where the trigger event (“T”) will be displayed.
- Step 3:** Press the Setup **ACQ** button to call up the Acquisition Menu.
- Step 4:** Select **Roll** and press the **ACQ** menu button again to exit the menu.
- Step 5:** Press the **SGL SWP** button.

Note that the trace moves across the screen continuously from right to left. Also, the **READY** light is on indicating the oscilloscope is waiting for a trigger signal. (If the **READY** light is not on, press the **SGL SWP** button again.)

When the trigger event occurs, the acquisition continues across the screen from right to left until it reaches the trigger point indicator. The oscilloscope then records the event coincident with the trigger, completes the record, and freezes the display.

Scan-roll-scan:

- Step 1:** Set the **A** Trigger Mode to **P-P AUTO**.
- Step 2:** Press the Acquisition **TRIG POS** button to select the position on the screen where the trigger event (“T”) will be displayed.
- Step 3:** Press the Setup **ACQ** button to call up the Acquisition Menu.

Step 4: Select **Scan** and press the **ACQ** menu button again to exit the menu.

Step 5: Press the **SGL SWP** button.

Note that the acquisition scans across the screen from left to right until it reaches the trigger point and then rolls right to left from the trigger point until a trigger occurs.

When a trigger occurs, the oscilloscope scans left to right until the record is filled and then freezes the display.

If you want to retain a waveform for later reference, transfer it to a **SAVE REF** memory location.

To rearm the trigger circuit, press **SGL SWP** again. The previous acquisition record will now disappear and the oscilloscope will be ready for the next trigger.

Accumulating Signal Peaks (ACCPEAK)

Acquiring signals in **ACCPEAK** (Figure 3-8) is the best mode to use when you want to observe the upper and lower boundaries of a signal's amplitude over time. It will also indicate how much the DC component of the signal drifts or the amount of noise present in the signal.

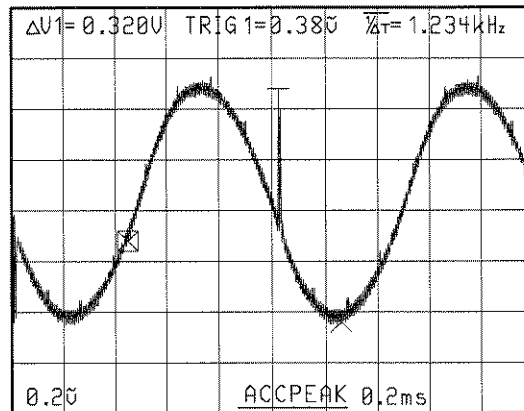

Figure 3-8: Accumulate Peak Mode Display

Detecting Signal Glitches

A signal glitch is an aberrant spike that is not characteristic of the waveform or level it rides on. Both the **ACCPEAK** (accumulate peak) and **PEAKDET** (peak detect) modes are excellent modes for viewing signal glitches. (If you *do not* want to see these spikes **AVERAGE** mode is best. Refer to *Averaging Signals*, page 3-14.) While **ACCPEAK** gives the best view of signal glitches over time, **PEAKDET** mode is the best default mode (for sweep speeds of 5 μ s and slower) because it automatically captures signal spikes and pres-

ents a truer view of the signal. Figure 3-9 shows how the signal in Figure 3-8 appears in the Peak Detect mode. Notice that the noise and glitches are detected, but not accumulated in Peak Detect.

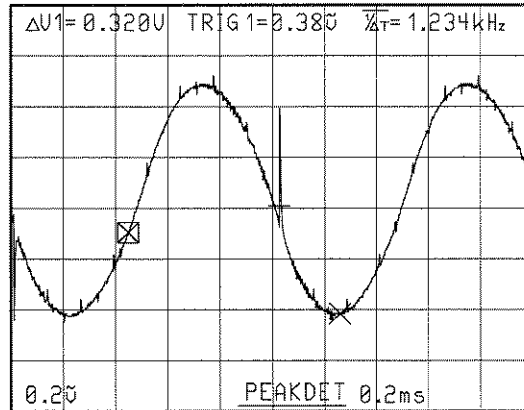

Figure 3-9: Peak Detect Mode Display

Averaging Signals

The **AVERAGE** mode (Figure 3-10) is excellent for visually eliminating random signal noise that rides on the waveform. Acquisitions are averaged over multiple records. The default weight of one acquisition is 1/4 but it may be changed using the **ACQUISITION** menu.

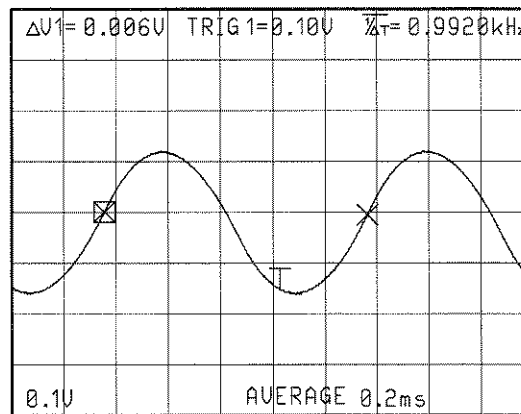

Figure 3-10: Average Mode Display

Sampling Signals

When you select **SAMPLE** the special features of the other modes are not used. The acquisition displayed is composed of 100 samples per division (Figure 3-11).

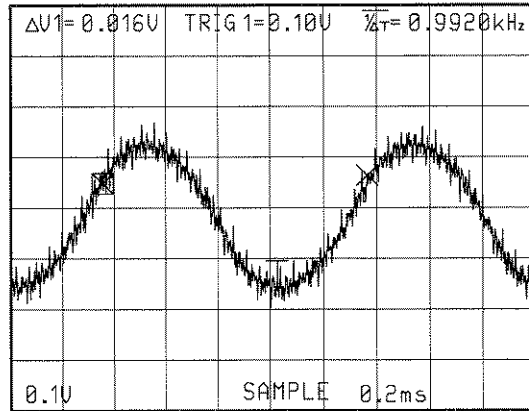

Figure 3-11: Sample Mode Display

Clocking Acquisitions

Normally, storage acquisitions are clocked internally. You can, however, supply an external clocking signal through the auxiliary connector on the side of the instrument. Refer to *Specification*, Appendix B.

Selecting the Acquisition Record Length (1K/4K)

A 1K acquisition consists of 1,024 data points spread across one display screen. A 4K acquisition consists of 4,096 data points spread across four screens. To view these additional screens in the 4K mode you must use the cursor knob.

- Step 1:** Press the **ACQUISITION 1K/4K** button. In the 4K mode an acquisition window indicator will appear.

The acquisition window indicator (Figure 3-12) displays the relative position of the cursors, what cursor is active, what part of the acquisition is displayed (display window indicator), and the trigger point.

- Step 2:** Position the active cursor one way or the other to view the rest of the acquisition record. (Note that the active cursor and the display window indicator also move along the acquisition window indicator)

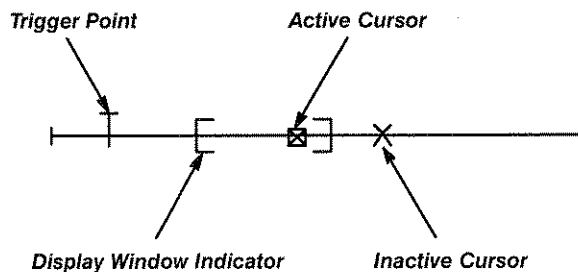

Figure 3-12: Acquisition Window Indicator

Compressing the Acquisition Record Length (4K Compress)

You can compress a 4K acquisition to one screen. However only 1,024 data points are displayed.

- Step 1:** Go to the **STORE** mode and display the signal in the 4K mode (Figure 3-13).
- Step 2:** Turn the **X10 CAL** knob counterclockwise. Note that the timing increases by a factor of four, the small letter "c" appears before the time base readout, and the signal is compressed (Figure 3-14).

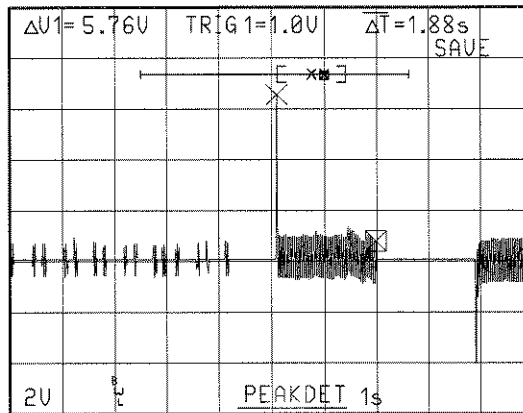

Figure 3-13: 4K Acquisition, 1K Window

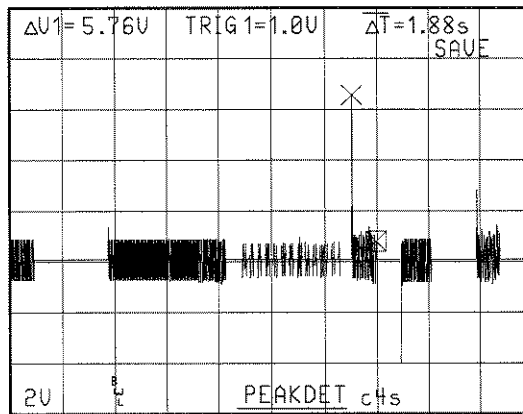

Figure 3-14: Compressed 4K Acquisition

Positioning the Acquisition Record

The acquisition record can be positioned relative to the trigger point. Pressing the Acquisition button labeled **TRIG POS** moves the trigger point indicator ("T") to select three different views of the record:

- Pretrigger (Figure 3-15)
- Midtrigger (Figure 3-16)
- Posttrigger (Figure 3-17)

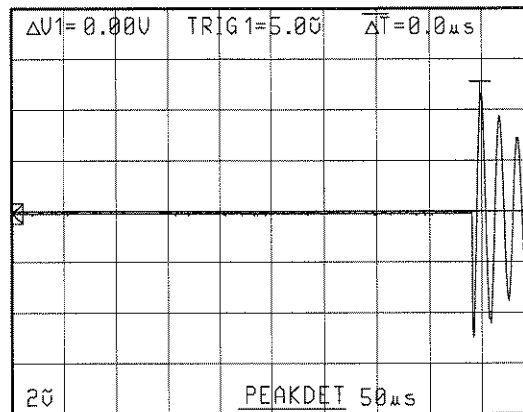

Figure 3-15: Pretrigger Acquisition

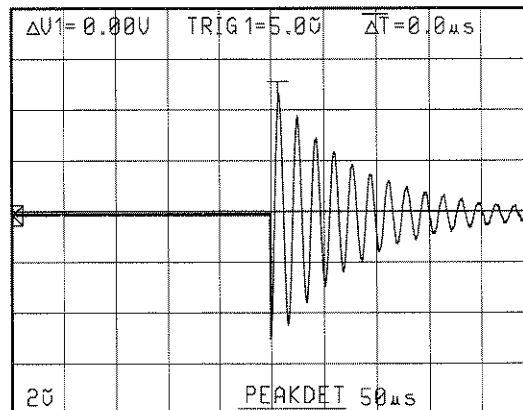

Figure 3-16: Midtrigger Acquisition

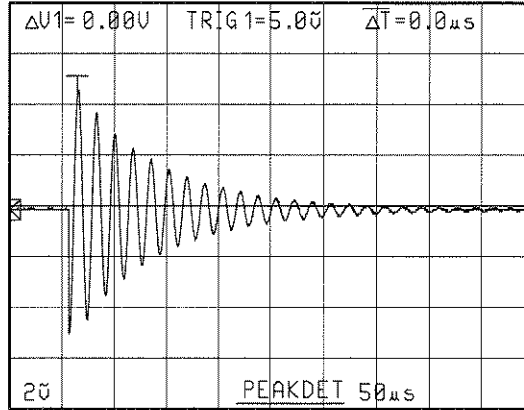

Figure 3-17: Posttrigger Acquisition

The trigger position is also “point selectable.” This means that the trigger point can be positioned anywhere along the acquisition record. Use the following procedure:

- Step 1:** Press the Setup **ACQ** button to call up the Acquisition Menu.
- Step 2:** Press the **Cursor Knob Func** button to select “Trig Pos.”
- Step 3:** Turn the **CURSORS** knob to set the trigger point to the desired location.

The 4K acquisition mode extends the acquisition record and the cursor knob adjusts which portion of the record is displayed. Refer to *Selecting the Acquisition Record Length (1K/4K)*, page 3-15.

Preventing Signal Aliases

Aliasing may occur in the digital mode because the oscilloscope cannot sample the signal fast enough to construct an accurate waveform record (Figure 3-18). When aliasing happens, you see a waveform with a frequency lower than the actual signal on the input or a waveform that is not stable even though the light next to **TRIG'D** is lit.

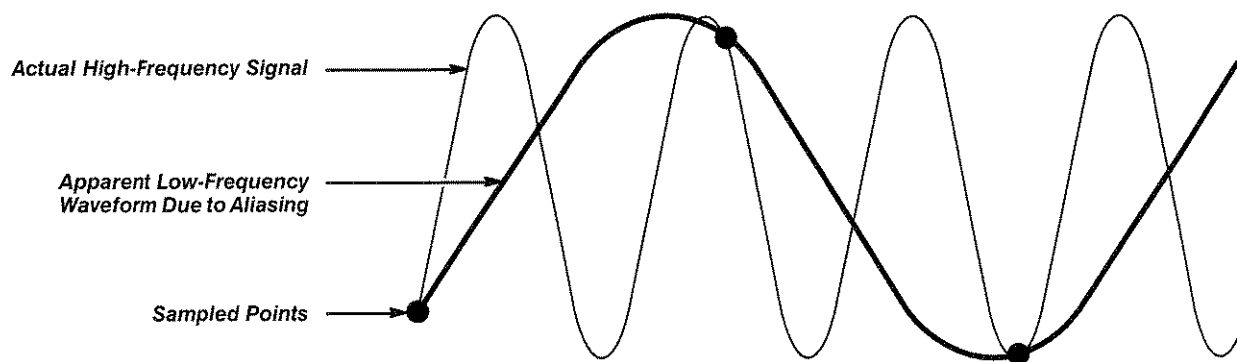

Figure 3-18: Aliasing

One simple way to check for aliasing is to slowly change the horizontal scale (time per division setting). If the shape of the displayed waveform changes drastically, you may have aliasing.

There are a couple of ways to prevent signal aliasing:

- Set up the signal display in the **NON-STORE** mode before switching to **STORE**. While the oscilloscope is in the **NON-STORE** mode you can set the time base for an appropriate speed.
- Set up the signal display in another mode besides Sample. Because the Peak Detect mode, for example, searches for samples with the highest and lowest values, it can detect faster signal components over time.

Displaying Magnified Sweeps

There are several ways to horizontally magnify the sweep:

- Change the time base to a faster sweep speed.
- Use the **B** Delayed Sweep. (Refer to *Displaying Two Sweeps*, page 3-22.)
- Use the X10 control to magnify (by ten times) the center one division of the **NON-STORE** display or one division centered around the active cursor in the **STORE** mode. The X10 magnifier also extends the upper range of sweep speeds (for example, .05 μ s to 5 ns per division).

Using the X10 Magnifier

The time per division readouts automatically change by the correct factor when the X10 knob is pulled. In the **STORE** mode an acquisition window indicator appears and **CURSORS** control can be used to scroll along the waveform.

Perform the following procedure to use the X10 magnifier in the **NON-STORE** mode:

- Step 1:** Position the sweep until the portion of the sweep you want to magnify is centered horizontally on the display.
- Step 2:** Pull out the **X10 CAL PULL** knob.
- Step 3:** Adjust the horizontal position control as necessary to center the display.

Perform the following procedure to use the X10 magnifier in the **STORE** mode:

- Step 1:** Center the active cursor on the portion of the sweep you want to magnify.
- Step 2:** Pull out the **X10 CAL PULL** knob.
- Step 3:** Adjust the **CURSORS** control as necessary to center the display.

Displaying Two Channels

By using both channels on the instrument you can compare one signal directly with another. With one signal in each channel it is also very easy to algebraically add them together or subtract them from each other.

Comparing Two Signals

- Step 1:** Connect one signal to Channel 1 and the other signal to Channel 2. Move the **CH1 BOTH CH2** switch to **BOTH**.
- Step 2:** Move the **ADD ALT CHOP** switch to **ALT** or **CHOP**. (In general, it is better to use **CHOP** when the **SEC/DIV** control is set in the millisecond (ms) range, and **ALT** when the **SEC/DIV** is in the microsecond (μ s) range.)
- Step 3:** Position both signals on screen and adjust the vertical and horizontal scales.

Adding Two Signals

- Step 1:** Connect one signal to Channel 1 and the other signal to Channel 2. Move the **CH1-BOTH-CH2** switch to **ADD**.
- Step 2:** Adjust the vertical position of the resultant display with both the Channel 1 and Channel 2 **POSITION** controls.

Subtracting Signals or Signal Components (Common Mode Rejection)

You can subtract an undesirable DC or AC signal component by inverting it in Channel 2 and adding it to Channel 1 (Figure 3-19).

- Step 1:** Connect one signal to Channel 1 and the other signal or signal component you want to subtract to Channel 2. Move the **CH1-BOTH-CH2** switch to **ADD**.
- Step 2:** Push the Channel 2 **INVERT** switch in.
- Step 3:** Adjust the vertical position of the resultant display with both the Channel 1 and Channel 2 **POSITION** controls.

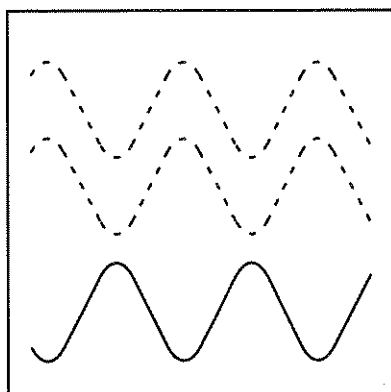

Channel 1 signal with undesired AC component

Channel 2 with undesired AC component inverted

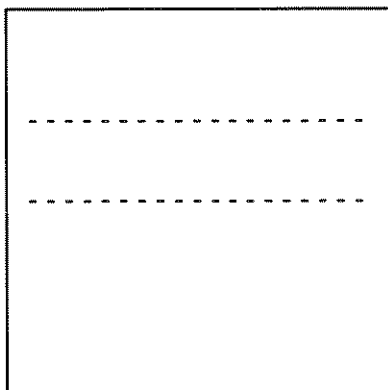

Channel 1 and Channel 2 (invert) in the ADD Mode. Undesired AC component is canceled.

Figure 3-19: Rejecting Common Mode Signal

Displaying Two Sweeps

Using the horizontal **BOTH** mode you can select a portion of the **A** sweep you wish to magnify and/or trigger separately on.

Using RUNS AFTER DELAY

- Step 1:** Set the **STORE/NON-STORE** control to **NON-STORE**.
- Step 2:** Set the instrument controls to obtain the **A** sweep on screen.
- Step 3:** Set the **HORIZONTAL MODE** switch to **BOTH** and the **B TRIGGER LEVEL** control to **B RUNS AFTER DLY**.
- Step 4:** Pull the gray **DLY'D SWEEP** knob and turn it clockwise to make separate **B SEC/DIV** settings. The intensified portion on the **A** sweep indicates what part of the **A** sweep is magnified by the **B** sweep as well as the amount of delay from the start of **A** sweep to the start of **B** sweep.
- Step 5:** Adjust the **B DELAY TIME POSITION** control to move the intensified zone over the portion of the **A** sweep you wish to display with the **B** sweep.
- Step 6:** Vertically separate the **A** intensified and **B** sweep displays by adjusting the **A/B SWP SEP** control in the **VERTICAL** section of the front panel (for **NON-STORE** mode only).

To view the **B** sweep by itself set the **HORIZONTAL MODE** switch to **B**.

To separately trigger on the **B** sweep, adjust the **B TRIGGER LEVEL** until the **B** display is stable.

NOTE

*The **B DELAY TIME POSITION** control will not provide continuously variable delay when the **B TRIGGER LEVEL** control is set to a position other than **B RUNS AFTER DLY**. Also, differential time measurements are invalid when the **B TRIGGER LEVEL** control is not set to **B RUNS AFTER DLY**.*

Displaying X-Y Patterns

Phase and frequency relationships between two signals can be viewed in the X-Y mode by pressing the X-Y button on the front panel (Figure 3-20).

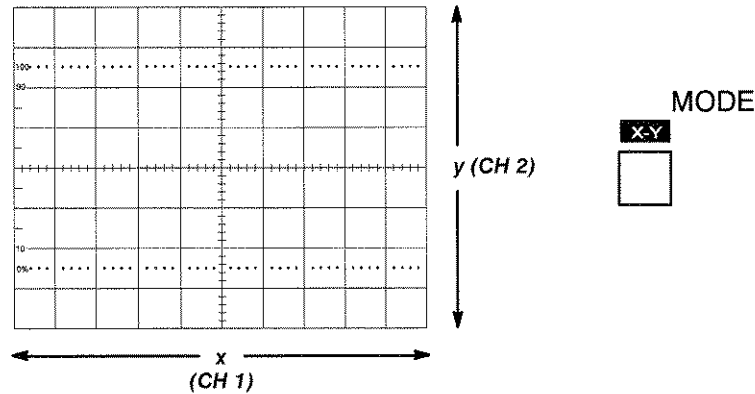

Figure 3-20: Selecting the X-Y Mode

The patterns displayed in the X-Y mode are called “Lissajous” figures. Some basic examples are given in Figures 3-21 and 3-22. With the **X-Y** button pressed in, the signal in Channel 1 drives the horizontal (or X) axis of the display and Channel 2 drives the vertical (or Y) axis.

Display two signals in the X-Y mode using the following procedure:

- Step 1:** Connect one signal to Channel 1 and the other to Channel 2.
- Step 2:** Adjust the **VOLTS/DIV** control for each channel. (If you want the amount of signal displacement to be exactly the same you may have to adjust the **VOLTS/DIV CAL** variable controls.)
- Step 3:** Press the X-Y button in. The signal in Channel 1 now drives the horizontal (or X) axis of the display and Channel 2 drives the vertical (or Y) axis.

When using the X-Y mode, measuring the precise phase and frequency differences between the signals requires a little more skill than other techniques. Making X-Y measurements in the analog mode also requires that you take the performance characteristics of the oscilloscope into consideration for frequencies above 150 kHz. The digital mode, however, has the same bandwidth as the vertical system. Refer to the section on X-Y Operation in *Specification*, Appendix B.

Refer to *Measuring Frequency*, page 3-39, and *Measuring Phase Difference*, page 3-42, for more discussion about phase and frequency measurement techniques.

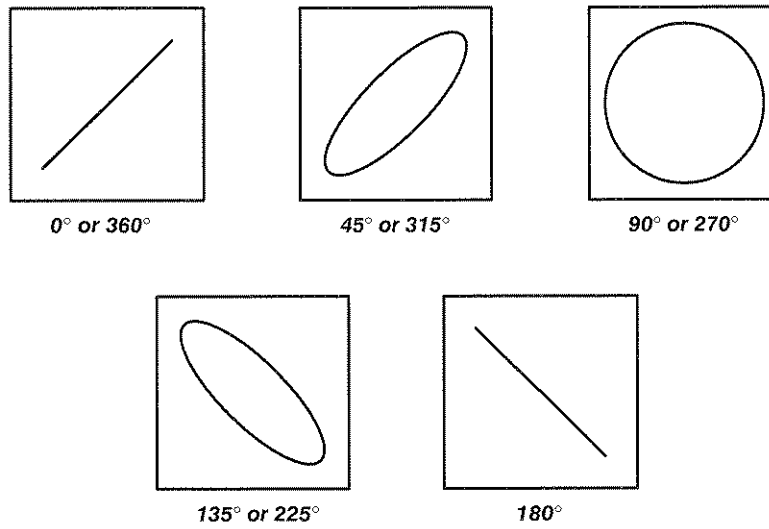
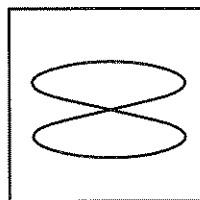
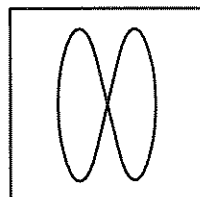

Figure 3-21: X-Y Phase Relationships



Frequency of the signal applied to X axis is twice that of the signal applied to the Y axis.



Frequency of the signal applied to Y axis is twice that of the signal applied to the X axis.

Figure 3-22: X-Y Frequency Relationships

Limiting Bandwidth



High-frequency noise from extraneous sources can sometimes interfere with a signal display. Push in the BW LIMIT button on the front panel to limit the vertical response of the scope to frequencies below 20 MHz. A "BWL" read-out will also appear on the display.

Modulating the Display Intensity

The **NON-STORE** intensity may be modulated with an external signal applied to the External Z-Axis connection (Figure 3-23) located on the rear panel of the oscilloscope. Certain specifications of the instrument must be observed. Refer to the Z-Axis section of *Specification*, Appendix B.

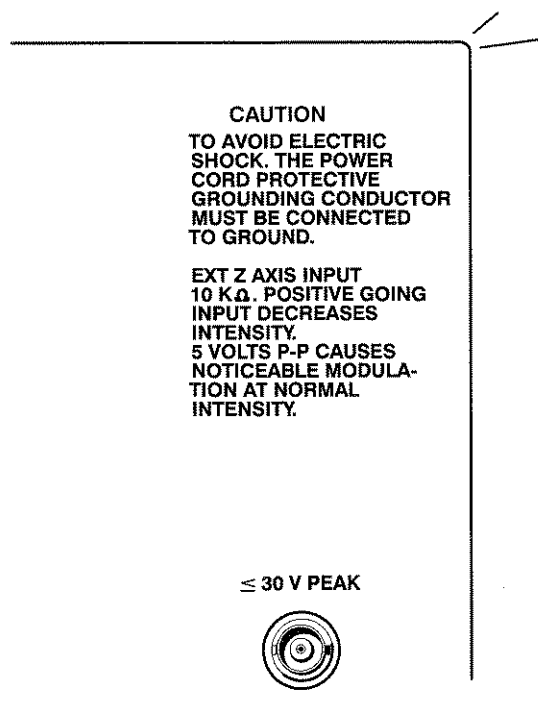

Figure 3-23: External Z-Axis Connection

Triggering on Signals

Triggering is an important function of the oscilloscope that allows you to stabilize the display of a signal. The trigger circuit of the oscilloscope synchronizes the beginning of a sweep (or acquisition) with a particular point on the rising or falling edge of a trigger signal. Without a proper trigger, the signal display may either “free-run” or not appear at all.

Triggering on Repetitive Signals

Repetitive signals, such as a fixed-frequency sine wave (Figure 3-24), can supply their own trigger signal to synchronize the display. The **P-P AUTO** mode is the easiest mode to use for repetitive signals because it automatically adjusts the range of the trigger-level control and generates a sweep when no trigger signal is present.

- Step 1:** Apply the repetitive signal to the Channel 1 input connector.
- Step 2:** Set trigger mode to **P-P AUTO** and the horizontal mode to **A**.
- Step 3:** Set the vertical mode to Channel 1 and the **A & B (trigger) SOURCE** to **VERT MODE**. (The trigger signal is obtained from the signal applied to the selected channel; in this case, Channel 1.)
- Step 4:** Set the **A COUPL** switch to **NORM**.
- Step 5:** Adjust the **A TRIGGER LEVEL**, if necessary, to stabilize the display.
- Step 6:** Adjust the vertical and horizontal controls to display a few cycles of the waveform.

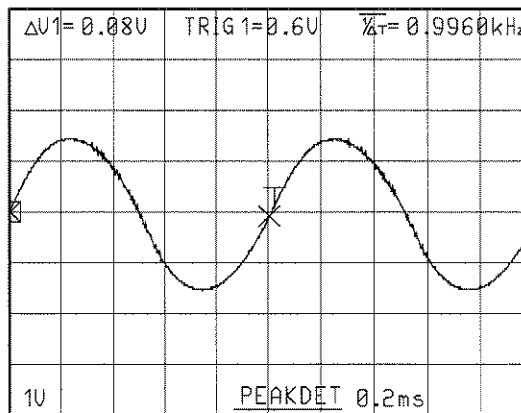

Figure 3-24: Repetitive Sine Wave

Triggering on Low-Frequency Signals

Use the **NORM** trigger mode for signals that are lower than 20 Hz in **NON-STORE** or 500 Hz in **STORE**. If the repetitive signal is lower than these frequencies, the **P-P AUTO** circuit interferes with obtaining a stable trigger. This is because the **P-P AUTO** circuit will start to generate its own signal to trigger a sweep or acquisition.

(Note: **NORM** trigger mode is *not* the same as **A COUPL NORM**.)

- Step 1:** Apply the repetitive signal to the Channel 1 input connector.
- Step 2:** Set trigger mode to **NORM** and the horizontal mode to A.
- Step 3:** Set the vertical mode to Channel 1 and the **A & B** (trigger) **SOURCE** to **VERT MODE**. (The trigger signal is obtained from the signal applied to the selected channel; in this case, Channel 1.)
- Step 4:** Set the **A COUPL** switch to **NORM**.
- Step 5:** Adjust the **A TRIGGER LEVEL** and **VAR HOLDOFF**, if necessary, to stabilize the display.
- Step 6:** Adjust the vertical and horizontal controls to display a few cycles of the waveform.
- Step 7:** Set the oscilloscope to **STORE** mode (Figure 3-25). Note that the annoying flicker of the **NON-STORE** display is removed.

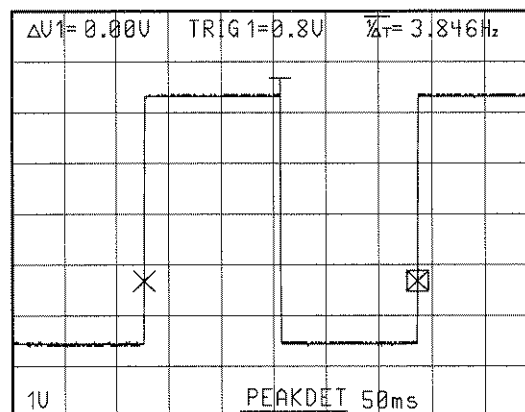

Figure 3-25: Low-Frequency Signal in the STORE Mode

Triggering on Random or Infrequent Events

Sometimes the event that you want to display occurs very infrequently. The oscilloscope can be set up to capture these events. Refer to *Capturing Random Events*, page 3-12.

Triggering on Complex or Non-Repetitive Signals

Some signals are too complex or irregular to provide a usable trigger of their own. Circuits that carry digital information are a good example. Often, however, a signal from another part of the circuit, such as a more widely spaced clocking signal, will provide a meaningful trigger event. You can even view the trigger signal at the same time as the other signal with a two-channel display:

- Step 1:** Connect one signal to Channel 1 and the trigger signal to Channel 2. Move the **CH1 BOTH CH2** switch to **CH 2**.
- Step 2:** Set the trigger mode to **NORM** and the **A & B SOURCE** to **CH 2**.
- Step 3:** Adjust the **A TRIGGER LEVEL** to trigger on the signal.
- Step 4:** Set the oscilloscope in **STORE**.
- Step 5:** Move the **CH1 BOTH CH2** switch to **BOTH**.
- Step 6:** Move the **ADD ALT CHOP** switch to **ALT** or **CHOP**. (In general, it is better to use **CHOP** when the **SEC/DIV** control is set in the millisecond (ms) range, and **ALT** when the **SEC/DIV** is in the microsecond (μ s) range.)
- Step 7:** Position both signals on screen and adjust the vertical and horizontal scales.

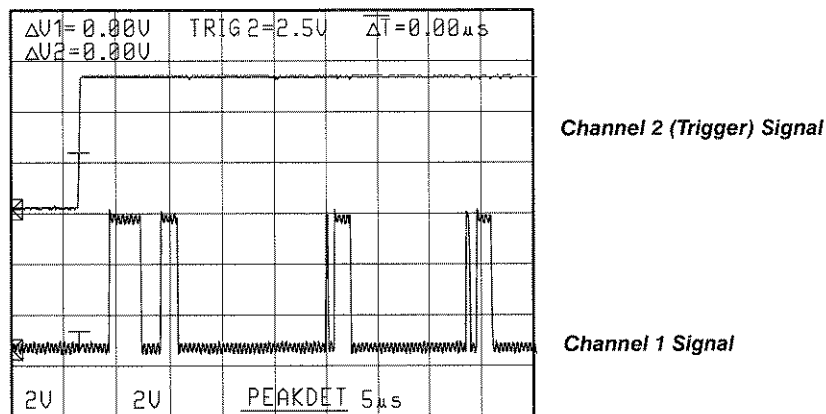

Figure 3-26: Channel 1 Signal Triggered with Channel 2

The **STORE** mode is ideally suited for viewing extended (4K) acquisitions and events that occur before during or after a trigger. Refer to *Selecting the Acquisition Record Length (1K/4K)*, page 3-15.

Triggering on Line Frequency

To trigger on power line signals, apply the signal to an input and move the **A COUPL** switch to **A LINE SOURCE**.

Triggering with an External Signal

Trigger one- or two-channel displays with an externally applied signal using the following procedure:

- Step 1:** Apply the external signal to the **EXT INPUT** connector using a coaxial cable.
- Step 2:** Set the **A & B SOURCE** to **A EXT**.
- Step 3:** Select the **A EXT COUPL** mode: **AC**, **DC**, or **DC ÷ 10**.
- Step 4:** Adjust the **A TRIGGER LEVEL** for a stable display.

Triggering on TV Signals

You can trigger on either TV line or TV field signals.

Triggering on a TV Line Signal

- Step 1:** Push in the **P-P AUTO/TV LINE** trigger mode button.
- Step 2:** Apply the TV signal to a channel input and display the channel.
- Step 3:** Set the **VOLTS/DIV** switch to display 0.3 or more of composite video signal.
- Step 4:** Set the **A SEC/DIV** switch to 10 μ s.
- Step 5:** Set the **A TRIGGER SLOPE** switch either out (for positive-going TV Signal sync pulses) or in (for negative-going TV signal sync pulses).
- Step 6:** Adjust the **A TRIGGER LEVEL** stabilize the display (Figure 3-27).

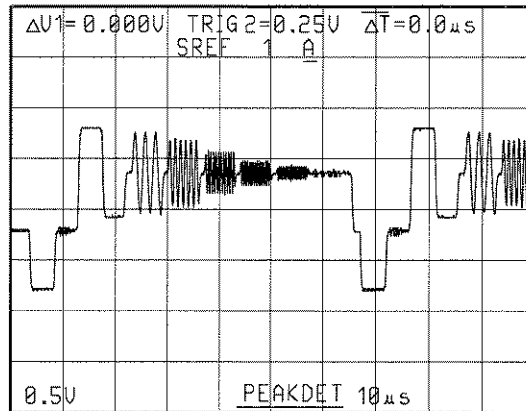

Figure 3-27: Multi-burst Signal Triggered in TV Line

Triggering on TV Field

- Step 1:** Set the **A TRIGGER** Mode to **TV FIELD**. (Press the **P-P AUTO** and **NORM** mode buttons in at the same time.)
- Step 2:** Apply the TV signal to a channel input and display the channel.
- Step 3:** Set the **VOLTS/DIV** switch to display 2.5 divisions or more of composite video signal.
- Step 4:** Set the **A TRIGGER SLOPE** switch either out (for positive-going TV signal sync pulses) or in (for negative-going TV signal sync pulses).
- Step 5:** Adjust the **A TRIGGER LEVEL** to stabilize the display (Figure 3-28).
- Step 6:** To display two separate fields individually, connect the TV signal to both **CH 1** and **CH 2** input connectors and select **BOTH** and **ALT VERTICAL MODE**.
- Step 7:** Set the **A SEC/DIV** switch to a faster sweep speed (displays of less than one full field). This will synchronize the Channel 1 display to one field and the Channel 2 display to the other field.

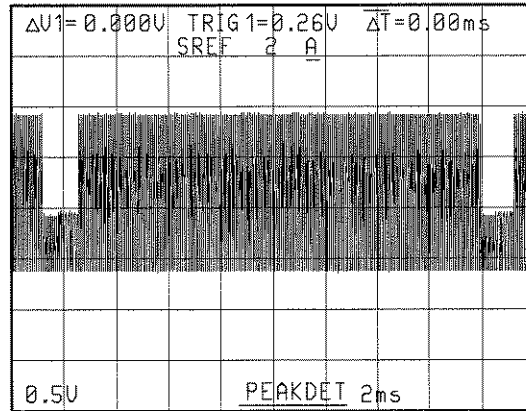

Figure 3-28: Multi-burst Signal Triggered in TV Field

Removing Unwanted Trigger Signal Components

Sometimes an unwanted high-frequency or low-frequency signal component can interfere with obtaining a stable trigger. To remove that component from the trigger signal, move the **A COUPL** switch to either **HF REJ** or **LF REJ**. The **HF REJ** position attenuates trigger signal components above 40 kHz and the **LF REJ** position attenuates trigger signal components below 40 kHz.

Measuring Signals

Measuring Signals details how you can measure waveform displays in terms of time, amplitude, frequency, and phase.

Measuring with the Graticule

Although you can measure any signal with cursors in the **STORE** mode, it is sometimes just as easy to use the graticule (Figure 3-29).

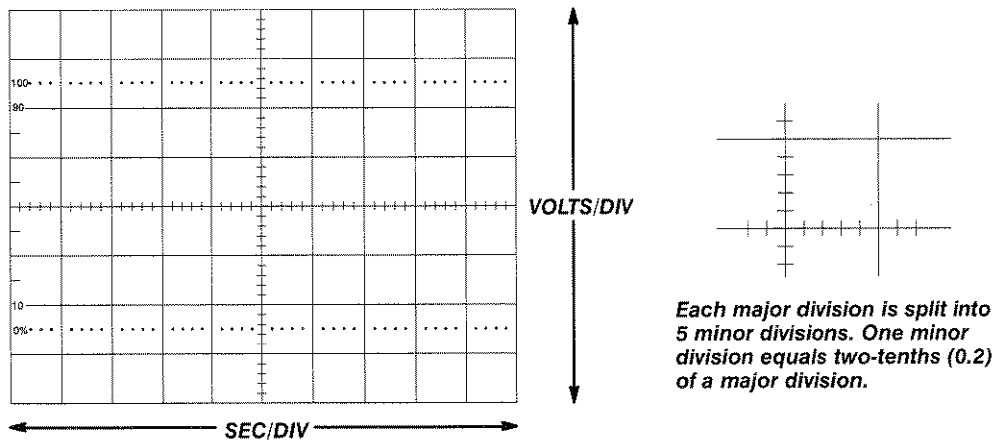

Figure 3-29: Measuring with the CRT Graticule

The graticule is a graph that you can change the vertical and horizontal scale factors. The **VOLTS/DIV** setting (or readout) indicates the vertical scale for each major division. The **SEC/DIV** setting (or readout) indicates the horizontal scale for each major division. Each minor division represents two-tenths (0.2) of the major division value.

Measuring with STORE Mode Cursors

Cursor measurements are highly accurate and eliminate the calculations of graticule measurements. In **STORE** mode the oscilloscope simultaneously displays the voltage and time difference between the cursor pair. Using the **DISPLAY** menu you can also measure frequency by selecting **1/ΔT**.



Positioning the Cursors

A cursor is either active or inactive. A box surrounds the active cursor to signify that it can be positioned by the **CURSORS** knob. The inactive cursor does not have a box around it and will stay fixed while you position the other cursor (Figure 3-30).

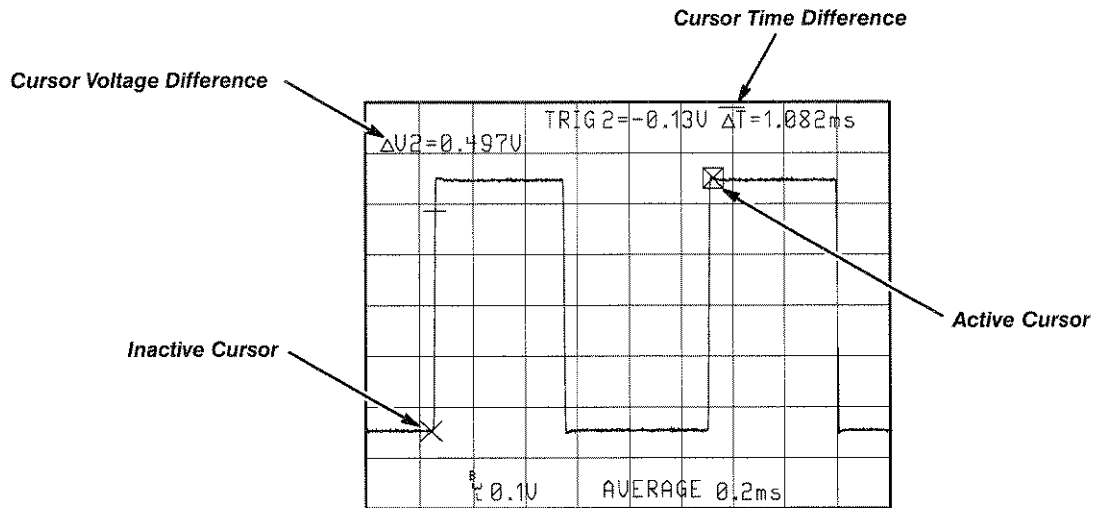

Figure 3-30: Cursor Measurements

Selecting a Cursor—Select the cursor you want to position by pushing in the **CURSORS** knob.

Selecting a Waveform—On two-channel alternate and chop displays there are two pairs of cursors with one active cursor apiece. The active cursors of each pair track together when you move the cursor knob. When you have more than one waveform recalled from memory, however, you must use press the **SELECT WAVEFORM** button to move the cursors from one waveform to another.

Measuring Voltage

Make amplitude or other vertical measurements between two points on a waveform using this basic procedure:

- Step 1:** Display the signal on screen so that the upper and lower points you wish to measure are on screen.
- Step 2:** In **NON-STORE** mode use the graticule lines to make a measurement — or go to **STORE** mode and use the rest of this procedure.
- Step 3:** In **STORE** mode, position a cursor on the lower point of the waveform using the cursor control.

- Step 4:** Push the **CURSORS** knob in to select the other cursor and position it on the upper point.
- Step 5:** Note the Δ volts (change or difference in volts) readout in the upper left corner of the display.

Figure 3-31 shows a typical Peak-to-peak voltage measurement.

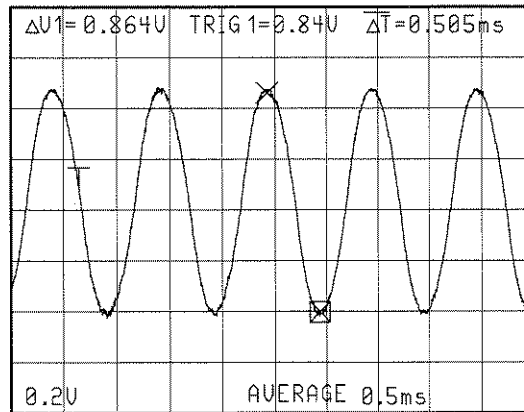

Figure 3-31: Peak-to-Peak Measurement

Measuring Voltages in Reference to Ground

When a signal is DC coupled at the input, you can measure DC voltage levels, DC components of an AC signal (Figure 3-32), or other voltage levels in reference to ground (Figure 3-33). The procedure varies slightly depending on whether you use graticule lines or cursors to measure the DC level.

Graticule lines:

- Step 1:** Set the input coupling to **GND** and the trigger mode to **P-P AUTO** to display a flat trace on screen.
- Step 2:** Align the trace with a horizontal graticule line. This line is now the ground reference point.
- Step 3:** Set the input coupling to **DC**.
- Step 4:** The amount of vertical offset is the DC component.

Cursors:

- Step 1:** Set the oscilloscope to **STORE**.
- Step 2:** Set the input coupling to **GND** and wait a couple of seconds. The oscilloscope will now recognize this point as ground and place a small dot at the left side of the screen. (This dot may not be readily apparent if you have a flat line trace on screen.)
- Step 3:** Set the input coupling to **DC**.

- Step 4:** Move one of the cursors over to the left side of the display. When this cursor aligns with the ground reference dot the Δ symbol next to the volts readout changes to a ground symbol (Figure 3-32 and Figure 3-33).
- Step 5:** Position the other cursor to make the DC level measurement.

NOTE

You may have to reset the coupling switch to ground in order to obtain the ground reference dot if you change a front panel control setting.

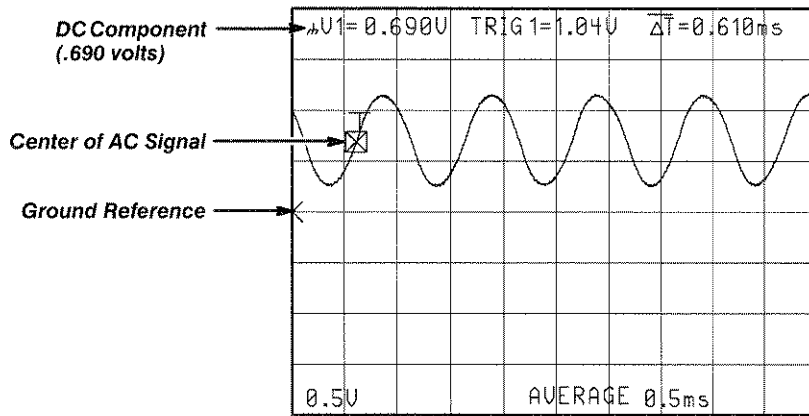

DC component of an AC signal

Figure 3-32: DC Component of AC signal

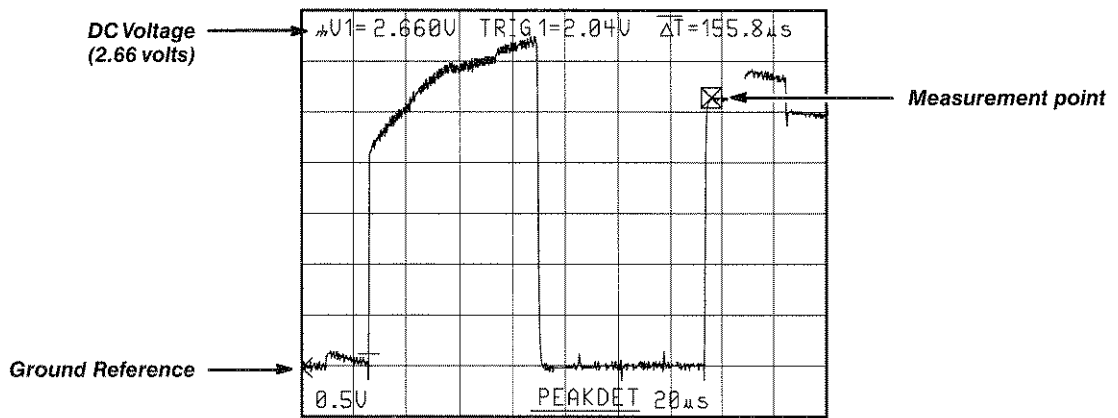

Figure 3-33: Ground-Referenced Voltage Measurement

Using the Oscilloscope as a Digital Voltmeter — With ground-referenced cursors, you can also use the oscilloscope as a digital voltmeter for measuring ordinary DC voltages (Figure 3-34).

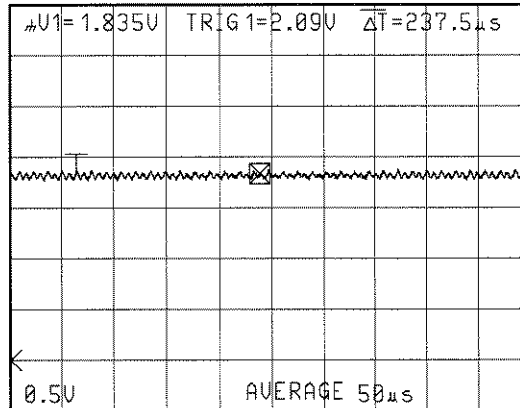

Figure 3-34: Measuring DC Levels with Cursors

Measuring Time with the Graticule or Cursors

Make period or other time measurements between two points on a waveform using this basic procedure:

- Step 1:** Display the signal on screen so that the first point you wish to measure from is on screen.
- Step 2:** In **NON-STORE** mode adjust the time base to place the other horizontal point on screen and use the graticule lines to make the measurement — or go to **STORE** mode and use the rest of this procedure.
- Step 3:** In **STORE** mode, position a cursor on the first point of the waveform with the cursor control.
- Step 4:** Push the **CURSORS** knob in to select the other cursor and position it on the second point. (On 4K or magnified displays an acquisition window indicator at the top of the display shows where the cursors are relative to the entire record length.)
- Step 5:** Note the Δ time (change or difference in time) readout in the upper right corner of the display.

Figure 3-35 shows a typical period measurement.

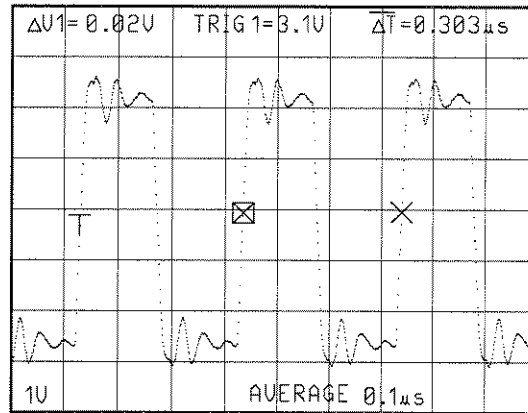

Figure 3-35: Period Measurement

Measuring Time Using the Delay Time Readout

The amount of time between events can be measured by taking the difference between two delay time readings:

- Step 1:** Select Horizontal **BOTH** and use the **A/B SWP SEP** control to separate the **A** sweep from the **B** sweep.
- Step 2:** Set the **B SEC/DIV** switch to the fastest sweep speed that provides a usable (visible) intensified zone.
- Step 3:** Adjust the **B DELAY TIME POSITION** control to move the intensified zone to the leading edge of the first horizontal point on the **A** trace; then fine-adjust until the rising portion on the **B** trace is aligned with any convenient vertical graticule line (Figure 3-36).

NOTE

*In the **NON-STORE** mode the **A** and **B** traces can be displayed simultaneously.*

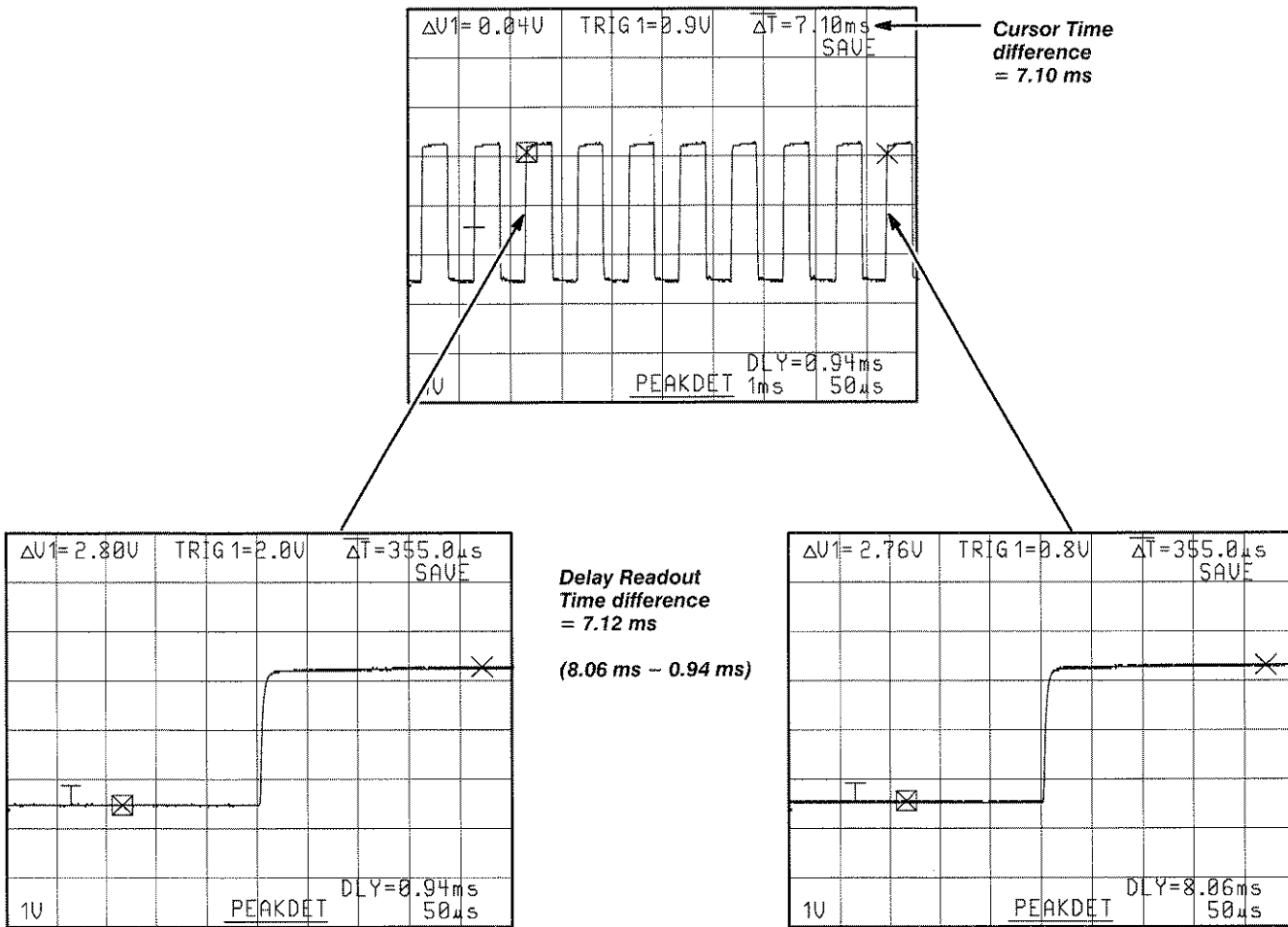

Figure 3-36: Delay Time Readout Difference

- Step 4:** Record the delay readout.
- Step 5:** Adjust the **B DELAY TIME POSITION** control clockwise to move the intensified zone to the leading edge of the second pulse on the **A** trace; then fine-adjust until the rising portion on the **B** trace is centered at the same vertical graticule used in Step 3.
- Step 6:** Record the delay readout.
- Step 7:** The difference between the two readings equals the time difference.

Measuring Frequency

Frequency is measured by calculating the inverse of a period measurement ($1/\Delta T$). With a graticule measurement you would have to calculate this yourself. Using the Display menu, however, you can set the **STORE** mode cursors to display the frequency:

- Step 1:** Press the Setup **DISPLAY** button on the front-panel.

- Step 2:** Push the left bezel button to place the selection box around "1/ΔT." Push the **DISPLAY** button again to return to the storage acquisition display.
- Step 3:** Position a cursor on the rising edge of the waveform where it crosses a graticule line.
- Step 4:** Push the **CURSORS** knob in to select the other cursor and position it at the *same* transition point on the *next* cycle of the signal (Figure 3-37).
- Step 5:** Note the 1/ΔT (frequency) readout in the upper right corner of the display.

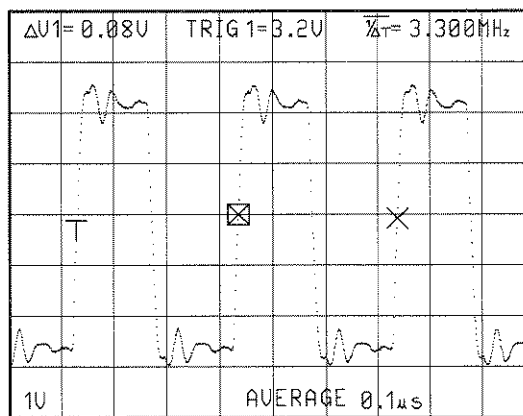

Figure 3-37: Cursor Frequency Measurement

Measuring Rise Time and Fall Time

Rise time is a measure of the time between the 10% and 90% points on the leading edge of a waveform (Figure 3-38). Fall time is a measure of time between the 90% and 10% points on the trailing edge of a waveform (Figure 3-39).

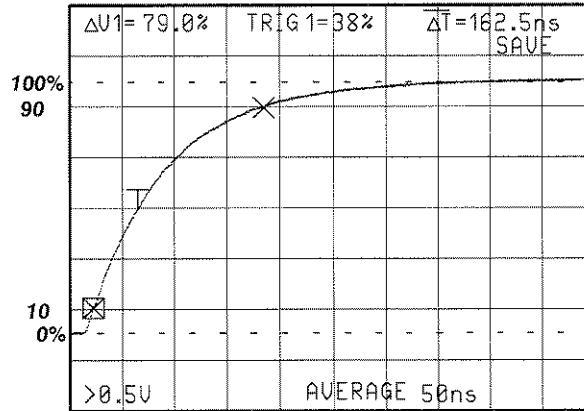

Figure 3-38: Measuring Rise Time

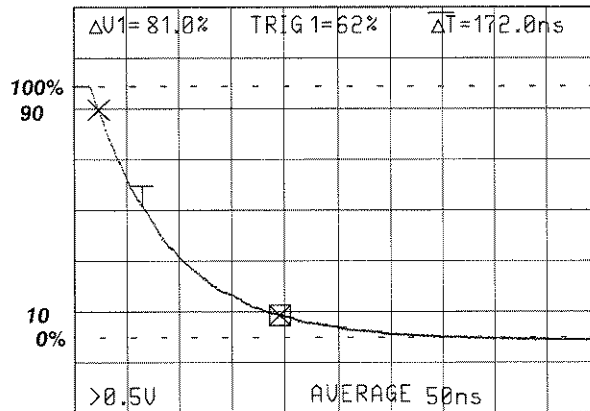

Figure 3-39: Measuring Fall Time

- Step 1:** Apply a signal to the oscilloscope.
- Step 2:** Set the trigger **SLOPE** out (positive) for a rise time measurement and in (negative) for a fall time measurement.
- Step 3:** Adjust the vertical dimension for exactly 5 divisions (you may have to use the **CAL** variable.)
- Step 4:** Vertically position the signal so that the bottom of the signal on the 0% graticule line and the top of the signal is on the 100% line.
- Step 5:** Magnify the rising edge of the signal horizontally so that the rise time is spread over 4 or 5 divisions. (Refer to *Displaying Magnified Sweeps*, page 3-19.)
- Step 6:** Measure the rise time horizontally from the 10(%) graticule line to the 90(%) graticule line.

Measuring Trigger Level

The trigger level is the point on the rising or falling edge of a signal where the oscilloscope triggers a sweep. This voltage level is indicated by the TRIG readout at the top of the CRT. TRIG1 represents the level of the trigger signal coming from Channel1 and TRIG2 represents Channel 2.

Measuring Phase Difference

With the two vertical channels on the oscilloscope you can measure phase differences on signals that range in frequency anywhere within the limits of the vertical system. Use the following procedure:

- Step 1:** Set both input coupling switches to the same position, depending on the type of input coupling desired.
- Step 2:** Using either probes or coaxial cables with equal time delays, connect a known reference signal to the Channel 1 input and the unknown signal to the Channel 2 input.
- Step 3:** Switch the Vertical Mode to **BOTH** and then select either **ALT** or **CHOP**.
- Step 4:** Set both **VOLTS/DIV** switches and both variable controls so the displays are equal in amplitude.
- Step 5:** Set the **A & B SOURCE** to **CH 1** so the oscilloscope uses only the reference signal for triggering. Adjust the **A TRIGGER LEVEL** control for a stable display.
- Step 6:** Set the **A SEC/DIV** switch to a sweep speed that displays about one full cycle of the reference waveform.
- Step 7:** Position the displays and adjust the **SEC/DIV** variable control so that one cycle of the reference signal occupies exactly 8 horizontal divisions. Each horizontal division of the graticule now represents 45° of the cycle ($360^\circ \div 8$ divisions).
- Step 8:** Measure the horizontal difference in divisions between the signals and multiply it by 45° (Figure 3-40).

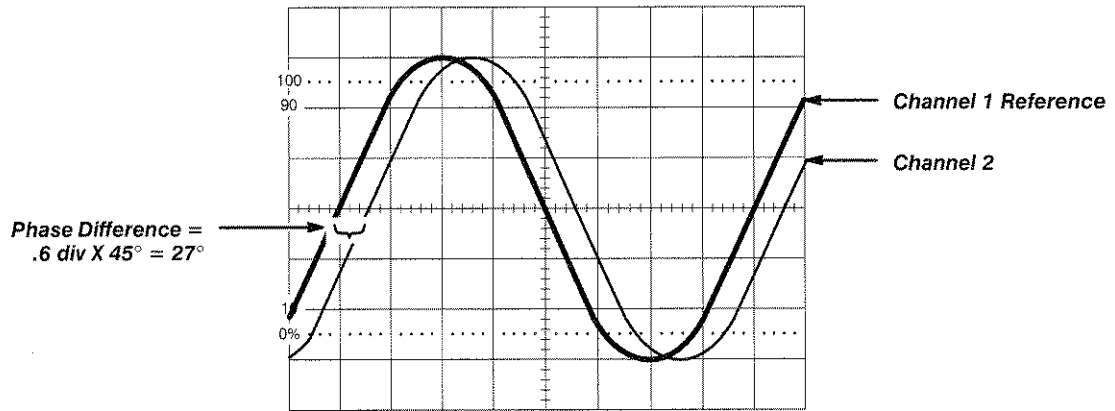

Figure 3-40: Measuring Phase Difference

For higher resolution measurements of the phase difference the display may be magnified horizontally by pulling the X10 magnification knob out (Figure 3-41).

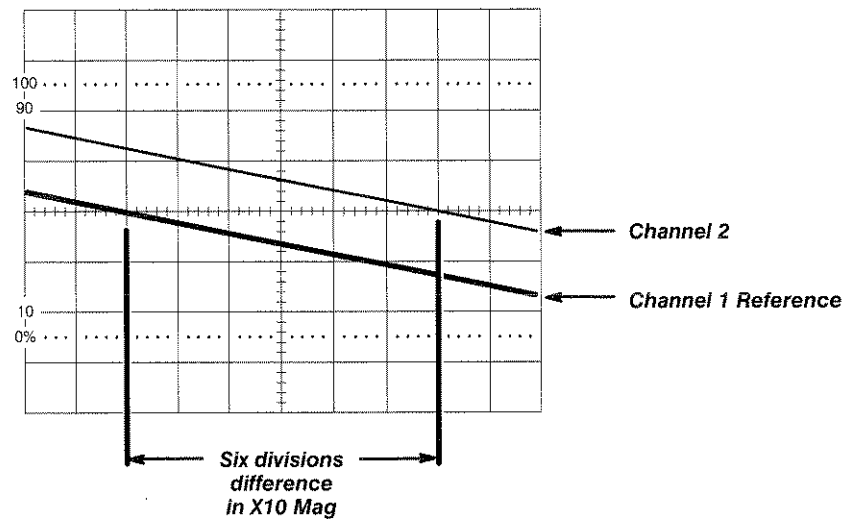

Figure 3-41: Phase Difference in X10 Magnification



Saving Waveforms and Setups

The 2232 Digital Storage Oscilloscope not only provides reference memories for saving digitized waveforms, but also allows you to retain **STORE** mode setup configurations.

Saving and Recalling Waveforms

With the 2232 oscilloscope you can “freeze” a waveform with the touch of a button. You can also keep a waveform for later reference by using a **SAVE REF** memory location. The contents of the **SAVE REF** memory locations remain intact when the scope is turned off and can be recalled during a later session.

Saving the Current Acquisition

One way to quickly save a waveform is to use the **SAVE/CONT** button.

- Step 1:** Acquire the signal in **STORE** mode.
- Step 2:** Press the **SAVE/CONT** button. The current acquisition stops and the waveform is “frozen” on screen. (At sweep speeds of 50 ms or faster a triggered acquisition is allowed to complete before it is saved.)
- Step 3:** Copy the waveform to a **SAVE REF** memory location if you want to retain the waveform for later reference. (Refer to the following section.)
- Step 4:** Press the **SAVE/CONT** button again to continue with normal acquisition.

Saving Waveforms in SAVE REF Memory

In the 1K acquisition mode you can save up to three waveform displays in **SAVE REF** memory. In the 4K mode, because of the greater record length, you can save only one. Each **SAVE REF** memory location can hold either a one- or two-channel acquisition record.

- Step 1:** Acquire the signal in **STORE** mode.
- Step 2:** Select the desired **1K** or **4K** acquisition mode.
- Step 3:** Press the **SAVE REF** button underneath the display (Figure 3-42). The current acquisition stops and a display readout appears that indicates the status of each memory location as either full or empty.
- Step 4:** Press the memory location you want to save to or overwrite. If you wait more than 5 seconds to choose the memory location, the oscilloscope will continue with normal acquisition.

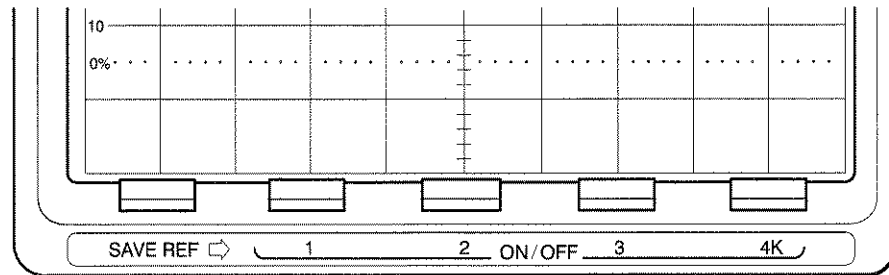

Figure 3-42: SAVE REF Memory Buttons

Recalling a Waveform from SAVE REF

Once a waveform is stored in a **SAVE REF** memory location, simply press the memory location button to recall or remove it from memory. The contents will remain intact even after the power is turned off. There is no overwrite protection on these memories, however. Pressing the **SAVE REF** and memory location button will save a new waveform to that location and overwrite the old.

Comparing Saved Waveforms

You can simultaneously display the contents of more than one **SAVE REF** memory location. This enables you to compare one saved waveform with another.

- Step 1:** Press one or more memory location buttons to display their respective contents.
- Step 2:** Change the position, horizontal magnification, or vertical gain of the saved waveform display using the **Format** reference menu. (Refer to the following section.)
- Step 3:** Press the **SELECT WAVEFORM** button (next to the cursor control) one or more times until the cursors appear on the waveform you want to measure. An underscore appears under the selected **SREF** memory number at the top of the display.

Formatting Saved Waveforms

You can change the horizontal magnification, vertical position, and vertical gain of a waveform in a **SAVE REF** memory location.

- Step 1:** Press the front-panel Setup **REF** button.
- Step 2:** Press the left **Save Ref** menu to indicate **Format**. The **Format Reference Menu** appears (Figure 3-43).
- Step 3:** Select the **Target Ref** (Ref1, Ref2, Ref3, or Ref4K) to indicate the desired memory location.

- Step 4:** Select the **Target Chnl.** (This is the particular channel of the **SAVE REF** display that you want to format.)
- Step 5:** Press the **Horiz Mag** button to select either X1 (default) or X10 (times ten) horizontal magnification.
- Step 6:** Press the **Cursor Knob Func** menu button to select either **Vert Gain** or **Vert Position**, and then use the cursor knob to adjust that parameter. (Vertical gain can only be changed by a factor of 10 in either direction.)

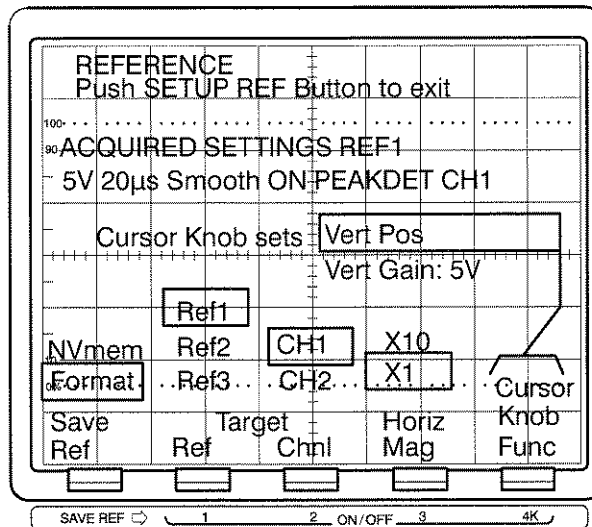

Figure 3-43: Format Reference Menu

Saving Waveforms in Long-Term Memory

The Non-volatile Memory Reference Menu (Figure 3-44) indicates that there are 26 (A–Z) 1K memory locations available; each of which can be “write” protected. The actual number of these additional memories that you can use, however, depends on the number of bytes stored at each location. For example, given the 26 kilobytes of memory available (26 × 1K), you can only store six 4K acquisitions. (A 4K acquisition in the Average mode will use 8K of memory.)

A memory location is filled if it indicates a number besides zero. The number “1” means 1,000 bytes, “4” means 4,000 bytes and so on.

Waveforms can be copied between any two memory locations. You cannot interchange 1K or 4K **SAVE REF** memories, however.

- Step 1:** Press the front-panel Setup **REF** button.
- Step 2:** Press the left **Save Ref** menu to indicate **NVMem**.

- Step 3:** Push the **Cursor Knob Func** (Or push the cursor knob itself) to select **Source**. The cursor knob will now move the source arrow (↓) when you turn it.
- Step 4:** Position the source arrow (↓) on the memory location you wish to copy.
- Step 5:** Select **Dest** and move the destination arrow (↑) with the cursor knob to the memory location you wish to copy to.
- Step 6:** Press **Copy Source to Dest** to fill that memory location.

Protect Destination

- Step 7:** If you want to protect that destination from being inadvertently deleted or overwritten, press **Protect Dest**. The number at that location intensifies to indicate that it is protected.

Remove Destination Protection

- Step 8:** If you want to remove the protection from a destination, select that location with the destination (↑) arrow and press **Protect Dest**. The number at that location will no longer be intensified.

Delete Destination

- Step 9:** If you want to delete the contents of a memory location, select that location with the destination (↑) arrow and press **Delete Dest**. The contents of that location will now indicate zero.

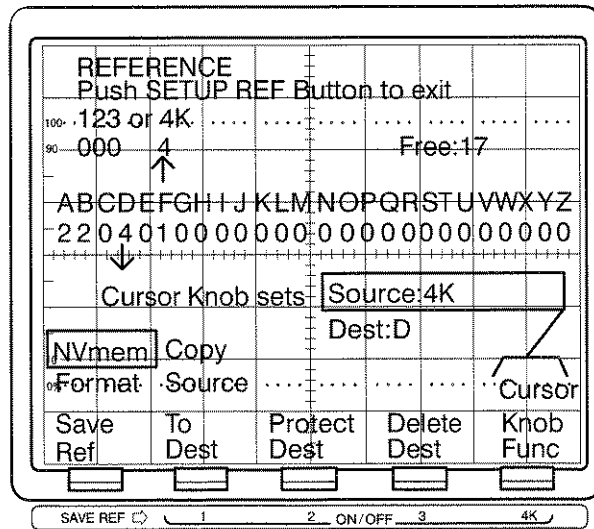

Figure 3-44: NVmem Reference Menu

Saving and Recalling Setups

The oscilloscope can retain front-panel and menu setups, even after the power is turned off. You can also select the **Power up State** or group of setups that the instrument will recall when the power is turned back on.

Saving a Setup

Save and recall menu and acquisition setups by using the **Save Setup Menu** located under the **ADV FUNCT** menu.

- Step 1:** Press the Setup **ADV FUNCT** button. The Advanced Functions menu appears.
- Step 2:** Press the button underneath **Save Setup Menu**.
- Step 3:** Press the **Select Setup** menu button to select either **Setup1** or **Setup2** memory location for the setup information.
- Step 4:** Press **Save Setup** to save to current acquisition and menu settings to the selected memory location.

Recalling a Setup from Memory

Recall a saved setup either by returning to the **ADV FUNCT/Save Setup Menu** or by specifying the **Power Up State** as the particular setup you want to recall. (Refer also to the following section, *Recalling a Power Up State*.)

- Step 1:** Press the Setup **ADV FUNCT** button. The Advanced Functions menu appears.
- Step 2:** Press the button underneath **Save Setup Menu**.
- Step 3:** Press the **Select Setup** menu button to select either **Setup1** or **Setup2** memory location.
- Step 4:** Press **Recall Setup** to recall the acquisition and menu settings previously saved to that memory location.

Recalling a Power Up State

The oscilloscope can be configured to return to one of four setups when the instrument is turned on.

- Step 1:** Press the Setup **ADV FUNCT** button. The Advanced Functions menu appears.
- Step 2:** Press the button underneath **Save Setup Menu**.
- Step 3:** Press the button underneath **Power Up State** to select one of the following alternatives:

Default — The instrument will use the factory default settings when instrument powers up.

Saving Waveforms and Setups

Pwr Dwn — The instrument will automatically save the software-controlled settings when the instrument is turned off. The instrument will return to these same settings when the instrument is turned back on.

Setup1 — The instrument will use the setup saved under **Setup1** at power up.

Setup2 — The instrument will use the setup saved under **Setup2** at power up.

Step 4: The selection is now saved. Press the **ADV FUNCT** button to return to normal operation.

Transmitting Waveforms

Digitized waveforms may be transmitted to an external device for printing, plotting, storage, or waveform analysis. Every instrument is equipped with an auxiliary connection for an analog X-Y plotter. Most applications, however, require either a GPIB (Option 10) or RS-232-C (Option 12) interface.

Communicating via Interface Options

The RS-232-C or GPIB interface is usually ordered as factory installed; however, you can order either interface separately for installation on existing instruments. (Only one interface can be installed in the instrument at a time.)

The two interface options are depicted in Figure 3-45 and Figure 3-46.

The 2221A, 2224, & 2232 *Optional GPIB & RS-232-C Interfaces User Manual* (070-8159-01) provides you with information about connecting the GPIB and RS-232-C communication options to external printers, plotters, or computer ports.

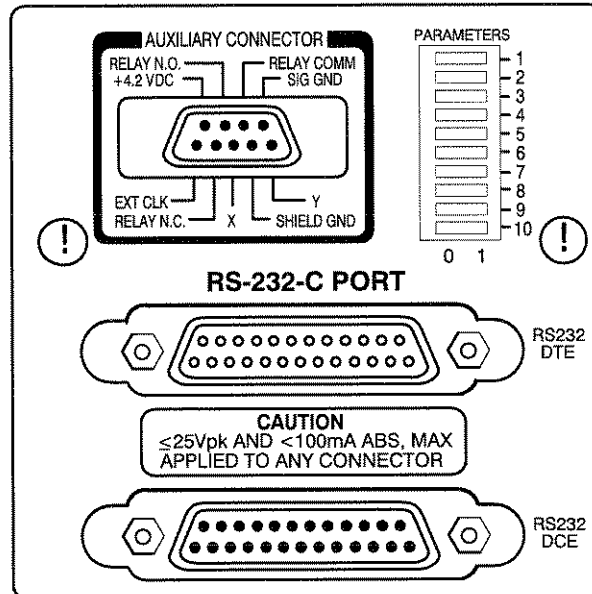

Figure 3-45: RS-232 Interface (Option 12)

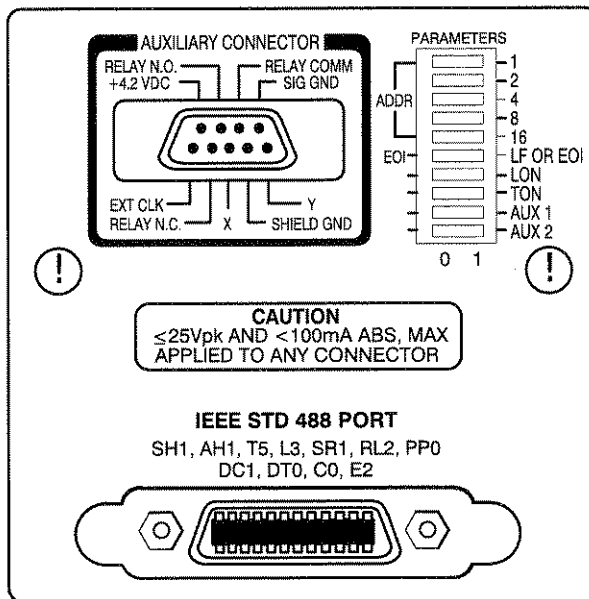

Figure 3-46: GPIB Interface (Option 10)

Plotting or Printing a Waveform

The auxiliary connection (Figure 3-47) is a standard feature on all instruments. The X, Y, and RELAY lines on the auxiliary connection allow you to drive an analog X-Y plotter. The section entitled X-Y Plotter Output in Appendix B supplies technical information pertaining to these outputs.

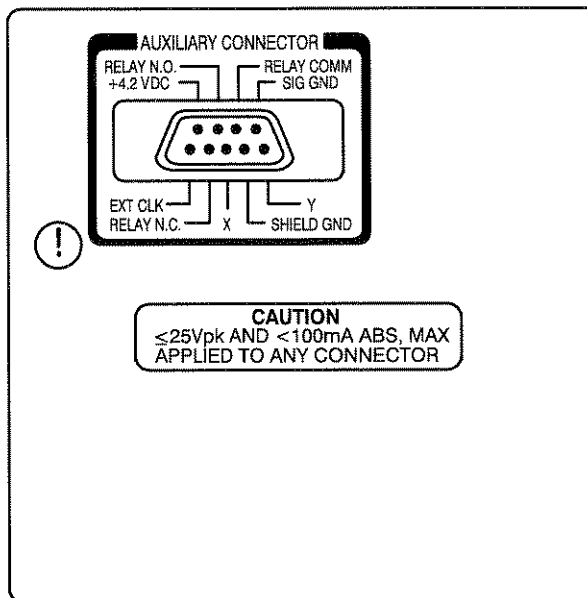

Figure 3-47: Auxiliary Connection

The 2221A, 2224, & 2232 *Optional GPIB & RS-232 Interfaces User Manual* (070-8159-01) provides you with information about using either interface option to drive a printer or plotter.

Plot Menu

The Plot menu (Figure 3-48) allows you to control and initiate the plot. Each item on the menu is described below.

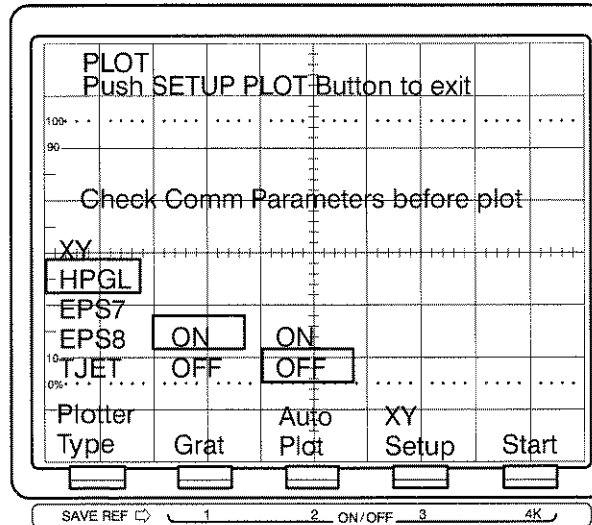

Figure 3-48: Plot Menu

Plotter Type

The **Plotter Type** menu button selects the analog X-Y Plotter or digital plotter output format. The digital output format requires a GPIB or RS-232 option.

XY — Analog X-Y plotter

HPGL — Hewlett-Packard® Graphics Language

EPS7 — Epson® low-speed

EPS8 — Epson® high-speed double-density

TJET — Hewlett-Packard® ThinkJet®

Grat

ON — Plots graticule lines.

OFF — Suppresses graticule lines.

Auto Plot

ON — Automatically plots acquisitions. The graticule and readouts are plotted on the first acquisition only. The oscilloscope will wait for each plot to finish before beginning another acquisition.

OFF — Disables Auto Plot.

XY Setup

XY Setup generates a pattern for calibrating analog X-Y plotter gain and offset.

Start

The **Start** menu button initiates transmission of the waveform display over the X-Y plotter or communications option.



Appendix A: Options and Accessories

This section describes the various options as well as the standard and optional accessories that are available for the 2232 Digital Storage Oscilloscope.

Options

The Options listed below may be ordered with the instrument or ordered separately:

Options A1–A5: International Power Cords

Besides the standard North American, 110 V, 60 Hz power cord, Tektronix ships any of five alternate power cord configurations with the oscilloscope when ordered by the customer.

Table A-1: International Power Cords

Option	Power Cord
A1	Universal European — 220 V, 50 Hz
A2	UK — 240 V, 50 Hz
A3	Australian — 240 V, 50 Hz
A4	North American — 240 V, 60 Hz
A5	Switzerland — 220 V, 50 Hz

OPTION 10: GPIB Interface

Option 10 provides a GPIB (General Purpose Interface Bus) communications interface. The interface implemented conforms to the specifications contained in *IEEE Standard Digital Interface for Programmable Instrumentation (ANSI/IEEE Std 488–1978)*. It also complies with a Tektronix Standard relating to GPIB Codes, Formats, Conventions and Features. The *2221A, 2224, & 2232 GPIB & RS-232-C Optional Interfaces User Manual (070-8159-01)* provides operating information for the Option 10 GPIB interface.

The GPIB option may be ordered separately as a kit (F-10). The kit includes the user manual listed above as well as instructions for installation.

OPTION 12: RS-232-C Interface

Option 12 provides an RS-232-C serial communications interface. The interface implemented conforms to RS-232-C specifications. The option provides both DTE and DCE capability to aid in hooking up the various

types of printers, plotters, personal computers, and modems that are available. The 2221A, 2224, & 2232 GPIB & RS-232-C Optional Interfaces User Manual (070-8159-01) provides operating information for the Option 12 RS-232-C interface.

The Option 12 also includes a 10-foot, RS-232-C interface cable (012-0911-00) and a 25-pin male-to-male adapter (131-4923-00).

The RS-232-C option may be ordered separately as a kit (F-12). The kit includes all of the items listed above as well as instructions for installation.

OPTION 33: Travel Line

The Travel Line option provides impact protection needed for rough industrial and service environments. When the instrument is ordered with Option 33, it comes equipped with the accessory pouch, front panel cover, shock absorbing rubber guards mounted on the front and rear of the cabinet, an easy-to-use power-cord wrap, and a carrying strap.

The Travel Line option can be installed on existing instruments by ordering the Travel Line kit (040-1202-04).

OPTION 3R: Rackmount

Option 3R allows you to mount the 2232 into a standard 19-inch equipment rack.

Standard Accessories

The following standard accessories are included with the 2232 Digital Storage Oscilloscope:

Table A-2: Standard Accessories

Accessory	Part Number
Probes (qty. two) P6109 10X Passive	P6109 (single unit)
User Manual	070-7066-01
Front Panel Cover	200-2520-00
Accessory Pouch	016-0677-02
Fuse, 3AG, 2A, 250 V Slo-Blo	159-0023-00
DB-9 Male Connector and Connector Shell	131-3579-00
Loop Clamp	343-0003-00
Flat Washer	210-0803-00
Self-Tapping Screw	213-0882-00

Other Accessories

The following accessories are recommended for use with the instrument:

Table A-3: Optional Accessories

Accessory	Part Number
Service Manual (SN B010100 to B029999)	070-7067-01
Service Manual (SN B030000 and Above)	070-8548-00
Probe Tips, IC grabber, (2 each for P6109 probes)	013-0191-00
Rack Adapter	016-0833-01
Viewing Hood	016-0566-00
Carrying Strap	346-0199-00
Carrying Case	016-0792-01
Rain Cover	016-0848-00
Camera	C9, Option 20
Portable Instrument Cart	K212
QuickStart Training Aid (U.S.)	020-1812-04
QuickStart Training Aid (International)	020-1812-06
WaveSaver Software	S41SAVE
HC100 Plotter	HC100 Opt 03 RS-232 or HC100 Opt 01 GPIB



Appendix B: Specification

This appendix begins with a *General Product Description* of the traits of the 2232 Digital Storage Oscilloscope. The *Characteristic Tables*, which list instrument characteristics and the requirements that correspond to them, follow.

General Product Description

The TEKTRONIX 2232 Digital Storage Oscilloscope is a portable, dual-channel oscilloscope suitable for use in a variety of test and measurement applications. It combines analog real-time (**NON-STORE** mode) and digital storage (**STORE** mode) capabilities to provide a 100 MHz analog bandwidth and up to a 100 Megasample/second digital sampling rate.

Vertical System

The vertical system offers the following features:

- Calibrated deflection factors from 2 mV to 5 V per division for both channels
- Variable **VOLTS/DIV** gain control that increases the deflection factor at least 2.5 to 1 for any **VOLTS/DIV** setting of either channel
- Vertical display modes **CH 1**, **CH 2**, and **BOTH**, with a choice in **BOTH** of **ADD**, **ALT**, or **CHOP**
- Bandwidth limiting that reduces bandwidth of the vertical amplifier system and the A Trigger system to 20 MHz

Horizontal System

The horizontal system offers the following features:

- Calibrated **A SEC/DIV** settings that range from 0.5 s to 50 ns per division; calibrated **B SEC/DIV** settings that range from 50 ms to 50 ns per division
- Variable **SEC/DIV** control to increase the non-store sweep time per division up to four times the calibrated time per division set by the **SEC/DIV** switch
- Horizontal magnification by X10 (extends the fastest sweep-speed time of 50 ns per division to 5 ns per division)

Digital Storage System

The digital storage offers the following features:

- Sampling at a maximum rate of 100 megasamples per second with both channels sampled simultaneously
- Glitch-catching capabilities for glitch widths as narrow as 10 ns
- Acquisition of waveforms in any of four acquisition modes: **SAMPLE**, **AVERAGE**, **ACCPEAK**, and **PEAKDET** (peak detect is available only at **SEC/DIV** settings slower than 2 μ s)
- Maximum stored record lengths per waveform of either 4096 bytes (4 K) for single-channel acquisitions or 2048 bytes (2 K) for dual-channel acquisitions (**ALT** or **CHOP**)
- Four calibrated storage time bases of 1, 2, and 5 s per division for low-frequency signal acquisitions (Horizontal Mode **A** only) using **X10 STORE ONLY** button
- Compression of the 4 K acquisition record into a 1 K acquisition record using the Variable **SEC/DIV** control (4 K Compress mode)
- Storage of up to three 1 K records (512 data points per waveform when dual-channel records are stored) or one 4 K record (2 K per waveform when dual-channel acquisitions are stored) in the **SAVE REF** memory
- Storage of up to 26 K of waveform records in up to 26 locations in extended memory
- Capability to move waveforms between **SAVE REF** memory, where they can be displayed, measured, or replaced, and extended storage memory, in order to free up **SAVE REF** memory for storing of new **STORE** waveforms

User Interface

An internal microprocessor provides front panel control and feedback on control settings.

Front Panel Controls — This oscilloscope uses a combination of front-panel buttons, knobs, and on-screen menus to control its many functions. The front-panel controls are grouped according to function: vertical, horizontal, trigger, setup, and acquisition.

Almost all **NON-STORE** (analog real-time) and **STORE** mode functions are set using front panel controls, which allows them to be quickly adjusted. Some setup functions, such as **SETUP ACQ** and **DISPLAY**, are set indirectly using menus.

Display — An internal microprocessor reads the front-panel controls to determine their settings and generates on-screen readouts of many of those settings. Settings are displayed for the following controls:

- **VOLTS/DIV** knobs and **AC-GND-DC** switches for both channels
- **SEC/DIV** knob
- **B DELAY TIME POSITION** knob
- Voltage and Time **CURSOR** measurement readouts (on **STORE** Mode displays only)
- A Trigger **LEVEL** knob

Additional readout information is displayed when in **STORE** (digital) mode. Shown are the acquisition mode, names of any **SAVE REF** memories displayed, **SAVE** if **SAVE/CONT** is so set, and **SWEEP LIMIT** if it is active.

Since all information just listed is read out on screen, it appears on all hardcopies made by the oscilloscope. Therefore, your waveform plots will also document the setup and measurement information associated with the waveform.

Measurement Features

You can measure voltage or time on both **NON-STORE** (analog) and **STORE** (digital) waveforms using the graticule. For **STORE** mode waveforms, you can also measure voltage and time using **CURSORS**. (Waveforms can be current acquisitions or **SAVE REF** acquisitions.)

The cursors are toggled to any displayed waveform of interest and then positioned using the **CURSORS** knob to any two points of interest on the waveform. The ΔV and ΔT readouts indicate the voltage difference and timing difference between the positions of the cursors.

For 4 K acquisition records, the **CURSORS** knob also scrolls the record back and forth horizontally, so any 1 K portion can be viewed on screen. (The screen can only display 1 K record points.)

Options and Accessories

For part numbers and information about both standard and optional accessories, refer to *Options and Accessories* which begins on page A-1 of this manual. Your Tektronix representative, local Tektronix Field Office, or Tektronix products catalog can also provide additional accessories information.

Performance Conditions

The following electrical characteristics (Table A-4) are valid when the instrument has been adjusted at an ambient temperature between +20° C and +30° C (+68° F and 86° F), has had a warm-up period of at least 20 minutes, and is operating at an ambient temperature between 0° C and +50° C (32° F and 122° F), unless otherwise noted.

Characteristic Tables

The characteristics listed in the tables that follow are valid when the performance conditions listed above are met. Items listed in the "Performance Requirements" column are verifiable qualitative or quantitative limits that define the measurement capabilities of the instrument.

Environmental characteristics are given in Table A-5 on page A-22. This instrument meets the requirements of MIL-T-28800D for Type III, Class 5 equipment, except where noted otherwise.

Physical characteristics of the instrument are listed in Table A-6 on page A-23.

Table A-4: Electrical Characteristics

Characteristics	Performance Requirements
Vertical Deflection System	
Deflection Factor	
Range	2 mV per division to 5 V per division in a 1-2-5 sequence.
DC Accuracy (NON-STORE)	
+15° C to +35° C	±2%.
0° C to +50° C	±3%. ¹ For 5 mV per division to 5 V per division VOLTS/DIV switch settings, the gain is set at a VOLTS/DIV switch setting of 10 mV per division. 2 mV per division gain is set with the VOLTS/DIV switch set to 2 mV per division.
On Screen DC Accuracy (STORE)	
+15° C to +35° C	±2%.
0° C to +50° C	±3%. ¹ Gain set with the VOLTS/DIV switch set to 5 mV per division.
Storage Acquisition Vertical Resolution	8-bits, 25 levels per division. 10.24 divisions dynamic range. ¹
Range of VOLTS/DIV Variable control	Continuously variable between settings. Increases deflection factor by at least 2.5 to 1.

¹Performance Requirement not checked in manual.

Table A-4: Electrical Characteristics (Cont.)

Characteristics	Performance Requirements	
NON-STORE Bandwidth (–3 dB)		
0° C to +35° C		
5 mV per division to 5 V per division	DC to at least 100 MHz	
2 mV per division	DC to at least 80 MHz	
+35° C to +50° C		
2 mV per division to 5V per division	DC to at least 80 MHz ¹	
	Measured with a vertically centered six-division reference signal, from a 50 Ω source driving a 50 Ω coaxial cable terminated in 50 Ω at the input connector; with the VOLTS/DIV Variable control in the CAL detent.	
BW LIMIT (–3dB)	20 MHz ±10%	
AC Coupled Lower Cutoff Frequency	10 Hz or less at –3 dB ¹	
Step Response (NON-STORE Mode)		
Rise Time		
0° C to +35° C		
5 mV per division to 5 V per division	3.5 ns or less. ¹	
2 mV per division	4.4 ns or less. ¹	
+35° C to +50° C		
5 mV per division to 5 V per division	3.9 ns or less. ¹	
2 mV per division	4.4 ns or less. ¹	
	Rise time is calculated from:	
	$\text{Rise Time} = \frac{0.35}{\text{Bandwidth} (-3 \text{ dB})}$	
Step Response (STORE Mode) ¹		
Useful Storage Rise Time		
SAMPLE	Single Trace	Dual Trace (CHOP/ALT)
	$\frac{\text{SEC/DIVsetting} \times 1.6}{100} \text{sec}$	$\frac{\text{SEC/DIVsetting} \times 1.6}{50} \text{sec}$
PEAKDET or ACCPEAK with SMOOTH	$\frac{\text{SEC/DIVsetting} \times 1.6}{50} \text{sec}$	$\frac{\text{SEC/DIVsetting} \times 1.6}{25} \text{sec}$
	Rise time is limited to 3.5 ns minimum with derating over temperature (see NON-STORE Rise Time).	

¹ Performance Requirement not checked in manual.

Table A-4: Electrical Characteristics (Cont.)

Characteristics	Performance Requirements	
Aberrations (NON-STORE and STORE in Default Modes)		
2 mV per division to 50 mV per division	+4%, -4%, 4% p-p	
0.1 V per division to 0.2 V per division	+6%, -6%, 6% p-p	
0.5 V per division	+6%, -6%, 6% p-p ¹	
1 V per division to 5 V per division	+12%, -12%, 12% p-p ¹	
	Measured with a five-division positive-going reference signal, from a 50 Ω coaxial cable terminated in 50 Ω at the input connector with the VOLTS/DIV Variable control in the CAL detent. Vertically center the top of the reference signal. Set A Trigger SLOPE switch to positive.	
Useful Storage Performance ²		
RECORD, SCAN and ROLL Store Modes		
SAMPLE Acquisition, no AVERAGE		
1 μs per division to 5 s per division	Single Trace	CHOP/ALT
	$\frac{10}{\text{SEC/DIV setting}} \text{ Hz}^1$	$\frac{5}{\text{SEC/DIV setting}} \text{ Hz}^1$
EXT CLOCK (up to 100 kHz)	$\frac{\text{EXT}}{10} \text{ Hz}^1$	$\frac{\text{EXT}}{20} \text{ Hz}^1$
PEAK DETECT		
Sine Wave Amplitude Capture (5% p-p maximum amplitude uncertainty)	10 MHz ¹	
Pulse Width Amplitude Capture (50% p-p maximum amplitude uncertainty)	10 ns	

¹ Performance Requirement not checked in manual.

² Useful storage performance is limited to the frequency where there are 10 samples per sine wave signal period at the maximum sampling rate. (Maximum sampling rate is 100 MHz.) This yields a maximum amplitude uncertainty of 5%. Accuracy at the useful storage bandwidth limit is measured with respect to a six-division 50 kHz reference sine wave

Table A-4: Electrical Characteristics (Cont.)

Characteristics	Performance Requirements	
REPETITIVE Store Mode		
SAMPLE and AVERAGE	Single Trace	CHOP/ALT
0.05 μ s per division	100 MHz (-3 dB) ³	100 MHz (-3 dB) ³
0.1 μ s per division	100 MHz (-3 dB) ^{1,3}	50 MHz (-3 dB) ¹
0.2 μ s per division to 2 μ s per division (5% maximum amplitude uncertainty)	$\frac{10}{\text{SEC/DIV setting}} \text{ Hz}^1$	$\frac{5}{\text{SEC/DIV setting}} \text{ Hz}^1$
ACCPEAK		
0.05 μ s per division to 5 s per division	Same as NON-STORE Bandwidth	
AVERAGE Mode		
Sweep Limit	Adjustable from 1 to 998,000 or NO LIMIT. May be set in increments of 1 from 1 to 200; 2 from 202 to 1000; 10 from 1010 to 2000; 20 from 2020 to 10,000; 100 from 10,100 to 20,000; 200 from 20,200 to 100,000; 1,000 from 101,000 to 200,000; 2,000 from 202,000 to 998,000. ¹	
Weight of Last Acquisition	$\frac{1}{4}, \frac{1}{2}, \frac{1}{4}, \frac{1}{8}, \frac{1}{16}, \frac{1}{32}, \frac{1}{64}, \frac{1}{128},$ or $\frac{1}{256}$ (MENU selections). AVERAGE mode default weight is $\frac{1}{4}$. ¹	
NON-STORE CHOP Mode Switching Rate	500 kHz \pm 30% ¹	
A/D Converter Linearity	Monotonic with no missing codes ¹	
Analog CH1/CH2 Delay Match	± 1.0 ns ¹	
NON-STORE Common-Mode Rejection Ratio (CMRR)	At least 10 to 1 at 50 MHz. Checked at 10 mV per division for common-mode signals of six divisions or less with the VOLTS/DIV Variable control adjusted for the best CMRR at 50 kHz.	
Input Current	1 nA or less (0.5 division or less trace shift when switching between DC and GND input coupling with the VOLTS/DIV switch set to 2 mV per division). ¹	
Input Characteristics		
Resistance	1 M Ω \pm 2% ¹	
Capacitance	20 pF \pm 2pF ¹	

¹Performance Requirement not checked in manual.³One hundred MHz bandwidth derated for temperatures outside 0° C to +35° C and at 2 mV per division VOLTS/DIV setting as for NON-STORE.

Table A-4: Electrical Characteristics (Cont.)

Characteristics	Performance Requirements		
Maximum Safe Input Voltage (CH 1 and CH 2)	See Figure A-1 on page A-21 for maximum input voltage versus frequency derating curve.		
DC and AC Coupled 	400 V (DC + peak AC) or 800 VAC p-p at 10 kHz or less. ¹		
Channel Isolation STORE and NON-STORE	Greater than 100 to 1 at 50 MHz		
POSITION Control Range	At least ± 11 divisions from graticule center.		
A/B SWP SEP Control Range (NON-STORE Mode Only)	± 3.5 divisions or greater.		
Trace Shift with VOLTS/DIV Switch Rotation	0.75 division or less; VOLTS/DIV Variable control in the CAL detent. ¹		
Trace Shift as the VOLTS/DIV Variable Control is Rotated	1 division or less ¹		
Trace Shift with INVERT	1.5 divisions or less ¹		
Trigger System			
A Trigger Sensitivity			
P-P AUTO and NORM	10 MHz	60 MHz	100 MHz
Internal	0.35 div	1.0 div	1.5 div
External	40 mV	120 mV	150 mV
External trigger signal from a 50 Ω source driving a 50 Ω coaxial cable terminated in 50 Ω at the input connector.			
HF REJ Coupling	Should not trigger with a one division peak-to-peak 250 kHz signal when HF REJ is ON. Reduces trigger signal amplitude at high frequencies by about 20 dB with rolloff beginning at 40 kHz $\pm 25\%$.		
LF REJ Coupling	Should not trigger with a 0.35 division peak-to-peak 25 kHz signal when LF REJ is on. Attenuates signals below 40 kHz (-3 dB point at 40 kHz $\pm 25\%$).		
P-P AUTO Lowest Usable Frequency (Non-Store Mode only)	20 Hz with 1 division internal or 100 mV external ¹		
P-P AUTO Lowest Usable Frequency (Store Mode only)	500 Hz with 1 division internal or 100 mV external ¹		

¹Performance Requirement not checked in manual.

Table A-4: Electrical Characteristics (Cont.)

Characteristics	Performance Requirements		
TV LINE			
Internal	0.35 div ¹		
External	35 mV p-p ¹		
TV FIELD	≥ 1 division of composite sync ¹		
B Trigger Sensitivity (Internal Only)	10 MHz 0.35 div	60 MHz 1.0 div	100 MHz 1.5 div
EXT INPUT			
Maximum Input Voltage 	400 V (DC + peak AC) or 800 VAC p-p at 10 kHz or less. ¹ See Figure A-1 on page A-21 for maximum input voltage versus frequency derating curve.		
Input Resistance	1 MΩ ± 2% ¹		
Input Capacitance	20 pF ± 2.5 pF ¹		
AC Coupled Lower Cutoff Frequency	10 Hz or less at -3 dB ¹		
LEVEL Control Range			
A Trigger (NORM)			
INT	May be set at any voltage level of the trace that can be displayed. ¹		
EXT, DC	At least ± 1.6 V, 3.2 V p-p.		
EXT, DC ÷ 10	At least ± 16 V, 32 V p-p. ¹		
B Trigger (Internal)	May be set at any point of the trace that can be displayed. ¹		
VAR HOLDOFF Control⁴ (NON-STORE Hold-off)	Increases A Sweep holdoff time by at least a factor of 10.		
Trigger Level Readout Accuracy +15° C to +35° C	± (0.3 division, +5% of reading) Applies to ±10 divisions from zero volts.		
Acquisition Window Trigger Points			
Pretrigger	Seven-eighths of the waveform acquisition window is prior to the trigger (other trigger points are selectable via the MENU).		

¹Performance Requirement not checked in manual.⁴Holdoff in STORE mode is a function of microprocessor activity and the pretrigger acquisition. The VAR HOLDOFF control maintains some control over the STORE holdoff by preventing a new trigger from being accepted by the storage circuitry until the next (or current, if one is in progress) NON-STORE holdoff has completed.

Table A-4: Electrical Characteristics (Cont.)

Characteristics	Performance Requirements		
Midtrigger	One-half of the waveform acquisition window is prior to the trigger (other trigger points are selectable via the MENU).		
Post Trigger	One-eighth of the waveform acquisition window is prior to the trigger (other trigger points are selectable via the MENU).		
Point-Selectable Triggering	PRETRIG¹	MIDTRIG¹	POST TRIG¹
1 K Record Length	128	512	896
4 K Record Length	512	2048	3584

Horizontal Deflection System

NON-STORE Sweep Rates

Calibrated Range

A Sweep	0.5 sec per division to 0.05 μ s per division in a 1-2-5 sequence of 22 steps. ⁵
B Sweep	50 ms per division to 0.05 μ s per division in a 1-2-5 sequence of 19 steps. ⁵

STORE Mode Ranges

REPETITIVE	0.05 μ s per division to 0.5 s per division. ^{1,6}
RECORD	1 μ s per division to 50 ms per division. ^{1,6}
ROLL/SCAN	0.1 s per division to 5 s per division. (A Sweep only). ^{1,6}

NON-STORE Accuracy

	Unmagnified	Magnified
+15° C to +35° C		
0.5 s per division to 0.1 μ s per division	$\pm 2\%$	$\pm 3\%$
0.05 μ s per division	$\pm 2\%$	$\pm 4\%$
0° C to +50° C		
0.5 s per division to 0.1 μ s per division	$\pm 3\%$ ¹	$\pm 4\%$ ¹
0.05 μ s per division	$\pm 3\%$ ¹	$\pm 6\%$ ¹

Sweep accuracy applies over the center eight divisions. Exclude the first 40 ns of the sweep for magnified sweeps and anything beyond the 100th magnified division.

¹Performance Requirement not checked in manual.

⁵The X10 MAG control extends the maximum sweep speed to 5 ns per division.

⁶The 4k COMPRESS control multiplies the SEC/DIV by 4.

Table A-4: Electrical Characteristics (Cont.)

Characteristics	Performance Requirements	
STORE Accuracy	See Horizontal Differential Accuracy and Cursor Time Difference Accuracy. ¹	
NON-STORE Sweep Linearity		
0.5 s per division to 10 ns per division	±0.1 division.	
5 ns per division	±0.15 division.	
	Linearity measured over any two of the center eight divisions. Exclude the first 40 ns and anything past the 100 th division of the X10 magnified sweeps.	
Digital Sample Rate	Single Trace	CHOP/ALT
SAMPLE (1 μs per division to 5 s per division)	$\frac{100}{\text{SEC/DIV setting}} \text{ Hz}^1$	$\frac{50}{\text{SEC/DIV setting}} \text{ Hz}^1$
PEAKDET or ACCPEAK (1 μs per division to 5 s per division)	100 MHz ¹	100 MHz ¹
REPETITIVE Store (0.05 μs per division to 0.5 μs per division)	100 MHz ¹	100 MHz ¹
External Clock		
Input Frequency		
Slow	DC to 1 kHz	
Fast	DC to 100 kHz	
Digital Sample Rate	100 MHz in ACCPEAK and PEAKDET, otherwise it is equal to the input frequency. ¹	
Screen Update Rate		
Slow	One data pair for every second falling clock edge. ¹	
Fast	Varies with record length and sweep speed. ¹	
Duty Cycle	10% or greater (5 μs minimum pulse width). ¹	
Ext Clock Logic Thresholds	Logic Thresholds are TTL compatible.	
Maximum Safe Input Voltage 	25 V (DC + peak AC) or 25 V _{p-p} AC at 1 kHz or less. ¹	
Input Resistance	Greater than 3.5 kΩ (LSTTL compatible). ¹	

¹Performance Requirement not checked in manual.

Table A-4: Electrical Characteristics (Cont.)

Characteristics	Performance Requirements
STORE Mode Resolution	
Acquisition Record Length	1024 or 4096 data points. ¹
Single Waveform Acquisition Display	1024 data points (100 data points per division across the graticule area).
CHOP or ALT Acquisition Display	512 data points (50 data points per division across the graticule area).
Horizontal POSITION Control Range	Start of the 10 th division will position past the center vertical graticule line in X1; start of the 100 th division will position past the center vertical graticule line in X10 magnified and NON-STORE .
Horizontal Variable Sweep Control Range	
NON-STORE	Continuously variable between calibrated settings of the SEC/DIV switch. Extends the A and the B Sweep speeds by at least a factor of 2.5 times over the calibrated SEC/DIV settings.
STORE	Horizontal Variable Sweep has no affect on the STORE Mode time base. Rotating the Variable SEC/DIV control out of the CAL detent position horizontally compresses a 4 K point acquisition record to 1 K points in length, so that the whole record length can be viewed on screen. Screen readout is altered accordingly.
Displayed Trace Length	
NON-STORE	Greater than 10 divisions.
STORE	10.24 divisions. ¹
Delay Time	
0.5 μ s per division to 0.5 s per division (A Sweep)	
Delay POSITION Range	Less than (0.5 div + 300 ns) to greater than 10 divisions. Delay Time is functional, but not calibrated, at A Sweep speeds faster than 0.5 μ s per division.
NON-STORE Delay Jitter	One part or less in 5,000 (0.02%) of the maximum available delay time.

¹Performance Requirement not checked in manual.

Table A-4: Electrical Characteristics (Cont.)

Characteristics	Performance Requirements
Delay Time Differential Measurement Accuracy (Runs After Delay only)	
+15° C to +35° C	±1% of reading, ±0.5% of full scale (10 divisions).
0° C to +50° C	±2% of reading, ±0.5% of full scale (10 divisions). ¹ Exclude delayed operation when the A and B SEC/DIV knobs are locked together at any sweep speed or when the A SEC/DIV switch is faster than 0.5 μs per division. Accuracy applies over the B DELAY TIME POSITION control range.
Digital Storage Display	
Vertical	
Resolution	10 bits (1 part in 1024). ¹ Display waveforms are calibrated for 100 data points per division.
Position Registration	
NON-STORE to STORE	±0.5 division at graticule center at VOLTS/DIV switch settings from 2 mV per division to 5 V per division.
CONTINUE to SAVE	±0.5 division at VOLTS/DIV switch settings from 2 mV per division to 5 V per division.
SAVE Mode Expansion or Compression Range	Up to 10 times as determined by the remaining VOLTS/DIV switch positions up or down. 2 mV per division acquisitions cannot be expanded, and 5 V per division acquisitions cannot be compressed. Any portion of a stored waveform vertically magnified or compressed up to 10 times can be positioned to the top and to the bottom of the graticule area.
Storage Display Expansion Algorithm Error	±0.1% of full scale. ¹
Storage Display Compression Algorithm Error	+0.16% of reading ±0.4% of full scale. ¹
Horizontal	
Resolution	10 bits (1 part in 1024). ¹ Calibrated for 100 data points per division.
Differential Accuracy	Graticule indication of time cursor difference is ±2% of the readout value, measured over the center eight divisions.
SAVE Mode Expansion Range (YT mode)	10 times as determined by the X10 MAG switch.
Expansion Accuracy	Same as the Vertical. ¹

¹ Performance Requirement not checked in manual.

Table A-4: Electrical Characteristics (Cont.)



Characteristics	Performance Requirements
Digital Readout Display	
CURSOR Accuracy	
Voltage Difference	$\pm 3\%$ of the ΔV readout value, $\pm 0.4\%$ of full scale (8 divisions). Applies within center 6 divisions.
Time Difference	
RECORD or ROLL/SCAN	
SAMPLE or AVERAGE	± 1 display interval. ⁷
PEAKDET or ACCPEAK	± 2 display interval. ^{1,7}
REPETITIVE	
SAMPLE or AVERAGE	$\pm (2 \text{ display interval} + 0.5 \text{ ns})$. ^{1,7}
ACCPEAK	$\pm (4 \text{ display interval} + 0.5 \text{ ns})$. ^{1,7}
X-Y Operation (X1 Magnification Only)	
Deflection Factors	Same as vertical deflection system with the VOLTS/DIV Variable controls in the CAL detent position.
NON-STORE Accuracy⁸	
X-Axis	
+15° C to +35° C	$\pm 3\%$
0° C to +50° C	$\pm 4\%$ ¹
Y-Axis	Same as vertical deflection system. ¹
NON-STORE Bandwidth (-3 dB)⁸	
X-Axis	DC to at least 2.5 MHz.
Y-Axis	Same as vertical deflection system. ¹
NON-STORE Phase Difference Between X-Axis and Y-Axis Amplifiers	± 3 degrees from DC to 150 kHz. ¹ Vertical Input Coupling set to DC.
STORE Accuracy	
X-Axis and Y-Axis	Same as digital storage vertical deflection system. ¹

¹Performance Requirement not checked in manual.

⁷A display interval is the time between two adjacent display points on a waveform.

⁸Measured with a DC-coupled, five-division reference signal.

Table A-4: Electrical Characteristics (Cont.)

Characteristics	Performance Requirements
Useful Storage Bandwidth	
RECORD and REPETITIVE Store Modes	$\frac{5}{SEC/DIV \text{ setting}} \text{ Hz}^1$
STORE Mode Time Difference Between Y-Axis and X-Axis Signals	
RECORD, SCAN, and ROLL Modes	$\pm 1.0 \text{ ns}^1$
REPETITIVE Store	$\frac{SEC/DIV \text{ setting}}{100} \times 4^1$
Probe Adjust	
Output Voltage on PRB ADJ Jack	0.5 V $\pm 5\%$
Probe Adjust Signal Repetition Rate	1 kHz $\pm 20\%$ ¹
Z-Axis	
Sensitivity (NON-STORE Only)	5 V causes noticeable modulation. Positive-going input decreases intensity. Usable frequency range is DC to 20 MHz.
Maximum Input Voltage 	30 V (DC + peak AC) or 30 V p-p at 1 kHz or less. ¹
Input Resistance	Greater than 10 k Ω . ¹
X-Y Plotter Output	
Maximum Safe Applied Voltage, Any Connector Pin 	25 V (DC + peak AC) or 25 V p-p AC at 1 kHz or less. ¹
X and Y Plotter Outputs	
Pen Lift/Down	Fused relay contacts, 100 mA maximum. ¹
Output Voltage Levels	500 mV per division $\pm 20\%$. Center screen is 0 V ± 1 division. Measured with a DC-coupled, five-division reference signal.
Series Resistance	2 k Ω $\pm 10\%$ ¹

¹Performance Requirement not checked in manual.

Table A-4: Electrical Characteristics (Cont.)

Characteristics	Performance Requirements
Power Supply	
Line Voltage Range	90 VAC to 250 VAC ¹
Line Frequency	48 Hz to 440 Hz ¹
Maximum Power Consumption	85 watts (150 VA) ¹
Line Fuse	2 A, 250 V, slow blow ¹
Primary Circuit Dielectric Requirement	Routine test to 1500 V _{rms} , 60 Hz, for 10 seconds without breakdown. ¹
CRT Display	
Display Area	8 cm X 10 cm. ¹
Standard Phosphor	P31 ¹
Nominal Accelerating Voltage	14 kV ¹
4.2 V Output	±10% through 2 kΩ ¹
Memory	
Nonvolatile Memory	26 Kbytes ¹
Power-Down	
Battery Voltage	Memory retained for battery voltages greater than 2.3 V. ¹
Data Retention	Memory maintained at least 6 months without instrument power. ¹
Battery Life	Power-down data retention specification shall be maintained for 3 years without battery change.
Power-Down Detection	
Threshold	Fail asserted for supply drop to less than 4.5 V. ¹ Reset held until supply is greater than 4.75 V. ¹
Reset Delay	Power-down interrupt to reset delay ≥ 1 ms. ¹

¹Performance Requirement not checked in manual.

Table A-4: Electrical Characteristics (Cont.)

Characteristics	Performance Requirements
GPIB Option	
GPIB Requirements	Complies with ANSI/IEEE Standard 488-1978. ¹
RS-232-C Option	
RS-232-C Requirements	Complies with EIA Standard RS-232-C. ¹
Baud Rates	
Available Rates	110, 300, 600, 1200, and 2400 baud. ¹
Accuracy	< 1% error. ¹

¹Performance Requirement not checked in manual.

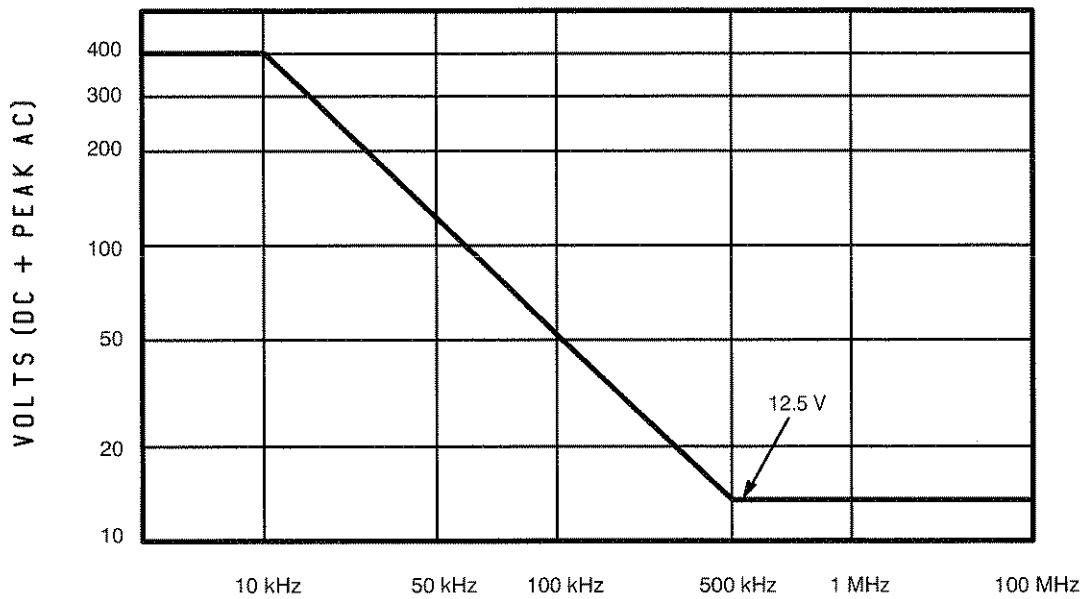

Figure A-1: Maximum input voltage versus frequency derating curve for the CH 1 OR X, CH 2 OR Y, and EXT INPUT connectors.

Table A-5: Environmental Characteristics

Characteristics	Performance Requirements
Environmental Requirements	The instrument meets the following MIL-T-28800D requirements for Type III, Class 5, Style D equipment, except where noted otherwise. ¹
Temperature	
Operating	0° C to +50° C (+32° F to +122° F) ¹
Nonoperating	–40° C to +71° C (–40° F to +160° F) ¹ Tested to MIL-T-28800D, para 4.5.5.1.3 and 4.5.5.1.4, except that in para 4.5.5.1.3 steps 4 and 5 (–10° C operating test) are performed before step 2 (–40° C nonoperating test). Equipment shall remain off upon return to room ambient temperature during step 6. Excessive condensation shall be removed before operating during step 7.
Altitude	
Operating	To 4,500 meters (13,716 feet) ¹ Maximum operating temperature decreases 1° C per 1,000 feet above 5,000 feet.
Nonoperating	To 15,240 meters (50,000 feet) ¹ Exceeds requirements of MIL-T-28800D, para 4.5.5.2.
Humidity	
Operating and Nonoperating	5 cycles (120 hours) referenced to MIL-T-28800D para 4.5.5.1.2.2 for Type III, Class 5 instruments. Operating and nonoperating at 95%, –5% to +0%, relative humidity. Operating, +30° C to +50° C; nonoperating, +30° C to +60° C. ¹
EMI (electromagnetic interference)	Meets radiated and conducted emission requirements per VDE 0871, Class B. ¹ To meet EMI regulations and specifications, use a double shielded cable and metal connector housing with the housing grounded to the cable shield on the AUXILIARY CONNECTOR.
Vibration	
Operating	15 minutes along each of three major axes at a total displacement of 0.015 inch p-p (2.3 g at 55 Hz) with frequency varied from 10 Hz to 55 Hz to 10 Hz in one-minute sweeps. Hold for 10 minutes at 55 Hz in each of the three major axes. All major resonances are above 55 Hz. ¹ Meets requirements of MIL-T-28800D, para 4.5.5.3.1.

¹Performance Requirement not checked in manual.

Table A-5: Environmental Characteristics (Cont.)

Characteristics	Performance Requirements
Shock	
Operating and Nonoperating	30 g half-sine, 11 ms duration, three shocks per axis each direction, for a total of 18 shocks. ¹
	Meets requirements of MIL-T-22800D, para 4.5.5.4.1, except limited to 30 g.
Bench Handling Test	Each edge lifted four inches and allowed to free fall onto a solid wooden bench surface. ¹
	Meets requirements of MIL-T-22800D, para 4.5.5.4.3.

¹Performance Requirement not checked in manual.

Table A-6: Physical Characteristics⁹

Characteristics	Performance Requirements
Weight	
With Power Cord, Cover, Probes, and Pouch	9.4 kg (20.7 lb).
With Power Cord Only	8.2 kg (18 lb).
Domestic Shipping Weight	12.2 kg (26.9 lb).
Height	137 mm (5.4 in).
Width	
With Handle	360 mm (14.2 in).
Without Handle	328 mm (12.9 in).
Depth	
With Front Cover	445 mm (17.5 in).
Without Front Cover	440 mm (17.3 in).
With Handle Extended	511 mm (20.1 in).

⁹See Figure A-2 on page A-24 for a dimensional drawing.

Appendix B: Specification

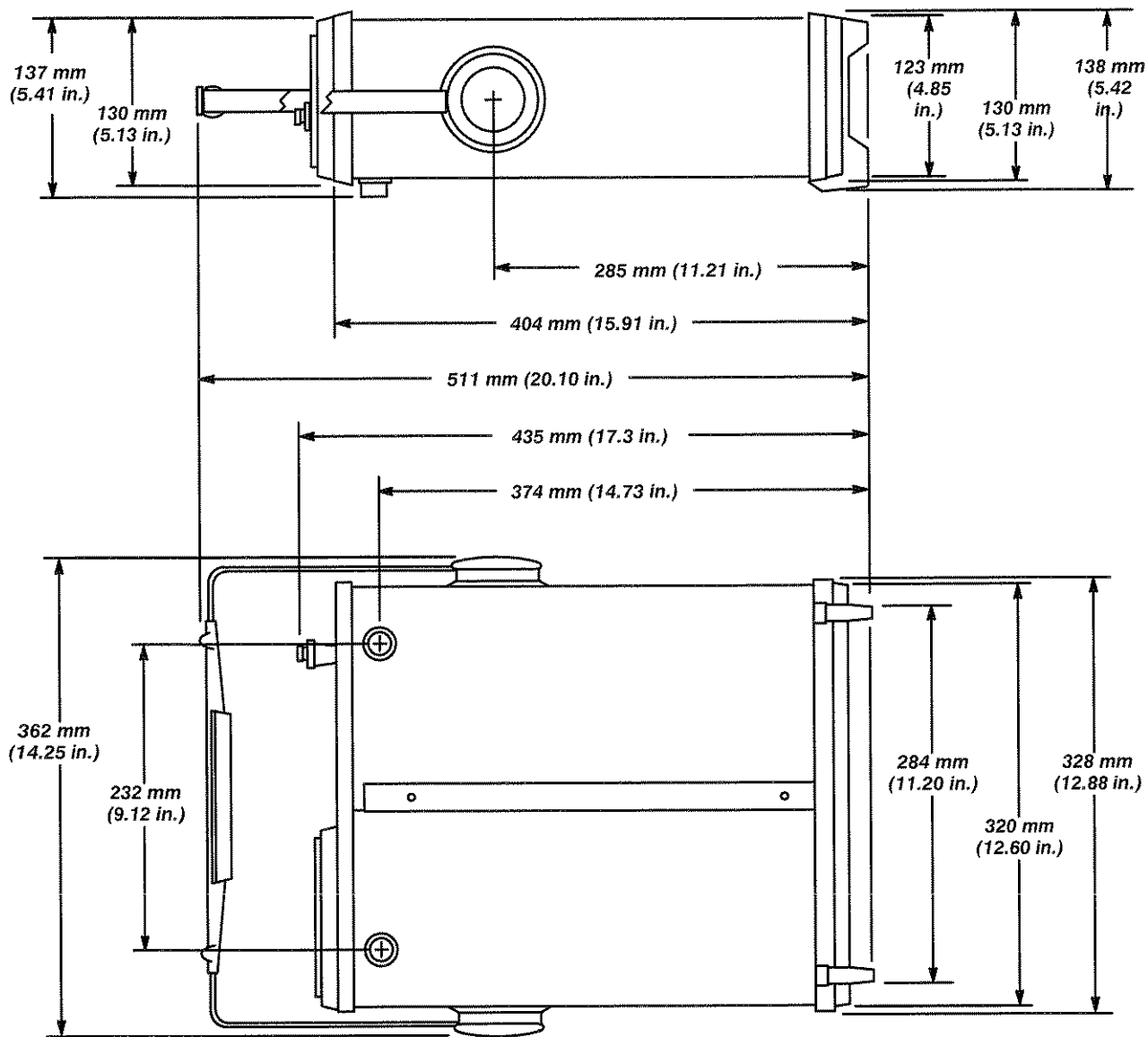

Figure A-2: Physical dimensions of the 2232 Digital Storage Oscilloscope



Appendix C: Performance Verification

This appendix begins with *General Information* which contains topics you should understand before performing the procedures in this appendix. The table *Test Equipment Required* follows. The performance checks are found under *Procedures*.

General Information

Read the following topics before performing the performance verification procedures in this appendix.

Purpose

The *Performance Verification* is used to verify the instrument against the performance requirements listed in Table A-4 (page A-8) and to determine the need for instrument adjustment. It may also be used as an acceptance test or as a preliminary troubleshooting aid.

Performance Check Interval

To ensure instrument accuracy, check its performance after every 2000 hours of operation or once each year, if used infrequently. A more frequent interval may be necessary, if the instrument is subjected to harsh environments or severe usage.

Structure

The *Performance Verification* is structured in subparts to permit checking individual sections of the instrument, whenever a complete verification of performance is not required.

Each subpart begins with a list of the test equipment required for performing the steps in that subpart. Following that equipment list is a list of all the front-panel control settings required to prepare the instrument for performing Step 1 of that subpart. The procedure steps follow.

When performing any subpart, start at the beginning and do each step within a particular subpart—both in the sequence presented and in its entirety—to ensure that control-setting changes will be correct for following steps.

Limits and Tolerances

The tolerances given in this procedure are valid for an instrument that is operating in and has been previously calibrated in an ambient temperature between +20° C and +30° C. The instrument also must have had at least a 20 minute warm-up period. Refer to Table A-4 for tolerances applicable to an

instrument that is operating outside this temperature range. All tolerances specified are for the instrument only and do not include test-equipment error.

Test Equipment Required

Table A-7 lists all the test equipment required to do the *Performance Verification* in this appendix. Also listed is the minimum specifications for the test equipment. All equipment used must meet or exceed its minimum specifications.

When equipment other than that recommended is used, control settings of the test setup might need to be altered. If the exact item of equipment given as an example in Table A-7 is not available, check the *Minimum Specification* column to determine if any other available test equipment might suffice to perform the check or adjustment.

Operating instructions for test equipment are not given in this procedure. If more operating information is required, refer to the appropriate test equipment instruction manual.

Table A-7: Test Equipment Required

Item and Description	Minimum Specification	Purpose	Example of Suitable Test Equipment
Calibration Generator	Standard-amplitude signal levels: 5 mV to 50 V. Accuracy $\pm 0.3\%$. High-amplitude signal levels: 1 V to 60 V. Repetition rate: 1 kHz. Fast-rise signal level: 1 V. Repetition rate: 1 MHz. Rise time: 1 ns or less. Flatness: $\pm 2\%$.	Signal source for gain and transient response.	TEKTRONIX PG 506A Calibration Generator. ¹
Leveled Sine Wave Generator	Frequency: 250 kHz to above 100 MHz. Output amplitude: variable from 10 mV to 5 V p-p. Output impedance: 50 Ω . Reference frequency: 50 kHz. Amplitude accuracy: constant within 3% of reference frequency as output frequency changes.	Vertical, horizontal, and triggering checks and adjustments. Display adjustments and Z-Axis check.	TEKTRONIX SG 503 Leveled Sine Wave Generator. ¹
Time-Mark Generator	Marker outputs: 10 ns to 0.5 s. Marker accuracy: $\pm 0.1\%$. Trigger output: 1 ms to 0.1 ms, time-coincident with markers.	Horizontal checks and adjustments. Display adjustment.	TEKTRONIX TG 501 Time-Mark Generator. ¹
Low-Frequency Generator	Range: 1 kHz to 500 kHz. Output amplitude: 300 mV. Output impedance: 600 Ω . Reference frequency: constant within 0.3 dB of reference frequency as output frequency changes.	Low-frequency trigger checks.	TEKTRONIX SG 502 Oscillator. ¹
Pulse Generator	Repetition rate: 1 kHz. Output amplitude: 5 V.	External clock and storage checks.	TEKTRONIX PG 501 Pulse Generator. ¹

Table A-7: Test Equipment Required (Cont.)

Item and Description	Minimum Specification	Purpose	Example of Suitable Test Equipment
Test Oscilloscope with 10X Probes	Bandwidth: DC to 100 MHz. Minimum deflection factor: 5 mV/div. Accuracy: $\pm 3\%$.	General trouble shooting, holdoff check.	TEKTRONIX 2235 Oscilloscope.
Digital Voltmeter	Range: 0 to 140 V. DC voltage accuracy: $\pm 0.15\%$ 4½ digit display.	Power supply checks and adjustments. Vertical adjustment.	TEKTRONIX DM 501A Digital Multimeter. ¹
Coaxial Cable (2 required)	Impedance: 50 Ω Length: 42 in. Connectors: BNC	Signal interconnection.	Tektronix Part Number 012-0057-01
Precision Coaxial Cable	Impedance: 50 Ω Length: 36 in. Connectors: BNC	Vertical bandwidth and aberrations checks.	Tektronix Part Number 012-0482-00
Dual-Input Coupler	Connectors: BNC female-to-dual-BNC male.	Signal interconnection.	Tektronix Part Number 067-0525-02
Coupler	Connectors: BNC female-to-BNC female.	Signal interconnection.	Tektronix Part Number 103-0028-00
T-Connector	Connectors: BNC	Signal interconnection.	Tektronix Part Number 103-0030-00
Termination	Impedance: 50 Ω Connectors: BNC	Signal termination.	Tektronix Part Number 011-0049-01
Termination	Impedance: 600 Ω Connectors: BNC.	Signal termination	Tektronix Part Number 011-0092-00
10X Attenuator	Ratio: 10X Impedance: 50 Ω Connectors: BNC	Vertical compensation and triggering checks.	Tektronix Part Number 011-0059-02
2X Attenuator	Ratio: 2X. Impedance: 50 Ω Connectors: BNC	External triggering checks.	Tektronix Part Number 011-0069-02
Adapter	Connectors: BNC male-to-miniature-probe tip.	Signal interconnection.	Tektronix Part Number 013-0084-02
Adapter	Connectors: BNC male-to-tip plug.	Signal interconnection.	Tektronix Part Number 175-1178-00
Low-Capacitance Alignment Tool	Length: 1 in. shaft. Bit size: $\frac{3}{32}$ in.	Adjust variable capacitors.	J.F.D. Electronics Corp. Adjustment Tool Number 5284.
Screwdriver	Length: 3 in. shaft. Bit size: $\frac{3}{32}$ in.	Adjust variable capacitors.	Xcelite R-3323.

¹Requires a TM500-Series Power Module.

Procedures

These procedures check all characteristics in Appendix B except those marked not checked. Be sure you have read *General Information* on page A-25, including *Limits and Tolerances* before doing these procedures.

For a list of each check and the page number on which it is found, see the *Performance Verification* entries in the index at the rear of this manual.

Initial Setup Procedure

Before performing any procedures, note the following items:

- It is not necessary to remove the instrument cover to accomplish any procedure in this *Performance Verification*, since all checks are made using operator-accessible front- and rear-panel controls and connectors.
- To make accurate display adjustments and checks, you want a stable, well-focused, low-intensity display. Therefore, unless otherwise noted, adjust the **A and B INTENSITY**, **STORAGE/READOUT INTENSITY**, **FOCUS**, and A and B Trigger **LEVEL** controls as needed to view the display when performing procedures.

Before doing the procedures that follow, perform these four steps to ensure performance accuracies for the digital portion of the instrument. Performance of the Factory Reset routine sets the digital part of the instrument to factory default settings.

Procedure Steps:

- Step 1:** Power on the instrument and allow it to warm up 20 minutes before doing the procedures that follow.
- Step 2:** Press the Setup **ADV FUNCT** button to display the Advanced Functions setup menu.
- Step 3:** Press the **Fact. Reset** menu button to set the instrument to factory default settings.
- Step 4:** Return the instrument to display mode by pressing the Setup **ADV FUNCT** button a second time.

Vertical System Checks

These procedures check those characteristics that relate to the vertical system and that are listed as checked in Appendix B of this manual.

Equipment Required (see Table A-7):

Calibration Generator	50 Ω BNC Precision Cable
Leveled Sine Wave Generator	Dual-Input Coupler
Pulse Generator	50 Ω BNC Termination

50 Ω BNC Cable

10X Attenuator

Initial Control Settings:**Vertical (Both Channels)**

POSITION
MODE
X-Y
BW LIMIT
VOLTS/DIV
VOLTS/DIV Variable
INVERT
AC-GND-DC

Midrange
CH 1
 Off (button out)
 On (button in)
2 mV
CAL (detent)
 Off (button out)
DC

Horizontal

POSITION
MODE
A SEC/DIV
SEC/DIV Variable
X10 Magnifier

Midrange
A
0.5 ms
CAL detent
 Off (knob in)

A Trigger

VAR HOLDOFF
 Mode
SLOPE
LEVEL
A & B SOURCE
A COUPL

NORM
P-P AUTO
 Positive (button out)
 Midrange
 Vertical **MODE**
NORM

Storage**STORE/NON-STORE****NON-STORE** (button out)**Procedure Steps:** **Step 1: Check Deflection Accuracy and Variable Range**

- a. Connect the standard-amplitude signal from the calibration generator via a 50 Ω cable to the CH 1 OR X input connector.
- b. CHECK — Deflection accuracy is within the limits given in Table A-8 for each **CH 1 VOLTS/DIV** switch setting and corresponding standard-amplitude signal.

When at the 20 mV **VOLTS/DIV** switch setting, rotate the **CH 1 VOLTS/DIV** Variable control fully counterclockwise and CHECK that the display decreases to 2 divisions or less. Then return the **CH 1 VOLTS/DIV** Variable control to the **CAL** detent and continue with the 50 mV check.

Table A-8: Deflection Accuracy Limits

VOLTS/DIV Switch Setting	Standard Amplitude Signal	Accuracy Limits (Divisions)
2 mV	10 mV	4.90 to 5.10
5 mV	20 mV	3.92 to 4.08
10 mV	50 mV	4.90 to 5.10
20 mV	0.1 V	4.90 to 5.10
50 mV	0.2 V	3.92 to 4.08
0.1 V	0.5 V	4.90 to 5.10
0.2 V	1 V	4.90 to 5.10
0.5 V	2 V	3.92 to 4.08
1 V	5 V	4.90 to 5.10
2 V	10 V	4.90 to 5.10
5 V	20 V	3.92 to 4.08

- c. Move the cable from the **CH 1 OR X** input connector to the **CH 2 OR Y** input connector. Set the Vertical **MODE** switch to **CH 2**.
- d. Repeat part b using the **CH 2** controls.

Step 2: Check Store Deflection Accuracy

- a. Set:

CH 2 VOLTS/DIV	2 mV
STORE/NON-STORE	STORE (button in)
Acquisition MODE	AVERAGE
- b. Set the generator to produce a five division standard amplitude signal.
- c. Use the **CURSORS** control and **SELECT C1/C2** switch (push in the **CURSORS** controls knob) to set one cursor at the bottom of the square wave and the other cursor at the top of the square wave.
- d. CHECK — Deflection accuracy is within the limits given in Table A-9 for each **CH 2 VOLTS/DIV** switch setting and corresponding standard-amplitude signal.
- e. Move the cable from the **CH 2 OR Y** input connector to the **CH 1 OR X** input connector. Set the Vertical **MODE** switch to **CH 1**.
- f. Repeat parts b and c using the **CH 1** controls.

Table A-9: Storage Deflection Accuracy

VOLTS/DIV Switch Setting	Standard Amplitude Signal	Divisions of Deflection	Voltage Readout Limits
2 mV	10 mV	4.90 to 5.10	9.70 to 10.30 mV
5 mV	20 mV	3.92 to 4.08	19.40 to 20.60 mV
10 mV	50 mV	4.90 to 5.10	48.5 to 51.5 mV
20 mV	0.1 V	4.90 to 5.10	97.0 to 103.0 mV
50 mV	0.2 V	3.92 to 4.08	194.0 to 206.0 mV
0.1 V	0.5 V	4.90 to 5.10	0.485 to 0.515 V
0.2 V	1 V	4.90 to 5.10	0.970 to 1.030 V
0.5 V	2 V	3.92 to 4.08	1.940 to 2.060 V
1 V	5 V	4.90 to 5.10	4.85 to 5.15 V
2 V	10 V	4.90 to 5.10	9.70 to 10.30 V
5 V	20 V	3.92 to 4.08	19.40 to 20.60 V

Step 3: Check Save Expansion and Compression

- a. Set the **CH 1 VOLTS/DIV** switch to 0.1 V.
- b. Set the generator to produce a 0.5 division standard-amplitude signal.
- c. Press in the **SAVE/CONT** button to select **SAVE**.
- d. Set the **CH 1 VOLTS/DIV** switch to 10 mV and reposition the display.
- e. CHECK—The display is expanded to five divisions in amplitude.
- f. Set:

CH 1 VOLTS/DIV	0.1 V
SAVE/CONT	CONT
- g. Set the generator to produce a five division standard-amplitude signal.
- h. Press in the **SAVE/CONT** button to select **SAVE**.
- i. Set the **CH 1 VOLTS/DIV** switch to 1 V.
- j. CHECK—The display is compressed to 0.5 division in amplitude.
- k. Move the cable from the **CH 1 OR X** input connector to the **CH 2 OR Y** input connector.
- l. Set:

Vertical MODE	CH 2
SAVE/CONT	CONT

m. Repeat parts a through j, using the **CH 2 VOLT/DIV** control.

Step 4: Check Position Range

- a. Set:

VOLTS/DIV (both)	10 mV
AC-GND-DC (both)	AC
STORE/NON-STORE	NON-STORE (button out)
- b. Set the generator to produce a 0.2 V standard-amplitude signal.
- c. CHECK — The bottom of the waveform can be vertically positioned at least one division above the center horizontal graticule line when the **CH 2 POSITION** control is rotated fully clockwise, and that the top of the waveform can be vertically positioned one division below the center horizontal graticule line when the **CH 2 POSITION** control is rotated fully counterclockwise.
- d. Move the cable from the **CH 2 OR Y** input connector to the **CH 1 OR X** input connector and set the Vertical **MODE** switch to **CH 1**.
- e. Repeat part c using the **CH 1** controls.
- f. Disconnect the test equipment.

Step 5: Check Acquisition Position Registration

- a. Set:

AC-GND-DC (both)	GND
A SEC/DIV	0.5 ms
- b. Position the trace exactly on the center horizontal graticule line using the **CH 1 POSITION** control.
- c. Set:

STORE/NON-STORE	STORE (button in)
SAVE/CONT	CONT
- d. CHECK — Trace remains within 0.5 division of the center graticule line.
- e. Set:

Vertical MODE	CH 2
STORE/NON-STORE	NON-STORE (button out)
- f. Repeat parts b through d for **CH 2** trace, using the **CH 2** controls.
- g. Position the trace 0.5 division below the top horizontal graticule line using the **CH 2 POSITION** control.
- h. Press in the **SAVE/CONT** button to select **SAVE**.
- i. CHECK — Trace shift of 0.5 division or less.
- j. Press in the **SAVE/CONT** button to select **CONT**.

- k. Position the trace 0.5 division above the bottom horizontal graticule line using the **CH 2 POSITION** control.
- l. Press in the **SAVE/CONT** button to select **SAVE**.
- m. CHECK — Trace shift of 0.5 division or less.
- n. Press in the **SAVE/CONT** button to select **CONT**. Then set the Vertical **MODE** switch to **CH 1**.
- o. Repeat steps g through m for **CH 1** trace.

Step 6: Check Bandwidth

- a. Set:

VOLTS/DIV (both)	2 mV
AC-GND-DC (both)	DC
A SEC/DIV	0.2 ms
BW LIMIT	Off (button out)
STORE/NON-STORE	NON-STORE (button out)
- b. Connect the leveled sine wave generator output via a 50 Ω precision cable and a 50 Ω termination to the **CH 1 OR X** input connector.
- c. Set the generator to produce a 50 kHz, six division display.
- d. CHECK — Display amplitude is 4.2 divisions or greater as the generator output frequency is increased up to the value shown in Table A-10 for the corresponding **VOLTS/DIV** switch setting.

Table A-10: Settings for Bandwidth Checks

VOLTS/DIV Switch Setting	Generator Output Frequency
2 mV	80 MHz
5 mV to 0.5 V	100 MHz

- e. Repeat parts c and d for all indicated **CH 1 VOLTS/DIV** switch settings, up to the output-voltage upper limit of the sine wave generator being used.
- f. Move the cable from the **CH 1 OR X** input connector to the **CH 2 OR Y** input connector.
- g. Set the Vertical **MODE** switch to **CH 2**.
- h. Repeat parts c and d for all indicated **CH 2 VOLTS/DIV** switch settings, up to the output-voltage upper limit of the sine wave generator being used.

Step 7: Check Repetitive Store Mode and Bandwidth

- a. Set:

CH 2 VOLTS/DIV	10 mV
-----------------------	-------

- A SEC/DIV** 0.2 ms
- b. Set the generator to produce a 50 kHz, six division display.
- c. Set:
 - A SEC/DIV** 0.05 μ s
 - X10 Magnifier** On (knob out)
- d. Set the generator to produce a 100 MHz display.
- e. Set:

STORE/NON-STORE	STORE (button in)
SAVE/CONT	CONT

NOTE

Allow the points to accumulate for a few seconds before saving the display.

- f. Press in the **SAVE/CONT** button to select **SAVE**.
- g. CHECK — The 100 MHz display is saved.
- h. CHECK — Display amplitude is 4.2 divisions or greater.
- i. Press in the **SAVE/CONT** button to select **CONT**.
- j. Set the Vertical **MODE** switch to **BOTH** and **ALT**.
- k. Repeat parts f through h.

Step 8: Check Single Sweep Sample Acquisition

- a. Set:

Vertical MODE	CH 2
A SEC/DIV	5 μ s
X10 Magnifier	Off (knob in)
A Trigger Mode	NORM
A & B SOURCE	CH 2
SAVE/CONT	CONT
- b. Set the generator to produce a 50 kHz, six division display.
- c. Press in the A Trigger Mode **SGL SWP** button.
- d. Set the generator output to 2 MHz.
- e. Press in the A Trigger Mode **SGL SWP** button.
- f. CHECK — the minimum peak-to-peak envelope amplitude is greater than 5.6 divisions.

Step 9: Check Bandwidth Limit Operation

- a. Set:

BW LIMIT	On (button in)
VOLTS/DIV (both)	10 mV

AC-GND-DC (both)	DC
A SEC/DIV	20 μ s
A Trigger Mode	P-P AUTO
A & B SOURCE	Vertical
MODE STORE/NON-STORE	NON-STORE (button out)

- b. Set the generator to produce a 50 kHz, six division display.
- c. Adjust the generator output frequency until the display amplitude decreases to 4.2 divisions.
- d. CHECK — Generator output frequency is between 18 and 22 MHz.
- e. Move the cable from the **CH 2 OR Y** input connector to the **CH 1 OR X** input connector.
- f. Set the Vertical **MODE** switch to **CH 1**.
- g. Repeat parts c and d.
- h. Disconnect the test equipment from the instrument.

Step 10: Check Common-Mode Rejection Ratio

- a. Set:

BW LIMIT	Off (button out)
INVERT	On (button in)
- b. Connect the leveled sine wave generator output via a 50 Ω cable, a 50 Ω termination, and a dual-input coupler to the **CH 1 OR X** and the **CH 2 OR Y** input connectors.
- c. Set the generator to produce a 50 MHz, six division display.
- d. Vertically center the display using the **CH 1 POSITION** control. Then set the Vertical **MODE** switch to **CH 2** and vertically center the display using the **CH 2 POSITION** control.
- e. Set the Vertical **MODE** switches to **BOTH** and **ADD**.
- f. CHECK — Display amplitude is 0.6 division or less.
- g. If the check in part f meets the requirement, skip to part p. If it does not, continue with part h.
- h. Set the Vertical **MODE** switch to **CH 2**.
- i. Set the generator to produce a 50 kHz, six division display.
- j. Set the Vertical **MODE** switch to **BOTH**.
- k. Adjust the **CH 1** or **CH 2 VOLTS/DIV** Variable control for minimum display amplitude.
- l. Set the Vertical **MODE** switch to **CH 2**.
- m. Set the generator to produce a 50 MHz, six division display.
- n. Set the Vertical **MODE** switch to **BOTH**.

- o. CHECK — Display amplitude is 0.6 division or less.
- p. Disconnect the test equipment from the instrument.

Step 11: Check Non-Store and Store Channel Isolation

- a. Set:

Vertical MODE	CH 1
VOLTS/DIV (both)	0.1 V
VOLTS/DIV Variable (both)	CAL detent
INVERT	Off (button out)
CH 1 AC-GND-DC	DC
CH 2 AC-GND-DC	GND
A SEC/DIV	0.1 μ s
- b. Connect the leveled sine wave generator output via a 50 Ω cable and a 50 Ω termination to the **CH 1 OR X** input connector.
- c. Set the generator to produce a 50 MHz, five division display.
- d. Set the Vertical **MODE** switch to **CH 2**.
- e. CHECK — Display amplitude is 0.05 division or less.
- f. Move the cable from the **CH 1 OR X** input connector to the **CH 2 OR Y** input connector.
- g. Set:

Vertical MODE	CH 1
CH 1 AC-GND-DC	GND
CH 2 AC-GND-DC	DC
- h. CHECK — Display amplitude is 0.05 division or less.
- i. Set:

CH 2 VOLTS/DIV	50 mV
STORE/NON-STORE	STORE (button in)
SAVE/CONT	CONT
- j. CHECK — Display amplitude is 0.1 division or less.
- k. Move the cable from the **CH 2 OR Y** input connector to the **CH 1 OR X** input connector.
- l. Set:

Vertical MODE	CH 2
CH 1 VOLTS/DIV	50 mV
CH 2 VOLTS/DIV	0.1 V
CH 1 AC-GND-DC	DC
CH 2 AC-GND-DC	GND
- m. CHECK — Display amplitude is 0.1 division or less.
- n. Disconnect the test equipment from the instrument.

Step 12: Check Store Pulse Width Amplitude

- a. Set:

CH 2 VOLTS/DIV	0.5 V
-----------------------	-------

- | | |
|------------------------|-------------------------------|
| CH 2 AC-GND-DC | AC |
| A SEC/DIV | 0.05 μ s |
| X10 Magnifier | On (knob out) |
| STORE/NON-STORE | NON-STORE (button out) |
- b. Connect the pulse generator pulse-period output via a 50 Ω coaxial cable and a 50 Ω termination to **CH 2 OR Y** input connector.
 - c. Set the generator to produce a 0.1 ms period, 10 ns pulse duration, five division display.
 - d. Set **X10** Magnifier off (knob in).
 - e. Set the Pulse Generator period to 1 ms.
 - f. Set **A SEC/DIV** to 1 ms.
 - g. Set:

STORE/NON-STORE	STORE (button in)
Acquisition MODE	PEAKDET
 - h. Adjust Horizontal **POSITION** control to center trace horizontally.
 - i. CHECK — The amplitude of the display is 2.5 divisions or greater.
 - j. Set the **A SEC/DIV** switch to 0.1 sec.
 - k. CHECK — The amplitude of the display is 2.5 divisions or greater.
 - l. Disconnect the test equipment from the instrument.

Horizontal System Checks

Equipment Required (see Table A-7):

Calibration Generator	50 Ω BNC Precision
Cable	
Leveled Sine Wave Generator	50 Ω BNC Termination
Time-Mark Generator	

Initial Control Settings:

Vertical

CH 1 POSITION	Midrange
MODE	CH 1
X-Y	Off (button out)
BW LIMIT	Off (button out) CH 1
VOLTS/DIV	0.5 V
CH 1 VOLTS/DIV Variable	CAL detent
CH 1 AC-GND-DC	DC
Horizontal POSITION	Midrange
MODE	A
A SEC/DIV	0.05 μ s
SEC/DIV Variable	CAL detent
X10 Magnifier	Off (knob in)
B DELAY TIME POSITION	Fully counterclockwise

B Trigger	
SLOPE	Positive (button out)
LEVEL	Fully clockwise
A Trigger	
VAR HOLDOFF	NORM
Mode	P-P AUTO
SLOPE	Positive (button out)
LEVEL	Midrange
A & B SOURCE	VERT MODE
A COUPL	NORM
A EXT COUPL	DC
Storage	
STORE/NON-STORE	NON-STORE (button out)

Procedure Steps:

Step 1: Check Timing Accuracy and Linearity

- a. Connect the time-mark generator output via a 50 Ω cable and a 50 Ω termination to the **CH 1 OR X** input connector.
- b. Select 50 ns time markers from the time-marker generator.
- c. Use the **CH 1 POSITION** control to center the display vertically. Adjust the A Trigger **LEVEL** control for a stable, triggered display.
- d. Use the Horizontal **POSITION** control to align the 2nd time marker with the 2nd vertical graticule line.
- e. CHECK — Timing accuracy is within 2% (0.16 division at the 10th vertical graticule line), and linearity is within 5% (0.1 division over any 2 of the center eight divisions).
- f. Repeat parts c through e for the remaining **A SEC/DIV** and time-mark generator setting combinations shown in Table A-11 under the Normal (X1) column.

When checking the timing accuracy of the **A SEC/DIV** switch settings from 50 ms to 0.5 s, watch the time marker tips only at the 2nd and 10th vertical graticule lines while adjusting the Horizontal **POSITION** control.

- g. Set:

A SEC/DIV	0.05 μ s
X10 Magnifier	On (knob out)
- h. Select 10 ns time markers from the time-mark generator.
- i. Use the Horizontal **POSITION** control to align the 1st time marker that is 40 ns beyond the start of the sweep with the 2nd vertical graticule line.

- j. CHECK — Timing accuracy is within 3% (0.24 division at the 10th vertical graticule line), and linearity is within 7.5% (0.15 division over any two of the center eight divisions). Exclude any portion of the sweep past the 100th magnified division.
- k. Repeat parts i and j for the remaining **A SEC/DIV** and time-mark generator setting combinations shown in Table A-11 under the **X10 Magnified** column.
- l. Set:

Horizontal MODE	B
A SEC/DIV	0.1 μ s
B SEC/DIV	0.05 μ s
X10 Magnifier	Off (knob in)
- m. Repeat parts b through k for the B Sweep.

Table A-11: Settings for Timing Accuracy Checks

SEC/DIV Switch Setting	Time-Mark Generator Setting	
	Normal (X1)	X10 Magnified
0.05 μ s	50 ns	10 ns
0.1 μ s	0.1 μ s	10 ns
0.2 μ s	0.2 μ s	20 ns
0.5 μ s	0.5 μ s	50 ns
1 μ s	1 μ s	0.1 μ s
2 μ s	2 μ s	0.2 μ s
5 μ s	5 μ s	0.5 μ s
10 μ s	10 μ s	1 μ s
20 μ s	20 μ s	2 μ s
50 μ s	50 μ s	5 μ s
0.1 ms	0.1 ms	10 μ s
0.2 ms	0.2 ms	20 μ s
0.5 ms	0.5 ms	50 μ s
1 ms	1 ms	0.1 ms
2 ms	2 ms	0.2 ms
5 ms	5 ms	0.5 ms
10 ms	10 ms	1 ms
20 ms	20 ms	2 ms

Table A-11: Settings for Timing Accuracy Checks (Cont.)

SEC/DIV Switch Setting	Normal (X1)	X10 Magnified
50 ms	50 ms	5 ms
A Sweep Only		
0.1 s	0.1 s	10 ms
0.2 s	0.2 s	20 ms
0.5 s	0.5 s	50 ms

Step 2: Check Store Differential and Cursor Time Difference Accuracy

- a. Set: **CH 1 AC-GND-DC** **GND**
Horizontal MODE **A**
A SEC/DIV **0.1 ms**
X10 Magnifier **Off (knob in)**
STORE/NON-STORE **STORE (button in)**
- b. Use the **CH 1 POSITION** control to center the base line vertically and the Horizontal **POSITION** control to align the start of the trace with the 1st vertical graticule line.
- c. Using the **CURSORS** control and **SELECT C1/C2** (push in the **CURSORS** control knob) switch, select one of the two cursors and set it exactly on the 2nd vertical graticule line. Select the other cursor and move it towards the right until the ΔT readout displays 0.800 ms.
- d. CHECK — Graticule indication of cursor difference at the 10th vertical graticule line is within 0.16 division.
- e. Set the **CH 1 AC-GND-DC** switch to **DC**.
- f. Select 0.1 ms time markers from the time-mark generator.
- g. Align the 2nd time marker with the 2nd vertical graticule line using the Horizontal **POSITION** control.
- h. Press in the **SAVE/CONT** button to select **SAVE** for a stable display.
- i. Use the **CURSORS** control and **SELECT C1/C2** (push in the **CURSORS** control knob) switch to set the first cursor on the trailing edge of the 2nd time marker.
- j. Press in the **CURSORS** control knob again to activate the second cursor.
- k. Set the second cursor on the trailing edge of the 10th time marker at the same voltage level as on the 2nd time marker.
- l. CHECK — The ΔT readout is between 0.798 ms and 0.802 ms.
- m. Press in the **SAVE/CONT** button to select **CONT**.

- n. Set the **A SEC/DIV** switch to 0.5 μ s.
- o. Select 0.5 μ s time markers from the time-mark generator.
- p. Align the 2nd time marker with the 2nd vertical graticule line using the Horizontal **POSITION** control.

NOTE

Allow the points to accumulate for a few seconds before saving the display.

- q. Repeat parts h through k.

NOTE

Pulses with fast rise and fall times have only a few sample points and it may not be possible to place the cursors at exactly the same voltage levels.

- r. CHECK — The ΔT readout is between 3.990 μ s and 4.010 μ s.

Step 3: Check Variable Range and Sweep Separation

- a. Set:

A and B SEC/DIV	0.2 ms
SEC/DIV Variable	Fully counterclockwise
STORE/NON-STORE	NON-STORE (button out)
- b. Select 0.5 ms time markers from the time-mark generator.
- c. CHECK — Time markers are one division or less apart.
- d. Set:

CH 1 AC-GND-DC	GND
SEC/DIV Variable	CAL detent
Horizontal MODE	BOTH
B TRIG	Fully clockwise (Runs After Delay)
- e. Use the **CH 1 POSITION** control to set the A Sweep at the center horizontal graticule line.
- f. CHECK — The B Sweep can be positioned more than 3.5 divisions above and below the A Sweep when the **A/B SWP SEP** control is rotated fully clockwise and counterclockwise respectively.

Step 4: Check Delay Time Differential Accuracy

- a. Use the Horizontal **POSITION** control to align the start of the A Sweep with the 1st vertical graticule line.

- b. Set the **B DELAY TIME POSITION** control fully counterclockwise.
- c. CHECK — Intensified portion of the trace starts within 0.5 division of the start of the sweep.
- d. Rotate the **B DELAY TIME POSITION** control fully clockwise.
- e. CHECK — Intensified portion of the trace is past the 11th vertical graticule line.
- f. Set the **A** and **B SEC/DIV** switch to 0.5 μ s.
- g. Repeat parts a through e. When performing step c, check that the trace starts with 1.1 division instead of 0.5 division.
- h. Set:

CH 1 AC-GND-DC	DC
B SEC/DIV	0.05 μ s
B DELAY TIME POSITION	Fully counterclockwise
- i. Select 0.5 us time markers from the time-mark generator.
- j. Rotate the **B DELAY TIME POSITION** control so that the top of the 2nd time marker on the B Sweep is aligned with a selected reference vertical line. Record the **DLY=** readout for part use with part l.
- k. Rotate the **B DELAY TIME POSITION** control fully clockwise until the top of the 10th time marker on the B Sweep is aligned with the same selected reference vertical line as in part k. Record the **DLY=** readout for part use with part l.
- l. CHECK — Delay time readout is within the limits given in Table A-12 (Delay Readout Limits column) by subtracting the delay time reading in part j from part k.
- m. Repeat parts j through l for the remaining **B SEC/DIV** and time-mark generator settings given in Table A-12, check the eight division delay time accuracy for each **A SEC/DIV** switch setting given in column 1 of the table.

Table A-12: Settings for Delay Time Differential Checks

Time-Mark Generator and A SEC/DIV Settings	B SEC/DIV Setting	Eight Division Delay	Delay Readout Limits
0.5 μ s	0.05 μ s	4.000 μ s	3.935 μ s to 4.065 μ s
5 μ s	0.5 μ s	40.00 μ s	39.35 μ s to 40.65 μ s
50 μ s	5 μ s	400.0 μ s	393.5 μ s to 406.5 μ s
0.5 ms	50 ms	4.000 ms	3.935 ms to 4.065 ms
5 ms	0.5 ms	40.00 ms	39.35 ms to 40.65 ms
50 ms	5 ms	400.0 ms	393.5 ms to 406.5 ms
0.5 s	50 ms	4.000 s	3.935 s to 4.065 s

Step 5: Check Delay Jitter

- a. Set:

A SEC/DIV	0.5 ms
B SEC/DIV	1 μ s
- b. Select 0.5 ms time markers from the time-mark generator.
- c. Rotate the **B DELAY TIME POSITION** control to position the intensified zone on the 10th time marker.
- d. Set the Horizontal **MODE** switch to **B**.
- e. CHECK — The jitter on the leading edge of the time marker does not exceed one division. Disregard slow drift.

 Step 6: Check Position Range

- a. Set:

Horizontal MODE	A
A SEC/DIV	10 μ s
- b. Select 10 μ s time markers from the time-mark generator.
- c. CHECK — Start of the sweep can be positioned to the right of the center vertical graticule line by rotating the Horizontal **POSITION** control fully clockwise.
- d. CHECK — The 11th time marker can be positioned to the left of the center vertical graticule line by rotating the Horizontal **POSITION** control fully counterclockwise.
- e. Select 50 μ s time markers from the time-mark generator.
- f. Align the 3rd time marker with the center vertical graticule line using the Horizontal **POSITION** control.
- g. Set the **X10** Magnifier knob to On (knob out).
- h. CHECK — Magnified time marker can be positioned to the left of the center vertical graticule line by rotating the Horizontal **POSITION** control fully counterclockwise.
- i. CHECK — Start of the sweep can be positioned to the right of the center vertical graticule line by rotating the Horizontal **POSITION** control fully clockwise.

 Step 7: Check Store Expansion Range

- a. Set:

A SEC/DIV	0.1 ms
X10 Magnifier	Off (knob in)
- b. Select 10 μ s time markers from the time-mark generator.
- c. Use the Horizontal **POSITION** control to align the start of the A Sweep with the 1st vertical graticule line.
- d. Set the **STORE/NON-STORE** switch to **STORE** (button in).

- e. Set the **X10** Magnifier knob to On (knob out).
- f. CHECK — The time markers are one division apart.

Step 8: Check 4K to 1K Display Compress

- a. Set:

A SEC/DIV	50 μ s
X10 Magnifier	Off (knob in)
1K/4K	4K
- b. Select 0.1 ms time markers from the time-mark generator and check that the time markers are two divisions apart.
- c. Rotate the **SEC/DIV** Variable control out of detent.
- d. CHECK — For two time markers per division over the center eight divisions.

Step 9: Check Non-Store Sweep Length

- a. Set:

SEC/DIV Variable	CAL detent
STORE/NON-STORE	NON-STORE (button out).
- b. Use the Horizontal **POSITION** control to align the start of the A Sweep with the 1st vertical graticule line.
- c. CHECK — End of the sweep is to the right of the 11th vertical graticule line.
- d. Disconnect the test equipment from the instrument.

Step 10: Check X Gain

- a. Set:

X-Y	On (button in)
CH 1 VOLTS/DIV	10 mV
Horizontal POSITION	Midrange
- b. Connect the standard-amplitude signal from the Calibration Generator via a 50 Ω cable to the CH 1 OR X input connector.
- c. Set the generator to produce a 50 mV signal.
- d. Use the **CH 2 POSITION** and Horizontal **POSITION** controls to center the display.
- e. CHECK — Display is 4.85 to 5.15 horizontal divisions.
- f. Disconnect the test equipment from the instrument.

Step 11: Check X Bandwidth

- a. Connect the leveled sine wave generator output via a 50 Ω cable and a 50 Ω termination to the CH 1 OR X input connector.
- b. Set the generator to produce a five division horizontal display at an output frequency of 50 kHz.
- c. Increase the generator output frequency to 2.5 MHz.
- d. CHECK — Display is at least 3.5 horizontal divisions.
- e. Disconnect the test equipment from the instrument.

Trigger System Checks

Equipment Required (see Table A-7):

Calibration Generator	Dual-Input Coupler
Leveled Sine Wave Generator	50 Ω BNC Termination
Low Frequency Generator	600 Ω BNC Termination
50 Ω BNC Cable	10X Attenuator

Initial Control Settings:

Vertical (Both Channels)

POSITION (both)	Midrange
MODE	CH 1
X-Y	Off (button out)
BW LIMIT	Off (button out)
CH 1 VOLTS/DIV	5 mV
CH 2 VOLTS/DIV	50 mV VOLTS/DIV
Variable (both)	CAL detent
INVERT	Off (button out)
AC-GND-DC (both)	DC

Horizontal

POSITION	Midrange
MODE	A
A and B SEC/DIV	0.2 μ s
SEC/DIV Variable	CAL detent
X10 Magnifier	Off (knob in)
B DELAY TIME POSITION	Fully counterclockwise
B Trigger SLOPE	Positive (button out)
LEVEL	Midrange

Trigger

A & B SOURCE	CH 1
-------------------------	-------------

Storage

STORE/NON-STORE	NON-STORE (button out)
------------------------	----------------------------------

Procedure Steps:

Step 1: Check Internal A and B Triggering

- a. Connect the leveled sine wave generator output via a 50 Ω cable and a 50 Ω termination to the CH 1 OR X input connector.
- b. Set the generator to produce a 10 MHz, 3.5 division display.
- c. Set the **CH 1 VOLTS/DIV** switch to 50 mV.
- d. CHECK — Stable display can be obtained by adjusting the A Trigger **LEVEL** control for each switch combination given in Table A-13.
- e. Set the Horizontal **MODE** switch to **B**.

Table A-13: Switch Combinations for A Triggering Checks

A Trigger Mode	A Trigger SLOPE
NORM	Positive
NORM	Negative
P-P AUTO	Negative
P-P AUTO	Positive

- f. CHECK — Stable display can be obtained by adjusting the B Trigger **LEVEL** control in a position other than the **RUNS AFTER DLY** position for both the positive and negative positions of the B Trigger **SLOPE** switch.
- g. Set:

Vertical MODE	CH 2
Horizontal MODE	A
A & B SOURCE	CH 2
- h. Move the cable from the **CH 1 OR X** input connector to the **CH 2 OR Y** input connector.
- i. Repeat parts d through f.
- j. Set:

Horizontal MODE	A
A SEC/DIV	0.1 μs
X10 Magnifier	On (knob out)
- k. Set the generator to produce a 60 MHz, 1.0 division display.
- l. Repeat parts d through f.
- m. Set:

Vertical MODE	CH 1
Horizontal MODE	A
A & B SOURCE	CH 1
- n. Move the cable from the **CH 2 OR Y** input connector to the **CH 1 OR X** input connector.

- o. Repeat parts d through f.
- p. Set:

Horizontal MODE	A
A SEC/DIV	0.05 μ s
- q. Set the generator to produce a 100 MHz, 1.5 division display.
- r. Repeat parts d through f.
- s. Set:

Vertical MODE	CH 2
Horizontal MODE	A
A & B SOURCE	CH 2
- t. Move the cable from the **CH 1 OR X** input connector to the **CH 2 OR Y** input connector.
- u. Repeat parts d through f.
- v. Disconnect the test equipment from the instrument.

Step 2: Check HF Reject A Triggering

- a. Set:

Vertical MODE	CH 1
VOLTS/DIV (both)	50 mV
Horizontal MODE	A
A SEC/DIV	5 μ s
X10 Magnifier	Off (knob in)
A Trigger Mode	NORM
A Trigger LEVEL	Midrange
A & B SOURCE	CH 1
- b. Connect the low frequency generator output via a 50 Ω cable and a 600 Ω termination to the CH 1 OR X input connector.
- c. Set the low frequency generator output to produce a 250 kHz, one division display.
- d. Adjust the A Trigger **LEVEL** control for a stable display.
- e. Set the **A COUPL** switch to **HF REJ** position.
- f. CHECK—Stable display cannot be obtained by adjusting the A Trigger **LEVEL** control for each switch combination given in Table A-13 on page A-46.

Step 3: Check LF Reject A Triggering

- a. Set:

A Trigger LEVEL	Midrange
A COUPL	NORM
- b. Set the generator to produce a 25 kHz, 0.35 division display.
- c. Set the **A COUPL** switch to **LF REJ** position.

- d. CHECK — The display cannot be obtained by adjusting the A Trigger **LEVEL** control.
- e. Set the generator to produce a 50 kHz, 0.35 division display.
- f. CHECK — Stable display can be obtained by adjusting the A Trigger **LEVEL** control.
- g. Disconnect the test equipment from the instrument.

Step 4: Check External Triggering

- a. Set:

CH 1 VOLTS/DIV	5 mV
A SEC/DIV	0.1 μ s
A & B SOURCE	A EXT
A COUPL	NORM
- b. Connect the leveled sine wave generator output via a 50 Ω cable, a 50 Ω termination, and a dual-input coupler to both the **CH 1 OR X** and **EXT INPUT** connectors.
- c. Set the leveled sine wave generator output voltage to 40 mV and the frequency to 10 MHz.
- d. CHECK — Stable display can be obtained by adjusting the A Trigger **LEVEL** control for each switch combination given in Table A-13 on page A-46.
- e. Set:

CH 1 VOLTS/DIV	50 mV
X10 Magnifier	On (knob out)
- f. Set the generator output voltage to 120 mV and the frequency to 60 MHz.
- g. Repeat part d.
- h. Set the generator output voltage to 150 mV and the frequency to 100 MHz.
- i. Repeat part d.

Step 5: Check External Trigger Ranges

- a. Set:

CH 1 VOLTS/DIV	0.5 V
A SEC/DIV	20 μ s
X10 Magnifier	Off (knob in)
A Trigger SLOPE	Positive (button out)
A Trigger Mode	NORM
- b. Set the generator to produce a 50 kHz, 6.4 division display.
- c. CHECK — Display is triggered along the entire positive slope of the waveform as the A Trigger **LEVEL** control is rotated.

- d. CHECK — Display is not triggered (no trace) at either extreme of rotation.
- e. Set the A Trigger **SLOPE** button to Negative (button in).
- f. CHECK — Display is triggered along the entire negative slope of the waveform as the A Trigger **LEVEL** control is rotated.
- g. CHECK — Display is not triggered (no trace) at either extreme of rotation.

Step 6: Check Single Sweep Operation

- a. Adjust the A Trigger **LEVEL** control to obtain a stable display.
- b. Set:

CH 1 AC-GND-DC	GND
A Trigger SLOPE	Positive (button out)
A & B SOURCE	CH 1
A COUPL	NORM
A SEC/DIV	20 ms
- c. Press in the **SGL SWP** button. The **READY** LED should illuminate and remain on.
- d. Set the **CH 1 AC-GND-DC** switch to DC.

NOTE

The A INTENSITY control may require adjustment to observe the single-sweep trace.

- e. CHECK — **READY** LED goes out and a single sweep occurs.
- f. Press in the **SGL SWP** button several times.
- g. CHECK — Single-sweep trace occurs, and the **READY** LED illuminates briefly every time the **SGL SWP** button is pressed in and released.
- h. Disconnect the test equipment from the instrument.

Step 7: Check Acquisition Window Trigger Points

- a. Set:

CH 1 AC-GND-DC	GND
A Trigger Mode	P-P AUTO
A SEC/DIV	0.1 μ s
STORE/NON-STORE	STORE (button in)
Acquisition 1K/4K	1k
- b. Use the Horizontal **POSITION** control to align the start of the display acquisition with the 1st vertical graticule line.

- c. Press in the Acquisition **TRIG POS** button until the store trigger point (T) is located on the left side of the screen.
- d. CHECK — The POST TRIG point (T) is 1.28 divisions from the start of the display acquisition.
- e. Press the **TRIG POS** button a second time to position the trigger point to the middle of the display acquisition.
- f. CHECK — The MIDTRIG point (T) is 5.12 divisions from the start of the display acquisition.
- g. Press the **TRIG POS** button a third time to position the trigger point to the right of the display acquisition.
- h. CHECK — The PRETRIG point (T) is 8.96 divisions from the start of the display acquisition.

Step 8: Check Trigger Level Readout

- a. Set:

Vertical MODE	CH 1
CH 1 VOLTS/DIV	20 mV
CH 1 AC-GND-DC	GND
SEC/DIV	0.5 ms
A Trigger Mode	P-P AUTO
A Trigger LEVEL	Midrange
A Trigger SOURCE	Vertical MODE
STORE/NON-STORE	NON-STORE
	(button out)
- b. Center the trace on the screen.
- c. CHECK — The trigger readout is between -6 mV and $+6$ mV.
- d. Connect the standard-amplitude signal from the calibration generator via a 50Ω cable to the CH1 or \times input connector.
- e. Set:

CH 1 AC-GND-DC	DC
A Trigger Mode	NORM
- f. Set the generator to produce a five division standard-amplitude signal.
- g. Adjust the A Trigger **LEVEL** control for a stable display and center the waveform on the screen.
- h. Set the **CH 1 VOLTS/DIV** switch to 10 mV for a 10 division display.
- i. Vertically position the top of the waveform display on the center horizontal graticule line.
- j. Set the A Trigger **SLOPE** switch to Negative (button in).
- k. Rotate the A Trigger **LEVEL** control clockwise until the triggering of the waveform display becomes unstable.
- l. CHECK — That the trigger readout is between 92 mV and 108 mV.

- m. Repeat procedure for CH 2 using the CH 2 controls.
- n. Disconnect the test equipment from the instrument.

External Z-Axis, Probe Adjust, External Clock, and X-Y Plotter Checks

Equipment Required (see Table A-26):

Leveled Sine Wave Generator	Two 50 Ω BNC Cables
BNC T-Connector Pulse Generator	50 Ω BNC Termination
Digital Voltmeter	BNC male-to-tip plug
10X Probe (provided with instrument)	

Initial Control Settings:

Vertical (Both Channels)

CH 1 POSITION	Midrange
MODE	CH 1
X-Y	Off (button out)
BW LIMIT	Off (button out)
CH 1 VOLTS/DIV	1 V
CH 1 VOLTS/DIV Variable	CAL detent
CH 1 AC-GND-DC	DC

Horizontal

POSITION	Midrange
MODE	A
A SEC/DIV	20 μ s
SEC/DIV Variable	CAL detent
X10 Magnifier	Off (knob in)

A Trigger

VAR HOLDOFF	NORM
Mode	P-P AUTO
SLOPE	Positive (button out)
LEVEL	Midrange
A & B SOURCE	Vertical MODE
A COUPL	NORM
A EXT COUPL	AC

Storage

STORE/NON-STORE	NON-STORE (button out)
------------------------	----------------------------------

Procedure Steps:

Step 1: Check External Z-Axis Operation

- a. Connect the leveled sine wave generator output via a 50 Ω cable and a T-connector to the **CH 1 OR X** input connector. Then connect a 50 Ω cable and a 50 Ω termination from the T-connector to the **EXT Z-AXIS INPUT** connector on the rear panel.

- b. Set the generator to produce a 5 V, 50 kHz signal.
- c. CHECK — For noticeable intensity modulation. The positive part of the sine wave should be of lower intensity than the negative part.
- d. Disconnect the test equipment from the instrument.

Step 2: Check Probe Adjust Operation

- a. Connect the 10X Probe to the **CH 1 OR X** input connector and insert the probe tip into the **PRB ADJ** (Probe Adjust) jack on the instrument front panel. If necessary, adjust the probe compensation for a flat-topped square-wave display.
- b. CHECK — Display amplitude is 4.75 to 5.25 divisions.
- c. Disconnect the probe from the instrument.

Step 3: Check External Clock

- a. Set:

CH 1 VOLTS/DIV	1 V
A SEC/DIV	1 ms
- b. Connect the Pulse Generator high amplitude output via a 50 Ω cable and a 50 Ω termination to **CH 1 OR X** input connector.
- c. Set the generator to produce a 10 μs square wave, with a pulse duration of 5 μs. Set the amplitude for a five division display, with a base (bottom) of 0 volts and a top of 5 volts (TTL levels).
- d. Disconnect the cable from the **CH 1 OR X** input connector and connect it to the BNC male-to-tip plug via BNC female to BNC female connector.
- e. Insert the BNC male-to-tip plug signal lead and ground lead into pin 1 (**EXT CLOCK**) and pin 6 (**SIG GND**) respectively of the X-Y Plotter connector.
- f. Set the **A SEC/DIV** switch to 0.1 sec.
- g. Connect the Calibration Generator high amplitude output via a 50 Ω cable and a 50 Ω termination to **CH 1 OR X** input connector.
- h. Set the generator to produce a 100 Hz, five division display.
- i. Set:

A SEC/DIV	EXT CLK
STORE/NON-STORE	STORE (button in)
- j. Press the Setup **ACQ** button to display the **ACQUISITION** menu and select Fast with the Ext Clock button. Return the instrument to display mode by pressing the Setup **ACQ** button a second time.
- k. CHECK — The 100 Hz signal is displayed on the screen and updated.
- l. Press in the **SAVE/CONT** button to select **SAVE**.

- m. CHECK — The display is save.
- n. Press in the **SAVE/CONT** button to select **CONT**.
- o. Disconnect the test equipment from the instrument.

Step 4: Check X-Y Plotter

- a. Set the **A SEC/DIV** switch to 10 ms.
- b. Connect the digital voltmeter low lead to either chassis ground or pin 7 (signal ground) of the X-Y Plotter connector. Connect the volts lead to pin 3 (X Output) of the X-Y Plotter connector.
- c. Set the digital voltmeter to the 20 V scale.
- d. Press the Setup **PLOT** button to display the **PLOT** menu. Set **Plotter Type** to **XY**, **Grat** to **ON**, and **Auto Plot** to **OFF**. Use the **CURSORS** knob to set **Plot Speed** to 10.
- e. Press in the **Start** button to activate the X-Y Plotter.

NOTE

Voltage reading of the X Output will be negative left of the center vertical graticule line and positive to the right of the center vertical graticule line. Voltage reading of the Y output will be negative below the center horizontal graticule line and positive above the center horizontal graticule line.

- f. Record the voltage reading as the instrument plots the 1st and the 10th graticule line (as the intensity spot moves along the graticule line).
- g. CHECK — The voltage difference between the 1st and 10th graticule line is between 4.0 V and 6.0 V.
- h. Move the volts lead of the voltmeter from pin 3 (X Output) to pin 5 (Y Output) to the X-Y Plotter connector.
- i. Press the Start button in again to activate the X-Y Plotter.
- j. Record the voltage reading as the instrument plots the top and the bottom of the graticule lines (as the intensity spot moves along the graticule line).
- k. CHECK — The voltage difference between the top and bottom graticule line is between 3.2 V and 4.8 V.
- l. Disconnect the test equipment from the instrument.



Appendix D: Storage Modes

The SEC/DIV and trigger mode settings determine the storage mode and corresponding set of available acquisition modes.

Table A-14: Storage Modes

SEC/DIV Setting	Trigger Mode	Resultant Storage Mode	Available Acquisition Modes ¹	Auto Vectors ^{1,2}
0.05 μ s/div to 0.5 μ s /div (or 0.05 to 0.2 μ s/div in ALT or CHOP Vertical Mode)	Any	Repetitive	AVERAGE SAMPLE ACCPEAK	OFF/ON
1 μ s/div to 2 μ s/div (or 0.5 μ s/div to 2 μ s/div in ALT or CHOP Vertical Mode)	Any	Fast Record	SAMPLE ACCPEAK AVERAGE	ON/OFF
5 μ s/div to 50 ms/div (or EXT CLK, Fast Mode: DC to 100 kHz) ³	Any	Slow Record	PEAKDET ACCPEAK SAMPLE AVERAGE	ON/OFF
0.1 s/div to 5 s/div (or EXT CLK, Slow Mode: DC to 1 kHz) ³	NORM	Triggered Scan ⁴	PEAKDET ACCPEAK SAMPLE AVERAGE	ON/OFF
	P-P AUTO	Untriggered Scan ⁴	PEAKDET SAMPLE	ON/OFF
	SGL SWP	Scan-roll-Scan ^{4,6}		
	P-P AUTO and NORM	Roll ⁵		
	SGL SWP	Triggered Roll ⁵		

¹The default modes for Acquisition and Auto Vectors are in bold face.

²In X-Y mode, Auto Vectors are turned off.

³External clock speed range is selected in the ACQUISITION menu.

⁴Scan is selected in the ACQUISITION menu.

⁵Roll is selected in the ACQUISITION menu.

⁶Storage mode is Triggered Scan if ACCPEAK or AVERAGE Acquisition mode is selected.



Glossary

Accumulate peak acquisition mode

A mode in which the oscilloscope acquires and displays a waveform that shows the variation extremes of several acquisitions.

Accuracy

The closeness of the indicated value to the true value.

Acquisition

The process of sampling signals from input channels, digitizing the samples into data points, and assembling the data points into a waveform record. The waveform record is stored in memory. The trigger marks time zero in that process.

Acquisition interval

The time duration of the waveform record divided by the record length. The oscilloscope displays one data point for every acquisition interval.

AC signal

The time-variant portion of voltage or current.

Active cursor

The cursor that moves when you turn the cursor knob. It is indicated in the display by a cursor with a box around it.

Aliasing

A false representation of a signal due to insufficient sampling of high frequencies or fast transitions. A condition that occurs when an oscilloscope digitizes at an effective sampling rate that is too slow to reproduce the input signal. The waveform displayed on the oscilloscope may have a lower frequency than the actual input signal.

Alternate (vertical)

A vertical mode of operation for a dual-trace oscilloscope. The oscilloscope makes a complete sweep of first one channel and then the other. This mode is generally used for SEC/DIV settings of less (or faster) than 1ms/div.

Alternating Current (AC)

An electric current whose instantaneous value and direction change periodically.

Amplitude

The difference between a high and a low point on a waveform. Signal amplitude can be measured in terms of "peak-to-peak" or "peak" for example.

Attenuation

The degree the amplitude of a signal is reduced when it passes through an attenuating device such as a probe or attenuator. That is, the ratio of the input measure to the output measure. For example, a 10X probe will attenuate, or reduce, the input voltage of a signal by a factor of 10.

Automatic trigger mode (P-P AUTO)

A trigger mode that causes the oscilloscope to automatically acquire or sweep if triggerable events are not detected within a specified time period.

Bandwidth

For an oscilloscope, bandwidth is the specified frequency range of the vertical system wherein the vertical response is greater than or equal to 0.707 (-3 db) of the specified frequency down to DC or 0 Hz.

Bezel

The frame around the CRT that holds the implosion shield in place.

Bezel Buttons

The buttons on the bezel that are used to store waveforms or make menu selections.

Cathode-ray tube (CRT)

An electron-beam tube in which the beam can be focused to a small cross section on a luminescent screen and varied in both position and intensity to produce a visible pattern.

Chop

A vertical mode of operation for dual-trace oscilloscopes in which the display is switched or sampled between the channels at some fixed rate. Chop is generally used at sweep speeds slower than 0.5 ms/div.

CRT

An acronym for the display device of the oscilloscope: **Cathode-Ray Tube**.

Compensation

In relation to oscilloscope probes, compensation is the act of adjusting the resistive and capacitive components of the probe to offset undesirable characteristics of both the probe and the input channel. Probe compensation ensures fidelity of the input signal.

Coupling

The method of connecting the input circuit to the signal source. A coupling circuit, for example, may pass only AC signals above a certain frequency or it may attenuate the signal by some designated factor.

Cursors

Paired markers that you can use to make measurements between two waveform locations. The oscilloscope displays the values (expressed in volts or time) of the difference between the two cursors.

Delay measurement

The difference in time between two points using a dual time base instrument.

Detent

A mechanical setting or switch position typified by a gradual increase in force to a position at which there is an immediate and marked reduction in force.

Digitizing

The process of converting a continuous analog signal such as a waveform to a set of discrete numbers representing the amplitude of the signal at specific points in time. Digitizing is composed of two steps: sampling and quantizing.

Direct current (DC)

An electric current that flows in only one direction with essentially constant value.

Display system

The part of the oscilloscope that shows waveforms, measurements, menu items, status, and other parameters.

Display menu

The setup menu on the 2232 Digital Storage Oscilloscope that allows the user to select the type of cursor time readout, digital smoothing, or data-point vectors.

Fall time

A measurement of the time it takes for trailing edge of a pulse to fall from 90% to 10% of its amplitude.

Frequency

A timing measurement that is the reciprocal of the period. Measured in Hertz (Hz) where 1 Hz = 1 cycle per second.

Ground

A connection or reference to the zero voltage potential of earth ground.

GPB (General Purpose Interface Bus)

An interconnection bus and protocol that allows you to connect multiple instruments in a network under the control of a controller. Also known as IEEE 488 bus. It transfers data with eight parallel data lines, five control lines, and three handshake lines.

Graticule

A grid on the display screen that creates the horizontal and vertical axes. You can use it to visually measure waveform parameters.

Hardcopy

An electronic copy of the display in a format useable by a printer or plotter.

Hertz

The unit of frequency, one cycle per second.

Holdoff, trigger

A specified amount of time after a trigger signal that elapses before the trigger circuit will accept another trigger signal. Holdoff helps to stabilize the display of a signal that is otherwise difficult to trigger.

Intensity

Display brightness.

Knob

A rotary control.

Megahertz (MHz)

A frequency of one million Hz (cycles per second), or 10^6 Hz.

Megasample per second (Ms/s)

One million (10^6) samples per second.

Noise

An unwanted voltage or current in an electrical signal.

Oscilloscope

An instrument for making a graph of two factors. These are typically voltage versus time.

Peak

The difference in amplitude between the maximum value and the average or mean value of a waveform.

Peak-to-Peak

Amplitude measurement of the absolute difference between the maximum and minimum amplitude.

Period

A timing measurement of the time covered by one complete signal cycle. It is the reciprocal of frequency and is measured in seconds.

Phase

A timing measurement between two waveforms of the amount one leads or lags the other in time. Phase is expressed in degrees, where 360° comprises one complete cycle of one of the waveforms. Waveforms measured should be of the same frequency or one waveform should be a harmonic of the other.

Probe

An oscilloscope input device.

Quantizing

The process of converting an analog input that has been sampled, such as a voltage, to a digital value.

Record length

The specified number of samples in a waveform.

Reference memory

Memory in a oscilloscope used to store waveforms or settings. The digital storage oscilloscope saves the data even when the oscilloscope is turned off or unplugged.

Repetitive acquisition

The particular mode on the instrument at the faster sweep speeds where numerous acquisitions are required to form a picture of the waveform because of the limits imposed by the sampling rate.

Repetitive signal

A signal that varies uniformly in terms of voltage over time.

Rise time

The time it takes for a leading edge of a pulse to rise from 10% to 90% of its amplitude.

Roll

A slow-speed storage mode where the acquired data first appears at the right side of the display and forms a record that continues to scroll right to left across the display at a rate set by the time base.

RS-232-C interface

A communications device that conforms to the Electronic Industries Association (EIA) RS-232-C standard for data terminal or data communications equipment.

Sampling

The internal process of the oscilloscope that captures an analog input (such as a voltage) at a discrete point in time and holds it constant until it is quantized. Two general methods of sampling are: *real-time sampling* and *equivalent-time sampling*.

Sampling Rate

This is the actual frequency at which the oscilloscope takes a sample. This frequency may be expressed in samples/second or hertz.

Scan

A slow-speed storage mode that updates the acquisition display left to right across the display at a rate determined by the time base setting.

Selected waveform

The waveform on which cursor measurements are performed. The “—” symbol underscores the selected memory location indicated by 1, 2, 3, or 4K. The symbol appears under the letter “A” when the waveform selected is the current acquisition.

Setup (menus)

A group of related controls for major oscilloscope functions that are located on the front panel of the oscilloscope above the intensity control.

Slope

The rising or falling edge of a signal (signal transition) that is selected for triggering the horizontal sweep of the oscilloscope.

Smooth

A digital process that examines the change in value of data points between adjacent intervals and reorders them for correct slope (and a smoother waveform) if the change in value does not exceed a certain limits.

Sweep

Time-dependent information created by the electron beam moving across a CRT screen.

Time base

The set of parameters that let you define the time and horizontal axis attributes of a waveform.

Trace

The visual representation of an individual signal on a CRT.

Trigger

The signal used to initiate a sweep or acquisition on an oscilloscope.

Trigger level

The vertical level the trigger signal must cross to generate a trigger.

Trigger position

The position of the trigger reference point in the acquisition record.

Vector

A line created by the storage mode display system of the oscilloscope that connects two data points.

Waveform

The shape or form (visible representation) of a signal.

X-Y

A display mode that compares the voltage levels of two signals. One signal drives the horizontal or "X" axis and the other signal drives the vertical or "Y" axis. It is useful for studying phase relationships between two waveforms.

Z-Axis

The intensity aspect of an electron-beam (CRT) display. Z-Axis may also refer to the circuitry that controls the CRT beam intensity.



Numbers

- 1K/4K, 3-15
- 1K/4K button
 - described, 2-21
 - located, 2-21
- 4K Compress, 3-16

A

- A BOTH B** switch
 - described, 2-15
 - located, 2-14
- A COUPL** switch
 - described, 2-19
 - located, 2-18
- A EXT COUPL** switch
 - described, 2-17
 - located, 2-16
- A SEC/DIV** switch
 - described, 2-15
 - located, 2-14
- A&B SOURCE** switch
 - described, 2-19
 - located, 2-18
- A/B SWP SEP** knob
 - described, 2-11
 - located, 2-10
- AC coupling, 3-2
- AC signal, defined, G-1
- Accessories, optional, List of, A-3
- Accessories, standard, List of, A-2
- Accumulate Peak acquisition mode
 - defined, G-1
 - when to use, 3-13
- Accuracy, defined, G-1
- Acquisition
 - defined, G-1
 - Interval, defined, G-1
- ACQUISITION** button, menu, 2-26, 2-28

- Acquisition menu
 - Acq Mode**, 2-26
 - Cursor Knob Func**, 2-27
 - Ext Clock**, 2-27
 - Reset Default Acq Modes**, 2-27
 - Roll/Scan**, 2-27
 - shown, 2-26

- Acquisition mode
 - Accumulate Peak, 3-8, 3-13
 - Average, 3-8, 3-14
 - Peak Detect, 3-9, 3-13
 - Sample, 3-8, 3-14
 - selecting, 3-9

Active cursor, defined, G-1

- ADD ALT CHOP** switch
 - description, 2-11
 - located, 2-10

ADV FUNCT button, menu, 2-33

- Advanced Functions menu
 - Comm Menu**, 2-33
 - Diag Menu**, 2-33
 - Factory Reset**, 2-33
 - Save Setup Menu**, 2-33
 - Save Setup Menu** submenu
 - Pwr Up State**, 2-34
 - Recall Setup**, 2-35
 - Save Setup**, 2-35
 - Select Setup**, 2-34
 - shown, 2-33

- Aliasing
 - defined, G-1
 - preventing, 3-18
 - symptoms of, 3-18

Alternate Current, defined, G-1

Alternate mode, defined, G-1

Amplitude, defined, G-1

Attenuation, defined, G-1

Automatic trigger mode, defined, G-2

Average mode, when to use, 3-14

B

- B DELAY TIME POSITION** knob
 - described, 2-15
 - located, 2-14

- B SEC/DIV** switch
 - described, 2-15
 - located, 2-14

Bandwidth

- defined, G-2
- limiting, 3-25

Bandwidth Limit, 3-25

- BEAM FIND** button
 - described, 2-9
 - location, 2-8

Bezel, defined, G-2

Bezel buttons, defined, G-2

Button

- POWER**, 1-4, 2-4
- STORE/NONSTORE**, 2-6

- BW LIMIT** button
 - described, 2-11
 - located, 2-10

C

- CAL** switch
 - described, 2-13
 - located, 2-12

Cautions and Warnings, definitions, 1-1

- CH 1 BOTH CH 2** switch
 - described, 2-13
 - located, 2-12

- CH 1 COUPLING** switch
 - described, 2-13
 - located, 2-12

CH 1 OR X input BNC, located, 2-12

CH 1 OR X input connector, described, 2-13

- CH 1 POSITION** knob
 - described, 2-11
 - located, 2-10

- CH 1 VOLTS/DIV** switch
 - described, 2-13
 - located, 2-12

- CH 2 CAL** knob
 - described, 2-11
 - location, 2-10

- CH 2 COUPLING** switch
described, 2-13
located, 2-12
- CH 2 OR X BNC**, located, 2-12
- CH 2 OR X** input connector, described, 2-13
- CH 2 POSITION** knob
described, 2-11
located, 2-10
- CH 2 VOLTS/DIV** knob
described, 2-11
located, 2-10
- Characteristics, Table of, A-8
- Chop mode, defined, G-2
- Clocking, external, 3-15
- Complex signals, triggering on, 3-28
- Connector
- CH 1 OR X BNC**
described, 2-13
located, 2-12
 - CH 2 OR X BNC**
described, 2-13
located, 2-12
 - EXT INPUT BNC**, described, 2-19
 - GND** jack
described, 2-13
located, 2-12
 - PRB ADJ** (probe adjust)
described, 2-13
located, 2-12
- Control
- 1K/4K** button
described, 2-21
located, 2-21
 - A BOTH B** switch
described, 2-15
located, 2-14
 - A COUPL** switch
described, 2-19
located, 2-18
 - A EXT COUPL** switch
described, 2-17
located, 2-16
 - A SEC/DIV** switch
described, 2-15
located, 2-14
 - A&B SOURCE** switch
described, 2-19
located, 2-18
 - A/B SWP SEP** knob
described, 2-11
located, 2-10
- ACQ** button, located, 2-25
- ACQUISITION** button, menu, 2-26, 2-28
- ADD ALT CHOP** switch
description, 2-11
located, 2-10
- ADV FUNCT** button
located, 2-25
menu, 2-33
- B DELAY TIME POSITION** knob
described, 2-15
located, 2-14
- B SEC/DIV** switch
described, 2-15
located, 2-14
- BEAM FIND** button
described, 2-9
location, 2-8
- BW LIMIT** button
described, 2-11
located, 2-10
- CAL** switch
described, 2-13
located, 2-12
- CH 1 BOTH CH 2** switch
described, 2-13
located, 2-12
- CH 1 COUPLING** switch
described, 2-13
located, 2-12
- CH 1 POSITION** knob
described, 2-11
located, 2-10
- CH 1 VOLTS/DIV** switch
described, 2-13
located, 2-12
- CH 2 CAL** knob
described, 2-11
located, 2-10
- CH 2 COUPLING** switch
described, 2-13
located, 2-12
- CH 2 POSITION** knob
described, 2-11
located, 2-10
- CH 2 VOLTS/DIV** knob
described, 2-11
located, 2-10
- CURSORS** knob
described, 2-20
located, 2-20
- DISPLAY** button, located, 2-25
- FOCUS** knob
described, 2-9
location, 2-8
- GRATICULE** knob
described, 2-9
location, 2-8
- INTENSITY A** knob
described, 2-9
location, 2-8
- INTENSITY B** knob
described, 2-9
location, 2-8
- INTENSITY STORE/READOUT** knob
described, 2-9
location, 2-8
- INVERT** button
described, 2-11
located, 2-10
- layout of, 2-1
- LEVEL** knob (A Trigger)
described, 2-17
located, 2-16
- LEVEL** switch (B Trigger)
described, 2-19
located, 2-18
- MODE** button (Acquisition)
described, 2-21
located, 2-21
- NORM** button
described, 2-17
located, 2-16
- P-P AUTO/TV LINE** button
described, 2-17
located, 2-16
- PLOT** button
located, 2-25
menu, 2-31
- POSITION** (Horizontal) knob
described, 2-15
located, 2-14
- REF** button
Format menu, 2-29
NVmem menu, 2-30
- SAVE REF** buttons
described, 2-22
located, 2-22
- SAVE/CONT** button
described, 2-21
located, 2-21
- SELECT WAVEFORM** button,
described, 2-20
- SGL SWP** switch
described, 2-19
located, 2-18
- SLOPE** button (B Trigger)
described, 2-17
located, 2-16
- SLOPE** switch (A Trigger)
described, 2-19
located, 2-18
- TRACE ROTATION** adjustment
described, 2-9
location, 2-8

TRIG POS button
described, 2-21
located, 2-21

VAR HOLDOFF knob
described, 2-17
located, 2-16

X10 (STORE ONLY) switch
described, 2-15
located, 2-14

X10 PULL knob
described, 2-15
located, 2-14

XY button
described, 2-11
located, 2-10

Coupling
channel input, 3-2
defined, G-2

CRT, defined, G-2

Cursors
defined, G-2
measuring time with, 3-37-3-38
measuring voltage with, 3-34-3-44

CURSORS knob
described, 2-20
located, 2-20

D

DC (direct current), defined, G-3

Definition
Accumulate Peak mode, 3-8
Average mode, 3-8
Peak Detect mode, 3-9
Sample mode, 3-8

Definitions, Glossary of, G-1

Delay measurement, defined, G-2

Description, display graticule, 2-5

Description, product, vii, A-5

Detent, defined, G-2

Digital storage system, described, A-6

Digitizing, 3-8
defined, G-3

Display
basic setup, 1-4, 3-3
CRT, A-20
Digital Readout, A-18
Digital Storage, A-17
focus, setting, 3-6

intensity
modulating externally, 3-25
setting, 3-6

Non-Store readouts, 2-6
readouts, 2-7
selecting mode, 3-3

Display menu
defined, G-3
Delta Time, 2-28
Frequency, 2-28
shown, 2-28
Smooth, 2-28
Vector, 2-28

Display system, defined, G-3

Displaying signals, 3-1-3-32

E

Envelope acquisition mode. See
Accumulate Peak acquisition mode

EXT INPUT BNC, described, 2-19

External clock, 3-15

External signals, triggering on, 3-29

F

Fall time
defined, G-3
measuring, 3-40

Focus, setting, 3-6

FOCUS knob
described, 2-9
location, 2-8

Format Reference menu
Cursor Knob Func, 2-29
Format, 2-29
Horiz Mag, 2-29
shown, 2-29
Target, 2-29

Frequency
defined, G-3
measuring with cursors, 3-39

Front Panel
layout of control sections, 2-1
left-side view, 2-2
right-side view, 2-3

Fuse, 1-4

G

Glitch detection, in peak detect, 3-13

GND connector, described, 2-13

GND jack, located, 2-12

GPIB, defined, G-3

GPIB Interface, option described, A-1

GPIB Option, A-21

Graticule
defined, G-3
described, 2-5
illustrated, 2-5
measuring time with, 3-37-3-38
measuring voltage with, 3-34-3-44

GRATICULE knob
described, 2-9
location, 2-8

Ground, defined, G-3

H

Hardcopy
defined, G-3
plotting or printing, 3-52

Hertz, defined, G-3

Holdoff, trigger, defined, G-3

Horizontal
selecting mode, 3-4
setting scale, 3-4

Horizontal system
described, A-5
Performance verification of, A-37

I

Installation, 1-3

Intensity
defined, G-3
modulating, 3-25
setting, 3-6

INTENSITY A knob
described, 2-9

Index

- location, 2-8
 - INTENSITY B** knob
 - described, 2-9
 - location, 2-8
 - INTENSITY STORE/READOUT** knob
 - described, 2-9
 - location, 2-8
 - Interface
 - auxiliary connection, 3-52
 - GPIB, G-3
 - described, A-1
 - GPIB (optional), 3-51
 - RS-232-C
 - defined, G-5
 - described, A-1
 - RS-232-C (optional), 3-51
 - Interface, user, described, A-6
 - International Power Cords, option
 - described, A-1
 - INVERT** button
 - described, 2-11
 - located, 2-10
-
- K**
- Knob, defined, G-3
-
- L**
- LEVEL** knob (A Trigger)
 - described, 2-17
 - located, 2-16
 - LEVEL** switch (B Trigger)
 - described, 2-19
 - located, 2-18
 - Line-frequency signals, triggering on, 3-29
 - List
 - of optional accessories, A-3
 - of standard accessories, A-2
 - Long-term memory, 3-47
 - protecting, 3-48
 - saving waveforms in, 3-47
 - Low frequency signals, triggering on, 3-27

M

- Magnified sweeps, selecting, 3-19
- Measurement
 - Amplitude, G-1
 - Delay, defined, G-2
 - Frequency, G-3
 - Peak to peak, G-4
 - Period, G-4
 - Phase, 3-42, G-4
 - Rise time, G-5
- Measurement features, described, A-7
- Measuring signals, 3-33-3-44
- Memory, A-20
 - SAVE REF, 3-45
- Memory,
 - long term, 3-47
 - non-volatile, 3-47
- Menu
 - Acquisition
 - Acq Mode**, 2-26
 - Cursor Knob Func**, 2-27
 - Ext Clock**, 2-27
 - Reset Default Acq Modes**, 2-27
 - Roll/Scan**, 2-27
 - shown, 2-26
 - Advanced Functions
 - Comm Menu**, 2-33
 - Diag Menu**, 2-33
 - Factory Reset**, 2-33
 - Save Setup Menu**, 2-33
 - Advanced Functions menu, shown, 2-33
 - Display
 - Delta Time**, 2-28
 - Frequency**, 2-28
 - shown, 2-28
 - Smooth**, 2-28
 - Vector**, 2-28
 - Format Reference
 - Cursor Knob Func**, 2-29
 - Format**, 2-29
 - Horiz Mag**, 2-29
 - shown, 2-29
 - Target**, 2-29
 - NVmem Reference
 - Copy Source to Dest**, 2-30
 - Cursor Knob Func**, 2-31
 - Delete Dest**, 2-31
 - NVmem**, 2-30
 - Protect Dest**, 2-30
 - shown, 2-30
- PLOT**, 3-53

Plot

- Auto Plot**, 2-32
- Plotter Type**, 2-31
 - shown, 2-31
- Start**, 2-32
- XY Setup**, 2-32
 - Save Setup (sub), shown, 2-34
- MHz (Megahertz), defined, G-4
- Mode, Display (Store/Nonstore), 2-6
- MODE** button (Acquisition)
 - described, 2-21
 - located, 2-21
- Ms/s (Megasample per second),
 - defined, G-4

N

- Noise, defined, G-4
- Non-repetitive signals, triggering on, 3-28
- Non-volatile memory, 3-47
 - protecting, 3-48
 - saving waveforms in, 3-47
- NORM** button
 - described, 2-17
 - located, 2-16
- NVmem Reference menu
 - Copy Source to Dest**, 2-30
 - Cursor Knob Func**, 2-31
 - Delete Dest**, 2-31
 - NVmem**, 2-30
 - Protect Dest**, 2-30
 - shown, 2-30

O

- Options
 - GPIB Interface, A-1
 - International Power Cords, A-1
 - List of, A-1
 - Rackmount, description, A-2
 - RS-232-C Interface, A-1
 - Travel Line, description, A-2
- Oscilloscope, defined, G-4

P

- P-P AUTO mode, defined, G-2

- P-P AUTO/TV LINE** button
 - described, 2-17
 - located, 2-16
- Peak, defined, G-4
- Peak Detect
 - view signal glitches with, 3-13
 - when to use, 3-13
- Peak to peak, defined, G-4
- Performance Conditions, A-7
- Performance Requirements, Table of, A-8
- Performance Verification, A-25–A-54
 - Horizontal system checks, A-37
 - 4K to 1K display compress, A-44
 - non-store sweep length, A-44
 - position range, A-43
 - store differential and cursor time difference accuracy, A-40
 - store expansion range, A-43
 - timing accuracy and linearity, A-38
 - X Bandwidth, A-45
 - X gain, A-44
- Initial setup procedure, A-28
- Interval, A-25–A-54
- Limits and tolerances, A-25
- Miscellaneous, external Z-axis operation, A-51
- Miscellaneous Checks
 - XY plotter, A-53
 - external clock, A-52
 - probe adjust operation, A-52
- Purpose, A-25–A-54
- Test equipment required, A-26
- Trigger system checks, A-45
 - acquisition window trigger points, A-49
 - external trigger ranges, A-48
 - external triggering, A-48
 - HF reject A triggering, A-47
 - internal triggering, A-46
 - LF reject A triggering, A-47
 - single sweep operation, A-49
 - trigger level readout, A-50
- Vertical system checks, A-28
 - acquisition position registration, A-32
 - bandwidth, A-33
 - bandwidth limit operation, A-34
 - common-mode rejection ratio, A-35
 - deflection accuracy and variable range, A-29
 - non-store and store channel isolation, A-36
 - position range, A-32
 - repetitive store mode and bandwidth, A-33
 - save expansion and compression, A-31
 - single sweep sample acquisition, A-34
 - store deflection accuracy, A-30
 - store pulse width amplitude, A-36
- Period, defined, G-4
- Phase
 - defined, G-4
 - measuring, 3-42
- PLOT** button, menu, 2-31
- Plot menu
 - Auto Plot**, 2-32
 - Plotter Type**, 2-31
 - shown, 2-31
 - Start**, 2-32
 - XY Setup**, 2-32
- Plotting, automatically, 3-54
- Plotting waveforms, 3-52
 - compatible plotters, 3-53
- POSITION** (Horizontal) knob
 - described, 2-15
 - located, 2-14
- Positioning, trigger point in record, 3-17
- Pouch, installing, 1-7
- Power
 - cord, 1-2
 - fuse, 1-2
 - source, 1-2
- Power connector, 1-4
- Power Cord, wrapping for transportation, 1-8
- Power on, 1-3
- Power Supply, A-20
- PRB ADJ** connector
 - described, 2-13
 - located, 2-12
- Precharging, of input channel, 3-2
- Printing waveforms, 3-52
- Probe
 - defined, G-4
 - low-frequency compensation, 1-6
- Probe Adjust, A-19
- Probe,
 - connecting, 3-1
 - description of, 3-1
- Procedure
 - adding two signals, 3-20
 - adjust trace rotation, 1-5
 - capturing random events, 3-12
 - comparing two signals, 3-20
 - compressing 4K records, 3-16
 - connecting probe, 3-1
 - connecting signals, 3-1
 - coupling signals, 3-2
 - displaying magnified sweeps, 3-19
 - displaying XY patterns, 3-23
 - finding "lost" displays, 3-7
 - formatting saved waveforms, 3-46
 - installation, 1-3
 - installing the accessory pouch, 1-7
 - measuring amplitude. *See measuring voltage*
 - measuring fall time, 3-40
 - measuring frequency, 3-39
 - measuring phase, 3-42
 - measuring rise time, 3-40
 - measuring time, 3-37–3-44
 - measuring voltage, 3-34–3-44
 - power cord wrap, 1-8
 - power on, 1-3
 - precharging input channel, 3-2
 - probe compensation, 1-6
 - recalling a waveform, 3-46
 - rejecting common mode signals, 3-20
 - saving and recalling setups, 3-49
 - saving and recalling waveforms, 3-45
 - saving the current acquisition, 3-45
 - saving waveforms in SAVE REF memory, 3-45
 - selecting acquisition mode, 3-9
 - selecting display mode, 3-3
 - selecting horizontal mode, 3-4
 - selecting record length, 3-15
 - selecting trigger mode, 3-4
 - selecting vertical mode, 3-5
 - setting display focus, 3-6
 - setting display intensity, 3-6
 - setting horizontal scale, 3-4
 - setting trigger position, 3-18
 - setting up display, 1-4, 3-3
 - setting vertical scale, 3-5
 - start up, 1-3

Index

- subtracting two signals, 3-20
 - time measurement using delay, 3-38
 - triggering on signals
 - complex, 3-28
 - external, 3-29
 - low frequency, 3-27
 - non-repetitive, 3-28, 3-29
 - repetitive, 3-26
 - TV, 3-29
 - using Runs After Delay, 3-22
 - viewing slow signals, 3-10
- Product description, *vii*, A-5
- Protection, optional impact, A-2

Q

- Quantizing, defined, G-4

R

- Rackmount, option described, A-2
- Rackmounting, optional impact, A-2
- Random event signals, triggering on, 3-12
- Readout, symbols in, 2-7
- Readouts
 - Non-Store, 2-6
 - Store, 2-7
- Record length
 - defined, G-4
 - selecting, 3-15
- REF** button
 - Format menu, 2-29
 - NVmem menu, 2-30
- Reference memory, defined, G-4
- Repetitive acquisition, defined, G-4
- Repetitive signal
 - defined, G-4
 - triggering on, 3-26
- Repetitive store mode, selecting, 3-9
- Rise time
 - defined, G-5
 - measuring, 3-40
- Roll mode, defined, G-5
- Roll store mode, selecting, 3-10

- RS-232-C interface, A-21
 - defined, G-5
 - option described, A-1
- Runs After Delay, selecting, 3-22

S

- Safety, 1-1
 - Covers or Panels, 1-2
 - Explosive Atmosphere, 1-2
 - grounding, 1-2
 - power fuse, 1-2
- Sample mode, 3-14
- Sampling
 - defined, G-5
 - rate, defined, G-5
- SAVE REF** buttons
 - described, 2-22
 - located, 2-22
- SAVE REF memory, 3-45
 - saving waveforms in, 3-45
- Save Setup submenu, shown, 2-34
- SAVE/CONT** button
 - described, 2-21
 - located, 2-21
- Saved waveforms
 - comparing, 3-46
 - deleting, 3-48
 - positioning and scaling, 3-46
 - protecting from overwriting, 3-48
 - recalling, 3-46
- Saving and Recalling
 - Setups, 3-49
 - waveforms, 3-45
- Saving setups, 3-45–3-50
- Saving waveforms, 3-45–3-50
- Scan mode
 - defined, G-5
 - selecting, 3-9
- SELECT WAVEFORM** button, described, 2-20
- Selected waveform, defined, G-5
- Setup
 - default at power up, 3-49
 - power down state at power up, 3-50
 - recalling at power up, 3-49
 - recalling from memory, 3-49
 - saving, 3-49
 - Setup1 at power up, 3-50
 - Setup2 at power up, 3-50

- Setup buttons
 - See also *individual button name*
 - defined, G-5

- Setups
 - saving, 3-45–3-50
 - Saving and Recalling, 3-49

- SGL SWP** switch
 - described, 2-19
 - located, 2-18

- Signals
 - adding, 3-20
 - capturing random event, 3-12
 - comparing, 3-20
 - connecting, 3-1
 - digitizing, 3-8
 - displaying, 3-1–3-32
 - measuring, 3-33–3-44
 - rejecting common mode, 3-20
 - subtracting, 3-20
 - triggering on, 3-26, 3-28
 - triggering on line-frequency, 3-29
 - triggering on non-repetitive, 3-28
 - triggering on external, 3-29
 - triggering on low-frequency, 3-27
 - triggering on TV, 3-29
 - viewing slow, 3-10

- Slope, defined, G-5

- SLOPE** button (B Trigger)
 - described, 2-17
 - located, 2-16

- SLOPE** switch (A Trigger)
 - described, 2-19
 - located, 2-18

- Smooth, defined, G-5

- Specification, A-5

- Start up, 1-3

- Storage mode
 - fast record, A-55
 - repetitive, 3-9, A-55
 - roll, 3-10, A-55
 - scan, 3-9, A-55
 - slow record, A-55

- Sweep, defined, G-5

- Switch
 - AC-GND-DC**, 3-2
 - POWER**, 2-4

- Symbols, in readout, 2-7

- System
 - Horizontal Deflection, A-14
 - Trigger, A-12

T

- Test equipment, A-26

Time
 cursor measurements of, 3-37–3-38
 graticule measurements of,
 3-37–3-38
 measuring with B Delay mode, 3-38

Time base, defined, G-5

Trace, defined, G-6

Trace rotation, 1-5

TRACE ROTATION adjustment
 described, 2-9
 location, 2-8

Transmitting waveforms, 3-51–3-54

Travel Line, option described, A-2

TRIG POS button
 described, 2-21
 located, 2-21

Trigger
 defined, G-6
 holdoff, G-3
 Level, defined, G-6
 position, defined, G-6
 selecting mode, 3-4

Trigger level, measuring, 3-42

Trigger position, 3-17
 setting, 3-18

Trigger system, Performance verification of, A-45

Triggering
 purpose of, 3-26
 removing unwanted components,
 3-31
 setting trigger position, 3-18

TV signals, triggering on, 3-29

V

VAR HOLDOFF knob
 described, 2-17
 located, 2-16

Vector, defined, G-6

Vertical
 selecting mode, 3-5
 setting scale, 3-5

Vertical system
 described, A-5
 Performance verification of, A-28

Voltage
 cursor measurements of, 3-34–3-44

graticule measurements of,
 3-34–3-44

W

Waveform, defined, G-6

Waveforms
 compatible plotters for, 3-53
 plotting or printing, 3-52
 saving, 3-45–3-50
 saving and recalling, 3-45
 transmitting, 3-51–3-54

X

X10 (STORE ONLY) switch
 described, 2-15
 located, 2-14

X10 PULL
 described, 2-15
 located, 2-14

XY button
 described, 2-11
 located, 2-10

XY mode, 3-23
 defined, G-6
 specification, A-18

XY Plotter Output, A-19

Z

Z-Axis, A-19
 defined, G-6

