

2246A

PORTABLE

OSCILLOSCOPE

OPERATORS

*Please Check for
CHANGE INFORMATION
at the Rear of This Manual*

Copyright © 1987, 1989 Tektronix, Inc. All rights reserved. Contents of this publication may not be reproduced in any form without the written permission of Tektronix, Inc.

Products of Tektronix, Inc. and its subsidiaries are covered by U.S. and foreign patents and/or pending patents.

TEKTRONIX, TEK, SCOPE-MOBILE and  are registered trademarks of Tektronix, Inc.

Printed in U.S.A. Specification and price change privileges are reserved.

INSTRUMENT SERIAL NUMBERS

Each instrument has a serial number on a panel insert, tag, or stamped on the chassis. The first number or letter designates the country of manufacture. The last five digits of the serial number are assigned sequentially and are unique to each instrument. Those manufactured in the United States have six unique digits. The country of manufacture is identified as follows:

- B000000 Tektronix, Inc., Beaverton, Oregon, U.S.A.
- G100000 Tektronix Guernsey, Ltd., Channel Islands
- E200000 Tektronix United Kingdom, Ltd., Marlow
- J300000 Sony/Tektronix, Japan
- H700000 Tektronix Holland, NV, Heerenveen, The Netherlands
- HK00000 Tektronix, Inc., Hong Kong

Certificate of the Manufacturer/Importer

We hereby certify that the _____

2246A OSCILLOSCOPE AND ALL INSTALLED OPTIONS

complies with the RF Interference Suppression requirements of
Amtsbl.-Vfg 1046/1984.

The German Postal Service was notified that the equipment is being
marketed.

The German Postal Service has the right to re-test the series and to
verify that it complies.

TEKTRONIX

Bescheinigung des Herstellers/Importeurs

Hiermit wird bescheinigt, daß der/die/das _____

2246A OSCILLOSCOPE AND ALL INSTALLED OPTIONS

in Übereinstimmung mit den Bestimmungen der Amtsblatt-Verfügung
1046/1984 funkentstört ist.

Der Deutschen Bundespost wurde das Inverkehrbringen dieses Gerätes
angezeigt und die Berechtigung zur Überprüfung der Serie auf Einhalten
der Bestimmungen eingeräumt.

TEKTRONIX

NOTICE to the user/operator:

The German Postal Service requires that Systems assembled by the operator/user of this instrument must also comply with Postal Regulation, Vfg. 1046/1984, Par. 2, Sect. 1.

HINWEIS für den Benutzer/Betreiber:

Die vom Betreiber zusammengestellte Anlage, innerhalb derer dies Gerät eingesetzt wird, muß ebenfalls den Voraussetzungen nach Par. 2, Ziff. 1 der Vfg. 1046/1984 genügen.

NOTICE to the user/operator:

The German Postal Service requires that this equipment, when used in a test setup, may only be operated if the requirements of Postal Regulation, Vfg. 1046/1984, Par. 2, Sect. 1.7.1 are complied with.

HINWEIS für den Benutzer/Betreiber:

Dies Gerät darf in Meßaufbauten nur betrieben werden, wenn die Voraussetzungen des Par. 2, Ziff. 1.7.1 der Vfg. 1046/1984 eingehalten werden.

OPERATORS SAFETY SUMMARY

The safety information in this summary is for operating personnel. Warnings and cautions will also be found throughout the manual where they apply.

Terms in this Manual

CAUTION statements identify conditions or practices that could result in damage to the equipment or other property.

WARNING statements identify conditions or practices that could result in personal injury or loss of life.

Terms as Marked on Equipment

CAUTION indicates a personal injury hazard not immediately accessible as one reads the markings, or a hazard to property, including the equipment itself.

DANGER indicates a personal injury hazard immediately accessible as one reads the marking.

Symbols in this Manual



This symbol indicates where applicable cautionary or other information is to be found. For maximum input voltage see Table 6-1.

Symbols as Marked on Equipment



DANGER—High voltage.



Protective ground (earth) terminal.



ATTENTION—Refer to manual.

Power Source

This product is intended to operate from a power source that does not apply more than 250 V rms between the supply conductors or between either supply conductor and ground. A protective ground connection, by way of the grounding conductor in the power cord, is essential for safe operation.

Grounding the Product

This product is grounded through the grounding conductor of the power cord. To avoid electrical shock, plug the power cord into a properly wired receptacle before making any connections to the product input or output terminals. A protective ground connection, by way of the grounding conductor in the power cord, is essential for safe operation.

Danger Arising From Loss of Ground

Upon loss of the protective-ground connection, all accessible conductive parts, including knobs and controls that may appear to be insulating, can render an electric shock.

Use the Proper Power Cord

Use only the power cord and connector specified for your product.

The power cord must be in good condition.

Read Section 1 for power-cord and connector information.

Use the Proper Fuse

To avoid fire hazard, use only a fuse of the correct type, voltage rating and current rating as specified on the back of your product and in Table 6-1.

Do Not Operate in an Explosive Atmosphere

To avoid explosion, do not operate this product in an explosive atmosphere.

Do Not Remove Covers or Panels

To avoid personal injury, do not remove the product covers or panels. Do not operate the product without the covers and panels properly installed.

.....

.....

.....

.....

.....

.....

.....

.....

.....

.....

.....

.....

.....

TABLE OF CONTENTS

	Page
LIST OF ILLUSTRATIONS	vi
LIST OF TABLES	viii
OPERATORS SAFETY SUMMARY	ix
 SECTION 1—INTRODUCTION	
PRODUCT OVERVIEW	1-1
Description	1-1
Standard Accessories	1-3
PREPARATION FOR USE	1-4
Safety	1-4
Line Fuse	1-4
Line Voltage and Power Cord	1-4
Instrument Cooling	1-6
Start-Up	1-6
Repackaging for Shipment	1-6
 SECTION 2—CONTROLS, CONNECTORS, AND INDICATORS	
CRT, Power and Display	2-1
Vertical	2-3
Horizontal	2-8
Trigger	2-12
A Trigger Modes	2-14
B Trigger Modes	2-15
Rear Panel	2-18
Menu System Controls	2-20
 SECTION 3—OPERATORS FAMILIARIZATION	
BASIC OPERATION	3-1
Readout Display	3-1
Graticule	3-1

Connecting Input Signals	3-3
Grounding	3-3
Probes	3-4
Coaxial Cables	3-4
External Triggering	3-4
Auto Setup	3-5
MIN SETUP	3-5
MENU SYSTEM OPERATION	3-5
Introduction	3-5
Clearing the Menu and Cursors Display	3-6
Setting Measurement Channel	3-6
Recalling the Last Measurement Mode	3-9
Channel 1 and Channel 2 Voltmeter	3-9
Voltmeter Measurements Page 1	3-9
Voltmeter Measurements Page 2, GATED Measurements	3-10
Cursor Volts Measurements	3-12
Time Menus	3-14
Conditions for Cursors Display	3-17
Measurement Cursors	3-17
Track Trig Lvl Cursors	3-17
Track <i>m</i> Cursors	3-18
Behavior for Horizontal Mode Changes	3-18
Measurement Compatibility and Error Messages	3-19
Measurements in Single Sequence Mode	3-20
Service Menu Features	3-21
Configure Menu	3-22
Self Cal Measurements	3-25
Internal Settings Menu	3-26
Store/Recall Setup Features	3-27
Factory Stored Setups	3-28
Store/Recall Setup Menu	3-28
Recovering A Deleted Record	3-32
Storing Setups in Sequences	3-33
Recall Only Menu	3-34

SECTION 4—OPERATOR CHECKS AND ADJUSTMENTS

Introduction	4-1
Initial Setup	4-1
Auto Setup Function	4-2

Trace Rotation Adjustment	4-3
Probe Low-Frequency Compensation	4-3
Vertical Deflection Check	4-5
Timing Checks	4-6

SECTION 5—BASIC APPLICATIONS

Introduction	5-1
CH 1/CH 2 Voltmeter Measurements	5-1
Peak Voltage Measurement	5-2
Gated Voltage Measurement	5-4
Voltage Measurement Cursors	5-6
Voltage Difference	5-6
Ground-Referenced Voltage	5-8
Time Measurement Cursors	5-10
Time Difference	5-10
Period Measurement	5-11
Frequency Measurement	5-12
Rise-Time Measurements	5-13
Phase Measurements	5-14
Time Delay Measurement	5-18
Track Trigger Level Cursors	5-20
Setting Trigger Level	5-24
Use of the Add Mode	5-25

SECTION 6—PERFORMANCE CHARACTERISTICS

Introduction	6-1
Recommended Calibration Schedule	6-1

SECTION 7—PERFORMANCE CHECK PROCEDURE

Introduction	7-1
Test Equipment Required	7-1
Performance Check Interval	7-1
Preparation	7-1
Index to Performance Check Procedure	7-6
DISPLAY	7-8
Trace Rotation	7-8
Geometry	7-9

VERTICAL	7-10
Input COUPLING Functional Check	7-10
CH 1 and CH 2 VOLTS/DIV Trace Shift	7-11
CH 3 and CH 4 VOLTS/DIV Trace Shift	7-12
CH 1 and CH 2 VAR VOLTS/DIV Trace Shift	7-12
CH 1 and CH 2 Input COUPLING Trace Shift	7-13
CH 2 INVERT Trace Shift	7-13
CH 1 and CH 2 VAR VOLTS/DIV Range	7-13
Low-Frequency Linearity Check	7-14
CH 1 and CH 2 Vertical Deflection Accuracy	7-15
CH 3 and CH 4 Vertical Deflection Accuracy	7-16
ADD Mode and CH 2 INVERT Deflection Accuracy	7-17
Vertical POSITION Range (all channels)	7-17
CH 1 to CH 2 Signal Delay Match	7-19
CH 1 to CH 4 Signal Delay Match	7-20
CH 3 to CH 4 Signal Delay Match	7-20
Ch 1 and CH 2 Vertical Bandwidth	7-20
CH 3 and CH 4 Vertical Bandwidth	7-21
SCOPE BW (Bandwidth Limit) Accuracy	7-22
Common-Mode Rejection Ratio	7-22
Channel Isolation	7-23
AC-Coupled Lower -3 dB Point	7-24
Vertical ALT and CHOP Modes	7-25
BEAM FIND Functional Check	7-26
A and B Trace Separation	7-26
TRIGGERING	7-27
500 Hz Trigger Sensitivity	7-27
500 kHz Trigger Sensitivity	7-28
25 MHz Trigger Sensitivity	7-29
150 MHz Trigger Sensitivity	7-30
Single Sweep Mode	7-31
Trigger LEVEL Control Range	7-32
TV Field Trigger Sensitivity	7-33
TV Line Trigger Sensitivity	7-33
Line Trigger Functional Check	7-34
HORIZONTAL	7-35
A and B Sweep Length	7-35
Horizontal POSITION Range	7-36
VAR SEC/DIV Range	7-36
Magnifier Registration	7-37
A and B Timing Accuracy and Linearity	7-37
A and B Magnified Timing Accuracy and Linearity	7-39
Delay Time Jitter	7-40
Delay Time Accuracy	7-41
Delay Time Position Range	7-42
X-Axis Gain Accuracy	7-42
X-Y Phase Difference	7-43
X-Axis Bandwidth	7-43

MEASUREMENT CURSORS	7-44
← SEC → and ← 1/SEC → Cursor Accuracy	7-44
← PHASE → Cursor Accuracy	7-45
← VOLTS → Cursor Accuracy	7-46
↗ VOLTS → Cursor Accuracy	7-46
Tracking Cursors Position Accuracy	7-46
CH 1/CH 2 VOLTMETER	7-48
DC Volts Accuracy	7-48
DC Volts Normal Mode Rejection Ratio	7-49
+Peak, -Peak, Peak-to-Peak Voltage Accuracy	7-50
25 MHz +Peak, -Peak, and Peak-to-Peak Volts Accuracy	7-51
100 MHz +Peak, -Peak, and Peak-to-Peak Volts Accuracy	7-51
Gated Volts Accuracy	7-52
EXTERNAL Z-AXIS, PROBE ADJUST AND AUTO SETUP	
FUNCTIONS	7-53
Check External Z-Axis Input	7-53
PROBE ADJUST Output	7-54
AUTO SETUP Functional Check	7-54
Run MAKE FACTORY SETTINGS Routine	7-54
OPTIONS 15	7-55
Signal Output	7-55
A GATE Output	7-56

SECTION 8—OPTIONS AND ACCESSORIES

Introduction	8-1
Options A1-A5 International Power Cords	8-1
Option 15	8-1
Standard Accessories	8-2
Optional Accessories	8-2
Instrument Enhancements	8-2
Transportation Aids	8-2
Cameras	8-2
Probes	8-3
Viewing Hoods	8-3

APPENDIX A - AUTO-SETUP Control Settings

APPENDIX B - Factory Settings

APPENDIX C - FACTORY STORED SETUPS

LIST OF ILLUSTRATIONS

Figure	Page
1-1	The 2246A Oscilloscope 1-1
1-2	Optional power cords 1-5
2-1	CRT, power, and display controls 2-2
2-2	CH 1 and CH 2 vertical controls and connectors 2-4
2-3	Vertical connectors and CH 3 and CH 4 controls 2-7
2-4	Horizontal controls and indicators 2-9
2-5	Trigger controls and indicators 2-13
2-6	Rear panel 2-19
2-7	Menu controls 2-21
3-1	Readout display locations 3-2
3-2	Graticule measurement markings 3-3
3-3	Voltmeter measurement channel menu 3-7
3-4	Delay-Time/Delta-Time channel menu 3-8
3-5	Voltmeter and Gated Measmt menus 3-11
3-6	Cursor Volts measurements menus 3-13
3-7	Time measurement menu 3-15
3-8	Service menu 3-21
3-9	Configure menu 3-22
3-10	Internal settings menu 3-26
3-11	Store/Recall Setup menu display 3-29
3-12	Alter Labels menu 3-31
3-13	Recall only menu 3-35
4-1	Probe compensation 4-5
5-1	+PEAK voltage measurement and tracking cursors 5-4
5-2	Gated voltage measurement 5-6
5-3	Voltage difference measurement using cursors 5-7
5-4	Voltage measurement 5-9
5-5	Period measurement 5-11
5-6	Frequency measurement 5-12
5-7	Rise time measurement 5-14
5-8	Making a phase difference measurement 5-17

5-9	Time difference between the two delays	5-20
5-10	A and B Track Trig Lvl cursors	5-21
5-11	Setting a specific trigger level	5-24
5-12	Eliminating common-mode signals	5-27
6-1	Maximum input voltage vs frequency derating curve for the CH 1, CH 2, CH 3, and CH 4 input connectors	6-14
6-2	Dimensional drawing, standard cabinet	6-20
6-3	Dimensional drawing, rackmount cabinet (2240 F1R)	6-21

LIST OF TABLES

Table	Page
2-1	VERT Trigger SOURCE 2-17
3-1	Behavior for Horizontal MODE Changes 3-19
5-1	Trigger Cursor Channel 5-23
6-1	Electrical Characteristics 6-2
6-2	Environmental Characteristics 6-15
6-3	Mechanical Characteristics 6-17
7-1	Test Equipment Required 7-3
7-2	Signal-to-Graticule Accuracy 7-15
7-3	Settings for Timing Accuracy Checks 7-38
7-4	Delay Time Accuracy 7-41
A-1	AUTO-SETUP Control Settings A-1
A-2	MIN SETUP Control Settings A-4
B-1	Factory Settings B-1

SECTION 1

INTRODUCTION

.....

.....

.....

.....

.....

.....

.....

.....

.....

.....

.....

.....

.....

.....

.....

PRODUCT OVERVIEW

Description

The 2246A is a 100 MHz, four-channel, dual-sweep, portable oscilloscope for general-purpose use (Figure 1-1). A microprocessor-based operating system controls most of the functions in the instrument, including a fully integrated menu-driven voltage and time measurement system with SmartCursors[®]. Other features include single-button automatic front-panel setup and a menu-driven store/recall setup function. A menu-driven service mode provides for configuring of certain menu and readout displays, internal calibration, and servicing diagnostics.

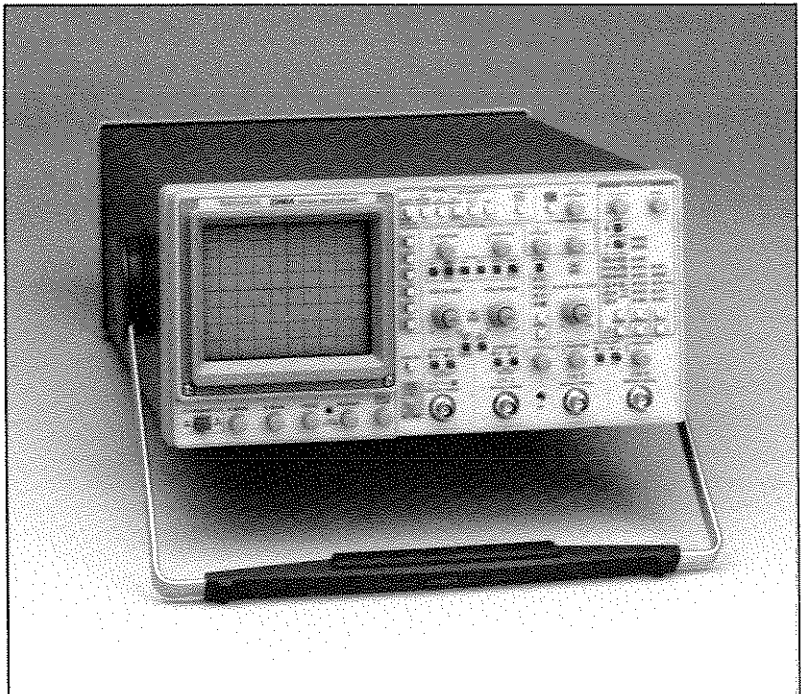

Figure 1-1. The 2246A Oscilloscope.

The vertical deflection system has four input channels. Two channels have 11 basic deflection factors from 2 mV to 5 V per division, and two channels have two basic deflection factors of 0.1 V and 0.5 V per division. Basic deflection factors can be extended with attenuator probes. VOLTS/DIV readouts are switched to display the correct vertical scale factors when properly coded probes are connected to the vertical input connectors.

The horizontal deflection system provides single, dual, or delayed sweeps from 0.5 s to 20 ns per division (delayed sweep, 5 ms to 20 ns per division). The trigger system provides stable triggering over the full bandwidth of the vertical deflection system.

Alphanumeric crt readouts of the vertical and horizontal scale factors are displayed at the bottom of the screen. On-screen vertical and horizontal cursors provide accurate voltage, time, frequency, and phase measurements; measurement values are displayed at the top of the crt.

The measurement features include voltage measurements for +Peak, -Peak, Peak-to-Peak, and average DC, or positionable cursors for measuring voltage difference, time difference, frequency, and phase. SmartCursors[®] that visually track voltage measurements, trigger levels, and ground can be placed on displayed waveforms. Delay-time and delta-delay measurements for time, frequency, and phase are available in ALT and B Horizontal Modes.

By pressing a single button (AUTO SETUP), the front-panel controls can be set up to produce a usable waveform display based on the voltage and time characteristics of the input signals.

The Store/Recall system lets you store and recall up to 20 different front-panel setups. Stored setups can be arranged in sequences as required for specific applications.

Standard Accessories

The following items are standard accessories shipped with the 2246A instrument:

- 2 Probes, 10X, 1.5 meter, with accessories
- 1 Power cord
- 1 Power cord clamp
- 1 Operators manual
- 1 Reference guide
- 1 CRT filter, blue plastic (installed)
- 1 Fuse, 2A, 250 V, slow-blow
- 1 Accessory pouch, ziploc

See Section 8 "Options and Accessories" for part numbers and further information about standard accessories and a list of the recommended optional accessories. For more information on accessories and ordering assistance, contact your Tektronix representative or local Tektronix Field Office.

PREPARATION FOR USE

Safety

Refer to the Operators Safety Summary at the front of this manual for power source, grounding, and other safety information about the use of the instrument. Before connecting the 2246A to a power source, read this section and the Safety Summary.

Line Fuse



This instrument can be damaged if the wrong line fuse is installed.

Verify the proper value of the power-input fuse with the following procedure.

1. Press in the fuse-holder cap and release it with a slight counterclockwise rotation.
2. Pull the cap (with the attached fuse inside) out of the fuse holder.
3. Verify proper fuse value.
4. Install the proper fuse and reinstall the fuse-holder cap.

Line Voltage and Power Cord

The 2246A operates on line voltages from 90 to 250 V with line frequencies ranging from 48 to 440 Hz. No line voltage selecting is necessary. Instruments are shipped with the power cord that was requested on the order. The power cord must match the power-source outlet; if it does not, contact your Tektronix representative or local Tektronix Field Office. See Figure 1-2 for optional power cords available.

The detachable three-wire power cord has a three-contact plug for connection to the power source and the protective ground. The power cord is

held to the rear panel by a clamp. The protective ground contact on the plug connects (through the power cord protective-ground conductor) to the accessible metal parts of the instrument.

WARNING

For electrical-shock protection, insert this plug into a power-source outlet that has a properly grounded protective-ground contact.





Plug Configuration	Usage	Line Voltage	Reference Standards	Option Number
	North American 120V/ 15A	120V	ANSI C73.11 NEMA 5-15-P IEC 83	Standard
	Universal Euro 240V/ 10-16A	240V	CEE (7), II, IV, VII IEC 83	A1
	UK 240V/ 13A	240V	BS 1363 IEC 83	A2
	Australian 240V/ 10A	240V	AS C112	A3
	North American 240V/ 15A	240V	ANSI C73.20 NEMA 6-15-P IEC 83	A4
	Switzerland 220V/ 6A	220V	SEV	A5
<p>Abbreviations:</p> <p>ANSI — American National Standards Institute AS — Standards Association of Australia BS — British Standards Institution CEE — International Commission on Rules for the Approval of Electrical Equipment IEC — International Electrotechnical Commission NEMA — National Electrical Manufacturer's Association SEV — Schweizerischer Elektrotechnischer Verein (2931-21)6083-35</p>				

Figure 1-2. Optional power cords.

Instrument Cooling

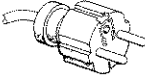
To prevent instrument damage from overheated components, make sure the internal airflow is not blocked. Before turning on the power, check that the ventilation holes on the bottom and side of the cabinet are not covered.

Start-up

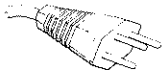
At power on, the instrument does a self-diagnostic check. If the instrument does not turn on and operate normally, turn power off then on again. If the instrument still does not turn on properly, refer the instrument to a qualified service person. TRIGGER MODE LEDs may be flashing to indicate the circuit location of a start-up error; you should report this information to the service person.

When the instrument is turned on, a self-cal routine may run to set the voltage- and timing-measurement constants. The power-on self cal runs only if the stored constants have been lost, possibly due to a dead memory back-up battery. The following warning message will be displayed for 5 seconds: "WARNING PROBABLE BATTERY FAILURE TURN OFF AND ON TO VERIFY". If the message reappears after having turned the power off and on, have the battery checked and/or replaced by a qualified service person. The instrument can still be used for accurate measurements by running the SELF CAL MEASUREMENTS routine from the SERVICE MENU after the instrument has warmed up for at least 20 minutes.

To run the SELF CAL MEASUREMENTS routine, press the top and bottom menu-item select buttons. Press down-arrow button to underline SELF CAL MEASUREMENTS. Press RUN to start the routine, then QUIT or CLEAR DISPLAY to return to the normal oscilloscope mode.

Repackaging for Shipment

Save the original shipping carton and packing material in case it is ever necessary to reship the instrument by a commercial transport carrier. If the original materials are unfit or not available, then repackage the instrument using the following procedure.

1. Use a corrugated cardboard shipping carton with a test strength of at least 275 pounds and an inside dimension at least six inches greater than the instrument dimensions.

2. If instrument is being shipped to a Tektronix Service Center, enclose the following information: owner's address, name and phone number of a contact person, type and serial number of the instrument, reason for returning, and a complete description of the service required.
3. Completely wrap the instrument with polyethylene sheeting or equivalent to protect the outside finish and keep harmful substances out of the instrument.
4. Cushion instrument on all sides with three inches of padding material or urethane foam, tightly packed between the carton and the instrument.
5. Seal the shipping carton with an industrial stapler or strapping tape.
6. Mark the address of the Tektronix Service Center and your own return address on the shipping carton.

SECTION 2

**CONTROLS,
CONNECTORS,
AND INDICATORS**

CRT, Power, and Display

Refer to Figure 2-1 for location of items 1 through 9.

- ① **POWER Switch**—Turns on or off instrument power. Press for ON or OFF.

At least one VERTICAL MODE button will light when the power is turned on. The front-panel setup existing when the power is turned off will return when the power is turned on again.

- ② **A INTEN Control**—Adjusts the brightness of the A trace.
- ③ **B INTEN Control**—Adjusts the brightness of the B Delayed sweep trace and the intensified zone on the A trace.
- ④ **FOCUS Control**—Adjusts the focus of the crt displays (traces, readout, and cursors).
- ⑤ **TRACE ROTATION Control**—Aligns the crt trace with the horizontal graticule lines. This is a screwdriver adjustment.
- ⑥ **READOUT Control**—Adjusts the brightness of the crt readout display (includes all alphanumerics and cursors).
- ⑦ **SCALE ILLUM Control**—Adjusts the illumination level of the graticule.

NOTE

Life of the graticule illumination lamps can be increased by setting the SCALE ILLUM control for the minimum intensity needed for viewing, and turning off scale illumination when not needed.

- ⑧ **BEAM FIND Button**—Locates off-screen and overscanned displays when the button is held in. Limits the vertical and horizontal deflection within the display area and unblanks the CRT.

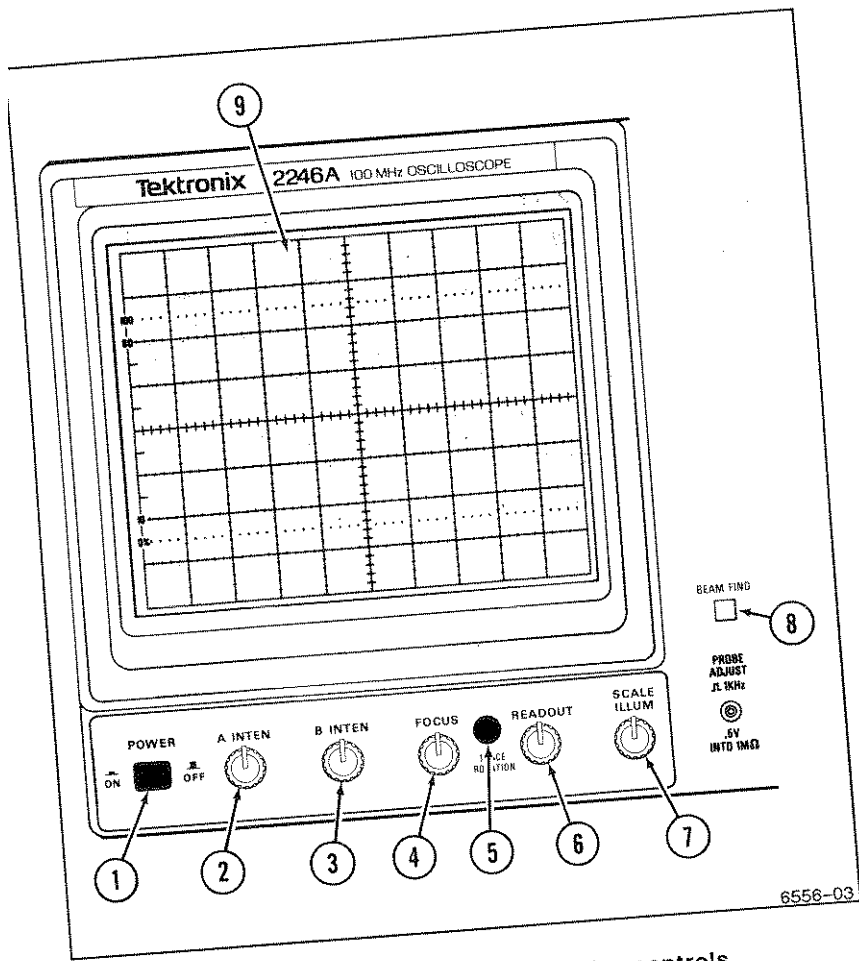

Figure 2-1. CRT, power, and display controls.

9 CRT—Displays waveforms and readouts in an 80 mm vertical by 100 mm horizontal graticule area.

Internal graticule lines provide parallax-free viewing of trace and graticule lines. 0%, 10%, 90% and 100% points marked at the left edge of the graticule aid in making rise- and fall-time measurements.

Vertical

Refer to Figure 2-2 for location of items 10 through 17.

- ⑩ **CH 1 and CH 2 POSITION Controls**—Adjust vertical position of the Channel 1 and Channel 2 waveform displays.
- ⑪ **MODE Buttons**—Select the vertical channels for display (CH 1, ADD channels 1 and 2, CH 2, CH 3, and CH 4). The CHOP/ALT MODE button selects method for switching input channels on the display (chopped or alternating).

Except for CHOP/ALT modes, pressing an unlit mode button turns on the mode, and pressing a lit button turns off the mode. CHOP is selected when the CHOP/ALT button is lit; ALT is selected when the button is not lit.

CH 1, CH 2, CH 3, and CH 4—Select vertical channels for display. At least one of the channels or ADD is always on and cannot be turned off until another channel is first turned on.

CHOP/ALT—In the CHOP mode the display chops between selected input channels at a rate of about 625 kHz. In the ALT mode, the selected channels are displayed in sequence (alternating at the end of each sweep).

ADD—Displays the algebraic sum of the Channel 1 and Channel 2 input signals. The ADD display is in addition to any other selected channel displays. In the ADD mode, a plus sign (+) is displayed between the Channel 1 and Channel 2 VOLTS/DIV readouts.

NOTE

In ADD mode when AUTO LEVEL TRIGGER MODE or CHOP VERTICAL MODE is selected, the algebraic sum of Channel 1 and Channel 2 displays provides the internal signal source for the trigger system when the trigger source is VERT.

- 12 Channel 1 and Channel 2 VOLTS/DIV Switches—Select calibrated deflection factors for Channel 1 and Channel 2 from 2 mV per division to 5 V per division in a 1-2-5 sequence of 11 steps.

The switches are detented, continuous-rotation controls with no end stops. The VOLTS/DIV readouts reflect attenuation factors of coded attenuator probes connected to the vertical inputs.

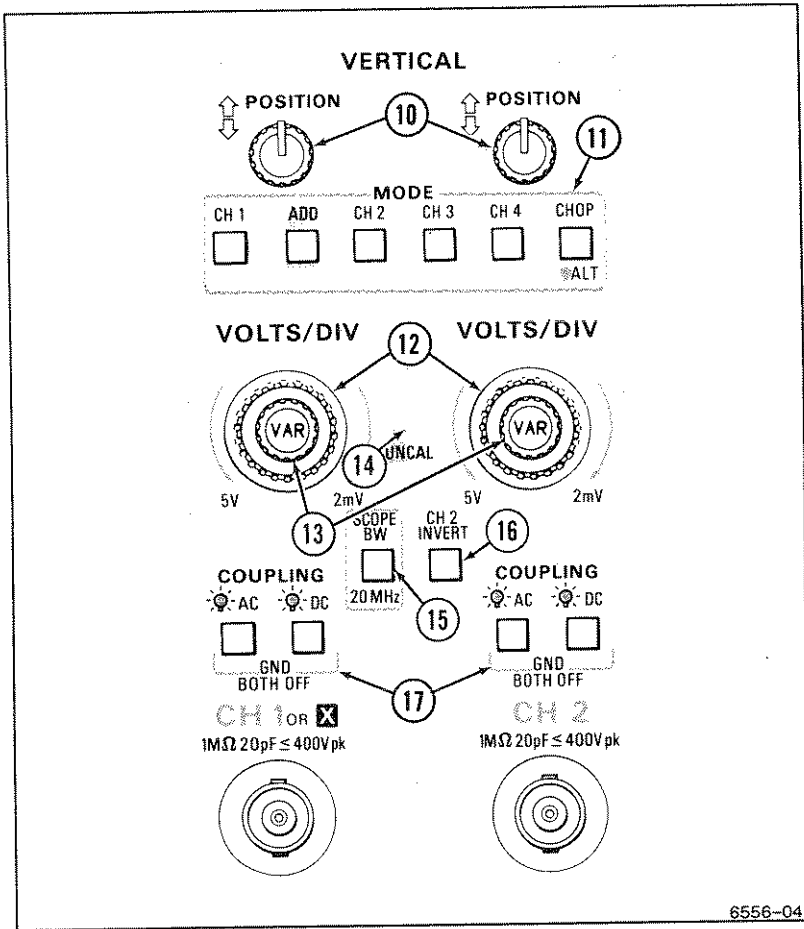

Figure 2-2. CH 1 and CH 2 vertical controls and indicators.

- ⑬ **CH 1 AND CH 2 VOLTS/DIV VAR Controls**—Allows the CH 1 and CH 2 vertical deflection factors to be increased up to at least 2.5 times.

Vertical deflection factors are greater than the VOLTS/DIV switch setting when the UNCAL indicator is lit and a greater-than symbol (>) is displayed to the left of the associated VOLTS/DIV readout.

NOTE

Normally the VOLTS/DIV settings are calibrated when the VAR control is in the fully clockwise (detent) position. However, if a front-panel setup had been recalled from the Store/Recall Setup memory, it is possible for the VOLTS/DIV settings to be calibrated or uncalibrated with the VOLTS/DIV VAR control in any position. When the controls are rotated, normal variable operation returns.

- ⑭ **UNCAL Indicator**—Lights when either CH 1 or CH 2 VOLTS/DIV settings are uncalibrated (variable function in effect).
- ⑮ **SCOPE BW Button**—Reduces the bandwidth of the vertical deflection system and trigger system to 20 MHz when the button is lit. The full bandwidth is available when the SCOPE BW button is not lit.
- ⑯ **CH 2 INVERT Button**—Inverts the Channel 2 input signal when the INVERT button is lit.

The Channel 2 input signal in ADD mode and the Channel 2 trigger signal pickoff are also inverted. A down-arrow symbol is displayed between the Channel 1 and Channel 2 VOLTS/DIV readout when the INVERT mode is on.

- ⑰ **COUPLING Buttons**—Select the method of coupling input signals to the Channel 1 and Channel 2 attenuators.

GND—Disconnects the input signal and grounds the input of the associated vertical attenuator to provide a zero (ground) reference voltage display.

The COUPLING switch is in the ground position when the AC and the DC buttons are not lit. A ground symbol (\perp) is displayed to the right of the associated VOLTS/DIV readout. The ground symbol is also displayed after the value readout of any of the VOLTMETER measurements.

AC—Capacitively couples the input signal to the vertical attenuator when the AC button is lit.

Turning on AC Coupling turns off DC Coupling. AC Coupling blocks the dc component of the input signal. The lower -3 dB frequency limit is 10 Hz or less when using either a 1X probe or properly terminated coaxial cable; it is 1 Hz or less using a compensated 10X probe. With AC Coupling selected, an AC symbol (\sim) is displayed to the right of the associated VOLTS/DIV readout. An ac symbol is also displayed after the value readout of any Peak or Peak-to-Peak voltage measurement.

NOTE

When AC Coupling is selected for DC voltmeter measurements an error message "SELECT DC COUPLING" is displayed.

DC—Couples dc and all frequency components of the input signal to the vertical attenuator when the DC button is lit.

Turning on DC coupling turns off AC coupling. With DC Coupling selected, a DC symbol (---) is displayed to the right of the associated VOLTS/DIV readout. Input resistance is 1 M Ω to ground.

Refer to Figure 2-3 for location of items 18 through 23

- 18 CH 1 OR X and CH 2 Input Connectors—Connect signals to the inputs of Channel 1 and Channel 2 vertical attenuators.

Input connectors are BNC type with an outer contact ring for recognizing attenuation factors of coded attenuator probes. A signal connected to the CH 1 OR X input connector produces the horizontal deflection (X-Axis) in the X-Y horizontal mode. Any of the vertical signal channels or ADD can provide vertical deflection (Y-Axis) for an X-Y display.

- 19 PROBE ADJUST Connector—Outputs a 0.5 V square-wave signal (at about 1 kHz into a 1 M Ω load) for compensating voltage probes and checking the vertical deflection accuracy.

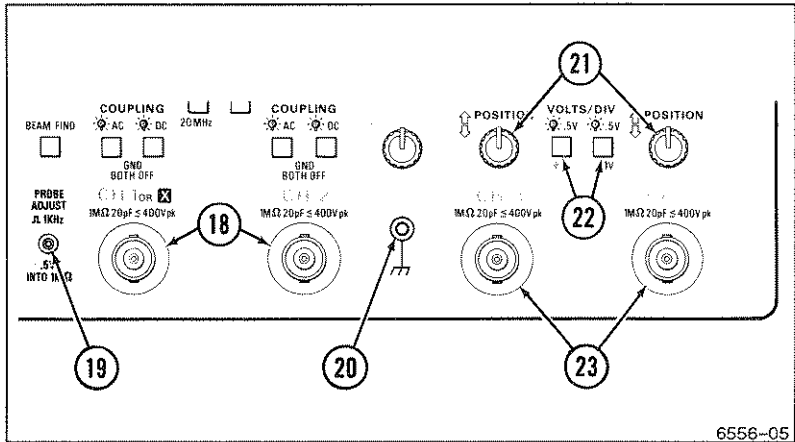

Figure 2-3. Vertical connectors and CH 3 and CH 4 controls.

- (20) **Auxiliary Ground Jack**—Provides an auxiliary chassis ground connection (banana jack) between the equipment under test and the 2246A.
- (21) **Channel 3 and Channel 4 POSITION Controls**—Adjust vertical position of Channel 3 and Channel 4 signal displays.
- (22) **Channel 3 and Channel 4 VOLTS/DIV Switches**—Select two basic deflection factors for Channel 3 and Channel 4, 0.5 volt/division (button lit) or 0.1 volt/division (button not lit).

The VOLTS/DIV switch setting displayed in the crt readout reflects the attenuation factor of coded attenuator probes that are connected to the vertical inputs.

- (23) **CH 3 and CH 4 Input Connectors**—Connect signals to the inputs of the Channel 3 and Channel 4 vertical attenuators. Input coupling is dc only.

The input connectors are BNC with probe-coding ring contacts (the same as Channel 1 and Channel 2). The limited choice of deflection factors for the Channel 3 and Channel 4 inputs makes them useful for digital and trigger signals.

Horizontal

Refer to Figure 2-4 for location of items 24 through 31.

- 24 **POSITION Control**—Adjusts the horizontal position of the waveform displays on the crt.
- 25 **X10 MAG Switch**—Magnifies the A and B sweeps by a factor of 10 and extends the fastest sweep speed to 2 ns per division. The center portion of an unmagnified sweep display will be within 0.5 division of the center of a magnified sweep display. No action occurs in X-Y mode.

When X10 MAG is on, a X10 symbol is displayed next to the SEC/DIV readouts. The readouts reflect correct display sweep speeds for the X10 MAG displays and the unmagnified displays.

- 26 **MODE Buttons (Up-Arrow and Down-Arrow) and Indicators**—Select the operating mode of the horizontal deflection system. Pressing the Up-/Down-Arrow buttons selects the horizontal deflection mode as shown by the MODE lights. Not all Menu Measurement modes are compatible with all horizontal deflection modes. See Table 3-2, Behavior for Horizontal MODE Changes, in Section 3.

A—Selects A sweep horizontal deflection. The A sweep speed is determined by the A SEC/DIV switch setting as displayed in the crt readout. Whenever A MODE is selected, the A/B SELECT switch is set to A Trigger.

ALT—Alternates between A sweep (with an intensified zone representing B sweep) and B delayed sweep. Both A and B SEC/DIV switch settings are displayed in the crt readout, but only the B can be adjusted. Whenever ALT MODE is selected, the A/B SELECT switch is set to B Trigger.

The B sweep speed cannot be set slower than the A sweep speed; attempting to do so forces the A sweep speed to follow the B sweep speed. To increase the A sweep speed in the ALT MODE, set the Horizontal MODE to A, adjust the SEC/DIV switch to a faster A sweep setting, and reset the Horizontal MODE switch to ALT. The B sweep speed and the length of the intensified zone are determined by the B SEC/DIV switch setting.

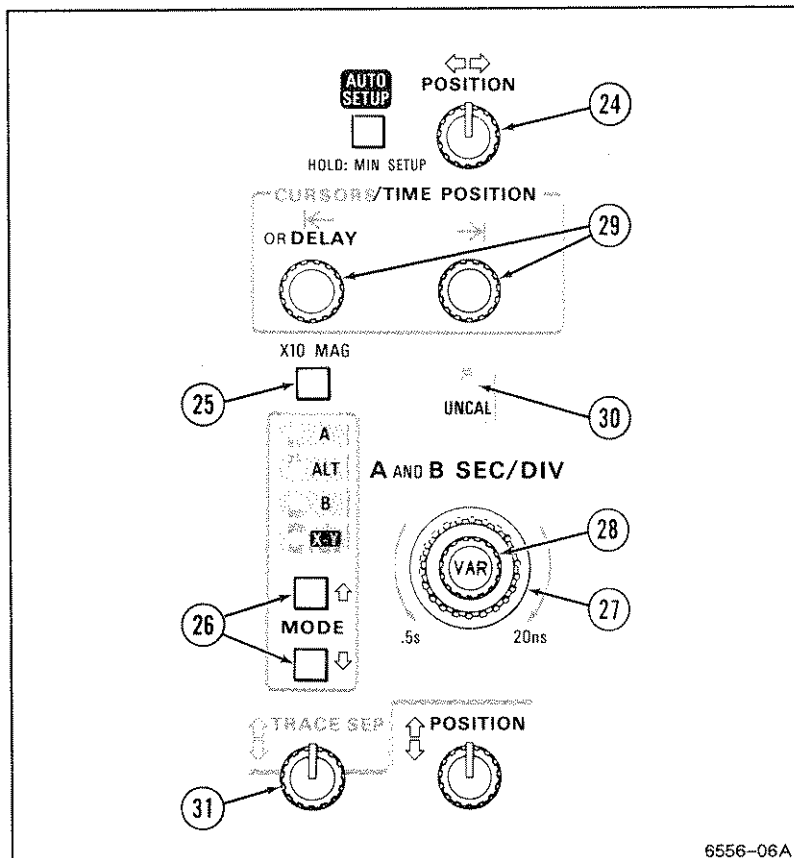

6556-06A

Figure 2-4. Horizontal controls and indicators.

B—Select B sweep horizontal deflection. The B sweep speed is determined by the B SEC/DIV switch setting as displayed in the CRT readout. Whenever B MODE is selected, the A/B SELECT switch is set to B Trigger.

The start of the B sweep in RUNS AFTER mode (or the arming of the B Trigger in any triggered mode) is delayed from the start of the A sweep by a time determined by the setting of the ← OR DELAY control. The B SEC/DIV switch setting and the Delay Time Position set-

setting are displayed in the crt readout. A greater-than sign (>) is displayed in front of the Delay Time readout if the B Trigger MODE is not RUNS AFTER.

X-Y—The signal applied to CH 1 OR X input connector produces the horizontal (X-Axis) deflection. Signals applied to any vertical input connector or ADD may be selected to provide the vertical deflection (Y-Axis).

The X-Y displays are horizontally positioned by the Horizontal POSITION control and vertically positioned by the associated vertical channel POSITION control.

- 27) **A AND B SEC/DIV Switch**—Selects the horizontal deflection rate (sweep speed) for both the A sweep and the B sweep in a 1-2-5 sequence. Calibrated sweep speeds are obtained with the A and B SEC/DIV VAR control in the detent (fully clockwise) position. The A SEC/DIV switch setting is set only from the A Horizontal MODE and the B SEC/DIV switch is set only from the ALT or B Horizontal MODE.

NOTE

The B sweep speed can never be slower than the A sweep speed. When the two sweep speeds are the same, they are "locked." At this point A will follow B to slower SEC/DIV settings (in ALT or B) and B will follow A to faster settings (in A).

A SEC/DIV—The calibrated A sweep speed is selected only in A Horizontal MODE from 0.5 s per division to 20 ns per division (X10 MAG off).

B SEC/DIV—The calibrated B sweep speed is selected either in ALT or B Horizontal MODE from 5 ms per division to 20 ns per division (X10 MAG off).

- 28) **A and B SEC/DIV VAR Control**—Provides continuously variable, uncalibrated A and B sweep speeds to at least 2.5 times slower than the calibrated SEC/DIV setting.

The VAR control extends the slowest A sweep speed to at least 1.25 sec per division. The UNCAL indicator is lit and a greater-than sign (>) is displayed before each SEC/DIV readout value when the sweep speeds are greater than the SEC/DIV settings.

NOTE

Normally the SECIDIV settings are calibrated when the VAR control is in the fully clockwise (detent) position. However, if a front-panel setup had been recalled from the Store/Recall Setup memory, it is possible for the SECIDIV settings to be calibrated or uncalibrated with the SECIDIV VAR control in any position. When the controls are rotated, normal variable operation returns.

- 29 CURSORS/TIME POSITION Controls—Sets the reference and delta cursors on the display.

NOTE

The reference and delta cursors will only track together as long as the reference delay plus the delta delay is less than 10 times the A SECIDIV setting (10 horizontal graticule divisions). The cursors cannot be positioned left of the 1st or right of the 11th vertical graticule lines.

← OR DELAY—This control has the following functions:

1. Positions the reference and delta cursors together in a cursor measurement mode (volts or time, A Horizontal MODE).
2. Positions the reference and delta delay together in the TIME measurement mode in the ALT or B Horizontal MODE.
3. Sets the B sweep delay time in the ALT or B Horizontal Mode in DELAY measurement mode.
4. Positions the intensified zone for GATED VOLTMETER measurements.

→ —This control has the following functions:

1. Positions the delta cursor in the cursor measurement mode.
2. Sets the B sweep delta delay in TIME measurement mode when in the ALT or B Horizontal Mode.
3. Sets the width of the intensified zone for GATED VOLTMETER measurements.

- 30 **UNCAL Indicator**—Lights when the A AND B SEC/DIV settings are uncalibrated (variable function in effect).
- 31 **TRACE SEP Control**—Positions the B sweep trace vertically with respect to the A sweep trace when ALT Horizontal MODE is selected.

Trigger

Refer to Figure 2-5 for location of items 32 through 38.

- 32 **A/B SELECT Button**—Directs the MODE, SOURCE, CPLG, SLOPE, and LEVEL controls and Trigger lights (TRIG'D and READY) to either the A or B Trigger system (A, when lit; B, when not lit).

Either A or B trigger can be selected for any Horizontal MODE; however, A/B SELECT is preset to A when A Horizontal MODE is selected, and B when ALT or B Horizontal MODE is selected. No change occurs when switching from B to X-Y Horizontal MODE.

- 33 **SLOPE Button**—Selects the slope (positive- or negative-going) of the trigger source signal that triggers either the A sweep or the B sweep. (Button lit = positive-going; button not lit = negative-going.)
- 34 **HOLDOFF Control**—Varies holdoff time between the end of one A sweep and the start of the next A sweep.

The HOLDOFF control can increase the minimum holdoff time by at least 10 times. Adjusting this control can improve triggering stability of aperiodic signals (i.e., complex digital waveforms).

- 35 **LEVEL Control**—Sets the amplitude level on the trigger signal at which either the A or B sweep is triggered.

Adjusting the LEVEL control to either end of its range, in the AUTO LEVEL trigger mode, resets the limits of the Trigger LEVEL control range to the peak-to-peak amplitude of the trigger source signal.

- 36 **MODE Buttons (Up- and Down-Arrows) and Indicators**—Select the operating modes of the A and B trigger systems. Pressing the Up-/Down-Arrow buttons selects the operating modes as shown by the TRIGGER MODE lights.

Selections available for the A Trigger (A/B SELECT button lit) are: AUTO LEVEL, AUTO, NORM, TV LINE, TV FIELD, and SGL SEQ. Selections for the B Trigger (A/B SELECT button not lit) are: AUTO LEVEL, RUNS AFTER, NORM, TV LINE FROM A SOURCE.

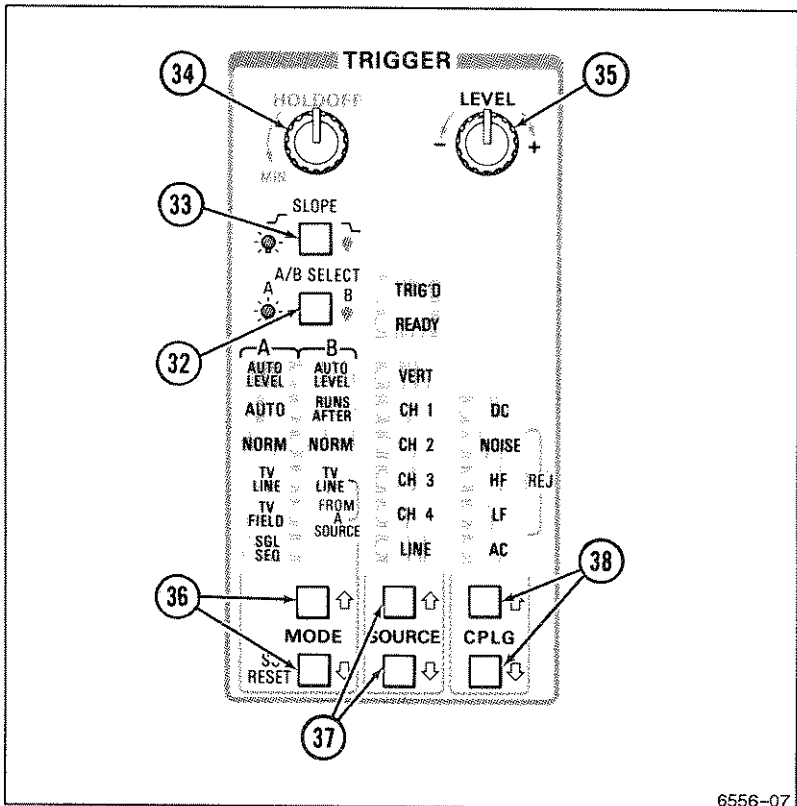

Figure 2-5. Trigger controls and indicators.

A Trigger Modes

AUTO LEVEL—Automatically sets the range of the Trigger LEVEL control to the peak-to-peak limits of an adequate A Trigger source signal and triggers the sweep.

Autoleveling is repeated if triggering is lost, if the TRIGGER LEVEL control is rotated to either end stop, or if AUTO LEVEL TRIGGER MODE is selected again. AUTO LEVEL mode is useful for quickly locating and maintaining an appropriate triggering level.

NOTE

The A sweep free-runs to produce a baseline trace when the A trigger source signal amplitude is too low or the frequency is below 10 Hz. Switch to NORM triggering if the repetition rate is too slow for autoleveling.

AUTO—Triggers the same as the NORM Trigger MODE when an adequate trigger signal is applied. However, the A sweep free-runs to display a baseline trace when there is no trigger signal or the frequency is below 10 Hz. The set triggering level changes only when the TRIGGER LEVEL control is adjusted to a new level setting.

NORM—Triggers the A sweep when the A Trigger LEVEL control is set within the peak-to-peak limits of an adequate trigger signal. When the A sweep is not triggered, no baseline trace is displayed.

TV LINE—Starts the A sweep at the beginning of a video signal line. SLOPE polarity must match the composite sync polarity (i.e.,  SLOPE for negative sync) to obtain TV LINE triggering on the horizontal sync pulse.

Instruments Serial Numbered B020100 or above can have the TV SLOPE polarity preset by changing the instrument configuration from the CONFIGURE menu (see "SERVICE Menu Features" in Section 3).

TV FIELD—Starts the A sweep at the beginning of a video signal field. SLOPE polarity must match the composite sync polarity to obtain TV FIELD triggering.

SGL SEQ (Single Sequence)—Sets up the A sweep for single-sequence operation. Each additional press of the down-arrow MODE button, when in single-sequence mode, resets the sweep and makes it ready to accept a trigger. As in NORM trigger MODE, the set triggering level changes only when the TRIGGER LEVEL control is adjusted to a new level setting.

When triggered, the sweep runs to produce a single sweep of each trace as required by the setting of the VERTICAL MODE and HORIZONTAL MODE switches. Each displayed sweep in the sequence requires a distinct A sweep triggering event. The READY light remains on until the final trace in the sequence is completed. The readout and cursors can be set to turn on briefly at the end of the sequence when using a camera (factory settings default mode), or they can be set to remain on by changing the instrument configuration from the CONFIGURE menu (see "Service Menu Features" in Section 3).

B Trigger Modes

AUTO LEVEL—Sets the range of the Trigger LEVEL control to the peak-to-peak limits of an adequate B Trigger-source signal and triggers the B sweep.

NOTE

The B sweep operates in RUNS AFTER mode when the trigger-source signal amplitude is too low or the frequency is below 10 Hz. Switch to NORM triggering if the repetition rate is too slow for autoleveling. The A Sweep must be running (free-running or triggered) for B Sweep to trigger.

Once set, autoleveling is repeated only if triggering is lost, if TRIGGER LEVEL control is rotated to either end stop, or if AUTO LEVEL Trigger MODE is reselected. AUTO LEVEL mode is useful for quickly locating an appropriate triggering level.

RUNS AFTER—Starts the B sweep immediately after the delay time selected by the **← OR DELAY** control.

The Trigger MODE must be in RUNS AFTER before timing measurements can be selected when the Horizontal Mode is ALT or B. A time measurement will be canceled if the Trigger MODE is changed from RUNS AFTER while in the ALT or B Horizontal Mode.

NORM—The B sweep is triggered when an adequate trigger signal is received after the delay time condition has been met. When there is no trigger signal, there is no B sweep trace.

TV LINE FROM A SOURCE—Starts the B sweep at the beginning of the video signal line received after the delay time has been met.

NOTE

SLOPE polarity defaults to the A Trigger SLOPE. This must match the composite sync polarity (same as A Trigger SLOPE) to obtain correct triggering on the horizontal sync pulse.

- 37 **SOURCE (Up-Arrow and Down-Arrow) Buttons and Indicators**—Select the trigger source for either the A or the B Trigger system as directed by the A/B SELECT button. Pressing the Up-/Down-Arrow SOURCE buttons selects the trigger source (for A or B trigger system) as shown by SOURCE lights.

VERT—Selects the trigger signal from the displayed waveforms.

The TRIGGER MODE and VERTICAL MODE switch settings determine the trigger signal source selection. When VERT is selected, one or more of the SOURCE lights will be on to indicate the trigger signal source. See Table 2-1 for VERT Trigger SOURCE selections.

CH 1—The signal applied to the CH 1 OR X input connector is the source of the trigger signal.

Table 2-1
VERT Trigger SOURCE

Trigger and Vertical Modes	ADD Mode	Trigger Source Selected
AUTO LEVEL or CHOP	On	Algebraic sum of CH 1 and CH 2 input signals.
	Off	Lowest numbered vertical channel displayed.
NON-AUTO LEVEL and ALT	On or Off	Alternates between displayed vertical channels in the following order: Ch 1, Ch 2, CH 3, CH 4, and ADD.

CH 2—The signal applied to the CH 2 input connector is the source of the trigger signal.

CH 3—The signal applied to the CH 3 input connector is the source of the trigger signal.

CH 4—The signal applied to the CH 4 input connector is the source of the trigger signal.

LINE—The triggering signal is obtained from a sample of the ac power-source waveform. This trigger source is useful when the displayed waveform frequency is time related to the ac power-source frequency.

- 38 **CPLG (Up-Arrow and Down-Arrow) Buttons and Indicators**—Select the method of coupling the input trigger signal to the A or B trigger system as directed by the A/B SELECT button. Pressing the Up-/Down Arrow buttons selects the trigger coupling as shown by the CPLG lights.

DC—Couples dc and all frequency components of a triggering signal to the trigger circuitry.

DC coupling is useful for most signals, but it is especially useful for providing a stable display of low-frequency or low-repetition-rate signals.

NOISE REJ (Noise Reject)—Couples all frequency components of the input signal to the trigger circuitry but increases the peak-to-peak signal amplitude required to produce a trigger event.

NOISE REJ coupling is useful for improving stability when the trigger signal is accompanied by low-level noise.

HF REJ (High Frequency Reject)—Attenuates high-frequency triggering signal components above 50 kHz.

HF REJ coupling is useful for providing a stable display of low-frequency components of complex waveforms and eliminates high-frequency interference from the trigger signal.

LF REJ (Low Frequency Reject)—Attenuates low-frequency triggering signal components below 100 kHz and blocks the dc component of the trigger signal.

LF REJ coupling is useful for producing stable triggering on the high-frequency components of complex waveforms and rejecting low-frequency interference or power supply hum from the trigger signal.

AC—Attenuates trigger signal frequency components below 50 Hz and blocks the dc component of the signal.

AC coupling is useful for triggering on ac waveforms that have a large dc offset.

Rear Panel

Refer to Figure 2-6 for location of items 39 through 41.

- 39 **EXT Z-AXIS INPUT Connector**—Connects external signals to the Z-Axis amplifier for intensity modulating the crt display.

Signals applied to the EXT Z-AXIS INPUT do not affect display waveshape. Signals with fast rise times and fall times provide the

most abrupt intensity change. The active region threshold level is 1.8 V. Z-Axis voltage above the threshold voltage decreases the intensity, and 3.8 V or more produces noticeable modulation. The Z-Axis signals must be time-related to the displayed signal to obtain a fixed intensity-modulated crt display.

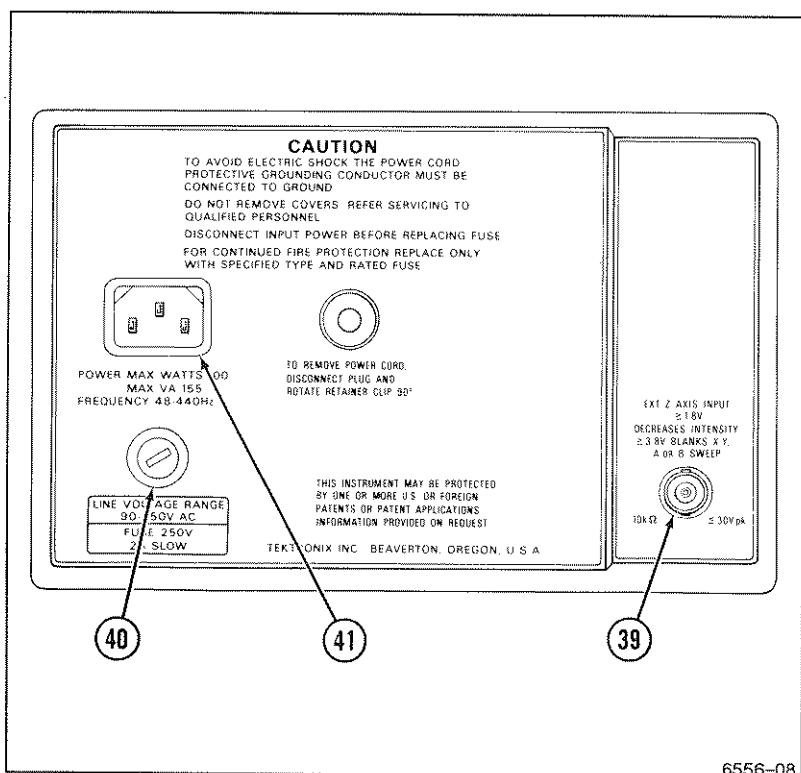

Figure 2-6. Rear panel.

- ④ Fuse Holder—Contains the primary power fuse.
- ④ Power Cord Receptacle—Connects the ac power source to the instrument power supply.

The power cord protective-ground connection is connected to the exposed metal parts of the instrument. The power cord must be connected to a properly grounded source for electrical-shock protection.

Menu System Controls

Refer to Figure 2-7 for location of items 42 through 48.

- ④2 **Menu Item Select Buttons**—Select items from the list displayed on the right side of a displayed menu. A Menu Item Select button that has no corresponding menu item does nothing when pressed. The menu display will clear when the item is selected (unless the SERVICE mode CONFIGURE menu is set for: KEEP MENU ON WHEN ITEM SELECTED? YES). The factory settings default is NO.

You can access the Service Mode by pressing the top and bottom Menu Item Select buttons at the same time. See "Service Menu Features" in Section 3 for using the operational modes of the SERVICE MENU.

- ④3 **CLEAR DISPLAY**—Clears displayed menus, measurement functions, and cursor functions in the following order:

1. Menu display (Service, Measurement, and Store/Recall Setup menus).
2. Measurement function (including TRACK MEASMT cursors if displayed).
3. TRACK TRIG LVL and TRACK μ .

- ④4 **SET MEAS' MT CHANNEL**—Calls up menus for setting measurement-source channels for active measurement modes.

There are two menus available, one for voltmeter measurements, and a two-page menu for delay- and delta-time measurements. Each menu lists input channels that can be selected for the active measurement mode.

If the SET MEAS' MT CHANNEL button is pressed for an invalid mode, one of the following messages will be displayed for two seconds:

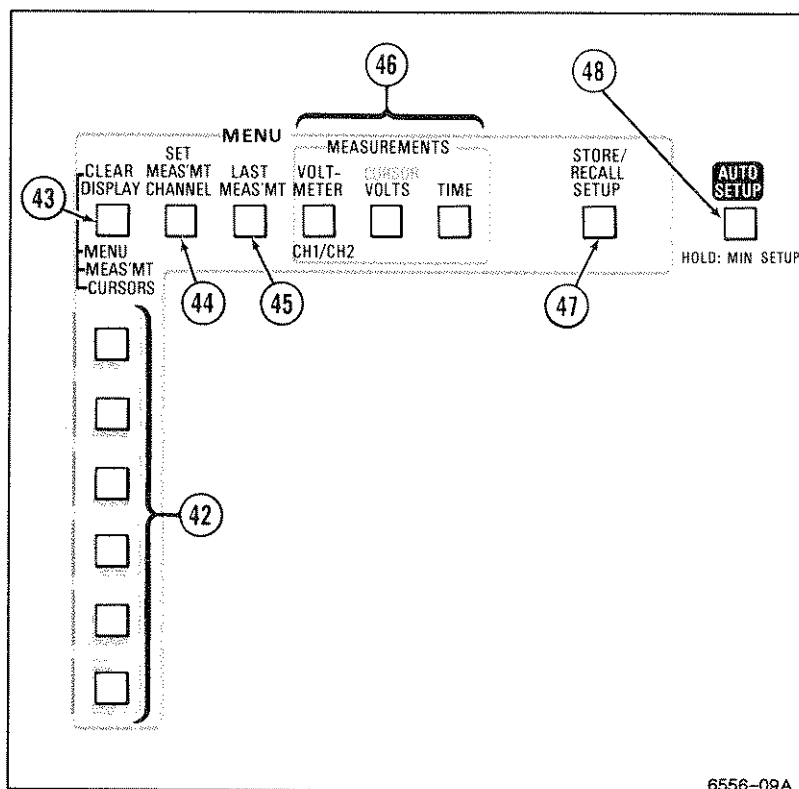

Figure 2-7. Menu controls.

1. SELECT A MEASUREMENT—When no measurement mode is active.
2. NO MEAS CHANNEL NEEDED—When a selected measurement mode (such as cursor time) does not require a measurement channel to be set.

When a SET MEAS'MT CHANNEL menu is displayed, changing the Horizontal MODE, except between ALT and B, clears the menu.

- 45 **LAST MEAS' MT**—Recalls the last active measurement mode to the display and resets the measurement channel. If the last active measurement mode is already displayed when the LAST MEAS' MT button is pressed, only the measurement channel is reset.

Measurement channel for VOLTMETER and VOLTS cursors measurement modes is set to Channel 1 or Channel 2 when either is displayed alone; otherwise it is set to Channel 1.

Measurement channels for time measurements in ALT or B Horizontal mode are set to the lowest number displayed channel for the delay time and the next lowest number displayed channel for the delta-delay time, if more than one channel is displayed. Both are set to the same channel when only one is displayed. ADD is considered the highest numbered channel.

NOTE

When the memory-backup battery is dead or has just been replaced, the last measurement is initialized to \leftarrow SEC \rightarrow at power on. The battery must be replaced by a qualified service person.

- 46 **Measurement Select Buttons**—Calls up Measurement selection menus. Measurements are selected from the list of menu items at the right side of the menu display.

VOLTMETER CH1/CH2—Calls up the voltage measurement menu. A selected measurement mode is shown by an underlined menu item. Tracking cursors (measurement, ground, trigger level) may be displayed to provide visual feedback to the user about the measurement points on the displayed signal (see CURSOR VOLTS).

CURSOR VOLTS—Calls up the menu for selecting cursor volts measurement modes. The first page of the menu lets you select positionable cursors; page 2 is for selecting the auto-tracking SmartCursors™.

TIME—Calls up the menu to select the type of timing measurement to be made. Menu choices are listed on the right side of the screen.

- 47 **STORE/RECALL SETUP Button**—Calls up store and recall menus that let you store and recall up to 20 front-panel setups. When you press the STORE/RECALL button, the STORE/RECALL menu (factory settings default) or the RECALL ONLY menu is displayed depending on how you set the SERVICE mode CONFIGURE menu. See "Service Menu Features" in Section 3 to set CONFIGURE menu.
- 48 **AUTO-SETUP Button**—Automatically sets up the front-panel controls to produce a usable crt display of the input signals. Setups are based on the characteristics of the applied signals. The voltage and frequency characteristics of the input signal must be within the limits of the 2246A specifications. Auto-setup action for each front-panel control is shown in Appendix A.

NOTE

MIN SETUP as described below is only available on Instruments Serial Numbered B020100 or above.

MIN SETUP—Pushing and holding the Auto-Setup button until instrument operation returns enters the MIN SETUP function. This sets up the front-panel controls as the Auto-Setup does but leaves many of the controls unchanged from what the user has previously set. MIN SETUP setup action for each front-panel control is shown in Appendix A.

SECTION 3

**OPERATORS
FAMILIARIZATION**

BASIC OPERATION

This subsection contains the basic operating information and techniques that should be considered before attempting any measurements. For location and function of instrument controls, connectors, and indicators see "CONTROLS, CONNECTORS, AND INDICATORS" Section 2 of this manual.

Readout Display

The crt readout display indicates how the instrument controls are set up. No physical markings are on the rotating switches and control knobs to indicate the control setting. A key to the location and type of readout information displayed is illustrated in Figure 3-1.

Graticule

The graticule is internally marked on the crt face to provide parallax-free viewing and enable accurate measurements (see Figure 3-2). The graticule is marked with eight vertical and ten horizontal major divisions. Major divisions are further divided into five sub-divisions of 0.2 division each, marked along the center vertical and horizontal graticule lines. Percentage marks for rise-time and fall-time measurements are marked on the left side of the graticule. Vertical deflection factors and horizontal timing are calibrated to the graticule so that accurate measurements can be made directly from the crt.

The waveform displays are calibrated to the crt graticule markings for making quick and very accurate measurements of waveform parameters. Voltage measurements are done by counting the vertical graticule divisions and partial divisions occupied by the portion of the display being measured and then multiplying by the VOLTS/DIV setting. Time measurements using the graticule markings are done in a similar manner. Count the number of horizontal graticule divisions and partial divisions occupied by the portion of the waveform being measured and multiply by the SEC/DIV setting.

To improve the accuracy of the estimate, position the display to take advantage of the 0.2 division minor graticule markings on the center graticule lines. Also position one of the measurement points of the waveform as precisely as possible on one of the major graticule marks to be used as a measurement reference point.

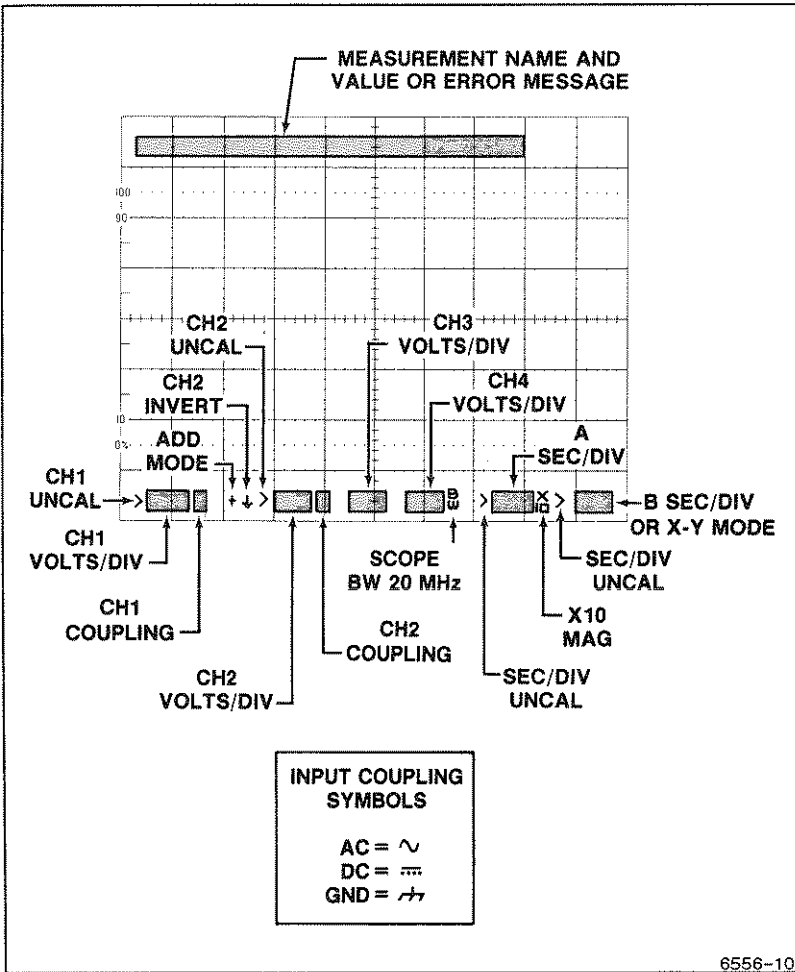

Figure 3-1. Readout display locations.

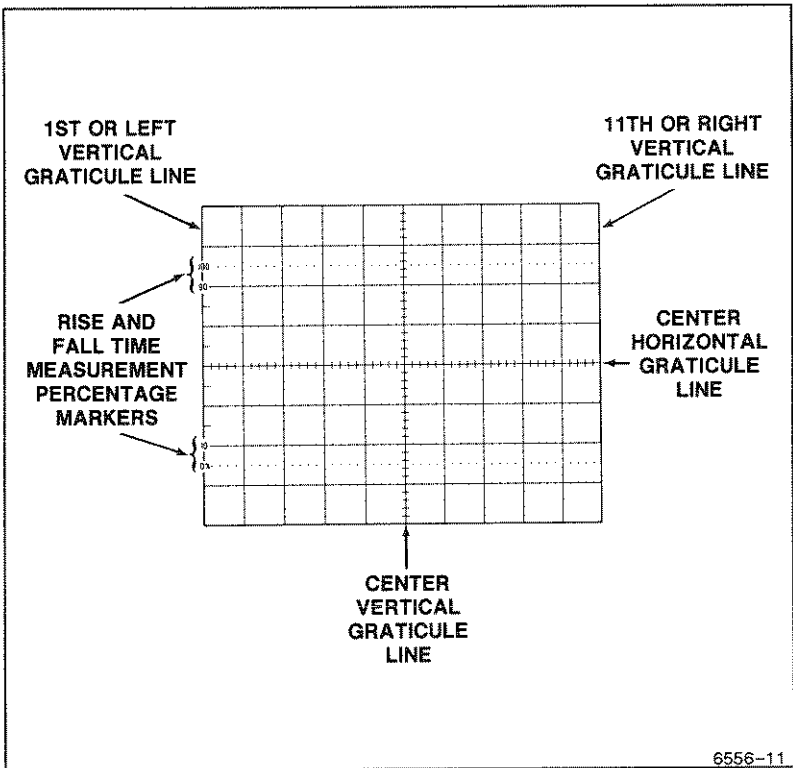

Figure 3-2. Graticule measurement markings.

Connecting Input Signals

Grounding

The most reliable signal measurements are made when the 2246A and the unit under test are connected by a common reference (ground lead) in addition to the single lead or probe. The ground lead of the probe provides the best grounding method for signal interconnection and ensures the maximum amount of signal-lead shielding in the probe cable. A separate ground lead (with a banana plug) can also be connected from the unit under test to the 2246A ground jack on the front panel.

Probes

A probe provides the most convenient way to connect an input signal to the oscilloscope. The standard 10X probes supplied with the 2246A are shielded against electromagnetic interference and have a high input impedance for low circuit loading. The subminiature probe bodies are designed for probing circuitry with closely spaced leads.

SCALE FACTOR SWITCHING. The VOLTS/DIV scale factors, displayed on the crt, reflect the probe attenuation factor when Tektronix coded probes are used.

OPERATING CONSIDERATIONS. To get the best waveform fidelity, keep probe ground and signal leads as short as possible.

Misadjusted probe compensation can cause measurement error. Check and adjust probe compensation whenever a probe is moved to a different channel or oscilloscope. For the probe compensation adjustment procedure, see Section 4 "Operator Checks and Adjustments."

For detailed operating considerations and probe maintenance, see the instruction sheet supplied with the probe.

Coaxial Cables

Signal input cable can greatly affect the accuracy of a displayed waveform. To maintain original frequency characteristics of the input signal, use only high-quality, low-loss coaxial cables. Coaxial cables must be terminated at both ends in their characteristic impedance to prevent signal reflections within the cable. Use suitable impedance-matching devices.

External Triggering

Any of the four vertical channels in the 2246A can be used as a source of A and B trigger signals. When you need a trigger signal source different from the one derived from displayed signals, you can use any free vertical input channel. CH 1 and CH 2 can "condition" a wide range of signals to produce triggers over the full vertical deflection range from millivolts to hundreds of volts. CH 3 and CH 4 have two basic attenuation factors (0.1 and 0.5 volts/division), making them especially useful for triggering on and viewing digital signal levels.

Auto Setup

Pressing the AUTO SETUP button automatically sets up the front-panel controls based on the characteristics of the applied signal. The voltage amplitude, sweep settings, trigger parameters, vertical and horizontal positioning, and trace intensities are preset to produce a usable waveform display. The waveform is horizontally centered and vertically positioned within the crt display. The voltage and frequency characteristics of the input signal must be within the limits of the 2246A specifications given in Section 6.

Auto-setup action for each front-panel control is shown in Appendix A.

MIN SETUP

MIN SETUP is only available on instruments Serial Numbered B020100 or above.

Pressing and holding the Auto-Setup button until the instrument returns to normal operation initiates the MIN SETUP function. This automatically sets up the front-panel controls but leaves many of the controls unchanged from what the user has set.

MIN SETUP action for each front-panel control is shown in Appendix A.

MENU SYSTEM OPERATION

This subsection provides operating details of the measurement menus, service menus, and Store/Recall Setup menus.

Introduction

Pressing one of the menu call-up buttons causes a list of menu items to be displayed on the right-hand side of the CRT beside a group of six Menu Item Select buttons. Pressing the menu button next to a menu item on the display selects that function (i.e., to another menu page, a measurement selection, a measurement source channel, service feature, store/recall setup features, or menu off). When a measurement mode, measurement source channel, or service feature in the menu list is selected, that label is underlined.

Normally, the menu display turns off after a measurement function is selected (if not configured to remain on), and the name and value of a selected measurement function appears in the top line of the CRT readout. However, when it is possible to make more than one selection from the menu list (or if the menu is configured to remain on), the display menu will remain on for making further choices until either MENU OFF is selected or the CLEAR DISPLAY button is pressed. The service menu can be turned off by selecting QUIT from the menu or pressing the CLEAR DISPLAY button.

Clearing the Menu and Cursors Display

The CLEAR DISPLAY button clears displayed menus, turns off measurement functions (including TRACK MEASMT cursors), and turns off the TRACK TRIG LVL and TRACK (*m*) cursors. Depending on what menus and measurements are displayed at the time, you may have to press the CLEAR DISPLAY button as many as three times to completely clear the display.

If a menu is on, pressing the CLEAR DISPLAY will remove the menu and return the display to a normal operating mode. Measurement functions are turned off with the second press (or the first press if no menu is displayed). Finally, the TRACK TRIG LVL and TRACK (*m*) cursors are canceled with a third press (or the first press if no menu is displayed and no measurement function is active).

Setting Measurement Channel

Press SET MEAS'MT CHANNEL button to call up one of two menus for setting the measurement channel(s). One menu is for voltmeter measurements (Figure 3-3), the other is a two page menu for delta-time measurements (Figure 3-4). Each menu lists vertical input channels that can be selected for the active measurement mode.

If the SET MEAS'MT CHANNEL button is pressed for an invalid mode, one of the following messages will be displayed in the top line for about two seconds.

SELECT A MEASUREMENT—When no measurement mode is active.

NO MEAS CHANNEL NEEDED—When a selected measurement mode (such as cursor time) does not require that a measurement channel be set.

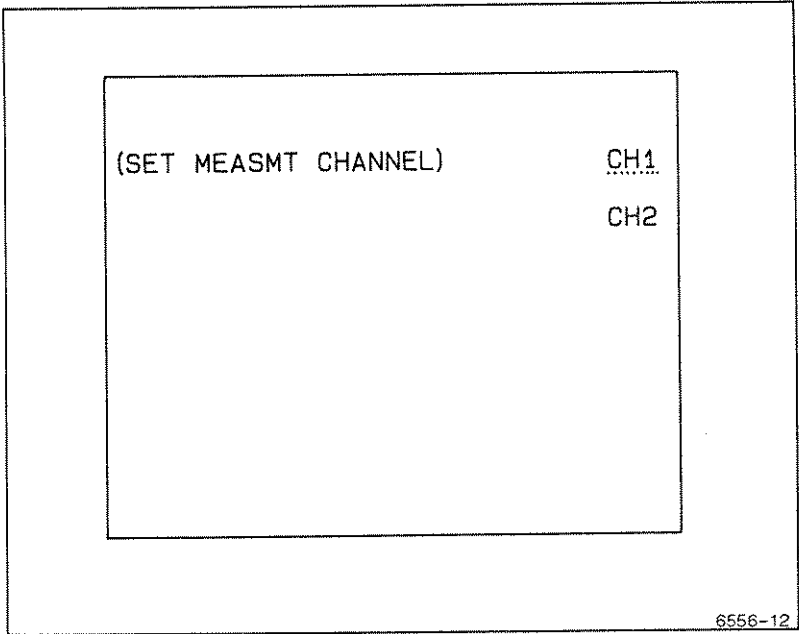

Figure 3-3. Voltmeter measurement channel menu.

When a SET MEAS' MT CHANNEL menu is displayed, changing the Horizontal MODE, except between ALT and B, clears the menu and turns off the active measurement mode.

Pressing a menu button next to a vertical channel number selects that choice as the source channel for the measurement. For Channel 1 or Channel 2 Voltmeter measurements, the selected source channel need not be displayed and is not automatically turned on when selected. It is possible therefore to view a Channel 1 display and have the Channel 2 voltage measurement value displayed by the readout (and vice versa).

When setting the measurement channel for \leftarrow VOLTS \rightarrow or ∇ VOLTS \rightarrow or when setting delay-time and delta-time channels, a vertical channel that is selected in the menu is turned on if not previously selected, and it remains displayed when deselected as the measurement source channel. Any vertical channel traces turned on that are not wanted in the display must be turned off using the VERTICAL MODE buttons.

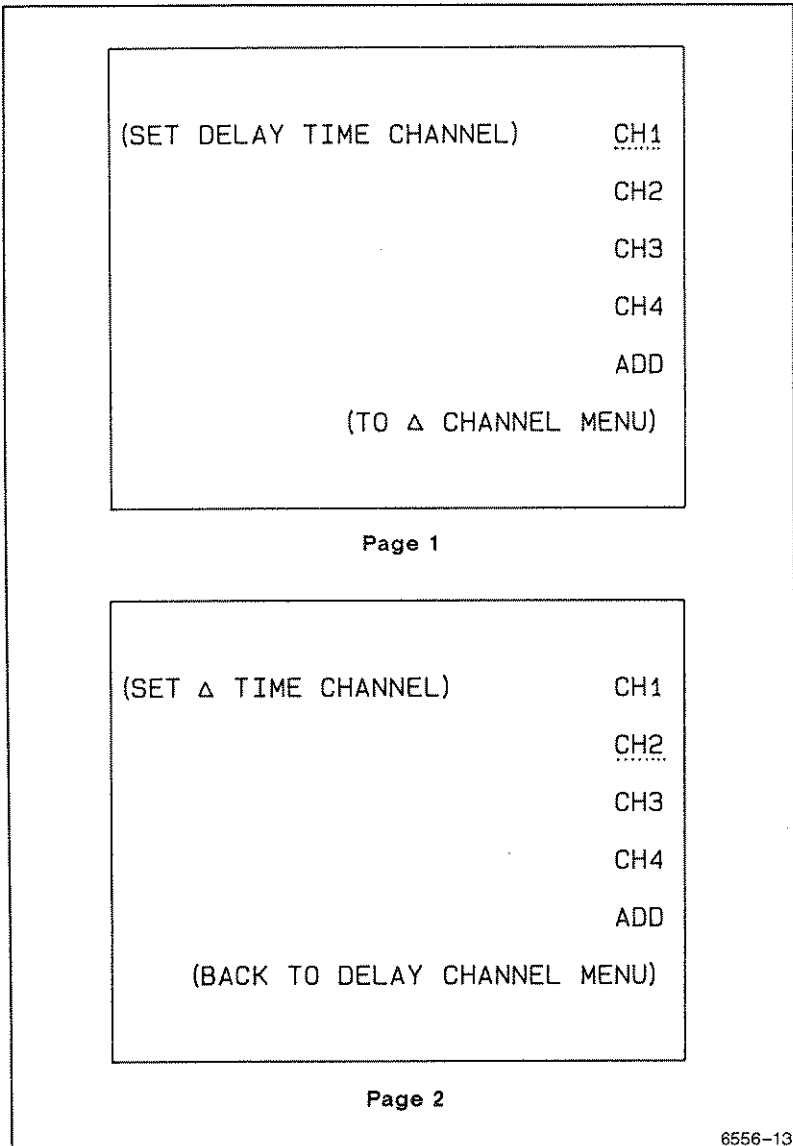

Figure 3-4. Delay-Time/Delta-Time channel menu.

Recalling the Last Measurement Mode

Press LAST MEAS'MT to recall the last selected measurement mode if no measurement mode is active. The LAST MEAS'MT button may also be used to reinitialize an active measurement mode. A press of the button cancels the active measurement and then recalls it in its initialized state. This feature is quite useful for returning VOLTS cursors and, under some conditions, TIME cursors or delays to their initialized positions after they have been adjusted away.

Channel 1 and Channel 2 Voltmeter

Press VOLTMETER CH1/CH2 button to display the choices of page 1 shown in Figure 3-5.

NOTE

If a single channel (CH 1 or CH 2) is selected for display, it becomes the default measurement source channel. If both CH 1 and CH 2 are being displayed, the default measurement source channel upon each initialization is CH 1. Use the SET MEAS'MT CHANNEL function to assign CH 2 as the measurement channel. Turn off the CH 1 display if CH 2 is the desired default measurement source channel. If both CH 1 and CH 2 are turned off when a Voltmeter measurement is active, the error message "VOLTMETER SOURCE: CH 1 OR 2 ONLY" will be displayed and the voltmeter measurement will be canceled.

Voltmeter Measurements Page 1

DC—Measures the average DC level of the measurement channel waveform.

+PEAK—Measures the most positive (screen-relative) voltage in the applied waveform.

-PEAK—Measures the most negative (screen-relative) voltage in the applied waveform.

PK-PK—Measures the peak-to-peak voltage of the applied waveform.

SELF CAL—Self characterizes the vertical system. SELF CAL may be performed at any time. Suggested times are: after a warmup period, whenever the ambient operating temperature changes by $\pm 15^{\circ}\text{C}$, and just prior to making any voltmeter measurements requiring the best possible accuracy.

(TO GATED MEASMT MENU)—Selects the gated-measurement menu.

Voltmeter Measurements Page 2, GATED Measurements

The oscilloscope must be properly triggered for gated measurements. If there is no trigger signal in NORM Trigger MODE, the message "LO REP RATE - STILL TRYING" will be displayed. If there is no trigger signal in AUTO LEVEL or AUTO Trigger MODE, the readout value will be unstable and meaningless.

Gated Voltmeter measurements are made within the gated (intensified) region on the displayed waveform. The position of the gated zone is set using the \leftarrow OR DELAY control, and the width is set using the \rightarrow control. Gated measurements are not allowed in SGL SEQ Trigger MODE; active gated measurements will be canceled if SGL SEQ Trigger MODE is selected. If the menu is displayed in SGL SEQ TRIGGER MODE, a gated measurement selection will call up a "NOT ALLOWED IN SSEQ" message to be displayed for about two seconds.

GATED +PEAK—Measures the most positive (screen-relative) voltage in the gated (intensified) portion of the waveform.

GATED -PEAK—Measures the most negative (screen-relative) voltage in the gated (intensified) portion of the waveform.

GATED PK-PK—Measures the peak-to-peak voltage in the gated (intensified) portion of the waveform.

(BACK TO PREVIOUS MENU)—Returns the first page of the Voltmeter menu.

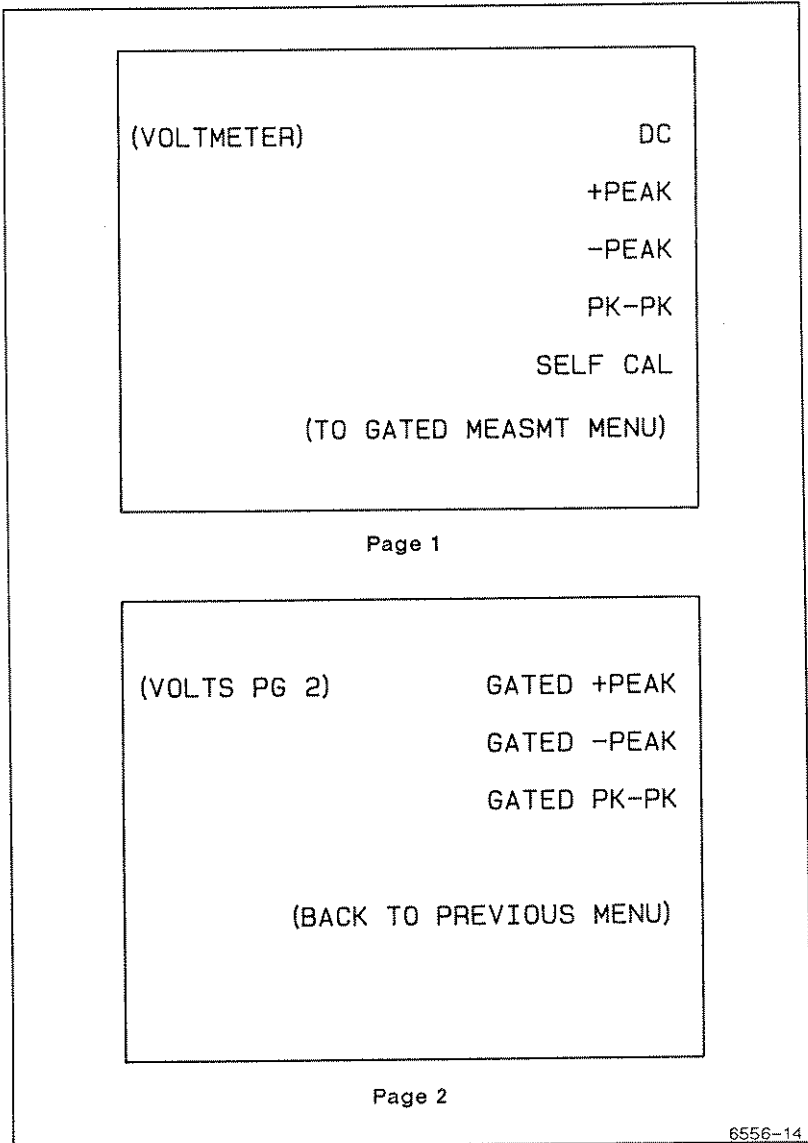

Figure 3-5. Voltmeter and Gated Measmt menus.

Cursor Volts Measurements

Press CURSOR VOLTS to display the measurement choices of menu 1 shown in Figure 3-6.

NOTE

Changing the Horizontal MODE will remove the Volts Cursors from the display. Set Horizontal MODE back to A or X-Y, and press LAST MEAS'MT button to redisplay cursors.

← VOLTS → —Measures the equivalent voltage difference between two horizontal cursors in either A Horizontal MODE or X-Y Horizontal MODE. Both cursors are positioned by the **← OR DELAY** control and the delta cursor is positioned by the **→** control. When the VOLTS cursors measurement is first turned on (or recalled as a last measurement mode), the peak voltages of the source channel signal are measured, and one cursor is placed at the most positive peak and the other is placed at the most negative peak.

⚡ VOLTS → —Measures the equivalent voltage between cursor and ground. Marks the ground position of the selected waveform display in either A Horizontal MODE or X-Y Horizontal MODE. The ground cursor follows the ground level of the source channel waveform as it is positioned vertically.

(TO AUTO TRACKING MENU)—Selects CURSOR VOLTS measurement page 2 choices.

All of the tracking cursor selections may be underlined, but only two cursors (of either type—tracking or measurement) may be displayed at a time. If TRACK MEASMT is selected and a Channel 1 or Channel 2 Voltmeter measurement is active, the TRACK **⚡** cursor is not displayed when TRACK TRIG LVL is also active. If the measurement-tracking cursor is turned off, the ground tracking cursor will return to the display.

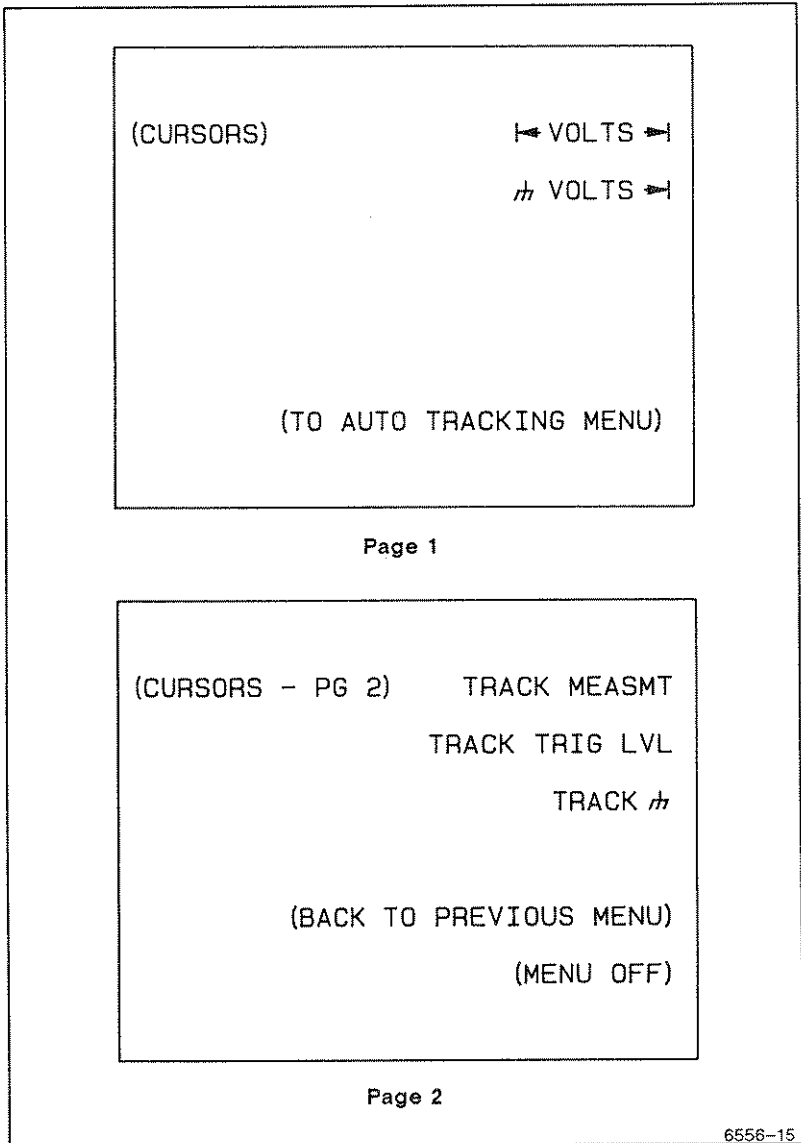

Figure 3-6. Cursor Volts measurements menus.

The CLEAR DISPLAY button may be used to turn off the MENU, MEASUREMENT, and TRACK TRIG LVL and TRACK $\overline{||}$ cursors in a priority scheme of three levels. MENU first, MEASUREMENT (and TRACK MEASMT cursors) second, and TRACK TRIG LVL and TRACK $\overline{||}$ cursor last. The highest level being displayed is turned off each time the CLEAR DISPLAY button is pressed.

TRACK MEASMT—Press to enable or disable the Channel 1 or Channel 2 Voltmeter measurement-tracking cursors (SmartCursors[®] that show the waveform-measurement points). The state of the TRACK MEASMT feature does not affect the positionable $\overline{||}$ VOLTS \rightarrow cursor operation. The CLEAR MENU button will not turn off the TRACK MEASMT feature; it only turns off the present display of the TRACK MEASMT cursor when it turns off the active measurement mode. The next time a Channel 1 or Channel 2 VOLTMETER measurement mode is selected, the TRACK MEASMT cursor or cursors will again be displayed.

TRACK TRIG LVL—Press to enable or disable the Trigger Level tracking cursor. See "Conditions For Cursors Display" in this section for conditions required to display the Trigger Level tracking cursors.

TRACK $\overline{||}$ —Press to enable or disable the ground level tracking cursor. The TRACK $\overline{||}$ cursor follows the VERTICAL MODE in that it follows the lowest displayed channel of either CH 1 or CH 2.

(BACK TO PREVIOUS MENU)—Returns the first page of the Cursors menu.

(MENU OFF)—Clears the menu from the display.

Time Menus

Press the TIME button to call up the time measurement choices shown in Figure 3-7.

Vertical cursors are displayed for use in setting the time-measurement points in A Horizontal MODE. In ALT Horizontal MODE, the delay measurement is made using either the intensified zones as the measurement points or the alternate B delayed sweeps. For B Delayed Horizontal MODE, the delayed sweeps only are available for making timing measurements.

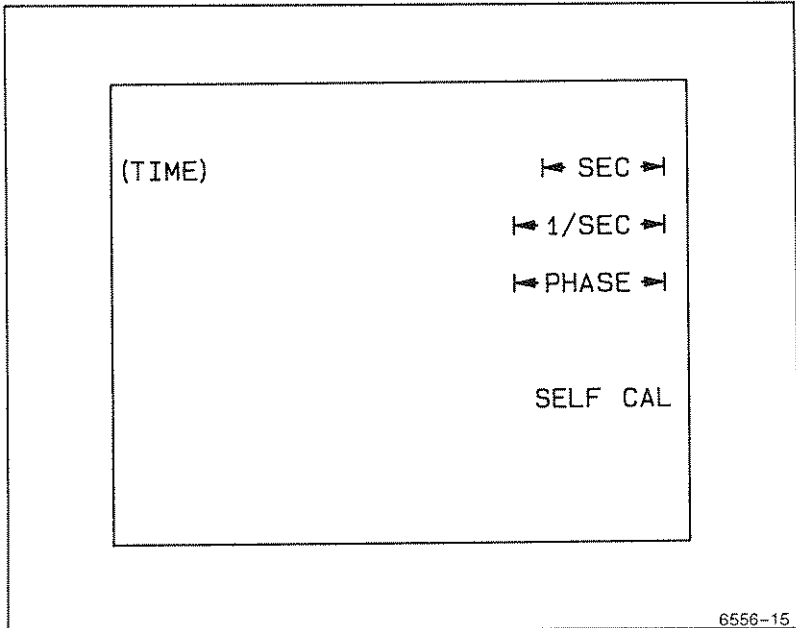

Figure 3-7. Time measurement menu.

When the Horizontal MODE is either ALT or B, the B Trigger MODE must be set to RUNS AFTER (if not, the following message will be displayed: USE RUNS-AFTER-DELAY TRIG MODE). If the B Trigger MODE is switched away from RUNS AFTER using the front panel Trigger MODE buttons, a selected TIME measurement will be canceled. Pressing LAST MEAS' MT will restart the last selected TIME measurement only if the B Trigger MODE is set to RUNS AFTER and no other measurement type has been selected first.

In the A Horizontal MODE, cursors are used to make the time measurements; in ALT or B Horizontal MODE, the timing measurements are made using either the Intensified zones that appear in the A sweep trace in ALT Horizontal MODE or the B delayed waveforms in either ALT or B Horizontal MODE. The ← OR DELAY control positions both cursors or delay times (reference and delta) together, and the → control positions the independent delta cursor or delay when TIME measurements are selected.

A selected TIME measurement mode is underscored when the menu is displayed. Only one active measurement at a time is allowed. Making a selec-

tion removes the menu (unless SERVICE mode CONFIGURE menu is set to keep menu on when measurement selected). The selected measurement type and value are displayed at the top of the screen.

← SEC → —Press to measure the equivalent time difference between the two vertical cursors displayed in the A Horizontal MODE or the two time delays in ALT or B Horizontal mode. The position of both cursors or both delays is controlled by the **← OR DELAY** control; the position of the delta cursor or the delta delay is controlled by the **→** control. The measured time difference between the two cursors or delays is displayed in the crt readout.

If the Horizontal MODE is X-Y, pressing the **← SEC →** button causes the message "USE A ALT OR B MODE" to be displayed for two seconds. Changing the Horizontal MODE to X-Y after **← SEC →** has been activated will cancel the measurement with no message.

← 1/SEC → —Measures the time difference in frequency units (hertz) between the cursor positions in A Horizontal MODE or between the delay-time setting and the delta-delay time setting in either ALT or B Horizontal MODE. Measurement points are the left ends of the two intensified zones in ALT Horizontal MODE.

← PHASE → —Calls up a lower level menu for phase measurement operation.

← PHASE → —Cursor positioning for delay and delta time setting are identical to the **← SEC →** mode. The value displayed for the phase-measurement readout has units of degrees and is calculated by the following formula:

$$\text{Phase (in degrees)} = \frac{\text{(time difference)}}{\text{(reference time)}} \times 360$$

The reference time is set using the **← SET 360° →** menu selection that appears along with the **← PHASE →** choice when phase measurements are selected. If the reference is already set to the desired reference value, pressing the **← PHASE →** menu selection exits the menu and activates the phase-measurement mode.

← SET 360° → —Permits resetting of the 360° reference for the **← PHASE →** measurements. Cursor difference or delay-time-to-delta-time difference is taken as the reference value when exiting the SET 360° reference function. Set the desired time that represents the complete 360 degrees of a reference waveform using the **← OR DE-**

LAY and → controls then select ← PHASE → to exit the menu and continue the phase measurement. Recalling the LAST MEAS' MT when ← PHASE → was the last selected measurement mode recalls the 360 degree reference as well.

SELF CAL—Self characterizes the horizontal system. SELF CAL may be performed at any time. Suggested times are: after a warmup period, whenever the ambient operating temperature changes by $\pm 15^{\circ}\text{C}$, and just prior to making any time measurements requiring the best possible accuracy.

Conditions for Cursors Display

The following information is an aid in understanding the order in which the menu measurement cursors are displayed.

Measurement Cursors

One or two measurement cursors may be displayed if any one of the following conditions is met:

VOLTMETER CH1/CH2—TRACK MEASMT is underlined and measurement source channel is on and the VOLTS/DIV VAR control in detent.

CURSOR VOLTS—Measurement source channel must be on and VOLTS/DIV VAR control in detent.

TIME—Horizontal MODE is in A.

Track Trig Lvl Cursors

If one or no measurement cursor is displayed, one or two trigger level cursors (not more than two cursors total) will be displayed if the following conditions are met:

TRACK TRIG LVL is underlined.

TRIGGER SOURCE switch is in CH 1 or CH 2.

The trigger-source channel is displayed.

Trigger-source channel VOLTS/DIV VAR control is in detent.

TRIGGER MODE switch is in AUTO LEVEL, AUTO, NORM, or SGL SWP.

TRIGGER CPLG switch is in DC or NOISE REJ.

Horizontal MODE switch is in A, ALT or B.

Track Cursors

If one or no measurement or trigger level cursor is displayed, up to two ground cursors (not more than two cursors total) may be displayed if the following conditions are met:

TRACK  is underlined and CH 1 and/or CH 2 VERTICAL MODE is selected.

Trigger-source channel (CH 1 and/or CH 2) VOLTS/DIV VAR control is in detent.

Behavior for Horizontal Mode Changes

If the Horizontal MODE is changed to a mode that cannot be used for the active measurement, that measurement will be canceled without a message being displayed. Returning to a mode that may be used and pressing the LAST MEAS' MT button will restore the canceled measurement mode (if no other measurement selection is made first). See Table 3-1 for compatible and incompatible modes.

The only Trigger MODE restriction is that gated-voltage measurements will not run in SGL SEQ Trigger MODE. Any gated measurement that is active will be canceled if SGL SEQ Trigger MODE is selected. If a gated-voltage measurement is selected while SGL SEQ is also selected, the message "NOT ALLOWED IN SSEQ" is displayed for two seconds (only if the menu is configured to remain on after the selection is made).

Table 3-1
Behavior for Horizontal MODE Changes

Measurement Mode	Compatible Horizontal Modes	Incompatible Horizontal Modes
← VOLTS →, μ VOLTS →	A, X-Y	ALT, B
← SEC →, ← 1/SEC →, ← PHASE →	A, ALT, B	X-Y
DC, +PEAK, -PEAK, PK-PK	A, X-Y	ALT, B
GATED +PEAK, GATED -PEAK, GATED PK-PK	A	ALT, B, X-Y

Measurement Compatibility and Error Messages

Channel 1 or Channel 2 Voltmeter measurements, except DC, cannot be made when the signal is larger than the range of the B trigger level. The displayed error message is "OUCH—TURN VOLTS/DIV CCW."

NOTE

When making DC measurements, overranged signals will not cause an error message to be displayed but can display incorrect voltage readings. To obtain accurate DC readings keep the waveform within the graticule limits.

The Channel 1 or Channel 2 Voltmeter measurement of DC cannot be made with the Input COUPLING set to AC; the displayed error message is "CH 1 (or CH 2) — SELECT DC COUPLING." If GND Input COUPLING is in use, a ground symbol is displayed after the readout value.

For +PEAK, -PEAK, and PK-PK measurements, the ac symbol (\sim) will be displayed for AC Input COUPLING, and the ground symbol will be displayed for GND Input COUPLING. The symbols will be displayed after the readout units.

The following measurements cannot occur when the VOLTS/DIV VAR control for the channel being measured is not in the detent position: +PEAK,

-PEAK, PK-PK, DC, GATED +PEAK, GATED -PEAK, GATED PK-PK, \leftarrow VOLTS \rightarrow , and ∇ VOLTS \rightarrow . The displayed error message is "MEAS SOURCE VAR OUT OF DETENT."

The following measurements cannot occur when the SEC/DIV VAR control for the channel being measured is out of the detent position: \leftarrow SEC \rightarrow , \leftarrow 1/SEC \rightarrow , \leftarrow PHASE \rightarrow , and \leftarrow SET 360° \rightarrow . The displayed error message is "VAR SECS/DIV OUT OF DETENT."

When in ALT or B Horizontal MODE, and the B Trigger MODE is not RUNS AFTER, a greater than symbol (>) will appear before the delay-time readout. The readout value displayed is the delay time between the A trigger and the time a B trigger can be accepted by the trigger system. A question mark (?) will appear in front of the delay time readout for delay measurements when the DELAY time is set to 0.25 division or less from the beginning of the sweep.

If a \leftarrow SEC \rightarrow or \leftarrow 1/SEC \rightarrow Time Measurement is selected when in ALT or B Horizontal MODE and the B Trigger MODE is not RUNS AFTER, the displayed error message is "USE RUNS-AFTER-DELAY TRIG MODE."

If the oscilloscope is not triggered when a gated voltage measurement mode is selected, the following error message is displayed: "LO REP RATE - STILL TRYING."

This can happen if the selected trigger channel has no trigger signal applied in NORM Trigger MODE or if the Trigger LEVEL control is not set to obtain a triggered display. An improperly triggered display in either AUTO LEVEL or AUTO Trigger MODE will cause the measurement readout value to be unstable, but no error message will be displayed.

Measurements in Single Sequence Mode

The following measurements run continuously during SGL SEQ Trigger MODE: DC, +PEAK, -PEAK, PK-PK, \leftarrow VOLTS \rightarrow , ∇ VOLTS \rightarrow , \leftarrow SEC \rightarrow , \leftarrow 1/SEC \rightarrow , and \leftarrow PHASE \rightarrow .

The readout and/or cursors are displayed briefly during single sequence mode for making a photographic record (or they may be configured to remain on—see the discussion on Configure Menu in the "Service Menu Features" part of this section.) The displayed readout is the value of the measurement at the instant it is displayed.

GATED +PEAK, GATED -PEAK, and GATED PK-PK measurements are not available during single sequence mode and will be canceled if active when SGL SEQ is selected.

B Trigger AUTO LEVEL acquisitions do not occur when the A Trigger MODE is SGL SEQ.

Service Menu Features

Most of the items in the SERVICE MENU are for diagnostics, troubleshooting, and calibration. However, there are four menu selections that are also for operational use: CONFIGURE, SELF CAL MEASUREMENTS, MAKE FACTORY SETTINGS, and LOAD STORE/RECALL SETUPS. Press the top and bottom menu-item select buttons to display the SERVICE MENU as shown in Figure 3-8.

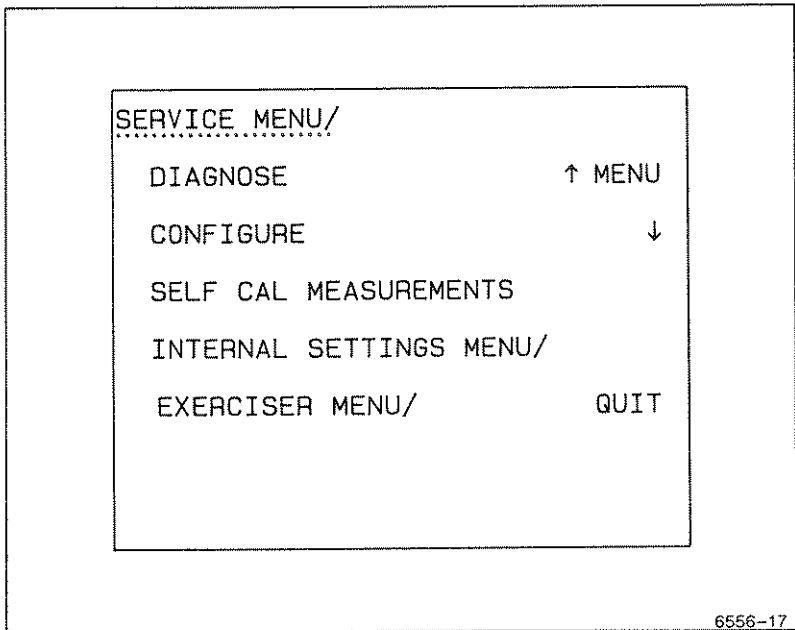

Figure 3-8. Service Menu.

Press the buttons opposite the displayed up- and down-arrows to move the displayed underline to the desired menu item of CONFIGURE, SELF CAL

KEEP MENU ON WHEN MEAS'MT SELECTED? (Factory Setting default is NO.) Selecting NO clears the measurement menu items from the display after a measurement function is selected. Measurement cursors remain displayed. The AUTO TRACKING MENU remains on after a selection has been made.

Selecting YES allows a measurement menu to remain displayed after a function is selected. The measurement menu items can be removed at any time by pressing the CLEAR DISPLAY button once.

RECALL ONLY (IN STORE/RECALL)? (Factory Setting default is NO.) Selecting NO displays the Store/Recall Setup menu when the STORE/RECALL SETUP button is pressed. From the Store/Recall Setup menu you can store, edit, and recall front-panel setups.

Selecting YES displays the Recall Only menu when the STORE/RECALL SETUP button is pressed. From the Recall Only menu you can easily step through all of the stored front-panel setups.

KEEP MENU ON WHEN S/R SELECTED. (Factory Setting default is NO.) Selecting NO clears the menu from the display when a store/recall setup function is selected.

Selecting YES keeps the Store/Recall Setup menu on the screen when using the store/recall setup functions. The menu can be removed at any time by pressing the CLEAR DISPLAY button once.

KEEP READOUT ON IN SGL SEQ? (Factory Setting default is NO.) Selecting NO will keep the readout off in Single-Sequence Trigger Mode. This mode is useful for single-sequence waveform photography. The readout is displayed briefly after the sequence is completed to expose the film, then cleared to prevent overexposure.

Selecting YES keeps the readout on when in the Single-Sequence Trigger Mode. This mode lets you view any of the measurements that continue to be made during SGL SEQ trigger mode even if no waveform is being displayed. The front panel control settings may also be made in SGL SEQ without having to select a different Trigger Mode to see the readouts as the controls are changed. The measurement readout is especially useful for the Voltmeter measurements because the signal on the selected input channel is continually monitored. (GATED Voltmeter measurements are not permitted in SGL SEQ Trigger MODE.)

NOTE

The following menu items, INITIALIZE TIME CURSORS/ DELAYS and PRESET TV TRIG SLOPE (+ or - SYNC) are only available on Instruments Serial Numbered B020100 or above.

INITIALIZE TIME CURSORS/DELAYS? (Factory Setting default is YES.)
If YES is selected, with the following condition: \leftarrow PHASE \rightarrow , and \leftarrow SET 360° \rightarrow .

\leftarrow SEC \rightarrow , \leftarrow 1/SEC \rightarrow , or \leftarrow SET 360° \rightarrow is selected, and none of the following conditions is true:

more than one channel is selected and the Horizontal MODE is not "A", or

A Trig MODE is VERT and Vertical MODE is ADD, or

more than one channel is selected and the A Trig Mode is VERT, or

Horizontal MODE is B,

the cursors or delays will be initialized as follows:

If the reference delay is appropriate to the measurement mode, it will be set inside a window that extends from 0.25 division after sweep start to one period of the trigger signal left of the 10th division after sweep start, if this window exists. If there is no window, it will be left at its original position.

If the reference cursor is appropriate to the measurement mode, it will be set as specified for the reference delay with the assumption that the sweep start is at the left graticule line.

The delta cursor or delta delay, as appropriate to the measurement, will be set one period of the trigger signal to the right of the reference cursor or delay, if possible; if not possible, it will remain unchanged.

Cursors and delays may remain unchanged if:

(1) there is no A trigger, or

(2) the trigger source channel's signal has a repetition rate slower than 50 Hz or faster than 30 MHz.

Under the conditions of 1 and 2 above, a question mark may appear before the measurement value and remain until the → or ← knob is moved. The user should, however, always inspect the display to determine that the cursors or intensified zones mark appropriate places on the waveform. There are waveforms, such as vary narrow pulses or multiple crossings of the trigger level within one period, that can cause erroneous initialization with no question mark.

When LAST MEAS' MT is selected and the last measurement was |← SEC →| or |← 1/SEC →|, or the last action was |← SET 360° →|, cursors or delays will be reinitialized as above if configured to initialize time measurements and the instrument's mode is appropriate.

Accuracy of the cursor or delay placement will be as specified for the selected measurement + 2ns.

PRESET TV TRIG SLOPE FOR -SYNC? (Factory Settings default is YES.) Selecting YES will cause the trigger slopes to preset to "-" when TV trig mode is selected, and the configure menu is exited. If NO is selected, a second question is presented:

PRESET TV TRIG SLOPE FOR +SYNC? (Factory Settings default is NO.) Selecting YES will cause the trigger slopes to preset to "+" when TV trig mode is selected, and the configure menu is exited. If NO is selected, the scope will not use a preset slope when a TV trig mode is selected.

When the final question is answered, the SERVICE MENU display returns.

Self Cal Measurements

This selection does a self-characterization of the vertical channels 1 and 2 and the horizontal timing. The SELF CAL MEASUREMENTS routine stores calibration constants that set the accuracy of the internal measurement system. Voltage or time measurements can be calibrated separately by selecting the SELF CAL Item from the VOLTMETER or TIME Measurement Menus.

NOTE

CALIBRATE MEASUREMENTS or SELF CAL can be performed anytime after a 20-minute warmup to ensure the accuracy stated in Section 6.

Internal Settings Menu

The INTERNAL SETTINGS MENU (see Figure 3-10) consists of MAKE FACTORY SETTINGS, LOAD STORE/RECALL STORED SETUPS, and ADJUST VERTICAL OUTPUT. All INTERNAL SETTINGS menu items, except ADJUST VERTICAL OUTPUT, are for use by the operator. To return to the main SERVICE MENU, press the up-arrow key to underline INTERNAL SETTINGS MENU and press the button again to display the SERVICE MENU. To return to the oscilloscope mode, select QUIT from the INTERNAL SETTINGS MENU or SERVICE MENU, or press the CLEAR DISPLAY button.

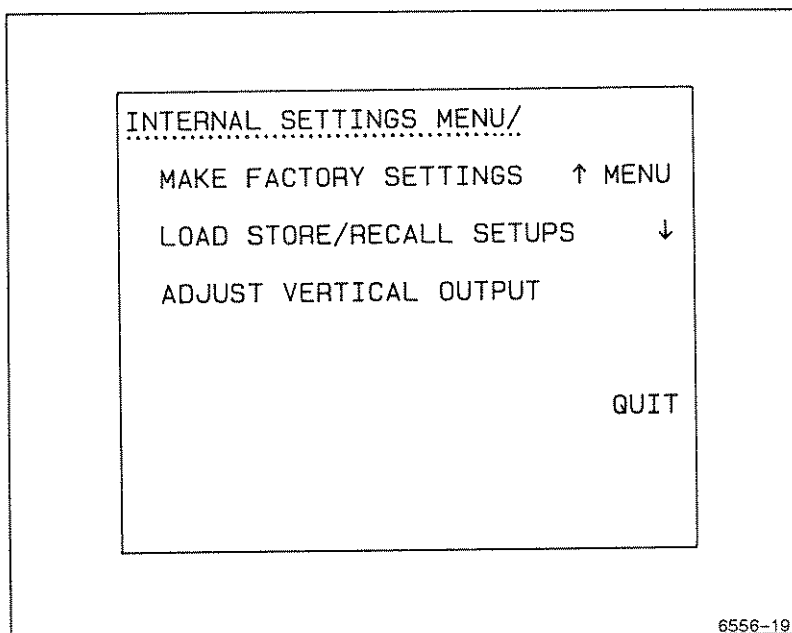

Figure 3-10. Internal settings menu.

MAKE FACTORY SETTINGS. Sets the front-panel controls and menu configurations as described in Appendix B.

LOAD STORE/RECALL SETUPS. Loads eight factory front-panel setups into the Store/Recall memory. The setups are stored in memory locations 01 through 08, and all previously stored setups in locations 01 through 20 will be deleted. When you select this item, a message will be displayed that will give you the choice to continue or not continue with the loading of the factory setups. Don't select YES unless you are sure that you want to delete all of your previously stored setups.

ADJUST VERTICAL OUTPUT. This menu item is to be used by a service technician during calibration and troubleshooting. It is not an operational function.

Store/Recall Setup Features

The menu-driven Store/Recall Setup system allows you to store and recall up to 20 front-panel setups. From the displayed menus, stored setups can be recalled, altered, deleted, or arranged in sequences. A menu is displayed by pressing the STORE/RECALL SETUP button. One of three menu configurations will be displayed depending on the YES/NO choices of the CONFIGURE items in the SERVICE MENU. The three different menu configurations are Recall Only, Store/Recall Setup, and Store/Recall Setup with access to the Recall Only menu.

The Recall Only menu lets you recall the stored setups in sequences. Only the name and number of the stored record are displayed along with up and down arrows for selecting higher or lower numbered setups. If more than one sequence is stored, a menu item (NEXT SEQ) also appears which allows you to change sequences.

With the Store/Recall Setup menu displayed, you can store, alter, or recall front-panel setups as desired. When you select a menu item the menu remains displayed. This is the menu to use when storing setups and setting up sequences. The menu can be removed from the display by pressing the CLEAR DISPLAY button.

The Store/Recall Setup menu with access to Recall Only operates the same as the Store/Recall Setup menu except that the menu display is cleared when the STORE or RECALL item is selected, and a menu item (SEQUENCE) provides direct access to the Recall Only menu.

Factory Stored Setups

When the 2246A is shipped from the factory, the Store/Recall Setup memory contains eight stored front-panel setups. These factory setups are stored in setup locations 01 through 08. The setups may be recalled and used for demonstration and training, or they may be used as a basis for setups which suit your specific applications. Appendix C lists the front-panel settings for each factory setup. The factory stored setups can be restored to the Store/Recall Setup memory if desired. See "Service Menu Features", "Internal Settings Menu", "LOAD STORE/RECALL SETUPS" in this section.

Store/Recall Setup Menu

To select Store/Recall Setup menu (see Figure 3-11) perform the following procedure:

1. Press the top and bottom Menu-Select buttons to display the SERVICE MENU.
2. Call up the CONFIGURE menu.
3. Set:

KEEP MENU ON WHEN S/R SELECTED?	YES
RECALL ONLY? (IN STORE/RECALL)	NO
4. Press the CLEAR DISPLAY button to return to the normal operating mode.
5. Press the STORE/RECALL SETUP button.

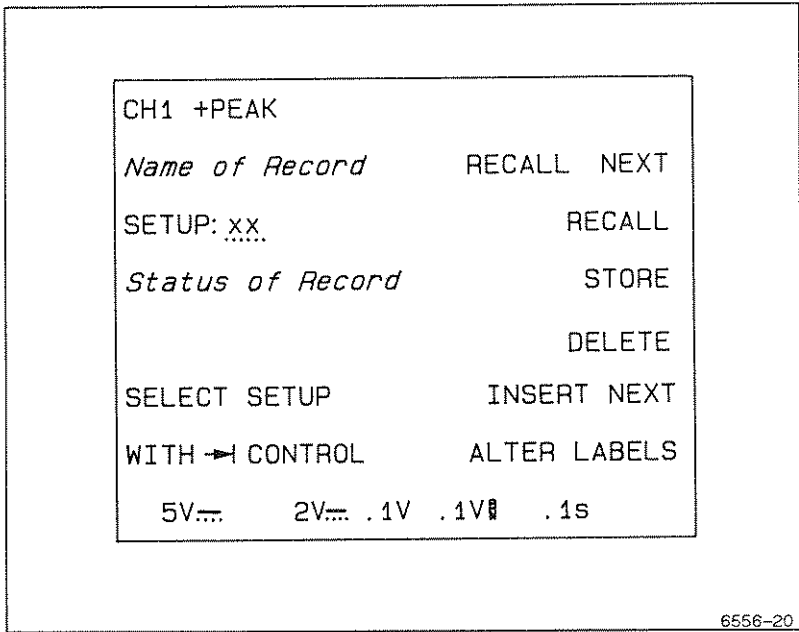

Figure 3-11. Store/Recall Setup menu display.

The descriptions of the readout locations and menu items are from top to bottom as follows:

Active Measurement Display—Indicates the voltage or time measurement that is currently active. The values are not displayed.

Name of Record—Name given to the currently displayed record. To alter name of record, select ALTER LABELS item and use the ← OR DELAY and → controls.

SETUP: xx—Display the setup number from 01 through 20 of the displayed record. The displayed setup number can be changed with the → control.

Status of Record—Indicates the status (EMPTY, END SEQ, blank, or DELETED) of the currently displayed record. EMPTY appears only when there are no stored front-panel setups. END SEQ is the end-of-sequence indication. DELETED appears only on the last record, after the DELETE function has been used or a record has been overwritten with the STORE function.

SELECT SETUP WITH → CONTROL—This message tells you to rotate the → control to select the number of the displayed record.

RECALL NEXT—Recalls front-panel settings for the next record in the current sequence. If the current record is the last in the sequence (status END SEQ or the highest numbered record stored), the menu item label becomes RECALL FIRST and when pressed, the first record of the current sequence will be recalled. A sequence starts with either 01 or the first record past a previous record with an END SEQ status.

SEQUENCE—Displayed in place of RECALL NEXT when "NO" is selected for both the "KEEP MENU ON WHEN S/R SELECTED" and "RECALL ONLY? (IN STORE/RECALL)" in the CONFIGURE menu. When SEQUENCE is pressed, the RECALL ONLY MENU is displayed. See "Recall Only Menu" in this section.

RECALL—Recalls front-panel settings for currently displayed record. If the SETUP number is blank, there are no stored records. A "NOTHING STORED" message is displayed and the front-panel settings remain unchanged.

STORE—Stores present front-panel settings, name, and status in record xx. Use this function for initially storing record 01 or for replacing the front-panel settings in any stored record. In most cases, the last record replaced by the STORE function can be recovered if necessary; see "Recovering A Deleted Record" in this section.

DELETE—Deletes the contents of record xx. The number of each record above the deleted record xx is reduced by one. In most cases, the last record deleted can be recovered if necessary; see "Recovering A Deleted Record" in this section.

INSERT NEXT—Creates a new record of the current front-panel setup and inserts the new record after record xx. All record numbers above xx are increased by one. The name and status of the new record will be blank. This is used for creating new front-panel setups and storing them in appropriate locations as required. To change a stored setup use the STORE menu function.

NOTE

If there are already 20 records stored, inserting another record will delete record 20. A message "INSERTION WILL CAUSE LOSS OF STEP 20" will be displayed. Selecting "INSERT" will delete the existing record 20 and replace it with a new one. Selecting "ABORT" will keep the existing record 20 and not save the new record. If record 20 is displayed, selecting "INSERT" will cause a message "NO MORE STEPS" to be displayed.

ALTER LABELS—Calls up the ALTER LABELS menu (see Figure 3-12) to name or alter a currently displayed stored record.

The descriptions of the readout locations and menu items of ALTER LABELS menu are from top to bottom as follows:

Name of Record—Name given to the currently displayed record. A name given to a record can consist of up to 15 characters. The characters available in order are: a space, letters from A to Z, numbers from 0 to 9, a period, and eight special characters ((,) , < , > , = , ? , / , Δ).

Characters are selected by placing the underline within the Name of Record brackets <> with the ← OR DELAY control. To select a character over the underline, rotate the → control until the desired character is displayed, then move the underline to the right with the ← OR DELAY control. Repeat the selection procedure until the name of the record is completed.

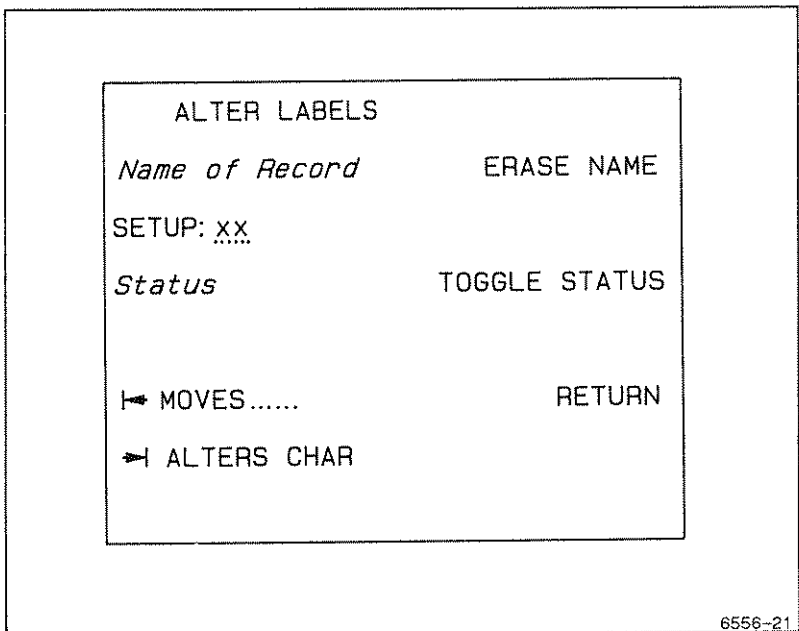

Figure 3-12. Alter Labels menu.

SETUP: xx—Displays the setup number from 01 through 20 of the displayed record as on page 1 of Store/Recall Setup menu. When the number is underlined with the **← OR DELAY** control, the displayed record can be changed with the **→** control. This allows specific records to be reviewed and altered.

Status of Record—Indicates the status (EMPTY, END SEQ, DELETED, or blank) of the currently displayed record. EMPTY appears only when there are no stored front-panel setups. END SEQ is the end-of-sequence indication. DELETED appears on the last record when it is a record saved from a STORE or DELETE function. A record with the "DELETED" status cannot be modified. Attempting to do so will display an error message: "CANNOT MODIFY DELETED STEP".

← MOVES —This message tells you to rotate the **← OR DELAY** control to move an underline through menu-display fields that can be changed by rotating the **→** control.

→ ALTERS CHAR—This message tells you to rotate the **→** control to change the information in the selected (underlined) field.

ERASE NAME—Erases the name currently displayed.

TOGGLE STATUS—Toggles status of record between blank and END SEQ. Select END SEQ to mark a record as the last in a sequence.

RETURN—Returns to the Store/Recall Setup menu.

Recovering A Deleted Record

A record deleted by a STORE or DELETE function is saved in the store/recall memory for recovery. Only the last deleted record can be recovered. Recovery must be done before the STORE or DELETE functions are used again. Also, a record should be recovered before using the INSERT NEXT function when there are already 19 or more stored records. A record that is deleted by the STORE function when 20 records are stored is not saved and cannot be recovered.

TO RECOVER A DELETED RECORD:

1. Select the Store/Recall Setup menu.
2. Rotate the **→** control clockwise until the last record is displayed. That record will have a status of "DELETED."

3. Press RECALL to recall the front-panel settings for the deleted record.
4. Decide where you want to store the deleted setup. You can replace an existing record using the STORE function, or you can insert a new record with the INSERT NEXT function.
 - a. To replace an existing record, rotate the → control to the setup number that is to be replaced and press the STORE button.
 - b. To insert a new record, rotate the → control to the setup number that is to precede the new record and press the INSERT NEXT button.
5. Press ALTER LABELS button.
6. Alter the name and status of the new record as desired. See "ALTER LABELS" description in this section.

Storing Setups in Sequences

Front-panel setups are stored in the store/recall memory and numbered starting at 01. A total of 20 setup records can be stored and recalled. Stored setups can be recalled individually by setup number, or sequentially within marked sequences. A sequence is defined as starting at setup number 01 or the first record after one marked with a status of END SEQ and ending with the next record with a status of END SEQ or the last stored record.

To store a sequence of front-panel setups perform the following procedure:

1. Set CONFIGURE in the Service Menu for the following:

KEEP MENU ON WHEN S/R SELECTED?	YES
RECALL ONLY (IN STORE/RECALL)?	NO
2. Press the STORE/RECALL SETUP button to call up the Store/Recall Setup menu.
3. Rotate the → control to review the stored setups. Determine whether there are enough EMPTY locations to store all of the setups in your sequence. There are a total of 20 locations available. It is a good idea to use only 19 and leave the 20th open so that the system will have a place to store the last deleted file for recovery when necessary.

If there are not enough locations available to store your setups, you can use DELETE to remove unneeded setups or you can use the STORE function to "write" over them.

4. Set the front-panel controls as desired for the first setup in your sequence. Set all controls the way you want them; even the intensity control settings can be stored for recall. You can set the front-panel controls in several ways: setting the individual controls manually, inputting the desired signals and pressing the AUTO SETUP button, or by recalling and modifying an already stored setup.
5. Rotate the → control to the setup location that is to precede or start the first setup in the sequence.
6. Press INSERT NEXT (or STORE, if the current setup location is to be "written" over).
7. Press ALTER LABELS to call up the ALTER LABELS menu and give the desired name to your setup. Also make sure that the status is blank for all of the setups in the sequence, except the last one, and that one should be END SEQ. END SEQ indicates "end of sequence". See ALTER LABELS description in this section.
8. Press RETURN to display the Store/Recall Setup menu.
9. Repeat the above process of inserting or storing (writing over) until all the setups in your sequence are stored in memory.
10. If your sequence does not begin with 01, enter the ALTER LABELS menu and make sure that the status of the setup just preceding your first setup in the sequence is set to END SEQ.

Recall Only Menu

The Recall Only menu (see Figure 3-13) can be displayed when the CONFIGURE menu has been appropriately set and there is at least one setup record stored in the store/recall memory. Depending on how the CONFIGURE menu questions are answered, the Recall Only menu can be displayed directly by pressing the STORE/RECALL SETUP button, or by selecting the SEQUENCE item from the Store/Recall menu. As with all menus, the Recall Only menu can be removed from the display by pressing the CLEAR DISPLAY button.

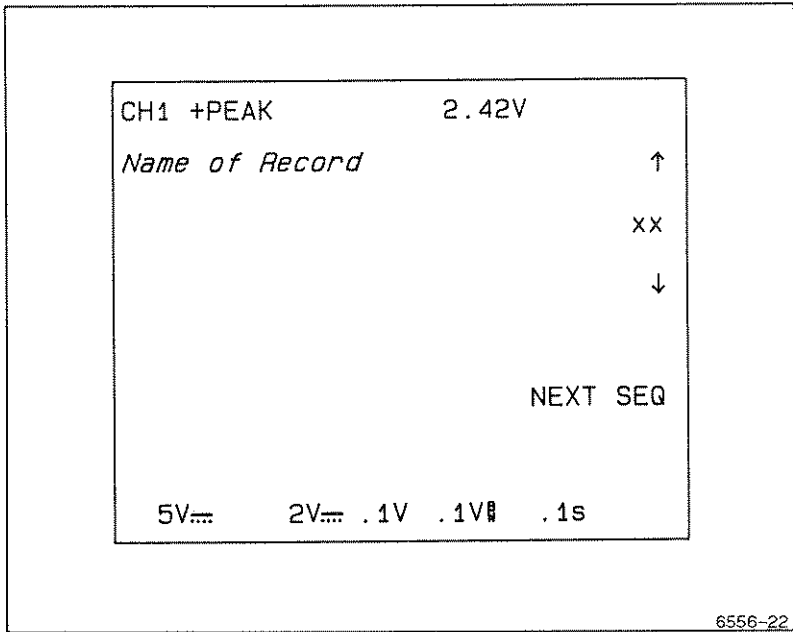

Figure 3-13. Recall only menu.

To set up access to the Recall Only menu:

1. Press the top and bottom Menu-Select buttons to display the SERVICE MENU.
2. Call up the CONFIGURE menu.
3. Follow this step to select the Recall Only menu directly with the STORE/RECALL SETUP button. Use step 4 if you want to select the Recall Only menu from the Store/Recall Setup menu.
 - a. Set:

KEEP MENU ON WHEN S/R SELECTED?	YES or NO
RECALL ONLY? (IN STORE/RECALL)	YES
 - b. Press the CLEAR DISPLAY button to exit the SERVICE MENU.
 - c. Press the STORE/RECALL SETUP button to display the Recall Only menu.

4. Follow this step to select the Recall Only menu from the Store/Recall Setup menu.
 - a. Set:

KEEP MENU ON WHEN S/R SELECTED	NO
RECALL ONLY? (IN STORE/RECALL)	NO
 - b. Press the CLEAR DISPLAY button to exit from the SERVICE MENU.
 - c. Press the STORE/RECALL SETUP button.
 - d. Press the SEQUENCE button to display the Recall Only menu.

The descriptions of the readout locations and menu items are from top to bottom as follows:

Up-Arrow Button—Recalls front-panel settings for the next record in the current sequence. If the current record is the last in the sequence (status END or the highest numbered record stored), the next record recalled will be the first record of the current sequence. A sequence starts with either 01 or the first record past a previous record with an END SEQ status.

xx—Recalls the currently displayed record number (xx). The record number will start at 01 when the RECALL ONLY menu is displayed by pressing the STORE/RECALL SETUP button. If the menu is displayed by selecting SEQUENCE from the Store/Recall, the record number will start at the same number as displayed on the Store/Recall Setup menu.

Down-Arrow Button—Recalls the front-panel settings for the previous record in the current sequence. If the displayed record is the first in a sequence, pressing the down-arrow button will recall the current record.

NEXT SEQ—Changes the current record number to the first step of the next sequence. If presently in the last sequence, pressing NEXT SEQ will change the current record number to 01. This item will not appear if there is only one sequence defined.

Active Measurement Display—Indicates the voltage or time measurement (with values) that is currently active (top and bottom of the display).

SECTION 4

**OPERATOR
CHECKS AND
ADJUSTMENTS**

Introduction

The checks and adjustments in this section are for the operator and involve using only controls and adjustments on the outside of the instrument. Internal adjustments must be made by a qualified service person.

Before operating the instrument for the first time and before connecting the power, refer to Section 1 "Preparation for Use" to prepare the instrument for the initial start-up.

Verify that the POWER switch is OFF (out position). Plug the power cord into a power-source outlet that supplies a voltage within the operating range of the instrument's power supply.

NOTE

If you notice an improper indication or instrument malfunction during these procedures, refer the instrument to a qualified service person.

Initial Setup

The following procedure may be used to set up front-panel controls when the instrument is first turned on or when a signal is not being applied to the input connectors.

1. Press in the POWER switch button (ON) and let the instrument warm up (20 minutes is recommended for maximum accuracy).
2. Set the instrument front-panel controls to obtain a baseline trace:

Vertical Controls

VERTICAL MODE	CH 1
POSITION	Center the trace
VOLTS/DIV	1 V
VOLTS/DIV VAR	Calibrated detent
Channel 1 COUPLING	GND

Horizontal Controls

MODE	A
POSITION	Center the trace

X10 MAG	Off
A SEC/DIV	0.1 ms
SEC/DIV VAR	Calibrated detent

Trigger Controls

HOLDOFF	MIN
A/B SELECT	A
MODE	AUTO LEVEL
SOURCE	VERT
CPLG	DC

Display

A INTEN	Desired brightness
FOCUS	Best trace definition
READOUT	Desired brightness
SCALE ILLUM	Desired brightness

MENU System Controls

MEASUREMENT MODES, TRACKING CURSORS MENUS and STORE/RECALL	All off (Press CLEAR DISPLAY three times to ensure all off.)
---	---

Auto Setup Function

The Auto Setup function can be used to automatically set up the front-panel controls to produce a usable display of the applied signal.

1. Connect signal(s) to be displayed to the appropriate input connector(s).

For triggering to be set up properly when the AUTO SETUP button is pressed, connect the trigger-source signal to the lowest numbered channel that will be turned on.

2. Set:

VERTICAL MODE	As desired (see NOTE)
Horizontal MODE	As desired

3. Press the AUTO SETUP button.

NOTE

Normally, the Auto Setup of the display is sufficient for measurement purposes. If further waveform enhancement is needed, use the appropriate front-panel controls to adjust the display. For Auto-setup action see Appendix A.

Trace Rotation Adjustment

1. Perform the "Initial Setup" procedure. Position the trace vertically to align it with the center horizontal graticule line and check that the trace is parallel with the graticule line.

NOTE

Normally, the trace will be parallel to the center horizontal graticule line, and the TRACE ROTATION adjustment will not be needed.

2. If necessary, adjust the TRACE ROTATION to make the baseline trace parallel to the center horizontal graticule line. Use a small straight-blade screwdriver or alignment tool.

Probe Low-Frequency Compensation

Misadjustment of probe compensation is a possible source of measurement error. The attenuator probes are equipped with compensation adjustments. To ensure the best measurement accuracy, always check probe compensation before making measurements.

1. Connect the two supplied 10X probes to the CH 1 and CH 2 BNC input connectors.

2. Connect the probe tips to the PROBE ADJUST connector and the probe ground leads to scope ground.
3. Set:

VERTICAL MODE	CH 1 & CH 2
Horizontal MODE	A
4. Press AUTO SETUP button.
5. Set the CH 1 VOLTS/DIV setting to 0.1 V (10 mV with probe disconnected) and vertically center the PROBE ADJUST square-wave signal.
6. Check the square-wave signal for overshoot and rolloff (see Figure 4-1). If necessary, use the special adjustment tool supplied in the probe accessory package to adjust the low-frequency compensation for a square front corner on the square wave displayed.
7. Press the CH 2 VERTICAL MODE button to turn CH 2 on in the display, and press the CH 1 Mode button to remove the CH 1 trace from the display.
8. Set the CH 2 VOLTS/DIV setting to 0.1 V (10 mV with probe disconnected) and vertically center the PROBE ADJUST square-wave signal.
9. Repeat Steps 5 and 6 for the second probe on the CH 2 BNC input connector.

NOTE

Refer to the instruction manual supplied with the probe for more detailed information about the probes and the adjustment procedure.

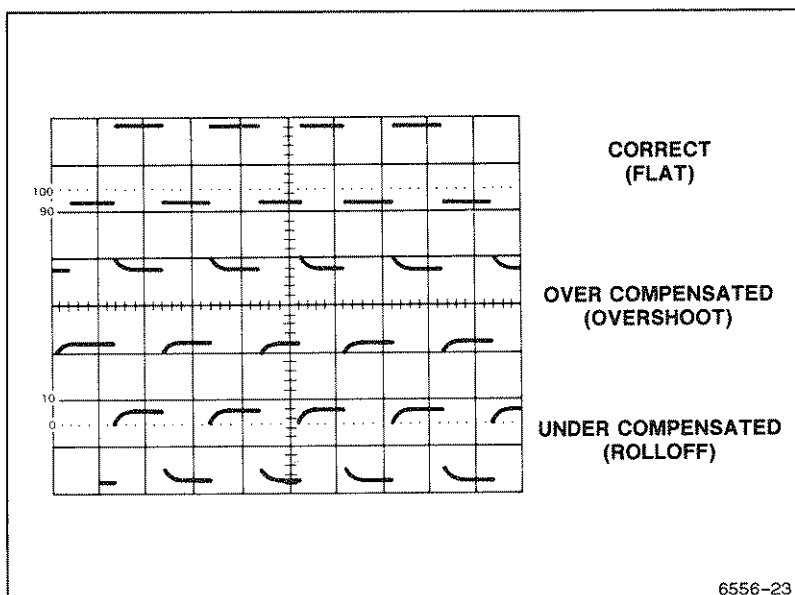

Figure 4-1. Probe compensation.

Vertical Deflection Check

The PROBE ADJUST square-wave signal may be used to check the Channel 1 and Channel 2 vertical deflection system in the following procedure:

1. Connect the two 10X probes (supplied) to the CH 1 and CH 2 input connectors.
2. Connect both probe hook tips to the PROBE ADJUST connector.
3. Set:

VERTICAL MODE	CH 1
Horizontal MODE	A
4. Press AUTO SETUP button.
5. Set CH 1 and CH 2 VOLTS/DIV switches to 0.1 V for the attached 10X probes.

6. Set the bottom of the trace of the PROBE ADJUST square-wave signal to a convenient horizontal graticule line with the Vertical POSITION control.
7. Check for a five-division display of the PROBE ADJUST square-wave signal.
8. Select CH 2 VERTICAL MODE and repeat steps 6 and 7.
9. Disconnect the probes from the instrument.

Timing Checks

The time measurement cursors may be used to check the horizontal deflection system.

1. Preset instrument controls and obtain a baseline trace and set the A SEC/DIV switch to 0.1 ms. Vertically center the baseline trace.
2. Press the TIME CURSORS button to call up the Time Measurement Mode menu on the crt and select \leftarrow SEC \rightarrow function for measuring time difference by pressing the Menu Select button opposite menu label.
3. Align the reference cursor to the second vertical graticule line using the \leftarrow OR DELAY control (both cursors are positioned together).
4. Adjust the \rightarrow control for a reading of 800.0 μ s
5. Check that the cursors are eight divisions apart.
6. Press the CLEAR DISPLAY button to remove the cursors from the display.

SECTION 5

**BASIC
APPLICATIONS**

Introduction

The TEKTRONIX 2246A Oscilloscope provides an accurate and flexible measurement system. After becoming familiar with the controls, indicators, menus, and capabilities of the instrument, you can develop convenient methods for making special measurements for your own applications. The measurements given in this section are examples of typical applications that may assist in developing efficient techniques for your specific measurements. A brief description of how the graticule markings are used in making measurements is given in Section 3 of this manual.

When a procedure calls for "Initial Setup" or "Auto Setup Function," refer to the "OPERATOR CHECKS AND ADJUSTMENTS" Section 4. Certain signals such as video or aperiodic signals (non-repeating) and signals containing many unrelated frequency components may require more trigger signal conditioning and/or holdoff to obtain the best display.

CH 1/CH 2 Voltmeter Measurements

The CH 1/CH 2 Voltmeter measurements are continuous measurements of the DC, +PEAK, -PEAK, or PK-PK values of an applied signal. The measurement value is displayed in the crt readout. Measurement tracking and/or ground tracking cursors may be displayed to give the user instant feedback about where on the applied signal the measurement is being made and the location of ground level.

GATED modes of +PEAK, -PEAK, and PK-PK measurements may be used to define the area of the measurement on the displayed waveform. The position and width of the gated region is displayed as an intensified zone on the A trace of the waveform display. Position of the gated region on the waveform is controlled by the ← OR DELAY control, and width of the gated region is controlled by the → control.

Some features of the CH 1/CH 2 Voltmeter function are:

- a. Measures CH 1 or CH 2 while viewing either channel. (Select the measurement source channel using the SET MEAS' MT CHANNEL menu.)
- b. Measures signal levels (DC values and peaks) in SGL SEQ (single-sequence) Trigger MODE continuously. (Use CONFIGURE function in the Service Menu to get menus and readouts to remain on between single sequence triggers.)

- c. Finds peaks of signal applied, not only just the displayed portions of the waveform.
- d. Defines a portion of the waveform (GATED measurements—especially useful for making measurements on a multi-level signal) on which to make the selected measurement. (Use page 2 of the VOLTMETER menu to select a GATED-measurement mode.)

NOTE

Very narrow-gated measurements at 20 ns per div sweep speed are impractical due to imprecise definition of the intensified zone at that sweep speed.

Peak Voltage Measurement

To make a +peak voltage measurement use the following procedure:

1. Apply the signal to be measured to CH 1 input connector.
2. Set:

VERTICAL MODE	CH 1
Horizontal MODE	A

3. Press AUTO SETUP button.
4. Press the VOLTMETER CH1/CH2 button to call up the selection menu and select the +PEAK choice. Any of the page one choices may be selected as required for the waveform measurement wanted.

Depending on the way the CONFIGURE choices of the SERVICE menu have been made, the menu will either go off when the measurement selection is made or it will stay on. If the menu remains on, press the CLEAR DISPLAY button once to remove it from the display. See the SERVICE Menu discussion in Section 3 for further details.

NOTE

The TRACK MEASMT cursor may be displayed with the waveform. Pressing CLEAR DISPLAY in the initial setup removes the measurement tracking cursor from the display (and also cancels the measurement) but does not disable the feature once it has been enabled; the next time a CH 1/CH 2 Voltmeter measurement mode is called for, the measurement tracking cursor is again displayed.

5. Press the CURSOR VOLTS button and display page 2 of the menu by selecting the (TO AUTO TRACKING MENU) choice. Of the three features available in page 2, select both TRACK MEASMT and TRACK \overline{m} . Menu labels are UNDERLINED when the function is enabled. The TRACK \overline{m} cursor is especially useful for providing feedback to the user about dc offset of the signal from ground level.

NOTE

In this menu, the select buttons toggle the choices on and off with each press, and all three choices may be selected (but not all displayed together because only two cursors are allowed). Also, pressing CLEAR DISPLAY (as many as three times may be necessary) does turn off the TRACK TRIG LVL and TRACK \overline{m} choices.

6. Press either MENU OFF (in the menu selection list) or CLEAR DISPLAY (once) to remove the AUTO TRACKING menu from the display.

NOTE

If VOLTMETER PK-PK measurement is selected, two TRACK MEASMT cursors are required; therefore, the TRACK \overline{m} cursor will not be displayed.

7. See Figure 5-1. The test signal used for the example has a dc offset (as shown by the position of the TRACK \overline{m} cursor) and +PEAK value (peak ac + dc) as indicated by the voltage readout.

Gated Voltage Measurement

If you need to track the +PEAK, -PEAK, or PK-PK voltage of a selected portion of a waveform, that portion can be defined using the GATED MEASUREMENTS available in page 2 of the VOLTMETER menu. The general steps given in the previous Peak Voltage Measurement procedure are used for this function also. Set up all the controls and apply the signal to be measured in the same way; but, after pressing the VOLTMETER CH1/CH2 button, select the (TO GATED MEASMT MENU) choice. After that, follow these additional steps to make the gated measurement.

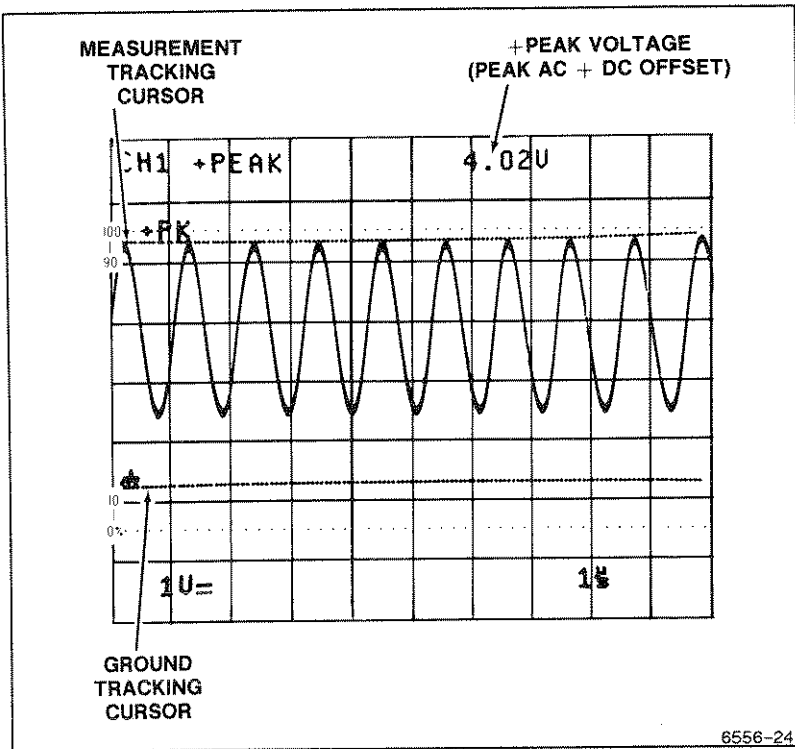

Figure 5-1. +PEAK voltage measurement and tracking cursors.

1. Select GATED +PEAK measurement mode. The menu will be removed (if configured to do so), and any enabled tracking cursors will be displayed. If none are enabled in page 2 of the CURSOR VOLTS menu, none will be displayed.

NOTE

Only two of the possible three available selections may be displayed (on a priority basis). TRACK MEASMT has the highest priority, followed by TRACK TRIG LVL and TRACK \overline{m} in that order. Also the TRACK TRIG LVL cursors may only be displayed on the Trigger SOURCE signal. The TRACK MEASMT cursor may be directed to either CH 1 or CH 2 input signal without regard to the trigger signal SOURCE.

2. Adjust the B INTEN and A INTEN controls to provide a good viewing contrast of the intensified zone that appears on the A Sweep trace.

NOTE

If the zone does not appear, it may be positioned out of the viewing area (but not past the end of the A Sweep trace). Turn the \leftarrow OR DELAY control counterclockwise to move the gate zone closer to the beginning of sweep.

3. Use the \leftarrow OR DELAY control to position the intensified zone to the area of interest on the waveform to be tracked. (See Figure 5-2.)
4. The width of the gated zone is controlled by the \rightarrow control. Adjust the width to define the gated measurement zone.
5. The voltage value that appears in the readout is the +PEAK voltage that occurs within the zone.

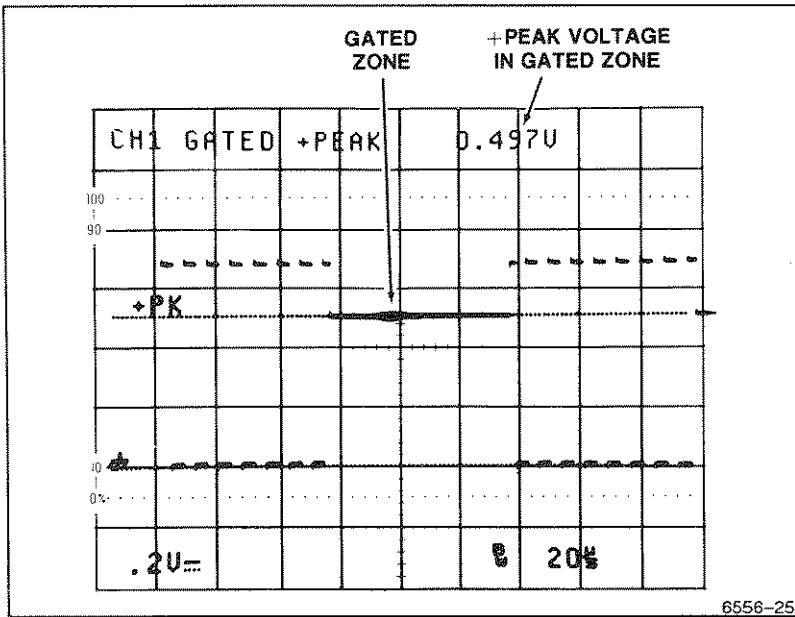

Figure 5-2. Gated voltage measurement.

Voltage Measurement Cursors

Voltage cursors can be used to measure signals displayed on CH 1 or CH 2. Voltage measurements using cursors may be done on the CH 3, the CH 4, or the ADD waveform by setting the VOLTS/DIV switch setting of the selected measurement channel to the same scale factor as the signal to be measured. However, the measurement accuracy on the CH 3 or CH 4 input signals will be less accurate than on the CH 1 or CH 2 input signals. Volts cursors are also available for making measurements in both the A Horizontal MODE and the X-Y Horizontal MODE.

Voltage Difference

Use the following procedure steps as a guideline in making voltage difference measurements using the positionable cursors.

1. Apply the signal to the input connector(s).

NOTE

For triggering to be set up properly when the AUTO SETUP button is pressed, connect the trigger-source signal to the lowest numbered channel that will be turned on.

2. Set:

VERTICAL MODE	As desired
Horizontal MODE	A or X-Y

3. Press AUTO SETUP button.

4. Press the CURSOR VOLTS button to display the measurement selection menu and select the \leftarrow VOLTS \rightarrow cursors. The voltage cursors are initialized to the peak-to-peak levels of the lowest numbered displayed channel of either CH 1 or CH 2 (see Figure 5-3).

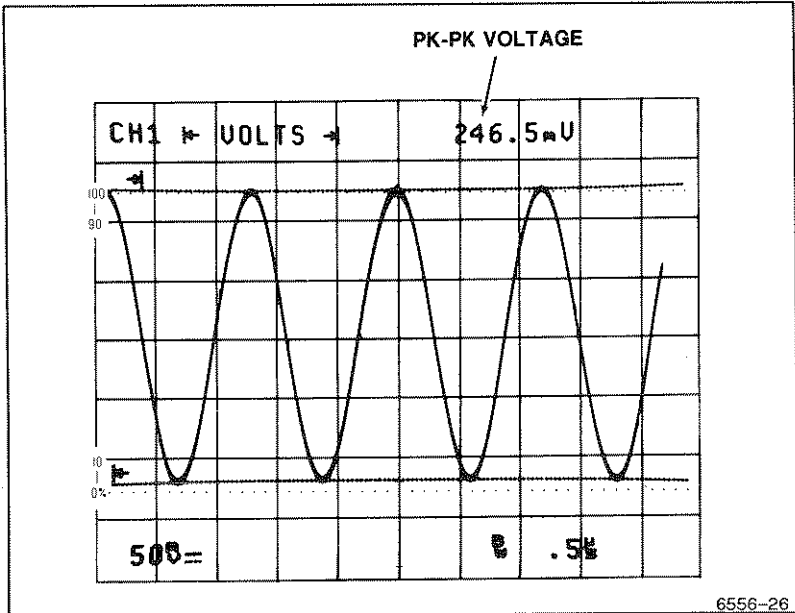

Figure 5-3. Voltage difference measurement using cursors.

NOTE

Voltage cursors are initialized to levels seen by the peak detector circuitry. Noise and other signals riding on the signal to be measured will cause a slight displacement of the cursors from the displayed waveform peaks, and above 50 MHz the bandwidth rolloff of the trigger circuit will affect the initial cursor positions on the waveform.

5. For a peak-to-peak voltage measurement, slightly reposition the cursors as necessary to precisely align them with the peak amplitudes of the waveform, and the work is done. The \leftarrow OR DELAY control positions both cursors together (keeping the original spacing), and the \rightarrow control positions the independent cursor. Then, simply read the measurement value displayed in the top line of the readout.
6. To make voltage difference measurements between any other locations on the waveform, simply move the \leftarrow cursor to the new point of interest and then position the independent \rightarrow cursor to the second point on the waveform and read the voltage difference.

Ground-Referenced Voltage

Voltage measurements using ground as a reference are made using the ∇ VOLTS \rightarrow cursors. The ground tracking cursor is fixed at the ground level of the applied signal and the independent cursor above or below ground as necessary to measure the voltage at the cursor position. Use the following procedure steps to set up to measure ground-referenced voltages.

1. Apply the signal to the input connector(s).

2. Set:

VERTICAL MODE	As desired
Horizontal MODE	A
CH 1/CH 2 COUPLING	DC

3. Press AUTO SETUP button.
4. Press the CURSOR VOLTS button to display the measurement selection menu and select the ∇ VOLTS \rightarrow cursors. The independent cursor is initialized to the +PEAK of the input waveform.

- Position the independent cursor using the \rightarrow control to the measurement point on the waveform and read out the value of the cursor position (shown in Figure 5-4). (The \leftarrow OR DELAY control has no effect.)

NOTE

The test signal used for illustration purposes in Figure 5-4 is a video test signal. For triggering on a video waveform, select TV LINE Trigger COUPLING and negative (\neg) Trigger SLOPE; for other signal types, no change of COUPLING or SLOPE is required.

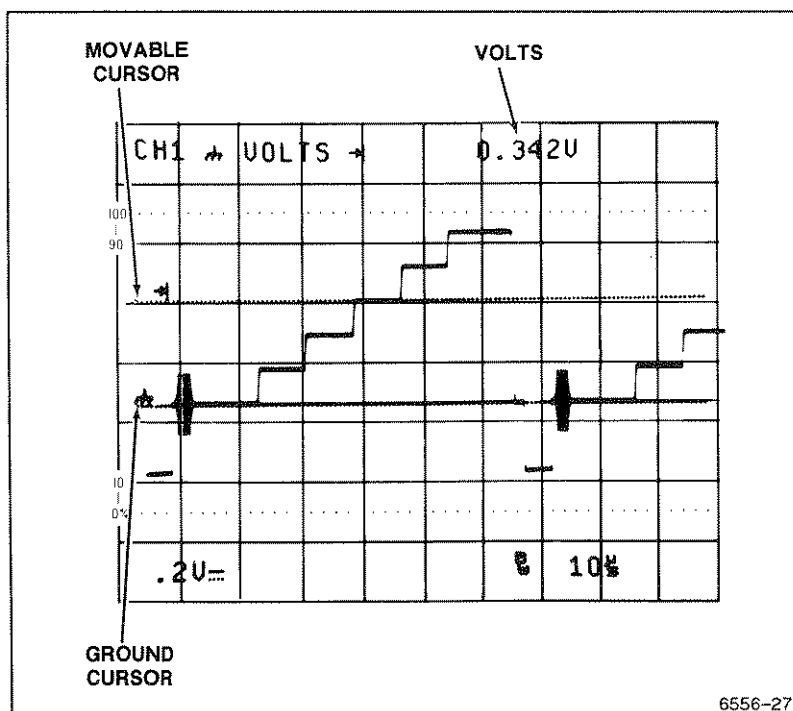

Figure 5-4. Voltage measurement.

Time Measurement Cursors

Time measurement cursors may be used on any of the input waveforms only in the A Horizontal MODE. (Time measurements are also available in ALT and B Horizontal modes; see "Time Delay Measurement" in this section.) The units of the time cursors may be selected to provide some automatic calculations for the user. The units of the \leftarrow SEC \rightarrow cursors are time (s, ms, μ s, and ns), the \leftarrow 1/SEC \rightarrow cursors have units of frequency (Hz, KHz, and MHz), and the \leftarrow PHASE \rightarrow cursor units are in degrees and scaled to a 360 degree reference set by the user.

Time Difference

Use the following procedure steps as a guideline in making time difference measurements using the \leftarrow SEC \rightarrow cursors. As with the \leftarrow VOLTS \rightarrow cursors, the \leftarrow OR DELAY control positions both cursors together, and the \rightarrow control positions the independent cursor.

1. Apply the signal to the input connector(s).
2. Set:

VERTICAL MODE	as desired
Horizontal MODE	A
3. Press AUTO SETUP button.
4. Select a SEC/DIV setting that provides the fewest number of cycles of the applied waveform necessary to display the measurement points of interest. This is to improve the accuracy of cursor placement for the measurement.
5. Press TIME button and select \leftarrow SEC \rightarrow from menu.

NOTE

The independent cursor cannot be positioned in front of the reference cursor.

6. Use the \leftarrow OR DELAY control to position the reference cursor to the point on the waveform to be measured from. Use the \rightarrow control to position the independent cursor to the second point of interest. Then, read the time difference value in the top line of the crt readout.

Period Measurement

This measurement is basically a time-difference measurement. The \leftarrow SEC \rightarrow cursors are positioned to define a full period of the input waveform, and the value is displayed. Use the setup for making time-difference measurement as a guideline for making period measurements (see Figure 5-5).

Instruments Serial Numbered B020100 or above have a new feature which makes period measurements a simple one button action, if the Time Cursors/Delays are initialized (see Configure Menu under Service Menu Features in Section 3 of this manual). The \leftarrow SEC \rightarrow cursors are automatically set one period apart on the waveform and the period of the waveform is displayed in the crt readout.

Complete explanation of the waveform and front panel setup conditions can be found in the Service Menu Features under Configure Menu.

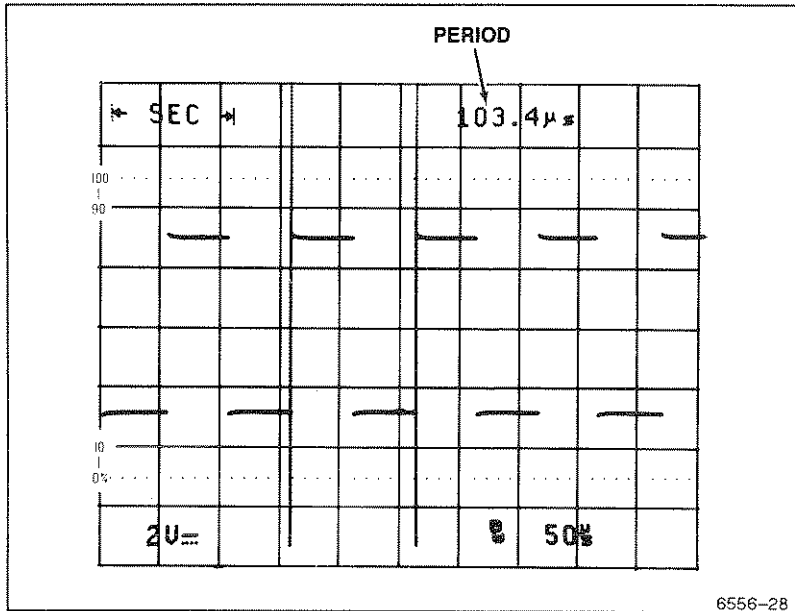

Figure 5-5. Period measurement.

Frequency Measurement

A frequency measurement is made the same as the period measurement; the difference being that the $\leftarrow 1/\text{SEC} \rightarrow$ cursors are selected from the TIME menu. The measurement value is displayed with units of frequency. When the exact period is defined by positioning the cursors, the frequency of the signal is displayed. Use the same front panel setup as for making a time-difference measurement as a guideline for making frequency measurements with cursors (see Figure 5-6).

Instruments Serial Numbered B020100 or above have a new feature which makes frequency measurements a simple one button action, if the Time Cursors/Delays are initialized (see Configure Menu under Service Menu Features in Section 3 of this manual). The $\leftarrow 1/\text{SEC} \rightarrow$ cursors are automatically set one period apart on the waveform and the frequency of the waveform is displayed in the crt readout.

Complete explanation of the waveform and front panel setup conditions can be found in the Service Menu Features under Configure Menu.

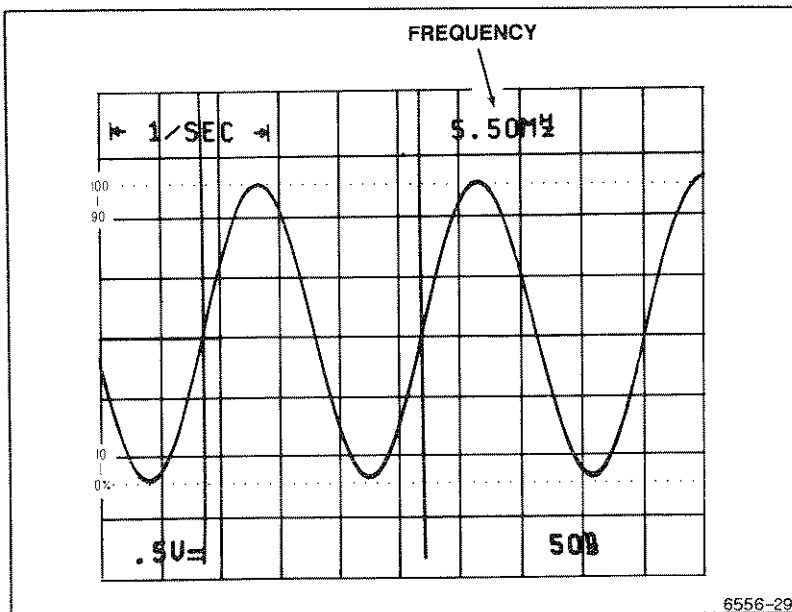

Figure 5-6. Frequency measurement.

Rise-Time Measurements

Making rise-time or fall-time measurement requires some additional signal scaling to use the graticule rise-time measurement aids. Notice that on the left edge of the graticule the numbers 0%, 10, 90, and 100 are etched. These marks provide convenient reference points when the signal to be measured is properly set up. Use the following procedure steps as a guideline in making rise-time measurements.

1. Apply the signal to CH 1 input connector.
2. Set:

VERTICAL MODE	CH 1
Horizontal MODE	A
3. Press AUTO SETUP button.
4. Set the VOLTS/DIV and VOLTS/DIV VAR controls to provide an exact five-division vertical display.
5. Use the Vertical POSITION control to place the negative amplitude of the signal on the 0% reference line and the positive amplitude on the 100% reference line.
6. Advance the SEC/DIV setting to stretch out the rising edge of the waveform as much as possible to improve the cursor placement accuracy (see Figure 5-7).

NOTE

If measuring fall time, use negative SLOPE. This places the trigger point at the beginning of the sweep so that when the SEC/DIV setting is advanced, the slope of interest remains within the viewing area.

7. Increase the A INTEN control if necessary to brighten the beginning of the trace, and use the Horizontal POSITION control to place the rising edge of the waveform at the center vertical graticule line.
8. Press TIME button and select the \leftarrow SEC \rightarrow menu choice.

- Use the ← OR DELAY control to align the first cursor to the rising edge at the point it crosses the 10% reference graticule line. Then use the → control to align the second cursor to the point the rising edge crosses the 90% graticule line and read the rise time displayed in the top line of the crt readout (see Figure 5-7).

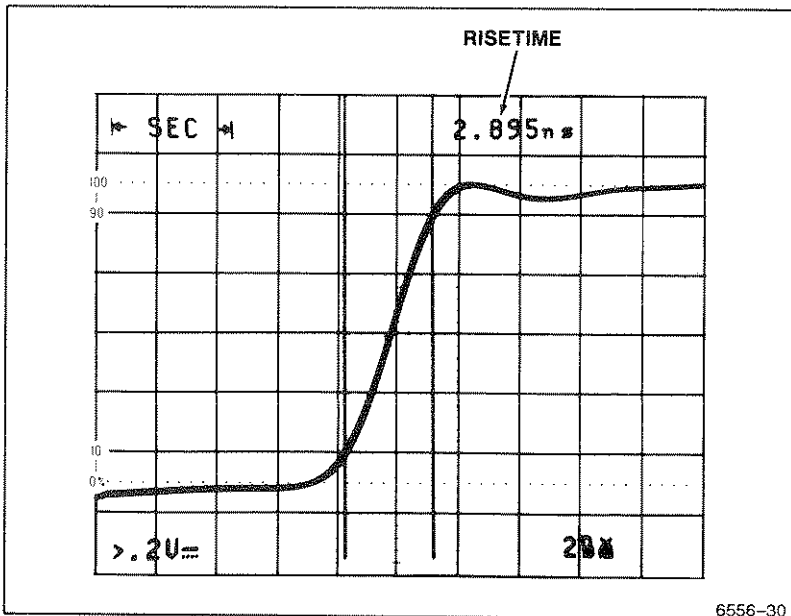

Figure 5-7. Rise time measurement.

Phase Measurements

Making a phase measurement is done by first setting a reference for the full 360 degree waveform period. Use the following procedure as a guide.

- Apply the reference waveform to the CH 1 input connector (any channel may be used, but CH 1 and CH 2 provide the most signal-scaling possibilities). Use the standard 10X attenuator probe supplied with the instrument to make the signal connections as they produce very little signal loading to a circuit under test and produce matched delays. For phase measurements, external loading of a circuit and different delays in the signal connection paths will produce incorrect results.

2. Select CH 1 for display using the VERTICAL MODE buttons and set the Input COUPLING for CH 1 and CH 2 to DC. AC may be used if the signals to be measured are riding on a dc voltage, but set both inputs to the same coupling. AC coupling produces some signal phase shift, especially at lower frequencies.
3. Set the CH 1 VOLTS/DIV control to display the reference waveform with about five divisions of amplitude. Vertically center the waveform.
4. Set the A SEC/DIV setting (in A Horizontal MODE) to display at least one complete reference waveform period and no more than two (if possible). An excessive number of cycles of the reference waveform in the display reduces the users' ability to make an accurate reference setting. (Triggering on the negative slope of the sine wave may position the waveform correctly within the graticule area for ease in measurement when viewing a single cycle of the reference signal.)
5. Press the TIME button to display the Cursor measurement choices.
6. Select \leftarrow PHASE \rightarrow . A second-level phase-measurement menu is then displayed with two choices: one to continue the phase measurement and one to set the 360 degree reference. Assume the present reference setting is not correct (if it were, selecting \leftarrow PHASE \rightarrow again continues the measurement using the present reference value).
7. Press \leftarrow SET 360° \rightarrow to activate the reference setting function. The position of the displayed cursors when \leftarrow PHASE \rightarrow is again selected defines the full waveform period (360 degrees).
8. Position the first vertical cursor to the point that the reference waveform crosses the center horizontal graticule line in the positive direction (see Figure 5-8A). The Horizontal POSITION control may be used as necessary to center the waveform period in the viewing area.
9. Position the delta cursor to the second positive crossing of the center horizontal graticule line by the reference waveform as shown in Figure 5-8A.
10. Select \leftarrow PHASE \rightarrow to continue with the phase measurement; the reference value will then be saved.
11. Apply the phase-shifted, sine-wave signal to be measured to the CH 2 input connector using a 10X attenuator probe, and turn CH 2 VERTICAL MODE on to display the signal.

12. Set the VOLTS/DIV and VOLTS/DIV VAR controls to match the amplitude of the phase-shifted signal to that of the reference waveform as shown in Figure 5-8B. Use the VERTICAL POSITION control as necessary to align the two waveforms vertically.
13. Reposition the second cursor to the first positive crossing of the phase-shifted signal, and read the phase difference.

NOTE

For increased resolution of the phase measurement, the sweep may be increased and both cursors repositioned to the measurement points (see Figure 5-8C). The X10 MAG feature may also be used in a similar manner by placing the measurement points at the center vertical graticule line before pressing the X10 MAG button (you may want to reduce the A SEC/DIV setting prior to turning on the X10 MAG feature).

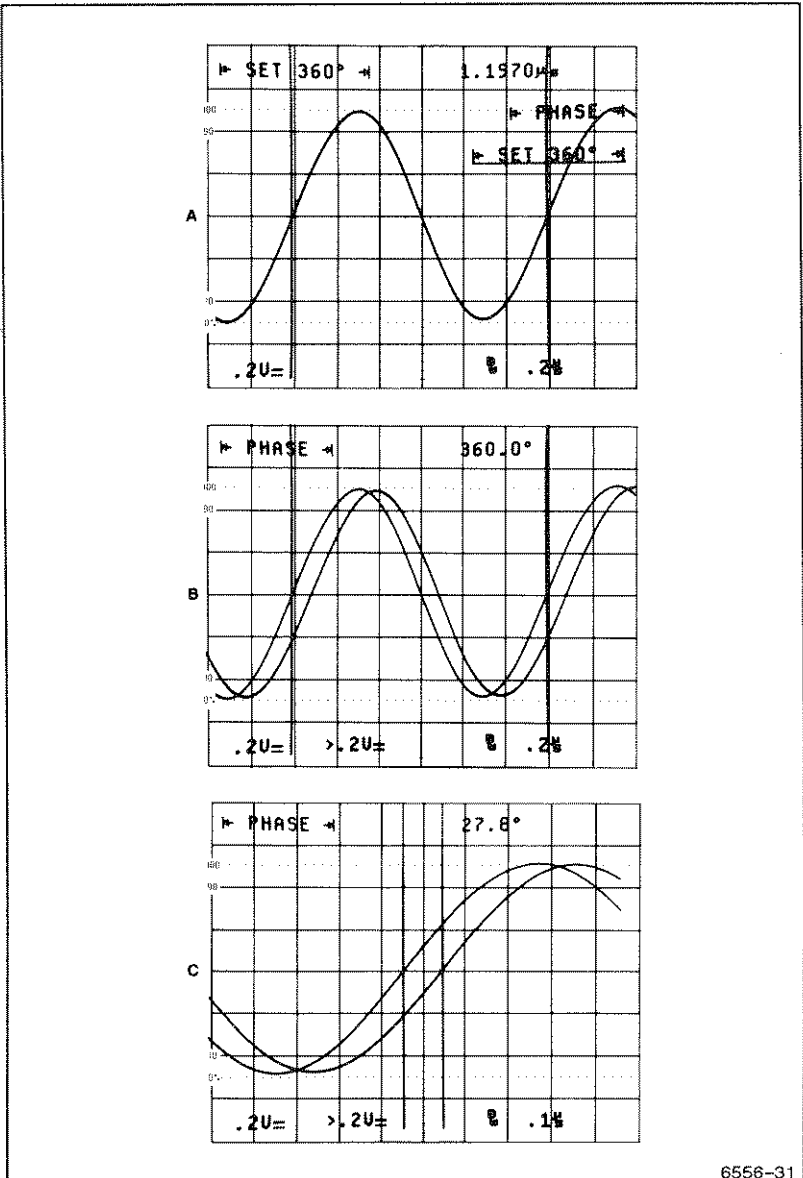

Figure 5-8. Making a phase difference measurement.

Time Delay Measurement

When using ALT Horizontal Mode, the TIME measurement mode provides two intensified zones on the A trace. There are also two associated B delayed traces matching the intensified zones. A direct readout of the delay difference between the two zones is displayed in the top line of crt readout. Use the following procedure steps as a guideline for making delta-time delay-time measurements.

1. Apply the signals that measurements are to be made on to the vertical input connectors. Turn on the VERTICAL MODE channels needed to display the signals.

NOTE

Probes are the most convenient for in-circuit testing, and coaxial cables are the most convenient when using signal generators as the source of the test signals. Use correct terminations to match the output impedance of any signal generator used. The CH 1 and CH 2 vertical channels provide the widest range of signal conditioning, and the CH 3 and CH 4 vertical channels are most useful for digital signal levels.

2. Use a VOLTS/DIV setting that produces a usable vertical display amplitude for viewing ease; use an A SEC/DIV setting that produces two to five repetitions or cycles of the signal across the graticule area.

NOTE

When viewing multiple traces, it is best to limit the vertical amplitude to about two divisions so that good trace separation may be obtained in the display.

3. Switch the Horizontal MODE to ALT. Advance the SEC/DIV setting at least one position to obtain a faster B SEC/DIV setting.
4. Set the B Trigger MODE to RUNS AFTER.

5. Press the TIME button, then select the \leftarrow SEC \rightarrow menu choice. This produces two intensified zones on the A Sweep trace and two alternate B Delay Sweeps. Use the TRACE SEP and VERTICAL POSITION controls to position the B Delay Sweeps vertically in the graticule area for ease of viewing the separate traces.
6. Use the SET MEAS'MT CHANNEL menu choices to select the desired channels to make the time measurements on.

NOTE

When making delay measurements between two different signals for time or phase difference, the SET MEAS'MT CHANNEL choices must be set to the correct measurement source channel to obtain the desired measurement results. BOTH delays must be set to the same channel source for making period, pulse width, or rise-time and fall-time measurements. If only a single channel is selected for display, both delays will default to that channel. If a channel is selected as a measurement source, it will be turned on if not already on; but it will not be turned off when deselected as a measurement source. Extra display channels must be turned off using the VERTICAL MODE buttons. If a channel is displayed but not selected as a measurement source, that waveform trace will not be intensified, and no alternate B Delayed trace will be displayed for that channel.

7. Set the \leftarrow OR DELAY control so that the reference-delay intensified zone is positioned at the first point of interest (point A, Figure 5-9) and the B sweep display of that point is at the center vertical graticule line.
8. Set the \rightarrow control so that the delta-delay intensified zone is positioned at the second point of interest (point B, Figure 5-9) and the B sweep display of that point is at the center graticule line. The time difference between the two points of interest is displayed at the top of the screen.

Once the measurement points are identified, the A Intensified Sweep traces may be removed from the display for ease in viewing the B Sweep traces by switching to B Delayed Horizontal MODE. In B Horizontal MODE, exact placement of the two delays may be obtained by positioning one trace over the other and then aligning the measurement point using the \rightarrow control. Additional resolution may be obtained by advancing the B SEC/DIV switch setting to further expand the B Sweep traces.

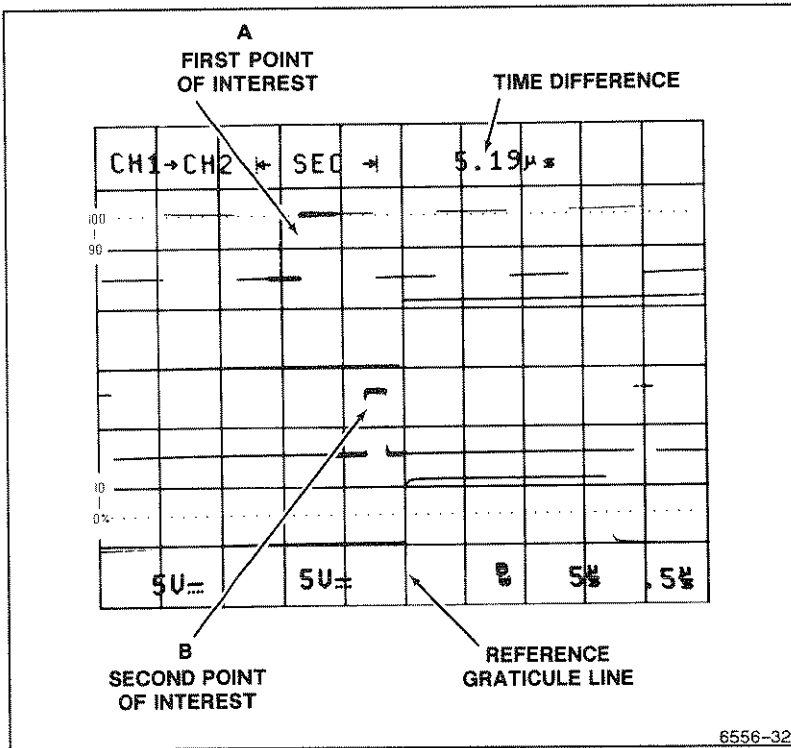

Figure 5-9. Time difference between the two delays.

Track Trigger Level Cursors

For most general purpose applications, the AUTO LEVEL Trigger MODE provides the user with the easiest method to obtain stable waveform triggering. When information regarding the actual trigger level setting is needed to set special triggering levels for NORM or SGL SEQ triggering, the user may use the TRACKING CURSORS features of the oscilloscope. The TRACK TRIG LVL cursors provide both a visual indication of location and a numeric readout of the Trigger LEVEL control setting. In ALT Horizontal MODE (with the A Intensified and the B Delayed traces both displayed) the A and the B TRACK TRIG LVL cursors will be displayed (see Figure 5-10). The A Trigger LEVEL may be set when the trigger controls are directed to

the A Trigger system (by the A/B SELECT switch), and the B Trigger LEVEL may be set when the trigger controls are directed to the B Trigger system.

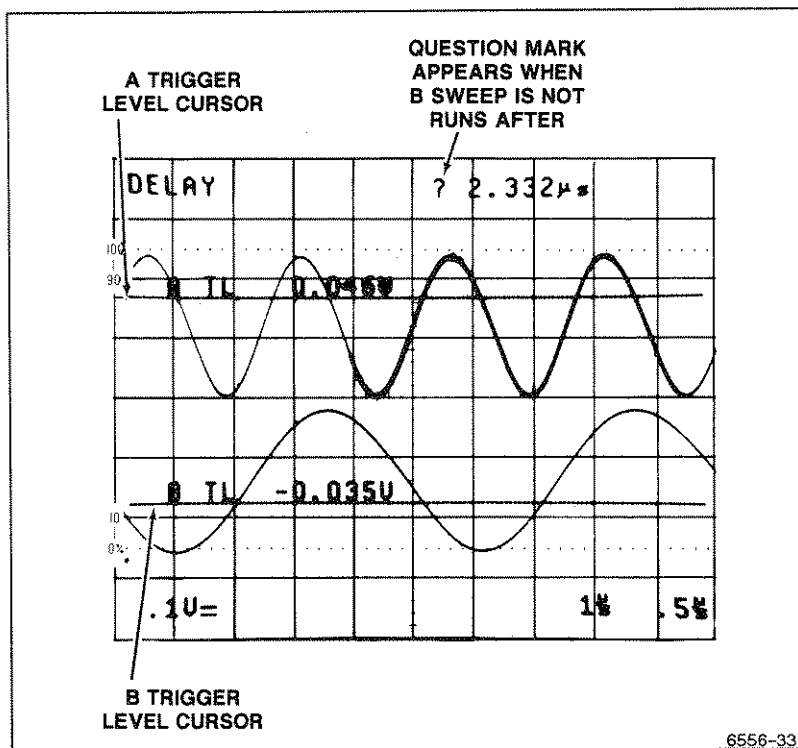

Figure 5-10. A and B Track Trig Lvl cursors.

The Trigger LEVEL cursor will be displayed when enabled if the following conditions exist:

- a. The Trigger SOURCE is either CH 1 or CH 2 (selected directly or with VERT SOURCE).
- b. The Trigger SOURCE channel is displayed.

- c. The Trigger CPLG is DC or NOISE REJ.
- d. The Trigger mode is AUTO LEVEL, AUTO, NORM, RUNS AFTER or SGL SEG.
- e. TRACK MEASMT has not been selected or no measurements are active.

Additionally, the A Trigger LEVEL cursor is displayed in A and ALT Horizontal MODE, and the B Trigger LEVEL cursor is displayed in ALT or B Horizontal MODE (both displayed in ALT if conditions are met).

The labels for the Trigger Level cursors are:

A TL	A trigger level
B TL	B trigger level

The A and B Trigger LEVEL readouts include the sign, the integer and decimal fractional value of the level, and the units when a cursor is displayed. For example:

..... A TL +3.25 mV

NOTE

In the AUTO LEVEL trigger mode when no waveform is displayed, the trigger-level cursor will be positioned at the level at which triggering would occur.

The A and B Trigger Level Cursors are not guaranteed to reach the waveform if the Horizontal POSITION control is set fully clockwise. Also, since the Trigger LEVEL cursor may be located anywhere within the viewing area (and beyond), the labels for those cursors may overlap each other or the +PK, -PK, and DC or TRACK *m* cursor labels in the displays.

The trigger cursor channel is determined from the Trigger source as indicated in Table 5-1.

Table 5-1
Trigger Cursor Channel

A or B Trigger Source	A or B Cursor Channel
VERT	Lowest-numbered channel displayed (CH 1 or CH 2)
CH 1	CH 1
CH 2	CH 2
CH 3	Not used
CH 4	Not used
LINE	Not used

To enable the TRACK TRIG LVL cursors, press the CURSOR VOLTS button to call up page one of the menu. The last selection in the menu is "TO AUTO TRACKING MENU." Press the menu select button for that choice to display page 2 with the tracking cursor choices. All of the choices, TRACK MEASMT, TRACK TRIG LVL, and TRACK \overline{m} , may be underlined, but they cannot all be displayed at the same time. Only two cursors at a time are permitted. If enabled, but not displayed in a particular waveform, omitted cursors will be displayed when a higher priority cursor is turned off. TRACK MEASMT cursors take priority over the TRACK TRIG LVL cursors. TRACK TRIG LVL cursors take priority over TRACK \overline{m} cursors. The cursors displayed when a CURSOR VOLTS measurement is active take priority over all the Auto Tracking Cursors.

NOTE

The CLEAR DISPLAY button will turn off the TRACK TRIG LVL and TRACK \overline{m} cursors if pressed the appropriate number of times. To enable either or both of these, it is necessary to re-enter the Cursor Volts menu and reselect them.

The TRACK MEASMT cursors are also turned off by the CLEAR DISPLAY button, but the function is not turned off; the TRACK MEASMT cursor(s) will be displayed again when a CH 1/CH 2 Voltmeter measurement is called up.

Setting Trigger Level

The trigger level readout supplied by the TRACK TRIG LVL cursor may be used to set a specific trigger level for triggering on a displayed waveform. As an example, assume the following conditions:

- a. The signal to be examined is a mix of two different signal levels (see Figure 5-11).

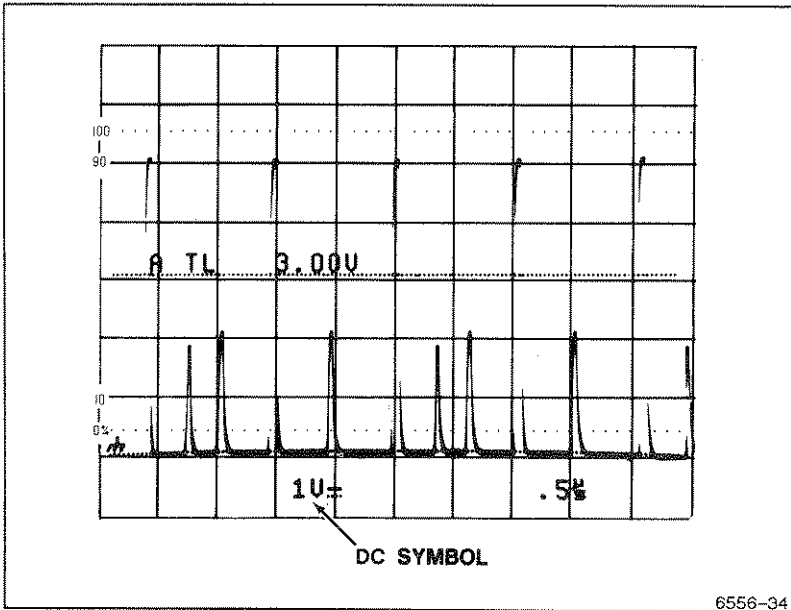

Figure 5-11. Setting a specific trigger level.

- b. It is necessary to trigger on the larger amplitude signals to make a closer examination of their waveshape and take pulse width and/or rise time measurements.

To set the Trigger LEVEL to the appropriate level with no signal applied (or with GND input coupling) use the TRACK μ cursor feature. (The TRACK μ cursor menu choice is reached through the same menu path as the TRACK TRIG LVL cursor.) The ground cursor provides feedback to the user so that the ground level may be positioned without the need for a ground baseline trace.

Set the VOLTS/DIV control so that the displayed signal will have a good viewing amplitude. For the assumed signal shown in Figure 5-11, a setting of 1 V/div will produce a four to five division display amplitude. Position the ground cursor (using the VERTICAL POSITION control) at about three graticule divisions below the center graticule line. (For negative-going signals, two divisions above the center graticule would about center the display; and for bipolar signals, centering the ground trace is appropriate.)

Zeroing the Trigger LEVEL control may be useful if the cursor is positioned out of the viewing area. Simply switch the Input COUPLING of the selected channel to GND and switch the Trigger MODE to AUTO LEVEL. Once zeroed, set the Trigger MODE to NORM so that the Trigger LEVEL you set will be maintained. (If AUTO LEVEL is left on, the Trigger LEVEL will continue to follow the applied signal; ground in this case.) Use the Trigger LEVEL control to position the trigger level cursor to about 3 V (measured from the ground cursor). For the assumed signal, this level is ample to avoid triggering on the lower amplitude signals in the display. For other waveforms, the user must determine what trigger level is needed to obtain triggering on a specific waveform amplitude.

Apply the signal to the appropriate input channel connector and set the Input COUPLING to DC. The waveform display will now appear (assuming the A INTENSITY is set to a viewing level), and it will be triggered on the larger amplitude pulses of the signal.

Once triggering is obtained, the A SEC/DIV setting may be set to a faster sweep speed to expand the triggering pulse for making any measurements wanted.

Use of the Add Mode

With the VERTICAL MODE set to ADD, the resulting waveform is the algebraic sum of the signals applied to the Channel 1 and Channel 2 inputs (CH 1 + CH 2). A plus symbol (+) appears in the readout between the CH 1 and CH 2 VOLTS/DIV setting readout to indicate that ADD is active. If the CH 2 INVERT feature is turned on (INVERT button lit), the waveform displayed is the difference between the signals applied to the Channel 1 and Channel 2 inputs. Neither the CH 1 nor CH 2 waveform needs to be displayed to obtain the ADD trace, but any or ALL vertical input channels may be displayed at the same time if wanted by the user.

When the VOLTS/DIV switches of CH 1 and CH 2 are both set to the same setting, the total deflection factor in the ADD mode is equal to the deflection factor indicated by either VOLTS/DIV readout. The ← VOLTS → cur-

sors may be used to make voltage measurements on the ADD trace if either CH 1 or CH 2 is displayed along with the ADD trace (and, of course, both CH 1 and CH 2 at the same VOLTS/DIV setting). If any voltage measurement function is active, turning off CH 1 and CH 2 to display the ADD trace by itself causes the message "VOLTMETER SOURCE: CH 1 or 2 ONLY" to appear and cancels the measurement. If calling for a voltage measurement with ADD displayed and neither CH 1 nor CH 2 displayed, the CH 1 VERTICAL MODE is turned on and the measurement is initialized to the signal applied to the CH 1 input.

Two common uses for ADD mode are: (1) providing a dc offset to bring an ac signal riding on top of a large dc voltage within the graticule viewing area and (2) canceling out a large line-frequency signal component to view some small feature riding on the waveform in greater detail using common-mode rejection.

The following general precautions should be observed when using ADD mode.

- a. Do not exceed the input-voltage rating of the oscilloscope or probe.
- b. Do not apply signals that exceed the equivalent of about eight times the VOLTS/DIV switch settings, since large voltages may distort the display. For example, with a VOLTS/DIV setting of 0.5 V, the voltage applied to that channel should not exceed 4 V.
- c. Use CH 1 and CH 2 POSITION control settings which most nearly position the signal on each channel to mid-screen, when viewed separately. This ensures the greatest dynamic range for ADD mode signal displays.
- d. To have similar responses for both channels, use the same Input COUPLING for both CH 1 and CH 2.

The following procedure shows how to eliminate an unwanted ac input-power frequency signal component from the displayed signal.

- a. Perform the "Initial Setup" in "OPERATOR CHECKS AND ADJUSTMENTS" Section 4, and center the baseline trace vertically.
- b. Apply the signal of interest containing the unwanted line-frequency component to the CH 1 input connector.
- c. Apply a line-frequency signal to the CH 2 input connector. To maximize cancellation, the signal applied to the CH 2 input must be exactly in phase (or exactly 180° out of phase) with the frequency component to be canceled from the CH 1 signal.

- d. Select CH 1 and CH 2 VERTICAL MODE.
- e. Set TRIGGER SOURCE switch to VERT.
- f. Set both VOLTS/DIV switches to produce displays of about two or three divisions in amplitude.
- g. Adjust the CH 2 VOLTS/DIV switch and VAR control so that the CH 2 display is about the same amplitude as the component to be canceled in the CH 1 waveform (see Figure 5-12A).

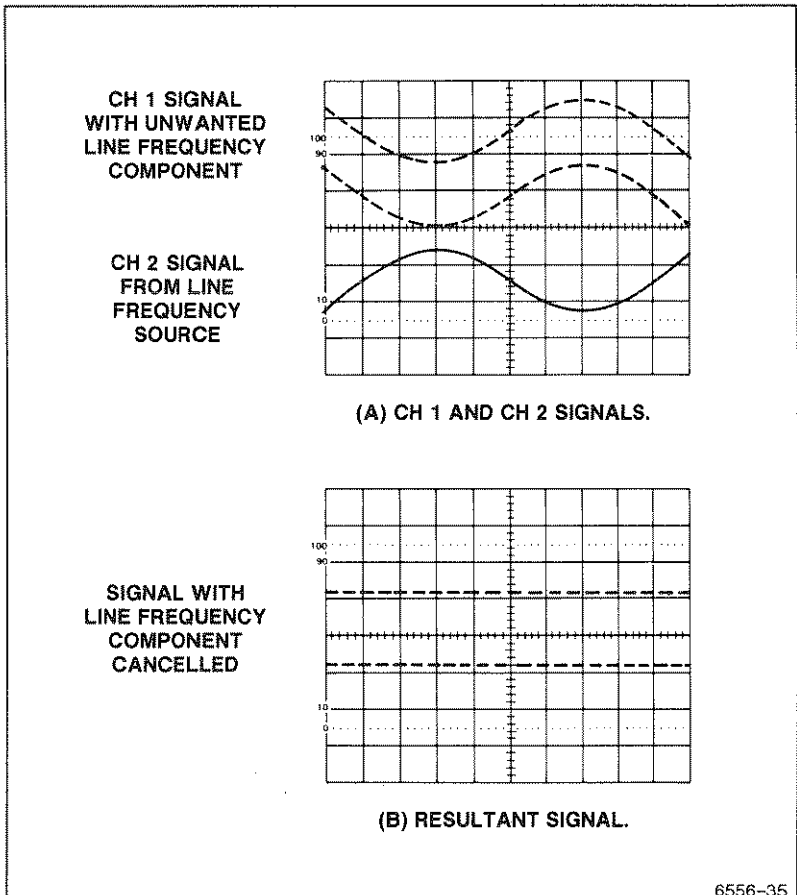

Figure 5-12. Eliminating common-mode signals.

- h. Select ADD, and then turn on CH 2 INVERT (unless cancellation signal is already 180° out of phase). Turn off the CH 1 and CH 2 displays and slightly readjust the CH 2 VOLTS/DIV VAR control for maximum cancellation of the line-frequency component (see Figure 5-12B).
- i. The SEC/DIV setting may be set to a faster sweep speed to expand the waveform, and the display amplitude may be increased by advancing both VOLTS/DIV switches and readjusting the VOLTS/DIV VAR controls as necessary to maintain cancellation of the undesired signal component.

SECTION 6

**PERFORMANCE
CHARACTERISTICS**

1
2
3
4
5
6
7
8
9
10
11
12
13
14
15
16
17
18
19
20
21
22
23
24
25
26
27
28
29
30
31
32
33
34
35
36
37
38
39
40
41
42
43
44
45
46
47
48
49
50
51
52
53
54
55
56
57
58
59
60
61
62
63
64
65
66
67
68
69
70
71
72
73
74
75
76
77
78
79
80
81
82
83
84
85
86
87
88
89
90
91
92
93
94
95
96
97
98
99
100

Introduction

Electrical characteristics in Table 6-1 apply when the 2246A has been calibrated at an ambient temperature between +20°C and +30°C, has warmed up at least 20 minutes, and is operating in an ambient temperature between -10°C and +55°C (unless otherwise noted).

Items listed in the "Performance Requirements" column are verifiable qualitative or quantitative limits that define the measurement capabilities of the instrument.

Environmental Specifications of the 2246A are in Table 6-2, and Mechanical Specifications are in Table 6-3.

Recommended Calibration Schedule

To ensure accurate measurements, check the performance of this instrument every 2000 hours of operation (once each year if used infrequently). When components are replaced, affected circuits may have to be readjusted.

Table 6-1
Electrical Characteristics

CHARACTERISTICS	PERFORMANCE REQUIREMENTS
VERTICAL DEFLECTION SYSTEM — CH 1 AND CH 2	
Deflection Factor	
Range	2 mV/div to 5 V/div in 1-2-5 sequence. ^a
Accuracy (includes ADD MODE and CH 2 INVERT)	
15°C to 35°C	Within ± 2%.
-10°C to 15°C and 35°C to 55°C	Within ± 3%. ^a
Variable Range	Increases deflection factor by at least 2.5:1.
Frequency Response (-3 dB bandwidth)	
-10°C to 35°C	
5 mV to 5 V/div	Dc to 100 MHz (at the input BNC and at the probe tip).
2 mV	Dc to 90 MHz (at the input BNC and at the probe tip).
35°C to 55°C	Dc to 90 MHz (at the input BNC and at the probe tip).
AC Coupled Lower -3 dB Point	
1X Probe	10 Hz or less.
10X Probe	1 Hz or less.
Step Response (5-division step)	
Rise Time	
-10°C to 35°C	
5 mV to 5 V/div	3.5 ns or less (calculated). ^a
2 mV	3.9 ns or less (calculated). ^a
35°C to 55°C	3.9 ns or less (calculated). ^a

^aPerformance Requirement not checked in manual.

Table 6-1 (cont)
Electrical Characteristics

CHARACTERISTICS	PERFORMANCE REQUIREMENTS				
Delay Match (CH 1 to CH 2)	Less than 200 ps difference.				
Common Mode Rejection Ratio (CMRR)	At least 10:1 at 50 MHz for signals of eight divisions or less with VOLTS/DIV VAR adjusted for best CMRR at 50 kHz.				
Channel Isolation (attenuation of deselected channel) 2 mV/Div to 0.5 V/Div	<table border="1"> <thead> <tr> <th>10 MHz</th> <th>100 MHz</th> </tr> </thead> <tbody> <tr> <td>50 db (\approx316:1) or more</td> <td>34 dB (\approx50:1) or more</td> </tr> </tbody> </table> <p>Channel isolation tested with eight-division input signal.</p>	10 MHz	100 MHz	50 db (\approx 316:1) or more	34 dB (\approx 50:1) or more
10 MHz	100 MHz				
50 db (\approx 316:1) or more	34 dB (\approx 50:1) or more				
Trace Shift as VAR VOLTS/DIV is Turned	1 division or less.				
Invert Trace Shift	1 division or less.				
Trace Shift Between VOLTS/DIV Switch Positions	0.2 division or less.				
Trace Shift Between GND and DC input Coupling					
-10°C to 35°C	Less than 0.5 mV.				
35°C to 55°C	Less than 2 mV. ^a				
Position Range	At least \pm 11 divisions from graticule center.				
Input Characteristics					
Resistance	1 M Ω \pm 1.0% ^a				
Capacitance	20 pF \pm 1 pF. ^a				
Capacitance Match Between Any Two VOLTS/DIV Settings	\pm 0.5 pF.				
Maximum Input Volts Δ	400 V (dc + peak ac); 800 V p-p at 10 kHz or less. ^a (See Figure 6-1.)				

^aPerformance Requirement not checked in manual.

Table 6-1 (cont)
Electrical Characteristics

CHARACTERISTICS	PERFORMANCE REQUIREMENTS
VERTICAL DEFLECTION SYSTEM — CH 3 AND CH 4	
Deflection Factor	
Range	0.1 V per division and 0.5 V per division. ^a
Accuracy	
15 °C to 35 °C	Within ± 2%.
-10 °C to 55 °C	Within ± 3%.
Frequency Response (-3 dB bandwidth)	
-10 °C to 35 °C	Dc to 100 MHz (at the input BNC and at the probe tip).
35 °C to 55 °C	Dc to 90 MHz (at the input BNC and at the probe tip). ^a
Step Response (5-division step)	
Rise Time	
-10 °C to 35 °C	3.5 ns or less. ^a
35 °C to 55 °C	3.9 ns or less. ^a
Delay Match (CH 3 to CH 4)	Less than 200 ps difference.
Trace Shift Between VOLTS/DIV Settings	1 division or less.
Position Range	At least ± 11 divisions from graticule center.
Channel Isolation (attenuation of deselected channel)	34 dB or more at 100 MHz. Channel isolation tested with eight-division input signal.
Input Characteristics	
Resistance	1 M Ω ± 1.0%. ^a
Capacitance	20 pF ± 1 pF. ^a
Maximum Input Volts Δ	400 V (dc + peak ac); 800 V p-p at 10 kHz or less. ^a (See Figure 6-1.)

^aPerformance Requirement not checked in manual.

Table 6-1 (cont)
Electrical Characteristics

CHARACTERISTICS	PERFORMANCE REQUIREMENTS	
VERTICAL DEFLECTION SYSTEM — ALL CHANNELS		
Bandwidth Limit (-3 dB bandwidth)	20 MHz \pm 15%.	
Low Frequency Linearity (Relative to center screen)	Within \pm 5%. Linearity is measured by positioning a two- division test signal anywhere on screen and noting the amplitude change.	
TRACE SEP Control Position Range	At least \pm 4 divisions.	
CHOP Mode Clock Rate	625 kHz \pm 10%. ^a	
Delay Match (CH 1 or CH 2 to CH 3 or CH 4)	Less than 200 ps difference.	
HORIZONTAL DEFLECTION SYSTEM		
Sweep Range		
A Sweep	0.5 s/div to 20 ns/div in a 1-2-5 sequence. ^a X10 magnifier extends maximum sweep speed to 2 ns/div.	
B Sweep	5.0 ms/div to 20 ns/div in a 1-2-5 sequence. ^a X10 magnifier extends maximum sweep speed to 2 ns/div.	
Accuracy	Unmagnified	Magnified
15°C to 35°C	\pm 2%	\pm 3%
-10°C to 15°C and 35°C to 55°C	\pm 3%	\pm 4%
Sweep Accuracy applies over the center eight divisions. Excludes the first 1/4 division or 25 ns from the start of the magnified sweep and anything beyond the 100th magnified division.		

^a Performance Requirement not checked in manual.

Table 6-1 (cont)
Electrical Characteristics

CHARACTERISTICS	PERFORMANCE REQUIREMENTS
HORIZONTAL DEFLECTION SYSTEM (cont)	
Sweep Linearity (relative to center two displayed divisions)	± 5%. Sweep Linearity applies over the center eight divisions. Excludes the first 1/4 division or 25 ns from the start of the magnified sweep and anything beyond the 100th magnified division
POSITION Control Range Normal Displays	Able to move the start of the sweep to the right of the center vertical graticule; able to move a time mark corresponding to the end of the tenth division of an unmagnified sweep to the left of the center graticule.
X-Y Displays	At least ± 13 divisions. ^a
X10 Magnifier	Expands the normal sweep by ten times around that portion of the sweep positioned at the center vertical graticule line. ^a
Registration (X10 to X1)	0.5 division or less shift.
Variable Control Range	Continuously variable between calibrated SEC/DIV settings. Extends both the A and B sweep time per division by at least a factor of 2.5.
Sweep Length	Greater than 10 divisions.
Delay Time Delay Control Range	Less than 0.1 division to 10 times the A SEC/DIV switch setting. Maximum value does not exceed end of the A Sweep.
Jitter	1 part in 20,000, or less, peak-to-peak, during a two-second time interval.
Delta Time Delta Control Range	0 to greater than 9.9 divisions to the right of setting of DELAY control, but maximum value does not exceed end of the A Sweep.

^aPerformance Requirement not checked in manual.

Table 6-1 (cont)
Electrical Characteristics

CHARACTERISTICS	PERFORMANCE REQUIREMENTS
A AND B TRIGGER	
Sensitivity—CH 1 through CH 4: AUTO LEVEL, NORM AND SINGLE SEQUENCE	Trigger sensitivity is defined as the minimum peak-to-peak sine-wave trigger signal amplitude required to show the test signal with horizontal jitter of less than 3.0% of one period (p-p viewed over two seconds), with Trigger LEVEL control set at mid-level, but not at control extremes.
COUPLING	
DC	0.35 division from dc to 25 MHz, increasing to 1.0 division at 150 MHz (100 MHz in AUTO LEVEL).
NOISE REJECT	1.4 division from dc to 25 MHz; increasing to 2.2 division at 100 MHz. 0.5 division or less will not trigger.
HF REJECT	0.35 division from dc to 50 kHz; attenuates signals above upper -3 dB cutoff frequency of 70 kHz.
LF REJECT	0.35 division from 100 kHz to 25 MHz, increasing to 1.0 division at 150 MHz (100 MHz in AUTO LEVEL); attenuates signals below the lower -3dB cutoff frequency of 50 kHz.
AC	0.35 division from 50 Hz to 25 MHz, increasing to 1.0 division at 150 MHz; (100 MHz in AUTO LEVEL); attenuates signals below the lower -3dB cutoff frequency of 20 Hz.
TV LINE, TV FIELD	0.5 division of composite sync will achieve a stable display.
Free Run Enable Frequency	
AUTO and AUTO LEVEL	The sweep will free run if trigger source frequency is less than 10 Hz. In AUTO LEVEL, if the trigger source frequency is ≤ 25 Hz, the range of the Trigger LEVEL control may be reduced.

Table 6-1 (cont)
Electrical Characteristics

CHARACTERISTICS	PERFORMANCE REQUIREMENTS
LEVEL Control Range AUTO, NORM, SGL SEQ	± 20 divisions referred to the appropriate vertical input. This range is sufficient to allow triggering at any point on a displayed waveform for all modes except "ADD". In ADD, the combined range of the two position controls exceeds the trigger level range, making it possible (though unlikely) to pull a signal on screen for display but fail to trigger on it due to insufficient trigger level range.
AUTO LEVEL	Does not exceed the peak-to-peak amplitude of the trigger signal that was present when the AUTO LEVEL limits were set.
TRIGGER LEVEL READOUT Accuracy	$\pm (0.3\% \text{ of reading} + 10\% \text{ of one vertical division})$.
HOLDOFF Control Range	Increases A Sweep holdoff time by at least a factor of 10^a .

FUNCTIONS WITH DIGITAL READOUT

	Specifications for functions with digital readout are valid only when the ambient temperature is within $\pm 10^\circ \text{C}$ of the temperature at the time of the last SELF CAL. For maximum performance, a recent SELF CAL is recommended.
VOLTMETER FUNCTIONS DC VOLTS Accuracy	$\pm (0.5\% \text{ of reading} + 2\% \text{ of one vertical division} + 250 \mu\text{V})$.
Normal Mode Rejection Ratio	Greater than 50 dB at 50 or 60 Hz.

^a Performance Requirement not checked in manual.

Table 6-1 (cont)
Electrical Characteristics

CHARACTERISTICS	PERFORMANCE REQUIREMENTS
PLUS or MINUS Peak	
Accuracy—Full Bandwidth	
25 Hz to 25 MHz	$\pm(2.0\%$ of reading + 10% of one vertical division + 1 mV).
Greater Than 25 MHz to 100 MHz (90 MHz at 35°C to 55°C)	+0.5 dB/-3 dB \pm 1 mV. Follows the trigger system frequency response curve.
Accuracy—Bandwidth Limited (25 Hz to 10 MHz)	$\pm(2.0\%$ of reading + 10% of one vertical division + 0.3 mV).
Gated Region Minimum Width (when gated)	(0.2 division + 50 ns) or less.
PK-PK VOLTS	
Accuracy—Full Bandwidth	
25 Hz to 25 MHz	$\pm(2.0\%$ of reading + 15% of one vertical division + 1.5 mV).
Greater Than 25 MHz to 100 MHz (90 MHz at 35°C to 55°C)	+0.5 dB/-3 dB \pm 1.5 mV. Follows the trigger system frequency response curve.
Accuracy—Bandwidth Limited	
25 Hz to 10 MHz	$\pm(2.0\%$ of reading + 10% of one vertical division + 0.5 mV).
Gated Region Minimum Width (when gated)	(0.2 division + 50 ns) or less.

Table 6-1 (cont)
Electrical Characteristics

CHARACTERISTICS	PERFORMANCE REQUIREMENTS
CURSOR FUNCTIONS	
← SEC → (manually positioned cursors) Accuracy	$\pm (0.5\% \text{ of reading} + 2\% \text{ of one horizontal division})$.
← 1/SEC → (manually positioned cursors) Accuracy	Readout calculated from ← SEC → cursor positions.
← VOLTS → (manually positioned cursors) Accuracy	$\pm (1.0\% \text{ of reading} + 2\% \text{ of one vertical division} + \text{high-frequency display errors})$.
$\overline{//}$ VOLTS → (manually positioned cursor) Accuracy	$\pm (1.0\% \text{ of reading} + 2\% \text{ of one vertical division} + \text{high-frequency display errors})$.
← PHASE → (manually positioned cursors) Accuracy	Readout calculated from ← SEC → cursor positions.
TRACK MEASUREMENT	
Position Accuracy (Cursor position on waveform versus digitally displayed measurement value)	Within ± 0.05 vertical division.
TRACK TRIG LEVEL	
Position Accuracy (Cursor position on waveform versus digitally displayed trigger level value)	Within ± 0.05 vertical division.

Table 6-1 (cont)
Electrical Characteristics

CHARACTERISTICS	PERFORMANCE REQUIREMENTS
TRACK GROUND Position Accuracy (Cursor position on waveform versus baseline displayed with grounded input)	Within ± 0.05 vertical division.
DELTA TIME FUNCTIONS	
DELTA TIME Accuracy	$\pm (0.5\% \text{ of reading} + 1.0\% \text{ of one division of the A Sweep})$.
DELTA 1/TIME Accuracy	Readouts calculated using DELTA TIME difference.
DELTA Phase Accuracy	Readouts calculated using DELTA TIME difference.
Delay Accuracy, A Sweep Trigger Point to Start of B Sweep	$\pm (0.5\% \text{ of reading} + 5.0\% \text{ of one division of the A Sweep} + 25 \text{ ns})$.
X-Y OPERATION	
Deflection Factors Accuracy Y Axis 15°C to 35°C	Same as Vertical deflection system with the VOLTS/DIV variable controls in calibrated detent position. ^a Within $\pm 2\%$.
-10°C to 15°C and 35°C to 55°C	Within $\pm 3\%$. ^a
X Axis 15°C to 35°C	Within $\pm 3\%$.
-10°C to 15°C and 35°C to 55°C	Within $\pm 4\%$. ^a

^a Performance Requirement not checked in manual.

Table 6-1 (cont)
Electrical Characteristics

CHARACTERISTICS	PERFORMANCE REQUIREMENTS
Horizontal (X-Axis) -3 dB Bandwidth	3 MHz or more.
Phase Match (DC Coupled)	± 3 degrees from dc to 50 kHz.
EXTERNAL Z-AXIS INPUT	
Active Region Lower Threshold (intensity decreases above this voltage)	+1.8 volts or less.
Signal Required to Modu- late an A or B Trace	+3.8 volts or less provides noticeable modu- lation of a normal intensity trace. Usable frequency range is dc to 10 MHz. External Z-Axis signal does not affect the readout or the intensified zone intensity.
Maximum Input Voltage Δ	30 V (dc + peak ac); 30 V p-p ac at 1 kHz or less. ^a
Input Loading	Represents less than one LSTTL load. ^a
PROBE ADJUST OUTPUT	
Overshoot (rising and falling edge)	0.1% or less.
Output Voltage on PROBE ADJUST Jack	0.5 V $\pm 2\%$ into 1 M Ω load.
Repetition Rate	1 kHz $\pm 25\%$.
FRONT PANEL SETUP MEMORY	
Battery Shelf Life	5 years.
Data Retention Time	Three years or the remainder of battery shelf life, whichever is less. ^a
Battery	3.0 V, 1200 mA \cdot H, Type BR-2/3AE2P, Lithium. ^a <i>WARNING—To avoid personal injury, have battery replaced only by a qualified service person who understands proper handling and disposal procedures for Lithium batteries.</i>

^aPerformance Requirement not checked in manual.

Table 6-1 (cont)
Electrical Characteristics

CHARACTERISTICS	PERFORMANCE REQUIREMENTS
POWER SOURCE	
Line Voltage Range	90 Vac to 250 Vac. ^a
Line Frequency	48 Hz to 445 Hz. ^a
Line Fuse	2 A, 250 V, slow blow. ^a
Maximum Power Consumption	100 Watts (155 VA). ^a
CRT DISPLAY	
Display Area	8 by 10 cm. ^a
Geometry	
Vertical	± 1/2 minor (0.1 div) at 8 by 8 cm centered area.
Horizontal	± 1/2 minor (0.1 div) at 8 by 10 cm centered area.
Trace Rotation Range	Adequate to align trace with center horizontal graticule line.
Standard Phosphor	P31. ^a
Y-Axis Orthogonality	0.1 division or less, over eight vertical divisions. No adjustment.
Nominal Accelerating Voltage	16 kV. ^a
OPTION 15	
CH 2 Signal Out	
Dynamic Range	± 7 divisions.
Deflection Factor	10 mV/div into 50 Ω ± 10%. 20 mV/div into 1 M Ω ± 10%.
3dB Bandwidth	DC to 25 MHz.
DC Offset (Adjusted)	< 0.5 div (measured at 2 mV/DIV).
A GATE Out	
Output Voltage	3.5 V to 5.25 V positive-going pulse starting at 0 V to 0.7 V.
Output Drive	Will supply 4 mA during HI state, will sink 20 mA during LO state (not tested in Performance Check).

^aPerformance Requirement not checked in manual.

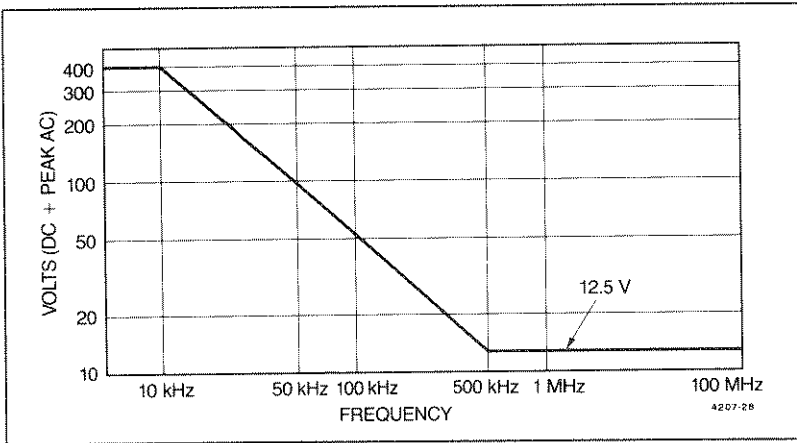

Figure 6-1. Maximum input voltage vs frequency derating curve for the CH 1, CH 2, CH 3, and CH 4 input connectors.

Table 6-2
Environmental Characteristics

CHARACTERISTICS	DESCRIPTION
STANDARD INSTRUMENT	
Environmental Requirements	Instrument meets or exceeds the environmental requirements of MIL-T-28800D for Type III, Class 3, Style D equipment. ^a
Temperature	
Operating	-10°C to +55°C (+14°F to +131°F).
Non-operating	-51°C to +71°C (-60°F to +160°F).
	Tested to MIL-T-28800D paragraphs 4.5.5.1.3 and 4.5.5.1.4, except in 4.5.5.1.3, steps 4 and 5 (-10°C operating test) are performed ahead of step 2 (-51°C non-operating test). Equipment shall remain off upon return to room ambient during step 6. Excessive condensation shall be removed before operating during step 7.
Altitude	
Operating	To 4,570 m (15,000 ft). Maximum operating temperature decreases 1°C per 1000 ft above 5000 ft.
Non-Operating	To 15,240 m (50,000 ft).
Humidity (Operating and Non-operating)	Five cycles (120 hours) referenced to MIL-T-28800D paragraph 4.5.5.1.2.2, for type III, class 3 instruments. Non-operating and operating at 95%, -0% to +2% relative humidity. Operating at +30°C and +55°C for all modes of operation. Non-operating at +30°C to +60°C.
Radiated and conducted Emission required per VDE 0871	Meets Category B.

^a Performance not checked in manual.

Table 6-2 (cont)
Environmental Characteristics

CHARACTERISTICS	DESCRIPTION
Electrostatic Discharge	<p>Withstands discharge of up to 20kV. Test performed with probe containing a 500 pF capacitor with 1 kΩ resistance charged to the test voltage.</p> <p>Conforms to Tektronix Standard 062-2862-00.</p>
Vibration (operating)	<p>15 minutes along each of 3 major axes at a total displacement of 0.25 inch p-p (4 g at 55 Hz) with frequency varied from 10 Hz to 55 Hz in 1-minute sweeps. Hold from 10 minutes at 55 Hz in each of the three major axes. All major resonances must be above 55 Hz.</p>
Bench Handling Test (cabinet on and cabinet off)	<p>MIL-STD-810D, Method 516.3, Procedure VI (MIL-T-28800D, Paragraph 4.5.5.4.3).</p>
Transportation	<p>Meets the limits of the National Safe Transit Association test procedure 1A-B-1; excursion of 1 inch p-p at 4.63 Hz (1.1 g) for 30 minutes on the bottom and 30 minutes on the side (for a total of 60 minutes).</p>
Package Drop Test	<p>Meets the limits of the National Safe Transit Association test procedure 1A-B-2; 10 drops of 36 inches.</p>

Table 6-3
Mechanical Characteristics

CHARACTERISTICS	DESCRIPTION
STANDARD INSTRUMENT	
Weight	
With Front Cover, Accessories, and Accessories Pouch (without manual)	8.9 kg (19.5 lb).
With Power Cord	7.9 kg (17.3 lb).
Shipping Weight (Domestic)	11.7 kg (25.8 lb).
Overall Dimensions	See Figure 6-2, Dimensional drawing.
Height	
With Feet and Accessories Pouch (empty)	Approx. 176.5 mm (6.95 in).
Without Accessories Pouch	164 mm (6.44 in).
Width (with handle)	362 mm (14.25 in).
Depth	
With Front Cover on	445.3 mm (17.53 in).
With Handle Extended	521 mm (20.53 in).
Cooling	Forced air circulation; no air filter.
Finish	Tek Blue, pebble-grain finish painted on aluminum cabinet.
Construction	Aluminum alloy chassis. Plastic-laminate front panel.

Table 6-3 (cont)
Mechanical Characteristics

CHARACTERISTICS	DESCRIPTION
RACKMOUNT INSTRUMENT	
Weight	
With Power Cord	10.0 kg (22.0 lb).
Shipping Weight	
Domestic, includes manual	14.2 kg (31.3 lb).
Overall Dimensions	See Figure 6-3, Dimensional drawing
Height	
Overall	168 mm (6.6 in).
Center of mounting rail to bottom of cabinet	89 mm (3.5 in).
From cabinet top or bottom to respective front-panel mounting holes	38 mm (1.5 in).
Between front-panel mounting holes	102 mm (4.0 in).
Width	
Overall	483 mm (19.0 in).
Between mounting hole centers	464 mm (18.3 in).
Between outer edges of mounting rails	427 mm (16.8 in).
Between handle centers	450 mm (17.7 in).

Table 6-3 (cont)
Mechanical Characteristics

CHARACTERISTICS	DESCRIPTION
Depth	
Overall	516 mm (20.35 in).
Front panel to rear of mounting rail (inside)	465 mm (18.3 in).
Front panel to rear of mounting rail (outside)	472 mm (18.6 in).
Handles	44 mm (1.75 in).
Required Clearance dimensions	
Height	≥ 178 mm (7 in).
Width	≥ 448 mm (17-5/8 in).
Depth	≥ 508 mm (20 in).
Cooling	Forced air circulation; no air filter.
Finish	Tek Blue, pebble-grain finish painted on aluminum cabinet.
Construction	Aluminum alloy chassis, front-panel frame, and rear support. Plastic-laminate front panel. Glass-laminate circuit boards.

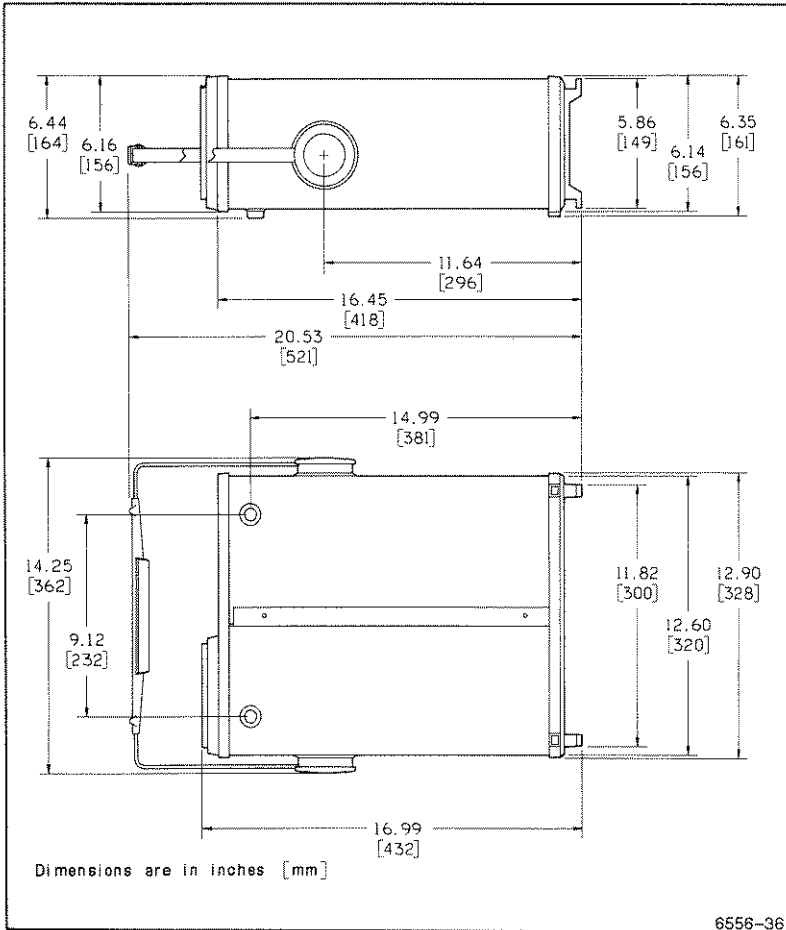

Figure 6-2. Dimensional drawing, standard cabinet.

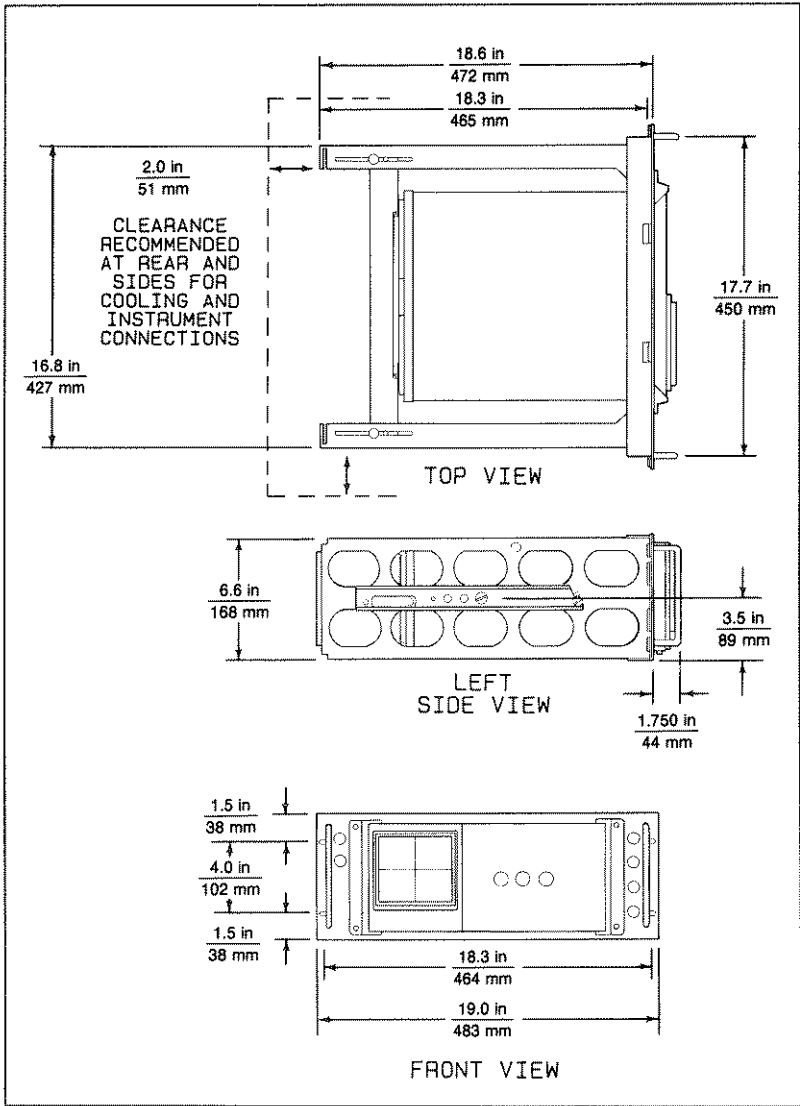

Figure 6-3. Dimensional drawing, rackmount cabinet (2240F1R).

SECTION 7

**PERFORMANCE
CHECK
PROCEDURE**

Introduction

This Performance Check Procedure verifies the Performance Requirements of the 2246A as listed in the Performance Characteristics (Section 6) and helps determine the need for readjustment. These checks may also be used as an acceptance test or as a preliminary troubleshooting aid.

You do not have to remove the wrap-around cabinet from the 2246A to do this procedure. All checks can be made with controls and connectors accessible from the outside.

Test Equipment Required

Table 7-1 lists all the test equipment required to do the Performance Check Procedure. Test equipment specifications described are the minimum necessary to provide accurate results. For test equipment operating information, refer to the appropriate test equipment instruction manual.

When you use equipment other than that recommended, you may have to make some changes to the test setups. If the exact example equipment in Table 7-1 is not available, use the Minimum Specification column to determine if any other available test equipment might be adequate to do the check.

Performance Check Interval

To ensure instrument accuracy, check the performance of the 2246A after every 2000 hours of operation, or once each year if used infrequently. If the checks indicate a need for readjustment or repair, refer the instrument to a qualified service person.

Preparation

This procedure is divided into subsections to let you check individual sections of the instrument when it is not necessary to do the complete Performance Check. An Equipment Required block at the beginning of each subsection lists the equipment from Table 7-1 that is needed to do the checks in that subsection.

The initial front-panel control settings at the beginning of each subsection prepare the instrument for the first step of the subsection. Do each of the steps in a subsection completely and in order to ensure the correct control settings for steps that follow. To ensure performance accuracies stated in the Performance Characteristics (Section 6), let the instrument warm up for 20 minutes and run the SELF CAL MEASUREMENTS routine.

To run the SELF CAL MEASUREMENTS routine:

Press the top and bottom menu-item select buttons to display the SERVICE MENU. Underline and select SELF CAL MEASUREMENTS. Press RUN to start the routine, then QUIT to return to the normal oscilloscope mode.

NOTE

Performance accuracies are ensured only when the SELF CAL MEASUREMENTS is done AFTER the 20-minute warmup.

Table 7-1
Test Equipment Required

Item and Description	Minimum Specification	Use	Example of Test Equipment
Leveled Sine-Wave Generator	Frequency: 250 kHz to above 150 MHz. Output amplitude: variable from 10 mV to 5 V p-p. Output impedance: 50 Ω . Amplitude accuracy: constant within 1.5% of reference frequency to 100 MHz.	Vertical, horizontal, triggering, measurement bandwidth, and Z-Axis checks and adjustments.	TEKTRONIX SG 503 Leveled Sine-Wave Generator. ^a
Calibration Generator	Standard-amplitude signal levels (Dc and Square wave): 5 mV to 50 V. Accuracy: $\pm 0.25\%$. High-amplitude signal levels: 1 V to 60 V. Repetition rate: 1 kHz. Fast-rise signal level: 1 V. Repetition rate: 1 MHz. Rise time: 1 ns or less. Flatness: $\pm 0.5\%$.	Signal source for gain and transient response checks and adjustments.	TEKTRONIX PG506A Calibration Generator. ^a
Time-Mark Generator	Marker outputs: 5 ns to 0.5 s. Marker accuracy: $\pm 0.1\%$. Trigger output: 1 ms to 0.1 μ s, time-coincident with markers.	Horizontal checks and adjustments. Display adjustment. Time cursor checks.	TEKTRONIX TG 501 Time-Mark Generator. ^a
Function Generator	Range: less than 1 Hz to 1 kHz; sinusoidal output; amplitude variable up to greater than 10 V p-p open circuit with dc offset adjust.	Low-frequency checks.	TEKTRONIX FG 502 Function Generator. ^a

^a Requires a TM500-series power Module.

Table 7-1 (cont)

Item and Description	Minimum Specification	Use	Example of Test Equipment
Coaxial Cable (2 required)	Impedance: 50 Ω Length: 42 in. Connectors: BNC	Signal inter-connection.	Tektronix Part Number 012-0057-01.
Precision Coaxial Cable	Impedance: 50 Ω Length: 36 in. Connectors: BNC	Used with PG 506 Calibration Generator and SG 503 Sine-Wave Generator.	Tektronix Part Number 012-0482-00.
Termination (2 required)	Impedance: 50 Ω Connectors: BNC	Signal termination.	Tektronix Part Number 011-0049-01.
10X Attenuator	Ratio: 10X. Impedance: 50 Ω Connectors: BNC	Triggering checks.	Tektronix Part Number 011-0059-02.
2X Attenuator	Ratio: 2X. Impedance: 50 Ω Connectors: BNC	Triggering checks.	Tektronix Part Number 011-0069-02.
Adapter	Connectors: BNC male-to-miniature-probe tip.	Signal inter-connection.	Tektronix Part Number 013-0084-02.
Alignment Tool	Length: 1-in shaft. Bit size: 3/32 in. Low capacitance; insulated.	Adjust TRACE ROTATION pot. Adjust variable capacitors and resistors.	Tektronix Part Number 003-0675-00.
Test Oscilloscope	Bandwidth: 20 MHz.	Z-Axis Response adjustment.	TEKTRONIX 2246A.
Dual-Input Coupler	Connectors: BNC female-to-dual-BNC male.	Signal inter-connection.	Tektronix Part Number 067-0525-01.
T-Connector	Connectors, BNC.	Signal inter-connection.	Tektronix Part Number 103-0030-00.
Precision Normalizer	Input Resistance: 1 M Ω ; Input Capacitance: 20 pF.	Input Capacitance adjustments.	Tektronix Part Number 067-1129-00.

Table 7-1 (cont)

Item and Description	Minimum Specification	Use	Example of Test Equipment
TV Signal Generator	Provide Composite TV Video and Line Sync Signals.	Check TV Trigger circuit.	TEKTRONIX TSG-100 Test Signal Generator
Digital Multimeter (DMM)	Dc Volts Range: 0 to 140 V. Dc Voltage accuracy: $\pm 0.15\%$. 4 1/2-digit display.	Power supply voltage checks and adjustments.	TEKTRONIX DM501A Digital Multimeter. ^a
BNC Coupling Capacitor	0.047 μ F.	Voltmeter dc volts normal mode rejection ratio check.	Tektronix Part Number 015-0221-00. ^a

^a Requires a TM500-series power Module.

INDEX TO PERFORMANCE CHECK PROCEDURE

DISPLAY

- 1. TRACE ROTATION 7-8
- 2. Geometry 7-9

VERTICAL

- 1. Input COUPLING Functional Check 7-10
- 2. CH 1 and CH 2 VOLTS/DIV Trace Shift 7-11
- 3. CH 3 and CH 4 VOLTS/DIV Trace Shift 7-12
- 4. CH 1 and CH 2 VAR VOLTS/DIV Trace Shift 7-12
- 5. CH 1 and CH 2 Input COUPLING Trace Shift 7-13
- 6. CH 2 INVERT Trace Shift 7-13
- 7. CH 1 and CH 2 VAR VOLTS/DIV Range 7-13
- 8. Low Frequency Linearity 7-14
- 9. CH 1 and CH 2 Vertical Deflection Accuracy 7-15
- 10. CH 3 and CH 4 Vertical Deflection Accuracy 7-16
- 11. ADD Mode and CH 2 INVERT Deflection Accuracy 7-17
- 12. Vertical POSITION Range (all channels) 7-17
- 13. CH 1 to CH 2 Signal Delay Match 7-19
- 14. CH 1 to CH 4 Signal Delay Match 7-20
- 15. CH 3 to CH 4 Signal Delay Match 7-20
- 16. CH 1 and CH 2 Vertical Bandwidth 7-20
- 17. CH 3 and CH 4 Vertical Bandwidth 7-21
- 18. SCOPE BW (Bandwidth Limit) Accuracy 7-22
- 19. Common-mode Rejection Ratio 7-22
- 20. Channel Isolation 7-23
- 21. AC-Coupled Lower -3 dB Point 7-24
- 22. Vertical ALT and CHOP Modes 7-25
- 23. BEAM FIND Functional Check 7-26
- 24. A and B Trace Separation 7-26

TRIGGERING

- 1. 500 Hz Trigger Sensitivity 7-27
- 2. 500 kHz Trigger Sensitivity 7-28
- 3. 25 MHz Trigger Sensitivity 7-29
- 4. 150 MHz Trigger Sensitivity 7-30
- 5. Single Sweep Mode 7-31
- 6. Trigger LEVEL Control Range 7-32
- 7. TV Field Trigger Sensitivity 7-33
- 8. TV Line Trigger Sensitivity 7-33
- 9. Line Trigger Functional Check 7-34

HORIZONTAL

1. A and B Sweep Length	7-35
2. Horizontal POSITION Range	7-36
3. VAR SEC/DIV Range	7-36
4. Magnifier Registration	7-36
5. A and B Timing Accuracy and Linearity	7-37
6. A and B Magnified Timing Accuracy and Linearity	7-39
7. Delay Time Jitter	7-40
8. Delay Time Accuracy	7-41
9. Delay Time Position Range	7-42
10. X-Axis Gain Accuracy	7-42
11. X-Y Phase Difference	7-43
12. X-Axis Bandwidth	7-43

MEASUREMENT CURSORS

1. \leftarrow SEC \rightarrow and \leftarrow 1/SEC \rightarrow Cursor Accuracy	7-44
2. \leftarrow PHASE \rightarrow Cursor Accuracy	7-45
3. \leftarrow VOLTS \rightarrow Cursor Accuracy	7-46
4. \rightarrow VOLTS \rightarrow Cursor Accuracy	7-46
5. Tracking Cursors Position Accuracy	7-46

CH1/CH2 VOLTMETER

1. DC Volts Accuracy	7-48
2. DC Volts Normal Mode Rejection Ratio	7-49
3. +Peak, -Peak, and Peak-Peak Volts Accuracy	7-50
4. 25 MHz +Peak, -Peak, and Peak-to-Peak Volts Accuracy	7-51
5. 100 MHz +Peak, -Peak, and Peak-to-Peak Volts Accuracy	7-51
6. Gated Volts Accuracy	7-52

EXTERNAL Z-AXIS AND PROBE ADJUST AND AUTO SETUP FUNCTIONS

1. Check External Z-Axis Input	7-53
2. PROBE ADJUST Output	7-54
3. AUTO SETUP Functional Check	7-54
4. Run MAKE FACTORY SETTINGS Routine	7-54

OPTION 15

1. Signal Output	7-55
2. AGATE Output	7-56

DISPLAY

Equipment Required (See Table 7-1)

Time-mark generator	50 Ω BNC coaxial cable
50 Ω BNC termination	

1. TRACE ROTATION

a. Set:

READOUT (Intensity)	For a viewable readout
A INTEN	For a viewable trace
VERTICAL MODE	CH 1
CH 1 VOLTS/DIV	0.1 V
CH 1 COUPLING	AC
A/B SELECT	A Trigger
TRIGGER MODE	AUTO LEVEL
TRIGGER SOURCE	VERT
TRIGGER CPLG	DC
TRIGGER SLOPE	 (positive-going)
TRIGGER HOLDOFF	Min
TRIGGER LEVEL	12 o'clock
Horizontal MODE	A
Horizontal POSITION	12 o'clock
A SEC/DIV	2 μ s
Measurements	All off (press CLEAR DISPLAY three times)
FOCUS	For best defined display
SCOPE BW	Off

- b. Position trace vertically to the center graticule line.
- c. CHECK—trace rotation control range is adequate to align trace with center graticule line using a small straight-bladed alignment tool.
- d. ADJUST—trace parallel to center horizontal graticule line.

2. Geometry

- a. Connect time-mark generator (TG 501) to CH 1 via a 50 Ω BNC coaxial cable and a 50 Ω BNC termination.
- b. Set generator for 0.2 μ S time marks.
- c. Position the bottom of the CH 1 signal below the bottom graticule line. It may be necessary to increase the A intensity in order to see the time markers.
- d. CHECK—deviation of any vertical line within the center eight horizontal divisions does not exceed 0.1 division (half a minor division).
- e. Set CH 1 COUPLING to GND.
- f. Position trace slowly from the bottom graticule line to the top graticule line while making the following check.
- g. CHECK—bowing or tilt of baseline trace doesn't exceed 0.1 division (half a minor division) within the eight vertical divisions.
- h. Disconnect test signal from the 2246A.

VERTICAL

Equipment Required (See Table 7-1)

Leveled sine-wave generator	50 Ω BNC coaxial cable
Calibration generator	50 Ω Termination
Function generator	Dual-Input coupler
50 Ω Precision BNC coaxial cable	

1. Input COUPLING Functional Check

a. Set:

READOUT (Intensity)	For a viewable readout
A INTEN	For a viewable trace
VERTICAL MODE	CH 1 and CH 2
CH 1 and CH 2	
VOLTS/DIV	1 V
CH 1 and CH 2	
Input COUPLING	DC
A/B SELECT	A TRIGGER
TRIGGER MODE	AUTO LEVEL
TRIGGER SOURCE	VERT
TRIGGER CPLG	DC
TRIGGER SLOPE	 (positive-going)
TRIGGER LEVEL	12 o'clock
TRIGGER HOLDOFF	Min
Horizontal POSITION	12 o'clock
Horizontal MODE	A
SEC/DIV	0.5 ms
FOCUS	For best defined display
Measurements	All off (press CLEAR DISPLAY three times)
SCOPE BW	Off
CH 2 INVERT	Off

b. Set Vertical MODE to CH 1 (CH 2 off).

c. Connect function generator (FG 502) sine-wave output to the CH 1 input via a 50 Ω BNC coaxial cable and a 50 Ω BNC termination.

- d. Set function generator output for 1 kHz sine-wave signal of five divisions peak-to-peak with maximum positive dc offset.
- e. Position the bottom of the signal to the center horizontal graticule line.
- f. Set CH 1 Input COUPLING to AC.
- g. CHECK—display is roughly centered about the center horizontal graticule line.
- h. Move the test signal to the CH 2 input.
- i. Set CH 2 VERTICAL MODE to on (CH 1 off).
- j. Repeat the procedure for CH 2.
- k. Disconnect the test signal from the 2246A.

2. CH 1 and CH 2 VOLTS/DIV Trace Shift

- a. Set:

CH 1 and CH 2	
VERTICAL MODE	On
CH 1 and CH 2	
VOLTS/DIV	2 mV
CH 1 and CH 2	
Input COUPLING	GND

- b. Set VERTICAL MODE to CH 1 (CH 2 off).
- c. Position trace to center horizontal graticule line.
- d. Switch CH 1 VOLTS/DIV through all positions from 2 mV to 5 V.
- e. CHECK—trace shift does not exceed 0.2 division between steps.
- f. Set VERTICAL MODE to CH 2 (CH 1 off).
- g. Position CH 2 trace to the center horizontal graticule line.
- h. Switch CH 2 VOLTS/DIV through all positions from 2 mV to 5 V.
- i. CHECK—trace shift does not exceed 0.2 division between steps.

3. CH 3 and CH 4 VOLTS/DIV Trace Shift

- a. Set VERTICAL MODE to CH 3 (CH 2 off).
- b. Position trace to the center horizontal graticule line.
- c. Switch CH 3 VOLTS/DIV between 0.1 V and 0.5 V.
- d. CHECK—trace shift does not exceed one division.
- e. Set VERTICAL MODE to CH 4 (CH 3 off).
- f. Position trace to the center horizontal graticule line.
- g. Switch CH 4 VOLTS/DIV between 0.1 V and 0.5 V.
- h. CHECK—trace shift does not exceed one division.

4. CH 1 and CH 2 VAR VOLTS/DIV Trace Shift

- a. Set:

VERTICAL MODE	CH 1 (CH 4 off)
CH 1 VOLTS/DIV	2 mV

- b. Position trace to center graticule line.
- c. Set CH 1 VAR VOLTS/DIV fully CCW.
- d. CHECK—trace shift does not exceed one division.
- e. Set:

CH 1 VAR VOLTS/DIV	Detent (calibrated)
VERTICAL MODE	CH 2 (CH 1 off)
CH 2 VOLTS/DIV	2 mV

- f. Position trace to center graticule line.
- g. Set CH 2 VAR VOLTS/DIV fully CCW.
- h. CHECK—trace shift does not exceed one division.
- i. Set CH 2 VAR VOLTS/DIV to detent (calibrated) position.

5. CH 1 and CH 2 Input COUPLING Trace Shift

- a. Position trace to center graticule line.
- b. Set CH 2 Input COUPLING to DC.
- c. CHECK—trace shift does not exceed 0.25 division.
- d. Set:

VERTICAL MODE	CH 1 (CH 2 off).
CH 1 Input COUPLING	GND

- e. Position trace to center graticule line.
- f. Set CH 1 Input COUPLING to DC.
- g. CHECK—trace shift does not exceed 0.25 division.

6. CH 2 INVERT Trace Shift

- a. Set:

VERTICAL MODE to CH 2	(CH 1 off).
CH 2 Input Coupling	GND

- b. Position trace to center horizontal graticule line.
- c. Set CH 2 INVERT On.
- d. CHECK—trace shift does not exceed one division.
- e. Set:

CH 2 INVERT	Off
CH 2 COUPLING	DC

7. CH 1 and CH 2 VAR VOLTS/DIV Range

- a. Set VERTICAL MODE to CH 1 (CH 2 off).
- b. Position CH 1 trace to the center horizontal graticule line.

Performance Check Procedure

c. Set:

CH 1 VOLTS/DIV	10 mV
CH 1 VAR VOLTS/DIV	Fully CCW

d. Connect calibration generator (PG 506) Std Ampl output to the CH 1 input via a 50 Ω precision BNC coaxial cable. Set generator to Std Ampl output to 50 mV.

e. CHECK—the signal amplitude is two divisions or less.

f. Set:

CH 1 VAR VOLTS/DIV	Detent (calibrated)
Vertical MODE	CH 2 (CH 1 off)
CH 2 VOLTS/DIV	10mV

g. Position CH 2 trace to the center horizontal graticule line.

h. Move the test signal to the CH 2 input.

i. Set CH 2 VAR VOLTS/DIV fully CCW.

j. Repeat the CHECK procedure for CH 2.

k. Set CH 2 VAR VOLTS/DIV to detent (calibrated) position.

8. Low-Frequency Linearity Check

a. Set:

VERTICAL MODE	CH 1 (CH 2 off)
CH 1 VOLTS/DIV	10 mV
SCOPE BW	On

b. Set calibration generator to Std Ampl output, 20 mV.

c. Move the test signal to the CH 1 input.

d. Position the top of the signal to top graticule line.

e. CHECK—the signal amplitude is between 1.9 and 2.1 divisions.

f. Set bottom of the signal to bottom graticule line.

g. CHECK—the signal amplitude is between 1.9 and 2.1 divisions.

h. Repeat the procedure for CH 2.

9. CH 1 and CH 2 Vertical Deflection Accuracy

- a. Set CH 2 VOLTS/DIV to 2 mV.
- b. Set calibration generator to Std Ampl output, 10 mV.
- c. Position the trace two graticule lines below the center horizontal graticule line.
- d. CHECK—all positions of the VOLTS/DIV settings for correct signal-to-graticule accuracy, using the settings in Table 7-2 for the checks.
- e. Set calibration generator to Std Ampl output, 10 mV.
- f. Move the test signal to the CH 1 input.
- g. Set:

VERTICAL MODE	CH 1 (CH 2 off)
CH 1 VOLTS/DIV	2 mV
- h. Same as c above.
- i. Repeat CHECK procedure for CH 1.

Table 7-2
Signal-to-Graticule Accuracy

VOLTS/DIV Setting	Std Ampl Setting	Deflection Accy. (in divisions)
2 mV	10 mV	4.90 to 5.10
5 mV	20 mV	3.92 to 4.08
10 mV	50 mV	4.90 to 5.10
20 mV	100 mV	4.90 to 5.10
50 mV	200 mV	3.92 to 4.08
0.1 V	500 mV	4.90 to 5.10
0.2 V	1 V	4.90 to 5.10
0.5 V	2 V	3.92 to 4.08
1 V	5 V	4.90 to 5.10
2 V	10 V	4.90 to 5.10
5 V	20 V	3.92 to 4.08

10. CH 3 and CH 4 Vertical Deflection Accuracy

a. Set:

VERTICAL MODE	CH 3 (CH 1 off)
CH 3 VOLTS/DIV	0.1 V

b. Position the trace to the second graticule line down from the center horizontal graticule line.

c. Move the test signal to the CH 3 input.

d. Set calibration generator to Std Ampl output, 0.5 V.

e. CHECK—the signal amplitude is between 4.90 and 5.10 divisions.

f. Move the test signal to the CH 4 input.

g. Set:

VERTICAL MODE	CH 4(CH 3 off)
CH 4 VOLTS/DIV	0.1 V

h. Same as b above.

i. Repeat CHECK for CH 4.

j. Set CH 4 VOLTS/DIV to 0.5 V.

k. Set calibration generator to Std Ampl output, 2 V.

l. CHECK—the signal amplitude is between 3.92 and 4.08 divisions.

m. Set:

VERTICAL MODE	CH 3 (CH 4 off)
CH 3 VOLTS/DIV	0.5 V

n. Move the test signal to the CH 3 input.

o. Repeat CHECK procedure for CH 3.

p. Disconnect the test setup from the 2246A.

11. ADD Mode and CH 2 INVERT Deflection Accuracy

a. Set:

VERTICAL MODE	ADD (all others off)
CH 1 and CH 2 VOLTS/DIV	0.1 V
CH 1 and CH 2 Input COUPLING	DC

- b. Connect calibration generator Std Ampl output to the CH 1 and CH 2 inputs via a 50 Ω precision BNC coaxial cable and a BNC dual-input coupler.
- c. Set the calibration generator to Std Ampl output, 0.2 V.
- d. Position the ADD signal to the center of the crt graticule with the CH 1 and CH 2 POSITION controls.
- e. CHECK—that the ADD signal amplitude is between 3.92 and 4.08 divisions.
- f. Set CH 2 INVERT On.
- g. CHECK—the ADD signal amplitude is 0.08 division (less than half a minor graticule division) or less excluding trace width (sweep will free run).
- h. Disconnect the test setup from the 2246A.

12. Vertical POSITION Range (all channels)

a. Set:

A SEC/DIV	0.1 ms
VERTICAL MODE	CH 1 (ADD off)
CH 1 VOLTS/DIV	1 V
CH 2 INVERT	Off
SCOPE BW	Off
CH 1 and CH 2 Input COUPLING	AC

- b. Connect leveled sine-wave generator (SG 503) output to the CH 1 and CH 2 inputs via a 50 Ω BNC coaxial cable, a 50 Ω BNC termination, and a BNC dual-input coupler.
- c. Position trace to center horizontal graticule line.

Performance Check Procedure

- d. Set leveled sine-wave generator output for two-division signal at 50 kHz.
- e. Set:
- | | |
|----------------|----------|
| CH 1 VOLTS/DIV | 0.1 V |
| CH 1 POSITION | Fully CW |
- f. CHECK—that the bottom of the waveform is at least one division above the center horizontal graticule line.
- g. Set CH 1 POSITION fully CCW.
- h. CHECK—that the top of the waveform is at least one division below the center horizontal graticule line.
- i. Set:
- | | |
|---------------|-----------------|
| CH 1 POSITION | 12 o'clock |
| VERTICAL MODE | CH 2 (CH 1 off) |
| CH 2 POSITION | Fully CW |
- j. CHECK—that the bottom of the waveform is at least one division above the center horizontal graticule line.
- k. Set CH 2 POSITION fully CCW.
- l. CHECK—that the top of the waveform is at least one division below the center horizontal graticule line.
- m. Set CH 2 POSITION to 12 o'clock.
- n. Move the BNC dual-Input coupler from the CH 1 and CH 2 inputs to the CH 3 and CH 4 inputs.
- o. Set:
- | | |
|---------------|-----------------|
| VERTICAL MODE | CH 3 (CH 2 off) |
| CH 3 and CH 4 | |
| VOLTS/DIV | 0.1 V |
| CH 3 POSITION | Fully CW |
- p. CHECK—that the bottom of the waveform is at least one division above the center graticule line.
- q. Set CH 3 POSITION fully CCW.

- r. CHECK—that the top of the waveform is at least one division below the center graticule line.
- s. Set:
 - CH 3 POSITION 12 o'clock
 - VERTICAL MODE CH 4 (CH 3 off)
- t. Repeat the procedure for CH 4.
- u. Set CH 4 POSITION to 12 o'clock.
- v. Disconnect the test setup from the 2246A.

13. CH 1 to CH 2 Signal Delay Match

- a. Set:
 - VERTICAL MODE CH 1 and CH 2 (CH 4 off)
 - CH 1 and CH 2
 - Input COUPLING DC
 - CH 1 and CH 2
 - VOLTS/DIV 0.1 V
 - SEC/DIV 20 ns
 - TRIGGER SOURCE CH 3
- b. Superimpose the CH 1 and CH 2 traces at the 100% graticule marking.
- c. Connect calibration generator (PG 506) FAST RISE, rising-edge signal to the CH 1 and CH 2 inputs via a 50 Ω precision BNC coaxial cable, a 50 Ω BNC termination, and a BNC dual-input coupler.
- d. Connect calibration generator TRIG OUT signal to the CH 3 input via a 50 Ω BNC coaxial cable and a 50 Ω BNC termination.
- e. Set the calibration generator to Fast Rise and adjust Pulse Amplitude for five divisions of signal amplitude at 1 MHz.
- f. Position the rising edges of the superimposed waveforms horizontally to the center vertical graticule line.

NOTE

It may be necessary to readjust the trigger level to display the rising-edge signal in the Delay Match steps. This can be done by pressing the upper Trigger MODE button to cause the trigger level to be automatically readjusted.

Performance Check Procedure

- g. Set X10 MAG On (for 2 ns/div sweep speed).
- h. CHECK—that the leading edges of the two waveforms have less than 0.1 horizontal division separation at the center graticule line excluding trace width.

14. CH 1 to CH 4 Signal Delay Match

- a. Set VERTICAL MODE to CH 1 and CH 4 (CH 2 off).
- b. Move the CH 2 signal to the CH 4 input connector.
- c. Superimpose the CH 4 waveform on the CH 1 waveform.
- d. CHECK—that the leading edges of the two waveforms have less than 0.1 horizontal division separation at the center graticule line excluding trace width.

15. CH 3 to CH 4 Signal Delay Match

- a. Set:

VERTICAL MODE	CH 3 and CH 4 (CH 1 off)
TRIGGER SOURCE	CH 2
- b. Move the CH 3 signal to the CH 2 input and the CH 1 trigger signal to the CH 3 input.
- c. Superimpose CH 3 and CH 4 waveforms at the center graticule line.
- d. CHECK—that the leading edges of the two waveforms have less than 0.1 horizontal division separation at the center graticule line.
- e. Disconnect the test setup.

16. CH 1 and CH 2 Vertical Bandwidth

- a. Set:

X10 MAG	Off
VERTICAL MODE	CH 1 (CH 3 and CH 4 off)
SEC/DIV	0.1 ms
CH 1 VOLTS/DIV	5 mV
CH 1 and CH 2 Input COUPLING	DC
TRIGGER SOURCE	VERT
Horizontal POSITION	12 o'clock

- b. Connect leveled sine-wave generator (SG 503) output to the CH 1 input via a 50 Ω precision BNC coaxial cable and a 50 Ω BNC termination.
- c. Set the Leveled Sine-Wave Generator output for a six-division signal amplitude at 50 kHz.
- d. Set the generator Frequency Range and Frequency Variable controls for a 90 MHz output signal.
- e. CHECK—the displayed signal amplitude is 4.2 divisions or more as the frequency is increased to 100 MHz.
- f. Repeat the frequency setup and CHECK procedure for VOLTS/DIV settings of 50 mV through 0.5 V.
- g. Move the test signal to the CH 2 input.
- h. Set:

VERTICAL MODE	CH 2 (CH 1 off)
CH 2 VOLTS/DIV	5 mV
- i. Repeat the complete Bandwidth check procedure for Channel 2.

17. CH 3 and CH 4 Vertical Bandwidth

- a. Set:

VERTICAL MODE	CH 3 (CH 2 off)
CH 3 and CH 4 VOLTS/DIV	0.1 V
- b. Connect leveled sine-wave generator (SG 503) output to the CH 3 input via a 50 Ω precision BNC coaxial cable and a 50 Ω BNC termination.
- c. Set the generator output for a six-division signal display at 50 kHz.
- d. Set the generator Frequency Range and Frequency Variable controls for a 90 MHz output frequency.
- e. CHECK—that the signal display amplitude is 4.2 divisions or more as the frequency is increased to 100 MHz.
- f. Repeat the procedure for 0.5 VOLTS/DIV setting.

- g. Move the test signal to the CH 4 input.
- h. Set VERTICAL MODE to CH 4
- i. Repeat the procedure for CH 4.

18. SCOPE BW (Bandwidth Limit) Accuracy

- a. Set:

VERTICAL MODE	CH 1 (CH 4 off)
CH 1 VOLTS/DIV	10 mV
SCOPE BW	On

- b. Move test signal from the CH 4 input to the CH 1 input.
- c. Set leveled sine-wave generator (SG 503) output for a six-division signal amplitude at 50 kHz.
- d. Increase the leveled sine-wave generator output frequency, using the Frequency Range and Frequency Variable controls, until a signal display amplitude of 4.2 divisions is obtained.
- e. CHECK—that the sine-wave generator output frequency is between 17 MHz and 23 MHz.
- f. Disconnect the test setup.

19. Common-Mode Rejection Ratio

- a. Connect leveled sine-wave generator (SG 503) output to the CH 1 and CH 2 input connectors via a 50 Ω precision BNC coaxial cable, a 50 Ω BNC termination, and a BNC dual-input coupler.
- b. Set the leveled sine-wave generator output for an eight-division signal-display amplitude at 50 kHz.
- c. Set:

Vertical MODE	ADD (CH 1 off)
CH 2 VOLTS/DIV	10 mV
CH 2 INVERT	On
SCOPE BW	Off

- d. Adjust CH 1 or CH 2 VAR VOLTS/DIV for smallest signal amplitude (as needed).
- e. Set the leveled sine-wave output frequency to 50 MHz.
- f. Set:

VERTICAL MODE	CH 1 (ADD Off)
---------------	----------------
- g. Set the leveled sine-wave output amplitude for an eight-division display.
- h. Set the VERTICAL MODE to ADD (CH 1 off).
- i. CHECK—the signal is less than 0.8 division in amplitude.
- j. Disconnect the test setup.

20. Channel Isolation

- a. Set:

VERTICAL MODE	CH 1 and CH 2 (ADD off)
CH 2 INVERT	Off
CH 1, CH 2, CH 3, and CH 4	
VOLTS/DIV	0.1 V
TRIGGER SOURCE	CH 1
- b. Connect the leveled sine-wave generator (SG 503) output to the CH 1 input via a 50 Ω precision BNC coaxial cable and a 50 Ω BNC termination.
- c. Set the leveled sine-wave generator (SG 503) output for a five-division signal display amplitude at 100 MHz.
- d. Set CH 2, CH 3, and CH 4 VERTICAL MODE On (CH 1 off).
- e. CHECK—display amplitude is 0.1 division or less, excluding trace width, on the CH 2, CH 3, and CH 4 traces.
- f. Move sine-wave generator signal to the CH 2 input.

Performance Check Procedure

g. Set:

CH 1, CH 3, and	
CH 4 VERTICAL MODE	On (CH 2 off)
TRIGGER SOURCE	CH 2

h. CHECK—display amplitude is 0.1 division or less, excluding trace width, on the CH 1, CH 3, and CH 4 traces.

i. Move sine-wave generator signal to the CH 3 input.

j. Set:

CH 1, CH 2, and CH 4	
VERTICAL MODE	On (CH 3 off)
TRIGGER SOURCE	CH 3

k. CHECK—display amplitude is 0.1 division or less, excluding trace width, on the CH 1, CH 2, and CH 4 traces.

l. Move sine-wave generator signal to the CH 4 input.

m. Set:

CH 1, CH 2, and CH 3	
VERTICAL MODE	On (CH 4 off)
TRIGGER SOURCE	CH 4

n. CHECK—display amplitude is 0.1 division or less, excluding trace width, on the CH 1, CH 2, and CH 3 traces.

o. Disconnect the test setup.

21. AC-Coupled Lower -3 dB Point

a. Set:

A SEC/DIV	10 ms
VERTICAL MODE	CH 1 (all others off)
TRIGGER SOURCE	VERT
TRIGGER MODE	NORM

b. Connect function generator (FG 502) output to the CH 1 input via a 50 Ω BNC coaxial cable and a 50 Ω BNC termination.

- c. Set the function generator output controls to produce a six-division sine-wave display at 10 Hz (with no dc offset).
- d. Set CH 1 Input COUPLING to AC.
- e. CHECK—display amplitude is 4.2 division or more.
- f. Set VERTICAL MODE to CH 2 (CH 1 off).
- g. Repeat the procedure for CH 2.
- h. Disconnect the test equipment from the 2246A.

22. Vertical ALT and CHOP Modes

- a. Set:

VERTICAL MODE	CH 1, CH 2, CH 3, and CH 4 on
CHOP VERTICAL MODE	Off (ALT mode)
CH 1 and CH 2	
VOLTS/DIV	10 mV
CH 3 and CH 4	
VOLTS/DIV	0.1 V
CH 1 and CH 2 Input COUPLING	DC
Horizontal MODE	A
SEC/DIV	0.1 ms
TRIGGER MODE	AUTO LEVEL

- b. Position all traces for two divisions of separation with the CH 1 trace near the top; then in order down the graticule area with the CH 4 trace near the bottom.
- c. Set SEC/DIV to 10 ms.
- d. CHECK—that four traces are sweeping across the screen alternately.
- e. Set CHOP VERTICAL MODE On.
- f. CHECK—that four traces are sweeping across the screen simultaneously.

23. BEAM FIND Functional Check

- a. Push BEAM FIND in and hold.
- b. CHECK—the signal is visible and compressed fully within the graticule area as the horizontal and vertical position controls are rotated through their ranges.
- c. Release the BEAM FIND button.
- d. Set all Vertical and Horizontal POSITION controls at the 12 o'clock position.

24. A and B Trace Separation

- a. Set:

A SEC/DIV	1 ms
VERTICAL MODE	CH 1 (others off)
Horizontal MODE	ALT
B SEC/DIV	0.5 ms
A/B SELECT	B
B Trigger MODE	RUNS AFTER
TRACE SEP	Fully CW

- b. Position the CH 1 trace below the center horizontal graticule line to display the separated B trace.
- c. CHECK—for at least four divisions of upward trace separation between the B trace and the A trace.
- d. Set TRACE SEP fully CCW.
- e. Position the CH 1 trace above the center horizontal graticule line to display the separated B trace.
- f. CHECK—for at least four divisions downward trace separation of the B trace from the A trace.

TRIGGERING

Equipment Required (See Table 7-1)

Leveled sine-wave generator	Function generator
50 Ω BNC coaxial cable	10X BNC attenuator
2X BNC attenuator	50 Ω termination
Dual-Input coupler	TV signal generator

1. 500 Hz Trigger Sensitivity

a. Set:

READOUT (Intensity)	For a viewable readout
A INTEN	For a viewable trace
VERTICAL MODE	CH 1
CH 1 and CH 2 Input COUPLING	DC
CH 1 VOLTS/DIV	0.1 V
SCOPE BW	On
Horizontal MODE	A
A SEC/DIV	1 ms
A/B SELECT	A Trigger
TRIGGER MODE	AUTO LEVEL
TRIGGER SOURCE	VERT
TRIGGER CPLG	AC
TRIGGER SLOPE	 (positive-going)
TRIGGER HOLDOFF	Min
FOCUS	For best defined display
Measurements	All off (press CLEAR DISPLAY three times)
Horizontal POSITION	12 o'clock

- b. Connect function generator (FG 502) output to the CH 1 input via a 50 Ω BNC coaxial cable, and a 50 Ω BNC termination.
- c. Set function generator (FG 502) output to produce a 7.0 division sine-wave display at 500 Hz.
- d. Add a 10X and a 2X BNC attenuator before the 50 Ω BNC termination (for a 0.35 division display).

NOTE

The TRIGGER LEVEL control may be used to obtain a stable display.

- e. CHECK—that the display is stably triggered with DC, HF REJ, and AC Trigger CPLG; and that the display will not trigger on NOISE REJ or LF REJ Trigger CPLG.

- f. Set:

Horizontal MODE	B
TRIGGER CPLG	DC
A/B SELECT	B Trigger
B TRIGGER MODE	NORM
B TRIGGER SOURCE	VERT
B TRIGGER SLOPE	↘ (positive-going)
B SEC/DIV	0.5 ms
DELAY Time	?0.000 (minimum delay time)
B INTEN	For viewable display

NOTE

It may be necessary to adjust the TRIGGER LEVEL control to obtain a display.

- g. CHECK—that using the Trigger LEVEL control the display can be stably triggered in DC, HF REJ, and AC Trigger CPLG; and that the display cannot be triggered in NOISE REJ or LF REJ Trigger CPLG.

- h. Disconnect the test setup from the CH 1 input.

2. 500 kHz Trigger Sensitivity

- a. Set:

SCOPE BW	Off
Horizontal MODE	A
A/B SELECT	A Trigger
A SEC/DIV	2 μ s

- b. Connect leveled sine-wave generator (SG 503) output to the CH 1 input via a 50 Ω BNC coaxial cable and a 50 Ω BNC termination.

- c. Set leveled sine-wave generator output to produce a 7.0 division sine-wave display amplitude at 500 kHz.
- d. Add a 10X and a 2X BNC attenuator before the 50 Ω BNC termination (for a 0.35 division display amplitude).
- e. CHECK—that the display cannot be triggered in either HF REJ of NOISE REJ CPLG.
- f. Set:

Horizontal MODE	B
A/B SELECT	B Trigger
B SEC/DIV	1 μ S
- g. CHECK—that the display cannot be triggered in HF REJ or NOISE REJ CPLG by adjusting the Trigger LEVEL control.

3. 25 MHz Trigger Sensitivity

- a. Set:

Horizontal MODE	A
A/B SELECT	A Trigger
TRIGGER CPLG	DC
A SEC/DIV	50 ns
- b. Remove the 10X and 2X BNC attenuators from the signal path.
- c. Set leveled sine-wave generator output to produce a 7.0 division display amplitude at 25 MHz.
- d. Add a 10X and a 2X BNC attenuator before the 50 Ω BNC termination.
- e. CHECK—that the display is stably triggered in DC, LF REJ, and AC Trigger CPLG; the display is not triggered in NOISE REJ and HF REJ Trigger CPLG settings.
- f. Set:

TRIGGER CPLG	DC
Horizontal MODE	B
A/B SELECT	B Trigger
B SEC/DIV	20 ns

Performance Check Procedure

- g. CHECK—that using the Trigger LEVEL control the display can be stably triggered in DC, LF REJ, and AC Trigger CPLG; the display cannot be triggered in NOISE REJ and HF REJ Trigger CPLG settings.
- h. Set leveled sine-wave generator (SG 503) to produce a 1.4 division display at 25 MHz.
- i. CHECK—that the display can be stably triggered with NOISE REJ Trigger CPLG but does not trigger with HF REJ CPLG.

j. Set:

Horizontal MODE	A
A/B SELECT	A Trigger

- k. CHECK—that the display is stably triggered with NOISE REJ Trigger CPLG but does not trigger with HF REJ CPLG. (The Trigger LEVEL control may be adjusted to improve display stability in NOISE REJ CPLG.)

4. 150 MHz Trigger Sensitivity

- a. Set TRIGGER CPLG to DC.
- b. Set leveled sine-wave generator to produce a 1.0 division display at 150 MHz.
- c. CHECK—that the display is stably triggered in DC, LF REJ, and AC Trigger CPLG.

d. Set:

Horizontal MODE	B
A/B SELECT	B Trigger

- e. CHECK—that using the Trigger LEVEL control the display can be stably triggered in DC, LF REJ, and AC Trigger CPLG.

f. Set:

Horizontal MODE	A
VERTICAL MODE	CH 2 (CH 1 off)
CH 2, CH 3, and CH 4	
VOLTS/DIV	0.1 V
A/B SELECT	A Trigger
TRIGGER CPLG	DC

- g. Move test signal from CH 1 to the CH 2 input.
- h. Set leveled sine-wave generator output to produce a 1.0 division display amplitude at 150 MHz.
- i. CHECK—that a stable display can be obtained. (The Trigger LEVEL control may be adjusted to improve the display stability.)
- j. Repeat procedure for the CH 3 and CH 4 (turn on the appropriate VERTICAL MODE and move the test signal as required).
- k. Move test signal to the CH 1 input.
- l. Set VERTICAL MODE to CH 1 (others off).
- m. Remove the 2X BNC attenuator from the test signal path.
- n. Set Leveled Sine-Wave Generator output for a 2.2 division display amplitude at 100 MHz.
- o. CHECK—that the display is stably triggered with NOISE REJ Trigger CPLG but is not triggered with HF REJ Trigger CPLG.
- p. Set leveled sine-wave generator output for a 0.5 division display amplitude at 100 MHz.
- q. CHECK—that the display is not triggered in NOISE REJ TRIGGER CPLG.
- r. Set:

TRIGGER CPLG	DC
Horizontal MODE	B
A/B SELECT	B Trigger
- s. Repeat 100 MHz NOISE REJ Trigger CPLG procedure for the B Trigger.

5. Single Sweep Mode

- a. Set:

Horizontal MODE	A
A SEC/DIV	10 μ s
A/B SELECT	A Trigger

- b. Remove the 10X BNC attenuator from the test signal path.
- c. Set leveled sine-wave generator output to produce a 7.0 division display amplitude at 50 kHz.
- d. Add a 10X and a 2X BNC attenuator before the 50 Ω BNC termination. (Display should stably trigger with AUTO LEVEL finding the correct trigger level setting.)

e. Set:

A TRIGGER MODE	NORM
CH 1 Input COUPLING	GND
TRIGGER MODE	SGL SEQ

f. CHECK—that the Trigger READY LED turns on and remains on.

g. Set:

A INTEN	3/4 fully CW
CH 1 Input COUPLING	DC (see CHECK below)

h. CHECK—that the TRIG'D LED flashes, and the READY LED turns off after a single sweep and readout display occurs when the Input COUPLING switches to DC.

6. Trigger LEVEL Control Range

a. Set:

TRIGGER MODE	AUTO (not AUTO LEVEL)
TRIGGER LEVEL	Fully CCW
A INTEN	For a good viewing intensity

- b. Remove 10X and 2X BNC attenuators from the test signal path.
- c. Reduce leveled sine-wave generator output level until a stably triggered display is just obtainable.
- d. Set TRIGGER LEVEL fully CW.
- e. Set leveled sine-wave generator output for a stable display (if necessary).
- f. Set CH 1 VOLTS/DIV to 1 V.
- g. CHECK—that the CH 1 signal display amplitude is four divisions or more (peak-to-peak). Note that the signal is not triggered.

- h. Disconnect the test setup from the 2246A.

7. TV Field Trigger Sensitivity

- a. Set:

VERTICAL MODE	CH 2 (CH 1 off)
CH 2 VOLTS/DIV	1 V
SEC/DIV	0.2 ms
TRIGGER SLOPE	 (negative-going)
TRIGGER MODE	TV FIELD

- b. Connect TV signal generator video output to the CH 2 input via a 50 Ω BNC cable.
- c. Set CH 2 VAR VOLTS/DIV control for a 0.5 division composite sync signal.
- d. CHECK—that a stable display is obtained.
- e. Set:

CH 2 INVERT	On
TRIGGER SLOPE	 (positive-going)

- f. CHECK—that a stable display is obtained.

8. TV Line Trigger Sensitivity

- a. Set:

CH 2 INVERT	OFF
TRIGGER SLOPE	 (negative-going)
A SEC/DIV	2 ms
Horizontal MODE	B
B SEC/DIV	20 μ s
A/B SELECT	B
B TRIGGER MODE	TV LINE

- b. CHECK—that a stable display is obtained for various portions of the TV Field as the \leftarrow OR DELAY control is rotated.



TRIGGER SLOPE	 (negative-going)
---------------	--

- c. Set CH 2 VAR VOLTS/DIV to Detent Position (calibrated).
- d. Disconnect the TV signal generator from the 2246A.

9. Line Trigger Functional Check

a. Set:

CH 2 VOLTS/DIV	0.1 V (without a 10X probe attached)
CH 2 Input COUPLING	DC
A SEC/DIV	5 ms
TRIGGER MODE	AUTO LEVEL
TRIGGER SOURCE	LINE
TRIGGER CPLG	DC

- b. Connect a 10X probe to the CH 2 input connector.
- c. Attach the probe tip to a length of wire at least four inches long. Hold the wire near the middle portion of the instrument power cord.
- d. CHECK—that the display can be triggered in both  (positive-going) and  (negative-going) slopes.
- e. Disconnect the test setup.

HORIZONTAL

Equipment Required (See Table 7-1)

Time-mark generator	50 Ω BNC coaxial cable
50 Ω BNC termination	

1. A and B Sweep Length

a. Set:

READOUT (Intensity)	For a viewable readout
A INTEN	For a viewable trace
VERTICAL MODE	CH 1
CH 1 and CH 2	
Input COUPLING	DC
CH 1 VOLTS/DIV	0.5 V
Horizontal MODE	A
A SEC/DIV	2 ms
Horizontal POSITION	12 o'clock
A/B SELECT	A Trigger
TRIGGER MODE	AUTO LEVEL
TRIGGER SOURCE	VERT
TRIGGER CPLG	AC
TRIGGER SLOPE	 (positive-going)
TRIGGER HOLDOFF	Min
TRIGGER LEVEL	12 o'clock
Measurements	All off (press CLEAR DISPLAY three times)
FOCUS	For best defined display

- b. Connect time-mark generator (TG 501) to the CH 1 input via a 50 Ω BNC coaxial cable and a 50 Ω BNC termination.
- c. Set generator for 2 ms time marks.
- d. CHECK—sweep length of the A trace is greater than 10 divisions.
- e. Set:

Horizontal MODE	B
B SEC/DIV	1 ms
A/B SELECT	B Trigger

Performance Check Procedure

TRIGGER MODE	RUNS AFTER
← OR DELAY Control	CCW to the lowest DELAY readout value
B INTEN	For a visible display

- f. CHECK—the Delay Time readout is 20.000 ms, and the B Sweep length is greater than 10 divisions.

2. Horizontal POSITION Range

- a. Set:

Horizontal MODE	A
Horizontal POSITION	Fully CW

- b. CHECK—that the start of trace positions past the center vertical graticule line.
- c. Set Horizontal POSITION fully CCW.
- d. CHECK—that the 11th time marker is positioned to the left of the center vertical graticule line.

3. VAR SEC/DIV Range

- a. Set:

SEC/DIV	1 ms
SEC/DIV VAR	Fully CCW
Horizontal POSITION	12 o'clock

- b. Set time mark generator for 5 ms time marks.
- c. CHECK—the time-mark spacing is equal to or less than two divisions.
- d. Set SEC/DIV VAR fully CW (calibrated detent).

4. Magnifier Registration

- a. Set X10 MAG on.
- b. Position the rising edge of a time marker to the center vertical graticule line.

Table 7-3
Settings for Timing Accuracy Checks

SEC/DIV Setting		Time-Mark Setting	
X1	X10 MAG	X1	X10 MAG
20 ns	2 ns	20 ns	5 ns
50 ns	5 ns	50 ns	5 ns
0.1 μ s	10 ns	0.1 ns	10 ns
0.2 μ s	20 ns	0.2 μ s	20 ns
0.5 μ s	50 ns	0.5 μ s	50 ns
1 μ s	0.1 μ s	1 μ s	0.1 μ s
2 μ s	0.2 μ s	2 μ s	0.2 μ s
5 μ s	0.5 μ s	5 μ s	0.5 μ s
10 μ s	1 μ s	10 μ s	1 μ s
20 μ s	2 μ s	20 μ s	2 μ s
50 μ s	5 μ s	50 μ s	5 μ s
0.1 ms	10 μ s	0.1 ms	10 μ s
0.2 ms	20 μ s	0.2 ms	20 μ s
0.5 ms	50 μ s	0.5 ms	50 μ s
1 ms	0.1 ms	1 ms	0.1 ms
2 ms	0.2 ms	2 ms	0.2 ms
5 ms	0.5 ms	5 ms	0.5 ms

A Sweep only

10 ms	1 ms	10 ms	1 ms
20 ms	2 ms	20 ms	2 ms
50 ms	5 ms	50 ms	5 ms
0.1 s	10 ms	0.1 s	10 ms
0.2 s	20 ms	0.2 s	20 ms
0.5 s	50 ms	0.5 s	50 ms

6. A and B Magnified Timing Accuracy and Linearity

a. Set time-mark generator for 20 ns time marks.

b. Set:

Horizontal MODE	A
A SEC/DIV	20 ns
Horizontal MODE	B
B SEC/DIV	20 ns
X10 MAG	On (for 2 ns/div sweep speed)
CH 1 VOLTS/DIV	0.5V (use 0.2 V for the 5 ns time markers if necessary)

c. Set the Horizontal POSITION control to 12 o'clock, and then align the rising edge of the nearest time marker to the second vertical graticule line (center the display vertical).

NOTE

For the fastest sweep speeds, where the time marker peaks are rounded and not well defined, greater resolution can be achieved by vertically centering the display and using the point where the rising edge of the time marks cross the center horizontal graticule line as a reference.

d. CHECK—that the rising edge of the fourth displayed time marker crosses the center horizontal graticule line at between 8.27 divisions and 8.73 division from the left-most graticule line.

e. CHECK—that the spacing of the time markers over any 2.5 division interval within the center eight divisions does not deviate from the value measured at the center 2.5 divisions by more than 0.12 division. Use the fifth vertical graticule line as a starting point for the measurement at the center 2.5 divisions. Exclude the first 1/4 division or 25 ns and any portion of the sweep past the 100th magnified division.

f. Set SEC/DIV to 5 ns.

g. Set the Horizontal POSITION control to 12 o'clock, and then align the nearest time marker to the second vertical graticule line.

h. CHECK—that the tenth displayed time marker is within 0.24 division (left or right) of the tenth graticule line.

- i. CHECK—that the spacing of the time markers over any two division interval within the center eight divisions does not deviate from the value measured at the center two divisions by more than 0.1 division. Exclude the first 1/4 division or 25 ns and any portion of the sweep past the 100th magnified division.
- j. Repeat the timing and linearity checks for all SEC/DIV settings between 10 ns and 0.5 ms. Use the SEC/DV and Time Mark Generator X10 MAG settings given in Table 7-3.

k. Set:

Horizontal MODE	A
SEC/DIV	2 ns (with X10 MAG on)

- l. Set time-mark generator for 5 ns time markers.
- m. Repeat the magnified accuracy and linearity checks for the A Sweep at all magnified SEC/DIV settings.

7. Delay Time Jitter

a. Set:

X10 MAG	Off
A SEC/DIV	1 ms
Horizontal MODE	ALT
SEC/DIV	0.5 μ s

- b. Set time-mark generator for 1 ms time marks.
- c. Position the intensified dot to the leading edge of the 10th time marker to display the rising edge on the B Trace (using the ← OR DELAY control). It may be necessary to reduce the A intensity level to observe the intensified dot.

d. Set:

Horizontal MODE	B
B INTEN	Fully CW (maximum intensity)

- e. CHECK—that the jitter on the leading edge does not exceed one division over a two-second interval. Disregard slow drift.

8. Delay Time Accuracy

a. Set:

Horizontal MODE	ALT
B SEC/DIV	10 μ s
TRACE SEP	Fully CCW (maximum downward position)
CH 1 POSITION	To display both the ALT and the B Delayed Traces

- b. Position the intensified dot to full left position (counterclockwise rotation of the \leftarrow OR DELAY control).
- c. Align the leading edge of the time marker displayed on the B trace to the left-most (first) graticule line, using only the Horizontal POSITION control.
- d. CHECK—that the readout is ?0.000 ms.
- e. Position the intensified zone to the second time marker and align the leading edge of the time marker displayed on the B Trace to the left-most (first) graticule line using only the \leftarrow OR DELAY control. Using the Readout Accuracy Limits given in Table 7-4, check the delay time accuracy.
- f. Repeat the procedure for the 3rd through 10th time markers.

Table 7-4
Delay Time Accuracy

Time Marker	Readout Accuracy Limits
1st	? 0.000 ms
2nd	0.945 ms to 1.055 ms
3rd	1.940 ms to 2.060 ms
4th	2.935 ms to 3.065 ms
5th	3.930 ms to 4.070 ms
6th	4.925 ms to 5.075 ms
7th	5.920 ms to 6.080 ms
8th	6.915 ms to 7.085 ms
9th	7.910 ms to 8.090 ms
10th	8.905 ms to 9.095 ms

9. Delay Time Position Range

- a. Set time-mark generator for 0.1 ms.
- b. Set:
- | | |
|--------------------|---------------|
| A SEC/DIV | 1 ms |
| B SEC/DIV | 5 μ s |
| ← OR DELAY control | CCW to ?0.000 |
- c. CHECK—that the intensified dot is positioned at or before the second time marker.
- d. Turn the ← OR DELAY control clockwise until the delay readout stops increasing (largest number).
- e. CHECK—that the intensified dot is positioned at or after the 99th time marker (located at a Delay Time of 9.9 ms).
- f. Disconnect the time-mark generator from the 2246A.

10. X-Axis Gain Accuracy

- a. Set:
- | | |
|---------------------|-----------------|
| Horizontal MODE | X-Y |
| VERTICAL MODE | CH 2 (CH 1 off) |
| CH 1 and CH 2 | |
| VOLTS/DIV | 10 mV |
| CH 1 Input COUPLING | DC |
| CH 2 Input COUPLING | GND |
- b. Connect calibration generator Std Ampl output to the CH 1 input via a 50 Ω precision BNC coaxial cable.
- c. Set calibration generator for Std Ampl output, 50 mV.
- d. CHECK—X-Axis amplitude is between 4.85 and 5.15 horizontal divisions.
- e. Disconnect calibration generator.

11. X-Y Phase Difference

a. Set:

HORIZONTAL MODE	A
VERTICAL MODE	CH 1 (CH 2 off)
CH 1 Input COUPLING	DC

b. Connect leveled sine-wave generator output to the CH 1 input via a 50 Ω BNC coaxial cable and a 50 Ω BNC termination.

c. Set leveled sine-wave generator output for six divisions of signal display amplitude at 50 kHz.

d. Set:

Horizontal MODE	X-Y
CH 1 Input COUPLING	GND

e. Position dot to graticule center.

f. Set CH 1 Input COUPLING to DC.

g. CHECK—ellipse opening at the center is 0.3 division or less, measured horizontally.

12. X-Axis Bandwidth

a. Set VERTICAL MODE to CH 2 (CH 1 off).

b. Set leveled sine-wave generator output for six divisions of horizontal display amplitude at 50 kHz.

c. Set leveled sine-wave output to 3 MHz.

d. CHECK—X-Axis display is 4.2 horizontal divisions or more.

e. Disconnect the test equipment from the 2246A.

MEASUREMENT CURSORS

Equipment Required (See Table 7-1)

Time-mark generator	Calibration generator
50 Ω BNC coaxial cable	50 Ω BNC termination

1. \leftarrow SEC \rightarrow and \leftarrow 1/SEC \rightarrow Cursor Accuracy

a. Set:

READOUT (Intensity)	For a viewable readout
A INTEN	For a viewable trace
VERTICAL MODE	CH 1
CH 1 VOLTS/DIV	0.5 V
CH 1 and CH 2 Input COUPLING	DC
Horizontal MODE	A
A SEC/DIV	1 ms
A/B SELECT	A Trigger
TRIGGER MODE	AUTO LEVEL
TRIGGER CPLG	DC
TRIGGER SOURCE	VERT
TRIGGER SLOPE	 (positive-going)
TRIGGER HOLDOFF	Min
CH 2 INVERT	Off
SCOPE BW	Off
FOCUS	For best defined display

NOTE

Instruments Serial Numbered BO20100 or above, go to CONFIGURE in the SERVICE MENU and select NO for INITIALIZE TIME CURSORS/DELAYS? before performing this check.

- b. Connect time-mark generator (TG 501) output via a 50 Ω BNC coaxial cable and a 50 Ω BNC termination to the CH 1 input.
- c. Set time-mark generator for 1 ms time marks.

- d. Position first time marker horizontally to the first vertical graticule line (left-most edge of the graticule).
- e. Press TIME button to display the TIME menu.
- f. Press \leftarrow SEC \rightarrow menu button to turn on time cursors.
- g. Position the reference cursor to the second time marker and the delta cursor to the tenth time marker.
- h. CHECK—that the readout is 7.940 ms to 8.060 ms.
- i. Press the TIME button to display the TIME menu.
- j. Set \leftarrow 1/SEC \rightarrow on.
- k. Reposition the reference cursor to the second time marker and the delta cursor to the tenth time marker.
- l. CHECK—that the readout is 124 Hz to 126 Hz.

2. \leftarrow PHASE \rightarrow Cursor Accuracy

- a. Press the TIME button to display the TIME menu.
- b. Press \leftarrow PHASE \rightarrow menu selection to display the \leftarrow PHASE \rightarrow and \leftarrow SET 360° \rightarrow menu choices.
- c. Set \leftarrow SET 360° \rightarrow on.
- d. Position the first time marker to first graticule line. Then position the Reference cursor to the leading edge of the third time marker and the delta cursor to the leading edge of the ninth time-marker.
- e. SET \leftarrow PHASE \rightarrow on.
- f. Position delta cursor to the leading edge of the sixth time marker.
- g. CHECK—that the readout is between 177.9 and 182.1 degrees.
- h. Disconnect time-mark generator.

3. \leftarrow VOLTS \rightarrow Cursor Accuracy

a. Set:

CH 1 VOLTS/DIV	0.1 V
SEC/DIV	0.5 ms
VOLTS CURSORS Menu	On
\leftarrow VOLTS \rightarrow CURSORS	On

- b. Select CURSOR VOLTS menu, then select \leftarrow VOLTS \rightarrow .
- c. Connect calibration generator (PG 506) output to the CH 1 input via a 50 Ω precision BNC coaxial cable.
- d. Set calibration generator to Std Ampl 0.5 V.
- e. Position bottom of the signal to the second horizontal graticule line from the bottom.
- f. Position the reference cursor to the bottom of the signal and the delta cursor to the top of the signal (both cursors move with the \leftarrow OR DELAY control).
- g. CHECK—that the readout is between 0.493 V and 0.507 V.

4. \nearrow VOLTS \rightarrow Cursor Accuracy

- a. Select CURSOR VOLTS menu, then select \nearrow VOLTS \rightarrow CURSORS.
- b. Position the \rightarrow control to align the delta CURSOR with the top of the waveform.
- c. CHECK—that the readout is between 0.493 V to 0.507 V, and none of the cursors move when the \leftarrow OR DELAY control is rotated.

5. Tracking Cursors Position Accuracy

- a. Press CLEAR DISPLAY (press twice).
- b. Set:

TRIGGER MODE	AUTO (not AUTO LEVEL)
--------------	-----------------------

- c. Press the CURSOR VOLTS button to display the CURSOR VOLTS menu. Press the TO AUTO TRACKING MENU button. Press the TRACK TRIG LVL and TRACK \hbar buttons so that those functions are underlined. Press the MENU OFF button to clear the menus.
- d. Adjust TRIGGER LEVEL control to align trigger level cursor with the bottom of the signal.
- e. CHECK—the readout is $0.000\text{ V} \pm 0.005\text{ V}$, and the GND cursor is aligned with the bottom of the signal.
- f. Set trigger level cursor to align with the top of the signal.
- g. CHECK—the readout is between 0.475 V and 0.525 V .
- h. Press CLEAR DISPLAY.
- i. Disconnect test equipment if ending here.

CH 1/CH 2 VOLTMETER

Equipment Required (See Table 7-1)

Calibration generator	50 Ω BNC coaxial cable
Leveled sine-wave generator	50 Ω BNC termination
Function generator	BNC Coupling Capacitor

1. DC Volts Accuracy

a. Set:

READOUT (Intensity)	For a viewable readout
A INTEN	For a viewable trace
VERTICAL MODE	CH 1
CH 1 VOLTS/DIV	50 mV
CH 2 INVERT	Off
SCOPE BW	Off
CH 1 Input COUPLING	GND
Horizontal MODE	A
A SEC/DIV	1 ms
A/B SELECT	A Trigger
TRIGGER MODE	AUTO LEVEL
TRIGGER CPLG	DC
TRIGGER SOURCE	VERT
TRIGGER SLOPE	 (positive-going)
TRIGGER HOLDOFF	Min
FOCUS	For best defined display
Horizontal POSITION	12 o'clock

- b. Press the VOLTMETER button and then press DC on the menu.
- c. CHECK—ground readout is 0.0 mV \pm 1.2 mV.
- d. Set calibration generator (PG 506) internal Square Wave/DC switch to DC.

NOTE

The PG 506 must be removed from the TM power supply to make the change to dc output from the generator. Turn the power off before removing or inserting any plug-in from the TM power supply

- e. Connect the calibration generator Std Ampl output to the CH 1 input via a 50 Ω precision BNC coaxial cable.
- f. Set calibration generator for Std Ampl output of 50 mV dc.
- g. Set:

CH 1 VOLTS/DIV	10 mV
CH 1 Input COUPLING	DC
- h. CHECK—the readout is between 49.0 mV and 51.0 mV.
- i. Set CH 1 VOLTS/DIV to 0.1 V.
- j. Set calibration generator for Std Ampl output 0.5 V.
- k. CHECK—the readout is between 0.495 V and 0.505 V.
- l. Set CH 1 VOLTS/DIV to 1 V.
- m. Set calibration generator for Std Ampl output of 5 V.
- n. CHECK—the readout is between 4.95 V and 5.05 V.
- o. Disconnect Std Ampl signal from the CH 1 input.

2. DC Volts Normal Mode Rejection Ratio

- a. Set SEC/DIV to 5 ms.
- b. Connect function generator (FG 502) output to the CH 1 input via a 50 Ω BNC coaxial cable and a BNC coupling capacitor.
- c. Set function generator for a six-division sine-wave display amplitude at 50 Hz (with CH 1 VOLTS/DIV at 1 V).
- d. Set CH 1 VOLTS/DIV to 0.2 V.
- e. CHECK—that the readout is less than ± 0.019 V.
- f. Disconnect the function generator signal from the 2246A.

3. +Peak, -Peak, Peak-to-Peak Volts Accuracy

a. Set:

VERTICAL MODE	CH 2 (CH 1 off)
CH 2 VOLTS/DIV	10 mV
CH 2 Input COUPLING	DC
CH1/CH2 VOLTMETER	+PEAK

- b. Press the VOLTMETER button and then press +PEAK from the menu.
- c. Set the calibration generator (PG 506) internal Square Wave/DC Switch for a square-wave output signal.

NOTE

It is necessary to remove the PG 506 from the TM power supply module to set the internal Square Wave/DC switch to square-wave output.

- d. Connect calibration generator Std Ampl output to the CH 2 input via a 50 Ω precision BNC coaxial cable.
- e. Set calibration generator for Std Ampl output of 50 mV.
- f. CHECK—that the readout is between 47.0 mV and 53.0 mV.
- g. Set SCOPE BW on.
- h. CHECK—the readout is between 47.7 mV and 52.3 mV.
- i. Set CH 2 INVERT to On and select -PEAK from the VOLTMETER menu.
- j. CHECK—the readout is between -47.7 mV and -52.3 mV.
- k. Set SCOPE BW Off.
- l. CHECK—the readout is between -47.0 mV and -53.0 mV.
- m. Set CH 2 INVERT to Off and select PK-PK from the VOLTMETER menu.

- n. CHECK—the readout is between 46.5 mV and 53.5 mV.
- o. Disconnect calibration generator.

4. 25 MHz +Peak, - Peak, and Peak-to-Peak Volts Accuracy

- a. Connect leveled sine-wave generator (SG 503) output to the CH 2 input via a 50 Ω BNC coaxial cable and a 50 Ω BNC termination.
- b. Set CH 2 VOLTS/DIV to 20 mV.
- c. Set leveled sine-wave generator output for a readout of 100.0 mV \pm 0.5 mV at 50 kHz.
- d. Set leveled sine-wave generator output for 25 MHz.
- e. CHECK—the readout is between 95.0 mV and 105.0 mV.
- f. Select -PEAK from the VOLTMETER menu.
- g. CHECK—the readout is between -46.0 mV and -54.0 mV.
- h. Select +PEAK from the VOLTMETER menu.
- i. CHECK—the readout is between 46.0 mV and 54.0 mV.

5. 100 MHz +Peak, -Peak, and Peak-to-Peak Volts Accuracy

- a. Set leveled sine wave generator (SG 503) output frequency to 100 MHz.
- b. CHECK—the readout is between 34.4 mV and 54.0 mV.
- c. Select VOLTMETER to -PEAK from the VOLTMETER menu.
- d. CHECK—the readout is between -34.4 mV and -54.0 mV.
- e. Select PK-PK VOLTMETER menu.
- f. CHECK—the readout is between 69.7 mV and 107.0 mV.
- g. Disconnect the leveled sine-wave signal from the 2246A.

6. Gated Volts Accuracy

a. Set:

A SEC/DIV	0.5 ms
CH 2 VOLTS/DIV	10 mV

- b. Press the VOLTMETER button and then select (TO GATED MEASMT MENU) from the VOLTMETER menu. Select GATE +PEAK from the GATED MEASMT menu.
- c. Connect calibration generator (PG 506) Std Ampl output to the CH 2 input via a 50 Ω precision BNC coaxial cable. Set the generator to Std Ampl output, 50 mV.
- d. Set the \rightarrow control for minimum intensified zone width (counterclockwise rotation).
- e. CHECK—that the width of the dot is less than 0.2 division.
- f. Set the intensified dot to a positive peak of the displayed waveform, using the \leftarrow OR DELAY control.
- g. CHECK—the readout is between 47.0 mV and 53.0 mV.
- h. Set the intensified dot to a negative peak of the displayed waveform.
- i. CHECK—the readout is 0.0 mV \pm 0.5 mV.
- j. Disconnect the test signal from the 2246A.

EXTERNAL Z-AXIS, PROBE ADJUST AND AUTO SETUP FUNCTIONS

Equipment Required (See Table 7-1)

Calibration generator	BNC T-connector
Two 50 Ω BNC coaxial cables	Test oscilloscope
50 Ω Precision BNC coaxial cable	with a 10X probe

1. Check External Z-Axis Input

a. Set:

READOUT (Intensity)	For a viewable readout
A INTEN	For a viewable trace
VERTICAL MODE	CH 1
CH 1 VOLTS/DIV	1 V
CH 2 INVERT	Off
SCOPE BW	Off
CH 1 Input COUPLING	DC
Horizontal MODE	A
A SEC/DIV	0.5 ms
A/B SELECT	A Trigger
TRIGGER MODE	AUTO LEVEL
TRIGGER CPLG	DC
TRIGGER SOURCE	VERT
TRIGGER SLOPE	 (positive-going)
TRIGGER HOLDOFF	Min
FOCUS	For best defined display
Horizontal POSITION	12 o'clock

- b. Connect calibration generator (PG 506) Std Ampl output to the CH 1 and the EXT Z-AXIS inputs via a 50 Ω precision BNC coaxial cable, a BNC T-connector, and two 50 Ω BNC coaxial cables. Set generator to Std Ampl output, 5 V.
- c. Set A INTEN to maximum intensity.
- d. CHECK—waveform display intensity starts decreasing at 1.8 V or less and the waveform is extremely modulated at 3.8 V.

- e. Set A INTEN to midrange.
- f. Disconnect the test equipment from the 2246A.

2. PROBE ADJUST Output

- a. Set:

CH 1 VERTICAL MODE	10 mV
SEC/DIV	0.2 ms

- b. Connect a 10X probe to the CH 1 input connector and connect the probe tip to the 2246A PROBE ADJUST output. (When using Tektronix coded probes the readout changes to .1V.)
- c. CHECK—For a 5-division vertical display of PROBE ADJUST square-wave signal (square-wave period is typically 1 ms, within 25%).

3. AUTO SETUP Functional Check

- a. Set:

CH 1 COUPLING	GND
CH 1 VOLTS/DIV	2 mV
A SEC/DIV	20 ns

- b. Press the AUTO SETUP button.
- c. Check that the Probe Adjust waveform is stably displayed on the upper half of the crt.

4. Run MAKE FACTORY SETTINGS Routine

- a. Press the top and bottom Menu-Select buttons to display the SERVICE MENU.
- b. Press the down-arrow menu button to underline the INTERNAL SETTINGS MENU and press SELECT.
- c. Press the down-arrow menu button once and press RUN to run the MAKE FACTORY SETTINGS routine.
- d. When the routine is finished, press the CLEAR DISPLAY button to return to the normal oscilloscope mode.

OPTION 15

Equipment Required (See Table 7-1)

Calibration generator	Two 50 Ω BNC coaxial cables
Test oscilloscope	50 Ω Precision BNC coaxial cable
Level sine-wave generator	Two 50 Ω BNC termination

1. Signal Output

a. Set:

VERTICAL MODE

CH 1 and CH 2	On (light on)
CH 3 and CH 4	Off (light off)
BW LIMIT	Off (light off)

VOLTS/DIV

CH 1 and CH 2	2 MV
---------------	------

Input Coupling

CH 1 and CH 2	GND
---------------	-----

A and B SEC/DIV

1 ms

TRIGGER MODE

AUTO LVL

SOURCE

VERT

COUPLING

NOISE REJ

- b. Push the CH 2 VERTICAL MODE button so that light is off.
- c. Connect the CH 2 signal from the rear-panel CH 2 SIGNAL OUT connector to the CH 1 OR X input connector via a 50 Ω BNC cable.
- d. Align the CH 1 trace to the center graticule line.
- e. Set CH 1 Input Coupling to DC.
- f. CHECK—Display amplitude to 4.5 to 5.5 divisions (neglect trace width).
- g. Connect a 1 kHz, 10 mV standard-amplitude signal from the Calibration Generator to the CH 2 Input Connector via a 50 Ω BNC cable.

- h. Set CH 2 Input Coupling to DC.
- i. Set CH 1 VOLTS/DIV to 20 mV.
- j. CHECK—Display amplitude to 4.5 to 5.5 divisions (neglect trace width).
- k. Connect a 50 Ω terminator to the CH 1 Input.
- l. Set CH 1 VOLTS/DIV to 10 mV.
- m. CHECK—Display amplitude to 4.5 to 5.5 divisions (neglect trace width).
- n. Set CH 2 VOLTS/DIV to 0.1 V.
- o. Connect to 50 kHz signal from the Leveled Sine-Wave Generator to the CH 2 input connector via a 50 Ω precision BNC cable and a 50 Ω BNC termination.
- p. Adjust the generator output level to produce a 6-division CH 1 display.
- q. Increase the generator frequency to 25 MHz.
- r. CHECK—Display amplitude is 4.24 divisions or greater.
- s. Disconnect the test setup.

2. A GATE Output

a. Set:

SEC/DIV	0.1 ms
TRIGGER MODE	Auto
HOLDOFF	Minimum (CCW)

- b. Connect a test oscilloscope to the A GATE OUT Connector from the rear-panel via 50 Ω BNC cable.
- c. CHECK—Test oscilloscope displays a signal with a high level between 2 V and 5.25 V and a low level between 0 V and 0.7 V.
- d. CHECK—Duration of the high level is greater than or equal to 0.2 ms.
- e. Set HOLDOFF Control to maximum (CW).
- f. CHECK—Duration of the high level is greater than or equal to 2 ms.
- g. Disconnect the test setup.

SECTION 8

**OPTIONS
AND
ACCESSORIES**

1. The first part of the document is a list of names and titles, including "The Hon. Mr. Justice" and "The Hon. Mr. Justice".

OPTIONS AND ACCESSORIES

Introduction

This section lists the instrument options and accessories that were available at the time this manual was published. To obtain additional information about these and other options and accessories, refer to a current Tektronix Product Catalog or contact your local Tektronix Field Office or representative.

Options A1–A5 International Power Cords

Instruments are shipped with the detachable power-cord option as ordered by the customer. Descriptive information about the international power-cord options is provided in "Preparation for Use" subsection in Section 1. Order power cords only by option number and description. The optional power cords available for the 2246A are as follows:

- Standard, North American 120 V, 60 Hz, 74 in.
- Option A1, Universal Euro 220 V, 50 Hz, 2.5 m
- Option A2, UK 240 V, 50 Hz, 2.5 m
- Option A3, Australian 240 V, 50 Hz, 2.5 m
- Option A4, North American 220 V, 50 Hz, 2.5 m
- Option A5, Switzerland 220 V, 50 Hz, 2.5 m

Option 15

The 2246A Option 15 oscilloscope provides two additional output signals from the rear of the instrument: a Channel 2 output signal and an A GATE output signal. The following paragraphs give a more detailed description of both of these outputs. Specifications and Performance Checks are integrated into the appropriate sections of this manual.

CH 2 Signal Output—Connector located on the rear-panel provides an output signal that is a normalized representation of the Channel 2 input signal. The output amplitude into a 1 M Ω load is approximately 20 mV per division of input signal. Into a 50 Ω load, the output amplitude is approximately 10 mV per division of input signal.

A GATE Output—Connector located on the rear-panel provides a TTL and CMOS compatible, positive-going gate signal that is HI during the A Sweep and LO when the A Sweep is not running.

Option 1R Rackmounted Instrument

When the 2246A Portable Oscilloscope is ordered with Option 1R, it is shipped in a configuration that permits easy installation into a 19-inch-wide equipment rack. Also, an optional rackmounting kit may be ordered to convert the standard 2246A to a rackmounted instrument. Installation instructions for rackmounting are provided in the documentation supplied with the rackmounting kit and the 1R Option.

Other Available Options

Option 02	Front Panel Cover and Accessory Pouch
Option 1C	C-5C Option 02 Camera
Option 1K	K212 Portable Instrument Cart
Option 17	P6408 Logic Probe included
Option 22	Two P6109 Option 1 10X voltage probes
Option 23	Two P6062B 1X/10X voltage probes, 6 feet

Standard Accessories

The following standard accessories are provided with each instrument:

	Part Number
2 Probes, 10X, 1.5 meter with accessories	P6109 or equivalent
1 Power cord (Option A0-A5)	As ordered
1 Power cord clamp	343-1213-00
1 Operators Manual	070-6556-01
1 Reference Guide	070-6576-01
1 CRT implosion shield, blue plastic (Installed)	337-2775-00
1 Fuse, 2 A, 250 V, slow-blow	159-0023-00
1 Accessory pouch, ziploc	004-0130-00

Optional Accessories

The following optional accessories are recommended for use with the 2246A Oscilloscope:

Instrument Enhancements

	Part Number
Protective Front-Panel Cover	200-3232-00
Attaching Accessories Pouch	016-0857-00
Protective Waterproof Vinyl Cover	016-0848-00
Clear Implosion Shield	337-2775-01
Rackmounting kit	2240F1R
DC Inverter Power Supply	1105
2246A Service Manual	070-6555-01

Transportation Aids

Carrying Strap	346-0199-00
Portable Instrument Cart	K212

Cameras

Low-Cost Scope Camera	C5 Option 02
Motorized Camera	C7 Options 03 and 30
High-Performance Camera	C30B Option 01

Probes

Active Probe	P6202A
Power Supply for Active Probe	1101A
Current Probes	P6021 (1.52 m); P6022 (1.52 m); A6302/AM503; A6303/AM503
Environmental Probe	P6008 (1.83 m)
High Voltage Probe	P6009 (2.74 m)
1X/10X Passive Probe	P6063B (1.83 m)
Subminiature 10X Probe	P6130 (2 m)
Ground Isolation Monitor	A6901
Isolator (for floating measurements)	A6902B

Viewing Hoods

Collapsible Viewing Hood	016-0592-00
Binocular Viewing Hood	016-0566-00
Polarized Collapsible Viewing Hood	016-0180-00

**AUTO-SETUP
CONTROL SETTINGS**

FACTORY SETTINGS

FACTORY STORED SETUPS

Table A-1
 AUTO-SETUP Control Settings

FRONT-PANEL CONTROL	AUTO-SETUP ACTION
SCOPE BW	Off.
X10 MAG	Off.
Horizontal POSITION	Midrange, if not within 1 division of midrange. The Horizontal position control does not affect the position of the trace until moved through the point corresponding to the trace position set by AUTO SETUP.
Horizontal MODE	A, if A or X-Y selected; ALT if ALT or B selected.
TRIGGER	
A/B SELECT	A, if A Horizontal MODE selected by AUTO SETUP; otherwise B.
A MODE	AUTO LEVEL.
B MODE	RUNS AFTER, if ALT or B selected; otherwise as selected.
A SOURCE	VERT.
B SOURCE	VERT, if ALT or B selected; otherwise as selected.
A CPLG	NOISE REJ, if SOURCE Volts/Div is set to 2 mV by AUTO SETUP, otherwise DC.
B CPLG	NOISE REJ, if SOURCE Volts/Div is set to 2 mV by AUTO SETUP, otherwise DC.
A SLOPE	As selected.
B SLOPE	As selected.
A LEVEL	Nominally midway between peaks of A SOURCE signal. Signal peaks must be $\leq (10 \text{ volts} \times \text{probe multiplier})$.
B LEVEL	Nominally midway between peaks of B SOURCE signal. Signal peaks must be $\leq (10 \text{ volts} \times \text{probe multiplier})$.
CH 1 and CH 2 COUPLING (Channel turned on)	DC, if COUPLING set to GND or DC; otherwise AC.

Table A-1 (cont.)
 AUTO-SETUP Control Settings

FRONT-PANEL CONTROL	AUTO-SETUP ACTION
VERTICAL MODE	
CH 1, CH 2, and ADD	CH 1 and CH 2, if ADD only was selected; otherwise only CH 1, CH 2, or both as selected.
CH 3, and CH 4	As selected.
CHOP/ALT	CHOP if A Sweep is 0.1 ms/div or slower, ALT if 50 μ s/div or faster.
CH 2 INVERT	Off.
VERTICAL POSITION	
CH 1	Ground level aligned with 3rd graticule line from top. ^a
CH 2	Ground level aligned with 5th graticule line from top. ^a
CH 3	Ground level aligned with 1st graticule line from top. ^a
CH 4	Ground level aligned with 7th graticule line from top. ^a The VERTICAL POSITION controls do not affect the position of the trace until moved through the point corresponding to the trace position set by AUTO SETUP.
CH 1 and CH 2 VOLTS/DIV	Lowest value for which all waveform values are within ± 2 divisions of ground. ^a
CH 3 and CH 4 VOLTS/DIV	0.5 V (plus probe factor if applicable). ^a
A SEC/DIV	One speed slower than the fastest speed that displays one complete cycle of the triggering signal, within the range 2 ms to 20 ns. Depending on input signal characteristics, if more than one complete cycle can be displayed at 20 ns, the A sweep may be set to either 50 ns or 20 ns.

^a Trace and readout are displayed if channel is active when AUTO SETUP button is pressed.

Table A-1 (cont.)
AUTO-SETUP Control Settings

FRONT-PANEL CONTROL	AUTO-SETUP ACTION
B SEC/DIV	20 ns, if A SEC/DIV was set to 20 ns or 50 ns by AUTO SETUP; otherwise two speeds faster than A SEC/DIV.
Menu Selection	As selected.
CURSORS/TIME POSITION	Measurement Reinitialized
A INTEN, B INTEN, READOUT	<p>40% of maximum intensity, if pot rotation is less than 28% from CCW stop; otherwise as selected.</p> <p>A intensify is set to 30% if Horizontal Mode is ALT.</p> <p>The A INTEN, B INTEN and READOUT controls do not affect display intensity until moved through the point corresponding to the intensity level set by the AUTO SETUP.</p>
TRACE SEP	<p>Midrange if ALT or B selected; otherwise as adjusted.</p> <p>The TRACE SEP control does not affect the trace separation until moved through the point corresponding to the trace position set by AUTO SETUP.</p>
HOLDOFF	As adjusted.
CH 1 VAR, CH 2 VAR, SEC/DIV VAR	As adjusted.

Table A-2
MIN SETUP Control Settings^a
B020100 and above

FRONT-PANEL CONTROL	MIN SETUP ACTION
HORIZONTAL MODE	Changes to ALT if B selected.
TRIGGER	
A LEVEL	Nominally midway between peaks of A SOURCE signal. Signal peaks must be \leq (10 volts X probe multiplier).
B LEVEL	Nominally midway between peaks of B SOURCE signal. Signal peaks must be \leq (10 volts X probe multiplier).
CH 1 and CH 2 COUPLING (Channel turned on)	DC, if COUPLING set to GND or DC; otherwise AC.
VERTICAL MODE CH 1, CH 2, and ADD	CH 1 and CH 2, if ADD only was selected; otherwise only CH 1, or CH 2, or both as selected.
CH 1 and CH 2 VOLTS/DIV	Lowest value for which all waveform values are within ± 2 divisions of ground. ^b If Horizontal MODE is X-Y, CH 1 VOLTS/DIV is stepped down one additional setting
A SEC/DIV	One speed slower than the fastest speed that displays one complete cycle of the triggering signal, within the range 2 ms to 20 ns. ^c Depending on input signal characteristics, if more than one complete cycle can be displayed at 20 ns, the A sweep may be set to either 50 ns or 20 ns. 5ms, if TV FIELD selected; 10 μ s, if TV LINE selected.
B SEC/DIV	20 ns, if A SEC/DIV was set to 20 ns or 50 ns by MIN SETUP; otherwise two speeds faster than A SEC/DIV. ^c 10 μ s, if TV LINE selected.
CURSORS/TIME POSITION	Measurement Reinitialized.

^a MIN SETUP only sets those controls listed. All other front panel controls remain as set by the user.

^b Trace and readout are displayed if channel is active when MIN SETUP button is pressed.

^c Sweep speed is set the same regardless of the setting of the X10 Horizontal MAG button.

Table B-1
Factory Settings

Controls	Settings
VERTICAL MODE	CH 1 AND CH 2
CH 1, CH 2 INPUT COUPLING	DC
CH 1, 2, 3, 4 VOLTS/DIV	0.1 V
CH 2 INVERT	OFF
SCOPE BW	OFF
HORIZONTAL MODE	A
X10 MAG	OFF
A SEC/DIV	0.1 ms
B SEC/DIV	1 μ s
A, B SLOPE	
A/B SELECT	A
A TRIGGER MODE	AUTO LEVEL
B TRIGGER MODE	RUNS AFTER
A and B TRIGGER SOURCE	CH 1
A and B TRIGGER COUPLING	DC
TRIGGER HOLDOFF	As selected
MEASUREMENTS	OFF

**Table B-1 (cont.)
Factory Settings**

Controls	Settings
TRACKING CURSORS	As selected
MENU Displays	OFF
CONFIGURE Selections:	
INITIALIZE TIME CURSOR/DELAYS? ^a	YES
PRESET TV TRIG SLOPE FOR -SYNC? ^a	YES
All other CONFIGURE selections	NO
A INTEN, B INTEN, READOUT	As selected

^a INITIALIZE TIME CURSORS/DELAYS and PRESET TV TRIG SLOPE only available on instruments Serial Numbered B020100 or above.

FACTORY STORED SETUPS

Setup #1: ADJUST FLAT TOP

CRT

A INTEN Level	25% of range
B INTEN Level	Mid range
READOUT	Mid range

VERTICAL



MODE	CH 1 (all others off)
CH 1/CH 2 COUPLING	DC
SCOPE BW	On
CH 2 INVERT	Off
CH 1/CH 2 VOLTS/DIV	10 mV*
CH 3/CH 4 VOLTS/DIV	.1 V*
CH 1/CH 2 VAR VOLTS/DIV	Calibrated (UNCAL off)
CH 1 POSITION	Ground level at 3rd graticule line below center screen
CH 2 POSITION	Ground level at 1st graticule line below center screen
CH 3 POSITION	Ground level at 1st graticule line above center screen
CH 4 POSITION	Ground level at 3rd graticule line above center screen

HORIZONTAL

MODE	A
X10 MAG	Off
POSITION	Mid range
A SEC/DIV	.2 ms
B SEC/DIV	20 μ s
SEC/DIV VAR	Calibrated (UNCAL off)
TRACE SEP	B sweep trace 2 divs below center graticule line

*Multiply scale factor by 10 when 10X probe attached.

TRIGGER

HOLD OFF	MIN
A LEVEL	Set for stable display of a .5 V signal with VOLTS/DIV set to .1 V (10X probe attached)
B LEVEL	Set for stable display of a .5 V signal with VOLTS/DIV set to .1 V (10X probe attached)
A SLOPE	
B SLOPE	
A/B SELECT	A
A MODE	AUTO LEVEL
A SOURCE	CH 1
A COUPLING	DC
B MODE	RUNS AFTER
B SOURCE	None
B COUPLING	DC

MEASUREMENTS

No measurements turned on.

Setup #2: AUTO TO 100 MHz

CRT

A INTEN Level	25% of range
B INTEN Level	Mid range
READOUT	Mid range

VERTICAL

MODE	CH 1 (all others off)
CH 1/CH 2 COUPLING	DC
SCOPE BW	On
CH 2 INVERT	Off
CH 1 VOLTS/DIV	20 mV*
CH 2 VOLTS/DIV	10 mV*
CH 3/CH 4 VOLTS/DIV	.1 V*
CH 1/CH 2 VAR VOLTS/DIV	Calibrated (UNCAL off)



*Multiply scale factor by 10 when 10X probe attached.

CH 1 POSITION	Ground level at 3rd graticule line below center screen
CH 2 POSITION	Ground level at 1st graticule line below center screen
CH 3 POSITION	Ground level at 1st graticule line above center screen
CH 4 POSITION	Ground level at 3rd graticule line above center screen

HORIZONTAL

MODE	A
X10 MAG	Off
POSITION	Mid range
A SEC/DIV	.2 ms
B SEC/DIV	20 μ s
SEC/DIV VAR	Calibrated (UNCAL off)
TRACE SEP	B sweep trace 2 divs below center graticule line

TRIGGER

HOLDOFF	MIN
A LEVEL	Set for stable display of a .5 V signal with VOLTS/DIV set to .1 V (10X probe attached)
B LEVEL	Set for stable display of a .5 V signal with VOLTS/DIV set to .1 V (10X probe attached)
A SLOPE	
B SLOPE	
A/B SELECT	A
A MODE	AUTO LEVEL
A SOURCE	CH 1
A COUPLING	DC
B MODE	RUNS AFTER
B SOURCE	None
B COUPLING	DC

MEASUREMENTS

VOLTMETER CH 1/CH 2	PK-PK
Measurement Channel	CH 1
TRACK MEASMT Cursors	Enabled
TRACK TRIG LVL	Disabled
TRACK \overline{m} Cursors	Disabled

Setup #3: SELECTABLE TIME

CRT

A INTEN Level	25% of range
B INTEN Level	Mid range
READOUT	Mid range

VERTICAL

MODE	CH 1 (all others off)
CH 1/CH 2 COUPLING	DC
SCOPE BW	On
CH 2 INVERT	Off
CH 1 VOLTS/DIV	20 mV*
CH 2 VOLTS/DIV	10 mV*
CH 3/CH 4/VOLTS/DIV	.1 V*
CH 1/CH 2 VAR VOLTS/DIV	Calibrated (UNCAL off)
CH 1 POSITION	Ground level at 3rd graticule line below center screen
CH 2 POSITION	Ground level at 1st graticule line below center screen
CH 3 POSITION	Ground level at 1st graticule line above center screen
CH 4 POSITION	Ground level at 3rd graticule line above center screen



HORIZONTAL

MODE	A
X10 MAG	Off
POSITION	Mid range

*Multiply scale factor by 10 when 10X probe attached.

A SEC/DIV	.2 ms
B SEC/DIV	20 μ s
SEC/DIV VAR	Calibrated (UNCAL off)
TRACE SEP	B sweep trace 2 divs below center graticule line

TRIGGER

HOLDOFF	MIN
A LEVEL	Set for stable display of a .5 V signal with VOLTS/DIV set to .1 V (10X probe attached)
B LEVEL	Set for stable display of a .5 V signal with VOLTS/DIV set to .1 V (10X probe attached)
A SLOPE	
B SLOPE	
A/B SELECT	A
A MODE	AUTO LEVEL
A SOURCE	CH 1
A COUPLING	DC
B MODE	RUNS AFTER
B SOURCE	None
B COUPLING	DC

MEASUREMENTS

VOLTMETER CH 1/CH 2	GATED +PEAK
Measurement Channel	CH 1
TRACK MEASMT Cursors	Enabled
TRACK TRIG LVL Cursors	Disabled
TRACK  Cursors	Enabled
Gated (intensified)	Starts at 7th graticule line ends at 8th graticule line.
Zone	

Setup #4: MANUAL Δ VOLTS**CRT**

A INTEN Level	25% of range
B INTEN Level	Mid range
READOUT	Mid range

VERTICAL

MODE	CH 1 (all others off)
CH 1/CH 2 COUPLING	DC
SCOPE BW	On
CH 2 INVERT	Off
CH 1/CH 2 VOLTS/DIV	10 mV*
CH 3/CH 4 VOLTS/DIV	.1 V*
CH 1/CH 2 VAR VOLTS/DIV	Calibrated (UNCAL off)
CH 1 POSITION	Ground level at 3rd graticule line below center screen
CH 2 POSITION	Ground level at 1st graticule line below center screen
CH 3 POSITION	Ground level at 1st graticule line above center screen
CH 4 POSITION	Ground level at 3rd graticule line above center screen

HORIZONTAL

MODE	A
X10 MAG	Off
POSITION	Mid range
A SEC/DIV	.2 ms
B SEC/DIV	20 μ s
SEC/DIV VAR	Calibrated (UNCAL off)
TRACE SEP	B sweep trace 2 divs below center graticule line

TRIGGER

HOLDOFF	MIN
A LEVEL	Set for stable display of a .5 V signal with VOLTS/DIV set to .1 V (10X probe attached)
B LEVEL	Set for stable display of a .5 V signal with VOLTS/DIV set to .1 V (10X probe attached)

*Multiply scale factor by 10 when 10X probe attached.

A SLOPE	
B SLOPE	
A/B SELECT	A
A MODE	AUTO LEVEL
A SOURCE	CH 1
A COUPLING	DC
B MODE	RUNS AFTER
B SOURCE	None
B COUPLING	DC

MEASUREMENTS

CURSOR VOLTS	← VOLTS →
Measurement Channel	CH 1
TRACK MEASMT Cursors	Disabled
TRACK TRIG LVL	Disabled
TRACK δ Cursors	Disabled
← (reference cursor)	Set to slightly above screen center.
→ (delta cursor)	Set to slightly below screen center

Setup #5: SET CURSORS

CRT

A INTEN Level	25% of range
B INTEN Level	Mid range
READOUT	Mid range

VERTICAL

MODE	CH 1 (all others off)
CH 1/CH 2 COUPLING	DC
SCOPE BW	On
CH 2 INVERT	Off
CH 1/CH 2 VOLTS/DIV	10 mV*
CH 3/CH 4 VOLTS/DIV	.1 V*
CH 1/CH 2 VAR	Calibrated (UNCAL off)
CH 1 POSITION	Ground level at 3rd graticule line below center screen



*Multiply scale factor by 10 when 10X probe attached.

CH 2 POSITION	Ground level at 1st graticule line below center screen
CH 3 POSITION	Ground level at 1st graticule line above center screen
CH 4 POSITION	Ground level at 3rd graticule line above center screen

HORIZONTAL

MODE	A
X10 MAG	Off
POSITION	Mid range
A SEC/DIV	.2 ms
B SEC/DIV	20 μ s
SEC/DIV VAR	Calibrated (UNCAL off)
TRACE SEP	B sweep trace 2 divs below center graticule line

TRIGGER

HOLDOFF	MIN
A LEVEL	Set for stable display of a .5 V signal with VOLTS/DIV set to .1 V (10X probe attached)
B LEVEL	Set for stable display of a .5 V signal with VOLTS/DIV set to .1 V (10X probe attached)
A SLOPE	
B SLOPE	
A/B SELECT	A
A MODE	AUTO LEVEL
A SOURCE	CH 1
A COUPLING	DC
B MODE	RUNS AFTER
B SOURCE	None
B COUPLING	DC

MEASUREMENTS

TIME	\leftarrow 1/SEC \rightarrow
Measurement Channel	CH 1
TRACK MEASMT Cursors	Disabled
TRACK TRIG LVL Cursors	Enabled

TRACK \overline{m} Cursors	Disabled
Reference Cursor	Slightly left of center graticule line
Delta Cursor	Slightly right of center graticule line

Setup #6: ADJUST CH 1 V/D

CRT

A INTEN Level	25% of range
B INTEN Level	Mid range
READOUT	Mid range

VERTICAL

MODE	CH 1 (all others off)
CH 1/CH 2 COUPLING	DC
SCOPE BW	On
CH 2 INVERT	Off
CH 1 VOLTS/DIV	100 mV*
CH 2 VOLTS/DIV	10 mV*
CH 3/CH 4 VOLTS/DIV	.1 V*
CH 1/CH 2 VAR	Calibrated (UNCAL off)
CH 1 POSITION	Ground level at 3rd graticule line below center screen
CH 2 POSITION	Ground level at 1st graticule line below center screen
CH 3 POSITION	Ground level at 1st graticule line above center screen
CH 4 POSITION	Ground level at 3rd graticule line above center screen



HORIZONTAL

MODE	A
X10 MAG	Off
POSITION	Mid range
A SEC/DIV	.2 ms
B SEC/DIV	20 μ s

*Multiply scale factor by 10 when 10X probe attached.

SEC/DIV VAR	Calibrated (UNCAL off)
TRACE SEP	B sweep trace 2 divs below center graticule line

TRIGGER

HOLDOFF	MIN
A LEVEL	Set for stable display of a .5 V signal with VOLTS/DIV set to .1 V (10X probe attached)
B LEVEL	Set for stable display of a .5 V signal with VOLTS/DIV set to .1 V (10X probe attached)
A SLOPE	
B SLOPE	
A/B SELECT	A
A MODE	AUTO LEVEL
A SOURCE	CH 1
A COUPLING	NOISE REJ
B MODE	RUNS AFTER
B SOURCE	None
B COUPLING	DC

MEASUREMENTS

TRACK MEASMT Cursors	Disabled
TRACK TRIG LVL Cursors	Enabled
TRACK $\#$ Cursors	Disabled

Setup #7: SELECT DELAY

CRT

A INTEN Level	25% of range
B INTEN Level	Mid range
READOUT	Mid range

VERTICAL



MODE	CH 1 (all others off)
CH 1/CH 2 COUPLING	DC
SCOPE BW	On
CH 2 INVERT	Off

CH 1 VOLTS/DIV	50 mV*
CH 2 VOLTS/DIV	10 mV*
CH 3/CH 4 VOLTS/DIV	.1 V*
CH 1/CH 2 VAR VOLTS/DIV	Calibrated (UNCAL off)
CH 1 POSITION	Ground level at 3rd graticule line below center screen
CH 2 POSITION	Ground level at 1st graticule line below center screen
CH 3 POSITION	Ground level at 1st graticule line above center screen
CH 4 POSITION	Ground level at 3rd graticule line above center screen

HORIZONTAL

MODE	ALT
X10 MAG	Off
POSITION	Mid range
A SEC/DIV	.2 ms
B SEC/DIV	20 μ s
SEC/DIV VAR	Calibrated (UNCAL off)
TRACE SEP	Set so that B sweep trace is about 1.5 divisions below the center graticule line.

TRIGGER

HOLDOFF	MIN
A LEVEL	Set for stable display of a .5 V signal with VOLTS/DIV set to .1 V (10X probe attached)
B LEVEL	Set for stable display of a .5 V signal with VOLTS/DIV set to .1 V (10X probe attached)
A SLOPE	
B SLOPE	
A/B SELECT	A
A MODE	AUTO LEVEL
A SOURCE	CH 1

*Multiply scale factor by 10 when 10X probe attached.

A COUPLING
 B MODE
 B SOURCE
 B COUPLING

DC
 RUNS AFTER
 CH 1
 DC

MEASUREMENTS

TRACK MEASMT Cursors
 TRACK TRIG LVL Cursors
 TRACK μ Cursors

Disabled
 Disabled
 Disabled

Setup #8: MATCH EDGES

CRT

A INTEN Level
 B INTEN Level
 READOUT

25% of range
 Mid range
 Mid range

VERTICAL

MODE
 CH 1/CH 2 COUPLING
 SCOPE BW
 CH 2 INVERT
 CH 1 VOLTS/DIV
 CH 2 VOLTS/DIV
 CH 3/CH 4 VOLTS/DIV
 CH 1 /CH 2 VAR
 CH 1 POSITION

CH 1 (all others off)
 DC
 On
 Off
 50 mV*
 10 mV*
 .1 V*
 Calibrated (UNCAL off)
 Ground level at 3rd
 graticule line below
 center screen
 Ground level at 1st
 graticule line
 below center screen
 Ground level at 1st
 graticule line
 above center screen
 Ground level at 3rd
 graticule line
 above center screen

CH 2 POSITION

CH 3 POSITION



CH 4 POSITION

*Multiply scale factor by 10 when 10X probe attached.

HORIZONTAL

MODE	ALT
X10 MAG	Off
POSITION	Mid range
A SEC/DIV	.2 ms
B SEC/DIV	20 μ s
SEC/DIV VAR	Calibrated (UNCAL off)
TRACE SEP	Set so that B sweep trace is about 1.5 divisions below the center graticule line.

TRIGGER

HOLDOFF	MIN
A LEVEL	Set for stable display of a .5 V signal with VOLTS/DIV set to .1 V (10X probe attached)
B LEVEL	Set for stable display of a .5 V signal with VOLTS/DIV set to .1 V (10X probe attached)
A SLOPE	
B SLOPE	
A/B SELECT	A
A MODE	AUTO LEVEL
A SOURCE	CH 1
A COUPLING	DC
B MODE	RUNS AFTER
B SOURCE	CH 1
B COUPLING	DC

MEASUREMENTS

TIME	← SEC →
TRACK MEASMT Cursors	Disabled
TRACK TRIG LVL Cursors	Enabled
TRACK $\overline{ }$ Cursors	Disabled
MEASUREMENT SOURCE	CH 1
Reference Delay Zone	Starts at beginning of 3rd division.
Delta Delay Zone	Starts at beginning of 8th division.

MANUAL CHANGE INFORMATION

At Tektronix, we continually strive to keep up with latest electronic developments by adding circuit and component improvements to our instruments as soon as they are developed and tested.

Sometimes, due to printing and shipping requirements, we can't get these changes immediately into printed manuals. Hence, your manual may contain new change information on following pages.

A single change may affect several sections. Since the change information sheets are carried in the manual until all changes are permanently entered, some duplication may occur. If no such change pages appear following this page, your manual is correct as printed.

1
2
3
4
5
6
7
8
9
10
11
12
13
14
15
16
17
18
19
20
21
22
23
24
25
26
27
28
29
30
31
32
33
34
35
36
37
38
39
40
41
42
43
44
45
46
47
48
49
50
51
52
53
54
55
56
57
58
59
60
61
62
63
64
65
66
67
68
69
70
71
72
73
74
75
76
77
78
79
80
81
82
83
84
85
86
87
88
89
90
91
92
93
94
95
96
97
98
99
100

Date: 5-8-89 Change Reference: C1/0589Product: 2246A OPERATORS Manual Part Number: 070-6556-01**DESCRIPTION**

Product Group 46

INSTALLING THE ACCESSORY POUCH

*REFER TO THE ILLUSTRATION ON THE FOLLOWING
PAGE WHILE PERFORMING THIS PROCEDURE*

1. Place the oscilloscope on a table or work bench with the rear against a firm support or wall and the front facing you.
2. Center the rear of the pouch plate and insert the rear edge of the plate in the space between the cabinet top and the rear panel trim (see part A of illustration).
3. Move the pouch sideways as necessary to line up the key slots in the pouch plate with the keys on the rear panel (the plate will be centered when aligned) and push the plate all the way in (see part B of illustration).
4. Grasp the pouch plate assembly with both hands near the front of the assembly.

NOTE

In the next step, use only enough force to clear the front panel trim with the plate front edge. Excessive force will cause a permanent bow in the plate.

5. Push back on the plate and press down with the heels of your hands to bow the plate enough to slide the front of the plate into the space between the cabinet top and the front panel trim (see part C of illustration).
6. Move the front of the pouch as needed to line up the key slots in the plate with the keys on the front panel.
7. Release the pressure on the plate to allow it to return to its normal flat shape.

MANUAL CHANGE INFORMATION

Product: 2246A OPERATORS

Date: 5-8-89

Change Reference: C1/0589

DESCRIPTION

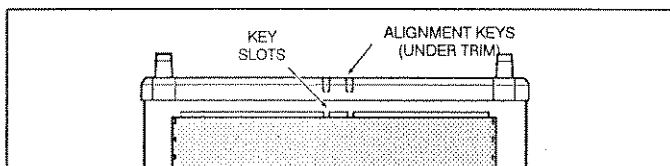

A. CENTER THE POUCH PLATE TO ALIGN THE KEY SLOTS.

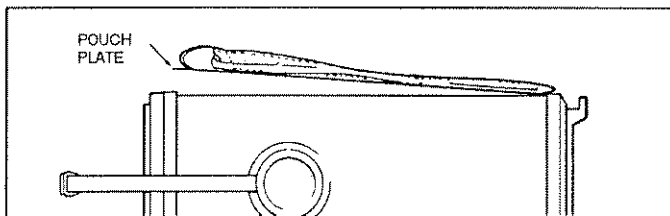

B. PUSH THE POUCH PLATE INTO THE REAR TRIM GAP.

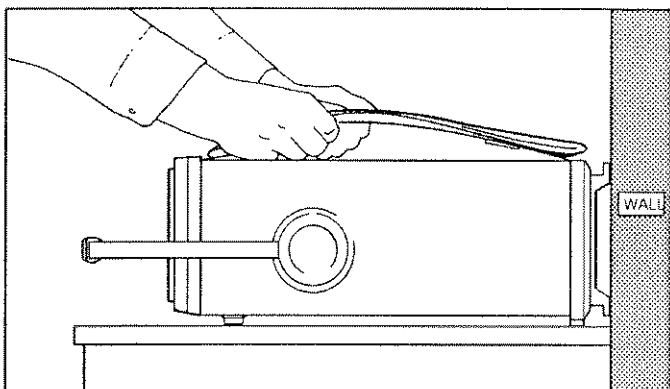

C. BOW THE PLATE AND SLIDE IT INTO THE FRONT TRIM GAP.

Date: 10-20-89 Change Reference: C2/0889(REV)

Product: 2246A OPERATORS

Manual Part Number: 070-6556-01

DESCRIPTION

Product Group 46

EFFECTIVE ALL SERIAL NUMBERS

Page 6-6 HORIZONTAL DEFLECTION SYSTEM

Replace the Sweep Linearity with the following:

Sweep Linearity

0.5 s/div to 5 ns/div

± 5%.

2 ns/div

± 15%

Sweep Linearity applies over the center eight divisions. Excludes the first 1/4 division or 25 ns from the start of the magnified sweep and anything beyond the 100th magnified division.

Date: 11-16-89 Change Reference: C3/1189 (Rev)

Product: 2246A OPERATORS

Manual Part Number: 070-6556-01

DESCRIPTION

Product Group 46

EFFECTIVE ALL SERIAL NUMBERS

Page 6-5 VERTICAL DEFLECTION SYSTEM

Replace Delay Match with the following:

Delay Match (CH 1 or CH 2 to CH 3 OR CH 4)	≤ 400 ps difference.
---	----------------------

Page 7-20

Step 14. CH 1 to CH 4 Signal Delay Match

d. CHECK—that the leading edges of the two waveforms have ≤ 0.2 horizontal division separation at the center graticule line excluding trace width.

DESCRIPTION

Product Group 46

EFFECTIVE ALL SERIAL NUMBERS**SECTION 7****PERFORMANCE CHECK PROCEDURE**

Change Step 6. Trigger Level Control Range page 7-33.
Item c to read as follows:

- c. Increase leveled sine-wave generator output level until a stably triggered display is just obtainable.

Change Step 2 PROBE ADJUST Output to read as follows:

2. PROBE ADJUST Output

- a. Set:

Test Oscilloscope VOLTS/DIV	10 mV
Test Oscilloscope SEC/DIV	0.2 ms
- b. Connect a 10X probe to the test oscilloscope and connect the probe tip to the 2246A PROBE ADJUST output.
- c. CHECK - For a 0.5V ($\pm 2\%$ into 1 M Ω) of PROBE ADJUST squarewave signal (square-wave period is typically 1 ms, within 25 %).

NOTE

Remember to take in to account the oscilloscope and probe specifications when determining the accuracy of the PROBE ADJUST square wave signal.

3. AUTO SETUP Functional Check

- a. Set:

CH 1 COUPLING	GND
CH 1 VOLTS/DIV	1 mV
A SEC/DIV	10 ns
- b. Press the AUTO SETUP button.
- c. Check that the Probe Adjust waveform is stably displayed on the upper half of the crt.
- d. Disconnect the test setup.



MANUAL CHANGE INFORMATION

Date: 3-20-90 Change Reference: C5/0390

Product: 2246A Operators Manual Manual Part Number: 070-6556-01

DESCRIPTION

Product Group

EFFECTIVE ALL SERIAL NUMBERS

Page 8-3

Optional Accessories

Listed below is the recommended 1X/10X switchable probe.

Probes

1X/10X Passive Probes

P6062B (6 ft.)

Date: 05-18-90 Change Reference: C6/0590

Product: 2246A OPERATORS Manual Part Number: 070-6556-01

DESCRIPTION

Product Group 46

EFFECTIVE ALL SERIAL NUMBERS

OPTION 15

Page 7-55

1.Signal Output

Change Step f to read.

- f. CHECK — Displayed trace is within 0.5 divisions of the ground reference set above (neglect trace width).

Date: 11-26-90 Change Reference: C7/1190Product: 2246A OPERATORS Manual Part Number: 070-6556-01**DESCRIPTION**

Product Group 46

EFFECTIVE ALL SERIAL NUMBERS**Page 7-31 Step 4. 150 MHz Trigger Sensitivity**

Replace parts o through s of Step 4 with parts o through u shown below

- o. CHECK—that the display is stably triggered with NOISE REJ Trigger CPLG.
- p. Set leveled sine-wave generator output for a 0.5 division display amplitude at 100 MHz.
- q. CHECK—that the display is not triggered in NOISE REJ Trigger CPLG.
- r. Set leveled sine-wave generator output for a 1.0 division display amplitude at 100 MHz.
- s. CHECK—that the display is not triggered in HF REJ Trigger CPLG.
- t. Set:

TRIGGER CPLG	DC
Horizontal MODE	B
A/B SELECT	B Trigger
- u. Repeat parts n through u for the B Trigger.

