

**TEK**

070-6599-00  
Product Group 37

**2440  
DIGITAL STORAGE  
OSCILLOSCOPE  
OPERATORS**

*Please Check for  
CHANGE INFORMATION  
at the Rear of This Manual*

First Printing SEP 1987  
Revised DEC 1988

**Tektronix**<sup>®</sup>  
COMMITTED TO EXCELLENCE

Copyright © 1987 Tektronix, Inc. All rights reserved.  
Contents of this publication may not be reproduced in any  
form without the written permission of Tektronix, Inc.

Products of Tektronix, Inc. and its subsidiaries are covered  
by U.S. and foreign patents and/or pending patents.

TEKTRONIX, TEK, SCOPE-MOBILE, and  are  
registered trademarks of Tektronix, Inc.

Printed in U.S.A. Specification and price change privileges  
are reserved.

#### INSTRUMENT SERIAL NUMBERS

Each instrument has a serial number on a panel insert, tag,  
or stamped on the chassis. The first number or letter  
designates the country of manufacture. The last five digits  
of the serial number are assigned sequentially and are  
unique to each instrument. Those manufactured in the  
United States have six unique digits. The country of  
manufacture is identified as follows:

B000000	Tektronix, Inc., Beaverton, Oregon, USA
100000	Tektronix Guernsey, Ltd., Channel Islands
200000	Tektronix United Kingdom, Ltd., London
300000	Sony/Tektronix, Japan
700000	Tektronix Holland, NV, Heerenveen, The Netherlands

**Certificate of the Manufacturer/Importer**

We hereby certify that the \_\_\_\_\_

2440 OSCILLOSCOPE AND ALL INSTALLED OPTIONS

complies with the RF Interference Suppression requirements of  
Amtsbl.-Vfg 1046/1984.

The German Postal Service was notified that the equipment is being  
marketed.

The German Postal Service has the right to re-test the series and to  
verify that it complies.

TEKTRONIX

**Bescheinigung des Herstellers/Importeurs**

Hiermit wird bescheinigt, daß der/die/das \_\_\_\_\_

2440 OSCILLOSCOPE AND ALL INSTALLED OPTIONS

in Übereinstimmung mit den Bestimmungen der Amtsblatt-Verfügung  
1046/1984 funkentstört ist.

Der Deutschen Bundespost wurde das Inverkehrbringen dieses Gerätes  
angezeigt und die Berechtigung zur Überprüfung der Serie auf Einhalten  
der Bestimmungen eingeräumt.

TEKTRONIX

NOTICE to the user/operator:

The German Postal Service requires that Systems assembled by the operator/user of this instrument must also comply with Postal Regulation, Vfg. 1046/1984, Par. 2, Sect. 1.

HINWEIS für den Benutzer/Betreiber:

Die vom Betreiber zusammengestellte Anlage, innerhalb derer dies Gerät eingesetzt wird, muß ebenfalls den Voraussetzungen nach Par. 2, Ziff. 1 der Vfg. 1046/1984 genügen.

NOTICE to the user/operator:

The German Postal Service requires that this equipment, when used in a test setup, may only be operated if the requirements of Postal Regulation, Vfg. 1046/1984, Par. 2, Sect. 1.7.1 are complied with.

HINWEIS für den Benutzer/Betreiber:

Dies Gerät darf in Meßaufbauten nur betrieben werden, wenn die Voraussetzungen des Par. 2, Ziff. 1.7.1 der Vfg. 1046/1984 eingehalten werden.

## ***Preface***

The documentation for the 2440 consists of the following publications:

1 Operators Manual	070-6599-00
1 Users Reference	070-6600-00
1 Programmers Reference Guide	070-6601-00
1 Pocket Programmers Guide	070-6602-00
1 Service Manual (Optional accessory)	070-6285-00

The Operators Manual is the authoritative reference for all operating information. The only exception is information regarding system interfacing and operating this instrument via the GPIB; the Programmers Reference Guide is the primary reference for GPIB operation.

This manual contains seven sections plus appendices. A brief description of each follows.

### ***Section 1***

This section introduces you to the instrument. It begins with a description of the instrument and continues with an explanation of how to prepare the instrument for initial start-up. Operating considerations necessary for preventing damage to the scope are also covered. Next, the user gets some "hands-on" experience with the instrument through a "Getting Acquainted" procedure.

### ***Section 2***

This is a two-part section. Part one, "Operating Considerations," details the basic things to be aware of when making measurements. Part two, "Operators Familiarization Procedures," gives you the opportunity to make some measurements that demonstrate various features while familiarizing you with the scope's controls and menus. Use of the important Self Calibration feature is also covered.

## ***Section 3***

This four-part section provides detailed procedures for making measurements with the scope. They are intended to help you develop your own methods for your specific measurement requirements.

The first part of the section, "Applications," details the more familiar graticule measurements of signal amplitude and time period. Use of the Vertical and Horizontal Display modes (including delay-time measurements) is also covered in part one.

Part two, "Special Applications," describes use of the versatile cursors for making highly accurate measurements of voltage, time, and frequency. It includes an application for the combined A\*B trigger source.

The third part, "Storage Applications," describes the various storage acquisition modes and their uses.

The final section, "Extended Features Applications," outlines use of the Auto Setup, AutoStep Sequencer, and MEASURE features.

## ***Section 4***

This section contains check and adjustment procedures the operator can use to ensure the accuracy of measurements.

## ***Section 5***

This is the reference section that describes instrument features. It illustrates the locations of the controls, connectors, and indicators and describes their functions. A listing of the control menus, at the rear of the section, includes information about their use.

## **Section 6**

This section contains tables of the electrical, environmental, and mechanical characteristics of the instrument. An introductory summary of the instrument's capabilities precedes the specification tables. A dimensional drawing of the instrument is included at the end of the section.

## **Section 7**

This section contains information about available instrument options, including operating instructions for the Video Option and the Word Recognizer Probe. It also contains a list of the standard instrument accessories and a partial list of the recommended optional accessories.

## **Appendix A**

The Extended Functions menus and the internal calibration and diagnostics capabilities of the scope are described. For the operator's information, a table at the rear of the appendix lists the Extended Diagnostics test codes and abbreviated names.

## **Appendix B**

This appendix contains supplemental reference tables and information.

## **Appendix C**

This appendix discusses special considerations for using the MEASURE feature to automatically extract and measure waveform parameters. It includes a table that lists and explains the error and warning messages issued by MEASURE.

.....



# Contents

	<i>Page</i>
Preface.....	i
Illustrations .....	xii
Tables .....	xiii
Operators Safety Summary .....	xiv

## **1** *General Information*

General Information.....	1-1
Introduction .....	1-1
Product Overview .....	1-1
Preparation For Use .....	1-3
Safety .....	1-3
Line Voltage Selection .....	1-3
Line Fuse .....	1-4
Power Cord .....	1-7
Instrument Cooling .....	1-7
Start-Up .....	1-8
Power-Down.....	1-9
Repackaging For Shipment .....	1-10
"Getting Acquainted" Procedure .....	1-11

## **2** *Operation*

Operating Considerations.....	2-1
Graticule .....	2-1
Time and Voltage Measurements.....	2-2
Acquiring Data.....	2-3
Grounding .....	2-4
Signal Connections .....	2-4
Probes .....	2-4
Coaxial Cables .....	2-5
Input Precharging.....	2-6
External Triggering.....	2-6

**2 Operation (cont)**

Operators Familiarization Procedures.....	2-7
Introduction .....	2-7
Readout Display .....	2-7
Front-Panel Controls.....	2-7
Familiarization Procedures.....	2-9
Getting a Display.....	2-9
Front-Panel Setup.....	2-11
Storing Front-Panel Setups.....	2-14
Performing SELF-CALibration .....	2-16
Using the SEC/DIV Control and a Horizontal Graticule Measurement.....	2-17
Using CH1 Controls and a Vertical Graticule Measurement .....	2-18
Using SAVE and DISPLAY REF Storage Modes.....	2-19
Using Dual-Channel Displays .....	2-22
Review of ENVELOPE and AVG (Average) ACQUIRE Modes .....	2-23
Using SINGLE SEQ Trigger Mode.....	2-24
Using The Cursors .....	2-25
Volts Cursors.....	2-25
V@T Cursors .....	2-27
SLOPE Cursors .....	2-28
TIME Cursors .....	2-29
1/TIME Cursors .....	2-30
DELAY Features .....	2-32
DELAY by TIME .....	2-32
DELAY by EVENTS .....	2-34
Extended Features.....	2-36
Using AUTOsetup .....	2-37
Using MEASURE .....	2-39
Using PRGM (AutoStep) .....	2-44

### 3 Applications

Applications .....	3-1
General Applications .....	3-2
Voltage Measurements .....	3-2
Peak-to-Peak Voltage .....	3-2
ADD Mode Measurements .....	3-4
Noise Reduction and Unwanted Signal Cancellation .....	3-6
MULT Mode Measurements .....	3-9
TIME AND FREQUENCY Measurements—Non-Delayed .....	3-12
Delay Time Measurements and Applications .....	3-14
DELAY TIME Mode As A Magnifier .....	3-14
Other Delay Applications .....	3-17
$\Delta$ Delay Time and Frequency Measurements .....	3-18
Delay By Events Measurements .....	3-21
General Information for Delay Acquisition Usage .....	3-23
Special Applications.....	3-24
Cursor Measurements .....	3-24
Voltage Measurements .....	3-24
Delta Voltage Measurements .....	3-25
Ratio Between Two Voltages .....	3-26
Absolute Voltage Cursor Measurements .....	3-29
Time and Frequency Measurements .....	3-30
$\Delta$ Time Cursor Measurements .....	3-31
Ratio Between Two Time Periods.....	3-34
Absolute TIME Cursor Measurements .....	3-35
Voltage Coupled to Time Cursors (V@T) .....	3-37
Slope Measurements .....	3-40
Special Units for Coupled Cursors .....	3-42
A*B Trigger Source Application.....	3-43
Storage Applications .....	3-46
Acquire Modes .....	3-46
NORMAL Mode .....	3-46
AVG (Average) Mode .....	3-46
ENVELOPE Mode .....	3-49
ROLL Mode .....	3-50
REPET Mode .....	3-51
SAVE Mode .....	3-51
SAVEREF SOURCE and DISPLAY REF .....	3-54
SAVE ON $\Delta$ Mode .....	3-56
Extended Features Applications.....	3-61
AUTOsetup.....	3-62
“Quick and Dirty” Display of a Signal .....	3-62
“Quick and Dirty” Displays of Parameters .....	3-62
Dual-Channel AUTOsetup Displays.....	3-64
Considerations for Using AUTOsetup.....	3-65

## Contents

---

### 3 Applications (cont)

MEASURE.....	3-67
SNAPSHOT, A Quick Measurement of Waveform Parameters.....	3-67
Interpreting the Display.....	3-70
Characterization of the Leading Edge of a Pulse.....	3-71
Parameter Measurements Using the Continuous-Update Mode.....	3-74
Delay Measurements Between Signals.....	3-77
AUTOSTEP SEQUENCER (PRGM).....	3-85
Storage of a Single Front-Panel Setup.....	3-86
Storage of a Sequence of Front-Panel Setups.....	3-86
Using a Sequence.....	3-88
Interaction of Sequencer with Acquisition Modes.....	3-89

### 4 Checks and Adjustments

Checks and Adjustments.....	4-1
Introduction.....	4-1
Starting Setup.....	4-1
Trace Rotation Adjustment.....	4-2
Focus and Astigmatism Adjustment.....	4-2
Vertical Gain Check.....	4-3
Horizontal Gain Check.....	4-3
Probe Low-Frequency Compensation.....	4-4

### 5 Controls, Connectors and Indicators

CRT Display, Menu Buttons and Power.....	5-1
Vertical Controls.....	5-6
Cursors.....	5-13
External Interface.....	5-20
General Purpose Interface Bus.....	5-22
Horizontal Controls.....	5-29
Delay Controls.....	5-31
Trigger Controls.....	5-34
Storage System.....	5-44
Extended Features.....	5-56
Rear Panel.....	5-79
System Menus.....	5-82

**6 Performance Characteristics**

Performance Characteristics ..... 6-1  
Introduction ..... 6-1  
Vertical System ..... 6-2  
Horizontal System ..... 6-2  
Trigger System ..... 6-2  
Cursor Measurements ..... 6-4  
Waveform Acquisition ..... 6-4  
Storage and I/O ..... 6-5  
Extended Features ..... 6-6  
Performance Conditions ..... 6-8  
Recommended Adjustments Schedule ..... 6-8

**7 Options and Accessories**

Options and Accessories ..... 7-1  
Options Descriptions ..... 7-1  
Options A1-A5 ..... 7-2  
Option 1R ..... 7-2  
Option 03—Word Recognizer Probe ..... 7-3  
Option 05—Video Option ..... 7-3  
Option 11—Probe Power ..... 7-3  
Option Operating Information ..... 7-4  
Video Options ..... 7-4  
Introduction ..... 7-4  
Video Option Accessories ..... 7-4  
Video Option Specifications ..... 7-4  
General Operation ..... 7-5  
Setting Up the Video Option ..... 7-6  
Setting a Line Number ..... 7-8  
System-M/Nonsystem-M Selection ..... 7-9  
Special Measurements ..... 7-9  
Identifying Fields, Frames, and Lines in 525/60 and 625/50 TV ..... 7-10  
Basic Applications ..... 7-11  
Initial Setup ..... 7-12  
Signal Input Coupling ..... 7-15  
Word Recognizer Probe Options ..... 7-16  
Word Probe Setup ..... 7-17  
Basic Application ..... 7-18  
Accessories ..... 7-19  
Standard Accessories ..... 7-19  
Rackmounting Accessories ..... 7-19  
Optional Accessories ..... 7-20

**Contents**

---

**A Appendix A**

Extended Functions.....	A-1
SPECIAL Functions.....	A-1
SYSTEM Functions.....	A-1
PREFLT ONOFF.....	A-2
PANEL.....	A-2
MISC.....	A-2
AUTO PROBE.....	A-3
VIDEO OPT.....	A-4
CAL/DIAG Functions.....	A-5
Internal Diagnostic Routines.....	A-5
Self Diagnostics.....	A-5
Power-on/Self Diagnostics Test Failure.....	A-5
Extended Diagnostics.....	A-8
Service Routines.....	A-8
Internal Calibration Routines.....	A-9
Self Calibration.....	A-9
Extended Calibration.....	A-9
Calibration/Diagnostics Operation.....	A-10
Self Calibration.....	A-11
Extended Calibration.....	A-11
Power-On Self Diagnostics.....	A-12
Front-Panel Self Diagnostics.....	A-12
Extended Diagnostics.....	A-12
UP/DOWN Arrows.....	A-13
RUN/SEL.....	A-14
MODE.....	A-14
HALT.....	A-14
GPIB Operation.....	A-15
Self Calibration.....	A-15
Extended Calibration.....	A-16
Self Diagnostics.....	A-16
Extended Diagnostics.....	A-16

**B Appendix B**

VOLTS/DIV Range With Attenuator Probes .....	B-1
Calibrator Frequency .....	B-2
Averaging SNIR .....	B-3
REPETITIVE Acquisition .....	B-3
SMOOTH .....	B-4
Variable HOLDOFF .....	B-4
Trigger LEVEL Range and Resolution .....	B-6
Auto Triggering and Auto Leveling .....	B-7
B Trigger Source .....	B-8
Trigger Position .....	B-9
Delay Time and Delay Time Resolution .....	B-10
Trigger Status Indicators .....	B-13
Waveform Display Summary .....	B-14
STACK REF Storage Operation .....	B-15
SAVE ON DELTA Operation .....	B-16
Front-Panel Settings for INIT PANEL .....	B-17
Front-Panel Settings for Auto Setup .....	B-22

**C Appendix C**

Introduction .....	C-1
Parameter Extraction from the Waveform .....	C-1
Overview .....	C-1
BASE-TOP Determination .....	C-2
MIN/MAX Method .....	C-2
HISTOgram Method .....	C-2
CURSOR Method .....	C-3
Level Calculations .....	C-4
Determination of Time-Reference Points .....	C-8
Time Reference Search Procedure .....	C-8
Calculation of the Waveform Parameters .....	C-9
Interaction of MEASURE with Acquisition Modes .....	C-13
Glossary of Parameter Extraction Terms .....	C-16
Warning and Error Messages for MEASURE .....	C-17
ERROR Messages .....	C-17
WARNING Messages .....	C-20

## Illustrations

<i>Figure</i>	<i>Page</i>
1-1	LINE VOLTAGE SELECTOR, fuse, and power cord receptacle..... 1-5
2-1	Graticule measurement markings ..... 2-1
2-2	Readout display locations..... 2-8
2-3	SELECT menu and menu control buttons..... 2-11
3-1	Sine wave peak-to-peak voltage ..... 3-3
3-2	Instantaneous DC voltage levels on a waveform ..... 3-5
3-3	Cancellation of common-mode noise for differential signals ..... 3-6
3-4	Cancellation of an unwanted component in a signal ..... 3-8
3-5	Rise time of a square wave (time duration)..... 3-13
3-6	DELAY TIME used as a positionable magnifier ..... 3-16
3-7	$\Delta$ DELAY TIME used to measure the period of a square wave..... 3-20
3-8	Delay and $\Delta$ Delay acquisitions as displayed for CH1, CH2, and ADD (or MULT) VERTICAL MODE ..... 3-21
3-9	Measuring a 3.5-V sine-wave signal using VOLTS cursors. .... 3-26
3-10	Measuring the ratio between the amplitudes of two sine-wave signals ..... 3-28
3-11	Voltage measurement of a step on a stair-case signal using the VOLTS cursor function in the ABS mode ..... 3-30
3-12	Time measurements using TIME Cursor function and modes ..... 3-33
3-13	Time measurement of an event relative to the Record Trigger ..... 3-36
3-14	VOLTS coupled to TIME cursors displayed on a triangle wave ..... 3-36
3-15	V@T measurements on triangle-wave signals ..... 3-39
3-16	High resolution measurement of the frequency of a sine-wave signal..... 3-41
3-17	Slope measurement on a triangle-waveform..... 3-42
3-18	Effect of signal averaging on a noisy square wave ..... 3-48
3-19	Using the SAVEREF function with ENVELOPE mode to monitor and save a square wave ..... 3-60
3-20	AUTOsetup for EDGE (rising) ..... 3-72
3-21	SNAPSHOT of a pulse's rise time..... 3-73
3-22	Continuous-Update Mode for MEASURE..... 3-76
3-23	Dual-Channel Auto Setup in VIEW mode..... 3-78
3-24	DELAY Measurement between a pulse and a gate..... 3-81
3-25	DELAY measurement locations on waveforms..... 3-82
3-26	Controlling measurement location with WINDOW mode..... 3-83
4-1	Probe low-frequency compensation ..... 4-5
5-1	POWER, DISPLAY controls, and MENU buttons..... 5-2
5-2	STATUS readout display ..... 5-5
5-3	Vertical controls and connectors ..... 5-14
5-4	Typical cursor displays ..... 5-15
5-5	External interface ..... 5-20
5-6	Horizontal and delay controls ..... 5-32
5-7	Storage and trigger controls..... 5-55
5-8	AUTO, PRGM, and MEASURE buttons..... 5-59
5-9	Event order for sequences..... 5-72
5-10	Rear-panel controls and connectors..... 5-79
5-11	GPIB-connector pin arrangement ..... 5-82



## Illustrations

<i>Figure</i>	<i>Page</i>
6-1 Dimensional drawing .....	6-35
7-1 Composite video signal with and without TV clamping .....	7-16
A-1 EXTENDED DIAGNOSTICS Menu .....	A-13
B-1 Amplitude response for smooth function .....	B-4
B-2 RTRIG versus horizontal display modes .....	B-12
C-1 Parameter extraction using HISTOgram method .....	C-7
C-2 Parameter extraction using MIN/MAX method .....	C-7

## Tables

<i>Table</i>	<i>Page</i>
1-1 Voltage, Fuse, and Power-Cord Data .....	1-6
2-1 Equipment Required .....	2-36
3-1 Delay Displays versus Vertical MODE .....	3-19
3-2 SNIR vs Number of Acquisitions .....	3-47
3-3 Vertical Expansion Factors .....	3-52
3-4 Horizontal Expansion Factors .....	3-53
5-1 Approximate Exponential-Averaging Time Constants at 10 Hz .....	5-48
5-2 Control Menus and Displays .....	5-83
6-1 Electrical Characteristics .....	6-9
6-2 Environmental Characteristics .....	6-26
6-3 Mechanical Characteristics .....	6-29
6-4 Video Option 05 (TV Trigger) Electrical Characteristics .....	6-31
A-1 Calibration and Diagnostics Codes and Names .....	A-17
B-1 VOLTS/DIV Readout Switching With Coded Probes .....	B-1
B-2 Calibrator Frequency and Period for Each A SEC/DIV Setting .....	B-2
B-3 Signal-to-Noise Improvement Ratio Versus Number of Averages .....	B-3
B-4 Repet Acquisitions Required To Complete a Single Sequence .....	B-3
B-5 Variable Trigger Holdoff .....	B-5
B-6 Trigger Resolution .....	B-6
B-7 Auto Triggering and Auto-Leveling intervals .....	B-7
B-8 B Trigger Source Menu Versus B Trigger Mode .....	B-8
B-9 RTRIG Point versus Trigger Position Menu Selection .....	B-9
B-10 Maximum B SEC/DIV Delay Time and Resolution .....	B-10
B-11 TRIG'D, READY, and ARM Indicator Status .....	B-13
B-12 Display Priority Versus Display Mode .....	B-14
B-13 REF Storage Operation versus Horizontal and Vertical Modes .....	B-15
B-14 SAVE ON DELTA Comparisons .....	B-16
B-15 INIT PANEL States .....	B-17
B-16 Front-Panel Settings After an Auto Setup .....	B-22
C-1 Definition of Parameters .....	C-9
C-2 Error Messages for MEASURE .....	C-17
C-3 Warning Messages for MEASURE .....	C-20

# Operators Safety Summary

*The general safety information in this part of the summary is for both operating and servicing personnel. Specific warnings and cautions will be found throughout the manual where they apply and do not appear in this summary.*

## Terms

### *In This Manual*

**CAUTION** statements identify conditions or practices that could result in damage to the equipment or other property.

**WARNING** statements identify conditions or practices that could result in personal injury or loss of life.

### *As Marked on Equipment*

**CAUTION** indicates a personal injury hazard not immediately accessible as one reads the markings, or a hazard to property, including the equipment itself.

**DANGER** indicates a personal injury hazard immediately accessible as one reads the marking.

## Symbols

### *In This Manual*



This symbol indicates where applicable cautionary or other information is to be found. For maximum input voltage see Table 6-1.

### *As Marked on Equipment*



**DANGER**—High voltage.



Protective ground (earth) terminal.



**ATTENTION**—Refer to manual.

***Power Source***

This product is intended to operate from a power source that does not apply more than 250 volts rms between the supply conductors or between either supply conductor and ground. A protective ground connection by way of the grounding conductor in the power cord is essential for safe operation.

***Grounding the Product***

This product is grounded through the grounding conductor of the power cord. To avoid electrical shock, plug the power cord into a properly wired receptacle before connecting to the product input or output terminals. A protective ground connection by way of the grounding conductor in the power cord is essential for safe operation.

***Danger Arising From Loss of Ground***

Upon loss of the protective-ground connection, all accessible conductive parts (including knobs and controls that may appear to be insulating) can render an electric shock.

***Use the Proper Power Cord***

Use only the power cord and connector specified for your product.

Use only a power cord that is in good condition.

For detailed information on power cords and connectors see Table 1-1.

***Use the Proper Fuse***

To avoid fire hazard, use only a fuse of the correct type, voltage rating and current rating as specified in the parts list for your product.

***Do Not Operate in Explosive Atmospheres***

To avoid explosion, do not operate this product in an explosive atmosphere unless it has been specifically certified for such operation.

***Do Not Remove Covers or Panels***

To avoid personal injury, do not remove the product covers or panels. Do not operate the product without the covers and panels properly installed.



---

# **General Information**

## **Introduction**

This section briefly describes your oscilloscope and tells you how to prepare for and proceed with the initial start-up. It also includes safety information, as well as information necessary to prevent damage to the instrument. PLEASE READ.

The "Getting Acquainted" procedure in this section is designed to provide some immediate "hands-on" experience with the instrument's front-panel controls. There is a more extensive familiarization procedure in Section 2, "Operation," and detailed instructions for making various kinds of measurements appear in Section 3, "Applications." Section 5 is a reference for the front- and rear-panel "Controls, Connectors, and Indicators."

### *NOTE*

*Information regarding the use of this instrument in systems, via the GPIB, is found in the Programmers Reference Guide included with the oscilloscope.*

## **Product Overview**

This instrument is a Digital Oscilloscope with a maximum sample rate of 500 megasamples/sec for a real-time bandwidth of 200 MHz. The equivalent-time bandwidth, for acquisition of repetitive signals, is 300 MHz. The scope can acquire and digitize input signals, process the information in a variety of ways, and display or store the results.

The instrument has two vertical channels that can be set independently for deflection factor, input resistance, and coupling. Calibrated deflection factors are available in a 1-2-5 sequence of 11 steps from 2 mV to 5 V per division; input resistance can be set to 1 M $\Omega$  or 50  $\Omega$ ; and coupling can be AC (but only if the input resistance is 1 M $\Omega$ ), DC, or GND (ground).

The trigger system provides for automatic triggering (AUTO LEVEL Trigger mode) on most signals when using the A Horizontal mode. Alternative triggering modes, plus a variety of source selections and coupling modes, allow optimum triggering on a wide range of signals in both A and B Horizontal modes.

## **General Information**

---

Two 20-division waveform records, A and B, are available, with display modes of A, B, or A intensified by B. The acquisition rate can be selected in a 1-2-5 sequence of 29 calibrated steps from 5 s to 2 ns per division. The B acquisition can be delayed from the A acquisition by using the Delay Time feature, and a second B acquisition can be delayed even further by using  $\Delta$  Delay.

Three acquisition modes are available with this instrument. NORMAL mode yields a "live" display, similar to that of an analog scope; the display is continually updated as new waveform information is acquired and digitized. AVERAGE mode improves the signal-to-noise ratio of the displayed waveform; corresponding data-point values are averaged to remove uncorrelated noise. ENVELOPE mode provides an image of the amount of change to a waveform (its envelope) over a selected number of acquisitions; the maximum and minimum value for each data point is saved and displayed.

Any of these three acquisition modes can be used with the REPET mode. The REPET mode forces the instrument to use equivalent-time (random) sampling of waveforms at acquisition rates faster than 100 ns/Division. When repetitive signals are acquired, REPET extends the bandwidth to 300 MHz.

Several features make the instrument versatile and easy to operate: Most front-panel buttons call up menus on the screen; menu buttons on the CRT bezel then select among the displayed control functions. Up to three lines of readout across the top of the screen depict vertical, horizontal, triggering, and other settings. Cursors allow direct measurement of amplitude, time, frequency, and other waveform parameters, and a cursor readout displays the results. Information about almost any front-panel control can be displayed on screen using the HELP feature.

The Auto Setup, MEASURE, and AutoStep features also contribute to ease of operation: Auto Setup produces a workable combination of front-panel settings for subsequent acquisitions; MEASURE displays a "snapshot" of 20 parameters for a single acquisition, or up to 4 continually-updated parameters for successive acquisitions; and AutoStep can store over 200 front-panel setups for later recall. AutoStep and MEASURE, used in tandem, can create setups that automatically make a waveform measurement.

Further details about the features of this instrument are contained in the product description at the beginning of Section 6.

## Preparation For Use

### Safety

Refer to the Safety Summary at the front of this manual for power source, grounding, and other safety considerations pertaining to the use of the instrument. Before connecting the oscilloscope to a power source, read both this subsection and the Safety Summary.

**CAUTION**

*This instrument may be damaged if operated with the LINE VOLTAGE SELECTOR switch set for the wrong applied ac input-source voltage or if the wrong line fuse is installed.*

### Line Voltage Selection

The scope operates from either a 115-V or 230-V nominal ac power-input source having a line frequency ranging from 48 Hz to 440 Hz. Before connecting the power cord to a power-input source, verify that the LINE VOLTAGE SELECTOR switch, located on the rear panel (see Figure 1-1), is set for the correct nominal ac input-source voltage. To convert the instrument for operation from one line-voltage range to the other, move the LINE VOLTAGE SELECTOR switch to the correct nominal ac source-voltage setting (see Table 1-1). The detachable power cord may have to be changed to match the particular power-source outlet.

## ***General Information***

---

### ***Line Fuse***

To verify the proper value of the instrument's power-input fuse, perform the following procedure.

1. Press the fuse-holder cap and then release it with a slight counter-clockwise rotation.
2. Pull the cap (with the attached fuse inside) out of the fuse holder.
3. Verify proper fuse value (see Table 1-1).
4. Install the proper fuse and reinstall the fuse-holder cap.

#### ***NOTE***

*A 4-A, 250-V, 5 × 20-mm Time-lag (T) fuse may be substituted for the factory-installed fuse. However, the two types of fuses are not directly interchangeable; each requires a different type of fuse cap.*



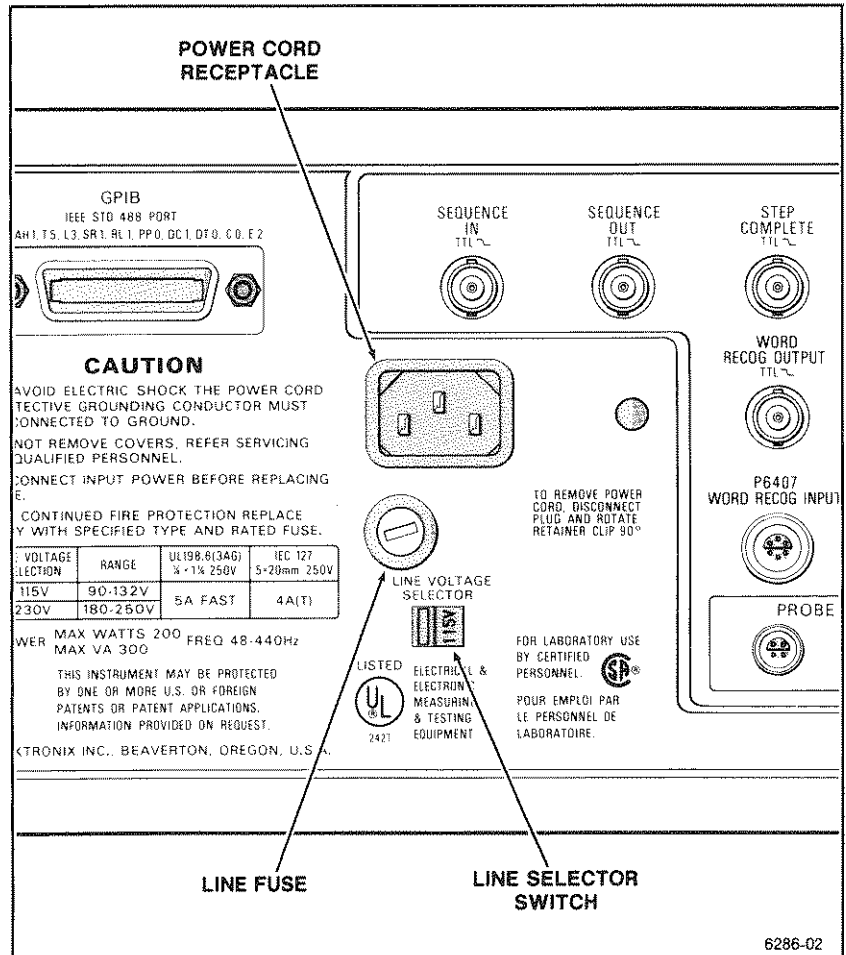
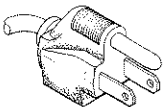
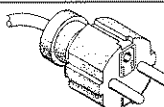

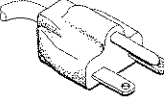
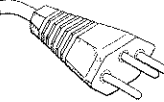

Figure 1-1. LINE VOLTAGE SELECTOR, fuse, and power cord receptacle.

**General Information**

**Table 1-1  
Voltage, Fuse,<sup>a</sup> and Power-Cord Data**

Plug Configuration	Category	Power Cord and Setting	Line Voltage Selector/ Voltage Range	Reference Standards <sup>c</sup>
	U.S. Domestic Standard	U.S. 120V 15A	115V 90V to 132V	ANSI C73.11 NEMA 5-15-P IEC 83 UL 198.6
	Option A1	EURO 240V 10-16A	230V 180V to 250V	CEE(7), II, IV, VII IEC 83 IEC 127
	Option A2	UK <sup>b</sup> 240V 6A	230V 180V to 250V	BS 1363 IEC 83 IEC 127
	Option A3	Australian 240V 10A	230V 180V to 250V	AS C112 IEC 127
	Option A4	North American 240V 15A	230V 180V to 250V	ANSI C73.20 NEMA 6-15-P IEC 83 UL 198.6
	Option A5	Switzerland 220V 6A	230V 180V to 250V	SEV IEC 127

<sup>a</sup>All options listed come with a factory-installed fuse with the following specifications: 5A, 250 V AGC/3AG Fast-blow (UL 198.6). The fuse holder used is AGC/3AG.

<sup>b</sup>A 6A, type C fuse is also installed inside the plug of the Option A2 power cord.

<sup>c</sup>Reference Standards Abbreviations:

- ANSI—American National Standards Institute
- AS—Standards Association of Australia
- BS—British Standards Institution
- CEE—International Commission on Rules for the Approval of Electrical Equipment
- IEC—International Electrotechnical Commission
- NEMA—National Electrical Manufacturer's Association
- SEV—Schweizerischer Elektrotechnischer Verein
- UL—Underwriters Laboratories Inc.

### ***Power Cord***

This instrument has a detachable three-wire power cord with a three-contact plug for connection to both the power source and protective ground. The power cord is secured to the rear panel by a cord-set securing clamp. The protective ground contact on the plug connects (through the power cord protective grounding conductor) to the accessible metal parts of the instrument. For electrical-shock protection, insert this plug into a power-source outlet that has a properly grounded protective-ground contact.

Instruments are shipped with the required power cord as ordered by the customer. Information on the available power cords is presented in Table 1-1, and part numbers are listed in "Options and Accessories" (Section 7). Contact your Tektronix representative or local Tektronix Field Office for additional power-cord information.

### ***Instrument Cooling***

To prevent instrument damage from overheated components, adequate internal airflow must be maintained. Before turning on the power, first verify that air-intake holes on the bottom and side of the cabinet and the fan exhaust holes are free of any obstruction to airflow. If overheating occurs, a thermal cutout immediately shuts down the scope with no attempt to save waveforms or front-panel settings. Power to the scope is disabled until the thermal cutout cools down, at which time the power-on sequence is repeated. The resulting loss of the last front-panel and waveform data causes the power-on self test to fail the CKSUM-NVRAM test (number 6000 in the main EXTENDED DIAGNOSTICS menu). The cause of the overheating must be corrected before attempting prolonged operation of the scope. Pressing the MENU OFF/EXTENDED FUNCTIONS button restores the scope to the normal operating mode.

## General Information

---

### Start-Up

This instrument automatically performs power-up tests each time it is turned on. These tests provide the highest possible confidence level that the instrument is fully functional. If no faults are encountered, the instrument will enter the Scope mode in either the ACQUIRE or SAVE Storage mode, depending on the mode in effect when it was powered off.

If the instrument fails any of its power-up tests, it will display the Extended Diagnostics menu. If the failure is in the range of 1000-5300 and the message **HARDWARE PROBLEM—SEE SERVICE MANUAL** is displayed with the menu, refer the instrument to qualified service personnel. If the failure is in the 1000-5300 range, but **RUN SELF CAL WHEN WARMED UP** is displayed, you should execute the SELF CAL procedure from the EXTENDED FUNCTIONS menu after the message **NOT WARMED UP** has disappeared from the SELF CAL menu. If failures persist after the SELF CAL is run (as evidenced by the **HARDWARE PROBLEM—SEE SERVICE MANUAL** message), refer the instrument to qualified service personnel.

Failure of a test in the range of 7000 to 9300 may not indicate a fatal scope fault. Several conditions can cause a non-fatal failure of the tests. The scope will display **RUN SELF CAL WHEN WARMED UP** to indicate that a SELF CAL should be performed. If SELF CAL does not clear the failure (**HARDWARE PROBLEM—SEE SERVICE MANUAL** is displayed), the scope may still be usable for your immediate measurement purposes. For example, if the problem area is in CH 2, CH 1 may still be used with full confidence of making accurate measurements. Press the **MENU OFF/EXTENDED FUNCTIONS** button to exit **EXTENDED DIAGNOSTICS** and enter Scope mode.

#### NOTE

*The SELF CAL procedure is detailed in Section 4 of this manual. Refer to Appendix A of this manual for information on the power-up tests and the procedures to follow in the event of a failed power-up test.*

A fatal fault in the operating system will cause the scope to abort. No displays are possible, and the user is notified of an abort situation only by the flashing of the Trigger LED indicators (if that is possible). Cycling the power off then back on may clear the problem, but a failure of this magnitude usually requires the scope to be referred to a qualified service person for checkout and repairs. Persistent or recurring failures of the power-on or self-diagnostic tests should be brought to the attention of a qualified service person at the first opportunity. Consult your service department, your local Tektronix Service Center, or nearest Tektronix representative if further assistance is needed.

## Power-Down

### NOTE

POWER INTERRUPTION TO THE INSTRUMENT WHEN THE SELF-CALIBRATION ROUTINE IS EXECUTING INVALIDATES THE INSTRUMENT CALIBRATION CONSTANTS. Upon such an interruption, the instrument sets an internal flag denoting that SELF CAL was running at shutdown. When power is re-established, the scope will display RUN SELF CAL WHEN WARMED UP. When the NOT WARMED UP message disappears from the SELF CAL menu, the user MUST perform a SELF CAL to escape the EXT DIAG menu (the 1 menu button MUST be used to access the SELF CAL menu—see Appendix A for more information). If failures persist after the SELF CAL is performed, refer the instrument to qualified service personnel.

For a normal power-off from the Scope mode, an orderly power-down sequence retains the SAVE and SAVEREF waveforms, the current front-panel control settings, and any stored front-panel settings. If a power-off or transient power fluctuation occurs during SELF CAL, or EXTENDED CALIBRATION, or the instrument shuts-down at any time due to overheating, the normal power-down sequence is not executed. The result is loss of stored calibration constants or last front-panel control settings (or both) and a failure of the next power-on self-test (6000-6400 range). If front panel, sequencer, or stored waveform information was lost, the error will clear itself on the next power-down/power-up cycle. If calibration constants were lost the instrument will display information indicating that calibration is needed. If failures persist, refer the instrument to qualified service personnel.

If power is momentarily interrupted, starting the power-off sequence, but is reestablished before the sequence completes, the scope will redo the power-on procedure. If the scope is in the middle of a waveform acquisition when power interruption occurs, the waveform data will not be saved, and the invalid waveform data display will be seen when power-on has completed. Press ACQUIRE to restart the acquisition and obtain valid waveform data.

## **General Information**

---

### ***Repackaging for Shipment***

It is recommended that the original carton and packing material be saved in the event it becomes necessary to reship the instrument using a commercial transport carrier. If the original materials are unfit or not available, then repackage the instrument using the following procedure.

1. Use a corrugated cardboard shipping carton having a test strength of at least 275 pounds and with an inside dimension at least six inches greater than the instrument dimensions.
2. If the instrument is being shipped to a Tektronix Service Center, enclose the following information: the owner's address, name and phone number of a contact person, type and serial number of the instrument, reason for returning, and a complete description of the service required.
3. Completely wrap the instrument with polyethylene sheeting or equivalent to protect the outside finish and prevent entry of harmful substances into the instrument.
4. Cushion instrument on all sides using three inches of padding material or urethane foam, tightly packed between the carton and the instrument.
5. Seal the shipping carton with an industrial stapler or strapping tape.
6. Mark the address of the Tektronix Service Center and also your own return address on the shipping carton in two prominent locations.

## **“Getting Acquainted” Procedure**

### **A. Let’s hook up and get a usable display . . .**



Read “Operators Safety Summary” and “Preparation for Use” (in this section) before performing this procedure.

1. Connect the scope to a suitable power source and POWER it ON. Wait for the scope to finish running its power-on self check. Push the front-panel button labeled PRGM (under the SEC/DIV control). Now press the menu button that is under the INIT PANEL label. (The five menu buttons are located in the bezel below the CRT.)

2. Install one of the two probes included with the scope to the CH 1 input BNC; install the second probe to CH 2. Connect both probes to the CALIBRATOR output and hook the probe’s ground leads to scope ground (the banana plug jack under the CALIBRATOR output can provide the ground if a suitable plug is inserted).

3. The scope can automatically set itself up for a usable display—press the button labeled AUTO under the A and B SEC/DIV knob.

Note that the instrument flashes the message AUTOSETUP WORKING: PLEASE WAIT on the screen as it searches for information about the signal(s) it’s acquiring. In a few seconds, front-panel settings are effected that deliver a display for CH 1. Some of these front-panel settings are displayed on-screen. The top line of information indicates the following:

- a. The CH 1 VOLTS/DIV setting
- b. The SEC/DIV mode and setting
- c. The trigger level on the waveform
- d. The signal source used for the trigger (VERT source)

## **General Information**

---

Two more lines of readout are available, directly below the top line, to display other front-panel settings such as: CH 2 VOLTS/DIV, B SEC/DIV, etc.

### **NOTE**

*Auto Setup is a useful and versatile feature. Demonstrating its complete capabilities requires an external signal generator and is, therefore, beyond the scope of this introductory procedure. We will examine Auto Setup more closely in Sections 2 and 3.*

### **B. Let's learn about the vertical controls and instrument control menus . . .**

1. Press the front-panel button labeled VERTICAL MODE. Note that the two lines of text at the bottom of the CRT display are replaced with two different lines. You have just called up a new instrument menu. Many front-panel buttons call up menus which display the modes available for the user to select.

2. Press the menu button in the bezel under the CH1 label.

Note that one press of the button removes the underline from the CH1 menu label and turns off the CH 1 display. A second press of the button restores the underline to the menu label and turns on the display. This is typical of the scope's menu operation: the buttons operate in a push/push manner, and underlined labels indicate the functions or modes that are active.

3. Turn on CH 1 and CH 2. Note that the readout for the CH 2 VOLTS/DIV setting appears on line 2. Set the CH 1 VOLTS/DIV control to 1 V (2 positions counterclockwise).

4. Press the menu button labeled ADD to display the algebraic sum of the CH 1 and CH 2 signals. The readout for ADD mode appears on line 3 at the top of the screen.

5. Turn on the MULT Vertical mode. Note that the ADD menu label is no longer underlined while the MULT label is. There are some features in the instrument that cannot be used with others. The ADD and MULT Vertical modes are mutually exclusive; therefore, turning on one cancels the other.



MULT multiplies two waveforms together and is useful for measuring power. See "MULT Mode Applications" in Section 3 for a more detailed discussion of this function.

6. Turn off CH 2 and MULT. Press the menu button under YT:XY. The instrument now leaves the YT mode, where acquired waveforms are plotted on the Y-axis against Time on the X-axis, and enters the XY mode, where the CH 2 waveform is plotted on the Y-axis against CH 1 on the X-axis.

Notice that the ADD and MULT selections are removed from the menu. These vertical modes are not allowed when XY is the display mode. The scope is "smart" enough to remove the labels of the modes or functions that cannot be used with the currently selected mode.

NOTE

*This action is different from that in Step 5. The instrument did not remove ADD from the menu when you selected MULT, because you could use the menu to go back to ADD.*

When you switched the instrument from YT mode to XY mode, the underline in the menu moved from YT to XY. This type of mode selection is different from the one you used to turn on CH 1, CH 2, ADD, etc. When two modes are mutually exclusive, but one or the other *must* be on, the modes appear as one label over a single button, and the mode presently in effect is underlined. By pressing the button, you "toggle" between the two modes.

7. Press the YT:XY menu button to toggle the display mode back to YT. Note that, although you switched off CH 2 in Step 6, CH 2 is now on (the CH2 label is underlined and CH 2 is displayed). The scope turned on CH 2 when XY mode was selected in Step 9, since the instrument "knew" that CH 2 must be on for an XY mode display. Turn off CH 2 again.

8. Press the front-panel button under the CH 1 VOLT/DIV knob labeled COUPLING/INVERT. Note that the coupling is set to DC. Push the COUPLING/INVERT button again. Note that the underline moves to the right to GND (ground setting). Push the button twice more. The underline "wraps around," first turning on AC coupling, then returning to DC coupling (leave coupling set to DC).

This wrap-around feature for switching between different mode settings is a shortcut method used for several instrument modes. For many menus, the first push of the front-panel button selects the menu, while subsequent pushes select from two or more menu choices in sequence. Some examples are: COUPLING/INVERT, BANDWIDTH, TRIGGER POSITION, TRIGGER COUPLING, and TRIGGER MODE.

### **General Information**

---

9. Press the front-panel button labeled BANDWIDTH. Notice that you can limit the bandwidth of the scope's vertical system to 20 MHz, 100 MHz, or FULL (300 MHz).

10. Rotate the SEC/DIV control clockwise to increase the A acquisition rate. Note that the A SEC/DIV readout changes, and the values for USB (USable Bandwidth) and USR (USable Rise time) also change. Since the bandwidth and rise time of the instrument depend on the acquisition rate, the scope displays their values as well as the SEC/DIV setting.

11. Switch SMOOTH ON:OFF in the displayed menu to ON. Notice the corners of the square wave roll off. This is because SMOOTH ON causes a moving 5-sample-point digital filter to be applied to the waveform. SMOOTH is useful for eliminating noise from non-repetitive waveforms that cannot be acquired in AVERAGE mode. Switch back to SMOOTH OFF.

Before we leave "vertical controls" let's look at the way the vertical positioning controls work...

12. Use the CH 1 Vertical POSITION control to adjust the display vertically on screen. Notice you can turn the control clockwise and counterclockwise far enough to position the waveform about 2 divisions up and down before you encounter stops on the control. Now gently rotate the control past one of the stops. The waveform now moves up or down outside of the two-division area up or down on screen. Rotating the control further past the stop increases the rate at which the waveform moves up or down the screen. The maximum rate is reached at the second stop (a "hard" stop).

VERTICAL POSITION is an example of a "position-rate" control. In the "position" region, inside the first stops, it acts like most rotating controls: it adjusts the controlled function by an amount directly proportional to the amount of rotation, at a rate directly proportional to the rate of rotation. But in the "rate" regions, between the "soft" and "hard" stops, it adjusts the controlled function at a rate directly proportional to the amount of rotation. This allows the function to be adjusted more quickly. In a sense, these controls are "smart" controls. They respond according to the assumption that small movements of the control are for fine adjustments and large movements for coarse. HORIZONTAL POSITION and CURSOR/DELAY are also position-rate controls.

13. Center the waveform vertically on the screen.

**C. Let's check out the HORIZONTAL controls and menus . . .**

1. Press the AUTO front-panel button. After Auto Setup executes, make sure the A SEC/DIV is set at 1 ms.

2. The resulting CH 1 display should be centered, with a small "T" riding on top of the square wave at mid-screen. If the T (indicating the trigger point on the waveform) is not easily visible, limit the bandwidth to 20 MHz by pressing the BANDWIDTH button twice. If the T still isn't evident, perform Steps a through e. Otherwise, go to Step 3.

a. Press the MENU OFF/EXTENDED FUNCTIONS front-panel button twice to remove the displayed menu and to substitute the Extended Functions menu.

b. Press the menu button labeled SYSTEM (menu will change).

c. Press the menu button labeled MISC (menu will change).

d. Set TRIG T ON:OFF to ON.

e. Press the MENU OFF/EXTENDED FUNCTIONS front-panel button to return to normal operation.

3. Use the Horizontal POSITION control to move the T, first to the extreme right side of the screen, then to the extreme left.

Note there are 10 horizontal divisions displayed on each side of the T. This is because the instrument displays its 1024 sample point waveform record over 20 divisions (as if it were "2X magnified" all the time). Reposition the T to center screen.

4. Press the front-panel button labeled A INTEN in the horizontal controls section. Note that this button does not call up a new menu. (There are six buttons that are not associated with menus; the others are: A HORIZONTAL MODE, B HORIZONTAL MODE, SLOPE, INIT @ 50%, and A/B TRIG.)

### **General Information**

---

A INTEN enables the B SEC/DIV switch and displays its setting below the A SEC/DIV readout. (B HORIZONTAL MODE has the same effect.) You may have noticed that the displayed waveform became brighter when A INTEN was switched on. This is because the entire A display is overlapped by an intensified zone whose duration is controlled by the B SEC/DIV setting.

5. Turn the SEC/DIV control clockwise three positions until the B SEC/DIV setting reads  $100\ \mu\text{s}$  on screen. Note that the intensified zone shrank until it now only covers about 1 cycle of the waveform around the small T. Since the B acquisition rate is now 10X faster than the A setting, the intensified zone now only overlaps about 2 horizontal divisions of the A display ( $2\ \text{divs}/20\ \text{divs} = 1/10$ ).

6. Press the front-panel button labeled HORIZONTAL MODE B to display the intensified zone at the B acquisition rate. Note that the A display is now replaced by a B display; the 2-division intensified zone is expanded to 20 divisions. We can further magnify the intensified zone by changing the B SEC/DIV setting to increase the B acquisition rate.

7. We can also pick the area on the A display we wish to magnify. Return the HORIZONTAL MODE to A INTEN. Push the front-panel button labeled DELAY TIME. A new menu containing the delay time setting is now displayed. Rotate the front-panel CURSOR/DELAY control clockwise. (This control is located between the CURSOR and DELAY sections of the front panel.) The intensified zone now moves along the waveform to the right of the T. Switch back to B Horizontal mode. Now when you rotate the control the waveform moves on screen, since you are magnifying a different part of the A waveform.

There are two time-delayed zones available, as well as a delay-by-events function. Section 2 explains these features in more detail, and Section 3 provides applications under "Delay Time Measurements and Applications".

8. Return the HORIZONTAL MODE setting to A.

One thing to remember when using the horizontal controls is that the SEC/DIV control adjusts the B acquisition rate whenever the B SEC/DIV readout is on screen (that is, when the scope is in A INTEN or B HORIZONTAL MODE).

#### D. Using the Trigger controls . . .

Trigger control settings for MODE, SOURCE, CPLG (coupling), and TRIG POSITION are also selected from menus. The method is similar to the one described for vertical controls. The following procedure covers only a few aspects of the trigger controls; see Section 2 for more information.

1. Push the front-panel button labeled MODE in the TRIGGER controls section. Rotate the control labeled TRIGGER LEVEL to untrigger the display and notice the unstable display on screen.

2. Select AUTO LEVEL mode. Note that the display automatically becomes triggered. Now rotate the level control as in Step 1.

Notice that the scope momentarily detriggers and then retriggers when you attempt to adjust the A trigger level outside of the signal level (peak-to-peak) range. The AUTO LEVEL feature establishes a new trigger level when signal levels change (or the user attempts to adjust the level outside the signal range). This feature is handy when making many consecutive measurements since you don't have to stop to adjust the trigger level.

3. Push the front-panel button labeled A/B TRIG. Note that the menu changes to the B TRIGGER MODE menu and that the B-Trigger level and source are displayed in the second line of the readout. The TRIGGER LEVEL control now adjusts the B-Trigger level for the B TRIG AFTER Delay mode (see "B-Trigger Modes" in Section 5 for more information).

4. Press the front-panel button labeled TRIGGER CPLG. Note that the B-Trigger Coupling menu is displayed.

5. Press the front-panel button labeled A/B TRIG. Note that the A-Trigger Coupling menu is now displayed.

As implied in Steps 4 and 5, the trigger system selection (A or B) determines which system's menu is displayed when TRIGGER MODE, SOURCE, CPLG, or TRIG POSITION is pushed. Using the A/B TRIG button to switch between the triggering systems also switches between the A and B menus for those functions.

## **General Information**

---

### ***E. Let's learn about the storage controls . . .***

1. Press the front-panel button labeled STORAGE ACQUIRE.

2. Repeatedly push the menu button labeled ENVELOPE. Note the count displayed above the ENVELOPE label is increased with each push. Continue to push the button until CONT (continuous) appears.

The count above the ENVELOPE, or AVG, label indicates the number of triggered acquisitions that will constitute an envelope, or average, sequence. (See SINGLE SEQ under "A-Trigger Mode" in Section 5 for a discussion of the difference between a single acquisition and a sequence.)

3. Use the CH 1 Position control to move the display about one division up or down. Notice that adding a vertical position offset to the signal creates a "filled" area between the previous amplitude level and the new one. This "envelope" waveform displays the minimum and maximum levels assumed by the signal during the acquisition sequence.

Although you created the change that was captured by ENVELOPE mode when you positioned the display in Step 3, all changes in minimum and maximum amplitude levels are captured in the same way.

4. Push STORAGE ACQUIRE again. Note the envelope is erased and the acquisition sequence restarted. Pushing STORAGE ACQUIRE always restarts the acquisition for *all* acquisition modes.

There are many other mode changes that can cause envelope or average sequences to restart. Some of these are changes to the settings for VOLTS/DIV, SEC/DIV, VERTICAL and HORIZONTAL MODE, etc. Examples of functions which don't cause the restart are: CURSORS, VERTICAL and HORIZONTAL POSITION, VERTICAL VARIABLE, and TRIGGER LEVEL.

5. Disconnect the CH 1 probe's ground lead from scope ground to create a noisy signal.

6. Change the menu selection from ENVELOPE to AVG (Average). Continue to push the AVG button several more times. Notice that any noise on the waveform is greatly reduced as you increase the number of acquisitions you specify for an acquisition sequence. Also, notice the count "rolls around" to the minimum count of 2 after the maximum of 256 is encountered. (The same roll-around action occurs after CONTInuous for ENVELOPE).

7. Set the ACQUIRE MODE to NORMAL to return to the "live" mode we used during the other subsections of this procedure. Reconnect the probe ground you disconnected in Step 5.

8. Press the front-panel button labeled SAVE. The instrument stops acquiring and "freezes" the display. Notice that although the waveform is saved, you can still use the CH 1 Vertical POSITION and Horizontal POSITION controls to move the saved waveform on screen.

The saved waveform can be stored for later reference—try this:

a. Push the button labeled CH1 in the SAVEREF SOURCE menu (menu changes).

b. Push any of the buttons labeled REF[1-4] for the SAVEREF DESTINATION menu.

c. Move the saved waveform to the top half of the screen and push ACQUIRE to resume acquiring the CH 1 waveform.

d. Push the front-panel button labeled DISPLAY REF and push the menu button that corresponds to the REF used for Step b.

Briefly, to store a waveform: First, SAVE the waveform you wish to store; Second, identify that waveform in the SAVEREF SOURCE menu; Third, select the storage location from the SAVEREF DESTINATION menu.

To view a stored waveform: first, press DISPLAY REF; then, select the appropriate storage location from the DISPLAY REF menu.

Many other details about acquisition and storage modes and features are covered by the "Operators Familiarization" procedure in the next section and "Storage Applications" in Section 3.

## **General Information**

---

### ***F. Let's make some measurements . . .***

1. Press the AUTO front-panel button to Auto Setup the scope. Make sure the A SEC/DIV is 1 ms.

2. Press the button labeled FUNCTION in the CURSOR section of the front panel. Select VOLTS from the CURSOR FUNCTION menu.

Note that two horizontal cursors are displayed. These are called the vertical cursors because they move vertically.

3. Rotate the CURSOR/FUNCTION control. Note that the segmented cursor moves up and down screen with that control. Align that cursor with the top of the square wave displayed.

4. Press the front-panel button labeled CURSOR SELECT. The cursor that was solid becomes segmented and can now be moved by the CURSOR/FUNCTION control. Align this cursor with the bottom of the square wave.

5. Read the peak-to-peak amplitude of the square wave from the cursor readout in the upper-right quadrant of the screen. It should read approximately 400 mV, since that is the amplitude of the calibrator output into 1 M $\Omega$ .

6. Increase the A SEC/DIV setting to 500  $\mu$ s.

7. Change the selected menu function from VOLTS to TIME. The cursors are now parallel to the vertical graticule lines, but they are called horizontal cursors because they move horizontally.

8. Rotate the CURSOR/FUNCTION control and notice which cursor moves. Although both of these cursors are segmented, the one with the most "dots" is the one that moves. Align this cursor with the rising edge of one cycle of the square wave.

9. Push SELECT and move the other cursor to the rising edge of the square wave that immediately precedes or follows the one used in Step 8.

10. Read the time period of the bracketed square wave from the cursor readout (approximately 2.000 ms).



11. Change the menu function selected from TIME to 1/TIME. Check the frequency readout (approximately 500 kHz).

These last few measurements illustrate only a fraction of those possible using the cursors. "Special Applications" in Section 3 of this manual shows you how to use the cursors to make a variety of other measurements.

### ***G. A word about HELP.***

1. This scope can display on-screen information about the functions and operations of its front-panel controls. Push the STATUS/HELP button under the CRT.

2. Only one menu selection is available with the STATUS/HELP menu; push the menu button labeled HELP.

You have just invoked the HELP mode for the instrument. In this mode, all front-panel controls (except POWER and the menu buttons) cause the instrument to display information about that control. Don't push any front-panel buttons yet; we'll try HELP in a moment, but first:

3. Read the four screens of introductory information, using the MORE button to get each new screen.

4. When MORE is no longer displayed in the menu, follow the instruction at the bottom of the screen.

5. Each time you press a button or turn a knob, information about that control appears on the screen. If there is more than one screen of information, MORE appears in the menu.

6. When you're through playing with HELP, press the EXIT button to return to Scope mode. Since using HELP does not change the instrument's setup conditions, you can use it any time you wish, except during internal calibration or diagnostic routines.

## ***General Information***

---

Now that you're familiar with most of the front-panel controls, you're ready to learn to make measurements that use some of this instrument's special features. A series of "Familiarization Procedures" in Section 2 should increase your understanding of these features and how to use them.

If you want to use this instrument for a specific application, but aren't sure how to do it, check the Table of Contents for Section 3 to see if your particular need is covered.

# Operation

This section is composed of two subsections. The first contains basic operating information and techniques that should be understood before you attempt to make measurements with your instrument. The second consists of procedures designed to quickly acquaint a first-time user with all the operating controls and most menu selections.

## Operating Considerations

### Graticule

The graticule is internally marked on the faceplate of the CRT to eliminate parallax-viewing error and to enable accurate measurements. The graticule is marked with eight vertical and ten horizontal major divisions. Major divisions are further divided into five subdivisions of 0.2 division each, marked along the center vertical and horizontal graticule lines (see Figure 2-1). Percentage marks for rise-time and fall-time measurements are located on the left side of the graticule. The vertical deflection factors and horizontal timing are calibrated to the graticule so that accurate measurements may be made directly from the CRT.

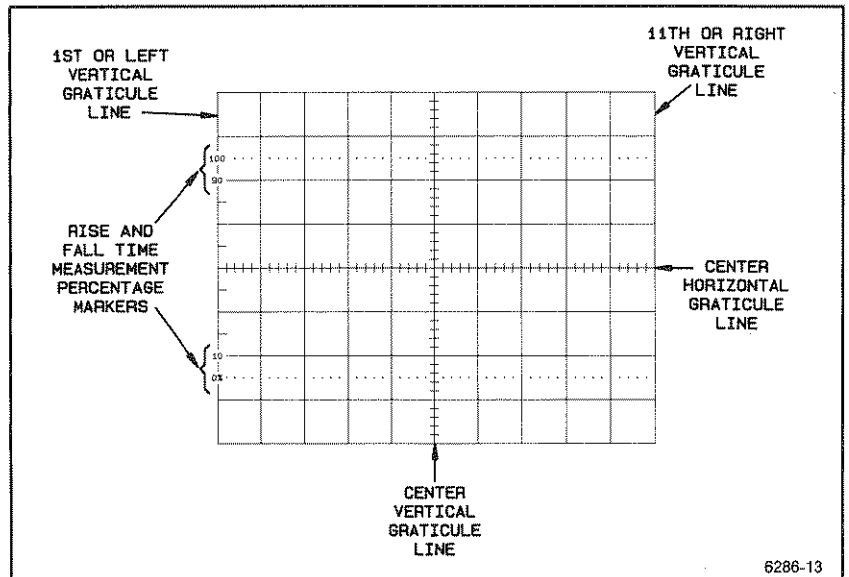

Figure 2-1. Graticule measurement markings.

## ***Time and Voltage Measurements***

This instrument provides several methods for making both time and voltage measurements. The various methods produce different degrees of accuracy and require different amounts of time and care.

Using the graticule markings to measure voltage or time produces the quickest, but least accurate, results. To improve the accuracy of this method takes a lot of time, because you must precisely position the waveform on the graticule and carefully count graticule divisions. Direct graticule measurements should be used only where precision is of less importance than speed.

Using the Cursor functions to measure voltage or time on displayed waveforms produces highly accurate, precise results. The setup time to make a particular measurement is fast, and the measurement result is displayed as readout on the CRT. Using the cursors avoids errors due to display gain and CRT trace non-linearity and eliminates the inconvenience of counting and interpolating graticule markings.

The cursors also offer flexibility in that they can be set up to measure either the difference between cursor positions or the difference between the cursor position and an absolute reference point, namely ground for voltage measurements and the Record Trigger Point for time measurements. Two coupled-cursor modes tie each VOLT cursor to a corresponding TIME cursor allowing slew rate to be measured (SLOPE mode) and voltage measurements to be made at chosen time points on the waveform (V@T mode). The 1/TIME-cursor mode is available for making frequency measurements. You can also select the units of measurement to serve a wide range of applications.

The Delay by Time and  $\Delta$ Time features for the B HORIZONTAL mode are used to make time-difference measurements that require the highest degree of accuracy and/or involve delays beyond the on-screen limits of the TIME cursors. Time measurements using the B Delayed trace take the most time to set up, but they avoid introducing errors due to cursor misalignment at the measurement point on the waveforms.

Details of all the available cursor functions and units are provided in Section 5 "Controls, Connectors, and Indicators." Use of the various cursor and B Delay modes for making measurements is described in Section 3, "Basic Applications."

## Acquiring Data

Both CH 1 and CH 2 input signals are acquired simultaneously at all times, whether the signal is being displayed or not; therefore, the user can call up the undisplayed channel signal after entering Save mode. Either channel signal may be independently inverted during acquisition.

Waveforms may be acquired in NORMAL, ENVELOPE, or AVG (average) Storage mode. NORMAL produces a "live" trace similar to that seen on a conventional oscilloscope. ENVELOPE mode depicts any variations of the waveshape, since minimum and maximum data-point values for each sample interval are displayed. AVG Storage mode gives a very clean display by averaging out uncorrelated noise. The user can select the number of acquired waveforms to be incorporated into the ENVELOPE or AVG display.

REPET mode may be used with any of the three acquisition modes to extend the Useful Storage Bandwidth to 300 MHz when viewing repetitive signals. REPET is also available for SINGLE SEQ operation, where the actual number of acquisitions occurring for a single sequence is the number required to meet the USB (Useful Storage Bandwidth) for the SEC/DIV setting used and adequately "fill in" the waveform for good display. When REPET is not used, the Useful Storage Bandwidth is 200 MHz, and digital interpolation is used to provide the waveform data points between samples taken at the maximum sampling rate (for SEC/DIV settings of 50 ns and faster).

A SAVE-ON- $\Delta$  feature enables the scope to compare the incoming signal against a reference envelope waveform. If the signal falls outside the reference envelope, the scope switches to the SAVE Mode to preserve the out-of-limit waveform for analysis. There are two applications in "Storage Applications" (Section 3) that illustrate methods of using this feature, both from the front panel and the GPIB.

Acquired waveforms are also saved when the user presses the front-panel button labeled SAVE. The scope immediately preserves the current CH 1 and CH 2 waveforms and ADD/MULT functions (whether they are displayed or not). All cursor functions can be used to make measurements on the saved waveform displays, and the SAVE waveforms may be horizontally and vertically positioned and expanded. Expansion of SAVED waveforms is nondestructive; it is done as a display function only, so the original waveform may be returned by merely de-expanding the display. Once saved, the waveforms may be transferred to a SAVEREF memory where they may be preserved for extended periods of time. Saved waveforms can be called up at any time for analysis or for use as reference waveforms to compare with the live waveforms being acquired.

## ***Grounding***

The most reliable signal measurements are made when the scope and the unit under test are connected by a common reference (ground lead) in addition to the single lead or probe. The ground lead of the probe provides the best grounding method for signal interconnection and ensures the maximum amount of signal-lead shielding in the probe cable. A separate ground lead can also be connected from the unit under test to the oscilloscope ground jack on the front panel using a banana-tip connector.

## ***Signal Connections***

### ***Probes***

Generally, probes offer the most convenient means of connecting an input signal to the instrument. Furthermore, they are shielded to prevent pickup of electromagnetic interference. The standard 10X probes supplied with this instrument offer a high input impedance that minimizes circuit loading. This allows the circuit under test to operate with a minimum of change from the normal, unloaded condition. Also, the subminiature body of these probes has been designed for ease of use when probing circuitry containing close lead spacing.

The probe and its accessories should be handled carefully at all times to prevent damage. Dropping the probe, or striking it against a hard surface, can cause damage to both the probe body and the tip. Use care to prevent the cable from being crushed or kinked, and do not place excessive strain on the cable by pulling it.

The standard-accessory probe is a compensated 10X voltage divider. It is a resistive voltage divider for low frequencies and a capacitive voltage divider for high-frequency signal components. Inductance introduced by long signal or ground leads may form a series-resonant circuit. This resonant circuit affects system bandwidth and can oscillate (ring) if driven by a signal containing significant frequency components at or near its resonant frequency. Ringing can then appear on the scope display and distort the true signal waveform. Always keep both the ground lead and the probe signal-input connections as short as possible to maintain the best waveform fidelity.

Misadjustment of probe compensation is a common source of measurement error. Because of variations in oscilloscope input characteristics, probe compensation should be checked and adjusted, if necessary, whenever a probe is moved from one oscilloscope to another or between channels of a multichannel oscilloscope. The probe compensation adjustment procedure is found in "Checks and Adjustments" in Section 4 of this manual, and in the instructions supplied with the probe.

**AUTOMATIC SCALE FACTOR SWITCHING:** The VOLTS/DIV scale factors, displayed on the CRT, can be automatically switched by either GPIB-initiated control changes or by any change in the probe attenuation factor. Table B-1 in Appendix B of this manual shows the range of the VOLTS/DIV switch for all available Tektronix coded probes. The Readout Volt/Div settings given in the section of the table labeled "Expanded" are obtained using firmware data expansion routines to process waveforms acquired at the basic minimum Volts/Div setting of 2 mV. These expanded settings are only available for SAVE and/or AVERAGE mode waveforms.

### ***Coaxial Cables***

Cables used to connect signals to the input connectors may have considerable effect on the accuracy of a displayed waveform. To maintain the original frequency characteristics of an applied signal, only high-quality, low-loss coaxial cables should be used. Coaxial cables must be terminated at both ends in their characteristic impedance to prevent signal reflections within the cable. The built-in 50- $\Omega$  termination for the input of the scope should be used for interconnection of 50- $\Omega$  system signals to the scope. If this is not possible, then use suitable impedance-matching devices.

### ***Input Precharging***

When the input coupling is set to GND, the input signal is connected to ground through a precharging network consisting of the input-coupling capacitor in series with a 1-M $\Omega$  resistor. Since this allows the input-coupling capacitor to charge to the average dc voltage level of the input signal, it prevents large voltage transients, which can be generated when the input coupling is switched from GND to AC, from reaching the amplifier input. This precharging network also protects external circuits to the extent that it reduces the current levels drawn from the external circuitry during capacitor charging.

### ***External Triggering***

The A and the B trigger signals can be independently obtained from a variety of sources. Samples of the CH 1, CH 2, and ADD waveforms are available as trigger sources. Sometimes, however, you may need a trigger source different from the one that corresponds to the input-channel for the signal of interest. In this case, you can apply a trigger-source signal to an unused vertical channel or to either of two external trigger input channels. While the vertical channels can condition a wide variety of signals to produce triggers ranging from millivolts to thousands of volts in amplitude, the external trigger input channels (without the use of external attenuation) can only divide their inputs by either a factor of 1 or a factor of 5.



## **Operators Familiarization Procedures**

### **Introduction**

The Tektronix 2440 is an easy-to-use Digital Oscilloscope that provides you with an accurate and flexible waveform measurement and analysis tool. A combination of front-panel controls and menu-driven selections provides fast and convenient setup of the instrument operating modes. Menu selections allow access to the many waveform acquisition and processing functions while maintaining an uncluttered front panel.

Selected menu functions, front-panel control settings, and measurement results are displayed in the CRT readout. In the menu displays, an underscore marks the active operating mode or processing function. A mode or function is off if there is no underscore beneath its menu entry.

### **Readout Display**

The CRT readout display tells you how the instrument controls are set up; therefore, the rotating switches and control knobs have no physical markings to indicate the control setting. A key to the type of readout information displayed and its location on the screen is illustrated in Figure 2-2.

### **Front-Panel Controls**

The front-panel controls are divided into two types:

- Those that directly affect system operation (that is, VOLTS/DIV, SEC/DIV, HORIZONTAL and VERTICAL POSITION, and the specific menu selection buttons)
- Those that call up a menu from which you must make a selection to change an instrument function (that is, VERTICAL MODE, CURSOR selections, and most of the TRIGGER selections)

**Operation**

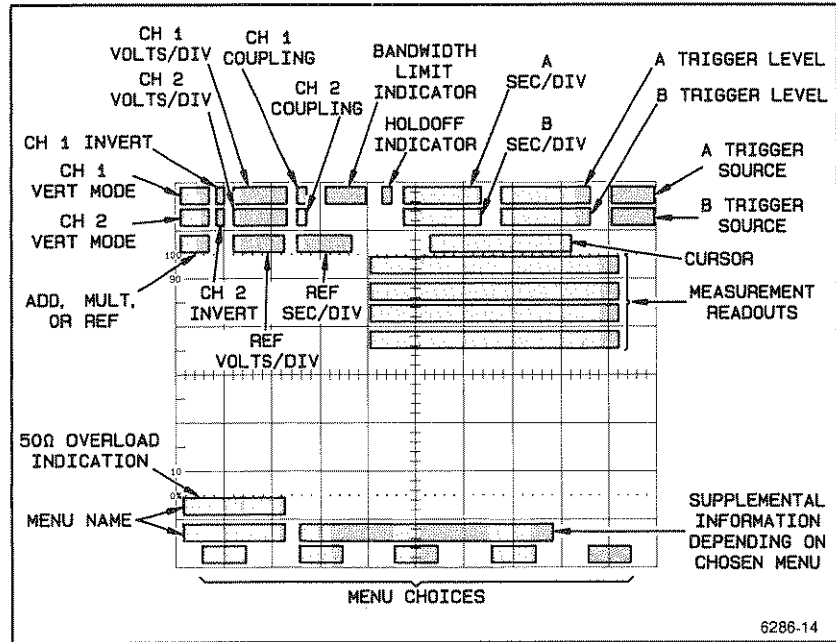

**Figure 2-2. Readout display locations.**

Menu control buttons work in several different ways as dictated by the type of function they are controlling. In certain instances they merely toggle a function on and off; in others, they are used to make further selections once the main function chosen by that menu button has been made. For some functions, the menu selections are self-canceling, such as when two menu choices are mutually exclusive.

In some menus it is possible, for convenience, to cycle through the displayed choices by repeatedly pressing the front-panel button that called up the menu. For example, while the COUPLING control menu is displayed, you can select among AC, DC, and GND simply by repeatedly pressing the appropriate COUPLING/INVERT button. The following familiarization procedures point out how the various menu control buttons work.

## Familiarization Procedures

These procedures will acquaint you with the system menus and front-panel function buttons. By following the step-by-step instructions and performing the simple exercises, you will see how the various controls affect the instrument. Once you understand how the menus control the operating system, and you see how quickly initial set-ups can be made, it should be easy to develop efficient techniques for making specific measurements.

The detailed operation of each control and connector is described in "Controls, Connectors, and Indicators," in Section 5 of this manual. A complete list of the control menus is included at the end of that section.

## Getting a Display

1. With the scope connected to an appropriate power source, push the POWER button IN (green indicator is seen in the button). The scope does a power-on self test each time it is turned on. After a few seconds, the self test will be completed and the instrument will be ready for operation.

**NOTE**

*If the instrument fails its power-up self test, see "Start Up" under "Preparation For Use" in Section 1. If the scope powers up in SAVE mode (not acquiring) a message is displayed instructing you to push STORAGE ACQUIRE.*

After the self test has finished, there may or may not be a visible display. This depends on the front-panel settings in effect when the instrument was powered off, because the same settings are reestablished when the instrument is turned back on. If the READOUT intensity has not been completely turned down, you should see some sort of readout display. If a display source (VERTICAL MODE) is turned on, and the DISPLAY intensity is not turned down, some waveform displays or traces should be on screen. Whether or not there are visible displays on screen, perform the following two steps:

2. Push STATUS/SELECT to set the READOUT INTENSITY to 65%. This level yields viewable readout and menu displays.

3. Push PRGM to display that menu, and push the menu button labeled INIT PANEL. This sets the front-panel to known default settings and yields a display of the CH 1 source.

*Remember to use this two-step procedure (Steps 2 and 3) whenever you want to get a visible display.*

## Operation

---

### NOTE

*While INIT PANEL changes most front-panel controls to predefined states, certain controls (such as those accessed via the EXTENDED FUNCTIONS menus) are not allowed to be changed. See Table B-15 in Appendix B for a list of the states set up by INIT PANEL.*

INIT PANEL can be used to quickly return the instrument to known operating conditions without searching the STATUS display or the menu selections to determine each front-panel control state. (This is useful when the front-panel controls have been left in seldom-used settings.)

If you want to readjust the intensity levels which were established by pushing STATUS and INIT, perform Steps 4-7; otherwise, go to the next procedure, "Front-Panel Setup."

4. Press the SELECT button to display the INTENSITY control menu. Figure 2-3 illustrates the SELECT menu entries and the position of the Menu Control buttons.

5. Press the READOUT menu button and use the INTENSITY control knob to set the readout intensity to a viewable level without excessive brightness. (Clockwise rotation of knob increases intensity.) The INTENSITY control is a continuous-rotation pot with no end stops to designate physical maximum or minimum rotation. You decide by observation when you have reached maximum or minimum intensity.

6. Now select GRATicule and adjust the illumination to the minimum (off) level. GRAT controls the edge lighting of the scribed CRT graticule markings for dimly lighted work areas and oscilloscope photography. The INTENS menu selection is used to adjust the contrast between the normal trace and the intensified zone in A INTEN displays. There's no need to adjust INTENS at this time.

7. Press the DISP menu button and use the INTENSITY control to adjust the waveform trace to a viewable level.

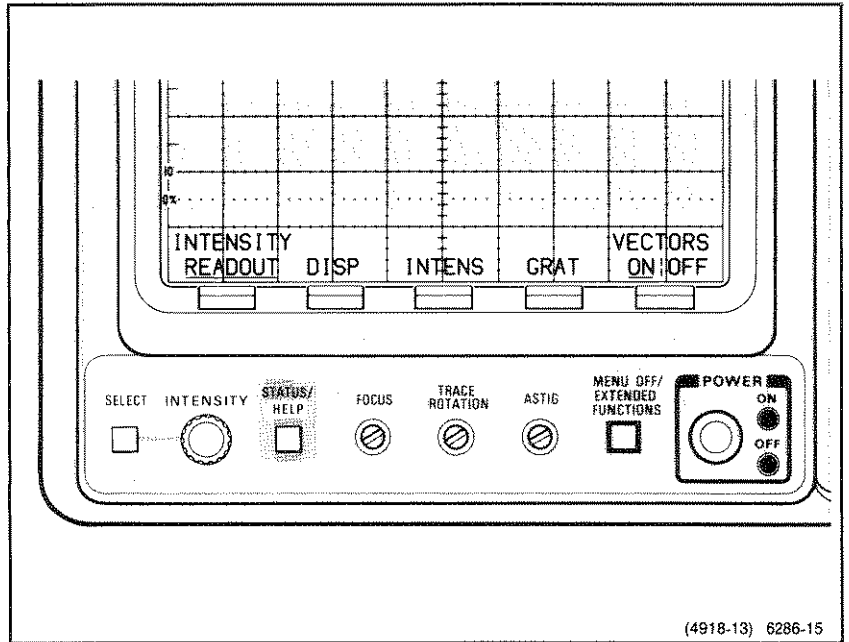

(4918-13) 6286-15

Figure 2-3. SELECT menu and menu control buttons.

### Front-Panel Setup

Assuming you performed Steps 1-3 of the previous procedure, you are now ready to set up the remaining front-panel controls for a basic operating mode. Proceed as follows:

1. Push TRIGGER MODE and select AUTO in the displayed Mode menu.

2. Now set up the front-panel shown in the following list. (Some controls may already be set correctly.) In general, the bold-face headings indicate the area on the front-panel where you will find the listed controls, the left column lists the control, and the right column gives its setting. Some controls call up a menu. Remember when using menus: to turn a function on, underline its menu label by pressing the button beneath it; to turn a function off, remove the underline in the same way. If necessary, review the procedure in Section 1 for more detailed instructions.

## Operation

---

### VERTICAL CONTROLS

MODE	
CH 1 and CH 2	ON (underlined)
ADD and MULT	OFF
YT:XY	YT (toggling choice)
VOLTS/DIV	
CH 1 and CH 2	20 mV
COUPLING/INVERT	
CH1, CH2 COUPLING	AC
CH1, CH 2 INVERT	OFF
CH 1 POSITION	Set trace to 1.5 divisions above graticule center.
CH 2 POSITION	Set trace to 1.5 divisions below graticule center.
BANDWIDTH	20 MHz
SMOOTH ON:OFF	OFF
CH 1 and CH 2 VARIABLE	CAL

### HORIZONTAL CONTROLS

MODE	A
A SEC/DIV	500 $\mu$ s

### B TRIGGER CONTROLS (Press A/B TRIG for B Trigger menus)

SLOPE	+ (plus, indicated by front-panel LED)
MODE	
RUNS AFTER	ON
EXT CLK	OFF
SOURCE	VERT (CH 1 is used)
CPLG	AC
TRIG POSITION	1/2
EXT CLK	OFF

### A TRIGGER CONTROLS (Press A/B TRIG for A Trigger menus)

SLOPE	+ (plus)
MODE	AUTO (already set in Step 1)
SOURCE	VERT (CH 1 is used)
CPLG	AC
TRIG POSITION	1/2

**CURSOR CONTROLS**

FUNCTION All OFF (none underlined)

**DELAY CONTROLS**

EVENTS OFF  
 $\Delta$  TIME OFF

**STORAGE CONTROLS**

ACQUIRE  
 NORMAL ON  
 REPET OFF  
 SAVE ON  $\Delta$  OFF  
 DISPLAY REF All OFF (none underlined)

3. Perform the following steps to set up the SYSTEM menu.

a. Press the MENU OFF/EXTENDED FUNCTIONS button (located immediately left of the POWER switch) twice. You should get the EXT FUNCT menu.

b. Press the bezel button under SYSTEM to get the SYSTEM menu. In the new menu, set PREFLT ON:OFF to ON.

c. Press the button under MISC to get the MISC menu; then set BELL ON:OFF to ON and TRIG T ON:OFF to ON.

d. Push the MENU OFF/EXTENDED FUNCTIONS button to exit the EXTENDED FUNCTIONS menus.

4. Center the Trigger Position Indicator (a small "T" riding on the CH 1 and CH 2 baseline traces) horizontally on the graticule using the Horizontal POSITION control.

5. Connect the two standard accessory 10X probes to the CH 1 and CH 2 Vertical Input BNC connectors. The CH 1 and CH 2 VOLTS/DIV readouts should now be 200 mV.

## ***Operation***

---

6. Connect the probe tips of both probes to the CALIBRATOR output connectors and the ground lead to scope ground. A two-division peak-to-peak display of the CALIBRATOR output signal should now be seen in both channels. The display may or may not be stable depending on the setting of the A Trigger LEVEL control.

7. Use the following procedure to set the A Trigger LEVEL.

a. Press the TRIGGER MODE button.

b. Press the A/B TRIG button, if necessary, to obtain the A TRIGGER MODE menu.

c. Select AUTO LEVEL Trigger mode. Now the trigger level automatically follows trigger signal changes to maintain stable triggering. If you adjust the TRIGGER LEVEL control to set the level beyond the peak-to-peak limits of the trigger signal, the scope automatically changes the level to regain a stable trigger.

You now have a basic front-panel display setup for viewing signals applied to the CH 1 and CH 2 inputs. In the "Getting Acquainted" procedure in Section 1, you saw how Auto Setup was used to perform much the same function; that is, to get the front-panel set up for a usable display. With Auto Setup, the instrument automatically executes many of the steps you have just performed, illustrating the power and convenience of this feature. We'll examine Auto Setup more closely later in this procedure.

## ***Storing Front-Panel Setups***

The AutoStep Sequencer function can be used to store single front-panel settings under a label. Let's save the current setup for later use...

1. Press the PRGM front-panel button to display the AUTOSTEP SEQUENCER menu.

2. Press the SAVE menu button. This calls up a submenu for labeling your front-panel setup with a 1-6 character name so it can be recalled later.

3. Create the label FP1 (front-panel 1) for your front-panel setup by using the arrows under ROLL-CHARS as outlined in Steps a-c:



a. Select the first character for your label. Press the ↓ to step forward through the alphabet first and then through the digits 0-9. The ↑ steps from 9-0 and from z-a. (There is a "blank space" character between the digit 9 and letter a.)

b. When you have displayed the letter or digit for the first character of the label, push CURSOR <> to move to the next character. Repeat Step a to select the letter or digit for the next character of your label.

c. Repeat Step b to include up to 6 characters in your label. You can return to any character by continually pushing the cursor button, since it reverses the selection order after the first or sixth character is selected.

4. Press the SAVE menu button to assign the completed label to the current front-panel settings.

*NOTE*

*You can create labels with as few as one character and can leave any character position (1-6) blank. Simply push SAVE when the label has the number of characters you want, in the positions you want them.*

5. When you push SAVE, the scope displays a message indicating your chosen label and telling you to set up the controls. You could now change the controls if you wish, but since you already set up the controls earlier in this procedure, just push the front-panel button PRGM to display the ACTIONS menu.

6. The ACTIONS menu allows you to specify different functions to be executed when the front panel is recalled. Since at this point we only want to store our front-panel settings, just push the menu button SAVE SEQ.

To recall any front panel stored, push PRGM and select RECALL from the AUTOSTEP SEQUENCER menu. Next, use the SELECT arrows in the RECALL menu to underline the label for the front-panel desired. Finally, press RECALL to implement the selected setup.

## Performing SELF CALibration

The SELF CAL feature assures you that the most accurate measurements possible are being made. Self Calibration should be performed after instrument warmup, whenever the ambient temperature changes by more than  $\pm 5^{\circ}\text{C}$ , and immediately prior to making a series of measurements when the highest level of accuracy is required.

### NOTE

*For about ten minutes after power-on (whether the instrument is warm or not), the message NOT WARMED UP is displayed in the CAL/DIAG menu. This message warns you that the temperature of the scope may not be stabilized. The message can be ignored and the SELF CAL procedure initiated at any time, but optimum calibration results are obtained after the temperature is stabilized and the message is removed.*

Let's do a SELF CAL of the scope...

1. Push the MENU OFF/EXTENDED FUNCTIONS button twice (the first time to turn off the menus, the second time to turn on the EXT FUNCT menu).
2. Press the CAL/DIAG menu button to display the Calibration/Diagnostic menu.
3. Press the SELF CAL menu button to start the calibration; the message "RUNNING" should appear in the menu display. After a few seconds the self calibration is completed ("RUNNING" message leaves the display) and a PASS message should be above the SELF CAL label. The scope is then ready to return to its operating state.

### NOTE

*If the self calibration fails, the self-diagnostic mode is entered. In this event, push MENU OFF/EXTENDED FUNCTIONS twice and repeat Step 2 to rerun the self calibration. If errors persist, the scope should be referred to a qualified service person. Any fatal test errors should also have caused a failure of the power-on self test when the scope was first turned on. See Appendix A for more information on the Self Test and Self Calibration features.*

Depending on the test failed, the scope may function adequately for the measurements you need to make. Press the MENU OFF/EXTENDED FUNCTIONS button to exit the error display, and check the scope operation to determine if it will function for your purposes. In any event, the instrument should be referred to a qualified service person at the first opportunity.

4. Press MENU OFF/EXTENDED FUNCTIONS to turn off the Calibration/Diagnostics menu, then push ACQUIRE to start the waveform acquisitions again. Note the scope is returned to the setup you created prior to executing SELF CAL. This is a characteristic of SELF CAL operation.

Since you won't need CH 2 displayed for the next part of the procedure, use the VERTICAL mode menu to turn it off. Then center the CH 1 display vertically on screen.

### ***Using the SEC/DIV Control and a Horizontal Graticule Measurement***

1. Turn the SEC/DIV control slowly clockwise through the settings to 500 ns, then counterclockwise back to 500  $\mu$ s. See how the A SEC/DIV readout changes and note the effects on the CALIBRATOR waveform.

Notice that the CALIBRATOR output frequency changes with the SEC/DIV switch setting every 3 settings between a maximum and a minimum output frequency. See Table B-2 in Appendix B for the CALIBRATOR output frequency for each SEC/DIV setting.

2. Now check the period of the CALIBRATOR signal by determining the time of one complete cycle using the following procedure.

a. Use the Horizontal POSITION control to align the beginning of a cycle (the negative-to-positive rising edge) with any convenient vertical graticule line, and determine the number of horizontal divisions needed for one complete cycle of the CALIBRATOR signal. The center horizontal graticule line is graduated in 0.2 division increments to help you interpolate between the large division markings.

b. Multiply the number of divisions (and/or decimal fraction parts of a division) by the SEC/DIV readout to calculate the CALIBRATOR signal period. Frequency is calculated by taking the reciprocal of the period. Since you set the SEC/DIV back to 500  $\mu$ s in Step 1, the period should equal approximately 2 ms and the frequency, 500 Hz.

## **Using CH1 Controls and a Vertical Graticule Measurement**

1. Set the CH 1 VOLTS/DIV control clockwise to 50 mV, then switch slowly through settings counterclockwise to 1 V. Note the effect on the VOLTS/DIV readout and the waveform amplitude.

### *NOTE*

*Between 500 mV and 1 V per division, the attenuator switch activates with a clicking sound.*

2. Set the CH1 VOLTS/DIV control to 100 mV for a four-division peak-to-peak display.

3. Use the graticule division markings and the VOLTS/DIV setting to determine the peak-to-peak voltage of the CALIBRATOR signal in the following manner:

a. Align a peak of the display with any convenient horizontal graticule marking to determine the peak-to-peak amplitude in divisions. The center vertical graticule line is graduated in 0.2 division increments to help you determine fractional parts of the major divisions.

b. Calculate the peak-to-peak amplitude of the CALIBRATOR signal by multiplying the number of divisions (and/or decimal fraction part of a division) by the VOLTS/DIV readout. (You should get 400 mV.)

4. Press CH 1 COUPLING/INVERT button to display the CH 1 COUPLING menu. Additional pushes of the button will rotate the input COUPLING selections first to DC, then GND, then back to AC. Watch the vertical position of CH 1 change as you switch between AC and DC. Also, note that the symbol displayed with the VOLTS/DIV readout changes with each COUPLING selection.

You can also use the menu buttons to select any of the functions in the COUPLING menu, including the 50- $\Omega$  termination and INVERT features.

### *NOTE*

*AC COUPLING and 50- $\Omega$  input termination are mutually exclusive; selecting one will deselect the other.*

5. Select 50- $\Omega$  input termination for Channel 1. Observe that the COUPLING switches from AC to DC and the  $\Omega$  symbol is displayed following the CH 1 VOLTS/DIV readout. (The signal display amplitude will drop to zero in 50- $\Omega$  termination as the CALIBRATOR signal is dropped across the 10X high impedance probe.)

6. Again select AC and observe that the 50- $\Omega$  termination is turned off.

7. Press the CH 1 VARIABLE button to display the VARIABLE menu. Press and hold the  $\downarrow$  menu button until the displayed peak-to-peak amplitude decreases to about 1 division. Also note the symbol preceding the VOLTS/DIV readout indicates when the CH 1 display is uncalibrated.

8. Press and hold the  $\uparrow$  menu button to increase the display amplitude back to about 1.5 divisions peak-to-peak.

9. Return to the calibrated VOLTS/DIV settings by pushing the CAL menu button.

### **Using SAVE and DISPLAY REF Storage Modes**

SAVE mode is normally entered in one of three ways: pushing the SAVE Storage mode button, as a result of a SAVE ON  $\Delta$ , or at the end of a SINGLE SEQ acquisition.

SAVE Mode freezes any waveform acquisition in process and holds the waveform displayed for saving as a reference, making any type of measurements needed, or outputting via the GPIB. SAVE mode may be entered using a command via the GPIB.

Displayed along with the SAVED waveform are a count of the number of acquisitions made in the current process before SAVE was entered and a real-time clock display. The time in HRS (hours) is the scope run-time since the last COLD START. (The two least-significant digits, right of the colon, indicate minutes.)

## *Operation*

---

Upon entering the SAVE Storage mode, the SAVEREF SOURCE control menu is displayed. The menu permits the selection of any displayed VERTICAL MODE signal as the source of the reference signal to be stored. Once a source is selected, the SAVEREF DESTINATION menu is displayed so the user can choose which of the four reference memories is to store the selected source.

Besides storing selected VERTICAL MODE signals, the SAVEREF SOURCE menu can be used to copy a stored REFERENCE waveform to another memory location. If REF is selected for the source, a menu is displayed to allow one of the four available reference waveforms to be selected. Once the REF is selected as a source, the SAVEREF DESTINATION menu appears as before for selection of the REF destination into which the REF source is to be copied.

The SAVEREF SOURCE menu provides a third option for selecting REF sources and destinations. The STACK REF selection treats the reference memories as a push-up stack. REF1 is the bottom stack location and REF4 is the top. The first push of STACK REF stores a single-channel display first into REF1, then repeated pushes moves it to REF2, then REF3, then REF4, and finally off the stack with each push. When more than one waveform is being displayed, a predefined storage plan is used to place selected waveforms in certain reference memory locations. Basically, if CH 1, CH 2, and either ADD or MULT are displayed, pushing STACK REF will store CH 1 in REF1, CH 2 in REF2, and the ADD or MULT function in REF3 or REF4. See Table B-13 in Appendix B for the detailed STACK REF storage arrangement.

1. You should have a display of CH 1 centered on screen from the previous procedure.
2. Press the SAVE Storage mode button. This freezes the waveform acquisition and displays the SAVEREF SOURCE menu.
3. In the SAVEREF SOURCE menu, push CH 1. The Channel 1 signal is now selected as the source of the reference waveform to be stored, and the SAVEREF DESTINATION menu is displayed to select the SAVEREF memory location to store it.
4. Press the REF1 menu button. The Channel 1 signal is now stored in reference memory 1, and the SAVEREF SOURCE menu returns for further source selections.
5. Now select REF as the source choice. The four reference locations are now displayed so you can choose which reference memory you want as the source.

6. Select REF1 as the source. In the SAVEREF DESTINATION menu that then appears, push REF3 as the storage location. You have now copied the REF1 waveform into the REF3 reference memory.

7. To display the stored references, push the DISPLAY REF button. This calls up a menu so you can choose the reference waveform for display. A REFERENCE memory with no waveform stored in it will be labeled EMPTY. If the empty memory is turned on for display, an invalid waveform is displayed. An invalid waveform has vertical "fill" areas alternated with short trace segments.

8. Press REF1 and REF3 to display those reference waveforms superimposed. Use the VERTICAL MODE menu to remove the CH 1 SAVED waveform from the display, then push DISPLAY REF again to return that menu to the display.

**NOTE**

*The fact that both waveforms are displayed can be deduced by noticing that both REF1 and REF3 must be turned off before the waveform disappears from the display. Also, although REF waveforms cannot be positioned vertically, they can be horizontally positioned independently and in unison, as we will see.*

9. Press the HORIZ POS REF menu button and set REF HPOS INDLOCK to LOCK (if not already on). Rotate the horizontal position control to simultaneously move all REF waveforms (whether displayed or not) with SAVED or "live" VERT MODE waveforms.

10. Set REF HPOS to IND to unlock the positioning. Press REF3P, then rotate the Horizontal POSITION control. Note that it now positions the REF3 waveform independently of other waveforms.

**NOTE**

*REF waveforms can be horizontally positioned only when the HORIZ POS REF menu is displayed. One and only one REF is always selected, as indicated by the underline. (If INDLOCK is set to LOCK, it doesn't matter which REF is selected since the REF waveforms are positioned in unison with each other and the VERT mode waveforms, whether displayed or not.) The HORIZONTAL POSITION menu must be displayed for the Horizontal POSITION control to position a reference waveform either independently or in unison.*

## ***Operation***

---

11. Select REF1P to be positioned horizontally, and position that reference waveform using the Horizontal POSITION control.

Although we could use the DISPLAY REF menu and the ACQUIRE front-panel button to turn off the REF waveforms and return to "live" acquisition mode, let's use the stored front panel we saved earlier in this section...

12. Recall the stored dual-channel front panel by doing the following:

- a. Push PRGM and select RECALL from the SEQUENCE menu.
- b. Use the SELECT arrows in the RECALL menu to underline the label (FP1) of the sequence you created for the dual-channel setup.

Press RECALL to implement the selected setup.

## ***Using Dual-Channel Displays***

1. Press VERTICAL MODE and select ADD. Three displays should now be present: CH 1, CH 2, and ADD. Observe that the CH 1 and CH 2 SAVED signals are digitally added together; it is not necessary to acquire a signal in ADD Vertical mode to obtain the ADD display.

2. Turn off the CH 1 and CH 2 displays. Check that the ADD display is four divisions in amplitude.

3. Use the CH 1 and CH 2 Vertical POSITION controls to observe that both controls position the ADD trace.

4. Press CH 1 COUPLING/INVERT panel button and turn CH 1 INVERT ON. Observe that the ADD display, the CH 2 signal minus the CH 1 signal, is reduced to approximately a baseline trace.

5. Press the CH 2 COUPLING/INVERT panel button and turn CH 2 INVERT ON. Observe that the ADD trace, the inverted CH 1 signal plus the inverted CH 2 signal, returns to four divisions in amplitude.

6. Turn on the CH 1 and CH 2 displays.



7. Press the SAVE button, then push the STACK REF button in the displayed menu. STACK REF treats the SAVEREF memories as a stack and automatically saves the CH 1 signal in REF 1, the CH 2 signal in REF 2, and the ADD waveform in REF 3.

8. Press the Vertical MODE button and turn off ADD.

9. Switch the display to XY mode and observe the display of CH 1 versus CH 2. In an XY display, the CH 1 signal is supplying the X-axis (horizontal) deflection and CH 2 is supplying the Y-axis (vertical) deflection. Therefore, the CH 1 Vertical POSITION control moves the display horizontally and the CH 2 Vertical POSITION control moves the display vertically. The Horizontal POSITION control does not position the XY display, but it does control which 512 data points of the 1024 data point record are displayed.

10. Return the display mode to YT and turn off CH 2.

### ***Review of ENVELOPE and AVG (Average) ACQUIRE Modes***

If you performed the introductory procedure in Section 1, this next exercise is a review and you can skip ahead to "Using SINGLE SEQ Trigger Mode" without missing information.

1. Press the ACQUIRE panel button. Next, press the ENVELOPE menu button several times, changing the number above the label each time. (This is how you vary the number of acquisitions that contribute to the ENVELOPE display before the sequence resets.)

2. Continue to press the ENVELOPE menu button until CONT (continuous) appears above the label. Now the instrument saves the cumulative maximum and minimum values for each sample point without resetting.

3. Use the CH 1 Vertical POSITION control knob to move the waveform up and down. Observe how the display grows vertically to approximate the effect of amplitude changes and dc level shifts in the incoming signal.

4. Now push the ACQUIRE panel button again to erase the continuous ENVELOPE display and start the acquisitions for a new ENVELOPE sequence.

## **Operation**

---

5. Select BANDWIDTH and change the menu setting to FULL. Press ACQUIRE to return to that menu.

6. Select AVG (Average) acquisition mode and vertically reposition the trace to center screen. Press and release the AVG menu button until the number 2 appears above the label.

7. Repeatedly press the AVG menu button, stepping through the range from 2 to 256. Notice that the displayed waveform becomes cleaner as the number of averaged waveforms increases. This shows how Average acquisition mode improves the signal-to-noise ratio of the displayed waveform. (Table B-3 in Appendix B gives the expected improvement ratio versus the number of averages.) Return the AVG setting to 16.

8. Rotate the CH 1 Vertical POSITION control a small amount and observe that averaging for the display starts over (as seen by the increased noise).

### **NOTE**

*Any change in a front-panel control that affects the waveform data being acquired causes the AVG acquisition sequence to start over. Pressing the ACQUIRE button also starts a new acquisition sequence.*

## **Using SINGLE SEQ Trigger Mode**

With the SINGLE SEQUENCE mode, you can select an acquisition process that, when completed, does not start again until you direct it to. As the SINGLE SEQ acquisition completes, the scope switches to the SAVE Storage mode to freeze the waveform display. That waveform may then be saved for reference, transmitted to a data collection device, or analyzed as required before you start another acquisition. Let's use AVERAGE mode (ENVELOPE could also be used) to explore this feature...

1. Set the ACQUIRE Mode to AVERAGE 64.

2. Set the A TRIGGER MODE to SINGLE SEQ.

3. Watch the Trigger Status Indicators (TRIG'D, READY, and ARM). When they stop flashing (or the TRIG'D indicator light goes out, depending on the SEC/DIV setting) and the SAVE mode is entered, the single-sequence acquisition of 64 averages is complete.

4. Press ACQUIRE to restart the SINGLE SEQ, and again watch as the Trigger Status Indicators flash (or TRIG'D light remains on solidly) until the single sequence has completed.

You could STORE this saved waveform, if needed as a reference, in SAVEREF memory using the process you learned previously in the demonstration about SAVE and DISPLAY REF modes.

## Using the Cursors

### Volts Cursors

Leave the display as set up from the SINGLE SEQ demonstration to start this part of the procedure; you will make the measurements on the SAVERED CH 1 waveform.

Remember, in Section 1, how we measured the amplitude of the calibrator using the CURSOR FUNCTIONS? Let's review that procedure and also look at some other uses and modes for the CURSORS...

1. Press the CURSOR FUNCTION button, then select VOLTS to make voltage measurements.

2. Press the CURSOR UNITS button to call up the UNITS menu and select VOLTS for units. Set the  $\Delta$ :ABS menu choice to  $\Delta$ .

Delta mode ( $\Delta$ ) provides two cursors for voltage difference measurements. ABS cursor mode provides a single cursor, referenced to the ground-position indicator.

3. Move CURSOR/DELAY knob clockwise and counterclockwise. Observe how the "active" (dashed line) cursor is positioned. Set the active cursor to the top of the CALIBRATOR signal waveform.

4. Press the SELECT button and see that the second cursor becomes the active one. Position it to the bottom of the waveform display. The cursor readout now indicates the CALIBRATOR amplitude.

## **Operation**

---

Now let's look at some ABS (absolute) measurements...

5. Switch  $\Delta$ !ABS to the ABS cursor mode. Only one cursor will be displayed.

6. Position the VOLTS cursor to the ground indicator (a small "+" at the left edge of the screen) and observe that the readout is 0 volts when exactly aligned with ground. Cursor measurements in ABS mode are taken relative to ground level.

7. Set the VOLTS cursor to the positive peak of the waveform to see that the readout is positive (above ground) and equal to about  $\frac{1}{2}$  the total amplitude of the square wave. Position the cursor to the negative peak. Notice the readout is now negative (below ground) and has about the same absolute value (as you would expect with an ac-coupled, square-wave CALIBRATOR signal).

8. Switch back to Delta mode cursors and align the cursors with the top and bottom of the waveform as you did in Steps 3 and 4.

This instrument lets you store the difference between the cursors for use as a reference. You can then make ratiometric comparisons between the stored value and other voltages measured with the cursors. Let's see how it's done...

9. Press the NEW REF menu button. You have just saved the present VOLTS cursor difference (approximately 400 mV) as the reference level for making percentage and dB measurements.

As long as you leave VOLTS selected as the units, the readout indicates only the present voltage difference between the cursors. When % (percent) or dB (decibels) is selected, the measurement function becomes ratiometric.

10. Select % units. The VOLTS cursor readout should now read 100%.

11. Move the active cursor to the vertical center of the waveform.

Notice the readout changes to about 50%, indicating the cursors are measuring about 1/2 of the total amplitude of the CALIBRATOR signal which was stored as a NEW REF. If you position the cursor so it's separated by more than 4 divisions from the other cursor, the readout exceeds 100% since the amplitude is greater than that stored for NEW REF. See "Cursor Measurements" in Section 3 for more information on making ratiometric measurements.

### ***V@T Cursors***

These coupled cursors provide voltage readout for VOLTS cursors that are confined within the amplitude extremes of the waveform. Each VOLT cursor (one for ABS, two for  $\Delta$ ) reads the amplitude of the waveform at the point where its coupled TIME cursor is positioned. Since you can't move the TIME cursors horizontally off the waveform, measurements using these coupled cursors are limited to the waveform amplitude. As with the VOLTS FUNCTION, alternative units of measurement are % and dB.

1. Set the CURSOR UNITS to VOLTS in the  $\Delta$  cursor mode. Press CURSOR FUNCTION and select V@T.
2. Rotate the CURSOR/DELAY control to move the active cursor pair over several cycles of the waveform. Did you notice that the active (segmented) vertical cursor moves to the amplitude level corresponding to the placement of the active horizontal cursor? Also, notice that the active vertical cursor does not leave the waveform.
3. Position the active cursor pair to read the peak amplitude of a positive peak of the CALIBRATOR signal.
4. Press SELECT and position the second TIME cursor to read the peak amplitude of the negative peak.
5. Read the peak-to-peak voltage of the waveform.
6. Press UNITS to display that menu. Push the NEW REF button, set the CURSOR UNITS to ABS mode, and select % units for the measurement.

## **Operation**

---

7. Read the peak amplitude as a percent of the reference you set in Step 6.

8. Position the cursor pair to the opposite peak of the signal and read the percentage. With AC input coupling, the percentage difference is a measure of the nonsymmetry of the CALIBRATOR square wave. (The difference is typically small.)

### **SLOPE Cursors**

SLOPE cursors behave just like V@T cursors. The readout is given in VOLTS/SEC to indicate slew rate or slope (rate of voltage change with time). Another unit of measurement for SLOPE cursors is percentage, used when comparing against a reference slope. SLOPE measurements require that delta cursors are on at all times; therefore, the  $\Delta$ !ABS label is omitted from the SLOPE UNITS menu.

The CALIBRATOR signal is a poor signal source for displaying SLOPE measurement unless the SAVE horizontal expansion is used. That is because the CALIBRATOR signal frequency changes for different settings of the SEC/DIV switch. The following procedure simulates an increased rise-time signal for demonstrating the SLOPE cursors.

1. Select SLOPE in the Cursor FUNCTION menu; then select SLOPE in the Cursor UNITS menu.

2. Use the Horizontal POSITION control to place the Trigger Point Indicator T, and the rising edge of the CALIBRATOR signal, on the center vertical graticule line.

3. Use the SELECT button and the Cursor Position knob to place both time markers of the SLOPE cursors on the trigger point.

4. The scope should still be in SAVE from the previous procedure. Advance the SEC/DIV switch to 5  $\mu$ s. This expands the display by a factor of 100 times and produces a display with noticeable rise time.

5. Position the SLOPE cursors to bracket a linear portion of the leading edge and check the SLOPE readout.

6. Change the position of the SLOPE cursors to bracket a portion of the waveform with a different slope and observe how the readout varies.

7. Switch the SEC/DIV setting back to 500  $\mu$ s.

**NOTE**

*The user must determine the sign of the slope from observing the waveform.*

**TIME Cursors**

TIME cursors enable rapid measurement of period, pulse width, or time difference in seconds. Alternative units, used for making ratiometric measurements, are % (percent) and DEGREES. Choose % from the UNITS menu to express your measurement as a percentage of the reference value; choose DEGREES to find phase differences between your measurement and the reference.

1. Press the CURSOR FUNCTION button and select TIME cursors.

2. Press the CURSOR UNITS button and select SEC for the time readout units.

3. Position the active cursor (the cursor with the most dots) to one of the rising edges of the displayed CALIBRATOR square-wave signal.

4. Press SELECT to activate the other cursor and position it to the next rising edge (either left or right, as convenient).

**NOTE**

*The waveform record is 1024 data points long; the display is 500 data points long. Since cursors may be positioned anywhere within the record length, the TIME cursors may be used to scroll through the complete record merely by positioning the active cursor from one end to the other.*

5. Read the time of one period of the CALIBRATOR signal.

6. Press NEW REF to set the reference value to the period of the CALIBRATOR signal.

## **Operation**

---

7. Now select the % units for the TIME cursor readout. Observe that the readout is 100%.

8. Measure the percentage of the first half cycle of the CALIBRATOR period compared to the whole period. Then measure the second half cycle. Are both half cycles of the CALIBRATOR square wave equal? (There is usually a small difference because the CALIBRATOR signal is not perfectly symmetrical.)

9. Position the TIME cursors for 100% at the original measurement points and select DEGREES units for the TIME cursors readout. Observe that the readout switches to  $360^\circ$  (one complete period =  $360^\circ$ ) when the cursors are correctly aligned.

10. Position the active cursor to the falling edge at the center of the CALIBRATOR signal period. Observe that the readout is approximately  $180^\circ$ .

11. Select SEC units for the TIME cursors and switch to ABS cursor mode.

12. Position the displayed cursor (only one in absolute mode) to the Trigger Point Indicator. Use the TIME cursor to scroll the display if the Trigger Point Indicator is not presently displayed near center screen horizontally.

13. Position the cursor to the left and to the right of the Trigger Point Indicator. Time is measured relative to that trigger point, and the time readout is negative when the TIME cursor is positioned before (to the left of), and positive when positioned after (to the right of), the Trigger Point.

### **1/TIME Cursors**

When you select 1/TIME as the Cursor function, Hz replaces SEC in the UNITS menu. You can now conveniently measure a signal's frequency because the scope automatically performs the calculation that converts seconds to hertz. If you want to express your measurement's frequency as a percentage of the reference frequency, choose % from the UNITS menu. For phase measurements, choose DEGREES; they work exactly the same as with TIME cursors.

1. Use PRGM to recall the front-panel setup FP1. (See Step 7 of "Storing Front-Panel Setups.")



2. Select 1/TIME cursors from the CURSOR FUNCTION menu.

Notice that when you selected the Cursor function, you also called up a target menu for CH 1 and CH 2. Whenever more than one signal is displayed, the target menu lets you specify the source to be used for cursor measurements. The readout for cursor measurements can then be scaled to take into account the settings (VOLTS/DIV, etc.) of the specified source.

Since the measurement is 1/TIME, and both CH 1 and CH 2 are acquired and displayed at the same SEC/DIV setting, the target selected in this case doesn't matter.

3. Push CURSOR UNITS and set to Hz.

4. Position the 1/TIME cursors to bracket one full period of the CALIBRATOR square wave. Verify that the frequency readout is very near 500 Hz.

5. Press NEW REF to replace the reference with the newly-measured frequency. Set the UNITS to % and check that the readout is 100%.

6. Set the SEC/DIV switch to 5 ms and, if necessary, reposition the CURSORS to define one full period of the displayed CALIBRATOR square wave.

7. Observe that the percentage readout is 10%, indicating that the CALIBRATOR signal frequency is now 10% of the reference frequency.

8. Switch UNITS to Hz and read the frequency ( $500 \text{ Hz} \times 10\% = 50 \text{ Hz}$ ).

## ***DELAY Features***

### ***DELAY by TIME***

The Delay-by-Time function is used with the A INTEN and B Horizontal modes. A INTEN mode is used to locate areas of interest within the A waveform record for closer examination using B Horizontal mode. Using  $\Delta$  TIME delay mode, precise timing measurements can be made between two points on a single channel (for pulse width and rise-time measurements) or between single points on different channels (for propagation-delay measurements).

Delay time may be set to many times the B SEC/DIV setting (5242.8 times for most B SEC/DIV settings--see Section 6). This means that B Delay acquisitions are not confined to within the time set by the A time base, and that the intensified zone will not be present on the A waveform record if the delay is set to more time than the total A record length. We start the procedure with setup conditions that set the delay time for a visible intensified zone on the A waveform record.

1. Recall the front-panel setup FP1.
2. Press the DELAY by TIME button. Then turn and hold the Cursor/Delay control fully counterclockwise to set the delay time to its minimum setting, as shown in the DELAY TIME readout.
3. Select A INTEN Horizontal mode and turn the A and B SEC/DIV knob clockwise until the B acquisition rate is 50  $\mu$ s.
4. Press the Intensity SELECT button and switch between DISP and INTENS, using the INTENSITY knob to adjust the levels for a visible intensified zone on the trace.
5. Press the DELAY TIME button again to return the delay time readout to the CRT.
6. Hold the Horizontal POSITION control counterclockwise to position the end of the waveform record to center screen.

7. Turn and hold the Cursor/Delay control clockwise to increase the delay-time setting. Observe that the intensified zone moves off the A trace when the delay time exceeds the time between the A trigger point and the end of the A record.

**NOTE**

*If the intensified zone is not present on the A trace in A INTEN Horizontal mode, it might be that the delay time exceeds the time from the A trigger point to the end of the A record.*

8. Recenter the A trigger point marker on the center vertical graticule line.

9. Reduce the delay time to minimum to bring the intensified zone on the display.

10. Select B Horizontal MODE and observe the B waveform record acquired at 50  $\mu$ s/div.

11. Rotate the Cursor/Delay control to observe the effect on the position of the delayed waveform.

12. The delay time readout is the amount of elapsed delay from the A Record Trigger to the B Record Trigger. Decrease the delay time to minimum.

13. Turn on  $\Delta$  TIME delay mode and select A INTEN Horizontal mode again.

14. If necessary, press the TIME button to underline the  $\Delta$  DELAY TIME menu label and set the corresponding delay time to minimum.

15. Set the B SEC/DIV to 10  $\mu$ s.

16. Now increase the  $\Delta$  DELAY TIME to about 2 ms, positioning the second intensified zone on the rising edge of the next cycle of CALIBRATOR signal to the right of the A Record Trigger point.

17. Switch to B Horizontal mode, and use the Cursor/Delay control to precisely align the two leading edges. (This is a fine adjustment, and you may need to increase the intensity to make the leading edges visible. Also, there will be a little trigger jitter.) You have now precisely measured the period of the CALIBRATOR square wave as indicated by the  $\Delta$  DELAY TIME readout.

## Operation

---

18. Turn  $\Delta$  TIME off. The DELAY TIME readout is the time elapsed from the A Record Trigger to the B Record Trigger.

19. Hold the Cursor/Delay control clockwise until you reach 52.429 ms, which is the maximum delay time at 10  $\mu$ s per division. (If  $\Delta$  TIME were on, it would be the maximum total delay of DELAY TIME plus  $\Delta$  DELAY TIME.)

20. Switch the B SEC/DIV setting to 5  $\mu$ s. Observe that the DELAY TIME readout is reduced to 26.214 ms, the maximum delay time possible for 5  $\mu$ s per division.

### NOTE

*When dealing with long delays at a particular B SEC/DIV setting, switching to the next faster B SEC/DIV setting will cause the DELAY TIME setting to be limited to the maximum for that SEC/DIV setting. The delayed waveform will be relocated in time, and you must reset the DELAY TIME to the desired value when switching back to the slower SEC/DIV setting. Also, if  $\Delta$  DELAY is on and the sum of the DELAY TIME plus the  $\Delta$  DELAY TIME reaches the maximum limit, any further increase in the DELAY TIME setting causes the  $\Delta$  DELAY TIME setting to decrease (down to zero if the DELAY TIME is increased to its maximum limit).*

## DELAY by EVENTS

With this delay feature, you can delay the A Record Trigger by a selected number of B-trigger events. Since the B-trigger circuitry is the source of the events, proper B-triggering conditions must be set (LEVEL, SOURCE, CPLG, etc.).

1. Recall front-panel setup FP1. The initial setup conditions saved for the B trigger are: MODE—RUNS AFTER; SOURCE—CH 1; CPLG—AC. Verify the trigger conditions by pushing the TRIG STATUS front-panel button.

2. Press A/B TRIG to display the B Trigger Level readout and set the LEVEL for 0 V. A level of 0 V with AC trigger coupling sets the level in the middle of the trigger signal and assures that triggering occurs.

3. Set the A SEC/DIV switch to 50  $\mu$ s. This yields a high enough CALIBRATOR signal frequency so that you won't have to wait very long for all the events to occur when the EVENTS COUNT is high.

4. Press the DELAY EVENTS button and turn EVENTS ON.

5. Use the Cursor/Delay control to set the EVENTS COUNT to 1, if not already there. The count will wrap around the end counts from minimum to maximum or maximum to minimum if the control knob is held in the rate region for a moment after the end count has been reached.

Notice the rate at which the display is continuously updating. In the next three steps, watch the effect on the update rate as you increase the EVENTS COUNT.

6. Increase the EVENTS COUNT number up about 1000 counts. Notice that the update rate is slowed slightly.

7. Increase the count to about 10,000 counts. Notice that now the display takes several seconds to update. Notice also that the Trigger READY Indicator can be seen slowly flashing; its rate indicates the length of time between A acquisitions. A new waveform is acquired only after the set number of B-trigger events has been counted.

8. Increase the EVENTS COUNT to maximum (65536), and then hold the control hard clockwise for a few seconds to wrap the count back around to 1.

9. Adjust the B-Trigger LEVEL to a point where the waveform stops updating (outside the  $\pm 200$  mV range).

10. Press STATUS/HELP and observe that the trigger message reads TRIG WAIT: EVENTS and that the EVENTS COUNT = 1. These messages tell you that no events are occurring. Probable causes are: wrong trigger level, wrong source, or wrong coupling.

11. Reset the B-trigger level to start acquiring again (set to 0 V) and push STATUS/HELP twice to rewrite the status display.

12. Note that the trigger message has changed to COMPLETING ACQUISITION.

## Extended Features

The following features allow you to operate the instrument in modes not usually available with conventional oscilloscopes. The Auto Setup feature is demonstrated first, followed by two automatic measurement features. Finally, the AutoStep Sequencer is demonstrated.

Remember how Auto Setup was used in "Get Acquainted" to quickly get you a usable display of the CALIBRATOR output? It turns out that the calibrator isn't the best signal to use to explore Auto Setup and the other Extended Features because the calibrator period and amplitude vary with the SEC/DIV setting. To explore the Extended Features, you need to obtain the following equipment:

**Table 2-1  
Equipment Required**

Item	Requirements	Recommended
1. Calibration Generator	Capable of outputting a square wave signal with an amplitude between 20 mV and 20 V. It should also have a period of 1 ms and a rise time longer than 50 ns, but less than 70 $\mu$ s.	TEKTRONIX PG506 Calibration Generator <sup>a</sup>
2. Coaxial Cable Connectors: BNC	Impedance: 50 $\Omega$ . Length: About 40 inches.	Tektronix Part No. 012-0057-00
3. Dual-Input Coupler	Connects: BNC female to dual-BNC male.	Tektronix Part No. 067-0525-01

<sup>a</sup>Requires a TM 500-Series Power-Module Mainframe.

### Using Auto Setup

1. Recall the front-panel setting FP1. Select VERTICAL MODE and turn off CH 2.
2. Connect the Standard Output of the Calibration Generator to CH 1 and CH 2 inputs through a 50- $\Omega$  cable and a dual-input coupler.
3. Set the generator's output to .5 V (the generator's frequency should be 1 kHz).
4. Push the front-panel button labeled AUTO to do an Auto Setup on the input waveform for CH 1.

The scope displays the message AUTOS SETUP WORKING: PLEASE WAIT as it acquires information about the CH 1 waveform. Once it has characterized the waveform sufficiently to allow vertical and horizontal scaling, the waveform is sized to yield a usable display on-screen.

When Auto Setup is executed, it uses the mode selected in the Auto Setup menu. When you did an Auto Setup in Step 4, the mode selected was VIEW, which is designed to yield a display of 3 to 5 cycles over 10 divisions. This gives a good overall display. (In case you're wondering, you selected VIEW mode when you reestablished the front-panel setup in Step 1.) Let's try some other modes...

5. Push the bezel button labeled PERIOD. Note that the menu entry RES HI:LO appears. Push the AUTO button.

In this mode, the scope automatically sets the acquisition rate so that about 1 cycle of the waveform, triggered on the positive TRIGGER SLOPE, is displayed on screen. (PERIOD and VIEW always trigger on the positive edge of the waveform; you can change the TRIGGER SLOPE manually if you wish.) The waveform is vertically scaled so that the waveform fits in about the center 5 divisions on screen.

The RES HI:LO entry you noted determines how the scope sizes the waveforms in the parameter-oriented modes (i.e., all modes except VIEW). This instrument has a 20-division horizontal record length. When resolution is set to low, the parameter associated with the mode (in this case, PERIOD) is sized for best display over the 10 divisions on screen.

## Operation

---

6. Switch RES HI:LO to HI and do another Auto Setup.

Notice that the period of the waveform is now spread over more divisions; in fact, it may not be completely contained within the 10 divisions on screen. For RES HI settings, the parameter associated with the mode is contained within the 20-division record length. You may have to position the trace horizontally to view the entire parameter. By spreading the parameter over more divisions, more sample points are obtained for the parameter. This yields better RESolution of the waveform.

The other modes are PULSE and EDGE. The vertical and horizontal scaling is similar for these modes. Briefly, in PULSE mode the scope does an Auto Setup which displays a positive or negative pulse. (The pulse is defined as that part of the rectangular waveform's cycle having the *least* time duration). EDGE mode yields a display of the rising or falling edge of the waveform depending on the EDGE mode setting. The horizontal resolution for both PULSE and EDGE mode is determined by the RES HI:LO setting the same as for PULSE. These modes are covered in detail in Sections 3 and 5. Let's look at PULSE...

7. Set PULSE mode on and execute another Auto Setup.

Notice that the positive section of the waveform is treated as a positive pulse and horizontally scaled to fit in about 20 horizontal divisions for the HI RES setting.

8. Switch RES to LO and reexecute Auto Setup. Notice the reduced horizontal scale (i.e. slower SEC/DIV setting).

9. Set the Auto Setup mode to PERIOD.

10. Push the VERTICAL MODE front-panel button. Turn CH 2 on.

11. Execute an Auto Setup.

Auto Setup can also make adjustments for various VERTICAL MODES. In this case, the waveforms in both CH 2 and CH 1 were sized to about 3 divisions and displayed overlapped at the vertical center of the screen. (Adjust vertical positioning slightly to see both waveforms.)



12. Set the Auto Setup mode to VIEW and do another Auto Setup.

Notice that this time the waveforms are scaled for about 2 divisions with the CH 1 waveform centered vertically around the graticule 2 divisions above graticule center and the CH 2 waveform centered around the graticule line 2 divisions below graticule center. Since in View mode it's assumed you want to see and compare waveform amplitudes, the waveforms are offset vertically on screen. If PULSE, PERIOD, or EDGE is selected, it's assumed that you are more interested in comparing time differences between waveforms. Therefore, the channels are displayed overlapped.

Before leaving Auto Setup, it's important to stress that various front-panel settings for VERTICAL MODE, TRIGGER SOURCE, and Auto Setup all influence how it operates. In general, VIEW mode will produce a usable display whenever a trigger source signal is available in the display source (CH 1 or CH 2) selected from the VERTICAL MODE menu, provided the signal can be triggered in AUTOLEVEL trigger mode. The sources the scope uses to trigger and size the displays vary with the front-panel conditions you set up. Read the description for control number 47, AUTO, in Section 5 and the applications for AUTO in Section 3. Once finished, you should be ready to use this convenient feature in all its modes.

### **Using MEASURE**

1. Recall FP1, the procedure stored earlier in this section. Turn off CH 2.
2. Push AUTO to do an Auto Setup on the CH 1 waveform. Since Auto Setup executed in VIEW mode, you should have several cycles of the square wave displayed on screen.
3. Press MEASURE (next to PRGM) to display that menu, then press the SNAPSHOT menu button.

You have just executed the Snapshot mode for the Measure feature. It allows you to see at a glance many of the characteristics of the waveform for a single acquisition.

## Operation

---

Realize that the accuracy of these measurements depends on the front-panel conditions set up. For instance, since we used Auto Setup in the VIEW mode, several cycles of the waveform are displayed on screen. This means that few sample points were obtained for the high-frequency components of the waveform. Those measurements relating to high-frequency components, such as RISE and FALL (rise- and fall-time) and OVR5 and UNDS (over- and undershoot), should be discounted for this setup. However, since we obtained complete cycles of the waveform, we can trust those measurements related to amplitude and frequency, such as P-P (peak-to-peak voltage), TOP and BASE (voltage at the Top and Bottom levels of the waveform, respectively), FREQ (frequency), etc.

In general, the screen tells you whether a particular parameter is valid or not. If you can't see the front-corner aberrations or you note that the rise time comprises little of the 20-division acquisition, you should set up the scope to display those parameters adequately. Let's do that now for the front edge of the waveform...

4. Press AUTO to display its menu. When Auto Setup finishes executing, set the mode to EDGE (  ) and RES to HI. Now do the Auto Setup for EDGE mode. Notice that in the resulting display the front corner is spread over several divisions.

5. Do another snapshot of the waveform. See Step 3 if you don't remember how.

Since the leading edge of the waveform is spread over several divisions, it now makes sense to use the measurements related to the front corner.

Note that some of the parameters have a string of "?" marks displayed instead of the parameter value. When the instrument cannot extract the parameter, it so indicates by displaying the string. In this case, since we used the EDGE mode to display the front corner of the waveform, the scope did not acquire an entire cycle of the square wave and could not extract those parameters pertaining to the period of the square wave.

6. Change the generator output to 1 V and push the menu button labeled AGAIN. The screen is updated with a new snapshot of the single acquisition of the waveform. (Note the new values for TOP and BASE.)

7. Select the VERTICAL MODE menu and turn on CH 2, leaving CH 1 turned on, also.

8. Press AUTO to display its menu. Change the mode to VIEW and re-execute Auto Setup.

9. Select the MEASURE menu. Set WINDOW OFF in the menu.

10. Push the menu button labeled MEAS TYPE.

The matrix you've displayed allows you to select up to four parameters that you wish to extract from the waveform. (When you select a parameter, DISPLAY in the MEASURE menu is automatically set to ON.) Selected parameters will be displayed on screen and continually updated for subsequent acquisitions. Let's select some parameters...

11. One parameter in the matrix is underlined (DISTAL). Push the button labeled ON in the menu. Note that the matrix menu is replaced by a target menu. Use it to select the waveform for which you want to see the parameter displayed. The target menu always appears after you select a parameter or execute a snapshot measurement if more than one display source is on screen.

12. Select CH 2 from the target menu. Since DISPLAY automatically turns ON in the main measure menu, the scope displays the parameter name and value on screen, along with the chosen display source. (It displays a default display source until you choose one.) Note that the parameter menu is also returned for further parameter selection.

Look at the parameter name you turned on in the parameter matrix. It's still underlined, but now there are two asterisks displayed, one on each side of the parameter name. The asterisks indicate which parameters are on so you can see that they are turned on regardless of whether DISPLAY is ON or OFF in the main MEASURE menu.

13. The arrow-labeled buttons allow you to select any parameter in the matrix. When you push an arrow button, the underline moves in the direction indicated.

14. Use the arrow-labeled buttons to move the underline to PERIOD in the matrix. Note that, as the underline moves away from the parameter you turned on, the parameter is no longer underlined; the underline selects the parameter, and the asterisks tell you when it's on.

15. When PERIOD is underlined, turn it on and select CH 1 as the target. The CH 1 period should be displayed.

## ***Operation***

---

16. Push ON to turn the PERIOD on again. Note that the target menu is displayed and a second CH 1 PERIOD readout appears on screen. This time select CH 2 as the target.

17. Turn DISTAL off in the matrix and turn PK-PK (peak-to-peak voltage) on. Select CH 1 as the target for PK-PK.

18. Increase the SEC/DIV setting 4 positions. Note that when the acquisition rate allows less than a complete period of a waveform to be acquired, the message NEED 3 EDGES replaces the parameter value in the readout. (Three transitions are needed to define a waveform cycle.) In general, the scope displays an error message if it can't extract the specified parameter.

19. Return the SEC/DIV back to its original setting. Now position the CH 1 waveform upward so that its top is several divisions off-screen. Notice that as the waveform exceeds the 10.24-division vertical-acquisition window, the message CLIP appears at left on screen. In general, the scope displays a warning message when it CAN extract a parameter, but detects a condition that makes the result questionable. A complete list of both error and warning messages is found in Appendix C of this manual.

20. Turn off CH 2 and center CH 1 vertically on screen.

21. Press MEASURE and set WINDOW on in that menu.

22. Press CURSOR FUNCTION and turn on the TIME cursors.

23. Use the CURSOR/DELAY control to move the active cursor toward the inactive one. Note that when the cursors no longer bracket at least one full cycle of the waveform, the message NEED 3 EDGES is displayed for the PERIOD measurements. Note also that the PK-PK voltage changes to approximately 0 Volts when the active cursor is superimposed on the inactive cursor.

When you switched WINDOW on in the MEASURE menu, you tied the measurements to the position of the TIME cursors. That's why, even though several cycles of the waveform are displayed on screen, you got the error message. There were not several cycles displayed *between the two cursors* when the message appeared.

24. Push MEASURE and select SETUP from the main MEASURE menu.

25. Set MARK ON/OFF to ON for the SETUP menu.

26. Move the active cursor so that the cursors bracket more than one waveform cycle.

Notice that two "X"'s appeared on screen. These are the markers you turned on in Step 25, and they indicate the points on the waveform where time-related measurements are being made.

27. Note the METHOD selections in the SETUP menu. These selections relate to the way the scope extracts waveforms.

28. Push LEVEL. This menu lets you define measurement reference levels on waveforms.

Let's learn more about the METHOD and LEVEL features by using HELP...

29. Push the STATUS/HELP button near the INTENSITY control. Select HELP from the menu displayed.

30. Push MEASURE.

The screen now displays a synopsis of MEASURE and its associated modes. The first two screens review some of the material you have already covered. (Why not read it as a review?) Use the menu key labeled MORE to step through the screens of information; METHOD and SETUP information is on screens 3 and 4. Push EXIT to return to Scope mode when finished.

The MEASURE feature is discussed in Section 5, "Controls, Connectors, and Indicators," and applications are found in Section 3. Also, in addition to other MEASURE-related information, Appendix C lists definitions of each parameter and the methods used for extracting those parameters.

### ***Using PRGM (AutoStep Sequencer)***

In this procedure, you have already used the AutoStep Sequencer to store front panels for later recall. While recalling front panels in this way is useful, AutoStep can be used for more powerful applications. Let's see how...

1. Connect the STD AMPLITUDE OUTPUT of the generator to CH 1 through a 50- $\Omega$  coaxial cable. Set the generator output for a 5-V, 1-kHz square wave.

We are going to assume that this waveform needs to be characterized for rise and fall times, top and base levels, and total amplitude peak-to-peak. What's more, we'll use our imagination and assume that this waveform is present on several instruments, so we need to make these measurements once for each instrument.

2. Recall the front panel you stored earlier. We will use it as a basis for our sequence steps.

3. Push the button PRGM and select SAVE from the AUTOSTEP SEQUENCER menu. Give the sequence a label (like TEST1) using the menu displayed.

4. When you have assigned the sequence a label, push the menu button SAVE to store the name and proceed with creating the sequence.

From the message on screen, you can see that this is where we set up the front panel for Step 1. Since we only want to make sure the instrument is operating properly and is set up to make the most accurate measurements possible, let's not change any front-panel settings now, but just proceed to the ACTIONS menu. We will use Auto Setup later, in Step 2.

5. Push PRGM to move to the ACTIONS menu for Step 1.

You have now displayed the ACTIONS menu for the first step of your sequence. Notice that the display indicates the flow of events by labeling the beginning and end of the step and the events that occur between them. (The ACTIONS menu is a kind of time line for the substeps that occur for each step). Actions followed by <N> (off) are not executed when the step is recalled; actions followed by <Y> (on) are executed. The LOAD STEP and MEASUREMENT events cannot be set; therefore, they are not marked either Y or N. They are in the menu to show when they occur relative to the actions that can be set.

Find the line under the Y or N following one of the actions. The arrow-labeled menu buttons are used to move that underline up and down in the ACTIONS menu to select the action desired.

6. Use the arrows in the menu to underline the SELF-CAL action and push Y/N to toggle that action on (Y). Repeat for the SELF-TEST and PROTECT action. (PROTECT keeps the sequence from being accidentally deleted). All other actions should be turned off.

7. Press NEXT STEP to exit the ACTIONS menu and store our first step.

The first step is now complete. When the sequence is recalled, the scope delivers the front panel you recalled prior to labeling this sequence (in procedure-Step 2), since you made no changes to the front panel when you created the step. Prior to recalling (loading) the front panel, it executes the SELF-CAL and SELF-TEST routines, since you selected those actions for Step 1.

8. The menu for setting up Step 2 is now displayed. Change the VERTICAL MODE setting to display CH 1 only, and change the COUPLING for CH 1 to DC. These menu changes will cause the scope to Auto Setup on the DC-coupled square wave in CH 1, when you later include Auto Setup as an action for this step.

9. Execute Auto Setup to verify that the Auto Setup menu is set to VIEW mode. (If not, set it to VIEW.) When Auto Setup finishes, push MEASURE to display that menu.

10. Select MEAS TYPE from the menu and turn on the parameter TOP, BASE, and PK-PK (Peak-to-Peak) using the method outlined under the MEASURE procedure in this section (Steps 11 to 17 under "Using MEASURE").

11. This completes the front-panel setup for Step 2. Push PRGM to proceed to the ACTIONS menu.

## Operation

---

Note that the ACTIONS menu is left as you set it up for Step 1. This feature allows you to just push NEXT STEP if you do not wish to change those actions. In this case, however, you do not need to SELF-CALibrate or SELF-TEST the scope again. Also, now that you have set up the scope to measure the Top and Base levels of the waveform in Step 2, you probably need to PAUSE so the user of your sequence can record the measurements, take photographs of the display, etc. This is also where we turn on the Auto Setup action so it executes during the step in the mode verified in Step 9.

12. Set the SELF-CAL, SELF-TEST, and PROTECT actions off (N); set PAUSE and Auto Setup on (Y). SET BELL on, also, to signal the user when the measurements are ready to be recorded.

13. Set the REPEAT action on; (we will see why later when we execute the procedure). Push NEXT STEP when finished.

14. Execute Auto Setup to display that menu. Change the mode to EDGE (  $\_ /$  ) and RES HI:LO to HI.

15. Turn TOP and BASE parameters off and the RISE parameter on in the MEAS TYPE menu.

16. Push PGRM to proceed to the actions. Set REPEAT off, but leave the BELL, PAUSE, and Auto Setup on for this step. That way, the scope will pause and signal the user after it has set up on the waveform's rising edge and is displaying its rise time. This concludes Step 3 of the sequence.

17. Push NEXT STEP to proceed to Step 4. Execute Auto Setup to display that menu. Change the mode to EDGE (  $\_ \_$  ), and leave RES HI:LO set to HI.

18. Turn the RISE parameter off and set the FALL parameter on in the MEAS TYPE menu.

Notice that the rising edge is displayed on screen, and, since no falling edge is present, the FALL parameter value displayed is NO EDGE. When the sequence is stored and recalled, the falling edge of the waveform *will* be displayed along with the fall-time parameter.



When you proceed to the actions menu in the next procedure step, notice the order of events. The front panel is loaded and then the Auto Setup is executed. Since you executed Auto Setup in the rising-edge mode when you created Step 4, the front panel loaded for Step 4 displays the rising edge. You changed EDGE from rising mode to falling mode *after* you executed Auto Setup in Step 4, so when Auto Setup executes *as an action associated with Step 4*, the falling edge will be displayed.

19. Push PGRM to proceed to the actions. Again, leave the BELL, PAUSE, and Auto Setup as for Step 3.

This completes the sequence; now let's store it.

20. Push the menu button SAVE SEQ to save the sequence.

You have now labeled, created, and saved a four-step sequence. Let's review what you've done by running the sequence just saved...

21. Select RECALL from the main AUTOSTEP SEQUENCER menu. Use the arrow-labeled menu buttons to select your sequence and push RECALL to run it.

The sequence begins by executing Step 1. Notice that the message RUNNING SELF-CAL appears as the scope runs through that routine. Next, the display disappears for a time and the Trigger Indicator LED's flash as the instrument runs its SELF-TEST. (The message RUNNING SELF-TEST appears part way through the routine). After a few minutes, the scope should finish Step 1 and immediately, since we didn't set the PAUSE action for Step 1, proceed to Step 2.

At Step 2, the BELL should ring to signal you that Step 2 is complete. Note that the square wave is sized properly for VIEW mode, and the TOP, BASE, and PK-PK (Peak-to-Peak) voltage values are displayed using the MEASURE feature. All these events correspond to our Step 2 setup.

22. Push PRGM to proceed to Step 3. Note that the rising edge is now displayed with the rise-time measurement chosen for Step 3. The PAUSE and BELL actions were also executed.

23. Push PRGM to execute the last step and display and measure the falling edge of the waveform.

## **Operation**

---

Note that the menu still displays the message PUSH PRGM TO CONTINUE, even though we have already executed the last step of the sequence. Remember when we set the REPEAT action on for sequence-Step 2? This action causes the scope to loop back to Step 2 (or whichever step contains REPEAT) when the last step of the sequence is finished.

24. Change the generator output to the 10-Volt setting.

25. Push PGRM to branch back to the REPEAT (Step 2).

At the beginning of this procedure we said we had to make our measurements on several instruments. Here we just changed the amplitude setting of our generator, but you could change devices under test, test points to be measured, etc. as required. REPEAT is included in Step 2 instead of Step 1 so the scope can run an initialization routine (such as the SELF-CAL and SELF-TEST) once when the sequence is recalled and then skip the routine by looping through Steps 2-4 for successive measurements.

26. The scope is now at Step 2 of our sequence, with the 10-Volt square wave displayed with new Top, Base, and Peak-Peak levels shown.

We could go on to display the rise and fall times of the waveform, but let's just exit the sequence...

27. Push the menu button EXIT to get out of the sequence and display the RECALL menu. Push EXIT in the RECALL menu to return to the main AUTOSTEP SEQUENCER menu.

If you want to change the label of your sequence, you must copy the existing sequence, give it a new label, then delete the old sequence. Here's how it's done...

28. Select EDIT from the AUTOSTEP SEQUENCER menu, and use the familiar arrow-labeled buttons to pick out the sequence you wish to copy.

29. Press COPY to continue.

30. Now create the new label for your sequence as done in Step 3 of this procedure, and press SAVE when finished.

Note that the new label for your sequence appears in the list of current sequences. Now you can delete the old one:

31. Press EXIT to return to the main AUTOSTEP SEQUENCER menu.

32. Press DELETE to display that menu, and use the normal method to select the label of the sequence you want to delete.

33. Press DELETE to remove the sequence.

When you press DELETE you should hear the bell and see the message ERROR: PROTECTED. (Remember, you turned on the PROTECT action in procedure-Step 6.) The only way you can kill a protected sequence is to edit it. Here's a quick way to do that...

34. Push exit to return to the main menu and select EDIT.

35. Select the sequence you want to delete, using the usual method, and press EDIT to display the first step of that menu. Notice that the message displayed includes the sequence label and step number, along with information about how to change the front panel that was loaded for the step. Note also the menu label DELETE TO BUFfer. Here, we don't want to change the step, we want to delete it:

36. Press DELETE TO BUF.

To protect a sequence you must set the PROTECT action on for the sequence Step 1. (PROTECT in any other step is ignored). When you deleted the first step, you also deleted the actions, thereby removing protection for this sequence.

37. Push EXIT to return to the main menu and select DELETE from that menu.

38. Use the arrow-labeled buttons to select the sequence you have just edited. Press DELETE. Note that the sequence label is removed from the list.

## ***Operation***

---

There are ways to edit sequences besides merely deleting steps, but before we look at them, let's create a simple sequence that helps keep track of the steps we're going to edit...

39. Press EXIT to return to the main menu. Recall the front-panel setup we used at the beginning of this procedure. Disconnect the generator from CH 1.

40. Create the label "ED 1" and save it as you did previously.

41. Turn off CH 2 and position the CH 1 trace to the graticule line 3 divisions above graticule center. Push PRGM to advance to Step 1 actions.

42. Turn on only the PAUSE action. Press NEXT STEP.

43. Position the CH 1 trace to the graticule line 1 division above graticule center. Push PRGM to advance to Step 2 actions.

44. PAUSE should be the only action on. Press NEXT STEP.

45. Position the CH 1 trace to the graticule line 1 division below graticule center. Push PRGM to advance to Step 3 actions.

46. PAUSE should be the only action on. Press NEXT STEP.

47. Position the CH 1 trace to the graticule line 3 divisions below graticule center. Push PRGM to advance to Step 4 actions.

48. PAUSE should be the only action on. Save the sequence by pushing SAVE SEQ.

Let's look at the sequence...

49. Select RECALL from the main menu, then select and recall the sequence you just saved. Step 1 should now be displayed.

50. Use PRGM to step through the sequence, noting that the vertical position relates to the step number (most positive, Step 1; 2nd-most positive, Step 2, etc.). When you reach Step 4, the main menu is displayed. Press EDIT to change menus.

Let's use this new sequence to explore methods of editing sequences...

51. Select ED 1 from the list of sequences, then press EDIT.

As the message indicates, the front-panel for Step 1 of our sequence has been loaded. (Notice the vertical position of the trace.) You can now change this setup, if you wish.

52. However, since no changes are needed here, just push PRGM to call up the actions associated with Step 1.

53. Keep PAUSE and turn on BELL.

You have now edited Step 1—both the front-panel setup (although you didn't change anything) and the associated actions. (You could also have continued without changing any of the Step 1 actions by pressing NEXT STEP.) If no other steps were to be edited, you would push SAVE SEQ to quit the edit session and save the revised sequence. In this case, however...

54. Press NEXT STEP to save the revised step and continue editing.

You are now at Step 2. Let's not edit this step now.

55. Push the up-arrow button in the menu.

Note the step number in the message changes back to 1. This is how you select steps to edit: when the front-panel is loaded and this menu is displayed, you can use the arrow-labeled buttons to select any step in the sequence you want to edit.

56. Select Step 4 for editing. Notice, as you proceed through Steps 1-4, that each step is loaded for editing in its proper order.

## **Operation**

---

57. Instead of editing Step 4, you are going to add a step. Press ADD.

58. Center the trace vertically on screen. Select VERTICAL MODE and set YT:XY to XY. Push PRGM, and then push NEXT STEP (without changing any actions).

The new step is now added as Step 5. Since Step 6 doesn't exist, the scope can't proceed; instead, it displays WARNING: NO MORE STEPS TO EDIT.

If you had selected Step 2 for editing (rather than Step 4) and had then pressed ADD, the new step would have become Step 3 and the remaining steps in the original sequence would have been incremented by one. ADD puts the new step *after* the step selected and pushes the following steps down as a stack.

You can move a step from one position in the sequence to another by deleting it to a buffer and adding it back in wherever you want.

59. Press DELETE TO BUF to delete the step you just added. Use the arrow-labeled buttons to move to Step 1.

60. Press ADD. When the menu changes, press LOAD BUFFER. Press PRGM to get the actions menu and select NEXT STEP. Step 5 has now been moved to Step 2, and Steps 2-4 have become Steps 3-5. Using the arrow buttons, go through all the steps of the sequence so you can verify the changes.

What if you want to add a step *before* Step 1? That also can be done. Move to Step 1 and add the new step. (You have already done this in procedure Steps 59 and 60.)

61. Select Step 1 and push DELETE TO BUF.

62. Press ADD and, when the menu changes, LOAD BUFFER. Then press PRGM followed by NEXT STEP to save what you have done.

When you deleted Step 1, Step 2 moved to Step 1. When you added the deleted Step 1, it was inserted after the new Step 1.

63. Return to Step 1 and press DELETE TO BUF. This should restore our sequence to its original 4 steps.

Copying steps is very similar to moving them. Let's put a copy of Step 3 after Step 4...

64. Select Step 3 and press DELETE TO BUF.

65. Select Step 2 and press ADD; when the menu changes, press LOAD BUFFER. Push PRGM, then NEXT STEP. You have just restored Step 3 to its original place in the sequence, but a copy of it remains in the buffer.

66. Select Step 4. To finish putting a copy of Step 3 after Step 4, press ADD, followed by LOAD BUFFER, PRGM, and NEXT STEP. You can use the arrow buttons to step through the sequence and verify that you've copied Step 3 and put it after Step 4.

In general, to copy a step to another location: delete that step to the buffer, then use ADD twice, once to put it back in its original location and once to put it in its new location.

This completes the Operators Familiarization Procedures. Although most of the controls and functions have been exercised in these procedures, not ALL functions have been covered. As mentioned earlier, Section 5 describes in depth the function of each control, connector, and indicator. Section 3 contains applications for many 2440 features, and the Programmers Reference Guide provides GPIB-related information. Also, in Section 7 of this manual is a short familiarization procedure for the Video Option, for those instruments equipped with this option.





---

## ***Applications***

The Tektronix 2440 Digital Oscilloscope is an accurate and flexible measurement system. When familiar with the controls, indicators, operating considerations and capabilities of the instrument, you can easily develop your own method for making any particular measurement. This section demonstrates and discusses some applications for the various measurement features this oscilloscope offers. You can build on this information (along with information from other sections) when forming your own methods and applications.

This section is divided into four subsections. "General Applications" covers the more familiar graticule measurements of signal amplitude and time period. Vertical and horizontal display modes are also detailed. "Storage Applications" describes the various acquisition modes and their applications, as well as how those acquisitions can be stored and displayed. "Special Applications" deals with methods for making measurements using the highly accurate and versatile cursors. Finally, "Extended Features" looks at applications for the Auto Setup, MEASURE, and AutoStep Sequencer features.

The procedures for the various applications assume you are familiar with obtaining front panel setups. Some control settings may require menu setups not fully described. In general, each procedure outlined assumes the Front Panel control settings in effect after an INIT PANEL is performed. All control and menu operations are explained in Section 5 of this manual, "Controls, Connectors, and Indicators." Additionally, the "Getting Acquainted" procedure (Section 1) and "Operators Familiarization" (Section 2) will help show the first-time user how this scope operates.

## **General Applications**

This oscilloscope has two channels (CH 1 and CH 2) available for signal input and display. The two channels can be displayed alone or together. They can be added or multiplied algebraically and the results can be displayed alone or with other display sources. The following applications illustrate the method for graticule measurements as well as some uses for the ADD and MULT Vertical modes.

### **Voltage Measurements**

#### **Peak-to-Peak Voltage**

Use the following procedure to make peak-to-peak measurements on signals:

1. Input the signal into CH 1 or CH 2 and trigger the display. Adjust the VOLTS/DIV and SEC/DIV controls so the display is within the graticule area.
2. Vertically position the waveform so that its negative peaks are aligned with a horizontal graticule line. See Figure 3-1.
3. Count the number of divisions from the negative peaks to the positive peaks of the waveform.
4. Calculate the peak-to-peak voltage using the following formula:

$$\text{Volts (p-p)} = \text{Number of Divisions} \times \text{VOLTS/DIV Setting}$$

Example calculation for the waveform pictured in Figure 3-1:

$$\text{Volts (p-p)} = 4.8 \text{ div.} \times 500 \text{ mV/div} = 2.4 \text{ V}$$

#### **NOTE**

*The probe attenuation factor does not need to be taken into account when computing voltage amplitudes. The VOLTS/DIV readout on screen reflects the VOLTS/DIV setting and the probe attenuation factor.*

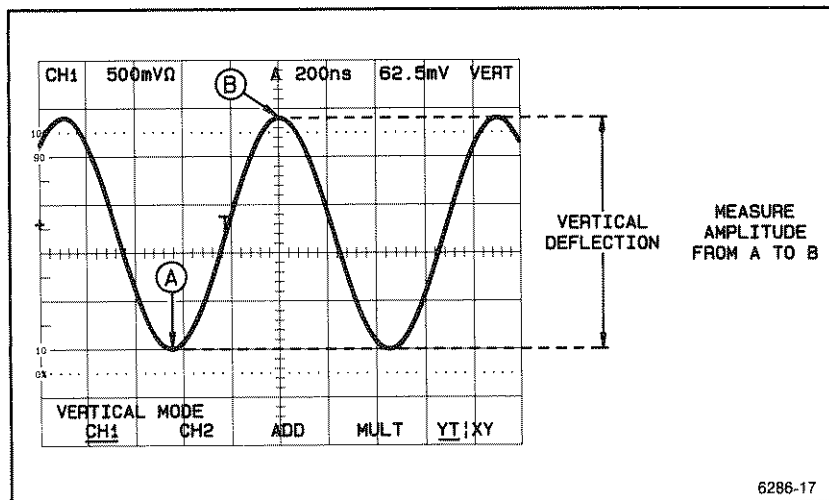

Figure 3-1. Sine wave peak-to-peak voltage.

### Instantaneous DC Voltage Level

Use the following procedure to make dc level measurements on signals:

1. Input the signal into CH 1 or CH 2 and trigger the display. Adjust the SEC/DIV control to display a few cycles of the waveform.
2. Adjust the appropriate VOLTS/DIV control for a setting that displays the waveform *and* the Ground Reference Indicator on screen. The Ground Reference Symbol is a small "+" at the left edge of the screen.

#### NOTE

*Do not adjust the VOLTS/DIV (Step 2) or the Vertical POSITION (Step 3) controls to display the ground reference symbol at the upper or lower graticule extremes. The symbol is limited to the graticule area, so it will not give a true indication when the ground reference is outside the graticule.*

### **Applications**

---

3. Vertically position the + indicator to a horizontal graticule line. Keep the waveform (or at least the point to be measured) on screen. See Figure 3-2.

4. Count the number of divisions between the measurement point and the +.

5. Calculate the dc voltage level using the following formula:

$$\text{Volts (DC Level)} = \text{Number of Divisions} \times \text{VOLTS/DIV Setting}$$

Multiply the result by a  $-1$  if the measurement point was below the + for Step 4; otherwise, the result is positive (assuming the channel used has not been inverted).

Example calculation for the dc level at point B of Figure 3-2:

$$\text{Volts (DC Level)} = 1.8 \text{ div} \times 10 \text{ mV/div} \times (-1) = -18 \text{ mV}$$

### **ADD Mode Measurements**

ADD Vertical mode can be used to add or subtract two waveforms. With the two waveforms displayed, one in CH 1, the other in CH 2, the ADD mode waveform is the algebraic sum of the two waveforms. Note that the ADD Vertical mode (as well as MULT) can only use CH 1 and CH 2 as signal sources for adding or subtracting. Use the following procedure to add or subtract two waveforms:

1. Input one signal into CH 1, the other into CH 2, and trigger the display. Adjust the SEC/DIV control to display a few cycles of the waveform.

2. Set CH 1 or CH 2 to INVERT ON if you want to subtract one waveform from the other.

3. Keeping their settings equal, adjust the CH 1 and CH 2 VOLTS/DIV controls so that the signal amplitude displayed on each channel is not more than about 3 divisions.

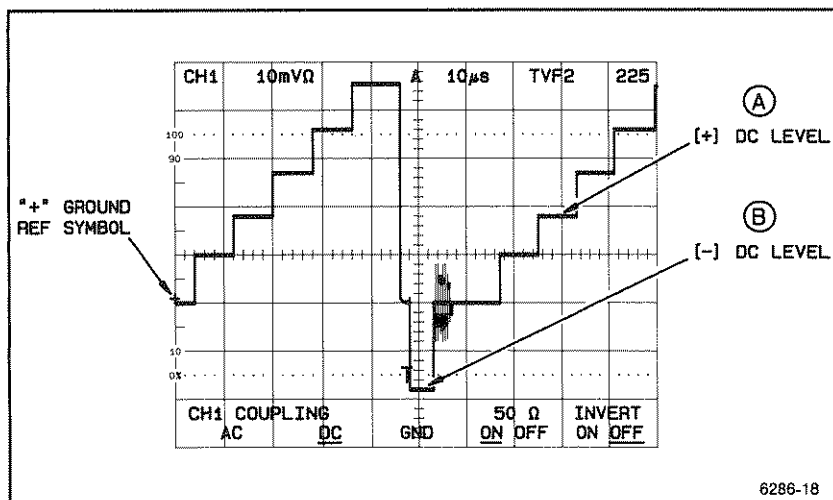

Figure 3-2. Instantaneous DC voltage levels on a waveform.

NOTE

If either signal is much greater than three divisions, the added waveform may extend vertically outside the graticule area. In that case, increase both VOLTS/DIV controls to the setting that results in 3 divisions or less for each channel.

4. Set the VERTICAL MODE to ADD. (It's easier to see the added waveform if you turn off CH 1 and CH 2.) Use the Vertical POSITION controls to position the waveform for measuring.

NOTE

The position of the ground reference (baseline trace) for the ADD mode waveform is based on the algebraic sum of the positions of the CH 1 and CH 2 ground reference traces.

Positions above the center graticule line are positive values; positions below the line are negative. As an example, if reference for CH 1 is one division above graticule center and the reference for CH 2 is 3 divisions below, the ADD mode ground reference will be two divisions below graticule center (+1 div + [-3] div = -2 div).

5. Use the general methods outlined in the previous two procedures to measure the peak-to-peak or dc level for the added waveform. The VOLTS/DIV setting for the ADD mode is indicated by the ADD readout.

## Applications

### Noise Reduction and Unwanted Signal Cancellation

The ability to add or subtract waveforms allows the following two useful applications. First, differential signals, such as the outputs of a paraphase amplifier, can be measured differentially to eliminate any common mode noise. Follow the basic procedure for adding two signals. Invert one of the channels to display the difference between the two added signals, while rejecting any common mode noise. If the exact amplitude of the added waveform is not critical, adjust the VARIABLE gain of one of the channels for best noise reduction. Figure 3-3 illustrates this method of noise reduction.

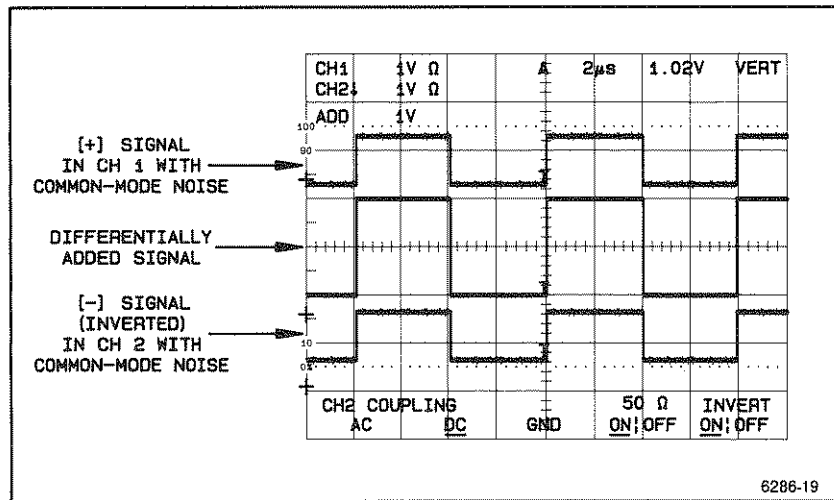

6286-19

Figure 3-3. Cancellation of common-mode noise for differential signals.

The second application is unwanted signal cancellation. In this case, the signal to be measured is riding on a large signal, as when a large ac hum is present. (See Figure 3-4.) Here, a source consisting of *ONLY* the unwanted signal is applied to one channel and the "composite" signal to the other. Invert the polarity of the unwanted signal and add the two channels, adjusting the VOLTS/DIV control and VARIABLE as necessary.

Use the following procedure to cancel an unwanted component from a signal:

1. Input the signal with the unwanted component to CH 1. Adjust the SEC/DIV control to display a few cycles of the waveform.

2. Input a source of the unwanted component to CH 2. Set INVERT ON for CH 2.

*NOTE*

*The phase of the source used for CH 2 should match that of the unwanted component in CH 1, if maximum elimination is to be obtained.*

3. Set the CH 1 VOLTS/DIV control to display about four divisions of signal amplitude.

4. Set the CH 2 VOLTS/DIV control so that the amplitude of the CH 2 signal is approximately equal to that of the unwanted component in the CH 1 display.

5. Use the CH 2 VARIABLE to match the CH 2 signal amplitude to the amplitude of the unwanted component in the CH 1 signal.

6. Set the Vertical MODE to ADD. (CH 1 and CH 2 may be turned off for easier viewing of the added waveform). Using the CH2 VARIABLE control menu, adjust the amplitude of the CH 2 display for maximum elimination of the unwanted signal component from the CH 1 display.

7. Use the general methods outlined in the previous procedures to measure the peak-to-peak or dc level for the added waveform. The VOLTS/DIV setting for the ADD mode is indicated by the readout.

Note that in the last procedure the signal applied to the CH 2 input was inverted for the sole purpose of canceling that signal component from the ADD mode waveform. In other words, we do not intend to measure the amplitude which the CH 2 signal contributes to the ADD mode signal, but we wish to use the CH 2 signal to eliminate the unwanted noise riding on the CH 1 signal. For such cases, the unwanted signal should always be applied via the CH 2 input, because when the CH 2 VOLTS/DIV and VARIABLE controls are adjusted for best elimination of the unwanted signal, the CH 1 VOLTS/DIV readout and VOLTS cursor measurements remain calibrated. In this way, a signal from perhaps the 200-mV winding of a transformer can be scaled up to eliminate a 2-V hum component. (See Figure 3-4.)

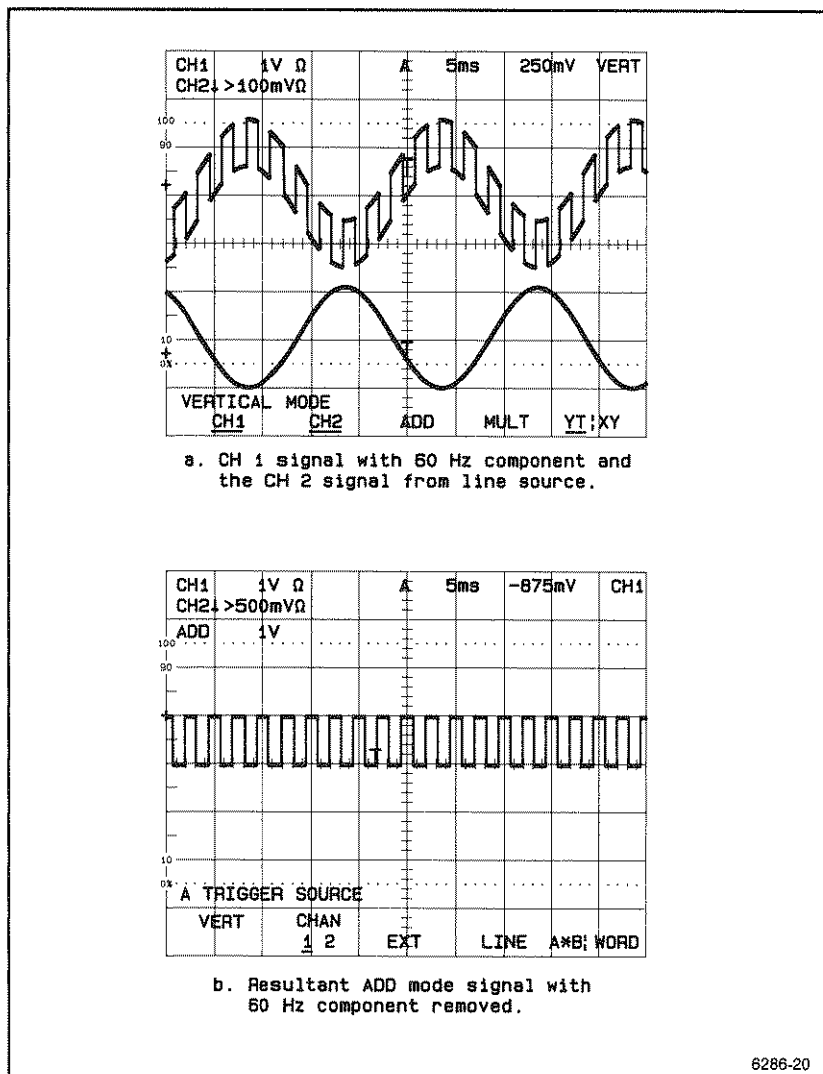

Figure 3-4 (a and b). Cancellation of an unwanted component in a signal.



When scaling CH 2 to eliminate a signal component from CH 1 (or any time the CH 2 VOLTS/DIV setting differs from that of CH 1), note that the ADD volts/div readout will be the same as the CH 1 readout. This feature allows the correct scale factor (that agreeing with CH 1) to be used when canceling unwanted signal components. When the ADD mode is *not* used for that application, the ADD readout will *not* be correct. In such cases, the VOLTS/DIV controls should be set to the same scale factor and the variables set to CAL (calibrated) for accurate adding or subtracting of waveforms.

**NOTE**

*If VOLTS, V@T, or SLOPE cursors are attached to ADD mode, they, too, will match CH 1's volts/div readout. Cursor use is covered later in this section.*

### **MULT Mode Measurements**

MULT VERTICAL MODE can be used to multiply two waveforms. With the two waveforms displayed, one in CH 1, the other in CH 2, the MULT mode waveform is the algebraic product of the two waveforms. Note that the signal sources to be multiplied must be applied to CH 1 and CH 2 as when using ADD mode.

In order to display the product of two waveforms at the same time that the two component waveforms are displayed, the MULT function scales the display to the screen and supplies an appropriate V<sup>2</sup>/Div scale factor (displayed next to the MUL designation on screen). This scale factor for the MULT Vertical mode is determined according to the following formula:

$$\text{Volts}^2/\text{Div (MULT)} = 5.12 \times \text{V/Div (CH 1)} \times \text{V/Div (CH 2)}$$

For a 2-V setting of both the CH 1 and CH 2 VOLTS/DIV controls, the MULT mode scale factor is:

$$5.12 \times 2 \text{ V/Div} \times 2 \text{ V/Div} = 20.48 \text{ V}^2/\text{Div}$$

**NOTE**

*When using MULT Vertical mode, it is usually desirable to adjust the VOLTS/DIV controls of each channel for a three- to five-division display. These settings will normally provide the best MULT display for viewing and measurement.*

## ***Applications***

---

To interpret MULT mode displays, remember that when values on a waveform are below the display channel's ground reference level, they are treated as negative quantities. Therefore, with a 2-V peak-to-peak sine wave signal applied to both CH 1 and CH 2, the MULT function would display a 1-V<sup>2</sup> peak-to-peak waveform with the positive peak at +1 V<sup>2</sup> and the negative peak at 0 V<sup>2</sup>. The frequency of the MULT waveform is twice that of the CH 1 and CH 2 waveforms because, in this example, when the negative values of the two waveforms are multiplied together, a positive product is obtained and two positive cycles of the multiplied waveform are produced for every complete cycle of the CH 1 and CH 2 waveforms.

MULT Vertical mode finds a major application in making power measurements. With a voltage waveform displayed in one channel and a current waveform in the other, the two waveforms can be multiplied to yield an instantaneous power waveform. Use of a current probe and a current probe amplifier are necessary for this application.

Use the following procedure when using the MULT Vertical mode for making power measurements:

1. Ensure that the CH 1 and CH 2 VARIABLE controls are in their CAL state.
2. Select VERTICAL MODE and set CH 1 and CH 2 on.
3. Set the CH 1 VOLTS/DIV control to the setting required by the current amplifier to calibrate the scope in amperes per division. Consult the operator's instructions for the current probe/amplifier combination used to determine the VOLTS/DIV setting as well as any output termination required.
4. Connect the current-to-voltage converted output to the CH 1 input connector, using a coaxial cable and the proper termination.
5. Connect the current probe/amplifier combination to the circuit under test. (Consult operator's instructions for the probe/amplifier combination.)
6. Connect the voltage waveform corresponding to the current being measured to the CH 2 input connector.
7. Set the CH 2 VOLTS/DIV control for an on-screen display. Adjust the SEC/DIV control to display several cycles of the waveforms.

8. Set the VERTICAL MODE menu to MULT. Adjust the CH 1 and CH 2 POSITION controls for convenient viewing of the MULT display. You can turn off CH1 and CH2 in the VERTICAL MODE menu for easier viewing of the MULT waveform.

9. Compute the multiplier for the MULT scale factor displayed on screen:

$$\text{Scale Factor Multiplier (Power Waveforms)} = \frac{\text{Current Amplifier Scale Factor}}{\text{CH 1 Volts/Div}}$$

**EXAMPLE:** The current-to-voltage converted output is connected to the CH 1 input and a 1 mA/div scale factor is obtained. The CH 1 VOLTS/DIV control is set for a 10 mV/div scale factor. Assuming the corresponding voltage waveform is input into CH 2, the resulting MULT waveform scale factor multiplier is:

$$\text{Scale Factor Multiplier (Power Waveforms)} = \frac{1 \text{ mA/div}}{10 \text{ mV/div}} = 0.1 \text{ Amp/Volt}$$

10. Compute the scale factor by multiplying the displayed MULT scale factor by the Scale Factor Multiplier. For the above example (a CH 2 VOLTS/DIV setting of 2 volts/div is assumed):

$$\text{Scale Factor (Power Waveforms)} = 0.1 \text{ A/V} \times 102 \text{ mV}^2/\text{div} = 10.2 \text{ mW/div}$$

*NOTE*

*The cursors can be used to measure the MULT mode waveform. (See "Cursor Measurements" in this section). With the cursors attached to the MULT waveform display, multiply the cursor measurement values seen in the readout by the Scale Factor Multiplier obtained in Step 9 to obtain the actual values for power waveform display.*

11. Count the number of vertical divisions for the MULT waveform and multiply by the scale factor obtained in Step 10. The result is the peak-to-peak power for the circuit under test. The RMS, peak, or mean values can be computed by applying the appropriate formulas.

## **Applications**

---

### ***TIME and FREQUENCY Measurements—Non-Delayed***

To measure time duration between two points on a waveform while using the graticule, it is only necessary to display the points on screen, count the number of horizontal divisions between the points, and apply the formula:

$$\text{Time Duration} = \text{Horizontal Div Counted} \times \text{SEC/DIV Setting}$$

If the time duration measured is for a single cycle of a periodic waveform, the frequency can be determined by the formula:

$$\text{Frequency} = \frac{1}{\text{Time Duration}}$$

The following application gives a specific example of measuring time; specifically, the rise time of a square wave.

1. Display the square wave to be measured in CH 1 or CH 2, and trigger on the positive (+) slope. Set the input coupling to DC.
2. Set the VOLTS/DIV control to display about 5 divisions. Use the VARIABLE function to adjust the display for exactly five divisions.
3. Adjust the vertical positioning so that the bottom of the square wave is aligned with the 0% reference line and the top of the square wave is aligned with the 100% reference line.
4. Set the SEC/DIV control to display the leading edge of the square wave over as many horizontal divisions as possible, while remaining within the graticule area.
5. Horizontally position the square wave so that the 10% point on the waveform intersects a vertical graticule line near the left side of the screen. (See point A of Figure 3-5).

6. Count the number of horizontal divisions, including fractional divisions, between the 10% and 90% amplitude levels on the waveform. (See points A and B of Figure 3-5.) To determine the rise time, use the following general formula for time duration measurements:

$$\text{Time Duration} = \text{Horizontal Div Counted} \times \text{SEC/DIV Setting}$$

**EXAMPLE:** Figure 3-5 gives the SEC/DIV control setting as  $5 \mu\text{s}$  for the A time base. Counting the number of divisions between the 10% and 90% graticule lines (marked as A and B in diagram) yields 2.2 divisions. Substituting these values into the above formula yields

$$\text{Rise Time} = 2.2 \text{ div} \times 5 \mu\text{s/div} = 11 \mu\text{s}$$

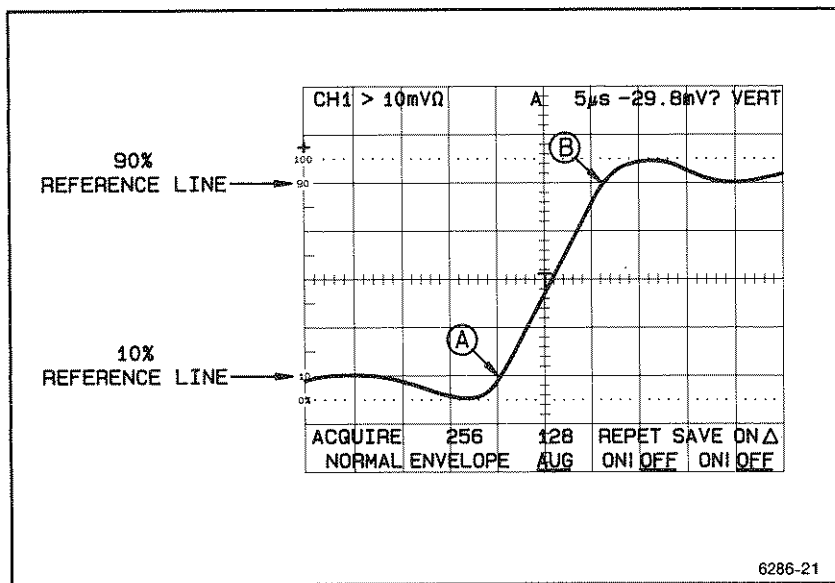

Figure 3-5. Rise time of a square wave (time duration).

## ***Delay Time Measurements and Applications***

The B-Acquisition system, coupled with DELAY TIME and  $\Delta$  DELAY TIME, provides several features. First, when the B-Trigger mode is set to RUNS AFTER (Delay), the B-Acquisition system can “magnify” events that are being displayed at the A-acquisition rate. The events to be magnified are selected using A INTEN mode. Second, the DELAY by TIME feature allows the user to delay the start of the B acquisition in relation to the start of the A acquisition by a specified amount. Third, the TRIG AFTER (Delay) mode allows the user to disable the B-Trigger system for a specified time delay after the start of the A acquisition. These features are examined below.

### ***DELAY TIME Mode As A Magnifier***

The A INTEN selection for Horizontal mode lets you highlight a portion of the A trace that you want to magnify. Use the Cursor/Delay control knob to position the intensified zone anywhere within the A waveform record length; then switch the Horizontal MODE to B. The selected region will now be displayed at the B-acquisition rate, so if you set the B SEC/DIV to a faster acquisition rate than the A SEC/DIV, the intensified portion of the A acquisition will be magnified according to this formula:

$$\text{Magnification} = \frac{\text{A SEC/DIV setting}}{\text{B SEC/DIV setting}}$$

When using the A INTEN mode for this application, the B-Trigger mode should be set to RUNS AFTER (Delay). For this mode, the intensified zone indicates when the B acquisition will occur relative to the A acquisition. It also indicates the time duration of the B acquisition relative to A. For the B TRIG AFTER (Delay) mode, on the other hand, the intensified zone tells nothing about the time duration of the B acquisition, nor even about whether a B acquisition will occur. It only shows the window of time during which a valid B Trigger, if it occurs, will trigger a B acquisition.

Use the following procedure for magnification using delayed acquisition modes:

1. Display the test waveform in one of the channels. Set the VOLTS/DIV control for five vertical divisions of display.
2. Set the A SEC/DIV control to display one or more waveform cycles.

3. Set the Horizontal mode to A INTEN and the B TRIG mode to RUNS AFTER (Delay).

4. Set the B SEC/DIV control to an acquisition rate 10 times faster than the A SEC/DIV. Adjust the brightness of the A-acquisition display (DISP) and the intensified zone (INTENS) for adequate contrast between the two portions of the trace.

**NOTE**

*If increasing the intensity for INTENS does not result in a visible intensified zone, pre-set DELAY TIME to minimum. An intensified zone, approximately two divisions long, should appear near the Trigger Point Indicator (T) on the displayed waveform.*

5. Push the DELAY TIME button to display that menu. Set  $\Delta$  TIME OFF if it is ON. Use the Cursor/Delay control knob to position the intensified zone to the part of the display you want to magnify.

6. Set the B SEC/DIV control to a setting which completely intensifies the part of the display to be magnified. Reposition the intensified zone as required. (See Figure 3-6a.)

7. Change the Horizontal mode to B. The intensified portion of the display will appear at the SEC/DIV setting of the B time base. (See Figure 3-6b).

**EXAMPLE:** For the waveform displayed in Figure 3-6b, the display readout indicates "A 10 $\mu$ s" and "B 500ns". Therefore,

$$\text{Magnification} = \frac{\text{A SEC/DIV setting}}{\text{B SEC/DIV setting}} = \frac{10 \mu\text{s}}{500 \text{ ns}} = 20$$

**NOTE**

*The magnified zone will be 20 divisions long when displayed in B mode. Horizontally position the display as required to see the entire magnified area.*

**Applications**

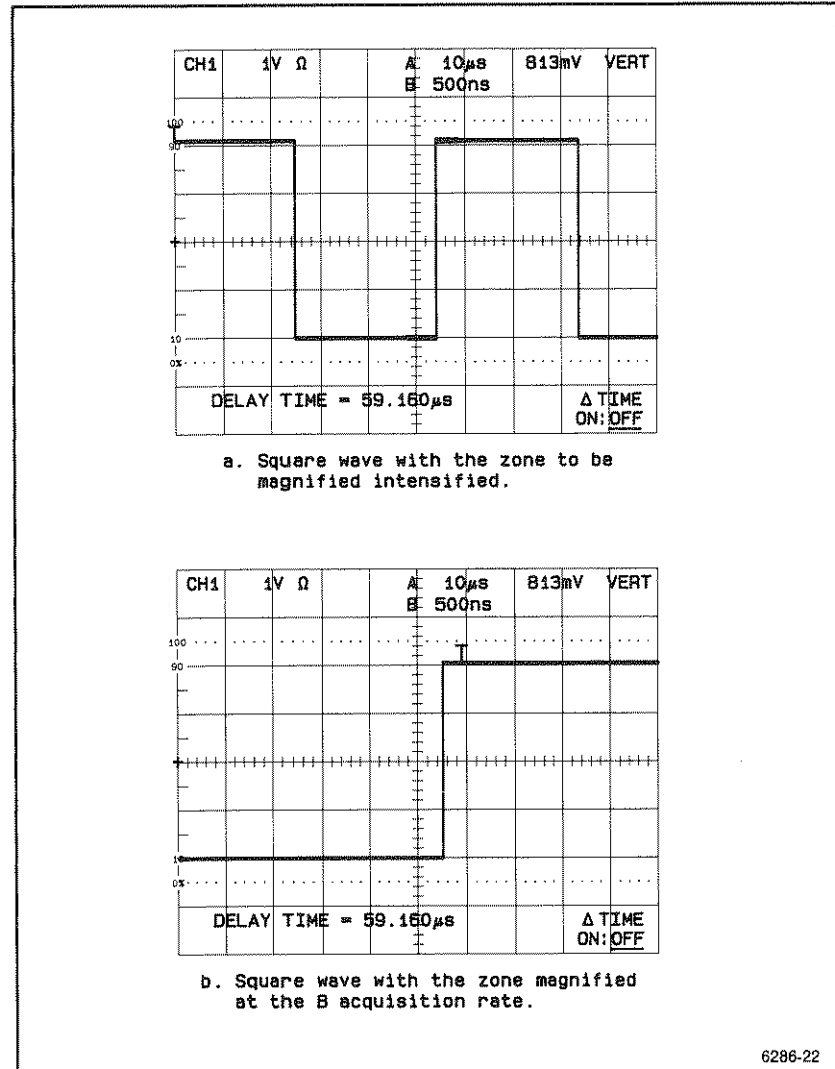

**Figure 3-6 (a and b). DELAY TIME used as a positionable magnifier.**



### Other Delay Applications

In the previous procedure, you positioned the intensified zone by delaying the B system's acquisition relative to the A system's acquisition. The DELAY TIME readout displayed a time which related the B acquisition to the A acquisition.

Specifically, the DELAY TIME readout indicates the following:

a. When the B-Trigger mode is set to RUNS AFTER (Delay), the readout indicates the exact time between the A-Record Trigger and the B-Record Trigger. The B-Record Trigger is forced at the end of the Delay time.

b. When the B-Trigger mode is set to TRIG AFTER (Delay), the readout indicates the minimum time between the A-Record Trigger and the B-Record Trigger. At the end of the Delay time set, the B-Trigger System is enabled to accept B triggers. The B-Record Trigger will be the first valid B-Trigger event that occurs after the end of the Delay time.

The maximum Delay times that can be set depend on the B SEC/DIV setting. Delay times of up to 5,242.8 times the B SEC/DIV setting are available. (For B SEC/DIV settings of 100 ns and faster, the maximum delay is 524  $\mu$ s.)

The minimum Delay times that can be set depend on both the B SEC/DIV setting and the B Trigger mode. For RUNS AFTER mode, you can set minimum delay to 0.8 times the B SEC/DIV setting. For TRIGS AFTER mode, the minimum delay settable is 8 ns at B SEC/DIV settings of 50 ns and faster. At settings slower than 50 ns, the minimum delay is the same as for RUNS AFTER mode.

Given the maximum delay times available, the B acquisition can be delayed beyond the end of the A acquisition. Since, for such Delay time settings, the B acquisition occurs after the A acquisition completes, the 2440 won't display the intensified zone. The B-Horizontal mode will, however, display the delayed B acquisition allowing you to view events that occur long after the events displayed for the A acquisition have passed.

The same maximum delay times are available for the TRIG AFTER mode as for the RUNS AFTER mode. After first setting up the B-Trigger controls and the Delay time, display the waveform in B Horizontal mode. With B-Trigger mode in RUNS AFTER, you can search for the event you want to display by gradually increasing the Delay time. You can then switch the B-Trigger mode to TRIG AFTER.

#### NOTE

See "General Information for Delayed Acquisition Usage," at the end of this sub-section, for limitations and cautions regarding use of the DELAY TIME and  $\Delta$  DELAY TIME.

## **$\Delta$ Delay Time and Frequency Measurements**

The  $\Delta$  DELAY TIME feature allows a second delay to be specified between the B acquisition and a second B acquisition. Specifically, the  $\Delta$  DELAY TIME readout indicates the following:

a. When the B-Trigger mode is set to RUNS AFTER (Delay), the  $\Delta$  DELAY TIME readout indicates the exact time between when the Record Trigger for the first B acquisition is forced and when the Record Trigger for the second B acquisition is forced. Thus the time from the A-Record Trigger to the second B-Record Trigger is the sum of the DELAY TIME and the  $\Delta$  DELAY TIME.

b. When the B-Trigger mode is set to TRIG AFTER (Delay), the  $\Delta$  DELAY TIME readout indicates the minimum time between the first B-Record Trigger and the second B-Record Trigger. In other words, at the end of Delay time, the B Trigger system is enabled. Then, when it receives a valid triggering event, the B-Record Trigger occurs for the first B acquisition. After the first B-record occurs, the  $\Delta$  Delay time must expire before the B Trigger System is again enabled. The next valid B-Trigger event produces the B-Record Trigger for the second B acquisition. Thus the time between the A-Record Trigger and the second B-Record Trigger is made up of the sum of four intervals: the Delay time, the  $\Delta$  Delay time, and the times from the end of each Delay to the next valid B Trigger.

The DELAY TIME and  $\Delta$  DELAY TIME functions provide a means to make high resolution time/frequency measurements of displayed waveforms. Use the following procedure to measure the time between the two displayed events:

1. Perform Steps 1 through 4 of the last procedure, setting the A SEC/DIV in Step 2 so that both points of interest are displayed. (See Figure 3-7a).
2. Push the DELAY TIME button to display that menu and set  $\Delta$  TIME on. The DELAY TIME front-panel button will now toggle the Cursor/Delay knob between controlling DELAY TIME and controlling  $\Delta$  DELAY TIME.

3. With both DELAY TIME and  $\Delta$  DELAY TIME set to minimum, two overlapping zones, about two divisions long, should be displayed at the Record Trigger indicator (T) on the waveform.

4. Select DELAY TIME and use the Cursor/Delay control knob to position both the main delay and the  $\Delta$  delay intensified zones to the first reference point.

5. Select  $\Delta$  DELAY TIME and position the  $\Delta$  delay intensified zone to the second reference point.

6. Set the Horizontal mode to B. Adjust the  $\Delta$  DELAY TIME to superimpose the two reference points. Adjust the DELAY TIME and/or Horizontal POSITION as required to view the displayed references. (See Figure 3-7b.)

The  $\Delta$  DELAY TIME readout indicates the time difference between the occurrence of the two reference events when the two events are superimposed.

**Table 3-1  
Delay Displays versus Vertical MODE**

<b>VERTICAL MODE</b>	<b>Main Delay Acquisition</b>	<b><math>\Delta</math> Delay Acquisition</b>
CH 1 (only)	CH 1	CH 1
CH 2 (only)	CH 2	CH 2
CH 1 and CH 2	CH 1	CH 2
ADD or MULT	func <sup>a</sup>	func

<sup>a</sup>Either ADD or MULT.

**Applications**

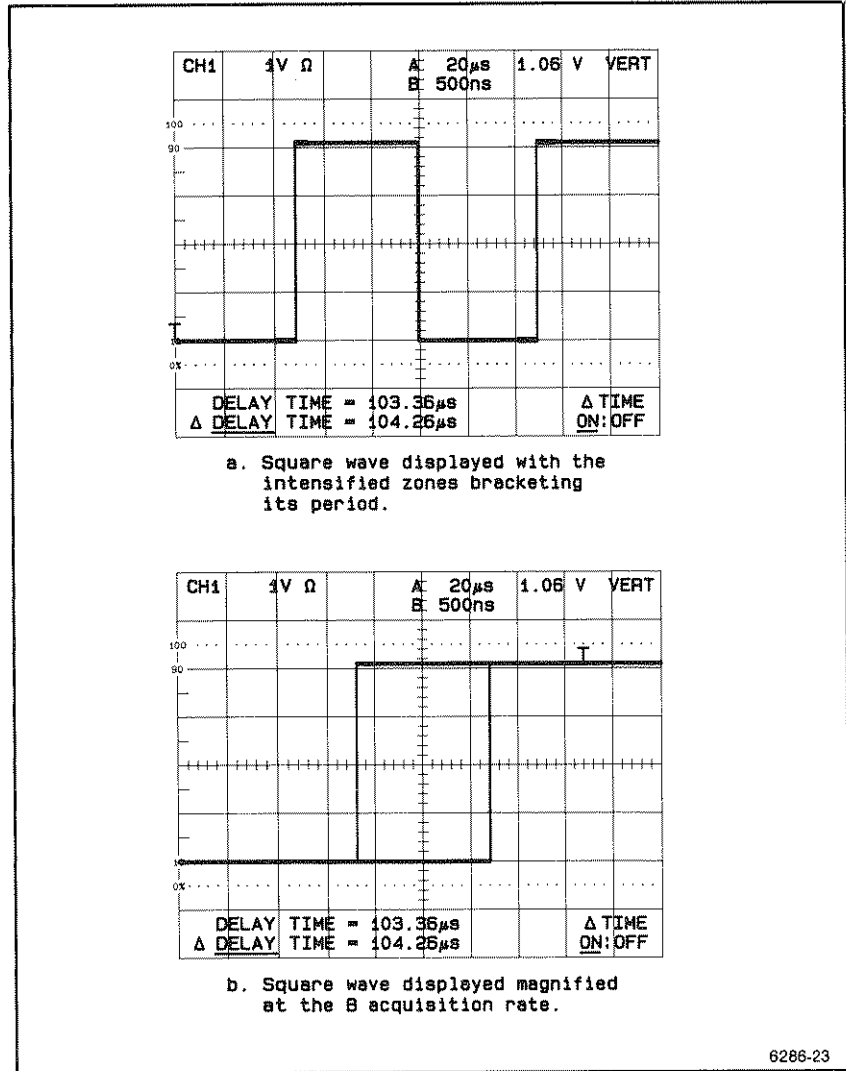

**Figure 3-7 (a and b).  $\Delta$  DELAY TIME used to measure the period of a square wave.**

As shown during the last procedure, the two B-delayed acquisitions are displayed at the same vertical position when they are obtained from a single channel. Table 3-1, above, and Figure 3-8 indicate where the main delay and  $\Delta$  delay B acquisitions are obtained and displayed for the various VERTICAL MODE settings.

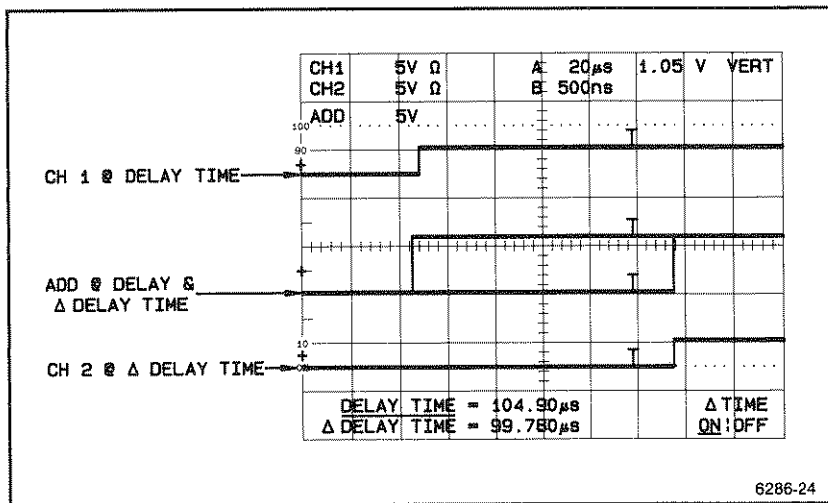

Figure 3-8. Delay and  $\Delta$  Delay acquisitions as displayed for CH1, CH2, and ADD (or MULT) VERTICAL MODE.

### Delay by Events Measurements

The DELAY by EVENTS mode makes it possible to create a delay between the normal A-triggering event and the A acquisition. The delay, which can be set by the user, consists of a specified number of B-Trigger events. The system starts counting at the normal A-Trigger event; as soon as it has counted the specified number of B Triggers, it generates the A-Record Trigger and displays the A acquisition.

To set the number of B Triggers for the delay, press the EVENTS front-panel button and turn the Cursor/Delay knob. The readout at the bottom of the screen shows the EVENTS COUNT.

Set up the EVENTS source by using the B TRIG SOURCE menu. You can use the A-acquisition waveform, or any of the other internal or external source selections available via that menu. Note that if the External Clock feature is turned on in the B TRIGGER MODE menu, the A- and B-acquisition rates will be set by the repetition rate of the EVENTS (B Trigger) source signal.

## **Applications**

---

When the A acquisition is delayed by B events, all the DELAY by TIME features are still available for displaying the B acquisition. Just remember that the B acquisition, like the A acquisition, is already delayed from the normal A triggering event by B events. You can use A INTEN, DELAY TIME, and  $\Delta$  DELAY TIME to delay the B acquisition(s) from the delayed A acquisition as usual.

Use the following procedure to delay the A acquisition by B-trigger events:

1. Input the signal which will provide the trigger to start the events counting into CH 1 or CH 2.
2. Input the signal which will provide the triggers to be counted into the desired source (CH 1, CH 2, EXT1, or EXT2).
3. Set the A TRIGGER SOURCE to the channel selected for Step 1 and trigger the display.
4. Set the B TRIGGER SOURCE to the source selected in Step 2.
5. Set B TRIGGER MODE to TRIG AFTER and set the HORIZONTAL MODE to B.
6. Set B TRIGGER CPLG and LEVEL control for a triggered display.
7. Return the HORIZONTAL MODE to A and the B TRIGGER MODE to RUNS AFTER.
8. Select DELAY by EVENTS and set EVENTS ON/OFF to ON.
9. Use the Cursor/Delay control knob to set the EVENTS COUNT to the desired number of events. The resultant display will be delayed from the Normal A Trigger (event) by that number.

The A-Record Trigger (T) is the event around which the A acquisition is displayed. The A-Record Trigger is delayed from the A-Trigger event (specified in Step 3) by the number of events specified in Step 9. The Source of the events was specified in Step 4.

### General Information for Delay Acquisition Usage

1. TRIGGER POSITION. When using the Delay by Time feature to set up exact time delays, the time between A and B acquisitions is affected by the TRIGGER POSITION settings for A and B. In general, set the A and B TRIGGER POSITION to equal settings. See Figure B-2 in Appendix B for further information regarding the position of the Record Trigger.

2. ENCOUNTERING MAXIMUM DELAY. The sum of DELAY TIME and  $\Delta$  DELAY TIME cannot exceed the maximum delay range for the B SEC/DIV setting. The maximum delay (and best delay resolution) depends on the B SEC/DIV setting, the B Trigger Mode setting, and whether REPET is ON or OFF. (See Table B-10, Appendix B, for a listing of both resolution and maximum delay for all B SEC/DIV settings.) In general, the maximum delay available decreases as the B-acquisition rate is increased. If you increase the B SEC/DIV so that the maximum delay at the new setting is less than the sum of the Delay times you specified at the old setting, the Delay times will be reduced to the limit for the new setting. To reestablish the old setting, you must return to the slower B SEC/DIV setting and readjust the Delay time(s). Note that the maximum time delay allowed does not affect the amount of time delay available for the DELAY by EVENTS function.

**EXAMPLE:** If B SEC/DIV is set to  $10 \mu\text{s}$ , the maximum allowed delay time is  $0.8 \times 65536 \times 10 \mu\text{s} = 52.428 \text{ ms}$ . Assume DELAY TIME is set to  $40.000 \text{ ms}$  and an event is on screen. If the B SEC/DIV setting is increased to  $5 \mu\text{s}$ , the maximum allowed time is  $0.8 \times 65536 \times 5 \mu\text{s} = 26.214 \text{ ms}$ . The event is no longer displayed; return the B SEC/DIV to  $10 \mu\text{s}$  and set the DELAY TIME back to  $40.000 \text{ ms}$  to see the event.

## ***Special Applications***

### ***Cursor Measurements***

The CURSOR FUNCTION offers fast and flexible measuring capabilities. With the exception of the  $\Delta$  DELAY TIME mode for measuring time delay, the cursor measurements are more accurate than the graticule type measurements described in the "General Applications" sub-section. It is also quicker to use them than to interpolate the graticule markings when accurate measurements are required.

Cursors are placed on a display by first pressing the Cursors FUNCTION button and then pressing the bezel button under the desired cursor type (VOLTS, TIME, V@T, SLOPE, 1/TIME). Repeatedly pressing a bezel button toggles the cursors on and off.

### ***Voltage Measurements***

If you use the VOLTS cursors, your display-amplitude measurements will be more accurate than if you use the graticule. And even though cursor measurements require "set-ups" and cursor manipulation, they may save time over graticule measurements since the results can be read directly, without computation.

Two cursor modes are available for amplitude measurement— $\Delta$  and ABS (absolute). For the  $\Delta$  mode, two cursors are displayed, and the readout indicates the difference between their voltage levels. The ABS mode displays only one cursor, and the readout indicates its voltage level with respect to the display ground reference.

The base units for amplitude displays are volts. In addition, two special unit types are available (percentage and decibels) for special measurement applications. Use of the base and special units is illustrated in the procedures that follow.



### Delta Voltage Measurements

Use the following procedure to make differential voltage measurements on displayed waveforms (see Figure 3-9):

1. Obtain a triggered display of the waveform to be measured.
2. Push the CURSOR FUNCTION button to display the CURSOR FUNCTION menu.
3. Select the VOLTS function. If more than one display source is presently active (for example, CH 1 and ADD), the ATTACH CURSORS TO: menu will be displayed. Select the source of the waveform you want to measure.

#### NOTE

*If there is only one active display source, the cursors will automatically be attached to that display source and the ATTACH CURSORS TO: menu will not appear.*

4. If VOLTS is already underlined in the CURSOR FUNCTION menu, push the CURSOR FUNCTION button again to display the ATTACH CURSORS TO: menu and select the desired source.
5. Press the CURSOR UNITS button. Select VOLTS units and set  $\Delta$ :ABS to  $\Delta$ .
6. Use the Cursor/Delay control knob to position the active (segmented) cursor at the first voltage level on the displayed waveform.
7. Press the CURSOR SELECT button to activate the other cursor, and position the newly active cursor at the second voltage level.

The cursor readout gives the difference between the two levels in volts.

## Applications

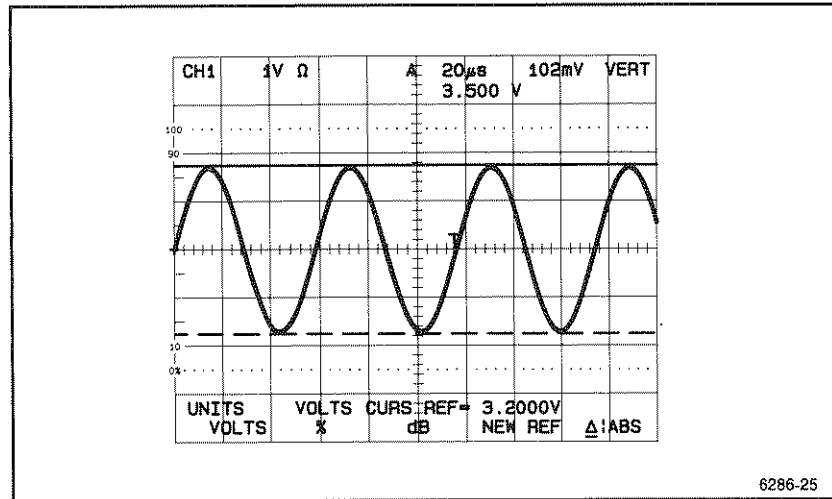

Figure 3-9. Measuring a 3.5-V sine-wave signal using VOLTS cursors.

### Ratio Between Two Voltages

The special units (% and dB) allow you to make ratiometric measurements. (Ratiometric measurements compare two quantities and express the results as the ratio of one to the other.) First you make a measurement and store its value as a reference. Then, when you measure the comparison signal, the readout gives you the ratio of the comparison signal to the reference in terms of percent or decibels.

Suppose you want to compare the peak-to-peak amplitudes of two signals...

1. Display the reference signal in CH 1 and the comparison signal in CH 2.
2. Attach VOLTS cursors to the reference signal (CH 1). In the CURSOR UNITS menu, select  $\Delta$  and %. Align the cursors with the peaks of the reference signal as shown in Figure 3-10a. (To do all of this, you can follow Steps 2 through 7 of the previous "Delta Voltage Measurements" procedure, substituting "%" for "VOLTS" in Step 5).
3. Press NEW REF in the CURSOR UNITS menu. Note that the cursor readout now shows 100%. (See Figure 3-10a.)

4. Align the cursors with the peaks of the comparison signal (CH 2) as shown in Figure 3-10b. Provided that CH 1 and CH 2 have the *same* VOLTS/DIV setting, the cursor readout now gives the peak-to-peak amplitude of the CH 2 signal as a percent of the peak-to-peak amplitude of the CH 1 signal.

**NOTE**

*If the comparison waveform does not have the same VOLTS/DIV setting as the reference waveform, then you must press the CURSOR FUNCTION button twice to get the ATTACH CURSORS TO: menu and select the comparison-signal source.*

5. If CH 2 does *not* have the same VOLTS/DIV setting as CH 1, press the CURSOR FUNCTION button twice to display the ATTACH CURSORS TO: menu and select CH 2. (See Figure 3-10b.) The cursor readout now gives the ratio between the comparison signal and the reference signal in percent.

The same procedure would yield results in dB (decibels) if you had selected dB rather than % in the CURSOR UNITS menu (Step 2). In fact, if you wish, you can recall that menu right now and change the units to dB.

Applications

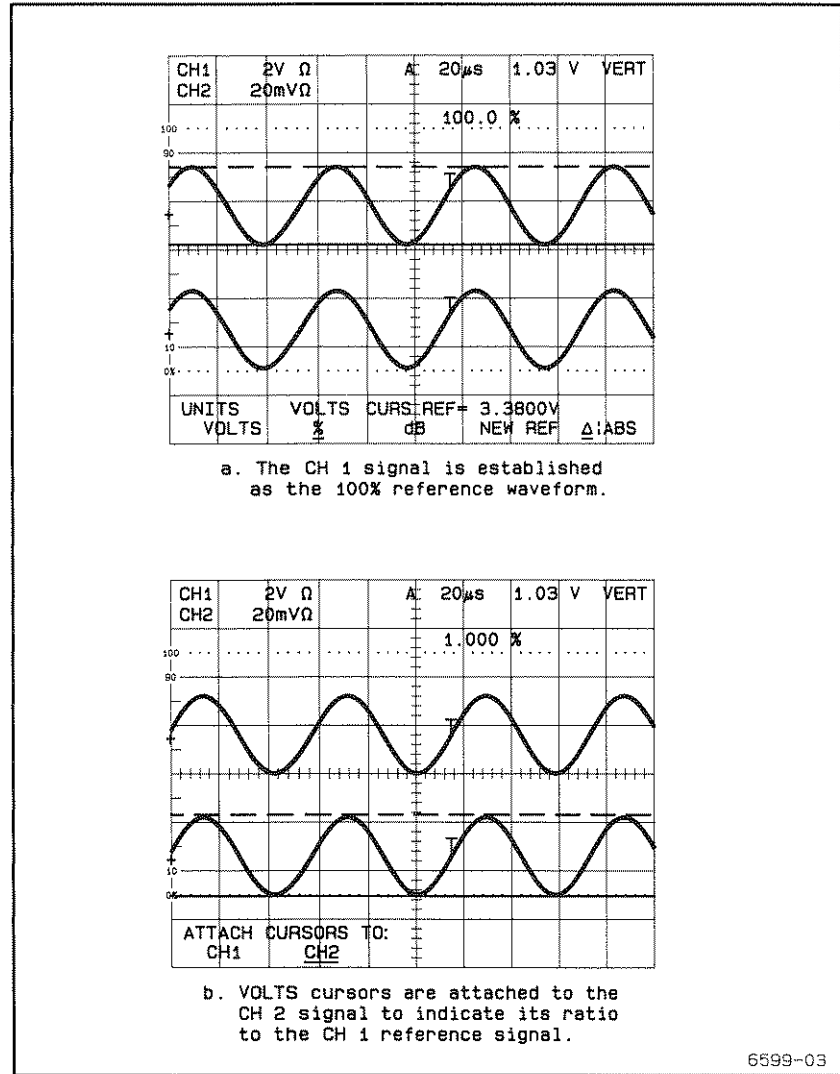

Figure 3-10 (a and b). Measuring the ratio between the amplitudes of two sine-wave signals.

You can make ratiometric measurements among signals from several different display sources; for example, signals displayed in CH 2, REF 1, etc. can be compared to any reference you choose, and you can establish a new reference whenever you wish. You can also use % and dB units to compare measurements made on the same signal; for example, you could compare the front corner aberration on a square wave to the overall amplitude. In every case, the method is essentially the same as just outlined:

- a. Use cursors to make the reference measurement.
- b. Store the reference measurement.
- c. Attach the cursors (if necessary) to the source of the comparison signal.
- d. Measure the comparison signal (again, with cursors).

### ***Absolute Voltage Cursor Measurements***

Use the following procedure to perform ground-referenced measurements on displayed waveforms:

1. Perform Steps 1 through 4 of the "Delta Voltage Measurements" procedure.
2. Press the CURSORS UNITS button. Select VOLTS units and set the  $\Delta$ !ABS menu choice to ABS.
3. Use the Cursor/Delay control knob to align the cursor with the desired level on the displayed waveform.

The cursor readout gives the voltage level of the cursor with respect to ground. (See Figure 3-11.)

## Applications

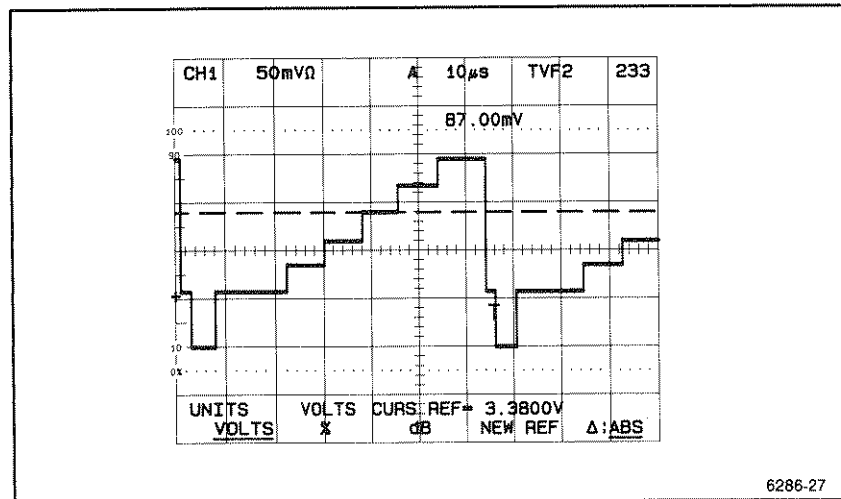

**Figure 3-11. Voltage measurement of a step on a stair-case signal using the VOLTS cursor function in the ABS mode.**

You can also use absolute voltage cursors to make ratiometric measurements. The method is similar to the one described in "Ratio Between Two Voltages." For example, you might want to compare the noise level on a pulse train during off times to the pulse level during on times. You would store the amplitude of the pulse (with respect to ground) as the reference, and then measure the noise level (again, with respect to ground) for comparison. If you change the VOLTS/DIV setting between measurements, or use a comparison signal whose display source has a different vertical deflection than the reference, remember to re-attach the cursors when you measure the comparison signal.

### **Time and Frequency Measurements**

Cursors increase the accuracy of time measurements, too. An internal crystal-controlled clock circuit determines the accuracy of the time cursors, which is specified as 0.0015% over two divisions. Since 0.0015% of two divisions is less than a ten-thousandth of a division, the accuracy of cursor measurements essentially depends on how accurately the user places them on the display. The accuracy of the graticule will be within approximately 1% of the cursor accuracy.

The same two cursor modes used for amplitude measurements,  $\Delta$  and ABS, are available for time measurements. For the  $\Delta$  cursor mode, the cursor readout indicates the elapsed time between the two cursors. For the ABS mode, the readout indicates the time between the single cursor and the Record Trigger point, around which the acquisition is displayed. For both modes, the cursor(s) are automatically attached to the A-acquisition rate for the A and A INTEN Horizontal modes and to the B-acquisition rate for the B Horizontal mode.

The cursors can also be attached to saved signals stored in Reference memory. This allows you to make time measurements on those waveforms based on the SEC/DIV setting at which they were acquired. Furthermore, the cursor displayed in ABS mode can be attached to either the DELAY TIME or the  $\Delta$  DELAY TIME display when the  $\Delta$  TIME mode is ON and more than one "live" display source (CH 1, ADD, etc) is displayed.

The base unit for time measurements is seconds. The special unit types are percent and degrees. The following procedures illustrate how to use both base and special units.

### **$\Delta$ Time Cursor Measurements**

Use the following procedure to make differential time measurements on displayed waveforms:

1. Obtain a triggered display of the waveform to be measured.
2. Press the CURSOR FUNCTION button to display the CURSOR FUNCTION menu.
3. Select TIME, if it is not already underscored. If more than one display source is presently selected (CH 1 and ADD, for example) the ATTACH CURSORS TO: menu will appear.

## Applications

---

### NOTE

*It is not necessary to attach the TIME or 1/TIME cursors to a Vertical Mode (CH 1, ADD, etc.). Ignore the ATTACH CURSOR TO: menu for TIME and 1/TIME cursor use, except when saved reference waveforms are displayed. If reference waveforms are displayed, the ATTACH CURSOR MENU TO: menu will display those sources for selection.*

4. Push the CURSORS UNITS button. Select SEC units and set  $\Delta$ :ABS to  $\Delta$ .

5. Use the Cursor/Delay control knob to align the cursors with the two desired reference points on the displayed waveform. Push the CURSOR SELECT button to toggle between the two cursors. (The cursor with the most dots is active.)

6. Read the time interval between the two reference points, in seconds, directly from the cursor readout. (See Figure 3-12a.)

7. Press CURSOR FUNCTION and change the function from TIME to 1/TIME. If the two reference points you selected in Step 5 happen to bracket one cycle of a periodic waveform (as in Figure 3-12a), the readout now indicates the frequency in Hz.



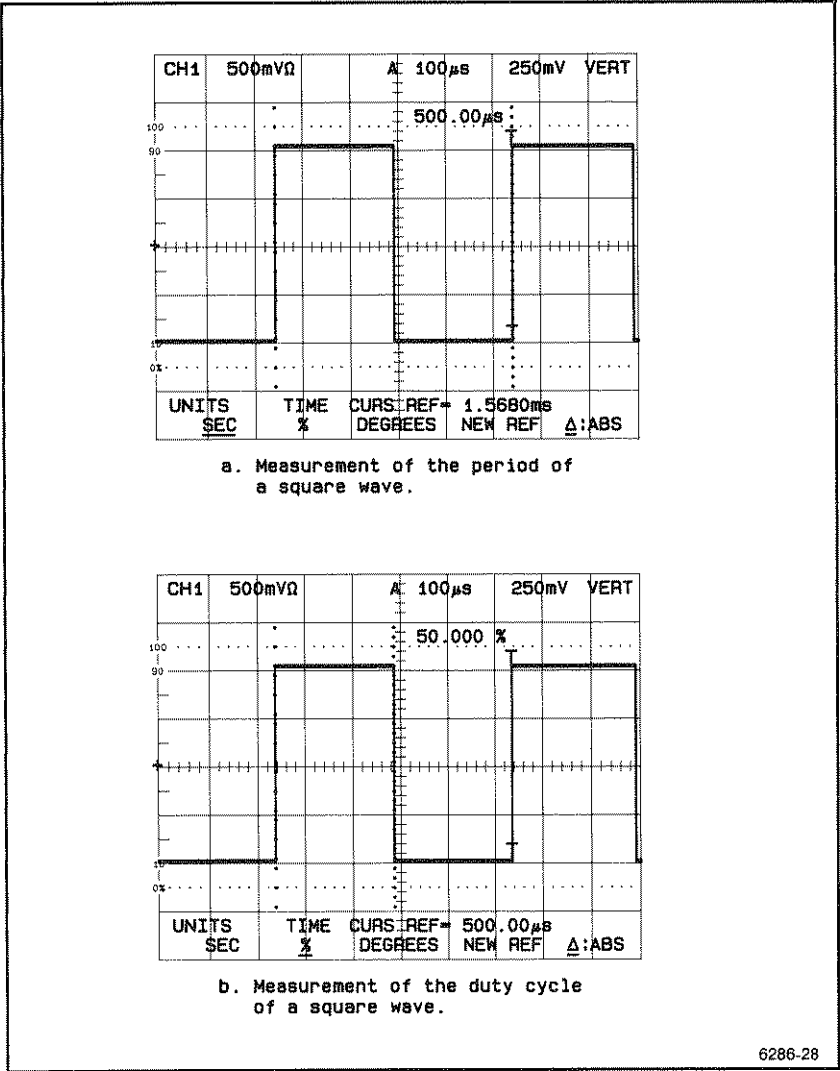

Figure 3-12 (a and b). Time measurements using TIME Cursor function and modes.

## Applications

---

### **Ratio Between Two Time Periods**

As with VOLTS cursors, TIME (or 1/TIME) cursors can be used to measure ratios between quantities, in this case two time periods. The special units used can be either percent or degrees. For illustration, the following procedure measures the duty cycle of a periodic rectangular pulse.

1. Perform Steps 1 through 3 of the "Δ Time Cursor Measurements" procedure.
2. Set the SEC/DIV to display one or two cycles of the pulse.
3. Press the CURSORS UNITS button. Select % units and set the Δ/ABS choice to Δ.
4. Adjust the cursors, as in Step 5 of the Δ Time Cursor Measurements procedure, to bracket one cycle of the rectangular pulse. (See Figure 3-12a.)
5. Press the NEW REF menu button to establish one cycle of the pulse as the 100% reference for the cursors. Note that the readout now indicates 100%.
6. Adjust one of the two cursors so that only the positive-going portion of the waveform cycle is bracketed by the cursors. (See Figure 3-12b.)
7. Read the ratio of the presently bracketed time period to the time period established as a reference in Step 5. For Figure 3-12b the ratio was:

$$\text{Duty Cycle} = \frac{\text{Time Pulse Duration}}{\text{Time Pulse Period}} \times 100 = 50\%$$

The general formula for ratio time comparisons is:

$$\text{Readout (\%)} = \frac{\text{Present Cursor Time Period}}{\text{100\% Reference Time Period}} \times 100$$

Note that ratiometric measurements can be made between signals in different display sources. For example, the 100% reference can be established for a time period in CH 1 and the comparison signal bracketed in CH 2. Be sure to attach the cursors to the proper source when SAVED waveforms are compared either with other SAVED waveforms or with "live" waveforms. This attachment is not necessary for comparisons on or between "live" waveforms, since they all have the same acquisition rates. However, reference waveforms may have been acquired at any rate allowed by the SEC/DIV control.

Also note that the special units selected for TIME and 1/TIME measurements can be DEGREES. In that case, the reference units will be 360° instead of 100% (as in Step 5 of the previous procedure). In the previous procedure, with degrees selected as the units of measurement, the readout will indicate 180° for Step 7, instead of 50%.

### **Absolute TIME Cursor Measurements**

As previously mentioned, the absolute mode is available for TIME cursor measurements. Only one cursor is displayed; the other cursor can be considered to be permanently placed at the Record Trigger position of the displayed acquisition. All absolute cursor measurements are with respect to the Record Trigger (indicated by a small T on the displayed acquisition).

Use the following general procedure for making absolute time cursor measurements:

1. Perform Steps 1 through 4 of the "Δ Time Cursor Measurements" procedure, setting Δ:ABS to ABS instead of Δ in Step 4.
2. Position the display to view both the Record Trigger (T) and the point on the waveform that you want to measure. Adjust the SEC/DIV as required.
3. Use the Cursor/Delay control knob to align the cursor with the desired point.
4. Read the time interval between the cursor-aligned point and the Record Trigger point directly from the cursor readout. (See Figure 3-13.)

Note that when seconds are selected for the units, time can appear as a signed ( $\pm$ ) quantity. The sign indicates whether the cursor-aligned point occurs before ( $-$ ) or after ( $+$ ) the Record Trigger.

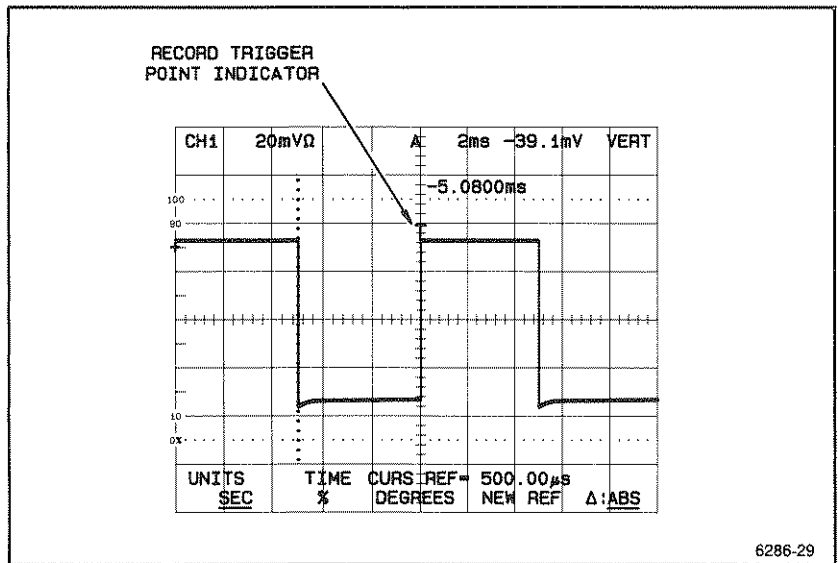

Figure 3-13. Time measurement of an event relative to the Record Trigger.

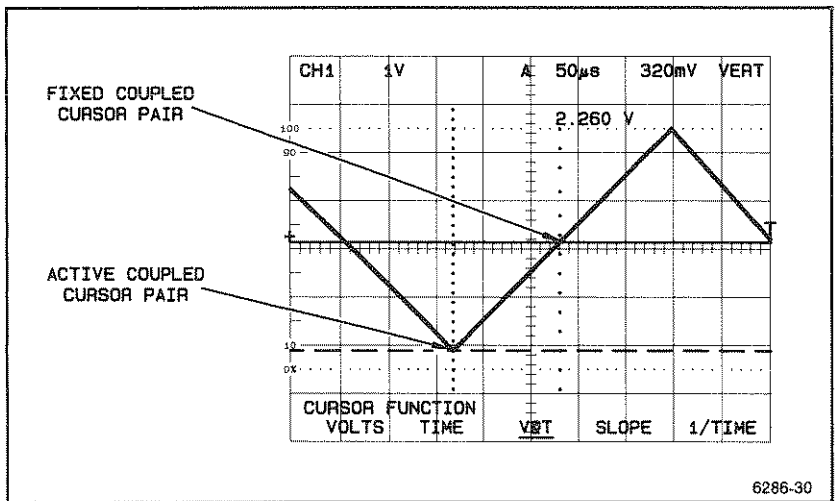

Figure 3-14. VOLTS coupled to TIME cursors displayed on a triangle wave.

### ***Voltage Coupled to Time Cursors (V@T)***

The two remaining cursor selections are coupled-cursor modes. For the V@T (Volts at Time) and SLOPE cursors, the vertical position of coupled VOLTS cursors depends on the placement of the associated TIME cursors on the waveform. In Figure 3-14, the first TIME cursor has been positioned to coincide with the peak of the displayed triangle wave. The VOLTS cursor coupled to the TIME cursor is also aligned with that peak. The second TIME cursor is set to the time when the amplitude is halfway up the positive slope, between the negative and positive peaks. Again, the coupled VOLTS cursor corresponds to that voltage level.

For V@T cursor type, both  $\Delta$  and ABS cursor modes are available. The operation of the two modes is the same as outlined for VOLTS cursors earlier in this section. The cursor readout indicates the voltage difference between the two coupled VOLTS cursors for  $\Delta$  cursor mode; it indicates the difference between the single, coupled VOLTS cursor and the ground reference for the ABS cursor mode.

SLOPE cursors do not have an absolute mode selection. There are always two VOLTS cursors (coupled to their two TIME cursors). When the CURSOR UNITS selection is SLOPE, the readout value is expressed in V/s and is determined by:

$$\text{Readout (V/s)} = \frac{\text{Voltage Difference between VOLTS Cursors}}{\text{Time Difference between TIME Cursors}}$$

**V@T MEASUREMENTS.** Use the following procedure when making V@T cursor measurements:

1. Trigger a display of the waveform you're going to measure.
2. Press the CURSOR FUNCTION button to display the CURSOR FUNCTION menu.
3. Select V@T if it is not already underscored in the menu. If more than one display source is presently selected (CH 1 and ADD, for example) the ATTACH CURSORS TO: menu will be displayed. Press the menu button to attach the cursors to the appropriate source.

## **Applications**

---

### **NOTE**

*If only one display source is selected, the cursors will automatically be attached to that display source, and the ATTACH CURSORS TO: menu will not appear.*

4. Press the CURSORS UNITS button and set VOLTS on. Set  $\Delta$ ABS to the desired mode.

5. Depending on the mode selected for Step 4, align the TIME cursor or cursors to the desired measurement point(s) on the waveform.

### **NOTE**

*When using cursors in a coupled mode, note that the active cursor is segmented for the VOLTS cursor and contains the most dots for the TIME cursor.*

6. Read the voltage directly from the readout.

If ABS mode was selected in Step 4 of the previous procedure, the value displayed is the voltage with respect to ground. If  $\Delta$  mode was selected, the value is the difference in voltage between the coupled cursors. In both cases, the voltage measured is at the point on the display determined by the coupled TIME cursor(s). See Figure 3-15 (a and b) for examples of V@T measurements using both the ABS and  $\Delta$  cursor modes.

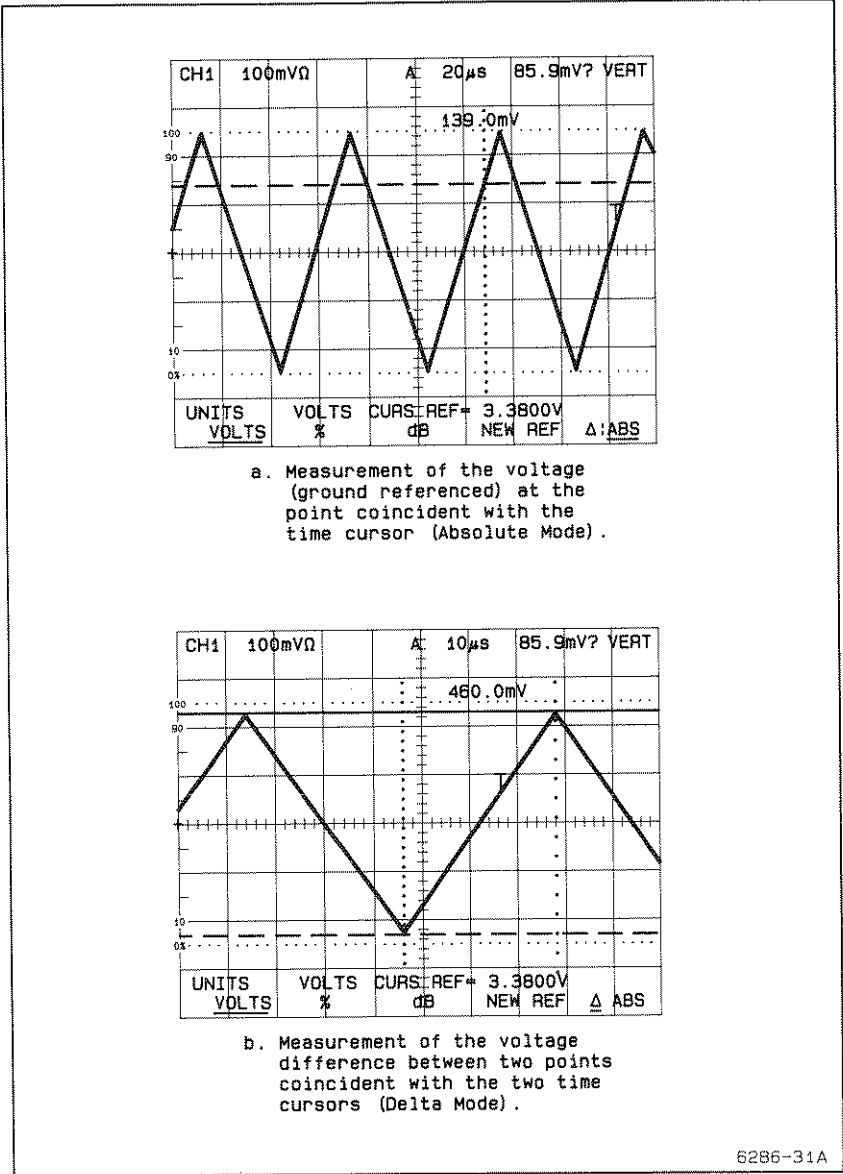

Figure 3-15 (a and b). V@T measurements on triangle-wave signals.

## **Applications**

**V@T TIME CURSOR PLACEMENT.** The V@T cursors can be used to provide high-accuracy frequency or period measurements for periodic waveforms. A main factor in the accuracy of such measurements is the uncertainty of cursor placement. Step 3 in the following procedure shows you a method for precise placement of the cursors. Use the following procedure to perform such measurements:

1. Perform Steps 1 through 4 of the "V@T MEASUREMENTS" procedure, setting  $\Delta$ :ABS to  $\Delta$  (delta) mode in Step 4.
2. Align the cursors to bracket just one cycle of the periodic waveform.
3. Fine-adjust the position of one of the TIME cursors until the VOLTS cursors are superimposed and the cursor readout indicates 0.0 V. (See Figure 3-16a.) You can set the ACQUIRE mode to AVG if noise makes it hard to get a 0.0-V reading.
4. Press the CURSOR FUNCTION button and select the TIME cursors. The readout now indicates the time period for one cycle of the waveform. Select the 1/TIME cursors. The readout now indicates the frequency in Hz. (See Figure 3-16b.)

## **Slope Measurements**

Use the following procedure to measure the average slope of a displayed waveform. The portion of the waveform to be measured is defined by the SLOPE cursors.

1. Perform Steps 1 through 3 of the "V@T MEASUREMENTS" procedure, selecting SLOPE in Step 3.
2. Press the CURSOR UNITS button and select SLOPE.
3. Position the TIME cursors to bracket the slope you want to measure.
4. The cursor readout indicates the average slope in V/s between the two points. (See Figure 3-17).



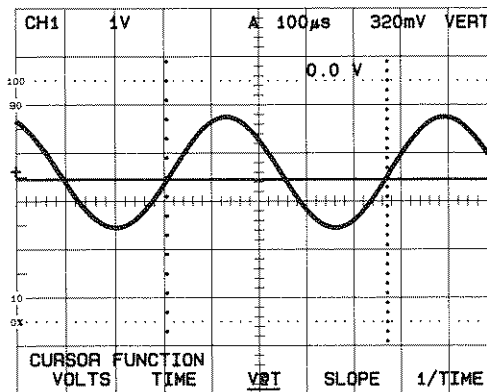

a. Time cursors adjusted to bracket the period of the sine wave. Note 0.0 V cursor reading.

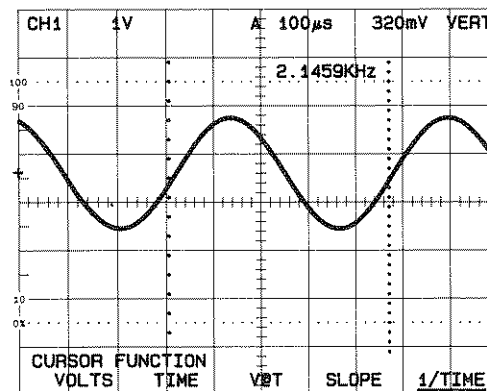

b. Frequency measurement of the sine wave. Note the function change to 1/TIME.

6286-32

Figure 3-16 (a and b). High resolution measurement of the frequency of a sine-wave signal.

## Applications

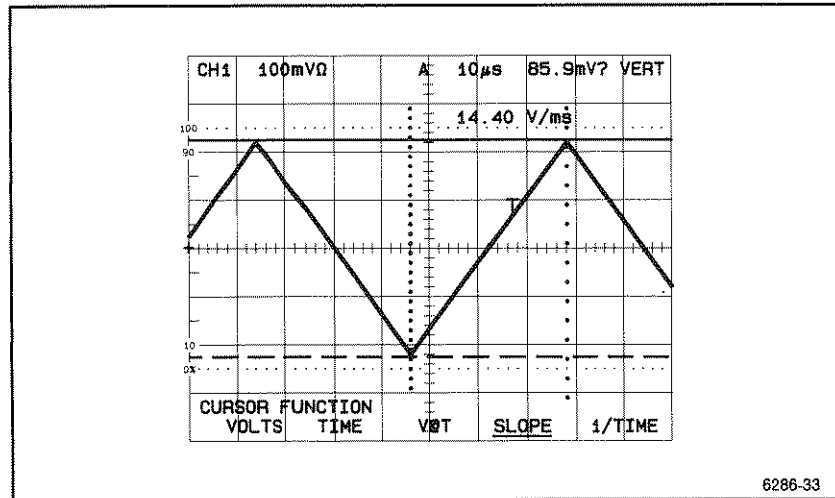

Figure 3-17. Slope measurement on a triangle-waveform.

### Special Units for Coupled Cursors

The special units for both types of coupled cursors are percent and decibels. References can be established and ratiometric measurements obtained using the same general method outlined in the "Ratio Between Two Voltages" procedure. Take care to attach the cursor(s) to the proper display source (CH 1, ADD, REF1, etc.).

When you use special units to compare two slopes, steeper slopes result in higher value readings, lesser slopes in lower readings. If a 2-V/ms slope is established as the 100% reference and a 4-V/ms slope is compared to it, the readout will indicate 200% as a ratio. If the same slopes are compared using decibels, the readout will indicate 6 dB. On the other hand, if the 4-V/ms slope is used as the 100% reference, the readout will indicate 50%, or -6 dB.

### **A\*B Trigger Source Application**

The A\*B composite trigger function, which is accessed via the A TRIGGER SOURCE menu, logically ANDs the A-Trigger source and the B-Trigger source to produce the A-Record Trigger. Thus an A acquisition can occur only when all the conditions you have set for *both* Trigger sources are true at the same time. (Since one of the trigger sources selected corresponds to the A Trigger system and the other to the B Trigger system, each source can be setup independently for Trigger Level, Slope, and Coupling.) This action is analogous to the familiar logical AND function; hence the name A AND B Trigger source.

The following paragraphs precisely define the criteria required for the A-Record Trigger (and therefore the acquisition) when A\*B Trigger is selected.

For an individual source to be true, the following conditions must be met:

a. If TRIGGER SLOPE is set to + (positive) *and* the level of the triggering signal is more positive than the triggering level set by the TRIGGER LEVEL control, then the source is true; otherwise, it is false.

b. If TRIGGER SLOPE is set to - (negative) *and* the level of the triggering signal is more negative than the level set by the TRIGGER LEVEL control, the source is true; otherwise, it is false.

For a Record Trigger to occur, the following conditions must be met:

a. Both A and B sources must be true as defined by items a and b, above.

b. There must be a transition through the level set by the TRIGGER LEVEL control for *at least one* of the two trigger sources.

c. The transition must be in the same direction (+ or -) as established by the TRIGGER SLOPE setting for the source.

## ***Applications***

---

The A\*B Trigger source should be used when you want to view events that occur, or should occur, only when two other events coincide. An example involving microprocessor accesses to RAM follows.

Typical microprocessor systems use the CS (Chip Select) and WE (Write Enable) inputs to write data to a particular RAM IC. With the WE pin held at the logic low state, a WRITE data function will occur when the CS pin makes a transition to the low state. Suppose you want to determine the states of the data lines when a WRITE occurs. You can use one of the two signals (CS and WE) as the A-Trigger source, the other as the B-Trigger source, and set the LEVEL and SLOPE of each trigger system to detect the conditions necessary for a WRITE. Using the A\*B Trigger function, you can then observe the state of the individual data lines via a probe connected to one of the vertical inputs.

Use the following procedure when making A\*B Trigger source measurements:

1. Connect the signal to be viewed to CH 1 or CH 2 input.
2. Set the appropriate VOLTS/DIV control for an on-screen display.
3. Apply one of the trigger-source signals to one of the unused input BNC connectors (CH 1, CH 2, EXT TRIG 1, or EXT TRIG 2).
4. Connect the second trigger-source signal to one of the other unused inputs. (Use the EXT TRIG inputs for one or both of the trigger signal sources so the vertical input channel(s) will be available for viewing the signal(s) to be monitored.)
5. Enter the A TRIGGER SOURCE menu and set A\*B:WORD to A\*B.
6. Select the source used in Step 3 to be the A-Trigger source.
7. Press TRIGGER MODE and select the desired mode.
8. Press TRIGGER COUPLING and select the desired coupling mode.

9. Use the TRIGGER LEVEL control knob to set the required triggering level as shown in the readout, and press the SLOPE button to choose positive (+) or negative (-) slope.

10. Press A/B TRIG to access the B-Triggering system. Press TRIGGER SOURCE and select the source used in Step 4 to be the B-Trigger source.

11. Repeat Steps 8 and 9 to select the Trigger coupling, level, and slope criteria for the B-Trigger source.

12. The scope is now set up to trigger on a composite of both sources, and it will acquire data if the proper triggering conditions are met for both the A- and the B-Trigger source. Push A/B TRIG to switch between A- and B-Trigger Systems as desired. Change the previously established triggering criteria as needed to develop the proper trigger conditions.

## ***Storage Applications***

This subsection to "Applications" discusses the various acquisition modes. It also covers the SAVE and SAVE ON  $\Delta$  features that are used to store acquisitions and the DISPLAY REF and other functions that control how stored acquisitions are displayed.

### ***Acquire Modes***

This instrument has three main acquisition modes—NORMAL, AVG (Average) and ENVELOPE. Two other modes, ROLL and REPET, affect the way in which signals are acquired. ROLL affects the display of NORMAL and ENVELOPE mode acquisitions, and REPET enhances the acquisition of high frequency, repetitive waveforms.

#### ***NORMAL Mode***

The NORMAL acquisition mode results in waveform displays most like those obtained with analog oscilloscopes. Changes in the waveform are quickly seen as newly acquired waveform data replaces earlier waveform data in the display. "Operators Familiarization" in Section 2 of this manual details the control setup required to make NORMAL mode acquisitions. Use this mode when features characteristic of the other modes are not required.

#### ***AVG (Average) Mode***

AVG mode reduces or eliminates random noise from displayed signals. You can predict the improvement in the signal-to-noise ratio, as compared with a NORMAL signal acquisition, based on the number of acquisitions that are averaged. Table 3-2 shows the Signal-to-Noise Improvement Ratio (SNIR) for each of the available Number of Acquisitions selections.

**Table 3-2**  
**SNIR vs Number of Acquisitions**

Number of Acquisitions	SNIR	SNIR (dB)
2	1.41	3.0
4	1.98	5.9
8	2.75	8.8
16	3.84	11.7
32	5.34	14.6
64	7.51	17.5
128	10.6	20.5
256	14.9	23.4

Several factors should be considered when using AVG mode.

1. If you change certain controls or menu selections during the series of acquisitions specified for the averaging sequence, the scope aborts the averaging sequence without completing any acquisitions not yet taken. It then starts a new averaging sequence. These are the controls that abort the sequence:

- HORIZONTAL or VERTICAL MODE.
- CH 1 or CH 2 VOLTS/DIV, VERTICAL POSITION, or COUPLING.
- BANDWIDTH menu settings (including SMOOTH).
- A and B SEC/DIV.
- TRIGGER MODE, COUPLING, SOURCE, POSITION or SLOPE; or INIT@50%.
- MENU OFF/EXTENDED FUNCTIONS.
- DELAY TIME (when in B HORIZONTAL MODE) or DELAY EVENTS.
- DISPLAY REF 1-4.

### Applications

2. It may take an extended period of time to average a signal that has a low frequency or a low repetition rate because, for such a signal, each acquisition takes longer. As an example, if you specify 256 acquisitions when the SEC/DIV is set to 5 s, it will take over 7 hours to complete the averaging. Be aware of this time factor when you select the number of acquisitions for the AVG mode.

3. AVG acquisition and ROLL trigger modes are mutually exclusive. (ROLL mode is discussed later in this subsection.) If the scope is in AVG mode when you select ROLL, the acquisition mode automatically switches from AVG to NORMAL. If the scope is in ROLL mode when you select AVG, the A-Trigger mode automatically switches from ROLL to NORMAL.

4. You cannot use the  $\Delta$  DELAY TIME feature in AVG mode. Selection of AVG mode prevents the display of  $\Delta$  Delayed B acquisitions (except for previously acquired REF waveforms) and NO  $\Delta$  DELAY IN AVG will appear with the STORAGE ACQUIRE and DELAY by TIME menus.

5. You should use NORMAL acquisition mode to set up proper display amplitude, timing, and triggering. You should also use NORMAL Trigger mode for signals with a low repetition rate so you can be sure that all averaged acquisitions are the result of the desired trigger event. AUTO and AUTO LEVEL Trigger modes can force Record Triggers, allowing uncorrelated acquisitions to be averaged.

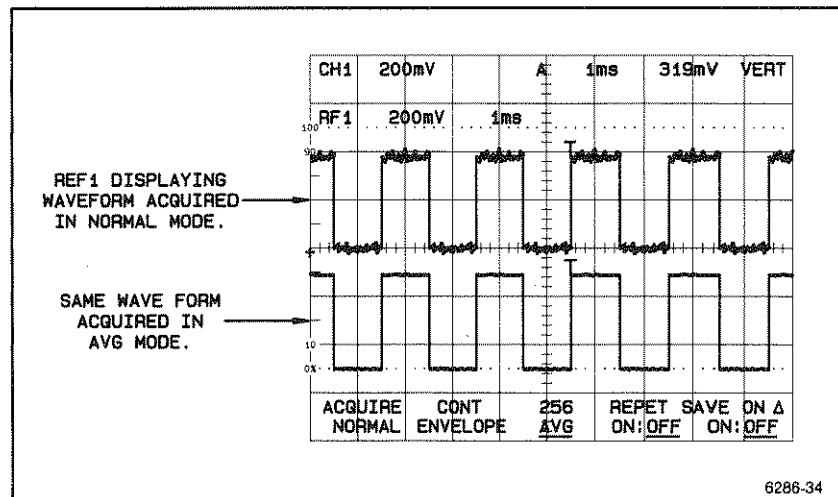

Figure 3-18. Effect of signal averaging on a noisy square wave.



## ENVELOPE Mode

The ENVELOPE acquisition mode is a repetitive process. As the scope makes the number of acquisitions you have specified, it accumulates a minimum and a maximum value for each data point and displays the resulting waveform envelope. If a newly acquired value falls between the currently stored minimum and maximum values, then it is discarded. Otherwise, it replaces the appropriate stored value.

One typical use for the envelope mode is to monitor a signal line for some point of interest. For example, if you are interested in a trigger-related amplitude change or switching transient, the envelope mode can be used to capture such an event. You would typically set up the trigger and other control settings to allow display of the event. Then, if you set the number of acquisitions for the envelope sequence to CONT, the scope would proceed to acquire continuously, accumulating the minimum and maximum values for each data point and displaying the envelope, so your constant attention would not be required.

Several factors should be considered when using ENVELOPE mode:

1. You can specify 1, 2, 4, 8, 16, 32, 64, 128, 256, or CONT (continuous) as the number of acquisitions required per envelope sequence.

2. In ENVELOPE mode, as in AVG, the acquisition sequence will abort and start over when certain controls or menu selections are changed. The controls that have this effect are the same as for AVG, with two exceptions: ENVELOPE does not reset with changes in Vertical POSITION, and CONT ENVELOPE does not reset with changes in DELAY TIME.

3. When ENVELOPE mode is used with ROLL acquisition mode, the number of acquisitions specified for the envelope sequence is irrelevant. For ROLL mode, the number of acquisitions in a sequence is always one, due to the way this mode acquires and displays data. (See ROLL mode later in this subsection.) ENVELOPE mode is useful with ROLL mode, however, due to the faster sampling rate ENVELOPE mode provides. (The faster sampling rate allows short duration events down to 2 ns in width to be captured and displayed.)

4. It is usually easier to set up the proper display amplitude, timing, and triggering in NORMAL acquisition mode, especially if you specify many acquisitions per envelope sequence. Using NORMAL, you avoid capturing the minimum and maximum data points caused by manipulation of the front-panel controls.

### ROLL Mode

In ROLL mode, the scope displays newly acquired data points in a continuous stream. Each newly acquired data point appears at the right side of the screen, causing previously acquired data points to “roll” toward the left side of the screen. The effect is similar to that of a chart recorder.

You can use ROLL mode when you want to continuously view a slowly changing signal. When ROLL mode is not used, the scope must be triggered on an appropriate event relative to the events you want to display. At the SEC/DIV settings required by slowly changing signals with low-repetition rates, the time between displays of triggered acquisitions can be lengthy. Furthermore, you may not know the trigger parameters for the events you want to view. Since ROLL is an untriggered mode, in which acquisitions are continuously displayed as described above, you can see the events of interest as they happen. You can also save them on screen or store them in a REF memory.

Consider the following factors when using ROLL mode:

1. To enter ROLL mode, you select AUTO Trigger mode and set the A SEC/DIV to 100 ms or slower. When the acquisition rate is between 100 ms per division and 5 s per division, ROLL automatically replaces AUTO in the A TRIGGER MODE menu.
2. ROLL mode is only available in A Horizontal mode. If you are in ROLL when you select A INTEN or B, the scope will switch from ROLL to AUTO and begin making triggered (or auto-triggered) acquisitions.
3. ROLL trigger mode and AVG acquisition mode cannot be used at the same time. If you select AVG when the scope is in ROLL, the A-Trigger mode automatically switches to NORMAL. Likewise, if you select ROLL when the scope is in AVG, the acquisition mode automatically switches to NORMAL.
4. Although the waveform record is 20 divisions long, the scope displays only 10 divisions at a time. In ROLL mode, it's a good idea to adjust the Horizontal POSITION control to display the *last* 10 divisions; then, not only will you see changing waveform parameters sooner, but when you vary control settings that affect the display, you will see the results right away. If, on the other hand, you were looking at the left-most 10 divisions when you changed the Vertical position, you would have to wait as long as 50 seconds (at 5 s/division) to see the effect on the display.

### **REPET Mode**

REPET (repetitive) mode extends the usable vertical bandwidth. Because the instrument has a maximum sample rate of 500 megasamples/second, its bandwidth is limited to 200 MHz for single acquisitions, and it must interpolate between sample points when the acquisition rate is faster than 100 ns/division. In REPET mode, however, the scope randomly samples many successive acquisitions. For repetitive waveforms, equivalent-time sampling acquires points that would otherwise have to be interpolated, thereby extending the maximum bandwidth to 300 MHz for such waveforms. When REPET is ON in the ACQUIRE menu, the scope automatically uses equivalent-time sampling at SEC/DIV settings of 50 ns and faster.

### **SAVE Storage Mode**

SAVE allows you to “freeze” the display on screen. You can then expand the saved waveform by up to three VOLTS/DIV settings for a 10X vertical expansion, and by up to six SEC/DIV settings for a 100X horizontal expansion. You can also use the Vertical and Horizontal POSITION controls to move the waveform around on the screen. Use the following procedure to save waveforms on screen:

1. Display the desired waveforms in CH 1 and/or CH 2 and select the desired VERTICAL MODE(s).
2. Push the STORAGE SAVE button to save the displayed waveforms.
3. Expand the saved waveform vertically by changing the VOLTS/DIV of the displayed channel to the next most sensitive setting.

**EXAMPLE:** A 0.5-V sine-wave is displayed in CH 1 with the VOLTS/DIV control set to 1 V when STORAGE SAVE is pressed. Changing the CH 1 VOLTS/DIV control yields the results shown in Table 3-3.

Table 3-3  
Vertical Expansion Factors

VOLTS/DIV Setting	Amplitude (Divisions)	Expansion Factor
1 V	0.5	1
500 mV	1.0	2
200 mv	2.5	5
100 mv	5.0	10

NOTE

To add or multiply saved waveforms that were acquired in Envelope mode, you must turn on ADD or MULT mode before entering SAVE mode. If you select ADD or MULT after saving CH 1 and CH 2 waveforms, and Envelope is already turned on, an invalid waveform is displayed. You can add or multiply waveforms after saving if Average or Normal acquisition mode is selected; however, switching the mode to Envelope replaces the ADD/MULT waveform with an invalid one.

To expand the saved display of any ADD or MULT Vertical mode waveform, change either the CH 1 or CH 2 VOLTS/DIV setting. The readout for the ADD Vertical mode VOLTS/DIV will be the same as for CH 1. This value may not be correct. See the discussion under "Unwanted Signal and Noise Cancellation" in the "General Applications" portion of this section for information on interpreting the ADD Vertical mode VOLTS/DIV setting.

4. Expand the saved waveform horizontally by changing the SEC/DIV setting to a faster acquisition rate. (See NOTE below).

**EXAMPLE:** A 10-kHz sine wave is displayed in CH 1 with the SEC/DIV control set to 1 ms when STORAGE SAVE is pressed. Changing the SEC/DIV control yields the results shown in Table 3-4.

**Table 3-4**  
**Horizontal Expansion Factors**

<b>SEC/DIV Setting</b>	<b>Cycles per Division(s)</b>	<b>Expansion Factor</b>
1 ms	10 per div	1
500 $\mu$ s	5 per div	2
200 $\mu$ s	2 per div	5
100 $\mu$ s	1 per div	10
50 $\mu$ s	1 per 2 div	20
20 $\mu$ s	1 per 5 div	50
10 $\mu$ s	1 per 10 div	100

**NOTE**

*If you save a waveform in either A or B Horizontal mode, you should use the same mode when you expand it horizontally. However, if you save a waveform in A INTEN Horizontal mode, you should change to A Horizontal mode before you expand it.*

When you press SAVE, in addition to saving the waveforms, the scope displays the SAVEREF SOURCE menu and a message showing how many acquisitions have occurred. The menu lets you store saved waveforms for later reference, while the message tells you how many acquisitions were made since the acquisition sequence started and before SAVE was entered. Changing any of the controls that restart an Average or Envelope sequence (see discussion on Average earlier in this section), or changing the acquisition mode itself, restarts the count. When using ENVELOPE or AVG, the count tells you how many times the waveforms was enveloped or averaged before the save occurred.

### **SAVEREF SOURCE and DISPLAY REF**

The SAVEREF SOURCE menu includes all the Vertical mode settings that were in effect when you pressed SAVE. It enables you to designate, by selecting the appropriate display source(s) from this menu, which waveform(s) you want to store.

Two other selections are also available as sources, namely REF and STACK REF. Choosing REF causes the SAVEREF SOURCE-REF sub-menu to be displayed, allowing the use of any of the REF memories as a source. (This feature enables you to copy waveforms from one REF memory to another.) Selecting STACK REF causes the displayed waveforms to be saved in REF memory locations as indicated by Table B-13 in Appendix B of this manual. Note that the destinations of the waveforms depend on the Vertical mode settings and that waveforms stored in certain REF locations are "pushed" to new REF locations.

Use the following procedure to store waveforms in and display waveforms from REF memory locations:

1. Perform Steps 1 and 2 of the "SAVE Storage Mode" procedure. Perform Steps 3 and 4 of that procedure if you want to store the waveform in an expanded form.
2. Press the menu button corresponding to the source of the waveform you want to store.
3. Vertically position the waveform before storing it; you won't be able to position it later, when it's being displayed from its memory location.
4. If you pressed the STACK REF menu button in Step 2, the displayed waveform(s) are stored as indicated in Table B-13; otherwise, the SAVEREF DESTINATION menu is displayed. Press the menu button corresponding to the REF location where you want to store the waveform.

The displayed waveform is now stored in the REF memory specified. To display the stored waveform perform the following steps:

5. Press DISPLAY REF to display that menu.
6. Press the menu button corresponding to the REF location in which the waveform is stored (the location chosen in Step 4). The stored REF waveform is now displayed at the same vertical position as the source waveform.

NOTE

*If the source waveform is still on screen, either in the "live" or SAVE mode, and it has not been repositioned since it was stored, you will have to move it to see the DISPLAY REF waveform.*

7. Press HORIZ POS REF to display the HORIZONTAL POSITION menu; then set REF HPOS to IND (independent).

8. To horizontally position one of the displayed REF waveforms, press the menu button that selects it and turn the Horizontal POSITION knob.

9. Press the DISPLAY REF button to return to that menu. The Horizontal POSITION control now positions "live" and SAVED waveform(s), but not stored waveform(s) displayed from REF memories.

10. Recall the HORIZ POS REF menu and set LOCK on again. Now Horizontal POSITION simultaneously positions all waveforms, whether "live," SAVED, or stored.

Several factors should be considered when storing and displaying SAVED waveforms:

1. Since you cannot change the vertical position of a waveform displayed from REF memory, it is important to position either the "live" or SAVED waveform before you store it.

2. When you use the HORIZ POS REF function to move a stored waveform horizontally, it loses its phase relationship to other stored waveforms. You can re-establish phase relationships either manually by aligning the Trigger Point Indicators or automatically by setting HORIZ POS REF to LOCK.

3. SAVED waveforms that have been expanded will be stored in the expanded form when moved to a REF memory.

### **SAVE ON $\Delta$ Mode.**

When SAVE ON  $\Delta$  is turned on, the scope automatically saves the acquired signal if it has amplitude values that exceed specified limits. These limits are defined by an envelope waveform that has previously been acquired, saved, and stored in the proper REF memory. Provided that signal source (CH 1, CH 2, etc.) is displayed with the correct REF (REF 1, REF2, etc.) envelope, the instrument compares the "live" acquisition to the stored reference. (See Table B-14 in Appendix B for how the signal source displays and REF memory envelopes must be paired for SAVE ON  $\Delta$  comparisons). Then, if a value of the live waveform in the signal source falls outside the envelope in the REF memory, the scope enters SAVE mode.

You can develop envelope waveforms for use with SAVE ON  $\Delta$  either from the front panel or via the GPIB (General Purpose Interface Bus). These will be discussed in order...

**FROM THE FRONT PANEL.** In the menu called up by the ACQUIRE button, select ENVELOPE and set it to CONTInuous. If your concern is to detect an out-of-limit dc error of a signal, you don't need a sample of the actual waveform. Instead, you can create a comparison envelope by vertically positioning a baseline trace to the desired positive and negative limits. (For example, positioning the baseline trace two divisions above graticule center, and then 2 divisions below, creates a four-division envelope around graticule center.) When this envelope is properly stored and displayed from REF, and SAVE ON  $\Delta$  mode is turned on, the acquired waveform will be saved on screen if it makes any excursion outside the envelope.

If, on the other hand, you are also concerned with limiting phase and frequency shifts, you will need a sample waveform that conforms to the ideal signal, and you will have to create both horizontal and vertical windows on it for the comparison envelope.

To create the horizontal window, select B Horizontal MODE. Set ENVELOPE to CONT, and acquire the sample waveform. Slightly vary the DELAY TIME setting to position the waveform left and right, thereby defining the horizontal limits for the envelope. Create the vertical envelope limits as before, by positioning the waveform vertically around the signal baseline. Then save the waveform, store it in the correct REF memory for making the live waveform comparison, and display it from REF. Leave the scope in B Horizontal mode to acquire the live waveforms and make the SAVE ON  $\Delta$  comparison. (See Figure 3-19).



The following procedure creates a comparison envelope for a particular waveform (in this case a 5-V, 1-kHz square wave) so that it can be monitored for any amplitude changes greater than  $\pm 0.25$  V and phase or frequency shifts greater than 5%. You should use this procedure as a guide for developing your own envelopes for other types of waveforms.

1. Input the square wave into the desired channel with VOLTS/DIV set to 1 V.
2. Set the A SEC/DIV control to 1 ms and select B Horizontal MODE.
3. Set the B SEC/DIV control to 200  $\mu$ s and B TRIG MODE to RUNS AFTER (Delay).
4. Position the displayed waveform at the required vertical position on screen. (Remember, when it is stored as a REF waveform it cannot be positioned vertically).
5. Push the DELAY by TIME button, and set  $\Delta$  TIME ON/OFF to OFF.
6. Set the DELAY TIME readout to a value that allows the waveform to be positioned several horizontal divisions in both directions.
7. Push ACQUIRE and select the ENVELOPE mode. Set the number of acquisitions to CONT.
8. Push DELAY by TIME and note the DELAY TIME readout value.
9. Carefully rotate the Cursor/Delay control knob clockwise until the readout indicates 0.0480 ms more than the value noted in Step 8. (Because the delay time resolution at 200  $\mu$ s per division is 8  $\mu$ s, you cannot get to exactly the 0.0500 ms that would represent a 5% change.) Note that the envelope increases  $\frac{1}{4}$  division to the left of the waveform.
10. Vertically position the square wave up  $\frac{1}{4}$  division, then down  $\frac{1}{2}$  to begin creating the  $\pm \frac{1}{4}$  (0.25 V) division vertical envelope.
11. Rotate the Cursor/Delay control knob counterclockwise until the readout indicates 0.0480 ms less than the value noted in Step 8. Note that the envelope increases  $\frac{1}{4}$  division to the right of the waveform.

## **Applications**

---

12. Position the waveform up 1/2 division (it was left at the  $-1/4$  position in Step 10) to complete the envelope waveform. (See Figure 3-19a.)

13. Return the DELAY TIME setting to the same value as noted in Step 8.

14. Push STORAGE SAVE and save the envelope waveform in the proper REF memory location. (See Table B-14 in Appendix B to determine which REF is appropriate for the VERTICAL MODE in effect.)

15. Change the acquisition mode to NORMAL.

16. Push DISPLAY REF and display the REF selected in Step 14.

17. Center the waveform to be monitored within the REF envelope, using the Vertical and Horizontal POSITION controls.

**USING THE GPIB.** Since use of the GPIB (General Purpose Interface Bus) to develop the envelope waveform depends on the particular equipment used to generate the waveform and control the GPIB interface of the scope, the procedure given here is merely an outline of a general method that allows the scope to do as much of the work as possible. By using the Programmers Reference Guide, which gives the various commands the scope uses in waveform transfer, together with the Operators Manuals for the equipment used, a system programmer can develop methods for entering comparison REF waveforms via the GPIB.

1. Create an envelope waveform in B Horizontal mode using the Vertical POSITION controls and the CURSOR/DELAY control knob (as described in "FROM THE FRONT PANEL") to define the rough limits of the envelope to be used for comparison.

2. Use WFMpre? to get the envelope waveform preamble portion of the message, letting the scope do the work for you.

3. Acquire the envelope waveform using CURVE? to obtain the waveform data points. The programmer must have set up arrays to receive and hold the curve and preamble data.

4. Adjust any of the 512 envelope data point MAX-MIN pairs stored in the waveform data array as necessary to create the comparison limits wanted. Fast rising edges need some horizontal width to widen the envelope for jitter. How this is done depends on what you want your comparison envelope to look like, and the exact manner in which it is done must be left to the programmer.

5. Set the DATA ENCDG for ASCII, RPBINary, or RIBINary as required by the type of data. Normally, the scope expects waveform data to be sent in two's complement format (RIBINary).

6. Set DATA TARGET in which to store the reference memory. Remember that waveforms are compared against designated reference memories. (See Table B-14 in Appendix B for the correct destination to make a comparison.)

7. Send the waveform preamble string using WFMpre followed by the captured preamble data as the arguments.

8. Send the envelope waveform data to the scope using the CURve command followed by the waveform data.

**Applications**

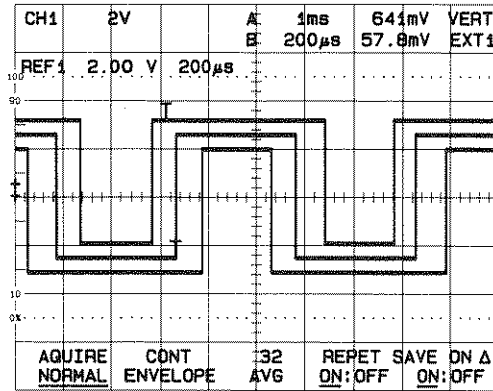

a. Square wave centered in the REF1 envelope for monitoring.

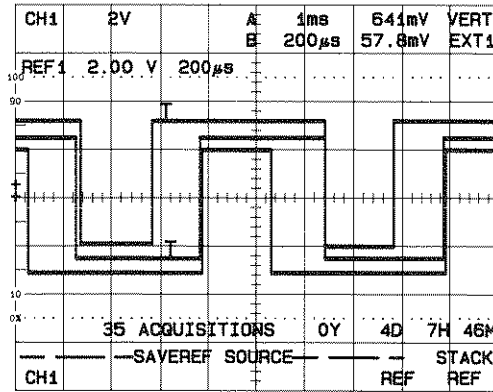

b. Square wave captured as it moves out of the envelope on the 35 acquisition. Note the change to the SAVE menu.

6286-35

**Figure 3-19 (a and b). Using the SAVEREF function with ENVELOPE mode to monitor and save a square wave.**

## Extended Features Applications

This instrument has three features that can be used separately or in tandem to extend its usefulness as a test and measurement tool as compared with conventional oscilloscopes. These features are Auto Setup, Measure, and the AutoStep Sequencer (which is accessed with the PRGM front-panel button).

The Auto Setup feature forces a front-panel setup that yields a triggered, viewable display based on the signals present at the CH 1 and CH 2 input connectors. The Auto Setup menu lets the user direct the scope to optimize the display for the parameter of greatest interest. VIEW mode displays several cycles of the signal. PERIOD, PULSE, or EDGE (leading or falling) are also available. HI RESolution gives the best measurement resolution over the 20-division horizontal and the 10.24-division vertical acquisition windows. LO RES tailors the display to the screen for best viewing.

Measure is a dual-mode, parameter-extraction feature. Executing the SNAPSHOT mode causes the scope to extract as many of the 20 available parameters as possible (depending on the user-specified front-panel settings). It is called SNAPSHOT because the scope uses only *one* waveform acquisition for its "snapshot" of the 20 parameters. Also available is the continuous-update Measure mode. Up to four parameters are selected from the 21 available (the same 20 available with SNAPSHOT, plus DELAY). With this mode, the parameters are extracted from successive waveform acquisitions resulting in a constant updating of the displayed parameter values. The waveform must be characterized before the parameters can be extracted. For both the SNAPSHOT and continuous-update Measure modes, the user can select the method (algorithm) of waveform characterization and can set the waveform levels (proximal, distal, etc.) used to determine measurement reference points.

The AutoStep Sequencer is a feature that allows you to store a sequence of front-panel setups for later recall. Furthermore, each setup can have a series of actions associated with it. The actions include such things as pausing at certain steps so you can check or photograph the display, printing or plotting certain measurements or waveforms, etc. Also, you can program the scope to automatically loop through this sequence of front-panel setups and actions. Taken together, these features allow users doing repetitive measurements to write routines that will greatly reduce the time and effort needed to get the job done.

## **Auto Setup**

### ***“Quick and Dirty” Display of a Signal***

VIEW is the best mode to use for overall viewing of waveforms. If you just want to quickly view a single input signal with minimum consideration of scope settings, do the following:

1. Input the signal to CH 1 or CH 2, turn on *only* that channel in the VERTICAL MODE menu, and press AUTO.
2. If VIEW is underlined in the resulting menu, the waveform should be displayed with between 3 and 5 cycles on screen, and it should be approximately within the center 4 divisions vertically if there is no DC offset, or within the top or bottom 4 divisions with offset.

#### **NOTE**

*References to vertical sizing should be interpreted as target values when they pertain to Auto Setup modes. For instance, in Step 2 the scope attempts to target (choose) a VOLTS/DIV setting that displays 4 divisions vertically on screen. The actual setting chosen may yield more or less than 4 divisions, depending on the amplitude of the signal and the available VOLTS/DIV settings. Different Auto Setup modes use different target values, but the concept remains the same.*

3. If VIEW is not underlined, select it in the Auto Setup menu and press AUTO again to obtain the results described in Step 2.

### ***“Quick and Dirty” Displays of Parameters***

Auto Setup can also optimize the display for one of three parameters: period, pulse, or edge (rising or falling). Single-channel viewing of parameters is just as easy as when using VIEW mode. Here's what you do:

1. Input the signal to CH 1 or CH 2, set Vertical MODE accordingly, and press AUTO.
2. Select the desired parameter in the AUTOSETUP menu and set RES HI:LO to LO. (LO is best for viewing waveform parameters.)
3. Press AUTO to re-execute Auto Setup using the mode and resolution specified in Step 2.

The parameters will be displayed as follows:

a. PERIOD: For the LO RES setting, at least one cycle is displayed on screen, and the waveform is vertically scaled and positioned to fit within the center three divisions. For HI RES, at least one cycle is displayed in the 20-division horizontal record and the waveform is vertically scaled and positioned to fit within the center five vertical divisions. For both LO and HI RES settings, the trigger position is set to 1/32 for best assurance that the whole period is acquired. The trigger slope, which is positive by default, can be changed by pressing the SLOPE button.

b. PULSE: For LO RES settings, the pulse (defined for rectangular waveforms as the portion of the cycle having the narrowest pulse width) is displayed on screen, while for HI RES, the pulse is displayed within the 20-division horizontal record. Vertical scaling and trigger position are the same as for PERIOD. Trigger slope is set to display the leading edge of the selected pulse.

c. EDGE: The rising or falling edge is displayed as specified by the toggle menu selection for EDGE. For LO RES, the rise/fall time is located within the center 3 horizontal divisions of the 20-division record. For HI RES, the rise/fall time is located within the center 9 divisions. Vertical scaling is the same as for PERIOD.

## **Applications**

---

### **Dual-Channel Auto Setup Displays**

This procedure is for using Auto Setup when signals are applied to both CH 1 and CH 2.

#### **NOTE**

*With signals in both channels, Auto Setup always uses the signal in CH 1 to trigger the acquisition and set the horizontal scale.*

1. Input one signal into CH 1, the other into CH 2.
2. Select both CH 1 and CH 2 in the VERTICAL MODE menu.
3. Press AUTO, and when Auto Setup finishes executing, select the mode and resolution you want.
4. Press AUTO again to execute Auto Setup using the mode and resolution you set in Step 3.

The display delivered by Auto Setup depends on the mode selected from the menu and the relation of the CH 2 signal to the CH 1 signal. Triggering and horizontal scaling are determined by the CH 1 signal based on the criteria that were explained in the previous two applications procedures, so the CH 2 display will be stable only if it's time-related to CH 1.

The vertical scale is independent for the two channels, but differs according to the Auto Setup mode chosen. For VIEW mode, each display (including dc offset) is scaled to fit within two vertical divisions. The ground reference is positioned two divisions above graticule center for CH 1 and two divisions below graticule center for CH 2. This scheme separates the two displays for best viewing to convey dc information. In the remaining modes, the vertical scaling depends on the RES setting and the dc offset (as explained in consideration 6, below). For LO RES, the ac components in both channels are scaled to approximately 3 divisions around graticule center; for HI RES they are scaled to approximately 5 divisions around the graticule center. This action results in an overlapping display for comparing parameters.



### Considerations for Using Auto Setup

1. Auto Setup cannot be used to display waveforms saved in REF memory.
2. Auto Setup cannot be used to display parameters that are outside the range of instrument specification. For instance, a 50-volt signal cannot be vertically sized to fit within the center 5 vertical divisions in VIEW mode, since such sizing requires a greater VOLTS/DIV setting than the maximum of 5 V. Likewise, there are limitations for trigger sensitivity, maximum and minimum acquisition rate, bandwidth, etc. The user must determine those limitations based on the specifications listed in Section 6.
3. Auto Setup cannot be used to reliably display signals which could not be triggered in AUTOLEVEL mode. This means the signal must be  $\geq 5$  mV and  $\geq 50$  Hz. If the selected Auto Setup mode dictates horizontal sizing that results in a setting of 100 ms/DIV or slower, the waveform cannot be properly displayed.
4. Auto Setup can be used with ADD and MULT displays. In ADD mode, the added signal provides the trigger source and determines the horizontal scaling; in MULT mode, the CH 1 signal does the same. These rules apply even if the CH 1 and CH 2 sources are not displayed. The position of the ADD or MULT display is the algebraic sum of the base levels for CH 1 and CH 2 as determined by the Auto Setup mode used. The vertical scale of the ADD or MULT display is determined first by the scale set by Auto Setup for the mode chosen, then by the normal rules for ADD and MULT mode operation. (See "General Applications" in this section for more information.) Again, the CH 1 and CH 2 sources do not have to be turned on to affect the position and scale of the ADD/MULT display.
5. Auto Setup makes certain changes to the front-panel when it executes. In general, it makes the minimum changes needed to display the signal.
  - a. The front-panel is set up for an acquisition using the A Horizontal mode and A Trigger. All Cursor and Delay modes are turned off and NORMAL acquisition mode is used.
  - b. If either the CH 1 or CH 2 input coupling is GND (ground), Auto Setup changes it to DC; otherwise, the coupling is left as previously set. INVERT is set to OFF for both channels.

## **Applications**

---

c. Trigger COUPLING is set to DC and Trigger SOURCE is set to VERT. The actual source used for the VERT source setting depends on the Vertical MODE setting. (See Table 5-1 in Section 5.)

d. A complete list of the front-panel settings affected by execution of Auto Setup can be found in Table B-16, Appendix B.

6. VIEW mode always scales the entire waveform, both ac component and dc offset. But the dc offset can affect the vertical sizing of the waveform in the other modes of Auto Setup, too. This happens when the dc offset exceeds the vertical channel's  $\pm 10$  division position range. To determine the vertical deflection factor in PERIOD, PULSE, or EDGE mode, the instrument first finds the VOLTS/DIV setting needed to properly scale the ac component of the signal. If the signal's dc offset is less than ten divisions at the VOLT/DIV setting found, the instrument can handle the offset using its position range. Therefore, it sizes the waveform as previously described. If the dc offset is greater than ten divisions, the instrument uses the VIEW mode method to size the entire display (ac plus dc offset).

7. Values given for both vertical and horizontal sizing in all Auto Setup modes should be considered target values. The scope chooses the deflection factor and acquisition rate that bring the display as close to the target values as possible. In general, LO RES settings limit the scales to keep the display on screen, while HI RES settings limit the scales to keep the display within the acquisition windows of 10.24 vertical divisions and 20 horizontal divisions. The target values are as previously indicated.

8. The execution of Auto Setup may result in changes to front-panel settings that are not immediately apparent. For this reason it is worth taking the time to learn how it behaves as described in this section. Auto Setup is also discussed in conjunction with the applications for Measure.

## MEASURE

### *SNAPSHOT, A Quick Measurement of Waveform Parameters*

1. Input the waveform for measurement to CH 1 or CH 2.
2. Obtain a triggered display of the waveform parameters to be measured.
3. Push MEASURE to display the menu.
4. Select SETUP to display the SETUP menu.
5. Select the METHOD the instrument is to use to determine the TOP and BASE of the waveform. The following settings are recommended:
  - Use MIN/MAX when measuring waveforms that have fairly constant slopes except at the positive and negative peaks, such as sine waves, triangle waves, and ramps.
  - Use HIST (histogram) when measuring waveforms that make relatively rapid transitions to longer-duration levels, such as square waves, rectangle waves, and pulses.
  - Use CURSOR only when you have considered the waveform to be measured and the parameters to be extracted and you wish to establish the TOP and BASE levels on the waveform. If that is the case, use the following procedure to set the levels:
    - a. Select CURSOR in the METHOD menu.
    - b. Press the front-panel Cursor FUNCTION button and select VOLTS in that menu.
    - c. Press the front-panel Cursor UNITS button and select VOLTS. Also, set  $\Delta$ :ABS to  $\Delta$ .

## Applications

---

- d. Set the active cursor to the level you want for TOP. (See Note.)
- e. Press Cursor SELECT to enable the alternate cursor and set it to the level you want for BASE. (See Note.)

### NOTE

*The scope uses the most positive cursor to determine the TOP and the most negative cursor to determine the BASE, once they are set to the desired levels. Also, if the TOP and BASE levels established by the cursors are outside the peak-to-peak amplitude of the waveform, error messages will be returned for time-related measurements, such as RISE, FALL, PER, etc. The error messages are in the form of written messages when the Continuous-Update method for Measure is used and a series of "?" marks when SNAPSHOT is used.*

*The CURSOR method sets the TOP and BASE for all waveforms displayed. Since you set TOP and BASE to levels on a particular waveform, they will likely be incorrect for waveforms displayed in other sources (CH 1, REF 1, etc.), and may cause error messages for any time-related measurements displayed for these waveforms. Histogram and MIN/MAX methods establish the TOP and BASE for each waveform source independently; therefore, are more suitable for use on multiple waveform displays.*

- f. Push MEASURE to recall that menu and select SETUP to return to the METHOD menu.
- g. Push LEVEL if you want to change the Time Reference Points (distal, proximal, mesial and mesial2). The rules for setting the levels follow:
  - The proximal level must be the least-positive level set on the waveform.
  - The distal level must be the most-positive set on the waveform.
  - The mesial levels must be more positive than the proximal level and more negative than the distal level.
  - Levels established outside the peak-to-peak amplitude of the waveform or out of the order specified in Steps a-c can result in error messages for some waveform measurements. (See Appendix C.)

LEVEL is like CURSOR in that you change the levels for the Time Reference Points when you have considered the waveform and the measurement to be made and determined more desirable levels than the defaults. When set in percent, the defaults are 10%, 90%, 50%, and 50% for PROXIMAL, DISTAL, MESIAL, and MESIAL2, respectively. When set in volts, the defaults are default TTL levels of 400 mV, 2.40 V, 1.30 V, and 1.30 V, respectively.

Once you change the levels, the instrument remembers them until you change them again. Doing an INIT PANEL from the PRGM menu quickly reestablishes the default levels, but you must re-set up the instrument for making your measurement(s). You can change the levels to new or default settings using the following procedure:

- a. Push the menu button corresponding to the level (distal, proximal, etc.) you want to change.
- b. Select % or VOLTS units using the toggle-menu button labeled %|VOLT.
- c. Observing the criteria in Step 7, use the Cursor/Delay knob to change the value above the selected Time Reference Point to the level you want.

If you select % as the unit and you have not used CURSOR method to set TOP and BASE, settings for the Time Reference Points are relative to, and confined within the peak-to-peak amplitudes of every waveform displayed. (Setting DISTAL to 10% sets it to 10% of the peak-to-peak amplitude above the BASE for every waveform.) Therefore, as you measure different waveforms, Time Reference Points will be set to the same relative levels and appropriate results returned.

**NOTE**

*Strictly speaking, the scope uses the difference between the TOP and the BASE to calculate the levels for the Time Reference Points. Therefore, TOP or BASE settings using the CURSOR method can cause error messages unless you keep the TOP and BASE levels on the waveform you want to measure. See above note for CURSOR.*

## Applications

---

If you select VOLT as the unit, settings are relative to the ground reference levels and NOT confined within the amplitudes of every waveform. (Setting DISTAL to 100 mV sets the distal level up 100 mV from the ground reference level for every waveform displayed.) Therefore, using VOLT as the level unit, you can set Time Reference Points outside the 0-100% levels on the waveform you are going to measure now, or set levels inside that waveform but outside another waveform you select to measure later. Such settings can cause error messages for some measurements. Make sure the voltage levels you set as Time Reference Points are within the peak-to-peak amplitude of the waveform being measured.

d. Repeat Steps a-c until you have adjusted all the levels you want to change. Press MEASURE to return to that menu.

8. Select SNAPSHOT. If more than one source is displayed a target menu appears; if so, select the target (CH1, CH2, etc.) for the waveform you want to measure.

## Interpreting the Display

The display that results from selecting SNAPSHOT and its target consists primarily of a list of 20 parameters with their measurement values. In addition, it shows the targeted display source, the method used to determine TOP and BASE, the levels set for DISTAL, MESIAL, and PROXIMAL, and two menu selections that let you take another "snapshot" or return to the main Measure menu.

Sometimes SNAPSHOT can't complete accurate measurements for all 20 of the parameters. There are three cases to consider:

**CASE 1:** SNAPSHOT can't extract the parameter because the waveform, as displayed, doesn't have the necessary characteristics. For example, if the SEC/DIV setting is too fast to acquire all three edges (transitions) needed to define one waveform cycle, SNAPSHOT can't extract the parameter PER (period). In this case, the display shows a string of question marks ("????") in place of the measurement value.

**CASE 2:** SNAPSHOT is able to extract the parameter, but for some reason the measurement obtained is suspect. For example, if a waveform with a rise time of 100 ns is displayed at 5  $\mu$ s per division, SNAPSHOT can extract the rise time and measure it. The accuracy, however, is in doubt because the value determined (with 50 samples per division) is based on only one sample point being obtained over the entire rise time:

$$\frac{100 \text{ ns}}{5 \mu\text{s}} \times 50 \text{ samples} = 1 \text{ sample point}$$

In this case, the display shows the measurement value, but puts a single question mark in place of the equal sign in front of it. If you need an accurate measurement, you should increase the acquisition rate to display the rise time over several horizontal divisions and re-execute SNAPSHOT.

**CASE 3:** SNAPSHOT can extract the parameter and obtain a measurement value that is accurate enough not to require a question mark in front of it, but still is less accurate than you want. Before accepting a value, you should always consider such things as how many samples were obtained for the parameter. In general, you should set up the instrument to display the parameters you are most interested in over as much of the 20-division horizontal record and the 10.24-division vertical window as possible.

Assuming the waveform is repetitive, you can see the error messages associated with Case 1 and Case 2 by displaying the parameter in question in Continuous-Update mode, which is discussed later in this section. Also, Appendix C explains the error messages, Time Reference Points, and other considerations for both Measure modes.

### ***Characterization of the Leading Edge of a Pulse***

Use the following procedure as a general guide to characterize a set of parameters on a waveform.

1. Make sure all of the parameters you wish to characterize can be displayed adequately using a single front-panel setup.

This application assumes that you want to measure rise time, overshoot, undershoot, and peak-to-peak amplitude of a positive-going pulse. Since undershoot occurs right before, and overshoot occurs right after the positive-going edge on the waveform, we should be able to display all three parameters with adequate resolution. Other parameters, such as fall time, might not be obtained, so they are ignored for this SNAPSHOT. Since a pulse is assumed, and steady-state values for the pulse ought to be obtained before and after the transition, peak-to-peak voltage will also be considered a valid parameter, in spite of the fact that less than one cycle of the waveform may be acquired.

2. Set up the front panel to display the characteristics with good vertical and horizontal resolution.

### Applications

Since we want to look at the front corners of our pulse, let's use the EDGE mode of Auto Setup to display the leading edge of the waveform:

- a. Input the pulse into the desired channel and set Vertical MODE to the corresponding channel. Set up the input coupling as desired.
- b. Press Auto Setup. When it finishes executing, set the mode to EDGE (  ) and RES to HI.
- c. Re-execute Auto Setup.

You should be able to tell from the display whether you will get good measurement results for the parameters of interest. As an example, Figure 3-20 shows the results from executing the previously described Auto Setup. The rise time is displayed over most of the ten on-screen divisions and the steady-state levels can be seen by repositioning horizontally.

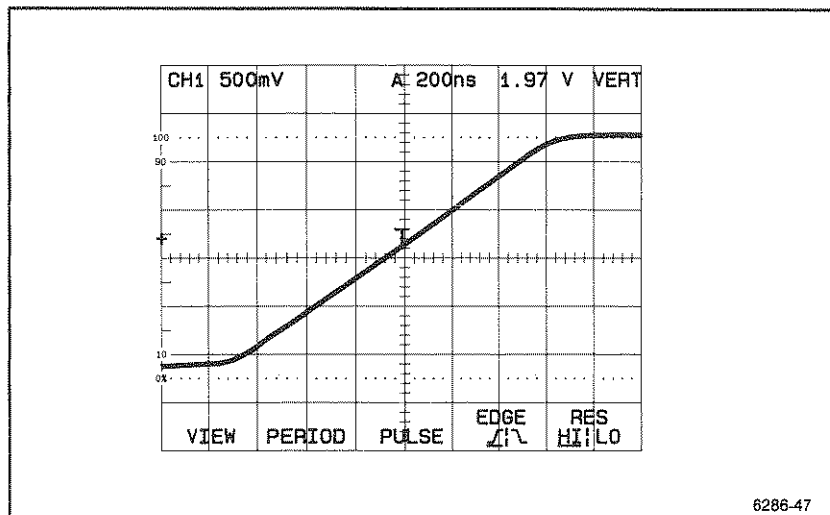

Figure 3-20. Auto Setup for EDGE (rising).



3. Press MEASURE, and select SETUP if you want to specify the METHOD for determining TOP and BASE or to change the LEVEL of any of the Time Reference Points. (If you use CURSOR METHOD, decrease the SEC/DIV setting to see more of the steady-state levels for best cursor placement and return to the previous setting when finished.)

Since you are measuring a pulse and are interested in undershoot and overshoot, which can't be extracted using MIN/MAX method, you should select HIST. You should leave the PROXIMAL and DISTAL Time Reference Points at default values to measure rise time at the standard levels of 10% and 90%, respectively. Leave MESIAL and MESIAL2 at default levels, also; they are not a consideration here since we are not interested in the SNAPSHOT values relating to TIME and/or DELAY.

4. Return to the main MEASURE menu. Press SNAPSHOT to execute.

The parameters are displayed with their values. An example of a snapshot for the waveform obtained with Auto Setup is shown in Figure 3-21.

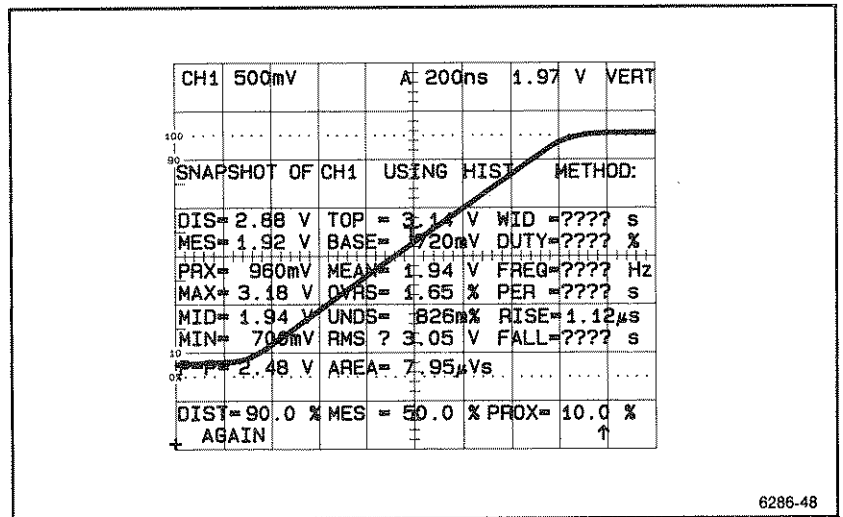

Figure 3-21. SNAPSHOT of a pulse's rise time.

## ***Applications***

---

In the figure, those parameter values we wanted to measure are displayed and we accept the values because we set up the scope to display those parameters. Note, however, that those parameters such as DUTY, FREQ, PERiod, FALL time, etc. are displayed with the question-mark string since only one edge (the rising edge) of the waveform was acquired. Note also that the RMS value has the question mark replacing the “=”. The RMS calculation is normally performed over the first valid period of the waveform that is found. Since no valid period is currently present, RMS is calculated over the full 1024-point waveform. The “?” indicates to the user that this has occurred.

The other values in the display could be accepted for the most part. The TOP and BASE levels are accepted because we selected the method to determine them. We accept the Time Reference Point levels since we accept the TOP and BASE levels. We might question MIN for the waveform because we didn't acquire the falling edge and it could have more or less aberrations than were present at the start of the rising edge. Also, MEAN (for mean average) should be considered the mean between the two levels since a whole cycle was not acquired and the duty cycle could not be taken into account when determining the mean.

## ***Parameter Measurements Using the Continuous-Update Mode***

An important point to remember about SNAPSHOT is that the parameters are extracted for one single triggered acquisition. It is necessary to press AGAIN in the SNAPSHOT menu (or re-execute from the main MEASURE menu) to update the parameter values for successive acquisitions.

With the Continuous-Update mode for MEASURE, up to four of twenty-one parameters can be displayed at one time. Unlike SNAPSHOT, these parameters are regularly updated as successive acquisitions are triggered. Using the Continuous-Update mode is very similar to using SNAPSHOT mode, as these application procedures illustrate.

Use the following procedure to display parameters using the Continuous-Update mode for MEASURE:

1. Use Steps 1-6 of the SNAPSHOT procedure, “A Quick Measurement of Waveform Parameters,” with the following additions:
  - a. At Step 3, turn WINDOW ON or OFF as desired.

WINDOW, when on, forces the parameters to be extracted from only that area on the 20-division horizontal acquisition that is bracketed by the TIME CURSORS. WINDOW has no effect in SNAPSHOT mode.

b. After displaying the SETUP menu in Step 4, set MARK ON or OFF as desired before proceeding to the next step.

MARK, when on, will display two "X" marks on the waveform. These marks indicate the area on the waveform from which time-related parameter values are extracted.

Keep in mind the considerations outlined in Steps 1-6 of "SNAPSHOT, A Quick Measurement of Waveform Parameters" when setting up the front-panel for parameter extraction, setting the levels determining Time Reference Points, and setting the METHOD for TOP and BASE determination.

2. Press MEASURE to return to the main menu.

3. Push MEAS TYPE to display the menu that specifies the parameters to be displayed.

4. Use the three arrow-labeled buttons to select the first parameter you want to display.

A parameter is selected by underlining it. Use the button labeled "→" to move the underline left-to-right and down the parameter matrix as one would read a paragraph. Use the button labeled "←" to reverse the direction. Use the button labeled ↓ to move down any individual column in the matrix.

5. Once the desired parameter is underlined, push ON in the menu to turn that parameter on. When on, the parameter will be bracketed with asterisks ("\*\*"). (See Figure 3-22. The parameters PK-PK and PERIOD are on; RISE is selected but presently turned off.)

6. If there is more than one display source on screen, a target menu appears. In this case, select the source containing the waveform from which the parameter is to be extracted.

**Applications**

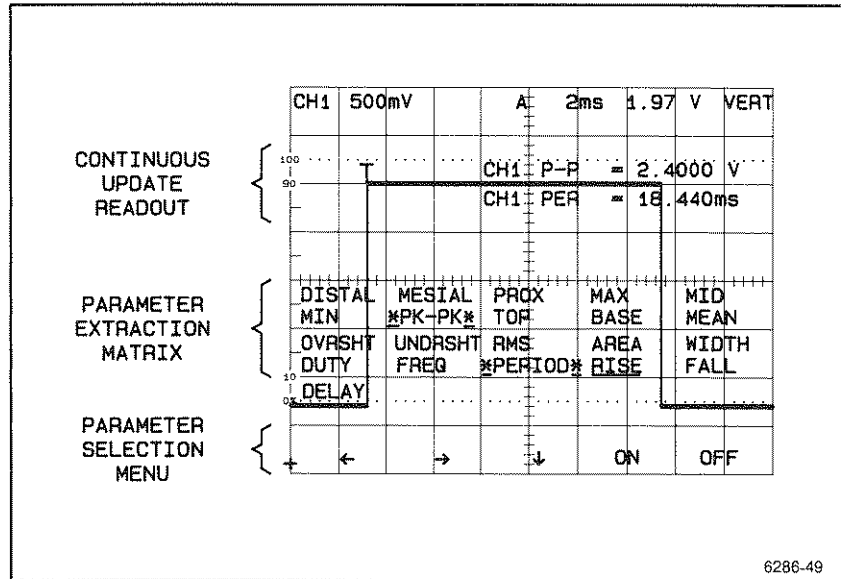

6286-49

**Figure 3-22. Continuous-Update mode for MEASURE.**

The source, the parameter, and its value are now displayed in the upper-right quadrant of the screen. The parameter value is regularly updated and will change if the waveform varies.

- Repeat Steps 4-6 of this procedure to select up to four parameters for display. To turn off parameters perform Steps 4-6, but press OFF in the menu instead of ON for Step 6.

### Delay Measurements Between Signals

Often a measurement of the delay between a gated signal and the gating signal is desired. The following procedure illustrates some such measurements using the DELAY parameter for the Continuous-Update Measure mode. It also illustrates the WINDOW and MARK features. Use this procedure as a general indicator of the things you should consider when using Measure in the Continuous-Update mode.

1. Make sure all the parameters you wish to characterize can be displayed using a single front-panel setup.

The application here assumes that you want to measure the delay times between the positive-going edge of a gating waveform and the rising and falling edges of a relatively short-duration, positive pulse. An example of how you might determine the setup is illustrated in the next step.

2. Set up the front panel to display the characteristics with good vertical and horizontal resolution.

Since the delay between the edges of our pulse is unknown, let's use the VIEW mode of Auto Setup to take a look at both waveforms:

- a. Input the gating square wave into CH 1 and the resultant pulse waveform into CH 2. Set Vertical MODE to CH 1 and CH 2. Set up the input coupling as desired.
- b. Press AUTO to get the menu. If not already in VIEW mode, wait until Auto Setup finishes executing. Then select VIEW and press AUTO again.

The display obtained should indicate how further to set up the front panel for good measurement results. Figure 3-23 shows what you get from executing the Auto Setup just described. Since the edges of the gated pulse occur so long after the rising edge of the gate, you could use the present display for making the measurements. (If the edges were closer and could be displayed within the 20-division horizontal window, you might re-execute in EDGE mode.) However, since the gate is in CH 1 (and therefore determines the horizontal scale), let's re-execute Auto Setup in the HI RES PERIOD mode to obtain increased resolution for our delay measurements. Figure 3-24 illustrates the waveforms after execution in the PERIOD mode. In addition, the vertical attenuation was decreased, acquisition rate increased, the Trigger SLOPE changed to "—", and the vertical position adjusted for best viewing.

## Applications

### NOTE

The last execution of Auto Setup illustrates another way it can be used. You execute VIEW mode to get an overall look at the waveform and choose another Auto Setup mode that ought to get a display close to that required for the measurement. After executing that mode, only minimum front-panel adjustment is needed to "fine-tune" the setup for your measurement. Figure 3-24 illustrates the result of this process.

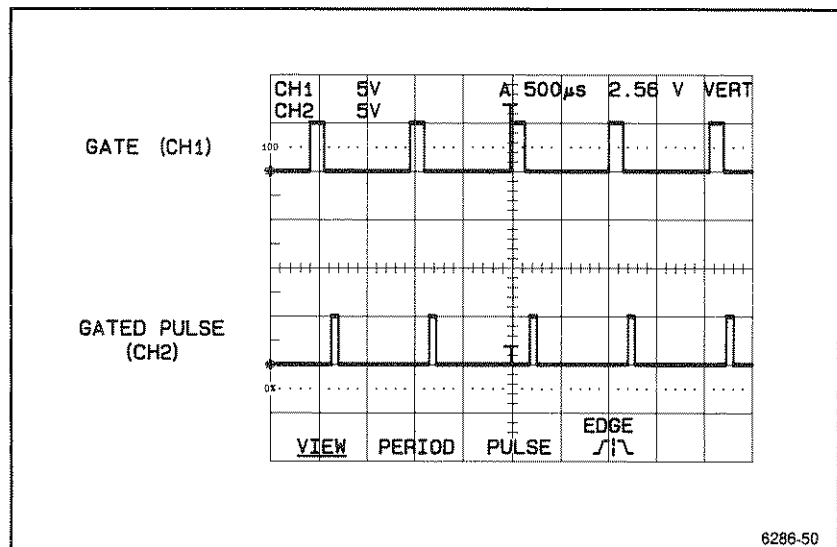

Figure 3-23. Dual-channel Auto Setup in VIEW mode.

3. Press MEASURE. If necessary, select SETUP and use the previously described method for setting TOP, BASE, and Time Reference Points. (If you use CURSOR METHOD, decrease the SEC/DIV setting to see more of the steady-state levels for best cursor placement. Return to the previous setting when finished.)

Since we are working with rectangular waveforms, HIST (histogram) is the proper METHOD to select here. Also, since we are measuring transition times on the edges, we probably need not be concerned with the placement of the PROXIMAL and DISTAL levels; the default values are fine. The MESIAL and MESIAL2 levels are important since they are the Time Reference Points between which DELAY is measured (see Appendix C). However, since the transitions are relatively fast compared to the overall delay to be measured, the default setting of 50% is adequate. WINDOW and MARK are turned on for this application.

**NOTE**

*In the case of measuring short delays between edges, the MESIAL levels might be adjusted for aberrations in the transitions or to pick a particular amplitude level.*

4. Return to the main MEASURE menu. Push MEAS TYPE to display the parameter matrix.

5. Select DELAY and turn it ON.

6. Select CH 1 as the DELAY FROM target. The DELAY TO target menu will appear. Select CH 2.

The DELAY parameter is now displayed (see Figure 3-24). Note that the arrow in the parameter indicates the delay is measured FROM CH 1 to CH 2. Also note the MARKs that were turned on earlier. These marks indicate that the measurement is from the falling edge of the gate to the rising edge of the pulse. If the MESIAL level had been changed in Step 3, the mark would be adjusted up or down on the edge accordingly. The same is true for the MESIAL2 level on the rising edge of the delayed pulse.

## **Applications**

---

**LOCATING THE MEASUREMENT ON TARGET WAVEFORMS.** You may wonder how the instrument decides where to put the marks, i.e., where to make the measurement in the 20-division record. Often the user determines where the measurements are made by setting up the scope so that only the characteristic corresponding to the parameters of interest is displayed. For example, the procedure used to characterize a rising edge of a pulse set up the scope so that the rise time encompassed much of the 20-division horizontal window. The only edge acquired was the leading edge, so that edge was used.

In general, if more than one area in the record can be used to extract a specified *time-related* parameter, the scope uses the area that occurs first in the record of the targeted display source. Thus, if 10 cycles of a sine wave are acquired, the scope uses the first cycle to determine the PERIOD, FREQUENCY, DUTY cycle, etc. If the parameter extracted is *amplitude-related*, the entire 20-division waveform record is used.

### **NOTE**

*An exception for amplitude-related parameters is RMS, which is normally defined as being measured over one cycle. This instrument calculates RMS using the first cycle it finds in the waveform record.*

**MEASUREMENT LOCATION FOR DELAY.** The DELAY parameter is a special case because there are always two target sources—the one the delay is FROM and the one the delay is TO. DELAY is defined as the time at the MESIAL2 crossing minus the time at the MESIAL crossing. The MESIAL crossing always occurs on the source defined as the DELAY FROM target (CH 1, in our procedure), and MESIAL2 on the DELAY TO target (CH 2). The scope finds the first edge, positive or negative, on the FROM source, and locates the MESIAL crossing. Next it finds the first edge, positive or negative, on the TO source and locates the MESIAL2 crossing. The computed difference is positive for delays where the MESIAL2 edge occurs after the MESIAL edge in the record; otherwise it is negative.

Figure 3-25 illustrates the importance of the front-panel setup in determining the edges used for DELAY measurements. The waveforms marked REF1 and REF2 are the CH 1 and CH 2 waveforms previously shown in Figure 3-24. In Figure 3-25, the front panel was readjusted to display the CH 1 and CH 2 waveforms at a different horizontal and vertical scale and to reposition them for storage. They were stored in REF 1 and REF 2, respectively, and then displayed using the DISPLAY REF function. The waveforms referred to as CH 1 and CH 2 in the figure are live versions of the REF 1 and REF 2 waveforms with one exception—the trigger position. The REF waveforms have a trigger position of 1/32 (which can't be set from the TRIGGER POSITION menu but is automatically set by Auto Setup PERIOD and PULSE modes), while the live waveforms have a trigger position of 1/2. (Note the difference in trigger position for the live and REF waveforms.)



Examine the readout for DELAY. The Measure function has been used to display the DELAY from REF1 to REF2. Since REF1 and REF2 are merely saved and displayed versions of the CH 1 and CH 2 waveforms shown in Figure 3-24, the REF1-REF2 DELAY of Figure 3-25 agrees with that for CH1-CH2 in Figure 3-24. (Note that the MARKs indicate the measurements occur on the same edges for both figures.) Now examine the readout for CH1-CH2 and the corresponding waveforms in Figure 3-25. Note that the first edge found in the record for these two targets is the rising edge of the gated pulse (CH 2), and the second edge found is the rising edge of the gate square wave (CH 1), since the change in trigger position made these two edges the earliest ones acquired. The CH1-CH2 DELAY is now based on these two edges and is negative since the first edge found belongs to the CH 2 waveform.

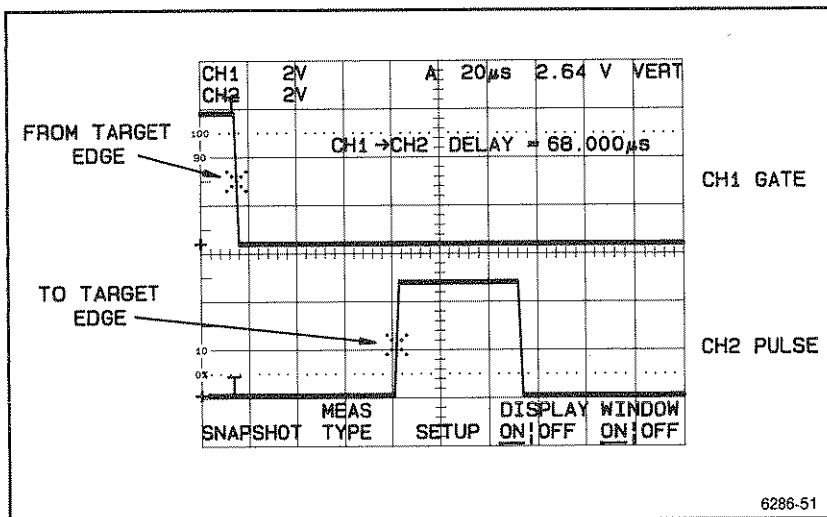

6286-51

Figure 3-24. DELAY measurement between a pulse and a gate.

## Applications

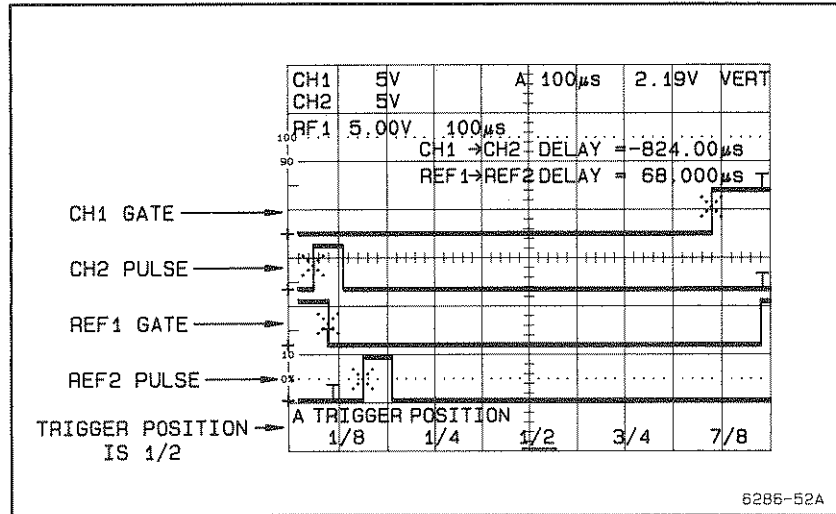
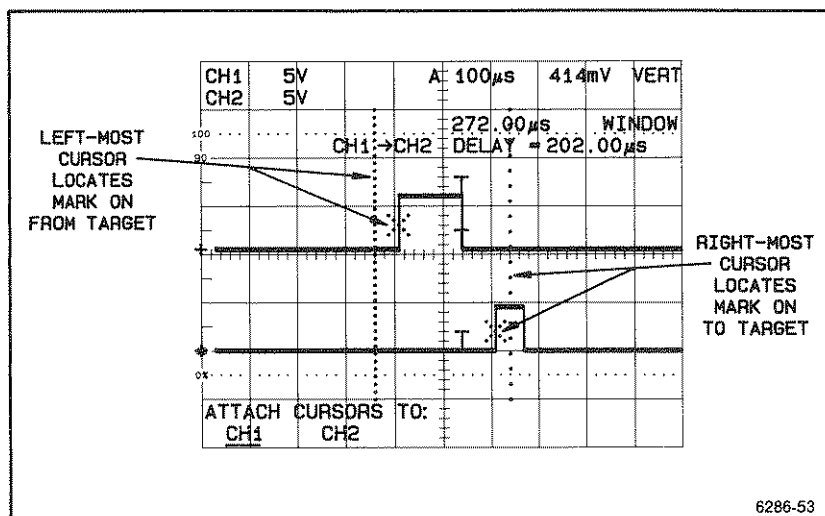

Figure 3-25. DELAY measurement locations on waveforms.

**CONTROLLING MEASUREMENT LOCATION.** The WINDOW function lets you tell the scope where on the waveform to make its measurements. Let's continue our procedure with an example:

7. Verify that WINDOW is ON in the main MEASURE menu.
8. Set the SEC/DIV control to display several cycles of the CH 1 gate and the CH 2 gated pulse.
9. Press Cursor FUNCTION and turn on the TIME Cursors. Attach the Cursors to either channel, since both are acquired at the same SEC/DIV setting.
10. Press Cursor UNITS and set  $\Delta$ :ABS to  $\Delta$ .
11. Using the Cursor SELECT button to toggle between cursors, adjust the cursors to bracket the area you want to measure.

Figure 3-26 shows the previously acquired waveforms with the cursors defining the measurement area. (REF1 and REF2 were turned off and the CH 1 and CH 2 waveforms repositioned.) Examine the CH 1 and CH 2 waveforms in Figure 3-25 and compare them with Figure 3-26. Note that in Figure 3-26 there is a mark on each of the targeted waveforms and both the marks are *between* the TIME cursors. The FROM waveform's mark is on the edge immediately to the right of the left-most cursor; the TO waveform's mark is on the edge immediately to the left of the right-most cursor. By properly positioning the cursors, you can measure the delay between any two edges on alternate waveform records over the entire 20-division record.



6286-53

Figure 3-26. Controlling measurement location with WINDOW mode.

## **Applications**

---

To WINDOW measurements using the TIME Cursors, remember the following rules:

**DELAY MEASUREMENTS:** The delay (in WINDOW mode) is always measured from left to right, so you must target the FROM and TO sources accordingly. Place one cursor immediately to the left of the edge on the FROM source where you want the measurement to start. Place the other cursor immediately to the right of the edge on the TO source where you want the measurement to end. Both edges will be between the cursors.

**TIME-RELATED MEASUREMENTS:** In general, the measurement is made on the first suitable area between the cursors: DUTY, FREQ, and PERIOD require 3 edges; WIDTH requires 2 edges; RISE and FALL require 1 edge. Normally, the scope measures rise and fall time between the proximal and distal levels on the waveform. However, if you move the window inside those two levels, the instrument either establishes new settings within the windowed area, for levels set in percent, or displays a LEVEL LIMIT error, for levels set in volts.

**AMPLITUDE-RELATED MEASUREMENTS:** The measurement of an amplitude parameter such as PK-PK, MESIAL, MEAN, etc. is made over the entire portion of the waveform that lies between the TIME cursors, using the TOP, BASE, and MIN/MAX levels found within that area.

### **NOTE**

*RMS extractions use the entire bracketed area also, allowing RMS measurements of base-line noise and complex waveforms.*

## **AUTOSTEP SEQUENCER (PRGM)**

### **Storage of a Single Front-Panel Setup**

Use this procedure to store a single front-panel setup under a label of your choice:

1. Press the PRGM front-panel button to display the main AUTOSTEP SEQUENCER menu.
2. Press the SAVE menu button. This calls up a sub-menu that lets you label your front-panel setup so you can recall it later.
3. Use the arrows under ROLL-CHARS to create a label for the front-panel setup as outlined here in Steps a-d:
  - a. Select the first character for your label. Press the ↓ to step forward—first through the alphabet, then through the digits 0-9. The ↑ steps from 9-0 and from Z-A. There is a "blank space" character between the digit 9 and letter A.
  - b. When you have displayed the letter or digit for the first character of the label, push CURSOR <> to move to the position of the next character. Repeat Step a to select the next letter or digit of your label.
  - c. Repeat Step b to include up to 6 characters in your label. You can return to any character by continually pushing the cursor button, since it reverses direction when in the position of the first or sixth character.
4. Press the menu button labeled SAVE when your label is complete.

#### **NOTE**

*You can create labels with as few as one character and can leave any character position (1-6) blank. Simply push SAVE when the label is as you want it.*

5. When you press SAVE, the scope displays a message that shows your chosen label and tells you to set up the controls. Set the instrument front-panel controls as desired.

## ***Applications***

---

In general, a stored front-panel setup can include all front-panel settings except those that are accessed via the MENU OFF/EXTENDED FUNCTIONS button and those that call up status-type menus (SNAPSHOT, STATUS, GPIB STATUS, TRIG STATUS, and HELP).

6. Push PRGM to display the ACTIONS menu. The ACTIONS menu allows you to specify certain functions that you want to execute when the front-panel setup is recalled.

Although you can include ACTIONS when you store a single front-panel setup, you are more likely to use them when you store a sequence of several front-panel setups.

### ***Storage of a Sequence of Front-Panel Setups***

1. Create a label by doing the following:

- a. Push PRGM to display the main SEQUENCE menu.
- b. Select SAVE from the menu.
- c. Create a 1-6 character name using the arrow keys as before, or leave the default name unchanged as desired.
- d. Press SAVE to label the sequence you are about to create.

2. Create a series of front-panel setups and associated ACTIONS that will accomplish your test or measurement task:

- a. Set up the front-panel for your measurement task.

b. Press PRGM to get the ACTIONS menu and use the arrow-labeled and Y!N-labeled buttons to turn on the actions associated with this front-panel setup. This is what the actions do:

- PAUSE makes the sequence stop until you tell it to continue. This allows you to make measurements, take photographs, etc.
- BELL sounds a tone when the step is complete.
- AUTOSSETUP automatically sets up the front-panel. Be aware that this occurs *after* the front panel is loaded, and will change the setup.
- REPEAT tells the sequence to continue to the end, then loop back to this step. If REPEAT is turned on in more than one step of a sequence, only the last one will be used.
- SELF-CAL and/or SELF-TEST execute those internal routines before the front panel is loaded and measurements are made. Typically these actions are included in an initialization step at the beginning of the sequence.
- PROTECT prevents accidental removal of the sequence. It is only effective if set in the first sequence step. See "Using PRGM" in the "Operators Familiarization" (Section 2) for information on removing protected sequences.
- PRINT/PLOT outputs information as defined by the fourth-level DEVICES menu (under MODE in the OUTPUT SETUP menu). See OUTPUT in Section 5 for more information about this menu. See the Programmers Reference Guide for more information about using this instrument in a GPIB/Controller environment.
- SRQ sends an SRQ to the GPIB at the completion of this step. See the Programmers Reference Guide for more information on sequencer SRQ's.

c. When you have specified the ACTIONS, push NEXT STEP in the menu to create the next step. Set up each successive sequence step as outlined in parts a and b of this procedure step.

3. When you are finished creating the sequence steps, press SAVE SEQ instead of NEXT STEP. The sequence will be saved under the label specified in Step 1.

## **Applications**

---

### **Using a Sequence**

1. Select and initiate the sequence you want to run as follows:
  - a. Press PRGM to display the main AUTOSTEP SEQUENCER menu.
  - b. Select RECALL from the menu.
  - c. Use the arrow keys to select the desired sequence, and press RECALL in the displayed menu.
2. The steps will begin to execute. Wait for any pause in the sequence.
3. At PAUSE make measurements, photograph the display, or output waveforms as desired.
4. To continue the sequence from the front-panel, push PRGM; over the GPIB, use the STEP command; from the rear panel, provide the falling edge of a TTL pulse into the SEQUENCE IN input BNC.
5. Repeat Steps 2-4 until the end of the sequence.
6. Then, if REPEAT is turned on in one of the steps of this sequence, change the input connections as required (install a new device to be tested, adjust test equipment, etc.).
7. Push PRGM to loop back to the step that contains REPEAT and continue to perform Steps 3-6 as needed. If REPEAT is not included in the sequence, the last step will exit to the main AUTOSTEP SEQUENCER menu.
8. If you want to discontinue a sequence, press EXIT in the menu when the sequence is paused. If a sequence is running, you can abort the sequence by pressing PRGM.



### **Interaction of Sequencer with Acquisition Modes**

When you recall a sequence, consider the acquisition mode and SEC/DIV setting each sequence step invokes. Depending on the SEC/DIV setting, some modes, such as Envelope and Average, may require considerable time to complete an acquisition sequence, and, therefore, the sequence step.

Consider a step that sets the SEC/DIV to 5 seconds and ACQUIRE MODE to AVG, 256 acquisitions. With 20 divisions per acquisition, the total time to complete an acquisition sequence is  $20 \text{ div's} \times 5 \text{ sec/div} \times 256$ , which is about 7 hours! If you're unaware that the sequence includes such a step, you might think the sequence is "hung up." Be aware of the SEC/DIV setting and the number of acquisitions specified for steps using Envelope and Average modes.

Other scope modes can delay or prevent the completion of a sequence step. For SAVE ON DELTA mode, the sequence step does not complete until an out-of-limit data point is acquired and SAVE mode entered. ROLL mode (entered when in AUTO Trigger Mode at SEC/DIV settings slower than 50 ms) ignores triggers and continuously acquires; therefore, this mode never completes an acquisition sequence and must be manually forced to the next step in a sequence. Also, the SINGLE SEQUENCE and NORMAL settings for Trigger Mode will prevent a step from completing if a trigger isn't received to start the acquisition sequence.

**MULTIPLE MODES.** Sequence steps that set multiple modes are a special case. If the trigger mode is set to Single-Sequence AND Save-On-Delta, for example, the scope completes the step when the single sequence is acquired OR when a data point is acquired that is outside the reference envelope. Say the acquisition mode is AVG 256 and SAVE-ON-DELTA is on. If no data points are outside the reference envelope, 256 acquisitions will occur, completing the single-sequence of 256 averaging acquisitions, and the sequence step completes. On the other hand, any data point acquired during the 256 acquisition that's outside the reference envelope forces a Save-On-Delta and completes the step.

## **Applications**

---

**FORCING STEP COMPLETION.** To force a sequence to move to the next step before the acquisition sequence completes, press ACQUIRE. Pressing ACQUIRE always ends the present acquisition sequence and restarts another sequence. This action completes the step. Adjusting any other control that restarts the acquisition sequence (SEC/DIV, VOLTS/DIV, 50% TRIG INIT, etc.) also forces the step to complete. Changing these control settings using GPIB commands, or sending "RUN SAVE" or "RUN ACQ" from the GPIB, also completes the step.

When the step completes, the instrument moves to the next step in the sequence (or ends the sequence if at the last step) unless PAUSE is turned on as an action for that step. If the step is paused (message is displayed), push PRGM as usual to advance to the next step (send the STEP command if operating via GPIB).

To end the sequence, push PRGM (or send the HALT command from GPIB). As just explained, if you push PRGM for a paused step, the sequencer moves to the next step. However, pressing PRGM for a step that's waiting for an acquisition sequence to complete stops the sequence. (The function is the same when the sequencer is executing steps in a long sequence without pausing; pressing PRGM stops the sequence.)

---

# Checks and Adjustments

## Introduction

To verify the operation and basic accuracy of your instrument before making measurements, perform the following checks and adjustment procedures. If further adjustments are required, refer the instrument to a qualified service person.

Refer to "Preparation for Use," Section 1 of this manual, before proceeding with these instructions. It explains how to prepare the instrument for its initial start-up before applying power.

Verify that the POWER switch is OFF (i.e., in the out position, with the green indicator switched to black). Then plug the power cord into an appropriate ac-power-source outlet supplying the correct nominal voltage. (*Check the LINE VOLTAGE SELECTOR switch*).

If, during the performance of these procedures, you notice an improper indication or instrument malfunction, refer the instrument to a qualified service person.

If you are not familiar with the operation of the front-panel controls, you may wish to review Section 2, "Operation," before beginning the checks and adjustments. The following procedure is written to be followed in sequential steps and is short enough that it takes only a few minutes after the warmup period.

## Starting Setup

1. Press the POWER switch button ON so that the green indicator shows in the button, and allow the instrument to warm up. The NOT WARMED UP message stays displayed for ten minutes in the CAL/DIAGNOSTICS menu under EXTENDED FUNCTIONS.
2. Press the PRGM front-panel button when the RUNNING SELF TEST message is cleared from the display.
3. Press the INIT PANEL menu button. This sets the front-panel controls to predefined states. Basically, the resulting setup is a single-channel, auto-level triggered display mode, with none of the special features turned on. The complete INIT PANEL setup is given in Table B-15 of Appendix B.

## **Checks and Adjustments**

---

4. Perform the SELF CAL procedure. (A demonstration procedure of SELF CAL is given in "Operator's Familiarization," Section 2, and a detailed description of the built-in calibration and diagnostics is given in Appendix A of this manual.)

5. When SELF CAL is finished, turn off the EXTENDED FUNCTIONS menu and press the ACQUIRE button to obtain a baseline trace; then press the SAVE button.

## **Trace Rotation Adjustment**

1. Check that the baseline trace is parallel with the horizontal graticule lines.

### *NOTE*

*Normally, the resulting baseline trace will be parallel to the center horizontal graticule line, and the TRACE ROTATION adjustment will not be needed.*

2. If the baseline trace is not parallel to the center horizontal graticule line, use a small straight-blade screwdriver or alignment tool to adjust the TRACE ROTATION pot for proper alignment of the trace.

## **Focus and Astigmatism Adjustment**

1. Press the STATUS button.

2. Use the INTENSITY control knob to reduce the intensity of the readout characters to a lower level. (Pressing STATUS automatically increases the READOUT intensity to 65%, as indicated in the display.)

3. Check the display for good focus over the entire graticule area.

4. If the display is not in good focus, adjust the FOCUS pot for the best focus over the entire graticule area.

### *NOTE*

*If the ASTIG adjustment is already set properly, all portions of the display will come into sharpest focus at the same adjustment position of the FOCUS pot.*

5. If focusing is not uniform, alternately adjust the ASTIG and FOCUS pots (a small amount at a time) for the best-defined display over the entire graticule area.

### **Vertical Gain Check**

1. Press the Cursor FUNCTION button and select VOLTS cursors.
2. Align the active cursor (dashed line) with the third horizontal graticule line up from the center.
3. Press SELECT and align the other cursor (now active) with the third horizontal graticule line below center, for a six-division difference between the VOLTS cursors.
4. Check that the VOLTS readout is  $600 \text{ mV} \pm 6 \text{ mV}$  (594 mV to 606 mV).

### **Horizontal Gain Check**

1. Select TIME cursors.
2. Align the active cursor (the one with most dots) with the third vertical graticule line left of the center.
3. Press SELECT and align the other cursor with the third vertical graticule line to the right of center, for a six-division difference between the TIME cursors.
4. Check that the TIME readout is  $6.0000 \text{ ms} \pm 0.06 \text{ ms}$  (5.94 ms to 6.06 ms).
5. Turn the cursors off by pressing the TIME menu button.

## ***Probe Low-Frequency Compensation***

Misadjustment of probe compensation is a possible source of measurement error. The attenuator probes are equipped with compensation adjustments. To ensure the best measurement accuracy, always check probe compensation before making measurements.

1. Connect the two supplied 10X probes to the CH 1 and CH 2 BNC input connectors.
2. Connect the probe tips to the CALIBRATOR loop and connect the probe ground leads to scope ground.
3. Press PRGM and initialize the front-panel setup by pressing the INIT PANEL menu button.
4. Press BANDWIDTH and set the Bandwidth Limit to 20 MHz.
5. Set the CH 1 VOLTS/DIV setting to 100 mV.
6. Press ACQUIRE and use the CH 1 Vertical POSITION control to center the four-division CALIBRATOR square wave in the graticule area.
7. Check the square-wave signal for overshoot and rolloff. (See Figure 4-1). If necessary, use a small-bladed screwdriver to adjust the low-frequency compensation for a square front corner on the square wave.
8. Press the Vertical MODE button and press the CH2 menu button to turn on CH 2 in the display. Then, press the CH1 menu button to turn off that channel.
9. Change the CH 2 VOLTS/DIV setting to 100 mV and vertically center the CALIBRATOR signal.
10. Repeat Step 7 for the second probe on the CH 2 BNC input connector.

NOTE

Refer to the instruction manual supplied with the probe for more detailed information about the probes and adjustment procedure.

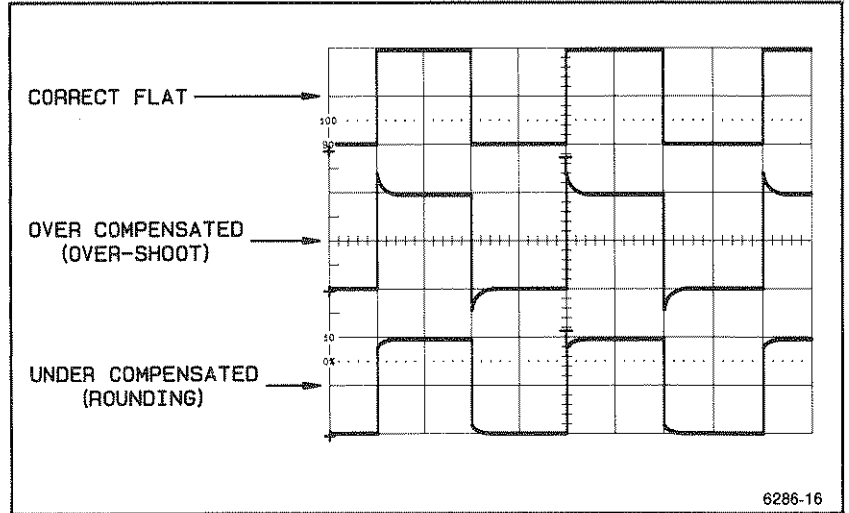
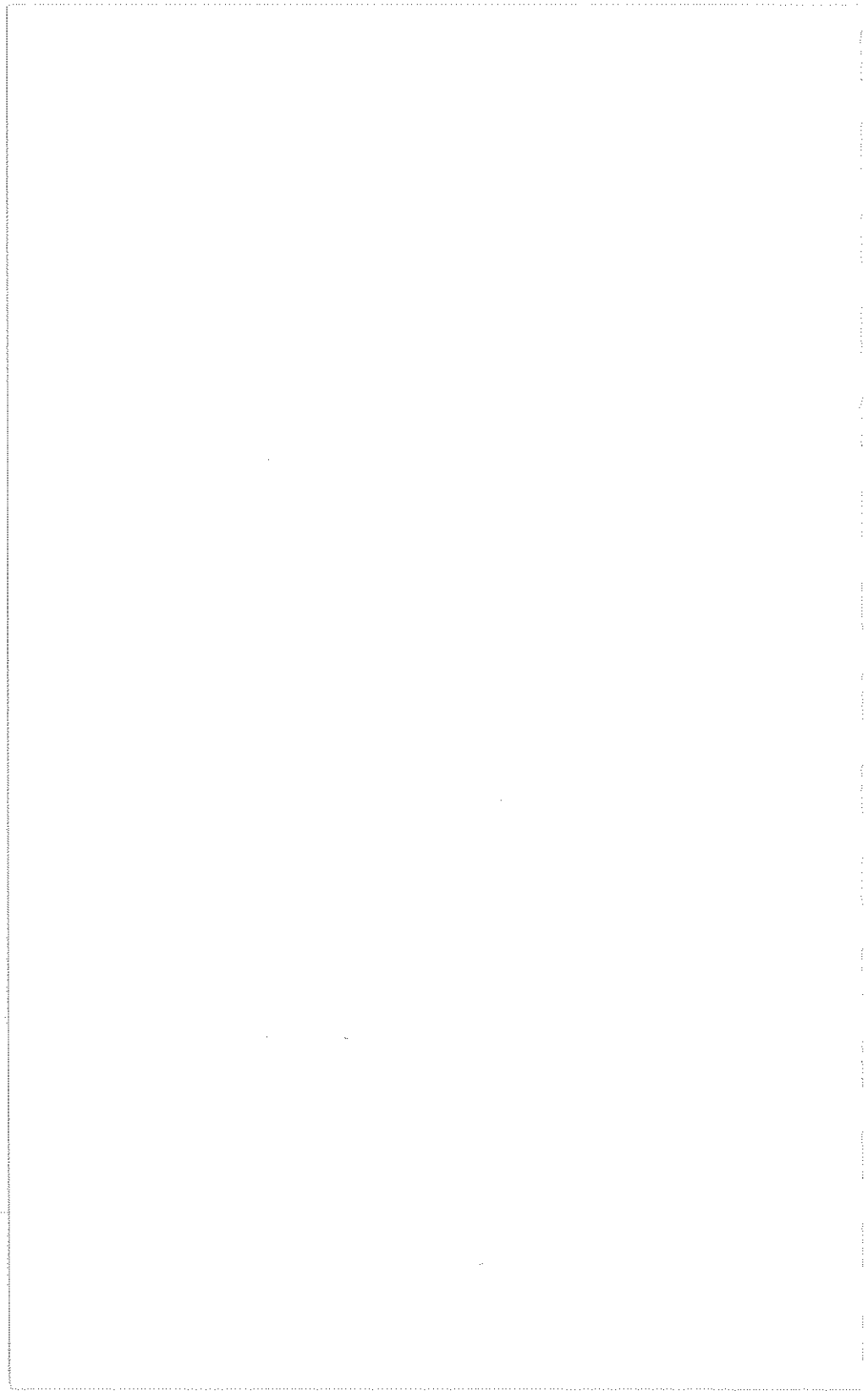

Figure 4-1. Probe low-frequency compensation.





---

## ***Controls, Connectors and Indicators***

This section is the primary reference for instrument function. It locates and describes the function of each control, connector, and indicator on the front and rear panels. To become familiar with scope operation, perform the familiarization procedures and read the information given in Sections 1 and 2 of this manual. Refer to this section when you need more detail regarding the function of a particular control, connector, or indicator.

### *NOTE*

*The HELP feature displays operating information about most front-panel controls. You may wish to read this on-screen information as a preview, or as a supplement to the material that follows. HELP is described at the beginning of "Extended Features" in this section.*

## ***CRT Display, Menu Buttons and Power***

Refer to Figure 5-1 for location of Items 1 through 10.

### **① Menu Buttons**

Select from the menu displayed along the bottom of the CRT. Mounted in the bezel under the CRT, their operation is programmable by the scope and depends on the function being controlled. For example, a button may:

- Turn on a function. (In some cases it simultaneously turns off an incompatible function; for example, selecting ADD automatically deselects MULT, and vice versa.)
- Toggle between two modes or states.
- Increment a counter (as with ENVELOPE and AVG).
- Call up a lower-level menu.

Underscored menu labels indicate functions or modes that are turned on. Table 5-2 at the end of this section lists all front-panel control menus.

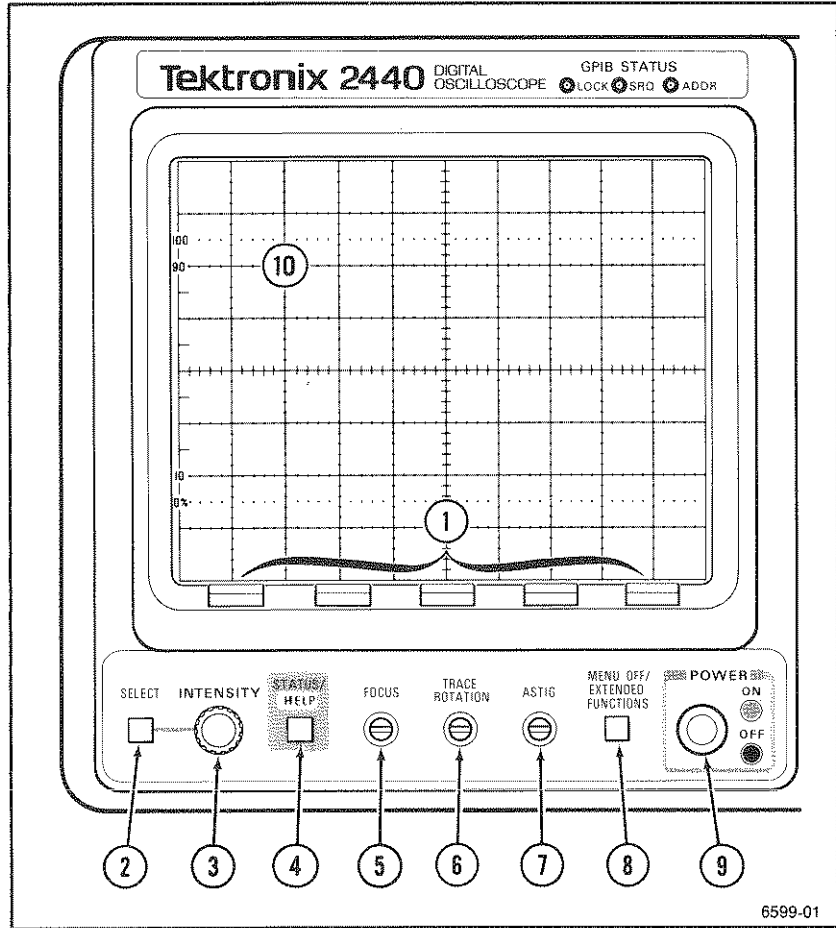

Figure 5-1. POWER, DISPLAY controls, and MENU buttons.



## 2 SELECT Button

Displays the INTENSITY menu. The menu lets you direct the INTENSITY knob to control READOUT, DISPlay, INTENSified zone, or GRATICule illumination. One of these functions is always on, with its menu label underlined. You can turn on any of the four by pressing the associated bezel button, or you can toggle between DISP and READOUT by repeatedly pressing the SELECT button.

VECTORS ON/OFF toggles between vector (line) and dot waveform displays in YT (vertical vs time) mode. Only dot displays are possible in XY mode.

## 3 INTENSITY Control Knob

Adjusts the brightness of the readout, the waveform, the intensified zone (in A INTEN mode), or the graticule illumination as determined by the underscored function in the SELECT menu. It works whether or not the menu is displayed.

## 4 STATUS/HELP Button

Displays the complete operating status of the scope. This can help you determine which control or function setup is preventing a display of the traces. The list includes the VOLTS/DIV for each Vertical mode, Horizontal mode, Acquisition mode, A and B Trigger Source, A and B Trigger Level, Trigger Status, the waveforms selected for display, etc. The readout intensity is boosted to 65%, if necessary, to ensure a visible status list, and the INTENSITY control is temporarily directed to the readout.

In the status list, all enabled functions are underlined. (See Figure 5-2.) The INTENSITY settings are shown as a percent of the total range so you can tell if the display intensity is too low to see.

To remove the STATUS menu from the screen and return any waveforms previously displayed, either press MENU OFF to return the waveform display with no menu, or STATUS/HELP to return the waveforms along with the menu displayed when you first pressed STATUS/HELP.

### NOTE

*The STATUS/HELP menu also gives access to the HELP feature, which is covered under "Extended Features" in this section.*

**⑤ FOCUS Adjustment**

Optimizes the focus of the display. This is a screwdriver adjustment that requires little attention after the initial setting. An auto-focusing circuit tracks any intensity changes during normal operation of the instrument and keeps the display focused.

**⑥ TRACE ROTATION Adjustment**

Aligns the CRT trace with the horizontal graticule lines. Once this screwdriver adjustment is set, it requires only occasional readjustment during normal operation of the instrument.

**⑦ ASTIG Adjustment**

Used in conjunction with the FOCUS adjustment to optimize the focus over the entire CRT. Once set, this screwdriver adjustment requires little attention during normal operation of the instrument.

**⑧ MENU OFF/EXTENDED FUNCTIONS Button**

Turns off the displayed menu, or if a menu is not displayed, turns on the EXTENDED FUNCTIONS menu for access to special features. (See Appendix A for operation of the Extended Functions.)

*NOTE*

*When MENU OFF turns off a displayed menu, it also resets the hardware to match the soft front-panel settings, reinitializes any acquisitions in progress, and erases and rewrites the CRT (which eliminates any messages written via the GPIB).*

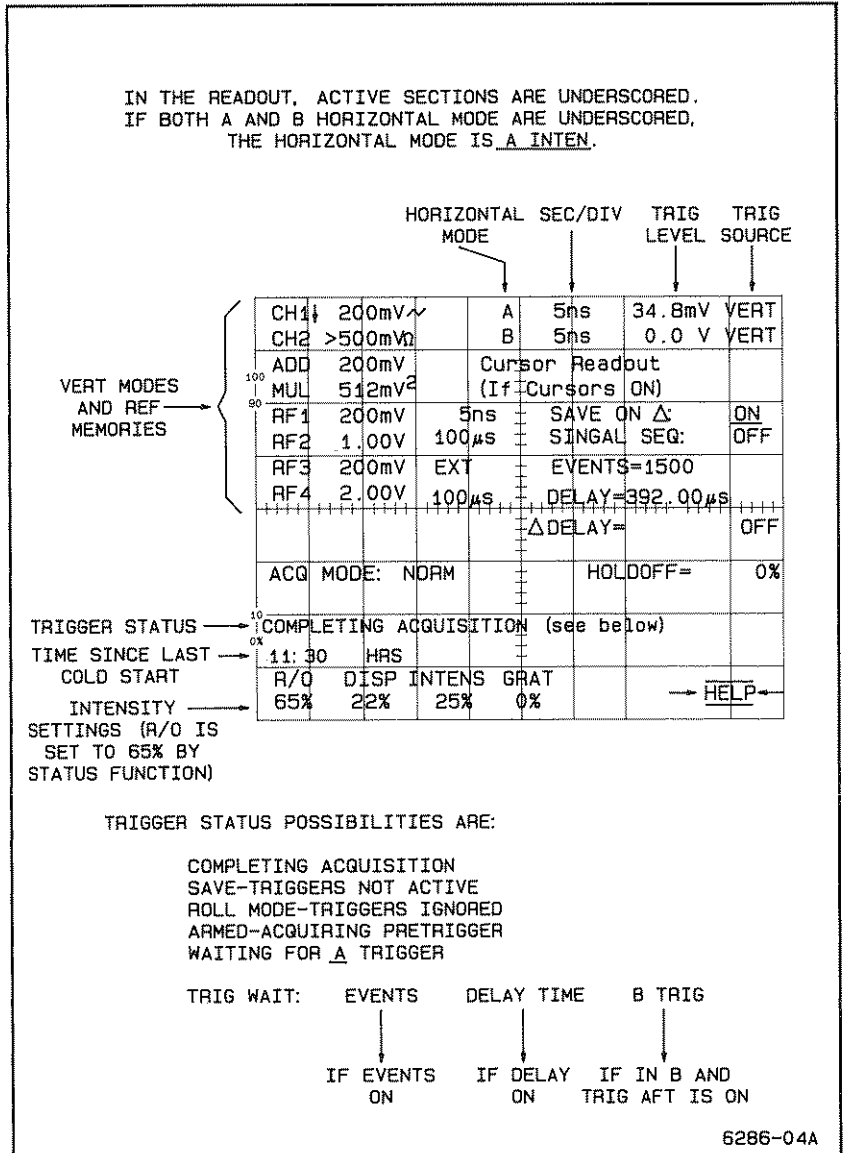

Figure 5-2. STATUS readout display.

**⑨ POWER ON/OFF Switch**

Turns instrument power on and off. Press in for ON; press again for OFF. An internal indicator in the switch shows green when the switch is on and black when it is off. The instrument powers up either with the same front-panel setup it had when it was last turned off, or with the predetermined INIT setup shown in Table B-15 in Appendix B, depending on whether PWR ON is set to LAST or INIT in the EXTENDED FUNCTIONS menu.

**⑩ CRT**

Produces the visible waveform and readout displays. The CRT display area is 80 mm vertically by 100 mm horizontally. Internally-etched graticule lines eliminate parallax viewing error between the trace and the graticule lines. Percentage points for measuring rise time are at the left edge of the graticule.

### **Vertical Controls**

Refer to Figure 5-3 for locations of Items 11 through 20.

**⑪ CH 1 and CH 2 BNC Input**

Connect external signals to the Channel 1 and Channel 2 vertical attenuators. The signal applied to CH 1 or X supplies the horizontal deflection for XY displays. Probe-encoding contact rings on the CH 1 and CH 2 BNC connectors enable the scale-factor-switching circuit to recognize attenuation-coded probes and change the VOLTS/DIV readout to reflect the attenuation factors of such probes.

**⑫ VERTICAL MODE Button**

Calls up the VERTICAL MODE menu. The YT:XY button toggles the display mode between Y-axis versus Time and Y-axis versus X-axis. Each of the other buttons toggles its associated mode on and off.

ADD and MULT are mutually exclusive functions. Turning on one turns off the other. Also, ADD and MULT cannot be turned on selected when XY is selected. Turning on XY mode turns off ADD or MULT and removes those choices from the VERTICAL MODE menu.

**CH1**

Toggles the display of the signal in Channel 1 on and off.

**CH2**

Toggles the display of the signal in Channel 2 on and off.

**ADD**

Digitally adds the Channel 1 and Channel 2 waveform data. The ADD waveform can be displayed even if CH 1 and CH 2 are not, since both channels are digitized regardless of whether they are selected. When saving an ADD waveform in ENVELOPE Acquire mode, the ADD waveform must be displayed before entering SAVE mode; turning on ADD after entering SAVE displays an "invalid" waveform. (The invalid waveform consists of sections of "fill" pattern that extend from top to bottom of the screen. These sections are alternated horizontally with short trace segments.) If the Acquire mode is NORMAL or AVG, ADD can be turned before or after SAVE mode is entered. For more information on use of ADD with ENVELOPE, see ENVELOPE description for ACQUIRE button in this section.

Waveforms are added in terms of divisions, without consideration for the vertical scale factors. If a two-division signal in Channel 1 and a three-division signal in Channel 2 are in phase, the ADD waveform will be five divisions no matter what the VOLTS/DIV settings for CH 1 and CH 2.

The ADD waveform always has the same vertical scale as Channel 1. Hence, the CH 1 VOLTS/DIV setting can be used to make calibrated VOLTS cursor measurements at the same time the CH 2 VARIABLE control is being used to null interfering signals in the ADD waveform. If CH 1 is uncalibrated, however, both the ADD and the CH 1 VOLTS/DIV readouts will display the uncal symbol (>), and VOLTS cursor measurements on these waveforms will be expressed in divisions.

**MULT**

Digitally multiplies the Channel 1 and Channel 2 waveforms. As for ADD mode, an ENVELOPE mode MULT display must be turned on before entering SAVE mode or an invalid waveform is displayed. See ENVELOPE description for the ACQUIRE button in this section.

MULT mode makes it possible to display a power waveform and make instantaneous power measurements. The readout for the MULT waveform has units of volts squared, since the scope cannot ascertain the correct scale factor of the current waveform without knowing the scale factor of the current probe (or the resistance value of the test setup).

## **Controls, Connectors and Indicators**

---

When two 8-bit-digitized signals are multiplied, the result can be expressed in 16 bits, which increases the dynamic range 256 times. Therefore, to ensure that the entire MULT waveform can be displayed in the  $\pm 5.12$  divisions available, it must be compressed back to 8 bits (with a resulting loss of resolution). Also, because its vertical values must be divided by 5.12 to bring the MULT waveform back on screen, the VOLTS<sup>2</sup>/DIV scale factor is multiplied by 5.12. For example, if two square waves, each stepping positive from 0 volts (ground) are to be multiplied, a 2 V square wave could be displayed in CH 1 as a 4-division peak-to-peak signal at 500 mV per division and a 12 V square wave as a 6-division p-p signal at 2 V per division in CH 2. When the waveforms are multiplied, the product of the negative peaks, both zero volts, is a 0 V negative peak for the MULT waveform. The product of the positive peaks, 2 and 12 volts respectively, is 24 volts; therefore, the resultant multiplied waveform is a square wave stepping positive from ground to 24 volts. The scope determines the scale factor, in this case 5.12 V<sup>2</sup> per division, by multiplying the product of the CH 1 and CH 2 VOLT/DIV settings by 5.12. It scales the MULT waveform accordingly, resulting in about a 4.7-division square wave display.

The zero value of a waveform is its ground reference when dc-coupled, or its average value when ac-coupled. Any signal level below the zero value is treated as negative. The zero value for the MULT waveform is the sum of the Channel 1 and Channel 2 Vertical POSITION settings, where positions above center screen are positive and those below center screen are negative.

### **YT:XY**

Switches between a Y-axis versus time (YT mode) or the X-axis versus Y-axis (XY mode) representation of the displayed signal. In XY mode, the signal applied to the CH 1 input supplies the horizontal deflection, and the signal applied to the CH 2 input supplies the vertical deflection, with 512 sample points displayed from each channel. (The horizontal position control selects which 512-point block is selected from CH 2 for the Y deflection. See "Horizontal Position Control Knob" in this section).

Channel 1 vs Channel 2 and REF1 vs REF2 can be displayed simultaneously for comparison.



**13 CH 1 and CH 2 VOLTS/DIV Switches**

Select the calibrated vertical deflection settings. These range from 2 mV per division to 5 V per division in a 1-2-5 sequence of 11 steps. The controls are continuous-rotation detent switches with no end stops. The VOLTS/DIV switch settings are displayed in the CRT readout. That readout also changes automatically to reflect the attenuation factors of coded probes connected to the vertical inputs.

In SAVE mode, if the VOLTS/DIV control is turned to more sensitive settings, it can expand the waveform vertically up to 10X. Expansion provides three additional VOLTS/DIV scale factors: 1 mV, 500  $\mu$ V, and 200  $\mu$ V. If the VOLTS/DIV control is turned to a setting less sensitive than the one at which the saved waveform was acquired, it will not affect the waveform display, but the readout will change to reflect the scale factor that will be used for the next acquisition when ACQUIRE is pressed.

In AVERAGE mode, extra resolution makes the three additional scale factors available for live waveforms as well as saved waveforms. If AVG mode is turned off when one of these scale factors is in effect, the VOLTS/DIV setting changes to 2 mV.

**NOTE**

*When averaging with a weighting factor of 32 averages or greater, the finite-precision, fixed-point arithmetic used to compute the weighted difference between sampled data points truncates the answer. The loss of decimal places in the result biases it toward discrete digitizing levels. This phenomenon may be seen in the averaged display under low-noise conditions when small-amplitude waveforms (either live or saved) are expanded vertically. It is especially evident with a weighting factor of 256.*

**14 CH 1 and CH 2 COUPLING/ INVERT Buttons**

Call up a coupling menu. Besides the AC, DC, and GND choices for input coupling, the menu includes 50  $\Omega$  ON:OFF for input termination, and INVERT ON:OFF for inversion of the signal. AC coupling and 50  $\Omega$  termination are mutually exclusive: If AC coupling is in effect when 50  $\Omega$  is switched ON, the coupling automatically switches to DC. Likewise, if 50  $\Omega$  is ON when AC is selected, 50  $\Omega$  automatically switches to OFF.

Repeatedly pressing the COUPLING/INVERT button cycles through the three input-coupling choices when 50  $\Omega$  termination is OFF, or toggles between DC and GND when 50  $\Omega$  is ON.

**AC**

Capacitively couples the input signal to the vertical attenuator, blocking its dc component. When AC coupling is selected, a question mark in the trigger level readout indicates that the dc level of the applied trigger signal is unknown. The lower  $-3$  dB frequency limit is 10 Hz or less when using either a 1X probe or a properly terminated coaxial cable; it is 1 Hz or less using a compensated 10X probe.

**DC**

Couples all frequency components of the input signal to the vertical attenuator. If  $50\ \Omega$  is OFF, the input resistance is  $1\ \text{M}\Omega$  to ground.

**GND**

Grounds the input of the associated vertical amplifier to provide a zero (ground-reference) voltage display. The input impedance is  $1\ \text{M}\Omega$  to ground through the input-coupling capacitor. (Precharging the capacitor keeps the trace from shifting suddenly if the coupling is switched to AC.) Selecting GND coupling automatically disconnects the  $50\ \Omega$  termination.

**$50\ \Omega$**

Terminates the input of the vertical attenuator with  $50\ \Omega$  to ground. When  $50\ \Omega$  is ON, the input coupling must be DC; all frequency components of the signal are passed to the vertical attenuator. Also, the front-panel microprocessor monitors the signal power applied to the vertical input connector. If the power exceeds a safe operating level, the overloaded channel automatically switches its input coupling to GND, and the COUPLING menu and  $50\ \Omega$  OVERLOAD message appear. Therefore, the user should not set  $50\ \Omega$  ON if the circuit under test might be damaged by the loss of termination. The overload message remains displayed in the COUPLING menu until a new coupling is successfully chosen or the menu is turned off.

When instrument power is turned OFF, the  $50\text{-}\Omega$  input termination is automatically switched out. This protects the termination resistor from unmonitored overloading.

**INVERT**

Inverts the polarity of the signal being acquired by the associated channel. Both Channel 1 and Channel 2 may be inverted. The INVERT function does not invert a signal after going to SAVE mode.

15 CH 1 and CH 2 VARIABLE Buttons

Call up the VARIABLE VOLTS/DIV function menu for the associated channel. The menu provides controls for continuously variable uncalibrated vertical deflection factors between the calibrated settings of the VOLTS/DIV switches.

1/1 Buttons

Vary the vertical attenuation factor. The lower limit is the calibrated VOLTS/DIV setting, and the upper limit is at least 2.5 times that value.

Pressing the ↓ menu button decreases the display amplitude by increasing the attenuation factor; pressing the ↑ menu button increases the display amplitude by decreasing the attenuation factor. Holding either button down causes the attenuation to change continuously until either the maximum or minimum variable attenuation limit is reached.

CAL

Removes all variable attenuation, and returns to the calibrated VOLTS/DIV setting.

In SAVE mode, changing the variable-gain controls does not affect the display; but when the mode is switched to ACQUIRE, the new variable-gain setting takes effect.

16 BANDWIDTH Button

Calls up a menu that gives the user a choice of three acquisition system bandwidths: 20 MHz, 100 MHz, and Full.

NOTE

*Bandwidths greater than 200 MHz can only be obtained when REPET is ON. (See the description for REPET ON/OFF under "Storage System ACQUIRE" in this section.)*

The first press of the BANDWIDTH button calls up the menu; additional presses cycle through the bandwidth selections in the following manner:

20 MHz → 100 MHz → FULL → 20 MHz.

FULL BANDWIDTH represents a bandwidth  $\geq 300$  MHz when REPET is ON.

In all modes except ENVELOPE, the USB (Useful Storage Bandwidth) and USR (Useful Storage Rise Time) are also displayed in the BANDWIDTH menu. They represent the maximum frequency and the fastest rise time of signals that can be acquired with good results, and they depend on the current BANDWIDTH, SEC/DIV, and REPET ON/OFF settings. With REPET OFF, USB is the lesser of either the selected bandwidth or the sample frequency divided by 2.5, and USR is the greater of either 0.35 divided by the selected bandwidth or 1.6 times the sample interval. Thus, the maximum USB is 200 MHz and the minimum USR is 3.2 ns. With REPET ON, the same definitions hold for SEC/DIV settings of 100 ns and slower, but at SEC/DIV settings of 50 ns and faster, random sampling occurs. Therefore, USB equals the selected bandwidth and USR equals 0.35 divided by the selected bandwidth, regardless of the SEC/DIV setting. This brings the maximum USB to 300 MHz and the minimum USR to 1.2 ns with REPET ON.

*NOTE*

*The bandwidth menu is also used to turn the SMOOTH function on or off for normal and average mode acquisitions. See the description for "SMOOTH ON/OFF" under "Storage System ACQUIRE" in this section.*

**17 CH 1 and CH 2 VERTICAL POSITION Controls**

Change the vertical position of the associated channel signal display. Clockwise rotation of the knob moves the trace up; counterclockwise rotation moves the trace down. Waveforms that are vertically positioned off the screen may be located by the presence of the trigger-point (T) and ground-level (+) indicators at the top or bottom edges of the graticule area. These indicators remain attached to the on-screen waveforms, but they cannot be moved off screen.

In XY display mode, the CH 1 POSITION control moves the display horizontally, with clockwise rotation moving it to the right. The CH 2 POSITION control moves the display vertically. XY displays may be moved horizontally to the extreme left or right edge of the graticule, but will remain visible there.

The CH 1 and CH 2 VERTICAL POSITION pots are position-rate controls. The center position area of the control produces linear positioning. Rotating a control into the spring-loaded region produces rate positioning of the display. The farther a knob is rotated toward the end-stop, the faster the positioning rate. Releasing the knob returns the control to the linear region of the pot.

## Cursors

The scope provides cursors for making parametric waveform measurements. Voltage, time, frequency, slope, decibels, degrees, and percent units give the cursors a wide variety of applications. A numeric readout on the CRT reflects either the difference between the position of two cursors (delta measurement mode) or the difference between a single cursor and a fixed reference (absolute measurement mode).

The CURSOR/DELAY knob is shared with the DELAY by TIME, DELAY by EVENTS, and measurement LEVEL functions. (Refer to "CURSOR/DELAY Control Knob," Item 30.) When one of the CURSOR buttons is pressed (FUNCTION, UNITS, or SELECT), the knob is directed to move the cursors.

In YT mode, the Cursor SELECT button toggles the two  $\Delta$  (delta) cursors between active and fixed. Switching to ABS (absolute) cursor mode removes the fixed cursor from the display, and the SELECT button then has no effect on the remaining active cursor.

When in XY mode and TIME or 1/TIME cursors are active, the SELECT button works the same as in YT mode. But when VOLTS, V@T, or SLOPE is chosen, there are four delta cursors and the SELECT button activates them one at a time in sequence. For VOLTS or V@T cursors, switching to ABS removes one vertical and one horizontal cursor; the SELECT button then toggles between the two that remain. Since absolute mode does not exist for SLOPE cursors, the UNITS menu omits that choice.

### 18 FUNCTION Button

Calls up the CURSOR FUNCTION menu for selecting cursor type. The choices are VOLTS, TIME, V@T, SLOPE, and 1/TIME. No more than one cursor FUNCTION can be active at a time, and the active choice, if any, is underlined in the menu. A cursor function can be deactivated either by pressing the menu button below the underlined label, or by selecting a different function. Units for the cursor measurement are selected by using the UNITS menu. (See Item 19.)

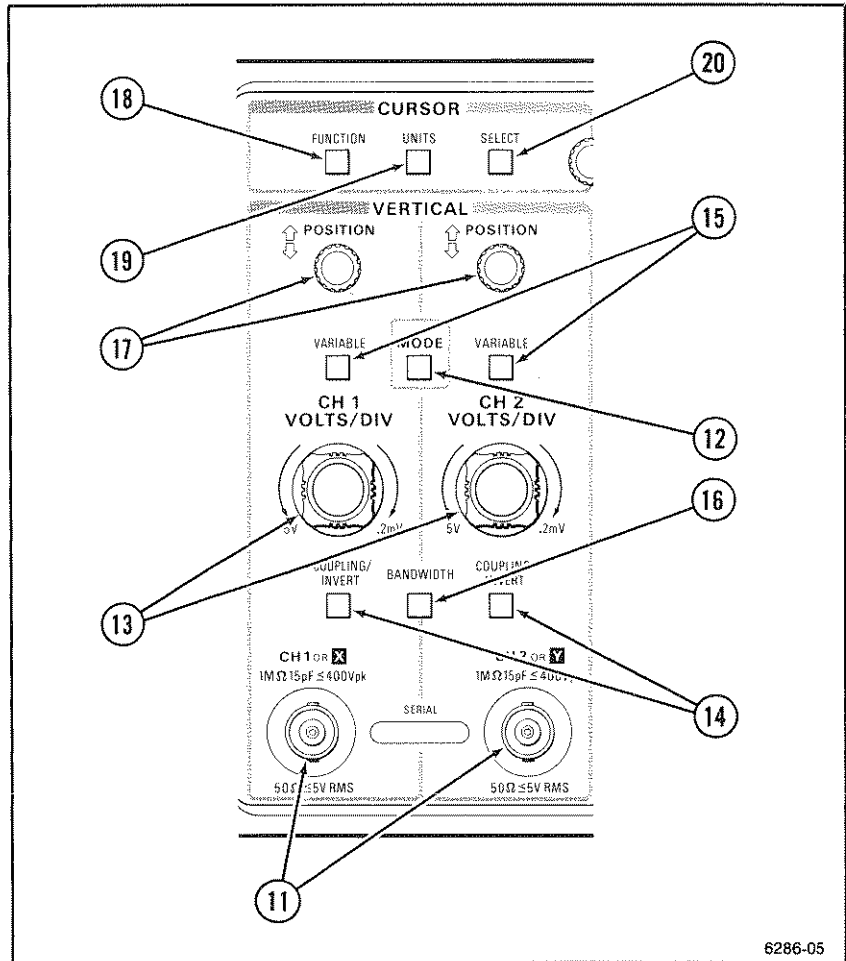

Figure 5-3. Vertical controls and connectors.

**VOLTS**

Calls up, or cancels, the VOLTS cursor display. (See Figure 5-4.)

	CURSOR FUNCTION				
	VOLTS	TIME	V @ T	SLOPE	1/TIME
Y-T				SAME AS V @ T	SAME AS TIME
Y-T ABS +				UNDEFINED FUNCTION	SAME AS TIME
X-Y				SAME AS V @ T	SAME AS TIME
X-Y ABS +				UNDEFINED FUNCTION	SAME AS TIME

Figure 5-4. Typical cursor displays.

**YT MODE:** A VOLTS cursor is a horizontal line extending completely across the screen. The  $\Delta$  (delta) cursor mode displays two VOLTS cursors. The active cursor is a dashed line; the fixed cursor is solid. The cursor readout, which is never negative, gives the voltage between the two cursors. The ABS (absolute) cursor mode displays only the active VOLTS cursor. The readout gives the voltage from the ground reference to the cursor; it is positive when the cursor is above ground, and negative when below.

**XY MODE:** A VOLTS cursor may be either a horizontal or a vertical line. The  $\Delta$  mode displays two pairs of VOLTS cursors: one pair of vertical lines that measure voltage along the x-axis and one pair of horizontal lines that measure voltage along the y-axis. When the active cursor (a dashed line) is a vertical line, the readout gives the voltage between it and the other vertical cursor based on the CH 1 or X VOLTS/DIV setting; when it's a horizontal line, the readout gives the voltage between the horizontal cursors based on the CH 2 or Y VOLTS/DIV setting.

The ABS mode displays two volts cursors. One is a horizontal line and measures the voltage along the x-axis from the ground reference to itself based on the CH1 or X VOLTS/DIV setting; the other is a vertical line that measures the voltage along the y-axis from the ground reference to itself based on the CH 2 or Y setting. As before, the active cursor is dashed. For Y-axis voltages, the readout gives positive voltages when the active cursor is positioned above the ground reference and negative when positioned below the ground reference. For X-axis voltages, the readout is positive if positioned to the right and negative if positioned to the left of ground reference.

#### **TIME**

Calls up, or cancels, the TIME cursor display. (See Figure 5-4.)

**YT MODE:** A TIME cursor is a dotted vertical line extending across the center six divisions of the screen: The  $\Delta$  cursor mode displays two TIME cursors with the active cursor having twice as many dots as the fixed cursor. The readout gives the time interval between the two cursors. The ABS cursor mode displays only the active cursor. The readout gives the time interval from the record trigger (marked by a small T on the waveform) to the cursor; it is positive when the cursor is to the right of (or after) the record trigger and negative when the cursor is to the left of (or before) the record trigger. If either the record-trigger marker or a TIME cursor is located at the very edge of the graticule area, its correct time position on the waveform may actually be off screen. (The record-trigger marker must be turned on or off via an Extended Functions submenu to be seen; see Appendix A.)

**XY MODE:** A TIME cursor is the vertical element of a small + attached to the waveform. The  $\Delta$  cursor mode displays two TIME cursors. The active and fixed cursors look exactly alike. The readout gives the time interval between the cursors. The ABS cursor mode displays only one TIME cursor. The readout gives the time interval from the record trigger to the cursor; it is positive when the cursor is to the right of the trigger and negative when the cursor is to the left *in the YT* display mode. In XY display mode, the record-trigger marker and time cursors are positioned to the X versus Y voltage levels at the time they occur. Since time is not plotted, the sign, positive or negative, of the readout is a better indicator of where the time cursor is positioned relative to the record trigger.



**V@T**

Calls up, or cancels, the V@T cursor display. (See Figure 5-4.)

**YT MODE:** A V@T-coupled cursor consists of a VOLTS cursor coupled to a TIME cursor so that the VOLTS cursor always intersects the waveform at the point determined by the TIME cursor. If the TIME cursor is located at the very edge of the graticule area, the warning message EDGE? is displayed to tell the user that its actual time position may differ from its displayed time position.

The  $\Delta$  cursor mode displays two V@T-coupled cursors. The active coupled cursor is made up of the active VOLTS cursor (dashed line) and the active TIME cursor (twice as many dots). The readout gives the voltage between the two VOLTS elements of the two V@T coupled-cursors. The  $\Delta$ -mode V@T coupled-cursors can be used to set up an accurate measurement of period or frequency: position the TIME elements on consecutive positive (or negative) edges of the waveform so the VOLTS elements exactly coincide and the readout is 0.0 V; then switch to TIME in the CURSOR FUNCTION menu for a cursor readout of period, or to 1/TIME for a readout of frequency.

The ABS mode displays only the active V@T cursor. The readout gives the voltage from ground to the VOLTS element; it is positive when the VOLTS element is above ground, and negative when below.

**XY MODE:** A V@T cursor consists of a pair of coupled VOLTS cursors, one horizontal and one vertical. Either the horizontal or the vertical element can be active (as indicated by a dashed line), but the two elements track each other so that they always intersect on the waveform. When the horizontal element is active, adjusting the cursor pair is equivalent to adjusting a V@T cursor attached to the CH2 (or REF2) waveform in YT mode—the vertical component of the XY display. When the vertical element is active, the V@T cursor is attached to the CH1 (or REF1) waveform in YT mode—the horizontal component of the XY display.

The  $\Delta$  cursor mode displays two V@T cursors. When the active element (a dashed line; the other three elements are solid) is a vertical cursor, the readout gives the voltage between the active cursor and the other vertical cursor based on the CH 1 or X VOLTS/DIV setting (or the setting at which REF 1 was acquired ). When the active element is a horizontal cursor, the readout give the voltage between the active cursor and the other horizontal cursor based on the CH 2 or Y VOLT/DIV setting (or the setting at which REF 2 was acquired ).

The ABS mode displays only one V@T cursor. The readout gives the voltage from the ground reference to the active element; it is positive when the active element is above or to the right of ground, and negative when below or to the left.

## **SLOPE**

Calls up, or cancels, the SLOPE cursor display. (See Figure 5-4.)

**YT MODE:** The SLOPE cursors consist of two coupled pairs made up of a VOLTS cursor and a TIME cursor. The SLOPE cursor display looks exactly like the  $\Delta$ -mode V@T cursor display, except the readout has units of volts per second since it gives the voltage between the VOLTS cursors divided by the time between the TIME cursors ( $\Delta V \div \Delta T$ ). When one of the time elements is located at the very edge of the graticule area, the warning message EDGE? is displayed to tell the user that its actual time position may differ from its displayed time position. SLOPE measurements require two pairs of cursors, so there is no ABS mode and that choice is omitted from the SLOPE UNITS menu.

**XY MODE:** The SLOPE cursors consist of two coupled pairs of VOLTS cursors. Each pair contains a horizontal element and a vertical element. The SLOPE cursor display looks exactly like the  $\Delta$ -mode V@T cursor display, except the readout has units of volts per volt since it gives the voltage between the horizontal elements divided by the voltage between the vertical elements ( $\Delta Y \div \Delta X$ ). Equivalently, this is the CH2 (or REF2) voltage difference divided by the CH1 (or REF1) voltage difference. As in YT mode, there is no ABS mode.

## **1/TIME**

Calls up, or cancels, the 1/TIME cursor display. (See Figure 5-4.)

The 1/TIME cursors are exactly like the TIME cursors in every respect, except the readout has the units of hertz. On a periodic signal, when the cursors are positioned at the exact beginning and ending points of a cycle, the readout gives the signal frequency. Correct positioning for this measurement is most easily accomplished by using V@T cursors (see V@T description).

## **Second-level ATTACH CURSORS TO Menu**

Automatically appears when a cursor FUNCTION is chosen while more than one waveform is displayed. The menu lists the sources of all displayed waveforms so the user can specify the one to be measured, ensuring that the cursor readout will be based on the correct scale factors. Repeatedly pressing the cursor FUNCTION button toggles between the CURSOR FUNCTION menu and the ATTACH CURSORS TO menu, even when only one waveform is displayed. This allows the user to verify or redesignate the cursor attachment without selecting a different cursor type.

**19 UNITS Button**

Calls up the cursor UNITS menu for the type of cursor selected in the CURSOR FUNCTION menu. If no cursor function is selected, it calls up the UNITS menu for VOLTS (or V@T) cursors. Each cursor UNITS menu provides a choice between absolute units (VOLTS, SEC, SLOPE, or Hz) and ratiometric units (% and dB or DEGREES). Ratiometric measurements require a reference for comparison. The user can set the reference: first adjust the cursors to a predetermined positional difference representing an absolute reference or position the cursors on a reference waveform to define a specific parameter such as peak-to-peak voltage or period; then press the NEW REF selection in the UNITS menu. The absolute value of the reference appears above the above the ratiometric and NEW REF menu selections. The ratiometric value is given in the cursor readout near the top of the screen. The ratiometric values for the reference are 100%, and 0 dB or 360°. If an acquired voltage reference becomes invalid because of switching between variable and calibrated VOLTS/DIV conditions, a UNITS? warning message is displayed.

 **$\Delta$ :ABS**

Toggles between delta and absolute cursor modes. This selection is not displayed in the UNITS menu for SLOPE cursors.

In  $\Delta$  (delta) cursor mode, measurements are made between the two cursors. In ABS (absolute) cursor mode, VOLTS and V@T measurements are made between the single displayed cursor and the ground reference; TIME and 1/TIME measurements are made between the cursor and the record trigger point. The last selected cursor in delta mode remains as the active cursor in absolute mode.

**20 SELECT Button**

Selects the active  $\Delta$ -mode cursor or cursor element. In YT mode, the SELECT button toggles the two cursors between active and fixed. In XY mode, it sequentially activates the four VOLTS cursors and the four V@T or SLOPE cursor elements. The CURSOR/DELAY knob controls the position of the active cursor except when the DELAY by TIME, DELAY by EVENTS, or MEASURE/SETUP/LEVEL menu is displayed; then, to restore cursor positioning to the CURSOR/DELAY knob, the user must press the MENU OFF button, or select another menu.

### External Interface

Refer to Figure 5-5 for location of Items 21 through 24.

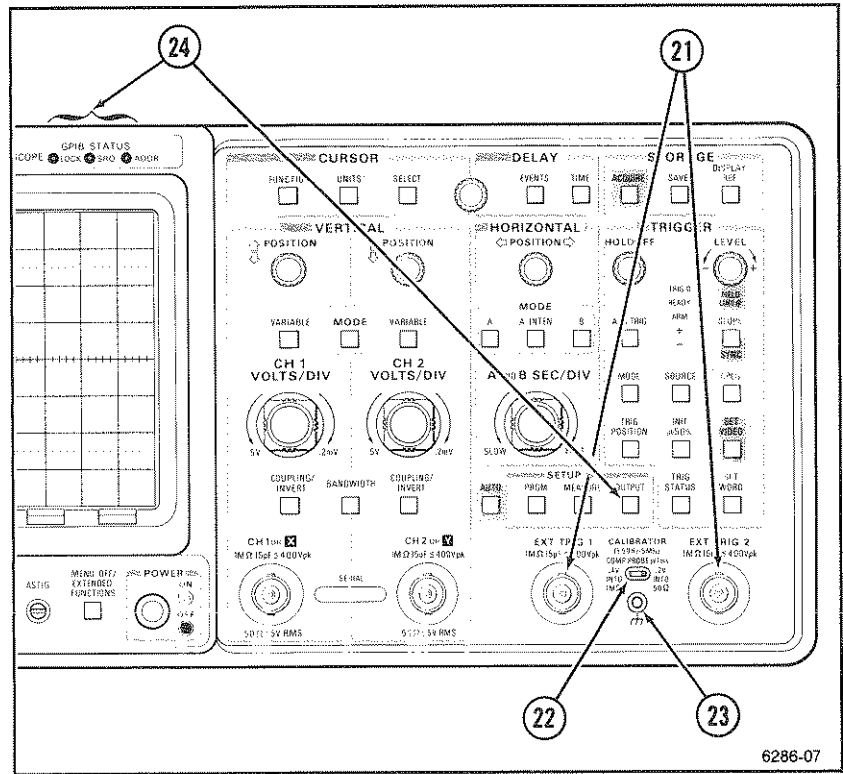

Figure 5-5. External interface.

21 **EXT TRIG 1 and EXT TRIG 2 BNC**

Input connectors to the A and B trigger system. These inputs make it possible to use external signals for triggering. Coding-ring contacts on the BNC connectors are identical in operation to CH 1 and CH 2 input connectors.

22 **CALIBRATOR Output Connector**

Provides a 0.4 V p-p square-wave signal into a 1-M $\Omega$  load, a 0.2-V p-p square-wave signal into a 50- $\Omega$  dc-coupled load, or an 8-mA p-p square-wave current signal into a zero-ohm load for an A SEC/DIV setting of 1 ms. The CALIBRATOR output signal is useful for verifying the accuracy of the sweep, the delays, and the vertical deflection; for checking the accuracy of current probes; and for compensating voltage probes. The correct A SEC/DIV setting for compensating voltage probes is 1 ms with a five-cycle display of the CALIBRATOR signal.

The frequency of the CALIBRATOR signal changes with the A SEC/DIV setting. (See Table B-2 in Appendix B for the CALIBRATOR signal repetition rates at each A SEC/DIV setting.) The CALIBRATOR signal amplitude at 5 MHz will be at least 50% of the signal amplitude at 500 Hz (when A SEC/DIV is 1 ms).

23 **Auxiliary Ground Jack**

A banana-plug jack that provides an auxiliary signal ground for use when connecting the equipment under test to the oscilloscope.

## **General Purpose Interface Bus**

The GPIB provides complete two-way digital communication between the scope and a GPIB controller. A special application of the GPIB enables hard copies to be made on certain plotters that use HPGL (Hewlett-Packard Graphics Language®) such as the Tektronix HC-100 Color Plotter, or the Hewlett-Packard HP 2225A ThinkJet® Printer. (See the DEVICES paragraph under OUTPUT/SETUP/MODE in this section.)

The oscilloscope can be instructed to output waveforms via the GPIB either locally from the front-panel or remotely from a GPIB controller. (See the Programmers Reference Guide for information about operating the GPIB from a controller.) The first-level OUTPUT menu offers choices that enable the user to: check the GPIB status; set up the GPIB; configure the debugging mode; and send an SRQ to the controller, print or plot a waveform, or send an AutoStep sequence to other instruments on the bus.

### **24 GPIB STATUS Indicators**

Indicate GPIB activity. The indicators are located above the CRT bezel and are labeled LOCK, SRQ, and ADDR.

#### **LOCK**

Turns on when the instrument is in the local-lockout state so that changes to the front-panel control settings are ignored. This condition exists as a result of the scope's LOCK command, or the universal LLO command that is sent when the controller needs uninterruptible control. The lockout condition is turned off at power-on, and the instrument defaults to user control. The lockout condition is also in effect during various other functions of the scope including PRINT, SENDPRGM, and SELF CAL.

#### **SRQ**

Turns on when the instrument is requesting service from the controller. It turns off when the controller reads the status byte sent by the scope during a poll unless there are other events pending that also require servicing.

#### **ADDR**

Turns on when the GPIB is in one of the addressed states: TACS (Talker-Active State), LACS (Listener-Active State), TADS (Talker-Addressed State), or LADS (Listener-Addressed State). If the instrument is in either Talk-Only or Listen-Only mode, the ADDR LED is always lit.

**24 OUTPUT Button**

Calls up the OUTPUT menu containing STATUS, SETUP, DEBUG, and either TRANSMIT, PLOT/PRINT, or SENDPRGM. Each of the first three choices produces at least a second-level menu, with the SETUP selection leading to four additional layers— including another SETUP.

**STATUS**

Displays the GPIB parameter settings of interest to a system user.

**SETUP**

Calls up a second-level menu to define operation of the GPIB. The menu entries are MODE, TERM, ADDR, and ENCDG. (MODE, TERM, and ADDR are not accessible via GPIB commands and must be defined by the user from the front panel.)

**MODE**

Calls up a third-level menu: T/ONLY, L/ONLY, T/L, DEVICES, and OFF BUS.

**T/ONLY**

Turns on the Talk-Only mode and presents a fourth-level menu for specifying the format of outgoing messages.

In T/ONLY mode the scope is always addressed to talk, so this mode is for data output, and a listen-only device (such as a tape or disk storage system) receives the transmitted waveform data. When the user presses the TRANSMIT button, the scope immediately starts sending the waveform message according to the selected format. If a controller is on the bus, it will not be able to untalk the scope. T/ONLY mode is also used when interfacing to one of the two operating modes of the Tektronix HC-100 Color Plotter. (See the HC-100 manual for further information.)

The formatting choices are: SEND CURVE ONLY—only waveform-data bytes are sent; SEND CURVE W/WFMPRE—all preamble information is sent prior to the waveform-data bytes; and SEND PRGM—the scope can send AutoStep sequences to another 2440, 2432 or 2430A on the bus. (See the Programmers Reference Guide for details.)

The CURVE ONLY vs. W/WFMPRE format choices for the waveform message are available as queries when a GPIB controller is directing transactions on the bus, but the scope must be in the T/L mode. The CURVe? query asks for only the waveform data, and the WAVfrm? query asks for the entire waveform message.

**L/ONLY**

Turns on the Listen-Only mode in which the GPIB controller can issue front-panel setups to the scope. Either the setup data can be acquired from a previous query of front-panel settings, or it can be generated by specific commands given to the scope via the GPIB controller.

L/ONLY is also the mode in which the scope can receive an AutoStep sequence from another 2440, 2432, or 2430A. (See the Programmers Reference Guide for more information.)

**T/L**

Turns on the Talk-Listen mode, which is the normal configuration for full two-way GPIB communication. In this mode, the scope can be completely controlled by a system controller.

**DEVICES**

Turns on a mode similar to T/ONLY for sending waveform data to a plotter or printer. Selecting DEVICES also calls up a fourth-level menu for identifying the type of output device that's being used and for setting up the format of the output. The plotter or printer must be set to Listen Only, and it should be the only device (other than the scope) on the bus.

**HPGL PLOTTER**

Sets up the GPIB to send waveform data to one of various plotters, such as the Tektronix HC100 Color Plotter®, the Hewlett-Packard 7470A Graphics Plotter, or the Hewlett-Packard HP 7475A Graphics Plotter, that use HPGL (Hewlett-Packard Graphics Language®).

**THINKJET PRINTER**

Sets up the GPIB to send waveform data to a Hewlett-Packard HP 2225A ThinkJet® Printer.

**SETUP**

Calls up a fifth-level menu used to select format parameters for the plotted or printed output. The user can specify whether readout, graticule, and waveform information is included. The menu choices are: SETTINGS ON:OFF, TEXT ON:OFF, GRAT ON:OFF, WFM ON:OFF, and PGSIZE US:A4.



**SETTINGS ON:OFF**

Turns ON or OFF the top three lines of the screen where the front-panel settings and menu choices for the scope are displayed.

**TEXT ON:OFF**

Turns ON or OFF the middle ten lines of the screen where additional textual information is displayed. The bottom three lines are only printed if they contain user-created messages/menus sent in via the GPIB under the direction of a controller.

**GRAT ON:OFF**

Turns ON or OFF the graticule lines. When OFF, the graticule is not shown on the plot or print.

**WFM ON:OFF**

Turns ON or OFF the waveform(s).

**PGSIZE US:A4**

Selects the paper size. US is for 8.5" × 11" paper, and A4 is for the European standard paper.

*NOTE*

*When HPGL PLOTTER or THINKJET PRINTER is chosen in the DEVICES menu, PLOT or PRINT replaces TRANSMIT in the first-level OUTPUT menu. To initiate the plot or print, press the front-panel OUTPUT button; then press the PLOT or PRINT menu button.*

**OFF BUS**

Isolates the scope from the GPIB so they cannot communicate and removes the TRANSMIT entry from the first-level OUTPUT menu.

**TERM**

Calls up a third-level menu for specifying the message-termination characters. The choices are: EOI—asserts end or identify on the last byte of a message; and LF/EOI—asserts carriage return, then line feed with EOI.

**ADDR**

Calls up a third-level menu for setting the address that must be sent to the scope to make it transmit waveforms or listen to commands over the bus. The ↑ and ↓ buttons are used to increment and decrement the address between 0 and 30. Each press of an arrow button changes the address by 1. The address cannot be set via the GPIB.

**ENCDG**

Calls up a third-level menu for specifying how waveform data is to be encoded. If the whole waveform (1024 data points) is to be sent, the choices are: ASCII; RP—positive-integer binary format; and RI—two's complement binary format. For partial waveforms, only the two binary formats are available. The coding type can also be specified via the GPIB using the DATA ENCDG command, and if switched via the GPIB, it is also switched in local and vice-versa. Upon power-on and INIT PANEL, the scope expects to receive waveform data in two's-complement format (RIBinary).

**DEBUG**

Calls up the menu used to control the debugging function of the GPIB. DEBUG mode is an important aid to a programmer when tracking down problems in a new system program or when hand-entering command strings via the controller keyboard.

**DEBUG ON:OFF**

Turns DEBUG mode ON or OFF.

**BUS:SCOPE**

Tells the instrument whether to monitor all GPIB traffic or just its own messages. If set to BUS, all messages sent over the GPIB will be displayed on the screen. (The scope must be in Listen-Only mode before it can be set to BUS.) If set to SCOPE, only communication between the scope and the controller, along with any appropriate error messages, will be displayed. When the scope receives a command string it does not understand, the incoming string is halted immediately. A user can then read the string and the error message to find out what went wrong. The message terminator is indicated by a special rectangle symbol at the end of the string. The characters displayed are from the scope's character set; the Programmer's Reference Guide has charts that show how to map them to an ASCII set.

**IN:OUT**

Specifies which messages the scope displays when SCOPE is selected. When set to IN, only incoming messages are displayed. When set to OUT, both incoming and outgoing communications are displayed. The outgoing messages, which are responses to queries, are underlined.

**NOTE**

*When using the SLOW and PAUSE features, it may be necessary to lengthen or disable the timeout period of the controller to keep from exceeding it.*

**SLOW**

Slows the character update rate on screen. An extra wait is observed on the message terminator.

**PAUSE**

Halts the character update on screen.

**TRANSMIT**

Sends an SRQ (service request) to the controller. The following sequence of events is typical of what occurs after TRANSMIT sends the SRQ:

1. The controller receives the SRQ and identifies its source.
2. The controller sets the DATA SOURCE pointer to indicate which waveform(s) it wants sent.
3. It next issues either a WAVfrm? query (wants both waveform preamble and data) or a CURVe? query (wants just data).
4. The controller releases the bus, and the scope transmits the waveform(s).

TRANSMIT is removed from the OUTPUT menu when the scope has been set to OFF BUS in the MODE menu under OUTPUT SETUP.

**PLOT/PRINT**

Initiates the output of waveform data to the selected plotter or printer. When DEVICES is selected under MODE in the OUTPUT SETUP menu, the TRANSMIT label in the OUTPUT menu changes to either PLOT or PRINT, depending on the type of device chosen. While plotting or printing a waveform, the front-panel controls (except ABORT—see below) are locked out, and the scope is in SAVE mode. If the scope is in SAVE ON  $\Delta$  mode, the switch to SAVE for an out-of-limit signal automatically causes an output to the printer. When the output is finished, the scope sends a page eject to the printer and resumes its SAVE ON  $\Delta$  mode acquisition.

**SENDPRGM**

Sends a stored AutoStep sequence to other scopes on the bus.

When SEND PRGM is selected (in the menu called up by pressing OUTPUT followed by SETUP, MODE, and T/ONLY), the TRANSMIT label in the OUTPUT menu changes to SENDPRGM. The user can then select a sequence from the RECALL menu under the AUTOSTEP SEQUENCER menu (see 49—PRGM) and send it to any other 2440's, 2432's and/or 2430A's on the GPIB that are set to Listen-Only by pressing the SENDPRGM button in the main OUTPUT menu. As when plotting or printing, the front-panel is locked out during transmission. (For further information on sending AutoStep sequences, see the Programmers Reference Guide.)

**ABORT**

Ends the transmission in progress.

The TRANSMIT/PLOT/PRINT/SENDPRGM label changes to ABORT after the button is pressed. A second press of the button ends the transmission and restores the original label. For TRANSMIT, pressing ABORT automatically sends LF (line feed) and EOI (end-or-identify) to the receiver and an SRQ and status byte to the controller to indicate the scope is through talking and the transmission has ended. Also, ABORT can be used to release the instrument when it is locked in SAVE mode after sending an SRQ to a controller that can't respond because it has the wrong address or has not been properly programmed to handle the scope.

## Horizontal Controls

Refer to Figure 5-6 for locations of items 25 through 30.

### 25 A AND B SEC/DIV Switch

Selects among 29 calibrated A or B SEC/DIV settings from 5 s through 2 ns. The sampling rate varies with the SEC/DIV setting to produce 50 data points per division of waveform display (or 25 min-max pairs in ENVELOPE mode) until the maximum sample rate of 500 megasamples per second is reached at 100 ns. For SEC/DIV settings faster than 100 ns, the scope must use interpolation to determine intermediate points for single (non-repetitive) event capture or, if the waveform is periodic, use random sampling (REPET mode must be turned on) to acquire the requisite number of data points per division.

#### NOTE

*If horizontal expansion is to be used, the Horizontal MODE must not be changed after entering SAVE.*

In SAVE mode, if the SEC/DIV control is turned to faster settings, it can expand the waveform horizontally up to 100X. If the SEC/DIV control is turned to a slower setting than the one at which the saved waveform was acquired, it will not affect the waveform display, but the readout will change to show the time per division for the next acquisition.

### 26 MODE Buttons

Select the Horizontal display mode. Selecting A Horizontal mode directs the SEC/DIV control to change the A SEC/DIV setting; selecting either A INTEN or B directs the SEC/DIV control to change the B SEC/DIV setting. (See Item 28—DELAY by TIME for assignment of delays to waveforms.)

#### NOTE

*A saved waveform must be horizontally expanded in the same Horizontal mode with which it was acquired. Do not change the Horizontal MODE after entering SAVE.*

#### A Button

Selects the A Horizontal mode. Waveforms are acquired at the A SEC/DIV setting.

**A INTEN Button**

Selects the A Intensified Horizontal mode. Waveforms are acquired at the A SEC/DIV setting, but an intensified zone on the waveform marks the portion of the trace that can be displayed at the B SEC/DIV setting if the MODE is changed to B. It is also possible for the waveform to have two intensified zones. (See Item 28— DELAY by TIME,  $\Delta$  TIME ON/OFF for more information.) For B TRIG AFTER (Delay) operation, the start of an intensified zone indicates the point on the A waveform where B triggering is enabled, not the point where the B Record Trigger will occur if the Horizontal MODE is switched to B.

**B Button**

Selects the B Horizontal mode and changes the acquisition rate to that specified by the B SEC/DIV setting.

**27 HORIZONTAL POSITION Control Knob**

Changes the horizontal position of signals displayed in YT mode. Clockwise rotation of the knob moves the trace to the right. The Horizontal POSITION pot is a position-rate control. The center position area of the control produces linear positioning. Rotating the control into its spring-loaded region produces rate positioning of the display. The farther the knob is rotated toward the end-stop, the faster the positioning rate. Releasing the knob returns the control to the linear region of the pot.

The Horizontal POSITION control does not affect the horizontal position of the XY display, but it does select which 512 data points, out of the 1024-point waveform record, are used for the display. This is true for stored XYREF, as well as both live and saved CH1 vs CH2 waveforms. In YT mode, the horizontal position of each stored REF waveform can be changed individually: Press HORIZ POS REF in the DISPLAY REF menu to call up the HORIZONTAL POSITION menu; set REF HPOS to IND (independent) and press one of the REFEXP buttons to assign the Horizontal POSITION control to the corresponding reference waveform; then, while in the HORIZONTAL POSITION menu, the POSITION knob controls the horizontal position of only the REF waveform (whether it is displayed or not).

The HORIZONTAL POSITION menu *must* be displayed and REF HPOS set to IND for the POSITION control to move REF waveforms independently of other reference and live waveforms. Setting REF POS to LOCK returns all REF waveforms to their original position and causes the Horizontal POSITION knob to move all saved, REF, and live waveforms in unison. Also, REF1 and REF2 waveforms that have been independently positioned in YT mode are automatically returned to their original positions when the scope is switched to XY mode.

**VERT**

Selects the trigger source from among the displayed waveforms. Whenever ADD is displayed, whether alone or in combination with other signals, VERT selects ADD as the trigger source. When CH 2 is displayed alone, or when only CH 2 and MULT are displayed, VERT selects CH 2 as the trigger source. In all other cases, VERT selects CH 1 as the trigger source.

**CHAN 1:2**

Selects either the CH 1 or the CH 2 input signal as the trigger source. The first press of the CHAN 1:2 button selects CH 1; each subsequent press toggles the source between Channel 1 and Channel 2. While CHAN 1:2 is selected, pressing the SOURCE button also toggles the trigger source between Channel 1 and Channel 2.

**EXT**

When in the A TRIGGER SOURCE menu, calls up the A EXT menu to select either the EXT TRIG 1 or the EXT TRIG 2 input signal as the trigger source for the A-Trigger system, and to set the gains of both external-trigger channels. This menu can be toggled to the B TRIG SOURCE menu by pushing the A/B TRIG front-panel button. When in the B TRIG SOURCE menu, the button labeled EXT calls up the B EXT menu to select the external-trigger source for the B-Trigger system and to set the gains, as above. The B EXT menu can be toggled to the A TRIGGER SOURCE menu by pushing the A/B TRIG button.

The SOURCE 1:2 toggles between the EXT TRIG 1 and EXT TRIG 2 sources. The A AND B EXT GAIN selections make it possible to configure each external-trigger input channel with an attenuation factor of one (EXT X) or of five (EXT X÷5). The EXT X÷5 selection reduces the amplitude of large external-trigger signals. The attenuation choices for each source are mutually exclusive; selection of one turns off the other.

**NOTE**

*The gains set for EXT TRIG 1 and EXT TRIG 2 are the same for both A- and B-Trigger systems. Changing a gain setting in either the A or B EXT menu changes that setting in the other menu as well.*

**LINE**

Selects the waveform of the ac power source as the trigger signal. The line trigger is useful when the frequencies of the displayed waveform and the ac power source are related. LINE triggering is not available for the B-Trigger system, and the selection is omitted from the B TRIG SOURCE menu.

**A\*B:WORD**

Selects either the logical AND of the A-Trigger and the B-Trigger, or the 16-bit Word Recognizer Probe as the trigger source.

The A\*B selection is available only in the A TRIGGER SOURCE menu. It requires that the triggering conditions (SOURCE, COUPLING, LEVEL, etc.) for both the A- and the B-Trigger systems be met before a trigger signal is valid. In the A TRIGGER SOURCE menu, the first press of the A\*B:WORD button selects A\*B as the trigger source. If the Word Recognizer Probe is attached, a subsequent press of the menu button toggles the selected trigger source to WORD, and a third press returns to the trigger source that was in effect just before A\*B was selected. VIDEO coupling is incompatible with A\*B and WORD triggering: When VIDEO coupling is in effect, it switches to DC if A\*B is selected; when A\*B or WORD triggering is in effect, it switches to the most recent compatible trigger-source selection if VIDEO coupling is selected.

WORD trigger source requires that an optional Word Recognizer probe be attached to the WORD RECOG INPUT connector on the rear panel of the scope. Attempting to select WORD as a source without the probe attached, or disconnecting the probe (while in ACQUIRE mode) after WORD is selected, will ring the warning bell, display the message WORD PROBE FAULT, and return the scope to the previously-selected trigger source. If the probe becomes disconnected while in SAVE mode, the bell and message do not occur until ACQUIRE mode is entered.

Setup of the Word Recognizer Probe for selecting a trigger word is described in Section 7, "Options and Accessories."



**33 CPLG Button**

Calls up the menu for coupling the trigger signal to the A- and B-Trigger circuits as directed by the A/B TRIG switch.

**DC**

Couples all frequency components of the trigger signal to the trigger circuitry. DC coupling is useful for most signals, but it is especially useful for providing a stable display of signals with low frequencies or low repetition rates.

**AC**

Attenuates trigger signal frequency components below 60 Hz and blocks the dc component of the signal. AC coupling is useful for viewing ac waveforms having large dc offsets.

**VIDEO (Video Option 05)**

Activates the Video Option trigger circuitry. (See Section 7, "Options and Accessories" for operating the Video Option.) With the Video Option installed, the A COUPLING menu makes room for the VIDEO selection by combining DC and AC over one menu button (DC!AC), which then toggles between them. VIDEO is not a choice in the B COUPLING menu.

**NOISE REJECT**

Couples all frequency components of the trigger signal to the trigger circuitry, but increases the peak-to-peak signal amplitude required to produce a trigger event. NOISE REJECT coupling is useful for improving trigger stability on signals accompanied by low-level noise.

**HF REJECT**

Attenuates trigger signal frequency components above 50 kHz. This coupling method is useful for producing stable triggering on the low-frequency components of complex waveforms by rejecting high-frequency interference from the trigger signal.

**LF REJECT**

Attenuates trigger signal frequency components below 50 kHz and blocks the dc component of the signal. LF REJECT coupling is useful for producing stable triggering on the high-frequency components of complex waveforms by rejecting low-frequency interference or power supply hum from the trigger signal.

**34 TRIGGER MODE Button**

Calls up either the A or the B TRIGGER MODE menu as directed by the A/B TRIG switch.

**A Trigger Modes**

**AUTO LEVEL**

Adjusts the Trigger LEVEL to within the peak-to-peak limits of the trigger signal. Loss of the trigger signal causes the scope to go through a trigger acquisition sequence to determine the peak-to-peak amplitude of the trigger signal and reset the trigger level to the midpoint.

For SEC/DIV settings faster than 100 ms/div, if the trigger signal amplitude decreases to below the trigger level setting, or if the Trigger LEVEL control is adjusted outside the peak levels on the trigger signal, the AUTO LEVEL trigger acquisition sequence is automatically performed to reset the trigger level. An AUTO LEVEL cycle can also be forced by selecting AUTO LEVEL again after it has already been selected or by pushing INIT @ 50%. (See Item 36.)

**AUTO/ROLL**

Free-runs the acquisition in the absence of a triggering signal by forcing an auto-trigger. The triggering level changes only when the LEVEL control knob is adjusted to a new setting. At SEC/DIV settings of 100 ms or slower, AUTO changes to the ROLL function.

In ROLL mode, the display is updated a data point at a time, scrolling from right to left across the screen. Although trigger signals are ignored, a Trigger Point Indicator (T) is displayed to identify the reference point for absolute TIME cursor measurements, and to define the waveform window that is captured for SAVE ON  $\Delta$ —which, in ROLL mode, is especially effective to monitor changes in the dc level of a power supply voltage.

When in ROLL mode: there is no DELAY by EVENTS because triggers are ignored; if A INTEN or B Horizontal mode is selected, triggering switches to AUTO; if AVG acquisition mode is selected, triggering switches to NORMAL (and conversely, when acquiring in AVG, if ROLL is selected the acquisition mode switches to NORMAL); and ENVELOPE acquisitions are based on a single record, regardless of the number shown above the menu label.

**NORMAL**

Permits an acquisition to occur either when triggered or when the input coupling of the selected trigger SOURCE channel is set to GND (as when it is necessary to acquire a ground reference level). The scope auto-triggers for the GND setting to allow the user to position the baseline trace vertically on screen while the normal trigger signal is shut off. Without this feature, the loss of trigger signal when the input coupling is switched to GND would stop the acquisition process, freezing the display and preventing vertical positioning.

**SINGLE SEQ (Single Sequence)**

Performs one complete storage sequence when triggered and enters SAVE mode. If SINGLE SEQ is not the desired Trigger mode for the next acquisition to be made, select the new Trigger mode before pressing ACQUIRE. If a different acquisition mode is required while in SINGLE SEQ, it may be necessary to temporarily select another Trigger mode while making the change; during a rapid storage sequence, there won't be time to change acquisition modes before the sequence ends and the scope enters SAVE mode.

An acquisition is a single ARMED-READY-TRIG'D cycle, during which 1024 data points per channel are digitized; a sequence is a logical grouping of one or more acquisitions. The number of individual triggered acquisitions required to complete a single sequence depends on the acquisition mode selected and the requirements of that mode. For instance, if the scope is set to NORMAL acquisition mode and the Horizontal mode is set to B, one acquisition completes a single sequence. However, if  $\Delta$  DELAY TIME is turned ON, the scope makes one acquisition for each delay specified, so two acquisitions are required to complete a single sequence. If the acquisition mode is now switched to ENVELOPE and the number of acquisitions set to 32, the scope must make 64 acquisitions to complete a single sequence: 32 envelopes of 2 delayed acquisitions.

**NOTE**

*REPET mode also affects the number of acquisitions needed to complete a single sequence. (See "REPET ON/OFF" in this section for details.)*

When a single sequence is complete, the scope updates the display and enters the SAVE mode. After the initial single sequence that is performed when the SINGLE SEQ Trigger mode menu button is pressed, subsequent single-sequence acquisitions must be started either by pressing the ACQUIRE front-panel button or by command via the GPIB.

## **B Trigger Modes**

### **RUNS AFTER**

Forces the B Record Trigger to occur immediately after the preset delay time, starting at the normal A Record Trigger event, has elapsed. The RUNS AFTER Trigger mode allows continuous, smooth delay positioning of the display for making delay time measurements. The basic delay time (main delay) is set by the CURSOR/DELAY knob when the system is in the DELAY by TIME mode. If  $\Delta$  TIME mode is turned on, there are two delays, the main delay and the delta delay, for making time difference measurements. The DELAY by TIME button alternately directs the CURSOR/DELAY knob to control the main delay time and the delta delay time. The B Trigger SOURCE, COUPLING, LEVEL, and SLOPE controls have no effect on B triggering in RUNS AFTER mode.

### **TRIG AFTER**

Permits the B Record Trigger to occur only when triggered after the preset delay time has elapsed. Since the B acquisitions are synchronized with the B Trigger signal, the delayed waveform display is stable even with jittering signals. In A INTEN displays, the start of the intensified zone is the point when B triggering is enabled, not necessarily where the B Record will occur. All the B Trigger controls are functional for selecting and conditioning the signal used as the B Trigger in TRIG AFTER Mode.

### **EXT CLK ON:OFF**

Disables the calibrated internal time base and uses an external signal as the sample clock when ON. The external clock signal is conditioned by the B Trigger circuitry and must meet the triggering requirements determined by the B Trigger controls before triggering can occur. The maximum usable external clock signal frequency is 100 MHz, and the minimum is 1 MHz.

When using the external clock, the A and B SEC/DIV switch (see Item 25) has no effect on the time-base setting, and, while both A and B acquisitions are possible, the ratio between A and B cannot be changed because the external clock frequency determines the acquisition rate for both. Also, the delay-time readouts are in terms of external clock events when either A INTEN or B Horizontal mode is selected. If DELAY by EVENTS and external clocking are both on, the same signal is the trigger source for both functions.

**35 TRIG POSITION Button**

Calls up the control menu used to select the Record Trigger position in the waveform display. The choices of 1/8, 1/4, 1/2, 3/4 and 7/8 determine the amount of pretrigger information that will be displayed prior to the Record Trigger in the next acquisition. The Record Trigger position cannot be changed in a saved waveform. (See Table B-9 in Appendix B for the waveform data-point number that corresponds to the fractional menu selections.)

The Record Trigger position may be set to any of 31 data-point selections, from 32 to 992, in the 1024 data point waveform record using commands via the GPIB. The Trigger Position is the horizontal point on the waveform where the Record Trigger occurs, and is marked with a T on the trace. (The points on the waveform are counted from 0 to 1023.)

**36 INIT @ 50% Button**

Forces the instrument to do a single AUTO LEVEL cycle (see Item 34) on the signal selected in the trigger source menu of either the A or B Trigger system, whichever system is selected by the A/B Trigger button. The trigger level is set to 50% of the peak-peak value of the trigger source signal, which may or may not be the signal displayed. If the signal amplitude is too small to find a valid trigger, one will be forced when the INIT @ 50% button is pressed. The forced trigger in turn forces a single acquisition, but it does not necessarily force a complete acquisition sequence. DELAY by EVENTS and DELAY by TIME requirements are ignored; therefore, any delay time readouts are meaningless when INIT @ 50% is used to generate the acquisition. Pushing the IDENT button on a probe connected to the scope's front panel is identical to pressing the INIT @ 50% button if the AUTO PROBE menu is set to INIT50% (see the SYSTEM submenu described in Appendix A).

**37 SET VIDEO Button (Video Option only)**

Calls up the menu used to set up the Video Option operation. See "Video Option" in Section 7 of this manual for operating instructions.

*NOTE*

*When the CLAMP function is turned on in the SET VIDEO menu, it remains on even if the VIDEO Coupling selection is off (as indicated in the CRT readout display). If the scope is not being triggered by a composite-sync or composite-video signal, the circuit action of the back-porch clamp circuitry on the CH 2 waveform becomes unpredictable. In this event, press SET VIDEO and switch CLAMP off.*

**38 SLOPE Button (SLOPE/SYNC with Video Option)**

Selects the slope of the signal that triggers the A and/or B acquisition. An illuminated indicator (+ and -) shows the slope selected for triggering. The A and B SLOPE settings can be selected independently. With the Video Option installed, the button is also used to select either sync-negative or sync-positive operation of the TV sync-separator.

**39 Status Indicators (TRIG'D, READY, and ARM)**

Show the state of the instrument trigger system during an acquisition sequence. (See Table B-11 in Appendix B for an interpretation of the trigger status shown by the Status Indicators.)

**40 HOLDOFF Control Knob**

Varies the amount of time from the A Trigger until the Trigger system will accept another A Trigger event. Use of this control often helps obtain stable triggering on aperiodic signals. (See Table B-5 of Appendix B for minimum and maximum holdoff values versus SEC/DIV settings.) The HOLDOFF setting between the minimum and maximum values is shown as a percentage in the STATUS display, with 0% being minimum. The knob can be rotated continuously in either direction; clockwise rotation increases holdoff until it reaches 100%, then resets it to 0% and repeats. A small HO symbol appears at the beginning of the A Trigger Level readout line whenever the HOLDOFF is set to anything other than 0%. HOLDOFF is reset to 0% whenever the A SEC/DIV is changed.

**41 LEVEL Control Knob**

**(LEVEL/FIELD LINE # with Video Option).** Sets the amplitude level on the triggering signal at which A or B acquisitions are triggered (as directed by the A/B TRIG switch). The trigger level readout is the voltage, relative to ground, at which triggering will occur. (See Figure 5-2 for the readout location.) The trigger level readout is correctly scaled for the attenuator setting and probe coding that affect the amplitude of the trigger signal. A question mark appears after the trigger level readout if the Trigger COUPLING is not DC or the vertical input SOURCE (CH 1 or CH 2) is either uncalibrated or not in DC Coupling.

When CH1, CH2, or VERT is the trigger source, the range to which trigger level can be set is limited to  $\pm 18$  divisions  $\times$  VOLT/DIV setting for the source selected. When EXT 1 or EXT 2 trigger source is selected, the range is  $\pm 900$  mV for EXT  $\div 1$  and  $\pm 4.5$  V for EXT  $\div 5$ , when X1 probes are used to connect the trigger signal to external input. (Like the CH1 and CH2 inputs, the EXT inputs recognize properly coded probes with attenuation factors of X10, X100, and X1000. When such probes are used, the trigger level range is multiplied by the probe attenuation factor and the trigger level readout reflects the multiplied range.) When LINE is selected, the range is  $\pm 360$  V.

If the trigger level is adjusted past either peak of the current trigger signal while the A Trigger is in AUTO LEVEL mode, a new trigger level will be calculated and set to about the midpoint of the trigger signal.

With the Video Option enabled, the LEVEL/FIELD LINE # control sets the specific line number that will trigger a video signal acquisition (FIELD1 or FIELD2 triggering). (See the "Video Option" information in Section 7 for operation of this control with the Video Option.)

#### 42 TRIG STATUS Button

Displays a readout of the present A and B Trigger control settings for MODE, SOURCE, CPLG, and TRIG POSITION. An underline below the A or B, which can be toggled by the A/B TRIG button, designates the Trigger system whose controls are currently active. If A\*B is selected, it is included in the display. Any trigger changes sent to the scope via the GPIB are immediately reflected in the TRIG STATUS display.

#### 43 SET WORD Button

Calls up the setup menu for programming the optional Word Recognizer Probe to produce a trigger on a specified parallel TTL data word. (See "Word Recognizer Probe" in Section 7 for setting up the data word to be recognized.)

The output of the Word Recognizer Probe can be selected as the trigger source for the A-Trigger and/or the B-Trigger system. It is also routed to the rear-panel BNC connector labeled WORD TRIG OUT for use in triggering an external device. A trigger signal appears at this connector each time a word match occurs, but if the selected trigger word occurs too often in a data stream, the holdoff time of the scope may prevent some matches from being accepted as trigger signals.

## Storage System

Refer to Figure 5-7 for the location of Items 44 through 46.

### 44 ACQUIRE Button

Calls up the menu for selecting the acquisition mode.

#### NOTE

*The number above the ENVELOPE or AVG menu-button label tells how many single acquisitions are needed for a sequence in that mode. This number can be changed by repeatedly pressing the corresponding button. Each single press of the button doubles the number until the maximum limit is reached (CONT for ENVELOPE and 256 for AVG), then the number wraps around to the minimum limit (1 for ENVELOPE and 2 for AVG).*

#### NORMAL

Selects a continuous acquisition and display mode that produces a live display similar to that of a conventional scope.

#### ENVELOPE

Causes the scope to “envelope” data in both channels using software or hardware enveloping techniques. This results in a display of the amount of change to a waveform (its envelope) over a selected number of acquisitions; the maximum and minimum value is saved and displayed for each data point. (Actually, two consecutive data points are saved and displayed as a min-max sample pair). The scope uses one of two methods of enveloping to capture the maximum and minimum values, or peaks, depending on the acquisition rate. At SEC/DIV settings of 500 ns and slower, fast-analog peak detectors are switched into the signal path invoking hardware enveloping. These fast peak detectors capture short term amplitude variations, or glitches, as brief as 2 ns— independent of the sample rate set by the SEC/DIV setting! At SEC/DIV settings of 200 ns and faster, the peak detectors do not operate and software enveloping is turned on. When software peak detection occurs, the glitch capture ability is limited by the sample rate set by the SEC/DIV switch.



The scope makes the number of acquisitions specified in the ACQUIRE menu to complete the envelope sequence. As it acquires each min-max sample pair, it compares the data values obtained with the corresponding data values saved from one of the previous acquisitions in the sequence. If a data value from the newly acquired sample pair exceeds a data value previously saved, the new data value replaces the old in acquisition memory; if it doesn't exceed the old value, the old value remains saved. This ensures that, for a given sample pair stored in memory, the data values are the minimum and maximum obtained for that pair in the present, or any previous acquisition in the envelope sequence and results in a continuously updated "envelope" display.

The number of waveform acquisitions that accumulate in an envelope display before a reset occurs can be set to 1, 2, 4, 8, 16, 32, 64, 128, 256, or CONT (continuous). If CONT is selected, the ENVELOPE acquisitions restart only when a control setting that affects the data being acquired is changed, or when the ACQUIRE button is pressed. A change to Vertical POSITION or DELAY TIME does not reset the envelope sequence. The SMOOTH ON:OFF function is ignored for ENVELOPE. (See "SMOOTH" in this section.)

ENVELOPE interacts differently with ADD and MULT Vertical modes than do AVG and NORMAL. When ADD or MULT are turned on for AVG or NORMAL, the scope does a digital addition or multiplication of the CH 1 and CH 2 waveforms. In ENVELOPE mode, however, the scope doesn't merely add or multiply the CH 1 and CH 2 envelopes; rather, it first adds or multiplies the CH 1 and CH 2 waveforms and then performs the enveloping process on the computed waveform. Amplitude shifts in opposite channels must occur at the same time *during the same acquisition* to be summed into the ADD envelope; shifts occurring at the same time relative to the record trigger but during different acquisitions are not summed together into the ADD envelope.

Assume the scope is performing an enveloping sequence with a 0-V dc level input in to CH 1 and CH 2. If the CH 1 dc level shifts (assume zero transition time) to +1 V during the first acquisition, but CH 2 stays at 0 V, the ADD envelope captures the +1-V shift and forms a 0-V min/+1-V max ADD envelope. If the CH 1 level returns to zero and during a subsequent acquisition CH 1 shifts to +1 V, the ADD envelope remains unchanged since the sum of the waveforms is still +1 V (the sum of the CH 1 and CH 2 envelopes is +2 V). If sometime during the acquisition sequence, both CH 1 and CH 2 shift to +1 V, the max ADD envelope shifts to 0-V min/+2-V max. This max value remains captured until the sum of the CH 1 and CH 2 waveforms exceeds the value or the envelope sequence ends.

Since an Envelope mode ADD/MULT waveform is formed by cumulatively enveloping the sum/product of the CH 1 and CH 2 waveforms, it must be displayed before entering SAVE mode; otherwise, no ADD/MULT waveform exists to be displayed. Switching to ADD or MULT or between ADD and MULT while in SAVE displays an invalid waveform. Press ACQUIRE to envelope the ADD/MULT waveform and then return to SAVE.

**AVG (average)**

Causes the instrument to average the set number of successive acquisitions, updating the display each time. The fidelity of noisy signals is improved with every average (the display is updated with each new acquisition taken) up to the set number. The user can select the number of acquisitions to be averaged from a binary sequence from 2 to 256. A front-panel change that affects the acquisition, or pressing the ACQUIRE button, erases the displayed waveform and restarts the acquisition sequence. (See Table B-3 in Appendix B for information regarding the signal-to-noise ratio improvement for the number of acquisitions averaged.)

The extra vertical resolution obtained in AVG mode permits "live" vertical expansion to three additional VOLTS/DIV settings: 1 mV, 500  $\mu$ V, and 200  $\mu$ V (with 1X attenuation of the input signal). When AVG mode is turned off, VOLTS/DIV settings in this range revert to 2 mV.

**NOTE**

*When the number of acquisitions in an average sequence is set to 32 or greater, the numerical result is truncated by the finite-precision, fixed-point arithmetic that is used to compute the weighted difference between sample points. The loss of decimal places biases the result toward discrete digitizing levels. This phenomenon can be seen in the display under low-noise conditions when vertically expanding a small-amplitude averaged waveform (either "live" or SAVEd), especially when AVG is set to 256.*

This instrument uses two different types of averaging: "Stable Averaging" and "Exponential Averaging." Stable Averaging is much like conventional averaging, wherein corresponding data points—accumulated during the user-specified number of acquisitions—would be added and the sum divided by the number of acquisitions. Stable Averaging, however, differs from conventional averaging in that a cumulative average is computed and displayed for every acquisition. When each new sample is acquired, it is used to compute a "correction" term; this is then added to the previous cumulative average to get the new cumulative average. In equation form:

$$S_d = S_{n-1} + \frac{\Delta n}{2^k}$$

where

$S_d$  = value to be displayed for present acquisition (cumulative average).

$S_{n-1}$  = value of previous cumulative average for this sample point.

$n$  = number of present acquisition.

$S_n$  = value of sample taken by present acquisition.

$\Delta n = S_n - S_{n-1}$ , discrepancy between present sample and previous cumulative average.

$k$  = integer such that  $2^{k-1} < n \leq 2^k$ .

#### NOTE

*In computing the values for display,  $2^k$  is used as the divisor of the correction term, instead of  $n$ , because it saves processing time.*

As the number of acquisitions increases, the size of  $2^k$  also increases. Thus the first acquisition has the greatest impact on the display, and succeeding acquisitions have less effect as the value of the correction term decreases. The impact or "weight" given each sample falls off exponentially as the number of averages increases. For example, a change that occurs during the second acquisition will show up on screen much faster than a change that occurs during the sixteenth. When the display is changed by adjusting a control such as POSITION, VOLTS/DIV, SEC/DIV, etc., a new acquisition sequence is started. Stable Averaging ensures that such changes show up immediately by putting the greatest weight on the first acquisition in the sequence.

Exponential Averaging uses the same formula as Stable Averaging, except that the divisor of the correction term is a constant. All samples are therefore given the same weight, no matter how many acquisitions have been taken. When the instrument has completed the user-specified number of acquisitions with Stable Averaging,  $2^k$  equals the total number of acquisitions. Then, unless the Trigger mode is SINGLE SEQUENCE, Exponential Averaging takes over, keeping the final value of  $2^k$  as the constant divisor of the correction term.

The Stable and Exponential methods both have an advantage over conventional averaging. They modify the average with each acquisition and continuously update the display, whereas conventional averaging accumulates all the user-specified acquisitions before it displays anything. With conventional averaging, it would take more than 25 seconds to display the result of 256 averages at 50 ms per division.

The user should be aware that when Exponential Averaging is in effect, it may require a significant period of time to completely reproduce changes in signal amplitude, frequency, phase, etc. Therefore, to avoid misleading results, it is always advisable to start a new average sequence (by pressing ACQUIRE) whenever the probe is moved to a different location.

Table 5-1 gives, as an example, the times required to reproduce exponentially-averaged signal changes when the acquisition/display-processing rate is 10 Hz. Times are given for reproducing the change with both 8-bit accuracy and 11.3-bit accuracy. (11.3-bit accuracy is needed if the waveform is vertically expanded by 10.)

**Table 5-1**  
**Approximate Exponential-Averaging Time Constants at 10 Hz**

<b>AVG. NO.</b>	<b>100% (8 Bits)</b>	<b>100% (11.3 Bits)</b>
2	900 ms	1.2 s
4	2.1 s	3.0 s
8	4.6 s	6.4 s
16	9.6 s	13.2 s
32	19.6 s	26.9 s
64	39.6 s	54.0 s
128	79.5 s	108.6 s
256	159.3 s	217.8 s

**REPET ON/OFF (Repetitive)**

When ON, repetitive sampling for NORMAL, ENVELOPE, and AVG mode acquisitions is enabled. At SEC/DIV settings of 100 ns and faster, the time base is sampling the incoming waveform at its maximum rate of 500 megasamples/second. With REPET OFF, data points that fall between the actual digitized points on the waveform are interpolated to obtain their displayed positions. Interpolation allows expansion of the acquired data to a SEC/DIV setting of 2 ns on a single event acquisition up to a Useful Storage Bandwidth of 200 MHz. At SEC/DIV settings of 50 ns and faster, REPET ON invokes random sampling (also called equivalent-time sampling) of the incoming signal, extending the bandwidth of the instrument to 300 MHz for repetitive signals.

**NOTE**

*The interpolation that occurs with REPET OFF is different for ENVELOPE mode. For NORMAL and AVERAGE, the scope uses a sine-interpolation algorithm to calculate data points between sample intervals. In ENVELOPE mode, the scope uses an algorithm that replicates the sampled data values a number of times determined by the expansion factor.*

Each REPET acquisition produces approximately 10 to 512 randomly-sampled display points. For AUTO LEVEL, AUTO, and NORMAL Trigger modes, the scope continues to take successive acquisitions until a predetermined number of data points are acquired. (At least enough points are taken to meet the Useful Storage Bandwidth of 300 MHz.) Any remaining points needed to fill the waveform record are determined by interpolating between the acquired points. (By interpolating the remaining points certain features, such as Auto Setup, can execute without waiting for these remaining points to be obtained.) These interpolated points are replaced by randomly-acquired data points as they become available from successive acquisitions. (Table B-4 gives the number of acquisitions taken before interpolation begins.)

**NOTE**

*When REPET is used with ENVELOPE mode, the 10 to 512 sample points are stored as min-max pairs, each pair comprising two consecutive sample points in the same acquisition. It is these pairs that are successively peak detected in software to form the envelope display.*

REPET ON affects the number of acquisitions needed to complete a sequence in SINGLE SEQ Trigger mode. In NORMAL acquisition mode, the single sequence is complete when at least the number of data points needed to meet Useful Storage Bandwidth of 300 MHz have been acquired. (This is the predetermined number of points after which remaining points are temporarily interpolated for non-single sequence Trigger modes—see Table B-4). In AVG mode, the single sequence is complete when 50% of the points have been averaged the user-specified number of times. In ENVELOPE mode, the criteria for completing a single-sequence in ENVELOPE mode are the same as for other ENVELOPE REPET acquisitions. (See below.) If N=CONT for ENVELOPE mode, the envelope sequence never ends; therefore, the single sequence never completes and the scope never enters SAVE mode. (See "SINGLE SEQ" under "A Trigger Mode" for more information on single sequence.)

REPET ON also affects the number of acquisitions needed to complete an ENVELOPE acquisition sequence. If the number of acquisitions specified is 1, the scope makes enough acquisitions to meet Useful Storage Bandwidth requirements before erasing the waveform. The number of acquisitions required depends on the SEC/DIV setting. (At 2 ns/div, 10 samples are min-maxed into, or compared against, 10 min-max pairs with each acquisition; at 5 ns, 25 samples are min-maxed into 25 min-max pairs, etc.) If the number specified (N) is greater than 1 but less than CONTinuous, 50% of the 1024 points comprising the 512 min-max pairs must have been enveloped N times, before the envelope sequence is complete. (In this case, the scope will interpolate points temporarily when Useful Storage Bandwidth requirements are met as previously described; however, it will continue to make acquisitions, and replace those points, until the requisite number of min-max pairs are enveloped.) If N=CONT, the envelope sequence never ends.

#### **SAVE ON Δ**

Controls the Save-on-Delta mode. When ON, and the ACQUIRE mode is NORMAL or ENVELOPE, the scope compares each incoming waveform to a stored envelope waveform and enters the SAVE mode if any part of the incoming waveform goes outside the limits set by the reference envelope. If waveforms are acquired using AVG (average) mode, the scope waits until the number of acquisitions specified in the ACQUIRE menu occur before comparing the cumulative-averaged waveform with the reference envelope. Once the requisite number of acquisitions are acquired, subsequent acquisitions are averaged in and, if the resultant cumulative waveform exceeds the reference envelope, SAVE mode is entered.

The reference envelope is generated from the front-panel by selecting CONTINUOUS ENVELOPE and using the vertical POSITION and DELAY by TIME controls to set the limits of the comparison. The reference is then saved in the correct REF memory. A more accurate comparison envelope can be generated by sending it into the desired REF memory via the GPIB. Both methods are described in "Applications," Section 3.

Any of four vertical modes, CH 1, CH2, and ADD or MULT can be compared against a reference waveform, but that reference waveform must be stored in the correct reference memory and then displayed from that memory on screen. For instance if CH 1 is on and DELTA Time is off, the CH 1 reference must be stored REF 1 and REF 1 and must be turned on in the DISPLAY REF menu. The various possible combinations of vertical modes require that the reference waveforms be stored in particular REF memories; if a wrong REF is displayed or if no REF is displayed, SAVE ON  $\Delta$  is ignored. See Table B-14 in Appendix B to determine which vertical mode will be compared with which REF memory for the different vertical mode combinations possible.

Upon entering SAVE mode, the readout displays the number of acquisitions taken while waiting for a change.

When using REPET mode to acquire the incoming waveform, only the data points acquired on each trigger event are compared to their corresponding data points in the reference waveform; the unfilled data points are ignored in the comparison.

It is possible to determine the time required for the SAVE ON  $\Delta$  to occur by using the power-on time since the last cold start. This time is displayed as HHHH:MM HRS (Hours:Minutes) in the SAVE menu. Record the time before starting the acquisition; then subtract this starting time from the time displayed at SAVE ON  $\Delta$  to determine the elapsed time.

When the scope enters SAVE because a change has occurred, SAVE ON  $\Delta$  is turned off so the user can return to the ACQUIRE menu without another SAVE immediately taking place.

**SMOOTH ON:OFF**

Turns ON or OFF the SMOOTH function, which is found in the menu called up by the front-panel BANDWIDTH button. When SMOOTH is turned ON, a five-sample-point, moving-average algorithm is applied to every sample point. Each digitized sample is averaged with the four previous sample values before it is displayed. The result is an overall smoothing of the waveform. The SMOOTH function only operates in AVG and NORMAL acquisition modes; if SMOOTH is turned on in ENVELOPE mode, it is ignored.

## 45 SAVE Button

Stops an acquisition in progress and freezes the display when pressed. SAVE mode is also entered when the input waveform exceeds the reference envelope in SAVE ON  $\Delta$  mode and at the completion of a SINGLE SEQ acquisition. The number of acquisitions making up the SAVED display is shown in the CRT readout. Pressing the ACQUIRE button returns the acquisition mode that was in effect before SAVE was entered. If front-panel control settings were changed while in SAVE mode, when ACQUIRE is pressed, the next acquisition is made with the new control settings.

The SAVEREF SOURCE menu appears when the scope enters SAVE mode. This menu is used to select waveforms from the save display for storage in the REF memories.

Saved waveforms can be measured using the cursor functions. They can also be vertically and horizontally positioned using the normal POSITION controls and vertically and horizontally expanded in steps with the SEC/DIV and the appropriate VOLTS/DIV controls. The Channel 1 and Channel 2 saved waveforms can be added or multiplied if they were acquired in NORMAL Acquire mode; the saved ADD/MULT display is obtained by calculating the CH 1 and CH 2 data. SMOOTHing can be turned on or off.

### NOTE

*While in SAVE mode, waveforms can be horizontally expanded up to 100X by turning the SEC/DIV knob to a faster setting, but they cannot be contracted to a SEC/DIV setting slower than the one at which they were acquired. Nevertheless, the SEC/DIV control can be adjusted throughout its entire range; its readout shows the acquisition rate that will be in effect the next time the ACQUIRE button is pressed.*

### SAVEREF SOURCE

This menu contains all the display sources (CH 1, CH 2, and either ADD or MULT) that are turned on in the VERTICAL MODE menu. It is used to select a displayed waveform for storage in a REF memory. REF is also offered as a source, even if no REF waveform is displayed. The REF button calls up a submenu for choosing any of the REF memories as a SAVEREF source. Since REF1-REF4 are provided as SAVEREF sources as well as SAVEREF destinations, waveforms can be copied from one REF location to another.



When  $\Delta$  TIME is used with B Horizontal mode, two delayed acquisitions are acquired for the CH 1, CH 2, and ADD/MULT sources. Whether or not both delays appear in a single source depends on the particular combination of sources selected in the Vertical mode menu; however, when selecting any of these sources from the SAVEREF SOURCE menu and TIME and B mode are BOTH on, the submenu DELAY1—DELAY2 is displayed so the desired waveform can be selected for saving.

Reference memories can be used as a push-up stack. A press of the STACK REF menu button stores the displayed SAVED waveforms according to predefined rules. The Vertical modes in effect when SAVE mode is entered determine the REF memory written into. If the STACK REF button is repeatedly pressed, previous reference waveforms get pushed into the next higher-numbered reference memory and finally out the top and are lost. (See Table B-13, Appendix B for the storage configuration when STACK REF is used for saving waveforms in reference memory.)

**SAVEREF DESTINATION**

This menu is called up when a source is selected in the SAVEREF SOURCE menu. It is used to store the chosen waveform in one of the reference memory locations (REF1, REF2, REF3, or REF4). Pressing the menu button under one of these choices copies the waveform from the previously selected SAVEREF SOURCE into the chosen memory location and returns to the SAVEREF SOURCE menu, permitting the user to store additional reference waveforms by making new SOURCE and DESTINATION selections.

A stored reference waveform can be displayed by using the DISPLAY REF menu. (See Item 46, "DISPLAY REF.")

**46) DISPLAY REF Button**

Calls up the menu for selecting the stored waveform or waveforms (REF1, REF2, REF3, and/or REF4) for display. Repeatedly pressing the appropriate menu button alternately turns on and off the display from that reference memory.

If EMPTY appears above a DISPLAY REF menu choice, it means that any waveform stored in that location is invalid. (See "Power-on/Self Diagnostics Test Failure" in Appendix A.) Once a valid waveform is saved in a REF memory, the EMPTY label disappears from above that REF choice.

The HORIZ POS REF selection calls up a menu that enables the Horizontal POSITION control to move the four reference waveforms individually—when REF HPOS is set to INDependent and the appropriate REF location is selected. Pressing the DISPLAY REF button returns the original DISPLAY REF menu.

In XY mode, the DISPLAY REF menu offers only one choice—XYREF, for which REF1 is the horizontal component and REF2 is the vertical. The associated menu button turns the display on and off. If either REF1 or REF2 is empty, XYREF will be marked EMPTY, also. Pressing the STACK REF button in the SAVEREF SOURCE menu simultaneously stores CH 1 in REF1 and CH 2 in REF2; this produces an XY waveform with a defined phase relationship, its components having been triggered by the same event. Waveforms for XYREF can also be entered individually in the REF1 and REF2 memories via the SAVEREF SOURCE and DESTINATION menus, and arbitrary waveforms can be transferred to these REF memories via the GPIB. In either case, there can be no guarantee of the actual phase relationship between the waveforms being compared; the XY phase difference seen on screen indicates only the phase difference of the displayed data, not that of the acquired data.

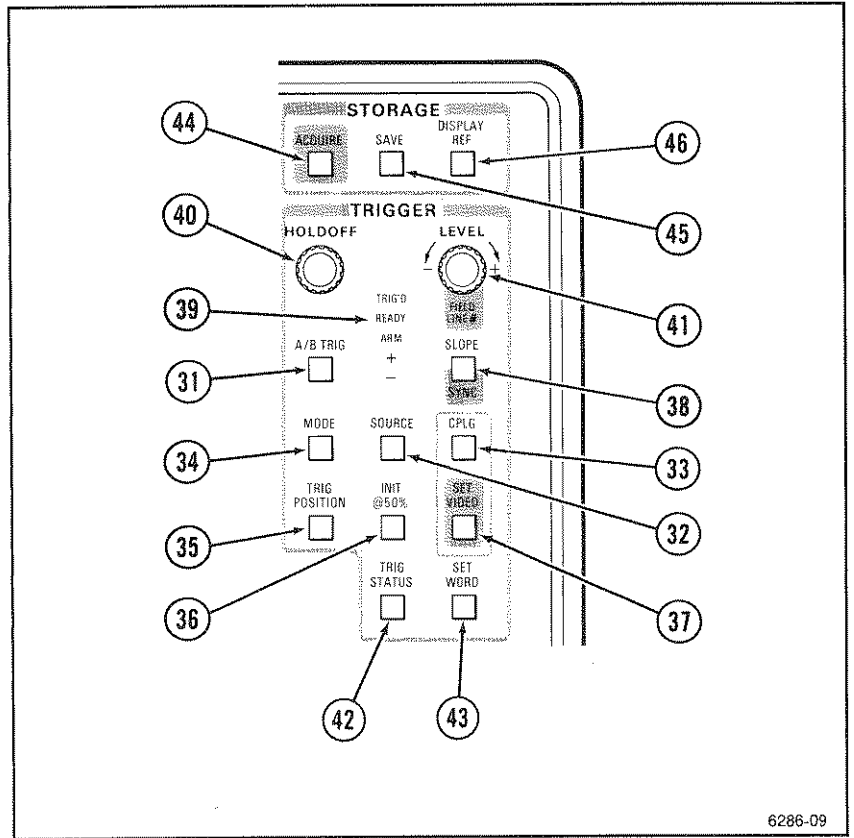

Figure 5-7. Storage and trigger controls.

## ***Extended Features***

### **HELP**

Displays operating information about the front-panel controls. To enter HELP mode, first press the front-panel button labeled STATUS/HELP to call up the STATUS menu; then press the menu button labeled HELP. All displayed waveforms, cursors, and readouts are temporarily shut off and replaced by an introduction to HELP mode that explains how to proceed:

#### **HELP MODE IS ON**

PUSH THE FRONT PANEL BUTTONS OR TURN THE KNOBS TO CALL UP SCREENS OF INFORMATION ABOUT THE CONTROLS (THE SCOPE SETUP WILL NOT CHANGE WHILE IN HELP MODE).

IF THE WORD -MORE- APPEARS ON THE BOTTOM LINE (AS IN THIS SCREEN), PUSH THE BEZEL BUTTON BELOW -MORE- TO DISPLAY FURTHER INFORMATION ABOUT THE CONTROL.

PUSH THE BEZEL BUTTON BELOW THE EXIT LABEL TO RETURN TO SCOPE OPERATION.

-MORE-

EXIT

As explained by this introduction, information about each control is obtained by manipulating the desired control. Note also that additional introductory information is obtained by pressing the menu button labeled -MORE- and that EXIT must be pressed to return to normal operation. (Operating *any* other control or button, except for POWER, FOCUS, ASTIG, and TRACE ROTATION, displays operating information associated with that control, and the function associated with the control is not implemented.)

Each HELP screen describes the function/action of the button the user selected. If the control normally calls up a menu, the description of that menu appears next. If the HELP screen requires more than 15 lines, pressing the MORE menu button (bezel button 1) displays the next screenful of information.

This is the first screen displayed in HELP mode when the ACQUIRE button is pressed:

PUSH THIS BUTTON TO BEGIN ACQUIRING WAVEFORMS  
<SEE TRIGGER MODE> AND CALL UP THE ACQUISITION  
MODE MENU.

NORMAL: SELECT 'LIVE' ACQUISITION MODE. ENVELOPE:  
CREATE WAVEFORM ENVELOPE BY SAVING MIN/MAX  
WAVEFORM POINTS DURING EACH SAMPLE INTERVAL  
FOR GLITCH CAPTURE AND ALIAS DETECTION. <REPET  
AFFECTS OPERATION AT SEC/DIVS OF 50ns/DIV AND  
FASTER; SEE MANUAL.> SUCCESSIVE PUSHES  
INCREMENT THE COUNT WHICH SETS THE NUMBER OF  
ACQUISITIONS BETWEEN WAVEFORM RESETS. 2ns GLITCH  
CAPTURE IN EFFECT FOR SWEEP SPEEDS 500ns/DIV AND  
SLOWER.

-MORE-

EXIT

④7 AUTO

Calls up the AUTOS SETUP menu and executes the Auto Setup function, which automatically makes a triggered acquisition and displays it according to the modes selected in the menu. If a new mode is selected from the menu, the next press of the AUTO button executes Auto Setup using the new mode. (Pressing the IDENT button on a probe connected to a front panel input executes the Auto Setup function if AUTO SETUP is selected in the AUTO PROBE menu. It does not, however, display the Auto Setup menu. See SYSTEM submenu in Appendix A for more information.)

Auto Setup determines and sets the vertical and horizontal scales for the display based on the amplitude and frequency of the input signal, and the currently active selections in the AUTOS SETUP, VERTICAL MODE, and CH1/CH2 COUPLING menus.

## ***Controls, Connectors and Indicators***

---

For Auto Setup to work, there must be a signal in the selected channel that is triggerable in AUTOLEVEL mode—i.e., it must be at least 50 Hz and 0.3 divisions at the most sensitive vertical scale factor (which is a function of the probe).

In general, Auto Setup does not change VERTICAL MODE menu selections except: if *no* vertical mode is selected, Auto Setup turns on CH1; and if XY is selected, Auto Setup changes it to YT. (Then, if CH1 vs CH2 was selected in XY mode, Auto Setup turns on both CH1 and CH2 when it switches to YT mode; otherwise, it turns on only CH1 in YT.) Similarly, Auto Setup preserves most INVERT/COUPLING menu selections except: it changes GND to DC, and INVERT ON to OFF.

Auto Setup turns off all cursor functions—with the one exception of TIME cursors when WINDOW is ON in the MEASURE menu—and all delay functions. Finally, regardless of previous settings, Auto Setup turns on the following Trigger functions: DC coupling, AUTO mode, and VERT source. (See VERT under Item 32 for the relationship between Vertical mode and VERT Trigger source.)

### **NOTE**

*Values given when describing vertical and horizontal sizing are target values only. The number of divisions and cycles to which a waveform is actually scaled depends on the available VOLTS/DIV and SEC/DIV settings and the amplitude and frequency of the waveform, as well as on the Auto Setup mode selected.*

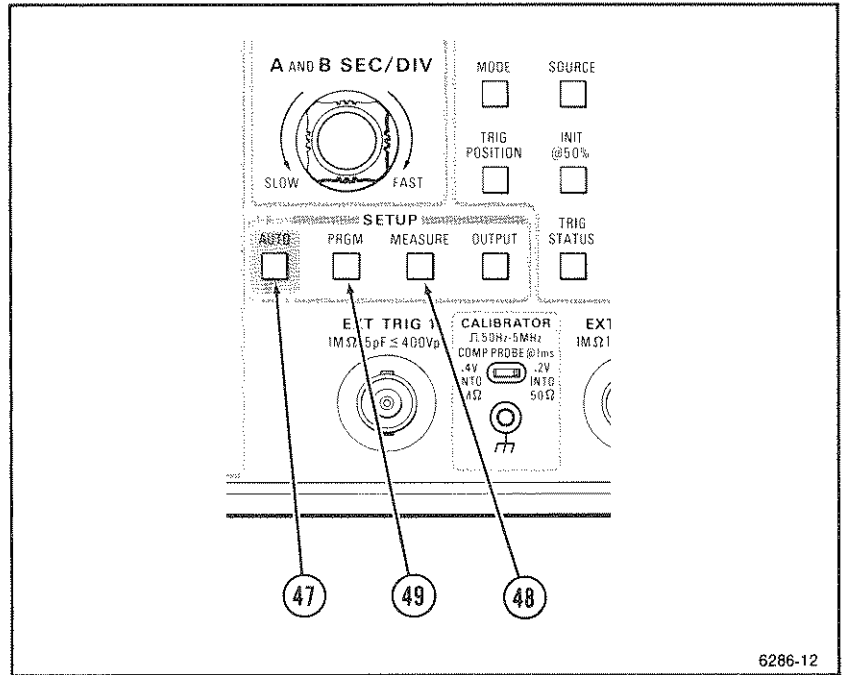

Figure 5-8. AUTO, PRGM, and MEASURE buttons.

**VIEW**

Sets up the display for best overall viewing. The vertical scale is determined by the peak value of the waveform, including any dc offset. If one channel is selected, its ground reference is positioned to the center graticule, and the displayed acquisition is scaled to fit vertically within about  $\pm 3$  divisions of ground. If two channels are selected, the CH 1 ground reference is placed 2 divisions above the center graticule and the CH 2 ground reference 2 divisions below, and both are scaled to fit vertically within about  $\pm 1.5$  divisions of their respective grounds.

If the ADD or MULT waveform is selected, its vertical scale and position are determined by the CH 1 and CH 2 scales and positions, according to the usual rules. (See ADD and MULT under Item 12.)

## **Controls, Connectors and Indicators**

---

The horizontal scale is chosen to display about 2 to 5 cycles of the trigger source waveform (which, for Auto Setup, is always VERT). The trigger POSITION is set to 1/2, and the trigger SLOPE to positive (+).

### **NOTE**

*For dc-coupled waveforms in PERIOD, PULSE, and EDGE modes, Auto Setup selects a vertical scale factor that optimizes the display of the signal's ac component. However, if the dc offset cannot be compensated within the  $\pm 10$  division position range at that setting—that is, if the ratio of the total signal amplitude to the optimum vertical scale is greater than ten—a larger VOLTS/DIV setting must be used. Auto Setup then scales the waveform according to the rules for VIEW mode and attempts to trigger on the ac component. (If one waveform is scaled using VIEW mode rules, all waveforms are scaled using the rules.) If successful, it proceeds to set the horizontal scale based on the VERT trigger source and the Auto Setup mode. In this situation, better resolution of the ac component can be obtained with ac coupling. In any case, the RES HI:LO selection determines the target values (in divisions) for both vertical and horizontal sizing. (See RES HI:LO.)*

### **PERIOD**

Scales the waveform to optimize the display of one period according to the RES HI:LO selection. The trigger POSITION is set to 1/32, and the trigger SLOPE is set to (+).

### **PULSE**

Scales the waveform to optimize the display of the minimum pulse width according to the RES HI:LO selection. The trigger POSITION is set to 1/32, and the trigger SLOPE is set to the polarity of the leading edge of the selected pulse.

### **EDGE (Rising)**

Scales the waveform to optimize the display of its rising edge according to the RES HI:LO selection. The trigger POSITION is set to 1/2, and the trigger SLOPE is set to (+) to display the rising edge.



**EDGE (Falling)**

Scales the waveform to optimize the display of its falling edge according to the RES HI:LO selection. The trigger POSITION is set to 1/2, and the trigger SLOPE is set to (–) to display the falling edge.

**RES HI:LO**

Selects the resolution that Auto Setup targets when scaling the waveform. In LO, the scaling is optimized for user viewing over the ten divisions of the screen; in HI, the scaling is optimized for the MEASURE feature over the 20 divisions of record length.

RES HI:LO does not affect VIEW mode and is removed from the menu when VIEW is selected. For PULSE, PERIOD, and EDGE modes, the RES HI:LO selection influences both vertical and horizontal scaling. The vertical scales and the positions of the CH 1 and CH 2 waveforms are arrived at independently (except in ADD mode) and the two waveforms are treated the same way, regardless of whether they are displayed separately or together. The horizontal scale is always determined by applying the criteria for the selected mode to the trigger-source waveform (VERT).

Vertically, the RES HI selection attempts to center the ac component at a VOLTS/DIV setting that confines the signal to about  $\pm 3$  divisions around the center graticule. Horizontally, the scale is selected to display the chosen parameter within the entire 20 divisions of the waveform record. For EDGE mode, horizontal scaling keeps the proximal (10%) and distal (90%) points within 9 divisions of each other.

Vertically, the RES LO selection attempts to center the ac component at a VOLTS/DIV setting that confines the signal to about  $\pm 1.5$  divisions around the center graticule. Horizontally, the scale is selected to display the chosen parameter within the first 10 divisions of the waveform record. For EDGE mode, horizontal scaling keeps the proximal (10%) and distal (90%) points within 3 divisions of each other.

For ADD displays, CH1 is scaled and positioned according to the previously stated rules, and CH2 is given the same scales as CH1 and is centered vertically. The ADD display then has the same vertical and horizontal scales as both CH1 and CH2, and its ground reference is the algebraic sum of the CH1 and CH2 grounds.

For MULT displays, CH1 and CH2 are scaled independently according to the rules. The MULT display then has a vertical scale factor of  $5.12 \times (\text{CH1 Vertical Scale Factor}) \times (\text{CH2 Vertical Scale Factor})$  in VOLTS<sup>2</sup>/DIV. Its horizontal scale factor is the same as for CH 1 and CH 2.

**48 MEASURE Button**

Accesses the Waveform Parameter Extraction feature, which allows the user to specify measurements of certain waveform parameters from the front panel, the AutoStep Sequencer, or the GPIB.

Two modes are available for extracting parameters. The SNAPSHOT method extracts 20 different parameters, based on the last acquisition, and displays the result. The Continuous-Update method dynamically extracts up to 4 different parameters, based on successive acquisition sequences, and updates the measurements approximately every 1/3 second (except at very slow acquisition rates).

Pressing the front-panel button labeled MEASURE displays a first-level menu that gives access to the two parameter extraction functions via the SNAPSHOT and MEAS TYPE menu buttons. This menu also includes SETUP, DISPLAY ON:OFF, and WINDOW ON:OFF. These menu entries and their sub-menus, if any, are discussed in order:

**SNAPSHOT**

Executes a SNAPSHOT parameter extraction. If more than one signal source is selected in the VERTICAL MODE menu, the TARGET menu appears so the user can select the waveform from which the parameters are to be extracted.

The second-level TARGET menu lists all of the displayed signal sources (CH1, CH2, ADD or MULT, and REF). Selecting one of these signal sources gives a "snapshot" of the parameters for the corresponding waveform. (See "Snapshot Readout.") In B Horizontal mode with  $\Delta$  TIME ON, both delays can occur on the same waveform. In this case, a third-level TARGET menu appears so the user can select DELAY1 or DELAY2 as the target for the snapshot. (The exception is: when CH 1 and CH 2 are *both* displayed, the main delay occurs on CH 1 and the delta delay on CH 2, so no third-level target menu is needed.) If more than one REF waveform is displayed and REF is chosen in the second-level TARGET menu, a different third-level TARGET menu appears that consists of all displayed REF sources. In both cases, selecting the target from the third-level menu gives the snapshot of the parameters for the targeted signal source. An example of the SNAPSHOT readout follows.

Snapshot Readout:

**SNAPSHOT OF CHX USING XXXXXXXX METHOD:**

<b>DIS = 4.35 V</b>	<b>TOP = 5.01 V</b>	<b>WID = 20.3<math>\mu</math>S</b>
<b>MES = 2.12 V</b>	<b>BASE = 2.00mV</b>	<b>DUTY = 50%</b>
<b>PRX = -1.23mV</b>	<b>MEAN = 2.32 V</b>	<b>FREQ = 24.6kHz</b>
<b>MAX = 5.15 V</b>	<b>OVRS = 2.0%</b>	<b>PER = 40.6<math>\mu</math>S</b>
<b>MID = 2.47 V</b>	<b>UNDS = 1.0%</b>	<b>RISE = 28.4nS</b>
<b>MIN = -21.4mV</b>	<b>RMS = 2.65 V</b>	<b>FALL = 18.3nS</b>
<b>P-P = 5.36 V</b>	<b>AREA = 47.5nVs</b>	
<b>DIST = 90.0%</b>	<b>MES = 50.0%</b>	<b>PROX = 10.0%</b>
<b>AGAIN</b>		<b>↑</b>

Pressing the AGAIN menu button takes another snapshot measurement. Pressing the up-arrow button returns the scope to the MEASURE menu.

**MEAS TYPE**

The Continuous-Update parameter extraction function is accessed by pressing the MEAS TYPE menu button in the MEASURE menu. This calls up the parameter selection menu:

<b>DISTAL</b>	<b>MESIAL</b>	<b>PROX</b>	<b>MAX</b>	<b>MID</b>
<b>MIN</b>	<b>PK-PK</b>	<b>TOP</b>	<b>BASE</b>	<b>MEAN</b>
<b>OVRSHT</b>	<b>UNDRSHT</b>	<b>RMS</b>	<b>AREA</b>	<b>WIDTH</b>
<b>DUTY</b>	<b>FREQ</b>	<b>PERIOD</b>	<b>RISE</b>	<b>FALL</b>
<b>DELAY</b>				
<b>←</b>	<b>→</b>	<b>↓</b>	<b>ON</b>	<b>OFF</b>

A parameter is selected by pressing the ON menu button when the name of the desired parameter is underlined. The arrow buttons move the underline around the matrix, "wrapping around" at the end of a row or column. The name of a selected parameter is bracketeted with two underlined asterisks. Pressing the OFF button when a selected parameter is underlined turns that parameter OFF and removes the underlined asterisks.

If more than one waveform is displayed, pressing the ON button calls up a third-level TARGET menu listing all displayed signal sources. If  $\Delta$  DELAY is ON, selecting a waveform that contains both delays calls up a fourth-level TARGET menu for choosing DELAY1 or DELAY2 for parameter extraction. Selecting REF as the target calls up a different fourth-level TARGET menu for choosing the desired REF waveform for parameter extraction. In any case, pressing the button that finally identifies the source for parameter extraction produces a readout of the parameter and returns the second-level parameter-selection menu to the screen.

Selecting DELAY as the parameter to be extracted causes a variation in the third- and fourth-level TARGET menus. Because delays are measured FROM the mesial crossing of one waveform TO the corresponding mesial crossing of another, DELAY measurements require two signal sources. Therefore, there are two third-level target menus—DELAY FROM TARGET and DELAY TO TARGET—both listing all displayed signal sources. As with the other parameters, there are fourth-level menus, if needed, for selecting DELAY1 or DELAY2 when  $\Delta$  TIME is ON and the selected source contains both delays, or for identifying the REF waveform to be targeted when REF is chosen in the third-level menu. Pressing the third- or fourth-level menu button that finally identifies the delay FROM target waveform calls up the third-level DELAY TO TARGET menu. Pressing the menu button that finally identifies the delay TO target waveform produces the readout of the parameter and returns the parameter-selection menu to the screen.

If the same parameter is being measured on more than one waveform, pressing the OFF button when that parameter is underlined in the parameter-selection menu calls up a third-level menu. The user then selects the target source containing the waveform that the parameter is to be turned off for; pressing the menu button for that source turns off the appropriate readout and returns the parameter-selection menu to the screen.

For further information on measurements, see Appendix C.

**SETUP**

Pressing the menu button labeled SETUP in the MEASURE menu causes this second-level menu to be displayed:

----- METHOD -----            MARK  
MIN/MAX HIST    CURSOR    LEVEL    ON:OFF

The SETUP menu is used to establish criteria for the extraction of parameters by either the SNAPSHOT or Continuous-Update method. The three selections under METHOD allow the user to choose the method for determining the TOP and BASE of the waveform. An underline indicates the active method.

**MIN/MAX**

The absolute maximum (positive peak) of the targeted waveform is used as the TOP, and the absolute minimum (negative peak) of the targeted waveform is used as the BASE.

**HIST**

A histogram of the vertical levels of the targeted waveform is used to determine the TOP and BASE in the following manner:

1. Form a histogram of levels and find the mid-point of their range.
2. Divide the histogram into halves.
3. Find the level bracket in the upper half that contains the most points, and use its value for the TOP. Find the level bracket in the lower half that contains the most points, and use its value for the BASE.
4. If two level brackets have equal numbers of points, use the larger (more positive) value when determining the TOP, and the smaller (more negative) when determining the BASE.

**CURSOR**

The level of the upper VOLTS Cursor (displayed or not) is used as the TOP and the level of the lower VOLTS Cursor is used as the BASE for the targeted waveform.

## **LEVEL**

Calls up a third-level menu for specifying the DISTAL, MESIAL, and PROXIMAL levels on the waveform and the units in which they are to be expressed:

### **DISTAL; MESIAL; PROXIMAL**

Direct the CURSOR/DELAY knob to adjust the level for the selected crossing type. The level is expressed as a percent of the total BASE-to-TOP amplitude of the waveform, or as an absolute voltage with reference to ground. (See "Level Calculations" in Appendix C for more information.)

### **MESIAL2**

Directs the CURSOR/DELAY knob to adjust the level for the second mesial crossing. This crossing is only used when DELAY is chosen as one of the parameters to be measured in Continuous-Update mode. DELAY is measured FROM the mesial crossing of one waveform TO the mesial crossing of a second waveform. Since the waveforms can have different amplitudes, it is sometimes useful to be able to specify a different mesial level, MESIAL2, for the second waveform.

There are certain limiting conditions for setting these crossing levels. They must all be greater than or equal to the BASE level and less than or equal to the TOP. Also, DISTAL must be greater than or equal to MESIAL and MESIAL must be greater than or equal to PROXIMAL. If they are not all set properly in relation to each other and to the TOP and BASE of the target waveform, the readout alerts the user by:

- displaying a string of "?" marks in place of the measurement results in SNAPSHOT mode.
- displaying an error message in place of the measurement in Continuous-Update mode. "LEVEL LIMIT?" indicates that DISTAL is greater than TOP or PROXIMAL is less than BASE; "LEVEL ORDER?" indicates that MESIAL is either less than PROXIMAL or greater than DISTAL. If both errors exist, the LEVEL ORDER? message takes precedence.

NOTE

The amplitude reference levels displayed in the LEVEL menu have greater resolution than the values in the SNAPSHOT or Continuous-Update readouts. The resolution for the readouts is limited to 1/25 of VOLT/DIV setting for the waveform the parameter is extracted from. For instance at a 100 mv/DIV setting, the resolution of the readouts is 4 mv, but the menu levels can be adjusted in 0.1 % or 0.1 mv increments, depending on the setting for %!VOLT. The readouts will round settings between resolution levels—up for settings at or above midway, and down for settings below midway between resolution levels.

Since the readouts use the rounded-off values, a setting in the LEVEL menu can violate the limiting conditions without generating an error message if the rounding off process corrects the error.

**%!VOLT**

Sets the unit of measurement for each crossing level. Repeatedly pressing the menu button toggles the unit of the underlined level between a percentage of the total amplitude from BASE to TOP and an absolute voltage with respect to ground. Different crossings can use different units, and the % and VOLT settings for each crossing are mutually independent.

The percent level can be set from 0 to 100% of the difference between the TOP and BASE of a waveform, while the voltage level can be set from -999 to +999 Volts, ± 999 V, regardless of the amplitude of the waveform. Therefore, unlike % units, VOLT units allow levels to be set outside the amplitude limits of the waveform; and therefore, they can cause level order errors—if improperly set.

When INIT PANEL (in the PRGM menu) is executed, %!VOLT is set to % and the levels are set as follows:

DISTAL	90%
MESIAL	50%
PROXIMAL	10%
MESIAL2	50%

## **Controls, Connectors and Indicators**

---

Executing INIT PANEL also sets the levels for VOLT units. If INIT PANEL is executed and %!VOLT is set to VOLT in the MEASure SETUP LEVEL menu, the INIT levels are displayed as follows:

DISTAL	2.40 V
MESIAL	1.30 V
PROXIMAL	400mV
MESIAL2	1.30 V

Returning to the SETUP menu requires use of the first-level MEASURE menu. (Press the MEASURE front-panel button.)

### **MARK ON!OFF**

Toggles "marks" ON and OFF for the targeted waveform. Marks are X's on the waveform that indicate the levels where time measurements are made in Continuous-Update mode. To display the marks, time-related parameters must be selected in the MEAS TYPE menu and DISPLAY must be set ON in the MEASURE menu as well as MARK set ON in the SETUP menu.

### **DISPLAY ON!OFF**

Toggles the readout ON and OFF for the parametric measurements made in Continuous-Update mode. Turning on a parameter in the MEAS TYPE menu also turns DISPLAY ON in the MEASURE menu. When ON, the readout is continuously updated with the measurement results from successive acquisitions (or acquisition sequences). When OFF there is no readout of parametric measurements; in fact, no parameters are calculated.

### **WINDOW ON!OFF**

Toggles the WINDOW function ON and OFF. The WINDOW function enables the TIME cursors to define a horizontal area on the displayed waveform from which the specified parameters are to be extracted. When WINDOW is ON, the scope begins at the left TIME cursor and searches the waveform record until it finds data that is adequate for extracting the user-specified parameter, or until the right TIME cursor is reached. WINDOW ON is ignored unless TIME is selected in the cursor FUNCTION menu.

For more information on measurements, see Appendix C.



49 PRGM

Calls up the AUTOSTEP SEQUENCER menu:

```

----- AUTOSTEP SEQUENCER ----- MEMORY nn%
      SAVE  RECALL  DELETE  EDIT  INIT  PANEL
    
```

This menu is used to create and store a sequence of steps that includes front-panel setups, parametric measurements, output functions, etc. and to run, erase, or modify such a sequence. Each step in the sequence can have certain associated "actions" such as REPEAT (which allows for looping), SELF-CAL, SELF-TEST, and PAUSE. (See the section on the SET STEP ACTIONS menu for more information on these and other actions.) Depending on the complexity of each step, a sequence of over 200 steps can be stored in non-volatile memory. A readout in the menu shows the percentage of memory still available.

Pressing the INIT PANEL button sets almost all the front-panel functions to default values. (See Table B-15, Appendix B, for a list of those settings.)

**Operation**

The AutoStep Sequencer can be operated from the front panel, the GPIB, or three rear-panel BNC connectors that enable full 2-way handshaking. During a pause, the sequence can be signaled to resume via the front panel, the GPIB, or the rear-panel SEQUENCE IN input. When each step ends, it produces an "Operation Complete" signal that can be detected via the GPIB or the rear-panel STEP COMPLETE output, and when the sequence ends, it produces an additional Operation Complete signal that can be detected via the GPIB or the rear-panel SEQUENCE OUT output.

**SAVE**

Calls up a second-level menu for naming the new sequence to be created:

```
USE ARROW KEYS TO CHANGE NAME: nn
ROLL-CHARS  CURSOR
  ↑ ↓      <>  SAVE  EXIT
```

The name of the sequence can contain up to six alphanumeric characters, including spaces. The two-digit number at the end of the first line is a default name that can be either used or replaced. The CURSOR menu button moves the underline cursor back and forth in the name field immediately to the right of "NAME:." The two menu buttons under ROLL-CHARS rotate the underlined character through 0-9 and A-Z. (There is a space character between 9 and A.) Pressing and holding the down-arrow button steps the characters forward; the up-arrow steps them in reverse. Press the EXIT button to abort the process and return to the first-level AUTOSTEP SEQUENCER menu.

Pressing the SAVE button calls up this message:

```
SETUP CONTROLS, PUSH PRGM TO CONTINUE
SEQUENCE <name> STEP <num> MEMORY <% >
```

**NOTE**

*At this point all front-panel controls, except the PRGM button, function normally. Some buttons (e.g. MEAS TYPE) call up menus that erase the SETUP CONTROLS message, but the message remains in effect—whether visible or not—until you press PRGM.*

Now is the time to make all necessary adjustments for the current step of the sequence, remembering to specify any Auto Setup or Output modes and any Continuous-Update parameters to be measured. When the setup is complete and the parameter(s) specified, press the PRGM front-panel button to call up the SET STEP ACTIONS menu:

```

SEQUENCE <name> STEP <num> MEMORY <%>

BEGIN STEP .....
REPEAT      <N> :      :
SELF-CAL    <N> :      :
SELF-TEST   <N> :      : PRINT/PLOT <N>
LOAD PANEL  :      : SRQ      <N>
AUTOSETUP   <N> :      : PAUSE   <N>
MEASUREMENTS :      : PROTECT <N>
:           :      : END STEP
:           :      :
:           :      :
.....:

-- SET STEP ACTIONS --   NEXT   SAVE
   ↑       ↓           Y;N   STEP   SEQ

```

This menu shows a list of all possible actions for each step of the sequence, arranged in the order they will occur when the sequence is run. With the exception of LOAD PANEL and MEASUREMENTS, the user can set each action on (Y) or off (N) for the current step. (BEGIN STEP and END STEP are not actions, but merely markers that show where the step starts and stops.) The arrow-buttons move the underline cursor among the settable actions, and the Y;N button toggles the selected action on and off. NEXT STEP increments the step number and recalls the SETUP CONTROLS message for programming the next step of the sequence. SAVE SEQ stores the finished sequence in non-volatile memory and recalls the AUTOSTEP SEQUENCER menu (including the additional SEQUENCE SAVED message).

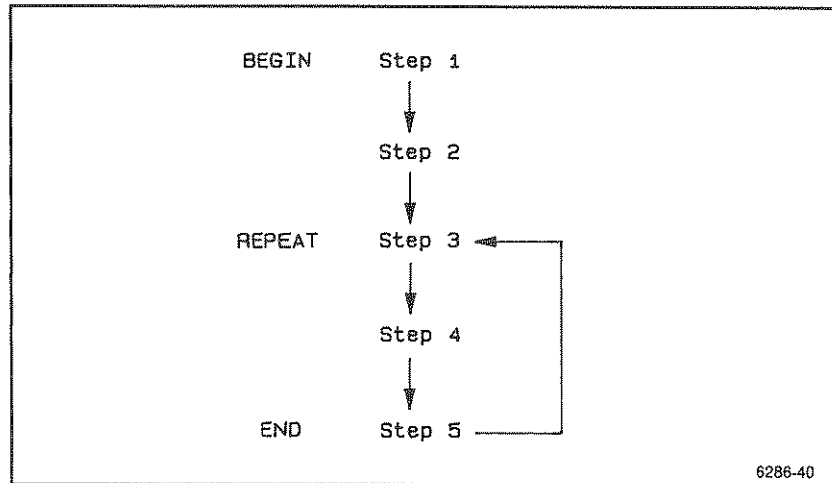

Figure 5-9. Event order for sequences.

Following are explanations of the various actions:

**REPEAT**

Creates an infinite loop by returning to the current step when the last step of the sequence is finished. (See Figure 5-9.) If REPEAT is included in more than one step, only the last occurrence is used. To abort a continuously-running sequence, press the PRGM button; the sequence aborts and the AUTOSTEP SEQUENCER menu is returned. If a current step includes PAUSE, pushing PRGM will pause the sequence at the end of the current step; press the menu button labeled EXIT to ABORT the sequence (press EXIT again to return to the AUTO SEQUENCER menu); press PRGM to resume the paused sequence. (You can also resume a paused sequence by pressing the IDENT button on a probe connected to the scope's front panel if the AUTO PROBE menu is set to STEP SEQ. See SYSTEM submenu described in Appendix A.)

**SELF-CAL**

Performs the Self Calibration routine prior to loading the instrument setup. If the instrument fails to calibrate, the sequence terminates and the EXTENDED DIAGNOSTICS menu appears.

**SELF-TEST**

Performs the Self Diagnostics routine prior to loading the instrument setup. If the instrument fails the diagnostics routine, the sequence terminates and the EXTENDED DIAGNOSTICS menu appears.

**LOAD PANEL**

Establishes the front-panel settings, the Auto Setup and Output modes, and the Continuous-Update parameters that were specified by the user while the SETUP CONTROLS message was in effect.

**AUTOSETUP**

Performs an Auto Setup according to the mode previously specified by the user and established by the LOAD PANEL action. This Auto Setup may change some of the front-panel settings loaded by the previous action. (See Table B-16 in Appendix B for settings affected.)

**PRINT/PLOT**

Sends out acquired waveforms and other data for the current step over the GPIB. The user must properly configure the scope through the OUTPUT SETUP menu for the type of communication desired. The output can be directed by a controller, but it is also possible to send prints or plots directly to certain devices. (See Item 24—OUTPUT for more information.)

**BELL**

Rings the instrument's bell to signal the operator when the step is finished. The bell must be enabled via the EXTENDED FUNCTIONS menu.

**SRQ**

Transmits an Operation Complete signal over the GPIB at the end of each step and an additional one at the end of the sequence.

**PAUSE**

Stops the sequence at the end of the current step and waits for a command to advance. To initiate the next step, either press the PRGM button, issue a STEP command over the GPIB, or apply a TTL HI to LO transition at the rear-panel SEQUENCE IN input. To terminate a paused sequence, either press the menu button labeled EXIT or issue a GPIB HALT command.



**PROTECT**

Prevents the sequence from being deleted. This action must be turned on in the first step of the sequence; otherwise it will be ignored. PROTECT can be defeated by deleting the first step of the sequence or by editing that step to turn the PROTECT action off.

**EXAMPLE:** The typical application that follows illustrates the procedure that should be followed in creating an AutoStep sequence. It points out certain special considerations that are explained in the following *NOTE*.

*NOTE*

*When creating a sequence that requires an Auto Setup, communication with other devices, or Continuous-Update measurements, the required modes and parameters must be selected before entering the SET STEP ACTIONS menu. (See Item 47—AUTO, Item 24—OUTPUT, and Item 48—MEASURE for information on setting modes and parameters.) To begin the sequence with the INIT PANEL states (see Table B-15), it is necessary to press INIT PANEL before pressing SAVE in the AUTOSTEP SEQUENCER menu.*

STEP NO.	FRONT-PANEL SETUP	ACTIONS (Y)
1 (BEGIN STEP)	Press PRGM, then INIT PANEL. Press PRGM, then SAVE. Create name and press SAVE. Press PRGM and set actions:	SELF-CAL SELF-TEST (NEXT STEP)
2	Press AUTO and select VIEW. Press OUTPUT and set up for printing of waveforms. Press PRGM and set actions:	
(LOOP TO)		REPEAT AUTOSETUP PRINT/PLOT (NEXT STEP)
3	Press AUTO and select  . Press MEASURE, then MEAS TYPE. Set RISE ON. Press PRGM and set actions:	AUTOSETUP PRINT/PLOT (NEXT STEP)
4	Press AUTO and select  . Press MEASURE, then MEAS TYPE. Set RISE OFF and FALL ON. Press PRGM and set actions:	
(END STEP)		AUTOSETUP PRINT/PLOT BELL SRQ PAUSE (SAVE SEQ)

When run, this sequence first performs the Self Calibration and Self Diagnostics routines, and then initializes the instrument to the INIT PANEL settings. Next it repeatedly executes the actions in the LOOP TO through END STEP block. In each step, Auto Setup is used to optimize the display of a particular aspect of the waveform, which is then printed or plotted. The rise time and fall time are also printed or plotted (in Steps 3 and 4, respectively). At the end of the last step (Step 4), the sequence stops and rings the bell to alert the operator, who can then install another device for testing and issue the command to advance to the next step (Step 2).

**RECALL**

Calls up the menu to run a selected sequence:

```
---- SELECT ----  
  ↑      ↓      RECALL      EXIT
```

The names of all existing sequences, with the current selection underlined, are listed in columns above the menu. The arrow-labeled menu buttons move the underline up and down through the list. To run the underlined sequence, press the RECALL menu button. (It is also possible to start the sequence via the GPIB or through the rear-panel SEQUENCE IN input.) Pressing EXIT returns to the first-level AUTOSTEP SEQUENCER menu without running the sequence. While running, a sequence can be terminated by pressing the PRGM button or by a GPIB HALT command.

**DELETE**

Calls up the menu to delete a selected sequence:

```
---- SELECT ----  
  ↑      ↓      DELETE      EXIT
```

The names of all existing sequences, with the current selection underlined, are listed in columns above the menu. The arrow-labeled menu buttons move the underline up and down through the list. To delete the underlined sequence, press the DELETE menu button. Pressing EXIT recalls the first-level AUTOSTEP SEQUENCER menu.



**NOTE**

*While a sequence is being deleted, the message RECLAIMING FREED MEMORY... appears on the screen, and front-panel controls are locked out. TURNING OFF THE INSTRUMENT WHILE IT IS RECLAIMING MEMORY CAN RESULT IN THE LOSS OF STORED SEQUENCES.*

**EDIT**

Calls up the menu to modify a selected sequence:

```

---- SELECT ----
  ↑           ↓   EDIT   COPY   EXIT
    
```

The names of all existing sequences, with the current selection underlined, are listed in columns above the menu. The arrow-labeled menu buttons move the underline up and down through the list. To modify the underlined sequence, press the EDIT menu button. To create a copy of the selected sequence under a different name, press the COPY menu button and use the resulting menu to create the new name. To return to the first-level AUTOSTEP SEQUENCER menu, press the EXIT menu button.

**EDIT**

Calls up a third-level menu for selecting the step(s) to be modified:

```

SETUP CONTROLS, PUSH PRGM TO CONTINUE
SEQUENCE <name> STEP<num> MEMORY<%>
SELECT STEP      DELETE
  ↑           ↓   TO BUF   ADD   EXIT
    
```

This menu contains the same message that was called up by pressing the SAVE button in the second-level SAVE menu when creating the sequence. The arrow-labeled menu buttons move forward and backward through the steps of the sequence, and the message shows the number of the current step. If the down-arrow button is pressed on the last step of the sequence, the message WARNING: NO MORE STEPS TO EDIT will appear. To modify the current step, proceed exactly as when creating the sequence: adjust the front-panel controls as desired; press PRGM to call up the SET STEP ACTIONS menu; reprogram the actions if desired; then press either NEXT STEP to continue editing or SAVE SEQ to stop editing and store the modified sequence.

**DELETE TO BUF**

Deletes the current step from the sequence and stores it in a buffer. The step remains in the buffer until either it is overwritten by pressing DELETE TO BUF again, or the power is turned off. The step in the buffer can be added to any sequence that is being edited. Loading a step from the buffer into a sequence does not erase the step from the buffer.

**ADD**

Calls up the menu for adding a step to the sequence being edited:

**SETUP CONTROLS, PUSH PRGM TO CONTINUE**  
**SEQUENCE <name> STEP <num> MEMORY <%>**

**LOAD**  
**BUFFER**

**EXIT**

Pressing ADD increments the step number in the message. Space is created for a new step, but the front-panel setup and actions from the previous step remain the same until they are changed. Press the LOAD BUFFER button to replace the current front-panel setup and actions with those currently in the step buffer. Otherwise, set up the front-panel and actions as previously described for creating or modifying a sequence. Press the EXIT button to return to the main AUTOSTEP SEQUENCER menu without adding a new step.

## Rear Panel

Refer to Figure 5-10 for location of Items 50 through 60.

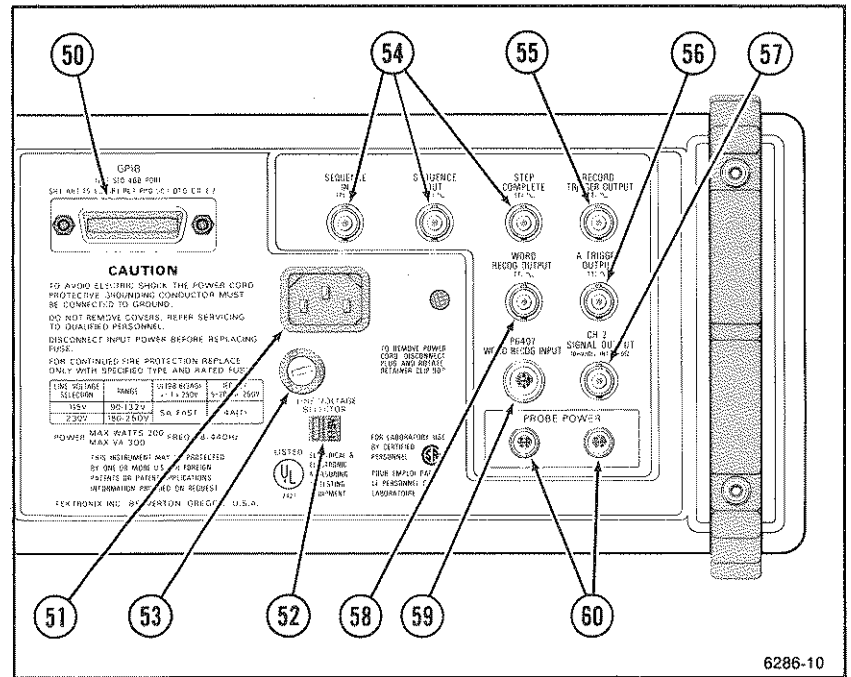

Figure 5-10. Rear-panel controls and connectors.

### 50 GPIB Connector

Provides a port for the IEEE-488 data bus. The electrical and physical arrangement of the 24-pin connector conforms to the IEEE General Purpose Interface Bus Standard. Refer to Figure 5-11 for an illustration of the connector and pin assignments.

### 51 Detachable-Power-Cord Receptacle

Provides contacts for connecting the instrument to the appropriate ac voltage source via a detachable power cord.

**52 LINE VOLTAGE SELECTOR Switch**

Selects the nominal input operating voltage for the instrument. When set to 115 V, the instrument operates from an ac-power source in the range of 90 V to 132 V. When set to 230 V, the instrument operates from an ac-power source in the range of 180 V to 250 V.

**53 Fuse Holder**

Contains the primary fuse for the ac-power source.

**54 SEQUENCE IN, SEQUENCE OUT, and STEP COMPLETE**

These TTL-compatible outputs are used with the sequencer for the following purposes:

SEQUENCE IN: A HI to LO transition at this input restarts the sequence after a pause.

SEQUENCE OUT: A HI to LO transition on this output signals the end of a sequence. While a sequence is in progress this output is high.

STEP COMPLETE: A HI to LO transition on this output signals the end of a step in a sequence. While a step is in progress this output is high.

See Item 49—PRGM in this section for more information on the AutoStep Sequencer.

**55 RECORD TRIGGER OUTPUT Connector**

Provides a negative-true TTL-compatible record trigger signal for use as a trigger with external instrument systems. (See Figure B-2 in Appendix B.)

**56) A TRIGGER OUTPUT Connector**

Provides a negative-true TTL-compatible A-Trigger signal for application to external instrument systems.

**57) CH 2 SIGNAL OUTPUT Connector**

Provides an output signal that is representative of the Channel 2 input signal. The output amplitude into a 50- $\Omega$  load is approximately 10 mV per division of input signal.

**58) WORD RECOG OUTPUT Connector**

Provides a negative-true, TTL-compatible Word-Trigger signal for use with external test equipment. (See Section 7, "Options.")

**59) P6407 WORD RECOG INPUT Connector**

Provides a dedicated control signal port for programming the optional Word Recognizer Probe and obtaining the word trigger output for use as the A and/or B trigger signal source. (See Item 32—SOURCE and Item 43—SET WORD.)

**60) PROBE POWER Connectors (Option 11)**

Provides output power for optional Tektronix active probes.

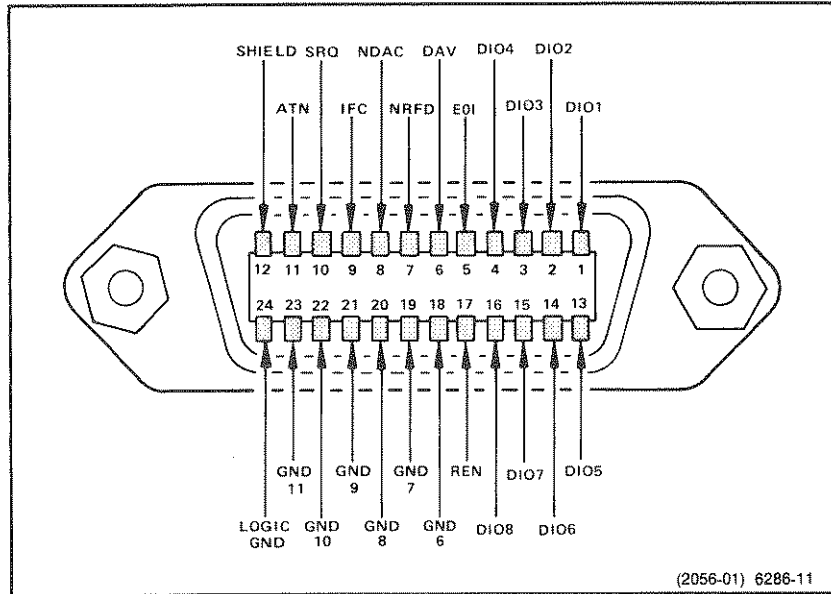

Figure 5-11. GPIB-connector pin arrangement.

## System Menus

The following information is an annotated list of the menus used to control operation of the scope from the front panel. Each menu is an extension of the front-panel button that calls it up. The menus replace multi-position front-panel switches by providing the same functions using the firmware-defined buttons mounted in the CRT bezel. Most of the menus are only one level deep, and the menu entries are self-explanatory. Table 5-2 is a reference listing of each first-level menu and any sub-level menus called up from the first-level menu.

The listing corresponds to the labeled front-panel button that calls up the menu. The menus in the table are grouped by major system functions in the following order: Display, Vertical, Cursor, Delay, Storage, A and B Trigger, Word Recognizer, Output, and Setup.

**Table 5-2  
Control Menus and Displays**

CRT Display Menus				
<b>SELECT</b>				
INTENSITY READOUT	DISP	INTENS	GRAT	VECTORS ON:OFF
<b>STATUS/HELP</b>				
Presents an instrument status display and increases the readout intensity to 65% to ensure visibility. (See Figure 5-2.) The HELP function can also be enabled from this menu.				
<b>MENU OFF/EXTENDED FUNCTIONS</b>				
Turns off any menu being displayed or, if none is on, calls up the EXTENDED FUNCTIONS menu. (See Appendix A for the Extended Functions Calibration and Diagnostics menu.)				
<b>EXT FUNCT</b>				
	SYSTEM	SPECIAL	CAL/DIAG	
Second-level menu for SYSTEM.				
PANEL	MISC	PREFLT ON:OFF	VIDEO OPT	
Third-level menu for PANEL.				
PWR ON LAST:INIT	ERASE MEMORY			↑
Third-level menu for MISC.				
BELL ON:OFF	TRIG T ON:OFF	AUTO PROBE	MENUS ON:OFF	ROLL ↑
Fourth-level menu for SELECT PROBE IDENTIFY FUNCTION				
AUTO SETUP	STEP PRGM	INIT50		↑
Third-level menu for VIDEO OPT				
TV SYS M:NON/M	CNT RST BOTH:F1			↑
Second-level menu for SPECIAL. Use of these functions (or the functions in submenus to CCD SIDES, CCD ADJ, and FORCE DAC) by the operator will cause the instrument to need a complete calibration to return it to normal operation. The selections may be internally disabled.				
WARNING: SERVICE ONLY—SEE MANUAL (if enabled) DISABLED—SEE MANUAL (if disabled)				
COLD START	CCD SIDES	CCD ADJ	CAL PATH ON:OFF	FORCE DAC

**Controls, Connectors and Indicators**

**Table 5-2 (cont)**

**VERTICAL Control Menus**

**VERTICAL MODE**

In YT Mode

VERTICAL MODE				
CH1	CH2	ADD	MULT	YT:XY

In XY Mode

VERTICAL MODE				
CH1 vs CH2				YT:XY

**VARIABLE**

CH1 VARIABLE			
CAL	↓	↑	

CH2 VARIABLE			
CAL	↓	↑	

**COUPLING/INVERT**

CH1 COUPLING					
AC	DC	GND	50 Ω	INVERT	
			ON:OFF	ON:OFF	

CH2 COUPLING					
AC	DC	GND	50 Ω	INVERT	
			ON:OFF	ON:OFF	

**BANDWIDTH**

USB=xxxxHz	USR=xxxx s	SR=xxxx samples/sec
-----BANDWIDTH-----		SMOOTH
20MHz	100MHz	FULL
		ON:OFF

The number xxxx depends on the Acquisition mode, the SEC/DIV setting, and the bandwidth selected.

			SR=EXT CLOCK
-----BANDWIDTH-----			SMOOTH
20MHz	100MHz	FULL	ON:OFF

If B TRIG mode is set to External Clock.



Table 5-2 (cont)

CURSOR Control Menus

FUNCTION

CURSOR FUNCTION	VOLTS	TIME	V@T	SLOPE	1/TIME
-----------------	-------	------	-----	-------	--------

Second-level ATTACH CURSORS menu.

In YT Mode.

ATTACH CURSORS TO:

No  $\Delta$  delay

CH1	CH2	(func)		REFn
-----	-----	--------	--	------

$\Delta$  delay—CH1 on

CH1	CH1 $\Delta$	(func)	(func) $\Delta$	REFn
-----	--------------	--------	-----------------	------

$\Delta$  delay—CH1 and CH2 on

CH1	CH2 $\Delta$	(func)	(func) $\Delta$	REFn
-----	--------------	--------	-----------------	------

Function is either ADD or MULT—they are mutually exclusive. Pressing REF rolls through the displayed reference waveforms. Only waveforms called up for display are included in the ATTACH CURSORS menu.

In XY Mode.

ATTACH CURSORS TO:

CH1 vs CH2	XYREF
------------	-------

UNITS in VOLTS or V@T

UNITS	VOLTS	CURS	REF=xxxxxxV	
VOLTS	%	dB	NEW REF	$\Delta$ :ABS

in TIME

UNITS	TIME	CURS	REF=xxxxxx s	
SEC	%	DEGREES	NEW REF	$\Delta$ :ABS

In SLOPE

UNITS	SLOPE	CURS	REF=xxxxxxV/s	
SLOPE	%	dB	NEW REF	

in 1/TIME

UNITS	TIME	CURS	REF=xxxxxx s	
Hz	%	DEGREES	NEW REF	$\Delta$ :ABS

**Controls, Connectors and Indicators**

**Table 5-2 (cont)**

<b>DELAY Control Menus</b>				
<b>DELAY by TIME (with ΔTIME OFF)</b>				
DELAY TIME = xxxxxx s		ΔTIME		
		ON:OFF		
<hr/>				
(with ΔTIME ON)				
DELAY TIME = xxxxxx s		ΔTIME		
ΔDELAY TIME = xxxxxx s		ON:OFF		
The DELAY by TIME button is pressed to switch the effect of the CURSOR/DELAY knob between the Main DELAY TIME and the Δ (delta) DELAY TIME.				
<hr/>				
<b>DELAY by EVENTS</b>				
EVENTS START AT	A TRIG		EVENTS	
EVENTS COUNT = xxxxx	B TRIGS		ON:OFF	
Events count may be changed using the CURSOR/DELAY knob.				
<hr/>				
<b>STORAGE Control Menus</b>				
<b>ACQUIRE</b>				
ACQUIRE	nnn	nnn	REPET	SAVE ON Δ
NORMAL	ENVELOPE	AVG	ON:OFF	ON:OFF
nnn selections:				
ENVELOPE—1,2,4,8,16,32,64,128,256,CONT				
AVG—2,4,8,16,32,64,128,256				
<hr/>				
<b>SAVE</b>				
xxxxx	ACQUISITIONS		xxxxx	HRS
-----SAVEREF SOURCE-----				
CH1	CH2	(function)	REF	STACK REF
Second-level menu displayed after SAFEREF SOURCE (except REF or STACK REF) is selected.				
-----SAVEREF DESTINATION-----				
REF1	REF2	REF3	REF4	SAVEREF SOURCE
Second-level menu if in Δ (delta) DELAY by TIME.				
SAVEREF SOURCE - (channel)				
DELAY 1	DELAY 2			
<hr/>				
Second-level menu if REF is selected.				
SAVEREF SOURCE - REF				
REF1	REF2	REF3	REF4	SAVEREF SOURCE

Table 5-2 (cont)

**STORAGE Control Menus (cont)**

DISPLAY REF In YT Mode.

DISPLAY REF					HORIZ
REF1	REF2	REF3	REF4		POS REF

In XY Mode

XYREF					HORIZ
					POS REF

Second-level menu displayed when HORIZ POS REF is called.

-----HORIZONTAL POSITION -----				REF HPOS
REF1P	REF2P	REF3P	REF4P	IND:LOCK

**A TRIGGER Control Menus**

TRIGGER MODE

A TRIGGER MODE				
AUTO				SINGLE
LEVEL	AUTO	NORMAL		SEQ

AUTO switches to ROLL at 100 ms/div and slower.

TRIGGER SOURCE

A TRIGGER SOURCE				
VERT	CHAN			
CH1	1:2	EXT	LINE	A*B:WORD
CH2				
ADD				

Second-Level menu for EXT.

A EXT				
SOURCE	-----A and B EXT GAIN-----			
1:	EXT 1	EXT 1+5	EXT 2	EXT 2+5

TRIGGER CPLG

Without the Video option.

A COUPLING					-----REJECT-----	
DC	AC	NOISE	HF	LF		

With the Video option installed.

A COUPLING					-----REJECT-----	
DC:AC	VIDEO	NOISE	HF	LF		

**Controls, Connectors and Indicators**

**Table 5-2 (cont)**

**A TRIGGER Control Menus (cont)**

SET VIDEO (Video Option only)

A VIDEO COUPLING					CLAMP
FIELD1	FIELD2	ALT		TV LINE	ON:OFF

FIELD2 and ALT are displayed only when the Video Option has an interlaced video signal applied. CLAMP remains ON even if TV COUPLING is not selected.

TRIG POSITION

A TRIGGER POSITION					
1/8	1/4	1/2		3/4	7/8

**B TRIGGER Control Menus**

TRIGGER MODE

B TRIG	RUNS	TRIG		EXT CLK
	AFTER	AFTER		ON:OFF

TRIGGER SOURCE

In B RUNS AFTER Delay Mode.

B TRIG SOURCE					
EXT CLOCK SOURCE				(with EXT CLK)	
EVENTS SOURCE				(with DELAY by EVENTS)	
EVENTS, EXT CLK SOURCE				(with both)	
VERT	CHAN				WORD
CH1	1:2	EXT			
CH2					
ADD					

In B TRIG AFTER Delay Mode.

B TRIG SOURCE					
B, EXT CLK SOURCE				(with EXT CLK)	
B, EVENTS SOURCE				(with DELAY by EVENTS)	
B, EXT CLK, EVNT SOURCE				(with both)	
VERT	CHAN				WORD
CH1	1:2	EXT			
CH2					
ADD					

Second-level menu for EXT.

B EXT					
SOURCE	-----A and B EXT GAIN -----				
1:2	EXT 1	EXT 1÷5	EXT 2	EXT 2÷5	

Table 5-2 (cont)

TRIGGER CPLG

In B RUNS AFTER Delay Mode.

B COUPLING  
 EXT CLK CPLG (with EXT CLOCK)  
 EVENTS COUPLING (with DELAY by EVENTS)  
 EVENTS, EXT CLK (with both)

DC AC NOISE HF -----REJECT-----  
 LF

In B TRIG AFTER Delay Mode.

B COUPLING  
 B, EXT CLK CPLG (with EXT CLOCK)  
 B, EVENTS CPLG (with DELAY by EVENTS)  
 B, CLK, EVENTS (with both)

DC AC NOISE HF -----REJECT-----  
 LF

TRIG POSITION

B TRIGGER POSITION  
 1/8 1/4 1/2 3/4 7/8

EXTERNAL Trigger and Trigger Status Menus

TRIG STATUS

TRIG STATUS  
 MODE SOURCE CPLG TRIG POS  
 A (Setup conditions for the A Trigger controls.)  
 B (Setup conditions for the B Trigger controls.)

Table 5-2 (cont)





WORD RECOGNIZER Control Menus				
SET WORD				
RADIX	-----	CLOCK	-----	SET
OCT:HEX			ASYNC	BITS
Second-level menu for SET BITS.				
In Hexadecimal:				
TRIG WORD:				
CLK=		????	x x	xxxx
	1	0	X	←      →
In Octal:				
TRIG WORD:				
CLK=		??????	x	x xxx
	1	0	x	←      →
SETUP MENUS				
AUTO				
VIEW	PERIOD	PULSE		EDGE
				RES
				HI:LO
RES HI:LO does not appear when VIEW is selected.				
PRGM (AutoStep Sequencer)				
--- AUTOSTEP SEQUENCER ---			MEMORY nn%	
SAVE	RECALL	DELETE	EDIT	PANEL

Table 5-2 (cont)

SETUP MENUS (cont)

Second-level menu for SAVE.

USE ARROW KEYS TO CHANGE NAME:

ROLL-CHARS	CURSOR		SAVE	EXIT
↑	↓	<>		

Instruction message displayed after pushing SAVE. (This message is displayed any time the user is expected to set up the front-panel controls).

SETUP CONTROLS, PUSH PRGM TO CONTINUE  
SEQUENCE <name> STEP <num> MEMORY <%>

Third-level menu for SAVE. This menu is displayed after pushing PRGM according to the instruction message.

SEQUENCE <name> STEP <num> MEMORY <%>

BEGIN STEP	.....		
REPEAT	<N> :	:	
SELF-CAL	<N> :	PRINT/PLOT	<N>
SELF-TEST	<N> :	BELL	<N>
LOAD PANEL	:	SRQ	<N>
AUTOSETUP	<N> :	PAUSE	<N>
MEASUREMENTS	:	PROTECT	<N>
:	:	END STEP	
.....			

SET STEP ATTRIBUTES

			NEXT	SAVE
↑	↓	Y;N	STEP	SEQ

Second-level menu for RECALL.

1st Labeled Sequence  
2nd Labeled Sequence  
:  
:  
nth Labeled Sequence

--- SELECT ---			
↑	↓	RECALL	EXIT

*Controls, Connectors and Indicators*

Table 5-2 (cont)

**SETUP MENUS (cont)**

Second-level menu for DELETE.

1st Labeled Sequence  
 2nd Labeled Sequence  
 :  
 :  
 nth Labeled Sequence

--- SELECT ---  
 ↑      ↓      DELETE      EXIT

Second-level menu for EDIT.

1st Labeled Sequence  
 2nd Labeled Sequence  
 :  
 :  
 nth Labeled Sequence

--- SELECT ---  
 ↑      ↓      EDIT      COPY      EDIT

Third-level menu for EDIT.

SELECT	STEP	DELETE		
↑	↓	TO BUF	ADD	EXIT

Fourth-level menu for ADD.

LOAD			
BUFFER			EXIT

Third-level menu for COPY.

USE ARROW KEYS TO CHANGE NAME:

ROLL-CHARS	CURSOR			
↑	↓	<>	SAVE	EXIT



Table 5-2 (cont)

SETUP MENUS (cont)

MEASURE

SNAPSHOT	MEAS TYPE	SETUP	DISPLAY ON/OFF	WINDOW ON/OFF
----------	-----------	-------	----------------	---------------

Second-level menu for SNAPSHOT when more than one source is displayed.

TARGET:

CH1	CH2	ADD/MULT	REF
-----	-----	----------	-----

Display that results from pressing SNAPSHOT when only one source is displayed, or selecting a waveform in the TARGET menu.

SNAPSHOT READOUT:

SNAPSHOT OF CHx USING MIN/MAX METHOD:

DIS = 4.35 V	TOP = 5.01 V	WID = 20.3 $\mu$ S
MES = 2.12 V	BASE = 2.00mV	DUTY = 50%
PRX = -1.23mV	MEAN = 2.32 V	FREQ = 24.6kHz
MAX = 5.15 V	OVR = 2.0%	PER = 40.6 $\mu$ S
MID = 2.47 V	UNDS = 1.0%	RISE = 28.4nS
MIN = -21.4mV	RMS = 2.65 V	FALL = 18.3nS
P-P = 5.36 V	AREA = 47.5nVs	
DIST = 90.0%	MES = 50.0%	PROX = 10.0%
AGAIN		↑

AGAIN: Extracts a new set of parameters.

↑: Returns the scope to the MEASURE menu.

Second-level menu for MEAS TYPE.

The Continuous-Update parameter extraction function is executed by selecting up to four parameters for display from a parameter matrix. Pushing the menu button labeled MEAS TYPE calls up the parameter selection menu:

DISTAL	MESIAL	PROX	MAX	MID
MIN	PK-PK	TOP	BASE	MEAN
OVRSH	UNDRSH	RMS	AREA	WIDTH
DUTY	FREQ	PERIOD	RISE	FALL
DELAY			ON	OFF

**Table 5-2 (cont)**

**SETUP MENUS (cont)**

Third-level TARGET menu for MEAS TYPE when more than one source is displayed and DELAY is not selected in the parameter matrix. (Selection of DELAY as the parameter to be extracted calls up different third-level TARGET menus.)

TARGET			
CH1	CH2	ADD/MULT	REF

Fourth-level menu for MEAS TYPE when REF is selected in the TARGET menu.

TARGET			
REF1	REF2	REF3	REF4

Third-level menu for MEAS TYPE when more than one source is displayed and DELAY is selected in the parameter matrix.

DELAY FROM			
TARGET			
CH1	CH2	ADD/MULT	REF

Fourth-level menu for MEAS TYPE when CH1, CH2, or ADD/MULT is selected in the DELAY FROM TARGET menu. (The scope must be in B Horizontal mode with  $\Delta$  TIME on. This menu does not appear if CH1 or CH2 is selected in the DELAY FROM TARGET menu when *both* CH1 *and* CH2 are displayed.)

DELAY FROM	
TARGET	
DELAY1	DELAY2

Fourth-level menu for MEAS TYPE when REF is selected in the DELAY FROM TARGET menu.

DELAY FROM			
TARGET			
REF1	REF2	REF3	REF4

Third-level menu for MEAS TYPE when more than one source is displayed and a selection is made in the DELAY FROM TARGET menu.

DELAY TO			
TARGET			
CH1	CH2	ADD/MULT	REF

Table 5-2 (cont)

SETUP MENUS (cont)

Fourth-level menu for MEAS TYPE when CH1, CH2, or ADD/MULT is selected in the DELAY TO TARGET menu. (The scope must be in B Horizontal mode with  $\Delta$  TIME on when DELAY is selected in the parameter matrix. This menu does not appear if CH1 or CH2 is selected in the DELAY TO TARGET menu when both CH1 and CH2 are displayed.)

DELAY TO	
TARGET	
DELAY1	DELAY2

Fourth-level menu for MEAS TYPE when REF is selected in the DELAY TO TARGET menu.

DELAY TO				
TARGET				
REF1	REF2	REF3	REF4	

Second-level menu for SETUP.

-----METHOD-----			MARK
MIN/MAX	HIST	CURSOR	LEVEL
			ON:OFF

This menu is used to select the criteria for extracting LEVEL. Pressing the menu button labeled LEVEL displays a third-level menu for specifying the DISTAL, MESIAL, and PROXIMAL levels on the waveform.

Third-level menu for LEVEL.

	ADJUST LEVELS WITH CURSOR/DELAY KNOB			
nn%	nn%	nn%	nn%	
DISTAL	MESIAL	PROXIMAL	MESIAL2	%:VOLT

Table 5-2 (cont)

SETUP MENUS (cont)

OUTPUT

STATUS      SETUP              DEBUG              TRANSMIT/(PLOT/PRINT)

STATUS calls up a display of most GPIB parameters that might interest a system user.

TRANSMIT/(PLOT/PRINT) switches to ABORT when the function is active. TRANSMIT/(PLOT/PRINT) is off in L/ONLY and OFF BUS modes.

Second-level menu for SETUP.

OUTPUT SETUP  
MODE      TERM              ADDR              ENCDG

Third-level menu for MODE.

T/ONLY    L/ONLY              T/L              DEVICES    OFF BUS

Selecting L/ONLY or OFF BUS turns off the TRANSMIT/(PLOT/PRINT) choice in the OUTPUT menu.

Fourth-level DEVICES menu.

HPGL      THINKJET  
PLOTTER    PRINTER              SETUP

Selecting HPGL PLOTTER or THINKJET PRINTER changes TRANSMIT in the OUTPUT menu to PLOT or PRINT, respectively.

Fifth-level SETUP menu.

SETTINGS    TEXT              GRAT              WFM              PGSIZE  
ON:OFF      ON:OFF              ON:OFF              ON:OFF      US:A4

Fourth-level T/ONLY menu.

-- SEND CURVE --  
ONLY    W/WFMPRE              SEND PRGM



1. The first part of the document discusses the importance of maintaining accurate records of all transactions and activities. It emphasizes the need for transparency and accountability in financial reporting.

2. The second part of the document outlines the various methods and techniques used to collect and analyze data. It highlights the importance of using reliable sources and ensuring the accuracy of the information gathered.

---

# ***Performance Characteristics***

## ***Introduction***

The TEKTRONIX 2440 Digital Oscilloscope is a portable, dual-channel instrument with a maximum digitizing rate of 500 megasamples per second. The scope is capable of simultaneous acquisition of Channel 1 and Channel 2 input signals. It has a real-time useful storage bandwidth of 200 MHz for single-event acquisitions, with an equivalent-time bandwidth of 300 MHz when repetitive acquisitions are acquired. Since both channels are acquired simultaneously, the XY display is available to full bandwidth. Options include a Word Recognition Probe, Video signal triggering, Probe Power, and Rackmounting.

The instrument is microprocessor-controlled and menu-driven, displaying at the top of the screen alphanumeric CRT readouts of the vertical and horizontal scale factors, trigger levels, trigger source, and cursor measurements. Menus, displayed at the bottom of the CRT display, are used by the operator to select the operating mode.

A user makes decisions as to what operation and mode setup the instrument must have to make the measurement wanted and then selects the proper functions using a combination of front-panel buttons and the displayed menu.

Five menu buttons mounted on the CRT bezel are used to make selections from the entry choices displayed. The top line of the menu display usually contains the menu title, and the bottom line labels the buttons with the control functions they select. The selection is made (indicated by an underscoring of the menu label in the display) when the bezel button below the selected function is pressed. The menus, system operating modes, and auxiliary functions are described in Section 5, "Controls, Connectors, and Indicators", and the "Getting Acquainted" procedure in Section 1 familiarizes the user with menu operation.

## ***Vertical System***

The two vertical channels have calibrated deflection factors from 2 mV to 5 V per division in a 1-2-5 sequence of 14 steps. Use of coded probes having attenuation factors of 1X, 10X, 100X, and 1000X extends the minimum sensitivity to 5,000 V per division (with the 1000X probe) and the maximum sensitivity to 200  $\mu$ V per division (using a 1X probe in SAVE or AVERAGE expanded mode).

VOLTS/DIV readouts are automatically switched to display a correct scale factor when properly coded probes are attached. Each channel can be separately inverted. ADD and MULT are display functions provided by the processor system.

In SAVE mode, the waveforms may be both horizontally and vertically repositioned, expanded horizontally and vertically, added to each other, or multiplied together for either XY or YT displays.

## ***Horizontal System***

The horizontal display modes of A, A INTEN, and B Delayed. The time base has 29 calibrated SEC/DIV settings in a 1-2-5 sequence from 2 ns per division to 5 s per division. An External Clock mode is provided that accepts clocking signals from 1 MHz to 100 MHz.

The B Trace and the intensified zone on the A INTEN Trace may be delayed by time with respect to the A trigger, and a DELAY by EVENTS function permits the A display to be delayed by a selected number of B Trigger events. In the case of DELAY by EVENTS, the B Trigger SOURCE, COUPLING, SLOPE, and LEVEL controls define the nature of the signal needed to produce events triggering. The number of events required to satisfy the delay may be set from 1 to 65,536, with a resolution of one event. The DELTA DELAY feature produces two independently settable delayed B Traces in DELAY by TIME.

## ***Trigger System***

The trigger system of the scope provides many features for selecting and processing the signal used in triggering the acquisition system. The conventional features of SOURCE selection, Trigger LEVEL control, Trigger SLOPE, Trigger MODE, and CPLG (coupling) include enhancements not normally found in a conventional oscilloscope.



The SOURCE selections for triggering A Horizontal Mode acquisitions are VERT, CH1 or CH2, EXT1 or EXT2, LINE, and A\*B or WORD (16-bit data word recognition). These sources for trigger signals allow a wide range of signals involving specialized triggering requirements. Except for A\*B (A AND B) and LINE (power-source frequency), the same Trigger SOURCE selections are available for triggering B acquisitions.

The selected trigger signal is conditioned by selecting input CPLG (coupling). The coupling selections are AC, DC, HF REF, LF REJ, and NOISE REJ. A Trigger LEVEL control is used to set the amplitude (with CRT readout) at which triggering occurs, and SLOPE control determines on which slope of the triggering signal (plus or minus) the acquisition is triggered.

Trigger MODE choices are AUTO LEVEL, AUTO, NORM, and SINGLE SEQ (single sequence), for the A and A INTENSified Modes, and Triggerable After Delay and Runs After Delay, for the B Mode. AUTO LEVEL sets the level automatically for triggering on the applied trigger signal. AUTO MODE forces an auto trigger if a trigger signal is either not received or not within the limits needed to produce a triggering event. When triggering conditions are met, a normal triggered display results. At SEC/DIV settings of 100 ms per division and longer, the AUTO MODE switches to ROLL. In ROLL MODE, the display is continually updated and trigger signals are disregarded.

NORM (normal) Trigger MODE requires that all triggering requirements be met before an acquisition will take place (no forced triggers occur). SINGLE SEQ (single sequence) MODE is a variation of the conventional single-shot displays found on many oscilloscopes. In SINGLE SEQ, a single complete acquisition is done on all called-up VERTICAL MODES. Since an acquisition depends on the acquisition mode in effect, many of the scope operating features are altered in SINGLE SEQ. A complete description of this mode is discussed in "Controls, Connectors, and Indicators" in Section 5 of this manual.

The user can choose the trigger point within the acquired waveform record by selecting the amount of pretrigger data displayed. The trigger location in the record is selectable from among five pretrigger lengths beginning at one-eighth of the record length and increasing to seven-eighths of the record length. A Record Trigger position is independently selectable for both A and B acquisitions. Additional trigger positions in the record are selectable via the GPIB commands.

## ***Cursor Measurements***

Time and Voltage cursors are provided for making parametric measurements on the displayed waveforms. Time may be measured either between the cursor positions (DELTA TIME) or between a selected cursor and the trigger point of an acquired waveform (ABSOLUTE). Time cursor readouts are scaled in seconds, degrees, or percentage values. The 1/TIME cursors may be scaled in hertz (Hz), degrees, or percentage.

Voltage cursor measurements on a waveform display can be selected to read either the voltage difference between the cursor positions or the absolute voltage position of a selected cursor with respect to ground. The volts measurement readouts may be scaled in units of volts, decibels (dB), or percent. The Voltage cursors and Time cursors may also be coupled to track together (V@T and SLOPE) and assigned to a particular waveform for ease in making peak-to-peak and slope waveform measurements. The units for V@T may be volts, percent, or dB; SLOPE may have units of slope (VOLTS/SEC), percent (VOLTS/VOLT), or dB.

## ***Waveform Acquisition***

Waveforms may be acquired in NORMAL, ENVELOPE, or AVG (Average) acquisition modes; the mode chosen depends on the measurement requirements. NORMAL mode continuously acquires and displays successive acquisitions producing a "live" waveform display similar to that seen with an analog oscilloscope. AVG (averaging) mode averages successive acquisitions of a waveform resulting in an improved signal-to-noise ratio of the displayed waveform. Low-amplitude signals masked by noise become easily visible for making measurements and analysis by averaging from 2 to 256 acquisitions for removing uncorrelated noise. ENVELOPE mode saves the maximum and minimum data-point values over a selected number of acquisitions from 1 to 256 plus CONT (continuous). The display presents a visual image of the amount of change (envelope) that occurs to a waveshape during the accumulated acquisitions. Frequency, phase, amplitude, and position changes are easily identified when acquiring in ENVELOPE mode. The glitch-catching capability of ENVELOPE mode can capture single-event pulses as narrow as 2 ns at the slowest SEC/DIV setting of 5 seconds per division.

For all three acquisition modes, equivalent-time sampling extends the Useful Storage Bandwidth to 300 MHz if the signal is repetitive and REPET mode is turned on. At 50 ns/DIV and faster, randomly-acquired data points (or samples) taken from successive acquisitions of a periodic signal are used to fill the complete record (1024 data points) of the signal waveform display. Depending on the SEC/DIV setting, as few as 10 data points (at 2 ns/DIV) or as many as 512 data points (at 50 ns/DIV) may be obtained on each triggered acquisition. Sampling of successive acquisitions continues until a predetermined number of data points are acquired and any remaining points in the record are determined by interpolating between the acquired points. (The predetermined number includes at least enough data point to meet the Useful Storage Bandwidth of 300 MHz specified for REPET mode.) These interpolated points are replaced by randomly-acquired data points as they become available from successive acquisitions.

Horizontally, the record length of acquired waveforms is 1024 data points (512 max/min pairs in ENVELOPE mode), of which 500 make up a one-screen display (50 data points per division for 10 divisions). The entire record may be viewed by using the Horizontal POSITION control to position any portion of the record within the viewing area.

### Storage and I/O

Acquired waveforms may be saved in any of four REF waveform nonvolatile memories. Any or all of the saved reference waveforms may be displayed for comparison with the waveforms being currently acquired. The source and destination of waveforms to be saved may be user designated. Assignment can be made to save either channel 1 or channel 2 (or the results of an addition or multiplication of the two channels) to any REF memory or to move a stored reference from one REF memory to another. Reference waveforms may also be written into a REF memory location via the GPIB interface.

The scope is fully controllable and capable of sending and receiving waveforms via the standard equipped GPIB interface. This feature makes the instrument ideal for making automated measurements in a production or research and development environment that calls for repetitive data taking. Self-calibration and self-diagnostic features built into the scope to aid in fault detection and servicing are also accessible via commands sent from the GPIB controller.

Another standard feature is the "DEVICES" setting for GPIB Interface control. This feature allows the user to output waveforms (and other on-screen information) from the front panel to many printers and plotters that use HP<sup>®</sup> Graphics Language. In this way, hard copies of acquired waveforms can be obtained without putting the scope into a system controller environment.

## ***Extended Features***

There are several other features incorporated into this instrument designed to make it more usable, namely, the HELP, Auto Setup, MEASURE, and AutoStep Sequencer features.

**HELP:** The HELP function can be used to display operational information about any front-panel control. When HELP mode is in effect, manipulating almost any front-panel control causes the scope to display information about that control. When HELP is first invoked, an introduction to HELP is displayed on screen.

**Auto Setup:** The Auto Setup function is used to automatically setup the scope for a viewable display based on the input signal. The user can specify the waveform characteristic the display is optimized for (front-edge, period, etc.) from a menu displayed upon executing Auto Setup.

**MEASURE:** MEASURE automatically extracts parameters from signal input to the scope. In the "SNAPSHOT" mode, 20 different waveform parameters are extracted and displayed for a single acquisition. In the continuous-extraction mode, up to four parameters are extracted continuously as the instrument continues to acquire.

**AutoStep Sequencer (PRGM):** With AutoStep, the user can save single front-panel setups or sequences of setups and specify associated flow control and Input/Output actions for later recall. If MEASURE and/or OUTPUT are saved as part of these setups they can be used for automatic parameter extraction and data printout. About 100 to 800 front-panel setups (depending on complexity) can be stored in one or more sequences.

The complete descriptions of these four features are found in Section 5 "Controls, Connectors, and Indicators". See Section 3, "Applications," for examples of applications for Auto Setup, MEASURE, and AutoStep.

The following items are standard accessories shipped with the instrument:

- 2 Probe packages
- 1 Snap-lock accessories pouch
- 1 Zip-lock accessories pouch
- 1 Operators manual
- 1 Programmer's Reference Guide
- 1 Users Reference Guide
- 1 Fuse
- 1 Power cord (installed)
- 1 Blue plastic CRT filter (installed)
- 1 Clear plastic CRT filter
- 1 Front-panel cover

For part numbers and further information about standard accessories and a list of the optional accessories, refer to "Options and Accessories" (Section 7) in this manual. For additional information on accessories and ordering assistance, contact your Tektronix representative or local Tektronix Field Office.

## ***Performance Conditions***

The following electrical characteristics (Table 6-1) apply when the scope has been calibrated at an ambient temperature between +20°C and +30°C, has had a warmup period of at least 20 minutes and is operating at an ambient temperature between -15°C and +55°C (unless otherwise noted).

Items listed in the "Performance Requirements" column are verifiable qualitative or quantitative limits that define the measurement capabilities of the instrument.

Environmental characteristics are given in Table 6-2. The scope meets the environmental requirements of MIL-T-28800C for Type III, Class 3, Style D equipment, with the humidity and temperature requirements defined in paragraphs 3.9.2.2, 3.9.2.3, and 3.9.2.4. The rackmounted scope meets the vibration and shock requirements of MIL-T-28800C for Type III, Class 5, Style D equipment when mounted using the rackmount rear-support kit supplied with both the 1R Option and the Rackmount Conversion kit.

Mechanical characteristics of the scope are listed in Table 6-3.

Video Option characteristics are given in Table 6-4.

## ***Recommended Adjustments Schedule***

For optimum performance to specification, the internal SELF CAL should be done:

1. If the operating temperature is changed by more than 5°C since the last SELF CAL was performed.
2. Immediately before making measurements requiring the highest degree of accuracy.

**Table 6-1  
Electrical Characteristics**

Characteristics	Performance Requirements
<b>ACQUISITION SYSTEM—CHANNEL 1 AND CHANNEL 2</b>	
Resolution	8 bits. Displayed vertically with 25 digitization levels (DL <sup>a</sup> ) per division.
Dynamic Range <sup>b</sup>	Variable between SEC/DIV settings.
100 $\mu$ s or slower	– 128 to + 127 DL's.
50 $\mu$ s to 500 ns	– 124 to + 123 DL's.
200 ns	– 121 to + 120 DL's.
100 ns	– 113 to + 112 DL's.
50 ns to 2 ns	
Repet OFF	– 113 to + 112 DL's.
Repet ON	– 121 to + 120 DL's.
Record Length	1024 samples. Displayed horizontally with 50 samples/per division, 20.48-division trace length.
Sample Rate	10 samples/sec to 500 megasamples per second (5 sec/DIV to 100 ns/DIV).
Sensitivity Range	80 $\mu$ V per DL to 0.2 Volts per DL in a 1-2-5 sequence of 11 steps (2 mV/DIV to 5 V/DIV).
Accuracy Normal and Average Modes	Within $\pm(2\% + 1 \text{ DL})$ at any VOLTS/DIV setting for a signal 1 kHz or less contained within $\pm 75$ DLs ( $\pm 3$ divisions) of center when a SELF CAL has been performed within $\pm 15^\circ\text{C}$ of the operating temperature.
Envelope Mode	Add 1% to Normal Mode specifications.
Variable Range	Continuously variable between VOLTS/DIV settings. Extends sensitivity to 0.5 V per DL or greater, 12.5 V per division or greater.

<sup>a</sup> "DL" is the abbreviation for "digitization level." A DL is the smallest voltage level change that can be resolved by the internal 8-bit A-D Converter, with the input scaled to the VOLTS/DIV setting of the channel used. Expressed as a voltage, a DL is equal to 1/25 of a division times the VOLTS/DIV setting.

<sup>b</sup>The dynamic range defines the size of the vertical window. For example, there are 256 DL's (counting the 0-level DL) for SEC/DIV settings 100  $\mu$ s and slower. With each division comprising 25 DL's, the vertical window is 10.24 divisions for those SEC/DIV settings.

**Performance Characteristics**

**Table 6-1 (cont)**

Characteristics	Performance Requirements
<b>ACQUISITION SYSTEM—CHANNEL 1 AND CHANNEL 2 (cont)</b>	
<p>Bandwidth</p>	<p>Bandwidth is measured with a leveled, low distortion, 50-Ω source, sine-wave generator, terminated in 50 Ω. The reference signal is set to 6 divisions or to the maximum leveled amplitude obtainable if the Volt/Div setting is too high to yield 6 div's on screen.</p> <p>Bandwidth with probe is checked using a probe-tip-to-GF termination adapter (017-0520-00).</p> <p>Bandwidth with external termination is checked using a BNC 50-Ω feed-through terminator (011-0049-01).</p>
<p>–3dB Bandwidth</p> <p>Normal or Average Modes. Envelope Mode at SEC/DIV settings of 0.2 μs or faster.</p> <p>– 15°C to +30°C +30C to +55C</p>	<p>Using standard accessory probe or internal termination (not checked with probe in manual).</p> <p>Dc to 300MHz.</p> <p>Upper Bandwidth Limit reduced by 2.5 MHz for each °C above 30°C.</p>
<p>Envelope Mode at SEC/DIV settings of 0.5 μs or slower.</p>	<p>Dc to 150 MHz using standard accessory probe, internal 50-Ω termination, or external 50-Ω termination on 1-MΩ input.</p>
<p>–4.7 dB Bandwidth</p> <p>Normal or Average Mode. Envelope Mode at SEC/DIV settings of 0.2 μs or faster.</p> <p>+30C to +55C</p>	<p>Using 50-Ω external termination on 1-MΩ input.</p> <p>Upper Bandwidth Limit reduced by 2.5 MHz for each °C above 30°C.</p>
<p>Single Event Useful Storage Bandwidth</p> <p>Normal or Average Mode; SEC/DIV at 0.1 μs or Faster; Repet and Smooth OFF</p>	<p>DC to 200 MHz (calculated).</p> $USB = \frac{F_{(sample\ freq\ max)}^c}{2.5}$

<sup>c</sup>Sample freq. max. is 500 MHz.



Table 6-1 (cont)

Characteristics	Performance Requirements
<b>ACQUISITION SYSTEM—CHANNEL 1 AND CHANNEL 2 (cont)</b>	
AC Coupled Lower -3 dB Point	
1X Probe	10 Hz or less.
10X Probe	1 Hz or less.
Step Response; Repet and Average ON; Average Set to 16	
Rise Time	1.2 ns or less (calculated)  $T_r(\text{in ns}) = \frac{350}{\text{BW in MHz}}$
Envelope Mode Pulse Response	
0.5 $\mu$ s and slower	
Minimum Single Pulse Width for 50% or Greater Amplitude Capture at 85% or Greater Confidence	2 ns.
Minimum Single Pulse Width for Guaranteed 50% or Greater Amplitude Capture.	4 ns.
Minimum Single Pulse Width for Guaranteed 80% or Greater Amplitude Capture.	8 ns.
Channel Isolation	Measured with a 10-division, sine-wave input and equal VOLT/DIV settings on both channels. 100:1 or greater at 100 MHz for VOLT/DIV settings from 2 mV/DIV and 500 mV/DIV; 50:1 or greater at 300 MHz for VOLT/DIV settings from 20 mV/DIV to 500 mV/DIV. 25:1 or greater at 300 MHz for VOLT/DIV settings of 5 mV/DIV and 10 mV/DIV.
Acquired Channel 2 Signal Delay with Respect to Channel 1 Signal at Full Bandwidth	$\pm 250$ ps.

**Performance Characteristics**

**Table 6-1 (cont)**



Characteristics	Performance Requirements
<b>ACQUISITION SYSTEM—CHANNEL 1 AND CHANNEL 2 (cont)</b>	
Input R and C (1 M $\Omega$ ) Resistance	1 M $\Omega$ $\pm$ 0.5%.  In each attenuator, the input resistance of all VOLTS/DIV positions is matched to within 0.5%.
Capacitance	15 pF $\pm$ 2 pF.  In each attenuator, the input capacitance of all VOLTS/DIV positions is matched to within 0.5 pF.
Input R (50 $\Omega$ ) Resistance	50 $\Omega$ $\pm$ 1%.
VSWR (DC to 300 MHz)	1.3:1 or better.
Maximum Input Voltage 	5 V rms; 0.5 W sec for any one-second interval for instantaneous voltages from 5 V to 50 V.
Maximum Input Voltages   Input Coupling set to DC, AC, or GND	400 V (dc + peak ac); 800 V p-p ac at 10 kHz or less.
Common Mode Rejection Ratio (CMRR); ADD Mode With Either Channel Inverted	At least 10:1 at 50 MHz for common-mode signals of 10 divisions or less with VARIABLE VOLTS/DIV adjusted for best CMRR at 50 kHz.
POSITION Range	$\pm$ (9.3 to 10.4) divisions, at 50 mV per division with INVERT off and when SELF CAL has been done within $\pm$ 5°C of the operating temperature.
Gain Match Between NORMAL and SAVE	$\pm$ 3 DLs for positions within $\pm$ 5 divisions from center.
Low-Frequency Linearity	3 DLs or less compression or expansion of a two-division, center-screen signal when positioned anywhere within the acquisition window.

Table 6-1 (cont)

Characteristics	Performance Requirements
<b>ACQUISITION SYSTEM—CHANNEL 1 AND CHANNEL 2 (cont)</b>	
20 MHz Bandwidth Limiter –3 dB Bandwidth	13 MHz to 24 MHz.
100 MHz Bandwidth Limiter –3 dB Bandwidth	80 MHz to 120 MHz.
Rise Time	3.2 ns to 4.4 ns. With a five-division, fast-rise step (rise time of 300 ps or less) using 50 $\Omega$ DC input coupling and VOLTS/DIV setting of 10 mV.
<b>TRIGGERING—A and B</b>	
Minimum P-P Signal Amplitude for Stable Triggering from Channel 1, Channel 2, or ADD <sup>c</sup>	
A Trigger	
DC Coupled	0.35 division from DC to 50 MHz, increasing to 1.0 division at 300 MHz; 1.5 divisions at 300 MHz in ADD mode.
NOISE REJ Coupled	1.2 divisions or less from DC to 50 MHz, increasing to 3 divisions at 300 MHz; 4.5 divisions at 300 MHz in ADD mode.
AC Coupled	0.35 division from 60 Hz to 50 MHz; increasing to 1.0 division at 300 MHz, 1.5 divisions at 300 MHz in ADD mode. Attenuates signals below 60 Hz.
HF REJ Coupled	0.50 division from DC to 30 kHz. Attenuates signals above 30 kHz.
LF REJ Coupled	0.50 division from 80 kHz to 50 MHz increasing to 1.0 division at 300 MHz; 1.5 divisions at 300 MHz in ADD mode. Attenuates signal below 80 kHz.
B Trigger	Multiply all A Trigger specifications by 2.
A*B Selected	Multiply all A Trigger specifications by 2.

<sup>c</sup>A stable trigger is one that results in a uniform, regular display triggered on the selected slope. The trigger point must not switch between opposite slopes on the waveform, and the display must not "roll" across the screen on successive acquisitions. The TRIG'D LED stays constantly lit when the SEC/DIV setting is 2 ms or faster, but may flash when the SEC/DIV setting is 10 ms or slower.

**Performance Characteristics**

**Table 6-1 (cont)**

Characteristics	Performance Requirements
<b>TRIGGERING—A AND B (cont)</b>	
Minimum P-P Signal Amplitude for Stable Triggering from EXT TRIG 1 or EXT TRIG 2 Source <sup>c</sup>	
A Trigger	
Ext Gain = 1	
DC Coupled	17.5 mV from DC to 50 MHz, increasing to 50 mV at 300 MHz.
NOISE REJ Coupled	60 mV or less from DC to 50 MHz; increasing to 150 mV at 300 MHz .
AC Coupled	17.5 mV from 60 Hz to 50 MHz, increasing to 50 mV at 300 MHz. Attenuates signals below 60 Hz.
HF REJ Coupled	25 mV from DC to 30 kHz.
LF REJ Coupled	25 mV from 80 kHz to 50 MHz; increasing to 50 mV at 300 MHz.
Ext Gain = $\times 5$	
	Amplitudes are five times those specified for Ext Gain = 1.
B Trigger	
	Multiply all A Trigger amplitude specifications by two.
A*B Selected	
	Multiply all A Trigger amplitude specifications by two.

<sup>c</sup>A stable trigger is one that results in a uniform, regular display triggered on the selected slope. The trigger point must not switch between opposite slopes on the waveform, and the display must not "roll" across the screen on successive acquisitions. The TRIG'D LED stays constantly lit when the SEC/DIV setting is 2 ms or faster, but may flash when the SEC/DIV setting is 10 ms or slower.

Table 6-1 (cont)

Characteristics	Performance Requirements
<b>TRIGGERING—A and B (cont)</b>	
Maximum P-P Signal Rejected by NOISE REJ Coupling within the Vertical Bandwidth	
Channel 1 or Channel 2 Source	0.4 division or greater for VOLTS/DIV settings of 10 mV and higher.
EXT TRIG 1 or EXT TRIG 2 Source	20 mV or greater when Ext Trig Gain = 1. 100 mV or greater when Ext Trig Gain = $\div 5$ .
EXT TRIG 1 and EXT TRIG 2 Inputs	
Resistance	1 M $\Omega$ $\pm$ 1%.
Capacitance	15 pF $\pm$ 3 pF.
Maximum Input Voltage 	400 V (dc + peak ac); 800 V p-p ac at 10 kHz or less.
LEVEL Control Range	
Channel 1 or Channel 2 Source	$\pm$ 18 divs x VOLTS/DIV setting.
EXT TRIG 1 or EXT TRIG 2 Source	
EXT GAIN = 1	$\pm$ 0.9 volts.
EXT GAIN = $\div 5$	$\pm$ 4.5 volts.

**Performance Characteristics**

**Table 6-1 (cont)**

Characteristics	Performance Requirements
<b>TRIGGERING—A and B (cont)</b>	
LEVEL Readout Accuracy (for triggering signals with transition times greater than 20 ns)  Channel 1 or Channel 2 Source  DC Coupled  +15°C to +35°C	Within $\pm$ [3% of setting + 3% of p-p signal + (0.2 division $\times$ VOLTS/DIV setting) + 0.5 mV + (0.5 mV $\times$ probe attenuation factor)].
-15°C to +55°C (excluding +15°C to +35°C)	Add (1.5 mV $\times$ probe attenuation) to +15°C to +35°C specification.
NOISE REJ Coupled	Add $\pm$ (0.6 division $\times$ VOLTS/DIV setting) to DC Coupled specifications.  Checked at 50 mV per division.
EXT TRIG 1 or EXT TRIG 2 Source  EXT GAIN = 1  DC Coupled	Within $\pm$ [3% of setting + 4% of p-p signal + 10 mV + (0.5 mV $\times$ probe attenuation factor)].
NOISE REJ Coupled	Add $\pm$ 30 mV to DC Coupled specifications.
EXT GAIN = $\div$ 5  DC Coupled	Within $\pm$ [3% of setting + 4% of p-p signal + 50 mV + (0.5 mV $\times$ probe attenuation factor)].
NOISE REJ Coupled	Add $\pm$ 150 mV to DC Coupled specifications.

Table 6-1 (cont)

Characteristics	Performance Requirements		
<b>TRIGGERING—A AND B (cont)</b>			
Variable A Trigger Holdoff	<b>A SEC/DIV</b>	<b>MIN HO</b>	<b>MAX HO</b>
	2 ns 5 ns 10 ns 20 ns 50 ns 100 ns 200 ns	2-4 $\mu$ s	9-15 $\mu$ s
	500 ns	5-10 $\mu$ s	
	1 $\mu$ s 2 $\mu$ s 5 $\mu$ s	10-20 $\mu$ s 20-40 $\mu$ s 50-100 $\mu$ s	100-150 $\mu$ s
	10 $\mu$ s 20 $\mu$ s 50 $\mu$ s	0.1-0.2 ms 0.2-0.4 ms 0.5-1.0 ms	1-1.5 ms
	100 $\mu$ s 200 $\mu$ s 500 $\mu$ s	1-2 ms 2-4 ms 5-10 ms	10-15 ms
	1 ms 2 ms 5 ms	10-20 ms 20-40 ms 50-100 ms	90-150 ms
	10 ms 20 ms 50 ms	0.1-0.2 s 0.2-0.4 s .5-1.0 s	0.9-1.5 s
	100 ms 200 ms	1-2 s 2-4 s	9-15 s
	500 ms 1 s 2 s 5 s	5-10 s	

**Performance Characteristics**

**Table 6-1 (cont)**

Characteristics	Performance Requirements
<b>TRIGGERING—A AND B (cont)</b>	
SLOPE Selection	Conforms to trigger-source waveform and ac-power source waveform.
Trigger Position Jitter (P-P)	Checked in NORMAL ACQUIRE mode with a 5-division step having less than or equal to 1 ns rise time.
A Mode, B Mode (TRIG AFTER)	
SEC/DIV 100 ns and slower	$0.04 \times \text{SEC/DIV setting}^d$
SEC/DIV 50 ns and faster	$(0.04 \times \text{SEC/DIV setting}^d) + 200 \text{ ps.}$
B Mode (RUNS AFTER)	
SEC/DIV 50 ns and faster	$(0.04 \times \text{B SEC/DIV setting}) + 200 \text{ ps.}$
SEC/DIV 50 $\mu\text{s}$ to 100 ns	$0.04 \times \text{B SEC/DIV setting.}$
SEC/DIV 100 $\mu\text{s}$ and slower	$0.08 \times \text{B SEC/DIV setting.}$
<b>TIME BASE</b>	
Sample Rate Accuracy	
Average Over 100 or More Samples	$\pm 0.0015\%$ .
External Clock	
Repetition Rate	
Minimum	1 MHz.
Maximum	100 MHz.
Events Count	1 to 65,536.
Events Maximum Repetition Rate	100 MHz.

<sup>d</sup>Use a B SEC/DIV setting if in B Mode; otherwise, use A SEC/DIV setting.



Table 6-1 (cont)

Characteristics	Performance Requirements
<b>TIME BASE (cont)</b>	
Signal Levels Required for EXT Clock or EVENTS	
Channel 1 or Channel 2 SOURCE	
DC Coupled	0.7 division from DC to 50 MHz; increasing to 2.0 division at 100 MHz; 3.0 divisions at 100 MHz in ADD mode.
NOISE REJ Coupled	2.4 divisions or less from DC to 50 MHz; increasing to 6.0 divisions at 100 MHz; 9.0 divisions at 100 MHz in ADD mode.
AC Coupled	0.7 division from 60 Hz to 50 MHz; increasing to 2.0 division at 100 MHz; 3.0 divisions at 100 MHz in ADD mode. Attenuates signals below 60 Hz.
HF REJ Coupled	1.0 divisions from DC to 30 kHz. Attenuates signals above 30 kHz.
LF REJ Coupled	1.0 division from 80 kHz to 50 MHz; increasing to 4.0 division at 100 MHz; 3.0 divisions at 100 MHz in ADD mode. Attenuates signals below 80 kHz.
EXT TRIG 1 or EXT TRIG 2 Source	
Ext Gain = 1	
DC Coupled	35 mV from DC to 50 MHz; increasing to 100 mV at 100 MHz.
NOISE REJ Coupled	120 mV or less from DC to 50 MHz; increasing to 300 mV at 100 MHz.
AC Coupled	35 mV from 60 Hz to 50 MHz; increasing to 100 mV at 100 MHz. Attenuates signals below 60 Hz.
HF REJ Coupled	50 mV from DC to 30 kHz.
LF REJ Coupled	50 mV from 80 kHz to 50 MHz; increasing to 100 mV at 100 MHz.

**Performance Characteristics**

**Table 6-1 (cont)**

Characteristics	Performance Requirements
<b>TIME BASE (cont)</b>	
Ext Gain = $\div 5$	Amplitudes are five times those specified for Ext Gain = 1.
Delay Time Range	
B RUNS AFTER DELAY	
SEC/DIV 50 ns and faster	
REPET ON	$(0.08 \times B \text{ SEC/DIV})$ to 1.05 ms.
REPET OFF	$(0.08 \times B \text{ SEC/DIV})$ to 524 $\mu\text{s}$ .
SEC/DIV 50 $\mu\text{s}$ to 100 ns	$(0.08 \times B \text{ SEC/DIV})$ to $(65,536 \times 0.08 \times B \text{ SEC/DIV})$ .
SEC/DIV 100 $\mu\text{s}$ and slower	$(0.04 \times B \text{ SEC/DIV})$ to $(65,536 \times 0.04 \times B \text{ SEC/DIV})$ .
B TRIGGERABLE AFTER DELAY	
SEC/DIV 50 ns and faster	
REPET ON	16 ns to 1.05 ms.
REPET OFF	8 ns to 524 $\mu\text{s}$ .
SEC/DIV 50 $\mu\text{s}$ to 100 ns	$(0.08 \times B \text{ SEC/DIV})$ to $(65,536 \times 0.08 \times B \text{ SEC/DIV})$ .
SEC/DIV 100 $\mu\text{s}$ and slower	$(0.04 \times B \text{ SEC/DIV})$ to $(65,536 \times 0.04 \times B \text{ SEC/DIV})$ .
Delay Time Resolution	
B RUNS AFTER DELAY	
SEC/DIV 50 $\mu\text{s}$ to 100 ns	$(0.08 \times B \text{ SEC/DIV})$ .
SEC/DIV 100 $\mu\text{s}$ and slower	$(0.04 \times B \text{ SEC/DIV})$ .
B TRIGGERABLE AFTER DELAY	
SEC/DIV 50 ns and faster	
REPET ON	16 ns.
REPET OFF	8 ns.
SEC/DIV 50 $\mu\text{s}$ to 100 ns	$(0.08 \times B \text{ SEC/DIV})$ .
SEC/DIV 100 $\mu\text{s}$ and slower	$(0.04 \times B \text{ SEC/DIV})$ .
Delay Time Accuracy	$\pm 0.0015\%$ .

Table 6-1 (cont)

Characteristics	Performance Requirements
<b>NONVOLATILE MEMORY</b>	
Front-Panel Setting, Waveform Data, Sequencer, and Calibration Data Retention Time	Greater than 3 years.
Battery	<p>3.6 Volt, 1.6 Amp Hour, Lithium Thionyl Chloride; Manufacturer EAGLE PICHER, Type LTC16P/P, TEK Part Number 146-0062-00; UL Listed. (See Warning below.)</p> <p style="text-align: center;"><b>WARNING</b></p> <p><i>To avoid personal injury, observe proper procedures for handling and disposal of lithium batteries. Improper handling may cause fire, explosion, or severe burns. Don't recharge, crush, disassemble, heat the battery above 212°F (100°C), incinerate, or expose contents of the battery to water. Dispose of battery in accordance with local, state, and national regulations. Typically, small quantities (less than 20) can be safely disposed of with ordinary garbage in a sanitary landfill. Larger quantities must be sent by surface transport to a hazardous waste disposal facility. The batteries should be individually packaged to prevent shorting and packed in a sturdy container that is clearly labeled "Lithium Batteries—DO NOT OPEN."</i></p>

**Performance Characteristics**

**Table 6-1 (cont)**

Characteristics	Performance Requirements
<b>SIGNAL OUTPUTS</b>	
<b>CALIBRATOR</b>  Voltage (with A SEC/DIV switch set to 1 ms) 1 M $\Omega$ Load 50 $\Omega$ Load  Current (short circuit load with A SEC/DIV switch set to 1 ms)  Accuracy  Symmetry	CALIBRATOR output amplitudes at 5 MHz are at least 50% of output amplitudes at 1 ms SEC/DIV setting.  0.4 V $\pm$ 1%. 0.2 V $\pm$ 1.5%. 8 mA $\pm$ 1.5%. $\pm$ 0.0015%. Duration of high portion of output cycle is 50% of output period $\pm$ (lesser of 500 ns or 25% of period).
<b>CH 2 SIGNAL OUTPUT</b>  Output Voltage  Offset  -3 dB Bandwidth	20 mV per division $\pm$ 10% into 1 M $\Omega$ . 10 mV/DIVision $\pm$ 10% into 50 $\Omega$ . $\pm$ 10 mV into 50 $\Omega$ , when dc balance has been performed within $\pm$ 5 $^{\circ}$ C of the operating temperature. DC to greater than 50 MHz.
<b>A TRIGGER, RECORD TRIGGER, and WORD RECOGNIZER Output</b>  Logic Polarity  Output Voltage HI Load of 400 $\mu$ A or less 50- $\Omega$ Load to Ground  Output Voltage LO Load of 4 mA or less 50- $\Omega$ Load to Ground	Negative true. HI to LO transition indicates the trigger occurred. 2.5 V to 3.5 V. 0.45 V or greater. 0.5 V or less. 0.15 V or less.

Table 6-1 (cont)

Characteristics	Performance Requirements
<b>SIGNAL OUTPUTS (cont)</b>	
<b>SEQUENCE OUT, SEQUENCE COMPLETE Outputs</b>	
Logic Polarity	Negative true. HI to LO transition indicates the event occurred.
Output Voltage HI	
Load of 400 $\mu$ A or less	2.5 V to 3.5 V.
50- $\Omega$ Load to Ground	0.45 V or greater.
Output Voltage LO	
Load of 4 mA or less	40.5 V or less.
50- $\Omega$ Load to Ground	0.15 V or less.
<b>SEQUENCE IN Input</b>	
Logic Polarity	Negative true. HI to LO transition restarts a paused sequence.
High-Level Input Current	20 $\mu$ A maximum at $V_{in} = 2.7$ V.
Low-Level Input Current	-0.4 mA maximum at $V_{in} = 0.4$ V.
High-Level Input Voltage	2.0 V minimum.
Low-level Input Voltage	0.8 V maximum.
<b>Absolute Maximum Ratings</b>	
$V_{in}$ max	+7.0 V.
$V_{in}$ min	-0.5 V.

**Performance Characteristics**

**Table 6-1 (cont)**

Characteristics	Performance Requirements
<b>DISPLAY</b>	
Graticule	80 mm × 100 mm (8 × 10 div).
Phosphor	P31.
Nominal Accelerating Potential	16 kV.
Waveform and Cursor Display, Vertical	
Resolution, Electrical	One part in 1024 (10 bit). Calibrated for 100 points per division.
Gain Accuracy	Graticule indication of voltage cursor difference is within 1% of CRT cursor readout value, measured over center six divisions.
Centering; Vectors OFF Offset with Vectors ON	Within ±0.1 division. Less than 0.05 division.
Linearity	Less than 0.1 division difference between graticule indication and CRT cursor readout when active VOLTS cursor is positioned anywhere on screen and inactive cursor is at center screen.
Vector Response	
NORMAL Mode	
Step Aberration	+4%, -4%, 4% p-p.
Fill	Edges of filled regions match reference lines within ±0.1 division.
ENVELOPE Mode	
Fill	Less than 1% change in p-p amplitude of a 6-division, filled ENVELOPE waveform when switching vectors ON and OFF.

Table 6-1 (cont)

Characteristics	Performance Requirements
<b>DISPLAY (cont)</b>	
Waveform and Cursor Display, Horizontal	
Resolution, Electrical	One part in 1024 (10 bit). Calibrated for 100 points per division.
Gain Accuracy	Graticule indication at time cursor difference is within 1% of CRT cursor readout value, measured over center 6 divisions.
Centering, Vectors OFF Offset with Vectors ON	Within $\pm 0.1$ division. Less than 0.05 division.
Linearity	Less than 0.1 division difference between graticule indication and CRT cursor readout when active time cursor is positioned anywhere along center horizontal graticule line and inactive cursor is at center screen.
<b>AC POWER SOURCE</b>	
Source Voltage	
Nominal Ranges	
115 V	90 V to 132 V.
230 V	180 V to 250 V.
Source Frequency	48 Hz to 440 Hz.
Fuse Rating	5 A, 250 V, AGC/3AG, Fast Blow; or 4 A, 250 V, 5 $\times$ 20 mm Time-Lag (T). Each fuse type requires a different fuse cap.
Power Consumption	
Typical (standard instrument)	160 watts (250 VA).
Maximum (fully-optioned instrument)	200 watts (300 VA).
Primary Grounding <sup>a</sup>	Type test 0.1 $\Omega$ maximum. Routine test to check grounding continuity between chassis ground and protective earth ground. <sup>a</sup>

<sup>a</sup>Routine test is with ROD-L/EPA Electronic Model 100AV Hi-Pot Tester. This tests both the Primary Circuit Dielectric Withstand and Primary Grounding in one operation. Contact Tektronix Product Safety prior to using any other piece of equipment to perform these tests.

*Performance Characteristics*

**Table 6-2  
Environmental Characteristics**

Characteristics	Performance Requirements
<b>STANDARD INSTRUMENT</b>	
Temperature	The Oscilloscope meets the environmental requirements of MIL-T- 28800C for Type III, Class 3, Style D equipment, with the humidity and temperature requirements defined in paragraphs 3.9.2.2, 3.9.2.3, and 3.9.2.4.
Operating	–15°C to +55°C.
Nonoperating (storage)	–62°C to +85°C.
Altitude	
Operating	To 15,000 feet (4500 meters). Maximum operating temperature decreased 1°C for each 1000 feet (300 meters) above 5000 feet (1500 meters).
Nonoperating (storage)	To 50,000 feet (15,000 meters).
Humidity	
Operating and Storage	Stored at 95% relative humidity for five cycles (120 hours) from 30°C to 60°C, with operation performance checks at 30°C and 55°C.
Vibration	
Operating	15 minutes along each of three axes at a total displacement of 0.025 inch (0.64 mm) p-p (4 g at 55 Hz), with frequency varied from 10 Hz to 55 Hz in one-minute sweeps. Hold 10 minutes at each major resonance, or if none exist, hold 10 minutes at 55 Hz (75 minutes total test time).
Shock	
Operating and Nonoperating	50-g, half-sine, 11-ms duration, three shocks on each face, for a total of 18 shocks.



Table 6-2 (cont)

Characteristics	Performance Requirements
<b>STANDARD INSTRUMENT (cont)</b>	
Transit Drop (not in shipping package)	12-inch (300-mm) drop on each corner and each face (exceeds MIL-T-28800C, paragraphs 3.9.5.2 and 4.5.5.4.2).
Bench Handling Cabinet On and Cabinet Off	MIL-STD-810C, Method 516.2, Procedure V (MIL-T-28800C, paragraph 4.5.5.4.3).
Topple (Cabinet Installed) Operating	Set on rear feet and allow to topple over onto each of four adjacent faces (Tektronix Standard 062-2858-00).
Packaged Transportation Drop	Meets the limits of the National Safe Transit Assn., test procedure 1A-B-2; 10 drops of 36 inches (914 mm) (Tektronix Standard 062-2858-00).
Vibration	Meets the limits of the National Safe Transit Assn., test procedure 1A-B-1; excursion of 1 inch (25.4 mm) p-p at 4.63 Hz (1.1 g) for 30 minutes (Tektronix Standard 062-2858-00).
EMI (Electromagnetic Interference)	Meets MIL-T-28800C; MIL-STD-461B, part 4 (CE-03 and CS-02), part 5 (CS-06 and RS-02), and part 7 (CS-01, RE-02, and RS-03—limited to 1 GHz); VDE 0871, Category B; Part 15 of FCC Rules and Regulations, Subpart J, Class A; and Tektronix Standard 062-2866-00.
Electrostatic Discharge Susceptibility	Meets Tektronix Standard 062-2862-00. The instrument will not change control states with discharges of less than 10 kV.
X-Ray Radiation	Meets requirements of Tektronix Standard 062-1860-00.

**Performance Characteristics**

**Table 6-2 (cont)**

Characteristics	Performance Requirements
<b>RACKMOUNTED INSTRUMENT</b>	
Environmental Requirements (cont)	Listed characteristics for vibration and shock indicate those environments in which the rackmounted instrument meets or exceeds the requirements of MIL-T-28800C with respect to Type III, Class 5, Style D equipment with the rackmounting rear-support kit installed. Refer to the Standard Instrument Environmental Specification for the remaining performance requirements. Instruments will be capable of meeting or exceeding the requirements of Tektronix Standard 062-2853-00, class 5.
Temperature (operating)	- 15°C to +55°C, ambient temperature measured at the instrument's air inlet. Fan exhaust temperature should not exceed +65°C.
Vibration	15 minutes along each of three major axes at a total displacement of 0.015 inch (0.38 mm) p-p (2.3 g at 55 Hz), with frequency varied from 10 Hz to 55 Hz to 10 Hz in one-minute sweeps. Hold 10 minutes at each major resonance, or if no major resonance is present, hold 10 minutes at 55 Hz (75 minutes total test time).
Shock (operating and nonoperating)	30-g, half-sine, 11-ms duration, three shocks per axis in each direction, for a total of 18 shocks.

**Table 6-3  
Mechanical Characteristics**

<b>Characteristics</b>	<b>Description</b>
<b>STANDARD INSTRUMENT</b>	
Weight	
With Front Cover, Accessories, and Accessories Pouch	12.8 kg (28.1 lbs).
Without Front Cover, Accessories, and Accessories Pouch	10.9 kg (23.9 lbs).
Domestic Shipping Weight	16.4 kg (36 lbs).
Overall Dimensions	See Figure 6-1 for a dimensional drawing.
Height	
With Feet and Accessories Pouch	190 mm (7.48 in).
Without Accessories Pouch	160 mm (6.3 in).
Width (with handle)	330 mm (130.0 in).
Depth	
With Front Cover	479 mm (18.86 in).
With Handle Extended	550 mm (21.65 in).
Cooling	Forced air circulation; no air filter.
Finish	Tek Blue vinyl-clad material on aluminum cabinet.
Construction	Aluminum-alloy/plastic composite chassis (spot-molded). Plastic-laminate front panel. Glass-laminate circuit boards.

**Performance Characteristics**

**Table 6-3 (cont)**

<b>Characteristics</b>	<b>Performance Requirements</b>
<b>RACKMOUNTING</b>	
Rackmounting Conversion Kit	
Weight	4.0 kg (8.8 lbs).
Domestic Shipping Weight	6.3 kg (13.8 lbs).
Height	178 mm (7 in).
Width	483 mm (19 in).
Depth	419 mm (16.5 in).
Rear Support Kit	
Weight	0.68 kg (1.5 lbs).
<b>OPTION 1R</b>	
Rackmounted Instrument (Option 1R)	
Weight	15.8 kg (34.9 lbs).
Domestic Shipping Weight	18.1 kg (39.9 lbs).
Height	178 mm (7 in).
Width	483 mm (19 in).
Depth	419 mm (16.5 in).

Table 6-4  
Video Option 05 (TV Trigger) Electrical Characteristics

Characteristics	Performance Requirements
<b>VERTICAL—CHANNEL 1 AND CHANNEL 2</b>	
Frequency Response	
Full Bandwidth	
50 kHz to 5 MHz	Within $\pm 1\%$ .
Greater than 5 MHz to 10 MHz	Within $+1\%$ , $-2\%$ .
Greater than 10 MHz to 30 MHz	Within $+2\%$ , $-3\%$ .
	For VOLTS/DIV switch settings between 5 mV and 0.2 V per division with VARIABLE VOLTS/DIV set to CAL. Five-division, 50-kHz reference signals from a 50- $\Omega$ system. With external 50- $\Omega$ termination on a 1-M $\Omega$ input.
20 MHz Bandwidth Limit	
50 kHz to 5 kHz	Within $+1\%$ , $-4\%$ .
Square Wave Flatness	
Field Rate	
5 mV/DIV to 20 mV/DIV	$\pm 1\%$ , 1% p-p at 60 Hz with input signal of 0.1 V.
50 mV/DIV	$\pm 1\%$ , 1% p-p at 60 Hz with input signal of 1.0 V.
	With fast-rise step (rise time 1 ns or less), 1-M $\Omega$ dc input coupling, an external 50- $\Omega$ termination, and VARIABLE VOLTS/DIV set to CAL. Exclude the first 20 ns following the step transition and exclude the first 30 ns when 20 MHz BW LIMIT is set.
Line Rate	
5 mV/DIV to 20 mV/DIV	$\pm 1\%$ , 1% p-p at 15 kHz with input signal of 0.1 V.
50 mV/DIV	$\pm 1\%$ , 1% p-p at 15 kHz with input signal of 1.0 V.

**Performance Characteristics**

**Table 6-4 (cont)  
Video Option 05 (TV Trigger) Electrical Characteristics**

Characteristics	Performance Requirements
<b>VERTICAL—CHANNEL 1 AND CHANNEL 2 (cont)</b>	
TV (Back-Porch) Clamp (CH 2 only)	
60 Hz Attenuation	18 dB or greater.  For VOLTS/DIV switch settings between 5 mV and 0.2 V with VARIABLE VOLTS/DIV set to CAL. Six-division reference signal.
Back-Porch Reference	Within $\pm 1.0$ div of ground reference.
<b>TRIGGERING</b>	
Sync Separation	Stable video rejection and sync separation from sync-positive or sync-negative composite video, 525 to 1280 lines, 50 Hz or 60 Hz, interlaced or noninterlaced systems.
Trigger Modes	
A Horizontal Mode	All Lines:  Field 1, selected line (1 to n), Field 2, selected line (1 to n), Alt fields, selected line (1 to n).  n is equal to or less than the number of lines in the frame and less than or equal to 1280.
B Horizontal Mode	Delayed by time.

Table 6-4 (cont)

Characteristics	Performance Requirements
<b>TRIGGERING (cont)</b>	
Minimum Input Signal Amplitude for Stable Triggering <sup>c</sup>	
Channel 1 and Channel 2	
Composite Video	2 divisions.
Composite Sync	0.6 division.
	Peak signal amplitude within 18 divisions of input ground reference.
EXT TRIG 1 or EXT TRIG 2	
EXT GAIN = 1	
Composite Video	60 mV.
Composite Sync	30 mV.
	Peak signal amplitude within $\pm 0.9$ V from input ground reference.
EXT GAIN = $\div 5$	
Composite Video	300 mV
Composite Sync	150 mV
	Peak signal amplitude within $\pm 4.9$ V from input ground reference.

<sup>c</sup>A stable trigger is one that results in a uniform, regular display triggered on the selected slope. The trigger point must not switch between opposite slopes on the waveform, and the display must not "roll" across the screen on successive acquisitions. The TRIG'D LED stays constantly lit when the SEC/DIV setting is 2 ms or faster, but may flash when the SEC/DIV setting is 10 ms or slower.

**Performance Characteristics**

---

**Table 6-5**  
**Video Option 05 (TV Trigger) Environmental Characteristics**

<b>Characteristics</b>	<b>Performance Requirements</b>
Environmental Requirements	Same as the standard scope Digital Oscilloscope.

**Table 6-6**  
**Video Option 05 (TV Trigger) Mechanical Characteristics**

<b>Characteristics</b>	<b>Performance Requirements</b>
Weight	Same as the standard scope Digital Oscilloscope.



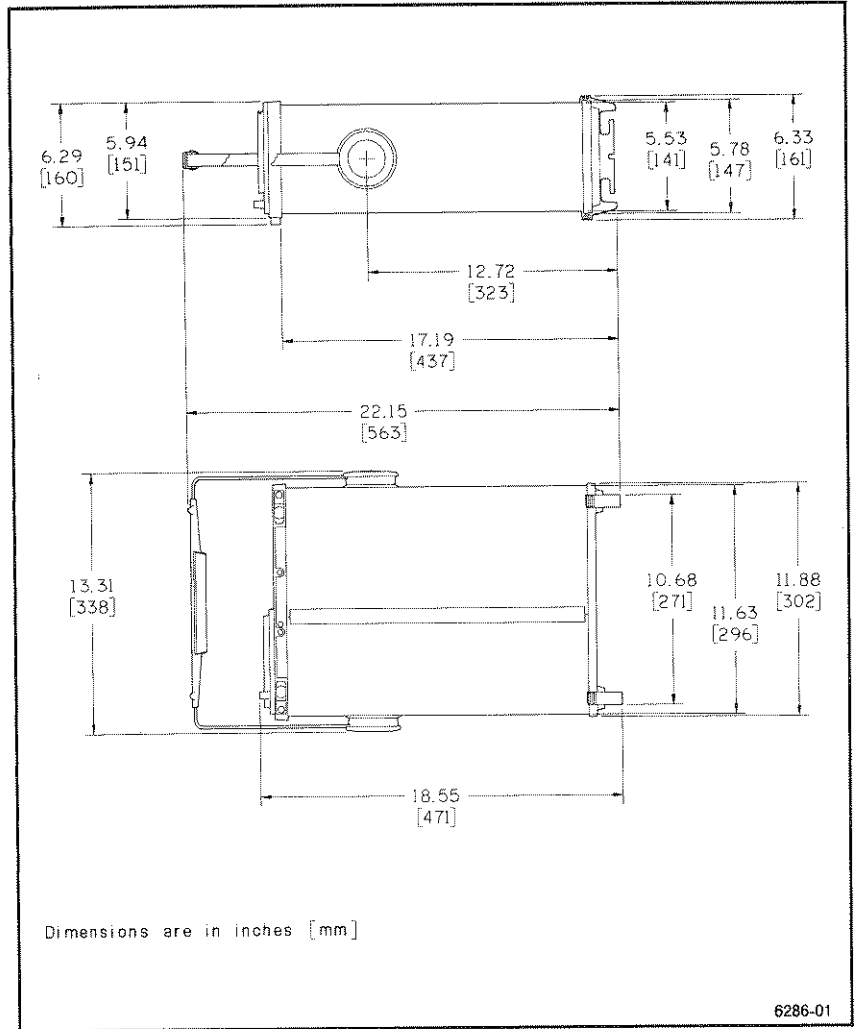
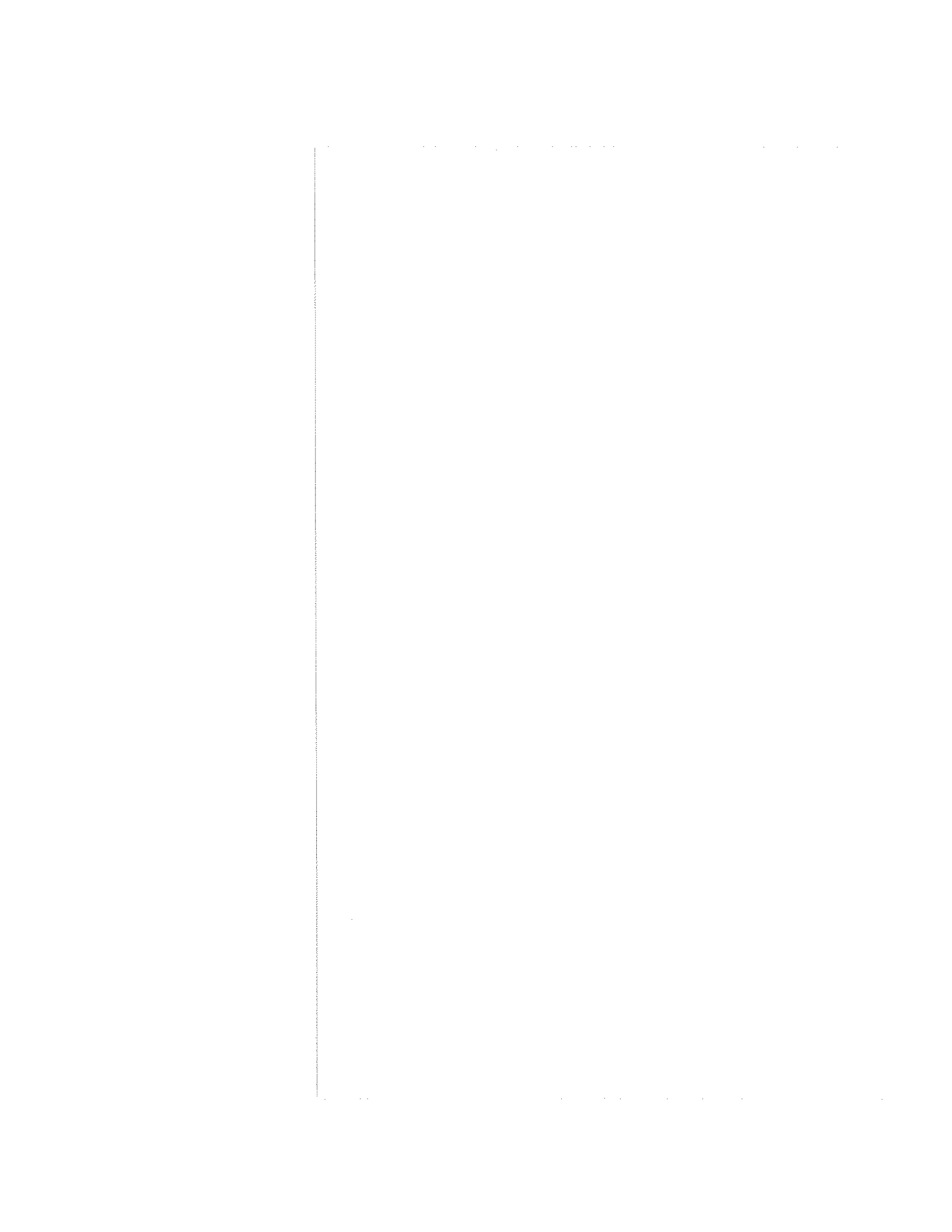

Figure 6-1. Dimensional drawing.



---

# ***Options and Accessories***

## ***Options Descriptions***

This section contains a general description of the options available for the 2440 Digital Storage Oscilloscope when the manual was published. The options are:

Options A1-A5	International Power Cords
Option 1R	Rackmounting
Option 03	Word Recognizer Probe
Option 05	Video Option
Option 11	Probe Power

Operating instructions for the Video Option and the Word Recognizer Probe Option/Optional accessory follow the general descriptions. A complete list of standard accessories supplied with the instrument and a list of suggested optional accessories, each identified by part number, is included at the rear of this section.

Additional information about instrument options, option availability, and other accessories can be obtained from the current Tektronix Products Catalog or by contacting your local Tektronix Field Office or representative.

### ***Options A1-A5—International Power Cords***

Instruments are shipped with the detachable power-cord configuration ordered by the customer. Descriptive information about the international power-cord options is provided in Section 1, "Preparation for Use." The following list identifies the Tektronix part number for the available power cords.

#### **Universal Euro**

Power cord (2.5 m)                      Option A1

#### **UK**

Power cord (2.5 m)                      Option A2

#### **Australia**

Power cord (2.5 m)                      Option A3

#### **North America**

Power cord (2.5 m)                      Option A4

#### **Switzerland**

Power cord (2.5 m)                      Option A5

### ***Option 1R—Rackmounting***

When this instrument is ordered with Option 1R, it is shipped in a configuration that makes it easy to install in a 19-inch-wide equipment rack. An optional rackmounting kit may be ordered to convert the standard instrument to a rackmounted instrument. Installation instructions for rackmounting are provided in the documentation supplied with the rackmounting kit and the 1R Option.

The rear-support kit supplied with the option must be used to ensure that the rackmounted instrument will meet all the electrical and environmental specifications of the standard instrument.

Connector-mounting holes are provided in the front panel of the rackmounted instrument. These holes make it possible to gain front access to the rear-panel BNC connectors, or rear access to the front-panel Vertical Channel and External Trigger connectors. The user decides which signals to route through the rackmounting front panel. Although the user must supply any additional cables and connectors needed for through-panel access, the necessary items can be ordered from Tektronix, Inc.

### **Option 03—Word Recognizer Probe**

The Word Recognizer Probe is available as an option or can be ordered as an optional accessory. In either case, it is used to trigger the instrument on a user-selected parallel TTL data word. The Probe recognizes a word having 16 bits plus a 17th qualifier bit. Each bit can be 0, 1, or X (don't care). Either recognition can be synchronous with the rising or the falling edge of an external clock signal, or it can be asynchronous.

The standard 2440 Digital Oscilloscope includes the hardware and firmware needed for using the Word Recognizer Probe. If your instrument was purchased without Option 03, it is only necessary to purchase the Word Recognizer Probe as an optional accessory. If your instrument was purchased with Option 03, the Word Recognizer Probe was included.

### **Option 05—Video Option**

Option 05 aids in examining composite video signals. With the Video Option installed, all basic instrument functions remain the same, but some menus are changed. These changes are shown in Table 5-2, "Control Menus and Displays" of Section 5, "Controls, Connectors, and Indicators." Features of this option include a sync separator, back-porch clamp circuitry, TV trigger coupling modes, and adjustment for closer tolerance on the 20-MHz BANDWIDTH LIMIT. This option permits the user to trigger on a specific line number within a TV field and provides sync-polarity switching for either sync-negative or sync-positive composite video signals.

### **Option 11—Probe Power**

Option 11 provides two probe-power connectors on the rear panel of the instrument. Voltages supplied at the PROBE POWER connectors meet the power requirements of standard Tektronix active oscilloscope probes.

## ***Option Operating Information***

### ***Video Options***

#### ***Introduction***

This instrument, with the Video Trigger (Option 05) installed, contains additional hardware and software components to simplify the triggering and viewing of video signals. All standard instrument operating controls and features remain unchanged. The Video Option is fully controllable via the GPIB. GPIB commands for the Video Option are given in the Programmers Reference Guide.

Features of this option include a sync separator, back-porch clamp circuitry, TV trigger coupling modes, and adjustment for closer tolerance on the 20-MHz bandwidth limit. This option permits the user to trigger on a specific line number within a TV field and provides sync polarity switching for either sync-negative or sync-positive composite video signals.

Both system-M and nonsystem-M operation are available, providing compatibility with most U.S. television signal line-numbering formats. Stable video rejection and sync separation is obtained from the sync-positive or sync-negative, interlaced or non-interlaced scan, composite video signals having 525 to 1280 horizontal lines per frame and 50- or 60-Hz field rates.

#### ***Video Option Accessories***

In addition to the standard accessories supplied with the 2440, the following accessories are provided when Option 05 is installed in the instrument:

- 1 CCIR Graticule, Tektronix Part Number 378-0199-04
- 1 NTSC Graticule, Tektronix Part Number 378-0199-05

#### ***Video Option Specifications***

The electrical characteristics of the Video Option are listed in Table 6-4 in Section 6 of this manual. All other electrical, environmental, and mechanical characteristics are the same as for the standard instrument.

## General Operation

Selecting VIDEO in the A TRIGGER COUPLING menu enables the sync separator circuitry of the Video Option. Pressing the front-panel button labeled SET VIDEO calls up the control menu for setting up the operating mode of the Video Option.

**CLAMP (CHANNEL 2 ONLY).** The Channel 2 back-porch clamp circuit is used to stabilize TV waveform displays by removing unwanted hum or tilt from displayed waveforms. With the CLAMP function on, the back-porch level of the video signal displayed on CH 2 will be held near ground level. Clamp circuit operation will be unpredictable if the Channel 2 signal is not a composite video or composite sync signal or if the scope is not being triggered with video sync signals.

If the back-porch clamp is enabled without a video sync signal applied to the sync separator, the CH 2 trace may drift vertically, which is normal. When the back-porch clamp is turned off, regular operation is restored.

When any front-panel change is made while back-porch clamp is enabled, the display may jump vertically. However, the back-porch clamp circuit will return the back-porch level to its previous position.

**FIELD TRIGGERING.** Either FIELD 1 or FIELD 2 in interlaced video signals may be selected for triggering. ALT (alternate field triggering) causes the triggering to alternate between the two fields.

With field triggering selected (Field 1 only for "noninterlaced" video signals), the A TRIGGER LEVEL/FIELD LINE # knob is used to select a specific line within the field on which to trigger. Line numbers may be selected from 1 to the maximum number of lines per frame in the video signal being viewed. The acquisition will trigger on the chosen horizontal line sync pulse after all holdoffs have been satisfied. In an interlaced TV signal, Field 1 has one more line than Field 2; however, the last line in Field 1 is not accessible when alternate (ALT) field triggering is selected because the line counter counts only to the highest common line number.

## **Options and Accessories**

---

**SYSTEM SELECTION.** System-M or nonsystem-M operation is selected using the SYSTEM menu under EXTENDED FUNCTIONS. In system-M operation, line counting begins three lines before the field sync; in nonsystem-M operation, line counting starts just after the field sync.

**SYNC POLARITY.** Sync polarity is selected with the A Trigger SLOPE/SYNC front-panel button. When VIDEO Coupling is selected, the SLOPE/SYNC selector button controls the signal polarity applied to the sync separator and operates independently of the SLOPE selection for the A and B Trigger signals. SYNC polarity for correct sync separator operation is chosen as follows.

For composite-video signal inputs (at the input BNC) with positive-going sync and negative-going picture information, the SLOPE/SYNC is set to + (plus). For composite-video signal input with negative-going sync, the SLOPE is set to - (minus). The INVERT feature of the Vertical inputs has no effect on the polarity of the trigger signal to the Video Option sync separator.

### **Setting Up the Video Option**

Pressing the SET VIDEO front-panel button calls up the following menu. (See Section 5, Item 37.)

<b>A VIDEO COUPLING</b>			<b>CLAMP</b>	
<b>FIELD1</b>	<b>FIELD2</b>	<b>ALT</b>	<b>TV LINE</b>	<b>ON/OFF</b>

**FIELD1:** Acquisition is triggered on a selected line during Field 1 of the input video signal. The line number and field indicator (TVF1) are displayed in place of the normal A-Trigger Level and Source readout.

**FIELD2:** Acquisition is triggered on a selected line in Field 2 of the input video signal. When Field 2 is the selected field, TVF2 is the displayed indicator in front of the line number readout. An input signal must be interlaced to activate and display FIELD 2 in the SET TV menu.



NOTE

*The Video Option circuitry does not detect the color-burst phase or Bruch Sequence color burst blanking information. In a four-field Pal Sequence with Bruch Sequence color burst blanking, Fields 1 and 3 will be displayed when Field 1 is selected (odd fields), and Fields 2 and 4 will be displayed when Field 2 is selected (even fields). On noninterlaced scan systems the TV circuitry detects the start of field information only.*

**ALT:** Acquisition is alternately triggered on a selected line during both fields of an interlaced video signal. With alternate field triggering selected, the indicator in front of the line number readout is TVFLD.

When B Horizontal mode is selected with  $\Delta$  TIME ON, one field of a single channel video signal will be displayed at the main delay and the other field will be displayed at the main delay plus the delta delay. If CH 1 and CH 2 are both on, the CH 1 signal will be one field at the main delay and the CH 2 signal will be the other field at the main delay plus the delta delay. If the delta delay is adjusted for zero delay time, a line-by-line comparison between the two fields may be done using the FIELD LINE # control knob to move through the two fields in unison.

**TV LINE:** Selects any line within either field for triggering the oscilloscope when the Video Option is enabled (TV CPLG on). An acquisition will be triggered by the first line-sync pulse encountered after all holdoffs have been satisfied. The indication for TV LINE triggering selected is TVLN without a line number readout being displayed.

**CLAMP ON:OFF:** Controls the Channel 2 back-porch clamp feature. The clamp circuit holds the video signal back-porch level to a constant dc level (the vertical position of the ground indicator) and eliminates vertical drift, hum, and tilt from the display. A stable display is provided despite changes in signal amplitude and luminance levels. When the Video Option CLAMP feature is ON, the message CLAMP appears on the screen, and the clamp circuitry continues to function for the Channel 2 display until CLAMP is set to OFF.

### ***Setting a Line Number***

When the Video Option is on, the A TRIGGER LEVEL/FIELD LINE # knob is used for selecting a specific horizontal line within a field. For line number selection within a specific field, the field and line numbers are displayed in the upper-right corner of the CRT screen in place of the normal A-Trigger Level readout.

Rotating the LEVEL/FIELD LINE # knob clockwise increases the selected line number in a field; rotating it counterclockwise decreases the line number. (The LEVEL/FIELD LINE # knob still sets the B-Trigger Level when the A/B TRIG button is pressed to select B-Trigger operation.)

When the user attempts to select lines beyond the maximum or minimum line number available in the selected field, the action taken depends on the user selection for CNT RST BOTH:F1 (Count Reset Both or F1). If set to BOTH, and ALT (alternate field coupling) is not selected in the A VIDEO COUPLING menu, attempting to turn the control past the first or last line number in the field selects the last or first number (respectively) of the opposite field. In these cases, the underscored FIELD choice in the SET VIDEO control menu and the field-number (TVF1 or TVF2) readout preceding the line number readout also switch to reflect the correct field.

If CNT RST is set to F1 (again, ALT not selected), the instrument treats the two fields as one large field, with the maximum line number available equaling the sum of field 1 and field 2. When the maximum line number of field 1 is encountered, the line readout will increment that number by 1 when line 1 of field 2 is selected. "Wrap-around" occurs at both ends in both directions (for example, for CCIR System B usage, attempting to select one count less than line one selects 625; one more than 625, line 1). Again, the menu and field-number readout indicate the field selected.

If ALT is selected, the selection for CNT RST doesn't matter. The instrument alternates between fields for triggering successive acquisitions, using the same line count for both fields. Further rotation of the control past the maximum or minimum line number only resets the line count to the beginning (line 1) or the end. (The end is the maximum line count common to both fields—for CCIR System M, it is line 262 in field 2.)

The user selects the setting for CNT RST via the EXTENDED FUNCTION menu. Steps 1 and 2 of the procedure "System-M/Nonsystem-M Protocol Selection" describes how.

### **System-M/Nonsystem-M Selection**

The following procedure is used to select a particular protocol using the EXTENDED FUNCTIONS menu.

1. Press the MENU OFF/EXTENDED FUNCTIONS front-panel button twice. (See Figure 5-1 and Item 8 in Section 5, "Controls, Connectors, and Indicators.") The first press turns off any menus being displayed and the second calls up the EXTENDED FUNCTIONS menu.
2. Press SYSTEM to call up the selection menu for the system extended functions. Press VIDEO OPT to select that menu.
3. Under TV SYS, use the menu button to toggle between M and NON-M as desired. (The selected protocol is underlined.)

Selecting an incorrect protocol for a given TV signal will not affect the ability to trigger on that signal. It will, however, cause the specific line number within the field to be inaccurate. When system-M is selected, the line count begins three lines before the field-sync pulse is encountered. When nonsystem-M is selected, the line count begins coincident with the field-sync pulse.

### **Special Measurements**

**OVERSCANNED DISPLAYS.** For various video measurements, it may be desirable to expand the video waveform vertically beyond the limits of the screen. Under these circumstances, the trigger amplifiers or the sync separator circuitry may be overloaded, blocking out sync pulses at the point of large signal transitions or losing sync pulses altogether. Therefore, to avoid overload problems, use the other vertical channel or one of the external trigger inputs (EXT1 or EXT2) to supply a constant amplitude trigger signal to the Video Option while the observations are being made on the expanded waveform.

**RF INTERFERENCE.** Operation near some FM and TV transmitters may impress objectionable amounts of rf signal energy on the input signal, even when coaxial cables are used to make the signal connections. Using the 20-MHz BANDWIDTH limit feature will usually eliminate such interference from the display, but it does not limit the signal reaching the Video Option circuitry. Where the rf energy interferes with the TV triggering operation, external filters will be required to limit the bandwidth of the trigger signal. In such cases, it is recommended that one of the external trigger inputs (EXT1 or EXT2) be used to supply the trigger signal, using the required external bandwidth limiters and attenuators to obtain the necessary trigger amplitudes.

### ***Identifying Fields, Frames, and Lines in 525/60 and 625/50 TV Systems***

**NTSC (CCIR SYSTEM M).** Field 1 is defined as the field whose first equalizing pulse is one full H interval (63.5  $\mu$ s) from the preceding horizontal sync pulse. The Field 1 picture starts with a full line of video, and its lines are numbered 1 through 263, starting with the leading edge of the first equalizing pulse. The first regular horizontal sync pulse after the second equalizing interval is the start of line 10.

Field 2 starts with an equalizing pulse a half-line interval from the preceding horizontal sync pulse. The Field 2 picture starts with a half line of video and its lines are numbered 1 through 262, starting with the leading edge of the second equalizing pulse. After the second equalizing interval, the first full line is line 9.

**CCIR SYSTEM B AND SIMILAR 625/50 SYSTEMS.** Except for PAL systems, identification of parts of the picture in most 625-line, 50-Hz field-rate systems relies primarily on continuous line numbering rather than on field-and-line identification.

The CCIR frame starts with the first (wide) vertical sync pulse following a field which ends with a half-line of video. The first line after the second equalizing interval is line 6; the first picture line is line 23 (half-line of video). The first field of the frame contains lines 1 through the first half of line 313, and the picture ends with a full line of video (line 310).

The second field of the frame commences with the leading edge of the first (wide) vertical sync pulse (middle of line 313) and runs through line 625 (end of equalizing interval). The first full line after the equalizing interval is line 318; the picture starts on line 336 (full line).

The first field is referred to as "odd," and the second field as "even." Note that the identification systems for System-M and System-B are reversed.

In the four-field PAL sequence with Bruch Sequence color-burst blanking, the fields are identified as follows:

- Field 1: Field that follows a field ending in a half-line of video, when preceding field has color burst on the last full line. Field 1 lines are 1 through 312 and half of line 313. Color burst starts on line 7 of Field 1; a half-line of video appears on line 23.
- Field 2: Field that follows a field ending in a full line which does not carry color burst. Field 2 lines are the last half of line 313 through line 625. Color burst starts on line 319 (one line without burst following the last equalizing pulse); a full line of video appears at line 336.
- Field 3: Field that follows a field ending in a half line when preceding field has no color burst on its last full line. Field 3 lines are 1 through the first half of line 313. Burst starts on line 6 (immediately following the last equalizing pulse); a half-line of video appears on line 23.
- Field 4: Field that follows a field ending in a full line carrying color burst. Field 4 lines are the second half of line 313 through line 625. Color burst for Field 4 starts on line 320 (two full lines without burst follow the last equalizing pulse); video starts with a full line on line 336.

### **Basic Applications**

This instrument, with the TV Option installed, is an accurate and flexible measurement system for displaying and analyzing video information. After becoming familiar with the controls, indicators, operating considerations, and capabilities of the instrument, perform the following procedures to become familiar with the functions for making TV-related measurements.

Verify that the POWER switch is OFF (push button out); then plug the power cord into the power outlet.

## **Initial Setup**

- a. Press in the POWER switch button (ON).
- b. Set the instrument controls to obtain a baseline trace as follows:

### **Trigger**

TRIG POS (A and B)	1/2
MODE	AUTO
SOURCE	CH 2
COUPLING	TV
SET TV	
FIELD 1	Selected
CLAMP	ON
LEVEL/FIELD LINE #	1
SLOPE/SYNC	— (minus)
HOLDOFF	Off (no Holdoff indicator displayed)

### **Storage Mode**

ACQUIRE	ENVELOPE (1 acquisition)
---------	--------------------------

### **Horizontal**

MODE	A
SEC/DIV	2 ms
POSITION	Center trigger-point indicator

### **Vertical**

CH 2 POSITION	Center baseline trace
MODE	CH 2
CH 2 VOLTS/DIV	500 mV
CH 2 COUPLING	GND

### **Extended Functions System**

TV SYS	M
--------	---

c. Adjust the DISPLAY and READOUT intensity for the desired brightness of the trace and readout.

d. Apply a composite video signal (with color-burst signal and negative-going sync) to the CH 2 input connector using a coaxial cable with the proper terminations for impedance matching.

e. Set CH 2 input coupling to DC; observe the field-rate signal envelope.

f. Press SET TV to display the Video Option menu.

g. Rotate the LEVEL/FIELD LINE # knob counterclockwise into the end region of Field 2. Observe that the field number indicator switches to TVF2 and that FIELD2 becomes the underscored field choice in the control menu.

h. Rotate the FIELD LINE # knob clockwise through the entire Field 1 display and set the line number for line one of Field 2.

i. Switch the A SEC/DIV setting to 50  $\mu$ s and set the ACQUIRE mode to NORMAL.

j. Observe that line number 1 is in the vertical blanking region prior to the vertical sync pulse.

k. Set the line number for line 263 of Field 1 and set the A SEC/DIV to 2  $\mu$ s for a close examination of the waveform around the horizontal sync pulse.

l. Supply a trigger signal to external trigger input EXT1.

m. Set the following controls:

B TRIGGER MODE	RUNS AFTER
B SEC/DIV	500 ns
A TRIGGER SOURCE	EXT1
EXT GAIN	EXT1/5
CH 2 VOLTS/DIV	100 mV
Horizontal MODE	B
DELAY by TIME	ON
DELTA TIME	OFF
DELAY TIME	Minimum

### ***Options and Accessories***

---

- n. Adjust the DELAY TIME to observe the color-burst signal (approximately 4 to 5  $\mu$ s delay from RTRIG).
- o. Press CURSOR FUNCTION and select VOLTS cursors. Measure the peak-to-peak voltage of the color-burst reference signal.
- p. Press the SAVE front-panel button.
- q. Save the color-burst signal in REF4.
- r. Expand the SAVED display by switching the B SEC/DIV setting to 100 ns.
- s. Measure the frequency of one cycle of the color-burst signal. A simple way to do this is: press the Cursor FUNCTION button and select V@T cursors; set the exact time by adjusting them so the TIME cursors are one period apart while the VOLTS cursors overlap at 0 V; then press 1/TIME to measure the frequency.
- t. Set the Horizontal MODE to A and press the ACQUIRE button.
- u. Press DISPLAY REF and press REF4 to recall the previously stored waveform.
- v. Set the SEC/DIV control back to 500 ns and compare the SAVED waveform with the REF4 waveform display.
- w. Switch the Horizontal Mode to A and press the ACQUIRE button to restart the waveform acquisition.



## Signal Input Coupling

The CH 2 back-porch clamp stabilizes video waveform displays by removing unwanted hum and tilt from the Channel 2 display. For the clamp circuit to be functional, the instrument must be triggered on a composite video or composite sync signal.

The following procedure demonstrates the appearance of a video signal with CLAMP either ON or OFF.

### NOTE

*When enabling the back-porch clamp (CLAMP ON), leave the rear-panel CH 2 SIG OUT connector unterminated (open) to preserve waveform fidelity of video signals applied to the CH 2 Vertical Input connector.*

- a. Connect a composite video signal (negative-going sync) along with an overriding ac signal of 60 or 120 Hz (simulating power-supply hum) to the CH 2 input connector.
- b. Set the A SEC/DIV to 5 ms.
- c. Set VOLTS/DIV to obtain a display amplitude of at least 2 divisions.
- d. Press the front-panel Trigger CPLG (coupling) button and select TV from the A TRIGGER COUPLING menu.
- e. Press SET TV panel button, and select FIELD 1 or FIELD 2 triggering; then press the CLAMP OFF menu button.
- f. Select the ENVELOPE acquisition mode and observe the presence of ac tilt or hum on the displayed trace.
- g. Press SET TV again and turn the CLAMP ON.
- h. With the CH 2 back-porch CLAMP enabled, observe that the ac hum on the waveform has been eliminated. (See Figure 7-1.)

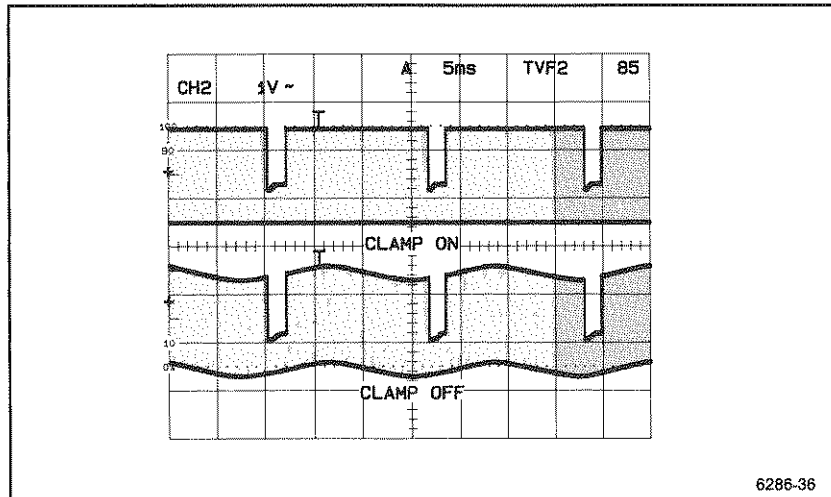

Figure 7-1. Composite video signal with and without TV clamping.

### Word Recognizer Probe Options

The Word Recognizer Probe is used to trigger on a selected parallel TTL data word. The following text is general operating information.

Electrical connection from the Word Recognizer Probe to the scope is via the rear-panel connector labeled P6407 WORD RECOG INPUT. The instrument has one Word Recognizer Probe connector, but the trigger output from the probe can be selected as the source for the A-Trigger signal or the B-Trigger signal, or for both using the A and B TRIG SOURCE menus. The system indicates whether the WORD trigger is the selected trigger Source for A- or B-Trigger, or both, in the TRIG WORD menu (displayed when the SET WORD front-panel button is pressed).

Attempting to select WORD as a trigger source or to program the probe operation without a Word Recognizer Probe connected will ring the warning bell and display the error message WORD PROBE FAULT. In that case, the trigger source remains as previously selected. The same error message will appear if the Word Recognizer Probe is disconnected after WORD is selected while the scope is acquiring. Disconnecting the probe will not be detected while the scope is in SAVE mode; however, any attempt to change the programmed word with the probe removed will result in a WORD PROBE FAULT.

A word length of 16 bits, plus a 17th qualifier bit, can be recognized. Each bit is selectable to 0, 1, or X (don't care). Word recognition may be either synchronous with an external clock signal (rising or falling edge) or asynchronous (ignoring clock signals).

The word-recognizer trigger signal is routed to the rear-panel BNC connector labeled WORD TRIG OUT for use as a trigger signal to external devices. A trigger signal will appear at the WORD TRIG OUT connector each time a word match occurs; however, the holdoff time of the scope may prevent it from accepting each trigger if the selected word appears too often in the data stream.

### **Word Probe Setup**

The front-panel button labeled SET WORD calls up the menu for setting up the Word Recognizer Probe operation. The RADIX choice lets you display the selected word in either octal or hexadecimal form. Under the CLOCK in the menu, you can select either the rising-edge of clock, falling-edge of clock, or ASYNChronous (ignore clock) for determining when a data match will produce an output trigger.

Pressing the SET BITS menu button calls up the TRIG WORD menu for setting the word to be recognized. The trigger word is displayed in binary form (for ease in setting the individual bits) and in either octal (six digits) or hexadecimal (four digits) as selected under the RADIX choice (for ease in user identification of the trigger word). Digits containing don't care bits (X) in the binary word display are shown in the octal or hex representation as a question mark (?).

The binary trigger-word bits are selected for setting by using the direction-arrow menu buttons to position the underline beneath the bit to be set. Once the underline is positioned as desired, that bit may be set by pressing a 1, 0, or X menu button. After a bit is set, the cursor automatically advances to the next bit as directed by the last arrow-button choice. The bit selection and arrow buttons are repeating; they continue their function and rotate through the bits as long as they are held down. Using the repeating feature, all the word bits (or any portion of the bits) may be set to one, zero, or X. The specific bits for change may then be selected one at a time by pressing the arrow keys as necessary to position the underline, and then pressing the correct bit button once.

### **Basic Application**

The following procedure is a general guide to Word Recognizer operation:

1. Connect the Word Recognizer Probe to the instrument and the system under test. Note that bits 0-7 and the clock appear on one side of the probe and bits 8-15 and the qualifier bit appear on the other. Be sure to connect at least one of the GND terminals to a good signal ground in the system, as close to the trigger source as possible.

2. Use A/B TRIG front-panel button to select the desired Triggering system.

3. Press TRIGGER SOURCE to display that menu.

4. Set A\*WORD to WORD in the displayed menu. (If the Word Recognizer Probe is not connected, the message WORD PROBE FAULT will be displayed and the coupling switched to VERT.)

5. Press the SET WORD front-panel button to display the WORD RECOGNIZER setup menu. Set the menu as desired to select OCTal or HEX RADIX, rising edge symbol ( $\uparrow$ ), falling edge symbol ( $\downarrow$ ), or ASYNCHRONOUS (no clock) as desired.

6. Press the SET BITS menu button to display the TRIG WORD menu. (Repeatedly pressing SET WORD also toggles between the SETUP and the TRIG WORD menus.)

7. Use the menu buttons to set the trigger word:

a. Use the arrow-labeled buttons in the menu to move the underline to a bit in the word you want to change.

b. Select 0, 1, or X (don't care) for the bit as required. (For convenience in setting, the underline automatically steps 1 bit at a time in the direction of the last arrow pressed.)

c. Repeat Steps a and b until all bits are set as desired. Note that the menu also displays the word in OCT or HEX (depending on the RADIX previously selected).

8. The instrument will now recognize the specified word for triggering purposes.

## Accessories

### Standard Accessories

The following standard accessories are provided with each instrument.

	PART NUMBER
2 Probes, 10X, 1.3 Meter, with Accessories	P6137
1 Accessory Pouch, Snap	016-0692-00
1 Accessory Pouch, Ziploc	016-0537-00
1 Operators Manual	070-6599-00
1 Programmers Reference Guide	070-6601-00
1 Pocket Programmers Guide	070-6602-00
1 Users Reference Guide	070-6600-00
1 Fuse, 5 A, 250 V, AGC/3AG	159-0014-00
1 CRT Filter, Blue Plastic (installed)	378-0199-03
1 CRT Filter, Clear Plastic	378-0208-00
1 Front Cover	200-3199-01

### Rackmounting Accessories

The following accessories are available to rackmount the instrument, if it was not purchased as a 1R option.

	PART NUMBER
Rackmounting conversion kit	016-0825-01
Rackmounting rear-support kit (for use with the rackmounted instruments)	016-0096-00

**Options and Accessories**

---

**Optional Accessories**

The following optional accessories are recommended for use with the 2440 Digital Oscilloscope.

	<b>PART NUMBER</b>
Service manual	070-6603-00
Word Recognizer probe	010-6407-01
Color Plotter	HC100
Oscilloscope cameras	C-5C, Option 02 C7, Option 03, Option 30
SCOPE-MOBILE cart	K212, K213
Carrying strap	346-0058-00

## ***Extended Functions***

The information in this section describes and defines the performance of the EXTENDED FUNCTIONS. There are two types of EXTENDED FUNCTIONS that operators can use: SYSTEM and CAL/DIAG. A third type, SPECIAL, is for servicing only and performs no user functions. The control menus under SYSTEM are seldom used and, once set for the system operation wanted, are not normally accessed. Control menus for the internal calibration and diagnostics are accessed using the CAL/DIAG menu selection. The instrument system supports three levels of internal diagnostics: Self Diagnostics, Extended Diagnostics, and Service Routines. Calibration is in two levels: Self Calibration and Extended Calibration.

### ***SPECIAL Functions***

The menu choices under SPECIAL are normally disabled, and if you press the SPECIAL button, the message DISABLED—SEE MANUAL is displayed. If the functions are not disabled, the the SPECIAL button calls up the display WARNING: SERVICE ONLY—SEE MANUAL with the choices COLD START, CCD SIDES, CCD ADJ, CAL PATH ON!OFF and FORCE DAC. All five choices are special service functions that should not be called up by operators/users. COLD START eliminates all the previous calibration constants. After a COLD START, a partial re-calibration is required to return the instrument to its previous state. CCD SIDES, CAL PATH ON!OFF and FORCE DAC are special diagnostic tools which service technicians can use to change the value of selected constants when troubleshooting the internal circuitry.

### ***SYSTEM Functions***

Pushing SYSTEM displays the SYSTEM menu. This menu allows the user to specify settings for certain seldom-changed functions.

In this menu, one button, PREFLT ON!OFF, turns a function on and off while the other three buttons, PANEL, MISC, and VIDEO OPT, call up submenus for controlling functions.

## **PREFLT ON/OFF**

When PREFLT is turned on, it operates on interpolated data points only. It reduces the filter overshoot in the  $\sin x/x$  interpolator which occurs when viewing very fast risetimes. Generally, PREFLT is set to on for normal operation; if viewing very fast risetimes, the user might prefer to turn off the prefilter.

## **PANEL**

PANEL calls up a submenu containing two menu choices: POWER ON LAST:INIT and ERASE MEMORY. POWER ON LAST:INIT is for specifying how the front-panel controls are set up at power-on. When the button is toggled to select LAST, the control settings in effect at power-off are reestablished at power-on. When toggled to INIT, a factory setup of initialized front-panel settings is established at power-on.

In general, powering up in INIT produces a simple setup with CH 1 only displayed and all special functions (such as Delay by Events, Cursors, and Envelope or Average acquisition) turned off. (The complete list of controls and states of the INIT feature is found in Table B-15 of Appendix B). The button labeled INIT PANEL in the AutoStep Sequencer menu (accessed via the PRGM front-panel button) produces exactly the same front-panel setup as when the instrument is powered on with POWER ON set to INIT.

ERASE MEMORY calls up another submenu which is used to erase any waveforms saved on screen or stored in REFERENCE Memories 1-4, as well as all sequences stored in the AutoStep Sequencer memory. This feature allows easy removal of confidential waveform data and sequences.

Pushing ERASE erases the memories/sequences, runs a SELF TEST, and sets the front panel to the same settings as obtained when INIT PANEL is pressed in the AutoStep Sequencer menu. *Be aware that all saved waveforms, sequences, and the present front-panel setup will be lost.* ABORT allows the user to return to the PANEL menu without executing ERASE.

## **MISC**

MISC calls up a submenu for selecting miscellaneous function settings. The menu choices are BELL ON/OFF, TRIG T ON/OFF, AUTO PROBE, and ROLL MENU ON/OFF. The up-arrow labeled button returns the scope to the SYSTEM menu.

When BELL is set to ON, any warnings to the user regarding system operating errors (especially with the GPIB interface) can be signaled by an audible tone. BELL must be on for it to sound when running sequences containing steps that require the BELL to sound.



TRIG T, when set to ON, indicates the point where the Record Trigger occurred on displayed acquisitions. It is a small "T" riding on the waveform.

ROLL MENUS, when set to ON, allow users to select between two or more menu settings (for certain menus) using the front-panel button that called up the menu in the first place. (The first push selects the menu, subsequent pushes select between menu settings.) The menus that can use this feature are: COUPLING/INVERT, BANDWIDTH, TRIGGER POSITION, TRIGGER COUPLING, and TRIGGER MODE. Setting ROLL MENUS to OFF disables this feature.

## **AUTO PROBE**

AUTO PROBE calls up a submenu for selecting which of three functions the IDENT button on a probe will actuate if pressed. (The probes supplied with this instrument are equipped with IDENT buttons.) The probe must be connected to one of the front-panel inputs of the scope. The three functions are AUTO SETUP, STEP SEQ, and INIT50. The up-arrow labeled button returns the scope to the MISC menu.

Selecting a function, by pressing the button below that function, underlines the selection and turns it on, deselecting any other AUTO PROBE function previously on. Pressing the button of the selected function, again, turns off that function. If all three functions are off and the IDENT button on the probe is pressed, the "normal" identify function, channel designator (CH 1 or CH 2) underlining the channel that the probe is connected to, is performed.

Pressing the IDENT button if a function is on executes that function as described below. If the channel that the probe is connected to is not selected, pushing IDENT will select it, regardless of whether a function is selected or not. Pressing and holding the IDENT button when a function is selected, first causes the function to be executed, and then underlines the appropriate channel designator if the button is held long enough.

When AUTO SETUP is selected in the AUTO PROBE menu, pressing the probe's IDENT button executes an Auto Setup of the front panel using the mode currently set in the AUTO SETUP menu. Pressing IDENT does *not* display the AUTO SETUP menu; AUTO must be pressed to change Auto Setup modes. If the channel the probe is connected to is not turned on in the VERTICAL MODE menu, it is turned on and then automatically setup; otherwise, Auto Setup operates as described in Section 5 of this manual (see description for AUTO button).

## **Appendix A**

---

When STEP SEQ is on, pressing IDENT causes a paused AutoStep Sequence to resume execution. See description for PRGM button in Section 5.

When INIT50 is on, pressing IDENT performs the same function as the INIT@50 front panel button; namely, it forces the scope to set the trigger level to 50% of the peak-to-peak amplitude of the signal selected in the Trigger Source menu. The Trigger System affected is the one currently selected by the A/B TRIG switch. See description for INIT@50 button in Section 5.

## **VIDEO OPT**

VIDEO OPT calls up a submenu for setting up Video Option operation.

The scope is set up to use either System-M protocol or nonsystem-M protocol for sync operation via the TV SYS M:NON-M menu button. Choosing the wrong protocol does not prevent TV Triggering; however, the line counter will not count the lines correctly. When System-M is selected, the line count begins three lines before the field-sync pulse is encountered. When nonsystem-M is selected, the line count begins coincident with the field-sync pulse. See "Video Option" in Section 7 for more information.

CNT RST BOTH:F1 (Count Reset, Both or F1) controls how the scope treats Field 1 and Field 2 when lines are selected beyond the maximum or minimum line number available in those fields. The way the fields are treated depends on settings used in the A VIDEO COUPLING menu. See "Video Option" in Section 7 for more information.

## ***CAL/DIAG Functions***

When you press the button under in the EXT FUNCT menu, you get four choices: SELF CAL, EXT CAL, SELF DIAG, and EXT DIAG.

### ***Internal Diagnostic Routines***

The SELF DIAG and EXT DIAG routines detect and isolate system faults. They begin at the heart of the software, examining the microprocessor, ROM, RAM, and the kernel of the operating system. If these are found to be normal, it then runs further diagnostics in the various hardware subsystems of the instrument. When a fault is detected, it is isolated to a particular subsystem.

#### ***Self Diagnostics***

These are menu-driven tests, automatically executed at power-on. Self Diagnostics test the functionality of all components that are controlled or accessed by the internal System microprocessor. The Self Diagnostics routines can be accessed from the instrument front-panel or via the GPIB. If all tests pass, the system enters Scope mode.

#### ***Power-on/Self Diagnostics Test Failure***

If any Self Diagnostics test fails, either at power-on or when called by the user from the front panel, the scope enters EXTENDED DIAGNOSTICS mode and displays a menu showing which test(s) failed. This gives you a starting point for isolating the fault. Failure of a test in the 7000 through 9300 range does not necessarily indicate a fatal instrument fault. (See Table A-1 for a list of the tests with their numbers.) An abnormal power-off or a power transient may have kept the scope from saving enough data to return to its most recent operating state. Self Diagnostics will also fail if the present temperature of the scope is very different from the temperature during the last Self Calibration. In that case, the stored calibration constants may not permit accurate measurements to be made.

## Appendix A

---

### NOTE

*If the power-on Extended Diagnostics fail because of a prior abnormal loss of power, the scope will display the message RUN SELF CAL WHEN WARMED UP and it will remain locked in the EXTENDED DIAGNOSTICS menu until the user presses the up-arrow button to get the SELF CAL menu. It will then remain locked in the SELF CAL menu until SELF CAL is run. The user should wait for the NOT WARMED UP message to disappear from the menu before running SELF CAL.*

At power-on, the instrument checks the stored self-calibration constants, waveform data, waveform scaling factors, and power-off front-panel control settings. Failure of a 6000 subset diagnostic test indicates a checksum failure of the data stored in the nonvolatile RAM. A failure in this area is not necessarily fatal; the user may be able to recover normal, or near-normal, operation.

When CAL-CONSTANTS (test 6100) fails, the instrument does a COLD START, replacing all calibration constants with nominal values and setting all front-panel controls and GPIB states to their INIT values. (See Table B-15 in Appendix B for a complete list of INIT settings.) Since a COLD START invalidates all stored waveforms, the REF memories will be marked EMPTY and the VERTICAL MODE menu will contain the message CH1/2 WAVEFORMS INVALID. Also, if ADD or MULT is selected in the VERTICAL MODE menu, the ADD or MUL readout will say EMPTY in place of the vertical scale factor.

You can continue to use the instrument after a COLD START if you first perform SELF CAL. (Use the up-arrow button in the EXTENDED DIAGNOSTICS menu to get to the CAL/DIAG menu.) The SELF CAL procedure will take longer than usual because it has to work with the nominal values from the COLD START rather than the more accurate calculated values from the last SELF CAL.

### NOTE

**DO NOT TURN OFF THE SCOPE WHILE THE SELF CAL ROUTINE IS RUNNING** *because it will again invalidate the calibration constants.*

After SELF CAL, you must also do the REPET calibration if you want to use REPET mode. Although the ATTEN and TRIGGER calibration routines are generally disabled to the user, the nominal values from the COLD START will let you make normal measurements. The menu labels for these routines will be marked UNCALD, however, and the trigger level readout and the vertical gain may be slightly less accurate. Press the MENU OFF/EXTENDED FUNCTIONS button when you want to return to Scope mode.

After a COLD START, the instrument keeps reminding you that it needs a complete Extended Calibration by always powering up in the EXTENDED DIAGNOSTICS menu with the RUN SELF CAL, THEN RUN EXT CAL message. Also it continues to mark ATTEN and TRIGGER with UNCALD in the EXT CAL menu. To replace the COLD START calibration constants with actual calculated values requires external test equipment and access to the inside of the scope, so it should only be done by a qualified service person.

Loss of the stored power-off front-panel settings, which is indicated by failure of FP-LAST (test 6200), causes the scope to do an INIT PANEL on power-up. (See Table B-15 in Appendix B for the INIT settings.) To recover normal operation, simply press the MENU OFF/EXTENDED FUNCTIONS button to get out of EXTENDED DIAGNOSTICS and set the front-panel controls however you want them. If there has been no permanent failure of the memory, the FAIL condition for test 6200 will be reset to PASS and the scope will not enter EXTENDED DIAGNOSTICS on the next power-up.

Loss of waveform scaling factors, indicated by failure of WFM-HEADERS (test 6300), invalidates all waveforms. At power-on, invalid waveforms may be displayed, but a CH1/2 WAVEFORMS INVALID message will appear in the VERTICAL MODE menu and the REF memories will be labeled EMPTY in the DISPLAY REF menu. You can restore normal operation of the scope by pressing the MENU/OFF EXTENDED FUNCTIONS button to exit EXTENDED DIAGNOSTICS, and then pressing ACQUIRE to resume acquiring waveform data.

Loss of individual waveforms from the SAVE memory will not cause a power-up test failure. Such a loss can occur if the scope is in the midst of acquiring when the power is turned off. The user is notified of this loss by replacing the invalid waveform(s) with a horizontal line broken by full-screen fill areas.

Failure of diagnostic tests numbered 7000 through 9300 may indicate that the calibration constants are invalid at the present temperature. This non-fatal condition can occur if the operating temperature at the last SELF CAL was very different from the present temperature. The instrument will power up in the EXTENDED DIAGNOSTICS mode with the RUN SELF CAL WHEN WARMED UP message. To recover normal operation, wait for the NOT WARMED UP message to disappear from the CAL/DIAG menu, then run SELF CAL.

If one of the tests numbered 7000-9300 continues to fail after SELF CAL, a condition exists that will prevent correct operation. However, depending on the nature of the failure, you may still be able to make limited use of the scope. For example, if the failure is in the CH 2 side only, you can still use CH 1 with confidence in its vertical accuracy. Press the MENU OFF/EXTENDED FUNCTIONS button to enter Scope mode.

## **Appendix A**

---

When Self Diagnostics is called via the GPIB, completion and/or failure will cause an SRQ to be issued by the instrument. The status bytes returned on a poll indicate a successful completion or failure of the Self Diagnostics sequence. Errors can then be queried via the GPIB and traced to the lowest level of the Extended Diagnostics in the same manner as from the front-panel. Failure of Self Diagnostics when run from the GPIB does not put the instrument into the Extended Diagnostics menu.

### ***Extended Diagnostics***

You can run Self Diagnostics tests individually or in selected groups by using the EXT DIAG menu. The tests minimize the need to apply external signals or use external test equipment for troubleshooting because they use internal feedback and the digitizing capabilities of the instrument. Testing of a failed area down to the lowest functional level possible (in some cases to the failed component) provides direction for further troubleshooting with service routines and/or conventional methods. Assumptions based on passed tests can also help with troubleshooting by eliminating good circuit blocks from consideration.

### ***Service Routines***

The Service Routines are menu, GPIB interface, or jumper-initiated routines for exercising the hardware, usually in a looping mode, that allow a service technician to troubleshoot an internal fault using external test and measurement equipment. Where possible, the Extended Diagnostics routines are used for looping so they can be accessed from both the front-panel EXTENDED FUNCTIONS menu and the GPIB interface.

These routines provide service personnel with signals and procedures that enable them to isolate faults and restore the instrument to a functional level that is supported by the Extended Diagnostics and/or other Service Routines.

Programmed routines that systematically exercise specific firmware or hardware functions may be implemented via the GPIB interface. This enhances troubleshooting performance by providing a comprehensive tool for instrument troubleshooting using controller programming.

## **Internal Calibration Routines**

The instrument system supports two levels of Internal Calibration routines: SELF CAL and EXT CAL. These routines calibrate the analog subsystems of the scope to meet specified performance requirements. Any detected faults in the control system and/or in the self-calibrating hardware are reported by a FAIL message displayed with the label of the failed area.

### **Self Calibration**

Self Calibration can be started either from the front panel using the EXTENDED FUNCTIONS menu or via the GPIB. Self Calibration routines automatically calibrate most of the scope's analog system in about 10 seconds. The user may do a Self Calibration at any time, but it is particularly advisable to do one after the instrument has warmed up, after the ambient operating temperature has changed by a significant amount, and just prior to making a measurement that requires the highest possible level of accuracy.

### **Extended Calibration**

#### **NOTE**

*The Extended Calibration feature is normally disabled, and the scope must be referred to a qualified service person to complete these procedures.*

Extended Calibration includes routines that require standard voltages must be applied to appropriate inputs to calibrate the attenuators and the trigger amplifiers.

If an Extended Calibration is attempted without the correct standard voltages, the calibration constants will not be changed. However, the FAIL message will appear above the appropriate menu label, the UNCALD message will appear in the EXTENDED DIAGNOSTICS menu, and the instrument will enter EXTENDED DIAGNOSTICS mode at each power-on.

If a correct Extended Calibration is done, but a FAIL message is still displayed, it means there is an actual hardware failure that should be repaired by a qualified service person.

## Calibration/Diagnostics Operation

All the calibration and diagnostic routines are accessible through the EXTENDED FUNCTIONS menu and via the GPIB. For front-panel access, press the MENU OFF/EXTENDED FUNCTIONS button when no other menu is displayed. Then, in the EXTENDED FUNCTIONS menu, select CAL/DIAG to get this second-level menu:

<status>	<status>	<status>	<warm-up>
SELF	EXT	SELF	EXT
CAL	CAL	DIAG	DIAG

<status> indicates the most current result of the test or calibration.

For calibration, <status> can be:

UNCALD: instrument has not been calibrated.  
FAIL: hardware errors were detected during calibration or calibration may not be valid.  
PASS: the instrument was successfully calibrated.

For diagnostics, <status> can be:

(blank): test has not been executed.  
FAIL: test failed on last attempt.  
PASS: test passed on last attempt.

<warm-up> is the warning NOT WARMED UP which is displayed for approximately ten minutes after power-on. Calibrating the instrument during this period is not recommended.

### NOTE

*The NOT WARMED UP message is displayed after every power-on for the ten-minute period, even if the scope is turned off and then right back on. In this case, calibration may be performed as soon as the instrument has stabilized after power-on.*



## Self Calibration

Press SELF CAL to start a complete Self Calibration of the instrument. The PASS message above SELF CAL means that no errors were detected and the instrument is ready to use. Assuming no failure or UNCALD condition exists, press the MENU OFF/EXTENDED FUNCTIONS button to exit the CAL/DIAG mode and return to Scope mode. If an error is found, the initial EXTENDED DIAGNOSTICS menu (shown in Figure A-1) will be displayed with the appropriate errors indicated.

### NOTE

*If, after running SELF CAL, any test sequence fails SELF DIAG, it is recommended that the instrument be brought to the attention of a qualified and authorized service person.*

## Extended Calibration

### NOTE

*If Extended Calibration is internally disabled, the scope will not respond to a press of the ATTEN, TRIGGER, or ADJUSTS menu buttons.*

Pressing the EXT CAL button calls up the Extended Calibration menu:

<status>	<status>	<status>		
ATTEN	TRIGGER	REPET	ADJUSTS	↑

The up-arrow returns you to the previous menu; ADJUSTS, REPET, and TRIGGER lead to fully- or semi-automatic calibration routines; and ATTEN calls up a third-level menu:

<status>	<status>	
ATTEN	CHAN	
GAIN	DLY	↑

The TRIGGER and ATTEN GAIN calibrations require the use of an external source that produces accurate dc voltages, and CHAN DLY requires a fast-rise pulse.

EXT CAL routines can be aborted at any time by pressing the MENU OFF/EXTENDED FUNCTIONS button, but once a calibration sequence is started, it must be completed (and passed) to assure correct calibration.

## ***Power-On Self Diagnostics***

In the first 15 seconds after power-on, the instrument automatically executes a self-test sequence. If it has been calibrated and no hardware errors are detected, the instrument will come up in the Acquire mode it was in when power off. (If PANEL INIT is set on, the scope comes up in NORMAL acquire mode—see "PANEL" in this appendix.) If it is not fully calibrated, or if errors are detected, the instrument will come up in the EXTENDED DIAGNOSTICS menu, which will display the errors and/or the UNCALD message at the bottom of the screen. Exit to Scope mode from the EXTENDED DIAGNOSTICS mode by pressing the MENU OFF/EXTENDED FUNCTIONS button.

## ***Front-Panel Self Diagnostics***

The complete Self Diagnostic test sequence can also be executed by pressing the SELF DIAG button from the CAL/DIAG menu. If no self-test errors occur, the word PASS will appear in the <status> position. If errors are detected, the instrument will, if possible, enter the EXTENDED DIAGNOSTICS menu with the appropriate errors displayed.

## ***Extended Diagnostics***

From the CAL/DIAG menu, a choice of EXT DIAG calls up the Extended Diagnostics menu:

```
<mode>
  ↑      ↓      RUN/SEL      MODE      HALT
```

<mode> indicates which looping mode is selected.

A list of the top-level tests, including test code, test name, and most recent status, is also displayed. (See Figure A-1.) A blank status means that the test has not been run since the last "Cold Start." If the instrument is not fully calibrated, the word UNCALD appears at the bottom of the screen.

<C> TEK, INC 1985, 86, ALL RIGHTS RESERVED DATE AND FIRMWARE VERSION NUMBERS					
100	0000	EXTENDED-DIAGNOSTICS			
90	1000	SYS-ROM		PASS	
	2000	REG		PASS	
	3000	SYS-RAM		PASS	
	4000	FPP		PASS	
	5000	WP		PASS	
	6000	CKSUM-NVRAM*		PASS	
	7000	CCD		PASS	
	8000	PA		PASS	
10	9000	TRIGS		FAIL	
0x					
	RUN ONCE		MENU OFF TO EXIT		
	↑	↓	RUN/SEL MODE	HALT	

6613-03

Figure A-1. EXTENDED DIAGNOSTICS menu.

Beneath each of the top-level tests is a hierarchy of lower-level tests whose structure is shown in Table A-1. For each level within a hierarchy there is a menu that displays a list of all the tests at that level. (See, for example, the top-level menu shown in Figure A-1.) Whenever a test runs, the set of all lower-level tests in the same hierarchy also runs.

### UP/DOWN Arrows

The up-arrow and down-arrow buttons move an underscore pointer through the displayed list of diagnostic tests. To recall a higher-level menu, move the pointer to the title line of the current menu and press the up-arrow button. To recall the CAL/DIAG menu, move the pointer to the 0000 line and press the up-arrow button.

### ***RUN/SEL.***

The RUN/SEL button can either run a set of diagnostic tests or select a menu of lower-level tests, depending on the location of the underscore pointer when the button is pressed. If the pointer is on the title line of the current menu, a press of the button will run all the tests at and below that level and display the cumulative result at the right of the title line. If the pointer is on any other line of the menu, a press of the button will display the menu of tests at the next level down from the test identified by the pointer.

### ***MODE***

The MODE button cycles through the four methods that can be used for running diagnostic tests: RUN ONCE, RUN CONTINUOUS, RUN UNTIL FAIL, and RUN UNTIL PASS. The last three modes automatically loop until the required condition has been met, or until HALTED by the user.

While a test is looping, the word RUNNING appears in the lower-right corner of the screen. When the test ends, or is stopped, the status for that run appears on the title line. If you try to execute an asterisked test by one of the looping modes, the mode immediately switches to RUN ONCE, the test does not run, and the status on the title line remains blank.

### ***HALT***

When you press HALT, all diagnostic test activity stops at the end of the test in progress. It is especially used to halt a continuously looping test.

## ***GPIB Operation***

Operation of the GPIB is described in the Programmers Reference Guide included with this manual. This additional information describes use of the diagnostic commands. Operation of any of the four Cal/Diagnostic modes is selected by using the keywords SELFCal, EXTCal, SELFDiag, or EXTDiag as arguments with the TESTType command via a GPIB controller. The selected TESTType will start when the EXECUTE command is received. During execution of the tests, the scope front panel is locked out, and only user prompts will be displayed. Menus required for controlling the scope from the front panel will not be displayed when controlling the scope via the GPIB. See the Programmers Reference Guide for the definition of the GPIB calibration and diagnostics commands.

### ***Self Calibration***

If TESTType SELFCal is selected, the Self Calibration portion of the test sequence will be run in its entirety when the EXECUTE command is received. If the OPC mask is on, a service request (SRQ) will be issued when the sequence is finished. The controller will receive a status byte that indicates whether the test completed with or without error. See the Programmers Reference Guide for a list of the status bytes.

If an error occurs during SELFCal, it is reported to the controller when the ERRor? query is issued to the instrument. ERRor? returns a string of error numbers (up to nine) resulting from the last EXECUTE command. These numbers will belong to the highest order in the hierarchy of the SELF CAL routine; so, to locate the exact test that failed in the tree, the TESTNum must be set to a lower level and the ERRor? query re-issued until the lowest detection level of the failure is reached. The ERRor? query returns 0 if no errors have occurred. This method of failure location is used for errors generated by any of the calibration or diagnostics sequences.

## ***Extended Calibration***

The EXTCAL TESTtype allows specifying the calibration sequence (TESTNum) to be performed. The calibration routine specified may be any steps or sub-steps of the EXT CAL or SELF CAL routines. The user is responsible for assuring that any externally required test equipment has been connected and programmed, and that any pauses in the procedure to make manual adjustments or equipment changes can be terminated via a menu button push or a GPIB STEP command to advance to the next step in the sequence. The external calibration sequence numbers to be used as the numerical argument for TESTNum are listed in Table A-1 under the "Test Code" column heading. The valid test numbers for Calibration are 7000 to 9300 in the table. Error handling is the same as in SELFCal.

## ***Self Diagnostics***

Invoking the TESTType SELFDiag causes execution of the entire self-diagnostic sequence when an EXECUTE command is received. Error handling is the same as in SELFCal.

## ***Extended Diagnostics***

TESTType EXTDiag allows a specific TESTNum to be selected for execution upon receiving an EXECUTE command. Error handling and reporting is the same as in SELFCal. Looping a test is done by issuing the LOOP command prior to the EXECUTE command, and the HALT command stops the looping test.

**Table A-1**  
**Calibration and Diagnostics Codes and Names**

Test Code	Test Name and Hierarchy
0000	CAL-DIAG
1000	SYS-ROM
1100	ROM1
1200	ROM0.0
1210	ROM0.0-0
1220	ROM0.0-4
1230	ROM0.0-8
1240	ROM0.0-C
1300	ROM0.1
1310	ROM0.1-1
1320	ROM0.1-5
1330	ROM0.1-9
1340	ROM0.1-D
1400	ROM0.2
1410	ROM0.2-2
1420	ROM0.2-6
1430	ROM0.2-A
1440	ROM0.2-E
1500	ROM0.3
1510	ROM0.3-3
1520	ROM0.3-7
1530	ROM0.3-B
1540	ROM0.3-F
2000	REG
2100	PROCESSOR
2110	DIAG0
2120	DCOK
2130	BUSTAKE
2140	DIAG1
2150	COMREG
2151	0000 0101
2152	0000 1011
2153	0000 0110
2154	0000 1101
2160	SSREG
2170	DIAG2
2180	FLD2
2190	MWPDN

Appendix A

Table A-1 (cont)

Test Code	Test Name and Hierarchy
	REG (cont)
2200	TB-DSP
2210	MISC
2211	1010 0101
2212	0100 1011
2213	1001 0110
2214	0010 1101
2220	MODECON
2221	1010 0101
2222	0100 1011
2223	1001 0110
2224	0010 1101
2230	DISCON
2231	1010 0101
2232	0100 1011
2233	1001 0110
2234	0010 1101
2300	TB-DSP
2310	VCURS
2311	1010 0101
2312	0100 1011
2313	1001 0110
2314	0010 1101
2320	TCURS
2321	1010 0101
2322	0100 1011
2323	1001 0110
2324	0010 1101
2330	U130
2331	1010 0101
2332	0100 1011
2333	1001 0110
2334	0010 1101
2340	U140
2341	1010 0101
2342	0100 1011
2343	1001 0110
2344	0010 1101



Table A-1 (cont)

Test Code	Test Name and Hierarchy
	REG (cont)
2350	U240
2351	1010 0101
2352	0100 1011
2353	1001 0110
2354	0010 1101
2360	U322
2361	1010 0101
2362	0100 1011
2363	1001 0110
2364	0010 1101
2370	U314
2371	1010 0101
2372	0100 1011
2373	1001 0110
2374	0010 1101
2400	TB-DSP
2410	A11U670-FISO
2420	A11U670-SISO
2500	MAIN
2510	INIT-SHFT-REGS
2520	ATTEN
2530	PEAK-DETECTOR
2540	GATE-ARRAY
2550	TRIG
2560	SYSTEM-DAC
2600	SIDE
2610	1010 0101
2620	0100 1011
2630	1001 0110
2640	0010 1101
3000	SYS-RAM
3100	A11U431
3110	0<-1'S
3120	0->1'S
3130	1->0'S
3140	1<-0'S

Appendix A

Table A-1 (cont)

Test Code	Test Name and Hierarchy
	SYS-RAM (cont)
3200	A11U440
3210	0<-1'S
3220	0->1'S
3230	1->0'S
3240	1<-0'S
3300	A12U350
3310	0<-1'S
3320	0->1'S
3330	1->0'S
3340	1<-0'S
3400	A11U430
3500	A11U600
3510	0<-1'S
3520	0->1'S
3530	1->0'S
3540	1<-0'S
3600	A12U440
3610	0<-1'S
3620	0->1'S
3630	1->0'S
3640	1<-0'S
3700	A12U664
3710	0<-1'S
3720	0->1'S
3730	1->0'S
3740	1<-0'S
3800	A12U664
3810	0<-1'S
3820	0->1'S
3830	1->0'S
3840	1<-0'S

Table A-1 (cont)

Test Code	Test Name and Hierarchy	
4000	FPP	
4100		U861-9
4200		U861-6
4300		WR-TO-HOST
4400		DIAG-BYTE
4410		FP-BUTTON-PUSHED
4420		FPP-RAM
4430		FPP-ROM
4440		FPP-A/D
4450		FPP-TIMER
4500		FPDNRD
4600		U742/U751
4700		BATT-STATUS
4710		HIGH
4720		LOW
5000	WP	
5100		RUN-TASK
5200		BUSGRANT
5300		VERSION-CK
6000	CKSUM-NVRAM	
6100		CAL-CONSTANTS
6200		FP-LAST
6300		WFM-HEADERS
6400		PRGM
7000	CCD	
7100		CENTERING
7110		NORM-SP
7111		CH1
7112		CH2
7120		NORM-FISO
7121		CH1
7122		CH2
7130		ENV-SP-SLOW
7140		ENV-FISO-SLOW
7200	GAIN	
7210		SHORT-PIPE
7211		CH1-1
7212		CH2-1
7220		FISO

Appendix A

Table A-1 (cont)

Test Code	Test Name and Hierarchy	
8000	PA	
8100		OFFSET
8110		NORM-SP
8111		CH1
8112		CH2
8200		POS-GAIN
8210		CH1
8220		CH2
8300		BALANCE
8310		50MV
8311		CH1
8312		CH2
8320		20MV
8321		CH1
8322		CH2
8330		10MV
8331		CH1
8332		CH2
8340		5MV
8341		CH1
8342		CH2
8350		2MV
8351		CH1
8352		CH2
8400		GAIN
8410		50MV
8411		CH1
8412		CH2
8420		20MV
8421		CH1
8422		CH2
8430		10MV
8431		CH1
8432		CH2
8440		5MV
8441		CH1
8442		CH2
8450		2MV
8451		CH1
8452		CH2

Table A-1 (cont)

Test Code	Test Name and Hierarchy
	PA (cont)
8500	INV-GAIN
8510	50MV
8511	CH1
8512	CH2
8520	20MV
8521	CH1
8522	CH2
8530	10MV
8531	CH1
8532	CH2
8540	5MV
8541	CH1
8542	CH2
8550	2MV
8551	CH1
8552	CH2
8600	VAR-MAX
8610	CH1
8620	CH2
8700	ATTEN-GAIN*
8710	CH1
8711	X1
8712	X10
8713	X100
8720	CH2
8721	X1
8722	X10
8723	X100
8800	ATTEN-CHAN-DLY*

Appendix A

Table A-1 (cont)

Test Code	Test Name and Hierarchy
9000	TRIGGERS
9100	OFFSET
9110	A-TRIG
9111	CH1
9112	CH2
9113	SLOPE
9114	EXT1X1*
9115	EXT1X5*
9116	EXT2X1*
9117	EXT2X5*
9120	B-TRIG
9121	CH1
9122	CH2
9123	SLOPE
9124	EXT1X1*
9125	EXT1X5*
9126	EXT2X1*
9127	EXT2X5*
9200	GAIN
9210	A-TRIG
9211	CH1
9212	CH2
9213	EXT1X1*
9214	EXT1X5*
9215	EXT2X1*
9216	EXT2X5*
9220	B-TRIG
9221	CH1
9222	CH2
9223	EXT1X1*
9224	EXT1X5*
9225	EXT2X1*
9226	EXT2X5*
9300	REPET*

## Appendix B

### ***VOLTS/DIV Range With Attenuator Probes***

The range of the VOLTS/DIV front-panel switch for all available probes is displayed in Table B-1.

**Table B-1**  
**VOLTS/DIV Readout Switching With Coded Probes**

Display Type	Basic Volts/Div	Readout Volts/Div with Indicated Probe			
		1X	10X	100X	1000X
EXPANDED	2 mV	200 $\mu$ V	2 mV	20 mV	200 mV
	2 mV	500 $\mu$ V	5 mV	50 mV	500 mV
	2 mV	1 mV	10 mV	100 mV	1 V
NORMAL	2 mV	2 mV	20 mV	200 mV	2 V
	5 mV	5 mV	50 mV	500 mV	5 V
	10 mV	10 mV	100 mV	1 V	10 V
	20 mV	20 mV	200 mV	2 V	20 V
	50 mV	50 mV	500 mV	5 V	50 V
	100 mV	100 mV	1 V	10 V	100 V
	200 mV	200 mV	2 V	20 V	200 V
	500 mV	500 mV	5 V	50 V	500 V
	1 V	1 V	10 V	100 V	1 kV
	2 V	2 V	20 V	200 V	2 kV
5 V	5 V	50 V	500 V	5 kV	

## Calibrator Frequency

Table B-2 shows the CALIBRATOR frequency and period for each A SEC/DIV setting.

**Table B-2**  
Calibrator Frequency and Period for Each A SEC/DIV Setting

A SEC/DIV Setting	Calibrator Frequency	Calibrator Period	DIV/Cycle
2 ns	5 MHz	200 ns	100
5 ns			40
10 ns			20
20 ns			10
50 ns			4
100 ns			2
200 ns			1
500 ns	1 MHz	1 $\mu$ s	2
1 $\mu$ s			1
2 $\mu$ s			0.5
5 $\mu$ s	50 kHz	20 $\mu$ s	4
10 $\mu$ s			2
20 $\mu$ s			1
50 $\mu$ s	5 kHz	200 $\mu$ s	4
100 $\mu$ s			2
200 $\mu$ s			1
500 $\mu$ s	500 Hz	2 ms	4
1 ms			2
2 ms			1
5 ms	50 Hz	20 ms	4
10 ms			2
20 ms			1
50 ms			0.4
100 ms			0.2
200 ms			0.1
500 ms			0.04
1 s			0.02
2 s			0.01
5 s			0.004



## Averaging SNIR

Table B-3 shows the signal-to-noise improvement ratio (SNIR) as the number of averages increases. The display updates with each new waveform acquired, so the user sees the averaged waveform improve with each new acquisition.

**Table B-3**  
Signal-to-Noise Improvement Ratio Versus Number of Averages

Number of Averages	SNIR	SNIR (in dB)
2	1.41	3
4	1.98	5.9
8	2.75	8.8
16	3.84	11.7
32	5.34	14.6
64	7.51	17.5
128	10.6	20.5
256	14.9	23.4

## REPETITIVE Acquisition

Table B-4 illustrates the number of acquisitions taken before a single sequence completes in REPET mode, or before data points are temporarily interpolated for a REPET-mode acquisition if the Trigger mode is not Single Sequence. The number taken assures that enough randomly-sampled data points are acquired to meet the requirements for the USB (Useful Storage Bandwidth) of 300 MHz specified for REPET. See REPET ON in section 5 for more information.

**Table B-4**  
Repet Acquisitions Required To Complete a Single Sequence

SEC/DIV (ns/div)	Number of Acquisitions
50	4
20	10
10	20
5	40
2	60

## SMOOTH

Figure B-1 indicates the amplitude rolloff with frequency for the moving, five-sample-point filter applied to waveforms when SMOOTH is ON in the BANDWIDTH menu. The frequency is expressed as a percentage of the Useful Storage Bandwidth, which is a function of the SEC/DIV setting and is displayed in the BANDWIDTH menu.

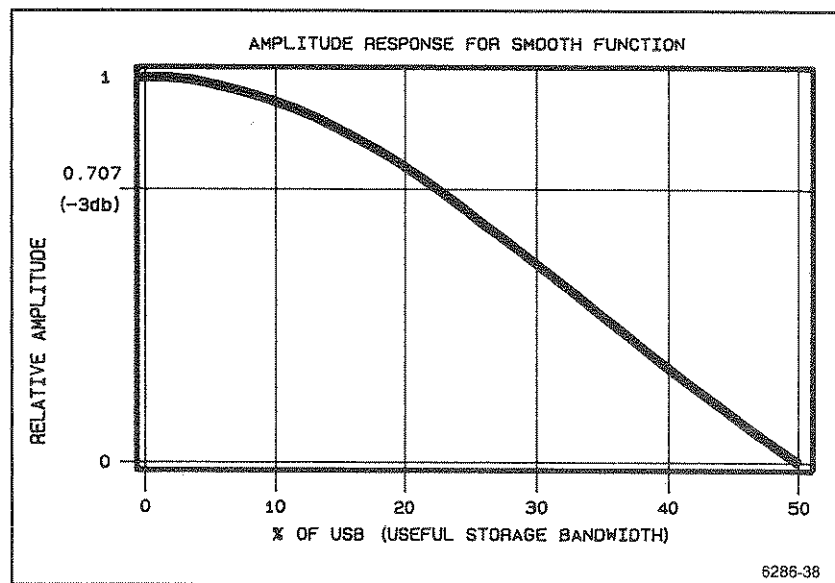

Figure B-1. Amplitude response for smooth function.

## Variable *HOLDOFF*

The front-panel *HOLDOFF* knob varies the length of time between the end of one acquisition and the potential start of the next. During the holdoff period, triggers are ignored; after the holdoff period has ended, the first valid trigger causes an acquisition. Table B-5, next page, shows the minimum and maximum holdoff times for each SEC/DIV setting. The STATUS display gives a readout for *HOLDOFF* as a percentage between the maximum and minimum values.

**Table B-5**  
**Variable Trigger Holdoff**

A SEC/DIV	MIN HO	MAX HO
2 ns	2-4 $\mu$ s	9-15 $\mu$ s
5 ns		
10 ns		
20 ns		
50 ns		
100 ns		
200 ns		
500 ns	5-10 $\mu$ s	
1 $\mu$ s	10-20 $\mu$ s	100-150 $\mu$ s
2 $\mu$ s	20-40 $\mu$ s	
5 $\mu$ s	50-100 $\mu$ s	
10 $\mu$ s	0.1-0.2 ms	1-1.5 ms
20 $\mu$ s	0.2-0.4 ms	
50 $\mu$ s	0.5-1.0 ms	
100 $\mu$ s	1-2 ms	10-15 ms
200 $\mu$ s	2-4 ms	
500 $\mu$ s	5-10 ms	
1 ms	10-20 ms	90-150 ms
2 ms	20-40 ms	
5 ms	50-100 ms	
10 ms	0.1-0.2 s	0.9-1.5 s
20 ms	0.2-0.4 s	
50 ms	0.5-1.0 s	
100 ms	1-2 s	9-15 s
200 ms	2-4 s	
500 ms	5-10 s	
1 s		
2 s		
5 s		

## Trigger LEVEL Range and Resolution

Table B-6 shows Trigger LEVEL range and resolution for each trigger-gain factor. Trigger gain is equal to the gain of the selected trigger source multiplied by the attenuation factor of the attached probe. The selected trigger gain for CH 1 and CH 2 SOURCE is the vertical deflection factor.

**Table B-6**  
**Trigger Resolution**

Trigger Gain (including probe)	Total Trigger Range		Trigger Resolution (1-point) 64 pt/div
	CH1 or CH2 (± 18 div)	EXT1 or EXT2 (± 9 div)	
5 kV/div	90 kV	---	78.125 V
2 kV/div	36 kV	---	31.25 V
1 kV/div	18 kV	---	15.625 V
500 V/div	9 kV	4.5 kV	7.8125 V
200 V/div	3.6 kV	---	3.125 V
100 V/div	1.8 kV	900 V	1.5625 V
50 V/div	900 V	450 V	781.25 mV
20 V/div	360 V	---	312.5 mV
10 V/div	180 V	90 V	156.25 mV
5 V/div	90 V	45 V	78.125 mV
2 V/div	36 V	---	31.25 mV
1 V/div	18 V	9 V	15.625 mV
500 mV/div	49 V	4.5 V	7.8125 mV
200 mV/div	3.6 V	---	3.125 mV
100 mV/div	41.8 V	900 mV	1.5625 mV
50 mV/div	900 mV	---	781.25 μV
20 mV/div	360 mV	---	312.5 μV
10 mV/div	180 mV	---	156.25 μV
5 mV/div	90 mV	---	78.125 μV
2 mV/div	36 mV	---	31.25 μV
1 mV/div	36 mV	---	31.25 μV
500 μV/div	36 mV	---	31.25 μV
200 μV/div	36 mV	---	31.25 μV

## Auto Triggering and Auto Leveling

In the absence of valid triggers, the AUTO and AUTO LEVEL Trigger modes produce forced triggers after specified periods of time. The "Trigger Lost?" column of Table B-7 shows the approximate time interval between the last valid trigger and the first forced trigger. In other words, this is the time it takes the scope to determine that it has lost triggering and respond with an "auto" trigger. The "Triggered?" column shows the approximate time interval that the scope waits between forced triggers. During this time, a valid triggering event stops the forced triggers and it triggers the scope instead. If the scope again loses the valid trigger, the time listed for "Trigger Lost?" must expire before forced triggers (auto triggering) can reoccur.

**Table B-7**  
Auto Triggering and Auto-Leveling Intervals

SEC/DIV Setting	Trigger Lost?	Triggered?
5 ms/div & faster	300 ms	100 ms
10 ms/div	600 ms	200 ms
20 ms/div	1.2 s	400 ms
50 ms/div	3 s	1 s

## ***B Trigger Source***

The B-Trigger circuit is used to precondition trigger signals as a source for three different functions: B Triggering, External Clock, and DELAY by EVENTS. The B TRIG SOURCE menu changes to correspond to the role that B Trigger is playing. Table B-8 shows the specific function.

**Table B-8  
B Trigger Source Menu Versus B Trigger Mode**

<b>B TRIGGER Mode</b>	<b>DELAY by EVENTS</b>	<b>EXT CLK</b>	<b>Menu Label</b>
RUNS AFTER	OFF	OFF ON	B TRIG SOURCE EXT CLK SOURCE
	ON	OFF ON	EVENTS SOURCE EVENTS, EXT CLK SOURCE
TRIG AFTER	OFF	OFF ON	B TRIG SOURCE B, EXT CLK SOURCE
	ON	OFF ON	B, EVENTS SOURCE B, EXT CLK, EVNT SOURCE

Table B-10 (cont)

B SEC/DIV Setting	Maximum Delay <sup>1</sup>	Delay Resolution <sup>2</sup>
50 $\mu$ s	262 ms	4 $\mu$ s
20 $\mu$ s	105 ms	1.6 $\mu$ s
10 $\mu$ s	52.4 ms	800 ns
5 $\mu$ s	26.2 ms	400 ns
2 $\mu$ s	10.5 ms	160 ns
1 $\mu$ s	5.24 ms	80 ns
500 ns	2.62 ms	40 ns
200 ns	1.05 ms	16 ns
100 ns	524 $\mu$ s	8 ns
50 ns	524 $\mu$ s/1.04 ms	4 ns
20 ns	524 $\mu$ s/1.04 ms	1.6 ns
10 ns	524 $\mu$ s/1.04 ms	800 ps
5 ns	524 $\mu$ s/1.04 ms	400 ps
2 ns	524 $\mu$ s/1.04 ms	160 ps

<sup>1</sup>Maximum Delay, at B SEC/DIV settings of 50 ns and faster, depends on whether REPET mode is ON or OFF in the ACQUIRE menu. The first number listed (524  $\mu$ s) is for REPET OFF and the second number listed (1.04 ms) is for REPET ON.

<sup>2</sup>Delay Resolution for B SEC/DIV settings of 5 sec to 100 ns are for both B Trig After and B Runs After trigger modes. For settings of 50 ns and faster, the number listed is the resolution for the B Runs After mode and is not affected by REPET. The Delay Resolution when in B Trig After mode is 8 ns if REPET is OFF and 16 ns if REPET is ON.

Appendix B

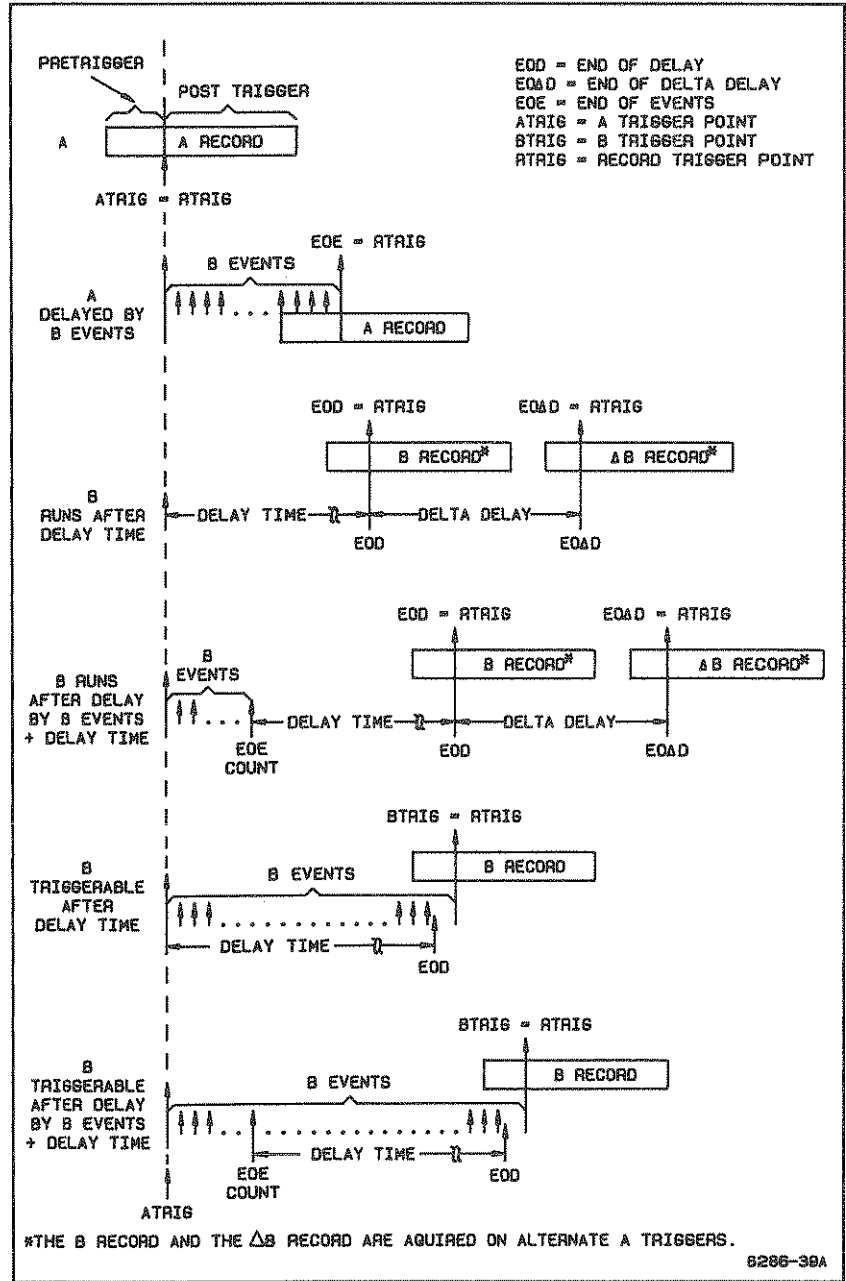

Figure B-2. RTRIG versus horizontal display modes.



## Trigger Status Indicators

The Trigger Status Indicators successively light up to indicate how acquisitions are progressing in the scope. At A SEC/DIV settings of 100 ms and longer, the acquisitions occur slowly enough that the indicators can be seen switching on and off, and the progress of the acquisition can be observed.

The only time during normal operation that all trigger status lights are off is when the scope is in SAVE mode. Table B-11 is a summary of the switching states of the indicators.

**ARMED.** Indicator lights up at the start of each acquisition while pretrigger data is being acquired. During this time, no triggers are accepted. Turns off at the end of pretrigger holdoff.

**READY.** Indicator lights up at the end of pretrigger holdoff. Pretrigger data continues to be acquired. While this indicator is on, the instrument is looking for RTRIG (the trigger event required to complete the record). When the Record Trigger occurs, the READY indicator turns off.

**TRIG'D.** Indicator lights up at the A Trigger; turns off when the acquisition is done.

### NOTE

*For an acquisition involving both A and B triggers, the READY and TRIG'D lights will both be lit during the time between the occurrence of the A Trigger and the final B Record Trigger.*

**Table B-11**  
TRIG'D, READY, and ARM Indicator Status

LIGHT	STATE				
	Armed	Ready	Atrig	Rtrig	Save
TRIG'D	Off	Off	Lit	Lit	Off
READY	Off	Lit	Lit	Off	Off
ARM	Lit	Off	Off	Off	Off

## Waveform Display Summary

This scope can display a maximum of six waveforms simultaneously; therefore, when more than six waveforms are selected for display, the system uses a priority scheme. Table B-12 shows the available waveforms and the display (in decreasing order of priority) versus the display modes. In the table, CHx is the selected vertical channel, FUNC refers to ADD or MULT, D1 and D2 are the two delays in DELTA mode, and REF1 through REF4 are the four SAVEREF memories.

Whether an available waveform is actually displayed or not is determined by the VERTICAL MODE menu, the DISPLAY REF menu, and the availability of memory.

**Table B-12**  
**Display Priority Versus Display Mode**

YT			XY Mode
DELTA			
OFF	ON		
	DUAL (CH1 and CH2)		
	NO	YES	
FUNC	FUNC @ D1	FUNC @ D1	CH1 vs CH2
CH1	FUNC @ D2	FUNC @ D2	REF1 vs REF2
CH2	CHx @ D1	CH1 @ D1	
REF1	CHx @ D2	CH2 @ D2	
REF2	REF1	REF1	
REF3	REF2	REF2	
REF4	REF3	REF3	
	REF4	REF4	

## STACK REF Storage Operation

Pushing either the STACK REF menu button or the SAVE front-panel button when the SAVE menu is displayed will store the displayed waveforms in predefined REF memory locations, treating the reference memories as a push-up stack. The STACK REF storage operation for each of the vertical and horizontal mode combinations is shown in Table B-13.

In Table B-13, the letter "F" and the heading FUNC denote either the ADD or MULT function. Also, CHx to Rx means that the selected channel will go into the correspondingly numbered reference memory (e.g. CH1 to R1 or CH2 to R2) and the FUNC (ADD or MULT) will go into Ry (the open REF). D1 and D2 refer to the two delays available in DELTA mode. The notation XXX with DELTA TIME and a FUNC ON means that it is a "don't care" situation, because neither CH 1 nor CH 2 is stored.

**Table B-13**  
REF Storage Operation versus Horizontal and Vertical Modes

DELTA TIME	FUNC (F)	Channels Displayed	Reference Waveform Storage			
OFF	OFF	ONE	R3 to R4	R2 to R3	R1 to R2	CHx to R1
		TWO	R2 to R4	R1 to R3	CH2 to R2	CH1 to R1
	ON	ONE	R2 to R4	R1 to R3	F to Ry	CHx to Rx
		TWO	R4 to R4	F to R3	CH2 to R2	CH1 to R1
		NONE	R3 to R4	R2 to R3	R1 to R2	F to R1
	ON	OFF	ONE	R2 to R4	R1 to R3	CHx@D2 to R2
TWO (YT)			R2 to R4	R1 to R3	CH2@D2 to R2	CH1@D1 to R1
TWO (XY)			R2 to R4	R1 to R3	CH2@D1 to R2	CH1@D1 to R1
ON		XXX	R2 to R4	R1 to R3	F@D2 to R2	F@D1 to R1

## SAVE ON DELTA Operation

The comparison channel for the SAVE ON Δ feature is given in Table B-14. The designated REF waveform must be displayed for the comparison to take place. The user must create the limits of the comparison waveform either by using CONT ENVELOPE acquisition mode or by sending in a comparison envelope waveform via the GPIB. The created reference is stored in the REF memory location against which the active channel is to be compared.

In the table, CHx vs REFx signifies that the displayed channel is compared against the correspondingly numbered reference waveform. REFy refers to either REF1 or REF2, opposite to what REFx is when used together in the same line of the table. The "don't care" condition, when neither CH 1 nor CH 2 is compared to a reference waveform, is indicated by XXX.

**Table B-14**  
**SAVE ON DELTA Comparisons**

Δ TIME	FUNC (F)	Channels Displayed	Waveform Comparison		
OFF	OFF	ONE	CHx vs REF1		
		TWO	CH2 vs REF2	CH1 vs REF1	
	ON	ONE	F vs REFy	CHx vs REFx	
		TWO	CH2 vs REF2	CH1 vs REF1	F vs REF3
		NONE	F vs REF1		
ON	OFF	ONE	CHx@D2 vs REF2	CHx@D1 vs REF1	
		TWO	CH2@D2 vs REF2	CH1@D1 vs REF1	
	ON	XXX	F@D2 vs REF2	F@D1 vs REF1	

## Front-Panel Settings for INIT PANEL

Table B-15 lists the front-panel settings which are returned when INIT PANEL is executed from the AUTOSTEP SEQUENCER menu (PRGM).

**Table B-15**  
**INIT PANEL States**

AUTOS SETUP Controls	
Mode	VIEW
RESolution	LO
CURSOR Controls	
CURSOR/DELAY Knob	CURSOR POSITION
CURSOR FUNCTION	All off
VOLTS UNITS	VOLTS
TIME UNITS	SEC
SLOPE UNITS	VOLTS/SEC
CURSOR Mode	$\Delta$
ATTACH CURSORS TO:	CH 1
X-Axis Cursor Position	$\pm 3$ divisions
Y-Axis Cursor Position	$\pm 3$ divisions
TIME Cursor Position	$\pm 4$ divisions
VOLTS Ref Value	1.0 V
TIME Ref Value	1.0 SEC
SLOPE Ref Value	1.0 V/SEC
DELAY Controls	
DELAY by EVENTS	OFF
$\Delta$ TIME	OFF
DELAY TIME	40 $\mu$ S
$\Delta$ DELAY Time	0.0
DELAY EVENTS Count	1

**Appendix B**

**Table B-15 (cont)**

<b>DEVICES/SETUP (OUTPUT)</b>	
<b>DEVICES</b>	
HPGL PLOTTER	OFF
THINKJET PRINTER	ON
<b>SETUP</b>	
Print SETTINGS	ON
Print TEXT	ON
Print GRAT	ON
Print WFM	ON
PGSIZ	US
<b>GPIB SETUP (OUTPUT)</b>	
DEBUG	OFF
LONG	ON
LOCK	LLO
PATH	ON
RQS Mask	ON
OPC Mask	ON
CER Mask	ON
EXR Mask	ON
EXW Mask	ON
INR Mask	ON
USER Mask	OFF
PID Mask	OFF
DEVDEP Mask	ON
Data Encoding (ENCDG)	BINARY
Data Target	REF 1
Data Source	CH 1
FASTXMIT	OFF
FASTXMIT	1
CURVE ONLY	OFF
START	256
STOP	512
LEVEL	0
HYSTERESIS	5
DIRECTION	PLUS
SETUP ATTRIBUTE	0
DT	OFF

Table B-15 (cont)

HORIZONTAL Mode Controls	
MODE	A
A SEC/DIV	1 ms
EXT CLK Expansion Factor	1
EXT CLK	OFF
POSITION Waveform	LIVE
POSITION Reference	REF 1
POSITION set to	Midscreen
POSITION REF mode	INdependent
INTENSITY Controls	
SELECT	DISP
READOUT Intensity	50%
DISP Intensity	40%
GRAT Illum	0%
INTENS Level	80%
VECTORS	ON
MEASURE Controls	
MARK	OFF
DISPLAY	OFF
WINDOW	OFF
METHOD	MIN/MAX
LEVEL (units)	%
LEVEL (settings)	
PROXIMAL	10%/0.4 volts
MESIAL	50%/1.3 volts
MESIAL2	50%/1.3 volts
DISTAL	90%/2.4 volts
TARGET	CH 1

**Appendix B**

**Table B-15 (cont)**

<b>STORAGE Mode Controls</b>	
STORAGE Mode	SAVE
ACQUIRE Mode	NORMAL
REPET	OFF
AVG Number	2
ENVELOPE Number	1
SAVE ON $\Delta$	OFF
REF1 through REF4	OFF

<b>TRIGGER Controls</b>	
A/B TRIG set for	A
A TRIG MODE	AUTO LEVEL
B TRIG MODE	RUNS AFTER
SOURCE (both)	CH 1
COUPLING (both)	DC
SLOPE (both)	+ (plus)
TRIG POSITION	1/2 (512)
LEVEL (both)	0.0
EXT GAIN (both)	+1
HOLDOFF	Minimum

<b>VERTICAL MODE Controls</b>	
CH 1	ON
VOLTS/DIV (both)	100 mV
VARIABLE (both)	CAL
COUPLING (both)	DC
50 $\Omega$ (both)	OFF
INVERT (both)	OFF
POSITION set to	Mid screen
Display Mode	YT
BANDWIDTH	FULL
SMOOTH	OFF



Table B-15 (cont)

VIDEO OPTION Setup (SET TV)	
Interlaced Coupling	FIELD1
Noninterlaced Coupling	FIELD1
TV SYNC	-(minus)
CLAMP	OFF
Line Count	525
Line Start	PREFLD

WORD RECOGNIZER (SET WORD)	
Word Match	Don't care (all x)
RADIX	HEX
CLOCK	ASYNC

## **Front-Panel Settings for Auto Setup**

Auto Setup forces some front-panel controls to certain settings. Table B-16 lists those controls and indicates whether or not they are affected when Auto Setup executes.

**Table B-16  
Front-Panel Settings After an Auto Setup**

<b>AUTO SETUP Controls</b>	
Mode	AS SELECTED
RESolution	AS SELECTED
<b>CURSOR Controls</b>	
CURSOR/DELAY Knob	LAST <sup>3</sup>
CURSOR FUNCTION	All off
ALL OTHER CURSOR SETTINGS LEFT AS LAST SET. SEE TABLE B-15 FOR THE NAMES OF THE REMAINING CONTROLS. <sup>2</sup>	
<b>DELAY Controls</b>	
DELAY by EVENTS	OFF
$\Delta$ TIME	OFF
DELAY TIME	40 $\mu$ S
$\Delta$ DELAY Time	0.0
DELAY EVENTS Count	1
<b>DEVICES/SETUP (OUTPUT)</b>	
ALL DEVICES SETTINGS ARE LEFT AS LAST SET. SEE DEVICES/SETUP in TABLE B-15 FOR A LIST OF THE CONTROLS. <sup>2</sup>	
<b> GPIB SETUP (OUTPUT)</b>	
ALL GPIB OUTPUT SETTINGS ARE LEFT AS LAST SET. SEE TABLE B-15 (GPIB SETUP) FOR A LIST OF THE CONTROLS. <sup>2</sup>	

## Trigger Position

The RTRIG (Record Trigger) position is the horizontal point on the waveform about which the waveform samples are displayed. Although a single time-base generator is used for both the A and the B acquisitions, the RTRIG point for each can be selected independently. Table B-9 indicates the data point at which RTRIG will occur for each of the TRIGGER POSITION menu choices.

Figure B-2 shows where the A or B Record Trigger occurs in relation to the A Trigger for each of the various Horizontal modes. It also shows the effects of DELAY by TIME and DELAY by EVENTS on the occurrence of the Record Trigger.

**Table B-9**  
RTRIG Point versus Trigger Position Menu Selection

Trigger Position Menu Entry	RTRIG Data Point In Display
1/8	128
1/4	256
1/2	512
3/4	768
7/8	896

## *Delay Time and Delay Time Resolution*

Table B-10 shows the maximum delay time and the delay time resolution for each B SEC/DIV setting.

**Table B-10**  
**Maximum B SEC/DIV Delay Time and Resolution**

<b>B SEC/DIV Setting</b>	<b>Maximum Delay<sup>1</sup></b>	<b>Delay Resolution<sup>2</sup></b>
5 sec	3.64 hrs	200 ms
2 sec	1.46 hrs	80 ms
1 sec	43.7 min	40 ms
500 ms	17.5 min	20 ms
200 ms	8.74 min	8 ms
100 ms	4.37 min	4 ms
50 ms	1.75 min	2 ms
20 ms	52.4 sec	800 $\mu$ s
10 ms	26.2 sec	400 $\mu$ s
5 ms	10.5 sec	200 $\mu$ s
2 ms	5.24 sec	80 $\mu$ s
1 ms	2.62 sec	40 $\mu$ s
500 $\mu$ s	1.05 sec	20 $\mu$ s
200 $\mu$ s	524 ms	8 $\mu$ s
100 $\mu$ s	262 ms	4 $\mu$ s

Table B-16 (cont)

<b>HORIZONTAL Mode Controls</b>	
MODE	A
A SEC/DIV	Auto Setup <sup>1</sup>
EXT CLK Expansion Factor	1
EXT CLK	OFF
POSITION Waveform	LIVE
POSITION Reference	LAST <sup>3</sup>
POSITION set to	Auto Setup <sup>1</sup>
POSITION REF mode	LAST <sup>3</sup>
<b>INTENSITY Controls</b>	
SELECT	LAST <sup>3</sup>
READOUT Intensity	LAST <sup>3</sup>
DISP Intensity	Auto Setup <sup>1</sup>
INTENS Level	LAST <sup>3</sup>
VECTORS	ON
<b>MEASURE Controls</b>	
ALL MEASURE SETTINGS ARE LEFT AS LAST SET. SEE MEASURE IN TABLE B-15 FOR A LIST OF THE CONTROLS. <sup>2</sup>	
<b>STORAGE Mode Controls</b>	
STORAGE Mode	ACQUIRE
ACQUIRE Mode	NORMAL
REPET	Auto Setup <sup>1</sup>
AVG Number	LAST <sup>3</sup>
ENVELOPE Number	LAST <sup>3</sup>
SAVE ON $\Delta$	OFF
REF1 through REF4	OFF
<b>TRIGGER Controls</b>	
A/B TRIG set for	A
A TRIG MODE	AUTO
B TRIG MODE	RUNS AFTER
SOURCE (both)	VERT
COUPLING (both)	DC

Table B-16 (cont)

TRIGGER Controls (cont)	
SLOPE (both)	Auto Setup <sup>1</sup>
TRIG POSITION	Auto Setup <sup>1</sup>
LEVEL (both)	Auto Setup <sup>1</sup>
EXT GAIN (both)	LAST <sup>3</sup>
HOLDOFF	Minimum

VERTICAL Controls	
MODE	LAST <sup>3,4</sup>
VOLTS/DIV	Auto Setup <sup>1</sup>
VARIABLE (both)	CAL
COUPLING (both)	Auto Setup <sup>1,5</sup>
50 $\Omega$ (both)	LAST <sup>3,5</sup>
INVERT (both)	OFF
POSITION set to	Auto Setup <sup>1</sup>
Display Mode	YT
BANDWIDTH	FULL
SMOOTH	OFF

**VIDEO OPTION Setup (SET TV)**

---

ALL GPIB OUTPUT SETTINGS ARE LEFT AS LAST SET. SEE TABLE B-15 (VIDEO OPTION) FOR A LIST OF THE CONTROLS.<sup>2</sup>

**WORD RECOGNIZER (SET WORD)**

---

ALL WORD RECOGNIZER SETTINGS ARE LEFT AS LAST SET. SEE TABLE B-15 (WORD RECOGNIZER) FOR A LIST OF THE CONTROLS.<sup>2</sup>

<sup>1</sup>Settings established depend on the mode and resolution for Auto Setup, as well as the input signal(s) being set up. (See AUTO in Section 5 for more information.)

<sup>2</sup>Use Table B-15 only to see a listing of unaffected controls. Since the controls are left as last set after executing an Auto Setup<sup>1</sup>, ignore the INIT values listed with the controls.

<sup>3</sup>The setting in effect before Auto Setup executes is left unchanged after Auto Setup executes.

<sup>4</sup>The Vertical MODE setting is only changed if no display source is selected. In that case, CH 1 is turned on.

<sup>5</sup>The input COUPLING is only changed if GND is selected. In that case coupling becomes DC.

# ***Waveform Parameter Extraction***

## ***Introduction***

This appendix describes the methods used to calculate waveform parameters returned by the MEASURE feature for this instrument.

This information helps the user understand how this instrument extracts the specified parameters. By knowing the methods used to characterize the waveform and calculate the parameters, users can better understand how to set up the scope for best measurement results and how to interpret such results.

This section does not describe all the ways to access and specify the MEASURE feature. Parameter extractions using the MEASURE features can be specified via the front-panel MEASURE menu, as explained in Section 5, "Controls, Connectors, and Indicators," or via the GPIB, as explained in the Programmer's Reference Guide. Once specified, extractions can be stored and later recalled as part of a sequence using the AutoStep Sequencer feature. An example of how MEASURE can be incorporated in an AutoStep Sequence is included in the familiarization procedure of Section 2 of this manual.

## ***Parameter Extraction from the Waveform***

### ***Overview***

Parameter extraction is done in two phases. First, the waveform is characterized to determine various amplitude-reference levels, TOP and BASE levels, and, if time-related parameters are requested, the time-reference points. Once these waveform references are found, the second phase is to calculate the requested parameters so they can be displayed.

## **Appendix C**

---

During the first phase, the scope first determines the minimum and maximum amplitude levels within the active window of the waveform. BASE and TOP levels for the targeted waveform are then determined according to the user-selected MEASURE METHOD. Next, the PROXIMAL, MESIAL, MESIAL2, and DISTAL amplitude-reference levels are calculated according to the current settings for LEVEL. At this point, if only amplitude-related parameters are requested, they can be extracted.

If time-related parameters are requested, the targeted waveform must next be searched for waveform crossings of the PROXIMAL, MESIAL, and DISTAL levels. The crossing times become the time-reference points and are then used to calculate parameters such as FREQUENCY, WIDTH, PERIOD, etc.

### ***BASE-TOP Determination***

Three methods of determining the TOP and BASE for waveforms can be user-selected: MIN/MAX, HISTogram, and CURSOR. The best method for BASE-TOP determination depends on the type of waveform that is to be measured.

#### ***MIN/MAX Method***

The MIN/MAX method is for general purpose use and is the default setting. MIN/MAX defines the 0% and 100% levels of the waveform as the lowest amplitude (most negative), and highest amplitude (most positive) samples found in the active window.

The MIN/MAX method is useful for measuring FREQUENCY, WIDTH, and PERIOD on most types of signals. MIN/MAX is sensitive to ringing and spikes on the waveform, however, and cannot be used to accurately measure RISE time, FALL time, OVerSHoot, and UNDeRSHoot.

#### ***HISTogram Method***

The HISTogram method attempts to ignore ringing and spikes on waveforms when determining the 0% (BASE), and 100% (TOP) levels. It's the best method to use when measuring square waves and pulse-type waveforms. Figures C-1 and C-2 illustrate the differences between HISTogram and MIN/MAX methods. (Note the differences in how the TOP and BASE levels are located on the waveform and how the amplitude-reference levels are affected.)



HISTogram makes several assumptions about the waveform.

1. The TOP level is always more positive than the BASE level.

2. The rising edge of a signal always has a positive slope, and the falling edge has a negative slope.

When a histogram determines the TOP and BASE levels, the process is as follows:

1. The waveform data-array is used to create a histogram array. This array consists of 256 value ranges or "buckets," each containing the number of times that the sample value occurs in the targeted waveform.

2. The absolute maximum and minimum points are also determined from the waveform data-array.

3. The absolute minimum point is subtracted from the absolute maximum point to determine the peak-to-peak amplitude of the waveform.

4. The peak-to-peak amplitude is divided by two to obtain the mid-point of the range for the waveform sample points (i.e., for a waveform with an absolute maximum of 120 and a minimum of 20, the peak-to-peak is 100 and the mid-point is  $(100/2) + 20 = 70$ ).

5. Beginning at the mid-point level, the histogram array is searched upward (values greater than the mid-point) to find the initial histogram maximum and downward (values less than mid-point) to find the initial histogram minimum. The value associated with the bucket containing the largest count of sample points ABOVE the mid-point becomes the waveform TOP. The value of the bucket containing the largest count BELOW the mid-point value becomes the waveform BASE.

### ***CURSOR Method***

The CURSOR method lets the user directly set the BASE and TOP levels for the waveform. The least-positive VOLTS cursor establishes the BASE of the waveform; the most-positive VOLTS cursor establishes the TOP. The user-specified BASE and TOP are then used with the current PROXIMAL, MESIAL, and DISTAL settings for LEVEL when the scope calculates the amplitude-reference levels.

## Level Calculations

Regardless which BASE-TOP determination method is used, once the BASE and TOP are found, the scope must next determine the amplitude-reference levels. These levels are called the PROXIMAL, MESIAL, DISTAL, and MESIAL2 reference levels. The reference levels are determined by the settings established for each in the LEVEL submenu for MEASURE. Each level can be set to a percentage of the current waveform's base-to-top amplitude or to an absolute voltage level relative to its ground reference level.

If the level is set in percentage, the corresponding voltage must be calculated. The resolution for the voltage calculated is determined by the VOLTS/DIV setting at which the targeted waveform was acquired. The vertical resolution of the scope is 25 digitization levels per division (25 DL's/DIV). The resolution is, therefore, 1/25 of the VOLTS/DIV setting for the target waveform. For example, if the VOLTS/DIV setting is 1 V, the resolution of the level calculation is:

$$\frac{1 \text{ VOLT/DIV}}{25 \text{ DL's/DIV}} = 0.04 = 40 \text{ mV resolution}$$

The resolution as just calculated applies to the amplitude-reference levels and to the TOP and BASE levels. With the 40-mV resolution found in our example, the TOP and BASE level will each be a positive and/or negative multiple of 40 mV and the amplitude-reference levels are positive multiples of 40 mV.

**Example:** Assume a 1-Volt peak-peak input signal, symmetrical around ground, with the VOLTS/DIV set to 1 V and the levels set to their default values: PROXIMAL=10%, MESIAL=50%, DISTAL=90%. As indicated previously, the resolution is 40 mV; therefore, for TOP and BASE:

$$\begin{aligned} \text{BASE} &= -500 \text{ mV, nominal; } -480, \text{ resolved.} \\ \text{TOP} &= +500 \text{ mV, nominal; } +480, \text{ resolved.} \end{aligned}$$

As shown here, BASE and TOP would normally be  $-500 \text{ mV}$  and  $+500 \text{ mV}$ , respectively; however, based on the resolution limit, the resolved values were  $\pm 12$  times  $40 \text{ mV}$ , or  $-480$  and  $+480 \text{ mV}$ , respectively. The values are rounded downward (in magnitude) if nominal value is exactly midway (as in this case) between levels of resolution. (Set the VOLTS/DIV switch to a more sensitive setting to increase resolution as needed; if the 1-Volt signal in our example had been displayed at  $200 \text{ mV}$  per division rather than at  $1 \text{ V/DIV}$  /division, the resolution would have been  $8 \text{ mV}$ , or  $0.8\%$ , instead of  $40 \text{ mV}$ , or  $4\%$ .)

The level values in volts are determined by multiplying the appropriate level percentage (expressed as a fraction) by the difference between the TOP and BASE and adding the result to the BASE. Here, the nominal level values are calculated using the resolved values for TOP and BASE:

$$\begin{aligned} \text{PROXIMAL value} &= \text{BASE} + [0.1 \times (\text{TOP} - \text{BASE})] \\ &= -480 \text{ mV} + [0.1 \times (480 - (-480))] \\ &= -384 \text{ mV, nominal} \\ \text{MESIAL value} &= -480 \text{ mV} + [0.5 \times (480 - (-480))] \\ &= 0 \text{ mV, nominal} \\ \text{DISTAL value} &= -480 + [0.9 \times (480 - (-480))] \\ &= 384 \text{ mV, nominal} \end{aligned}$$

These calculated values must also be rounded to the nearest resolution level (as for BASE and TOP, any values exactly midway of resolution levels are rounded down):

$$\begin{aligned} \text{PROXIMAL} &= -400 \text{ mV, resolved} \\ \text{MESIAL} &= 0 \text{ mV, resolved} \\ \text{DISTAL} &= 400 \text{ mV, resolved} \end{aligned}$$

The following is a quick way to predict the voltage that Measure mode would calculate, for given percentage level and waveform:

1. Determine the waveform amplitude between TOP and BASE: Turn on BASE and TOP in the MEAS TYPE menu to display those values on screen. Subtract the BASE value from the TOP value.
2. Display the LEVEL menu to determine the percent setting for the level to be calculated in volts: Read the percent setting directly from the menu.
3. Calculate the number of resolution increments represented by the percent setting: Convert the percent obtained in Step 2 to a decimal, multiply it by the difference obtained in Step 1, and divide the result by the resolution obtainable at the VOLT/DIV setting used. Round the answer to the nearest whole number (round a midway result downward).
4. Calculate the resolved level: Multiply the rounded number from Step 3 by the obtainable resolution to get the resolved value in volts. Add the resolved value to the BASE level displayed in Step 1 to obtain level of interest in volts.

As an example, find the distal level of a 5-volt square wave that is symmetrical around ground ( $\pm 2.50$  V peak). Assume a VOLT/DIV setting of 2 V; and, therefore a resolution of 0.08 V.

1. Turn on BASE and TOP to display the resolved BASE and TOP values of  $-2.48$  V and  $+2.48$  V, respectively, and calculate their difference:

$$2.48 - (-2.48) = 5.96.$$

## Appendix C

---

2. Display LEVEL menu (assume DISTAL=70%).
3. Calculate number of resolution increments:

$$\text{DISTAL (nominal)} = \frac{.70 \times 5.49\text{V}}{0.08 \text{ V}} = 43.4, \text{ rounding to } 43.$$

4. Calculate resolved level:

$$\text{DISTAL (resolved)} = 43 \times 0.08 \text{ V} + (-2.48) = 0.96 \text{ V}$$

If the LEVEL menu is switched to set the amplitude-reference level in VOLTS instead of %, the vertical resolution for the current VOLTS/DIV setting again limits the values that can be obtained. If, for example, the PROXIMAL level was set to 100 mV at 1 V/DIV, it would be rounded to 120 mV as was calculated for percent.

The PROXIMAL, MESIAL, and DISTAL levels are shown in Figure C-1 for HISTogram method waveforms and in Figure C-2 for MIN/MAX method waveform.

MESIAL2 is an independent amplitude-reference level for use with DELAY—the only parameter extraction that uses two target waveforms. MESIAL2 lets the user set a crossing threshold on the TO target of the DELAY measurement that is independent of the crossing thresholds on the FROM target.

Error messages are provided to ensure that the proper relationships among PROXIMAL, MESIAL, and DISTAL ( $\text{PROXIMAL} \leq \text{MESIAL} \leq \text{DISTAL}$ ) are maintained. PROXIMAL must also be greater than or equal to BASE, and DISTAL must be less than or equal to TOP. MESIAL2 must be within the BASE and TOP of the DELAY TO waveform if the DELAY measurement is selected. (Table C-2 contains more information about error messages.)

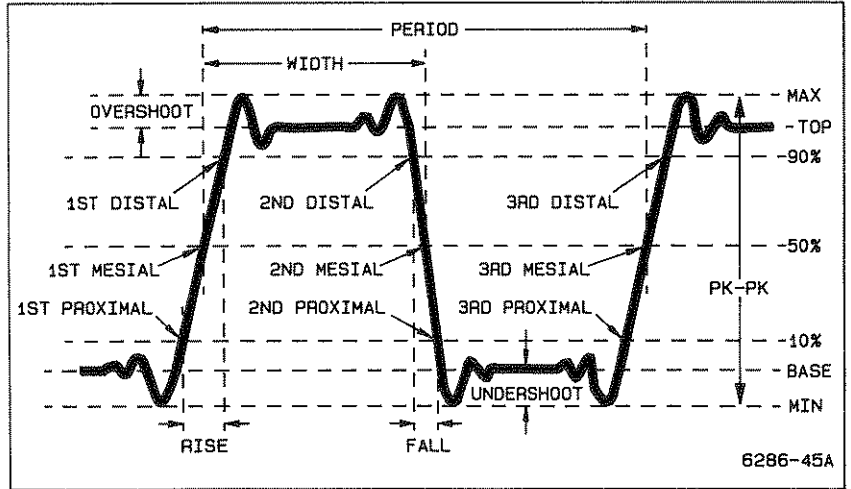

Figure C-1. Parameter extraction using HISTogram method.

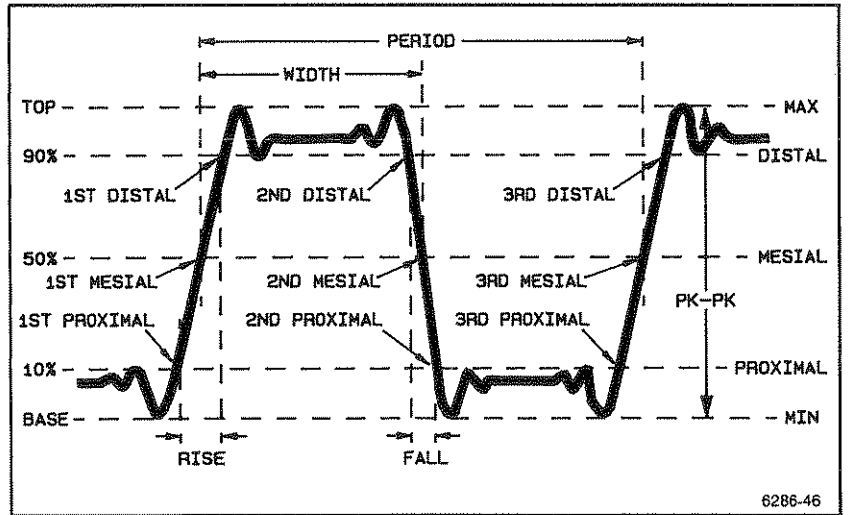

Figure C-2. Parameter extraction using MIN/MAX method.

**NOTE**

*The amplitude-reference levels just found are shown for the first through third edge on Figures C-1 and C-2. The crossing points labeled "1st" (1st MESIAL, etc.) are on the first edge; those labeled "2nd" are on the second edge; etc.*

***Determination of Time-Reference Points***

Once the amplitude-reference levels have been calculated, the waveform data-array can be searched for crossings at these reference levels. The direction (positive or negative) of the waveform and the time at these crossings define the time-reference points for calculating the waveform parameters.

***Time-Reference Points Search Procedure***

The scope uses the amplitude-reference points in a search algorithm to determine where (at what time) in the waveform record the reference points occur, and in what direction (positive or negative) the waveform is moving at each crossing. In general, the MESIAL level crossings are used to determine where valid edges exist, and the search sequence locates the PROXIMAL and DISTAL crossings on those edges. Once found, the time at each crossing is mapped into one of three arrays to be used later in calculating the waveform parameters.

The first MESIAL crossing in the waveform record (or active window) is located and the polarity of the crossing determined. The waveform is then searched backward in the record. If the first MESIAL found was on a rising edge (positive crossing), the scope searches for a PROXIMAL level; it looks for a DISTAL crossing if the MESIAL was on a falling edge (negative crossing).

After finding the first level that occurred before the first MESIAL, the search is again reversed, and the scope looks forward in the record to find the first level after the first MESIAL (DISTAL, after a positive MESIAL crossing, or PROXIMAL, after a negative MESIAL crossing). At this point, the search has located all three amplitude-reference crossings for the first edge in the record (or in the active window). The search continues forward until the next MESIAL crossing is found.

Once the second MESIAL is found, the backward/forward search just described repeats to locate the other two reference levels for the second edge, followed by the next MESIAL for the third edge (last rising edge in Figures C-1 and C-2). This process of finding the amplitude-reference points (and using the corresponding times to build arrays of time-reference points) is repeated until four sets of edge information are collected or until the entire active window has been searched.

## Calculation of the Waveform Parameters

Table C-1 shows how each waveform parameter is calculated. Some parameters are calculated directly from the time-reference points derived from the three arrays. For example, the parameter WIDTH is calculated by subtracting the time at the first MESIAL crossing from the time at the second MESIAL crossing of the waveform, where both MESIAL crossings are on edges bracketing the pulse. All array-derived time-reference points are illustrated in Figure C-1; this figure is useful in visualizing the calculations made directly from these reference points.

Some parameters are calculated indirectly from the reference points. The duty cycle parameter (DUTY), for example, is calculated by dividing the width of the positive pulse (TIME ON) by the period (PERIOD). Both TIME ON and PERIOD are calculated directly from the time-reference points and used in the indirect calculation for DUTY.

**Table C-1**  
**Definition of Parameters**

The 21 parameters available for extraction are defined as follows:

**AREA:** The area under the waveform:

$$\text{AREA} = \sum_{i=j}^k W(i)$$

Where

Window OFF

$j = 1$

$k = 1024$

Window ON

$j =$  Location of left TIME Cursor

$k =$  Location of right TIME Cursor

$W =$  Target waveform array

Points above ground contribute positive AREA;

Points below ground contribute negative AREA.

## Appendix C

**BASE:** Determined by the method chosen in the second-level SETUP menu. Defines the 0% level of the waveform for calculating percentage-based DISTAL, MESIAL, and PROXIMAL levels.

**DELAY:** Time delay is defined as:

WINDOW mode OFF:

DELAY = Time @ first MESIAL of TO target – Time @ first MESIAL of FROM target + calibration constant to null mismatch between CH 1 and CH 2.

Window ON:

DELAY = Time @ last MESIAL before right-most TIME cursor on TO target – Time @ first MESIAL before left-most TIME cursor on FROM target + calibration constant to null mismatch between CH 1 and CH 2.

WINDOW ON definition allows delay measurements from any selected edge on the FROM waveform to any edge on the TO waveform.

**DISTal:** Determined by the method chosen in the second-level SETUP menu and the DISTAL percentage or voltage level chosen in the third-level LEVEL menu.

**DUTY:** Duty cycle is defined as:

$$\text{DUTY CYCLE} = \frac{\text{TIME ON}}{\text{PERIOD}} \times 100\%$$

where "TIME ON" is the duration of the positive portion of the waveform.

**FALL time:** The time between the DISTAL and PROXIMAL crossings of the first complete negative-going edge.



**FREQ:** This measurement is simply the reciprocal of the PERIOD measurement, which requires the acquisition of three consecutive MESIAL points.

$$\text{FREQ} = \frac{1}{\text{Time @ third MESIAL} - \text{Time @ first MESIAL}}$$

**MAXimum:** The largest (most positive) value found in the active window.

**MEAN:** The mean value of the waveform:

$$\text{MEAN} = 1/(k - j + 1) \times \sum_{i=j}^k W(i)$$

Where

Window OFF

$$j = 1$$

$$k = 1024$$

Window ON

j = Location of left TIME Cursor

k = Location of right TIME Cursor

W = Target Waveform Array

**MESial:** Determined by the method chosen in the second-level METHOD menu and the MESIAL percentage or voltage level chosen in the third-level LEVEL menu.

**MIDpoint:** The vertical midpoint for the waveform:

$$\text{MID} = (\text{MAX} + \text{MIN})/2$$

**MINimum:** The smallest (most negative) value found in the active window.

**OVeRShooT (TOP Overshoot):**

$$\text{OVRSH} = \frac{\text{MAX} - \text{TOP}}{\text{TOP} - \text{BASE}} \times 100\%$$

This calculation does not select the maximum on the first rising edge. Instead, the maximum is the most positive value found within the entire active window of the waveform.

## Appendix C

**PERiod:** The measurement of period requires the acquisition of three consecutive MESIAL points. The period is defined as:

$$\text{PERIOD} = \text{Time @ third MESIAL} - \text{Time @ first MESIAL.}$$

**PROXimal:** Determined by the method chosen in the second-level METHOD menu and the PROXIMAL percentage or voltage level chosen in the third-level LEVEL menu.

**PK-PK (peak-to-peak):** MAX - MIN

**RISE time:** The time between the PROXIMAL and DISTAL crossings of the first complete positive-going edge.

**RMS:** The voltage in RMS.

$$\text{RMS} = \left[ \frac{1}{(k-j+1)} \sum_{i=j}^k (W(i)^2) \right]^{1/2}$$

Where

For WINDOW OFF:

If Period exists

j = First MESIAL crossing found

k = Third MESIAL crossing found

If Period does not exist

j = 1

k = 1024

For WINDOW ON:

j = Location of left TIME Cursor

k = Location of right TIME Cursor

W = target waveform array

With WINDOW OFF, the calculation returns an RMS measurement of a periodic signal; with WINDOW ON, the scope returns an RMS measurement over the user-specified "windowed" area.

**TOP:** Determined by the method chosen in the second-level SETUP menu. Defines the 100% level of the waveform for calculating percentage-based PROXIMAL, MESIAL, and DISTAL levels.

**UNDerShoot (BASE Overshoot):**

$$\text{UNDRSHT} = \frac{\text{BASE} - \text{MIN}}{\text{TOP} - \text{BASE}} \times 100\%$$

Similar to overshoot, this calculation does not select the minimum on the first falling edge. Instead, the minimum is found within the entire active window of the waveform.

**WIDTH:** This is an edge-to-edge measurement, defined as:

$\text{WIDTH} = \text{Time @ second MESIAL on the pulse} - \text{Time @ first MESIAL on the pulse}$ , where the pulse is that portion, positive or negative, of a periodic waveform having the *least* duration relative to the waveform period.

Note that WIDTH might be measured from a rising to a falling edge or from a falling to a rising edge, depending on which of the available edges in the active window define a pulse. This instrument defines a pulse as that part of the waveform having the shortest duty cycle. In other words, for a rectangular waveform that is at a more positive level 60% of the time and a more negative level 40% of the time, the two mesials for the edges bracketing the negative 40% of the waveform are used for measuring WIDTH.

## ***Interaction of MEASURE with Acquisition Modes***

### ***ENVELOPE Mode***

MEASURE can be used with waveforms acquired in ENVELOPE mode; however, a wide envelope can cause unintended results for time-related parameter extractions. ENVELOPE mode finds the MIN and MAX values for each sample point, and, when they are displayed, the transitions between these MIN and MAX values (for each sample point) can cross amplitude-reference levels. Such crossings can cause the time-reference points to be located on undesired points of the waveform. For this reason an ENV? warning message is displayed to the left of the selected measurement. Always use MARKs when using MEASURE with ENVELOPE mode, so measurement points on the waveform are seen.

## Appendix C

---

MEASURE uses the envelope when determining amplitude-related parameters.

When measuring ADD or MULT waveforms that are SAVEd, remember those waveforms must be displayed in ADD or MULT mode before SAVEd mode is entered. If ADD or MULT is selected after SAVE is entered, an invalid waveform is displayed and, if ADD or MULT is selected as the measurement target for a Continuous-Update measurement, an error message will be displayed in place of the measurement results.

### **AVERAGE Mode**

Waveform Parameter Extraction is always performed on 8 bits of data; for AVERAGE Mode the 8 bits measured are the 8 upper (most-significant) bits of the 16-bit average data.

### **REPET Mode**

In REPET mode, a minimum number of acquisitions must be taken before enough sample points are accumulated for parameter extraction. Until enough sample points are acquired, the selected parameter value is replaced with ?? WAIT ?? in the MEASURE display.

### **SAVED Expanded Waveforms**

The area that parameters are extracted from on waveforms that have been SAVEd and then horizontally expanded depends on the horizontal position. Up to 200 horizontal screens of data are available (with 100× expansion), but only 2 screens are available for measurement at any one time. Normally, the area measured is the 2 screens (2 screens comprise 20 horizontal divisions, or 1024 points of data) that start at the left edge of the graticule and continue to one screen of data (10 divisions) beyond the right edge of the graticule. The exceptions to this rule are when the beginning or end of the expanded waveform are positioned inside the 2 screen area just described:

- If the beginning of the expanded waveform is positioned to the right of the left edge of the screen, the 1024 points the parameter is extracted from *start* at the *beginning* of the waveform. The beginning of the waveform cannot be positioned to the right of center screen.
- If the end of the waveform is positioned less than 10 divisions beyond the right edge of the screen, the 1024 points the parameter is extracted from *stop* at the *end* of the waveform. In other words, the measurement begins as far to the left of the screen's left edge as is necessary to use the full 1024 sample points. The end of the waveform cannot be positioned to the left of center screen.

### ***Vertical Expansion***

If a SAVEd waveform is vertically expanded, the expansion is done before the parameter is extracted. If the waveform is expanded beyond the 10.24-division vertical window, inaccurate amplitude measurements may result. The CLIP message (see Table C-3) warns the user of this situation. Resolution is not increased for parameter extraction by vertically expanding waveforms.

### ***SMOOTH Acquisition Mode***

Smoothing, if enabled, is performed prior to any parameter extraction calculations. Since SMOOTH performs a moving, 5-point average on waveforms, it can affect the values returned for MEASURE. See Section 5 for more information about SMOOTH.

### ***ROLL Acquisition Mode***

Parameters cannot be extracted from a "live" waveform in ROLL mode, but they can be extracted using SAVE mode. When the ROLL waveform has been SAVEd, either by a press of the SAVE button or by the occurrence of a SAVE-ON-DELTA, the selected parameter can be displayed.

## ***Glossary of Parameter Extraction Terms***

**Active Window:** The portion of the waveform over which the selected parameter is extracted. If WINDOW is OFF, the active window is from the first waveform sample to the last waveform sample: sample 1 to sample 1024. If window is ON, the active window is the section of waveform between and including the left and right time cursors. All parameter extraction is performed within the active window.

**BASE:** The 0% level of the waveform determined by the currently selected measurement method (MIN/MAX, HISTogram, or CURSOR).

**Crossing:** The time location where the waveform crosses an amplitude-reference level (PROXIMAL, MESIAL, MESIAL2, or DISTAL).

**DISTAL Level:** This is a voltage threshold that provides the ending time-reference point for rise-time measurements and the starting time-reference point for fall-time measurements. It can be set by the user to any voltage from -999 V to +999 V or from 0 to 100%. The INIT PANEL value for DISTAL is 90%, which is the typical value for rise-time and fall-time measurements.

**MESIAL Level:** This voltage threshold is typically 50% of the waveform. MESIAL crossings determine the time-reference points used to calculate frequency, width, period, RMS, and delay.

**MESIAL2 Level:** This voltage threshold is similar to MESIAL, but it is used to determine the time-reference point for the TO waveform target when measuring DELAY. (DELAY is a two-channel measurement.) The MESIAL2 level can be set independently from MESIAL, but the default is 50%.

**PROXIMAL Level:** This is the other threshold that is used with the DISTAL crossing to calculate the rise-time and fall-time parameters. The default value of PROXIMAL is 10%.

**TOP:** The 100% level of the waveform determined by the current measurement method (MIN/MAX, HISTogram, or CURSOR).

## Warning and Error Messages for MEASURE

### ERROR Messages

Error messages are issued when the scope cannot perform the requested parameter extraction.

#### NOTE

When "active window" is used in descriptions for error or warning messages, it refers to the section of the targeted waveform that is being measured. If WINDOW is on and the TIME cursors are on, the active window is the section between and including the left and right TIME cursors. If WINDOW is off, the active window is the entire 1024-sample, 20-horizontal division waveform.

Table C-2  
Error Messages for MEASURE

Error Messages	Description
EMPTY REF	A measurement was requested on an empty DISPLAY REF waveform.
INVALID WFM	Parameter target contains invalid waveform data. Data may have been lost due to interruption of power while acquiring or failure of the battery-backup to memory. Press ACQUIRE to acquire new valid data for the selected parameter.
LEVEL LIMIT?	The level settings do not satisfy the condition: $\text{PROXIMAL} \geq \text{BASE}$ and $\text{DISTAL} \leq \text{TOP}$
LEVEL ORDER?	The level settings do not satisfy the condition: $\text{PROXIMAL} \leq \text{MESIAL} \leq \text{DISTAL}$
MES2 LIMIT?	The MESIAL2 level does not satisfy the condition: $\text{BASE} \leq \text{MESIAL2} \leq \text{TOP}$

Appendix C

Table C-2 (cont)



Error Messages	Description
CURSOR METH?	<p>PROXIMAL, MESIAL, MESIAL2, and DISTAL levels are determined based on the settings for TOP and BASE, which are in turn determined by the VOLTS CURSORS if the measurement method is set to CURSOR. The error message is displayed when CURSOR establish settings for TOP and BASE that cause the following conditions not to be met:</p> <p style="padding-left: 40px;"><math>PROXIMAL \geq MIN</math> and <math>DISTAL \leq MAX</math>,</p> <p>plus for DELAY measurements:</p> <p style="padding-left: 40px;"><math>MIN \leq MESIAL2 \leq MAX</math>.</p> <p>Since RMS is measured over one cycle, TOP/BASE settings that do not meet the conditions listed display the error message unless WINDOW mode is used define the measurement area.</p> <p>This error may be corrected by re-positioning the volts cursors so that they vertically bracket the waveform being measured.</p>
NO DEL DELAY	<p>A measurement was requested on a delta-delayed waveform, and the scope is not in B Horizontal mode or <math>\Delta</math> TIME was off.</p>
NEED 2 EDGES	<p>Less than two edges were found in the active window.</p>
NEED 3 EDGES	<p>Less than three edges were found in the active window.</p>
NO  EDGE	<p>No rising edge was found in the active window.</p>
NO  EDGE	<p>No falling edge was found in the active window.</p>



Table C-2 (cont)

Error Messages	Description
OVERFLOW	This message is displayed for the RMS measurement when the dynamic range capability of the RMS calculation has been exceeded. This may happen with certain combinations of SAVED vertical expansion settings and data values.
ROLL-NO MEAS	Measurements are not permitted while the trigger mode is ROLL and the scope is acquiring. SAVE the waveform to make the measurement.
???TIME/DIV	The SEC/DIV settings of the FROM and TO targets of the delay parameter don't match.
?? WAIT ??	The REPET waveform has not yet acquired enough sample points.

**WARNING Messages**

Warning messages are issued when the requested parameter may not be valid.

*NOTE*

*When "active window" is used in descriptions for error or warning messages, it refers to the section of the targeted waveform that is being measured. If WINDOW is on and the TIME cursors are on, the active window is the section between and including the left and right TIME cursors. If WINDOW is off, the active window is the entire 1024-sample, 20-horizontal division waveform.*

**Table C-3  
Warning Messages for MEASURE**

Warning Message	Description
CLIP	The amplitude of the targeted waveform is outside the 10.24 <sup>1</sup> divisions available for vertical display. Increase the VOLTS/DIV or vertically position the waveform toward center screen.
ENV?	The measurement is taken on an ENVELOPE waveform and MIN to MAX transitions may cross level thresholds, generating unintended results. Use the MARKS to determine if the correct level crossings were obtained.
HISTO?	Displayed when less than $2 \times \sqrt{N}$ points are available for determining either the TOP and/or BASE when using the HISTogram METHOD. N is the number of points in the active measurement window. If WINDOW is off (N = 1024), there must be more than 60 points in both the TOP and BASE levels or this warning is displayed.
LO AMPL?	Time measurements were requested on a waveform with less than 12 DL's (digitization levels) from the BASE to the TOP. (There are 25 DL's per vertical division.)

<sup>1</sup>The size of the vertical window gradually decreases from 10.24 divisions at SEC/DIV settings above 100  $\mu$ s/DIV. See "Dynamic Range" in Section 6 for the vertical window sizes for these settings.

Table C-3 (cont)

Warning Message	Description
LO RES?	<p>Greater resolution may be needed for an accurate result. Go to a faster SEC/DIV setting to obtain greater resolution. The warning message is displayed when:</p> <ul style="list-style-type: none"> <li>a. RISE or FALL is specified and the rise time or fall time allowed less than 5 samples to be acquired for the parameter.</li> <li>b. FREQ or PERIOD is specified and <math>\leq 15</math> samples are acquired for the parameter.</li> <li>c. Pulse WIDTH is specified and <math>\leq 10</math> samples are acquired for the parameter.</li> <li>d. DELAY is specified and the absolute value of the delay is <math>\leq 5</math> samples.</li> </ul>
MIN/MAX?	<p>Overshoot or undershoot was requested and MIN/MAX was the METHOD specified. Overshoot and undershoot are always 0% for MIN/MAX.</p>
NO DISP	<p>Measurements were requested on a waveform that is not displayed.</p>
< 1 PER?	<p>Less than one period was found in the active window. RMS will be calculated from sample 1 to sample 1024, since this warning is only displayed if WINDOW is off.</p>

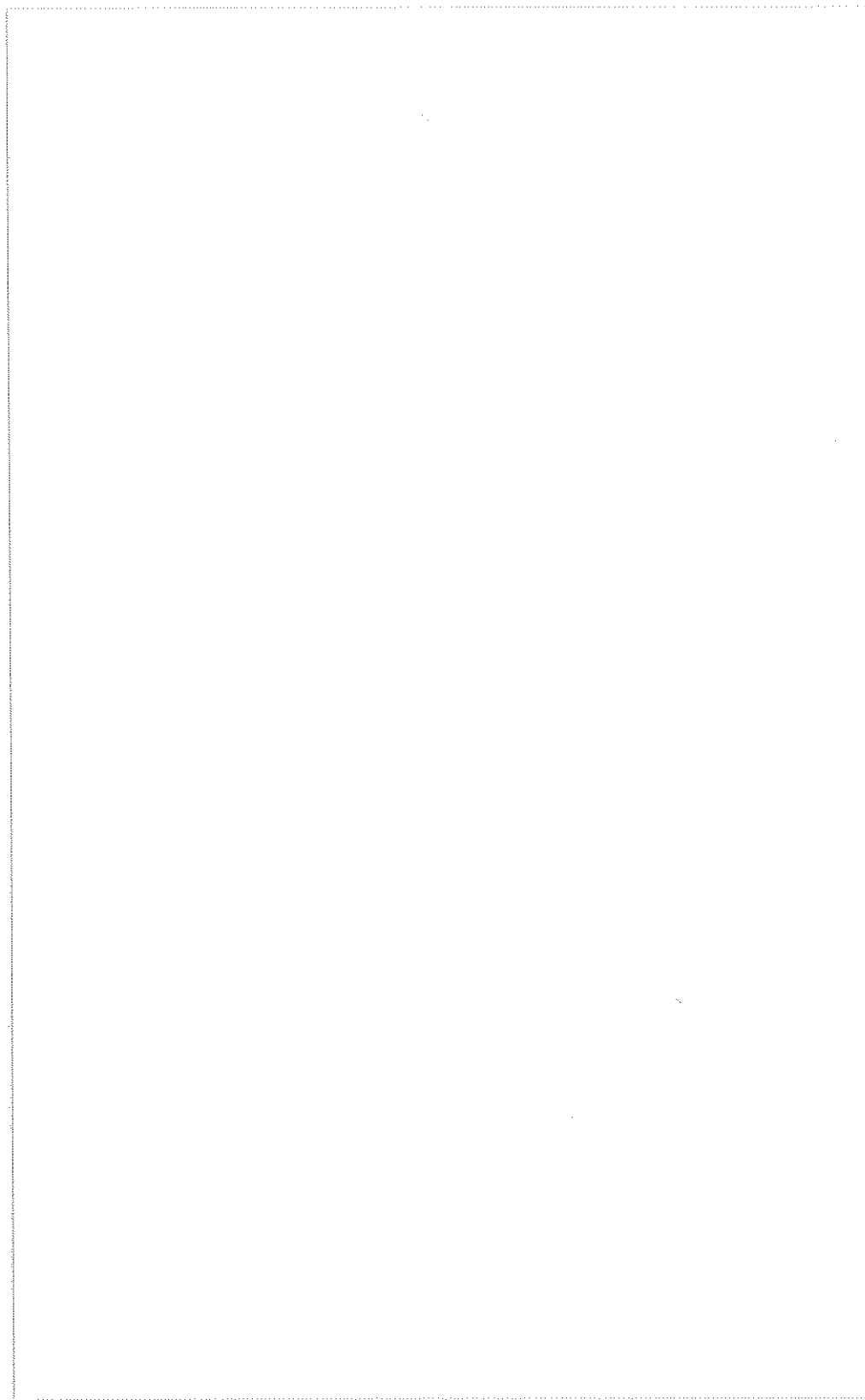

## Index

Δ!ABS CURSOR MODE, 5-19  
Δ DELAY TIME, 3-18  
Δ TIME, 5-31  
Δ TIME CURSORS, 3-31  
1/TIME CURSORS, 2-30, 5-13, 5-18  
50 Ω OVERLOAD, 5-10  
50 Ω TERMINATION, 5-10

A AND B SEC/DIV SWITCH, 5-29  
A INTEN, 5-30  
A TRIGGER, B-9  
A TRIGGER CONTROL MENUS, 5-87  
A TRIGGER MODES, 5-38  
A TRIGGER OUTPUT CONNECTOR, 5-81  
A/B TRIG BUTTON, 5-34  
A\*B TRIGGER, 3-43  
A\*B!WORD SOURCE, 5-35  
ABSOLUTE TIME CURSORS, 3-35  
ABSOLUTE VOLTAGE CURSORS, 3-29  
AC COUPLING, 5-10, 5-37  
AC POWER SOURCE, 6-25  
ACCESSORIES, 7-19  
ACQUIRE BUTTON, 5-44  
ACQUIRE MODES, 5-44  
ACQUIRING DATA, 2-3  
ACQUISITION SYSTEM SPECIFICATIONS, 6-9  
ADD MODE, 3-4, 5-7  
ADDR, 5-26  
ALT, 7-7  
APPLICATIONS, 3-1  
ARMED, B-13  
ARMED-READY-TRIG'D 5-42  
ASTIG ADJUSTMENT, 4-2, 5-4  
ATRIG (A TRIGGER), B-13  
ATTACH CURSORS TO:, 5-18  
AUTO, 5-57  
AUTO LEVEL, 5-38  
AUTO TRIGGERING AND AUTO LEVELING, B-7  
AUTOMATIC SCALE FACTOR SWITCHING, 2-5  
AUTO/ROLL, 5-38  
AUTOSETUP, 3-62, 5-73, B-22  
EDGE, 5-60  
PERIOD, 5-60  
PULSE, 5-60  
VIEW, 5-60

## **2440 Operators**

---

AUTOSTEP SEQUENCER, 3-85, 5-69, 5-71  
DELETE, 5-76  
EDIT, 5-77  
RECALL, 5-76  
SAVE, 5-70  
AUXILIARY GROUND, 5-21  
AVG ACQUISITION MODE, 3-46, 5-46, C-14

B TRIGGER CONTROL MENUS, 5-88  
B TRIGGER MODES, 5-40  
B TRIGGER SOURCE, B-8  
BACK-PORCH CLAMP, 7-5, 7-7  
BANDWIDTH BUTTON, 5-11  
BATTERY, 6-21  
BELL, 5-73, A-2  
BELL, WARNING, 5-73, A-2

CALIBRATION, A-5, A-9  
CALIBRATOR, 5-21  
CALIBRATOR FREQUENCY, B-2  
CCIR SYSTEM B, 7-10  
CH 2 SIGNAL OUTPUT, 5-81  
CHAN 1:2, 5-34  
CLAMP, 7-5, 7-7  
CLOCK, REAL-TIME, 2-19  
COAXIAL CABLES, 2-5  
CODED PROBES, 6-2, B-1  
COLD START, A-1, A-6  
COOLING, 1-7  
COUPLED CURSORS, 3-37  
COUPLING, 5-9, 5-37  
COUPLING/INVERT, 5-9  
CPLG BUTTON, 5-37  
CRT, 5-6  
CRT DISPLAY MENUS, 5-83  
CURSOR CONTROL MENUS, 5-85  
CURSOR MEASUREMENTS, 3-24, 6-4  
CURSOR/DELAY CONTROL KNOB, 5-33  
CURSORS, 2-26

DC COUPLING, 5-10, 5-37  
DC INPUT COUPLING, 5-36  
DC OFFSET, 5-60  
DEBUG, 5-26  
DELAY BY EVENTS, 2-34, 3-22, 5-33  
DELAY BY TIME, 2-32, 3-14, 5-31  
DELAY CONTROL MENUS, 5-86  
DELTA VOLTAGE, 3-25  
DETACHABLE-POWER-CORD RECEPTACLE, 5-79  
DEVICES, 5-24  
DIAGNOSTIC ROUTINES, A-5  
DIAGNOSTICS, A-5, A-10, A-16  
DIMENSIONAL DRAWING, 6-35  
DISABLED--SEE MANUAL, A-1  
DISP, 5-83  
DISPLAY PRIORITY, B-14  
DISPLAY REF, 5-53  
DISPLAY SPECIFICATIONS, 6-24

EDGE?, 5-17  
EMPTY REF, 2-21, 5-54  
ENCDG, 5-26  
ENVELOPE ACQUISITION MODE, 3-49, 5-43, C-13  
ENVIRONMENTAL CHARACTERISTICS, 6-26  
ERROR MESSAGES, C-17  
EXPANSION, 3-52  
EXT 1:2, 5-35 f  
EXT CLK, 5-40  
EXT TRIG GAIN, 5-35  
EXTENDED CALIBRATION, A-9, A-11, A-16  
EXTENDED DIAGNOSTICS, A-8, A-12, A-16  
  HALT, A-14  
  MODE, A-14  
  RUN/SEL., A-14  
  UP/DOWN ARROWS, A-12  
EXTENDED FEATURES, 5-56, 6-6  
EXTENDED FEATURES APPLICATIONS, 3-61  
EXTENDED FUNCTIONS, 5-4, A-1  
EXTERNAL INTERFACE, 5-20  
EXTERNAL TRIG INPUT CONNECTORS, 5-21  
EXTERNAL TRIGGERING, 2-6  
EXTERNAL TRIGGER AND TRIGGER STATUS MENUS, 5-89

## 2440 Operators

---

FAIL, A-9  
FAMILIARIZATION PROCEDURES, 2-9  
FIELD LINE # CONTROL, 5-42  
FIELD TRIGGERING, 7-5  
FIELD1, FIELD2, 7-6  
FOCUS ADJUSTMENT, 4-2, 5-4  
FORCE DAC, A-1  
FREQUENCY MEASUREMENTS, 3-12, 3-18, 3-30  
FRONT-PANEL CONTROLS, 2-7  
FRONT-PANEL SETUP, 2-12  
FUNCTION BUTTON, 5-13  
FUSE RATING, 6-25

GENERAL APPLICATIONS, 3-2  
GENERAL PURPOSE INTERFACE BUS, 5-22  
GETTING A DISPLAY, 2-9  
"GETTING ACQUAINTED" PROCEDURE, 1-11  
GND, 5-10  
GPIB CONNECTOR, 5-79  
GPIB MODE, 5-23  
GPIB OPERATION, A-15  
GPIB STATUS, 5-23  
GRATICULE, 2-1  
GROUNDING, 2-4

HALT, A-14  
HELP, 5-56  
HF REJECT COUPLING, 5-37  
HOLDOFF CONTROL, 5-42, B-5  
HORIZ POS REF, 5-54  
HORIZONTAL CONTROLS, 5-29  
HORIZONTAL EXPANSION, 3-53, 5-29  
HORIZONTAL GAIN CHECK, 4-3  
HORIZONTAL MODES, 5-29  
HORIZONTAL POSITION CONTROL KNOB, 5-30  
HORIZONTAL SCALING, 5-57, 5-59  
HORIZONTAL SOURCE, 5-64  
HORIZONTAL SYSTEM, 6-2

ILLUSTRATIONS, xii  
INIT @ 50% Button, 5-41  
INIT PANEL, B-17  
INPUT-COUPLING CAPACITOR PRECHARGING, 2-6  
INSTANTANEOUS DC VOLTAGE LEVEL, 3-3  
INSTRUMENT COOLING, 1-7  
INTENSITY CONTROL KNOB, 5-3  
INTERNATIONAL POWER CORDS, 7-2  
INTERPOLATION, 5-49  
INVERT, 5-10



L/ONLY, 5-24  
LEVEL, 3-69  
LEVEL CONTROL, 5-42  
LEVEL/FIELD LINE #, 5-42  
LF REJECT COUPLING, 5-37  
LINE FUSE, 1-4, 1-5  
LINE SOURCE, 5-35, 7-6  
LINE VOLTAGE SELECTION, 1-3  
LINE VOLTAGE SELECTOR SWITCH, 1-5, 5-80  
LOCK, 5-22

MARK, 3-75  
MAXIMUM DELAY, B-10, B-11  
MEASURE, 3-67, 5-62  
  AREA, C-9  
  BASE, C-10, C-16  
  CONTINUOUS-UPDATE, 3-74  
  CROSSING, C-16  
  DELAY, C-10  
  DISTAL, 5-63, 5-66, 5-67, 5-68, C-16, C-17  
  DUTY, C-10  
  FALL TIME, C-10  
  FREQUENCY, C-11  
  MAXIMUM, 5-65, C-11  
  MEAN, C-11  
  MEASUREMENT LOCATION, 3-80  
  MESIAL, 5-63, 5-64, 5-66, C-11, C-16  
  MIDPOINT, C-11  
  MINIMUM, 5-63, C-11  
  OVERSHOOT, C-11  
  PERIOD, C-12  
  PROXIMAL, 5-66, 5-67, 5-68, C-12, C-16  
  PK-PK, C-12  
  RISE TIME, C-12  
  RMS, C-12  
  SNAPSHOT, 5-62  
  TOP, C-13, C-16  
  UNDERSHOOT, C-13  
  WIDTH, C-13  
  WINDOW, 5-68, C-15, C-16  
MECHANICAL CHARACTERISTICS, 6-29  
MENU BUTTONS, 5-1  
MENU OFF, 5-4  
MESSAGES, C-17  
MISC., A-2  
MULT MODE, 3-9, 5-8  
MULT SCALING, 3-9, 5-8, 5-61

## **2440 Operators**

---

NEW REF, 3-34, 5-19  
NO  $\Delta$  DELAY IN AVG, 3-48, 5-32  
NOISE REJECT COUPLING, 5-37, 6-14, 6-15, 6-16, 6-19  
NOMINAL SOURCE VOLTAGES, 1-3, 6-25  
NONVOLATILE MEMORY, 6-5, 6-21, A-6  
NORMAL ACQUISITION MODE, 3-46, 5-44  
NORMAL TRIGGER MODE, 5-39  
NOT WARMED UP, A-10  
NTSC (CCIR SYSTEM M), 7-10

OFF BUS, 5-25, 5-93  
OPERATING CONSIDERATIONS, 2-1  
OPERATORS CHECKS AND ADJUSTMENTS, 4-1  
OPERATORS FAMILIARIZATION, 2-7  
OPERATORS SAFETY SUMMARY, xiv  
OPTIONAL ACCESSORIES, 7-20  
OPTIONAL WORD RECOGNIZER PROBE, 7-3, 7-17  
OPTIONS, 7-1  
OUTPUT BUTTON, 5-23  
OUTPUT CONTROL MENUS, 5-96  
OVERSCANNED TV DISPLAYS, 7-9

P6407 WORD RECOG INPUT CONNECTOR, 5-81  
PANEL, A-2  
PASS, A-10, A-12  
PAUSE, 5-27, 5-71, 5-74  
PEAK-TO-PEAK VOLTAGE, 3-2  
PERFORMANCE CHARACTERISTICS, 6-1  
PERFORMANCE CONDITIONS, 6-8  
PLOT, 5-28, 5-73  
PLOTTER, 5-24  
POWER CORDS, 1-6, 1-7, 7-2  
POWER-DOWN, 1-9  
POWER ON/OFF SWITCH, 5-6  
POWER-ON/SELF TEST FAILURE, A-5  
PREFLT (PREFILTER), A-2  
PRGM, 3-85, 5-69  
PRINT, 5-73  
PRINTER, 5-24  
PROBE CODING, B-1  
PROBE LOW-FREQUENCY COMPENSATION, 4-4  
PROBE POWER CONNECTORS, 5-81  
PROBE POWER, 7-3  
PROBES, 2-4  
PROTECT, 5-71  
PWR ON INIT, 5-6, 5-83, B-17  
PWR ON LAST, 5-6, 5-83

RACKMOUNTING, 7-2  
RACKMOUNTING ACCESSORIES, 7-19  
RADIX, 7-17  
RATIO (between two voltages), 3-26  
RATIO (between two time periods), 3-34  
READOUT DISPLAY, 2-7, 2-8  
READY, B-11  
REAL-TIME CLOCK, 2-19  
REAR PANEL, 5-79  
RECORD TRIGGER, B-9 f B-11  
RECORD TRIGGER OUTPUT CONNECTOR, 5-80  
REPACKAGING FOR SHIPMENT, 1-10  
REPEAT, 5-79  
REPET MODE, 3-51, 5-49, C-14  
REPETITIVE ACQUISITION, B-3  
ROLL MODE, 3-50, 5-38, C-15  
RTRIG (RECORD TRIGGER), B-9 f B-11  
RUN/SEL, A-14  
RUNS AFTER, 5-40

SAFETY, 1-3  
SAVE ON  $\Delta$  MODE, 3-56, 5-50, B-16  
SAVE STORAGE MODE, 3-51, 5-52  
SAVED EXPANDED WAVEFORMS, C-14  
SAVEREF SOURCE, 3-54, 5-52  
SAVEREF DESTINATION, 5-53  
SEC/DIV SWITCH, 5-29  
SELECT BUTTON, 5-3, 5-19  
SELF CALIBRATION, 2-16, 5-69, A-9, A-11, A-15  
SELF DIAGNOSTICS, A-5, A-21, A-16  
SELF TEST, 5-73  
SERVICE ROUTINES, A-8  
SET BITS, 7-17  
SET VIDEO BUTTON, 5-41  
SET WORD BUTTON, 5-43, 7-17  
SETUP, 5-23, 5-24  
SETUP MENUS, 5-90  
SIGNAL CANCELLATION, 3-6  
SIGNAL CONNECTIONS, 2-4  
SIGNAL OUTPUTS, 6-22  
SINGLE SEQ TRIGGER MODE, 5-39  
SLOPE CURSORS, 2-28, 3-40, 5-18  
SLOPE/SYNC BUTTON, 5-42  
SMOOTH, B-4, C-15  
SMOOTH ON/OFF, 5-51  
SNIR, B-3  
SOURCE, 5-34  
SPECIAL APPLICATIONS, 3-24  
SPECIAL MENU, A-1  
SPECIAL UNITS, 3-26, 3-42

## 2440 Operators

---

SPECIFICATIONS, 6-1  
SRQ, 5-22, 5-71  
STACK REF, 5-53, 5-54, B-15  
START-UP, 1-8  
STATUS/HELP BUTTON, 5-3  
STORAGE AND I/O, 6-5  
STORAGE APPLICATIONS, 3-46  
STORAGE CONTROL MENUS, 5-86  
STORAGE SYSTEM, 5-44  
STORING FRONT-PANEL SETUPS, 2-14  
SYNC POLARITY, 7-6  
SYSTEM FUNCTIONS, A-1  
  MISC., A-2  
  PANEL, A-2  
  PREFLT ON/OFF, A-2  
  VIDEO OPT., A-3  
SYSTEM MENUS, 5-82  
SYSTEM SELECTION, 7-6  
SYSTEM-M/NONSYSTEM-M PROTOCOL, 7-9, A-4

T/L, 5-23  
T/ONLY, 5-23  
TABLES, xi, xiii, Appendix B  
TERM, 5-25  
TEST CODES, A-17  
THINKJET® PRINTER, 5-24  
TIME CURSORS, 2-29, 5-16  
TIME MEASUREMENTS, 2-2, 3-12, 3-31  
TIMEBASE SPECIFICATIONS, 6-18  
TRACE ROTATION ADJUSTMENT, 4-2, 5-4  
TRANSMIT, 5-27  
TRIG AFTER, 5-40  
TRIG POSITION BUTTON, 5-41  
TRIG STATUS BUTTON, 5-43  
TRIG'D, B-13  
TRIGGER LEVEL RANGE, B-6  
TRIGGER MODE BUTTON, 5-38  
TRIGGER POSITION, B-9  
TRIGGER STATUS INDICATORS, B-12  
TRIGGER SYSTEM, 6-3  
TRIGGERING SPECIFICATIONS, 6-14  
TV LINE NUMBER, 7-7, 7-8  
TV RF INTERFERENCE, 7-9  
TV SYSTEM, 7-9, A-4

UNCALD, A-10  
UNITS BUTTON, 5-19  
UP/DOWN ARROWS, A-13  
USING THE CURSORS, 2-25



COMMITTED TO EXCELLENCE

## MANUAL CHANGE INFORMATION

Date: 4-20-88

Change Reference: C1/0488

Product: 2440 Operators

Manual Part No.: 070-6599-00

DESCRIPTION

Product Group

### EFFECTIVE ALL SERIAL NUMBERS

#### Page 1-2

Replace the first paragraph with the following.

Two 20-division waveform records, A and B, are available, with display modes of A, B, or A intensified by B. The acquisition rate can be selected in a 1-2-5 sequence of 29 calibrated steps from 5 s to 2 ns per division. The B acquisition can be delayed from the A acquisition by using the Delay Time feature, and a second B acquisition can be delayed even further by using  $\Delta$  Delay.

#### Page 3-23

Replace information #2 and example with the following.

2. ENCOUNTERING MAXIMUM DELAY. The sum of DELAY TIME and  $\Delta$  DELAY TIME cannot exceed the maximum delay range for the B SEC/DIV setting. The maximum delay (and best delay resolution) depends on the B SEC/DIV setting, the B Trigger Mode setting, and whether REPET is ON or OFF. (See Table B-10, Appendix B, for a listing of both resolution and maximum delay for all B SEC/DIV settings.) In general, the maximum delay available decreases as the B-acquisition rate is increased. If you increase the B SEC/DIV so that the maximum delay at the new setting is less than the sum of the Delay times you specified at the old setting, the Delay times will be reduced to the limit for the new setting. To reestablish the old setting, you must return to the slower B SEC/DIV setting and readjust the Delay time(s). Note that the maximum time delay allowed does not affect the amount of time delay available for the DELAY by EVENTS function.

**EXAMPLE:** If B SEC/DIV is set to 10  $\mu$ s, the maximum allowed delay time is  $0.8 \times 65536 \times 10 \mu\text{s} = 52.428 \text{ ms}$ . Assume DELAY TIME is set to 40.000 ms and an event is on screen. If the B SEC/DIV setting is increased to 5  $\mu$ s, the maximum allowed time is  $0.8 \times 65536 \times 5 \mu\text{s} = 26.214 \text{ ms}$ . The event is no longer displayed; return the B SEC/DIV to 10  $\mu$ s and set the DELAY TIME back to 40.000 ms to see the event.

DESCRIPTION

Page 3-30

Replace the first paragraph of Time and Frequency Measurements with the following.

***Time and Frequency Measurements***

Cursors increase the accuracy of time measurements, too. An internal crystal-controlled clock circuit determines the accuracy of the time cursors, which is specified as 0.0015% over two divisions. Since 0.0015% of two divisions is less than a ten-thousandth of a division, the accuracy of cursor measurements essentially depends on how accurately the user places them on the display. The accuracy of the graticule will be within approximately 1% of the cursor accuracy.

Page 5-8

Replace the first paragraph of YT:XY with the following.

Switches between a Y-axis versus time (YT mode) or the X-axis versus Y-axis (XY mode) representation of the displayed signal. In XY mode, the signal applied to the CH 1 input supplies the horizontal deflection, and the signal applied to the CH 2 input supplies the vertical deflection, with 512 sample points displayed from each channel. (The horizontal position control selects which 512-point block is selected from CH 2 for the Y deflection. See \* Horizontal Position Control Knob\* in this section).

Page 5-29

Replace the first paragraph of Horizontal Controls #25, A AND B SEC/DIV Switch, with the following.

②5 A AND B SEC/DIV Switch

Selects among 29 calibrated A or B SEC/DIV settings from 5 s through 2 ns. The sampling rate varies with the SEC/DIV setting to produce 50 data points per division of waveform display (or 25 min-max pairs in ENVELOPE mode) until the maximum sample rate of 500 megasamples per second is reached at 100 ns. For SEC/DIV settings faster than 100 ns, the scope must use interpolation to determine intermediate points for single (non-repetitive) event capture or, if the waveform is periodic, use random sampling (REPET mode must be turned on) to acquire the requisite number of data points per division.

DESCRIPTION

Page 5-31

Replace the second and third paragraph of  $\Delta$  TIME ON:OFF, under Delay Control #28, with the following paragraphs and note.

**$\Delta$  TIME ON:OFF**

The maximum delay and best delay resolution depends on the B SEC/DIV setting, the B Trigger Mode setting, and whether REPET is ON or OFF. For settings of 100  $\mu$ s/DIV and slower, the maximum delay is  $0.04 \times 65536 \times B$  SEC/DIV setting and, from settings of 50  $\mu$ s/DIV to 100 ns/DIV,  $0.08 \times 65526 \times B$  SEC/DIV setting, regardless of the B Trigger Mode and REPET settings. For settings faster than 100 ns/DIV, the maximum delay is 1.05 ms if REPET is ON and 524  $\mu$ s if REPET is OFF, regardless of B Trigger Mode setting.

NOTE

*In  $\Delta$  TIME mode, i. e., the sum of the delay times cannot exceed the maximum delay allowed for the B SEC/DIV setting. When the limit is reached, if the main delay is increased, the delta delay will be commensurately decreased until the main delay reaches the maximum and the delta delay is zero.*

The delay resolution, for settings of 100  $\mu$ s/DIV and slower, is  $0.04 \times B$  SEC/DIV setting and, from settings of 50  $\mu$ s/DIV to 100 ns/DIV,  $0.08 \times B$  SEC/DIV setting, regardless of B Trigger Mode and REPET setting. For settings faster than 100 ns/DIV, the delay resolution is 8 ns if REPET is ON or 16 ns if REPET is off if B Trigger Mode is set to TRIG AFTER. If B Trigger mode is set to RUNS AFTER, resolution is  $0.08 \times B$  SEC/DIV setting, regardless of whether REPET is ON or OFF. (See Table B-10, Appendix B, for a listing of both resolution and maximum delay for all B SEC/DIV settings.)

**DESCRIPTION****Page 5-49**

Replace the first paragraph of REPET ON:OFF (Repetitive) with the following.

**REPET ON:OFF (Repetitive)**

When ON, repetitive sampling for NORMAL, ENVELOPE, and AVG mode acquisitions is enabled. At SEC/DIV settings of 100 ns and faster, the time base is sampling the incoming waveform at its maximum rate of 500 megasamples/second. With REPET OFF, data points that fall between the actual digitized points on the waveform are interpolated to obtain their displayed positions. Interpolation allows expansion of the acquired data to a SEC/DIV setting of 2 ns on a single event acquisition up to a Useful Storage Bandwidth of 200 MHz. At SEC/DIV settings of 50 ns and faster, REPET ON invokes random sampling (also called equivalent-time sampling) of the incoming signal, extending the bandwidth of the instrument to 300 MHz for repetitive signals.

**Page 5-50**

Replace the second paragraph with the following.

REPET ON also affects the number of acquisitions needed to complete an ENVELOPE acquisition sequence. If the number of acquisitions specified is 1, the scope makes enough acquisitions to meet Useful Storage Bandwidth requirements before erasing the waveform. The number of acquisitions required depends on the SEC/DIV setting. (At 2 ns/div, 10 samples are min-maxed into, or compared against, 10 min-max pairs with each acquisition; at 5 ns, 25 samples are min-maxed into 25 min-max pairs, etc.) If the number specified (N) is greater than 1 but less than CONTinuous, 50% of the 1024 points comprising the 512 min-max pairs must have been enveloped N times, before the envelope sequence is complete. (In this case, the scope will interpolate points temporarily when Useful Storage Bandwidth requirements are met as previously described; however, it will continue to make acquisitions, and replace those points, until the requisite number of min-max pairs are enveloped.) If N=CONT, the envelope sequence never ends.



**DESCRIPTION****Page 6-2**

Replace the first paragraph of Horizontal System with the following.

***Horizontal System***

The horizontal display modes of A, A INTEN, and B Delayed. The time base has 29 calibrated SEC/DIV settings in a 1-2-5 sequence from 2 ns per division to 5 s per division. An External Clock mode is provided that accepts clocking signals from 1 MHz to 100 MHz.

**Page 6-5**

Replace the first paragraph with the following.

For all three acquisition modes, equivalent-time sampling extends the Useful Storage Bandwidth to 300 MHz if the signal is repetitive and REPET mode is turned on. At 50 ns/DIV and faster, randomly-acquired data points (or samples) taken from successive acquisitions of a periodic signal are used to fill the complete record (1024 data points) of the signal waveform display. Depending on the SEC/DIV setting, as few as 10 data points (at 2 ns/DIV) or as many as 512 data points (at 50 ns/DIV) may be obtained on each triggered acquisition. Sampling of successive acquisitions continues until a predetermined number of data points are acquired and any remaining points in the record are determined by interpolating between the acquired points. (The predetermined number includes at least enough data point to meet the Useful Storage Bandwidth of 300 MHz specified for REPET mode.) These interpolated points are replaced by randomly-acquired data points as they become available from

## DESCRIPTION

Page 6-9

Replace Resolution, and add Dynamic Range and footnote b as shown below.

Table 6-1  
Electrical Characteristics

Characteristics	Performance Requirements
<b>ACQUISITION SYSTEM—CHANNEL 1 AND CHANNEL 2</b>	
Resolution	8 bits. Displayed vertically with 25 digitization levels (DL <sup>a</sup> ) per division.
Dynamic Range <sup>b</sup>	Variable between SEC/DIV settings.
100 $\mu$ s or slower	–128 to +127 DL's.
50 $\mu$ s to 500 ns	–124 to +123 DL's.
200 ns	–121 to +120 DL's.
100 ns	–113 to +112 DL's.
50 ns to 2 ns	
Repet OFF	–113 to +112 DL's.
Repet ON	–121 to +120 DL's.
Accuracy	
Normal and Average Modes	Within $\pm(2\% + 1 \text{ DL})$ at any VOLTS/DIV setting for a signal 1 kHz or less contained within $\pm 75 \text{ DLs}$ ( $\pm 3$ divisions) of center when a SELF CAL has been performed within $\pm 15^\circ\text{C}$ of the operating temperature.

<sup>b</sup>The dynamic range defines the size of the vertical window. For example, there are 256 DL's (counting the 0-level DL) for SEC/DIV settings 100  $\mu$ s and slower. With each division comprising 25 DL's, the vertical window is 10.24 divisions for those SEC/DIV settings.

**DESCRIPTION**

**Page 6-10**

Change \* Normal or Average Mode; SEC/DIV at 0.1 μs or Faster; Repet OFF\*, of Single Event Useful Storage Bandwidth, to include Smooth as shown below.

Table 6-1 (cont)

Characteristics	Performance Requirements
<b>ACQUISITION SYSTEM—CHANNEL 1 AND CHANNEL 2 (cont)</b>	
Single Event Useful Storage Bandwidth  Normal or Average Mode; SEC/DIV at 0.1 μs or Faster; Repet and Smooth OFF	DC to 200 MHz (calculated).  $USB = \frac{F_{(\text{sample freq max})}^c}{2.5}$

**Page 6-11**

Replace Channel Isolation with the following.

Table 6-1 (cont)

Characteristics	Performance Requirements
<b>ACQUISITION SYSTEM—CHANNEL 1 AND CHANNEL 2 (cont)</b>	
Channel Isolation	Measured with a 10-division, sine-wave input and equal VOLT/DIV settings on both channels. 100:1 or greater at 100 MHz for VOLT/DIV settings from 2 mV/DIV and 500 mV/DIV; 50:1 or greater at 300 MHz for VOLT/DIV settings from 20 mV/DIV to 500 mV/DIV. 25:1 or greater at 300 MHz for VOLT/DIV settings of 5 mV/DIV and 10 mV/DIV.

**DESCRIPTION**

**Page 6-17**

Remove A SEC/DIV 1 ns reference line and add MIN HO of 2-4  $\mu$ s to A SEC/DIV 20 ns reference line as shown below.

Table 6-1 (cont)

Characteristics	Performance Requirements		
<b>TRIGGERING—A AND B (cont)</b>			
Variable A Trigger Holdoff	<b>A SEC/DIV</b>	<b>MIN HO</b>	<b>MAX HO</b>
	2 ns		
	5 ns		
	10 ns		
	20 ns	2-4 $\mu$	9-15 $\mu$ s

**Page 6-18**

Replace Trigger Position Jitter (P-P) and Sample Rate Accuracy as shown below.

Characteristics	Performance Requirements
<b>TRIGGERING—A AND B (cont)</b>	
Trigger Position Jitter (P-P)	Checked in NORMAL ACQUIRE mode with a 5-division step having less than or equal to 1 ns rise time.
A Mode, B Mode (TRIG AFTER)	
SEC/DIV 100 ns and slower	$0.04 \times \text{SEC/DIV setting}^d$
SEC/DIV 50 ns and faster	$(0.04 \times \text{SEC/DIV setting}^d) + 200 \text{ ps.}$
B Mode (RUNS AFTER)	
SEC/DIV 50 ns and faster	$(0.04 \times \text{B SEC/DIV setting}) + 200 \text{ ps.}$
SEC/DIV 50 $\mu$ s to 100 ns	$0.04 \times \text{B SEC/DIV setting.}$
SEC/DIV 100 $\mu$ s and slower	$0.08 \times \text{B SEC/DIV setting.}$
<b>TIME BASE</b>	
Sample Rate Accuracy	
Average Over 100 or More Samples	$\pm 0.0015\%$ .

<sup>d</sup>Use B SEC/DIV setting if in B Mode; other, use A SEC/DIV setting.

DESCRIPTION

Page 6-20

Replace Table 6-1 (cont) on page 6-20 with the following.

Table 6-1 (cont)

Characteristics	Performance Requirements
<b>TIME BASE (cont)</b>	
Ext Gain = +5	Amplitudes are five times those specified for Ext Gain = 1.
Delay Time Range	
B RUNS AFTER DELAY	
SEC/DIV 50 ns and faster	
REPET ON	(0.08 × B SEC/DIV) to 1.05 ms.
REPET OFF	(0.08 × B SEC/DIV) to 524 μs.
SEC/DIV 50 μs to 100 ns	(0.08 × B SEC/DIV) to (65,536 × 0.08 × B SEC/DIV).
SEC/DIV 100 μs and slower	(0.04 × B SEC/DIV) to (65,536 × 0.04 × B SEC/DIV).
B TRIGGERABLE AFTER DELAY	
SEC/DIV 50 ns and faster	
REPET ON	16 ns to 1.05 ms.
REPET OFF	8 ns to 524 μs.
SEC/DIV 50 μs to 100 ns	(0.08 × B SEC/DIV) to (65,536 × 0.08 × B SEC/DIV).
SEC/DIV 100 μs and slower	(0.04 × B SEC/DIV) to (65,536 × 0.04 × B SEC/DIV).
Delay Time Resolution	
B RUNS AFTER DELAY	
SEC/DIV 50 μs to 100 ns	(0.08 × B SEC/DIV)
SEC/DIV 100 μs and slower	(0.04 × B SEC/DIV)

DESCRIPTION	
Table 6-1 (cont)	
Characteristics	Performance Requirements
TIME BASE (cont)	
B TRIGGERABLE AFTER DELAY	
SEC/DIV 50 ns and faster	
REPET ON	16 ns
REPET OFF	8 ns
SEC/DIV 50 $\mu$ s to 100 ns	$(0.08 \times B \text{ SEC/DIV})$
SEC/DIV 100 $\mu$ s and slower	$(0.04 \times B \text{ SEC/DIV})$
Delay Time Accuracy	$\pm 0.0015\%$
<p><b>Page 6-22</b></p> <p>Replace Accuracy, under CALIBRATOR, as shown below.</p>	
Table 6-1 (cont)	
Characteristics	Performance Requirements
SIGNAL OUTPUTS	
Accuracy	$\pm 0.0015\%$
<p><b>Page 10 of 16</b></p>	

## DESCRIPTION

Page A-2

Replace the two paragraphs under PANEL with the following.

**PANEL**

PANEL calls up a submenu containing two menu choices: POWER ON LAST:INIT and ERASE MEMORY. POWER ON LAST:INIT is for specifying how the front-panel controls are set up at power-on. When the button is toggled to select LAST, the control settings in effect at power-off are reestablished at power-on. When toggled to INIT, a factory setup of initialized front-panel settings is established at power-on.

In general, powering up in INIT produces a simple setup with CH 1 only displayed and all special functions (such as Delay by Events, Cursors, and Envelope or Average acquisition) turned off. (The complete list of controls and states of the INIT feature is found in Table B-15 of Appendix B). The button labeled INIT PANEL in the AutoStep Sequencer menu (accessed via the PRGM front-panel button) produces exactly the same front-panel setup as when the instrument is powered on with POWER ON set to INIT.

ERASE MEMORY calls up another submenu which is used to erase any waveforms saved on screen or stored in REFERENCE Memories 1-4, as well as all sequences stored in the AutoStep Sequencer memory. This feature allows easy removal of confidential waveform data and sequences.

Pushing ERASE erases the memories/sequences, runs a SELF TEST, and sets the front panel to the same settings as obtained when INIT PANEL is pressed in the AutoStep Sequencer menu. *Be aware that all saved waveforms, sequences, and the present front-panel setup will be lost.* ABORT allows the user to return to the PANEL menu without executing ERASE.

DESCRIPTION

Page A-22

Remove Test Codes 7300 to 7328 and 8120 to 8152. Table on Page A-22 should look as shown below.

Table A-1 (cont)

Test Code	Test Name and Hierarchy
	CCD (cont)
8000	PA
8100	OFFSET
8110	NORM-SP
8111	CH1
8112	CH2
8200	POS-GAIN
8210	CH1
8220	CH2



**DESCRIPTION**

**Page B-2**

Remove A SEC/DIV Setting 1 ns line reference. Change 500 ns, 1  $\mu$ s and 2  $\mu$ s as shown below.

**Table B-2**  
**Calibrator Frequency and Period for Each A SEC/DIV Setting**

A SEC/DIV Setting	Calibrator Frequency	Calibrator Period	DIV/Cycle
2 ns	5 MHz	200 ns	100
5 ns			40
10 ns			20
20 ns			10
50 ns			4
100 ns			2
200 ns			1
500 ns	5 MHz	1 $\mu$ s	2
1 $\mu$ s			1
2 $\mu$ s			0.5

**Page B-3**

Change Table B-4 as shown below.

**Table B-4**  
**Repet Acquisitions Required To Complete a Single Sequence**

SEC/DIV (ns/div)	Number of Acquisitions
50	4
20	10
10	20
5	40
2	60

## DESCRIPTION

**Page B-5**

Remove A SEC/DIV Setting 1 ns line reference.

**Page B-10 & B-11**

Replace the paragraphs for Delay Time and Delay Time Resolution, and Table B-10 with the following.

***Delay Time and Delay Time Resolution***

Table B-10 shows the maximum delay time and the delay time resolution for each B SEC/DIV setting.

**Table B-10**  
**Maximum B SEC/DIV Delay Time and Resolution**

<b>B SEC/DIV Setting</b>	<b>Maximum Delay<sup>1</sup></b>	<b>Delay Resolution<sup>2</sup></b>
5 sec	3.64 hrs	200 ms
2 sec	1.46 hrs	80 ms
1 sec	43.7 min	40 ms
500 ms	17.5 min	20 ms
200 ms	8.74 min	8 ms
100 ms	4.37 min	4 ms
50 ms	1.75 min	2 ms
20 ms	52.4 sec	800 $\mu$ s
10 ms	26.2 sec	400 $\mu$ s
5 ns	10.5 sec	200 $\mu$ s
2 ns	5.24 sec	80 $\mu$ s
1 ns	2.62 sec	40 $\mu$ s
500 $\mu$ s	1.05 sec	20 $\mu$ s
200 $\mu$ s	5.24 sec	8 $\mu$ s
100 $\mu$ s	2.62 sec	4 $\mu$ s

## DESCRIPTION

Page B-11

Table B-10 (cont)

B SEC/DIV Setting	Maximum Delay <sup>1</sup>	Delay Resolution <sup>2</sup>
50 $\mu$ s	262 ms	4 $\mu$ s
20 $\mu$ s	105 ms	1.6 $\mu$ s
10 $\mu$ s	52.4 ms	800 ns
5 $\mu$ s	26.2 ms	400 ns
2 $\mu$ s	10.5 ms	160 ns
1 $\mu$ s		524 ns
500 ns	2.62 ms	40 ns
200 ns	1.05 ms	16 ns
100 ns	524 $\mu$ s	8 ns
50 ns	524 $\mu$ s	4 ns
20 ns	524 $\mu$ s	1.6 ns
10 ns	524 $\mu$ s	800 ps
5 ns	524 $\mu$ s	400 ps
2 ns	524 $\mu$ s	160 ps

<sup>1</sup>Maximum Delay, at B SEC/DIV settings of 50 ns and faster, depends on whether REPET mode is ON or OFF in the ACQUIRE menu. The first number listed (524  $\mu$ s) is for REPET OFF and the second number listed (1.05 ms) is for REPET ON.

<sup>2</sup>Delay Resolution for B SEC/DIV settings of 5 sec to 100 ns are for both B Trig After and B Runs After trigger modes. For settings of 50 ns and faster, the number listed is the resolution for the B Runs After mode and is not affected by REPET. The Delay Resolution when in B Trig After mode is 8 ns if REPET is OFF and 16 ns if REPET is ON.

**DESCRIPTION**

**Page C-20**

**Add footnote 1 and a reference to footnote 1 as shown below.**

**Table C-3  
Warning Messages for MEASURE**

Warning Message	Description
CLIP	The amplitude of the targeted waveform is outside the 10.24 <sup>1</sup> divisions available for vertical display. Increase the VOLTS/DIV or vertically position the waveform toward center screen.

**<sup>1</sup>The size of the vertical window gradually decreases from 10.24 divisions at SEC/DIV settings above 100  $\mu$ s/DIV. See "Dynamic Range" in Section 6 for the vertical window sizes for these settings.**



## MANUAL CHANGE INFORMATION

Date: 10-16-90 Change Reference: C2/1090

Product: 2440 OPERATORS Manual Part Number: 070-6599-00

### DESCRIPTION

Product Group 37

### EFFECTIVE ALL SERIAL NUMBERS

The following is a list of changes to specific pages. The bracketed information indicates the change(s) that was made to the step, paragraph, menu, etc.



Page 1-21: Change Procedures F. step 11 and G. step 4 to the following:

**F. Let's make some measurements . . .**

11. [ Turn 1/TIME on. ] Check the frequency readout (approximately [ 500 Hz ]).

**G. A word about HELP.**

4. When MORE is no longer displayed in the menu, follow the instruction, [ "GO AHEAD, TRY A CONTROL: MAKE MY DAY.", and press a front panel button or control. ]

Page 2-9: Change the procedure Getting a Display step 2 to the following:

2. Press the [ STATUS/HELP ] button to set the READOUT INTENSITY to [ 35% ]. This level yields viewable readout and menu displays.

Page 2-13: Change the procedure Front-Panel Setup step 3 subparts b and c to the following:

3. Perform the following steps to set up the SYSTEM menu.
  - b. Select SYSTEM to get the SYSTEM menu. [ Select INTERP. ] In the new menu, set PREFLT ON|OFF to ON.
  - c. [ Select ↑ to return to the SYSTEM menu. ] Select MISC to get the MISC menu; then set BELL ON|OFF to ON and TRIG T ON|OFF to ON.

**Page 2-15: Change the procedure Storing Front-Panel Setup step 3 subpart a to the following:**

- a. [ Select the first character for your label. Press the ↑ or ↓ to step through the alphabet and digits 0-9. (There is a "blank space" character between the digit 9 and letter a.) ]

**Page 2-22: Change the procedure Using Dual-Channel Displays step 6 to the following:**

6. [ Press the VERTICAL MODE button ] and turn CH 1 and CH 2 on.

**Page 2-34: Change the procedure Delay by Events steps 2 and 11 to the following:**

2. Press the TRIGGER A/B TRIG button to display the B Trigger Level readout and [ press the INIT @ 50% button to obtain a stable trigger.]
11. Reset the B-trigger level to start acquiring again and [ press the INIT @ 50% button to obtain a stable trigger.] Press the [ STATUS/HELP ] button twice to rewrite the status display.

**Page 2-50: Add the following step 39a after step 39 to the procedure Using PRGM (AutoStep Sequencer) :**

- 39a. Press the TRIGGER MODE button and turn AUTO on.

**Page 3-17: Change the fourth paragraph for Other Delay Applications to the following:**

The minimum Delay times that can be set depend on both the B SEC/DIV setting and the B Trigger mode. For RUNS AFTER mode, you can set minimum delay to [ 0.08 ] times the B SEC/DIV setting. For TRIGS AFTER mode, the minimum delay settable is 8 ns at B SEC/DIV settings of 50 ns and faster. At settings slower than 50 ns, the minimum delay is the same as for RUNS AFTER mode.



**Page 3-23: Change the Example for General Information for Delay Acquisition Usage to the following:**

**EXAMPLE:** If B SEC/DIV is set to 10  $\mu$ s, the maximum allowed delay time is [ 0.08 ]  $\times$  65536  $\times$  10  $\mu$ s = 52.428 ms. Assume DELAY TIME is set to 40.000 ms and an event is on screen. If the B SEC/DIV setting is increased to 5 ms, the maximum allowed time is [ 0.08 ]  $\times$  65536  $\times$  5  $\mu$ s = 26.214 ms. The event is no longer displayed; return the B SEC/DIV to 10  $\mu$ s and set the DELAY TIME back to 40.000 ms to see the event.

**Page 3-85: Change the procedure Storage of a Single Front-Panel Setup step 3 subpart a to the following:**

- b. [ Select the first character for your label. Select  $\downarrow$  or  $\uparrow$  to step through the alphabet and digits 0-9. There is a "blank space" character between the digit 9 and letter A. ]

**Page 4-2: Add the following step 6 to the procedure Starting Setup:**

6. Press the TRIGGER MODE button and turn AUTO on.

**Page 4-2: Change the procedure Focus and Astigmatism Adjustment steps 1 and 2 to the following:**

1. Press the [ STATUS/HELP ] button.
2. Use the INTENSITY control to reduce the intensity of the readout characters to a lower level. (Pressing the [ STATUS/HELP ] button automatically increases the READOUT intensity to [ 35% ], as indicated in the display.)

**Page 4-4: Add the following step 5a after step 5 to the procedure Probe Low-Frequency Compensation:**

- 5a. Set the SEC/DIV to 500  $\mu$ s.

**Page 5-3: Change the first paragraph for the STATUS/HELP button to the following:**

Displays the complete operating status of the scope. This can help you determine which control or function setup is preventing a display of the traces. The list includes the VOLTS/DIV for each Vertical mode, Horizontal mode, Acquisition mode, A and B Trigger Source, A and B Trigger Level, Trigger Status, the waveforms selected for display, etc. The readout intensity is boosted to [ 35% ], if necessary, to ensure a visible status list, and the INTENSITY control is temporarily directed to the readout.

**Page 5-5: Change INTENSITY SETTINGS status for Figure 5-2. STATUS readout display illustration to the following:**

INTENSITY SETTINGS (R/O IS SET TO [ 35% ] BY STATUS FUNCTION)	R/O [ 35% ]
--	----------------

**Page 5-32: Change the third paragraph for  $\Delta$  TIME ON|OFF of the DELAY by TIME button to the following:**

The delay resolution, for settings of 100  $\mu$ s/DIV and slower, is  $0.04 \times$  B SEC/DIV setting and, from settings of 50  $\mu$ s/DIV to 100 ns/DIV,  $0.08 \times$  B SEC/DIV setting, regardless of B Trigger Mode and REPET setting. For settings faster than 100 ns/DIV, the delay resolution is [ 8 ns if REPET is OFF or 16 ns if REPET is ON ] if B Trigger Mode is set to TRIG AFTER. If B Trigger mode is set to RUNS AFTER, resolution is  $0.08 \times$  B SEC/DIV setting, regardless of whether REPET is ON or OFF. (See Table B-10, Appendix B, for a listing of both resolution and maximum delay for all B SEC/DIV settings.)

Page 5-63: Change the Snapshot menu for the MEASURE button to the following:

SNAPSHOT OF CHX USING XXXXXXXX METHOD:

DIS = 4.35 V	TOP = 5.01 V	WID = 20.3 $\mu$ S
MES = 2.12 V	BASE = 2.00 MV	DUTY = 50%
PRX = -1.23 mV	MEAN = 2.32 V	FREQ = 24.6 kHz
MAX = 5.15 V	OVRS = 2.0%	PER = 40.6 $\mu$ S
MID = 2.47 V	UNDS = 1.0%	RISE = 28.4 nS
MIN = 021.4 mV	RMS = 2.65 V	FALL = 18.3 nS
P-P = 5.36 V	AREA = 47.5 nVs	
DIST = 90.0%	MES = 50.0%	PROX = 10.0%
AGAIN	[ PRINT/PLOT ]	↑

Pressing the AGAIN menu button takes another snapshot measurement. Pressing the up-arrow button returns the scope to the MEASURE menu.

[ PRINT or PLOT: This menu selection will be displayed if DEVICES is selected in the third-level menu for MODE in the OUTPUT SETUP menu. (For more information, see item 24 – OUTPUT Button or Table 5-2, SETUP menus, OUTPUT in this section.) ]

Page 5-65: Change the Setup menu for the MEASURE button to the following:

SETUP

Pressing the menu button labeled SETUP in the MEASURE menu causes this second-level menu to be displayed:

---

-----METHOD-----	[ MARK ]			
MIN/MAX	HIST	CURSOR	LEVEL	ON OFF

---

Page 5-87: Add the following menu to the end of Storage Control Menu, Table 5-2:

STORAGE Control Menu (cont)

---

Second-level menu for HORIZ POS REF in XY Mode.

-----HORIZONTAL POSITION -----	REF HPOS
XYREFP	IND LOCK



---

Page 5-90: Change the menus for SET WORD of WORD RECOGNIZER Control Menu, Table 5-2, to the following:

WORD RECOGNIZER Control Menu (Cont.)

SET WORD

WORD RECOGNIZER SETUP

RADIX	---- CLOCK ----	SET
OCT HEX	  ASYNC	BITS

---

Second-level menu for SET BITS (except when CLOCK is set to ASYNC).

In OCTal:

TRIG WORD:

CLK = *	??????	X X	XXX	XXX	XXX	XXX
1	0	X	←	→		

---

In HEXadecimal:

TRIG WORD:

CLK = *	????	X	XXXX	XXXX	XXXX	XXXX
1	0	X	←	→		

\*Depends on the CLOCK setting in the first-level menu for SET WORD.

---

Page 5-91: Change the third-level menu for SAVE of SETUP Menus, Table 5-2, to the following:

**SETUP Menu (Cont.)**

Third-level menu for SAVE. This menu is displayed after pushing PRGM according to the instruction message.

```

SEQUENCE <name> STEP <num> MEMORY <%>
BEGIN STEP
REPEAT      <N> : .....
SELF-CAL   <N> : PRINT/PLOT <N>
SELF-TEST  <N> : BELL      <N>
LOAD PANEL : SRQ        <N>
AUTOS setup <N> : PAUSE     <N>
MEASUREMENTS : PROTECT  <N>
              : END STEP
              : .....
              : .....
-- [ SET STEP ACTIONS ] --      NEXT      SAVE
  ↑           ↓           Y|N    STEP      SEQ

```

Page 5-92: Change the second-level menu for EDIT of SETUP Menu, Table 5-2, to the following:

**SETUP Menu (Cont.)**

Second-level menu for EDIT.

```

1st Labeled Sequence
2nd Labeled Sequence
  :
  :
nth Labeled Sequence
--- SELECT ---
  ↑           ↓           EDIT      COPY      [ EXIT ]

```

Page 5-93: Change the the display that results from pressing SNAPSHOT of SETUP Menus, Table 5-2, to the following:

**SETUP Menus (Cont.)**

Display that results from pressing SNAPSHOT when only one source is displayed or selecting a waveform in the TARGET menu.

**SNAPSHOT READOUT:**

**SNAPSHOT OF CHx USING MIN/MAX METHOD:**

DIS = 4.35 V	TOP = 5.01 V	WID = 20.3mS
MES = 2.12 V	BASE = 2.00mV	DUTY = 50%
PRX = -1.23mV	MEAN = 2.32 V	FREQ = 24.6kH
MAX = 5.15 V	OVRS = 2.0%	PER = 40.6mS
MID = 2.47 V	UNDS = 1.0%	RISE = 28.4nS
MIN = -21.4mV	RMS = 2.65 V	FALL = 18.3nS
P-P = 5.36 V	AREA = 47.5nVs	
DIST = 90.0%	MES = 50.0%	PROX = 10.0%
AGAIN	[ PLOT PRINT ]	↑

AGAIN: Extracts a new set of parameters.

[ PRINT or PLOT: This menu selection will be displayed if DEVICES is selected in the third-level menu for MODE in the OUTPUT SETUP menu. (For more information, see the OUTPUT menu section listed last in this table.) ]

↑: Returns the scope to the MEASURE menu.

Page 6-21: Change the Characteristic for the Battery specification of Nonvolatile Memory, Table 6-1, to the following:

**NONVOLATILE MEMORY (cont.)**

[ Battery (For instruments with Serial Number B013314 and below only) ]	3.6 Volt, 1.6 Amp Hour, Lithium Thionyl Chloride; Manufacturer EAGLE PICHER, Type LTC16P/P; TEK Part Number 146-0062-00; UL Listed. (See Warning below.)
--	--

Page A-5: Change the first paragraph of CAL/DIAG Functions to the following:

When you press [ the menu button under CAL/DIAG ] in the EXT FUNCT menu, you get four choices: SELF CAL, EXT CAL, SELF DIAG, and EXT DIAG.

Page A-11: Change the note, EXT CAL menu and Attens third level menu paragraph of Extended Calibration to the following:

### **Extended Calibration**

**NOTE**

*If Extended Calibration is internally disabled, the scope will not respond to a press of the ATTEN, TRIGGER, [ CTE CAL ] or ADJUSTS menu buttons.*

Pressing the EXT CAL button calls up the Extended Calibration menu:

<status>	<status>	<status>	[ <status>	
			CTE	
ATTEN	TRIGGER	REPET	CAL ]	ADJUSTS

[ ATTEN calls up a third-level menu: ]

Page B-19: Change the READOUT Intensity state of INTENSITY Controls, Table B-15, to the following:

<b>INTENSITY Controls</b>	
READOUT Intensity	[ 35% ]

Page B-21: Remove the following states from VIDEO OPTION Setup (SET TV), Table B-15:

<b>VIDEO OPTION Setup (SET TV)</b>	
Line Count	525
Line Start	FREFLD

Page B-22: Change the DELAY TIME state for DELAY Controls, Table B-15, to the following:

DELAY Controls	
DELAY TIME	[ Auto Setup <sup>1</sup> ]

Page C-5 and C-6: Change the procedure Level Calculations equations for steps 1 and 3 to the following:

1. Turn on BASE and TOP to display the resolved BASE and TOP values of -2.48 V and +2.48 V, respectively, and calculate their difference:

$$2.48 - (-2.48) = [ 4.96 ]$$

3. Calculate number of resolution increments:

$$DISTAL \text{ (nonimal)} = \frac{.70 \times 4.96 \text{ V}}{0.08 \text{ V}} = 43.4, \text{ rounding } 43$$