

# 2465A/2455A/2445A OSCILLOSCOPES and OPTIONS

*Please Check for  
CHANGE INFORMATION  
at the Rear of This Manual*

---

First Printing JUN 1986  
Revised NOV 1986

**Tektronix**<sup>®</sup>  
COMMITTED TO EXCELLENCE

Copyright © 1986 Tektronix, Inc. All rights reserved.  
Contents of this publication may not be reproduced in any  
form without the written permission of Tektronix, Inc.

Products of Tektronix, Inc. and its subsidiaries are covered  
by U.S. and foreign patents and/or pending patents.

TEKTRONIX, TEK, SCOPE-MOBILE, and  are  
registered trademarks of Tektronix, Inc. TELEQUIPMENT  
is a registered trademark of Tektronix U.K. Limited.

Printed in U.S.A. Specification and price change privileges  
are reserved.

### INSTRUMENT SERIAL NUMBERS

Each instrument has a serial number on a panel insert, tag,  
or stamped on the chassis. The first number or letter  
designates the country of manufacture. The last five digits  
of the serial number are assigned sequentially and are  
unique to each instrument. Those manufactured in the  
United States have six unique digits. The country of  
manufacture is identified as follows:

B000000	Tektronix, Inc., Beaverton, Oregon, USA
100000	Tektronix Guernsey, Ltd., Channel Islands
200000	Tektronix United Kingdom, Ltd., London
300000	Sony/Tektronix, Japan
700000	Tektronix Holland, NV, Heerenveen, The Netherlands

NOTICE to the user/operator:

The German Postal Service requires that Systems assembled by the operator/user of this instrument must also comply with Postal Regulation, Vfg. 1046/1984, Par. 2, Sect. 1.

HINWEIS für den Benutzer/Betreiber:

Die vom Betreiber zusammengestellte Anlage, innerhalb derer dies Gerät eingesetzt wird, muß ebenfalls den Voraussetzungen nach Par. 2, Ziff. 1 der Vfg. 1046/1984 genügen.

NOTICE to the user/operator:

The German Postal Service requires that this equipment, when used in a test setup, may only be operated if the requirements of Postal Regulation, Vfg. 1046/1984, Par. 2, Sect. 1.7.1 are complied with.

HINWEIS für den Benutzer/Betreiber:

Dies Gerät darf in Meßaufbauten nur betrieben werden, wenn die Voraussetzungen des Par. 2, Ziff. 1.7.1 der Vfg. 1046/1984 eingehalten werden.



Certificate of the Manufacturer/Importer

We hereby certify that the 2465A, 2455A, 2445A OSCILLOSCOPES

AND ALL INSTALLED OPTIONS

complies with the RF Interference Suppression requirements of  
Amtsbl.-Vfg 1046/1984.

The German Postal Service was notified that the equipment is being  
marketed.

The German Postal Service has the right to re-test the series and to  
verify that it complies.

TEKTRONIX

Bescheinigung des Herstellers/Importeurs

Hiermit wird bescheinigt, daß der/die/das 2465A, 2455A, 2445A

OSCILLOSCOPES AND ALL INSTALLED OPTIONS

in Übereinstimmung mit den Bestimmungen der Amtsblatt-Verfügung  
1046/1984 funkentstört ist.

Der Deutschen Bundespost wurde das Inverkehrbringen dieses Gerätes  
angezeigt und die Berechtigung zur Überprüfung der Serie auf Einhalten  
der Bestimmungen eingeräumt.

TEKTRONIX



# Contents

	<i>Page</i>
Illustrations .....	iv
Tables .....	v
Operators Safety Summary .....	vi
The 2465A, 2455A, 2445A .....	ix
<b>1</b> <i>General Information</i>	
Preparation for Use .....	1-1
Safety .....	1-1
Line Voltage Selection .....	1-1
Line Fuse .....	1-1
Power Cord .....	1-3
Instrument Cooling .....	1-4
Start-up .....	1-4
Repackaging For Shipment .....	1-5
<b>2</b> <i>Operation</i>	
Fundamentals .....	2-1
Getting a Display .....	2-1
Vertical .....	2-2
Horizontal .....	2-4
Trigger Controls .....	2-4
Video Triggering .....	2-6
Readout .....	2-8
Measurements with Cursors .....	2-10
Display Operation .....	2-12
Signal Connections .....	2-12
Magnify Waveform Details with Delayed-Sweep .....	2-13
B-Trigger Operation .....	2-14
Delta-Delay-Time .....	2-15
Single-Delay-Time Measurements .....	2-16
Precision Timing .....	2-17
Triggered Delta-Delay-Time Measurements .....	2-18
Time Interval Resolution .....	2-20
Measurement Updating .....	2-20
Frequency, Period, and Totalize Counting .....	2-22
Delay Sweeps by Event Counts .....	2-23
Logic Triggering .....	2-28
Word Recognizer Operation .....	2-30
The Word Out Signal .....	2-31
DMM .....	2-31
Save and Recall Operation .....	2-32

### 3 Applications

Peak-to-Peak Voltage .....	3-1
Absolute Voltages .....	3-1
Noise Immunity .....	3-2
"Quick and Dirty" DC Voltage Measurement .....	3-2
Amplitude Modulation .....	3-2
Frequency Modulation .....	3-3
Measuring Video Signals in IRE Units .....	3-4
Avoiding False Displays with Multi-Mode Signals .....	3-4
Algebraic Addition to Detect Coincidence or Cancel Interference .....	3-4
Observing Coincidence of Digital Signals .....	3-5
Measuring Off-Ground Signals And Cancelling Interference .....	3-5
Period and Frequency .....	3-6
Rise Time and Fall Time .....	3-7
Propagation Delay .....	3-8
Setup and Hold Times .....	3-8
Slew Rate .....	3-9
Time Ratio .....	3-10
Phase Difference Between Two Signals .....	3-11

### 4 Checks and Adjustments

Introduction .....	4-1
Initial Setup .....	4-1
Trace Rotation and Adjustment .....	4-1
Astigmatism Adjustment .....	4-2
Auto DC Balance Routine .....	4-2
Probe Compensation .....	4-3
Matching Channel 2 Delay .....	4-4
Amplitude Check .....	4-5
Timing Check .....	4-5

### 5 Controls, Connectors, and Indicators

Introduction .....	5-1
Power And Display .....	5-1
Setup and Vertical .....	5-4
Horizontal .....	5-11
Delay and Delta Controls .....	5-14
Rear Panel .....	5-25
DMM .....	5-27
DMM Displays .....	5-31
Display-Mode Interactions .....	5-31



<b>6</b>	<b>Performance Characteristics</b>	
	Performance Conditions .....	6-1
<b>7</b>	<b>Options and Accessories</b>	
	Introduction .....	7-1
	Option 11 .....	7-1
	Option 1R .....	7-1
	Power Cord Options .....	7-2
	Standard Accessories .....	7-3
	Optional Accessories .....	7-4
<b>A</b>	<b>Appendix A</b>	
	Extended Functions with Diagnostic Exercisers .....	A-1
<b>B</b>	<b>Appendix B</b>	
	Sequence Programming and Operation .....	B-1
	Executing Sequences .....	B-3
<b>C</b>	<b>Appendix C</b>	
	Power Up Tests .....	C-1
	Kernel Test .....	C-1
	Confidence Tests .....	C-1
<b>D</b>	<b>Appendix D</b>	
	Delta-Time and Delta-Delay-Time Accuracy under Noted Conditions for the C/T/T Option .....	D-1
	Delay-Time Accuracy under Noted Conditions for the C/T/T Option .....	D-2

## Illustrations

Figure	Page
1-1 Line selector switch, line fuse, and detachable power cord .....	1-3
2-1 Readout display locations .....	2-9
3-1 Instantaneous voltages .....	3-1
3-2 Eliminating common-mode signals .....	3-6
3-3 Measuring rise times .....	3-7
3-4 Time between two pulses (cursor method) .....	3-9
3-5 Time ratio (duty factor) .....	3-10
3-6 Phase difference between two signals .....	3-11
3-7 Small-angle phase difference .....	3-11
4-1 Probe low-frequency compensation .....	4-3
5-1 Power and display controls .....	5-3
5-2 SETUP and MODE buttons, and CH 1 and CH 2 POSITION controls .....	5-5
5-3 Channel 1 and Channel 2 controls and connectors .....	5-7
5-4 CH 3 and CH 4 controls and connectors and CALIBRATOR output .....	5-9
5-5 Horizontal and delta measurement controls .....	5-11
5-6 Trigger controls and indicators .....	5-18
5-7 Rear panel controls and connectors .....	5-26
5-8 DMM controls and connectors .....	5-28
6-1 Dimensional drawing .....	6-35

## Tables

<i>Table</i>	<i>Page</i>
1-1 Power Cord and Voltage Data .....	1-2
2-1 Resolution Selections .....	2-21
2-2 Auto Resolution .....	2-21
2-3 Delay-by-Events Combinations .....	2-24
2-4 Sweep Triggering .....	2-29
6-1 2465A/2455A/2445A Electrical Characteristics .....	6-6
6-2 Option 01 (DMM) Electrical Characteristics .....	6-15
6-3 Option 05 (TV) Electrical Characteristics .....	6-22
6-4 Option 06 (C/T/T) Electrical Characteristics .....	6-24
6-5 Option 09 (WR) Electrical Characteristics .....	6-31
6-6 Option 10 (GPIB) Electrical Characteristics .....	6-33
6-7 Mechanical Characteristics .....	6-34
6-8 Environmental Requirements .....	6-36
C-1 Confidence Test Numbers and Affected Functions .....	C-2

# Operators Safety Summary

The general safety information in this part of the summary is for both operating and servicing personnel. Specific warnings and cautions will be found throughout the manual where they apply and do not appear in this summary.

## Terms

### In This Manual

**CAUTION** statements identify conditions or practices that could result in damage to the equipment or other property.

**WARNING** statements identify conditions or practices that could result in personal injury or loss of life.

### As Marked on Equipment

**CAUTION** indicates a personal injury hazard not immediately accessible as one reads the markings, or a hazard to property, including the equipment itself.

**DANGER** indicates a personal injury hazard immediately accessible as one reads the marking.

## Symbols

### In This Manual



This symbol indicates where applicable cautionary or other information is to be found. For maximum input voltage see Table 6-1.

### As Marked on Equipment



**DANGER**—High voltage.



Protective ground (earth) terminal.



**ATTENTION**—Refer to manual.

### ***Power Source***

This product is intended to operate from a power source that does not apply more than 250 volts rms between the supply conductors or between either supply conductor and ground. A protective ground connection by way of the grounding conductor in the power cord is essential for safe operation.

### ***Grounding the Product***

This product is grounded through the grounding conductor of the power cord. To avoid electrical shock, plug the power cord into a properly wired receptacle before connecting to the product input or output terminals. A protective ground connection by way of the grounding conductor in the power cord is essential for safe operation.

### ***Danger Arising From Loss of Ground***

Upon loss of the protective-ground connection, all accessible conductive parts (including knobs and controls that may appear to be insulating) can render an electric shock.

### ***Use the Proper Power Cord***

Use only the power cord and connector specified for your product.

Use only a power cord that is in good condition.

For detailed information on power cords and connectors see Table 1-1.

### ***Use the Proper Fuse***

To avoid fire hazard, use only a fuse of the correct type, voltage rating and current rating as specified in the parts list for your product.

### ***Do Not Operate in Explosive Atmospheres***

To avoid explosion, do not operate this product in an explosive atmosphere unless it has been specifically certified for such operation.

### ***Do Not Remove Covers or Panels***

To avoid personal injury, do not remove the product covers or panels. Do not operate the product without the covers and panels properly installed.



## The 2465A, 2455A, and 2445A

The TEKTRONIX 2465A, 2455A, and 2445A portable oscilloscopes have four vertical channels with DC to 350 MHz, 250 MHz, and 150 MHz bandwidths. Deflection factors run from 2 mV to 5 V per division, in a 1-2-5 sequence, with either 1 M $\Omega$  or 50  $\Omega$  input resistance, in channels 1 and 2. Either AC or DC input coupling is available at 1 M $\Omega$ . Channels 3 and 4 give 0.1 V or 0.5 V per division, with 1 M $\Omega$  input resistance, and DC coupling. With the standard 10X probes, channels 1 and 2 display 20 mV to 50 V/division and channels 3 and 4 display 1 V or 5 V/division.

The trigger systems work automatically for most signals. They operate in various modes, from any channel, with couplings for a wide range of signals. The 2445A triggers from DC to 250 MHz. The 2455A and 2465A trigger from DC to 500 MHz.

Sweep speeds range from 1.5 s to 1 ns per division on the 2445A and 2455A and to 500 ps per division on the 2465A, including the effects of the X10 magnifier and the calibrated variable between 1-2-5 steps. Horizontal displays include A-Sweep, B-Sweep (delayed), A alternated with B, and CH 1 (for X/Y displays).

The SETUP features, AUTO, SAVE, and RECALL, save time and prevent errors, whether you are a novice operator or a master. AUTO Setup works with almost any signal. For repeating measurements, the Save and Recall functions record and restore as many as 30 instrument setups, including the extended-function options. Setups can be recalled either immediately or sequentially.

Digital readouts of time, voltage, scale factors, trigger levels, and auxiliary information also save time and reduce errors.

With the available Counter/Timer/Trigger (*CTT*), Option 06 or Option 09, measurements require even less effort and give better accuracy. The *CTT* increases trigger selectivity, especially in digital systems. Option 09 includes the *CTT* and a 17-bit Word Recognizer (*WR*). The available Television/Video (*TV*) enhancement, Option 05, can trigger at any desired point in a frame and it can reduce the effects of ac coupling and hum in a video signal. The available Digital Multimeter (*DMM*) measures dc voltage, dc current, ac rms voltage, ac rms current, resistance, and temperature with floating inputs.

Instruments with *CTT* include MENU in the Trigger Mode selection. The *WR* adds a Word Recognizer Probe connector on the rear panel. The *TV* enhancement adds LINES, FLD1, and FLD2 Trigger Coupling.

The available GPIB interface accesses all controls and digital readings. The interface adds GPIB status indicators, just above the CRT. See the *2455A/2467 GPIB (Option 10) Instrument Interfacing Guide* for information on integrating the instrument into a GPIB system.

The 2465A CT includes *CTT* and *WR* (Option 09) and *GPIB* (Option 10). The 2465A DM adds *DMM* (Option 01) and also includes *CTT* and *WR* (Option 09) and *GPIB* (Option 10). The 2465A DV adds *TV* (Option 05) to the features of the 2465A DM.

Illustrations at the back of the manual show the instrument front and rear panels.





*General Information*

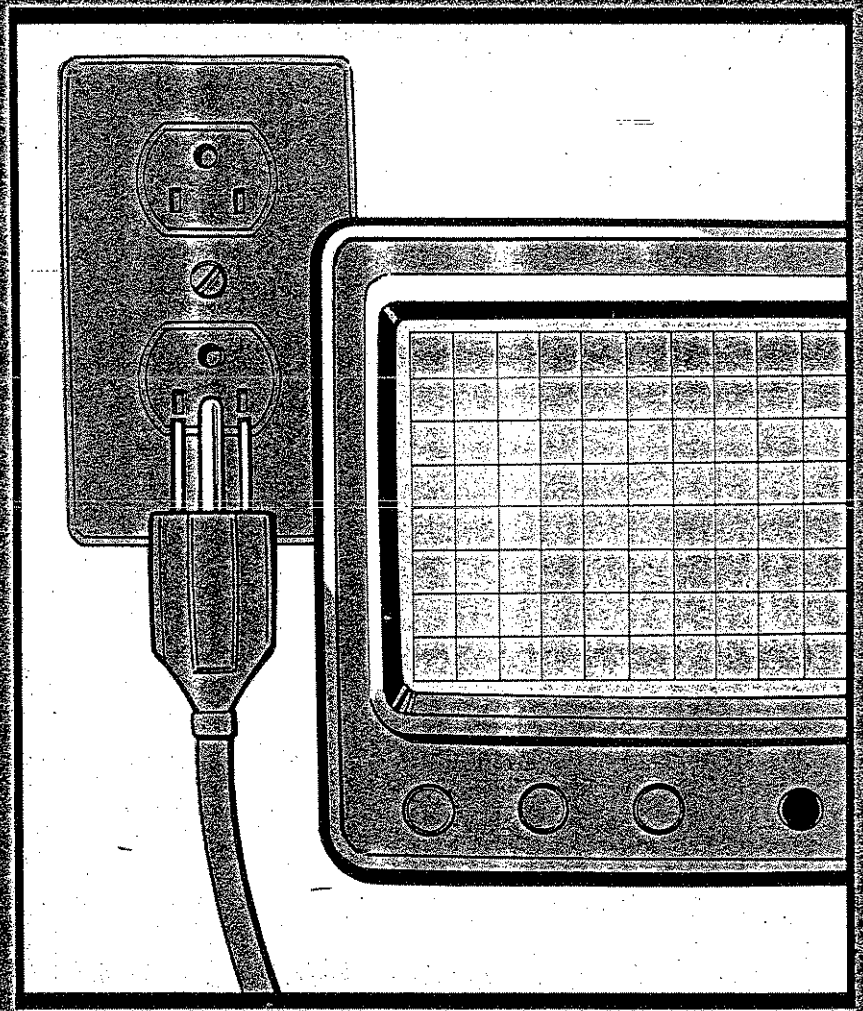

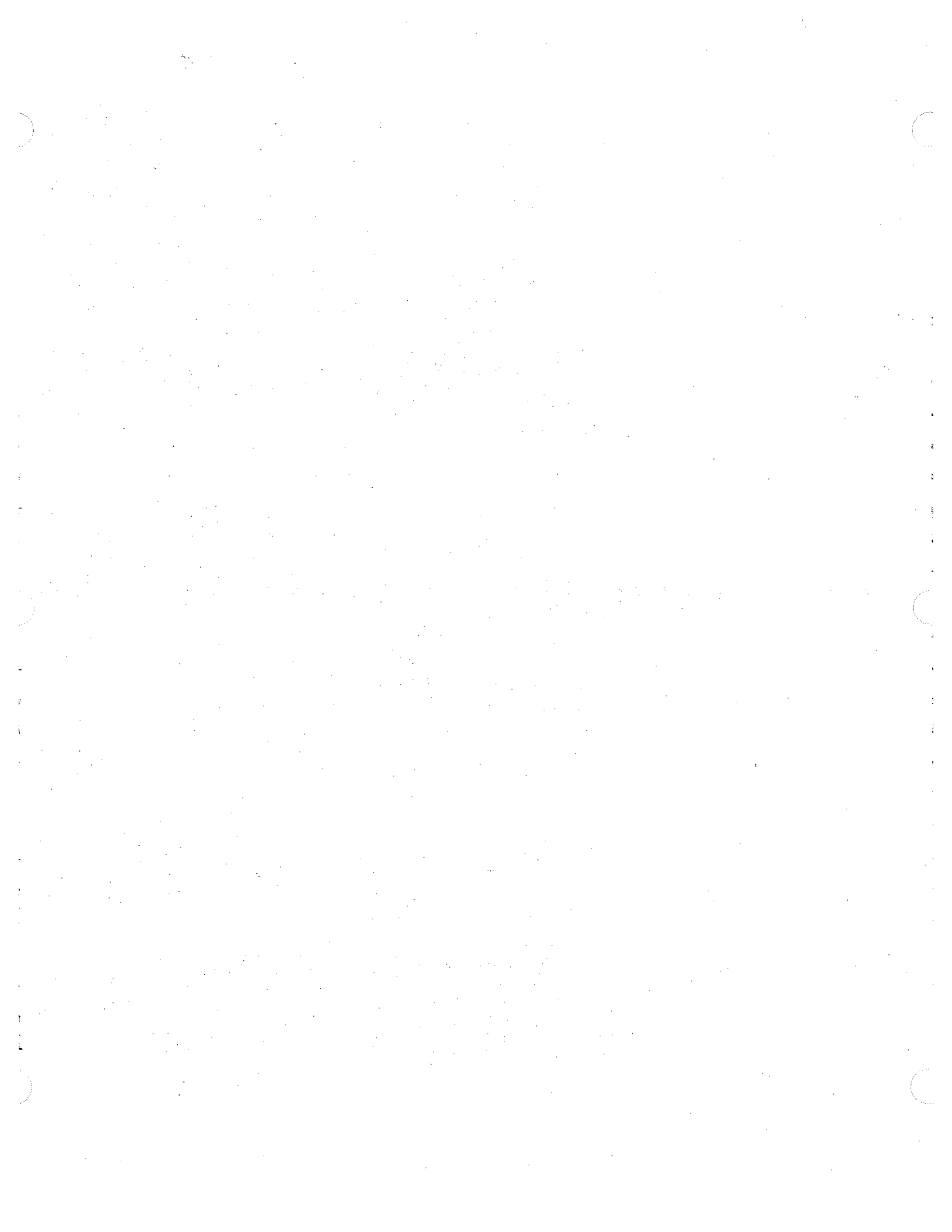

## Preparation for Use

### Safety

Before connecting the oscilloscope to a power source, read entirely both this section and the Safety Summary at the front of this manual. Be sure you have the training required to safely connect the instrument inputs to the signals you will be measuring. Refer to the Safety Summary for power source, grounding, and other safety considerations pertaining to the use of the instrument.

**CAUTION**

*This instrument may be damaged if operated with the LINE VOLTAGE SELECTOR switch set for the wrong applied ac input-source voltage or if the wrong line fuse is installed.*

### Line Voltage Selection

The oscilloscope operates from either a 115-V or a 230-V nominal ac power-line with any frequency from 48 Hz to 440 Hz. Before connecting the power cord to a power source, verify that the LINE VOLTAGE SELECTOR switch, located on the rear panel (see Figure 1-1), is set correctly (see Table 1-1) and that the line fuse is correct. To convert the instrument for operation on the other line-voltage range, move the LINE VOLTAGE SELECTOR switch to the correct nominal ac source-voltage setting. The detachable power cord may have to be replaced to match the



### Line Fuse

To verify the instrument power-input fuse rating, do the following steps:

1. Press the fuse-holder cap and release it with a slight counterclockwise rotation. Pull the cap (with the attached fuse inside) out of the fuse holder.
2. Verify that the fuse is of the type listed on the back of the instrument. Then install the proper fuse and reinstall the proper fuse-holder cap. The two types of fuses listed are not directly interchangeable; they require different types of fuse caps. Included in the accessory pouch is a 5x20 mm fuse holder cap for use with 1.6 A, 250 V, 5x20 mm (IEC 127) fuses.

General Information

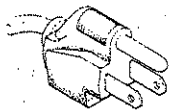
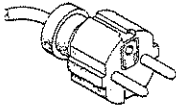
Table 1-1  
Power Cord and Voltage Data

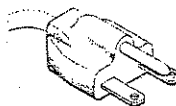
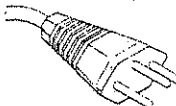
Plug Configuration	Option	Power Cord/ Plug Type	Line Voltage Selector	Reference Standards <sup>b</sup>
	U.S. Std.	U.S. 120V	115V	ANSI C73.11 NEMA 5-15-P IEC 83 UL 198.6
	A1	EURO 220V	230V	CEE(7), II, IV, VII IEC 83 IEC 127
	A2	UK <sup>a</sup> 240V	230V	BS 1363 IEC 83 IEC 127
	A3	Australian 240V	230V	AS C112 IEC 127
	A4	North American 240V	230V	ANSI C73.20 NEMA 6-15-P IEC 83 UL 198.6
	A5	Switzerland 220V	230V	SEV IEC 127

<sup>a</sup>A 8A, type C fuse is also installed inside the plug of the Option A2 power cord.

<sup>b</sup>Reference Standards Abbreviations:

ANSI—American National Standards Institute  
AS—Standards Association of Australia  
BS—British Standards Institution  
CEE—International Commission on Rules for the Approval of Electrical Equipment  
IEC—International Electrotechnical Commission  
NEMA—National Electrical Manufacturer's Association  
SEV—Schweizerischer Elektrotechnischer Verein  
UL—Underwriters Laboratories Inc.

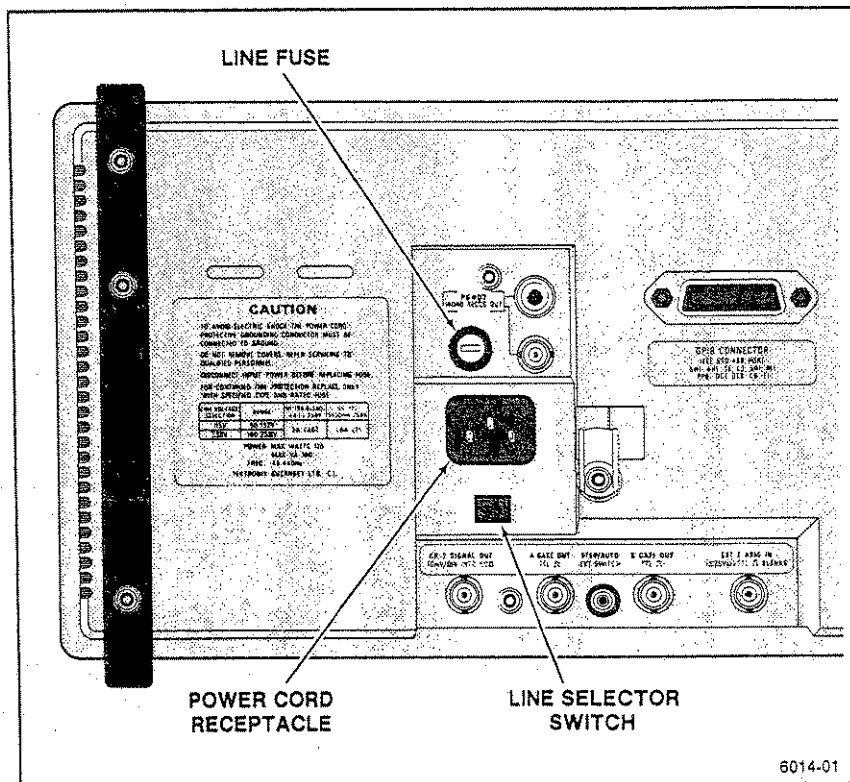

Figure 1-1. Line selector switch, line fuse, and detachable power cord.

### Power Cord

This instrument has a detachable, three-wire power cord with a three-contact plug for connection to both the power source and protective ground. The power cord is secured to the rear panel by a cord-set-securing clamp. The protective-ground contact on the plug connects through the power-cord to the external metal parts of the instrument. For electrical-shock protection, insert this plug into a power-source outlet that has a properly grounded protective-ground contact.

Instruments are shipped with the required power cord as ordered by the customer. Available power-cord information is presented in Table 1-1, and part numbers are listed in "Options and Accessories" (Section 7). Contact your Tektronix representative or local Tektronix Field Office for additional power-cord information.

## ***Instrument Cooling***

To prevent instrument damage from internally generated heat, adequate air flow must be maintained. Before turning on the power, verify that the spaces around the air-intake holes on the bottom of the cabinet and the fan-exhaust holes in the rear panel are free of any obstruction to airflow.

## ***Start-up***

The oscilloscope automatically performs a set of diagnostic tests each time the instrument is turned on. These tests warn the user of any available indication that the instrument may not be fully functional. The tests run for several seconds after power is applied. If no faults are encountered, the instrument operates normally. A failure of any of the power-up tests will be indicated by either a flashing TRIG'D indicator on the instrument front panel or a bottom-line readout on the CRT in the form: **TEST XX FAIL YY** (where XX is the test number and YY is the failure code of the failed test).

If a failure of any power-up test occurs, the instrument may still be usable for some applications. To operate the instrument after a power-up test failure, press the A/B TRIG button. Even if the instrument then functions for your particular measurement requirement, it should be repaired by a qualified service technician at the earliest convenience. Additional information on the power-up tests may be found in Appendix A at the rear of this manual. Consult your service department, your local Tektronix Service Center, or nearest Tektronix representative if additional assistance is needed.

## ***Repackaging For Shipment***

If this instrument is to be shipped by commercial transportation, it should be packaged in the original manner. The carton and packaging material in which your instrument was shipped to you should be retained for this purpose.

If the original packaging is unfit for use or is not available, repackage the instrument as follows:

1. Obtain a corrugated cardboard shipping carton having inside dimensions at least six inches greater than the instrument dimensions and having a carton test strength of at least 275 pounds.
2. If the instrument is to be shipped to a Tektronix Service Center for service or repair, attach a tag to the instrument showing the following: owner of the instrument (with address), the name of a person at your firm who can be contacted, complete instrument type and serial number, and a description of the service required.
3. Wrap the instrument with polyethylene sheeting or equivalent to protect the outside finish and prevent entry of packing materials into the instrument.
4. Cushion the instrument on all sides by tightly packing dunnage or urethane foam between the carton and the instrument, allowing three inches on each side.
5. Seal the carton with shipping tape or with an industrial stapler.
6. Mark the address of the Tektronix Service Center and your return address on the carton in one or more prominent locations.





*Operation*

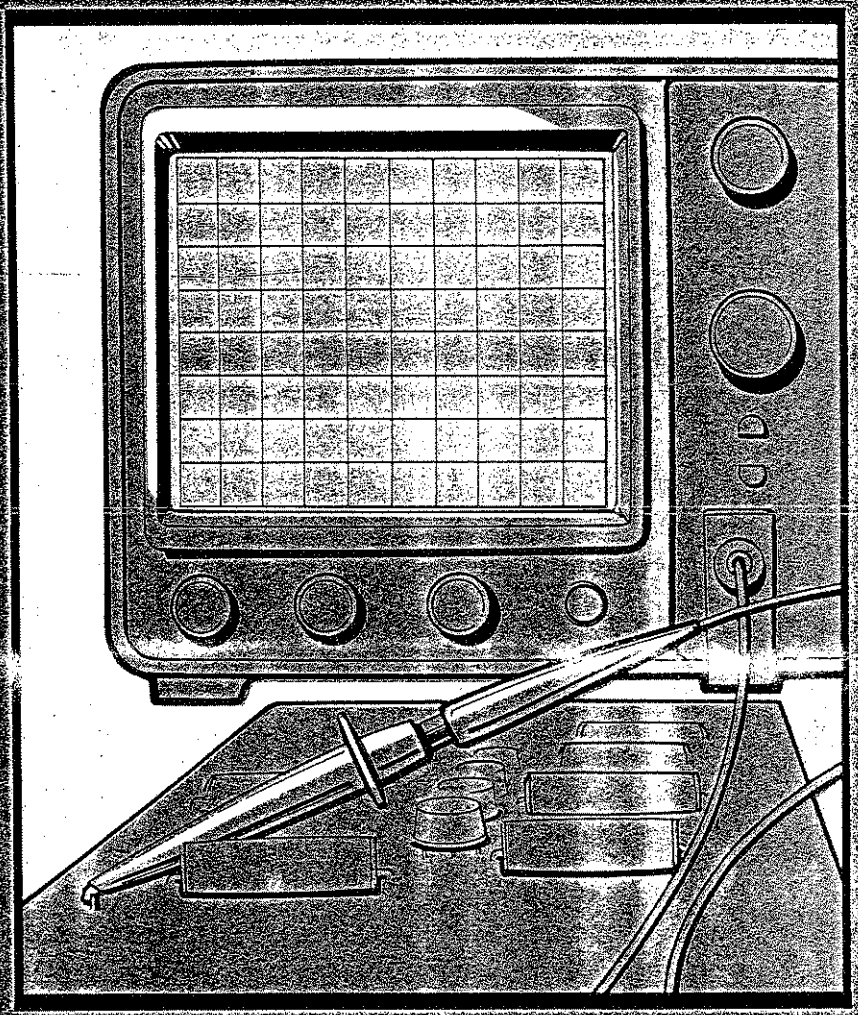



## ***Fundamentals***

Like any oscilloscope, this instrument draws a graph of voltage as a function of time. The VERTICAL controls, marked off by a heavy gray line, define the voltage axis of the display. SEC/DIV, X10 MAG, and horizontal POSITION control the time axis of the display. The TRIGGER controls, marked off by a green box, define the signals required to initiate sweeps across the time axis. The controls under the CRT affect the display but not the waveform.

## ***Getting a Display***

1. Connect a probe from the input of a Vertical channel to a signal.
2. Select the channel using the Vertical MODE buttons. You may select any combination of vertical channels (if you are using the standard accessory probes, make sure the CH 1 and CH 2 input are not set at 50  $\Omega$ ).
3. Press AUTO Setup to initialize vertical, horizontal, trigger, and display intensity for a usable display. (If STEP is illuminated, first push RECALL to extinguish it.)
4. If the resulting display isn't exactly what you want, adjust the appropriate VOLTS/DIV, SEC/DIV, POSITION, or Trigger controls.

## ***Characteristics of AUTO Setup***

With one channel, Auto Setup centers the 0-volt level and makes the vertical display as large as possible, within the graticule. With more than one channel, the 0-volt levels of CH 1, CH 2, CH 3, and CH 4 are set at +2, 0, -2, and -3 divisions from center, respectively. When ADD is displayed, the 0-volt level of CH 2 is set at -2 divisions.

AUTO sets Sec/Div within the range from 20 ns to 2 ms, to show two to five cycles of most signals. With narrow, low repetition-rate pulses, the sweep runs faster to stretch out the display, with the appropriate trigger slope.

AUTO Setup sets the trigger for Auto Lvl Mode, Vert Source, DC Coupling, and Min Holdoff, with level at the midpoint between signal peaks.

The STEP/AUTO EXT SWITCH connector on the rear panel produces the same functions as the STEP/AUTO button, in response to a switch closure or TTL-low signal.

See "Save and Recall Operation" for the sequence function of Step/Auto.

## Vertical

For voltage measurements, set VOLTS/DIV VAR fully clockwise. For best accuracy, set VOLTS/DIV for the largest display possible.

### Input Coupling

Use 1 M $\Omega$  DC input mode for most applications. This mode is compatible with the standard accessory, high-impedance probes and it displays logic levels and dc levels of static signals. Use the pair of buttons near the CH 1 and CH 2 inputs to select input coupling. CH 3 and CH 4 inputs are fixed at 1 M $\Omega$  DC.

GND input mode shows where the 0-volt level will be displayed with DC coupling.

Use AC coupling for the special cases where you need to see small signals on large dc voltages.

Use the 50  $\Omega$  DC input mode for the best possible vertical performance with active probes, 50- $\Omega$  signal sources, and low-impedance passive probes. A low-impedance probe can present less than 2 pF load to the signal-source, in parallel with 500  $\Omega$  or 5000  $\Omega$  with 10X or 100X attenuation.

### Input Conditioning for Video Signals

Video signals can be distorted by ac coupling or by low-frequency interference. The available Television/Video (TV) enhancement adds a TV CLAMP to the CH 2 input to eliminate such distortion.

To use the TV clamp:

1. Apply a composite video signal to CH 2.
2. Select CH 2 Trigger Source and set SLOPE to the displayed polarity of the sync pulses.
3. Set the CH 2 input to TV CLAMP by pressing the upper input-coupling button for CH 2 until the readout shows "TVC". The "back porch" of the video signal will be locked to a fixed level.

Keep the TV Clamp turned off when the trigger source is not composite video or sync, to preserve normal operation of Channel 2. Leave the rear-panel CH 2 SIGNAL OUT unloaded to avoid a minor distortion in the video signal when TV Clamp is on.

### **Channel Selection**

Using the Vertical MODE buttons, you can display any combination of the four vertical channels. To manually switch between CH 1 and another channel, with minimum button pushing, deselect CH 1 and press the button for the other channel to turn it on and off; CH 1 is displayed when all other verticals are off.

### **ADD and INVERT**

Press ADD to display the algebraic sum of CH 1 and CH 2. Select INVERT to change the sense of the CH 2 waveform or to see the difference between CH 1 and CH 2 on the ADD trace. If you use ADD, the CH 1 and CH 2 VOLTS/DIV settings should be equal.

### **Choosing CHOP or ALT**

With two or more channels, the display is time-shared. Chop mode displays each channel for a short time and multiplexes during the sweep to give the appearance of displaying all channels at once. Chop works better than Alt for sweeps slower than 1 ms/division and for low repetition-rate signals that make the display flicker, up to 2  $\mu$ s/division.

Alt mode displays each channel for the duration of a complete sweep. Alt gives a "cleaner" display of multiple channels than Chop does and is usually preferred at moderate to high sweep speeds.

### **20 MHz BW Limit**

This mode can give you a sharper trace by eliminating high-frequency interference. Before using it, check to make sure it doesn't distort the waveform.

## ***Horizontal***

The A-Sweep is the only horizontal function you need for most applications. The A SWP indicator is on when the A-Sweep is displayed. To make sure the A-Sweep is displayed, press AUTO Setup and push SEC/DIV in. You can also restore the A-Sweep display by pushing the SEC/DIV knob in and turning it counterclockwise until the A SWP indicator lights. If both A SWP and B SWP indicators are off, push SEC/DIV in and turn it clockwise to escape the X/Y display mode.

The X10 MAGnifier expands the center of the unmagnified waveform.

For best measurement accuracy, set SEC/DIV for the fastest sweep that will display the interval of interest and set VAR fully clockwise.

See "Delayed Sweep Operation" for more information about B-Sweep, B-Trigger, and trace separation.

## ***Trigger Controls***

For "hands-off" triggering with most signals, select Auto Lvl Mode, Vert Source, DC Coupling, and MINimum Holdoff.

**Auto Lvl** mode, with LEVEL in the center half of its range, sets the trigger point near the midpoint between signal peaks. When LEVEL is set to the — or + end of its range, this mode initiates triggering near the 10% or 90% point between signal peaks. You can select a level anywhere in about the middle 80% of the signal amplitude. Once set, the level doesn't change unless the signal ceases to trigger the sweep. The sweep free-runs without a trigger signal. With signals below 50 Hz, AUTO LVL may not find the correct level.

With Auto Lvl mode and Vert Source, the displayed channel or the first one of a multichannel display supplies the trigger signal.

**Auto** mode maintains the trigger level setting and the sweep free-runs if the signal doesn't meet the triggering requirements.

Use Auto for monitoring logic signals. Set the LEVEL control to the mean threshold of the logic system, +1.4 V for TTL. The sweep then triggers on valid transitions and free-runs to show static highs and lows.

**Normal** mode produces a sweep only when the trigger signal meets the Level and Slope criteria.

Use Normal mode for infrequent events and erratic signals.

**Sgl Seq** mode accepts one trigger for each sweep in the display. Press the lower Mode button to arm the trigger and illuminate the READY indicator for each sequence. With a multi-trace display, a sequence comprises up to sixteen sweeps.

Use Sgl Seq to detect a rare event or to eliminate all but the first one of a chaotic burst of pulses. Set the trigger for the signal of interest in Normal mode. Then press the lower Mode button to select Sgl Seq and illuminate the READY indicator. To detect the occurrence of a rare event, display a single trace and arm Sgl Seq with the trigger set for the event. Periodically check to see if READY is on. If a burst of trigger events occurs, the sweep runs once for each trace displayed and READY extinguishes.

### **Trigger Source**

Choose a single trigger source to correctly display the timing relationships among multiple channels. Choose the channel with the lowest-frequency signal to avoid ambiguous displays.

With Vert trigger source, Auto Lvl trigger mode or Chop vertical mode automatically selects a single trigger source, the first one of the displayed channels.

Use a composite A-Trigger source only to compare asynchronous signals. To generate a composite trigger, select Vert trigger source, a trigger mode other than Auto Lvl, and Alt vertical mode.

### **Trigger Coupling**

For noisy signals or signals with strongly interfering components, Noise Reject, HF Reject, and LF Reject coupling give added selectivity. AC coupling continues triggering when the dc level of the signal changes.

### ***Trigger Slope***

Press SLOPE to select the rising (+) or falling (–) edge of the signal to trigger the sweep.

### ***Trigger Level***

INIT@50% sets the trigger level near the midpoint between signal peaks, in any mode. Some signals below 50 Hz may not produce the correct level setting.

LEVEL gives you complete freedom to choose the most appropriate threshold voltage on a signal to initiate sweeps, in case neither the Auto Lvl mode nor INIT@50% provides a suitable threshold.

### ***Trigger Holdoff***

With irregular signals such as bursts, the Trigger HOLDOFF setting can improve display stability. Also, if the signal has a fixed pattern of variation from cycle to cycle, some modes of the signal may be omitted from the display. Changing the Holdoff setting can force the instrument to display all the modes of the signal. Normally, HOLDOFF should be set at MIN.

## ***Video Triggering***

The available Television/Video (TV) enhancement adds TV LINES, FLD1, and FLD2 Coupling to the A-Trigger. See Appendix A to change the line-number format and the sync polarity automatically selected when you select TV triggering.

To trigger at the video line rate:

1. Select a composite video signal as the trigger source.
2. Select LINES coupling.
3. Set SLOPE to the polarity of the sync.



To trigger at a specific video line:

1. Select a composite video signal as the trigger source.
2. Select FLD1, FLD2, or ALT coupling.
3. Set SLOPE to the polarity of the sync.
4. Turn FLD LINE # ( $\Delta$ ) to the desired line number.

When you increment or decrement the line number outside the range of the selected field, the other field is automatically selected.

With ALT field coupling, the line number is referred to the beginning of both fields.

To compare two video signals with the same format that are not perfectly synchronized, such as from a camera and a VCR or from the input and output of a time base corrector:

1. Display the signals on CH 1 and CH 2, with Alt Vertical mode.
2. Select VERT Trigger Source, and ALT field trigger coupling.
3. The CH 1 display triggers on field 1 and the CH 2 display triggers on field 2.

TV Lines trigger coupling with multiple vertical channels, Alt Vertical mode, and Vert Trigger source produces unpredictable results.

A " $\Delta$ " symbol with the line number display shows when the  $\Delta$ /FLD LINE # control can change the line number. If  $\Delta V$ ,  $\Delta t$ , or  $1/\Delta t$  is on, press a trigger Coupling button to redirect the control to line number selection. Press  $\Delta V$  or  $\Delta t$  to redirect the control to cursor or delay adjustment. The first push redirects the control. A second push will change the  $\Delta$  function or trigger coupling.

If you magnify the vertical display beyond the graticule, the trigger may be degraded. To avoid trigger overload, use one channel for display and another channel with an appropriate video signal as the trigger source. A composite sync signal can be used for the trigger source as well as composite video.

## Readout

To aid waveform interpretation, the readout shows scale factors, delta measurements, delay times, trigger settings, and other information. To display all readout information, set the READOUT INTENSITY control clockwise from OFF (SCALE FACTORS ON). See Figure 2-1.

### Trigger Readout

The trigger readout shows which trigger (A or B) is affected by the controls (Mode, Source, Coupling, Slope, Level, and INIT@50%), which channel (1-4) is supplying the trigger signal, and the voltage at which triggering takes place, with the following settings:

Trigger Coupling	DC or Noise Reject
Trigger Source	Any Single Channel
Vertical Input	Dc or Gnd
VOLTS/DIV VAR	Fully Clockwise.

If the trigger comes from the word recognizer, which is available with the CTT, the readout shows the defined word.

### Readout Intensity

To display nothing but measurements, set the READOUT INTENSITY control counterclockwise from OFF (SCALE FACTORS OFF). Rotate the control toward OFF to decrease readout brightness. When the sweep is faster than 50  $\mu$ s/division, random 2- $\mu$ s segments of the waveform may be missing. Set the control near the center of the word "OFF" to eliminate this interference between the waveform and the readout.

### Scale Factors

CH 1 and CH 2 scale factors include "mV" or "V" units indicators. A tilde (~) over the V indicates AC input coupling. A ground symbol in front of the number indicates Gnd input coupling. A greater-than symbol (>) indicates the VOLTS/DIV VAR control is not at its clockwise, calibrated position. A plus sign (+) shows that Add, the algebraic sum of CH 1 and CH 2, is displayed. A down arrow shows that CH 2 is inverted.

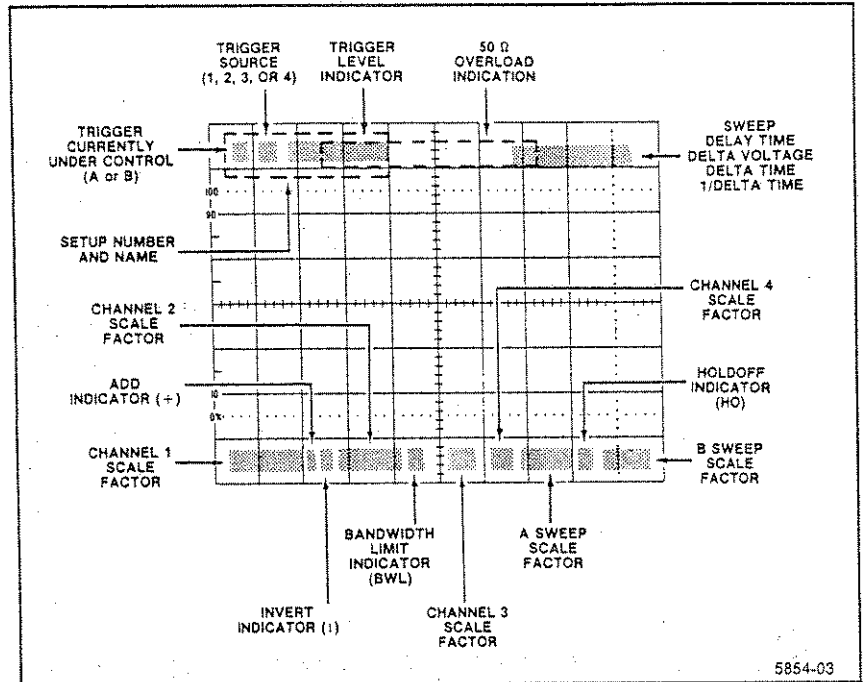

Figure 2-1. Readout display locations.

CH 3 and CH 4 scale factors assume volts/division units.

The A-Sweep and B-Sweep time-scale readouts are always calibrated, combining the effects of SEC/DIV, VAR, and X10 MAG. If SEC/DIV VAR is not at its clockwise setting, the time scale factor includes a decimal point.

### Holdoff Indicator

The holdoff indicator, "HO," is displayed when the HOLDOFF control is not at minimum.

### Probe Effects

Probe attenuation effects are included in scale factors, trigger levels, and delta volts readouts, if you use the standard accessory probes or other compatible probes. Pressing the identification button on other Tektronix probes replaces the scale factor for the channel with "ID" and shifts the trace.

## **Measurements with Cursors**

The controls in the gray box ( $\Delta V$ ,  $\Delta t$ , TRACK/INDEP,  $\Delta$  REF OR DLY POS, and  $\Delta$ ) operate cursors and sweep delays. With the cursors, you can measure voltage, time, frequency, ratios, and phase. We often refer to the  $\Delta$  REF OR DLY POS control as " $\Delta$  REF" for convenience.

Cursors are more accurate and easier to use than the graticule. They eliminate the inconvenience and errors of counting and interpolating graticule markings and they avoid CRT linearity errors.

For best  $\Delta V$  accuracy, display the signal on either CH 1 or CH 2 with VOLTS/DIV set for three to eight divisions of waveform amplitude. For best  $\Delta t$  and  $1/\Delta t$  accuracy, use the fastest sweep that will include the interval of interest.

### **Measure Voltage**

1. Turn on the  $\Delta V$  cursors and readout with the  $\Delta V$  button.
2. Align the cursors with points of interest, such as waveform peaks, using the  $\Delta$  REF and  $\Delta$  knobs.
3. The readout shows the voltage between the points marked by the cursors.
4. Press  $\Delta V$  to turn off the  $\Delta V$  cursors and readout.

### **Measure Time, with A-Sweep or B-Sweep Alone (SEC/DIV in)**

1. Turn on the  $\Delta t$  cursors and readout with the  $\Delta t$  button.
2. Align the cursors with points of interest, such as waveform zero-crossings, using the  $\Delta$  REF and  $\Delta$  knobs.
3. The readout shows the time between the points marked by the cursors.
4. Press  $\Delta t$  to turn off the  $\Delta t$  cursors and readout.

### **Measure Frequency with Cursors**

1. Turn on the  $1/\Delta t$  cursors and readout by pressing the  $\Delta V$  and  $\Delta t$  buttons together.
2. Align the cursors with identical points, such as zero crossings, on *adjacent cycles* of the waveform, using the  $\Delta$  REF and  $\Delta$  knobs.
3. The readout shows the frequency of the signal.
4. Press  $\Delta V$  and  $\Delta t$  together or press either  $\Delta$  button twice to turn off the  $1/\Delta t$  cursors and readout.

### **Measure Voltage Ratio, Time Ratio (such as Duty Factor), or Phase**

1. Set VOLTS/DIV or SEC/DIV so a feature of the waveform which you consider the 100% reference covers more than five divisions of the graticule.
2. Turn the VOLTS/DIV VAR or SEC/DIV VAR counterclockwise from the detent until the 100% reference feature covers exactly five divisions. You can use one signal as a reference and compare others to it. For phase, set one cycle, which is the 360 degree reference, to five divisions.
3. Press  $\Delta V$  to measure voltage ratio,  $\Delta t$  for time ratio, or  $\Delta V$  and  $\Delta t$  together for phase. The VAR must be counterclockwise from the detent position to turn on the RATIO or PHASE readout.
4. Turn  $\Delta$  REF and  $\Delta$  to align the cursors with the portion of the waveform to be compared to the reference portion. Phase is usually a two-channel measurement between zero crossings. (Be sure zero crossings for phase measurements are positioned at the graticule center.)
5. The readout shows the ratio or phase shift.
6. Press the same  $\Delta V$  or  $\Delta t$  button, or both, to turn off the cursors and readout.

### **Choosing Tracking or Independent Delta Mode**

Use the INDEP mode for most measurements, with each cursor independently adjustable. Use TRACK mode, where the  $\Delta$  REF knob moves both cursors as a pair, to compare waveform features. The  $\Delta$  control moves only the  $\Delta$  cursor.

## ***Display Operation***

Set both INTENSITY and READOUT INTENSITY controls for comfortable viewing, but no brighter than you need. Use high intensity settings to observe low repetition-rate signals, narrow pulses in long time intervals, or occasional variations in fast signals.

## ***Signal Connections***

A probe is usually the most convenient way to connect an input signal to the instrument. Shielded to prevent pickup of electromagnetic interference, the standard 10X probes supplied with the instrument present a high impedance to a circuit under test. While the 10 M $\Omega$  and 11 pF of the probe are a negligible load on most circuits, very fast circuits or very high impedance circuits may be seriously affected.

### ***Waveform Fidelity and Probe Grounds***

A probe ground must be used for accurate measurements and observations. Use the shortest ground connection possible if you want good waveform fidelity.

The standard-accessory probe is a compensated 10X voltage divider. It appears resistive at low frequencies and capacitive for high-frequency signal components. The probe input capacitance can interact with the inductance of either a long signal lead or a long ground lead to form a series-resonant circuit. This circuit can affect system bandwidth and can ring if driven by a fast step. Always keep both the ground lead and the probe signal-input connections as short as possible to maintain the best waveform fidelity.

In some cases, a separate ground from the unit under test to the ground receptacle on the oscilloscope front panel can reduce interference from low-frequency hum and noise. For rough checks of larger signals, such as 5-volt logic, a ground lead separate from the probe or even the safety ground connection which is shared with the unit under test may work for a signal ground. Fast signal transitions will be highly distorted and extraneous noise will be induced without the probe ground connection.

### ***Probe Compensation***

Misadjustment of probe compensation is a common source of measurement error. Due to variations in oscilloscope input characteristics, probe compensation should be checked whenever the probe is moved from one oscilloscope to another or between channels of a multichannel oscilloscope. See the procedure in the "Checks and Adjustments" section of the manual.

### ***Probe Handling***

Both the probe and the probe accessories should be handled carefully to prevent damage. Striking a hard surface can damage both the probe body and the probe tip. Exercise care to prevent the cable from being crushed, kinked, or excessively strained.

### ***Coaxial Cables***

To maintain good waveform fidelity and accuracy, only high-quality, low-loss coaxial cables should be used. The instrument is optimized for 50  $\Omega$  sources, driving the 50  $\Omega$  dc input through 50  $\Omega$  cable. If you use another signal source impedance, such as 75  $\Omega$ , use the appropriate coaxial cable and an external terminator to match, with the input set at 1 M $\Omega$ . Some high frequency response will be lost with external termination.

## ***Magnify Waveform Details with Delayed-Sweep***

1. Display a waveform with the A-Sweep, then pull SEC/DIV out to activate B-Sweep and light both the A SWP and B SWP indicators (INTEN mode).
2. If a B-Trigger Mode indicator is on, select RUN AFT DLY. (If an A-Trigger Mode indicator is on, the B-Trigger has been set previously to RUN AFT DLY.)
3. Set  $\Delta$  REF OR DLY POS to place the small intensified zone at a point of interest. (This zone may be more apparent with a lower Intensity setting.) If the A-Sweep terminates just after the intensified zone, you can move the HOLDOFF control and set it at MIN. (Two intensified zones appear if you have selected  $\Delta t$  or  $1/\Delta t$ . See "Delta-Delay-Time.")
4. Turn SEC/DIV clockwise, with the knob pulled out, to expand the point of interest on the B-Sweep, while observing its relationship to everything else on the A-Sweep (ALT mode). Use TRACE SEP to separate the A-Sweep and B-Sweep traces.
5. If you want to simplify the display and obtain the best possible view of the magnified details, push the SEC/DIV knob in to display only the B-Sweep. If you want the brightest trace possible, set HOLDOFF to B ENDS A, which makes the sweep repetition rate as high as possible.
6. Select  $\Delta V$ ,  $\Delta t$ , or  $1/\Delta t$  when the SEC/DIV knob is pushed in to measure waveform details with cursors. The  $\Delta$  REF and  $\Delta$  controls have no effect on sweep delay while cursors are displayed.

## ***B-Trigger Operation***

Use the B Trigger to eliminate jitter in B-Sweep displays. With the available Counter-Timer-Trigger (*CTT*), the B Trigger locks a delay-time or delta-delay-time measurement to the signal, so any variations are tracked automatically. However, without the *CTT*, the B Trigger obscures delay or delta-delay measurements and the readout includes a question mark.

### ***Distinguish RUN AFT DLY and TRIG AFT DLY***

With RUN AFT DLY mode, the  $\Delta$  REF OR DLY POS and  $\Delta$  controls adjust the delay-time or delta-delay-time. The intensified zones on the A-Sweep trace move continuously as the controls are adjusted. If the B-Trigger mode is TRIG AFT DLY and a signal triggers the B Sweep, the delay times and intensified zones jump to successive B-Trigger points as delay time is adjusted. With TRIG AFT DLY, the actual delay time is controlled by the signal, as enabled by the A Sweep and the  $\Delta$  REF and  $\Delta$  settings.

### ***Setting the B Trigger***

1. When the B SWP indicator is on, press A/B/TRIG (A/B/MENU with *CTT*) to illuminate a B-Trigger Mode indicator. (If B-Trigger mode is not RUN AFT DLY, a B-Trigger Mode indicator will be on when the B SWP indicator is on.)
2. Select TRIG AFT DLY Mode.
3. Set SOURCE, COUPLING, SLOPE, INIT@50%, and LEVEL controls as required.

### ***Changing the A Trigger while B Trigger is Active***

1. Press and hold A/B/TRIG (A/B/MENU with *CTT*) while adjusting SOURCE, COUPLING, SLOPE, INIT@50%, and LEVEL controls for the A Trigger.
2. Alternatively, choose RUN AFT DLY B-Trigger mode and momentarily press A/B/TRIG (or A/B/MENU), then adjust A Trigger. With RUN AFT DLY B-Trigger mode or SGL SEQ A-Trigger mode (or an active *CTT* function that uses the B Trigger), the trigger controls alternate between A Trigger and B Trigger each time A/B/TRIG (or A/B/MENU) is momentarily pressed.



## Delta-Delay-Time

Use the delayed (B) sweep to magnify both ends of a time interval for the best measurement accuracy available. Appendix D gives relative accuracies of the various time-measurement techniques.

### Measure Time or Frequency with Delta-Delay-Time

1. Display the time interval or signal period with the A Sweep running as fast as possible, unmagnified, up to one speed slower than the fastest SEC/DIV setting. If the interval is a propagation delay or other two-signal measurement, display the signals on CH 1 and CH 2 and trigger A Sweep on the earlier of the two.
2. Pull SEC/DIV out to activate B Sweep and light the A SWP and B SWP indicators (INTEN mode). (If you inadvertently chose the fastest A-Sweep speed, the CH2 Delay Match function will be active. See the "Operator Checks and Adjustments" section.)
3. If a B-Trigger Mode indicator is on, select RUN AFT DLY. (If an A-Trigger Mode indicator is on, the B-Trigger has been set previously to RUN AFT DLY.)
4. Select  $\Delta t$  or  $1/\Delta t$  while the SEC/DIV knob is out.
5. Adjust  $\Delta$  REF OR DLY POS and  $\Delta$  to place the pair of intensified zones at the beginning and end of the interval of interest. If the A Sweep terminates just after the intensified zones, you can move the HOLDOFF control and set it at MIN.
6. Turn SEC/DIV clockwise with the knob pulled out to magnify the ends of the interval on the B Sweep while observing the entire interval on the A Sweep (ALT mode). Use TRACE SEP to separate the A-Sweep and B-Sweep traces as desired.
7. Set  $\Delta$  REF and  $\Delta$  to superimpose the magnified displays of the beginning and end of the interval. The readout shows the interval.

Without the CTT, make delta-delay-time measurements only in the RUN AFT DLY trigger mode, where the B Sweep runs immediately after the set delays. If the B Sweep is triggered, it waits for a trigger after the set delay, so the actual delay time may differ from the delay or  $\Delta t$  readout by as much as twice the signal period.

### ***Delta-Delay-Time Measurement Characteristics***

A delta-delay-time measurement is valid between a pair of points superimposed on the pair of B Sweeps, regardless of display positions, Trace Sep setting, and CRT-distortion errors. In other words, the only points that can be superimposed are those points that are separated by the delta-time value. (Good accuracy for short intervals does depend on correct CH 2 DLY adjustment. See "Operator Checks and Adjustments" section.)

The main sweep trigger event begins the interval of interest for many measurements. The delta-delay-time measurement can include the A-Sweep trigger event with A SEC/DIV set faster than 50  $\mu$ s. If an interval begins less than 0.05 division from the beginning of A Sweep, the readout shows a question mark. Move  $\Delta$  REF clockwise and change the A-Trigger controls as required to eliminate the question mark and still see a suitable waveform feature for the beginning of the interval.

### ***Single-Delay-Time Measurements***

For intervals longer than 10  $\mu$ s or for low repetition rate signals that make the display flicker, you may prefer to use the B Sweep without  $\Delta t$ . Without  $\Delta t$ , the display repetition rate is higher and the Dly readout shows the time from the start of A Sweep to the start of B Sweep. Compared to delta-delay-time measurements, some accuracy will be lost, unless you can take the difference between one delay time and another.

1. Display the time interval with the A Sweep running as fast as possible, unmagnified. If the interval is a propagation delay or other two-signal measurement, apply the signals to CH 1 and CH 2. For maximum display repetition rate, display only the channel with the end of the interval. Trigger the A Sweep at the beginning of the interval. Turn off  $\Delta t$  or  $1/\Delta t$ .
2. Pull SEC/DIV out to activate B Sweep and light both the A SWP and B SWP indicators (INTEN mode).
3. If a B-Trigger Mode indicator is on, select RUN AFT DLY. (If an A-Trigger Mode indicator is on, the B-Trigger has been set previously to RUN AFT DLY.)
4. Set  $\Delta$  REF OR DLY POS to place the intensified zone at the end of the interval.
5. Turn SEC/DIV clockwise with the knob pulled out to magnify the end of the interval on the B Sweep while observing its relationship to the beginning of the interval on the A Sweep (ALT mode). Use TRACE SEP to separate the A-Sweep and B-Sweep traces.
6. Set  $\Delta$  REF OR DLY POS to align the end of the interval with the left end of the B Sweep. The DLY reading is the length of the interval.
7. If you want to simplify the display and obtain the best possible view of the end of the interval, push the SEC/DIV knob in when A and B SEC/DIV settings are unequal to display only the B Sweep.

## Precision Timing

The available Counter/Timer/Trigger (*CTT*) directly and precisely measures any interval defined by the delayed (B) Sweep and the B Trigger. The *CTT* also reduces the effort required for repetitive measurements or measurements on changing signals.

### Direct and Indirect Measurements

As the counter completes each *direct* measurement, the last character of the units symbol blinks. If the readout includes the word "SET," it indicates an *indirect* measurement of delay-time, including delta-delay-time or 1/delta-delay-time. Indirect measurements are inferred from the A Sweep and control settings.

Indirect delay-time measurements are displayed when any Count, Delay-by-Events, or Logic-Trigger function of the *CTT* is active, except B Sweep triggered by the Word Recognizer. Indirect measurements are also displayed for a few seconds when  $\Delta$  REF or  $\Delta$  are adjusted. Moving any control that affects direct measurements produces an indirect reading until a new, direct measurement is complete.

Direct, counted measurements may be different from indirect ("SET") measurements for any of the following reasons:

1. Direct measurements are more accurate and show more digits of resolution;
2. When B Sweep is triggered, both the waveform display and the direct measurement respond to the signal. Indirect measurements respond only to control settings, regardless of the signal, and they include a question mark when B Sweep is triggered;
3. Both direct and indirect measurements in RUN AFT DLY Mode suffer from offset errors. Direct delay measurements, without  $\Delta t$  or  $1/\Delta t$ , are accurately calibrated in TRIG AFT DLY Mode, from the A-Trigger event to the B-Trigger event.

### Condition Messages

One of the following messages, indicating the described condition, may appear instead of a measurement:

<b>AVERAGING</b>	the selected resolution requires more sweeps;
<b>NO A TRIGGER</b>	the A-Trigger event has not occurred;
<b>MISSING B TRIG</b>	at least one A Sweep occurred without a B-Trigger event during the A Sweep.

## Triggered Delta-Delay-Time Measurements

The available Counter-Timer-Trigger (CTT) directly measures intervals defined by the B-Sweep delays and B Trigger. B Trigger with  $\Delta t$  and  $1/\Delta t$  can have different sources, levels, and slopes for the pair of B-sweeps. Repeatedly pressing the lower Mode button selects the following sequence of B-Trigger modes with the noted characteristics:

### **With or without $\Delta t$ or $1/\Delta t$ :**

#### **RUN AFT DLY**

B Sweep runs immediately after the set delay.

### **Without $\Delta t$ or $1/\Delta t$ :**

#### **TRIG AFT DLY**

B Sweep runs at the first trigger after the set delay.

### **With $\Delta t$ or $1/\Delta t$ :**

#### **TRIG AFT DLY and TRIG $\Delta$ DLY (both indicators on)**

SLOPE and LEVEL settings for triggering at  $\Delta$  REF delay and  $\Delta$  delay are common.

#### **TRIG $\Delta$ DLY**

SLOPE and LEVEL for  $\Delta$  delay can be set independent of the setting for  $\Delta$  REF delay.

#### **TRIG AFT DLY**

SLOPE and LEVEL for  $\Delta$  REF can be set independent of the setting for  $\Delta$  delay.

#### **TRIG $\Delta$ DLY**

Repeated operation of the lower Mode button toggles between TRIG AFT DLY and TRIG  $\Delta$  DLY.

With  $\Delta t$  or  $1/\Delta t$  and TRIG AFT DLY or TRIG  $\Delta$  DLY, the upper Mode button selects the TRIG AFT DLY and TRIG  $\Delta$  DLY mode, where Slope and Level are common for both delays.

---

**Measure a Time Interval Defined by the B Trigger**

1. Follow the first five steps of the procedure in "Measure Time or Frequency with Delta-Delay-Time," earlier in this section.
2. If the interval is a propagation delay or other two-signal measurement, select ALT Vertical Mode and be sure A-Trigger Source is a single channel. Note that  $\Delta$  REF controls the intensified zone on the CH 1 trace.
3. Select TRIG  $\Delta$  DLY B-Trigger Mode. For the special case of a measurement on one signal where the beginning and end of the interval have the same slope and threshold, select TRIG AFT DLY and TRIG  $\Delta$  DLY (both indicators on).
4. Set B-Trigger Source to VERT. If the measurement is limited to one signal and more than one signal is displayed, either deselect the other signals or set Source to the appropriate channel.
5. Set B-Trigger Coupling to DC. For unusual applications, other couplings may be preferred.
6. Press INIT@50%. If necessary, adjust LEVEL for the desired trigger threshold.
7. Select TRIG AFT DLY Mode and repeat step 6. (For the special case noted in step 3, skip this step.)
8. If required, readjust  $\Delta$  REF and  $\Delta$  to intensify the transitions that mark the beginning and end of the interval. In some cases, A-Trigger or B-Trigger settings may need to change in order to trigger on the beginning of the interval.
9. Turn SEC/DIV clockwise to magnify the ends of the interval and readjust LEVEL as required to superimpose them. (Skip this step if signal transition times are much shorter than the required accuracy.)
10. Read the measurement from the readout when "SET" disappears.

## ***Time Interval Resolution***

The available Counter-Timer-Trigger (CTT) measures Delay-Time, Delta-Delay-Time, and 1/Delta-Delay-Time, with the delayed sweep. You can choose the optimum time-interval resolution for these measurements.

1. Activate the CTT MENU.
  - a. If the A-SWP indicator is off or the B-SWP indicator is on, press AUTO Setup and push the SEC/DIV knob in for an A-Sweep display.
  - b. Press A/B/MENU to turn on the MENU indicator and Main Menu:  
**COUNT DLY/EVTS LOGIC-TRIG RES**  
.....
2. Turn either MENU-SELECT to position the cursor under RES.
3. Push the upper Trigger-MODE button to display the Time Resolution Menu.  
**RESOLUTION <AUTO 1ns 100ps 10ps>**
4. Turn either MENU-SELECT to select the desired resolution.
5. Push the upper Trigger-MODE button to store the selected resolution.

## ***Measurement Updating***

AUTO updates the measurement either every 1/2 second or when a measurement is available, whichever is longer. With 1 ns, 100 ps, and 10 ps resolution, the measurement is updated after enough sweeps have occurred for a valid average, as indicated under "N for Average" in Table 2-1.

**Table 2-1  
Resolution Selections**

A SEC/DIV	Selection	Least Digit	N for Average
10 ns to 500 ms	AUTO	See Table 2-2	See Table 2-2
10 ns to 5 $\mu$ s	10 ps	10 ps	$> 10^6$
	100 ps	100 ps	$> 10^4$
	1 ns	1 ns	$> 100$
10 $\mu$ s to 50 $\mu$ s	10 ps or 100 ps	100 ps	$> 10^4$
	1 ns	1 ns	$> 100$
100 $\mu$ s to 500 $\mu$ s	10 ps to 1 ns	1 ns	$> 100$
1 ms to 5 ms	Any	10 ns	$> 1$
10 ms to 50 ms	Any	100 ns	$> 1$
100 ms to 500 ms	Any	1 $\mu$ s	$> 1$

**Table 2-2  
Auto Resolution**

A SEC/DIV	Trigger Rate	Least Digit	N for Average
10 ns to 2 $\mu$ s	$> 20$ kHz	100 ps	$> 10^4$
10 ns to 2 $\mu$ s	200 Hz to 20 kHz	1 ns	$> 100$
5 $\mu$ s to 200 $\mu$ s	$> 200$ Hz	1 ns	$> 100$
10 ns to 200 $\mu$ s	$< 200$ Hz	10 ns	$> 1$
500 $\mu$ s to 5 ms	Any	10 ns	$> 1$
10 ms to 50 ms	Any	100 ns	$> 1$
100 ms to 500 ms	Any	1 $\mu$ s	$> 1$

## Frequency, Period, and Totalize Counting

The available Counter-Timer-Trigger (*CTT*) makes various counting measurements.

### Measure Frequency or Period

1. Activate the Main *CTT* Menu.
  - a. Select an A-Sweep display. (You can press AUTO Setup and push the SEC/DIV knob in to force the A Sweep on.)
  - b. Press A/B/MENU to turn on the MENU indicator and Main Menu:

```
COUNT  DLY/EVTS  LOGIC-TRIG  RES
.....
```

2. Turn either MENU-SELECT to position the cursor under COUNT.
3. Push the upper Trigger-MODE button to display the Count Menu.
  - a. Without the available Word Recognizer:

```
MODE <FREQ PERIOD TOT> EVT = A TRIG
.....
```

- b. With the available Word Recognizer (*WR*):

```
MODE <FREQ PERIOD TOT> EVT <A WR>
.....
```

4. Select the desired count Mode.
  - a. Without the *WR*:  
Turn Right-MENU-SELECT to FREQ or PERIOD.
  - b. With the *WR*:
    1. Turn Left-MENU-SELECT to underline MODE.
    2. Turn Right-MENU-SELECT to FREQ or PERIOD.
    3. Turn Left-MENU-SELECT to EVT.
    4. Turn Right-MENU-SELECT to A (A Trigger) or WR (Word Recognizer), the source of counting events. When counting *WR* events, the A Sweep is also triggered by the *WR* event.
5. Push the upper Trigger-MODE button to display the frequency or period measurement. If the measured event is defined by the Word Recognizer, the *WR* Configuration Menu comes up next, before the frequency or period measurement. See "Word Recognizer Operation".



### **Totalize Random or Low Repetition-Rate Events**

1. Select the Totalize Count Mode, as described above, for frequency and period counting.
2. Move any front panel switch to reset the displayed count.

### **Canceling Menu Functions**

To cancel any function selected through the menu, press the A/B/MENU button to light the MENU indicator, then press the lower Trigger-MODE button. When a menu is displayed, you can either press the lower Trigger-MODE button to escape the menu and deactivate all menu-selected functions or press the upper Trigger-MODE button to step through the menu levels and restore the previous measurement.

The main menu comes up if you select AUTO trigger with Totalize or AUTO LVL with the Word Recognizer active. Selecting either LINE Source or SGL SEQ Mode cancels any counting measurement.

### **Delay Sweeps by Event Counts**

The available Counter-Timer-Trigger (*CTT*) menu includes delay-by-events for either the A Sweep or the B Sweep. Event counting begins at a starting event on a vertical input, defined by the A Trigger. Delay-counting events are defined by the B Trigger. In addition, the available Word Recognizer (*WR*) can define either start or delay-counting events. The combinations available are shown in Table 2-3.

### **Which Sweep to Delay**

When the A Sweep is delayed by events, the event count can accumulate for unlimited time. Then the B Sweep can be delayed by time to magnify waveform details.

When the B Sweep is delayed by events, the event count must accumulate during the A Sweep. Then the intensified A Sweep can show the timing between the start event and the delay count.

*Operation*

**Table 2-3  
Delay-by-Events Combinations**

<b>Sweep to Delay</b>	<b>Start At</b>	<b>Event to Delay by</b>	<b>Explanation</b>
A	A Trigger	B Trigger	Delay begins at the A-Trigger event; then A Sweep runs after the selected number of B-Trigger events.
B	A Trigger	B Trigger	Delay begins when the A Sweep is triggered by the A-trigger event; then B Sweep runs after the selected number of B-Trigger events, if the A Sweep has not terminated.
<b>Added Delay-by-Events Combinations with Word Recognizer</b>			
A	A Trigger	Word Recognizer	Delay begins at the A Trigger; then A Sweep runs after the selected number of words are recognized.
B	A Trigger	Word Recognizer	Delay begins when the A Sweep is triggered by the A-Trigger event; then B Sweep runs after the selected number of words are recognized, if the A Sweep has not terminated.
A	Word Recognizer	B Trigger	Delay begins when a word is recognized; then A Sweep runs after the selected number of B-Trigger events.
A	Word Recognizer	Word Recognizer	The A Sweep runs after the selected number of words are recognized.

**Initiate a Sweep by an Event Count (Delay-by-Events)**

1. Activate the Main CTT Menu.
  - a. Select an A-Sweep display. (You can press AUTO Setup and push the SEC/DIV knob in to force the A Sweep on.)
  - b. Press A/B/MENU to turn on the MENU indicator and the Main Menu:  
 COUNT DLY/EVTS LOGIC-TRIG RES  
 .....
2. Turn either MENU-SELECT to position the cursor under DLY/EVTS.
3. Push the upper Trigger-Mode button to display the Delay-by-Events Menu.
  - a. Without the WR:  
 SWP<A B> START=A DLY BY B  
 .....
  - b. With the WR:  
 SWP<A B> START<A WR> DLY BY<B WR>  
 .....
4. Select a Sweep to delay, a Start event, and an event to Delay by.
  - a. Without the WR: Turn Left-MENU-SELECT to select A or B, the sweep to delay.
  - b. With the WR:
    1. Turn Right-MENU-SELECT to select SWP, START, or DLY BY.
    2. At SWP, turn Right-MENU-SELECT to select A or B, the sweep to delay.  
  
 At START, turn Right-MENU-SELECT to select A, for a start event defined by the A Trigger, or WR, for a start event defined by the Word Recognizer.  
  
 At DLY BY, turn Right-MENU-SELECT to select B, for delaying events defined by the B Trigger, or WR, for delaying events defined by the Word Recognizer.
5. Push the upper Trigger Mode button to display the delay-by-events measurement and delay count. If the start event or delaying event is defined by the Word Recognizer, the Word Recognizer Configuration Menu is displayed next, before the delay-by-events measurement. See "Word Recognizer Operation."

## **Operation**

---

If B Sweep is delayed by events, the message "PULL SEC/DIV" appears until the B Sweep is activated.

The display shows "A" or "B" to identify the sweep delayed, "DBE" to indicate the Delay-by-Events function, and the number of events required to initiate the sweep, for example:

A DBE 1234567

### **Change the Number of Events**

1. Turn off any competing function, such as  $\Delta t$ , so the Delay-by-Events display appears on the right-hand side of the CRT.
2. Turn Left-MENU-SELECT to underline a digit.
3. Turn Right-MENU-SELECT to change the value of the digit.

### **Reset the Number of Events to Zero**

1. Turn Left-MENU-SELECT to underline the most significant digit of the number.
2. Turn Right-MENU-SELECT counterclockwise until all digits are 0.

Decrementing the most significant digit when it is 0 or incrementing a digit when it and higher order digits are at maximum moves the underline cursor to the right.

### **Changing Trigger Settings**

To change trigger settings, select the desired trigger by pushing A/B/MENU. If A Trigger defines the start event, set the SOURCE, COUPLING, SLOPE, and LEVEL controls to define the start event when the NORM or SGL SEQ indicator is on. When the MENU indicator is on, the trigger controls affect the B Trigger, if it defines the delaying events. If the word recognizer is active, change the word definition with the MENU-SELECT controls.

### ***Avoid Ambiguous Event Counts***

With slow signal transitions, the start event detected by the A Trigger may also be detected as a delaying event by the B Trigger, depending on SLOPE and LEVEL settings of the two triggers.

When the time between the start event and the first delaying event is less than 4 ns, the first delaying event may or may not be counted. In most cases, the ambiguity can be resolved by choosing appropriate trigger slopes for the start and delaying events.

To see exactly which event is counted as the first event, select B-Sweep Delayed-by-Events, pull SEC/DIV out to display the intensified A Sweep, and set the event count to 1. The intensified zone will show which event is counted first.

### ***Cancelling Menu Functions***

To cancel any function selected through the menu, press the A/B/MENU button to light the MENU indicator, then press the lower Trigger-MODE button. When a menu is displayed, you can either press the lower Trigger-MODE button to escape the menu and deactivate all menu-selected functions or press the upper Trigger-MODE button to step through the menu levels and restore the previous measurement.

If the A Sweep is delayed by events, selecting AUTO trigger mode will display the Main Menu.

## Logic Triggering

The available Counter-Timer-Trigger (*CTT*) enhances trigger selectivity. Sweeps can be initiated by combinations of two vertical signals, defined by A Trigger and B Trigger. The available Word Recognizer (*WR*) expands logic triggering to 17-bit patterns, either synchronous or asynchronous.

### Initiate a Sweep with the Logic Trigger

1. Activate the *CTT* MENU.
  - a. Select an A-Sweep display. (You can press AUTO Setup and push the SEC/DIV knob in to force the A Sweep on.)
  - b. Press A/B/MENU to turn on the MENU indicator and Main Menu:

COUNT DLY/EVTS LOGIC-TRIG RES

2. Turn Left-MENU-SELECT to position the cursor under LOGIC-TRIG.
3. Push the upper Trigger-MODE button to display the Logic Trigger Menu.

- a. Without the *WR*:

TRIG A SWEEP BY <A·B A+B>

- b. The *WR* adds two functions and changes the menu:

SWP:TRIG <A:A·B A:A+B A:WR B:WR>

4. Turn either MENU-SELECT to select the sweep to trigger and the logic function to trigger it.
5. Push the upper Trigger-MODE button to activate the trigger. The readout will show which of the A/B trigger combinations is selected. If the trigger is defined by the *WR*, the *WR* Configuration Menu is displayed next, before the trigger activates. See "Word Recognizer Operation."
6. Set the A-Trigger and B-Trigger controls or the *WR* pattern for the desired trigger. Set SOURCE, COUPLING, SLOPE, and LEVEL for the B Trigger with the MENU indicator on. Press A/B/MENU to light the AUTO or NORM indicator, then set the A Trigger.

Each input to the A/B logical AND or logical OR is TRUE with + SLOPE and a trigger-source voltage above the trigger level or with - SLOPE and a trigger-source voltage below the trigger level.

When the B Sweep is triggered by the WR, delay-time or delta-delay-time is measured by the crystal-controlled timer. With any other logic-trigger function, delay-time and delta-delay-time measurements are derived from delay settings or cursors.

**Table 2-4**  
**Sweep Triggering**

Selection	Triggers	When
A·B	A Sweep	AND of A and B Triggers A:A·B changes from FALSE to TRUE.
A+B	A Sweep	OR of A and B Triggers A:A+B changes from FALSE to TRUE.
A:WR	A Sweep	Word Recognizer detects the selected word.
B:WR	B Sweep	Word Recognizer detects the selected word.

### ***Cancelling Menu Functions***

To cancel any function selected through the menu, press the A/B/MENU button to light the MENU indicator, then press the lower Trigger-MODE button. When a menu is displayed, you can either press the lower Trigger-MODE button to escape the menu and deactivate all menu-selected functions or press the upper Trigger-MODE button to step through the menu levels and restore the previous measurement.

When a logic trigger is active, selecting AUTO LVL Trigger Mode displays the Main Menu.

## Word Recognizer Operation

Count functions, Delay-by-Events, and Logic Trigger functions can invoke the available Word Recognizer (*WR*), if it is included in the instrument. The *WR* requires a data radix, clock parameters, and a data pattern.

When the *WR* is invoked, the following display guides radix and clock specification:

      RADIX <  BIN OCT HEX> CLOCK <  ↑ ↓ X>

1. Turn Left-MENU-SELECT to underline RADIX.
2. Turn Right-MENU-SELECT to the desired data format; BIN (binary), OCT (octal), or HEX (hexadecimal).
3. Turn Left-MENU-SELECT to CLOCK.
4. Turn Right-MENU-SELECT to the desired clock function; ↑ (rising edge), ↓ (falling edge), or X (asynchronous or no clock).
5. Press the upper Trigger-MODE button to activate the function that invoked the *WR*.
6. Specify the desired pattern. During operation of the function driven by the *WR*, the *WR* status is displayed in this format:

  scq word

where the "s" character indicates the affected sweep (A or B); "c" is the clock mode (↑, ↓, or X); "q" is the qualifier bit (0, 1, or X); and "word" is a 16-bit pattern in the selected radix.

- a. Turn Left-MENU-SELECT to the clock mode character, the qualifier bit, or a digit of the word.
  - b. Turn Right-MENU-SELECT to define the underlined character. Digits of the word can be set to 0, 1, or X with BIN radix, 0 to 7 or X with OCT, and 0 to F or X with HEX. Note that the clock can be redefined here.
7. Connect the *WR* probe to the system under test. Note that bits 0 to 7 and the clock appear on one side of the probe and bits 8 to 15 and the qualifier appear on the other. Be sure to connect at least one of the GND terminals to a good signal ground in the system, as close to the signal test points as possible.



If a word is defined in one radix then displayed in another, some but not all bits of a hexadecimal or octal digit may be X (irrelevant), rendering the digit ambiguous. Ambiguous digits are displayed as question marks.

A1011XX XXX0	A10 1?X077	A10 ???F
BIN	OCT	HEX

When the *WR* defines the starting event or the counting event for Delay-by-Events, the display shows both the *WR* status and the delay count. Any character in either field can be defined with MENU-SELECT.

### ***The Word Out Signal***

The available Word Recognizer (*WR*) generates a WORD OUT signal at a BNC connector on the rear panel. The output is TTL-high when the selected word is recognized. The most recent word definition controls the signal, whether or not the function that invoked the *WR* is active. The timing of the word occurrence, relative to other signals, can be observed by connecting the WORD OUT signal to one vertical channel and using the remaining vertical channels for the other signals.

Propagation delay of word recognition prevents the oscilloscope from displaying the signal transition that generates the trigger, when triggered by the *WR* or the WORD OUT signal.

### ***DMM***

The available Digital Multimeter (*DMM*) adds a powerful set of floating-input measurements. See the last few pages of the "Controls, Connectors, and Indicators" section for operating information.

## Save and Recall Operation

You can easily record any instrument setup for unlimited future use. Eight setups are directly accessible by using SAVE and RECALL as prefixes to the setup number buttons, 1 through 8, which are also the Vertical MODE buttons. Twenty-two more setups are accessible using the  $\Delta$  control to scroll through the list. You can arrange setups in sequence and recall them in order by pressing STEP/AUTO. Sequences automatically restart when they are completed.

### Save and Recall Help

Any time you need more information to proceed with a SAVE or RECALL operation, press SAVE/HELP or RECALL/HELP again. Each time you press SAVE/HELP or RECALL/HELP, the readout shows another message. The messages appear in a repeating sequence.

### Save a Setup

1. Set the instrument to make a particular measurement or observation.
2. Press SAVE. The readout will indicate the Direct Save mode.

Top Row -- SAVE 1-8 DIRECTLY. NAME:xxxxxxx  
Cursor

Bottom Row -- PUSH ANY OF 1-8 TO SAVE SETUP.

(If the Direct-Save mode displays "SAVE FUNCTIONS DISABLED," refer to EXER 07, described in Appendix A.)

3. If you want a new name for the setup, turn  $\Delta$  to define the first character, then turn  $\Delta$  REF to select and  $\Delta$  to define each additional character, up to seven. A small cursor marks the character selected for definition.
4. Press one of the setup number buttons. The readout will show, in the corner, the number of the button you pushed and either the new name you defined or the name of the setup previously associated with that setup number.

You can also save more than 8 setups by pressing STEP/AUTO, turning  $\Delta$  to the desired one, then pressing STEP/AUTO again.

### Save a Sequence

See Appendix B for sequence programming instructions.

### **Recall a Setup**

1. Press RECALL. The readout will indicate the Direct Recall mode by showing the names of the four setups numbered 1 through 4 in the top row and the names of the four setups numbered 5 through 8 in the bottom row. For example:

Top Row -- SKEW ADJ.PLL TP-2467 CLOCK  
Bottom Row -- ACE KING QUEEN JACK

2. Press the setup number button (1 through 8) that occupies the same position among the buttons as the name of the desired setup occupies among the names display. The readout will show, in the upper left corner, the number of the button you pushed and the name of the setup associated with that setup number.

You can also recall any of the setups beyond 8 by turning  $\Delta$  to the desired one, then pressing STEP/AUTO. This does not establish the Step mode.

### **RECALL a Sequence**

1. Press RECALL. The readout will indicate the Direct Recall mode by showing the user-defined menu of the first eight setups.
2. Press STEP. The readout will show the name of the beginning step of the first sequence and the names of additional sequences, up to four.
3. Press the setup number button, 1 through 4, that occupies the same position among the buttons as the name of the desired sequence occupies among the names display. The readout will show, in the upper left corner, the number and the name of the first setup in the selected sequence. If more than four sequences have been saved and you want to run a sequence other than the first four, turn  $\Delta$  to the number and name of the first step in the desired sequence.
4. Press STEP to recall each setup in the sequence, in turn. When the last setup in the sequence has been recalled, the next operation of STEP recalls the first step in the sequence.
5. Press RECALL to cancel the sequence mode.

### **The STEP Indicator**

If the STEP indicator is off, AUTO/STEP automatically establishes a waveform display, as described earlier. If the indicator is on, AUTO/STEP sequentially recalls setups. If the STEP indicator is on, press SAVE or RECALL to extinguish it. A switch closure or TTL-low signal connected to the STEP/AUTO EXT SWITCH connector on the rear panel has the same effect as pushing the STEP/AUTO button.



*Applications*

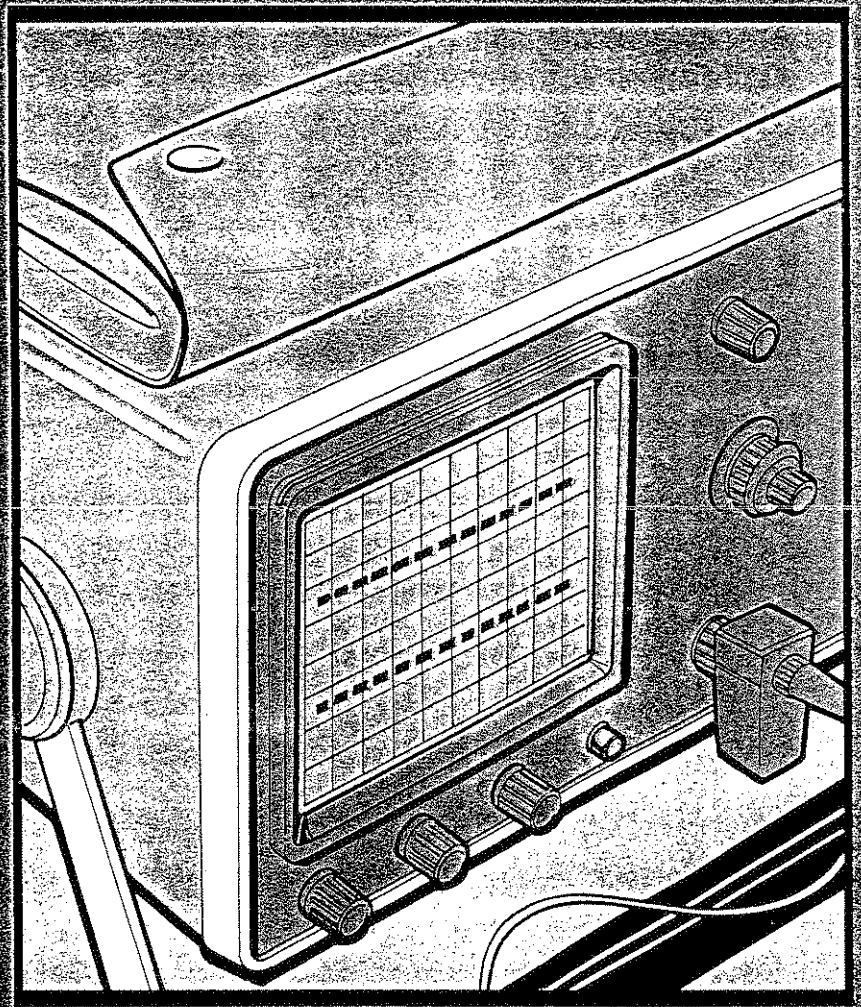

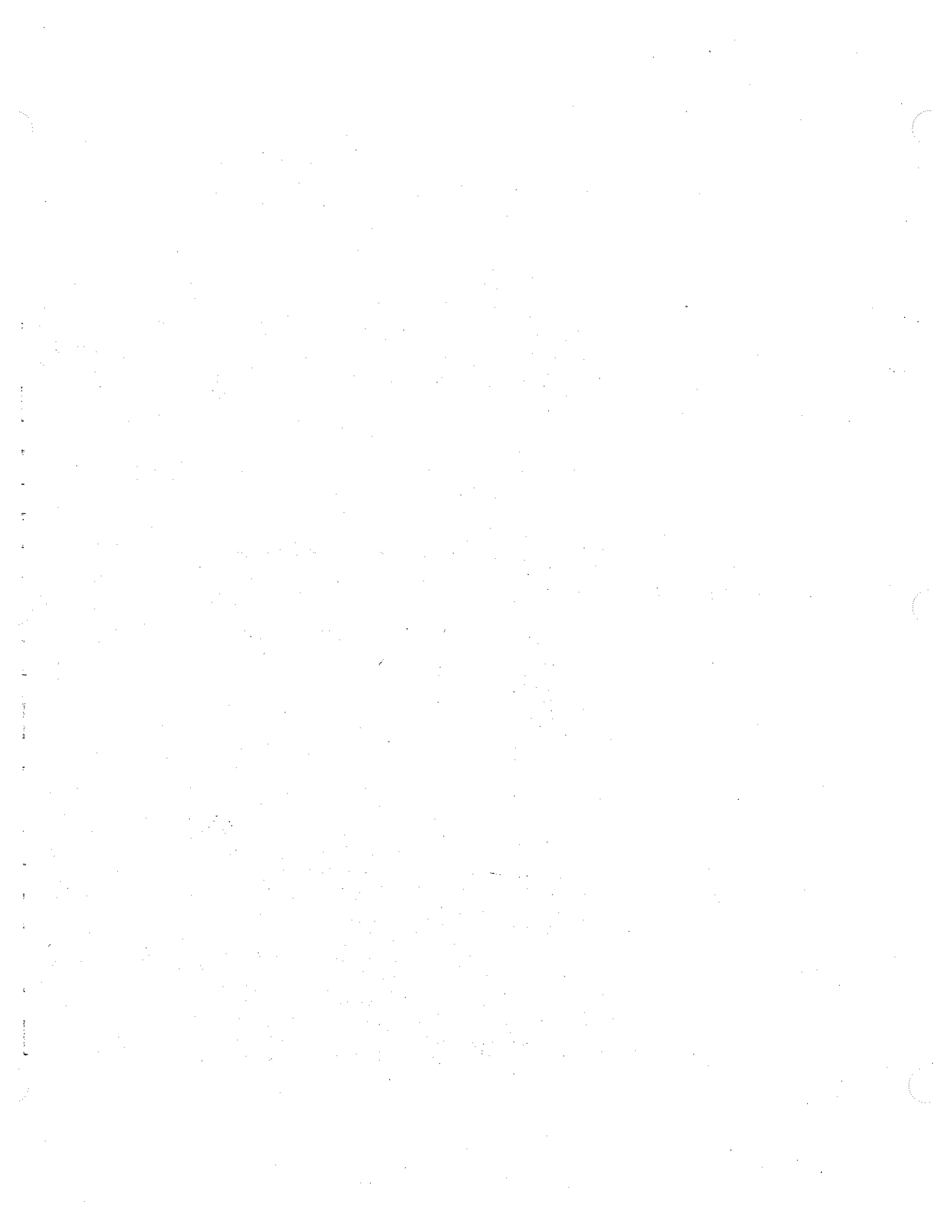

## Peak-to-Peak Voltage

With  $\Delta V$  turned on and VOLTS/DIV VAR fully clockwise, align the  $\Delta$  REF cursor with the bottom of a waveform and align the  $\Delta$  cursor with the top. The readout shows the equivalent voltage between the cursors anywhere on a waveform. Accuracy is degraded at frequencies approaching the instrument bandwidth.

## Absolute Voltages

1. Position the waveform as desired for convenient viewing, with VOLTS/DIV VAR fully clockwise and with VOLTS/DIV set for the largest usable display amplitude.
2. Momentarily switch Input Coupling to GND and align the  $\Delta$  REF cursor with the trace.
3. Switch Input Coupling to DC and set the  $\Delta$  cursor to the point of interest.

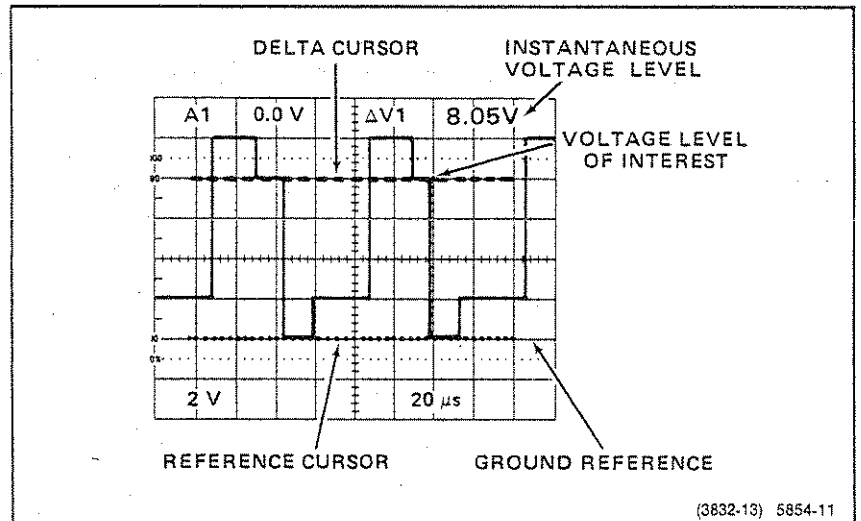

Figure 3-1. Instantaneous voltages.

## **Noise Immunity**

Set the  $\Delta V$  cursors to the upper and lower threshold limits of a digital circuit. For example, with TTL:

1. Superimpose the  $\Delta$  REF cursor on the trace with input coupling at GND.
2. Set the  $\Delta$  cursor for a 2.0 V readout.
3. Set the  $\Delta$  REF cursor for 1.2 V readout, the difference between the 0.8 V lower-threshold limit and the 2.0 V upper-threshold limit.
4. Set Input Coupling to DC and observe the relationship between the signal and the cursors. The signal is faulty if it changes direction between cursors or if either the high level or the low level appears between cursors.

## **"Quick and Dirty" DC Voltage Measurement**

Sometimes a 5% estimate of a dc voltage is good enough to verify the operation of a power supply, trace power supply distribution, or verify the state of a control system.

1. Display either CH 1 or CH 2, and connect it to the voltage.
2. Push AUTO Setup and read the voltage in the trigger level readout. For voltages in the same range, simply touch the probe to the voltage. For best accuracy, set VOLTS/DIV so the measured voltage is five to fifteen divisions.

## **Amplitude Modulation**

1. Set VOLTS/DIV and VAR for five divisions of carrier amplitude. Carrier amplitude is the difference between positive peaks of the modulated signal and negative peaks of the minimum-amplitude part of the envelope.
2. Align the reference  $\Delta V$  cursor with the positive peaks of the minimum-amplitude part of the envelope and the  $\Delta$  cursor with the positive peaks of the signal envelope.
3. The RATIO readout shows the modulation index in percent.



## Frequency Modulation

For modulation index more than 1%:

1. Set SEC/DIV and VAR so the average signal period covers five divisions.
2. If deviation is less than 1 division in one cycle (20%), turn on X10 MAG.
3. Align  $\Delta t$  cursors with the extremes of the deviation.
4. The readout shows the peak-to-peak deviation in percent. If X10 MAG is on, divide the reading by 10.

For modulation index from 0.1% to 2%:

1. Measure the carrier period.
2. Display A-Sweep with SEC/DIV between 1 and 2.5 times the period.
3. Turn off  $\Delta t$ , pull SEC/DIV, and turn  $\Delta$  REF for a DLY reading 10 times the carrier period. If a B-Trigger mode indicator is on, select RUN AFT DLY.
4. Turn and push SEC/DIV to display the B-Sweep and set SEC/DIV at 0.2 times the period, using the switch and VAR. (The display will show one cycle in five horizontal divisions.) If the DLY setting is less than 200 ns, turn  $\Delta$  REF to zero DLY, then turn  $\Delta$  REF to move ten cycles past a point in the display.
5. Align  $\Delta t$  cursors with the deviation extremes.
6. Divide the reading by 10 to determine the peak-to-peak deviation in percent.

For modulation index from 0.01% to 0.2%, proceed as above for 0.1% to 2% except:

- at step 2 set SEC/DIV between 10 and 25 times the period;
- at step 3 set  $\Delta$  REF for 100 times the carrier period; and
- at step 6 divide the reading by 100.

The instrument adds about 0.01% spurious modulation to the display. This error can be minimized by measuring the apparent frequency modulation of an unmodulated carrier, at the same frequency and with the same control settings, and subtracting that value from very low modulation-index readings.

### ***Measuring Video Signals in IRE Units***

1. Display a video signal with VOLTS/DIV VAR adjusted out of detent for five divisions amplitude from the white level to the black level. (The black level is defined by the front and back "porches.")
2. Measure the features of interest with  $\Delta V$  cursors. The RATIO readings in percent are equivalent to IRE units.

### ***Avoiding False Displays with Multi-Mode Signals***

A signal that has two characteristic forms on alternate cycles can produce incomplete displays. With Alt Vertical mode and two displayed channels, the oscilloscope could show the same one of the two forms every time a particular channel is shown. Also, if a signal's period is less than the total duration of the sweep plus the trigger holdoff, the display could show only one of several signal modes.

1. You can display all the modes of a multi-mode waveform by changing the setting of Trigger HOLDOFF, so the modes are superimposed in the display.
2. CHOP Vertical Mode often will superimpose the multiple modes of waveforms in multi-channel displays.

### ***Algebraic Addition to Detect Coincidence or Cancel Interference***

With the Add Vertical mode, the waveform is the algebraic sum of the signals applied to Channel 1 and Channel 2. If Channel 2 is Inverted, the Add waveform is the difference between the signals applied to Channel 1 and Channel 2. The deflection factor of the Add trace is the same as CH 1 and CH 2 VOLTS/DIV when they are equal.

The following general precautions should be observed when using Add mode:

1. Signal peaks should not exceed  $\pm 8$  times the VOLTS/DIV setting.
2. Position both Channel 1 and Channel 2 waveforms near center screen, when viewed separately. This ensures the greatest dynamic range for the Add trace.
3. To obtain similar responses from each channel, set Channel 1 and Channel 2 input couplings the same.

## Observing Coincidence of Digital Signals

With digital signals applied to CH 1 and CH 2, the Add waveform is high when both signals are high, low when both are low, and at an intermediate level when one signal is high and the other is low. By inverting CH 2, you can observe the coincidence of one signal and NOT the other. To observe coincidence of TTL signals:

1. Connect the signals of interest to CH 1 and CH 2. If the coincidence of interest has one signal high and the other one low, invert CH 2.
2. Display CH 1, CH 2, and Add. Set both VOLTS/DIV to 2 V and both inputs to GND. Position both channels on screen and the Add trace one division above the bottom of the graticule. Then deselect CH 1 and CH 2.
3. Set both inputs to DC. Set Trigger mode to Auto and Source to Vert. If the coincidence of interest is high-high, set trigger SLOPE to +. If the coincidence is low-low, set SLOPE to -. (If CH 2 is inverted, consider the inverse of the CH 2 signal in the high-high or low-low combination.) Press INIT@50%, then carefully adjust the trigger level to respond to the high-high or low-low state combination. (Trigger level readout doesn't operate with Add Source.)
4. Now you can observe and measure coincidence durations and other time intervals. Channels 3 and 4 can show relationships to other signals.

## Measuring Off-Ground Signals And Cancelling Interference

The Add mode can measure voltage between a pair of points where neither point is ground. The technique can cancel interfering signals or uninteresting components of a signal through common-mode rejection.

1. Display the signal on CH 2 at the point you consider low, common, or inverse and display on CH 1 the high or active signal.
2. Set both VOLTS/DIV equally and for three to eight divisions of amplitude on the larger of the pair of signals.
3. Select the Add display, invert CH 2, connect the CH 1 probe temporarily to the CH 2 point, and adjust either the CH 1 or CH 2 VAR control, if necessary, to minimize the amplitude of the Add display.
4. Move the CH 1 probe back to the active signal and observe the desired, differential signal.

You may be able to increase vertical sensitivity by one Volts/Div step, keeping CH 1 and CH 2 equal, without serious distortion. If the common mode signal has the same repetition rate as the signal of interest, CH 1 or CH 2 may be usable as the trigger source. Vert Trigger Source is often more desirable because it responds only to the differential signal. Figure 3-2 shows an example.

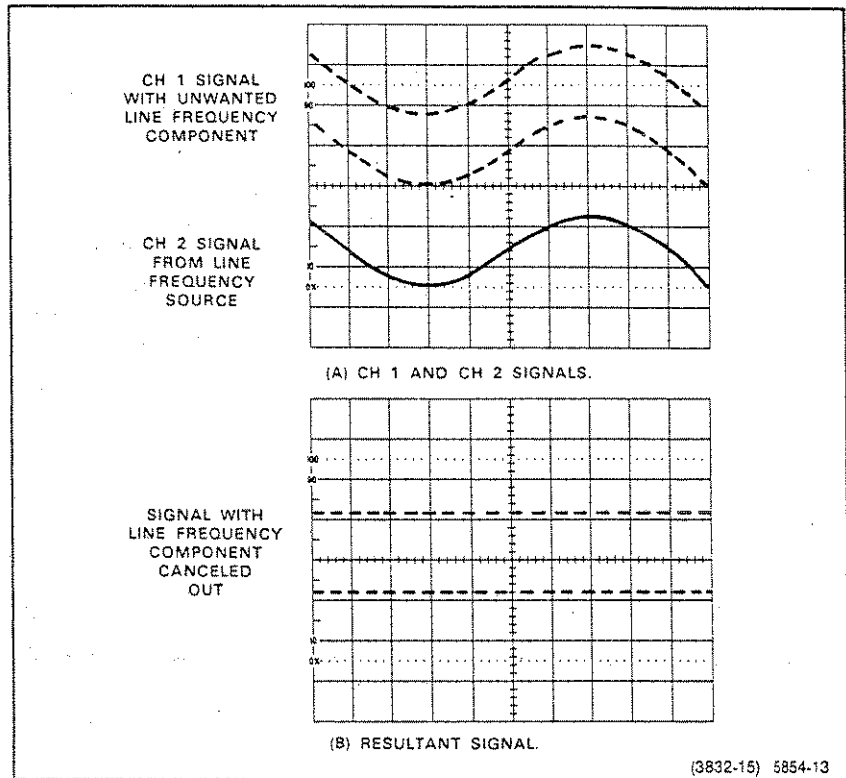

Figure 3-2. Eliminating common-mode signals.

## Period and Frequency

1. Set SEC/DIV and, if necessary, X10 MAG to spread one cycle over as wide a span as possible.
2. Turn on  $\Delta t$  or  $1/\Delta t$  and align the cursors with identical, fast-slewing points on consecutive cycles, such as zero-crossings.

With the available Counter-Timer-Trigger (CTT) you can measure period and frequency more accurately and with less effort.

1. Press A/B/MENU to display the main CTT Menu.
2. Turn  $\Delta$  to select COUNT, then press the upper Trigger MODE button.
3. Turn  $\Delta$  to select FREQ or PERIOD, then press the upper MODE button.
4. The readout will automatically show the frequency or period of the A-Trigger signal, up to 150 MHz, until a conflicting function is selected or the function is cancelled by pressing AUTO Setup or by selecting the Menu and pressing the lower Trigger Mode button.

### Rise Time and Fall Time

1. Set VOLTS/DIV, VAR, and POSITION to align the bottom of the waveform with the 0% graticule line and the top with the 100% line.
2. Set Trigger SLOPE to + for rise time or to - for fall time.
3. Set SEC/DIV and, if necessary, X10 MAG to spread the transition over as wide a span as possible.
4. Turn on  $\Delta t$  and align the cursors with the points where the transition intersects the 10% and 90% graticule lines.

For best accuracy, observe the considerations given in the Signal Connection parts of the "Operation" section and be sure TRACE ROTATION is set correctly, as described in the "Checks and Adjustments" section.

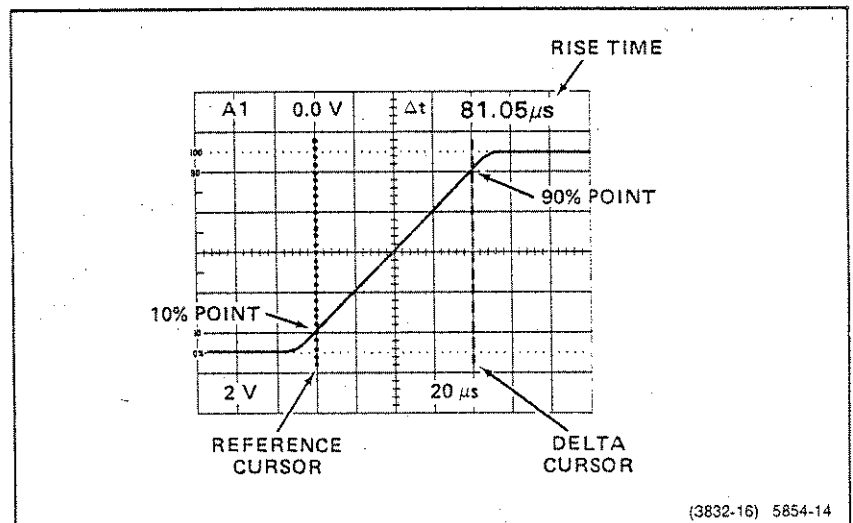

Figure 3-3. Measuring rise times.

## ***Propagation Delay***

1. Display the input to the device under test on one channel and the output on another, with the largest practical vertical amplitude while keeping the zero-volt level on screen.
2. Trigger the sweep on the input signal.
3. Vertically position each waveform so the appropriate threshold voltage or the 50% point on transitions is aligned with a horizontal graticule line. You can use the same or different graticule lines for each waveform.
  - a. Turn on  $\Delta V$  and adjust  $\Delta$  for the desired threshold voltage.
  - b. Press TRACK/INDEP to select TRACK.
  - c. Adjust  $\Delta$  REF to align the  $\Delta$  cursor, the one with dashes, with the graticule line you want the signal to cross.
  - d. Select GND vertical input coupling and adjust POSITION to align the trace with the  $\Delta$  REF cursor, the one with dots.
  - e. Select DC vertical input coupling.
4. Set SEC/DIV as fast as possible while containing the measured time on screen. Use X10 MAG if needed.
5. Turn on  $\Delta t$  and align the cursors with the intersections of the waveforms with the chosen graticule lines.

For best accuracy, observe the considerations in the Signal Connection parts of the "Operation" section and make sure the vertical delays are matched by connecting both probes to one signal. If the delays are not precisely matched, see "Matching Channel 2 Delay" in the "Checks and Adjustments" section.

## ***Setup and Hold Times***

Proceed as if measuring propagation delay, treating the clock as an input and the data signal as an output. Use high settings of INTENSITY to observe variations. If setup time exceeds 30 or 40 ns, you may prefer to treat the data as input and the clock as output.

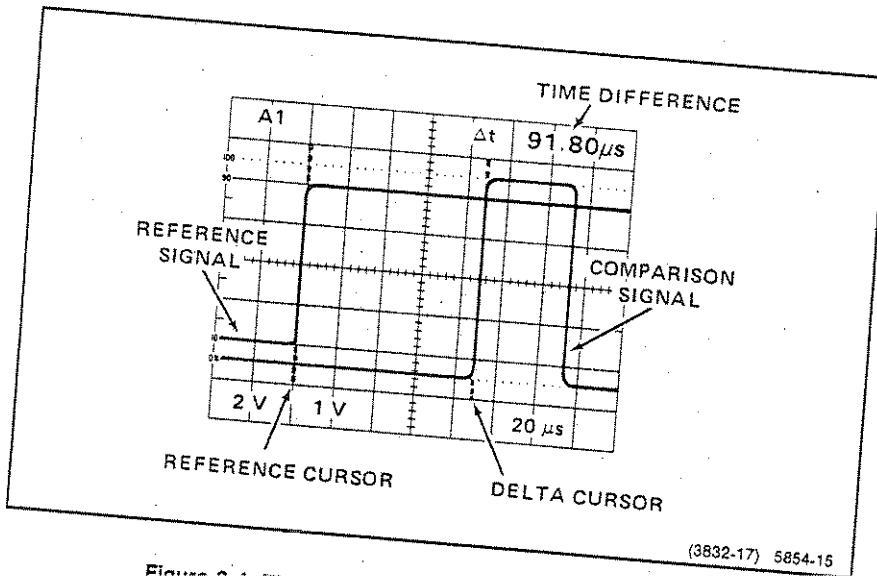

Figure 3-4. Time between two pulses (cursor method).

## Slew Rate

Slew rate is the slope of a signal in volts/second.

1. Display the slope of the signal over the largest practical span of horizontal deflection and vertical deflection.
2. Activate  $1/\Delta t$  and set the cursors to intersect the signal slope at points that are separated by one volt or by a power-of-ten multiple or fraction of one volt.
3. Interpret the frequency (Hz) readout as volts/second instead of cycles/second (Hz). Multiply the result by the power-of-ten multiple of one volt between the cursors. For example, if the cursors intersect the waveform at points separated by one volt and the readout shows 173 kHz, the slew rate is 173 V/ms. With 10 mV between cursors and 55.3 MHz readout, the slew rate is 0.553 V/μs or 553 kV/s, etc.

## In Two Signals

With equal time delays, display the reference comparison signal on CH 2. For higher frequencies, time delay is critical. The procedure for matching delays is "Channel 2 Delay" in Section 4.

Use the S/DIV and VAR controls to obtain equal amplitudes and the comparison signals. Set the amplitudes

controls to center both displays vertically. Phase depends on the accuracy of vertical centering.

Set the display one cycle of the reference signal over five

cycles by both the  $\Delta t$  and  $\Delta V$  buttons together.

Align the comparison signal with a zero-crossing of the reference signal. Align the comparison signal with the nearest zero-crossing of the comparison signal as the reference signal zero-crossing (see Figure 3-7). Use the horizontal graticule line as the reference for aligning the

readings from the CRT readout.

For a 1 horizontal division (72 degrees), you can make a measurement. Use the X10 MAGnifier, without the X10 expand the display; align the cursors with the zero-crossing of the reference signal (see Figure 3-7).

## Signals

When using attenuation probes, deflection factors range down to 100. The vertical sensitivity by a factor of ten, either use a 10X probe with CH 1. To obtain 200 μV/division, use a 1X probe with the signal to CH 2 and cascade CH 2 with CH 1. To

connect the output on the rear panel, through a 50-Ω cable, to the front panel.

Set the input at 1 MΩ DC or AC.

LIMIT on. This will reduce the trace "thickening" caused by noise and avoid oscillation of the vertical system. If you use a 1 source, you probably need to use HF REJ coupling.

Set S/DIV at 2 mV (20 mV with 10X probe) and set CH 1 at 10 divisions.

Set CH 1 scale factor and delta-volts readings agree with the delta-volts probe-tip with a 10X probe. With a 1X probe, the scale factor readings should be divided by ten.

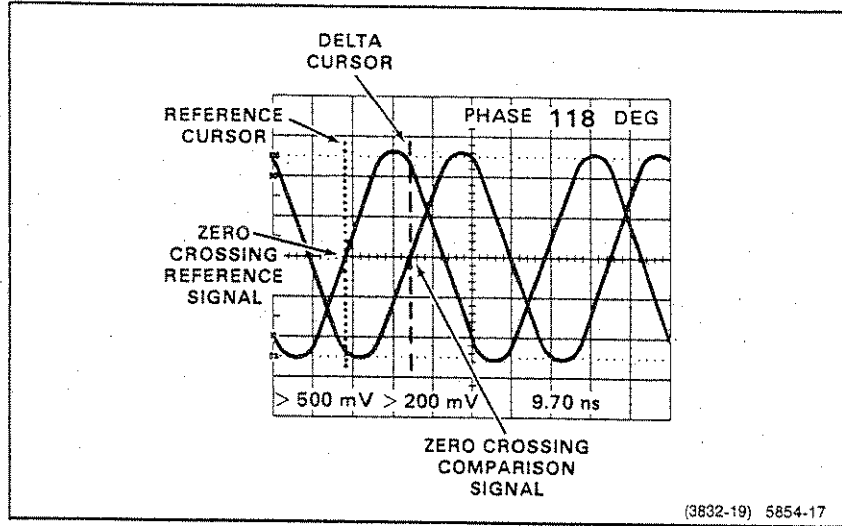

Figure 3-6. Phase difference between two signals.

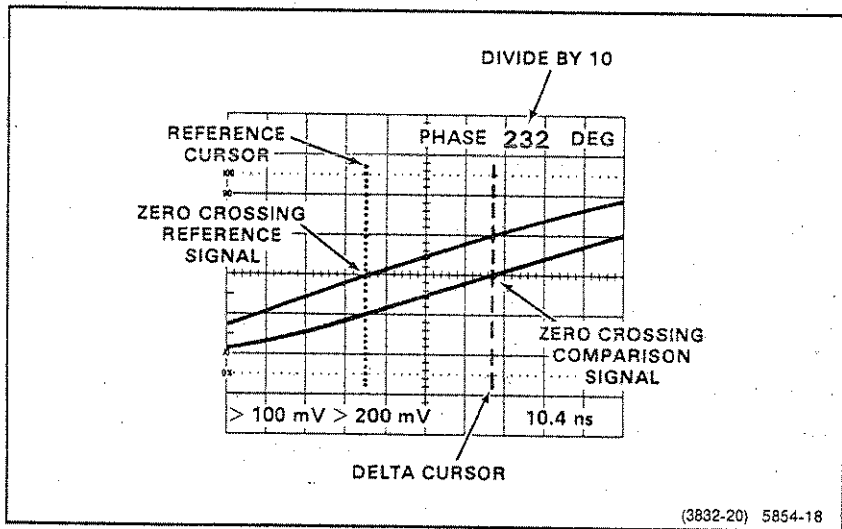

Figure 3-7. Small-angle phase difference.



SECTION

4

*Checks and Adjustments*

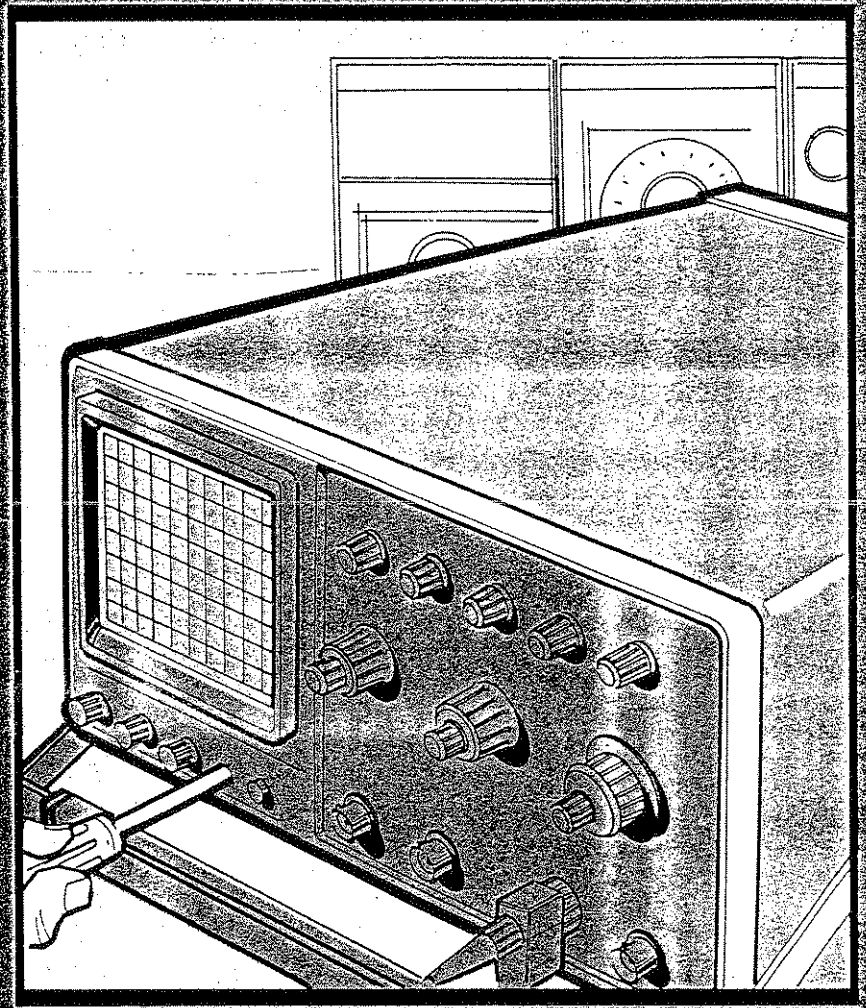

2465A/2455A/2445A Operators

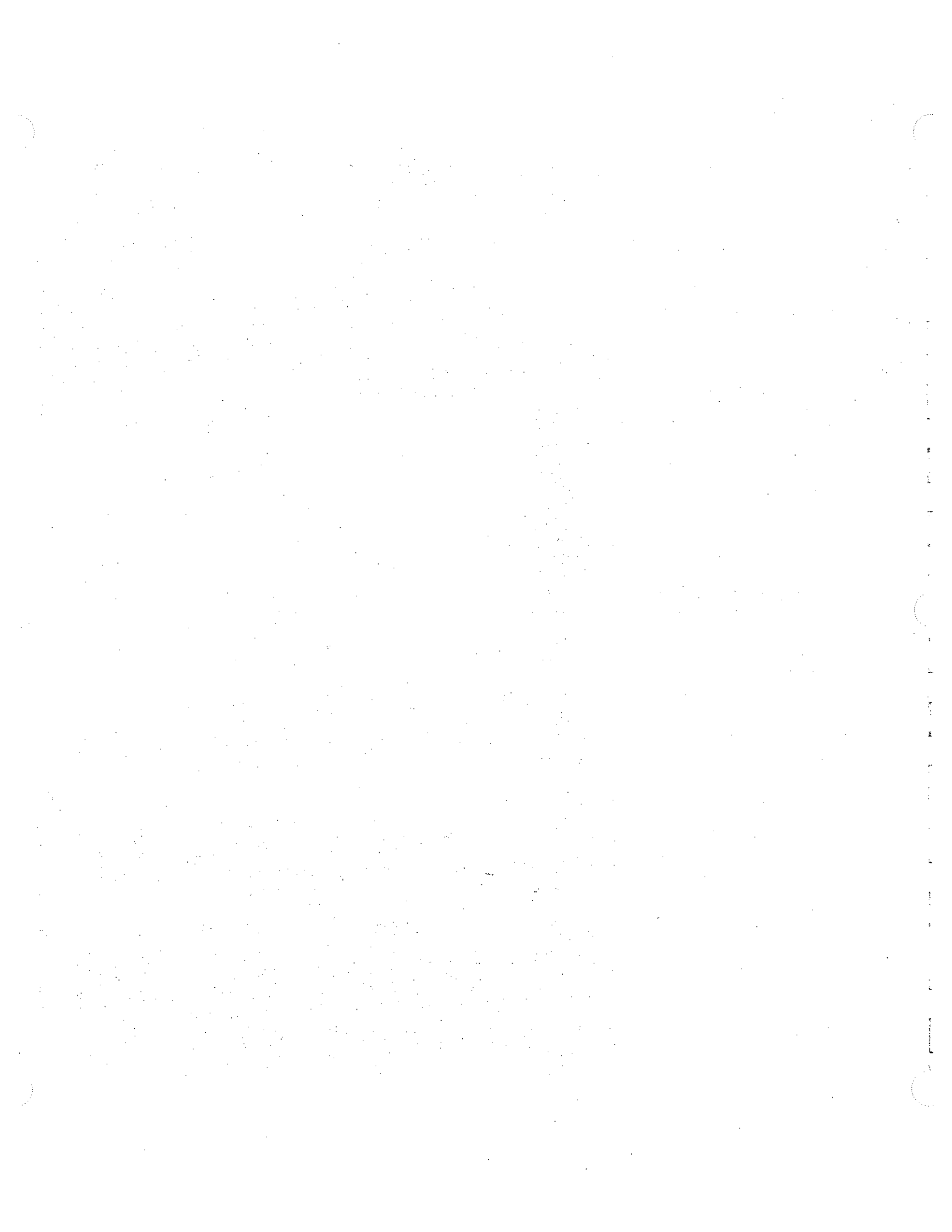

## Introduction

The checks and adjustments in this section eliminate some significant sources of measurement error and improve measurement confidence. If adjustments are required beyond the scope of this section, refer the instrument to a qualified service technician.

## Initial Setup

1. Press in the POWER switch button (ON) and allow the instrument to warm up (20 minutes is recommended for maximum accuracy).
2. Set instrument controls to obtain a display:

READOUT INTENSITY	Midrange between "OFF" and fully clockwise
INTENSITY	Midrange
FOCUS	Midrange
VERTICAL MODE	CH 1
CH 1 Input Coupling	1 M $\Omega$ DC
3. Connect the Calibrator output to the CH 1 input with a standard accessory probe and ground the probe near the Calibrator output.
4. Press the AUTO Setup button to obtain a display. (If the STEP indicator is illuminated, press RECALL to cancel the Step mode, then press AUTO to obtain a display.) Adjust the INTENSITY and READOUT INTENSITY controls as desired. Set the FOCUS control for the best trace definition.

## Trace Rotation and Adjustment

1. Preset instrument controls and obtain a display as described in "Initial Setup."
2. Set CH 1 Input Coupling to GND, 20 MHz BW LIMIT on, and adjust the CH 1 POSITION control to position the trace on the center horizontal graticule line.
3. If the trace is not parallel to the center horizontal graticule line, use a small-bladed screwdriver to adjust the TRACE ROTATION control and align the trace with the center horizontal graticule line.

## **Astigmatism Adjustment**

1. Obtain a display as described in "Initial Setup."
2. Set 20 MHz BW LIMIT on and adjust the CH 1 POSITION control to center the display on the screen.
3. Select  $\Delta V$  and position the cursors near the top and bottom of the screen.
4. Set SEC/DIV to 1  $\mu$ s.
5. Slowly adjust the FOCUS control to its optimum setting (best defined display of cursor dots).
6. Use a small-bladed screwdriver to adjust the ASTIG control for best defined display of cursor dots. The waveform and the entire readout should be well-defined.
7. Since the ASTIG and FOCUS adjustments interact, repeat steps 5 and 6 until the best-defined display over the entire graticule area is obtained.

### **NOTE**

*Once set, the ASTIG adjustment should be correct for any display. However, it may be necessary to reset the FOCUS control slightly when the INTENSITY control setting is changed.*

## **Auto DC Balance Routine**

The oscilloscope can automatically dc-balance Channel 1 and Channel 2. This routine minimizes trace shifts when adjusting the VOLTS/DIV and VOLTS/DIV VAR controls, and when switching Channel 2 between noninverted and inverted. This dc balance remains valid as long as the instrument is operating within 5°C of the ambient temperature at which the routine was performed, provided the instrument has had a 20-minute warm-up period.

To initiate the adjustment, press the upper, input-coupling buttons for both Channel 1 and Channel 2 at the same time. When the Auto DC Balance cycle is complete, the instrument will return to normal operation.

### **NOTE**

*If a circuit defect prevents accurate dc balance, the routine halts and LIMIT is displayed. Press the upper Trigger COUPLING button to continue balancing the remainder of the circuitry.*

If power to the instrument is interrupted before the balancing cycle is complete, a DC balance error may be apparent in subsequent operation. When power is restored, restart the DC balance routine, after the instrument has warmed up.

## Probe Compensation

Accurate measurements require accurate probe compensation. To ensure optimum measurement accuracy, check probe compensation any time a probe is attached to the instrument or any other time you are not certain of correct compensation. Because of minor differences between channels, CH 1 and CH 2 probes should be compensated on their respective channels. CH 3 and CH 4 probes should be compensated on CH 1 or CH 2. Check and adjust probe low-frequency compensation as follows:

1. Obtain a display as described in "Initial Setup."
2. Set the SEC/DIV control to 1 ms and 20 MHz BW LIMIT on. If the probe to be compensated is connected to CH 2, enable the Channel 2 display. Set the appropriate VOLTS/DIV control to 100 mV.
3. Connect the probe to the CALIBRATOR output.
4. Check the waveform for overshoot and rolloff (see Figure 4-1). If necessary, adjust the probe for a square front corner on the waveform, using the small adjustment tool supplied in the probe accessory package. Insert the tool through the small hole in the side of the box attached to the vertical input connector.

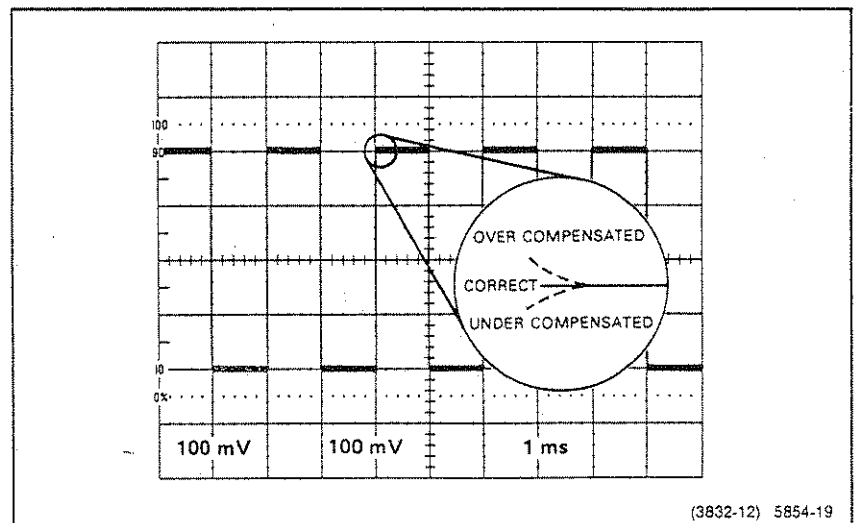

Figure 4-1. Probe low-frequency compensation.

## Matching Channel 2 Delay

The apparent signal delay in Channel 2 may be adjusted up to  $\pm 500$  ps to match the apparent delay present in any of the other three channels. This adjustment is most commonly used to eliminate delay differences between Channel 1 and Channel 2 that may be introduced by the probes. It has no effect on common-mode rejection when ADD Vertical Mode is selected. Match Channel 1 and Channel 2 as follows:

1. Connect two 10X probes supplied with the instrument to the CH 1 OR X and CH 2 inputs.
2. Check and adjust, if necessary, the probe's low-frequency compensation. Refer to "Probe Compensation" in this section.
3. Connect both probes via hook tips to a fast-rise pulse generator output.
4. Select both CH 1 and CH 2 Vertical mode displays.
5. Press AUTO Setup to obtain a display.
6. Set the CH 1 and CH 2 VOLTS/DIV and POSITION controls for 3 to 6 divisions of amplitude and superimposed displays.
7. Set SEC/DIV to 5 ns.
8. Pull out the SEC/DIV knob and observe the message CH 2 DELAY—TURN  $\Delta$  in the upper right-hand corner of the screen.

### NOTE

*If the message CH 2 DLY DISABLED appears in the readout, the instrument has been set to disable the delay-offset adjusting feature. If adjustment of the delay matching is disabled, refer the adjustment to a qualified service technician.*

9. Set X10 MAG On and adjust the  $\Delta$  control until the two fast edges are superimposed horizontally.

### NOTE

*The  $\Delta$  REF OR DLY POS control can also be used to make the adjustment.*

10. Push in the SEC/DIV switch. The adjustment is then permanently stored for future operation, even when power is interrupted.

## Amplitude Check

1. Obtain a display as described in "Initial Setup."
2. Set the VOLTS/DIV switch to 100 mV, the SEC/DIV switch to 1 ms, and 20 MHz BW LIMIT on.
3. Adjust the CH 1 POSITION control to center the display on the screen.
4. CHECK—Amplitude of the CALIBRATOR signal is between 3.88 and 4.12 divisions as measured on the center vertical graticule line.
5. Select  $\Delta V$  and carefully superimpose the cursors on the high and low levels of the waveform. CHECK— $\Delta V$  readout is between 392 mV and 408 mV.
6. Repeat this procedure using the Channel 2 connector and controls.

## Timing Check

The period of the CALIBRATOR signal automatically tracks the A SEC/DIV setting within the range of 100 ms to 100  $\mu$ s. Within that SEC/DIV range, the CALIBRATOR period is 200 ms to 200 ns, 5 cycles per 10 divisions of the A Sweep. To quickly check the operation and calibration of the oscilloscope timing, use the following procedure:

1. Obtain a display as described in "Initial Setup."
2. CHECK—Timing accuracy by confirming that five complete cycles of the square-wave signal are displayed over 10 major divisions ( $\pm 0.1$  division) along the center horizontal graticule line for all A SEC/DIV settings from 100 ms to 100 ns. Confirm that 2 cycles of the Calibrator signal cover 8 divisions at 50 ns/div and that 1 cycle covers 10 divisions at 20 ns/div. Observe that the displayed transition time of the signal remains approximately the same when A SEC/DIV is changed to 10 ns and 5 ns. (The number of horizontal divisions covered by the transition time at 10 ns per division should be two times the number covered at 20 ns, and the number of divisions at 5 ns should be four times the number at 20 ns.) Return A SEC/DIV to 1 ms, switch the X10 MAG on, and CHECK—that 1/2 cycle covers 9.8 to 10.2 divisions.
3. Set X10 MAG Off and carefully align the  $\Delta t$  cursors with the falling edges of the first and fifth cycles. CHECK— $\Delta t$  reading is within 7.93 ms to 8.07 ms. Repeat the test at any A-Sweep speed in the 100 ms to 100 ns range.
4. If desired, delay timing can be checked by using Alt horizontal display mode, RUN AFT DLY B-Trigger mode, and  $\Delta t$ . Set the  $\Delta$  REF AND DLY POS and  $\Delta$  controls to align the intensified zones with the falling edges of the first and fifth cycles and superimpose the expanded display of the edges on the B Sweep, running at least 10 times faster than the A Sweep. CHECK— $\Delta t$  reading is 8 times the A SEC/DIV setting,  $\pm 0.5\%$ .





*Controls, Connectors,  
and Indicators*

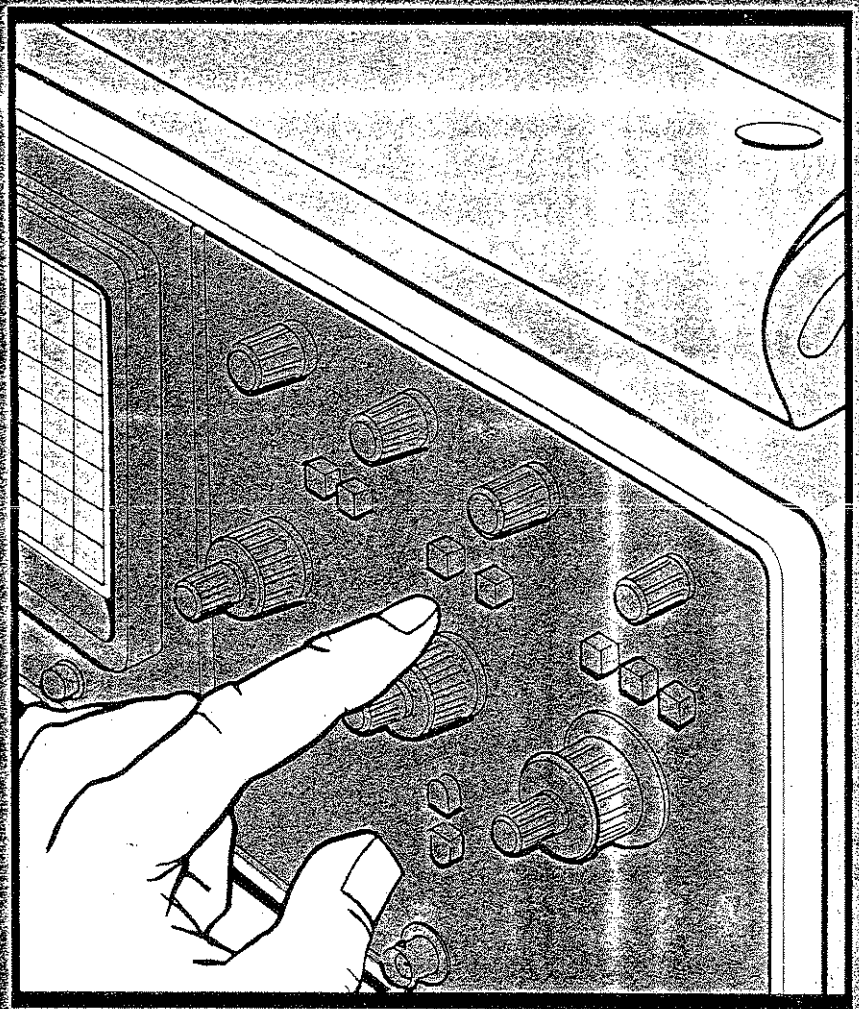



## Introduction

The following descriptions are intended to familiarize the operator with the location and function of the instrument's controls, connectors, and indicators.

All continuously variable controls, except FOCUS, TRACE ROTATION, ASTIGMATISM, and SCALE ILLUMINATION have fine resolution for a portion of their rotation after each reversal. Continued rotation in the same direction gives progressively coarser resolution.

## Power And Display

Refer to Figure 5-1 for the location of items 1 through 10.

- |   |                                  |   |
|---|----------------------------------|---|
| ① | <b>INTENSITY Control</b>         | Adjusts the brightness of the waveform.   |
| ② | <b>BEAM FIND Button</b>          | Limits the CRT deflection both vertically and horizontally to within the graticule. Display intensity is not affected by the BEAM FIND button.  |
| ③ | <b>FOCUS Control</b>             | Adjusts the CRT writing beam for optimum display definition.  |
| ④ | <b>TRACE ROTATION Control</b>    | Aligns the no-signal trace with the horizontal graticule lines. Relocating the instrument to a different magnetic ambient may result in slight misalignment of the trace and graticule, indicating a need to readjust the TRACE ROTATION control, using a screwdriver.  |
| ⑤ | <b>READOUT INTENSITY Control</b> | Adjusts the intensity of the CRT readout display and either enables or disables the display of scale factors. Digital measurements, Save/Recall readouts, the "50 $\Omega$ OVERLOAD" message, the available Counter-Timer-Trigger (CTT) menu, and the available Television/Video (TV) function indicators are always enabled. |

Various functions generate displays in the upper row. The most recently selected function displaces any previous readout. If delta or delay readouts displace displays generated by the available *TV* enhancement or *CTT*, the *TV* or *CTT* displays shift to the upper left corner, in lieu of the trigger level readout.

Minimum intensity occurs at the control's midrange, OFF position. Clockwise rotation from midrange increases the intensity and enables all displays. Counterclockwise rotation from midrange increases the intensity and disables the scale-factor and control-status displays.

- ⑥ **ASTIG Control** Adjusts the CRT beam shape to obtain a well-defined display over the entire graticule area, in conjunction with the FOCUS control. Once adjusted with a screwdriver, it normally does not require readjustment.
  
- ⑦ **SCALE ILLUM Control** Adjusts the level of graticule illumination.
  
- ⑧ **POWER Switch** Turns instrument power on and off. Press in for ON; press again for OFF. An indicator in the switch shows green when the switch is on and black when it is off. Front-panel settings are returned when power is reapplied to the instrument, unless saved setup number 1 is selected by EXER 06, described in Appendix A.
  
- ⑨ **CRT** Has a 80-mm vertical by 100-mm horizontal display area. Internal graticule lines eliminate parallax-viewing error between the trace and the graticule lines. The graticule includes 0%, 10%, 90%, and 100% marks for rise-time measurements.
  
- ⑩ **GPIB STATUS Indicators** Included only with the available IEEE-Standard-488 interface (*GPIB*); show key interactions with a GPIB system. LOCK lights when the instrument controls are disabled by a local lockout message from the system controller. SRQ lights when the instrument requests a service response from the system controller. REM lights when the system controller assumes control of the instrument. See *24X5A/2467 Option 10 Instrument Interfacing Guide* for detailed information on using the instrument in a GPIB system.

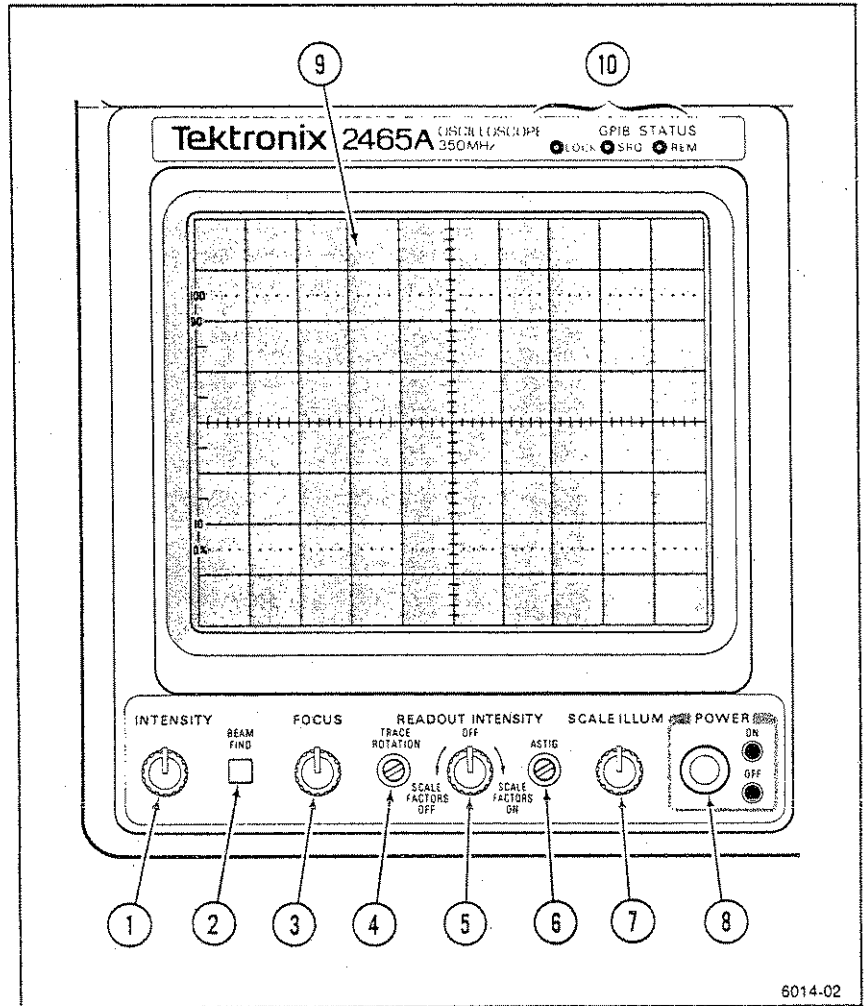

Figure 5-1. Power and display controls.

## Setup and Vertical

Refer to Figure 5-2 for the location of items 11 through 17.

- ⑪ **STEP/AUTO Button** Recalls the next step in a stored sequence of setups, if the STEP indicator is illuminated. If the STEP indicator is not illuminated, the oscilloscope automatically establishes triggering and scales the waveform display vertically and horizontally (AUTO).
- ⑫ **SAVE/HELP Button** Saves the current oscilloscope control settings in a numbered setup when followed by one of the setup-number buttons, 1 through 8, which are also the Vertical MODE buttons. Pushing the SAVE/HELP button replaces the top and bottom rows of the normal readout display with prompting and help messages. These help messages may be cycled through by repeatedly pushing the SAVE/HELP button. Additional setups are accessible by using  $\Delta$  and STEP. For operational information, see the "Operation" section and Appendix B.
- ⑬ **RECALL/HELP Button** Restores previous oscilloscope control settings saved in a numbered setup when followed by one of the setup-number buttons. Pushing the RECALL/HELP button replaces the top and bottom rows of the normal readout with the user defined menu. Repeated operation of the HELP button produces a cycle of help messages. Additional setups are accessible by using  $\Delta$  and STEP. For operational information, see the "Operation" section and Appendix B.

Each setup carries a name with one to seven characters. The name of a setup can be defined when it is saved or redefined at any time. The names of setups one through eight appear on the screen as a user-defined menu when RECALL is pressed. The names appear on the screen in the same relative positions as the corresponding setup number buttons, also used as Vertical MODE buttons. When a setup is recalled, the setup number and name appear in the upper left of the readout until a control is moved or a measurement changes the readout.

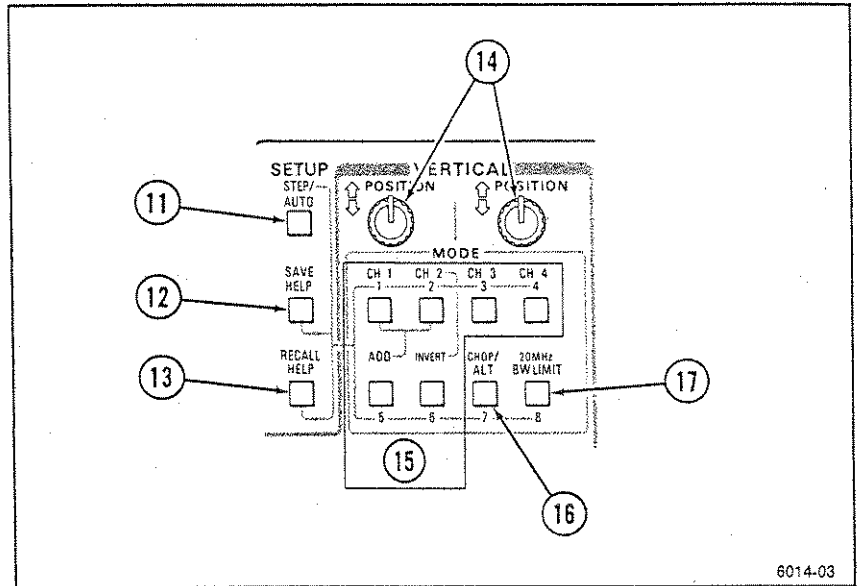

6014-03

Figure 5-2. SETUP and MODE buttons, and CH 1 and CH 2 POSITION controls.

- 14 POSITION Controls**

Set vertical position of the Channel 1 and Channel 2 signal displays. Clockwise rotation of a control moves the associated trace upward. When the X-Y display feature is in use, Channel 1 POSITION control moves the display horizontally; clockwise moves it to the right. The Channel 2, Channel 3, and Channel 4 vertical POSITION controls move the associated X-Y display vertically.
  
- 15 MODE Buttons**

Select the indicated channel(s) for display. Any combination of the five possible signal selections can be displayed by pressing the appropriate buttons. The Channel 1 signal will be displayed if none of the displays are selected. Each button has an associated indicator to show when the respective display or characteristic is active. Pressing a button toggles the display or characteristic on or off. These buttons have a secondary function of selecting setup memories (1) through (8) when pressed after pressing SAVE or RECALL.

When multiple channels are selected, they are displayed sequentially in order of priority. The established priority order is: CH 1, CH 2, ADD, CH 3, then CH 4.

The algebraic sum of Channel 1 and Channel 2 is displayed when the Add display is selected. When both Add and Invert displays are selected, the waveform displayed is the difference between the Channel 1 and Channel 2 signals. The INVERT button also inverts the polarity of the signal output at the CH 2 SIG OUT connector on the rear panel. At the same time, the Channel 2 trigger-signal polarity is inverted so that if CH 2 is selected as the TRIGGER SOURCE, the displayed slope will agree with the TRIGGER SLOPE setting.

①6 CHOP/ALT  
Button

Selects the vertical display mode for multiple-channel displays.

CHOP/ALT has no effect on the switching rate of X-Y function displays. If more than one vertical display is selected for X-Y, the display switches at 2.5 MHz.

CHOP

When more than one channel is selected, the vertical display switches sequentially through the selected channels at the chop-switching rate.

When more than one channel is selected, if the SEC/DIV setting for the displayed sweep is in the range of 20  $\mu$ s/div to 2  $\mu$ s/div, each channel is displayed for 400 ns. Otherwise, each channel is displayed for 1  $\mu$ s. The chop switching rate is desynchronized from sweep repetitions to minimize waveform breaks when viewing repetitive signals.

ALT

When more than one channel is selected, the vertical display switches sequentially through the selected channels. Alternate switching occurs during sweep-retrace times. If both A and B Sweeps are displayed, in Alt horizontal mode, vertical switching occurs at the completion of the B Sweep.

The Alt vertical mode enables a slaved delta-time mode for measuring time intervals between two channels. In the slaved delta-time mode, the first selected display in the sequence is displayed with the delta reference delay and the second selected display in the sequence is displayed with the delta delay. Any additional channels are displayed with both delays. The slaved delta-time mode also requires the following control conditions: either  $\Delta t$  or  $1/\Delta t$  selected, Inten, Alt, or B horizontal display with the dual delays and not cursors, multiple vertical displays, and a single A-Sweep trigger source.



- 17 **20 MHz BW LIMIT Button** Limits the bandwidth of the vertical deflection system to 20 MHz. Full vertical bandwidth is available when the bandwidth limit function is off. Neither the trigger signals nor the output from the CH 2 SIG OUT connector is affected by the 20 MHz BW LIMIT.

Refer to Figure 5-3 for the location of items 18 through 21.

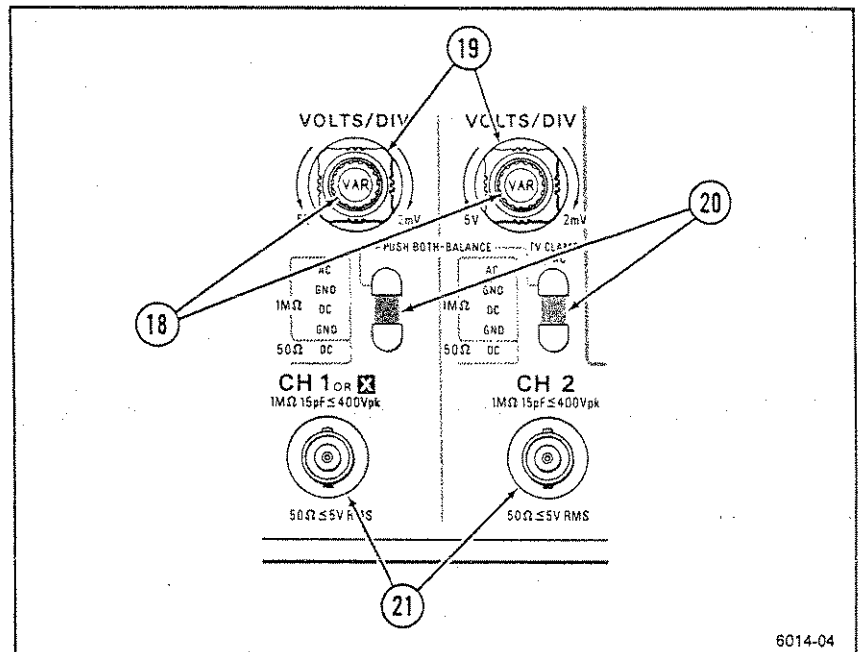

Figure 5-3. Channel 1 and Channel 2 controls and connectors.

- 18 **VAR Controls** Provide continuously variable, uncalibrated deflection factors between the calibrated settings of the VOLTS/DIV switches. These controls vary the deflection factors from calibrated (fully clockwise detent position) to at least 2.5 times the calibrated deflection factor (fully counterclockwise position). When out of the calibrated detent, a greater than (>) sign appears in front of the associated VOLTS/DIV readout display.

**19 VOLTS/DIV Switches** Select vertical deflection factor settings in a 1-2-5 sequence with 11 positions. The VAR control must be in the detent (fully clockwise) position to obtain a calibrated deflection factor. Basic deflection factors are from 2 mV per division to 5 mV per division. The switches can rotate continuously, but have no effect beyond the extreme settings. Deflection factors shown in the CRT readout reflect actual deflection factors when Tektronix attenuation-coded probes are connected to the inputs.

**20 Input Coupling Buttons and Indicators** Select the method of coupling input signals to Channel 1 and Channel 2 and indicate the selection made. If the upper Channel 1 and Channel 2 Input Coupling buttons are both pressed together, the instrument automatically performs a dc balance of Channel 1 and Channel 2 vertical circuitry.

**1 M $\Omega$  AC** Input signal is capacitively coupled to the vertical attenuator. The dc component of the input signal is blocked. The low-frequency limit ( $-3$  dB point) is 10 Hz or less when using either a 1X probe or a coaxial cable and is 1 Hz or less when using a properly compensated 10X probe.

Only with the available Television/Video (TV) enhancement, the CH 2 input has a back porch clamp for composite video signals. When the input coupling is AC, pressing the upper button activates the clamp and displays "TVC" in the readout. The clamp locks the back porch feature of the video signal to a constant level and eliminates drift, hum, and tilt, despite changes in signal amplitude and average luminance levels. Pressing the lower button restores AC coupling and turns off the clamp.

**1 M $\Omega$  GND (2 identical positions)** The input of the vertical amplifier is grounded to provide a zero (ground) reference-voltage display. Input resistance is 1 M $\Omega$  to ground. This input selection allows precharging of the input-coupling capacitor to prevent a sudden shift of the trace if AC input coupling is selected later. The input signal is not grounded. If the input coupling of a channel selected as an A-Trigger source is set at GND, the A-Sweep free runs. However, when A TRIGGER SOURCE is set to VERT and the Add vertical display is selected, the sweep free runs only if both Channel 1 and the Channel 2 input couplings are set to GND. While power is off, coupling is at 1 M $\Omega$  GND.

- 1 MΩ DC** All frequency components of the input signal are coupled to the vertical. Input resistance is 1 MΩ to ground.
- 50 Ω DC** All frequency components of the input signal are coupled to the vertical, with the input terminated by 50 Ω to ground. If excessive signal is applied to either the CH 1 or the CH 2 input connector while 50 Ω DC input coupling is selected, input coupling will revert to 1 MΩ GND and a CRT readout will indicate the overloaded condition. Changing the input coupling of the affected channel removes the overload message.

- 21 CH 1 OR X and CH 2 Input** Conduct external signals to the Channel 1 and Channel 2 vertical inputs. A signal applied to the CH 1 OR X connector provides the horizontal deflection for an X-Y display. Each connector includes a coding-ring contact for Tektronix-coded probes.

Refer to Figure 5-4 for the location of items 22 through 26.

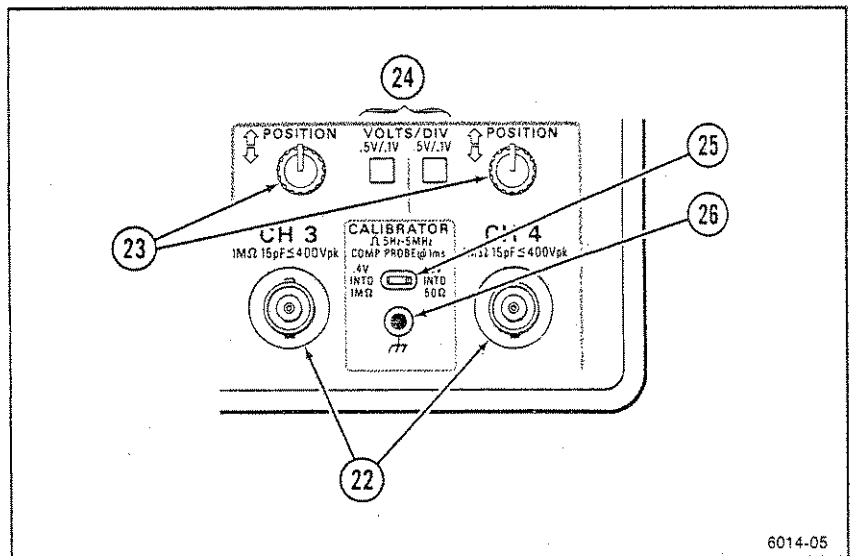

Figure 5-4. CH 3 and CH 4 controls and connectors and CALIBRATOR output.

## Controls, Connectors, and Indicators

---

- 22 **CH 3 and CH 4 Input Connectors** Conduct external signals to the Channel 3 and Channel 4 vertical inputs. Each connector includes a coding-ring contact for Tektronix-coded probes. Input coupling from these connectors is DC only. Channel 3 and Channel 4 are most useful as digital-signal and trigger-signal input channels, given their limited choice of deflection factors.
- 23 **POSITION Controls** Set vertical position of the Channel 3 and Channel 4 signal displays. The controls operate identically to the Channel 2 POSITION control, but with less range on their associated traces.
- 24 **VOLTS/DIV Switches** Toggle between 0.1 V and 0.5 V per division deflection factors for Channel 3 and Channel 4.
- 25 **CALIBRATOR Connector** Provides a 0.4-V p-p square-wave into a 1 M $\Omega$  load, 0.2-V p-p into a 50  $\Omega$  dc-coupled load, or 8-mA p-p into a short circuit. The signal is useful for checking sweeps, delay-times, and vertical deflection accuracies, as well as compensating voltage probes and checking the accuracy of current probes. The repetition rate of the square wave changes with A-Sweep SEC/DIV changes. From 100 ms per division to 100 ns per division, the A-Sweep of the instrument supplying the CALIBRATOR signal displays five cycles per 10 divisions. At 100 ms per division and slower, the CALIBRATOR frequency is 5 Hz; at 100 ns per division and faster, the frequency is 5 MHz. The signal amplitude at 5 MHz is at least 50% of the signal amplitude obtained when the sweep speed is set to 1 ms per division.

### NOTE

*The calibrator signal changes phase during trigger holdoff. This does not affect the accuracy of the calibrator signal that is present during a sweep. However, if the CALIBRATOR signal is used with other instruments, the sweep of the instrument must be shut off. If it is not, the signal will appear to jitter and will give false (low) frequency counts. The sweep of the instrument is easily shut off by setting TRIGGER MODE to SGL SEQ.*

- 26 **Auxiliary Ground Jack** Provides an auxiliary signal ground. The jack is compatible with standard banana plugs. A standard accessory binding post plugged into the jack provides a probe ground when probing the CALIBRATOR output and provides a versatile ground connection.

## Horizontal

Refer to Figure 5-5 for the location of items 27 through 36.

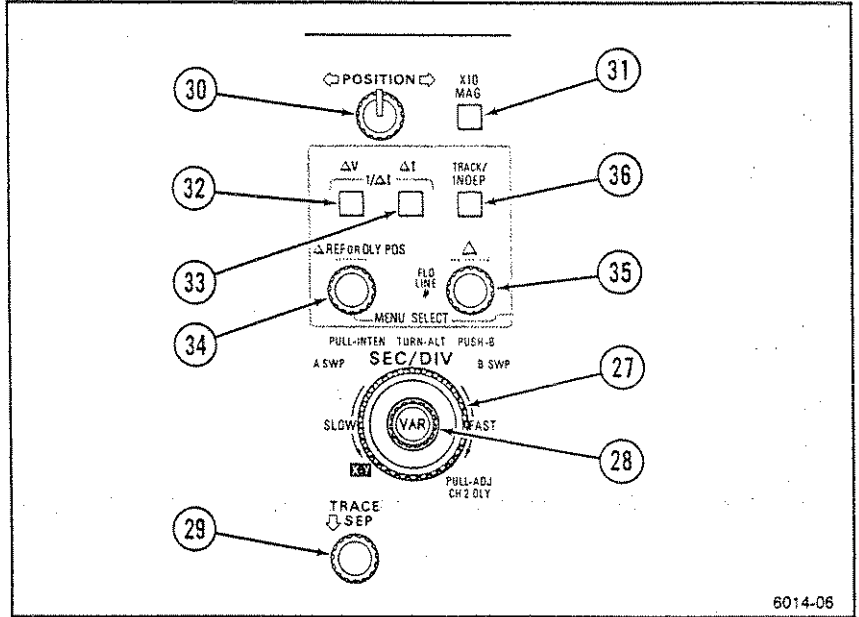

Figure 5-5. Horizontal and delta measurement controls.

- 27 SEC/DIV Switch and Indicators** Selects A-Sweep speeds, B-Sweep speeds, Delay Time ranges, horizontal display mode, and CH 2 Delay Matching mode. The SEC/DIV switch can be rotated continuously in either direction, but further rotation has no effect when either extreme setting has been reached. The A SWP and B SWP indicators show which sweep or sweeps are displayed.

**A SEC/DIV** When the A Sweep is displayed without the B Sweep, SEC/DIV selects 25 calibrated A-Sweep speeds from 500 ms/div to 5 ns/div in a 1-2-5 sequence (24 steps to 10 ns/div in the 2455A and 2445A). Full counterclockwise rotation of the SEC/DIV switch selects the X-Y display feature. In X-Y, the CH 1 OR X input drives the horizontal deflection system.

**B SEC/DIV** When the B Sweep is displayed, SEC/DIV selects B-Sweep speeds in 22 calibrated steps from 50 ms/div to 5 ns/div in a 1-2-5 sequence (21 steps to 10 ns/div in the 2455A and 2445A).

**Horizontal Display Mode Selection (PULL-INTEN TURN-ALT PUSH-B):**

**A** When the SEC/DIV knob is in, the A Sweep is displayed, unless the B Sweep has been displayed and the B Sec/Div setting remains faster than the A Sec/Div setting. The exception is that Channel 1 is displayed in the horizontal at the extreme counterclockwise setting of SEC/DIV.

**PULL-INTEN** Pulling the SEC/DIV knob out while the A Sweep is displayed selects the Intensified horizontal display mode and cancels the Delta Volts function if it is active. The A-Sweep display intensifies during the B Sweep. The B Sweep is not displayed, but it runs either 100 times faster than the A Sweep or at 5 ns per division, whichever is slower. In Alt horizontal display mode, setting B Sec/Div equal to A Sec/Div also selects the intensified horizontal display mode.

With  $\Delta t$  or  $1/\Delta t$ , a pair of intensified zones appears. With multiple vertical displays, Alt vertical mode, and a single A-Trigger source (CH 1, CH 2, ADD, CH 3, or CH 4), the pair of intensified zones appear as follows:

1. The reference zone appears on the first selected trace in the display sequence: CH 1, CH 2, ADD, CH 3, CH 4.
2. The delta zone appears on the second selected trace.
3. Both zones appear on additional traces when more than two traces are selected.

Both zones appear on all traces with Chop vertical mode or multiple A-Trigger sources.

Pulling the SEC/DIV switch knob out at the fastest A Sec/Div rate selects the CH 2 delay offset adjustment. The readout displays one of two messages: "CH 2 DLY-TURN  $\Delta$ " or "CH 2 DLY DISABLED." If the adjustment is enabled, the  $\Delta$  control or the  $\Delta$  REF control can adjust the apparent delay between the Channel 1 signal and the Channel 2 signal. The adjustment range is sufficient to compensate for propagation delay variations up to  $\pm 500$  ps. Adjusting the delay offset between Channel 1 and Channel 2 signals has no effect on the common-mode rejection between Channel 1 and Channel 2.

**TURN-ALT**

When the SEC/DIV knob is out, clockwise rotation activates the Alternate Horizontal Display mode. The Alt mode presents the intensified A-Sweep alternating with the delayed B-Sweep. The position of the intensified zone on the A-Sweep indicates the time position of the B-Sweep, and the length of the intensified zone indicates the B-Sweep duration. A separate B-Sweep runs for each intensified zone.

**PUSH-B**

In the Alt horizontal display mode, pushing in the SEC/DIV knob displays only B-Sweeps.

When the B-Sweep speed is set equal to the A-Sweep speed in Alt or B display mode, the mode changes from A to B or from Inten to Alt.

**28 VAR Control**

Continuously varies the sweep speed between SEC/DIV switch settings, for either the A-Sweep or B-Sweep. The detent position (full clockwise rotation) produces the basic sweep speed selected by the SEC/DIV switch. The fully counterclockwise position slows the sweep by a nominal factor of three. The CRT readout displays the actual time-per-division scale factor for all settings of the VAR control. When the Intensified A-Sweep or the B-Sweep is displayed, VAR affects only the B-Sweep scale factor.

- ②⑨ **TRACE SEP Control** Positions the B trace downward from the A trace in Alt horizontal display mode. In the B horizontal display mode, with  $\Delta t$  or  $1/\Delta t$ , TRACE SEP positions the trace associated with the  $\Delta$  control downward. Fully clockwise rotation eliminates separation between the traces.
- ③⑩ **POSITION Control** Horizontally positions the sweep displays.
- ③① **X10 MAG Button** Horizontally magnifies the portion of the sweep display positioned at the center vertical graticule line by a factor of 10. When in Alt or B horizontal display mode, only the B-Sweep is affected.

### Delay and Delta Controls

The  $\Delta V$ ,  $\Delta t$ , and TRACK/INDEP buttons, with the  $\Delta$  REF OR DLY POS and  $\Delta$  rotary controls, are used to make voltage, time, frequency, ratio, and phase measurements. These controls also affect the SAVE and RECALL functions and the CH 2 DLY matching function. With the available TV enhancement,  $\Delta$  also serves as a line number selector and "FLD LINE #" nomenclature is added. With the available CTT,  $\Delta$ .REF and  $\Delta$  serve as menu selectors, with "MENU SELECT" nomenclature added, and also as delaying-event-count controls. With the available WR, they serve as word definition controls.

- ③②  **$\Delta V$  Button** Activates the Delta Volts measurement function and cancels the  $\Delta t$  or  $1/\Delta t$  measurement function. When the  $\Delta V$  function is active, two horizontal cursors are superimposed on the display. The CRT readout shows the equivalent voltage between the two cursors. Cursors are positioned by the  $\Delta$  REF OR DLY POS control and the  $\Delta$  control. With multiple vertical displays, the deflection factor of the first selected channel in the display sequence determines the cursor scale factor. The cursor readout is displayed as a percent RATIO under either of the following conditions:
1. When the VOLTS/DIV VAR control of the channel determining the scale factor is out of the detent position.
  2. When the Add vertical display mode is selected alone and the Channel 1 and Channel 2 VOLTS/DIV settings are not the same.

Pressing the  $\Delta V$  button when the function is active cancels  $\Delta V$ . Pulling SEC/DIV out also cancels the Delta Volts function.



33  $\Delta t$  Button

Activates the Delta Time measurement function and cancels the  $\Delta V$  or  $1/\Delta t$  measurement functions. When  $\Delta t$  is selected with Inten or Alt horizontal display modes, two delay times are defined. When  $\Delta t$  is selected with either A-Sweep or B-Sweep horizontal display, two vertical cursors are established. One delay time or cursor position is controlled by the  $\Delta$  REF OR DLY POS control, and the other is controlled by the  $\Delta$  control. The CRT readout displays either the difference between the two delay times or the equivalent time between the vertical cursors.

If SEC/DIV VAR is not in the detent position, and either the A-Sweep or the B-Sweep horizontal display mode is selected, the CRT readout displays delta-time as a ratio, where five divisions correspond to 100% ratio.

When  $\Delta t$  is active, pressing the  $\Delta t$  button deactivates the function.

1/ $\Delta t$   
Function

Momentarily pressing the  $\Delta t$  and  $\Delta V$  buttons together activates the 1/Delta-Time function and cancels any other Delta measurement function. The waveform display and the Delta controls operate the same as for  $\Delta t$ , but the readout shows the reciprocal of the time in Hz (frequency).

If the SEC/DIV VAR control is not in the detent position (full clockwise rotation), and the A-Sweep or B-Sweep horizontal display mode is selected, the readout displays the time between cursors as degrees of phase, where five divisions are equal to 360 degrees.

When the 1/Delta Time function is active, pressing the  $\Delta t$  and  $\Delta V$  buttons together deactivates the function.

**DLY,  $\Delta V$ ,  $\Delta t$ ,  
and  $1/\Delta t$   
Readouts**

Each of these readouts includes a function name, a signed, floating-point numeral, and the appropriate unit symbol. Numerals are displayed with larger sized characters. A numeral immediately following " $\Delta V$ " indicates which channel provides the delta voltage scaling, the lowest numbered of the displayed channels. Sweep Delay Time (DLY) is displayed for the Inten, Alt, and B horizontal display modes when none of the delta functions are selected. Except for DLY, these readouts are enabled with Readout Intensity set for Scale Factors On or Scale Factors Off.

A question mark appears after the  $\Delta V$  function label when the function applies to CH 3 or CH 4, indicating poorer accuracy than is available with CH 1 or CH 2.

A question mark appears in a DLY readout or in a  $\Delta t$  or  $1/\Delta t$  readout with a pair of sweep delays, when one or both of the sweep delay settings is less than 1% of maximum delay (full scale) setting or when the B-Trigger mode is TRIG AFT DLY (or, with *CTT*, TRIG  $\Delta$  DLY). With the *CTT*, these question marks disappear when a direct measurement is complete. A question mark also appears when the difference between the pair of delays in  $1/\Delta t$  is less than 1% of full scale, and the *CTT* does not remove it.

For the lowest 0.5% of the range of DLY settings, the reading is zero. This offset lends accuracy to delay time settings. It is related to the circuit offset that makes the A-Sweep triggering event viewable at minimum delay.

**34  $\Delta$  REF OR  
DLY POS  
Control**

Sets the B-Sweep Delay Position. It sets the reference B-Sweep delay when  $\Delta t$  or  $1/\Delta t$  is active with two delays. When any cursor mode is active, the  $\Delta$  REF OR DLY POS control positions the reference cursor (dotted line) and has no effect on B-Sweep delay.

When TRACK mode is selected,  $\Delta$  REF moves both the reference and delta cursors or delays, equally.

When a Save mode is active,  $\Delta$  REF selects character positions in a setup name or attribute fields in a sequence step definition.

With the available *CTT*,  $\Delta$  REF selects items or item groups in the *CTT* menu and selects character positions in event-count definition displays. With the *WR*,  $\Delta$  REF selects character positions in word-definition displays.

35  $\Delta$  Control

Positions the delta B-Sweep delay or time cursor (dashed vertical line) when either  $\Delta t$  or  $1/\Delta t$  is active. When  $\Delta V$  is active, the  $\Delta$  control positions the delta cursor (dashed horizontal line).

When a Save mode is active,  $\Delta$  defines each character in a setup name definition and each attribute field in a sequence step definition.

With the available *CTT*,  $\Delta$  selects items in the *CTT* menu and defines characters in event-count definition displays. With the *WR*,  $\Delta$  defines characters in word-definition displays.

With the available *TV* enhancement, the control nomenclature includes "FLD LINE #." The control selects specific line numbers within a video field for triggering the A Sweep when trigger Coupling is set to FLD 1, FLD 2, or alternate FLD 1-FLD 2. Possible line numbers range from 1 to the maximum number of lines per frame in the television signal. Rotating the control clockwise increases the line number; rotating it counterclockwise decreases the line number. Increasing the line number above the number of lines in a field or decreasing the number below the minimum automatically sets the line number to the minimum or the maximum in the other field and selects the opposite FLD 1 or FLD 2 coupling. In ALT, the coupling does not change and line numbers are limited to the numbers shared by both fields. See TV EXER 61 and TV EXER 62 in Appendix A to define the desired line number format. For example, the lines in a 525-line, interlaced-scan signal can be numbered:

... | 1 2 ... 262 263 | 1 2 ... 261 262 | ...

or

... | 1 2 ... 262 263 | 264 265 ... 524 525 | ...

With FLD 1 or FLD 2 trigger coupling, the readout displays the selected line number. The line number readout is followed by a  $\Delta$  symbol if the  $\Delta$  FLD LINE # control is directed to line number selection. If the  $\Delta$  symbol is not present, the control is directed to another function and the line number is fixed. The control is redirected to line-number selection or back to a  $\Delta$  function by pressing a Trigger Coupling button or the respective  $\Delta$  button(s).

- 36 **TRACK/INDEP Button** Selects either the Tracking or Independent mode for the  $\Delta$  REF OR DLY POS control. In the Tracking mode, rotating the  $\Delta$  REF OR DLY POS control changes both delays or both cursors equally until the limit of either is reached.

In the Indep mode,  $\Delta$  REF OR DLY POS affects only the reference delay or cursor. In either Tracking or independent mode, the  $\Delta$  control moves only the  $\Delta$  cursor.

Refer to Figure 5-6 for the location of items 37 through 46.

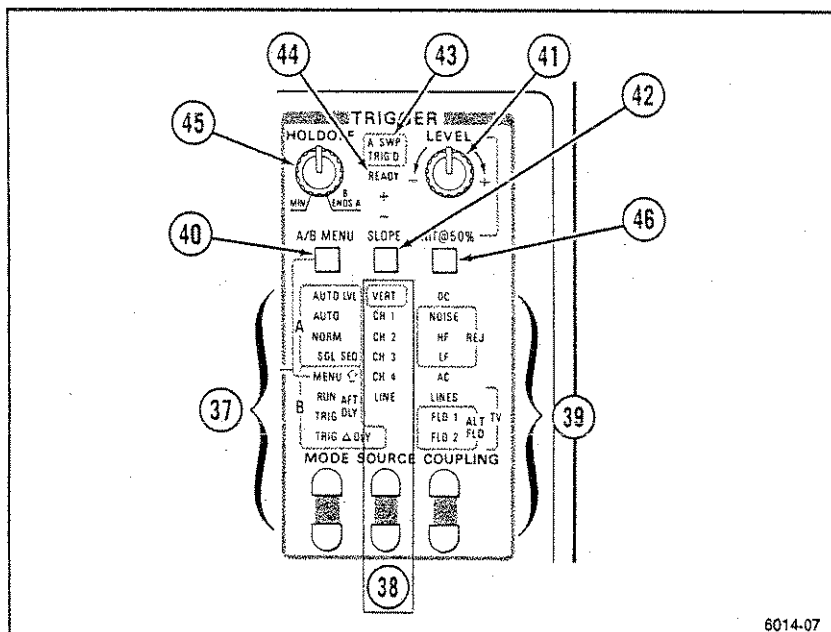

Figure 5-6. Trigger controls and indicators.

- 37 **MODE Buttons and Indicators** Select the mode of either the A Trigger or the B Trigger. Pressing a button steps the MODE selection once; holding the button causes the MODE selection to step repeatedly. Indicators show the selected mode of either the A Trigger or the B Trigger according to the selected horizontal display mode and as directed by the A/B TRIG button (or A/B/MENU, with the CTT).

**A-Trigger Modes:**

**AUTO LVL** Automatically establishes the trigger level on a triggering signal and free runs the sweep in the absence of a triggering signal.

In Auto Lvl mode, LEVEL covers the range between the positive and negative peaks of repetitive triggering signals. If the triggering signal amplitude changes, the trigger level does not change unless a trigger is no longer produced at the established level. The signal peaks are measured and the trigger level is redefined when triggering ceases, when the LEVEL control is turned to either extreme, or when the upper MODE button is pressed. If the LEVEL control is set near either end position, the trigger level is set near the corresponding signal peak. If LEVEL is in the midrange between either end, the trigger level set by AUTO LVL is near the midpoint between the trigger signal peaks. When INIT@50% is pressed, the trigger level is set near the midpoint of the signal, regardless of the setting of LEVEL. The established trigger level remains in effect when switching to Auto trigger mode.

To obtain triggered sweeps, the triggering signal repetition rate must be greater than a nominal limit, depending on the selected sweep speed.

With Auto Lvl mode and Vert trigger source, the lowest numbered channel displayed, or Add if it is displayed, provides the trigger signal. When the trigger mode is changed from Auto Lvl to Auto while more than one channel is displayed, the single channel trigger source is retained and the VERT indicator is turned off unless Add is being displayed. When Add is displayed, Vert source is retained when trigger mode changes to Auto.

**AUTO** Sweep free runs in the absence of a triggering signal. The trigger level changes only when the LEVEL control is adjusted to a new position or when INIT@50% is pressed.

**NORM** Sweep is triggered and runs when an adequate triggering signal is applied. In the absence of an adequate triggering signal, the A Sweep does not run, except when the input coupling of the trigger-source channel is set to GND. If the selected source is Vert, and the Add vertical display is selected, the A Sweep free runs if Channel 1 and Channel 2 input coupling are both set to GND.

**SGL SEQ** When armed by pushing the lower MODE button, the sweep runs once for each of the traces defined by the following controls: Vertical MODE, A and B SEC/DIV, and  $\Delta t$  or  $1/\Delta t$ . Each sweep requires a distinct A-Sweep triggering event. The READY indicator remains illuminated until the final trace in the sequence is completed. At the end of the display sequence, scale-illumination flashes and the readout display is written once to present the scale factors and other readout data.

**B-Trigger Modes:**

**MENU** Only with the available CTT, the Menu indicator lights when a menu is displayed and when the trigger controls are directed to the B Trigger with a Delay-by-Events or Logic Trigger function. Pressing A/B/MENU with the A-Sweep displayed, not intensified, displays the main CTT menu and lights MENU. Pressing the upper trigger Mode button with the B Sweep active (Inten, Alt, or B horizontal mode) and RUN AFT DLY B-Trigger mode also displays the CTT main menu and lights the indicator. Pressing the lower trigger Mode button while MENU is on cancels any Logic Trigger or Delay-by-Events mode and turns MENU off.

**RUN AFT DLY** The B Sweep runs immediately after the delay time set by A SEC/DIV,  $\Delta$  REF OR DLY POS, and, if  $\Delta t$  or  $1/\Delta t$  is active,  $\Delta$ .

**TRIG AFT DLY** The B Sweep runs when triggered after the set delay, determined by the same controls as for RUN AFT DLY, provided the A Sweep has not terminated.

**TRIG  $\Delta$  DLY** Only with the available *CTT*, and with  $\Delta t$  or  $1/\Delta t$  active, the B-Trigger Slope and Level for the  $\Delta$  delay can be set separately from those for the REFERENCE delay. If both TRIG AFT DLY and TRIG  $\Delta$  DLY indicators are on, the B-Trigger Slope and Level are common for the two delays. TRIG  $\Delta$  DLY should normally be used with VERT trigger source for B Trigger. Pressing the lower trigger Mode button alternates between TRIG AFT DLY and TRIG  $\Delta$  DLY and the controls are alternately directed to the two triggers.

**38 SOURCE Buttons and Indicators**

Select the trigger-signal source for either A Sweep or B Sweep.

**VERT**

The sweep triggers on the displayed channel when only one channel is selected. If multiple vertical displays are selected, both the trigger Mode and the Chop/Alt selection affect the triggering source. With Alt vertical mode and with A-Trigger modes other than Auto Lvl, each displayed channel in turn provides the triggering signal and the respective LED indicator for each displayed channel is illuminated. With Auto Lvl trigger mode or with Chop vertical mode, the lowest-numbered channel, or ADD if it is displayed, is the triggering-signal source. The Source indicators show the source of the triggering signal in any case. When ADD is selected, both the CH 1 and the CH 2 indicators are illuminated.

**CH 1, CH 2, CH 3, or CH 4**

A triggering signal is obtained from the corresponding vertical channel.

**LINE (A-Trigger Only)**

A triggering signal is obtained from a sample of the ac power-source waveform. This trigger source is useful when vertical input signals are related (multiple or submultiple) to the frequency of the ac power-source voltage.

**39 COUPLING Buttons and Indicators**

Select the method of coupling the triggering signal to the trigger generator.

**DC**

All frequency components of the signal are coupled to the trigger. This coupling is preferred for most signals.

### ***Controls, Connectors, and Indicators***

---

<b>NOISE REJ</b>	All frequency components of the input signal are coupled to the trigger. This coupling improves trigger stability with signals accompanied by low-level noise.
<b>HF REJ</b>	Attenuates high-frequency triggering-signal components above 50 kHz. This coupling eliminates radio-frequency interference and high-frequency noise components from the signal applied to the trigger. It allows triggering on the low-frequency components of a complex waveform.
<b>LF REJ</b>	Signals are capacitively coupled, blocking the dc component of the triggering signal and attenuating the low-frequency signal components below 50 kHz. This coupling allows triggering on the high-frequency components of a complex waveform.
<b>AC</b>	Signals are capacitively coupled. Frequency components below 60 Hz are attenuated, and the dc component of the input signal is blocked. This coupling works for signals that are superimposed on slowly changing dc voltages. This method will work for most signals when trigger-level readout is not desired.

Only with the available TV enhancement, the trigger Coupling buttons and indicators select four additional trigger couplings. The readout shows which of these couplings and which line number are selected, in the upper right corner of the CRT. If that corner is occupied, the TV information is displayed in the upper left corner.

<b>LINES</b>	The A Sweep triggers at TV horizontal line-sync pulses. AUTO trigger mode is automatically selected.
<b>FLD 1</b>	The A Sweep triggers on a selected line in the first field of a TV signal. NORM trigger mode is automatically selected.
<b>FLD 2</b>	The A Sweep triggers on a selected line in the second field of a TV signal. NORM trigger mode is automatically selected.



**ALT**

The A Sweep alternately triggers on the same selected line in both TV fields. Both the FLD 1 and the FLD 2 indicators light. NORM trigger mode is automatically selected.

With CHOP vertical mode, all channels are displayed with both the FLD 1 and the FLD 2 triggers.

With Alt vertical mode and more than one channel displayed, field 1 of the video signal triggers the sweep with the first displayed channel and field 2 triggers the sweep with the next displayed channel. With more than two channels, each additional channel is displayed with triggers from both fields.

**40 A/B TRIG (or A/B/MENU) Button**

The MODE, SOURCE, COUPLING, SLOPE, LEVEL, and INIT@50% controls are normally directed to the A Trigger. They are directed to the B Trigger with Inten, Alt, or B-Sweep horizontal displays, if B mode is TRIG AFT DLY (or, with the CTT, TRIG Δ DLY). The trigger controls are directed to the opposite trigger while the A/B TRIG (or, with the CTT, A/B/MENU) button is pressed. With Inten, Alt, or B-Sweep horizontal displays, and with B-Trigger mode set to RUN AFT DLY or with A-Trigger mode set to Sgl Seq, the trigger controls are alternately directed to the A Trigger or to the B Trigger each time the button is pushed.

**41 LEVEL Control**

Sets the amplitude point on the triggering signal at which A-Sweep or B-Sweep triggering occurs.

When the A-Trigger mode is set to Auto Lvl, the effect of the LEVEL control is spread over the peak to peak amplitude of the triggering signal. When the control is rotated to either extreme, the peak values are measured, and the control range is redefined to correspond to the peak values. If LEVEL is fully clockwise, the initial level is near the positive peak. If LEVEL is fully counterclockwise, the initial level is near the negative peak.

**Controls, Connectors, and Indicators**

---

- ④② **SLOPE Button and Indicators** Determines whether the A Trigger or B Trigger respond to the positive-going or the negative-going slope of a signal. With the available *TV* enhancement, Slope selects positive or negative sync polarity. With the available *CTT*, in Logic Trigger modes, Slope determines whether the high (+) or low (-) state of the signal is the true input to the logic function.
- ④③ **A SWP TRIG'D Indicator** Illuminates when the A Sweep is triggered. It extinguishes a short time after completion of a sweep unless a triggering signal is received.
- ④④ **READY Indicator** Illuminates when Sgl Seq mode is selected and the A Sweep is armed and waiting for a triggering event to occur. It extinguishes following the completion of all the traces selected for the Sgl Seq display.
- ④⑤ **HOLDOFF Control** Varies the time from the end of an A Sweep to enabling the next sweep to be initiated by the triggering signal. This control can be set to stabilize some aperiodic signals. In the B ENDS A position (fully clockwise) trigger holdoff time is minimum, and A Sweep terminates immediately at the end of the B Sweep. This enables the fastest possible sweep-repetition rate at slow A-Sweep speeds.
- ④⑥ **INIT@50% Button** Initializes the trigger level at the midpoint between peaks, for either the A Trigger or B Trigger, in any mode.
- If Vert trigger source is selected and more than one channel is displayed, INIT@50% automatically sets the trigger source to the lowest numbered of the displayed channels. However, with the available *CTT*, with a "slaved delta-time" display and separate B-Trigger settings for reference and delta delays, INIT@50% sets the level for each of the first two channels separately and does not change the trigger source. If Sgl Seq mode is selected, the A-Trigger mode changes to Norm.

## Rear Panel

Refer to Figure 5-7 for the location of items 47 through 57.

- |    |   |   |
|----|---|---|
| 47 | <b>A GATE OUT<br/>and B GATE<br/>OUT<br/>Connectors</b> | Provide TTL-compatible, positive-going gate signals that are HI during their respective sweeps and LO while the sweep is not running. When the A SEC/DIV switch is set to 5 ns per division, a gate signal is present at both the A GATE OUT and the B GATE OUT connectors. |
| 48 | <b>Line Voltage<br/>Selector<br/>Switch</b>             | Selects either 115 V or 230 V nominal ac-power-source voltage.  |
| 49 | <b>EXT Z-AXIS<br/>IN Connector</b>                      | Provides an input for external signals to modulate the display intensity.   |
| 50 | <b>Fuse Holder</b>                                      | Contains the ac power-source fuse.  |
| 51 | <b>Detachable<br/>Power Cord<br/>Receptacle</b>         | Connects the ac power source to the instrument.   |
| 52 | <b>CH 2 SIGNAL<br/>OUT<br/>Connector</b>                | Supplies a normalized signal that represents the Channel 2 input signal.  |
| 53 | <b>Mod Slots</b>  | Contain identification of any installed instrument modifications.   |
| 54 | <b>STEP/AUTO<br/>EXT Switch<br/>Connector</b>           | A connector on the rear panel accepts a standard, 2.5-mm, micro-phono plug, compatible with some commonly available remote-control switches for audio recorders. A contact closure or TTL-low at this input produces the same effect as operating the STEP/AUTO button.     |

- 55 **Word Recognizer Probe Connector or Probe Power Connector** Connects the 17-Bit Word Recognizer Probe to the instrument, only with the available *WR* (Option 09), or supplies conditioned dc voltages to active probes, only with Option 11.
- 56 **WORD RECOG OUT Connector or Probe Power Connector** Provides a LSTTL-compatible, positive-going pulse when the Word Recognizer detects the selected word, only with the available *WR* (Option 09), or supplies conditioned dc voltages to active probes, only with Option 11.
- 57 **GPIB Connector** Provides the IEEE Std 488-1978 compatible electrical and mechanical connection to the GPIB.

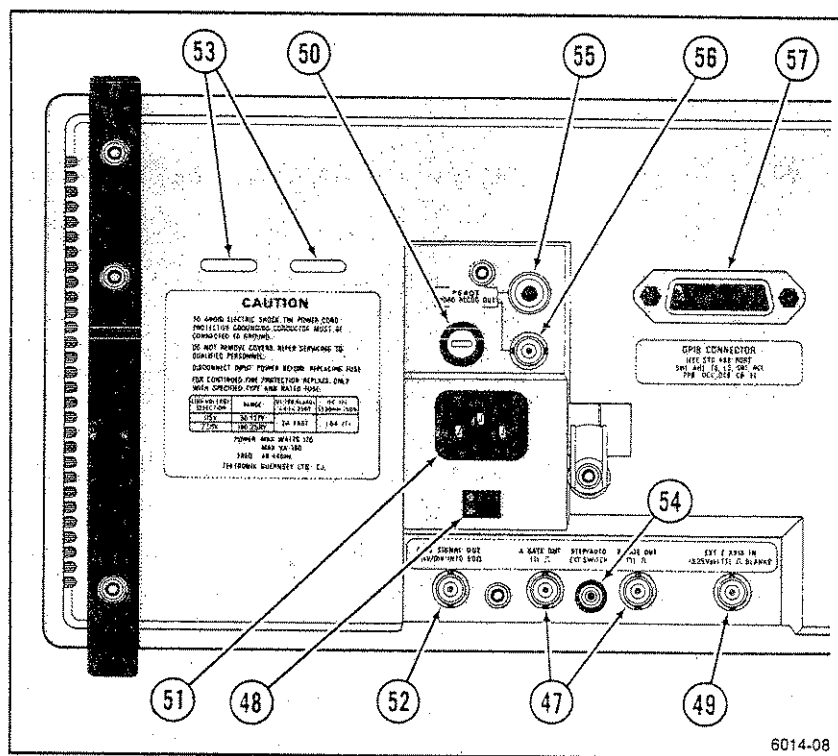

Figure 5-7. Rear panel controls and connectors.

**DMM**

All DMM controls are momentary push buttons. The buttons alternately select and deselect functions. Refer to Figure 5-8 for the location of items 58 through 70.

- 58 RANGE Buttons** Select full-scale ranges for measurements.
- AUTO** Selects autorange. The measurement range changes as necessary to maintain the reading within 9% to 100% of full scale. Autoranging is automatically selected each time a new measurement function is selected. If autoranging is active, pressing AUTO deselects autoranging. When the button is pressed again, autoranging returns.
- When a measurement range changes, the display blanks momentarily. If a measurement exceeds a manually selected range or the highest range with autoranging, "OVER" is displayed in the readout.
- UP and DOWN** Change the measurement range. In autorange mode, pressing either button disables autoranging and selects the next range above or below the present range. Pressing the UP button at the highest range or DOWN at the lowest range does not change the range, but changes the mode either from autoranging to manual ranging or from manual to automatic. With manual ranging, the display shows "MNL."
- With manual ranging, measurements can exceed the nominal full scale by 10%, except at the highest range.
- 59 DC V/DC A** Turns the dc volts or dc amps function on or off.
- 60 AC V/AC A** Selects or cancels ac rms volts or ac rms amps.
- 61 dBV/dBm** Selects or cancels dBV or dBm.
- dBV** Displays ac rms voltage measurements as the log of the ratio of the input voltage to 1 V. Readings equal  $20 \times \log(V_{\text{input}}/V_{\text{ref}})$ , where  $V_{\text{input}}$  is the input voltage and  $V_{\text{ref}}$  is 1 V. With zero input, the readout displays "OVER."

**dBm** Displays ac rms voltage measurements as the log of the ratio of the input voltage to a 1 mW reference at 600  $\Omega$ . Readings equal  $20 \times \log(V_{\text{input}}/V_{\text{ref}})$ , where  $V_{\text{input}}$  is the input voltage and  $V_{\text{ref}}$  is 0.7746 V. With zero input, the readout displays "OVER."

**62 CONT** Selects or deselects continuity. If the resistance between the probes is less than 10  $\Omega$ , the instrument produces an audible tone. The readout shows either "SHORT < 10  $\Omega$ " or "OPEN > 10  $\Omega$ ." The tone responds to continuity within about 100 ms.

Continuity operation is not affected by AUTO, UP, DOWN, HOLD, SMOOTH, MIN/MAX DISPLAY, MIN/MAX RESET, REF DISPLAY, or REF SET.

**63 HI  $\Omega$ /LO  $\Omega$**  Selects or deselects resistance measurement.

**HI  $\Omega$**  Measures resistance within 2 k, 20 k, 200 k, 2 M, and 20 M  $\Omega$  ranges. At full scale, 2 V appears across the test leads, which will bias a silicon semiconductor junction to forward conduction.

**LO  $\Omega$**  Measures resistance within 200, 2 k, 20 k, 200 k, and 2 M  $\Omega$  ranges. At full scale, 0.2 V appears across the test leads, which will not bias a silicon semiconductor junction to forward conduction.

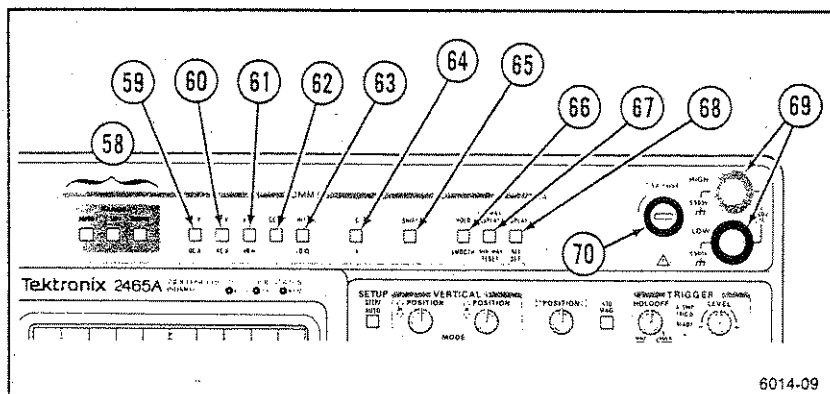

Figure 5-8. DMM controls and connectors.

- ⑥4 °C/°F Selects or deselects temperature measurement. If a temperature probe is not connected to the input jacks, the readout shows "ATTACH TEMP PROBE."
- °C Measures temperature in Celsius degrees.
- °F Measures temperature in Fahrenheit degrees.
- ⑥5 SHIFT Selects the secondary functions of the other DMM buttons. Primary functions are indicated on the panel above the DMM buttons and secondary functions are indicated below. Pressing SHIFT while shift is pending cancels the shift prefix. A pending shift prefix will clear automatically if another DMM button is not pressed within 10 seconds. While the shift prefix is pending, "SHIFT" appears in the readout.
- ⑥6 HOLD/SMOOTH Changes the display mode.
- HOLD "Freezes" the display, which also shows "HLD." Display updating resumes when any DMM button is pressed.
- SMOOTH Filters measurement variations from the display. The display represents the mean value calculated from a series of accumulated measurements. A numeral in the upper right of the display shows how many measurements the displayed average includes: 8, 16, 24, 32, 40, 48, 56, or 64. After 64 measurements are accumulated, the running average is updated, after each eight measurements, to reflect the most recent 64 measurements. To reset the averaging process, smoothing must be deselected, then selected again.
- ⑥7 MIN/MAX  
DISPLAY —  
MIN/MAX  
RESET Displays the minimum or maximum measurement or resets the minimum and maximum to the next measurement value.
- Repeated operation of MIN/MAX DISPLAY steps the display through the sequence of minimum, maximum, then present measurements. Minimum and maximum values are updated with each measurement, regardless of which of the three displays is selected and regardless of whether smoothing is in effect.

- |   |  |
|---|--|
| <b>MIN/MAX<br/>RESET</b>                  | Initializes the minimum and maximum values when the next measurement is made. Selecting a new DMM function also resets the minimum and maximum values.   |
| <br>                                      |  |
| <b>68 REF DISPLAY<br/>/REF SET</b>        | Displays or sets a reference measurement.  |
| <br>                                      |  |
| <b>REF<br/>DISPLAY</b>                    | Shows the present reference value. If no reference has been set, the display will show 0.  |
| <br>                                      |  |
| <b>REF SET</b>                            | Initializes the reference value to the present display. All subsequent measurements will be displayed with this reference value subtracted from them. If no measurement is displayed, or if the present measurement is out of range, REF SET has no effect.  |
| <br>                                      |  |
|   | When a measurement has a reference value subtracted from it, the display includes a $\Delta$ symbol. With dBV or dBm, the reference takes the place of $V_{ref}$ . Selecting a new DMM function or turning off power clears the reference. The reference is retained if another instrument function, such as $\Delta t$ , displaces the DMM measurement and then the same DMM measurement is selected again.                                     |
| <br>                                      |  |
| <b>69 HIGH and<br/>LOW<br/>Connectors</b> | Provide high-impedance, floating inputs to the DMM. For DC and resistance measurements, the upper, red terminal is positive and the lower, black input is negative.  |
| <br>                                      |  |
| <b>70 Fuse</b>                            | Excessive input in a current-measuring mode may open the input fuse. If the fuse opens, none of the DMM functions will work. To replace the fuse, turn off the instrument, remove the DMM probes, and unscrew the fuse holder. Replace the fuse with a 1.5 A, fast acting, 3AG fuse. (The fuse holder will accept a 5 X 25 mm fuse, with the appropriate cap substituted for the original.) Then, replace the probes and turn on the instrument. |



### DMM Displays

Large digits indicate measured values. Parameter units and other text except "OVER" are displayed as smaller letters and digits. The following examples show various display formats:

DC Voltage	15.693 V DC
SMOOTH	1.4356 A DC /64/
Using a Reference Value	Δ 0.9861 A DC
Reference Display	1.3461 V DC=REF
Minimum Display	0.5201 V AC=MIN
Maximum Display (with Reference)	Δ 0.8293 V DC=MAX
Continuity Display	OPEN > 10 Ω SHORT < 10 Ω
Over-Range Display	OVER

### Display-Mode Interactions

Selecting REF SET or SMOOTH cancels any HOLD, REF DISPLAY, or MIN/MAX DISPLAY, but those displays can be reselected and work with reference values or with the SMOOTH display mode. With SMOOTH, MIN/MAX DISPLAY continues to show the extremes of measurements, not the smoothed values.



*Performance  
Characteristics*

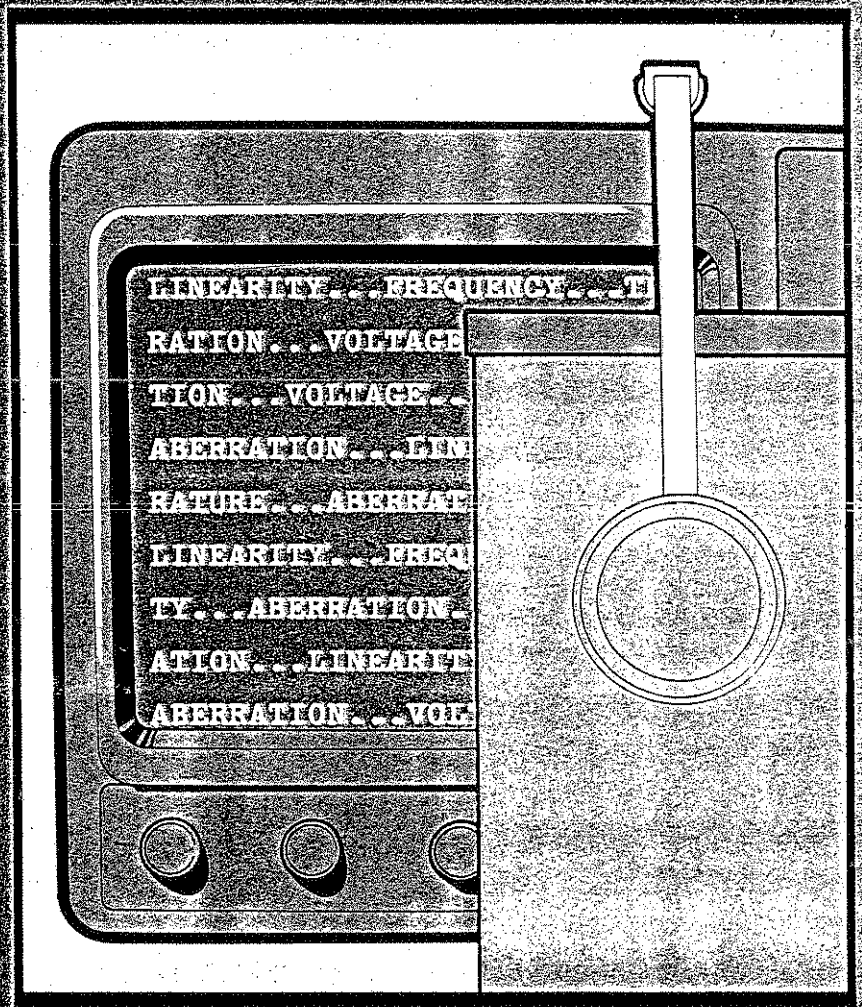

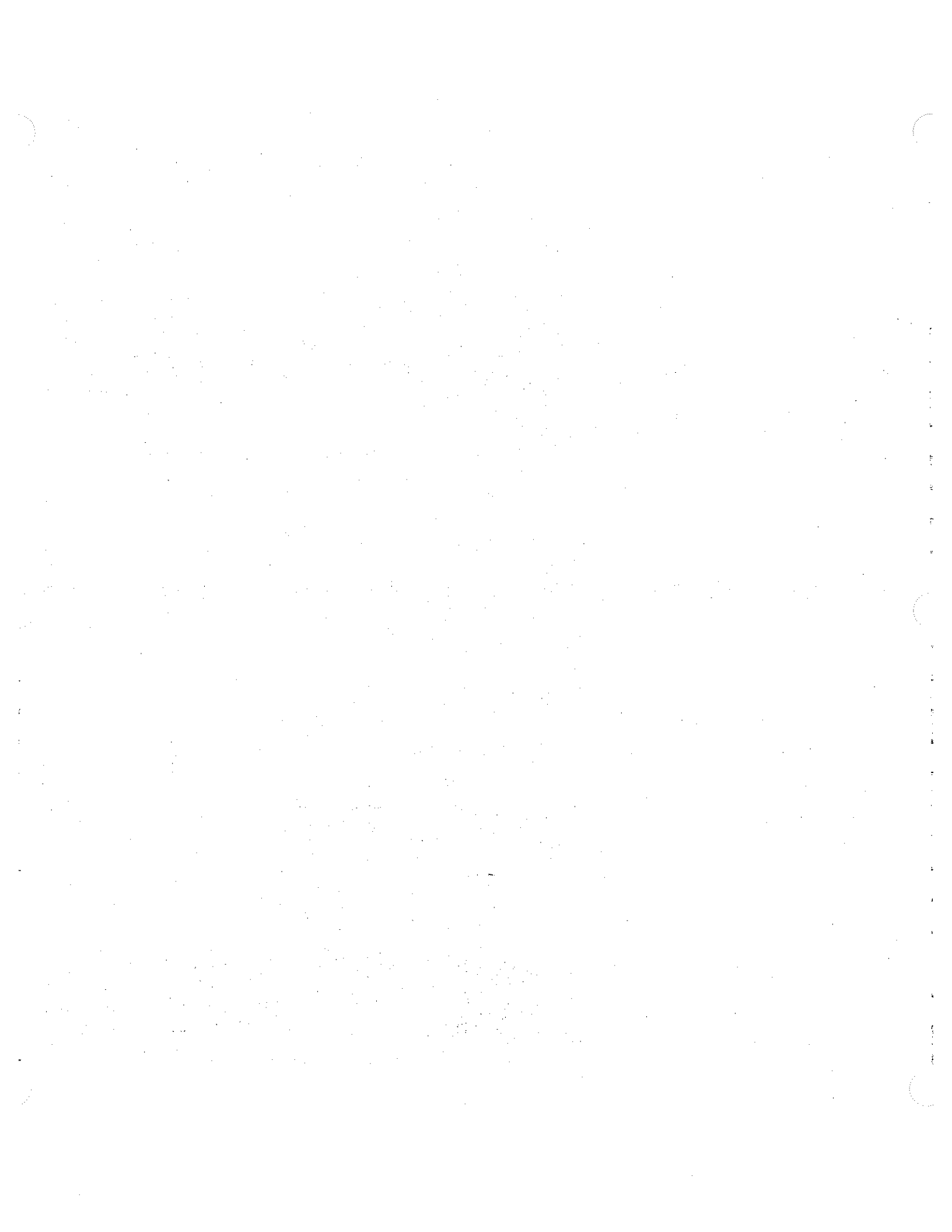

## **Performance Conditions**

The following electrical characteristics (Tables 6-1 through 6-6) are valid for the instrument when it has been adjusted at an ambient temperature between +20°C and +30°C, has had a warm-up period of at least 20 minutes, and is operating at an ambient temperature between -15°C and +55°C (unless otherwise noted).

Items listed in the "Performance Requirements" column define the measurement capabilities of the instruments. Supplementary measurement conditions may also be listed in the "Performance Requirement" column.

Mechanical characteristics are listed in Table 6-7.

Environmental characteristics are given in Table 6-8. The oscilloscope meets the environmental requirements of MIL-T-28800C for Type III, Class 3, Style C equipment, with the humidity and temperature requirements defined in paragraphs 3.9.2.2, 3.9.2.3, and 3.9.2.4.

**Performance Characteristics**

**Table 6-1  
2465A/2455A/2445A Electrical Characteristics**

Characteristics	Performance Requirements
<b>VERTICAL DEFLECTION SYSTEM—CHANNEL 1 AND CHANNEL 2</b>	
Deflection Factor	
Range	2 mV/division to 5 V/division in a 1-2-5 sequence of 11 steps.
Accuracy	1 M $\Omega$ input, noninverted.
+15°C to +35°C	
On-Graticule Accuracy	Within $\pm 2\%$ at any VOLTS/DIV setting for a four or five-division signal centered on the screen.
$\Delta V$ Accuracy (using cursors over entire graticule area)	$\pm (1.25\% \text{ of reading} + 0.03 \text{ div} + \text{signal aberrations})$ .
-15°C to +15°C and +35°C to +55°C	Add $\pm 2\%$ of reading.
50 $\Omega$ Coupling	Add $\pm 1\%$ of reading.
CH 2 Inverted	Add $\pm 1\%$ of reading.
$\Delta V$ Range	$\pm 8 \times \text{VOLTS/DIV setting}$ .
V/DIV VARIable, noninverted	Continuously variable between VOLTS/DIV settings. Extends deflection factor to $>12.5$ V/division.

Table 6-1 (cont)  
2465A/2455A/2445A Electrical Characteristics

Characteristics	Performance Requirements
Frequency Response	<p>Bandwidth is measured with a leveled, low distortion, 50-<math>\Omega</math> source, sine-wave generator, terminated in 50 <math>\Omega</math>. The reference signal amplitude is set at the lesser of 6 divisions or the maximum leveled amplitude.</p> <p>Bandwidth with probe is checked using a probe-tip-to-GR (017-0520-00) termination adapter.</p> <p>Bandwidth with external termination is checked using a BNC 50-<math>\Omega</math> feed through terminator (011-0049-01).</p>
-3 dB Bandwidth	Using standard accessory probe or internal 50- $\Omega$ termination.
2465A	
+15°C to +35°C	Dc to 350 MHz.
-15°C to +15°C and +35°C to +55°C	Dc to 300 MHz.
2455A	
+15°C to +35°C	Dc to 250 MHz.
-15°C to +15°C and +35°C to +55°C	Dc to 200 MHz.
2445A	Dc to 150 MHz.
-4.7 dB Bandwidth	Using 50- $\Omega$ external termination on 1-M $\Omega$ input.
2465A	
-15°C to +35°C	Dc to 350 MHz.
+35°C to +55°C	Dc to 300 MHz.
2455A	
-15°C to +35°C	Dc to 250 MHz.
+35°C to +55°C	Dc to 200 MHz.
2445A	Dc to 150 MHz.

**Performance Characteristics**

**Table 6-1 (cont)  
2465A/2455A/2445A Electrical Characteristics**



Characteristics	Performance Requirements
AC Coupled, Lower -3 dB Frequency	10 Hz or less.
With Standard Accessory Probe	1 Hz or less.
Step Response Rise Time	Calculated from $T_r = 0.35/BW$ .
2465A	$\leq 1$ ns.
2455A	$\leq 1.4$ ns.
2445A	$\leq 2.33$ ns.
Channel Isolation	$\geq 100:1$ attenuation of deselected channel at 100 MHz; $\geq 50:1$ at 350 MHz, for an eight-division input signal from 2 mV per division to 500 mV per division, with equal VOLTS/DIV settings on both channels.
Displayed Channel 2 Signal Delay with Respect to Channel 1 Signal	Adjustable through a range of at least -500 ps to +500 ps.
Input R and C (1 M $\Omega$ )	
Resistance	1 M $\Omega$ $\pm$ 0.5%.
Capacitance	15 pF $\pm$ 2 pF.
Maximum Input Voltage 	
DC, AC, or GND Coupled	400 V (dc + peak ac). 800 V p-p ac at 10 kHz or less.
Input R (50 $\Omega$ )	
Resistance	50 $\Omega$ $\pm$ 1%.
VSWR	
2465A	
Dc to 300 MHz	$\leq 1.3:1$ .
300 to 350 MHz	$\leq 1.5:1$ .
2455A, 2445A	$\leq 1:3:1$ for Dc to Nominal Bandwidth.
Maximum Input Voltage 	5 V rms, averaged for 1 second; $\pm 50$ V peak.



Table 6-1 (cont)  
2465A/2455A/2445A Electrical Characteristics

Characteristics	Performance Requirements
Cascaded Operation	Channel 2 Vertical Signal Output into Channel 1 input; DC coupled using a 50 $\Omega$ RG-58C/U coaxial cable, terminated in 50 $\Omega$ at the Channel 1 input. Channel 1 and Channel 2 VOLTS/DIV set at 2 mV and Bandwidth Limit On.
Deflection Factor	400 $\mu$ V per division $\pm$ 10%.
CMRR (ADD Mode with Channel 2 inverted)	At least 20:1 at 50 MHz for common-mode signals of eight divisions or less, with VAR VOLTS/DIV control adjusted for best CMRR at 50 kHz, at any VOLTS/DIV setting.
<b>VERTICAL DEFLECTION SYSTEM—CHANNEL 3 AND CHANNEL 4</b>	
Deflection Factors	
Values	100 mV and 500 mV per division.
Accuracy	Within $\pm$ 10%.
Frequency Response	Bandwidth is measured with a leveled, low distortion, 50- $\Omega$ source, sine-wave generator, terminated in 50 $\Omega$ . The reference signal amplitude is set at the lesser of 6 divisions or the maximum leveled amplitude.  Bandwidth with probe is checked using a probe-tip-to-GR (017-0520-00) termination adapter.  Bandwidth with external termination is checked using a BNC 50- $\Omega$ feed through terminator (011-0049-01).
– 3 dB Bandwidth	Using standard accessory probe.
2465A	
+15°C to +35°C	Dc to 350 MHz.
–15°C to +15°C and +35°C to +55°C	Dc to 300 MHz.
2455A	
+15°C to +35°C	Dc to 250 MHz.
–15°C to +15°C and +35°C to +55°C	Dc to 200 MHz.
2445A	Dc to 150 MHz.

**Performance Characteristics**

**Table 6-1 (cont)  
2465A/2455A/2445A Electrical Characteristics**

Characteristics	Performance Requirements
-4.7 dB Bandwidth	Using 50-Ω external termination.
2465A	
+15°C to +35°C	Dc to 350 MHz.
-15°C to +15°C and +35°C to +55°C	Dc to 300 MHz.
2455A	
+15°C to +35°C	Dc to 250 MHz.
-15°C to +15°C and +35°C to +55°C	Dc to 200 MHz.
2445A	Dc to 150 MHz.
Step Response Rise Time	Calculated from $T_r = 0.35/BW$ .
2465A	≤ 1 ns.
2455A	≤ 1.4 ns.
2445A	≤ 2.33 ns.
Channel Isolation	≥ 50:1 attenuation of deselected channel at 100 MHz with an 8-division input signal.
Signal Delay Between Channel 1 and Either Channel 3 or Channel 4	Within ± 1.0 ns, measured at the 50% points.
Input Resistance	1 MΩ ± 1%.
Input Capacitance	15 pF ± 3 pF.
Maximum Input Voltage 	400 V (dc + peak ac). 800 V p-p ac at 10 kHz or less.
<b>VERTICAL DEFLECTION SYSTEM—ALL CHANNELS</b>	
Low-frequency Linearity	0.1 division or less compression or expansion of a two-division, center-screen signal when positioned anywhere within the graticule area.
Bandwidth Limiter	Reduces upper 3 dB bandpass to a limit of 13 MHz to 24 MHz.

Table 6-1 (cont)  
2465A/2455A/2445A Electrical Characteristics

Characteristics	Performance Requirements
Vertical Signal Delay	At least 30 ns of the sweep is displayed before the triggering event is displayed at any SEC/DIV $\geq 10$ ns/div. At 5 ns/div, at least 10 ns of the sweep is displayed before the triggering event.
Chopped Mode Switching Rate	With displayed SEC/DIV in the 20 $\mu$ s to 2 $\mu$ s/div range, the switching rate is 2.5 MHz $\pm 0.2\%$ . Otherwise, the switching rate is 1 MHz $\pm 0.2\%$ . The display cycle rate equals the chop switching rate divided by the number of channels displayed. The chop switching rate is modulated slightly to minimize waveform breaks with repetitive signals.
<b>TRIGGERING</b>	
Minimum P-P Signal Amplitude for Stable Triggering from Channel 1 or Channel 2 Source 2465A and 2455A	
DC Coupled	0.35 division from dc to 50 MHz; increasing to 1.0 division at 300 MHz and 1.5 divisions at 500 MHz.
NOISE REJ Coupled	$\leq 1.2$ divisions from dc to 50 MHz; increasing to 3 divisions at 300 MHz and 4.5 divisions at 500 MHz.
AC Coupled	0.35 division from 60 Hz to 50 MHz; increasing to 1.0 division at 300 MHz and 1.5 divisions at 500 MHz. Attenuates signals below 60 Hz.
HF REJ Coupled	0.5 division from dc to 30 kHz.
LF REJ Coupled	0.5 division from 80 kHz to 50 MHz; increasing to 1.0 division at 300 MHz and 1.5 divisions at 500 MHz.
2445A	
DC Coupled	0.35 division from dc to 50 MHz; increasing to 1.5 divisions at 250 MHz.
NOISE REJ Coupled	$\leq 1.2$ divisions from dc to 50 MHz; increasing to 4.5 divisions at 250 MHz.

*Performance Characteristics*

Table 6-1 (cont)  
2465A/2455A/2445A Electrical Characteristics

Characteristics	Performance Requirements
AC Coupled	0.35 division from 60 Hz to 50 MHz; increasing to 1.5 divisions at 250 MHz. Attenuates signals below 60 Hz.
HF REJ Coupled	0.5 division from dc to 30 kHz.
LF REJ Coupled	0.50 division from 80 kHz to 50 MHz; increasing to 1.5 divisions at 250 MHz.
Minimum P-P Signal Amplitude for Stable Triggering from ADD Source	Add 0.5 division to CH 1 or CH 2 requirement at 300 MHz and 500 MHz for 2465A and 2455A.
Minimum P-P Signal Amplitude for Stable Triggering from CH 3 or CH 4 Source	0.5 × CH 1 or CH 2 requirement.
Minimum P-P Signal Amplitude for Stable Triggering from Composite, Multiple Channel Source, ALT Vertical Mode	Add 1 division to the single-channel source specification.  Checked at 50 mV per division.
Maximum P-P Signal Rejected by NOISE REJ COUPLING Signals Within the Vertical Bandwidth CH 1 or CH 2 SOURCE	≥0.4 division for VOLTS/DIV settings of 10 mV/div and higher.  Maximum noise amplitude rejected is reduced at 2 mV/div and 5 mV/div.
CH 3 or CH 4 SOURCE	≥0.2 division.
Jitter	
2465A	≤50 ps with 5 divisions of 300 MHz at 500 ps/division.
2455A	≤50 ps with 5 divisions of 250 MHz at 1 ns/division.
2445A	≤100 ps with 5 divisions of 150 MHz at 1 ns/division.
LEVEL Control Range	
CH 1 or CH 2 SOURCE	±18 × VOLTS/DIV setting.
CH 3 or CH 4 SOURCE	±9 × VOLTS/DIV setting.

Table 6-1 (cont)  
2465A/2455A/2445A Electrical Characteristics

Characteristics	Performance Requirements
LEVEL Readout Accuracy	For triggering signals with transition times greater than 20 ns.
CH 1 or CH 2 SOURCE +15°C to +35°C	Within $\pm[3\%$ of setting + 3% of p-p signal + 0.2 division + 0.5 mV + (0.5 mV $\times$ probe attenuation factor)] with Vertical Input at 1 M $\Omega$ DC, CH 2 Source Not Inverted, and Trigger DC Coupled.
-15°C to +35°C and +35°C to +55°C	Add 1.5 mV $\times$ probe attenuation to +15°C to +35°C specification.
50 $\Omega$ Input	Add $\pm 1\%$ to 1 M $\Omega$ input specification.
CH 2 Inverted	Add $\pm 1\%$ of setting to non-inverted specification.
NOISE REJ Coupled	Add $\pm 0.6$ division to DC Coupled specifications.
CH 3 or CH 4 SOURCE	Within $\pm[3\%$ of setting + 4% of p-p signal + 0.1 division + (0.5 mV $\times$ probe attenuation factor)] and Trigger DC Coupled.
NOISE REJ Coupled	Add $\pm 0.3$ division to the DC Coupled specification.
AUTO LVL Mode Maximum Triggering Signal Period A SEC/DIV Setting	
<10 ms	At least 20 ms.
10 ms to 50 ms	At least four times the A-SEC/DIV setting.
>50 ms	At least 200 ms.
AUTO Mode Maximum Triggering Signal Period A-SEC/DIV Setting	
<10 ms	At least 80 ms.
10 ms to 50 ms	At least 16 times the A-SEC/DIV setting.
>50 ms	At least 800 ms.

**Performance Characteristics**

**Table 6-1 (cont)**  
**2465A/2455A/2445A Electrical Characteristics**

Characteristics	Performance Requirements
AUTO LVL Mode Trigger Acquisition Time	Eight to 100 times the AUTO LVL Mode maximum triggering signal period, depending on the triggering signal period and waveform.
Trigger Holdoff	
Minimum	The greater of the A-SEC/DIV setting value or 2 $\mu$ s, within +33% to -10%, except 1 $\mu$ s at 5 ns/div.
Variable	Increases trigger holdoff time to 10 to 25 times the minimum holdoff.
SLOPE Selection	Conforms to trigger-source waveform or ac power-source waveform.

**HORIZONTAL DEFLECTION SYSTEM**

A Sweep Time Base Range	
2465A	500 ms/div to 5 ns/div in a 1-2-5 sequence of 25 steps. X10 MAG extends maximum sweep rate to 500 ps/div.
2455A and 2445A	500 ms/div to 10 ns/div in a 1-2-5 sequence of 24 steps. X10 MAG extends maximum sweep rate to 1 ns/div.
B Sweep Time Base Range	
2465A	50 ms/div to 5 ns/div in a 1-2-5 sequence of 22 steps. X10 MAG extends maximum sweep rate to 500 ps/div.
2455A and 2445A	50 ms/div to 10 ns/div in a 1-2-5 sequence of 21 steps. X10 MAG extends maximum sweep rate to 1 ns/div.
Timing Accuracy	+15°C to +35°C, A-Sweep, with SEC/DIV at 100 ms/div or faster.
Sweep Accuracy Unmagnified	$\pm$ (0.7% of time interval + 0.6% of full scale).
$\Delta t$ Accuracy With Cursors, Unmagnified	$\pm$ (0.5% of time interval + 0.3% of full scale).
$\Delta t$ Accuracy with Sweep Delay	$\pm$ (0.3% of time interval + 0.1% of full scale).
Delay Accuracy, A Sweep Trigger to Start of B Sweep	$\pm$ (0.3% of delay setting + 0.6% of full scale) +0 to -25 ns.
B-Sweep Accuracy and $\Delta t$ Accuracy with Cursors on B Sweep	Add $\pm$ 0.3% of time interval to A-Sweep specifications.

Table 6-1 (cont)  
2465A/2455A/2445A Electrical Characteristics

Characteristics	Performance Requirements
X10 MAG Accuracy	Add $\pm 0.5\%$ of time interval to unmagnified Sweep and $\Delta t$ Cursors specifications. Exclude the first 0.5 division after the sweep starts (the first 0.5% of the full 100 division sweep).
500 ms or 200 ms/div Timing Accuracy (A Sweep only)	Add $\pm 0.5\%$ of interval to specifications for A SEC/DIV at 100 ms or faster.
SEC/DIV VAR Timing Accuracy	Add 2% of time interval to sweep accuracy specifications when VAR is out of detent.
Timing Accuracy ( $-15^{\circ}\text{C}$ to $+15^{\circ}\text{C}$ and $+35^{\circ}\text{C}$ to $+55^{\circ}\text{C}$ )	Add $\pm 0.2\%$ of time interval to all $\Delta t$ and delay specifications. Add $\pm 0.5\%$ of interval to sweep accuracy specification.
$\Delta t$ Readout Resolution	
2465A	Greater of either 10 ps or 0.025% of full scale.
2455A, 2445A	Greater of either 20 ps or 0.25% of full scale.
$\Delta t$ Range	$\pm 10$ times A-SEC/DIV setting with Cursors, $\pm 9.95$ times A-SEC/DIV setting with Sweep Delay.
Sweep Delay Range	0 to 9.95 times the A SEC/DIV setting, from 500 ms to 10 ns with 2465A, or 500 ms to 20 ns with the 2455A and 2445A. A-Sweep triggering event is observable on B Sweep with zero delay setting for A SEC/DIV settings 50 $\mu\text{s}$ or faster.
Delay Jitter	Within 0.004% (one part or less in 25,000) of the maximum available delay, plus 50 ps.
X10 MAG Registration	Within 0.5 division from graticule center at 1 ms SEC/DIV setting (X10 MAG on to X10 MAG off).
Horizontal POSITION Range	Start of 1 ms per division sweep can be positioned from right of graticule center to at least 10 divisions left of graticule center. Some portion of 1 ms per division sweep is always visible with X10 MAG off.

**Performance Characteristics**

**Table 6-1 (cont)  
2465A/2455A/2445A Electrical Characteristics**

<b>Characteristics</b>	<b>Performance Requirements</b>
<b>X-Y Operation</b>	
X-Axis Deflection Factor Range, Variable, and Input Characteristics	Same as Channel 1.
Deflection Factor Accuracy	Same as Channel 1.
X-Axis Bandwidth	Dc to 3 MHz.
Phase Difference Between X and Y with BW Limit Off	$\leq 1^\circ$ from dc to 1 MHz; $\leq 3^\circ$ from 1 MHz to 2 MHz.
X-Axis Low-frequency Linearity	0.1 division or less compression or expansion of a two-division, center-screen signal when positioned within the graticule area.
<b>DISPLAY</b>	
<b>Cursor Position Range</b>	
Delta Volts ( $\Delta V$ )	At least the center 7.6 vertical divisions.
Delta Time ( $\Delta t$ )	At least the center 9.6 horizontal divisions.
<b>Graticule</b>	
Size	80 mm X 100 mm.
Markings	8 major divisions vertically and 10 major divisions horizontally, with auxiliary markings.
<b>Trace Rotation Range</b>	Adequate to align trace with the center horizontal graticule line.



Table 6-1 (cont)  
2465A/2455A/2445A Electrical Characteristics

Characteristics	Performance Requirements
<b>Z-AXIS INPUT</b>	
Sensitivity	
Dc to 2 MHz	Positive voltage decreases intensity; +2 V blanks a maximum intensity trace.
2 MHz to 20 MHz	+2 V modulates a normal intensity trace.
Input Resistance	9 k $\Omega$ $\pm$ 10%.
Maximum Input Voltage 	$\pm$ 25 V peak; 25 V p-p ac at 10 kHz or less.
<b>SIGNAL OUTPUTS</b>	
<b>CALIBRATOR</b>	
Output Voltage and Current	With A SEC/DIV set to 1 ms. 0.4 V $\pm$ 1% into a 1-M $\Omega$ load, 0.2 V $\pm$ 1.5% into a 50- $\Omega$ load, or 8 mA $\pm$ 1.5% into a short circuit.
Repetition Period	Two times the A SEC/DIV setting for SEC/DIV from 100 ns to 100 ms.
Accuracy	$\pm$ 0.1%, during sweep time.
<b>CH 2 SIGNAL OUT</b>	
Output Voltage	20 mV/division $\pm$ 10% into 1 M $\Omega$ , 10 mV/division $\pm$ 10% into 50 $\Omega$ .
Offset	$\pm$ 20 mV into 1 M $\Omega$ , when dc balance has been performed within $\pm$ 5°C of the operating temperature.
<b>A GATE OUT and B GATE OUT</b>	
Output Voltage	2.4 V to 5 V positive-going pulse; starting at 0 V to 400 mV.
Output Drive	Will supply 400 $\mu$ A during HI state; will sink 2 mA during LO state.

*Performance Characteristics*

Table 6-1 (cont)  
2465A/2455A/2445A Electrical Characteristics

Characteristics	Performance Requirements
<b>AC POWER SOURCE</b>	
Source Voltage	
Nominal Ranges	
115 V	90 V to 132 V.
230 V	180 V to 250 V.
Source Frequency	48 Hz to 440 Hz.
Fuse Rating	2 A, 250 V, AGC/3AG, Fast blow; or 1.6 A, 250 V, 5 × 20 mm Quick-acting.
Maximum Power Consumption (fully optioned instrument)	120 watts (180 VA).
Primary Circuit Dielectric Voltage Withstand Test	1500 V rms, 60 Hz for 10 seconds without breakdown.
Primary Grounding	Type test to 0.1 $\Omega$ maximum. Routine test to check grounding continuity between chassis ground and protective earth ground.

Table 6-2  
Option 01 (DMM) Electrical Characteristics

Characteristics	Performance Requirements
<b>DC VOLTS</b>	
Accuracies by Range	
+18°C to +28°C	
200 mV to 200 V	$\pm(0.03\% \text{ of reading} + 0.01\% \text{ of full scale})$ .
500 V	$\pm(0.3\% \text{ of reading} + 0.04\% \text{ of full scale})$ .
-15°C to +18°C and +28°C to +55°C	
200 mV to 200 V	Add $\pm(0.003\% \text{ of reading} + 0.001\% \text{ of full scale})/^{\circ}\text{C}$ below 18°C or above 28°C.
500 V	Add $\pm(0.003\% \text{ of reading} + 0.004\% \text{ of full scale})/^{\circ}\text{C}$ below 18°C or above 28°C.
Common Mode Rejection Ratio	>100 dB at dc: >80 dB at 50 and 60 Hz, with 1 k $\Omega$ imbalance.
Normal Mode Rejection Ratio	>60 dB at 50 and 60 Hz.
Resolution	1 part in 20,000 of full scale except 0.1 V on 500 V range.
Step Response Time	
Manual Range	Less than 1 second.
Auto Range	Less than 2 seconds.
Input Resistance	
200 mV and 2 V Ranges	>1 G $\Omega$ or 10 M $\Omega$ , $\pm 1\%$ .
20 V to 500 V Ranges	10 M $\Omega$ $\pm 1\%$ .
Input Bias Current at 23°C Ambient Temperature	Less than 10 pA.
Reading Rate	Approximately 3 per second.

**Performance Characteristics**

**Table 6-2 (cont)  
Option 01 (DMM) Electrical Characteristics**

Characteristics	Performance Requirements
<b>AC VOLTS</b>	
Accuracies by Range	Crest Factor $\leq 4$ .
+18°C to +28°C	
200 mV to 200 V	Input signal between 5% and 100% of full scale.
40 Hz to 10 kHz	$\pm(0.6\%$ of reading + 0.1% of full scale).
20 Hz to 40 Hz and 10 kHz to 20 kHz	$\pm(1\%$ of reading + 0.1% of full scale).
20 kHz to 100 kHz	$\pm(5\%$ of reading + 0.1% of full scale).
500 V	Input signal between 100 V and 500 V.
40 Hz to 10 kHz	$\pm(0.6\%$ of reading + 0.2% of full scale).
20 Hz to 40 Hz and 10 kHz to 20 kHz	$\pm(1\%$ of reading + 0.2% of full scale).
20 kHz to 100 kHz	$\pm(5\%$ of reading + 0.2% of full scale).
-15°C to +18°C and +28°C to +55°C	
200 mV to 200 V	Input signal between 5% and 100% of full scale.
40 Hz to 10 kHz	$\pm(0.8\%$ of reading + 0.1% of full scale).
20 Hz to 40 Hz and 10 kHz to 20 kHz	$\pm(1.3\%$ of reading + 0.1% of full scale).
20 kHz to 10 kHz	$\pm(6\%$ of reading + 0.1% of full scale).
500 V	Input signal greater than 100 V and less than 500 V.
40 Hz to 10 kHz	$\pm(0.8\%$ of reading + 0.3% of full scale).
20 Hz to 40 Hz and 10 kHz to 20 kHz	$\pm(1.3\%$ of reading + 0.3% of full scale).
20 kHz to 100 kHz	$\pm(6\%$ of reading + 0.3% of full scale).
Common Mode Rejection Ratio	$>60$ dB from dc to 60 Hz, with 1 k $\Omega$ imbalance.
Resolution	1 part in 20,000 of full scale except 0.1 V on 500 V range.

Table 6-2 (cont)  
Option 01 (DMM) Electrical Characteristics

Characteristics	Performance Requirements
Response Time	
Manual Range	Less than 2 seconds.
Auto Range	Less than 3 seconds.
Input Impedance	1 M $\Omega$ $\pm$ 1% in parallel with less than 100 pF.
dBV, dBm	
Accuracy	dB readings are calculated from AC VOLTS measurements.
Resolution	0.01 dB.
<b>HI OHMS</b>	
Accuracies by Range	
+18°C to +28°C	
2 k $\Omega$ to 2 M $\Omega$	$\pm$ (0.1% of reading + 0.01% of full scale).
20 M $\Omega$	$\pm$ (0.5% of reading + 0.01% of full scale).
-15°C to +18°C and +28°C to +55°C	
2 k $\Omega$ to 200 k $\Omega$	Add $\pm$ (0.01% of reading + 0.001% of full scale)/°C above 28°C or below 18°C.
2 M $\Omega$	Add $\pm$ (0.01% of reading + 0.001% of full scale)/°C above 28°C or below 18°C $\pm$ 2% of reading per 10% relative humidity above 70% relative humidity.
20 M $\Omega$	Add $\pm$ (0.05% of reading + 0.001% of full scale)/°C above 28°C or below 18°C $\pm$ 2% of reading per 10% relative humidity above 70% relative humidity.
Voltage at Full Scale	Approximately 2 V.
Maximum Open Circuit Voltage	Less than 6 V.
Resolution	One part in 20,000 of full scale.

*Performance Characteristics*

Table 6-2 (cont)  
Option 01 (DMM) Electrical Characteristics

Characteristics	Performance Requirements
Measuring Current by Range	
2 k $\Omega$	Approximately 1 mA.
20 k $\Omega$	Approximately 0.1 mA.
200 k $\Omega$	Approximately 10 $\mu$ A.
2 M $\Omega$	Approximately 1 $\mu$ A.
20 M $\Omega$	Approximately 0.1 $\mu$ A.
Response Time	
2 k $\Omega$ to 2 M $\Omega$	
Manual Range	Less than 1 second.
Auto Range	Less than 2 seconds.
20 M $\Omega$ Range	Less than 5 seconds.
Reading Rate by Range	
2 k $\Omega$ to 2 M $\Omega$	Approximately 3 per second.
20 M $\Omega$	Approximately 1.5 per second.

Table 6-2 (cont)  
Option 01 (DMM) Electrical Characteristics

Characteristics	Performance Requirements
<b>LO OHMS</b>	
Accuracies by Range	
+18°C to +28°C	
200 Ω	±(0.1% of reading + 0.1% of full scale).
2 kΩ to 200 kΩ	±(0.1% of reading + 0.01% of full scale).
2 MΩ	±(0.25% of reading + 0.01% of full scale).
-15°C to +18°C and +28°C to +55°C	
200 Ω to 20 kΩ	Add ±(0.01% of reading + 0.001% of full scale)/°C above 28°C or below 18°C.
200 kΩ	Add ±(0.01% of reading + 0.001% of full scale)/°C above 28°C or below 18°C ±2% of reading per 10% relative humidity above 70% relative humidity.
2 MΩ	Add ±(0.025% of reading + 0.001% of full scale)/°C above 28°C or below 18°C ±2% of reading per 10% relative humidity above 70% relative humidity.
Voltage at Full Scale	Approximately 0.2 V.
Maximum Open Circuit Voltage	Less than 6 V.
Measuring Current by Range	
200 Ω	Approximately 1 mA.
2 kΩ	Approximately 0.1 mA.
20 kΩ	Approximately 10 μA.
200 kΩ	Approximately 1 μA.
2 MΩ	Approximately 0.1 μA.
Resolution	1 part in 20,000 of full scale.
Response Time	
Manual Range	Less than 1 second.
Auto Range	Less than 2 seconds.
Reading Rate	Approximately 3 per second.

*Performance Characteristics*

Table 6-2 (cont)  
Option 01 (DMM) Electrical Characteristics

Characteristics	Performance Requirements
<b>AMPS</b>	
DC Accuracy	
+18°C to +28°C	±(0.1% of reading + 0.02% of full scale).
-15°C to +18°C and +28°C to +55°C	±(0.15% of reading + 0.06% of full scale).
AC Accuracy	20 Hz to 10 kHz sinusoidal waveform.
+18°C to +28°C	±(0.6% of reading + 0.1% of full scale).
-15°C to +18°C and +28°C to +55°C	±(0.7% of reading + 0.15% of full scale).
Response Time	
Manual Range	Less than 1 second.
Auto Range	Less than 2 seconds.
Input Resistance by Range	
100 µA	Approximately 1.0 kΩ.
1 mA	Approximately 100.0 Ω.
10 mA	Approximately 10.5 Ω.
100 mA	Approximately 1.5 Ω.
1 A (1000 mA)	Approximately 0.5 Ω.
Maximum Input Current	1 A.
Resolution	1 part in 10,000 of full scale.



Table 6-2 (cont)  
Option 01 (DMM) Electrical Characteristics

Characteristics	Performance Requirements
<b>CONTINUITY</b>	
Response Time	Approximately 0.1 second.
Threshold Resistance	10 $\Omega$ $\pm$ 1 $\Omega$ .
<b>TEMPERATURE</b>	
Accuracy	
+18°C to +28°C Ambient Temperature	$\pm$ (2% of reading + 1.5°C).
-15°C to +18°C and +28°C to +55°C Ambient Temperature	$\pm$ (2% of reading + 2.0°C).
Probe Tip Measurement Range	-62°C to +230°C in one range.
Resolution	0.1°C or 0.1°F.
<b>ADDITIONAL CHARACTERISTICS</b>	
Warmup time to Meet Electrical Specification	45 minutes.
Maximum Voltage between Inputs from either Input to Ground	
DC to 20 kHz	500 V rms; 700 V peak.
Above 20 kHz	10 <sup>7</sup> V*Hz.

**NOTE**

*For AMPS modes, maximum voltage between inputs is limited by maximum input current.*

*Performance Conditions*

**Table 6-3**  
**Option 05 (TV) Electrical Characteristics**

Characteristics	Performance Requirements
<b>VERTICAL DEFLECTION SYSTEM—CHANNEL 1 AND CHANNEL 2</b>	
Frequency Response	For VOLTS/DIV settings between 5 mV and 0.2 V with VAR control in calibrated detent. Five-division, 50-kHz reference signal from a 50- $\Omega$ system. With external 50- $\Omega$ termination on 1 M $\Omega$ input.
Full Bandwidth	
50 kHz to 5 MHz	Within $\pm 1\%$ .
>5 MHz to 10 MHz	Within +1%, -2%.
>10 MHz to 30 MHz	Within +2%, -3%.
Bandwidth Limit	
50 kHz to 5 MHz	Within +1%, -4%.
Square Wave Flatness	With fast-rise step (rise time $\leq 1$ ns), 1 M $\Omega$ dc input coupling, an external 50 $\Omega$ termination, and VAR VOLTS/DIV control in calibrated detent. Exclude the first 50 ns following the step transition. For signals with rise times $\leq 10$ ns, add 2% p-p between 155 ns and 165 ns after step transition.
Field Rate	
5 mV/div to 10 mV/div	1.5% p-p at 60 Hz with input signal of 0.1 V.
20 mV/div	1% p-p at 60 Hz with input signal of 0.1 V.
50 mV/div	1% p-p at 60 Hz with input signal of 1.0 V.
Line Rate	
5 mV/div to 10 mV/div	1.5% p-p at 15 kHz with input signal of 0.1 V.
20 mV/div	1% p-p at 15 kHz with input signal of 0.1 V.
50 mV/div	1% p-p at 15 kHz with input signal of 1.0 V.

Table 6-3 (cont)  
Option 05 (TV) Electrical Characteristics

Characteristics	Performance Requirements
TV (Back-Porch) Clamp (CH 2 only)	For VOLTS/DIV settings between 5 mV and 0.2 V with VAR control in calibrated detent. Six-division reference signal.
60 Hz Attenuation	≥ 18 dB.
Back-Porch Reference	Within 1.0 division of ground reference.
<b>TRIGGERING</b>	
Sync Separation	Stable video rejection and sync separation from sync-positive or sync-negative composite video, 525 to 1280 lines, 50 Hz or 60 Hz, interlaced or noninterlaced systems.  For noninterlaced scan systems, the video signal source must start and end with full lines of video for correct line identification in the field trigger modes.
Line Selection Range in FLD1, FLD2, or Both Coupling Modes	The lesser of 1280 or the number of lines in the field.
Input Signal Amplitude for Stable Triggering	
Channel 1 or Channel 2	Minimum sync-pulse amplitude within 18 divisions of input ground reference.
Composite Video	1 division.
Composite Sync	0.3 division.
Channel 3 or Channel 4	Minimum sync-pulse amplitude within 9 divisions of input ground reference.
Composite Video	0.5 division.
Composite Sync	0.25 division.

**Performance Characteristics**

**Table 6-4  
Option 06 (C/T/T) Electrical Characteristics**

Characteristics	Performance Requirements	
<b>SIGNAL INPUT</b>		
Maximum Input Frequency for Count and Delay by Events	With DC Coupling of A Trigger and B Trigger.	
	≥150 MHz.	
Minimum Width of High or Low State of Input Signal for Count and Delay by Events	≤3.3 ns.	
Sensitivity	For Count, Delay by Events, and Logic Trigger Functions Excluding Word Recognizer.	
Dc to 50 MHz (0.5 Hz to 50 MHz for Frequency and Period)		
CH 1 and CH 2	1.5 divisions.	
CH 3 and CH 4	0.75 division.	
50 MHz to 150 MHz		
CH 1 and CH 2	4.0 divisions.	
CH 3 and CH 4	2.0 divisions.	
<b>FREQUENCY</b>		
Ranges	<b>RANGE</b>	<b>LSD</b>
	1 Hz	100 nHz
	10 Hz	1 μHz
	100 Hz	10 μHz
	1 kHz	100 μHz
	10 kHz	1 mHz
	100 kHz	10 mHz
	1 MHz	100 mHz
	10 MHz	1 Hz
	100 MHz	10 Hz
	150 MHz	100 Hz
Automatic Ranging	Upranges at 100% of full scale; downranges at 9% of full scale. Downrange occurs at 90 MHz on 150 MHz range.	
	Full scale corresponds to the value given in the Range column. The maximum displayed value for any range is the Range value minus the LSD value.	

Table 6-4 (cont)  
Option 06 (C/T/T) Electrical Characteristics

Characteristics	Performance Requirements	
Accuracy	$\pm [\text{Resolution} + (\text{Frequency} \times \text{TBE})]$ Hz.	
Time Base Error (TBE)	10 ppm with less than 5 ppm per year drift.	
Resolution	$\frac{1.4 \times \text{Frequency}^2 \times \text{TJE}}{N} + \text{LSD}$ .	
Display Update Rate	Twice per second or twice the period of the input signal, whichever is slower.	
<b>PERIOD</b>		
Ranges	<b>RANGE</b>	
	<b>LSD</b>	
	10 ns	1 fs
	100 ns	10 fs
	1 $\mu$ s	100 fs
	10 $\mu$ s	1 ps
	100 $\mu$ s	10 ps
	1 ms	100 ps
	10 ms	1 ns
	100 ms	10 ns
	1 s	100 ns
	2 s	1 $\mu$ s
Minimum Period	$\leq 6.7$ ns.	
Automatic Ranging	Upranges at 100% of full scale; downranges at 9% of full scale.  Full scale corresponds to the value given in the Range column. The maximum displayed value for any range is the Range value minus the LSD value.	
Accuracy	$\pm [\text{Resolution} + (\text{TBE} \times \text{Period})]$ .	
Resolution	$\pm [\text{LSD} + (1.4 \times \text{TJE}/N)]$ .	
Display Update Rate	Twice per second or twice the period of the input signal, whichever is slower.	

**Performance Characteristics**

**Table 6-4 (cont)  
Option 06 (C/T/T) Electrical Characteristics**

<b>Characteristics</b>	<b>Performance Requirements</b>
<b>TOTALIZE</b>	
Maximum Count	9999999.
Display Update Rate	Twice per second or once per event, whichever is slower.
<b>DELAY BY EVENTS</b>	
Maximum Event Count	4194303.
Minimum Time from Start Signal to Any Delay Event	4 ns.
<b>LOGIC TRIGGER</b>	
Minimum Function-True Time	4 ns.
Minimum Function-False Time	4 ns.

Table 6-4 (cont)  
Option 06 (C/T/T) Electrical Characteristics

Characteristics	Performance Requirements
<b>ADDED DELAY TIME CHARACTERISTICS WITH C/T/T</b>	
Run After Delay Accuracy	$LSD^b + [0.0012 \times (A \text{ SEC/DIV})] + [0.03 \times (B \text{ Time/Div})^f] + A \text{ Trigger Level Error} + 50 \text{ ns.}$  When the A Sweep is triggered by the Word Recognizer in synchronous mode, add 100 ns for probe delay; in asynchronous mode, add 200 ns for probe delay.
Triggerable After Delay Accuracy	For intervals within 70 ns to 10 times the A-SEC/DIV Setting.  $LSD^b + [10 \text{ ppm} \times (\text{measured interval})] + TJE + A\text{-Trigger Level Error} + B\text{-Trigger Level Error} + 0.5 \text{ ns.}$  If the A and B Sweeps are triggered from different channels, add 0.5 ns for channel-to-channel mismatch.  When the A Sweep is triggered by the Word Recognizer in synchronous mode, add 100 ns for probe delay; in asynchronous mode, add 200 ns for probe delay.
Minimum Measurable Delay Time	$\leq 70 \text{ ns.}$
Display Update Rate	In Auto Resolution, twice per second or once for every sweep, whichever is slower.  In 1 ns, 100 ps, and 10 ps resolution modes, the update rate depends on the A SEC/DIV setting and the trigger repetition rate.

<sup>b</sup>See Tables 2-1 and 2-2.

<sup>f</sup>B Time/Div includes SEC/DIV, X10 MAG, and VAR.

Performance Characteristics

Table 6-4 (cont)  
Option 06 (C/T/T) Electrical Characteristics

Characteristics	Performance Requirements
<b>ADDED DELTA-DELAY-TIME CHARACTERISTICS WITH C/T/T</b>	
Run After Delay Accuracy	$LSD^b + [0.0008 \times (A \text{ SEC/DIV})] + [0.01 \times (B \text{ Time/Div})^c] + 83 \text{ ps.}$  When the A Sweep is triggered by the Word Recognizer in synchronous mode, add 1 ns for probe jitter; in asynchronous mode, add 20 ns for probe jitter.
Triggerable After Delay Accuracy	Both delays are within 70 ns to 10 times the A-SEC/DIV setting.
Superimposed Delta Time	$LSD^b + [0.01 \times (B \text{ Time/Div})^c] + [10 \text{ ppm} \times (A \text{ SEC/DIV})] + [10 \text{ ppm} \times (\text{measured interval})] + 50 \text{ ps} + \text{TJE.}$  If CH 3 or CH 4 is one channel of a two-channel measurement, add 0.5 ns for channel-to-channel delay mismatch.
Nonsuperimposed Delta Time	$LSD^b +  t_{REF} - t_{DEL} ^d + \text{TJE} + [(0.0005 \text{ div}) \times (1/SR_{REF} + 1/SR_{DEL})] + [10 \text{ ppm} \times (A \text{ SEC/DIV})] + [10 \text{ ppm} \times (\text{measured interval})] + 50 \text{ ps.}$  If A and B sweeps are triggered from different channels, add 0.5 ns for channel-to-channel mismatch + $[0.5 \text{ div} \times (1/SR_{REF} + 1/SR_{DEL})]$ for trigger offset.
Display Update Rate	In Auto Resolution, twice per second or once for every four sweeps, whichever is slower.  In 1 ns, 100 ps, and 10 ps resolution modes, the update rate depends on the A SEC/DIV setting and the trigger repetition rate.

<sup>b</sup>See Tables 2-1 and 2-2.

<sup>c</sup>B Time/Div includes SEC/DIV, X10 MAG, and VAR.

<sup>d</sup>This term assumes the trigger points are between the 10% and 90% points of the waveforms. Fall time is expressed as a negative risetime.



Table 6-4 (cont)  
Option 06 (C/T/T) Electrical Characteristics

Characteristics	Performance Requirements
-----------------	--------------------------

## DEFINITIONS

A Trigger Level Error = (A Trigger Level Readout Error)/SR<sub>A</sub>.

B Trigger Level Error = (B Trigger Level Readout Error)/SR<sub>B</sub>.

t<sub>rREF</sub> = rise time, reference trigger signal.

t<sub>rDELTA</sub> = rise time, delta trigger signal.

SR<sub>A</sub> = slew rate at trigger point, A sweep trigger signal in div/sec.

SR<sub>B</sub> = slew rate at trigger point, B sweep trigger signal in div/sec.

SR<sub>REF</sub> = slew rate at trigger point, reference trigger signal in div/sec.

SR<sub>DELTA</sub> = slew rate at trigger point, delta trigger signal in div/sec.

TJE = trigger jitter error.

For delay or delta time, disregarding noise in the signal, this term contributes <1 LSD if the slew rate is greater than 0.03 vertical div/ns or if the slew rate is greater than 30000 vertical div/horizontal div.

Trigger Jitter = [(Reference Trigger Signal Jitter)<sup>2</sup> + (Delta Trigger Signal Jitter)<sup>2</sup> + (A Sweep Trigger Signal Jitter)<sup>2</sup>]<sup>1/2</sup>.

Reference Trigger Signal Jitter = (e<sub>NS</sub> + e<sub>nREF</sub>)/SR<sub>REF</sub>.  
= 0 for Frequency mode.

e<sub>NS</sub> = scope noise in div.

= 0.05 div for HF REJ trigger coupling.

= 0.1 div for DC trigger coupling, 5 mV to 5 V sensitivity.

= 0.15 div for DC trigger coupling, 2 mV sensitivity.

e<sub>nREF</sub> = reference signal rms noise in div.

**Performance Characteristics**

---

**Table 6-4 (cont)  
Option 06 (C/T/T) Electrical Characteristics**

<b>Characteristics</b>	<b>Performance Requirements</b>
Delta Trigger Signal Jitter = $(e_{nS} + e_{nDELTA})/SR_{DELTA}$ = 0 for Frequency or Delay mode.	
$e_{nDELTA}$ = delta signal rms noise in div.	
A Trigger Signal Sweep Jitter = $(e_{nS} + e_{nA})/SR_A$	
$e_{nA}$ = A sweep trigger signal rms noise in div.	
When the Word Recognizer supplies a trigger in synchronous mode, the trigger jitter of the associated trigger signal is <1 ns; in asynchronous mode, the associated trigger signal jitter is <20 ns.	
N = number of averages during measurement interval.	
= see Table 2-1 for Delay or Delta Time.	
= (measured frequency) × (measurement interval) for Frequency or Period.	
Measurement Interval = 0.5 s or two periods of measured signal, whichever is greater.	

Table 6-5  
Option 09 (WR) Electrical Characteristics

Characteristics	Performance Requirements
<b>SYNCHRONOUS MODE</b>	
Data Setup Time D <sub>0</sub> —D <sub>15</sub> and Q	25 ns.
Data Hold Time D <sub>0</sub> —D <sub>15</sub> and Q	0 ns.
Minimum Clock Pulse Width	
High	20 ns.
Low	20 ns.
Minimum Clock Period	50 ns.
Delay from Selected Clock Edge to Word Out from C/T/T	≤55 ns.
<b>ASYNCHRONOUS MODE</b>	
Maximum Trigger Frequency	10 MHz.
Minimum Coincidence Between Data Inputs (D <sub>0</sub> —D <sub>15</sub> & Q) Resulting in a Trigger	<85 ns.
Maximum Coincidence Between Data Inputs (D <sub>0</sub> —D <sub>15</sub> & Q) Without Producing a Trigger	>20 ns.
Delay from Input Word Coincidence to Word Out	≤140 ns.

*Performance Characteristics*

Table 6-5 (cont)  
Option 09 (WR) Electrical Characteristics



Characteristics	Performance Requirements
<b>INPUTS AND OUTPUTS</b>	
Input Voltages	
Minimum Input Voltage 	-0.5 V.
Maximum input Voltage 	5.5 V.
Maximum input Low Voltage	0.6 V.
Minimum Input High Voltage	2.0 V.
WORD RECOG OUT	
High	> 2.5 V LSTTL output.
Low	< 0.5 V LSTTL output.
Input High Current	≤ 20 μA.
Input Low Current	≥ -0.6 mA source.

Table 6-6  
Option 10 (GPIB) Electrical Characteristics

Characteristics	Performance Requirements
Vertical Position Accuracy	Position accuracy is only valid when: <ol style="list-style-type: none"> <li>1. Positioning occurs after a BALANCE command is invoked at the ambient temperature in which the instrument is operating.</li> <li>2. The VOLTS/DIV VAR control is in the calibrated detent.</li> </ol>
CH 1, CH 2 (noninverted) +15°C to +35°C	$\pm(0.3 \text{ div} + 3\% \text{ of distance from center screen in div} + 0.5 \text{ mV/V/DIV setting.})$
CH 2 Inverted	Add 0.2 div.
-15°C to +15°C and +35°C to +55°C	Add 1.5 mV/V/DIV setting.
CH 3 and CH 4	$\pm(0.7 \text{ div} + 3\% \text{ of distance from center screen in div.})$
IEEE 488 Outputs	
Volts Out for True ( $I_{OT} = 48 \text{ mA}$ )	Max 0.5 V.
Volts Out for False ( $I_{OF} = -5.2 \text{ mA}$ )	Min 2.5 V.
Volts Out with Output Disabled	Max 3.7 V, Min 2.5 V.
Output Leakage Current with Power OFF ( $0 \text{ V} < V_{IN} < 2.5 \text{ V}$ )	Max 40 $\mu\text{A}$ .
IEEE 488 Inputs	
Volts In for True	Max 0.8 V, Min 0 V.
Volts In for False	Max 5.5 V, Min 2.0 V.
Current In for True ( $V_{IT} = 0.5 \text{ V}$ )	Max -0.1 mA.
Current In for False ( $V_{IF} = 2.7 \text{ V}$ )	Max 20 $\mu\text{A}$ .

**Performance Characteristics**

**Table 6-7  
Mechanical Characteristics**

<b>Characteristics</b>	<b>Description</b>
<b>Weight</b>	
With Accessories and Pouch	10.2 kg (22.4 lb).
With Option 05, 06 and 09, or 10	12.0 kg (26.44 lb).
With Option 01	13.1 kg (28.8 lb).
Without Accessories and Pouch	9.3 kg (20.5 lb).
<b>Domestic Shipping Weight</b>	
2465A, 2455A, 2445A	12.8 kg (28.2 lb).
With Option 05, 06 and 09, or 10	17.6 kg (38.8 lb).
With Option 01	19.2 kg (42.2 lb).
<b>Height</b>	
Without Accessories Pouch	
2465A, 2455A, 2445A with or without Options 05, 06 and 09, and 10	160 mm (6.29 in).
2465A, 2455A, 2445A with Option 01	202 mm (7.96 in).
With Feet and Accessories Pouch	
2465A, 2455A, 2445A with or without Options 05, 06 and 09, and 10	202 mm ± 25.4 mm (7.94 in ± 1.0 in).
2465A, 2455A, 2445A with Option 01	243 mm ± 25.4 mm (9.56 in ± 1.0 in).
<b>Width (with handle)</b>	338 mm (13.31 in).
<b>Depth</b>	
With Front Panel Cover	434 mm (17.1 in).
With Handle Extended	508 mm (20.0 in).
<b>Cooling</b>	Forced-air circulation.
<b>Finish</b>	Tek Blue vinyl clad material on aluminum cabinet.
<b>Construction</b>	Aluminum-alloy chassis (sheet metal). Plastic-laminate front panel. Glass-laminate circuit boards.

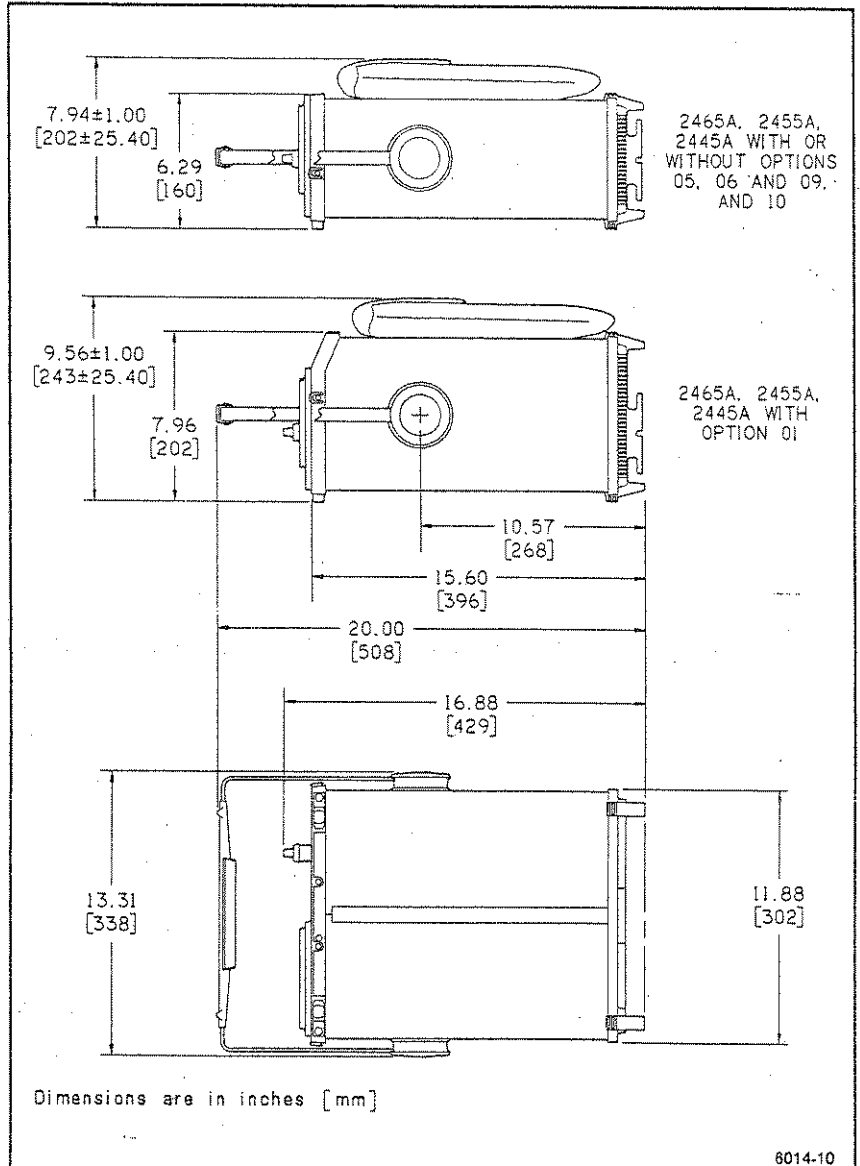

Figure 6-1. Dimensional drawing.

**Performance Characteristics**

**Table 6-8  
Environmental Requirements**

Characteristics	Performance Requirements
	Environmental requirements qualify the electrical and mechanical specifications. When not rack mounted, the instrument meets the environmental requirements of MIL-T-28800C for Type III, Class 3, Style C equipment, with the humidity and temperature requirements defined in paragraphs 3.9.2.2, 3.9.2.3, and 3.9.2.4. Rack mounting changes the temperature, vibration, and shock capabilities. The rack mounted instruments meet or exceed the requirements of MIL-T-28800C with respect to Type III, Class 5, Style C equipment with the rack-mounting rear-support kit installed. Rack mounted instruments will be capable of meeting or exceeding the requirements of Tektronix Standard 062-2853-00, class 5.
Temperature Operating	-15°C to +55°C.  For a rack mounted instrument, ambient temperature should be measured at the instrument's air inlet. Fan exhaust temperature should not exceed +65°C.
Nonoperating (Storage)	-62°C to +85°C.
Altitude Operating	To 15,000 feet. Maximum operating temperature decreases 1°C for each 1000 feet above 5000 feet.
Nonoperating (Storage)	To 50,000 feet.
Humidity Operating and Storage	Stored at 95% relative humidity for five cycles (120 hours) from 30°C to 60°C, with operational performance checks at 30°C and 55°C.
Vibration (operating) Not Rack Mounted	15 minutes along each of three axes at a total displacement of 0.025 inch p-p (4 g at 55 Hz), with frequency varied from 10 Hz to 55 Hz in one minute sweeps. Hold 10 minutes at each major resonance or, if none exists, hold 10 minutes at 55 Hz (75 minutes total test time).
Rack Mounted	Change displacement to 0.015 inch p-p (2.3 g at 55 Hz).



**Table 6-8 (cont)**  
**Environmental Requirements**

Characteristics	Performance Requirements
Shock (operating and nonoperating)	
Not Rack Mounted	50 g, half sine, 11 ms duration, three shocks on each face, for a total of 18 shocks.
Rack Mounted	30 g.
Transit Drop (not in shipping package)	8-inch drop on each corner and each face (MIL-T-28800C, para. 4.5.5.4.3).
Bench Handling (cabinet on and cabinet off)	MIL-STD-810C, Method 516.2, Procedure V (MIL-T-28800C, para. 4.5.5.4.3).
Topple (operating with cabinet installed)	Set on rear feet and allow to topple over onto each of four adjacent faces (Tektronix Standard 062-2858-00).
Packaged Transportation Drop	Meets the limits of the National Safe Transit Assn., test procedure 1A-B-2; 10 drops of 36 inches (Tektronix Standard 062-2858-00).
Packaged Transportation (Vibration)	Meets the limits of the National Safe Transit Assn., test procedure 1A-B-1; excursion of 1 inch p-p at 4.63 Hz (1.1 g) for 30 minutes (Tektronix Standard 062-2858-00).
EMI (Electro-magnetic Interference)	Meets MIL-T-28800C; MIL-STD-461B, part 4 (CE-03 and CS-02), part 5 (CS-06 and RS-02), and part 7 (CS-01, RE-02, and RS-03)—limited to 1 GHz; VDE 0871, Category B; Part 15 of FCC Rules and Regulations, Subpart J, Class A; and Tektronix Standard 062-2866-00.
Electrostatic Discharge Susceptibility	Meets Tektronix Standard 062-2862-00. The instrument will not change control states with discharges of less than 10 kV.
X-Ray Radiation	Meets requirements of Tektronix Standard 062-1860-00.



SECTION

7

*Options and Accessories*

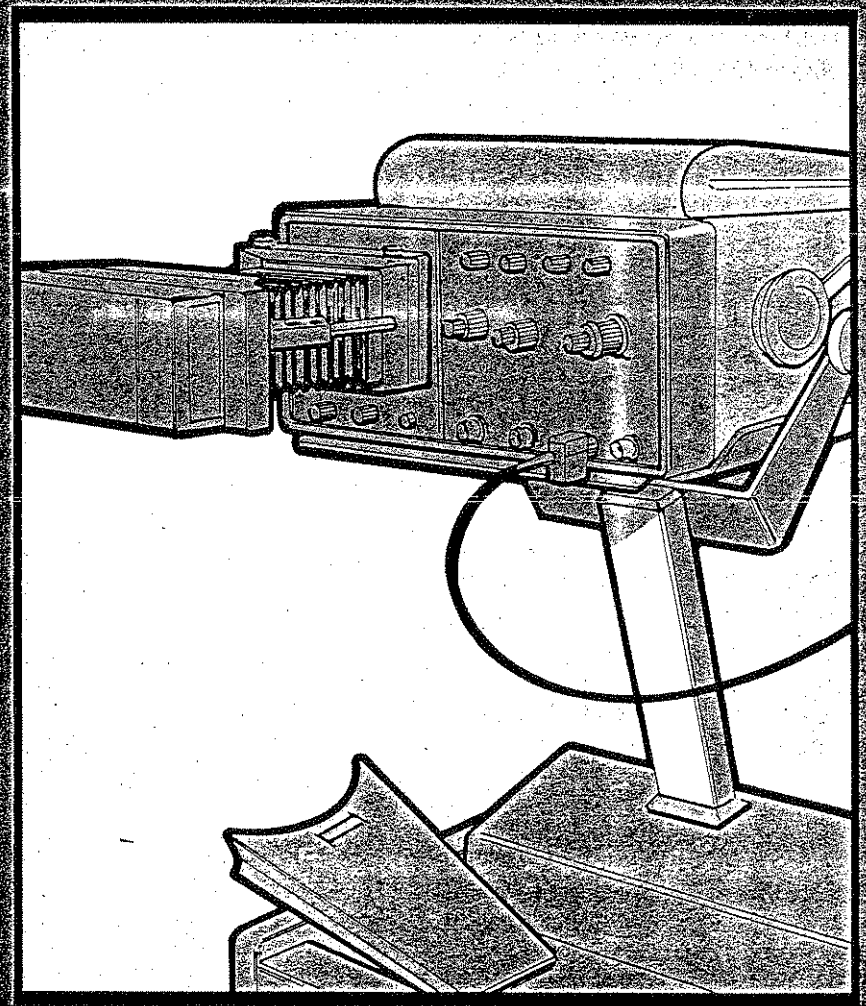

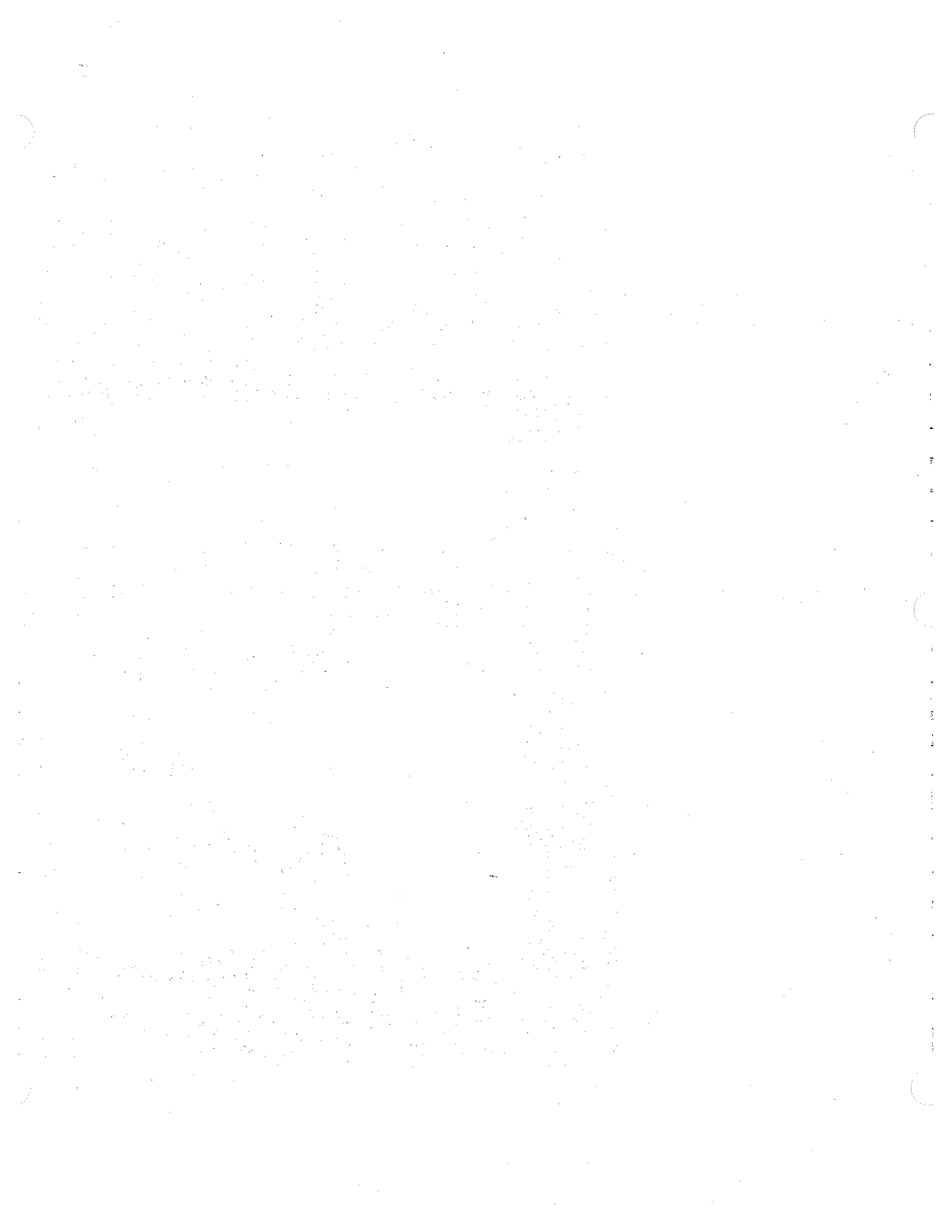

## ***Introduction***

This section contains a general description of instrument options available at the time of publication of this manual. Also included is a complete list (with Tektronix part numbers) of standard accessories included with each instrument and a partial list of optional accessories. Additional information about instrument options, option availability, and other accessories can be obtained either by consulting the current Tektronix Product Catalog or by contacting your local Tektronix Field Office or representative.

Options 01, 05, 06 and 09, and 10 are discussed throughout this manual.

## ***Option 11***

Option 11 provides two probe-power connectors on the rear panel of the instrument. Voltages supplied at these connectors meet the power requirements of standard Tektronix active oscilloscope probes.

## ***Option 1R***

When the oscilloscope is ordered with Option 1R, it is shipped in a configuration that permits easy installation into a 19-inch-wide electronic-equipment rack.

When rackmounting the instrument, the rear-support kit enables the rackmounted instrument to meet appropriate electrical and environmental specifications.

Connector-mounting holes are provided in the front panel of the rackmounted instrument. These enable convenient accessing of the four bnc connectors (CH 2 SIGNAL OUT, A GATE OUT, B GATE OUT, and EXT Z AXIS IN) and the two PROBE POWER connectors located on the rear panel. Additional cabling and connectors required to implement any front-panel access to the rear-panel connectors are supplied by the user; however, these items can be separately ordered from Tektronix.

Complete rackmounting instructions are provided in a separate document shipped with Option 1R. These instructions also contain appropriate procedures to convert a standard instrument into the Option 1R configuration by using the rackmounting conversion kit.

## **Power Cord Options**

Instruments are shipped with the detachable power-cord configuration ordered by the customer. Descriptive information about the international power-cord options is provided in Section 1, "Preparation for Use." The following list identifies the Tektronix part numbers for the available power cords and associated fuses.

### **Option A1 (Universal Euro)**

Power cord (2.5 m)	161-0104-06
Fuse (1.6 A, 250 V, 5 x 20 mm, Quick-acting)	159-0098-00

### **Option A2 (UK)**

Power cord (2.5 m)	161-0104-07
Fuse (1.6 A, 250 V, 5 x 20 mm, Quick-acting)	159-0098-00

### **Option A3 (Australian)**

Power Cord (2.5 m)	161-0104-05
Fuse (1.6 A, 250V, 5 x 20 mm, Quick-acting)	159-0098-00

### **Option A4 (North American)**

Power Cord (2.5 m)	161-0104-08
Fuse (2 A, 250 V, AGC/3AG, Fast-blow)	159-0021-00

### **Option A5 (Switzerland)**

Power Cord (2.5 m)	161-0167-00
Fuse (1.6 A, 250 V, 5 x 20 mm, Quick-acting)	159-0098-00

## Standard Accessories

The following standard accessories are provided with each instrument:

Qty	Description	Part Number
2	Probes (10X, 1.3 m) with Accessories (2465A and 2455A)	P6136 Opt 01
2	Probes (10X, 2 m) with Accessories (2445A)	P6133 Opt 01
1	Banana Plug/ Binding Post Adaptor	134-0016-01
1	Accessory Pouch, Snap Fastener	016-0692-00
1	Accessory Pouch, Zip-lock Fastener	016-0537-00
1	Operators Manual	070-6014-00
1	Fuse (2 A, 250 V)	159-0021-00
1	CRT Filter, Blue Plastic (installed)	378-0199-00
1	CRT Filter, Clear Plastic	378-0208-00
1	Front Cover	200-3199-00
1	U.S. Power Cord	161-0104-00

The following standard accessories are provided with instruments containing Option 01 (DMM):

Qty	Description	Part Number
1	Probe Set	012-0941-01
1	Accessories to Probe Set	020-0087-00
1	P6602 Temperature Probe	010-6602-00

***Options and Accessories***

---

The following standard accessories are provided with instruments containing Option 05 (TV):

<b>Qty</b>	<b>Description</b>	<b>Part Number</b>
1	CCIR Graticule	378-0199-01
1	NTSC Graticule	378-0199-02
1	Polarized Viewing Hood	016-0180-00

The following standard accessories are provided with instruments containing Option 09 (WR):

<b>Qty</b>	<b>Description</b>	<b>Part Number</b>
1	P6407 Word Recognizer Probe	010-6407-01
2	10-wide comb, 10-inch leads (without grabbers)	012-0747-00
20	Grabber Tips	206-0222-00



## Optional Accessories

The following optional accessories are recommended:

Description	Part Number
Protective Cover, Waterproof, Blue Vinyl	016-0720-00
Probe Package: 2465A and 2455A	P6136 Opt 01
2445A	P6133 Opt 01
Rackmounting Conversion Kit	016-0825-01
Polarized Collapsible Viewing Hood	016-0180-00
Folding Viewing Hood, Light-shielding	016-0592-00
Collapsible Viewing Hood, Binocular	016-0566-00
Oscilloscope Camera	See C30B Series
SCOPE-MOBILE Cart	200C
Carrying Strap	346-0058-00
2465A Service Manual	070-6019-00
2455A and 2445A Service Manual	070-6017-00
24X5A/2467 Options Service Manual [covers Option 01 (DMM), Option 05 (TV), Option 06 (CTT), Option 09 (WR), and Option 10 (GPIB)]	070-5857-00







## ***Extended Functions with Diagnostic Exercisers***

Diagnostic exercisers provide access to an operating-time log and they control instrument setup modes and the viewing-time display. The available GPIB interface adds exercisers to establish system parameters of the instrument and to transfer the set of thirty saved setups from one instrument to one or more other instruments. With the available Television/Video (TV) enhancement, added exercisers control video line numbering. The available DMM also adds an exerciser, DM EXER 72. The Service Manual describes other exercisers which are used only for instrument testing and troubleshooting.

<b>EXER 05</b>	Display Operating Time and Power Cycle Count
<b>EXER 06</b>	Select Setup to Use at Power Up
<b>EXER 07</b>	Enable/Disable Setup SAVE and Sequence Definition
<b>EXER 08</b>	Initialize Setups
<b>GP EXER 11</b>	Program GPIB Address
<b>GP EXER 12</b>	Program GPIB Message Terminator and Talk/Listen
<b>GP EXER 13</b>	Receive-Setups Mode
<b>GP EXER 14</b>	Send-Setups Mode
<b>TV EXER 61</b>	Select TV system-M or non-system-M
<b>TV EXER 62</b>	Select TV line numbering format
<b>TV EXER 63</b>	Select TV sync polarity default
<b>DM EXER 72</b>	Select DMM Continuity Tone and Input Resistance

To operate these features:

1. Enter the Diagnostic Monitor mode by pressing and holding both  $\Delta V$  and  $\Delta t$ , then pressing Trigger SLOPE while holding  $\Delta V$  and  $\Delta t$ . The readout will display "DIAGNOSTIC. PUSH A/B TRIG TO EXIT," indicating the Diagnostic Monitor mode.
2. Repeatedly press the upper or lower Trigger MODE button to sequence through the TEST and EXER routine labels and select the one you want to run.
3. Press the upper Trigger COUPLING button to execute the selected Exerciser. In all listed exercisers except EXER 05, the GP EXER's, and DM EXER 72, repeatedly pressing the upper Trigger COUPLING button cycles through the available selections.
4. To exit an exerciser, press the lower Trigger COUPLING button.
5. To return to normal instrument operation, press A/B/TRIG (or, with the available CTT, press A/B/MENU).

## Appendix A

---

In the descriptions below, the lines marked with ">" show what is displayed in the top row of the readout.

### EXER 05 Display Operating Time and Power Cycle Count

> HRS ON nnnn OFF/ON CYCLES mmmmm

nnnn = Accumulated Number of Hours with Power Applied

mmmm = Accumulated Number of Power Cycles

### EXER 06 Select Setup to Use at Power Up

> POWER UP TO POWER DOWN SETUP

Instrument will power up with the setup in effect at power down.

> POWER UP TO SETUP 1

Instrument will power up with the setup stored as setup 1.

### EXER 07 Enable/Disable Setup SAVE and Sequence Definition

> ENABLE SAVE AND SEQUENCE-CHANGE

All Save and Sequence functions are enabled.

> DISABLE SAVE AND SEQUENCE-CHANGE

All Save and Sequence-definition functions are disabled.

> ENABLE SAVE 1 - 8, NO SEQ-CHANGE

Only setups 1 through 8 can be changed. BEGIN/STEP/END attributes cannot be changed for any setup.

### EXER 08 Initialize Setups

> COUPLING UP CLEAR SAVED SETUPS

Press upper Trigger COUPLING to clear all saved setups.

Press lower Trigger COUPLING to retain saved setups.

**GP EXER 11** Program GPIB Address

> GPIB ADDRESS nn

nn = a primary address within 0 to 31. Turn the  $\Delta$  control to select the appropriate address. With address 31, bus data has no effect on the instrument and is unaffected by the instrument.

**GP EXER 12** Program GPIB Message Terminator and Talk/Listen

Press the upper MODE button to select EOI or LF as message terminator. Press the upper COUPLING button to select TALK/LISTEN or LISTEN operation.

> TERMINATOR EOI MODE TALK LISTEN

The instrument accepts only the EOI bus message as the end of a string of received bytes. The instrument asserts EOI at the end of a string of transmitted bytes. The instrument can be addressed as a talker to send settings and readings.

> TERMINATOR LF MODE TALK LISTEN

The instrument accepts either the EOI bus message or an LF (line feed) character as the end of a string of received bytes. The instrument asserts CR (carriage return) then LF with EOI at the end of a string of transmitted bytes.

> TERMINATOR EOI MODE LISTEN ONLY

The instrument will not operate as a bus talker.

> TERMINATOR LF MODE LISTEN ONLY

**GP EXER 13** Receive-Setups Mode

> READY TO RECEIVE SETUPS

1. Connect the instrument to another instrument of the same model and with the same options by a GPIB cable. If the instrument is a different model in the following list: 2445A, 2455A, 2465A, 2465A CT, 2465A DM, 2465A DV, and 2467, or one with a different set of options, most setups will be valid, but some will give unpredictable results.
2. Select GP EXER 14 in the other instrument.

> RECEIVING SETUPS

When the transfer is complete, the instrument will exit EXER 13 automatically.

**GP EXER 14** Send-Setups Mode

Before executing this exerciser, make sure the instrument is connected to another by a GPIB cable and be sure the other instrument is in the "READY TO RECEIVE SETUPS" state initiated by GP EXER 13.

> SENDING SETUPS

When the transfer is complete, the instrument will exit EXER 14 automatically.

**TV EXER 61** Select TV system-M or non-system-M

> LINE 1 OCCURS PRIOR TO FLD SYNC

System-M protocol is selected and the line count begins three lines before the field-sync pulse.

> LINE 1 COINCIDENT WITH FLD SYNC

Non-system-M protocol is selected and the line count begins coincident with the field-sync pulse.



**TV EXER 62** Select TV line numbering format

## &gt; LINE NO RESETS ON EACH FIELD

Line numbering begins with the first line of both field 1 and field 2.

## &gt; LINE NO RESETS ON FLD 1 ONLY

Line numbering begins at the first line of field 1 and continues through field 2.

**TV EXER 63** Select TV sync polarity default

## &gt; TVSYNC:SLOPE DEFAULT

Trigger Slope, which corresponds to sync polarity, does not change when LINES Coupling is selected.

## &gt; TVSYNC:POSITIVE

Trigger Slope is initialized to + when Coupling is changed from AC to LINES.

## &gt; TVSYNC:NEGATIVE

Trigger Slope is initialized to - when Coupling is changed from AC to LINES.

**DM EXER 72** Select DMM Continuity Tone and Input Resistance

## &gt; MOVE SOURCE FOR CONTINUITY TONE

Short the test leads together and press the upper SOURCE button to increase the pitch of the continuity tone or press the lower button to lower the pitch.

Press the upper COUPLING button to exit the continuity tone mode and press it again as required to select the desired input resistance.

> INPUT Z ON 0.2VDC 2VDC = 10 M $\Omega$ 

Input resistance on all DCV ranges = 10 M $\Omega$

> INPUT Z ON 0.2VDC 2VDC > 100G $\Omega$ 

The input approaches an open circuit on the two lowest DCV ranges and equals 10 M $\Omega$  on all other DCV ranges.



APPENDIX

---

# B



## Sequence Programming and Operation

As many as thirty stored setups can be organized into one or more sequences to be sequentially recalled by the STEP/AUTO button. Unless otherwise defined, all thirty setups can be recalled in one sequence.

A sequence is defined as a contiguous group of saved setups, where the first setup includes the BEGIN attribute and the last setup includes the END attribute. The Sequence-Save mode provides access to the BEGIN/END attributes and provides sequence editing facilities to REPLACE, INSERT, and DELETE setups.

Pressing SAVE establishes the Direct-Save mode, as described in the "Operation" section. Pressing STEP then establishes the Sequence-Save mode. The readout shows a definition mode, a step attribute, a setup number, the "NAME:" prompt, and the name argument in the top row and a HELP message in the bottom row. (If the Direct-Save mode displays "SAVE FUNCTIONS DISABLED" or if the Sequence-Save mode displays "SEQUENCE DEFINITION DISABLED," refer to EXER 07, described in Appendix C.)

Top Row	--	REPLACE STEP	:nn	NAME:xxxxxx
	or	REPLACE BEGIN	:nn	NAME:xxxxxx
	or	REPLACE END	:nn	NAME:xxxxxx
Bottom Row	--	PUSH STEP TO REPLACE SETUP.		

$\Delta$  REF moves a cursor to the definition mode field, the step attribute field, the setup number field, or any character in the NAME argument. The  $\Delta$  control selects a definition mode, REPLACE, INSERT, or DELETE; a step attribute, STEP, BEGIN, or END; a setup number, 1-30; or a character for each position of the setup name.

The initial definition mode is REPLACE. Initial values of the step attribute and setup NAME are the values previously stored at the selected setup number, unless NAME was changed in the Direct-Save mode. The initial value of the setup number is one more than the previously defined or selected setup. The cursor initially remains in the NAME argument, as it was in the Direct-Save mode.

When STEP is pressed in the REPLACE definition mode, the current instrument setup, with the displayed step attribute and the displayed NAME, if the NAME has been changed, replaces setup "nn."

A step with the BEGIN attribute begins a sequence of setups. END defines a step that ends a sequence.

## Appendix B

---

While REPLACE is selected, repeated operation of SAVE presents this cycle of HELP messages in the bottom row.

Top Row	--	REPLACE STEP	:nn	NAME:xxxxxxx
or	--	REPLACE BEGIN	:nn	NAME:xxxxxxx
or	--	REPLACE END	:nn	NAME:xxxxxxx
Bottom Row	--	PUSH STEP TO REPLACE SETUP.		
or	--	TURN Δ REF TO FIELD, THEN--		
or	--	TURN Δ TO DESIRED SETTING.		
or	--	PUSH RECALL TO CANCEL THIS MODE.		

When STEP is pressed in the INSERT definition mode, the numbers attached to the currently selected setup and each higher-numbered setup are increased by one and setup 30 is discarded. The current instrument setup, the displayed step attribute, and the displayed NAME are then stored in the selected memory location.

While INSERT is selected, repeated operation of SAVE presents this cycle of HELP messages in the bottom row.

Top Row	--	INSERT STEP	:nn	NAME:xxxxxxx
or	--	INSERT BEGIN	:nn	NAME:xxxxxxx
or	--	INSERT END	:nn	NAME:xxxxxxx
Bottom Row	--	INSERT WILL DESTROY STEP 30.		
or	--	PUSH STEP TO INSERT SETUP.		
or	--	TURN Δ REF TO FIELD, THEN--		
or	--	TURN Δ TO DESIRED SETTING.		
or	--	PUSH RECALL TO CANCEL THIS MODE.		

In the DELETE definition mode, the attribute and NAME fields cannot be changed. When STEP is pressed, the currently selected setup is moved to step 30 and the numbers associated with each higher-numbered setup decreases by one.

While DELETE is selected, repeated operation of SAVE presents this cycle of HELP messages in the bottom row.

Top Row	--	DELETE STEP	:nn	NAME:xxxxxxx
or	--	DELETE BEGIN	:nn	NAME:xxxxxxx
or	--	DELETE END	:nn	NAME:xxxxxxx
Bottom Row	--	PUSH STEP TO DELETE SETUP.		
or	--	TURN Δ REF TO FIELD, THEN--		
or	--	TURN Δ TO DESIRED SETTING.		
or	--	PUSH RECALL TO CANCEL THIS MODE.		

## Executing Sequences

Pressing **RECALL** establishes the Direct-Recall mode, as described in the Operation section. Then pressing **STEP** in the Direct-Recall mode enables the Sequence-Recall mode. The top row of the readout shows the names of the first four defined **BEGIN** steps. If no **BEGIN** steps are defined, step 1 is the beginning of a sequence, by default. Pressing a setup-number button initiates the corresponding sequence and illuminates the **STEP** indicator. The position of each button among the others corresponds to the position of a sequence name among the others on the screen. Pressing **STEP** initiates the first defined sequence and illuminates the **STEP** indicator.

Repeatedly pressing **RECALL** presents this cycle of **HELP** messages. In message 1, "**n**" is blank, "**-2**," "**-3**," or "**-4**," depending on how many sequences are defined.

Bottom Row	--	PUSH 1-n OR STEP TO START SEQ.
	or	TURN $\Delta$ TO SELECT ANY STEP.
	or	PUSH SAVE TO CANCEL THIS MODE.

Turning  $\Delta$  **REF** or  $\Delta$  while in the Sequence-Recall mode accesses to any setup.

**STEP** recalls any selected setup, initiates sequential setups, and illuminates the **STEP** indicator. If the step number is decremented below 1, the Direct-Recall mode is reestablished.

Top Row	--	nn xxxxxx TURN $\Delta$ TO SELECT.
Bottom Row	--	PUSH STEP TO BEGIN SEQ HERE.
	or	PUSH SAVE TO CANCEL THIS MODE.

Repeated operation of **STEP/AUTO** sequentially steps through the sequentially stored setups. When an **END** step or step 30 is encountered, the sequence reverts to the previous **BEGIN** step, or to step 1, if no previous **BEGIN** step exists.





APPENDIX

---

# C



## ***Power Up Tests***

Power-up tests are automatically performed each time the instrument is turned on. These tests provide the user with the highest possible confidence that the instrument is operational. They include a Kernel test and Confidence tests.

### ***Kernel Test***

A kernel test failure is considered "fatal" to the operation of the instrument. A Kernel test failure causes the TRIG'D indicator to flash and displays a binary code pattern on other front panel indicators. If a kernel test fails, the user can attempt to operate the instrument normally by pressing the A/B TRIG button. Operation is unpredictable; it depends on the nature of the failure.

### ***Confidence Tests***

Confidence tests are performed after the processor kernel has been found operational. These tests check a portion of the instrument for correct operation.

If a Confidence test fails, the readout will indicate the nature of the failure by a coded message in this format:

**TEST XX FAIL YY**

where XX is a two-digit test number and YY is a failure code. Table C-1 shows the function affected by detected failures.

Appendix C

---

Table C-1  
Confidence Test Numbers and Affected Functions

Test Number	Description
01	Controller Timing Signal Missing or Wrong Period
02	Momentary Switch Stuck
03	Readout Interface or Memory Failure
04	Calibration Data Parity or Checksum Error
05	Main Board Failure Detected by Auto Level Trigger on LINE Source
06	Memory-Battery Voltage Too High or Too Low
GP 11	GPIB Interface Failure Detected
DM 76	Digital Multimeter Failure Detected
CT 81 - 87	Counter-Timer-Trigger Failure Detected

APPENDIX

---

# D

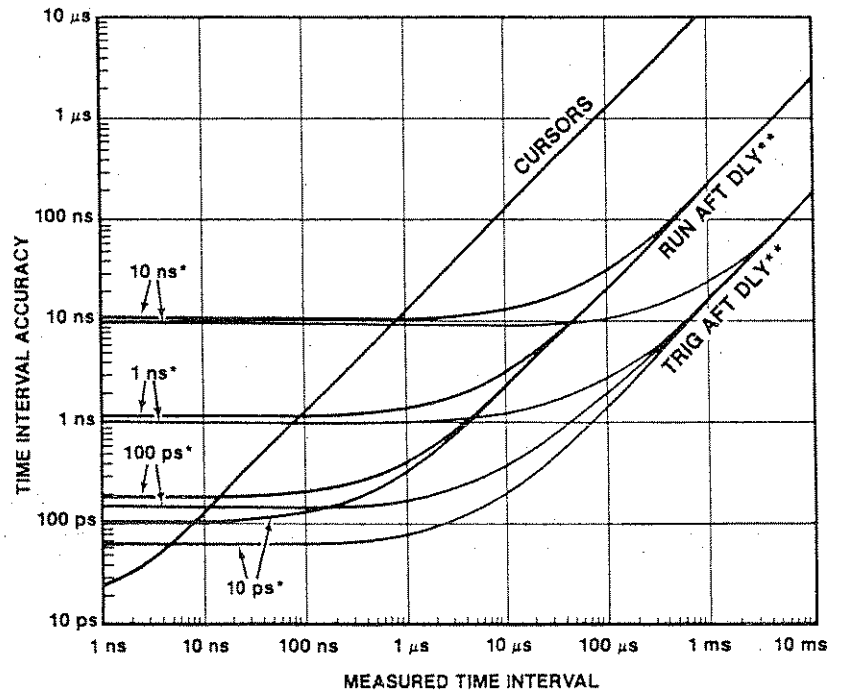

**Delta-Time and Delta-Delay-Time  
Accuracy under Noted Conditions  
for the C/T/T Option**

**CONDITIONS:**

- 1) Input signal is 5 vertical divisions with a 2 ns rise time.
- 2) Measured times are 4 horizontal divisions.
- 3) TJE is negligible for slew rates greater than 0.1/div ns.
- 4) For all B-Trigger modes, the beginning and end of the measured interval are visually superimposed.
- 5) RUN and TRIG accuracies are with RUN AFT DLY and TRIG AFT DLY B-Trigger Modes.

\* Selected resolution. See "Resolution Selections" table for resolutions corresponding to trigger rates with AUTO resolution.

\*\*B-Trigger Modes

### Delay-Time Accuracy under Noted Conditions for the C/T/T Option

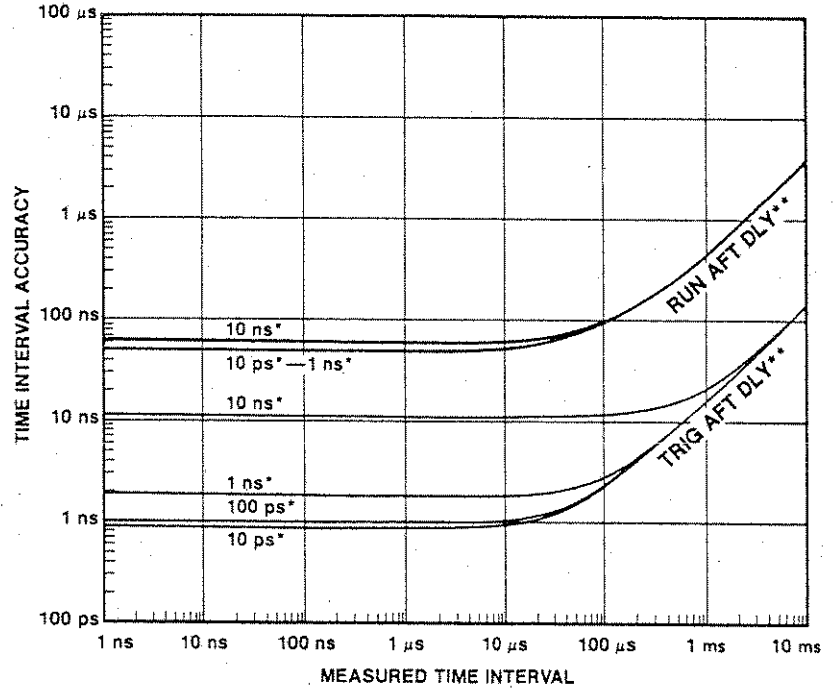

**CONDITIONS:**

- 1) Input signal is 5 vertical divisions with a 2 ns rise time.
- 2) Measured times are 4 horizontal divisions.
- 3) TJE is negligible for slew rates greater than 0.1 div/ns.
- 4) RUN and TRIG accuracies are with RUN AFT DLY and TRIG AFT DLY B-Trigger Modes.

\* Selected resolution. See "Resolution Selections" table for resolutions corresponding to trigger rates with AUTO resolution.

\*\*B-Trigger Modes



**CAUTION**

TO AVOID ELECTRIC SHOCK THE POWER CORD PROTECTIVE GROUNDING CONDUCTOR MUST BE CONNECTED TO GROUND.  
DO NOT REMOVE COVERS, KEYS, SWITCHES OR DISCONNECT INPUT POWER BEFORE REPLACING FUSE FOR CONTINUED FINE PROTECTION. REPLACE ONLY WITH SPECIFIED TYPE AND RATED FUSE.

FUSE VOLTAGE SELECTION	RATING	USE 198 69346	USE 197
115V	90 1/2T	4 X 1/4 250V	500000 250V
230V	180 250V	2A FAST	1BA 1T

POWER MAX WATTS: 120  
FREQ: 48-440HZ  
TECHNIX GUERNGEY LTD. E.I.

P8407 OUT  
WOUND HEADS OUT

GP18 CONNECTOR  
IEEE STD 488 PORT  
SHL. AHL. 18, 13, SHI. R11  
P84. DCL. DT8. CA. E1

CH 2 SIGNAL OUT  
IMMEDIAT. INTO SOL

A GATE OUT  
TTL A

STEP/PAUSE  
EXT SWITCH

B GATE OUT  
TTL B

EXT Z AXIS IN  
1525VPH TTL A BLANKS

**DMM**

RANGE  
AUTO RANGING  
HOLD  
MIN/MAX

DCV	ACV	dBV	Ω	Hz	100
DCA	ACA	dBm	10 Ω		

MIN/MAX REF  
HOLD DISPLAY DISPLAY  
SMOOTH MIN/MAX REF  
RESET SET

°C °F

1.5A FUSE  
HIGH 5.00V 50mA  
LOW 5.00V 50mA

**Tektronix 2465A** OSCILLOSCOPE 350MHz GPIB STATUS LOCK SRG BEM

**VERTICAL POSITION**

CH 1 CH 2 CH 3 CH 4  
MODE  
ADD INVERT COPY/ ZOMH- ALT BW/LIMIT

**VERTICAL POSITION**

Δ REF OR BLY POS  
LINE  
MENU SELECT

**TRIGGER LEVEL**

HOLD OFF TRIG SWP INT@50%  
A SWP B SWP  
A/R MENU SLOPE INT@50%  
NOISE CH 1 CH 2 CH 3 CH 4  
AUTO LIN VERT DC HF REA LF AC

**MODE SOURCE COUPLING**

MODE SOURCE COUPLING  
LINE TRIG Δ BLY  
TRIG Δ BLY

**VOLTS/DIV**

5V 2mV  
5V 2mV  
5V 2mV  
5V 2mV

**SEC/DIV**

A SWP 8 SWP  
SLOW VAR FAST

**CH 1 or Σ**  
IMΩ 15pF = 400Vpk  
50 Ω ≤ 5V RMS  
AC GND DC GND DC

**CH 2**  
IMΩ 15pF = 400Vpk  
50 Ω ≤ 5V RMS  
AC GND DC GND DC

**CH 3**  
IMΩ 15pF = 400Vpk  
50 Ω ≤ 5V RMS  
AC GND DC GND DC

**CH 4**  
IMΩ 15pF = 400Vpk  
50 Ω ≤ 5V RMS  
AC GND DC GND DC

CALIBRATOR  
INTO 50Ω  
INTO 50Ω

POSITION  
VOLTS/DIV .5V/IV .5V/IV

TRACE SEP

TRIGGER  
TRIG SWP INT@50%  
A SWP B SWP

INTEGRITY BEAM FIND INTENSITY

TRACE ROTATION FOCUS READOUT INTENSITY SCALE ILLUM POWER

ARTIC OFF ARTIC ON  
SCAL FACTORS OFF SCAL FACTORS ON

INTELLIGENT DMM (DMM) panel on the left side of the main unit.





