

2710 Spectrum Analyzer User's Guide

Introduction

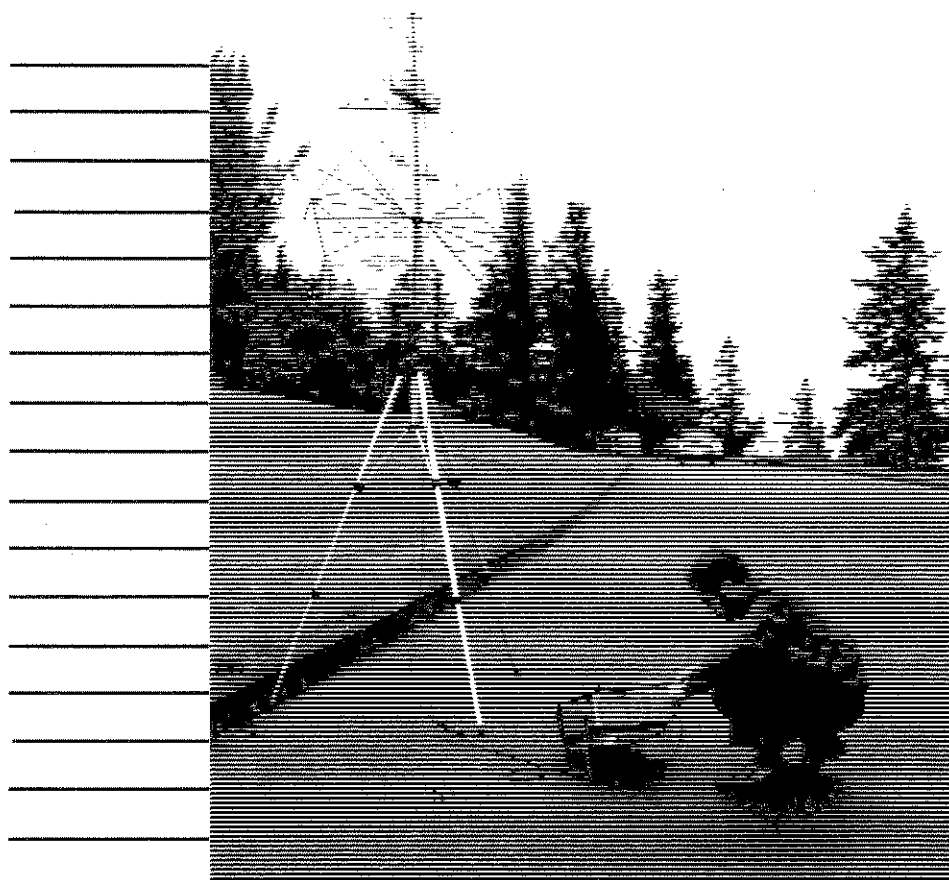

Table of Contents

Introduction 1-1

Using This Manual	1-1
Typographical conventions	1-3
What is a Spectrum Analyzer?	1-5
What Can You Do with a Spectrum Analyzer?	1-8
About the 2710	1-8

Getting Started 2-1

Precautions	2-1
Turning on the 2710	2-3
Restoring the Factory Default Settings	2-4
The Spectral Display	2-4
The Control Panel	2-7
Sounds	2-9
The Built-in Calibrator	2-10
Making Your First Measurement	2-11

The Controls 3-1

Fundamental Operations	3-1
Frequency Span/Division	3-2
Maximum Span	3-3
Zero Span	3-3
Center Frequency Control	3-4
Reference Level, Higher - Lower	3-5
Reference Level, 1dB/10dB per Step	3-6
Enhanced Versatility	3-7
Resolution Bandwidth, Wider - Narrower	3-7
Resolution Bandwidth, AUTO Mode	3-9
Resolution Bandwidth, Video Filter	3-10
Vertical Scale, 10dB/5dB/1dB per Step	3-12
Vertical Scale, LIN	3-13

Sweep, FAST - SLOW	3-14
Sweep, AUTO Mode	3-15
Sweep, SGL SWP	3-16
Sweep, LEVEL	3-17
Display Storage and the Analog Display	3-18
Display Storage, SAVE	3-20
Display Storage, Waterfall Mode	3-22
Display Storage, MAX HOLD	3-24
Frequency/Markers, MKR/ /Off	3-25
Frequency/Markers, CTR MEAS/TRKG	3-28
Frequency/Markers, Next Peak Right/Left	3-32
Frequency/Markers, MKR PEAK FIND	3-33

Miscellaneous Controls	3-33
Graticule Illumination	3-34
INTENSITY	3-34
TRACEROT, VERT POS, HORIZ POS	3-35

The Menus — Ultimate Flexibility 4-1

Input Menu	4-7
Turning the Calibrator On and Off	4-7
Changing the Reference Level	4-8
Setting the RF Attenuation	4-8
Changing Reference Level Units	4-9
Accommodating External Amplification/Attenuation	4-10
Accommodating a 75 Ohm Source	4-11A
Setting the First Mixer Input Level	4-13
Turning the Preamplifier On and Off	4-14
Using the dBUV/M	4-15

Marker/Frequency Menu	4-25
Setting the Center Frequency Using the MKR/FREQ MENU	4-25
Setting the Span/Division Using the MKR/FREQ MENU	4-26
Using the Keypad to Set Start and Stop Frequencies	4-26
Using Markers to Set Start and Stop Frequencies	4-27A
Transposing Markers	4-27A

Changing the Knob Function	4-28A
Moving the Marker to the	
Next Higher or Lower Peak	4-29A
Marker to the Reference Level	4-30A
Selecting the Tuning Increment	4-31
Center or Start Frequency	4-32
Setting the Signal Threshold	4-32
Counter Resolution	4-33
Programmed Tuning	4-34
Tabular Tuning	4-35
Frequency Offsets	4-36
Display Menu	4-38
Ensemble Averaging	4-38
Subtracting Stored Signals	4-43
Changing Acquisition Mode	4-47
Activating Minimum Hold	4-48
Adding Titles and Labels	4-49
Turning the On-screen Readouts On and Off	4-51
The Display Line and Limit Detector	4-52
Measuring Frequency Deviation	4-54
Measuring Percent Modulation	4-57
Displaying an External Source	4-58
Applications Menu	4-58
Measuring Occupied Bandwidths	4-59
Measuring Average Noise	4-60
Measuring Carrier to Noise Ratios	4-61
Searching for Signals	4-63
Detector/Generator Menu	4-66A
Listening to FM Transmissions	4-66A
Listening to AM Transmissions	4-67A
Listening to FM or AM Transmissions	4-67A
Using the Tracking Generator	4-67A1
Turning the Tracking Generator	
on and off	4-67A3
Normalizing the Tracking Generator	4-67A3
Setting the Tracking Generator	
Amplitude	4-67A4
Accounting For External Amplification	
or Attenuation	4-67A7
A Practical Example	4-67A9

Utility Menu	4-68A
Keypad Entered Control Settings	4-68A
Recalling Last Power-Down Settings	4-70
User-Defined Power-Up Settings	4-70
Other User-Defined Settings	4-71
Normalizing the 2710	4-72A
System Configuration	4-75A
The Communications Port	4-75A
Selecting the Screen Plotter	
Configuration	4-76A1
Selecting the Printer Configuration	4-76A2
Instrument Configuration	4-76A2
The Audio Alert Level	4-77
Setting the Minimum Signal Size	4-77
Sending Waveforms to a Computer	4-78
Turning Phase Lock On and Off	4-78
Turning Frequency Corrections	
On and Off	4-79
The Spectral Display in Menus	4-79
Changing the Sweep Holdoff	4-80A
Setting the Date and Time	4-80A
Protecting Stored Settings	4-80A
The 2710 File System	4-80A1
Protecting Files	4-80A1
Confirming Installed Options	4-81A
Instrument Diagnostics and Adjustments	4-81A
Aligning the Display with the Screen	4-82A
Service Normalizations	4-82A
If You Lose NVRAM	4-84A
Plotting the Displayed Waveform	4-85A
Generating a Service Request	4-85A
Printing the On-screen Readouts	4-86A
Sweep/Trigger Menu	4-87
Free Running the Sweep Generator	4-87
"Oscilloscope" Trigger Modes	4-87
TV Line Triggering	4-90
TV Video Field Triggering	4-93
Setting the Sweep Rate	4-93
Manually Scanning	4-94
The Video Monitor	4-94
User-Definable Key	4-97

//////////////////////////////////// 2710 Spectrum Analyzer User's Guide //////////////////////////////////////

External I/O	5-1
<hr/>	
Mains Power	5-1
J101 — TV Sideband Adapter Interface	5-1
J102 — External Trigger	5-2
J103 — Accessory Connector	5-3
Pin 1 — Video Input	5-3
Pin 2 — Chassis and Signal Ground	5-4
Pin 3 — Video Output	5-5
Pin 6 — Sweep Gate	5-5
Pin 7 — Sweep Ramp	5-7
Appendix A — Broadcast AM, FM, and TV signal sources	A-1
<hr/>	
Appendix B — Error Messages.	B-1
<hr/>	
Appendix C — Global Resets On the 2710	AC-1
<hr/>	
Index	I-1
<hr/>	

List of Illustrations and Tables

Illustrations

Figure 1-1. Spectrum analyzer block diagram (late model).	1-7
Figure 2-1. 2710 display with factory power-up settings.	2-5
Figure 2-2. 2710 calibration signal and harmonics.	2-12
Figure 2-3. Calibration signal and second harmonic.	2-14
Figure 3-1. Example of a waterfall display.	3-23
Figure 4-1. The 2710 menu hierarchy.	4-2A,4-3A
Figure 4-2. The Input Menu.	4-4
Figure 4-3. Reference Level Units Menu.	4-5
Figure 4-4. 75/50 ohm matching minimum loss pad.	4-13
Figure 4-5. Equipment setup for field strength measurements.	4-18
Figure 4-6. Average signal plus noise and average signal plus noise subtracted from the current sweep.	4-44
Figure 4-7. Average MEAN noise and MAX HOLD signal plus noise spectra.	4-45
Figure 4-8. B, C MINUS A OFFSET TO CENTER.	4-46
Figure 4-9. B, C MINUS A OFFSET TO TOP.	4-47
Figure 4-10. 2710 plot with title and plot label.	4-51
Figure 4-11. Portion of US broadcast FM band.	4-55
Figure 4-12. Instantaneous frequency deviation and maximum observed deviation.	4-56
Figure 4-13. Frequency deviation by MAX HOLD technique.	4-57
Figure 4-14. The SIGNAL SEARCH frequency range.	4-64
Figure 4-14A. Equipment setup for tracking generator measurement of 50-ohm devices.	4-67A2
Figure 4-14B. Bandpass filter response using the 2710 op- tional tracking generator and B,C MINUS A mode. ..	4-67A9
Figure 4-15. Typical plotter output from the 2710 showing a broadcast television spectrum.	4-86A
Figure 4-16. Video field using internal or TV field triggering. ..	4-89
Figure 4-17. Video signal using continuous horizontal line triggering.	4-91
Figure 4-18. Video signal using knob-selectable horizontal line triggering.	4-92
Figure 4-19. 2710 screen in video monitor mode.	4-96
Figure 5-1. Sweep gate and ramp timing.	5-6

Tables

Table 2-1. Effect of arrow keys. 2-11
Table 3-1. Display register status. 3-26
Table 4-1. Units associated with the letter-keys. 4-5
Table 4-2. Equivalent decibel - voltage values. 4-23
Table 4-3. The 2710 file system. 4-80A2

//////////////// 2710 Spectrum Analyzer User's Guide //////////////////



INTRODUCTION

This chapter introduces you to the *2710 Spectrum Analyzer User's Guide* and the typographical conventions used herein. It briefly describes scanning spectrum analyzers in general and gives an overview of the Tektronix 2710 Spectrum Analyzer.

Using This Manual

This manual tells you how to carry out a variety of practical measurements using your 2710 Spectrum Analyzer. It does not replace your Operators Manual. The Operators Manual defines the functions of each control or menu; this manual tells you how to use those controls and menus to make measurements quickly and easily. Read the *User's Guide* interactively with the 2710; carry out the instructions in the manual using the spectrum analyzer. In this way you will quickly acquire the knowledge and skills necessary to confidently make accurate measurements.

Proceed serially through this manual. Although each section of the manual can stand alone, it has been written to acquaint you with the most important features of the analyzer first, and to gain you increased experience with previously-discussed controls as you proceed through the tutorial. If you are new to the 2710 or spectrum analysis in general, we recommend that you also read Tektronix application note 26W-7037, *Spectrum Analyzer Fundamentals*.

/////// 2710 Spectrum Analyzer User's Guide /////

The *User's Guide* is divided into small lessons. The end of one lesson and start of the next are indicated by a "settings box" that looks like this:

100.0MHz	(AUTO SWEEP)	ATTN 10DB
-20.0DBM		VF WIDE
20.0MHz/ 5MHz RBW (AUTO)	CALIBRATOR	10 DB/

The box shows what the control settings of the 2710 should be to continue with the section of the manual which follows it. The contents of the box resemble the analyzer's standard on-screen data readouts which will be explained in more detail in the next chapter. Each lesson begins with the sweep and resolution bandwidth controls in AUTO mode. To remind you of this, (AUTO SWEEP) is shown in the top center of the box and (AUTO) follows the resolution bandwidth setting. The parentheses mean the enclosed item is not part of the normal on-screen readouts.

As a newcomer to spectrum analysis, you will find the material in the *Introduction* and *Getting Started* sections of this manual especially helpful. The *Introduction* contains a brief description of spectrum analysis and reviews the characteristics of the Tektronix 2710 Spectrum Analyzer. *Getting Started* enables you to safely apply power and signals to the 2710. You become acquainted with the front panel of the instrument and make your first measurement using the built-in calibration signal. The *Introduction* and *Getting Started* are complete lessons and, therefore, contain no settings boxes.

The Controls and *The Menus--Ultimate Versatility* explain – with the help of examples you carry out – the features of the 2710 and the benefits you gain from each control and menu option. You learn to easily obtain accurate spectral *and time-domain measurements*.

External I/O teaches you how to get signals in and out of the back panel of your spectrum analyzer.

////////// 2710 Spectrum Analyzer User's Guide //////////

If you are already familiar with the 2710, this guide can serve as a handy "how to" reference. Check the index or table of contents for the location of information about specific functions. Then set up the analyzer according to the settings box preceding the topic of interest and refresh your memory by following the example.

Typographical Conventions

A few typographical conventions are used to make this manual more convenient to use. Text consists of information and instructions. Instructions are printed in **bold type** to distinguish them from purely informational statements. For example, the instruction:

Change the center frequency by turning the **FREQ/
MARKERS knob.**

is distinguished from the informational statement:

Turning the **FREQ/MARKERS** knob changes the frequency.

by the **bold** text.

Textual information that appears on the spectrum analyzer screen, such as the data in the readout areas, is printed as it appears on screen. For instance, the span per division and resolution bandwidth appear in the upper left of the screen in this format:

**20.0 MHz/
5 KHz RBW**

Square brackets enclose the names of keys which you press on the 2710 Spectrum Analyzer. The names will be in upper-case print (with the exception of the d in dB) as they appear on the spectrum analyzer front panel except that names occupying more than one line on the analyzer are printed on a single line.

//////////////////// **2710 Spectrum Analyzer User's Guide** //////////////////////

For instance, if we tell you to **press**:

[MAX SPAN]

we mean "**Press the key that looks like**



in the upper center of the 2710 control panel."

When making choices from menus, twelve numerical keypad indicators adjacent to certain keys are illuminated by green LED's. Then the key is referred to by the number adjacent to it. For instance, when the MAX SPAN key is being used as keypad number 7, a green LED next to the key will backlight a numeral 7. We will then tell you to **press**:

[7]

When we want you to press a series of keys, we print the series using slashes (/) as delimiters. For instance, if we tell you to **press**:

[UTIL MENU]/[1]/[1]

we mean **sequentially press the UTIL MENU key, the 1 key, and the 1 key a second time.**

When selection of an item from a menu is required, the item number, its description as it appears on the menu, or both are given. For instance, soon you will select item 9 from the Input Menu. This is how the description of item 9 appears on the menu and in text:

CAL SIG @ 100MHZ -30DBM

There are two other important conventions. The first is the Caution symbol:

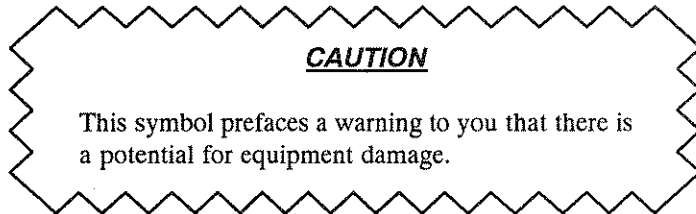

The second is the Note symbol:

NOTE

This symbol prefaces information which is not essential to an operation but may promote a fuller understanding.

What is a Spectrum Analyzer?

There are several types of spectrum analyzers, but we will describe only the heterodyne or scanning analyzer. A scanning spectrum analyzer is essentially a radio receiver. Imagine you tune a conventional FM broadcast receiver from one end of the band to the other. As you tune, plot the reading of the tuning meter versus frequency. The graph you produce is a *frequency domain* representation, or spectrum, of the FM broadcast band; it tells you at which frequencies the signals occur and how strong they are. If stations are too close together, you will hear them simultaneously and you will not be able to get an independent meter reading for each. This is because the intermediate frequency (IF) filter of the receiver has a bandwidth too wide to *resolve*, or separate, the stations.

In this thought-experiment, you are manually tuning, or *scanning*, the FM broadcast band with a *resolution bandwidth* (RBW) equal to the bandwidth of the IF filter in your receiver. Suppose you plot your measurements on graph paper with one centimeter divisions, making each division equal one MHz. The span/division of the resulting plot is then 1 MHz/division. When you stop tuning, your receiver is no longer scanning; it is

//////////////////// **2710 Spectrum Analyzer User's Guide** //////////////////////

in *zero span* mode. The output of the receiver is now a *time domain* representation (signal amplitude vs. time) of the signal coming through the IF filter at the frequency to which the receiver is presently tuned. After detection, the signal appears at the receiver's speaker as the sound you hear.

A spectrum analyzer performs similarly except that the scan is usually performed automatically (and faster than you do it manually) and there is a selection of IF bandwidths or RBW's to choose from. Multiple RBW's are needed because in some cases you will want to separate closely-spaced, narrowband signals, while in others you will want to examine signals with larger bandwidths. There is a maximum speed at which a band can be accurately scanned with a RBW of a given width; generally the smaller the RBW, the slower the speed. The 2710 can automatically select the fastest speed for you.

You can find additional information about basic spectrum analyzer concepts and definitions in *Spectrum Analyzer Fundamentals* .

Figure 1-1 is a conceptual illustration of how the 2710 is put together. As you proceed through the tutorial, you may find it useful to refer to this block diagram to understand how the various features of the analyzer operate.

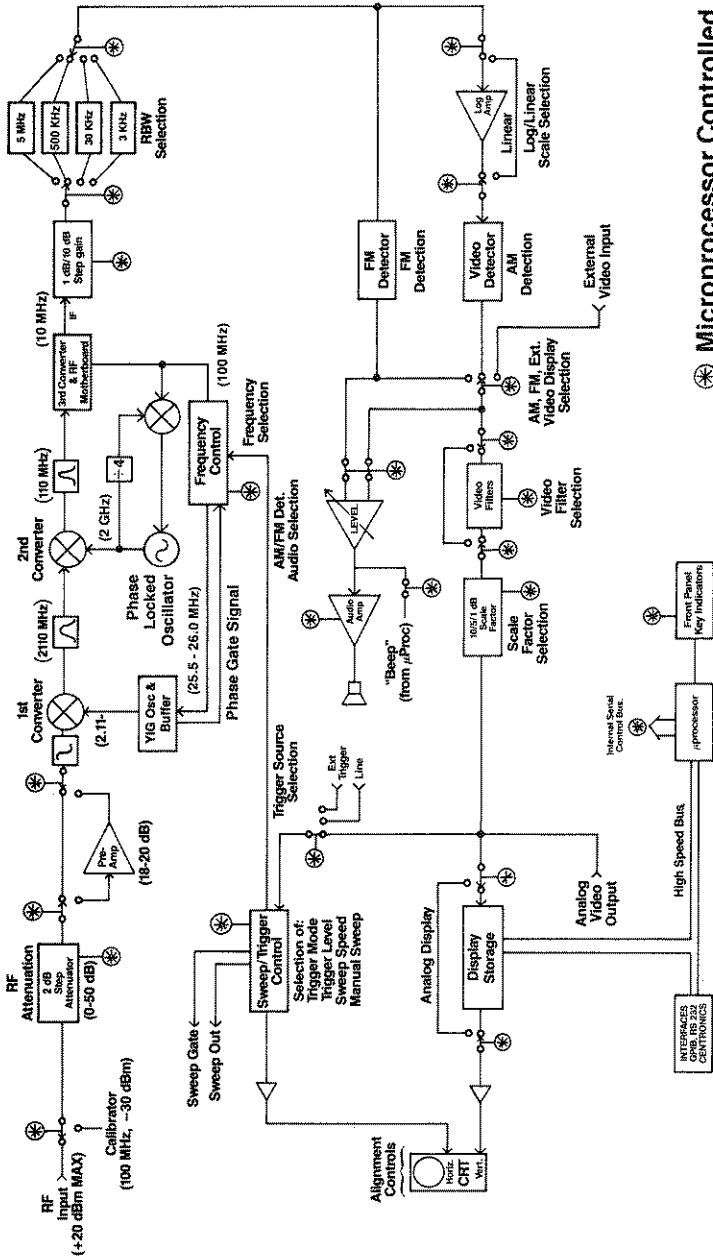

Figure 1-1. Spectrum analyzer block diagram (late model).

What Can You Do with a Spectrum Analyzer?

Spectrum analyzers measure how the power in an input signal is distributed in frequency. Therefore, you can use them to determine signal amplitudes and frequencies, noise power, carrier-to-noise (C/N) ratios, signal or filter bandwidths, distortion (harmonic and intermodulation), FM deviation, per cent modulation, detect spurious signals, align transmitters and receivers, check specifications, and so forth.

About The 2710

The Tektronix 2710 is a portable radio frequency (RF) scanning spectrum analyzer designed for use in the field as well as the laboratory. It is light weight (less than 21 lbs/9.5 kg) and can be equipped with battery and inverter for use in locations without AC power. The instrument is very durable, but rough handling or liquids, dust, or other contaminants inside the case can cause damage. The optional Travel Line package provides additional protection during transportation.

The 2710's user interface is simple enough for the neophyte but versatile enough to satisfy an expert. Fundamental measurement parameters (center frequency, span/division, reference level, etc.) can be controlled directly with dedicated keys. In fact, as you'll learn in the next chapter, *you can display a spectrum by touching only three controls*. Making measurements can be so easy that even experienced engineers get the feeling of "1, 2, 3...how simple can it get?" On the other hand, call-up menus enable you to automate certain operations, such as bandwidth or carrier-to-noise ratio measurements, and to directly enter front-panel control settings. Measurement parameters and results are displayed on-screen.

To increase measurement flexibility, the 2710 has a broad range of standard features. Input signal sensitivity with the built-in preamp activated is -129 dBm, and signals as large as +20 dBm can be accommodated. A frequency-corrected oscillator provides accuracy of 1×10^{-5} of center frequency ± 5 KHz.

////// 2710 Spectrum Analyzer User's Guide ////

AUTO operation allows both sweep speed and resolution bandwidth to be selected automatically. *Digital* and *analog* displays are standard, as are time domain functions (with 1μ sec/div sweep speed in analog mode), AM/FM detection, built-in preamplifier, user-definable modes, and 3 kHz - 5 MHz RBW's.

Standard post-detection digital sampling (at a 2.5 MHz conversion rate) and storage is used with a unique max/min display mode that provides a close approximation of analog displays. Peak detection is also provided. It is possible to display up to four traces simultaneously and to perform ensemble statistics. A continuously updated "waterfall" display mode can be used to compare the four most recent spectral sweeps. Standard non-volatile random access memory (NVRAM) enables you to save nine front-panel configurations and about 18 on-screen displays. The exact number depends on what else you are storing in the instrument (such as user-defined keystroke sequences), and whether certain other options are also installed.

Optional 2710 capabilities result in even greater performance. Option 1 includes phaselocked stability and a 300 Hz RBW filter. Sensitivity is increased to -139 dBm with the built-in preamp activated and 10 times greater resolution is provided than the standard 3 kHz filter. Option 2 is a digital frequency counter which reads out on screen. Along with Option 1, it increases frequency accuracy to 5×10^{-7} of center frequency ± 10 Hz ± 1 least significant digit.

NOTE

Since Tektronix continually improves its products, it is possible there may be a few differences in how your 2710 operates compared to the description in this document. Check with Tektronix if further information is needed.

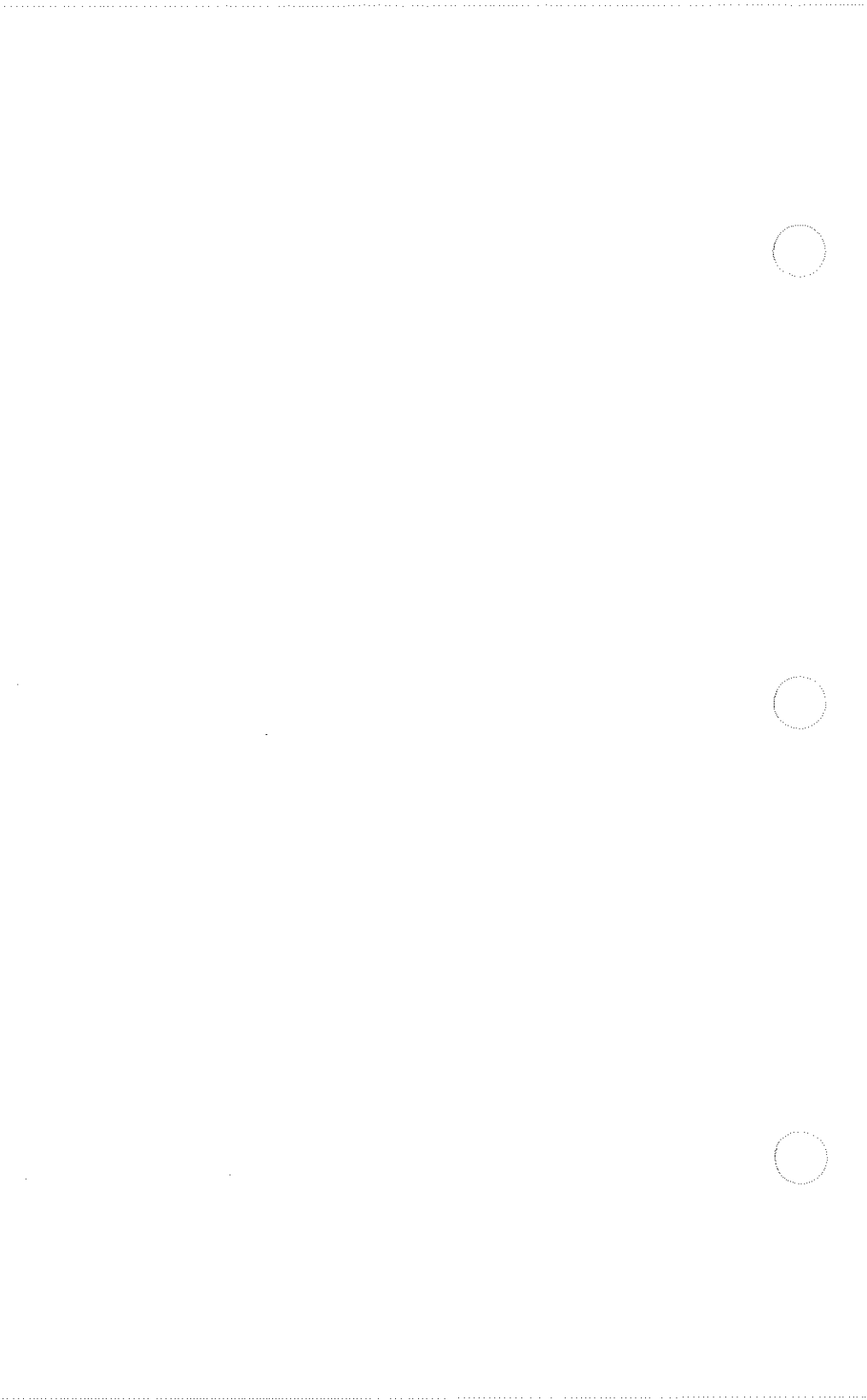

GETTING STARTED

In this chapter you are going to make your first measurement with the 2710 Spectrum Analyzer. It is a simple verification of the built-in calibrator signal. Along the way you will learn precautions to safeguard the instrument, discover the necessity for normalization procedures, and become acquainted with the layout of the front panel and display.

Precautions

The 2710 is tough but not indestructable. It can be damaged by:

- applying too large a signal to the input
- applying incorrect mains power
- allowing moisture, dust, or other contaminants inside the case
- handling the analyzer with undue roughness
- not providing proper ventilation

Never input signals to the analyzer if their combined amplitude is greater than +20 dBm or has a DC component greater than 100 volts. If you exceed the maximum input ratings,

You Can Turn the 2710 Into a Smoke Generator!

If necessary, use an external attenuator first. Further, to prevent damaging transients, use maximum RF attenuation when connecting a signal with a DC component. Then remove attenuation as needed to make the measurement. Also be aware that the 2710 is optimized for a -30 dBm input to the first mixer. A larger input signal may lead to nonlinear operation and inaccurate results.

We recommend that you *Do Not* connect the 2710 directly to a CATV trunk carrying AC power. The mixer can be overloaded making accurate measurements impossible, and a surge in the AC power might place the peak AC voltage above the 100 volt level tolerable by the 2710.

//////////////////// **2710 Spectrum Analyzer User's Guide** //////////////////////

NOTE

The maximum safe RF and DC input levels are clearly printed near the signal input jack.

The 2710 uses mains power of 90 - 250 VAC and 48 - 440 Hz. In the normal laboratory or factory environment, using standard plugs and receptacles, it is unlikely that you will apply incorrect power. However, in the field or during abnormal conditions, you might have to rig temporary power. Be certain that any power source connected to the 2710 applies less than 250 V AC rms between conductors or between either conductor and ground. To safeguard the source, ensure that it is rated for at least 120 Watt operation.

Electronic circuits do not mix well with water, chemicals, dust, or grit. Avoid exposing your instrument to these or other contaminants; its case is not water- or airtight. Do not place liquid containers on or near the analyzer where they can be spilled into it. Use the Travel Line rain cover, part number 016-0848-00 (or other suitable covering), when transporting the 2710 out of doors.

CAUTION

Do not operate the 2710 in rain. Water or other liquids inside its case can permanently damage the instrument.

A cooling fan is an integral part of the 2710. Although the instrument can be operated in any orientation, you must ensure that the clearance provided by the feet is maintained on the bottom and that there are at least two inches (more if practical) clearance around other sides. In no case should you block the air intake areas at the front of the 2710 or the exhaust areas at the rear. Never run the instrument inside the Travel Line case.

Do not physically abuse the 2710. It is capable of withstanding a fair amount of rough handling but dropping it off a workbench or bouncing it around the trunk of a car or the back of a truck may cause damage. Protect the instrument while transporting it and use it where it cannot be accidentally hit, kicked, or dropped.

Turning on the 2710

After you have observed the foregoing precautions, you are ready to turn on the 2710. **Make sure there is no signal source connected to the analyzer and plug in the power cord. Press:**

[POWER]

The green LED adjacent to the power switch lights indicating that power is turned on. The LED indicators flash and you hear a few beeps as the analyzer performs its power-up self test. A display appears onscreen almost immediately. You may see the messages:

STAND BY WARMUP TIME 15 MIN

When the factory default power-up settings are being used, the STAND BY message does not appear and it is possible to make general observations and measurements immediately after the power is turned on. If user-defined power-up settings (see **USER-DEFINED POWER-UP SETTINGS** in *The Menus -- Ultimate Flexibility*) are implemented, the STAND BY message appears briefly. The 2710 front panel is locked out while the message is displayed. After the message disappears, the factory default settings are replaced by the user-defined settings, and you can proceed with your observations. Whichever settings are used, the WARMUP message is displayed. It disappears after a few seconds. Remember, however, that the analyzer may require the full 15 minutes to be operating within specification.

It is possible that you may see the phrase:

NORMALIZATION SUGGESTED

Normalization is a procedure by which the 2710 measures and memorizes its own calibration parameters using a built-in reference. When this message appears, the instrument is telling you that its self-test feature has determined that the performance of the 2710 no longer matches that predicted by the previous normalization. This is not unusual during the warm up

//////////////////////////////////// 2710 Spectrum Analyzer User's Guide //////////////////////////////////////

period, especially if a narrow RBW filter is called for by user-defined power-up settings and/or the ambient temperature is different than that at which the previous normalization was performed. The phrase should disappear from the screen shortly. If it doesn't disappear with a few minutes, a new normalization should be carried out. Normalization ensures the utmost precision when making measurements. It is suggested, that when maximum accuracy is required, you allow your instrument to reach a stable operating temperature in the environment in which the measurements will be carried out, and then perform a normalization before making the measurements. See the Utility Menu section of *The Menus* for the procedure.

Restoring the Factory Default Settings

When power is first applied to the 2710, it initializes its front-panel controls to settings stored in memory. If the instrument has been used before, those settings may be user-defined (see **USER-DEFINED POWER-UP SETTINGS** in *The Menus*). If no user-defined settings exist, the instrument defaults to the factory power-on settings which are permanently stored in read-only memory (ROM). **To ensure that you are using the factory default power-on settings, press:**

[UTIL MENU]/[1]/[1]

Pressing this sequence of buttons always restores the factory default settings no matter what the analyzer was doing previously. It is a handy method of returning to a fixed set of conditions if you ever get lost.

The Spectral Display

When spectral measurements are being performed, the 2710 screen can display front-panel control settings, the results of certain measurements, and one or more signal spectra. Let's look at it more closely.

//////////////////////////////////// 2710 Spectrum Analyzer User's Guide //////////////////////////////////////

Figure 2-1 shows what the 2710 screen looks like with the factory power-up settings implemented. The displayed spectrum represents the *noise floor* of the 2710. The noise floor is the amplitude of the noise generated internally by the analyzer itself and passed through the RBW filter. Narrowing the RBW lowers the noise floor (because noise power is proportional to the resolution bandwidth). The noise appears as a thick, irregular band across the bottom half of the screen. To achieve this appearance, we've used digital display storage. The unique MAX/MIN display shown here is designed to resemble the analog spectra which the 2710 inherently produces. The maximum and minimum amplitudes of the analog spectrum are alternately sampled at 512 successive points. Plotting the two interleaved sets of 256 points produces the graph of the spectrum that you see. This display not only imitates the analog spectrum, but can also assist in detecting low level signals by more effectively showing the characteristic void they produce under the noise floor.

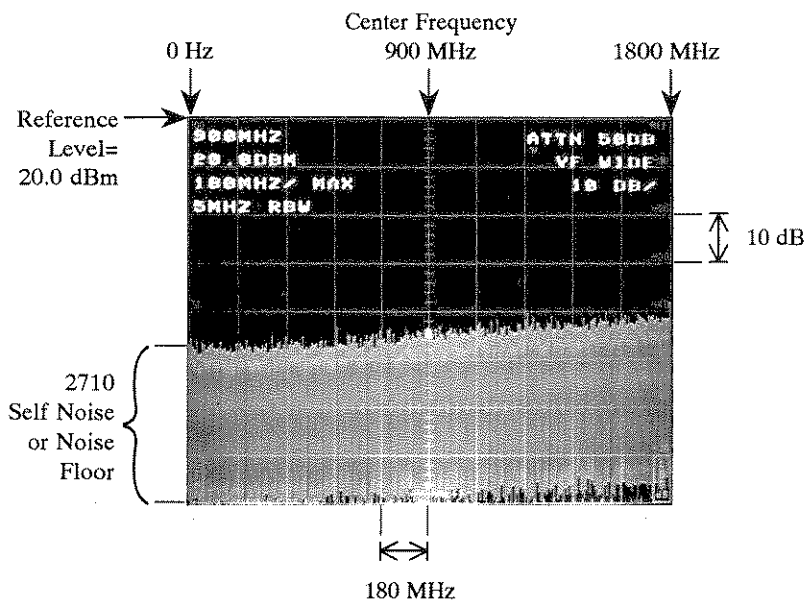

Figure 2-1. 2710 display with factory power-up settings.

//////////////////////////////// 2710 Spectrum Analyzer User's Guide //////////////////////////////////

Other data are also displayed. The on-screen data readout includes two columns of information. Listed in order in the left column are:

- center or starting frequency
- reference level (signal amplitude at the top graticule line)
- horizontal scale factor (frequency or time per major horizontal division)
- resolution bandwidth

Normally the item at the top of the left column is the center frequency of the display, but you can choose to have the starting frequency (frequency at the left edge of the display) listed instead. When the factory power-up settings are used, the entire input frequency range is displayed. In this mode (called MAX SPAN and indicated by /MAX following the horizontal scale factor), the first item in the column lists the frequency at the location of the *marker* (intensified spot on the display).

The types of information displayed in the right column can change. Normally the column lists:

- RF attenuation
- video filter bandwidth
- vertical scale factor (decibels or voltage per vertical division)

However, in some operating modes the results of measurements or other data appear on the right. We will point out when to expect alternate information as we deal with the various modes.

Later you will learn how to turn off the on-screen readouts or add other information to them.

The Control Panel

The 2710 control panel possesses several characteristics which make it easy and convenient to operate:

- Controls that have related functions are grouped together. The groupings are defined by the background color surrounding the related controls. We shall refer to the groupings as *function blocks*.
- The three controls most fundamental to spectrum measurement are located near the top of the control panel (on later model 2710's, they have a distinctive blue background).
- *Dedicated function keys* permit quick setting of all critical measurement parameters.
- *Menu keys* surrounded by black borders *call up menus* of features.
- Red LED *status indicators* adjacent to certain keys indicate when the function is active.
- Green LED *keypad indicators* labeled 0 - 9, ., and <- (backarrow) laid out in conventional calculator numeric keypad configuration are illuminated when any menu is active. Pressing the key adjacent to each selects the numbered menu option. The keypad is also used to enter numerical data or settings.

Spectrum measurements can be carried out using only the front-panel dedicated function keys; you don't have to use menus. However, the menus do provide flexibility and a degree of measurement automation. The most important controls when measuring spectra are the center frequency, span/div and reference level. These controls are located across the top right of the 2710 where they are convenient to most users.

NOTE

The SWEEP and RESOLUTION BW function blocks have AUTO keys with an LED indicator adjacent to them. The AUTO mode allows the 2710 to pick the best combination of sweep speed and resolution bandwidth for a given span/division. When these blocks are in

//////////////////////////////////// **2710 Spectrum Analyzer User's Guide** //////////////////////////////////////

AUTO mode (LED is lit) it is possible to make spectrum measurements by touching no more than three controls!

There are several "arrow" keys on the control panel. The most frequently used are the FREQ SPAN/DIV and REF LEVEL arrow keys. We've tried to make their use intuitive by causing the displayed spectrum to change in the same direction as the arrows. For instance, arrows pointing towards each other squeeze or compress the spectrum. When an arrow key is pressed, the on-screen readout also changes to reflect the new value of the parameter controlled by the arrow key. This behavior is summarized in Table 2-1.

Table 2-1. Effect of arrow keys.

FREQ	SPAN/DIV	REF LEVEL	
↔	⇄	↑ SIG	SIG ↓
Expand spectrum	Compress spectrum	Raise signal display	Lower signal display
SPAN/DIV decreases	SPAN/DIV increases	REF LEVEL & attenuation decrease	REF LEVEL & attenuation increase

One other noteworthy feature: many of the keys are toggle-action. The ability to undo an action, including menu selection, by pushing the same button or sequence of buttons that carried out the action is typical of operations you perform with the 2710. **To watch this happen, press:**



twice. You will see the spectral display shrink vertically following the first push (which turns on the filter), and then expand to its original size following the second push (which turns off the filter).

Sounds

The 2710 emits tones under the following conditions:

- during power-on self test
- during operator-initiated audio alert testing
- when a front-panel key is pressed
- when an abnormal condition occurs
- when a message appears

You heard the self test beeps when you turned on the 2710. The analyzer also emits a series of tones if you select the Audio Beep option via [UTIL MENU]/[5]/[1]/[2].

If the built-in sound generator is turned on, a beep is emitted when a front-panel key is pressed. The beep can be set to low, high, CW, or off using the Utility Menu. The factory default is low.

If an abnormal condition exists, such as a request to extend a measurement parameter beyond its range, the 2710 emits the high level beep. A message is simultaneously displayed on screen describing the abnormal condition.

The 2710 can also emit more interesting sounds. It is equipped with AM and FM detection circuits which extract the audio modulation on amplitude or frequency modulated RF signals. The detector output is amplified and placed on the built-in speaker. This feature can be used to identify most voice channels based on their content or call signs, and can help to identify others by enabling you to determine the type of modulation (frequency shift keying, pulsed CW, etc.). For better audio (essentially hi-fi quality) or private listening, use the headphone jack on the right side of the analyzer. The AM/FM detectors are covered in the discussion of the Detector/Generator Menu.

The Built-in Calibrator

The 2710 is equipped with a built-in calibration source. But the calibrator for the 2710 is a bit different from others you've encountered in that there is no external "Cal Signal" jack. Instead, the calibrator is tucked securely inside the analyzer and "connected" to the input of the 2710 without the need for external cabling (and attendant mismatches) by selecting the proper Input Menu option.

To call up the Input Menu, press:

[INPUT MENU]

Item 9 specifies a CAL SIG @ 100MHz -30DBM. The calibrator emits a CW signal with a fundamental frequency of 100 MHz \pm 5kHz (\pm 2kHz with Option 01) at an amplitude of -30 \pm 0.3 dBm. Higher order harmonics at lower levels are also present. Item 9 toggles the calibrator on and off. **Turn the calibrator on by pressing:**

[9]

The screen reverts immediately to the spectral display. The word CALIBRATOR now appears near the bottom right of the screen signifying that the calibrator is turned on.

Turn the calibrator off by pressing:

[INPUT MENU]/[9]

NOTE

When the calibrator is turned on the normal RF input is disconnected internally from the input attenuator and cannot be viewed.

Making Your First Measurement

Now let's make a measurement with the 2710. We'll verify the frequency and amplitude of the calibration signal. Although the calibration signal is used, the technique is the same for measuring any continuous signal. In the process, you will learn to use three of the most important controls on the analyzer.

If you have not already done so, **turn on the power to the 2710 and allow your instrument to reach a stable operating temperature.** If the NORMALIZATION SUGGESTED message is displayed, it will usually disappear as the 2710 reaches normal operating temperature. **Restore the factory default power-on settings by pressing [UTIL MENU]/[1]/[1].** The RF attenuation is set to 50 dB. This affords maximum protection to the analyzer because any signal at the input undergoes maximum attenuation before reaching the power-sensitive mixer circuit. It is recommended that you use this setting when connecting unknown signals to the 2710. The span is set to 180 MHz per division. This is maximum span and it is indicated by the word MAX in the span readout. This is the safe setting for introducing new signals. It enables you to view the entire measurement range (1.8 GHz) of the analyzer. If a smaller span is used, large signals can be present off-screen. Remember -- the *total signal amplitude* (that is, all signals on screen or off added together), not just the signal of interest, must remain below +20 dBm. With a small span it is also possible to reduce the attenuation to view a low level, on-screen signal while inadvertently allowing an off-screen high-level signal to saturate the mixer.

Turn on the calibrator via the Input Menu. The word CALIBRATOR appears on screen and you may notice a few signal peaks towards the left of the display. These are the calibration signal's fundamental and harmonics. If you don't see them, your eyes are probably not going bad; the amplitudes of the harmonics may be lower than the 2710's noise floor.

2710 Spectrum Analyzer User's Guide

Make the calibration signal peaks higher and more visible by pressing:



in the REF LEVEL function block three times. You have reduced the RF attenuation 30 dB (The attenuation readout now indicates 20 dB). The resulting reference level (top graticule line) is -10 dBm. Normally, the reference level and RF attenuation and/or IF gain change 10 dB each time you press [SIG↑] or [SIG↓]. Figure 2-2 shows what the display should look like. Don't be concerned if some of the signal peaks on your analyzer have slightly different amplitudes.

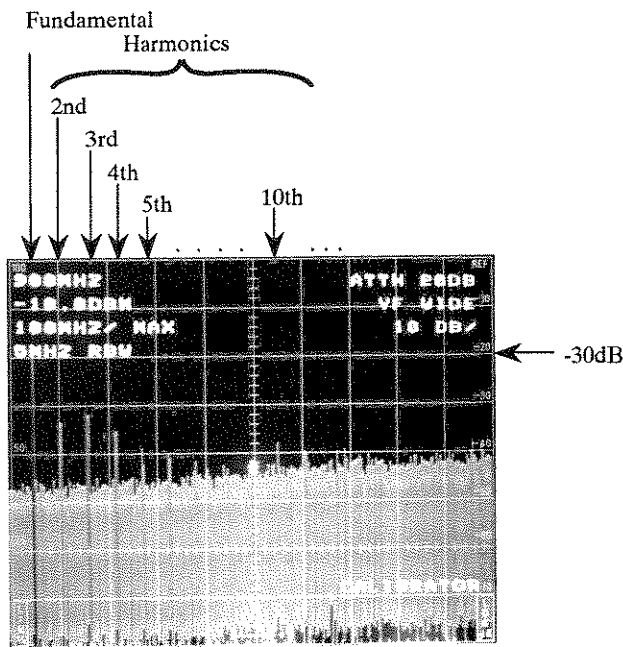

Figure 2-2. 2710 calibration signal and harmonics.

2710 Spectrum Analyzer User's Guide

Let's look at the calibration signal more closely. Turn the large round knob in the **FREQ/MARKERS** function block several clicks counter-clockwise. Do you see what's happened? The marker has moved to the left and the frequency readout has decreased. In most modes of operation, the knob controls the center frequency of the display. It is essentially the "tuning" knob of our receiver. However, because the 2710 is spanning its maximum frequency range (1.8 GHz), the center frequency must be constant at 900 MHz. The knob now controls the position of the marker while the uppermost readout in the left column indicates marker frequency. Continue turning the knob until the frequency readout indicates 100 MHz.

Expand the display by pressing:



in the **FREQ SPAN/DIV** function block. What happened? Since you are no longer in **MAX SPAN**, the intensified spot reverts to a center frequency marker and the readout now indicates center frequency. Simultaneously, the marker and the spectral display shift to the right to center around 100 MHz. The signal one division to the left of center is the *zero frequency peak*. Although it is an artifact produced by the analyzer, it is a true marker of zero frequency. Signals to the left of zero frequency can be ignored; they are also artifacts, or images, of signals on the right.

Again press:



See the spectrum spread out? This key enables you to "zoom in" on the spectral display. Press the key until the span readout indicates 20 MHz/. The display should now look like Figure 2-3. The high peak at 100 MHz is the calibrator's fundamental and the peak at the right edge of the screen is its second harmonic. Since the fundamental is two divisions down from the top graticule line and the vertical scale is 10 dB/division, the amplitude of the calibration signal is -30 dBm {-10dBm ref level - (2 x 10dB/div) = -30dBm}.

//////////////////////////////////// **2710 Spectrum Analyzer User's Guide** //////////////////////////////////////

By manipulating only three controls you've just determined the frequency and amplitude of the calibration signal. One, two, three.....how simple it can be!

Believe it or not, by using the same 3 controls plus a fourth, it not only gets easier, but also more accurate. You'll find out how in the next chapter.

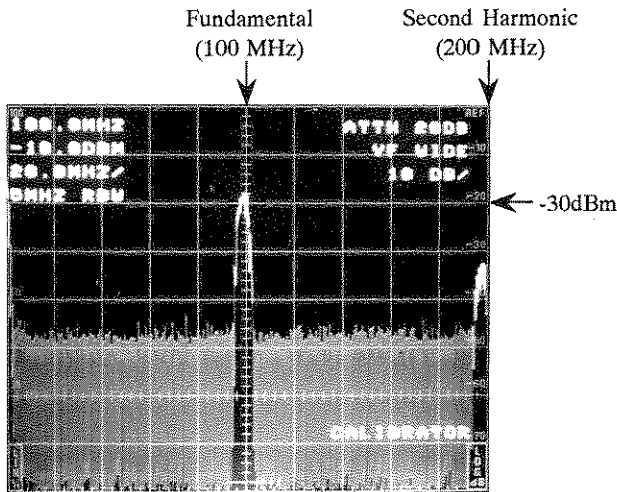

Figure 2-3. Calibration signal and second harmonic.

THE CONTROLS

This chapter describes the controls of the 2710 in detail and indicates how they are used to effectively measure signal spectra. We look first at the controls fundamental to spectrum analysis.

Fundamental Operations

In the previous chapter you learned to quickly measure the amplitude and frequency of a continuous narrowband signal using only three keys. In this section we'll repeat that initial measurement, but this time we'll look more closely at the **FREQ/MARKERS**, **FREQ SPAN/DIV**, and **REF LEVEL** function blocks. These blocks contain the controls which are most fundamental to the operation of the spectrum analyzer. You could even perform the majority of spectral measurements with only these controls if you choose.

900.0MHz	(AUTO SWEEP)	ATTN 50DB
20.0DBM		VF WIDE
180MHz/ MAX		10 DB/
5MHz RBW (AUTO)	CALIBRATOR	

Frequency Span/Division



Restore the factory default power-on settings and ensure that the calibrator is turned on. Reset the frequency to approximately 400 MHz and the reference level to -10.0 dBm. Remember that in MAX SPAN it is the marker that changes position and not the center frequency.



The arrow keys in the FREQ SPAN/DIV function block are used to directly increase or decrease the span/div. **Beginning with the maximum span, press:**

[⇐ ⇨]

several times to decrease the span/div to 20 MHz.¹ See how you "zoom in" on the spectral display? Now press:

[⇨ ⇐]

until the span/division increases to 180 MHz. Watch the spectral display "zoom out" just as though it was moving away from you.

These two keys perform inverse functions. The inward-facing arrows compress or squeeze the spectrum together whereas the outward-facing arrows expand or stretch the spectrum. Experiment if you wish and **then set the span to 20 MHz/.**

¹ If you request a narrow span before the 2710 is completely warmed up, you may get a NORMALIZATION SUGGESTED message. This message should disappear as the analyzer warms up.

Maximum Span

To obtain the largest span available on the 2710 press:

[MAX SPAN]



MAX
SPAN

The span/div readout now indicates 180 MHz/ MAX. Press [MAX SPAN] a second time to return to 20 MHz/. Many of the keys on the 2710 are toggle-action. The ability to undo an action by pushing the same button that carried out the action is typical. [MAX SPAN] is a toggle-action key taking you from the current span/div to 180 MHz/div and back again.

Zero Span

For your next experiment, reset the center frequency to 100 MHz and notice that the calibration signal peak is centered in the display. Press:

[ZERO SPAN]



ZERO
SPAN

The signal is a straight, horizontal line! In ZERO SPAN the analyzer remains at a fixed center frequency. What you see is the time variations of the signal coming through the RBW filter at that frequency. Since the calibration signal has constant amplitude, the spectral display is constant. **Slowly increase the center frequency.** The noise generated internally by the analyzer has a time-varying random amplitude. You will notice the signal amplitude decrease and the noise increase as you tune away from the calibration signal.

In the zero span mode, the 2710 does not sweep the frequency spectrum. Rather, the local oscillator remains at a fixed frequency so that the resolution bandwidth filter brackets the designated center frequency. Because the display screen is still swept, the span readout indicates sweep speed (time per

division rather than frequency per division). The word ZSPAN follows the sweep speed to denote zero span operation. In a sense, you turned your spectrum analyzer into an oscilloscope. [ZERO SPAN] is another toggle-action key. **Press it again to return to 20 MHz/div span. Reset the center frequency to 400 MHz and the span to 100 MHz/.**

Center Frequency Control

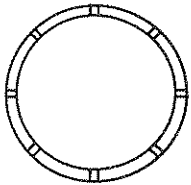

Turn the FREQ/MARKERS knob a few clicks clockwise. Each click of the knob increases the center frequency by 2.0 MHz. Turn the knob counter-clockwise and the center frequency decreases by the same amount. Continue turning the knob until the center frequency readout indicates 100 MHz. Now press [↔] in the FREQ SPAN/DIV function block until

the span readout indicates 20 MHz/. Again turn the FREQ/MARKERS knob a few clicks clockwise. The spectral display appears to move sideways at about the same rate as it originally did. However, it is now moving only 0.4 MHz per click. We call this visual behavior *constant rate tuning*. It occurs because the knob normally changes the center frequency at 0.02 of the span/div per click. The indicated frequency changes alternately by 3 or 4 MHz in MAX SPAN and as a percent of the RBW in ZERO SPAN. In *Selecting the Tuning Increment*, you will learn how to change the tuning rate.

Do you see why we originally changed the center frequency before changing the span? How many more clicks of the knob would it take to change the center frequency back to the original 400 MHz using .02 of this span? Any time you have to manually make a significant change in the center frequency, use a large span. Later you will learn to directly enter a center frequency using the Marker/Frequency Menu.

//////////////////// 2710 Spectrum Analyzer User's Guide //////////////////////

100.0MHz	(AUTO SWEEP)	ATTN 20DB
-10.0DBM		VF WIDE
20.0MHz/		10 DB/
5MHz RBW (AUTO)	CALIBRATOR	

Reference Level

Let's review signal height adjustment. In the REF LEVEL function block, Press:

[SIG ↑]



The reference level is now -20 dBm and the attenuation is 10 dB. The calibration signal peak is one division below the reference level. The signal peak appeared to increase 10 dB when you pressed the key.² Now reduce the on-screen signal height one division by pressing:



[SIG ↓]

Both the RF attenuation and the reference level readouts increased 10 dB but the signal amplitude is still -30.0 dBm.

NOTE

Signal amplitude does not change, only its displayed height does.

[SIG ↑] raises the signal height whereas [SIG ↓] lowers it. Experiment if you wish and then reset the reference level to -10 dBm.

² Remember that you are dealing with negative numbers: -20 dBm is a smaller number than -10 dBm. What you did to achieve the apparent increase in signal height was to slide the whole display upwards 10 dB by decreasing the RF attenuation.

Reference Level



In the REF LEVEL function block, press:

[1dB 10dB]

Nothing happened on screen, but the red LED next to the key lit. The LED is telling you that the rate at which [SIG ↑] and [SIG ↓] change the on-screen signal height and reference level is now 1 dB per push rather than 10 dB. Try pressing [SIG ↑] five times. The signal peak raises half a division and the reference level readout indicates -15 dBm. Press [SIG ↓] five times and watch the reverse happen. [1 dB 10 dB] is another toggle-action key. Press [1 dB 10 dB] again to return to 10 dB per push and extinguish the LED. Ensure the reference level is set to -10 dBm.

Enhanced Versatility

In the preceding section you learned to operate the fundamental controls of the 2710. In this section you will learn how the remaining controls enhance your ability to make accurate spectral measurements easily and conveniently. You will discover how to change the resolution bandwidth and vertical scale factor, and how to control sweep speed. You will learn that display storage and marker control enable you to quickly measure signal amplitude and frequency with maximum accuracy. You will also learn to make direct spectral comparisons and, with non-volatile RAM (NVRAM), to save important results for future reference.

100.0MHz	(AUTO SWEEP)	ATTN 20DB
-10.0DBM		VF WIDE
20.0MHz/		10 DB/
5MHz RBW (AUTO)	CALIBRATOR	

Resolution Bandwidth

Thus far, we have ignored the RESOLUTION BW function block. It's been left in AUTO mode which enables you to make measurements without worrying about where the RBW is set, but there are circumstances in which you will want to control the RBW yourself. For instance, when you look at the time domain representation of a TV video signal using zero span, you will want to use the 5 MHz (maximum) RBW to ensure that all the energy of the wideband signal gets through the filter. In other cases you may wish to select a very narrow RBW in order to resolve signal sidebands or intermodulation distortion products. The resolution bandwidth arrow keys enable you to select RBW's of 3 kHz, 30 kHz, 300 kHz, or 5 MHz in the standard 2710 (also 10 kHz, 100 kHz, and 1 MHz with option 14; 300 Hz with option 01; and 1 kHz with options 01 and 14).



Consider this: how far do signals have to be separated before we can see them as separate? The exact answer depends on the

2710 Spectrum Analyzer User's Guide

particular filters, bandwidths, signal levels and other factors, but two rules of thumb apply:

- If the signal amplitudes are less than 3 dB different, they are resolved when their frequency separation equals the RBW.
- For signals more widely separated in amplitude and frequency, let A be the amplitude difference. Then:

$$F = (1 + A/22) \text{ RBW}$$

where F is the required frequency separation. This rule is based on the fact that the 2710's 60 dB filter bandwidths tend to be about 7 times the 6 dB bandwidth and assumes the filter roll-off is approximately linear in dB. Using this condition, if the signals are 30 dB different in amplitude, A , then they have to be separated by about $2.4 \times \text{RBW}$.

Set the span to 2.0 MHz/. The RBW readout indicates 300 kHz.

NOTE

Because early models of the 2710 use a 500 kHz filter instead of 300 kHz, your readout may indicate 500 kHz. Both filters produce comparable results.

Let's change the RBW to see what happens. In the **RESOLUTION BW** function block, press:

[↔]

The LED went out indicating that the analyzer is no longer in AUTO RBW mode and the RBW readout indicates 5 MHz. What else happened? The calibration signal now appears to be 5 MHz wide! Theoretically, the cal signal should be infinitely narrow -- a spike at 100 MHz. To understand what has happened, you must recall the process going on within the analyzer. It is sweeping a narrowband signal (the calibration signal) past a broadband filter (the 5 MHz resolution filter). As the signal is moved past the filter, it maps the shape of the resolution filter. What you see is the spectral shape of the filter

2710 Spectrum Analyzer User's Guide

rather than that of the cal signal. The lesson is that, on unmodulated signals, a RBW filter that is too wide can artificially broaden the displayed spectrum (although the signal peak remains accurate).

Did you also notice the noise floor increase 12 dB as you switched from 300 kHz RBW to 5 MHz? Do you know why? The noise coming through a filter is proportional to the filter bandwidth. For white noise at the analyzer input, the difference in noise power coming through filters with bandwidths RBW_1 and RBW_2 is:

$$\Delta \text{ Noise (dB)} = 10 \text{ Log } (RBW_1/RBW_2)$$

In this case, $10 \text{ Log } (5 \text{ MHz}/300 \text{ kHz}) = 12 \text{ dB}$ more noise coming through a 5 MHz filter than through a 300 kHz filter.

Narrow the RBW by repeatedly pressing:

[⇐ ⇨]

in the RESOLUTION BW function block until the on-screen readout indicates 3 kHz. You hear a high level beep and see the message "UNCAL". The analyzer is now sweeping the calibration signal past the resolution filter too quickly for the filter output to rise to its steady-state value before the signal is no longer present at the filter input. This can result in low amplitude and skewed frequency readings. The lesson is that RBW's which are too narrow can result in incorrect amplitude and skewed frequency measurements. Ultimate measurement accuracy is at risk when the "UNCAL" message is present.

Resolution Bandwidth

Pressing the AUTO key in the RESOLUTION BW function block toggles the 2710 between automatic and operator selection of the RBW. When the RBW is being selected by the 2710, the LED adjacent to the key is lit. **Place the RBW in automatic mode by pressing:**



[AUTO]

//////////////////////////////// 2710 Spectrum Analyzer User's Guide //////////////////////////////////

The red LED will be illuminated. You can take the analyzer out of AUTO mode by pressing a RESOLUTION BW arrow key or by pressing [AUTO].

Set the span/div to 50 MHz. Note the indicated RBW and, in the RESOLUTION BW function block, press:

[⇨ ⇩]

The LED has gone out and the RBW is 300 KHz. Press:

[AUTO]

The LED comes back on and the RBW has switched back to 5 MHz. Press:

[AUTO]

again. The LED goes out but the RBW is still 5 MHz. Toggling out of AUTO mode with the AUTO key maintains the automatically selected RBW until you change it with a RBW arrow key.

700.0MHz	(AUTO SWEEP)	ATTN 20DB
-10.0DBM		VF WIDE
50.0MHz/		10 DB/
5MHz RBW (AUTO)	CALIBRATOR	

Resolution Bandwidth



A *video filter* is a post-detection filter (sometimes referred to as a *noise averaging filter*) used to reduce noise in the displayed spectrum to its average value, which makes low level signals more easily detectable. Normally, the 2710 uses a video filter about as wide as the RBW to limit post-detection noise while still allowing all the energy coming through the RBW filter to be displayed. This is indicated in the on-screen readouts by

VF (bandwidth)

//////////////////////////////////// 2710 Spectrum Analyzer User's Guide //////////////////////////////////////

where (bandwidth) is equal to the bandwidth of the video filter (and RBW filter) being used except in the case of the 5 MHz filter or the 1 MHz option 14 filter. Then

VF WIDE

is substituted. In this case, the "filter" consists of the natural lowpass characteristics of the circuitry following the detector.

When you press the VIDEO FLTR key, the 2710 automatically selects a narrower video filter bandwidth approximately 1/100 of the RBW (later you will learn how to specify a particular filter bandwidth via the Utility Menu). The narrow video filter dramatically reduces the noise and enhances the visibility of narrow band signals. However, care must be exercised in its use, because it will also reduce the indicated amplitudes of wide band signals such as video modulation and short duration pulses.

To see the video filter work, ensure that the 2710 is set as in the preceding settings box. Can you see signal peaks at 700, 800, and 900 MHz? Press:

[VIDEO FLTR]

The red LED adjacent to the key comes on indicating that a narrow video filter is being used and the bandwidth of the filter is indicated on screen. Notice how much less "noisy" the lower portion of the spectral display appears. By filtering the noise, it is sometimes possible to reveal low level signals that were in the noise. This is the primary reason for using a video filter. Now can you see signal peaks at 700, 800, and 900 MHz (the seventh, eighth, and ninth harmonics of the calibration signal)? There are small differences from instrument to instrument, but you should be able to spot the peaks above the noise. Video filtering works well for CW and other narrow band signals, but when examining pulsed or wide band signals such as television video (especially the sync pulses), a video filter may prevent you from accurately seeing signal characteristics in much the same way that using too narrow a RBW does.

//////////////////////////////// 2710 Spectrum Analyzer User's Guide //////////////////////////////////

Although it may not have been apparent, the sweep speed also decreased in order to accommodate the longer time constant of the video filter. Just as with the RBW filter, a signal needs more time to reach its peak amplitude when propagating through a narrow video filter.

Now toggle the video filter off by pressing [VIDEO FILTER] again.

100.0MHz	(AUTO SWEEP)	ATTN 20DB
-25.0DBM		VF WIDE
20.0MHz/ 5MHz RBW (AUTO)	CALIBRATOR	10 DB/

Vertical Scale

10dB/
5dB/
1dB/

The VERTICAL SCALE function block contains a three-way toggle key labeled 10dB/ 5dB/ 1dB/. This label expresses the three logarithmic vertical scale factors available on the 2710 in decibels per major division; 5 dB/ means 5 decibels per major vertical division. Pressing the key advances the vertical scale factor through the sequence 10 - 5 - 1 - 10... a step at a time. **Press:**

[10 dB/ 5 dB/ 1 dB/]

Two things happen. First, the signal peak is now one division down from the reference level. Second, the vertical scale factor on-screen readout now indicates 5 dB/. The noise also seems to have disappeared, but this is fictitious. The signal to noise difference is the same, but the scale factor change has moved the noise below the bottom of the screen. **Again press:**

[10 dB/ 5 dB/ 1 dB/]

The signal peak is five divisions down and the readout says 1 dB/. The primary use for this feature is to more accurately read displayed signal peaks. **Press the key once again to restore the 10 dB/ setting.**

Vertical Scale

The second key in the VERTICAL SCALE function block is toggle-action. It converts the vertical scale from logarithmic to linear and back again. **With the calibration signal centered and the reference level set to -25 dBm, press:**



[LIN]

The vertical scale readout now indicates 1.57 MV/. When LIN mode is initially selected, the 2710 converts the vertical scale such that the bottom graticule line is zero volts and the reference level is converted from dB's to voltage. The display is similar to what you see on an oscilloscope. Thereafter, the arrow keys in the REF LEVEL function block change the scale factor in a 1, 2, 5 sequence. Consequently, the reference level changes by 6 or 8 dB when changing scale factors. If the 1 dB reference level step size is selected while in LIN mode, the arrow keys change the scale factor at a rate of about 0.02 division per step and the corresponding reference level changes about 0.2 dB. **Experiment with the scale factor if you wish. Press [LIN] to toggle back to logarithmic mode.** When switching back to logarithmic from linear, the last selected log scale is implemented.

2710 Spectrum Analyzer User's Guide

100.0MHz	(AUTO SWEEP)	ATTN 0DB
-70.0DBM		VF 3KHz
50.0KHz		10 DB/
3KHz RBW (AUTO)		

Sweep

FAST

SLOW

The SWEEP function block controls the 2710 sweep speed and trigger modes (you will learn about the trigger modes in the next chapter). The rate at which a CRT beam sweeps across the screen of the tube is known as the sweep speed. The FAST and SLOW keys perform reciprocal actions. [FAST] increases the 2710 sweep speed and [SLOW] decreases the sweep speed. During routine spectral measurements, satisfactory results are obtained with the 2710 in AUTO mode. However, in some cases, such as when looking at the time domain representation of a signal in zero span, you may want to vary the sweep speed for a better view of the signal. Let's try it now. **Ensure the calibrator is turned off and enter zero span mode.** The sweep speed readout indicates 100 msec/division. You are looking at the internal noise. **Now press:**

[FAST]

The LED next to [AUTO] in the SWEEP function block goes out indicating the sweep speed is no longer being selected automatically. **Continue pressing [FAST] until the sweep speed readout changes to 1 millisecond/division.** The noise no longer looks like "grass"; you can see variations in the noise waveform taking place in a millisecond or less. You can sweep even faster (1μ sec/div) with display storage disabled. **For now, though, press:**

[SLOW]

several times. The noise is compressed to a grass-like appearance and the indicated sweep speed slows. The 2710 is acting as an oscilloscope. Pressing [FAST] or [SLOW] removes the 2710 from automatic sweep speed selection mode and the FAST/SLOW keys thereafter function as the sweep speed selector on a conventional oscilloscope.

//////////////////// **2710 Spectrum Analyzer User's Guide** //////////////////////

Reset the sweep speed to 100 msec/division and the span to 50 kHz/division. Set the reference level to -10 dBm and turn on the calibrator. Increase the sweep speed by repeatedly pressing [FAST]. Again you hear a beep and the word UNCAL appears. Continue to increase the sweep speed and notice the signal peak decrease and shift to the right. This condition is achieved by sweeping too fast for a given RBW and demonstrates how measurement errors can occur. You are sweeping the resolution filter so fast that its output does not have time to reach steady-state. Reselect ZERO SPAN. The UNCAL message disappears because in zero span mode the filter is not being swept at all. Set the displayed sweep speed to 1 msec/division.

Sweep

The AUTO key in the SWEEP function block is used in much the same way as the AUTO key in the RESOLUTION BW function block. [AUTO] is a toggle-action key which switches the 2710 between automatic and manual selection of sweep speeds. When AUTO mode is activated, the sweep speed selected by the 2710 depends on the span/div, RBW, and video filter in use.



Continuing with the example from above, press [ZERO SPAN] to exit zero span mode. Notice how distorted the calibration signal is and then press:

SWEEP
[AUTO]

The LED adjacent to the key lights indicating the sweep speed is being automatically selected by the analyzer. The sweep speed is now 100 msec/division, the UNCAL message has disappeared, and the calibration signal is correctly indicated as -30 dBm and 100 MHz. Again press:

SWEEP
[AUTO]

//////////////////////////////// 2710 Spectrum Analyzer User's Guide //////////////////////////////////

The LED goes out but the display doesn't change. Toggling out of AUTO mode maintains the automatically selected rate until you change it with the FAST or SLOW keys. **Reactivate AUTO sweep mode.**

100.0MHz	(AUTO SWEEP)	ATTN 20DB
-10.0DBM		VF 300KHz
1.0MHz/		10 DB/
300KHz RBW (AUTO)		

Sweep



The 2710 is equipped with a single sweep capability. When activated, the analyzer makes only one sweep. Other controls operate normally and signals at the input to the analyzer are treated just as they otherwise would be.

Exactly when the sweep begins depends on how the 2710 is being triggered. The factory default mode is free run (the sweep generator cycles continuously). If you have been following our examples, this is the mode the analyzer is in currently. **Reset the RBW to 3 kHz.** The sweep now takes 2 seconds. **Watch the display being refreshed. Press:**

[SGL SWP]

The current sweep is aborted and the LED adjacent to the SGL SWP key lights. This message appears on-screen under the right readout column:

SGLSWP MODE

The message means the sweep circuit is ready and waiting for operator action. **Press [SGL SWP] again.** A message reading:

SGLSWP ARM

momentarily appears and a single sweep is carried out. You'll see the sweep progress across the screen as a new spectral display is created. When the sweep is completed, the SGLSWP

//////////////////// 2710 Spectrum Analyzer User's Guide //////////////////////

MODE message reappears indicating the analyzer is ready for another sweep.

If the 2710 is in any other trigger mode (later you will learn to choose a variety of trigger modes via the Swp/Trig Menu), behavior is much the same. Pressing [SGL SWP] causes the current sweep to abort, the LED to light and the SGLSWP MODE message to appear. If you press the key again, the SGLSWP ARM message appears. The analyzer waits for the next trigger signal; when detected, a single sweep begins. After the sweep is complete the SGLSWP MODE message reappears.

You can start a new single sweep in any trigger mode as often as you wish by pressing [SGL SWP] after the SGLSWP MODE message appears. However, if you press [SGL SWP] too soon, you may exit from single sweep mode. **Exit normally from single sweep mode by pressing:**

[SGL SWP]

twice or holding it for 1/2 second (If the audio alert is turned on, press the key until the second beep is heard). When released, the LED is goes out and the 2710 is no longer in single sweep mode.

Single sweep mode is useful when you want to prevent a succeeding sweep from overwriting a trace you just acquired, or to capture the characteristics of intermittent signals.

Sweep - Level Control

There is a dual-concentric-shaft LEVEL control to the right of the SWEEP function block. The inner knob controls the triggering level when the 2710 is in internal, external, or line trigger modes just as the equivalent control does on a conventional oscilloscope. In the other trigger modes it has no effect. The outer knob controls the volume for the AM and FM detectors. It is discussed when we cover the Detector/Generator Menu.

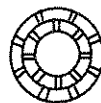

2710 Spectrum Analyzer User's Guide

100.0MHz	(AUTO SWEEP)	ATTN 20DB
-10.0DBM		VF 300KHz
5.0MHz/		10 DB/
300KHz RBW (AUTO)	CALIBRATOR	

Display Storage and the Analog Display



The 2710 can display an analog spectrum or up to four digitally sampled and stored spectra. A major advantage of display storage is that it results in a flicker-free display. The digital display storage registers are named A, B, C, and D. Their status is controlled by [A A], [B B], [C C], and [D ]; the red and green LED's to the left of each key indicate the status

of the corresponding register. Whenever a red LED is lit, the contents of the corresponding register are displayed. The contents of a register are either the measurement currently being carried out or previously stored information. When only the red LED is lit, the contents are the result of the analyzer's current activity. Current results are updated from the signal at the analyzer input during each sweep. The present control settings are used for the update. Any time an A, B, or C green LED is lit, the corresponding register has a trace stored in it; the trace cannot be erased, modified, or updated without additional operator interaction. The on-screen readouts are stored along with the trace. When the D green LED is lit, the display is placed in "waterfall" mode. Any register is deactivated (its contents are not displayed) when its red LED is extinguished, although it still contains stored information as long as its green LED is lit. Register status is summarized below.

Table 3-1. Display register status

LED		All Registers	
Red	Green		
off	off	not displayed	no stored data
on	off	displayed	updated each sweep
A, B, C Registers			
off	on	not displayed	contains stored data
on	on	displayed	contains stored data
D Register			
on	on	waterfall mode, cannot use A, B, C registers independently, turns on A, B, C LED's	

In the default mode (D red LED lit) the D register is updated and displayed each sweep.

[A A], [B B], [C C], and [D ~~III~~] are toggle-action keys used to activate and deactivate the display registers. **Turn on the C register by pressing:**

[C C]

Did you notice any changes after pressing [C C]? The only change that might be apparent is an increase in intensity since the 2710 is now displaying the C trace on top of the D trace. **Now turn on the A and B registers by pressing:**

[A A]/[B B]

Again, you may notice an increase in intensity, but the shape of the spectral display should not change because each register

2710 Spectrum Analyzer User's Guide

contains exactly the same information. Deactivate the B, C, and D registers by pressing:

[B B]/[C C]/[D 

This display is no different than the D register waveform. Verify this by turning on the D register and turning off the A (Press [D ] and then [A A]). Verify that this is true of the other registers also by alternately switching a new one on and the previous one off.

Deactivate all registers. What happened? You are now looking at the analog output of the analyzer. Note its similarity to the MAX/MIN display. Any time all four red LED's are extinguished, the analog output of the 2710's detector is displayed. The digitizer is still working; you have just disabled all the display registers. The analog display can be very useful for viewing time-varying modulation such as television video signals. It is also useful if you are graduating from an older analyzer which may not have digital display capabilities; it provides a display you are familiar with and allows you to see the similarity between the 2710's MAX/MIN display and the analog signal. You can usually obtain a "crisper" analog display, especially at higher sweep speeds, by varying the intensity (see the INTENSITY section under *Miscellaneous Controls* in this chapter) and/or by turning off the on-screen readouts (see TURNING THE ON-SCREEN READOUTS ON AND OFF in *The Menu -- Ultimate Flexibility*)

Activate the D register.

Display Storage



The SAVE key modifies the function of the A, B, C, and D keys. When used with [A A], [B B], or [C C] it enables you to save the current digitizer output in the corresponding register.



To see how this works, press:

[SAVE]

//////////////////// 2710 Spectrum Analyzer User's Guide //////////////////////

The red LED adjacent to [SAVE] lights. This indicates that the SAVE function is "armed". To save, in the A register, what is presently being displayed, press:

[A A]

The A green LED lights, but observe that the A register was turned off and remains turned off. **Turn off the D register and turn on the A register.** Notice that the display does not change with time. The contents of the A register are not being updated. You are viewing a saved sweep.

Now let's save something in B. **Activate the B register and ensure the A register is turned off. Set the RBW to 30 kHz.** Press:

[SAVE]/[B B]

The B green LED lights and the register remains active, but now the spectral display is frozen. The B register is no longer being updated.

NOTE

The status of the red LED is not changed by the saving operation.

Deactivate all registers (extinguish the red LED's). Set the RBW to 5 MHz and press:

[SAVE]/[C C]

The C green LED lights, but what has been saved? **Activate the C register.** You see the digitized and saved version of the analog sweep. The digitizer is continuously updated, whether it is being displayed or not. Further, it is always the current digitizer output which is saved. You cannot, for instance, save one register into another. However, with non-volatile RAM, it is possible to permanently save the contents of the display registers by transferring them to stored settings registers (see **OTHER USER-DEFINED SETTINGS** in *The Menus -- Ultimate Flexibility*).

2710 Spectrum Analyzer User's Guide

The on-screen readouts are stored along with the sweep, but the analyzer can display only one group of readouts at a time. When viewing multiple registers, the readouts for the highest priority register are displayed (register priority is D, C, B, A). To see this, let's compare some spectra. **Deactivate C and activate only the A register. Note the on-screen readouts. Turn on B.** What is the indicated RBW? (It should be 30 KHz.) **Now turn on C.** The RBW should read 5 MHz. **Turn on the D register and set the RBW back to AUTO. Notice the RBW readout change.** Do you have a better understanding of which display the on-screen readouts apply to?

OK, now deactivate all but the A register. How do you clear it? You do the same thing you did to store the spectrum. **Press:**

[SAVE]/[A A]

The A green LED goes out indicating there is nothing stored in the A register. The register remains active, but the displayed spectrum is now updated during each sweep. **Clear and deactivate the B and C registers. Activate only the D register.**

100.0MHz	(AUTO SWEEP)	ATTN 40DB
10.0DBM		VF 300KHz
5.0MHz/		10 DB/
300KHz RBW (AUTO)CALIBRATOR		

Display Storage



The SAVE key also changes the function of the D key. When used with [D ], it places the display in "waterfall" mode. This display is more effective in peak acquisition mode (which will be discussed in the Display Menu section of *The Menus -- Ultimate Flexibility*). Press [DSPL MENU]/[4] to enter peak acquisition mode and then press:



[SAVE]/[D ]

2710 Spectrum Analyzer User's Guide

All eight of the register status LED's light and four traces appear. See Figure 3-1. Because waterfall mode uses all four registers, A, B, and C registers must be cleared before the 2710 allows you to enter waterfall mode. This is a safeguard to prevent accidental overwriting of previously saved data. If you attempt to enter this mode without first clearing the registers, you receive an error message.

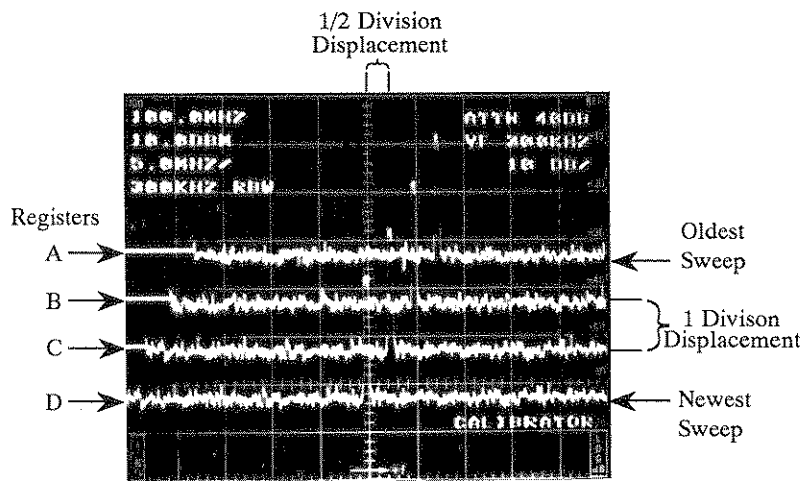

Figure 3-1. Example of a waterfall display.

D is the bottom waveform and A the top. Each waveform is displaced upwards one division from the preceding and shifted 1/2 division to the right. The most recent (current) sweep is in the D register, the previous sweep in C, the next previous in B, and so on. At the end of each sweep, the waveforms are all shifted up one register. This display can be used to watch slowly varying spectra evolve or to obtain a "feel" for the variability of signals. Waterfall is also useful for "catching" an event which occurs quickly. In the present case of the calibration signal, you will observe that there is virtually no variation. **Create a small signal shift by slightly changing the center frequency.** See how the waterfall mode records the shift?

You can halt the waterfall action at any time by pressing [SGL SWP]. Thereafter, each time you press [SGL SWP] the waterfall will advance one trace. Exit normally from single sweep mode to continue the waterfall display.

2710 Spectrum Analyzer User's Guide

You do not have to view all the traces. **Turn off the A and C registers. Turn off B and D and turn A and C back on.** You can view any, all, or none of the registers. Turn them all off and the analog display reappears. However, the analyzer is still in waterfall mode. You cannot selectively erase a register or store new data in it without first exiting from waterfall mode. **Turn on all registers.**

Exit from the waterfall display mode the same way you entered it; press:

[SAVE]/[D ]

All LED's except the red D go out and the waterfall display collapses to a single D register trace. **Reset the center frequency to 100 MHz. Return to MAX/MIN acquisition mode by again pressing [DSPL MENU]/[4].**

Display Storage



The A and B registers can be used in MAX HOLD mode to save the peak values of measured spectra. Either register must be cleared before you can use it with the MAX HOLD feature.



The MAX HOLD feature compares the amplitude of the current sweep, point for point, with the stored maximum value of previous sweeps. If the current amplitude is greater, the current value becomes the new stored maximum; if not, the previous value is retained.

Deactivate the D register. Make sure the A register is cleared and activated, then press:

[MAX HOLD]

The red LED at the upper left of the MAX HOLD key lights signifying that you have entered the MAX HOLD mode. The spectral display, especially the noise is much smoother. If you wait several minutes, you'll notice the noise floor appears to

2710 Spectrum Analyzer User's Guide

drift upwards a couple of dB. Because the calibration signal is constant, you don't notice any change in it. The upward drift of the noise floor slows and stops as the most likely maximum values are observed and stored. Now only an occasional noise peak exceeds the previously stored values. Activate the D register. Observe how the waveform in the D register (waveform without MAX HOLD) is always less than the A register waveform. Recording the peak signal excursions observed during a large number of sweeps using the MAX HOLD feature yields an estimate of the maximum signal values. It can also be very useful for determining maximum signal amplitude during transient conditions, or for making low level fluctuating signals more apparent by saving their peak value. You can observe as many sweeps as you wish. You could equally as well have used the B register for the MAX HOLD. **When you are ready to exit the MAX HOLD mode, press:**

[MAX HOLD]

and turn off the A register. The red LED goes out and only the register D sweep remains.

A capability called MIN HOLD, similar to MAX HOLD, saves the minimum signal values. Using both MIN HOLD and MAX HOLD, you can estimate a signal's total excursion. For details, see DISPLAY MENU in *The Menus -- Ultimate Flexibility*.

100.0MHz	(AUTO SWEEP)	ATTN 20DB
-10.0DBM		VF 300KHz
5.0MHz/		10 DB/
300KHz RBW (AUTO)	CALIBRATOR	

Frequency Markers

The Marker-Delta-Off key is a three-way toggle switch which enables you to control one, or a pair, of markers. A marker is a bright spot which appears on the digitized waveform. Markers cannot be used with the analog display. When marker mode is turned off, the spot on the display indicates either the center or starting frequency of the display. When a single marker is turned on, it can be moved to



/////// 2710 Spectrum Analyzer User's Guide /////

any point along the displayed waveform using the **FREQ/MARKERS** knob. The corresponding signal amplitude and frequency is displayed on screen. Furthermore, the marker amplitude readout represents the most accurate determination of signal amplitude that is possible with the 2710 (unless a separate extremely precise signal is used for direct comparison). The accuracy is further enhanced if the signal being measured is first moved to within one division of the top graticule line using the **REF LEVEL** controls.

In delta (Δ) marker mode, two markers designate the points on the waveform between which the differences in signal amplitudes and frequencies are measured and displayed. It is not possible to display one marker on a particular trace while displaying the second marker on another trace. More than one register can be displayed, but the markers appear only on the highest priority waveform.

To use the marker, press:

[MKR Δ OFF]

The LED adjacent to the key lights and the RF attenuation and video filter readouts have changed to (approximately):

M 100.0MHz
M -30.0DBM

The M preceding the first two items in the right-hand on-screen readouts represent the amplitude and frequency of the signal at the marker position. Turn the **FREQ/MARKERS** knob several clicks clockwise. The marker moves to the right and the readout tracks it. The knob now controls the marker position rather than the center frequency. Move the marker into the noise. Notice that the marker actually moves back and forth between the max and min noise values on alternate clicks of the knob. Turn the knob counter-clockwise and the marker moves left. Again, the readout tracks the signal amplitude and frequency at the marker position. Be aware that the marker frequency accuracy is not as good as the center frequency accuracy (see the **CTR MEAS/TRKG** discussion in this chapter for a discussion of frequency measurement accuracies) because it includes a span nonlinearity component.

//////////////////// 2710 Spectrum Analyzer User's Guide //////////////////////

If you attempt to move the marker past either edge of the display, the spectrum will move towards the opposite edge while the marker remains stationary. **Try moving the marker past the right edge. See how the signal peak moves to the left. Now turn the knob a few clicks counter-clockwise. The marker moves to the left but the spectrum will not move back towards its original position until you attempt to move the marker past the other edge of the display. Go ahead and re-center the calibration signal peak by trying to move the marker past the left edge of the display.**

Ensure the marker and the calibration signal peak are centered. Again press:

[MKR  OFF]

The spectral display did not change but the first two items of the right column now read:

D 0KHz
D 0.0DB

You have turned on the delta-marker mode. **Turn the tuning knob clockwise.** You now have two markers on screen. One remains at the original marker position while the position of the second is controlled by the knob. The right column indicates the difference (denoted by the letter D preceding the readouts) in frequency and amplitude between the two marker positions. **Increase the span to 50 MHz/division. Use the tuning knob to place the movable marker at the top of the first signal peak to the right of center (the calibration signal second harmonic).** The right column now reads (approximately):

D 100MHz
D -13.0 DB

You are measuring the difference in frequency and amplitude between the fundamental and second harmonic of the calibration signal. Your instrument may not read these values exactly, but it should be close.

If you attempt to steer the movable marker past the edge of the display, you'll see that the spectral display behaves almost the

//////////////////// 2710 Spectrum Analyzer User's Guide //////////////////////

same as it did for the single marker. The difference is that the stationary marker remains fixed with respect to the spectrum. You can even force the stationary marker off screen and the readout will continue to indicate the difference between the two marker positions. In this way you can make measurements across the whole input range of the analyzer. **Position the movable marker 900 MHz to the right of the stationary marker.** Can you see the sixth or seventh harmonics of the calibration signal bracketing center screen? **If not, turn on the video filter.** You should now see the peaks. **Place the moveable marker on either peak to measure its difference in amplitude and frequency relative to the fundamental.**

Turn off the marker mode, either single or delta, by pressing [MKR Δ OFF] until the red LED adjacent to the key extinguishes. Turn off the video filter.

140.0MHz	(AUTO SWEEP)	ATTN 10DB
-20.0DBM		VF WIDE
50.0MHz/		10 DB/
5MHz RBW (AUTO)	CALIBRATOR	

Frequency Markers

CTR
MEAS/
TRKG

The center measure feature detects the signal peak nearest the marker and above a preset amplitude threshold (you will learn to change the threshold in the Marker/Frequency Menu discussion). When the marker is turned off, the signal peak nearest center screen is used. It then measures the signal frequency and makes it the new center frequency. This feature means that you don't have to play finicky games with the tuning knob to measure a signal frequency. All you have to do is place the marker close to the signal of interest and press the center measure key! Press the key again to enable the signal track feature which keeps drifting signals centered by continuously repeating the center measure feature.

The center measure feature provides the easiest method of determining the frequency of a signal and the most accurate without the counter option. If the marker is first turned on, it also provides the most accurate method of measuring signal

//////////////////// 2710 Spectrum Analyzer User's Guide //////////////////////

amplitude. With the counter option installed, center measure yields both the signal frequency and amplitude as accurately as possible with the 2710.

Two slightly different approaches are taken depending on whether the counter option is installed. We will use the calibration signal in our example, but the procedure is the same for any signal.

To use the center measure feature with or without the counter installed, turn on the marker and place it near the calibration signal using the *FREQ/MARKERS* knob. If you do not turn on the marker, the amplitude will not be read out unless the counter is installed. Set the reference level so that the signal peak is within one division of the top graticule line and press:

[CTR MEAS/TRKG]

With the counter installed, you do not have to turn on the marker. Move the calibration signal close to center screen and press [CTR MEAS/TRKG].

In either case, the calibration signal will be recentered.

If the counter option is installed, the amplitude and frequency of the centered signal are read out at the upper right of the screen preceded by a "C" (counter). The counter readout provides the most accurate frequency determination available on the 2710 and its resolution can be set to 1 Hz if desired. The counter readings disappear if any control is altered.

If you do not have the counter option in your 2710, the amplitude and frequency of the centered signal are read out at the upper right of the screen preceded by an "M" (marker) providing you first turned on the marker.

The amplitude readouts with and without the counter are equally accurate. The signal amplitude indicated by the position of the marker relative to the graticule may differ slightly from the amplitude readout. The readout is more accurate because it contains no display nonlinearities.

//////////////////// 2710 Spectrum Analyzer User's Guide //////////////////////

The center frequency readout is more accurate than the frequency indicated by the position of the marker for the same reason, but not as accurate as the counter frequency. Center frequency and counter accuracy depends on the options installed:

Standard 2710

$\pm 10^{-5}$ of center frequency ± 5 kHz

With 300 Hz filter/phase lock option

$\pm 5 \times 10^{-7}$ of center frequency ± 700 Hz

Counter option in standard 2710

$\pm 10^{-5}$ of center frequency ± 10 Hz ± 1 LSD

Counter and 300 Hz filter/phase lock options

$\pm 5 \times 10^{-7}$ of center frequency ± 10 Hz ± 1 LSD

Now let's look at the calibration signal third harmonic more closely. **Place the marker near the third harmonic, say about 280 MHz, and press:**

[CTR MEAS/TRKG]

The calibration signal third harmonic is made the new center frequency and its frequency and amplitude are displayed at the top of the right-hand readouts.

Now enter delta-marker mode. Place the movable marker near the calibration signal fundamental (at 100 MHz) and press:

[CTR MEAS/TRKG]

This mode of operation centers the signal peak nearest the movable marker and measures the difference between the centered signal and the signal at the fixed marker. In this case, the fundamental is recentered and the markers appear atop it and the third harmonic. Readings of approximately 200 MHz and 12 dB appear at the top of the left column. Readings made with the counter are preceded by the letters DC (delta-counter); readings made without the counter are preceded by D (delta). The center measure feature with delta marker mode provides a very convenient method of determining precise signal differences without manual tuning or interpolation of graphical data. **Turn off the markers.**

//////////////////// 2710 Spectrum Analyzer User's Guide //////////////////////

The center measure feature can perform still another function. When center measure is used in zero span mode, the counter measures the frequency at the output of the 2710 detector. Because the output varies only if the signal is modulated, the counter is actually measuring the frequency of the modulation (if none is present, you receive a message saying so). Normally AM detection is used, but you can select FM detection (see *Measuring Frequency Deviation* in the next chapter). Whichever detector is selected, the center measure feature provides a quick method of determining the frequency of the modulating signal.

100.0MHz	(AUTO SWEEP)	ATTN 10DB
-20.0DBM		VF WIDE
20.0MHz/		10 DB/
5MHz RBW (AUTO)	CALIBRATOR	

The signal track feature of the 2710 continuously repeats the center measure operation. On each sweep the signal nearest midscreen is remeasured and recentered. This is useful for keeping a slowly varying or jittering signal centered for close observation.

To activate signal track, press and hold:

[CTR MEAS/TRKG]

until the red LED adjacent to the key lights (about 1/2 second or until the second beep). The term:

TRKG

appears in center screen indicating that the 2710 is in signal track mode. Try turning the tuning knob while a sweep is underway. On the next sweep you may see the signal displaced a bit, but on the following sweep it is recentered. Tracking mode continuously repeats the center measure feature.

If the signal being tracked falls below a preset threshold (see **SETTING THE SIGNAL THRESHOLD** in *The Menu -- Ultimate Flexibility*), tracking halts and the message:

NO SIGNAL FOUND ABOVE THRESHOLD

////// 2710 Spectrum Analyzer User's Guide ////

is displayed. The message is accompanied by a beep. When the signal rises back above threshold, signal track mode resumes automatically. **Simulate signal loss and recovery by turning the calibrator off and then back on again.** The audible beep makes this signal track mode useful as an amplitude threshold detector.

It is also possible to obtain a continuous counter readout while in signal track mode. **Turn on the counter by pressing [MKR/FREQ MENU]/[9]/[2]/[2]** (See the *Marker/Frequency Menu* for additional discussion).

Now let's continuously monitor a frequency difference. **Again press [CTR MEAS/TRKG] to exit from tracking mode and turn off the LED. Reset the span to 50 MHz/division and enter the delta-marker mode. Place the movable marker near the third harmonic. Re-enter tracking mode.** You are using the delta-counter feature in signal track mode. The third harmonic is centered and the frequency difference between the fundamental and third harmonic is being constantly monitored, just like that! **Exit from tracking mode and turn off the markers.**

Frequency/Markers



Center the calibration signal and turn on the marker.
Press:

[MKR ⇨]



The marker jumps to the second harmonic peak. Press the key again. It jumps to the third harmonic. Now press:

[MKR ⇨]

The marker jumps in the other direction. The marker arrow keys move the marker in the direction of the arrow to the next signal peak above the preset threshold, but they will not go beyond the edge of the display or lower than 0 Hz.

2710 Spectrum Analyzer User's Guide

Enter delta-marker mode. Try pressing the arrow keys now. The movable marker jumps in the direction of the arrows just as the single marker did and the readouts behave the same as if you'd manually moved the marker. Center measure and tracking perform the same also.

Frequency/Markers

Ensure the markers are turned off and set center frequency to 275 MHz. Press:



[MKR PEAK FIND]

The 2710 automatically entered marker mode (red LED adjacent to [MKR Δ OFF] came on) and the marker jumped to the peak of the calibration signal at 100 MHz. When this key is pressed, the analyzer detects the highest signal peak on screen and automatically moves the marker to it. After the move, the 2710 behaves exactly as if you had moved the marker there with the tuning knob. Use [MKR \rightleftarrows] to move the marker to the peak of the third harmonic. Press [MKR PEAK FIND] again. The marker moves back to the fundamental. It does not matter that the marker is already on a peak; the marker peak find feature always locates the highest peak on screen.

Any control settings can be used

Miscellaneous Controls

We have discussed and experimented with all the 2710 functions except the menu keys and a few oscilloscope-like controls. These miscellaneous controls will be covered very briefly here.

Graticule Illumination



The graticule is the array of grid lines overlaying the face or the display tube. It can be sidelighted for greater visibility using built-in illumination.

Turn the graticule illumination on by pressing:

[GRAT ILLUM]

This is another toggle-action key. The LED adjacent to the key lights and extinguishes in synchronism with the graticule illumination. **Press the key several times and observe the display graticule. Leave the graticule illuminated or not, as you choose.**

NOTE

The graticule illumination also controls the printing of grid lines with an optional printer/plotter. Grid lines are produced on the hard copy only when the graticule illumination is turned on.

Intensity

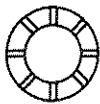

The intensity control is a rotary knob that works exactly like any other oscilloscope intensity control. **Twist the INTENSITY knob slowly back and forth. Observe the display grow brighter and dimmer as you turn the control.** Leave the intensity set to a level sufficient for good contrast in your ambient light conditions. If you have to turn it to full intensity, try reducing the ambient light or shielding the display. **If the 2710 is used in direct sunlight, use of an optional contrast-enhancing filter is recommended (Tektronix part number 337-2775-02).**

//////////////////// 2710 Spectrum Analyzer User's Guide //////////////////////

Trace Rot	Vert Pos	Horiz Pos
--------------	-------------	--------------

There are three non-locking slotted controls at the upper right of the 2710 rear panel which are used with a built-in test display to adjust trace alignment. The control shafts are recessed within hex nuts which attach the controls to the analyzer chassis. Do not attempt to turn the hex nuts and do not use excessive force when turning the slotted shafts. A plastic "tweaking" tool is recommended in preference to a screwdriver. Display alignment instructions, utilizing these controls, are located in the **UTILITY MENU** section of *The Menus*.

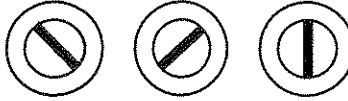

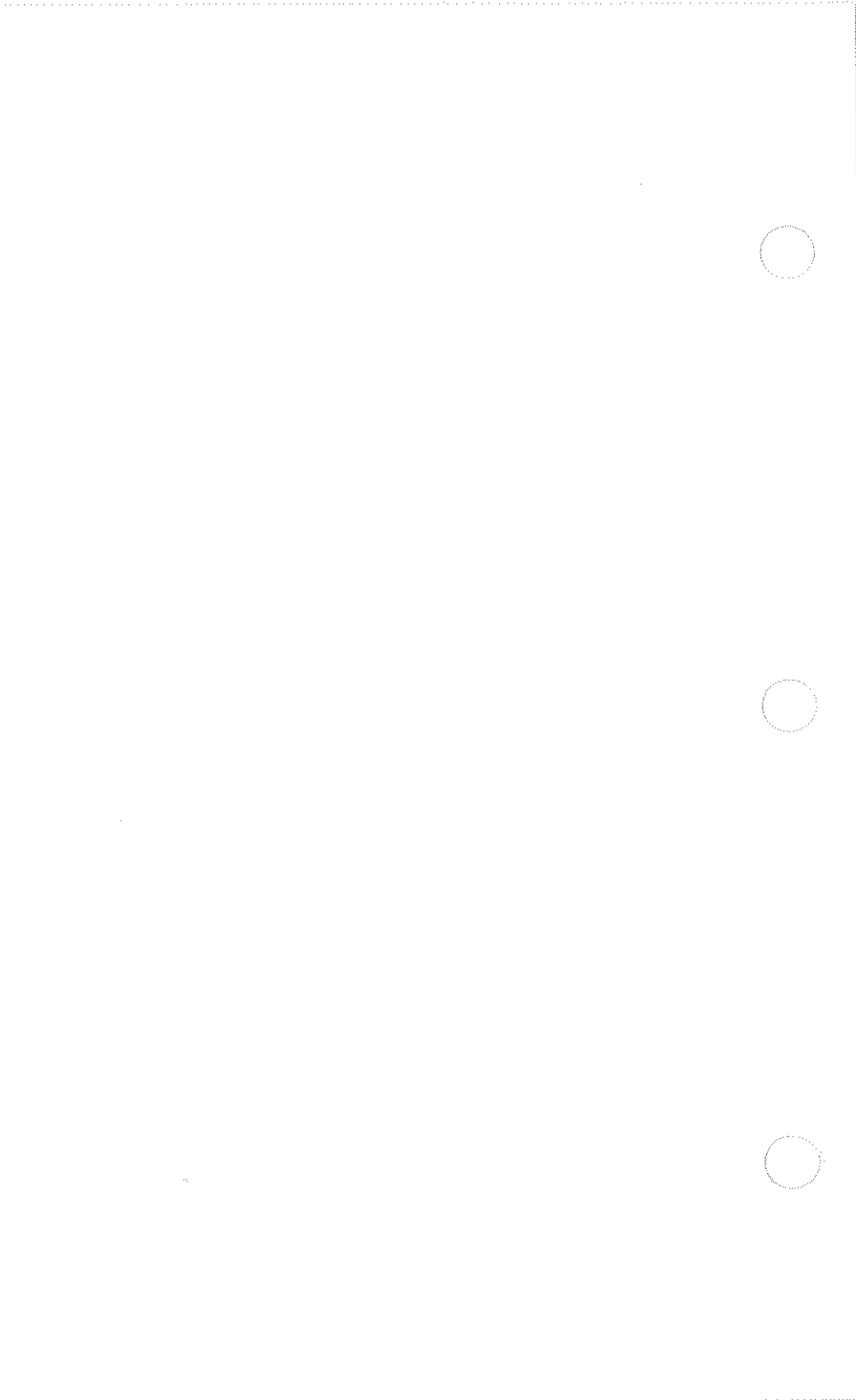

THE MENUS -- ULTIMATE FLEXIBILITY

This chapter describes in detail the menu-selected, software-driven features of the 2710. You will discover how this approach to instrument control provides a degree of measurement flexibility otherwise unattainable without a large, cumbersome, and hard to understand control panel.

If you glance at the front panel of the 2710, you'll notice there are black-bordered menu keys in most of the function blocks. Pressing these keys *calls up*, or causes to be displayed on the screen of the 2710, a *menu*. Each menu is related to the functions in the block in which its key is located. The menus enable you to perform a variety of tasks, some of which are not possible from the front panel. These include:

- Controlling spectrum analyzer operational modes
- Changing control increments and settings
- Storing and recalling control settings
- Normalizing the spectrum analyzer
- Altering measurement parameters
- Executing diagnostic routines
- Automating measurements

Each menu is a list of numbered items. Items are selected by pressing the corresponding numeric keypad keys. The keypad keys are a group of 2710 front panel keys which have numbered and illuminated green LED's adjacent to them whenever a menu is called up. The A - D display register keys also have green LED's adjacent to them, and are used for terminating data entry according to on-screen prompts.

Selecting an item from a menu frequently results in a secondary menu being displayed. A few not-often-used items from the secondary menu may call up a tertiary menu. An abridged menu hierarchy showing all of the items needed to perform most measurements is illustrated in figure 4-1. It is a good idea to have a copy of this figure handy while learning to use the analyzer.

//////////////////////////////////// 2710 Spectrum Analyzer User's Guide //////////////////////////////////////

UTIL MENU (page 4-68)

- 0 INITIALIZE INSTR SETTINGS
- 1 STORED SETTINGS
 - 0 LAST POWER-DOWN
 - 1 FACTORY DEFAULT POWER-UP
 - 2 USER-DEFINED POWER-UP
 - 3-9 USER-DEFINED SETTINGS
- 2 KEYPAD-ENTERED SETTINGS
 - 0 FREQUENCY
 - 1 REFERENCE LEVEL
 - 2 SPAN/DIV
 - 3 RF ATTENUATION
 - 4 RESOLUTION BW
 - 0 AUTO
 - 1 FIXED
 - 5 VIDEO FILTER
 - 0 AUTO
 - 1 FIXED
 - 6 VERTICAL SCALE
 - 0 LOG 1 DB/DIV
 - 1 LOG 5 DB/DIV
 - 2 LOG 10 DB/DIV
 - 3 LINEAR
 - 7 SWEEP RATE
- 3 NORMALIZATIONS
 - 0 ALL PARAMETERS
 - 1 FREQUENCY ONLY
 - 2 AMPLITUDE ONLY
 - 3 TRACKING GENERATOR ONLY
- 4 SYSTEM CONFIGURATION
 - 0 COMMUNICATION PORT CONFIG
 - 0 GPIB
 - 0 STATUS
 - 1 GPIB ADDRESS
 - 2 POWER ON SRQ
 - 3 EOI/LF MODE
 - 4 TALK ONLY MODE
 - 1 CENTRONICS
 - 1 SCREEN PLOT CONFIG
 - 0 COMM PORT
 - 1 PLOTTER LANGUAGE
 - 2 PLOT SPEED
 - 3 PLOTS PER PAGE
 - 4 PLOT POSITION
 - 2 PRINTER CONFIGURATION
- 3 INSTRUMENT CONFIGURATION
 - 0 AUDIO ALERT LEVEL
 - 1 MINIMUM SIGNAL SIZE
 - 2 WAVEFORM TO PRINTER
 - 3 WAVEFORM OUTPUT FORMAT
 - 4 PHASELOCK
 - 5 FREQUENCY CORRECTIONS
 - 6 SPECTRAL DISPLAY IN MENUS
 - 7 SWEEP HOLDOFF
 - 4 REAL-TIME CLOCK SETUP
 - 5 STORED SETTINGS PROTECT
 - 6 FILE SYSTEM DIRECTORY

- 7 PROTECT FILE
- 9 INSTALLED OPTIONS DISPLAY
- 5 INST DIAGNOSTICS/ADJUSTMENTS
 - 0,1,3,4,6 Various factory troubleshooting aids
- 2 MANUAL ADJUSTMENTS
 - 2 DISPLAY STORAGE CAL
(Plus other factory tests)
- 5 SERVICE NORMALIZATIONS
 - 0 FREQUENCY NORMALIZATIONS
 - 1 REFERENCE NORMALIZATIONS
 - 2 AMPLITUDE NORMALIZATIONS
 - 3 NORMALIZATION VALUES
 - 4 PRINT ALL NORM VALUES
 - 5 NORM DEBUG TO PRINTER
- 6 WAVEFORM PLOT
- 7 SERVICE REQUEST
- 9 MORE
 - 0 PRINT READOUTS

MKR/FREQ MENU (page 4-25)

- 0 FREQUENCY ENTRY
- 1 SPAN/DIV ENTRY
- 2 KNOB FUNCTION
 - 0 FREQUENCY
 - 1 MARKER
 - 2 VIDEO LINE
 - 3 TG TRACKING
- 3 MARKER TO REFERENCE LEVEL
- 4 MOVE MARKER TO NEXT PEAK
- 5 TRANSPOSE MARKERS
- 6 MARKER START/STOP
- 7 FREQUENCY START/STOP
 - 0 FREQ START ENTRY
 - 1 FREQ STOP ENTRY
- 8 TUNING INCREMENT
- 9 SETUP TABLE
 - 0 CENTER//START FREQ
 - 1 THRESHOLD
 - 2 COUNTER RESOLUTION
 - 0 COUNTER OFF WHEN
- TRKG(1HZ)
 - 1 1 HZ
 - 2 1 KHZ
- 3 PROGRMD TUNING INC
 - 0 CENTER FREQ
 - 1 MARKER FREQ
 - 2 KEYPAD-ENTERED INC
 - 3 KEYPAD ENTRY
 - 4 RETURN TO AUTO
 - 4 TABULAR TUNING INC
 - 0-9 Various user-selectable tuning tables including US broadcast and cable TV, and various foreign frequency standards
 - 5 FREQ OFFSET
 - 6 FREQ OFFSET MODE

//////////////////////////////////// 2710 Spectrum Analyzer User's Guide //////////////////////////////////////

SWP/TRIGMENU (page 4-87)

TRIGGER MENU

- 0 FREE RUN
- 1 INTERNAL
- 2 EXTERNAL
- 3 LINE
- 4 TV LINE
- 5 TV FIELD

SWEEP MENU

- 6 SWEEP RATE
- 7 MANUAL SCAN
- 8 VIDEO DETECT MODE
- 9 SETUP TABLE

MONITOR

- 0 VIDEO MONITOR MODE
- 1 SYNC POLARITY
- 2 VIDEO POLARITY

HORIZONTAL LINE TRIGGERING

- 3 CONTINUOUS
- 4 KNOB SELECTABLE
- 5 KEYPAD-ENTERED LINE
- 6 KEYPAD ENTRY
- 7 TV LINE STANDARD

INPUT MENU (page 4-7)

- 0 REF LEVEL ENTRY
- 1 PREAMP
- 2 50 OHM DBM/75 OHM DBMV
- 3 REF LEVEL UNIT
 - 0 DBM
 - 1 DBMV
 - 2 DBV
 - 3 DBUV
 - 4 DBUW
 - 5 DBUV/M IN WFM x
- 9 DBUV/M SETUP
 - 0 EDIT ANTENNA TABLE
 - 1-5 stored antenna tables
 - 6 MEASUREMENT DIST
 - 7 SAVE RESULTS IN WFM
 - 9 MARKER DISPLAY
- 4 1ST MXR INPUT LVL
- 5 RF ATTENUATION
- 6 EXTERNAL ATTN/AMPL
 - 0 ON/OFF
 - 1 ATTN/AMPL ENTRY
- 9 CAL SIGNAL @ 100MHZ -30DBM

USER DEF MENU (page 4- 97)

- 0-8 stored and numbered keystroke sequences called routines executed by pressing [USER DEF]/[routine no.]
- 9 USER DEF PROGRAM UTILITIES
 - 0 ACQUIRE/EXIT KEY STROKES
 - 1 TITLE EDIT
 - 2 WAIT FOR END OF SWEEP
 - 3 DISPLAY MESSAGE

4 PAUSE FOR "USER DEF" KEY

- 5 CONTINUOUS EXECUTION
- 6 STORE
- 7 DELETE
- 8 PROTECT

DET/GEN MENU (page 4-66)

- 0 OFF
- 1 AM DETECTOR
- 2 FM DETECTOR
- 3 AM & FM DETECTOR
- 4 TRACKING GENERATOR
- 5 TG FIXED LEVEL
- 6 TG VARIABLE LEVEL
- 7 TG TRACKING
- 8 TG EXT ATTN/AMPL

APPL MENU (page 4-58)

- 0 BANDWIDTH MODE
- 1 CARRIER TO NOISE
- 2 NOISE NORMALIZED
- 3 SIGNAL SEARCH MENU
 - 0 BEGIN FREQ
 - 1 END FREQ
 - 2 START TEST
 - 3 DISPLAY RESULTS
- 9 SETUP TABLE
 - 0 DB DOWN OF BW MODE
 - 1 NORM BW FOR C/N
 - 2 NOISE NORM'D BW

DSPL MENU (page 4-38)

- 1 ENSEMBLE AVERAGING
 - 1 INITIATE AVERAGING
 - 2 TERMINATE AVERAGING
 - 3 MAX
 - 4 MEAN
 - 5 MIN
 - 6 MAX/MIN
 - 7 NUMBER OF AVERAGES
 - 8 SAVE RESULTS IN DISPLAY
- 2 B,C MINUS A
- 3 B,C MINUS A OFFSET TO
- 4 ACQUISITION MODE
- 5 TITLE MODE
- 6 READOUT
- 7 DISPLAY SOURCE
 - 1 AM DETECTOR
 - 2 FM DETECTOR
 - 3 EXTERNAL INPUT
- 8 DISPLAY LINE
 - 1 ON/OFF
 - 2 VALUE ENTRY
 - 3 DISPLAY LINE TO MARKER
 - 4 LIMIT DETECTOR
 - 9 MIN HOLD IN WFM nn

Figure 4-1. The 2710 menu hierarchy.

2710 Spectrum Analyzer User's Guide

Each menu lists the analyzer parameters or features controllable from that menu. A status indicator at the end of each menu item shows the present value or condition of the parameter or feature. See Figure 4-2 for examples. Depending on the parameter, there are three ways its status may be changed:

- When only two or three values or conditions are permitted, pressing the keypad key corresponding to the item number cycles through the acceptable values. At each step, the new status appears at the end of the line.
- If the 2710 accepts a larger but still limited range of values, it presents a secondary menu consisting of a list of the values. For instance, if you select item 3 from the Input Menu shown in figure 4-2, the Reference Level Units Menu shown in figure 4-3 appears. An asterisk inserted between the item number and its description indicates the value presently selected.
- If a parameter can have a full range of numerical values, two things happen. First, the analyzer precedes the selected item number with an asterisk (to ensure there is no confusion regarding which item was selected). Then the 2710 produces a prompt near the bottom of the screen indicating that you should enter the new value. This is illustrated in figure 4-2 where item 0 has been selected.

```
INPUT MENU
* 0 REF LEVEL ENTRY      -20.0DBM
  1 PREAMP                OFF
  2 50 OHM DBM/75 OHM DBMV  50
  3 REF LEVEL UNIT        DBM
  4 1ST MXR INPUT LEVEL   -30DBM
  5 RF ATTENUATION        AUTO 10DB
  6 EXTERNAL ATTEN/AMPL   NONE

  9 CAL SIGNAL @ 100MHz -30DBM OFF

ENTER NEW VALUE: __

A = -DBM                B = +DBM
```

Figure 4-2. The Input Menu.

REFERENCE LEVEL UNITS	
0	*DBM
1	DBMV
2	DBV
3	DBUV
4	DBUW
5	DBUV/M IN WFM C ANT EMPTY
9	DBUV/M SETUP
"←" = PREVIOUS MENU	
MENU KEY = RETURN TO DISPLAY	

Figure 4-3. Reference Level Units Menu.



The keypad is used for numerical entry; [A A], [B B], [C C], and [D 

Table 4-1. Units associated with the letter-keys.

[A A]	-dB, Hz, RECALL, or "ENTER"
[B B]	+dB, kHz, or STORE
[C C]	MHz, DELETE, or AUTO
[D  <td>GHz or ABORT</td>	GHz or ABORT

The appropriate unit is indicated by the prompt. For example, to enter a value of -6.5 dBm in response to the prompt in figure 4-2, you press:

[6]/[.]/[5]/[A A]

If no units are called for, [A A] is used to terminate the entry. If you press an incorrect key, the back-arrow key, [←], is used to move the cursor back one space, blanking the incorrect character.

//////////////////////////////// 2710 Spectrum Analyzer User's Guide //////////////////////////////////

There are three ways to exit from a menu:

1. Many selections cause the analyzer to revert automatically to the measurement mode it was in before calling up the menu; you do nothing but make the selection. In such cases you will not see the status indicator at the end of the menu line change before the analyzer returns to the spectral display. This is usually not a problem because the change is indicated by the on-screen readouts or the nature of the spectral display itself. If confirmation of the change is needed, reselect the menu to view the status indicator.
2. This prompt is displayed at the bottom of all menus prior to making a selection from that menu:

"<-" = PREVIOUS MENU
MENU KEY = RETURN TO DISPLAY

Simply pressing the menu key for the displayed menu returns you instantly to the spectral display. You can also use this technique if you decide not to make a selection.

3. Pressing the back arrow key, [, returns you to the previous menu. If there is no previous menu, you return to the spectral display. The back arrow can, therefore, be used to return to a previous menu to alter a selection, or to back entirely out of a menu and return to the spectral display. This technique is also useful if you can't recall which menu you are using.

In general, the menus are not reproduced here. It is intended that you call up the menus on the 2710 and follow along with the experiments in this manual as they are described. However, should you need a handy reference, use the abridged menu hierarchy shown in figure 4-1. Your *2710 Operators Manual* also contains a brief description of the menus.

You have already made use of three menus. You used the Utility Menu to restore factory default settings to the analyzer, the Input Menu to turn on the calibration signal, and the Display Menu to activate PEAK acquisition mode for the waterfall display. In the following sections you will learn in detail how to use each of the 2710's menus.

////////// 2710 Spectrum Analyzer User's Guide //////////

To continue, turn on your 2710 and set it according to the following settings box.

100.0MHz	(AUTO SWEEP)	ATTN 10DB
-20.0DBM		VF WIDE
20.0MHz/		10 DB/
5MHz RBW (AUTO)	CALIBRATOR	

Input Menu

The Input Menu is used to control analyzer parameters which alter signal sensitivity and height and to turn the calibration signal on and off. It also controls amplitude measurement units. **To call up the Input Menu, press:**



[INPUT MENU]

The menu shown in Figure 4-2 appears on screen.

Turning the Calibrator On and Off

The word OFF following item 9 of the Input Menu indicates the 2710 calibration signal is turned off. **Turn on the calibration signal by pressing:**

[9]

The spectral display reappears and the word CALIBRATOR is now displayed at the lower right of the screen indicating the calibration signal is on. The calibrator signal is the peak at center screen. Turning on the calibrator also internally disconnects the normal analyzer input from the RF attenuator and prevents viewing external signals. **Again press:**

[INPUT MENU]

The word following item 9 now is ON. In this way, the menu enables you to toggle between the two possible settings, and appraises you of the current setting. **Turn the calibrator off by**

//////////////////////////////// 2710 Spectrum Analyzer User's Guide //////////////////////////////////

pressing keypad key 9 again. You get the spectral display back but without CALIBRATOR displayed. Press [INPUT MENU]/[9] once again to turn the calibrator back on.

Changing the Reference Level

You've learned to use [SIG \uparrow] and [SIG \downarrow] to control signal height, but now let's learn another method. **Call up the Input Menu and select item 0.** The prompt:

ENTER NEW VALUE: __

A = -DBM B = +DBM

appears at the bottom of the screen. Press:

[1]/[.]/[3]/[B B]

The 2710 reverts to measurement mode. You entered the value + 1.3 dBm for the reference level and this value is now reflected by the on-screen readout. What's more, you entered a value that cannot be entered from the front panel. **Use item 0 on the Input Menu to set the value to 0.0 dBm.**

Setting the RF Attenuation

Press [SIG \uparrow] twice. Notice that the signal peak rises but the noise floor does not. This is because the RF attenuation is decreased each time you pressed the key; the increased signal height is achieved by reducing attenuation. The analyzer noise floor, however, is generated after the RF attenuator, so it is not affected. **Set the reference level back to 0.0 dBm and select the Input Menu.** Item 5 informs you that the RF attenuation is 30 dB and that it is selected automatically by the 2710. We can control the RF attenuation so that it remains at a fixed value. **Select item 5 and this prompt appears:**

ENTER NEW VALUE OR "C": ___
< 0 TO 50 IN 2 DB STEPS >
A = DB C = AUTO

Enter a fixed value of 30 dB by pressing:

[3]/[0]/[A A]

The display returns unchanged. Press [SIG \uparrow] twice. Now both the signal peak and the noise floor rise. This is because the analyzer IF gain has been increased 20 dB to lower the reference level, but the RF attenuation is unchanged. Press:

[INPUT MENU]/[5]/[C C]

to place the RF attenuation back in automatic mode.

Changing Reference Level Units

Suppose you want the reference level in some other units. You can change the units via the Input Menu. **Ensure the reference level is set to 0.0 dBm and then choose item 3 from the Input Menu.** A list of six possible units appears. Select item 2, dBV. The spectral display is restored but the reference level now reads -13.0 dBV because 1 mW across 50 ohm (0 dBm) represents .223 volts which is 13 dB below a 1 volt reference (0 dBV). Only the units change, not the analyzer gain, attenuation, or input impedance. Therefore, the height of the spectrum is unchanged. **Change the units back to dBm and turn off the calibrator.**

Each of the six units except the DBUV/M represents a simple change of scale. Be aware that the 2710 always measures the voltage at its input across its 50 ohm input impedance, and then scales the result according to the selected units. Because the DBUV/M is not just a simple unit conversion, it is discussed separately in a later section.

Accommodating External Amplification/Attenuation

Any time you wish to measure a high amplitude signal, it is probable that you will have to attenuate that signal before inputting it to the spectrum analyzer. (Remember, the maximum total signal power at the input to the 2710 should not exceed +20 dBm, or 100 mW.) On the other hand, if you have a very weak signal, you may need to amplify it. You could mentally add the extra attenuation or amplification to the displayed signal peak to determine the correct signal amplitude, but the 2710 has a better way. **Ensure the calibrator is turned off and select the Input Menu.** Item 6 tells you there is presently no external attenuation or amplification. **Choose item 6.** A secondary menu appears which enables you to enter the amount of external attenuation or amplification. **Select item 1.** Suppose you've attenuated an RF transmitter output 40 dB prior to measuring it. **Following the on-screen prompts, press:**

[4]/[0]/[A A]

to enter an external attenuation of 40 dB. The spectral display does not change, but the reference level now indicates 40 dBm and is followed by the term

OFST

indicating that the reference level has been offset, in this case by 40 dB. The reference level is offset automatically when you enter any value for external attenuation or gain. **To turn off the offset, first press:**

[INPUT MENU]/[6]

Item 0 tells you the offset is turned on. **Turn it off by selecting item 0.** As you do, the spectral display reappears and OFST is gone. **Toggle the offset back on without reentering the external attenuation value by pressing:**

[INPUT MENU]/[6]/[0]

Now turn off the offset and then enter a value of 0 dB for external attenuation.

Accommodating a 75 Ohm Source

The 2710 has a 50 ohm input impedance and expects a 50 ohm signal source impedance. However, a 75 ohm source impedance is typically associated with some applications such as cable television, which uses the dBmV as a "standard" amplitude measurement unit. The 2710 provides two ways to deal with this situation.

On the one hand, when making narrowband measurements (carrier-to-noise ratios, relative amplitudes of signals close together in frequency such as television visual and aural carriers, bandwidths of narrow signals, interference levels relative to a nearby signal, etc.), you can generally connect the 2710 directly to a 75 ohm source. For these cases, item 2 of the Input Menu automatically inserts correction factors to account for the 75/50 ohm impedance difference and the conversion from dBm to dBmV. If a 75 ohm source is connected to the input of a 75 ohm instrument, the voltage will be 1.9 dB higher than it is with the same source connected to the 50 ohm input of the 2710. We can also calculate that 0 dBm dissipated in 50 ohms is equal to 47 dBmV across the same resistance. The total difference is, therefore, 48.9 dB. Item 2 of the Input Menu differs from the dBmV unit chosen via [INPUT MENU]/[3]/[1] by including the 1.9 dB factor to account for the higher voltage which would be present at the input to a 75 ohm instrument.

Ensure the reference level is set to 0.0 dBm. Toggle the input impedance/reference units between 50 ohm/dBm and 75 ohm/dBmV by pressing:

[INPUT MENU]/[2]

Once again the spectral display is unchanged, but the reference level has been converted to 48.9 dBmV to reflect the new source impedance and units. **Return to 50 ohm/dBm by pressing [INPUT MENU]/[2] again.** If you do not reselect the 50 ohm mode, a 1.9 dB impedance correction remains regardless of the units you select.

NOTE

Selecting item 2 from the Input Menu does not change the impedance of the 2710; it only inserts a correction to account for the 50/75 ohm impedance mismatch and a conversion factor from dBm to dBmV.

On the other hand, when making broadband measurements or measurements of absolute amplitude (antenna, system, or amplifier sweeps; absolute carrier amplitude; comparison of signals widely separated in frequency; etc.), you may want to present a matched load to the source to provide maximum flatness and to minimize standing wave ratios. You can do so by inserting the matching minimum loss pad (a standard 2710 accessory) shown in Figure 4-4 between the source and the analyzer. To obtain correct dBmV readings, you then set the Input Menu measurement parameters as follows :

Item 2:	50 OHM DBM/75 OHM DBMV	50
Item 3:	REF LEVEL UNIT	DBMV
Item 6:	EXTERNAL ATTEN/AMPL	-7.5

In this case, you select the dBmV unit via [INPUT MENU]/[3]/[1] and the 50 ohm source because the analyzer is matched to the 50 ohm side of the minimum loss pad and the signal really is being terminated in a 75 ohm impedance. Further, it is the attenuation of the pad which is entered under item 6 and not its insertion loss. The 7.5 dB accounts for both the insertion loss and the fact that the signal at the input to the minimum loss pad is 1.9 dB greater than it would be if the 75 ohm source were connected directly to the analyzer.

If in doubt whether the pad is needed, compare a measurement with the pad to the same measurement without the pad. If there is no significant difference, abandon the pad. In some cases, such as carrier-to-noise measurements, the use of a pad may drop your system noise level below the analyzer noise floor. In such cases, the pad cannot be used. Removing the pad typically does not distort C/N measurements.

When a 75 ohm source is routinely used, you can make the settings above part of the spectrum analyzer user-defined power-up (see the *Utility Menu* later in this chapter); then you won't have to change the settings each time the 2710 is used.

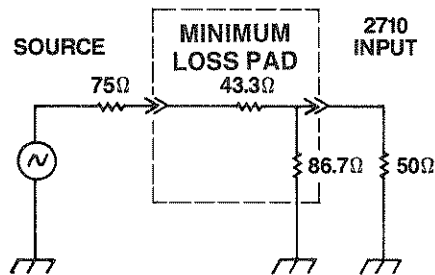

Figure 4-4. 75/50 ohm matching minimum loss pad.

Setting the First Mixer Input Level

Overdriving the analyzer's first mixer circuit can generate spurious signals and cause inaccurate measurements. As the signal amplitude increases past the maximum linear range of the circuit, its output amplitude becomes less than it should be. This creates lower-than-actual amplitude measurements and generates spurious signals through the processes of intermodulation or harmonic distortion. On the other hand, if the signal amplitude at the mixer is too low, signals may become lost in the analyzer's internally generated noise. An optimum compromise is achieved within the 2710 by making the top graticule line represent a -30 dBm level at the input to the first mixer.

However, in cases where total signal energy is large, it may be beneficial to restrict the input to the mixer to a smaller value. By resetting the first mixer input level to, say, -40 dBm, you increase the RF attenuation by 10 dB while simultaneously increasing the IF gain 10 dB. This provides additional protection to the first mixer. In other cases, you may want to examine a low-level signal adjacent to a high-level signal. A -20 dBm level at the first mixer allows you to get an additional 10 dB of sensitivity by reducing the RF attenuation 10 dB but decreasing the IF gain 10 dB to compensate. The danger is that internally generated distortion products may become more noticeable. To change the signal level at the mixer, press:

[INPUT MENU]/[4]

You are prompted to enter a new mixer input level. You can enter values from -50 dBm to -20 dBm in 2 dB steps. Try -20

//////////////////////////////////// **2710 Spectrum Analyzer User's Guide** //////////////////////////////////////

-30 dBm and -40 dBm while observing the level of the noise. Because the RF attenuation is increased by the same amount the first mixer input is decreased, the noise floor rises as the mixer level is reduced. **When you are done experimenting, set the mixer input level back to -30 dBm.**

100.0MHz	(AUTO SWEEP)	ATTN 0DB
-50.0DBM		VF 300KHz
5MHz/		10 DB/
300KHz RBW (AUTO)		

Turning the Preamp On and Off

Your spectrum analyzer is equipped with an internal preamplifier. The preamplifier can be very useful when measuring cable TV noise (see the C/N discussion later in this chapter) or other signals below the normal analyzer noise floor. It is also useful for increasing the sensitivity of radiated RF energy measurements (leakage, RFI/EMI, etc.). The nominal gain in sensitivity using the preamp is 12 dB. Above 600 MHz the preamp remains useable and useful, but its flatness rolls off somewhat and is not specified. To be effective, the preamp must be used with no RF attenuation. The preamp is not normally turned on because it can easily result in overdriving the first mixer. The signal amplitude at the first mixer with the preamp on and no RF attenuation is equal to the input signal level plus about 18 dB. In other words, a -40 dBm signal would overdrive the first mixer. Total signal amplitude greater than -48 dBm at the input to the analyzer with the preamp turned on may create spurious signal components and produce unreliable amplitude measurements.

Note the level of the noise floor and then press:

[INPUT MENU]/[1]

2710 Spectrum Analyzer User's Guide

Item 1 of the Input Menu toggles the preamp on and off. The preamp is now turned on as indicated by the term:

PRE

following the reference level readout. **Again note the noise floor; it should be about 12 dB lower than before.** The analyzer has automatically reduced its internal gain (thus lowering the normal noise floor) to compensate for the added gain of the preamplifier. The result is that you can now see signals which are up to 12 dB below the normal analyzer noise floor. **Toggle the preamp off.**

Using the DBUV/M

The decibel relative to a microvolt per meter ($\text{dB}\mu\text{V}/\text{m}$) is an electric field strength unit that characterizes the intensity of radiated RF energy. Typically, the radiated signal amplitude is measured at the terminals of a calibrated antenna to determine the field strength. With most spectrum analyzers, you then correct the measured signal amplitude for any gain or attenuation external to the analyzer, convert the signal amplitude to the radiated intensity using the antenna factor (often referred to as the K-factor) for your antenna, and scale the field strength for the difference between the measurement distance and the required reference distance. This provides ample opportunity for arithmetical errors. With the 2710, the correction, conversion, and scaling are performed automatically. You input any external gain or attenuation, the antenna factor, and measurement distance using the Input Menu. Then select the $\text{dB}\mu\text{V}/\text{m}$ reference unit and the 2710 does the rest. The signal intensity is read out on screen using the marker, corrected for distance, in either $\text{dB}\mu\text{V}/\text{m}$ or volts/meter. Using the Display Menu, it is also possible to have the 2710 sound a high level audible alert whenever the the measured signal exceeds a threshold that you set. This feature facilitates go/no-go or present/absent type measurements.

Figure 4-5 shows how to set up your equipment. A balun may be included as part of your antenna. The filter and external matching network are optional. The filter is intended primarily to prevent off-the-air signals, such as radio and television, from

//////////////////// 2710 Spectrum Analyzer User's Guide //////////////////////

swamping the analyzer. The matching network may be necessary for maximum accuracy. If in doubt, try the measurement with and without the network. If there is no difference, omit the network for maximum sensitivity.

The following formula relates the radiated field strength in dB relative to a microvolt per meter ($\text{dB}\mu\text{V}/\text{m}$) to the measured signal amplitude in dB relative to a milliwatt (dBm), and scales the result measured at a distance d_{meas} to a reference distance, d_{ref} . The reference distance is often specified by the regulatory agencies.

$$P_{\text{dB}\mu\text{V}/\text{m}} = P_{\text{dBm}} + 107 + 20 \log (d_{\text{meas}}/d_{\text{ref}}) - A + K$$

- d_{meas} = distance from radiation source at which measurement is carried out
- d_{ref} = reference distance at which the intensity is desired
- A = attenuation or gain between antenna and analyzer. If the filter is used, its gain or attenuation should be included in this number. If balun losses are not included in the antenna factor, they should be included here. Cable loss, if significant, can also be included here.
- K = antenna factor; supplied by manufacturer or calculated from:

$$K = 20 \log f - G - 10 \log (19 * R_{\text{ant}})$$

- G = antenna gain as a function of frequency
- f = frequency of signal in MHz
- R_{ant} = output resistance of the antenna or the balun, if the balun is treated as part of the antenna

//////////////////// **2710 Spectrum Analyzer User's Guide** //////////////////////

With the 2710, you enter the attenuation using the EXTERNAL ATTEN/AMPL feature from the Input Menu, and the antenna factor, measurement distance, and reference distance using the DBUV/M SETUP under the REFERENCE LEVEL UNITS of the Input Menu. Note that many commercial antenna suppliers include the balun losses in the antenna factor. For the most accurate results, use an antenna calibrated at the specified reference distance and perform the measurement at that distance. If possible, measure the return loss of the antenna to make certain it is properly tuned to the desired frequency. See *Spectrum Analyzer Fundamentals*, Tektronix application note 26W-7037, concerning return loss measurements.

COMMERCIAL BICONICAL ANTENNA WITH BALUN ATTACHED

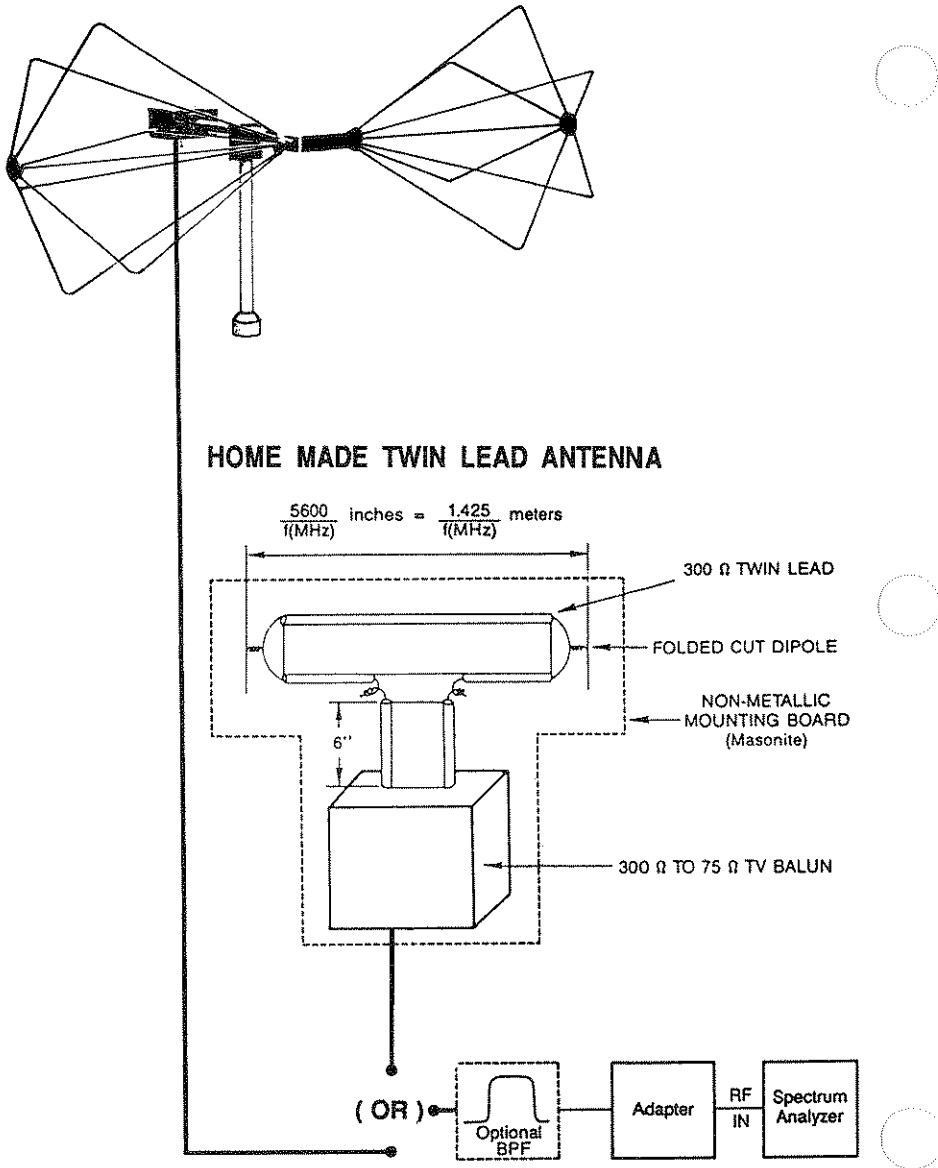

Figure 4-5. Equipment setup for field strength measurements.

To use the dB μ V/m, follow this procedure:

- Select item 3, REF LEVEL UNIT, from the INPUT MENU.
- Select item 9, DBUV/M SETUP, from the REFERENCE LEVEL UNITS.
- Select item 6, MEASUREMENT DISTANCE, from the DBUV/M SETUP and enter the distance at which the measurement will actually be carried out (default distance is 3.0 m). You can enter distances in feet, meters, kilometers, or miles, but the 2710 converts them to meters or kilometers before displaying them.
- Repeatedly select item 7, SAVE RESULTS IN WFM x, until the indicated register (A, B, C) is the one in which you want the resulting measurement to appear. The waveforms are repeatedly saved, deleted, saved, and so on until you terminate the dB μ V/m mode. At that point, the last sweep is retained in the selected register.
- Item 9, MARKER DISPLAY, controls whether the on-screen marker amplitude reads out in decibels relative to a microvolt per meter (DBUV/M) or directly in volts per meter (V/m). The reference unit does not change; only the marker amplitude readout changes. Toggle item 9 to select the units you prefer. Table 4-2 also lists equivalent voltage and decibel values in 4 dB steps. Interpolate between values if closer results are required.

Table 4-2. Equivalent decibel - voltage values.

dB μ V/m	0	4	8	12	16	
0	1	1.58	2.51	3.98	6.31	microvolt
20	10	15.8	25.1	39.8	63.1	per meter
40	100	158	251	398	631	
60	1	1.58	2.51	3.98	6.31	millivolt
80	10	15.8	25.1	39.8	63.1	per meter
100	0.1	0.158	0.251	0.398	0.631	volt
120	1	1.58	2.51	3.98	6.31	per meter

2710 Spectrum Analyzer User's Guide

- Select the antenna number (1-5) which matches the antenna you are using.
- Press the back arrow key to return to the REFERENCE LEVEL UNITS and select item 5, DBUV/M IN WFM x.
- Press [INPUT MENU]/[6] and enter any external gain or attenuation (skip this step if none is present). This number should include the gain or attenuation of any external amplifier or filter, and the losses of any balun which are not included in the manufacturers K factor table for your antenna.
- Connect your antenna and proceed with your measurement. To obtain a measure of the maximum signal strength, save the measurement in the A or B register and select MAX HOLD. Rotate the antenna until the maximum reading is obtained.
- Turn on the marker and use it to read out the field strength directly in dB μ V/m or V/M.

While you are using the dB μ V/m unit, you can not unsave the destination register or use the LIN, FM DETECTOR, or EXTERNAL SOURCE features (you also can not select the dB μ V/m unit while using these features). Attempting to do so will result in an error message.

If you turn off the destination register while using the dB μ V/m, the message:

DBUV/M MEASUREMENT MODE IDLE

is displayed. The dB μ V/m measurement is not made while idling, and you still can not unsave the destination register or use the LIN, FM DETECTOR, or EXTERNAL SOURCE features.

To disable the dB μ V/m measurement mode, select any other reference unit.

If you are using an antenna for the first time, you need to create an antenna table. From time to time you may also need to alter

//////////////////// **2710 Spectrum Analyzer User's Guide** //////////////////////

an existing table. Whether creating new antenna tables or changing old tables, all editing takes place in the "local buffer" or "editing buffer" using the EDIT ANTENNA TABLE. New antenna data are written directly to the buffer prior to permanent storage; old data are loaded into the buffer prior to editing and re-storage. **If you wish to enter new antenna data or change old data, use this procedure:**

- **Select DBUV/M SETUP as above and then select item 0, EDIT ANTENNA TABLE.**
- **To create a new antenna entry, select item 6, ANTENNA SETUP. Enter the start, stop, and frequency steps at which measurements will be made. Enter the reference distance.** The reference distance is the distance to which you want the field strength referred. For maximum accuracy your antenna should be calibrated at the reference distance, and your measurement made at that distance. However, **if you require another distance, enter it here.** For instance, if you are making measurements at 10 meters, but want the field strength at 3 meters, then enter 3 meters. **Press the back arrow key to return to EDIT ANTENNA TABLE.** Item 0 will continue to indicate EMPTY at the end of the line because there are still no antenna factors in the local buffer.
- **To edit an old antenna, select item 3, LOAD, from the EDIT ANTENNA TABLE and choose the antenna you want to edit.** If there is already something in the local buffer, you are given the choice:

**C = OVERWRITE LOCAL BUFFER
D = ABORT**

If you need the data currently in the local buffer, abort the procedure and store it. Otherwise, select the C option. After the antenna is loaded, its name (if it has one) or number is shown at the end of the first line of the EDIT ANTENNA TABLE indicating that the antenna factors for that antenna have been loaded into the local buffer.

//////////////////// **2710 Spectrum Analyzer User's Guide** //////////////////////

- If you attempt to change the frequencies at which you plan to use an antenna, whether it is a newly created antenna or an old, you must delete the local buffer and start over as though it is a new antenna. **To delete the local buffer, select item 4, DELETE, from the EDIT ANTENNA TABLE and then select item 6, EDITING BUFFER. Confirm the deletion by pressing [C] and proceed as though you are creating a new antenna table.**
- After you have loaded an old antenna table or established the frequency range and calibration distance for a new one, select item 0 from the EDIT ANTENNA TABLE. A list of frequencies beginning with the start frequency and ending with the stop frequency appears. The numbers to the right of the frequencies are the antenna factors, or K-factors. When creating antenna tables, the 2710 supplies default values of zero for the K-factors. **To begin changing the antenna factors, press [A A] and enter the appropriate factor. The asterisk indicates which factor is to be edited. After you enter a value for a factor, the asterisk moves to the next frequency. If you do not want to change the antenna factor at the indicated frequency, turn the **FREQ/MARKERS** knob to move the asterisk to the desired frequency.**



For instance, if an antenna manufacturer specifies the antenna factors for his antenna as:

f	K	f	K	f	K
.....	55.0	2.7	60.0	3.5
51.0	2.1	56.0	2.9	61.0	3.6
52.0	2.3	57.0	3.0	62.0	3.8
53.0	2.4	58.0	3.2	63.0	3.9
54.0	2.5	59.0	3.3

//////////////////// 2710 Spectrum Analyzer User's Guide //////////////////////

and you wish to make measurements from 55 to 60 MHz, then the entries in the antenna table should look like this:

1>	55.000000 :	2.7
2>	56.000000 :	2.9
3>	57.000000 :	3.0
4>	58.000000 :	3.2
5>	59.000000 :	3.3
6>	60.000000 :	3.5

- When you are done entering antenna factors, press the back arrow key and [D - Naming antennas is not required, but names can provide quick reminders of the purpose of each antenna. To name an antenna, select item 1, TITLE EDIT. Press [A A] to begin editing. If an old antenna table is being modified, its name appears at the upper left with an underscore cursor beneath the first letter. If the antenna table is new, only the cursor appears. You can delete the old name entirely by pressing [C C]. [D FREQ/MARKERS knob to select letters. Use [MKR - To store the antenna data and title, select item 2, **STORE**, and choose any unused antenna number. The new or modified antenna table will be stored under that number. Its name is displayed adjacent to the number. If you do not name the antenna, it is given a name of ANTENNA #. If all five antenna tables are already in use, you will have to delete an existing antenna before you can store the new or modified table. For instance suppose you have modified an existing antenna table and wish to store the modified version in the place of the original table using the same antenna name. Even though the name and location are the same, you must first delete

//////////////////// 2710 Spectrum Analyzer User's Guide //////////////////////

the original antenna table. Deleting the original antenna from the antenna list does not delete the edited version in the local buffer. After you delete the original, store the edited version in the original location.

- You can print a hard copy of antenna data if your 2710 is equipped with an optional communications port and appropriate printer. **To print the antenna data, select item 5, PRINT, from the EDIT ANTENNA TABLE and simply choose the antenna data you want to print from the resulting list.**
- The DISPLAY LINE feature ([DSPL MENU]/[8]) can be used with the dB μ V/m for making vehicular surveys of leakage from cable TV installations, or in other applications where an audible alert is useful whenever a signal amplitude crosses a preset threshold. **To sound a high level alert whenever the measured RF field strength exceeds the threshold, set the DISPLAY LINE at the desired threshold. See *The Display Line and Limit Detector* section for complete details.**

To look for very low amplitude RF energy, you can turn on the 2710's preamplifier. Actual sensitivity depends on the antenna used and losses in cabling and coupling to the analyzer. With minimum cable losses and an antenna that matches the 50 ohm analyzer impedance, you should be able to see signals ranging from about 2 dB μ V/m (1.3 μ V/m) at 55 MHz to 14 dB μ V/m (5 μ V/m) at 216 MHz.

If greater sensitivity is required, three options are possible:

- a. Provide an external preamplifier
- b. Use a higher gain antenna. Sensitivity increases directly with antenna gain.
- c. If the signal being measured is narrowband, reduce the RBW to the narrowest setting still capable of passing the signal. For instance, the 3 kHz filter increases sensitivity by a further 20 dB over the 300 kHz filter.

100.0MHz	(AUTO SWEEP)	ATTN 10DB
-20.0DBM		VF WIDE
20.0MHz/ 5MHz RBW (AUTO)	CALIBRATOR	10 DB/

Marker/Frequency Menu

With the Marker/Frequency Menu you can directly affect the frequency characteristics of the spectral display and control the markers in ways not available from the front panel.



Setting the Center Frequency Using the MKR/FREQ MENU

Until now, you have been controlling the center frequency with the tuning knob. This works fine, but sometimes requires a lot of turning to get the correct frequency. With the Marker/Frequency Menu, all that turning is unnecessary. Press:

[MKR/FREQ MENU]

Item 0 enables you to directly enter the desired frequency without touching the tuning knob. Press:

[0]

Follow the:

ENTER NEW VALUE: __

prompt by pressing:

[3]/[0]/[0]/[C C]

The center frequency is now 300 MHz.

Setting the Span/Division Using the MKR/FREQ MENU

You can also set the span from the keypad. **Select the Marker/Frequency Menu again and choose item 1. Follow the prompt and enter 33.3 MHz by pressing:**

[3]/[3]/[.]/[3]/[C C]

The spectral display returns and the calibration signal harmonics are three divisions apart. The span is 33.3 MHz/division, a value not available from the dedicated span/div keys! **Use the Marker/Frequency Menu to set the span back to 20 MHz/division.**

Using the Keypad to Set Start and Stop Frequencies

Perhaps you would rather specify the total span of the display. This, too, is possible. **Press:**

[MKR/FREQ MENU]/[7]

The secondary menu that appears enables you to specify start and stop frequencies for the spectral display. **Choose item 0 and, following the prompt, press:**

[1]/[7]/[5]/[C C]

to specify a start frequency of 175 MHz. Note that the indicated start frequency has changed. Now choose item 1 and enter a value of 425 MHz for the stop frequency. Return to the spectral display by pressing [MKR/FREQ MENU]. The span is 25 MHz/division making the start and stop frequencies 175 MHz and 425 MHz respectively. If you make the start frequency greater than the stop frequency, the analyzer enters ZERO SPAN mode tuned to the start frequency.

Using Markers To Set Start and Stop Frequencies

You can also do things with the markers that aren't possible from the front panel. **Turn on the marker and place it just to the left of the calibration signal harmonic at 300 MHz. Enter delta-marker mode and place the active marker just to the right of the harmonic at 400 MHz. Select item 6, MARKER START/STOP, from the Marker/Frequency Menu.** The spectral display reappears and brackets the calibration signal third and fourth harmonics. The marker start/stop selection automatically adjusts the starting frequency of the display and the span/division so that what is displayed is what was between the markers. **Now turn off the markers. Notice that the RBW has also changed because resolution BW was in AUTO mode.** The marker start/stop feature provides a convenient method of isolating and expanding signals which are of particular interest. If you are not in delta-marker mode when you choose this item, the analyzer will enter zero span at the current center or marker frequency.

300.0MHZ	(AUTO SWEEP)	ATTN 10DB
-20.0DBM		VF WIDE
50.0MHZ/		10 DB/
5MHZ RBW (AUTO)	CALIBRATOR	

Transposing Markers

Suppose you want to measure the difference in frequency between the peaks at 300 MHz and 500 MHz and between 500 MHz and 200 MHz (forget that you can do it in your head!). **In marker mode, position the marker on the 300 MHz peak. Enter delta-marker mode and place the active marker on the 500 MHz peak.** Naturally, the difference is 200 MHz. Now comes the neat part. **Select item 5, TRANSPOSE MARKERS, from the Marker/Frequency Menu. Turn the FREQ/MARKERS knob.** The movable marker has become the reference and the old reference is now the movable marker. **Move the marker to the 200 MHz peak and note the frequency difference.** How much easier that was than having to turn the markers off, and then back on again for the second difference measurement. **Exit from delta-marker mode.**

100.0MHZ	(AUTO SWEEP)	ATTN 10DB
-20.0DBM		VF WIDE
20.0MHZ/		10 DB/
5MHZ RBW (AUTO)	CALIBRATOR	

Changing the Knob Function

Here is a feature which enables you to select one of up to four parameters to be controlled by the Freq/Markers knob. The knob is normally used to vary the center/start frequency or marker position, but if the video monitor and tracking generator options are installed, you can also vary the video line selection and TG tracking. **To change the knob function, call up the Marker/Frequency Menu and select item 2, KNOB FUNCTION.** The Knob Function Menu appears.

To see how this feature is used to make precision frequency difference measurements across the whole range of the analyzer, enter delta-marker mode with both markers at the cal signal peak. What you're now going to do is measure the frequency difference between the cal signal and each of its harmonics, but you could use the same procedure to measure any series of signals. **Choose item 2 from the Marker/Frequency Menu.** Currently, the knob is controlling the markers, as you would expect in delta-marker mode. **Select item 0 from the Knob Function Menu Choose to change to frequency control and then press [MKR/FREQ MENU].** The spectral display reappears and seems unchanged. **Rotate the tuning knob several clicks clockwise. Notice that the center frequency increases as the spectrum slides to the left.** One marker remains fixed atop the cal signal peak while the other remains fixed at center scale. Consequently, the difference frequency also increases. **Continue turning the knob until the second harmonic approaches center scale.** Press [CTR MEAS/TRKG]. The second harmonic is automatically centered. The amplitude and frequency difference between the fundamental and the harmonic are displayed at the top of the right column. If the frequency counter option is installed and turned on, the readouts are preceded by DC (delta count); otherwise the readouts begin with D. **Repeat this procedure for the third harmonic.** Did you notice that although the reference peak (the cal signal

fundamental) is now far off-screen to the left, you are still accurately measuring the difference frequency? You can continue this process all the way to 1.8 GHz. **Go ahead, try measuring a few more harmonics. Exit from this mode by turning off the markers.**

This feature is particularly useful when you want to measure the differences between two or more signals so widely separated in frequency that they do not fit on screen at the span/division at which you wish to view them. If you're already using the Marker/Frequency Menu, item 2 also conveniently turns on marker mode when toggled to MARKER.

If you choose KNOB SELECTABLE from the Sweep/Trigger Menu Setup Table, the TV LINE trigger mode is automatically entered and the Knob Function Menu offers another choice: VIDEO LINE. Selecting VIDEO LINE lets you use the tuning knob to control which TV line triggers the sweep, while selecting FREQUENCY or MARKER continues to let you control the center or marker frequency. This feature enables you to conveniently flip between frequency and TV line control. This can be very useful when viewing multiple TV channels. You can select FREQUENCY for changing channels and then to VIDEO LINE for choosing the scan line. For a complete explanation of TV LINE trigger mode, see *TV Line Triggering* later in this chapter.

If the tracking generator option is installed in your 2710 and turned on, still another choice of knob function is possible: TG tracking. The knob now varies the frequency by which the tracking generator output frequency differs from the frequency currently being scanned by the 2710. This makes it possible to peak the response of narrow filters and to compensate for the signal delay encountered when testing long cables (the signal received at the end of the cable is delayed and, hence, differs in frequency from that currently being scanned).

300.0MHZ	(AUTO SWEEP)	ATTN 10DB
-20.0DBM		VF WIDE
50.0MHZ/		10 DB/
5MHZ RBW (AUTO)	CALIBRATOR	

Moving the Marker To the Next Higher or Lower Peak

Turn on the single marker and place it in the noise. You are going to jump the marker from peak to peak in ascending order and then jump down again in descending order. Select item 4 from the Marker/Frequency Menu and then press [A A]. The marker is now atop the lowest of the calibration signal harmonics. Select item 4 and press [A A] again. The marker's now atop the second lowest peak. Repeat this process until the marker reaches the highest peak (the fundamental). After the marker is on the highest peak, select item 4 and press [B B]. Repeat this process several times and watch the marker jump to progressively lower peaks. If you try to jump the marker above the highest peak or below the lowest, you are told:

NO SIGNAL FOUND ABOVE THRESHOLD

You cannot jump the marker to off-screen signals.

MARKER TO THE REFERENCE LEVEL

Moving the marker to the reference level is a feature that can be used with the marker peak moves to quickly and easily determine signal amplitudes. Using any method you wish, place the marker atop the signal you want to measure (in this example, use the calibration signal fundamental). With the marker at the signal peak of interest, press [MRK/FREQ MENU]/[3]. The reference level is changed to the signal amplitude. This is a handy way to place signals at the reference level for making relative measurements. It is also a convenient method of setting the video carrier to the reference level when using the video monitor option.

When you are finished, turn off the marker.

300.0MHz	(AUTO SWEEP)	ATTN 10DB
-20.0DBM		VF WIDE
50.0MHz/ 5MHz RBW (AUTO)	CALIBRATOR	10 DB/

Selecting the Tuning Increment

Earlier, you learned the tuning increment (amount per click by which the tuning knob changes frequency) is 0.02 of the span/division. You are now going to learn how this can be changed. **Call up the Marker/Frequency Menu and look at item 8.** It is a three-way toggle function indicating the tuning increment is presently being automatically selected by the 2710. In AUTO mode, the tuning increment is:

Zero span:

- .033 of the resolution BW for 300 Hz, 3 kHz, and 30 kHz filters
- .05 of the resolution BW for 1 kHz, 10 kHz, 100 kHz, and 1 MHz filters
- 20 kHz for the 300 kHz or 500 kHz filter
- 200 kHz for the 5 MHz filter

All other spans:

- .02 of the span/division (because of the readout resolution, this appears as 3 and 4 MHz on alternate clicks of the knob in MAX SPAN)

Slowly press:

[8]

three times. The tuning increment progresses from AUTO to PROGRAMD (programmed) to TABULAR and back to AUTO again. If programmed tuning is selected (see *Programmed Tuning* later in this chapter), you can specify whether the center frequency, marker frequency, or keypad entered frequency increment will be used as the tuning increment. You determine which is used with the setup table ([MKR/FREQ MENU]/[9]). If tabular tuning is selected, the tuning increment

//////////////////////////////// 2710 Spectrum Analyzer User's Guide //////////////////////////////////

varies according to tables of values stored in ROM. Tables exist for standard broadcast and cable TV channel allocations of many countries.

Center or Start Frequency

Let's look at the setup table. **Choose item 9 from the Marker/Frequency Menu.** A secondary menu of seven items appears. The first item toggles frequency control between center and start frequency. When start frequency is selected, the tuning knob controls the frequency at the left edge of the display rather than the frequency at the center. **Choose item 0 from the setup table.** The spectral display reappears but the "center frequency" bright spot is now moved to the left edge of the screen and the frequency readout is:

SF 300MHz

indicating that the start frequency is now 300 MHz. Some users prefer to run the analyzer in this mode. Whether you do or not, this feature can be useful for viewing sidebands or performing harmonic distortion measurements. **Toggle back to center frequency control by pressing [MKR/FREQ MENU]/[9]/[0].**

Setting the Signal Threshold

Earlier you discovered there was a threshold below which the 2710 would not automatically detect signal peaks. Normally the analyzer estimates the minimum displayed signal peak amplitude (which usually represents the noise floor) and automatically sets the threshold one division higher. However, when the displayed signal is everywhere greater than the noise, the analyzer sets the threshold in proportion to the signal peaks rather than the noise floor. The threshold is then artificially high, and may result in other signals which rise only slightly above the threshold being ignored. Consequently, item 1 of the setup table has been provided to enable you to set the threshold to a fixed amplitude suitable for detecting the signals present in your particular application. The fixed threshold is also handy when you simply want to exclude low level signals while jumping the marker amongst high level peaks.

To set the threshold, choose Item 1 from the setup table and, following the prompts, enter a value of -45 dBm. Press [MKR/FREQ MENU] to return to the spectral display. Using either the MOVE MARKER selection from the Marker/Frequency Menu or the marker arrow keys, attempt to move the marker from peak to peak. It will only jump to the peaks above -45 dBm in amplitude. Turn off the marker and restore automatic threshold selection by pressing;

[MKR/FREQ MENU]/[9]/[1]/[C C]

and then return to the spectral display.

Counter Resolution

If you have the counter option installed, it is possible to turn off its readout when Signal Track mode is in use, or to specify the resolution as 1 kHz or 1 Hz. Be aware that this feature only changes the counter resolution to one Hertz, not the accuracy (see the CTR MEAS/TRKG section of *The Controls* for a discussion of frequency measurement accuracies). Press [MKR/FREQ]/[9]/[2] and select item 0, COUNTER OFF WHEN TRKG, from COUNTER RESOLUTION. Press [CTR MEAS/TRKG] and notice the counter reads out to 1 Hz. Enter TRKG mode and note that there is no counter reading. If you select items 1 or 2, the counter will read out to the indicated resolution in either TRKG or CTR MEAS mode. Return to COUNTER RESOLUTION and select item 2, 1 KHz. Notice the counter is now reading in TRKG mode. Can you see how much longer it takes to update the display when the counter reads out? Speeding up the signal tracking capability is the primary reason for disabling the counter during TRKG mode. Reselect item 0 from COUNTER RESOLUTION and turn off TRKG mode.

300.0MHz	(AUTO SWEEP)	ATTN 10DB
-20.0DBM		VF WIDE
50.0MHz/		10 DB/
5MHz RBW (AUTO)	CALIBRATOR	

Programmed Tuning

Let's look at programmed tuning increments. Choose item 3 from the Marker/Frequency Menu setup table. The Programmed Tuning Increment Menu appears. Programmed tuning increments can be determined by the center or start frequency, the marker or delta-marker frequency, or numeric keypad entries.

The first item indicates the center frequency is approximately 300 MHz. (It would indicate start frequency if you placed the analyzer in that mode.) Let's select it as the tuning increment. Press:

[0]

The spectral display reappears. Turn the tuning knob one click clockwise. The frequency changed 300 MHz in one click! Well, that's what you selected as the tuning increment. Turn the knob another click. 900 MHz, right? Now reset the frequency to 300 MHz.

Turn on the marker. Position the marker at 150 MHz. Again select item 3 from the setup table. Now choose item 1, which currently reads MARKER FREQ, from the Programmed Tuning Increment Menu to select the marker frequency as the tuning increment. Turn off the marker and turn the tuning knob one click. The frequency should change 150 MHz. Now reset the frequency to approximately 300 MHz.

Now turn on the marker and position it on the calibration signal peak. Enter delta-marker mode and place the movable marker on the second harmonic. From the Programmed Tuning Increment Menu reselect item 1 which now reads DELTA MKR FREQ.

//////////////////////////////////// **2710 Spectrum Analyzer User's Guide** //////////////////////////////////////

Turn off the markers and turn the tuning knob one click. The frequency now changes by one harmonic (100 MHz) per click. When making distortion measurements, this is one way to look at positions where harmonics should be present. In fact, anytime your measurements require you to look at multiples of a frequency difference, but you don't want to be bothered with actually entering the frequency, the delta-marker tuning increment mode provides a quick, convenient way of doing it.

Return to the Programmed Tuning Increment Menu. You are going to specify a particular tuning increment. Choose the keypad entry, item 3. Following the prompt, enter a value of 7 MHz. The spectral display reappears. Turn the tuning knob. The frequency changes by 7 MHz per click, a value not available from the front panel. Entering a keypad tuning increment automatically places the 2710 in programmed tuning mode. You can turn this keypad entered increment (or any programmed increment) on and off in two ways without having to reenter it. First, toggle item 8 on the Marker/Frequency Menu to read AUTO. This turns off the keypad value and restores automatic selection of the tuning increment. Turn the keypad increment back on by selecting item 2 (KEYPAD ENTRD INC) from the Programmed Tuning Increment Menu. Now turn off the keypad selected increment by the second method; select the programmed tuning increment from the setup table and choose item 4 (RETURN TO AUTO) from the Programmed Tuning Increment Menu.

100.0MHz	(AUTO SWEEP)	ATTN 10DB
-20.0DBM		VF WIDE
20.0MHz/		10 DB/
5MHz RBW (AUTO)	CALIBRATOR	

Tabular Tuning

There is yet another way in which tuning increments can be chosen. Call up the setup table and select item 4, TABULAR TUNING INC. A TABULAR TUNING TABLE appears offering you a number of choices. Choose item 0 from the TABULAR TUNING TABLE and then press the back arrow key twice to return to the Marker/Frequency Menu.

//////////////////////////////////// **2710 Spectrum Analyzer User's Guide** //////////////////////////////////////

Toggle item 8 until:

TABULAR

appears at the end of the line. Press the Marker/Frequency Menu key to return to the spectral display. Turn the tuning knob one click counter-clockwise. The frequency is 87.7 MHz. Turn the knob three more clicks. The indicated frequencies are 83.2 MHz, 81.7 MHz, and 77.2 MHz. Do you recognize the sequence? The analyzer is stepping through the visual and aural carrier frequencies of US broadcast TV stations. It will step through the entire range of VHF and UHF stations. Had you chosen one of the other items from the TABULAR TUNING TABLE, the analyzer would have stepped through the various TV assignments peculiar to those settings. Tabular tuning can be a great convenience if you work in the video communications industry. Restore tuning increment selection to automatic.

300.0MHz	(AUTO SWEEP)	ATTN 10DB
-20.0DBM		VF WIDE
20.0MHz/		10 DB/
5MHz RBW (AUTO)	CALIBRATOR	

Frequency Offsets

Return to the MKR/FREQ SETUP TABLE and select item 5, FRQ OFFSET. This selection enables you to offset the on-screen center frequency readout. The center frequency is not actually changed, and the counter readout will indicate the true frequency rather than the offset value. The primary purpose of this feature is to allow the output frequencies of the block down converters (LNB's) used by the video communications and other industries to be correctly indicated. However, it can be used anytime a signal has been shifted in frequency by a known amount, and you wish the frequency prior to shifting to be displayed. Let us suppose that the signal we are viewing is the output of a down converter with a 5.15 GHz local oscillator. Enter an offset of 5.15 GHz (ignore the CALIBRATOR DOESN'T MATCH READOUT warning). Notice that the status of item 6 changed from OFF to ON PLUS. Select item

//////////////////// **2710 Spectrum Analyzer User's Guide** //////////////////////

6 several times; it cycles the status of the frequency offset through OFF - ON PLUS - ON MINUS. **Leave item 6 set to ON PLUS and return to the spectral display.** The center frequency is now indicated as 5450.0 MHz (300 MHz + 5150 MHz offset). **Press [CTR MEAS/TRKG];** the counter still indicates the true center frequency. **Turn on the marker and turn the MKR/FREQ knob clockwise.** The marker frequency is also increased by 5.15 GHz. **Return to the MKF/FREQ SETUP TABLE and toggle item 6 to ON MINUS.** **Return to the spectral display.** The center frequency now reads 4850.0 MHz and the marker reads progressively lower frequencies as it is advanced to the right -- the frequency axis is reversed! Why is this? There are no negative frequencies. The output frequency of the converter may be represented as:

$$f_{out} = | f_{sig} \pm f_{lo} |$$

Any time the local oscillator in the frequency converter is above the frequency of the original signal, the output frequencies are reversed. That is, the higher the input signal frequency, the lower the output frequency. This is exactly the process that occurs in C-band block down converters. Therefore, you use ON MINUS when viewing their output. Ku-band converters, on the other hand, have local oscillator frequencies below the input signal frequency, and you use ON PLUS when viewing their output signals.

300.0MHz	(AUTO SWEEP)	ATTN 10DB
-40.0DBM		VF WIDE
20.0MHz/		10 DB/
5MHz RBW (AUTO)	CALIBRATOR	

Display Menu



The Display Menu offers you the capability of altering the on-screen data readouts and the nature of the spectral display. It makes possible ensemble averaging of spectra and direct subtraction of a stored trace from an active trace. The menu enables you to switch between MAX/MIN and PEAK signal acquisition modes and to change the analyzer detector from AM to FM. Using the FM detector, it is possible to directly measure frequency deviation. An on-screen reference line can be displayed to simplify amplitude measurements.

Ensemble Averaging

In general, ensemble averaging techniques are used for the same reason as filters; to enhance the desired-signal-to-unwanted-noise ratio. Narrow RBW or video filters reduce the noise by reducing the spectrum analyzer's bandwidth. Unfortunately, they also require slower sweep speeds, and in the cases of broadband signals, the filters may limit the signal energy. For these applications, we can use ensemble averaging. However, if ensemble averaging is used with pulsed waveforms without taking special care to synchronize the analyzer to the signal, erroneous measurements result. This is because of the way scanning analyzers determine the spectrum of pulsed signals. See Tektronix application note 26W-7037, *Spectrum Analyzer Fundamentals*, for more information about pulse measurements.

Ensemble averaging computes the average value of some parameter (peak, mean, minimum, etc.) of a number of signal spectra. If the randomness of the signal plus noise doesn't change during the period over which the average is compiled, the parameter being averaged rapidly approaches its mean value. This results in an enhancement of the signal-to-noise

//////////////////////////////////// **2710 Spectrum Analyzer User's Guide** //////////////////////////////////////

ratio without reducing the bandwidth or slowing the sweep speed. All this doesn't mean you can't ensemble average continuous narrowband signals -- you can. But in those cases you can also use video filtering, which may prove faster and more convenient.

The result of the ensemble average is an estimate of the mean value of the parameter being averaged. The estimate is also a random variable. That is, successive estimates, or averages, will vary from each other in a random fashion. However, the random variability is less than that encountered with a single sweep, and therein lies the advantage of ensemble averaging. The larger the number of sweeps averaged, the more accurate an estimate of the spectral characteristic that is obtained.

Call up the Display Menu by pressing:

[DSPL MENU]

Select item 1, ENSEMBLE AVERAGING. The Ensemble Averaging Menu appears. Items 1 and 2 start and stop the averaging process. The remaining items specify which values to average, how many sweeps to average, and where to store the result.

Let's start at the bottom. If you are going to store just the one ensemble average, it makes little difference where you put it. You can use registers A, B, or C, but you cannot store the average in a register which already contains data. Register D is not available because it always contains the current trace. If you plan to use the stored average as a reference and perhaps intend to subtract it from other spectra, you must store it in register A. Whichever register is used, it must be cleared before you attempt to store new data in it or you'll receive an error message. Item 8 is a three-way toggle that switches register to register in the sequence A, B, C, A.... **Ensure that register A is clear and then repeatedly press:**

[8]

until the last character on the line is A.

//////////////// 2710 Spectrum Analyzer User's Guide //////////////////

You can average a fixed number of spectra or choose continuous averaging. Continuous, or running, averages are used when the mean value of the signal you are viewing can change slowly with time, or when you want to watch a mean value estimate change in real time -- or when you simply wish to continuously monitor a process.

If you select a fixed ensemble size, you can average up to 1024 sweeps. The 2710 computes:

$$\text{PARAMETER AVG (f)} = (1/N) \sum_{i=1}^N \text{PARAMETER}_{\text{sweep } i}(\text{f})$$

where N is the number of sweeps to be averaged, f is frequency, and the parameter being averaged can be the maximum, minimum, max/min, or mean of the spectral display. Averaging begins when item 1 is selected and ends when the Nth sweep has been completed. You can also stop the averaging by selecting item 2 from the Ensemble Averaging Menu.

Continuous averaging works differently. Until ten sweeps have been accumulated, the continuous average looks exactly like the fixed ensemble average; but after the Nth sweep the continuous average approaches:

$$\text{PARAMETER AVG}_N(\text{f}) = 0.1 \sum_{i=0}^N (.9)^{N-i} \text{PARAMETER}_{\text{sweep } i}(\text{f})$$

That is, continuous averaging weights older sweeps so that they have a progressively smaller effect on the average. Each step back in time reduces the impact of a sweep to 90 per cent of its previous value.

The factory default setting is a 16 sweep fixed average. Let's change the number to 24. **Choose item 7 from the Ensemble Averaging Menu. Enter 24 by pressing:**

[2]/[4]/[A A]

Item 7 will update as you press [A A].

//////////////////////////////// 2710 Spectrum Analyzer User's Guide //////////////////////////////////

You are now ready to compile a parameter average. There are four choices. You have used the max/min display almost exclusively thus far, so let's begin with it. **Choose item 6, MAX/MIN, from the Ensemble Averaging Menu; you'll see the asterisk move down. To start averaging, press:**

[1]

The spectral display reappears and both status indicators for register A light. At the bottom of the right-hand readout column the number of sweeps averaged is displayed. When all 24 sweeps have been included in the average, the readout stops indicating the number unless the A register is the only one turned on. Turn the D register on and off several times. See the difference? Most of the sweep-to-sweep variations in the noise have disappeared.

Let's repeat the experiment, this time storing the MAX average in register B. In this case, only the 256 maximum values of each max/min sweep are averaged and stored. **Press:**

[DSPL MENU]/[1]/[3]

Toggle item 8 to register B and select item 1 to start the averaging process. Both status indicators for register B light. Not too surprisingly, the average peak value almost coincides with the upper edge of the MAX/MIN average. Turn off the A register to see the average maximum by itself.

Turn the A register back on and press:

[DSPL MENU]/[1]/[5]/[8]

to store the MIN average in register C. In computing the average MIN, only the 256 minimum points from each max/min sweep are used. **Select item 1 from the Ensemble Averaging Menu to start. Both status indicators for register C light. Here, too, we see that the average minimum coincides closely with the lower edge of the MAX/MIN average.**

//////////////////////////////// 2710 Spectrum Analyzer User's Guide //////////////////////////////////

One more to go! Press:

[DSPL MENU]/[1]/[4]/[8]

to store the mean value of the spectra in register A. Select item 1 to start. Press [A A] to overwrite the previously stored max/min average. Again, not too surprisingly, the mean value of the noise appears to be half way between the max and min values. The average MEAN is what you get if you add successive maximum and minimum values in dB from the MAX/MIN display, divide by two, and average the results. The MEAN average is a "visual mean", not a true mean. As you will see below, it can be very useful in making weak signals visible. Turn on the D register to see the current sweep with its visual mean and average maximum and minimum values superimposed. The mean along with the max and min values provide an estimate of the variability of the signal.

Why doesn't the signal peak appear to change? Because the calibration signal is essentially constant (little or no variability), so its min, max, and mean amplitude are all about the same. This can be used to advantage. Turn off the A, B, and C registers. Set the reference level to +10 dBm. The calibration signal third harmonic is almost lost in the noise. Now ensemble average the spectrum MEAN values and store the result in A. The mean spectrum leaves little doubt as to the presence or location of the signal peak. Sometimes you can achieve even better results using the average minimum.

Experiment if you like before proceeding, then clear all registers and leave only the D register active.

400.0MHz	(AUTO SWEEP)	TTN 10DB
-20.0DBM		VF WIDE
100.0MHz/		10 DB/
5MHz RBW (AUTO)	CALIBRATOR	

Subtracting Stored Signals

The B,C MINUS A feature of the Display Menu enables you to subtract a sweep stored in register A from an active sweep in registers B or C. Using it, you can flatten a noise spectrum, negate unwanted signals, and easily detect signal changes. You can probably find more uses. **Observe the zero-frequency and calibration signal peaks and notice how the noise floor rises slightly with increasing frequency. Perform a 24 sweep MAX/MIN ensemble average and store the result in A. Wait until the ensemble is complete. Ensure item 3 of the Display Menu reads:**

3 B,C MINUS A OFFSET TO CENTER

If it does not, select item 3 once. To activate the B,C MINUS A mode, press:

[DSPL MENU]/[2]

Turn on the B register and turn off A and D. The display now consists of a much reduced and totally flat noise floor and some intermittent peaks similar to Figure 4-6. The zero-frequency and calibration signal peaks have almost disappeared. You have subtracted the average max/min spectrum stored in the A register from the active sweep in the B register (you can also use the C register), and are displaying the result which consists only of the sweep-by-sweep variations. The vertical center of the screen represents zero amplitude difference between the waveforms.

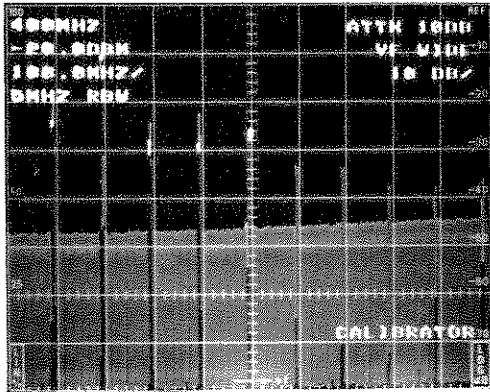

Average calibration signal plus noise

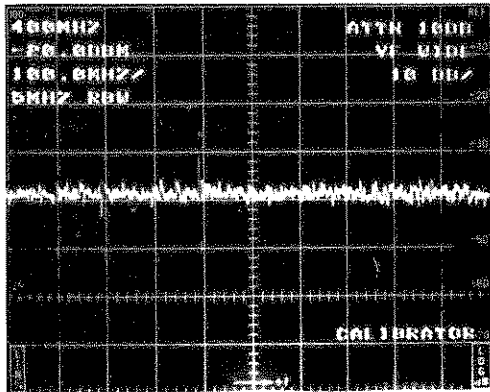

Average calibration signal plus noise subtracted from the current sweep

Figure 4-6. Average signal plus noise and average signal plus noise subtracted from the current sweep.

Suppose you were trying to measure a weak signal which you could turn on and off, in the presence of interfering noise and signals. You could turn the signal off, compile the ensemble average and subtract it as above. Then, when you turn the weak signal back on, it would show up loud and clear because it was not part of the stored average. Waveform subtraction can also be used as a sensitive detector of signal changes. **Decrease the reference level 10 dB.** See the calibration signal peaks appear? **Increase the reference level 20 dB.** The technique works no matter the direction of the signal change. **Reset the reference level to -20 dBm and change the center frequency slightly.**

//////////////////// 2710 Spectrum Analyzer User's Guide //////////////////////

Again the calibration signal peaks appear. Any change from the average, either amplitude or frequency becomes obvious.

What happens if the waveform in B gets so much larger than that in A that the result goes off screen? Let's subtract the average MEAN noise from the MAX HOLD signal plus noise to find out. This provides a measure of the maximum signal variations about the mean noise level. **Toggle out of B, C MINUS A mode ([DSPL MENU]/[2]). Ensure the center frequency is set to 400 MHz and the reference level to -30 dBm. Now turn off the calibrator and store a 24 sweep MEAN average of the noise in register A (you will need to overwrite the display currently stored in register A). After the average is complete, turn the calibrator back on and activate MAX HOLD in register B. The resulting traces are shown in Figure 4-7.**

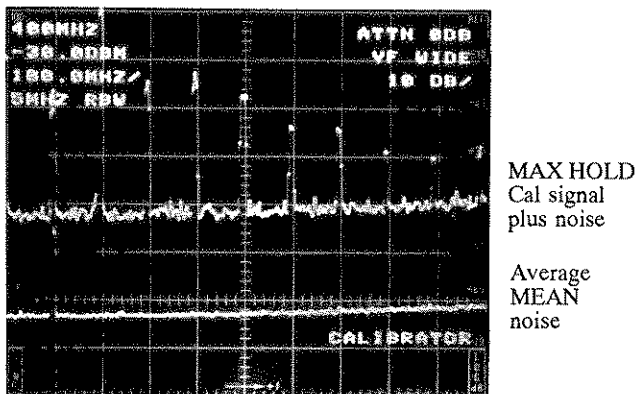
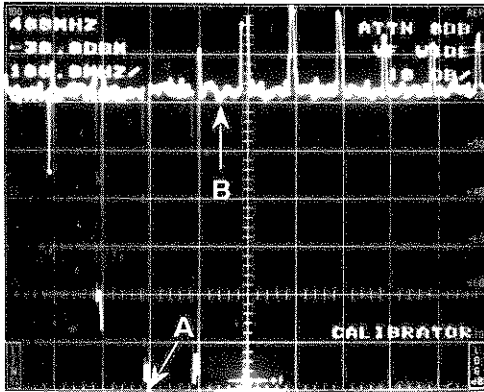

Figure 4-7. Average MEAN noise and MAX HOLD signal plus noise spectra.

Turn off the A register and enter B, C MINUS A mode. Notice that the resulting noise floor is about two divisions down from the reference level and that some of the calibration signal peaks fold over and point downward. See Figure 4-8.



Note
folded over
signal peaks

Figure 4-8. B, C MINUS A OFFSET TO CENTER.

Press:

[DSPL MENU]/[3]

The waveform is now nearer the bottom of the screen where we can see it more clearly. We have offset the difference between the B and A register waveforms, which is always greater than zero, to the top of the screen (zero difference is at the reference level). However, because of the binary arithmetic used in the 2710, values above the reference level overflow into the sign bit of the data word and appear at the bottom of the screen! See Figure 4-9. The points labeled A and B in figures 4-8 and 4-9 have exactly the same value in each figure. Imagine that the screen curves backwards at the top and bottom until it joins itself, forming a cylinder. All points of zero difference lie along the joint. Now cut the joint and uncurl the cylinder, allowing it to become a flat screen again. Both the top and bottom of the screen represent zero difference with negative signal peaks descending from the top of the screen, and positive peaks rising from the bottom. **Experiment if you wish before proceeding and then clear all registers, turn on register D only, turn off B,C MINUS A, and reset the B, C MINUS A offset to center.**

//////////////////////////////////// 2710 Spectrum Analyzer User's Guide //////////////////////////////////////

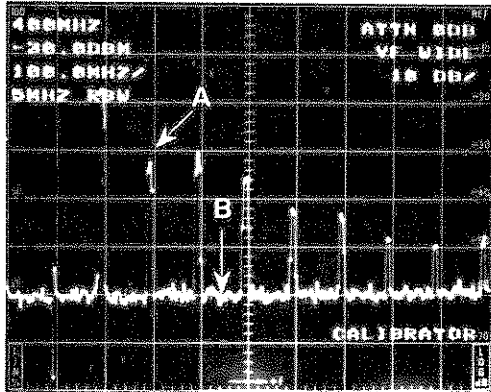

Note
signal peaks
no longer
folded over

Figure 4-9. B, C MINUS A OFFSET TO TOP.

100.0MHz	(AUTO SWEEP)	ATTN 10DB
-20.0dBm		VF WIDE
20.0MHz/		10 DB/
5MHz RBW (AUTO)	CALIBRATOR	

Changing Acquisition Mode

Item 4 on the Display Menu toggles between MAX/MIN and PEAK signal acquisition modes. To change acquisition modes, press:

[DSPL MENU]/[4]

Quickly toggle Display Menu item 4 back and forth between MAX/MIN and PEAK several times. Do you see that the PEAK display is essentially the top of the MAX/MIN display? The 2710 inherently produces an analog spectrum. In the MAX/MIN acquisition mode, the maximum and minimum amplitudes of this spectrum are alternately sampled at 512 successive points. Plotting the two interleaved sets, of 256 points each, produces the analog-like MAX/MIN spectrum that you see. In the PEAK acquisition mode, the maximum amplitude only is sampled and displayed at all 512 points. Which acquisition mode you choose is up to you, but the max/min mode has the advantage of bearing some semblance to the

//////////////////////////////// 2710 Spectrum Analyzer User's Guide //////////////////////////////////

analog signal and readily revealing pulsed versus constant carrier signals -- pulsed signals cause the signal peaks to be "filled in". For now, leave the display in MAX/MIN mode.

400.0MHz	(AUTO SWEEP)	ATTN 0DB
-40.0DBM		VF WIDE
20.0MHz/		10 DB/
5MHz RBW (AUTO)	CALIBRATOR	

Activating Minimum Hold

Here's a trick for determining approximate upper and lower bounds on a spectrum by using the MIN HOLD and MAX HOLD features. While MAX HOLD is accessible by dedicated keys, MIN HOLD can be accessed only from the Display Menu. The register in which the minimum signal excursions are accumulated is specified by item 8 of the Ensemble Averaging Menu. Call up the Ensemble Averaging Menu and ensure item 8 reads:

8 SAVE RESULTS IN DISPLAY A

Press the back arrow key to return to the Display Menu and turn on the MIN HOLD IN WFM A function by pressing:

[9]

This function is analogous to the MAX HOLD feature you learned to use in the previous chapter; minimum hold compares the amplitude of the current sweep, point for point, with the stored minimum value of previous sweeps. If the current amplitude is less, the current value becomes the new stored minimum.

Now press:

[MAX HOLD]/[B B]

to accumulate the maximum spectrum amplitude in register B. With the A, B, and D registers displayed, you have an upper and lower bound on the real-time signal in D. As time passes, you will notice that the upper and lower bounds no longer

//////////////////////////////// 2710 Spectrum Analyzer User's Guide //////////////////////////////////

change, because the probability of new random spectral peaks exceeding those already observed becomes very small. Item 9 on the Display Menu is a toggle. **Turn off the minimum hold feature by selecting item 9 again. Clear and turn off the A and B registers and the maximum hold feature.**

175.0MHz	(AUTO SWEEP)	ATTN 10DB
-20.0DBM		VF WIDE
20.0MHz/		10 DB/
5MHz RBW (AUTO)	CALIBRATOR	

Adding Titles and Labels

Suppose you want to permanently store a spectral display, either by photographing the screen or by plotting the display. It would be nice to title the display -- and you can. If you are plotting the display, you can also label significant points.
Press:

[DSPL MENU]/[5]

Choose item 2, **TITLE MODE EDIT**, from the Display Menu. The highest priority register currently being displayed (WFM D in this case) is indicated at the end of the line, and this is the display to which the title will be added. The title can be up to 31 characters on a single line. You can only title one display at a time. Whenever title mode is turned on, the left-hand readouts move down one row to accommodate the title, even if the title field is blank. This is also a convenient way to position the readouts lower on the screen if you wish. Let's call the D register display:

TEST 0123

Press **[A A]** to begin editing. If the display is already titled, its title appears at the upper left with an underscore cursor beneath the first letter. If the display is untitled, just the cursor appears. To change the old title or create a new, turn the tuning knob. Alphanumeric characters appear above the cursor. To change an old title, direct the cursor to where you want to make a change and enter the new character, or delete the entire title by pressing **[C C]**.

//////////////////// **2710 Spectrum Analyzer User's Guide** //////////////////////

To create the new title, rotate the knob until the letter T appears. The MKR/FREQ arrow keys (also the Span/Division arrow keys) control right and left cursor movement. **Move the cursor one place to the right by pressing [MKR →]. Rotate the knob until E appears. Continue this process until you've spelled TEST.** You can enter numbers without rotating the knob by using the numeric keypad, and the cursor will advance automatically. **Go ahead and modify the title to suit yourself. When you're done, press [B B] to store the result.** You can also exit from the title edit mode without saving the title or any changes by pressing [D To make the title visible on screen or on a print out, toggle ON item 1, TITLE MODE, of the Title Mode Menu. Toggle item 1 again to turn off the title.

Now select item 4, PLOT LABELING EDIT. Editing plot labels works the same way as title editing except that the cursor can be placed anywhere on the display using the MKR/FREQ and REF LEVEL arrow keys. **Press [A A] to begin editing. Move the cursor one division to the right of center screen and two divisions down from the reference level. Enter the characters:**

2ND HARMONIC

Then move the cursor to the peak at the left of the screen and label it:

FUNDAMENTAL

The labels denote the calibrator signal and its second harmonic. **Press [B B] to store the label(s) or [D **

To make labels appear on your plot, select item 3 from the Title Mode Menu. Item 3 is a toggle which turns the labels on and off. Press [DSPL MENU] to return to the spectral display. Labels do not appear on screen, but only on the printer/plotter output. See Figure 4-10 for an example of what the plot should look like and then turn off the title and plot labels.

2710 Spectrum Analyzer User's Guide

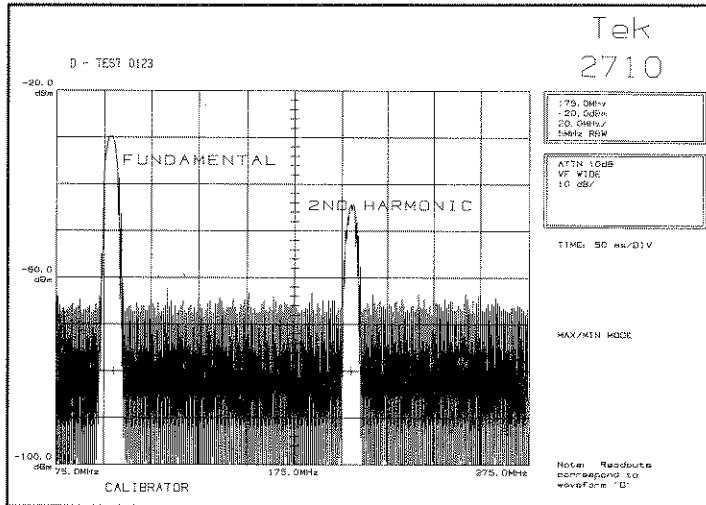

Figure 4-10. 2710 plot with title and plot labels.

Turning the On-screen Readouts On and Off

You can turn off the standard on-screen readouts. There are two reasons for doing so. First, it prevents the readouts from overlapping the signal spectrum. **To understand the second reason, enter analog display mode. Notice the regularly spaced dark areas of the sweep. Now turn off the readouts by pressing:**

[DSPL MENU]/[6]

The dark areas are gone now. The dark areas represent time when the CRT beam is writing the on-screen readouts. By eliminating the readouts, you eliminate the dark areas. You will also notice that the trace has intensified. This is because the analyzer does not have to take time out from each sweep to write the on-screen data. The added intensity can be important when viewing analog data at high sweep speeds. **Turn the data readouts back on by toggling Display Menu item 6 and activate register D.**

300.0MHz	(AUTO SWEEP)	ATTN 10DB
-20.0DBM		VF WIDE
50.0MHz/		10 DB/
5MHz RBW (AUTO)	CALIBRATOR	

The Display Line And Limit Detector

Suppose you want to quickly ascertain whether signal peaks are higher or lower than some particular level, or whether they fall within a specified range. Here is a convenient way to do it.

Press:

[DSPL MENU]/[8]

The DISPLAY LINE feature displays a horizontal line at a level you specify. You can specify the level directly in reference level units, such as dBm. Select item 2, VALUE ENTRY, and enter -50 dBm by pressing:

[5]/[0]/[A A]

The 2710 reverts automatically to the spectral display which now contains a horizontal line three divisions down (-50 dBm). You'll notice the A register red LED is lit. When you display the line, you cannot display the contents of the A register. Any data stored in A are not destroyed, but you cannot see them until you turn off the line.

There is another way to set the level of the line. Turn on a single marker and set it at the peak of the calibration signal third harmonic. Press [DSPL MENU]/[8] again and select item 3, DISPLAY LINE TO MARKER. The spectral display reappears with a horizontal line at the point where the marker was placed. This provides a convenient way to identify all signals greater or less than another signal. If the marker is not turned on when item 3 is selected, you receive an error message.

Press [DSPL MENU]/[8] again and select item 4, LIMIT DETECTOR. The end-of-line status indicator changes to OVER; the display line has been made an upper limit. If any on-screen signal goes over that limit, a high level audio alarm

//////////////////////////////// 2710 Spectrum Analyzer User's Guide //////////////////////////////////

is sounded. Press [DSPL MENU] to return to the spectral display. The alarm should be sounding. When the limit detector and the display line are both selected, the marker also automatically turns on and moves to the highest signal peak on screen. This is a convenience which enables you to read the amplitude of the largest signal after the alarm alerts you that the limit has been exceeded.

Enter a new value of -25 dBm for the display line; the alarm should stop because all signals are now below the limit. Press [DSPL MENU]/[8] and again select item 4. The status indicator changes to UNDER. The display line has now changed to a lower limit; the alarm will sound when all signals on screen are under the limit. Press [DSPL MENU] to return to the spectral display. The alarm should be sounding.

Select the LIMIT DETECTOR once again. The status indicator changes to OVER-UNDER. The display line becomes an upper limit and the threshold set using [DSPL MENU]/[9]/[1] becomes a lower limit. Press [DSPL MENU] to return to the spectral display. The limits are indicated by the broken horizontal line. If all signals are within the limits, no alarm sounds, but if all signals fall below the lower limit or if one exceeds the upper limit, the alarm will sound.

The limit detecting features are very useful for go/no-go or yes/no type tests. They are especially useful for doing vehicular leakage surveys of cable television facilities. Simply set the display line to the desired number of dB μ V/m, and when the alarm sounds, note the location and magnitude (using the marker readout) of the leak for later investigation and correction.

Further, the display line/limit detector feature converts the user-definable command "WAIT FOR END OF SWEEP" to a "WAIT FOR LIMIT" command (see *User-Definable Key* at the end of this chapter). This is a handy way to halt the execution of the user-defined routine until the alarm condition has been satisfied.

//////////////////////////////// 2710 Spectrum Analyzer User's Guide //////////////////////////////////

If you change the reference level while using the display line/limit detector feature, the line changes position on screen to track the new reference level. Press [SIG \uparrow] to observe this. However, the line can not be moved off screen. Continue pressing [SIG \uparrow] until the line reaches the top of the screen. You will receive the message:

DISPLAY LINE OUT OF RANGE

Lower the line and the message will disappear. Now turn off the limit detector by selecting LIMIT DETECTOR one more time and turn off the line by selecting item 1.

100.0MHz	(AUTO SWEEP)	ATTN 10DB
-20.0DBM		VF 300KHz
1.0MHz/		10 DB/
300KHz RBW (AUTO)		

Measuring Frequency Deviation

There is one more item on the Display Menu. Normally, the display you see represents the input signal after it has been AM detected. The result is a conventional spectral display with frequency on the horizontal axis. However, by selecting the FM detector as display source, you can measure frequency deviation. To see how this works, you must input a frequency modulated signal to the 2710. Ensure the calibrator is turned off and connect a short antenna or TV cable to the analyzer input as outlined in *Appendix A*. Adjust the reference level until you can see individual FM broadcast or TV sound carrier signal peaks and then tune the analyzer until a strong signal is centered. Your display should resemble figure 4-11.

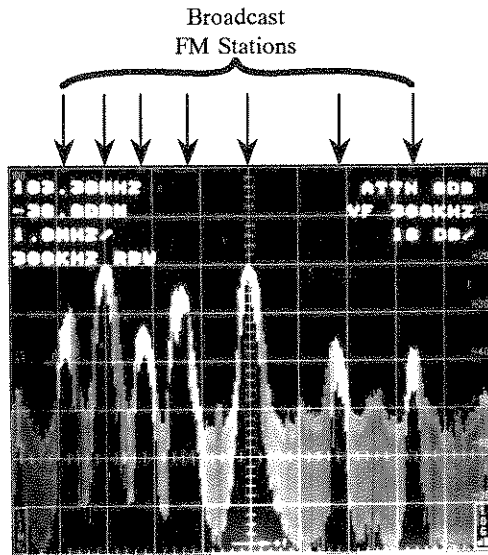

Figure 4-11. Portion of US broadcast FM band.

Select item 7, **DISPLAY SOURCE**, from the Display Menu and choose item 2, **FM DETECTOR**, from the secondary Display Source Menu. The 2710 reverts to the waveform display in zero span. The bottom line of the right column reads:

FM 10 KHz/

indicating that the FM detector is now being used and that the vertical scale factor has changed to 10 kHz/division -- the vertical axis now measures frequency! The trace being displayed should resemble that in Figure 4-12. It is an approximate indication of the instantaneous frequency deviation. The nominal vertical scale calibration can be changed from 10 kHz/division to 5 kHz/division to 1 kHz/division. **Cycle through the vertical frequency scales by repeatedly pressing [10 dB/5 dB/1 dB/].**

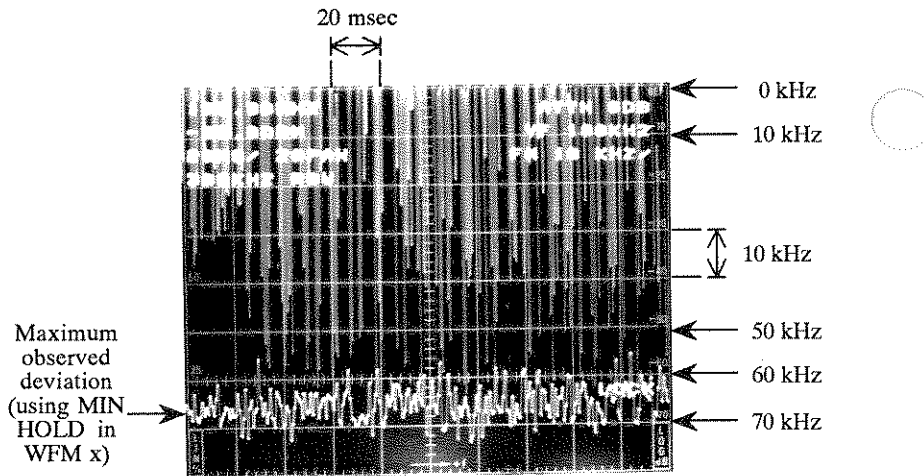

Figure 4-12. Instantaneous frequency deviation and maximum observed deviation.

Want to check the maximum deviation? Set the vertical scale to 10 kHz/division, select MIN HOLD IN WFM A from the Display Menu, and let the data accumulate for 2-3 minutes. A ragged horizontal waveform develops indicating the maximum frequency excursions during the period of observation. To read out the frequency deviation with the marker, turn the marker on and leave only the A register active. Move the marker to the point at which you want the measurement.

NOTE

Because of the FM detector bandwidth, the modulating signal used with the deviation monitor mode should consist of normal program material or single tone signals of 5 kHz or less.

The foregoing technique allows you a coarse view of frequency deviation in only one direction, with the carrier frequency being at the reference level. A downward excursion of 7 divisions represents a nominal downward deviation in frequency of 70 kHz and may be interpreted -- because FM spectra are usually symmetrical -- as a peak to peak deviation

//////////////////////////////// 2710 Spectrum Analyzer User's Guide //////////////////////////////////

of about 140 kHz. However, if you need to see the deviation in both directions, try this. **Reselect the AM detector from the Display Source Menu, exit from ZERO SPAN, and clear register A. Center a strong broadcast FM signal as described above. Change the span to 20 kHz/division and actuate MAX HOLD in register B.** In a short time a broad spectral peak develops. Figure 4-13 shows a typical MAX HOLD waveform from an FM stereo broadcast with one sweep during a period of minimum modulation superimposed. The relatively sharp skirts of the upper sweep denote the upper and lower limits of frequency deviation while the single sweep displays the instantaneous spectrum. We can see the pilot tones and subcarriers in the instantaneous spectrum **When you're done, turn off MAX HOLD and register B.**

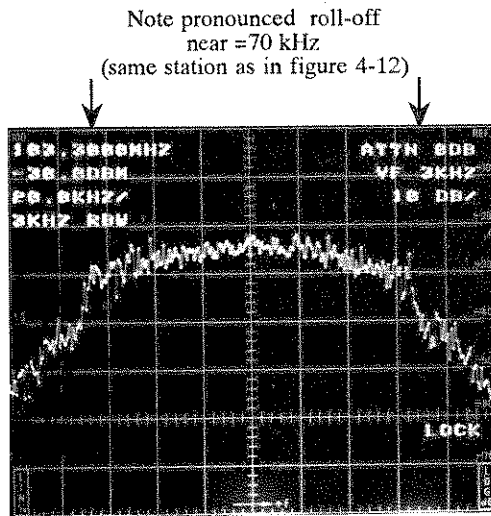

Figure 4-13. Frequency deviation by MAX HOLD technique.

Measuring Percent Modulation

Can we measure the percent modulation for AM signals? Yes, if a signal is available with a single modulating tone. Because a modulating RF signal generator is required, we won't actually carry out the measurement here. Instead, we'll merely review how such a measurement might be made. Suppose that a 0 dBm

//////////////////////////////// 2710 Spectrum Analyzer User's Guide //////////////////////////////////

RF carrier, say at 1 MHz, is amplitude modulated with a 20 kHz tone. Set the RBW to 3 kHz and the span to 10 kHz/division. The spectral display should show the carrier peak at 1 MHz with a pair of sidebands at 1 MHz \pm 20 kHz. The percent modulation is given by:

$$\% \text{ mod} = 200 \times 10^{-(\text{sideband peak in dB down from carrier}/20)}$$

The percent modulation is maximum (100 %) when the sideband peaks are 6 dB below the carrier peak. The foregoing is valid for any carrier amplitude modulated by a single tone. See *Spectrum Analyzer Fundamentals*, Tektronix application note 26w-7037 for additional information.

Displaying an External Source

Item 3 on the Display Source Menu enables you to display an external video signal on the 2710. The signal must be input to the analyzer on pin 1 of the rear panel J103 and must be in the range of 0 - 1.4 volts with a 6 dB bandwidth not greater than 100 kHz. The digital storage and vertical scale (10 dB/5 dB/1 dB key) features can be used to process the external signal. Refer to the video input discussion in Chapter 5 for additional details.

100.0MHz	(AUTO SWEEP)	ATTN 10DB
-20.0DBM		VF 30KHz
100.0KHz/		10 DB/
30KHz RBW (AUTO)	CALIBRATOR	

Applications Menu

APPL
MENU

The 2710 supplies an Applications Menu which automates some routine, but often time consuming, spectral measurements. It enables you to quickly determine signal bandwidths, normalized noise amplitudes, carrier-to-noise ratios, and to detect and measure signals in a specified frequency range.

//////////////////////////////// 2710 Spectrum Analyzer User's Guide //////////////////////////////////

The first three items on this menu (BANDWIDTH MODE, CARRIER TO NOISE, NOISE NORM'D) are toggles which turn the indicated measurement mode on and off. You can specify certain measurement parameters using item 9, SETUP TABLE. Because each of the measurement modes makes use of the markers, you can also exit from these modes by turning off the markers.

The fourth item (SIGNAL SEARCH) calls up a menu of measurement parameters. You specify the parameters, including a beginning and ending frequency, and the 2710 searches the indicated frequency range for any signals above the threshold you specified. The signal amplitudes and frequencies are measured and the results can then be displayed on screen or sent to a printer.

Measuring Occupied Bandwidths

To see how to measure bandwidths, first change the RBW to 300 kHz. We've expanded the signal as much as possible while still containing it on screen because when making bandwidth measurements, maximum accuracy is obtained by increasing the width of the signal in the spectral display. Press:

[APPL MENU]

Item 0 indicates the BANDWIDTH MODE at -3 dB. You're being told that selecting this item measures the bandwidth of a displayed spectral peak at points 3 dB down its slopes. You can change the dB-down points at which the bandwidth is measured. Any dB value can be used to specify the measurement points. Select item 9, SETUP TABLE, from the Applications Menu. Choose item 0 from the setup table and, following the prompt, enter a value of -6 dB by pressing:

[6]/[A A]

Return to the Application Menu and select item 0 to implement BANDWIDTH MODE and return to the spectral display. The delta markers have been activated and bracket the calibration signal peak. If the signal peak is not centered, the

//////////////////// **2710 Spectrum Analyzer User's Guide** //////////////////////

2710 selects the peak nearest the center of the screen. The first two items in the right on-screen column read:

**BW 300KHZ
@ -6DBC**

You are measuring the bandwidth of the RBW filter. Don't worry if the indicated bandwidth is not exactly 300 kHz; it will vary slightly either side of 300 kHz. Change the span to 10 kHz/division and the RBW to 30 kHz. The bandwidth should now read roughly 30 kHz. The 2710 remains in bandwidth mode until you call up the Applications Menu, toggle it off, make an alternate selection, or until you turn off the markers. **Turn off bandwidth mode.**

100.0MHz	(AUTO SWEEP)	ATTN 10DB
-30.0DBM		VF WIDE
20.0MHz/ 5MHz RBW (AUTO)		10 DB/

Measuring Average Noise

Select the Applications Menu again. Item 2 causes the 2710 to measure the current average noise and normalize it to a specified bandwidth. The default bandwidth is 1 Hz, but you can change it to suit your application. If you're in the CATV business, you'll probably use 4 MHz frequently. For now, let's change it to 5 MHz to obtain an approximation of the analyzer's in-band noise floor. **Select item 9 from the Applications Menu and then choose item 2 from the setup table. Enter a value of 5 MHz and return to the Applications Menu. Choose item 2, NOISE NORM'D.** The spectral display reappears and the marker is turned on. The first two items in the right on-screen column read:

**N -93.0DBM
@ 5.0MHZ**

Your instrument's reading may vary somewhat. The reading is the analyzer's average internal noise at the marker frequency.

//////////////////// 2710 Spectrum Analyzer User's Guide //////////////////////

You will also receive the warning:

NOISE LEVEL LESS THAN 2DB

This is because the analyzer recognizes when the noise it is measuring approaches its own noise floor. It knows that it can not accurately measure signals too close to that value.

Reposition the marker in the noise at the bottom of the MAX/MIN display. **Notice that the noise amplitude does not change significantly.** The noise reading appears to be about -- but not exactly -- half way between the max and min values of the spectral display. There are several reasons for the difference between the displayed and read out noise values. The analyzer does not actually compute the arithmetic mean of the min and max values; doing so with decibel values yields an incorrect answer. Rather, the 2710 measures the average noise amplitude "behind the scene". You don't see any change in the display, but you may notice a pause while it carries out the noise measuring algorithm. First, the 2710 actually measures the average noise power in ZERO SPAN using a very narrow bandwidth video filter. **To see a better approximation of the average noise, turn on the video filter.** It then corrects the average for the difference between average and RMS amplitude. Another small correction is added for the effects of log amplification. Further, the equivalent noise bandwidth of the RBW is not exactly 5 MHz; a small correction must be applied to account for the filter's rolloff and skirts, and the resulting noise normalized to the specified bandwidth. **Now turn off the markers and the video filter.**

Measuring Carrier To Noise Ratios

To demonstrate the carrier-to-noise (C/N) ratio feature of the 2710 we will measure the calibrator-to-analyzer-noise-floor ratio in a 5 MHz bandwidth. In the real world, you are more likely to measure a carrier peak to system noise ratio, but the technique is the same.

Turn on the calibrator, call up the Application Menu, and select the set up table. Choose item 1 and again enter 5 MHz

//////////////////////////////// 2710 Spectrum Analyzer User's Guide //////////////////////////////////

for the normalized noise bandwidth for this carrier-to-noise (C/N) measurement. Return to the Application Menu and select item 1. The spectral display reappears with the fixed marker atop the 100 MHz signal peak. The 2710 automatically places the fixed marker on the signal peak nearest the center of the screen. The moveable marker is positioned 1 division from the left hand screen edge.

NOTE

The noise marker position is intended only to clearly separate it from the carrier marker. You must reposition the noise marker to the frequency at which you actually want the noise measured.

Position the marker about 50 MHz above the signal. The first two items in the right on-screen column read:

**C/N 63.0DB
@ 5.0MHZ**

Your instrument's reading may vary slightly. You will also receive the warning "NOISE LEVEL LESS THAN 2DB" that was discussed in the previous section.

The C/N reading is the ratio of the signal amplitude at the fixed marker's position to the average noise at the position of the movable marker. The noise reading is corrected as indicated in the previous section. Since the noise level you measured earlier was about -93 dBm and the signal peak is -30 dBm, the ratio should be approximately 63 dB.

The preamplifier discussed in the Input Menu section of this chapter can be very important when making noise or C/N measurements in broadband networks. For instance, in the U.S., good cable television operating practice requires that the video signal be at least 0 dBmV while picture quality requires the noise to be about 45 dB lower, or about -45 dBmV in a 4 MHz band. **Change the reference units to dBmV and reset the noise bandwidth to 4 MHz. Select NOISE NORM'D and notice the measured noise is about -42 dBmV.** If we were to connect the 2710 to a cable television tap with a 0 dBmV video signal and a 45 dB C/N, we would be unable to measure the noise or C/N because the cable noise (-45 dBmV in this

//////////////////////////////////// **2710 Spectrum Analyzer User's Guide** //////////////////////////////////////

example) is below the normal analyzer noise floor. Using the **Input Menu**, turn off the calibrator, turn on the preamplifier, and remove all RF attenuation. We have reduced the analyzer noise floor by over 12 dB to about -55 dBmV, making it possible to measure both noise and C/N on our hypothetical cable. Turn off the noise measurement mode and the preamp. Reinitialize the analyzer to the factory default power-up settings.

900.0MHz	(AUTO SWEEP)	ATTN 50DB
20.0DBM		VF WIDE
180MHz/MAX		10 DB/
5MHz RBW	(AUTO)	

Searching For Signals

The 2710 provides a signal search feature which enables you to detect signal peaks over a wide frequency range while still using a narrow span and/or RBW filter. What it does is to sequentially implement a series of signal searches using a marker peak find capability and the currently selected control settings. Each search range is equal to 10 times the span/div that you select, but each search range except the first overlaps the previous range by one division. The first search starts at the beginning frequency and the last stops at, or overlaps, the end frequency as indicated in Figure 4-14. Although the last search range may overlap the end frequency, no signals are reported above the end frequency. A verification process looks at the entire range twice and reports only those signals which are present both times.

//////////////////////////////////// 2710 Spectrum Analyzer User's Guide //////////////////////////////////////

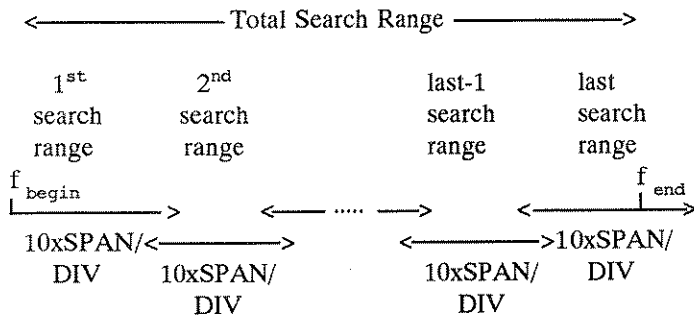

Note the SPAN/DIV overlap of each search range.

Figure 4-14. The SIGNAL SEARCH frequency range.

To see how this works, turn on the calibrator and reset the following analyzer controls:

SPAN/DIV	5.0MHz
RESOLUTION BW	300.0KHz
REFERENCE LEVEL	-20.0DBM
VIDEO FILTER	300.0KHz

Select items, SIGNAL SEARCH MENU, from the Applications Menu. We will search the frequency range from 55 to 550 MHz. Choose item 0 and enter 55MHz. Then choose item 1 and enter 550 MHz. The frequency and amplitude of any signal peaks below the reference level but above the detection threshold and within the specified frequency range will be stored. The threshold is normally set automatically by the 2710 at about one division above the minimum signal peaks, but you can reset it manually if desired via [MKR/FREQ MENU]/[9]/[1]. See *Setting the Signal Threshold* earlier in this chapter for details.

Start the search by selecting item 8, START TEST. You will see the measurement parameters change, and the message:

SIGNAL SEARCH IN PROCESS

is displayed while the search is occurring. You will also notice the center frequency change as each search range is completed. When the search is complete, the message disappears and the analyzer is reset to its original measurement parameters.

Press [UTIL MENU]/[4]/[2] and press [0] until the status indicator reads CRT (this feature is explained in the *Utility Menu* section). Press [UTIL MENU] again. Reselect the SIGNAL SEARCH MENU from the Application Menu. Notice that the number of signals detected is displayed at the end of item 9, DISPLAY RESULTS. Now select item 9. A table of SIGNAL SEARCH RESULTS appears. You should see five signals listed (the fundamental and first four harmonics of the calibration signal). The amplitude and frequency of each are indicated.

Return to the spectral display by pressing [APPL MENU] twice.

NOTE

If the 2710 is in PEAK acquisition mode, it reverts to MAX/MIN mode whenever the normalized noise or carrier-to-noise features are activated. You can return it to PEAK mode by pressing [DSPL MENU]/[4].

100.0MHz	(AUTO SWEEP)	ATTN 50DB
-20.0DBM		VF 300KHz
1.0MHz/		10 DB/
300KHz RBW (AUTO)		

Detector/Generator Menu

DET/
GEN
MENU

The Detector/Generator Menu provides a means of activating and controlling the optional built-in 2710 tracking generator (TG). The TG is a powerful tool for measuring the frequency response of a variety of active and passive devices. For examples, see *Spectrum Analyzer Fundamentals*, Tektronix publication 26W-7037-1.

The Detector/Generator Menu also enables you to listen to amplitude or frequency modulation that is present on the signals you are analyzing. This often helps to identify the signal you are observing. You can hear the demodulated AM or FM on the analyzer's built-in speaker. If higher fidelity is needed, or you are using the 2710 at a noisy location, use headphones. A 1/8" miniature phone jack is located near the front of the right side of the analyzer. Stereo decoding is not supported.

Listening to FM Transmissions

To experiment with the Detector/Generator Menu, connect an antenna or cable to the 2710 as outlined in *Appendix A*. Change the signal height and center frequency until you see signal peaks in the 88 - 108 MHz FM broadcast band (if you don't have broadcast FM in your area, you can tune to a TV station audio carrier). Set the center frequency to coincide with one of the peaks and press:

[DET/GEN MENU]

The Detector/Generator Menu appears. Select item 2, FM DETECTOR. The spectral display reappears and you may hear the sweep of the analyzer. If you hear nothing, turn the outer

knob on the LEVEL control, which functions as a volume control. Turning it clockwise increases the volume. Press [ZERO SPAN]. You will now hear whatever is being transmitted by the station. Leave the analyzer in zero span mode and tune it as you would a radio receiver, using the tuning knob. The signal level will rise as you tune-in stations and fall to the noise floor when no station is present. When you're finished, turn off the FM detector by selecting item 0 (OFF) from the Detector/Generator Menu and press [ZERO SPAN] to return to the normal spectral display.

Listening to AM Transmissions

To listen to AM transmissions, connect an antenna to the 2710 as outlined in *Appendix A*. The antenna will probably need to be much longer than for FM. Set the center frequency to 1 MHz, span to 10 kHz/division, sweep and RBW to AUTO, and calibrator off. Increase the signal height until you can see signal peaks in the 500 kHz - 1.7 MHz area (this is the medium wave broadcast band). Change the center frequency until one of the peaks is centered. Call up the Detector/Generator Menu and select item 1, AM DETECTOR. The spectral display reappears. Press [ZERO SPAN] and adjust the LEVEL control as needed. You'll hear whatever is being transmitted by the station. Leave the analyzer in zero span mode and use the tuning knob to tune other stations if desired. When you're finished, turn off the AM detector by selecting item 0 (OFF) from the Detector/Generator Menu.

Listening to FM or AM Transmissions

Now select item 3, AM & FM DETECTOR, from the Detector/Generator Menu. Tune to the same stations you did above and again select ZERO SPAN. Now you can hear both the AM and FM stations. This mode is convenient if you are simply looking for signal identification but don't know (or care) whether the signal is AM or FM. Another approach is to use this mode to find audio modulated signals and then switch on only the AM or FM detector to determine which type of modulation is being used. Experiment if you wish and then turn off the detectors.

900.0MHZ	(AUTO SWEEP)	ATTN 50DB
20.0DBM		VF WIDE
180MHZ/MAX		10 DB/
5MHZ RBW (AUTO)		

Using the Tracking Generator

The 2710 optional built-in tracking generator (TG) is an RF sine wave signal source whose output frequency follows, or tracks, the frequency currently being analyzed by the 2710. That is, if the 2710 is currently sweeping from 55 to 300 MHz, the output frequency of the TG also sweeps from 55 to 300 MHz in synchronism with the analyzer. However, it is possible to offset the TG slightly (-5 kHz to +60 kHz) with respect to the analyzer frequency to account for circuit drift or signal delays in propagating through the device under test.

The TG amplitude can be varied in 0.1 dB steps from -48 dBm to 0 dBm (or the equivalent in the other reference level units available on the 2710). It is also possible to vary the TG output amplitude over a range of about ± 2 dB relative to its designated amplitude using the front-panel LEVEL control.

The 2710 tracking generator provides a powerful tool for all types of swept frequency measurements. You can conveniently determine the frequency response of filters, crystals, amplifiers, cables, modulators, and most other 2-port devices. Because the tracking generator is built into the 2710, no other instrumentation is required in many cases. Figure 4-14A indicates how simple the equipment setup can be. However, if you are testing a broad-band device that does not have a 50 ohm input and output, it may be necessary to insert matching networks between the TG output/device input and the device output/analyzer input. Provision is made in both the Input Menu and the Detector/Generator Menu to account for the attenuation of these external networks.

The status of all TG parameters and controls is preserved when power to the 2710 is turned off. The condition of the TG will be the same after the power to the 2710 is turned back on that it was before power was turned off. The current parameters are

//////////////////////////////////// 2710 Spectrum Analyzer User's Guide //////////////////////////////////////

also retained when the TG is turned off. Therefore, to ensure that we all begin this discussion with the same settings, press:

[UTIL MENU]/[1]/[1]

This recalls the factory default power-up settings to the 2710, turning off the TG and setting its parameters to their default values.

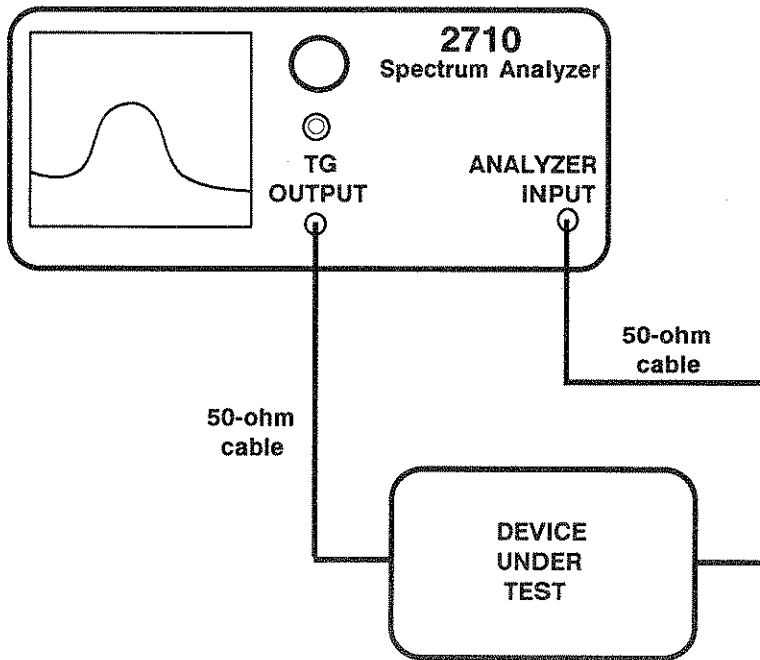

Figure 4-14A. Equipment setup for tracking generator measurement of 50-ohm devices.

Turning the Tracking Generator On and Off

Call up the Detector/Generator Menu by pressing:

[DET/GEN MENU]

Item 4, TRACKING GENERATOR, is a toggle that turns the TG on and off. Its current status is indicated at the end of the line. **Press [4] to toggle the TG ON.** The LED above the TG output lights indicating the TG is active and the screen reverts to the spectral display. At the lower left of the screen the TG output amplitude is displayed (the default is -48.0 dBm) in the current reference level units. **Toggle item 4 again to turn the TG off. Now turn the TG on and leave it on.**

Normalizing the Tracking Generator

The TG is normalized by determining the VCO voltage needed to center its output signal in the 3 kHz resolution BW filter at 100 MHz. Its output amplitude at 100 MHz is then measured by the 2710 and properly adjusted as it is stepped through its entire range. To ensure maximum accuracy when making TG measurements, it is necessary to normalize the TG before using it. Because TG normalizations depend on the 2710 reference, the analyzer normalizations must be valid to achieve optimum results. See the *Normalizing The 2710* and *Service Normalizations* sections.

To normalize the TG, return to the spectral display and press:

[UTIL MENU]/[3]

Then select item 3, TRACKING GENERATOR ONLY, from the Normalizations Menu. Note that the ALL PARAMETERS selection from the Normalization Menu includes only 2710 parameters, not the tracking generator. Following the on-screen prompt, connect a short cable between the TG output and the analyzer input and press [C]. In about two minutes, a NORMALIZATION COMPLETE message should appear on screen. If you receive a

NORMALIZATION FAILED message, repeat the normalization. If it cannot be completed satisfactorily, contact your Tektronix representative.

TG normalization is not automatically checked by the 2710 except at the time of normalization. To avoid changes due to temperature differentials, long-term drift, or other causes, it is recommended that you periodically renormalize the TG during long measurement sessions, or readjust the tracking to keep narrow resolution BW filters properly aligned.

Further, it has been discovered that in some 2710s, the peak of the 5 MHz resolution BW filter does not occur precisely at the center of its bandpass. This can result in small amplitude differences when switching from the 5 MHz filter to narrower filters. Relative responses using the 5 MHz filter are unaffected. To determine the amount of error (if any), make a TG measurement using first the 5 MHz and then the 300 kHz filters (the 300 kHz filter is symmetric about its peak response). Note the difference and correct any absolute power measurements that you make with the 5 MHz filter by that amount.

Setting the Tracking Generator Amplitude

The -48 dBm TG output level is hidden in the analyzer noise with the 5 MHz resolution BW. To reset the output amplitude, call up the Detector/Generator Menu and select item 5, TG FIXED LEVEL. Following the on-screen prompts, enter a new value of -10.0 dBm, and press [DET/GEN MENU] to return to the spectral display. Notice that the new amplitude value is now shown at the lower left of the screen. Activate the video filter and reset the reference level to 10 dBm. What is displayed is the combined TG/analyzer frequency response across the 2710's entire input frequency range. You may find the flatness of the response varies slightly as you change the TG output level. This is normal and within specification. However, any variation in flatness can be removed like this:

- Establish the test parameters including center frequency, span, resolution BW, reference level, and TG output.

- Connect the TG output to the analyzer input, and save the resulting sweep in the A register.
- Insert the device to be tested.
- Conduct all measurements in the B,C MINUS A mode. This approach subtracts out the variations in combined TG/analyzer response leaving only the response of the device.

Turn on the A register and then save the display. Call up the Detector/Generator Menu again and this time select item 6, TG VARIABLE LEVEL. This is an ON/OFF toggle which enables you to vary the TG output amplitude from -2 dB to plus several dB relative to the fixed amplitude specified by item 5. **Return to the spectral display by pressing [DET/GEN MENU].**

Notice that the indicated TG output level is now followed by an asterisk (*). This indicates that TG variable level is enabled. **Rotate the 2710 LEVEL control (outer knob) all the way counter-clockwise.** The D-register sweep should drop about 2 dB below the sweep saved in register A. **Rotate the LEVEL control fully clockwise.** The D sweep should rise several dB above the A sweep. **Note that the indicated TG output amplitude has not changed; the TG output level is not calibrated when TG VARIABLE LEVEL is ON.**

When the variable level control is set above the fixed level, it is also possible to slightly compress the TG signal. This may cause some degradation of the second harmonic specification. This is normally not a problem with passive linear devices, but can result in some intermodulation products with nonlinear components, and spurious radiation from active devices such as modulators or transmitters. To avoid these problems, we suggest that you use the TG fixed level and analyzer reference level controls to move signals vertically on the screen, rather than using the variable level feature.

Now unsave the A register and toggle the TG VARIABLE LEVEL to OFF.

Adjusting the Tracking

The TG tracking is the amount by which the TG output frequency is offset from the frequency currently being analyzed

by the 2710. The tracking can be adjusted from -5 kHz to +60 kHz. For most measurements, the tracking is not turned on (tracking = 0 Hz). However, when making measurements with very narrow resolution BW filters (e.g., the 300 Hz optional filter), or when the device under test creates a significant delay between its input and output ports (e.g., a long cable), it is necessary to adjust the tracking to ensure the TG signal is centered in the analyzer resolution BW filter.

To see how the tracking adjustment works, first reset the center frequency and span as follows:

Center Frequency	100 MHz
Span	10 kHz/div

The 3 kHz resolution BW is automatically selected, and the display is a single horizontal line at about -10 dBm. Save the display in register A. Turn on TG tracking by pressing:

[DET/GEN MENU]/[7]

and return to the spectral display. It is unchanged except for the message TRKG 0HZ at the lower right of the screen. Turn the Freq/Markers knob several clicks in either direction. The indicated tracking should change by about 30 Hz per click, but nothing else happens. Continue turning the knob until the D-register sweep decreases 6 dB relative to the A sweep. Now turn the knob in the opposite direction until the D sweep again decreases 6 dB. The indicated tracking should change polarity. What you have done is to offset the TG output to the 6 dB down points of the 3 kHz resolution BW filter.

If you have the 300 Hz filter (Option 01) installed in your analyzer, select it. The D sweep may decrease dramatically because the 300 Hz and 3 kHz filters are not always concentric. Rotate the knob until the D sweep returns to the level of the A sweep. The TG output is now centered in the 2710's 300 Hz resolution BW filter.

Whenever you make measurements with the 300 Hz filter, always peak the response with the tracking control to ensure you are measuring the maximum signal. It is also

recommended that you periodically check the tracking during long measurement sessions when using the 3 kHz filter. Further, whenever you use a 3 kHz or narrower filter to test a device which imposes a significant group delay on the received signal (such as a long cable), vary the tracking to ensure the analyzer is correctly peaked. Because the TG signal is delayed, it lags behind the analyzer frequency by an amount that depends on the analyzer sweep rate and the group delay.

Unsave the A register and select the 3 kHz filter.

Accounting For External Amplification or Attenuation

It is possible to insert another device such as an impedance matching network, attenuator, or amplifier between the TG output and the device under test. You can account for the gain or attenuation (and impedance change) introduced by the device. The altered output level appears on screen. This feature is a valuable aid whether recording data photographically, with a printer/plotter, or via the GPIB.

Suppose, for instance, that you want to drive the device under test with a +10 dBm signal. You can do this by setting the TG output to -10 dBm and inserting a +20 dB amplifier between the TG and the device under test. In another case, you may wish to drive the TG at full output (0 dBm) but insert an external impedance matching pad to produce a better SWR.

To account for external amplification or attenuation press:

[DET/GEN MENU]/[8]/[1]

and enter the appropriate value following the on-screen prompts. The TG EXT ATTEN/AMPL shows the value entered and TG FIXED LEVEL changes to include the offset. Note that entering a non-zero value automatically turns on the amplitude offset feature, while a value of zero automatically turns it off; you can also toggle the offset on and off using [DET/GEN MENU]/[8]/[0]. Return to the spectral display. The on-screen TG output level has changed

//////////////////////////////////// 2710 Spectrum Analyzer User's Guide //////////////////////////////////////

to show the offset value and is followed by OFST to indicate the amplitude has been externally altered.

Suppose you wish to use the TG and analyzer with a device that has a 75 ohm input and output, and the desired reference level unit is the dBmV. To carry out a measurement:

- Insert a matching minimum loss pad such as the units supplied with the 2710 into the TG output and the analyzer input.
- Call up the Input Menu and select the dBmV ([INPUT MENU]/[3]/[1]). Notice that the TG output level units as well as the reference units change.
- Again call up the Input Menu and enter -7.5 dB to account for the external attenuation and impedance change of the analyzer minimum loss pad ([INPUT MENU]/[6]/[1] and follow the prompts).
- Call up the Detector/Generator Menu and enter -4.0 dB to account for the external attenuation and impedance change of the TG minimum loss pad ([DET/GEN MENU]/[8]/[1] and follow the prompts). The value is different because the impedance change is in the opposite direction. Return to the spectral display. TG output level should indicate 33.0 dBmV.
- To verify your setup, connect the two pads together with a short cable. Set the center frequency to 100 MHz, the span to 1 MHz/div, and turn on a marker. Change the reference level until the sweep is within one division of the top graticule line. The measured amplitude should agree with the indicated TG output to within a few tenths of a dB.
- Set the TG output to the required level, and the analyzer parameters to those desired for the measurement. Readjust the reference level as needed to get the sweep to the top of the screen, and then save the sweep in the A register. (For amplifiers it is best to adjust the reference level so the sweep is n dB down from the top to the screen, where n is the amplifier gain.)
- Now connect the output of the pad on the TG to the input of the device under test, and the device output to the input of the pad on the analyzer input. Carry out your measurement in the B,C MINUS A mode.

A Practical Example

Figure 4-14B shows the frequency response of a passive bandpass filter near its resonant frequency (105 MHz). To obtain the picture, the TG output was first connected directly to the analyzer input. The sweep at the top of the figure was obtained and saved in the A register. It represents the combined TG - 2710 response over the displayed frequency span. The bandpass filter was then substituted for the device under test in Figure 4-14A, and the analyzer placed in B,C MINUS A mode. This approach subtracts the measured instrumentation response (the A sweep) from the combined filter - instrumentation response to obtain the true filter response in the B register. The analyzer was set as indicated by the on-screen readouts. Notice that the bandwidth feature ([APPL MENU]/[0]) is also enabled.

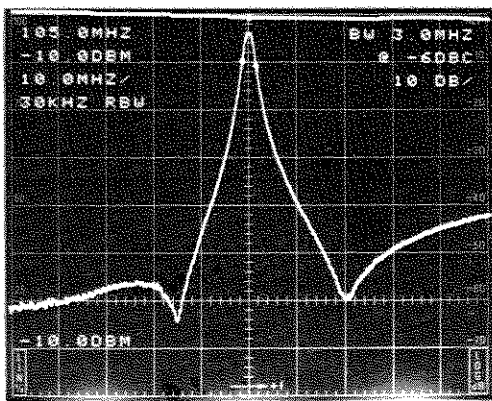

Figure 4-14B. Bandpass filter response using the 2710 optional tracking generator and B,C MINUS A mode.

This page intentionally left blank.

Utility Menu



The Utility Menu provides access to system configuration and initialization features, front-panel settings and waveform storage capabilities, instrument normalization and diagnostics, and a screen plot facility. Some of the selections within the Utility Menu and its submenus are used by service personnel to troubleshoot the 2710. Therefore, not all selections are discussed here.

You have already used the Utility Menu to restore the factory default power-up settings to the 2710. **Do it again now by pressing:**

[UTIL MENU]/[1]/[1]

900.0MHz	(AUTO SWEEP)	ATTN 50DB
20.0DBM		VF WIDE
180MHz/ MAX		10 DB/
5MHz RBW (AUTO)		

Keypad Entered Control Settings

You are going to use the Utility Menu to reset the center frequency, reference level, and span. **Call up the Utility Menu and select item 2, KEYPAD ENTERED SETTINGS.** This selection enables you to set all measurement parameters to specific values from a single menu without having to repeatedly press or turn front-panel controls. **From the secondary menu, select item 0, FREQUENCY.** Following the prompt, **enter a value of 100.000 MHz for the center frequency.** The Keypad Entered Settings Menu shows the frequency to three decimal places whereas the on-screen readout displays the specified frequency from zero to four decimal places depending on the span. Both values are truncated figures, but the 2710 still controls the frequency to the nearest Hertz specified. The number of decimal places in the on-screen readout is commensurate with the screen resolution at the selected span.

//////////////////////////////// 2710 Spectrum Analyzer User's Guide //////////////////////////////////

You can also enter decimal values for the reference level and span. Select items 1 and 2 and enter values of -22.2 dBm and 22.600 MHz/division respectively. Notice that this menu enables you to enter values not possible using the dedicated function keys. The analyzer truncates and displays the reference level to one decimal place (0.1 dB) on screen. The span can be entered to many decimal places, but it is also truncated and displayed to one place on screen. Press [UTIL MENU] to see the display you've created.

We will leave the remaining parameters set as they are, but return to the Keypad Entered Settings Menu and note the following:

- RF attenuation can be set to AUTO (the default) or fixed from 0 to 50 dB in 2 dB steps.
- The RBW can be set to AUTO (the default), 3 kHz, 30 kHz, 300 kHz, or 5 MHz (also 10 kHz, 100 kHz, and 1 MHz with option 14; 300 Hz with Option 01; and 1 kHz with options 01 and 14). If you enter another value, the 2710 will convert it to the nearest permissible value.
- This menu provides the only method of manually setting the video filter bandwidth. The video filter bandwidth can be set to AUTO (in which case it is 1/100 of the RBW) or fixed from 3 Hz to 300 kHz in a 1-3 sequence (3 Hz, 10 Hz,...100 kHz, 300 kHz). Other values will be converted to the nearest permissible values.
- Selecting item 6, VERTICAL SCALE, calls up another menu which enables you to select any of the normal values of 10 dB/division, 5 dB/division, 1 dB/division, or Linear.
- Sweep rate can be set from 1 microsecond/division to 2 second/division in a 1-2-5 sequence. Other values will be converted to the nearest permissible value. Rates faster than 100 microsecond/division can be used only with analog displays (i.e., display storage turned off).

Re-enter a span/div of 20 MHz and a reference level of -20 dBm. Restore the spectral display by pressing [UTIL MENU].

Recalling Last Power-Down Settings

Turn off the analyzer and then turn it on again. We want to use the same parameters as above. Do we have to reset each of them? Not at all! Call up the Utility Menu and select item 1, STORED SETTINGS. Choose item 0, LAST POWER-DOWN, from the secondary menu that appears. The settings that were in effect the last time power to the 2710 was turned off are immediately recalled. Our settings are back again.

100.0MHz	(AUTO SWEEP)	ATTN 10DB
-20.0DBM		VF WIDE
20.0MHz/		10 DB/
5MHz RBW (AUTO)	CALIBRATOR	

User-Defined Power-Up Settings

We've used the LAST POWER DOWN parameters, above, for many of our experiments. Wouldn't it be nice if they were the power-up parameters? Let's make them. Call up the Utility Menu and again select item 1, STORED SETTINGS. From the secondary menu that appears, select item 2, USER DEFINED POWER-UP. Following the prompt, press [B B] to store the current settings. If other settings are already stored as the user defined power-up, you receive a message. Delete the old settings by pressing [C C] and then store the current settings. Turn the instrument's power off and back on. During the standby period, the factory default power-up settings are displayed, but afterwards the settings you just stored are automatically implemented. At power-up, following the standby period, the analyzer implements the user defined power-up settings if they exist. If they don't, it uses the factory default settings. If the user defined power-up settings include a narrow span, the NORMALIZATION SUGGESTED message may appear. The message should disappear as the analyzer warms up.

//////////////// 2710 Spectrum Analyzer User's Guide //////////////////

Change the measurement parameters (it doesn't matter to what), then restore the user defined parameters by pressing:

[UTIL MENU]/[0]

This does one of two things. If user defined power-up settings have been stored, they are implemented. If not, the factory default power-up settings are implemented.

Other UserDefined Settings

Great! But what about those blank items 3-9 on the Stored Settings Menu? Each one of them can be used exactly as you used USER DEFINED POWER-UP SETTINGS. The difference is that they aren't automatically implemented at power-up time or by the initialization selection. They must be recalled from the Stored Settings Menu. **Turn on the calibrator and change the frequency to 90 MHz and the reference level to -10 dBm. Save a 16 sweep ensemble mean in register A and save the max hold values in B. Turn off the calibrator.**
Press:

[UTIL MENU]/[1]/[3]/[B B]

This saves the settings under item 3 of the stored settings secondary menu. Now reinitialize the analyzer ([UTIL MENU]/[0]). Recall the settings you just saved by pressing:

[UTIL MENU]/[1]/[3]/[A A]

Not only the settings, but also the stored waveforms are restored! Whenever you store front-panel settings (including LAST POWER-DOWN and USER DEFINED POWER-UP), you also store the contents of digital storage registers A, B, and C. This means you can store approximately 18 waveforms and nine groups of front-panel settings (actual numbers depend on what else, such as user-defined routines, is being stored).

Furthermore, this information is saved even with the power turned off. You can do things like record waveforms in the field and bring them back to the lab with you for further analysis or permanent recording — or store reference waveforms in the lab for comparison in the field!

You can also store settings and waveforms by title. Using the **Display Menu**, create a title for the current display (see the *Adding Titles and Labels* section). Call it **MY SETTINGS**. Turn on title mode and return to the spectral display. Press:

[UTIL MENU]/[1]/[4]/[B B]

This saves the settings under item 4 of the stored settings menu. Again press **[UTIL MENU]/[1]**. Item four on the menu is now “**MY SETTINGS**”. The settings are recalled like any other, but the title often helps remind you what the settings are used for.

Any control settings can be used

Normalizing the 2710

Call up the Utility Menu and select item 3, **NORMALIZATIONS**. What is normalization? Normalization is a set of procedures contained in ROM which calculate and store gain and frequency characteristics of the circuits in the 2710 based on the built-in 100 MHz, -30 dBm calibration signal. Later you will learn how external signals can be used to achieve even greater measurement accuracy (or to renormalize the reference if NVRAM should ever be lost). The characteristics must be accurately known to correctly scale and display the analyzed signal, and to correctly control the optional tracking generator.

If the self-test feature of the 2710 detects that the present analyzer gain or frequency characteristics differ significantly from those determined during the previous normalization, it displays:

NORMALIZATION SUGGESTED

in mid-screen. You should then perform a normalization, although the analyzer remains useable for “rough” measurements. The **NORMALIZATION SUGGESTED** message may also appear while the analyzer is warming up, especially if the user-defined power-up settings include a narrow span. This is normal. You need not perform a normalization unless the message persists beyond the warm up period. Any time you require the utmost accuracy, we recommend a normalization first. Normalization may be required because of:

- Circuit or component variation with time (drift)
- Large temperature difference from that at which previous normalization was carried out
- Non-Volatile Random Access Memory (NVRAM) is lost for any reason

Always perform the normalizations in environments, especially temperatures, like those in which the subsequent measurements will be carried out. Also remove any input signals from the analyzer before performing amplitude or frequency normalizations. Although we recommend that you wait a full 15 minutes after power-up before making measurements with the 2710 (it's within spec by then), it's possible to make them shortly after power-up. If you must make measurements immediately after the instrument is turned on and the **NORMALIZATION SUGGESTED** message is on screen, then carry out a normalization directly. Note, however, that if you do so, the analyzer may require renormalization after it is fully warmed up.

The Normalizations Menu enables you to normalize the 2710 amplitude parameters (**AMPLITUDE ONLY**), the frequency parameters (**FREQUENCY ONLY**), or both (**ALL PARAMETERS**). It takes longer for amplitude normalization than for frequency normalization, but only a few minutes for both. Routinely select **ALL PARAMETERS** to ensure the 2710 is measuring amplitude and frequency as accurately as possible, but if you are in a hurry, you can select only the parameters that are more important to your measurements.

If the tracking generator option is installed in your instrument, a fourth choice is possible: item 3, **TRACKING GENERATOR ONLY**. You should always normalize the TG before using it.

See **Using the Tracking Generator** later in this section. The tracking generator is not normalized by selecting **ALL PARAMETERS**.

To normalize the 2710 amplitude and frequency parameters, ensure that all signals are disconnected from the analyzer input. Then select item 0, ALL PARAMETERS. Typically, you will see a number of changing waveforms and messages on screen telling you which normalizations are being carried out. However, if NVRAM is ever lost, the factory reference normalizations are lost with it (see the *If You Lose NVRAM* section). Then, regardless of which normalizations you are carrying out, you will receive this message:

ONE OR MORE REFERENCE NORMALIZATIONS HAS NOT BEEN PERFORMED. EXECUTING THE REQUESTED NORMALIZATION, WITHOUT INTERNAL REFERENCES NORMALIZED, MAY RESULT IN LESS THAN OPTIMUM INSTRUMENT ACCURACY.

**PRESS "C" TO CONTINUE
PRESS "D" TO ABORT**

If you have facilities to carry out the reference normalizations (see the *Service Normalizations* section of this chapter), abort this process and do so before continuing. Otherwise, press [CC] to continue. A recently normalized instrument is more accurate than an unnormalized one, even if the references have not been normalized.

The normalization process executes without further operator intervention. When it is complete, a beep sounds and this message appears:

NORMALIZATION COMPLETE

If you receive a message that either frequency or amplitude normalization failed, try the procedure again. In case of repeated failures, contact your Tektronix Service Center. The spectral display reappears automatically upon completion of normalization.

System Configuration

Call up the Utility Menu and select item 4, **SYSTEM CONFIGURATION**. The secondary System Configuration Menu presents you with nine choices. Let's look at them in order.

The Communications Port

Select item 0. If your instrument doesn't have a communications port, the message **NOT INSTALLED** appears. Otherwise, the **COMMUNICATION PORT CONFIG** Menu appears. If you have option 09 (the Centronics printer port) installed in your 2710, the menu lists:

1 CENTRONICS

This is an 8-bit parallel port using a Centronics printer pin configuration. Press [1] to see the **current printer/plotter status messages**. **PRINTER SELECT ON** is the message when everything is normal. No operator action is needed. **Return to the System Configuration Menu.**

If GPIB option 03 is installed in your analyzer, this item appears:

0 GPIB OFF LINE/ADDR #

If the port is currently on line, its GPIB address is displayed at the end of the line. Otherwise, the line ends with **OFF LINE**.

The GPIB port is intended primarily to enable the 2710 to communicate with a system controller (computer) or GPIB plotter. **To configure the 2710 for either of these options, press [0].** The GPIB Port Configuration Menu appears.

Item 0 simply enables you to toggle the GPIB port on and off line. The port must be online to communicate with any other device.

Item 1 specifies the primary address of the 2710 (the 2710 does not support secondary addresses). It can be any value from 0 to 30, but when the 2710 is used with a system controller, the value must match that used to configure the controller. The address 0 is conventionally reserved for the controller itself. When the 2710 is used in the TALK ONLY mode with a plotter, any address can be used. The address you set is read immediately by the 2710 and retained in NVRAM until you change it.

Item 2 determines whether the 2710 generates a service request (SRQ) at power up. Because there is normally no need for a SRQ at power up, the default setting of item 2, POWER ON SRQ, is OFF. However, in some cases you may want to sense that power has been turned on before continuing your test. For those cases you can toggle the POWER ON SRQ to ON by pressing [2].

When a message is transmitted over the GPIB, the instrument sending the message signifies to other instruments on the bus (including the system controller) that the message has been completed. This can be done in two ways.

- The interface management line named End Or Identify (EOI) is asserted (brought to its low state) simultaneously with the last data byte that is transmitted.
- The ASCII codes for carriage return (CR) and line feed (LF) are appended to the message string. EOI is still asserted simultaneously with the transmission of LF.

All Tektronix instruments and controllers use EOI. You should, therefore, toggle item 3, EOI/LF MODE, until the end of the line indicates EOI. The EOI/LF MODE option is included for controllers which do not use the EOI signal line. The option selected is retained in NVRAM until you change it.

Item 4, TALK ONLY MODE, must be set to OFF when the spectrum analyzer is used with a controller, because the controller determines whether the analyzer is talking or listening. If you normally use the analyzer with a controller, set the TALK ONLY MODE to OFF.

However, to send 2710 screen plot data directly to a GPIB plotter without a controller, set the TALK ONLY MODE to ON, and disconnect all instruments except the 2710 and the plotter from the bus. Place the plotter in the listen only mode (usually done with controls on the plotter). With the talk only and listen only modes selected, you can send screen data from the 2710 to the plotter by pressing [UTIL MENU]/[6].

Be sure to see the *2710 GPIB Programmers Manual* for detailed information about setting up and configuring the analyzer for GPIB operations.

Selecting the Screen Plotter Configuration

If your analyzer has a digital communications port installed, the spectral display and its attendant information can be sent to a printer or plotter by pressing [UTIL MENU]/[6]. **To select a communications language suitable for the range of printers and plotters which can be used for screen plots, select item 1 of the System Configuration Menu, SCREEN PLOT CONFIGURATION.** The resulting menu also enables you to select a range of plotter speeds and the number of plots per page. If the communications port is not present in your instrument, the message NOT INSTALLED is displayed briefly and the menu does not appear.

Item 0 on the Screen Plot Configuration Menu simply indicates which communications port is installed in your instrument.

To cycle through the printer and plotter models supported by the 2710, repeatedly select item 1 from the menu. Each time you press [1], the printer or plotter displayed at the end of the line changes. EPSON FX (the default) refers to FX-series printers produced by Epson and HPGL stands for Hewlett Packard Graphics Language. **Stop when the model of your printer/plotter (or the one yours emulates) is displayed.**

If you select a plotter, plot speed and number of plots per page options appear on the Screen Plot Configuration Menu. **Repeatedly select item 2, PLOT SPEED, and watch the**

indicated PLOT SPEED cycle through FAST, FASTER, FASTEST, SLOW, and NORMAL (the default). Try the various speeds with your plotter to see which produces the most satisfactory results.

If you select 4 plots per page, a plot position option appears which enables you to select the quadrant of the paper on which the current plot will be placed. Repeatedly select item 4, PLOT POSITION, to cycle through the available positions.

Selecting the Printer Configuration

Certain features of the 2710 enable you to send ASCII character strings (exclusive of screen plots) to a printer, or to the analyzer's display CRT. Return to the System Configuration Menu and select item 2, PRINTER CONFIGURATION. Then select item 0, PRINTER DEVICE. If the Centronics interface is installed, the PRINTER DEVICE will toggle between CENT and CRT. If Centronics is not installed, CRT is always displayed. Select CRT if you want results that would normally be sent to a printer to be displayed on the 2710 screen instead. On-screen display is sometimes not satisfactory if there is more than one screen of data, because only the last screen remains visible.

Changes to this setting are not retained in NVRAM; the 2710 always defaults to CENT if the Centronics interface is installed.

Instrument Configuration

Item 3, INSTRUMENT CONFIGURATION, of the System Configuration Menu enables you to reset 2710 internal parameters and conditions. Some of the more useful ones are described in the following subsections.

The Audio Alert Level

Item 0, AUDIO ALERT LEVEL, of the Instrument Configuration Menu is a four-way toggle whose status is indicated at the end of the line. You can choose LOW, HIGH, CW, or OFF. The low setting is the factory default; it's what you hear when you press any key.

Change the AUDIO ALERT LEVEL to HIGH by selecting item 2 from the System Configuration Menu; you'll notice a change in pitch and loudness. This is the preferred setting if you are using the 2710 in a noisy environment (if in extremely noisy environments, use the headphone output).

Change the AUDIO ALERT LEVEL to CW by selecting item 2 again. In CW mode, the low tone is used. During the power-up period the 2710 sounds the Morse code for QRX (standby).

To turn the tone OFF completely, select item 2 one more time. Pressing the key additional times cycles through the same settings. **Restore the LOW setting.**

Setting the Minimum Signal Size

Select item 1, MINIMUM SIGNAL SIZE, from the Instrument Configuration Menu. Minimum signal size is the smallest amplitude difference that must exist between signal peaks for them to be recognized during "Next Higher" and "Next Lower" or Marker arrow operations. It is expressed in bits, full scale being 255 bits. Factory default is 20 bits or about 8% of full scale. **Type a new value and enter it by pressing [A A].** The new value appears at the end of item 0. **Experiment if you wish, and then restore the factory default value.**

Sending Waveforms To a Computer

Item 2 from the Instrument Configuration Menu, WAVEFORM TO PRINTER, is actually intended to send binary or ASCII representations of the displayed waveform to a computer following each sweep. The computer must be equipped with a Centronics type parallel port capable of receiving 8-bit data bytes. Select item 2 to toggle data transmission ON and OFF. Select item 3 to toggle the data format between ASCII and binary. Unless you are actually transmitting data, leave the feature turned off.

100.0000MHz	(AUTO SWEEP)	ATTN 10DB
-20.0DBM		VF 3KHz
20.0KHz/		10 DB/
3KHz RBW (AUTO)	CALIBRATOR	

Turning Phase Lock On and Off

The 2710 uses internal reference oscillators to analyze the input signal. When using wide spans, a slight amount of drift in an internal oscillator is not noticeable. However, as the span is reduced to a few kHz/div or less, any internal oscillator jitter becomes apparent. The on-screen indication is phase noise close to the base of a signal and/or an apparently drifting signal. Therefore, when operating at narrow spans with a 2710 equipped with Option 01, the oscillators in the spectrum analyzer are typically *phase locked* to a stable reference. This happens normally automatically and is indicated by the Message:

LOCK

displayed on screen when the span is 20 kHz/div or less. Phase lock minimizes the amplitude of the noise pedestal close to a signal, but may actually increase it slightly at greater frequency differences. Therefore, the 2710 enables you to turn off phase lock when desirable. **Toggle phase lock between AUTO and OFF using item 4, PHASELOCK, from the Instrument Configuration Menu. Return to the spectral display to see the effects. Leave PHASELOCK in AUTO when you are done.**

//////////////////////////////// 2710 Spectrum Analyzer User's Guide //////////////////////////////////

300.0MHz	(AUTO SWEEP)	ATTN 10DB
-20.0DBM		VF WIDE
50.0MHz/		10 DB/
5MHz RBW (AUTO)	CALIBRATOR	

Turning Frequency Corrections On and Off

During normal operation, the 2710 periodically computes frequency corrections (to compensate for short-term drift within the analyzer itself) and applies them to the displayed trace. It does this between sweeps. If your application requires continuous monitoring of the signal, you may want to turn off these corrections temporarily, even though some high frequency accuracy may be sacrificed. Item 5, FREQUENCY CORRECTIONS, of the Instrument Configuration Menu is a toggle which enables you to turn the corrections off and on. To see how this works, observe the spectral display for a few sweeps. Can you see the slight pause about every fourth sweep? This is the period during which the corrections are computed and implemented. Reduce the span to 50.0 kHz/div. Watch the signal peak for several minutes and notice how it drifts relative to screen center and then is recentered. Now select item 5 from the Instrument Configuration Menu to turn off the corrections and then return to spectral display. Notice how the signal now continues to drift. Reselect item 5 to turn the frequency corrections back on. Return to the spectral display and note that the signal is again centered.

The Spectral Display In Menus

Press [UTIL MENU]/[4]/[3] to activate the Instrument Configuration Menu. Repeatedly select item 6, SPECTRAL DISPLAY IN MENUS. See how the spectral display is superimposed on the menu? Some people prefer to have the display present when working with menus, others do not. Leave the display turned on.

Changing the Sweep Holdoff

There is a holdoff period between the end of one sweep and the start of the next to give the internal circuits in the 2710 time to stabilize. For faster response time when continuous observation of signals is necessary, the delay can be minimized. When using a short holdoff in AUTO sweep mode, a fictitious signal sometimes appears at the left edge of the screen. **Ensure the spectral display is turned on in the menus and select item 7, SWEEP HOLDOFF, from the Instrument Configuration Menu. Read the messages that appear, and then press C to continue.** The SWEEP HOLDOFF status switches from NORMAL to SHORT HOLDOFF and a signal peak appears at the left edge of the screen. **Reset the sweep holdoff to NORMAL and turn off the SPECTRAL DISPLAY IN MENUS.**

Setting the Date and Time

Return to the System Configuration Menu and select item 4, REAL-TIME CLOCK SETUP. This feature enables you to label printer/plotter outputs with the date and time. The information does not appear on the spectral display and is not automatically updated; you must reenter the data as the time/date changes. **Select any of the six items to update the date/time data. Terminate each entry by pressing [A A].**

Protecting Stored Settings

Select item 5 from the System Configuration Menu. The end-of-line status indicator toggles from OFF to ON. **Change it to ON. Press the back arrow key to return to the Utility Menu and select STORED SETTINGS/DISPLAYS. Attempt to delete the user-defined power-up settings (or any other stored settings). This message appears:**

ONLY WAVEFORMS DELETED

When STORED SETTINGS PROTECT is turned on, you cannot delete the stored settings, but waveforms stored along with them will be deleted. **Turn the protection off.**

The 2710 File System

The 2710 stores settings, waveforms and other data in a system of files in NVRAM. Normally you do not access or alter those files. To view a directory of existing file names, press:

[UTIL MENU]/[4]/[6]

2710 file names are established by the firmware. Table 4-3 lists the file names and describes their contents. Files are created only as required. That is, you won't find a BSET03 settings file unless you have previously saved the B-register settings in the third storage location.

DSET00 and SET0BU are special files. They are created automatically by the 2710 and contain the D-register settings used when the analyzer was last turned off. SET0BU is a backup in case DSET00 becomes corrupted at next power-up.

Other files of a temporary or transitory nature may also be created by the 2710 for internal purposes.

Protecting Files

Files you wish to preserve such as waveform, settings, or UDP files can be protected from accidental erasure in several ways. For instance, UDP files can be selectively protected from the User Def Menu, while all settings files can be protected by pressing **[UTIL MENU]/[4]/[5]**. However, to selectively protect any file in the 2710's file system, first determine its file number by viewing the file directory (**[UTIL MENU]/[4]/[6]**). The number is listed under the FID column in the directory. Return to the System Configuration Menu and select item 7, **PROTECT FILE**. Following the on-screen prompt, enter the number of the file you want to protect. Confirm your selection by pressing **C**. It is now impossible to delete the file without first unprotecting it.

To unprotect a previously protected file, repeat the foregoing process. The process constitutes a toggle which alternately protects and unprotects the designated file.

A word of caution: don't protect the 2710's routine housekeeping files. Doing so may prevent the analyzer from carrying out its normal functions or providing current data.

Table 4-3. The 2710 file system.

Settings files: Each file saves the 2710 control settings for a particular register (A, B, C, D) in a designated location (00-09). BSET03 saves B-register settings in the number 3 location.

Curve files: Each file saves the curve data from a particular register (A, B, C) in a designated location (00-09). D-register curves are never saved. AWFM04 saves the A-register curve in location 4.

User-Definable Program files: Each file saves a keystroke command sequence in a designated location (00-09) representing a particular user-defined program. UDP01 is the second user-defined program.

Antenna Table files: Each file saves the antenna table in a designated location (1-5) representing antenna data for a particular antenna. ACF3 saves the antenna information in location 3.

Normalization file: The normalization file saves the data generated by normalizing the 2710, including reference and TG normalizations.

FILE NAMES

Curves	Settings	User-Definable Programs	Antenna Tables	Normalizations
nWFM00	nSET00	UDP00	ACF1	NORM
:	:	:	:	
nWFM09	nSET09	UDP08	ACF5	
n=A,B,C	n=A,B,C,D			

Several other files representing system parameters may also be present:

NAME	DESCRIPTION	NAME	DESCRIPTION
S_PLOT	Plotter configuration	12.88	Version
SETUP	Instrument configuration	S_GPIB	GPIB configuration
S_CENT	Centronics configuration		
SEARCH	Signal search configuration		
S_RTC	Real-time clock configuration		

Confirming Installed Options

If you are in doubt as to which options are installed in your instrument, press:

[UTIL MENU]/[4]

One of the items on the resulting System Configuration Menu is labeled **INSTALLED OPTIONS DISPLAY**. In older firmware versions it is item 5, in newer, item 9. **Press the item number indicated by your instrument.** The resulting display begins by listing the instrument's firmware version and the Tektronix copywrite. Below that, two columns list the options installed in your analyzer. You may see items such as:

VIDEO MONITOR	COUNTER
NVM 9.87	300HZ FILTER
PHASE LOCK	CENTRONICS

The number following NVM (non-volatile memory) is for internal Tektronix use only and of no value to the user.

Any control settings can be used.

Instrument Diagnostics and Adjustments

Call up the Utility Menu and select item 5, **INSTR DIAGNOSTICS/ADJUSTMENTS**. Many of the items on the resulting secondary menu are intended for servicing of the 2710. However, we will discuss a few of them you can use to verify instrument performance. Items not discussed are reserved for service personnel or for use under factory supervision.

Aligning the Display with the Screen

To align the display, select **MANUAL ADJUSTMENTS** from the Instr Diagnostics/Adjustments Menu, and then select **DISPLAY STORAGE CAL** from the resulting Manual Adjustments Menu ([UTIL MENU]/[5]/[2]/[2]). This creates a checkerboard display used to adjust trace position and rotation. The alignment controls are located on the back of the analyzer (see *The Controls*). Turn the **TRACE ROT** control until the checkerboard test pattern is rotationally aligned with the graticule. Adjust the **VERT POS** control until the the top line of the pattern coincides with the top graticule line. Last, turn the **HORIZ POS** control until the vertical center line of the display coincides with the center vertical line of the graticule. After completing the alignment, repeatedly press [UTIL MENU] until the spectral display reappears.

Service Normalizations

The 2710 contains a set of frequency and amplitude normalization values when it is shipped from the factory. The normalizations are based on reference values, called reference normalizations, determined at the time of manufacture. The reference normalizations specify the 2710 gain step sizes and the frequency and amplitude of the internal calibrator signal. The references are determined by comparison with an accurate external attenuator and signal source. If NVRAM is ever lost, the factory reference normalizations are lost with it (see the next section) and you must perform a service reference normalization to achieve maximum accuracy from the 2710. However, if you have signal sources available which are more precise than the on-board calibration signal, you can use them at any time to achieve added accuracy when normalizing the analyzer.

Select item **5, SERVICE NORMALIZATIONS**, from the Instr Diagnostics/Adjustments Menu ([UTIL MENU]/[5]/[5]). Using the **REFERENCE NORMALIZATIONS** selection from the Service Normalizations Menu, you can measure new

reference values for the on-board calibration signal and attenuator with respect to more precisely known alternate sources. The alternate sources must exceed these specifications:

- frequency: $5 \text{ parts in } 10^7 \pm 10 \text{ Hz}$
- amplitude: $-30 \pm 0.1 \text{ dBm @ } 100 \pm 1 \text{ MHz}$
- attenuation (gain step): $10 \pm 0.5 \text{ dB @ } 100 \pm 1 \text{ MHz}$

We won't give you examples for all reference normalizations, but we will show you how to determine a new frequency reference. **Connect an external frequency source to the analyzer input meeting the frequency specification given above.** Various sources are available: WWV in the U.S., some broadcast television carriers (check with the station), assorted frequency standards, etc. A frequency of 100-500 MHz would be very good, but signals as low as 5 MHz can be used. **Return to the spectral display and perform a center measure to ensure the external reference is centered. Then select item 1, REFERENCE NORMALIZATIONS, from the Service Normalizations Menu. Next select item 1, INTERNAL REF FREQ, from the resulting Reference Normalizations Menu.** On-screen prompts appear for each of the reference normalizations. **Select item 1 and enter the frequency of the external source. Now simply select item 2 and press [A A] when you are ready to have the analyzer determine the new reference. After a few seconds you'll receive a NORMALIZATION COMPLETE message.**

Determining new gain step and amplitude references is done in a similar fashion (follow the prompts). **After you determine the new reference values, complete the process of optimizing the 2710's accuracy by performing a complete normalization ([UTIL MENU]/[3]/[0]).**

The remaining items on the Service Normalizations Menu are normally used only by service personnel. However, menu item 4 can be used to view selected normalization values, and item 5 sends the normalization values to a printer. These can be handy for future reference. Item 6 sends any messages that occur during normalization to the printer.

To obtain hard copy of the normalization values, ensure your Epson FX-compatible printer is on-line (sorry, a plotter won't work unless it can emulate an FX-series printer — the Tek HC-100 does), with the paper in correct position, and select item 5 from the Service Normalizations Menu. Printing starts immediately. Control of the analyzer is returned after the printout.

If You Lose NVRAM

The NVRAM in your 2710 is supplied power from a lithium battery inside the analyzer. Every few years it may become necessary to replace the battery. When this happens (or if NVRAM is lost for any other reason), the contents of memory are lost. All stored settings, tables, and waveforms disappear, as well as all normalization data.

Following such an event, the 2710 must be renormalized. **To begin the process, press [UTIL MENU]/[3]/[1] to carry out a frequency normalization.** The analyzer will use default reference values from internal EPROM's or DIP switches. The default values will not result in optimum accuracy, but will enable you to make approximate measurements. More importantly, they will enable you to carry out the reference normalizations required to ensure the 2710 is fully within its specification and operating at maximum accuracy. **Follow the instructions in the preceding section and the resulting on-screen prompts to perform the service reference normalizations. After the reference normalizations are complete, press [UTIL MENU]/[3]/[0] to complete the frequency and amplitude normalizations.**

If external reference sources are not available, simply perform the frequency and amplitude normalizations ([UTIL MENU]/[3]/[0]). The 2710 will be useable, but the references should be renormalized at the earliest opportunity.

Any control settings can be used.

Plotting the Displayed Waveform

Item 6 on the Utility Menu, SCREEN PLOT, causes an optional printer or plotter to draw an image of the screen. The standard readouts are printed on the drawing in the border area so they don't interfere with the waveform. If you wish to have graticule lines on the printout, the graticule illumination must be turned on. **To make a plot of the screen, first check that the communications port is properly configured (see The Communications Port and Selecting Screen Plot Configuration in this chapter). Then ensure your printer or plotter is powered up, on line, and that the paper is in correct registry. With the 2710 displaying the desired trace(s), choose item 6, SCREEN PLOT, from the Utility Menu.** The printer or plotter quickly begins to draw the trace. A typical plot is shown in Figure 4-15. Because the printer/plotter output data are buffered, the analyzer returns to the spectral display and is ready to accept additional commands immediately after printing/plotting begins.

You can reduce plotting time by choosing peak acquisition mode, or using the video filter, to minimize noise variations. Noise variations do not affect printing time when using a dot-matrix printer.

Generating a Service Request

If the GPIB option is installed in your 2710, item 7, SERVICE REQUEST, is added to the Utility Menu. Item 7 enables you to generate a service request (SRQ) whenever required for testing or other purposes. To generate an SRQ, simply press [UTIL MENU]/[7]. The request is generated immediately and reflected on-screen by the message REQUEST at bottom center. The message remains on screen until serviced by the controller, or until the GPIB option is cycled on and off line using [UTIL MENU]/[4]/[0]/[0]/[0].

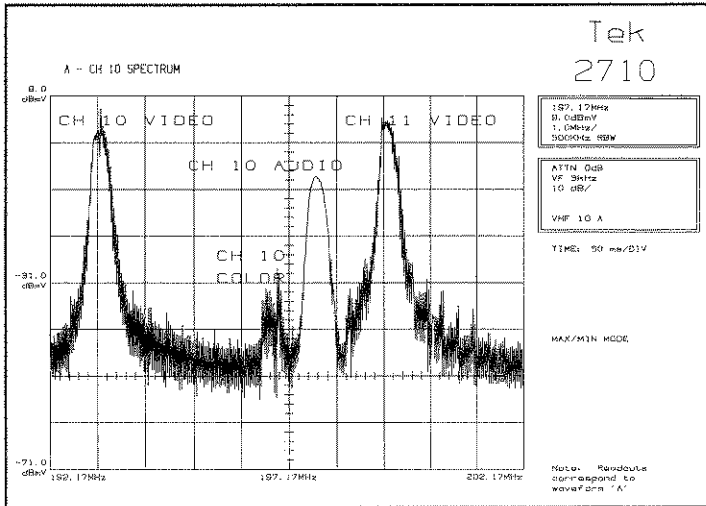

Figure 4-15. Typical plotter output from the 2710 showing a cable television spectrum.

Printing The On-screen Readouts

The Utility Menu also enables you to print the on-screen readouts on an FX-series printer. This feature can be handy if you wish to print results during a user-defined keystroke (UDK) sequence. For instance, suppose that you perform a marker peak find function during the UDK. The frequency and amplitude of the signal are displayed at the upper right of the screen (the normal marker readouts). **To have the 2710 print the readouts via the Centronics communications port, ensure your printer is powered up, on line and ready, and press [UTIL MENU]/[9]/[0].** This selects the PRINT READOUTS option under the MORE heading (item 9) of the Utility Menu. Printing begins immediately.

If the Centronics interface is not present in your instrument, you receive the message NOT INSTALLED.

100.0MHz	(AUTO SWEEP)	ATTN 10DB
-20.0DBM		VF 300KHz
1.0MHz/		10 DB/
300KHz RBW (AUTO)		

Sweep/Trigger Menu

During normal operation of the analyzer, the sweep generator is free running. That is, a new sweep begins as soon as possible after the cessation of the previous sweep regardless of the input signal. If frequency corrections are turned off, the next sweep begins immediately; otherwise, a short period of time is taken every few sweeps to compute and implement the corrections. In the case of time domain analysis or when dealing with pulsed signals, it may be advantageous to slave the sweep to some input signal characteristic or to a characteristic of another signal related in a fixed way to the input signal. The Sweep/Trigger Menu enables you to do this and other tasks.



Free Running the Sweep Generator

Call up the Sweep/Trigger Menu by pressing:

[SWP/TRIG MENU]

Choose item 0, FREE RUN, to place the 2710 sweep generator in the free running or continuous mode. This is the factory default setting and it is usually satisfactory for spectral analysis of continuous signals. It is also a good mode for examining the time domain representation of CW and noise-like signals.

"Oscilloscope" Trigger Modes

Just as on a conventional oscilloscope, you can choose the input signal (sampled internally), an external signal applied at the back panel of the analyzer, or the AC power line (sampled

internally) as the trigger source. You do this by selecting items 1, 2, or 3, respectively, from the Trigger Menu. The INTERNAL, EXTERNAL, and LINE trigger modes cause the sweep generator to start a new sweep when the trigger signal amplitude crosses a threshold determined by the setting of the LEVEL control (inner rotary control adjacent to [SWP/TRIG MENU]). If the analyzer is placed in zero span and linear amplitude mode, the resulting waveforms resemble those that you would see on an oscilloscope.

Internal triggering requires the signal to be at least one division in amplitude (LIN or LOG mode) and is most often used for time domain analysis. The level control adjusts a threshold so that the sweep begins when the amplitude of the input signal crosses the threshold. For instance, you might want to trigger internally on the leading edge of a pulsed signal, be it the output of a CW radio transmitter, a radar or sonar device, or the output of a video modulator. If internal triggering is used for spectral analysis, the triggering signal must be tuned to the beginning of the spectral display.

Connect an antenna or cable to the RF input of the analyzer as outlined in Appendix A. Tune to a strong television video carrier and adjust the signal height to near the reference level. Set the analyzer to LIN mode, zero span, and 300 kHz RBW. Use [FAST] to set the sweep speed to 2 msec/division. Deactivate all storage registers. You are looking at one field of video information. The dark vertical spaces in the waveform are caused by the time taken to write the on-screen readouts: turn off the readouts. The waveform on screen should resemble Figure 4-16 except it will be "sliding" across the screen because the sweep generator is free running. Select item 1, INTERNAL, from the Sweep/Trigger Menu and slowly rotate the LEVEL control until the display is stationary. The sweep is now being triggered by the vertical sync pulse.

//////////////////////////////////// **2710 Spectrum Analyzer User's Guide** //////////////////////////////////////

pulse generally triggers each sweep. The video signals following each sync pulse are not quite the same, but are nevertheless displayed on top of each other. The result is an intense but fuzzy display.

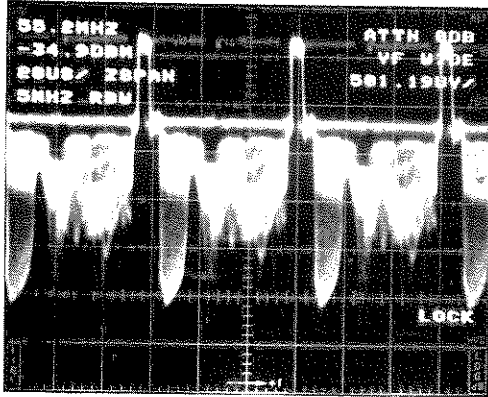

Figure 4-17. Video signal using continuous horizontal line triggering.

Call up the Setup Table again and select item 4, **KNOB SELECTABLE**. Return to the spectral display. The tuning knob now controls which pulse is used. Pulses are numbered from 6 to 1023. The current line number (the horizontal video line number and sync pulse number are the same) is displayed at the bottom of the right on-screen column. If more than one sync pulse is displayed, the number is that of the pulse nearest the left edge of the screen. Turning the knob clockwise increases the line number and counter-clockwise decreases it. Turn to line 17. You can conveniently view the vertical interval test signal (VITS). This signal is usually present on line 17 in the U.S. See Figure 4-18. The display is not as intense as it was in continuous mode because the analyzer is triggering on, and displaying, only one horizontal line out of every 525. If the display is too dim, adjust the **INTENSITY** control.

If you have an older model 2710 (prior to S/N B021102), the display may occasionally appear to "slip" sideways by one sync pulse, or the nature of the VITS may change. This is because a TV picture consists of alternate odd and even fields with different VITS which are displaced from one another by half a

2710 Spectrum Analyzer User's Guide

horizontal line period. Older analyzers did not differentiate the odd field from the even field and will trigger on either one, or both.

When knob-selectable TV line triggering is active, pressing [MKR/FREQ MENU]/[2] changes the knob function from frequency control to marker control or video line selection. This is a great convenience if you want to change TV channels. See *Changing the Knob Function* for additional information.

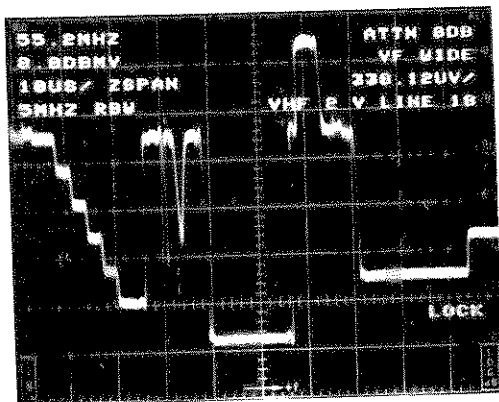

Figure 4-18. Video signal using knob-selectable horizontal line triggering (VITS visible).

Again call up the setup table and select item 5, **KEYPAD ENTERED LINE**. The number of the sync pulse to be used as trigger is indicated at the end of the line. Select item 6 to use the keypad to enter a new sync pulse number. The number you enter appears at the end of the **KEYPAD ENTERED LINE**. This number also changes when you operate in the knob selectable mode; it shows the number of the sync pulse last used as trigger. Enter number 279 and return to the waveform display. On most U.S. NTSC stations you now see the VITS for the second picture field. When using the keypad-entered lines, the tuning knob controls frequency instead of line number.

TV Video Field Triggering

Item 5, TV FIELD, of the Sweep/Trigger Menu is the second of two logic-controlled triggering modes that are particularly useful for time domain analysis of television signals. **Call up the Sweep/Trigger Menu and choose item 5.** The display is now being triggered by the TV vertical sync pulse which occurs near the beginning of each field. **Slow the sweep speed to 2 milliseconds/division.** The display resembles Figure 4-16. You can now see an entire frame of video information with the start of frame at the left of the display. **If you wish, eliminate the dark vertical spaces in the display by turning off the readouts.**

Setting the Sweep Rate

Let's slow the sweep speed some more. Instead of using [SLOW], **call up the Sweep/Trigger Menu and choose item 6, SWEEP RATE. Following the prompt, enter 5 milliseconds/division.** The analyzer reverts immediately to the display mode and you can now see three whole video frames. This feature enables you to conveniently set sweep speed when you are already working in the Sweep/Trigger Menu and may have turned off the readouts.

Return to FREE RUN mode.

100.0MHz	(AUTO SWEEP)	ATTN 10DB
-20.0DBM		VF 300KHz
1.0MHz/		10 DB/
300KHz RBW (AUTO)		

Manually Scanning

Center a strong video carrier and then select item 7, **MANUAL SCAN**, from the Sweep/Trigger Menu. The spectral display reappears, but it doesn't appear to be updating. Turn the LEVEL control and watch the screen carefully. See a portion of the display update as you turn the knob? In this mode, the LEVEL knob controls the horizontal sweep position. Turn the LEVEL control slowly from full counter-clockwise to full clockwise and watch the screen update. This feature enables you to carefully examine a small portion of the spectrum. It is also convenient for manually scanning a broadcast or communications band while listening to demodulated signals -- the 2710 acts like a radio receiver. The operator can stop at any station since he has control of the sweep. **Toggle the manual scan mode off by selecting item 7 again.**

100.0MHz	(AUTO SWEEP)	ATTN 10DB
-20.0DBM		VF 300KHz
1.0MHz/		10 DB/
300KHz RBW (AUTO)		

The Video Monitor

With the video monitor option (Option 10) installed, you can perform a little magic; you can turn the 2710 into a video monitor. **Call up the Sweep/Trigger Menu and select the SETUP TABLE.** Item 0, VIDEO DETECT MODE, toggles between BROADCAST (or AM) and SATELLITE (or FM) video modulation. The BROADCAST mode is used for off-air or cable TV signals; SATELLITE is used when viewing transponder signals at the output of a block down converter (LNB). In the following example we will use the AM monitor mode to view an off-air or cable TV signal, but remember that

//////////////////// **2710 Spectrum Analyzer User's Guide** //////////////////////

SATELLITE can be very useful when identifying transponder signals. First, some cautions:

- The carrier-to-noise ratio (C/N) must be sufficiently large -- at least 30 dB in BROADCAST mode (10 dB in SATELLITE mode) in a 4 MHz bandwidth (it is possible to get a poor quality display at slightly lower C/N's).
- You will not be able to satisfactorily monitor "scrambled" or sync-less signals in either mode.
- The video carrier in either mode should be placed at the reference level for satisfactory operation.
- Energy dispersal dithering is generally not a problem in SATELLITE mode.

To continue with the example, select **BROADCAST** mode and return to the spectral display. Connect an antenna or cable drop to the analyzer as outlined in *Appendix A* and tune to a strong video carrier. Adjust the reference level until the signal peak is at the top line. This can be conveniently done by placing the marker atop the video carrier and selecting item 3, **MARKER TO REFERENCE LEVEL**, from the Marker/Frequency Menu. This signal level is very important for proper performance. The signal must also be well above the noise floor. Call up the **Sweep/Trigger Menu** and choose item 8, **BROADCAST (AM) VIDEO**. Presto, a TV picture! Item 8 presets a number of measurement parameters (see Chapter 4 in the Operator's Manual) in order to generate a TV picture. Vary the reference level (use the 1 dB step size) and experiment with the **INTENSITY** control to obtain optimum contrast. Use the outer barrel of the **LEVEL** control to change vertical size and **[FAST]** and **[SLOW]** to compress or expand the picture horizontally. Figure 4-19 shows a typical 2710 monitor mode display with good C/N. Being able to view a TV picture is useful not only for station identification, but also to observe interfering signals and modulation problems. The video monitor is turned off by selecting item 8 a second time. When the monitor is disabled, the settings used prior to entering monitor mode are restored; any changes you've made while using the video monitor are forgotten. The defaults for this mode assume normal US broadcast television with positive sync pulses and negative

//////////////////// **2710 Spectrum Analyzer User's Guide** //////////////////////

video. However, the setup table (item 9) enables you to accommodate other broadcast standards by independently inverting the sync and/or video portion of the signal. **Reinitialize your instrument.**

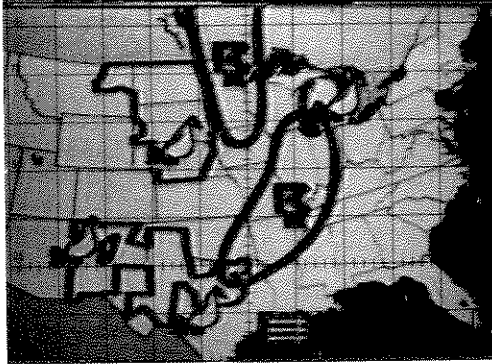

Figure 4-19. 2710 screen in video monitor mode.

2710 Spectrum Analyzer User's Guide

100.0MHz	(AUTO SWEEP)	ATTN 10DB
-20.0DBM		VF WIDE
20MHz/		10 DB/
5MHz RBW (AUTO)		

User-Definable Menu

The User-definable Menu enables you to store and execute user-definable sequences of keystrokes called routines. The routines are intended to permit a series of operations to be carried out with only two keystrokes. Press [USER DEF MENU] and select the routine you want to run -- the 2710 does the rest! This feature is particularly useful when you have to make a series of repetitious measurements.



NOTE

On older instruments the user-definable Menu key is labeled USER DEF and has no black border. However, it performs the same function as the USER DEF MENU key.

Before you can use routines, they must be created, and each routine must have a well defined starting point. One good way to ensure the routine starts with the correct instrument settings is to begin by recalling a specific group of settings. Another way is to start with a known group of settings, say the factory or user-defined power-ups, and manually change them to the configuration at which your routine begins (this can be done within the routine, but it uses up additional memory).

In the following example, we shall acquire a 20 sweep MAX/MIN ensemble average of the analyzer noise in register A with no calibration signal present, subtract the A register contents from the B register, and display a message cueing us to turn on the calibrator when the average is complete. The result will be the calibrator signal with the average noise subtracted out.

Begin by recalling the factory default power-up settings ([UTIL MENU]/[1]/[1]) and then implementing the settings in the preceding box at the beginning of this section. Store the settings in location 5 ([UTIL MENU]/[1]/[5]/[B B]).

To create the user-defined routine:

1. Press [USER DEF MENU] and select item 9, USER DEF PROGRAM UTILITIES. Select item 1, TITLE EDIT and press [A A] to begin editing. Enter a title of TEST01. The procedure is the same used to title a display (see *Adding Titles and Labels*). The title can be up to 28 characters long. Remember to press [B B] to store the title. Titling the routine is not mandatory (if you don't supply a title, the routine is named PROGRAM # by default) but does help you to recall what a routine is supposed to do.
2. Select item 0, ACQUIRE KEYSTROKES. This begins the actual accumulation of keystrokes. The spectral display reappears with the routine name superimposed and this message:

ACQUIRE KEY STROKES 0 BYTES

Each key that you press will now be memorized in the order in which you press it. This sequence of key strokes constitutes the bulk of the user-defined routines. The function of that key is also carried out as you watch. You can return to the USER DEF PROGRAM UTILITIES at any time by pressing [USER DEF MENU].

3. Press [UTIL MENU]/[1]/[5]/[A A]. This recalls the stored settings.
4. Press [DSPL MENU]/[1]/[7]/[2]/[0]/[A A]. This sets the ensemble size to 20.
5. Toggle [8] until line 8 of the menu reads:

SAVE RESULTS IN DISPLAY A

This places the average in the A register.

6. Press [6]. This selects the MAX/MIN average.
7. Press [DSPL MENU]/[USER DEF MENU]/[3]/[A A]. This returns to the USER DEF PROGRAM UTILITIES and enters DISPLAY MESSAGE edit mode. The message can be up to 32 characters long.

//////////////////// 2710 Spectrum Analyzer User's Guide //////////////////////

The message remains on screen until deleted. Enter the message:

20 MAX/MIN AVG

Remember to press [B B] to store the message.

8. Press [USER DEF MENU]/[DSPL MENU]/[1]/[1]. This starts the average.
9. After the average is complete, press [B B]/[DSPL MENU]/[2]. This turns on the B,C MINUS A in register B.
10. Press [D 1]/[A A]. This turns off the A and D registers.
11. Press [USER DEF MENU]/[3]/[C C]. This deletes the old message.
12. Press [3]/[A A] to re-enter the DISPLAY MESSAGE mode. Enter the message:

WHEN AVG IS DONE

Terminate with [B B].

13. Press [4] to select PAUSE FOR "USER DEF" KEY. This creates a PRESS "USER DEF" TO CONTINUE message on screen and halts the routine until you press [USER DEF MENU].
14. Press [USER DEF MENU]/[3]/[C C]. This deletes the old message.
15. Press [USER DEF MENU]/[INPUT MENU]/[9]. This turns on the calibrator.
16. Press [USER DEF MENU] and select item 2, WAIT FOR END OF SWEEP. This is a message to the analyzer itself instructing it to wait for the completion of the current sweep before proceeding with further instructions. All end of sweep processing is completed before the routine resumes. The analyzer also displays:

WAIT FOR END OF SWEEP

while the processing completes. The delay here guarantees the calibrator time to come on before the succeeding center measure is carried out.

//////////////////// **2710 Spectrum Analyzer User's Guide** //////////////////////

If the display line/limit detector feature is active, it converts the WAIT FOR END OF SWEEP message to WAIT FOR LIMIT. This halts the execution of the user-defined routine until the alarm condition has been satisfied. You could then use [SAVE]/[register] to store the alarming signal, or readout its amplitude using the marker.

17. Press [CTR MEAS/TRKG]. This will center and count the calibrator signal.
18. Press [USER DEF] and select item 2, WAIT FOR END OF SWEEP. Features like Center Measure require the delay this instruction yields to prevent parameters from changing before the count is completed.
19. Press [USER DEF MENU]/[6]/[3]. This stores the routine in location 3. You can not store a routine in a location in which another is already stored. You must first delete the prior routine.
20. To prevent your routine from accidental erasure, press [USER DEF MENU]/[9] and select item 8, PROTECT, and then press [3]. Select DELETE and notice the # next to your routine indicating that it is protected. Press [3]/[C C]. The message:

REMOVE PROTECTION FIRST

appears. To remove the protection, press [←]/[8]/[3]. You can now delete the routine if you wish.

Normally, there is no need to repeat this measurement. Running it once determines how much the amplitude of the calibration signal is above the average noise coming through the 5 MHz resolution BW filter. However, in the case of other routines it may be desirable to have the routine repeat indefinitely. For instance, you might determine the frequency and amplitude of a series of oscillators. Here is the general approach:

1. Do any titling or message generation.
2. Use a PAUSE FOR "USER DEF" KEY command. When the routine is actually running, you attach the

//////////////////// **2710 Spectrum Analyzer User's Guide** //////////////////////

external oscillator and press [USER DEF MENU] to continue.

3. **Perform a center measure to determine the frequency and amplitude of the oscillator signal.**
4. **Use a WAIT FOR END OF SWEEP command to allow the measurement to be carried out by the 2710.**
5. **Optionally output the result to a printer.**
6. **Select item 5, CONTINUOUS EXECUTION, from the USER DEF PROGRAM UTILITIES.** The status indicator at the end of the line will change from OFF to ON. This causes the routine to repeat indefinitely.
7. **Store the routine and optionally protect it.**

Before executing any user-defined routine, it is generally good practice to reinitialize the analyzer and clear all registers.

To actually start a routine running, press:

[USER DEF MENU]

and select the number of the routine you want to run. The routine begins to execute immediately.

While the routine is running, its title is displayed beneath the left on-screen readout column. If you elect to include a DISPLAY MESSAGE in your routine, it is displayed beneath the title. Error and progress messages are also displayed under the right-hand readouts. You can interrupt any executing routine by pressing [USER DEF MENU] (except when PRESS "USER DEF" TO CONTINUE is displayed). A continuously executing routine will continue to run until you press [USER DEF MENU].

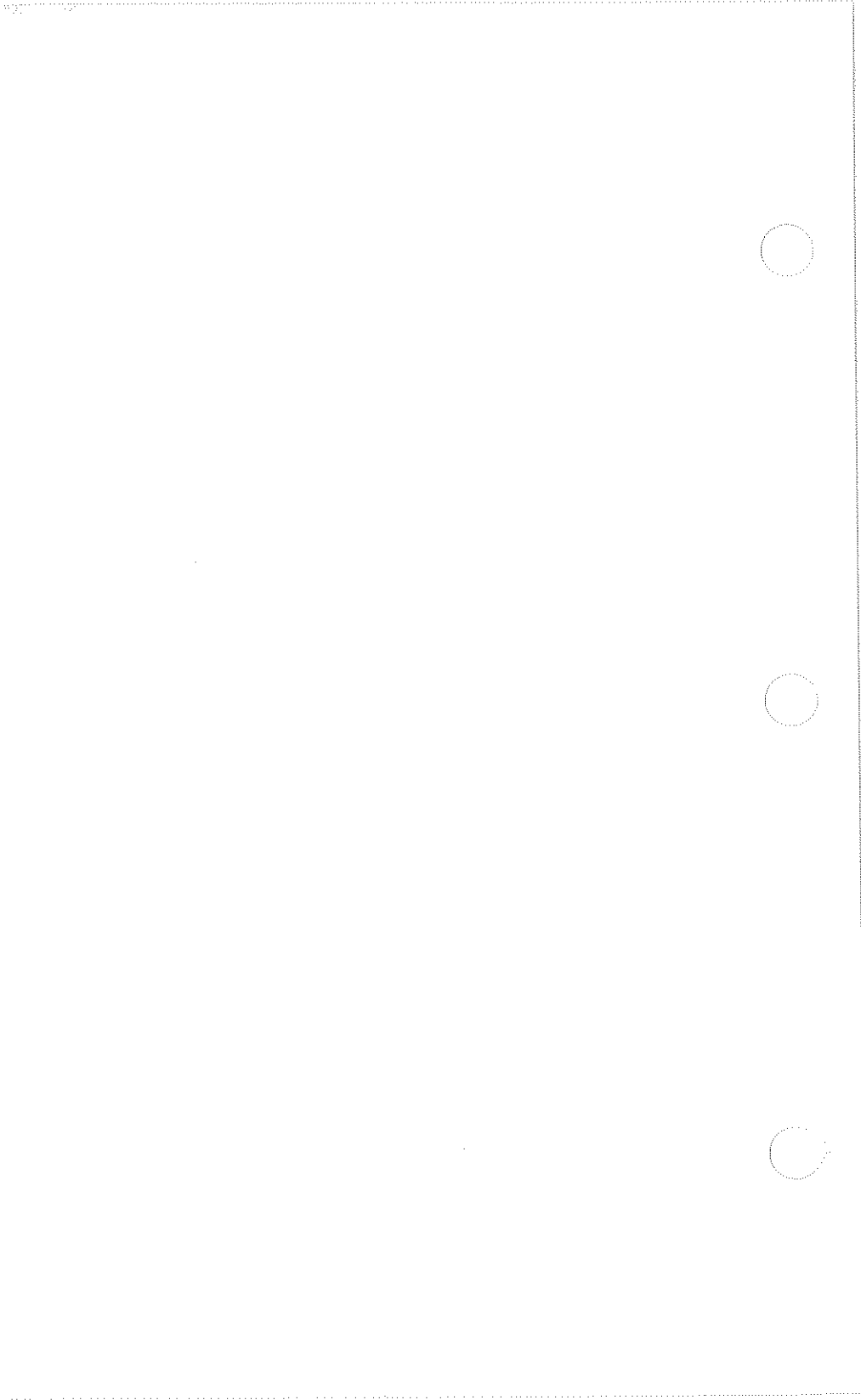

EXTERNAL I/O

Thus far we've largely ignored the back panel of the 2710, but it contains several input/output (I/O) connectors. One or more may not be used on your instrument depending on which options you have installed.

Any control settings can be used.

Mains Power

For safety, be sure to use a 3-wire AC power cord and be certain the ground conductor is properly connected. Adjacent to the power receptacle is the mains fuse; its size is marked. If the fuse repeatedly blows, it is likely you have a hardware problem. Contact Tektronix.

J101 -- TV Sideband Analyzer Interface

This jack provides a local oscillator signal for the Tektronix 1405 TV Sideband Analyzer (option 15). The 1405 is designed specifically for testing video modulators, transmitters, and CATV headends. The sideband analyzer provides standard video signals to the input of the modulator, whose output is quickly and accurately measured using the 2710. Simply insert a SMA-to-SMA connecting cable, Tek P/N 012-0649-00, between the LO IN jack on the back of the 1405 and J101 on the back of the 2710. With late model 2710's, you can also superimpose frequency markers generated by the 1405 on the

//////////////////////////////////// 2710 Spectrum Analyzer User's Guide //////////////////////////////////////

sweep produced by the 2710 (early models did not have the appropriate video interface -- consult your sales representative if you want this feature retrofitted). The markers consist of variable width "dips" in the 2710 sweep, and are in addition to the intensified frequency markers internally generated by the 2710. To superimpose the markers, connect the Z AXIS OUT signal from the 1405 to the external video input of the 2710, pin 1 of accessory connector J103; use pin 2 of J103 for signal ground. Turn the markers on or off with the push-buttons on the 1405 and control their width and depth using the WIDTH and INTEN controls on the 1405 front panel. Consult the 1405 operators manual; *Antenna To Tap...No Loose Ends*, Tektronix publication 26W-7043; or *TV Operational Measurements*, Tektronix publication AX-3323-1 for instructions on making measurements with the 1405/2710 combination.

J102 -- External Trigger

This BNC input connector is clearly labeled both J102 and EXT TRIG. The shell of the connector is at chassis ground. If you plan to use an external trigger signal with the 2710 (see the SWP/TRIG MENU section), this is where the signal is input to the analyzer. The trigger signal must be positive-going and rise above 100 millivolts for at least 0.1 microsecond.

CAUTION

To avoid instrument damage, the combined AC plus DC trigger signal level must not exceed 35 volts peak.

If the previous sweep is completed and item 2, EXTERNAL, is selected from the Sweep/Trigger Menu, an external trigger signal meeting the foregoing specification will start a new sweep each time it rises above a threshold established by the setting of the trigger LEVEL control. Typical external trigger signals might be a +5 volt logic level signifying that a transmitter has been keyed on, or that a receiver has detected a signal which rises above its squelch setting. For instance, to determine

//////////////////////////////// 2710 Spectrum Analyzer User's Guide //////////////////////////////////

the spectrum of a gated CW signal, you could apply the gated CW to the analyzer input while triggering the 2710 externally with the gating signal. The analyzer would then perform a spectral sweep only when the CW signal was present at its input.

To trigger the 2710 externally, connect the external trigger signal to the EXT TRIG jack and select item 2, EXTERNAL, from the Sweep/Trigger Menu. Turn the LEVEL control fully counter-clockwise and then rotate it slowly clockwise until a sweep occurs. If the external trigger is pulsing, the analyzer sweep should now remain in synchronism with it (if not, you may have to adjust the LEVEL control a bit more). When you are finished, reselect FREE RUN trigger mode.

J103 -- Accessory Connector

The accessory jack, J103, is a 9-pin "D" connector but it is not RS-232 compatible. Instead, it provides an interface for video I/O and the analyzer's sweep gate and ramp signals.

100.0MHZ	(AUTOSWEEP)	ATTN 10DB
-20.0DBM		VF WIDE
20.0MHZ/		10 DB/
5MH RBW (AUTO)	CALIBRATOR	

Pin 1 -- Video Input

Pin 1 enables you to introduce an external "video" signal to the analyzer, in effect giving it limited oscilloscope capabilities. It is also used to introduce the frequency markers from the 1405 TV Sideband Analyzer (see the discussion of J101 in this chapter). The "video" signal, in this case, can be any signal limited to a bandwidth of 0-100 kHz and an amplitude range of 0-1.4 volts. The analyzer preamplifier, RF attenuator, mixer, RBW filter, and log amplifier circuits are bypassed; the sweep and vertical scale facilities are utilized. In addition, the 2710's digital storage remains active. This means you can use the spectrum analyzer to store images of external signals for

//////////////////////////////// 2710 Spectrum Analyzer User's Guide //////////////////////////////////

comparison purposes, or compile statistical estimates of their parameters using ensemble averaging. To experiment, you'll need a signal meeting the input amplitude and frequency criteria; the calibrator output on many oscilloscopes is satisfactory. A 1.2 volt NiCad cell rapidly switched on and off (as by tapping a wire to its terminals) works. **Connect the positive terminal of the signal source to pin 1 of the accessory connector and the negative lead to pin 2. Select item 7, DISPLAY SOURCE, from the Display Menu and then choose item 3, EXTERNAL INPUT, from the resulting Display Source Menu.** The analyzer reverts to display mode in zero span (there is no need to sweep the signal past the RBW since these circuits are bypassed). The top graticule line is 0 volts. The only information in the left on-screen readout that is meaningful is the sweep speed. The sweep speed is initially the speed which was in effect before you switched to external source, in this case, 50 milliseconds/division. In the right column only the bottom line:

EXT 175MV/

telling you that you are looking at an external (EXT) signal with a vertical scale factor of 175 millivolt/division is meaningful. **Press [10 dB/5 dB/1 dB/] three times and notice that the scale changes to 87.5MV/, 17.5MV/, and back to 175MV/.** The DISPLAY STORAGE function block remains operational, enabling you to compile ensemble statistics or select other items from the Display Menu. You can also view the signal in analog mode by turning off all registers.

Pin 2 -- Chassis and Signal Ground

Pin 2 of the accessory connector is both chassis and signal ground.

//////////////////// 2710 Spectrum Analyzer User's Guide //////////////////////

100.0MHZ	(AUTO SWEEP)	ATTN 10DB
-20.0DBM		VF WIDE
20.0MHZ/		10 DB/
5MHZ RBW (AUTO)	CALIBRATOR	

Pin 3 -- Video Output

Pin 3 of the accessory connector is the analog video output from the 2710. The analog video output is a 0-1.6 volts signal representing the vertical deflection of the display you see on the analyzer with all registers turned off. 0 volts is the top graticule line and +1.6 volts is the bottom line. The output signal range remains constant regardless of analyzer reference level, attenuation, and vertical scale. The signal can be used to drive an external oscilloscope (or other video display unit). When viewing analog spectra, a 'scope sometimes presents an improved image. This is the result of the different persistence of the oscilloscope screen phosphor. **Connect pin 3 to an input channel of an oscilloscope. At the oscilloscope, select 0.2 volt/division and 50 millisecond/division scale factors; invert the input and trigger internally.** You may have trouble triggering because of the multiple signal peaks and blanking period of the video signal, but you should see a spectrum on the 'scope similar to the one on the 2710. If not, **adjust your 'scope trigger and vertical position controls.** We'll show you how to overcome this problem in the next paragraph.

Pin 6 -- Sweep Gate

Pin 6 of the accessory connector contains the sweep gate. The sweep gate is a +5 volt pulse whose leading edge is synchronous with the start of the 2710's sweep; the trailing edge marks the end of sweep. See figure 5-1. The signal is usually used in conjunction with the video output to indicate when a new sweep is beginning. **Continuing with the setup from the previous paragraph, connect pin 6 to the external trigger input of your oscilloscope and select the external trigger mode, positive slope.** Adjust the oscilloscope trigger level control until the spectral display locks in place. Now turn off all the analyzer's registers. Compare the analyzer and oscilloscope displays. Do you find the oscilloscope image

//////////////////////////////////// 2710 Spectrum Analyzer User's Guide //////////////////////////////////////

better or worse? This can be especially important when you are trying to view time-varying analog spectra. **Turn on the maximum hold and register A -- in fact, turn on all the registers. Notice the analog trace is still displayed on the oscilloscope.** By using the video output to view the analog display, all four registers remain available for digital storage and display; you can have an analog display and four (different) digital traces. **Does your 'scope have a sweep magnifier or delayed sweep facility? Use either to obtain an enhanced view of the central signal peak on the oscilloscope without altering the analyzer settings.** The oscilloscope horizontal scale factor equals the 2710 span/division times the ratio of the analyzer and 'scope sweep speeds.

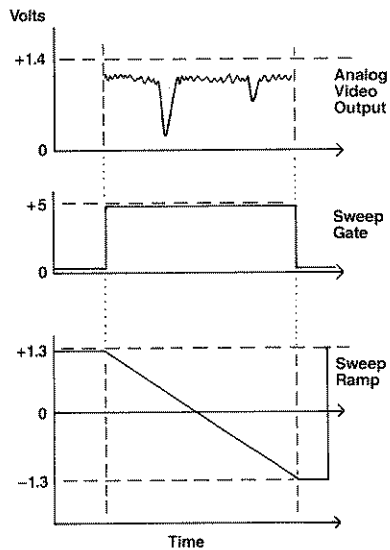
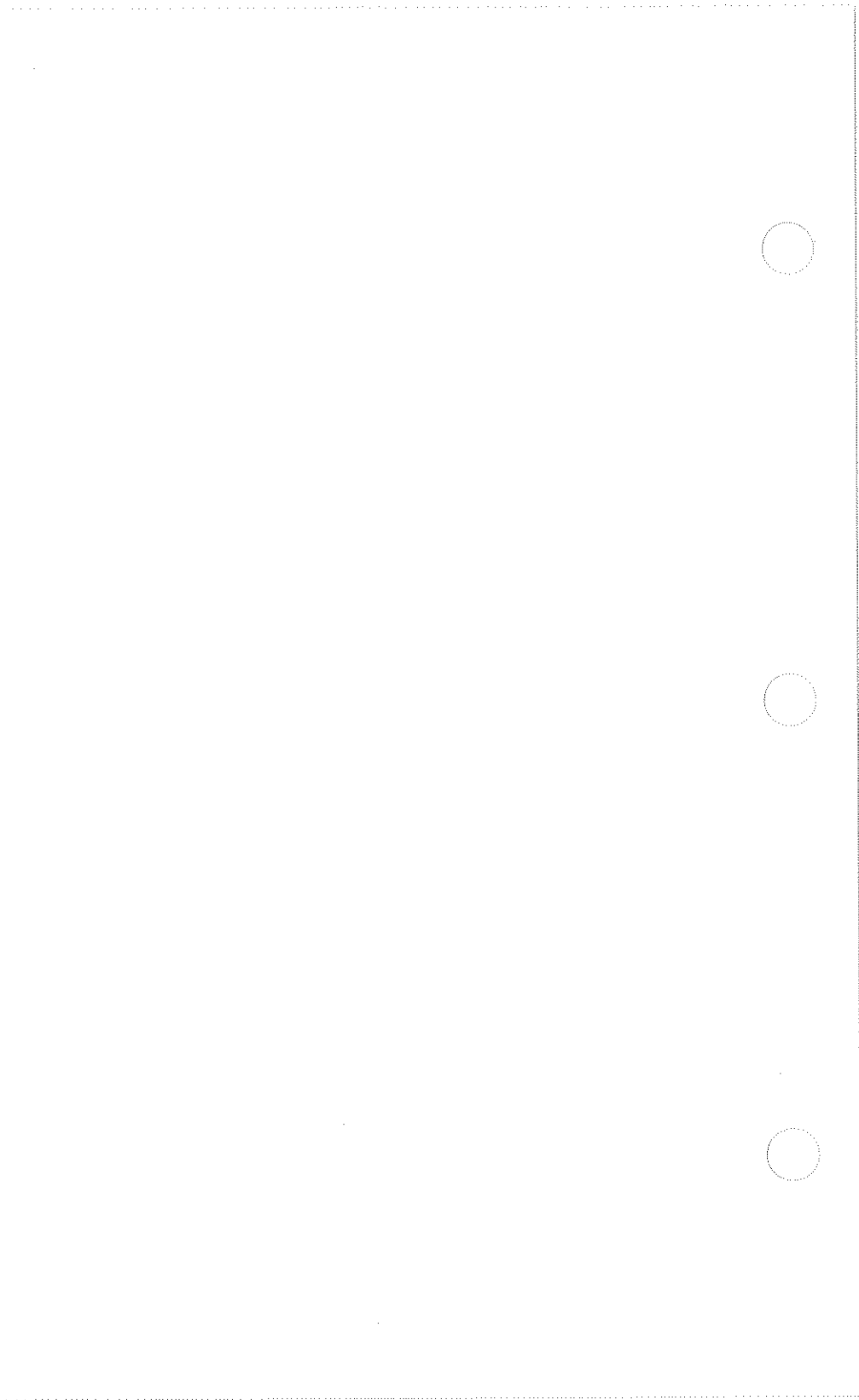

Figure 5-1. Sweep gate and ramp timing.

Pin 7 -- Sweep Ramp

Pin 7 of the accessory connector contains the sweep ramp. The sweep ramp is a +1.3 to -1.3 volt signal. The value of the linear ramp portion of the signal is proportional to the horizontal position of the sweep as it crosses the screen; the start of the ramp is synchronous with the start of the 2710's sweep; the bottom of the ramp marks the end of sweep. See figure 5-1. The signal is usually used in conjunction with the video output to generate the horizontal deflection for an external video unit such as an XY oscilloscope or recorder. **Continuing with the setup from the previous paragraph, connect pin 7 to the X-axis input of your oscilloscope and the video output to the Y-axis. Place the oscilloscope in XY mode. Adjust the X-axis gain on the oscilloscope until the sweep just fills the screen. If the sweep is backwards, invert the X-axis input (or just use it the way it is).** The advantage in using the ramp to control the 'scope is that there is no difference in the time bases used by the 2710 and the 'scope. The disadvantage is that you cannot control the 'scope time base independently of the analyzer.



**APPENDIX A - BROADCAST AM, FM
AND TV SIGNAL SOURCES**

For some of the experiments in this tutorial, you need AM or FM modulated signals. The most readily available signals are AM and FM broadcasts. To receive AM or FM broadcast radio stations, you can plug a piece of wire directly into the center terminal of the input signal connector on the 2710 and hang the other end out a nearby window. If your building is not metal framed, you can probably dead end the wire in the same room as the analyzer. The required length of wire will depend on the strength, location, and frequency of the transmitter among other variables. 50 kW FM stations 40 miles distant have been received with a wire paperclip, straightened and inserted directly into the input connector -- the 2710 is very sensitive! TV stations (as well as FM broadcasts) can also be received on a standard television antenna or other suitable RF antenna. In strong signal areas, a one meter telescoping antenna performs well. Before connecting any wire or antenna to the analyzer, ensure there is no static charge on it by momentarily grounding it to the input connector shell. If you are uncertain, use a voltmeter to confirm there are no high-level signals superimposed on the antenna system (such as from a nearby, high-power broadcasting station). Maximum total input to the 2710 must not exceed +20 dBm.

If cable TV is available in your facility, it provides an ideal source of FM and TV signals. Using appropriate connectors, you can plug the cable directly into the analyzer.

CAUTION

Before connecting any signal source to the 2710, be certain the total signal strength does not exceed +20 dBm. If in doubt, check with a broadband RF wattmeter or voltmeter first.

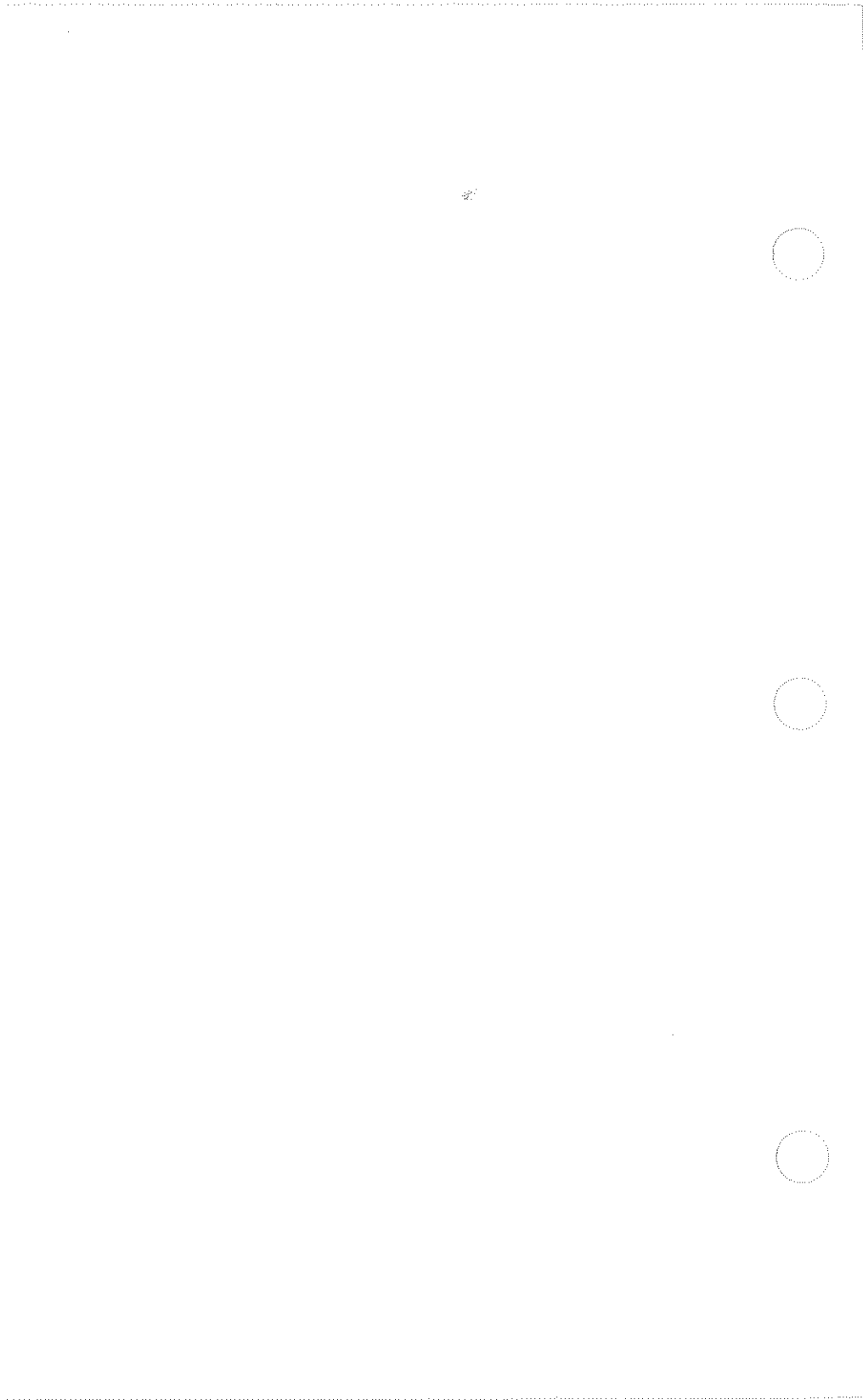

APPENDIX B - ERROR MESSAGES

Error messages occur when the self-check routines built into the 2710 detect abnormalities, when you enter incorrect information, or when you attempt an improper operation. The error messages which you may encounter are contained in quotation marks in the following list; their causes and corrections are indicated immediately below the message. If you are unable to correct an abnormal situation, contact your local Tektronix Service Center and report the error message.

"1ST MEASUREMENT COMPLETE"

Go to the next step in the procedure.

"300HZ FILTER NOT INSTALLED"

Feature not installed on this instrument.

"500KHZ RBW USED FOR COUNTING"

This message occurs only in non-phaselock instruments. Its purpose is to alert the user to the fact that under some circumstances signals may not be resolved because of the size of the resolution bandwidth filter.

"ADDITIONAL NVRAM NOT INSTALLED"

Occurs when attempting to access a file located in the optional NVRAM if optional NVRAM isn't installed.

"AMPL NORM SUGGESTED (VR PIN DAC)"

Perform amplitude normalization. Consult service center if message persists.

"AMPL OUT OF RANGE (NORMALIZATIONS)"

"AMPL OUT OF RANGE (AUTO CAL)"

Perform amplitude normalization again. If message persists consult service center.

"AMPLITUDE NORMALIZATION FAILED"

Perform amplitude normalization again. If message persists consult service center.

//////////////////// 2710 Spectrum Analyzer User's Guide //////////////////////

"AMPLITUDE OUT OF CALIBRATION"

The analyzer amplitude may be out of calibration. This message may be generated by the auto sweep rate measurement routine.

"AVERAGE NOISE TOO LOW"

The average noise level in the Carrier-to-Noise or Noise Normalization measurement is below the bottom of the screen and cannot be digitized. To correct the problem reduce the reference level to bring the noise level onto the screen.

"CALIBRATOR DOESN'T MATCH READOUT"

The calibrator is enabled and an external attenuation or external frequency offset is enabled.

"CAN'T COUNT WITH CORRECTIONS OFF"

Turn Frequency Corrections ON. The location of this selection is [UTIL MENU] / Sys Config[4] / Inst Config[3].

"CANNOT CALC. VERT. SENSITIVITY"

Perform amplitude normalization. Consult service center if message persists.

"CANNOT COUNT (VCO IF)"

Perform frequency normalization. If message persists consult service center. Either the VCO counter input or the IF counter input failure can cause this error to occur.

"CANNOT COUNT BEAT FREQUENCY"

Perform frequency normalization. If message persists consult service center.

"CANNOT DELETE FILE WHILE IN USE"

Occurs when attempting to delete a file that is in use.

"CANNOT NORMALIZE PLL VCO"

Perform frequency normalization. Consult service center if message persists.

//////////////////////////////// 2710 Spectrum Analyzer User's Guide //////////////////////////////////

"CANNOT OVERWRITE SAVED DISPLAY"

Old data must be deleted or transferred to STORED SETTINGS before new data can be saved.

"CANNOT OVERWRITE STORED WAVEFORM"

A waveform is already stored in this register. Old waveform(s) must be deleted first.

"CANNOT OVERWRITE STORED SETTING"

An instrument setting is already stored in this register. Old setting must be deleted first.

"CANNOT STORE - NV MEMORY FULL"

Must delete other settings if further storage is desired.

"CNTR SIGNAL OUT OF IF PASSBAND"

The signal in zero span is not above the threshold. Perform CTR MEAS again or use a wider resolution bandwidth filter. Performing a frequency normalization may also facilitate a count. Because of span and display storage inaccuracies the signal may not be exactly centered in the digital display.

"COMM PORT NOT INSTALLED"

Feature not installed on this instrument.

"COMMAND NOT IMPLEMENTED"

Feature not installed on this instrument.

"COUNTER FREQUENCY UNSTABLE"

Perform normalizations again. If message continues to repeat consult service center. Frequency counter or input to it is unreliable.

"COUNTER NOT INSTALLED"

Feature not installed on this instrument.

"DATA ERROR IN FILE"

Firmware/Hardware error. Consult service center if message continues to repeat.

//////////////////// 2710 Spectrum Analyzer User's Guide //////////////////////

"DBUV/M MEASUREMENT MODE IDLE"

Destination waveform for DBUV/M is not being displayed and the correction calculation is disabled. The mode can be restarted by turning on the destination waveform register.

"DEFAULT DATA LOADED"

Since a file could not be read to load a data structure the default values were loaded into the file and into the data structure.

"DELETE EDITING BUFFER FIRST"

The editing buffer must be deleted before the desired function or entry can be accomplished.

"DELETE EXISTING PROGRAM FIRST"

A user defined program already exists in this register. It must be deleted before the new one can be stored.

"DELETE EXISTING TABLE FIRST"

The user has attempted to store an antenna correction factor table in a file position which is already occupied. The user must delete the file via the table deletion menu prior to attempting to store of the new file.

"DIRECTORY ERROR IN FILE"

Firmware/Hardware error. Consult service center if message continues to repeat.

"DISCONNECT INPUT SIGNAL"

Input signal needs to be removed in following step.

"EDITING BUFFER IS EMPTY"

The local editing buffer is empty; no keystrokes have yet been acquired. Select "Acquire Keystrokes" in the User Def Program Utilities menu to begin acquisition. Select "Begin Edit" in the Edit Antenna Table menu to begin acquisition. If deletion of the editing buffer is being attempted the error message is simply to inform the user that the selected action is invalid.

//////////////////////////////// 2710 Spectrum Analyzer User's Guide //////////////////////////////////

"END OF FILE"

Firmware/Hardware error. Consult service center if message continues to repeat.

"ERROR"

Firmware error. Consult service center if message persists.

"FREQ NORM SUGGESTED (INNER PLL)"

Perform frequency normalization. If message persists consult service center.

"FREQ NORM SUGGESTED (SET VCO)"

Perform frequency normalization. If message persists consult service center.

"FREQ NORM SUGGESTED (SET BEAT)"

Perform frequency normalization. If message persists consult service center.

"FREQ NORM SUGGESTED (1ST LO)"

Perform frequency normalization. If message persists consult service center.

"FREQ NORM SUGGESTED (FIND SIDE)"

Perform frequency normalization. If message persists consult service center.

"FREQ NORM SUGGESTED (SPAN DAC)"

Perform frequency normalization. If message persists consult service center.

"FATAL ERROR IN FILE"

Firmware/Hardware error. Consult service center if message continues to repeat.

"FILE NOT FOUND"

Occurs when attempting to access a file that does not exist.

"FILE SIZE ERROR"

Occurs when attempting to create a new file in NVRAM and the size of the new file is not the same as the size of

2710 Spectrum Analyzer User's Guide

the existing file. The most probable cause is that there is a version mismatch between the file system and the current firmware.

"FILE SYSTEM DIRECTORY FULL"

Occurs when attempting to store a file in the NVRAM and there are no more directory entries available.

"FILE SYSTEM FULL"

Occurs when attempting to store a file in the NVRAM there is no more room to store the file.

"FIRST STEP MUST BE DONE FIRST"

Preceding step must be performed prior to selected one.

"FORMATTING PLOT"

Downloading plot file to hardcopy device.

"FREQ OUT OF RANGE (NORMALIZATIONS)"

"FREQ OUT OF RANGE (AUTO CAL)"

Perform frequency normalization again. If message persists consult service center.

"FREQUENCY NORMALIZATION FAILED"

Perform frequency normalization again. If message persists consult service center.

"FUNC NOT AVAIL IN CURRENT MODE"

Consult manual for proper instrument settings. This error message may appear, for instance, upon the invocation of instrument functions such as carrier to noise, noise normalized bandwidth, and antenna correction factors while in linear scaling mode. In these particular cases the vertical scaling mode would have to be changed to logarithmic before invoking the functions. Another case would be the invocation of a user defined routine while in the user defined routine acquisition mode. The acquisition mode must be exited before any routine can be activated.

"FUNCTION NOT AVAIL IN MAX SPAN"

Signal track function incompatible with MAX SPAN. Try a smaller span.

//////////////////////////////////// **2710 Spectrum Analyzer User's Guide** //////////////////////////////////////

"FUNCTION NOT AVAIL. IN LIN MODE"

Switch to LOG mode vert scale to obtain proper functioning. This error message may appear upon the invocation of instrument functions such as carrier to noise, noise normalized bandwidth, and antenna correction factors.

"ILLEGAL COMMAND"

Firmware error. Consult service center if message persists.

"ILLEGAL PARAMETER PASSED" (new)

"ILLEGAL PARAMETER ENTERED" (old)

Firmware error. Consult service center if message persists.

"ILLEGAL START/STOP/INC VALUES"

Illegal Start, Stop, or Increment values are present for the antenna correction factor table which the user is attempting to edit. Either the initial non-usable values are present (the user has not even attempted to enter his values) or the values entered have some inconsistency such as the start value being greater than the stop value.

"INACTIVE MARKER OFF SCREEN"

The frequency value of the inactive marker has been retained. The marker itself is not visible being out of the range of the display.

"INSUFFICIENT MEMORY AVAILABLE"

Not enough memory is available for this operation. Likely to be found when insufficient RAM is installed in the instrument and a waveform plot is attempted.

"INTERNAL REF AMPL TOO INACCURATE"

Perform reference amplitude normalization again checking for the presence of the correct external reference frequency and amplitude. If message persists consult service center.

"INTERNAL REF FREQ TOO INACCURATE"

Perform reference frequency normalization again checking for the presence of the correct external reference frequency and its correct entry from the keypad. If message persists, consult service center.

2710 Spectrum Analyzer User's Guide

"INTERRUPT FAULT AT FF"

Firmware/Hardware error. Consult service center if message persists.

"INTERRUPT FAULT"

Firmware/Hardware error. Consult service center if message persists.

"INVALID DEVICE NUMBER"

Firmware/Hardware error. Consult service center if message continues to repeat.

"INVALID FILE NUMBER"

Firmware/Hardware error. Consult service center if message continues to repeat.

"LAST PWR DOWN REG CHECKSUM ERR"

Last power down settings bad. Defaults used. Consult service center if problem recurs.

"MALLOC: RAN OUT OF MEMORY"

Memory allocation firmware/hardware error. Consult service center if message persists.

"MARKERS ARE OFF"

Marker(s) must be turned on to obtain desired function.

"MUST BE IN DELTA MARKER MODE"

Turn on Delta Markers to obtain desired function.

"NO MODULATION ON SIGNAL"

Occurs in zero span when CTR MEAS is attempted and there is no constant frequency modulation on the carrier.

"NO SIGNAL (NORMALIZATIONS)"

"NO SIGNAL (AUTO CAL)"

Perform normalizations again. If message persists consult service center.

"NO SIGNAL FOUND ABOVE THRESHOLD"

There is no displayed signal exceeding the marker threshold value. Threshold can be reset in the 'Setup Table' of the MKR/FREQ MENU.

//////////////////// 2710 Spectrum Analyzer User's Guide //////////////////////

"NO SIGNAL AT CENTER OF DISPLAY"

Firmware/Hardware error. Consult service center if message continues to repeat.

"NO SIGNAL AT COUNTER INPUT"

Perform normalizations again. If message continues to repeat consult service center.

"NOISE LEVEL LESS THAN 2DB"

Measured system noise level is less than 2dB above the 2710 noise floor. Noise power correction has been made by 'Noise Normalized' or 'Carrier to Noise' mode algorithms in the 2710.

"NON-COMPATIBLE NVM FORMAT"

The firmware version was not compatible with the non-volatile memory. Consequently the NVM was reinitialized. Consult service center if message continues to repeat.

"NONE OF THE TRACES ARE ACTIVE"

A digitized waveform must be on to employ desired function.

"NORMALIZATION COMPLETE"

Normalization routine successfully finished.

"NORMALIZATION SUGGESTED"

Frequency normalization needed. If message persists consult service center.

"NORMALIZED RESULT OUT OF RANGE"

Perform normalizations again. If message persists consult service center.

"NORMALIZING"

Normalization routine running.

"NOT AVAILABLE WITH DBUV/M IDLE."

The selected function is not available with DBUV/M mode idled. Select new reference unit to enable operation.

2710 Spectrum Analyzer User's Guide

"NOT AVAIL IN SHORT HOLDOFF MODE"

Certain functions that require end of sweep processing are not available when in the 'No holdoff' mode.

"NOT AVAIL IN WATERFALL MODE"

The selected function is not available in waterfall mode.

"NOT AVAIL W/ DISPLAY STORAGE ON"

Desired function incompatible with digitized display. Use analog display.

"NOT INSTALLED"

Feature not installed on this instrument.

"NVM CHECKSUM ERROR"

Non-Volatile Memory has been corrupted and consequently reinitialized. Consult service center if message continues to repeat.

"NVM FRAGMENTATION ERR"

Firmware/Hardware error. Consult service center if message persists.

"NVM SEGMENTATION ERROR"

Firmware/Hardware error. Consult service center if message persists.

"NVM VERSION MIS-MATCH"

Firmware/Hardware error. Consult service center if message continues to repeat.

"ONLY WAVEFORMS DELETED"

When attempting to delete stored settings the current settings are protected. Only the saved waveforms and their associated settings were deleted.

"ONLY WAVEFORMS SAVED"

When attempting to save stored settings the current settings are protected. Only the saved waveforms and their associated settings were saved.

//////////////////// 2710 Spectrum Analyzer User's Guide //////////////////////

"OUT OF RANGE"

A value has been entered that is outside the permitted range. The instrument will default to the closest permissible value. If the message appears at times other than data entry a firmware/hardware error is probable. Consult the service center if message persists.

"PLOT ABORTED"

New plot request has caused currently running plot to be aborted. New plot must be requested again in order to restart plot process and obtain new plot.

"POLYNOMIAL HAS NO SOLUTION"

Firmware/Hardware error. Consult service center if message continues to repeat.

"PORT OFFLINE"

Select "Online" in proper port configuration submenu.

"PRINTER ERROR"

Check the printer. Some printers return "Printer Error" for all conditions which need attention (offline out of paper etc.); consult the printer manual.

"PRINTER IS NOT CONNECTED"

Connect printer to appropriate port. Check printer cable.

"PRINTER OUT OF PAPER"

Reload printer paper.

"PROGRAM NOT EXECUTABLE"

The selected user-defined program is corrupted or too big to fit into available internal memory. Delete and resave the affected program.

"PROTECTED FILE"

Occurs when attempting to delete a file that is protected.

"QUERY NOT AVAILABLE"

Query attempted on function for which there is no query response.

//////////////// 2710 Spectrum Analyzer User's Guide //////////////////

"REAL TIME CLOCK HW FAILURE"

Firmware/Hardware error. Consult service center if message persists.

"REAL TIME CLOCK NOT INSTALLED"

Feature not installed on this instrument.

"REFERENCE NORMALIZATION FAILED"

Perform the reference normalization again checking for the presence of the correct external reference frequency and its correct entry from the keypad if required. If message persists consult service center.

"REMOVE PROTECTION FIRST"

The selected user-defined program cannot be deleted until its file protection is removed.

"RETURN TO LOCAL REQUEST"

The UTIL MENU/RETURN TO LOCAL option has been selected. This command is used with GPIB and RS-232 only.

"RUNTASK: CANNOT START PROCESS"

Firmware error. Consult service center if message persists.

"SATELLITE VIDEO MNTR NOT INSTLD"

Feature not installed on this instrument.

"SELECTED PROGRAM IS EMPTY"

The selected user defined program is empty. No action has been taken.

"SELECTED STORED SETTING IS EMPTY"

Setting must be stored before it can be recalled.

"SELECTED TABLE IS EMPTY"

The selected antenna correction factor table is empty.

"SETTING CORRUPTED"

Requested stored setting has been deleted because of a corrupted data value. Consult service center if message persists. This message may also occur in general instru-

////////////////////////////////// **2710 Spectrum Analyzer User's Guide** //////////////////////////////////

ment operation if "Settings Verify" of [UTIL MENU] /Inst Diag and Adj[5]/Intern Param[4] is turned ON. This selection checks all data transactions involving the instrument settings. No deletions occur in the general operation.

"SHORT HOLDOFF MODE NOT INSTLD"

Feature not installed on this instrument. This feature is part of the version of the sweep board containing the satellite video monitor mode. You must have the satellite video monitor option installed in order to invoke the "Short Holdoff" mode.

"SIGNAL CANNOT BE SET PROPERLY"

Perform normalizations again. If message continues to repeat consult service center.

"SIGNAL OUT OF IF PASSBAND"

Frequency to be counted is not within one resolution bandwidth of the center frequency. Perform CTR MEAS again or use a wider resolution bandwidth filter. Performing a frequency normalization may also facilitate a count. Because of span and display storage inaccuracies the signal may not be exactly centered in the digital display.

"SIGNAL OVER RANGE"

The signal peak is above the top of the crt display. Lower the reference level.

"SINGLE SWEEP ARMED"

Instrument armed for single sweep.

"SINGLE SWEEP MODE"

Instrument in single sweep mode.

"SINGLE SWEEP TRIGGER"

Single sweep has been triggered.

"SIGNAL SEARCH COMPLETE"

Firmware routine finished.

"SIGNAL SEARCH IN PROCESS"

Firmware routine running.

//////////////////////////////// 2710 Spectrum Analyzer User's Guide //////////////////////////////////

"STAND BY"

Required delay in use of instrument until message disappears.

"START FREQUENCY CHANGED"

Change in stop frequency necessitated a change in start frequency.

"STOP FREQUENCY CHANGED"

Change in start frequency necessitated a change in stop frequency.

"STORAGE REGISTER EMPTY"

No data yet stored in the register accessed.

"TABLE CURRENTLY IN USE"

The table is currently in use but the user may still delete it if he wishes.

"TABLE IS TOO LARGE TO EDIT"

The current combination of start/stop/increment setup frequencies results in a correction table with too many elements.

"TIMER INTERRUPT FAULT"

Firmware/Hardware error. Consult service center if message persists. Possible malfunction of interrupt timer on processor board indicated.

"TOO MANY FILES OPEN"

Firmware/Hardware error. Consult service center if message continues to repeat. Indicates that MAX_OPEN_FILES are already open. Cannot open any more files at one time.

"TRACKING GENERATOR NOT INSTALLED"

Feature not installed on this instrument.

"UNCAL OFF"

An uncalibrated state has been corrected and exited.

"UNCAL ON"

An uncalibrated state has been entered.

//////////////////////////////////// **2710 Spectrum Analyzer User's Guide** //////////////////////////////////////

"UNDEFINED ERROR CODE"

Firmware/Hardware error. Consult service center if message persists. Returned error code has overrun established limits.

"UNDEFINED EVENT CODE"

Firmware/Hardware error. Consult service center if message persists. Returned error code has overrun established limits.

"USE ANTENNA SETUP MENU FIRST"

The antenna start/stop/increment frequencies must be set prior to editing the correction table.

"USER REQUEST"

A user request SRQ has been initiated.

"VERT MODE/SCALE MISMATCH ON DIFF"

B minus A function attempted with mixed vertical modes (log/linear display, source am/fm) or mixed scales (1/5/10 dB/, 1/5/10KHz/, 17.5/87.5/175MV/). Reset the vertical modes or scales to be consistent. Amplitude mode/scale choices are found in [UTIL MENU] / Keypad Entered Settings[2] / Vertical Scale[6] with scale choices also available from the front panel VERTICAL SCALE key. Display source choices are found in [DISPLAY MENU] / Display Source[7].

"VIDEO MONITOR NOT INSTALLED"

Feature not installed on this instrument.

"WAIT ABORTED SWEEP NOT ARMED"

Requested WAIT FOR END OF SWEEP was aborted immediately to avoid an endless wait loop. This error will occur if WAIT is requested while in single sweep mode with the sweep not armed.

"WARNING: USING EMPTY ANT TABLE"

The table called for is empty. The function is still being performed but with values of zero for each increment of the table.

"ZERO SPAN ENTERED"

Instrument is now in zero span.

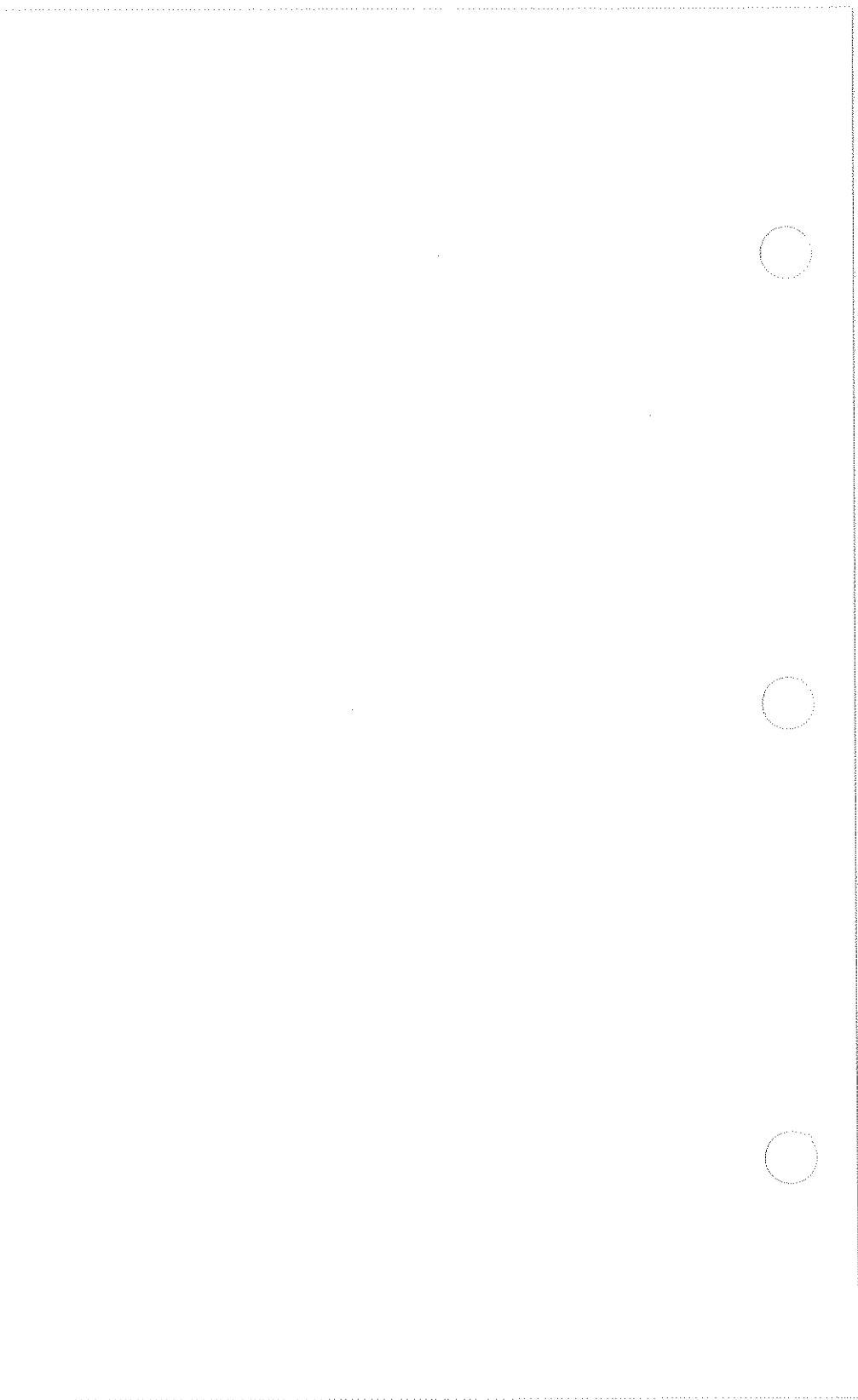

Appendix C — Global Resets On the 2710

Settings on the 2710 Spectrum analyzer can be reset in many ways. Some of instrument settings are always reset, while others are never reset, and still others are reset during certain reset cycles only. This appendix includes a description of which settings are in each category, and when each category of settings are reset.

Definitions

These definitions are included to make the following explanations more clear:

Reset — To restore a setting to a previous state. This is what happens to the Center Frequency, for example, when power is removed and re-applied: The Center Frequency setting is RESET.

Reset Category — Each setting belongs to one RESET CATEGORY, such as Center Frequency belongs to the “fragile” reset category. The categories are described later in this appendix.

Reset Cycle — an operation which causes one of the reset categories to be operated upon.

Retain — The opposite of RESET. A setting is RETAINED for a particular RESET CYCLE if its value can be set to any allowable value and remains at that value after the RESET CYCLE completes.

Reset Cycle Description

Following is a list of all the reset cycles possible in the 2710:

POWER DOWN/UP Cycle — This cycle is invoked by powering the instrument down and back up again.

INITIALIZE INSTRUMENT SETTINGS Cycle — This cycle is invoked via [UTIL] [0].

RECALL LAST POWER DOWN Cycle — This cycle is

invoked via [UTIL] [1] [0].

RECALL FACTORY DEFAULT POWER-UP Cycle— This cycle is invoked via [UTIL] [1] [1]

RECALL USER DEFINED POWER-UP Cycle— This cycle is invoked via [UTIL] [1] [2] [A].

RECALL NUMBERED SETTINGS Cycle— This cycle is invoked via [UTIL] [1] [3-9] [A].

POWERUP DIAG AND REBOOT Cycle— This cycle is invoked via [UTIL] [5] [0] [9].

Reset Categories

There are several distinct reset categories in the 2710:

Precious Settings

Precious settings are not reset by any reset cycle. The settings in this class can only be changed by manually setting each to its desired value. Settings in this category include:

Saved Waveforms, Centronics Configuration (Centronics option only), Plot Configuration (including Comm Port, Plot Language, and Plot Speed--Plotter Option only), Audio Alert Level, Settings Protect Mode, and Signal Search Parameters.

Mode-related Settings

These are settings which are reset for some reset cycles and retained for others:

Utility Menu Items
Spectral Display in Menus

Marker/Freq Menu Items
Frequency Reference Mode (CENTER/START),
Counter Resolution, Frequency Tuning Mode (AUTO and TABULAR only, others revert to AUTO),
Entered Frequency Tuning Increment, Tabular Tuning Table, Frequency Offset, Frequency Offset Mode (ON/OFF)

Input Menu Items
Input Impedance, Reference Level Units, External

//////////////////// 2710 Spectrum Analyzer User's Guide //////////////////////

Gain/Attenuation, External Gain/Attenuation Mode (ON/OFF), dBuV/M Measurement Distance, dBuV/M Antenna Table, dBuV/M Target Waveform

Sweep/Trigger Menu Items

Video Monitor Mode (BROADCAST/SATELLITE), Video Monitor Sync Polarity, Video Monitor Video Polarity, Video Line Triggering Mode (CONTINUOUS/KNOB/ENTERED), Video Line Triggering Standard (NTSC/SECAM/PAL/OPEN)

Display Menu Items

Ensemble Averaging Destination Waveform Ensemble Averaging Mode Ensemble Averaging Number-of-sweeps, B, C Minus A Offset Mode, Display Acquisition Mode (PEAK/MAX-MIN), Display Line Value

Applications Menu Items

Bandwidth Display dBc Value, Carrier-to-noise Reference Bandwidth, Normalized Noise Reference Bandwidth

Detector/Generator Menu Items

All tracking generator functions

The Mode-Related settings are reset as follows:

During a INITIALIZE INSTRUMENT SETTINGS cycle, reset to the values retained at the last physical power down.

During a POWER DOWN/UP cycle, reset to the values retained at the last physical power down, unless a User-Defined Powerup exists. In that case, reset to those stores in the User-Defined Powerup setting.

During a POWERUP DIAG AND REBOOT cycle, reset the same as during a POWER DOWN/UP cycle, but instead of the values resetting to those retained at the last physical power down, they reset as if a physical power down had just occurred.

During all other cycles, do not reset.

Normalization values

The normalization values are modified by executing some or all of the instrument's normalizations. These values are

only lost in the case of certain NVRAM failures. The values being used by the instrument may be set to default values via the service menus. The actual (most recently passed) normalization values are always restored during the POWER DOWN/UP and the POWERUP DIAG AND REBOOT cycles. The other cycles do not affect the normalization values.

Fragile Settings

Fragile settings are those which are reset during ANY reset cycle. Any settings not covered by the previous categories are FRAGILE. Resets occur as follows:

- During POWER DOWN/UP, INITIALIZE INSTRUMENT SETTINGS, and POWERUP DIAG AND REBOOT cycles, reset to user-defined powerup (if it exists). Otherwise, reset to default values.
- During RECALL LAST POWER DOWN cycle, reset to last power-down settings.
- During RECALL FACTORY DEFAULT POWER-UP, reset to the factory default settings.
- During RECALL USER DEFINED POWER-UP and RECALL NUMBERED SETTINGS cycles, reset to the specified settings storage register.

Index

- 2710, cooling 2-2
- 2710, rough handling 2-2
- 2710, use out doors 2-2

- 300 Hz RBW 1-9
- 50 ohm/75 ohm 4-11
- 75 ohm/50 ohm 4-11

- A**
- abnormal condition alert 2-9
- AC line trigger 4-89
- AC power 2-2
- AC power connector 5-1
- AC power fuse 5-1
- accessory connector,
 - back panel 5-4
- accuracy 1-9
- accuracy, external sources 4-83
- ACQUIRE
 - KEYSTROKES 4-98
- acquisition mode 4-47
- activating
 - storage registers 3-18
- adjusting
 - horizontal position 3-35
 - vertical position 3-35
- adjustments 4-81
- alarm, limit 4-52
- algorithms,
 - ensemble average 4-40
- aligning display 4-82
- aligning trace 3-35
- AM and FM detector 4-67
- AM detector 4-54, 4-67
- AM detector sound output 4-67
- amplification, external 4-10
- amplitude normalization 4-73

- analog display 3-27
- antenna A-1
- APPL MENU 4-58
- Applications Menu 4-58
- arithmetic mean 4-42
- arrow keys
 - FREQ SPAN/DIV 3-2
 - FREQ/MARKERS 3-32
 - REF LEVEL 3-5
 - RESOLUTION BW 3-7
- asterisk in menu 4-4
- attenuation, external 4-10
- attenuation, RF 2-11, 3-5, 4-8
- audio alert 4-77
- average noise 4-60
- averaging, ensemble 4-38

- B**
- B,C MINUS A 4-43
- B,C MINUS A OFFSET 4-45
- back panel
 - accessory connector 5-4
 - back panel controls 3-35
 - back panel I/O 5-1
- bandwidth measurement 4-59
- bandwidth mode 4-59
- bandwidth, noise 4-60
- battery, NVRAM 4-84
- begin/end frequency 4-26
- broadcast signals A-1

- C**
- C/N measurements 4-61
- cable connection A-1
- calibration sources, ext. 4-83
- calibrator, 2710 2-10
- calibrator control 4-7

//////////////////////////////////// **2710 Spectrum Analyzer User's Guide** //////////////////////////////////////

call up menus	2-7		
carrier to noise ratios (C/N)	4-61		
center frequency	4-40		
center/start frequency	4-32		
center frequency control	3-4		
center frequency, setting	4-25		
center measure/tracking	3-28		
centering signal	3-29		
changing acquisition mode	4-47		
changing mixer input level	4-13		
changing sweep holdoff	4-80		
changing tuning knob function	4-28		
changing units	4-9		
chassis ground connector	5-6		
communications port config	4-75		
conector chassis ground	5-6		
configuration	4-75		
connector,			
external video output	5-6		
connector,			
TV sideband adapter	5-1		
connectors, back panel	5-1		
constant rate tuning	3-4		
CONTINUOUS			
EXECUTION	4-101		
control panel	2-7		
controlling audio alert	4-77		
controlling freq corrections	4-79		
controlling on-screen readouts	4-5		
controlling reference level	4-8		
controlling screen intensity	3-34		
controls, back panel	3-35		
controls, front panel	3-1		
controls, miscellaneous	3-33		
cooling	2-2		
correction factor, impedance	4-11		
corrections,			
frequency	4-79		
counter resolution	4-33		
counter, frequency	1-9		
creating titles	4-49		
		D	
		damage, 2710	2-1
		data readout	2-6
		date and time	4-80
		DBUV/M	4-15
		deactivating storage registers	3-19
		delay, sweep	4-79
		delta marker tuning increment	4-34
		DET/GEN MENU	4-66
		Detector/Generator Menu	4-66
		detector, limit	4-52
		diagnostics	4-81
		digital sampling	1-9
		digital storage	1-9
		digital storage	3-18
		display alignment	4-82
		Display Menu	4-38
		DISPLAY MESSAGE	4-99
		display source	4-55
		DISPLAY STORAGE	3-18
		[MAX HOLD]	3-24
		[SAVE]	3-20
		waterfall mode	3-22
		display tilt	3-35
		display titles	4-49
		display, 2710 screen	2-4
		display, waterfall	3-22
		displaying	
		external video signals	5-5
		displaying reference line	4-52
		DSPL MENU	4-38
		E	
		end/begin frequency	4-26
		ensemble averaging	4-38
		algorithms	4-40
		max	4-41
		max/min	4-41
		mean	4-42
		min	4-41

ensemble size 4-40
entering settings from keypad,
 UTIL MENU 4-68
error messages B-1
exit from menus 4-6
ext. amplification/attenuation 4-10
external calibration sources 4-83
external I/O 5-1
external output, sweep gate 5-7
external output, sweep ramp 5-8
external source 4-58
external trigger 4-89
external trigger input 5-2
external video output 5-6
external video signals,
 displaying 5-5

F

factory defaults, restoring 2-4
field strength 4-15
finding signal peaks 3-33
first measurement 2-11
FM and AM detector 4-67
FM detector 4-54, 4-66
FM detector sound output 4-66
free running sweep 4-87
FREQ/MARKERS
 arrow keys 3-32
 [CTR MEAS/TRKG] 3-28
 [MKR PEAK FIND] 3-33
 [MKR△OFF] 3-25
FREQ/MARKERS knob 2-13, 3-54
FREQ SPAN/DIV 2-13
FREQSPAN/DIVISION
 arrow keys 3-2
 MAX SPAN 3-3
 ZERO SPAN 3-3
frequency, center/start 4-32
frequency corrections 4-79
frequency counter 1-9, 4-33

frequency deviation 4-54
frequency domain 1-5
frequency normalization 4-73
front panel controls 3-1
function blocks 2-7
function keys 2-7
fuse, AC power 5-1

G

gating signal 4-89
Getting Started 2-1
GPIB 4-75A
grass 3-14
graticule illumination 3-34

H

headphone jack 4-66
hierarchy, menu 4-2
horizontal sync pulse 4-90

I

illumination, graticule 3-34
impedance matching 4-12
impedance, input 4-11
increment, tuning 4-31
indicators
 keypad 2-7
 status 2-7
Input Menu 4-7
input/output, external 5-1
input voltage limits 2-1
installed options 4-81
instr diagnostics/adjustment 4-81
INTENSITY control 3-34
interface,
 TV sideband adapter 5-1
intermediate frequency (IF) 1-5
internal normalization 4-72

//////////////////////////////////// 2710 Spectrum Analyzer User's Guide //////////////////////////////////////

internal trigger	4-88	manual, tutorial	1-1
introduction	1-1	MARKER DISPLAY	4-19
item, menu	4-1	marker mode	3-25
item selection	4-1	marker to ref level	4-30
J		Marker/frequency Menu	4-25
jumping to signal peaks	3-32,4-29	marker placement, C/N	4-62
J101	5-1	markers	3-25
J102	5-2	markers, transposing	4-27
J103	5-4	max ensemble average	4-41
K		max/min acquisition	4-47
key standards	4-5	max/min ensemble average	4-41
keypad	1-4	maximum span	3-3
keypad entered settings	4-68	mean ensemble average	4-42
keypad		measurements, basic	2-11
entered tuning increment	4-35	measurements,	
keypad		spectrum analyzer	1-8
entered TV line trigger	4-92	measuring bandwidths	4-59
keypad indicators	2-7	measuring C/N	4-61
keys, units	4-5	measuring	
knob function	4-28	frequency deviation	4-54
knob-select TV line trigger	4-91	measuring noise	4-60
L		menu, asterisk	4-4
labels, plot	4-50	menu, exiting	4-6
last power-down settings	4-70	menu hierarchy	4-2
LEVEL control	3-17	menu items	4-1
level, audio alert	4-77	menu keys	2-7
Limit Detector	4-52	Menu	4-1
line, display	4-52	Application	4-58
line trigger	4-89	Detector/Generator	4-65
listening to		Display	4-38
AM/FM detectors	4-66	Input	4-7
listing installed options	4-81	Marker/Frequency	4-25
M		Sweep/Trigger	4-87
making titles	4-49	User-definable	4-97
manual scan	4-94	Utility	4-68
		messages, error	B-1
		microvolt per meter	4-15
		min ensemble average	4-41
		minimum hold	4-48
		minimum loss pad	4-12
		minimum signal size	4-77
		miscellaneous controls	3-33

//////////////////////////////// 2710 Spectrum Analyzer User's Guide //////////////////////////////////

mixer input level 4-13
 MKR/FREQ MENU 4-25
 modulation,
 measuring percent 4-57
 monitor, video 4-94

N

next higher/next lower peak 4-29
 next signal peak left/right 3-32
 noise bandwidth 4-78
 noise floor 2-5
 noise floor vs. RBW 3-9
 noise measurement 4-60
 noise measurement,
 preamplifier 4-62
 normalization 2-3
 NORMALIZATION
 SUGGESTED 2-3, 4-72
 normalization, external 4-82
 normalizations, service 4-82
 normalized
 noise measurement 4-60
 normalizing the 2710 4-72
 NVRAM
 (non-volatile RAM) 4-84
 NVRAM battery 4-84

O

off-scale measurements 4-28
 offset, frequency 4-36
 on-screen data readout 2-6
 on-screen readouts 4-51
 Option 01 1-9
 Option 02 1-9
 option, video monitor 4-94
 options, installed 4-81
 overvoltage warning A-1

P

PAUSE FOR USER DEF 4-99
 peak acquisition 4-47
 peak jumping 4-29
 percent modulation 4-57
 phaselock ON/OFF 4-78
 picture, TV 4-94
 plot, labels 4-50
 plotter type 4-75
 plotting displayed waveform 4-85
 port, communications 4-75
 power, AC 2-2
 power-up, user defined 4-70
 preamplifier
 controlling 4-14
 noise measurement 4-62
 precautions 2-1
 printer configuration 4-76
 programmed tuning 4-35
 PROTECT 4-100
 protecting stored settings 4-80

R

rain cover 2-2
 RBW sweeping too fast 3-9, 3-15
 RBW too wide 3-12
 RBW vs. noise floor 3-9
 readout resolution 4-68
 readout, on-screen data 2-6
 readouts, on-screen 4-51
 recalling settings 4-70
 REF LEVEL
 [1dB-10 dB] 3-6
 arrow keys 3-5
 reference level 4-8
 reference level units 4-8
 reference line, displaying 4-52
 register status indicators 3-18
 register, storage 3-18
 reinitializing the 2710 4-71

//////////////////// 2710 Spectrum Analyzer User's Guide //////////////////////

resolution bandwidth	3-7	signal height	3-5
resolution bandwidth (RBW)	1-5	signal level control	3-5
RESOLUTION BW		signal peak jumping	3-32
arrow keys	3-7	signal peaks, finding	3-33
[AUTO]	3-9	signal resolution	3-8
[VIDEO FLTR]	3-10	signal search	4-63
resolution, counter	4-33	signal size, minimum	4-77
resolution, readout	4-68	signal sources	A-1
resolution, signal	3-8	signal threshold	4-30
resolve	1-5	signal threshold, setting	4-32
restoring defaults	2-4, 4-70	signal track mode	3-31
RF attenuation	4-8	signal, sweep gate	5-7
rough handling	2-2	signal, sweep ramp	5-8
routines, user-defineable	4-97	single sweep	3-16
S		slashes (/)	1-4
saving data in storage reg	3-20	sounds, analyzer	2-9
saving settings	4-71	sound output, AM detector	4-67
saving waveforms	4-71	sound output, FM detector	4-66
scanning	1-5	sound, headphones	4-66
scanning manually	4-94	source impedance	4-11
screen alignment	4-82	source, external	4-58
search, signal	4-63	span/division	3-2
selecting items	4-1	span/division, setting	4-26
selecting plotter type	4-75	spectra in menus	4-79
selecting tuning increment	4-31	spectral display	2-4
sensitivity	1-9	spectrum analyzer diagram	1-7
service normalizations	4-82	spectrum analyzer	
setting center frequency	4-25, 4-68	measurements	1-8
setting date and time	4-80	spectrum analyzer, 2710	1-8
setting minimum signal size	4-77	spectrum analyzer, defined	1-5
setting reference level	4-69	speed, sweep	3-14
setting span/division	4-26, 4-68	square brackets []	1-3
setting start/stop frequency	4-26	standardization, keys	4-5
setting sweep rate	4-93	start frequency	4-32
setting the signal threshold	4-32	start/center frequency	4-32
setting video filter BW	4-69	start/stop frequency	4-26
settings, saving	4-71	status indicators	2-7
signal centering	3-29	storage register status	3-18
signal, external trigger	5-2	storage registers	3-18
signal, external video input	5-4	subtracting stored signals	4-43
		SWEEP	
		[AUTO]	3-15

