

Instructions



**3066 & 3086
Software Upgrade Kit
Version 2.25
075-0535-00**

Table of Contents

Introduction	1
Kit Part List	1
Software Installation	3
Preparation	4
Connecting a Mouse and Keyboard	4
Accessing Windows 95	5
Terminating the Current Application Software	5
Basic Application Software Installation	6
Uninstalling the Old Software	6
Installing the New Software	6
Confirming the Window Size	7
Option 15 cdmaOne Analysis Software Installation (<i>Optional</i>)	8
Uninstalling the Old Software	8
Installing the New Software	9
Option 16 W-CDMA/cdmaOne Analysis Software Installation (<i>Optional</i>)	10
Uninstalling the Old Software	10
Installing the New Software	11
Option 20 CCDF Analysis Software Installation (<i>Optional</i>)	13
Uninstalling the Old Software	13
Installing the New Software	14
Running the Analyzer	16

Introduction

This is the instruction sheet of the software upgrade kit for the 3066 and 3086 instrument. The kit allows you to upgrade your 3066 or 3086 Basic Application Software version 2.15 and below into version 2.25 and add optional software.

This instruction sheet describes the software installation procedures. For details on how to use the analyzer, refer to the *3066 & 3086 User Manual* (Tektronix part number 071-0501-01).

Kit Parts List The upgrade kit contains these items:

Item	Tektronix part number	Instrument	
		3066	3086
Basic Application Software			
3066 Basic Application Software V 2.25 (5 FDs)	063-3236-01	✓	
3086 Basic Application Software V 2.25 (5 FDs)	063-3235-01		✓
Optional Software			
Option 15 cdmaOne Analysis Software V 1.1 (2 FDs)	063-3320-00	✓	
Option 16 W-CDMA Analysis Software V 1.2 (3 FDs) cdmaOne Analysis Software V 1.1 (2 FDs)	063-3319-00 063-3320-00		✓
Option 20 CCDF Analysis Software V 1.7 (1 FD)	063-3318-00	✓	✓
Installation Manual			
Instruction sheet	075-0535-00	✓	✓

NOTE. The optional software works on the Basic Application Software version 2.25 or later.

Software Installation

To install the software, perform the steps listed here. The following pages provide detailed instructions.

1. Preparation

- a. Connecting a mouse and keyboard
- b. Accessing Windows 95
- c. Terminating the current application software

2. Basic Application Software installation

- a. Uninstalling the old software
- b. Installing the new software
- c. Confirming the window size

3. Option 15 cdmaOne Analysis Software installation

Optional

- a. Uninstalling the old software
- b. Installing the new software

4. Option 16 W-CDMA/cdmaOne Analysis Software installation

Optional

- a. Uninstalling the old software
- b. Installing the new software

5. Option 20 CCDF Analysis Software installation

Optional

- a. Uninstalling the old software
- b. Installing the new software

6. Running the analyzer

Preparation

Connecting a Mouse and Keyboard

1. Turn off the analyzer.
2. Connect a serial mouse to the rear panel connector. See Figure 1.
3. If you install the Option 16 W-CDMA/cdmaOne Analysis Software and/or the Option 20 CCDF Analysis Software, you will need a PC/AT keyboard. Connect the keyboard to the rear panel connector. See Figure 1 again.

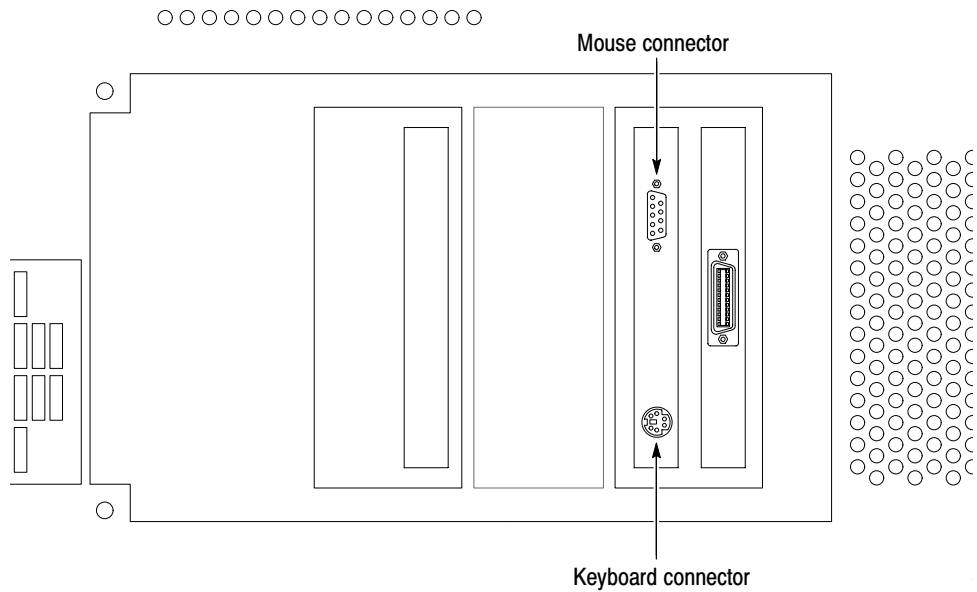
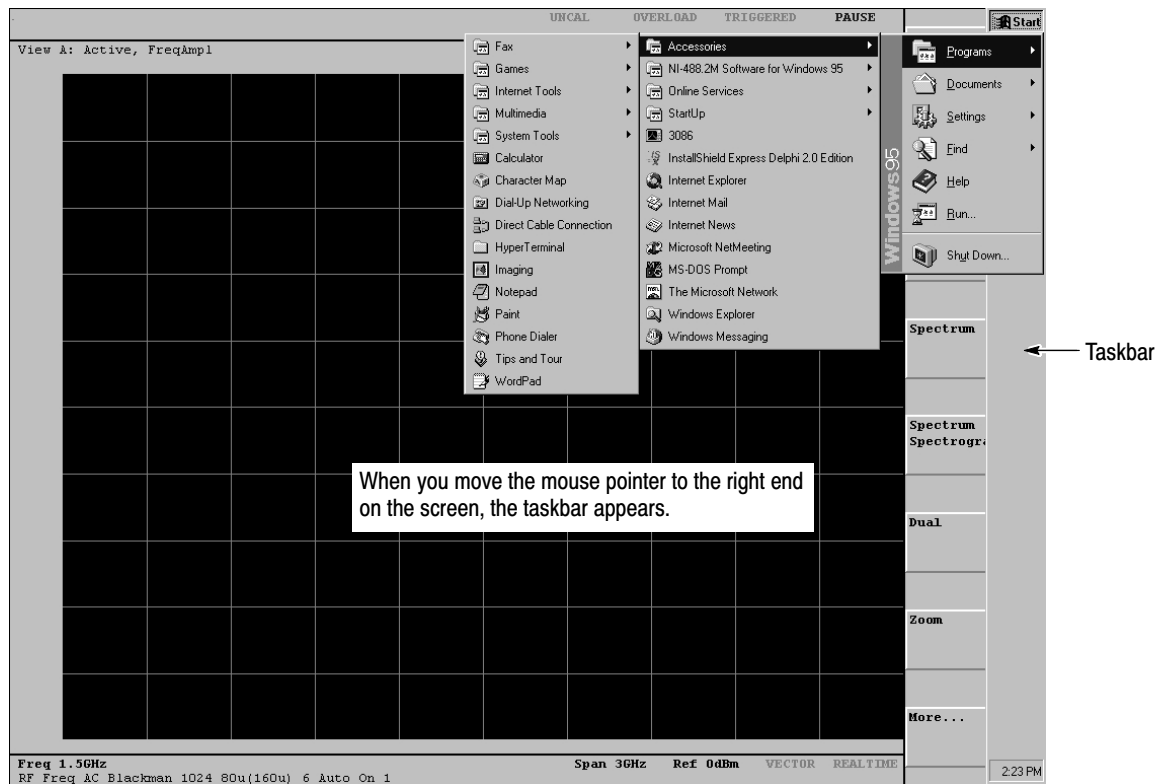

Figure 1: Mouse and keyboard connector location (rear panel)

Accessing Windows 95

1. Turn on the analyzer. The mouse pointer is displayed on the screen.
2. Move the mouse pointer to the right end of the screen to display the taskbar. The taskbar may remain hidden at another corner depending on your setting.

**Figure 2: Displaying the Windows 95 menu****Terminating the Current Application Software**

1. Move the mouse pointer to the **Sapnl** icon on the taskbar. Then, press the right mouse button. A menu appears.
2. Select **Close** from the menu.

The basic application software terminates and the Windows 95 desktop screen is displayed.

Basic Application Software Installation

Uninstalling the Old Software

1. On the desktop, double-click **My Computer** → **Control Panel** → **Add/Remove Programs** in this order.
2. In the Add/Remove Programs Properties dialog box, select the 3066 or 3086 application depending on your analyzer, then click **Add/Remove....**
3. The Confirm File Deletion dialog box opens. Click **Yes** to confirm the deletion.
4. The Remove Programs From Your Computer dialog box appears. Click **OK**.
5. In the Add/Remove Programs Properties dialog box, click **OK**.
6. Close all windows.

Installing the New Software

1. Depending on your analyzer, insert the 3066 or 3086 Basic Application Software Disk 1 into the floppy disk drive of the analyzer.
2. Double-click **My Computer** and then **3.5 inch FD**.
3. In the floppy disk window, double-click the **Setup.exe** icon to start the Setup Wizard.

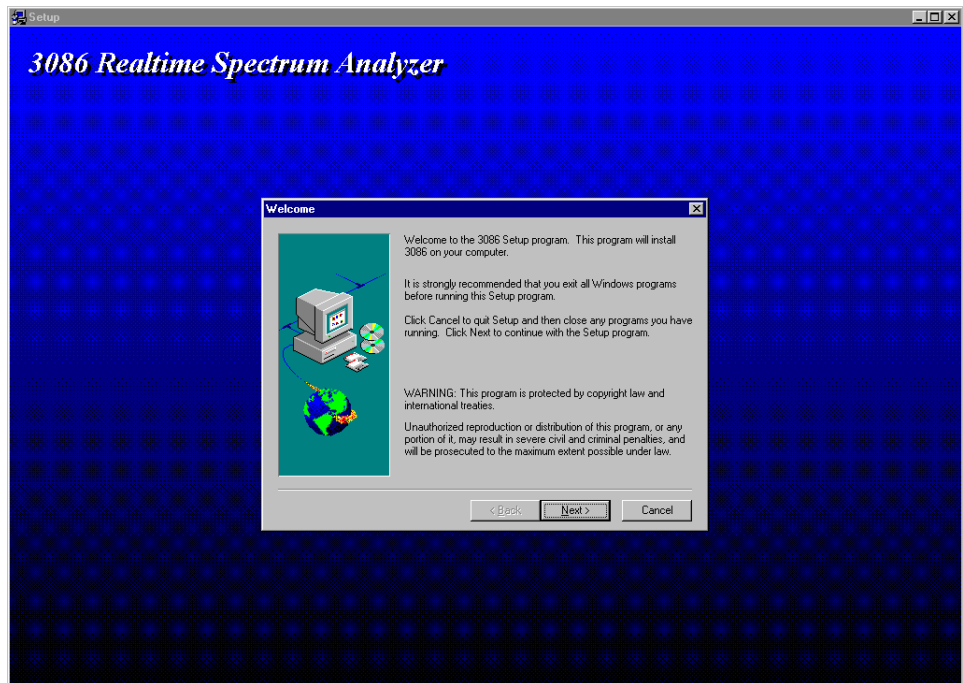

Figure 3: Setup Wizard initial screen of the Basic Application Software (3086)

4. In the Setup Wizard, do the following steps:
 - a. In the Welcome dialog box, click **Next**.
 - b. In the Choose Destination Location dialog box, click **Next**.
 - c. In the Start Copying Files dialog box, click **Next**.
 - d. When the Setup Needs The Next Disk message box appears, change the floppy disk as prompted.
 - e. When the Setup Complete dialog box appears, eject the floppy disk and then click **Finish**.
5. Close all windows.

Confirming the Window Size

1. With the mouse, point to the right end of the screen to display the taskbar. The taskbar may remain hidden at another corner depending on your setting.
2. Right-click the **Start** icon on the taskbar and select **Open**. The Start Menu window appears.
3. Double-click the **Programs** icon. The Programs window appears.
4. Right-click the **3066** or **3086** icon in the window. A menu appears.
5. Select Properties from the menu to open the property setup window.
6. Click the Shortcut tag in the property setup window.
7. Confirm that **Minimum** has been set in the Run field. If not, select **Minimum** in that field.
8. Click **OK** button. The property setup window disappears.

If you made a shortcut to the 3066 or 3086 application on the desktop, you also need the above settings for the shortcut.

9. Close all windows.

Option 15 cdmaOne Analysis Software Installation (*Optional*)

If you add the optional cdmaOne Analysis Software to your 3066 analyzer, do the following procedures.

Uninstalling the Old Software

If you have installed an earlier version of the cdmaOne Analysis Software, remove the old files.

1. On the desktop, double-click **My Computer** → **Control Panel** → **Add/Remove Programs** in this order.
2. In the Add/Remove Programs Properties dialog box, select the 3086 cdmaOne Fwd Link application, then click **Add/Remove...**
3. The Confirm File Deletion dialog box opens. Click **Yes** to confirm the deletion.
4. The Remove Programs From Your Computer dialog box appears. Click **OK**.
5. In the Add/Remove Programs Properties dialog box, click **OK**.
6. Close all windows.

Installing the New Software

1. Insert the cdmaOne Analysis Software Disk 1 into the floppy disk drive of the analyzer.
2. Double-click **My Computer** and then **3.5 inch FD**.
3. In the floppy disk window, double-click the **Setup.exe** icon to start the Setup Wizard.

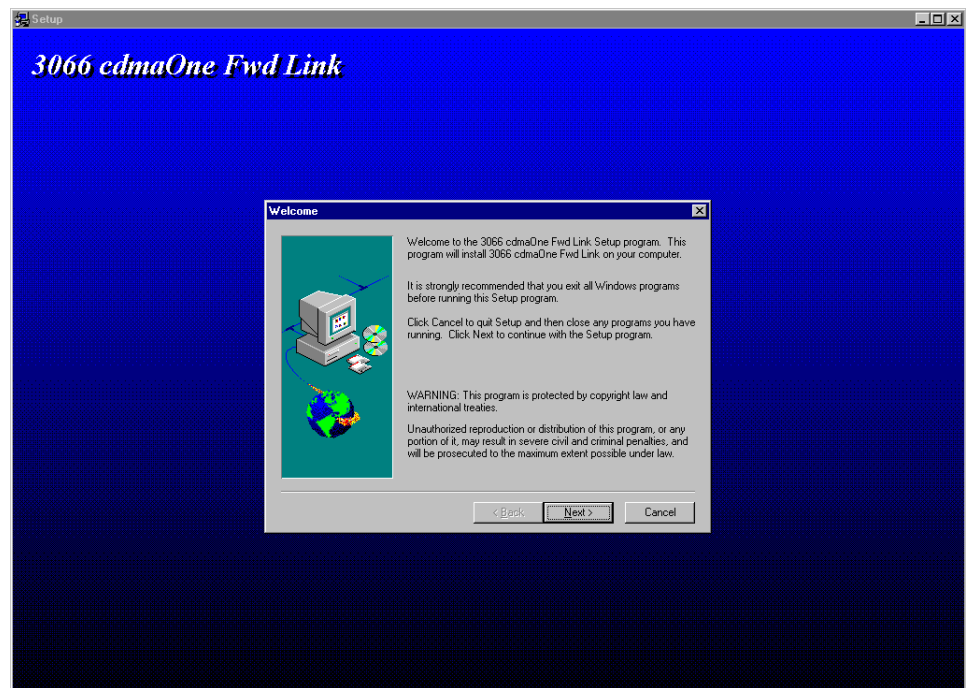

Figure 4: Setup Wizard initial screen of the cdmaOne Analysis Software

4. In the Setup Wizard, do the following steps:
 - a. In the Welcome dialog box, click **Next**.
 - b. In the Choose Destination Location dialog box, click **Next**.
 - c. In the Start Copying Files dialog box, click **Next**.
 - d. When the Setup Needs The Next Disk message box appears, change the floppy disk as prompted.
 - e. When the Setup Complete dialog box appears, eject the floppy disk and then click **Finish**.
5. Close all windows.

Option 16 W-CDMA/cdmaOne Analysis Software Installation (*Optional*)

If you add the optional W-CDMA/cdmaOne Analysis Software to your 3086 analyzer, do the following procedures.

Uninstalling the Old Software

If you have installed earlier versions of the W-CDMA and cdmaOne Analysis Software, remove the old files.

1. On the desktop, double-click **My Computer** → **Control Panel** → **Add/Remove Programs** in this order.
2. In the Add/Remove Programs Properties dialog box, select the 3086 W-CDMA Code Domain Power application, then click **Add/Remove....**
3. The Confirm File Deletion dialog box opens. Click **Yes** to confirm the deletion.
4. The Remove Programs From Your Computer dialog box appears. Click **OK**.
5. In the Add/Remove Programs Properties dialog box, select the 3066 cdmaOne Fwd Link application, then click **Add/Remove....**
6. The Confirm File Deletion dialog box opens. Click **Yes** to confirm the deletion.
7. The Remove Programs From Your Computer dialog box appears. Click **OK**.
8. In the Add/Remove Programs Properties dialog box, click **OK**.
9. Close all windows.

Installing the New Software

1. Insert the W-CDMA Analysis Software Disk 1 into the floppy disk drive of the analyzer.
2. Double-click **My Computer** and then **3.5 inch FD**.
3. In the floppy disk window, double-click the **Setup.exe** icon to start the Setup Wizard.

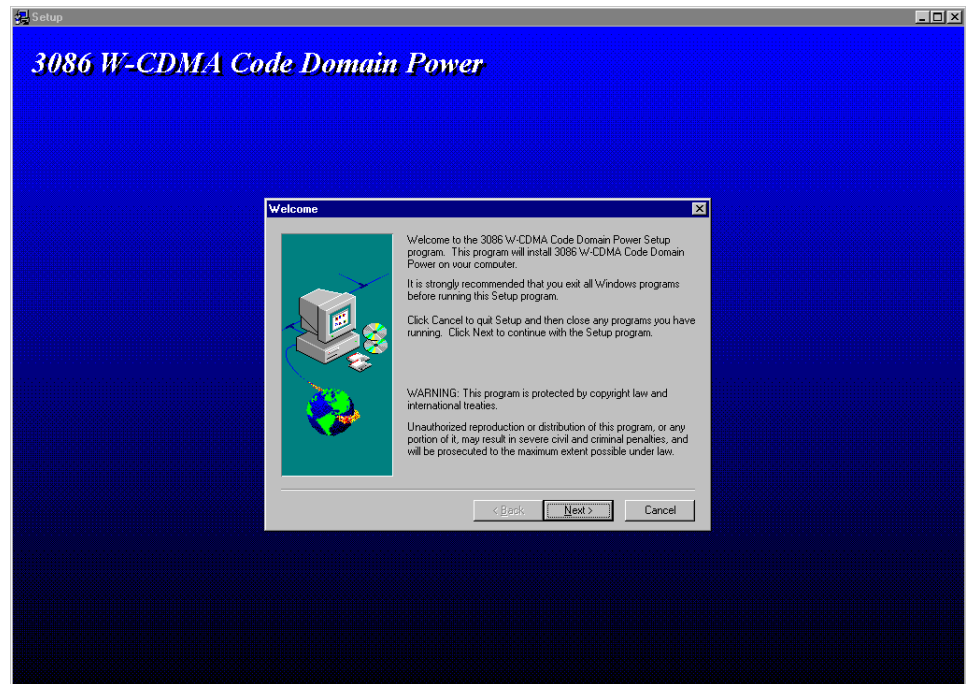

Figure 5: Setup Wizard initial screen of the W-CDMA Analysis Software

4. In the Setup Wizard, do the following steps:
 - a. In the Welcome dialog box, click **Next**.
 - b. In the Choose Destination Location dialog box, click **Next**.
 - c. In the Start Copying Files dialog box, click **Next**.
 - d. When the Setup Needs The Next Disk message box appears, change the floppy disk as prompted.
 - e. When the Setup Complete dialog box appears, eject the floppy disk and then click **Finish**.

5. Insert the cdmaOne Analysis Software Disk 1 into the floppy disk drive.
6. Double-click **My Computer** and then **3.5 inch FD**.
7. In the floppy disk window, double-click the **Setup.exe** icon to start the Setup Wizard.
8. In the Setup Wizard, do the following steps:
 - a. In the Welcome dialog box, click **Next**.
 - b. In the Choose Destination Location dialog box, click the **Browse...** button in the Destination Directory box.
 - c. In the Choose Directory dialog box, change the path as follows using the keyboard:

From C:\Program Files\SONY Tektronix\3066\opCode
To C:\Program Files\SONY Tektronix\3086\opCode

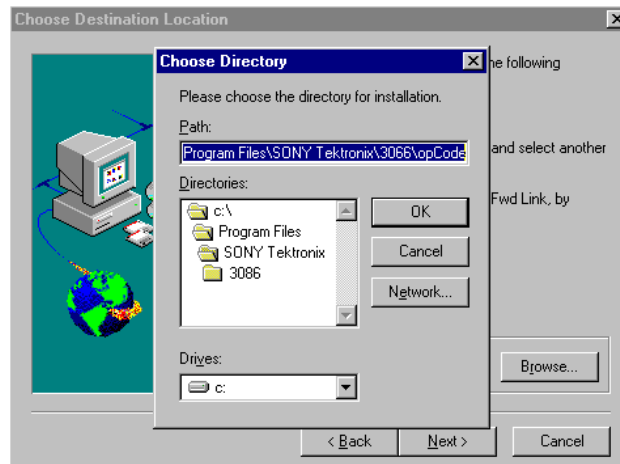

Figure 6: Choose Destination Location dialog box

- d. Click **OK** in the Choose Directory dialog box, and then click **Next** in the Choose Destination Location dialog box.
 - e. In the Start Copying Files dialog box, click **Next**.
 - f. When the Setup Needs The Next Disk message box appears, change the floppy disk as prompted.
 - g. When the Setup Complete dialog box appears, eject the floppy disk and then click **Finish**.
9. Close all windows.

Option 20 CCDF Analysis Software Installation (*Optional*)

If you add the optional CCDF Analysis Software to your 3066 or 3086 analyzer, do the following procedures.

Uninstalling the Old Software

If you have installed an earlier version of the CCDF Analysis Software, remove the old files.

1. On the desktop, double-click **My Computer** → **Control Panel** → **Add/Remove Programs** in this order.
2. In the Add/Remove Programs Properties dialog box, select the 3086/56/66 CCDF (Complementary Cumulative Distribution Function) application, and then click **Add/Remove....**
3. The Confirm File Deletion dialog box opens. Click **Yes** to confirm the deletion.
4. The Remove Programs From Your Computer dialog box appears. Click **OK**.
5. In the Add/Remove Programs Properties dialog box, click **OK**.
6. Close all windows.

Installing the New Software

1. Insert the CCDF Analysis Software floppy disk into the disk drive of the analyzer.
2. Double-click **My Computer** and then **3.5 inch FD**.
3. In the floppy disk window, double-click the **Setup.exe** icon to start the Setup Wizard.

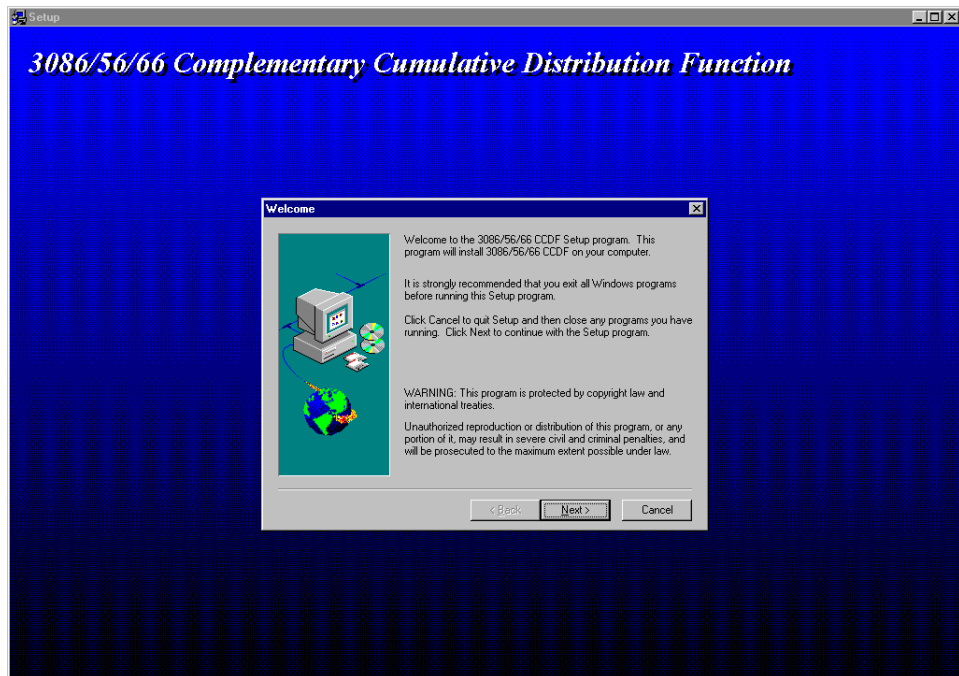

Figure 7: Setup Wizard initial screen of the CCDF Analysis Software

4. In the Setup Wizard, do the following steps:
 - a. In the Welcome dialog box, click **Next**.
 - b. In the Choose Destination Location dialog box, click the **Browse...** button in the Destination Directory box.

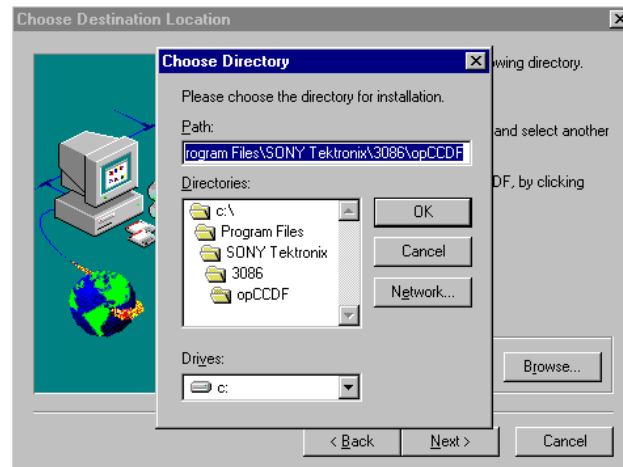

Figure 8: Choose Destination Location dialog box

- c. In the Choose Directory dialog box, do one of the following depending on your analyzer.
 - **For the 3086 analyzer**
Make sure that the path is as follows:
C:\Program Files\SONY Tektronix\3086\opCCDF
 - **For the 3066 analyzer**
Change the path as follows using the keyboard:
From C:\Program Files\SONY Tektronix\3086\opCCDF
To C:\Program Files\SONY Tektronix\3066\opCCDF
 - d. Click **OK** in the Choose Directory dialog box, and then click **Next** in the Choose Destination Location dialog box.
 - e. When the Setup Complete dialog box appears, eject the floppy disk and then click **Finish**.
5. Close all windows.

Running the Analyzer

- From the taskbar, select **Start** → **Program** → **3066** or **3086** in this order to start the application.

Be sure to run the 3066 or 3086 program. You can not perform the shutdown process unless the program is in operation.

For details on how to use the analyzer, refer to the *3066 & 3086 User Manual* (Tektronix part number 071-0501-01).