

Tektronix®
COMMITTED TO EXCELLENCE

**PLEASE CHECK FOR CHANGE
INFORMATION AT THE REAR
OF THIS MANUAL.**

**465B
OSCILLOSCOPE AND
DM44
DIGITAL MULTIMETER**

Tektronix, Inc.
P.O. Box 500
Beaverton, Oregon 97077
070-2756-01
Product Group 40

INSTRUCTION MANUAL

Serial Number _____ First Printing MAR 1979
Revised JUN 1982

Copyright © 1979, 1982 Tektronix, Inc. All rights reserved. Contents of this publication may not be reproduced in any form without the written permission of Tektronix, Inc.

Products of Tektronix, Inc. and its subsidiaries are covered by U.S. and foreign patents and/or pending patents.

TEKTRONIX, TEK, SCOPE-MOBILE, and  are registered trademarks of Tektronix, Inc. TELEQUIPMENT is a registered trademark of Tektronix U.K. Limited.

Printed in U.S.A. Specification and price change privileges are reserved.

INSTRUMENT SERIAL NUMBERS

Each instrument has a serial number on a panel insert, tag, or stamped on the chassis. The first number or letter designates the country of manufacture. The last five digits of the serial number are assigned sequentially and are unique to each instrument. Those manufactured in the United States have six unique digits. The country of manufacture is identified as follows:

B000000	Tektronix, Inc., Beaverton, Oregon, USA
100000	Tektronix Guernsey, Ltd., Channel Islands
200000	Tektronix United Kingdom, Ltd., London
300000	Sony/Tektronix, Japan
700000	Tektronix Holland, NV, Heerenveen, The Netherlands

SYMBOLS

As Marked on Equipment

 DANGER – High voltage.

 Protective ground (earth) terminal.

Power Source

This product is intended to operate from a power source that will not apply more than 250 volts rms between the supply conductors or between either supply conductor and ground. A protective ground connection by way of the grounding conductor in the power cord is essential for safe operation.

Grounding the Product

This product is grounded through the grounding conductor of the power cord. To avoid electrical shock, plug the power cord into a properly wired receptacle before connecting to the product input or output terminals. A protective ground connection by way of the grounding conductor in the power cord is essential for safe operation.

SAFETY SUMMARY

The general safety information in this summary is for operating personnel. Specific warnings and cautions will be found throughout the manual where they apply and do not appear in this summary.

TERMS

In This Manual

CAUTION statements identify conditions or practices that could result in damage to either the instrument or other property.

WARNING statements identify conditions or practices that could result in either personal injury or loss of life.

As Marked on Equipment

CAUTION indicates either a personal injury hazard not immediately accessible as you read the marking or a hazard to property, including the instrument itself.

DANGER indicates a personal injury hazard immediately accessible as you read the marking.

Use the Proper Power Cord

Use only the power cord and connector specified for your product.

Use only a power cord that is in good condition.

Refer cord and connector changes to qualified service personnel.

Use the Proper Fuse

To avoid fire hazard, use only the fuse specified for your product. Replacement fuses should be identical in type, voltage rating, and current rating.

Do Not Operate in Explosive Atmospheres

To avoid explosion, do not operate this product in an atmosphere of explosive gases unless it has been specifically certified for such operation.

Do Not Remove Covers or Panels

To avoid personal injury, do not remove covers or panels from this product. Do not operate the product without properly installed covers and panels.

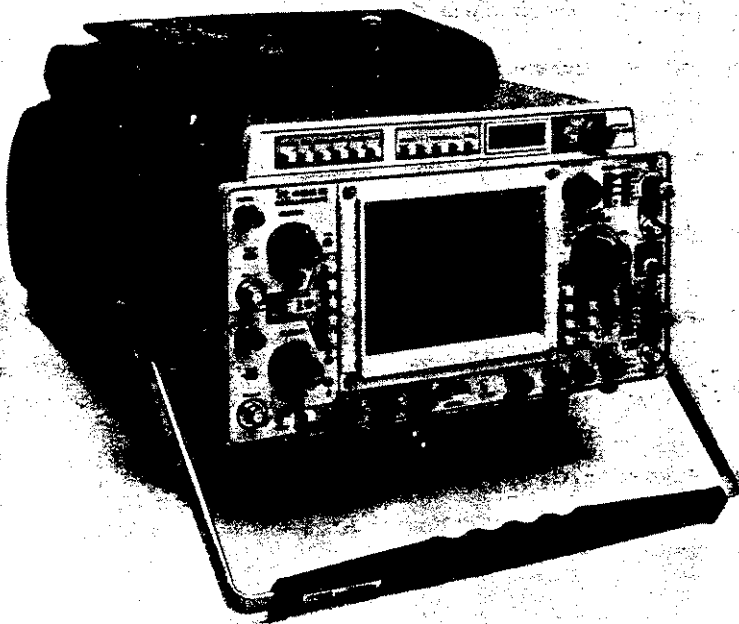

2756-33

465B Oscilloscope with DM44 Digital Multimeter.

BEFORE OPERATING

INTRODUCTION

The Tektronix 465B Oscilloscope is a dual-channel, four-trace portable instrument, providing traces for two input channels, a trigger view from an external trigger input, and an add function. Calibrated deflection factors from 5 millivolts/division to 5 volts/division are provided by the dc-to-100 MHz vertical system for the input channels and add function. Sweep trigger circuits are capable of stable triggering over the full bandwidth capabilities of the vertical deflection system. The horizontal deflection system provides calibrated sweep rates from 0.5 second/division to 0.02 microsecond/division along with delayed sweep features for accurate relative-time measurements. A X10 magnifier extends the calibrated sweep rate to 2 nanoseconds/division. The instrument operates over a wide variation of line voltages and frequencies with maximum power consumption of approximately 100 watts.

Increased measurement capabilities are achieved by the 465B when it is equipped with an optional Tektronix DM44 Digital Multimeter. The DM44 measures 0 to 20 megohms resistance, 0 to 1200 dc volts (+ or -), and -55° C to $+150^{\circ}$ C temperature (using a temperature probe). Measurement values are displayed on a 3½-digit LED readout while the oscilloscope continues normal operation.

The digital multimeter and oscilloscope combine to provide a digital readout of time difference between any two points on the oscilloscope display. Both time measurement points are displayed simultaneously on the crt. Direct measurement of frequency is provided by a 1/TIME function.

OPERATING SAFETY

Refer to the Safety Summary in the front of this manual for power source, grounding, and other safety considerations pertaining to use of the instrument. Before applying power, verify that the Line Voltage Selector Switch and the Regulating Range Selector Bar are both set for the line voltage being used and that the proper line fuse is installed.

CAUTION

This instrument may be damaged if operated with the Line Voltage Selector switch or the Regulating Range Selector Bar set for the wrong applied line voltage or if the wrong line fuse is used.

LINE VOLTAGE SELECTION

This instrument operates from either a 115-volt or a 230-volt nominal line voltage source at 48 hertz to 440 hertz. To convert the instrument for operation from one line voltage range to the other, move the Line Voltage Selector switch located on the right side panel (Figure 1) to the position indicating the correct nominal voltage. In special applications the power cord plug may require replacement with a type to match the power source.

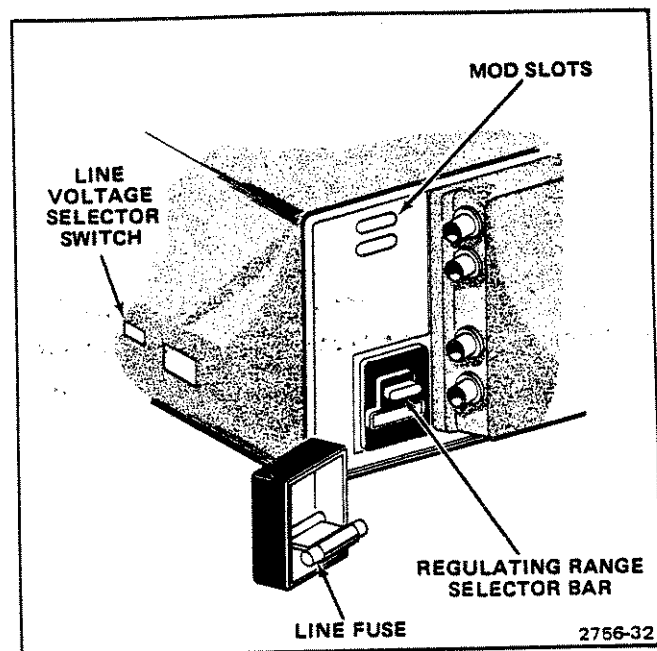

Figure 1. Regulating range selection and line fuse.

REGULATING RANGE SELECTION

The Regulating Range Selector assembly located on the rear panel contains the Regulating Range Selector Bar and the line fuse (Figure 1). Verify that the selector bar is set for the average line voltage being used and that the proper line fuse is installed. To change the regulating range:

1. Disconnect the instrument from its power source.
2. Loosen the two captive screws that hold the cover on the selector assembly; then pull to remove the cover.
3. Pull-out the range selector bar. Select a range from Table 1 which corresponds to the average line voltage and plug the selector bar into the desired position.
4. Insert the proper fuse (selected from Table 2) into its holder. Push the cover on and tighten the captive screws.

Table 1
Regulating Ranges

Regulating Range Selector Bar Position	Regulating Range	
	115-Volt Nominal	230-Volt Nominal
Upper Holes	108 to 132 volts	216 to 250 volts
Middle Holes	104 to 126 volts	208 to 250 volts
Lower Holes	99 to 121 volts	198 to 242 volts

Table 2
Fuse Selection

Line Voltage Selector Switch Position	Fuse Size
115-Volt Nominal	1.5 A, 3AG, Fast-blow
230-Volt Nominal	0.75 A, 3AG, Fast-blow

INSTRUMENT COOLING

To maintain adequate instrument cooling, the ventilation holes in the cabinet must remain open, and the air filter must be cleaned or replaced when it gets dirty.

CH 1—Displays Channel 1 signals when push button is pressed in.

A TRIG VIEW—Displays the A external trigger input signal when push button is pressed in and when the A TRIGGER SOURCE switch is set to EXT or EXT/10.

ADD—Displays the algebraic sum of the Channel 1 and Channel 2 input signals when ADD push button is pressed in. The INVERT switch in Channel 2 allows the display to be either CH 1 plus CH 2 or CH 1 minus CH 2. The ADD capability is useful for common-mode rejection to remove an undesired signal or dc offset.

CHOP ALT: OUT—The 465B "chops" (switches) between two or more of the display modes at a 500-kHz rate when CHOP ALT: OUT button is pressed in. When released, the 465B "alternates" between two or more of the four display modes at the end of each trace sweep. CHOP and ALT functions are disabled if only one VERT MODE push button (CH 1, CH 2, ADD, or A TRIG VIEW) is selected or if the X-Y mode is selected.

CH 2—Displays Channel 2 signals when push button is pressed in.

⑨ **20 MHz BW LIMIT (FULL BW OUT) Switch**—Limits the bandwidth of the vertical amplifier to approximately 20 MHz when pressed in. Push button must be depressed and released a second time to regain full 100-MHz bandwidth operation.

⑩ **20 MHz BW LIMIT Indicator**—This LED is illuminated whenever the 20 MHz BW LIMIT push button is pressed in, and bandwidth is limited to 20 MHz.

⑪ **INVERT**—Inverts Channel 2 display when push button is pressed in. Push button must be depressed and released a second time to present a noninverted display.

DISPLAY AND CALIBRATOR

Refer to Figure 3 for location of items 12 through 26.

⑫ **Internal Graticule**—Eliminates parallax. Risetime and amplitude measurement points are indicated at the left edge of the graticule.

⑬ **BEAM FINDER Switch**—Compresses the display to within the graticule area and provides a visible viewing intensity to aid in locating off-screen displays.

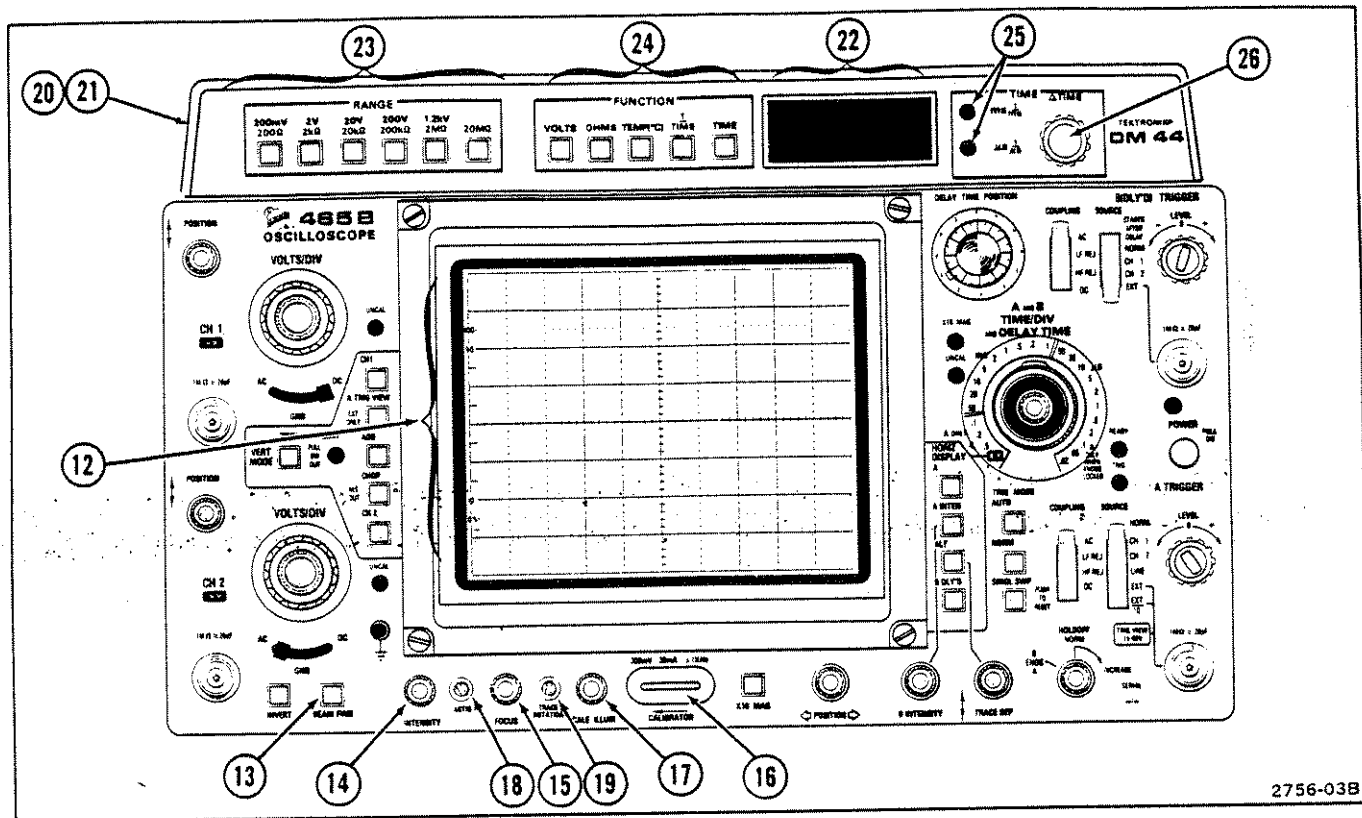

Figure 3. Display, calibrator, and DM44 controls, connectors, and indicators.

⑭ **INTENSITY Control**—Determines overall brightness of the A Sweep and B Sweep crt displays. Interacts with B INTENSITY control on B Sweep crt displays.

⑮ **FOCUS Control**—Adjusts for optimum display definition.

⑯ **CALIBRATOR Loop**—A combination 30-milliamp current loop and 0.3-volt square wave voltage output (approximately 1 kilohertz) that permits the operator to compensate voltage probes and to check oscilloscope vertical operation. It is not intended to verify precise time-base calibration.

⑰ **SCALE ILLUM Control**—Adjusts graticule illumination.

⑱ **ASTIG Control**—Screwdriver control used in conjunction with the FOCUS control to obtain a well-defined display. It does not require readjustment during normal use of the instrument.

⑲ **TRACE ROTATION Control**—Screwdriver control used to align trace with the horizontal graticule lines.

DM44 OPTION

⑳ **Input Connectors**—Two banana jacks provide COM (black) and + (red) inputs for dc voltage and resistance measurements.

㉑ **Probe Connector**—Used to connect a temperature probe.

㉒ **Readout**—A 3½-digit LED display using five 7-segment arrays. Negative polarity indication is automatic for negative dc voltage and temperature. No polarity indication is displayed for positive values. A blinking display indicates an overrange condition. The decimal point location is controlled by the multimeter's FUNCTION and RANGE controls and by the oscilloscope's A TIME/DIV switch (in the TIME or 1/TIME modes).

CAUTION

The maximum safe input in the 1.2 kilovolts dc mode is 1200 volts.

②③ **RANGE**—Pushbutton switches select from 0.2 volts to 1.2 kilovolts dc in five ranges or from 200 ohms to 20 megohms in six ranges.

②④ **FUNCTION**—Five pushbutton switches [VOLTS, OHMS, TEMP (°C), 1/TIME, and TIME] are used to select respective functions for measurement.

②⑤ **ms (or 1/ms) and μ s (or 1/ μ s) Indicators**—Two LEDs automatically indicate correct units of measurements.

With the TIME function selected, the units of time difference (milliseconds or microseconds) between the two intensified zones on the crt display is indicated by illumination of either the ms or μ s LED. Seconds are indicated when both LEDs are in a non-illuminated state.

With the 1/TIME function selected, the number of measured intervals per unit of time (milliseconds or microseconds) is indicated by illumination of the respective 1/ms or 1/ μ s LED. If the duration of one event is being measured, the LEDs indicate

frequency. An illuminated 1/ms LED indicates frequency in kilohertz and an illuminated 1/ μ s LED indicates megahertz. Frequency in hertz is indicated when both LEDs are in a non-illuminated state.

②⑥ **Δ TIME Control**—Used in conjunction with the DELAY TIME POSITION control in the TIME and 1/TIME functions. The Δ TIME control moves only the time-measurement point while the DELAY TIME POSITION control moves both the reference point and the time-measurement point. With the time-measurement point to the left of the reference point, the Readout indicates a negative time difference.

NOTE

The DM44 may be modified to make the DELAY TIME POSITION control move only the reference point. The procedure for making this modification is located in the Maintenance Section of the DM44 Instruction Manual. Modification is to be done by qualified service personnel only.

TRIGGER (BOTH A AND B IF APPLICABLE)

Refer to Figure 4 for location of items 27 through 35.

- 27 TRIG MODE Switches—Three push button switches determine the mode of trigger operation for the A Sweep.

AUTO—Sweep is initiated by the applied trigger signal. In the absence of an adequate trigger signal, or if the trigger repetition rate is less than about 20 hertz, the sweep free runs and provides a bright reference trace.

NORM—Sweep is initiated by the applied trigger signal. In the absence of an adequate trigger signal, there is no trace. When the trigger rate is too low for AUTO, use NORM.

SINGLE SWP—When this push button is pressed, the A Sweep operates in the single-sweep mode. After a single sweep is displayed, further sweeps cannot be presented until the SINGL SWP push button is again pressed. SINGL SWP is useful in displaying and photographing either nonrepetitive signals or signals that cause unstable conventional displays (e.g., signals that vary in amplitude, shape, or time).

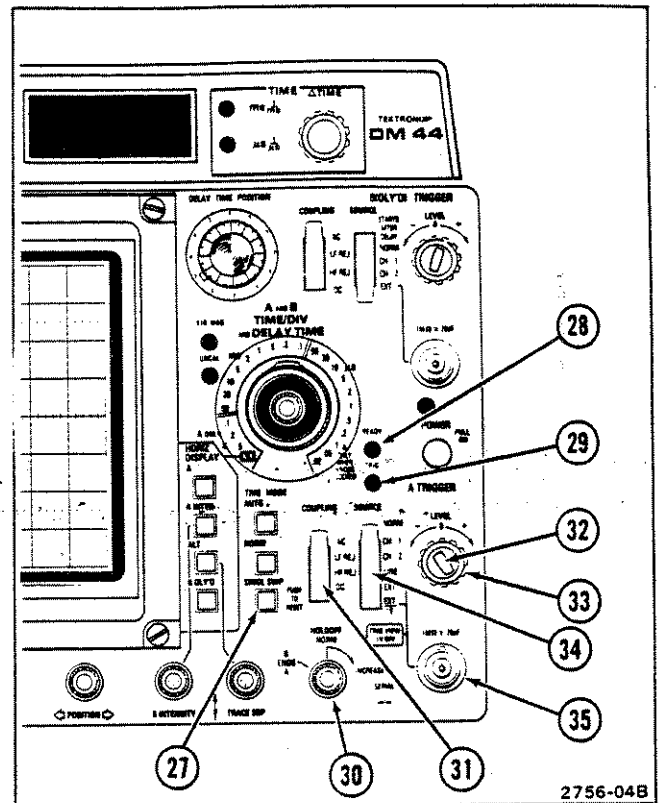

Figure 4. Trigger controls, connectors, and indicators.

②8 **READY Indicator**—LED illuminates to indicate that A Sweep is "armed" and will present a single-sweep display upon receipt of an adequate trigger signal.

②9 **TRIG Indicator**—LED illuminates to indicate that A Sweep is triggered and will produce a stable display. It is useful for setting up the trigger circuits when a trigger signal is available without a display on the crt (for example, when using external triggers).

③0 **A TRIG HOLDOFF Control**—Provides continuous control of time between sweeps. Allows triggering on aperiodic signals (such as complex digital words). In the fully clockwise position (B ENDS A), the A Sweep is automatically terminated at the end of the B Sweep to provide the fastest possible sweep repetition rate for delayed-sweep presentations and low-repetition rate signals. In this position Holdoff is approximately ten times NORM. Use the A trigger controls for most stable triggering before setting the the A TRIG HOLDOFF control to a position other than NORM.

③1 **COUPLING Switch**—Determines method used to couple signals to the trigger generator circuit.

AC—Signals are capacitively coupled to the input of the trigger circuit. Dc is rejected, and signals below about 30 hertz are attenuated. Triggering is allowed only on the ac portion of the vertical signal.

LF REJ—Signals are capacitively coupled to the input of the trigger circuit. Dc is rejected, and signals below about 50 kilohertz are attenuated. It is useful for providing a stable display of the high-frequency components of a complex waveform.

HF REJ—Signals are capacitively coupled to the input of the trigger circuit. Dc is blocked, and signals below about 30 hertz and above 50 kilohertz are attenuated. It is useful for providing a stable display of the low-frequency components of a complex waveform.

DC—All frequency components of a trigger signal are coupled to the input of the trigger circuit. It is useful for providing a stable display of low-frequency or low-repetition rate signals.

32 SLOPE Switch—Selects the slope of the signal that triggers the sweep.

+: Sweep can be triggered from the positive-going portion of a trigger signal.

-: Sweep can be triggered from the negative-going portion of a trigger signal.

33 LEVEL Control—Selects the amplitude point on the trigger signal at which the sweep is triggered. It is usually adjusted for the desired display after trigger **SOURCE**, **COUPLING**, and **SLOPE** have been selected.

34 SOURCE Switch—Determines the source of the trigger signal coupled to the input of the trigger circuit.

NORM—Trigger source is a sample of the signal displayed on the crt.

CH 1—A sample of the signal applied to the CH 1 input is used as a trigger signal. Channel 2 signal is unstable if it is not time-related.

CH 2—A sample of the signal applied to the CH 2 input is used as a trigger signal. Channel 1 signal is unstable if it is not time-related.

LINE (A Trigger Circuit Only)—A sample of the power-line sinusoid is used as a trigger signal. It is useful when the input signal is time-related (multiple or submultiple) to the line frequency or when it is desirable to provide a stable display of a line-frequency component in a complex waveform.

EXT—Signals connected to the External Trigger input connectors are used for triggering. External signals must be time-related to the displayed signal for a stable display. It is useful when the internal signal is either too small or contains undesired signals that could cause unstable triggering. It is also useful when operating in the CHOP mode. EXT and EXT/10 trigger signals may be viewed on the crt by selecting A TRIG VIEW on the VERT MODE switch.

EXT/10 (A Trigger Circuit Only)—External trigger signal is attenuated by a factor of 10.

STARTS AFTER DELAY (B Trigger Circuit Only)—B Sweep starts immediately after the delay time selected by the DELAY TIME POSITION control and is independent of the B Trigger signal. When making differential time measurements, you must use this mode to obtain valid measurements. On instruments equipped with a DM44 you must use this mode to obtain valid measurements when using the TIME or 1/TIME functions.

- 35 External Trigger Input bnc Connectors—Connect external trigger input signals for A TRIGGER and B (DLY'D) TRIGGER circuits, when either EXT or EXT/10 (A Trigger only) SOURCE is selected.

HORIZONTAL AND POWER

Refer to Figures 5 and 6 for location of items 36 through 47.

- 36a A AND B TIME/DIV AND DELAY TIME Switches—A TIME/DIV (clear plastic skirt) selects the sweep rate of the A Sweep circuit for A Sweep operation only. Also selects the basic delay time (used in conjunction with the DELAY TIME POSITION control) for delayed sweep operation. B TIME/DIV

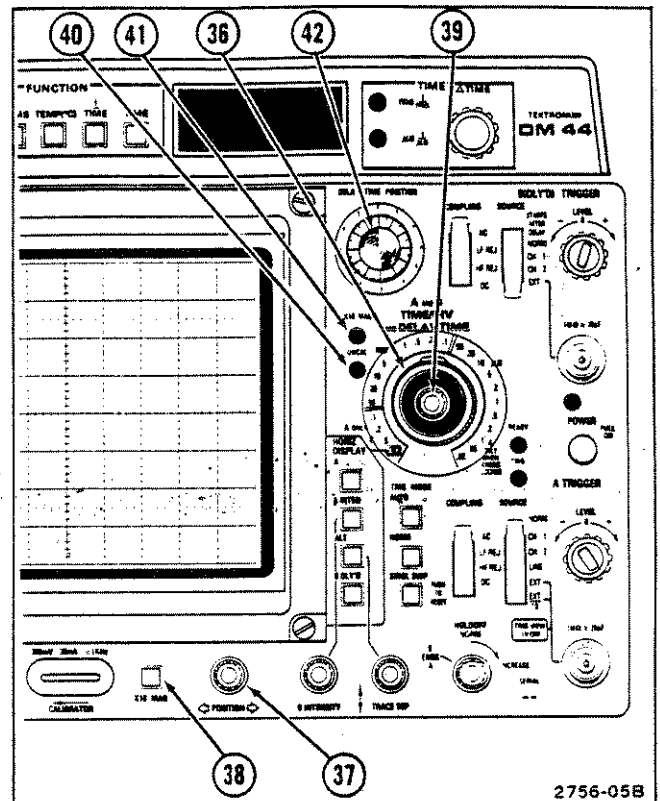

Figure 5. Horizontal controls and indicators.

switch (pull out and rotate to unlock) selects the sweep rate for the B Sweep circuit for delayed sweep operation only. VAR control must be in the calibrated detent for calibrated A Sweep rates. When the A TIME/DIV switch is rotated fully counterclockwise to the X-Y position, the horizontal (X-axis) deflection is controlled by the Channel 1 input signal.

36b **A AND B TIME/DIV AND DELAY TIME Switches (used with DM44)**—Operation is the same as 36a. The A TIME/DIV switch also controls the TIME indicators and decimal point location when the DM44 is in the TIME or 1/TIME Function.

37 **POSITION Control**—Positions the display horizontally for A Sweep and B Sweep, or on the X-axis (horizontally) in the X-Y mode. Provides both coarse and fine control action. Reverse the direction of rotation to actuate fine positioning action.

38 **X10 MAG Switch**—When pressed in, increases displayed sweep rate by a factor of 10. Extends fastest sweep rate to 2 nanoseconds/division. The magnified sweep expands the center division of the unmagnified display (0.5 division either side of the center graticule line).

39 **VAR Control**—Provides continuously variable sweep rates between the calibrated settings of the A TIME/DIV switch. It extends the slowest A Sweep rate to at least 1.25 seconds/division. The A Sweep rate is calibrated when the control is set fully clockwise to the calibrated detent. It must be in the detent position to make accurate differential time measurements. On instruments equipped with a DM44, the VAR control must be in the detent position to make accurate measurements in the TIME and 1/TIME functions.

40 **UNCAL Indicator**—LED illuminates to indicate that the A Sweep rate is uncalibrated (VAR control is out of the calibrated detent).

41 **X10 MAG Indicator**—LED illuminates to indicate that the X10 magnifier is on.

42a **DELAY TIME POSITION Control**—Selects the amount of delay time between the start of A Sweep and start of B Sweep. Delay time is variable to at least 10 times the time indicated by the A TIME/DIV switch.

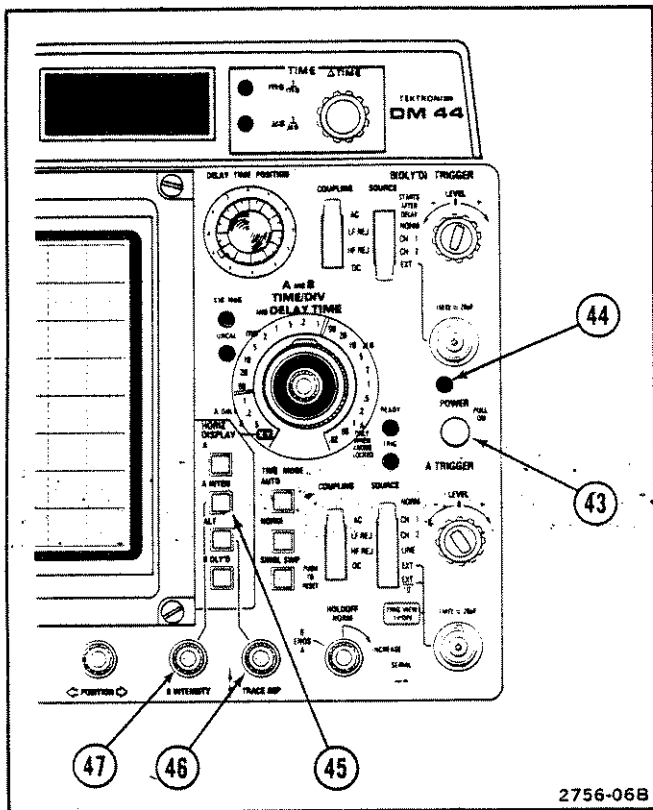

Figure 6. Horizontal and power controls and indicators.

- ④2b) DELAY TIME POSITION (used with DM44)—Operates in the same manner as 42a. In addition, when the DM44 is in the TIME or 1/TIME function, this control operates in conjunction with the Δ TIME control. The DELAY TIME POSITION control moves both the reference point and the time-measurement point, while the Δ TIME control moves only the time-measurement point. With the time-measurement point to the left of the reference point the Readout indicates a negative time difference.

NOTE

The DM44 may be modified to make the DELAY TIME POSITION control move only the reference point. The procedure for making this modification is located in the Maintenance Section of the DM44 Instruction Manual. Modification is to be done by qualified service personnel only.

- ④3) POWER Switch—PULL ON turns instrument power on; button pushed in turns power off.
- ④4) POWER ON Indicator—LED illuminates when power is applied to the instrument, and POWER switch is pulled to ON.
- ④5) HORIZ DISPLAY Switches—Four pushbutton switches determine the mode of operation for the horizontal deflection system.

A—Horizontal deflection is provided by A Sweep at a sweep rate determined by the setting of the A TIME/DIV switch. Only A Sweep is displayed; B Sweep is inoperative.

A INTEN—Displays the A Sweep at a rate determined by the A TIME/DIV switch. An intensified portion can appear on the display during the B Sweep time. This switch position provides an indication of both the duration and position of the B Sweep (delayed sweep) with respect to the A Sweep (delaying sweep).

ALT—Alternates the displays between the A INTEN and B DLY'D Sweeps. In ALT operation, use TRACE SEP to vertically position B Trace; use B INTENSIFY control to adjust B Trace intensity.

B DLYD—Displays only the B Sweep. The B Sweep rate is determined by the B TIME/DIV switch, with the delay time determined by the setting of both the A TIME/DIV switch and the DELAY TIME POSITION control.

- ④⑥ TRACE SEP Control—Positions the B Sweep vertically when the ALT HORIZ DISPLAY mode is selected.

- ④⑦ B INTENSITY Control—Determines the intensity of the B Trace.

REAR PANEL

Refer to Figure 7 for location of items 48 through 57.

- ④⑧ A +GATE—Output bnc connector provides a positive-going pulse coincident with the A Sweep time.
- ④⑨ B +GATE—Output bnc connector provides a positive-going pulse coincident with the B Sweep time.
- ⑤⑩ CH 1 VERT. SIGNAL OUT—Output bnc connector provides a sample of the signal applied to the Channel 1 preamplifier via the input connector.
- ⑤⑪ EXT Z-AXIS—Input bnc connector permits the application of an external signal to intensity modulate the crt display. Does not affect display wave-shape. Signals with fast rise time and fall time provide the most abrupt intensity change. Signals must be time-related to the display for a stable presentation on the crt. The connector is useful for adding time markers in uncalibrated modes of operation.

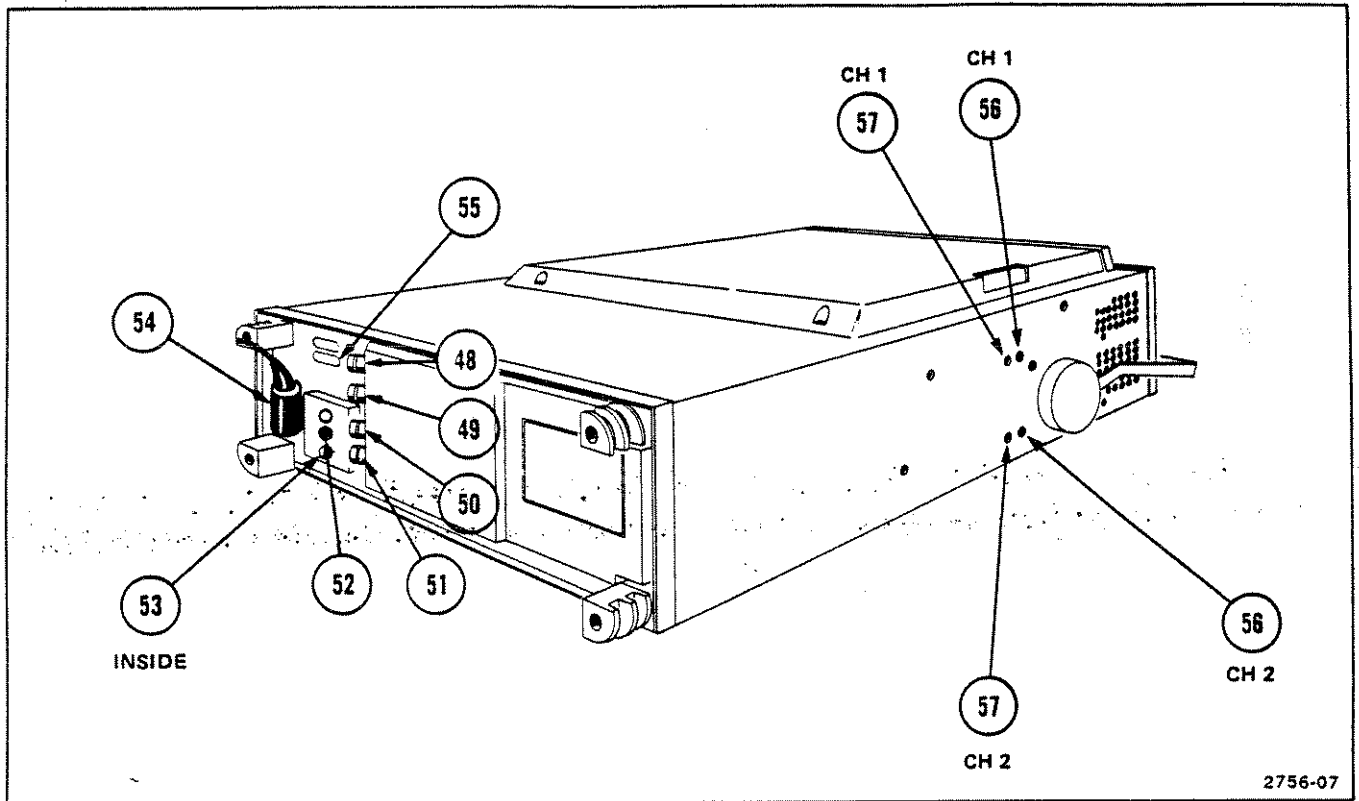

Figure 7. Rear panel and left side panel controls, connectors, and indicators.

52 **Regulating Range Selector Bar**—Selects the regulating range of the 465B power supplies to match the available power input source. It is shown on Figure 7 in the Medium regulating range. See Table 1 for change information.

53 **Line Fuse Holder**—Contains the line fuse and the regulating range selector. See Table 2 for change information.

54 **Line Cord**—Makes the connection between the oscilloscope and the power source. The cord may be conveniently stored by wrapping around the feet on rear panel.

55 **MOD Slots**—A number in either slot indicates the instrument contains an option or other modification.

LEFT SIDE PANEL

56 **Variable Balance Controls (accessible through left side panel)**—Screwdriver adjustments to set balance of the vertical channels.

57 **Vertical Gain Controls (accessible through left side panel)**—Screwdriver adjustments to set the gain of the vertical channels.

RIGHT SIDE PANEL

Line Voltage Selector Switch—Selects either 115 volts or 230 volts nominal line voltage. Refer to Table 1 for ranges and to Figure 1 for location of the switch. Change the fuse to match the range selected.

BASIC OSCILLOSCOPE DISPLAYS

PRELIMINARY

The procedures in this section will allow you to set up and operate your instrument to obtain the most commonly used basic oscilloscope displays. Before proceeding with these instructions, verify that the Line Voltage Selector switch and the Regulating Range Selector bar are placed in the proper positions and that the correct fuse is installed

for the line voltage being used. Refer to the Operating Safety section of this manual for the information and procedures relating to line voltage, regulating range, and fuse selection. Verify that the POWER switch is off (push button pressed in) before plugging the power cord into the line voltage socket.

PRESET INSTRUMENT CONTROLS

Preset the instrument controls as follows:

VERTICAL

VERT MODE VOLTS/DIV VOLTS/DIV VAR AC-GND-DC Vertical POSITION 20 MHz BW LIMIT INVERT	CH 1 Proper setting determined by amplitude of signal to be applied Calibrated detent AC Midrange Not limited (push button out) Off (push button out)
--	--

HORIZONTAL

TIME/DIV Switches A TIME/DIV VAR HORIZ DISPLAY X10 MAG POSITION	Locked together at 1 ms Calibrated detent A Off (push button out) Midrange
---	--

TRIGGER

(BOTH A AND B IF APPLICABLE)

SLOPE LEVEL SOURCE COUPLING TRIG MODE (A only) A TRIG HOLDOFF	+ 0 NORM AC AUTO NORM
--	--------------------------------------

DISPLAY

INTENSITY FOCUS SCALE ILLUM	Fully counterclockwise Midrange Midrange
-----------------------------------	--

NORMAL SWEEP DISPLAY

1. Preset instrument controls and pull the POWER switch (on). After allowing the instrument to warm up connect a signal to the CH 1 input connector.

NOTE

Instrument warmup time required to meet all specification accuracies is 20 minutes.

2. Adjust the INTENSITY control for the desired display brightness. If the display is not visible with the INTENSITY control at midrange, press the BEAM FIND push button and hold it in while adjusting the Channel 1 VOLTS/DIV switch to reduce the vertical display size. Center the compressed display using the

vertical and horizontal POSITION controls; release the BEAM FIND push button. Adjust LEVEL control if necessary.

3. Set the CH 1 VOLTS/DIV switch and the vertical and horizontal POSITION controls to locate the display within the graticule area.
4. Adjust the A Trigger LEVEL control for a stable display.
5. Set the A TIME/DIV switch for the desired number of cycles of displayed signal; then adjust the FOCUS control as necessary.

MAGNIFIED SWEEP DISPLAY

1. Preset instrument controls and obtain a Normal Sweep Display.
2. Adjust the horizontal POSITION control to move the area to be magnified to within the center graticule division of the crt (0.5 division on each side of the center vertical graticule line). Change the TIME/DIV switch setting as desired.
3. Push the X10 MAG switch (on) and adjust the horizontal POSITION control for precise positioning of the magnified display. Divide the TIME/DIV setting by 10 to determine the magnified sweep rate.

DELAYED SWEEP DISPLAY

1. Preset instrument controls and obtain a Normal Display.

NOTE

Differential time measurements and measurements using the TIME or 1/TIME functions of the DM44 are invalid when the B Trigger SOURCE switch is not set to STARTS AFTER DELAY.

2. Set the HORIZ DISPLAY switch to A INTEN and the B Trigger SOURCE switch to STARTS AFTER DELAY.
3. Pull out on the B TIME/DIV knob and turn clockwise from counterclockwise stop until the intensified zone is the desired length. Adjust the INTENSITY and B INTENSITY controls as needed to make the intensified zone distinguishable from the rest of the display. If your instrument is equipped with a DM44, select a function other than TIME or 1/TIME for a single delayed sweep. Dual delayed displays are discussed in step 7.

4. Adjust the DELAY TIME POSITION control to move the intensified zone to cover the portion of the display that will be displayed in delayed form.
5. Set the HORIZ DISPLAY switch to B DLY'D. The intensified zone adjusted in steps 3 and 4 is now displayed in delayed form. The delayed sweep rate is indicated by the dot on the B TIME/DIV knob.
6. To obtain a delayed display with less jitter, set the B Trigger SOURCE switch to the same position as the A

Trigger SOURCE switch and adjust the B LEVEL control for a stable display.

7. If your instrument is equipped with a DM44, delayed displays of two vertical channel signals can be obtained at the same time. The DM44 will indicate the time difference between the delayed displays. To obtain two delayed displays, select the TIME function and set the VERT MODE to ALT, CH 1 and CH 2. The DELAY TIME POSITION control is used to position both delayed displays. The Δ TIME control positions only the Channel 2 delayed display.

ALTERNATE SWEEP DISPLAY

1. Preset instrument controls and obtain a Normal Sweep Display.
2. Pull out on the B TIME/DIV knob to unlock it and turn clockwise to the desired sweep rate. If the instrument is equipped with a DM44, select a function other than TIME or 1/TIME.
3. Set the HORIZ DISPLAY switch to ALT. Set B (DLY'D) TRIGGER SOURCE to STARTS AFTER DELAY. Adjust Channel 1 POSITION and TRACE SEP as required to display A Sweep above B Sweep. This will provide a display that alternates between A INTEN trace (upper) and B DLY'D trace (lower). Adjust B INTENSITY as necessary to view the B DLY'D trace (lower).

4. The start of B Sweep may be changed by adjusting the DELAY TIME POSITION control.

5. If the instrument is equipped with a DM44 and a time difference (or period) measurement is desired, select the TIME function and adjust the Δ TIME control to move the time-measurement point with respect to the reference point.

6. The display now contains a second intensified zone on the A INTEN trace (upper) and a second signal, which may be partially or fully superimposed, on the B DLY'D trace (lower).

7. The DELAY TIME POSITION control will change the position of both delayed displays (reference and time measurement), while the Δ TIME control will position only the second (measurement point) delayed display.

X-Y DISPLAY

1. Preset instrument controls and pull the POWER switch (on). Allow the instrument to warm up.

2. Set the A TIME/DIV switch fully counterclockwise to X-Y. Apply the vertical signal to the CH 2 OR Y input connector and the horizontal signal to the CH 1 OR X input connector.

3. Advance the INTENSITY control until the display is visible. If the display is not visible with the INTENSITY control at midrange, press and hold in the BEAM FIND push button while adjusting the CH 1 and CH 2 VOLTS/DIV switches until the display is reduced in size, both vertically and horizontally. Center the compressed display with the POSITION controls (Channel 2 POSITION control for vertical movement, and horizontal POSITION control for horizontal movement). Release the BEAM FIND push button. Adjust the FOCUS control for a well-defined display.

SINGLE SWEEP DISPLAY

1. Preset instrument controls and obtain a Normal Sweep Display. For random signals, set the trigger circuit to trigger on a signal that is approximately the same amplitude and frequency as the random signal.
2. Press the SINGL SWP push button on the A TRIG MODE switch. The next trigger pulse starts the sweep and displays a single trace. If no triggers are present, the READY indicator should illuminate, indicating that the A Sweep generator circuit is set and waiting for a trigger.
3. When the sweep is complete, the circuit is "locked out", and the READY indicator turns off.
4. Press the SINGL SWP push button again to prepare the circuit for another Single Sweep Display.

DM44 DISPLAYS AND MEASUREMENTS

Except for the TIME and 1/TIME functions, the DM44 is independently usable whenever the oscilloscope is turned on. The TIME and 1/TIME functions are discussed in the Adjustments and Measurements section of this manual

under the subsection titled DM44 Delayed Sweep Time Measurements. Additional use of the DM44 in the TIME and 1/TIME functions is described in the Basic Oscilloscope Displays section under the Delayed Sweep Display subsection.

RESISTANCE

CAUTION

The DM44 may be damaged if it is operating in the resistance mode (OHMS function selected) and a voltage exceeding 120 volts rms is applied between the + and COM leads.

1. Press the OHMS FUNCTION push button and the 20 M Ω RANGE push button (see Figure 8).
2. Connect the + and COM leads to the unknown resistance.

3. Observe the readout. Press the next lower-value RANGE push buttons as necessary to obtain a proper readout (see Table 3).

NOTE

When the DM44 is connected to any unknown resistance, a blinking readout for any RANGE value selected indicates an overrange condition. The next higher RANGE value should be selected.

If no resistance is connected to the DM44 and any RANGE value is selected, a normal blinking readout occurs.

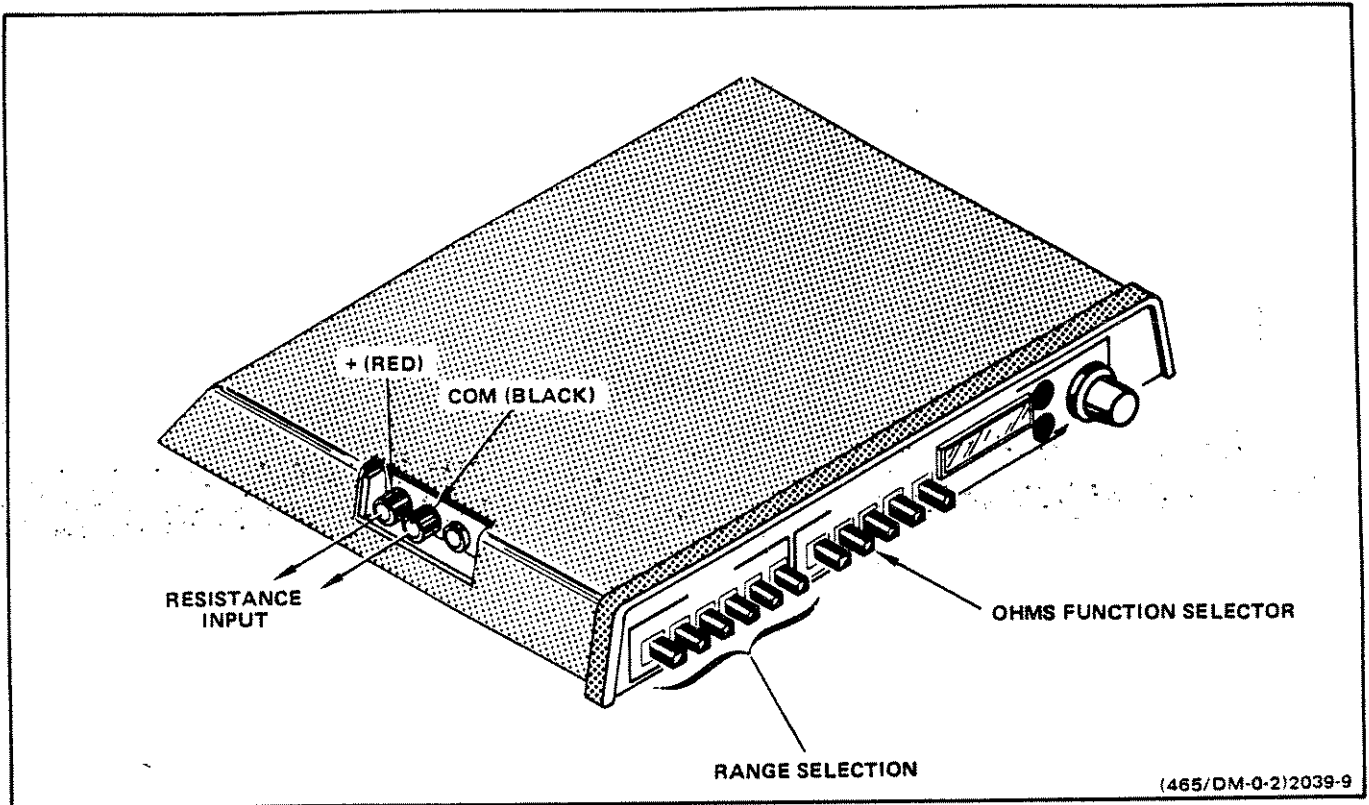

(465/DM-0-2)2039-9

Figure 8. Resistance measurement.

@

Table 3
Resistance Ranges

Range	Readout	Measurement
20 M Ω	20.00—02.00	20 M Ω —2 M Ω
2 M Ω	2.000—0.200	2 M Ω —200 k Ω
200 k Ω	200.0—20.00	200 k Ω —20 k Ω
20 k Ω	20.00—02.00	20 k Ω —2 k Ω
2 k Ω	2.000—0.200	2 k Ω —200 Ω
200 Ω	200.0—000.0	200 Ω —0 Ω

VOLTS

CAUTION

The maximum safe input voltage is ± 1200 volts (dc + peak ac) between the + and COM inputs or between the + input and chassis.

The maximum COM floating voltage is ± 500 volts (dc + peak ac) to chassis.

The DM44 may be damaged if it is operating in the resistance mode (OHMS function selected) and a voltage exceeding 120 volts rms is applied between the + and COM leads.

If the readout exceeds 1200 volts or the readout blinks (indicating overrange), immediately disconnect the + lead to prevent possible instrument damage.

1. Press both the VOLTS FUNCTION push button and the 1.2 kV RANGE push button (see Figure 9).
2. Connect the COM lead to the reference point (usually a ground or test point) and the HIGH lead to the unknown voltage to be measured.

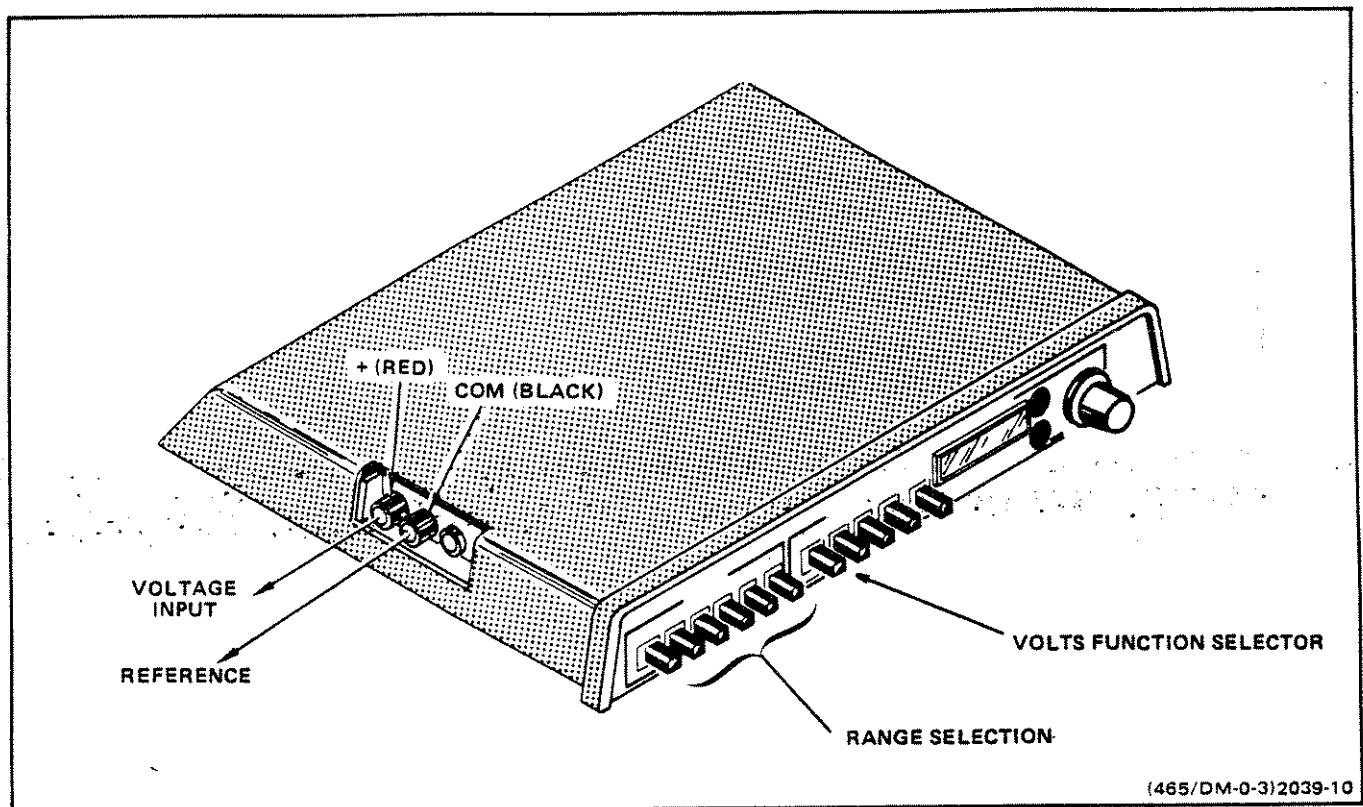

Figure 9. Volts measurement.

3. Observe the readout. Press the next lower-value RANGE push buttons as necessary to obtain a proper readout (see Table 4).

NOTE

If no voltage is applied to the DM44 while in the 20 volt to 1.2 kilovolt ranges, the readout is 0000, and individual readout elements may blink. Also, noise picked up by the meter leads may increase the readout while in the 0.2 volt and 2 volt ranges.

A blinking readout for any RANGE value selected indicates an overrange condition. The next higher RANGE value should be selected.

Table 4
Voltage Ranges

Range	Readout	Measurement
1.2 kV	1.200–0.200	1.2 kV–200 V
200 V	200.0–020.0	200 V–20 V
20 V	20.000–02.00	20 V–2 V
2 V	2.000–0.200	2 V–0.2 V
200 mV	0.200–0.000	0.2 V–0 V

TEMPERATURE

CAUTION

The maximum safe voltage on the measurement surface is ± 100 volts (dc + peak ac) above chassis ground.

The sensor tip is fragile and may break if dropped or subjected to excessive stress. Force exerted on the sensor tip should not exceed 20 pounds.

If the readout exceeds -55° C or $+150^{\circ}$ C, immediately remove the probe to prevent probe damage.

1. Press the TEMP ($^{\circ}$ C) FUNCTION push button (see Figure 10).
2. Apply the temperature probe to the device whose temperature is being measured. Refer to the probe's Instruction Manual for specific instructions regarding probe use.
3. Observe the readout. Refer to Table 5 to convert the readout from degrees Celsius to degrees Fahrenheit.

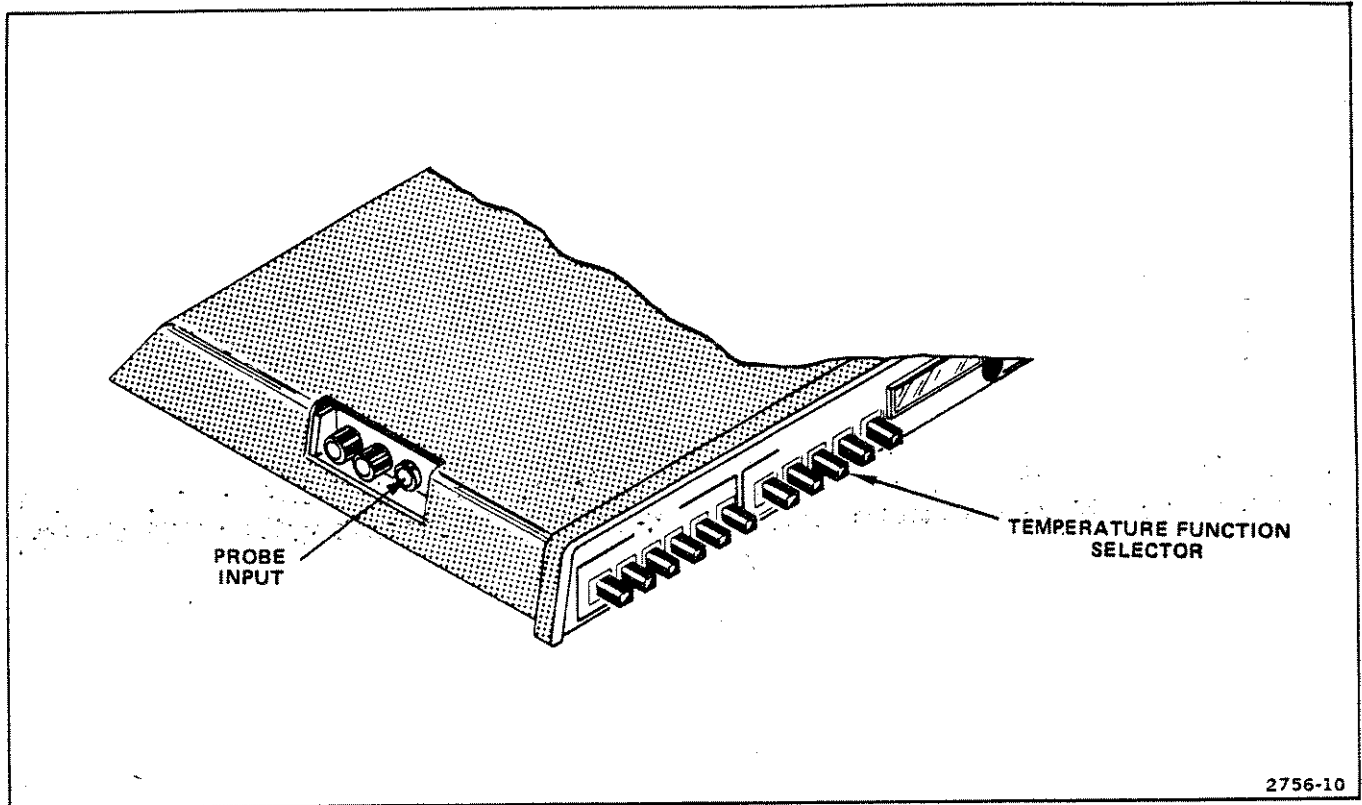

Figure 10. Temperature measurement.

TEMPERATURE ACCURACY CHECKS

The DM44 is calibrated to its original temperature probe and should be recalibrated to any replacement probe. Refer to the DM44 Instruction Manual for calibration procedures.

For the following accuracy checks, use an accurate thermometer to verify water temperature. Anything in solution affects the melting temperature, and the boiling point is affected by changes in altitude and barometric pressure.

Low Temperature

1. Allow a container (preferably insulated) of crushed ice to melt until there are only a few pieces of ice remaining.

CAUTION

To prevent possible probe damage, ensure that only the sealed portion of the probe is immersed (see Figure 10).

2. Put the probe tip into the water, avoiding the sides or bottom of the container. Wait for the readout to stabilize, indicating the probe has reached the water temperature.
3. The readout should be between -2°C to 2°C . There should be ice remaining after the test to verify that inserting the probe did not raise the water temperature.

High Temperature

1. Bring water to a slow boil (to prevent splattering).
2. Put the probe tip into the water, avoiding the sides or bottom of the container. Wait for the readout to stabilize, indicating the probe has reached the water temperature.
3. The readout should be between 98°C and 102°C for fresh water at sea level.

Table 5
Temperature Conversion

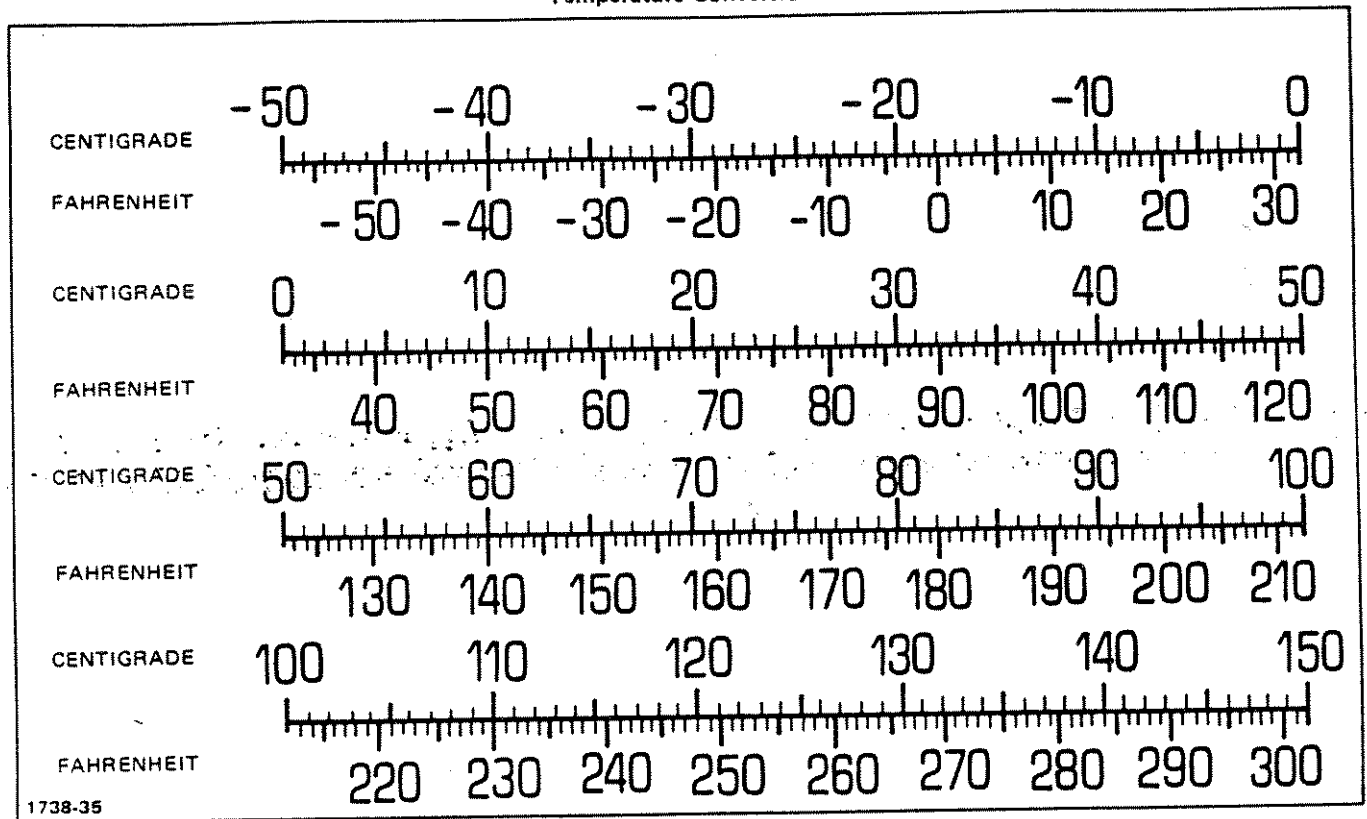

1738-35

@

ADJUSTMENTS AND MEASUREMENTS

This section provides the procedures and information you will need to make precision measurements with the 465B and the DM44 (if your instrument is equipped with this option). It is divided into three subsections. The first contains basic operating information and techniques that should be considered before attempting any measurements.

The second subsection is comprised of a series of operator's checks and adjustments which, when performed, should verify instrument operation and ensure optimum measurement accuracies. The final subsection details the procedures, formulas, and examples required to make the various types of precision measurements with your instrument.

OPERATING CONSIDERATIONS

GRATICULE

The graticule is internally marked on the faceplate of the crt to provide accurate measurements without parallax. It is marked with eight vertical and ten horizontal major divisions. In addition, each major division is divided into five minor divisions. The vertical deflection and horizontal timing are calibrated to the graticule so that accurate measurements can be made directly from the crt.

GROUNDING

The most reliable signal measurements are made when the 465B and the unit under test are connected together by a common reference (ground) lead in addition to the signal lead or probe. The ground strap on the probe provides the best grounding method. Also, you can connect a ground lead from the unit under test to the chassis ground banana jack located on the lower left portion of the instrument front panel.

SIGNAL CONNECTIONS

Probes

Generally, probes offer the most convenient means of connecting an input signal to the instrument. They are shielded to prevent pickup of electrostatic interference. The supplied 10X probe offers a high input impedance, which minimizes circuit loading and allows the circuit under test to operate very close to normal conditions thus providing accurate measurements. Conversely, it also attenuates the input signal amplitude by a factor of 10.

Coaxial Cables

Cables may also be used to connect signals to the input connectors and may have a considerable effect on the accuracy of a displayed waveform. To maintain the original frequency characteristics of an applied signal, only high-quality, low-loss coaxial cables should be used. Also, cabling should be terminated at both ends in its characteristic impedance. If this is not possible, use suitable impedance-matching devices.

PROBE COMPENSATION

Misadjustment of probe compensation is one of the greatest sources of operator error. Most attenuator probes are equipped with compensation adjustments. To ensure optimum measurement accuracy, always compensate your probe before making measurements. Probe compensation is accomplished as follows:

1. Set the appropriate VOLTS/DIV switch to 0.1 V and the AC-GND-DC switch to DC.
2. Preset instrument controls and obtain a Normal Sweep Display presentation (see Basic Oscilloscope Displays section of this manual) using the ≈ 1 kHz CALIBRATOR square-wave output as the input signal. Display several cycles of the CALIBRATOR square-wave at approximately four divisions amplitude.
3. Check the waveform presentation for overshoot and rolloff. Readjust, if necessary, the probe compensation for flat tops on the waveforms (see Figure 11). Refer to the appropriate probe manual for compensation adjustment instructions.

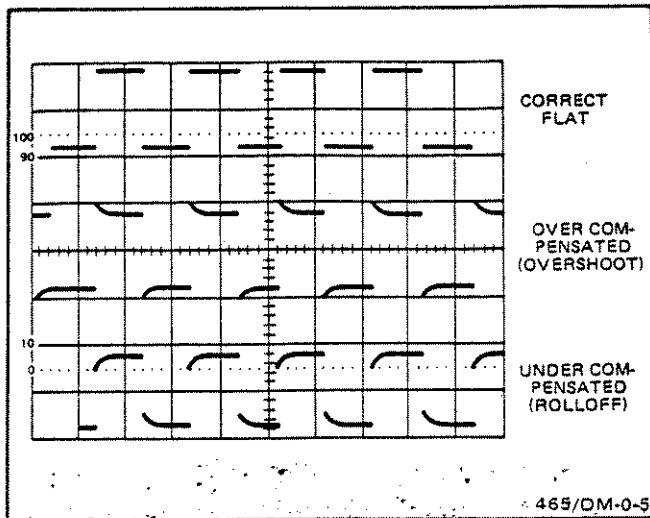

Figure 11. Probe compensation.

INPUT COUPLING CAPACITOR PRECHARGING

In the GND position, the input signal is connected to ground through a one-megohm resistor to form a precharging network. This network allows the input coupling capacitor to charge to the average dc-voltage level of the signal applied to the probe. Thus, any large voltage transients accidentally generated will not be applied to the am-

plifier input. The precharging network also provides a measure of protection to the external circuitry by reducing the current levels that can be drawn from the external circuitry during capacitor charging.

The following procedure should be used whenever the probe tip is connected to a signal source having a different dc level than that previously applied, especially if the dc level difference is more than 10 times the VOLTS/DIV setting:

1. Set the AC-GND-DC switch to GND before connecting the probe tip to a signal source.
2. Touch the probe tip to the oscilloscope chassis ground.
3. Wait several seconds for the input coupling capacitor to discharge.
4. Connect the probe tip to the signal source.
5. Wait several seconds for the input coupling capacitor to charge.
6. Set the AC-GND-DC switch to AC. The display will remain on the screen, and the ac component of the signal can be measured in the normal manner.

OPERATOR'S CHECKS AND ADJUSTMENTS

To verify the operation and accuracy of your instrument, perform the following checks and adjustments before making a measurement. If adjustments are required beyond the scope of these operator's checks and adjustments, refer to a qualified service technician for instrument calibration.

TRACE ROTATION ADJUSTMENT

1. Preset instrument controls and obtain a Normal Sweep Display (refer to Basic Oscilloscope Displays section of this manual).
2. Set the CH 1 AC-GND-DC switch to GND to display a free-running trace with no vertical deflection.

NOTE

Normally, the resulting trace will be parallel with the center horizontal graticule line and should not require adjustment.

3. If the resulting trace is not parallel with the center horizontal graticule line, rotate the TRACE ROTATION adjustment screw, located just below the crt graticule (see Figure 3), to align the trace with the center horizontal graticule line.

BASIC 465B TIMING CHECK

1. Preset instrument controls and obtain a Normal Sweep Display (refer to Basic Oscilloscope Displays section in this manual) using the ≈ 1 kHz CALIBRATOR square-wave output as the input signal (see following NOTE).

NOTE

Attach a bnc-to-binding post adapter to the A TRIGGER external input jack. Using a test lead with an alligator clip at each end, connect one alligator clip to the adapter and the other clip to the ≈ 1 kHz CALIBRATOR output.

2. Set A TRIGGER SOURCE switch to EXT.
3. Depress VERT MODE A TRIG VIEW push button and release CH 1 VERT MODE push button.
4. Adjust A TRIGGER SLOPE and LEVEL controls to stabilize and center the display.

NOTE

The CALIBRATOR signal is not intended to be used as a precise timing reference. It is employed in the following steps only as a convenient means of demonstrating basic instrument operation.

5. Verify a display of approximately one square wave (first positive edge to second positive edge) per

graticule division (see Figure 12). Use the horizontal POSITION control to align the waveform with graticule lines.

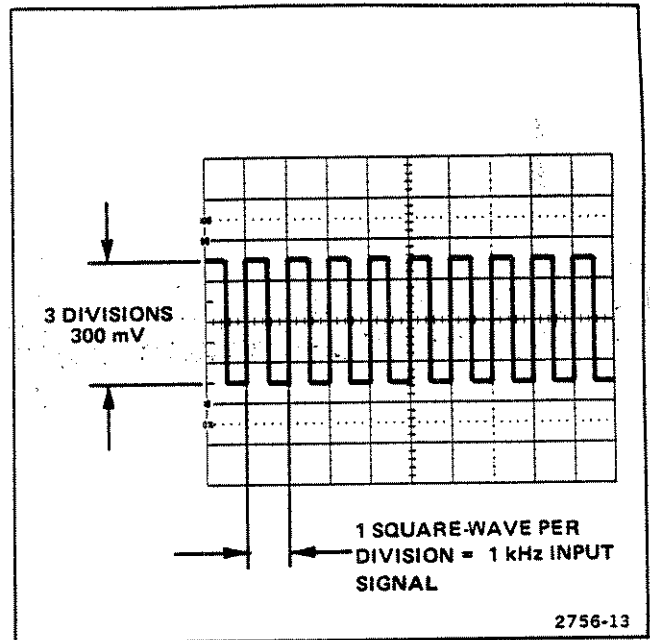

Figure 12. Basic 465B timing check.

DM44 TIMING CHECK

1. Perform steps 1 through 5 of the preceding Basic 465B Timing Check.

2. Depress HORIZ DISPLAY A INTEN push button.

3. Set B Sweep and DM44 FUNCTION controls as follows:

B TIME/DIV	5 μ s
B SOURCE	STARTS AFTER DELAY
FUNCTION	TIME
Δ TIME	To move the time-measurement point to the right of the reference point

NOTE

Adjust B INTENSITY control, if necessary, to display reference point.

4. Using the DELAY TIME POSITION control, move the reference point to a leading edge of the square wave (see Figure 13, Point A).

5. Using the DM44 Δ TIME control, move the time-measurement point to the leading edge of the next square wave (see Figure 13, Point B).

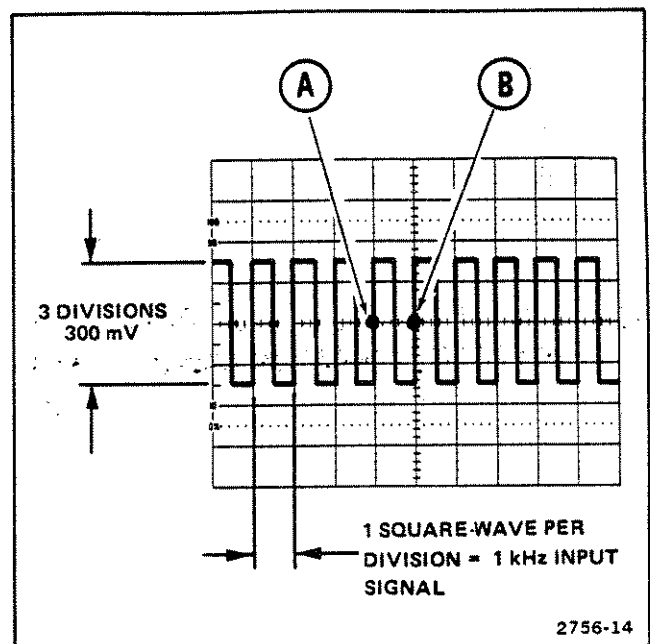

Figure 13. DM44 timing check.

6. Observe the DM44 readout. It should indicate approximately 1.000 ms.
7. Using the Δ TIME control to position the time-measurement point to each succeeding square-wave leading edge, observe that respective readouts indicate approximately 2.000 ms, 3.000 ms, 4.000 ms, etc.

A TRIGGER INPUT COUPLING CHECK

1. Perform steps 1 through 5 of the preceding Basic 465B Timing Check.
2. With the A TRIGGER COUPLING lever set to AC, verify that the dc component of input is rejected. The display should show an almost flat top and bottom of the square wave, with centering around the graticule center line. Three graticule divisions denotes a 300-mV signal (set vertical VOLTS/DIV as required).
3. Move the A TRIGGER COUPLING lever to LF REJ and verify rejection of the 1-kHz square-wave input. Display should show differentiated spikes as a result of filtering circuits.

4. Move the A TRIGGER COUPLING lever to HF REJ. The display should show rounding off of the rising and falling edges of the square-wave input. High-frequency filtering causes exclusion of components making up the square edges.
5. Move the A TRIGGER COUPLING lever to DC and adjust the A TRIGGER SLOPE LEVEL control, if necessary, to align the bottom edges of the square wave with the graticule center line. Display should show all ac and dc components of the input signal.

EXTERNAL HORIZONTAL GAIN CHECK

1. Perform steps 1 through 5 of the preceding Basic 465B Timing Check.
2. Set the A TIME/DIV control to X-Y.
3. Set the CH 1 VOLTS/DIV switch to 50 m.
4. The crt display should show two dots with a horizontal separation of approximately 5.75 to 6.25 divisions.

MAKING PRECISION MEASUREMENTS

AC PEAK-TO-PEAK VOLTAGE

NOTE

Either channel input connector may be used for the signal input. Use the VERT MODE switch to select the appropriate channel for display.

1. Obtain a Normal Sweep Display (refer to Basic Oscilloscope Displays section of this manual, using the signal to be measured as the channel input).
2. Ensuring that the VAR VOLTS/DIV control is in the calibrated detent, vertically position the display so that the negative peak of the waveform coincides with one of the horizontal graticule lines (see Figure 14, Point A).
3. Horizontally position the display so that one of the positive peaks coincides with the center vertical graticule line (see Figure 14, Point B).

4. Measure the vertical deflection from peak to peak (see Figure 14, Point A to Point B).

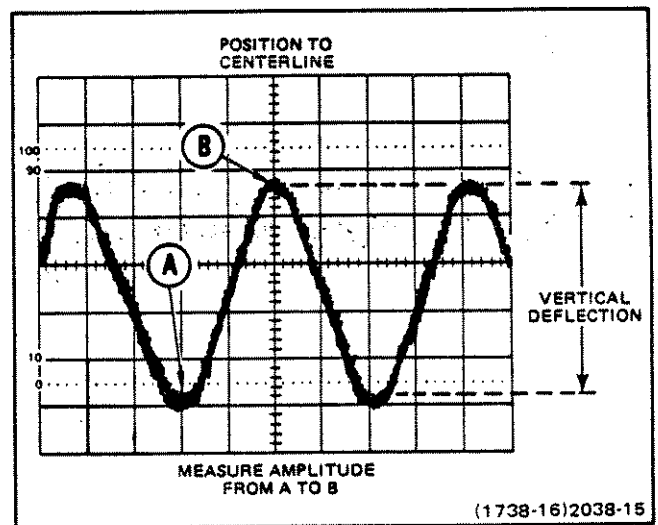

Figure 14. Peak-to-peak waveform voltage.

NOTE

If the amplitude measurement is critical or if the trace is thick as a result of hum and/or noise on the signal, a more accurate measurement can be obtained by measuring from the top of a peak to the top of a valley. This will eliminate trace thickness from the measurement.

5. Calculate the peak-to-peak voltage, using the following formula:

$$\begin{array}{rcl} \text{Volts} & & \text{VOLTS/DIV} \\ \text{(p-p)} & = & \text{deflection} \times \text{switch} \\ & & \text{factor} \quad \quad \text{setting} \end{array}$$

Also include the attenuation factor of the probe being used, if it is not a 10X scale-factor-switching probe.

EXAMPLE: The measured peak-to-peak vertical deflection is 4.6 divisions (see Figure 14) with a VOLTS/DIV switch setting of 0.5, using a 10X scale-factor-switching probe.

Substituting the given values:

$$\text{Volts (p-p)} = 4.6 \text{ divisions} \times 0.5 \text{ V/divisions} = 2.3 \text{ volts}$$

INSTANTANEOUS DC VOLTAGE

NOTE

Either channel input connector may be used for the signal input. Use the VERT MODE switch to select the appropriate channel for display.

1. Obtain a Normal Sweep Display (refer to Basic Oscilloscope Displays section of this manual). Make sure the VAR VOLTS/DIV control is in the calibrated detent.
2. Determine the polarity of the voltage to be measured as follows:
 - a. Set the AC-GND-DC switch to GND and vertically position the baseline to the center graticule line of the crt.
 - b. Set the AC-GND-DC switch to DC. If the waveform moves above the center line of the crt, the voltage is positive. If the waveform moves below the center line of the crt, the voltage is negative.
3. Set the AC-GND-DC switch to GND and position the baseline to a convenient reference line. For example, if the voltage to be measured is positive, then position

the baseline to the bottom graticule line. If a negative voltage is to be measured, position the baseline to the top graticule line.

4. Switch the AC-GND-DC switch to DC. Measure the divisions of vertical deflection between the reference line and the desired point on the waveform (see Figure 15).

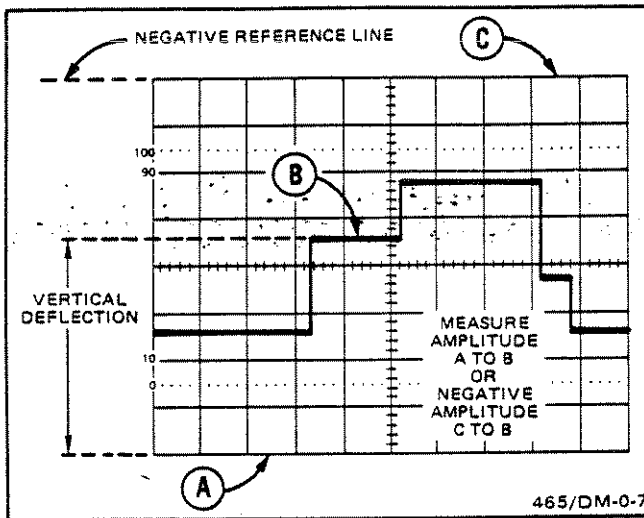

Figure 15. Instantaneous voltage measurement.

5. Calculate instantaneous voltage, using the following formula:

$$\text{Instantaneous Voltage} = \text{vertical distance (divisions)} \times \text{polarity (+ or -)} \times \text{VOLTS/DIV switch setting}$$

Also include the attenuation factor of the probe being used, if it is not a 10X scale-factor-switching probe.

EXAMPLE: The vertical distance measured is 4.6 divisions (see Figure 15). The waveform is above the reference line, and the VOLTS/DIV switch is set to 2.

Substituting the given values:

$$\text{Instantaneous Voltage} = 4.6 \times (+1) \times 2 \text{ V} = +9.2 \text{ volts.}$$

ALGEBRAIC ADDITION

With the VERT MODE switch in the ADD position, the waveform displayed is the algebraic sum of the signals applied to the Channel 1 and Channel 2 inputs (CH 1 + CH 2). If the Channel 2 INVERT switch is depressed, the waveform displayed is the difference of the signals applied to the Channel 1 and Channel 2 inputs (CH 1 - CH 2). The

total deflection factor in the ADD mode is equal to the deflection factor indicated by either VOLTS/DIV switch (when both VOLTS/DIV switches are set to the same position factor). A common use for the ADD mode is to provide a dc offset for a signal riding on a dc level.

2. Do not apply signals that exceed the equivalent of about eight times the VOLTS/DIV switch settings, since large voltages may distort the display. For example, with a VOLTS/DIV switch setting of 0.5, the voltage applied to that channel should not exceed about four volts.

The following general precautions should be observed when using the ADD mode:

1. Do not exceed the input voltage rating of the oscilloscope.

EXAMPLE: Using the graticule center line as zero volts, the Channel 1 signal is on a three-division, positive dc level (see Figure 16A).

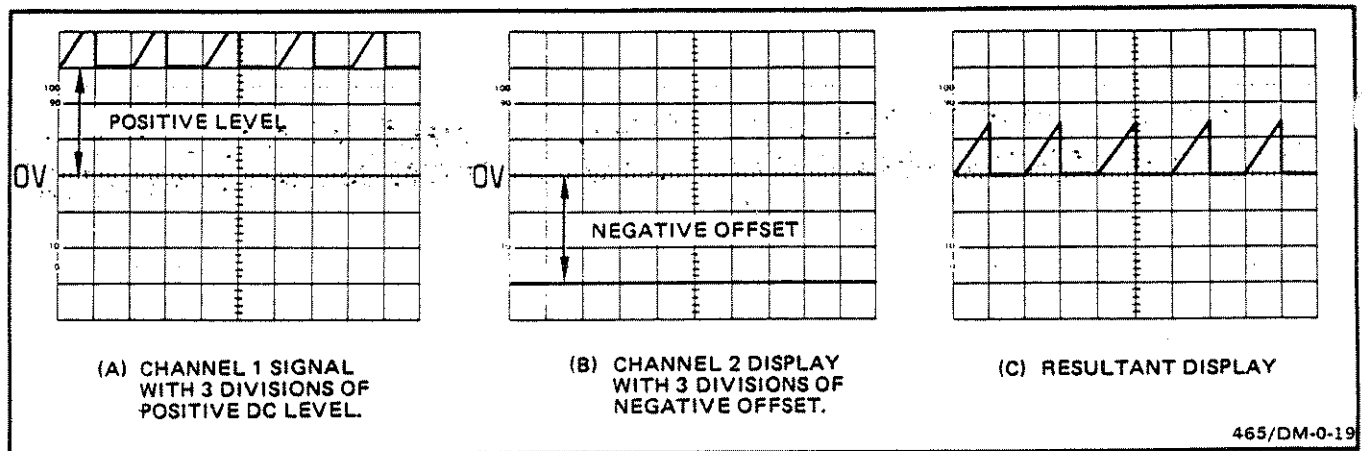

Figure 16. Algebraic addition.

1. Multiply 3 divisions by the VOLTS/DIV switch setting to determine the dc-level value.
2. To the Channel 2 input apply a negative dc level (or a positive level, using the Channel 2 INVERT switch) of the value determined (see Figure 16B).
3. Depress the ADD push button to put the resultant display within the operating range of the POSITION controls (see Figure 16C).
4. Release the CH 1 and CH 2 push buttons to eliminate possible confusion, if you wish to view the ADD display only.

COMMON-MODE REJECTION

The ADD mode can also be used to display signals that contain undesirable components. These undesirable components can be eliminated through common-mode rejection. The precautions given under the preceding Algebraic Addition should be observed.

EXAMPLE: The signal applied to the Channel 1 input contains unwanted line frequency components (see Figure 17A). To remove the undesired components use the following procedure:

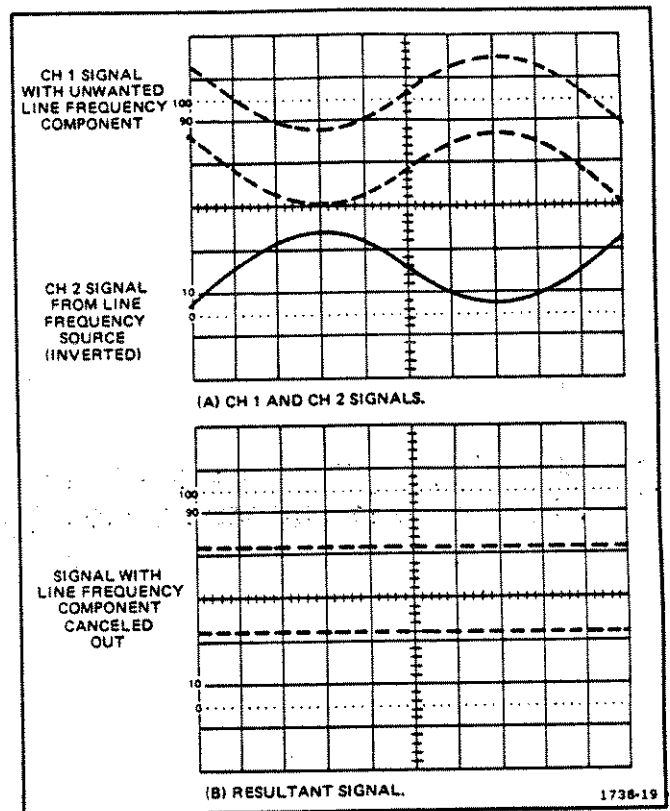

Figure 17. Common-mode rejection.

1. Connect a line frequency signal to the Channel 2 input.
2. Set the VERT MODE ALT switch out and the Channel 2 INVERT switch in. Adjust the Channel 2 VOLTS/DIV and VAR controls so that the Channel 2 display is about the same amplitude as the undesired portion of the Channel 1 display (see Figure 17A).
3. Depress the ADD push button. Slightly readjust the Channel 2 VAR VOLTS/DIV control for maximum cancellation of the undesired signal component (see Figure 17B).

AMPLITUDE COMPARISON

Repetitious amplitude comparisons of unknown signals with a reference signal (e.g., on an assembly line test) may be easily and accurately made using the 465B. To accomplish this, a reference signal of known amplitude is first set to an exact number of vertical divisions by adjusting the VOLTS/DIV and the VAR VOLTS/DIV controls. Unknown signals can then be quickly and accurately compared with the reference signal without disturbing the setting of the VAR VOLTS/DIV control. The procedure is as follows:

1. Set the amplitude of the reference signal to an exact number of vertical divisions by adjusting the VOLTS/DIV and VAR VOLTS/DIV controls.

2. Establish a vertical conversion factor, using the following formula (reference signal amplitude must be known):

$$\text{Vertical Conversion Factor} = \frac{\text{reference signal amplitude (volts)}}{\text{vertical deflection (divisions)} \times \text{VOLTS/DIV switch setting}}$$

3. For the unknown signal, adjust the VOLTS/DIV switch to a setting that provides sufficient vertical deflection to make an accurate measurement. Do not readjust the VAR VOLTS/DIV control.

4. Establish an arbitrary deflection factor, using the following formula:

$$\text{Arbitrary Deflection Factor} = \text{Vertical Conversion Factor} \times \text{VOLTS/DIV switch setting}$$

5. Measure the vertical deflection of the unknown signal in divisions and calculate its amplitude using the following formula:

$$\text{Unknown Signal Amplitude} = \text{Arbitrary Deflection Factor} \times \text{Vertical Deflection (divisions)}$$

EXAMPLE: The reference signal amplitude is 30 volts, with a VOLTS/DIV switch setting of 5 and the VAR VOLTS/DIV control adjusted to provide a vertical deflection of exactly four divisions.

Substituting these values in the vertical conversion factor formula:

$$\text{Vertical Conversion Factor} = \frac{30 \text{ volts}}{4 \text{ divisions} \times 5 \text{ volts/division}} = 1.5$$

For the unknown signal, the VOLTS/DIV switch setting is 1, and the peak-to-peak amplitude spans five vertical divisions. The arbitrary deflection factor is then determined by substituting values in the formula:

$$\text{Arbitrary Deflection Factor} = 1.5 \times 1 \text{ volt/division} = 1.5 \text{ volts/division}$$

The amplitude of the unknown signal can then be determined by substituting values in the unknown signal amplitude formula:

$$\text{Amplitude} = 1.5 \text{ volts/division} \times 5 \text{ divisions} = 7.5 \text{ volts.}$$

TIME DURATION

1. Obtain a Normal Sweep Display (ensure that the VAR TIME/DIV control is set to the calibrated detent).
2. Set the TIME/DIV switch for a single event and position the display to place the time-measurement points on the center horizontal graticule line (see Figure 18).

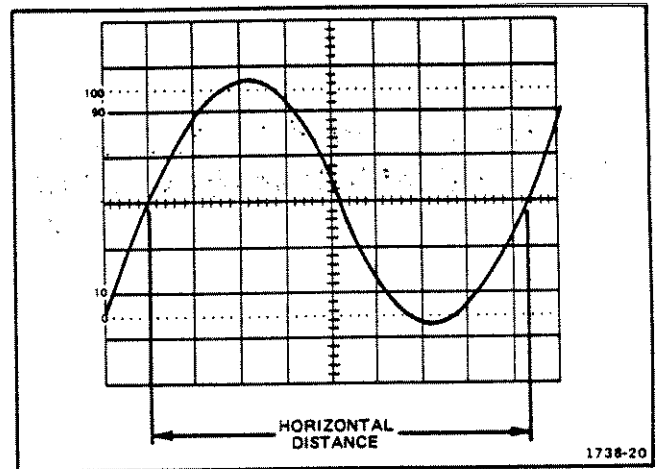

Figure 18. Time duration.

3. Measure the horizontal distance between the time-measurement points.

4. Calculate time duration, using the following formula:

$$\text{Time Duration} = \frac{\text{horizontal distance (divisions)} \times \text{TIME/DIV switch setting}}{\text{magnification}}$$

EXAMPLE: The distance between the time-measurement points is 8.3 divisions (see Figure 18), and the TIME/DIV switch is set to 2 ms. No magnification is used.

Substitute the given values:

$$\text{Time Duration} = 8.3 \text{ div} \times 2 \text{ ms/div} = 16.6 \text{ ms}$$

FREQUENCY

The frequency of a recurrent signal can be determined from its time duration measurement as follows:

1. Measure the time duration of one waveform cycle using the preceding Time Duration measurement procedure.

2. Calculate the reciprocal of the time duration value to determine the frequency of the waveform.

EXAMPLE: The signal shown in Figure 18 has a time duration of 16.6 milliseconds.

Calculating the reciprocal of time duration:

$$\text{Frequency} = \frac{1}{\text{time duration}} = \frac{1}{16.6 \text{ ms}} = 60 \text{ Hz}$$

RISE TIME

Rise time measurements use the same methods as time duration, except that the measurements are made between the 10% and 90% points on the leading edge of the waveform (see Figure 19). Fall time is measured between the 90% and 10% points on the trailing edge of the waveform.

1. Obtain a Normal Sweep Display (refer to Basic Oscilloscope Displays section of this manual).
2. Set A TRIGGER SLOPE control to +. Use a sweep speed setting that displays several cycles or events (if possible) and ensure that the VAR TIME/DIV control is in the calibrated detent.
3. Set the VOLTS/DIV switch and VAR control (or signal amplitude) for an exact five-division display.
4. Set vertical positioning so that the zero reference of the waveform touches the 0% graticule line and the top-of-the-waveform touches the 100% graticule line.
5. Set the TIME/DIV switch for a single-event display, with the rise time spread horizontally as much as possible.
6. Horizontally position the display so the 10% point on the waveform intersects the second vertical graticule line (see Figure 19).

7. Measure the horizontal distance between the 10% and 90% points and calculate the time duration using the following formula:

$$\text{Time Duration (rise time)} = \frac{\text{horizontal distance (divisions)} \times \text{TIME/DIV switch setting}}{\text{magnification}}$$

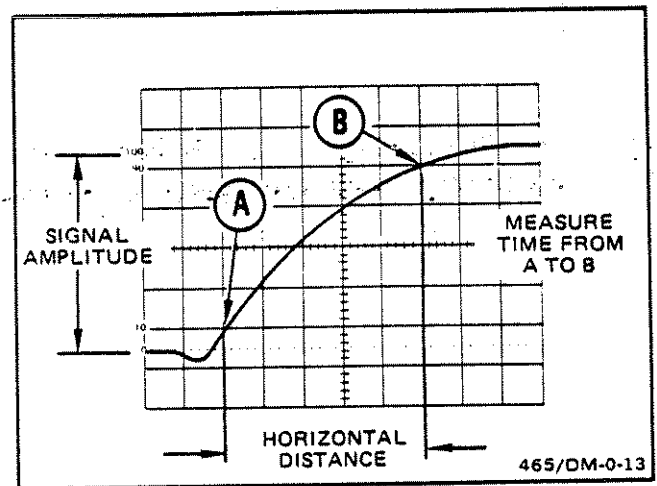

Figure 19. Rise time.

EXAMPLE: The horizontal distance between the 10% and 90% points is 5 divisions (see Figure 19) and the TIME/DIV switch is set to 1 μ s. No magnification is used.

Substituting the given values:

$$\text{Rise time} = \frac{5 \text{ divisions} \times 1 \mu\text{s/division}}{1} = 5 \mu\text{s}$$

TIME DIFFERENCE BETWEEN TWO TIME-RELATED PULSES

1. Obtain a Normal Sweep Display (refer to Basic Oscilloscope Displays section of this manual). Ensure that the VAR TIME/DIV control is in the calibrated detent.
2. Set the A TRIGGER SOURCE switch to CH 1.
3. Using probes or cables with equal time delays connect the reference signal to Channel 1 and the comparison signal to Channel 2 inputs.
4. Depress the CH 1 and CH 2 VERT MODE push buttons. Use either CHOP (in) or ALT (out) VERT MODE switch depending on the frequency of input signals. In general, CHOP is more suitable for low-

frequency signals and ALT is best for high-frequency signals. Center each of the displays vertically (see Figure 20).

NOTE

Input signals must be time related for a stable (measurable) display.

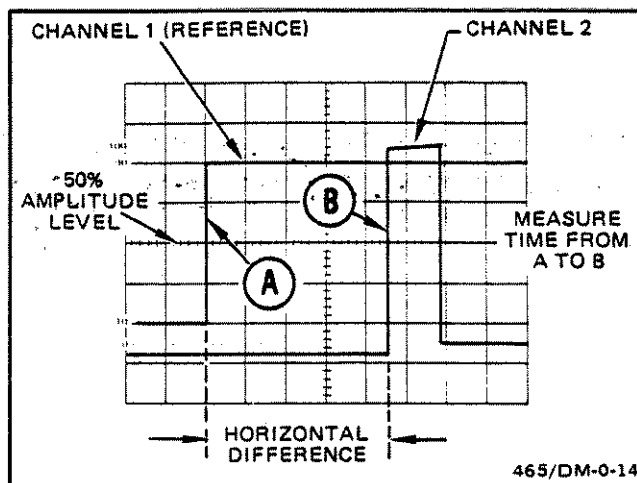

Figure 20. Time difference between two time-related pulses.

5. Measure the horizontal difference between the two signals and calculate the time difference using the following formula:

$$\text{Time Difference} = \frac{\text{TIME/DIV switch setting} \times \text{horizontal difference (divisions)}}{\text{magnification}}$$

EXAMPLE: The TIME/DIV switch is set to 50 μs , the MAG switch to X10, and the horizontal difference between waveforms is 4.5 divisions (see Figure 20).

Substituting the given values:

$$\text{Time Difference} = \frac{50 \mu\text{s/division} \times 4.5 \text{ divisions}}{10} = 22.5 \mu\text{s}$$

TIME COMPARISON

Repetitious time comparisons of unknown signals with a reference signal (e.g., on assembly line test) may be easily and accurately made using the 465B. To accomplish this a reference signal of known time duration is first set to an exact number of horizontal divisions by adjusting the TIME/DIV and the VAR TIME/DIV controls. Unknown

signals can then be quickly and accurately compared with the reference signal without disturbing the setting of the VAR TIME/DIV control. The procedure is as follows:

1. Set the time duration of the reference signal to an exact number of horizontal divisions by adjusting the TIME/DIV and VAR TIME/DIV controls.
2. Establish a horizontal conversion factor, using the following formula (reference signal time duration must be known):

$$\text{Horizontal Conversion Factor} = \frac{\text{reference signal time duration (seconds)}}{\text{horizontal deflection (divisions)} \times \text{TIME/DIV switch setting}}$$

3. For the unknown signal, adjust the TIME/DIV switch to a setting that provides sufficient horizontal deflection to make an accurate measurement. Do not readjust the VAR TIME/DIV control.
4. Establish an arbitrary deflection factor, using the following formula:

$$\text{Arbitrary Deflection Factor} = \frac{\text{Horizontal Conversion Factor} \times \text{TIME/DIV switch setting}}$$

5. Measure the horizontal deflection of the unknown signal in divisions and calculate its time duration using the following formula:

$$\text{Time Duration} = \frac{\text{Arbitrary Deflection Factor}}{\text{horizontal deflection (divisions)}} \times$$

6. Frequency of the unknown signal can then be determined by calculating the reciprocal of its time duration.

EXAMPLE: The reference signal time duration is 2.19 milliseconds (2.19×10^{-3} seconds), with a TIME/DIV switch setting of 0.2 ms and the VAR TIME/DIV control adjusted to provide a horizontal deflection of exactly eight divisions.

Substituting these values in the horizontal conversion factor formula:

$$\text{Horizontal Conversion Factor} = \frac{2.19 \text{ ms}}{8 \text{ divisions} \times 0.2 \text{ ms/divisions}} = 1.37$$

For the unknown signal, the TIME/DIV switch setting is $50 \mu\text{s}$, and one complete cycle spans seven horizontal divisions. The arbitrary deflection factor is then determined by substituting values in the formula:

$$\text{Arbitrary Deflection Factor} = 1.37 \times 50 \mu\text{s/division} = 68.5 \mu\text{s/division}$$

The time duration of the unknown signal can then be computed by substituting values in the formula:

$$\text{Time Duration} = 68.5 \mu\text{s/division} \times 7 \text{ divisions} = 480 \mu\text{s}$$

The frequency of the unknown signal is then calculated:

$$\text{Frequency} = \frac{1}{480 \mu\text{s}} = 2.083 \text{ kHz}$$

PHASE DIFFERENCE

1. Obtain a Normal Sweep Display (refer to Basic Oscilloscope Displays section of this manual).
2. Using probes or coaxial cables with equal time delays, connect a known reference signal to one channel input and the unknown signal to the other channel input.
3. Depress the CH 1 and CH 2 VERT MODE push buttons. Use either CHOP (in) or ALT (out) VERT MODE switch depending on the input frequencies. In general, ALT is best for high-frequency signals and

CHOP is more suitable for low-frequency signals. The reference signal should precede the comparison signal in time.

4. If the signals are of opposite polarity, set the INVERT switch to invert the Channel 2 display.

5. Set the CH 1 and CH 2 VOLTS/DIV switches and the CH 1 and CH 2 VAR controls to produce displays that are equal in amplitude.

6. Use vertical position controls to vertically center both signals around the center horizontal graticule line.

7. Set the TIME/DIV switch to show about one cycle of the waveform. Position the display and adjust the VAR TIME/DIV control to place one reference signal cycle in exactly eight divisions at the 50% risetime points (see Figure 21). Each division of the graticule now represents 45° of the cycle ($360^\circ \div 8$ divisions) and the sweep rate can be stated as $45^\circ/\text{division}$.

8. Measure the horizontal difference between corresponding points on the waveforms at a common horizontal graticule line (at 50% of risetime) and calculate the phase difference using the following formula:

$$\text{Phase Difference (degrees)} = \frac{\text{horizontal difference (divisions)}}{\text{sweep rate (degrees/div)}}$$

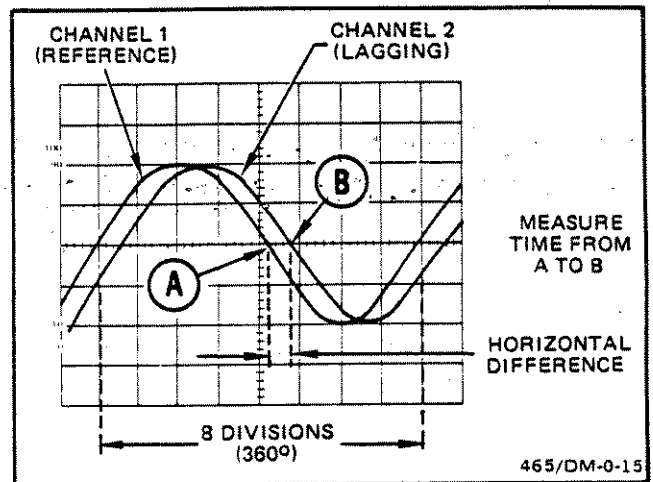

Figure 21. Phase difference.

EXAMPLE: The horizontal difference is 0.6 division with a sweep rate of $45^\circ/\text{division}$ as shown in Figure 21.

Substituting the given values:

$$\text{Phase Difference} = 0.6 \text{ divisions} \times 45^\circ/\text{division} = 27^\circ$$

Substituting the given values:

$$\text{Phase Difference} = 6 \text{ divisions} \times 4.5^\circ/\text{division} = 27^\circ$$

HIGH RESOLUTION PHASE DIFFERENCE

More accurate phase measurements can be made by using the X10 MAG mode to increase the sweep rate without changing the VAR TIME/DIV control (see Figure 22).

EXAMPLE: If the sweep rate were increased 10 times with the magnifier (X10 MAG), the magnified sweep rate would be $45 \div 10 = 4.5^\circ/\text{division}$. Figure 22 shows the same signals used in Figure 21, but the X10 MAG push button is depressed, resulting in a horizontal difference of 6 divisions. The phase difference is:

$$\text{Phase Difference} = \text{horizontal difference (divisions)} \times \text{magnified sweep rate (degrees/div)}$$

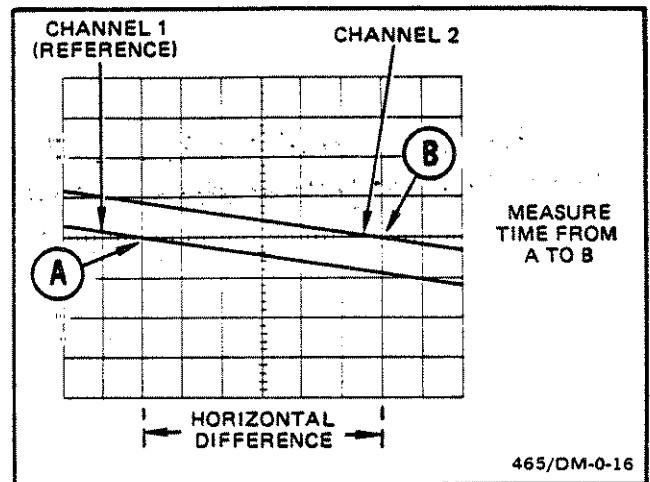

Figure 22. High resolution phase difference.

PULSE JITTER

Pulse jitter is displayed as the slight horizontal movement of a pulse and includes the inherent jitter of the delayed sweep.

1. Obtain a Normal Sweep Display (refer to Basic Oscilloscope Displays section of this manual). Ensure that the VAR TIME/DIV switch is in the calibrated detent.
2. Set the B TIME/DIV switch to intensify the full rising portion of the pulse.
3. Set the HORIZ DISPLAY switch to B DLY'D.
4. Referring to Figure 23, measure the distance between Point A and Point B in divisions and calculate the pulse jitter time using the following formula:

$$\text{Pulse Jitter Time} = \frac{\text{horizontal difference (divisions)}}{\text{B TIME/DIV switch setting}}$$

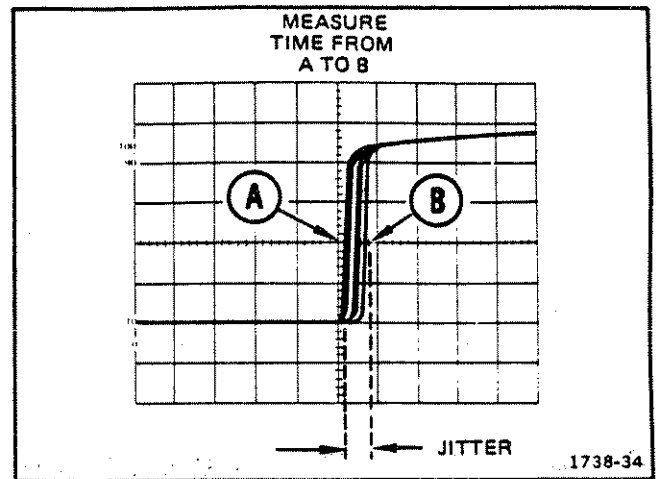

Figure 23. Pulse jitter.

DELAYED SWEEP MAGNIFICATION USING ALT SWEEP DISPLAY

The delayed sweep features of the 465B can be used to provide higher apparent magnification than is provided by

the X10 MAG switch. The sweep rate of the delayed sweep (B Sweep) is not actually increased. The apparent magnification is the result of delaying the B Sweep an amount of time determined by both the A TIME/DIV switch and the DELAY TIME POSITION control before the display is presented at the sweep rate selected by the B TIME/DIV switch. The following method uses the STARTS AFTER DELAY position of the B (DLY'D) TRIGGER SOURCE switch to allow the delayed portion to be positioned with the DELAY TIME POSITION control. If too much jitter occurs in the delayed display, use the Triggered Delay Sweep Magnification procedure, which follows the Magnified Sweep Starts After Delay procedure.

Magnified Sweep Starts After Delay

1. Obtain a Normal Sweep Display (refer to Basic Oscilloscope Displays section of this manual).
2. Set the appropriate VOLTS/DIV switch to produce a display about two divisions in amplitude.

3. Set the A TIME/DIV switch to a sweep rate which displays several waveform cycles.
4. Depress the HORIZ DISPLAY ALT push button and set the B (DLY'D) TRIGGER SOURCE switch to STARTS AFTER DELAY. If the instrument is equipped with a DM44, verify that neither the TIME nor 1/TIME FUNCTION switch is set.
5. Adjust channel POSITION control and TRACE SEP to display A and B Sweeps, one above the other.
6. Position the start of the intensified zone with the DELAY TIME POSITION control to the part of the display to be magnified.
7. Set the B TIME/DIV switch to a setting which intensifies the full portion to be magnified and displays that portion as the B Sweep (see Figure 24). The B INTENSITY control may require adjustment to display the B Sweep (magnified portion).

8. Time measurement can be made from the B Sweep display in the conventional manner. The sweep rate is determined by the setting of the B TIME/DIV switch. The B DLY'D switch of the HORIZ DISPLAY may be used, as well as the ALT switch, for time measurements.

9. The apparent sweep magnification can be calculated from the following formula:

$$\text{Apparent Delayed Sweep Magnification} = \frac{\text{A TIME/DIV switch setting}}{\text{B TIME/DIV switch setting}}$$

EXAMPLE: The apparent magnification of a display with an A TIME/DIV switch setting of 0.1 ms and a B TIME/DIV switch setting of 1 μs.

Substituting the given values:

$$\text{Apparent Magnification} = \frac{1 \times 10^{-4}}{1 \times 10^{-6}} = 100 \text{ times}$$

Triggered Delay Sweep Magnification

The delayed sweep magnification method just described may produce excessive jitter at high apparent magnification

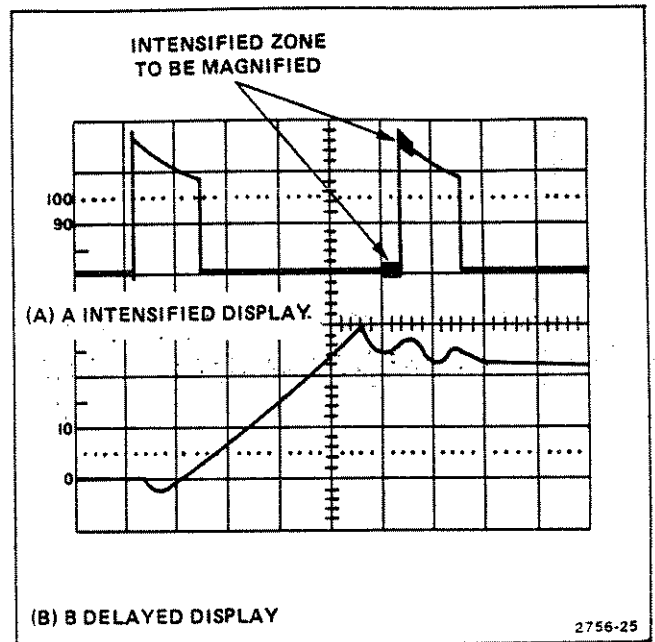

Figure 24. Delayed sweep magnification.

ranges. Operating the B Sweep in a triggered mode provides a more stable display, since the delayed display is triggered at the same point each time.

1. Perform steps 1 through 6 of the preceding Magnified Sweep Starts After Delay procedure.
2. Set the B (DLY'D) TRIGGER SOURCE switch to the same position as the A TRIGGER SOURCE switch.
3. Adjust the B LEVEL control so the intensified zone on the trace is stable. (If an intensified zone cannot be obtained, see step 4).
4. Inability to intensify the desired portion indicates that the signal does not meet the triggering requirements. If the condition cannot be remedied with the B Sweep triggering controls or by increasing the display amplitude, you should lower the VOLTS/DIV setting, set B (DLY'D) TRIGGER SOURCE switch to EXT, and trigger the B Sweep externally.
5. Measurements are made and magnification factors are calculated in the same manner described in the Magnified Sweep Starts After Delay procedure.

BASIC 465B DELAYED SWEEP TIME MEASUREMENTS

Operating the 465B oscilloscope in ALT HORIZ DISPLAY or in A INTEN HORIZ DISPLAY will permit time measurements to be made with a greater degree of accuracy than attained with A HORIZ DISPLAY.

Time Duration (Basic 465B)

1. Obtain a Normal Sweep Display (refer to Basic Oscilloscope Displays section of this manual). Ensure that the VAR TIME/DIV switch is in the calibrated detent. Depress either the ALT HORIZ DISPLAY push button or the A INTEN HORIZ DISPLAY push button.
2. For the most accurate measurement, set the B TIME/DIV switch to the fastest sweep that provides a usable (visible) intensified zone. Vertically position the A Sweep display to place the time measurement points on the center horizontal graticule line (see Figure 25).

3. Use the DELAY TIME POSITION control to move the start of the intensified zone so that it just touches the intersection of the signal and the center horizontal graticule line (see Figure 25, Point A).

4. Record the DELAY TIME POSITION control dial setting.

5. Use the DELAY TIME POSITION control to move the start of the intensified zone to the second time measurement point (see Figure 25, Point B).

6. Record the DELAY TIME POSITION control dial setting.

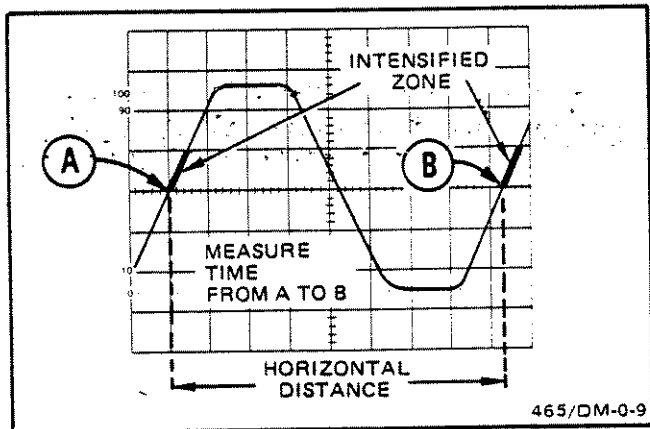

Figure 25. Time duration.

7. Determine time difference using the following formula:

$$\text{Time Difference (or Duration)} = \left[\begin{array}{c} \text{second} \\ \text{dial} \\ \text{setting} \end{array} - \begin{array}{c} \text{first} \\ \text{dial} \\ \text{setting} \end{array} \right] \left[\begin{array}{c} \text{A TIME/DIV} \\ \text{switch} \\ \text{setting} \end{array} \right]$$

EXAMPLE: The DELAY TIME POSITION dial setting at Point A is 1.20 and the DELAY TIME POSITION dial setting at Point B is 9.53 with A TIME/DIV switch set to 2 ms (see Figure 25).

Substituting the given values:

$$\begin{aligned} \text{Time Duration} &= (9.53 - 1.20) (2) = 8.33 \times 2 \\ &= 16.66 \text{ ms} \end{aligned}$$

Frequency (Basic 465B)

The frequency of a recurrent signal is determined by computing the reciprocal of the time duration of one event.

EXAMPLE: The time duration of one event (Point A to Point B, Figure 25) is 16.66 milliseconds.

Using the formula and substituting the given value:

$$\text{Frequency} = \frac{1}{\text{time duration}} = \frac{1}{16.66 \text{ ms}} = 60 \text{ Hz}$$

Rise Time (Basic 465B)

Rise time measurements use the same methods as time duration, except that the measurements are made between the 10% and 90% points on the leading edge of the waveform. Fall time is measured between the 90% and 10% points on the trailing edge of the waveform.

1. Obtain a Normal Sweep Display (refer to Basic Oscilloscope Displays section of this manual). Use a sweep speed setting that displays several cycles or events if possible and ensure that the VAR TIME/DIV control is in the calibrated detent.

2. Set the VOLTS/DIV switch and VAR control (or signal amplitude) for an exact five-division display on either Channel 1 or Channel 2.

3. Vertically position the trace so that the zero reference of the waveform touches the 0% graticule line and the top of the waveform touches the 100% graticule line (see Figure 26).

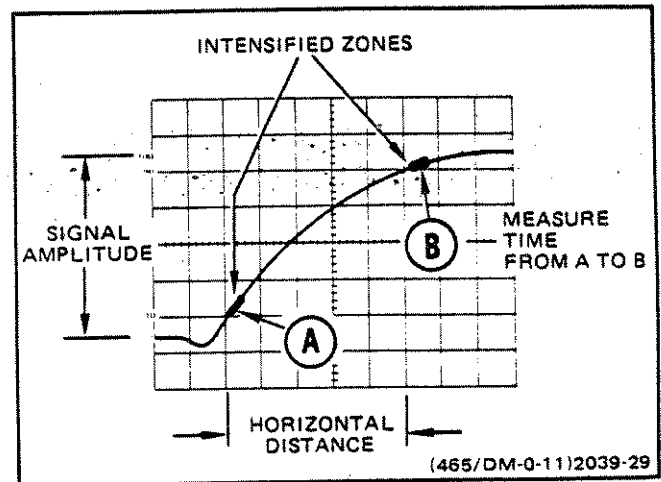

Figure 26. Rise time.

4. Set the A TIME/DIV switch for a single-event display, with the rise time spread horizontally as much as possible. Horizontally position the display so the 10% point of the waveform intersects the third vertical graticule line (see Figure 26).

5. Depress either the A INTEN HORIZ DISPLAY push button or the ALT HORIZ DISPLAY push button. Set the B (DLY'D) TRIGGER SOURCE switch to STARTS AFTER DELAY. Set the B TIME/DIV switch to the fastest sweep speed that provides a usable (visible) intensified zone.

6. Use the DELAY TIME POSITION control to move the start of intensified zone (left-hand edge) until it just touches the intersection of the signal and the 10% graticule line (see Figure 26, Point A).

7. Record the DELAY TIME POSITION dial setting.

8. Use the DELAY TIME POSITION control to move the start of the intensified zone until it just touches the intersection of the signal and the 90% graticule line (see Figure 26, Point B).

9. Record the DELAY TIME POSITION dial setting.

10. Determine time difference using the following formula:

$$\text{Time Difference} = \text{Rise Time} = \left[\begin{array}{c} \text{second} \\ \text{dial} \\ \text{setting} \end{array} - \begin{array}{c} \text{first} \\ \text{dial} \\ \text{setting} \end{array} \right] \left[\begin{array}{c} \text{A TIME/DIV} \\ \text{switch} \\ \text{setting} \end{array} \right]$$

EXAMPLE: The A TIME/DIV switch is set to $1 \mu\text{s}$. The DELAY TIME POSITION dial setting at Point A is 2.50 and the DELAY TIME POSITION dial setting at Point B is 7.50 (see Figure 26).

Substituting the given values:

$$\text{Rise Time} = (7.50 - 2.50) (1) = 5 \mu\text{s}$$

Time Difference Between Repetitive Pulses (Basic 465B)

1. Obtain a Normal Sweep Display (refer to Basic Oscilloscope Displays section of this manual).

2. Depress the ALT HORIZ DISPLAY push button and set the B (DLY'D) TRIGGER SOURCE switch to

STARTS AFTER DELAY. For the most accurate measurement, set the B TIME/DIV switch to the fastest sweep that provides usable (visible) intensified zones. Use the DELAY TIME POSITION control to move the intensified zone to the first pulse (see Figure 27, A Sweep Display).

3. Observe the B Sweep display and adjust the DELAY TIME POSITION control to move the rising portion of the pulse to a vertical reference line (see Figure 27, B Sweep Display).
4. Record the setting of the DELAY TIME POSITION control dial.
5. Turn the DELAY TIME POSITION control clockwise to move the rising portion of the second pulse to the same vertical reference line. Observe the A Sweep display to position the intensified zone to the correct pulse. Do not change the settings of the horizontal POSITION controls.
6. Record the setting of the DELAY TIME POSITION dial.
7. Determine time difference using the following formula:

$$\text{Time Difference} = \left[\begin{array}{cc} \text{second} & \text{first} \\ \text{dial} & \text{dial} \\ \text{setting} & \text{setting} \end{array} \right] \left[\begin{array}{c} \text{A TIME/DIV} \\ \text{switch} \\ \text{setting} \end{array} \right]$$

EXAMPLE: The first dial setting is 1.31 and the second dial setting is 8.81 with the A TIME/DIV switch set to $0.2 \mu\text{s}$ (see Figure 27).

Substituting the given values:

$$\text{Time Difference} = (8.81 - 1.31) (0.2) = 1.5 \mu\text{s}$$

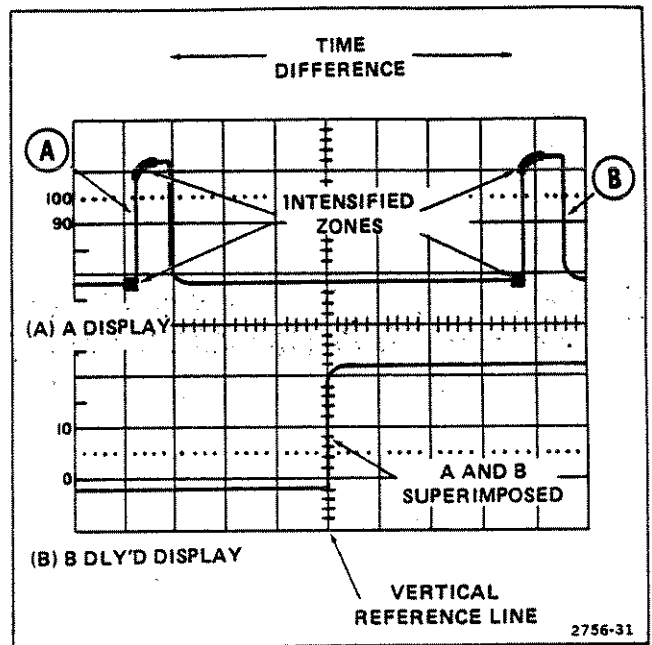

Figure 27. Time difference between repetitive pulses.

Time Difference Between Two Time-Related Pulses (Basic 465B)

1. Obtain a Normal Sweep Display (refer to Basic Oscilloscope Displays section of this manual). Ensure that the VAR TIME/DIV control is in the calibrated detent.
2. Set the A TRIGGER SOURCE switch to CH 1.
3. Using probes or cables having equal time delays, connect the reference signal to Channel 1 and the comparison signal to Channel 2 inputs.
4. Depress the CH 1 and CH 2 VERT MODE push buttons. Use either CHOP (in) or ALT (out) VERT MODE switch, depending on the frequency of the input signals. In general, CHOP is more suitable for low-frequency signals, and ALT is best for high-frequency signals. Center each of the displays vertically.
5. Depress the HORIZ DISPLAY A INTEN push button and set the B (DLY'D) TRIGGER SOURCE switch to STARTS AFTER DELAY. Set the B TIME/DIV switch 20 times faster than the A TIME/DIV switch (when possible) to obtain the smallest usable intensified zone. Observe intensified zones on the

display (see Figure 28). Point A and Point B also relate to intensified zones on Figure 29.

6. Depress the ALT HORIZ DISPLAY push button and release the CH 2 VERT MODE push button. Adjust Channel 1 POSITION and TRACE SEP so that A Sweep and B Sweep are displayed one above the other. Use the DELAY TIME POSITION control to move the intensified zone to the rising edge of a

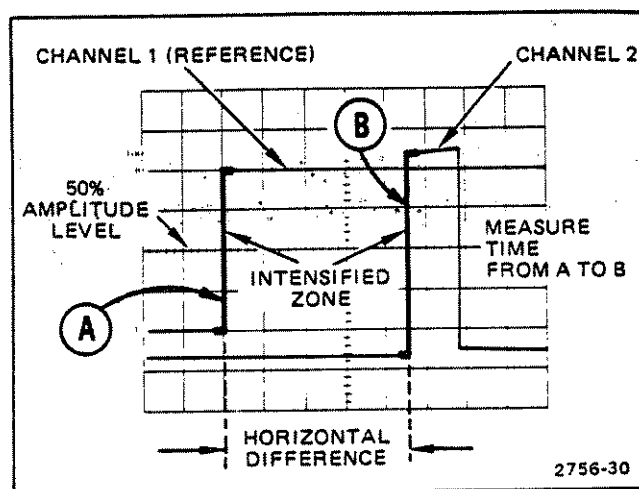

Figure 28. Time difference between two time-related pulses.

pulse and adjust until the rising portion is centered at some vertical graticule line (see Figure 29, Point A).

7. Record the DELAY TIME POSITION control dial setting.
8. Press CH 2 VERT MODE push button and release CH 1 push button. Adjust Channel 2 POSITION and

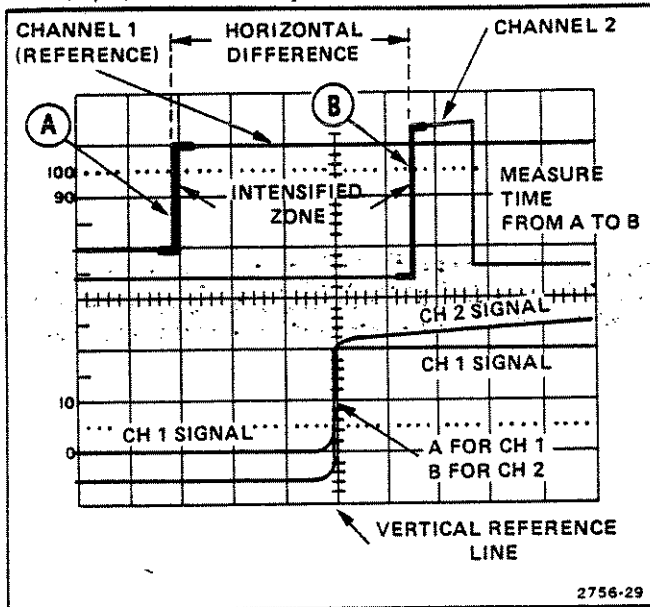

Figure 29. Time difference between two time-related pulses, delayed sweep display.

TRACE SEP controls if necessary. Use the DELAY TIME POSITION control to move the Channel 2 pulse (rising portion) to the same vertical reference line as the Channel 1 pulse (see Figure 29, Point B).

9. Record the DELAY TIME control dial setting.
10. Determine time difference using the following formula:

$$\text{Time Difference} = \left[\begin{array}{cc} \text{second} & \text{first} \\ \text{dial} & \text{dial} \\ \text{setting} & \text{setting} \end{array} \right] \left[\begin{array}{c} \text{A TIME/DIV} \\ \text{switch} \\ \text{setting} \end{array} \right]$$

EXAMPLE: The A TIME/DIV switch is set to 50 μs , and the B TIME/DIV switch is set to 2 μs . The DELAY TIME POSITION dial setting for the Channel 1 pulse is 2.60 and for the Channel 2 pulse is 7.10.

Substituting the given values:

$$\text{Time Difference} = (7.10 - 2.60) (50) = 225 \mu\text{s}$$

DM44 DELAYED SWEEP TIME MEASUREMENTS

Most measurements of time, time duration, frequency, time difference, and rise time are more easily performed using the TIME function of the DM44 and either the ALT HORIZ DISPLAY or A INTEN HORIZ DISPLAY mode of the oscilloscope. Table 6 relates the DM44 functions and oscilloscope operating modes with crt displays obtained.

Table 6
DM44 Delayed Sweep Displays

DM44 FUNCTION	HORIZ DISPLAY	VERT MODE	DISPLAY OBTAINED
VOLTS, OHMS, or TEMP	A INTEN ^a	any one of: CH 1, CH 2, A TRIG VIEW or ADD	One intensified zone. DELAY TIME POSITION control moves intensified zone.
	ALT	CH 1 and CH 2 and either ALT or CHOP	One intensified zone on each of two channel traces. Intensified zones are coincident in time. DELAY TIME POSITION control moves both intensified zones.
		either A TRIG VIEW or ADD	A INTEN Sweep and B Sweep. Position of intensified zone on A Sweep is determined by DELAY TIME POSITION control.
		CH 1 and CH 2 and either ALT or CHOP	Two alternating traces for each channel: A INTEN Sweep and B Sweep. Position of intensified zone on A Sweep is determined by DELAY TIME POSITION control. Position of B Sweep waveform is determined by DELAY TIME POSITION control.

Table 6 (cont)

DM44 FUNCTION	HORIZ DISPLAY	VERT MODE	DISPLAY OBTAINED
TIME or 1/TIME	A INTEN ^b	any one of: CH 1, CH 2 or A TRIG VIEW	Two intensified zones. DELAY TIME POSITION control moves both intensified zones. Δ TIME control moves only one intensified zone.
		CH 1 and CH 2 and CHOP	Two intensified zones on each channel trace. DELAY TIME POSITION control simultaneously moves both intensified zones on both channels. Δ TIME control moves one intensified zone on each trace.
		CH 1 and CH 2 and ALT	One intensified zone on each of two channel traces. DELAY TIME POSITION control moves both intensified zones. The Δ TIME control moves only the intensified zone on the Channel 2 trace.
	ALT	any one of: CH 1, CH 2, A TRIG VIEW or ADD	A INTEN Sweep and B Sweep are displayed. Two intensified zones appear on the A trace. Two B traces appear at the same vertical position (partially or fully superimposed). The DELAY TIME POSITION control moves both A Sweep intensified zones and both B Sweep traces. The Δ TIME control moves one A Sweep intensified zone and one B Sweep trace.

Table 6 (cont)

DM44 FUNCTION	HORIZ DISPLAY	VERT MODE	DISPLAY OBTAINED
TIME or 1/TIME (cont)	ALT (cont)	CH 1 and CH 2 and CHOP	A INTEN traces for both Channel 1 and Channel 2, each with two intensified zones. Two B Sweep traces (partially or fully superimposed) for Channel 1 and two B Sweep traces (partially or fully superimposed) for Channel 2. DELAY TIME POSITION control moves all four A Sweep intensified zones and all four B Sweep traces. The Δ TIME control moves one intensified zone on each A trace and one B Sweep trace for each channel.
		CH 1 and CH 2 and ALT	A INTEN Sweep and B Sweep are displayed for each channel. One intensified zone on each A trace. DELAY TIME POSITION control moves both A Sweep intensified zones and both B traces. The Δ TIME control moves only the Channel 2 intensified zone and B trace.

^aIn the B DLY'D mode, the intensified zones (that are displayed in the A INTEN mode) will be displayed at the B Sweep rate.

^bYour instrument may be modified to make the DELAY TIME POSITION and Δ TIME controls operate independently. The instructions for making this modification are located in the Maintenance section of the DM44 Instruction Manual.

Time Duration Using DM44

Obtain a Delayed Sweep Display, with controls set as follows:

DM44 FUNCTION	TIME
HORIZ DISPLAY	ALT
B (DLY'D) TRIGGER	
SOURCE	STARTS AFTER DELAY
VAR TIME/DIV	Calibrated detent position
A TIME/DIV	Set to display a single event
B TIME/DIV	Three or four positions more clockwise than A TIME/DIV setting
DM44 Δ TIME	To move the time measurement point to the right of the reference point

1. Using the DELAY TIME POSITION control, move the reference point to a convenient horizontal graticule line (see Figure 30, Point A).
2. Using the Δ TIME control, move the time-measurement point along the same horizontal graticule line to the beginning of the next waveform cycle (see Figure 30, Point B).

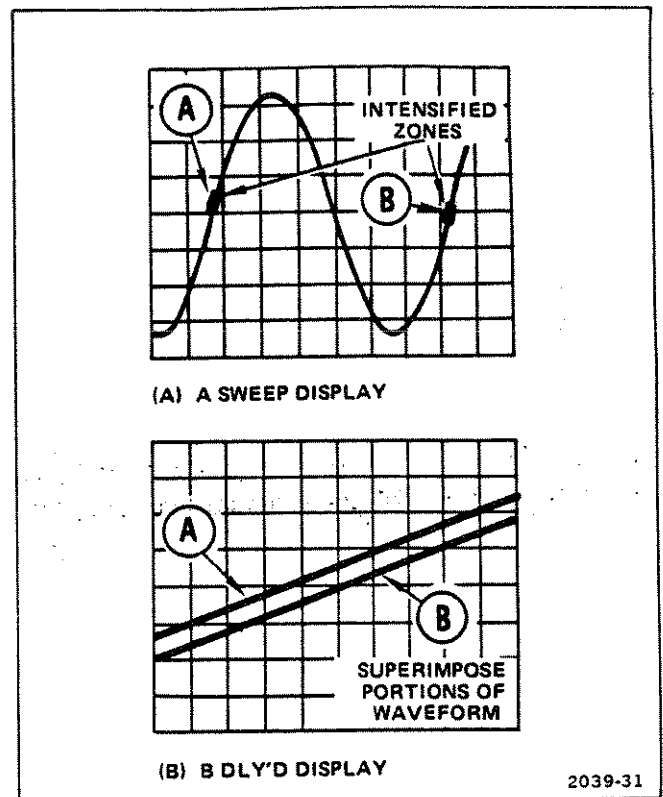

Figure 30. Time duration and frequency.

3. Slightly readjust the Δ TIME control to superimpose the waveforms on the B Sweep display (see Figure 30).

4. Read the time duration (or waveform period) on the DM44 Readout.

Frequency Using DM44

To determine the frequency of a recurring waveform:

1. Measure time duration of the waveform using the preceding measurement procedure.
2. Depress the DM44 1/TIME FUNCTION push button.
3. Read the frequency on the DM44 Readout. Observe the illumination of the 1/ms and 1/ μ s indicators and use the following table to determine frequency units.

1/ms	1/ μ s	Frequency Units
OFF	OFF	Hz
ON	OFF	kHz
OFF	ON	MHz

NOTE

A blinking display indicates an overrange condition. This will occur under the following conditions:

<i>With A TIME/DIV Switch Set To Decade Multiples Of</i>	<i>And Spacing Between Intensified Zones Is Less Than</i>
1	0.25 division
2	0.5 division
5	1.0 division

Rise Time Using DM44

This method is not recommended for extremely fast rise times.

Obtain a Delayed Sweep Display, with controls set as follows:

DM44 FUNCTION
HORIZ DISPLAY
B (DLY'D) TRIGGER
SOURCE
B TIME/DIV

TIME
A INTEN

STARTS AFTER DELAY
Three or four positions more clockwise than A TIME/DIV setting
To move the time measurement point to the right of the reference point

DM44 Δ TIME

1. Set the A TIME/DIV switch to a setting that displays all of the rising edge of the waveform.

2. Adjust the VOLTS/DIV and VAR VOLTS/DIV controls to display signal amplitude of exactly five divisions.

3. Vertically position the trace so that the zero reference of the waveform just touches the 0% graticule line and the top of the waveform touches the 100% graticule line (see Figure 31).

4. Adjust the DELAY TIME POSITION control to move the reference point to the 10% graticule line (see Figure 31, Point A).

5. Adjust the Δ TIME control to move the time measurement point to the 90% graticule line (see Figure 31, Point B).

6. Read the rise time on the DM44 Readout.

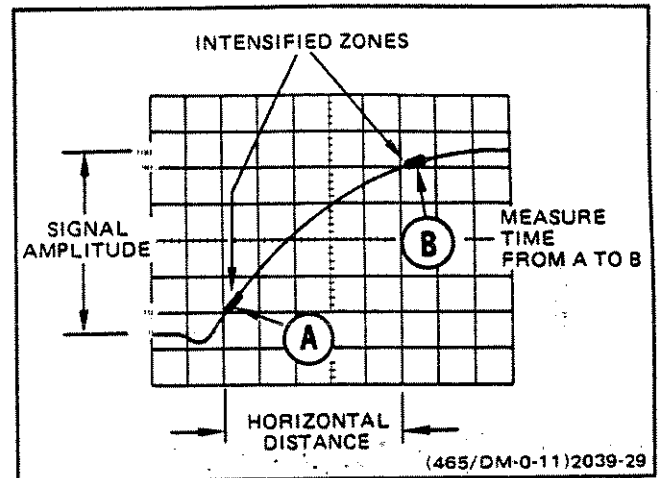

Figure 31. Rise time.

Time Difference Between Repetitive Pulses Using DM44

Obtain a Delayed Sweep Display, with controls set as follows:

DM44 FUNCTION	TIME
HORIZ DISPLAY	ALT
B (DLY'D) TRIGGER SOURCE	STARTS AFTER DELAY

VAR TIME/DIV
A TIME/DIV
B TIME/DIV

DM44 Δ TIME

Calibrated detent position
To display two pulses
Three or four positions
more clockwise than A
TIME/DIV setting

To move the time
measurement point to the
right of the reference
point

4. Using the Δ TIME control and observing movement of the B Sweep waveform, move the time-measurement point to the second pulse (Figure 32, Point B).

1. Position the two traces approximately as shown in Figure 32.
2. Using the DELAY TIME POSITION control, move the reference point to the first pulse (Figure 32, Point A).
3. Observe B Sweep display and center the left waveform leading edge. Both intensified zones will move when the DELAY TIME POSITION control is adjusted.

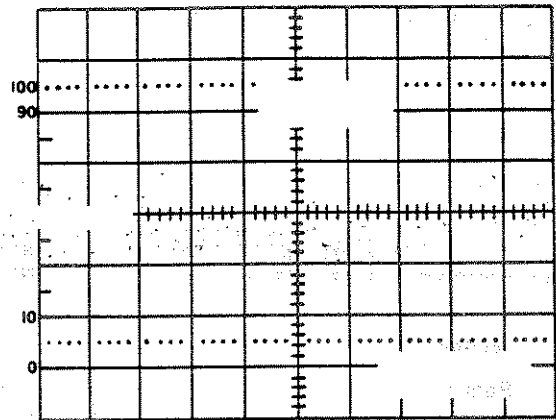

Figure 32. Time difference between repetitive pulses.

SPECIFICATION

The following electrical characteristics (Table 7) are valid only if the instrument has been calibrated at an ambient temperature between +20° C and +30° C, the instrument is operating at an ambient temperature between 0° C and +50° C (unless otherwise noted), and the instrument has had a warmup period of about 20 minutes.

Environmental characteristics of the 465B are presented in Table 8, and physical characteristics listed in Table 9.

Table 7
Electrical Characteristics

Characteristic	Performance Requirements	Supplemental Information
VERTICAL SYSTEM		
Deflection Factor		
Range	5 mV per division to 5 V per division in 10 steps, with a 1-2-5 sequence.	
Uncalibrated (VAR) Range	Continuously variable between settings. Extends deflection factor to at least 12.5 V per division.	
Accuracy	Within 3%.	Gain set at 5 mV per division.

5. Slightly readjust the Δ TIME control to superimpose the B Sweep display waveform.

6. Read the time difference on the DM44 Readout.

7. To determine the pulse repetition rate, depress the DM44 1/TIME FUNCTION push button and read the pulse repetition rate on the Readout.

Time Difference Between Two Time-Related Pulses Using DM44

Obtain a Delayed Sweep Display, with controls set as follows:

DM44 FUNCTION	TIME	STARTS AFTER DELAY
VERT MODE	ALT: out, CH 1, CH 2	Three or four positions more
HORIZ DISPLAY	A INTEN	clockwise than A TIME/DIV
A TRIGGER SOURCE	CH 1	Calibrated detent position
B (DLY'D) TRIGGER SOURCE		
B TIME/DIV		
VAR TIME/DIV		

1. Using probes or cables having equal time delays, connect the reference signal to Channel 1 and the comparison signal to Channel 2 inputs.

2. Adjust VOLTS/DIV switches for vertical displays of about two divisions.

3. Adjust the channel POSITION controls and the TRACE SEP control for a display similar to Figure 33.

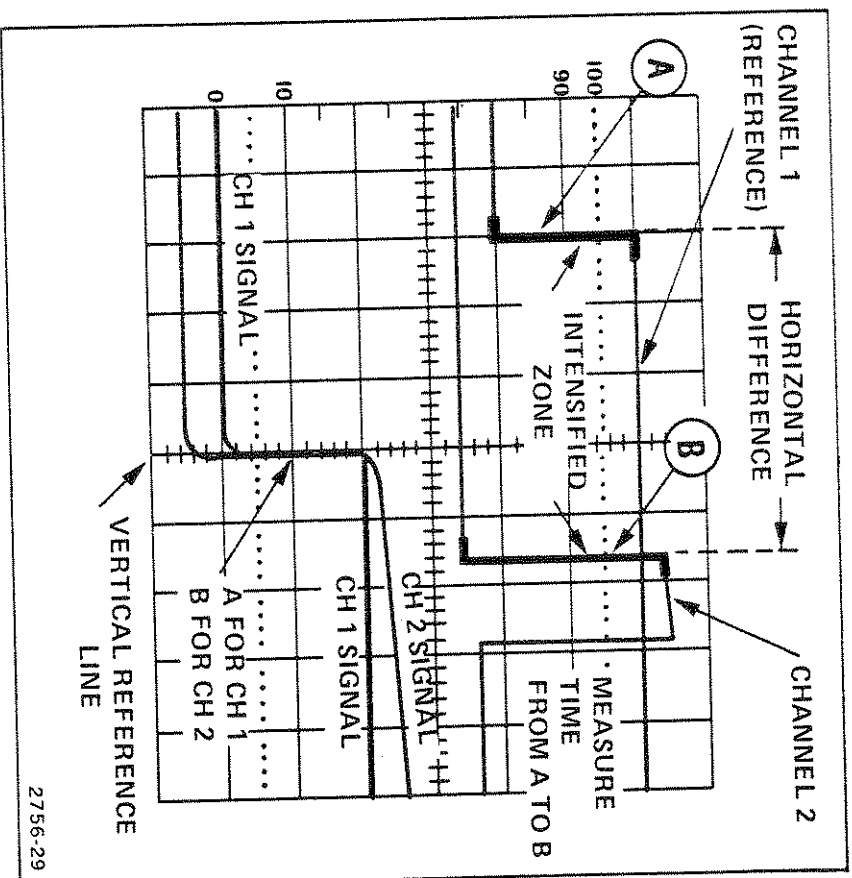

Figure 33. Time difference between two time-related pulses.

4. Adjust the DELAY TIME POSITION control to move the reference point to desired spot on the reference signal trace (see Figure 33, Point A).
5. Observe leading edge of the B Sweep reference signal and use DELAY TIME POSITION control to move it to a convenient vertical graticule line.
6. Adjust the Δ TIME control to move the time measurement point to the desired spot on the Channel 2 trace (see Figure 33, Point B).
7. Observe the leading edge of the B Sweep comparison signal and use the Δ TIME control to superimpose the reference and comparison signal leading edges.
8. Read the time difference on the DM44 Readout.

@

465B/DM44 Operators

SPECIFICATION

The following electrical characteristics (Table 7) are valid only if the instrument has been calibrated at an ambient temperature between +20° C and +30° C, the instrument is operating at an ambient temperature between 0° C and +50° C (unless otherwise noted), and the instrument has had a warmup period of about 20 minutes.

Environmental characteristics of the 465B are presented in Table 8, and physical characteristics listed in Table 9.

Table 7

Electrical Characteristics

Characteristics	Performance Requirements	Supplemental Information
VERTICAL SYSTEM		
Deflection Factor Range	5 mV per division to 5 V per division in 10 steps, with a 1-2-5 sequence.	
Uncalibrated (VAR) Range	Continuously variable between settings. Extends deflection factor to at least 12.5 V per division.	
Accuracy	Within 3%.	Gain set at 5 mV per division.

Table 7 (cont)

Characteristics	Performance Requirements	Supplemental Information
VERTICAL SYSTEM (cont)		
Low-Frequency Linearity		0.1 division or less compression or expansion of a 2-division signal at center screen with waveform positioned to upper and lower extremes of graticule area.
Frequency Response		5-division reference signal centered vertically from a 25-ohm source with VAR VOLTS/DIV control in calibrated detent position.
Bandwidth		
-15° C to +40° C	Dc to at least 100 MHz.	
+40° C to +55° C	Dc to at least 85 MHz.	
AC Coupled Lower -3 dB Point		
1X Probe	10 Hz or less.	
10X Probe	1 Hz or less.	

Table 7 (cont)

Characteristics	Performance Requirements	Supplemental Information
VERTICAL SYSTEM (cont)		
Step Response		5-division reference signal centered vertically, dc coupled at all deflection factors, from a 25-ohm source with VAR VOLTS/DIV control in calibrated detent position.
Rise Time (0° C to +40° C)	3.5 nanoseconds or less.	
Positive-Going Step (Excluding ADD Mode) Aberrations (0° C to +40° C)		+4%, -4%, 4% p-p or less (5 mV to 2 V). +6%, -6%, 6% p-p or less (5 V setting only).
Position Effect (0° C to +40° C)		Total aberrations less than +6%, -6%, 6% p-p; checked at 5 mV per division.
Negative-Going Step		Add 2% to all positive-going step specifications; checked at 5 mV per division.
ADD Mode Operation		Add 5% to all aberration specifications; checked at 5 mV per division.



Table 7 (cont)

Characteristics	Performance Requirements	Supplemental Information
VERTICAL SYSTEM (cont)		
Common-Mode Rejection Ratio (ADD Mode with Channel 2 Inverted)		At least 10:1 at 20 MHz for common mode signals of 6 divisions or less, with GAIN adjusted for best CMRR at 50 kHz.
Trace Shift as VAR VOLTS/DIV is Rotated		1.0 division or less.
Inverted Trace Shift		Less than 2 divisions when switching from noninverted to inverted.
Input Gate Current		0.5 nA or less (0.1 divisions at 5 mV per division.
+20° C to +30° C		4 nA or less (0.8 divisions at 5 mV per division.
-15° C to +55° C		At least 100:1 at 25 MHz.
Channel Isolation		At least +12 and -12 divisions from graticule center.
Position Range		
Chopped Mode Repetition Rate	Approximately 500 kHz.	Within 20%.

Table 7 (cont)

Characteristics	Performance Requirements	Supplemental Information
VERTICAL SYSTEM (cont)		
Input R and C		
Resistance	1 M Ω .	Within 2%.
Capacitance	Approximately 20 pF.	Within 3%.
R and C Product (+20° C to +30° C)		Aberrations 2% or less using a P6105 probe.
Maximum Input Voltage		
DC Coupled	250 V (dc + peak ac). 500 V (p-p ac at 1 kHz or less).	
AC Coupled	250 V (dc + peak ac). 500 V (p-p ac at 1 kHz or less).	
Cascaded Operation		CH 1 VERT SIGNAL OUT into CH 2 input; AC coupled; using 50-ohm, 42-inch, RG58 A/U cable terminated in 50 Ω at CH 2 input.
Bandwidth	Dc to at least 50 MHz.	
Sensitivity	At least 1 mV per division.	

Table 7 (cont)

Characteristics	Performance Requirements	Supplemental Information
TRIGGER SYSTEM		
Sensitivity		
AC Coupled Signal	0.3 divisions internal or 50 mV external from 30 Hz to 10 MHz, increasing to 1.5 divisions internal or 150 mV external at 100 MHz.	When in EXT/10, multiply performance requirement by 10.
LF REJ Coupled Signal	0.5 divisions internal or 100 mV external from 50 kHz to 10 MHz, increasing to 1.5 divisions internal or 300 mV external at 100 MHz.	Attenuates signals below about 50 kHz.
HF REJ Coupled Signal	0.5 divisions internal or 50 mV external from 30 Hz to 50 kHz.	Attenuates signals above about 50 kHz.
DC Coupled Signal	0.3 divisions internal or 50 mV external from dc to 10 MHz, increasing to 1.5 divisions internal or 150 mV external at 100 MHz.	
Trigger Jitter	0.5 ns or less at 100 MHz at 2 ns per division with X10 MAG depressed.	

Table 7 (cont)

Characteristics	Performance Requirements	Supplemental Information
TRIGGER SYSTEM (cont)		
External Trigger Inputs		
Maximum Input Voltage	250 V (dc + peak ac). 250 V (p-p ac at 1 KHz or less).	
Input Resistance	1 MΩ.	Within 10%.
Input Capacitance		Approximately 20 pF, within 10%.
LEVEL Control Range		
EXT	At least +2 and -2 V; 4 V p-p.	
EXT/10	At least +20 and -20 V; 40 V p-p.	
Trigger View (A TRIGGER)		
Deflection Factor		DC trigger COUPLING only; checked with 1 KHz signal.
EXT	100 mV per division ±5%.	
EXT/10	1 V per division ±5%.	
Rise Time	5 ns or less.	20 MHz BW LIMIT at full bandwidth (switch out).

Table 7 (cont)

Characteristics	Performance Requirements	Supplemental Information
TRIGGER SYSTEM (cont)		
Trigger View (A TRIGGER) (cont)		
Delay Difference	$\leq \pm 0.15$ divisions ($\leq \pm 300$ ps at 2 ns per division).	With a 5-division signal having a 5-ns rise time or less from a 25-ohm source, centered vertically, with equal 50-ohm cable lengths from signal sources to vertical channel and external trigger inputs terminated in 50 Ω at each input.
Centering of Trigger Point		Within 1.0 division of center screen.
Flatness and Aberrations		+10%, -10%, 10% p-p.
HORIZONTAL DEFLECTION SYSTEM		
Sweep Rate		
Calibrated Range		
A Sweep	0.5 s per division to 0.02 μ s per division in 23 steps in a 1-2-5 sequence. X10 MAG extends maximum sweep rate to 2 ns per division.	

Table 7 (cont)

Characteristics	Performance Requirements	Supplemental Information				
HORIZONTAL DEFLECTION SYSTEM (cont)						
Sweep Rate (cont) B Sweep	50 ms per division to 0.02 μ s per division in 20 steps in a 1-2-5 sequence. X10 MAG extends maximum sweep rate to 2 ns per division.					
			<table border="1" style="width: 100%;"> <tr> <td data-bbox="1006 724 1079 987">Ummagnified</td> <td data-bbox="1006 987 1079 1333">Magnified</td> </tr> <tr> <td data-bbox="925 724 998 987">Within $\pm 2\%$</td> <td data-bbox="925 987 998 1333">Within $\pm 3\%$</td> </tr> <tr> <td data-bbox="844 724 917 987">Within $\pm 3\%$</td> <td data-bbox="844 987 917 1333">Within $\pm 4\%$</td> </tr> </table>	Ummagnified	Magnified	Within $\pm 2\%$
Ummagnified	Magnified					
Within $\pm 2\%$	Within $\pm 3\%$					
Within $\pm 3\%$	Within $\pm 4\%$					
Accuracy +20° C to +30° C -15° C to +55° C Two-Division Linearity Check		Accuracy specification applies over the full 10 divisions. When in X10 MAG, exclude first and last 50 ns of the sweep on 2-ns, 5-ns, 10-ns, and 20-ns sweep rates. $\pm 5\%$ over any two-division (or less) portion of the full 10 divisions. When in X10 MAG, exclude first and last magnified divisions when checking 2-ns, 5-ns, and 10-ns per division rates.				
Alternate Sweep Trace Separation		$\geq \pm 4$ divisions.				
Variable Range (A Only)	Continuously variable between calibrated settings. Extends slowest A Sweep rate to at least 1.25 s per division.	At least 2.5:1.				



Table 7 (cont)

Characteristics	Performance Requirements	Supplemental Information
HORIZONTAL DEFLECTION SYSTEM (cont)		
Sweep Length (A Only)		10.5 to 11.5 divisions.
A Trigger Holdoff Variable	Increases A Sweep holdoff time by at least a factor of 10.	
X10 Magnifier Registration		Within 0.2 divisions from graticule center (X10 MAG on to X10 MAG off).
Position Range		Start of sweep must position to right of graticule center. End of sweep must position to left of graticule center.
Differential Time Measurement Accuracy	For Measurements of One or More Major Dial Divisions	For Measurements of Less than One Major Dial Division
		Within $\pm 1\%$
	Within $\pm 2.5\%$	With the A TIME/DIV switch at 0.5 μ s and 0.2 μ s the differential time measurement accuracy limit is valid only for DELAY TIME POSITION dial settings between 1.50 and 8.50.
		± 0.01 major dial division.
		± 0.03 major dial division.

Table 7 (cont)

Characteristics	Performance Requirements	Supplemental Information
HORIZONTAL DEFLECTION SYSTEM (cont)		
Delay Time Jitter	One part (or less) in 50,000 (0.002%) of ten times the A TIME/DIV switch setting, when operating on power-line frequencies other than 50 Hz. One part (or less) in 20,000 (0.005%) of A TIME/DIV switch setting, when operating on 50 Hz power-line frequency.	
Calibrated Delay Time	Continuous from 0.2 μ s to at least 5 seconds after start of the delaying (A) sweep.	With VAR control in calibrated detent.
X-Y Operation		With TIME/DIV switch set to extreme counterclockwise position.
X-Axis		With X10 MAG off.
Deflection Factor	Same as Vertical System.	
Bandwidth	Dc to at least 4 MHz.	10-division reference signal.
Variable Range	Continuously variable between settings. Extends deflection factor to at least 12.5 V per division.	

Table 7 (cont)

Characteristics	Performance Requirements	Supplemental Information
HORIZONTAL DEFLECTION SYSTEM (cont)		
X-Y Operation (cont)		
Input R and C		
Resistance	1 MΩ.	Within 2%.
Capacitance	Approximately 20 pF.	Within 3%.
Maximum Usable Input Voltage		
DC Coupled	250 V (dc + peak ac). 500 V (p-p ac at 1 KHz or less).	
AC Coupled	250 V (dc + peak ac). 500 V (p-p ac at 1 KHz or less).	
Phase Difference Between X and Y Axis Amplifiers		
Deflection Accuracy	Within ±4%.	Within 3°, from dc to 50 KHz.
CALIBRATOR		
Output Voltage (-15° C to +55° C)		0.3 V, within 1.5%.
Repetition Rate	Approximately 1 KHz.	Within 25%.
Output Resistance		Approximately 10.3 Ω.

Table 7 (cont)

Characteristics	Performance Requirements	Supplemental Information
CALIBRATOR (cont)		
Output Current	30 mA, within 2%.	
+20° C to +30° C		
-15° C to +55° C		30 mA, within 2.5%.
Z-AXIS INPUT		
Sensitivity	5-volt p-p signal causes noticeable modulation at normal intensity.	Positive-going signal decreases intensity.
Usable Frequency Range	Dc to 50 MHz.	
Maximum Input Voltage		25 V (dc + peak ac).
SIGNAL OUTPUTS		
Channel 1 Output		
Voltage	At least 50 mV per division into 1 MΩ. At least 25 mV per division into 50 Ω.	
Resistance		Approximately 50 Ω.
Bandwidth	Dc to at least 50 MHz into 50 Ω.	
A and B Gates Output Resistance		Approximately 500 Ω.

Table 7 (cont)

Characteristics	Performance Requirements	Supplemental Information
POWER SOURCE		
Line Voltage Ranges		
115 V Nominal		
(Low)	99 V to 121 V.	
(Medium)	104 V to 126 V.	
(High)	108 V to 132 V.	
230 V Nominal		
(Low)	198 V to 242 V.	
(Medium)	208 V to 250 V.	
(High)	216 V to 250 V.	
Line Frequency	48 Hz to 440 Hz.	
Power Consumption		
Typical	65 W at 115 V, 60 Hz, medium range.	
Maximum	85 W at 115 V, 60 Hz medium range.	

Table 7 (cont)

Characteristics	Performance Requirements	Supplemental Information
CATHODE-RAY TUBE		
Display Area	8x10 cm.	
Geometry		0.1 division or less of tilt or bowing.
Trace Rotation Range		Adequate to align trace with horizontal center line. At least 3%.
Standard Phosphor	P31.	
Optional Phosphor	P11.	
DM44		
Dc Voltage		
Ranges	0 to 1.2 kV in 5 steps: 200 mV, 2 V, 20 V, 200 V, and 1.2 kV.	
Resolution	100 μ V.	
Accuracy	Within 0.1% of reading, ± 1 count.	
Input Resistance	10 M Ω , all ranges (user has option to remove an internal wire strap to increase input resistance to 1000 M Ω on the 200 mV and 2 V ranges).	

Table 7 (cont)

Characteristics	Performance Requirements	Supplemental Information
DM44 (cont)		
Dc Voltage (cont)		
Rejection Ratio	At least 60 dB at 50 and 60 Hz.	
Normal Mode	At least 100 dB at dc; 80 dB at 50 and 60 Hz.	
Common Mode	Approximately 3.3 measurements per second.	
Recycle Time	Within 0.5 second.	
Response Time	45 parts/million/ $^{\circ}$ C.	
Temperature Dependence	± 1200 V (dc + peak ac) between + and COM inputs or between + input and chassis.	
Maximum Safe Input Voltage, All Ranges	± 500 V (dc + peak ac) to chassis.	
COM (Common) Floating Voltage		
Resistance	0 to 20 M Ω in six steps: 200 Ω , 2 k Ω , 20 k Ω , 200 k Ω , 2 M Ω , and 20 M Ω .	
Resistance Ranges		
Resolution	0.1 Ω .	

Table 7 (cont)

Characteristics	Performance Requirements	Supplemental Information
DM44 (cont)		
Accuracy		
200 Ω and 2 k Ω Ranges	Within 0.25%, ± 1 count, + probe resistance.	
20 k Ω , 200 k Ω , and 2 M Ω Ranges	Within 0.25%, ± 1 count.	
20 M Ω Range	Within 0.30%, ± 1 count.	
Recycle Time	Approximately 3.3 measurements per second.	
Response Time		
200 Ω through 200 k Ω Ranges	Within 1 second.	
2 M Ω and 20 M Ω Ranges	Within 5 seconds.	
Maximum Safe Input Voltage	120 V rms between + and COM inputs for an indefinite time.	220 V rms between + and COM inputs for 1 minute or less.
Temperature Dependence		
20 k Ω through 2 M Ω		250 parts/million/ $^{\circ}$ C.
200 Ω , 2 k Ω , and 20 M Ω Ranges		350 parts/million/ $^{\circ}$ C.

Table 7 (cont)

Characteristics	Performance Requirements	Supplemental Information																		
Approximate current supplied to unknown resistance	DM44 (cont)																			
	-55° C to +150° C in one range.	<table border="0"> <tr> <td style="text-align: right;">OHMS RANGE</td> <td style="text-align: left;">CURRENT</td> </tr> <tr> <td>200 Ω and 2 kΩ</td> <td>1 mA</td> </tr> <tr> <td>20 kΩ</td> <td>100 μA</td> </tr> <tr> <td>200 kΩ</td> <td>10 μA</td> </tr> <tr> <td>2 MΩ</td> <td>1 μA</td> </tr> <tr> <td>20 MΩ</td> <td>100 nA</td> </tr> </table>	OHMS RANGE	CURRENT	200 Ω and 2 kΩ	1 mA	20 kΩ	100 μA	200 kΩ	10 μA	2 MΩ	1 μA	20 MΩ	100 nA						
OHMS RANGE		CURRENT																		
200 Ω and 2 kΩ	1 mA																			
20 kΩ	100 μA																			
200 kΩ	10 μA																			
2 MΩ	1 μA																			
20 MΩ	100 nA																			
Temperature Range Accuracy (with constant temperature and infinite heat source)	<table border="1"> <thead> <tr> <th>Ambient Temperature (°C)</th> <th>Probe Tip Temperature (°C)</th> <th>Accuracy (°C)</th> </tr> </thead> <tbody> <tr> <td>+15 to +35</td> <td>-55 to +150</td> <td>±2</td> </tr> <tr> <td>-15 to +55</td> <td>-55 to +125</td> <td>±3</td> </tr> <tr> <td>-15 to +55</td> <td>+125 to +150</td> <td>±4</td> </tr> <tr> <td>+15 to +35</td> <td>-55 to +150</td> <td>±6</td> </tr> <tr> <td>-15 to +55</td> <td>-55 to +150</td> <td>±8</td> </tr> </tbody> </table>	Ambient Temperature (°C)	Probe Tip Temperature (°C)	Accuracy (°C)	+15 to +35	-55 to +150	±2	-15 to +55	-55 to +125	±3	-15 to +55	+125 to +150	±4	+15 to +35	-55 to +150	±6	-15 to +55	-55 to +150	±8	
Ambient Temperature (°C)	Probe Tip Temperature (°C)	Accuracy (°C)																		
+15 to +35	-55 to +150	±2																		
-15 to +55	-55 to +125	±3																		
-15 to +55	+125 to +150	±4																		
+15 to +35	-55 to +150	±6																		
-15 to +55	-55 to +150	±8																		
Time (Differential Delay) Accuracy	Within 1% of reading = 1 count. +15° C to +35° C -15° C to -55° C																			
Within 2.5% = 1 count.																				

Table 7 (cont)

Characteristics	Performance Requirements	Supplemental Information
DM44 (cont)		
1/TIME		
Accuracy		
+15° C to +35° C	Within 2% of reading, ±1 count.	
-15° C to +55° C	Within 3.5%, ±1 count.	

Table 8

Environmental Characteristics

Characteristics	Description
Temperature	
Operating	-15° C to +55° C.
Storage	-62° C to +85° C.
Altitude	
Operating	To 4,500 m (15,000 ft). Maximum operating temperature decreased 1° C per 300 m (1,000 ft) above 1,500 m (5,000 ft).
Storage	To 15,000 m (50,000 ft).

465B/DM44 Operators

REV A AUG 1979

Table 8 (cont)

Characteristics	Description
Humidity (Operating and Storage)	Five cycles (120 hr) referenced to MIL-T-28800B, para 3.9.2.2. Class C, 95% to 97% humidity.
Vibration (Operating)	15 minutes along each of three major axes at a total displacement of 0.025 inch p-p (4 g at 55 Hz) with frequency varied from 10 Hz to 55 Hz to 10 Hz in one-minute sweeps. After sweep vibration in each axis, frequency held steady at each major resonance for 10 minutes, or if no such resonances found, held at 55 Hz for 10 minutes.
Shock (Operating and Nonoperating)	30 g, half-sine, 11-ms duration, 3 shocks per axis each direction, for a total of 18 shocks.

Table 9

Physical Characteristics

Characteristics	Description
Weight	
With Panel Cover, Accessories, and Accessory Pouch	11.5 kg (25.3 lb).
Without Panel Cover, Accessories, and Accessory Pouch	10.4 kg (22.8 lb).

Table 9 (cont)

Characteristics	Description
Domestic Shipping Weight	14.9 kg (32.7 lb).
Export Shipping Weight	Approximately 22 kg (48 lb).
Height	
With Feet and Pouch	19.1 cm (7.5 in).
Without Pouch	15.7 cm (6.2 in).
Width	
With Handle	32.8 cm (12.9 in).
Without Handle	29.2 cm (11.5 in).
Depth	
Including Panel Cover	46.0 cm (18.1 in).
With Handle Extended	51.6 cm (20.3 in).

ACCESSORIES

STANDARD ACCESSORIES INCLUDED

OPTIONAL ACCESSORIES

2	Probes, 10X, 2 m, with accessories	010-6105-03	C-5B Option 02 low-cost general-purpose Camera—Order C-5B Option 02.
1	Accessory Pouch, Snap (w/o DM)	016-0535-02	Protective Cover—Waterproof, blue vinyl—Order 016-0554-00.
1	Accessory Pouch (DM)	016-0594-00	Polarized Collapsible Viewing Hood—Order 016-0180-00.
1	Accessory Pouch, Zipper	016-0537-00	Folding Viewing Hood, light-shielding—Order 016-0592-00.
1	Operator's Manual	070-2756-00	Collapsible Viewing Hood, binocular—Order 016-0566-00.
1	Service Manual (465B)	070-2757-00	Mesh Filter—Improves contrast and emi filter—Order 378-0726-01.
2	Fuses, 1.5 A, 3AG, fast-blow	159-0016-00	SCOPE-MOBILE Cart—Occupies less than 17 inches aisle space, with storage area in base—Order 200C.
1	Fuse, 0.75 A, 3AG, fast-blow	159-0042-00	Test Lead Set—1 black lead with banana plug and grounding clip, 1 red lead with banana plug and probe. Includes retractable hook tip and CI tester probe cover. May be used with other miniature probe tip accessories. Order 012-0427-00.
1	Filter, Blue Plastic (installed)	337-1674-00	
1	Crt Filter, Clear Plastic	337-1674-01	
1	Adapter, Ground Wire	134-0016-01	
1	Pair Test Leads (DM)	003-0120-00	
1	Service Manual (DM44)	070-2036-01	
1	Temperature Probe (DM44)	010-6430-00	

OPTIONS

Your 465B may be equipped with one or more instrument options. A brief description of each option is given in the following discussion. Unique and more detailed operating information pertaining to Options 05 and 07 are presented on succeeding pages of this section. For further information on instrument options, see your Tektronix Catalog or contact your Tektronix Field Office or representative.

GENERAL DESCRIPTION

OPTION 01

This option deletes the temperature probe from the DM44.

OPTION 05

Option 05, when installed in the 465B oscilloscope, adds a TV Sync Separator and other changes to provide stable sweep triggering from composite video waveforms. Two positions are added to the A TRIGGER COUPLING switch: TV FIELD and TV LINE. When these positions are selected, the A Sweep may be triggered at the Field or Line rate with the A TRIGGER LEVEL control. A TV LINE position is added to the B TRIGGER SOURCE switch. In this position, the B Sweep may be triggered at the line rate. Option 05 circuitry accepts sync-positive or sync-negative video from Channel 1, Channel 2, or external input. Recognition circuits accommodate 405-, 525-, and 625-line, 50 or 60 Hz field-rate broadcast systems and are compatible with closed-circuit systems with up to 1201-line, 60 Hz field rates.

OPTION 04

The instrument is modified to meet certain specifications related to radiated interference requirements. This option does not affect the basic instrument's operating instructions presented in this manual.

OPTION 07

Option 07 permits operation of the instrument on either 12 or 24 Vdc with no performance deterioration. Circuitry is provided to protect against damage due to connection of 24 V when in the 12 V mode of operation. The 24-volt external input permits use with marine and aircraft conventional dc power. The modified oscilloscope has a three-position voltage input selection slide switch (visible through the right-hand side panel) at the rear of the line voltage selector switch. A dc input connector is located below the fan cover on the rear panel.

Option 07 is not provided with 465B oscilloscopes equipped with the DM44 digital multimeter.

OPTION 05

TV SYNC SEPARATOR

The information and instructions presented in this part apply only to use of the 465B Option 05 instrument in TV applications.

GENERAL INFORMATION

Option 05 provides the instrument with front-panel selection of additional processing of trigger signals to facilitate observation and measurement of composite video and related television waveforms. Added circuits provide amplification, selectable polarity inversion, clipping, and vertical-sync recognition.

Two positions are added to the A TRIGGER COUPLING switch: TV FIELD and TV LINE. When the A TRIGGER COUPLING switch is set to TV FIELD or TV LINE, the A TRIGGER SOURCE switch selects the source of signals to be processed in the Sync Separator. This includes NORM (composite vertical signal), CH 1, CH 2, EXT, or EXT/10 (LINE source is not a usable function with TV FIELD or TV LINE coupling).

When the A TRIGGER COUPLING switch is set to TV FIELD or TV LINE, the output of the Sync Separator is automatically applied to the A Sweep Trigger circuits, and only this signal may be used for triggering the A Sweep. For B Sweep, the horizontal sync signal (line-rate sync) from the Separator is fed only to the TV LINE position on the B TRIGGER SOURCE switch, which may be selected at the option of the user.

The Option 05 circuitry may be operated either from normal sync-negative composite video (with the A TRIGGER SLOPE switch at —) or from inverted video (SLOPE switch set to +). This applies to most standard broadcast systems using from 405 to 819 lines, 50 or 60 Hz field rates or to closed-circuit systems using up to 1201 lines and 60 Hz field rates.

To optimize video measurements, the vertical amplifier AC input coupling capacitors are increased from 0.02 to 0.2 μF . The larger physical size of these capacitors increases the input shunt capacitance, which is normalized at 24 pF.

SPECIFICATION

Triggering

Sync Separation

Electrical characteristics and performance requirements listed in the Specification section of this manual are applicable to the 465B Option 05 oscilloscope with the following exceptions or additions.

Stable video rejection and sync separation from sync-positive or sync-negative composite video, 405- to 819-line, 50 or 60 Hz field rate, or for closed-circuit systems using up to 1201 lines on a 60 Hz field.

Input

Resistance	1 M Ω \pm 2%
Capacitance	24 pF \pm 2%
Time Constant	24 μ s \pm 2%

Amplitude (p-p)

Min Max

AC Input Coupling

Low Frequency	-3 dB
Direct	\leq 1 Hz
Via 10X Passive Probe	0.1 Hz
Tilt (10-ms pulse)	
Direct	\leq 2.5%
Via 10X Passive Probe	\leq 0.25%

Internal	Composite Video (nominal) ¹	1.2 div	20 div
	Composite sync	0.5 div	20 div
External	Composite video (nominal)	225 mV	4 V
	Composite sync	75 mV	4 V
Ext/10	Composite video (nominal)	2.25 V	40 V
	Composite sync	750 mV	40 V

¹Peak video \approx 7/3 sync amplitude.

OPTION 05 ACCESSORIES

NOTE

- 1 Graticule, NTSC (CCIR System M): -40 to +100 units, with 7.5-unit setup line; horizontal divisions along line 0. Tektronix Part Number 337-1674-02.

The extended tab at the bottom of the graticule mates with the slightly wider (bottom) margin of the graticule cover.

- 1 Graticule, CCIR (CCIR System B): 0 to +100 units, 35-unit setup line; horizontal divisions along line 30. Tektronix Part Number 337-1674-03.

The graticule can be moved slightly horizontally to align the external graticule and mask with the crt graticule and viewing area. Reinstall the bezel.

OPERATING INFORMATION

The following instructions and information pertain primarily to the use of the 465B Option 05 oscilloscope in TV applications. Refer to preceding sections of this manual for use and operation of the unmodified instrument.

When the video graticule is installed, the 10 horizontal divisions along line 0 correspond to the internal graticule divisions, and the TIME/DIV calibration of the oscilloscope is correct. However, the vertical divisions represent only proportions of the 100-unit (CCIR) or 140-unit (NTSC) video waveform, and the vertical VOLTS/DIV calibration is inapplicable.

Installation of Video Graticule

To install a video graticule, loosen (about six turns) the four captive screws holding the crt bezel in place and remove the bezel. Remove the light filter from the two bosses on the bezel and install the desired graticule on these bosses, with the marking on the outside.

To calibrate for a standard 1 V (nominal) studio video signal, apply the 300 mV CALIBRATOR waveform to the Vertical input and adjust the VOLTS/DIV and VAR controls so that the displayed waveform occupies just 30 units (CCIR graticule) or 42 units (NTSC graticule). This adjustment may be performed with a free-running sweep.



Triggering the Sweep

The output of the Sync Separator is fed directly to the A Sweep Trigger circuit; all that is required for triggering is the proper setting of the A TRIGGER LEVEL control. To trigger the B Sweep from the Line-rate trigger output, perform the following steps:

1. Make sure the A Sweep is running.

NOTE

The B Sweep cannot be operated independently and cannot run more than once per operation of the A Sweep. For Composite line displays, refer to Special Measurements in this section.

2. Set the B TRIGGER SOURCE switch to TV LINE.
3. Set the B TRIGGER LEVEL control for a stable triggered sweep.

Vertical Operating Modes—Special Considerations

DUAL TRACE MODES. For dual trace operation, the Sync Separator input must be taken from CH 1, CH 2, or an external source. (When only one trace is displayed, the NORM position of the A TRIGGER SOURCE switch may be used.) The Sync Separator is not capable of correct processing of switched (composite vertical deflection) waveforms present on the NORM bus in the ALT or CHOP modes; it is therefore not possible to obtain stable simultaneous displays of two independent video signals that are not time-related.

SINGLE CHANNEL TRIGGERING. When triggering from Channel 1 or Channel 2, the waveform fed to the Sync Separator is the same (except for positioning) as that displayed on-screen when the channel is turned on. If the VOLTS/DIV VAR control is used to reduce displayed amplitude, the signal to the Sync Separator is also reduced. When the Channel 2 INVERT switch is pushed in, the CH 2 signal to the A TRIGGER SOURCE switch is also inverted. Therefore, in selecting the position of the A TRIGGER SLOPE switch in internal triggering, it is only necessary to note the polarity of the displayed waveform, disregarding its actual polarity as applied to the Vertical input connector. For external triggering, the actual applied polarity will determine the necessary A TRIGGER SLOPE setting.

It is not necessary to display Channel 1 or Channel 2 to obtain CH 1 or CH 2 triggering. Whenever the AC-GND-DC switch for the channel is not in GND, the input amplifier and trigger channel are active, regardless of the selection of VERT MODE pushbuttons.

ADD MODE. A single-channel trigger signal amplitude is not affected by the contribution of the other channel to an ADD mode display. When the ADD mode with CH 2 inverted is used to compare two video waveforms by subtraction, the CH 1 or CH 2 signal to the Sync Separator will be adequate for stable triggering providing the individual channel signal (when displayed alone) meets the signal requirements.

When the ADD mode is used to display a signal from two sides of a balanced line, the A TRIGGER SOURCE switch NORM (composite vertical) position may be used if neither Channel signal alone is of sufficient amplitude for stable sync separation and triggering.

Typical Operation

In a typical operating mode for the Option 05 instrument, the A Sweep establishes the basic frame and field presentation, and the B Sweep allows detailed observation and measurement of various portions of the video waveform.

To obtain stable displays free of interlace jitter (for systems which have 2:1 interlace), the A TIME/DIV switch

should be set to display an odd number of fields, plus a fraction of a field, in the unmagnified display. For 50 and 60 Hz field rates, the 2 ms/div setting is usually selected. For some PAL system observations, a setting of 5 ms/div (approximately $2\frac{1}{2}$ field display), with the A TRIGGER HOLDOFF control set to approximately the four o'clock position (additional one-field holdoff), may be desirable to maintain a stable display relationship to the four-field PAL burst-blanking sequence. All detail measurements are then made with B Sweep, using the B DLY'D or ALT Horizontal Display, with the B TRIGGER SOURCE switch set to either STARTS AFTER DELAY (continuously variable B Sweep start point) or to TV LINE (B Sweep starts after the leading edge of the next horizontal sync pulse following the delay interval set by the DELAY TIME POSITION control and the A TIME/DIV switch setting).

Because the leading edge of the sync pulse will not be displayed, the typical B TIME/DIV setting for width measurements on front porch, back porch and horizontal blanking intervals, horizontal sync, serration, and equalizing pulses will be 10 μ s/division to allow display of two consecutive pulses. Use the 10X Magnifier to display the second pulse at 1 μ s/division.

For rise and fall time measurements on blanking and sync waveforms, trigger the A or B Sweep directly from the displayed waveform (avoiding the processing delay of the sync separator). This permits viewing the triggering edge at sweep rates from 0.5 to 0.02 μ s/division.

@

Selecting an Individual Line

NOTE

For field and line identification systems, refer to Identifying Fields, Frames, & Lines in 525/60 and 625/50 TV Systems at the end of this section.

The Sync Separator circuit does not differentiate between the two fields of an interlaced frame or among the four fields of the PAL color frame sequence. However, if a 1½ or 3½ field basic A Sweep cycle is used, the sweep will remain stably locked to a given display until the signal is interrupted.

ONE FRAME CYCLE. To display an entire vertical blanking interval and locate a specific line (e.g., one of the lines containing a specific VIT waveform), set the A TIME/DIV switch to 2 ms and the B TIME/DIV switch (pull to unlock from A) to 10 μs. Use the Horizontal POSITION control to center the second vertical blanking interval to center-screen and depress the 10X MAG pushbutton. This will provide sufficient resolution to identify the field. Adjust the A TRIGGER HOLDOFF as necessary.

If the displayed field is not the desired one, first rotate the A TRIGGER SLOPE control momentarily to the opposite polarity then rotate back again until the start of the desired field is displayed.

Press A INTEN and use the DELAY TIME POSITION control to position the intensified zone (B Sweep) on the desired line. Pressing the B DLY'D button will then display the desired line. Select ALT Horizontal Display if you wish to view the A INTEN trace and B DLY'D trace simultaneously.

TWO FRAME CYCLE. If PAL burst blanking is to be checked, an A Sweep 3½-field cycle (5 ms/div, with the A TRIGGER HOLDOFF at about four o'clock) is required, using B Sweep (ALT mode recommended) to identify fields and lines. At 5 ms/div, only two and a fraction fields will be displayed with a full field covered by the trigger holdoff interval. To put a specific field on-screen in a particular location will typically require several operations of the A TRIGGER SLOPE switch.



Special Measurements

OVERSCANNED DISPLAYS. For various video measurements, it may be desirable to magnify the video waveform vertically beyond the limits of the screen. Under these circumstances, the trigger amplifiers or Sync Separator may be overloaded, blocking out some sync pulses in the vicinity of strong video transitions, or losing sync pulses altogether. To avoid overload problems, use external sync or use the other vertical channel to supply a constant amplitude signal to the Sync Separator while the overscanned observations are being made. Note, however, that transient-response aberrations in the main vertical amplifier will be increased when the signal is driven offscreen, becoming relatively serious if the amplifier is driven to saturation and cutoff.

HORIZONTAL SYNC PULSE MEASUREMENTS. Rise and fall times and width of horizontal sync pulses may be measured while using the Sync Separator to determine whether part or all of the lines or groups of lines appear to be abnormal. A bright display of all horizontal sync pulses is obtained when the A TRIGGER COUPLING switch is set to TV LINE.

RF INTERFERENCE. Operation in the vicinity of some FM and TV transmitters may show objectionable amounts of rf signal energy in the display, even when coaxial input

connections are used. The front-panel 20 MHz BW LIMIT switch will usually eliminate such interference from the display, but will not affect the signal reaching the Sync Separator. Where the rf interferes with Sync Separator operation, external filters will be required. Use of probes designed for 10-30 MHz oscilloscopes will provide 6 to 10 dB attenuation in the 50-100 MHz range and may be beneficial in reducing interference.

IDENTIFYING FIELDS, FRAMES AND LINES IN 525/60 AND 625/50 TV SYSTEMS

NTSC (CCIR System M)

Field 1 is defined as the field whose first equalizing pulse is one full H interval (63.5 μ s) from the preceding horizontal sync pulse. The Field 1 picture starts with a full line of video. Field 1 lines are numbered 1 through 263, starting with the leading edge of the first equalizing pulse. The first regular horizontal sync pulse after the second equalizing interval is the start of line 10.

Field 2 starts with an equalizing pulse a half-line interval from the preceding horizontal sync pulse. The Field 2 picture starts with a half line of video. Field 2 lines are numbered 1 through 262, starting with the leading edge of the second equalizing pulse. After the second equalizing interval, the first full line is line 9.

CCIR System B and Similar 625/50 Systems (including PAL)

In most 625-line, 50 Hz field-rate systems, identification of parts of the picture relies primarily on continuous line numbering rather than on field-and-line identification, except for PAL systems.

The CCIR frame starts with the first (wide) vertical sync pulse following a field which ends with a half-line of video. The first line after the second equalizing interval is line 6; the first picture line is line 23 (half-line of video). The first field of the frame contains lines 1 through the first half of line 313, the picture ending with a full line of video (line 310).

The second field of the frame commences with the leading edge of the first (wide) vertical sync pulse (middle of line 313), and runs through line 625 (end of equalizing interval). The first full line after the equalizing interval is line 318; the picture starts on line 336 (full line).

The first field is referred to as "odd," the second field as "even." Note that the identification systems for System M and System B are reversed.

In the four-field PAL sequence with Bruch Sequence Color-burst blanking, the fields are identified as follows:

Field 1: Field that follows a field ending in a half-line of video, when preceding field has color burst on the last full line. Field 1 lines are 1 through 312 and half of line 313. Color burst starts on line 7 of Field 1; a half-line of video appears on line 23.

Field 2: Field that follows a field ending in a full line which does not carry color burst. Field 2 lines are the last half of line 313 through line 625. Color burst starts on line 319 (one line without burst following the last equalizing pulse); a full line of video appears at line 336.

Field 3: Field that follows a field ending in a half line when preceding field has no color burst on its last full line. Field 3 lines are 1 through the first half of line 313. Burst starts on line 6 (immediately following the last equalizing pulse); a half-line of video appears on line 23.

Field 4: Field that follows a field ending in a full line carrying color burst. Field 4 lines are the second half of line 313 through line 625. Color burst for Field 4 starts on line 320 (two full lines without burst follow the last equalizing pulse); video starts with a full line on line 336.

OPTION 07

EXTERNAL DC OPERATION

SPECIFICATION

Electrical characteristics and performance requirements listed in the Specification section of this manual are applicable to the 465B Option 07 oscilloscope with the following exceptions or additions:

AC

Permits application of ac power to the oscilloscope power switch.

DC 12

Permits operation of the instrument from an external 12-volt source.

DC 24

DC REQUIREMENTS. Either 11.5 to 14 volts or 22 to 28 volts. Operation with 11.5 to 14 volts excludes graticule light function and Option 05. Operating range may be extended to 15 volts or 30 volts with a series dropping resistor. Maximum elevation for + or - power lead is 50 volts with respect to oscilloscope chassis or ground.

CONTROLS AND CONNECTORS

Mode Switch

Three-position switch located adjacent to the Line Voltage Selector switch on the right side panel and used to select the proper input power to the 465B.

DC Input Connector

Used for connecting external dc power source to the 465B Option 07; located on rear panel.

OPTIONAL ACCESSORY

1106 BATTERY PACK. This unit permits freedom to operate the Tektronix 465B Option 07 oscilloscope at remote locations or when isolation from the line or ground is required. It supplies 22 to 26 volts dc at a 140 watt-hour capacity from full charge. The oscilloscope and battery pack can be carried or operated separately. For carrying ease, this provides two packages of almost equal weight, each with its own handle. Because the 1106 can easily be disconnected from the oscilloscope and has an internal battery charger, the oscilloscope can be operated either from external ac or dc or from a second 1106 while the batteries are being recharged. Order Tektronix 1106 Battery Pack.

OPERATING INFORMATION

To operate the 465B Option 07 oscilloscope:

CAUTION

Connect the oscilloscope frame to a ground (earth) reference before using.

1. Set the 465B Line Selector switch and the Option 07 Mode switch to the appropriate positions for the power source to be used. Refer to the following table for proper switch positions.

Power Source	465B Line Selector Switch	Option 07 Mode Switch
115 V ac	115	AC
230 V ac	230	AC
12 V dc	—	DC 12
24 V dc	—	DC 24
1106 Battery Pack	—	DC 24

2. The 465B Option 07 oscilloscope may now be operated using the information, instructions, and procedures contained in preceding sections of this manual with the exception of DM44 digital multimeter operation.

NOTE

Option 07 is not provided with 465B oscilloscopes equipped with the DM44 digital multimeter.



[The main body of the page contains several paragraphs of text that are extremely faint and illegible due to low contrast and heavy noise. The text appears to be organized into multiple sections, possibly separated by headings or sub-sections, but the specific content cannot be discerned.]

