

494/494P SPECTRUM ANALYZER

*Please Check for
CHANGE INFORMATION
at the Rear of This Manual*

Copyright © 1983 Tektronix, Inc. All rights reserved.
Contents of this publication may not be reproduced in any
form without the written permission of Tektronix, Inc.

Products of Tektronix, Inc. and its subsidiaries are covered
by U.S. and foreign patents and/or pending patents.

TEKTRONIX, TEK, SCOPE-MOBILE, and  are
registered trademarks of Tektronix, Inc. TELEQUIPMENT
is a registered trademark of Tektronix U.K. Limited.

Printed in U.S.A. Specification and price change privileges
are reserved.

PREFACE

This manual is one of a set of product manuals for the TEKTRONIX 494 and 494P (programmable) Spectrum Analyzer. It describes the installation and operation of the 494/494P Spectrum Analyzer. These instructions assume the user is knowledgeable about frequency domain analysis. Our intent is to explain the operation of the 494/494P so that meaningful measurements can be made under adverse as well as laboratory conditions. The manual organization and content is listed in the Table of Contents. Programming information is in a separate Programmers manual, and service information is contained in a two-volume Service manual.

Standards and Conventions Used

Most terminology is in accordance with those standards adapted by IEEE and IEC. A glossary of terms is provided as an appendix. Abbreviations in the documentation are in accordance with ANSI Y1.1-1972, with exceptions and additions explained in parentheses after the abbreviation. Graphic symbols comply with ANSI Y32.2-1975. Logic symbology is based on ANSI Y32.14-1973 and the manufacturer's data description. GPIB functions for the programmable version conforms to IEEE 488-1978 Standard. A copy of

ANSI and IEEE standards may be obtained from, the Institute of Electrical and Electronic Engineers Inc., 345 East 47th Street, New York, N.Y. 10017.

Change/History Information

Change information that involves manual corrections and/or additional information pending manual reprint and bind is located at the back of this manual in a CHANGE INFORMATION section.

History information, with the updated data, is integrated into the text when the page(s) is revised. A revised page is identified by a revision date located in the lower left corner of the page (e.g., REV JAN 1984).

Unpacking and Preparation for Use

Instructions for unpacking and preparing the instrument for use are described under "Preparing the Instrument for Use" which follows.

TABLE OF CONTENTS

	Page		Page
PREFACE	i	Section 5	TURN-ON PROCEDURE AND
LIST OF ILLUSTRATIONS	iv		OPERATIONAL CHECK
LIST OF TABLES	iv		Firmware Version and Error Message
OPERATORS SAFETY SUMMARY	v		Readout
SERVICE SAFETY SUMMARY	vii		5-1
			Firmware Version
			5-1
			Error Message Readout
			5-1
Section 1	GENERAL INFORMATION		Turn On Procedure and Preparation for
	Product Overview	1-1	Use
	Options for Power Cord		5-1
	Configuration	1-1	1. Initial Turn On
	Options	1-1	5-1
	Accessories	1-1	2. Calibrate Center Frequency,
	Firmware Version and Error Message		Reference Level, and Dynamic
	Readout	1-3	Range
			5-2
			Functional or Operational Check
			5-3
			Equipment Required
			5-3
			Preliminary Preparation
			5-3
			1. Check Operation of Front Panel
			Pushbuttons and Controls
			5-3
			2. Check Gain Variation Between
			Resolution Bandwidths
			5-9
			3. Check Counter Accuracy
			5-10
			4. Check Span Accuracy and
			Linearity
			5-10
			5. Check Resolution Bandwidth
			and Shape Factor
			5-10
			6. Check Reference Level Gain and
			RF Attenuator Steps
			5-10
			7. Check Sensitivity
			5-11
			8. Check Residual FM
			5-13
			9. Check Frequency Drift or
			Stability
			5-14
			10. GPIB Verification Program
			5-14
Section 2	SPECIFICATION		Section 6
	Introduction	2-1	GENERAL OPERATING PROCEDURE
	Electrical Characteristics	2-1	Firmware Version and Error Message
			Readout
			6-1
Section 3	INSTALLATION AND PREPARATION		Using the Help Feature
	FOR USE		6-1
	Introduction	3-1	Crt Light Filters
	Unpacking and Initial Inspection ...	3-1	6-1
	Power Source and Power		Intensity Level and Beam Alignment
	Requirements	3-1	6-1
	Repackaging for Shipment	3-2	Signal Application
	Storage	3-3	6-1
			Resolution Bandwidth, Frequency
			Span, and Sweep Time
			6-2
			Using the MANUAL PEAK Control or
			AUTO PEAK Mode
			6-3
			Using the Signal Identifier
			6-3
			Using the Video Filters
			6-4
			Time Domain Operation
			6-5
Section 4	CONTROLS, CONNECTORS, AND		
	INDICATORS		
	Introduction	4-1	
	Front-Panel Controls and Selectors	4-1	
	Shift Functions of the Pushbuttons	4-1	
	Instrument Power Control	4-1	
	Crt Controls	4-2	
	Sweep or Scan	4-2	
	Display Parameters	4-3	
	General Purpose Pushbuttons	4-9	
	494P (GPIB) Controls	4-9	
	Front-Panel Input/Output Connectors	4-10	
	Rear-Panel Input/Output Connectors	4-10	
	Un-Nomenclated Front Panel		
	Pushbutton Functions	4-12	
	Operational Functions	4-12	
	Service Related Functions	4-12	

TABLE OF CONTENTS (cont)

	Page		Page
Section 6		Section 6	
GENERAL OPERATING PROCEDURE		GENERAL OPERATING PROCEDURE	
(cont)		(cont)	
Triggering the Display	6-5	Connecting to a System	6-16
Sweeping the Display	6-5	Operational Precautions for the	
Manual Scan of the Spectrum	6-5	494/494P	6-16
Reference Level, RF Attenuation, and		Service Manual	6-17
Vertical Display	6-6	Product Service	6-17
Δ A Mode	6-6		
Using Min Noise or Min Distortion			
Mode	6-6	Section 7	
Digital Storage	6-7	OPTIONS	
Store/Recall Feature	6-8	Option 08	7-2
Using the Counter	6-8	Option 12	7-2
Using the Automatic Calibration		Option 13	7-2
Feature	6-8	Option 14	7-2
Un-Nomenclated Front Panel		Option 20	7-2
Pushbutton Functions	6-8	Option 21	7-3
External Mixers and Diplexer	6-9	Option 22	7-3
Reference Level Readout and		Options 30, 31, and 32	
Conversion Loss for External Mixers	6-9	(Rackmount/Benchtop Versions)	7-4
Handling	6-10	Option 30	7-4
Installation	6-10	Option 31	7-4
Operation	6-11	Option 32	7-4
494P GPIB Controls, Indicators, and		Options 30, 31, and 32 Environmental	
Connectors	6-11	Characteristics	7-4
GPIB Function Readout	6-11	Safety Requirements	7-6
RESET TO LOCAL (REMOTE)	6-11	Accessories	7-6
ADDRESSED	6-12	Option 41	7-6
PLOT	6-12	Option 52	7-6
Setting the GPIB ADDRESS			
Switches	6-13	Appendix A	
Talk/Listen-Only Operation	6-13	GLOSSARY	
TALK ONLY, LISTEN ONLY		General Terms	A-1
Switches	6-13	Terms Related to Frequency	A-1
Data Logging	6-14	Terms Related to Amplitude	A-2
Restoring Control Settings and the		Terms Related to Digital Storage for	
Display	6-15	Spectrum Analyzers	A-3

LIST OF ILLUSTRATIONS

Fig. No.	Page	Fig. No.	Page
	viii		
	2-12	6-3	Graph to illustrate the relationship between dBm, dBmV and dB μ V (matching attenuator included where necessary)
2-1	Probe power connector		6-3
2-2	Dimensions	6-4	Typical display generated by a signal into the waveguide mixer
3-1	International power cord configuration (Option A1-A5) for 494/494P		6-4
4-1	Front panel selectors, controls, and connectors	6-5	Identifier mode displays
4-2	Rear panel connectors on the 494/494P	6-6	Integrating the display with the Video Filter
5-1	Crt display and readout for power-up state	6-7	Using B—SAVE A to observe the differential between SAVE A and B displays
5-2	Typical display of calibration markers in MAX SPAN position	6-8	Diagram showing external waveguide mixer installation
5-3	Integrating a display with the Video Filter	6-9	Typical display from an external mixer
5-4	Using IDENT feature to identify a real or true response	6-10	GPIB selectors and indicators unique to the 494P
5-5	Displays that illustrate how bandwidth and shape factor are determined	6-11	Status of GPIB as shown on the crt readout
5-6	Typical display showing how to determine residual FM	6-12	GPIB ADDRESS switch on the rear panel
6-1	Volts/dBm-Watts conversion chart for 50 Ω impedance	6-13	TEKTRONIX 4924 Digital Cartridge Tape Drive in a Talk/Listen Only system
6-2	Circuit of a 75 to 50 Ω matching pad (ac coupled)	6-14	Controls on the 4924 and 494P that are used to the Talk/Listen Only transfers
	6-3	7-1	International power cord and plug configuration for the 494/494P

LIST OF TABLES

Table No.	Page	Table No.	Page
1-1	Standard Accessories	2-11	494/494P Safety Standard and Regulatory Requirement Conformance
1-2	Tektronix High Performance Waveguide Mixers	3-1	Shipping Carton Test Strength
2-1	Frequency Related Characteristics	5-1	494/494P Sensitivity
2-2	IF Frequency, LO Range, and Harmonic Number (N)	7-1	Power Cord Options
2-3	Amplitude Related Characteristics	7-2	Option 20 (General Purpose Waveguide Mixers) Characteristics
2-4	Sensitivity	7-3	Option 21 (WM 490-2) Characteristics
2-5	Input Signal Characteristics	7-4	Option 22 (WM 490-3) Characteristics
2-6	Output Signal Characteristics	7-5	Options 30, 31, & 32 Environmental Characteristics
2-7	General Characteristics	7-6	Options 30, 31, & 32 Physical Characteristics
2-8	Power Requirements		
2-9	Environmental Characteristics		
2-10	Physical Characteristics		

OPERATORS SAFETY SUMMARY

The information in this safety summary is for both operating and servicing personnel. Specific warnings and cautions will be found throughout the manual where they apply, but may not appear in this summary.

CONFORMANCE TO INDUSTRY STANDARDS

The 494/494P complies with the following Industry Safety Standards and Regulatory Requirements:

Safety

CSA—Electrical Bulletin

FM—Electrical Utilization Standard Class 3820

ANSI C39.5—Safety Requirements for Electrical and Electronic Measuring and Controlling Instrumentation.

IEC 348 (2nd addition)—Safety Requirements for Electronic Measuring Apparatus.

Regulatory Requirements

VDE 0871 Class B—Regulations for RFI Suppression of High Frequency Apparatus and Installations.

TERMS

In This Manual

CAUTION statements identify conditions or practices that could result in damage to the equipment or other property.

WARNING statements identify conditions or practices that could result in personal injury or loss of life.

As Marked on Equipment

CAUTION indicates a personal injury hazard not immediately accessible as one reads the marking, or a hazard to property, including the equipment itself.

DANGER indicates a personal injury hazard immediately accessible as one reads the marking.

SYMBOLS

In This Manual



This symbol indicates where applicable cautionary or other information is to be found.

As Marked on Equipment



DANGER — High voltage.



Protective ground (earth) terminal.



ATTENTION — refer to manual.

POWER

Power Source

This product is intended to operate from a power source that will not apply more than 250 V rms between the supply conductors or between either supply conductor and ground. A protective ground connection by way of the grounding conductor in the power cord is essential for safe operation.

Grounding the Product

This product is grounded through the grounding conductor of the power cord. To avoid electrical shock, plug the power cord into a properly wired receptacle before connecting it to the product input or output terminals. A protective ground connection by way of the grounding conductor in the power cord is essential for safe operation.

Danger From Loss of Ground

Upon loss of the protective-ground connection, all accessible conductive parts (including knobs and controls that may appear to be insulating) can render an electric shock.

Use the Proper Power Cord

Use only the power cord and connector specified for your product.

494/494P Operators

Use only a power cord that is in good condition.

For detailed information on power cords and connectors, see Figure 1-3.

Refer cord and connector changes to qualified service personnel.

Use the Proper Fuse

To avoid fire hazard or damage to the equipment, use only the fuse of correct type, voltage rating, and current rating (as specified in the Replaceable Electrical Parts list in Volume 2 of the Service manual) for your product. Refer fuse replacement to qualified service personnel.

OPERATIONAL PRECAUTIONS

Do Not Operate in Explosive Atmosphere

To prevent an explosion, do not operate this product in an explosive atmosphere unless it has been specifically certified for such operation.

Do Not Remove Covers or Panels

To avoid personal injury, do not remove the product covers or panels. Do not operate the product without the covers and panels properly installed.

SERVICE SAFETY SUMMARY
FOR QUALIFIED SERVICE PERSONNEL ONLY
Refer also to the preceding Operators Safety Summary

Do Not Service Alone

Do not perform internal service or adjustment of this product unless another person capable of rendering first aid and resuscitation is present.

Use Care When Servicing With Power On

Dangerous voltages exist at several points in this product. To avoid personal injury, do not touch exposed connections and components while power is on. Disconnect power

before removing protective panels, soldering, or replacing components.

Power Source

This product is intended to operate from a power source that will not apply more than 250 V rms between the supply conductors or between either supply conductor and ground. A protective ground connection, via the grounding conductor in the power cord, is essential for safe operation.

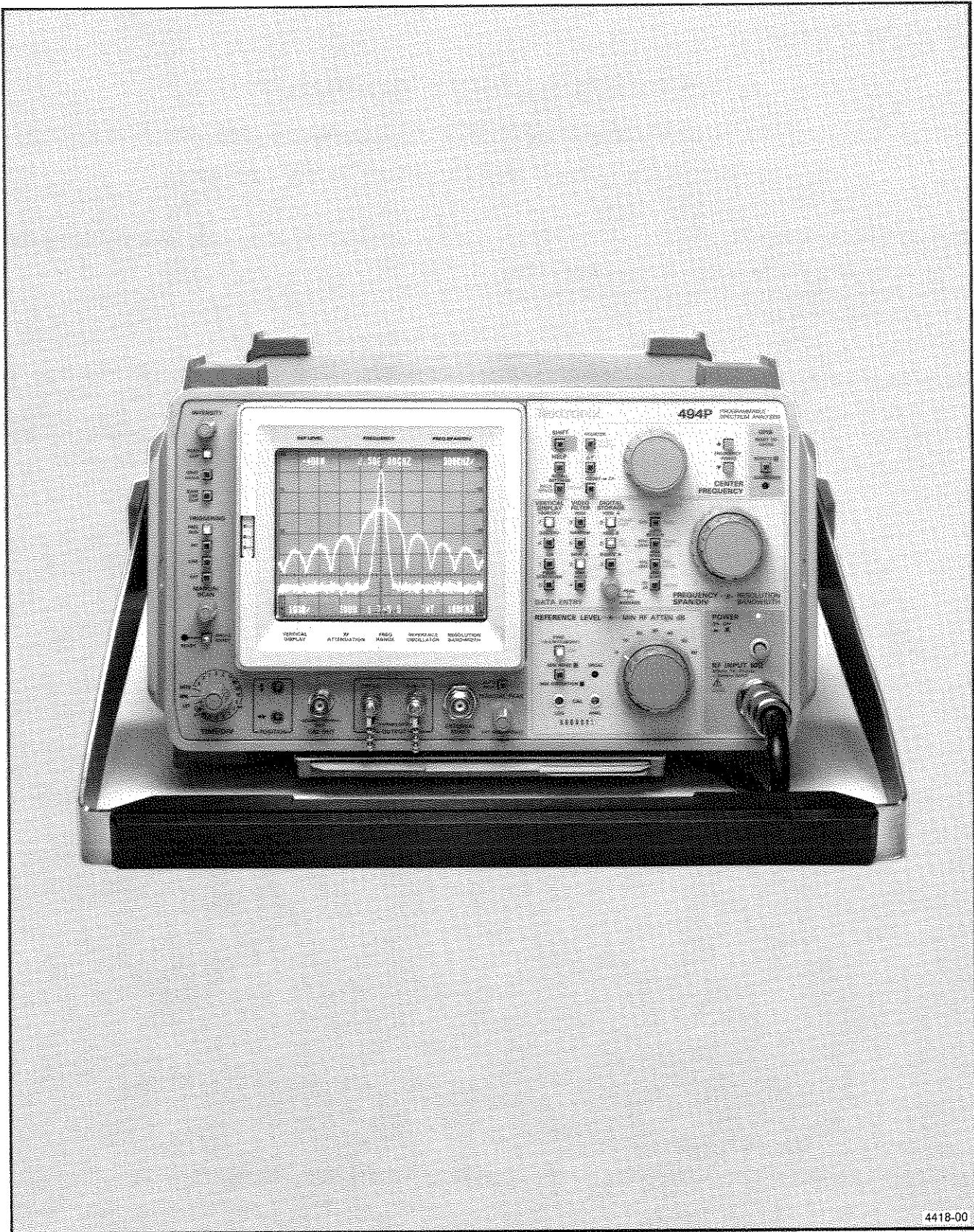

4418-00

494/494P Spectrum Analyzer.

GENERAL INFORMATION

Product Overview

The 494 and the 494P programmable instruments are high performance, compact, portable spectrum analyzers. Microcomputer control of most functions simplifies and enhances operation. Its main features are; synthesizer frequency accuracy and stability, precision signal counting ability, precise amplitude measurement capability, digital storage display, non-volatile memory to retain front panel settings and displays, and crt message readout that describes function of the front panel controls and selectors along with messages that explain operating errors.

The frequency range is 10 kHz to 21 GHz with the internal mixer, and up to 325 GHz when using external waveguide mixers. A minimum resolution bandwidth of 30 Hz, with a minimum span of 50 Hz/div, provides measurement resolution that is commensurate with the frequency accuracy. Digital storage provides flicker free displays plus functions such as SAVE A, B—SAVE A, MAX HOLD with which to compare and subtract displays, save maximum values. In addition to the conventional digital storage feature, up to nine separate displays with their parameter readouts, can be stored in non-volatile memory, then later recalled for additional analysis and comparison. Up to ten different front-panel control setups can also be stored for future recall.

Center frequency may be selected by means of the front-panel tuning knob or directly selected by the Data Entry keyboard. When using the keyboard, it is not necessary to alter the Span/Div setting regardless of the frequency selected. Other parameters, such as vertical display and reference level, may also be keyboard selected with the flexibility previously available only under GPIB program control. Counter accuracy to 1 Hz resolution is available.

In addition, the 494/494P requires only a short warm-up time for stable operation. In 15 minutes or less the frequency drift is less than 500 Hz per minute of sweep time. After one hour, it is less than 50 Hz per minute of sweep time. Display dynamic range is 80 dB, with calibrated reference level readout from -117 dBm to $+30$ dBm, in selectable steps from 1 to 15 dB, and 0.25 dB for a delta A (amplitude) mode. When the vertical display is selected with the Data Entry keyboard, the reference level steps correspond to the display mode (see General Operating information in Section 6). Sensitivity at 30 Hz resolution bandwidth is -121 dBm to 7.1 GHz, decreasing to -96 dBm at 21 GHz.

The 494P adds remote control capability to the standard instrument features of the 494. The front-panel controls (except those intended for local use, such as INTENSITY) can be remotely operated through the GPIB port, which allows the 494P to be used with a variety of systems and controllers. This operation is described in detail in the Programmers manual.

The rackmount version (Option 30) of the 494/494P Spectrum Analyzer is the instrument in a cabinet designed to mount in a standard 19-inch rack. Option 31 includes semi-rigid cabling from the front panel connectors (e.g., RF INPUT, 1st LO, 2nd LO, etc.) to the back of the cabinet. This provides access to all front-panel connectors via the cabinet rear panel.

The benchtop version (Option 32) is the 494 or 494P in the rackmount version cabinet with the addition of side panels and feet on the bottom of the cabinet. Both rackmount and benchtop cabinets include a larger (external) fan for additional cooling. This fan must be installed and operating before applying power to the instrument.

Options For Power Cord Configuration

Tektronix has implemented options that provide internationally approved power cord and plug configurations. These are listed and illustrated in the Options section of this manual.

Options

Options for the 494/494P are described in the Options section of the manuals including rackmount/benchtop versions.

Accessories

Standard accessories that come with each instrument are listed in Table 1-1. In addition there are optional accessories such as; waveguide mixer sets, Tracking Generators, etc. Table 1-2 lists Tektronix waveguide mixers that are available. Standard accessories, with part numbers, are listed in Volume 2 of the service instructions, following the Replaceable Mechanical Parts list. Optional accessories such as cables and adapters are listed, where appropriate, throughout the manual and in the Tektronix catalog.

Table 1-1
STANDARD ACCESSORIES

Nomenclature	Quantity	Storage
50 ohm coaxial cable, n to n connector, 72"	1	Front Cover or Drawer
50 ohm Coax cable, bnc to bnc connector, 18"	1	Front Cover or Drawer
Adapter, n male to bnc female	1	Front Cover or Drawer
Fuses, 4 A fast ^a	2	Front Cover or Drawer
Power cord	1	Front Cover or Drawer
Cord clamp	1	Front Cover or Drawer
Crt light filter, amber	1	Front Cover or Drawer
Crt light filter, grey	1	Front Cover or Drawer
Crt mesh filter	1	Front Cover or Drawer
Diplexer Assembly ^b	1	Front Cover or Drawer
Adapter, tnc to sma	1	Part of Diplexer Assy
Cable, semi-rigid coaxial	1	Part of Diplexer Assy
Visor, crt	1	Front Cover or Drawer
Manual, Operators Handbook	1	Front Cover or Drawer
Manual, Operators	1	Not applicable
Manual, Service, Volume 1	1	Not applicable
Manual, Service, Volume 2	1	Not applicable
Manual, Programmers (494P only)	1	Not applicable
GPIO interconnect cable (494P only)	1	Not applicable

^aThe power cord and fuses are replaced with an appropriate power cord for the power cord option (A1, A2, A3, A4, A5) and the fuses are changed to 2A slow blow. Option 52 (North American Configuration for 220 V with standard power cord) replaces fuses with 2A slow blow.

^bDeleted for Option 08 instruments.

Table 1-2
TEKTRONIX HIGH PERFORMANCE WAVEGUIDE MIXERS

Nomenclature	Frequency Range
WM 490K	18 to 26.5 GHz
WM 490A	26.5 to 40 GHz
WM 490U	33 to 60 GHz
WM 490V	50 to 75 GHz
WM 490E	60 to 90 GHz
WM 490W	75 to 110 GHz
WM 490F	90 to 140 GHz
WM 490D	110 to 170 GHz
WM 490G	140 to 220 GHz
G-J Band flange transition	220 to 325 GHz

Firmware Version and Error Message Readout

This feature of the 494/494P provides readout of the firmware version when the power on/off is cycled. During initial power-up cycle, the firmware version flashes on screen for approximately two seconds. The Replaceable Electrical Parts list section, under Memory Board (A54), lists the ROM's and their Tektronix part number for each firmware version.

An additional feature is error message readout. If the microcomputer fails to complete any routine or function, an error message will flash on screen explaining the nature of the error (i.e., failed to complete phase lock).

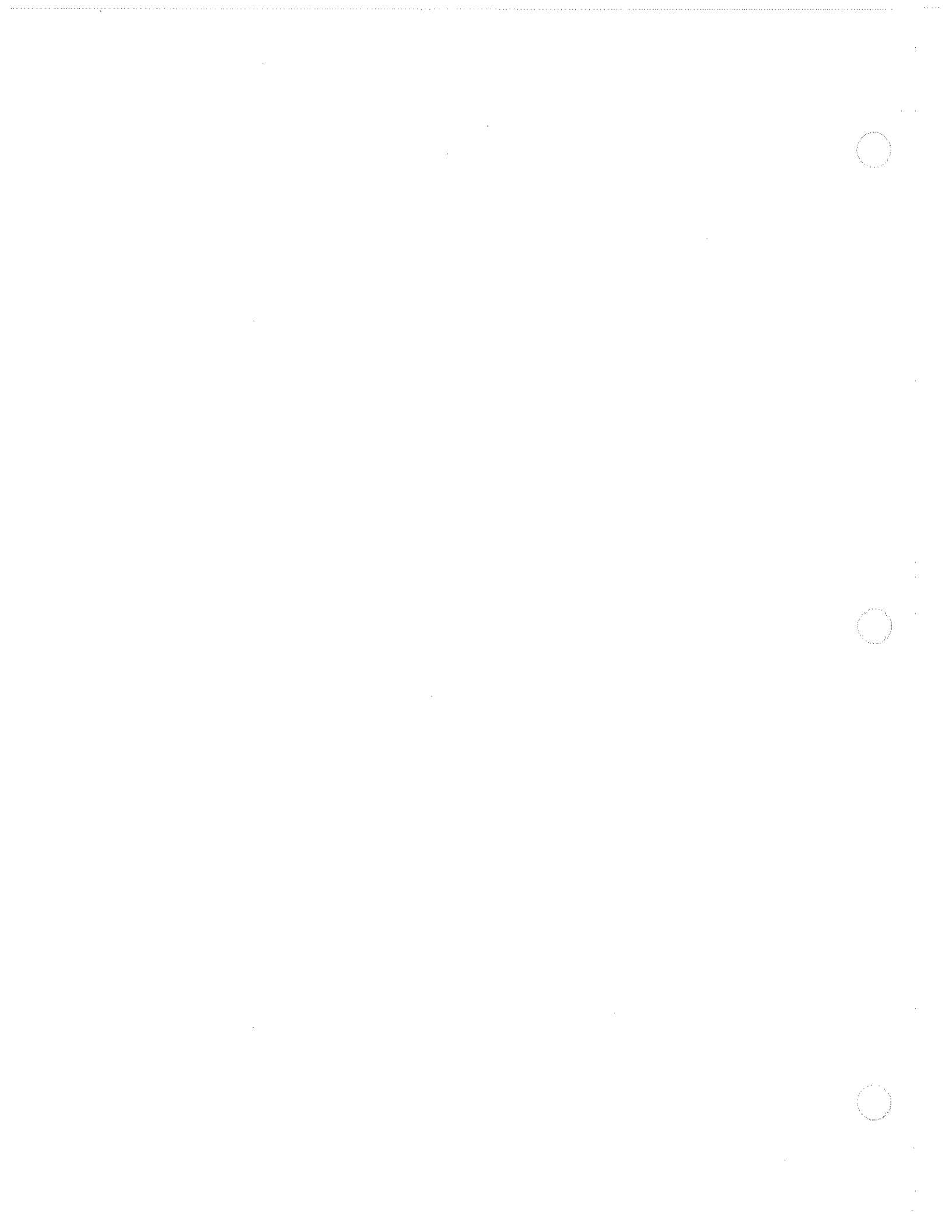

SPECIFICATION

Introduction

This section includes electrical, physical, environmental, and safety characteristics of this instrument. Changes to

this specification, due to options are listed in the Options section.

ELECTRICAL CHARACTERISTICS

The following tables of electrical characteristics and features apply to the 494/494P Spectrum Analyzer after a 30-minute warmup, except as noted. The Performance Requirement column defines some characteristics in quantitative terms and in limit form. The Supplemental column explains performance requirements or provides performance information. Statements in this column are not considered to be guaranteed performance and are not ordinarily supported by a performance check procedure. Procedures to verify performance requirements are provided in the Performance section of the service manual.

The instrument microprocessor performs an internal calibration check each time power is turned on and verifies that the instrument frequency and amplitude performance is as specified. An operation or functional check procedure, which does not require external test equipment or technical expertise, is provided in the operators instructions to satisfy most incoming inspections and help familiarize the operator with the capabilities of the instrument.

Table 2-1
FREQUENCY RELATED CHARACTERISTICS

Characteristic	Performance Requirement	Supplemental Information
Center Frequency Range (internal mixer)		10 kHz to 21 GHz. Tuned by the front panel knob or front panel Data Entry keyboard.
Accuracy (after the front panel CAL has been performed)		Accuracy of the center frequency is a function of the accuracy to which the center frequency is set between sweeps (covered by CF accuracy specification), and the amount of center frequency drift during a sweep. Center frequency drift can be significant during the first 30 min. after turn-on, or after a change in ambient temperature.
Bands 1 & 5-12 with Span/Div >200 kHz, and Bands 2-4, with Span/Div >100 kHz	$\pm[(20\% \text{ of Span/Div or Resoln Bandwidth, whichever is greater}); + (CF \times \text{ref freq error}) + (N \times 15 \text{ kHz})]$	Refer to "IF Frequency, LO Range, and Harmonic Number" specification for value of N. The 1st LO is unlocked in these spans. When the center frequency is changed within a band, a settling time of 1 s/GHz change in center frequency, divided by N should be allowed.
Bands 1 & 5-12 with Span/Div \leq 200 kHz and bands 2-4 with Span/Div \leq 100 kHz	$\pm[(20\% \text{ of Span/Div or Resoln Bandwidth, whichever is greater}); + (CF \times \text{ref freq error}) + (2N + 25)\text{Hz}]$	The 1st LO is phase locked in these spans

Table 2-1 (cont)

Characteristic	Performance Requirement	Supplemental Information
CF Drift (constant ambient temperature and fixed center frequency)		Since the center frequency is corrected before each sweep the only error observed is during sweep time.
After 30 minute warmup: Bands 1 & 5-12 with Span/Div >200 kHz, and Bands 2-4 with Span/Div >100 kHz		$\leq (25 \text{ kHz})N$ per minute of sweep time
Bands 1 & 5-12 with Span/Div ≤ 200 kHz Bands 2-4 with Span/Div ≤ 100 kHz		≤ 150 Hz per minute of sweep time
After 1 hour warmup: Bands 1 & 5-12 with Span/Div >200 kHz and Bands 2-4 with Span/Div >100 kHz		$\leq (5 \text{ kHz}) N$ per minute of sweep time
Bands 1 & 5-12 with Span/Div ≤ 200 kHz and Bands 2-4 with Span/Div ≤ 100 kHz	≤ 50 Hz per minute of sweep time	
Readout Resolution		At least 10% of Span/Div
Signal Counter Accuracy	$\pm [(\text{Counter frequency} \times \text{frequency reference error}) + (10 + 2N)\text{Hz} + 1 \text{ LSD}]$	
Sensitivity	Signal level at center screen must 20 dB or more above the average noise level and within 60 dB of the Reference Level	
Readout Resolution		1 Hz through 1 GHz, selectable with COUNT RESOLN control
Reference Frequency Error Aging Rate		1×10^{-7} for first six months then less than 1×10^{-7} per year
Accuracy during warmup at 25°C (ambient) and 30 minutes after power on		Within 5×10^{-8} of the frequency after 24 hours
Temperature sensitivity		Within 2×10^{-8} over the instrument operating range of -15°C to +55°C, referenced to +25°C
Residual FM (short term) after 1 hour warmup: Bands 1 & 5-12 with Span/Div >200 kHz, and bands 2-4 with Span/Div >100 kHz	$\leq (7 \text{ kHz})N$ total excursion in 20 ms	
Bands 1 & 5-12 with Span/Div ≤ 200 kHz Bands 2-4 with Span/Div ≤ 100 kHz	$\leq (10 + 2N)\text{Hz}$ total excursion in 20 ms	

Table 2-1 (cont)

Characteristic	Performance Requirement	Supplemental Information		
"Static" Resolution Bandwidth (6 dB down)	30 Hz then 100 Hz to 1 MHz in decade steps plus an AUTO position. Resolution bandwidth is within 20% of the selected bandwidth.	In AUTO position the bandwidth is automatically selected by an internal computer whose output depends on the setting of the SPAN/DIV, TIME/DIV, Vertical Display, and VIDEO Filter selectors. When the RESOLUTION BANDWIDTH and TIME/DIV selectors are set to AUTO the microcomputer selects the optimum resolution for the SPAN/DIV settings.		
Shape Factor (60 dB/6 dB)	7.5:1 or less, and 15:1 or less for 30 Hz resolution bandwidth.			
Noise Sidebands	At least -75 dBc at 30 times the resolution offset (-70 dBc for resolution bandwidths ≤100 Hz).			
Video Filter Narrow		Reduces video bandwidth to approximately 1/300 of the selected resolution bandwidth and 1/100 for 30 Hz bandwidth.		
Wide		Reduces video bandwidth to approximately 1/30 of the selected resolution bandwidth and 1/10 for 30 Hz bandwidth.		
Pulse Stretcher Falltime		30 μs/div (± 50%)		
Frequency Span/Div Range—in a 1-2-5 sequence with the SPAN/DIV control, or by two significant digits from the Data Entry keyboard		Band	Narrow Span/Div	Wide Span/Div
		1-3 (0-7.1 GHz)	50 Hz	200 MHz
		4-5 (5.4-21 GHz)	50 Hz	500 MHz
		6 (18-26 GHz)	50 Hz	1 GHz
		7-9 (26-90 GHz)	50 Hz	2 GHz
		10 (75-140 GHz)	50 Hz	5 GHz
		11-12 (110-325 GHz)	50 Hz	10 GHz
		Two additional positions provide full band (MAX Span) display or 0 Hz (Zero Span) display.		
Accuracy/Linearity	Within 5%, of the selected Span/Div over the center 8 divisions of a 10 division display.			

Table 2-1 (cont)

^a Frequency Response Coaxial (direct) Input	About the mid- point (mean) between two extremes	Referenced to 100 MHz	Frequency response is measured with 10 dB of RF attenuation and Peaking optimized for each center frequency setting, when applicable. Response includes the effect of input vswr, mixing mode (N), gain variation, pre-selector, and mixer. Digital storage typically increases errors by $\pm 0.5\%$. Display flatness is typically 1 dB greater than frequency response. Refer to Rackmount/Benchtop data (Option 30, 31, and 32) in the Options section for variance.
<p>Band 1 50 kHz-1.8 GHz 10 kHz-1.8 GHz</p> <p>Band 2 1.7-5.5 GHz</p> <p>Band 3 3.0-7.1 GHz</p> <p>Band 4 5.4-18.0 GHz</p> <p>Band 5 15.0-21.0 GHz</p>	<p>± 1.5 dB ± 2.0 dB</p> <p>± 2.5 dB</p> <p>± 2.5 dB</p> <p>± 3.5 dB</p> <p>± 5.0 dB</p>	<p>± 2.5 dB ± 3.0 dB</p> <p>± 3.5 dB</p> <p>± 3.5 dB</p> <p>± 4.5 dB</p> <p>± 6.5 dB</p>	
External Tektronix High Performance Waveguide Mixers	<p>Band 6 18.0-26 GHz</p> <p>Band 7 26.0-40.0 GHz</p> <p>Band 8 33.0-60.0 GHz</p> <p>Band 9 50.0-90.0 GHz</p> <p>Band 10 75.0-140.0 GHz</p> <p>Band 11 110-220 GHz</p> <p>Band 12 170-325 GHz</p>	<p>± 3.0 dB</p> <p>± 3.0 dB</p> <p>± 3.0 dB</p>	<p>Typically ± 3 dB over any 5 GHz bandwidth</p> <p>Typically ± 3 dB over any 5 GHz bandwidth</p> <p>Typically ± 3 dB over any 5 GHz bandwidth</p> <p>Typically ± 3 dB over any 5 GHz bandwidth</p>

^aRefer to "Verification of Tolerance Limits" at the beginning of this specification.

Table 2-2
IF Frequency, LO Range, and Harmonic Number (N)

Band and Freq Range		LO Range and Harmonic (N)	1st IF (MHz)
1 (0—1.8 GHz)		2072-3872 (1 -)	2072
2 (1.7—5.5 GHz)		2529-6329 (1 -)	829
3 (3.0—7.1 GHz)		2171-6271 (1 +)	829
4 (5.4—18.0 GHz)		2072-6276 (3 -)	829
5 (15—21 GHz)		4309-6309 (3 +)	2072
6 (18—26 GHz)		2655-4071 (6 +)	2072
7 (26—40 GHz)		2443-3793 (10 +)	2072
8 (33—60 GHz)		3792-5790 (10 +)	2072
9 (50—90 GHz)		3195-5862 (15 +)	2072
10 (75—140 GHz)		3170-6000 (23 +)	2072
11 (110—220 GHz)		2917-5790 (37 +)	2072
12 (170—325 GHz)		2998-5841 (56 +)	2072

Table 2-3
AMPLITUDE RELATED CHARACTERISTICS

Characteristic	Performance Requirement	Supplemental Information
Vertical Display Modes		10 dB/Div, 2 dB/Div, and linear. Any integer between 1-15 dB/Div can also be selected with the Data Entry keyboard.
Reference Level (full screen) Range		-117 dBm to +40 dBm; +40 dBm includes 10 dB of IF gain reduction, +30 dBm is the maximum safe input for log mode. In LIN mode, range is 20 nV/Div to 2 V/Div, 1 W maximum safe input
Steps		In the 10 dB/DIV display mode, steps are 10 dB for the coarse mode and 1 dB for the FINE mode. In the 2 dB/DIV mode, steps are 1 dB for coarse and 0.25 dB for FINE. When the dB/Div is set through the Data Entry keyboard, the coarse steps correspond to the display mode. The FINE steps are 1 dB when the mode is 5 dB/Div or more and 0.25 dB/Div for display modes of 4 dB/Div or less (referred to as ΔA mode). In LIN mode the steps are in equivalent 1 dB increments for FINE and in a 1-2-5 Volts/Div sequence for coarse.

Table 2-3 (cont)

Characteristic	Performance Requirement	Supplemental Information
Accuracy		Accuracy is a function of RF attenuation, IF gain, resolution bandwidth, display mode, calibrating source (i.e., internal calibrator), frequency band and response. Refer to accuracies of these characteristics. When the CAL button is activated the processor runs a calibrating routine, which, if completed, reduces the REF LEVEL error between different resolution bandwidths. Also, if the instrument ambient temperature is changed after a calibration is run, the REF LEVEL error typically can change ± 0.05 dB/°C but may increase to ± 0.15 dB/°C with some instrument settings. The input RF attenuator steps 10 dB for reference level changes above -30 dBm (-20 dBm when MIN NOISE is active) unless the MIN RF ATTEN setting is greater than zero. The IF gain increases 10 dB for each 10 dB reference level change below -30 dBm (-20 dBm for MIN NOISE mode).
Display Dynamic Range		80 dB maximum, for log mode, and 8 divisions linear
Accuracy	± 1.0 dB/10 dB to a maximum cumulative error of ± 2.0 dB over 80 dB range ± 0.4 dB/2 dB to a maximum cumulative error of ± 1.0 dB over 16 dB range LIN mode is $\pm 5\%$ of full scale	
RF Attenuator Range		0-60 dB in 10 dB steps
Accuracy °Dc to 4 GHz	Within 0.3 dB/10 dB to a maximum of 0.7 dB over the 60 dB range	
4 GHz to 18 GHz	Within 0.5 dB/10 dB to a maximum of 1.4 dB over the 60 dB range	
IF Gain Range		87 dB of gain increase, 10 dB of gain decrease (MIN NOISE activated), in 10 dB and 1 dB steps.
Accuracy	Gain steps are monotonic (same direction) with the following limits: Within 0.2 dB/dB to a maximum of 0.5 dB/9 dB, except at the decade transistions of -19 to -20 dBm, -29 to -30 dBm, -39 to -40 dBm, -49 to -50 dBm, and -59 to -60 dBm; where an additional 0.5 dB can occur, for a total of 1.0 dB per decade. Maximum deviation over the 97 dB range is within ± 2 dB.	

Table 2-3 (cont)

Characteristic	Performance Requirement	Supplemental Information		
Gain Variation between Resolution Bandwidths; (after CAL routine has been run)		Measured at -20 dBm MIN DISTORTION mode		
With respect to 1 MHz filter	Less than ±0.4 dB			
Between any two filters	Less than 0.8 dB			
Differential Amplitude Measurement		ΔA mode provides differential measurements in 0.25 dB increments.		
Range		0 dB above to 48 dB below the reference level established when the ΔA mode was activated. DO NOT USE ΔA mode above +30 dBm reference level.		
Accuracy		dB Difference	Steps	Error
		0.25	1	0.15 dB
		2	8	0.4 dB
		10	40	1.0 dB
		50	200	2.0 dB
Spurious Responses Residual (no input signal), referenced to mixer input, and fundamental mixing for bands 1-3.	-100 dBm or less			
Intermodulation products 50 kHz to 1.8 GHz (Band 1 and 1.8 to 21.0 GHz for Bands 2-4)	At least -70 dBc from any two on screen signals within any frequency span	≥ -100 dBc when signals are separated 100 MHz or more in preselected bands		
1.7-1.8 GHz (Band 2 only)	At least -70 dBc from any two -40 dBm signals within any frequency span			
Harmonic Distortion 50 kHz-1.8 GHz (Band 1)	At least -60 dBc below a full screen signal in MIN DISTORTION mode			
1.7-21 GHz	At least -100 dBc			
LO Emission, with no (0) RF attenuation	Less than -70 dBm to 21 GHz			

*Refer to "Verification of Tolerance Limits" at the beginning of this specification.

Table 2-4
SENSITIVITY

Equivalent maximum input noise for each resolution bandwidth, using the internal mixer for bands 1–5 (100 kHz–18 GHz), and Tektronix High Performance Waveguide Mixers for bands 6–12 (18–325 GHz).

Band/Frequency	Equivalent Input Noise in dBm versus Resolution Bandwidth					
	30 Hz	100 Hz	1 kHz	10 kHz	100 kHz	1 MHz
Band 1 50 kHz–1.8 GHz	–121	–118	–110	–100	–90	–80
Bands 2 & 3 1.7–7.1 GHz	–121	–118	–110	–100	–90	–80
Band 4 5.4–12.0 GHz	–106	–103	–95	–85	–75	–65
Band 4 12.0–18.0 GHz	–101	–98	–90	–80	–70	–60
Band 5 15.0–21.0 GHz	–96	–93	–85	–75	–65	–55
^a Band 6 18.0–26.5 GHz	–111	–108	–100	–90	–80	–70
^a Band 7 26.5–40.0 GHz	–106	–103	–95	–85	–75	–65
^a Band 8 33.0–60.0 GHz	–106	–103	–95	–85	–75	–65
^a Band 9 50.0–90.0 GHz	Typically –95 dBm for 1 kHz bandwidth at 50 GHz, degrading to –85 dBm at 90 GHz					
^a Band 10 75.0–140 GHz	Typically –90 dBm for 1 kHz bandwidth at 75 GHz, degrading to –75 dBm at 140 GHz					
^a Band 11 110–220 GHz	Typically –80 dBm for 1 kHz resolution bandwidth at 110 GHz, degrading to –65 dBm at 220 GHz					
^a Band 12 170–325 GHz	Typically –70 dBm for 1 kHz resolution bandwidth at 170 GHz, degrading to –55 dBm at 325 GHz					

^aTektronix High Performance Waveguide Mixers

Table 2-5
INPUT SIGNAL CHARACTERISTICS

Characteristic	Performance Requirement	Supplemental Information
RF INPUT		Type N female connector, specified to 21 GHz.
Input Impedance		50 Ω ; vswr with RF attenuation ≥ 10 dB: 50 kHz-2.5 GHz; 1.3:1 (typically 1.2:1) 2.5-6.0 GHz; 1.7:1 (typically 1.5:1) 6.0-18 GHz; 2.3:1 (typically 1.9:1) 18-21 GHz; 3.5:1 (typically 2.7:1)
Maximum Safe Input		+30 dBm (1 W) continuous, 75 W peak, pulse width 1 μ s or less with a maximum duty factor of 0.001 (attenuator limit). DO NOT APPLY DC VOLTAGE TO THE RF INPUT
1 dB Compression Point (minimum)		
1.7-2.0 GHz	-28 dBm	With no RF attenuation
Otherwise	-18 dBm	
Optimum level for linear operation		-30 dBm, referenced to input mixer. This is achieved in MIN DISTORTION mode when not exceeding full screen display.
External Mixer		Input for an IF signal and the source of bias for external waveguide mixers. Bias range +1.0 to -2.0 V, 70 Ω source.
EXTERNAL REFERENCE		
Frequency	1, 2, 5, or 10 MHz, ± 5 ppm	
Power	-15 dBm to +15 dBm.	
Waveshape		Sinewave, ECL or TTL. (Allowable duty cycle symmetry is 40-60%)
Input Impedance		50 Ω ac, 500 Ω dc
HORIZ/TRIG		Dc coupled input for horizontal drive and ac coupled for trigger signal
Input Voltage Range Sweep		0 to +10 V (dc + peak ac) for full screen deflection
Trigger	1.0 V peak, frequency 15 Hz to 1 MHz	Maximum input: 50 V (dc + peak ac). Maximum ac input: 30 Vrms to 10 kHz then derate linearly to 3.5 Vrms at 100 kHz and above. Pulse width is 0.1 μ s minimum.
MARKER/VIDEO		Video, 0 to +4 V, if Ext Video is selected; or, it interfaces with the 1405 TV Sideband Adapter to insert an externally generated marker on internal video. Marker 0 to -10 V
ACCESSORY (J104)		
Pin 1—External Video Select		TTL logic 0 selects the External Video Input
Pin 2—External Preselector Out		± 15 V maximum
Pin 3—External Preselector Return		
Pin 5—Chassis Gnd		

Table 2-6
OUTPUT SIGNAL CHARACTERISTICS

Characteristic	Performance Requirement	Supplemental Information
Calibrator (CAL OUT)	-20 dBm \pm 0.3 dB at 100 MHz (phase locked to reference oscillator)	100 MHz comb of markers provide amplitude calibration at 100 MHz and markers for frequency and span calibration, to 1.0 GHz
1st LO and 2nd LO		Provides access to the output of the respective local oscillators. 1st LO +7.5 dBm minimum, to a maximum of +15 dBm; 2nd LO -22 dBm minimum, to a maximum of +15 dBm. THESE PORTS MUST BE TERMINATED IN 50 Ω AT ALL TIMES.
EXTERNAL MIXER		In the EXTERNAL MIXER mode, bias range is +1.0 to -2.0 V; or, with change of internal straps, -1.0 to +2.0 V.
VERTical		Provides 0.5 V \pm 5% of signal per division of video that is above and below the centerline. Source impedance approximately 1 k Ω .
HORIZ Out		Provides 0.5 V/div either side of center. Full range -2.5 V to +2.5 V. Source impedance approximately 1 k Ω .
PEN LIFT		TTL compatible, nominal +5 volts to lift pen.
10 MHz IF		Access to the 10 MHz IF. Output level is approximately -5 dBm for a full screen signal at -30 dBm reference level. Nominal impedance approximately 50 Ω .

Table 2-7
GENERAL CHARACTERISTICS

Characteristic	Performance Requirement	Supplemental Information
IEEE Std 488-1978 Port (GPIB) 494P		In accordance with IEEE 488 standard, and Tektronix codes and format standard Version 81.1
PROBE POWER		Provides operating voltages for active probes. Output voltages are: Pin 1, +5 V @ 100 mA max. Pin 2, ground. Pin 3, -15 V @ 100 mA max. Pin 4, +15 V @ 100 mA max. (see Figure 2-1)
Sweep Sweep Time	20 μ s/Div to 5 s/Div in 1-2-5 sequence (10 s/Div available in AUTO).	Triggered, auto, manual, and external.
Accuracy	$\pm 5\%$.	
Triggering	2 division or more of signal for internal; and 1.0 V peak, minimum, for external	
Crt Readout		Displays: Reference level, frequency, vertical display mode, frequency span/div, frequency range, resolution bandwidth, RF attenuation, internal or external frequency reference, and GPIB states (494P only)
Non-volatile Memory		Instrument settings, displays, calibration offsets, and preselector peaking codes for each band are stored in back-up battery powered CMOS RAM. Battery life @ +55°C instrument ambient temperature, is 1-2 years. At +25°C, life should be greater than 5 years. Retention of data in non-volatile memory will occur over the range of -15°C to +55°C operating, and -30 to +85°C non-operating.

Specification—494/494P Operators

PROBE POWER. The PROBE POWER connector on the rear panel of this instrument provides operating power for active probe systems. It is not recommended that these connectors be used as a power source for applications other than the compatible probes or other accessories which are specifically designed for use with this source.

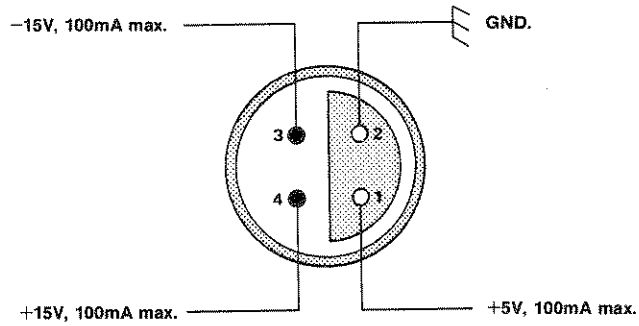

2726-21

Figure 2-1. Probe power connector.

**Table 2-8
POWER REQUIREMENTS**

Characteristic	Description
Input Voltage	90 to 132 Vac or 180 to 250 Vac, 48 to 440 Hz.
Power	At 115 V, 60 Hz; 210 watts maximum, 3.2 amperes.
Leakage Current	5 mA maximum

NOTE

If power to this instrument is interrupted, it may be necessary to re-initialize the microcomputer; when power is restored, turn the POWER switch OFF for 5 seconds then back ON.

**Table 2-9
ENVIRONMENTAL CHARACTERISTICS**

Meets MIL T-28800C, type III class 3, style C specifications, comprised of the following:

Characteristic	Description
Temperature	
Operating and Humidity	-10 to +55°C/95% (+5%, -0%) relative humidity. (Instrument is tested and meets -15 to +55°C)
Non-operating	-62 to +85°C.

Table 2-9 (cont)

Characteristic	Description	
<i>NOTE</i>		
<p><i>After storage at temperatures below the operating range, the microcomputer may not initialize on power-up. If so, allow the instrument to warm up for 15 minutes and re-initialize the microcomputer by turning the POWER Off for 5 seconds then back On.</i></p>		
Altitude		
Operating	15,000 feet	
Non-operating	40,000 feet	
Humidity (Non-operating)	Five cycles (120 hours) in accordance with Mil-Std-810	
Vibration		
Operating (instrument secured to a vibration platform during test)	MIL-Std-810, Method 514 Procedure X (modified). Resonant searches along all three axis at 0.020 inch displacement, frequency varied from 5-55 Hz for 15 minutes. All major resonances must be minimum/axis plus dwell at the resonant frequency, or 55 Hz if no resonance is found for 10 minutes minimum. Total vibration time about 75 minutes.	
Shock (operating and non-operating)	Three shocks of 30 g, one-half sine, 11 ms duration each direction along each major axis. Guillotine-type shocks. Total of 18 shocks.	
Transit drop (free fall)	8 inch, one per each of six faces and eight corners. (Instrument is tested and meets drop height of 12 inches.)	
Electromagnetic Interference (EMI)	Meets requirements described in Mil-Std-461B Part 4, except as noted	
	Test Method	Remarks
Conducted Emissions	CEO1—60 Hz to 15 kHz.	1 kHz to 15 kHz only.
	CEO3—15 kHz to 50 MHz power leads.	15 kHz to 50 kHz, relaxed by 15 dB.
Conducted Susceptibility		
	CSO1—30 Hz to 50 kHz power leads.	Full limits.
	CSO2—50 kHz to 400 MHz power leads.	Full limits.
	CSO6—spike power leads.	Full limits.
Radiated Emissions		
	REO1—30 Hz to 50 kHz magnetic field.	Relaxed by 10 dB for fundamental to 10th harmonic of power line. Excepted, 30 kHz to 36 kHz.
	REO2—14 kHz to 10 GHz.	Full limit.
Radiated Susceptibility		
	RSO1—30 Hz to 50 kHz.	Full limit.
	RSO2—Magnetic Induction	To 5 A only
	RSO3—14 kHz to 10 GHz	Up to 1 GHz

Table 2-10
PHYSICAL CHARACTERISTICS

Characteristic	Description
Weight (standard accessories and cover, except manuals)	52 pounds (24 kg) maximum
Dimensions	
Without front cover, handle, or feet	6.9 X 12.87 X 19.65 inches (175 X 327 X 499 millimeters)
With front cover, feet, and handle	9.15 X 15.05 X 23.1 inches (232 X 382 X 587 millimeters) with the handle folded back over the instrument, 28.85 inches (732.8 mm) with the handle fully extended

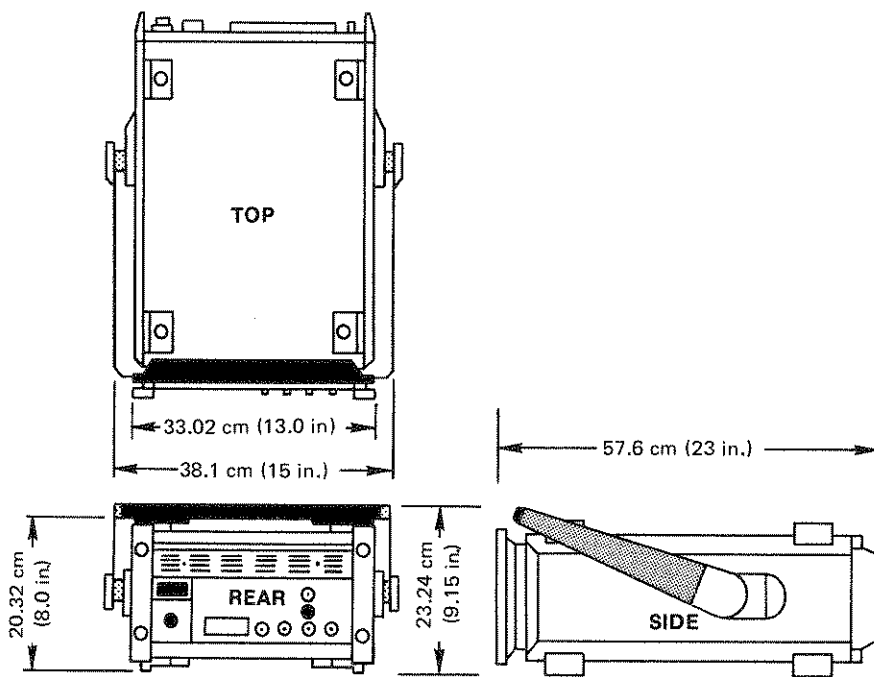

2726-10B

Figure 2-2. Dimensions.

Table 2-11
494/494P SAFETY STANDARD AND REGULATORY REQUIREMENT CONFORMANCE

Subject	Description
Safety Standards	
CSA	Electrical Bulletin
FM	Electrical Utilization Standard Class 3820
ANSI C39.5	Safety Requirements for Electrical and Electronic Measuring and Controlling Instrumentation
IEC 348 (2nd edition)	Safety Requirements for Electronic Measuring Apparatus
Regulatory Requirement	
VDE 0871 Class B	Regulations for RFI Suppression of High Frequency Apparatus and Installations

INSTALLATION AND PREPARATION FOR USE

Introduction

This section describes unpacking, installation, power requirements, repackaging, and storage information for the 494/494P Spectrum Analyzer.

Unpacking and Initial Inspection

Before unpacking the 494/494P from its shipping container or carton, inspect for signs of external damage. If the carton is damaged, notify the carrier. The shipping carton contains the basic instrument and its standard accessories. Refer to the Standard Accessories list in Section 1 of the Operators manual or the list following the Mechanical Parts Replacement listing in Volume 2 of the Service Instructions.

If the contents of the shipping container are incomplete, if there is mechanical damage or defect, or if the instrument does not meet operational check requirements, contact your local Tektronix Field Office or representative. If the shipping container is damaged, notify the carrier as well as Tektronix, Inc.

The instrument was inspected both mechanically and electrically before shipment. It should be free of mechanical damage and meet or exceed all electrical specifications. Procedures to check functional or operational performance are in the Operation section. Performing the functional check procedure verifies the instrument is operating properly. This check should satisfy the requirements for most receiving or incoming inspections. A detailed electrical performance verification procedure, in the Service instructions, provides a check of all specified performance requirements, as listed in the Specification section.

The 494/494P can be installed in any position that allows air flow in the bottom and out the rear of the instrument. Feet on the four corners allow ample clearance even if the instrument is stacked with other instruments. A fan draws air in through the bottom and expels air out the back. Avoid locating the instrument where paper, plastic, or like material might block the air intake.

The front panel cover provides a dust-tight seal and convenient place to store accessories and external waveguide mixers. Use the cover to protect the front panel when stor-

ing or transporting the instrument. The cover is removed by first pulling up and in on the two release latches, then pull up on the cover. The door to the accessories compartment is unlatched and opened by pressing the latch to the side and lifting the cover.

The handle of the 494/494P can be positioned at several angles to serve as a tilt stand, or it can be positioned at the top rear of the instrument between the feet and the rear panel, so instruments can be stacked. To position the handle, press in at both pivot points and rotate the handle to the desired position.

CAUTION

Removing or replacing the cabinet on the instrument can be hazardous. The cabinet should only be removed by qualified service personnel.

Installation instructions for the rackmount/benchttop versions of the instrument are described in the Service Instruction manual. Refer installation to qualified service personnel.

CAUTION

If the rackmount version is extended out of the rack and tipped up to gain access to the bottom or back panels of the cabinet, it can fall back into the rack unless it is held. Use care when doing this to avoid damaging the front panel or equipment that may be mounted above the 494/494P.

Power Source and Power Requirements

The 494/494P is designed to operate from a single-phase power source that has one of its current-carrying conductors (neutral) at ground (earth) potential. Operating from power sources where both current-carrying conductors are isolated or above ground potential (such as phase-to-phase on a multi-phase system or across the legs of a 110-220 volt single-phase, three-wire system) is not recommended, since only the line conductor has over-current (fuse) protection within the unit. Refer to the Safety Summary at the front of this manual.

Installation and Preparation for Use—494/494P Operators

The ac power connector is a three-wire polarized plug with the ground (earth) lead connected directly to the instrument frame to provide electrical shock protection. If the unit is connected to any other power source, the unit frame must be connected to an earth ground.

The 494/494P can be operated from either 115 Vac or 230 Vac nominal line voltage with a range of 90 to 132 or 180 to 250 Vac, at 48 to 440 Hz. Power and voltage requirements are printed on a back-panel plate mounted below the power input jack. Refer power input changes to qualified service personnel. Instructions for changing input voltage range are contained in the Service Instruction manual.

Power cord configurations for the instrument are shown in Figure 3-1

Repackaging for Shipment

When the 494/494P is to be shipped to a Tektronix Service Center for service or repair, attach a tag showing:

owner and address, name of individual at your firm that can be contacted, complete serial number, and a description of the service required. If the original package is unfit for use or not available, repackage the equipment as follows:

1. Obtain a carton of corrugated cardboard having inside dimensions that are at least six inches more than the equipment dimensions, to allow for cushioning. Table 3-1 lists instrument weights and the carton strength requirements.

2. Install the front cover and surround the instrument with polyethylene sheeting to protect the finish.

3. Cushion the equipment on all sides with packing material or urethane foam between the carton and the sides of the instrument.

4. Seal with shipping tape or industrial stapler.

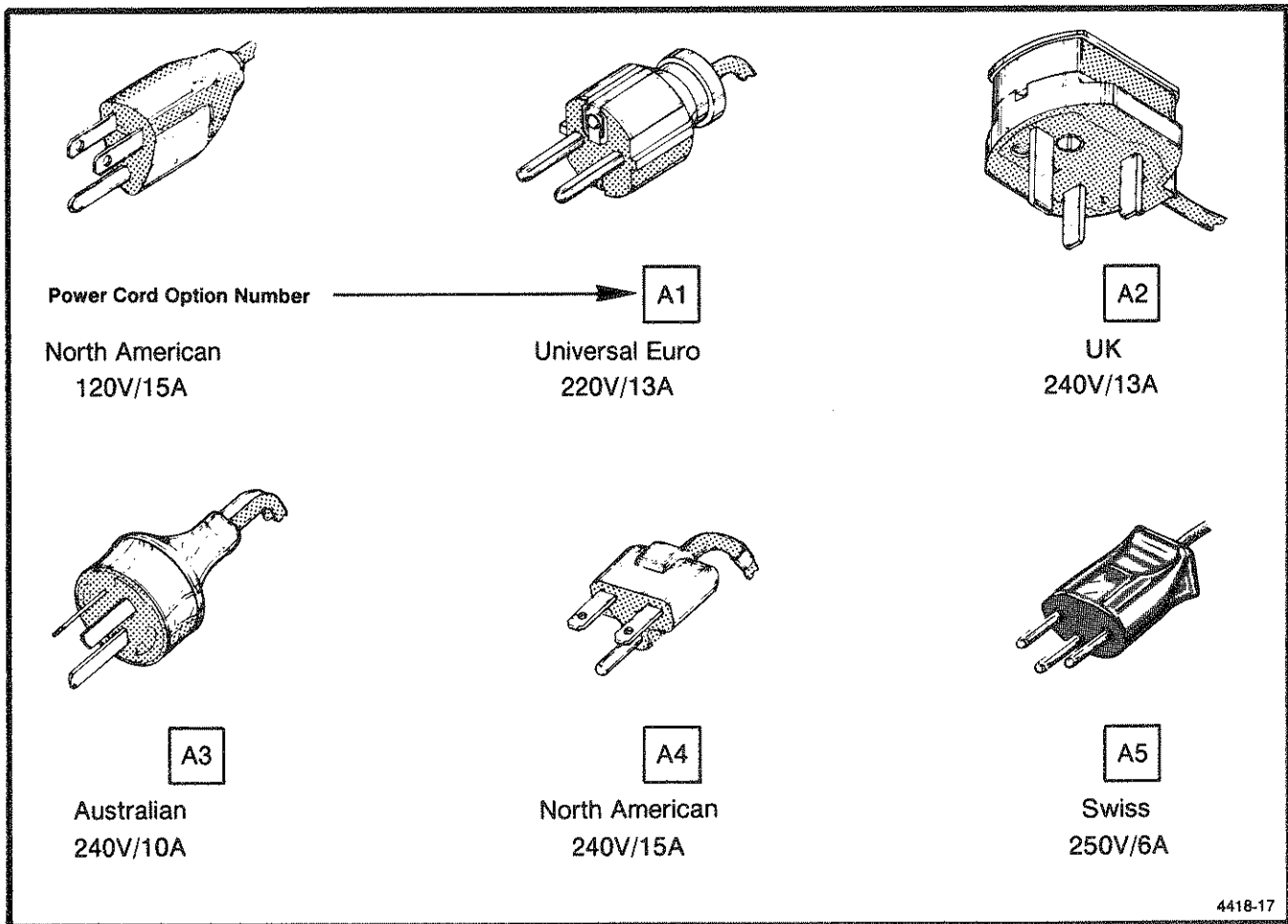

Figure 3-1. International power cord configuration (Option A1–A5) for 494/494P.

Table 3-1
SHIPPING CARTON TEST STRENGTH

Gross Weight		Carton Test Strength	
Pounds	Kilograms	Pounds	Kilograms
0-10	0- 3.73	200	74.6
10-30	3.73-11.19	275	102.5
30-120	11.19-44.76	375	140.0
120-140	44.76-52.22	500	186.5
140-160	52.22-59.68	600	223.8

in an environment that meets the non-operating environmental specifications.

Long Term—If you plan to store the instrument for more than 90 days, retain the shipping container to repackage the instrument. The battery in the instrument is lithium, which does not require removal. Package the instrument in a vapor bag with dessicant and store in a location that meets the environmental non-operating specifications.

Storage

Short Term—There are no requirements for short term storage (less than 90 days) other than store the instrument

If you have any questions, contact your local Tektronix Field Office or representative.

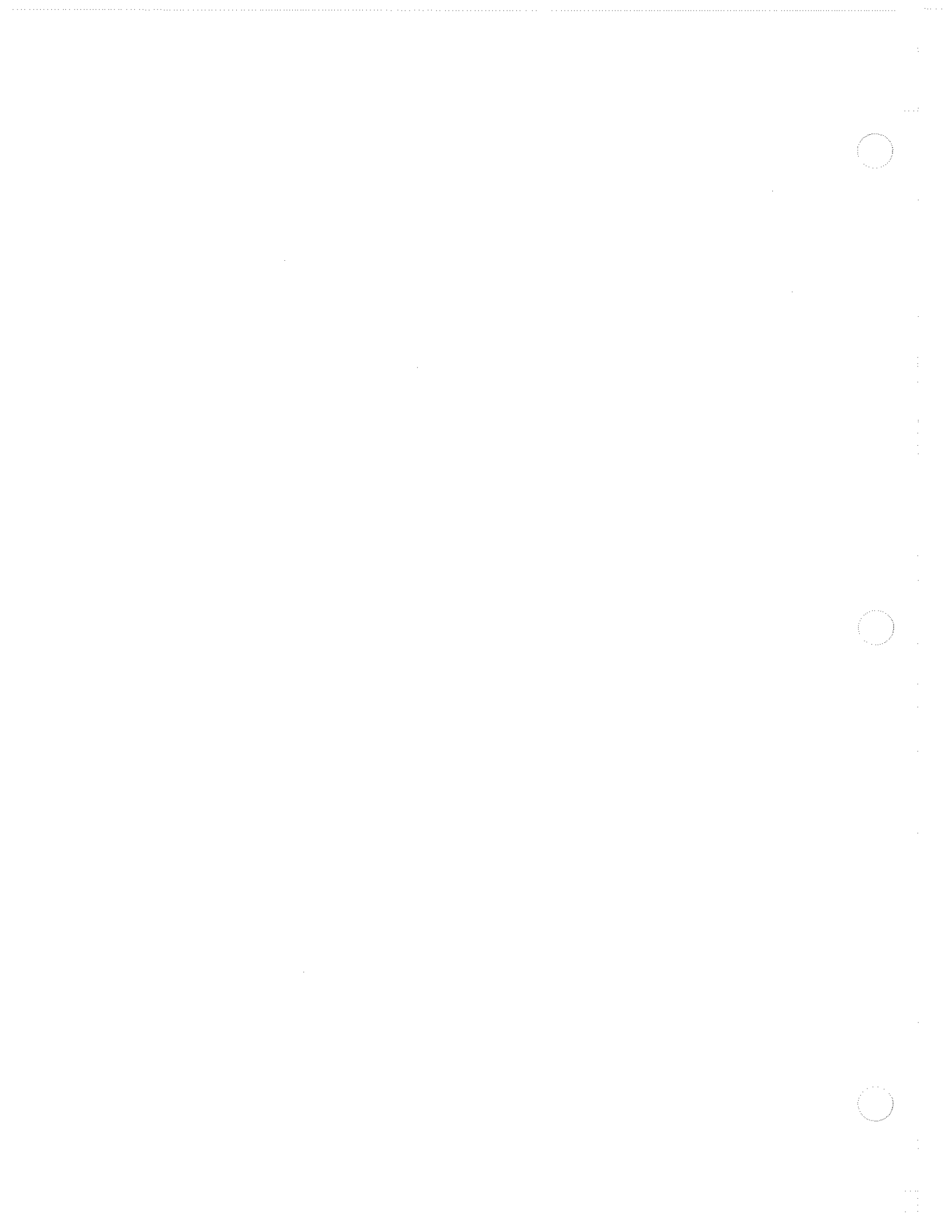

CONTROLS, CONNECTORS, AND INDICATORS

Introduction

This section describes the function of the controls, selectors, indicators, and connectors for the 494/494P. Figures 4-1 and 4-2 show and identify these controls, selectors, and connectors. This is followed (in Section 5) by an operational checkout of the instrument and some basic applications of the control functions.

Front-Panel Controls and Selectors

The 494/494P features a help mode (press HELP button) wherein a message will come on screen describing the function of any selected control or pushbutton. Many of the selectors or buttons on the front panel perform a secondary as well as primary function. In their primary mode (black lettered nomenclature) the pushbuttons set either operational modes or select functional parameters. Most primary modes are identical to the controls on the 492 and 496 Spectrum Analyzers; thus the basic operational procedure is the same for analyzers in this family.

In their secondary or shift mode (blue lettered nomenclature) the pushbuttons activate alternate functions or add additional data to the parameter. Buttons within the Data Entry keyboard (orange lettered nomenclature) are used to add numerical values to the entered parameter or terminate the entry with a multiplier (GHz, MHz, kHz, Hz), unit value (+dBm or -dBm), or display factor (dB).

Messages are displayed on the crt to guide the user as data is entered through the keyboard.

Shift Functions of the Pushbuttons

Entering some parameters requires pressing more than two buttons in sequence. When an entry is made via the blue lettered pushbuttons, such as **FREQ**, **SPAN/DIV**, **REF LEVEL**, **dB/DIV**, or **COUNT RESOLN**; those buttons which are used to add numerical data to the parameter light. These are the orange lettered and numbered buttons within the keyboard. A "BACK SPACE" button, outside the keyboard area, is used to back space so entered data can be corrected. In addition a message on screen guides the user through each step.

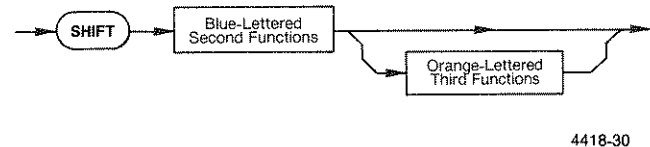

4418-30

When the shift sequence is completed the entered function or mode is implemented and the shift mode cancelled. In addition, pressing the <SHIFT> button will cancel the selected function and return the instrument to normal operation.

The following instructions first describe the primary function (black lettering) of these selectors, controls, and connectors; then the second, or shift function (blue lettering) if applicable. In some cases a run-down on how to enter a display mode or parameter from the Data Entry keyboard is included.

Some of the front panel pushbuttons have shift functions that are not nomenclated. These functions, if they pertain to operation, are described with the pushbutton explanation. If the function is service related, such as troubleshooting diagnostics, their shift function is described in the service manual. A listing of these un-nomenclated buttons is given at the end of this section.

Syntax diagrams are included with some of the descriptions to help explain their operation.

Instrument Power Control

- 1 **POWER**—This push-push type switch, turns the main power supply on or off. When power is switched off, the current instrument front panel set-up is stored in memory register 0 (see **RECALL SETTINGS/STORE** description) so that this set-up can be easily recalled. Full RF attenuation is also switched in when power is switched off to protect the 1st mixer from overload and damage.

The internal reference oscillator is not powered up when the instrument power is off—there is no standby mode.

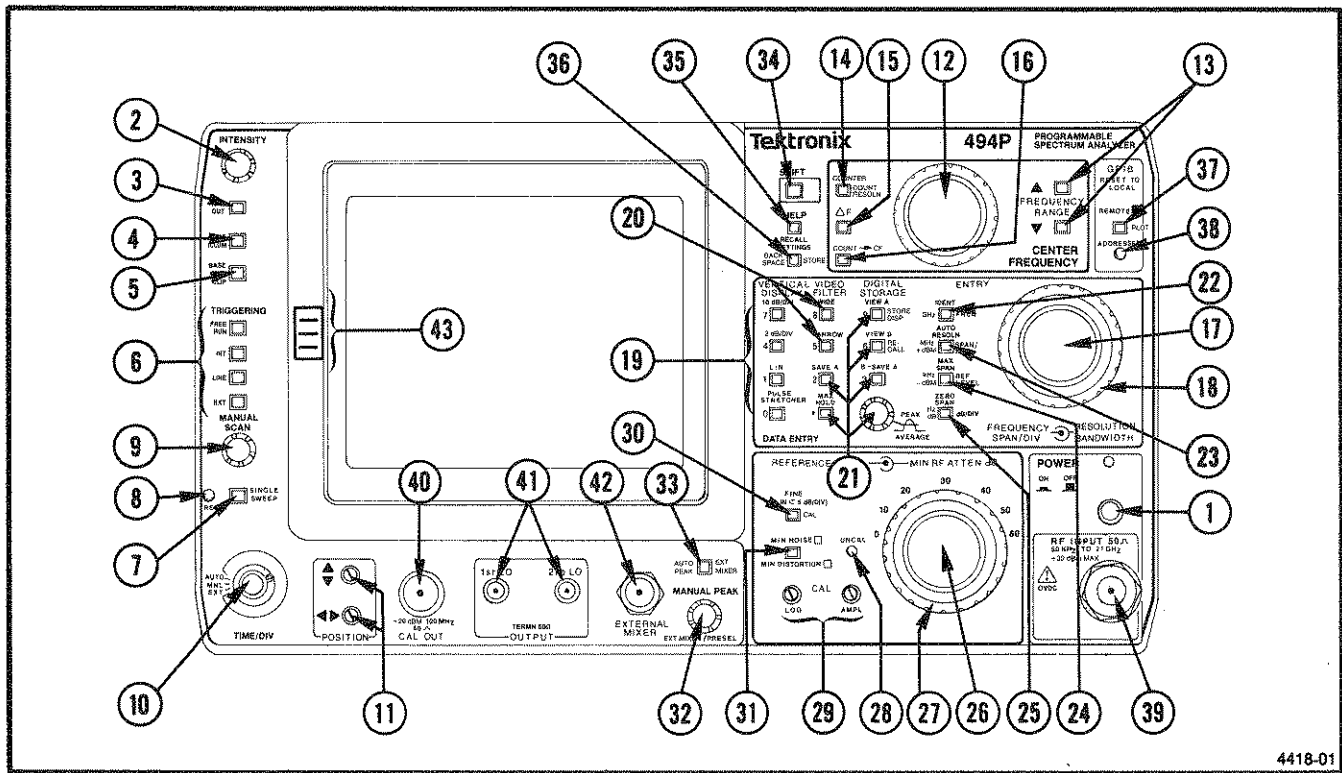

Figure 4-1. Front panel selectors, controls, and connectors.

Crt Controls

- 2 **INTENSITY**—adjusts the brightness of the crt trace, readout and text. Beam focus is automatically controlled.
- 3 **READOUT**—When this button is activated (illuminated), crt readout of control parameters is on. The parameter readout is located adjacent to their position on the crt bezel. Brightness is proportional to the trace brightness. This button does not affect prompt messages activated by many front panel functions.
- 4 **GRAT ILLUM**—When this function is activated (illuminated), the graticule lights are switched from dim to bright. Graticule illumination is usually used when photographing displays. The dim (button not illuminated) position provides appropriate illumination for a low light environment.
- 5 **BASELINE CLIP**—When this function is activated (illuminated), about one graticule division at the baseline of the display is clipped or subdued. Used to observe the readout at the bottom of the screen, or to eliminate the bright baseline when photographing displays.

Sweep or Scan

- 6 **TRIGGERING**—One of four triggering modes can be selected by pushbuttons that illuminate when activated. A SINGLE SWEEP pushbutton plus a READY light are also included for single sweep operation.
 - FREE RUN**—When this button is activated, the sweep is free running without regard to trigger source. When selected, all other trigger modes are cancelled, including single sweep mode.
 - This button also has a shift function and when activated in the <SHIFT> mode, the frequency correction for the local oscillator is disabled, thus enabling the operator to operate the instrument with reduced performance, if the oscillator frequency cannot be calibrated. The crt readout will display an appropriate message.
 - INT**—When this button is activated, the sweep is triggered by any signal at the left edge of the display that has an amplitude of 2.0 divisions or more. Other trigger modes are cancelled, including single sweep mode.
 - LINE**—When this button is activated, a sample of the ac power line voltage is used to trigger the sweep. All other modes are cancelled when LINE is selected, including single sweep mode.

EXT—When this button is pushed, the sweep is triggered by signals between 1.0 V peak (minimum) to 50 V peak (maximum) that are applied through the rear-panel HORIZ/TRIG (EXT IN) connector. When EXT is selected, the other modes are cancelled, including single sweep mode.

7 SINGLE SWEEP—When this button is first pressed, single sweep is activated and the current sweep is aborted. When pressed again the sweep trigger circuit is armed and the oscillator frequency is corrected. The sweep will run only after it receives a trigger signal. Selecting SINGLE SWEEP does not change the Triggering mode. While the sweep circuit is waiting to be triggered, the frequencies of the oscillators are corrected on a regular basis to maintain accuracy. Any trigger signal received during a correction cycle, will be ignored.

8 The READY indicator lights when the sweep circuit is armed and ready for a trigger signal. It remains lit until the sweep ends.

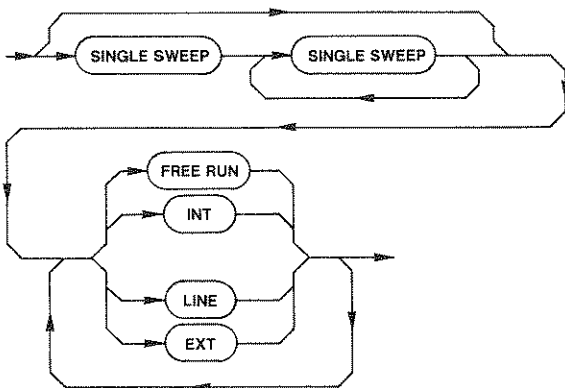

4418-31

9 MANUAL SCAN—With the TIME/DIV in the MNL position, this control will manually scan the spectrum as it is rotated. Oscillator corrections are done on a periodic basis to maintain frequency accuracy.

10 TIME/DIV—This control selects sweep rates from 5 s/div to 20 μ s/div, in a 5-2-1 sequence. AUTO, EXT, and MNL modes, as the following describes, can also be selected.

AUTO (automatic)—With the control in this position, the sweep rate is selected by the microcomputer to maintain a calibrated display for most FREQ SPAN/DIV, RESOLUTION BANDWIDTH, VIDEO FILTER, and Vertical Display selections.

EXT (external input)—With the selector in this position the sweep circuit is driven by a signal applied

to the rear-panel HORIZ/TRIG (EXT IN) connector. A voltage ramp of 0 to +10 V will sweep 10 divisions of horizontal (X) axis. Oscillator corrections are done on a periodic basis and when the sweep crosses +10 V (end of sweep condition).

MNL (manual)—With the control in the MNL position the spectrum or display can be manually scanned, as previously described, with the MANUAL SCAN control.

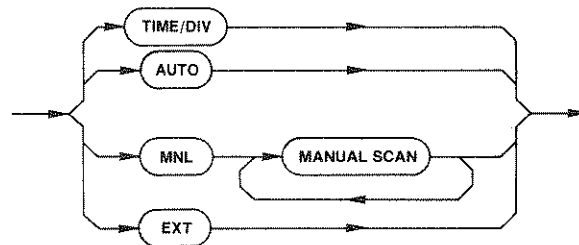

4418-32

11 ∇ \blacktriangleleft **(POSITION)**—These screwdriver adjustments position the display along the horizontal and vertical axes. To adjust, position the center frequency dot at center screen, when FREQ SPAN/DIV is other than MAX, and the display baseline on the bottom graticule line. The CAL function <SHIFT> CAL guides the user through the adjustment of these controls.

Display Parameters

12 CENTER FREQUENCY—Tunes the center frequency. Tuning is done in 0.1 division increments, regardless of the selected FREQ SPAN/DIV. In MAX SPAN, the tuning range depends on the band; for example, in band 2 (1.7-5.5 GHz) the frequency dot will not tune to the extreme left edge of the graticule, or in band 6 (15-21 GHz) the dot will tune only to the right of center. Tuning range in narrow spans is identical to wide spans (i.e., equal to the frequency range of the band selected).

13 FREQUENCY RANGE (band)—These two push-buttons shift the frequency range up or down. Frequency range of the current band is displayed by the crt readout. When the frequency range (band) is changed, an attempt to preserve the 1st and 2nd LO frequencies is made. If this is not possible, the nearest center frequency limit of the band is selected. When returning to a previous band, without changing Center Frequency, the original LO frequencies are always used so the Center Frequency is preserved.

14 COUNTER/COUNT RESOLN—This two function pushbutton performs the following:

COUNTER—When activated (illuminated), the signal at the dot marker position is counted with up to 1 Hz resolution at any Freq Span/Div. The actual resolution is selected in the COUNT RESOLN (shift) mode. The signal must be 20 dB or more above the noise level and above a level that is 60 dB down from the REF LEVEL.

<SHIFT>COUNT RESOLN (blue lettering)—is used to select the desired counter resolution via the orange nomenclated Data Entry keys. Terminate with one of the frequency suffixes (GHz, MHz, kHz, or Hz) buttons. Counter resolution will be truncated to the decade that is less than or equal to the selected resolution.

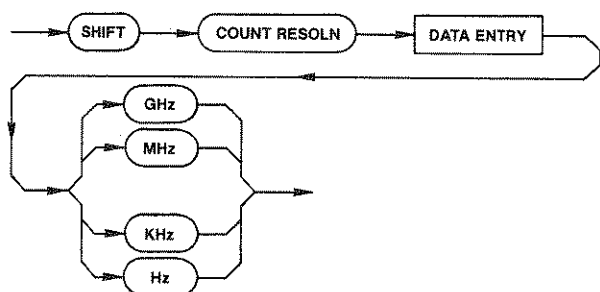

4418-33

15 ΔF—When pressed, frequency offset can be easily measured (see General Operating Information). When selected (illuminated) the frequency readout goes to 0.00. The readout now shows the offset or deviation from this reference as the CENTER FREQUENCY is changed. The resolution of the readout will be the less accurate of the current center frequency resolution, or the center frequency resolution when ΔF was activated.

16 COUNT→CF—If close-in analysis of a signal, in narrow spans, is desired, tune the signal under the frequency dot marker and press this button. The signal will be counted once (even if the COUNTER is inactive), then the center frequency is tuned to the counted frequency. The FREQ SPAN/DIV can now be reduced to any span and the signal will be centered without retuning the FREQUENCY to center the signal. The count resolution and the resulting center frequency readout accuracy is the current counter resolution.

17 FREQUENCY SPAN/DIV—This continuous detented control selects the frequency span/div of the analyzer display. The span/div is indicated by the crt readout. Range depends on the frequency band. Selection is in

a 1-2-5 sequence, plus MAX span, and zero, or time domain. Freq Span/Div can also be entered by pressing the <SHIFT> SPAN/DIV button and entering the data via the Data Entry keyboard. The microcomputer will try to maintain a calibrated display if the TIME/DIV selector is in the AUTO position and the AUTO RESOLN button is active (illuminated).

When the FREQ SPAN/DIV control is in the MAX span position, the full band is displayed. Sweep beyond the internal mixer bands is clamped to the baseline. A dot marker near the top of the screen indicates the center frequency readout position on the span. This dot and the center frequency position will be center screen when the FREQ SPAN/DIV is reduced from the MAX span position. In zero span, the analyzer operates as a tunable receiver that displays signals, within the resolution bandwidth, in the time domain. The FREQ SPAN/DIV readout changes to time rather than frequency.

18 RESOLUTION BANDWIDTH—This is a continuous detented control that selects the final IF bandwidth. Bandwidth is indicated by crt readout. Bandwidth range is 30 Hz, and 100 Hz to 1 MHz in decade steps. Changing the RESOLUTION BANDWIDTH deactivates AUTO RESOLN. Sweep rate is automatically selected to maintain a calibrated display by the processor when the TIME/DIV is in the AUTO position.

19 VERTICAL DISPLAY—These four pushbuttons select the display mode. The crt readout indicates scale factor. Vertical display factor, in Log mode, can also be entered via the Data Entry keyboard (see dB/Div entry function). The 10 dB/DIV, 2 dB/DIV, and LIN buttons are mutually canceling.

10 dB/DIV—When activated (illuminated), the dynamic range of the display is a calibrated 80 dB with each major graticule division representing 10 dB.

2 dB/DIV—When activated (illuminated), this increases resolution so that each major graticule division represents 2 dB. Dynamic range is 16 dB.

LIN—When activated (illuminated), a linear display between zero volt (bottom graticule line) and the reference level (top graticule line), scaled in volts/division is selected (see REFERENCE LEVEL, which follows).

PULSE STRETCHER—When activated (illuminated), the fall-time of pulse signals is increased so very narrow pulses can be seen. The effect is most apparent for discrete signals analyzed at resolution bandwidths that are narrow compared to the span; Pulse Stretcher operation may be necessary for digital storage display of such signals, especially if they are averaged.

20 VIDEO FILTER—One of two (NARROW and WIDE) filters can be selected to reduce the video (post-detection) bandwidth and reduce high-frequency components for display noise averaging. Selecting either filter cancels the other filter. Each pushbutton is self cancelling.

WIDE—filter is approximately 1/30th the bandwidth except it is 1/10th of the 30 Hz filter.

NARROW—filter is approximately 1/300th of the selected resolution bandwidth except it is 1/100th of the 30 Hz filter.

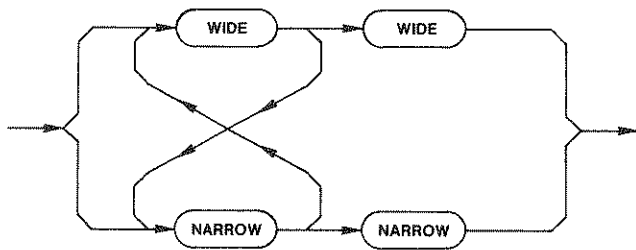

4418-34

21 DIGITAL STORAGE—Five pushbuttons and one control operate the digital storage. Four of these pushbuttons have dual functions; VIEW A/STORE DISPLAY, VIEW B/RECALL, B—SAVE A/B—Save A Offset, and SAVE A/Select Plotter Type. The latter two shift functions are not identified by front panel nomenclature.

VIEW A, VIEW B—VIEW A button activates one half the digital storage and displays the "A" waveform. VIEW B activates the other half of the digital storage and displays the "B" waveform. When SAVE A is off, and VIEW A, VIEW B are on, both the "A" and "B" waveforms are displayed and updated each sweep. The "A" waveform is interlaced with the "B" waveform. When SAVE A is on, only the waveform selected is displayed and only the "B" waveform is updated.

<SHIFT> STORE DISP—Pressing <SHIFT> STORE DISP starts a sequence to store, either the "A" or "B" waveform and its associated readout, in a numbered (0-8) memory register. This information is retained in non-volatile memory so it can be recalled at a later time. Informative messages, displayed on the crt, aid the user in completing the multiple button sequence. First a list of the center frequencies of current stored displays is shown. The number of digits in the readout is an indication of the Span/Div of each stored display (a greater resolution indicates a narrower span). A register without an associated frequency is empty. This display includes a prompt for the register number into which the display will be stored. The register is selected, via the Data Entry

keyboard, then a prompt asks which display ("A" or "B") to store in the selected register. Selection of the waveform completes the sequence and returns the instrument to normal operation.

To exit Store Display function press the <SHIFT> button.

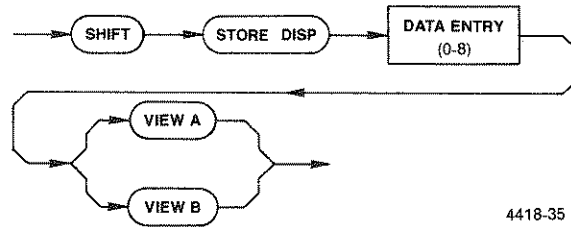

4418-35

<SHIFT> RECALL—This button is used to recall a selected waveform, with its readout, from non-volatile memory, and send it to the "A" or "B" part of digital storage. To see the display, activate the respective part of digital storage (VIEW A or VIEW B). The readout for the "A" waveform will only be shown if VIEW B and B—SAVE A are off, whereas the readout for a recalled "B" waveform will only be displayed if VIEW B or B—SAVE A are on. When RECALL is activated, SAVE A is also activated. This protects the recalled waveform from overwrite when placed in "A" and the current waveform when placed in "B". SINGLE SWEEP must be activated before a waveform is placed in "B", to prevent an overwrite by the next sweep. VIEW B must be activated to observe the recalled waveform in "B".

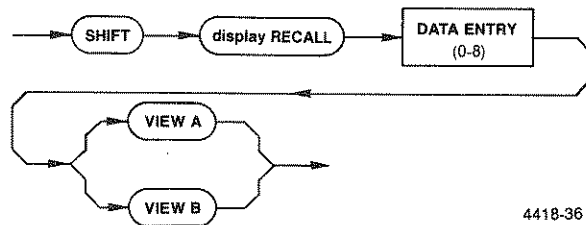

4418-36

B—SAVE A/ B—Save A Offset—This dual function button does not have its secondary or shift function identified by front panel nomenclature.

B—SAVE A—When activated, the arithmetic difference between the "B" and the "A" waveform is displayed; SAVE A mode is automatically activated. The zero reference line is set mid screen at the factory, so positive differences are displayed above this line and negative differences below. The position of the zero reference line can be changed by authorized service personnel.

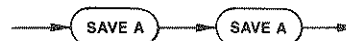

4418-37

<SHIFT> B-Save A Offset—As described above, the zero reference line for the B-SAVE A display is an internal selection. However, the zero reference for a plotter must be entered by this shift function. The range for the offset is 0 to 225 with 125 representing center screen. Enter this offset via the Data Entry keyboard, when prompted by the crt message. The offset is then stored in non-volatile memory.

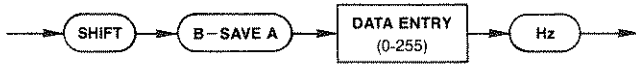

4418-38

SAVE A/Select Plotter Type—This is also a dual function pushbutton with only the primary function nomenclated beside the button. The shift function, like the B-Save A Offset, has no relationship with digital storage.

SAVE A—Pressing this button freezes or saves the “A” waveform and its readout. VIEW A must be on to display the waveform. Readout for the waveform will be displayed if VIEW B and B-SAVE A are off. If either VIEW B or B-SAVE A is on, the readout reflects the current analyzer setup.

<SHIFT> Select Plotter Type—When activated, three types of plotters are listed in numerical order on screen for the user to select. The selected plotter type is then stored in non-volatile memory for later use.

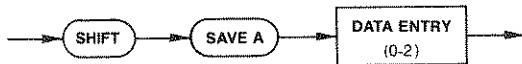

- 0= (TEK 4662)
- 1= (TEK 4662 OPT. 31)
- 2= (HP 7470A)

4418-39

MAX HOLD—When activated (illuminated), the digital storage retains the maximum signal amplitude at every storage location (512 locations). If SAVE A is on, the “A” waveform is not affected. This feature can be used to measure drift and stability, or record peak amplitude excursions of a signal.

PEAK/AVERAGE—This control selects the point (shown by a horizontal line or cursor) at which the digital storage switches from peak detection to signal averaging. Video signals above the cursor are peak detected, video signals below the cursor are digitally averaged.

22 IDENT/FREQ—The primary mode for this button is IDENTify, its shift function is FREQUENCY entry and to terminate data entry with GHz.

IDENT—This mode can only be activated when the FREQ SPAN/DIV is 50 kHz or less for the 0 to 21 GHz bands and 50 MHz or less for the waveguide bands. When IDENT is pressed in these spans, every other sweep is displaced vertically and the 1st and 2nd local oscillator frequencies are shifted so that real or true signals remain aligned while false or spurious signals shift horizontally on alternate sweeps. False signals shift at least 100 MHz or in most cases off screen. In the waveguide bands, with FREQ SPAN/DIV settings above 50 kHz, the 1st LO frequency is shifted 2072/N MHz for the alternate sweep. Therefore the mixer response should be peaked before and during IDENTify mode so a true conversion will appear on the alternate sweep.

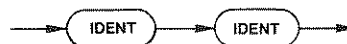

4418-40

<SHIFT> FREQ—In this mode, an entry of center frequency, to 1 Hz resolution, can be entered, via the orange numbered buttons and terminators, of the Data Entry keyboard. If the selected center frequency is not in the current band, the nearest band that includes this frequency will be selected. Range is 0 Hz to 320 GHz. Values that are entered outside this range will be ignored. Frequency digits that are entered, via the keyboard, are terminated with one of four unit buttons (GHz, MHz, kHz, or Hz).

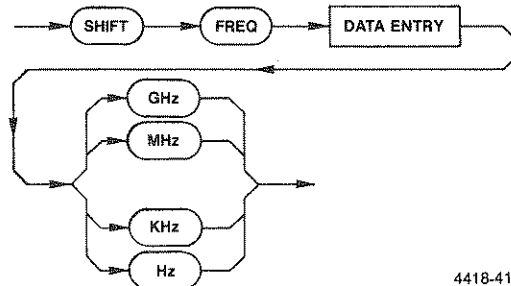

4418-41

23 AUTO RESOLN/SPAN/DIV—This pushbutton activates automatic resolution bandwidth, as its primary function, SPAN/DIV entry in the shift mode and the unit terminators MHz or +dBm for data entry.

AUTO RESOLN—When activated, the internal microcomputer selects resolution bandwidth according to the Freq Span/Div, Time/Div, Video Filter, and Vertical Display selections to maintain a calibrated display. When TIME/DIV is in the AUTO position, resolution bandwidth is a function of the Freq Span/Div, with a sweep rate as fast as possible to maintain a calibrated display.

<SHIFT> SPAN/DIV—When activated, direct entry of FREQ SPAN/DIV, with two significant digits of resolution, is possible. The selection range is 50 Hz/div (minimum) to 10 GHz/div maximum. Maximum selection depends on the band. Entering a value outside the allowable range will cause the SPAN/DIV to switch to ZERO SPAN or MAX SPAN. Spans entered, via the Data Entry keyboard, are terminated with one of four unit keys (GHz, MHz, kHz, or Hz).

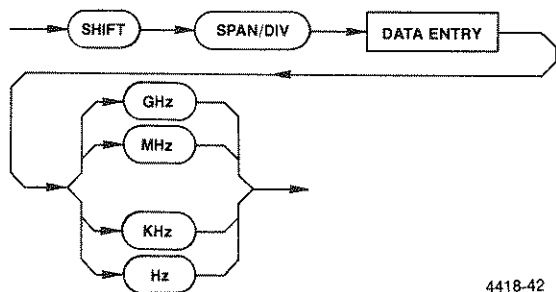

4418-42

24 MAX SPAN/REF LEVEL—This dual function pushbutton selects MAX SPAN, in the non-shift mode, and allows entry of the REF LEVEL, via the Data Entry keyboard, in the shift function. It also provides kHz, and -dBm terminators.

MAX SPAN—When activated (illuminated) the analyzer sweeps over the full frequency range (see MAX SPAN information under FREQUENCY SPAN/DIV description). When switched off, the span returns to the previous FREQ SPAN/DIV setting.

<SHIFT> REF LEVEL—Entry of reference level, with 1 dB resolution, can be made via the Data Entry keyboard. Range is +30 dBm to -117 dBm (+40 dBm if MIN NOISE mode is selected). Values entered outside this range are ignored. Levels entered are terminated with +dBm or -dBm buttons.

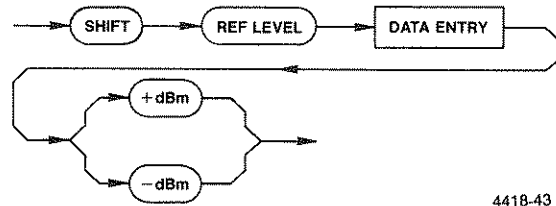

4418-43

25 ZERO SPAN/ dB/DIV—Switches the frequency span to zero, in its non-shift mode, dB/DIV vertical scale factor in the shift mode, and terminates keyboard entries with dB or Hz.

ZERO SPAN—Switches the span to zero for time domain display. When deactivated, the SPAN/DIV returns to its previous value.

<SHIFT> dB/DIV—Selects dB/Div entry mode, for vertical scale factor, via the Data Entry keyboard; range is 1 to 15 dB/div. Although a display with greater than 80 dB range can be selected, the actual measurement range will not exceed 80 dB. Numbers outside the allowable range will be ignored. Terminate the entry with the "dB" button.



4418-44

26 REFERENCE LEVEL—A continuous and detented control that changes the reference level one step for each detent. In the Log Vertical Display mode, when FINE is not activated, the step size equals the selected dB/DIV factor, except the 2 dB/DIV display, where step size is 1 dB. When FINE is activated, the step size is 1 dB for dB/div factors of 5 or more and 0.25 dB for Vertical Display factors of 4 dB/div or less. When the display factor is 4 dB/div or less and FINE is activated, the ΔA mode is selected (see description under General Operating Procedures in Section 6).

27 MIN RF ATTEN dB—This control specifies the lowest value of input attenuation that the microcomputer will use. Actual attenuation is set by the microcomputer according to the RF ATTEN dB, REFERENCE LEVEL, and the MIN NOISE/MIN DISTORTION selections. Total attenuation is displayed on the crt readout. If the MIN RF ATTEN dB setting is increased, the microcomputer automatically changes IF gain to maintain the current reference level. This control allows the operator to protect the front end of the analyzer against signal compression or mixer overload, and/or damage to the mixer.

Controls, Connectors, and Indicators—494/494P Operators

- 28** **UNCAL**—This indicator lights when the display amplitude is no longer calibrated (e.g., sweep rate is not compatible with the frequency span/div and resolution bandwidth).
- 29** **LOG and AMPL CAL**—These adjustments calibrate the dynamic range of the display. LOG CAL adjusts the display amplitude at the top graticule line and AMPL CAL adjusts the logarithmic gain in dB/div. Press <SHIFT> CAL to initiate a microcomputer calibration routine that guides the operator through these and the position adjustments.
- 30** **FINE (ΔA IN <5 dB/DIV)/ CAL**—The primary function of this button is to activate FINE and ΔA mode. Its secondary function starts a microcomputer routine that calibrates the center frequency and reference level.

FINE—When activated, the REFERENCE LEVEL control changes the REF LEVEL in 1 dB steps for display factors of 5 dB/div or more, and in 0.25 dB increments for the ΔA (amplitude differential) mode (display factors of 4 dB/div or less). In the ΔA mode, the REF LEVEL readout goes to 0.00 dB and the REFERENCE LEVEL control steps the REF LEVEL in 0.25 dB increments from this reference, so accurate relative amplitude measurements over a 48 dB measurement range can be made. (Refer to “ ΔA Mode Operation” under General Operating Information in Section 6 for more details.) When deactivated the REF LEVEL returns to its previous value.

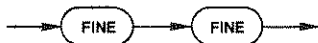

4418-45

<SHIFT> **CAL**—Pressing this button initiates a frequency and reference level calibration procedure. First a message on screen guides the operator through a procedure to set the vertical and horizontal POSITION adjustments, then the LOG and AMPL vertical display adjustments. The microcomputer then runs an automatic frequency and relative amplitude calibration routine for the resolution bandwidth filters.

The frequency routine calibrates the center frequency and the relative amplitude routine reduces gain variation between resolution bandwidth filters. This calibration routine should be run when the ambient temperature changes from the previous calibration. This will ensure that the instrument meets frequency and amplitude performance characteristics. Calibration settings are retained in non-volatile memory.

To display the calibration correction factors for each bandwidth, press <SHIFT> MIN NOISE.

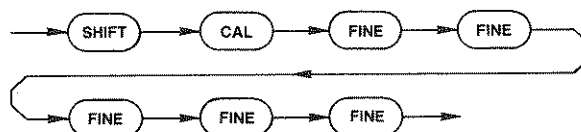

4418-46

- 31** **MIN NOISE/MIN DISTORTION**—This button selects one of two algorithms that sets the ratio of RF attenuation versus IF gain for a given reference level. In addition it performs a shift function.

MIN DISTORTION—In this mode, intermodulation distortion, generated by the 1st mixer because of overload, is minimized. This is the usual operating mode.

MIN NOISE (button illuminated)—In this mode, the noise level is reduced by changing the ratio of attenuation and gain. Both are reduced 10 dB so noise generated in the IF stages is decreased; however, intermodulation distortion, produced in the 1st mixer, will increase.



4418-47

<SHIFT> **MIN NOISE**—When pressed in this mode, a display is shown that lists the calibration correction factors for each bandwidth filter.



4418-48

- 32** **MANUAL PEAK (EXT MIXER/PRESEL)**—This control varies the mixer bias for external mixers and peaks the internal preselector tracking in the 1.7 to 21 GHz frequency range (bands 2—5). The control is used to peak signal response. Refer to “Using the MANUAL PEAKING Control and External Mixer Operation”, under General Operating Information in Section 6, for more detailed information.
- 33** **AUTO PEAK/EXT MIXER**—This button selects either an automatic peaking routine, or external mixer operation.

AUTO PEAK—Peaks the internal preselector tracking or the bias for an external mixer. The peaking routine uses the largest signal within the center two divisions of the screen. When peaked it then stores this code in non-volatile memory for use when returning to this band, if AUTO PEAK is on. If there is no signal on screen, the algorithm reverts to the setting stored in memory, or centers the bias setting. While the peaking routine is running, the screen will display "PEAKING" and the SINGLE SWEEP indicator will blink. Peaking should be performed when optimum reference level accuracy is desired. The routine will run each time AUTO PEAK is cycled.

<SHIFT> EXT MIXER—Deactivate AUTO PEAK then press <SHIFT> EXT MIXER. In this mode, the EXTERNAL MIXER port is connected to the 2nd Converter and a dc bias source. Operation is described following Front Panel Input/Output Connectors under "EXTERNAL MIXER". AUTO PEAK still functions in the Ext Mixer mode. To return to the internal mixer, press <SHIFT> EXT MIXER.



4418-49

RECALL SETTINGS—Recalls any selected front panel setup from non-volatile memory. When pressed, the crt displays the center frequency of each setup by register number. Registers that do not have a setup are shown as empty. To recall, select a register number. To exit without recalling a setup, press <SHIFT>.

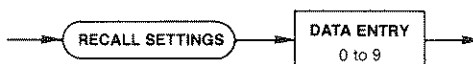

4418-51

<SHIFT> STORE—Stores front panel control and selector setups in non-volatile memory. A list of center frequency for each stored setup is displayed. Select the desired register to complete the operation. To exit, without storing a setup, press <SHIFT>.



4418-52

BACK SPACE—When this button is lit, it backspaces the number entry so corrections can be made.



4418-53

General Purpose Pushbuttons

- 34 **SHIFT**—When pressed (illuminated), buttons or keys with two or more functions shift to their second (blue nomenclature) and third function. When pressed again it aborts multiple key sequence operations.
- 35 **HELP**—When on (illuminated), any front-panel control or pushbutton that is selected, will produce a display that explains their function. In addition <SHIFT> HELP will display any error messages. To exit, press HELP again.

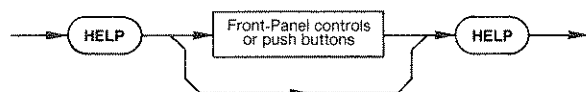

4418-50

- 36 **RECALL SETTINGS/STORE/BACKSPACE**—A multi-function button that initiates the following:

494P (GPIB) Controls

- 37 **RESET TO LOCAL/PLOT**
 - REMOTE**—This button lights when the GPIB controller takes control of the analyzer. Except for RESET TO LOCAL, front-panel controls are not active when the 494P is under remote control. However, front panel indicators will still show current status of the control functions.
- 38 **ADDRESSED**—This indicator lights when the 494P is addressed to either talk or listen.

<SHIFT> PLOT—When pressed, display information is sent over the GPIB to directly drive a plotter. The TEKTRONIX 4662, 4662 Option 31, and the Hewlett Packard 7470A, are examples of plotters that are supported. Refer to "Using the Plotter Feature", under General Operating Information for details on how to plot a display.



4418-54

Front-Panel Input/Output Connectors

- 39 **RF INPUT 50 Ω**—A 50 Ω coaxial input connector for RF signals to 21 GHz. The maximum, non-destructive, input signal level to the input mixer is +13 dBm or 20 mW. Signals above -18 dBm may cause compression. If the input signal has a dc component, use a blocking capacitor in line with the signal.

CAUTION

The maximum rating of the RF attenuator is +30 dBm (1 W average, 75 W peak, pulse width 1 μs or less, with a duty cycle that does not exceed 0.001). If MIN NOISE is activated with the RF ATTEN dB at 60, a full screen signal will exceed this maximum rating by 10 dB and burn-out can occur. Input signals must not contain any dc component. Refer to "Signal Application", under General Operating Procedure in Section 6 for more information.

- 40 **CAL OUT (Calibrator output)**—This connector is the source of a calibrated -20 dBm (±0.3 dB) 100 MHz signal, and a comb of frequency markers 100 MHz apart. This 100 MHz source is phase locked to the instrument reference frequency.
- 41 **OUTPUT (1st LO and 2nd LO)**—These connectors are the outputs of the respective local oscillators. The connectors must be terminated into 50 Ω when they are not connected to an external device.
- 42 **EXTERNAL MIXER**—When the <SHIFT> EXT MIXER is activated, this connector is the dc bias source for external mixers and the ac coupled input for the IF signal from an external mixer. This mode is indicated by EXT on the crt readout in place of RF ATTEN. Bias voltage is set by the MANUAL PEAK control or the microprocessor when AUTO PEAK is on. External mixer operation is explained under "Waveguide Mixers" in the General Operating Procedures in Section 6.

CAUTION

Do not exceed mixer input limits.

- 43 **Camera Power**—This connector is the source of power for the C-50 Series Tektronix cameras which have electrical actuated shutters. Single sweep reset is not provided. (Tektronix C-5 or C-59 Cameras are recommended.)

Rear-Panel Input/Output Connectors

- 1 **PROBE POWER**—This connector provides operating power for active probe systems. This connector should be used only with compatible probes or accessories specifically designed for use with this power source.
- 2 **HORIZ/TRIG**—Horizontal or triggering modes depend on the 494/494P Triggering and TIME/DIV selections. In the External Triggering mode, the connector is an ac coupled input for trigger signals. Trigger amplitudes from 1.0 V to 50 V peak, with a 0.1 μs minimum pulse width within the frequency range of 15 Hz to 1 MHz, are required for trigger. When the TIME/DIV selection is EXT, the connector is a dc coupled input for horizontal drive voltages. Deflection sensitivity is 1 volt/div. A 0 to +10 (dc + peak ac) voltage will deflect the beam across the screen.
- 3 **MARKER/VIDEO**—This connector interfaces the 494/494P with a Tektronix TV Adapter, such as the 1405, to display an externally generated marker.
- 4 **HORIZ (OUTPUT)**—This connector supplies a 0.5 V/division signal with respect to center screen. Full range is -2.5 V to +2.5 V. Source impedance is approximately 1 kΩ.
- 5 **VERT (OUTPUT)**—This connector provides access to video signal that is 0.5 V for each division of displayed video that is above and below the center line. Source impedance is approximately 1 kΩ.

NOTE

Both HORIZ and VERT output signals are driven from digital storage if on, or the analyzer sweep and video amplifier stage if digital storage is off.

- 6 **PEN LIFT (OUTPUT)**—At this connector a TTL compatible pulse is provided to lift the pen of a chart recorder during retrace. This signal is always derived from the analyzer sweep, regardless of the selection of the digital storage.

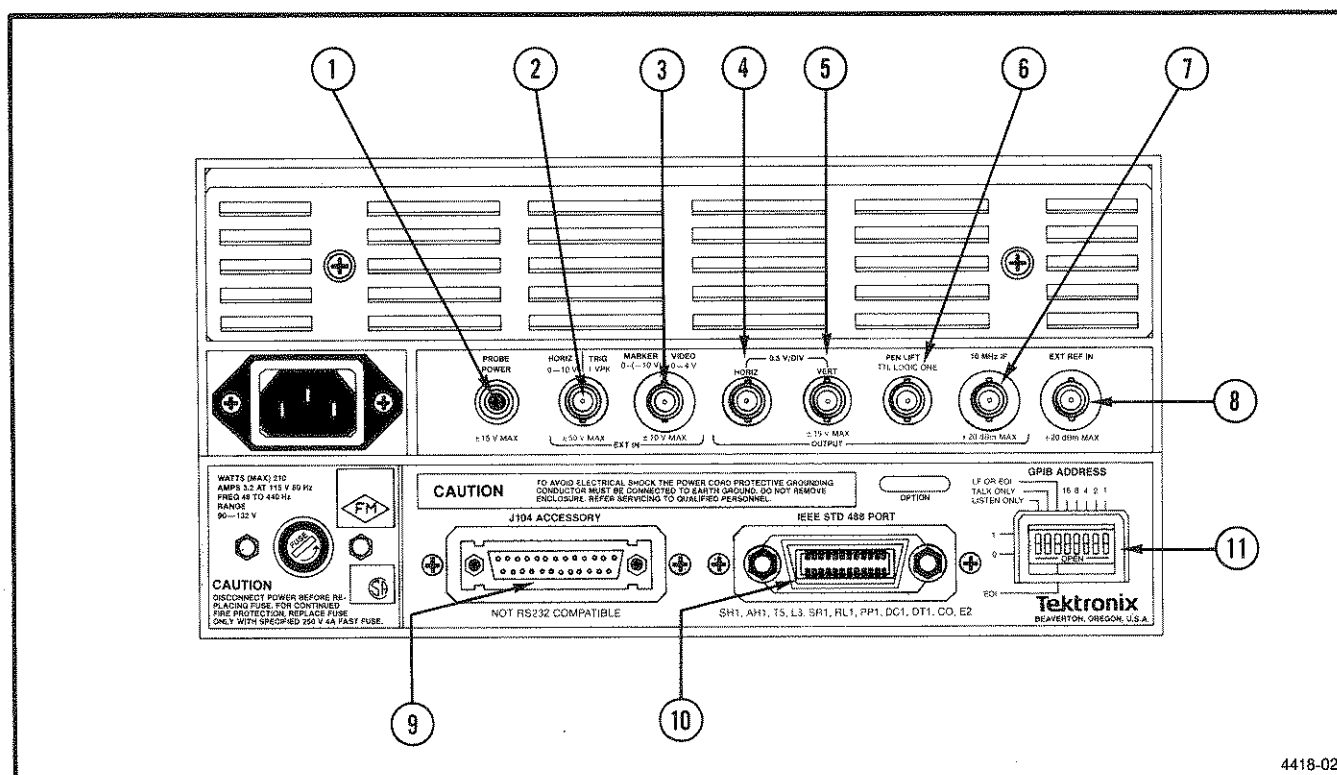

Figure 4-2. Rear panel connectors on the 494/494P.

- 7 10 MHz IF (OUTPUT)**—Access to the 10 MHz IF signal is provided with this connector. Output level is about -16 dBm for a full screen signal at -30 dBm reference level, maximum output is $+20$ dBm.
- 8 EXT REF IN**—A 50Ω input for a 1, 2, 5, or 10 MHz, external reference signal, within -15 dBm to $+15$ dBm level. Phase noise should be no greater than -110 dBc, in a 1 Hz bandwidth at 10 Hz offset, referenced to 10 MHz. Input signal must be a sine wave with a duty cycle symmetry of 35 to 65%. Input is ECL or TTL.
- 9 J104 ACCESSORY**—This connector provides bi-directional access to the instrument bus. It is not RS-232 compatible. TTL logic 0, applied to pin 1, selects External Video which connects video signals, applied to the rear-panel MARKER/VIDEO connector, to the video path ahead of the video filters. Pins 2 and 3 provide the output and return lines to drive an external preselector.
- 10 IEEE STD 488 PORT (GPIB)—494P Only**—This connector interfaces the 494P to the GPIB bus. The interface functions provided are: SH1, AH1, T5, L3, SR1, RL1, PP1, DC1, DT1, and CO.
- 11 GPIB ADDRESS—494P Only**—These switches set the primary GPIB address of the 494P, select the Talk Only and Listen Only operating modes, and select the message terminator for input and output. Address 31 (11111) logically disconnects the 494P from the bus; address 0 (00000) is reserved for 4050-Series controllers.

UN-NOMENCLATED FRONT PANEL PUSH-BUTTON FUNCTIONS

The following shift functions are not nomenclated. Service related functions are normally disabled and are described in the service manual.

Operational Functions

<SHIFT> **FREE RUN**—Switches center frequency corrections off or on. Enables the operator to continue operating the instrument with reduced performance. Use when frequency control failure error message comes on screen.

<SHIFT> **HELP**—Lists all current error conditions.

<SHIFT> **ΔF**—Enables the user to select alternate language if the instrument has Option 12, 13, or 14.

<SHIFT> **MIN NOISE**—Displays the results of the <SHIFT> **CAL** mode.

<SHIFT> **SAVE A**—Enables the user to select an external type plotter from a displayed menu.

<SHIFT> **B—SAVE A**—Allows the user to key-in the B—SAVE A offset for a plotter only.

Service Related Functions

<SHIFT> **READOUT**—Alternate frequency display of 1st LO, 2nd LO, and 3rd IF.

<SHIFT> **GRAT ILLUM**—Frequency correction trace mode.

<SHIFT> **INT**—Frequency corrections on/off, count is on.

<SHIFT> **EXT**—Frequency control diagnostics.

<SHIFT> **10 dB/DIV**—Enables, disables, resets the CAL results.

<SHIFT> **PULSE STRETCHER**—Module calibration procedure.

TURN-ON PROCEDURE AND OPERATIONAL CHECK

FIRMWARE VERSION AND ERROR MESSAGE READOUT

Firmware Version

During initial turn-on, or power-up cycle, the instrument plus the front panel processor firmware versions will be displayed on screen for approximately two seconds. The Replacement Parts List in the Service manual (Volume 2), lists the ROMs used for each version. The service manual also lists the firmware operating notes associated with each version.

Error Message Readout

If the microcomputer detects a hardware failure, a failure report will come on screen and remain for about 2 seconds. A status message will then appear and remain for as long as the failure exists. Pressing HELP will provide an error message that explains the impact of the failure on instrument operation. If the processor cannot set the oscillator frequency, due to a hardware failure, it will continue to try each sweep. The sweep holdoff time will increase substantially as it continues to try. To disable attempted oscillator corrections, press SHIFT and then FREE RUN. Center frequency accuracy specifications will not be met in this mode. Pressing SHIFT and FREE RUN again will re-enable oscillator correction routines. Another failure message will appear if the failure has not been corrected. The following are other error messages that may appear:

CALIBRATION FAILED—see Reference Level and Frequency Calibration part.

COUNTER FAILURE—either a hardware problem will not allow the counter to work or there is insufficient signal to count.

POWER SUPPLY FAILURE—one or more of the power supplies is out of regulation.

NON-VOLATILE RAM CHECK SUM ERROR—a checksum error on data in this memory has occurred. Either the battery or the RAM has failed.

Press <SHIFT> HELP to get a listing of all existing errors.

TURN ON PROCEDURE AND PREPARATION FOR USE

The following procedure should produce a display and calibrate center frequency readout, display reference level, and dynamic range.

1. Initial Turn On

a. Connect the 494/494P power cord to an appropriate power source (see "Power Requirements" under Installation Instructions in Section 3) and switch POWER on.

When POWER is switched on (power up), the processor will run a memory and I/O test. If a problem exists a failure message will appear on screen. By pressing the continue key, as directed in the message, the operator can bypass the failed test and attempt to use the instrument; however, performance may not be as specified. If a problem does not exist, the program will complete in about 6 seconds and the instrument will be ready to operate. Note that the crt readout is functioning (see Figure 5-1).

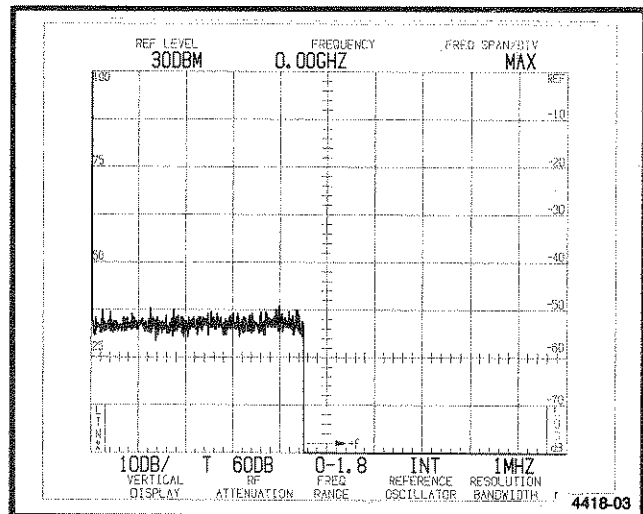

Figure 5-1. Crt display and readout for power-up state.

Check Procedure—494/494P Operators

The operating functions and modes of the 494/494P should initialize to the following "power up" state:

REF LEVEL	+30 dBm
FREQUENCY	0.00 GHz
FREQ SPAN/DIV	MAX
Vert Display	10 dB/DIV
RF ATTENUation	60 dB
FREQ RANGE	0.0-1.8 GHz
REFERENCE OSCILLATOR	INT (May read INT UNLK (unlocked) on initial turn-on and up to 5 minutes of operation, due to warmup of the reference oscillator oven. This is normal.)
RESOLUTION BANDWIDTH	1 MHz
READOUT	On
Triggering	FREE RUN
AUTO RESOLUTION	On
Digital Storage	VIEW A/VIEW B on
All other pushbuttons	Inactive or off

b. Set MIN RF ATTEN dB to 0 and the PEAK/AVERAGE control fully ccw. Set the TIME/DIV to AUTO, the REFERENCE LEVEL to -20 dBm, and adjust the INTENSITY for the desired brightness. Note the RF ATTEN readout is now 10 dB.

c. Apply the CAL OUT signal to the RF INPUT by connecting a 50 Ω coaxial cable between the CAL OUT connector and the RF INPUT. Note the comb of 100 MHz markers at the left side of the display (see Figure 5-2).

d. In the MAX frequency span mode a dot marker, in the upper portion of the screen, indicates the location of the center frequency. With a frequency readout of 0.00 GHz, this dot will appear in the upper left portion of the screen. Adjust the CENTER FREQUENCY control and note that the dot marker moves across the display.

e. Select the 100 MHz mark by pressing SHIFT, then FREQ, enter 100, from the Data Entry keyboard, and terminate with MHz.

In the procedures that follow, if a mode or function is to be entered from the Data Entry keyboard, it will be described as; press <SHIFT> FREQ, 100, MHz.

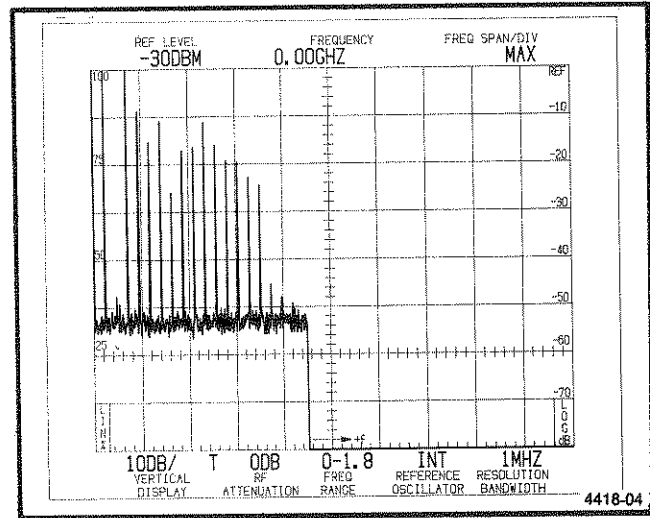

Figure 5-2. Typical display of calibration markers in MAX SPAN position.

f. Change the FREQ SPAN/DIV to 100 MHz. Note that the dot marker is now horizontally centered and the 100 MHz calibrator signal is at center screen.

2. Calibrate Center Frequency, Reference Level, and Dynamic Range

NOTE

When the <SHIFT> CAL buttons are pressed, the 494/494P microcomputer performs a center frequency and reference level calibration. This needs to be done before the instrument will meet its center frequency and reference level accuracy performance specifications. A recalibration should be done at regular intervals, or when the instrument ambient temperature changes from the last calibration. An explanation of Reference Level Accuracy, with respect to ambient temperature is described in the Specifications section.

After the microcomputer has completed a calibration routine, the results can be observed by pressing SHIFT then MIN NOISE. The "Internal Calibration Result" message shows the correction factor used to center the resolution bandwidth filters and the correction used to bring the amplitude level within 0.4 dB of the 1 MHz filter.

a. Press SHIFT then CAL to start the calibration routine. A message on the crt will guide the user how to set the Vertical and Horizontal POSITION, AMPL and LOG CAL adjustments. This sets the absolute Reference Level for the 1 MHz resolution bandwidth filter. An automatic calibration is then performed by the microcomputer which measures and corrects any frequency and amplitude errors of the fil-

ters, unless the errors are excessive. It will then display a message on screen that calibration failed. As stated above, these correction factors are held in battery-powered memory. Press SHIFT to exit the routine.

b. If the processor can complete the calibration routine, the instrument control settings will return to their previous settings. If a CALIBRATION FAILED message appears, refer to the correction factors by pressing SHIFT then MIN NOISE. The frequency correction routine can be disabled by pressing SHIFT then FREE RUN, or have the instrument serviced. Remember, if the frequency correction loop is bypassed, the center frequency accuracy characteristics are no longer in specifications.

FUNCTIONAL OR OPERATIONAL CHECK

This procedure uses minimum test equipment to check instrument operating modes, functions, and basic performance. The procedure will check that the instrument is operating properly. The internal calibrator and attenuator are used as the source for checking most of the operational characteristics. Since both are very accurate, this check should satisfy most incoming inspection or pre-operational check-out requirements. This check will also help familiarize an operator with the instrument operation. A detailed Performance Check that verifies all performance requirements listed in the Specification section is part of the service instructions.

Equipment Required

The only external equipment used is an N male to bnc female adapter, and the 50 Ω coaxial cable, which are supplied as standard accessories.

Preliminary Preparation

Perform the initial calibration described under "Turn On Procedure and Preparation for Use", then allow the instrument to warm-up for at least 15 minutes before proceeding with this check.

1. Check Operation of Front Panel Pushbuttons and Controls

The following procedure checks the operation of all front panel pushbuttons and controls and ensures that the buttons illuminate when the function is active.

The LED's for the pushbuttons indicate when the primary function is active and/or the allowable selections for any of the shift mode, multiple function buttons; for example, all Data Entry buttons on the keyboard light after one of the

shift functions (except CAL, EXT MIXER, or PLOT) have been selected. This indicates buttons that can enter data for that selection. Messages are also displayed to guide the user as to the sequence of these selections.

Connect the CAL OUT signal to the RF INPUT by using the 50 Ω cable and bnc to N adapter. Tune the 100 MHz, -20 dBm, signal to center screen. Reduce the FREQ SPAN/DIV to 20 kHz and change the Vertical Display to 2 dB/DIV. Press or change the following pushbuttons and controls and note their effect on the operation.

INTENSITY—Rotate the control through its range and note crt beam brightness change.

READOUT—In the active state (button illuminated), there is crt readout of REF LEVEL, FREQUENCY, FREQ SPAN/DIV, VERT DISPLAY, RF ATTEN, FREQ RANGE, REFERENCE OSCILLATOR and RESOLUTION BANDWIDTH. The INTENSITY control changes The brightness of the readout characters as well as the display.

GRAT ILLUM—When activated, the graticule is illuminated.

BASELINE CLIP—When activated the baseline of the display, up to about one graticule division, is clipped (blanked).

Triggering—Triggering mode is activated by pressing one of four pushbuttons. Button illuminates when in the active state. Pressing any one of the buttons cancels or deactivates the other mode.

FREE RUN: In the active state, trace free runs.

INT—When active, sweep is triggered when signal or noise level at left edge is ≥ 2.0 division.

(1) Change the RESOLUTION BANDWIDTH to 100 kHz. Tune one of the 100 MHz markers to the left edge of the display and adjust the REF LEVEL so the amplitude of the marker is two or more divisions. Turn Digital Storage off.

(2) Activate INT Triggering and note that the sweep is triggered.

(3) Activate FREE RUN then tune the signal away from the left edge so the signal amplitude, at the left edge, is about one division.

(4) Reactivate INT Triggering and note that the sweep is not triggered.

LINE—When acted, the trace is triggered at power line frequency. Switch Triggering mode to LINE and note sweep is triggered.

Check Procedure—494/494P Operators

EXT—When this function is on, the trace runs only when an external signal ≥ 1.0 volt peak is applied to the back panel HORIZ/TRIG connector. Since external test equipment is required to check this function, a check cannot be made with this procedure.

SINGLE SWEEP—When this function is activated, single sweep aborts the current sweep; pressing the button again, arms the sweep generator and lights the READY indicator. When triggering conditions are met, after the circuit is armed, the analyzer will make only one sweep. The indicator will remain lit until the sweep has run. Single sweep mode is canceled when any Triggering button is pressed. The effect of SINGLE SWEEP is more apparent with digital storage off.

- (1) Press FREE RUN Triggering and set the TIME/DIV to 0.5 s.
- (2) Press SINGLE SWEEP and note that the sweep aborts.
- (3) Press SINGLE SWEEP again and note that the READY indicator lights and the sweep runs.
- (4) Press FREE RUN to cancel single sweep and return the TIME/DIV to AUTO.

TIME/DIV—This control selects sweep rate, manual scan, and external sweep operation. In the MNL position, MANUAL SCAN control should move the crt beam across the full frequency span and horizontal axis of the crt graticule. In the EXT position a voltage of 0 to +10 volt, applied to the rear panel HORIZ/TRIG connector, should deflect the crt beam across the full 10 division screen.

Vertical Display—Display modes are activated by three pushbuttons. Pressing any of these buttons cancels the other mode.

10 dB/DIV—When this button is activated, the display is a calibrated 10 dB/division with an 80 dB dynamic range.

- (1) With a REF LEVEL of -20 dBm activate 10 dB/DIV and AUTO RESOLN. Set the FREQ SPAN/DIV to 20 kHz and tune the calibrator signal to center screen.
- (2) Change REF LEVEL and note that the display steps are in one division increments, representing 10 dB/division. Return the REF LEVEL to -20 dBm.

2 dB/DIV—When this button is pressed, the display is a calibrated 2 dB/division with 16 dB of dynamic range.

- (1) Activate the 2 dB/DIV mode and change the REF LEVEL to -6 dBm.

- (2) Note that the display steps 1.0 division for each two steps of the REFERENCE LEVEL control.

- (3) Return the REF LEVEL to -20 dBm.

LIN—When this button is activated, the display is linear between the reference level (top of graticule) and zero volt (bottom of graticule); the crt VERT DISPLAY reads out in volts/division.

Activate the LIN mode and note that the Vertical Display readout changes to mV/division.

PULSE STRETCHER—When this button is activated, the fall-time of video signals increases so narrow video pulses will show on the display.

- (1) Increase the FREQ SPAN/DIV to 100 MHz, change the Vertical Display to 10 dB/DIV, increase TIME/DIV to 1 ms, activate AUTO RESOLN, and switch VIEW A and VIEW B off.
- (2) The markers should increase in brightness when PULSE STRETCHER is activated.
- (3) Switch the PULSE STRETCHER off, return TIME/DIV to AUTO and switch VIEW A and VIEW B on.

Video Filter—Two filters can be independently selected to provide, WIDE or NARROW (1/30th or 1/300th of the resolution bandwidth) filtering to reduce noise.

- (1) Change the FREQ SPAN/DIV to 500 kHz, switch AUTO RESOLN on, and tune the calibrator signal to center screen.
- (2) Activate WIDE and NARROW Video Filters and note the reduction in noise as each filter is switched in (see Figure 5-3). The NARROW filter will have a more pronounced effect on noise reduction. Also note the change in sweep rate, if the TIME/DIV selector is in the AUTO position.
- (3) Switch both Video Filters off.

DIGITAL STORAGE—Either one or both the "A" and "B" waveforms, from digital storage, can be selected. The amplitude of a signal should remain constant when digital storage is switched on (VIEW A or VIEW B activated). The PEAK/AVERAGE control positions a cursor over the vertical window of the screen with noise and signal level averaged below the cursor and peaked above the cursor.

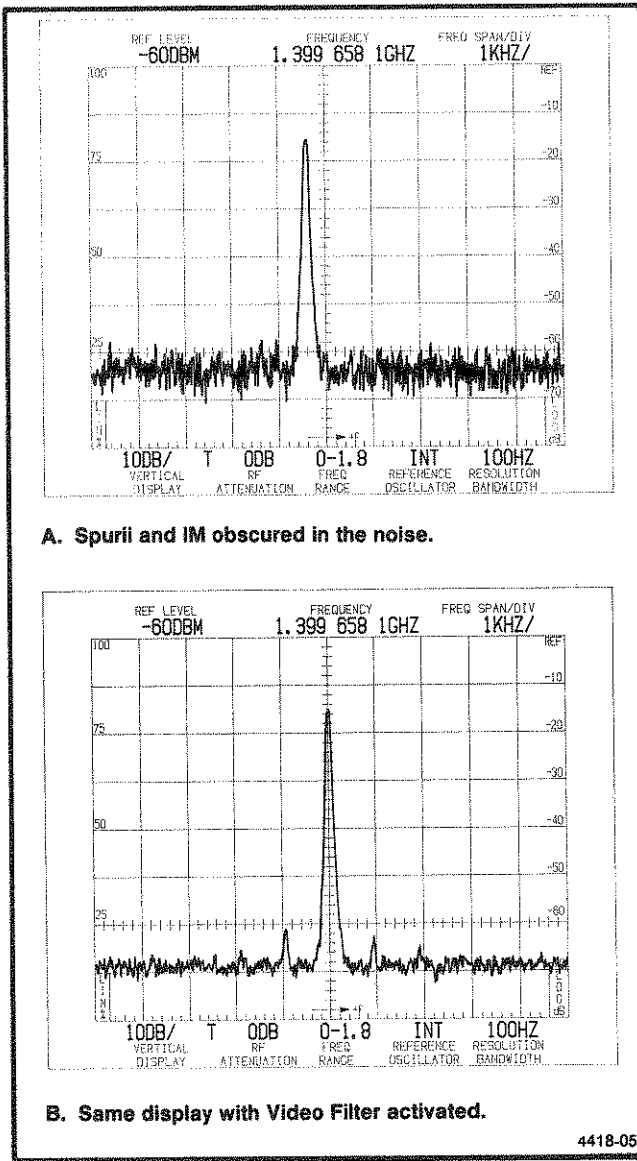

Figure 5-3. Integrating a display with the Video Filter.

VIEW A—When this button is pressed, the “A” waveform, from digital storage, is displayed. With SAVE A off, the “A” waveform is updated each sweep as the beam travels from left to right. With SAVE A on, the waveform and readout are not updated.

VIEW B— When the button is pressed the “B” waveform is displayed. When both VIEW A and VIEW B are active, the “A” and “B” waveforms are interlaced and displayed. Both waveforms are updated each sweep. Update of the “A” waveform depends on the state of SAVE A.

SAVE A—When SAVE A is activated, the “A” waveform, with its readout, is saved. In this mode the data for the A waveform is not updated each sweep.

Switch VIEW B off then change REF LEVEL and note that the “A” display does not change. The readout for the saved waveform should be displayed anytime SAVE A is on and VIEW B and B—SAVE A are off. If either VIEW B or B—SAVE A is on, the readout reflects current analyzer setup.

MAX HOLD—When this button is on, the maximum signal amplitude at each memory location is stored. The waveform is updated only when signal data is greater than that previously stored. Verify operation by changing FREQUENCY or REF LEVEL and note that the maximum level at each location is retained.

B—SAVE A—Activating this button will display the arithmetic difference between an updated “B” waveform and a SAVE A waveform. SAVE A function is automatically activated when B—SAVE A is pressed.

Press B—SAVE A then change the REF LEVEL so the difference between the “B” and SAVE A waveform is displayed with VIEW A and VIEW B off. The reference (zero difference) level is factory set at graticule center. The position of this reference level can be changed by qualified service personnel. Positive differences between the two displays appear above this line and negative differences below the line.

PEAK/AVERAGE—When digital storage is on, this control positions a horizontal line or cursor anywhere within the graticule window. Signals above the cursor are peak detected, signals below the cursor are averaged by the digital storage. Verify operation by moving the cursor within the noise level and note the noise amplitude change as the cursor is positioned.

IDENTify— When the identify function is activated, every other sweep, with its waveform, is vertically displaced from the other and the frequencies of the 1st and 2nd local oscillators are moved such that true signals are not displaced horizontally on alternate sweeps while spurious signals are shifted 100 MHz or off screen. The FREQ SPAN/DIV must be 50 kHz or less for the coaxial bands and 50 MHz or less for the waveguide bands (21 GHz or more) before the processor will activate the Identify mode. Refer to “Using the Signal Identifier” under General Operating Information in Section 6.

(1) With the 500 MHz marker tuned to center frequency, decrease the FREQ SPAN/DIV to 50 kHz or less and press IDENT.

(2) Note that there is no horizontal displacement of the 500 MHz signal on alternate sweeps. To help determine if the signal is true or spurious, (see Figure 5-4) decrease the sweep rate, or activate SAVE A with both VIEW A and VIEW B on, so a comparison can be easily made.

(3) Switch IDENT off.

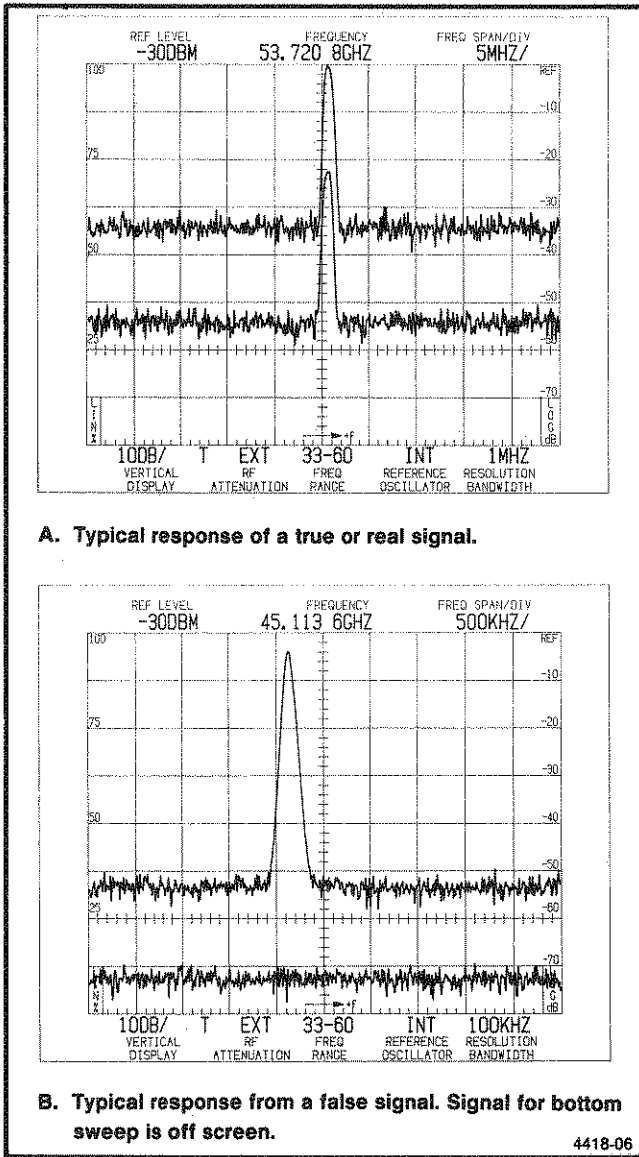

Figure 5-4. Using IDENT feature to identify a real or true response.

AUTO RESOLN—When this function is on, resolution bandwidth is automatically selected by the processor to maintain a calibrated display, when the FREQ SPAN/DIV and TIME/DIV are changed. Check operation by changing FREQ SPAN/DIV or TIME/DIV settings and note the RESOLUTION BANDWIDTH change. UNCAL indicator should not light over the FREQ SPAN/DIV range if the TIME/DIV selector is in AUTO position.

MAX SPAN—When activated, the span switches to maximum and the analyzer sweeps the full band. When deactivated, the span/div will return to its previous setting.

ZERO SPAN—When activated, the span should shift to zero for a time-domain display. When deactivated, the span returns to its previous setting.

FREQUENCY SPAN/DIV—As this control is rotated, the Span/Div should change between 0 and Max. The display should indicate this change. Range of selections depends on frequency band (see specifications).

RESOLUTION BANDWIDTH—As this control is rotated from a full counterclockwise position, the resolution bandwidth should change from 30 Hz to 100 Hz and then in decade steps to 1 MHz.

REFERENCE LEVEL—In the 10 dB/DIV Vertical Display mode, with FINE off, the REF LEVEL should step in 10 dB increments as the control is rotated. When FINE is activated, the steps are 1 dB. In the 2 dB/DIV mode, the steps are 1 dB, with FINE off, and 0.25 dB with FINE active. When the Vertical Display factor is 4 dB/div or less, with FINE on, the analyzer should switch to the ΔA mode where the REF LEVEL readout goes to 0.00 dB then steps in 0.25 dB increments as the REFERENCE LEVEL control is rotated.

- (1) Set the MIN RF ATTEN to 0 dB, Vertical Display to 10 dB/DIV, and rotate the REFERENCE LEVEL control counterclockwise to +30 dBm then clockwise to -117 dBm.
- (2) Note that the REF LEVEL readout changes in 10 dB increments.
- (3) Press FINE and again change the setting of the REFERENCE LEVEL control. Note the REF LEVEL now steps in 1 dB increments.
- (4) Press <SHIFT> dB/DIV and enter 4 dB, with the Data Entry keyboard. Note that the REF LEVEL goes to 0.00 dB. Rotate the REFERENCE LEVEL control and note the REF LEVEL now steps in 0.25 dB increments from the 0.00 dB reference.
- (5) Return the REF LEVEL to -20 dBm and note that 10 dB of RF ATTEN is switched in at a REF LEVEL of -20 dBm. This prevents signal compression of any signals whose amplitude remains in the graticule area.

MIN RF ATTEN—This control sets the minimum amount of RF attenuation in the signal path, regardless of the REF LEVEL setting. Verify proper operation by setting the MIN RF ATTEN dB selector to 20 and change the REF LEVEL settings. Note that the RF ATTEN readout does not go below 20 dB.

FINE—When activated, the REFERENCE LEVEL steps decrease to the Fine mode. (Refer to REFERENCE LEVEL check).

MIN NOISE/MIN DISTORTION—This button selects one of two algorithms that select RF attenuator and IF gain. MIN NOISE (button illuminated) reduces the noise level by reducing attenuation 10 dB and decreasing IF gain 10 dB. MIN DISTORTION reduces IM distortion due to

input mixer overload. The normal mode of operation is with minimum distortion. To observe any change, the amount of RF ATTEN, displayed by the crt readout, must be 10 dB higher than the MIN RF ATTEN selector setting.

(1) Set the REF LEVEL to -20 dBm and the MIN RF ATTEN at 0 dB. Note that the RF ATTEN readout indicates 10 dB.

(2) Activate MIN NOISE and note that the noise floor drops approximately 10 dB and the RF ATTEN readout changes to 0 dB.

(3) Deactivate MIN NOISE mode.

UNCAL—This indicator lights when the display is uncalibrated.

(1) Set the TIME/DIV to 50 ms, deactivate the AUTO RESOLUTION, and set the RESOLUTION BANDWIDTH to 10 kHz.

(2) UNCAL indicator should light and remain lit until the FREQ SPAN/DIV is reduced to 200 kHz, or the RESOLUTION BANDWIDTH is increased to 1 MHz.

(3) Return the TIME/DIV to AUTO, press AUTO RESOLUTION, and set the FREQ SPAN/DIV to 100 MHz.

SHIFT—Pressing this button shifts those pushbuttons with two functions to their secondary function. The designation for this secondary function is printed in blue lettering next to the pushbutton. The shift mode deactivates after the function has been performed. Data entry buttons for the shift mode are nomenclated with orange lettering.

HELP—When this mode is activated, pressing or operating any control or selector produces a help message on the crt that explains the function of that control or pushbutton. Help messages will also prompt the user or explain any error message that may appear. Activate this mode and press various buttons and observe the crt message for each. Press the button again to cancel.

RECALL SETTINGS/STORE—Pressing this button in its primary, ("Recall Settings") mode, will cause the processor to list the settings with their center frequency, stored in non-volatile memory by memory registers (0-9). The 0 register retains the power-down settings so it can be recalled after power-up. In the SHIFT STORE mode, pressing this button stores the existing front panel setup in one of nine selected locations. A listing of all registers with the center frequency of the stored setup is displayed to indicate those registers that have previous setups stored.

(1) Press <SHIFT> STORE, and select register number 1, via the Data Entry keyboard, to store the current front panel setup.

(2) Change front panel control and selector settings.

(3) Press RECALL, then press the Data Entry key "1" to recall the setup.

(4) Note that the instrument front panel set-up returns to that previously entered.

COUNT/COUNT RESOLN—The primary function of this pushbutton is to activate a count for any signal within the center two divisions of the screen, or below the dot marker, provided the signal is 20 dB above the noise floor and greater than 60 dB below the reference level. The resolution of the counter is selected when in the Count Resoln mode. When activated, counter resolution to 1 Hz can be selected, via the Data Entry keyboard and the units terminator button.

(1) Set the FREQUENCY to 100 MHz, FREQ SPAN/DIV to 10 kHz, RESOLUTION BANDWIDTH to 10 kHz, and REF LEVEL to $+30$ dBm. Adjust CENTER FREQUENCY to position the 100 MHz signal so the 20 dB level, above the noise floor, crosses the center graticule line.

(2) Establish a counter resolution of 100 Hz by pressing <SHIFT> COUNT RESOLN, and enter 100 Hz via the Data Entry keyboard.

(3) Press COUNTER and note that the count is accurate to a resolution of 10 Hz.

ΔF —When the ΔF function is activated, center frequency readout initializes to 0.0 MHz or 0.00 kHz, depending on FREQ SPAN/DIV setting. The frequency difference, to a desired signal or point on the display, can now be determined by tuning that point to center screen and noting the readout. Check by measuring the difference between calibrator markers. If the frequency is tuned below "0" the readout will indicate (–) sign. Deactivate and note that the readout returns to the previous center FREQUENCY.

COUNT→CF—This button is used when a close-in analysis of a display in narrow spans is desired. When pressed, the signal under the frequency dot is counted once (even if the COUNTER mode is inactive) then the Center Frequency is shifted to the counted frequency. Any Freq Span/Div can now be selected and the signal will remain centered on screen. The count resolution and the resulting accuracy of the tuning is the current counter resolution.

Check Procedure—494/494P Operators

(1) Decrease the **FREQ SPAN/DIV** and increase the **RESOLUTION BANDWIDTH** so the calibrator signal spans 3 or 4 divisions on the screen. Tune the signal so approximately 20 dB of signal is at the frequency dot.

(2) Press **COUNT→CF** and note that the signal moves under the frequency dot and the Frequency readout changes to indicate the frequency of the marker.

FREQUENCY RANGE—These pushbuttons shift the 494/494P frequency range up or down from the current band. Press first one and then the other and note that the frequency bands change accordingly. If the operator selects a frequency via the Data Entry keyboard, the micro-processor automatically selects the appropriate frequency range.

AUTO PEAK/EXT MIXER—This dual function button selects Auto Peaking, in its primary mode, and External Mixer when in the shift mode.

AUTO PEAK—When **AUTO PEAK** is activated one of two things occur:

(1) If the analyzer is operating in the preselector bands (1.7-21 GHz), the preselector initiates a peaking routine on any signal within the center two divisions of the screen. The algorithm will peak the preselector tuning for this center frequency setting, then store this peak setting in non-volatile memory. If a signal is not on screen, the algorithm will revert to the code that was previously stored in memory; or, if there is no setting to the mid-point of the peaking range. After a setting for band has been stored, the operator can then switch between preselector bands with the assurance that the preselector is peaked well enough to track the oscillator and provide reasonable sensitivity.

(2) If the analyzer is operating in the External Mixer mode, the peaking routine sets the external mixer bias so as to peak the mixer response. If a signal is not present, the algorithm reverts to the previous bias setting stored in memory, or if there is no previous setting, it sets the bias voltage mid range.

In the Shift mode this button selects External Mixer operation. This dc couples the **EXTERNAL MIXER** port to an internal bias source for external mixers and ac couples the IF return, from the mixer, to the 2nd converter. This bias voltage is either manually set, with the **MANUAL PEAK** control, or automatically set by the processor Auto Peak algorithm. When in the External Mixer mode the crt readout, for **RF ATTEN**, reads **EXT**. To exit this mode, press **<SHIFT> EXT MIXER**. The **REF LEVEL** automatically goes to +30 dBm and the **RF ATTEN** to 60 dB to protect the internal mixer from any high level signals at the **RF INPUT**.

(1) With the calibrator signal applied to the **RF INPUT**, select a **FREQUENCY** of 3.0 GHz, by pressing **<SHIFT> FREQ** and enter 3 GHz, via the Data Entry keyboard. Select a **REF LEVEL** of -40 dBm, a **FREQ SPAN/DIV** of 10 kHz, and a **RESOLUTION BANDWIDTH** of 1 kHz.

(2) Peak the 3 GHz signal with the **MANUAL PEAK** control.

(3) Press **AUTO PEAK**. Note the message "PEAKING" on screen and the **READY** indicator for **SINGLE SWEEP** mode flash, as the processor runs the auto peak routine.

(4) When complete, the signal amplitude should equal or exceed that obtained with manual peaking.

(5) Change bands by increasing or decreasing the **FREQUENCY RANGE**, then return to band 2. Note that auto peak maintains the setting stored in memory.

(6) Press **<SHIFT> EXT MIXER**, the analyzer should shift to the External Mixer mode (indicated by a read-out of **EXT** above **RF ATTEN**). If **AUTO PEAK** mode is still active the button will remain lit.

(7) Connect a voltmeter between the **EXTERNAL MIXER** port and ground. Measure the bias voltage. If in the Auto Peak mode, the bias should be a steady dc voltage. (If Auto Peak has not been run for this band, the bias voltage will read approximately mid-range.)

(8) Switch to the manual peak mode by pressing **AUTO PEAK** button again. The button should not be lit and the bias voltage at the **EXTERNAL MIXER** port should now vary between approximately -2.5 V to +1.0 V, as the **MANUAL PEAK** control is rotated through its range.

Setting Parameters via the Data Entry Keyboard

Pressing **<SHIFT>** changes those buttons with more than one function to their shift or secondary mode. Some functions require a parameter or command to be entered that includes numerical data. This data is entered via the Data Entry keyboard as described in the following examples:

(1) Set the **FREQ SPAN/DIV** to 50 kHz and switch **AUTO RESOLN** on. Set the center frequency to 2.0 GHz by pressing **<SHIFT> FREQ**, and enter 2 GHz, via the Data Entry keyboard. Note that the **FREQUENCY** sets to 2.000 GHz. (The number of digits is a function of the span/div that was previously entered.)

(2) Enter frequencies of 200 MHz, 200 kHz, and 200 Hz by repeating the above procedure and terminating with the appropriate units multiplier. Note that the FREQUENCY sets to those figures entered via the Data Entry keyboard.

(3) Set the SPAN/DIV to any desired setting, via the keyboard and note that the entered Span/Div is set.

(4) Enter a REF LEVEL with the keyboard and note that the entry is set.

(5) Enter a desired Vertical Display factor with the keyboard and note that the keyed-in dB/div is set.

STORE DISPLAY and RECALL

In the shift mode these two buttons store a waveform or display, with its readout, in a selected register; or recall a selected display from memory.

STORE DISPLAY—Press <SHIFT> STORE DISPLAY, then the register number in which you wish to place the display. Terminate with the display ("A" or "B") you want stored.

RECALL—Press <SHIFT> RECALL, then the register number from the displayed menu and select the part of digital storage ("A" or "B") in which you wish to have the recalled waveform placed. If "A" is selected, SAVE A is automatically activated to prevent an overwrite. VIEW A must be on to observe the recalled waveform and VIEW B must be off to see the readout that applies to the recalled waveform. If VIEW B and VIEW A are on, both the recalled waveform in "A" and the current waveform in "B" will be displayed. Readout will apply to the current "B" waveform.

If "B" is selected for the recalled waveform, the next sweep will overwrite the display unless SINGLE SWEEP was activated before selecting "B". A message on screen will remind the user that this will occur. Again VIEW B must be on to observe the recalled waveform and its readout. Remember to de-activate SINGLE SWEEP when leaving this recalled mode.

(1) Establish a display on the screen. Press <SHIFT> STORE DISPLAY, enter the memory register number (0-8) that you wish to place the display and terminate with the display ("A" or "B") you wish stored.

(2) Change the characteristics of the current display with the REF LEVEL or FREQUENCY control.

(3) Press <SHIFT> RECALL, select the register number where the above display was stored (note the center frequency listing of the stored displays in each register) then press VIEW A so the recalled waveform is placed in the "A" part of digital storage.

(4) If VIEW A is on and VIEW B off, the recalled display, with its readout, should now become the "A" display. SAVE A should activate to prevent overwrite. If VIEW A and VIEW B are on, both the recalled display and the current "B" display will be on screen. Since the most current display is the "B" waveform, the readout will depict the parameters for the "B" display. Switch VIEW B off to observe the readout applicable to the recalled "A" waveform.

(5) Recall a stored display into "B" section by repeating the above process. Before starting the process press SINGLE SWEEP so the recalled waveform will not be overwritten by the next sweep. (A message will appear when you select "B" section reminding the user of this.) Remember to deactivate SINGLE SWEEP when returning to normal operation.

This completes the functional check of front panel controls and selectors.

2. Check Gain Variation Between Resolution Bandwidths (less than 0.4 dB with respect to the 1 MHz filter and less than 0.8 dB between any two filters)

a. Perform the "Calibrate Center Frequency, Reference Level, and Dynamic Range" procedure under "Preparation for Use" at the beginning of this section.

b. Set FREQUENCY to 100 MHz by pressing <SHIFT> FREQ and enter 100 MHz, via the Data Entry keyboard. Set FREQ SPAN/DIV to 1 MHz, RESOLUTION BANDWIDTH to 1 MHz, REF LEVEL to -20 dBm, TIME/DIV to AUTO and activate AUTO RESOLN.

c. Apply 100 MHz markers from the Calibrator to the RF INPUT. Set the Vertical Display factor to 1 dB/DIV by pressing <SHIFT> dB/DIV and terminate with dB.

d. Verify that the amplitude of the 100 MHz signal is at the top graticule line. If not, repeat the front panel calibration procedure by pressing <SHIFT> CAL.

e. Change the REF LEVEL to -19 dBm and note the position of the 100 MHz signal. This is the reference for checking the other filters.

f. Change the RESOLUTION BANDWIDTH and FREQ SPAN/DIV to 100 kHz.

g. Check—the amplitude of the 100 MHz signal should be within 0.25 dB of the 1 MHz reference established in part

Check Procedure—494/494P Operators

e, and within 0.2 division from the frequency dot (center screen).

h. Set the RESOLUTION BANDWIDTH to each of its settings and the FREQ SPAN/DIV for a readable display so the amplitude accuracy and frequency can be checked with respect to the 1 MHz reference and between any two filters. Reference level error should not exceed 0.4 dB from the reference and 0.8 dB between any filter.

3. Check Counter Accuracy [Within $(10 + 2N)\text{Hz} + 1 \text{ LSD}$]

a. With the Calibrator signal applied to the RF INPUT, set the FREQUENCY to 100 MHz, FREQ SPAN/DIV to 500 kHz, TIME/DIV in AUTO, and REF LEVEL at 0 dBm.

b. Select 1 Hz counter resolution by pressing <SHIFT> COUNT RESOLN and enter 1 via the Data Entry keyboard and terminate with Hz.

c. Press COUNT and note that the counter error over several counts does not exceed $\pm 13 \text{ Hz}$ (10.000 013 to 9.999 987).

d. Change the FREQ SPAN/DIV to 200 kHz and repeat part c.

e. Select a counter resolution of 1 kHz and repeat the count accuracy check as described above. Error should not exceed $\pm 1 \text{ kHz}$.

f. Activate the NARROW Video Filter then set the FREQUENCY to one of the Calibrator markers at the high end of the band (1.6—1.8 GHz). Signal amplitude must equal or exceed 20 dB above the noise floor.

g. Repeat the count accuracy check as described above.

4. Check Span Accuracy and Linearity

Span accuracy is the displacement error of calibrator markers from the center reference over ± 4 divisions of span. Linearity accuracy is determined by the displacement of calibrator frequency markers, from their specified positions over the center eight divisions of the display area, using the 1st graticule line as the reference.

a. Set the FREQUENCY to 500 MHz, the FREQ SPAN/DIV to 100 MHz, REF LEVEL to -20 dBm and activate AUTO RESOLN. Change the Vertical Display to 10 dB/DIV.

b. Check span accuracy by noting that the 100 MHz markers are within 5% of their reference graticule line over the center eight divisions. (It may be easier to observe the markers with digital storage off.)

c. Tune the CENTER FREQUENCY to align one of the markers at the 1st graticule line from the left edge.

d. Check linearity by noting that the displacement of successive markers, over the center eight divisions, does not exceed 5% of 100 MHz (the FREQ SPAN/DIV setting) or 0.2 division.

5. Check Resolution Bandwidth and Shape Factor (bandwidth is within 20% of the selected 1 MHz to 30 Hz range, in decade steps to 100 Hz then 30 Hz; shape factor is 7.5:1 or less, and 15:1 or less for the 30 Hz bandwidth)

a. With the Calibrator output applied to the RF INPUT and the FREQUENCY set to 100 MHz, set the REF LEVEL to -20 dBm , FREQ SPAN/DIV to 500 kHz, RESOLUTION BANDWIDTH to 1 MHz, TIME/DIV at AUTO, Vertical Display to 2 dB/DIV, and activate MIN NOISE.

b. Measure the 6 dB down bandwidth (see Figure 5-5A). Bandwidth should equal $1 \text{ MHz} \pm 200 \text{ kHz}$.

c. Change the Vertical Display to 10 dB/DIV and measure the 60 dB down bandwidth (see Figure 5-5B).

d. Calculate the shape factor as the ratio of 60 dB/6 dB down bandwidths (see Figure 5-5). Shape factor should equal 7.5:1 or less.

e. Change the RESOLUTION BANDWIDTH to 100 kHz and the FREQ SPAN/DIV to 100 kHz.

f. Check the resolution bandwidth and shape factor of the 100 kHz filter by repeating the above process.

g. Repeat the process to check the resolution bandwidth and shape factor for the 10 kHz, 1 kHz, 100 Hz, and 30 Hz filters. Shape factor should equal 7.5:1 for all except the 30 Hz filter which is 15:1 or less.

6. Check Reference Level Gain and RF Attenuator Steps

a. With the Calibrator signal applied to the RF INPUT and the FREQUENCY set to 100 MHz, set the FREQ

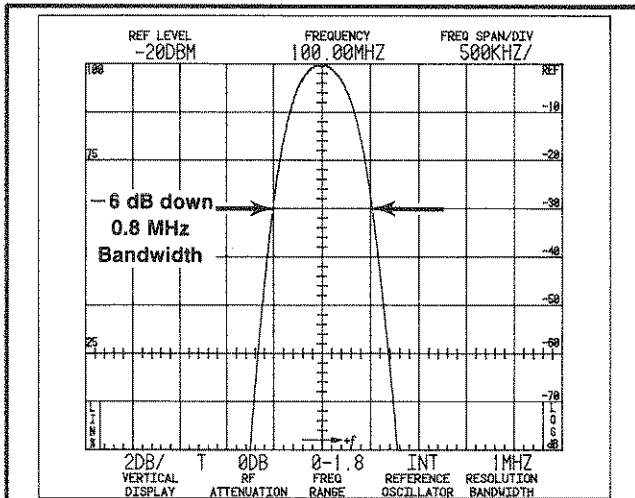

A. Measuring 6dB down bandwidth.

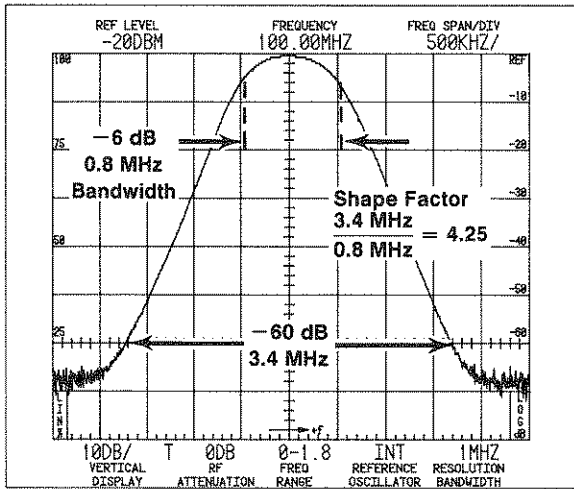

B. Measuring 60dB down bandwidth and computing shape factor.

4418-07

Figure 5-5. Displays that illustrate how bandwidth and shape factor are determined.

SPAN/DIV and RESOLUTION BANDWIDTH to 100 kHz. Set Vertical Display to 10 dB/DIV, REF LEVEL to -20 dBm, and activate MIN NOISE and NARROW Video Filter.

b. Check the attenuator by increasing REF LEVEL to +40 dBm and note that the signal peak decreases 1 division per 10 dB step of the RF ATTEN.

c. Set FREQUENCY to 200 MHz, REF LEVEL to -20 dBm.

d. Increase MIN RF ATTEN dB to 60 dB and note that the noise level increases 1 division for each 10 dB step.

e. Check IF gain steps by switching REF LEVEL between -20 dBm and +40 dBm and note that the noise level decreases 1 division per step.

f. Activate FINE then check that the trace rises 1 dB/step of the REF LEVEL as it is changed to +30 dBm.

g. Switch FINE off and reduce MIN RF ATTEN dB to 0.

h. Switch MIN NOISE off and note the noise floor rise about 1 division as the RF ATTEN increases 10 dB. REF LEVEL should not change.

i. Change REF LEVEL to -60 dBm and switch Vertical Display to 2 dB/DIV. Adjust REF LEVEL so signal level is near the top graticule line.

j. Change the REF LEVEL and note that the signal amplitude changes in 2 dB increments (0.2 div).

k. Set Vertical Display to 1 dB/DIV by pressing SHIFT then dB/DIV, enter 1 via the Data Entry keyboard and terminate with dB.

l. Change the REFERENCE LEVEL control and note that the REF LEVEL changes in 1 dB steps and the display in 1 division steps.

m. Activate FINE (ΔA mode). Note that the REF LEVEL now reads 0.00 dB. This denotes the ΔA mode.

n. Change the REFERENCE LEVEL control positions and note the REF LEVEL readout change in + or - 0.25 dB increments.

o. Deactivate FINE and adjust the REFERENCE LEVEL control for a 10 dB multiple of REF LEVEL, then change the Vertical Display to 10 dB/DIV and the REF LEVEL to -20 dBm.

7. Check Sensitivity (refer to Table 5-1)

NOTE

Sensitivity is specified according to the input mixer average noise level. The Calibrator signal is the reference used to calibrate the display.

Check Procedure—494/494P Operators

a. Remove the Calibrator signal from the RF INPUT. Set the Vertical Display to 10 dB/DIV, REF LEVEL to -30 dBm, FREQ SPAN/DIV to 5 MHz, RESOLUTION BANDWIDTH to 1 MHz, TIME/DIV at 1 s, and FREQ RANGE 0-1.8 GHz. Adjust the PEAK/AVERAGE control so the cursor is at the top of the screen and activate the WIDE Video Filter.

b. Check—the noise floor (level) should be at least -80 dBm (as indicated in Table 5-1) or five divisions down from the REF LEVEL of -30 dBm.

c. Change the REF LEVEL to -40 dBm, FREQ SPAN/DIV to 1 MHz, and RESOLUTION BANDWIDTH to 100 kHz.

d. Check—the noise floor should be at least -90 dBm (refer to Table 5-1).

e. Change REF LEVEL to -60 dBm, FREQ SPAN/DIV to 10 kHz, TIME/DIV to AUTO, RESOLUTION BANDWIDTH to 1 kHz, and activate the NARROW Video Filter.

f. Check that the average noise level for the 1 kHz resolution bandwidth is as listed in Table 5-1.

g. Change REF LEVEL to -70 dBm, FREQ SPAN/DIV to 200 Hz, and RESOLUTION BANDWIDTH to 100 Hz.

h. Check that the noise level for the 100 Hz resolution bandwidth is as listed in Table 5-1.

i. Change RESOLUTION BANDWIDTH to 30 Hz, and FREQ SPAN/DIV to 50 Hz.

j. Check that the noise level for the 30 Hz resolution bandwidth is as listed in Table 5-1.

k. Repeat this procedure for the remaining coaxial input frequency range (0 to 21 GHz). If desired, the waveguide band sensitivity can be checked against the figures listed in Table 5-1. The 50 GHz to 325 GHz numbers are typical and should not be used as a performance requirement.

Table 5-1 shows the equivalent maximum input noise (average noise) for each resolution bandwidth with internal mixer and TEKTRONIX High Performance Waveguide Mixers.

Table 5-1
494/494P SENSITIVITY

Band/Frequency	Equivalent Input Noise (dBm) versus Resolution Bandwidth					
	1 MHz	100 MHz	10 kHz	1 kHz	100 Hz	30 Hz
Band 1-3 50 kHz-7.1 GHz	-80	-90	-100	-110	-118	-121
Band 4 5.4-12.0 GHz	-65	-75	-85	-95	-103	-106
Band 5 15.0-21.0 GHz	-55	-65	-75	-85	-93	-96
^a Band 6 18.0-26.5 GHz	-70	-80	-90	-100	-108	-111
^a Band 7 26.5-40.0 GHz	-65	-75	-85	-95	-103	-106
^a Band 8 33-60 GHz	-65	-75	-85	-95	-103	-106
^a Band 9 50-90 GHz	Typically -95 dBm for 1 kHz resolution bandwidth at 50 GHz, degrading to -85 dBm at 90 GHz.					
^a Band 10 75-140 GHz	Typically -90 dBm for 1 kHz bandwidth at 75 GHz, degrading to -75 dBm at 140 GHz.					
^a Band 11 110-220 GHz	Typically -80 dBm for 1 kHz bandwidth at 110 GHz, degrading to -65 dBm at 220 GHz.					
^a Band 12 170-325 GHz	Typically -70 dBm for 1 kHz resolution bandwidth at 170 GHz, degrading to -55 dBm at 325 GHz.					

^aTEKTRONIX High Performance Waveguide Mixers

8. Check Residual FM (within 7 kHz over 20 ms, with FREQ SPAN/DIV greater than 200 kHz, and within 12 Hz, over 20 ms, with FREQ SPAN/DIV of 200 kHz or less)

a. With the Calibrator signal applied to the RF INPUT, set the FREQUENCY to 100 MHz, FREQ SPAN/DIV to 1 MHz, RESOLUTION BANDWIDTH to 100 kHz, Vertical Display to 2 dB/DIV, and REF LEVEL to -23 dBm.

b. Press <SHIFT> FREE RUN. A message "FREQUENCY CORRECTIONS DISABLED" will appear on screen, which indicates that the 1st LO synthesis and phase lock are disabled; this is normal. It is now possible to switch the FREQ SPAN/DIV to narrower spans with the 1st LO phase lock disabled.

c. Decrease the FREQ SPAN/DIV and RESOLUTION BANDWIDTH to 10 kHz, keep the 100 MHz calibrator signal centered on screen with the CENTER FREQUENCY control.

d. Switch the Vertical Display to LIN. Position the signal so the slope (horizontal versus vertical excursion) of the response can be determined (see Figure 5-6A). It may help to determine slope by using SINGLE SWEEP and SAVE A to freeze the display at a convenient point on the graticule for measuring slope.

e. If SAVE A was used in part d, de-activate SAVE A. Activate ZERO SPAN, set TIME/DIV to 20 ms and adjust the CENTER FREQUENCY control to position the display

Check Procedure—494/494P Operators

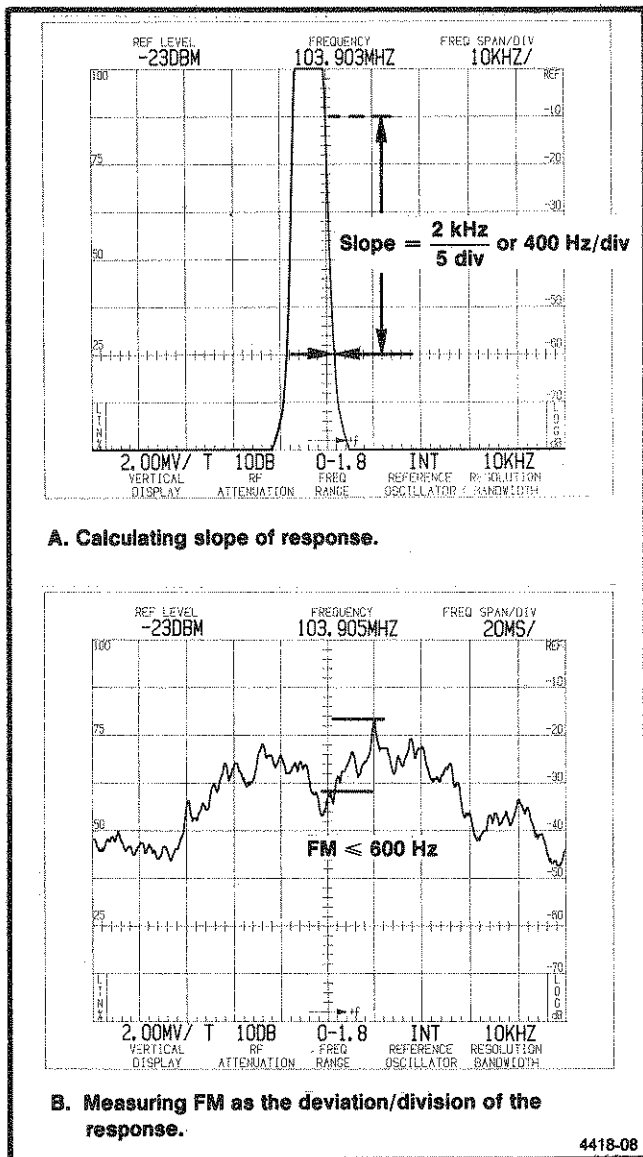

Figure 5-6. Typical display showing how to determine residual FM.

near center screen as shown in Figure 5-6B. Use SINGLE SWEEP and SAVE A to freeze the display for ease in measuring the FM. The peak-to-peak amplitude of the display per any horizontal division, scaled to the vertical deflections according to the slope estimated in part d is the residual FM. Residual FM must not exceed 7 kHz for 20 ms (1 division).

f. Press <SHIFT> FREE RUN to re-enable the phase lock, and set the FREQUENCY to 100 MHz. Switch the TIME/DIV to AUTO, reduce the FREQ SPAN/DIV and RESOLUTION BANDWIDTH to 100 Hz.

g. Adjust the CENTER FREQUENCY control to position the signal so its slope can be determined. Use SINGLE SWEEP and SAVE A to freeze the display at a convenient position on the graticule.

h. Deactivate SAVE A and SINGLE SWEEP and switch the TIME/DIV to 20 ms. Activate ZERO SPAN and position the display near center screen so the vertical excursions per horizontal division (20 ms) can be measured. Residual FM must not exceed 12 Hz.

9. Check Frequency Drift or Stability (50 Hz or less per minute of sweep time, when the FREQ SPAN/DIV is 200 kHz or less, after 1 hour of warmup, and within a stable ambient temperature)

a. With the Calibrator signal applied to the RF INPUT, set the FREQUENCY to 100 MHz, TIME/DIV to AUTO, FREQ SPAN/DIV at 50 Hz, RESOLUTION BANDWIDTH to 30 Hz, Vertical Display of 2 dB/DIV, and REF LEVEL of -23 dBm. Switch VIEW A and VIEW B on.

b. Adjust the CENTER FREQUENCY control so one side of the signal intersects the sixth division graticule line from the left edge, then press SINGLE SWEEP and activate SAVE A to save the display.

c. Select the NARROW Video Filter and press SINGLE SWEEP again to start the sweep. The sweep will now run at a 10 s/div rate.

d. Note the frequency difference between the two displays at the sixth graticule line. Label this difference Δf .

e. Check frequency drift rate in Hz/minute = $300 \times \Delta f / (250 + \Delta f)$. Drift rate must not exceed 50 Hz/minute.

10. GPIB Verification Program

Volume 1 of the service manuals contains a GPIB verification program. If you wish to check the operation of the GPIB interface, request the program from service personnel.

This completes the 494/494P operational check.

GENERAL OPERATING PROCEDURE

Firmware Version and Error Message Readout

For information, refer to the subsection that follows the description of the Controls, Indicators, and Connectors in Section 5.

Using the Help Feature

When a question arises as to the function of any control or selector, press the HELP button then turn the control or press the pushbutton in question. A message will then be displayed that describes the function of the selected control. The initial HELP screen message also explains any errors due to malfunction that may exist.

Crt Light Filters

Two light filters, amber and grey, are supplied with the 494/494P accessories. Filter selection depends on ambient light conditions, light reflections, and operator's viewing needs. The filter is installed by pulling the top of the plastic mask out and placing the filter behind the crt bezel. It is best to remove the light filter when taking display photographs.

Intensity Level and Beam Alignment

Operate the instrument with the intensity level no higher than that required to clearly observe the display. Trace alignment and beam focus are internal adjustments that must be performed by qualified service personnel.

The required intensity level for some displays, such as pulsed spectra, may be high enough to produce a bright and flared baseline. This bright baseline can be clipped or subdued by activating the BASELINE CLIP. Baseline Clip is useful when photographing displays and it also allows the lower readout characters to be more easily viewed.

Signal Application

Signal frequencies to 21 GHz can be applied through a short, high quality, 50 Ω coaxial cable to the RF INPUT connector. These signals pass through an internal RF attenuator to the first (1st) mixer. The microcomputer automatically selects either a low-pass filter or tuned preselector (depending on frequency range) between the RF attenuator and the 1st mixer.

External mixers can be used if desired, by connecting the mixer through the supplied Diplexer to the EXTERNAL MIXER port. Signals from an external mixer by-pass the internal RF attenuator, preselector, and 1st mixer. Above 21 GHz, external waveguide mixers are External Mixers. Their application is described in detail near the end of this section.

RF INPUT Connector. The nominal input impedance of the coaxial RF INPUT is 50 Ω . Because cable losses can be significant at microwave frequencies, it is important to keep the cables as short as possible. Impedance mismatch between the signal source and the RF INPUT will produce reflections that degrade flatness, frequency response, sensitivity, and may increase spurious responses. Impedance mismatch can be caused by poor connections, incorrect signal source impedance, long or low quality coaxial cable, etc. When optimum flatness or frequency response is desired and signal strength is adequate, set the MIN RF ATTENUATION to 10 dB or more. The addition of the attenuator helps minimize reflections to improve the input characteristics.

CAUTION

The front end of the 494/494P is specified at +30 dBm maximum. It is possible, with MIN NOISE activated and with 60 dB of MIN RF ATTENUATION, to set the REF LEVEL to +40 dBm. If the signal level is increased for a full screen display, the input level will exceed the power rating of the attenuator. Do not apply any dc potential to the RF INPUT. Use a dc block if a signal is riding on any dc potential.

Signal levels of -28 dBm or more, for 1.7 to 2.0 GHz range, and -18 dBm or more for the other ranges (see Specifications) may be compressed. This can degrade signal reference level measurements and generate spurious responses.

Spurious responses can be minimized if the signal amplitude is kept within the graticule window. Therefore, a recommended procedure is to select a REF LEVEL that limits stronger signals to the graticule window.

General Operating Procedure—494/494P Operators

As stated above, high level signals can cause compression and if excessive (+30 dBm or +20 dBm in MIN NOISE mode), the 1st mixer may be destroyed. Signals above +30 dBm must be reduced by external attenuators. Ensure that the frequency range of any external attenuator is adequate.

Line stabilizing networks, used for conducting EMI/RF measurements, will often have several volts of 60 Hz signal at the output. Use a dc block, such as Tektronix Part No. 015-0221-00, to protect the input mixer.

Amplitude Conversion. A conversion chart, shown in Figure 6-1, can be used to convert input signal levels of voltage or power to dBm.

Connecting to 75 Ω Source: Signals from a 75 Ω source, at the lower frequencies (50 kHz-1 GHz), can be applied to the RF INPUT by using a 75Ω-to-50 Ω minimum loss attenuator. (Refer to the optional accessories list in the catalog for ordering information.)

Sensitivity and power levels are often rated in dBm (dB with reference to 1 mW regardless of impedance). Sensitivity and power levels for 75 Ω systems are usually rated in dBmV (dB with reference to 1 mV across 75 Ω). A circuit diagram of a suitable matching pad for this purpose is shown in Figure 6-2. Figure 6-3 shows the relationship between 50 Ω and 75 Ω units with matching attenuators included; the conversion is as follows:

1. dBmV (75 Ω) = dBm (50 Ω) + 54.47 dB:
e.g. -60 dBm (50 Ω) + 54.47 dB = -5.5 dBmV (75 Ω).
2. dBm (75 Ω) = dBm (50 Ω) + 5.72 dB:
e.g. -60 dBm (50 Ω) + 5.72 dB = -54.3 dBm (75 Ω).
3. For 50 Ω systems dBm_{μV} = dBm + 107 dB.

Resolution Bandwidth, Frequency Span, and Sweep Time

Resolution is the ability of a spectrum analyzer to display discrete frequency components within a frequency span. This ability is a function of the analyzer bandwidth, sweep time, frequency span, and incidental FM. Frequency span and sweep time are normally selected so the resolution bandwidth for a particular cw signal is minimum. Bandwidth also has an effect on noise level. As the bandwidth decreases, signal-to-noise ratio or sensitivity increases, therefore maximum sensitivity is attained with the narrow resolution bandwidths.

As the analyzer sweep rate is increased, a critical rate is reached where both sensitivity and resolution are degraded. Therefore, sweep time for a calibrated display is dependent on the resolution bandwidth and frequency span.

In other than MAX SPAN, the frequency span is symmetrical about the center frequency. In MAX SPAN the display represents the full frequency range of the selected

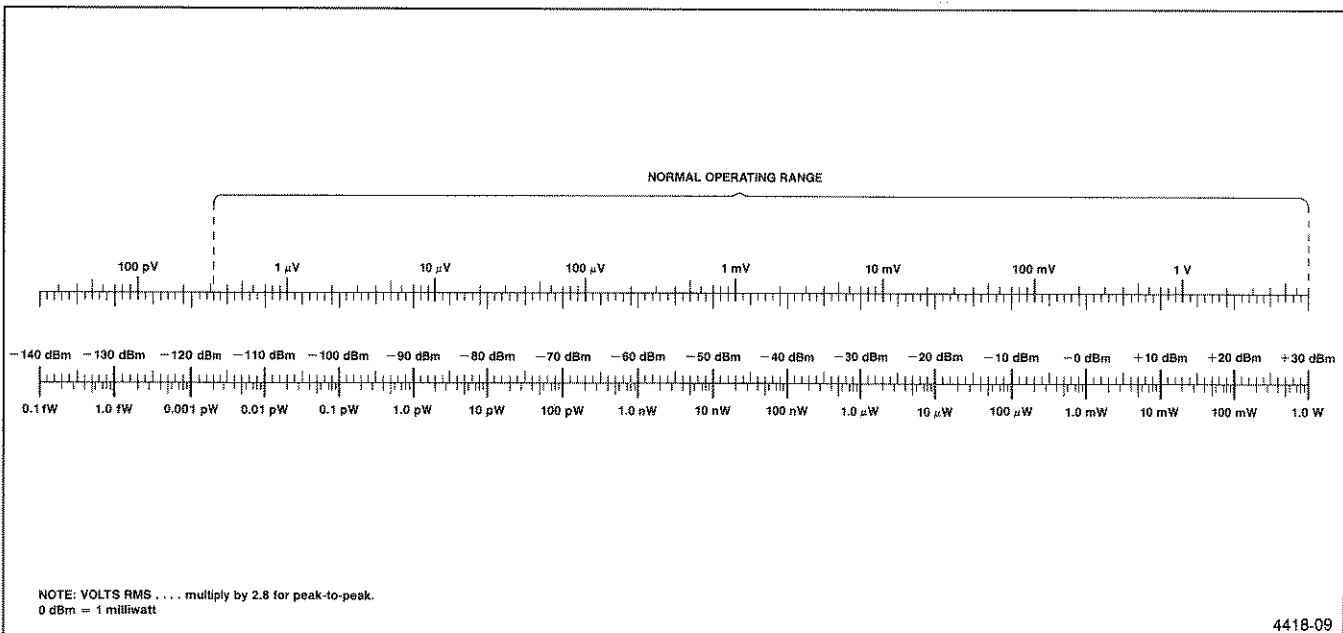

Figure 6-1. Volts-dBm-Watts conversion chart for 50 Ω impedance.

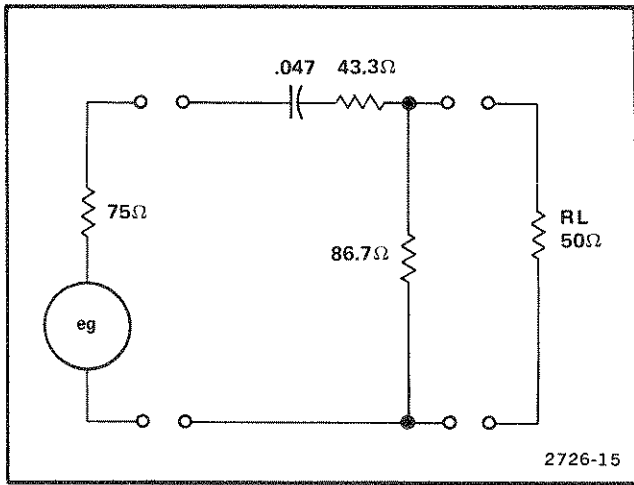

Figure 6-2. Circuit of a 75 to 50 Ω matching pad (ac coupled).

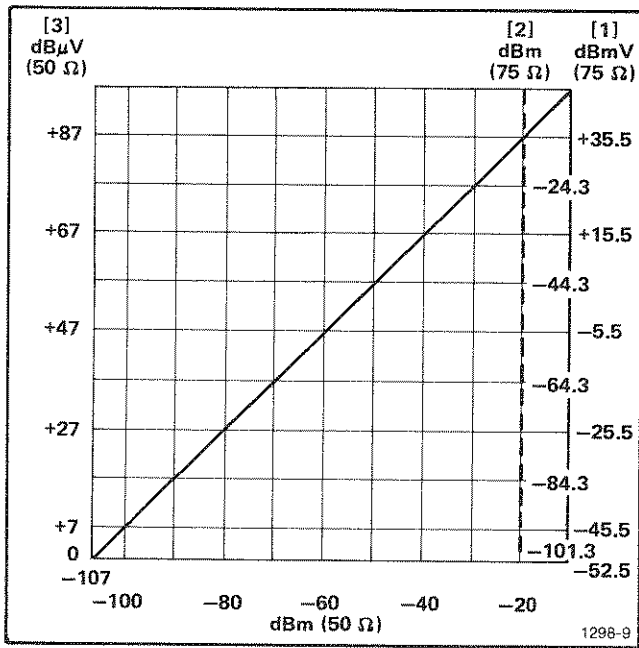

Figure 6-3. Graph to illustrate the relationship between dBm, dBmV and dBμV (matching attenuator included where necessary).

band. A frequency dot above the display signifies where on the span the frequency that is read out on the display is located. This dot and frequency point will shift to center screen when the FREQ SPAN/DIV is reduced to some setting other than MAX. The Frequency Span/Div setting depends on the measurement application. Wide spans are usually used to monitor a frequency spectrum for spurious signals, check harmonic content, etc. Narrow spans are used to analyze the characteristics about or near a particular signal, such as modulation side bands, bandwidth, power line related distortion, etc. When wide spans are used for non-digital store displays, the sweep rate is usually set for minimum flicker, which requires wider resolution bandwidths

to maintain a calibrated display. Slow sweep rates are required when using narrow spans and high resolution to observe signal phenomena.

The internal microcomputer will select the sweep rate and resolution bandwidth so the display remains calibrated, for the selected Frequency Span/Div if the TIME/DIV is in the AUTO position and AUTO RESOLN is active. AUTO RESOLN optimizes bandwidth for the selected FREQ SPAN/DIV and TIME/DIV settings unless either is outside the range of calibration. When this occurs, the UNCAL indicator lights and a ">" symbol prefixes the REF LEVEL readout on the crt display.

To analyze pulsed signals, a wider bandwidth than that provided by the automatic feature is usually required. Set the RESOLUTION BANDWIDTH on the order of 1/10 the side lobe frequency width, or the reciprocal of the pulse width if known, in order to ensure adequate bandwidth. The resolution bandwidth is usually set for optimum main lobe detail after the sweep rate has been selected.

Using the MANUAL PEAK Control or AUTO PEAK Mode

The MANUAL PEAK control is used to set the bias voltage out the EXTERNAL MIXER port, or the internal preselector tracking for the 1.7 to 21 GHz bands. It is adjusted for maximum signal amplitude or optimum conversion.

If AUTO PEAK is activated, the microcomputer will run a peaking routine one time that uses any signal within the center two divisions of the screen and sets the preselector tracking or external mixer bias for maximum signal response. When the response is peaked, it stores the setting in non-volatile memory for use when switching between bands or returning to the peaked band. If no signal is present during the peaking routine, the processor recalls the previous peak setting from memory or, if no setting is stored in memory, the processor sets the peaking mid-range. When AUTO PEAK mode is active, these settings are recalled as you switch between frequency ranges or bands.

It is always good practice to re-adjust peaking before making amplitude or power measurements, especially if the measurement is to be made after a significant change in center frequency. If in the Auto Peak mode, press the AUTO PEAK button twice to re-activate the auto peak routine.

Using the Signal Identifier

When external mixers are used, there is no preselection ahead of the mixer; therefore, many spurious responses are

General Operating Procedure—494/494P Operators

generated in the 1st mixer (see Figure 6-4). This is due to multiple harmonics of the local oscillator and incoming signals converting to intermediate frequencies that are within the band-pass of the 1st IF. These responses pass through the IF band-pass and appear as signals on screen.

The 494/494P features a signal "Identify" mode to help identify true from false signals. When in this mode, the frequency of the local oscillator is shifted on alternate sweeps. At the same time the sweeps are vertically displaced about two divisions. True signals shift only a small amount on alternate sweeps, false signals or spurious responses will shift several MHz especially in the millimeter bands where the N factor is large. This mode can only be activated when the FREQ SPAN/DIV is 50 kHz or less for the coax bands (0-21 GHz) and 50 MHz or less for the waveguide bands (18-325 GHz).

The 1st LO is not phase locked when the FREQ SPAN/DIV is 500 kHz or more, in the waveguide bands; therefore, true or real signals can shift a slight amount between sweeps, due to limits of the oscillator setting accuracies. True signals may shift up to 2 MHz but false signals will shift 80 MHz or more. If there is any question as to whether the signal is true or false, decrease the FREQ SPAN/DIV to 200 kHz or less so the oscillator is phase locked.

In the millimeter bands, the oscillator frequency is shifted far enough that it is possible to lose the signal on alternate sweeps; therefore, if a signal is not visible for the alternate sweep, re-adjust the MANUAL PEAK and if the signal is true it will appear on both sweeps.

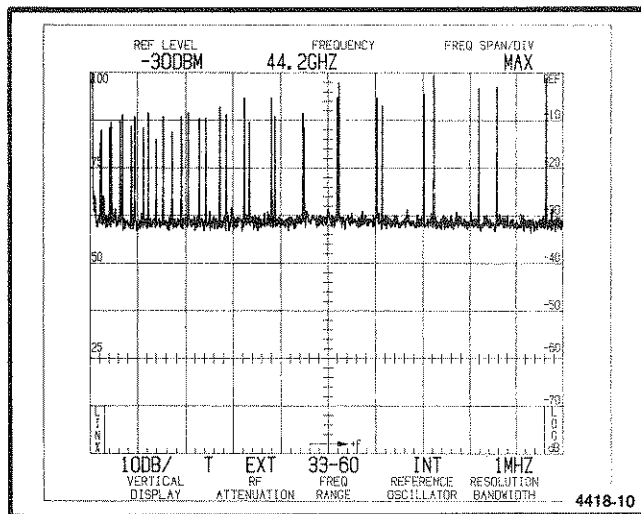
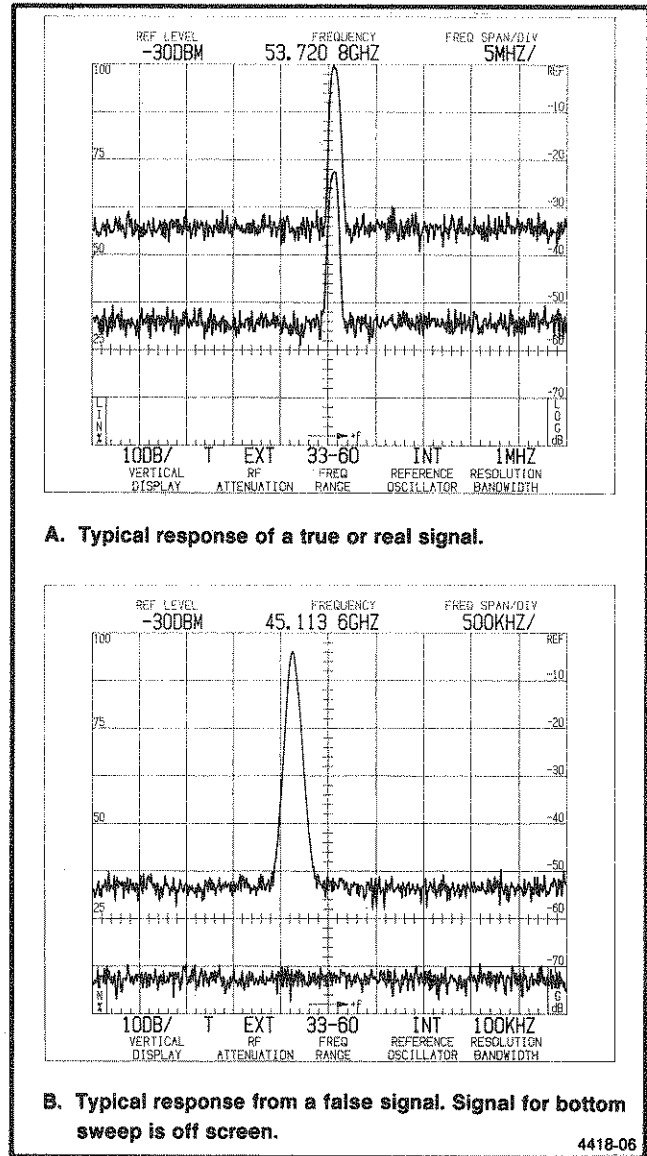

Figure 6-4. Typical display generated by a signal into the waveguide mixer.

Figure 6-5 illustrates two typical examples of signal identification. The amount of horizontal displacement depends on the band and the harmonic number of the signal or oscillator fundamental.



A. Typical response of a true or real signal.

B. Typical response from a false signal. Signal for bottom sweep is off screen.

4418-06

Figure 6-5. Identifier mode displays.

Using the Video Filters

The video filters restrict the video bandwidth so noise and beat signal amplitudes are reduced (see Figure 6-6) or when signals are closely spaced, the filter may reduce the modulation between two signals to make it easier to analyze the display. The filters can also be used to average the envelope of pulsed RF spectra that has a relatively high prf (pulse repetition frequency); however, because the filter is basically an integrating circuit, the Video Filter will not be very effective when measuring low prf spectra.

Triggering the Display

Trigger mode is usually FREE RUN for spectrum displays; however, it may be desirable or necessary to trigger the display when the event is time related to some source, or when the frequency span has been reduced to zero for time domain analysis. In the FREE RUN mode, the sweep will not synchronize with any input signal.

In addition to the FREE RUN mode, the sweep can be internally triggered by the video signal, at the line frequency rate of the power supply, or by an external signal applied to the HORIZ/TRIG connector on the back panel. The required amplitude for triggering is two (2.0) divisions or more for internal triggering, and from 1.0 to 50 V maximum (dc + peak ac) for external triggering.

In addition to the four trigger source selections, a SINGLE SWEEP mode is provided. In the SINGLE SWEEP mode, the sweep will run once after the circuit has been armed and a trigger signal arrives. The READY indicator lights when the circuit is armed and waiting to be triggered, it remains lit during sweep time. Push the SINGLE SWEEP button once to activate single sweep mode and abort the current sweep, push again to arm the trigger circuit so it is ready for a trigger signal. This mode is useful for single event phenomenon.

Sweeping the Display

Horizontal sweep voltage for the display can be internal or from an external source. Sweep rate and source are selected with the TIME/DIV switch. When the TIME/DIV switch is in the AUTO position, the sweep rate is automatically selected by the internal microcomputer which looks at the FREQ SPAN/DIV and RESOLUTION BANDWIDTH then sets the sweep rate to maintain a calibrated display.

When the TIME/DIV is in the EXT position, a signal source of 0 to +10 volts, applied to the HORIZ/TRIG connector, will sweep the crt beam across the 10 division span. The input is dc coupled, sensitivity is 1 volt/division. External input impedance is about 10 kΩ.

The beam can be manually positioned by the MANUAL SCAN control when the TIME/DIV is in the MNL position (see Manual Scan of the Spectrum that follows).

Manual Scan of the Spectrum

Manual scan is usually used to examine a particular point or sector of a display, such as one of the null points of a frequency modulation spectrum, or it takes unnecessarily long to look at a small segment of the full span because of the slow sweep rate. With a wide span/div and/or a narrow

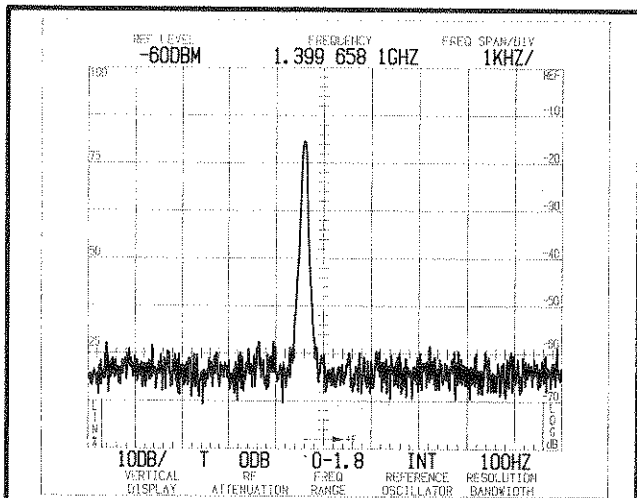

A. Spurious and IM obscured in the noise.

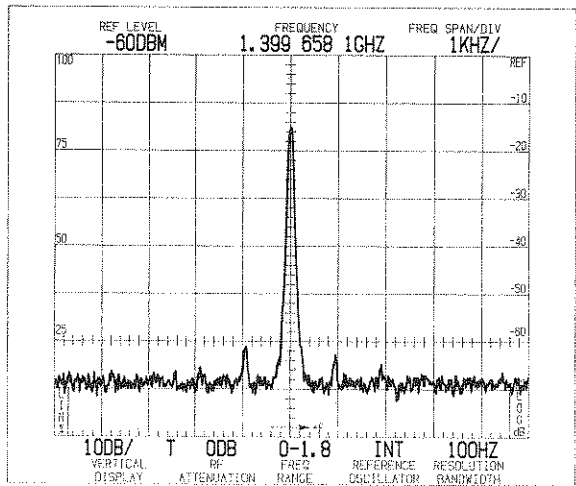

B. Same display with Video Filter activated.

4418-05

Figure 6-6. Integrating the display with the Video Filter.

The WIDE filter reduces the bandwidth to approximately 1/30th the selected resolution bandwidth; the NARROW filter about 1/300th. Using the filter may require a reduction in the sweep rate to maintain a calibrated display. The UNCAL indicator will light if the sweep rate is not compatible with the other parameters to maintain a calibrated display.

Time Domain Operation

When the FREQ SPAN/DIV is zero, the analyzer functions as a tunable receiver to display time domain characteristics within the selected resolution bandwidth. Such characteristics as modulation pattern, pulse repetition rates, etc., can now be analyzed with TIME/DIV selections. Resolution bandwidth is usually maximum (1 MHz) for time domain analysis of the signal.

General Operating Procedure—494/494P Operators

resolution bandwidth it is very possible to manually scan too fast to achieve an accurate display. Best results are obtained without digital storage because digital storage can produce unpredictable results due to the sweep rate and because the digital storage display is only updated when scanning from left-to-right. Center frequency accuracy will also be degraded due to the long period between local oscillator frequency correction which occurs at the beginning of each sweep.

Reference Level, RF Attenuation, and Vertical Display

When a change is made in the REF LEVEL setting, the microcomputer selects the gain distribution (IF gain and input RF attenuation) for the new reference level according to the setting of the Vertical Display mode, FINE, MIN RF ATTEN dB, and MIN NOISE/MIN DISTORTION selectors.

The amount of input RF attenuation, set by the microcomputer, is based on the reference level requested and the setting of the MIN RF ATTEN dB and MIN NOISE/MIN DISTORTION selectors. The microcomputer assumes the MIN RF ATTEN dB selection is the minimum attenuation required for the expected signal levels, and will not reduce RF attenuation below this value. As the MIN RF ATTEN is increased, the lower limit reference level is raised an equal amount. At 0 dB minimum attenuation, the lower limit reference level is -117 dBm. At 10 dB minimum attenuation, the reference level goes to -107 dBm, etc. The processor also selects the best ratio of rf attenuation and IF gain according to the MIN NOISE/MIN DISTORTION mode (see description that follows).

The REFERENCE LEVEL control steps depend on the Vertical Display and FINE selector modes. In log mode, the REFERENCE LEVEL control steps in 1 dB to 15 dB increments with FINE off, and in 1 dB increments for display factors of 5 dB/div or better or 0.25 dB for display factors of 4 dB/div or less with FINE on. The 0.25 dB increments apply to the ΔA mode, see description that follows. In the LIN mode, with FINE off, the bottom of the crt graticule is zero volt and the top of the crt graticule is eight times the vertical display factor. The display factor changes in a 1-2-5 volts/division sequence from 500 mV to 50 nV. With FINE on, the reference level changes in 1 dB steps and the scale factor/division is 1/8 the voltage equivalent of the reference level.

ΔA Mode

This mode is selected by activating the FINE pushbutton with a Vertical Display factor of 4 dB/div or less. The REF LEVEL readout goes to 0.00 dB and the REFERENCE LEVEL steps in 0.25 dB increments from this reference.

The ΔA mode is used to accurately measure signal relative amplitude difference. This is possible because the gain distribution (IF gain and RF attenuation) does not change when ΔA mode is activated. The REF LEVEL is changed by shifting the log amplifier offset. The total range of the ΔA mode is 58 dB. The measurement range depends on the REF LEVEL that is current at the time ΔA mode is activated. It is typically at least 0 to 48 dB below the REF LEVEL that was current at the time ΔA mode was activated. The overall instrument reference level range of -117 dBm to $+30$ dBm can not be exceeded.

The ΔA mode is aborted when the Vertical Display factor is increased above 4 dB/div, or the FINE mode is deactivated by, pushing the FINE button or changing the gain distribution with MIN RF ATTEN or MIN NOISE selections. The analyzer also deactivates ΔA mode when the EXT MIXER is selected.

Signals with large amplitude differences that are within the ΔA range, can be compared without the distortion usually introduced when signals are driven off-screen. Signals shifted off-screen, by changes in the ΔA reference level, are not overdriving the input because the attenuator and IF gain do not change; thus, the mixers do not see any change in signal levels even though the ΔA reference level changes.

To measure amplitude level differences of two signals:

1. Select ΔA mode by activating FINE. Select a Vertical Display of 4 dB/div or less, via the dB/DIV entry key, or activate the 2 dB/DIV pushbutton.
2. Set the peak of the larger signal to a graticule line with the REFERENCE LEVEL control.
3. Press the FINE pushbutton twice to deactivate and re-activate the ΔA mode, readout will return to 0.00 dB.
4. Set the peak of the lower amplitude signal to the same graticule line, established in step 2, with the REFERENCE LEVEL control.
5. The REF LEVEL readout will now indicate the amplitude difference between the two signals in dB.

Using Min Noise or Min Distortion Mode

One of two algorithms can be selected to control attenuator and IF gain settings. MIN NOISE minimizes noise level by decreasing input attenuation and IF gain by 10 dB. MIN DISTORTION minimizes input mixer overload by increasing

input attenuation and IF gain 10 dB. MIN DISTORTION is the normal mode of operation. MIN NOISE is used to increase signal-to-noise ratio when looking at wide span displays with wide resolution bandwidths.

CAUTION

With MIN NOISE activated and 60 dB of MIN RF ATTEN, the REF LEVEL can be set to +40 dBm. The front end of the 494/494P is specified at +30 dBm maximum. Do not increase input signal level to full screen with a REF LEVEL of +40 dBm because this will exceed the attenuator rating.

Digital Storage

Digital storage provides a smooth (flicker free) display. Two complete waveforms can be digitized and stored. In addition, the Display STORE/RECALL function will store up to eight displays in non-volatile memory (see the description that follows). One of the two digitized waveforms can be saved and then compared to subsequent updated waveforms. A MAX HOLD feature updates the digital storage data only when the input signal amplitude is greater than previous data. This allows monitoring and graphic plotting of display changes (amplitude and frequency) with time.

The display can be divided by a cursor, or horizontal line, that is positioned with the PEAK/AVERAGE control. Above the cursor, video information is peak detected and displayed; below the cursor, signal averaging occurs.

This feature suppresses noise in that portion below the cursor and allows full peak detection of vertical data above the cursor. An intensified spot on the cursor, that is coincident with the crt beam as it sweeps the span, indicates the horizontal position at which memory is being updated. The average (number of samples) is a function of the sweep rate, the slower the rate the more samples.

When digital storage is used, an additional quantization error of 0.5% of full screen must be added to the amplitude performance characteristics (i.e., frequency response, sensitivity, etc.).

Digital storage display is functionally divided into a "A" and "B" section. Data can be stored in either "A" or "B" or in both. There are 512 horizontal locations in A and 512 horizontal locations in B. When both are displayed, the origin of the "B" waveform is shifted such that the A and B coordinates are interlaced to provide 1024 display increments. Data in memory is continually updated with each sweep so the display, when viewing "A" or "B", is always current.

When SAVE A function is activated, data in "A" is saved and only the "B" section of storage is updated. This inhibition takes place whether "A" waveform is displayed or not. This mode captures an event or waveform with its readout for comparison with a subsequent event displayed by VIEW B mode. If VIEW B is on, the readout applies to the current "B" waveform. If SAVE A, VIEW A are on and VIEW B, B-SAVE A are off, the readout applies to the saved "A" waveform.

When B-SAVE A is activated, the arithmetic difference between the "B" waveform and the saved "A" waveform is displayed (see Figure 6-7). Thus the two waveforms can be compared by their algebraic difference. This convenient mode can be used to align filters or other devices. The reference waveform is stored in "A" and the unknown is displayed by "B". If the device, under test is active, the "B" waveform may be larger than the reference that produced a shift in the zero reference line so that the difference is off screen. The reference level is usually set mid-screen so positive and negative quantities can be observed; however, the position of the zero reference can be changed by an internal switch. Contact qualified service personnel to have the reference level repositioned.

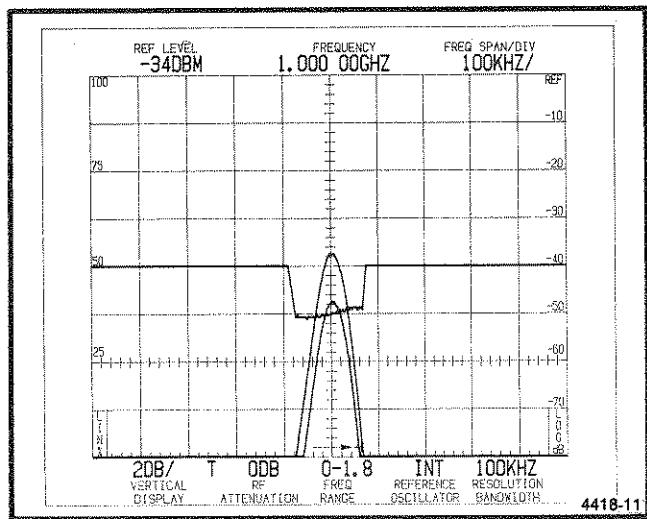

Figure 6-7. Using B-SAVE A to observe the differential between SAVE A and B displays.

MAX HOLD causes the digital memory to be updated only if the new input is of higher magnitude than the former (B memory only if SAVE A is active). This allows monitoring of signals that may change with time and provides a graphic record of amplitude versus frequency excursions.

As previously described, signal averaging is useful for suppressing noise. The number of samples averaged per horizontal digitized slot is a function of the spectrum analyzer sweep rate. The slower the sweep speed, the more samples averaged per horizontal slot. Resolution bandwidth

General Operating Procedure—494/494P Operators

affects the amplitude difference between peak detected and average levels of cw signals. When the resolution bandwidth is less than 1/30th the span/division (e.g., 100 kHz or less with 5 MHz span/div) there will be significant error in the average amplitude levels of cw signals, especially if only "A" or "B" is displayed. The peak value will be the true value. It is best to run digital storage with both "A" and "B" waveform interlaced and the cursor at the bottom of the display when using narrow resolution bandwidth with wide frequency spans.

To measure signal amplitude level, set the cursor at the bottom of the screen. To average noise, set the cursor at least one division above the noise level.

Store/Recall Feature

The 494/494P features a STORE/RECALL function that can store up to eight waveforms with read out in non-volatile memory to be recalled later for review or analyses. The description on how to use this feature is described under Front Panel Controls and Selectors in Section 4.

Using the Counter

Very precise frequency measurements can be made with the counter. When the COUNTER button is activated the internal counter will count a signal at the dot marker when the signal level is at least 20 dB above the noise floor and less than 60 dB below the REF LEVEL. The count resolution is determined by the resolution selected when the COUNT RESOLN button is activated.

Tune the desired signal to the dot marker. The count resolution defaults to 1 Hz on power up. If a different resolution is desired, press SHIFT then COUNT RESOLN and enter the desired resolution with the Data Entry keyboard. Terminate with GHz, MHz, kHz, or Hz. Now press COUNT and the frequency read-out will indicate the counted frequency of the signal.

When COUNT→CF button is pressed, the signal under the dot marker is counted once then the center frequency is shifted to the counted frequency. The count resolution and the accuracy of the tuning is the current counter resolution. This is useful when it is desired to tune the center frequency precisely to a given signal that is near center screen, even at wide FREQ SPAN/DIV settings.

Using the Automatic Calibration Feature

The CAL feature, as described under Front Panel Controls and Selectors, activates a routine that calibrates frequency and relative amplitude. This routine should be done any time the ambient temperature changes. Calibration

settings are retained in non-volatile memory after the routine has run.

Un-nomenclated Front Panel Pushbutton Functions

The following shift functions are not nomenclated. Service related functions are normally disabled and are described in the service manual.

Operational Functions

<SHIFT> FREE RUN—Switches center frequency corrections off or on. Enables the operator to continue operating the instrument with reduced performance. Use when frequency control failure error message comes on screen.

<SHIFT> HELP—Lists all current error conditions.

<SHIFT> ΔF—Enables the user to select alternate language if the instrument has Option 12, 13, or 14.

<SHIFT> MIN NOISE—Displays the results of <SHIFT> CAL mode.

<SHIFT> SAVE A—Enables the user to select an external type plotter from a displayed menu.

<SHIFT> B—SAVE A—Allows the user to key-in the B—SAVE A offset for a plotter only.

Service Related Functions

<SHIFT> READOUT—Alternate frequency display of 1st LO, 2nd LO, and 3rd IF.

<SHIFT> GRAT ILLUM—Frequency correction trace mode.

<SHIFT> INT—Frequency corrections on/off, count is on.

<SHIFT> EXT—Frequency control diagnostics.

<SHIFT> 10 dB/DIV—Enables, disables, resets the CAL results.

<SHIFT> PULSE STRETCHER—Module calibration procedure.

External Mixers and Diplexer

When an external mixer is used, the EXTERNAL MIXER port is the source for mixer bias and receives IF output from the mixer. A diplexer is used to couple the dc bias and the local oscillator signal to the mixer and couple the IF signal, from the mixer, to the EXTERNAL MIXER connector. The Diplexer, which is part of the standard accessories, is connected between the EXTERNAL MIXER port, the 1st LO OUTPUT, and the external mixer. The 1st LO OUTPUT is connected to the LO port of the Diplexer through a short semi-rigid 50 Ω coaxial cable. The mixer is connected to the Diplexer through a standard 50 Ω coaxial cable (see Figure 6-8).

External mixers are usually the waveguide type which extend the frequency range above that of the internal coaxial mixer. TEKTRONIX WM 490-Series High Performance Waveguide Mixers cover both microwave and millimeter-wave frequency bands. The 18 to 26.5 GHz and 26.5 to 40 GHz frequency ranges are considered microwave bands; frequencies above 40 GHz are considered the millimeter-wave bands. General purpose mixers are also available (see Option 20). These cover the frequency range of 18-40 GHz, however they are not recommended where high performance is desired.

The WM 490-Series Tektronix Waveguide Mixers are two-port, broad-band mixers, designed specifically for use with the Tektronix 49X-Series Spectrum Analyzers. This family of mixers covers the 18 to 325 GHz range.

Two microwave mixers that cover the 18-26.5 GHz and 26.5-40 GHz bands have standard rectangular flanges. Each use a field replaceable diode, and have a frequency response of ± 3 dB, when used with 49X-Series Spectrum Analyzers.

Five of the millimeter-wave mixers cover the 40-220 GHz range in the standard Mil-spec band ranges. A 140-220 GHz mixer, designed specifically for this range, is available; or by means of a flange transition, the 90-140 GHz mixer can be used to cover this range. A flange transition is also available to allow the 140-220 GHz mixer to be used in the 220-325 GHz band. The mixers are optimized for flatness over each waveguide band. The 40-60 GHz mixer has a ± 3 dB frequency response. Typical performance characteristics for the mixers is listed in the data sheet or instruction manual that accompanies the mixers.

Both the high performance and general purpose microwave mixers have field replaceable diodes. The millimeter-wave mixers are NOT field repairable and must be returned to Tektronix, Inc. for repair.

Reference Level Readout and Conversion Loss for External Mixers

In the External Mixer mode (EXTERNAL MIXER activated), the REF LEVEL initializes to -30 dBm because the internal RF ATTEN is no longer in the signal path. When

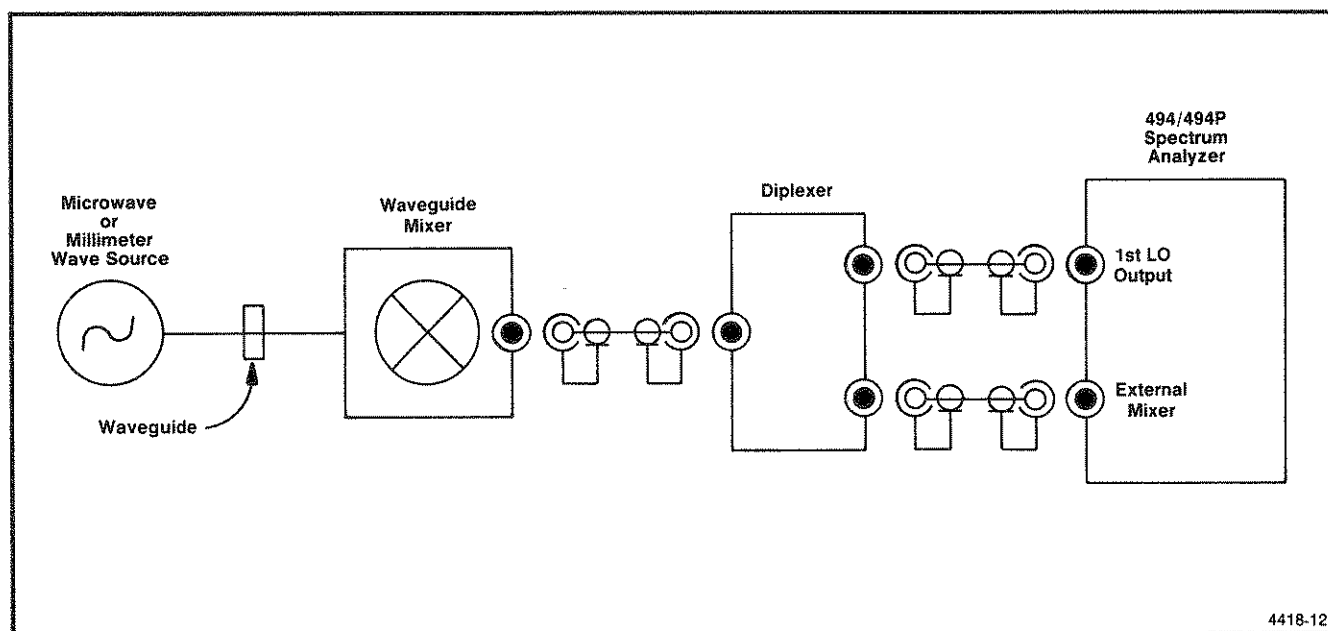

Figure 6-8. Diagram showing external waveguide mixer installation.

General Operating Procedure—494/494P Operators

switching to the 50 to 140 GHz waveguide bands, the REF LEVEL will increase 20 dB (initialize to -10 dBm) and when switching to the 110 to 325 GHz bands, the REF LEVEL will increase another 10 dB (initialize to 0 dBm).

NOTE

REF LEVEL will increase an additional 10 dB if MIN NOISE is activated.

Conversion loss of the WM 490 Mixers for the 50 to 90 GHz and 75 to 140 GHz bands is approximately 20 dB more than the lower waveguide bands. Typical loss for mixers in the 110 to 220 GHz and 175 to 325 GHz bands is about 30 dB more than the lower waveguide bands. This means the REF LEVEL readout is 20 dB and 30 dB higher for these bands; however, the display measurement dynamic range is not affected.

As previously explained, the reference level is calibrated to compensate for the nominal conversion loss of the waveguide mixers in each waveguide band. Slight variations between waveguide mixers result in an amplitude inaccuracy of about 6 dB, including the 3 dB frequency response of each mixer. The absolute power level accuracy of each waveguide mixer/spectrum analyzer system can be calibrated to within 3 dB by adjusting the front panel AMPL CAL so the display amplitude for the known level of an external input signal to the mixer is correct.

CAUTION

The mixers can be damaged unless the following instructions on handling and installing the mixers is observed.

Handling

Handle the waveguide mixers with care. The mixer diode is sensitive to static discharges and excessive rf energy. The maximum input level to all Tektronix waveguide mixers is $+10$ dBm (10 mW cw) and 1 W peak with 0.001 maximum duty factor and $1 \mu\text{s}$ pulse width for pulse signals. Bias for Tektronix Waveguide Mixers is a negative-going (-2.0 V to $+0.5$ V with respect to the mixer body) voltage. Check bias requirements of non-Tektronix mixers before connecting them to the 494/494P Spectrum Analyzer.

Ensure that the shorting cap is installed when the mixer is not in use and install the flange cover on the mixer before returning it to the storage box. The mixer diode can also be destroyed by mechanical vibration or shock.

Do not use an ohmmeter to test or check the mixer diode. The voltage across the test leads of many ohmmeters is capable of destroying the diode.

Try to avoid scratching the flange surface because scratches can degrade the performance.

Installation

As previously described, the waveguide mixer is connected to the Diplexer and the analyzer as shown in Figure 6-8. Physically the mixer is bolted to a waveguide flange at or near the rf signal source. When installing the mixer, make sure the flange surfaces are clean and free of scratches. Install and tighten all flange screws evenly. This care will minimize input vswr and provide optimum frequency response. A ball tipped Allen screwdriver will access the flange screws at the angles required to tighten them.

The Diplexer assembly includes a sma-to-tnc adapter and a shaped semi-rigid coaxial cable to connect the Diplexer to the 1st LO Output and the EXTERNAL MIXER port. When installing, be careful to ensure that the connectors are not cross threaded. A flexible cable is used to connect the mixer to the External Mixer port on the Diplexer. Connect the cable to the External Mixer port first to discharge any static build-up in the cable before connecting it to the waveguide mixer. Static can damage the mixer diode. It is also advisable to set the MANUAL PEAK control at the 9 o'clock position (0 volt bias position) before connecting the mixer to the Diplexer. For best performance use the cable supplied with the waveguide mixer set. Do not extend its length.

Never apply more than $+10$ dBm of continuous rf energy to the input of the waveguide mixer port. The waveguide mixers saturate at -20 dBm (typical); therefore, little is gained with inputs above this level. If the input level is unknown, use a general purpose mixer or appropriate waveguide attenuator and rf power meter to check the input level.

Tektronix mixers require $+7$ dBm (min) to $+15$ dBm (max), typically $+10$ dBm, of LO signal, and a variable bias from -2.0 V to $+1.0$ V through a current limiting resistor, to meet sensitivity and frequency response characteristics.

CAUTION

The bias voltage out of the EXTERNAL MIXER port is negative-going. This is the bias requirement for Tektronix mixers. Service personnel, or a Tektronix Field Representative, can change this bias to positive-going if desired. If changed, attach a label near the EXTERNAL MIXER port to reflect this change.

When EXT MIXER is activated or the FREQUENCY RANGE is in the external mixer bands, the internal RF attenuator is no longer in the signal path. As a protective measure, the REF LEVEL will not set to a value greater than -30 dBm or -20 dBm with MIN NOISE activated.

Operation

When the FREQUENCY RANGE is switched to the waveguide bands, the instrument automatically switches to External Mixer mode. If there is no signal on screen, set the MANUAL PEAK control mid-range. If in the Auto Peak mode, mixer bias will be set to the previous setting stored in memory or it will also mid-range the bias. If a signal is present, tune to center screen and peak the response with the MANUAL PEAK control or activate AUTO PEAK. Adjusting the MANUAL PEAK control through its range will usually produce several peaks, select the maximum of these peaks as your setting.

Because there is no preselection or filters ahead of the mixer, many spurious signals will usually occur. A typical display, generated by a -30 dBm signal at 40 GHz, is shown in Figure 6-9. Before an analysis can be made of any signal it must be determined if the signal is true or real. Signal identification, as to true or false, is best accomplished by use of the IDENTIFY feature, which was covered near the beginning of this section. Refer to this subtitle for information on using the IDENTify mode.

Because of the many spurious signals on screen, and the tedious task of operating the IDENTify feature on each signal, the approximate frequency of the signal should be known. A cavity wavemeter can be used to determine the signal frequency. The dip, when the meter is tuned to the input frequency, is easily seen on a power meter, if it is connected into the signal path; otherwise, use the 2 dB/DIV or less display mode to observe the dip.

Set the CENTER FREQUENCY near the signal frequency then peak the response with MANUAL PEAK control or activate AUTO PEAK. It may be desirable to increase the instrument sensitivity by reducing the SPAN/DIV and RESOLUTION BANDWIDTH settings. Reduce the FREQ SPAN/DIV to 50 MHz or less so the IDENT feature can be activated. If there is a significant change in input signal frequency and CENTER FREQUENCY setting, it is best to re-adjust peaking to maintain sensitivity and frequency response characteristics.

494P GPIB CONTROLS, INDICATORS, AND CONNECTORS

The 494P (programmable instrument) adds remote program control to the features of the 494. Remote control is

accomplished by a controller connected to the 494P through the General Purpose Interface Bus (GPIB) to the IEEE Std 488 port. The controls, indicators, and connectors that are unique to the 494P are shown in Figure 6-10 and are described below. Instructions on how to program the 494P are given in the Programmers manual.

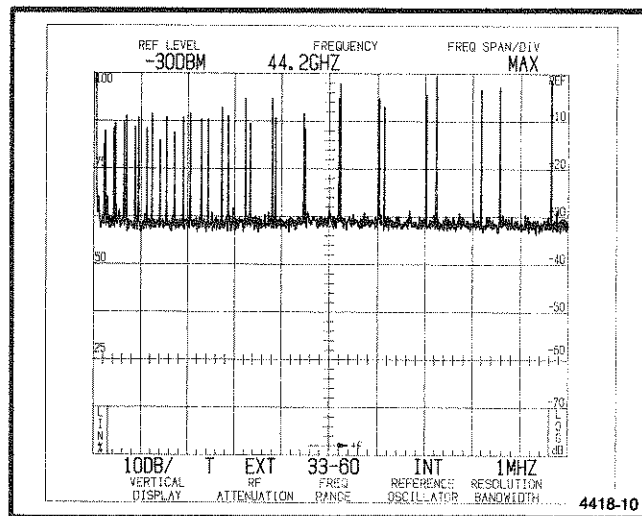

Figure 6-9. Typical display from an external mixer.

GPIB Function Readout

Characters displayed on the crt readout indicate when the 494P is a talker, listener, or requesting service. These characters appear in the position shown in Figure 6-11, but only while the 494P is addressed to talk or listen or is asserting SRQ.

RESET TO LOCAL (REMOTE)

This button is lighted when the GPIB controller takes remote control of the analyzer. While the 494P is under remote control, its other front-panel controls are not active but indicators still reflect the current state of front-panel functions.

This button is not lit when the operator has local control. While the analyzer is under local control, it does not execute GPIB messages that would conflict with front-panel controls or change the waveforms in digital storage.

Pressing this button restores local control unless the controller prevents this with the local lockout message. Programmable functions do not change when switching from remote to local control except as necessary to match the settings of the front panel controls for TIME/DIV, MIN RF ATTEN, and PEAK/AVERAGE.

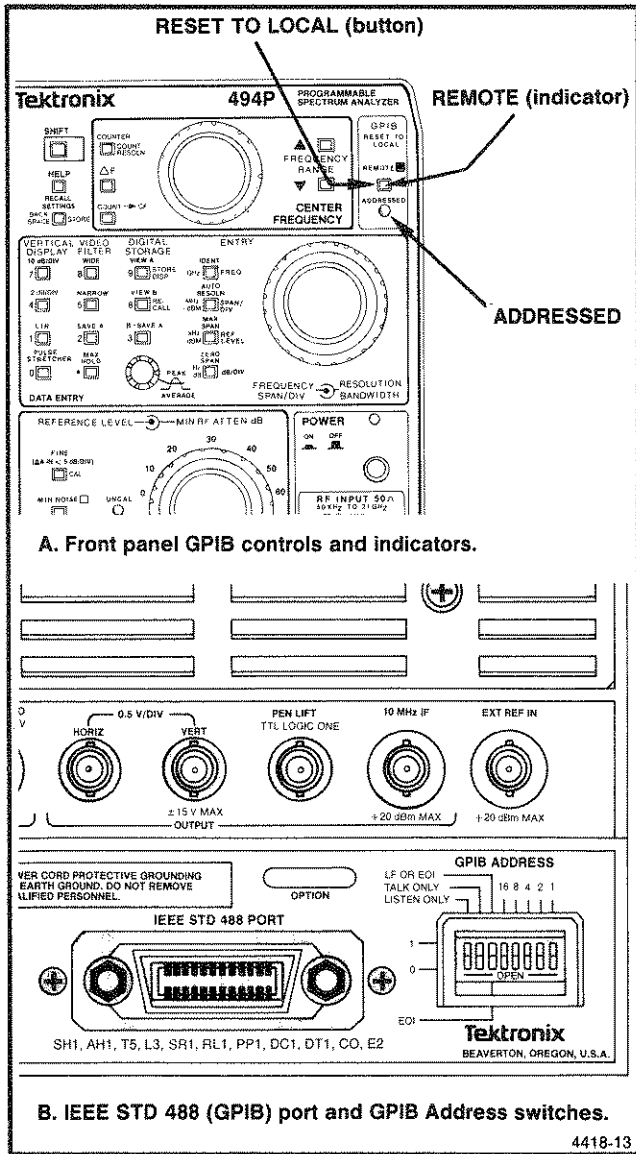

Figure 6-10. GPIB selectors and indicators unique to the 494P.

The internal 494P microcomputer flashes the instrument firmware version number, front panel firmware version number, and GPIB address on the crt when the button is pressed. This also causes the microcomputer to update the GPIB primary address if the GPIB ADDRESS switches have been changed.

This button has another function in talk-only mode. See Talk/Listen Only Operation that follows.

When the 494P is executing a message that includes the REPEAT command, the REPEAT loop can only be aborted by DCL. Pressing RESET TO LOCAL does not abort the loop but only causes execution errors to be reported if the loop contains front-panel commands.

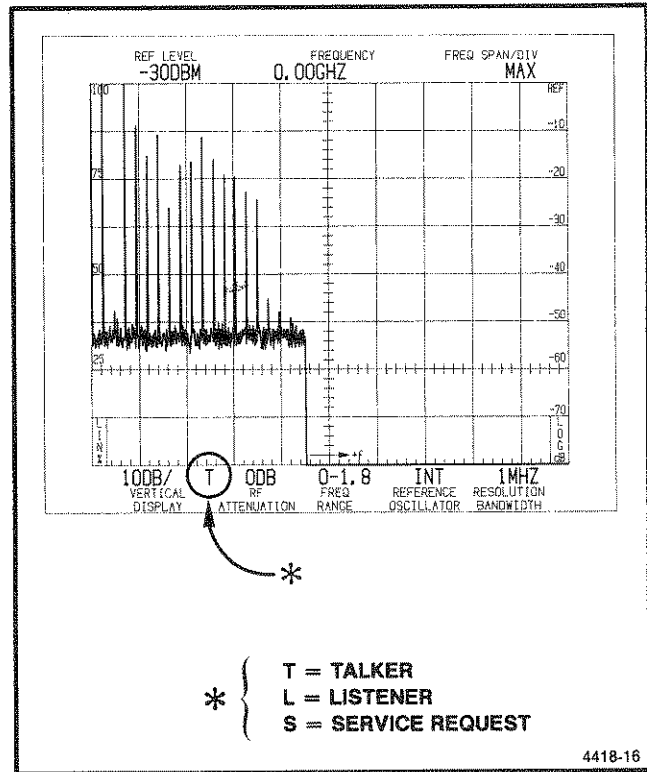

Figure 6-11. Status of GPIB as shown on the crt readout.

ADDRESSED

Lights when analyzer is addressed to listen or talk.

PLOT

When SHIFT then PLOT are pressed, display and/or graticule information is sent over the GPIB to drive an external plotter such as the TEKTRONIX 4662, 4662 Option 31, or a Hewlett-Packard 7470A.

To use the plot feature, connect the Digital Plotter to the 494P with a IEEE STD 488 (GPIB) cable and perform the following:

a. Set the corners of the plot for a 3:2 aspect ratio for the Tektronix plotters, or 6:5 for the Hewlett-Packard plotter. The Digital Plotter must be in the Listen Only mode and the 494P must be in either the TALK ONLY or TALK/LISTEN ONLY mode (appropriate switches on the rear panel GPIB ADDRESS switch, closed or in the 1 position).

b. Set the Plotter Interface switches as follows:

Tektronix 4662 or 4662 Option 31

- A = 0, 1, 8, or 9
- B = C or D
- C = X (don't care)
- D = X (don't care)

Tektronix 4663

Interface Select = 1 if Option 04 or 2 if Option 01
 Initial Command/Response Format = 5
 Interface Mode = Listen Only

Hewlett-Packard

Address = 31

c. Select the plotter type by pressing <SHIFT> SAVE A on the 494P. Answer the question on the crt message. The selection is stored in battery-powered memory and need not be selected again unless the type of plotter is changed. To use a 4663 emulating a 4662, select 0 (4662) for a one-pen configuration or select 1 (4662 Option 31) for a two-pen configuration.

d. Select the display and the information that you wish to plot. The PLOT feature is similar to using a camera, in that a plot is made of everything that is turned on for the crt display. The information plotted depends on the state of several front panel selectors and controls. If READOUT is on, the crt readout will be plotted with the display. If GRAT ILLUM is on, the bezel and graticule will be included with the plot. If VIEW A, VIEW B, or B—SAVE A are on, these waveforms will be part of the plot. By the same token if any of these functions are off or inactive, they will not be plotted.

The zero level for a B—SAVE A waveform is assumed to be the graticule center line. (Switches within the instrument can set the level; contact your service personnel for this change.) If you desire to shift the zero level for the PLOT only, press <SHIFT> B—SAVE A and enter the desired level in display units (25 is bottom graticule line, 25 units/div is required). This zero level is retained in battery-powered memory; however, it is not related to the display zero level since the processor has no way of determining the internally set zero level for the crt display or no way of changing it.

e. Press SHIFT then PLOT. During the plot operation, the front panel controls are operational except STORE DISP, RECALL DISP, and AUTO PEAK. The instrument can be used for other measurements.

Setting the GPIB ADDRESS Switches

GPIB ADDRESS Switches, on the rear panel (Figure 6-12), set the value of the instrument's GPIB addresses. The state to which these switches are set determines the instrument's primary address. Details of how the switches are used in remote control are found in the Programmer's manual.

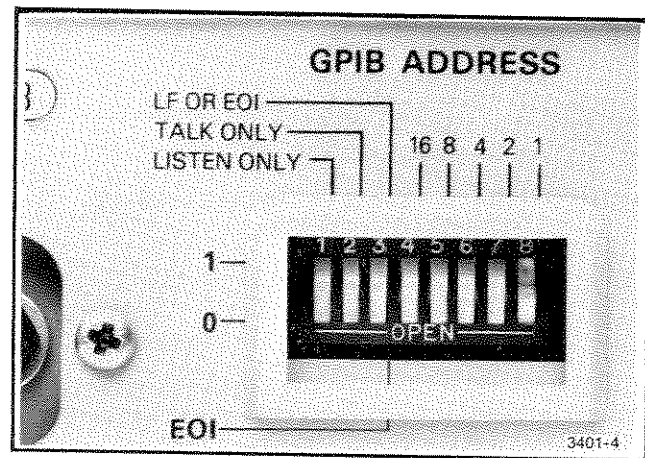

Figure 6-12. GPIB ADDRESS switch on the rear panel.

The switches can be set as desired except when using TEKTRONIX 4050-Series controllers, they reserve this address 0 for their use. Selecting a primary address of 31 logically removes the 494P from the bus; it does not respond to any GPIB address, but remains both unlistened and untalked. If the switches are changed, after power-up, the RESET TO LOCAL button must be activated so the microcomputer will update the primary address.

Talk/Listen-Only Operation

The 494P can be operated as a talker only, or a listener only, on the GPIB under local control. A simple system requires only the 494P and a talker or listener. Such a system, using TEKTRONIX 4924 Digital Cartridge Tape drive is shown in Figure 6-13. This system can be used to save spectrum measurements in addition to those in battery-powered memory, for later display on the 494P or analysis by a controller. This system can also be used to save and restore analyzer control settings.

TALK ONLY, LISTEN ONLY Switches

The 494P switches for talk-only and listen-only operation are part of the GPIB ADDRESS switch bank (Figure 6-12). Set either or both switches (an extension of the IEEE 488 standard allows you to enable both talk-only and listen-only operation) as desired. If the 494P is already powered up, press RESET TO LOCAL to activate the change in these switch settings.

Set the LF OR EOI switch to EOI for use with Tektronix equipment. The switches marked 1, 2, 4, 8, and 16 may be set to any combination except all 1's (decimal 31), which logically disconnects the 494P from the bus.

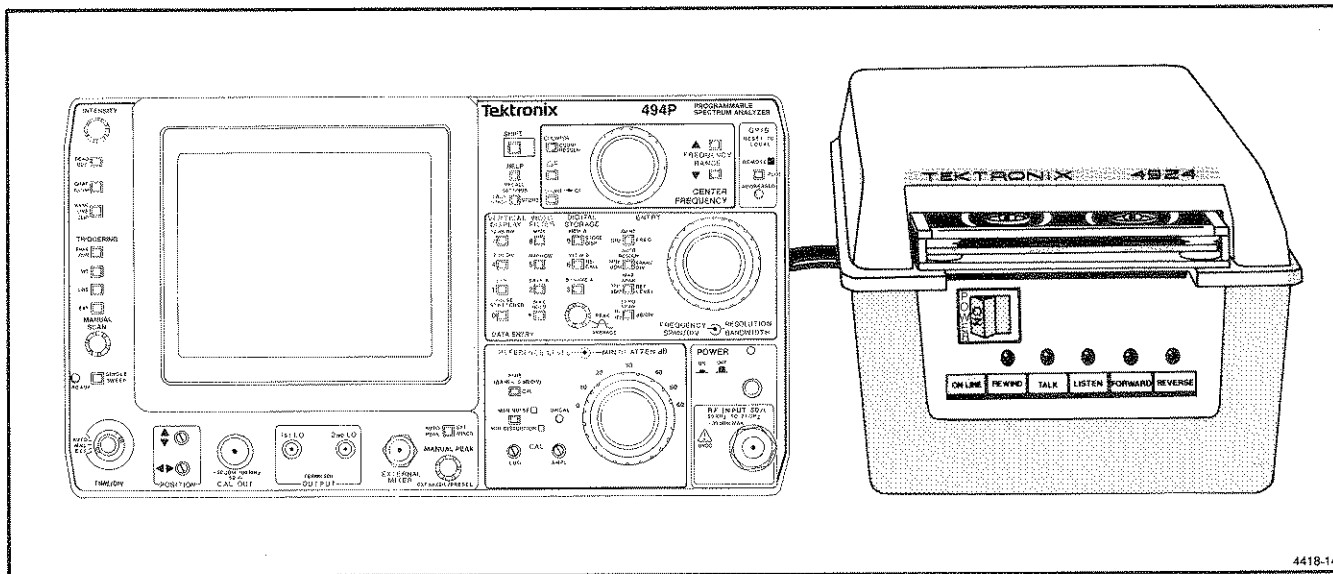

Figure 6-13. TEKTRONIX 4924 Digital Cartridge Tape Drive in a Talk/Listen Only system.

The Mode Control switches, on the 4924 rear panel, must be set as a pair to operate with the 494P. Set SW1 to On and SW2 to Off (same position used when operating with the 4051) or set both switches to either the Off or On position.

Data Logging

With the TALK ONLY switch set, spectrum data can be written on a tape in the TEKTRONIX 4924 as follows. (Refer to the controls shown in Figure 6-14.)

- a. Insert a marked tape into the 4924. The tape must be previously marked for the size and number of files you expect to record (see the Programmer's manual for tape marking).
- b. Connect the GPIB cable between the 4924 and the 494P after both are powered up.
- c. Set the 4924 On Line switch in the Off Line position (out), and rewind the tape.
- d. Press Forward to advance to file 1, then press Forward again, as desired, to reach a file further into the tape.
- e. To save the current control settings and waveform in digital storage, press Listen, on the 4924, and RESET TO LOCAL on the 494P.

Pressing the RESET TO LOCAL button causes the analyzer to transmit instrument settings and a waveform. The message is formatted so that when it is played back to the analyzer, it restores the settings and display. The message is a combination of the responses to the SET and CURVE queries.

If SAVE A is OFF, A and B are transmitted as a full waveform (A and B memories merged for 1000 points):

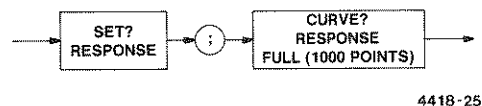

If SAVE A is ON, A and B are transmitted as separate waveforms (500 points each):

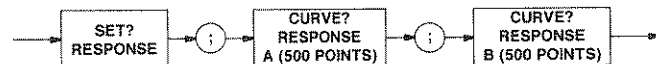

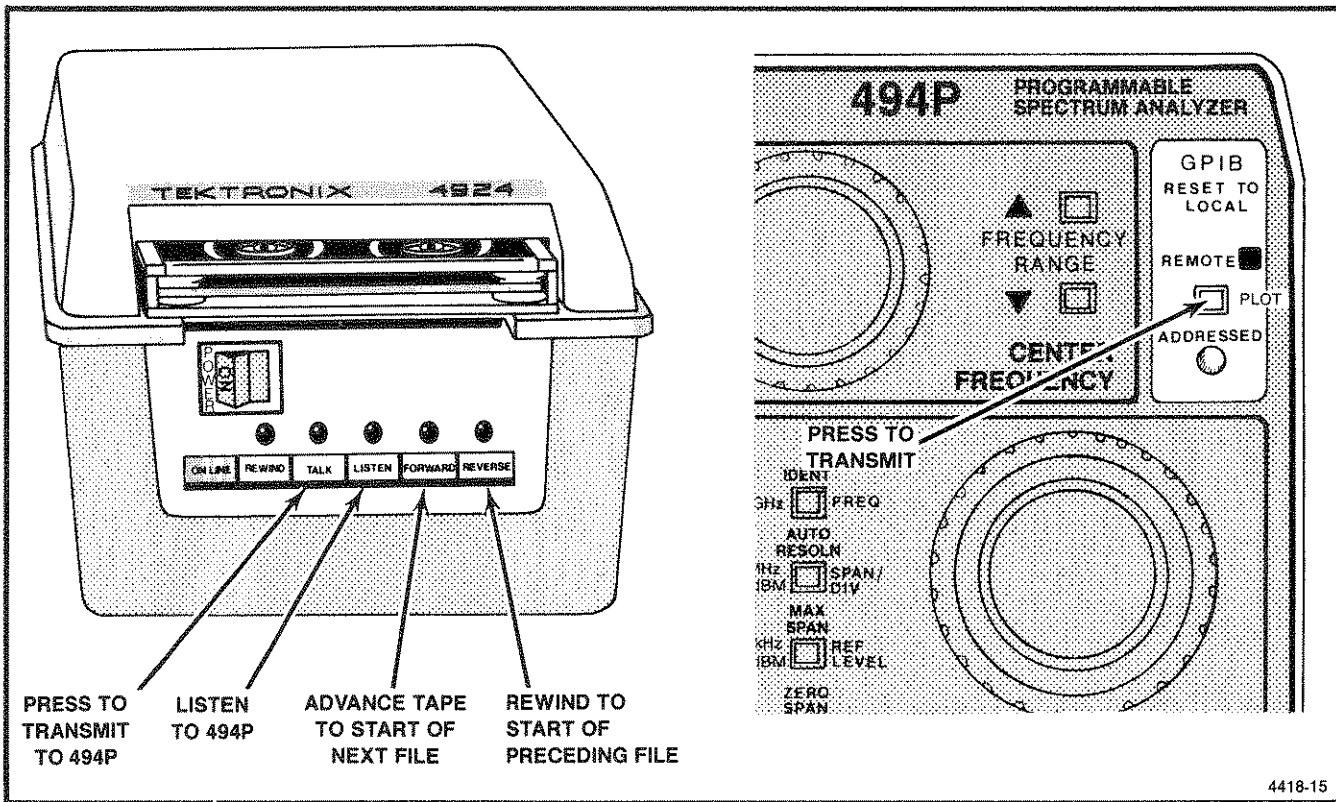

Figure 6-14. Controls on the 4924 and 494P that are used for the Talk/Listen Only transfers.

The analyzer transmits waveform data as ASCII-coded decimal numbers unless changed by the ENCDG argument in a WFMPRE command. You'll find the full CURVE? response syntax diagram in Section 5 of the Programmer's manual. Refer to Section 7 of the Programmer's manual, for the full SET? response syntax diagram.

NOTE

If an internal switch is changed, the analyzer reports only control settings when RESET TO LOCAL is pressed. Refer questions about setting this internal switch to qualified service personnel.

The Tektronix 4924 keeps listening (or talking if TALK is pressed) until the message transfer ends, there is no reset switch except for POWER. The 494P can not be interrupted after it starts talking unless the power is turned off. (This is true only if the 494P begins transmitting—if there is no listener, it flashes a message to the operator and returns to local control.)

Restoring Control Settings and the Display

With the LISTEN ONLY switch set, the 494P buffers and executes device-dependent messages (except for interrupt control commands EOS and RQS). Since the remote-local

state diagram in the IEEE 488 standard does not cover the listen-only mode, we have chosen to implement this mode so the 494P goes to remote state after buffering a message. This makes listen-only mode consistent with the nonlisten-only mode, which requires that the 494P be under remote control to execute commands that change front-panel settings or waveform data in digital storage.

To restore control settings and a display previously recorded:

1. Find the file on the tape using Forward or Reverse on the 4924.
2. Press Talk. The 494P goes to remote to execute the message and then returns to local control.

Listen-only mode can be used for a comparison test. Settings and a waveform previously recorded with SAVE A on, can be played back to the analyzer. The analyzer automatically sets up to make the same measurement (turning on SAVE A), and saves the comparison waveform in A memory. If B—SAVE A is selected, the operator can compare the current spectrum data being acquired in B memory to the saved waveform in A memory.

Connecting to a System

Connect the 494P to a GPIB system through the GPIB cable supplied with the instrument. The GPIB port is shown in Figure 6-12. Connect the cable after the power for the 494P has been turned on or the controller is turned off to avoid generating interference on the bus.

OPERATIONAL PRECAUTIONS FOR THE 494/494P

The following are some operational precautions to observe and traps that can occur when analyzing displays.

1. Measurements Outside the Specified Frequency and Tuning Range versus the Span of the Display:

Signal level or frequency measurements outside the specified frequency range of the band are not reliable. The total span of the display for some bands exceeds the frequency range; for example, the display extends below the 1.7 GHz lower limit of Band 2 and below the 15 GHz limit of Band 5 (15-21 GHz). The center frequency tuning range and the frequency indicating dot correspond to the specified frequency range of the band. Because of this difference, it may be confusing if the frequency dot fails to tune across a full MAX span display or if a displayed signal, outside the frequency range of the band, will not tune to center screen. This occurs in bands 1, 2, and 5 and the waveguide bands.

The frequency range for external mixer bands is commensurate with the frequency range of the Waveguide Mixers. The span of the displays, however, for these external mixer bands, is much wider. Band 6 (18-26.5 GHz) for example, displays at least a 15-39 GHz span.

2. Correct Trigger Mode:

The triggering mode is usually FREE RUN. In pulsed RF applications, a triggered display is required to measure between pulse repetition lines for determining the pulse repetition rate.

Since INTERNAL triggering requires one or more division of signal amplitude to trigger, tune the center frequency so a reasonable sized signal is located at the sweep start before changing the trigger source from FREE RUN to INT.

3. Level of Pulsed Signals:

The spectrum for a pulsed signal is spread out. Consequently, the height of the crt response is less for a pulsed signal than for a cw signal of the same peak

amplitude. This loss in display height means in effect a loss in sensitivity. The amount of loss can be computed from:

$$\text{Voltage loss} = (t_0 B)(10^{-1})$$

where t_0 = pulse duty cycle
 B = resolution bandwidth

The power of the self-generated noise increase is proportional to bandwidth. Pulsed RF voltage level is also proportional. Since power is proportional to voltage squared, a wider bandwidth gives better sensitivity and greater dynamic range for pulsed RF inputs.

When in doubt about signal level overdrive problems, reduce the signal level by inserting RF attenuation, then repeat the measurement. If the two agree, the measurement is correct; if not, the input mixer stage is probably overdriven.

An important consideration for pulsed RF measurements is the peak signal level at the mixer; it is greater by $(t_0 B)(10^{-1})$ than the peak level displayed on the crt. Taking the sensitivity loss into account is the only sure way of ascertaining that the mixer peak power input for linear operation is not exceeded.

4. Level of Continuous Wave Signals:

Similar problems can occur when analyzing cw signals at relatively narrow span widths. The large cw signal may not appear on screen because its frequency is outside the set span width. The mixer nevertheless is saturated and will compress signals.

5. Using Auto Resolution:

Use AUTO RESOLUTION with care when measuring absolute amplitude level. Always use a bandwidth wider than the incidental FM level of the signal source.

6. Excessive Input Signal Level:

Too much input power will destroy the front end mixer or attenuator. Replacement mixers and attenuators are costly. When working with high power signals, use couplers or other devices to reduce the signal down to acceptable levels. Once the signal is down below the rating of the RF attenuator, prevent possible mixer damage by starting with the MIN RF ATTEN dB fully in, then reduce attenuation if needed.

7. No Crt Trace:

The BASELINE CLIP is used to reduce the intensity of the baseline. If Triggering, Intensity, Vertical Position, etc.,

all seem to be in order and there is no crt trace, check the BASELINE CLIP state.

8. Digital Storage Effects on Signal Analyses:

When operating with digital storage, the frequency base is divided into storage slots. For peak displays (above the PEAK/AVERAGE cursor), the display point in each slot corresponds to the maximum sampled value of the signal. Samples are taken at about 9 μ s intervals. When sweeping at one second per division, this is about 1000 samples per slot. For average displays (below the cursor), the values of all samples per slot are summed and divided by the number of samples used to compute the display point for each slot. Each display point is interconnected to create a smooth display. When A or B are displayed independently, only half of the slots are interconnected. The following are a few pitfalls that can occur.

For wide spans and relatively narrow resolution bandwidth (50 or more resolutions per division), the resolution bandwidth equals a digital storage slot. If that slot is in A memory and only B memory is displayed, that point of the signal will not be displayed and an erroneous level would result. SAVE A will display the correct value because an algorithm chooses the larger of adjacent display points to store in A memory.

If the PEAK/AVERAGE cursor is set above the signal level, the average value for each digital slot will be displayed. With narrow resolution bandwidths compared to the slot width, the average value of the resolution response shape will be displayed, which has nothing to do with signal amplitude.

To avoid the above pitfalls, it is best to run digital storage with A and B interlaced. Do not set the PEAK/AVERAGE cursor to average a cw signal. It is best to set the cursor about 1/4 division above the signal to be averaged and about 1/2 division below the signal to be analyzed.

None of these restrictions apply when the resolution bandwidth is wide compared to a digital storage slot (e.g., 50 MHz/div with 1 MHz resolution).

9. Stored Display Averaged in Wide Spans:

When operating in wide spans with digital storage, low level signals will be averaged with the noise and lost if the PEAK/AVERAGE cursor is above the display. Turn the control fully counterclockwise for peak detection when operating with wide spans.

10. Cold Storage or Power-Interrupt Initialization:

After storage below the operating temperature range (see Environmental Characteristics under Specification), the microcomputer may not power up correctly. If this occurs, allow the instrument to warm up for at least 15 minutes, then reinitialize the microcomputer by turning the power off for five seconds, then back on. Repeat if necessary.

FIRMWARE OPERATING NOTES

Following are exceptions to normal instrument operation that relate to the different firmware versions. The instrument displays its version number for approximately 3 seconds whenever instrument power is turned on or the RESET TO LOCAL/REMOTE pushbutton is pressed.

Version 2.2: Plotting on a 4662 Option 31 Plotter

The 4662 Option 31 plotter does not respond to the move command issued by the 494P immediately following the initial pen selection or a pen change command. This results in the pen drawing from its "home" position rather than the selected location. To avoid this, use only a one-pen (one-color) configuration or manually select the second-color pen to be used.

Follow these steps to make a two-color plot.

1. Turn on the graticule illumination and turn off the crt readout and digital storage. Following are exceptions to normal instrument operation that relate to the different firmware versions. The instrument displays its version number for approximately 3 seconds whenever instrument power is turned on or the RESET TO LOCAL/REMOTE pushbutton is pressed.
2. Manually select a pen and plot the information.
3. Turn off the graticule illumination and turn on the crt readout and digital storage.
4. Manually select the second-color pen and plot the information.

Version 2.2: Auto Peaking Function with External Mixers

When using external mixers, the automatic peaking function does not always succeed in setting the correct peak value. To be sure of having the correct value, set peaking manually with the front-panel PEAK/AVERAGE control or use the PEAK command with specific numeric arguments.

General Operating Procedure—494/494P Operators

11. Failure of 494P Instruments to Indicate Correct Version Number or Address:

If the GPIB address on the crt message, of the 494P analyzer, keeps coming up as 0, or if the instrument does not respond to an address change of the GPIB ADDRESS switches, a probable cause could be failure to properly seat the GPIB board in its connector or failure to turn the locking key that locks the GPIB board to the GPIB Extender board connector. Contact your service personnel to investigate.

Service Manual

The 494/494P Service Instruction manuals are separate publications that include circuit description, troubleshooting information, calibration procedures, schematic diagrams, and other maintenance information. Service manuals are intended for use by **QUALIFIED SERVICE PERSONNEL ONLY**. To avoid electrical shock, **DO NOT** perform any servicing unless qualified to do so.

Product Service

To assure adequate product service and maintenance for our instruments, Tektronix, Inc. has established Field Offices and Service Centers at strategic points throughout the United States and outside the United States in all countries where our products are sold. Contact your local Service Center, representative, or sales engineer for details regarding: Warranty, Calibration, Emergency Repair, Repair Parts, Scheduled Maintenance, Maintenance Agreements, Pickup and Delivery, On-Site Service for fixed installations, and other services available through these centers.

Emergency Repair.—This service provides immediate attention to instrument malfunction if you are in an emergency situation such as a field trip. Again, contact any Tektronix Service Center for assistance to get you on your way within a minimum of time.

Maintenance Agreements.—Several types of maintenance or repair agreements are available. For example: for a fixed fee, a maintenance agreement program provides maintenance and recalibration on a regular basis. Tektronix, Inc. will remind you when a product is due for recalibration and perform the service within a specified time-frame. Any Service Center can furnish complete information on costs and types of maintenance programs.

OPTIONS

The following describes the various options that are available for the 494/494P. Information on or about some of these options may also be integrated within the appropriate sections of the manual(s). Options are factory installed or supplied except as noted.

**Table 7-1
POWER CORD OPTIONS**

Option	Description	Tektronix Part Number
A1	Universal Euro, 220 V/50 Hz @ 16A	161-0132-00
A2	United Kingdom U.K., 240 V/50 Hz @ 13A	161-0133-00
A3	Australian, 240 V/50 Hz, @ 10A	161-0135-00
A4	North American, 240 V/60 Hz, @ 12A	161-0134-00
A5	Swiss, 250 V/50 Hz, @ 6A	161-0167-00

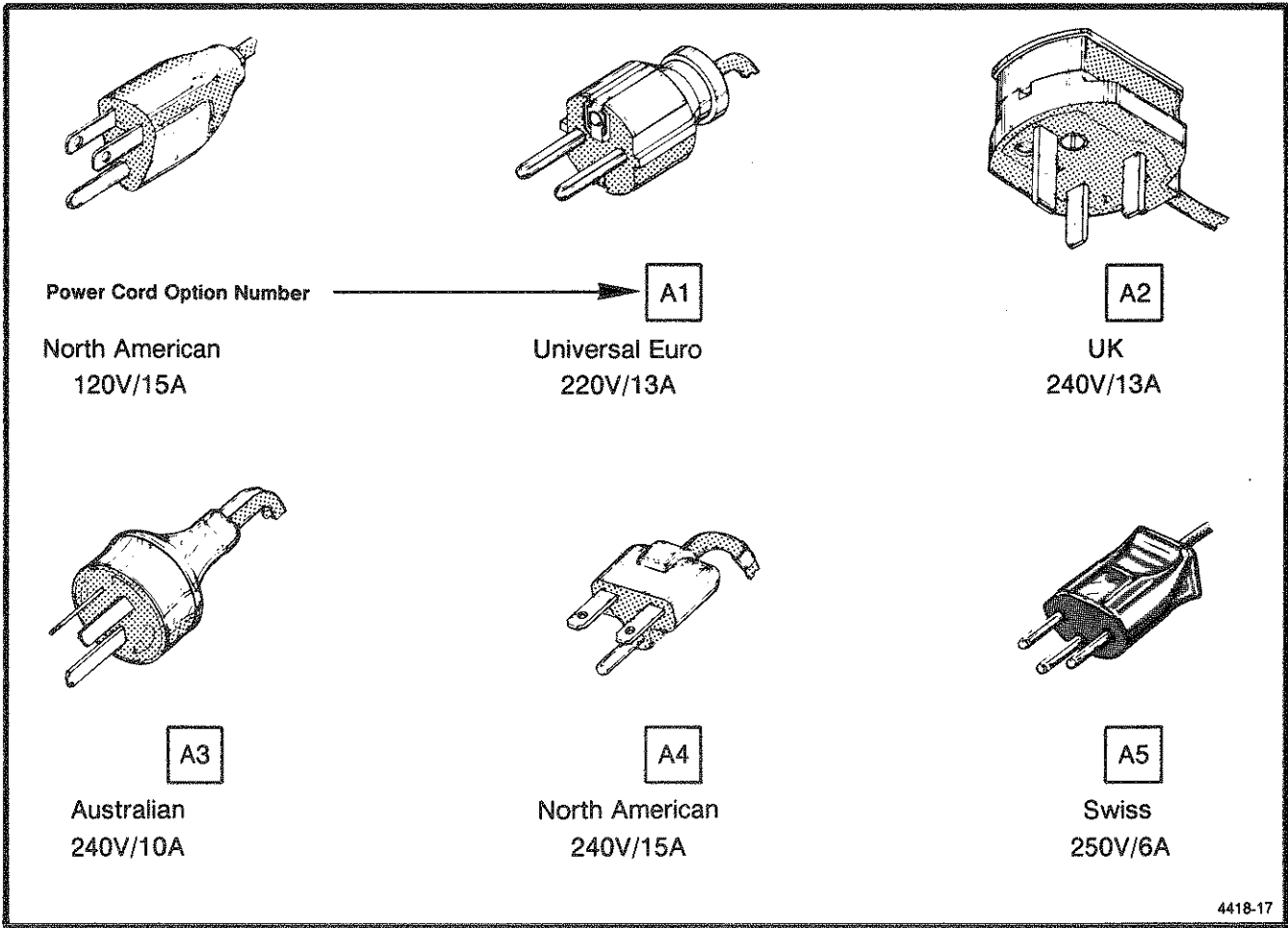

Figure 7-1. International power cord and plug configuration for the 494/494P.

OPTION 08

Deletes external mixer capability. Standard accessories do not include the Diplexer. Frequency range is 50 kHz to 21 GHz.

OPTION 12

Contains firmware that provides English and German as a second language for display messages.

OPTION 13

Contains firmware that provides English and French as a second language for display messages.

OPTION 14

Contains firmware that provides English and Spanish as a second language for display messages.

OPTION 20

Includes General Purpose Waveguide Mixers; frequency range 12.5 to 40 GHz, as listed in Table 7-2.

Table 7-2
OPTION 20 (GENERAL PURPOSE WAVEGUIDE MIXERS) CHARACTERISTICS
Tektronix Part No. 016-0640-00

Frequency Range	Part No.	Sensitivity: Equivalent Input Noise @ 1 kHz Bandwidth (Typical)
12.4-18 GHz	119-0097-00	-75 dBm
18-26.5 GHz	119-0098-00	-70 dBm
26.5-40 GHz	119-0099-00	-60 dBm

Cable: Tnc to sma male connections 012-0748-00

OPTION 21

Includes High Performance Waveguide Mixers; frequency range 18–40 GHz as described in Table 7-3.

Table 7-3
OPTION 21 (WM 490-2) CHARACTERISTICS

Frequency Range	Nomenclature	Sensitivity: Equivalent Input Noise @ 1 kHz Bandwidth (maximum)	Frequency Response	Referenced to 100 MHz
18–26.5 GHz	WM 490K	–100 dBm	±3.0 dB	±6.0 dB
26.5–40 GHz	WM 490A	–95 dBm	±3.0 dB	±6.0 dB

Cable: SMA to SMA connector 012-0649-00

OPTION 22

Includes High Performance Waveguide Mixers that cover the frequency range 18–60 GHz as listed in Table 7-4.

Table 7-4
OPTION 22 (WM 490-3) CHARACTERISTICS

Frequency Range	Nomenclature	Sensitivity: Equivalent Input Noise @ 1 kHz Bandwidth (maximum)	Frequency Response	Referenced to 100 MHz
18–26.5 GHz	WM 490K	–100 dBm	±3.0 dB	±6.0 dB
26.5–40 GHz	WM 490A	–95 dBm	±3.0 dB	±6.0 dB
40–60 GHz	WM 490U	–95 dBm	±3.0 dB	±6.0 dB

Cable: SMA to SMA male connectors 012-0649-00

NOTE

These characteristics assume that the waveguide mixer is connected to a cw signal source and that the PEAKING control is adjusted for maximum signal amplitude. The signal must be stable (not frequency modulated more than the resolution bandwidth); otherwise, frequency response performance cannot be met.

OPTIONS 30, 31, AND 32 (RACKMOUNT/BENCHTOP VERSIONS)

Environmental, physical, and safety characteristics, plus accessories for these options follow the general descriptions.

OPTION 30

This is a rackmount version of the 494/494P. The instrument is installed in a rackmount cabinet. Additional cooling is provided and a front panel accessories drawer provides storage for most accessories used with the 494/494P. Rackmount versions subjected to external vibrations, from rack cooling fans or surrounding equipment, may show degradation of the FM-characteristic. Because of different rack configurations, this degradation cannot be specified. In a typical fan cooled rack, degradation increases by a factor of two.

OPTION 31

Option 31 includes the necessary cabling to provide access to all front panel connectors at the cabinet rear panel for Option 30 instruments. This provision may degrade the response flatness and sensitivity at the high end of the frequency range. Degradation is about 2 dB above 3.0 GHz. Environmental characteristics are the same as Option 30. The semi-rigid cables between the front panel connectors and the connectors on the cabinet grill must be removed for vibration tests.

OPTION 32

Option 32 is a benchtop version of the instrument and consists of the rackmount cabinet with the side rails removed. Environmental and electrical characteristics are the same as the Option 30 instrument. The bail for tilting the instrument must be folded for benchtop handling.

OPTIONS 30, 31, 32 ENVIRONMENTAL CHARACTERISTICS

Rackmount versions meet MIL-T-28800C, type III, class 5, style F specification. Benchtop versions meet MIL-T-28800C, type III, class 5, style E specification, except the vibration test limit is 1 g.

For verification tests, the rackmount version (Options 30 and 31) shall have the instrument secured to the rack at the front and back. Option 31 instruments shall also have the semi-rigid cables between the front panel connectors and the cabinet grill connectors removed. Table 7-5 lists the environmental changes from the non-rackmount version.

Table 7-5
OPTIONS 30, 31, & 32 ENVIRONMENTAL CHARACTERISTICS

Characteristic	Description	
Temperature Operating	Temperature °C	Relative Humidity %
	0 to 25	95 +5, -0
	25 to 40	75 ±5
	40 to 50	45 ±5
Non-operating	-55 to 75	95 +5, -0
Humidity (non-operating)	Same as 494/494P	
Altitude	10,000 feet	
	40,000 feet	
Vibration Operating	Method 514 Procedure X (modified)/MIL-STD-810C. Vibration limit is 1 g. Resonance searches along all three axes at 0.0065 inch displacement, frequency varied from 10 to 55 Hz, 15 minutes per axis, plus dwell at the resonant frequency or 33 Hz, if no resonance is found, for 10 minutes per axis. Total vibration time of 75 minutes. Instrument secured to vibration platform during test.	
Transportation Package Vibration	Meets National Safe Transit Association's pre-shipment test (project 1A-B-1) when correctly packaged. One hour vibration of 1 g.	
	Operable after a 24 inch drop on any corner or flat surface.	
Electromagnetic Interference (EMI)	Within limits described in MIL-STD-461 (same as standard 494/494P)	

Table 7-6
OPTIONS 30, 31, & 32 Physical CHARACTERISTICS

Characteristic	Description
Weight (standard accessories except manuals)	Option 30 & 31 (rackmount)
	72 pounds maximum
Option 32 (benchtop)	70 pounds
Dimensions	Rackmount (without side rails)
	8.75 × 16.89 × 25.00 inch (222 × 429 × 635 mm)
	Benchtop (with feet and handles)
9.25 × 17.9 × 25.00 inch (235 × 455 × 635 mm)	
Benchtop (without feet or handles)	8.75 × 16.89 × 25.00 inch (222 × 429 × 635 mm)

Options—494/494P Operators

Safety Requirements

Safety requirements are the same as they are for the standard 494/494P.

Accessories

Standard

Standard accessories are the same as the 494/494P with the addition of rack slides for the rackmount (Tektronix Part No. 351-0623-00). An accessories drawer provides storage space in place of the front cover.

Optional

Same as the standard 494/494P except the Transit case is not applicable.

OPTION 41

Provides enhanced measurement capability for Digital Microwave Radio. These include: 1) A wider bandwidth preselector for better signal symmetry in the digital radio bands; 2) A narrow video filter (approximately 1/3000th of the resolution bandwidth) to improve amplitude variation analyses, at specific frequency spans that are unique to the digital radio measurements; 3) Improved frequency span/div accuracy at 5 MHz/DIV span, to make accurate signal bandwidth measurements.

OPTION 52

North American 220 V configuration with standard power cord. Fuses are replaced with 2A slow blow.

GLOSSARY

The following glossary is presented as an aid to better understand the terms as they are used in this document and with reference to spectrum analyzers.

GENERAL TERMS

Baseline Clipper (Intensifier). Increasing the brightness of the signal relative to the baseline portion of the display.

Center Frequency. That frequency which corresponds to the center of a frequency span, expressed in hertz.

Effective Frequency Range. That range of frequency over which the instrument performance is specified. The lower and upper limits are expressed in hertz.

Envelope Display. The display produced on a spectrum analyzer when the resolution bandwidth is greater than the spacing of the individual frequency components.

dBc. dB below carrier level.

Frequency Band. A part of effective frequency range over which the frequency can be adjusted, expressed in hertz.

Full Span (Maximum Span). A mode of operation in which the spectrum analyzer scans an entire frequency band.

Zero Span. A mode of operation in which the frequency span is reduced to zero.

Line Display. The display produced on a spectrum analyzer when the resolution bandwidth is less than the spacing of the signal amplitudes of the individual frequency components.

Line Spectrum. A spectrum composed of signal amplitudes of the discrete frequency components.

Maximum Safe Input Power

WITHOUT DAMAGE. The maximum power applied at the input which will not cause degradation of the instrument characteristics.

WITH DAMAGE. The minimum power applied at the input which will damage the instrument.

Intermodulation Spurious Response (Intermodulation Distortion). An unwanted spectrum analyzer response resulting from the mixing of the n th order frequencies, due to non-linear elements of the spectrum analyzer, the resultant unwanted response being displayed.

Pulse Stretcher. A pulse shaper that produces an output pulse, whose duration is greater than that of the input pulse, and whose amplitude is proportional to that of the peak amplitude of the input pulse.

Spectrum Analyzer. An apparatus which is generally used to display the power distribution of an incoming signal as a function of frequency.

It is useful in analyzing the characteristics of repetitive electrical waveforms in general, since repetitively sweeping through the frequency range of interest will display all components of the signal.

Signal Identifier. A means to identify the spectrum of the input signal when spurious responses are possible.

Scanning Velocity. Frequency span divided by sweep time and expressed in hertz per second.

Video Filter. A post detection lowpass filter.

TERMS RELATED TO FREQUENCY

Display Frequency. The input frequency as indicated by the spectrum analyzer and expressed in hertz.

Frequency Span (Dispersion). The magnitude of the frequency band displayed, expressed in hertz or hertz per division.

Appendix A—494/494P Operators

Frequency Linearity Error. The error of the relationship between the frequency of the input signal and the frequency displayed (expressed as a ratio).

Frequency Drift. Gradual shift or change in displayed frequency over the specified time due to internal changes in the spectrum analyzer, and expressed in hertz per second, where other conditions remain constant.

Residual FM (Incidental FM). Short term displayed frequency instability or jitter due to instability in the spectrum analyzer local oscillators, given in terms of peak-to-peak frequency deviation and expressed in hertz or percent of the displayed frequency.

Impulse Bandwidth. The displayed spectral level of an applied pulse divided by its spectral voltage density level assumed to be flat within the pass-band.

Static (Amplifier) Resolution Bandwidth. The specified bandwidth of the spectrum analyzer's response to a cw signal, if sweep time is kept substantially long.

NOTE

This bandwidth is the frequency separation of two down points, usually 6 dB, on the response curve, if it is measured either by manual scan (true static method) or by using a very low-speed sweep (quasi-static method).

Shape Factor (Skirt Selectivity). The ratio of the frequency separation of the two (60 dB/6 dB) down points on the response curve to the static resolution bandwidth.

Zero Pip (Response). An output indication which corresponds to zero input frequency.

TERMS RELATED TO AMPLITUDE

Deflection Coefficient. The ratio of the input signal magnitude to the resultant output indication.

NOTE

The ratio may be expressed in terms of volts (rms) per division, decibels per division, watts per division, or any other specified factor.

Display Reference Level. A designated vertical position representing a specified input level.

NOTE

The level may be expressed in decibels (e.g., 1 mW), volts, or any other units.

Sensitivity. Measure of a spectrum analyzer's ability to display minimum level signals, at a given IF bandwidth, display mode, and any other influencing factors, and expressed in decibels (e.g., 1 mW).

Equivalent Input Noise Sensitivity. The average level of a spectrum analyzer's internally generated noise referenced to the input.

Display Flatness. The unwanted variation of the displayed amplitude over a specified frequency span, expressed in decibels.

Relative Display Flatness. The display flatness measured relative to the display amplitude at a fixed frequency within the frequency span, expressed in decibels.

NOTE

Display flatness is closely related to frequency response. The main difference is that the spectrum display is not recentered.

Frequency Response. The unwanted variation of the displayed amplitude over a specified center frequency range, measured at the center frequency, expressed in decibels.

Display Law. The mathematical law that defines the input-output function of the instrument.

NOTE

The following cases apply:

1) *Linear—A display in which the scale divisions are a linear function of the input signal voltage;*

2) *Square law (power)—A display in which the scale divisions are a linear function of the input signal power;*

3) *Logarithmic*—A display in which the scale divisions are a logarithmic function of the input signal voltage.

4) *Dynamic Range*. The maximum ratio of the levels of two signals simultaneously present at the input which can be measured to a specified accuracy.

Display Dynamic Range. The maximum ratio of the levels of two non-harmonically related sinusoidal signals each of which can be simultaneously measured on the screen to a specified accuracy.

Gain Compression. Maximum input level where the scale linearity error is below that specified.

Spurious Response. A response of a spectrum analyzer wherein the displayed frequency does not conform to the input frequency.

Hum Sidebands. Undesired responses created within the spectrum analyzer, appearing on the display, that are separated from the desired response by the fundamental or harmonic of the power line frequency.

Noise Sidebands. Undesired response caused by noise internal to the spectrum analyzer appearing on the display around a desired response.

Residual Response. A spurious response in the absence of an input signal. (Noise and zero pip are excluded.)

Input Impedance. The impedance at the desired input terminal. This is usually expressed in terms of vswr, return loss, or other related terms for low impedance devices and resistance-capacitance parameters for high impedance devices.

TERMS RELATED TO DIGITAL STORAGE FOR SPECTRUM ANALYZERS

Digitally Stored Display. A display method whereby the displayed function is held in a digital memory. The display is generated by reading the data out of memory.

Digitally Averaged Display. A display of the average value of digitized data computed by combining serial samples in a defined manner.

Multiple Display Memory. A digitally stored display having multiple memory sections which can be displayed separately or simultaneously.

Clear (Erase). Presets memory to a prescribed state, usually that denoting zero.

Save A. A function that inhibits storage update, saving existing data in a section of a multiple memory (e.g., Save A).

View (Display). Enables viewing of the contents of the chosen memory section (e.g., "View A" displays the contents of memory A; "View B" displays the contents of memory B).

Max Hold (Peak Mode). Digitally stored display mode which, at each frequency address, compares the incoming signal level to the stored level and retains the greater. In this mode, the display indicates the peak level at each frequency after several successive sweeps.

Scan Address. A number representing each horizontal data position increment on a directed beam type display. An address in a memory is associated with each scan address.

