



**PLEASE CHECK FOR CHANGE INFORMATION
AT THE REAR OF THIS MANUAL.**

**5440/R5440
OSCILLOSCOPE**

INSTRUCTION MANUAL

**Tektronix, Inc.
P.O. Box 500
Beaverton, Oregon 97077
070-2139-01
Product Group 52**

Serial Number _____

**First Printing APR 1976
Revised MAR 1987**

Copyright © 1976, 1981 Tektronix, Inc. All rights reserved.
Contents of this publication may not be reproduced in any
form without the written permission of Tektronix, Inc.

Products of Tektronix, Inc. and its subsidiaries are covered
by U.S. and foreign patents and/or pending patents.

TEKTRONIX, TEK, SCOPE-MOBILE, and  are
registered trademarks of Tektronix, Inc. TELEQUIPMENT
is a registered trademark of Tektronix U.K. Limited.

Printed in U.S.A. Specification and price change privileges
are reserved.

INSTRUMENT SERIAL NUMBERS

Each instrument has a serial number on a panel insert, tag,
or stamped on the chassis. The first number or letter
designates the country of manufacture. The last five digits
of the serial number are assigned sequentially and are
unique to each instrument. Those manufactured in the
United States have six unique digits. The country of
manufacture is identified as follows:

B000000	Tektronix, Inc., Beaverton, Oregon, USA
100000	Tektronix Guernsey, Ltd., Channel Islands
200000	Tektronix United Kingdom, Ltd., London
300000	Sony/Tektronix, Japan
700000	Tektronix Holland, NV, Heerenveen, The Netherlands

SERVICING SAFETY SUMMARY

FOR QUALIFIED SERVICE PERSONNEL ONLY

Refer also to the preceding Operators Safety Summary.

Do Not Service Alone

Do not perform internal service or adjustment of this product unless another person capable of rendering first aid and resuscitation is present.

Use Care When Servicing With Power On

Dangerous voltages exist at several points in this product. To avoid personal injury, do not touch exposed connections or components while power is on.

Disconnect power before removing protective panels, soldering, or replacing components.

Power Source

This product is intended to operate from a power source that does not apply more than 250 volts rms between the supply conductors or between either supply conductor and ground. A protective ground connection by way of the grounding conductor in the power cord is essential for safe operation.

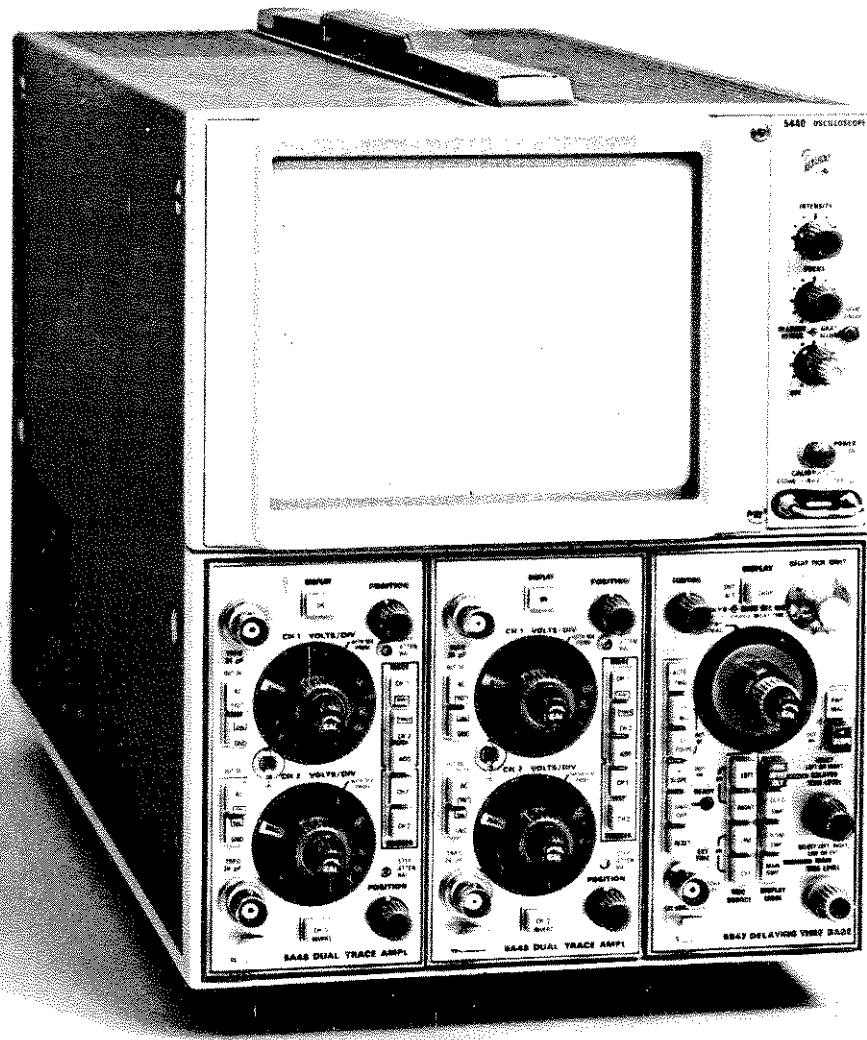

2139-01

5440 Oscilloscope

5440

@

OPERATING INFORMATION

The Tektronix 5440 Oscilloscope is a solid-state instrument designed for general-purpose applications. This instrument has three plug-in compartments that accept 5000-series plug-in units to form a complete measurement system. To effectively use this instrument, the operation and capabilities of the instrument must be known. This section describes front-panel control functions, giving first-time and general operating information. Information on operating voltage, instrument conversion, rackmounting, operating temperature, and plug-in installation is also included.

FIRST TIME OPERATION

Steps 1 through 19 of the following procedure provide an operational check to verify satisfactory operation of the oscilloscope and associated plug-ins. Refer to Fig. 1-1 for front-panel control and connector locations.

1. For the following procedure, a 5A-series amplifier plug-in should be in one of the vertical (left or center) plug-in compartments and a 5B-series time-base plug-in should be in the horizontal (right) compartment.

2. See Operating Voltage in this section before proceeding. Set the POWER switch to off (pushed in) and connect the 5440 to a power source that meets the voltage and frequency requirements of this instrument.

3. Turn the INTENSITY and READOUT INTENS controls counterclockwise and pull the POWER switch out to turn the instrument on. Set the front-panel controls as follows:

Amplifier Plug-In

Display	On
Position	Centered
CH 1 Volts/Div	.1
CH 1 Variable Volts/Div	Cal (fully clockwise)
CH 1 Input Coupling	DC
Trigger	CH 1
Mode	CH 1

Time-Base Plug-In

Display	Alternate (button out)
Position	Centered
Main Sec/Div	5 ms
Variable Seconds/Div	Cal (fully clockwise)
Swp Mag	Off (button out)
Main Trig Level	Counterclockwise
Source	Left (or Right if the amplifier plug-in is in the center compartment)
Coupling	Auto Trig, AC Coupl, +Slope
Mode	Main Sweep

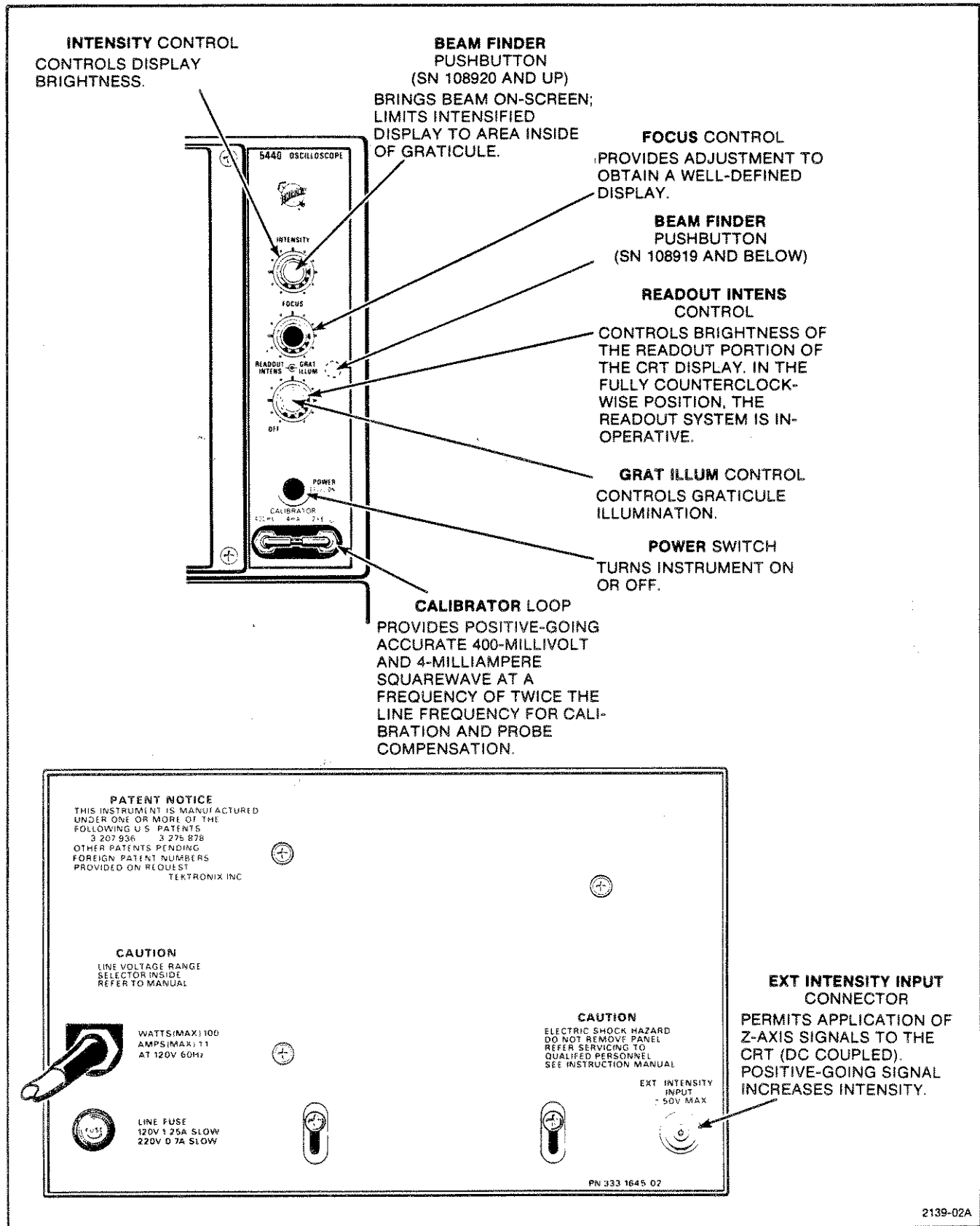

4. Advance the INTENSITY control until the trace is at the desired viewing level. The trace should appear near the graticule center.

5. Connect a 1X probe, or a test lead from the amplifier plug-in input connector to the CALIBRATOR loop.

6. Turn the Main Trig Level control clockwise until a stable display is obtained. Adjust the vertical and horizontal Position controls so that the display is centered vertically and starts at the left edge of the graticule.

7. Adjust the FOCUS control for a sharp, well-defined display over the entire trace length.

8. Disconnect the input signal and position the trace vertically so that it coincides with the center horizontal line of the graticule.

9. If the trace is not parallel with the center horizontal line, see Trace Alignment Adjustment in this section.

10. Rotate the GRAT ILLUM control throughout its range and notice that the graticule lines are illuminated as the control is turned clockwise. Set the control so graticule lines are illuminated as desired.

Calibration Check

11. Move the trace two divisions below graticule center and reconnect the calibrator signal to the amplifier plug-in input connector.

12. The display should be four divisions in amplitude with six complete cycles (five complete cycles for 50-hertz line frequency) shown horizontally. An incorrect display indicates that the oscilloscope mainframe or plug-ins need to be recalibrated.

Readout

13. Turn the READOUT INTENS control clockwise until an alphanumeric display is visible within the top or bottom division of the crt (reset the FOCUS adjustment if necessary for best definition of the readout). Change the Volts/Div switch of the amplifier plug-in that is selected for display. Notice that the readout portion of the display changes as the deflection factor is changed. Likewise, change the Sec/Div switch of the time-base unit that is selected for display. Notice that the readout display for the time-base unit changes also as the sweep rate is changed.

14. Set the time-base unit for magnified operation. Notice that the readout display changes to indicate the correct magnified sweep rate. If a readout-coded 10X probe is available for use with the vertical unit, install it on the input connector of the vertical plug-in. Notice that the deflection factor indicated by the readout is increased by 10 times when the probe is added. Return the time-base unit to normal sweep operation and disconnect the probe.

15. Notice that the readout from a particular plug-in occupies a specific location on the display area. If either of the vertical plug-in units is a dual-trace unit, notice that the readout for Channel 2 appears within the lower division of the crt below the readout for Channel 1.

Beam Finder

16. Move the display off-screen with the vertical position control.

17. Push the BEAM FINDER button and observe that the display compresses into the screen area. Reposition the display to screen center and release the BEAM FINDER button.

External Intensity Input

18. Connect a 5 volt, 1 kHz sine-wave or square-wave signal to the EXT INTENSITY INPUT connector on the rear panel. Also, use the signal to externally trigger the time-base plug-in.

19. Slowly rotate the INTENSITY control counter-clockwise until the trace appears to be a series of dimmed and brightened segments. The brightened segments correspond with the tops of the calibrator squarewaves.

GENERAL OPERATING INFORMATION

Display Focus

If a well-defined display cannot be obtained with the FOCUS control, even at low intensity settings, adjustment of the internal astigmatism control may be required.

To check for proper setting of the Astig control, slowly turn the FOCUS control through the optimum setting with a signal displayed on the crt screen. If the Astig control is correctly set, the vertical and horizontal portions of the trace will come into sharpest focus at the same position of the FOCUS control.

Beam Finder

The BEAM FINDER switch provides a means of locating a display that overscans the viewing area either vertically or horizontally. When the BEAM FINDER switch is pressed, the display is compressed within the graticule area and the display intensity is increased. To locate and reposition an overscanned display, use the following procedure:

1. Press the BEAM FINDER switch, hold it in, then increase the vertical and horizontal deflection factors until the display is within the graticule area.
2. Adjust the vertical and horizontal position controls to center the display about the vertical and horizontal centerlines.
3. Release the BEAM FINDER switch; the display should remain within the viewing area.

Readout (Works Only With 5400-Series Plug-In Units)

The readout system of the power supply/amplifier and display modules allows alphanumeric display of information on the crt, along with the analog waveform displays. The information displayed by the readout system is obtained from the plug-in units that are installed in the plug-in compartments. The characters of the readout display are written by the crt beam on a time-shared basis with the signal waveforms.

The Readout System operates in a free-running mode to interrupt the waveform display to present characters. The waveform display is interrupted for only about 20 microseconds for each character that is displayed.

The readout information from each plug-in is called a word. Up to six (eight with Option 3) words of readout information can be displayed. The location at which each readout word is presented is fixed and is directly related to the plug-in unit and channel from which it originated. Fig. 1-2 shows the area of the graticule where the readout from each plug-in unit channel is displayed (external readout programming is available only with Option 3). Notice that the readout from Channel 1 of each plug-in unit is displayed within the top division of the graticule and the readout from Channel 2 is displayed directly below within the bottom division of the graticule. Only the readout from plug-in channels that are selected by display switches, or by the mode switches of dual-channel plug-ins, appear in the readout display.

The READOUT INTENS control determines the intensity of only the readout portion of the display independent of the other traces. The readout system is inoperative in the fully counterclockwise OFF position. This may be desirable when the top and bottom divisions of the graticule are to be used for waveform display, or when the trace interruptions necessary to display characters do not allow a satisfactory waveform display to be obtained.

Option 3, Externally Programmed Seventh and Eighth Readout Words

This option adds a 25-pin connector to the rear-panel of the 5440 through which two ten-character readout words can be displayed on the crt, see Fig. 1-2.

Display Switching Logic

The electronic switching for time-shared displays is produced at the plug-in interface within the mainframe; however, the switching logic is selected in the plug-in units. The system allows any combination of plug-ins and Display switch settings. Refer to the individual plug-in manuals for specific capabilities and operating procedures.

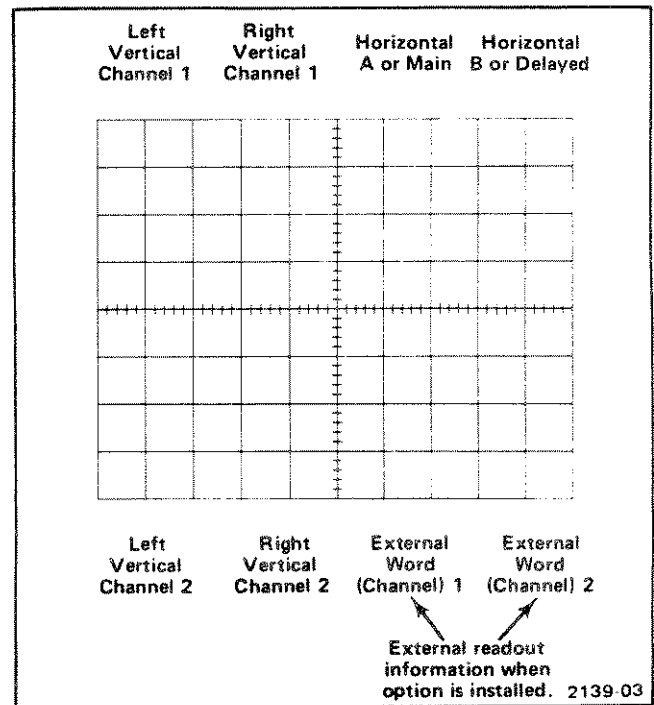

Fig. 1-2. Location of readout on the crt identifying the originating plug-in unit and channel (and external, if Option 3 is installed).

NOTE

At sweep rates faster than approximately 1 μ s, the 5B10, 5B12, and 5B13 Time Base plug-in trigger circuit will not respond fast enough, when used in a 5440, to allow the leading edge of the display to be observed.

Differences in wiring between the 5100-series and 5400-series oscilloscope plug-in interfaces will not allow the use of the composite trigger mode of the 5B10, 5B12, and 5B13 Time Base plug-ins when used in the 5440. If the time base units are put in this mode, they will trigger off the left vertical plug-in only.

Vertical Plug-In Compartments. When a vertical plug-in is in the active mode (Display button pushed in), a logic level is applied to the switching circuit in the mainframe and a display from this plug-in will occur. When two plug-ins are both active in the vertical compartments, a multi-trace display will occur (Alternate or Chopped). When no plug-in is in the active mode, the signal from the left compartment will be displayed. A time-base unit operated in one of the vertical compartments has a permanent internal connection to apply a logic level to the switching circuit; thus, a vertical trace produced by this unit will always be displayed.

Horizontal Plug-In Compartment. Alternate or Chopped display switching is selected on a time-base unit operated in the horizontal compartment. When the Display switch is out (Alt), a negative impulse is supplied at the end of the sweep to allow alternate switching between plug-ins and plug-in channels. When the Display switch is pushed in (Chop), a chopped display will appear if a multi-trace display is required by the plug-ins in the vertical compartments. A vertical plug-in unit operated in the horizontal compartment has a permanent internal connection to provide a chopped display if it is required.

Switching Sequence. Four display time slots are provided on a time-sharing basis. When two vertical plug-ins are active, each receives two time slots, so the switching sequence is: left, left, center, center, etc. The two time slots allotted to each plug-in are divided between amplifier channels in a dual-trace unit; if two dual-trace plug-ins are active, then the switching sequence is: left Channel 1, left Channel 2, center Channel 1, center Channel 2, etc. If only one vertical plug-in is active, it receives all four time slots. The switching sequence is the same for both the Alternate and Chopped display modes.

Vertical Display Mode

Display On. To display a signal, the Display button of the applicable vertical plug-in unit must be pushed in to activate the unit. If two plug-ins are installed in the vertical compartments and only the signal from one of the units is wanted, set the Display switch of the unwanted unit to Off (button out). If neither plug-in is activated, the signal from the left unit is displayed. Both plug-ins can be activated for multi-trace displays.

Alternate Mode. The alternate position of the time-base unit Display switch produces a display that alternates between activated plug-ins and amplifier channels with each sweep of the crt. The switching sequence is described under Display Switching Logic in this section. Although the Alternate mode can be used at all sweep rates, the Chop mode provides a more satisfactory display at sweep rates from about one millisecond/division to five seconds/division. At these slower sweep rates, alternate-mode switching becomes difficult to view.

Chopped Mode. The Chop position of the time-base unit Display switch produces a display that is electronically switched between channels at a 100-kilohertz rate. The switching sequence is discussed earlier. In general, the Chop mode provides the best display at sweep rates slower than about one millisecond/division or whenever dual-trace, single-shot phenomena are to be displayed. At faster sweep rates, the chopped switching becomes apparent and may interfere with the display.

Dual-Sweep Displays. When a dual-sweep time-base unit is operated in the horizontal compartment, the alternate and chopped time-shared switching for either the A or B sweep is identical to that for a single time-base unit. However, if both the A and B sweeps are operating, the 5440 operates in the independent pairs mode. Under this condition, the left vertical unit is always displayed at the sweep rate of the A time base and the right vertical unit is displayed at the sweep rate of the B time-base (non-delayed sweep only). This results in two displays that have completely independent vertical deflection and chopped or alternate sweep switching.

X-Y Operation

In some applications, it is desirable to display one signal versus another (X-Y) rather than against an internal sweep. The flexibility of the plug-in units available for use with the 5440 provides a means for applying a signal to the horizontal deflection system for this type of display. Some of the 5B-series time-base units can be operated as amplifiers, in addition to their normal use as time-base generators.

Raster Display

A raster-type display can be used to effectively increase the apparent sweep length. For this type of display, the trace is deflected both vertically and horizontally by sawtooth signals, and is accomplished by installing a 5B-series time-base unit in the left vertical compartment, as well as one in the horizontal compartment. Normally, the unit in the vertical compartment should be set to a slower sweep rate than the one in the horizontal compartment; the number of horizontal traces in the raster depends upon the ratio between the two sweep rates. Information can be displayed on the raster using the Ext Intensity Input to provide intensity modulation of the display. This type of raster display can be used to provide a television-type display.

Intensity Modulation

Intensity (Z-Axis) modulation can be used to relate a third item of electrical phenomena to the vertical (Y-Axis) and the horizontal (X-Axis) coordinates without affecting the waveshape of the displayed signal. The Z-Axis modulating signal, applied to the EXT INTENSITY INPUT, changes the intensity of the displayed waveform to provide this type of display. The voltage amplitude required for visible trace modulation depends on the setting of the INTENSITY control. About +5 volts will turn on the display to a normal brightness level from an off level, and about -5 volts will turn the display off from a normal brightness level. "Gray scale" intensity modulation can be obtained by applying signals between these levels. Maximum safe input voltage is ± 50 volts. Usable frequency range of the Z-Axis circuit is dc to two megahertz.

Time markers applied to the EXT INTENSITY INPUT provide a direct time reference on the display. With uncalibrated horizontal sweep or X-Y operation, the time markers provide a means of reading time directly from the display. However, if the markers are not time-related to the displayed waveform, a single-sweep display should be used (for internal sweep only) to provide a stable display.

Calibrator

The internal calibrator of the 5440 provides a convenient signal source for checking basic vertical gain and sweep timing. The calibrator signal is also very useful for adjusting probe compensation, as described in the probe instruction manual. The output square-wave voltage is 400 millivolts, within 1%, and the square-wave current is 4 milliamperes, within 1%. The frequency of the square-wave signal is twice the power-line frequency. The signal is obtained by clipping the probe to the loop.

Display Photography

A permanent record of the crt display can be obtained with an oscilloscope camera system. The crt bezel of the 5440 provides integral mounting for a Tektronix oscilloscope camera. The instruction manuals for the Tektronix oscilloscope cameras include complete instructions for obtaining waveform photographs.

OPERATING VOLTAGE

CAUTION

This instrument is designed for operation from a power source with its neutral at or near earth (ground) potential, and with a separate safety-earth conductor. It is not intended for operation from two phases of a multi-phase system, or across the legs of a single-phase, three-wire system.

INSTRUMENT CONVERSION

The 5440 Power Supply/Amplifier module and the display module can be fastened together stacked or side by side; this permits operation as a bench oscilloscope, or in a standard 19-inch rack. The two modules can quickly be converted from a bench model to a rackmount model, or vice versa. Field conversion kits, including the necessary parts, and instructions are available and can be installed at a later time. See your Tektronix Catalog or contact your Tektronix field office.

NOTE

Before attempting to operate the instrument, make sure the module wiring interconnections are correct.

RACKMOUNTING

The rackmount version of the 5400-series oscilloscope is designed for operation in a standard 19-inch wide rack that has Universal, EIA, RETMA, or Western Electric hole spacing. When properly mounted, this instrument will meet all electrical and environmental specifications given in Section 2.

Mounting Method

This instrument will fit most 19-inch wide racks whose front and rear holes conform to Universal hole spacing, some drilling may be required on racks having EIA, RETMA, or Western Electric hole spacing. The slide-out tracks easily mount to the cabinet rack front and rear vertical mounting rails if the inside distance between the front and rear rails is within 10-9/16 inches to 24-3/8 inches. If the inside distance exceeds 24-3/8 inches, some means of support is required for the rear ends of the slide-out tracks. (For example, make extensions for the rear mounting brackets.)

Rack Dimensions

Height. At least 5-1/4 inches of vertical space is required to mount this instrument in a rack. If other instruments are operated in the rack, an additional 1/4 inch is required, both above and below the oscilloscope, to allow space for proper circulation of cooling air.

Width. A standard 19-inch wide rack may be used. The dimension of opening between the front rails must be at least 17-5/8 inches for a cabinet in which the front lip of the stationary section is mounted behind an untapped front rail as shown in Fig. 1-4A. If the front rails are tapped, and the stationary section is mounted in front of the front rail as shown in Fig. 1-4B, the dimension between the front rails should be at least 17-3/4 inches. These dimensions allow room on each side of the instrument for the slide-out tracks to operate so the instrument can move freely in and out of the rack.

Depth. For proper circulation of cooling air, allow at least two inches clearance behind the rear of the instrument and any enclosure on the rack. If it is sometimes necessary or desirable to operate the oscilloscope in the fully extended position, use cables that are long enough to reach from the signal source to the instrument.

WARNING

During rackmount installation, interchanging the left and right slide-out track assemblies defeats the extension stop (safety latch) feature of the tracks. Equipment could, when extended, come out of the slides and fall from the rack, possibly causing personal injury and equipment damage.

When mounting the supplied slide-out tracks, inspect both assemblies to find the LH (left hand) and RH (right hand) designations to determine correct placement. Install the LH assembly to your left side as you face the front of the rack and install the RH assembly to your right side. Refer to the rackmounting instructions in this manual for complete information.

Installing The Slide-Out Tracks

The slide-out tracks for the instrument consist of two assemblies, one for the left side of the instrument and one for the right side. Each assembly consists of three sections. A stationary section attaches to the front and rear rails of the rack, the chassis section attaches to the instrument (and is installed at the factory), and the intermediate section fits between the other two sections to allow the instrument to fully extend out of the rack.

The small hardware components included with the slide-out track assemblies are used to mount the tracks to most standard 19-inch rack rails having this compatibility.

NOTE

1. *Front and rear rail holes must be large enough to allow inserting a 10-32 screw through the rail mounting hole if the rails are untapped (see Fig. 1-4A).*
2. *Or, front and rear rail holes must be tapped to accept a 10-32 screw if Fig. 1-4B mounting method is used. Note in Fig. 1-4B right illustration that a No. 10 washer (not supplied) may be added to provide increased bearing surface for the slide-out track stationary section front flange.*

Because of the above compatibility, there will be some small parts left over. The stationary and intermediate sections for both sides of the rack are shipped as a matched set and should not be separated. The matched sets of both sides including hardware are marked 351-0195-00 on the package. To identify the assemblies, note that the automatic latch and intermediate section stop is located near the top of the matched set.

Mounting Procedure. Use the following procedure to mount both sides. See Fig. 1-4 for installation details.

1. To mount the instrument directly above or below another instrument in a cabinet rack, select the appropriate holes in the front rack rails for the stationary sections, using Fig. 1-5 as a guide.

2. Mount the stationary slide-out track sections to the front rack rails using either of these methods:

(a) If the front flanges of the stationary sections are to be mounted behind the front rails (rails are countersunk or not tapped), mount the stationary sections as shown in Fig. 1-4A right illustration.

(b) If the front flanges of the stationary sections are to be mounted in front of the front rails (rails are tapped for 10-32 screws), mount the stationary sections as shown in Fig. 1-4B right illustration. To provide increased bearing surface for the screw head to securely fasten the front flange to the rail, a flat washer (not supplied) may be added under the screw head. However, if this mounting method is used, the front panel will not fit flush against the front rail because of the stationary section and washer thickness. If a flush fit is preferred, method 2 (a) should be used.

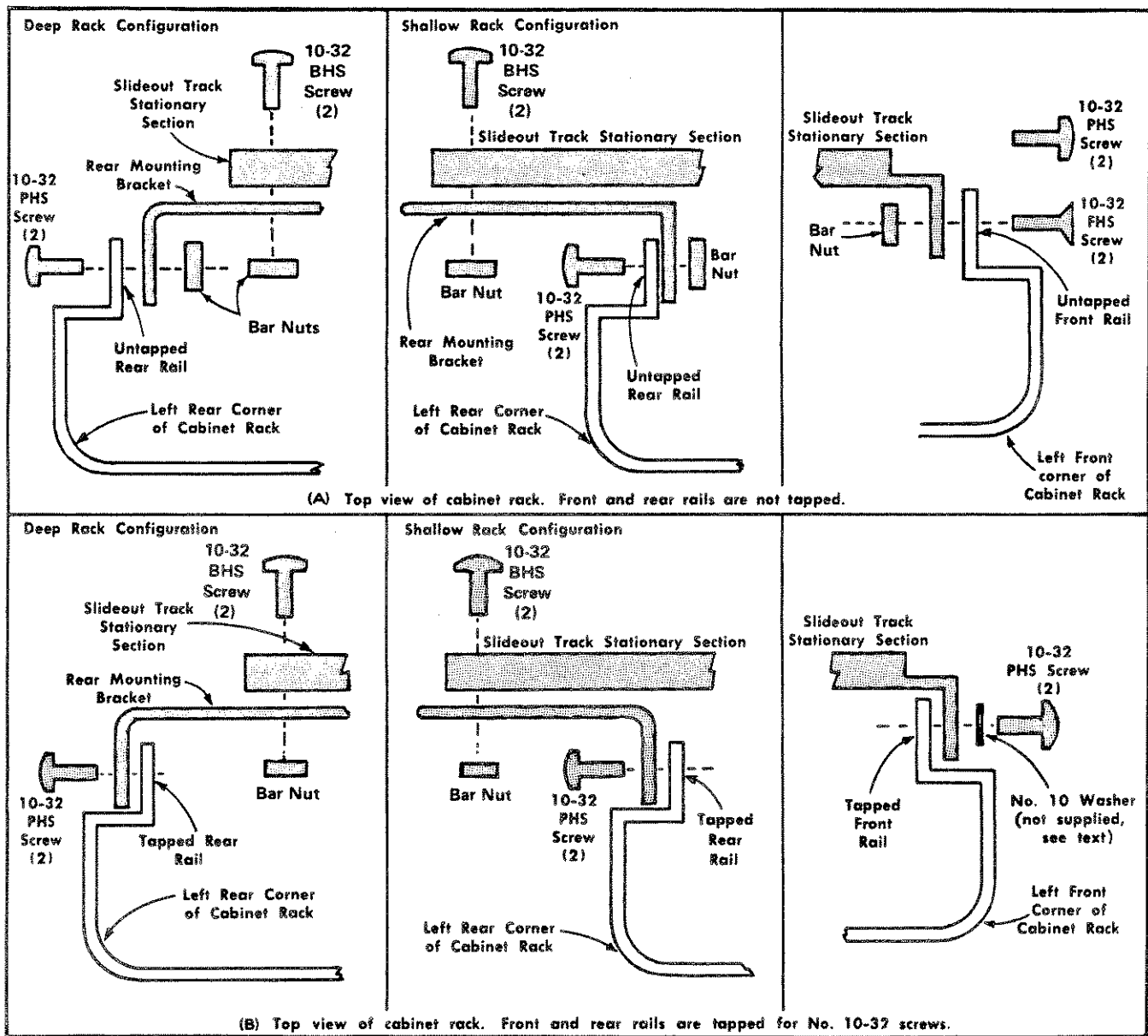

Fig. 1-4. Mounting the left stationary section (with its matched intermediate section, not shown in illustrations A and B) to the rack rails.

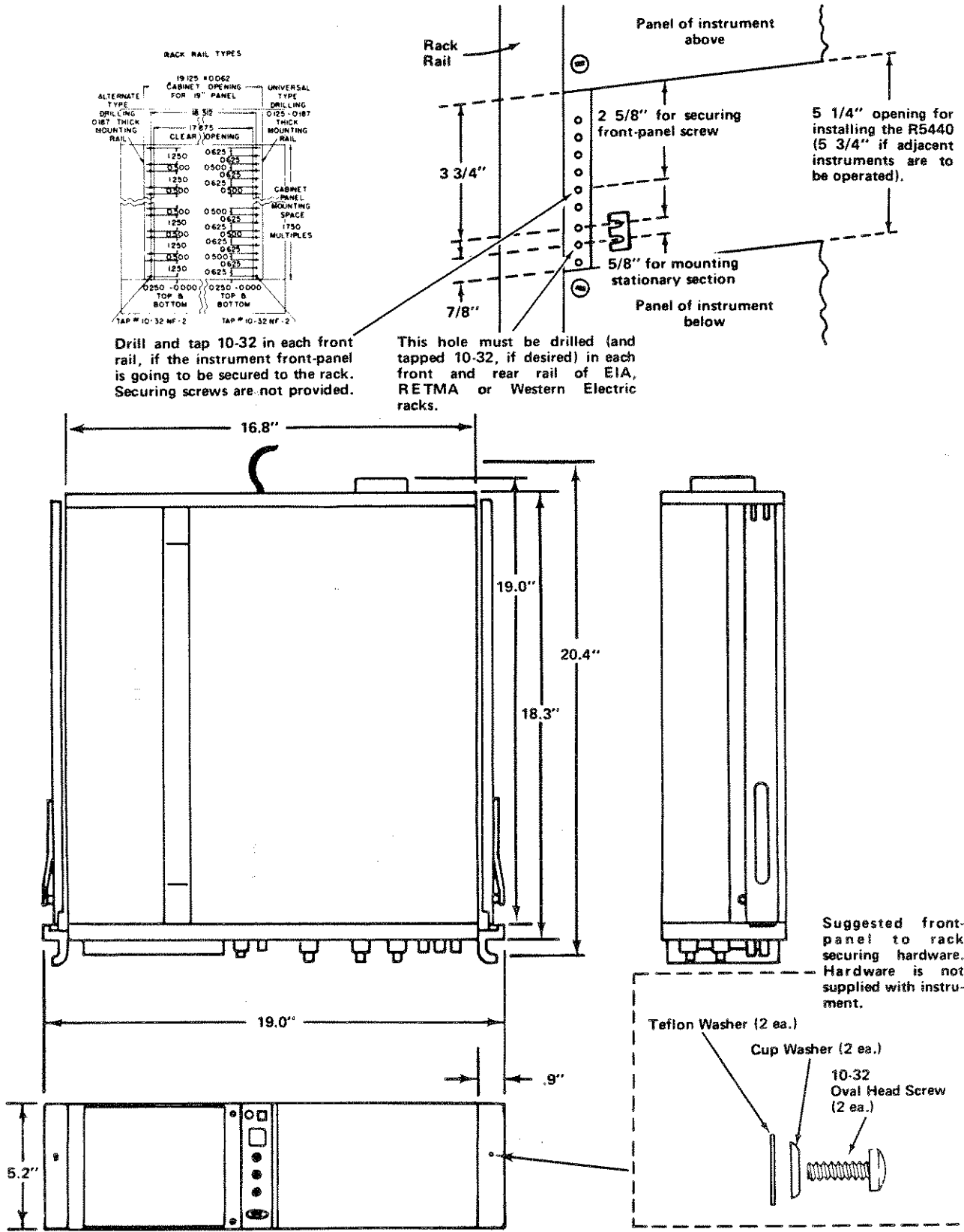

Fig. 1-5. Dimensional diagram.

Operating Information—5440

3. Mount the stationary slide-out sections to the rear rack rails using either of these methods.

(a) If the rear rack rail holes are not tapped to accept 10-32 machine screws, mount the left stationary section with hardware provided as shown in the left or center illustration of Fig. 1-4A. Note that the rear mounting bracket can be installed either way so the slide-out tracks will fit a deep or shallow cabinet rack. Use Fig. 1-4A as a guide for mounting the right stationary section. Make sure that the stationary sections are horizontally aligned so they are level and parallel with each other.

(b) If the rear rack rail holes are tapped to accept 10-32 machine screws, mount the left stationary section with hardware provided as shown in the left or center illustration of Fig. 1-4B. Note that the rear mounting bracket can be installed either way so the slide-out tracks will fit a deep or shallow cabinet rack. Use Fig. 1-4B as a guide for mounting the right stationary section. Make sure the stationary sections are horizontally aligned so they are level and parallel with each other.

Installation And Adjustment

To insert the instrument into the rack, proceed as follows:

1. Pull the slide-out track intermediate sections out to the fully extended position.
2. Insert the instrument chassis sections into the intermediate sections.
3. Press the stop latches on the chassis sections and push the instrument toward the rack until the latches snap into their holes.
4. Again press the stop latches and push the instrument into the rack.

To adjust the slide-out tracks for smooth sliding action, loosen the screws used to join the stationary sections to the rails of the rack. Center the instrument, allowing the slide-out tracks to seek the proper width, then tighten the screws.

To secure the instrument front-panel to the rack, the rack must either have universal hole spacing, or a hole must be drilled and tapped for a 10-32 screw, see Fig. 1-5. Using the hardware (not furnished) indicated in Fig. 1-5, secure the R5440 to the front rails of the rack.

Slide-Out Track Maintenance

The slide-out tracks require no lubrication. The special dark gray finish on the sliding parts is a permanent lubrication.

OPERATING TEMPERATURE

The 5440 can be operated where the ambient air temperature is between 0°C and +50°C. The instrument can be stored in ambient temperature between -40°C and +70°C. After storage at a temperature beyond the operating limits, allow the chassis temperature to come within the operating limits before power is applied.

A thermal cutout in the display module provides thermal protection and disconnects the power to the instrument if the internal temperature exceeds a safe operating level. This device will automatically re-apply power when the temperature returns to a safe level.

PLUG-IN UNITS

The 5440 is designed to accept up to three Tektronix 5000-series plug-in units. (Only the plug-in units without an N suffix will provide display readout.) This plug-in feature allows a variety of display combinations and also allows selection of bandwidth, sensitivity, display mode, etc., to meet the measurement requirements. In addition, it allows the oscilloscope system to be expanded to meet future measurement requirements. The overall capabilities of the resultant system are in large part determined by the characteristics of the plug-ins selected.

Installation

To install a plug-in unit into one of the plug-in compartments, align the slots in the top and bottom of the plug-in with the associated guides in the plug-in compartment. Push the plug-in unit firmly into the plug-in compartment until it locks into place. To remove a plug-in, pull the release latch on the plug-in unit to disengage it and pull the unit out of the plug-in compartment. Plug-in units can be removed or installed without turning off the instrument power. It is not necessary that all of the plug-in compartments be filled to operate the instrument, the only plug-ins needed are those required for the measurement to be made.

When the display unit is adjusted in accordance with the adjustment procedure given in the display unit instruction manual, the vertical and horizontal gain are standardized. This allows adjusted plug-in units to be changed from one plug-in compartment to another without readjustment. However, the basic adjustment of the individual plug-in units should be checked when they are installed in this system to verify their measurement accuracy. See the service information section of the plug-in unit manual for verification procedure.

Selection

The plug-in versatility of the 5400-series oscilloscope allows a variety of display modes with many different plug-ins. The following information is provided here to aid in plug-in selection.

To produce a single-trace display, install a single-channel vertical unit (or dual-channel unit set for single-channel operation) in either of the vertical (left or center) compartments and a time-base unit in the horizontal (right) compartment. For dual-trace displays, either install a dual-channel vertical unit in one of the vertical compartments or install a single-channel vertical unit in each vertical compartment. A combination of a single-channel and a dual-channel vertical unit allows a three-trace display; likewise, a combination of two dual-channel vertical units allows a four-trace display.

To obtain a vertical sweep with the input signal displayed horizontally, insert the time-base unit into one of the vertical compartments and the amplifier unit in the horizontal compartment. If a vertical sweep is used, there is no retrace blanking and the time-base unit triggering must be accomplished externally.

For X-Y displays, either a 5A-series amplifier unit or a 5B-series time-base unit having an amplifier channel can be installed in the horizontal compartment to accept the X signal. The Y signal is connected to a 5A-series amplifier unit installed in a vertical compartment.

Special purpose plug-in units may have specific restrictions regarding the compartments in which they can be installed. This information will be given in the instruction manuals for these plug-ins.

BASIC OSCILLOSCOPE APPLICATIONS

The 5400-series oscilloscope and its associated plug-in units provide a very flexible measurement system. The capabilities of the overall system depend mainly upon the plug-ins that are chosen. The following information describes the techniques for making basic measurements. These applications are not described in detail, since each application must be adapted to the requirements of the individual measurement. Specific applications for the individual plug-in units are described in the manuals for these units. Contact your local Tektronix Field Office or representative for additional assistance.

Peak-to-Peak Voltage Measurements—AC

To make peak-to-peak voltage measurements, use the following procedure:

1. Set the input coupling on the vertical plug-in unit to Gnd and connect the signal to the input connector.
2. Set the input coupling to ac and set the Volts/Div switch to display about 5 or 6 vertical divisions of the waveform. Check that the variable Volts/Div control (red knob) is in the Cal position.
3. Adjust the time-base triggering controls for a stable display and set the Sec/Div switch to display several cycles of the waveform.
4. Turn the vertical Position control so that the lower portion of the waveform coincides with one of the graticule lines below the center horizontal line, and the top of the waveform is in the viewing area. Move the display with the horizontal Position control so that one of the upper peaks is aligned with the center vertical reference line (see Fig. 1-6).
5. Measure the vertical deflection from peak to peak (divisions).

NOTE

This technique may also be used to make measurements between two points on the waveform, rather than peak to peak.

6. Multiply the distance (in divisions) measured in step 5 by the Volts/Div switch setting. Also include the attenuation factor of the probe, if applicable.

EXAMPLE: Assume a peak-to-peak vertical deflection of 4.6 divisions and a Volts/Div switch settings of 5 V.

$$\text{Peak-to-peak volts} = \frac{4.6}{(\text{divisions})} \times 5 \text{ (Volts/Div setting)} = 23 \text{ volts}$$

NOTE

If an attenuator probe is used that cannot change the scale factor readout (Volts/Div), multiply the right side of the above equation by the attenuation factor.

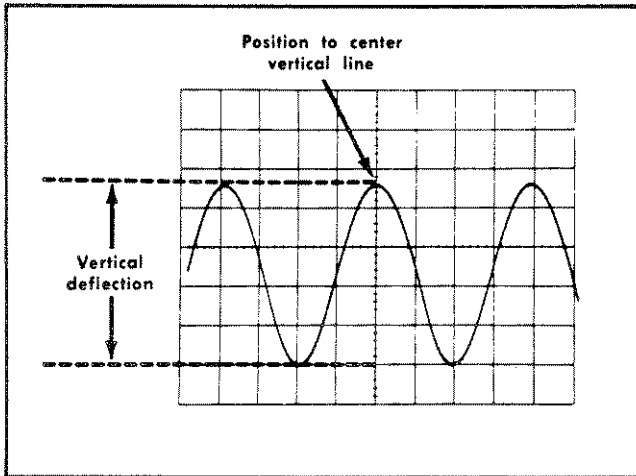

Fig. 1-6. Measuring peak-to-peak voltage of a waveform.

2. Connect the signal to the input connector. Set the input coupling to dc (the ground reference can be checked at any time by setting the input coupling to Gnd).

3. Set the Volts/Div switch to display about 5 or 6 vertical divisions of the waveform. Check that the variable Volts/Div control (red knob) is in the Cal position. Adjust the time-base triggering controls for a stable display.

4. Measure the distance in divisions between the reference line and the point on the waveform at which the dc level is to be measured. For example, in Fig. 1-7 the measurement is made between the reference line and point A.

5. Establish the polarity. The voltage is positive if the signal is applied to the + input connector and the waveform is above the reference line.

6. Multiply the distance measured in step 4 by the Volts/Div switch setting. Include the attenuation factor of the probe, if applicable (see the note following the Peak-to-Peak Voltage Measurement example).

EXAMPLE: Assume that the vertical distance measured is 4.6 divisions, the polarity is positive, and the Volts/Div switch setting is 2 V.

$$\text{Instantaneous Voltage} = 4.6 \text{ (divisions)} \times 2 \text{ (Volts/Div)} = +9.2 \text{ volts}$$

Instantaneous Voltage Measurement—DC

To measure the dc level at a given point on a waveform, use the following procedure:

1. Set the input coupling of the vertical plug-in unit to Gnd and position the trace to the bottom line of the graticule (or other selected reference line). If the voltage to be measured is negative with respect to ground, position the trace to the top line of the graticule. Do not move the vertical Position control after this reference has been established.

NOTE

To measure a voltage level with respect to a voltage other than ground, make the following changes to step 1: Set the input coupling switch to dc and apply the reference voltage to the input connector, then position the trace to the reference line.

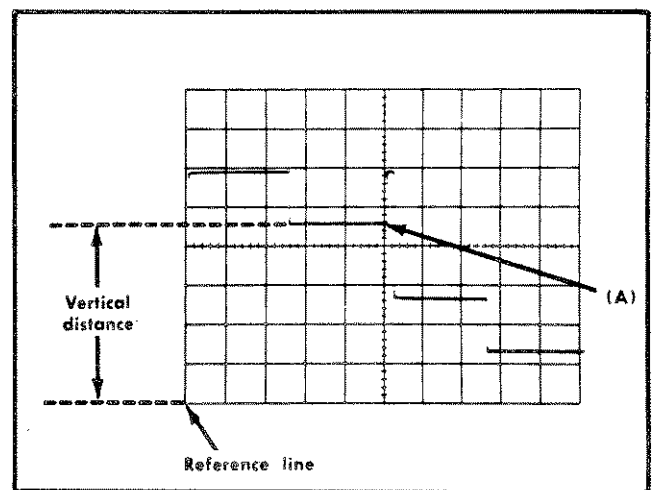

Fig. 1-7. Measuring instantaneous dc voltage with respect to a reference voltage.

Comparison Measurements

In some applications, it may be necessary to establish a set of deflection factors other than those indicated by the Volts/Div or Sec/Div switches. This is useful for comparing signals to a reference voltage amplitude or period. To establish a new set of deflection factors based upon a specific reference amplitude or period, proceed as follows:

Vertical Deflection Factor

1. Apply a reference signal of known amplitude to the vertical input connector. Using the Volts/Div switch and variable Volts/Div control, adjust the display for an exact number of divisions. Do not move the variable Volts/Div control after obtaining the desired deflection.

2. Divide the amplitude of the reference signal (volts) by the product of the deflection in divisions (established in step 1) and the Volts/Div switch setting. This is the Deflection Conversion Factor.

$$\text{Deflection Conversion Factor} = \frac{\text{reference signal amplitude (volts)}}{\text{deflection (divisions)} \times \text{Volts/Div setting}}$$

3. To determine the peak-to-peak amplitude of a signal compared to a reference, disconnect the reference and apply the signal to the input connector.

4. Set the Volts/Div switch to a setting that provides sufficient deflection to make the measurement. Do not readjust the variable Volts/Div control.

5. To establish a Modified Deflection Factor at any setting of the Volts/Div switch, multiply the Volts/Div switch setting by the Deflection Conversion Factor established in step 2.

$$\text{Modified Deflection Factor} = \text{Volts/Div setting} \times \text{Deflection Conversion Factor}$$

6. Measure the vertical deflection in divisions and determine the amplitude by the following formula:

$$\text{Signal Amplitude} = \text{Modified Deflection Factor} \times \text{Deflection (divisions)}$$

EXAMPLE: Assume a reference signal amplitude of 30 volts, a Volts/Div switch setting of 5 V and a deflection of four divisions. Substituting these values in the Deflection Conversion Factor formula (step 2):

$$\frac{30 \text{ V}}{(4) (5 \text{ V})} = 1.5$$

Then, with a Volts/Div switch setting of 2 V, the Modified Deflection Factor (step 5) is:

$$(2 \text{ V}) (1.5) = 3 \text{ volts/division}$$

To determine the peak-to-peak amplitude of an applied signal that produces a vertical deflection of five divisions with the above conditions, use the Signal Amplitude formula (step 6):

$$(3 \text{ V}) (5) = 15 \text{ volts}$$

Sweep Rate

1. Apply a reference signal of known frequency to the vertical input connector. Using the Sec/Div switch and variable Sec/Div control, adjust the display so that one cycle of the signal covers an exact number of horizontal divisions. Do not change the variable Sec/Div control after obtaining the desired deflection.

2. Divide the period of the reference signal (seconds) by the product of the horizontal deflection in divisions (established in step 1) and the setting of the Sec/Div switch. This is the Deflection Conversion Factor.

$$\text{Deflection Conversion Factor} = \frac{\text{reference signal period (seconds)}}{\text{horizontal deflection (divisions)} \times \text{Sec/Div switch setting}}$$

3. To determine the period of an unknown signal, disconnect the reference and apply the unknown signal.

4. Set the Sec/Div switch to a setting that provides sufficient horizontal deflection to make an accurate measurement. Do not readjust the variable Sec/Div control.

5. To establish a Modified Deflection Factor at any setting of the Sec/Div switch, multiply the Sec/Div switch setting by the Deflection Conversion Factor established in step 2.

$$\text{Modified Deflection Factor} = \text{Sec/Div switching setting} \times \text{Deflection Conversion Factor}$$

Operating Information—5440

6. Measure the horizontal deflection in divisions and determine the period by the following formula:

$$\text{Period} = \frac{\text{Modified Deflection Factor}}{\text{horizontal deflection (divisions)}} \times \text{horizontal deflection (divisions)}$$

EXAMPLE: Assume a reference signal frequency of 455 hertz (period 2.2 milliseconds), a Sec/Div switch setting of .2 ms, and a horizontal deflection of eight divisions. Substituting these values in the Deflection Conversion Factor formula (step 2):

$$\frac{2.2 \text{ ms}}{(8) (0.2 \text{ ms})} = 1.375$$

Then, with a Sec/Div switch setting of 50 μ s, the Modified Deflection Factor (step 5) is:

$$(50 \mu\text{s}) (1.375) = 68.75 \text{ microseconds/division}$$

To determine the time period of an applied signal which completes one cycle in seven horizontal divisions, use the Period formula (step 6):

$$(68.75 \mu\text{s}) (7) = 481 \text{ microseconds}$$

This product can be converted to frequency by taking the reciprocal of the period (see application of Determining Frequency).

Time Period Measurement

To measure the time (period) between two points on a waveform, use the following procedure:

1. Connect the signal to the vertical input connector, select either ac or dc input coupling, and set the Volts/Div switch to display about four divisions of the waveform.

2. Set the time-base triggering controls to obtain a stable display. Set the Sec/Div switch to the fastest sweep rate that will permit displaying one cycle of the waveform in less than eight divisions (some non-linearity may occur in the first and last graticule divisions of display). Refer to Fig. 1-8.

3. Adjust the vertical Position control to move the points between which the time measurement is made to the center horizontal line. Adjust the horizontal Position control to center the time-measurement points within the center eight divisions of the graticule.

4. Measure the horizontal distance between the time measurement points. Be sure the variable Sec/Div control is in the Cal position.

5. Multiply the distance measured in step 4 by the setting of the Sec/Div switch.

EXAMPLE: Assume that the horizontal distance between the time-measurement points is five divisions and the Sec/Div switch is set to .1 ms. Using the formula:

$$\text{Period} = \frac{\text{horizontal distance (divisions)}}{\text{Sec/Div setting}} = (5) (0.1 \text{ ms}) = 0.5 \text{ ms}$$

The period is 0.5 millisecond.

Determining Frequency

The time measurement technique can also be used to determine the frequency of a signal. The frequency of a periodically recurrent signal is the reciprocal of the time duration (period) of one cycle. Use the following procedure:

1. Measure the period of one cycle of the waveform as described in the previous application.

2. Take the reciprocal of the period to determine the frequency.

EXAMPLE: The frequency of the signal shown in Fig. 1-8, which has a period of 0.5 millisecond is:

$$\text{Frequency} = \frac{1}{\text{period}} = \frac{1}{0.5 \text{ ms}} = 2 \text{ kilohertz}$$

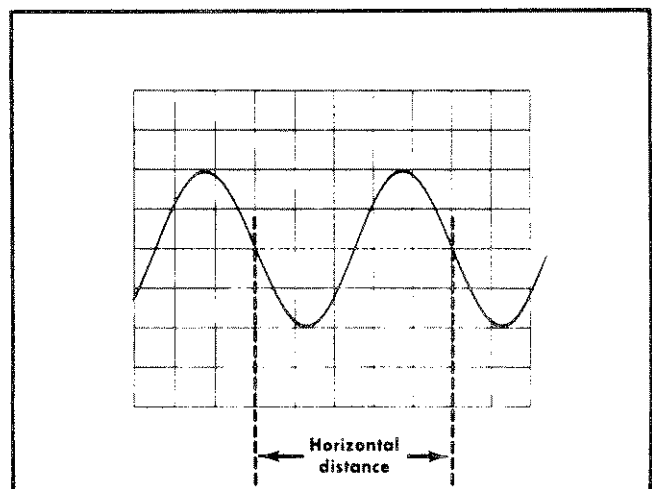

Fig. 1-8. Measuring time duration (period) between points on a waveform.

Risetime Measurement

Risetime measurements employ basically the same techniques as the time-period measurements. The main difference is the points between which the measurement is made. The following procedure gives the basic method of measuring risetime between the 10% and 90% points of the waveform.

1. Connect the signal to the input connector.
2. Set the Volts/Div switch and variable Volts/Div control to produce a display exactly five divisions in amplitude.
3. Center the display about the center horizontal line with the vertical Position control.
4. Set the time-base triggering controls to obtain a stable display. Set the Sec/Div switch to the fastest sweep rate that will display less than eight divisions between the 10% and 90% points on the waveform (see Fig. 1-9).
5. Adjust the horizontal Position control to move the 10% point of the waveform to the second vertical line of the graticule.
6. Measure the horizontal distance between the 10% and 90% points. Be sure the variable Sec/Div control is in the Cal position.
7. Multiply the distance measured in step 6 by the setting of the Sec/Div switch.

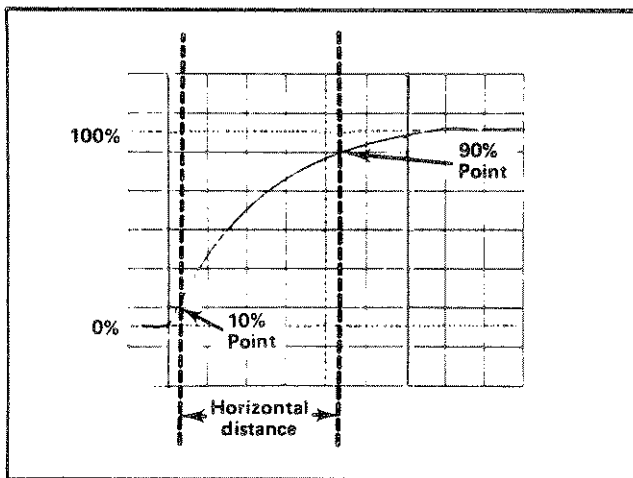

Fig. 1-9. Measuring risetime.

EXAMPLE: Assume that the horizontal distance between the 10% and 90% points is four divisions and the Sec/Div switch is set to $1 \mu\text{s}$.

Using the period formula to find risetime:

$$\text{Risetime period} = \frac{\text{horizontal distance}}{\text{(divisions)}} \times \frac{\text{Sec/Div switch setting}}{\text{setting}} = (4) (1 \mu\text{s}) = 4 \mu\text{s}$$

The risetime is 4 microseconds.

Time Difference Measurements

When used in conjunction with a calibrated time-base plug-in unit, the multi-trace feature of the 5400-series oscilloscope permits measurement of time difference between two or more separate events. To measure time difference, use the following procedure:

1. Set the input coupling switches of the amplifier channels to either ac or dc.
2. Set the Display switch on the time-base unit to either Chop or Alt. In general, Chop is more suitable for low-frequency signals. More information on determining the mode is given under Vertical Display Mode in this section.
3. Set the vertical plug-in triggering switches to trigger the display on Channel 1 (or left plug-in) only.
4. Connect the reference signal to the Channel 1 input connector and the comparison signal to the Channel 2 (or center plug-in) input connector. The reference signal should precede the comparison signal in time. Use coaxial cables or probes which have similar time-delay characteristics to connect the signal to the input connectors.

5. If the signals are of opposite polarity, invert the Channel 2 (or center plug-in) display. (Signals may be of opposite polarity due to 180° phase difference; if so, take this into account in the final calculation.)

6. Set the Volts/Div switches to produce about four divisions of display waveform.

7. Set the time-base triggering controls for a stable display. Set the Sec/Div switch for a sweep rate which shows three or more divisions between the measurement points, if possible.

8. Adjust the vertical Position controls to bring the measurement points to the center horizontal reference line.

Operating Information—5440

9. Adjust the horizontal Position control so the Channel 1 (or left plug-in) waveform (reference) crosses the center horizontal line at a vertical graticule line.

10. Measure the horizontal distance between the two measurement points (see Fig. 1-10).

11. Multiply the measured distance by the setting of the Sec/Div switch.

EXAMPLE: Assume that the Sec/Div switch is set to $50 \mu\text{s}$ and the horizontal distance between measurement points is four divisions. Using the formula:

$$\begin{array}{l} \text{Time} \\ \text{Delay} \end{array} = \begin{array}{l} \text{Sec/Div} \\ \text{switch} \end{array} \times \begin{array}{l} \text{horizontal} \\ \text{distance} \\ \text{(divisions)} \end{array} = (50 \mu\text{s}) (4) = 200 \mu\text{s}$$

The time delay is 200 microseconds.

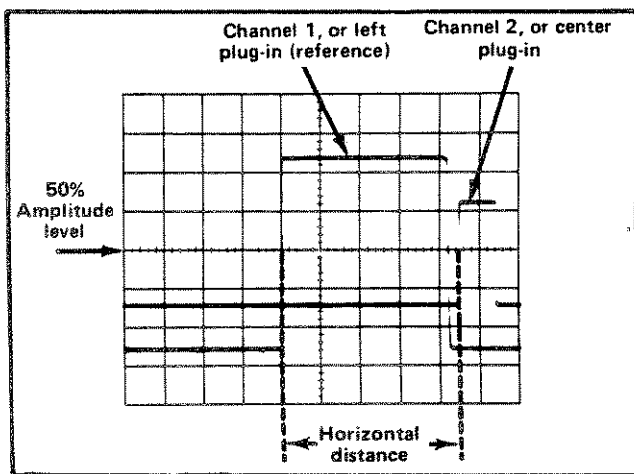

Fig. 1-10. Measuring time difference between two pulses.

Multi-trace Phase Difference Measurement

Phase comparison between two or more signals of the same frequency can be made using a dual-trace plug-in or two single-trace plug-ins. This method of phase difference measurement can be used up to the frequency limit of the vertical system. To make the comparison, use the following procedure:

1. Set the input coupling switches of the amplifier channels to either ac or dc.

2. Set the Display switch on the time-base unit to either Chop or Alt. In general, Chop is more suitable for low-frequency signals and the Alt position is more suitable for high-frequency signals. More information on determining the mode is given under Vertical Display Mode in this section.

3. Set the vertical plug-in triggering switches to trigger the display on Channel 1 (or left plug-in) only.

4. Connect the reference signal to the Channel 1 input connector and comparison signal to the Channel 2 (or center plug-in) input connector. The reference signal should precede the comparison signal in time. Use coaxial cables or probes which have similar time-delay characteristics to connect the signals to the input connectors.

5. If the signals are of opposite polarity invert the Channel 2 (or center plug-in) display. (Signals may be of opposite polarity due to 180° phase difference; if so, take this into account in the final calculation.)

6. Set the Volts/Div switches and the variable Volts/Div controls so the displays are equal and about five divisions in amplitude.

7. Set the time-base triggering controls to obtain a stable display. Set the Sec/Div switch to a sweep rate which displays about one cycle of the waveform.

8. Move the waveforms to the center of the graticule with the vertical Position controls.

9. Turn the variable Sec/Div control until one cycle of the reference signal (Channel 1, or left plug-in) occupies exactly eight divisions between the second and tenth vertical lines of the graticule (see Fig. 1-11). Each division of the graticule represents 45° of the cycle ($360^\circ \div 8 \text{ divisions} = 45^\circ/\text{division}$). The sweep rate can be stated in terms of degrees as $45^\circ/\text{division}$.

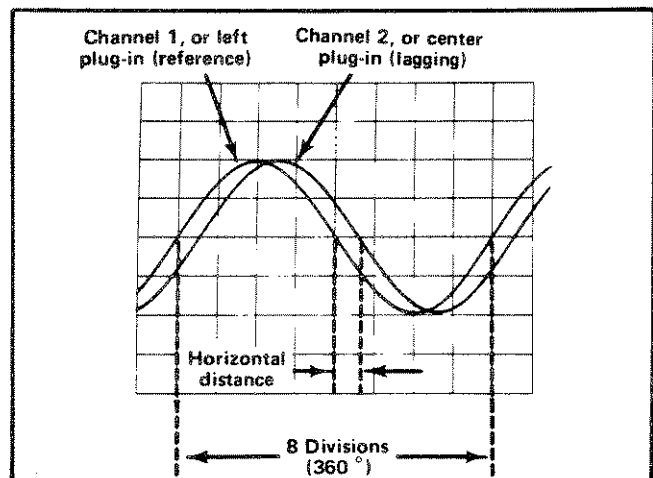

Fig. 1-11. Measuring phase difference.

10. Measure the horizontal difference between corresponding points on the waveforms.

11. Multiply the measured distance (in divisions) by 45°/division (sweep rate) to obtain the exact amount of phase difference.

EXAMPLE: Assume a horizontal difference of 0.6 division with a sweep rate of 45°/division as shown in Fig. 1-11. Use the formula:

$$\text{Phase Difference} = \frac{\text{horizontal difference (divisions)}}{\text{sweep rate (degrees/division)}} = (0.6) (45^\circ) = 27^\circ$$

The phase difference is 27°.

High Resolution Phase Measurement

More accurate dual-trace phase measurements can be made by increasing the sweep rate (without changing the variable Sec/Div control setting). One of the easiest ways to increase the sweep rate is with the Swp Mag (10X) button on the time-base unit. The magnified sweep rate is automatically indicated by the crt readout and knob-skirt scale-factor readout.

EXAMPLE: If the sweep rate were increased 10 times with the magnifier, the magnifier sweep rate should be 45°/division ÷ 10 = 4.5°/division. Fig. 1-12 shows the same signals as used in Fig. 1-11, but with the Swp Mag button pushed in. With a horizontal difference of six divisions the phase difference is:

$$\text{Phase Difference} = \frac{\text{horizontal difference (divisions)}}{\text{magnified sweep rate (degrees/division)}} = (6) (4.5^\circ) = 27^\circ$$

The phase difference is 27°.

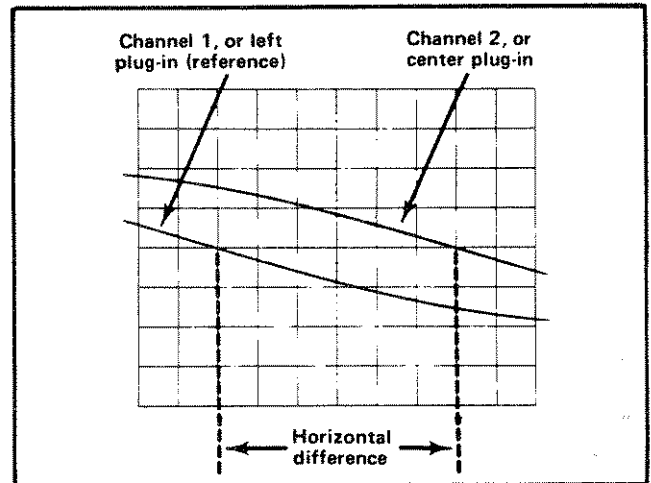

Fig. 1-12. High-resolution phase difference measurement with increased sweep rate.



10

SPECIFICATION AND PERFORMANCE CHECK

The electrical specifications are valid only if (1) the instrument has been calibrated at an ambient temperature between +20°C and +30°C; (2) the instrument is operating at an ambient temperature between 0°C and +50°C, unless otherwise noted; (3) each plug-in must be operating (fully installed) in a calibrated system.

SPECIFICATION

TABLE 2-1
Vertical Amplifier

Characteristics	Performance Requirements	Supplemental Information
Input Signal Amplitude (Differential)		50 mV/division $\pm 2\%$. Less than 0.5% difference between left and right vertical plug-in compartments.
Bandwidth (6-Division Reference)	Dc to at least 85 MHz with a 067-0680-00 Calibration Fixture. Dc to at least 50 MHz with a calibrated 5A48.	
Risetime (6-Division Reference)	4.0 ns or less with a 067-0680-00 Calibration Fixture. 7 ns or less with a calibrated 5A48.	
Aberrations (6-Division Reference)	5% or less measured with a 067-0680-00 Calibration Fixture. 4% or less measured with a calibrated 5A48.	
Position Effect on Aberrations (6-Division Reference with a 067-0680-00 Calibration Fixture)		Front corner aberrations of +step or -step response signal should not exceed $\pm 5\%$ when the waveform is positioned not more than 1 division beyond graticule center.
Vertical Centering		Within ± 0.5 division of graticule center.
Delay Line Length		140 ns.
Modes	Chop and Alt.	
Rate		
Chop		50 kHz +50% -30%; 3 μ s on, 2 μ s off.
Alt	Once every two sweeps.	

TABLE 2-2
Horizontal Amplifier

Characteristics	Performance Requirements	Supplemental Information
Bandwidth	Dc to at least 2 MHz. 8-division signal used as a reference.	
Horizontal Centering		Within 0.5 division of graticule center.
X-Y Operation	Less than 2° phase shift from dc to at least 20 kHz.	

TABLE 2-3
Z-Axis Amplifier

Characteristics	Performance Requirements	Supplemental Information
External Input		
Input Voltage	+5 V turns crt beam on from off condition. -5 V turns crt beam off from on condition.	
Usable Frequency Range	Dc to 2 MHz.	
Input Impedance		Resistance: 10 kΩ. Capacitance: 40 pF.
Maximum Safe Input	50 V (dc + peak ac).	

TABLE 2-4
Display

Characteristics	Performance Requirements	Supplemental Information
Geometry	Bowing or tilt ≤ 0.1 division.	
Orthogonality	90° $\pm 0.7^\circ$.	
Photographic Writing Rate	90 cm/ μ s, using a C-59 camera and Polaroid 3000 speed film.	
Phosphor	P31 standard; P7 and P11 optional.	
Deflection	Electrostatic, with mesh magnification.	
Acceleration Potential	15 kV.	

TABLE 2-5
Power Supply and Calibrator

Characteristics	Performance Requirements	Supplemental Information
Power Line Input		
Line Voltage (RMS)	Nominal 100 V, 110 V, 120 V, 200 V 220 V, 240 V $\pm 10\%$.	
Line Frequency	50 to 400 Hz.	
Input Power	100 W maximum at 120 V ac, 60 Hz.	
Fuse Data	1.25 A slow blow (120 V ac). 0.7 A slow blow (240 V ac).	
Calibrator		
Voltage	400 mV, $\pm 1\%$.	
Current	4 mA, $\pm 1\%$.	
Frequency	Twice the power line frequency.	

TABLE 2-6
Readout

Characteristics	Performance Requirements	Supplemental Information
Intensity Range	Off to full brightness. Readout inoperative when READOUT INTENS fully counterclockwise in detent position.	
Location		Top words are displayed in top major graticule division between left and right extreme graticule lines. Bottom words are displayed in bottom major graticule division between left and right extreme graticule lines.

TABLE 2-7
Miscellaneous

Characteristics	Description	
Graticule		
Scale	8 x 10 divisions with 1.22 cm/Div.	
Scale Color and Type		
Normal	White internal graticule lines.	
Optional	Black internal graticule lines.	
Beam Finder	Brings trace within viewing area and intensifies trace.	

TABLE 2-8
Environmental

Characteristics	Description
Temperature	
Operating	0°C to +50°C.
Storage	-40°C to +70°C.
Altitude	
Operating	To 15,000 feet.
Storage	To 50,000 feet.
Vibration	
Operating and Non-Operating	With the instrument complete and operating, vibration frequency swept from 10 to 50 to 10 Hz at 1 minute per sweep. Vibrate 15 minutes in each of the three major axes at 0.015" total displacement. Hold 3 minutes at any major resonance, or if none, at 50 Hz. Total time, 54 minutes.
Shock	
Operating and Non-Operating	30 g's, 1/2 sine, 11 ms duration, 2 shocks in each direction along 3 major axes for a total of 12 shocks.
Transportation	Qualified under National Safe Transit Committee Test Procedure 1A, Category II.

TABLE 2-9
Physical

Characteristics	Description
Finish	Anodized aluminum panel with gray vinyl coated frame. Blue-vinyl coated cabinet.
Net Weight of Cabinet Version with Feet and Handle	25 lbs (11 kg).
Overall Dimensions	See Fig. 2-1.
Overall rack depth	19.5 inches.

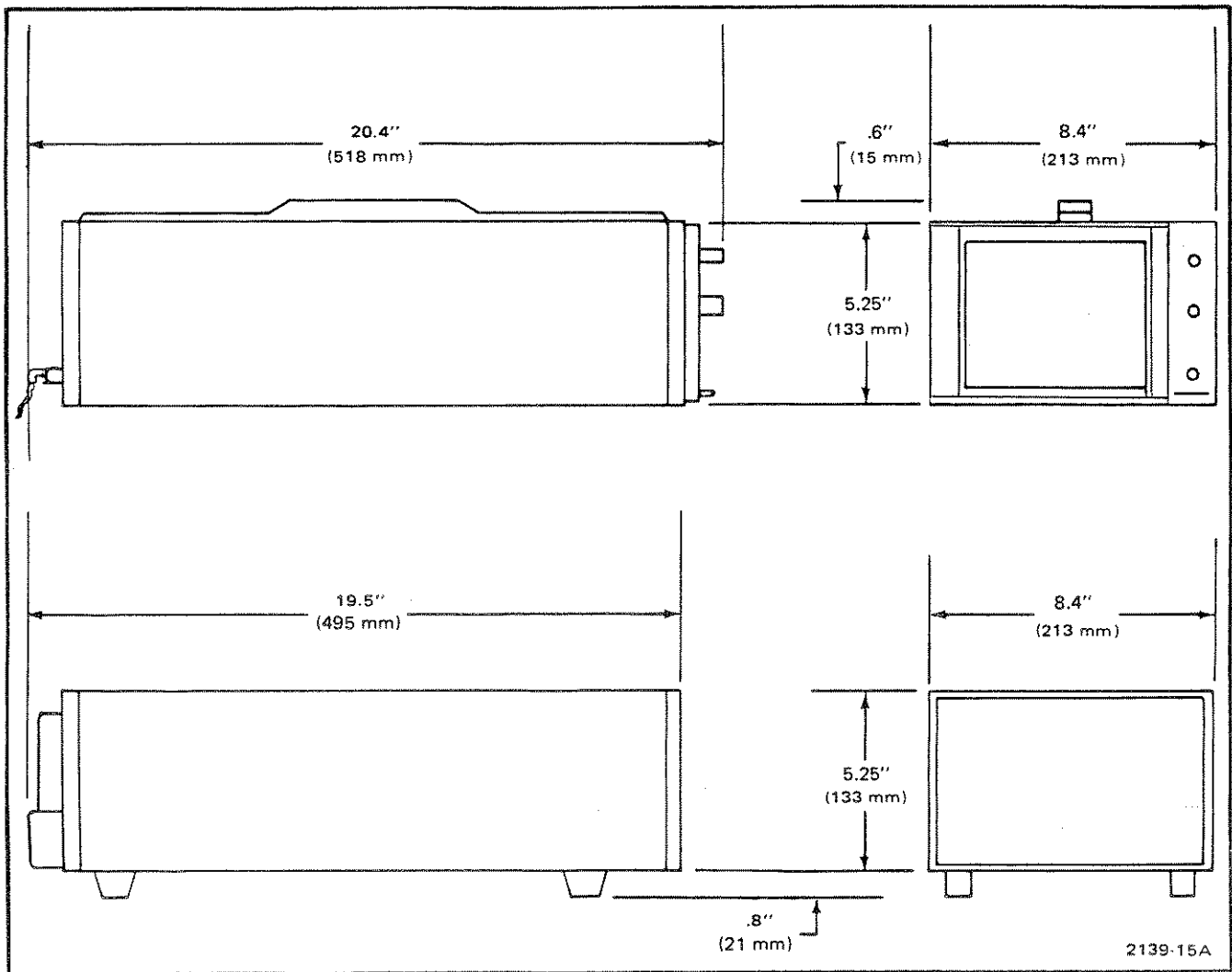

Fig. 2-1. Illustration showing dimensions of the cabinet version of the 5440.

POWER TO EXTERNAL EQUIPMENT

With the plug-in units removed from the Oscilloscope, the unused power capability of the Oscilloscope power supplies may be used to operate external electronic equipment. The recommended access to the power supplies is through the Main Interface circuit board. Special equipment is available from Tektronix, Inc. to facilitate connection to the individual power supply voltages. Order the equipment through your local Tektronix Field Office or representative.

Table 2-10 lists the maximum current draw and Main Interface pin assignment for only those power supply voltages recommended for operating external electronic equipment.

TABLE 2-10
Power Available to External Equipment

Power Supply Voltage	Maximum Current	Main Interface Pin Number
+200 V	30 mA	A1
+30 V	240 mA	A5
+15 V	600 mA	A6
+5 V	1.5 A	B2
-15 V	600 mA	B6
-30 V	240 mA	B5

PERFORMANCE CHECK

Introduction

This procedure checks the 5440 electrical characteristics against the performance requirements that appear in the Specification section of this manual. If the instrument fails to meet the requirements given in this performance check, the adjustment procedure should be performed. This procedure can also be used by an incoming inspection facility to determine acceptability of performance.

Tolerances that are specified in this performance check procedure apply to the instrument under test and do not include test equipment error.

Test Equipment Required

The following test equipment, or equivalent, is required to perform the performance check and adjustment procedure. Test equipment characteristics listed are the minimum required to verify the performance of the equipment under test. Substitute equipment must meet or exceed the stated requirements. All test equipment is assumed to be operating within tolerance.

Special test devices are used where necessary to facilitate the procedure. Most of these are available from Tektronix, Inc. and can be ordered through your local Tektronix Field Office or representative.

TABLE 2-11

List of Test Equipment Requirements

Description	Performance Requirements	Application	Examples
Digital Voltmeter ¹	Range, zero to 200 volts; accuracy, within 0.1%	LV power supply check and adjustment.	a. Tektronix DM 501A Option 2 Digital Multimeter. ²
DC voltmeter (vom) ¹ With Test Leads	Range, zero to 3000 volts; accuracy, checked to within 1% at 3000 volts.	HV power supply check.	a. Valhalla Model 4500 H.V. Digital Multimeter. Tektronix part number 003-0120-00 test leads.
Calibration generator	Amplitude calibration, 10 mV to 1 V; accuracy, $\pm 0.25\%$ into 1M Ω output, square wave at approximately 1 kHz.	Vert and horiz gain check and adjustment.	a. Tektronix PG 506 Calibration Generator. ²
Time-mark generator	Marker outputs, 5 ns and 10 ns; accuracy, within 1%.	Sweep timing checks and adjustment at 5 and 10 ns.	a. Tektronix TG 501 Time-Mark Generator. ²
Pulse generator	Pulse duration, 10 ns or less; pulse amplitude, .5 V to at least 5 V into 50 Ω load.	Vert compensation check and adjustment.	a. Tektronix PG 501 Pulse Generator. ²
Medium-frequency signal generator	Sinewave output, to at least 500 MHz, leveled; output amplitude 5 V p-p; accuracy, 2%.	Vertical band-width check.	a. Tektronix SG 503 Signal Generator. ²

TABLE 2-11 (cont.)

List of Test Equipment Requirements

Description	Performance Requirements	Application	Examples
Amplifier plug-in unit. ³	Bandwidth, dc to 500 MHz; display mode, CH 1 and dual-trace; deflection factor, 5 mV to 10 V/div.	Vert and Horiz gain check and adjustment.	a. Tektronix 5A48 Amplifier plug-in unit.
Time-base unit	Sweep rate, at least 10 ns/div.	Sweep timing check and adjustment. Used to provide sweep throughout procedure.	a. Tektronix 5B42 Time-Base unit.
Calibration fixture	Produces gain-check and pulse-response waveforms.	Vert and Horiz gain check and adjustment.	a. Tektronix Calibration Fixture 067-0680-00.
Coaxial cable (2 required)	Impedance, 50Ω; length, 42 inch; connectors, bnc.	Provides signal interconnection.	a. Tektronix part 012-0057-01.
1X passive probe	Compatible with 5A-series amplifiers used in the oscilloscope.	Calibrator signal check.	a. Tektronix P6101A Probe.
Termination	Impedance, 50Ω; accuracy, within 2%; connectors, bnc.	Vert check and adjustment.	a. Tektronix part 011-0049-01.
T-connector	Connectors, bnc.	External Z-axis amplifier check.	a. Tektronix part 103-0030-00.
Screwdriver	3-inch shaft, 3/32 inch bit.	Adjustments.	a. Xcelite R3323.

¹Required only for Adjustment procedure. A high-voltage probe can be used with the DM501A in lieu of the DC voltmeter. Order 010-0277-00.

²Requires TM 500-Series Power Module.

³ Additional amplifier, such as 5A38 required to check dual amplifier operation.

Preliminary Procedure

1. Ensure that the line voltage selector block has been installed on the correct line selector pins on the Low Voltage and Calibrator circuit board and that the regulating range includes the applied line voltage. Refer to the Operating Voltage section of this manual.

2. Ensure that all test equipment is suitably adapted to the applied line voltage.

3. If applicable, install the TM 500-series test equipment into the test equipment Power Module.

4. Install a vertical amplifier unit into the left vertical compartment of the 5440.

5. Install a time-base unit in the horizontal compartment of the 5440.

6. Connect the equipment under test and the test equipment to a suitable line voltage source. Turn all equipment on and allow at least 20 minutes for the equipment to stabilize.

Specification and Performance Check—5440

Initial Control Settings

Set the following controls during warm-up time:

Oscilloscope

Intensity, Focus Set for well-defined trace
and normal brightness.

Amplifier Plug-In

Display On.
Position Centered.
CH 1 Volts/Div .1
CH 1 Cal Fully clockwise.
CH 1 Input coupling Dc.
Trigger CH 1.
Mode CH 1.

Time Base Plug-In

Display Alternate.
Position Centered.
Main Sec/Div 1 ms.
Main Variable Cal.
Swp Mag Off.
Triggering + Slope,
Auto Trig,
AC Coupl.
Trig Source Left.

PERFORMANCE CHECK PROCEDURE

1. Check Trace Alignment

- a. Position the horizontal trace over the center horizontal graticule line.
- b. CHECK—For alignment error of .1 division or less.
- c. Press the POWER switch to turn off the Oscilloscope.
- d. Interchange the amplifier and time-base units in their respective compartments. Pull the POWER switch to on.
- e. Position the vertical trace over the center vertical graticule line.
- f. CHECK—For alignment error of .1 division or less.

2. Check Geometry

- a. Set the FOCUS and INTENSITY controls for a well-defined trace, extending vertically above and below the graticule area.
- b. CHECK—Vertical bowing and tilt of the trace display is less than .1 division when positioned horizontally across the entire graticule area.
- c. Press the POWER switch to turn off the Oscilloscope and interchange the amplifier and time-base units.
- d. Pull the POWER switch to on.

3. Check Beam Finder

- a. Press the BEAM FINDER switch.
- b. CHECK—The display is compressed within the graticule area and is intensified.
- c. Press and hold the BEAM FINDER switch in, then rotate the position control of the vertical amplifier and the time-base unit fully clockwise and counterclockwise.
- d. CHECK—The display is compressed within the graticule area and is intensified.

4. Check Trigger Amplifier

- a. Connect a 50 MHz sine-wave signal from the MF (Medium Frequency) generator to the vertical amplifier input, using a 42 inch bnc cable and a 50 ohm termination.
- b. Set the vertical amplifier and generator controls to obtain a signal amplitude of 1 major division.
- c. Set the time-base unit for 20 ns/div (SWP MAG on) and adjust the trig level control for a stable display.
- d. CHECK—That a stable display can be obtained.
- e. Press the POWER switch to turn off the Oscilloscope and change the amplifier from the left vertical compartment to the center compartment.
- f. Pull the POWER switch to on, select the right trigger source, and repeat parts b through d of this step.

g. Disconnect the bnc cable and termination from the vertical amplifier input connector and release the SWP MAG pushbutton.

5. Check Alternate Operation

- a. Push both CH 1 and CH 2 pushbuttons in.
- b. Set the time-base unit for 10 ms/div and position the traces about two divisions apart.
- c. Turn the time-base Sec/Div switch throughout its range.
- d. CHECK—Trace alternation at all sweep rates (except AMP position). At faster sweep rates, alternation is not apparent; instead, display appears as two traces on the screen.
- e. Press the POWER switch to turn off the Oscilloscope and change the amplifier from the center vertical compartment to the left compartment.
- f. Pull the POWER switch on and repeat parts a through d of this step.

6. Check Chop Operation

- a. Push the CHOP button in on the time-base unit.
- b. Turn the time-base Sec/Div switch throughout its range.
- c. CHECK—For dual-trace display at all sweep rates, without alteration (except AMP position).
- d. Press the POWER switch to turn off the Oscilloscope and change the amplifier from the left vertical compartment to the center compartment.
- e. Pull the POWER switch to on and repeat parts a, b, and c of this step.

7. Check Alternate Operation Between Amplifiers

- a. Install a second vertical dual-trace plug-in unit in the left plug-in compartment and set its controls for dual-trace operation.
- b. Set the time-base Chop pushbutton to its out position and the Sec/Div switch to 20 ms/div.

c. CHECK—For two traces for the left amplifier (one for each channel), then two traces for the center amplifier, alternately. (If a single-channel amplifier is used instead of the second dual-trace amplifier, the single-channel trace will appear twice for each alternation.)

d. Press the POWER switch to turn off the Oscilloscope and interchange the two vertical amplifiers in their respective compartments. Remove the vertical amplifier from the center compartment. Pull the POWER switch to on.

NOTE

The 5A48 is used for the vertical system performance procedure. When a different amplifier plug-in is used to verify vertical specifications, the oscilloscope system frequency response may be degraded.

8. Check Vertical Gain

- a. Connect a 1 kHz square-wave signal from the calibration Generator to the amplifier input, using a 42-inch bnc cable. Set the time-base Sec/Div to 1 ms.
- b. Set the amplifier and generator controls to obtain a five-volt reference signal. Center the display.
- c. CHECK—The crt display for a vertical deflection of 5 divisions ± 0.15 division ($\pm 3\%$).
- d. Press the POWER switch to turn off the Oscilloscope and remove the amplifier from the left vertical compartment and install it in the center compartment. Pull the POWER switch to on.
- e. CHECK—The crt display for a vertical deflection of 5 divisions ± 0.15 division ($\pm 3\%$).
- f. Disconnect the bnc cable from the 5A48 input connector.

9. Check Vertical Compensation

- a. Set the amplifier CH 1 VOLTS/DIV switch to .1. Connect the pulse generator to the CH 1 input connector with the 42 inch cable and a 50 ohm termination.
- b. Set the time-base unit for a calibrated sweep rate of 20 ns/div and triggering for auto mode, ac coupled, and RIGHT trigger source. Adjust the trigger level control for a stable display, triggered on the rising portion of a 1 MHz pulse. Center the pulse horizontally on the graticule.

Specification and Performance Check—5440

c. CHECK—For optimum square leading corner and flat top on a 5-division displayed pulse with aberrations not to exceed +0.15 or -0.15 division, with total peak-to-peak aberrations not to exceed 0.15 division.

d. Press the POWER switch to turn off the Oscilloscope and install the amplifier in the left compartment. Pull the POWER switch to on.

e. Push in the LEFT Trigger Source button. Adjust trigger level control for a stable display, triggered on the rising portion of the pulse. Center the pulse horizontally on the graticule.

f. CHECK—For optimum square leading corner and flat top on a 5-division displayed pulse with aberrations not to exceed +0.15 or -0.15 division, with total peak-to-peak aberrations not to exceed 0.15 division.

10. Check Vertical Bandwidth

a. Disconnect the bnc cable from the pulse generator and connect it to the output connector of the MF generator.

b. Set the amplifier VOLTS/DIV switch to .1 and adjust the MF generator controls for a 6-division display, at a frequency of 50 kHz. Center the display on the graticule.

c. Set the time-base unit for a sweep rate of 10 μ s/div.

d. Without changing the output amplitude, increase the generator frequency until the displayed amplitude is reduced to 4.2 divisions.

e. CHECK—The generator for a reading of at least 50 megahertz.

f. Press the POWER switch to turn off the Oscilloscope and install the amplifier in the center compartment. Pull the POWER switch to on.

g. Repeat parts b through e for the center vertical compartment.

h. Disconnect the bnc cable and termination from the amplifier input connector.

NOTE

The 5A48 amplifier is used for the horizontal system adjustment procedure. When a different amplifier plug-in is used to verify horizontal specifications, the amplifier frequency must be considered.

11. Check Horizontal Gain

a. Press the POWER switch to turn off the Oscilloscope and interchange the amplifier and the time-base units in their respective compartments. Pull the POWER switch to on.

b. Connect a 1 kHz square-wave signal from the Calibration Generator to the amplifier input connector, using a 42 inch bnc cable.

c. Set the amplifier and generator controls to obtain a five-volt reference signal. Center the display between the second and seventh vertical graticule lines.

d. CHECK—The crt display for a horizontal deflection of 5 divisions \pm 0.15 division.

e. Disconnect the bnc cable from the amplifier input connector.

12. Check Horizontal Bandwidth

a. Connect a 50 kHz sine-wave signal from the MF generator to the amplifier input, using a 42 inch bnc cable and 50 ohm termination.

b. Set the amplifier and generator controls to obtain a 6-division display. Center the display between the second and eighth vertical graticule lines.

c. Without changing the output amplitude, increase the generator frequency until the displayed amplitude is reduced to 4.2 divisions.

d. CHECK—The generator for a reading of at least 2 megahertz.

e. Press the POWER switch to turn off the Oscilloscope and interchange the amplifier and the time-base units in their respective compartments. Pull the POWER switch to on.

13. Check 10 ns Timing

NOTE

A 5B42 time-base or a time-base having a 10 ns sweep must be used.

a. Disconnect the bnc cable and 50 ohm termination from the amplifier input connector and connect the time-mark generator signal to the input connector.

b. Set the time-mark generator for 10 nanosecond markers. Set the deflection factor of the amplifier so the markers are at least five divisions in amplitude.

c. Set the time-base unit for a sweep rate of 10 ns/div. Adjust the time-base triggering control for a stable display.

d. CHECK—For one 10 nanosecond marker per division over the center eight graticule divisions of the display (position as necessary). Sweep accuracy is $\pm 5\%$ over the entire sweep, excluding the first 30 and the last 100 ns of the magnified sweep.

14A. Check 5 ns Timing with a 5B42

a. Set the time-mark generator for 5 ns markers.

b. Adjust the time-base triggering control for a stable display.

c. CHECK—For 5 ns marker per division over the center eight graticule divisions of the display (position as necessary). Sweep accuracy is $\pm 6\%$ over the entire sweep, excluding the first 30 and the last 100 ns of the magnified sweep.

d. Disconnect all cables.

14B. Check 5 ns Timing with a 5B44

NOTE

This step can be performed only with a time-base unit having a 5 ns sweep rate, such as Tektronix 5B44.

a. Press the POWER switch to turn off the Oscilloscope and install an appropriate time-base unit in the horizontal compartment. Pull the POWER switch to on.

b. Set the time-base unit for a sweep rate of 5 ns/div. Adjust the time-base triggering control for a stable display.

c. CHECK—For one 5 nanosecond marker per division over the center eight graticule divisions of the display (position as necessary). Sweep accuracy is $\pm 6\%$ over the entire sweep, excluding the first 30 and the last 100 ns of the magnified sweep.

d. Disconnect all cables.

NOTE

If the Readout System was deleted from the instrument (Option 1), omit step 15.

15. Check Readout Modes

a. Set the time-base unit for a free-running sweep.

b. Set the READOUT INTENSITY control for a visible readout display.

c. Select dual-trace operation on the amplifier.

d. CHECK—That the characters are displayed at the top and bottom of the crt. Characters do not touch or overlap and they correlate to the respective volts/div dial settings.

e. Rotate both CH 1 and CH 2 CAL controls counterclockwise.

f. CHECK—That a > symbol is displayed at the left of the readout character. Return the CAL controls to the calibrated position (fully clockwise).

g. Rotate the time-base MAIN SEC/DIV control throughout its range.

h. CHECK—That the characters are displayed at the top-center of the crt. Characters do not touch or overlap and they correlate to the respective s/div dial settings.

i. Rotate the MAIN VARIABLE control counterclockwise.

Specification and Performance Check—5440

j. CHECK—That a > symbol is displayed at the left of the readout character. Return the control to the calibrated position (fully clockwise).

k. Push the DLY'D SWP pushbutton in on the time-base unit.

l. CHECK—That characters are displayed at the top-right of the crt and that characters do not touch or overlap and they correlate to the dly'd swp s/div dial settings.

m. Push the Display Mode button to MAIN SWP.

16. Check Calibrator Signal

a. Connect the 1X probe to the CH 1 input of the amplifier. Connect the probe tip to the calibrator loop.

b. Set the amplifier CH 1 Volts/Div switch to .1, and select CH 1.

c. Set the time-base sweep rate to 5 ms/div.

d. CHECK—The crt display for a vertical deflection of 4 divisions ± 0.04 division.

e. Disconnect the 1X probe.

17. Check Z Axis Amplifier

a. Connect a 50 kHz sine-wave signal from the generator to the amplifier input connector (use a bnc T connector at the amplifier input), using a 42 inch bnc cable.

b. Set the amplifier and generator controls to obtain a calibrated five volt reference display.

c. Set the time-base unit for auto, internal triggering at a sweep rate of 10 μ s/div.

d. Connect the signal from the output of the T connector at the amplifier input to the EXT INTENSITY INPUT connector on the rear panel.

e. CHECK—The bottom portion of the waveform is blanked out (reduce trace brightness to observe Z axis modulation).

f. Turn off all equipment and remove all plug-ins and cables.

This completes the Performance Check of the 5440 Oscilloscope.