



**PLEASE CHECK FOR CHANGE INFORMATION
AT THE REAR OF THIS MANUAL.**

**7603/R7603
OSCILLOSCOPE
OPERATORS**

INSTRUCTION MANUAL

**Tektronix, Inc.
P.O. Box 500
Beaverton, Oregon 97077**

070-1310-00
Product Group 42

Serial Number _____

First Printing JUN 1972
Revised OCT 1984

Copyright © 1972 Tektronix, Inc. All rights reserved.
Contents of this publication may not be reproduced in any
form without the written permission of Tektronix, Inc.

Products of Tektronix, Inc. and its subsidiaries are covered
by U.S. and foreign patents and/or pending patents.

TEKTRONIX, TEK, SCOPE-MOBILE, and  are
registered trademarks of Tektronix, Inc. TELEQUIPMENT
is a registered trademark of Tektronix U.K. Limited.

Printed in U.S.A. Specification and price change privileges
are reserved.

INSTRUMENT SERIAL NUMBERS

Each instrument has a serial number on a panel insert, tag,
or stamped on the chassis. The first number or letter
designates the country of manufacture. The last five digits
of the serial number are assigned sequentially and are
unique to each instrument. Those manufactured in the
United States have six unique digits. The country of
manufacture is identified as follows:

B000000	Tektronix, Inc., Beaverton, Oregon, USA
100000	Tektronix Guernsey, Ltd., Channel Islands
200000	Tektronix United Kingdom, Ltd., London
300000	Sony/Tektronix, Japan
700000	Tektronix Holland, NV, Heerenveen, The Netherlands

TABLE OF CONTENTS

	Page
OPERATING INSTRUCTIONS	
Operating Checkout	1-3
Controls and Connectors	1-4
Simplified Operating Instructions	1-7
General Operating Information	1-9
SPECIFICATIONS	
Electrical	2-1
Environmental and Physical	2-6
System Specification	2-7
RACKMOUNTING INSTRUCTIONS	
Dimensional Drawing	3-5

OPERATORS SAFETY SUMMARY

The general safety information in this part of the summary is for both operating and servicing personnel. Specific warnings and cautions will be found throughout the manual where they apply, but may not appear in this summary.

TERMS

In This Manual

CAUTION statements identify conditions or practices that could result in damage to the equipment or other property.

WARNING statements identify conditions or practices that could result in personal injury or loss of life.

As Marked on Equipment

CAUTION indicates a personal injury hazard not immediately accessible as one reads the marking, or a hazard to property including the equipment itself.

DANGER indicates a personal injury hazard immediately accessible as one reads the marking.

SYMBOLS

In This Manual



This symbol indicates where applicable cautionary or other information is to be found.

As Marked on Equipment



DANGER — High voltage.



Protective ground (earth) terminal.



ATTENTION — refer to manual.

Power Source

This product is intended to operate from a power module connected to a power source that will not apply more than 250 volts rms between the supply conductors or between either supply conductor and ground. A protective ground connection by way of the grounding conductor in the power cord is essential for safe operation.

Grounding the Product

This product is grounded through the grounding conductor of the power module power cord. To avoid electrical shock, plug the power cord into a properly wired receptacle before connecting to the product input or output terminals. A protective ground connection by way of the grounding conductor in the power module power cord is essential for safe operation.

Danger Arising From Loss of Ground

Upon loss of the protective-ground connection, all accessible conductive parts (including knobs and controls that may appear to be insulating) can render an electric shock.

Use the Proper Fuse

To avoid fire hazard, use only the fuse of correct type, voltage rating and current rating as specified in the parts list for your product.

Refer fuse replacement to qualified service personnel.

Do Not Operate in Explosive Atmospheres

To avoid explosion, do not operate this product in an explosive atmosphere unless it has been specifically certified for such operation.

Do Not Operate Without Covers

To avoid personal injury, do not operate this product without covers or panels installed. Do not apply power to the plug-in via a plug-in extender.

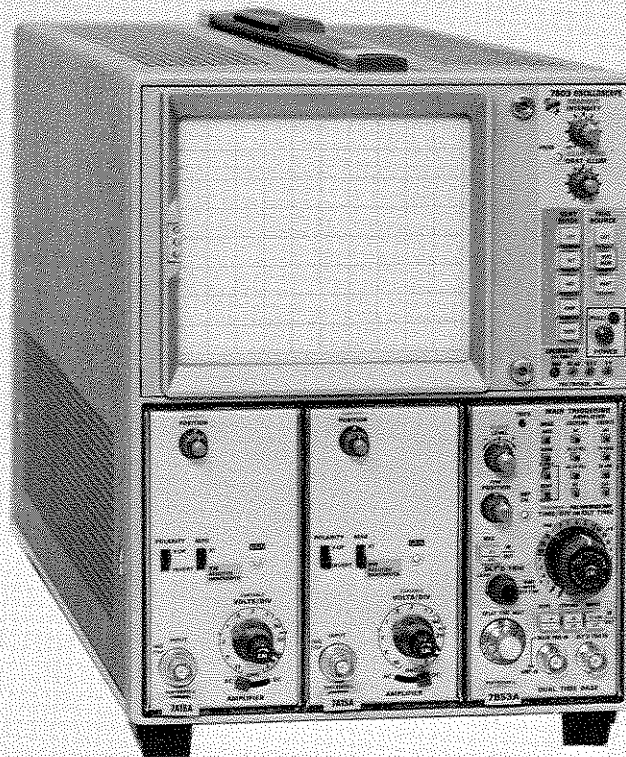

7603 Features

The TEKTRONIX 7603 Oscilloscope is a solid state, light weight instrument designed for general-purpose measuring applications. This instrument has three plug-in compartments that accept TEKTRONIX 7-series plug-in units to form a complete measurement system. The two plug-in compartments on the left are connected to the vertical deflection system. The right plug-in compartment is connected to the horizontal deflection system. Electronic switching between the vertical plug-in compartments allows a multi-trace vertical display. The flexibility of this plug-in feature and the variety of plug-in units available allow this system to be used for many measurement applications. In addition, the instrument contains a readout system to provide a CRT display of alphanumeric information from the plug-in units. Data such as deflection factor, sweep rate, etc. can be encoded and displayed on the CRT.

This instrument features a large-screen, 8 X 10 division display; each division equals 1.22 centimeters. The CRT provides small spot size and fast writing speed. Regulated DC power supplies assure that performance is not affected by variations in line voltage and frequency, or by changes in the load due to the varying power requirements of the plug-in units. Maximum power consumption is about 170 watts (60 hertz, 115-volt line).

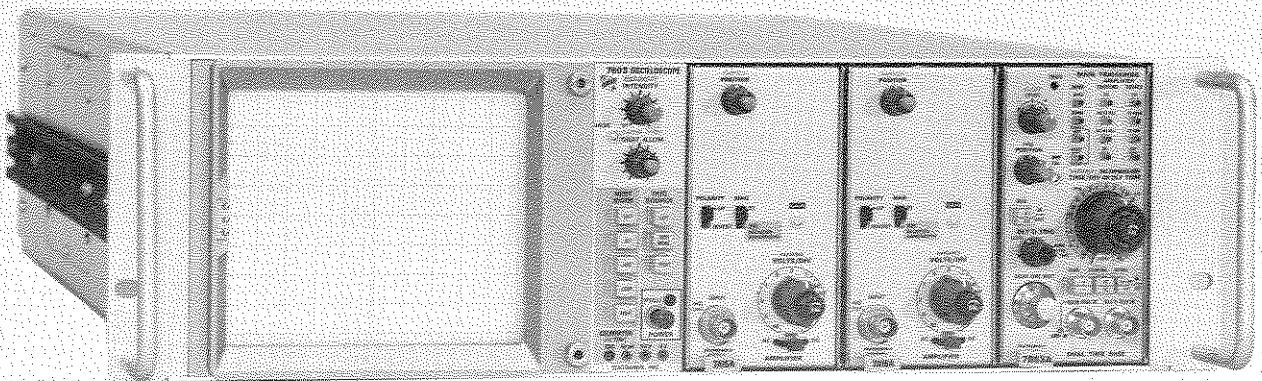

OPERATING INSTRUCTIONS

General

To effectively use the 7603, the operation and capabilities of the instrument must be known. This section describes the operation of the front- and rear-panel controls and connectors and gives simplified and general operating information.

WARNING

For line voltage and fuse selection, refer qualified service personnel to the Service manual for instructions.

PRELIMINARY INFORMATION

Operating Voltage

WARNING

This instrument is designed for operation from a power source with its neutral at or near earth (ground) potential with a separate safety-earth conductor. It is not intended for operation from two phases of a multi-phase system, or across the legs of a single-phase, three-wire system.

The 7603 can be operated from either a 110-volt or a 220-volt nominal line-voltage source.

The 7603 is designed to be used with a three-wire AC power system. If a three- to two-wire adapter is used to connect this instrument to a two-wire AC power system, be sure to connect the ground lead of the adapter to earth (ground). Failure to complete the ground system may allow the chassis of this instrument to be elevated above ground potential and pose a shock hazard.

Operating Temperature

The 7603 can be operated where the ambient air temperature is between 0°C and +50°C. This instrument can be stored in ambient temperatures between -55°C and +75°C. After storage at temperatures beyond the operating limits, allow the chassis temperature to come within the operating limits before power is applied.

The 7603 is cooled by forced air flow through the instrument. Components which require the most cooling are mounted externally on a heat radiator at the rear. Adequate clearance must be provided on all sides to allow heat to be dissipated from the instrument. Do not block or restrict the air flow through the holes in the cabinet or the heat radiator on the rear. Maintain the clearance provided by the feet on the bottom and allow about two inches clearance on the top, sides, and rear (more if possible).

The R7603 is cooled by air drawn in through the air filter on the rear panel and blown out through the holes on the right side. Adequate clearance must be provided at these locations. Allow at least one and one-half inches clearance behind the air filter and at least one inch on the right side.

A thermal cutout in this instrument provides thermal protection and interrupts the power to the instrument if the internal temperature exceeds a safe operating level. Power is automatically restored when the temperature returns to a safe level. Operation in confined areas or in close proximity to heat-producing instruments may cause the thermal cutout to open more frequently.

Operating Position

A bale-type stand is mounted on the bottom of this instrument. This stand permits the 7603 to be tilted up about 10° for more convenient viewing.

Rackmounting

Instructions and dimensional drawings for rackmounting the R7603 are located in Section 3 of the operators manual.

DISPLAY DEFINITIONS

General

The following definitions describe the types of displays which can be obtained with a 7603 Oscilloscope system with real-time amplifiers, time-base units, or combinations of these. Use of special purpose plug-in units may result in different types of displays, which are defined in the instruction manuals for these special units. The following terminology will be used throughout this manual.

Alternate Mode

A time-sharing method of displaying two or more signals with a single cathode-ray tube beam. Channel switching is sequential and occurs at the end of each sweep.

Chopped Mode

A time-sharing method of displaying two or more signals with a single cathode-ray tube beam. Channel switching is sequential and occurs at a rate determined by an internal clock generator (chopping rate).

NOTE

See Simplified Operating Instructions in this section for set-up information to obtain each of the following displays.

Single Trace

A display of a single plot produced by one vertical signal and one sweep.

Dual Trace

A display of two plots produced by two vertical signals and one sweep.

Delayed Sweep — Single Trace

A display of a single plot produced by one vertical signal and a delayed sweep. Two sweeps are used to produce this display; the sweeps are operating with a delaying/delayed relationship where one sweep (identified as the delaying sweep) delays the start of the second sweep (identified as the delayed sweep).

Delayed Sweep — Dual Trace

A display of two plots produced by combining two vertical signals and a delayed sweep. Two sweeps are used to produce this display; the sweeps are operating with a delaying/delayed relationship. Each vertical signal is displayed against the delayed sweep.

X-Y

A plot of two variables, neither of which represents time. X refers to the horizontal axis and Y refers to the vertical axis.

PLUG-IN UNITS

General

The 7603 is designed to accept up to three TEKTRONIX 7-series plug-in units. This plug-in feature allows a variety of display combinations and also allows selection of bandwidth, sensitivity, display mode, etc. to meet the measurement requirements. In addition, it allows the oscilloscope system to be expanded to meet future measurement requirements. The overall capabilities of the resultant system are in large part determined by the characteristics of the plug-in selected. For complete information on plug-ins available for use with this instrument, see the current Tektronix, Inc. catalog.

Plug-In Installation

To install a plug-in unit into one of the plug-in compartments, align the slots in the top and bottom of the plug-in with the associated guide rails in the plug-in compartment. Push the plug-in unit firmly into the plug-in compartment until it locks into place. To remove a plug-in, pull the release latch on the plug-in to disengage it and pull the unit out of the plug-in compartment.

It is not necessary that all of the plug-in compartments be filled to operate the instrument; the only plug-in units needed are those required for the measurement to be made. However, at environmental extremes, excess radiation may be radiated into or out of this instrument through the open plug-in compartments. Blank plug-in panels are available from Tektronix, Inc. to cover the unused compartment; order TEKTRONIX Part No. 016-0155-00.

When the 7603 is calibrated in accordance with the calibration procedure given in the service manual, the vertical and horizontal gain are standardized. This allows calibrated plug-in units to be changed from one plug-in compartment to another without recalibration. However, the basic calibration of the individual plug-in units should be checked when they are installed in this system to verify their measurement accuracy. See the operating instructions section of the plug-in unit instruction manual for verification procedure.

Special purpose plug-in units may have specific restrictions regarding the plug-in compartments in which they can be installed. This information will be given in the instruction manual for these plug-in units.

NOTE

Later production of rackmount oscilloscopes are provided with support posts between the individual plug-in compartments. A post or posts must be removed if a multiwidth plug-in is to be installed. To remove a post, unfasten the screws that secure it at the top and bottom of the plug-in housing.

CONTROLS AND CONNECTORS

The major controls for operation of the 7603 are located on the front panel of the instrument. Fig. 1-1, and 1-2 provide a brief description of each control and connector. More detailed operating information is given under General Operating Information.

OPERATING CHECKOUT

General

The following Operating Checkout provides a means of verifying instrument operation and basic calibration without removing the covers or making internal adjustments. Since it demonstrates the use of all controls and connectors, it can also be used to provide basic training on the operation of this instrument. If re-calibration of the 7603 or plug-in unit appears to be necessary, refer qualified service personnel to the appropriate service manual.

Set-Up Information

1. Set the front-panel controls as follows:

INTENSITY	Counterclockwise
FOCUS	Midrange
BEAM FINDER	Released
GRATICULE ILLUM	As desired
VERT MODE	LEFT
TRIG SOURCE	VERT MODE
POWER	Pushed in

2. Connect the 7603 to a power source which meets the voltage and frequency requirements of this instrument. The applied voltage should be near the center of the voltage range marked on the rear panel (see Operating Voltage in this section for information on converting this instrument from one operating voltage to another).

3. Install TEKTRONIX 7A-series amplifier units into both the left and right vertical plug-in compartments. Install a 7B-series time-base unit into the horizontal compartment.

4. Pull the POWER switch to turn the instrument on. Allow several minutes warmup before proceeding.

5. Set both vertical units for a deflection factor of two volts/division and center the vertical position controls. Set both vertical units for AC input coupling.

6. Set the time-base unit for a sweep rate of one millisecond/division in the auto, internal trigger mode.

7. Advance the INTENSITY control until the trace is at the desired viewing level (near midrange). Advance the READOUT until the readout display is at the desired viewing level.

8. Connect the 4 V calibrator pin-jack to the input of the left vertical unit with a BNC to pin-jack cable (supplied accessory).

Display Focus

9. Adjust the FOCUS control for a sharp, well-defined display over the entire trace length. If a properly focused display cannot be obtained with the FOCUS control, the internal Astigmatism adjustment must be re-set; refer qualified service personnel to service manual.

Trace Alignment

10. Disconnect the input signal and position the trace with the left vertical unit position control so it coincides with the center horizontal line of the graticule. If the trace is not parallel to the center horizontal line of the graticule, refer qualified service personnel to service manual.

Graticule Illumination

11. Rotate the GRAT ILLUM control throughout its range and notice that the illumination of the graticule lines increases as the control is turned clockwise (most obvious with tinted filter installed). Set the control so the graticule lines are illuminated as desired.

Vertical Deflection System

12. Connect the 4 V calibrator signal to the input connector of the left vertical unit with the BNC to pin-jack cable. Set both vertical units for a deflection factor of one volt/division. The display amplitude should be four divisions. Note the exact display amplitude for step 15.

13. Notice that the position control of only the left vertical unit has an effect on the position of the display. Position the display to the upper half of the graticule.

14. Press the RIGHT button of the VERT MODE switch. Remove the calibrator signal from the left vertical and connect it to the right vertical. The display amplitude should be four divisions within 0.12 division. Note the exact display amplitude for the next step.

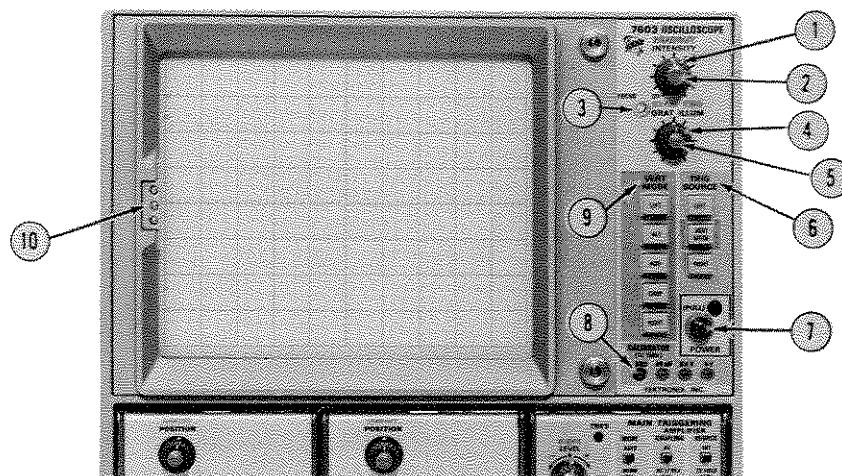

Front Panel

1. **INTENSITY**—Controls brightness of the display. Control is inoperative when horizontal compartment is vacant.

2. **READOUT**—Turns on the readout display and controls the readout intensity.

3. **FOCUS**—Provides adjustment for optimum display definition.

4. **GRATICULE ILLUM**—Controls graticule illumination.

5. **BEAM FINDER**—When pressed, the scan is limited to within the graticule area.

6. **TRIG SOURCE**—Selects source of internal trigger signal for the time base plug-in in the horizontal compartment.

LEFT: The trigger signal is obtained from the plug-in unit in the left vertical compartment only.

VERT MODE: Trigger signal automatically follows the vertical display except in CHOP and ADD; then the trigger signal is the algebraic sum of the signals from the left and right vertical compartments.

RIGHT: The trigger signal is obtained from the plug-in unit in the right vertical compartment only.

7. **POWER**—

Switch: Controls power to the instrument.

Light: Indicates that the power switch is on and that the instrument is connected to a line voltage source.

8. **CALIBRATOR**—Calibrator output pin jacks (4 V, 0.4 V, 40 mV, ground). Positive-going pulse or DC voltage can be selected. Repetition rate is approximately one kilohertz.

9. **VERT MODE**—Selects vertical mode of operation.

LEFT: Signals from plug-in unit in left vertical compartment are displayed.

ALT: Signals from plug-in units in both the left and right vertical compartments are displayed (dual trace). Display switched between vertical plug-in units after each sweep.

ADD: Signals from plug-in units in both the left and right vertical compartments are algebraically added and the sum is displayed on the CRT.

CHOP: Signals from plug-in units in both the left and right vertical compartments are displayed (dual trace). The display is switched between vertical plug-in units at approximately one megahertz rate.

RIGHT: Signals from plug-in unit in right vertical compartment is displayed.

10. **Camera Power (Not Labeled)**—Three-pin connector on CRT bezel provides power output (+15 V). Receives remote single sweep reset signal from compatible camera systems, and a ground pin connection.

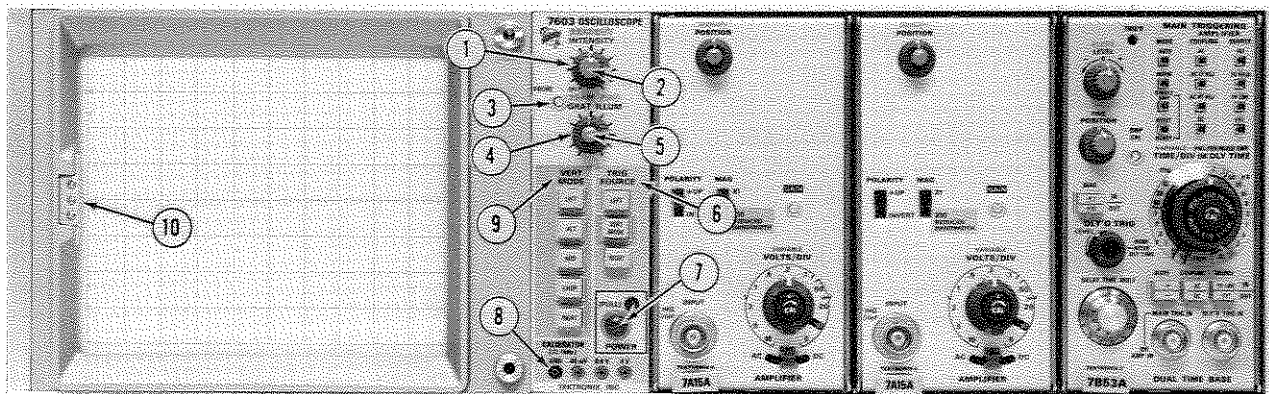
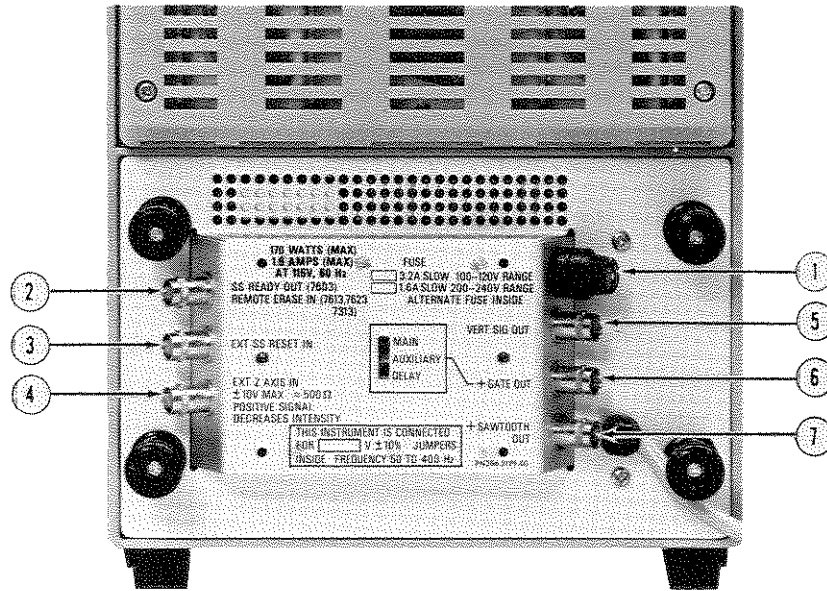

Fig. 1-1. Front-panel controls and connectors.



Rear Panel

1. FUSE—Line voltage fuse for instrument.
2. SS READY OUT—Provides an external single sweep ready indicator signal after the single sweep has been reset.
3. EXT SS RESET IN—Remote single sweep reset.
4. EXT Z AXIS IN—Input connector for intensity modulation of the CRT display.
5. VERT SIG OUT—Vertical signal selected by TRIG SOURCE switch (LEFT, RIGHT, ALT and ADD).
6. GATE OUT—Gate signal selected by gate selector switch (MAIN, AUXILIARY, and DELAY).
7. +SAWTOOTH OUT—Positive-going sawtooth from time-base unit.

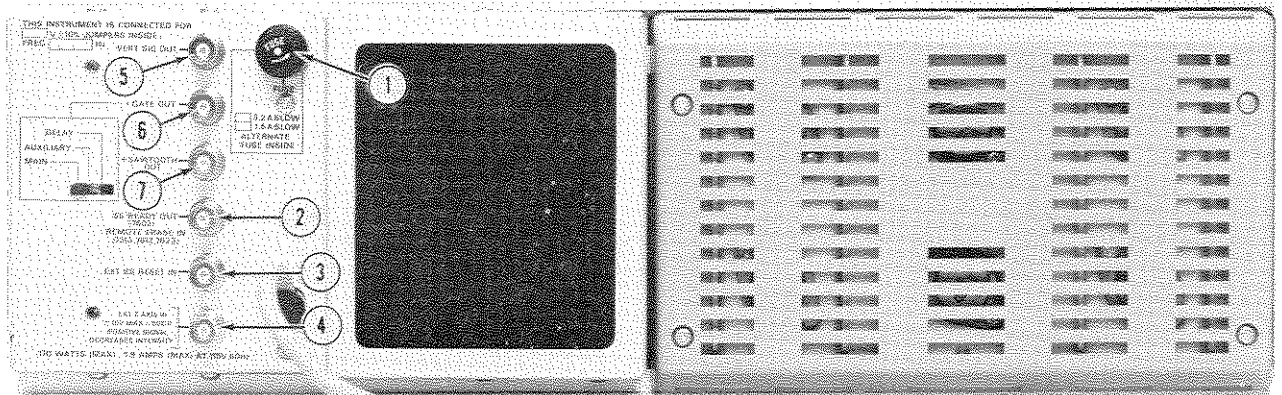

Fig. 1-2. Rear-panel controls and connectors.

15. A correct display in both steps 12 and 14 indicates that the 7603 Vertical Deflection System and the vertical plug-in units are calibrated. If the displays noted previously are both outside the given tolerance in the same direction (i.e., high or low), the Vertical Gain or 4 Volts calibrator adjustment probably needs re-adjustment. Otherwise, the calibration of the vertical plug-in units, refer qualified service personnel to service manual.

16. Notice that the position control of only the right vertical unit has an effect on the position of the display. Position the display to the lower half of the graticule. Set both vertical units for a deflection factor of two volts/division. Connect calibrator signal to both vertical units by using a dual input coupler.

17. Press the ALT button of the VERT MODE switch. Notice that two traces are displayed on the CRT. The top trace is produced by the left vertical unit and the bottom trace is produced by the right vertical unit. Set the sweep rate to 50 milliseconds/division. Notice that the display alternates between the left and right vertical units after each sweep. Turn the sweep rate switch throughout its range. Notice that the display alternates between vertical units at all sweep rates.

18. Press the CHOP button of the VERT MODE switch. Turn the sweep rate throughout its range. Notice that a dual-trace display is presented at all sweep rates, but unlike ALT both vertical units are displayed on each sweep in a time-sharing manner. Return the sweep rate to 0.5 millisecond/division.

19. Press the ADD button of the VERT MODE switch. The display should be four divisions in amplitude. Notice that the position control of either vertical unit moves the display. Return the VERT MODE switch to LEFT.

Triggering

20. Center the display on the CRT with the left vertical unit position control. Disconnect the input signal from the right vertical unit input connector. Sequentially press all of the VERT MODE switch buttons. Notice that a stable display is obtained in all positions of the VERT MODE switch (straight line in RIGHT position).

21. Press the LEFT button of the TRIG SOURCE switch. Again, sequentially press all of the VERT MODE buttons. Notice that the display is again stable in all positions, as in the previous step.

22. Press the RIGHT button of the TRIG SOURCE switch. Sequentially press all of the VERT MODE buttons and notice that a stable display cannot be obtained in any position. This is because there is no input signal connected to the right vertical unit. Return the TRIG SOURCE switch to VERT MODE. Remove calibrator signal from left vertical unit and connect it to right vertical unit. Repeat steps 20 to 22. The trigger signal will come from right vertical. When the LEFT button is pressed off the TRIG SOURCE switch the display is not stable because there is no input signal connected to the left vertical. Return the TRIG SOURCE switch to VERT MODE.

Horizontal Deflection System

23. Position the start of the sweep to the left graticule line with the time-base unit position control.

24. Connect a 1X probe to the input of the right vertical unit. Set the right vertical unit for a deflection factor of 1 volts/division and set the VERT MODE switch to RIGHT. Set the time-base unit for a sweep rate of one milliseconds/division.

25. Connect the probe tip to a 4 V in and, 1 kHz signal source. The display should show one complete cycle per division over the 10 divisions within 0.3 division. A correct display indicates that the 7603 Horizontal Deflection System and the time-base unit are correctly calibrated. If the display is outside the given tolerance, either the 7603 or the time-base unit needs to be recalibrated. Refer qualified service personnel to appropriate service manual for instructions.

26. Disconnect the probe from the signal source and the right vertical unit and connect the probe to the left vertical unit. Set the VERT MODE switch to LEFT and set the time-base unit for a sweep rate of 0.5 millisecond/division.

Beam Finder

27. Set the deflection factor of the left vertical unit to 0.1 volt/division. Notice that a square-wave display is not visible, since the deflection exceeds the scan area of the CRT.

28. Press and hold the BEAM FINDER switch. Notice that the display is returned to the viewing area in compressed form. Increase the vertical and horizontal deflection factors until the display is reduced to about two divisions vertically and horizontally (when the horizontal unit is operated in the time-base mode, change only the deflection factor of the vertical unit). Adjust the position controls of the

displayed vertical unit and the time-base unit to center the compressed display about the center lines of the graticule. Release the BEAM FINDER switch. Notice that the display remains within the viewing area.

Z-Axis Input

29. If an external signal is available (five volts peak-to-peak minimum at two megahertz or less), the function of the EXT Z AXIS input can be demonstrated. Connect the external signal to both the input of the right vertical unit and the EXT Z AXIS connector with two BNC cables and a BNC T connector. Set the VERT MODE switch to RIGHT and set the vertical unit for a deflection factor of two volts/division. Set the time-base unit for a sweep rate which displays several cycles of the signal. Adjust the amplitude of the signal generator until intensity modulation is visible on the display. The positive peaks of the waveform should be blanked out and the negative peaks intensified. Notice that the setting of the INTENSITY control determines the amount of intensity modulation that is visible.

30. Disconnect the signal from the EXT Z AXIS connector, but leave it connected to the right vertical unit input. Check that peak-to-peak amplitude of the displayed signal is four divisions maximum.

31. This completes the Operating Checkout procedure for the 7603. Instrument operations not explained here, or operations which need further explanation are discussed under General Operating Information.

SIMPLIFIED OPERATING INSTRUCTIONS

The following information is provided to aid in quickly obtaining the correct setting for the 7603 controls to present a display. The operator should be familiar with the complete function and operation of this instrument as described elsewhere in this section before using this procedure. For detailed operating information for the plug-in units, see the instruction manuals for the applicable units.

Single-Trace Display

The following procedure will provide a display of a single-trace vertical unit against one time-base unit. For simplicity of explanation, the vertical unit is installed in the left vertical compartment. The right vertical compartment can be used if the procedure is changed accordingly.

1. Install a 7A-series vertical unit in the left vertical compartment.

2. Press the LEFT button of the VERT MODE switch.

3. Install a 7B-series time-base unit in the horizontal compartment.

4. Press the VERT MODE button of the TRIG SOURCE switch.

5. Connect the signal to the input connector of the vertical unit.

6. Set the vertical unit for AC input coupling and calibrated deflection factors.

7. Set the time-base unit for auto mode, internal triggering at a calibrated sweep rate of one millisecond/division.

8. Advance the INTENSITY control until a display is visible. (If no display is visible with INTENSITY at about midrange, press and hold the BEAM FINDER switch and adjust the vertical deflection factor until the display is reduced in size vertically; then center the compressed display with vertical and horizontal position controls; release the BEAM FINDER). Adjust the FOCUS control for a well-defined display. Adjust Readout INTENSITY for the desired viewing level.

9. Set the vertical deflection factor and vertical position control for a display which remains within the graticule area vertically.

10. If necessary, set the time-base triggering controls for a stable display.

11. Adjust the time-base position control so the display begins at the left edge of the graticule. Set the time-base sweep rate to display the desired number of cycles.

Dual-Trace Display

The following procedure will provide a display of two single-trace vertical units against one time-base unit.

1. Install 7A-series vertical units in both vertical plug-in compartments.

2. Press the LEFT button of the VERT MODE switch.

3. Install a 7B-series time-base unit in the horizontal compartment.
4. Press the VERT MODE button of the TRIG SOURCE switch.
5. Connect the signal to the input connectors of the vertical units.
6. Set the vertical units for AC input coupling and calibrated deflection factors.
7. Set the time-base unit for auto mode, internal triggering at a sweep rate of one millisecond/division.
8. Advance the INTENSITY control until a display is visible. (If no display is visible with INTENSITY at midrange, press and hold BEAM FINDER switch and adjust vertical deflection factor until display is reduced in size vertically; then center compressed display with vertical and horizontal position controls; release the BEAM FINDER switch). Set the FOCUS control for a well-defined display.
9. Set the left vertical unit deflection factor for a display about four divisions in amplitude. Adjust the left vertical position control to move this display to the top of the graticule area.
10. Press the RIGHT button of the VERT MODE switch.
11. Set the RIGHT vertical unit deflection factor for a display about four divisions in amplitude (if display cannot be located, use BEAM FINDER switch). Position this display to the bottom of the graticule area with the right vertical unit position control.
12. Press the ALT or CHOP button of the VERT MODE switch. A dual-trace display of the signal from the left vertical and right vertical plug-in units should be presented on the CRT. (For more information on choice of dual-trace mode, see Vertical Mode in this section).
13. If necessary, adjust the time-base triggering controls for a stable display.
14. Adjust the time-base position control so the display begins at the left edge of the graticule. Set the time-base sweep rate for the desired horizontal display.

Delayed Sweep — Single Trace

The following procedure will provide a delayed sweep display of a single-trace vertical unit.

1. Follow the complete procedure given under Single-Trace Displays.
2. Be sure the time-base unit installed in the horizontal compartment is a dual time-base with delaying/delayed capabilities.
3. Follow the procedure given in the instruction manual for the dual time-base unit to obtain a delayed-sweep display.

Delayed Sweep — Dual Trace

The following procedure will provide a delayed-sweep display of two single-trace vertical units.

1. Follow the complete procedure given under Dual-Trace Display.
2. Be sure the time-base unit installed in the horizontal compartment is a dual time-base unit with delaying/delayed capabilities.
3. Follow the procedure given in the instruction manual for the dual time-base unit to obtain a delayed-sweep display.

X-Y Display

The following procedure will provide an X-Y display (one signal versus another rather than against time).

NOTE

Some 7B-series time-base units have provisions for amplifier operation in the X-Y mode; see X-Y operation in this section for details of operation in this manner.

1. Install 7A-series amplifier units in both the left vertical and the horizontal compartments.
2. Press the LEFT button of the VERT MODE switch.
3. Connect the X-signal to the amplifier unit in the horizontal compartment.

4. Connect the Y-signal to the amplifier unit in the left vertical compartment.

5. Set both amplifier units for AC input coupling and calibrated deflection factors.

6. Advance the INTENSITY control until a display is visible. (If no display is visible, press and hold BEAM FINDER switch and adjust the deflection factors of both amplifier units until display is reduced in size both vertically and horizontally; then center compressed display with the position controls; release the BEAM FINDER switch). Adjust the FOCUS control for a well-defined display.

GENERAL OPERATING INFORMATION

Intensity Control

The setting of the INTENSITY control may affect the correct focus of the display. Slight re-adjustment of the FOCUS control may be necessary, when the intensity level is changed. To protect the CRT phosphor; do not turn the INTENSITY control higher than necessary to provide a satisfactory display. The light filters reduce the observed light output from the CRT. When using these filters, avoid advancing the INTENSITY control to a setting that may burn the phosphor. When the highest intensity display is desired, remove the filters and use only the clear faceplate protector (permanently installed behind bezel). Apparent trace intensity can also be improved in such cases by reducing the ambient light level or using a viewing hood. Also, be careful that the INTENSITY control is not set too high when changing the time-base unit sweep rate from a fast to a slow sweep rate, or when changing to the X-Y mode of operation. The instrument incorporates protection circuitry which automatically reduces the display intensity to a lower level when the time-base unit is set to a slow sweep rate. This reduces the danger of damaging the CRT phosphor at these slower sweep rates.

Display Focus

The FOCUS control allows adjustment for best definition of the CRT display. The Readout intensity should be turned on, when adjusting the Focus control. Slight re-adjustment of this control may be necessary as the display conditions change. If a properly focused display cannot be obtained with the FOCUS control, the internal Astigmatism adjustment must be re-set; refer qualified service personnel to service manual.

Graticule

The graticule of the 7603 is marked on the inside of the faceplate of the CRT, providing accurate, no-parallax measurement. The graticule is divided into eight vertical divisions and ten horizontal divisions. Each division is 1.22 centimeters square. In addition, each major division is divided into five minor divisions. The vertical gain and horizontal timing of the plug-in units are calibrated to the graticule so accurate measurements can be made from the CRT. The illumination of the graticule lines can be varied with the GRATICULE ILLUM control.

NOTE

Two types of crt graticules have been used in some Tektronix oscilloscopes. One graticule has 0% and 100% risetime reference points that are separated by 6 vertical graticule divisions. The other graticule has the 0% and 100% risetime reference points separated by 5 vertical divisions. In your manual, illustrations of the crt face or risetime measurement instructions may not correspond with the graticule markings on your oscilloscope.

Fig. 1-3 shows the graticule of the 7603 and defines the various measurement lines. The terminology defined here will be used in all discussions involving graticule measurements. Notice the 0%, 10%, 90% and 100% markings on the left side of the graticule. These markings are provided to facilitate risetime measurements.

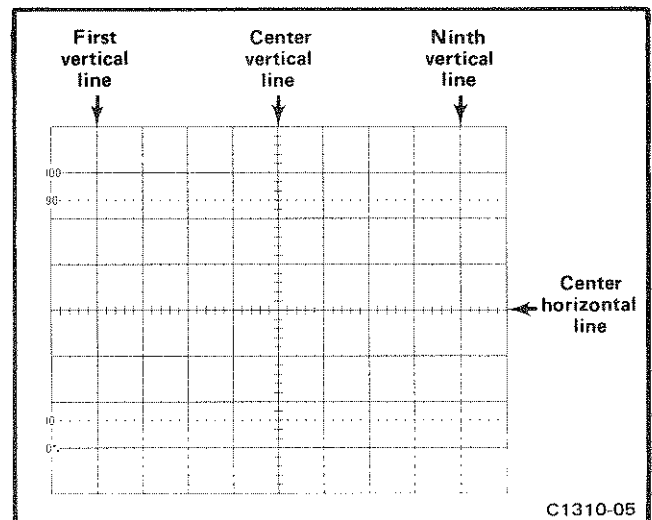

Fig. 1-3. Definition of measurement lines on 7603 graticule.

Light Filter

The tinted filter provided with the 7603 minimizes light reflections from the face of the CRT to improve contrast when viewing the display under high ambient light conditions. This filter should be removed for waveform photographs or when viewing high writing rate displays. To remove the filter, loosen the two screws on the right side of the bezel and remove the bezel. Remove the tinted filter; leave the clear plastic faceplate protector installed and replace the bezel. The faceplate protector should be left in place at all times to protect the CRT faceplate from scratches.

An optional mesh filter is available for use with the 7603. This filter provides shielding against radiated EMI (electromagnetic interference) from the face of the CRT. It also serves as a light filter to make the trace more visible under high ambient light conditions. The mesh filter fits in place of the plastic CRT mask and the tinted filter.

Beam Finder

The BEAM FINDER switch provides a means of locating a display which overscans the viewing area either vertically or horizontally. When the BEAM FINDER switch is pressed and held, the display is compressed within the graticule area. Release the BEAM FINDER switch to return to a normal display. To locate and reposition an overscanned display, use the following procedure:

1. Press and hold the BEAM FINDER switch.
2. Increase the vertical and horizontal deflection factors until the vertical deflection is reduced to about two divisions and the horizontal deflection is reduced to about four divisions (the horizontal deflection needs to be reduced only when in the X-Y mode of operation).
3. Adjust the vertical and horizontal position controls to center the display about the vertical and horizontal center lines of the graticule.
4. Release the BEAM FINDER switch; the display should remain within the viewing area.

Readout Modes

The characters of the readout display are written by the CRT beam on a time-share basis with signal waveforms. The Readout system operates in a free running mode to randomly interrupt the waveform display to present the

readout characters. The readout system can also operate in a GATE TRIG'D mode. No readout signal is produced until after the sweep has occurred. In this mode the sweep must run to have the readout displayed.

Display Photography

A permanent record of the CRT display can be obtained with an oscilloscope camera system. The instruction manuals for the TEKTRONIX Oscilloscope Cameras include complete instructions for obtaining waveform photographs. The following specific information applies to the 7603.

The CRT bezel of the 7603 provides integral mounting for a TEKTRONIX Oscilloscope Camera. The three pins located on the left side of the CRT bezel connect power to compatible camera systems. It also receives control signals from TEKTRONIX automatic cameras to allow camera-controlled single-shot photography (see camera manual for further information).

Vertical Mode

Left and Right Mode. When the LEFT or RIGHT button of the VERT MODE switch is pressed, only the signal from the plug-in unit in the selected compartment is displayed.

Alternate Mode. The ALT position of the VERT MODE switch produces a display which alternates between the plug-in units in the left vertical and right vertical compartments with each sweep of the CRT. Although the ALT mode can be used at all sweep rates, the CHOP mode provides a more satisfactory display at sweep rates below about 20 milliseconds/division. At these slower sweep rates, alternate-mode switching becomes visually perceptible.

NOTE

This instrument will not operate in the ALT mode if the horizontal plug-in unit is not operated in the time-base mode.

The TRIG SOURCE switch allows selection of the triggering for an alternate display. When this switch is set to the VERT MODE position, each sweep is triggered by the signal being displayed on the CRT. This provides a stable display of two unrelated signals, but does not indicate the time relationship between the signals. In either the LEFT or RIGHT positions of the TRIG SOURCE switch, the two signals are displayed showing true time relationship. However, if the signals are not time-related, the display from the plug-in unit which is not providing a trigger signal will appear unstable on the CRT.

Chopped Mode. The CHOP position of the VERT MODE switch produces a display which is electronically switched between channels at a one-megahertz rate. In general, the CHOP mode provides the best display at sweep rates lower than about 20 milliseconds/division, or whenever dual-trace single-shot phenomena are to be displayed. At faster sweep rates, the chopped switching becomes apparent and may interfere with the display.

Correct internal triggering for the CHOP mode can be obtained in any of the three positions of the TRIG SOURCE switch. When the TRIG SOURCE switch is set to VERT MODE, the internal trigger signals from the vertical plug-in units are algebraically added and the time-base unit is triggered from the resultant signal. Use of the LEFT or RIGHT trigger-source positions triggers the time-base unit on the internal trigger signal from the selected vertical unit only. This allows two time-related signals to be displayed showing true time relationship. However, if the signals are not time-related, the display from the channel which is not providing the trigger signal will appear unstable. The CHOP mode can be used to compare two single-shot, transient, or random signals which occur within the time interval determined by the time-base unit (ten times selected sweep rate). To provide correct triggering, the display which provides the trigger signal must precede the second display in time. Since the signals show true time relationship, time-difference measurements can be made from the display.

Algebraic Addition. The ADD position of the VERT MODE switch can be used to display the sum or difference of two signals, for common-mode rejection to remove an undesired signal, or for DC offset (applying a DC voltage to one channel to offset the DC component of a signal on the other channel). The common-mode rejection ratio between the vertical plug-in compartments of the 7603 is greater than 20:1 at 50 megahertz. The rejection ratio increases to 100:1 at DC.

The overall deflection factor on the CRT in the ADD mode is the resultant of the algebraic addition of the signals from the two vertical plug-in units. It is difficult to determine the voltage amplitude of the resultant display unless the amplitude of the signal applied to one of the plug-in units is known. This is particularly true when the vertical units are set to different deflection factors, since it is not obvious which portion of the display is a result of the signal applied to either plug-in unit. Also, the polarity and repetition rate of the applied signals enters into the calculation.

The following general precautions should be observed to provide the best display when using the ADD mode:

1. Do not exceed the input voltage rating of the plug-in units.

2. Do not apply large signals to the plug-in inputs. A good rule to follow is not to apply a signal which exceeds an equivalent of about eight times the vertical deflection factors. For example, with a vertical deflection factor of 0.5 volt/division, the voltage applied to that plug-in unit should not exceed 4 volts. Larger voltages may result in a distorted display.

3. To ensure the greatest dynamic range in the ADD mode, set the position controls of the plug-in units to a setting which would result in a mid-screen display if viewed in the LEFT or RIGHT positions of the VERT MODE switch.

4. For similar response from each channel, set the plug-in units for the same input coupling.

Trigger Source

The TRIG SOURCE switch allows selection of the internal trigger signal for the time-base unit. For most applications, this switch can be set to the VERT MODE position. This position is the most convenient, since the internal trigger signal is automatically switched as the VERT MODE switch is changed, or as the display is electronically switched between the left vertical and right vertical plug-in units in the ALT position of the VERT MODE switch. It also provides a usable trigger signal in the ADD or CHOP positions of the VERT MODE switch, since the internal trigger signal in these modes is the algebraic sum of the signals applied to the vertical plug-in units. Therefore, the VERT MODE position ensures that the time-base unit receives a trigger signal regardless of the VERT MODE switch setting, without the need to change the trigger source selection.

If correct triggering for the desired display is not obtained in the VERT MODE position, the LEFT or RIGHT positions can be used to obtain the trigger signal from either the left vertical or right vertical plug-in unit. The internal trigger signal is obtained from the selected vertical compartment, whether the plug-in unit in that compartment is selected for display on the CRT or not. If the internal trigger signal is obtained from one of the vertical units, but the other vertical unit is selected for display, the internal trigger signal must be time-related to the displayed signal in order to obtain a triggered (stable) display.

X-Y Operation

In some applications, it is desirable to display one signal versus another (X-Y) rather than against time (internal sweep). The flexibility of the plug-in units available for use with the 7603 provides a means for applying an external signal to the horizontal deflection system for this type of display. Some of the 7B-series time-base units can be operated as amplifiers in addition to their normal use as time-

base generators. This feature allows an external signal to provide the horizontal deflection on the CRT. For most of the time-base units with the amplifier function, the X (horizontal) signal can be connected either to an external input connector on the time-base unit or it can be routed to the time-base unit through the internal triggering system (see time-base instruction manual for details). If the latter method is used, the TRIG SOURCE switches must be set so that the X (horizontal) signal is obtained from one of the vertical units and the Y (vertical) signal is obtained from the other vertical unit. The advantages of using the internal trigger system to provide the X signal are that the attenuator switch of the amplifier unit providing the horizontal signal determines the horizontal deflection factor to allow full-range operation and the plug-in units do not have to be moved between compartments when X-Y operation is desired.

Another method of obtaining an X-Y display is to install an amplifier plug-in unit in one of the horizontal plug-in compartments (check amplifier unit gain as given in the plug-in instruction manual to obtain calibrated horizontal deflection factors). This method provides the best X-Y display, particularly if two identical amplifier units are used, since both the X and Y input systems will have approximately the same delay time, gain characteristics, input coupling, etc. For further information on obtaining X-Y displays, see the plug-in unit manuals. Also, operator section of the reference books listed under Applications provide information on X-Y measurements and interpreting the resulting lissajous displays.

Intensity Modulation

Intensity (Z-axis) modulation can be used to relate a third item of electrical phenomena to the vertical (Y-axis) and the horizontal (X-axis) coordinates without affecting the wave-shape of the displayed signal. The Z-axis modulating signal applied to the CRT circuit changes the intensity of the displayed waveform to provide this type of display. "Gray scale" intensity modulation can be obtained by applying signals which do not completely blank the display. Large amplitude signals of the correct polarity will completely blank the display; the sharpest display is provided by signals with a fast rise and fall. The voltage amplitude required for visible trace modulation depends upon the setting of the INTENSITY control. A two-volt peak-to-peak signal will completely blank the display even at maximum intensity levels. Lower amplitude signals can be used to only change the trace brightness rather than completely blank the display. Negative-going modulating signals increase the display intensity and positive-going modulating signals decrease the display intensity. Useful input frequency range is DC to 10 megahertz (input voltage derating necessary above two megahertz). The maximum input voltage should be limited to 10 volts (DC plus peak AC).

Time markers applied to the EXT Z AXIS input connector provide a direct time reference on the display. With uncalibrated horizontal sweep or external horizontal mode operation, the time markers provide a means of reading time directly from the display. However, if the markers are not time-related to the displayed waveform, a single-sweep display should be used (for internal sweep only) to provide a stable display.

Raster Display

A raster-type display can be used to effectively increase the apparent sweep length. For this type of display, the trace is deflected both vertically and horizontally by sawtooth signals. This is accomplished in the 7603 by installing a 7B-series time-base unit in one of the vertical plug-in compartments. Normally, the time-base unit in the vertical compartment should be set to a slower sweep rate than the time-base unit in the horizontal compartment; the number of horizontal traces in the raster depends upon the ratio between the two sweep rates. Information can be displayed on the raster using several different methods. In the ADD position of the VERT MODE switch, the signal from an amplifier unit can be algebraically added to the vertical deflection. With this method, the vertical signal amplitude on the CRT should not exceed the distance between the horizontal lines of the raster. Another method of displaying information on the raster is to use the EXT Z AXIS input to provide intensity modulation of the display. This type of raster display could be used to provide a television-type display. Complete information on operation using the Z-axis feature is given under Intensity Modulation.

To provide a stable raster display, both time-base units must be correctly triggered. Internal triggering is not provided for the time-base units when they are in the vertical compartments; external triggering must be used. Also, blanking is not provided from the time-base units when they are installed in a vertical compartment. To blank out the retrace portion from the time-base unit in the vertical compartment, special connections must be made from this time-base unit to the blanking network of the 7603. If this mode of operation is desirable, contact your local TEKTRONIX Field Office or representative for specific information on obtaining blanking with the specific time-base unit being used in the vertical compartment.

Calibrator

General. The internal calibrator of the 7603 provides a convenient signal source for checking basic vertical gain and for adjusting probe compensation as described in the probe instruction manual. In addition, the calibrator can be used as a convenient signal source for application to external equipment.

Voltage. The calibrator provides accurate output voltage of 40 millivolts, 0.4 volt, and 4 volts at the three front-panel pin-jack connectors into high-impedance loads. Output resistance is approximately 50 ohms at the 40 mV and 0.4 V pin jacks and approximately 450 ohms at the 4 V pin jack.

Current. A 40-milliamphere, one-kilohertz output current is provided when the optional current-loop accessory (TEKTRONIX Part No. 012-0259-00) is connected between the 4 V pin-jack and ground. This output can be used to check and calibrate current-measuring probe systems.

Waveshape. The square-wave output signal of the calibrator can be used as a reference waveshape when checking or adjusting the compensation of passive, high-resistance probes. Since the square-wave output from the calibrator has a flat top, any distortion in the displayed waveform is due to the probe compensation. DC voltage output is also available. To change modes refer qualified service personnel to the service manual for instructions.

Signals Out

Vertical Signal. The VERT SIG OUT connector provides a sample of the vertical deflection signal. The source of the output signal is determined by the TRIG SOURCE switch. The source will follow the setting of the TRIG SOURCE switch. When the TRIG SOURCE is in the VERT MODE the output will follow the VERTICAL MODE switch except CHOP, then the signals are ADDED. The output signals are LEFT, ALT, ADD and RIGHT. The output signal into 50 ohms is about 25 millivolts/division of the vertical signal displayed on systems CRT. The output signal into 1 megohm is about 0.5 volts/division of the vertical signal displayed on the systems CRT.

+ Gate. The + gate connector provides a sweep gate signal that is generated by the time base plug-in unit. The gate selector switch provides three gates MAIN, AUXILIARY, and DELAY. The duration of the gate pulse is determined by the respective sweep. Auxiliary and Delay gates can only be produced by dual sweep time base plug-in units. The amplitude of the gate signal is about 50 millivolts into 50 ohms or 10 volts into 1 megohm.

+ Sawtooth. The + sawtooth connector provides a positive going sample of the sawtooth from the time base unit in the horizontal compartment. The rate of rise of the sawtooth signal is about 50 millivolts/unit of time into 50 ohms or 1 volt/unit of time into 1 megohm. Unit of time is determined by the time/division switch of the horizontal plug-in unit.

Applications

The 7603 Oscilloscope and its associated plug-in units provide a very flexible measurement system. The capabilities of the overall system depend mainly upon the plug-in units that are chosen for use with this instrument. Specific applications for the individual plug-in units are described in the plug-in manuals. The overall system can also be used for many applications which are not described in detail either in this manual or in the manuals for the individual plug-in units. Contact your local TEKTRONIX Field Office or representative for assistance in making specific measurements with this instrument.

The following books describe oscilloscope measurement techniques which can be adapted for use with this instrument.

John D. Lenk, "Handbook of Oscilloscopes, Theory, and Application", Prentice-Hall Inc., Englewood Cliffs, New Jersey, 1968.

J. Czech, "Oscilloscope Measuring Techniques", Springer-Verlag, New York, 1965.

J.F. Golding, "Measuring Oscilloscopes", Transatlantic Arts, Inc., 1971.

Charles H. Roth Jr., "Use of the Oscilloscope", A Programmed text, Prentice-Hall Inc., Englewood Cliffs, New Jersey, 1970.

REPACKAGING FOR SHIPMENT

If the Tektronix instrument is to be shipped to a Tektronix Service Center for service or repair, attach a tag showing: owner (with address) and the name of an individual at your firm that can be contacted. Include complete instrument serial number and a description of the service required.

Save and re-use the package in which your instrument was shipped. If the original packaging is unfit for use or not available, repackage the instrument as follows:

Surround the instrument with polyethylene sheeting to protect the finish of the instrument. Obtain a carton of corrugated cardboard of the correct carton strength and having inside dimensions of no less than six inches more than the instrument dimensions. Cushion the instrument by tightly packing three inches of dunnage or urethane foam between carton and instrument, on all sides. Seal carton with shipping tape or industrial stapler.

The carton test strength for your instrument is 375 pounds.

Operating Instructions—7603/R7603 Operators

output signal into 50 ohms is about 25 millivolts/division of the vertical signal displayed on systems CRT. The output signal into 1 megohm is about 0.5 volts/division of the vertical signal displayed on the systems CRT.

+ **Gate.** The + gate connector provides a sweep gate signal that is generated by the time base plug-in unit. The gate selector switch provides three gates MAIN, AUXILIARY and DELAY. The duration of the gate pulse is determined by the respective sweep. Auxiliary and Delay gates can only be produced by dual sweep time base plug-in units. The amplitude of the gate signal is about 50 millivolts into 50 ohms or 10 volts into 1 megohm.

+ **Sawtooth.** The + sawtooth connector provides a positive going sample of the sawtooth from the time base unit in the horizontal compartment. The rate of rise of the sawtooth signal is about 50 millivolts/unit of time into 50 ohms or 1 volt/unit of time into 1 megohm. Unit of time is determined by the time/division switch of the horizontal plug-in unit.

Applications

The 7603 Oscilloscope and its associated plug-in units provide a very flexible measurement system. The capabilities of the overall system depend mainly upon the plug-in units that are chosen for use with this instrument. Specific applications for the individual plug-in units are described in the plug-in manuals. The overall system can also be used for many applications which are not described in detail either in this manual or in the manuals for the individual plug-in units. Contact your local TEKTRONIX Field Office or representative for assistance in making specific measurements with this instrument.

The following books describe oscilloscope measurement techniques which can be adapted for use with this instrument.

John D. Lenk, "Handbook of Oscilloscopes, Theory, and Application", Prentice-Hall Inc., Englewood Cliffs, New Jersey, 1968.

J. Czech, "Oscilloscope Measuring Techniques", Springer-Verlag, New York, 1965.

J. F. Golding, "Measuring Oscilloscopes", Transatlantic Arts, Inc., 1971.

Charles H. Roth Jr., "Use of the Oscilloscope", A Programmed text, Prentice-Hall Inc., Englewood Cliffs, New Jersey, 1970.

REPACKAGING FOR SHIPMENT

If the Tektronix instrument is to be shipped to a Tektronix Service Center for service or repair, attach a tag showing: owner (with address) and the name of an individual at your firm that can be contacted. Include complete instrument serial number and a description of the service required.

Save and re-use the package in which your instrument was shipped. If the original packaging is unfit for use or not available, repackage the instrument as follows:

Surround the instrument with polyethylene sheeting to protect the finish of the instrument. Obtain a carton of corrugated cardboard of the correct carton strength and having inside dimensions of no less than six inches more than the instrument dimensions. Cushion the instrument by tightly packing three inches of dunnage or urethane foam between carton and instrument, on all sides. Seal carton with shipping tape or industrial stapler.

The carton test strength for your instrument is 375 pounds.

SPECIFICATION

Information given in this manual applies to the R7603 Oscilloscope also, unless otherwise indicated. The R7603 is electrically identical to the 7603, but it is adapted for mounting in a standard 19-inch rack. Rackmounting instructions and a dimensional drawing for the R7603 are given in Section 3.

This instrument will meet the following electrical specifications after complete calibration as given in Section 5. The Operating Checkout procedure which is given in Section 1 provides a convenient method of checking instrument performance without making internal checks or adjust-

ments. The following electrical characteristics apply over an ambient temperature range of 0°C to +50°C, except as otherwise indicated. Warmup time for given accuracy is 20 minutes.

NOTE

Many of the measurement capabilities of this instrument are determined by the choice of plug-in units. The following characteristics apply to the 7603 Oscilloscope only. See the System Specification at the end of this section for specifications of the complete system.

VERTICAL DEFLECTION SYSTEM

Characteristic	Performance Requirements	Supplemental Information
Deflection Factor	Compatible with all 7000-series plug-in units.	
Between Compartments	Within 1%.	
Low Frequency Linearity	0.1 division or less compression or expansion of a center-screen 2 division signal when positioned anywhere vertically within the graticule area.	
Bandwidth	See system specifications for 7000-series instruments.	
Step Response Risetime	See system specifications for 7000-series instruments.	
Isolation Between Vertical Compartments	At least 100:1 from DC to 100 MHz.	
Delay Line		Permits viewing leading edge of trigger signal.
Chopped Mode		
Repetition Rate	1 MHz within 20%.	

VERTICAL DEFLECTION SYSTEM (cont)

Characteristic	Performance Requirements	Supplemental Information
Time Segment From Each Compartment	0.4 to 0.6 μ s.	
Difference In Delay Between Vertical Compartments		0.5 ns or less.
Vertical Display Modes	LEFT: Left vertical unit only. ALT: Dual trace, alternate between vertical units. ADD: Added algebraically. CHOP: Dual trace, chopped between vertical units. RIGHT: Right vertical unit only.	Selected by VERT MODE switch.

TRIGGERING

Characteristic	Performance Requirements	Supplemental Information
Trigger Source	LEFT VERT: From left vertical only. VERT MODE: Determined by vertical mode. RIGHT VERT: From right vertical only.	Selected by TRIGGER SOURCE switch.

HORIZONTAL DEFLECTION SYSTEM

Characteristic	Performance Requirements	Supplemental Information
Fastest Calibrated Sweep Rate	5 ns/div.	
Deflection Factor	Compatible with all 7000-series plug-in units.	
Low Frequency Linearity	0.1 div or less compression or expansion of a center-screen 2 div signal when positioned anywhere horizontally within the graticule area.	
Phase Shift Between The Vertical and Horizontal Amplifiers	Less than 2° from DC to 35 kHz.	
Frequency Response Bandwidth (8 div Reference)	At least 2 MHz.	

CALIBRATOR

Characteristic	Performance Requirements	Supplemental Information
Waveshape	Positive-going squarewave or DC (DC voltage selected by internal jumper). Refer qualified service personnel to service manual.	
Voltage Output Range	40 mV, 0.4 V, and 4 V.	Into 1 M Ω load.
Voltage Output Accuracy		
+15°C to +35°C	Within 1%.	
0°C to +50°C	Within 2%.	
Current Output Accuracy	40 mA.	
+15°C to +35°C	Within 2%.	With optional current loop accessory (012-0259-00) connected between 4 V pin jack and ground pin jack.
0°C to +50°C	Within 3%.	
Repetition Rate		Approximately 1 kHz.
Output Resistance		
40 mV and 0.4 V		Approximately 50 Ω .
4 V		Approximately 450 Ω .

EXTERNAL Z AXIS INPUT

Characteristic	Performance Requirements	Supplemental Information
Sensitivity (Full Intensity Range)	2 V peak to peak.	
Useful Input Voltage Versus Repetition Frequency	2 V peak to peak, DC to 2 MHz; reducing to 0.4 V peak to peak at 10 MHz.	
Polarity of Operation	Positive-going signal decreases intensity.	
Maximum Input Voltage		10 V (DC to peak AC).
Input Resistance		Approximately 500 Ω .

OUTPUTS

Characteristic	Performance Requirements	Supplemental Information
Camera Power (P1041 at CRT Bezel)		
Pin 1 — +15 V		
Pin 3 — single sweep reset		
Pin 5 — ground		

CHARACTER GENERATOR

Characteristic	Performance Requirements	Supplemental Information
Character Size	Adjustable	
Modes of Operation	Free-run independent of sweep	For internal READOUT mode switch, refer qualified service personnel to service manual.
	Triggered after sweep	

DISPLAY (CRT) and OPTIONS

Characteristic	Performance Requirements			Supplemental Information
Cathode Ray Tube Type	T 7400.			
Graticule				
Type	Internal and illuminated.			
Area	8 X 10 div.			
Standard	1 div equals 1.22 cm.			
Option 4	1 div equals 1 cm.			
Option 6	1 div equals 1.22 cm (Spectrum Analyzer).			
Phosphor				
Standard	P31			
Option 8	P11 of P7 on request.			
Beam Finder				Limits display to within graticule area when BEAM FINDER switch is actuated.
Photographic Writing Specifications	Phosphor	Standard	Option 4	Polaroid ¹ film type 107 (3000 ASA). Without film fogging techniques.
C53 Camera (f1.9 lens 1:0.85 Image-to-Object Ratio)	P31	100 div/ μ s	180 cm/ μ s	
	P11	140 div/ μ s	260 cm/ μ s	

¹Registered trademark Polaroid Corporation.

POWER SOURCE

Characteristic	Performance Requirements	Supplemental Information
Line Voltage Ranges		
110 V nominal	100 V \pm 10%.	
	110 V \pm 10%.	
	120 V \pm 10%.	
220 V nominal	200 V \pm 10%.	
	220 V \pm 10%.	
	240 V \pm 10%.	
Line Frequency		50 to 400 Hz.
Maximum Power Consumption (115 V AC; 60 Hz)		170 W, 1.9 A.

SIGNALS OUT

Characteristic	Performance Requirements	Supplemental Information
VERT SIG OUT	See systems specifications for 7000-series instruments.	
Vertical Signals	LEFT, RIGHT, ALT, and ADD.	Selected by TRIG SOURCE switch.
Gain		
Into 50 Ω		25 mV/div.
Into 1 M Ω		0.5 V/div. \pm 20% system CRT to VERT SIG OUT.
Risetime (Into 50 Ω)		5 ns or less.
Aberrations		
Centering		\pm 3 div system CRT to VERT SIG OUT. (1.5 V into 1 M Ω or 75 mV into 50 Ω .)
Output Resistance		950 Ω within 2%.
+GATE OUT		
Gate Signals	MAIN, AUXILIARY, and DELAY.	Selected by Gate selector switch.
Output		
Into 50 Ω		0.5 V within 10%.
Into 1 M Ω		10 V within 10%.

SIGNALS OUT (cont)

Characteristic	Performance Requirement	Supplemental Information
Risetime (Into 50 Ω)		20 ns or less.
Output Resistance		950 Ω within 2%.
+SAWTOOTH OUT		
Output		
Into 50 Ω		50 mV/unit time ² within 15%.
Into 1 MΩ		1 V/unit time ² within 10%.
Output Resistance		950 Ω within 2%.

ENVIRONMENTAL

Characteristic	Information
<i>NOTE</i>	
<i>This instrument will meet the electrical characteristics given in the Performance Requirement column of the Specifications over the following environmental limits.</i>	
Temperature Range	
Operating	0°C to +50°C.
Non-operating	-55°C to +75°C.
Altitude	
Operating	15,000 ft.
Non-operating	Test limit 50,000 ft.

Transportation (packaged instrument, without plug-in units) qualifies under National Safe Transit test procedure 1A, Category II.

PHYSICAL

Characteristic	Information
Ventilation	Safe operating temperature maintained by convection cooling (7603) or forced air cooling (R7603). Automatic resetting thermal cutout protects instrument from overheating.

PHYSICAL (cont)

Characteristic	Information
Finish	Anodized aluminum front panel. Painted cabinet.
7603 Overall Dimensions (measured at maximum points)	
Height	12.0 in (30.4 cm).
Width	8.7 in (22.0 cm).
Length	22.7 in (57.6 cm).
Net Weight (instrument only)	30 lb (13.6 kg).
R7603 Overall Dimensions (measured at maximum points)	
Height	5.25 in (13.4 cm).
Width	19.0 in (48.5 cm).
Length	21.5 in (62.0 cm).
Net Weight (instrument only)	30 lb (13.6 kg).

STANDARD ACCESSORIES

Standard accessories supplied with the 7603 are given in the Mechanical Parts List illustrations. For optional accessories available for use with this instrument, see the Tektronix, Inc. catalog.

² Referenced to Time/Div setting.

7600-SERIES SYSTEM SPECIFICATIONS

Amplifier Plug-In Unit	Vertical System							
	Probe	BW	T _r	EXT CAL	INT CAL	INT CAL	SIG OUT	
				0 to 50°C	15 to 35°C	0 to 50°C	BW	T _r
7A11	Integral	100 MHz	3.5 ns	2%	3%	4%	60 MHz	5.9 ns
7A12	None	85 MHz	4.2 ns	2%	3%	4%	55 MHz	6.4 ns
	P6053			3%	4%	5%	55 MHz	6.4 ns
7A13	None	80 MHz	4.4 ns	1.5%	2.5%	3.5%	55 MHz	6.4 ns
	P6055			1.5%	2.5%	3.5%	45 MHz	7.8 ns
7A14	P6021	50 MHz	7.0 ns	2%	3%	4%	40 MHz	8.8 ns
	P6022	85 MHz	4.2 ns	2%	3%	4%	50 MHz	7.0 ns
7A15A	None	65 MHz	5.4 ns	3%	4%	5%	50 MHz	7.0 ns
	P6053			3%	4%	5%	50 MHz	7.0 ns
7A16	None	100 MHz	3.5 ns	2%	3%	4%	60 MHz	5.9 ns
	P6053			3%	4%	5%	60 MHz	5.9 ns
7A17	None	100 MHz	3.5 ns				15 MHz	24 ns
7A18	None	70 MHz	5.0 ns	2%	3%	4%	50 MHz	7.0 ns
	P6053			3%	4%	5%	50 MHz	7.0 ns
7A19	None or P6051	110 MHz	3.2 ns	2%	3%	4%	65 MHz	5.4 ns
	P6056/ P6057			3%	4%	5%	65 MHz	5.4 ns
7A22	None or Any	1.0 MHz ±10%	350 ns ±9%	2%	3%	4%	1.0 MHz ±10%	350 ns ±9%

The bandwidth of a vertical plug-in used in the horizontal compartment is 2 MHz except for the 7A22 which has a bandwidth of 850 kHz. The X-Y phase shift between 2 similar units is 2° at 35 kHz.

TIME BASE PLUG-INS

Time Base	Performance Feature	Max Sweep Rate	Triggering Freq Range
7B50	Delayed Sweep & Ext Amplifier	5 ns/div	DC to 100 MHz
7B51	Delaying Sweep	5 ns/div	DC to 100 MHz
7B52	Delayed & Mixed Sweeps	5 ns/div	DC to 100 MHz
7B53N	Delayed & Mixed Sweeps	5 ns/div	DC to 100 MHz
7B70	Delayed Sweeps & Ext Amplifier	5 ns/div	DC to 200 MHz
7B71	Delaying Sweep	5 ns/div	DC to 200 MHz
7B92	Display Switching	5 ns/div	DC to 250 MHz

SPECIAL PURPOSE and SAMPLING PLUG-INS

Plug-In	Performance Feature
7CT1N	Low Power Semiconductor Curve Tracer
7D13	Measures: Temperature, Voltage, Current, and Resistance
7D14	Directly Gated Counter to 525 MHz
7L12	1 MHz to 1.8 GHz Spectrum Analyzer
7M11	High Quality Dual Delay Line
7S11	Accepts Plug-In Sampling Heads
7S12	TDR and Sampling Applications
7T11	Random or Sequential; Equivalent or Real-Time Sampling

For more complete specifications on plug-in units for the 7600-Series Oscilloscope System, refer to the TEKTRONIX Catalog.

1
2
3
4
5
6
7
8
9
10
11
12
13
14
15
16
17
18
19
20
21
22
23
24
25
26
27
28
29
30
31
32
33
34
35
36
37
38
39
40
41
42
43
44
45
46
47
48
49
50
51
52
53
54
55
56
57
58
59
60
61
62
63
64
65
66
67
68
69
70
71
72
73
74
75
76
77
78
79
80
81
82
83
84
85
86
87
88
89
90
91
92
93
94
95
96
97
98
99
100

1

1

1

RACKMOUNTING

Introduction

The R7603 Oscilloscope is designed to be installed in a standard 19-inch wide rack. It can be mounted in racks with Universal, EIA, RETMA, or Western Electric mounting-hole spacing. The following information provides complete rackmounting instructions for this instrument.

Instrument Dimensions

A dimensional drawing showing the major dimensions of the R7603 is shown in Fig. 3-6.

Rack Dimensions

Height. At least 5¼ inches of vertical space is required to mount this instrument in a rack. This allows sufficient clearance for adjacent instruments or panels. Additional height may be necessary if an oscilloscope camera system is to be used with this instrument.

Width. Minimum dimension between the front rails of the rack is 17 5/8 inches. This allows room on each side of the instrument for the slide-out tracks to operate freely, permitting the instrument to move in and out of the rack.

Depth. Total depth necessary to mount this instrument in an enclosed cabinet rack is 24 inches. This allows sufficient room for air circulation, power cord and signal connections, and for the necessary mounting hardware.

NOTE

If this instrument is mounted in a shallow rack where the rear mounting brackets must extend behind the instrument, a maximum of 26 inches clearance behind the front rails is required.

The rear mounting brackets supplied allow mounting this instrument in racks which have rear rails spaced between 14 5/8 and 28 1/2 inches from the front rail. Do not mount the R7603 in an installation where it is not correctly supported at the rear, as the instrument may be damaged.

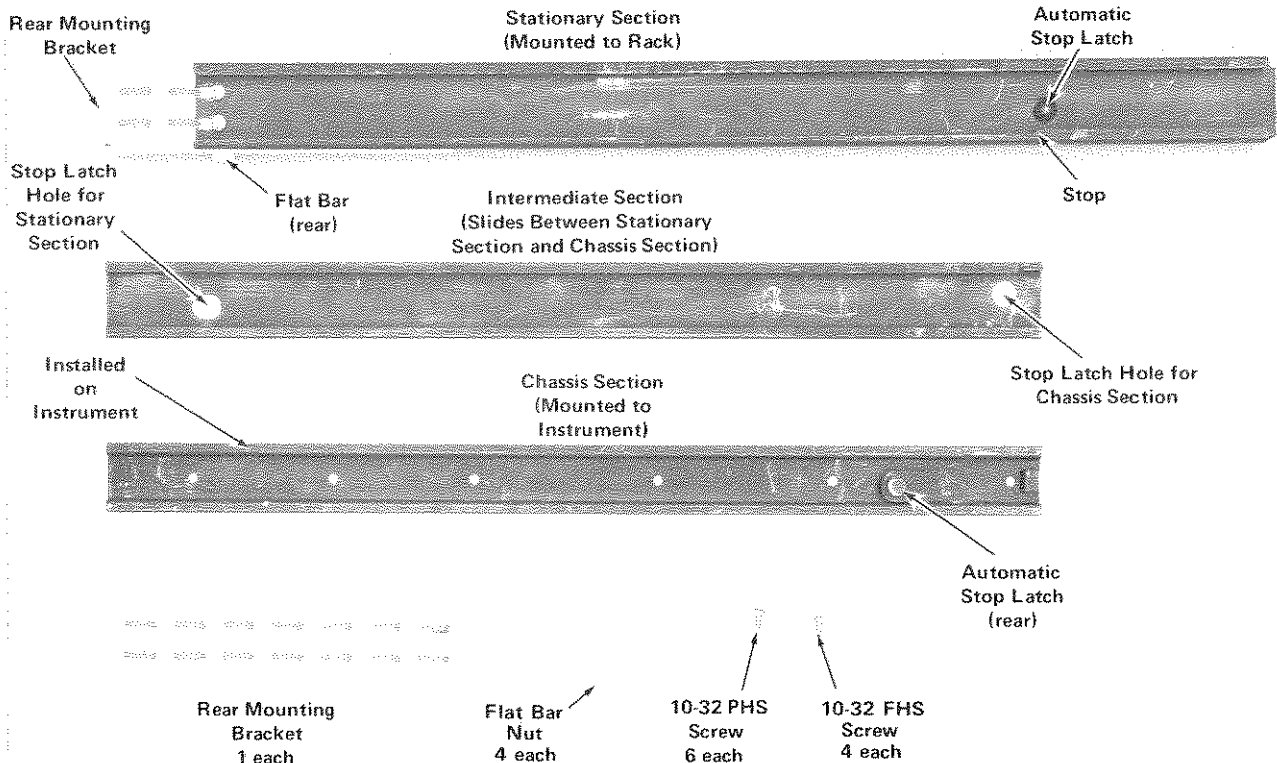

Fig. 3-1. Left side slide-out track assembly.

Slide-Out Tracks

The slide-out tracks provided with this instrument permit it to be extended out of the rack for maintenance and calibration without removing it from the rack. To operate this instrument in the extended position, be sure the power cord and any signal cables are long enough for this purpose.

The slide-out tracks consist of two assemblies; one for the left side of the instrument and one for the right side. Fig. 3-1 shows the complete slide-out track assemblies. The stationary section of each assembly attaches to the front and rear rails of the track, and the chassis section is attached to the instrument. The intermediate section slides between the stationary and chassis sections to allow the instrument to be extended out of the rack.

The hardware needed to mount the slide-out tracks to the rack is shown in Fig. 3-1. Since the hardware supplied is intended to make the tracks compatible with a variety of

cabinet racks and installation methods, not all of it will be needed for this installation. Use only the hardware that is required for the mounting method used.

WARNING

During rackmount installation, interchanging the left and right slide-out track assemblies defeats the extension stop (safety latch) feature of the tracks. Equipment could, when extended, come out of the slides and fall from the rack, possibly causing personal injury and equipment damage.

When mounting the supplied slide-out tracks, inspect both assemblies to find the LH (left hand) and RH (right hand) designations to determine correct placement. Install the LH assembly to your left side as you face the front of the rack and install the RH assembly to your right side. Refer to the rackmounting instructions in this manual for complete information.

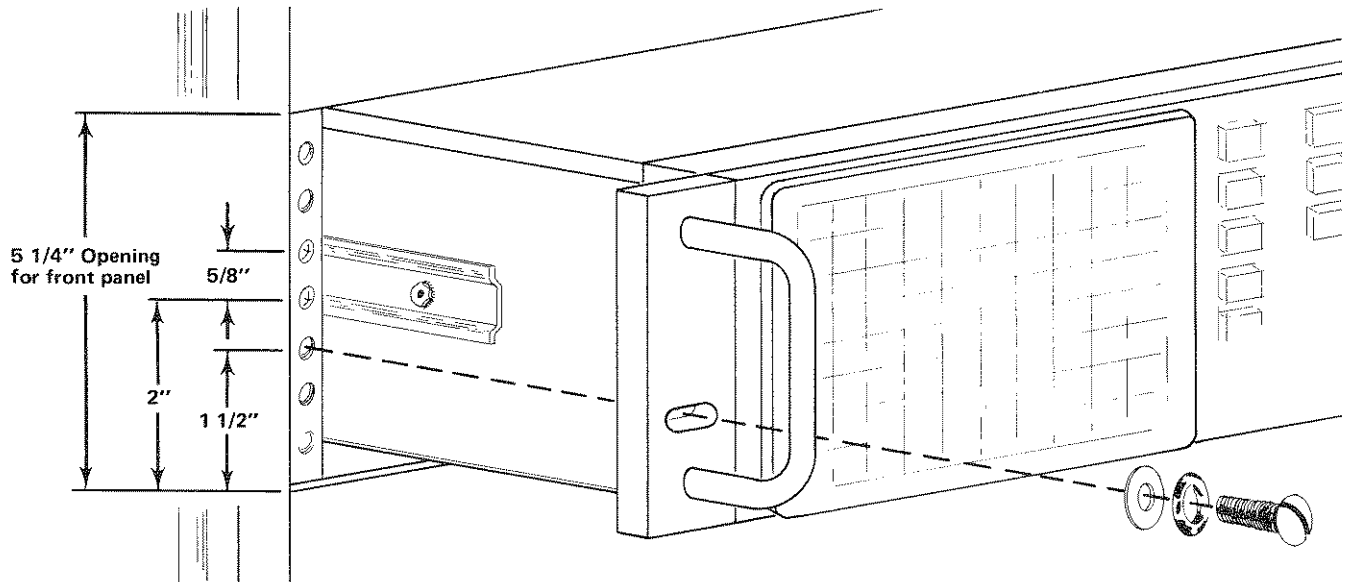

Fig. 3-2. Locating the mounting holes for the left stationary section. Same dimensions apply to right stationary section.

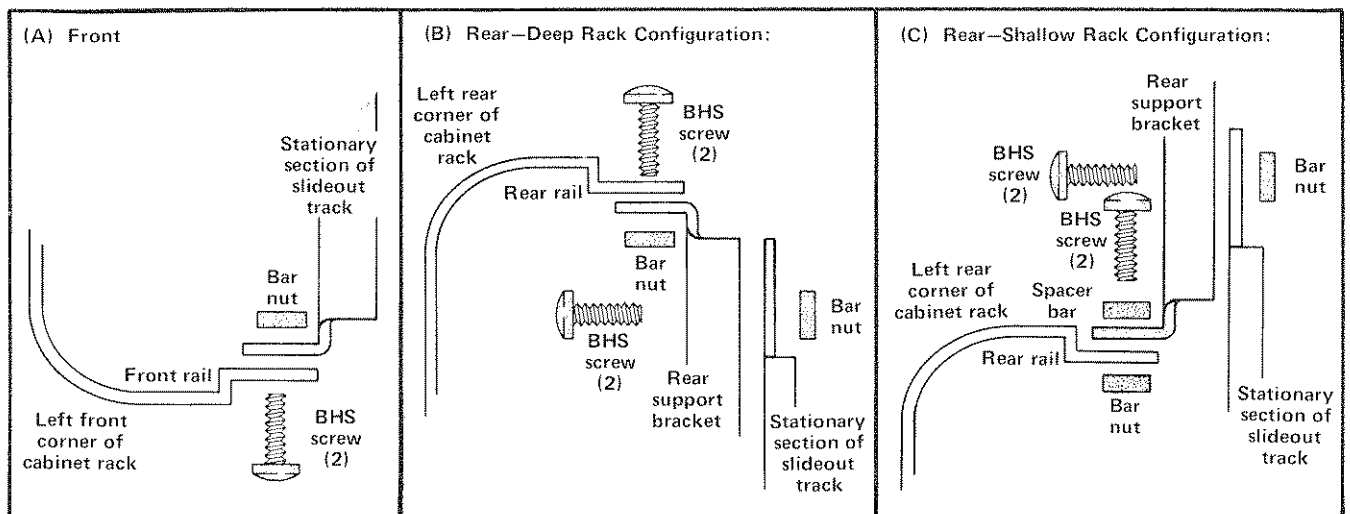

Fig. 3-3. Details for mounting stationary sections.

Mounting Procedure

Use the following procedure to install this instrument in a rack:

1. Select the proper front-rail mounting holes for the stationary sections using the measurements shown in Fig. 3-2.
2. Mount the front-flanges of the stationary sections to the front rails of the rack with a bar nut and two pan-head screws (see Fig. 3-3A).

NOTE

If the rails of the rack are tapped, drill out these three holes with a 0.196-inch drill.

3. Mount the rear of the stationary sections to the rear rails using the method shown in either 3-3B or 3-3C. Be sure the tracks are mounted level.
4. Refer to Fig. 3-4 to install the instrument into the rack.
5. Follow the procedure given in Fig. 3-5 to adjust the alignment of the stationary sections.

6. After the tracks operate smoothly, connect the power cord to the power source and connect any necessary cables to the rear panel connectors.

7. Push the instrument all the way into the rack and secure it to the front-rail of the rack with the securing screws and washers shown in Fig. 3-2. If the securing hole is not tapped, use a "speed-nut" or similar item to install the securing screw.

Removing or Installing the Instrument

After initial installation and adjustment of the slide-out tracks, the instrument can be removed or installed by following the instructions given in Fig. 3-4. No further adjustments are required under normal conditions.

Slide-Out Track Lubrication

The special finish on the sliding surfaces of the slide-out tracks provides permanent lubrication. However, if the tracks do not slide smoothly even after proper adjustment, a thin coating of paraffin can be rubbed onto the sliding surfaces for additional lubrication.

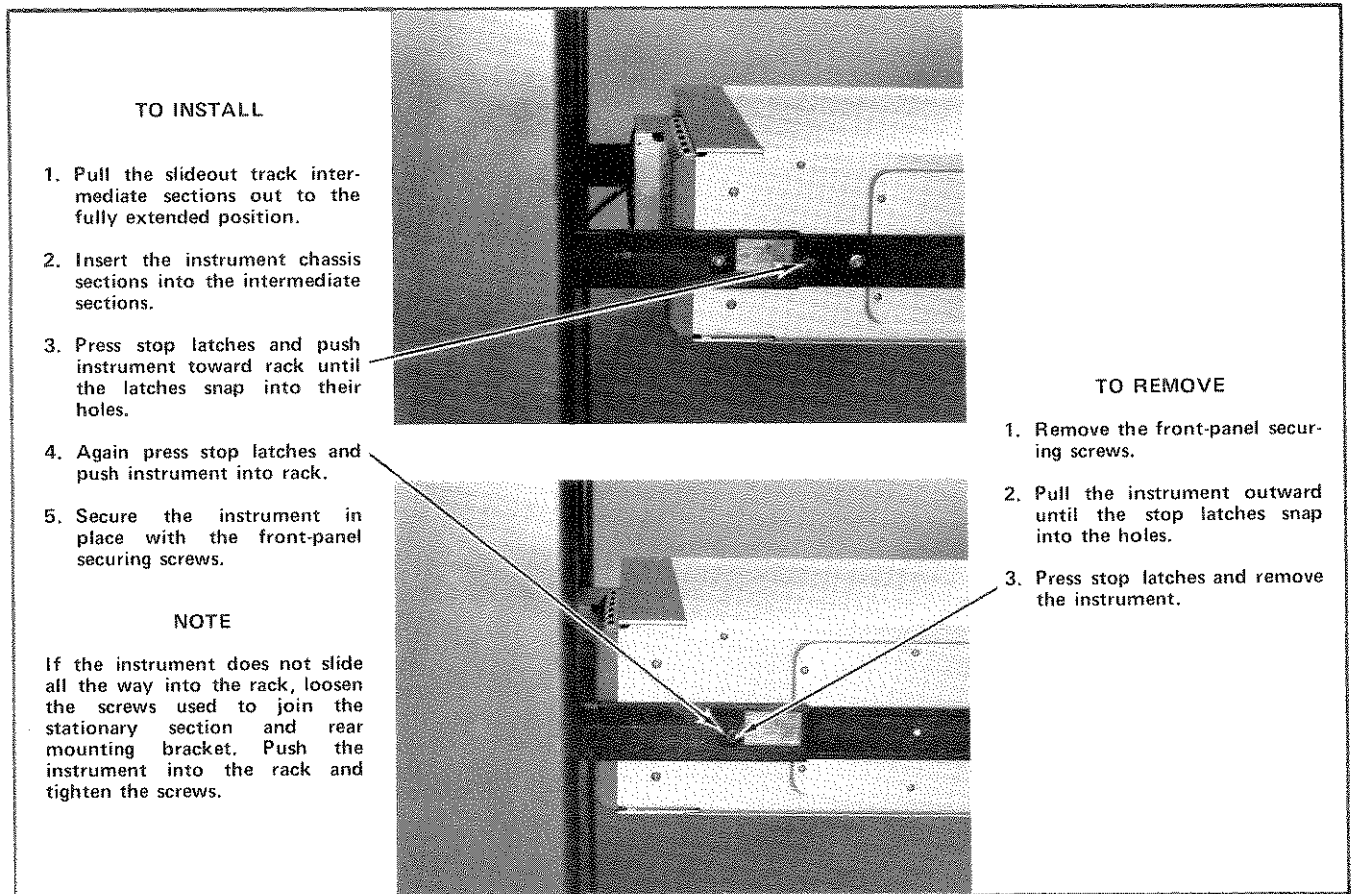

Fig. 3-4. Installing and removing the instrument after the tracks have been installed.

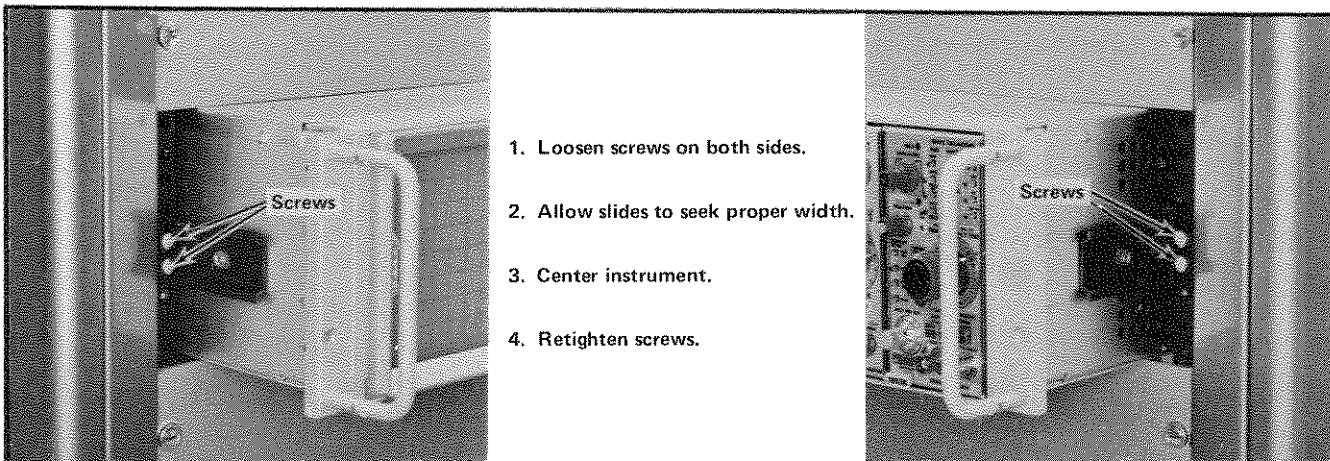

Fig. 3-5. Adjusting the slide-out tracks for smooth sliding action.

NOTES

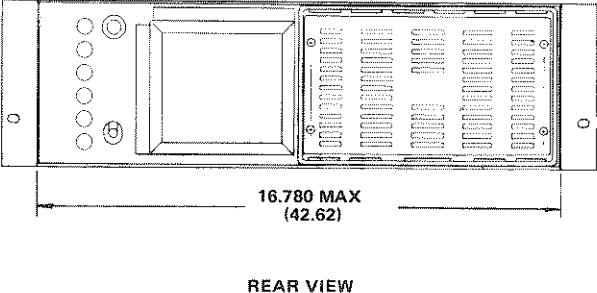
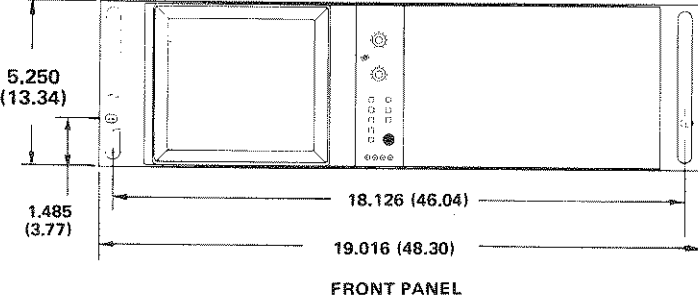
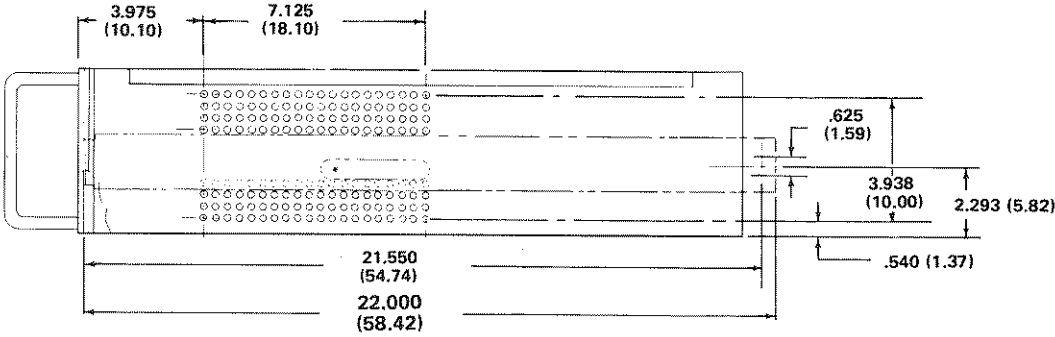
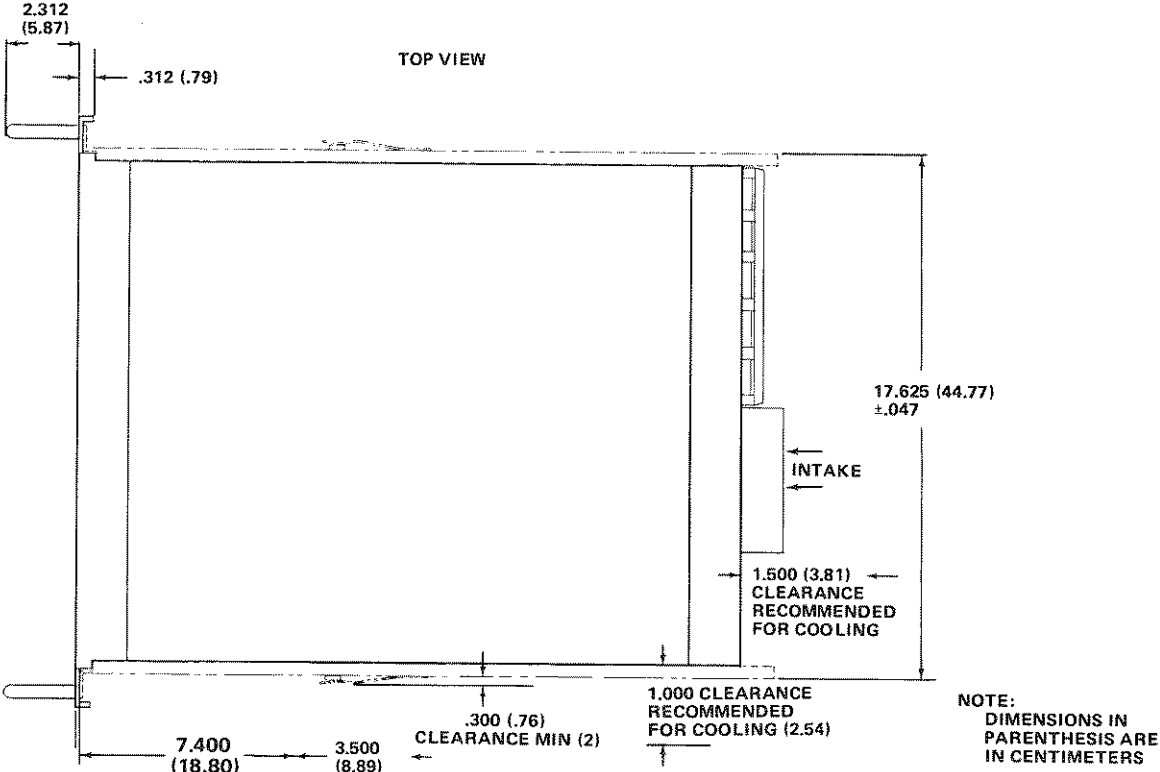

Fig. 3-6. Dimensional drawing.

1
) 2
3
4
5
6
7
) 8
9
10
11
12
) 13
14
15

16

17

18

MANUAL CHANGE INFORMATION

At Tektronix, we continually strive to keep up with latest electronic developments by adding circuit and component improvements to our instruments as soon as they are developed and tested.

Sometimes, due to printing and shipping requirements, we can't get these changes immediately into printed manuals. Hence, your manual may contain new change information on following pages.

A single change may affect several sections. Since the change information sheets are carried in the manual until all changes are permanently entered, some duplication may occur. If no such change pages appear following this page, your manual is correct as printed.

11
12
13
14
15
16
17
18
19
20

21