

Programmer Manual



AWG510 & AWG520 Arbitrary Waveform Generator

071-0100-00

This document supports firmware version 1.0
and above.



Copyright © Sony/Tektronix Corporation. All rights reserved.

Copyright © Tektronix, Inc. All rights reserved.

Tektronix products are covered by U.S. and foreign patents, issued and pending. Information in this publication supercedes that in all previously published material. Specifications and price change privileges reserved.

Printed in Japan.

Sony/Tektronix Corporation, P.O.Box 5209, Tokyo Int'l, Tokyo 100-31 Japan

Tektronix, Inc., P.O. Box 1000, Wilsonville, OR 97070-1000

TEKTRONIX and TEK are registered trademarks of Tektronix, Inc.

WARRANTY

Tektronix warrants that this product will be free from defects in materials and workmanship for a period of one (1) year from the date of shipment. If any such product proves defective during this warranty period, Tektronix, at its option, either will repair the defective product without charge for parts and labor, or will provide a replacement in exchange for the defective product.

In order to obtain service under this warranty, Customer must notify Tektronix of the defect before the expiration of the warranty period and make suitable arrangements for the performance of service. Customer shall be responsible for packaging and shipping the defective product to the service center designated by Tektronix, with shipping charges prepaid. Tektronix shall pay for the return of the product to Customer if the shipment is to a location within the country in which the Tektronix service center is located. Customer shall be responsible for paying all shipping charges, duties, taxes, and any other charges for products returned to any other locations.

This warranty shall not apply to any defect, failure or damage caused by improper use or improper or inadequate maintenance and care. Tektronix shall not be obligated to furnish service under this warranty a) to repair damage resulting from attempts by personnel other than Tektronix representatives to install, repair or service the product; b) to repair damage resulting from improper use or connection to incompatible equipment; or c) to service a product that has been modified or integrated with other products when the effect of such modification or integration increases the time or difficulty of servicing the product.

THIS WARRANTY IS GIVEN BY TEKTRONIX WITH RESPECT TO THIS PRODUCT IN LIEU OF ANY OTHER WARRANTIES, EXPRESSED OR IMPLIED. TEKTRONIX AND ITS VENDORS DISCLAIM ANY IMPLIED WARRANTIES OF MERCHANTABILITY OR FITNESS FOR A PARTICULAR PURPOSE. TEKTRONIX' RESPONSIBILITY TO REPAIR OR REPLACE DEFECTIVE PRODUCTS IS THE SOLE AND EXCLUSIVE REMEDY PROVIDED TO THE CUSTOMER FOR BREACH OF THIS WARRANTY. TEKTRONIX AND ITS VENDORS WILL NOT BE LIABLE FOR ANY INDIRECT, SPECIAL, INCIDENTAL, OR CONSEQUENTIAL DAMAGES IRRESPECTIVE OF WHETHER TEKTRONIX OR THE VENDOR HAS ADVANCE NOTICE OF THE POSSIBILITY OF SUCH DAMAGES.



Table of Contents

Preface	vii
Getting Started	
Getting Started	1-1
Overview of the Manual	1-1
Setting Up Remote Communications	1-3
Syntax and Commands	
Command Syntax	2-1
SCPI Commands and Queries	2-2
IEEE 488.2 Common Commands	2-9
Constructed Mnemonics	2-10
Syntax Diagrams	2-12
Command Groups	2-13
Functional Groups	2-13
Command Quick Reference	2-14
Command Summaries	2-16
Command Descriptions	2-25
Retrieving Response Messages	2-91
Data Transfer	2-93
Data File	2-93
Data Transfer Procedures	2-99
Status and Events	
Status and Event Reporting	3-1
Status Reporting Structure	3-1
Registers	3-4
Status Registers	3-4
Enable Registers	3-8
Queues	3-10
Status and Event Processing Sequence	3-11
I/O Status and Event Screen	3-13
Synchronizing Execution	3-14
Messages	3-14
Messages and Codes	3-15
Command Errors	3-16
Execution Errors	3-18
Device Specific Errors	3-20
Query Errors	3-21
Power-On Events	3-21
Operation Complete Events	3-21
Device Errors	3-22

Programming Examples

Programming Examples	4-1
-----------------------------------	------------

Appendices

Appendix A: Character Charts	A-1
Appendix B: Reserved Words	B-1
Appendix C: GPIB Interface Specification	C-1
Appendix D: SCPI Conformance Information	D-1
Appendix E: Factory Initialization Settings	E-1

Glossary and Index

List of Tables

Table 2-1: BNF symbols and meanings	2-1
Table 2-2: Query response examples	2-3
Table 2-3: Parameter types used in syntax descriptions	2-4
Table 2-4: Functional groups in the command set	2-13
Table 2-5: AWG Control commands	2-16
Table 2-6: Calibration commands	2-16
Table 2-7: Diagnostic commands	2-17
Table 2-8: Display commands	2-17
Table 2-9: Hardcopy commands	2-18
Table 2-10: Mass storage in AWG500 series	2-19
Table 2-11: Mass Memory commands	2-19
Table 2-12: Output channel	2-20
Table 2-13: Output commands	2-20
Table 2-14: Available sources and markers	2-20
Table 2-15: Source commands	2-21
Table 2-16: Status commands	2-22
Table 2-17: Synchronization commands	2-22
Table 2-18: System commands	2-23
Table 2-19: Trigger commands	2-24
Table 2-20: Selecting run modes	2-28
Table 2-21: Self-Test Routines	2-36
Table 3-1: SBR bit functions	3-5
Table 3-2: SESR bit functions	3-6
Table 3-3: OCR bit functions	3-7
Table 3-4: QCR bit functions	3-7
Table 3-5: Definition of event codes	3-15
Table 3-6: Command errors	3-16
Table 3-7: Execution errors	3-18
Table 3-8: Device specific errors	3-20
Table 3-9: Query errors	3-21
Table 3-10: Power-on events	3-21
Table 3-11: Operation complete events	3-21
Table 3-12: Device errors	3-22

Table of Contents

Table A-1: The AWG500 character set	A-1
Table A-2: ASCII & GPIB code chart	A-2
Table C-1: GPIB interface function implementation	C-1
Table C-2: AWG500 standard interface message	C-3
Table D-1: SCPI conformance information	D-1
Table E-1: Factory initialization settings	E-1

List of Figures

Figure 1-1: Common message elements	1-1
Figure 1-2: Functional groupings and an alphabetical list of commands	1-2
Figure 1-3: The status reporting function provides for event driven programs	1-2
Figure 1-4: The floppy disk supplied with the waveform generator .	1-3
Figure 1-5: GPIB connector location	1-3
Figure 1-6: How to stack GPIB connectors	1-4
Figure 1-7: Typical GPIB network configurations	1-5
Figure 1-8: Selecting the GPIB configuration and address	1-6
Figure 2-1: Example of SCPI subsystem hierarchy tree	2-2
Figure 2-2: Example of abbreviating a command	2-5
Figure 2-3: Example of chaining commands and queries	2-6
Figure 2-4: Example of omitting root and lower-level nodes in a chained message	2-6
Figure 2-5: Typical syntax diagrams	2-12
Figure 2-6: Retrieving response messages	2-91
Figure 2-7: The Waveform File format	2-94
Figure 2-8: The Pattern File format	2-95
Figure 2-9: The Sequence File format	2-96
Figure 2-10: The Code Convert File format	2-98
Figure 3-1: Error and Event handling process overview	3-2
Figure 3-2: The Status Byte Register (SBR)	3-5
Figure 3-3: The Standard Event Status Register (SESR)	3-6
Figure 3-4: The Operation Condition Register (OCR)	3-7
Figure 3-5: The Questionable Condition Register (QCR)	3-7
Figure 3-6: The Event Status Enable Register (ESER)	3-8
Figure 3-7: The Service Request Enable Register (SRER)	3-9
Figure 3-8: The Operation Enable Register (OENR)	3-9
Figure 3-9: The Questionable Enable Register (QENR)	3-9
Figure 3-10: Status and Event processing sequence — Operation status block	3-11
Figure 3-11: Status and Event processing sequence — Questionable status block	3-11
Figure 3-12: Status and Event processing sequence — Standard/Event status block	3-12

Figure 3-13: Status and Event screen	3-13
Figure 4-1: Equipment needed to run the example programs	4-1

Preface

This is the Programmer Manual for the AWG500 Series Arbitrary Waveform Generators. This manual provides information on operating the instrument over a General Purpose Interface Bus (GPIB) interface.

This manual provides the following information:

- *Getting Started* describes how to connect and set up the waveform generator for remote operation.
- *Syntax and Commands* defines the command syntax and processing conventions and describes each command in the waveform generator command set.
- *Status and Events* explains the status information and event messages reported by the waveform generator.
- *Programming Examples* describes how to use the Sample Program floppy disk supplied with the waveform generator.
- *Appendices* contains various tables of reference information.
- *Glossary and Index* contains a glossary of common terms and an index to this manual.

Related Manuals

Other documentation for the waveform generator includes:

- The *AWG510 & AWG520 Arbitrary Waveform Generator User Manual* (Tektronix part number 071-0099-XX) describes the operation of the instrument.
- The *AWG510 & AWG520 Arbitrary Waveform Generator Service Manual* (Tektronix part number 071-0101-XX) provides information for maintaining and servicing the waveform generator.



Getting Started

The AWG500 series waveform generators have GPIB interface capability. You can write computer programs that remotely set the front panel controls or that transfer waveform data.

To help you get started with programming the waveform generator, this section includes the following sections:

- *Overview of the Manual* – summarizes the type of programming information contained in each major section of this manual.
- *Setting Up Remote Communications* – describes how to physically connect the waveform generator to a controller and set the appropriate front panel controls.

Overview of the Manual

The information contained in each major section of this manual is described below.

Syntax and Commands

The *Syntax and Commands* chapter describes the structure and content of the messages your program sends to the waveform generator. You can use the Standard Commands for Programmable Instruments (SCPI) and IEEE 488.2 Common Commands. Figure 1-1 shows a syntax diagram and command parts as described in the *Command Syntax* subsection.

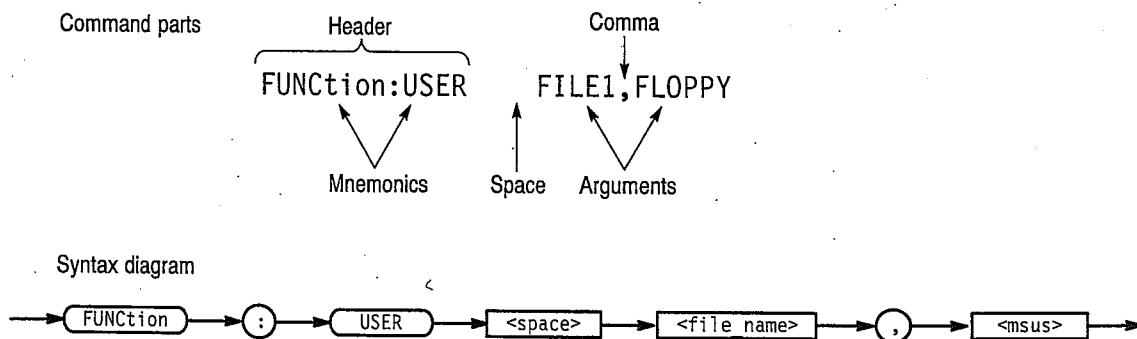

Figure 1-1: Common message elements

Chapter 2 also describes the effect of each command and provides examples of how you might use it. The *Command Groups* section provides a list by functional area. The *Command Descriptions* section arranges commands alphabetically (Figure 1-2).

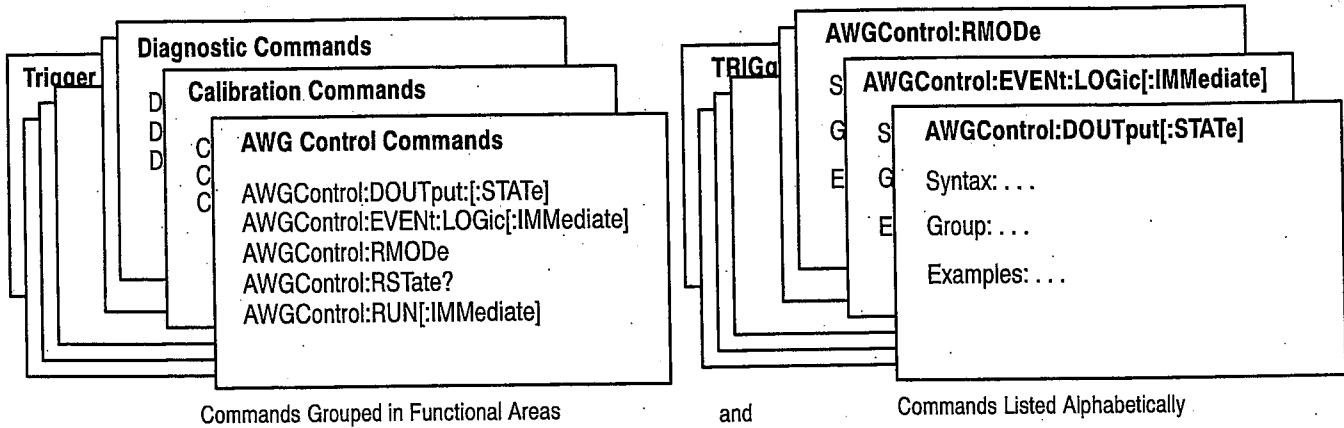

Figure 1-2: Functional groupings and an alphabetical list of commands

Status and Events

The program may request information from the waveform generator. The waveform generator provides information in the form of status and error messages. Figure 1-3 illustrates the basic operation of this system.

The *Status and Events* chapter starting on page 3-1 describes how to use the status reporting function that conforms to the SCPI and IEEE-488.2 in your programs.

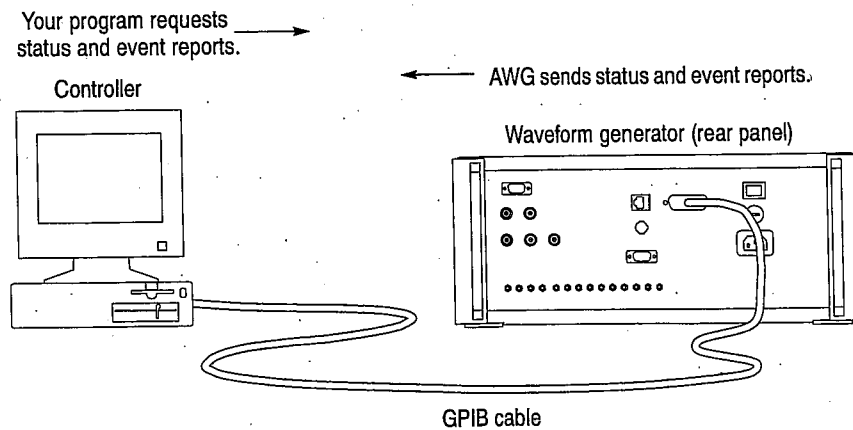

Figure 1-3: The status reporting function provides for event driven programs

Programming Examples

The *Programming Examples* chapter starting on page 4-1 describes some example waveform generator programs. The floppy disk supplied with the waveform generator manual (Figure 1-4) has a Microsoft Visual C++ and Visual BASIC source-code version of each program.

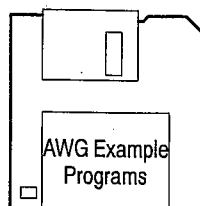

Figure 1-4: The floppy disk supplied with the waveform generator

Setting Up Remote Communications

For remote operations, the instrument must be connected to the controller. The following topics provide connection information.

The waveform generator has a 24-pin GPIB connector on its rear panel, as shown in Figure 1-5. This connector has a D-type shell and conforms to IEEE Std 488.1-1987.

Attach an IEEE Std 488.1-1987 GPIB cable (available from Tektronix as part number 012-0991-xx) to the GPIB connector.

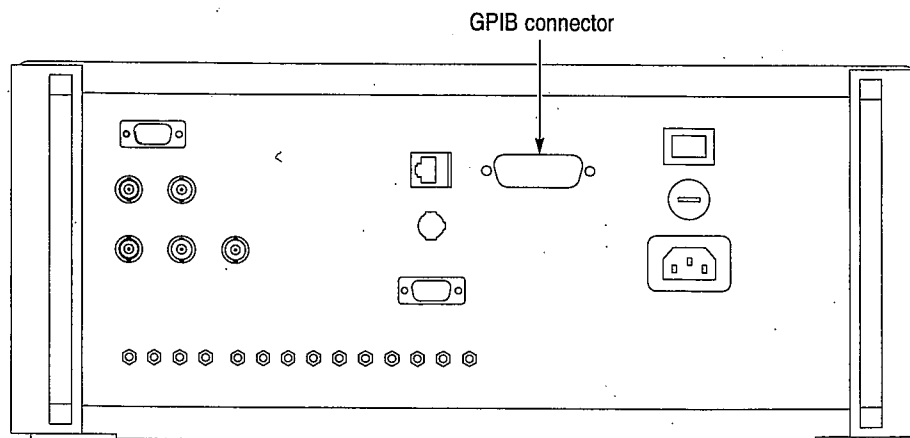

Figure 1-5: GPIB connector location

If needed, you can stack GPIB connectors as shown in Figure 1-6.

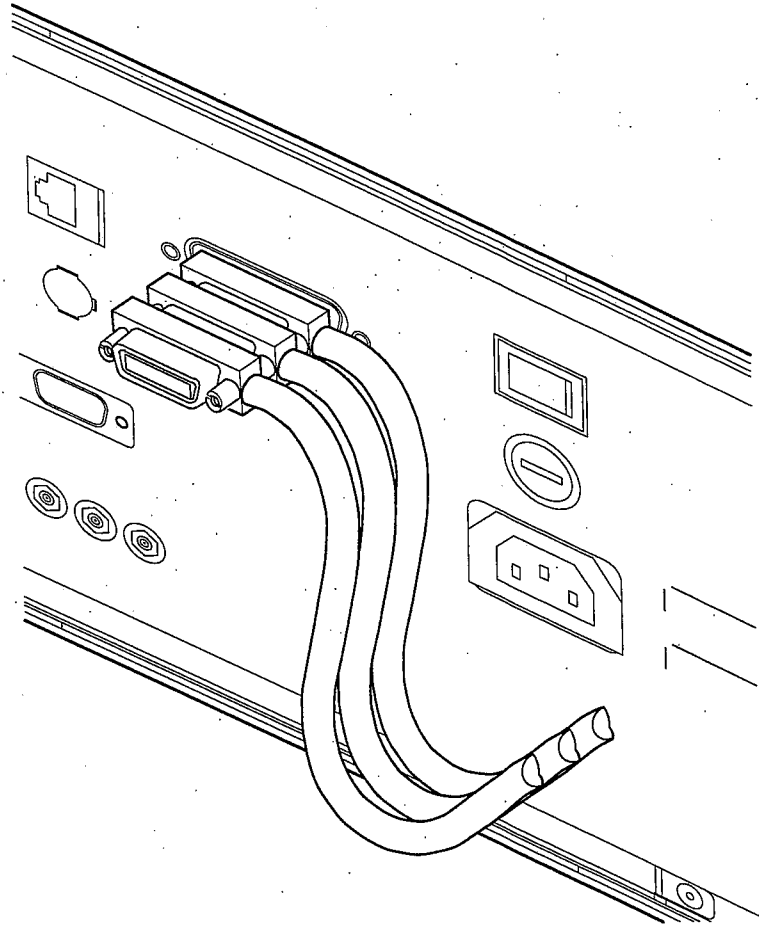

Figure 1-6: How to stack GPIB connectors

GPIB Requirements

Observe these rules when you use your waveform generator with a GPIB network:

- Assign a unique device address to each device on the bus. No two devices can share the same device address.
- Do not connect more than 15 devices to any one bus.
- Connect one device for every 2 meters (6 feet) of cable used.
- Do not use more than 20 meters (65 feet) of cable to connect devices to a bus.
- Turn on at least two-thirds of the devices on the network while using the network.
- Connect the devices on the network in a star or linear configuration as shown in Figure 1-7. Do not use loop or parallel configurations.

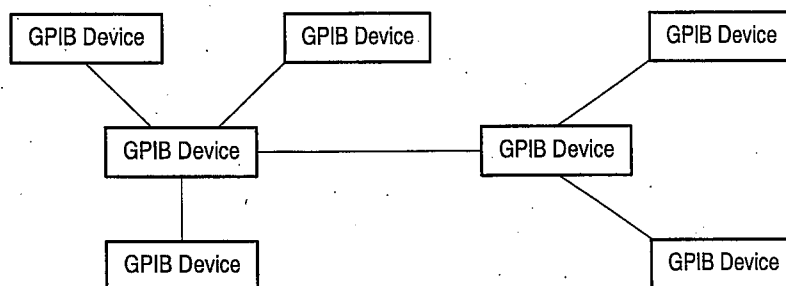

Figure 1-7: Typical GPIB network configurations

Appendix C: Interface Specifications gives more information on the GPIB configuration of the waveform generator.

Setting the GPIB Parameters

You must set the GPIB parameters of the waveform generator to match the configuration of the bus. Once you have set these parameters, you can control the waveform generator through the GPIB interface.

1. Push the **UTILITY** button to display the Utility screen.
2. Push the **Comm** bottom menu button.
3. Move the cursor to the **GPIB Configuration** field using the up/down (\uparrow/\downarrow) arrow buttons, then select **Talk/Listen** using either the general purpose knob or the left/right (\leftarrow/\rightarrow) arrow buttons. See Figure 1-8.
4. Move the cursor to the **GPIB Address** field using the down (\downarrow) arrow button, then set the address using either the general purpose knob or the keypad.

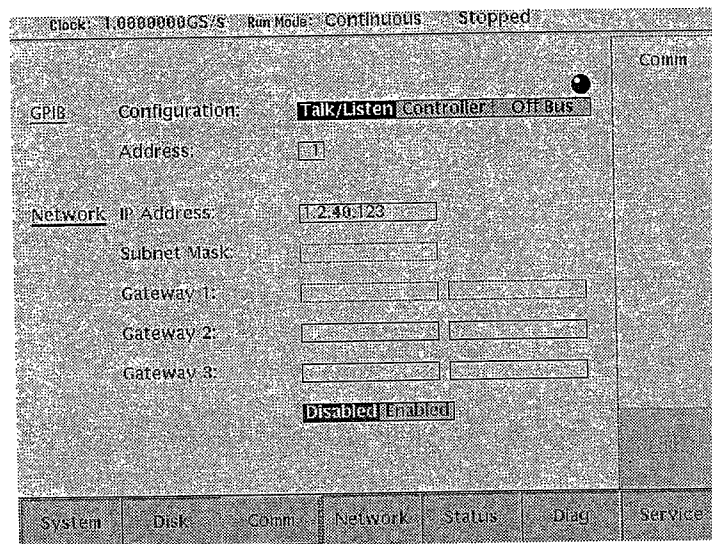

Figure 1-8: Selecting the GPIB configuration and address

The waveform generator is set up for bidirectional communication with your controller. If you want to isolate the waveform generator from the bus, do the following:

- Select **Off Bus** in the **GPIB Configuration** field. This selection disables all communication with the controller.

Syntax and Commands



Command Syntax

This section contains general information on command structure and syntax usage. You should familiarize yourself with this material before using the waveform generator command descriptions.

This manual describes commands and queries using the Backus-Naur Form (BNF) notation. Table 2-1 defines the standard BNF symbols.

Table 2-1: BNF symbols and meanings

Symbol	Meaning
< >	Defined element
::=	Is defined as
	Exclusive OR
{ }	Group; one element is required
[]	Optional; can be omitted
. . .	Previous element(s) may be repeated
()	Comment

SCPI Commands and Queries

The AWG500 Series Arbitrary Waveform Generator uses a command language based on the SCPI standard. The SCPI (Standard Commands for Programmable Instruments) standard was created by a consortium to provide guidelines for remote programming of instruments. These guidelines provide a consistent programming environment for instrument control and data transfer. This environment uses defined programming messages, instrument responses, and data formats that operate across all SCPI instruments, regardless of manufacturer.

The SCPI language is based on a hierarchical or tree structure (see Figure 2-1) that represents a subsystem. The top level of the tree is the root node; it is followed by one or more lower-level nodes.

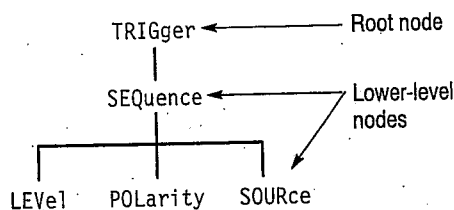

Figure 2-1: Example of SCPI subsystem hierarchy tree

You can create commands and queries from these subsystem hierarchy trees. Commands specify actions for the instrument to perform. Queries return measurement data and information about parameter settings.

Creating Commands

SCPI commands are created by stringing together the nodes of a subsystem hierarchy and separating each node by a colon.

In Figure 2-1, TRIGger is the root node and SEQuence, LEVel, POLarity, and SOURce are lower-level nodes. To create a SCPI command, start with the root node TRIGger and move down the tree structure adding nodes until you reach the end of a branch. Most commands and some queries have parameters; you must include a value for these parameters. If you specify a parameter value that is out of range, the parameter will be set to a default value. The command descriptions, which start on page 2-25, list the valid values for all parameters.

For example, TRIGger:SEQuence:SOURce EXTernal is a valid SCPI command created from the hierarchy tree in Figure 2-1.

Creating Queries

To create a query, start at the root node of a tree structure, move down to the end of a branch, and add a question mark. TRIGger:SEQuence:SOURce? is an example of a valid SCPI query using the hierarchy tree in Figure 2-1.

Query Responses

The query causes the waveform generator to return information about its status or settings. When a query is sent to the waveform generator, only the values are returned. When the returned value is a mnemonic, it is noted in abbreviated format.

Table 2-2: Query response examples

Query	Response
SOURce:VOLTage:AMPLitude?	1.000
AWGControl:RM0De?	CONT

A few queries also initiate an operation action before returning information. For example, the *CAL? query runs a calibration.

Parameter Types

Parameters are indicated by angle brackets, such as <file_name>. There are several different types of parameters, as listed in Table 2-3. The parameter type is listed after the parameter. Some parameter types are defined specifically for the AWG500 series command set and some are defined by ANSI/IEEE 488.2-1987.

Table 2-3: Parameter types used in syntax descriptions

Parameter Type	Description	Example
arbitrary block ¹	A block of data bytes	#512234xxxxx... where 5 indicates that the following 5 digits (12234) specify the length of the data in bytes; xxxxx... indicates the data or #0xxxxx...<LF><&EOI>
boolean	Boolean numbers or values	ON or 1 OFF or 0
discrete	A list of specific values	MIN, MAX
binary	Binary numbers	#B0110
octal	Octal numbers	#Q75, #Q3
hexadecimal ²	Hexadecimal numbers (0-9, A- F)	#HAA, #H1
NR1 ^{2,3} numeric	Integers	0, 1, 15, -1
NR2 ² numeric	Decimal numbers	1.2, 3.141516, -6.5
NR3 ² numeric	Floating point numbers	3.1415E-9, -16.1E5
NRf ² numeric	Flexible decimal number that may be type NR1, NR2, or NR3	See NR1, NR2, NR3 examples
string ⁴	Alphanumeric characters (must be within quotation marks)	"Testing 1, 2, 3"

1 Defined in ANSI/IEEE 488.2 as "Arbitrary Block Program Data."

2 An ANSI/IEEE 488.2-1992-defined parameter type.

3 Some commands and queries will accept an octal or hexadecimal value even though the parameter type is defined as NR1.

4 Defined in ANSI/IEEE 488.2 as "String Response Data" and "String Program Data."

Special Characters

The Line Feed (LF) character or the New Line (NL) character (ASCII 10) and all characters in the range of ASCII 127-255 are defined as special characters. These characters are used in arbitrary block arguments only; using these characters in other parts of any command yields unpredictable results.

Abbreviating Commands, Queries, and Parameters

You can abbreviate most SCPI commands, queries, and parameters to an accepted short form. This manual shows these commands as a combination of upper and lower case letters. The upper case letters indicate the accepted short form of a command, as shown in Figure 2–2. The accepted short form and the long form are equivalent and request the same action of the instrument.

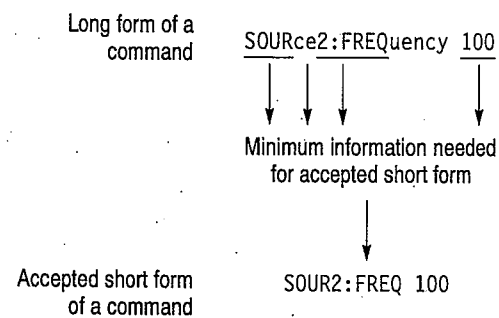

Figure 2–2: Example of abbreviating a command

NOTE. The numeric suffix of a command or query may be included in either the long form or short form; the AWG500 series will default to “1” if no suffix is used. In Figure 2–2, the “2” of “SOUR2” indicates that the command is directed to the second channel.

Chaining Commands and Queries

You can chain several commands or queries together into a single message. To create a chained message, first create a command or query, then add a semicolon (;), and finally add more commands or queries and semicolons until you are done. If the command following a semicolon is a root node, precede it with a colon (:). Figure 2-3 illustrates a chained message consisting of several commands and queries. The chained message should end in a command or query, not a semicolon. Responses to any queries in your message are separated by semicolons.

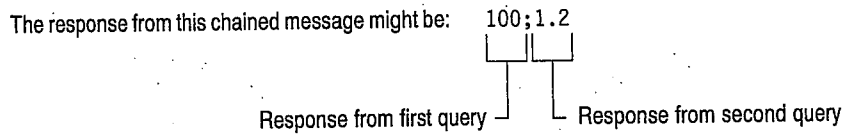
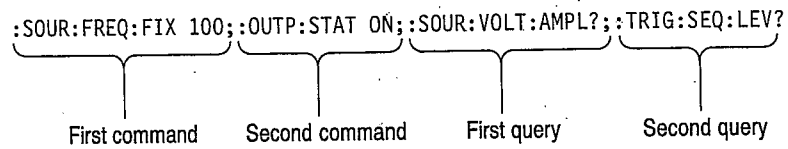

Figure 2-3: Example of chaining commands and queries

If a command or query has the same root and lower-level nodes as the previous command or query, you can omit these nodes. In Figure 2-4, the second command has the same root node (SEQUENCE) as the first command, so these nodes can be omitted.

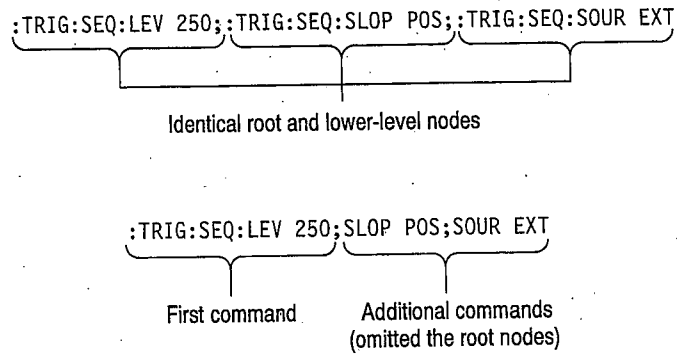

Figure 2-4: Example of omitting root and lower-level nodes in a chained message

Unit and SI Prefix

If the decimal numeric argument refers to voltage, frequency, impedance, or time, you can express it using SI units instead of using the scaled explicit point input value format <NR3>. (SI units are units that conform to the Systeme International d'Unites standard.) For example, you can use the input format 200 mV or 1.0 MHz instead of 200.0E-3 or 1.0E+6, respectively, to specify voltage or frequency.

You can omit the unit, but you must include the SI unit prefix. You can use either upper or lowercase units.

V or v for voltage

Hz, HZ, or hz for frequency

ohm, OHM, or Ohm for impedance

s or S for time

The SI prefixes, which must be included, are shown below. Note that either lower or upper case prefixes can be used.

SI prefix *	p/P	n/N	u/U	m/M	k/K	M/M	G/G
Corresponding power	10^{-12}	10^{-9}	10^{-6}	10^{-3}	10^3	10^6	10^9

* Note that the prefix m/M indicates 10^{-3} when the decimal numeric argument denotes voltage or time, but 10^6 when it denotes frequency.

General Rules

Here are three general rules for using SCPI commands, queries, and parameters:

- You can use single (') or double (" ") quotation marks for quoted strings, but you cannot use both types of quotation marks for the same string.

correct: "This string uses quotation marks correctly."

correct: 'This string also uses quotation marks correctly.'

incorrect: "This string does not use quotation marks correctly."

- You can use upper case, lower case, or a mixture of both cases for all commands, queries, and parameters.

:OUTPUT:FILTER:LPASS:FREQUENCY 250MHZ

is the same as

output:filter:lpass:frequency 250mhz

and

OUTPUT:filter:LPASS:frequency 250MHz

NOTE. *Literal strings (quoted) are case sensitive. For example: file names.*

- No embedded spaces are allowed between or within nodes.

correct: OUTPUT:FILTER:LPASS:FREQUENCY 250MHZ

incorrect: OUTPUT: FILTER: LPASS:FREQ UENCY 250MHZ

IEEE 488.2 Common Commands

ANSI/IEEE Standard 488.2 defines the codes, formats, protocols, and usage of common commands and queries used on the interface between the controller and the instruments. The waveform generator complies with this standard.

The syntax for an IEEE 488.2 common command is an asterisk (*) followed by a command and, optionally, a space and parameter value. The syntax for an IEEE 488.2 common query is an asterisk (*) followed by a query and a question mark. All of the common commands and queries are included in the *Syntax and Commands* section. The following are examples of common commands:

- *ESE 16
- *CLS

The following are examples of common queries:

- *ESR?
- *IDN?

Constructed Mnemonics

Some command headers list a range of mnemonics. When constructing the command, you select one mnemonic from the list. You then use these mnemonic in the command just as you do any other mnemonic. Mnemonic ranges can be presented in either of the following formats:

`MNEMonic[a|b|c]`. The values a, b, and c represent the actual list of valid selections. You cannot list more than one value.

For example, for the command `[SOURce[1|2|5]]:FUNction:USER`, the output source mnemonic could be any of the following: `SOURce1`, `SOURce2`, or `SOURce5`. Therefore, a valid usage of this command would be: `SOURce5:FUNCTion:USER`.

`MNEMonic<n>`. The value of `<n>` is the upper range of valid suffixes. If the numeric suffix is omitted, the waveform generator uses the default value of "1".

Source Channel Mnemonics

Commands specify the source channel to use as a mnemonic in the header.

Symbol	Meaning
SOURce1	CH1 signal of the waveform generator
SOURce2	CH2 signal of the waveform generator (AWG520 only)
SOURce3	Not used
SOURce4	Not used
SOURce5	Digital data of the pattern generator (Option 03)
SOURce6	Not used
SOURce7	Internal noise generator signal
SOURce8	External input signal

Output Channel Mnemonics

Commands specify the output channel to use as a mnemonic in the header.

Symbol	Meaning
OUTPut1	CH1 output from the waveform generator
OUTPut2	CH2 output from the waveform generator (AWG520 only)
OUTPut3	Not used
OUTPut4	Not used

Symbol	Meaning
OUTPut5	Digital data output from the pattern generator (Option 03)
OUTPut6	Not used
OUTPut7	Output from the noise generator

Direct D/A Output Mnemonics

Commands specify the direct D/A converter output to use as a mnemonic in the header.

Symbol	Meaning
DOUTput1	Direct output from CH1 D/A converter
DOUTput2	Direct output from CH2 D/A converter (AWG520 only)

Marker Mnemonics

Commands specify the marker to use as a mnemonic in the header.

Symbol	Meaning
MARKer1	The signal for the marker 1
MARKer2	The signal for the marker 2

Remote Device Mnemonics

Commands specify the remote device to use as a mnemonic in the header.

Symbol	Meaning
RDEvice1	Network drive 1
RDEvice2	Network drive 2
RDEvice3	Network drive 3

Gateway Mnemonics

Commands specify the gateway to use as a mnemonic in the header.

Symbol	Meaning
GATeway1	Gateway 1
GATeway2	Gateway 2
GATeway3	Gateway 3

Syntax Diagrams

The syntax of each command and query is explained by both syntax diagrams and BNF notation. Figure 2-5 shows some typical syntax diagram structures. The syntax diagrams are described by the following symbols and notation:

- Oval symbols contain literal elements, such as a command or query header and a nonquoted string argument.
- Circle symbols contain separators or special symbols, such as (:), (,), and (?).
- Box symbols contain the defined element, such as <NR1>.
- Arrow symbols connect elements to show the paths that can be taken through the diagram and, thereby, the order in which the elements can be sent in a command structure.
- Parallel paths show that one and only one of the paths must be taken in the command. (See the top diagram of Figure 2-5.)
- A loop around an element(s) shows the element can be repeated. (See the middle diagram.)
- A path around a group of elements shows that those elements are optional. (See the bottom diagram.)

NOTE. The unit and SI prefix that can be added to decimal numeric arguments are not described in the syntax diagram. See Unit and SI Prefix on page 2-5.

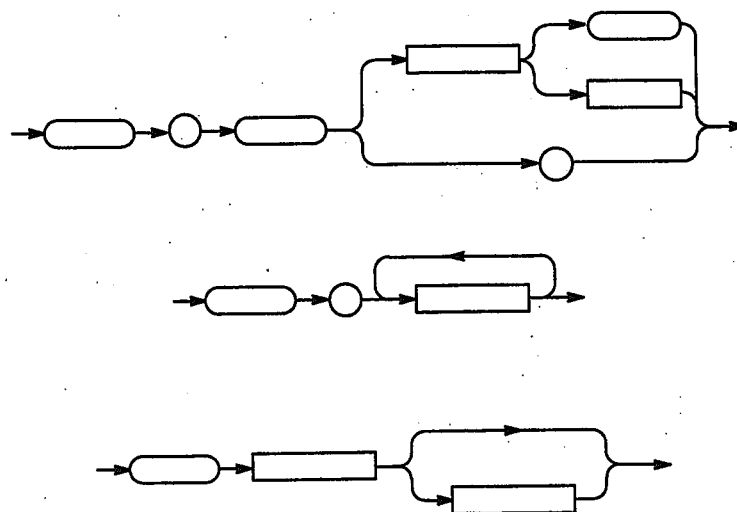

Figure 2-5: Typical syntax diagrams

Command Groups

This section lists commands in two ways, by functional groups and alphabetically. The functional group list starts below. The alphabetical list provides more detail on each command and starts on page 2-25.

The GPIB interface conforms to SCPI (Standard Commands for Programmable Instruments) 1995.0 and IEEE Std 488.2-1987 except where noted.

Functional Groups

Table 2-4 lists the functional groups into which the waveform generator commands are classified.

Table 2-4: Functional groups in the command set

Group	Function
AWG Control	Control operating mode
Calibration	Perform calibration
Diagnostic	Control self-test routines
Display	Control the presentation of information on the front panel display
Hardcopy	Dump the whole display into the file on the mass storage
Mass Memory	Control file operations on the mass storage
Output	Control the characteristics of the waveform output port
Source	Set waveform and marker output parameters, such as frequency and level
Status	Set and query the registers and queues of the reporting system
Synchronization	Control operation complete and pending command execution
System	Control miscellaneous instrument functions such as LAN, security, and time
Trigger	Synchronize the waveform generator actions with events

Command Quick Reference

The next page lists all the commands in each functional group and can be copied for use as a quick reference. The minimum accepted character string for each command is shown in uppercase characters.

AWG Control commands

AWGControl:DOUtpuT<x>:STATe (?)
 AWGControl:EVENT:LOGic:IMMediate
 AWGControl:RMODE (?)
 AWGControl:RSTate?
 AWGControl:RUN:IMMediate
 AWGControl:SREStore
 AWGControl:SSave
 AWGControl:STOP:IMMediate

Calibration commands

*CAL?
 CALibration:ALL (?)

Diagnostic commands

DIAGnostic:DATA?
 DIAGnostic:IMMediate (?)
 DIAGnostic:SElect (?)
 *TST?

Display commands

DISPlay:BRIGHtness (?)

Hardcopy commands

HCOPy:DEStination
 HCOPy:DEvice:LANGuage (?)
 HCOPy:IMMediate
 HCOPy:SDUMp:IMMediate

Mass memory commands

MMEMory:CATalog?
 MMEMory:CDIRectory (?)
 MMEMory:CLOSe
 MMEMory:COpy
 MMEMory:DATA
 MMEMory:DELeTe
 MMEMory:FEED (?)
 MMEMory:INITialize
 MMEMory:MDIRectory
 MMEMory:MSIS (?)
 MMEMory:MOVE
 MMEMory:NAME (?)
 MMEMory:OPEN

Output commands

OUTPut<x>:FILTer:LPASs:FREQuency (?)
 OUTPut<x>:STATe (?)
 OUTPut1:ISTate (?)

Source commands

SOURce1:COMBine:FEED (?)
 SOURce<x>:FREQuency:CW|:FIXed (?)
 SOURce<x>:FUNctioN:USER (?)
 SOURce<x>:MARkeR<y>:DELay (?)
 SOURce<x>:MARkeR<y>:VOLTagE:LEVel:IMMediate:HIGH (?)
 SOURce<x>:MARkeR<y>:VOLTagE:LEVel:IMMediate:LOW (?)
 SOURce7:POWer:LEVel:IMMediate:AMPLitude (?)
 SOURce<x>:ROSCillator:SOURce (?)
 SOURce<x>:VOLTagE:LEVel:IMMediate:AMPLitude (?)
 SOURce5:VOLTagE:LEVel:IMMediate:HIGH (?)

SOURce5:VOLTagE:LEVel:IMMediate:LOW (?)
 SOURce<x>:VOLTagE:LEVel:IMMediate:OFFSet (?)

Status commands

*CLS
 *ESE (?)
 *ESR?
 *PSC (?)
 *SRE (?)
 STATus:OPERation:EVENT?
 STATus:OPERation:CONDition?
 STATus:OPERation:ENABle (?)
 STATus:QUESTionable:EVENT?
 STATus:QUESTionable:CONDition?
 STATus:QUESTionable:ENABle (?)
 STATus:PRESet
 STATus:QUEue:NEXT?
 *STB?

Synchronization commands

*OPC (?)
 *WAI

System commands

*IDN?
 *OPT?
 *RST
 SYSTem:BEEPper:IMMediate
 SYSTem:COMMunicate:LAN:FTP:SERVer:STATe (?)
 SYSTem:COMMunicate:LAN:GATeway<x>:ADDResS (?)
 SYSTem:COMMunicate:LAN:PING?
 SYSTem:COMMunicate:LAN:RDEvice<x>:ADDResS (?)
 SYSTem:COMMunicate:LAN:RDEvice<x>:FSYSstem (?)
 SYSTem:COMMunicate:LAN:RDEvice<x>:NAME (?)
 SYSTem:COMMunicate:LAN:RDEvice<x>:PROTocol (?)
 SYSTem:COMMunicate:LAN:RDEvice<x>:STATe (?)
 SYSTem:COMMunicate:LAN:SELF:ADDResS (?)
 SYSTem:COMMunicate:LAN:SELF:SMASK (?)
 SYSTem:DATE (?)
 SYSTem:ERRor?
 SYSTem:KDIRectioN (?)
 SYSTem:KEYBoard:TYPE (?)
 SYSTem:KLOCK (?)
 SYSTem:SECurity:IMMediate
 SYSTem:TIME (?)
 SYSTem:UPTime?
 SYSTem:VERSion?

Trigger commands

ABORT
 *TRG
 TRIGger:SEQuence:IMMediate
 TRIGger:SEQuence:IMPedance (?)
 TRIGger:SEQuence:LEVel (?)
 TRIGger:SEQuence:POLarity (?)
 TRIGger:SEQuence:SLOPe (?)
 TRIGger:SEQuence:SOURce (?)
 TRIGger:SEQuence:TImer (?)

Command Summaries

Tables 2-6 through 2-19 describe each command in each of the 12 functional groups.

AWG Control Commands

The AWG Control commands control operating modes. This command group is not SCPI approved.

Table 2-5: AWG Control commands

Header	Description
AWGControl:DOUTput[1 2] [:STATe] (?)	Output the raw D/A converter output
AWGControl:EVENT[:LOGic] [:IMMediate]	Generate the event signal for logic jump
AWGControl:RMODE (?)	Select the run mode, such as triggered or gated
AWGControl:RSTate?	Query the current running status
AWGControl:RUN[:IMMediate]	Enable the output from CH<x>
AWGControl:SREStore	Restore the settings from the specified file
AWGControl:SSAVe	Store the settings to the specified file
AWGControl:STOP[:IMMediate]	Stop the output from CH<x>

Calibration Commands

The Calibration commands calibrate the waveform generator.

Table 2-6: Calibration commands

Header	Description
*CAL?	Perform calibration
CALibration[:ALL] (?)	Perform calibration

Diagnostic Commands

The Diagnostic commands control self-test diagnostic routines.

Table 2-7: Diagnostic commands

Header	Description
DIAGnostic:DATA?	Query results of self-test
DIAGnostic[:IMMediate] (?)	Start the self-test
DIAGnostic:SELEct (?)	Select the self-test routine
*TST?	Perform self-test

Display Commands

The Display commands control the presentation of textual information on the front panel display.

Table 2-8: Display commands

Header	Description
DISPlay:BRIGHtness (?)	Control brightness of the display

Hardcopy Commands

The Hardcopy commands are used to print the whole display into a specified file rather than printing to an external device.

The hardcopy commands used in this application do not conform to the 1995 SCPI hardcopy standard. (The 1995 SCPI standards state that the MMEemory:OPEN and MMEemory:CLOSe commands are to be used to open and close the file specified by MMEemory:NAME, to accommodate feeding data from the HCOPY subsystem. This state-dependent style of feeding data is not used in the waveform generator.) Instead, the hardcopy commands are implemented in a way that more closely resembles previous waveform generator usage. The waveform generator implements the hardcopy commands as illustrated in the following example:

```
MMEemory:NAME "SAMPLE1.BMP"
MMEemory:OPEN
HCOPY:DESTINATION "MMEM"
HCOPY
MMEemory:CLOSe
```

The above command sequence can be written as follows for the waveform generator:

```
MMEemory:NAME "SAMPLE1.BMP"
HCOPY
```

In this case, the whole display will be written to the SAMPLE1.BMP file.

Table 2-9: Hardcopy commands

Header	Description
HCOPY:DESTINATION	Set the destination
HCOPY:DEVICE:LANGUAGE (?)	Select the data format
HCOPY[:IMMEDIATE]	Initiate the plot or print immediately
HCOPY:SDUMP[:IMMEDIATE]	Plot or print the whole display

Mass Memory Commands

The Mass Memory commands provide mass storage capabilities.

Selecting Mass Memory Devices. The waveform generator supports the devices listed below. The network drives can be specified with the SYSTem command group.

Table 2-10: Mass storage in AWG500 series

String argument	Description
MAIN	Internal hard disk drive
FLOP or FLOPPY	Internal floppy disk drive
NET1	Network drive 1
NET2	Network drive 2
NET3	Network drive 3

File Names. The <file_name> parameter is described in some Mass Memory commands with a string. The content of the string depends on the format needs of the mass storage media. In particular, the file name may contain characters for specifying subdirectories (e.g. "/") and the period separator ("."). The instrument checks the file format when reading, and processes the file based on its content, regardless of the file extension.

Table 2-11: Mass Memory commands

Header	Description
MMEemory:CATalog?	Query information on the mass storage media
MMEemory:CDIRectory (?)	Change the default directory for a file system
MMEemory:CLoSe	Close the file specified in NAME
MMEemory:COpy	Copy an existing file to a new file
MMEemory:DATA	Load data into the file
MMEemory:DELeTe	Remove a file
MMEemory:FEED (?)	Feed data into the file specified in NAME
MMEemory:INITialize	Initialize the specified mass storage
MMEemory:MDIRectory	Make a directory
MMEemory:MSIS (?)	Select the current mass storage
MMEemory:MOVE	Move an existing file to another file
MMEemory:NAME (?)	Set the file name to be opened or closed
MMEemory:OPEN	Open the file specified in NAME

Output Commands

The Output commands control the characteristics of the waveform output port. In Table 2-13, OUTPut<x> refers to the waveform output channel, where <x> represents related channel number as shown in Table 2-12.

Table 2-12: Output channel

Mnemonic	Description
OUTPut1	CH1 output of the waveform generator
OUTPut2	CH2 output of the waveform generator
OUTPut3	Not used
OUTPut4	Not used
OUTPut5	Output of the pattern generator
OUTPut6	Not used
OUTPut7	Output of the noise generator

Table 2-13: Output commands

Header	Description
OUTPut[1 2]:FILTer[:LPASS] :FREQuency (?)	Determine the cutoff frequency of the low pass filter
OUTPut[1 2 5 7][:STATe] (?)	Control whether the output terminal is open or closed
OUTPut[1]:ISTate (?) (AWG510)	Set the inverted output on or off

Source Commands

The Source commands set waveform and marker output parameters, such as frequency and level. SOURce<x> and MARKer<y> in these commands have the meanings as shown in Table 2-14 below.

Table 2-14: Available sources and markers

Mnemonic	Description
SOURce1	CH1 waveform
SOURce2	CH2 waveform
SOURce3	Not used
SOURce4	Not used

Table 2-14: Available sources and markers (Cont.)

Mnemonic	Description
SOURce5	Pattern generator signal
SOURce6	Not used
SOURce7	Noise generator signal
SOURce8	External input signal
MARKer1	Marker 1 signal
MARKer2	Marker 2 signal

Table 2-15: Source commands

Header	Description
[SOURce[1]:]COMBine:FEED (?)	Add noise or external signal to the output
[SOURce[1 2 5]:]FREQuency [:CW]:FIXed (?)	Set sampling frequency for outputting waveform
[SOURce[1 2 5]:]FUNction:USER (?)	Specify the user-defined waveform or pattern file
[SOURce[1 2 5]:]MARKer[1 2] :DELay (?)	Set the marker delay relative to waveform output
[SOURce[1 2 5]:]MARKer[1 2] [:LEVEL][:IMMediate]:HIGH (?)	Set high level for marker output
[SOURce[1 2 5]:]MARKer[1 2] [:LEVEL][:IMMediate]:LOW (?)	Set low level for marker output
SOURce7:POWer[:LEVe1] [:IMMediate][:AMPLitude] (?)	Set the level for the noise generator output
[SOURce[1 2 5]:]ROSCillator :SOURce (?)	Select the reference oscillator source
[SOURce[1 2]:]VOLTag[:LEVe1] [:IMMediate][:AMPLitude] (?)	Set the actual magnitude of the output signal
SOURce5:VOLTag[:LEVe1] [:IMMediate]:HIGH (?)	Set the high level of a digital pattern signal
SOURce5:VOLTag[:LEVe1] [:IMMediate]:LOW (?)	Set the low level of a digital pattern signal
[SOURce[1 2]:]VOLTag[:LEVe1] [:IMMediate]:OFFSet (?)	Set the offset that is added to the output signal

Status Commands

The external controller uses the Status commands to coordinate operation between the waveform generator and other devices on the bus. The Status commands set and query the registers/queues of the waveform generator event/status reporting system. For more information about the registers and queues described in Table 2-16, refer to *Status and Event Reporting* on page 3-1.

Table 2-16: Status commands

Header	Description
*CLS	Clear all the event registers and queues
*ESE (?)	Set and query ESER
*ESR?	Query SESR
*PSC (?)	Set power-on status clear flag
*SRE (?)	Set and query SRER
STATus:OPERation[:EVENT]?	Query the contents of OEVR
STATus:OPERation:CONDition?	Query the contents of OCR
STATus:OPERation:ENABle (?)	Set the enable mask of OENR
STATus:QUESTionable[:EVENT]?	Query the contents of QEVR
STATus:QUESTionable:CONDition?	Query the contents of QCR
STATus:QUESTionable:ENABle (?)	Set the enable mask of QENR
STATus:PRESet	Preset OENR and QENR
STATus:QUEue[:NEXT]?	Query the next item from the error/event queue
*STB?	Query SBR

Synchronization Commands

The external controller uses the Synchronization commands to prevent external communications from interfering with waveform generator operation.

Table 2-17: Synchronization commands

Header	Description
*OPC (?)	Generate or return the operation complete message
*WAI	Hold off all commands until all pending operations complete

System Commands

The System commands control miscellaneous instrument functions, such as LAN communication, security, and time.

Table 2-18: System commands

Header	Description
*IDN?	Query ID information about the waveform generator
*OPT?	Query installed options
*RST	Reset the waveform generator
SYSTEM:BEEP[:IMMEDIATE]	Generate an audible tone
SYSTEM:COMMUNICATE:LAN:FTP[:SERVER][:STATE] (?)	Control the FTP server function
SYSTEM:COMMUNICATE:LAN:GATEWAY[1 2 3]:ADDRESS (?)	Set IP address of the gateway
SYSTEM:COMMUNICATE:LAN:PING?	Execute PING test for the specified IP address
SYSTEM:COMMUNICATE:LAN:RDEVICE[1 2 3]:ADDRESS (?)	Set IP address of the remote host
SYSTEM:COMMUNICATE:LAN:RDEVICE[1 2 3]:FSYSTEM (?)	Set the mount directory of the remote host
SYSTEM:COMMUNICATE:LAN:RDEVICE[1 2 3]:NAME (?)	Set the name of the remote host
SYSTEM:COMMUNICATE:LAN:RDEVICE[1 2 3]:PROTOCOL (?)	Set the protocol of the communication between the waveform generator and the remote host
SYSTEM:COMMUNICATE:LAN:RDEVICE[1 2 3][:STATE] (?)	Control whether the communication with the specified remote host is enabled
SYSTEM:COMMUNICATE:LAN[:SELF]:ADDRESS (?)	Set IP address of the waveform generator
SYSTEM:COMMUNICATE:LAN[:SELF]:SMASK (?)	Set the subnet mask of the waveform generator
SYSTEM:DATE (?)	Set the internal calendar
SYSTEM:ERROR?	Query the next entry from the waveform generator's error/event queue
SYSTEM:KDIRECTION (?)	Set the direction of cursor movement controlled by the general purpose knob
SYSTEM:KEYBOARD[:TYPE] (?)	Select the keyboard type
SYSTEM:KLOCK (?)	Lock the front panel and keyboard
SYSTEM:SECURITY:IMMEDIATE	Destroy all data and settings for security
SYSTEM:TIME (?)	Set the internal clock
SYSTEM:UPTIME?	Query elapsed time from the power-on
SYSTEM:VERSION?	Query the SCPI version number

Trigger Commands

The Trigger commands synchronize the waveform generator actions with events.

Table 2-19: Trigger commands

Header	Description
ABORt	Reset the trigger system
*TRG	Generate the trigger event
TRIGger[:SEquence][:IMMediate]	Immediately trigger the sequence operation
TRIGger[:SEquence]:IMPedance (?)	Select the input impedance of the external trigger
TRIGger[:SEquence]:LEVe1 (?)	Set the trigger level
TRIGger[:SEquence]:POLarity (?)	Select the polarity of the trigger signal
TRIGger[:SEquence]:SLOPe (?)	Select the slope of the trigger signal
TRIGger[:SEquence]:SOURce (?)	Select the source for the event detector
TRIGger[:SEquence]:TIMER (?)	Set the period of the internal clock

Command Descriptions

This subsection lists each command and query in the AWG500 series Arbitrary Waveform Generator command set alphabetically. Each command entry includes a command description and command group, related commands (if any), syntax, and arguments. Each entry also includes one or more usage examples.

This subsection fully spells out headers, mnemonics, and arguments with the minimal spelling shown in upper case. For example, to use the abbreviated version of the `SOURce:FREQuency` command, just type `SOUR:FREQ`.

The symbol “(?)” follows the command header of those commands that can be used as either a command or a query; the symbol “?” follows those commands that can only be a query. Commands that are command-only or query-only are noted as such.

ABORt (No Query Form)

Resets the trigger system and places all trigger sequences in the idle state. This command is equivalent to depressing the FORCE TRIGGER button on the front panel in the gated mode.

Group Trigger

Related Commands TRIGger[:SEquence] [:IMMediate], *TRG

Syntax ABORt

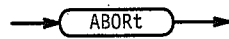

Arguments None

Examples ABORt
resets the trigger system.

AWGControl:DOUTput[1|2][:STATE] (?)

Supplies raw output of the waveform generator D/A converter for the specified channel. The settings of SOURce:VOLTage and OUTPut:FILTer commands are ignored.

Group AWG Control

Related Commands SOURce:VOLTage command group, OUTPut:FILTer command group

Syntax AWGControl:DOUTput[1|2] [:STATE] { OFF | ON | <NR1> }
AWGControl:DOUTput[1|2] [:STATE]?

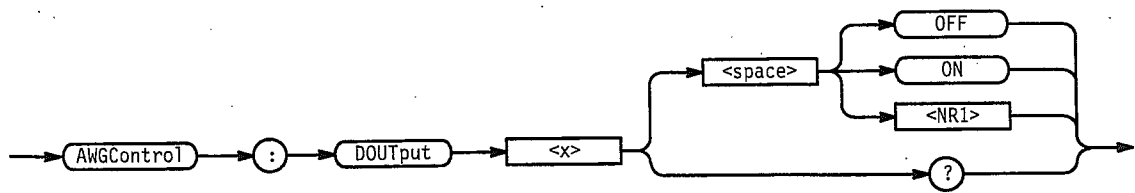

Arguments OFF or <NR1>=0 provides the D/A converter output normally.
 ON or <NR1>≠0 provides raw output of the D/A converter.
 At *RST, this value is set to 0.

Examples AWGControl:DOUTput1:STATE ON
 supplies the D/A converter output directly to CH 1.

AWGControl:EVENT[:LOGic][:IMMediate] (No Query Form)

Generates a trigger event for the “logic jump” specified in the sequence file. This has the same effect as pushing the FORCE EVENT button on the front panel.

Group AWG Control

Related Commands AWGControl:RUN[:IMMediate], *TRG

Syntax AWGControl:EVENT[:LOGic][:IMMediate]

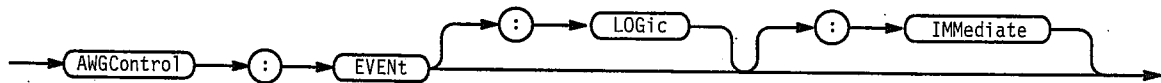

Arguments None

Examples AWGControl:EVENT:LOGic:IMMediate
 generates a trigger event for the “logic jump”.

AWGControl:RMODE (?)

Selects the mode used to output waveforms or sequences.

Group AWG Control

Related Commands ABORT, TRIGger[:SEquence][:IMMediate], *TRG

Syntax AWGControl:RMODE { CONTinuous | TRIGgered | GATED | ENHanced }
 AWGControl:RMODE?

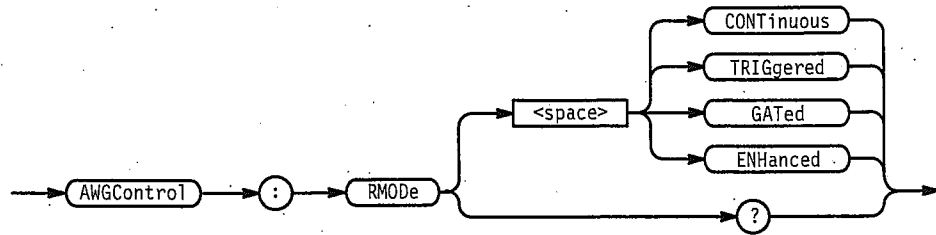

Arguments You can select the modes listed in Table 2–20.

Table 2-20: Selecting run modes

Arguments	Descriptions
CONTInuous	Sets the continuous mode, which continuously outputs the waveform. The external trigger, including FORCE TRIGGER button and the corresponding remote commands, have no effect.
TRIGgered	Sets the triggered mode, which outputs one waveform cycle for each trigger.
GATed	Sets the gated mode, which continuously outputs the waveform or sequence as long as the trigger remains enabled. The trigger remains effective as long as any of the following events occur: <ul style="list-style-type: none"> ■ The FORCE TRIGGER button remains pressed ■ A valid external gate signal remains input ■ The TRIGger[:SEQUence] [:IMMediate] or *TRG command has been executed but a ABORt command has not yet been issued
ENHanced	Sets the enhanced mode, which outputs the waveform according to the sequence file specified with the SOURce:FUNCTion:USER command. If the sequence file is not loaded, this mode is the same as the triggered mode.

At *RST, this parameter is set to CONTInuous.

Examples SOURce:FUNCTion:USER "SAMPLE1.SEQ";:AWGControl:RMODe ENHanced;RUN outputs waveform according to the sequence file SAMPLE1.SEQ.

AWGControl:RState? (Query Only)

Returns the current running status.

Group AWG Control

Syntax AWGControl:RState?

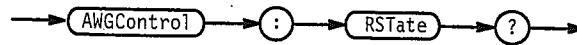

Arguments None

Returns <NRI>

- 0 The waveform generator is stopped.
- 1 The waveform generator is waiting for a trigger.
- 2 The waveform generator is running.

Examples AWGControl:RState?
might return the following response:
1

AWGControl:RUN[:IMMEDIATE] (No Query Form)

Starts the output of a waveform or a sequence. This has the same effect as pressing the RUN button on the front panel.

Group AWG Control

Related Commands AWGControl:STOP[:IMMEDIATE], *TRG

Syntax AWGControl:RUN[:IMMEDIATE]



Arguments None

Examples AWGControl:RUN[:IMMEDIATE]
starts the output of a waveform or a sequence.

AWGControl:SREStore (No Query Form)

Restores the settings from the specified file.

Group AWG Control

Related Commands AWGControl:SSAVE, MMEemory:CDIRectory, MMEemory:MSIS

Syntax AWGControl:SREStore <file_name>[,<msus>]

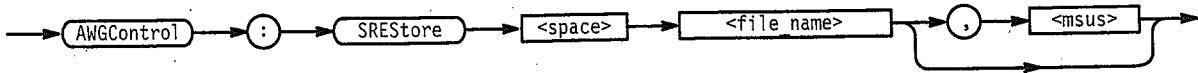

Arguments <file_name>::=<string> specifies the file to restore the settings.
 <msus> (mass storage unit specifier)::=<string> is the media on which the file exists:

MAIN	Internal hard disk drive
FLOppy	Internal floppy disk drive
NET1, NET2, or NET3	Network drive 1, 2, or 3 (specified with the SYSTem:COMMUnicate:LAN commands)

Examples AWGControl:SREStore "SAMPLE1.SET", "FLOppy"
 restores the settings from the file SAMPLE1.SET on the floppy disk.

AWGControl:SSAVE (No Query Form)

Stores the current settings to the specified file.

Group AWG Control

Related Commands AWGControl:SREStore, MMEemory:CDIRectory, MMEemory:MSIS

Syntax AWGControl:SSAVE <file_name>[,<msus>]

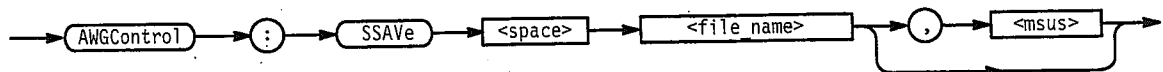

Arguments <file_name>::=<string> specifies the file to store the settings.
 <msus> (mass storage unit specifier)::=<string> is the media on which the file exists:

MAIN	Internal hard disk drive
FLOppy	Internal floppy disk drive
NET1, NET2, or NET3	Network drive 1, 2, or 3 (specified with the SYSTem:COMMUnicate:LAN commands)

Examples `AWGControl:SSAVE "SAMPLE1.SET", "FLOppy"`
stores the current settings to the file SAMPLE1.SET on the floppy disk.

AWGControl:STOP[:IMMEDIATE] (No Query Form)

Terminates waveform output. When the mode is *not* set to continuous, it also resets the sequence pointer to output the waveform from the top of the sequence with the next trigger event.

Group AWG Control

Related Commands `AWGControl:RUN[:IMMEDIATE], *TRG`

Syntax `AWGControl:STOP[:IMMEDIATE]`

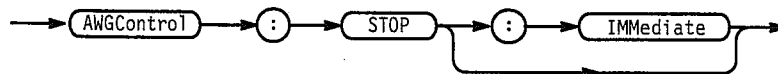

Arguments None

Examples `AWGControl:STOP[:IMMEDIATE]`
stops the output of a waveform.

*CAL? (Query Only)

The *CAL? query performs an internal calibration and returns status that indicates whether the waveform generator completes the calibration successfully. If an error is detected during calibration, execution immediately stops and an error code is returned. This query performs the same function as the CALibration [:ALL]? query.

NOTE. *Up to 15 seconds are required to complete the internal calibration. During this time, the waveform generator does not respond to any commands or queries issued.*

Group Calibration

Related Commands CALibration[:ALL]?

Syntax *CAL?



Arguments None

Returns <NR1>
 0 Terminated without error.
 -340 Calibration failed.

Examples *CAL?
 performs an internal calibration and returns the results. For example, the query might return 0, which indicates the calibration terminated without any detected errors.

CALibration[:ALL] (?)

The CALibration[:ALL] command performs a full calibration of the waveform generator.

The CALibration[:ALL]? query performs a full calibration and responds with a <NR1> indicating the success of the calibration. This query has the same function as the *CAL? query.

If an error is detected during calibration, a message is queued in the error/event queue, and the error code “-340” is returned.

NOTE. Up to 15 seconds are required to complete the internal calibration. During this time, the waveform generator does not respond to any commands or queries issued.

Group Calibration

Related Commands *CAL?

Syntax CALibration[:ALL]
 CALibration[:ALL]?

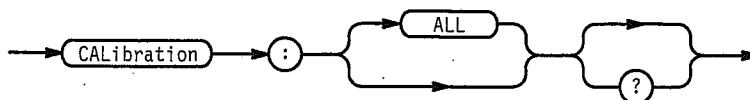

Arguments None

Returns <NR1>
 0 Terminated without error.
 -340 Calibration failed.

Examples CALibration[:ALL]
 performs a full calibration.
 CALibration[:ALL]?
 performs a full calibration and returns the results. For example, it might return 0, which indicates the calibration terminated without any errors detected.

*CLS (No Query Form)

Clears all the event registers and queues, which are used in the waveform generator status and event reporting system. For more details, refer to Section 3, *Status and Events*.

Group Status

Syntax *CLS

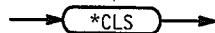

Arguments None

Examples *CLS
 clears all the event registers and queues.

DIAGnostic:DATA? (Query Only)

Returns the results of self-test.

Group Diagnostic

Related Commands DIAGnostic[:IMMediate], DIAGnostic:SElect

Syntax DIAGnostic:DATA?



Arguments None

Returns <NR1>

0 Terminated without error.
 -330 Self-test failed.

Examples DIAGnostic:DATA?
 might return 0.

DIAGnostic[:IMMediate] (?)

The DIAGnostic[:IMMediate] command executes the self-test routine(s) selected by the DIAGnostic:SElect command. The query DIAGnostic[:IMMediate]? executes the routine(s) and returns the results.

If an error is detected during execution, the routine that detected the error terminates. If all of the self-test routines are selected, self-testing continues with execution of the next self-test routine.

Group Diagnostic

Related Commands DIAGnostic:SElect, DIAGnostic:DATA?

Syntax DIAGnostic[:IMMediate]
 DIAGnostic[:IMMediate]?

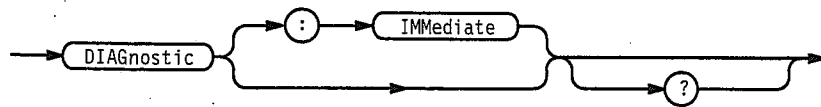

Arguments None

Returns <NR1>

- 0 Terminated without error.
- 330 Self-test failed.

Examples `DIAGnostic:SElect ALL;IMMediate?`
 executes all of the self-test routines. After all self-test routines finish, the results of the self-tests are returned.

DIAGnostic:SElect (?)

Selects the self-test routine(s).

Group Diagnostic

Related Commands `DIAGnostic[:IMMediate]`

Syntax `DIAGnostic:SElect { ALL | OUTPut | RMODe | ROSCillator
 | SMEMory | SYSTem | WMEMory }`

`DIAGnostic:SElect?`

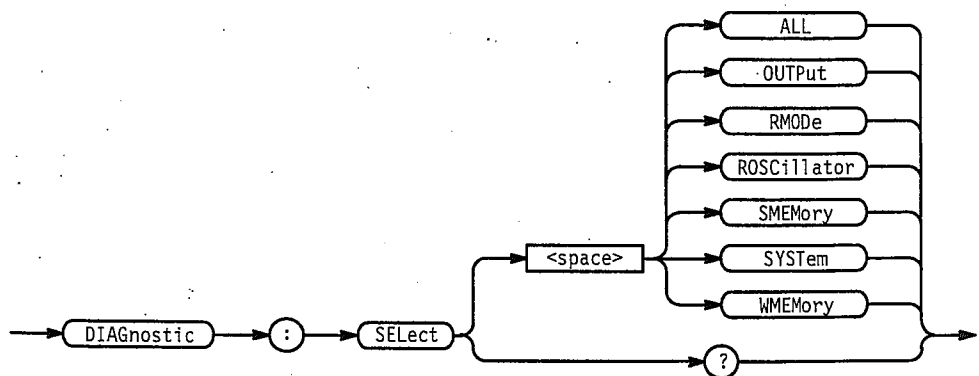

Arguments You can select the following self-test routines:

Table 2-21: Self-Test Routines

Argument	Description
ALL	Checks all routines that follow
AOUTput	Checks the analog output unit
ROSCillator	Checks the reference oscillator unit
SMEemory	Checks the sequence memory
SYSTEM	Checks the system unit, such as the system memory
TRIGger	Checks the trigger unit
WMEemory	Checks the waveform memory

At *RST, this parameter is set to ALL.

Examples `DIAGnostic:SElect WMEemory;IMMediate`
executes the waveform memory self-test routine.

DISPlay:BRIGhtness (?)

Controls the intensity of the display.

Group Display

Syntax `DISPlay:BRIGhtness <NRf>`
`DISPlay:BRIGhtness?`

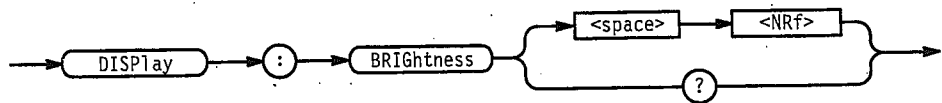

Arguments <NRf> ranges from 0 to 1, where 1 is full intensity and 0 is fully blanked.

Examples `DISPlay:BRIGhtness 0.8`
sets the intensity of the display to 80% of maximum intensity.

***ESE (?)**

The *ESE command sets the bits of the ESER (Event Status Enable Register) used in the status and events reporting system of the waveform generator. The *ESE? query returns the contents of the ESER. Refer to Section 3 *Status and Events* for more information about the ESER.

Group Status

Related Commands *CLS, *ESR?, *PSC, *SRE, *STB?

Syntax *ESE <bit_value>

*ESE?

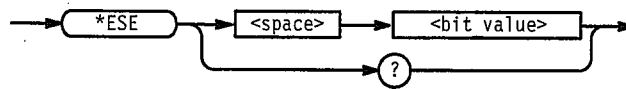

Arguments <bit_value>::=<NR1>
 where <NR1> is a decimal integer in the range 0 to 255. The binary bits of the ESER are set according to this value.

The power-on default for ESER is 0 if *PSC is 1. If *PSC is 0, the ESER maintains its value through a power cycle.

Examples *ESE 177
 sets the ESER to 177 (binary 10110001), which sets the PON, CME, EXE and OPC bits.

*ESE?
 might return 176, which indicates that the ESER contains the binary number 10110000.

*ESR? (Query Only)

Returns the contents of the Standard Event Status Register (SESR) used in the status and events reporting system in the waveform generator. *ESR? also clears the SESR (since reading the SESR clears it). Refer to Section 3 *Status and Events* for more information.

Group Status

Related Commands *CLS, *ESE?, *SRE, *STB?

Syntax *ESR?



Returns <NR1> indicates the content of the SESR in a decimal integer.

Examples *ESR?
might return 181, which indicates that the SESR contains the binary number 10110101.

HCOPY:DESTINATION (No Query Form)

Sets the hardcopy destination. For the waveform generator, the destination is fixed to MMEemory (mass memory), and this command is included only for compatibility with the SCPI standard. The destination file on the mass memory device is specified by the MMEemory:NAME command. For more information about hardcopy, see *Hardcopy Commands* on page 2-18.

Group Hardcopy

Related Commands MMEemory:NAME

Syntax HCOpy:DESTination <data_handle>

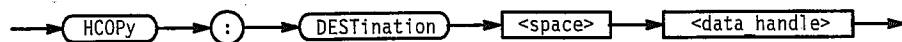

Arguments <data_handle>::=<string>
where <string> is fixed to "MMEemory" for the waveform generator.

Examples HCOPY:DESTination "MMEM"
sets the hardcopy destination to a file specified with the MMEMemory:NAME command.

HCOPY:DEVIce:LANGUage (?)

Sets the hardcopy data format.

Group Hardcopy

Related Commands HCOPY[:IMMediate]

Syntax HCOPY:DEVIce:LANGUage { BMP | TIFF }
HCOPY:DEVIce:LANGUage?

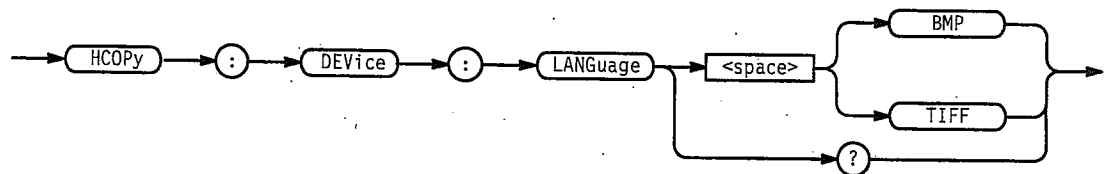

Arguments BMP specifies the Windows bitmap file format.

TIFF specifies the TIFF format.

At *RST, the parameter is set to BMP.

Examples HCOPY:DEVIce:LANGUage TIFF
specifies the TIFF data format for hardcopy.

HCOPY[:IMMediate] (No Query Form)

Immediately initiates hardcopy output according to the current HCOPY setup parameters. For the waveform generator, this command is the same as HCOPY:SDUMp[:IMMediate]. For more information about hardcopy, see *Hardcopy Commands* on page 2-18.

Group Hardcopy

Related Commands HCOpy:DESTination, HCOpy:SDUMp[:IMMediate]

Syntax HCOpy[:IMMediate]

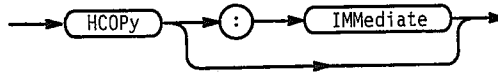

Arguments None

Examples HCOpy:IMMediate
starts hardcopy output.

HCOpy:SDUMp[:IMMediate] (No Query Form)

Initiates a screen dump of the whole display. For the waveform generator, this is the same as the HCOpy[:IMMediate] command.

Group Hardcopy

Syntax HCOpy:SDUMp[:IMMediate]



Arguments None

Examples MMEemory:NAME "SAMPLE1.BMP";:HCOpy:SDUMp:IMMediate
prints the whole display to the file SAMPLE1.BMP.

*IDN? (Query Only)

Returns identification information for the waveform generator.

Group System

Syntax *IDN?

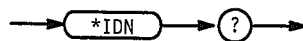

Arguments None

Returns <manufacturer>, <model>, <serial_number>, <firmware_level>
 where
 <manufacturer>::=SONY/TEK
 <model>::={ AWG510 | AWG520 }
 <serial_number>::=0
 <firmware_level>::=SCPI:95.0 OS:x.y USR:x'.y'

Examples *IDN?
 might return SONY/TEK,AWG520,0,SCPI:95.0 OS:1.0 USR:1.0

MMEMory:CATalog? (Query Only)

Returns information on the current contents and state of the mass storage media.

Group Mass Memory

Related Commands MMEMory:CDIRectory, MMEMory:MSIS

Syntax MMEMory:CATalog? [<msus>]

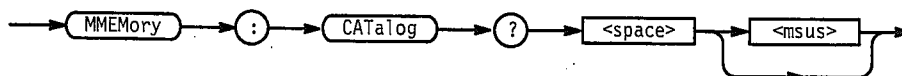

Arguments <msus> (mass storage unit specifier)::=<string> is one of the following:

MAIN	The internal hard disk drive
FLOppy	The internal floppy disk drive
NET1, NET2, or NET3	The network drive 1, 2, or 3 (specified with the SYSTEM :COMMunicate:LAN commands)

Returns <NR1>,<NR1>[,<file_entry>]...

where:

The first <NR1> is the total amount of storage currently used, in bytes.
For the network drives, <NR1>=0.

The second <NR1> is the total amount of storage available.
For the network drives, <NR1>=0.

<file_entry>::="<file_name>,<file_type>,<file_size>"

where

<file_name> is the exact name of a file,
<file_type> is DIR for directory, otherwise it is blank, and
<file_size> is the size of the file, in bytes.

Examples MMEemory:CATalog? "MAIN"
might return the following response:
546322,3878625,"SAMPLE1.WFM,,2948"

MMEemory:CDIRectory (?)

Changes the default directory for a mass memory file system. The default mass storage device is selected by MMEemory:MSIS command.

Group Mass Memory

Related Commands MMEemory:MSIS

Syntax MMEemory:CDIRectory [<directory_name>]
MMEemory:CDIRectory?

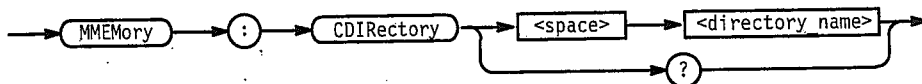

Arguments <directory_name>::=<string>
is the default directory for a mass memory file system.

If you do not specify a parameter, the directory is set to the *RST value.

At *RST, this parameter is set to the root.

Examples MMEemory:CDIRectory "/AWG/WORK1"
changes the default directory to /AWG/WORK1.

MMEemory:CLOSE (No Query Form)

Closes the file specified in the MMEemory:NAME command. This command is included only for compatibility with the SCPI standard and may not be used.

Group Mass Memory

Related Commands MMEemory:NAME, MMEemory:OPEN

Syntax MMEemory:CLOSE



Arguments None

Examples MMEemory:NAME "TEST1.WFM";CLOSE
closes the file TEST1.WFM.

MMEemory:COPY (No Query Form)

Copies an existing file to a new file. An error is generated if the source file does not exist.

Group Mass Memory

Related Commands MMEemory:CDIRectory, MMEemory:DELeTe, MMEemory:MSIS

Syntax MMEemory:COPY <file_source>,<file_destination>

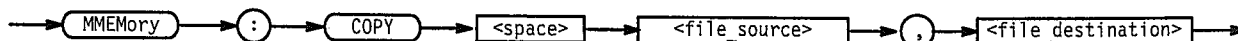

Arguments : <file_source> and <file_destination>
 ::= { <file_name> | <file_name>, <msus> }

where:

<file_name> ::= <string> is the source or destination file name.

<msus> (mass storage unit specifier) ::= <string> is the media on which the file exists:

MAIN	Internal hard disk drive
FLOppy	Internal floppy disk drive
NET1, NET2, or NET3	Network drive 1, 2, or 3 (specified with the SYSTem:COMMUnicate:LAN commands)

Examples MMEMory:COPY "FILE1.WFM", "MAIN", "FILE2.WFM", "FLOppy"
 copies the file FILE1.WFM on the waveform generator hard disk to the file FILE2.WFM on the floppy disk.

MMEMory:DATA (No Query Form)

Loads block data into the file on the default mass storage device.

Group Mass Memory

Related Commands MMEMory:CDIRectory, MMEMory:MSIS

Syntax MMEMory:DATA <file_name>,<data>

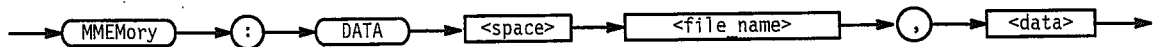

Arguments <file_name> ::= <string> specifies the file to be loaded with data.
 <data> is in 488.2 block format.

Examples MMEMory:DATA "FILE1", #41024xxxxx...
 loads data into the file FILE1.

MMEMory:DELeTe (No Query Form)

Removes a file from the specified mass storage device.

Group Mass Memory

Related Commands MMEemory:CDIRectory, MMEemory:MSIS

Syntax MMEemory:DELeTe <file_name>[,<msus>]

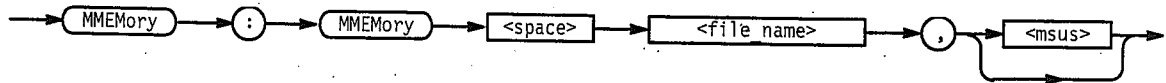

Arguments <file_name>::=<string> specifies the file to be removed.

<msus> (mass storage unit specifier)::=<string> is the media on which the file exists:

MAIN	Internal hard disk drive
FLOppy	Internal floppy disk drive
NET1, NET2, or NET3	Network drive 1, 2, or 3 (specified with the SYSTem:COMMunicate:LAN commands)

Examples MMEemory:DELeTe "FILE1.WFM", "FLOppy"
removes the file FILE1.WFM on the floppy disk.

MMEemory:FEED (?)

Sets the data handle to be used to feed data into the file specified by MMEemory:NAME. For the waveform generator, the data handle is fixed to HCOPY. This command is included only for compatibility with the SCPI standard, and may not be used (refer to *Hardcopy Commands* on page 2-18).

Group Mass Memory

Related Commands MMEemory:NAME

Syntax MMEemory:FEED <data_handle>
MMEemory:FEED?

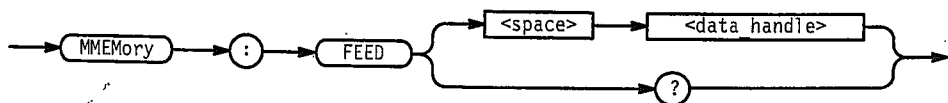

Arguments <data_handle>::="HCOPY" is the data handle for the waveform generator.
 At *RST, this parameter is set to "HCOPY".

Examples MMEemory:FEED "HCOPY"
 sets the data handle.

MMEemory:INITialize (No Query Form)

Initializes the specified mass storage media. In this application, you can initialize the internal hard disk or floppy disk.

NOTE. *The initializing process erases all information already on the disk.*

Group Mass Memory

Related Commands MMEemory:MSIS

Syntax MMEemory:INITialize[<msus>[,DOS[,<NRf>]]]

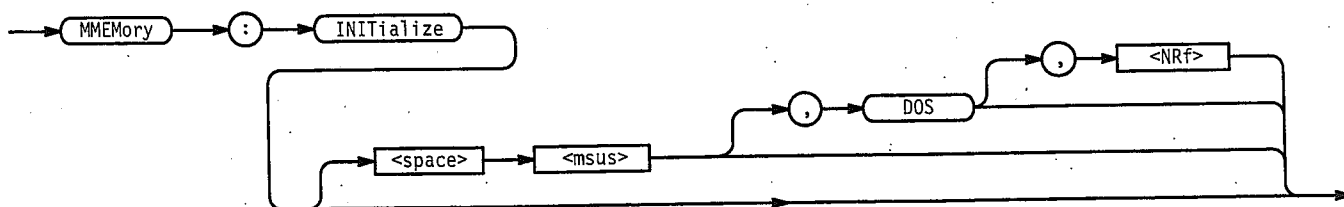

Arguments <msus> (mass storage unit specifier)::={ "MAIN" | "FLOppy" }
 where MAIN means the internal hard disk, and FLOppy means the floppy disk.
 The media is initialized in DOS format.

<NRf> is ignored in this application (It usually specifies media-dependent information.)

When you specify MAIN, this command returns the instrument settings to the factory defaults except the communication parameters (see *Appendix E: Factory Initialization Settings*).

Examples `MMEemory:INITialize "FLOppy"`
initializes a floppy disk in DOS format.

MMEemory:MDIRectory (No Query Form)

Makes a directory on the specified mass storage.

Group Mass Memory

Related Commands `MMEemory:CDIRectory`, `MMEemory:MSIS`

Syntax `MMEemory:MDIRectory <directory_name>[,<msus>]`

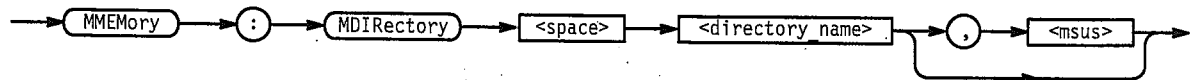

Arguments `<directory_name>::=<string>` specifies a new directory.

`<msus>` (mass storage unit specifier): `::=<string>` is the media on which you make the directory:

MAIN	Internal hard disk drive
FLOppy	Internal floppy disk drive
NET1, NET2, or NET3	Network drive 1, 2, or 3 (specified with the <code>SYSTEM:COMMunicate:LAN</code> commands)

Examples `MMEemory:MDIRectory "WAVEFORM", "FLOppy"`
makes the directory "WAVEFORM" on the floppy disk.

MMEemory:MSIS (?)

The "Mass Storage IS" command selects a default mass storage device that is used by all MMEemory commands except `INITialize`.

Group Mass Memory

Related Commands All MMEemory commands except `INITialize`.

Syntax MMEemory:MSIS [{ "MAIN" | "FLOppy" | "NET1" | "NET2" | "NET3" }]
 MMEemory:MSIS?

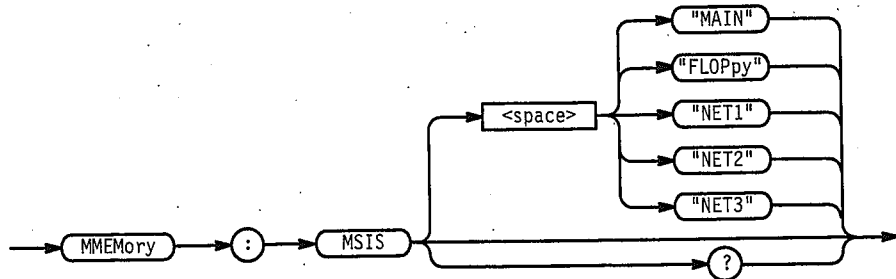

Arguments MAIN selects the internal hard disk drive. This is the default value.
 FLOppy selects the internal floppy disk drive.
 NET1, NET2, or NET3 selects the network drive 1, 2, or 3. (The network drive is specified by the SYSTem:COMMUnicate:LAN command.)
 At *RST, this parameter is set to MAIN.

Examples MMEemory:MSIS "FLOppy"
 selects the floppy disk drive as the default mass storage device.

MMEemory:MOVE (No Query Form)

Moves an existing file to another file name. If the source file does not exist, error occurs.

Group Mass Memory

Related Commands MMEemory:CDIRectory, MMEemory:COpy, MMEemory:DELeTe, MMEemory:MSIS

Syntax MMEemory:MOVE <file_source>,<file_destination>

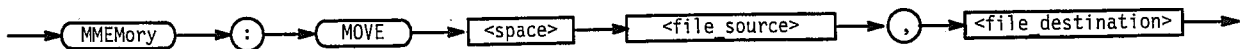

Arguments <file_source>,<file_destination>
 ::=<file_name>[,<msus>]

where:

<file_name>::=<string> is the source or destination file name.

<msus> (mass storage unit specifier)::=<string> is the media on which the file exists:

- MAIN Internal hard disk drive
- FLOppy Internal floppy disk drive
- NET1, NET2, or NET3 Network drive 1, 2, or 3 (specified with the SYSTEM:COMMunicate:LAN commands)

Examples

MMEemory:MOVE "FILE1.WFM", "MAIN", "FILE2.WFM", "FLOppy".
 moves the file FILE1.WMF on the waveform generator hard disk to FILE2.WFM on the floppy disk.

MMEemory:NAME (?)

Sets the name of the file specification used by MMEemory:OPEN or CLOSe commands.

Group Mass Memory

Related Commands MMEemory:OPEN, MMEemory:CLOSe

Syntax MMEemory:NAME <file_name>[,<msus>]
 MMEemory:NAME?

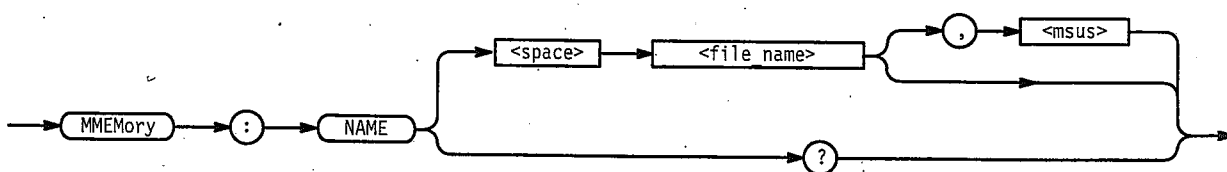

Arguments

<file_name>::=<string> is the name of the file to be opened or closed.

<msus> (mass storage unit specifier)::=<string> is the media on which the file exists:

- MAIN Internal hard disk drive
- FLOppy Internal floppy disk drive
- NET1, NET2, or NET3 Network drive 1, 2, or 3 (specified with the SYSTEM:COMMunicate:LAN commands)

At *RST, this parameter is set to "HARDCOPY".

Examples MMEemory:NAME "SAMPLE1.WFM", "NET1";OPEN
opens the file SAMPLE1.WFM on the network drive 1.

MMEemory:OPEN (No Query Form)

Opens the file specified in the MMEemory:NAME command. This command is included only for compatibility, and may not be used.

Group Mass Memory

Related Commands MMEemory:CDIRectory, MMEemory:CLOSE, MMEemory:MSIS, MMEemory:NAME

Syntax MMEemory:OPEN



Arguments None

Examples MMEemory:NAME "SAMPLE1.WFM", "NET1";OPEN
opens the file SAMPLE1.WFM on the network drive 1.

*OPC (?)

Operation complete command (query). Use this command between two other commands to ensure completion of the first command before processing the second command.

In this application, all commands are designed to be executed in the order in which they are sent from the external controller. The *OPC (?) command is included to ensure compliance with the SCPI standard. You do not need to use this command.

Refer to page 3-6 about the OPC bit of SESR (Standard Event Status Register).

Group Synchronization

Related Commands *WAI

Syntax *OPC
*OPC?

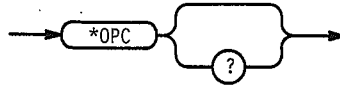

Arguments None

Returns <NR1>=1 when all pending operations are finished.

Examples SOURce:FUNCTION:USER "SAMPLE1.WFM";*OPC
completes the SOURce:FUNCTION:USER "SAMPLE1.WFM" command before
proceeding to the next command.

*OPT? (Query Only)

Returns the implemented options of the waveform generator.

Group System

Syntax *OPT?

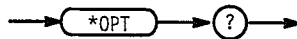

Arguments None

Returns <string>

where:

- 0 the waveform generator has no options installed.
- DD0 the waveform generator has Option 03 (Digital Data Out) installed.

Examples *OPT?
might return DD0 indicating that the option 03 (Digital Data Out) installed in the
instrument.

OUTPut[1|2]:FILTer[:LPASs]:FREQUency (?)

Determines the cutoff frequency of the low pass filter for the specified channel.

Group Output

Syntax OUTPut[1|2]:FILTer[:LPASs]:FREQUency { <NRf> | INFinity }
 OUTPut[1|2]:FILTer[:LPASs]:FREQUency?

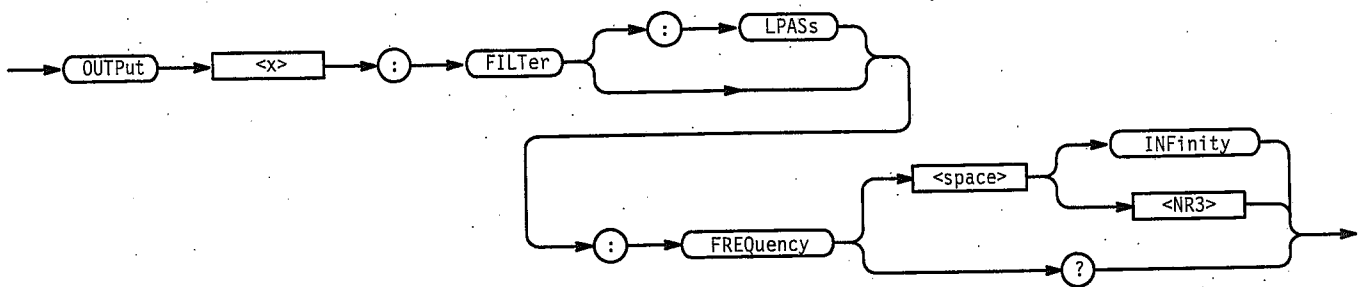

Arguments <NRf> is the cutoff frequency of the low pass filter, in Hz. You can select 10e6 (10MHz), 20e6 (20MHz), 50e6 (50MHz), 100e6 (100MHz), or 9.9e37 (INFinity, that means “through”).

At *RST, this value is set to 9.9e37 (“through”).

Examples OUTPut1:FILTer:LPASs:FREQUency 10e6
 sets the cutoff frequency of the low pass filter for CH 1 to 10 MHz.

OUTPut[1|2|5|7][:STATe] (?)

Controls whether the output terminal is open or closed. When the function is OFF, the terminal is at maximum isolation from the signal.

Group Output

Related Commands SOURce1:COMBine:FEED

Syntax OUTPut[1|2|5|7][:STATe] { ON | OFF | <NR1> }
 OUTPut[1|2|5|7][:STATe]?

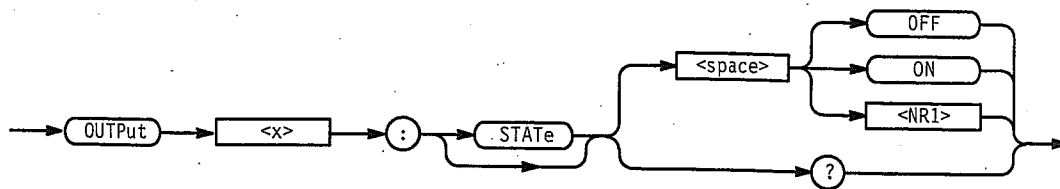

Arguments <ON> or <NR1> ≠ 0 turns the output on.

<OFF> or <NR1> = 0 turns the output off.

OUTPut7[:STATE] can not be set to ON when SOURce1:COMBine:FEED is specified as SOURce7 (the noise generator).

At *RST, this value is set to 0 (OFF).

Examples OUTPut1:STATE 1
turns the CH 1 output on.

OUTPut[1]:ISate (?)

AWG510 Only

Controls whether the waveform generator inverted CH 1 output terminal ($\overline{\text{CH1}}$) is enabled or disabled. When the function is OFF, the $\overline{\text{CH1}}$ terminal is at maximum isolation from the signal.

Group Output

Syntax OUTPut[1]:ISate { ON | OFF | <NR1> }

OUTPut[1]:ISate?

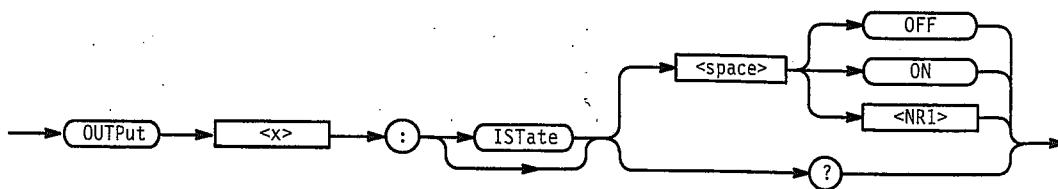

Arguments <ON> or <NR1> ≠ 0 enables the $\overline{\text{CH1}}$ output.

<OFF> or <NR1> = 0 disables the $\overline{\text{CH1}}$ output.

At *RST, this value is set to 0 (OFF).

Examples OUTPUT1:IS \overline{T} ate 1
enables the $\overline{CH1}$ output.

***PSC (?)**

Sets and queries the power-on status flag that controls the automatic power-on handling of the SRER, ESER, OENR, and QENR registers. When *PSC is true, the registers are set to 0 at power-on. When *PSC is false, the current values in the registers are preserved in nonvolatile memory when power is shut off and are restored at power-on. For a complete discussion of the use of these registers, refer to Section 3, *Status and Event*.

Group Status

Related Commands *ESE, *SRE, STATus:OPERation:ENABLE, STATus:QUESTIONable:ENABLE

Syntax *PSC <NR1>
*PSC?

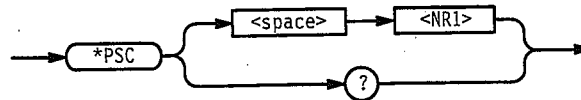

Arguments <NR1> = 0 sets the power-on status clear flag to false, disables the power-on clear and allows the waveform generator to possibly assert SRQ after power-on.

<NR1> \neq 0 sets the power-on status clear flag true. Sending *PSC 1 therefore enables the power-on status clear and prevents any SRQ assertion after power-on. Using an out-of-range value causes an execution error.

Examples *PSC 0
sets the power-on status clear flag to false.

*PSC?
might return the value 1, showing that the power-on status clear flag is set to true.

***RST (No Query Form)**

Resets the waveform generator to the default state. This command has no effect on the network and communication settings, such as GPIB or IP address. Refer to Appendix E: *Factory Initialization Settings*.

Group System

Related Commands SYSTEM:SECURITY:IMMEDIATE

Syntax *RST

→  →

Arguments None

Examples *RST
resets the instrument.

[SOURCE[1]:]COMBine:FEED (?)

Adds the signal from the noise generator or the external input to the CH 1 output.

Group Source

Related Commands OUTPut7:STATe

Syntax [SOURCE[1]:]COMBine:FEED { "SOURCE7" | "SOURCE8" | "" }
[SOURCE[1]:]COMBine:FEED?

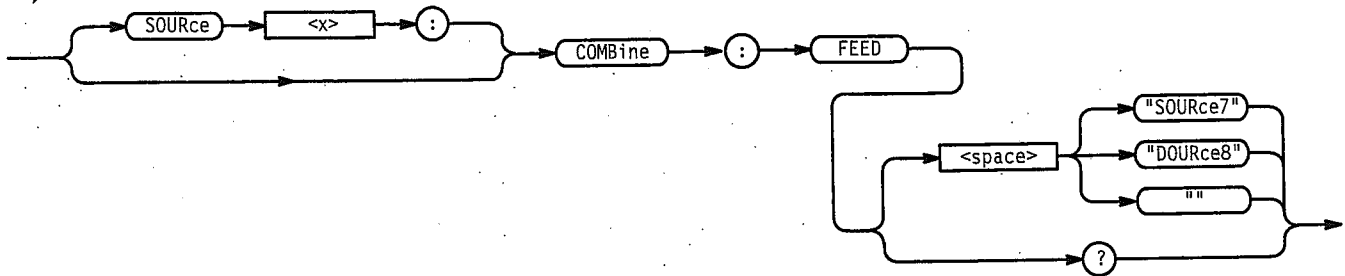

Arguments SOURCE7 adds the signal from the noise generator to the CH 1 output. When you set the OUTPut7:STATe command to 1 (ON), you can not specify SOURCE7 in this command.

SOURCE8 adds the signal from the external input to the CH1 output.

"" (null) adds no signal.

At *RST, the parameter is set to "" (null).

Examples SOURCE1:COMBine:FEED "SOURCE7"
adds noise to the CH 1 output.

[SOURCE[1|2|5]:]FREQuency[:CW|FIXed] (?)

Sets the sampling frequency to output a waveform or pattern file. The file is specified by the SOURCE<x>:FUNctioN:USER command. For the waveform generator, SOURCE1 (CH 1), SOURCE2 (CH 2), and SOURCE5 (pattern) have the same frequency.

CW (Continuous Wave) and FIXed are aliases, and have the same effect.

Group Source

Related Commands [SOURCE<x>]:FUNCTION:USER

Syntax [SOURCE[1|2|5]:]FREQUENCY[:CW|:FIXed] <NRF>
[SOURCE[1|2|5]:]FREQUENCY[:CW|:FIXed]?

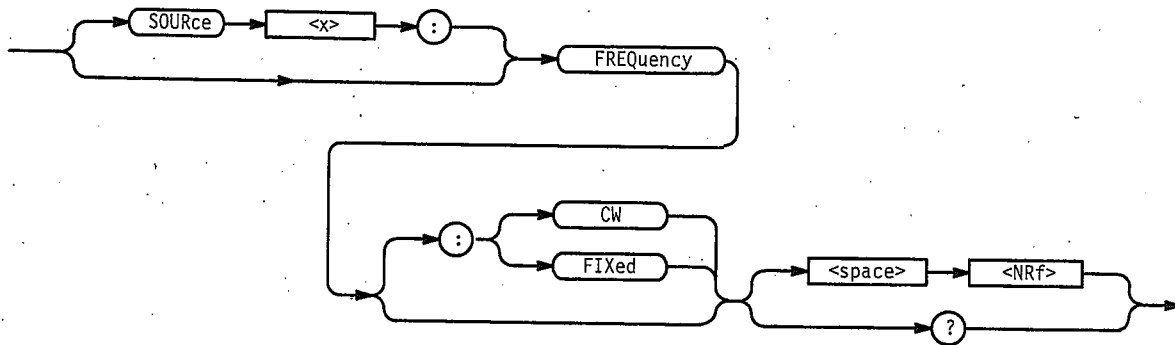

Arguments <NRF> is the sampling frequency. The range is 50 kHz to 1 GHz.
At *RST, this value is set to 100 MHz.

Examples SOURCE1:FREQUENCY 500MHz
sets the sampling frequency to 500 MHz.

[SOURCE[1|2|5]:]FUNCTION:USER (?)

Specifies a waveform or pattern file that you have created as the output source. This command causes the file to be loaded into the waveform generator's RAM prior to output.

Group Source

Related Commands [SOURCE<x>]:FREQUENCY[:CW|FIXed]

Syntax SOURCE[1|2|5]:FUNCTION:USER <file_name> [, <msus>]
SOURCE[1|2|5]:FUNCTION:USER?

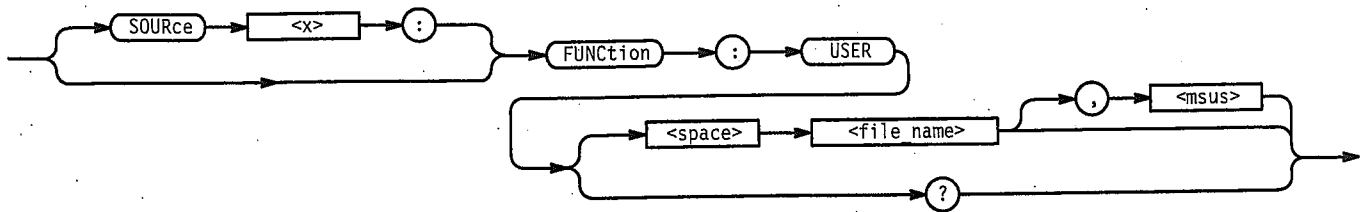

Arguments <file_name>::=<string> is the name of a waveform or pattern file to output.

<msus> (mass storage unit specifier) ::= <string> is the media on which the file exists:

- MAIN The internal hard disk drive
- FLOppy The internal floppy disk drive
- NET1, NET2, or NET3 The network drive 1, 2, or 3 (specified with the SYSTEM :COMMUnicate:LAN commands)

At *RST, this value is set to "" (null).

Examples SOURCE1:FUNCTION:USER "SAMPLE1.WFM", "FLOppy" specifies the file SAMPLE1.WFM on the floppy disk as the CH 1 output source.

[SOURCE[1|2|5]:]MARKER[1|2]:DELAY (?)

Sets the marker output delay referenced to the continuous clock output for the specified channel.

Group Source

Syntax [SOURCE[1|2|5]:]MARKER[1|2]:DELAY <NRf>

[SOURCE[1|2|5]:]MARKER[1|2]:DELAY?

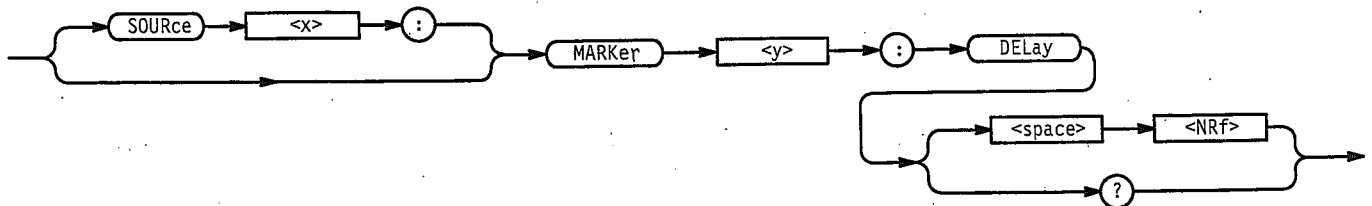

Arguments <NRf> is the delay time in seconds. The range is -1.0 ns to +1.0 ns with a resolution of 20 ps.

At *RST, this value is set to 0.

Examples SOURCE1:MARKer1:DELay 500ps
sets the delay of marker1 to 500 ps for CH 1 output.

[SOURCE[1|2|5]:]MARKer[1|2]:VOLTage[:LEVe1][:IMMediate]:HIGH (?)

Sets the high level for the marker output.

Group Source

Related Commands [SOURCE[1|2|5]:]MARKer[1|2]:VOLTage[:LEVe1][:IMMediate]:LOW

Syntax [SOURCE[1|2|5]:]MARKer[1|2]:VOLTage[:LEVe1][:IMMediate]:HIGH
<NRf>

[SOURCE[1|2|5]:]MARKer[1|2]:VOLTage[:LEVe1][:IMMediate]:HIGH?

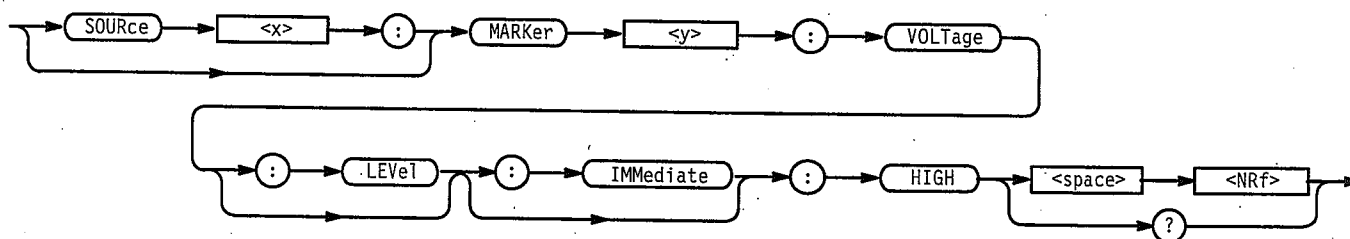

Arguments <NRf> is the high level voltage of the marker output. The range is -2.0 V to 2.0 V (into 50 Ω) with a resolution of 0.05 V. Note that the high level must be larger than the low level.

At *RST, this value is set to 2 V.

Examples SOURCE1:MARKer1:VOLTage:LEVe1:IMMediate:HIGH 1.2
sets the high level of the marker 1 output on CH 1 to 1.2 V.

[SOURCE[1|2|5]:]MARKer[1|2]:VOLTage[:LEVe1][:IMMediate]:LOW (?)

Sets the low level for the marker output.

Group Source

Related Commands [SOURCE[1|2|5]:]MARKer[1|2]:VOLTage[:LEVEL][:IMMediate]:HIGH

Syntax [SOURce[1|2|5]:]MARKer[1|2]:VOLTage[:LEVEL][:IMMEDIATE]:LOW
<NRf>

[SOURce[1|2|5]:]MARKer[1|2]:VOLTage[:LEVEL][:IMMEDIATE]:LOW?

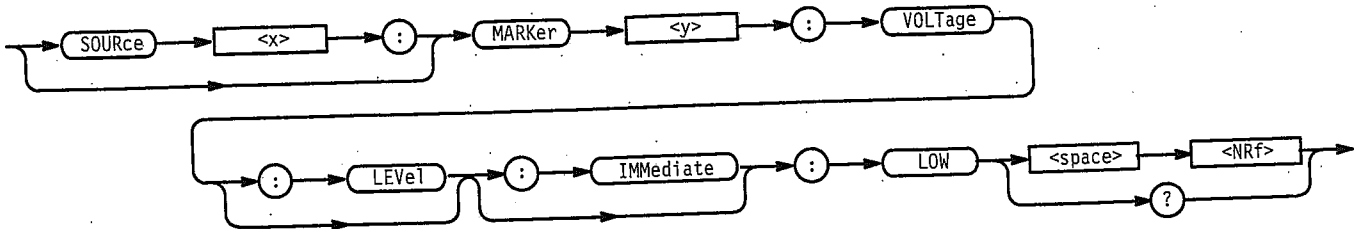

Arguments <NRf> is the low level voltage of the marker output. The range is -2.0 V to 2.0 V (into 50 Ω) with a resolution of 0.05 V. Note that the low level must be smaller than the high level.

At *RST, this value is set to 0.

Examples SOURce1:MARKer1:VOLTage:LEVel:IMMEDIATE:LOW -1.2
sets the low level of the marker 1 output on CH 1 to -1.2 V.

SOURce7:POWER[:LEVEL][:IMMEDIATE][:AMPLITUDE] (?)

Sets the level of the noise generator output, in dBm/Hz.

Group Source

Syntax SOURce7:POWER[:LEVEL][:IMMEDIATE][:AMPLITUDE] <NRf>
SOURce7:POWER[:LEVEL][:IMMEDIATE][:AMPLITUDE]?

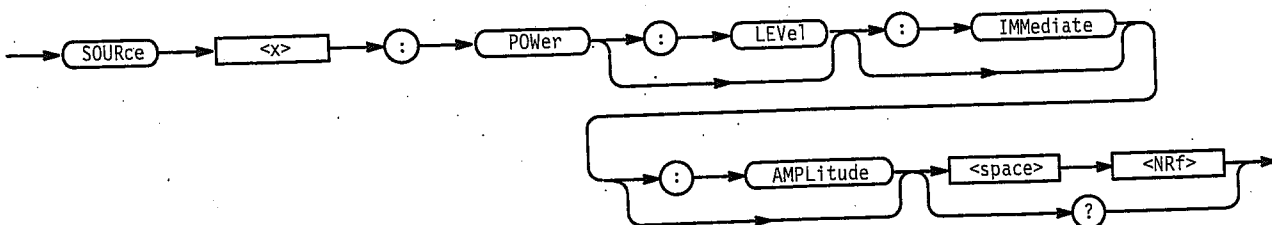

Arguments <NRf> is the noise output level.
The range is -145 to -105 dBm/Hz in 1 dB step.

At *RST, this value is set to -105 dBm/Hz.

Examples `SOURce7:POWer:LEVel:IMMediate:AMPLitude -120`
 sets the level of the noise generator output to -120 dBm/Hz.

[SOURce[1|2|5]:]ROSCillator:SOURce (?)

Selects the reference oscillator. For the waveform generator, SOURce1 (CH 1), SOURce2 (CH 2), and SOURce5 (pattern) have the same oscillator.

Group Source

Syntax `[SOURce[1|2|5]:]ROSCillator:SOURce { INTernal | EXTernal }`
`[SOURce[1|2|5]:]ROSCillator:SOURce?`

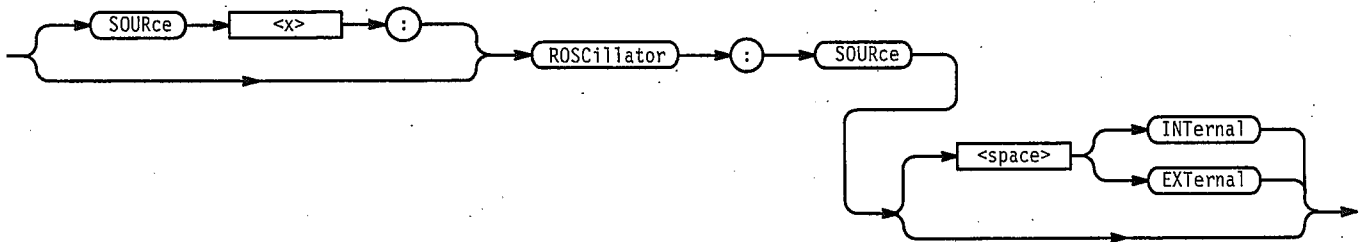

Arguments `INTernal` means that the reference frequency is derived from the internal precision oscillator.

`EXTernal` means the reference frequency is derived from an external signal supplied through the Reference Clock Input connector.

At *RST, this parameter is set to `INTernal`.

Examples `SOURce1:ROSCillator:SOURce EXTernal`
 selects the external clock source.

[SOURce[1|2]:]VOLTage[:LEVel][:IMMediate][:AMPLitude] (?)

Sets the actual magnitude of the output signal from SOURce1 (CH 1), or SOURce2 (CH 2).

Group Source

Related Commands `[SOURce[1|2]:]VOLTage[:LEVel] [:IMMediate]:OFFSet`

Syntax [SOURce[1|2]:]VOLTage[:LEVel][:IMMediate][:AMPLitude] <NRf>
 [SOURce[1|2]:]VOLTage[:LEVel][:IMMediate][:AMPLitude]?

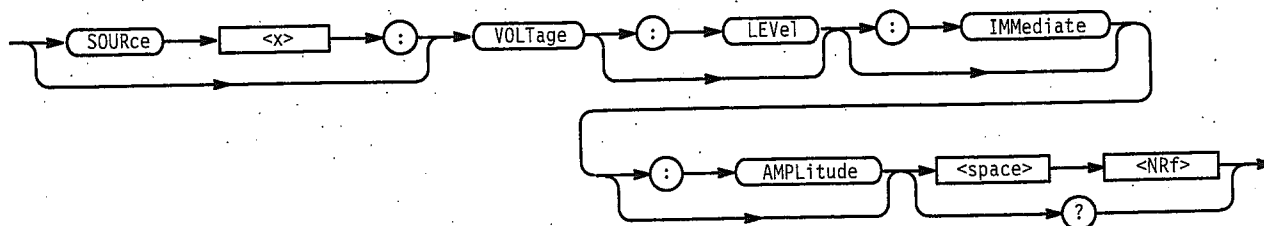

Arguments <NRf> is the amplitude:
 SOURce1, 2 The range is 20 mV to 2.0 V (into 50 Ω), in 1 mV steps.
 At *RST, this value is set to 1 V for SOURce1 and SOURce2.

Examples SOURce1:VOLTage:LEVel:IMMediate:AMPLitude 230mV
 sets the amplitude of CH 1 waveform to 230 mV.

SOURce5:VOLTage[:LEVel][:IMMediate]:HIGH (?)

Sets the high level of the signal from the pattern generator (SOURce5, Option 03). This command is used in conjunction with LOW.

Group Source

Related Commands SOURce5:VOLTage[:LEVel][:IMMediate]:LOW

Syntax SOURce5:VOLTage[:LEVel][:IMMediate]:HIGH <NRf>
 SOURce5:VOLTage[:LEVel][:IMMediate]:HIGH?

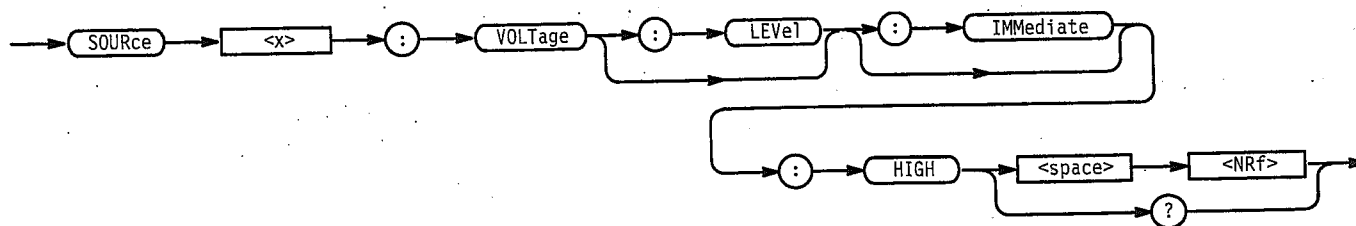

Arguments <NRf> is the high level of the pattern generator output. The range is -2.0 V to +2.0 V in 1mV steps.
At *RST, this value is set to 2 V.

Examples SOURce5:VOLTage:LEVel:IMMediate:HIGH 230mV
sets the high level of the pattern generator output to 230 mV.

SOURce5:VOLTage[:LEVel][:IMMediate]:LOW (?)

Sets the low level of the signal from the pattern generator (SOURce5, Option 03). This command is used in conjunction with HIGH.

Group Source

Related Commands SOURce5:VOLTage[:LEVel][:IMMediate]:HIGH

Syntax SOURce5:VOLTage[:LEVel][:IMMediate]:LOW <NRf>
SOURce5:VOLTage[:LEVel][:IMMediate]:LOW?

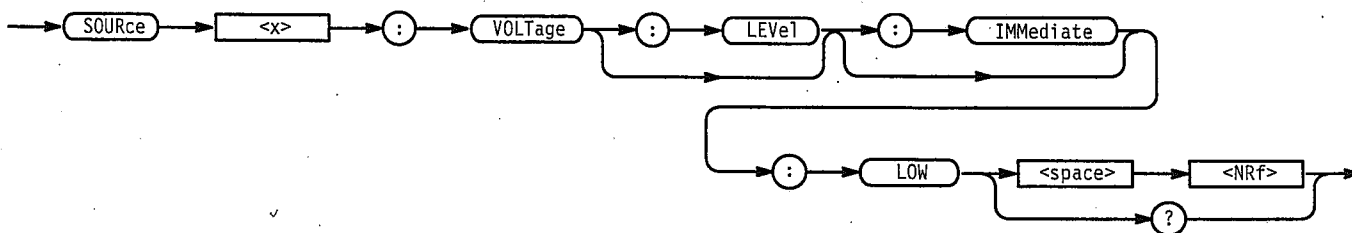

Arguments <NRf> is the low level of the pattern generator output in volts. The range is -2.0 V to +2.0 V in 1 mV steps.
At *RST, this value is set to 0.

Examples SOURce5:VOLTage:LEVel:IMMediate:LOW -230mV
sets the low level of the pattern generator output to -230 mV.

[SOURce[1|2]:]VOLTage[:LEVe1][:IMMediate]:OFFSet (?)

Sets the non-time-varying component of the signal that is added to SOURce1 (CH 1) or SOURce2 (CH 2).

Group Source

Related Commands [SOURce[1|2|7]:]VOLTage[:LEVe1][:IMMediate][:AMPLitude]

Syntax [SOURce[1|2]:]VOLTage[:LEVe1][:IMMediate]:OFFSet <NRf>
[SOURce[1|2]:]VOLTage[:LEVe1][:IMMediate]:OFFSet?

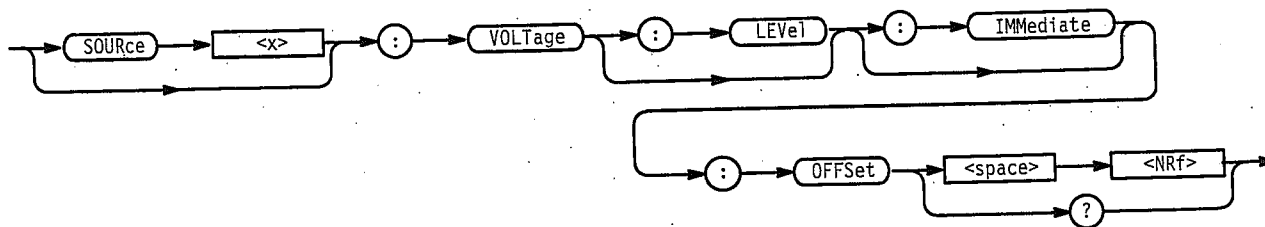

Arguments <NRf> is the offset voltage. The range is -1.000 V to +1.000 V, in 1 mV steps.

Examples SOURce1:VOLTage:LEVe1:IMMediate:OFFSet 50mV
sets the offset voltage of the CH 1 output to 50 mV.

*SRE (?)

Sets and queries the bits in the Service Request Enable Register (SRER). For a complete discussion of the use of these registers, refer to Section 3 *Status and Events*.

Group Status

Related Commands *CLS, *ESE, *ESR?, *PSC, *STB?

Syntax *SRE <NR1>

*SRE?

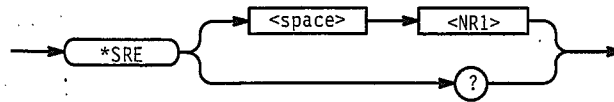

Arguments <NR1> is a value in the range from 0 to 255. The binary bits of the SRER are set according to this value. Using an out-of-range value causes an execution error. The power-on default for SRER is 0 if *PSC is 1. If *PSC is 0, the SRER maintains its value through a power cycle.

Examples *SRE 48
sets the bits in the SRER to 00110000 binary.

*SRE?
might return a value of 32, showing that the bits in the SRER have the binary value 00100000.

STATus:OPERation:CONDition? (Query Only)

Returns the contents of the Operation Condition Register (OCR). For more information on registers, refer to Section 3, *Status and Events*.

Group Status

Related Commands STATus:OPERation:ENABLE, STATus:OPERation[:EVENT]?

Syntax STATus:OPERation:CONDition?

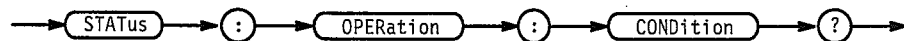

Arguments None

Returns <NR1> indicates the content of the OCR in a decimal number.

Examples STATus:OPERation:CONDition?
might return 32 which indicates that the OCR contains the binary number 00000000 00100000 and the instrument is waiting for trigger.

STATus:OPERation:ENABLE (?)

Sets the enable mask for the Operation Enable Register (OENR). For more information on registers, refer to Section 3, *Status and Events*.

Group Status

Related Commands STATus:OPERation:CONDition?, STATus:OPERation[:EVENT]?

Syntax STATus:OPERation:ENABle <NR1>
 STATus:OPERation:ENABle?

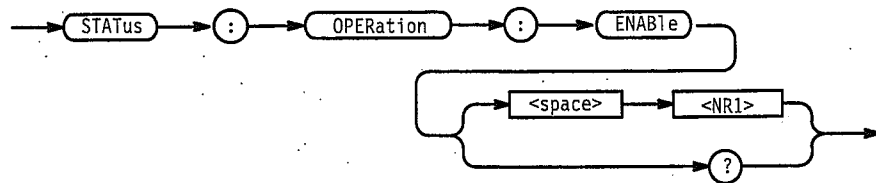

Arguments <NR1> is the enable mask for the OENR. The range is 0 to 32767.

Returns <NR1> indicates the content of the OENR in a decimal number.

Examples STATus:OPERation:ENABle 1
 sets the CALibrating bit in the OENR to “enable”.

STATus:OPERation:ENABle?
 might return 1 which indicates that the OENR contains the binary number 00000000 00000001 and the CAL bit is set to “enable”.

STATus:OPERation[:EVENT]? (Query Only)

Returns the contents of the Operation Event Register (OEVr) and clears it. For more information on registers, refer to Section 3, *Status and Events*.

Group Status

Related Commands STATus:OPERation:CONDition?, STATus:OPERation:ENABle

Syntax STATus:OPERation[:EVENT]?, STATus:OPERation:ENABle

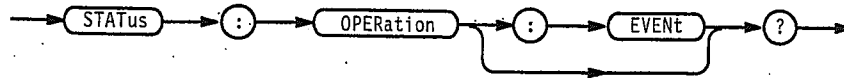

Returns <NR1> indicates the content of the OEVR in a decimal number.

Examples STATus:OPERation:EVENT?
might return 1 which indicates that the OEVR contains the binary number 00000000 00000001 and the CAL bit is set.

STATus:PRESet (No Query Form)

Presets the SCPI enable registers OENR and QENR. For more information on registers, refer to Section 3, *Status and Events*.

Group Status

Syntax STATus:PRESet



Arguments None

Examples STATus:PRESet
presets the SCPI enable registers.

STATus:QUESTionable:CONDition? (Query Only)

Returns the contents of the Questionable Condition Register (QCR). For more information on registers, refer to Section 3, *Status and Events*.

Group Status

Related Commands STATus:QUESTionable:ENABle, STATus:QUESTionable[:EVENT]?

Syntax STATus:QUEStionable:CONDition?

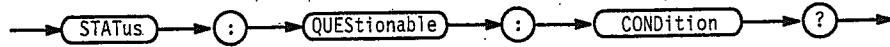

Returns <NR1> indicates the content of the QCR in a decimal number.

Examples STATus:QUEStionable:CONDition?
 might return 32 which indicates that the QCR contains the binary number 00000000 00100000 and the accuracy of frequency is questionable.

STATus:QUEStionable:ENABle (?)

Sets the enable mask for the Questionable Enable Register (QENR). For more information on registers, refer to Section 3, *Status and Events*.

Group Status

Related Commands STATus:QUEStionable:CONDition?, STATus:QUEStionable[:EVENT]?

Syntax STATus:QUEStionable:ENABle <NR1>

STATus:QUEStionable:ENABle?

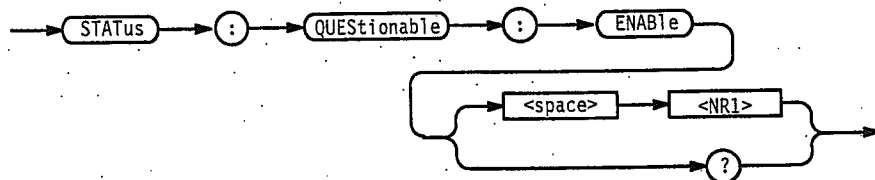

Arguments <NR1> is the content of the QENR. The range is 0 to 32767.

Returns <NR1> indicates the content of the QENR in a decimal number.

Examples STATus:QUEStionable:ENABle #H20
 sets the FREQuency bit in the QENR to "enable".

STATus:QUEStionable:ENABle?
 might return 32 which indicates that the QENR contains the binary number 00000000 00100000 and the FREQ bit is set to "enable."

STATus:QUESTionable[:EVENT]? (Query Only)

Returns the contents of the Questionable Event Register (QEVr) and clears it. For more information on registers, refer to Section 3, *Status and Events*.

Group Status

Related Commands STATus:QUESTionable:CONDition?, STATus:QUESTionable:ENABle

Syntax STATus:QUESTionable[:EVENT]?

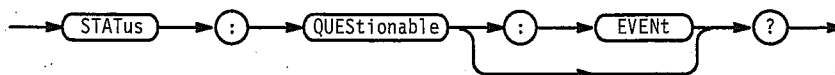

Returns <NR1> indicates the contents of the QEVr in a decimal number.

Examples STATus:QUESTionable:EVENT?
might return 32 which indicates that the QEVr contains the binary number 00000000 00100000 and the FREQ bit is set”.

STATus:QUEue[:NEXT]? (Query Only)

Returns the next item from the error/event queue and removes that item from the queue. Operation is identical to that of the SYSTem:ERRor? query. Refer to Section 3, *Status and Events* for more details.

Group Status

Related Commands SYSTem:ERRor?

Syntax STATus:QUEue[:NEXT]?

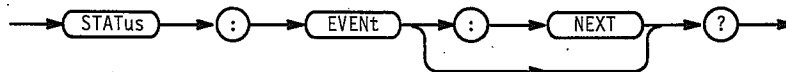

Returns <Error/event number>,"<Error/event description>
[;<Device dependent info>]"

where
 <Error/event number> is an integer between -32768 and 32767.
 0 indicates that no error or event has occurred.
 Positive values are error/event numbers determined by this instrument.
 Negative values are error/event numbers reserved in SCPI standards.

<Error/event description> is a message relating to the error/event number.

<Device dependent info> is more detailed information relating to the error/event number.

Examples STATus:QUEue:NEXT?
 might return the following response:
 -102,"Syntax error;possible invalid suffix - :SOUR:FREQ 2V"
 In this case, the unit is invalid.

***STB? (Query Only)**

Returns the contents of the Status Byte Register (SBR) using the Master Summary Status (MSS) bit. For a complete discussion of the use of these registers, refer to Section 3, *Status and Events*.

Group Status

Related Commands *CLS, *ESE, *ESR?, *SRE

Syntax *STB?



Arguments None

Returns <NR1> indicates the content of the SBR in a decimal number.

Examples *STB?
 might return 96, which indicates that the SBR contains the binary number 0110 0000.

SYSTEM:BEEPPer[:IMMediate] (No Query Form)

Causes the waveform generator to emit an audible tone.

Group System

Syntax SYSTEM:BEEPPer[:IMMediate] [<frequency>[,<time>[,<volume>]]]

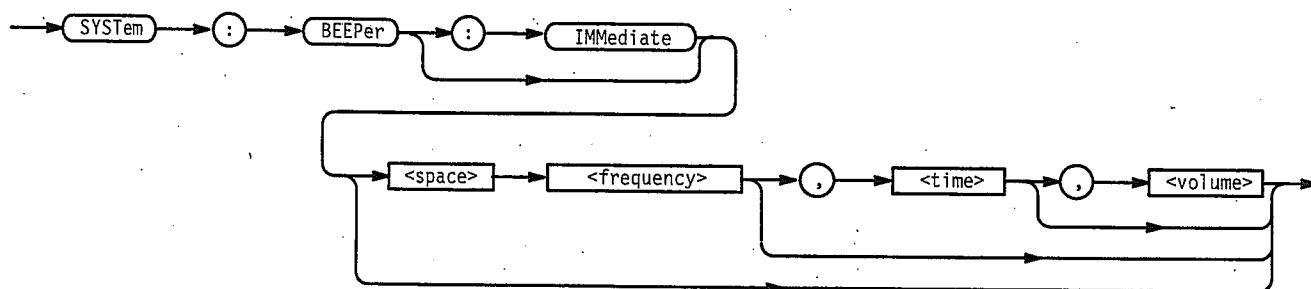

Arguments The following parameters are available, but ignored:

<frequency> The pitch of audible tones
 <time> The duration of audible tones
 <volume> The volume of audible tones

Examples SYSTEM:BEEPPer:IMMediate
 turn on the beep sound.

SYSTEM:COMMunicate:LAN:FTP[:SERVer][:STATe] (?)

Turns on or off the FTP (File Transfer Protocol) server function.

Group System

Syntax SYSTEM:COMMunicate:LAN:FTP[:SERVer][:STATe] { ON | OFF | <NR1> }
 SYSTEM:COMMunicate:LAN:[:SERVer][:STATe]?

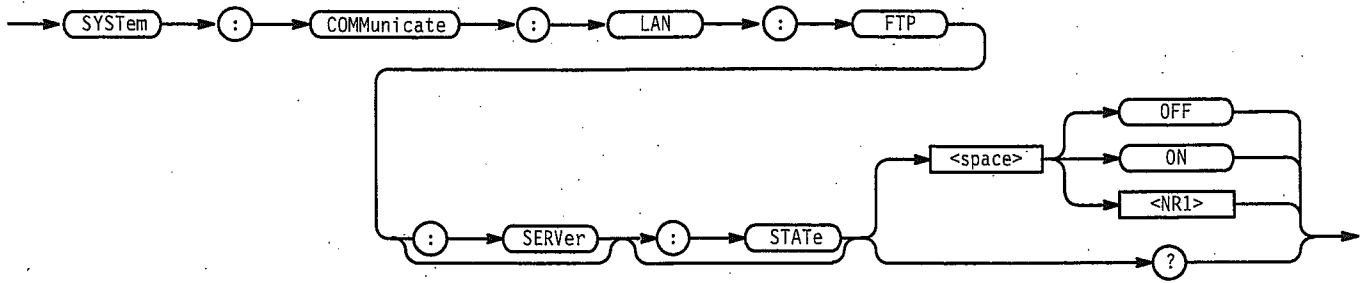

Arguments OFF or <NR1>=0 turns off the FTP server function.
 ON or <NR1>≠0 turns on the FTP server function.
 *RST has no effect on the value.

Examples SYSTEM:COMMunicate:LAN:FTP:SERVer:STATe ON
 sets the FTP server function on.

SYSTEM:COMMunicate:LAN:GATeway[1|2|3]:ADDRes (?)

Sets the IP address of the gateway when you communicate with the waveform generator from anywhere other than the local network segment.

Group System

Syntax SYSTEM:COMMunicate:LAN:GATeway[1|2|3]:ADDRes
 <net_address>,<ip_address>

SYSTEM:COMMunicate:LAN:GATeway[1|2|3]:ADDRes?

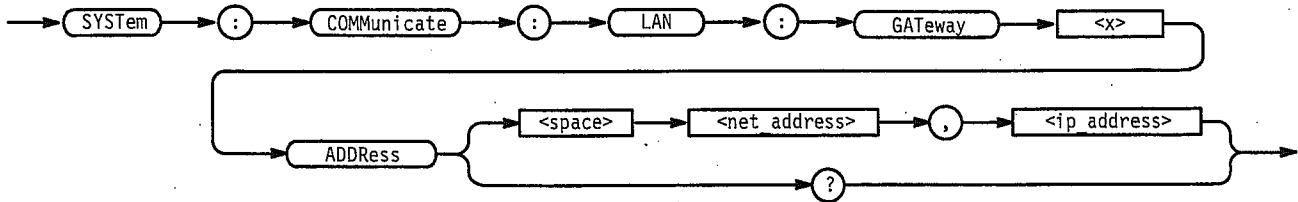

Arguments <net_address>::=<string> is the network address.
 <ip_address>::=<string> is the IP address of the gateway.
 *RST has no effect on the value.

Examples `SYSTEM:COMMunicate:LAN:GATeway1:ADDRess "91.0.0.0","90.0.0.2"`
 sets the IP address of gateway 1 to 90.0.0.2 on the net 91.0.0.0.

SYSTEM:COMMunicate:LAN:PING? (Query Only)

Executes the ping test, sending the ICMP ECHO_REQUEST packet to the specified IP address.

Group System

Related Commands `SYSTEM:COMMunicate:LAN:GATeway:ADDRess`
`SYSTEM:COMMunicate:LAN[:SELF]:ADDRess`

Syntax `SYSTEM:COMMunicate:LAN:GATeway:PING? <ip_address>`

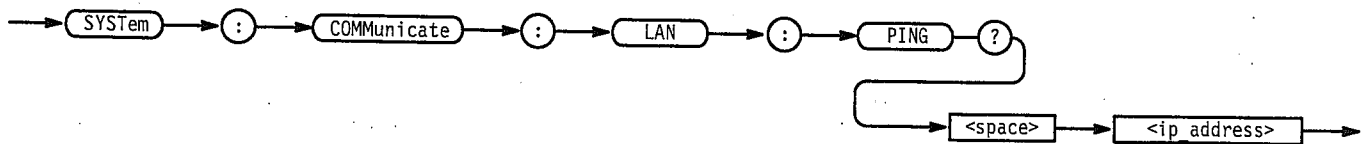

Arguments `<ip_address>::=<string>` is the IP address to be tested.

Returns `<NR1>=1` indicates there was a response to the ECHO_REQUEST packet.
`<NR1>=0` indicates there was no response to the ECHO_REQUEST packet.

Examples `SYSTEM:COMMunicate:LAN:PING? "2.199.55.1"`
 might return 1, indicating that there was a response from the host 2.199.55.1.

SYSTEM:COMMunicate:LAN:RDEvice[1|2|3]:ADDRess (?)

Sets the IP address of the remote host. The host corresponds to "NET<x>" in the menu display. (You can change this name by the `SYSTEM:COMMunicate:LAN:RDEvice<x>:NAME` command.)

Group System

Related Commands `SYSTEM:COMMunicate:LAN:RDEvice[1|2|3]:FSYSTEM`
`SYSTEM:COMMunicate:LAN:RDEvice[1|2|3]:NAME`

Syntax SYSTEM:COMMunicate:LAN:RDEvice[1|2|3]:ADDRESS <ip_address>
 SYSTEM:COMMunicate:LAN:RDEvice[1|2|3]:ADDRESS?

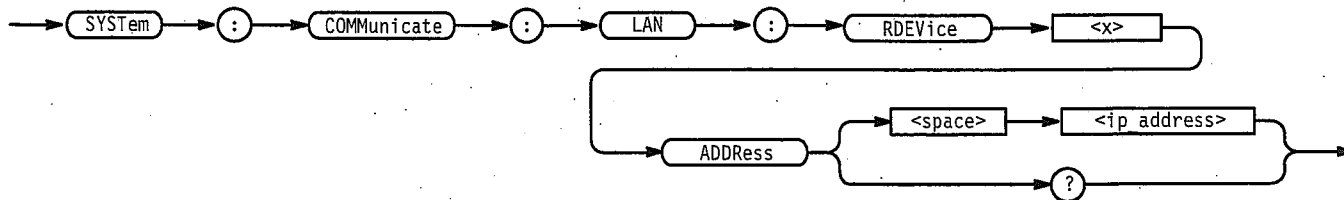

Arguments <ip_address>::=<string> is the IP address of the remote host.
 *RST has no effect on the value.

Examples SYSTEM:COMMunicate:LAN:RDEvice1:ADDRESS "2.199.55.1"
 sets the IP address of the remote host 1 (NET1) to 2.199.55.1.

SYSTEM:COMMunicate:LAN:RDEvice[1|2|3]:FSYSstem (?)

Sets the mount directory on the specified remote host.

Group System

Related Commands SYSTEM:COMMunicate:LAN:RDEvice[1|2|3]:ADDRESS

Syntax SYSTEM:COMMunicate:LAN:RDEvice[1|2|3]:FSYSstem
 <directory_name>

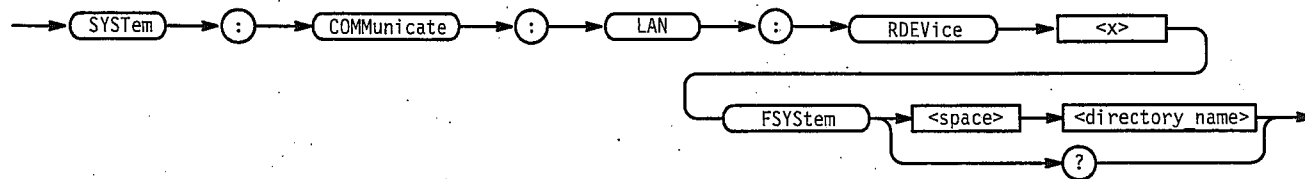

Arguments <directory_name>::=<string> is the mount directory on the remote host.
 *RST has no effect on the value.

Examples SYSTEM:COMMunicate:LAN:RDEvice1:FSYSstem "/AWG/SAMPLE"
 sets the mount directory to /AWG/SAMPLE on the remote host 1 (NET1).

SYSTem:COMMunicate:LAN:RDEvice[1|2|3]:NAME (?)

Sets the name of the specified remote host. The factory default name is "NET<x>", which may be displayed on the waveform generator menu. You can change the displayed host name using this command.

Group System

Related Commands SYSTem:COMMunicate:LAN:RDEvice[1|2|3]:ADDRESS

Syntax SYSTem:COMMunicate:LAN:RDEvice[1|2|3]:NAME <host_name>
 SYSTem:COMMunicate:LAN:RDEvice[1|2|3]:NAME?

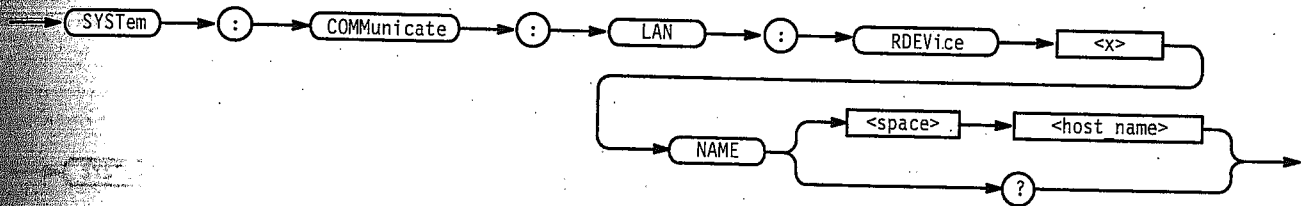

Arguments <host_name>::=<string> is the name of the remote host. The name must be ten characters or less.

*RST has no effect on the parameter.

Examples SYSTem:COMMunicate:LAN:RDEvice1:NAME "HOST1"
 sets the name of the remote host 1 to HOST1.

SYSTem:COMMunicate:LAN:RDEvice[1|2|3]:PROTOcol (?)

Selects the protocol of communication with the remote host. For this application, however, the protocol is fixed to NFS (Network File System), and this command exists for compatibility only.

Group System

Related Commands SYSTem:COMMunicate:LAN:RDEvice[1|2|3]:ADDRESS

Syntax SYSTem:COMMunicate:LAN:RDEvice[1|2|3]:PROTOcol NFS
 SYSTem:COMMunicate:LAN:RDEvice[1|2|3]:PROTOcol?

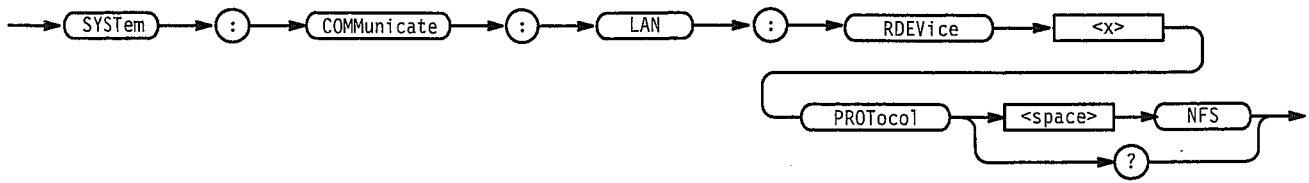

Arguments NFS selects the NFS protocol. This is fixed.
 *RST has no effect on this parameter.

Examples SYSTEM:COMMUNICATE:LAN:RDEVICE1:PROTOCOL NFS
 selects the NFS protocol.

SYSTEM:COMMUNICATE:LAN:RDEVICE[1|2|3][:STATE] (?)

Turns on or off the LAN communication with the remote host.

Group System

Related Commands SYSTEM:COMMUNICATE:LAN:RDEVICE[1|2|3]:ADDRESS

Syntax SYSTEM:COMMUNICATE:LAN:RDEVICE[1|2|3][:STATE] { ON | OFF |<NR1>}
 SYSTEM:COMMUNICATE:LAN:RDEVICE[1|2|3][:STATE]?

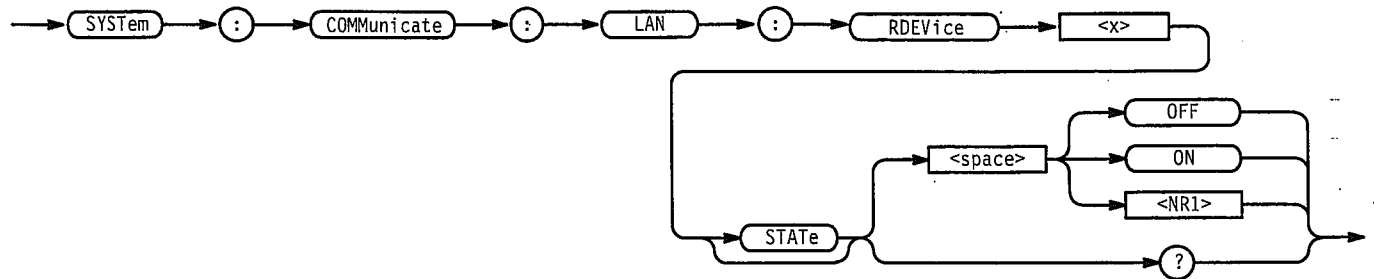

Arguments OFF or <NR1> = 0 turns off the LAN communication with the remote host.
 ON or <NR1> ≠ 0 turns on the LAN communication with the remote host.
 *RST has no effect on the value.

Examples SYSTEM:COMMUNICATE:LAN:RDEVICE1:STATE ON
 turns on LAN communication with the remote host.

SYSTem:COMMunicate:LAN[:SELF]:ADDRess (?)

Sets the IP address of the waveform generator.

NOTE. You must set the IP address of the waveform generator to use its LAN functions. If you specify "" (null) for the IP address, the LAN functions will not work.

Group System

Related Commands SYSTem:COMMunicate:LAN[:SELF]:SMASK

Syntax SYSTem:COMMunicate:LAN[:SELF]:ADDRess <ip_address>
SYSTem:COMMunicate:LAN[:SELF]:ADDRess?

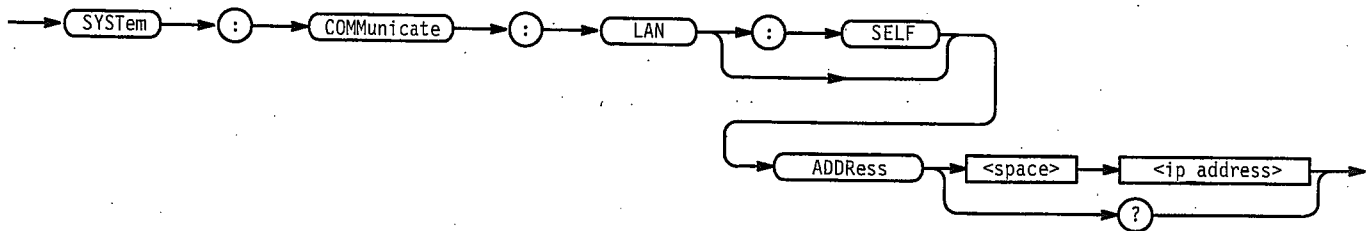

Arguments <ip_address> ::= <string> is the IP address of the waveform generator.

*RST has no effect on the value.

Examples SYSTem:COMMunicate:LAN:SELF:ADDRess "2.199.55.1"
sets the IP address of the waveform generator.

SYSTem:COMMunicate:LAN[:SELF]:SMASK (?)

Sets the subnet mask of the waveform generator.

Group System

Related Commands SYSTem:COMMunicate:LAN[:SELF]:ADDRess

Syntax SYSTEM:COMMUnicate:LAN[:SELF]:SMASK <ip_mask>
 SYSTEM:COMMUnicate:LAN[:SELF]:SMASK?

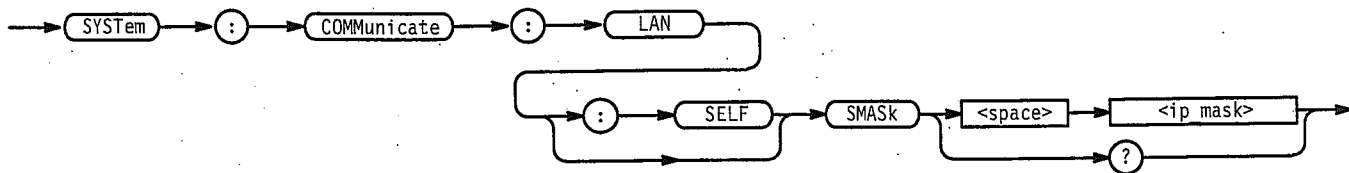

Arguments <ip_mask>::=<string> is the subnet mask of the waveform generator.
 *RST has no effect on the value.

Examples SYSTEM:COMMUnicate:LAN:SELF:SMASK "255.0.0.0"
 sets the subnet mask to 255.0.0.0 for the waveform generator.

SYSTEM:DATE (?)

Sets the date for the waveform generator operating system.

Group System

Syntax SYSTEM:DATE <year>,<month>,<day>
 SYSTEM:DATE?

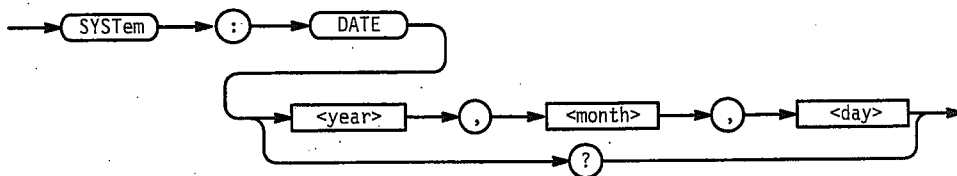

Arguments <year>::=<NRf> must be entered as a four-digit number.
 <month>::=<NRf> ranges 1 to 12.
 <day>::=<NRf> ranges 1 to 31.
 <NRf> is rounded to the nearest integer.
 *RST has no effect on the value.

Examples SYSTem:DATE 1998,10,31
sets the date.

SYSTem:ERRor? (Query Only)

Retrieves and returns error data from the Error and Event Queue. It has the same function as the STATus:QUEue[:NEXT]? query. For more details, refer to Section 3 *Status and Event*.

Group System

Related Commands SYSTem:QUEue[:NEXT]?

Syntax SYSTem:ERRor?

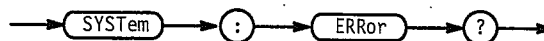

Arguments None

Returns <error/event_number>,
"<error/event_description>[:<device_dependent_info>]"
where:
<error/event_number> is an integer between -32768 and 32767.
0 indicates that no error or event has occurred.
Positive values are error/event numbers determined by this instrument.
Negative values are error/event numbers reserved in SCPI standards.

<error/event_description> is a message relating to the error/event number.

<device_dependent_info> is more detailed information relating to the error/event number.

Examples SYSTem:ERRor?
might return the following response:

-102,"Syntax error;possible invalid suffix - :SOUR:FREQ 2V"

This response indicates that the unit is invalid.

SYSTem:KDIRrection (?)

Determines the direction the cursor moves in response to the general purpose knob.

Group System

Syntax SYSTem:KDIRrection { FORWard | BACKward }

SYSTem:KDIRrection?

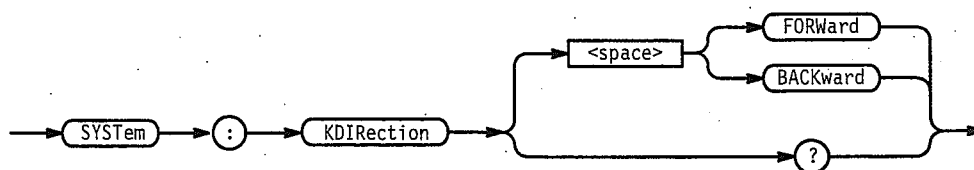

Arguments FORWARD means the cursor moves to the right when the general purpose knob turns clockwise.

BACKward means the cursor moves to the left when the general purpose knob turns clockwise.

At *RST, the parameter is set to FORWARD.

Examples SYSTem:KDIRrection BACKward makes the cursor move to the left when the general purpose knob turns clockwise.

SYSTem:KEYBoard[:TYPE] (?)

Selects the type of keyboard that connects to the waveform generator.

Group System

Syntax SYSTem:KEYBoard[:TYPE] { ASCii | JIS }

SYSTem:KEYBoard[:TYPE]?

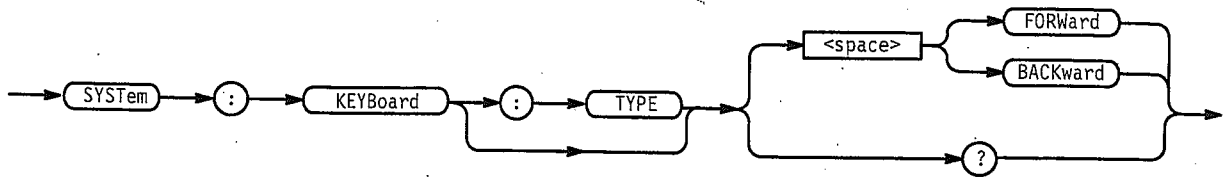

Arguments ASCi i selects the ASCII 101-key keyboard.
 JIS selects the JIS 106-key keyboard.
 At *RST, the parameter is set to ASCi i.

Examples SYSTem:KEYBoard:TYPE JIS
 selects the JIS 106-key keyboard.

SYSTem:KLOCK (?)

Locks or unlocks the front panel and keyboard. Use this command to disable manual operation while the waveform generator is being controlled externally. If the front panel and keyboard are not explicitly locked out using this command, the waveform generator accepts input from both the external controller and the front panel and keyboard.

Group System

Syntax SYSTem:KLOCK { ON | OFF | <NR1> }
 SYSTem:KLOCK?

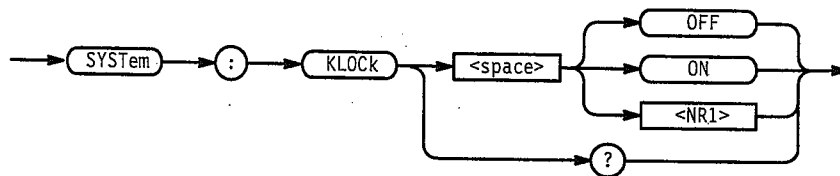

Arguments OFF or <NR1> = 0 unlocks controls of the front panel and keyboard.
 ON or <NR1> ≠ 0 locks controls of the front panel and keyboard.
 *RST has no effect on the parameter.

Returns <NR1> = 0 indicates the front panel and keyboard are unlocked.
 <NR1> = 1 indicates the front panel and keyboard are locked.

Examples SYSTem:KLOCK ON
 locks the front panel and keyboard.
 SYSTem:KLOCK?
 might return 1, which indicates that the front panel and keyboard are locked.

SYSTem:SECurity:IMMediate (No Query Form)

Immediately destroys all waveform generator. data and settings. Current settings are initialized to their *RST values.

NOTE. This command erases all information already on the internal hard disk ("MAIN").

Group System

Related Commands *RST

Syntax SYSTem:SECurity:IMMediate

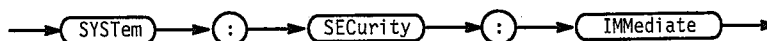

Arguments None.

Examples SYSTem:SECurity:IMMediate
 destroys all waveform generator data and settings.

SYSTem:TIME (?)

Sets the internal clock.

Group System

Related Commands SYSTem:DATE

Syntax SYSTem:TIME <hour>,<minute>,<second>

SYSTem:TIME?

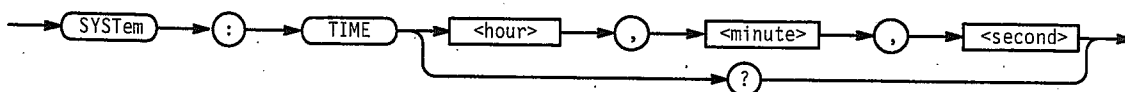

Arguments <hour>,<minute>,<second>

<hour>::=<NRf> ranges 0 to 23.

<minute>::=<NRf> ranges 0 to 59.

<second>::=<NRf> ranges 0 to 59.

It is always rounded to the nearest integer.

Examples SYSTem:TIME 11,23,58
sets the time.

SYSTem:UPTime? (Query Only)

Query elapsed time from the generator power-on.

Group System

Syntax SYSTem:UPTime?



Returns <hour>,<minute>,<second>

where

<hour>::=<NR1> ranges 0 to 23.

<minute>::=<NR1> ranges 0 to 59.

<second>::=<NR1> ranges 0 to 59.

Examples `SYSTem:UPTime?`
 might return 3,18,52, which indicates 3 hours 18 minutes and 52 seconds have elapsed after turning on the waveform generator.

SYSTem:VERSion? (Query Only)

Returns the SCPI version number for which the waveform generator complies.

Group System

Syntax `SYSTem:VERSion?`



Returns `<NR2>:::=YYYY.V`
 where YYYY represents the year version and V represents an approved revision number for that year.

Examples `SYSTem:VERSion?`
 might return 1995.0.

*TRG (No Query Form)

Generates a trigger event. This command is equivalent to the `TRIGger[:SE-
 Quence] [:IMMediate]` command or pushing the FORCE TRIGGER button on the front panel.

Group Trigger

Related Commands `TRIGger[:SEQuence] [:IMMediate]`

Syntax `*TRG`

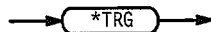

Arguments None

Examples *TRG
generates a trigger event.

TRIGger[:SEquence][:IMMediate] (No Query Form)

Generates a trigger event. This command is equivalent to the *TRG command or pushing the FORCE TRIGGER button on the front panel.

Group Trigger

Related Commands *TRG

Syntax TRIGger[:SEquence][:IMMediate]

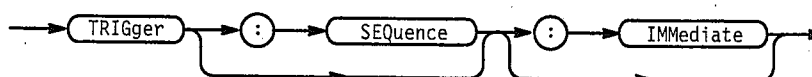

Arguments None

Examples TRIGger:SEquence:IMMediate
generates the trigger event.

TRIGger[:SEquence]:IMPedance (?)

Selects the impedance of the external trigger input.

Group Trigger

Syntax TRIGger[:SEquence]:IMPedance <NRf>

TRIGger[:SEquence]:IMPedance?

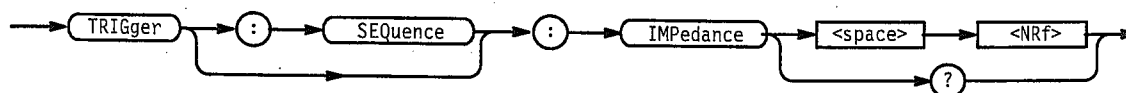

Arguments <NRf> is 50 (50 Ω) or 1e3 (1 k Ω).
At *RST, the value is set to 50 Ω .

Examples TRIGger:SEquence:IMPedance 1k
 selects 1 kΩ impedance for the external trigger input.

TRIGger[:SEquence]:LEVel (?)

Sets the trigger level on the selected SOURCE.

Group Trigger

Related Commands TRIGger[:SEquence]:SOURCE

Syntax TRIGger[:SEquence]:LEVel <NRf>
 TRIGger[:SEquence]:LEVel?

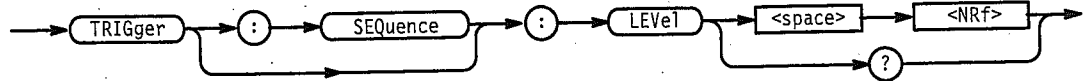

Arguments <NRf> is the trigger level. The range is -5.0 V to +5.0V, in 0.1 V steps.
 At *RST, the value is set to 1.4 V.

Examples TRIGger:SEquence:LEVel 200mV
 sets the trigger level to 200 mV.

TRIGger[:SEquence]:POLarity (?)

Selects the polarity relative to the trigger level that is required to activate the gate signal. This command is effective only when the waveform generator is in the gated mode.

Group Trigger

Related Commands AWGControl:RMODE, TRIGger[:SEquence]:LEVel

Syntax TRIGger[:SEquence]:POLarity { POSitive | NEGative }
 TRIGger:POLarity?

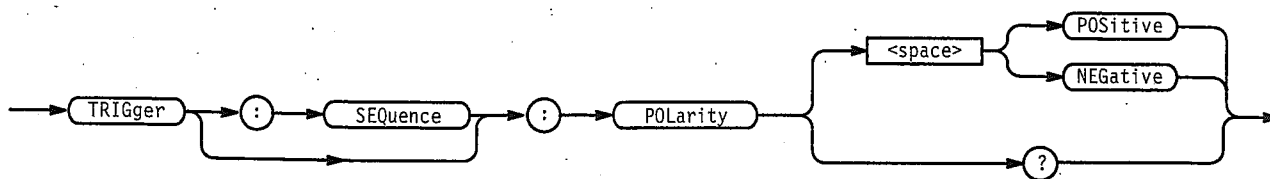

Arguments POSitive means the gate signal is activated when the external trigger signal is greater (more positive) than the trigger level.

NEGative means the gate signal is activated when the external trigger signal is less (more negative) than the trigger level.

At *RST, the parameter is set to POSitive.

Examples TRIGGER[:SEQUENCE]:POLARITY NEGative selects the negative polarity.

TRIGGER[:SEQUENCE]:SLOPE (?)

Determines whether the event occurs on the the rising edge or falling edge of the external trigger signal.

Group Trigger

Related Commands TRIGGER[:SEQUENCE]:SOURCE

Syntax TRIGGER[:SEQUENCE]:SLOPE { POSitive | NEGative }
TRIGGER[:SEQUENCE]:SLOPE?

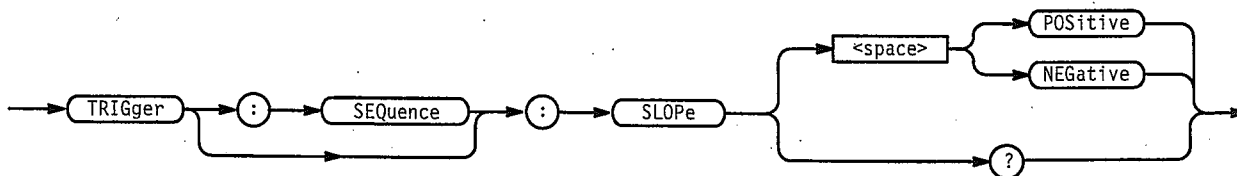

Arguments POSitive means the event occurs on the rising edge of the external trigger signal.

NEGative means the event occurs on the falling edge of the external trigger signal.

At *RST, the parameter is set to POSitive.

Examples TRIGger:SEQuence:SLOPe NEGative
selects the negative slope.

TRIGger[:SEQuence]:SOURce (?)

Selects the trigger source.

Group Trigger

Related Commands TRIGger[:SEQuence]:LEVel, TRIGger[:SEQuence]:POLarity,
TRIGger[:SEQuence]:SLOPe, TRIGger[:SEQuence]:TIMER

Syntax TRIGger[:SEQuence]:SOURce { INTernal | EXTernal }
TRIGger[:SEQuence]:SOURce?

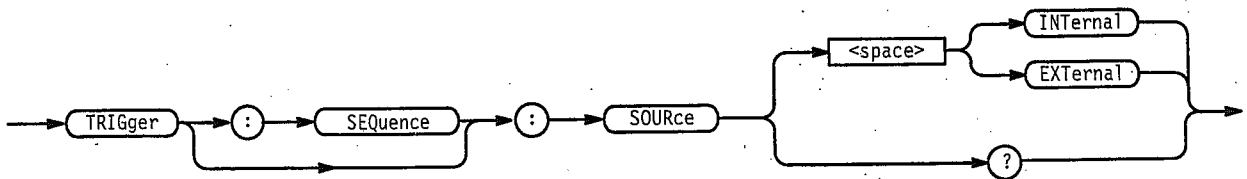

Arguments INTernal selects the internal clock as the trigger source.
EXTernal selects the external trigger input as the trigger source.
At *RST, the parameter is set to EXTernal.

Examples TRIGger:SEQuence:SOURce INTernal
selects the internal clock as the trigger source.

TRIGger[:SEQuence]:TIMER (?)

Sets the period of the internal clock when you select the internal clock as the trigger source with the TRIGger[:SEQuence]:SOURce command.

Group Trigger

Related Commands TRIGger[:SEQuence]:SOURce

Syntax TRIGger[:SEQuence]:TIMer <NRf>
 TRIGger[:SEQuence]:TIMer?

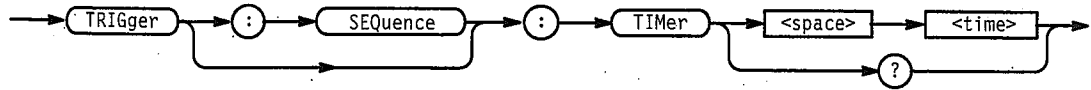

Arguments <NR3> is the internal trigger rate. The range is 1.0 μ s to 10.0 s.
 At *RST, this value is set to 100 ms.

Examples TRIGger:SEQuence:TIMer 5ms
 sets the internal trigger rate to 5 ms.

*TST? (Query Only)

Performs the self test and returns the results. If an error is detected during self test, execution is immediately stopped.

NOTE. This command takes several minutes to run the self test, and the waveform generator will not respond to any commands and queries while it runs.

Group Diagnostic

Related Commands *CAL?, CALibration[:ALL], DIAGnostic[:IMMediate]

Syntax *TST?

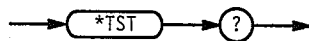

Arguments None

Returns <NR1>

0 Terminated without error.
 -330 Self-test failed.

Examples *TST?
might return -330 indicating the self-test failed.

***WAI (No Query Form)**

Prevents the waveform generator from executing further commands or queries until all pending operations finish.

In this application, all commands are designed to be executed in the order in which they are sent from the external controller. The *WAI command is included to ensure compliance with the SCPI standard. You do not need to use this command.

Group Synchronization

Related Commands *OPC

Syntax *WAI



Arguments None

Examples *WAI
prevents the execution of any commands or queries until all pending operations complete.

Retrieving Response Messages

When a query command is sent from the external controller, the waveform generator puts the response message on the output queue. This response message cannot be retrieved unless you perform a retrieval operation through the external controller. For example, call IBREAD subroutine with the National Instruments drivers.

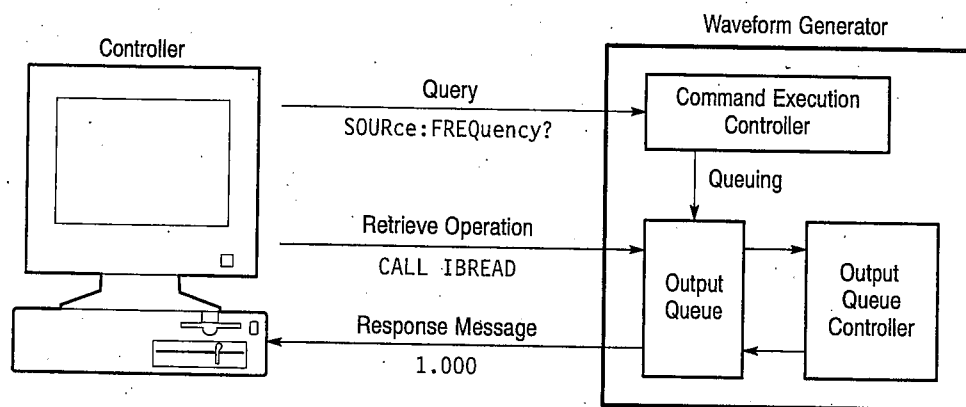

Figure 2-6: Retrieving response messages

Before a response message is placed in the output queue, the previous response message, if any, is deleted. Thus, if a second query occurs before the first response message is retrieved, the first response message is lost.

The SBR (status byte register) MAV bit can be used to check the response message queuing state. Refer to Chapter 3, *Status and Events*, for more information on the output queue, SBR, and control methods.

Data Transfer

You can transfer data between the waveform generator and external devices through the GPIB and Ethernet LAN interface. This section discusses the data format along with the data transfer procedures.

Data File

The waveform generator handles these types of files:

- The Waveform File contains waveform data in single precision floating point format.
- The Pattern File contains waveform data in binary format.
- The Sequence File defines the output sequence.
- The Code Convert File contains the Code Convert Table.

The waveform generator creates these files automatically during front panel operation. However, when you operate the waveform generator remotely, you must create the files by editing or programming according to the specified format described in the following topics.

Waveform File The Waveform File contains waveform data in single precision floating-point numbers and marker data.

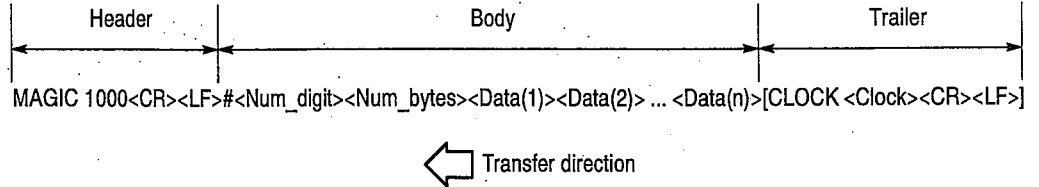

Figure 2-7: The Waveform File format

File Format. The Waveform File consists of three main parts. See Figure 2-7.

`<Waveform File> ::= <Header> <Body> [<Trailer>]`

where:

`<Header> ::= MAGIC <space> 1000 <CR> <LF>`

`<Body> ::= # <Num_digits> <Num_bytes> <Data(1)> <Data(2)> ... <Data(n)>`

`<Num_digits>` means the number of digits in `<Num_bytes>`.

`<Num_bytes>` means the byte count of the data that follows.

`<Data(n)> ::= <Waveform> <Marker>`

`<Waveform>` is the single precision floating-point number of 4-byte Little Endian format specified in IEEE488.2. The full scale of the D/A converter of the waveform generator corresponds to -1.0 to 1.0.

`<Marker>` is one byte of marker data. The bit 0 (LSB) and bit 1 represent markers, 1 and 2, respectively.

`<Trailer> ::= CLOCK <space> <Clock> <CR> <LF>`

`<Clock>` is the value of the sample clock in ASCII.

Example. This example shows the contents of a Waveform File that contains two point data.

4D 41 47 49 43 20 31 30 30 30 0D 0A 23 32 31 30	MAGIC 1000..#210
00 00 00 00 03 00 00 00 00 00 43 4C 4F 43 4B 20CLOCK
31 2E 30 30 30 30 30 30 30 30 30 30 65 2B 30 38	1.0000000000E+08
0D 0A	..

Pattern File The Pattern File contains waveform data in the binary format.

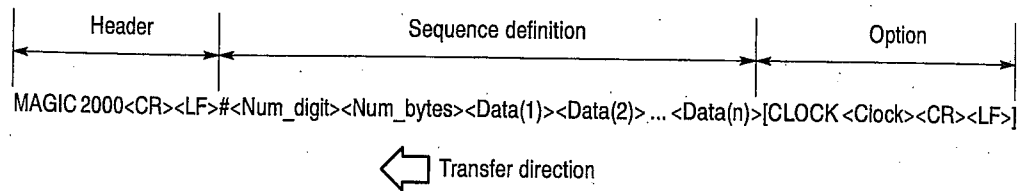

Figure 2-8: The Pattern File format

File Format. The data consists of three main parts. See Figure 2-8.

`<Pattern File> ::= <Header><Body> [<Trailer>]`

where:

`<Header> ::= MAGIC<space>2000<CR><LF>`

`<Body> ::= #<Num_digits><Num_bytes><Data(1)><Data(2)>...<Data(n)>`

`<Num_digits>` means the number of digits in `<Num_bytes>`.

`<Num_bytes>` means the byte count of the data that follows.

`<Data(n)>` represents each data point in two bytes (16 bits). The low byte is transferred first.

Bit 0 (LSB) – Bit 9 corresponds to D0 – D9 on the rear panel (Digital Data Out, Option 03).

Bits 13 and 14 are used for Markers 1 and 2, respectively.

`<Trailer> ::= CLOCK<space><Clock><CR><LF>`

`<Clock>` is the value of the sample clock in ASCII.

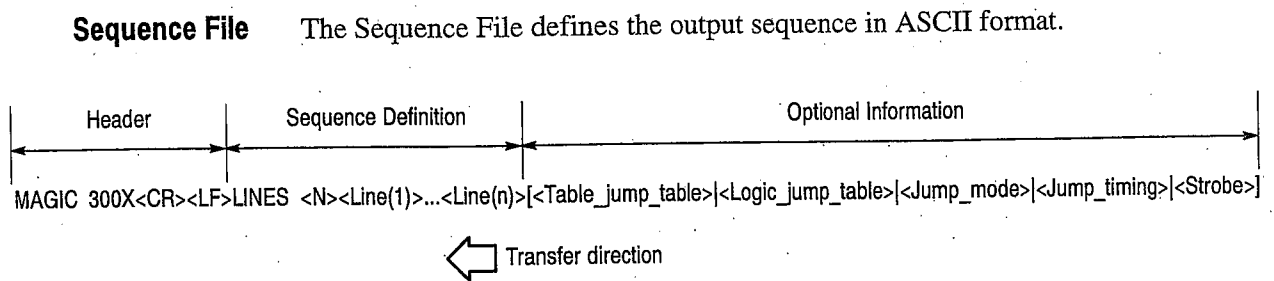

Figure 2-9: The Sequence File format

File Format. The data consists of three main parts. See Figure 2-9.

```
<Sequence File>
::=<Header><Sequence Definition>[<Optional Information>]
```

where:

```
<Header>::=MAGIC<space>300x<CR><LF>
```

x=1 or 2 represents the number of channels for which sequences are defined in the file.

```
<Sequence Definition>
::=LINES<space><N><Line(1)><Line(2)>...<Line(n)>
```

<N> is the number of lines that follow.

```
<Line(n)>::=<CH1_file_name>,<CH2_file_name>,<Repeat_count>
[,<Wait_trigger>[Goto-1[,<Logic_jump_target>]]]<CR><LF>
```

<CHx_file_name>::=<string> is the waveform or pattern file name for the specified channel.

<Repeat_count>::=<NR1> is the repeat count for the line. 0 means infinity.

<Wait_trigger>::=<NR1> specifies whether or not to wait for a trigger. <NR1>=0 means Off, ≠0 for On.

[Goto-1]::=<NR1> specifies whether or not to go to the next line. <NR1>=0 means Off, ≠0 for On.

<Logic_jump_target>::=<NR1> is line number for the Logic-Jump. 0 means Off, -1 for Next, and -2 for Table-Jump. The default is Off.

```
<Optional Information>
::={ <Table_jump_table> | <Logic_jump_table> | <Jump_mode> |
<Jump_timing> | <Strobe> }
```

```
<Table_jump_table>
::=TABLE_JUMP<space><Jump_target(1)>,<Jump_target(2)>,
...<Jump_target(16)><CR><LF>
```

<Jump_target(n)>::=<NR1> is the line number to the Table-Jump or 0 (off). The default is Off.

```
<Logic_jump_table>
::=LOGIC_JUMP<space><Jump_on/off(1)>,<Jump_on/off(2)>,
<Jump_on/off(3)>,<Jump_on/off(4)><CR><LF>
```

<Jump_on/off(n)>::=<NR1> sets the Logic-Jump on or off. <NR1>=0 means Off, 0 for On, and <0 for Ignore. The default is Ignore.

```
<Jump_mode>::=JUMP_MODE<space>{ LOGIC | TABLE }<CR><LF>
sets the jump mode. The default is TABLE.
```

```
<Jump_timing>::=JUMP_TIMING<space>{ SYNC | ASYNC }<CR><LF>
sets the jump mode. The default is ASYNC.
```

```
<Strobe>::=STROBE<space><NR1><CR><LF> determines whether to use the
STROBE signal from the EVENT IN connector on the rear panel. <NR1>=0
means Off, ≠0 for On. The default is Off.
```

Example. This Sequence File contains two lines of sequence definitions for CH 1 and CH 2.

```
MAGIC 3002
LINES 2
"SAMPLE1.wfm","SAMPLE2.wfm",1,0,0,0
"SAMPLE3.wfm","SAMPLE4.wfm",1,0,0,0
TABLE_JUMP 0,0,0,0,0,0,0,0,0,0,0,0,0,0,0
LOGIC_JUMP -1,-1,-1,-1
JUMP_MODE TABLE
JUMP_TIMING ASYNC
STROBE 0
```

Code Convert File

The Code Convert File is an ASCII text file that describes the Code Convert Table as displayed in the Edit menu.

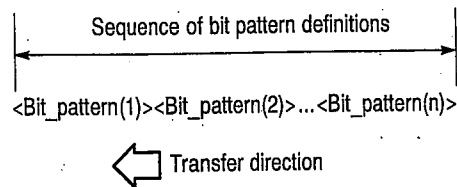

Figure 2-10: The Code Convert File format

File Format. The Code Convert File consists of bit pattern definitions. See Figure 2-10.

```
<Code Convert File> ::= <Bit_pattern(1)><Bit_pattern(2)> ...
<Bit_pattern(n)>
```

where:

```
<Bit_pattern(n)> ::= [<Past Source>, <Current Source>,
<Next Source>, <Past Output>, <Output Code><CR><LF>]
```

<Past Source>, <Current Source>, <Next Source>, <Past Output>, and <Output Code> specifies the bit patterns in the Code Convert Table. The bit pattern is specified with "0", "1", and "-" (don't care). For more information about the Code Convert Table, refer to the *AWG510 & AWG520 Arbitrary Waveform Generator User Manual*.

Example. This Code Convert File describes NRZI conversion.

```
-,0---,0,0
-,0---,1,1
-,0---,0,1
-,0---,1,0
```

Data Transfer Procedures

Data can be loaded from the external controller to the waveform generator. When the waveform generator is connected to the Ethernet LAN, you can also transfer files to and from up to three network drives.

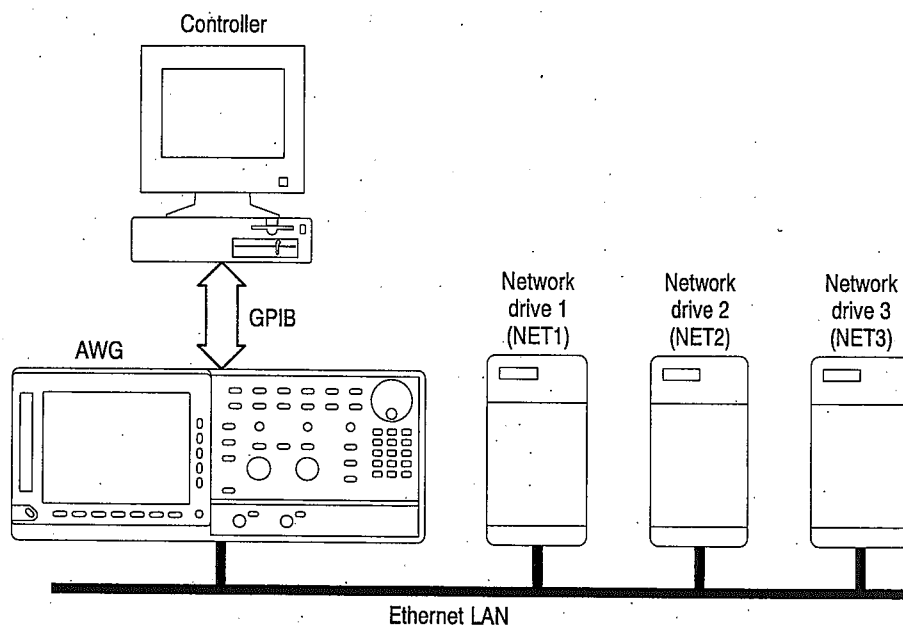

External Device to Waveform Generator

There are two ways to transfer data from the external device to the waveform generator: through the GPIB interface and through the Ethernet interface.

Through GPIB interface only. Use the MMEemory:DATA command.

```
MMEemory:DATA <file_name>,<data>
```

This command loads <data> into the file <file_name> on the internal hard disk, floppy disk, or the network drive. The default directory and mass memory device are specified by the MMEemory:CDIRECTory and MMEemory:MSIS commands respectively. The <data> is in IEEE488.2 block format.

For example, the following command string will load 2048 bytes of data to the file AWG1.

```
MMEemory:DATA "AWG1",#42048<data(1)><data(2)>...<data(2048)>
```

Through Ethernet Interface. Use the MMEMory:COPI command.

```
MMEMory:COPI <file_source>,<file_destination>
```

The file <file_source> is on the network device (NET1, NET2, or NET3) specified by the SYSTem:COMMunicate:LAN:RDEvice commands.

For example, the following command string will copy the file FILE-PC on the network drive (defined as NET1) to the file FILE-AWG on the waveform generator hard disk.

```
MMEMory:COPI "FILE-PC","NET1","FILE-AWG","MAIN"
```

Waveform Generator to External Device

You can transfer file data from the waveform generator to an external device through Ethernet interface.

Through Ethernet Interface. Use the MMEMory:COPI command.

```
MMEMory:COPI <file_source>,<file_destination>
```

The file <file_destination> is on the network device (NET1, NET2, or NET3) specified by the SYSTem:COMMunicate:LAN:RDEvice command.

For example, the following command string will copy the file FILE-AWG on the waveform generator floppy disk to the file FILE-PC on the network drive (defined as NET1).

```
MMEMory:COPI "FILE-AWG","FLOppy","FILE-PC","NET1"
```

Status and Events

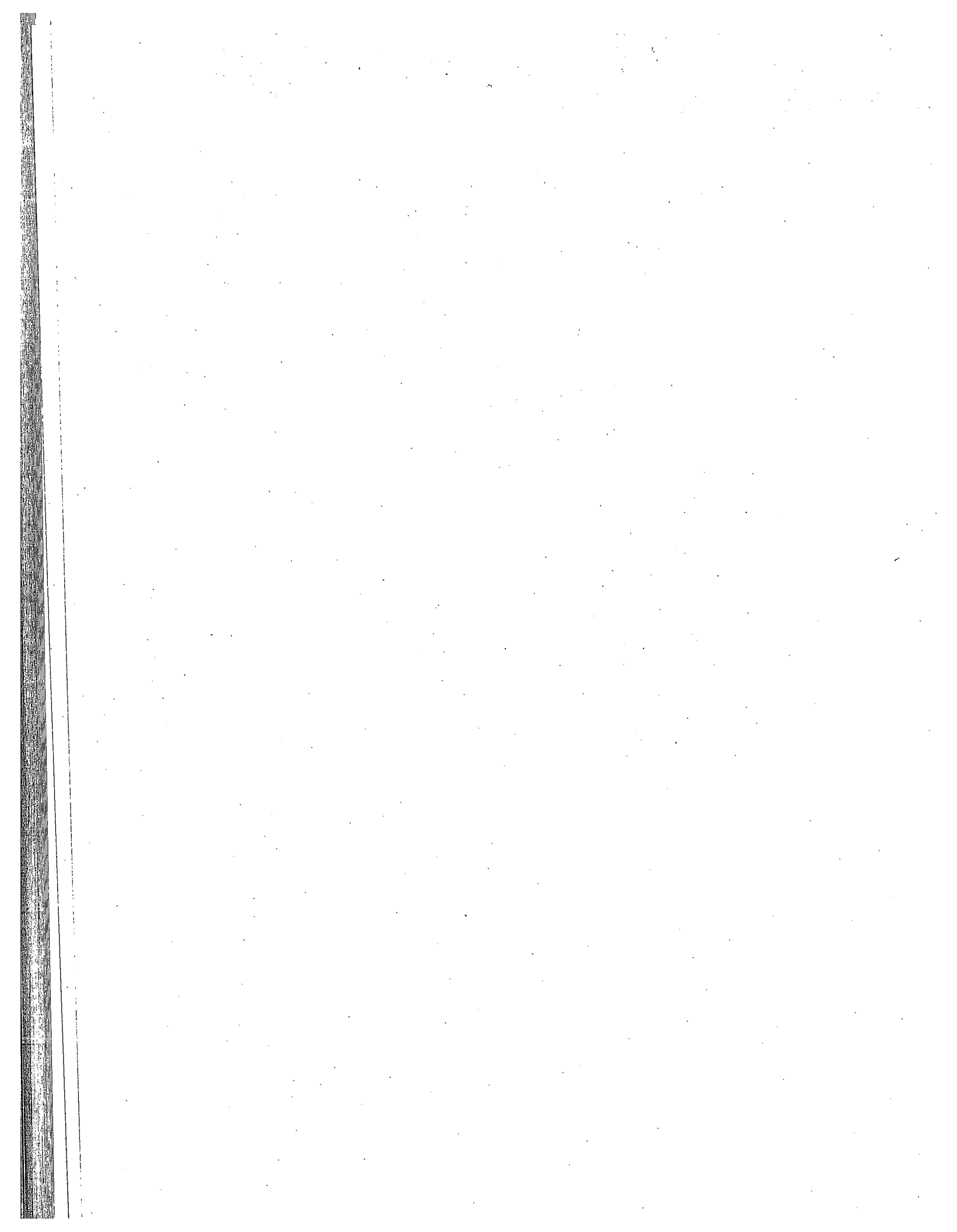

Status and Event Reporting

This section provides details on status information and events reported by the waveform generator.

Status Reporting Structure

The waveform generator status reporting function conforms to the IEEE-488.2 and SCPI standards. The status reporting function is used to check for instrument errors and to identify the types of events that have occurred on the instrument.

Figure 3-1 shows an outline of the instrument's status reporting function. The status reporting function is divided into three functional blocks:

- Standard/Event Status
- Operation Status
- Questionable Status

The operations processed in these three blocks are summarized in status bytes, which provide the error and event data.

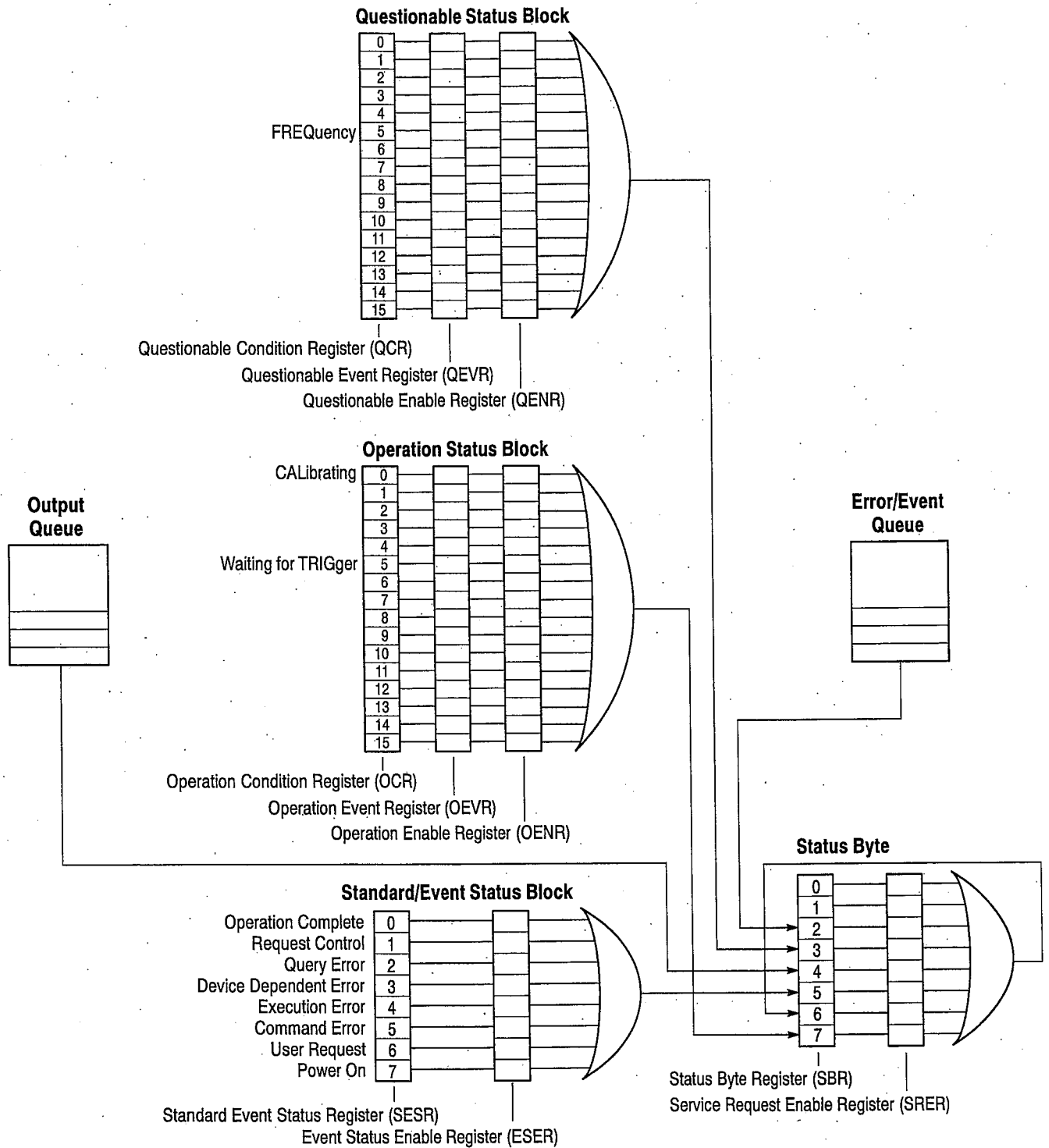

Figure 3-1: Error and Event handling process overview

Standard/Event Status Block

This block is used to report on power on/off, command error, and command execution status.

This block is made up of two registers: the Standard Event Status Register (SESR) and the Event Status Enable Register (ESER). See the Standard/Event Status Block shown at the bottom of Figure 3-1.

The SESR is an eight-bit status register. When an error or other type of event occurs on the instrument, the corresponding bit is set. This register cannot be written to by the user. The ESER is an eight-bit enable register that masks the SESR. This mask can be set by the user and can take AND with the SESR to determine whether or not the ESB bit in the Status Byte Register (SBR) should be set. Refer to *Event Status Enable Register (ESER)* on page 3-8 and *Standard Event Status Register (SESR)* on page 3-6 for the contents of these registers.

Operation Status Block

This block is used to report on the status of several operations being executed by the waveform generator.

This block is made up of three registers: the Operation Condition Register (OCR), the Operation Event Register (OEVR) and the Operation Enable Register (OENR). See the Operation Status Block shown in the middle of Figure 3-1.

When the instrument achieves a certain status, the corresponding bit is set to the OCR. This register cannot be written to by the user. OCR bits that have changed from false (reset) to true (set) status are set in the OEVR. The function of the OENR is to mask the OEVR. This mask can be set by the user and can take AND with the OEVR to determine whether or not the OSS bit in the Status Byte Register (SBR) should be set. Refer to *Operation Condition Register (OCR)* on page 3-7, *Operation Event Register (OEVR)* on page 3-7, and *Operation Enable Register (OENR)* on page 3-9 for the contents of these registers.

Questionable Status Block

This block reports on the status of signals and data, such as the accuracy of entered data and signals generated by the instrument. The register configuration and process flow are the same as for the Questionable Status Block. Refer to *Questionable Condition Register (QCR)* on page 3-7, *Questionable Event Register (QEVR)* on page 3-8, and *Questionable Enable Register (QENR)* on page 3-9 for the contents of these registers.

Registers

There are two main types of registers:

- **Status Registers:** store data relating to instrument status. These registers are set by the waveform generator.
- **Enable Registers:** determine whether to set events that occur in the instrument to the appropriate bits in the status registers and event queues. This type of register can be set by the user.

Status Registers

There are six types of status registers:

- Status Byte Register (SBR)
- Standard Event Status Register (SESR)
- Operation Condition Register (OCR)
- Operation Event Register (OEVR)
- Questionable Condition Register (QCR)
- Questionable Event Register (QEVR)

Read the contents of these registers to determine errors and conditions.

Status Byte Register (SBR)

The SBR is made up of 8 bits. Bits 4, 5 and 6 are defined in accordance with IEEE Std 488.2-1987 (see Figure 3-2 and Table 3-1). These bits are used to monitor the output queue, SESR and service requests, respectively. The contents of this register are returned when the *STB? query is used.

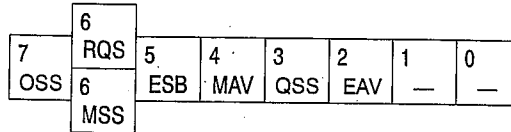

Figure 3-2: The Status Byte Register (SBR)

Table 3-1: SBR bit functions

Bit	Function
7	Operation Summary Status (OSS).
6	RQS (Request Service)/MSS (Master Summary Status). When the instrument is accessed using the GPIB serial poll command, this bit is called the Request Service (RQS) bit and indicates to the controller that a service request has occurred (in other words, that the GPIB bus SRQ line is LOW). The RQS bit is cleared when serial poll ends. When the instrument is accessed using the *STB? query, this bit is called the Master Summary Status (MSS) bit and indicates that the instrument has issued a service request for one or more reasons. The MSS bit is never cleared to 0 by the *STB? query.
5	Event Status Bit (ESB). This bit indicates whether or not a new event has occurred after the previous Standard Event Status Register (SESR) has been cleared or after an event readout has been performed.
4	Message Available Bit (MAV). This bit indicates that a message has been placed in the output queue and can be retrieved.
3	Questionable Summary Status (QSS).
2	Event Queue Available (EAV).
1-0	Not used

Standard Event Status Register (SESR)

The SESR is made up of 8 bits. Each bit records the occurrence of a different type of event, as shown in Figure 3-3 and Table 3-2. The contents of this register are returned when the *ESR? query is used.

7	6	5	4	3	2	1	0
PON	—	CME	EXE	DDE	QYE	—	OPC

Figure 3-3: The Standard Event Status Register (SESR)

Table 3-2: SESR bit functions

Bit	Function
7	Power On (PON). Indicates that the power to the instrument is on.
6	Not used.
5	Command Error (CME). Indicates that a command error has occurred while parsing by the command parser was in progress.
4	Execution Error (EXE). Indicates that an error occurred during the execution of a command. Execution errors occur for one of the following reasons: <ul style="list-style-type: none"> ■ A value designated in the argument is outside the allowable range of the instrument, or is in conflict with the capabilities of the instrument ■ The command could not be executed properly because the conditions for execution differed from those essentially required
3	Device-Specific Error (DDE). An instrument error has been detected.
2	Query Error (QYE). Indicates that a query error has been detected by the output queue controller. Query errors occur for one of the following reasons: <ul style="list-style-type: none"> ■ An attempt was made to retrieve messages from the output queue, despite the fact that the output queue is empty or in pending status. ■ The output queue messages have been cleared despite the fact that they have not been retrieved.
1	Not used.
0	Operation Complete (OPC). This bit is set with the results of the execution of the *OPC command. It indicates that all pending operations have been completed.

Operation Condition Register (OCR)

The OCR is made up of 16 bits which note the occurrence of three different types of events as indicated in Figure 3-4 and Table 3-3.

15	14	13	12	11	10	9	8	7	6	5	4	3	2	1	0
										TRIG					CAL

Figure 3-4: The Operation Condition Register (OCR)

Table 3-3: OCR bit functions

Bit	Function
15 - 6	Not used.
5	Waiting for Trigger (TRIG). Indicates whether the instrument is waiting for a trigger. This bit is set when CH 1 or another channel is waiting for a trigger. It is reset when the waiting-for-trigger status is canceled.
4 - 1	Not used.
0	Calibration (CAL): Indicates whether the instrument is being calibrated. This bit is set when calibration is in progress and is reset when calibration ends.

Operation Event Register (OEVR)

In this instrument, this register has the same content as the Operation Condition Register described above.

Questionable Condition Register (QCR)

The QCR is made up of 16 bits which note the occurrence of only one type of event as explained below.

15	14	13	12	11	10	9	8	7	6	5	4	3	2	1	0
										FREQ					

Figure 3-5: The Questionable Condition Register (QCR)

Table 3-4: QCR bit functions

Bit	Function
15 - 6	Not used. Must be set to zero for the waveform generator operation.
5	Frequency (FREQ). Indicates whether frequency accuracy of the signal is of questionable quality.
4 - 0	Not used. Must be set to zero for the waveform generator operation.

Questionable Event Register (QEVR)

In this instrument, this register has the same content as the Questionable Condition Register described above.

Enable Registers

There are four types of enable registers:

- Event Status Enable Register (ESER)
- Service Request Enable Register (SRER)
- Operation Enable Register (OENR)
- Questionable Enable Register (QENR)

Each bit in these enable registers corresponds to a bit in the controlling status register. By setting and resetting the bits in the enable register, you can determine whether or not events that occur will be registered to the status register and queue.

Event Status Enable Register (ESER)

The ESER is made up of bits defined exactly the same as bits 0 through 7 in the SESR (see Figure 3-6). You can use this register to designate whether the SBR ESB bit should be set when an event has occurred and to determine whether the corresponding SESR bit has been set.

To set the SBR ESB bit (when the SESR bit has been set), set the ESER bit corresponding to that event. To prevent the ESB bit from being set, reset the ESER bit corresponding to that event.

Use the *ESE command to set the bits of the ESER. Use the *ESE? query to read the contents of the ESER.

7	6	5	4	3	2	1	0
PON	—	CME	EXE	DDE	QYE	—	OPC

Figure 3-6: The Event Status Enable Register (ESER)

Service Request Enable Register (SRER)

The SRER is made up of bits defined exactly the same as bits 0 through 7 in the SBR (see Figure 3-7). You can use this register to determine which events will generate service requests.

The SRER bit 6 cannot be set. Also, the RQS is not maskable.

The generation of a service request with the GPIB interface involves changing the SRQ line to LOW and making a service request to the controller. The result is that a status byte for which an RQS has been set is returned in response to serial polling by the controller.

Use the *SRE command to set the bits of the SRER. Use the *SRE? query to read the contents of the SRER. Bit 6 must normally be set to 0.

7	6	5	4	3	2	1	0
OSS	—	ESB	MAV	QSS	EAV	—	—

Figure 3-7: The Service Request Enable Register (SRER)

Operation Enable Register (OENR)

The OENR is made up of bits that are defined exactly the same as bits 0 through 15 in the OEVR (see Figure 3-8). This register is used for the operator to define whether the OSB bit in the SBR is set when an event occurs and the corresponding OEVR bit is set.

Use the STATUS:OPERation:ENABle command to set the bits in the OENR. Use the STATUS:OPERation:ENABle? query to read the contents of the OENR.

15	14	13	12	11	10	9	8	7	6	5	4	3	2	1	0
										TRIG					CAL

Figure 3-8: The Operation Enable Register (OENR)

Questionable Enable Register (QENR)

The QENR is made up of bits that are defined exactly the same as bits 0 through 15 in the QEVR (see Figure 3-9). You can use this register to define whether the QSB bit in the SBR is set when an event occurs and the corresponding QEVR bit is set.

Use the STATUS:QUESTionable:ENABle command to set the bits in the QENR. Use the STATUS:QUESTionable:ENABle? query to read the contents of the QENR.

15	14	13	12	11	10	9	8	7	6	5	4	3	2	1	0
										FREQ					

Figure 3-9: The Questionable Enable Register (QENR)

Queues

There are two types of queues in the status reporting system used in the waveform generator: output queues and error/event queues.

Output Queue

The output queue is a FIFO (first-in, first-out) queue and holds response messages to queries, where they await retrieval. When there are messages in the queue, the SBR MAV bit is set.

The output queue is emptied each time a command or query is received, so the controller must read the output queue before the next command or query is issued. If this is not done, an error occurs and the output queue is emptied; however, the operation proceeds even if an error occurs.

Error/Event Queue

The event queue is a FIFO queue and stores events as they occur in the instrument. If more than 64 events occur, the 64th event will be replaced with event code -350 ("Queue Overflow"). The oldest error code and text are retrieved using one of the following queries:

- `SYSTEM:ERROR?`
- `STATUS:QUEUE[:NEXT]?`

First, issue the `*ESR?` query to read the contents of the SESR. The contents of the SESR are cleared after the read. If an SESR bit is set, events are stacked in the Error/Event Queue. Retrieve the event code with the following command sequence:

```
*ESR?  
SYSTEM:ERROR? or STATUS:QUEUE[:NEXT]?
```

If you omit the `*ESR?` query, the SESR bit will remain set even if the event disappears from the Error/Event Queue.

Status and Event Processing Sequence

Operation Status Block See Figure 3-10. When an event occurs, a signal is sent to the OEVR (1). If the corresponding bit in the OENR is also enabled (2), then the OSS bit in the SBR is set to one (3). See Figure 3-12.

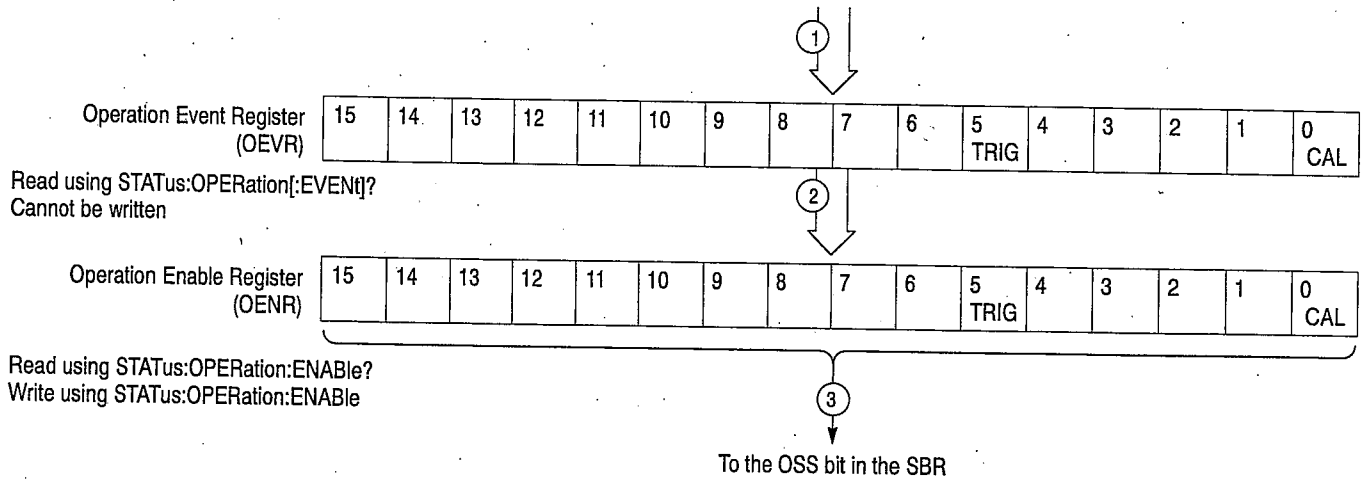

Figure 3-10: Status and Event processing sequence — Operation status block

Questionable Status Block See Figure 3-11. When an event occurs, a signal is sent to the QEVR (1). If the corresponding bit in the QENR is also enabled (2), then the QSS bit in the SBR is set to one (3). See Figure 3-12.

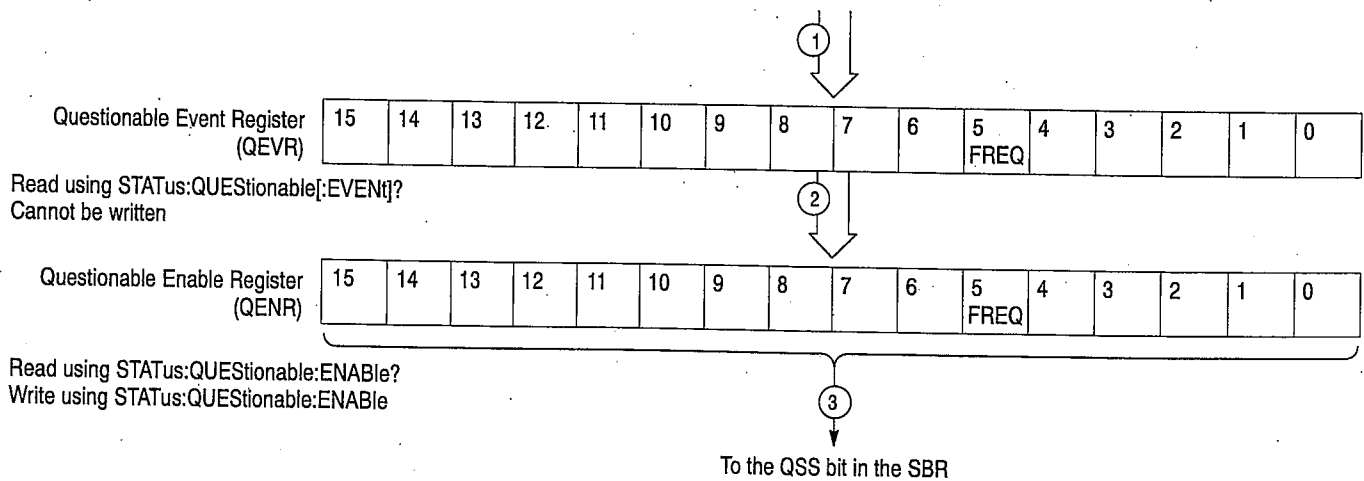

Figure 3-11: Status and Event processing sequence — Questionable status block

Standard/Event Status Block

See Figure 3-12. When an event occurs, a signal is sent to the SESR and the event is recorded in the Event Queue (1). If the corresponding bit in the ESER is also enabled (2), then the ESB bit in the SBR is set to one (3).

When output is sent to the Output Queue, the MAV bit in the SBR is set to one (4).

When a bit in the SBR is set to one and the corresponding bit in the SRER is enabled (5), the MSS bit in the SBR is set to one and a service request is generated (6).

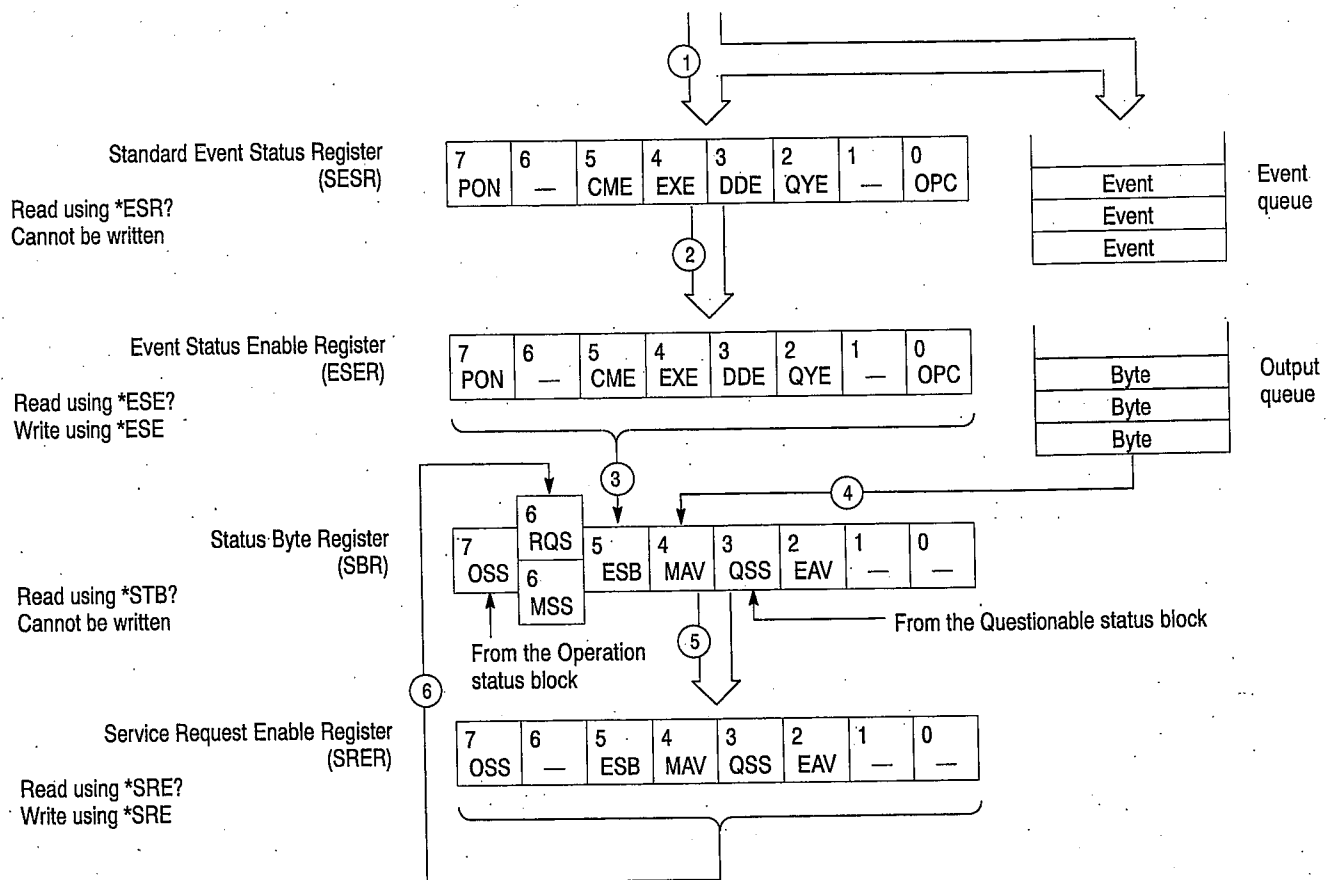

Figure 3-12: Status and Event processing sequence — Standard/Event status block

I/O Status and Event Screen

Figure 3-13 shows the contents of the GPIB status and event reporting system displayed on the screen. Use the following procedure to display the status and event screen.

1. Push the **UTILITY** menu button on the front panel. The UTILITY menu appears on the screen.
2. Push the **Status** bottom menu button to display the Status submenu.
3. Push the **SCPI registers** side menu button to display the status and event screen.

The status and event screen displays the registers: SESR, ESER, SBR, SRER, OEVR, and QEVR. Each of these registers is displayed with the decimal equivalent of its contents shown in brackets. All events currently in the queue are listed in the Event Queue part of the display.

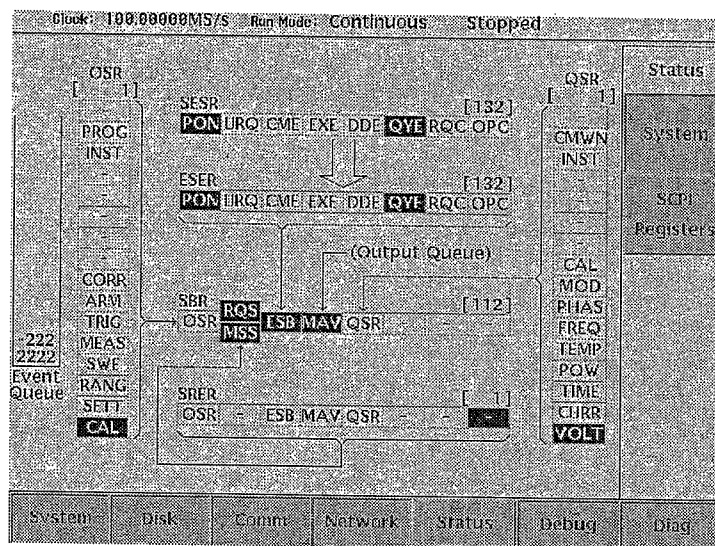

Figure 3-13: Status and Event screen

Synchronizing Execution

All commands used in this waveform generator are designed to be executed in the order in which they are sent from the external controller. The following synchronization commands are included to ensure compliance with the SCPI standard.

*WAI
*OPC
*OPC?

Messages

Tables 3-6 through 3-12 show the codes and messages used in the status and event reporting system.

Event codes and messages can be obtained by using the queries `SYSTEM:ERROR?` and `STATUS:QUEUE[:NEXT]?`. These are returned in the following format:

`<event code>,"<event message>"`

Messages and Codes

Error and event codes with a negative value are SCPI standard codes; errors and events with a positive value are unique to the waveform generator.

Table 3-5 lists the definition of event codes. When an error has occurred, it is possible to find out what class of error has occurred by checking the code range. See Tables 3-6 through 3-12 for more information on events used by the waveform generator; events are organized by class in these tables.

Table 3-5: Definition of event codes

Event class	Code ranges	Descriptions
No error	0	No event nor status
Command errors	-100 to -199	Command syntax errors
Execution errors	-200 to -299	Command execution errors
Device-specific errors	-300 to -399	Internal device errors
Query errors	-400 to -499	System event and query errors
Power-on events	-500 to -599	Power-on events
Operation complete events	-800 to -899	Operation complete events
Extended device-specific errors	1 to 32767	Device dependent device errors
Reserved	other than above	not used

Command Errors

Command errors are returned when there is a syntax error in the command.

Table 3-6: Command errors

Error code	Error message
-100	Command error
-101	Invalid character
-102	Syntax error
-103	Invalid separator
-104	Data type error
-105	GET not allowed
-108	Parameter not allowed
-109	Missing parameter
-110	Command header error
-111	Header separator error
-112	Program mnemonic too long
-113	Undefined header
-114	Header suffix out of range
-120	Numeric data error
-121	Invalid character in number
-123	Exponent too large
-124	Too many digits
-128	Numeric data not allowed

Table 3-6: Command errors (Cont.)

Error code	Error message
-130	Suffix error
-131	Invalid suffix
-134	Suffix too long
-138	Suffix not allowed
-140	Character data error
-141	Invalid character data
-144	Character data too long
-148	Character data not allowed
-150	String data error
-151	invalid string data
-158	String data not allowed
-160	Block data error
-161	Invalid block data
-168	Block data not allowed
-170	Expression error
-171	Invalid expression
-178	Expression data not allowed
-180	Macro error
-181	Invalid outside macro definition
-183	Invalid inside macro definition
-184	Macro parameter error

Execution Errors

These error codes are returned when an error is detected during command execution.

Table 3-7: Execution errors

Error code	Error message
-200	Execution error
-201	Invalid while in local
-202	Settings lost due to RTL
-203	Command protected
-210	Trigger error
-211	Trigger ignored
-212	Arm ignored
-213	Init ignored
-214	Trigger deadlock
-215	Arm deadlock
-220	Parameter error
-221	Settings conflict
-222	Data out of range
-223	Too much data
-224	Illegal parameter value
-225	Out of memory
-226	Lists not same length
-230	Data corrupt or stale
-231	Data questionable
-232	Invalid format
-233	Invalid version
-240	Hardware error
-241	Hardware missing
-250	Mass storage error
-251	Missing mass storage
-252	Missing media

Table 3-7: Execution errors (Cont.)

Error code	Error message
-253	Corrupt media
-254	Media full
-255	Directory full
-256	File name not found
-257	File name error
-258	Media protected
-260	Expression error
-261	Math error in expression
-270	Macro error
-271	Macro syntax error
-272	Macro execution error
-273	Illegal macro label
-274	Macro parameter error
-275	Macro definition too long
-276	Macro recursion error
-277	Macro redefinition not allowed
-278	Macro header not found
-280	Program error
-281	Cannot create program
-282	Illegal program name
-283	Illegal variable name
-284	Program currently running
-285	Program syntax error
-286	Program runtime error
-290	Memory use error
-291	Out of memory
-292	Referenced name does not exist
-293	Referenced name already exists
-294	Incompatible type

Device Specific Errors

These error codes are returned when an internal instrument error is detected. This type of error can indicate a hardware problem.

Table 3-8: Device specific errors

Error code	Error message
-300	Device specific error
-310	System error
-311	Memory error
-312	PUD memory lost
-313	Calibration memory lost
-314	Save/recal memory lost
-315	Configuration memory lost
-320	Storage fault
-321	Out of memory
-330	Self-test failed
-340	Calibration failed
-350	Queue overflow
-360	Communication error
-361	Parity error in program message
-362	Framing error in program message
-363	Input buffer overrun

Query Errors

These error codes are returned in response to an unanswered query.

Table 3-9: Query errors

Error code	Error message
-400	query error
-410	query INTERRUPTED
-420	query UNTERMINATED
-430	query DEADLOCKED
-440	query UNTERMINATED after indefinite response

Power-On Events

These events occur when the instrument detects an off to on transition in its power supply.

Table 3-10: Power-on events

Error code	Error message
-500	Power on

Operation Complete Events

These events occur when the instrument's synchronization protocol, having been enabled by an *OPC command, completes all selected pending operations.

Table 3-11: Operation complete events

Error code	Error message
-800	Operation complete

Device Errors

These error codes are unique to the waveform generator.

Table 3-12: Device errors

Error code	Error message
1101	CH1 internal offset
1102	CH1 output offset
1103	CH1 gain
1111	CH1 x3dB attenuator
1112	CH1 x6dB attenuator
1113	CH1 x12dB attenuator
1114	CH1 x20dB attenuator
1121	CH1 10MHz filter
1122	CH1 20MHz filter
1123	CH1 50MHz filter
1124	CH1 100MHz filter
1201	CH2 internal offset
1202	CH2 output offset
1203	CH2 gain
1211	CH2 x3dB attenuator
1212	CH2 x6dB attenuator
1213	CH2 x12dB attenuator
1214	CH2 x20dB attenuator
1221	CH2 10MHz filter
1222	CH2 20MHz filter
1223	CH2 50MHz filter
1224	CH2 100MHz filter
2100	System failure
2101	Real-time clock power
2102	Configuration record and checksum status
2103	Incorrect configuration
2104	Memory size miscompare
2105	Fixed-disk drive initialization status
2106	Time status

Table 3-12: Device errors (Cont.)

Error code	Error message
2110	Front panel failure
2111	Front panel configuration
2112	Front panel communication
2113	Front panel RAM
2114	Front panel ROM
2115	Front panel A/D
2116	Front panel timer
2301	A30 board failure
2401	Clock delay data not found
2402	Clock delay data checksum
2700	Calibration data failure
2701	Calibration data not found
2702	Calibration data checksum
3100	Control1 register failure
3101 to 3104	Control1 register bit0 to bit3
3200	Event table data bus failure
3201 to 3216	Event table data bus bit0 to bit15
3250	Event table address bus failure
3251 to 3274	Event table address bus bit0 to bit23
3300	Event table memory chip select failure
3301	Event table memory chip select 0
3302	Event table memory chip select 1
3350	Event table memory chip cell failure
3351	Event table memory chip 0
3352	Event table memory chip 1
4100	A40 board failure
4101	PLL 500MHz locked
4102	PLL 600MHz unlocked
4103	PLL 1350MHz unlocked
4104	PLL 1500MHz locked
5100	Sequence memory data bus failure
5101 to 5116	Sequence memory data bus bit0 to bit15

Table 3-12: Device errors (Cont.)

Error code	Error message
5150	Sequence memory address bus failure
5151 to 5174	Sequence memory address bus bit0 to bit23
5200	Sequence memory chip select failure
5201 to 5206	Sequence memory chip select 0 to select 5
5250	Sequence memory chip cell failure
5251 to 5256	Sequence memory chip 0 to chip 5
5300	CH1 Waveform memory data bus failure
5301 to 5316	CH1 Waveform memory data bus bit0 to bit15
5350	CH1 Waveform memory address bus failure
5351 to 5374	CH1 Waveform memory address bus bit0 to bit23
5400	CH1 Waveform memory chip select failure
5401 to 5449	CH1 Waveform memory chip select 0 to select 48
5500	CH1 Waveform memory chip cell failure
5501 to 5549	CH1 Waveform memory chip 0 to chip 48
5600	CH2 or CH1 Waveform memory data bus failure
5601 to 5616	CH2 or CH1 Waveform memory data bus bit0 to bit15
5650	CH2 or CH1 Waveform memory address bus failure
5651 to 5674	CH2 or CH1 Waveform memory address bus bit0 to bit23
5700	CH2 or CH1 Waveform memory chip select failure
5701 to 5748	CH2 or CH1 Waveform memory chip select 0 to select 47
5800	CH2 or CH1 Waveform memory chip cell failure
5801 to 5848	CH2 or CH1 Waveform memory chip 0 to chip 47
5900	CH1 Arb D/A failure
5901 to 5912	CH1 Arb D/A data bit0 to bit11
5950	CH2 Arb D/A failure
5951 to 5962	CH2 Arb D/A data bit0 to bit11
7110	CH1 output offset failure
7111	CH1 output offset
7120	CH1 internal offset failure
7121	CH1 internal offset
7130	CH1 Arb gain failure
7131	CH1 Arb gain

Table 3-12: Device errors (Cont.)

Error code	Error message
7140	CH1 attenuator failure
7141	CH1 3dB attenuator
7142	CH1 6dB attenuator
7143	CH1 12dB attenuator
7144	CH1 20dB attenuator
7150	CH1 filter failure
7151	CH1 10MHz filter
7152	CH1 20MHz filter
7153	CH1 50MHz filter
7150	CH1 100MHz filter
7170	CH1 output key failure
7171	CH1 output key
7210	CH2 or CH1 output offset failure
7211	CH2 or CH1 output offset
7220	CH2 or CH1 internal offset failure
7221	CH2 or CH1 internal offset
7230	CH2 or CH1 Arb gain failure
7231	CH2 or CH1 Arb gain
7240	CH2 or CH1 attenuator failure
7241	CH2 or CH1 3dB attenuator
7242	CH2 or CH1 6dB attenuator
7243	CH2 or CH1 12dB attenuator
7244	CH2 or CH1 20dB attenuator
7250	CH2 or CH1 filter failure
7251	CH2 or CH1 10MHz filter
7252	CH2 or CH1 20MHz filter
7253	CH2 or CH1 50MHz filter
7254	CH2 or CH1 100MHz filter
7270	CH2 or CH1 output key failure
7271	CH2 or CH1 output key

Programming Examples



Programming Examples

The example programs illustrate methods you can use to control the waveform generator from the GPIB interface. The floppy disk supplied with the waveform generator contains listing for these programs written in Microsoft Visual C++ and Visual BASIC. The programs will also work with National Instruments LabVIEW.

The diskette also contains the file *README.TXT*. Refer to the file for details about how to run the programs.

The programs run on a PC-compatible system equipped with a National Instruments GPIB board and associated drivers.

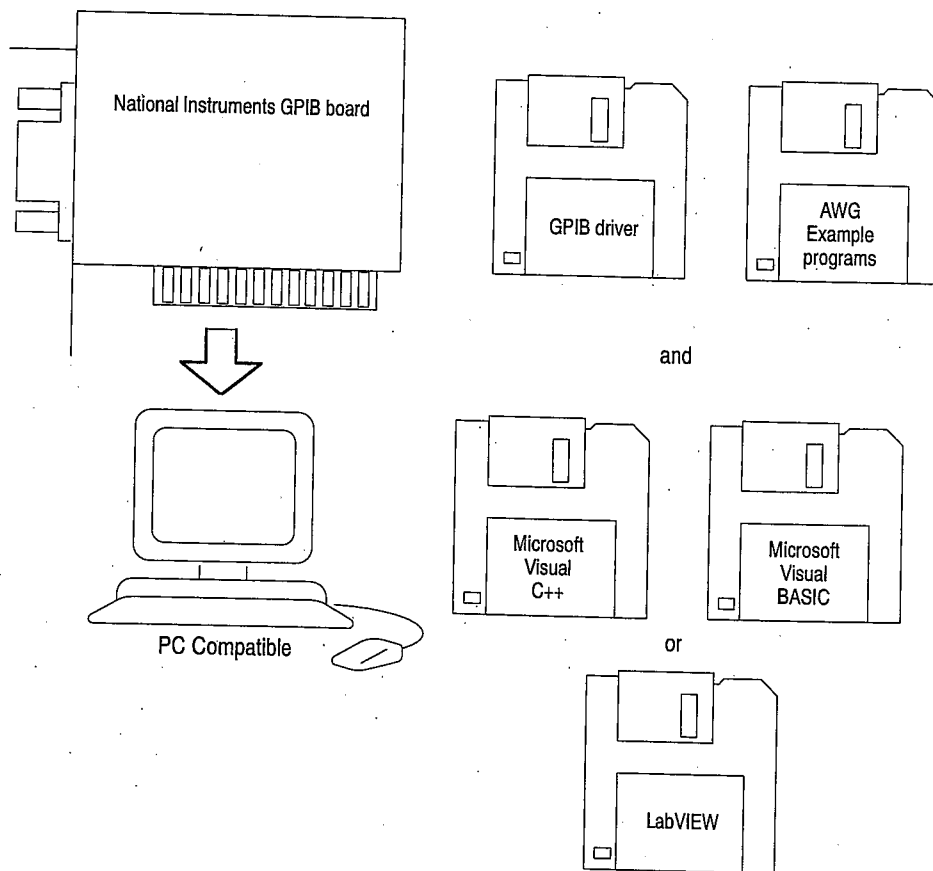

Figure 4-1: Equipment needed to run the example programs

Appendices



Appendix A: Character Charts

Table A-1: The AWG500 character set

	0	1	2	3	4	5	6	7
0	NUL 0		space 32	0 48	@ 64	P 80	' 96	p 112
1			! 33	1 49	A 65	Q 81	a 97	q 113
2			" 34	2 50	B 66	R 82	b 98	r 114
3			# 35	3 51	C 67	S 83	c 99	s 115
4			\$ 36	4 52	D 68	T 84	d 100	t 116
5			% 37	5 53	E 69	U 85	e 101	u 117
6			& 38	6 54	F 70	V 86	f 102	v 118
7			' 39	7 55	G 71	W 87	g 103	w 119
8			(40	8 56	H 72	X 88	h 104	x 120
9	HT 9) 41	9 57	I 73	Y 89	i 105	y 121
A	LF 10		* 42	: 58	J 74	Z 90	j 106	z 122
B		ESC 27	+ 43	; 59	K 75	[91	k 107	{ 123
C			, 44	< 60	L 76	\ 92	l 108	 124
D	CR 13		- 45	= 61	M 77] 93	m 109	} 125
E			. 46	> 62	N 78	^ 94	n 110	~ 126
F			/ 47	? 63	O 79	_ 95	o 111	rubout 127

Table A-2: ASCII & GPIB code chart

B7 B6 BITS B5 B4 B3 B2 B1	0 0		0 0 1		0 1 0		0 1 1		1 0 0		1 0 1		1 1 0		1 1 1	
	CONTROL				NUMBERS SYMBOLS				UPPER CASE				LOWER CASE			
0 0 0 0	0	NUL	20	DLE	40	SP	60	0	100	@	120	P	140	,	160	p
0 0 0 1	1	SOH	21	DC1	41	!	61	1	101	A	121	Q	141	a	161	q
0 0 1 0	2	STX	22	DC2	42	"	62	2	102	B	122	R	142	b	162	r
0 0 1 1	3	ETX	23	DC3	43	#	63	3	103	C	123	S	143	c	163	s
0 1 0 0	4	EOT	24	DC4	44	\$	64	4	104	D	124	T	144	d	164	t
0 1 0 1	5	ENQ	25	NAK	45	%	65	5	105	E	125	U	145	e	165	u
0 1 1 0	6	ACK	26	SYN	46	&	66	6	106	F	126	V	146	f	166	v
0 1 1 1	7	BEL	27	ETB	47	'	67	7	107	G	127	W	147	g	167	w
1 0 0 0	10	GET	30	SPE	50	(70	8	110	H	130	X	150	h	170	x
1 0 0 1	11	HT	31	EM	51)	71	9	111	I	131	Y	151	i	171	y
1 0 1 0	12	LF	32	SUB	52	*	72	:	112	J	132	Z	152	j	172	z
1 0 1 1	13	VT	33	ESC	53	+	73	;	113	K	133	[153	k	173	{
1 1 0 0	14	FF	34	FS	54	,	74	<	114	L	134	\	154	l	174	
1 1 0 1	15	CR	35	GS	55	-	75	=	115	M	135]	155	m	175	}
1 1 1 0	16	SO	36	RS	56	.	76	>	116	N	136	^	156	n	176	~
1 1 1 1	17	SI	37	US	57	/	77	?	117	O	137	_	157	o	177	RUBOUT (DEL)
		ADDRESSED COMMANDS		UNIVERSAL COMMANDS		LISTEN ADDRESSES		TALK ADDRESSES		SECONDARY ADDRESSES OR COMMANDS						

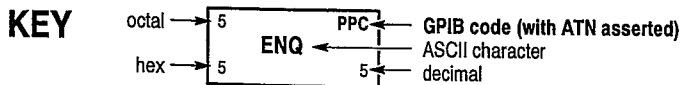

Tektronix
 REF: ANSI STD X3.4-1977
 IEEE STD 488.1-1987
 ISO STD 646-2973

Appendix B: Reserved Words

The words in the following list are reserved words for use with the AWG500 Series Arbitrary Waveform Generator.

*CAL	CONTInuous	INITialize	QUEue
*CLS	COPY	IState	RDEvice<x>
*ESE	COUNT	JIS	RMODE
*ESR	CW	KDIRection	ROSCillator
*IDN	DATA	KEYBoard	RState
*OPC	DATE	KLOCK	RUN
*OPT	DELay	LAN	SDUMp
*PSC	DELete	LANGUage	SECurity
*RST	DESTination	LEVel	SELect
*SRE	DEvice	LOGic	SELF
*STB	DIAGnostic	LOW	SEQUence
*TRG	DISPlay	LPASs	SLOPe
*TST	DOUtput	MAIN	SMASk
*WAI	ENABle	MARKer	SMEMory
ABORT	ENHanced	MDIRectory	SREStore
ADDRess	ERRor	MMEMemory	SOURce
ALL	EVENT	MSIS	SSAVE
AMPLitude	EXTernal	NAME	STATE
AOUTput	FEED	NEGative	STOP
ASCii	FILTer	NET<x>	SYSTEM
AWGControl	FIXed	NFS	TEXT
BACKward	FLOPPy	NORMal	TIFF
BEEPer	FORWard	OFFSet	TIME
BMP	FREQuency	OPEN	TIMER
BRIGHtness	FSYStem	OPERation	TRIGger
CALibration	FUNcTion	OUTPut	TYPE
CATalog	GATed	PING	UNLock
CDIRectory	GATeway<x>	POLarity	UPTime
CH<x>	HCOPY	POSitive	USER
CLOCK	HIGH	POWer	VERSIon
CLOSE	INTernal	PRESet	VOLTage
COMMunicate	IMMediate	PROTOcol	WMEMory
CONDition	IMPedance	QUESTionable	

Appendix C: GPIB Interface Specification

This appendix lists and describes the GPIB functions and messages that the AWG500 Series Arbitrary Waveform Generator implements.

Interface Functions

Table C-1 shows which GPIB interface functions are implemented in this instrument. Following the table is a brief description of each function.

Table C-1: GPIB interface function implementation

Interface Function	Implemented Subset	Capability
Acceptor Handshake (AH)	AH1	Complete
Source Handshake (SH)	SH1	Complete
Talker (T)	T6	Basic Talker, Serial Poll Unaddress if my-listen-address (MLA) No Talk Only mode
Listener (L)	L4	Basic Listener Unaddress if my talk address (MTA) No Listen Only mode
Service Request (SR)	SR1	Complete
Remote/Local (RL)	RL1	Complete
Parallel Poll (PP)	PP0	None
Device Clear (DC)	DC1	Complete
Device Trigger (DT)	DT1	Complete
Controller (C)	C0	None
Electrical Interface	E2	Three-state driver

- Acceptor Handshake (AH). Allows a listening device to help coordinate the the proper reception of data. The AH function holds off initiation or termination of a data transfer until the listening device is ready to receive the next data byte.
- Source Handshake (SH). Allows a talking device to help coordinate the proper transfer of data. The SH function controls the initiation and termination of the data byte transfer.
- Talker (T). Allows a device to send device-dependent data over the interface. This capability exists only when the device is addressed to talk. The function uses a one-byte address.
- Listener (L). Allows a device to receive device-dependent data over the interface. This capability exists only when the device is addressed to listen. This function uses a one-byte address.
- Service Request (SR). Allows a device to request service from the controller.
- Remote/Local (RL). Allows a device to select between two sources for operating control. This function determines whether input information from the front panel controls (local) or GPIB commands (remote) control the waveform generator.
- Device Clear (DC). Allows a device to be cleared or initialized, either individually or as part of a group of devices.
- Controller (C). Allows a device with the capability to send the device address, universal commands, and addressed commands to other devices over the interface to do so.
- Electrical Interface (E). Identifies the type of electrical interface. The notation E1 indicates the electrical interface uses open collector drivers, while E2 indicates the electrical interface uses three-state drivers.

Interface Messages

Table C-2 shows the standard interface messages that are supported by the waveform generator.

Table C-2: AWG500 standard interface message

Message	GPIB
DCL	Yes
GET	Yes
GTL	Yes
LLO	Yes
PPC	No
PPD	No
PPE	No
PPU	No
SDC	Yes
SPD	Yes
SPE	Yes
TCT	No
UNL	Yes
UNT	Yes
Listen Addresses	Yes
Talk Addresses	Yes

- Device Clear (DCL). Clears (initializes) all devices on the bus that have a device clear function, whether the controller has addressed them or not.
- Group Execute Trigger (GET). Triggers all applicable devices and causes them to initiate their programmed actions.
- Go To Local (GTL). Causes the listen-addressed device to switch from remote to local (front-panel) control.
- Local Lockout (LLO). Disables the return to local function.
- Parallel Poll Configure (PPC). Causes the listen-addressed device to respond to the secondary commands Parallel Poll Enable (PPE) and Parallel Poll Disable (PPD), which are placed on the bus following the PPC command. PPE enables a device with parallel poll capability to respond on a particular data line. PPD disables the device from responding to the parallel poll.
- Select Device Clear (SDC). Clears or initializes all listen-addressed devices.
- Serial Poll Disable (SPD). Changes all devices on the bus from the serial poll state to the normal operating state.
- Serial Poll Enable (SPE). Puts all devices on the bus, that have a service request function, into the serial poll enabled state. In this state, each device sends the controller its status byte, instead of its normal output, after the device receives its talk address on the data lines. This function may be used to determine which device sent a service request.
- Take Control (TCT). Allows the controller in charge to pass control of the bus to another controller on the bus.

Appendix D: SCPI Conformance Information

All commands in the AWG500 Series Arbitrary Waveform Generator are based on SCPI Version 1995.0. Table D-1 lists the commands supported by the generator.

Table D-1: SCPI conformance information

Command	Defined in SCPI 1995.0	Not defined in SCPI 1995.0
ABORT	✓	
AWGcontrol		
DOUtput [STATe] (?)		✓
EVENT LOGic [IMMediate]		✓
RMODe(?)		✓
RSTATE?		✓
RUN [IMMediate]		✓
SREStore		✓
SSAVe		✓
STOP [IMMediate]		✓
CALibration [ALL] (?)	✓	
DIAGnostic		
DATA?		✓
[IMMediate] (?)		✓
SELEct(?)		✓
DISPlay		
BRIGHtness(?)	✓	
HCOpy		
DESTination	✓	
DEVIce LANGUage(?)	✓	
[IMMediate]	✓	
SDUMp [IMMediate]	✓	

Appendix D: SCPI Conformance Information

Table D-1: SCPI conformance information (Cont.)

Command		Defined in SCPI 1995.0	Not defined in SCPI 1995.0
MEMory	CATalog?	✓	
	CDIRectory(?)	✓	
	CLOSe	✓	
	COPY	✓	
	DATA	✓	
	DELeTe	✓	
	FEED(?)	✓	
	INITialize	✓	
	MDIRectory	✓	
	MSIS(?)		✓
	MOVE	✓	
	NAME(?)	✓	
	OPEN	✓	
	OUTPut	FILTer [LPASs] FREQuency(?)	✓
ISTate(?)			✓
[STATe] (?)		✓	
SOURce	COMBine FEED(?)	✓	
	FREQuency [CW FIXed] (?)	✓	
	FUNCTion USER(?)		✓
	MARKer DELay(?)		✓
	VOLTage [LEVe1] [IMMediate] HIGH(?)		✓
	VOLTage [LEVe1] [IMMediate] LOW(?)		✓
	POWer [LEVe1] [IMMediate] [AMPLitude] (?)	✓	
	ROSCillator SOURce(?)	✓	
	VOLTage [LEVe1] [IMMediate] [AMPLitude] (?)	✓	
	OFFSet(?)	✓	
HIGH(?)	✓		
LOW(?)	✓		

Table D-1: SCPI conformance information (Cont.)

Command		Defined in SCPI 1995.0	Not defined in SCPI 1995.0	
STATus	OPERation	[EVENT]?	✓	
		CONDition?	✓	
		ENABle(?)	✓	
	QUESTionable	[EVENT]?	✓	
		CONDition?	✓	
		ENABle(?)	✓	
	PRESet	✓		
	QUEue	[NEXT]?	✓	
	SYSTem	BEEPer	[IMMediate]	✓
COMMunicate		LAN	FTP [SERVer] [STATE] (?)	✓
			GATeway ADDRESS (?)	✓
		PING?	✓	
		RDEvice	ADDRESS (?)	✓
			FSYStem (?)	✓
			NAME (?)	✓
			PROTOcol (?)	✓
		[STATE] (?)	✓	
[SELF]		ADDRESS (?)	✓	
SMASK (?)		✓		
DATE (?)		✓		
ERRor?		✓		
KDIRection (?)			✓	
KEYBoard		[TYPE] (?)		✓
KLOCK (?)			✓	
SECurity		IMMediate	✓	
TIME (?)		✓		
UPTime?			✓	
VERSIon?		✓		

Appendix D: SCPI Conformance Information

Table D-1: SCPI conformance information (Cont.)

Command	Defined in SCPI 1995.0	Not defined in SCPI 1995.0
TRIGger [SEquence] [IMMediate]	✓	
IMPedance(?)		✓
LEVel(?)	✓	
POLarity(?)		✓
SLOPe(?)	✓	
SOURce(?)	✓	
TIMer(?)	✓	
*CLS	✓	
*ESE(?)	✓	
*ESR?	✓	
*IDN?	✓	
*OPC(?)	✓	
*OPT?		✓
*RST	✓	
*SRE(?)	✓	
*STB?	✓	
*TST?	✓	
*WAI?	✓	

Appendix E: Factory Initialization Settings

The following table lists the commands affected by a factory initialization.

The SYSTEM:SECURITY:IMMEDIATE command initializes all the settings as shown below, while the *RST command has no effect on the Status commands and the SYSTEM:COMMUNICATE:LAN commands.

Table E-1: Factory initialization settings

Header	Default settings
AWGcontrol commands	
AWGControl:DOUTput[1 2]	0
AWGControl:RMODE	CONTInuous
Diagnostic commands	
DIAGnostic:SElect	ALL
Display commands	
DISPlay:BRIGHtness	0.7
Hardcopy commands	
HCOPY:DEvIce:LANGUage	BMP
MMemory commands	
MMEMemory:CDIRectory	"/"
MMEMemory:FEED	"HCOP"
MMEMemory:MSIS	"MAIN"
MMEMemory:NAME	"HARDCOPY", "MAIN"
Output commands	
OUTPut[1 2]:FILTer[:LPASS]:FREQuency	9.9E+37
OUTPut[1]:ISTate	0
OUTPut[1 2 5 7][:STATE]	0

Table E-1: Factory initialization settings (Cont.)

Header	Default settings
Source Commands	
[SOURce1]:COMBine:FEED	"" (null)
[SOURce[1 2 5]]:FREQuency[:CW :FIXed]	1.0000000E+8
[SOURce[1 2 5]]:FUNctIon:USER	"" (null), "MAIN"
[SOURce[1 2 5]]:MARKer<y>:DELay	0
[SOURce[1 2 5]]:MARKer<y>:VOLTage[:LEVe1] [:IMMediate]:HIGH	2.00
[SOURce[1 2 5]]:MARKer<y>:VOLTage[:LEVe1] [:IMMediate]:LOW	0.00
SOURce7:POWer[:LEVe1] [:IMMediate] [:AMPLitude]	-105
[SOURce[1 2 5]]:ROSCillator:SOURce	INTerna1
[SOURce[1 2]]:VOLTage[:LEVe1] [:IMMediate] [:AMPLitude]	1.000
SOURce5:VOLTage[:LEVe1] [:IMMediate]:HIGH	2.00
SOURce5:VOLTage[:LEVe1] [:IMMediate]:LOW	0.00
[SOURce[1 2]:VOLTage[:LEVe1] [:IMMediate]: OFFSet	0.000
Status Commands	
*ESE ¹	0
*PSC ¹	1
*SRE ¹	0
STATus:OPERation:ENABle ¹	0
STATus:QUESTionable:ENABle ¹	0

Table E-1: Factory initialization settings (Cont.)

Header	Default settings
System Commands	
SYSTem:COMMunicate:LAN:GATeway<x>:ADDRess ¹	"" (null)
SYSTem:COMMunicate:LAN:RDEvice<x>:ADDRess ¹	"" (null)
SYSTem:COMMunicate:LAN:RDEvice<x>:FSYStem ¹	"" (null)
SYSTem:COMMunicate:LAN:RDEvice<x>:NAME ¹	"NET<x>"
SYSTem:COMMunicate:LAN:RDEvice<x>:PROTOcol ¹	NFS
SYSTem:COMMunicate:LAN:RDEvice<x>[:STATe] ¹	0
SYSTem:COMMunicate:LAN[:SELf]:ADDRess ¹	"" (null)
SYSTem:COMMunicate:LAN[:SELf]:SMASK ¹	"" (null)
SYSTem:KDIRection	FORWard
SYSTem:KEYBOrd[:TYPE]	ASCii
SYSTem:KLOCK	0
Trigger Commands	
TRIGger[:SEQuence]:IMPedance	5.0E+1
TRIGger[:SEQuence]:LEVel	1.4
TRIGger[:SEQuence]:POLarity	POSitive
TRIGger[:SEQuence]:SLOPe	POSitive
TRIGger[:SEQuence]:SOURce	EXTernal
TRIGger[:SEQuence]:TIMER	1.00E-1

¹ These commands are not affected by the *RST command.

Glossary and Index

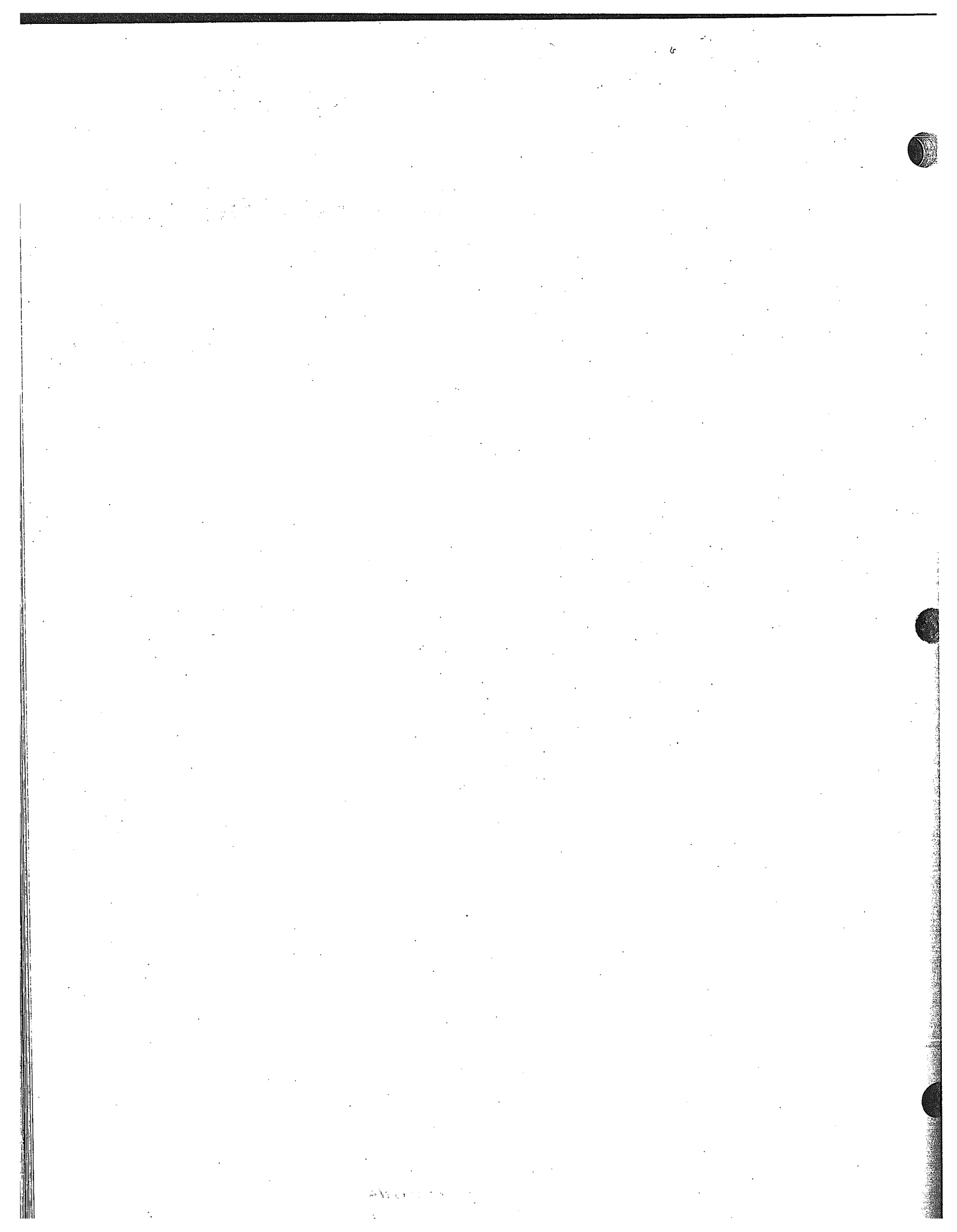

Glossary

ASCII

Acronym for the American Standard Code for Information Interchange. Controllers transmit commands to the instrument using ASCII character encoding.

Address

A 7-bit code that identifies an instrument on the communication bus. The instrument must have a unique address for the controller to recognize and transmit commands to it.

BNF (Backus-Naur Form)

A standard notation system for command syntax diagrams. The syntax diagrams in this manual use BNF notation.

Controller

A computer or other device that sends commands to and accepts responses from the digitizing oscilloscope.

EOI

A mnemonic referring to the control line "End or Identify" on the GPIB interface bus. One of the two possible end-of-message terminators.

EOM

A generic acronym referring to the end-of-message terminator. The end-of-message terminator can be either an EOI or the ASCII code for line feed (LF).

GPIB

Acronym for General Purpose Interface Bus, the common name for the communications interface system defined in IEEE Std 488.

IEEE

Acronym for the Institute for Electrical and Electronic Engineers.

QuickC

A computer language (distributed by Microsoft) that is based on C.

SCPI

Acronym for Standard Commands for Programmable Instruments.

Index

Symbols

- *CAL?, 2-31
- *CLS, 2-33
- *ESE, 2-37
- *ESR, 2-38
- *IDN?, 2-40
- *OPC, 2-50
- *OPT?, 2-51
- *PSC, 2-54
- *RST, 2-55
- *SRE, 2-64
- *STB?, 2-70
- *TRG, 2-84
- *TST?, 2-89
- *WAI, 2-90

A

Abbreviations, commands, queries, and parameters, 2-5

ABORt, 2-26

Arguments, parameters, 2-4

AWG control command group, 2-16

AWG control commands

AWGControl:DOUtpuT[1|2][:STATe], 2-26

AWGControl:EVENt[:LOGic][:IMMediate], 2-27

AWGControl:RMODE, 2-27

AWGControl:RSTate?, 2-28

AWGControl:RUN[:IMMediate], 2-29

AWGControl:SREStore, 2-29

AWGControl:SSAVe, 2-30

AWGControl:STOP[:IMMediate], 2-31

AWGControl:DOUtpuT[1|2][:STATe], 2-26

AWGControl:EVENt[:LOGic][:IMMediate], 2-27

AWGControl:RMODE, 2-27

AWGControl:RSTate?, 2-28

AWGControl:RUN[:IMMediate], 2-29

AWGControl:STOP[:IMMediate], 2-31

B

Backus-Naur Form, 2-1

BNF (Backus-Naur form), 2-1

C

Calibration command group, 2-16

Calibration commands

*CAL?, 2-31

CALibration[:ALL], 2-32

CALibration[:ALL], 2-32

Case sensitivity, 2-8

Character chart, A-1

Code, error, 3-15

Code Convert File, 2-98

Command, summaries, 2-16

Command group

AWG control, 2-16

Calibration, 2-16

Diagnostic, 2-17

Display, 2-17

Hardcopy, 2-18

Mass memory, 2-19

Output, 2-20

Source, 2-20

Status, 2-22

Synchronization, 2-22

System, 2-23

Trigger, 2-24

Command syntax, 2-1

Commands

chaining, 2-6

Parts of, 1-1

structure of IEEE 488.2 commands, 2-9

Creating commands, 2-3

D

Data transfer, 2-93

DCL, C-3

Device Clear, C-3

Diagnostic command group, 2-17

Diagnostic commands

*TST?, 2-89

DIAGnostic:DATA?, 2-34

DIAGnostic:SELEct, 2-35

DIAGnostic[:IMMediate], 2-34

DIAGnostic:DATA?, 2-34

DIAGnostic:SELEct, 2-35

DIAGnostic[:IMMediate], 2-34

Diagram, syntax, 2-12

Disks included with this manual, 1-3

Display command group, 2-17

Display commands, DISPlay:BRIGhtness, 2-36

DISPlay:BRIGhtness, 2-36

E

- Enable registers, 3-8
- Error code, 3-15
- Error codes
 - AWG 500 unique, 3-22
 - commands, 3-16
 - device specific, 3-20
 - execution, 3-18
 - hardware, 3-20, 3-22
 - query, 3-21
- Error message, 3-15
- Example programs, 1-3

F

- Factory initialization settings, E-1
- File
 - Code Convert, 2-98
 - Pattern, 2-95
 - Sequence, 2-96
 - Waveform, 2-94

G

- GET, C-3
- Go to local, C-3
- GPIB
 - Configurations, 1-5
 - Connection rules, 1-5
 - interface messages, C-3
 - interface specification, C-1
 - Setting parameters, 1-6
- Group execute trigger, C-3
- GTL, C-3

H

- Hardcopy command group, 2-18
- Hardcopy commands
 - HCOPY:DESTination, 2-38
 - HCOPY:DEvice:LANGuage, 2-39
 - HCOPY:SDUMp[:IMMEDIATE], 2-40
 - HCOPY[:IMMEDIATE], 2-39
- HCOPY:DESTination, 2-38
- HCOPY:DEvice:LANGuage, 2-39
- HCOPY:SDUMp[:IMMEDIATE], 2-40
- HCOPY[:IMMEDIATE], 2-39

I

- IEEE 488.2 common commands, 2-9
- IEEE Std 488.2-1987, 1-3
- Instrument setup, 1-3
- Interface message, C-3

L

- LLO, C-3
- Local lock out, C-3

M

- Mass memory command group, 2-19
- Mass memory commands
 - MMEMory:CATalog?, 2-41
 - MMEMory:CDIRectory, 2-42
 - MMEMory:CLOSe, 2-43
 - MMEMory:COpy, 2-43
 - MMEMory:DATA, 2-44
 - MMEMory:DELeTe, 2-44
 - MMEMory:FEED, 2-45
 - MMEMory:INITialize, 2-46
 - MMEMory:MDIRectory, 2-47
 - MMEMory:MOVE, 2-48
 - MMEMory:MSIS, 2-47
 - MMEMory:NAME, 2-49
 - MMEMory:OPEN, 2-50
- Message, error, 3-15
- MMEMory:CATalog?, 2-41
- MMEMory:CDIRectory, 2-42
- MMEMory:CLOSe, 2-43
- MMEMory:COpy, 2-43
- MMEMory:DATA, 2-44
- MMEMory:DELeTe, 2-44
- MMEMory:FEED, 2-45
- MMEMory:INITialize, 2-46
- MMEMory:MDIRectory, 2-47
- MMEMory:MOVE, 2-48
- MMEMory:MSIS, 2-47
- MMEMory:NAME, 2-49
- MMEMory:OPEN, 2-50
- Mnemonics, Constructed, 2-10

O

- Output command group, 2-20

Output commands

OUTPut[1]:IState, 2-53
 OUTPut[1|2]:FILTer[:LPASs]:FREQuency, 2-52
 OUTPut[1|2][:STATe], 2-52
 OUTPut[1]:IState, 2-53
 OUTPut[1|2]:FILTer[:LPASs]:FREQuency, 2-52
 OUTPut[1|2|5|7][:STATe], 2-52

P

Parallel poll, C-3
 Parameter setting, GPIB, 1-6
 Parameter types used in syntax descriptions, 2-4
 Parts of commands, 1-1
 Pattern File, 2-95
 PPC, C-3
 PPD, C-3
 PPE, C-3
 PPU, C-3
 Programming Examples, 4-1

Q

Queries, 2-3
 Query Responses, 2-3
 Queues, 3-10
 event, 3-10
 output, 3-10
 Quotes, 2-8

R

Registers, 3-4
 Event Status Enable Register (ESER), 3-8
 Operation Condition Register (OCR), 3-7
 Operation Enable Register (OENR), 3-9
 Operation Event Register (OEVR), 3-7
 Questionable Condition Register (OCR), 3-7
 Questionable Enable Register (QENR), 3-9
 Questionable Event Register (OEVR), 3-8
 Service Request Enable Register (SRER), 3-8
 Standard Event Status Register (SESr), 3-6
 Status Byte Register (SRB), 3-5
 Reserved words, B-1
 Rules, for using SCPI commands, 2-8

S

SCPI
 abbreviating, 2-5
 chaining commands, 2-6

 commands, 2-2
 conformation information, D-1
 general rules, 2-8
 parameter types, 2-4
 subsystem hierarchy tree, 2-2
 SCPI commands and queries syntax, 2-2-2-8
 creating commands, 2-3
 creating queries, 2-3
 SDC, C-3
 Selected device clear, C-3
 Sequence File, 2-96
 Serial poll
 Disable, C-3
 Enable, C-3
 Setup, Instrument preparation, 1-3
 SI prefix and unit, 2-7
 Source command group, 2-20
 Source commands
 [SOURce[1]:]COMBine:FEED, 2-56
 [SOURce[1|2]:]VOLTag[:LEVel][:IMMediate]
 :OFFSet, 2-64
 [SOURce[1|2]:]VOLTag[:LEVel][:IMMediate]
 [:AMPlitude], 2-61
 [SOURce[1|2|5]:]FREQuency{:CWIFIXed}, 2-56
 [SOURce[1|2|5]:]FUNctIon:USER, 2-57
 [SOURce[1|2|5]:]MARKer[1|2]:DELay, 2-58
 [SOURce[1|2|5]:]MARKer[1|2]:VOLTag[:LEVel]
 [:IMMediate]:HIGH, 2-59
 [SOURce[1|2|5]:]MARKer[1|2]:VOLTag[:LEVel]
 [:IMMediate]:LOW, 2-59
 [SOURce[1|2|5]:]ROSCillator:SOURce, 2-61
 SOURce5:VOLTag[:LEVel][:IMMediate]:HIGH,
 2-62
 SOURce5:VOLTag[:LEVel][:IMMediate]:LOW,
 2-63
 SOURce7:POWer[:LEVel][:IMMediate]
 [:AMPlitude], 2-60
 [SOURce[1]:]COMBine:FEED, 2-56
 [SOURce[1|2]:]VOLTag[:LEVel][:IMMediate]
 :OFFSet, 2-64
 [SOURce[1|2]:]VOLTag[:LEVel][:IMMediate]
 [:AMPlitude], 2-61
 [SOURce[1|2|5]:]FREQuency{:CWIFIXed}, 2-56
 [SOURce[1|2|5]:]FUNctIon:USER, 2-57
 [SOURce[1|2|5]:]MARKer[1|2]:DELay, 2-58
 [SOURce[1|2|5]:]MARKer[1|2]:VOLTag[:LEVel]
 [:IMMediate]:HIGH, 2-59
 [SOURce[1|2|5]:]MARKer[1|2]:VOLTag[:LEVel]
 [:IMMediate]:LOW, 2-59
 [SOURce[1|2|5]:]ROSCillator:SOURce, 2-61
 SOURce5:VOLTag[:LEVel][:IMMediate]:HIGH, 2-62
 SOURce5:VOLTag[:LEVel][:IMMediate]:LOW, 2-63

- SOURce7:POWer[:LEVel][:IMMediate][:AMPlitude], 2-60
- SPD, C-3
- SPE, C-3
- Special characters, 2-5
- Status and error commands
 - STATus:OPERation:ENABle, 3-9
 - STATus:QUEStionable:ENABle, 3-9
- Status and events, displaying on screen, 3-13
- Status command group, 2-22
- Status commands
 - *CLS, 2-33
 - *ESE, 2-37
 - *ESR?, 2-38
 - *PSC, 2-54
 - *SRE, 2-64
 - *STB?, 2-70
 - STATus:OPERation:CONDition?, 2-65
 - STATus:OPERation:ENABle, 2-66
 - STATus:OPERation[:EVENTi]?, 2-66
 - STATus:PRESet, 2-67
 - STATus:QUEStionable:CONDition?, 2-67
 - STATus:QUEStionable:ENABle, 2-68
 - STATus:QUEStionable[:EVENTi]?, 2-69
 - STATus:QUEue[:NEXT]?, 2-69
- Status registers, 3-4
- Status reporting, 3-1
- STATus:OPERation:CONDition?, 2-65
- STATus:OPERation:ENABle, 2-66, 3-9
- STATus:OPERation[:EVENTi]?, 2-66
- STATus:PRESet, 2-67
- STATus:QUEStionable:CONDition?, 2-67
- STATus:QUEStionable:ENABle, 2-68, 3-9
- STATus:QUEStionable[:EVENTi]?, 2-69
- STATus:QUEue[:NEXT]?, 2-69
- Synchronization command group, 2-22
- Synchronization commands
 - *OPC, 2-50
 - *WAI, 2-90
- Synchronizing execution, 3-14
- Syntax
 - Command, 2-1
 - diagrams, 2-12
- Syntax diagrams, 1-1
- System command group, 2-23
- System commands
 - *IDN?, 2-40
 - *OPT?, 2-51
 - *RST, 2-55
 - SYSTem:BEEPer[:IMMediate], 2-71
 - SYSTem:COMMunicate:LAN:FTP[:SERVer][:STATE], 2-71
 - SYSTem:COMMunicate:LAN:GATeway:ADDRes, 2-72
 - SYSTem:COMMunicate:LAN:PING?, 2-73
 - SYSTem:COMMunicate:LAN:RDEVice[1|2|3]:ADDRes, 2-73
 - SYSTem:COMMunicate:LAN:RDEVice[1|2|3]:MDIRectory, 2-74
 - SYSTem:COMMunicate:LAN:RDEVice[1|2|3]:NAME, 2-75
 - SYSTem:COMMunicate:LAN:RDEVice[1|2|3]:PROTOcol, 2-75
 - SYSTem:COMMunicate:LAN:RDEVice[1|2|3][:STATE], 2-76
 - SYSTem:COMMunicate:LAN[:SELF]:ADDRes, 2-77
 - SYSTem:COMMunicate:LAN[:SELF]:SMASk, 2-77
 - SYSTem:DATE, 2-78
 - SYSTem:ERRor?, 2-79
 - SYSTem:KDIRection, 2-80
 - SYSTem:KEYBoard[:TYPE], 2-80
 - SYSTem:KLOCK, 2-81
 - SYSTem:SECurity:IMMediate, 2-82
 - SYSTem:TIME, 2-82
 - SYSTem:UPTime, 2-83
 - SYSTem:VERSion?, 2-84
 - SYSTem:BEEPer[:IMMediate], 2-71
 - SYSTem:COMMunicate:LAN:FTP[:SERVer][:STATE], 2-71
 - SYSTem:COMMunicate:LAN:GATeway:ADDRes, 2-72
 - SYSTem:COMMunicate:LAN:PING?, 2-73
 - SYSTem:COMMunicate:LAN:RDEVice[1|2|3]:ADDRes, 2-73
 - SYSTem:COMMunicate:LAN:RDEVice[1|2|3]:MDIRectory, 2-74
 - SYSTem:COMMunicate:LAN:RDEVice[1|2|3]:NAME, 2-75
 - SYSTem:COMMunicate:LAN:RDEVice[1|2|3]:PROTOcol, 2-75
 - SYSTem:COMMunicate:LAN:RDEVice[1|2|3][:STATE], 2-76
 - SYSTem:COMMunicate:LAN[:SELF]:ADDRes, 2-77
 - SYSTem:COMMunicate:LAN[:SELF]:SMASk, 2-77
 - SYSTem:DATE, 2-78
 - SYSTem:ERRor?, 2-79
 - SYSTem:KDIRection, 2-80
 - SYSTem:KEYBoard[:TYPE], 2-80
 - SYSTem:KLOCK, 2-81
 - SYSTem:SECurity:IMMediate, 2-82
 - SYSTem:TIME, 2-82

SYSTem:UPTime, 2-83
SYSTem:VERSIon?, 2-84

T

TCT, C-3
Transfer, data, 2-93
Trigger command group, 2-24
Trigger commands
 *TRG, 2-84
 ABORt, 2-26
 TRIGger[:SEQuence]:IMPedance, 2-85
 TRIGger[:SEQuence]:LEVel, 2-86
 TRIGger[:SEQuence]:POLarity, 2-86
 TRIGger[:SEQuence]:SLOPe, 2-87
 TRIGger[:SEQuence]:SOURce, 2-88
 TRIGger[:SEQuence]:TIMer, 2-88
 TRIGger[:SEQuence][:IMMediate], 2-85
TRIGger[:SEQuence]:IMPedance, 2-85

TRIGger[:SEQuence]:LEVel, 2-86
TRIGger[:SEQuence]:POLarity, 2-86
TRIGger[:SEQuence]:SLOPe, 2-87
TRIGger[:SEQuence]:SOURce, 2-88
TRIGger[:SEQuence]:TIMer, 2-88
TRIGger[:SEQuence][:IMMediate], 2-85

U

Unit and SI prefix, 2-7
UNL, C-3
Unlisten, C-3
UNT, C-3
Untalk, C-3

W

Waveform File, 2-94

