

**Tektronix**<sup>®</sup>  
COMMITTED TO EXCELLENCE

**SG 5010  
PROGRAMMABLE  
160 kHz  
OSCILLATOR**

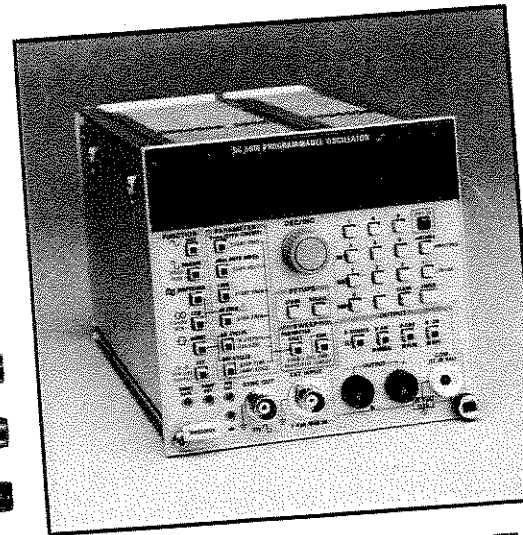

**REFERENCE GUIDE**



## TABLE OF CONTENTS

|  | Page |
|--|------|
| <b>Section 1 OPERATING INSTRUCTIONS</b>      |      |
| Introduction .....                           | 1-1  |
| Description of Controls .....                | 1-3  |
| <b>Section 2 PROGRAMMING</b>                 |      |
| Introduction .....                           | 2-1  |
| GPIO Address and Terminator<br>Setting ..... | 2-6  |
| Command Format .....                         | 2-7  |
| Argument Format .....                        | 2-7  |
| Delimiters .....                             | 2-8  |
| Command List .....                           | 2-9  |
| SG 5010 Commands and<br>Descriptions .....   | 2-14 |
| Sending Interface Control<br>Messages .....  | 2-30 |
| Power-up Settings .....                      | 2-31 |
| Talker Listener Programs .....               | 2-34 |
| <b>Section 3 ERROR CODES</b>                 |      |
| Status Reporting .....                       | 3-1  |
| Error Codes .....                            | 3-3  |
| Error Query and Status<br>Information .....  | 3-4  |

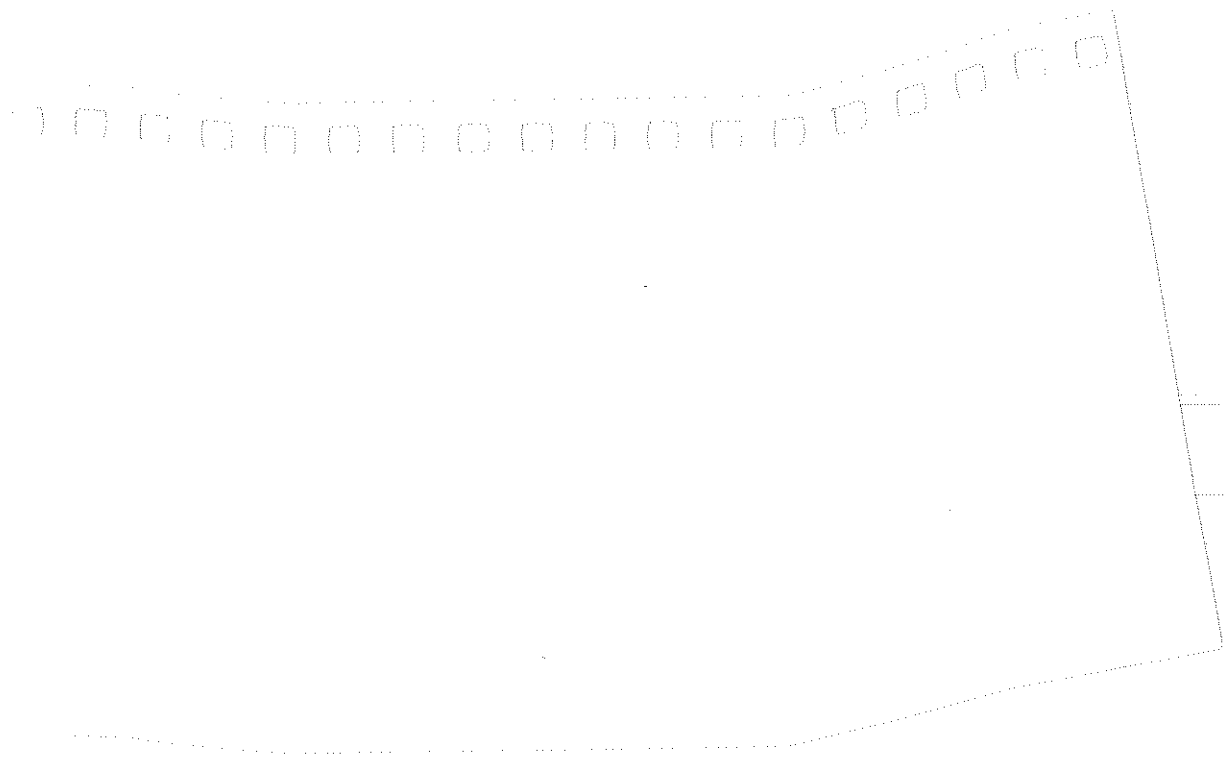

## SECTION 1 OPERATING INSTRUCTIONS

### Introduction

This section briefly describes front panel operation of the TEKTRONIX SG 5010 Programmable 160 KHz Oscillator. The SG 5010 generates five waveforms: sine wave, square wave, SMPTE/DIN Intermodulation test signal, CCIF Intermodulation test signal, and sine wave burst. All of these signals may be swept in main frequency or amplitude. Frequency, amplitude, and burst parameters are fully programmable, as are the sweep parameters. Parameter values are displayed by 5 seven-segment LEDs in the display window. The window also indicates parameter units, remote or addressed state, and error events. Three source impedances are selectable and the output signal can be grounded or floating, balanced or unbalanced. Output amplitude is programmable from 0.2 mV to 21.2 V, supplying V-peak to 28 dBm into a 600 ohm load. An ON-OFF function turns the output signal on or off at the output connectors. Additional connectors supply a sync signal, sweep ramp and pen lift signals, and accept burst triggering and input signals from external sources.

### SG 5010-Operating Instructions

At power-up, the instrument performs a self-test and assumes the settings in use when previously powered-down, with the exception that the output is in off, the readout displays amplitude, and certain interrupt functions are disabled. Instrument functions can be set to ten user-definable configurations stored in memory. Rear interface connections provide access to versions of all front panel signals except the main output.

For more detailed information on functions and specifications, see the Operating Instructions in the SG 5010 Instruction manual. Also refer to the warning and caution statements in the instruction manual.

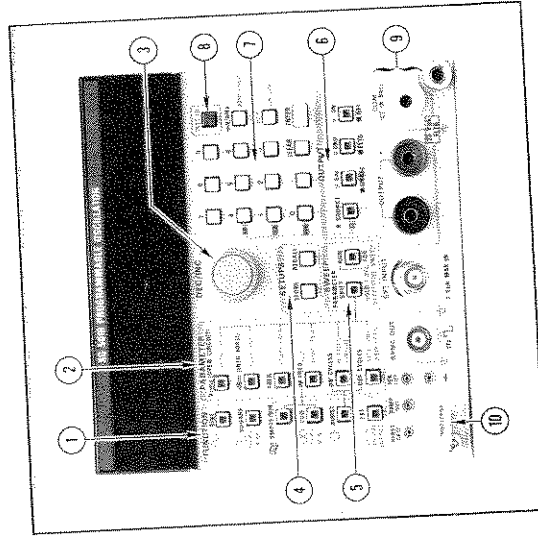

Fig. 1-1. SG 5010 front panel controls.

## Description of Controls

### 1 FUNCTION

These functions are mutually exclusive--active function button illuminates. Parameter buttons set the amplitude and frequency.

**SINE**—Selects sine wave signal for output.

**SQUARE**—Selects square wave signal for output.

**SMPTE/DIN**—Selects SMPTE/DIN intermodulation test signal for output. Ratio of lower (IM) frequency sine wave to upper frequency sine wave is 4:1 or 1:1. The 1:1 ratio is selected by pressing RECALL, then SMPTE/DIN buttons. The FREQ parameter sets upper frequency; IM FREQ sets the lower tone.

**CCIF**—Selects CCIF intermodulation test signal for output (two equal-amplitude sine waves with a constant frequency offset) from the center frequency. The FREQ parameter sets the center frequency; IM FREQ sets the offset frequency for each tone.

**BURST**—Selects sine wave burst signal for output. The amplitude of the *off* portion of the burst can be 0 or 10% of the *on* portion amplitude. The 10% is selected by pressing RECALL, then BURST. OFFCYCLES and ONCYCLES set number of cycles; OFFCYCLES value enables gated or single burst operation (triggered by BURST GATE input signal).

**EXT**—Selects signal applied to EXT IN connector for output. A 2 V rms external input provides a calibrated output signal.

## SG 5010-Operating Instructions

### ② PARAMETER

The primary parameters (shown above buttons) set the value and units of the amplitude and frequency for the selected function signal; the secondary parameters (shown to right of buttons) control sweep operation. Value and units of any parameter are displayed when the parameter is selected. Press parameter button to select a primary parameter; press PARAMETER SHIFT button, and then parameter button to select secondary parameter. While a parameter is selected, its value or units can be changed, using numeric keypad and pressing ENTER, or by adjusting DEC/INC control. Note that none of the sweep parameters can be changed during the operation of a sweep with the exception of STEPTIME. Secondary parameters are described with the associated primary parameter. Units for frequency parameters are Hz or kHz.

#### Vrms (START VOLT) dBm (STOP VOLT)

Sets amplitude of output signal in volts rms, open circuit; or dBm into an assumed 600 ohm load. The dBm display compensates for source impedance other than 600 ohms. Units are V or mV rms (mV/kHz button), or dBm.

START VOLI sets starting amplitude in Vrms for amplitude sweep; STOP VOLT sets final amplitude.

#### FREQ (START FREQ)

Sets main frequency of output signal except EXT.

START FREQ sets frequency at which frequency sweep begins.



## SG 5010-Operating Instructions

### IM FREQ triangle (STOP FREQ)

Sets low or offset frequency for SMPTE/DIN and CCIF functions. Frequency can be 40, 50, 60, 80, 100, 125, 250, or 500 Hz. Entry is rounded to nearest legal value.

STOP FREQ sets frequency at which frequency sweep ends.

### ON CYCLES (N STEPS, LIN/LOG)

Sets number of *on* cycles for BURST function (1 to 65,535).

N STEPS sets number of steps (1 to 99) from beginning to end of sweep. LIN/LOG selects linear or logarithmic sweep type.

### OFF CYCLES (STEPTIME, AMP/FREQ)

Sets number of *off* cycles for the BURST function (1 to 65,535). Selecting 0 enables gated burst operation while the BURST GATE input signal is asserted. Selecting 1 to 65535 enables repetitive burst operation. Selecting 99999 enables single burst operation (triggered by assertion of BURST GATE input signal).

STEPTIME sets time for each sweep step (0.1 to 25.0 seconds, in 0.1 s increments). AMP/FREQ selects amplitude or frequency sweep.

### ③ DEC/INC

Varies value of selected parameter.

## SG 5010-Operating Instructions

### 4 SETUPS

#### STORE

Stores current settings in specified storage location (0 through 9). All settings are stored except DT, RQS, USEREQ, PLI, and CLI. Stored settings are retained in memory when the instrument is powered down.

#### RECALL

Recalls instrument settings from a specified storage location (0 through 9) and configures the instrument to those settings. If location is undefined, instrument is set to the INIT command front panel settings. INIT settings are recalled by pressing RECALL and decimal point button.

### 5 SWEEP

#### PARAMETER SHIFT

Enables selection of a secondary parameter.

#### RUN

Starts a frequency or amplitude sweep. Momentarily pressing RUN button starts a single sweep; if held in for more than 1 second, sweep repeats. Pressing button during a sweep stops the sweep. Button illuminates while sweep is in progress; blinks at start of each sweep for repetitive sweeps.

## SG 5010-Operating Instructions

### 6 OUTPUT

#### R SOURCE

Sets source impedance (50, 150, or 600 ohms). Button illuminates while source impedance is displayed.

#### BAL/UNBAL

Selects balanced or unbalanced output. Button illuminates during balanced operation.

#### GND/FLTG

Selects grounded or floating output. Button illuminates during grounded operation.

#### ON/OFF

Turns output *on* or *off* at output connectors. Button illuminates while output is on. Source impedance is maintained while output is off. Powers-up to *off* state.

### 7 Numeric Pushbuttons

#### 0 — 9, Decimal Point, ± (LIN/LOG)

Used to enter a numeric value for the selected PARAMETER, R SOURCE, sweep type (linear or logarithmic), or GPIB address.

#### mV/KHz (AMP/FREQ)

Alternates units for Vrms amplitude parameter (V or mV).

While STEPTIME is selected, alternates sweep type (amplitude or frequency).

## SG 5010-Operating Instructions

### CLEAR

Used before ENTER is pressed to cancel a numeric entry and to reset the display. After ENTER is pressed, used to clear a settings entry error and reset the display to the last legal value. Also used after STORE or RECALL to cancel the STORE or RECALL operation and reset the display.

### ENTER

Enters a valid numeric entry into the current operating setup. Pressing ENTER is not required when selecting a source impedance, or when STOREing or RECALLing settings.

### 8 INST ID

Displays the SG 5010 GPIB address, and if USER REQUEST and RQS commands are enabled, generates a service request (SRQ) over the GPIB. Also used with RECALL button to change the GPIB address.

### 9 CONNECTORS

#### BURST GATE

Input connector for TTL trigger signal to start burst output (in BURST trigger mode), or to gate the output signal (in BURST gated mode). See OFFCYCLES.

#### RAMP OUT

Outputs a staircase ramp voltage that corresponds to the sweep steps, when a sweep is in progress. Ramp begins at 0 V and ends at 10 V. The number of steps between 0 and 10 V equals the selected number of sweep steps.

## SG 5010-Operating Instructions

### PEN LIFT

Outputs a TTL signal that goes low during frequency or amplitude transitions in a sweep. Used to blank the display or lift the pen when plotting frequency response or distortions on an XY display or plotter.

### SYNC OUT

Outputs a TTL signal at the frequency of the sine, square wave, or the 1M FREQ signals, or the envelope of the burst signal.

### EXT INPUT *triangle*

Differential input which is connected to internal gain and output attenuation circuits when the EXT function is selected.

### $\pm$ OUTPUT, COM

Banana jack connectors that carry the output signal. The + and - OUTPUT connectors carry the output signal in both balanced and unbalanced modes. The COM connector provides access to the CT in the balanced mode and is tied to the - OUTPUT connector in the unbalanced mode.

### Chassis Ground

Chassis ground connector.

### **10** Release Latch

Pull to remove plug-in from power module.



## **SECTION 2**

### **PROGRAMMING**

#### **Introduction**

This section contains information for programming the TEKTRONIX SG 5010 Programmable 160 KHz Oscillator. All instrument functions are programmable via high level commands sent over a general purpose bus (GP/B), as specified in the IEEE Standard 488-1978. The IEEE interface function subsets that apply to the SG 5010 are listed in Table 2-1.

Figure 2-1 is an abbreviated listing of the SG 5010 commands and their relationship to the front-panel controls, nomenclature, and internal parameters.

SG 5010-Programming

Table 2-1  
IEEE 488 INTERFACE FUNCTION SUBSETS

| Function              | Subset |
|-----------------------|--------|
| Source Handshake      | SH1    |
| Acceptor Handshake    | AH1    |
| Basic Talker          | T6     |
| Basic Listener        | L4     |
| Service Request       | SR1    |
| Remote-Local Function | RL1    |
| Parallel Poll         | PP0    |
| Device Clear          | DC1    |
| Device Trigger        | DT1    |
| Controller Function   | C0     |
| Electrical Interface  | E2     |

The SG 5010 responds to query commands when in either the local or remote state. The SG 5010 responds to all other listed commands only when in the remote state.



## SG 5010-Programming

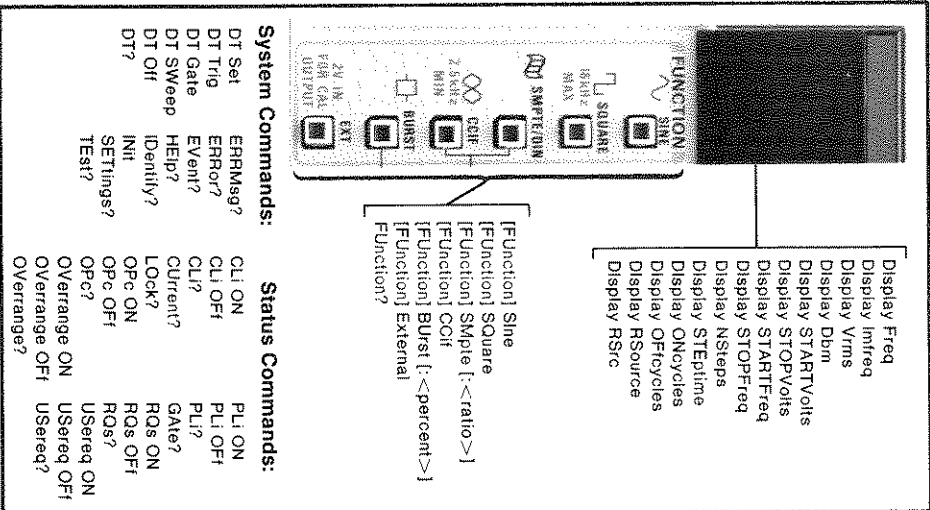

Fig. 2-1a. Commands by function.

# SG 5010-Programming

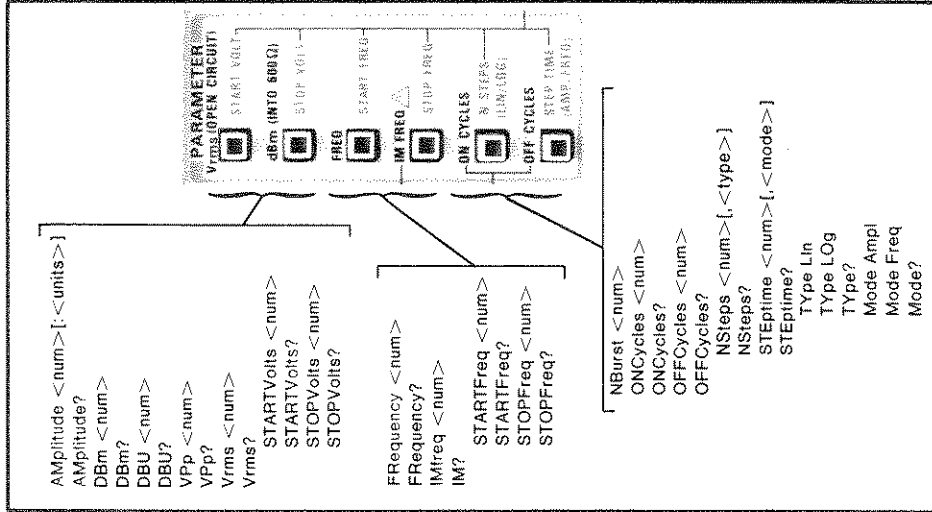

Fig. 2-1b. Commands by function.

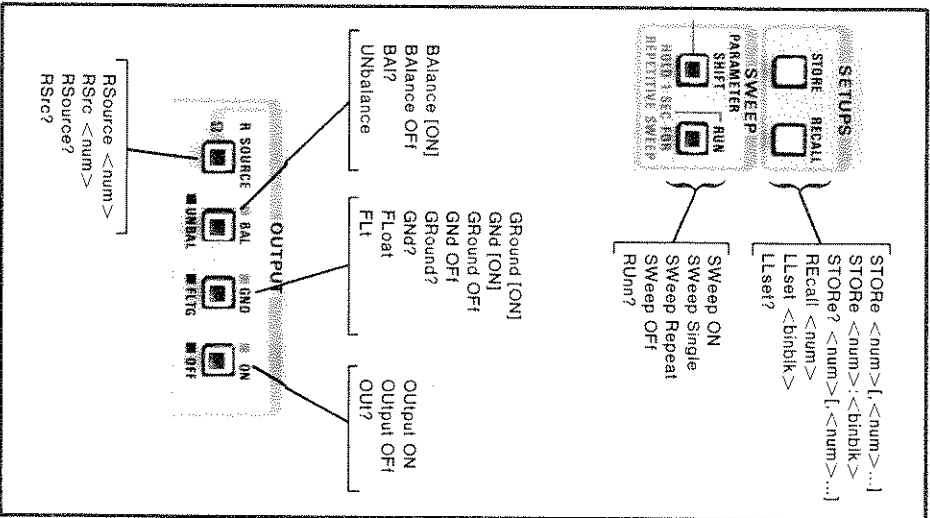

Fig. 2-1c. Commands by function.

## SG 5010-Programming

### GPIB Address and Terminator Setting

The SG 5010 GPIB address is stored in memory and maintained at power-down. It responds to one of two possible message terminators (LF and EOI, or EOI ONLY). Pressing INST ID displays the SG 5010 GPIB address and the instrument firmware version. The right-hand decimal point also illuminates if the selected message terminator is LF/EOI. Both the message terminator and GPIB address are selected, as follows:

Press RECALL

Press INST ID

Press the numeric buttons to display the desired primary address, most significant digit first. To select the LF/EOI terminator, press the decimal point; the EOI ONLY terminator is assumed, otherwise.

Press ENTER

The GPIB address can be set to any number in the series 0 through 31. Address 31 effectively removes the SG 5010 from the bus. The address and message terminator may be changed at any time except when the instrument is in the Local Lockout state. The SG 5010 is shipped with its GPIB address set to 25 and message terminator set to EOI ONLY. Refer to the Programming section of the SG 5010 Instruction manual for additional information about message terminators.

### Command Format

Each command consists of a header, usually followed by an alpha or numeric argument.

Examples:

```
FREQ 1000  
OUT ON  
SET?
```

All commands except query commands should be sent with a space between header and argument. Additional formatting characters (CR, LF, and SP) may be added between the space and the argument. Query commands must be sent without a space between the header and question mark character.

### Argument Format

The SG 5010 accepts the following kinds of numbers for numeric arguments:

- Signed or unsigned integers, including zero. Unsigned integers are interpreted to be positive. Examples: +1, 2, -1, -10.
- Signed or unsigned decimal numbers. Unsigned decimals are interpreted to be positive. Examples: -3.2, +5.0, 1.2.
- Numbers expressed in scientific notation. Examples: +1.0E-2, -1.0E-2, 0.01E+0.

The SG 5010 sends an integer followed by a decimal point (may be in scientific notation) for data and many query responses.

Alpha arguments must be sent as listed in the command list.

## SG 5010-Programming

### Delimiters

The following message delimiters are used to punctuate commands to the SG 5010:

| Delimiter    | Placement                            |
|--------------|--------------------------------------|
| <space>      | After header (except query commands) |
| <comma>      | Between multiple arguments           |
| <semi-colon> | After message unit (command)         |
| <colon>      | Between argument and link argument   |

Examples:

```
FUN BURST:10;  
STOR 3,7;  
RQS?;  
OUT OF:SET?;
```

## Table 2-2 COMMAND LIST

### NOTE

Brackets [ ] indicate the enclosed item is optional, and carets ^ indicate a defined element. Capitalized letters are the required characters; the lower case letters may also be used.

## INSTRUMENT COMMANDS

### Function Commands

[Function] Sine  
[Function] Square  
[Function] SMpte [:<ratio>]  
[Function] CClf  
[Function] Burst [:<percent>]  
[Function] External  
Function?

### Amplitude Commands

Amplitude <num>[:<units>]  
Amplitude?  
DBm <num>  
DBm?  
DBU <num>  
DBU?  
Vpp <num>  
Vpp?  
Vrms <num>  
Vrms?

Table 2-2 (cont)

Frequency Commands

Ffrequency <num>  
FRfrequency?  
IMfreq <num>  
IM?

Burst Control Commands

NBurst <num>  
ONcycles <num>  
ONcycles?  
OFFcycles <num>  
OFFcycles?

Sweep Control Commands

STARTfreq <num>  
STARTfreq?  
STOPfreq <num>  
STOPfreq?  
STARTVolts <num>  
STARTVolts?  
STOPVolts <num>  
STOPVolts?  
NSteps <num> [. <type> ]  
NSteps?  
STEptime <num> [. <mode> ]  
STEptime?  
TType LIn  
TType LOG  
TType?



**Table 2-2 (cont)**

Mode Ampl  
 Mode Freq  
 Mode?  
 SWEEP ON or SWEEP Single  
 SWEEP Repeat  
 SWEEP OFF  
 Runn?

**Stored Setting Commands**

STORE <num>[<num>...]  
 STORE <num>:<binblk>  
 STORE? <num>[,<num>...]  
 Recall <num>  
 LSet <binblk>  
 LSet?

**Display Control Commands**

Display Freq  
 Display limfreq  
 Display Vrms  
 Display Dbm  
 Display STARTVolts  
 Display STOPVolts  
 Display STARTFreq  
 Display STOPFreq  
 Display Nsteps  
 Display STEptime  
 Display ONcycles  
 Display OFFcycles  
 Display RSource or Display RSrc

Table 2-2 (cont)

**OUTPUT COMMANDS**

Output ON  
Output OFF  
OUT?  
Balance [ON]  
Balance OFF  
BAI?  
UNbalance  
GROund [ON] or GNd [ON]  
GROund OFF or GNd OFF  
GROund? or GNd?  
FLOat or FLT  
RSource <<num>> or RSrc <num>  
RSource? or RSrc?

**SYSTEM COMMANDS**

DT Set  
DT Trig  
DT Gate  
DT SWEEP  
DT Off  
DT?  
ERRMsg?  
ERRor? or EVent?  
HElp?  
IDentify?  
INIt  
SETtings?  
TEst?

Table 2-2 (cont)

**STATUS COMMANDS**

CU ON  
CU OFF  
CU?  
Current?  
Gate?  
Lock?  
OPc ON  
OPc OFF  
OPc?  
OVrrange ON  
OVrrange OFF  
OVrrange?  
PLI ON  
PLI OFF  
PLI?  
RQs ON  
RQs OFF  
RQs?  
USerreq ON  
USerreq OFF  
USerreq?

**Table 2-3**  
**SG 5010 COMMANDS AND**  
**DESCRIPTIONS**

[ ] = Optional, < > = Defined

| Header     | Argument            | Description   |
|------------|---------------------|---|
| Amplitude  | <num><br>[:<units>] | Sets amplitude and units of output signal.<br>Units: VPP, VRMS, DBM, or DBU. If undefined, the units are Vrms if previously set to Vp-p, Vrms, or DBU; otherwise <units> are dBm. |
| Amplitude? |                     | Returns amplitude and units.  |
| Balance    | [ON]                | Selects balanced output.  |
| Balance    | OFF                 | Selects unbalanced output.  |
| BAI?       |                     | Response indicates signal output is balanced or unbalanced.   |
| CLI        | ON                  | Enables assertion of SRQ when instrument goes into or out of current limit.   |

SG 5010-Programming

Table 2-3 (cont)

|          |        |   |
|----------|--------|---|
| CLI      | OFF    | Disables assertion of SRQ when instrument goes into or out of current limit.  |
| CLI?     |        | Response indicates the current limit interrupt state (on or off).   |
| Current? |        | Returns *CURR <num>:, where <num> is 0 if instrument is not current limited; <num> is 1 if instrument is current limited. |
| DBm      | <num>  | Sets amplitude to specified dBm value.  |
| DBm?     |        | Returns amplitude in dBm.   |
| DBU      | <num>  | Sets amplitude to equivalent Vrms value.  |
| DBU?     |        | Returns amplitude in dBu.   |
| Display  | Dbm    | Displays amplitude setting in dBm.  |
| Display  | Freq   | Displays frequency setting.   |
| Display  | Imfreq | Displays IM frequency setting.  |

**Table 2-3 (cont)**

|         |            |   |
|---------|------------|---|
| Display | Nsteps     | Displays number of steps set for sweep.         |
| Display | ONcycles   | Displays number of on cycles for burst.         |
| Display | OFcycles   | Displays number of off cycles for burst.        |
| Display | RSource    | Displays source impedance setting.              |
| Display | RSrc       | Displays sweep mode setting for stop frequency. |
| Display | STARTFreq  | Displays starting sweep amplitude in Vrms.      |
| Display | STARTVolts | Displays time per sweep step.                   |
| Display | STEptime   | Displays sweep mode setting for stop frequency. |
| Display | STOPFreq   | Displays stopping sweep amplitude in Vrms.      |
| Display | STOPVolts  | Displays amplitude setting in Vrms.             |
| Display | Vrms       |   |

**Table 2-3 (cont)**

|    |       |  |
|----|-------|--|
| DT | Gate  | A <GET> interface message toggles the burst gate, if the instrument is set to FUNC BURST, OFFCYC 0, and no external signal is connected to the BURST GATE input. While BURST GATE is unasserted (floating high), the instrument outputs a sine wave. |
| DT | Off   | Disables all DT (Device Trigger) functions.  |
| DT | Set   | Causes instrument to wait for <GET> interface message before updating instrument settings, except for SWEEP ON, SWEEP SINGLE, and SWEEP REPEAT, which are executed when received (<GET> not required).   |
| DT | SWEEP | A <GET> interface message causes instrument to start a single sweep sequence.  |

**Table 2-3 (cont)**

|                  |       |   |
|------------------|-------|---|
| DT               | Trig  | A <GET> interface message initiates a single burst, if instrument is set to FUNC BURST, OFFCYC 99999, and no external signal is connected to the BURST GATE input.                                  |
| DT?              |       | Response indicates which DT function is enabled.  |
| ERRMsg?          |       | Returns an event code and a brief description of the event. If RQS is ON, the code indicates the most recent event. If RQS is OFF, the code indicates the highest priority event that has occurred. |
| ERRor?<br>EVent? |       | Same as ERRMsg except that the event description is eliminated.   |
| FLoad<br>FLt     |       | Sets instrument to floating signal output.  |
| FRequency        | <num> | Sets frequency (main frequency) for all functions except EXT.   |



**Table 2-3 (cont)**

|            |                     |  |
|------------|---------------------|--|
| [Function] | Frequency?          | Returns frequency setting (main frequency).  |
| [Function] | Sine                | Selects the sine wave for output.  |
| [Function] | Square              | Selects the square wave for output.  |
| [Function] | SMpte<br>[:<ratio>] | Selects SMPTE/DIN signal for output and specifies amplitude ratio between low and high frequency tones. Valid values for <ratio> are 1 or 4; 4 is the default ratio.           |
| [Function] | CCIF                | Selects CCIF signal for output.  |
| [Function] | Burst<br>[:<ratio>] | Selects sine wave burst signal for output and specifies amplitude of the off cycles (as a percent of the on cycles amplitude). Valid percent is 0 or 10; default percent is 0. |
| [Function] | External            | Selects signal at EXT INPUT connector as the output.   |

**Table 2-3 (cont)**

|                 |   |
|-----------------|---|
| Function?       | Returns enabled function (and number indicating SMPTE/DIN ratio or burst percent, if applicable).                             |
| Gate?           | Returns "GATE <num>," where <num> is 0 if signal at BURST GATE connector is unasserted; <num> is 1 if BURST GATE is asserted. |
| GRound<br>Gnd   | [ON]<br>[ON]<br>Sets instrument to grounded signal output.  |
| GRound<br>Gnd   | OFF<br>OFF<br>Sets instrument to floating signal output.  |
| GRound?<br>Gnd? | Response indicates whether signal output is grounded or floating.   |
| Help?           | Returns a string list of all SG 5010 command headers.   |
| Identify?       | Returns the instrument type, Tektronix Codes and Formats version, and the instrument firmware version.                        |

SG 5010-Programming

**Table 2-3 (cont)**

|        |       |  |
|--------|-------|--|
| IMfreq | <num> | Sets IM frequency for SMPTE/DIN and CCIF functions. Valid frequencies are 40, 50, 60, 80, 100, 125, 250, and 500 Hz. |
| IMF?   |       | Returns IM frequency setting.  |
| INIt   |       | Initializes instrument to the following settings:  |

- AMP.L
- 1:VRMS;
- BAL ON;
- CLI OFF;
- DISP VRMS;
- DT OFF;
- FREQ 10000;
- FUNC SINE;
- GND OFF;
- IMF 60;
- NSTEP
- 30.LOG;
- OFFCYC 90;
- OPC OFF;
- ONCYC 10;
- OUT OFF;
- OVER OFF;
- PLI OFF;
- RQS ON;
- RSRC 600;
- STARTF 20;
- STOPF 20000;

**Table 2-3 (cont)**

|             |   |          |  |
|-------------|---|----------|--|
| Init (cont) | STARTV 0.1;<br>STOPV 10.0;<br>STEPT<br>0.1.FREQ;<br>SWEEP OFF;<br>USER OFF;   | <binblk> | Sets instrument to settings stored in <binblk>, except DT, CLI, OVER, OPC, PLI, RQS, and USEREQ. |
| LLset?      | Returns instrument settings in binary format.   |          |  |
| Lock?       | Returns "LOCK <num>";, where <num> is 1 if instrument has not been in phase lock for more than 1 ms; <num> is 0 if instrument is in phase lock. |          |  |
| Mode        | Sets sweep to amplitude mode.   | Ampl     |  |
| Mode        | Sets sweep to frequency mode.   | Freq     |  |
| Mode?       | Returns sweep mode (amplitude or frequency).  |          |  |

**Table 2-3 (cont)**

|           |                    |  |
|-----------|--------------------|--|
| NBurst    | <num>              | Specifies number of <i>on</i> cycles for burst; sets number of <i>off</i> cycles to infinity (99999), for single burst mode. Valid range for <i>on</i> cycles is 1 to 65535. A single burst is triggered by assertion (floating high) of the signal of the BURST GATE input connector. |
| NSteps    | <num><br>[,<type>] | Sets number of sweep steps. Valid range is 1 to 99. Type specifies linear (LIN) or logarithmic (LOG) sweep; default type is the previously specified type.   |
| NSteps?   |                    | Returns number of sweep steps and type.  |
| OFFCycles | <num>              | Specifies number of <i>off</i> cycles for burst (0 for gated burst; 1 to 65535 for repetitive burst; 99999 for single burst). Gated and single burst are triggered when the signal at the BURST GATE input connector is asserted (high).   |

**Table 2-3 (cont)**

|            |       |  |
|------------|-------|--|
| OFFCycles? |       | Returns number of <i>off</i> cycles for burst.   |
| ONCycles   | <num> | Specifies number of <i>on</i> cycles for burst. Valid range is 1 to 65535.                                     |
| ONCycles?  |       | Returns number of <i>on</i> cycles.  |
| OPc        | ON    | Enables operation complete interrupt; instrument asserts SRQ when it completes one sweep.                      |
| OPc        | OFF   | Disables operation complete interrupt; instrument does not assert SRQ when it completes one sweep.             |
| OPc?       |       | Returns setting of operation complete interrupt: "OPC ON;" or "OPC OFF;".                                      |
| OVerrange  | ON    | Enables sweep overrange interrupt; instrument asserts SRQ when the sweep exceeds a limit of a sweep parameter. |

SG 5010-Programming

Table 2-3 (cont)

|            |     |  |
|------------|-----|--|
| Overrange  | OFF | Disables sweep overrange interrupt; instrument does not assert SRQ when the sweep exceeds a limit of a sweep parameter.            |
| Overrange? |     | Returns setting of sweep overrange interrupt: "OVER ON;" or "OVER OFF;".   |
| Output     | ON  | Turns on signal output.  |
| Output     | OFF | Turns off signal output.   |
| OUT?       |     | Response indicates signal output state (on or off).  |
| PLI        | ON  | Enables phase lock interrupt; instrument asserts SRQ when it goes out of phase lock from a reportable out-of-phase lock condition. |

Table 2-3 (cont)

|                 |                |   |
|-----------------|----------------|---|
| PLI             | OFF            | Disables phase lock interrupt; instrument does not assert SRQ when it goes out of phase lock for more than 1 ms, or into phase lock after being out for more than 1 ms. |
| PLI?            |                | Returns setting of phase lock interrupt: "PLI ON;" or "PLI OFF;".   |
| REcall          | <num>          | Sets instrument to the settings recalled from specified storage location. Location numbers are 0 through 9.   |
| RQs             | ON             | Enables service request interrupt.  |
| RQs             | OFF            | Disables service request interrupt.   |
| RQs?            |                | Returns setting of service request interrupt: "RQS ON;" or "RQS OFF;".  |
| RSource<br>RSrc | <num><br><num> | Sets source impedance. Valid impedances are 50, 150, and 600 $\Omega$ .   |



SG 5010-Programming

Table 2-3 (cont)

|                                   |   |   |   |                                  |  |  |  |                    |
|-----------------------------------|---|---|---|----------------------------------|--|--|--|--------------------|
| RSource?                          | RSrc?   | Runn?   | Settings?                                     | STARTFreq                        | STARTFreq?   | STARTVols                                | STARTVols?   | STEptime           |
|                                   |   |   |   | <num>                            | <num>  | <num>                                    | <num>  | <num><br>[,<mode>] |
| Returns source impedance setting. | Returns 0 (sweep not running) or 1 (sweep running). | Returns a string list of current instrument settings. | Sets the start frequency for sweep operation. | Returns start frequency setting. | Sets start amplitude for sweep operation, in Vrms. | Returns start amplitude setting in Vrms. | Sets time per sweep step and sweep mode. Valid range for time is .1 to 25.0 seconds with .1 second resolution. Sweep mode is either FREQUENCY or AMPLITUDE; default mode is the previously specified mode. |                    |

**Table 2-3 (cont)**

|            |                      |   |
|------------|----------------------|---|
| STEptime?  |                      | Returns time per sweep step and sweep mode.   |
| STOPFreq   | <num>                | Sets stop frequency for sweep operation.  |
| STOPFreq?  |                      | Returns stop frequency setting.   |
| STOPVolts  | <num>                | Sets stop amplitude for sweep operation, in Vrms.   |
| STOPVolts? |                      | Returns stop amplitude in Vrms.   |
| STORE      | <num><br>[,<num>...] | Stores the current settings in specified storage location(s) (except CLI, DT, OVER, OPC, PLI, RQS, USEREQ0). Locations are 0 through 9. |
| STORE      | <num>:<br><binblk>   | Stores <binblk> settings data in specified storage location (0 through 9).  |
| STORE?     | <num><br>[,<num>...] | Outputs settings stored in specified location(s) 0 through 9, using the format STORE <num>:<binblk>:.                                   |

SG 5010-Programming

Table 2-3 (cont)

|           |        |  |
|-----------|--------|--|
| Sweep     | ON     | Starts a single sweep sequence.  |
| Sweep     | Single |  |
| Sweep     | Repeat | Starts a repetitive sweep sequence.  |
| Sweep     | OFF    | Stops the sweep.   |
| Test?     |        | Initiates instrument self test; returns 0 (no errors), or event codes of detected failures.                |
| Type      | Lin    | Sets sweep type to linear sweep.   |
| Type      | Log    | Sets sweep type to logarithmic sweep.  |
| Type?     |        | Returns sweep type setting.  |
| Unbalance |        | Sets instrument to unbalanced signal output.   |
| USereq    | ON     | Enables user request interrupt; instrument asserts SRQ when front panel INST ID button is pushed.          |
| USereq    | OFF    | Disables user request interrupt; instrument does not assert SRQ when front panel INST ID button is pushed. |

**Table 2-3 (cont)**

|         |       |  |
|---------|-------|--|
| USereq? |       | Response indicates the user request interrupt state (on or off). |
| Vpp     | <num> | Sets amplitude to equivalent Vrms value of argument.             |
| Vpp?    |       | Returns amplitude in V p-p units.                                |
| Vrms    | <num> | Sets amplitude to specified Vrms value.                          |
| Vrms?   |       | Returns amplitude in Vrms.                                       |

**Sending Interface Control Messages**

Bus communications are performed through use of controller input and output statements. Commands are transmitted in ASCII by TEKTRONIX 4041 and 4050-Series controllers using PRINT statements; IN-PUT statements are used to return data from the SG 5010. The SG 5010 GPIB address is factory set to decimal address 25; message terminator to EOI ONLY.

```
PRINT @25:"SET?"
INPUT @25:A$
```

### SG 5010-Programming

Interface control messages are sent to the SG 5010 using WBYTE statements (4050-Series controllers). In the following examples, A and B are the SG 5010 listen and talk addresses. A = SG 5010 primary address + 32; B = address + 64.

|                             |               |
|-----------------------------|---------------|
| Listen (MLA)                | WBYTE @ A:    |
| Unlisten (UNL)              | WBYTE @ 63:   |
| Talk (MTA)                  | WBYTE @ B:    |
| Untalk (UNT)                | WBYTE @ 95:   |
| Device Clear (DCL)          | WBYTE @ 20:   |
| Selected Device Clear (SDC) | WBYTE @ A,4:  |
| Go to Local (GTL)           | WBYTE @ A,1:  |
| Remote With Lockout (RWLS)  | WBYTE @ A,17: |
| Local With Lockout (LWLS)   | WBYTE @ 17:   |
| Group Execute Trigger (GET) | WBYTE @ A,8:  |
| Serial Poll Enable (SPE)    | WBYTE @ 24:   |
| Serial Poll Disable (SPD)   | WBYTE @ 25:   |

Refer to the 4041 and 4050-Series controller manuals for information on using RBYTE statements.

### Power-up Settings

When powered up, the SG 5010 performs a diagnostic self-test, during which all front panel lights illuminate. If no internal errors are detected, the instrument enters the Local State (LOCS) and asserts SRQ. It assumes the settings enabled when last powered down, with the following exceptions:

CLI OFF  
OPC OFF  
OVER OFF  
PLI OFF  
ROS ON  
USER OFF

# SG 5010-Programming

| ADDRESS<br>COMMANDS | UNIVERSAL<br>COMMANDS | LISTEN ADDRESSES | TALK ADDRESSES | SECONDARY<br>ADDRESSES<br>OR COMMANDS |
|---------------------|-----------------------|------------------|----------------|---------------------------------------|
| 0 NUL               | 80 SP                 | 100 @            | 120 P          | 160 A                                 |
| 1 SOH               | 81 !                  | 101 A            | 121 Q          | 161 a                                 |
| 2 STX               | 82 "                  | 102 B            | 122 R          | 162 b                                 |
| 3 ETX               | 83 #                  | 103 C            | 123 S          | 163 c                                 |
| 4 EOT               | 84 \$                 | 104 T            | 124 D          | 164 d                                 |
| 5 ENQ               | 85 %                  | 105 E            | 125 U          | 165 e                                 |
| 6 ACK               | 86 &                  | 106 F            | 126 V          | 166 f                                 |
| 7 BEL               | 87 '                  | 107 G            | 127 W          | 167 g                                 |
| 8 BS                | 88 (                  | 108 H            | 128 X          | 168 h                                 |
| 9 HT                | 89 )                  | 109 I            | 129 Y          | 169 i                                 |
| 10 LF               | 90 *                  | 110 J            | 130 Z          | 170 j                                 |
| 11 VT               | 91 +                  | 111 K            | 131 [          | 171 k                                 |
| 12 FF               | 92 ,                  | 112 L            | 132 \          | 172 l                                 |
| 13 CR               | 93 -                  | 113 M            | 133 ]          | 173 m                                 |
| 14 SO               | 94 .                  | 114 N            | 134 ^          | 174 n                                 |
| 15 SI               | 95 /                  | 115 O            | 135 _          | 175 o                                 |
|                     |                       | 116 P            | 136 `          | 176 p                                 |
|                     |                       | 117 Q            | 137 {          | 177 q                                 |
|                     |                       | 118 R            | 138            | 178 r                                 |
|                     |                       | 119 S            | 139 }          | 179 s                                 |
|                     |                       | 120 T            | 140 ~          | 180 t                                 |
|                     |                       | 121 U            | 141 [          | 181 u                                 |
|                     |                       | 122 V            | 142 ]          | 182 v                                 |
|                     |                       | 123 W            | 143 ^          | 183 w                                 |
|                     |                       | 124 X            | 144 _          | 184 x                                 |
|                     |                       | 125 Y            | 145 `          | 185 y                                 |
|                     |                       | 126 Z            | 146 {          | 186 z                                 |
|                     |                       | 127 [            | 147            | 187 [                                 |
|                     |                       | 128 \            | 148 }          | 188 \                                 |
|                     |                       | 129 ]            | 149 ~          | 189 ]                                 |
|                     |                       | 130 ^            | 150 [          | 190 ^                                 |
|                     |                       | 131 _            | 151 ]          | 191 _                                 |
|                     |                       | 132 `            | 152 [          | 192 `                                 |
|                     |                       | 133 {            | 153 ]          | 193 {                                 |
|                     |                       | 134              | 154 [          | 194                                   |
|                     |                       | 135 }            | 155 ]          | 195 }                                 |
|                     |                       | 136 ~            | 156 [          | 196 ~                                 |
|                     |                       | 137 [            | 157 ]          | 197 [                                 |
|                     |                       | 138 ]            | 158 [          | 198 ]                                 |
|                     |                       | 139 ^            | 159 ]          | 199 ^                                 |
|                     |                       | 140 _            | 160 [          | 200 _                                 |
|                     |                       | 141 `            | 161 ]          | 201 `                                 |
|                     |                       | 142 {            | 162 [          | 202 {                                 |
|                     |                       | 143              | 163 ]          | 203                                   |
|                     |                       | 144 }            | 164 [          | 204 }                                 |
|                     |                       | 145 ~            | 165 ]          | 205 ~                                 |
|                     |                       | 146 [            | 166 [          | 206 [                                 |
|                     |                       | 147 ]            | 167 ]          | 207 ]                                 |
|                     |                       | 148 [            | 168 [          | 208 [                                 |
|                     |                       | 149 ]            | 169 ]          | 209 ]                                 |
|                     |                       | 150 [            | 170 [          | 210 [                                 |
|                     |                       | 151 ]            | 171 ]          | 211 ]                                 |
|                     |                       | 152 [            | 172 [          | 212 [                                 |
|                     |                       | 153 ]            | 173 ]          | 213 ]                                 |
|                     |                       | 154 [            | 174 [          | 214 [                                 |
|                     |                       | 155 ]            | 175 ]          | 215 ]                                 |
|                     |                       | 156 [            | 176 [          | 216 [                                 |
|                     |                       | 157 ]            | 177 ]          | 217 ]                                 |
|                     |                       | 158 [            | 178 [          | 218 [                                 |
|                     |                       | 159 ]            | 179 ]          | 219 ]                                 |
|                     |                       | 160 [            | 180 [          | 220 [                                 |
|                     |                       | 161 ]            | 181 ]          | 221 ]                                 |
|                     |                       | 162 [            | 182 [          | 222 [                                 |
|                     |                       | 163 ]            | 183 ]          | 223 ]                                 |
|                     |                       | 164 [            | 184 [          | 224 [                                 |
|                     |                       | 165 ]            | 185 ]          | 225 ]                                 |
|                     |                       | 166 [            | 186 [          | 226 [                                 |
|                     |                       | 167 ]            | 187 ]          | 227 ]                                 |
|                     |                       | 168 [            | 188 [          | 228 [                                 |
|                     |                       | 169 ]            | 189 ]          | 229 ]                                 |
|                     |                       | 170 [            | 190 [          | 230 [                                 |
|                     |                       | 171 ]            | 191 ]          | 231 ]                                 |
|                     |                       | 172 [            | 192 [          | 232 [                                 |
|                     |                       | 173 ]            | 193 ]          | 233 ]                                 |
|                     |                       | 174 [            | 194 [          | 234 [                                 |
|                     |                       | 175 ]            | 195 ]          | 235 ]                                 |
|                     |                       | 176 [            | 196 [          | 236 [                                 |
|                     |                       | 177 ]            | 197 ]          | 237 ]                                 |
|                     |                       | 178 [            | 198 [          | 238 [                                 |
|                     |                       | 179 ]            | 199 ]          | 239 ]                                 |
|                     |                       | 180 [            | 200 [          | 240 [                                 |

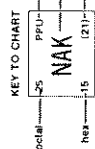

Fig. 2-2. ASCII & IEEE 488 (GPIB) Code Chart.

### SG 5010-Programming

During the power-up self-test, if the instrument detects a checksum error in the RAM location in which the power-down settings were stored, it assumes the following settings, and displays an error code that identifies the storage location in error:

```
AMPL 1:VRMS;  
BAL ON;  
CLI OFF;  
DISP VRMS;  
DT OFF;  
FREQ 10000;  
FUNC SINE;  
GND OFF;  
IMF 60;  
NSTEP 30.LOG;  
OFFCYC 90;  
OPC OFF;  
ONCYC 10;  
OUT OFF;  
OVER OFF;  
PLI OFF;  
RQS ON;  
RSRC 600;  
STARTF 20;  
STOPF 20000;  
STARTV 0.1;  
STOPV 10.0;  
STEPT 0.1,FREQ;  
SWEEP OFF;  
USER OFF;
```

## SG 5010-Programming

### Talker Listener Programs

Refer to the SG 5010 Instruction Manual for additional Talker/Listener Program information.

#### NOTE

*The double asterisks shown in the 4052A and 4041 program code lines indicate a line wrap-around and are not part of the program coding.*

### 4052A Controller Program

The following program allows a user to send any SG 5010 commands from the controller to the instrument and return data from the SG 5010 to the controller. The program includes an SRQ handler.

```
540 INIT
550 DIM Sg_response$(300),Sg_command$(100),
** Addr_list(15)
560 Sg_pri_addr=25
570 !
580 CALL "config",Config_code,Addr_list
590 IF Config_code THEN
600 PRINT "Configuration routine failed
** due to problem on GPIB."
610 STOP
620 END IF
630 !
640 ON SRQ THEN 790
650 !
660 PRINT "SG 5010 TALKER/LISTENER PROGRAM"
670 !
680 PRINT "Enter command message: ";
690 INPUT Sg_command$
700 PRINT @Sg_pri_addr:Sg_command$
710 INPUT @Sg_pri_addr:Sg_response$
720 PRINT Sg_response$
730 GO TO 680
740 END
```



### SG 5010-Programming

```
750 !  
760 ! Serial poll routine  
770 LOCAL Sg_report$  
780 DIM Sg_report$(80)  
790 POLL Addr_list_indx,Spoll_stat;Addr_list  
800 IF Addr_list(Addr_list_indx)=Sg_pri_addr  
THEN  
**  
810 PRINT @Sg_pri_addr;"Id?errmsg?"  
820 INPUT @Sg_pri_addr:Sg_report$  
830 PRINT "ADDRESS=";Addr_list  
**  
840 (Addr_list_indx),"STATUS=";Spoll_stat  
850 PRINT Sg_report$  
860 END IF  
870 RETURN ! From service request subroutine
```

### 4041 Controller Program

The following program allows a user to send any SG 5010 commands from the controller to the instrument and return data from the SG 5010 to the controller. The program includes an SRQ handler.

```
550 Dim response$ to 300,command$ to 100,  
** sgstrem$ to 20  
560 Integer sg_pa,spollsta,spolladd,  
** sg_port  
570 Sg_pa=25  
580 Sg_port=0  
590 !  
600 Sgstrem$="gpib"&str$(sg_port)&"(pri=  
** "&str$(sg_pa)&")."  
610 Open #100:sgstrem$  
620 Select sgstrem$  
630 On srq then call pollbus  
640 Enable srq  
650 !  
660 Tlk_lisn: input prompt "Enter  
** command message: ":command$  
670 Input #100 prompt command$::response$
```

## SG 5010-Programming

```
680 Print respons$ ! SG 5010 returns
** blank line if not queried in
** commands$
690 Goto tk_lisn
700 End ! Main
800 Sub pollbus local report$
810 ! PURPOSE:
820 ! Handles gpib service requests.
** Polls all primary addresses until
830 ! source of srq is found. If srq from
** instrument at SG 5010 primary
840 ! address, routine queries id and
** error message.
850 !
860 ! LOCAL VARIABLE:
870 ! Report$: Id and event report from
** instrument at sg_pa if it has srq.
880 !
890 Dim report$ to 80
900 Poll spillsta,spilladd
910 If spilladd=sg_pa then input #100
** prompt "id?;errmsg?":report$
920 Print report$,"STATUS=";spillsta,
** "ADDRESS=";spilladd,"PORT=";
** val(sgstrem$)
930 Resume
940 End ! Sub pollbus
```

## SECTION 3 ERROR CODES

### Status Reporting

Through the Service Request function (defined in the IEEE-488 Standard), the instrument may alert the controller that it requires service. This service request is also a means of indicating that an event (a change in status or an error) has occurred. To service a request, the controller performs a Serial Poll. In response, the instrument returns a Status Byte (STB), which indicates whether it was requesting service or not. The STB can also provide a limited amount of information about the request. The format of the information encoded in the STB is given in Fig. 3-1. Note that, when data bit 8 is set, the STB conveys Device Status information, which is contained in bits 1 through 4.

Because the STB conveys limited information about an event, the events are divided into classes: the Status Byte reports the class. The instrument can provide additional information about many of the events, particularly the errors reported in the Status Byte. After determining that the instrument requested service (by examining the STB), the controller may request the additional information by sending an ERR query (ERR?). In response, the instrument returns a code that defines the event. These codes are described in Table 3-1.

## SG 5010-Error Codes

If there is more than one event to be reported, the instrument continues to assert SRQ until it reports all events. (SRQ "stacking" consists of reporting only the latest event of each priority level.) Each event is automatically cleared when it is reported via Serial Poll. The Device Clear (DCL) interface message may be used to clear all events except Power-On.

Commands are provided to control the reporting of some individual events and to disable all service requests. For example, the User Request command (USER) provides individual control over the reporting of the user request event that occurs when the front panel INST ID button is pressed. The Request for Service command (RQS) controls whether the instrument reports any events with SRQ.

RQS OFF inhibits all SRQ's. When RQS is OFF, the ERR query allows the controller to find out about events without first performing a Serial Poll. With RQS OFF, the controller may send the ERR query at any time and the instrument will return an event waiting to be reported. The controller can clear all events by sending the ERR query until a zero (0) code is returned, or clear all events except Power-Up through the DCL interface message.

With RQS OFF, the controller may perform a Serial Poll, but the Status Byte contains only Device Dependent Status information.

With RQS ON, the STB contains the class of the event; a subsequent error query returns additional information about the previous event reported in the STB.



