



**PLEASE CHECK FOR CHANGE INFORMATION
AT THE REAR OF THIS MANUAL.**

SG 5030
Programmable
Leveled Sine Wave Generator
SERVICE MANUAL

Tektronix, Inc.
P.O. Box 500
Beaverton, OR 97077
070-7703-01
Product Group 75

Serial Number _____
First Printing JUL 1990
Revised MAR 1992

Copyright © 1990, 1991, 1992 Tektronix, Inc. All rights reserved. Contents of this publication may not be reproduced in any form without the written permission of Tektronix, Inc.

Products of Tektronix, Inc. and its subsidiaries are covered by U.S. and foreign patents and/or pending patents.

TEKTRONIX, TEK, SCOPE-MOBILE and  are registered trademarks of Tektronix, INC. TELEQUIPMENT is a registered trademark of Tektronix U.K. Limited:

Printed in the U.S.A. Specification and price change privileges are reserved.

INSTRUMENT SERIAL NUMBERS

Each instrument has a serial number on a panel insert, tag, or stamped on the chassis. The first number or letter designates the country of manufacture. The last five digits of the serial number are assigned sequentially and are unique to each instrument. Those manufactured in the United States have six unique digits. The country of manufacture is identified as follows:

B010000Tektronix, Inc., Beaverton, Oregon, USA
J300000Sony/Tektronix, Japan
H700000Tektronix Holland, NV, Heerenveen,
The Netherlands

Instruments manufactured for Tektronix by external vendors outside the United States are assigned a two digit alpha code to identify the country of manufacture (e.g. JP for Japan, HK for Hong Kong, IL for Israel, etc.)

Operator Safety Summary

The general safety information in this part of the summary is for both operating and servicing personnel. Specific warnings and cautions will be found throughout the manual where they apply, but may not appear in this summary.

Terms In This Manual



CAUTION statements identify conditions or practices that could result in damage to the equipment or other property.



WARNING statements identify conditions or practices that could result in personal injury or loss of life.

As Marked on Equipment



CAUTION indicates a hazard to property, including the equipment itself, and could cause minor personal injury.



WARNING indicates solely a personal injury hazard not immediately accessible as you read the marking.



DANGER indicates a personal injury hazard immediately accessible as one reads the marking.

Symbols In This Manual



This symbol indicates where applicable cautionary or other information is to be found.

As Marked on Equipment



DANGER-High voltage.



Protective ground (earth) terminal.



ATTENTION-Refer to manual.

Power Source

This product is intended to operate in a power module connected to a power source that will not apply more than 250 volts RMS between the supply conductors or between either supply conductor and ground. A protective ground connection by way of the grounding conductor in the power cord is essential for safe operation.

Grounding the Product

This product is grounded through the grounding conductor of the power module power cord. To avoid electrical shock, plug the power cord into a properly wired receptacle before connecting to the product input or output terminals. A protective ground connection by way of the grounding conductor in the power cord is essential for safe operation. (I.E.C. Safety Class I)

Danger Arising From Loss of Ground

Upon loss of the protective-ground connection, all accessible conductive parts (including knobs and controls that may appear to be insulating) can render an electric shock.

Use The Proper Fuse

To avoid fire hazard, use only the fuse specified in the parts list for your product, and which is identical in type, voltage rating and current rating.

Refer fuse replacement to qualified service personnel.

Fuse replacement information can be found in the SG 5030 Service Manual (070-7703-01).

Do Not Operate in Explosive Atmospheres

To avoid explosion, do not operate this product in an explosive atmosphere unless it has been specifically certified for such operation.

Do Not Operate Plug-In Unit Without Covers

To avoid personal injury, do not operate this product without covers or panels installed. Do not apply power to the plug-in via a plug-in extender.

Remove from Operation

If you have reason to believe that the instrument has suffered a component failure, do not operate the instrument until the cause of the failure has been determined and corrected.

Service Safety Summary

FOR QUALIFIED SERVICE PERSONNEL ONLY

Refer also to the preceding Operators Safety Summary

Do Not Service Alone

Do not perform internal service or adjustment of this product unless another person capable of rendering first aid and resuscitation is present

Use Care When Servicing With Power On

Dangerous voltages may exist at several points in this product. To avoid personal injury, do not touch exposed connections and components while power is on.

Disconnect power before removing protective panels, soldering, or replacing components.

Use Care When Servicing With Covers Off

With the side and top covers off, access is available to several heatsinks and power resistors which can cause severe skin burns.

When operating the SG 5030 outside the Power Module on flexible extender cables, a cooling fan should be used to blow air across the RF and Output Board heatsink. This is necessary to cool components for both service personnel safety and to prevent heat stressing electrical components.

Do Not Wear Jewelry

Remove jewelry prior to servicing. Rings, necklaces, and other metallic objects could come into contact with dangerous voltages and currents.

Section 1

Specifications

Introduction

This section of the manual contains a general description of the TEKTRONIX SG 5030 Programmable Leveled Sine Wave Generator and its electrical, environmental, and physical specifications.

Instrument Description

The SG 5030 Programmable Leveled Sine Wave Generator is a GPIB programmable TM 5000-series plug-in instrument designed to provide a low-distortion sinusoidal waveform with leveled output amplitude. Frequency, amplitude, and the front-panel store/recall parameters are fully programmable. Parameter values are displayed by 8 seven-segment LEDs in the display window. The SG 5030 output amplitude is programmable from 4.5mV to 5.5V peak-to-peak into 50Ω, and has a frequency range of 0.1Hz to 550MHz with a reference frequency of 50kHz. Additional connectors provide timebase input and output reference signals to external sources.

At power up, the instrument performs a self-test and assumes the settings in use when previously powered down, with the exception that the output is in the "OFF" condition. Up to twenty user-definable instrument configurations stored in memory.

Rear interface connections provide access to versions of all front-panel signals except the main output.

Output Leveling Head

Each SG 5030 is provided with a matching Output Leveling Head. This leveling head must be installed on the SG 5030 at all times for proper operation.

A label attached to the leveling head cable identifies the serial number of the SG 5030 to which the leveling head is calibrated. If it is necessary to change leveling heads, the complete Adjustment Procedure must be performed to match the new leveling head to the SG 5030. After adjustment, it is recommended a new identification label be attached to the leveling head.

IEEE 488 (GPIB) Functions

The SG 5030 can be remotely programmed via the digital interface specified in IEEE Standard 488.1-1987, IEEE Standard Digital Interface for Programmable Instrumentation. In this manual, the digital interface is called the General Purpose Interface Bus (GPIB).

The IEEE standard identifies the interface function repertoire of an instrument on the GPIB in terms of interface function subsets. The subsets that apply to the SG 5030 are listed in Table 1-1.

NOTE

Refer to IEEE Standard 488.1-1987 for more detailed information. The standard is published by the Institute of Electrical and Electronics Engineers, Inc., 345 East 47th Street, New York, New York 10017.

Table 1-1: Interface Function Subsets

Function	Subset	Capability
Source Handshake	SH1	Complete Capability
Acceptor Handshake	AH1	Complete Capability
Basic Talker	T6	Responds to serial poll. Untalks if My Listen Address (MLA) is received.
Basic Listener	L4	Unlistens if My Talk Address (MTA) is received
Service Request	SR1	Complete Capability
Remote-Local	RL1	Complete Capability
Parallel Poll	PP0	Does not respond to Parallel Poll
Device Clear	DC1	Complete Capability
Device Trigger	DT0	Does not respond to GET
Controller Function	C0	No controller function
Electrical Interface	E2	Tri-state drivers

Electrical Characteristics

Performance Conditions

The limits stated in the Performance Requirements column of the following tables are valid with the following conditions:

1. All measurements are made at the output connector of the Output Leveling Head. The SG 5030 must have been adjusted with the same leveling head that is used during specification verification measurements.
2. The SG 5030 internal adjustments are performed at an ambient temperature of +20°C to +30°C.

3. The SG 5030 must be in a noncondensing environment whose limits are described under Table 1-3, Environmental.
4. Allow thirty minutes warm-up time for operation to specified accuracy; sixty minutes after exposure to or storage in high-humidity or condensing environment.

Items listed in the Performance Requirements column of the Electrical Characteristics are verified by completing the Performance Check in the Service Manual. Items listed in the Supplemental Information and Description columns is provided for user information only and should not be interpreted to be Performance Check Requirements.

Note

The SG 5030 has been designed in accordance with the intent of UL Standard 1244, "Safety Requirements for Electrical and Electronic Measuring and Test Equipment".

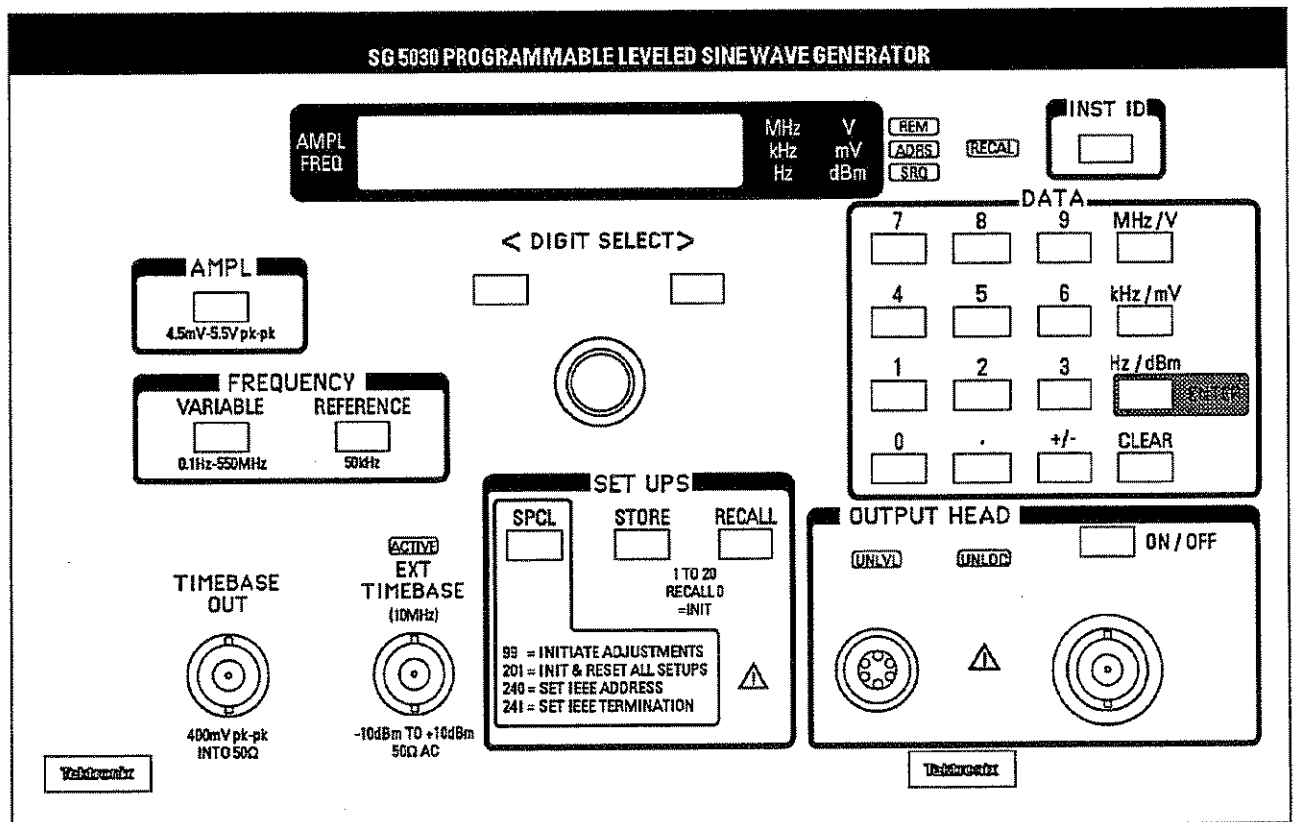

Figure 1-1: The SG 5030

Table 1-2: Electrical

Characteristics	Performance Requirement	Supplemental Information
Frequency Range/Resolution 0.1Hz to 4.9999kHz 5.000kHz to 49.999kHz 50.00kHz to 550.00000MHz		0.1Hz steps 1Hz steps 10Hz steps
Frequency Accuracy Using Internal Timebase (within 1 year of last adjustment) 0.1Hz to 4.9999kHz 5.000kHz to 49.999kHz 50.00kHz to 550.00000MHz Frequency Aging Using External Timebase (10MHz \pm 1.5 ppm) 0.1Hz to 4.9999kHz 5.000kHz to 49.999kHz 50.00kHz to 550.00000MHz Input Amplitude Requirement Input Resistance Lock Time	$\pm(0.0003\%$ of setting +0.06Hz) $\pm(0.0003\%$ of setting +0.3Hz) $\pm(0.0003\%$ of setting +3Hz)	1ppm/year \pm (external timebase error + 0.06Hz) \pm (external timebase error + 0.3Hz) \pm (external timebase error + 3Hz) -10dBm to +10dBm (70mV to 700mV RMS) 50 Ω AC, 500 Ω DC Less than 3 seconds
Timebase Out Output Frequency Frequency Accuracy Output Amplitude Output Resistance	10MHz \pm 3ppm (using internal timebase)	\pm X ppm (using external timebase) Where X ppm is external timebase accuracy 400mV pk-to-pk into 50 Ω 50 Ω
Amplitude Range/Resolution 4.50mV to 55.00mV pk to pk 55.2mV to 550.0mV pk to pk 0.552V to 5.500V pk to pk -42.95dBm to +18.75dBm		0.02mVolts peak to peak per step 0.2mVolts peak to peak per step 2mVolts peak to peak per step 0.05dBm per step
Amplitude Accuracy ¹ (0.1Hz to 50kHz)	\pm 1.5% of setting	

¹ Accuracy guaranteed only when the Leveling Head and SG 5030 have been calibrated together.

**Electrical
(continued)**

Characteristics	Performance Requirement	Supplemental Information
Amplitude Flatness 50.00kHz to 100MHz >100MHz to 250 MHz >250MHz to 550MHz	±1.5% (of 50kHz ref) ±3% (of 50kHz ref) ±4% (of 50kHz ref)	Voltage peak-to-peak into 50 ohms
Output Source Resistance		50Ω, ±1%
Output DC Offset		< ± 1% of amplitude (V _{pp}) for 20°C to 30°C < ± 2% of amplitude (V _{pp}) for 0°C to 40°C
Output VSWR	Less than 1.2:1 up to 550MHz	
Spectral Purity 0.1Hz to 49.999kHz 50.00kHz to 550.00000MHz Harmonics Nonharmonics Phase Noise	Less than -30dBc 2nd harmonic Less than -35dBc 3rd harmonic Less than -40dBc all others	All harmonics and spurs less than -50dBc Less than -40 dBc Less than -85 dBc/Hz at 10kHz offset
GPIB Settling Time Output OFF to ON All other function changes		From trailing edge of GPIB EOI until sine wave output is stable <150mS <80mS

Table 1-3: Environmental¹

Characteristics	Description
Temperature	Meets MIL-T-28800D, class 5, with exception to operating temperature.
Operating	0°C to +40°C
Nonoperating	-40°C to +71°C
Humidity (Noncondensing)	Exceeds MIL-T-28800D, class 5
Operating	95% ±5% RH, +10°C to +30°C, 75% ±5% RH, +30°C to +40°C, RH not controlled below +10°C
Altitude	Exceeds MIL-T-28800D, class 5
Operating	10,000 ft (4.5 Km)
Nonoperating	50,000 ft (15 Km)
Vibration ²	Meets MIL-T-28800D, class 5
Operating	Displacement (peak-to-peak), 0.38mm (0.015"). 10Hz to 55Hz. Total time, 75 minutes.
Shock	
Nonoperating	30 g's, half sine, 11ms duration, 3 shocks in each direction along 3 major axis; 18 total shocks.
Bench Handling	Meets MIL-T-28800D, class 5
Operating	45 degrees or 4 inches or point of balance, whichever occurs first.
ESD	Meets IEC 802-2 ESD Test Meets 20kV maximum discharge applied to instrument case per Tektronix Product Design
EMC ³	Within conducted emissions limit for FCC Regulations, Part 15, Subpart J, Class A and VDE 0871 Class B. Exceeds radiated emissions limit for FCC Regulations Part 15, Subpart J, Class A and VDE 0871 at the selected OUTPUT signal frequency. Within conducted emissions limits for MIL STD 461B/462 CE01, part 2 and CE03. Within conducted susceptibility limits for MIL STD 461C CS01, CS02 and CS06.

¹Note: The SG 5030 will meet MIL-T-28800D, Class 5 only as specified in the table below.

²Meets MIL-T-28800D, class 3, when tested outside a TM 5000-series power module.

³Tested with a TM 5006A, Option 15 Power Module.

Table 1-4: Mechanical

CHARACTERISTICS	DESCRIPTION
Maximum Overall Dimensions without leveling head	
Height	5.0"
Width	7.950"
Length	12.2"
Net Weight	
Standard Instrument Including leveling head	7.0 lbs

Section 2

Operating Instructions

This section of the manual contains plug-in installation and removal instructions and describes the functions of the SG 5030 front-panel controls, connectors, and indicators. Operators familiarization information is also provided as an aid in understanding how to operate the SG 5030 under local (manual) control only.

Complete information for programming the SG 5030 via the GPIB (General Purpose Interface Bus) is found in the Programming section of this manual.

Preparation For Use

The SG 5030 is calibrated and ready for use when received. The SG 5030 is designed to operate only in the TM 5000-Series power modules. Make certain the line selector block on the power module is positioned correctly.

The SG 5030 must also have the Output Leveling Head installed before use. The leveling head is calibrated to match the SG 5030. The two cables from the leveling head connect to the two OUTPUT HEAD connectors on the lower right portion of the SG 5030 front panel.

Installation and Removal

CAUTION

To prevent possible damage to the SG 5030, turn off the power module before installing or removing the instrument. Do not use excessive force to install or remove.

Check to see that the plastic barriers on the interconnecting jacks of the selected power module compartments match the cutouts in the SG 5030 rear interface connectors. If they do not match, do not install the SG 5030 until the reason is investigated. When the units are properly matched, align the SG 5030 chassis with the upper and lower guides of the selected compartments. Push the SG 5030 chassis in and press firmly to seat the rear-interface connectors in the interconnection jacks. Connect the two cables from the leveling head to the two connectors labeled OUTPUT HEAD on the SG 5030 front panel. Apply power to the SG 5030 by turning on the power module.

To remove the SG 5030 from the power module, pull out both the release latches (located on the lower front panel) until the interconnecting jacks disengage and the SG 5030 slides out.

Repackaging For Shipment

If the instrument is to be shipped by commercial transportation, we recommend that it be packaged in the original manner. The carton and packaging material in which your instrument was shipped should be saved and used for this purpose.

Also, if the SG 5030 is to be shipped to a Tektronix Service Center for service or repair, attach a tag to the instrument showing the following:

- Owner of the instrument (with address);
- Name of person to contact at your firm;
- Complete instrument type and serial number;
- Describe the service required, or the symptoms of trouble the instrument exhibited.

If the original package is unfit for use or not available, package the instrument as follows:

1. Obtain a corrugated cardboard shipping carton with a 200-pound test strength and having inside dimensions at least six inches greater than the instrument dimensions.
2. Wrap the instrument with polyethylene sheeting or equivalent material to protect the finish.
3. Cushion the instrument on all sides by tightly packing dunnage or urethane foam between the carton and the instrument, allowing three inches on each side.
4. Seal the carton with shipping tape or with an industrial stapler.

Mark the address of the Tektronix Service Center and your return address on the carton in one or more prominent locations.

Front Panel Controls, Connectors And Display

All controls necessary for local operation of the SG 5030 are located on the instrument front panel. Some push buttons illuminate to provide visual indication that associated functions are active. A brief description of these controls, connectors, and indicators follows. Refer to Figure 2-1.

1 Display Indicators

The SG 5030 uses seven-segment LED's to display a numerical value up to eight digits. In addition, LED indicators in the left and right areas of the display window illuminate when appropriate to indicate the selected function modes and parameter units of measure.

Function Mode

The function is defined by the illuminated mode indicator in the left side of the readout display window. The two function modes are:

- AMPL** Activated when the AMPL button is pressed.
- FREQ** Activated when the FREQUENCY VARIABLE or REFERENCE buttons are pressed.

Parameter Units of Measure

Display value units are defined by the illuminated units indicator in the right side of the readout display window. These units are:

- MHz** Activated when the FREQUENCY VARIABLE button is selected. Frequency selected is from 1MHz to 550MHz.
- kHz** Activated when the FREQUENCY VARIABLE or REFERENCE button is selected. Frequency selected is from 1kHz to 999.99kHz.
- Hz** Activated when the FREQUENCY VARIABLE button is selected. Frequency selected is from 0.1Hz to 999.9Hz.
- V** Activated when the AMPL button is selected. Amplitude selected is from 1V to 5.500V.
- mV** Activated when the AMPL button is selected. Amplitude selected is from 4.5mV to 998mV.
- dBm** Activated when the AMPL button is selected. Amplitude selected is from -42.95dBm to +18.75dBm.

2 GPIB STATUS indicators

The current status of the GPIB is shown by the illuminated indicators just to the right of the readout display window. They are:

- REM** Illuminates when the SG 5030 is operating under remote control via the GPIB.
- ADRS** Illuminates when the SG 5030 is addressed via the GPIB.
- SRQ** Illuminates when the SG 5030 has detected an error or event. The controller must conduct a serial poll to query the error or event and to extinguish the SRQ indicator.

NOTE

At power-on the SRQ indicator is illuminated. This may not indicate an error condition but only that the power-on SRQ has not yet been serviced by a GPIB controller.

3 RECAL Indicator

Indicates the loss of the calibration constants. Most likely this is due to nonvolatile memory failure. This indicator will remain illuminated until the instrument has been readjusted by performing the Adjustment Procedure in the Service Manual.

4 INST ID push button

Causes the SG 5030 to display its primary GPIB address and message terminator. If USEREQ has been enabled, it will generate a Service Request (SRQ) over the GPIB.

The message terminator currently selected in the SG 5030 (either EOI or LFEOI) will be displayed in the readout display window.

See Section 3-Programming, for instructions to change the GPIB address and to select the message terminator required by your controller.

5 DATA entry keypad

0 through 9, Decimal Point, +/-

Used to enter a numeric value for the amplitude, frequency, or the argument when using STORE, RECALL, or SPCL.

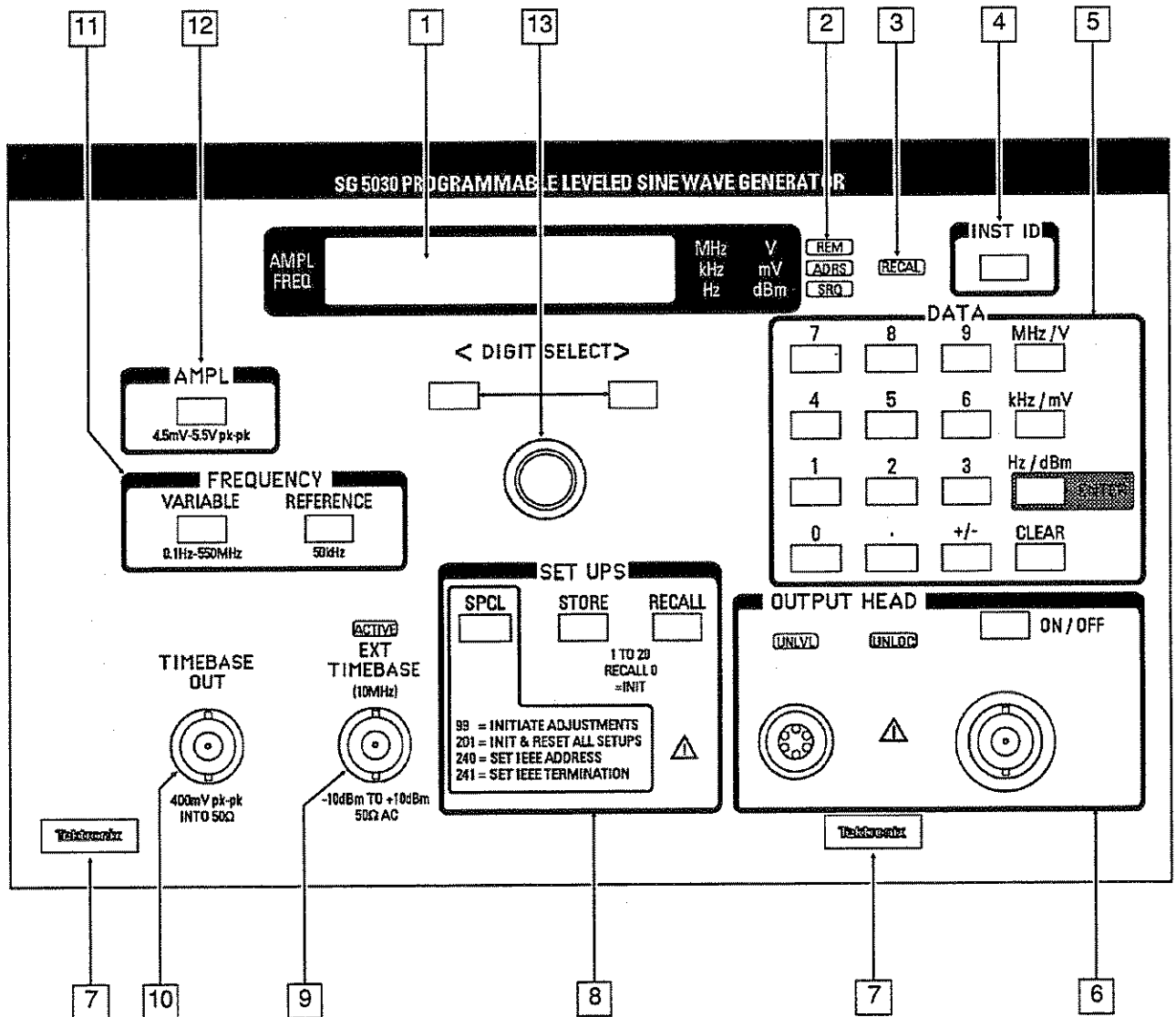

Figure 2-1: Front Panel Controls and Connectors

7703-1

MHz/V, kHz/mV, Hz/dBm

Used to terminate the entry of a parameter value and specify the unit of measure after you have selected the amplitude or frequency function. The appropriate unit will illuminate in the readout display window, indicating the selected unit.

ENTER

Used only with the front-panel SET UPS, entry of the STORE/RECALL storage locations, and the SPCL push button functions (e.g., setting the GPIB address).

CLEAR

Used to delete a partial entry. The SG 5030 will return to the previous valid instrument settings.

Also used after STORE or RECALL is pressed to cancel the STORE or RECALL operation and reset the display.

6 Output Leveling Head

Connectors

The Output Leveling Head provides the connection between the SG 5030 and the Instrument-Under-Test. Within the leveling head are attenuators, signal level sense detectors, and precision impedance matching circuits. The leveling head must be used for all SG 5030 operations and should be connected directly to the load to maximize performance. The use of extension cables, matching networks, transformers, etc., between the leveling head and the Instrument-Under-Test can cause performance degradation due to transmission losses and reflections.

If extension cabling is absolutely necessary between the leveling head and the Instrument-Under-Test, coaxial air line is recommended to minimize frequency dependent losses that affect the apparent leveling performance.

Two cables connect the leveling head to the SG 5030; the BNC cable carries the output signal, and the multi-wire cable carries control and status signals back to the SG 5030. If the multi-wire cable is disconnected, the SG 5030 output will be automatically turned off. If only the BNC cable is disconnected, the SG 5030 signal may still be present at the front panel BNC but it is effectively removed from the Instrument-Under-Test.

The SG 5030 is adjusted and shipped from the factory with a matching leveling head. The serial number on the leveling head cable must match the SG 5030 serial number for calibrated operation. Do not interchange

leveling heads between instruments, as performance may no longer be to specification. If the leveling head is interchanged, the complete calibration Adjustment Procedure must be performed before use.

ON/OFF push button

Disconnects the sine-wave signal output from the leveling head. The output impedance at the signal output connector remains at 50Ω.

UNLVL Indicator

When illuminated, indicates sine-wave output is unlevelled (e.g., excessive loading, open signal or control line, leveling circuit failure, etc.).

UNLOC Indicator

When illuminated, indicates one of the frequency setting loops is not locked to the timebase reference frequency (e.g., out-of-range reference signal, circuit failure, etc.).

7 Release Latches

Plug-in release latches. Pull both latches to remove the SG 5030 from the power module.

8 SET UPS

STORE push button

Stores the current instrument setting in the specified user-definable storage location. Twenty locations (1 through 20) are available. Instrument settings are retained in memory when the instrument is powered down.

RECALL push button

Recalls an instrument setting from user-specified storage locations (1 through 20) and configures the instrument to those settings. Recall 0 configures the instrument to factory-default settings that are the same as the INIT settings.

SPCL push button

- Allows you to initialize the current front-panel settings and all twenty storage location setups at one time.
- Used in the Adjustment procedure to change calibration constants.
- Allows you to set the GPIB address or message terminator from the front panel. See Section 3-Programming.

9 EXT TIMEBASE Connector

Allows the SG 5030 timebase to be frequency-locked to a precision external 10MHz reference frequency.

ACTIVE Indicator

Indicates the external 10MHz reference frequency signal has sufficient amplitude and approximately the correct frequency to lock the internal timebase.

10 TIMEBASE OUT Connector

Provides the internal 10MHz timebase frequency output to frequency lock other signal sources to the SG 5030.

11 FREQUENCY

VARIABLE push button

Selects the variable frequency function. Allows you to vary the sine-wave output frequency, using the Control knob or the DATA keypad. Frequency values can be selected in Hertz, KiloHertz, or Megahertz.

The VARIABLE push button and the **FREQ** indicator in the readout display window are both illuminated when the VARIABLE function is active.

REFERENCE push button

Selects the fixed 50kHz Reference frequency, and displays 50.00kHz in the readout display window. To return to the variable frequency setting that was last selected, press the VARIABLE push button.

The REFERENCE push button and the **FREQ** indicator in the readout display window are both illuminated when the REFERENCE function is active.

12 AMPL push button

Selects the variable amplitude function. Allows you to vary the sine-wave output amplitude using either the Control knob or the DATA keypad. Amplitude values can be selected in volts, millivolts or dBm.

The **AMPL** indicator in the readout display window and the **AMPL** button is illuminated when the amplitude function is active.

The amplitude can be set in either the **REFERENCE** or **VARIABLE FREQUENCY** mode, and remains the same when switching between modes.

13 Control Knob

Varies the value of the selected parameter. The smallest rate of change (increment) of a digit is determined by the mode and range that you select. For example, if you are in the amplitude mode and have selected a value within the range of 0.552V to 5.500V, the readout will increment or decrement in as small as 2mV steps.

DIGIT SELECT push buttons

Selects the Control Knob resolution (i.e., the digit that will change when the Control knob is rotated).

Each push of the left or right button will cause the selected digit to blink as it steps one place left or right.

Rear Panel Switches

On the rear panel of the SG 5030 is a four position DIP switch which is used to configure the instrument at power up. These switches are used to activate service functions and will not need to be used under normal operation. Their function however is described briefly below.

For normal operation, all toggles are set for open contacts (the contacts are closed when the toggle is depressed to the left, facing the rear of the instrument). The following functions are activated when the contacts are closed:

Toggle	Function
1	Reinitialize Firmware
2	Diagnostic Bypass
3	Enable Adjustment
4	Not Used

Operators Familiarization

General Operating Information

With the SG 5030 properly installed in the power module, allow 20 minutes warmup time for operation to specified accuracy; 60 minutes after storage in or exposure to a high humidity (condensing) environment.

Power-Up Sequence

When powered up, the SG 5030 performs a diagnostic self-test to check the functionality of its ROM, RAM, and some hardware circuits. It also illuminates all front panel LEDs and indicators. If a self-test error is detected, an E followed by a three-digit error code will appear in the readout window indicating an internal malfunction. Should this occur, refer the condition to qualified service personnel. Pressing any button clears the error code from the readout window and allows the instrument to complete initialization, but does not clear the condition causing the error code. If more than one error has been detected a button may have to be pushed several times to clear each of the errors in turn from the display.

Upon successful completion of the self-tests, the SG 5030 restores the instrument settings that were in use when the instrument was last turned off. The sine wave signal to the output head however will always be turned off at power up.

In addition the SG 5030 always powers up with the frequency displayed in the display window and with the control knob digit select resolution set to the default value.

Initializing the Instrument Settings

You can initialize the current front-panel settings, or all twenty of the instrument setting storage locations at one time.

To initialize the current front-panel settings:

1. Press the RECALL button.
2. Enter 0 (zero) on the DATA keypad.
3. Press the ENTER button.

The SG 5030 is now initialized to the following settings:

Output ON/OFF	OFF
AMPL	1.000V
FREQUENCY	10.00000MHz
REFERENCE (50kHz)	OFF
VARIABLE (0.1Hz - 550MHz)	ON
RQS	ON
USEREQ	OFF

To initialize the current instrument setting and all twenty of the storage locations:

1. Press the SPCL button.
2. Enter 201 on the DATA keypad.
3. Press the ENTER button.

The instrument settings and all storage locations are now initialized to the settings listed above.

Function and Parameter Selection

The SG 5030 generates an amplitude-leveled sine wave signal with two variable functions; amplitude and frequency. The parameters of these two functions are set from the front panel using either the Control knob or the DATA entry keypad (for GPIB operation, refer to Section 3-Programming). The ranges for each function and the parameter resolutions are specified in Section 1-Specification of this manual.

Setting Amplitude Parameters

To select a specific amplitude value, press the AMPL button. The amplitude parameter and unit of measure last selected will appear in the readout display window.

Voltage Resolution vs Range

Voltage Range	Resolution
-42.96dBm to +18.75dBm	0.05dBm
4.50mV to 55.00mV	0.02mV
55.2mV to 550mV	0.2mV
0.552V to 5.500V	2mV

Next, enter the desired amplitude value using either the Control knob or DATA entry keypad as follows:

Control knob entry

Press the DIGIT SELECT buttons to select the significant digit you wish to change (each digit will blink once when selected). Clockwise knob rotation will increment the selected digit, and counterclockwise rotation will decrement the selected digit.

DATA keypad entry

Select the numeric value first and then the units desired (e.g., V, mV, or dBm) on the keypad; this action enters the selected amplitude value. If the amplitude value entered on the keypad has a higher resolution than is allowed, the SG 5030 will round it off to the nearest allowable setting.

Setting Frequency Parameters

To select a specific frequency, press the VARIABLE FREQUENCY button. The frequency parameter and unit of measure last selected will appear in the readout display window.

Frequency Resolution vs Range

Frequency Range	Resolution
0.1Hz to 4.9999Hz	0.1Hz
5.000kHz to 49.999kHz	1Hz
50kHz to 550.0000MHz	10Hz

Next, enter the desired frequency value using either the Control knob or DATA keypad as follows:

Control knob entry

Press the DIGIT SELECT buttons to select the significant digit you wish to change (each digit will blink once when selected). Clockwise knob rotation will increment the selected digit, and counterclockwise knob rotation will decrement the selected digit.

DATA keypad entry

Select the numeric value first and then the units desired (e.g., Hz, kHz, or MHz) on the keypad; this action enters the selected frequency value. If the frequency value entered on the keypad has a higher resolution than is allowed, the SG 5030 will round it off to the nearest allowable setting.

Table 2-1: Front Panel Error Codes

Error	Description
E101	Command header error
E102	Header delimiter error
E103	Command argument error
E104	Argument delimiter error
E105	Non-numeric argument
E106	Missing argument
E107	Invalid message unit delimiter
E150	Bad symbol
E151	Syntax error
E153	Symbol number too long
E154	Invalid input character
E155	Invalid string input
E156	Numerical underflow
E205	Argument out of range
E250	Not in adjustment mode
E251	I/O buffers full, output flushed
E252	Settings buffer empty
E253	Illegal settings number specified
E254	Beyond calibration limit
E301	Interrupt fault
E302	System error
E350	HF unleveled
E351	Reference loop unlocked
E352	Wide loop unlocked
E353	Narrow loop unlocked
E354	Offset loop unlocked
E355	DDS loop unlocked
E356	Unplugged error
E360	EPROM checksum failure
E361	NVRAM test failure
E362	RAM test failure
E363	NVRAM lost
E364	CAL Constant Checksum failure
E370	Output Off test failure
E371	Ref Freq test failure
E372	DDS OFF test failure
E373	10.00000MHz test failure
E374	10.00001MHz test failure
E375	500.00000MHz test failure
E376	Wide Loop Divider test failure
E377	Output Amp powered test failure

Setting the 50kHz Reference Frequency

Press the REFERENCE FREQUENCY button. The readout window will display 50.00kHz (the reference frequency is not adjustable). You can set the Reference Frequency amplitude by selecting the AMPL button and entering the desired amplitude as described under Setting Amplitude Parameters above.

Select the VARIABLE FREQUENCY button to return to the previous variable frequency settings, and to turn off the reference frequency. The amplitude will be the same as the reference frequency amplitude.

Storing and Recalling Instrument Setups

You can store up to 20 instrument setups in a battery backed-up nonvolatile RAM. To store a setup, set the instrument parameters and units of measure as desired, and press the STORE button. Enter a storage location between 1 and 20 on the DATA keypad, and press the ENTER button. The current instrument setup is now stored in that location (in nonvolatile RAM), and will be retained when the instrument is powered down.

To recall a specific set of instrument settings, first press the RECALL button, enter any previously set storage location (1 through 20) on the DATA keypad, then press the ENTER button.

Displayed Errors

When powered up, the SG 5030 performs a diagnostic self-test to check its functionality. If an error is found, an error code will be displayed in the display window. The error can be cleared by pressing any key. Error code definitions are listed in Table 2-1.

If no error is found during self test, the SG 5030 restores the instrument settings that were in use when the instrument was last turned off, except the output is OFF.



Special Functions

The SG 5030 has several special functions that allow the user to check or change operational settings. These functions are listed in Table 2-2.

To invoke an SPCL function, press the SPCL button. Then enter the two or three-digit SPCL code and press ENTER.



Output Loading

The SG 5030 is designed to operate into a 50Ω impedance load at the leveling head output connector. If load impedance is substantially greater than 50Ω, connect a low-loss precision feed-through termination of the appropriate value to the leveling head, and then make connection to the load. Refer to Figure 2-2(B) for reference.

NOTE

When lit, the UNLVL light on the front panel indicates a mismatched load or that the output is shorted. When the leveling head is disconnected from the front panel, the UNLVL light is also illuminated, and the instrument will turn its output off.

Table 2-2: Special Functions

Code	Description
99	This function initiates the instrument adjustment process, and is intended for use by qualified service personnel only. If the user accidentally selects this function, the instrument will show error code E250 (not in adjustment mode) in the display window, indicating the internal DIP switch toggles have not been set to allow adjustment.
201	Initializes the current front-panel settings and all twenty storage location setups at one time. See Initializing the Instrument Settings earlier in this section.
240	Shows the current GPIB address in the display window, and allows the user to enter a new address from the keypad, if desired. See resetting the GPIB Address and Message Terminator in Section 3-Programming.
241	Shows the currently selected message terminator in the display window, and allows the user to select either LFEOI or EOI. See Resetting the GPIB Address and Message Terminator in Section 3-Programming.

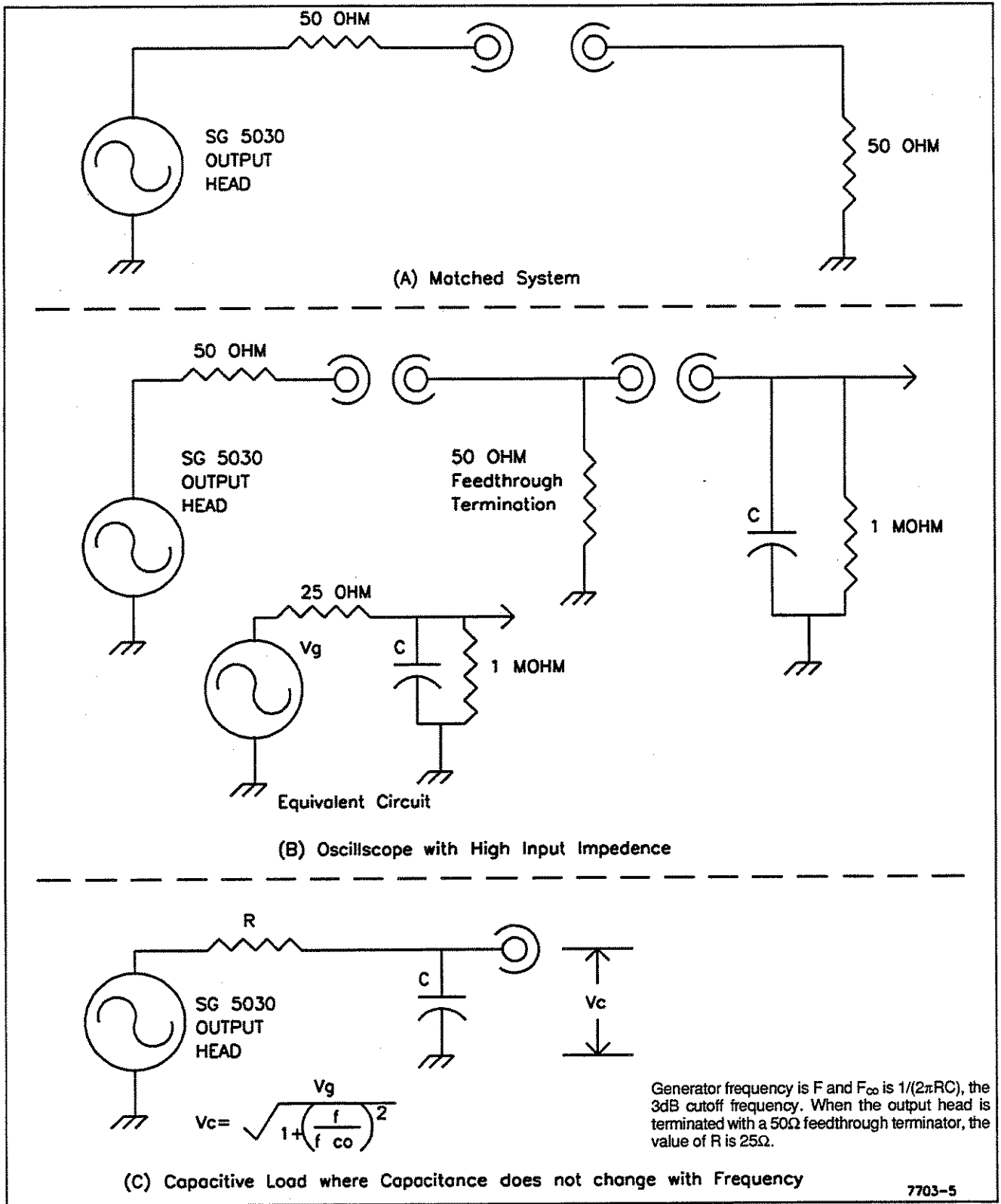

Figure 2-2: Signal Termination Configurations

The SG 5030 adjusts signal amplitude and distortion at the leveling head. To maintain signal integrity, it is important to minimize adapter and transmission line discontinuities and reflections between the leveling head and the Instrument-Under-Test. Adding coaxial cable or other devices between the output head and the load impairs the constant amplitude function, since transmission line insertion losses vary with frequency.

If there is a DC voltage across the load, use a DC blocking capacitor between the output head and the load. A DC blocking capacitor, listed in the Optional Accessories list in the Service Manual, can be used with minimal loss at frequencies greater than 1 MHz.

A DC block is also useful as a protective device when the SG 5030 signal is applied to RF equipment which is sensitive to DC voltage, such as some spectrum Analyzer inputs. Although the SG 5030 has only a small DC offset, it can output high amplitude low frequency AC signals which may be a problem to some sensitive RF circuits.

If signal amplitudes less than the minimum (4.5mV p-p) are desired, use appropriate attenuators connected between the leveling head and the device under test.

NOTE

Tektronix BNC attenuators with -02 suffix are recommended. Other attenuators may be used; however, measurement accuracy may be compromised.

When operating the SG 5030, always consider the total load impedance and its effect on the output amplitude. The input capacitance of the equipment under test will affect the bandwidth. The equivalent circuit shown in Figure 2-2(C) is useful in estimating the amplitude changes caused by capacitive loads. Note that as system input capacitance increases, output signal decreases.

Making Bandpass Measurements

Making bandpass measurements are easy with the SG 5030. Basically, a reference amplitude at the device-under-test output is set at a reference frequency, then the SG 5030 frequency is increased (or decreased)

until the device-under-test output decreases by 3dB (29.3%) from the reference amplitude. This is shown graphically in Figure 2-3. It is important that the reference amplitude be set at a frequency where the device-under-test is known to be linear. For most devices, the 50kHz reference frequency of the SG 5030 is valid, though other frequencies may be used. An oscilloscope whose bandwidth is substantially greater than the device-under-test makes an ideal measurement device for bandwidth checks.

1. Connect the oscilloscope to the output of the Device-Under-Test (DUT). To make the bandwidth measurement, set the reference frequency amplitude first. Adjust the SG 5030 output amplitude, the DUT gain, and the oscilloscope controls to display a sinewave of exactly six divisions, as shown in Figure 2-4.
2. Next, slowly increase (or decrease) the SG 5030 frequency until the oscilloscope display is reduced to 4.2 divisions, as shown in Figure 2-5. Allowing the oscilloscope trigger to free-run may make the display amplitude easier to judge. Do not adjust the gain or amplitude controls during this step.
3. Check the SG 5030 frequency readout display. This is the -3dB frequency of the DUT.

In some applications, a wide bandwidth DVM can be substituted for the oscilloscope. The following procedure may be used.

1. Connect the DVM to the output of the DUT. Set the reference frequency amplitude first. Adjust the SG 5030 output amplitude and the DUT gain to show some convenient value on the DVM, such as 1 volt.
2. Next, slowly increase (or decrease) the SG 5030 frequency until the DVM reading is 70.7% of the reference amplitude. Do not adjust the gain or amplitude controls during this step.
3. Check the SG 5030 frequency readout display. This is the -3dB frequency of the DUT.

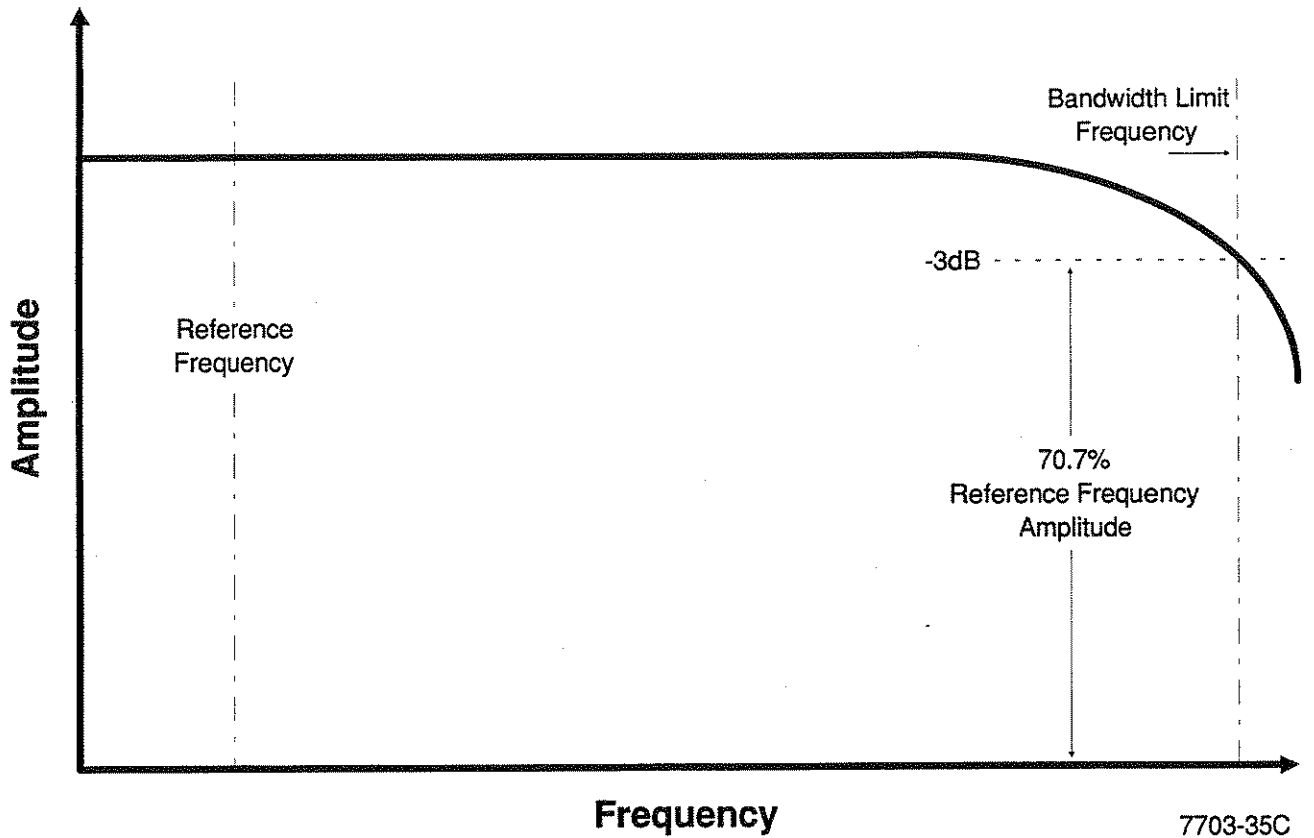

Operating Instructions

Figure 2-3: Bandpass Measurement

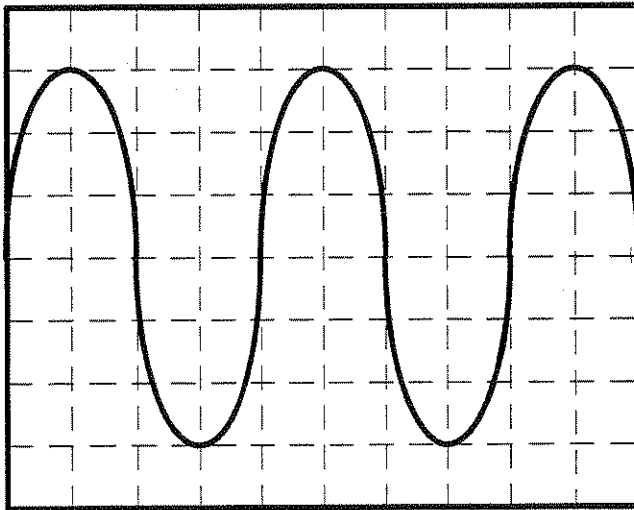

Part A
Set the Reference Amplitude

7703-35A

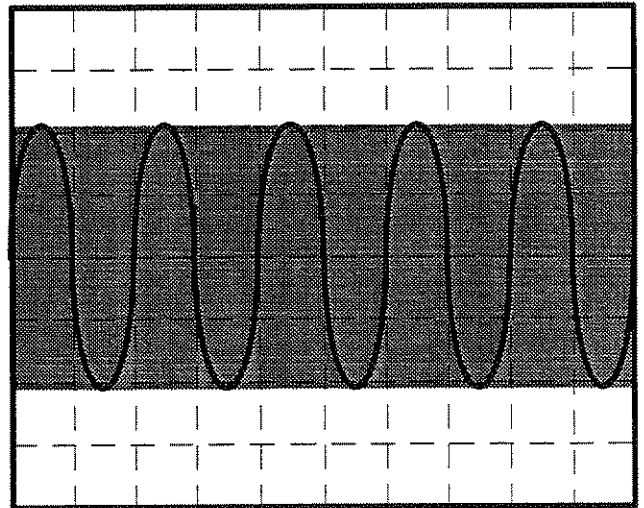

Part B
Find the -3dB Point

7703-35B

Figure 2-4: Reference Setup

Figure 2-5: The -3dB Point

Section 3

Programming

Introduction

This manual section provides the information required for programming the Tektronix SG 5030 Leveled Sine Wave Generator through the IEEE-488 bus, commonly called the General Purpose Interface Bus (GPIB). The IEEE-488 bus interface is specified and described in the IEEE-Standard 488.1-1987, Standard Digital Interface for Programmable Instrumentation.¹

The information in this section assumes that the reader is knowledgeable in IEEE-488 bus communication and has some experience in programming a system that uses a GPIB-style interface.

All Tektronix programmable TM 5000 instruments are designed to communicate with any controller that can send and receive ASCII messages (commands) over the IEEE-488 bus. The instruments are connected to the IEEE-488 bus through a TM 5000 power module. Refer to the Operating Instructions section of this manual for information on installing the SG 5030 in the power module. Also, it is helpful to review that section and become familiar with front-panel functions.

Commands for TM 5000 programmable instruments either alter instrument settings or request information from the instrument. The command set for each instrument is designed for compatibility between TM 5000 instrument types. When possible, the same commands are used in different instruments to control similar functions. In addition, commands are specified in mnemonics that are related to the functions implemented. For example, the INIT command initializes instrument settings to predefined default settings.

¹ Published by the Institute of Electrical and Electronics Engineers, Inc., 345 East 47th Street, New York, N.Y., 10017.

IEEE-488 Interface Function Subsets

The SG 5030 IEEE-488 interface is based on the IEEE-488.1-1987 interface (described above) and the Tektronix, Inc. C&F (062-1780-02) interface standard.

Table 3-1 shows the compatibility of SG 5030 operation with these combined standards.

GPIB Address and Message Terminator

The SG 5030 primary GPIB address can be set to any decimal number in the range 0 to 31. Address 31 effectively removes the SG 5030 from the bus, though it remains an electrical load. The SG 5030 is shipped with the GPIB address set to 10.

The SG 5030 responds to one of two possible message terminators (LF and EOI or EOI only). The message terminator must match that required by the controller. The SG 5030 is shipped with the message terminator

Table 3-1: IEEE-488 Interface Function Capability

Function	Subset	Capability
Source Handshake	SH1	Complete Capability
Acceptor Handshake	AH1	Complete Capability
Basic Talker	T6	Responds to serial poll. Untalks if My Listen Address (MLA) is received.
Basic Listener	L4	Unlistens if My Talk Address (MTA) is received
Service Request	SR1	Complete capability
Remote-Local	RL1	Complete capability
Parallel Poll	PP0	Does not respond to Parallel Poll
Device Clear	DC1	Complete Capability
Device Trigger	DT0	Does not respond to GET
Controller Function	C0	No controller function

set to EOI only. The message terminator and the primary GPIB address are stored in nonvolatile RAM memory.

The front panel SPCL button allows the current GPIB primary address and message terminator to be displayed on the SG 5030 readout. To display the GPIB address, press the SPCL button, enter 240 from the keypad, and press ENTER. The address is then displayed, for example GPIB 10. Pressing the ID button will also display the GPIB address.

To display the message terminator, press the SPCL button, enter 241 from the keypad, and press ENTER. The letters LF EOI are then displayed if the selected message terminator is LF EOI, and the letters EOI are displayed if the terminator is EOI only.

Resetting the GPIB Address and Message Terminator

The SPCL button can also be used to change the GPIB primary address and the message terminator. To reset the GPIB address, perform the following operation:

1. Press SPCL
2. Enter 240 from keypad
3. Press ENTER
4. After current GPIB address setting is displayed, enter the new address from the keypad
5. Press ENTER

To reset the message terminator, perform the following operation:

1. Press SPCL
2. Enter 241 from keypad
3. Press ENTER
4. After current message terminator is displayed, use the knob to select the new terminator
5. Press ENTER

Commands

The SG 5030 is controlled either by front panel controls or by remote commands that it receives from the controller through the GPIB interface. The remote commands are divided into three types:

- **Setting commands** — control instrument settings.
- **Query/Output commands** — request data.
- **Operational commands** — changes instrument operational commands (i.e. store, test, etc.).

When the instrument is in the remote state, it executes all three types of commands in the appropriate manner (for example, sets an instrument control or returns the requested data). In the local state (that is, when the instrument is under front-panel control), the instrument only executes query/output commands.

In the following sections, the SG 5030 commands are presented in three ways:

- **Command Summary** — A command list divided into functional groups, with brief descriptions of each command.
- **Control/Command Descriptions** — A front panel illustration showing command relationships to front panel operation and internal parameters.
- **Detailed Command Descriptions** — An alphabetically arranged presentation of all the commands with complete detailed descriptions.

Command Format

A command consists of a header and, if necessary, one or more arguments. The command headers are English-language words that denote the operation to be carried out, such as INIT (initialize the instrument), or FREQUENCY (set the output signal frequency). Only the first three characters of a command header must be given, although it is acceptable to enter the entire command header.

When a command requires arguments, they are entered after the command header. For example, the FREQUENCY command requires an argument to give the desired frequency setting (FRE 15000). The header and arguments are generally separated by a space character, although the command will be accepted without the space.

The headers for query commands include a terminating question mark (?) symbol (USREQ?). Since only the first three characters of a command header must be given, the ? may be given after these characters (for example, USE?).

Additional information about the command format is given in the section titled Message Format.

Tektronix Codes and Formats

In addition to compliance with the IEEE-488.1 interface standard, the command headers, arguments, and syntax also meet the Tektronix Codes and Formats standard. This standard makes programming simple because the language and syntax between Tek instruments is consistent and easy to use. Standard instruments-data formats open up the lines of bus communication and makes the test system easy to set up and operate.

Command Summary

This section provides a summary of the SG 5030 commands. The list is arranged in functional groups: instrument commands, status commands, and system commands.

NOTE

Capitalized letters in the command header word are required characters, the lower case characters may be optionally entered. Angle brackets < > indicate a required user supplied element. Square brackets [] indicate an optional element.

Instrument Commands

The following commands control instrument operations that are associated with front-panel controls.

AMPLitude <num>[:<dBm>] — Sets the amplitude of the output signal. The default units are volts, if desired, dBm can be selected.

AMPLitude? — Returns the current amplitude setting.

FREquency <num> — Sets the frequency of the output signal.

FREquency? — Returns the current frequency setting.

REFreq ON — Turns on the 50kHz reference frequency and sends it to the output.

REFreq OFF — Turns off the 50kHz reference frequency and enables the variable frequency controls.

REFreq? — Returns the current status of the reference frequency (REFREQ ON or OFF).

OUTput ON — Turns the output on.

OUTput OFF — Turns the output off.

OUTput? — Returns the current status of the output (OUTPUT ON or OFF).

STOre <num> — Stores the current front-panel setup at location 1 to 20.

RECall <num> — Recalls the front-panel setup from location 0 to 20. (Location 0 contains the initialization settings.)

Status Commands

The following commands enable and disable service requests and return status information about instrument operation.

- RQS ON — Enables generation of service requests.
- RQS OFF — Disables generation of service requests.
- RQS? — Returns status of service requests (RQS ON or OFF).
- USEReq ON — Enables SRQ operation when the ID button is pushed.
- USEReq OFF — Disables SRQ operation when the ID button is pushed.
- USEReq? — Returns status of user request (USEREQ ON or OFF).
- LEveled? — Returns current status of output signal (LEVELED YES or NO).
- EXTtb? — Returns current status of the external timebase input (EXTTB ACTIVE or INACTIVE).

System Commands

The following commands perform system wide operations.

- ID? — Returns instrument identification and firmware version.
- INIT — Initializes instrument settings.
- SET? — Returns the current instrument settings to the GPIB interface. This command can be used for storage of set-ups on the host controller for later retrieval. It can

also be used during development of an automated test procedure by allowing the host controller to “learn” a series of manual front panel settings.

TEST — Initiates a self test on the instrument. When the test is complete, the instrument returns to the settings last entered. If the self test failed, the SG 5030 returns an SRQ to the controller.

EVENT? or ERROR? — Returns information about the event reported in the last serial poll.

HELP? — Returns a list of all the command headers the SG 5030 accepts.

ABStouch <nrl> — Provides a means of remotely activating (touching) front-panel buttons and controls through the GPIB interface. Refer to Table 3-2.

CAL? — Returns a list of all the Calibration settings (SPCL 99) stored in NVRAM.

Control/Command Descriptions

Fig. 3-1 shows the instrument commands and their relationship to the front-panel controls.

Detailed Command List

The following section provides a detailed description of the SG 5030 commands and their command syntax.

NOTE

Capitalized letters in the command header word are required characters, the lower case characters may be optionally entered. Angle brackets < > indicate a required user supplied element. Square brackets [] indicate an optional element.

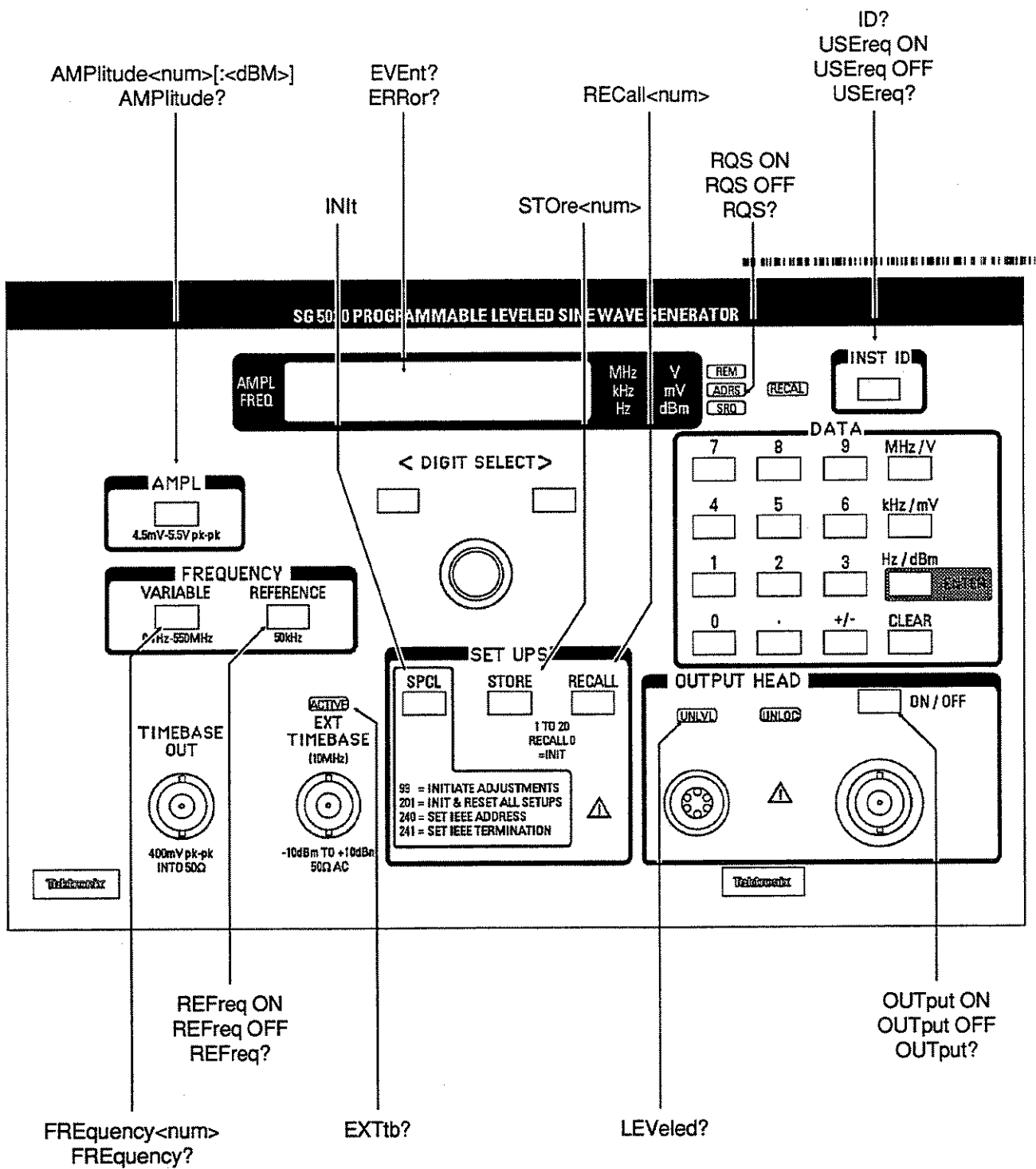

7703-7

Figure 3-1: Instrument Commands & Front Panel Controls

ABSTOUCH

Type:

Setting

Setting syntax:

ABStouch <nr1>

Examples:

ABSTOUCH 5
ABS 5

Discussion:

This command causes one or more front-panel buttons or controls to be remotely activated (touched) through the GPIB interface. This feature is useful for evaluation and applications procedures that simulate operator actions.

Table 3-2: ABSTOUCH Command Arguments

Front Panel Switch Function	Argument (decimal number)
Knob Increment	0
Knob Decrement	1
Output ON	2
CLEAR	3
0	4
.	5
+/-	6
Hz/dBm/ENTER	7
1	8
2	9
3	10
KhZ/mV	11
4	12
5	13
6	14
MHz/V	15
7	16
8	17
9	18
INST ID	19
AMPLITUDE	20
VARIABLE	21
STORE	22
SPCL	23
<	24
>	25

AMPLITUDE

Type:

Setting or query

Setting syntax:

AMPlitude <num>[:dBm]

Examples:

AMPLITUDE 4.5
AMPL .5
AMP 3.5E-2
AMP 0:dBm
AMP -30:dBm

Amplitude selected:

4.5V p-p
500mV p-p
35mV p-p
0dBm
-30dBm

Query syntax:

AMPlitude?

Query response syntax:

AMPLITUDE <num>
AMPLITUDE <num>:dBm

Query response examples:

AMPLITUDE 3.250
AMPLITUDE 400.0E-3
AMPLITUDE -15.00:DBM

Discussion:

This command sets the amplitude of the output signal in volts peak-to-peak or dBm. If dBm units are not specified, volts are assumed. The dBm range is -42.95dBm to +18.75dBm, with a resolution of 0.05dBm. The voltage peak-to-peak range of the instrument is 4.50mV to 5.500V. This range is divided into three subranges, and the amplitude resolution is different in each of these subranges as follows:

Range	Resolution
-42.95dBm to +18.75dBm	0.05dBm
4.50mV to 55.00mV	0.02mV
55.2mV to 550.0mV	0.2mV
0.552V to 5.500V	2mV

If the amplitude specified in the command has a greater resolution than the subrange it falls in, the amplitude is rounded off to the closest allowable resolution.

The AMPlitude? command causes the current amplitude setting to be returned.

CAL?

Type:

Query

Query Syntax:

CAL <num>, <num>, <num>, <num>, <num>,
<num>, <num>, <num>, <num>, <num>, <num>,
<num>

Query Response Examples:

CAL 139, 136, 140, 2746, 2755, 2747, 2838,
340, 2843, 341, 2841, 342

Discussion:

This query returns the current DAC settings stored in NVRAM that were set either by default or by selection of the SPCL 99 calibration routine. Table 3-3 below shows a list of the DACs and the name of each DAC setting, listed in the order returned by the CAL? query.

Table 3-3: DAC Setting Names

DAC Name	DAC Setting Name
Offset DAC (high byte)	lf_power_amp_offset
Offset DAC (low byte)	lf_preamp_offset
Offset DAC (high byte)	rf_power_amp_offset
LF Level DAC	lf_gain_cal_x1
LF Level DAC	lf_gain_cal_x10
LF Level DAC	lf_gain_cal_x100
RF Level DAC	rf_gain_max_x1
RF Level DAC	rf_gain_min_x1
RF Level DAC	rf_gain_max_x10
RF Level DAC	rf_gain_min_x10
RF Level DAC	rf_gain_max_x100
RF Level DAC	rf_gain_min_x100

**ERROR?
EVENT?**

Type:

Query

Query syntax:

ERRor?
EVENt?

Query response syntax:

ERROR <num>
EVENT <num>

Query response examples:

ERROR 205
EVENT 351

Discussion:

These commands return information about the event reported in the last serial poll. If RQS is ON, the <num> response for both commands is the event code for the last reported status byte. If RQS is OFF, <num> is the event code for the highest priority event that has occurred. The event code will be cleared upon completion of these commands. Refer to the section titled Status and Error Reporting for a discussion of event codes and status bytes. Table 3-3 lists all the SG 5030 error/event codes.

These two commands are equivalent and either may be used to preserve compatibility with other Tektronix GPIB products.

EXTTB?

Type:

Query

Query syntax:

EXTtb?

Query response: (one of the following)

EXTTB ACTIVE
EXTTB INACTIVE

Discussion:

This command returns the current status (ACTIVE or INACTIVE) of the external timebase input (EXT TIMEBASE connector).

FREQUENCY

Type:

Setting or query

Setting syntax:

FREquency <num>

Examples:

FREQUENCY 120E3
FREQ 1.5E4
FRE 5E+4
FRE .9

Query syntax:

FREquency?

Query response syntax:

FREQ <num>

Query response examples:

FREQ 125.00E+3
FREQ 1.0000E+3

Discussion:

This command sets the frequency of the output signal. The frequency range of the instrument is 0.1Hz to 550.00000 MHz. This range is divided into three subranges, and the frequency resolution is different in each of these subranges as follows:

Range	Resolution
0.1Hz to 4.9999kHz	0.1Hz
5.000kHz to 49.999kHz	1Hz
50.00kHz to 550.00000MHz	10Hz

If the frequency specified in the command has a greater resolution than the subrange it falls in, the frequency is rounded off to the nearest allowable resolution.

The FREquency? query causes the current frequency setting to be returned.

HELP?**Type:**

Query

Query syntax:

HELp?

Query response:

HELP ABSTOUCH,AMPLITUDE,CAL,ERROR,
EVENT,EXTREF,FREQUENCY,HELP,ID,INIT,
LEVELED,OUTPUT,RECALL,REFREQ,RQS,SET,
STORE,TEST,USEREQ

Discussion:

This command returns the word `HELP` followed by a list of all the command headers the SG 5030 accepts.

ID?**Type:**

Query

Query syntax:

ID?

Query response:

ID TEK/SG5030,V81.1,Fx.x

Discussion:

This command returns the instrument identification and the firmware version, as follows:

TEK/SG5030 — identifies the instrument type.

V81.1 — identifies the version of the Tektronix Codes and Formats used in the SG 5030 firmware design.

Fx.x — identifies the instrument's firmware version. For example, F1.0 indicates the firmware version 1.0.

INIT

Type:

System

Setting syntax:

INIT

Example:

INIT

Discussion:

The INIT command clears the current settings and initializes the SG 5030 to the following predefined settings:

```
OUTPUT OFF
AMPLITUDE 1.000
FREQUENCY 1.000000E+7
REFREQ OFF
RQS ON
USEREQ OFF
```

After the SG 5030 has executed the INIT command, the display shows `FREQ 10.0000MHz`, and the switch button `VARIABLE` is lighted. (No other switches are lighted.)

This command has the same effect as the `RECALL 0` command. Neither of these commands affects the `UNLVL` or `EXT TIMEBASE` Active LED. The stored settings buffer is not affected.

LEVELED?

Type:

Query

Query syntax:

LEVEled?

Query response: (one of the following)

```
LEVELED YES
LEVELED NO
```

Discussion:

This command returns the leveled-signal status of the output signal (YES or NO).

OUTPUT**Type:**

Setting or query

Setting syntax:

```
OUTput ON
OUTput OFF
```

Examples:

```
OUTPUT ON
OUT OFF
```

Query syntax:

```
OUTput?
```

Query response: (one of the following)

```
OUTPUT ON
OUTPUT OFF
```

Discussion:

This command turns the signal output on or off at the OUTPUT HEAD connectors, depending on the argument specified. The source impedance is maintained when the output is off. At power-up, the output is set to OFF.

The `OUTput?` command returns the current status of the output signal (ON or OFF).

RECALL**Type:**

Operational

Syntax:

```
RECall <num>
```

Examples:

```
RECALL 2
REC 7
REC 0
```

Discussion:

This command recalls the instrument settings from the non-volatile RAM location specified in the `<num>` argument, and sets the instrument to those settings. The `<num>` argument can be from 0 to 20 (decimal). Numbers 1 through 20 are used for user-selectable setups; number 0 references the initialization setup (that is, the `RECALL 0` command is equivalent to the `INIT` command). If no settings are stored in the specified location, the instrument assumes the `INIT` command settings.

REFREQ

Type:

Setting or query

Setting syntax:

REFreq ON
REFreq OFF

Query syntax:

REFreq?

Query response: (one of the following)

REFREQ ON
REFREQ OFF

Discussion:

This command turns the 50kHz reference frequency ON and OFF. When the reference frequency is ON, the variable frequency controls are disabled and the reference frequency is connected to the output. When the reference frequency is OFF, the variable frequency controls are enabled and control the frequency of the output signal. The output frequency is returned to the previous variable frequency. The output amplitude remains at its last setting.

The REFreq? command returns the current status of the reference frequency (ON or OFF).

RQS

Type:

Setting or query

Setting syntax:

RQS ON
RQS OFF

Query syntax:

RQS?

Query response: (one of the following)

RQS ON
RQS OFF

Discussion:

This command enables and disables the instruments ability to generate service requests (SRQs). When RQS (request for service) is ON, the instrument asserts an SRQ on the GPIB whenever an event occurs that requires a service request. The events that normally cause service requests to be asserted include the power-up sequence, self-test errors, front-panel operation errors, programming errors, and internal errors.

When RQS is OFF, SRQs are saved, and the SRQ annunciator light on the instrument front panel is lit. An ERROR? or EVENT? command query can then be used to determine which SRQs have been generated.

The RQS? command returns the current status of the SRQ function (ON or OFF).

SET?**Type:**

Query

Query syntax:

SET?

Query response example:

```
OUTPUT ON;AMPLITUDE
17.40E-3;FREQUENCY
123.34543E+6;REFREQ OFF;RQS ON;USEREQ
OFF
```

Discussion:

This command returns the current instrument setting for OUTPUT (ON or OFF), AMPLITUDE, FREQUENCY, REFREQ (ON or OFF), RQS (ON or OFF), and USEREQ (ON or OFF). The maximum length of the settings query data string is 84 bytes.

STORE**Type:**

Operational

Syntax:

STOre <num>

Examples:

```
STORE 8
STO 13
```

Discussion:

This command causes the current instrument front-panel control settings to be stored in non-volatile RAM at a location specified with the <num> argument. The <num> argument can be from 1 to 20 (decimal). Twenty front-panel control settings are saved for each instrument setup. Nonvolatile RAM is provided so that the settings are saved when power is turned off to the instrument.

TEST

Type:

Operational

Syntax:

TEST

Example:

TEST

Discussion:

This command causes the instrument to perform a self test. When the test is complete, the instrument returns to the settings last entered. If the self test failed, the SG 5030 returns an SRQ to the controller.

USEREQ

Type:

Setting or query

Setting syntax:

USEReq ON
USEReq OFF

Examples:

USEREQ ON
USE OFF

Query syntax:

USEReq?

Query response: (one of the following)

USEREQ ON
USEREQ OFF

Discussion:

This command enables or disables the SRQ interrupt that is generated when the front-panel INST ID button is pressed. When the USEREQ (user request) function is OFF, the instrument is inhibited from returning the instrument ID SRQ when the INST ID button is pressed.

The USEReq? command returns the current status of the instrument ID SRQ (ON or OFF).

B7 B6 B5			0 0 0	0 0 1	0 1 0	0 1 1	1 0 0	1 0 1	1 1 0	1 1 1
BITS			CONTROL		NUMBERS SYMBOLS		UPPER CASE		LOWER CASE	
B4	B3	B2 B1								
0	0	0 0	NUL	DLE	SP	0	@	P	'	p
0	0	0 1	SOH	DC1	!	1	A	Q	a	q
0	0	1 0	STX	DC2	"	2	B	R	b	r
0	0	1 1	ETX	DC3	#	3	C	S	c	s
0	1	0 0	EOT	DC4	\$	4	D	T	d	t
0	1	0 1	ENQ	NAK	%	5	E	U	e	u
0	1	1 0	ACK	SYN	&	6	F	V	f	v
0	1	1 1	BEL	ETB	,	7	G	W	g	w
1	0	0 0	BS	CAN	(8	H	X	h	x
1	0	0 1	HT	EM)	9	I	Y	i	y
1	0	1 0	LF	SUB	*	:	J	Z	j	z
1	0	1 1	VT	ESC	+	;	K	[k	{
1	1	0 0	FF	FS	,	<	L	\	l	
1	1	0 1	CR	GS	-	=	M]	m	}
1	1	1 0	SO	RS	.	>	N	^	n	~
1	1	1 1	SI	US	/	?	O	_	o	DEL (RUBOUT)
			ADDRESSED COMMANDS	UNIVERSAL COMMANDS	LISTEN ADDRESSES		TALK ADDRESSES		SECONDARY ADDRESSES OR COMMANDS (PPE) (PPD)	

KEY

octal	25	PPU	GPIB code
	NAK		ASCII character
hex	15	21	decimal

Tektronix
COMMITTED TO EXCELLENCE

REF: ANSI STD X3. 4-1977
IEEE STD 488-1978
ISO STD 646-1973

TEKTRONIX STD 062-5435-00 4 SEP 80
COPYRIGHT © 1979, 1980 TEKTRONIX, INC. ALL RIGHTS RESERVED.

Figure 3-2: ASCII Character Chart

Messages And Communication Protocol

Command Separator

A message consists of a command or a series of commands, followed by a message terminator. Messages consisting of multiple commands must have the commands separated by semicolons. A semicolon at the end of a message is optional. For example, each line below is a message:

```
INIT
INIT;RQS ON;USER OFF;ID?;SET?
init;
```

Message Terminator

Messages may be terminated with EOI (the GPIB End-Or-Identify signal) or the ASCII line feed (LF) character. Some controllers assert EOI concurrently with the last data byte; others use only the LF character as a terminator. The SG 5030 can be set via the front panel to accept either terminator. With EOI only selected as the terminator, the instrument interprets any data byte received with EOI asserted as the end of an input message; it also asserts EOI concurrently with the last byte of an output message. With LFEOI selected as the terminator, the SG 5030 interprets either a LF character or EOI as a message terminator. Here, the instrument interprets the LF character without EOI asserted (or any data byte received with EOI asserted) as the end of an input message. To terminate output messages, the instrument transmits a carriage return (CR) followed by a LF character with EOI asserted. The SG5030 is shipped with EOI only selected.

Formatting a Message

Commands sent to the SG5030 must have the proper format (syntax) to be understood; however, this format is flexible in that variations are acceptable. The following describes this format and the acceptable variations.

The instrument expects all commands to be encoded in ASCII; however, it accepts both upper and lower case ASCII characters. All data output is in upper case (see Fig. 3-2).

As previously discussed, a command consists of a header followed, if necessary, by arguments. A command with arguments may have a header delimiter, which consists of the space character (SP) between the header and the argument.

The SG 5030 ignores any extra formatting characters SP, CR (carriage return), and LF that are added between the header delimiter and the argument, as shown in the following examples. (In these examples, the formatting characters are shown inside parenthesis.)

Example 1: RQS(SP)ON;

Example 2: RQS(SPSP)ON;

Example 3: RQS(SPCRLFSPSP)ON

(In the LFEOI message terminator mode, the LF character can also be used to terminate messages.)

In general, these formatting characters are ignored after any delimiter and at the beginning and end of a message.

- (SP)RQS(SP)ON;(CRLF)
- (SP)USER(SP)OFF

Number Formats

The SG5030 recognizes the following three number formats:

- **NR1** (integer) — Signed or unsigned decimal integers (for example, +0, -0, +1, 2, -1, -10).
- **NR2** (real) — Signed or unsigned decimal real numbers (for example, -3.2, +5.0, .2).
- **NR3** (floating point) — Floating-point numbers expressed in scientific notation (for example, +1.0E-2, 1.47E1, 1.E-2, 0.01E+0).

In each of these formats, an unsigned value is interpreted as a positive value (that is, 2 is equivalent to +2).

Rounding of Numeric Arguments

The SG 5030 rounds numeric arguments to the nearest unit of resolution and then checks for out-of-range conditions. If the argument is outside the allowable range, the instrument sets the value to the highest (or lowest) allowable value within the range. For example, if a frequency of 700MHz is given, the instrument

frequency is set to 550MHz, the maximum allowable frequency and an Error 205 (argument out of range) is generated.

Message Protocol

As the SG 5030 receives a message it is stored in the input Buffer, processed, and executed. Processing a message consists of decoding commands, detecting delimiters, and checking syntax. If an error is detected during processing, the instrument will assert SRQ.

Executing a message consists of performing the actions specified by its command(s). For setting commands, this involves updating the instrument settings. The setting commands are executed in order received. Execution of the settings occurs when the instrument has received enough characters of the command to determine a valid setting. The instrument does not require a message terminator to execute a valid command.

The SG 5030 behaves the same regardless of whether each command is sent as a separate message or several commands are included in one message. The only difference is that multiple-command messages require less bus overhead. When the SG 5030 receives a query/output command in a message, it executes the command by retrieving the appropriate data and putting it in the output buffer. The instrument then continues to process and execute the remainder of the commands in the message. The query data is sent to the controller when the SG 5030 is made a talker.

Note:

It is not recommended that multiple queries be placed in one message. If more than one query is in a message, one or more response(s) may be lost. No error message will be generated.

Multiple Messages

The SG 5030 input buffer has finite capacity and a single message may be long enough to fill it. In this case, the instrument will process the first portion of the message before the instrument accepts additional input. While the commands in the full input buffer are being processed, the instrument holds off additional data (by asserting NRFQ) until space is available in the input buffer.

When space is available, the instrument can accept the next message before the first has been completely processed.

As described above, after the SG 5030 executes a query-output command in a message, it holds the response in its output buffer until the controller makes the instrument a talker. If the instrument receives a new message before all of the output from the previous message is read, it clears the output buffer before execution the new message. This prevents the controller from getting unwanted data from old messages.

One other situation can cause the SG 5030 to delete output. The execution of a long message might cause both the input and output buffers to become full. When this occurs, the instrument cannot finish execution of the message because it is waiting for the controller to read the data it has generated; but the controller cannot read the data because it is waiting to finish sending its message. Because the instrument's input buffer is full and it is holding off the rest of the controller's message with NRFQ, the system hangs up with the controller and instrument waiting for each other. When the SG 5030 detects this condition, it generates an error, asserts SRQ, and deletes the data in the output buffer.

Instrument Responses to IEEE-488 Interface Messages

The IEEE-488.1-1987 bus standard defines a set of interface commands and the effects of those commands on the instrument's interface functions. This section describes the effects of the IEEE-488 interface messages on SG 5030 operation. The standard abbreviations for these commands are used here.

UNL (Unlisten) and UNT (Untalk)

The UNL command cause the SG 5030 listener function goes to its idle state (unaddressed). In the idle state, the instrument does not accept instrument commands from the IEEE-488 bus.

The UNT command causes the instrument talker function to its idle state. In this state, the instrument cannot supply output data via the bus.

The ADRS indicator is off when both the talker and listener functions are idle. If the SG 5030 is either talk-addressed or listen-addressed, the indicator is on.

IFC (Interface Clear)

The IFC command has the same effect as issuing both the UNT and UNL commands. The front-panel ADRS indicator is off.

DCL (Device Clear)

The DCL command reinitializes communication between the SG 5030 and its controller. In response to DCL, the instrument clears any input and output messages. Also cleared are any errors or events waiting to be reported, except the power-on event. If the SRQ line is asserted for any reason other than power-on when DCL is received, SRQ is unasserted.

SDC (Selected Device Clear)

The SDC command has the same function as DCL; however, only instruments specifically addressed respond to SDC.

SPE (Serial Poll Enable)

The SPE command enables the SG 5030 to supply output serial poll status bytes when it is talk-addressed.

SPD (Serial Poll Disable)

The SPD command switches the SG 5030 to its normal operation of sending the data from the output buffer.

MLA (My Listen Address) and MTA (My Talk Address)

The SG 5030 IEEE-488 bus address establishes the primary listen and talk addresses. The current setting of the bus address is displayed on the instrument front-panel readout window when the INST ID button is pressed. When the instrument is addressed to either talk or listen, the front-panel ADRS indicator is lighted.

LLO (Local Lockout)

The LLO command causes the SG 5030 to change to a lockout state: from LOCS to LWLS or from REMS to RWLS. The LLO command sent by itself does not set the instrument into Local Lockout. You must send a following command to cause the GPIB circuitry to recognize and assert LLO.

REN (Remote Enable)

If REN is true, the SG 5030 will change to a remote state (from LOCS to REMS if the internal message return-to-local (rtl) is false, or from LWLS to RWLS when its listen address is received). REN false causes a transition from any state to LOCS; the instrument stays in LOCS as long as REN is false.

A REN transition may occur after message processing has begun. In this case, execution of the message being processed is not affected by a transition.

GTL (Go To Local)

If the instrument is listen addressed, the GTL command causes the SG 5030 to change to local state. Remote-to-local transitions caused by GTL do not affect the execution of the message being processed when GTL is received.

Remote-Local Operation

The preceding discussion of interface messages describes the state transitions that the GTL and REN commands cause. Most front-panel controls cause a transition from REMS to LOCS by asserting a message called return-to-local (rtl). This transition may occur during message execution; but, in contrast to GTL and REN transitions, a transition initiated by rtl affects message execution. In this case, the instrument generates an error if there are any unexecuted setting or operational commands. Front-panel controls that change only the display (such as INST ID) do not affect the remote-local states; only front-panel controls that

change settings assert rtl. The rtl message remains asserted while multiple keystroke settings are entered, and it is unasserted after the execution of the settings.

The SG 5030 maintains a record of its settings in the current settings buffer and new settings from the front panel or the controller update these recorded settings. In addition, the front panel is updated to reflect setting changes caused by commands. Instrument settings are unaffected by transitions between the four remote-local states. The REM indicator is lighted when the instrument is in REMS or RWLS.

Local State (LOCS)

In LOCS, the operator controls the SG 5030 settings via the front-panel push buttons and knob. The only bus commands that are executed are those that do not change instrument settings (query-output commands). All other bus commands (setting and operational commands) generate an error since those functions are under front-panel control.

Local Without Lockout State (LWLS)

When the SG 5030 is in LWLS, it operates the same as it does in LOCS, except that rtl does not inhibit a transition to remote.

Remote State (REMS)

In REMS, the SG 5030 executes all instrument commands from the GPIB bus. For commands having associated front-panel indicators, the front panel is updated when the commands are executed.

Remote with Lockout State (RWLS)

In RWLS, the SG 5030 operates similar to REMS operation except that the rtl message is ignored. (The front panel is locked out.)

Status And Error Reporting

The SG 5030 can alert the controller that it requires service through the service request function (defined in the IEEE-488 Standard). The service request function also provides a means of indicating that an event (a change in status or an error) has occurred. To service a request, the controller performs a serial poll. In response to this poll, the SG 5030 returns a status byte (STB), which indicates whether or not it was requesting service. The STB can also provide a limited amount of information about the request. The format of the information encoded in the STB is given in Fig. 3-3. Note that, when data bit 8 is set, the STB conveys Device Status information, which is contained in bits 1 through 4. (The SG 5030 does not utilize this feature.)

In case of an intermittent error condition multiple SRQs may be stored in the SG 5030 internal stack. These SRQs can all be simultaneously cleared with a DCL (Device Clear) command.

NOTE

The SG 5030 status is available over the bus by Serial Poll and/or Error Query, with or without RQS on.

Because the STB conveys limited information about an event, the events are divided into classes, which the STB reports. The classes of events are defined as follows:

Command Error	Indicates that the SG 5030 has received a command that it cannot understand. The command does not affect the current state of the instrument.
Execution Error	Indicates that the instrument has received a command that it understands, but cannot execute because of the present state of the instrument, or because the command is out of the instrument's range.
Internal Error	Indicates that the instrument has detected a hardware condition or firmware problem that prevents operation.

Error Messages Sent to the Front Panel

Error messages sent to the front panel remain displayed until any front-panel button is pushed or a GPIB command is executed.

An NVRAM Battery Test (E363) error means the battery backed up memory failed, resulting in the front panel setups and the GPIB address & message terminator

information being lost. Front-panel setups will default to the factory default settings with the GPIB address 25 and message terminator of EOI only.

A CAL Constant Checksum Failure (E364) means the calibration constants are in some way not correct. The instrument then defaults to a nominal set of calibration constants and the Front Panel RECAL LED will be illuminated.

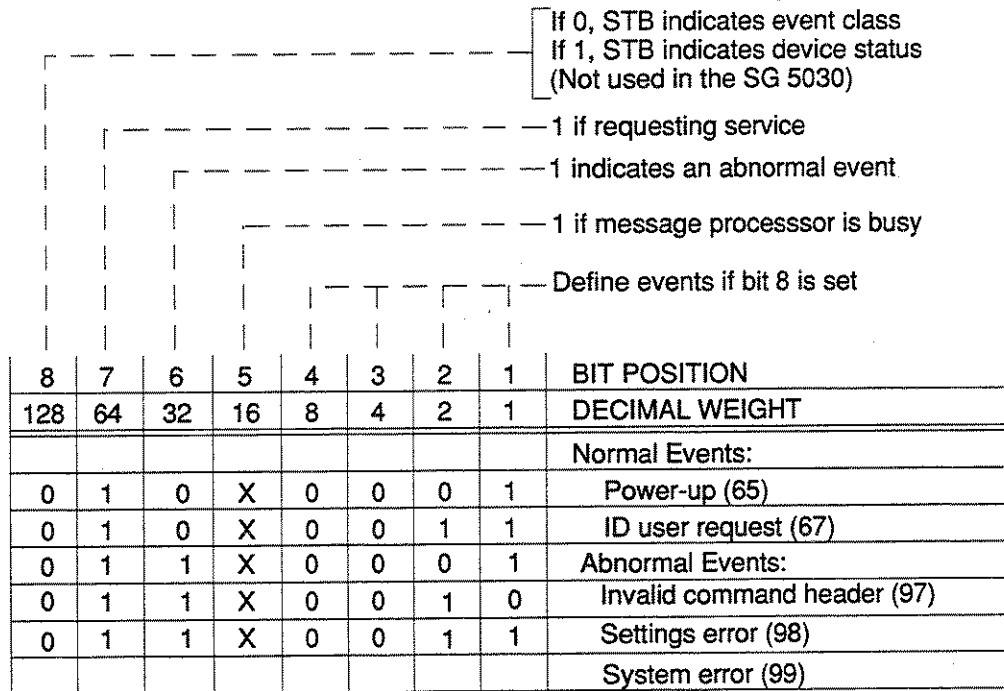

7703-9

Figure 3-3: STB Bit Configuration

Bus Error/Event Codes And Serial Poll Response

The SG 5030 provides additional information about many of the events, particularly the errors reported in the STB. The controller can request the additional information by issuing an `ERROR?` or `EVENT?` command. In response, the SG 5030 returns a code that defines the event. These codes are described in Table 3-4.

Power-on Sequences And Settings

Each time power is applied to the SG 5030, the internal microprocessor performs a self test diagnostic routine to check the instrument RAM and ROM functionality. If no RAM or ROM error is found, the microprocessor performs further routines that check the functionality of other instrument hardware.

If a hard ROM, RAM or NVRAM failure is found at power up, the instrument will lock up and indicate the error type with the four LEDs on the CPU board. The LED code is shown below:

	LED 1	LED 2	LED 3	LED 4
ROM	off	on	on	on
RAM	off	off	on	on
NVRAM	on	off	on	on

If a functional failure is detected, an error code will appear in the display window. The error will remain displayed until cleared by pressing any front-panel button or executing any GPIB command. The SG 5030 will respond to input and attempt to function in spite of the error. Refer to Table 3-4 for bus error codes and front-panel error codes.

Upon successful completion of the self tests, the SG 5030 restores the instrument settings that were in use when the instrument was last turned off, except that the sine-wave signal to the output head will be turned off.

Table 3-4: Error Query and Status Responses

Description	Error/Event Query Response	SerialPoll (Decimal) ¹
Command Errors/Events		
System normal	0	NSB ²
Command header error	101	97 or 113
Header delimiter error	102	97 or 113
Command argument error	103	97 or 113
Argument delimiter error	104	97 or 113
Non-numeric argument	105	97 or 113
Missing argument	106	97 or 113
Invalid message unit delimiter	107	97 or 113
Bad symbol	150	97 or 113
Syntax error	151	97 or 113
Symbol number too long	153	97 or 113
Invalid input character	154	97 or 113
Invalid string input	155	97 or 113
Numerical underflow	156	97 or 113
Execution Errors/Events		
Argument out of range	205	98 or 114
Not in adjustment mode	250	98 or 114
I/O buffers full, output flushed	251	98 or 114
Settings buffer empty	252	98 or 114
Illegal settings number specified	253	98 or 114
Beyond adjustment limit	254	98 or 114
Internal Errors/Events		
Interrupt fault	301	99 or 115
System error	302	99 or 115
HF unlevelled	350	99 or 115
Reference loop unlocked	351	99 or 115
Wide loop unlocked	352	99 or 115
Narrow loop unlocked	353	99 or 115
Offset loop unlocked	354	99 or 115
DDS loop unlocked	355	99 or 115
Unplugged error	356	99 or 115
CPU Self Test Errors		
EPROM checksum failure	360	99 or 115
NVRAM test failure	361	99 or 115
RAM test failure	362	99 or 115
NVRAM battery test failure	363	99 or 115
CAL constant checksum failure	364	99 or 115

Table 3-4: Error Query and Status Responses (Continued)

Description	Error/Event Query Response	SerialPoll (Decimal) ¹
Hardware Self Test Errors		
Output OFF test failure	370	99 or 115
REF Freq test failure	371	99 or 115
DDS OFF test failure	372	99 or 115
10.00000 MHz test failure	373	99 or 115
10.00001 MHz test failure	374	99 or 115
500.00000 MHz test failure	375	99 or 115
Wide Loop Divider test failure	376	99 or 115
Output Amp powered test failure	377	99 or 115
System Errors/Event		
No errors or events	0	NSB ²
Power on	401	65 or 81
ID User request	403	67 or 83
SRQ pending	455	NSB ²

¹ If the message processor is busy, the instrument returns a number 16 (decimal) higher than the serial poll response.

² No Status Byte.

Programming Examples

Talker/Listener Utility Programs

The following sample programs allow a user to send any of the commands listed in the Functional Command List and receive the data generated.

Talker/Listener Utility Program for IBM PC Compatibles

```

' *****
' *****SG 5030 TALKER/LISTENER
PROGRAM*****
' *****
' THIS PROGRAM REQUIRES THAT THE SG 5030 ADDRESS BE SET TO THE
' FACTORY DEFAULT OF 10.
COMMON SHARED IBSTA%, IBERR%, IBCNT%
ID$ = "TEKDEVI"
CALL IBFIND (ID$, BD%)          ' SELECT TEKDEVI FOR GPIB ACCESS
SG% = 10                        ' SG% = FACTORY DEFAULT ADDRESS OF 10
CALL IBPAD (BD%, SG%)          ' CHANGE TEKDEVI PRIMARY ADDRESS TO
ID$ = "GPIB0"                  ' SET UP GPIB FOR BOARD LEVEL
CALL IBFIND (ID$, GP%)          ' COMMUNICATION
REMOTE% = 1
CALL IBSRE (GP%, REMOTE%)      ' SET REMOTE ENABLE
CLS                              ' CLEAR SCREEN
REPLY$ = SPACE$(125)           ' DIMENSION RD$ TO 125
PRINT
"*****"
PRINT "*****SG 5030 TALKER/LISTENER
PROGRAM*****"
PRINT
"*****"
MAINPROG:
PRINT "RETURN TO EXIT; "
INPUT "ENTER MESSAGE(S)"L WRT$
IF WRT$ = " " THEN GOSUB TERMINATE
CALL IBWRT (BD%, WRT$)          ' SEND MESSAGE TO SG 5030
GOSUB CHECKGPIB                 ' CHECK FOR GPIB ERROR
' *****INPUT FROM
DEVICE*****
FOR T = 1 TO 1000
NEXT T
CALL IBRD (BD%, REPLY$)         ' INPUT DATA FROM SG 5030
GOSUB CHECKGPIB                 ' CHECK FOR GPIB ERROR GOSUB
CHECKSG                          ' GET SG 5030 ERROR MESSAGE
PRINT : PRINT "INSTRUMENT REPLY ", REPLY$
PRINT : PRINT "Returned status byte:'; SPR%,
PRINT : PRINT ERRM$
GOTO MAINPROG
' *****ERROR
ROUTINE*****

```

```

CHECKSG:
ERRM$ = SPACE$(50)
CALL IBRSP (BD%, SPR%)
CALL IBWRT (BD%, "ERR?")
CALL IBRD (BD%, ERRM$)
RETURN
CHECKGPIB:
IF IBSTA% >=0 AND BD% >=0 AND IBSTA% < &H4000 AND IBERR% <> 6 THEN RETURN'no error
to report
IF BD% < 0 THEN PRINT "device not installed - use IBCONF then reboot"
IF IBSTA% > 0 AND IBSTA% >= &H4000 THEN PRINT "timeout"
IF IBERR% = 6 THEN PRINT "timeout"
PRINT "gpib error "; IBERR%
IF IBERR% = 0 THEN PRINT "DOS error device not installed"
IF IBERR% = 1 THEN PRINT "function requires GPIB-PC to be CIC"
IF IBERR% = 2 THEN PRINT "no listener on write function"
IF IBERR% = 3 THEN PRINT "GPIB-PC not addressed correctly"
IF IBERR% = 4 THEN PRINT "invalid argument to function call"
IF IBERR% = 5 THEN PRINT "GPIB-PC not system controller as required"
IF IBERR% = 6 THEN PRINT "I/O operation aborted"
IF IBERR% = 7 THEN PRINT "non-existant GPIB-PC board"
IF IBERR% =10 THEN PRINT "I/O started before previous operation completed"
IF IBERR% =11 THEN PRINT "no capability for operation"
IF IBERR% =12 THEN PRINT "file system error"
IF IBERR% =14 THEN PRINT "command error during device call"
IF IBERR% =15 THEN PRINT "serial poll status byte lost"
IF IBERR% =16 THEN PRINT "SRQ stuck in ON position"
INPUT "[ENTER] TO CONTINUE"; A$ ' if help$ then
RETURN
' *****TERMINATE PROGRAM*****
TERMINATE:
REMOTE% = 0
CALL IBSRE (GP%, REMOTE%) ' CLEAR REMOTE ENABLE
PRINT "PROGRAM TERMINATED."
END

```

