

Performance Verification

Tektronix

**TDS 420 & 460
Digitizing Oscilloscopes**

070-8721-00

Instrument Serial Numbers

Each instrument manufactured by Tektronix has a serial number on a panel insert or tag, or stamped on the chassis. The first letter in the serial number designates the country of manufacture. The last five digits of the serial number are assigned sequentially and are unique to each instrument. Those manufactured in the United States have six unique digits. The country of manufacture is identified as follows:

B010000	Tektronix, Inc., Beaverton, Oregon, USA
E200000	Tektronix United Kingdom, Ltd., London
J300000	Sony/Tektronix, Japan
H700000	Tektronix Holland, NV, Heerenveen, The Netherlands

Instruments manufactured for Tektronix by external vendors outside the United States are assigned a two digit alpha code to identify the country of manufacture (e.g., JP for Japan, HK for Hong Kong, IL for Israel, etc.).

Tektronix, Inc., P.O. Box 500, Beaverton, OR 97077

Printed in U.S.A.

Copyright © Tektronix, Inc., 1992. All rights reserved. Tektronix products are covered by U.S. and foreign patents, issued and pending. The following are registered trademarks: TEKTRONIX, TEK, TEKPROBE, and SCOPE-MOBILE.

WARRANTY

Tektronix warrants that this product will be free from defects in materials and workmanship for a period of three (3) years from the date of shipment. If any such product proves defective during this warranty period, Tektronix, at its option, either will repair the defective product without charge for parts and labor, or will provide a replacement in exchange for the defective product.

In order to obtain service under this warranty, Customer must notify Tektronix of the defect before the expiration of the warranty period and make suitable arrangements for the performance of service. Customer shall be responsible for packaging and shipping the defective product to the service center designated by Tektronix, with shipping charges prepaid. Tektronix shall pay for the return of the product to Customer if the shipment is to a location within the country in which the Tektronix service center is located. Customer shall be responsible for paying all shipping charges, duties, taxes, and any other charges for products returned to any other locations.

This warranty shall not apply to any defect, failure or damage caused by improper use or improper or inadequate maintenance and care. Tektronix shall not be obligated to furnish service under this warranty a) to repair damage resulting from attempts by personnel other than Tektronix representatives to install, repair or service the product; b) to repair damage resulting from improper use or connection to incompatible equipment; or c) to service a product that has been modified or integrated with other products when the effect of such modification or integration increases the time or difficulty of servicing the product.

THIS WARRANTY IS GIVEN BY TEKTRONIX WITH RESPECT TO THIS PRODUCT IN LIEU OF ANY OTHER WARRANTIES, EXPRESSED OR IMPLIED. TEKTRONIX AND ITS VENDORS DISCLAIM ANY IMPLIED WARRANTIES OF MERCHANTABILITY OR FITNESS FOR A PARTICULAR PURPOSE. TEKTRONIX' RESPONSIBILITY TO REPAIR OR REPLACE DEFECTIVE PRODUCTS IS THE SOLE AND EXCLUSIVE REMEDY PROVIDED TO THE CUSTOMER FOR BREACH OF THIS WARRANTY. TEKTRONIX AND ITS VENDORS WILL NOT BE LIABLE FOR ANY INDIRECT, SPECIAL, INCIDENTAL, OR CONSEQUENTIAL DAMAGES IRRESPECTIVE OF WHETHER TEKTRONIX OR THE VENDOR HAS ADVANCE NOTICE OF THE POSSIBILITY OF SUCH DAMAGES.



This is the Performance Verification for the TDS 420 and TDS 460 Oscilloscopes. It contains procedures suitable for determining if the instrument functions, was adjusted properly, and meets the performance characteristics as warranted.

Also contained in this document is a copy of the specifications for the TDS 400 Digitizing Oscilloscopes.

Related Manuals

The following documents are related to the use or service of the digitizing oscilloscope.

- The TDS 420 & TDS 460 User Manual (Tektronix part number 070-8034-02).
- The TDS Family Programmer Manual (Tektronix part number 070-8318-05) describes using a computer to control the digitizing oscilloscope through the GPIB interface.
- The TDS 420 & TDS 460 Reference (Tektronix part number) gives you a quick overview of how to operate your digitizing oscilloscope.
- The TDS 420 & TDS 460 Service Manual (Tektronix part number) provides information for maintaining and servicing your digitizing oscilloscope to the module level.
- The TDS 420 & TDS 460 Technical Reference (Tektronix part number) provides full component-level service information for your digitizing oscilloscope.
- The TDS Family Option 2F Instruction Manual (Tektronix part number 070-8582-01) describes use of the Advanced DSP Math option (for TDS oscilloscopes equipped with that option only).
- The TDS Family Option 13 Instruction Manual (Tektronix part number 070-8567-00) describes using the optional Centronics® and RS-232 interfaces for obtaining hard copies (for TDS oscilloscopes equipped with that option only).
- The TDS Family Option 3P Instruction Manual (Tektronix part number 070-8567-00) describes using the optional Printerpak (for TDS oscilloscopes equipped with that option only).



Performance Verification Procedures

Brief Procedures	1-1
General Instructions	1-1
Conventions	1-2
Self Tests	1-4
Verify Internal Adjustment, Self Compensation, and Diagnostics	1-4
Functional Tests	1-6
Verify All Input Channels	1-6
Verify the Time Base	1-8
Verify the Main and Delayed Trigger Systems	1-9
Performance Tests	1-13
Prerequisites	1-13
Equipment Required	1-13
Test Record	1-16
Signal Acquisition System Checks	1-18
Check Offset Accuracy	1-18
Check DC Voltage Measurement Accuracy (Averaged)	1-20
Check Analog Bandwidth	1-22
Check Delay Match Between Channels	1-27
Time Base System Checks	1-31
Check Accuracy for Long-Term Sample Rate, Delay Time, and Delta Time Measurements	1-31
Trigger System Checks	1-35
Check Accuracy, Trigger Level or Threshold, DC Coupled ..	1-35
Sensitivity, Edge Trigger, DC Coupled	1-38
Maximum Input Frequency, Auxiliary Trigger	1-42
Check Video Trigger Sensitivity (Option 05 Equipped Models Only)	1-44
Output Signal Check	1-48
Check Probe Adjust Output	1-48

Specifications

Specifications	2-1
General	2-1
Nominal Traits	2-2
Warranted Characteristics	2-7

Performance Conditions	2-7
Typical Characteristics	2-13



List of Illustrations

Figure 1-1: Map of Display Functions	1-3
Figure 1-2: Verifying Adjustments and Signal Path Compensation ..	1-5
Figure 1-3: Universal Test Hookup for Functional Tests	1-7
Figure 1-4: Initial Test Hookup	1-18
Figure 1-5: Initial Test Hookup	1-20
Figure 1-6: Initial Test Hookup (TDS 420)	1-23
Figure 1-7: Initial Test Hookup (TDS 460)	1-23
Figure 1-8: Measurement of Analog Bandwidth	1-26
Figure 1-9: Initial Test Hookup	1-28
Figure 1-10: Measurement of Channel Delay	1-29
Figure 1-11: Initial Test Hookup	1-31
Figure 1-12: Measurement of Accuracy—Long-Term and Delay-Time	1-33
Figure 1-13: Initial Test Hookup	1-35
Figure 1-14: Initial Test Hookup	1-38
Figure 1-15: Measurement of Trigger Sensitivity	1-40
Figure 1-16: Initial Test Hookup	1-42
Figure 1-17: Confirming Auxiliary Triggering at Maximum Triggering Frequency	1-43
Figure 1-18: Initial Test Hookup	1-44
Figure 1-19: Adjusting Sync Pulse Amplitude	1-45
Figure 1-20: Measurement of Video Sensitivity	1-46
Figure 1-21: Initial Test Hookup	1-48
Figure 1-22: Measurement of Probe Compensator Limits	1-49



List of Tables

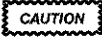

Table 1-1: Test Equipment	1-14
Table 1-2: DC Offset Accuracy	1-19
Table 1-3: Analog Bandwidth (TDS 420)	1-24
Table 1-4: Analog Bandwidth (TDS 460)	1-25
Table 2-1: Nominal Traits—Signal Acquisition System	2-2
Table 2-2: Nominal Traits—Time Base System	2-3
Table 2-3: Nominal Traits—Triggering System	2-4
Table 2-4: Nominal Traits—Display System	2-4
Table 2-5: Nominal Traits—Data Storage	2-5
Table 2-6: Nominal Traits—GPIB Interface, Video Output, and Power Fuse	2-5
Table 2-7: Nominal Traits—Mechanical	2-6
Table 2-8: Warranted Characteristics—Signal Acquisition System ..	2-7
Table 2-9: Warranted Characteristics—Time Base System	2-9
Table 2-10: Warranted Characteristics—Triggering System	2-10
Table 2-11: Warranted Characteristics—Probe Compensator Output	2-11
Table 2-12: Power Requirements	2-11
Table 2-13: Warranted Characteristics—Environmental, Safety, and Reliability	2-12
Table 2-14: Typical Characteristics—Signal Acquisition System	2-13
Table 2-15: Typical Characteristics—Time Base System	2-14
Table 2-16: Typical Characteristics—Triggering System	2-14
Table 2-17: Typical Characteristics—Data Handling	2-15

Safety

Please take a moment to review these safety precautions. They are for your protection and to prevent damage to the digitizing oscilloscope. This safety information applies to all operators and service personnel.

Symbols and Terms

These two terms appear in manuals:

-  statements identify conditions or practices that could result in damage to the equipment or other property.
-  statements identify conditions or practices that could result in personal injury or loss of life.

These two terms appear on equipment:

- *CAUTION* indicates a personal injury hazard not immediately accessible as one reads the marking, or a hazard to property including the equipment itself.
- *DANGER* indicates a personal injury hazard immediately accessible as one reads the marking.

This symbol appears in manuals:



Static-Sensitive Devices

These symbols appear on equipment:



DANGER
High Voltage



Protective
ground (earth)
terminal



ATTENTION
Refer to
manual

Specific Precautions

Observe all of these precautions to ensure your personal safety and to prevent damage to either the digitizing oscilloscope or equipment connected to it.

Power Source

The digitizing oscilloscope operates from a power source that will not apply more than 250 V_{RMS} between the supply conductors or between either supply conductor and ground. A protective ground connection, through the grounding conductor in the power cord, is essential for safe system operation.

Grounding the Digitizing Oscilloscope

The digitizing oscilloscope is grounded through the power cord. To avoid electric shock, plug the power cord into a properly wired receptacle where earth ground has been verified by a qualified service person. Do this before making connections to the input or output terminals of the digitizing oscilloscope.

Without the protective ground connection, all parts of the digitizing oscilloscope are potential shock hazards. This includes knobs and controls that may appear to be insulators.

Use the Proper Power Cord

Use only the power cord and connector specified for your product. Use only a power cord that is in good condition.

Use the Proper Fuse

To avoid fire hazard, use only the fuse specified in the parts list for your product, matched by type, voltage rating, and current rating.

Do Not Remove Covers or Panels

To avoid personal injury, do not operate the digitizing oscilloscope without the panels or covers.

Electric Overload

Never apply to a connector on the digitizing oscilloscope a voltage that is outside the range specified for that connector.

Do Not Operate in Explosive Atmospheres

The digitizing oscilloscope provides no explosion protection from static discharges or arcing components. Do not operate the digitizing oscilloscope in an atmosphere of explosive gases.



Brief Procedures

The *Self Tests* use internal routines to confirm basic functionality and proper adjustment. No test equipment is required to do these test procedures.

The *Functional Tests* utilize the probe-adjust output at the front panel as a test-signal source for further verifying that the oscilloscope functions properly. A standard-accessory probe, included with this oscilloscope, is the only equipment required.

General Instructions

These procedures verify the TDS 400 Digitizing Oscilloscopes.

Besides the *Brief Procedures*, the set of procedures that can be used to verify oscilloscope performance includes the *Performance Tests*, found later in this section. You may not need to perform all of these procedures, depending on what you want to accomplish:

- To rapidly confirm that this oscilloscope functions and was adjusted properly, just do the procedures under *Self Tests*, which begin on page 1-4.

Advantages: These procedures are quick to do, require no external equipment or signal sources, and perform extensive functional and accuracy testing to provide high confidence that the oscilloscope will perform properly. They can be used as a quick check before making a series of important measurements.

- To further check functionality, first do the *Self Tests* just mentioned; then do the procedures under *Functional Tests* that begin on page 1-6.

Advantages: These procedures require minimal additional time to perform, require no additional equipment other than a standard-accessory probe, and more completely test the internal hardware of this oscilloscope. They can be used to quickly determine if the oscilloscope is suitable for putting into service, such as when it is first received.

- If more extensive confirmation of performance is desired, do the *Performance Tests*, beginning on page 1-13, after doing the *Functional* and *Self Tests* just referenced.

Advantages: These procedures add direct checking of warranted specifications. They require more time to perform and suitable test equipment is required. (See *Equipment Required* on page 1-13.)

If you are not familiar with operating this oscilloscope, read *General Operating Instructions* in Section 3 of this manual. These instructions will acquaint you with the use of the front-panel controls and the menu system.

Conventions

Throughout these procedures the following conventions apply:

- Each test procedure uses the following general format:

Title of Test

Equipment Required

Prerequisites

Procedure

- Each procedure consists of as many steps, substeps, and subparts as required to do the test. Steps, substeps, and subparts are sequenced as follows:

1. First Step

- a. First Substep

- First Subpart
- Second Subpart

- b. Second Substep

2. Second Step

- In steps and substeps, the lead-in statement in italics instructs you what to do, while the instructions that follow tell you how to do it: in the example step below, "*Initialize the oscilloscope*" by doing "Press save/recall **SETUP**. Now, press the main-menu button..."

Initialize the oscilloscope: Press save/recall **SETUP**. Now, press the main-menu button **Recall Factory Setup**; then the side-menu button **OK Confirm Factory Init**.

- Where instructed to use a front-panel button or knob, or select from a main or side menu, or verify a readout or status message, the name of the button or knob appears in boldface type: "press **SHIFT**; then **ACQUIRE MENU**," "press the main-menu button **Coupling**," or "verify that the status message is **Pass**."



The symbol at the left is accompanied by information you must read to do the procedure properly.

- Refer to Figure 1-1: “Main menu” refers to the menu that labels the seven menu buttons under the display; “side menu” refers to the menu that labels the five buttons to the right of the display.

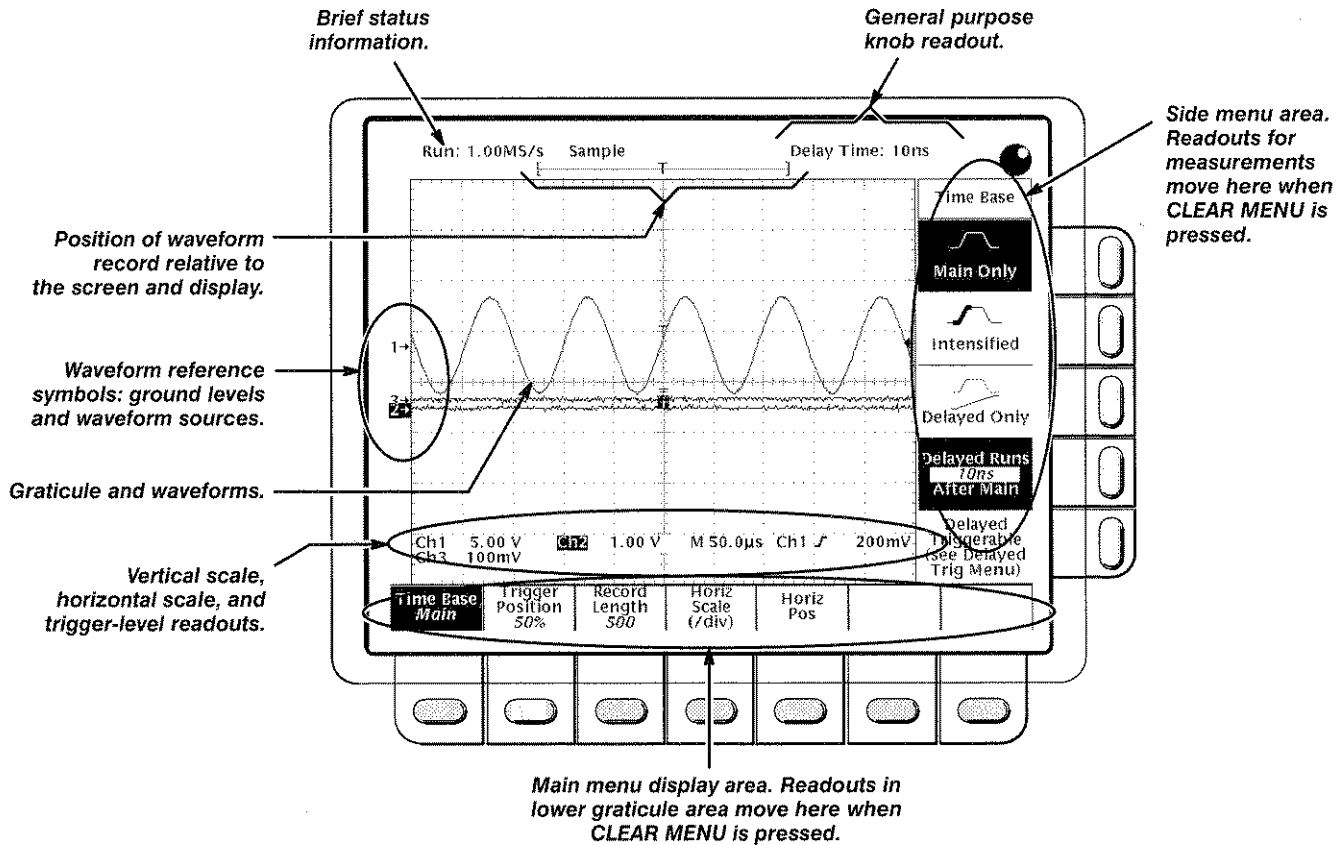

Figure 1-1: Map of Display Functions

- Where instructed to use a front-panel button or knob, or select from a main or side menu, or verify a readout or status message, the name of the button or knob appears in boldface type: “press **SHIFT**; then **ACQUIRE MENU**,” “press the main-menu button **Coupling**,” or “verify that the status message is **Pass**.”
- In steps and substeps, the lead in statement in italics instructs you what to do, while the instructions that follow tell you how to do it: in the example step below, “*Initialize the instrument*” by doing “Press save/recall **SETUP**. Now, press the main-menu button... .”

Initialize the instrument: Press **SAVE/RECALL SETUP**. Now, press the main-menu button **Recall Factory Setup**; then the side-menu button **OK Confirm Factory Init**.

Self Tests

This procedure uses internal routines to verify that this oscilloscope functions and passes its internal self tests and signal path compensations. It also confirms that the oscilloscope was adjusted properly at the time it was last adjusted. No test equipment or hookups are required.

Verify Internal Adjustment, Self Compensation, and Diagnostics

Equipment Required: None.

Prerequisites: Power on the digitizing oscilloscope and allow a 20 minute warm-up before doing this procedure.

Procedure:

1. *Verify that internal diagnostics pass:* Do the following substeps to verify passing of internal diagnostics.
 - a. *Display the system diagnostics menu:*
 - Press **SHIFT**; then press **UTILITY**.
 - Repeatedly press the main-menu button **System** until **Diag/Err** is highlighted in the menu that pops up.
 - Repeatedly press the main-menu button **Area** until **All** is highlighted in the menu that pops up.
 - b. *Run the system diagnostics:* Press the main-menu button **Execute**; then press the side-menu button **OK Confirm Run Test**.
 - c. *Wait:* The internal diagnostics do an exhaustive verification of proper oscilloscope function. This verification will take up to a minute. While it progresses, a variety of test patterns will flash on screen. When finished, the resulting status will appear on the screen.
 - d. *Confirm no failures are found:* Verify that no failures are found and reported on-screen.
 - e. *Confirm the four adjustment sections have passed status:*
 - Press **SHIFT**; then press **UTILITY**.
 - Press the main menu button **System** until **Cal** is highlighted in the pop-up menu.
 - Verify that the word **Pass** appears in the main menu under the following menu labels: **Voltage Reference**, **High Frequency Response**, **Low Frequency Response**, and **Trigger Skew**. (See Figure 1-2.)

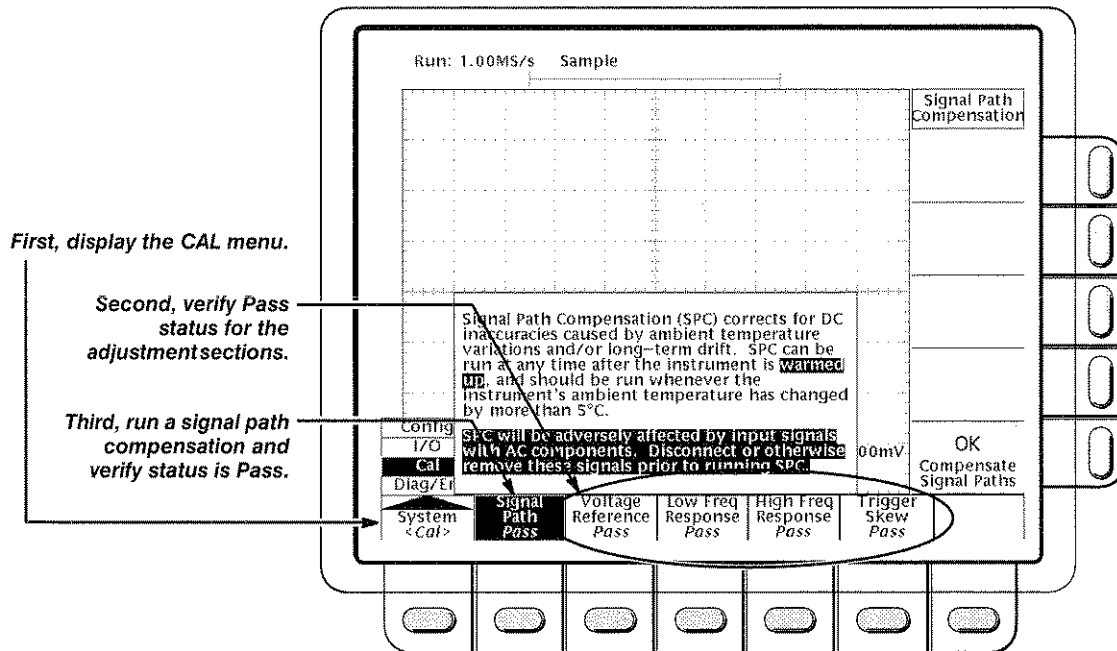

Figure 1-2: Verifying Adjustments and Signal Path Compensation

This oscilloscope lets you compensate the internal signal path used to acquire the waveforms you acquire and measure. By executing the signal path compensation feature (SPC), you optimize the oscilloscope capability to make accurate measurements based on the ambient temperature.

You *must* run an SPC anytime you wish to ensure that the measurements you make are made with the most accuracy possible. You should also run an SPC if the temperature has changed more than 5°C since the last SPC was performed.

- f. *Run the signal path compensation:* Press the main-menu button **Signal Path**; then press the side-menu button **OK Compensate Signal Paths**.

NOTE

Failure to run the signal path compensation may result in the oscilloscope not meeting warranted performance levels.



- g. *Wait:* signal path compensation runs in one to three minutes. While it progresses, a “clock” icon (shown at left) is displayed on-screen. When compensation completes, the status message will be updated to *Pass* or *Fail* in the main menu (see step h).
- h. *Confirm signal path compensation returns passed status:* Verify the word **Pass** appears under **Signal Path** in the main menu. (See Figure 1-2.)

2. *Return to regular service:* Press **CLEAR MENU** to exit the system menu.

Functional Tests

The purpose of these procedures is to confirm that this oscilloscope functions properly. The only equipment required is one of the standard-accessory probes.



These procedures verify functions; that is, they verify that oscilloscope features *operate*. They *do not* verify that they operate within limits.

Therefore, when the instructions in the functional tests that follow call for you to verify that a signal appears on-screen “that is about five divisions in amplitude” or “has a period of about six horizontal divisions,” etc., do **NOT** interpret the quantities given as limits. Operation within limits is checked in *Performance Tests*, which begin on page 1-13.



DO NOT make changes to the front-panel settings that are not called out in the procedures. Each verification procedure will require you to set the oscilloscope to certain default settings before verifying functions. If you make changes to these settings, other than those called out in the procedure, you may obtain invalid results. In this case, just redo the procedure from step 1.

When you are instructed to press a menu button, the button may already be selected (its label will be highlighted). If this is the case, it is not necessary to press the button.

Verify All Input Channels

Equipment Required: One P6138 probe.

Prerequisites: None.

Procedure:

1. *Install the test hookup and preset the oscilloscope controls:*

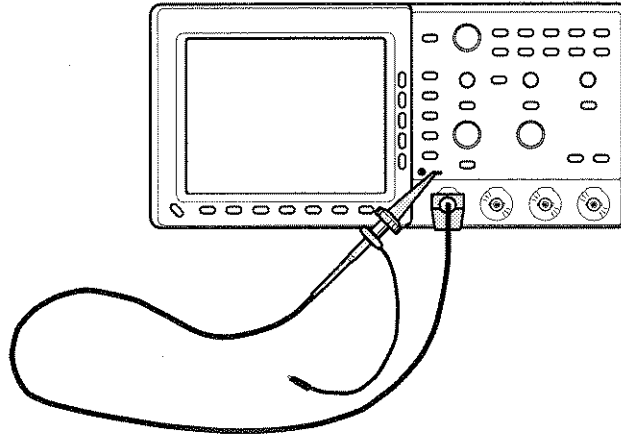

Figure 1-3: Universal Test Hookup for Functional Tests

- a. *Hook up the signal source:* Install the probe on **CH 1**. Connect the probe tip to **PROBE COMP** on the front panel; leave the probe ground unconnected.
 - b. *Initialize the oscilloscope:*
 - Press save/recall **SETUP**.
 - Press the main-menu button **Recall Factory Setup**.
 - Press the side-menu button **OK Confirm Factory Init**.
2. *Verify that all input channels operate:* Do the following substeps—test CH 1 first, *skipping substep a since CH 1 is already set up for verification from step 1*.
 - a. *Select an unverified channel:*
 - Press **WAVEFORM OFF** to remove from display the channel just verified.
 - Press the front-panel button that corresponds to the channel you are to verify.
 - Move the probe to the channel you selected.
 - b. *Set up the selected channel:*
 - Press **AUTOSET** to obtain a viewable, triggered display in the selected channel.
 - Set the vertical **SCALE** to 100 mV. Use the vertical **POSITION** knob to center the waveform vertically on screen.
 - Set the horizontal **SCALE** to 200 μ s.
 - Press **TRIGGER MENU**.
 - Press the main-menu button **Coupling**; then press the side menu-button **HF Rej**.

- c. *Verify that the channel is operational:* Confirm that the following statements are true.
 - The vertical scale readout for the channel under test shows a setting of 100 mV, and a square-wave probe-compensation signal about five divisions in amplitude is on-screen. (See Figure 1-1 on page 1-3 to locate the readout.)
 - The vertical **POSITION** knob moves the signal up and down the screen when rotated.
 - Turning the vertical **SCALE** knob counterclockwise decreases the amplitude of the waveform on-screen, turning the knob clockwise increases the amplitude, and returning the knob to 100 mV returns the amplitude to about five divisions.

- d. *Verify that the channel acquires in all acquisition modes:* Press **SHIFT**; then press **ACQUIRE MENU**. Use the side menu to select, in turn, each of the five hardware acquire modes and confirm that the following statements are true. Refer to the icons at the left of each statement as you confirm those statements.



- **Sample** mode displays an actively acquiring waveform on-screen. (Note that there is noise present on the peaks of the square wave.)



- **Peak Detect** mode displays an actively acquiring waveform on-screen with the noise present in Sample mode "peak detected."



- **Hi Res** mode displays an actively acquiring waveform on-screen with the noise that was present in Sample mode reduced.



- **Envelope** mode displays an actively acquiring waveform on-screen with the noise displayed.



- **Average** mode displays an actively acquiring waveform on-screen with the noise reduced like in Hi Res mode.

- e. *Test all channels:* Repeat substeps a through d until all four input channels are verified.

- 3. *Remove the test hookup:* Disconnect the probe from the channel input and the probe-adjust terminal.

Verify the Time Base

Equipment Required: One P6138 probe.

Prerequisites: None.

Procedure:

- 1. *Install the test hookup and preset the oscilloscope controls:*
 - a. *Hook up the signal source:* Install the probe on **CH 1**. Connect the probe tip to **PROBE COMP** on the front panel; leave the probe ground unconnected. (See Figure 1-3 on page 1-7.)

- b. *Initialize the oscilloscope:*
 - Press save/recall **SETUP**.
 - Press the main-menu button **Recall Factory Setup**; then press the side-menu button **OK Confirm Factory Init**.
 - c. *Modify default settings:*
 - Press **AUTOSET** to obtain a viewable, triggered display.
 - Set the horizontal **SCALE** to 200 μ s.
 - Press **VERTICAL MENU**.
 - Press the main-menu button **Bandwidth**. Then press the side-menu button **20 MHz**.
 - Press **CLEAR MENU** to remove the vertical menu from the screen.
2. *Verify that the time base operates:* Confirm the following statements.
 - a. One period of the square-wave probe-compensation signal is about five horizontal divisions on-screen for the 200 μ s horizontal scale setting (set in step 1c).
 - b. Rotating the horizontal **SCALE** knob clockwise expands the waveform on-screen (more horizontal divisions per waveform period), and that counterclockwise rotation contracts it, and that returning the horizontal scale to 200 μ s returns the period to about five divisions.
 - c. The horizontal **POSITION** knob positions the signal left and right on-screen when rotated.
 3. *Remove the test hookup:* Disconnect the probe from the channel input and the probe-adjust terminal.

Verify the Main and Delayed Trigger Systems

Equipment Required: One P6138 probe.

Prerequisites: None.

Procedure:

1. *Install the test hookup and preset the oscilloscope controls:*
 - a. *Hook up the signal source:* Install the probe on **CH 1**. Connect the probe tip to **PROBE COMP** on the front panel; leave the probe ground unconnected. (See Figure 1-3 on page 1-7.)
 - b. *Initialize the oscilloscope:*
 - Press save/recall **SETUP**.
 - Press the main-menu button **Recall Factory Setup**.
 - Press the side-menu button **OK Confirm Factory Init**.
 - c. *Modify default settings:*

- Press **AUTOSET** to obtain a viewable, triggered display.
 - Set the horizontal **SCALE** for the **M** (main) time base to 200 μ s.
 - Press **VERTICAL MENU**.
 - Press the main-menu button **Bandwidth**. Then press the side-menu button **20 MHz**.
 - Press **TRIGGER MENU**.
 - Press the main-menu button **Mode & Holdoff**.
 - Press the side-menu button **Normal**.
 - Press **CLEAR MENU** to remove the menus from the screen.
2. *Verify that the main trigger system operates:* Confirm that the following statements are true.
- The trigger-level readout for the main trigger system changes with the trigger **MAIN LEVEL** knob.
 - The trigger-level knob can trigger and untrigger the square-wave signal as you rotate it. (Leave the signal *untriggered*.)
 - Pressing **SET LEVEL TO 50%** triggers the signal that you just left untriggered. (Leave the signal triggered.)
3. *Verify that the delayed trigger system operates:*
- a. *Select the delayed time base:*
 - Press **HORIZONTAL MENU**.
 - Press the main-menu button **Time Base**.
 - Press the side-menu button **Delayed Triggerable**; then press the side-menu button **Delayed Only**.
 - Set the horizontal **SCALE** for the **D** (delayed) time base to 200 μ s.
 - b. *Select the delayed trigger-level menu:*
 - Press **SHIFT**; then press **DELAYED TRIG**.
 - Press the main-menu button **Level**; then press the side-menu button **Level**.
 - c. *Confirm that the following statements are true:*
 - The trigger-level readout for the delayed trigger system changes with the general purpose knob.
 - The general purpose knob can trigger and untrigger the square-wave probe-compensation signal as you rotate it. (Leave the signal *untriggered*.)
 - Pressing the side-menu button **Set to 50%** triggers the probe-compensation signal that you just left untriggered. (Leave the signal triggered.)

- d. *Verify the delayed trigger counter:*
 - Press the main-menu button **Delay by Time**.
 - Press the side-menu button **Events**, just below the **Triggerable after Time** selection.
 - Use the General Purpose knob to enter an event count of 325 events.
 - Verify that the trigger **READY** indicator on the front panel flashes about once every second as the waveform is updated on-screen.
4. *Remove the test hookup:* Disconnect the standard-accessory probe from the channel input and the probe-adjust terminal.



Performance Tests

This subsection contains a collection of procedures for checking that the TDS 400 Digitizing Oscilloscopes perform as warranted.

The procedures are arranged in four logical groupings: *Signal Acquisition System Checks*, *Time Base System Checks*, *Triggering System Checks*, and *Output Ports Checks*. They check all the characteristics that are designated as checked in Section 2, *Specifications*. (The characteristics that are checked appear in **boldface** type under *Warranted Characteristics* in Section 2.) You can use form at the end of this section as a test record.



These procedures *extend* the confidence level provided by the basic procedures described on page 1-1. The basic procedures should be done first, then these procedures performed if desired.

Prerequisites

The tests in this subsection comprise an extensive, valid confirmation of performance and functionality when the following requirements are met:

- The cabinet must be installed on the digitizing oscilloscope.
- You must have performed and passed the procedures under *Self Tests*, found on page 1-4, and those under *Functional Tests*, found on page 1-6.
- A signal-path compensation *must* have been done within the recommended calibration interval and at a temperature within $\pm 5^{\circ}$ C of the present operating temperature. (If at the time you did the prerequisite *Self Tests*, the temperature was within the limits just stated, consider this prerequisite met.)
- The digitizing oscilloscope must have been last adjusted at an ambient temperature between $+20^{\circ}$ C and $+30^{\circ}$ C, must have been operating for a warm-up period of at least 20 minutes, and must be operating at an ambient temperature between 0° C and $+50^{\circ}$ C. (The warm-up requirement is usually met in the course of meeting the first prerequisite listed above.)

Equipment Required

These procedures use external, traceable signal sources to directly check warranted characteristics. The required equipment list follows this introduction.

Performance Tests

Table 1-1: Test Equipment

Item Number and Description	Minimum Requirements	Example	Purpose
1 Attenuator, 10X (two required)	Ratio: 10X; impedance 50 Ω ; connectors: female BNC input, male BNC output	Tektronix part number 011-0059-02	Signal Attenuation
2 Attenuator, 5X (two required)	Ratio: 5X; impedance 50 Ω ; connectors: female BNC input, male BNC output	Tektronix part number 011-0060-02	Signal Attenuation
3 Termination, 50 Ω	Impedance 50 Ω ; connectors: female BNC input, male BNC output	Tektronix part number 011-0049-01	Checking Delay Match Between Channels
4 Termination, 75 Ω	Impedance 75 Ω ; connectors: female BNC input, male BNC output	Tektronix part number 011-0102-01	Used to Test Video Option 05 Equipped Instruments Only
5 Cable, Precision Coaxial (three required)	50 Ω , 36 in, male to male BNC connectors	Tektronix part number 012-0482-00	Signal Interconnection
6 Cable, Coaxial	75 Ω , 36 in, male to male BNC connectors	Tektronix part number 012-1338-00	Used to Test Video Option 05 Equipped Instruments Only
7 Connector, Dual-Banana (two required)	Female BNC to dual banana	Tektronix part number 103-0090-00	Various Accuracy Tests
8 Connector, BNC "T"	Male BNC to dual female BNC	Tektronix part number 103-0030-00	Checking Trigger Sensitivity
9 Coupler, Dual-Input	Female BNC to dual male BNC	Tektronix part number 067-0525-02	Checking Delay Match Between Channels
10 Generator, DC Calibration	Variable amplitude to ± 110 V; accuracy to 0.1%	Data Precision 8200, with 1 kV option installed	Checking DC Offset and Measurement Accuracy
11 Generator, Leveled Sine Wave, Medium Frequency	200 kHz to 250 MHz; Variable amplitude from 5 mV to 4 V p-p into 50 Ω	TEKTRONIX SG 503 Leveled Sine Wave Generator ¹	Checking Trigger Sensitivity at low frequencies
12 Generator, Leveled Sine Wave, High Frequency	250 MHz to 500 MHz; Variable amplitude from 5 mV to 4 V p-p into 50 Ω ; 6 MHz reference	TEKTRONIX SG 504 Leveled Sine Wave Generator ¹ with SG 504 Output Head	Checking Trigger Sensitivity at high frequencies

¹Requires a TM 500 or TM 5000 Series Power Module Mainframe.

Table 1-1: Test Equipment (Cont.)

Item Number and Description	Minimum Requirements	Example	Purpose
13 Generator, Time Mark	Variable marker frequency from 10 ms to 10 ns; accuracy within 2 ppm	TEKTRONIX TG 501 Time Mark Generator ¹	Checking Sample-Rate and Delay-time Accuracy
14 Probe, 10X, included with this instrument	A P6138 probe	Tektronix number P6138	Signal Interconnection
15 Generator, Video Signal	Provides NTSC compatible outputs	TEKTRONIX TSG 1001	Checking Video Trigger Sensitivity

¹Requires a TM 500 or TM 5000 Series Power Module Mainframe.

Test Record

Photocopy the next two pages and use them to record the performance test results for your instrument.

TDS 420 & TDS 460 Test Record

Instrument Serial Number: _____ Certificate Number: _____
 Temperature: _____ RH %: _____
 Date of Calibration: _____ Technician: _____

Performance Test		Minimum	Incoming	Outgoing	Maximum
Offset Accuracy					
CH1 Offset	+1 V	995 mV	_____	_____	+1.005 V
	+10 V	9.935 V	_____	_____	+10.065 V
	+99.9 V	99.2505 V	_____	_____	+100.5495 V
CH2 Offset	+1 V	995 mV	_____	_____	+1.005 V
	+10 V	9.935 V	_____	_____	+10.065 V
	+99.9 V	99.2505 V	_____	_____	+100.5495 V
CH3 Offset	+1 V	995 mV	_____	_____	+1.005 V
	+10 V	9.935 V	_____	_____	+10.065 V
	+99.9 V	99.2505 V	_____	_____	+100.5495 V
CH4 Offset	+1 V	995 mV	_____	_____	+1.005 V
	+10 V	9.935 V	_____	_____	+10.065 V
	+99.9 V	99.2505 V	_____	_____	+100.5495 V
DC Voltage Measurement Accuracy (Averaged)					
CH1	100 mV	-20.8 mV	_____	_____	+20.8 mV
CH2	100 mV	-20.8 mV	_____	_____	+20.8 mV
CH3	100 mV	-20.8 mV	_____	_____	+20.8 mV
CH4	100 mV	-20.8 mV	_____	_____	+20.8 mV
Analog Bandwidth					
CH1	100 mV	424 mV	_____	_____	N/A
CH2	100 mV	424 mV	_____	_____	N/A
CH3	100 mV	424 mV	_____	_____	N/A
CH4	100 mV	424 mV	_____	_____	N/A
Delay Between Channels					
Delay Between Channels		N/A	_____	_____	450 ps
Time Base System					
Long Term Sample Rate/ Delay Time @ 500 ns/10 ms		-3.0 Div	_____	_____	+3.0 Div
Delta Time @ 5 ns (100 MHz)		49.592 ns	_____	_____	50.408 ns

TDS 420 & TDS 460 Test Record (Cont.)

Performance Test	Minimum	Incoming	Outgoing	Maximum
Trigger System (DC Coupled Threshold)				
Main Trigger	-18 mV	_____	_____	+18 mV
Main Trigger – Falling	-18 mV	_____	_____	+18 mV
Delayed Trigger	-18 mV	_____	_____	+18 mV
Delayed Trigger – Falling	-18 mV	_____	_____	+18 mV
Probe Compensator Output Signal				
Frequency	950 Hz	_____	_____	1050 Hz
Voltage	475 mV	_____	_____	525 mV

Signal Acquisition System Checks

These procedures check those characteristics that relate to the signal-acquisition system and are listed as checked under *Warranted Characteristics* in Section 2, *Specifications*.

Check Offset Accuracy

Equipment Required: Two dual-banana connectors (Item 7), one BNC T connector (Item 8), one DC calibration generator (Item 10), and two precision coaxial cables (Item 5).

Prerequisites: The oscilloscope must meet the prerequisites listed on page 1-13.

1. *Install the test hookup and preset the instrument controls:*

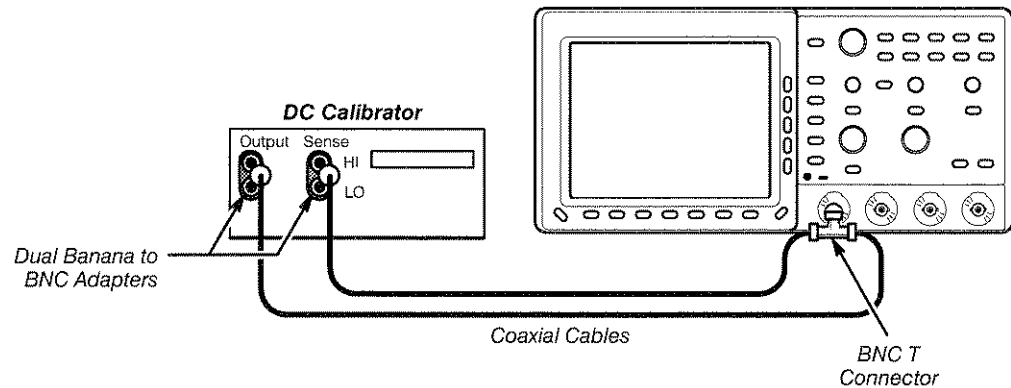

Figure 1-4: Initial Test Hookup

- a. *Hook up the test-signal source:*
 - Set the output of a DC calibration generator to 0 volts.
 - Connect the output of a DC calibration generator through a dual-banana connector followed by a 50 Ω precision coaxial cable to one side of a BNC T connector.
 - Connect the Sense output of the generator through a second dual-banana connector followed by a 50 Ω precision coaxial cable to the other side of the BNC T connector. Now connect the BNC T connector to **CH 1**.
- b. *Initialize the oscilloscope:*
 - Press save/recall **SETUP**.
 - Press the main-menu button **Recall Factory Setup**.
 - Press the side-menu button **OK Confirm Factory Init**.
- c. *Modify the default settings:*
 - Set the horizontal **SCALE** to 1 ms.

- Press **SHIFT**; then **ACQUIRE MENU**.
 - Press the main-menu button **Mode**; then press the side-menu button **Hi Res**.
 - Press **DISPLAY**.
 - Press the main-menu button **Graticule**; then press the side-menu button **Frame**.
 - Press **MEASURE**.
 - Press the main-menu button **Select Measurement for CHx**; then press the side-menu button **Mean**. (You will have to press **MORE** several times to access the **Mean** measurement.)
 - Press **CLEAR MENU**.
2. *Confirm input channels are within limits for offset accuracy: Do the following substeps—test CH 1 first, skipping substep a since CH 1 is already set up to be checked from step 1.*
- a. *Select an unchecked channel: Press **WAVEFORM OFF** to remove the channel just confirmed from the display. Then, press the front-panel button that corresponds to the channel you are to confirm.*

Table 1-2: DC Offset Accuracy

Vertical Scale Setting	Vertical Position	Offset Setting	Generator Setting	Offset Accuracy Limits
1 mV	0	+1 V	+1 V	±5 mV
100 mV	0	+10 V	+10 V	±65 mV
1 V	0	+99.9 V	+99.9 V	±649.5 mV

- b. *Set the vertical scale: Set the vertical **SCALE** to one of the settings listed in Table 1-2 that is not yet checked. (Start with the first setting listed.)*
- c. *Set the offset: Press the **VERTICAL MENU** button and then the **Offset** main-menu button. Using the **General Purpose** knob, set the offset to match the vertical scale as dictated by Table 1-2. (Start with the first setting listed.)*
- d. *Set the generator: Set the DC calibration generator to match the vertical scale as dictated by Table 1-2. (Start with the first setting listed.)*
- e. *Check against limits: Do the following subparts in the order listed.*
- Subtract the measured mean from the generator setting. The result is the offset accuracy

- CHECK that the offset accuracy is within the limits listed for the current vertical scale setting.
 - Repeat substeps b through e until all vertical scale settings listed in Table 1-2 are checked for the channel under test.
- f. *Test all channels:* Repeat substeps a through e for all input channels.
3. *Disconnect the hookup:*
- a. *Set the generator output to 0 V.*
 - b. Then disconnect the cable from the generator output at the input connector of the channel last tested.

Check DC Voltage Measurement Accuracy (Averaged)

Equipment Required: Two dual-banana connectors (Item 7), one BNC T connector (Item 8), one DC calibration generator (Item 10), and two precision coaxial cables (Item 5).

Prerequisites: The oscilloscope must meet the prerequisites listed on page 1-13.

Procedure:

1. *Install the test hookup and preset the instrument controls:*

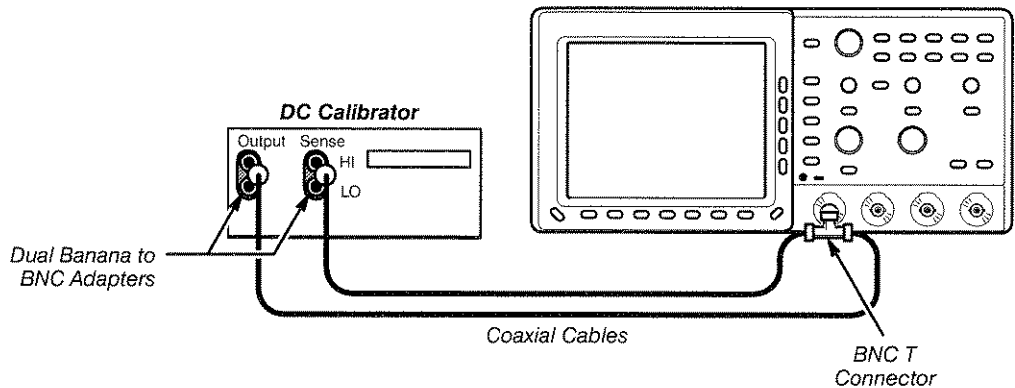

Figure 1-5: Initial Test Hookup

- a. *Hook up the test-signal source:*
- Set the output of a DC calibration generator to 0 volts.
 - Connect the output of a DC calibration generator through a dual-banana connector followed by a 50 Ω precision coaxial cable to one side of a BNC T connector.

- Connect the Sense output of the generator through a second dual-banana connector followed by a 50 Ω precision coaxial cable to the other side of the BNC T connector. Now connect the BNC T connector to **CH 1**.
- b. *Initialize the oscilloscope:*
- Press save/recall **SETUP**.
 - Press the main-menu button **Recall Factory Setup**.
 - Press the side-menu button **OK Confirm Factory Init**.
- c. *Modify the default settings:*
- Press **SHIFT**; then **ACQUIRE MENU**.
 - Press the main-menu button **Mode**; then press the side-menu button **Average 16**.
 - Press **DISPLAY**.
 - Press the main-menu button **Graticule**; then press the side-menu button **Frame**.
 - Press **MEASURE**.
 - Press the main-menu button **Select Measurement for CHx**; then press the side-menu button **Mean**. (You will have to press **MORE** several times to access the **Mean** measurement.)
 - Set the vertical **SCALE** to 100 mV.
 - Press the **VERTICAL MENU** button and then the **Offset** main-menu button. Set the offset to 0 V.
 - Set the vertical **POSITION** to 0 V.
2. *Confirm input channels are within limits for DC delta voltage accuracy: Do the following substeps—test CH 1 first, skipping substep a since CH 1 is already selected from step 1.*
- a. *Select an unchecked channel:*
- Set the generator output to 0 V.
 - Press **WAVEFORM OFF** to remove the channel just confirmed from the display.
 - Press the front-panel button that corresponds to the next channel you are to confirm.
 - Move the test hook up to the channel you select.
 - Set the vertical **SCALE** to 100 mV.
 - Set the vertical **POSITION** to 0 V.
 - Press the **VERTICAL MENU** button and then the **Offset** main-menu button. Set the offset to 0 V.
- b. *Set the generator:* Set the DC calibration generator to +0.35 V.

- c. *Record Measurement:* Read the mean at the measurement readout and record this number on a piece of scratch paper.
 - d. *Set the generator:* Set the DC calibration generator to -0.35 V .
 - e. *Check against limits:* Do the following subparts in the order listed.
 - Use this formula to calculate voltage measurement accuracy.
$$700\text{ mV} - (\text{mean from step c} - (\text{present mean}))$$

For example:

$$700\text{ mV} - (347\text{ mV} - (-358\text{ mV})) = -5\text{ mV}$$
 - CHECK that the voltage measurement accuracy is within $\pm 20.8\text{ mV}$.
 - f. *Test all channels:* Repeat substeps a through e for all four channels.
3. *Disconnect the hookup:*
 - a. *Set the generator output to 0 V.*
 - b. Then disconnect the cable from the generator output at the input connector of the channel last tested.

Check Analog Bandwidth

Prerequisites: See page 1-13.

Procedure:

1. *Install the test hookup and preset the instrument controls:*
 - a. *Initialize the oscilloscope:*
 - Press save/recall **SETUP**. Then press the main-menu button **Recall Factory Setup**.
 - Press the side-menu button **OK Confirm Factory Init**.
 - b. *Modify the default settings:*
 - Set the horizontal **SCALE** to $10\ \mu\text{s}$ (TDS 420) or $50\ \text{ns}$ (TDS 460).
 - Press **TRIGGER MENU**.
 - Press the main-menu button **COUPLING**; then press the side menu button **Noise Rej**.
 - Press **SHIFT**; then **ACQUIRE MENU**.
 - Press the main-menu button **Mode**; then press the side-menu button **Average 16**.
 - Press **Measure**. Now press the main-menu button **High-Low Setup**; then press the side-menu button **Min-Max**.

Figure 1-6: Initial Test Hookup (TDS 420)

Figure 1-7: Initial Test Hookup (TDS 460)

2. *Confirm the input channels are within limits for analog bandwidth: Do the following substeps—test CH 1 first, skipping substeps a and b since CH 1 is already set up for testing from step 1.*
 - a. *Select an unchecked channel:*
 - Press **WAVEFORM OFF** to remove the channel just confirmed from display.
 - Press the front-panel button that corresponds to the channel you are to confirm.
 - Move the leveling head to the channel you select.
 - b. *Match the trigger source to the channel selected:*
 - Press **TRIGGER MENU**.
 - Press the main-menu button **Source**.
 - Press the side-menu button that corresponds to the channel selected.
 - c. *Set its input impedance:*
 - Press **VERTICAL MENU**; then press the main-menu button **Coupling**.
 - Press the side-menu button Ω to toggle it to the 50 Ω setting.
 - d. *Set the vertical scale: Set the vertical **SCALE** to one of the settings listed in Table (TDS 420) or (TDS 460) not yet checked. (Start with the 100 mV setting.)*
 - e. *Display the test signal: Do the following subparts to first display the reference signal and then the test signal.*
 - Press **MEASURE**; then press the main-menu button **Select Measurement for CHx**.
 - Now press the side menu button **more** until the menu label **Pk-Pk** appears in the side menu (its icon is shown at the left). Press the side-menu button **Pk-Pk**.
 - Press **CLEAR MENU**.
 - Set the generator output so the CHx Pk-Pk readout equals the reference amplitude in Table (TDS 420) or (TDS 460) that corresponds to the vertical scale set in substep d.
 - Press the front-panel button **SET LEVEL TO 50%** as necessary to trigger a stable display.
 - f. *Measure the test signal:*



- Increase the frequency of the generator output to the test frequency in Table (TDS 420) or (TDS 460) that corresponds to the vertical scale set in substep d.
- Set the horizontal **SCALE** to 5 ns (TDS 420) or 2 ns (TDS 460).
- Press **SET LEVEL TO 50%** as necessary to trigger the display.
- Read the results at the CHx Pk-Pk readout, which will automatically measure the amplitude of the test signal. (See Figure 1-8.)

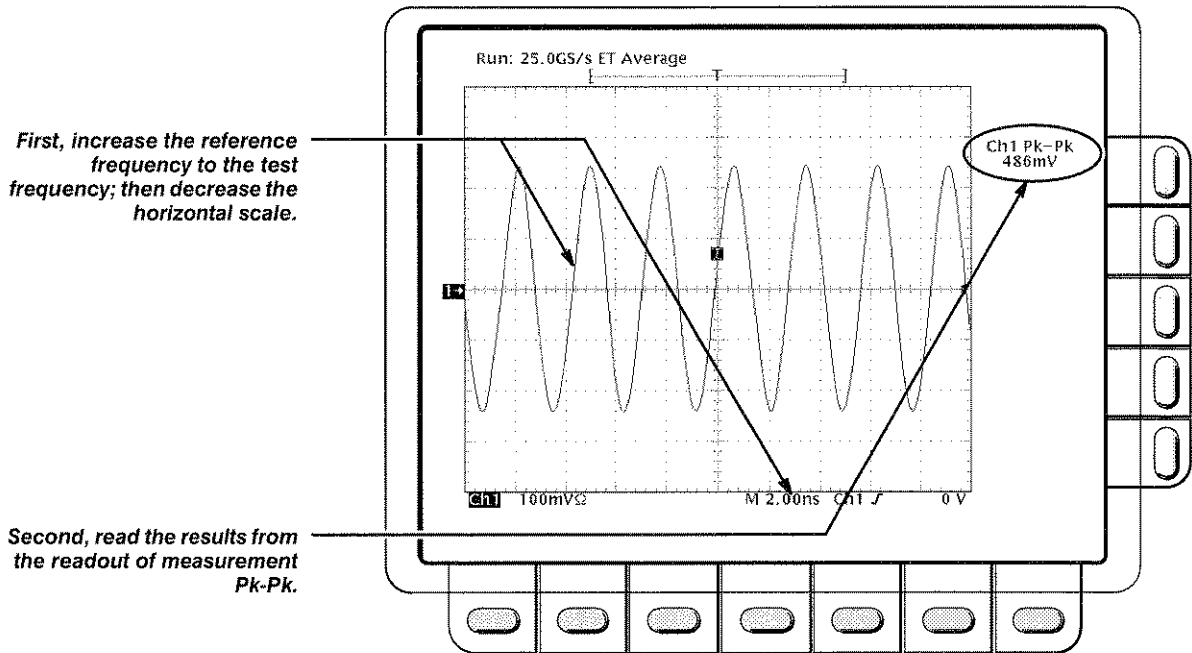

Figure 1-8: Measurement of Analog Bandwidth

g. Check against limits:

- CHECK that the **Pk-Pk** readout on screen is within the limits listed in Table (TDS 420) or (TDS 460) for the current vertical scale setting.
- When finished checking, set the horizontal **SCALE** back to the 10 μ s (TDS 420) or 50 ns (TDS 460) setting.



Checking each channel's bandwidth at all vertical scale settings is time consuming and unnecessary. You may skip checking the remaining vertical scale settings in Table (TDS 420) or (TDS 460) (that is, skip the following substep, h) if this digitizing oscilloscope has performed as follows:

- Passed the 100 mV vertical scale setting just checked in this procedure.

- Passed the *Verify Internal Adjustment, Self Compensation, and Diagnostics* procedure found under *Self Tests*, on page 1-4.

NOTE

Passing the signal path compensation confirms the signal path for all vertical scale settings for all channels. Passing the internal diagnostics ensures that the factory-set adjustment constants that control the bandwidth for each vertical scale setting have not changed.

- h. *Check remaining vertical scale settings against limits (optional):*
 - If desired, finish checking the remaining vertical scale settings for the channel under test by repeating substeps d through g for each of the remaining scale settings listed in Table (TDS 420) or (TDS 460) for the channel under test.
 - When doing substep e, skip the subparts that turn on the CHx Pk-Pk measurement until you check a new channel.
 - Install/remove 10X attenuators between the generator leveling head and the channel input as is needed to obtain the six division reference signals listed in the table.
 - i. *Test all channels:* Repeat substeps a through g for all four channels.
3. *Disconnect the hookup:* Disconnect the test hook up from the input connector of the channel last tested.

Check Delay Match Between Channels

Equipment Required: One medium-frequency leveled sine-wave generator (Item 11), one precision coaxial cable (Item 5), one 50 Ω terminator (Item 3), and a dual-input coupler (Item 9).

Prerequisites: See page 1-13.

Procedure:



DO NOT use the vertical position knob to reposition any channel while doing this check. To do so invalidates the test.

1. *Install the test hookup and preset the instrument controls:*
 - a. *Initialize the front panel;*
 - Press save/recall **SETUP**.
 - Press the main-menu button **Recall Factory Setup**.
 - Press the side-menu button **OK Confirm Factory Init**.
 - b. *Modify the initialized front-panel control settings:*

- Do *not* adjust the vertical position of any channel during this procedure.
- Set the horizontal **SCALE** to 1 ns.
- Press **SHIFT**; then press **ACQUIRE MENU**.
- Press the main-menu button **Mode**, and then press the side-menu button **Average 16**.

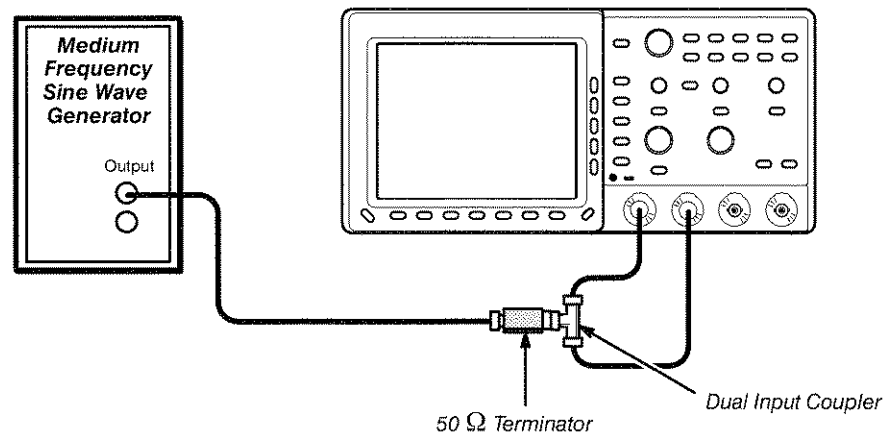

Figure 1-9: Initial Test Hookup

- c. *Hook up the test-signal source:*
 - Connect, through a 50 Ω precision coaxial cable, followed by a 50 Ω termination, the sine wave output of a medium-frequency sine wave generator to a dual-input coupler.
 - Connect the coupler to both **CH 1** and **CH 2**. *Ensure that the coupler cables are of equal length.*
2. *Confirm CH 1 through CH 4 are within limits for channel delay:*
 - a. *Set up the generator:* Set the generator frequency to 250 MHz and the amplitude for about five divisions in CH 1.
 Hint: as you are adjusting the generator amplitude, push **SET LEVEL TO 50%** frequently to speed up the updating of the waveform amplitude on screen.
 - b. *Save a CH 2 waveform:* Press **CH 2**; then press save/recall **WAVEFORM**. Now, press the main-menu button **Save Waveform**; then press the side-menu button **To Ref 2**.
 - c. *Save a CH 3 waveform:* Move the coupler from **CH 2** to **CH 3**, so that **CH 1** and **CH 3** are driven. Press **CH 3**; then press the side-menu button **To Ref 3**.
 - d. *Display all test signals:*

- Press **WAVEFORM OFF** twice to remove CH 2 and CH 3 from the display.
 - Move the coupler from **CH 3** to **CH 4**, so that CH 1 and CH 4 are driven. Press **CH 4** to display.
 - Now, press the front-panel button **MORE**. Press the main-menu buttons **Ref 2** and **Ref 3**.
- e. *Measure the test signal:*
- Locate the point on the rising edge of the left-most waveform where it crosses the center horizontal graticule line. This is the *time reference point* for this waveform. Note the corresponding *time reference point* for right-most waveform. See Figure 1-10.
 - Press **CURSOR**; then press the side-menu button **V Bars**.
 - Press **CLEAR MENU**.
 - Rotate the General Purpose knob to align one cursor to the *time reference point* of the left-most waveform edge and the other cursor to the *time reference point* of the right-most waveform edge. (Press **TOGGLE** to switch between the two cursors.) See Figure 1-10.
 - Read the measurement results at the Δ : cursor readout, not the @: readout on screen.

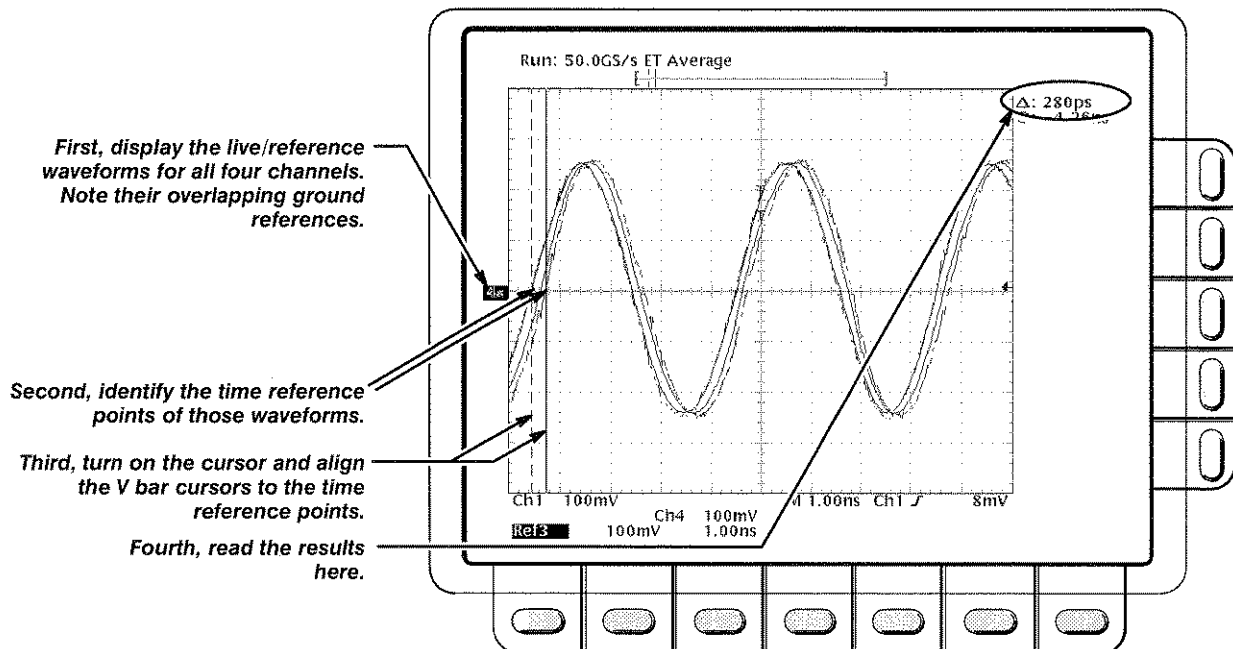

Figure 1-10: Measurement of Channel Delay

Performance Tests

- f. *Check all channels against limit:* CHECK that the cursor readout on screen is ≤ 450 ps. If the cursor readout is ≤ 200 ps, skip the next substep (g).
- g. *Check CH 1 to CH 2 and CH 3 to CH 4 against limit:*
 - Press **WAVEFORM OFF** four times to remove all waveforms.
 - Press **CH 1**.
 - Press **MORE**; then press the main-menu button **Ref 2**.
 - Measure the delay between CH 1 and Ref 2 using the method described in substep e above.
 - CHECK that the cursor readout on screen is ≤ 200 ps.
 - Press **WAVEFORM OFF** twice to turn off CH 1 and Ref 2; then press **CH 4** to turn on CH 4.
 - Press **MORE**; then press the main-menu button **Ref 3** to display the CH 3 waveform stored in Ref 3.
 - Measure the delay between Ref 3 and CH 4 using the method described in substep e above.
 - CHECK that the cursor readout on screen is ≤ 200 ps.
3. *Disconnect the hookup:* Disconnect the cable from the generator output at the input connectors of the channels.

Time Base System Checks

These procedures check those characteristics that relate to the Main and Delayed time base system and are listed as checked under *Warranted Characteristics* in Section 2, *Specifications*.

Check Accuracy for Long-Term Sample Rate, Delay Time, and Delta Time Measurements

Equipment Required: One time-marker generator (Item 13) and one precision coaxial cable (Item 5).

Prerequisites: See page 1-13.

Procedure:

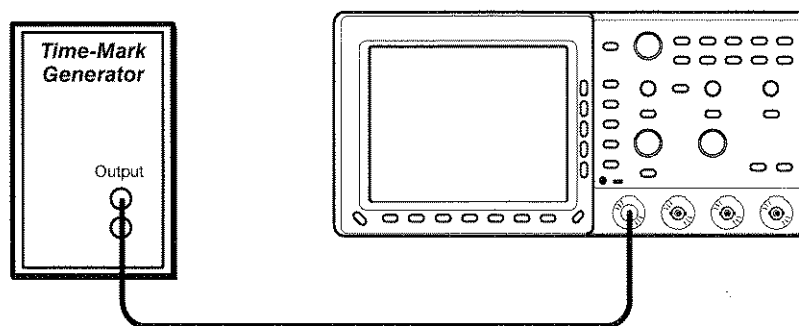

Figure 1-11: Initial Test Hookup

1. *Install the test hookup and preset the instrument controls:*
 - a. *Hook up the test-signal source:* Connect, through a 50 Ω precision coaxial cable, the time-mark output of a time-marker generator to **CH 1**. Set the output of the generator for 10 ms markers.
 - b. *Initialize the oscilloscope:*
 - Press save/recall **SETUP**.
 - Press the main-menu button **Recall Factory Setup**.
 - Press the side-menu button **OK Confirm Factory Init**.
 - c. *Modify the initialized front-panel control settings:*
 - Set the vertical **SCALE** to 500 mV.
 - Press **VERTICAL MENU**; then press the main-menu button **Coupling**. Press the side-menu button Ω the coupling setting to 50 Ω .
 - Press **SET LEVEL TO 50%**.
 - Use the vertical **POSITION** knob to center the test signal on screen.

- Set the horizontal **SCALE** of the Main time base to 1 ms.
 - Press **TRIGGER MENU**; then press the main-menu button **Mode & Holdoff**. Now press the side-menu button **Normal**.
 - Press **SET LEVEL TO 50%**.
 - Press horizontal **MENU**. Press the main-menu button **Record Length**; then press the side-menu button **1000 points in 20 divs**.
 - Press the main-menu button **Trigger Position**. Press the side-menu button **Pretrigger**; then use the **General Purpose** knob to set pretrigger to 20%.
2. *Confirm Main and Delayed time bases are within limits for accuracies:*
- a. *Display the test signal:*
 - Adjust the horizontal **POSITION** to move the trigger **T** to the right and on to the screen. Continue to position the trigger **T** to align it to the center vertical graticule line.
 - Press the main-menu button **Time Base**.
 - Press the side-menu buttons **Delayed Only** and **Delayed Runs After Main**.
 - b. *Measure the test signal:*
 - First set the horizontal **SCALE** of the **D** (delayed) time base to 1 ms. Then use the **General Purpose** knob to set delayed time to 10 ms.
 - Set the horizontal **SCALE** of the **D** (delayed) time base to 500 ns.
 - c. *Check long-term sample rate and delay time accuracies against limits:* CHECK that the rising edge of the marker crosses the center horizontal graticule line at a point within ± 3.0 divisions of center graticule (see Figure 1-12).

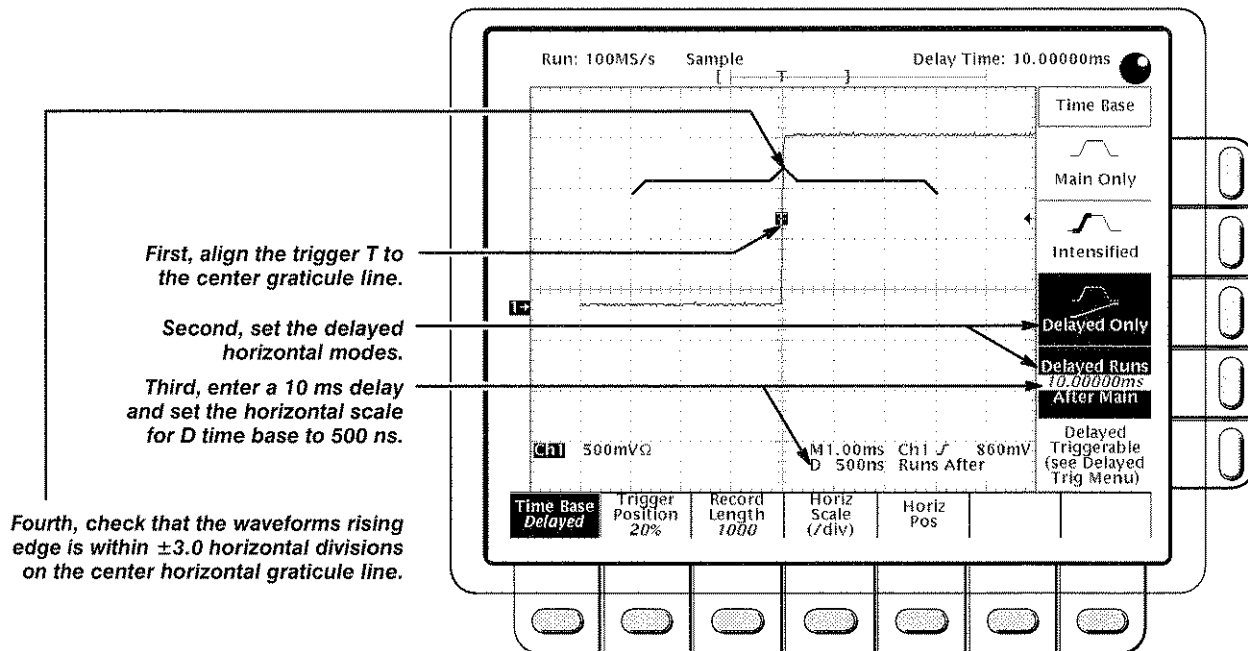

Figure 1-12: Measurement of Accuracy—Long-Term and Delay-Time

d. Check delta-time accuracy against limits:

- Press the side-menu button **Main Only**. Set horizontal **SCALE** to 5 ns.
- Set the output of the generator for 50 ns markers.
- Press **SET LEVEL TO 50%**.
- Press **VERTICAL MENU**.
- Press the main-menu button **Bandwidth**; then press the side menu button 100 MHz.
- Press **SHIFT**; then **ACQUIRE MENU**. Now press the main-menu button **Mode**; then press the side-menu button **Average**.
- Use the **General Purpose** knob to set the number of averages to 8.
- Press **MEASURE**.
- Press the main-menu button **High-Low Setup**; then press the side-menu button **Min-Max**.
- Press the main-menu button **Select Measurement for Ch1**.
- Press the side-menu button **—more—**, until **PERIOD** appears in the side menu. Press **PERIOD**.
- Press **CLEAR MENU**.

Performance Tests

- CHECK that the readout for **CH 1 Per** is within 49.592 ns to 50.408 ns.
3. *Disconnect the hookup:* Disconnect the cable from the generator output at the input connector of **CH 1**.

Trigger System Checks

These procedures check those characteristics that relate to the Main and Delayed trigger systems and are listed as checked under *Warranted Characteristics* in Section 2, *Specifications*.

Check Accuracy, Trigger Level or Threshold, DC Coupled

Equipment Required: One DC calibration generator (Item 10), one BNC T connector (Item 8), and two precision coaxial cables (Item 5).

Prerequisites: The oscilloscope must meet the prerequisites listed on page 1-13.

Procedure:

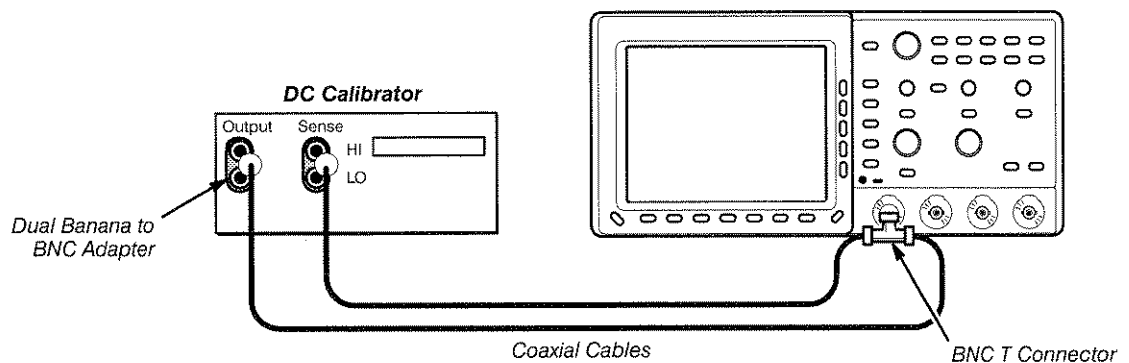



Figure 1-13: Initial Test Hookup

1. *Install the test hookup and preset the instrument controls:*
 - a. *Hook up the test-signal source:*
 - Set the output of a DC calibration generator to 0 volts.
 - Connect the output of a DC calibration generator through a dual-banana connector followed by a 50 Ω precision coaxial cable to one side of a BNC T connector.
 - Connect the Sense output of the generator, through a second dual-banana connector followed by a 50 Ω precision coaxial cable, to other side of the BNC T connector. Now connect the BNC T connector to **CH 1**.
 - b. *Initialize the oscilloscope:*
 - Press save/recall **Setup**.
 - Press the main-menu button **Recall Factory Setup**.
 - Press the side-menu button **OK Confirm Factory Init**.

2. *Confirm Main trigger system is within limits for Trigger-level/Threshold accuracy:*
 - a. *Display the test signal:*
 - Set the vertical **SCALE** to 50 mV.
 - Set the standard output of a DC calibration generator to +0.3 V.
 - b. *Measure the test signal:*
 - Press **SET LEVEL TO 50%**.
 - Press **TRIGGER MENU**.
 - Read the measurement results from the readout below the label **Level** in the menu rather than from the trigger readout in the graticule area.
 - c. *Check against limits:*
 - Subtract the trigger level readout from the DC calibration generator setting. The result is the trigger level accuracy.
 - CHECK that the trigger level is accurate to within ± 18 mV.
 - Press **TRIGGER MENU**. Press the main-menu button **Slope**; then press the side-menu button for negative slope. (See icon at left.) Repeat substep b.
 - Subtract the trigger level readout from the DC calibration generator setting. The result is the trigger level accuracy.
 - CHECK that the trigger level is accurate to within ± 18 mV.
3. *Confirm Delayed trigger system is within limits for Trigger-level/Threshold accuracy:*
 - a. *Select the Delayed time base:*
 - Press **HORIZONTAL MENU**.
 - Press the main-menu button **Time Base**.
 - Press the side-menu buttons **Delayed Only** and **Delayed Triggerable**.
 - Set **D** (delayed) horizontal **SCALE** to 500 μ s.
 - b. *Select the Delayed trigger system:*
 - Press **SHIFT**; then press the front-panel button **DELAYED TRIG**.
 - Press the main-menu button **Level**.
 - c. *Measure the test signal:* Press the side-menu button **SET TO 50%**. Read the measurement results in the side menu below the label **Level**.
 - d. *Check against limits:* Do the following subparts in the order listed.

- 
- Subtract the trigger level readout from the DC calibration generator setting. The result is the trigger level accuracy.
 - CHECK that the trigger level is accurate to within ± 18 mV.
 - Press **TRIGGER MENU**. Press the main-menu button **Slope**; then press the side-menu button for negative slope. (See icon at left.)
 - Subtract the trigger level readout from the DC calibration generator setting. The result is the trigger level accuracy.
 - CHECK that the trigger level is accurate to within ± 18 mV.

4. *Disconnect the hookup:*

- a. *First set the output of the DC calibration generator to 0 volts.*
- b. Then disconnect the cable from the generator output at the input connector of **CH 1**.

Sensitivity, Edge Trigger, DC Coupled

Equipment Required: One medium-frequency leveled sine-wave generator (Item 11), one high-frequency leveled sine-wave generator (Item 12), one precision 50 Ω coaxial cable (Item 5), one 10X attenuator (Item 1), and one 5X attenuator (Item 2).

Prerequisites: See page 1-13.

Procedure:

1. *Install the test hookup and preset the instrument controls:*
 - a. *Initialize the oscilloscope:*
 - Press save/recall **SETUP**.
 - Press the main-menu button **Recall Factory Setup**.
 - Press the side-menu button **OK Confirm Factory Init**.
 - b. *Modify the initialized front-panel control settings:*
 - Set the horizontal **SCALE** for the **M** (main) time base to 20 ns.
 - Press **HORIZONTAL MENU**; then press the main-menu button **Time Base**.
 - Press the side-menu button **Delayed Only**; then press the side-menu button **Delayed Triggerable**.
 - Set the horizontal **SCALE** for the **D** (delayed) time base to 20 ns; then press the side-menu button **Main Only**.
 - Press **TRIGGER MENU**; then press the main-menu button **Mode & Holdoff**. Now press the side-menu button **Normal**.
 - Press **VERTICAL MENU**; then press the main-menu button **Coupling**. Now press the side-menu button Ω select the 50 Ω setting.
 - Press **SHIFT**; then press **ACQUIRE MENU**. Now press the main-menu button **Mode**; then press the side-menu button **Average 16**.

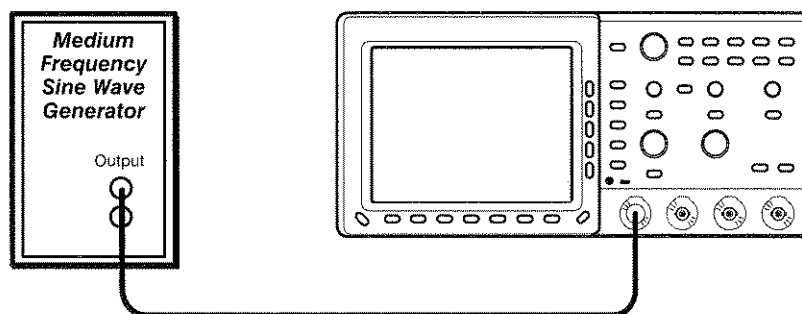

Figure 1-14: Initial Test Hookup

2. *Confirm Main and Delayed trigger systems are within sensitivity limits (50 MHz):*

a. *Display the test signal:*

- Set the generator frequency to 50 MHz.
- Press **MEASURE**.
- Press the main-menu button **High-Low Setup**; then press the side-menu button **Min-Max**.
- Press the main-menu button **Select Measurement for Ch1**.
- Press the side-menu button **–more–** until **Amplitude** appears in the side menu (its icon is shown at the left). Press the side-menu button **Amplitude**.
- Adjust trigger **MAIN LEVEL** knob to obtain stable triggered waveform.
- Press **CLEAR MENU**.
- Set the test signal amplitude for about three and a half divisions on screen. Now fine adjust the generator output until the **CH 1 Amplitude** readout indicates the amplitude is 350 mV. (Readout may fluctuate around 350 mV.)
- Disconnect the 50 Ω precision coaxial cable at **CH 1** and reconnect it to **CH 1** through a 10X attenuator.



b. *Check for Main trigger system for stable triggering at limits:*

- Read the following definition: A stable trigger is one that is consistent; that is, one that results in a uniform, regular display triggered on the selected slope (positive or negative). This display should *not* have its trigger point switching between opposite slopes, nor should it “roll” across the screen. At horizontal scale settings of 2 ms/division and faster, **TRIG'D** will remain constantly lit. It will flash for slower settings.
- Press **TRIGGER MENU**; then press the main-menu button **Slope**.
- Press **SET LEVEL TO 50%**. CHECK that a stable trigger is obtained for the test waveform on both the positive and negative slopes. (Use the side menu to switch between trigger slopes; use the trigger **MAIN LEVEL** knob to stabilize the trigger if required.)
- Leave the Main trigger system triggered on the positive slope of the waveform before continuing to the next step.

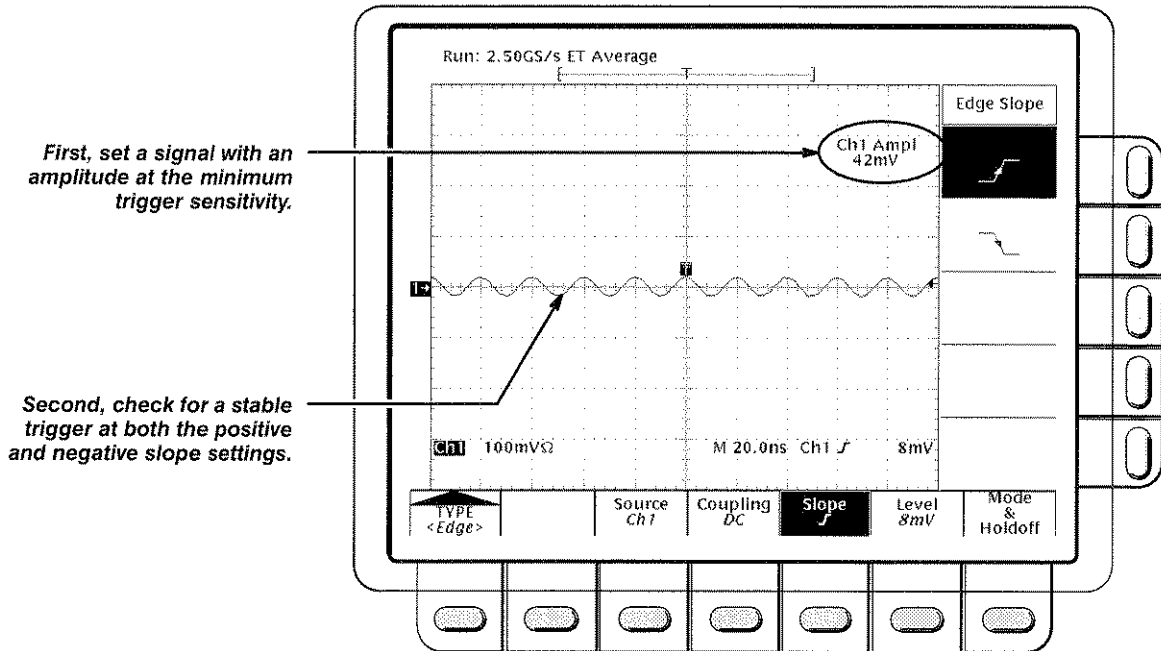

Figure 1-15: Measurement of Trigger Sensitivity

- c. Check delayed trigger system for stable triggering at limits: Do the following subparts in the order listed.
 - Press **HORIZONTAL MENU**; then press the main-menu button **Time Base**. Now press the side-menu button **Delayed Only**.
 - Press **SHIFT**; then press **DELAYED TRIG**. Press the main-menu button **Level**.
 - Press the side-menu button **SET TO 50%**. CHECK that a stable trigger is obtained for the test waveform for both the positive and negative slopes of the waveform. (Use the General Purpose knob to stabilize the trigger if required.) Press the main-menu button **Slope**; then use the side menu to switch between trigger slopes.
 - Leave the delayed trigger system triggered on the positive slope of the waveform before continuing to the next step. Also, return to the main time base: Press **HORIZONTAL MENU**; then press the main-menu button **Time Base**. Now press the side-menu button **Main Only**.
3. Confirm that the Main and Delayed trigger systems are within sensitivity limits (at upper frequency limits):
 - a. Hook up the test-signal source: Disconnect the hookup installed in step 1. Connect, through its leveling head, the signal output of a high-frequency leveled sine-wave generator to **CH 1**.

- b. *Set the Main and Delayed Horizontal Scales:*
 - Set the horizontal **SCALE** to 5 ns for the **M** (Main) time base.
 - Press the side-menu button **Delayed Only**.
 - Set the horizontal **SCALE** to 2 ns for the **D** (Delayed) time base. Press the side-menu button **Main Only**.
 - c. *Display the test signal:*
 - Set the generator frequency to 350 MHz (TDS 420) or 500 MHz (TDS 460).
 - Set the test signal amplitude for about five divisions on screen. Now fine adjust the generator output until the **CH 1 Amplitude** readout indicates the amplitude is 500 mV. (Readout may fluctuate around 500 mV.)
 - Disconnect the leveling head at **CH 1** and reconnect it to **CH 1** through a 5X attenuator.
 - d. Repeat step 2, substeps b and c only.
4. *Confirm that the Main and Delayed trigger systems couple trigger signals from all channels:* Doing the procedure *Check Analog Bandwidth*, which begins on page 1-22, checks coupling. If you have not done that procedure, do so after finishing this procedure. See the following note.

NOTE

Steps 1 through 3 confirmed trigger sensitivity for the Main and Delayed triggering systems using the CH 1 input. Doing the procedure Check Analog Bandwidth ensures that trigger signals are coupled from all four channels.

5. *Disconnect the hookup:* Disconnect the cable from the generator output at the input connector of the channel last tested.

Maximum Input Frequency, Auxiliary Trigger

Equipment Required: One medium-frequency leveled sine-wave generator (Item 11), two precision 50 Ω coaxial cables (Item 5), and a BNC T connector (Item 8).

Prerequisites: See page 1-13.

Procedure:

1. Install the test hookup and preset the instrument controls:

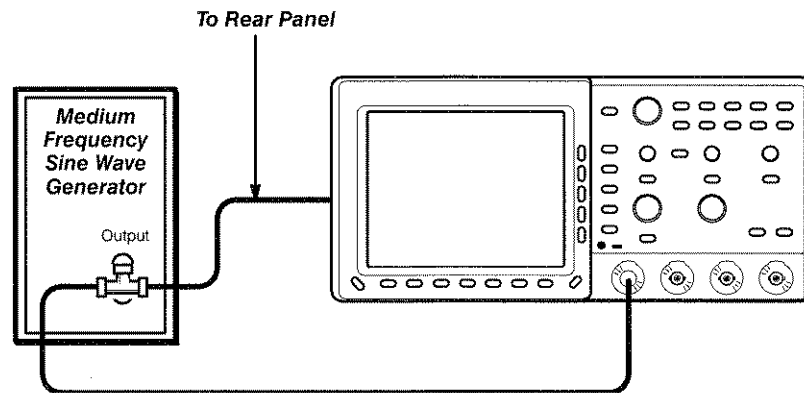

Figure 1-16: Initial Test Hookup

- a. Initialize the oscilloscope:
 - Press save/recall **SETUP**.
 - Press the main-menu button **Recall Factory Setup**.
 - Press the side-menu button **OK Confirm Factory Init**.
- b. Modify the initialized front-panel control settings:
 - Set the vertical **SCALE** to 1 volt; set the horizontal **SCALE** to 20 ns.
 - Push **VERTICAL MENU**.
 - Press the main-menu button **Coupling**. Push the side-menu button Ω to toggle it to the 50 Ω setting.
 - Press **TRIGGER MENU**. Push the main-button **SOURCE**; then push the side-menu button **–more–** until **Auxiliary** appears in the side menu. Press the side-menu button **Auxiliary**.
 - Press the **Coupling** main-menu button; then push the **AC** side-menu button.
- c. Hook up the test-signal source:
 - Connect a BNC T connector to the output of the sine-wave generator.

- Connect one 50 Ω cable to one side of the BNC T connector; connect a second 50 Ω cable to the other side of the BNC T connector.
 - Connect one of the cables just installed to **CH 1**; connect the other cable just installed to the **AUX TRIGGER** input at the rear panel.
2. *Confirm the Trigger input:*
- a. *Display the test signal:*
 - Set the generator for a 10 MHz, four division signal.
 - b. *Check for Main trigger system for stable triggering at limits:*
 - Read the following definition: A stable trigger is one that is consistent; that is, one that results in a uniform, regular display triggered on the selected slope (positive or negative). This display should *not* have its trigger point switching between opposite slopes, nor should it “roll” across the screen.

First, set a signal with a four division amplitude and a 10 MHz frequency.

Second, check for a stable trigger at both the positive and negative slope settings.

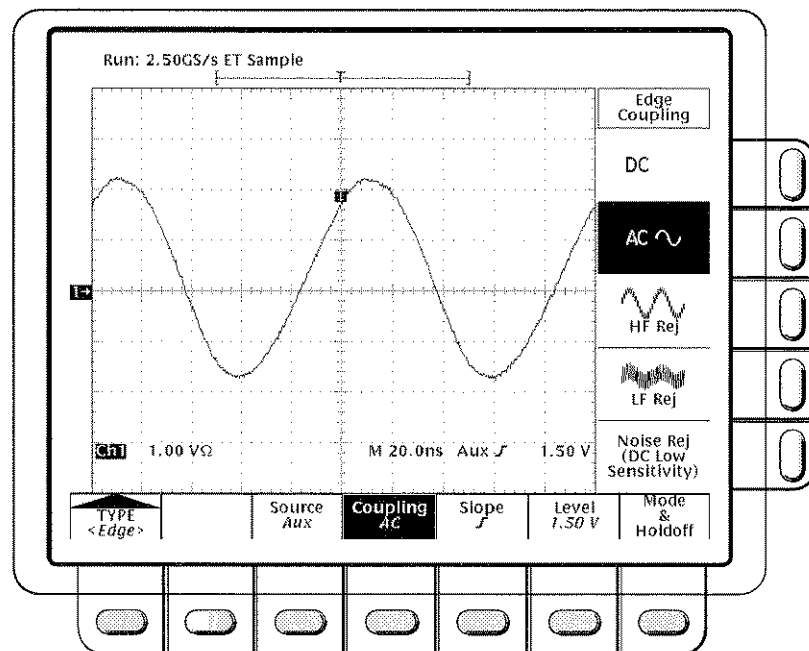

Figure 1-17: Confirming Auxiliary Triggering at Maximum Triggering Frequency

3. *Disconnect the hookup:* Disconnect the cable from the generator output at the input connector of the channel last tested.

Check Video Trigger Sensitivity (Option 05 Equipped Models Only)

Equipment Required: One NTSC format video generator (Item 15), 75 Ω coaxial cable (Item 6), and one 75 Ω terminator (Item 4).

Prerequisites: See page 1-13.

Procedure:

1. *Install the test hookup and preset the instrument controls:*
 - a. *Initialize the instrument:*
 - Press save/recall **SETUP**.
 - Press the main menu button **Recall Factory Setup**.
 - Press the side menu button **OK Confirm Factory Init**.
 - b. *Modify the default setup:*
 - Set the vertical **SCALE** to 500 mV.
 - Set the horizontal **SCALE** to 20 μ s.
 - Press **HORIZONTAL MENU**.
 - Press the main menu button **Record Length**.
 - Press the side menu button **5000 points in 100 divs**.

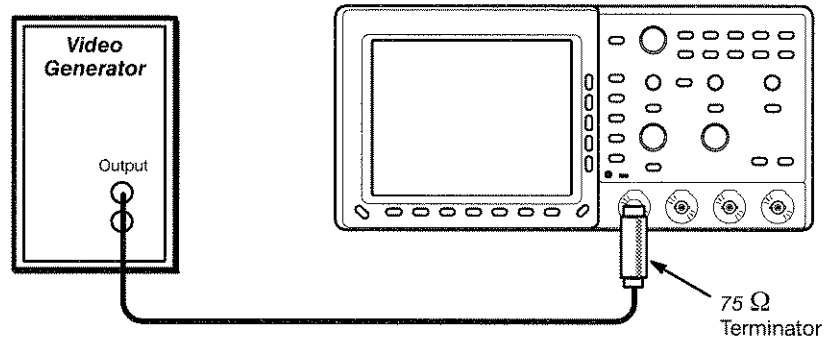

Figure 1-18: Initial Test Hookup

- c. *Hook up the test-signal source:* Connect, through a 75 Ω precision coaxial cable, followed by a 75 Ω terminator, the output of a NTSC format video generator to CH 1 (see Figure 1-18).
2. *Confirm the video trigger system is within limits for:*
 - a. *Display the test signal:*
 - Set video generator to NTSC format.
 - Set the output of the generator for a five step ramp with color burst.

- Press **SET TO 50%**. Use the trigger **MAIN LEVEL** knob to stabilize the display as required.
 - Press **TRIGGER MENU**.
 - Press the main menu button **Mode & Holdoff**. Then press the side menu button **Normal**.
- b. *Fine adjust the sync pulse amplitude:* The amplitude of the TV waveform should now be about 2 divisions pk-pk. Do the following sub-parts to fine adjust the vertical gain until the sync pulses measure exactly 0.6 divisions peak-to-peak using the graticule:
- Press **VERTICAL MENU**.
 - Press the main menu button **Fine Scale**.
 - Use the General Purpose knob, adjust the fine gain until the sync pulse amplitude is 0.6 divisions measured using the graticule (see Figure 1-19).

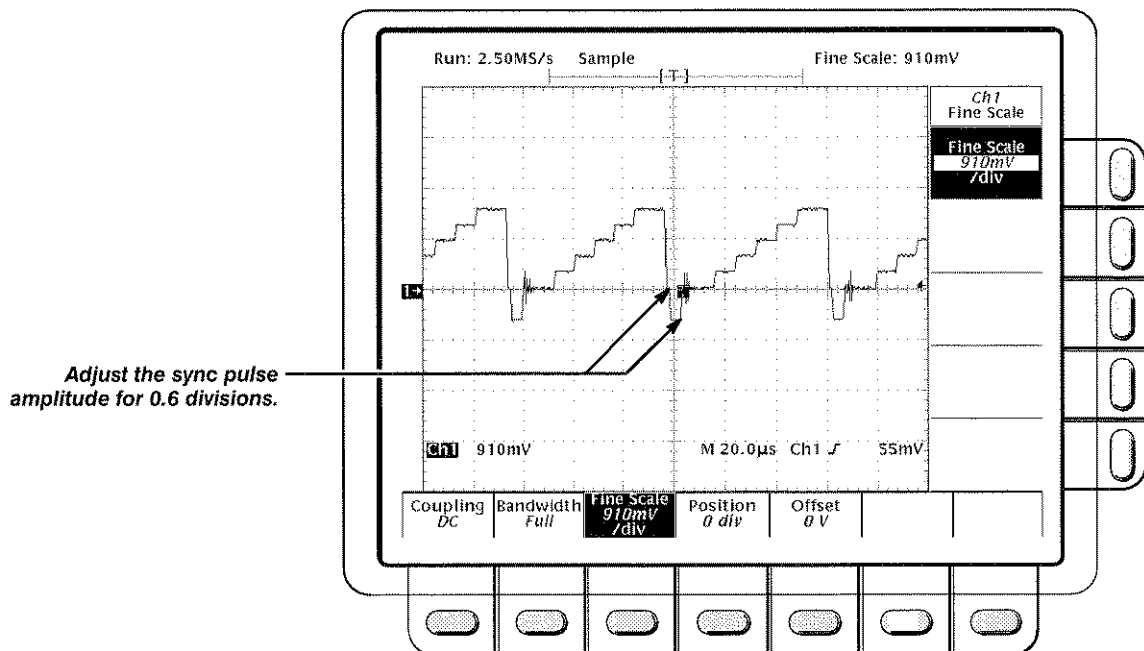

Figure 1-19: Adjusting Sync Pulse Amplitude

- c. *Check for stable triggering against limits:*
- Read the following definition: A stable trigger is one that is consistent; that is, one that results in a uniform, regular display triggered on the selected slope (positive or negative). This display should *not* have its trigger point switching between opposite slopes, nor should it “roll” across the screen. At horizontal scale settings of appropriate for viewing video waveforms, the **TRIG'D** light will remain constantly lit.

- Press **TRIGGER MENU**. Press the main menu button **Type** twice—first to pop up its menu and then to toggle it to **Video**.
- Press the main menu button **Class** to pop up its menu. Press it again as needed to toggle it to **NTSC**.
- Press the main menu button **Scan** to pop up its menu.
- Press the side menu button **Interlaced Field One**. Center the display at mid screen.
- CHECK that a stable trigger is obtained with the last two lines of TV field 2 and the beginning of TV field 1 displayed. (If the last line is a full TV line duration ($63.5 \mu\text{s}$), then it is the end of field 2—see waveform R1 in Figure 1-20.)
- Press the side menu button **Interlaced Field Two**. Center the display at mid screen.
- CHECK that a stable trigger is obtained with the last of TV field 1 and the beginning of TV field 2 displayed. (If the last line is a $\frac{1}{2}$ TV line duration ($31.75 \mu\text{s}$), then it is the end of field 1—see waveform R2 in Figure 1-20.)
- Press the side menu button **Non Interlaced Both Fields**.
- Press the main menu button **Mode and Holdoff**. Then press the side menu button **Holdoff**.
- Use the **General Purpose** knob to set the holdoff to 1.

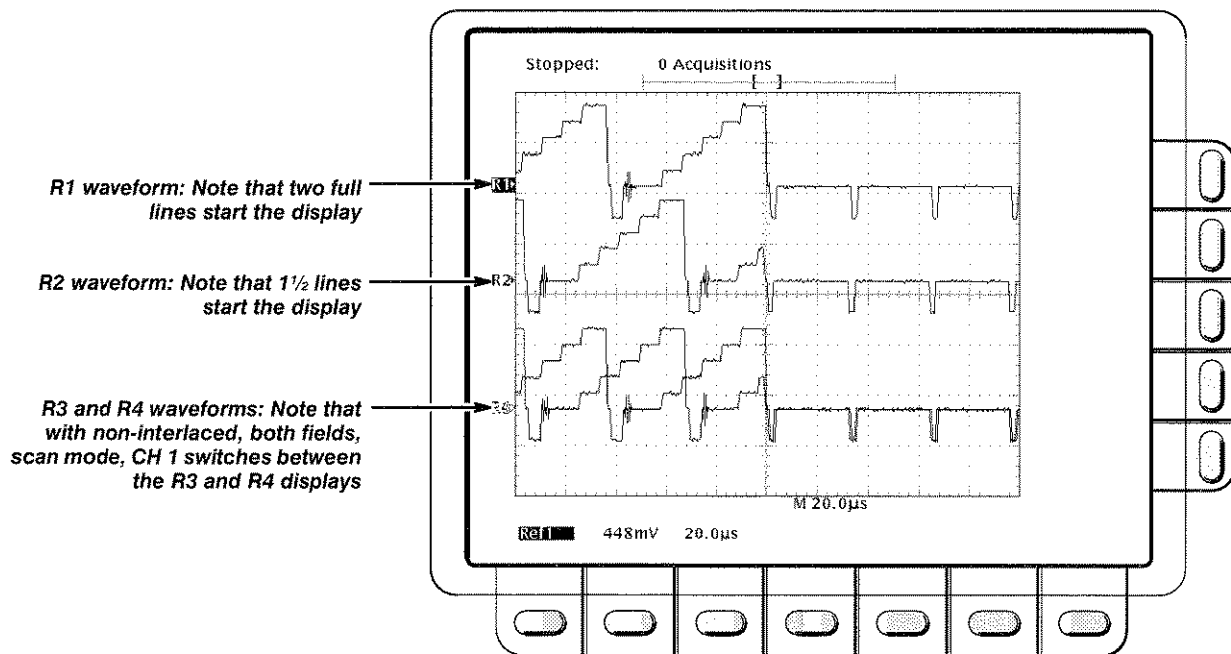

Figure 1-20: Measurement of Video Sensitivity

- Rotate the horizontal **POSITION** control clockwise to move the ends of both fields to the center of the display.
 - CHECK that a stable trigger is obtained while alternating between field 1 and field 2. (If the last line is alternating between a full TV line and $\frac{1}{2}$ a line in duration (63.5 μ s and 31.75 μ s respectively), then triggering is occurring on both fields—see waveforms R3 and R4 in Figure 1-20.)
- d. *Check delay by lines:*
- Press the main menu button **Scan**.
 - Press the side menu button **Interlaced Field One**.
 - Rotate the horizontal **POSITION** control counter clockwise and align the trigger "T" to center screen
 - Press the main menu button **TV Delay Mode**.
 - Press the side menu button **Delay by Lines**.
 - Use the General Purpose knob to set the line count to **10**.
 - CHECK that the selected line is the first line that has the color burst signal.
- e. *Check sync trigger:*
- Using the Vertical **POSITION** knob move the video waveform from the top to the bottom of the display.
 - CHECK that the **TRIG'D** LED stays on and the waveform is stable.
 - Using the Vertical **POSITION** knob return the waveform to the center of the display.
3. *Disconnect the hookup:* Disconnect the cable from the generator output at the input connector of **CH 1**.

Output Signal Check

The procedure that follows checks the characteristics of the probe compensation signal that are listed as checked under *Warranted Characteristics* in Section 2, *Specifications*.

Check Probe Adjust Output

Equipment Required: One standard-accessory 10X probe (Item 14).

Prerequisites: See page 1-13. Also, this digitizing oscilloscope must have passed *Check Accuracy—Long-Term Sample Rate, Delay time, Time Measurement* on page 1-29 and *Check DC Voltage Measurement Accuracy (Averaged)* on page 1-20.

Procedure:

1. *Install the test hookup and preset the instrument controls:*

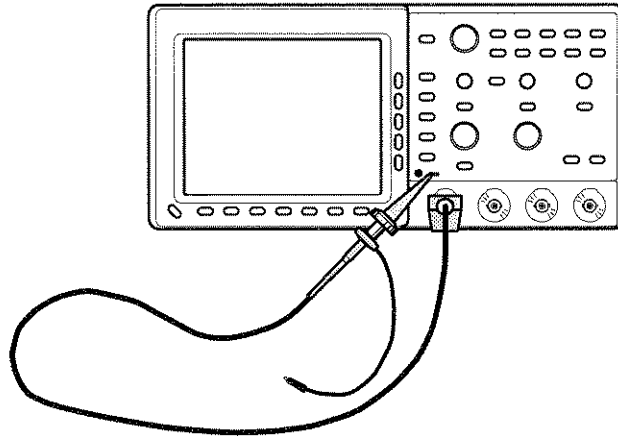

Figure 1-21: Initial Test Hookup

- a. *Hook up test-signal:* Install the standard-accessory probe on **CH 1**. Connect the probe tip to **PROBE COMP** on the front panel; leave the probe ground unconnected.
- b. *Initialize the oscilloscope:*
 - Press save/recall **SETUP**.
 - Press the main-menu button **Recall Factory Setup**.
 - Press the side-menu button **OK Confirm Factory Init**.
- c. *Modify the initialized front-panel control settings:*
 - Press **AUTOSET**. Set the horizontal **SCALE** to 200 μ s.
 - Press **SHIFT**; then press **ACQUIRE MENU**.
 - Press the main-menu button **Mode**; then press the side-menu button **Hi Res**.

2. Confirm that the Probe Compensator signal is within limits for amplitude and frequency:
 - a. Measure amplitude and frequency of the probe compensation signal:
 - Press **MEASURE**; then press the main-menu button **Select Measurement for Ch1**.
 - Now repeatedly press the side-menu button **—more—** until **Amplitude** appears in the side menu (its icon is shown at the left). Press the side-menu button **Amplitude**.
 - Repeatedly press the side-menu button **—more—** until **Frequency** appears in the side menu (its icon is shown at the left). Press the side-menu button **Frequency**.
 - Press **CLEAR MENU** to remove the menus from the display. See Figure 1-22.

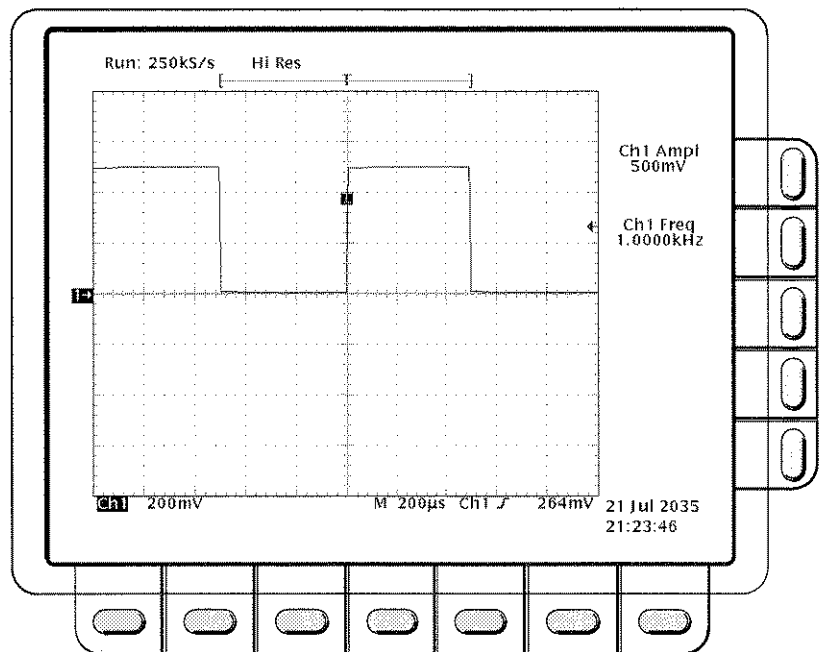

Figure 1-22: Measurement of Probe Compensator Limits

- b. *Check against limits:* CHECK that the **CH 1 Freq** readout is within 950 Hz to 1.050 kHz, inclusive, and that the readout for **Ch1 Ampl** is within 475 mV to 525 mV, inclusive.
- c. *Disconnect the test hookup:* Remove the test probe as desired.





Specifications

This subsection begins with a general description of the traits of the TDS 400 Digitizing Oscilloscopes. Three subsections follow, one for each of three classes of traits: *nominal traits*, *warranted characteristics*, and *typical characteristics*.

General

The Tektronix TDS 400 Digitizing Oscilloscopes are portable, four-channel instruments suitable for use in a variety of test and measurement applications and systems. Key features include:

- Four input channels, each with a record length of 500 to 15,000 points and 8-bit vertical resolution. (Option 1M extends the maximum record length to 60,000 points.)
- Video triggering capabilities (with Option 5, Video Trigger).
- Full programmability and printer/plotter output.
- Advanced functions, such as continuously updated measurements.
- Specialized display modes, such as infinite and variable persistence.
- A unique graphical user interface (GUI), an on-board help mode, and a logical front-panel layout which combine to deliver a new standard in usability.

Nominal Traits

Nominal traits are described using simple statements of fact such as “Four, all identical” for the trait “Input Channels, Number of,” rather than in terms of limits that are performance requirements.

Table 2-1: Nominal Traits—Signal Acquisition System (Cont.)

Name	Description	
Digitizers, Number of	Four, all identical	
Digitized Bits, Number of	8 bits ¹	
Input Channels, Number of	Four, all identical, called CH 1–CH 4	
Input Coupling	DC, AC, or GND	
Input Resistance Selections	1 MΩ or 50 Ω	
Ranges, Offset, All Channels	Volts/Div Setting	Offset Range
	1 mV/div–99.5 mV/div	±1 V
	100 mV/div–995 mV/div	±10 V
	1 V/div–10 V/div	±100 V
Range, Position	±5 divisions	
Range, Sensitivity ²	1 mV/div to 10 V/div	

¹Displayed vertically with 25 digitization levels (DLs) per division and 10.24 divisions dynamic range with zoom off. A DL is the smallest voltage level change that can be resolved by the 8-bit A-D Converter, with the input scaled to the volts/division setting of the channel used. Expressed as a voltage, a DL is equal to 1/25 of a division times the volts/division setting.

²The sensitivity ranges from 1 mV/div to 10 V/div in a 1–2–5 sequence of coarse settings. Between consecutive coarse settings, the sensitivity can be finely adjusted with a resolution of 1% of the more sensitive setting. For example, between 50 mV/div and 100 mV/div, the volts/division can be set with 0.5 mV resolution.

³Rise time is defined by the following formula:

$$\text{Rise Time (ns)} = \frac{350}{\text{BW (MHz)}}$$

Table 2-2: Nominal Traits—Time Base System

Name	Description
Range, Sample-Rate ^{1,3}	2.5 Samples/s to 100 MSamples/s
Range, Equivalent Time or Interpolated Waveform Rate ^{2,3}	200 MSamples/s to 50 GSamples/s (5 ns/Sample to 20 ps/Sample)
Range, Seconds/Division	1 ns/div to 20 s/div
Range, Time Base Delay Time	0 to 20 seconds (settings of 20 μs and slower are displayed in roll mode)
Reference Frequency, Time Base	100 MHz

Table 2-2: Nominal Traits—Time Base System (Cont.)

Name	Description
Record Length Selection	500 points, 1,000 points, 2,500 points, 5,000, and 15,000 points. Record lengths of 30,000 and 60,000 points are available with Option 1M. ⁴

¹The range of real-time rates, expressed in samples/second, at which a digitizer samples signals at its inputs and stores the samples in memory to produce a record of time-sequential samples

²The range of waveform rates for equivalent time or interpolated waveform records.

³The Waveform Rate (WR) is the equivalent sample rate of a waveform record. For a waveform record acquired by real-time sampling of a single acquisition, the waveform rate is the same as the real-time sample rate; for a waveform created by interpolation of real-time samples from a single acquisition or by equivalent-time sampling of multiple acquisitions, the waveform rate is faster than the real time sample rate. For all three cases, the waveform rate is $1/(\text{Waveform Interval})$ for the waveform record, where the waveform interval (WI) is the time between the samples in the waveform record.

⁴The maximum record length of 60,000 points available with Option 1M is selectable with all acquisition modes except Hi Res and Average. In Hi Res and Average, the maximum record length is 15,000 points.

Table 2-3: Nominal Traits—Triggering System (Cont.)

Name	Description						
Range, Events Delay	1 to 9,999,999						
Ranges, Trigger Level or Threshold	<table border="1"> <thead> <tr> <th>Source</th> <th>Range</th> </tr> </thead> <tbody> <tr> <td>Any Channel</td> <td>± 12 divisions from center of screen</td> </tr> <tr> <td>Line</td> <td>± 400 Volts</td> </tr> </tbody> </table>	Source	Range	Any Channel	± 12 divisions from center of screen	Line	± 400 Volts
Source	Range						
Any Channel	± 12 divisions from center of screen						
Line	± 400 Volts						
Video Mode (Option 05 Equipped Instruments Only)	<p>Line Rate Class: Four classes are provided as follows.</p> <ul style="list-style-type: none"> ■ NTSC, which provides a default line rate compatible with the NTSC standard (525/60) ■ PAL, which provides a default line rate compatible with the PAL standard (625/50) ■ SECAM, which provides a default line rate compatible with the SECAM standard ■ Custom, which provides user selectable line rate ranges (see "Custom Line Rate Ranges" below) <p>Custom Line Rate Ranges: 15 kHz–20 kHz, 20 kHz–25 kHz, and 25 kHz–35 kHz, and 35 kHz–64 kHz</p> <p>Holdoff: Automatically adjusts to 50 ms (nominal) for NTSC class; to 140 ms (nominal) for PAL class</p> <p>Triggerable on Field Selections: Odd, Even, or Both</p> <p>Delayed Acquisition: Settable for delay by line number or runs after time delay</p>						

Table 2-4: Nominal Traits—Display System

Name	Description
Video Display Resolution	640 pixels horizontally by 480 pixels vertically in a display area of 5.04 inches horizontally by 3.78 inches vertically
Waveform Display Graticule	A single graticule 401 × 501 pixels (8 × 10 divisions, with divisions that are 1 cm by 1 cm)
Waveform Display Grey Scale	Sixteen levels in infinite-persistence and variable-persistence display styles

Table 2-5: Nominal Traits—Data Storage

Name	Description
Capacity, Nonvolatile Waveform Memory	Standard Instrument: Total capacity is 20,000 points (four waveforms acquired with maximum record lengths of 5,000 points each). Option 1M Equipped Instrument: Total capacity is 60,000 points (two to four waveforms acquired with any combination of record lengths that add up to 60,000 points). For available record lengths, see "Record Length Selection" on page 2-3 of this section.
Capacity, Nonvolatile Setup Memory	Ten setups.
Retention Time, Nonvolatile Memories	Internal batteries, installed at time of manufacture, have a life of ≥ 5 years when operated and/or stored at an ambient temperature from 0° C to 50° C. Retention time of the nonvolatile memories is equal to the remaining life of the batteries.
Batteries ¹ Required	Two lithium poly-carbon monofluoride. Both are type BR2/3A, UL listed. Both are rated at 3.0 volt, 1.2 amp-hour.

¹Batteries are not accessible from the outside of the instrument; therefore, they can only be replaced by a service technician.

Table 2-6: Nominal Traits—GPIB Interface, Video Output, and Power Fuse

Name	Description
Interface, GPIB	GPIB interface complies with IEEE Std 488.1-1987 and IEEE Std 488.2-1987.
Output, Video	Provides a video signal, non-interlaced, with levels that comply with ANSI RS343A. Output is through a rear-panel DB9 connector.
Fuse Rating	Either of two fuses ¹ may be used: a .25" \times 1.25" (UL 198.6, 3AG): 5 A FAST, 250 V, or a 5 mm \times 20 mm, (IEC 127): 4 A (T), 250 V.

¹Each fuse type requires its own fuse cap.

Table 2-7: Nominal Traits—Mechanical

Name	Description
Cooling Method	Forced-air circulation with no air filter.
Construction Material	Chassis parts constructed of aluminum alloy; front panel constructed of plastic laminate; circuit boards constructed of glass-laminate.
Finish Type	Tektronix Blue textured finish on aluminum cabinet.
Weight	<p>Standard digitizing oscilloscope</p> <ul style="list-style-type: none"> 8.6 kg (19.0 lbs), oscilloscope only. 10.2 kg (22.5 lbs), with front cover, accessories, and accessories pouch installed. 14.5 kg (32.0 lbs), when packaged for domestic shipment. <p>Rackmount digitizing oscilloscope</p> <ul style="list-style-type: none"> 8.2 kg (18.0 lbs) plus the weight of rackmount parts, for the rackmounted digitizing oscilloscope (Option 1R). 16.3 kg (36.0 lbs), when the rackmounted digitizing oscilloscope is packaged for domestic shipment. <p>Rackmount conversion kit</p> <ul style="list-style-type: none"> 4.5 kg (10.0 lbs), parts only; 7.9 kg (17.5 lbs), parts plus package for domestic shipping.
Overall Dimensions	<p>Standard digitizing oscilloscope</p> <ul style="list-style-type: none"> Height 191 mm (7.5 in), when feet and accessories pouch are installed. 165 mm (6.5 in), without the accessories pouch installed. Width 362 mm (14.25 in), with handle. Depth 471 mm (18.55 in), oscilloscope only; 490 mm (19.28 in), with optional front cover installed; 564 mm (22.2 in) with handle fully extended. <p>Rackmount digitizing oscilloscope</p> <ul style="list-style-type: none"> Height 178 mm (7.0 in). Width 483 mm (19.0 in). Depth 472 mm (18.6 in), without front-panel handles; 517 mm (20.35 in) with front-panel handles installed.

Warranted Characteristics

This subsection lists the various *warranted characteristics* that describe the TDS 400 Digitizing Oscilloscopes. Included are electrical and environmental characteristics.

Warranted characteristics are described in terms of quantifiable performance limits which are warranted. This subsection lists only warranted characteristics. A list of *typical characteristics* starts on page 2-13.

NOTE

In these tables, those warranted characteristics that are checked in the procedure Performance Tests, found in Section 1, appear in boldface type under the column Name.

Performance Conditions

The electrical characteristics found in these tables of warranted characteristics apply when the oscilloscope has been adjusted at an ambient temperature between +20° C and +30° C, has had a warm-up period of at least 20 minutes, and is operating at an ambient temperature between 0° C and +50° C (unless otherwise noted).

Table 2-8: Warranted Characteristics—Signal Acquisition System

Name	Description	
Accuracy, DC Voltage Measurement, Averaged	Measurement Type Average of ≥ 16 waveforms	DC Accuracy $\pm(1.5\% \times (\text{reading} - \text{Net Offset}^1) + \text{Offset Accuracy} + 0.06 \text{ div})$
	Delta volts between any two averages of ≥ 16 waveforms ²	$\pm(1.5\% \times \text{reading} + 0.1 \text{ div} + 0.3 \text{ mV})$
Accuracy, DC Gain ³	$\pm 1.5\%$	

¹Net Offset = Offset – (Position x Volts/Div). Net Offset is the voltage level at the center of the A-D converter's dynamic range. Offset Accuracy is the accuracy of this voltage level.

²The samples must be acquired under the same setup and ambient conditions.

³DC Gain Accuracy is confirmed in the Performance Verification Procedure (Section 4) by passing the checks for Offset Accuracy and DC Voltage Measurement Accuracy (Averaged).

Table 2-8: Warranted Characteristics—Signal Acquisition System (Cont.)

Name	Description	
Accuracy, Offset	Volts/Div Setting	Offset Accuracy
	1 mV/div–9.95 mV/div	$\pm(0.4\% \times \text{Net Offset}^1 + 0.9 \text{ mV} + 0.1 \text{ div})$
	10 mV/div–99.5 mV/div	$\pm(0.4\% \times \text{Net Offset}^1 + 1.5 \text{ mV} + 0.1 \text{ div})$
	100 mV/div–995 mV/div	$\pm(0.4\% \times \text{Net Offset}^1 + 15 \text{ mV} + 0.1 \text{ div})$
	1 V/div–10 V/div	$\pm(0.4\% \times \text{Net Offset}^1 + 150 \text{ mV} + 0.1 \text{ div})$
Accuracy, Position ⁴	$\pm(1.5\% \times (\text{Position} \times \text{Volts/div}) + \text{Offset Accuracy} + 0.04 \text{ div})$	
Analog Bandwidth, DC-50 Ω Coupled and DC-1 M Ω with Standard-accessory Probe Attached (TDS 420)	Volts/Div	Bandwidth⁵
	5 mV/div–10 V/div	DC–150 MHz
	2 mV/div–4.98 mV/div	DC–110 MHz
	1 mV/div–1.99 mV/div	DC–90 MHz
Analog Bandwidth, DC-50 Ω Coupled and DC-1 M Ω with Standard-accessory Probe Attached (TDS 460)	Volts/Div	Bandwidth⁵
	5 mV/div–10 V/div	DC–350 MHz
	2 mV/div–4.98 mV/div	DC–250 MHz
	1 mV/div–1.99 mV/div	DC–100 MHz
Cross Talk (Channel Isolation)	Volts/Div	Isolation
	$\geq 500 \text{ mV/div}$	$\geq 50:1$ at 50 MHz for any two channels having equal volts/division settings
	$\leq 9.95 \text{ mV/div}$	$\geq 50:1$ at 50 MHz for any two channels having equal volts/division settings
	10 mV/div–500 mV/div	$\geq 100:1$ at 100 MHz and $\geq 30:1$ at full rated bandwidth for any two channels having equal volts/division settings
Delay Between Channels, Full Bandwidth, Equivalent Time	$\leq 200 \text{ ps}$ between CH 1 and CH 2 and between CH 3 and CH 4 when both channels have equal volts/division and coupling settings $\leq 450 \text{ ps}$ for any other combination of two channels with equal volts/division and coupling settings	

¹Net Offset = Offset – (Position x Volts/Div). Net Offset is the voltage level at the center of the A-D converter's dynamic range. Offset Accuracy is the accuracy of this voltage level.

⁴Position Accuracy is confirmed in the Performance Verification Procedure (Section 4) by passing the checks for Offset Accuracy and DC Voltage Measurement Accuracy (Averaged).

⁵The limits given are for the ambient temperature range of 0°C to +30°C. Reduce the upper bandwidth frequencies by 2.5 MHz for each °C above +30°C.

Table 2-8: Warranted Characteristics—Signal Acquisition System (Cont.)

Name	Description	
Input Impedance, DC-1 M Ω Coupled	1 M Ω \pm 0.5% in parallel with 15 pF \pm 2.0 pF. Matched to within \pm 1% for resistance and \pm 1.0 pF for capacitance	
Input Impedance, DC-50 Ω Coupled (TDS 420)	50 Ω \pm 1% with VSWR \leq 1.2:1 from DC–150 MHz	
Input Impedance, DC-50 Ω Coupled (TDS 460)	50 Ω \pm 1% with VSWR \leq 1.6:1 from DC–350 MHz	
Input Voltage, Maximum, DC-1 M Ω , AC-1 M Ω , or GND Coupled	Volt/Div	Rating
	0.1 V/div–10 V/div	\pm 400 V (DC + peak AC); derate at 20 dB/decade above 10 MHz until the minimum rating of \pm 5 V (DC + peak AC) is reached
	1 mV/div–9.99 mV/div	\pm 400 V (DC + peak AC); derate at 20 dB/decade above 10 kHz until the minimum rating of \pm 5 V (DC + peak AC) is reached
Input Voltage, Maximum, DC-50 Ω or AC-50 Ω Coupled	5 V rms, with peaks less than or equal to \pm 30 V	
Lower Frequency Limit, AC Coupled	\leq 10 Hz when AC–1 M Ω coupled; \leq 200 kHz when AC-50 Ω coupled ⁶	

⁶The AC Coupled Lower Frequency Limits are reduced by a factor of 10 when 10X, passive probes are used.

Table 2-9: Warranted Characteristics—Time Base System

Name	Description
Accuracy, Long Term Sample Rate and Delay Time	\pm 150 ppm over any \geq 1 ms interval
Accuracy, Absolute Time and Delay Time Measurements ^{1, 2}	For single-shot acquisitions using sample or high-resolution acquisition modes and a bandwidth limit setting of 100 MHz: $\pm(1 \text{ WI} + 150 \text{ ppm of } \text{Reading} + 450 \text{ ps})$
	For single-shot acquisitions using sample or high-resolution acquisition modes and a bandwidth limit setting of 20 MHz: $\pm(1 \text{ WI} + 150 \text{ ppm of } \text{Reading} + 1.3 \text{ ns})$
	For repetitive acquisitions using average acquisition mode with \geq 8 averages and a bandwidth limit setting of FULL: $\pm(1 \text{ WI} + 150 \text{ ppm of } \text{Reading} + 200 \text{ ps})$

¹For input signals \geq 5 divisions in amplitude and a slew rate of \geq 2.0 divisions/ns at the delta time measurement points. Signal must have been acquired at a volts/division setting \geq 5 mV/division.

²The WI (waveform interval) is the time between the samples in the waveform record. Also, see the footnotes for *Sample Rate Range and Equivalent Time or Interpolated Waveform Rates* in Table 2-2 on page 2-2.

Table 2-9: Warranted Characteristics—Time Base System (Cont.)

Name	Description
Accuracy, Delta Time Measurement^{1, 2}	<p>For single-shot acquisitions using sample or high-resolution acquisition modes and a bandwidth limit setting of 100 MHz:</p> $\pm(1 \text{ WI} + 150 \text{ ppm of } \text{Reading} + 650 \text{ ps})$ <p>For repetitive acquisitions using average acquisition mode with ≥ 8 averages and a bandwidth limit setting of FULL:</p> $\pm(1 \text{ WI} + 150 \text{ ppm of } \text{Reading} + 300 \text{ ps})$

¹For input signals ≥ 5 divisions in amplitude and a slew rate of ≥ 2.0 divisions/ns at the delta time measurement points. Signal must have been acquired at a volts/division setting ≥ 5 mV/division.

²The WI (waveform interval) is the time between the samples in the waveform record. Also, see the footnotes for *Sample Rate Range and Equivalent Time or Interpolated Waveform Rates* in Table 2-2 on page 2-2.

Table 2-10: Warranted Characteristics—Triggering System

Name	Description
Accuracy, Trigger Level or Threshold, DC Coupled	$\pm(2\% \text{ of } \text{Setting} - \text{Net Offset}^1 + 0.2 \text{ div} \times \text{volts/div setting} + \text{Offset Accuracy})$ for any channel as trigger source
Sensitivity, Edge-Type Trigger, DC Coupled²	0.35 division from DC to 50 MHz, increasing to 1 division at 350 MHz (TDS 420) or 500 MHz (TDS 460) for any channel as trigger source
Sensitivity, Video-Type, TV Field and TV Line²	0.6 division of video sync signal
Pulse Width, minimum, Events-Delay	5 ns
Auxiliary Trigger Input	Connector: BNC at rear panel Input Voltage (maximum): -5 VDC to +10 VDC Duty Cycle (minimum required): 20% Input Load: equivalent to three TTL gate loads
Auxiliary Trigger, Maximum Input Frequency	10 MHz

¹Net Offset = Offset - (Position x Volts/Div). Net Offset is the voltage level at the center of the A-D converter's dynamic range. Offset Accuracy is the accuracy of this voltage level.

²The minimum sensitivity for obtaining a stable trigger. A stable trigger results in a uniform, regular display triggered on the selected slope. The trigger point must not switch between opposite slopes on the waveform, and the display must not "roll" across the screen on successive acquisitions. The TRIG'D LED stays constantly lighted when the SEC/DIV setting is 2 ms or faster but may flash when the SEC/DIV setting is 10 ms or slower.

Table 2-11: Warranted Characteristics—Probe Compensator Output

Name	Description	
Output Voltage and Frequency, Probe Compensator	Characteristic	Limits
	Voltage	0.5 V (base-top) $\pm 5\%$ into a 1 M Ω load
	Frequency	1 kHz $\pm 5\%$

Table 2-12: Power Requirements

Name	Description
Source Voltage and Frequency	90 to 132 VAC rms, continuous range, for 48 Hz through 62 Hz 100 to 132 VAC rms, continuous range, for 48 Hz through 440 Hz 180 to 250 VAC rms, continuous range, for 48 Hz through 440 Hz
Power Consumption	≤ 240 Watts (225 VA)

Table 2-13: Warranted Characteristics—Environmental, Safety, and Reliability

Name	Description
Atmospherics	Temperature: 0° C to +50° C, operating; –40° C to +75° C, non-operating Relative humidity: 0 to 95%, at or below +30° C; 0 to 75%, +31° C to +50° C Altitude: To 15,000 ft. (4570 m), operating; to 40,000 ft. (12190 m), non-operating
Dynamics	Random vibration: 0.31 g rms, from 5 to 500 Hz, 10 minutes each axis, operating; 2.46 g rms, from 5 to 500 Hz, 10 minutes each axis, non-operating
Emissions ^{1,2}	Meets or exceeds the requirements of the following standards: VDE 0871, Category B FCC Rules and Regulations, Part 15, Subpart B, Class A
User-Misuse Simulation	Electrostatic Discharge Susceptibility: Up to 8 kV with no change to settings or impairment of normal operation; up to 15 kV with no damage that prevents recovery of normal operation

¹To maintain emission requirements when connecting to the IEEE 488 GPIB interface of this oscilloscope, use only a high-quality, double-shielded (braid and foil) GPIB cable. The cable shield must have low impedance connections to both connector housings. Acceptable cables are Tektronix part numbers 012-0991-00, -01, -02, and -03.

²To maintain emission requirements when connecting to the VGA-compatible video output of this oscilloscope, use only a high-quality double-shielded (braid and foil) video cable with ferrite cores at either end. The cable shield must have low impedance connections to both connector housings. An acceptable cable is NEC® part number 73893013. (Use an appropriate adapter when other than a 9-pin monitor connection is needed.)

Typical Characteristics

This subsection contains tables that lists the various *typical characteristics* that describe the TDS 400 Digitizing Oscilloscopes.

Typical characteristics are described in terms of typical or average performance. Typical characteristics are not warranted.

This subsection lists only typical characteristics. A list of warranted characteristics starts on page 2-7.

Table 2-14: Typical Characteristics—Signal Acquisition System

Name	Description		
Accuracy, DC Voltage Measurement, Not Averaged	Measurement Type	DC Accuracy	
	Any Sample	$\pm(1.5\% \times (\text{reading} - \text{Net Offset}^1) + \text{Offset Accuracy} + 0.13 \text{ div} + 0.6 \text{ mV})$	
	Delta Volts between any two samples ²	$\pm(1.5\% \times \text{reading} + 0.26 \text{ div} + 1.2 \text{ mV})$	
Frequency Limit, Upper, 100 MHz Bandwidth Limited	100 MHz		
Frequency Limit, Upper, 20 MHz Bandwidth Limited	20 MHz		
Nonlinearity	< 1 DL, differential; ≤ 1 DL, integral, independently based ³		
Step Response Settling Error	Volts/Div Setting	Step Amplitude	Settling Error (%)⁴
			20 ns 500 ns 20 ms
	1 mV/div–99.5 mV/div	≤2 V	≤0.5 ≤0.2 ≤0.1
	100 mV/div – 995 mV/div	≤20 V	≤2.0 ≤0.5 ≤0.2
	1 V/div–10 V/div	≤200 V	≤2.0 ≤0.5 ≤0.2

¹Net Offset = Offset – (Position x Volts/Div). Net Offset is the voltage level at the center of the A-D converter’s dynamic range. Offset Accuracy is the accuracy of this voltage level.

²The samples must be acquired under the same setup and ambient conditions.

³A DL (digitization level) is the smallest voltage level change that can be resolved by the 8-bit A-D Converter, with the input scaled to the volts/division setting of the channel used. Expressed as a voltage, a DL is equal to 1/25 of a division times the volts/division setting.

⁴The values given are the maximum absolute difference between the value at the end of a specified time interval after the mid-level crossing of the step, and the value one second after the mid-level crossing of the step, expressed as a percentage of the step amplitude.

Table 2-16: Typical Characteristics—Triggering System (Cont.)

Name	Description
Frequency, Maximum for Events Delay ⁵	90 MHz
Width, Minimum Pulse and Rearm, Events Delay ⁶	5 ns

⁵The maximum frequency for a delaying events input.

⁶The minimum pulse width and rearm width required for recognizing a delaying event.

Table 2-17: Typical Characteristics—Data Handling

Name	Description
Time, Data-Retention, Nonvolatile Memory ^{1,2}	5 Years

¹The time that reference waveforms, stored setups, and calibration constants are retained when there is no power to the oscilloscope.

²Data is maintained by lithium poly-carbon monofluoride.

