

THE
TDS 520
& TDS 540
DIGITIZING
OSCILLOSCOPES

Tutorial/User
Manual

*Please check for CHANGE INFORMATION
at the rear of this manual.*

WARRANTY

Tektronix warrants that this product will be free from defects in materials and workmanship for a period of three (3) years from the date of shipment. If any such product proves defective during this warranty period, Tektronix, at its option, either will repair the defective product without charge for parts and labor, or will provide a replacement in exchange for the defective product.

In order to obtain service under this warranty, Customer must notify Tektronix of the defect before the expiration of the warranty period and make suitable arrangements for the performance of service. Customer shall be responsible for packaging and shipping the defective product to the service center designated by Tektronix, with shipping charges prepaid. Tektronix shall pay for the return of the product to Customer if the shipment is to a location within the country in which the Tektronix service center is located. Customer shall be responsible for paying all shipping charges, duties, taxes, and any other charges for products returned to any other locations.

This warranty shall not apply to any defect, failure or damage caused by improper use or improper or inadequate maintenance and care. Tektronix shall not be obligated to furnish service under this warranty a) to repair damage resulting from attempts by personnel other than Tektronix representatives to install, repair or service the product; b) to repair damage resulting from improper use or connection to incompatible equipment; or c) to service a product that has been modified or integrated with other products when the effect of such modification or integration increases the time or difficulty of servicing the product.

THIS WARRANTY IS GIVEN BY TEKTRONIX WITH RESPECT TO THIS PRODUCT IN LIEU OF ANY OTHER WARRANTIES, EXPRESS OR IMPLIED. TEKTRONIX AND ITS VENDORS DISCLAIM ANY IMPLIED WARRANTIES OF MERCHANTABILITY OR FITNESS FOR A PARTICULAR PURPOSE. TEKTRONIX' RESPONSIBILITY TO REPAIR OR REPLACE DEFECTIVE PRODUCTS IS THE SOLE AND EXCLUSIVE REMEDY PROVIDED TO THE CUSTOMER FOR BREACH OF THIS WARRANTY. TEKTRONIX AND ITS VENDORS WILL NOT BE LIABLE FOR ANY INDIRECT, SPECIAL, INCIDENTAL, OR CONSEQUENTIAL DAMAGES IRRESPECTIVE OF WHETHER TEKTRONIX OR THE VENDOR HAS ADVANCE NOTICE OF THE POSSIBILITY OF SUCH DAMAGES.

INSTRUMENT SERIAL NUMBERS

Each instrument manufactured by Tektronix has a serial number on a panel insert or tag, or stamped on the chassis. The first letter in the serial number designates the country of manufacture. The last five digits of the serial number are assigned sequentially and are unique to each instrument. Those manufactured in the United States have six unique digits. The country of manufacture is identified as follows:

B010000	Tektronix, Inc., Beaverton, Oregon, USA
E200000	Tektronix United Kingdom, Ltd., London
J300000	Sony/Tektronix, Japan
H700000	Tektronix Holland, NV, Heerenveen, The Netherlands

Instruments manufactured for Tektronix by external vendors outside the United States are assigned a two digit alpha code to identify the country of manufacture (e.g., JP for Japan, HK for Hong Kong, IL for Israel, etc.).

Tektronix, Inc., P.O. Box 500, Beaverton, OR 97077

Printed in U.S.A.

Copyright © Tektronix, Inc., 1991. All rights reserved. Tektronix products are covered by U.S. and foreign patents, issued and pending. The following are registered trademarks:

TEKTRONIX, TEK, TEKPROBE, SCOPEMOBILE and



Deskjet, HPGL, Laserjet and Thinkjet are products of the Hewlett-Packard Company.

Epson is a registered trademark of Epson America, Inc.

Interleaf is a trademark of Interleaf, Inc.

PostScript is a registered trademark of Adobe Systems, Inc.

DESCRIPTION

Product Group 55

EFFECTIVE ALL FOR SERIAL NUMBERS

Add this insert to page A-50,
Table A-27: Analog Bandwidth

Table A-1: Analog Bandwidth

Vertical Scale ¹	Attenuators (10X)	Reference Amplitude (at 6 MHz)	Horizontal Scale	Test Frequency	Limits
100 mV	none	600 mV (6 divisions)	1 ns	500 MHz	≥424 mV
1 V	none	5 V (5 divisions)	1 ns	500 MHz	≥3.535 V
500 mV	none	3 V (6 divisions)	1 ns	500 MHz	≥2.121 V
200 mV	none	1.2 V (6 divisions)	1 ns	500 MHz	≥848 mV
50 mV	1	300 mV (6 divisions)	1 ns	500 MHz	≥212 mV
20 mV	1	120 mV (6 divisions)	1 ns	500 MHz	≥84 mV
10 mV	1	60 mV (6 divisions)	1 ns	500 MHz	≥42 mV
5 mV	2	30 mV (6 divisions)	1 ns	500 MHz	≥21 mV
2 mV	2	12 mV (6 divisions)	2 ns	350 MHz	≥8.4 mV
1 mV	2	6 mV (6 divisions)	2 ns	250 MHz ²	≥4.2 mV

¹Only the 100 mV, 1 V, and 10 V vertical scale settings are available for the AUX 1 and AUX 2 input channels. Ignore all other settings listed when checking those channels.

²200 MHz for TDS540 Channel 2.



COMMITTED TO EXCELLENCE

MANUAL CHANGE INFORMATION

Date: 14-OCT-91

Change Reference: C2-1091

Product: TDS 520/TDS 540 Tutorial/Users Manual

Manual Part No.: 070-8317-00

DESCRIPTION

Product Group 55

Effective for All Serial Numbers

Pull and Replace the following pages:

Pages 3-39 & 3-40

Pages 3-41 & 3-42

Pages 3-43 & 3-44

Hardcopy

You can get a copy of the digitizing oscilloscope's display by using the hard-copy feature. Depending of the output format you select, you create either an image or a plot. Images are direct bit map representations of the digitizing oscilloscope display. Plots are vector (plotted) representations of the objects on the display.

Operation

Before you make a hardcopy, you need to set up communications and hard-copy parameters.

Setting Communication Parameters

Do the following to set up the communication parameters:

- Step 1:** Press the **UTILITY** button (**SHIFT** and then **DISPLAY**) to show the Utility menu.
- Step 2:** Select **I/O** from the **System** main menu pop-up (see Figure 3-16).

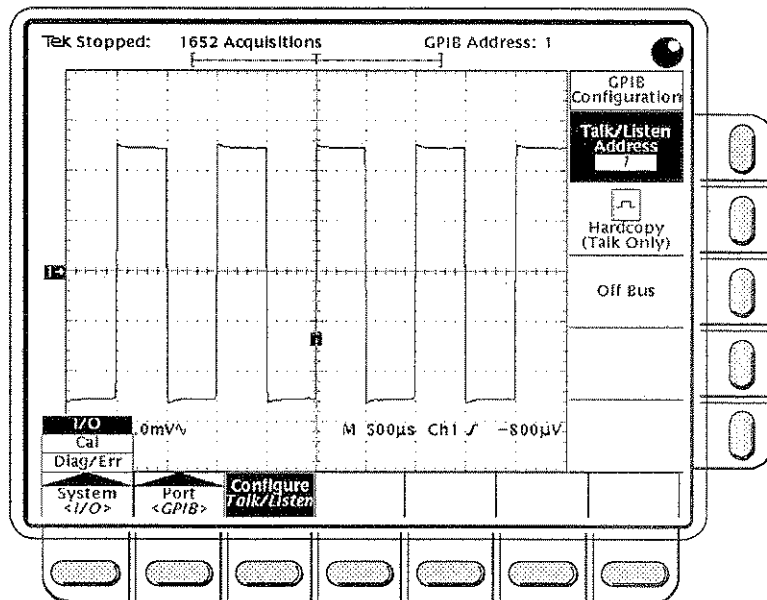

Figure 3-16: Utility Menu – System I/O

- Step 3:** Choose **Configure** from the main menu.
- Step 4:** Select the **Hardcopy (Talk Only)** option from the side menu.

Setting Hardcopy Parameters

You can specify the hardcopy's format, layout, and type of port using the hardcopy menu. Press the **HARDCOPY MENU** button (**SHIFT** and then **HARDCOPY**) to bring up the Hardcopy menu.

Format main menu item lets you change the way the oscilloscope formats the hardcopy data.

- Step 1:** Press the main menu **Format** button.
- Step 2:** You can choose **Thinkjet**, **Deskjet**, **Laserjet**, **Epson**, **Interleaf**, **EPS Image** (Postscript) or **HPGL** from the side menu item.

Layout main menu item lets you specify whether to print the hardcopy in landscape or portrait format.

- Step 1:** Press the **Layout** main menu button.
- Step 2:** Select the appropriate side menu item. You can choose **Landscape** or **Portrait** (see Figure 3-17).

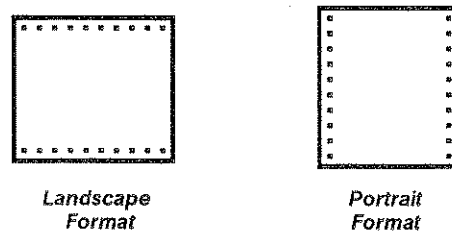

Figure 3-17: Hardcopy Formats

Port main menu item lets you specify the output channel to send your hardcopy through. The only choice is **GPIB**.

Printing the Hardcopy

To print a copy of the display, simply press the **HARDCOPY** button. If for some reason you want to stop the hardcopy process, press the **HARDCOPY** button on the front panel again.

Connection Strategies

The digitizing oscilloscope's ability to print a copy of its display in many formats (Thinkjet, Deskjet, Laserjet, Epson, Interleaf, EPS Image (Postscript), and HPGL) gives you flexibility in choosing a hardcopy device. It also makes it easier for you to read TDS screen copies into a desktop publishing system.

However, since the TDS has only a GPIB interface port and many hardcopy devices have only RS-232 or Centronics ports, you need a connection strategy for sending the hardcopy data from the digitizing oscilloscope to the printer or plotter. Three such strategies exist. You can:

- use a printer/plotter with a GPIB connector,
- use a GPIB-to-Centronics or GPIB-to-RS232 converter box, or
- send the data to a computer with both GPIB and RS-232 or Centronics ports.

Using a GPIB-Based Hardcopy Device

You can connect the digitizing oscilloscope directly to a GPIB-based hardcopy device (see Figure 3-18). An example of a GPIB hardcopy device is the Tektronix HC100 Plotter.

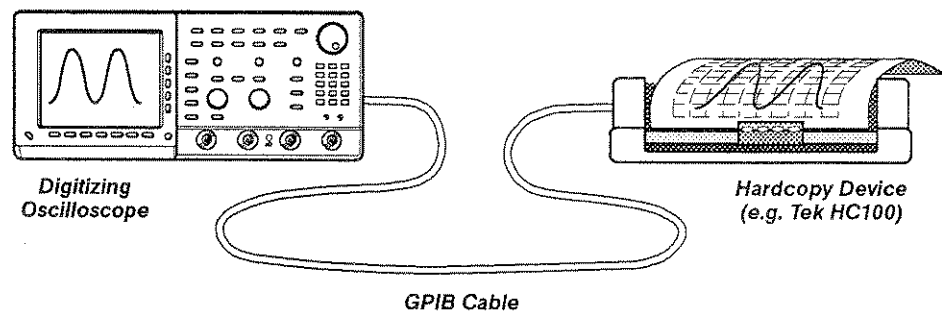

Figure 3-18: Connecting the TDS Directly to the Hardcopy Device

Using a GPIB-to-Centronics or GPIB-to-RS232 Converter

You can put a GPIB-to-Centronics or GPIB-to-RS232 interface converter box between the TDS and the RS-232 or Centronics hardcopy device (see Figure 3-19). For example, a National Instruments GPIB-PRL GPIB-to-Parallel Converter will permit you to make screen prints on a Tektronix HC200 Dot Matrix printer with just a Centronics port.

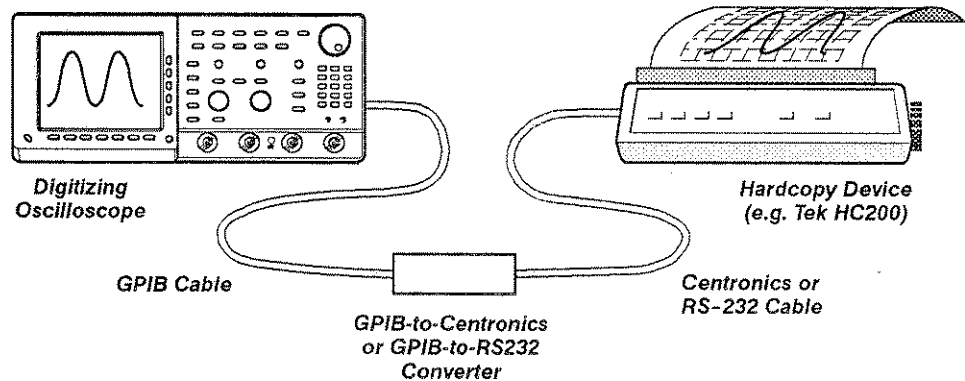

Figure 3-19: Connecting the TDS and Hardcopy Device Via a Converter

Using a Controller

You can put a controller with two ports between the TDS and the hardcopy device (see Figure 3-20). One port must be a GPIB and the other must be either an RS-232 or a Centronics port.

If your controller is PC-compatible and it uses the Tektronix GURU or S3FG210 (National Instruments GPIB-PCII/IIA) GPIB package, you can operate this setup as follows:

- Step 1:** Use the MS-DOS `cd` command to move to the directory that holds the software that came with your GPIB board. For example, if you installed the software in the GPIB-PC directory, type: `cd GPIB-PC`
- Step 2:** Run the IBIC program that came with your GPIB board. Type: `IBIC`
- Step 3:** Type: `IBFIND DEV1`
where "DEV1" is the name for the digitizing oscilloscope you defined using the IBCONF.EXE program that came with the GPIB board. Note: if you defined another name then, of course, use it instead of "DEV1". Also, remember that the digitizing oscilloscope's device address as set with the IBCONF.EXE program should match the address set in the TDS' Utility menu (typically, use "1").
- Step 4:** Type: `IBWRT "HARDCOPY START"`
Be sure the TDS Utility menu is set to **Talk/Listen** and not **Hardcopy (Talk Only)** or you will get an error message at this step. Setting the TDS Utility menu was described in the start of this Hardcopy section under the heading **Setting Communication Parameters**.

- Step 5: Type: IBRDF <Filename>**
where <Filename> is a valid DOS file name you want to call your hardcopy information. It should be <= 8 characters long with up to a 3 character extension. For example, you could type: *ibrdf screen1*.
- Step 6: Exit the IBIC program by typing: EXIT**
- Step 7: Type: COPY <Filename> <Output port>**
where <Filename> is the name you defined in step 5 and <Output port> is the PC output port your hardcopy device is connected to (such as LPT1 or LPT2). Copy the data from your file to your hardcopy device. First, ensure your printer or plotter is properly attached to your PC. Then copy the file. For example, if your file is called *screen1* and your printer is attached to the *lpt1* parallel port, type: *copy screen1 lpt1*.

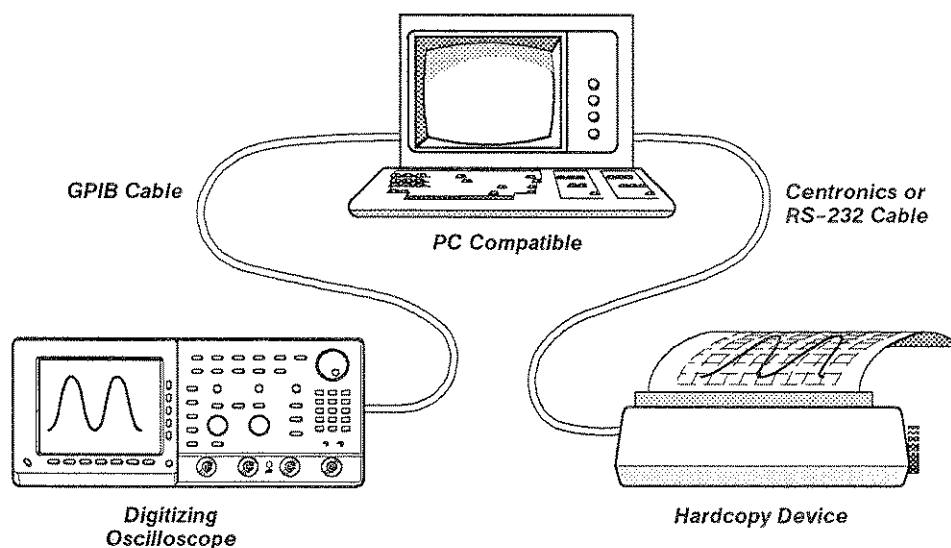

Figure 3-20: Connecting the TDS and Hardcopy Device Via a PC

Your hardcopy device should now print a picture of the TDS screen.

For More Information

See *Save and Document*, on page 2-31.

See *Remote Communications*, on page 2-35.

See *Remote Communication Tasks*, on page 3-87.





This is the Tutorial/User Manual for the TDS 520 and TDS 540 Digitizing Oscilloscopes.

If you are a new user, try the *Tutorial* section to become familiar with your digitizing oscilloscope's operation.

The *Concepts* section covers basic principles of the oscilloscope's operation. These articles help you understand why your instrument works the way it does.

Use the *In Detail* section to quickly figure out how to perform a specific task.

The *Appendices* provide an option and accessories listing, product specifications, performance verification instructions, and other useful information.

Related Manuals

Other documentation for the digitizing oscilloscope includes:

- The TDS 520 and 540 Programmer Manual (Tektronix part number 070-8318-00) describes using a computer to control the digitizing oscilloscope through the GPIB interface.
- The TDS Quick Reference (Tektronix part number 070-8316-00) to give you a quick overview of how to operate your digitizing oscilloscope.
- The TDS 520 Service Manual (Tektronix part number 070-8312-00) and the TDS 540 Service Manual (070-8314-00) provide information to maintain and service TDS 500 Series Digitizing Oscilloscopes, and provide a complete board-level description of the digitizing oscilloscope's operation.



Product Description	v
Safety	vii
Start Up	ix

Tutorial

Example 1: Displaying a Waveform	1-1
Example 2: Multiple Waveforms	1-9
Example 3: Automated Measurements	1-13
Example 4: Saving Setups	1-19

Concepts

Overview	2-1
Triggering	2-5
Scaling Waveforms	2-13
Acquisition	2-19
Measurements	2-27
Save and Document	2-31
Remote Communications	2-35

In Detail

Overview	3-1
At a Glance	3-3
Acquisition Modes	3-13
Autoset	3-17
Cursor Measurements	3-19
Delayed Triggering	3-23
Display Modes	3-29
Glitch Triggering	3-37

Hardcopy	3-39
Help	3-41
Horizontal Scale and Position	3-43
Logic Triggering	3-49
Measurement System	3-53
Probe Compensation	3-63
Probe Connection	3-65
Probe Selection	3-77
Remote Communication Tasks	3-87
Runt Triggering	3-89
Saving and Recalling Setups	3-91
Saving and Recalling Waveforms	3-93
Selecting Channels	3-95
Status	3-97
Trigger Settings	3-99
Vertical Scale and Position	3-105
Waveform Math	3-107
Zoom	3-109

Appendices

Appendix A: Options and Accessories	A-1
Appendix B: Specification	A-7
Appendix C: Performance Verification	A-27
Appendix D: Algorithms	A-75
Appendix E: Packaging for Shipment	A-87
Appendix F: Factory Initialization Settings	A-89

Glossary & Index

Glossary	G-1
Index	I-1

Change Information



Product Description

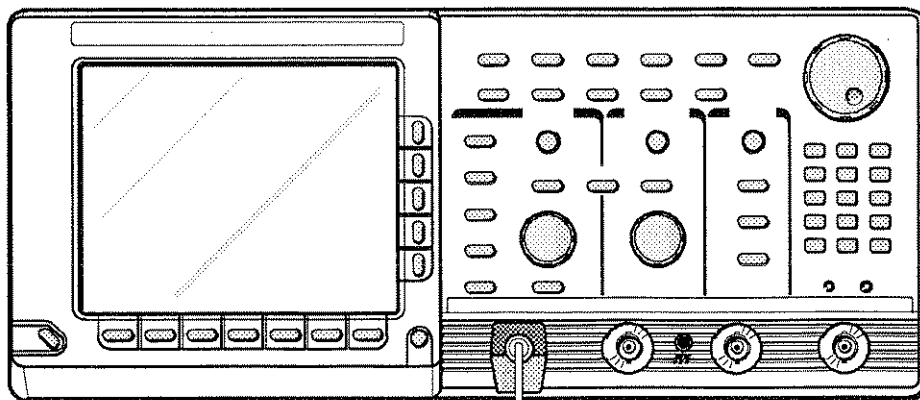

Your Tektronix digitizing oscilloscope is a superb tool for acquiring, displaying and measuring waveforms. Its performance addresses the needs of both benchtop lab and portable applications with:

- 500 MHz maximum analog bandwidth (TDS 520 and 540)
- 1 Gigasamples/second maximum digitizing rate (TDS 540)
500 Megasamples/second maximum digitizing rate (TDS 520)
- Four-channel acquisition
(The TDS 540 offers 4 full-featured channels
The TDS 520 offers 2 full-featured channels and 2 channels with limited vertical resolution: 100 mV, 1 V, and 10 V)
- Eight-bit digitizers
- Up to 15,000-point record length per channel (50,000-point optional)
- Full software programmability
- Complete measurement and documentation ability
- Intuitive graphical icon operation blended with the familiarity of traditional horizontal and vertical knobs
- On-line help at the touch of a button

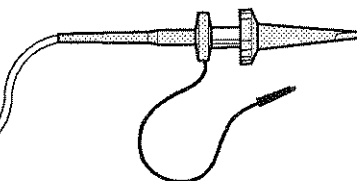





Safety

Please take a moment to review these safety precautions. They are provided for your protection and to prevent damage to the digitizing oscilloscope. This safety information applies to all operators and service personnel.

Symbols and Terms

These two terms appear in manuals:

-  statements identify conditions or practices that could result in damage to the equipment or other property.
-  statements identify conditions or practices that could result in personal injury or loss of life.

These two terms appear on equipment:

- *CAUTION* indicates a personal injury hazard not immediately accessible as one reads the marking, or a hazard to property including the equipment itself.
- *DANGER* indicates a personal injury hazard immediately accessible as one reads the marking.

This symbol appears in manuals:



Static-Sensitive Devices

These symbols appear on equipment:



DANGER
High Voltage



Protective
ground (earth)
terminal



ATTENTION
Refer to
manual

Specific Precautions

Observe all of these precautions to ensure your personal safety and to prevent damage to either the digitizing oscilloscope or equipment connected to it.

Power Source

The digitizing oscilloscope is intended to operate from a power source that will not apply more than 250 V rms between the supply conductors or between either supply conductor and ground. A protective ground connection, through the grounding conductor in the power cord, is essential for safe system operation.

Grounding the Digitizing Oscilloscope

The digitizing oscilloscope is grounded through the power cord. To avoid electric shock, plug the power cord into a properly wired receptacle where earth ground has been verified by a qualified service person. Do this before making connections to the input or output terminals of the digitizing oscilloscope.

Without the protective ground connection, all parts of the digitizing oscilloscope are potential shock hazards. This includes knobs and controls that may appear to be insulators.

Use the Proper Power Cord

Use only the power cord and connector specified for your product. Use only a power cord that is in good condition.

Use the Proper Fuse

To avoid fire hazard, use only the fuse specified in the parts list for your product, matched by type, voltage rating, and current rating.

Do Not Remove Covers or Panels

To avoid personal injury, do not operate the digitizing oscilloscope without the panels or covers.

Do Not Operate in Explosive Atmospheres

The digitizing oscilloscope provides no explosion protection from static discharges or arcing components. Do not operate the digitizing oscilloscope in an atmosphere of explosive gases.

Electric Overload

Never apply to a connector on the digitizing oscilloscope a voltage that is outside the range specified for that connector.

Start Up

Before you use the digitizing oscilloscope, ensure that it is properly installed and powered on.

Operation

To properly install and power on the digitizing oscilloscope, do the following:

Installation

- Step 1:** Check that you have the proper electrical connections. The digitizing oscilloscope requires 90 to 250 VAC rms, continuous range, 47 Hz to 63 Hz, and may require up to 300 W.
- Step 2:** Connect the proper power cord from the rear-panel power connector (Figure i) to the power system.

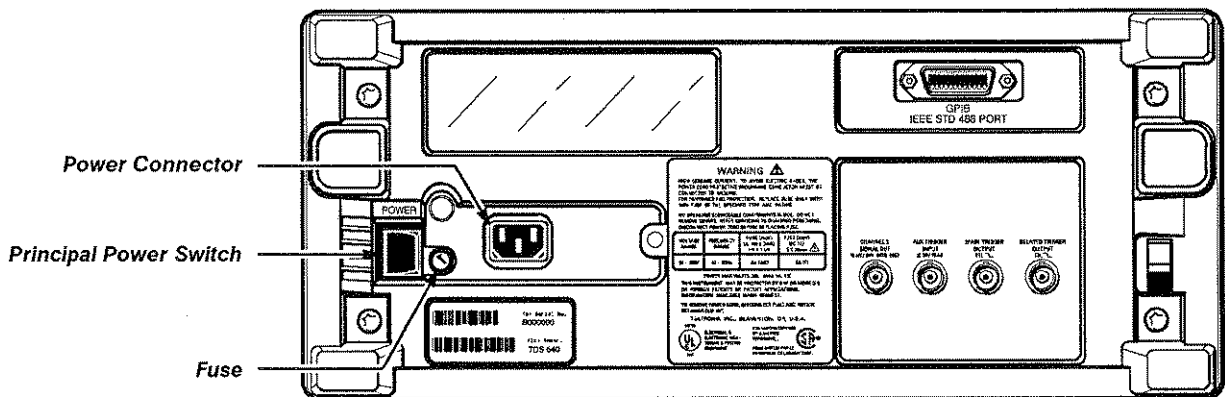

Figure i: Rear Panel Controls Used in Start Up

- Step 3:** Check the fuse to be sure it is of the proper type and rating (Figure i). You can use either of two fuses. Each requires its own fuse cap. These are:
 - .25 inch \times 1.25 inch (UL 198.6, 3AG): 6 A FAST, 250 V.
 - 5 mm \times 20 mm (IEC 127): 5 A (T), 250 V.
- Step 4:** Be sure you have the appropriate operating environment. Specifications for temperature, relative humidity, altitude, vibrations and emissions are included in *Appendix B: Specifications* at the rear of this manual.
- Step 5:** Leave space for cooling. Do this by verifying that the air-intake holes of the sides of the cabinet (where the fan operates) are free of any airflow obstructions (leave at least 2 inches (5.1 cm) free on each side).

Power On

- Step 6:** Check that the rear-panel principal power switch is on (Figure i). The principal power switch controls all AC power to the instrument.
- Step 7:** If the oscilloscope isn't powered on (the screen is blank), check that the front-panel **ON/STBY** button is toggled on (Figure ii).

The **ON/STBY** button controls power to most of the instrument's circuits. Power continues to go to certain parts even when this switch is set to STBY.

Once the digitizing oscilloscope is installed, it is typical to leave the principal power switch on and use the **ON/STBY** button as the power switch.

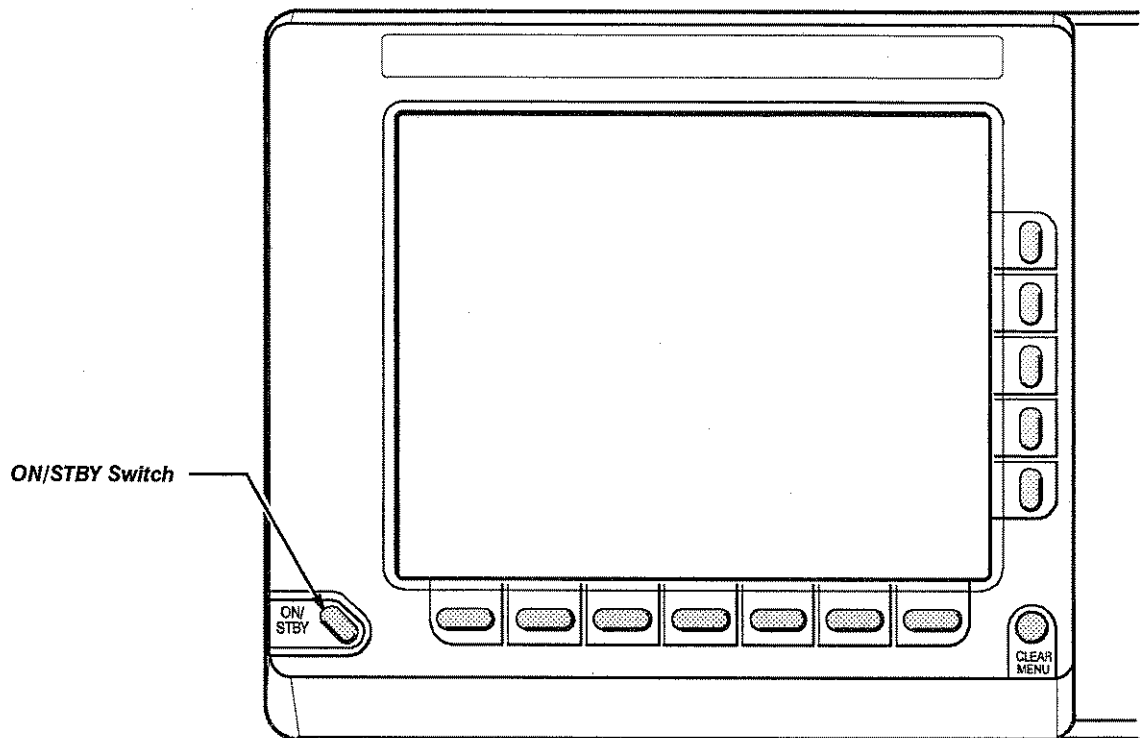

Figure ii: ON/STBY Switch

Self Test

- Step 8:** Check the self test results. The digitizing oscilloscope automatically performs power-up tests each time it is turned on. It will come up with a display screen that states whether or not it passed self test.

If the self test fails, call your local Tektronix Service Center. Depending on the type of failure, you may still be able to use the oscilloscope in the interim.

Power Off

- Step 9:** Toggle the **ON/STBY** switch.



Example 1: Displaying a Waveform

This section presents four examples of using your digitizing oscilloscope. You may choose to go through these examples very carefully, or you may elect to skip the examples and investigate the digitizing oscilloscope on your own.

If you don't perform the examples, use the *Concepts* section to find out how the digitizing oscilloscope is arranged, or use the *In Detail* section to answer any specific questions you encounter.

The examples are not intended to give you a complete inventory of every feature and function of the digitizing oscilloscope. Rather, the examples are to give you quick insight, so that you can easily explore those features that are of interest to you.

Setting Up for the Examples

All the examples use the same setup. Once you perform this setup, you can go through all the examples without changing signal connections.

- Step 1:** Remove all probes and signal inputs from the input BNC connectors along the lower right of the front panel. Then, use one of the probes supplied with the digitizing oscilloscope to connect from the **CH 1** connector to the **PROBE COMPENSATION** connectors. Figure 1-1 shows the proper connection of this probe.

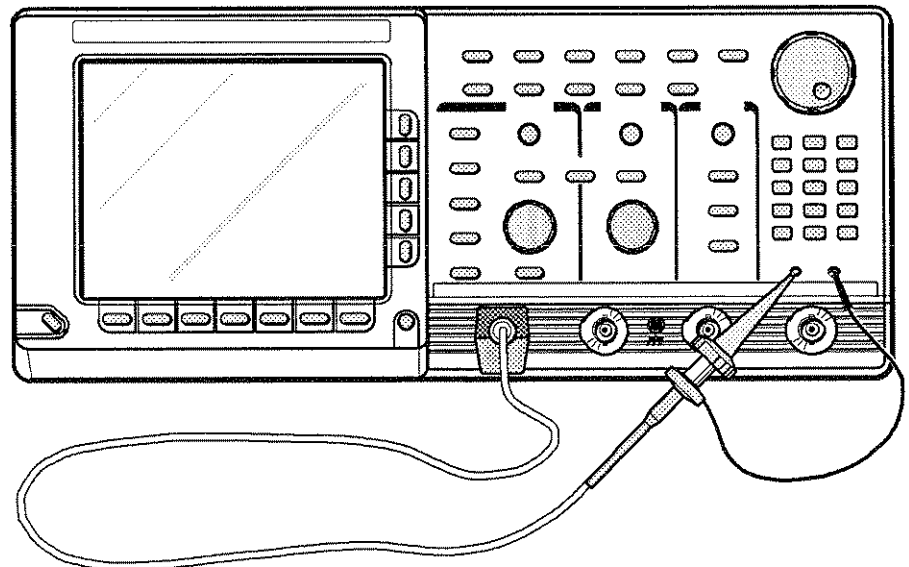

Figure 1-1: Connecting a Probe for the Examples

Resetting the Digitizing Oscilloscope

All examples in the tutorial begin by resetting the digitizing oscilloscope to a known, factory default state. This is useful when you begin a new task and need to “start fresh” with known default settings. Without resetting, the digitizing oscilloscope could be left with one or more parameters set to values that interfere with the job you are trying to accomplish.

The digitizing oscilloscope displays main menus along the bottom of the screen, and side menus along the right side of the screen. Figure 1-2 shows the locations of the buttons that display main menus. This figure also shows the location of the save/recall **SETUP** button, which displays the Setup main menu.

- Step 2:** Press the save/recall **SETUP** button to display the Setup menu.

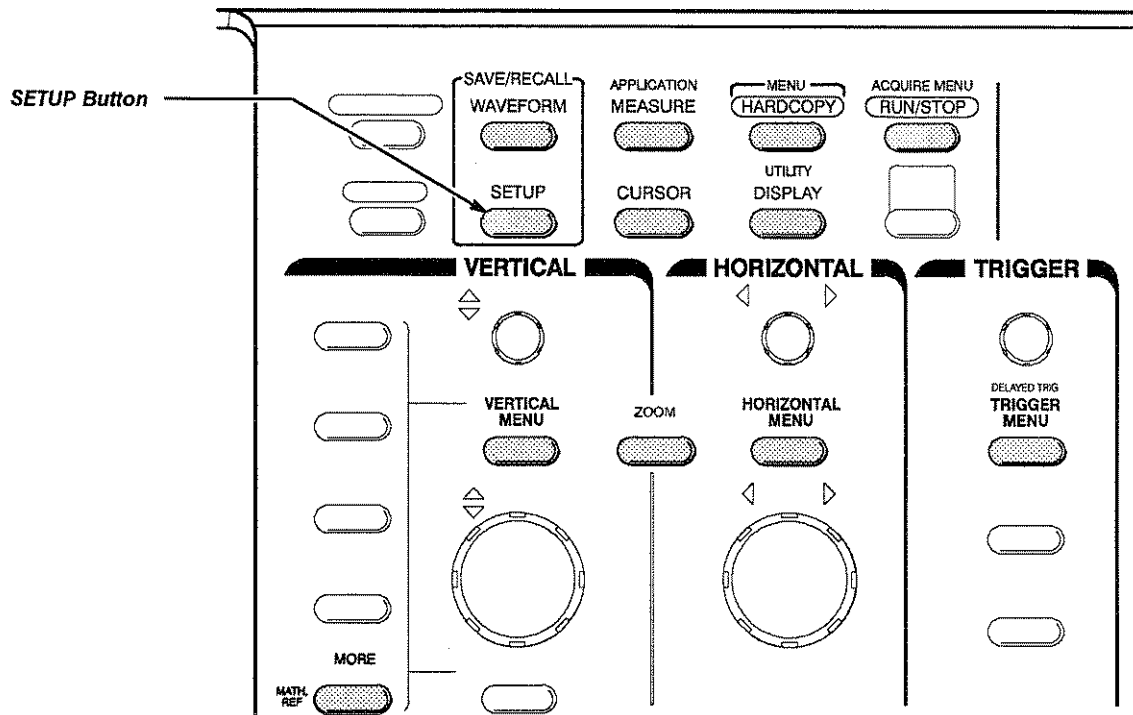

Figure 1-2: Menu Button Locations (Gray Buttons)

Figure 1-3 shows the Setup menu along the bottom of the display.

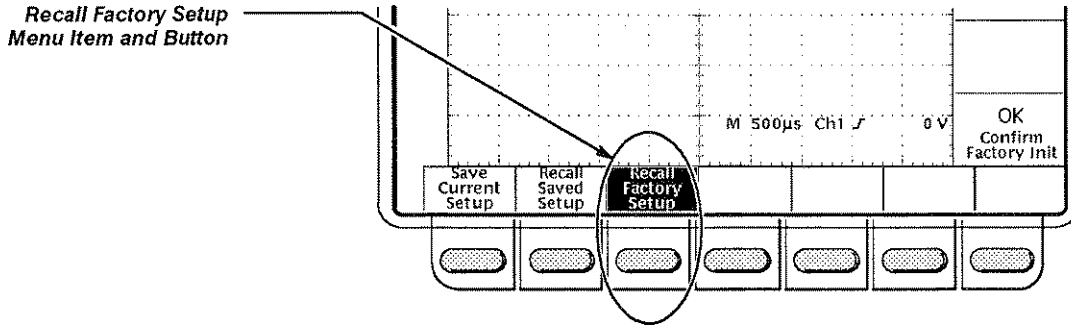

Figure 1-3: The Displayed Setup Menu

You select menu items from a displayed main menu by pressing the button below the desired menu item. For example, the third menu item from the left is **Recall Factory Setup**, which is what you want to do.

- Step 3:** Press the button directly below the **Recall Factory Setup** menu item.

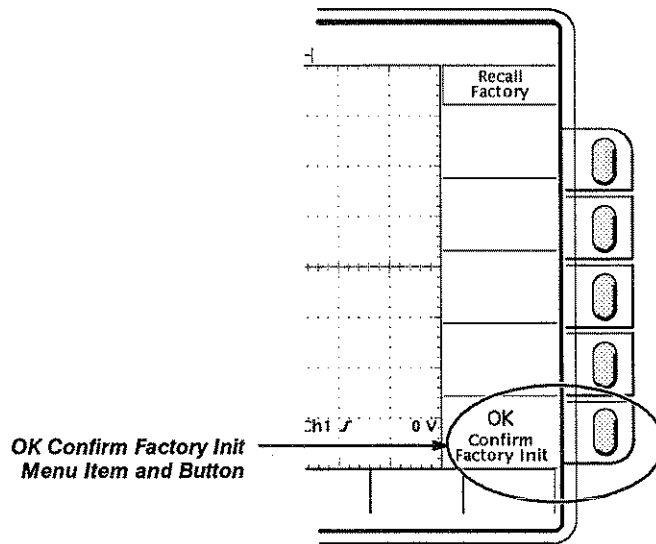

Figure 1-4: The Recall Factory Side Menu

The display shows the side menu along the right side of the display. The buttons to select these side menu items are to the right of the display.

Because an accidental instrument reset could destroy a setup that took a long time to create, the digitizing oscilloscope asks you to verify the **Recall Factory Setup** main menu selection.

- Step 4:** Press the button to the right of the **OK Confirm Factory Init** side menu item.

Display Elements

Figure 1-5 shows the display that results from the instrument reset.

There are several important points to observe:

- The channel readout indicates that channel 1 (**Ch1**) is being displayed, at 100 mV/div with DC coupling (in AC coupling, a ~ appears after the volts/div readout). The digitizing oscilloscope always displays channel 1 at reset.
- The time base readout shows that the main (M) time base is showing a horizontal scale of 500 μ s/div.
- The trigger readout shows that that the digitizing oscilloscope is triggering on channel 1 (**Ch1**) on a rising edge, and that the trigger level is 0 V.
- The channel ground reference indicator shows the vertical position of channel 1 ground.
- The trigger position indicator shows that the trigger position of the waveform is in the horizontal center of the graticule.

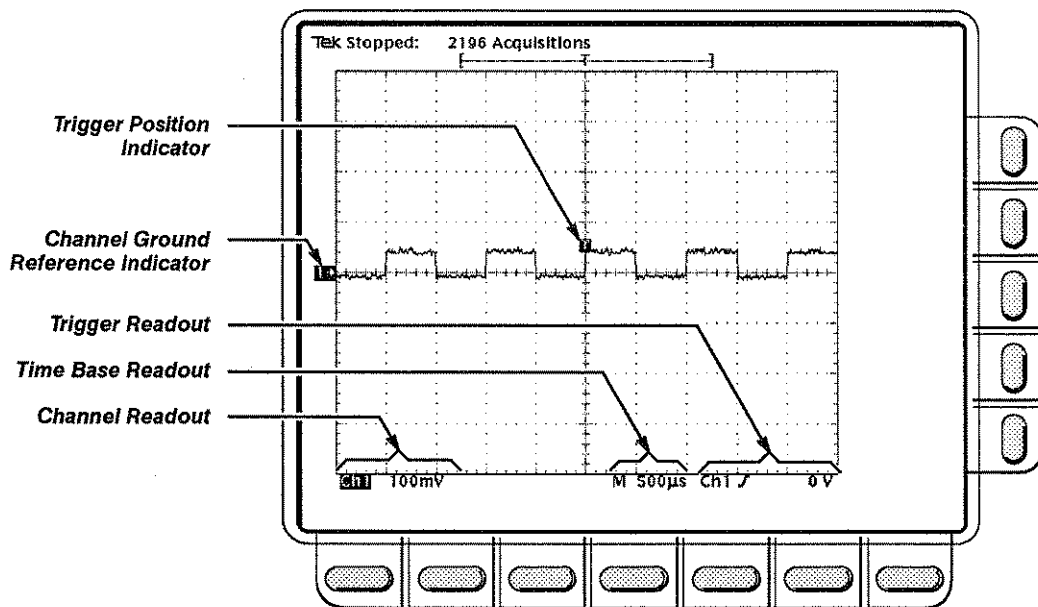

Figure 1-5: The Display After Factory Initialization

Right now, the channel, time base, and trigger readouts appear below the graticule. When you press a menu button to display a main menu, these readouts move up into the graticule area. You can always press the **CLEAR MENU** button to remove all menus and move the readouts below the graticule.

Adjusting the Waveform Display

The display shows the probe compensation signal. It is a 1 kHz square wave of approximately 0.5 V amplitude. You can adjust the size and placement of the waveform using the front-panel knobs.

Figure 1-6 shows the main **VERTICAL**, **HORIZONTAL**, and **TRIGGER** sections of the front panel. The vertical and horizontal sections each have **SCALE** and **POSITION** knobs.

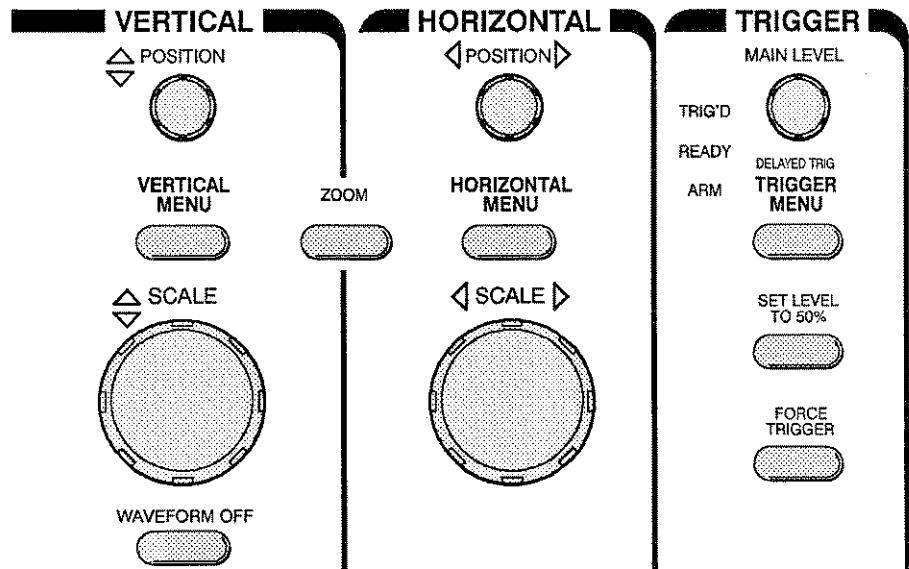

Figure 1-6: The **VERTICAL**, **HORIZONTAL**, and **TRIGGER** Controls

- Step 5:** Turn the vertical **SCALE** knob one click clockwise, then a second click clockwise. Observe the change in the displayed waveform. Also observe the change in the channel readout at the bottom of the display.
- Step 6:** Turn the vertical **POSITION** knob first one direction, then the other. Observe the change in the displayed waveform. When you are done, use the **POSITION** knob to return the waveform to the center of the graticule.
- Step 7:** Slowly turn the horizontal **SCALE** knob seven clicks counter-clockwise. At each click, observe the time base readout at the bottom of the display. When you are done, the time base should be set to 200 $\mu\text{s}/\text{div}$, and you should see two complete waveform cycles on the display.
- Step 8:** Slowly turn the trigger **MAIN LEVEL** knob first one direction, then the other. Observe what happens when you move the trigger level above the highest part of the displayed waveform. Leave the trigger level in this untriggered state.

Using Autoset

When you reset the digitizing oscilloscope, you see a clear, stable display of the probe compensation waveform. This is because the probe compensation signal happens to have characteristics that match the default settings of the digitizing oscilloscope.

Usually, when you first connect a signal to a channel and display it, the signal characteristics will not provide such a useable display. Often, you will not see a waveform display at all because the trigger parameters do not match the signal. You do see a display now, but the waveform appears untriggered.

The digitizing oscilloscope has an autoset feature to quickly set the settings for a clear, stable display.

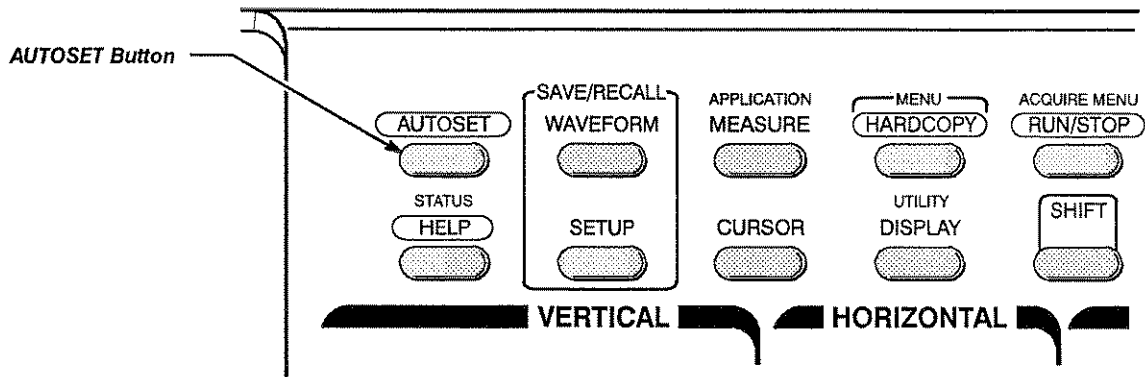

Figure 1-7: AUTOSSET Button Location

- Step 9:** Press the **AUTOSSET** button. Observe the clear, stable waveform display.

Figure 1-8 shows the display after pressing **AUTOSSET**.

If the signal on your display doesn't look like this one, you may need to compensate your probe. See Probe Compensation, on page 3-63, for instructions.

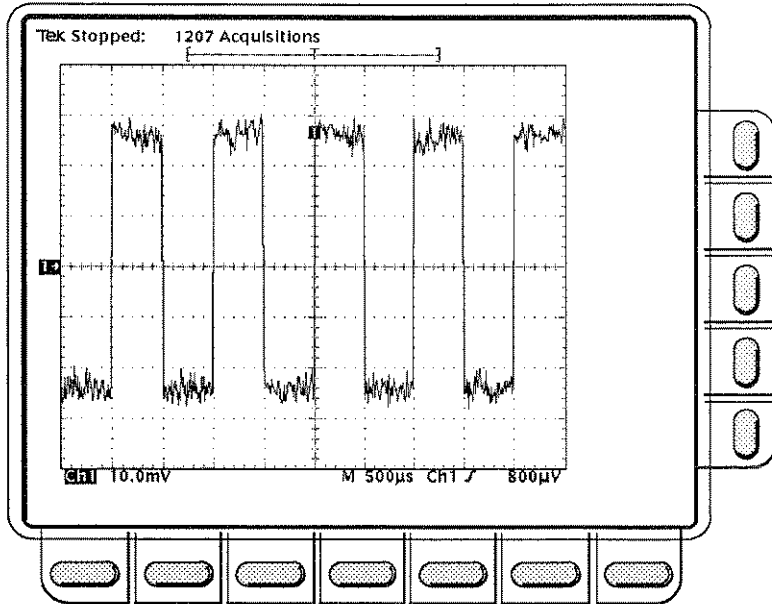

Figure 1-8: The Display After Pressing Autoset

If necessary, you can adjust the waveform now by using the knobs that you have used already.

Example 1: Displaying a Waveform





Example 2: Multiple Waveforms

This example shows you how to display and control more than one waveform on the display at one time.

- Step 1:** If you aren't continuing from the previous example, remove all probes and signal inputs from the input BNC connectors along the lower right of the front panel. Then, use one of the probes supplied with the digitizing oscilloscope to connect from the **CH 1** connector to the **PROBE COMPENSATION** connectors. If you need a review, this step is described on page 1-1 under the heading "Setting Up for the Examples".
- Step 2:** Reset the digitizing oscilloscope. (Press the **SETUP** button, and on the main menu press the **Recall Factory Setup** button. Finally, on the side menu, press the **OK Confirm Factory Init** button.)

Adding a Waveform

The **VERTICAL** section of the front panel contains the channel selection buttons. On the TDS 540 Digitizing Oscilloscope, these are **CH 1**, **CH 2**, **CH 3**, **CH 4**, and **MORE**; on the TDS 520, they are **CH 1**, **CH 2**, **AUX 1**, **AUX 2**, and **MORE**. These are shown in Figure 1-9.

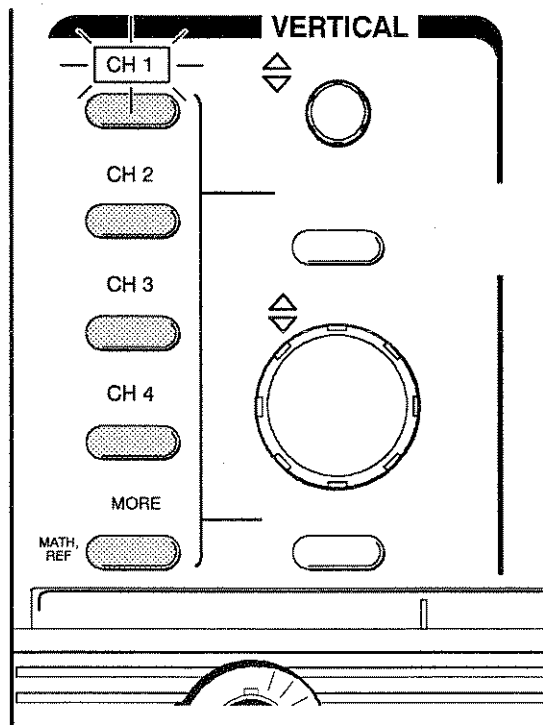

Figure 1-9: The Channel Buttons and Lights (TDS 540 Shown)

Each of the channel (**CH**) buttons has a light behind its label. Right now, the **CH 1** light is on. This indicates that the vertical controls are set to adjust channel 1. You can verify this by turning the vertical **POSITION** knob in either direction and observing the motion of the channel 1 waveform.

Step 3: Press the **CH 2** button.

The display shows a second waveform, which represents the signal on channel 2. Since there is nothing connected to the **CH 2** input connector, this waveform is a flat line.

There are several other important things to observe:

- The channel readout on the display now shows the settings for both **Ch1** and **Ch2**.
- There are now two channel indicators at the left edge of the graticule. Right now, they overlap.
- The light above the **CH 2** button is now on, and the **CH 1** light is off. This means the vertical controls are now set to adjust channel 2. That is, channel 2 is *selected*. Even though there are two channels displayed, only one channel light is on because the knobs control only one channel at a time.
- The trigger readout still indicates that the trigger is detecting trigger events on **Ch1**. This has not been changed by your adding a channel. (If you wanted to change the trigger source, you would use the **TRIGGER MENU** button to display the trigger menu. Don't do that now, because you will be unable to trigger the display from a channel having no signal.)

Step 4: Turn the vertical **POSITION** knob clockwise, to move the channel 2 waveform up on the graticule. The channel ground reference indicator for channel 2 moves with the waveform.

The **VERTICAL MENU** button displays a menu that gives you control over many vertical channel parameters. The channel button lights indicate which channel this menu sets, just as the channel button lights indicate which channel the vertical knobs adjust.

Step 5: Press the **VERTICAL MENU** button.

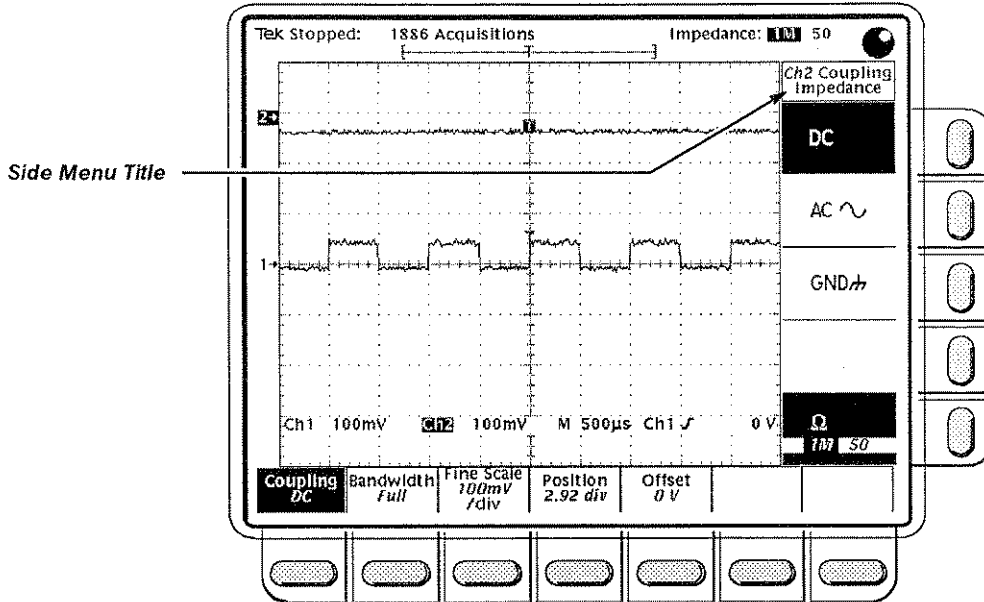

Figure 1-10: The Vertical Main Menu and Coupling Side Menu

Each menu item in the Vertical menu displays a side menu. Right now, the **Coupling** item in the main menu is highlighted, which means that the side menu shows the coupling choices. At the top of the side menu, the menu title shows the channel affected by the menu choices. This always matches the channel button light.

- Step 6:** Press the Ω button on the side menu twice; once to select it, and again to toggle the selection to **50 Ω** . This changes the input coupling of channel 2 from 1 M Ω to 50 Ω . Observe that the channel readout for channel 2 (near the bottom of the graticule) shows an Ω indicator now.

Changing Controls to Another Channel

When you press the channel (**CH**) button for a channel that is not being displayed, it displays that channel and sets the controls to that channel.

When you press the channel (**CH**) button for a channel that is already being displayed, it does not change the channel display, but simply assigns the controls to that channel.

- Step 7:** Press the **CH 1** button in the vertical section of the front panel.

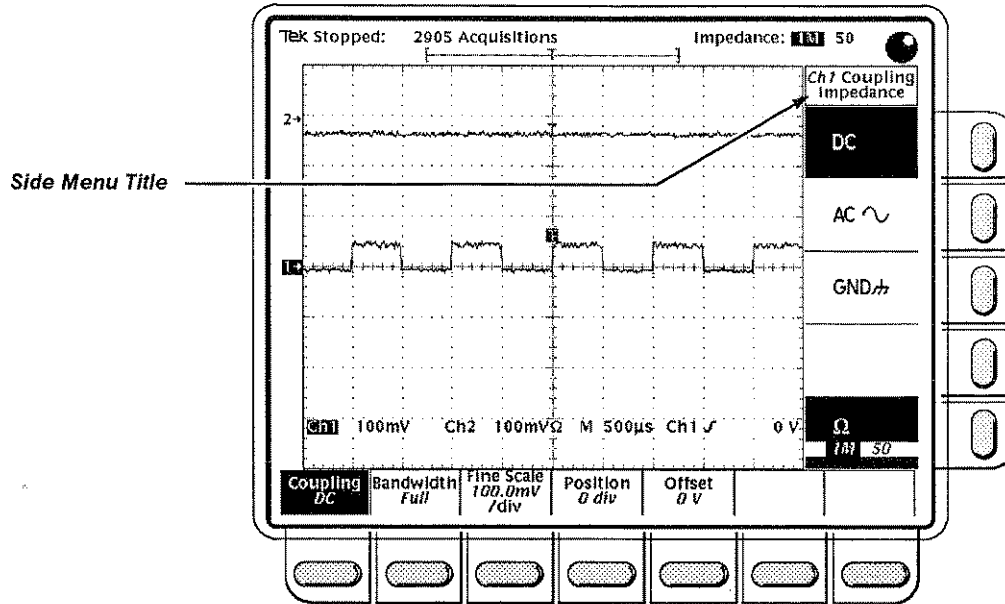

Figure 1-11: The Menu After Changing Channels

Observe that now the side menu title shows **Ch1**, and that the **CH 1** light is lit. The highlighted menu item in the side menu has changed from the Ω channel 2 setting to the **DC** coupling, **1 M Ω** impedance setting of channel 1.

- Step 8:** Turn the vertical **POSITION** knob counterclockwise to move the channel 1 waveform down on the display.

Removing a Waveform

You use a two-step process to remove waveforms from the display. First, select the channel using the channel (**CH**) button. Second, press the **WAVEFORM OFF** button.

- Step 9:** Press the **WAVEFORM OFF** button.

Since the **CH 1** light was on when you pressed the **WAVEFORM OFF** button, the channel 1 waveform was removed.

The channel (**CH**) lights now indicate channel 2. Channel 2 has become the selected channel. When you remove the last waveform, all the **CH** lights are turned off.



Example 3: Automated Measurements

This example shows you how to use the automated measurement system to get numeric readouts of important waveform characteristics.

- Step 1:** If you aren't continuing from the previous example, remove all probes and signal inputs from the input BNC connectors along the lower right of the front panel. Then, use one of the probes supplied with the digitizing oscilloscope to connect from the **CH 1** connector to the **PROBE COMPENSATION** connectors. If you need a review, this step is described on page 1-1 under the heading "Setting Up for the Examples".
- Step 2:** Reset the digitizing oscilloscope. (Press the save/recall **SETUP** button, and on the main menu press the **Recall Factory Setup** button. Finally, on the side menu, press the **OK Confirm Factory Init** button.)
- Step 3:** Press the **AUTOSET** button.

Displaying Automated Measurements

To use the automated measurement system, you must first obtain a stable display of your signal. As you can see, autoset makes this easy.

The waveform record must include all the segments of the waveform that will be measured. For example, a rise time measurement requires at least one rising edge. On the other hand, a frequency measurement requires at least one full cycle of the waveform.

- Step 4:** Press the **MEASURE** button to display the Measure main menu.
- Step 5:** If it is not already highlighted, press the button for the **Select Measrmnt** menu item. The readout for this menu item indicates the channel the measurement will be taken from.

The right side of the display shows the Select Measurement side menu. This menu lists measurements that can be taken on the waveform. Four measurements are shown. Pressing the **-more-** menu item can bring up more selections.

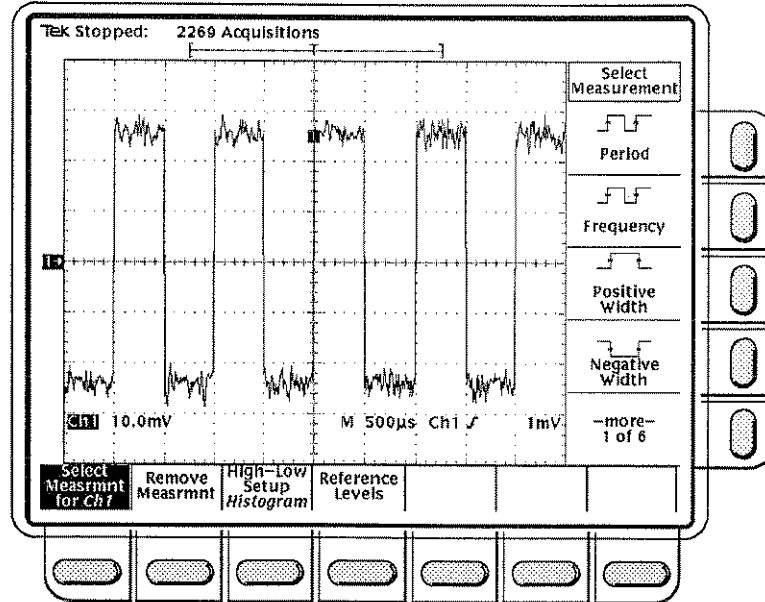

Figure 1-12: Measure Main Menu and Select Measurement Side Menu

There are many different measurements available. From the list of available measurements, you can select up to four measurements to be taken and displayed at any one time.



- Step 6:** Press the **Frequency** button from the side menu. If the **Frequency** menu item is not visible, press the **-more-** button repeatedly until the **Frequency** item appears, then press the **Frequency** menu button.

Observe that the frequency measurement appears within the right side of the graticule area. The measurement readout includes the notation **Ch1**, meaning that this measurement is taken on the channel 1 waveform. (To take a measurement on another channel, you would select that channel, then select the measurement.)



- Step 7:** Press the **Positive Width** side menu button.



- Step 8:** Press the **-more-** side menu button once, and then press the **Rise time** and **Positive Duty Cycle** side menu buttons.

Observe that all four measurements are displayed. Right now, they cover a part of the graticule area, including the displayed waveforms. You can move the measurement readouts outside the graticule by pressing the **CLEAR MENU** button.

- Step 9:** Press the **CLEAR MENU** button.

The measurement readouts move to the right of the graticule, into the space formerly occupied by the side menu.

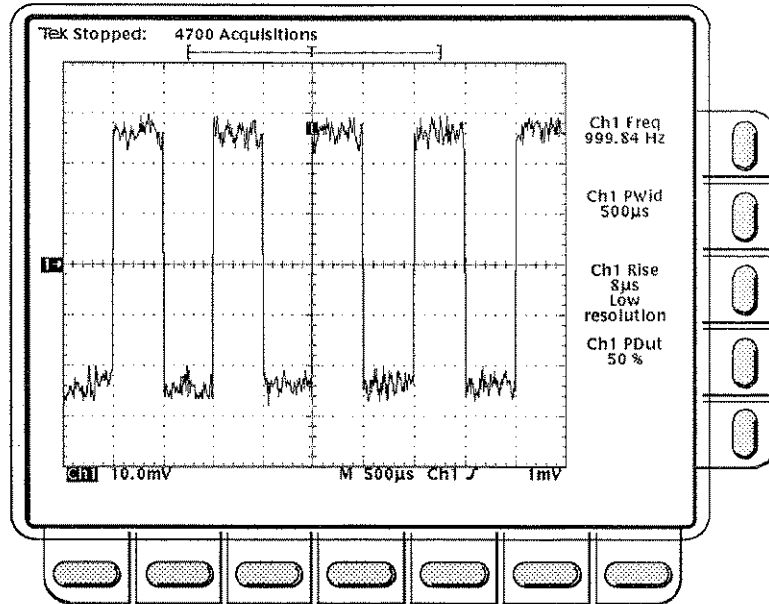

Figure 1-13: Four Simultaneous Measurement Readouts

Removing Measurement Readouts

The Measure menu lets you remove measurements when you no longer want to display them. You can remove any one measurement, or you can remove them all with a single menu item.

- Step 10:** Press the **MEASURE** button to display the Measure main menu.
- Step 11:** Press the **Remove Measrmt** main menu button to display the Remove Measurement side menu.
- Step 12:** Press the **Measurement 1**, **Measurement 2**, and **Measurement 4** side menu buttons to remove those measurements. Leave the rise time measurement displayed.

Had you wished to remove all the measurements, you could have pressed the **All Measurements** side menu button.

Changing the Measurement Reference Levels

By default, the measurement system will use the 10% and 90% levels of the waveform for taking the rise time measurement. You can change these values to other percentages, or change them to absolute voltage levels.

- Step 13:** On the main menu, press the **Reference Levels** button.
- Step 14:** On the side menu, press the **High Ref** button.

The General Purpose Knob

The general purpose knob, the large knob with the indentation, is now set to adjust the high reference level. There are several important things to observe on the screen:

- The knob icon appears at the top of the screen. This indicates that the general purpose knob has just been set to adjust a different parameter.
- The upper right corner of the screen shows the readout **High Ref: 90.0%**.
- The **High Ref** side menu item is highlighted, and a box has been drawn around the 90% readout in the **High Ref** menu item. The box indicates that the general purpose knob is currently set to adjust this parameter.

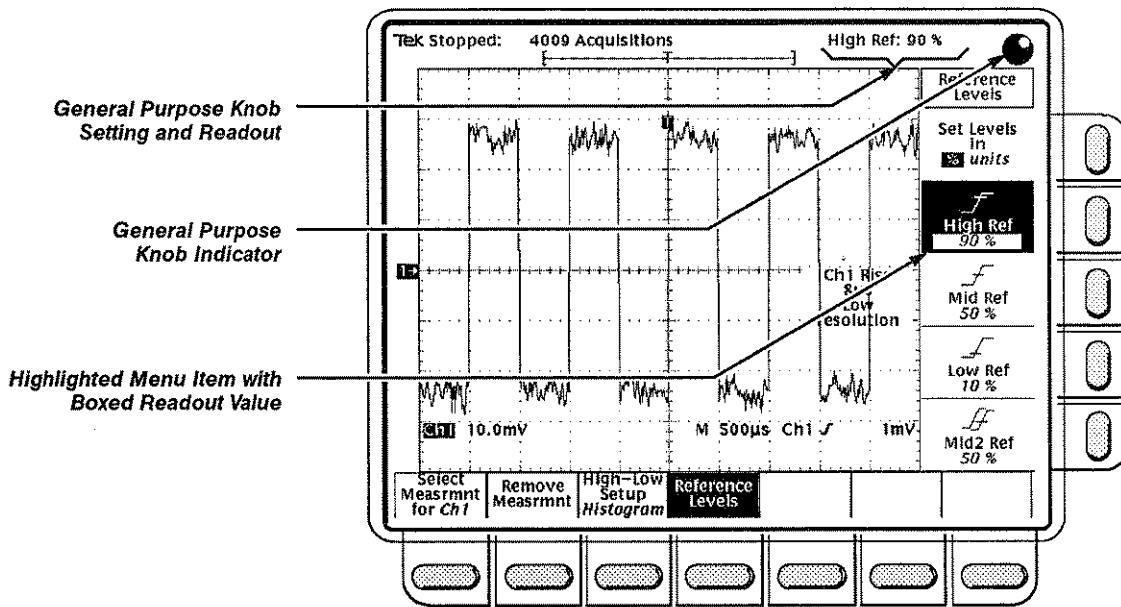

Figure 1-14: General Purpose Knob Indicators

- Step 15:** Turn the general purpose knob left and right, and then use it to adjust the high level to 80%.

The Numeric Keypad

Any time the general purpose knob is set to adjust a parameter, you can instead enter the value as a number using the keypad. Always end the entry of a number by pressing the **ENTER** (↵) button.

- Step 16:** On the side menu, press the **Low Ref** button.
- Step 17:** On the numeric keypad, press the **2** button, the **0** button, and the **ENTER** (↵) button.

This sets the low measurement reference to 20%.

The numeric keypad also provides multipliers for engineering exponents, such as **m** for milli, **M** for mega, and μ for micro. To enter these multiplier values, press the **SHIFT** button, then press the multiplier.

You will also use the **SHIFT** button to access certain menus. As with the numeric keypad, the shift labels for these menu buttons are printed in blue above the unshifted label.

Example 3: Automated Measurements





Example 4: Saving Setups

When you power off the digitizing oscilloscope, it remembers all the parameter settings for the next time you power it on. This lets you continue where you left off without having to reconstruct the state of the digitizing oscilloscope.

The digitizing oscilloscope can also save several complete “setups”. This example shows you how to save all the settings of the digitizing oscilloscope in a setup location, and how to recall the setup later to quickly re-establish the previously saved state.

- Step 1:** If you aren't continuing from the previous example, remove all probes and signal inputs from the input BNC connectors along the lower right of the front panel. Then, use one of the probes supplied with the digitizing oscilloscope to connect from the **CH 1** connector to the **PROBE COMPENSATION** connectors. If you need a review, this step is described on page 1-1 under the heading “Setting Up for the Examples”.
- Step 2:** Reset the digitizing oscilloscope. (Press the save/recall **SETUP** button, and on the main menu press the **Recall Factory Setup** button. Finally, on the side menu, press the **OK Confirm Factory Init** button.)

Saving a Setup



First, create an instrument setup that you want to save. The next several steps establish a two-waveform display with a measurement on one waveform. This setup is complex enough that you wouldn't want to go through all these steps each time you want to see this display.

- Step 3:** Press the **AUTOSET** button.
- Step 4:** Press the **MEASURE** button, then press **Select Measrmt** in the main menu and press the **Frequency** side menu button. (Press the **-more-** button if the **Frequency** selection does not appear in the side menu.)
- Step 5:** Press the **CH 2** button in the vertical section of the front panel.
- Step 6:** Press the **CLEAR MENU** button.

Once you have established an instrument setup, you can save it in any of several setup locations.

NOTE

The next step asks you to save a setup in a setup location of your choice. If you work in a laboratory environment where several people share the digitizing oscilloscope, check with the other users first to be certain the setup location you are using is not already being used by someone else.

- Step 7:** Press the **SETUP** button to display the Setup main menu. If it is not already highlighted, press the **Save Current Setup** main menu button.
- Step 8:** Then, press one of the **To Setup** side menu buttons to store the current instrument settings into that setup location.

There are more setup locations than can be listed at one time in the side menu. The **-more-** side menu item gives you access to all the setup locations.

Once you have saved the digitizing oscilloscope setup, you can change the settings as you wish, knowing that you can come back to this setup at any time.



- Step 9:** Press the **MEASURE** button to display the Measure main menu. Press the **Positive Width** side menu item to add that measurement to the display.

Recalling a Setup

Recalling a setup you saved earlier is very easy.

- Step 10:** Press the **SETUP** button to display the Setup main menu.
- Step 11:** Press the **Recall Saved Setup** main menu button to display the Recall Setup side menu.
- Step 12:** Press the **Recall Setup** side menu button for the setup location you used in Step 7.

The oscilloscope returns to the setup you saved in Step 8. You can see this because the positive width measurement is now removed from the display.

Overview

Understanding the basic concepts of your digitizing oscilloscope will help you obtain the greatest benefits from using it. This section explains concepts behind the following areas:

- the **triggering** system which establishes conditions to acquire signals. Properly set, triggers can convert displays from unstable jumbles or blank screens into meaningful waveforms. See page 2-5.

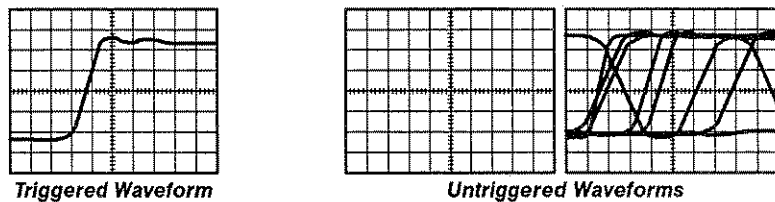

Figure 2-1: Examples of Triggered Waveforms

- the **waveform scaling** and positioning system which changes the dimensions of the waveform display. Scaling waveforms involves increasing or decreasing their displayed size and moving them up, down, right, and left on the display. See page 2-13.

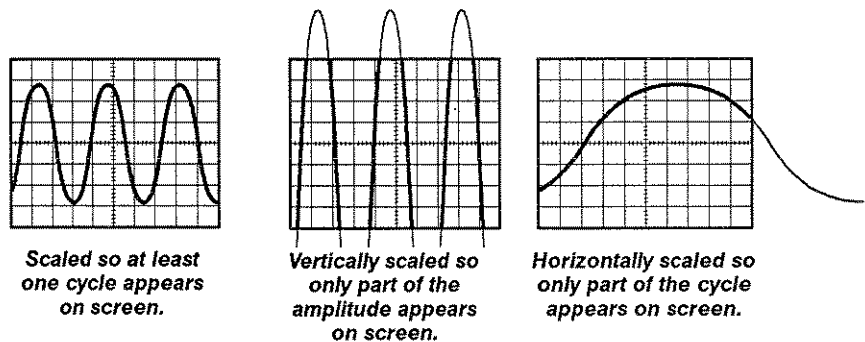

Figure 2-2: Examples of Scaling

- the **acquisition** system which lets you select the modes for converting analog data into digital form. See page 2-19.



Figure 2-3: Acquisition: Input Analog Signal, Sample, and Digitize

- the **measurement** system which provides numeric information on the displayed waveforms. Three measurement classes are graticule, cursor and automated. See page 2-27.

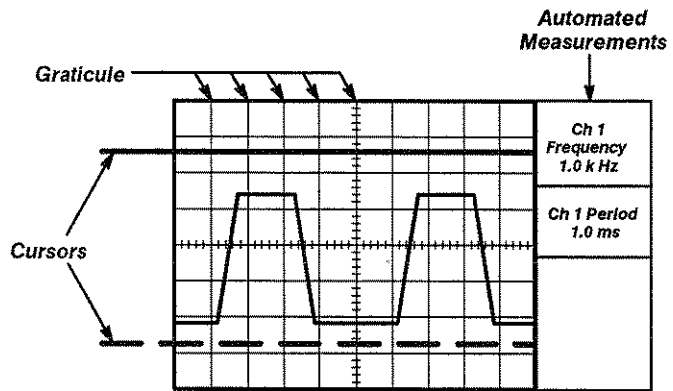

Figure 2-4: Examples of Three Measurement Classes

- the **save and document** system which makes hardcopies and saves and retrieves waveform data or setup information for later analysis, reporting, or archiving. See page 2-31.

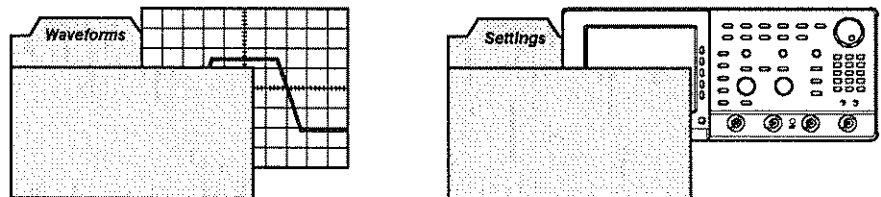

Figure 2-5: Save Waveforms and Settings

- the **remote communications** system which uses the GPIB interface to connect the oscilloscope with other instruments. You can use a computer to remotely control the digitizing oscilloscope or read measurements for later analysis and storage. You can also set up the oscilloscope to send a screen hardcopy to a printer or plotter. See page 2-35.

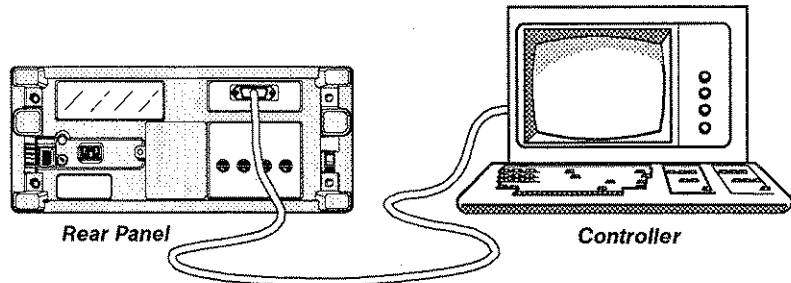

Figure 2-6: GPIB Enables Data Transfers Between the Oscilloscope and a Remote Computer



Triggering

Triggers determine when the digitizing oscilloscope starts acquiring and displaying a waveform. They help convert displays from unstable jumbles or blank screens — to meaningful waveforms.

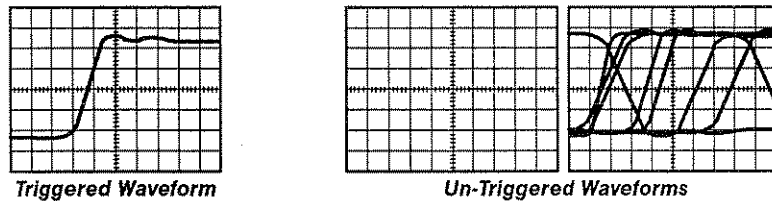

Figure 2-7: Examples of Triggered Waveforms

A typical edge trigger event occurs when the trigger *source* (the signal that the trigger circuit monitors) passes through a specified voltage *level* in the specified direction (the trigger *slope*). This event becomes a time reference point that helps define when the digitizing oscilloscope combines waveform samples into a waveform record. The TDS 500 Series Digitizing Oscilloscope also provides more advanced triggering options.

Trigger Sources

You can derive your trigger from various sources. Trigger sources can be:

- any of the four input channels (four full-featured on the TDS 540; two full-featured and two limited on the TDS 520).
- the AC line voltage, and
- an auxiliary trigger input (on the rear panel of the TDS 540).

Select the trigger source using the Main Trigger menu **Source** menu item.

Input Channel

This is the normal trigger source. You can select any one of the four input channels as the trigger source. If the trigger source is one of the channels selected for display, you can view the trigger source. You can also trigger from an input channel not being displayed.

AC Line Voltage

Triggering on the AC Line Voltage is useful when you're looking at signals related to the power line frequency. Examples include devices like lighting equipment and power supplies.

Auxiliary Trigger

This is often useful in digital design and repair. For example, you might want to look at a long train of very similar pulses while triggering with an external clock or with a signal from another part of the circuit. To use the auxiliary trigger, connect the external triggering signal to the appropriate Auxiliary Trigger input connector on the oscilloscope rear panel (TDS 540).

Types

The main trigger types are edge, pulse, and logic.

You can set the trigger type on the digitizing oscilloscope with the Main Trigger menu **Type** pop-up menu.

Edge Trigger

Edge trigger is typically considered the "basic" trigger. You can use it with both analog and digital test circuits. An edge trigger event occurs when the trigger *source* (the signal trigger circuit is monitoring) passes through a specified voltage *level* in the specified direction (the trigger *slope*).

Edge triggers are available through both the main and the delayed trigger system. (The delayed trigger system is explained on page 3-23.)

Pulse Trigger

Pulse triggering is particularly useful on digital circuits. Three classes of pulse triggers are width, runt and glitch. Pulse triggering is available on the main trigger only.



Width — trigger occurs when the oscilloscope finds a signal pulse on the triggering channel that has the

- polarity (positive or negative) you choose, and
- time limits you choose (inside or optionally outside the limits).

Width triggering is useful for checking the accuracy of pulses in pulse trains. The width trigger is different from the glitch trigger (see below) because the width trigger requires you to specify both the minimum and maximum values.



Runt — trigger occurs when the oscilloscope detects a pulse crossing one user-set voltage threshold but failing to cross a second voltage threshold before recrossing the first threshold. For example, the waveform of a positive

runt would cross the lower amplitude threshold and rise but not cross the upper amplitude threshold before heading down again past the lower threshold. The crossings detected can be positive or negative.

One example of where runt triggers are useful is in troubleshooting an intermittent tristate bus problem. The situation might arise where you suspect that the interaction of multiple gates is causing a problem. One gate might pull the line down while another gate pulls it up. This could create a pulse with medium amplitude. It's too low to qualify as a high logic level and too high to qualify as a low logic level. You can trigger on the runt whenever it appears. Then you can examine the gating operations that occur at the same time.



Glitch — trigger occurs when the oscilloscope finds a signal pulse on the triggering channel of the polarity (positive, negative or either) you choose and the width (in time) you choose. It's particularly useful for finding short voltage spikes. This is different from the width trigger (see above) because you specify only the maximum width value. You do not include a minimum value. This helps you work in terms of a spike.

Logic Triggers

Logic triggering is useful for working on digital logic circuits. You select Boolean operators to apply to the trigger sources. Triggering occurs when the Boolean conditions are satisfied. The two kinds of logic triggers are state and pattern (available on the main trigger only).

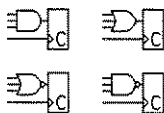

State — In the logic state trigger, the oscilloscope:

1. Waits until channel 4 (Aux 2 on the TDS 520) meets the set condition. For example, checks if it is a positive (or negative) slope of a certain voltage level.
2. When the channel 4 (Aux 2 on the TDS 520) condition is met, the oscilloscope checks for certain conditions you've defined on each of channels 1, 2 and 3 (Aux 1 on the TDS 520). That is, it checks whether they're at the logic high, low or don't care conditions you set. The actual logic levels are determined by threshold voltages you assign to each channel. If channels 1, 2, and 3 meet the settings according to a Boolean logic you define (AND, OR, NAND or NOR), then the trigger occurs.

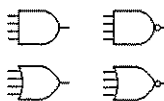

Pattern — In the logic pattern trigger, the oscilloscope triggers depending on whether the logic conditions of channels 1, 2, 3, and 4 (1, 2, Aux 1 and Aux 2 on the TDS 520) are met. That is you can define whether each channel should be at a logic high, low or don't care condition. Then you can AND, OR, NAND or NOR the results together. When the Boolean condition turns true, the trigger occurs.

Holdoff

The trigger system recognizes only one trigger during the time base duration. Also, it will not recognize a trigger during a short period following the time base duration (the *holdoff* period).

Sometimes the normal waveform period doesn't provide enough time to ensure you get a stable display. This possibility exists, for example, when the trigger signal is a complex waveform with many possible trigger points on it. Though the waveform is repetitive, a simple trigger might get you a series of patterns on the screen instead of the same pattern each time. Digital pulse trains are good examples. Each pulse looks like any other so many possible trigger points exist. Not all of these will result in the same display. The holdoff period provides additional time to ensure that your display is stable, as illustrated in Figure 2-8.

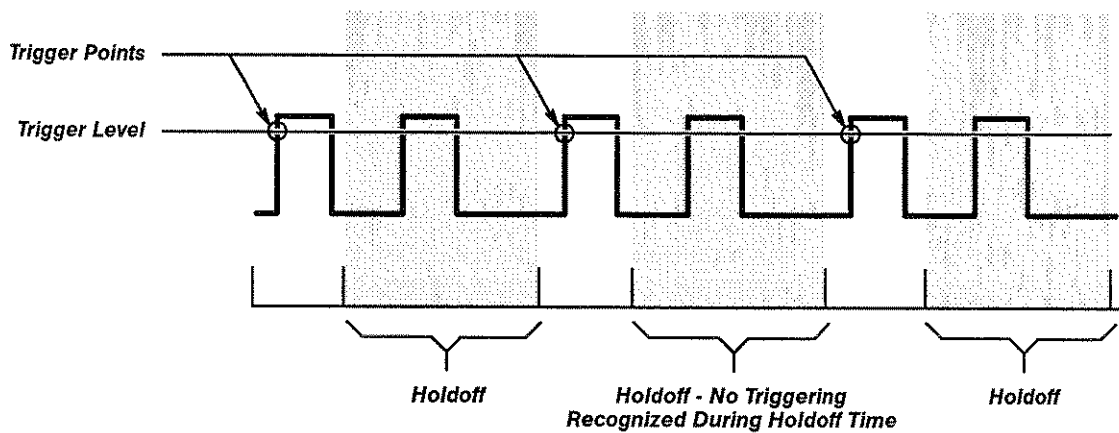

Figure 2-8: Trigger Holdoff Time Ensures Valid Triggering

To set the trigger holdoff on the digitizing oscilloscope, press the **TRIGGER MENU** button to bring up the Main Trigger menu. Then select the main menu **Mode & Holdoff** item and the side menu **Holdoff** item. You can set the holdoff from 0% to 100%. Use the general purpose knob or the keypad to set holdoff.

Delay

You can also set a delayed trigger to occur an absolute time or a set number of trigger events after a main trigger event.

There are two main types of delayed triggering (Figure 2-9).

- *Delayed Runs After Main* waits for a main trigger, then waits a user-defined time, then triggers (Figure 2-10).
- *Delayed Triggerable* waits for a main trigger, then waits a user-defined time or number of delayed trigger events, then looks for a delayed trigger event (Figure 2-10).

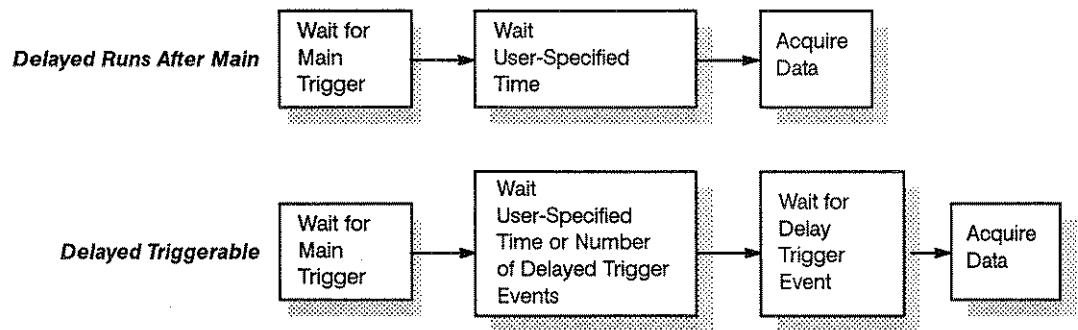

Figure 2-9: Delayed Triggering

The digitizing oscilloscope provides only a conventional Edge trigger for the delayed time base. The delayed time base cannot be triggerable if the main trigger type (as defined in the Main Trigger menu) is Logic, if the main trigger type is Edge with its source set to Auxiliary (TDS 540), or if the main trigger type is Pulse with the Runt trigger class selected.

To use the delayed trigger on the digitizing oscilloscope, press the **DELAYED TRIG** button to display the Delayed Trigger menu. Then enter values with the appropriate main and side menus. Also press the **HORIZONTAL MENU** button to bring up the Horizontal menu and change the time base mode as desired. See *Delayed Trigger* on page 3-23 for more details.

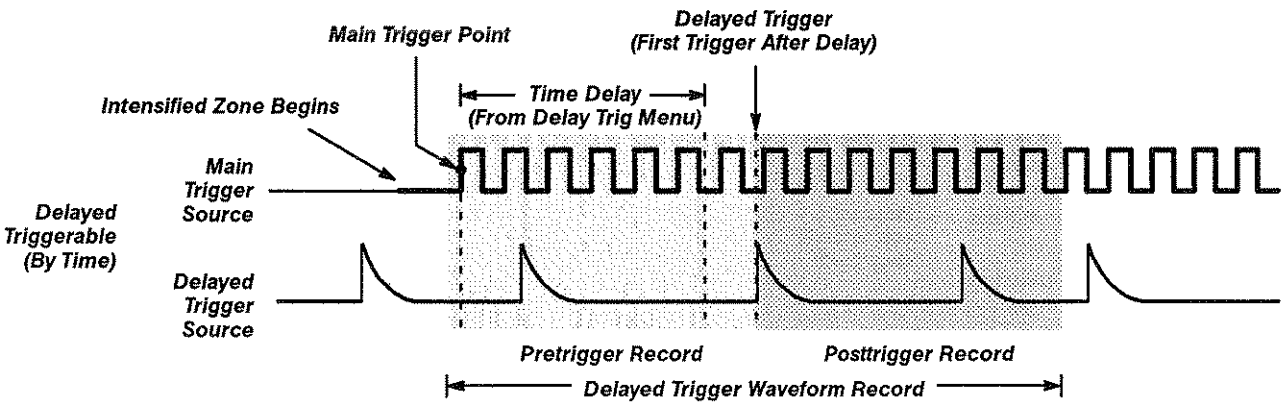
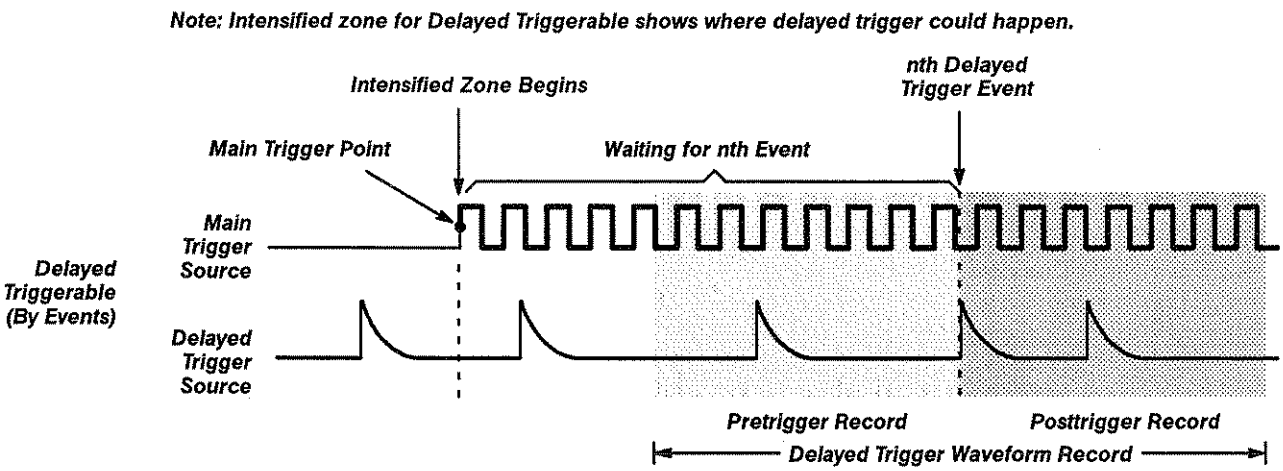
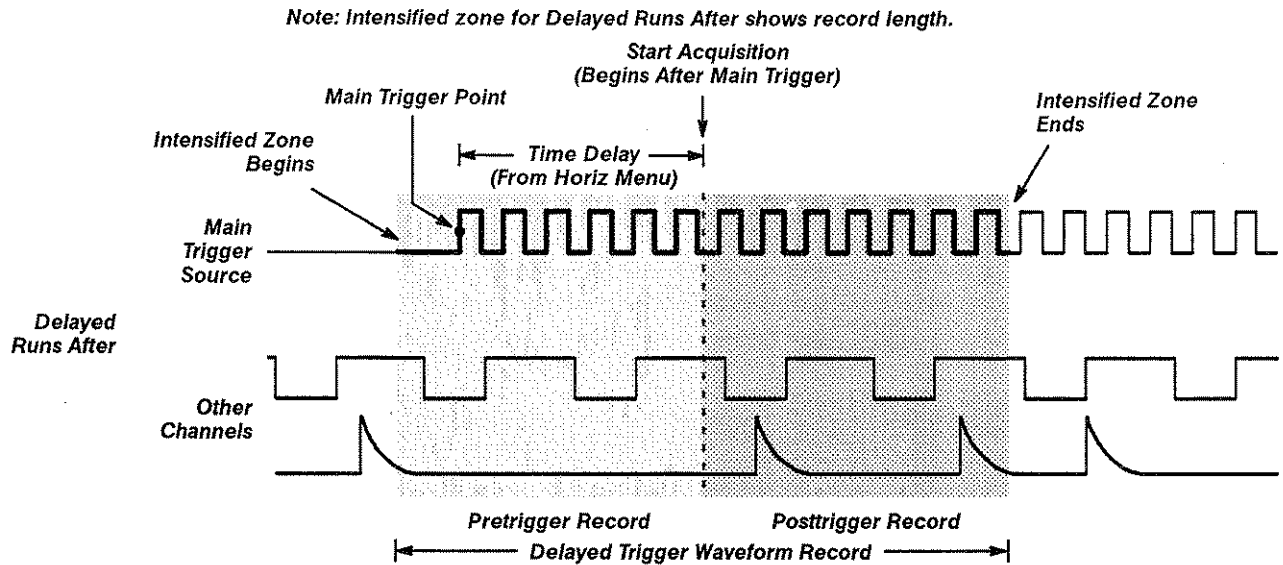

Figure 2-10: How the Delayed Triggers Work

Modes

The trigger mode determines how the oscilloscope behaves in the absence of trigger events. The digitizing oscilloscope provides two different trigger modes. These are *normal* and *automatic*.

You can choose either Auto or Normal trigger mode using the Main Trigger menu **Mode** item.

Normal trigger mode lets the oscilloscope acquire a waveform only when it is triggered. When no trigger occurs, the oscilloscope will not acquire a waveform.

Automatic trigger mode (auto mode) lets the oscilloscope initiate acquisition when a trigger occurs or after a certain time period (that varies based on the time/div setting) following the end of the last acquisition — whichever occurs first. This allows a waveform to be displayed even though the oscilloscope is untriggered.

In other words, automatic mode uses a timer that starts after a trigger event occurs. If another trigger event is not detected before the timer runs out, the oscilloscope generates another trigger anyway. No matter where you set your trigger level, the oscilloscope generates a trigger. This mode is particularly useful in letting you observe signals having a changing amplitude pattern without your having to readjust the trigger level.

Slope and Level

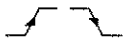

The slope control determines whether the oscilloscope finds the trigger point on the rising or the falling edge of a signal (see Figure 2-11).

You set trigger slope with the Main Trigger menu **Slope** item and the resulting side menu's rising or falling slope icons.

The level control determines where on that edge the trigger point occurs (see Figure 2-11).

The digitizing oscilloscope lets you set the main trigger level with the trigger **MAIN LEVEL** knob.

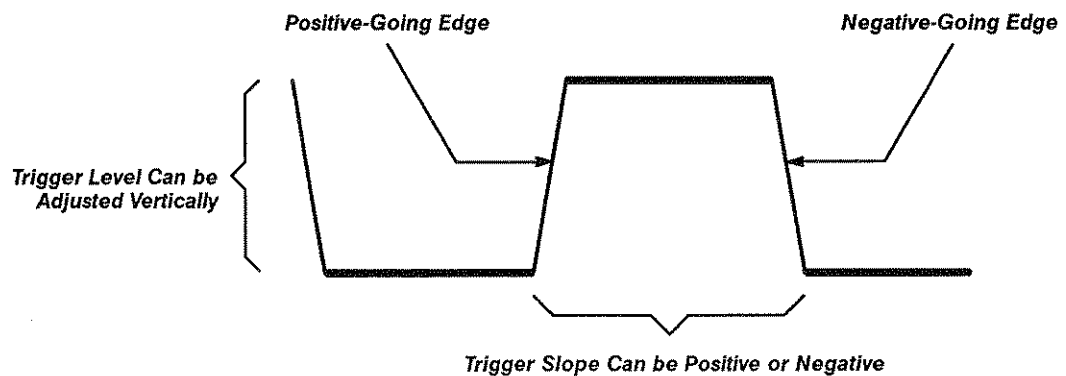

Figure 2-11: Slope and Level Controls Help Define the Trigger

Coupling

Trigger coupling determines what part of the signal is passed to the trigger circuit. Available coupling types include: AC, DC, Low Frequency Rejection, High Frequency Rejection, and Noise Rejection.

You set the trigger coupling on the digitizing oscilloscope using the Main Trigger menu **Coupling** item.

DC

DC coupling passes all of an input signal. In other words, it passes both AC and DC components to the trigger circuit.

AC 

AC coupling passes only the alternating components of an input signal (above 60 Hz). It removes the trigger signal's DC components.

In addition, the trigger system also has *high frequency rejection* and *low frequency rejection*. These eliminate specific frequency components (noise) from the trigger signal. This noise may otherwise prevent the trigger signal from starting the time base at the same point every time.



High frequency rejection removes the high frequency portion of the triggering signal. This allows only the low frequency components to pass on to the triggering system and subsequently start any acquisition. On the digitizing oscilloscope, high frequency rejection filter roll off attenuates signals above 30 kHz.



Low frequency rejection accomplishes the opposite of high frequency. Low frequency rejection filter roll off affects signals below 80 kHz.

Noise Rejection provides DC low sensitivity. It requires additional signal amplitude for stable triggering and so reduces false triggering on noise.

For More Information

See *Delayed Triggering*, on page 3-23.

See *Glitch Triggering*, on page 3-37.

See *Logic Triggering*, on page 3-49.

See *Runt Triggering*, on page 3-89.

See *Trigger Settings*, on page 3-99.

Scaling Waveforms

Scaling waveforms means increasing or decreasing their displayed size and moving them up, down, right, and left on the display.

There are many reasons for you to scale waveforms. You can increase the displayed size to see more resolution. You can decrease it to obtain a better overall view of a waveform. You can adjust a waveform up or down on the display to see multiple waveforms without overlap.

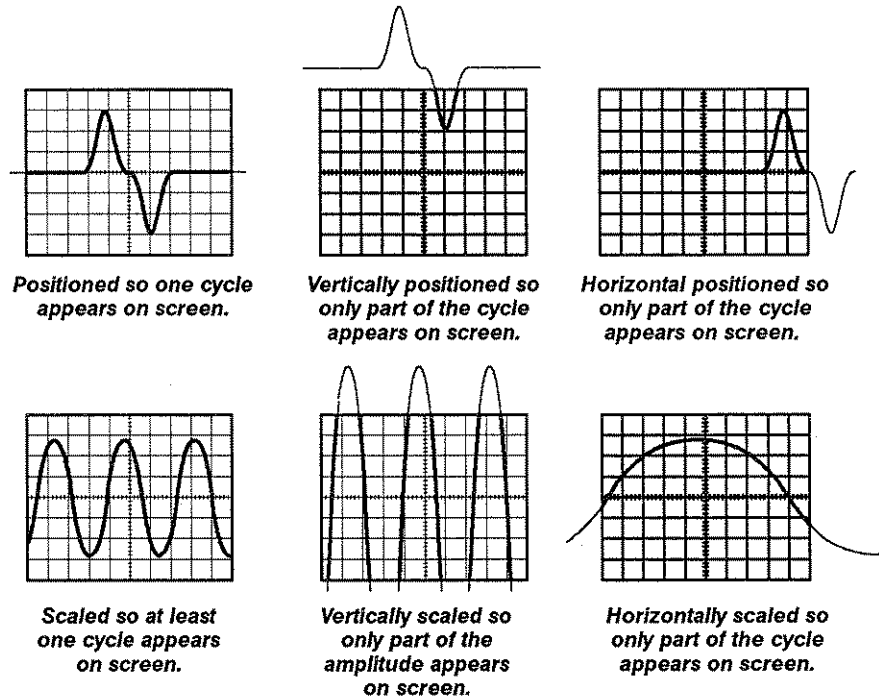

Figure 2-12: Proper and Improper Scaling and Positioning

Vertical System

You can adjust the vertical position of the selected waveform. This means you move it up or down on the display. For example, when trying to compare multiple waveforms, you can put one signal's display above another and visually compare them, or you can overlay the two waveforms on top of each other. To move the selected waveform up, turn the **VERTICAL POSITION** knob clockwise. To move it down, turn the knob counter clockwise.

You can also alter the vertical scale. The digitizing oscilloscope provides a minimum of 256 levels (8 bits) of vertical resolution. You can manipulate the voltage range to let you display a signal over more of the vertical window. You'll, perhaps, see less of it as part of it may be off the display. However,

you'll have increased resolution on what you see. You can also display it over less of the vertical window. You'll then, perhaps, see more of it but with decreased resolution.

The digitizing oscilloscope shows the scale you use toward the bottom left of the display. The scale readout shows the channel and the volts per division used. As you turn the **VERTICAL SCALE** knob clockwise, the value decreases (higher resolution because you see a smaller range on the same size display) and as you turn it counter-clockwise the value increases (lower resolution because you can see more of the vertical axis on the same size display),

In addition to using the position and scale knobs mentioned above, you can set the vertical scale and position with exact numbers. You can do this with the Vertical menu **Fine Scale** and **Position** selections and the general purpose knob and/or the keypad.

Coupling

You can define how to couple your input signal to the digitizing oscilloscope using the vertical system. You can choose from AC, DC, or Ground (GND). You can also set input impedance.

DC

DC coupling shows all of an input signal. In other words, it passes both AC and DC components to the scope.

AC 

AC coupling shows only the alternating components of an input signal. It removes the input signal's DC components.

GND 

Ground (GND) coupling disconnects the input signal for the vertical system.

Input Impedance lets you select either 1 M Ω or 50 Ω impedance.

You can set the digitizing oscilloscope's coupling using the Vertical menu **Coupling** selection.

Bandwidth



Bandwidth refers to the range of frequencies which an oscilloscope can acquire and display accurately, that is, with less than 3 dB attenuation.



You can set different bandwidths with the digitizing oscilloscope. Using lower bandwidth settings lets you reduce unwanted signals at higher frequencies. The TDS offers **Full**, **100 MHz**, and **20 MHz** bandwidth settings.



You can set the bandwidth with the Vertical menu **Bandwidth** item.

Offset and Position

Vertical position and offset change where the ground reference point is shown with respect to the graticule. You can use both offset and position interchangeably if you just want to move the waveform up and down on the display.

Position adds screen divisions to the reference point. Adding divisions moves the waveform up and subtracting them moves the waveform down.

Offset adds volts to the reference point. (Adding volts moves the waveform down and subtracting volts moves the waveform up.)

Position is limited to a range of ± 5 divisions. Offset has a wider range. This makes offset useful in cases where a waveform has a DC bias. One example is where you're trying to look at a small ripple on a power supply output. You may be trying to look at a 100 mV ripple on top of a 15 V supply. Offset's range can prove valuable as you try to move and scale the ripple to meet your needs.

Horizontal System

Adjusting the horizontal position of waveforms moves them right or left on the display. This is useful when the waveform's record length is so large (greater than 500 points) that the digitizing oscilloscope cannot display the entire waveform at one time. To see a waveform section beyond the right or left edge of the display, adjust the horizontal position control.

You can also change the horizontal scale. This is useful, for example, when you want to see one cycle, and just one cycle, on the display at one time.

Scaling and Positioning

Typically, you can adjust the horizontal scale of the displayed traces using the horizontal **SCALE** knob and the horizontal position using the horizontal **POSITION** knob.

The digitizing oscilloscope shows the actual scale in the bottom right of the display. The scale readout shows the time per division used. Since all live waveforms use the same time base, your instrument only needs to display one value for all channels used.

Real-time Sampling

The horizontal **SCALE** knob affects the time base. Generally, turning the knob clockwise causes the scope to assign shorter and shorter time periods to the same space on the screen. The acquisition rate increases and the signal you see on the display has finer resolution. In the real time mode, the oscilloscope acquires all the sample points for a complete waveform record in a single trigger event.

Equivalent-time Sampling

At some point you turn the horizontal **SCALE** knob so far that the oscilloscope can't acquire points any faster in real time. That means the oscilloscope can't track single-shot (one time) events any faster. It still can track faster, repetitive events, however, by using equivalent time sampling. That means the oscilloscope acquires signals over many repetitions of the event. It only takes a few samples at each repetition. This allows the digitizing oscilloscope to accurately acquire signals whose frequency components are much higher than the oscilloscope's real-time acquisition rate.

The Tektronix Digitizing Oscilloscope has a maximum equivalent-time rate of 100 Gigasamples/second.

Aliasing

Aliasing occurs when the highest frequency component of the input signal is greater than $\frac{1}{2}$ the current sample rate. That is, the oscilloscope cannot acquire the signal fast enough to construct an accurate waveform record. Figure 2-13 illustrates this by showing a slower aliased waveform on top of the actual input waveform.

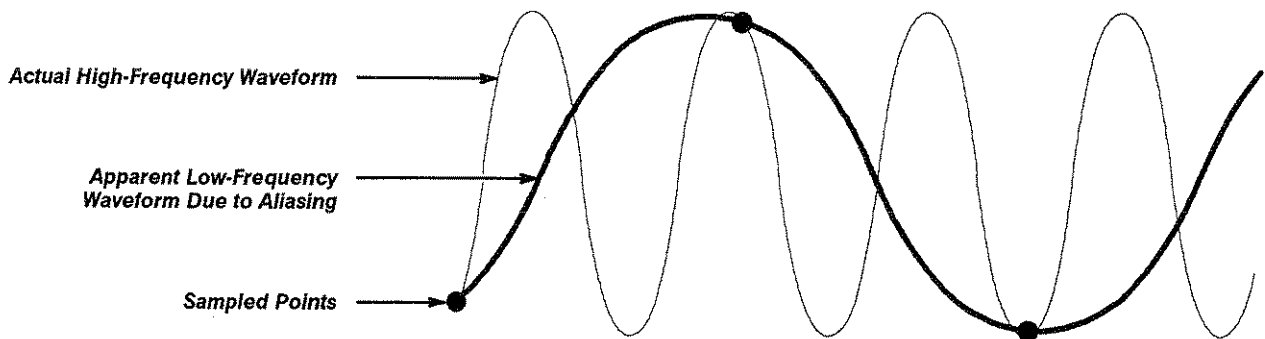

Figure 2-13: Aliasing

In real time sampling, the oscilloscope must acquire events in the same time frame that they occur. If the acquisition rate is not fast enough, aliasing can occur. That means you may see a lower frequency waveform.

In order to accurately represent a signal and avoid aliasing, you must sample the signal at least twice as fast as the highest frequency component (according to the Nyquist theory). For example, a signal with frequency components as high as 500 MHz would require a sample rate of at least 1 Gigasample/second to accurately represent it.

One simple way to check for aliasing is to slowly change the horizontal scale (time per division setting). If the shape of the displayed waveform changes drastically, you may have aliasing. To overcome the problem, adjust the horizontal scale as needed. You can prevent some aliasing by simply pressing the **AUTOSET** button.

You can also counteract some aliasing by changing the acquisition mode. The *Acquisition* article that follows (page 2-19) explain this in more detail. Briefly, however, if you're using the sample mode and suspect aliasing, you may want to change to the peak detect mode. In the peak detect mode the oscilloscope makes use of more samples and can help detect faster signal components.

Time Base

The *time base* consists of the horizontal (time) axis parameters of every waveform record. You set these parameters. They determine how the digitizing oscilloscope generates the waveform with respect to time and how it displays the waveform. A description of the digitizing oscilloscope's horizontal system is a description of the time base.

You can set a main time base and a delayed time base. Each time base has its own trigger. The delayed time base has two additional parameters which describe its triggering relationship to the main time base. These are: 1) delayed run mode and 2) delay amount (time or events). The delayed time base is useful in catching events that follow other events.

Trigger Position

The *trigger position* defines where on the waveform record the trigger occurs. It lets you properly align and measure data within records.

The part of the record that occurs *before* the trigger is the pretrigger portion. The part of the record that occurs *after* the trigger is the posttrigger portion. Many users find keeping pretrigger information a valuable troubleshooting technique. For example, if you're trying to find the cause of an unwanted glitch in your test circuit, it may prove valuable to trigger on the glitch and set a pretrigger to capture data (from various channels) right before the glitch. By analyzing what happened right before the glitch, you may uncover clues about the source of the glitch.

Record Length

The *record length* sets the length of the waveform, in terms of points. The digitizing oscilloscope provides record lengths of 500, 1000, 2500, 5000, and 15000 points. You can order, as an option, a record length of 50000 points. This option is available only at the time of original purchase. It cannot be added in the field.

Zoom

You use *zoom* if you want to view a magnified version of your waveform without changing the voltage scale or the time per division at which the waveform was acquired. Zoom is a display-only function. It does not affect acquisition.

You can use zoom to see more detail without changing the acquired signal. For example, if you've just acquired a single shot event (with the Acquire menu **Stop After Single Acquisition Sequence** setting) and want to magnify the display, you can't change the time base or the displayed signal would disappear. Instead you can use zoom.

You might also use zoom if you've acquired data while using the maximum time per division and want to magnify the results.

To use zoom on the digitizing oscilloscope, press the **ZOOM** button and then use the resulting side menu.

Autoset

Autoset lets you quickly obtain a stable, meaningful waveform display.

Autoset automatically adjusts a wide variety of settings. These include vertical and horizontal scaling. They also include trigger coupling, type, position, slope, mode and display intensities. *Autoset* on page 3-17 describes in more detail what autoset does.

For More Information

See *Autoset*, on page 3-17.

See *Horizontal Scale and Position*, on page 3-43.

See *Vertical Scale and Position*, on page 3-105.

See *Zoom*, on page 3-109.

Acquisition

Acquisition is the process of analog-to-digital conversion of input signals. The digitizing oscilloscope creates a digital representation of the input signal by sampling levels of the signal at regular time intervals (sampling rate). The sampled points are stored in memory along with corresponding timing information. You can use this digital representation of the signal for display, measurements or further processing (Figure 2-14).

You can specify the mode in which the digitizing oscilloscope acquires and processes signals. That is, you can define how the digitizing oscilloscope acquires data points and assembles them into the waveform record that it displays and analyzes. For example, in certain cases you can reduce apparent noise by introducing signal averaging or you can capture elusive glitches with peak detection mode.

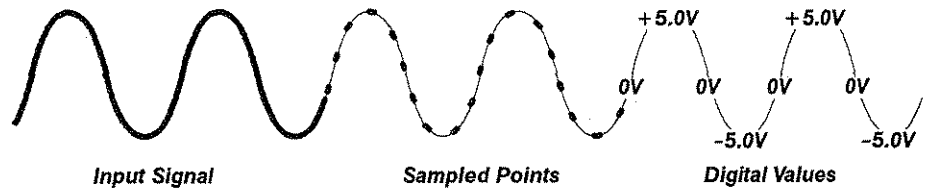

Figure 2-14: Acquisition: Input Analog Signal, Sample, and Digitize

Sampling and Digitizing

The digitizing oscilloscope creates waveforms from multiple data points. Each point represents a voltage level that was sampled at a determined amount of time from a trigger event.

Each time the digitizer takes a sample, the digitizer produces a numeric representation of the signal at that time. The number of points sampled, however, may not equal the number of points in your waveform. In fact, the oscilloscope may take one or several samples for each point used to create the waveform (Figure 2-15).

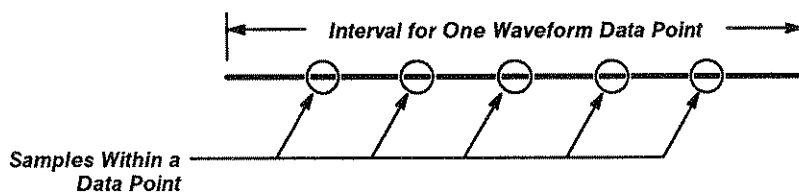

Figure 2-15: Several Points May be Acquired for Each Point Used

The digitizer can use the extra points to perform added processing, such as looking for minimum and maximum values, or averaging.

The number of points that make up the waveform is defined by the record length. You can set the record length in the instrument's Horizontal menu.

Sampling

Sampling is the process of converting the analog input signal to digital form for display and processing. Two general methods of sampling are:

- *real-time sampling*
- *equivalent-time sampling*

Real-Time Sampling – In real-time (RT) sampling, the oscilloscope digitizes all the points it acquires in one trigger event (Figure 2-16). Use real-time sampling to capture single-shot or transient events.

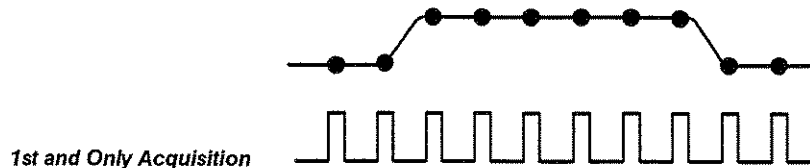

Figure 2-16: Real-Time Sampling

Two factors that affect real time sampling on the digitizing oscilloscope are *interleaving* and *interpolation*.

Interleaving refers to the digitizing oscilloscope's ability to attain high digitizing speeds by combining the efforts of several digitizers. For example, if you want to digitize on all channels at one time (four on the TDS 540 and two on the TDS 520), each of those channels can digitize at a maximum real time speed of 250 Megasamples/second (per channel). If you use two channels, the TDS 540 oscilloscope can combine the efforts of two digitizers to each channel and acquire at 500 Megasample/second (per channel). If you focus on only one channel at the maximum possible real-time rate, the TDS 520 oscilloscope can use both its digitizers and acquire at 500 Megasamples/second, while the TDS 540 oscilloscope can combine all four digitizers and acquire at 1 Gigasample/second.

Interpolation refers to how the digitizing oscilloscope assigns values to points in its record (interpolates) when you set the oscilloscope to sample in real time at rates faster than it can actually sample at. The digitizing oscilloscope gives you two options: linear or $\sin(x)/x$ interpolation.

Linear interpolation works by assigning values using a straight line fit between the actual values acquired. It assumes all the interpolated points fall in their appropriate point in time on that straight line. This is useful for many linear waveforms like pulse trains.

Sin(x)/x interpolation works by assigning values using a curve fit between the actual values acquired. It assumes all the interpolated points fall along that curve. This is particularly useful when acquiring more rounded waveforms like sine waves. Actually, it is appropriate for general use, although it may introduce some overshoot in signals with fast rise times.

To select an interpolation method on the digitizing oscilloscope, press the **DISPLAY** button to bring up the Display menu and then press the **Filter Types** button on the main menu. Select from **Sin(x)/x** or **Linear** on the resulting side menu.

Equivalent-Time Sampling — In equivalent-time (ET) sampling the oscilloscope acquires signals over many repetitions of the event (Figure 2-17). Thus, you use it on repetitive signals. The oscilloscope takes a few samples at each repetition, and then reconstructs the waveform in equivalent time. This allows your instrument to accurately acquire signals whose frequency components are much higher than its real-time sample rate.

The digitizing oscilloscope uses a type of equivalent-time sampling called *random equivalent-time sampling*. It uses the fact that the oscilloscope sample clock runs asynchronously with respect to the input signal and the signal trigger. The oscilloscope takes samples continuously, independent of the trigger position, and displays them based on the time difference between the sample and the trigger. Although the samples are taken sequentially in time, they are random with respect to the trigger. That is why this is called “random” equivalent-time sampling.

The oscilloscope automatically selects real-time or equivalent-time sampling based on the sampling speed, number of channels in use, and digitizing oscilloscope model.

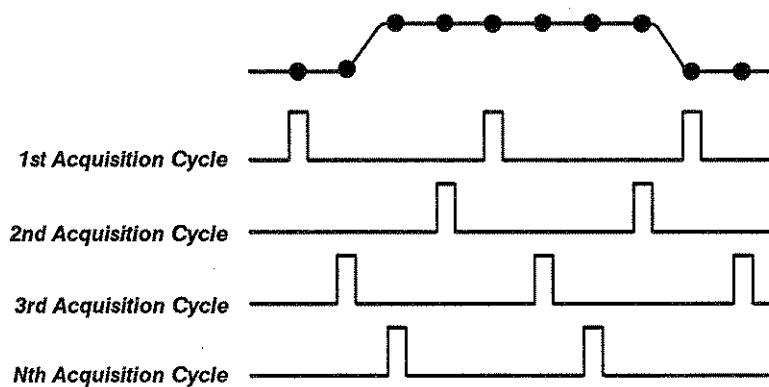

Figure 2-17: Equivalent Time - Random Sequential Sampling

Acquisition Modes

The acquisition mode you select affects how the several samples taken during a single acquisition interval are combined into a data point value.

The digitizing oscilloscope supports five acquisition modes. These are:

- *sample*
- *peak detect*
- *hi res*
- *envelope*
- *average*

The first three modes (*sample*, *peak detect* and *hi res*) can operate in real time on a single trigger event, provided the sample rate is sufficient.

The last two modes involve multiple acquisitions. The digitizing oscilloscope averages or envelopes together several waveforms on a point-by-point basis.

Figure 2-18 illustrates differences between the modes and lists some benefits of using each mode. You should find this of interest when trying to decide which mode to select.

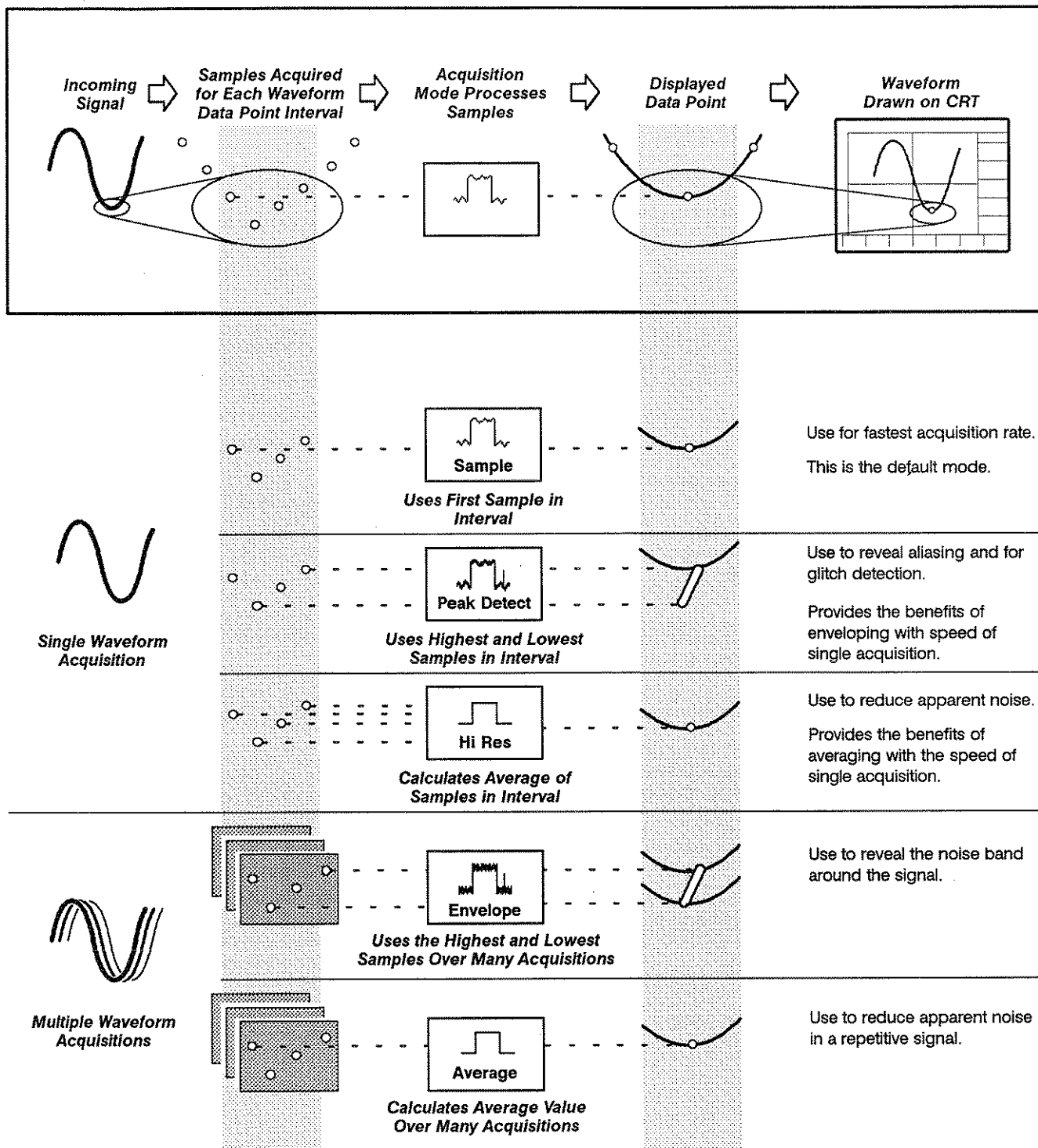

Figure 2-18: How the Acquisition Modes Work

Sample Mode



In Sample mode, the oscilloscope saves one sample during each acquisition interval. (An acquisition interval is the time duration of the waveform record divided by the record length) This is the default mode.

Peak Detect Mode



Peak Detect mode lets you acquire and display a waveform that shows the variation extremes over all samples in an acquisition interval. This is the same as envelope mode with a single time period selected This mode works with real time, non-interpolated sampling only.

For many glitch-free signals, this mode is indistinguishable from the sample mode. If you set the digitizing oscilloscope to operate so fast that it requires real time interpolation or equivalent time sampling, the mode automatically changes to sample, although the menu selection will not change.

Hi Res Mode



In Hi Res mode, the digitizing oscilloscope averages all samples taken during a waveform interval. This average (a boxcar or block average) results in a higher-resolution, lower-bandwidth waveform. This mode works with real-time, non-interpolated sampling only. If you set the digitizing oscilloscope to operate so fast it requires real-time interpolation or equivalent time sampling, the mode automatically becomes sample, although the menu selection will not change.

A key advantages of Hi Res is its potential for increasing resolution regardless of input signal. The equations shown below illustrate how you can obtain up to 15 significant bits with hi res mode (Table 2-1). Note that the resolution improvements are limited to speeds below 400 ns/div. Also, resolutions above 15 bits are not allowed by internal hardware and computation limitations.

$$S_i = \text{Sampling Interval or A/D conversion rate} = 4 \text{ ns}$$

$$\Delta t = \text{Sample Interval} = \frac{\text{Time/Div}}{\text{Number Of Points/Div}} = \frac{5 \mu\text{s/Div}}{50 \text{ Points/Div}} = 100 \text{ ns}$$

$$N_d = \text{Number of points per decimation interval} = \frac{\Delta t}{S_i} = 25$$

$$\text{Resolution Enhancement (bits)} = 0.5 * \text{LOG}_2(N_d) = 2 \text{ extra bits}$$

Table 2-1: Theoretical Resolution in Hi Res Mode at Different Time/Div Settings

8 Bits	9 Bits	10 Bits	11 Bits	12 Bits	13 Bits	14 Bits	15 Bits
400 ns and faster	1 μs to 2 μs	5 μs to 10 μs	20 μs to 50 μs	100 μs to 200 μs	500 μs	1 ms to 2 ms	5 ms and slower

Envelope Mode



Envelope mode lets you acquire and display a waveform that shows the variation extremes of several acquisitions. The oscilloscope detects peaks as in the peak detect mode. No smoothing algorithm is applied to the data. Instead, you can specify a number of acquisitions over which to accumulate and display the min/max data. The oscilloscope compares the min/max values from the current acquisition with those stored from previous acquisitions up to the specified number of acquisitions. Envelope mode is distinct from peak detect in its ability to accumulate peaks over many acquisitions.

Average Mode



Average mode lets you acquire and display a waveform that is the combined result of several acquisitions. This reduces the random noise. The oscilloscope acquires data as in the sample mode and then averages it according to the number of averages that you specify.

Sampling and Acquisition Mode

The sampling speeds and the number of channels you use can affect the acquisition mode the digitizing oscilloscope uses (Table 2-2). Basically, if the sampling speed is equal to or slower than 200 ns/division (10 s/div to 200 ns/div), then the digitizing oscilloscope will sample in real time in the mode you've selected. For speeds greater than 20 ns/division (20 ns to 500 ps), the oscilloscope will use either equivalent time sampling or real time sampling with interpolation.

Table 2-2: Theoretical Resolution in Hi Res Mode at Different Time/Div Settings General Sampling Mode Selection

≥ 200 ns/divs	100 ns/div to 50 ns/div	≤ 20 ns/div
Real time	Real time or equivalent time	Equivalent time or interpolated real time

For speeds between 100 ns/division and 50 ns/division the oscilloscope may run in either

- real time without interpolation, or
- equivalent time, or
- real time with interpolation sampling.

The sampling strategy the oscilloscope uses (real time or equivalent time, interpolation or not) depends on the number of input channels and the type of oscilloscope you're using.

**Table 2-3: Theoretical Resolution in Hi Res Mode
at Different Time/Div Settings Sampling Mode Selection –
100 ns/Div to 50 ns/Div**

Instrument and Number of Channels	100 ns/div	50 ns/div or Faster
TDS 540, any 1 channel	Real time	Real time or equivalent time or interpolated real time
TDS 540, any 2 channels	Real time	Equivalent time or interpolated real time
TDS 540, 3 or more channels	Equivalent time or interpolated real time	Equivalent time or interpolated real time
TDS 520, CH1 or CH2	Real time	Equivalent time or interpolated real time
TDS 520, other	Equivalent time or interpolated real time	Equivalent time or interpolated real time

Finally, at sampling speeds faster than 200 ns/division the peak detect and hi res acquisition modes become functionally equivalent to sample mode, because the oscilloscope can only sample one point per waveform interval.

**For More
Information**

See *Scaling Waveforms*, on page 2-13.

See *Acquisition Modes*, on page 3-13.

Measurements

The TDS 500 Series Digitizing Oscilloscopes not only display graphs of voltage versus time, but also can help you take measurements on the information displayed. These measurements can provide numeric information to further help you solve problems.

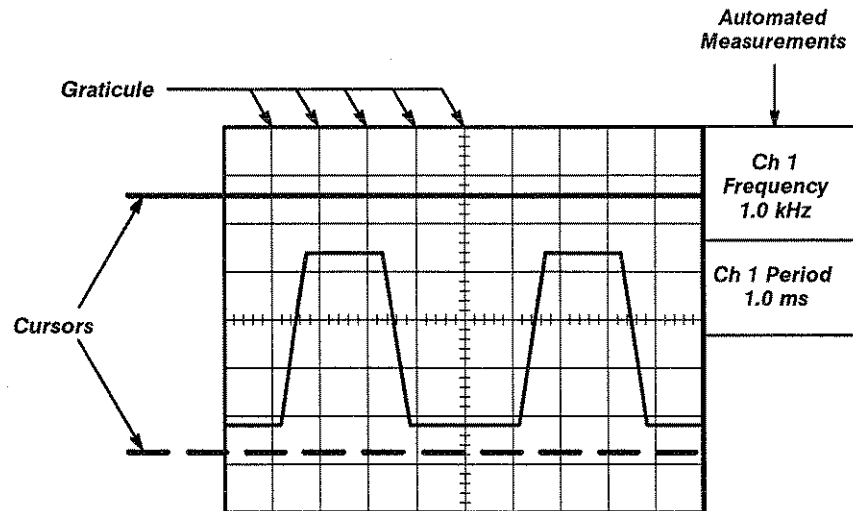

Figure 2-19: Graticule, Cursor and Automated Measurements

Measurement Sources

The oscilloscope provides three measurement classes. These are: graticules, cursors and automated measurements.

Graticules are fixed marks on the display (the grid). Graticule measurements are quick visual estimations derived from these marks.

Cursors are movable lines on the display. You set their value by positioning them on the display. Their actual value, however, comes from internal data. This makes them more precise than graticules. They use numeric readouts to present results.

Automated measurements are even more precise than cursors. They rely on internal acquisition and display data. Like the cursors they use numeric readouts to present results. They are more consistent from case to case than graticules and cursors because the oscilloscope derives them from internally stored waveform data.

Graticule Measurements

Graticule measurements provide you with quick, visual estimates. For example, you might look at a waveform's amplitude and say "it's a little more than a volt".

You can perform simple measurements by counting the number of major and minor graticule divisions involved and multiplying by the scale factor. For example, if you counted five major vertical graticule divisions between a waveform's minimum and maximum values and knew you had a scale factor of 2 volts/division then you could easily calculate your peak-to-peak voltage as:

$$5 \text{ divisions} \times 2 \text{ volts/division} = 10 \text{ volts.}$$

Cursor Measurements

Cursor measurements are more accurate than graticule measurements. Unlike graticules, they include a readout area on the display that shows numeric values. Cursors are also fast and easy-to-understand measurements. You take measurements by moving the cursors and displaying their horizontal or vertical values.

Cursors appear in pairs. One is *active* and the other *inactive*. You move the active cursor with the general purpose knob. The screen readout can show not only the values of the cursors but also the difference between them.

Two types of cursors are available. These are horizontal bar and vertical bar cursors (Figure 2-20).

Horizontal bar cursors measure vertical parameters (typically volts).

Vertical bar cursors measure horizontal parameters (typically time).

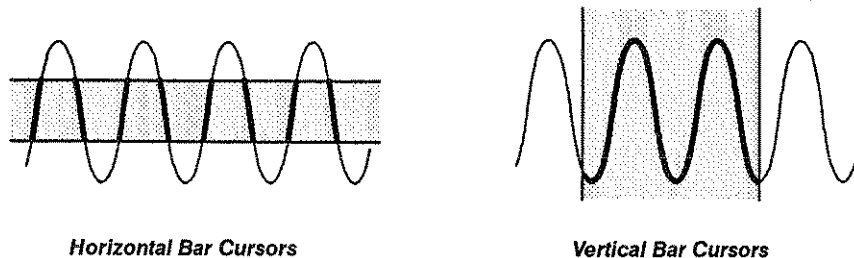

Figure 2-20: Cursor types

Cursor measurement readouts show measurement status. These readouts are updated as you adjust cursor positions (by moving the general purpose knob). The horizontal bar cursor's readout shows the voltage level of the active horizontal bar relative to ground and the voltage difference between the two horizontal bars. The vertical bar cursor's readout shows the time of the active vertical bar relative to the trigger and the time difference between the two vertical bars. The **TOGGLE** button lets you select (toggle) which of the two horizontal or vertical bars is active.

To take cursor measurements on the digitizing oscilloscope, press the **CURSOR** button to call up the **Cursor Menu**. Then press the main menu **Function** item and select the cursor type from the side menu.

Automated Measurements

You use automated measurements merely by pressing a few buttons. The digitizing oscilloscope does the calculating for you.

Because these measurements use the waveform record points directly, they are more accurate than cursors or graticules.

Measurements cover *amplitude* and *timing*.

Amplitude measurements are made on vertical parameters. This typically means voltage. They include minimum, maximum, high, low, positive overshoot, negative overshoot, peak to peak, amplitude, mean, cycle mean, RMS, and cycle RMS.

Timing measurements are made on horizontal parameters. This typically means seconds or Hertz. They include period, frequency, positive width, negative width, rise time, fall time, positive duty cycle, negative duty cycle, propagation delay, and burst width.

See Appendix D for more details on how the digitizing oscilloscope calculates each measurement.

Measurement Display

Automated measurements use readouts to show measurement status. These readouts are continuously updated as the oscilloscope acquires new data or as you change settings. You can select and display up to four measurements.

Each measurement relates to the channel that was active when you selected that measurement. Each measurement remains displayed until you remove it or turn the related waveform off with the **WAVEFORM OFF** button.

To take automated measurements, press the **MEASURE** button to bring up the Measure menu. Then press the main menu **Select Measurement** button and select the relevant measurements from the side menu.

For More Information

See *Tutorial Example 3: Automated Measurements*, on page 1-13.

See *Cursor Measurements*, on page 3-19.

See *Measurement System*, on page 3-53.

See *Appendix D: Algorithms*, on page A-77.



Save and Document

You can save data or setup information for later analysis, reporting, or archiving. For example, you can electronically save waveforms for later comparison to other waveforms. You can also save setup information to help replicate test procedures. You can print a copy of what's on the screen to use for analysis or documentation.

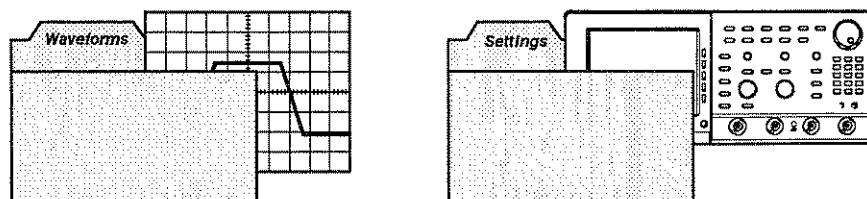

Figure 2-21: Save Setup and Waveform Data

Saving and Recalling Waveforms

A stored waveform is a record of a waveform. You can also think of it as a snapshot of a waveform.

The digitizing oscilloscope can save acquired waveforms in any of four internal, nonvolatile reference (REF) memories. You can later recall them, display them, and use them for a variety of tasks including performing waveform math with stored or newly acquired waveforms or for comparing newly acquired waveforms with stored template waveforms.

Stored waveforms are saved when you turn off the digitizing oscilloscope. They will be available when you turn the power back on.

To save waveforms on the digitizing oscilloscope, press the save/recall **WAVEFORM** button to bring up the Save/Recall Waveform menu. Select the **Save Waveform** main menu item and then select the desired destination reference memory from the side menu.

If you run out of memory when you try to save a waveform, you can choose the Save/Recall Waveform menu's **Delete Refs** main menu item and then select the references you no longer need from the side menu. You'll know if you run out of memory because the digitizing oscilloscope will display a message.

To recall waveforms, press the **MORE** button to bring up the More menu. Then select the reference waveform desired from the main menu (**Ref1**, **Ref2**, **Ref3**, or **Ref4**).

The digitizing oscilloscope only lets you save 50,000 waveform points total. Therefore, you can save four 500, 1000, 2500, or 5000-points waveforms. You can save up to three 15000-point waveforms. You can also save combinations of these waveforms, providing they contain less than 50000 points total. If you have option 1M, you can save one 50000-point waveform.

Saving and Recalling Setups

The digitizing oscilloscope can save front panel setups in any of ten nonvolatile reference (REF) internal memories. You can later recall them to reset the oscilloscope. This is useful, for example, when trying to reproduce your exact settings to accurately re-create an experimental or testing situation at a later date.

You can also recall the factory setup at any time.

Stored settings are saved when you power off the digitizing oscilloscope, and are available when you turn the power back on.

To save and recall setups on the digitizing oscilloscope, use the save/recall **SETUP** button. This calls up the Save/Recall Setup menu. Select from the main menu **Save Current Setup**, **Recall Saved Setup**, or **Recall Factory Setup**. Use the resulting side menu to choose which internal setup memory to use.

Hardcopies

The digitizing oscilloscope can output a copy of exactly what's on the screen to a variety of graphics printers and plotters. The output includes waveforms, graticules and measurements.

The TDS 500 series oscilloscope uses the GPIB port to interface with a printer. GPIB is described in more detail in a concept article titled *Remote Communications* on page 2-35.

Different hardcopy devices use different formats. The digitizing oscilloscope supports several. These include HP Thinkjet, Deskjet, Laserjet, Epson®, Interleaf®, Postscript® and HPGL. Some formats, particularly Interleaf, Postscript, and HPGL, are compatible with various desktop publishing packages. This means you can paste files created from these output formats directly into a document on any of various desktop publishing systems.

You can send information in landscape or portrait format (see Figure 2-22).

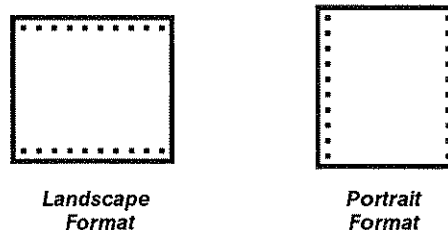

Figure 2-22: Hardcopy Formats

To make a hardcopy on the digitizing oscilloscope, simply press the **HARD-COPY** button. To set up hardcopy parameters, press the **HARDCOPY MENU** button (**SHIFT** and then **HARDCOPY**). This brings up the Hardcopy menu. Select **Format**, **Layout**, or **Port** from the main menu and then make a selection from the resulting side menu.

For More Information

See *Tutorial Example 4: Saving Setups*, on page 1-19.

See *Hardcopy*, on page 3-39.

See *Remote Communications (Concepts)*, on page 2-35.

See *Remote Communication Tasks*, on page 3-87.

See *Saving and Recalling Settings*, on page 3-91.

See *Saving and Recalling Waveforms*, on page 3-93.



Remote Communications

You can use a computer to remotely set the oscilloscope's front panel controls or take measurements and read those measurements for later analysis and storage. You can also set up the oscilloscope to make a screen hardcopy on a printer or a plotter.

The standard protocol for remote communications available on the digitizing oscilloscope is the General Purpose Interface Bus (GPIB or IEEE Std 488.2-1987).

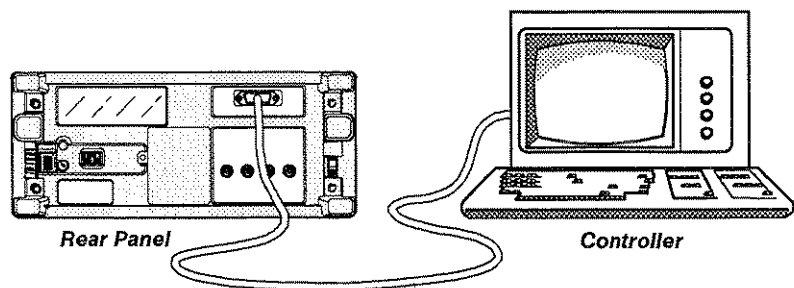

Figure 2-23: GPIB Enables Data Transfers Between the Oscilloscope and a Remote Computer

GPIB Protocol

GPIB enables data transfers between instruments that support the GPIB protocols. It provides:

- Remote instrument control
- Bidirectional data transfer
- Device compatibility
- Status and event reporting

In addition to the base protocols, Tektronix has defined codes and formats for messages to travel over GPIB. Each device that follows these codes and formats, such as the TDS 520 and TDS 540, supports standard commands. Use of instruments that support these commands can greatly simplify development of GPIB systems.

Why GPIB?

GPIB is a good solution for setups requiring speed (up to 1 Megabyte/second) and multiple instrument control (up to 15 devices on a bus). GPIB uses a parallel bus that provides faster data transfer rates than typical serial RS-232-C devices. The GPIB addressing scheme allows you to hook multiple instruments together in a system.

GPIB Setup

Before connecting devices to GPIB, you need to be aware of some rules concerning GPIB networks, cables, and connectors.

GPIB Interface Requirements — You can connect GPIB networks in many configurations provided you adhere to these rules:

- You can include no more than 15 devices, including the controller, on a single bus.
- You must connect one device load every two meters (about six feet) of cable length to maintain bus electrical characteristics. Generally, each instrument represents one device load on the bus.
- The total cumulative cable length must not exceed 20 meters.
- You must power on at least two-thirds of the device loads when you use your network.
- You must have only one cable path from each device to each other device on your network. You cannot create loop configurations (see Figure 2-24).

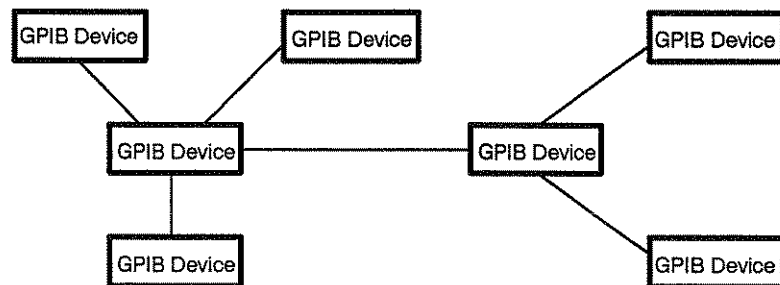

Figure 2-24: Typical GPIB Network Configuration

Cables — An IEEE Std 488.1-1987 GPIB cable (available from Tektronix) is required to connect two GPIB devices.

Connector — A 24-pin GPIB connector is located on the oscilloscope (on the rear panel). The connector has a D-type shell and conforms to IEEE Std 488.1-1987. You can stack GPIB connectors on top of each other as shown in Figure 2-25.

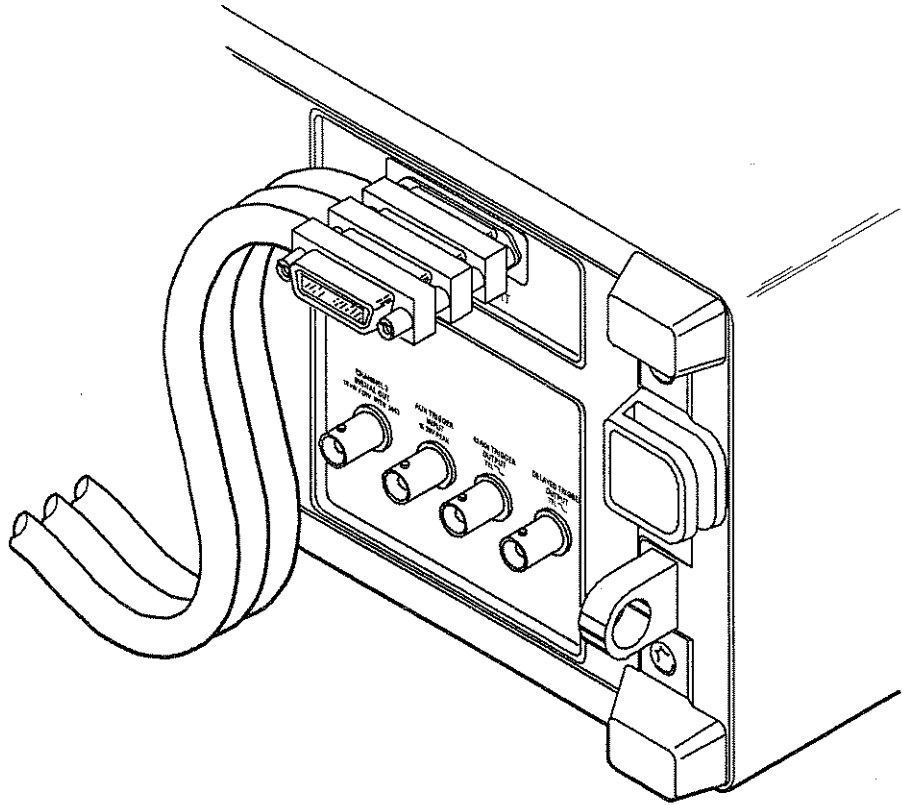

Figure 2-25: Stacking GPIB Connectors

GPIB Parameters – Important GPIB parameters are:

- **Mode:** Set the mode to: talker/listener, talker, or listener.
- **Address:** Set the primary communication address from 0 to 30.
- **Terminator:** Set the method of indicating the end of device-dependent messages sent between the controller and the instrument. The choices include: EOI (assert EOI line with transmission of last message byte) or EOI/LF (send line feed character and assert EOI line with its transmission).

Specific Operations

To set up the digitizing oscilloscope for GPIB operation, press the **UTILITY** button (the **SHIFT** and **DISPLAY** buttons) to call up the Utility menu. Press the main menu item **System** to bring up a pop-up menu. On this menu select **I/O**. Press the main menu item **Port** and use the resulting pop-up menu to select **GPIB**. To see a screen of GPIB status information, press the **STATUS** button (**SHIFT** and then **HELP**). Then select **GPIB** from the side menu.

Set GPIB Address – Press the Utility menu **Configure** item and select **Talk/Listen Address** from the side menu. Enter the actual address using the general purpose knob or the keypad.

Set GPIB Mode — Press the Utility menu main menu **Configure** item and select **Talk/Listen** or **Talk Only** from the side menu.

**For More
Information**

See *Remote Communication Tasks*, on page 3-87.



Overview

This section describes the details of operating the digitizing oscilloscope.

The first part, called *At a Glance*, presents general roadmaps to the rest of the section (and some very general operating instructions). The roadmaps show parts of the instrument and the page numbers of the *In Detail* articles that discuss those items. This section includes:

- Front Panel Map – Left Side
- Front Panel Map – Right Side
- Rear Panel Map
- Display Map
- Basic Menu Operation
- Menu Map

The second part contains an alphabetical list of tasks you can run with the digitizing oscilloscope. Use this section to answer specific questions about instrument operation. These tasks include:

- Acquisition Modes
- Autoreset
- Cursor Measurements
- Delayed Triggering
- Display Modes
- Glitch Triggering
- Hardcopy
- Help
- Horizontal Scale and Position
- Logic Triggering
- Measurement System
- Probe Compensation
- Probe Connection
- Probe Selection
- Remote Communication Tasks
- Runt Triggering
- Saving and Recalling Setups
- Saving and Recalling Waveforms

Overview

- Selecting Channels
- Status
- Trigger Settings
- Vertical Scale and Position
- Waveform Math
- Zoom



At a Glance

The *At a Glance* section contains maps of the display, front and rear panel and menu system. These should help you navigate the digitizing oscilloscope. It also contains a visual guide to using the menu system.

- The *Display Map* shows the parts of a typical display and what they mean.
- The *Front Panel Maps* show the location's and purposes of the various buttons and knobs on the front panel of the digitizing oscilloscope.
- The *Rear Panel Map* shows the various parts of your instrument's rear panel.
- The *Menu Map* shows each of the main menus (the menus on the bottom of the display that use the bottom bezel buttons) and their associated side menu items.

Front Panel Map – Left Side

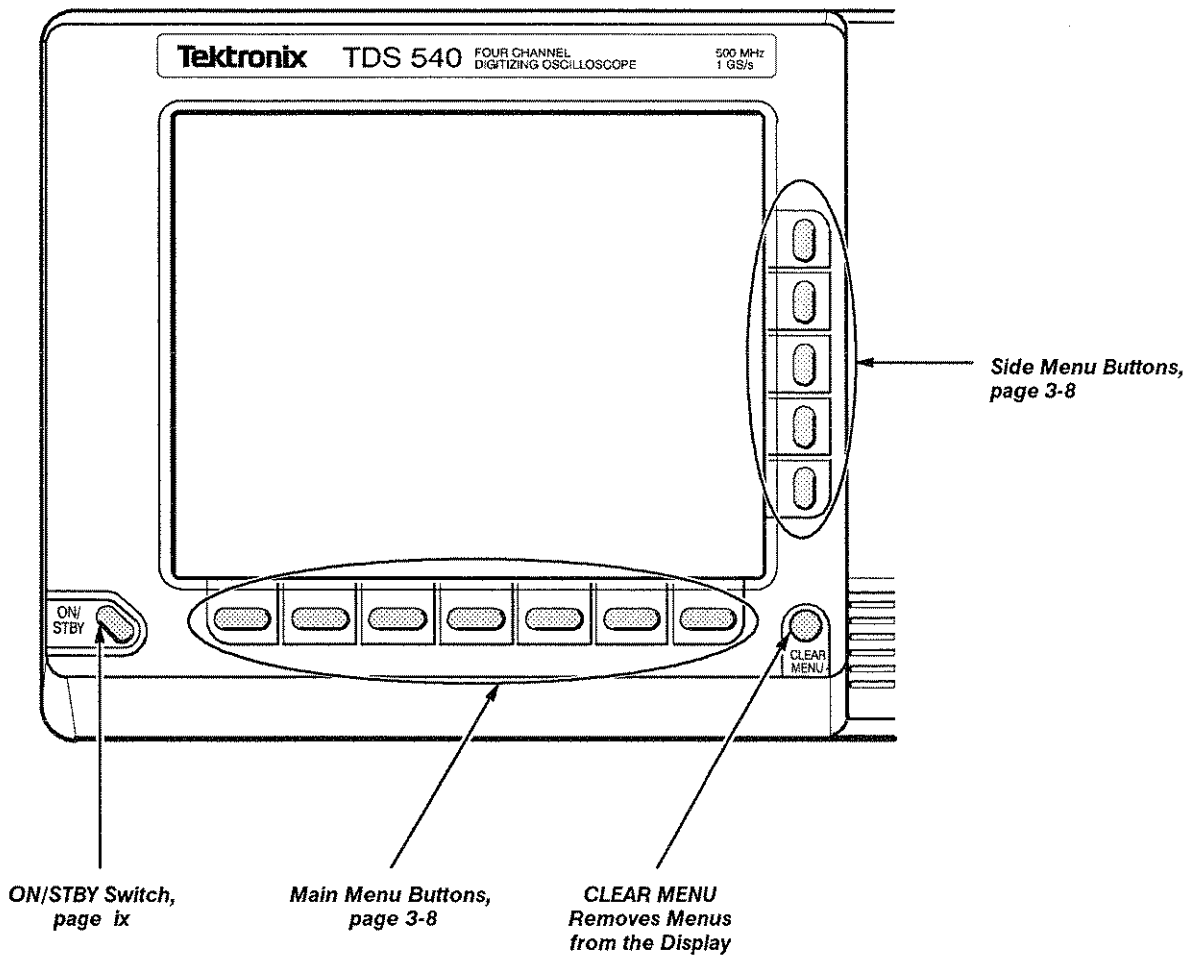

Front Panel Map - Right Side

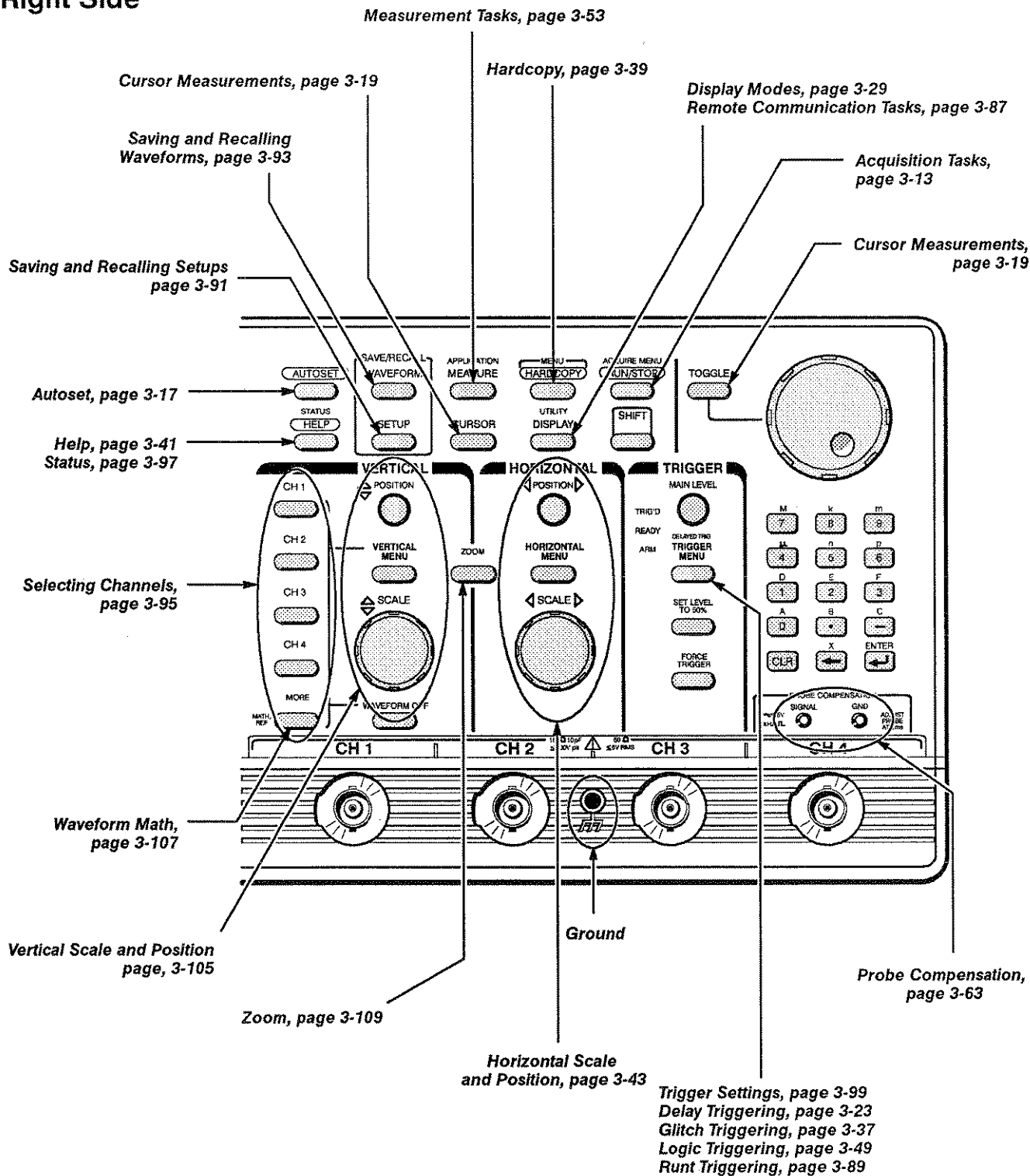

Rear Panel Map

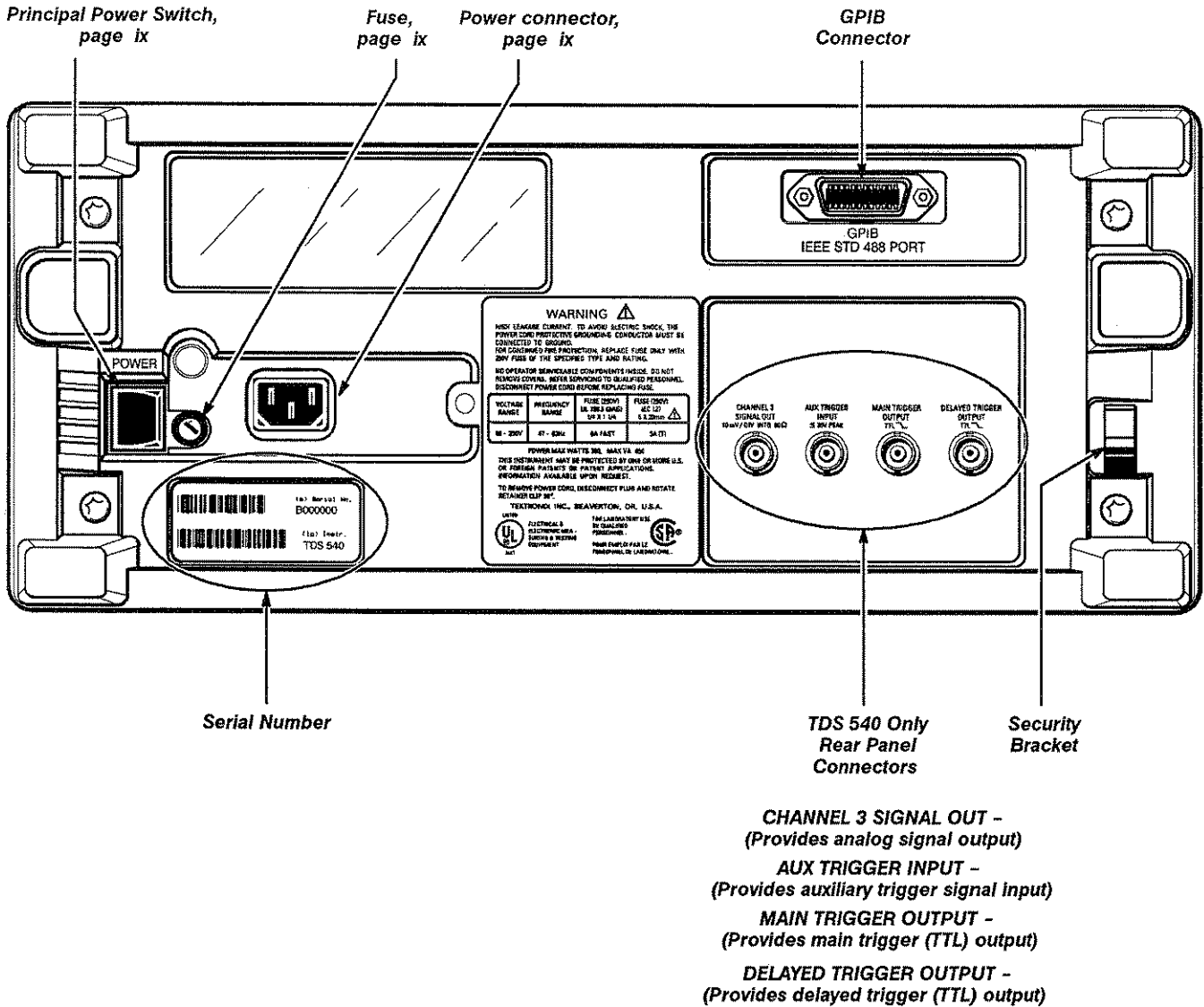

CHANNEL 3 SIGNAL OUT -
(Provides analog signal output)

AUX TRIGGER INPUT -
(Provides auxiliary trigger signal input)

MAIN TRIGGER OUTPUT -
(Provides main trigger (TTL) output)

DELAYED TRIGGER OUTPUT -
(Provides delayed trigger (TTL) output)

Display Map

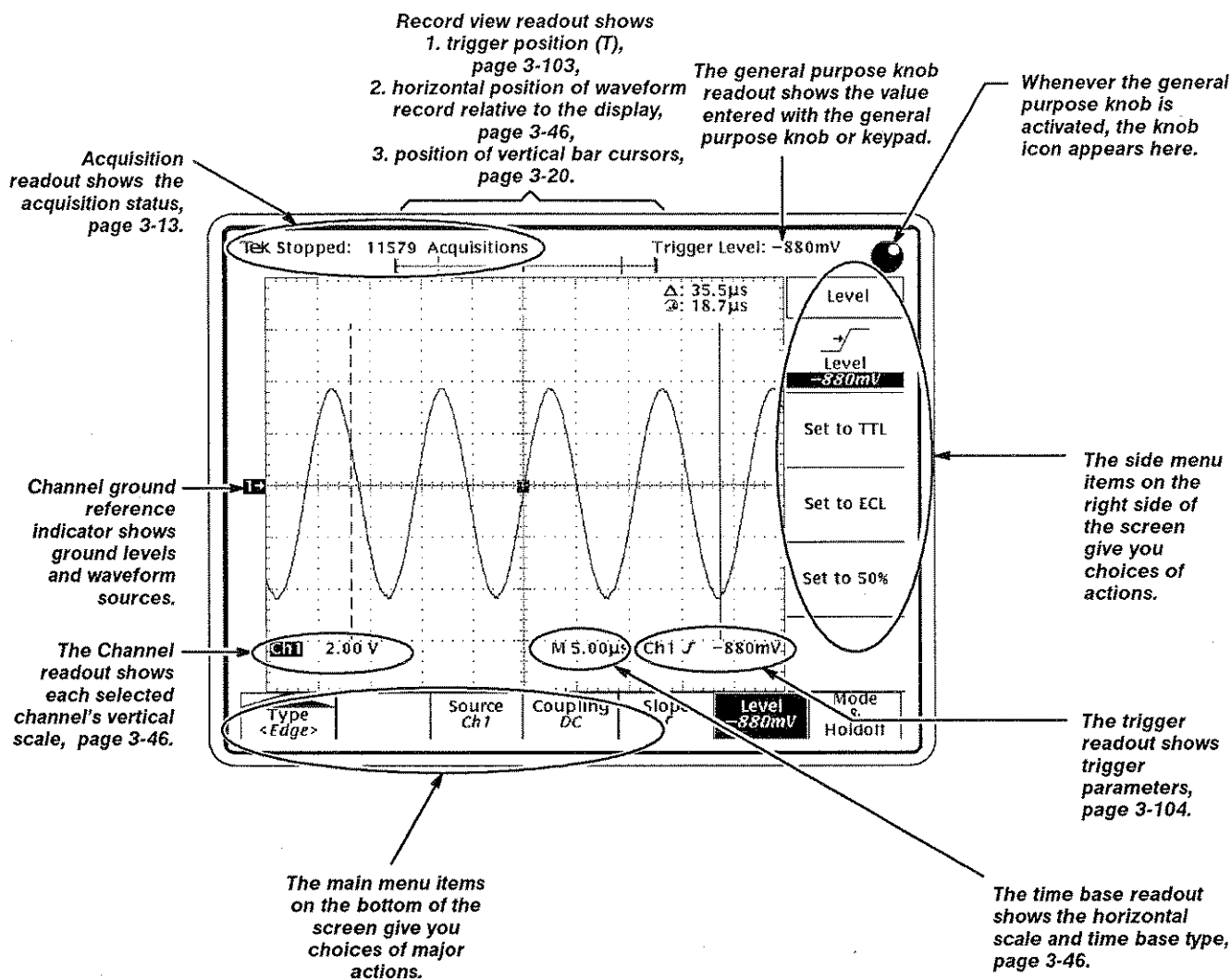

To Operate A Menu

1. Press front-panel menu button.

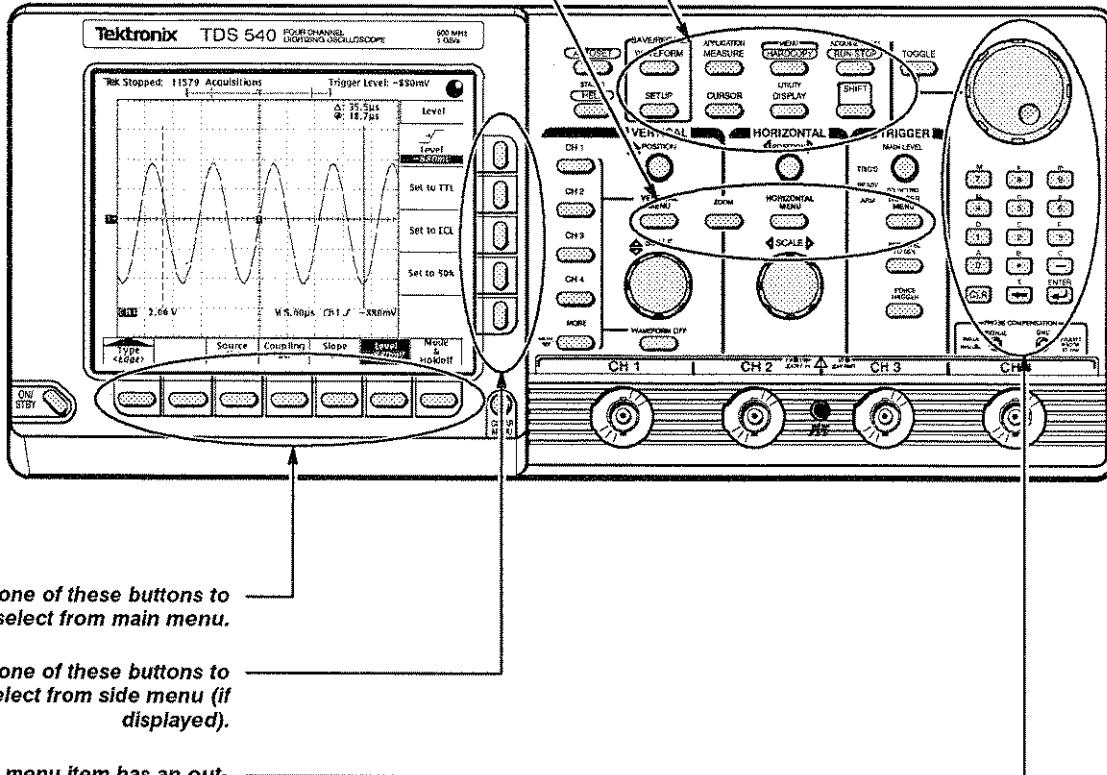



2. Press one of these buttons to select from main menu.

3. Press one of these buttons to select from side menu (if displayed).

4. If side menu item has an outlying number, adjust it with the general purpose knob or by entering keypad value.

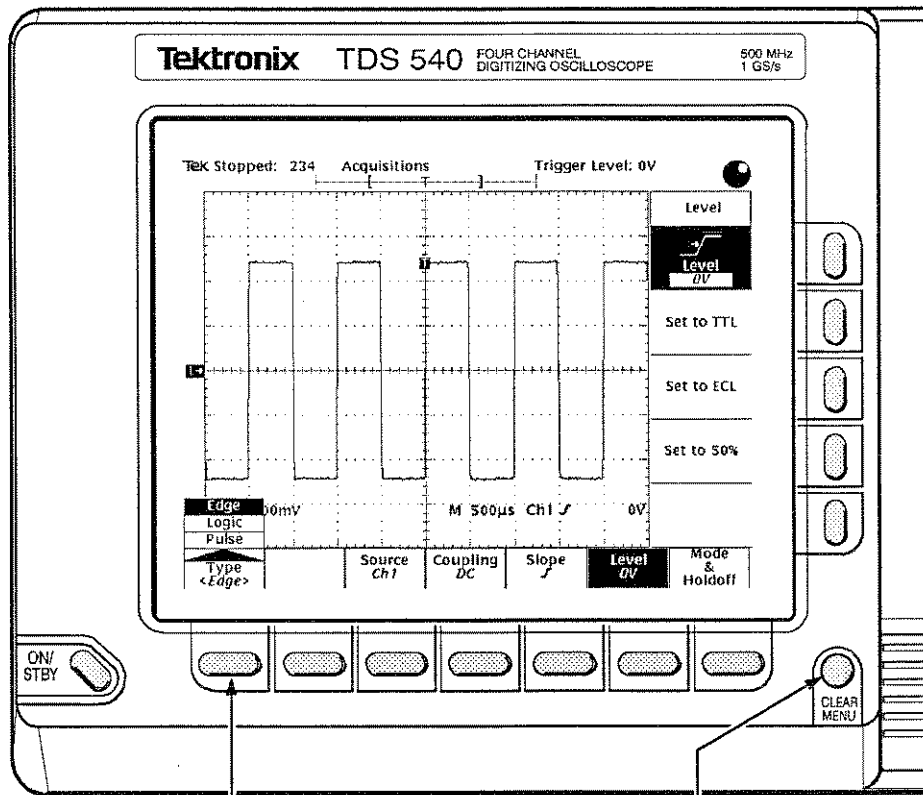
To Operate A Pop-Up Menu



Press  to display pop-ups.

Press it again to make selection.

A pop-up selection changes the other main menu titles.

Press here to remove menus from screen.

Menu Map

Press these buttons:

To bring up these menus:

To do these tasks:

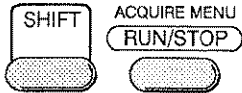

Acquire menu

Mode Sample	Repetitive Signal ON	Stop, After R/S button
----------------	----------------------------	---------------------------

Define acquisition mode, page 3-13

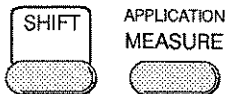

Application menu

--	--	--	--	--	--	--

Bring up user-defined menu (see Programmer Manual for more details)



Cursor menu

Function OFF	Time Units seconds
-----------------	--------------------------

Define cursor types, page 3-19

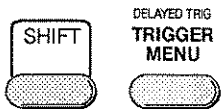

Delayed Trigger menu

	Delay by Time	Source Ch 1	Coupling DC	Slope J	Level 0 V	
--	------------------	----------------	----------------	------------	--------------	--

Define delayed time base, page 3-23



Display menu

Style Vectors	Intensity	Readout Options	Filter Sin(x)/x	Graticule Full	Format VT	
------------------	-----------	--------------------	--------------------	-------------------	--------------	--

Define display style, page 3-29

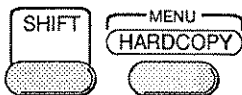

Hardcopy menu

Format Interleaf	Layout Portrait	Port GPIB
---------------------	--------------------	--------------

Define hardcopy parameters, page 3-39



Horizontal menu

Time Base Main	Trigger Position 50%	Record Length 500	Horiz Scale (/div)	Horiz Pos		
-------------------	----------------------------	-------------------------	--------------------------	--------------	--	--

Define time base parameters, page 3-43



Main Trigger menu - Edge

Type <Edge>		Source Ch 1	Coupling DC	Slope J	Level 0 V	Mode & Holdoff
----------------	--	----------------	----------------	------------	--------------	-------------------

Define edge trigger parameters, page 3-99

Press these buttons:

To bring up these menus:

To do these tasks:

DELAYED TRIG
TRIGGER
MENU



Main Trigger menu - Logic

Type <Logic>	Class <Pattern>	Define Inputs	Define Logic AND	Trigger when Goes TRUE	Set Thresholds	Mode & Holdoff
-----------------	--------------------	--------------------------	------------------------	------------------------------	-------------------	----------------------

Define logic trigger parameters, page 3-49, 3-99,

DELAYED TRIG
TRIGGER
MENU



Main Trigger menu - Pulse

Type <Pulse>	Class <Glitch>	Source Ch1	Polarity and width	Filter ON	Level 0 V	Mode & Holdoff
-----------------	-------------------	-----------------------	--------------------------	--------------	--------------	----------------------

Define pulse trigger parameters, page 3-37, 3-89, 3-99

APPLICATION
MEASURE



Measure menu

Select Measrmt for Ch1	Remove Measrmt	High-Low Setup Histogram	Reference Levels
---------------------------------------	-------------------	--------------------------------	---------------------

Select/delete automatic measurements, page 3-53

MORE



Move menu

Math1 Ch1+Ch2	Math2 Ch1-Ch2	Math3 inv(Ch1)	Ref1	Ref2	Ref3	Ref4
--------------------------	------------------	-------------------	------	------	------	------

Define math and recall reference waveforms, page 3-107

SETUP



Save/Recall Setup menu

Save Current Setup	Recall Saved Setup	Recall Factory Setup
-----------------------------------	--------------------------	----------------------------

Save/recall instrument settings, page 3-91

SAVE/RECALL
WAVEFORM



Save/Recall Waveform menu

Save Waveform Math1	Recall Waveform	Delete Refs				
------------------------------------	--------------------	----------------	--	--	--	--

Save/recall waveform, page 3-93



STATUS
HELP

Status menu

Status Snapshot
System
Trigger
Waveforms
GPIB

Provide snapshot of instrument status, page 3-97

Press these buttons:

To bring up these menus:

To do these tasks:

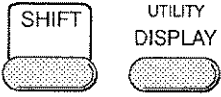

Utility menu - I/O

System <I/O>	Port <GPIB>	Configure Talk/Listen	Status
-----------------	----------------	----------------------------------	--------

Define communications ports, page 3-87

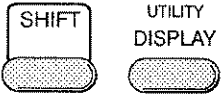

Utility menu - Calibration

System <Cal>	Signal Path Pass	Voltage Reference Initialized	Frequency Response Initialized	Pulse Trigger Initialized		
-----------------	-----------------------------	----------------------------------	-----------------------------------	------------------------------	--	--

Run thermal compensation routine, page A-27

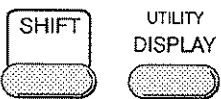

Utility menu - Diagnostics

System <Diag/Err>	Area <All Areas>	Tests Run All	Execute Halted	Loop Once		Error Log
----------------------	---------------------	--------------------------	-------------------	--------------	--	-----------

Run diagnostic tests, page A-27



Vertical Channel menu

Coupling DC	Bandwidth Full	Fine Scale 50mV/div	Position 0 div	Offset 0 V		
------------------------	-------------------	------------------------	-------------------	---------------	--	--

Define vertical system parameters, page 3-105



Zoom menu

Zoom
OFF
ON
Horizontal Lock Live
Reset Zoom Factors

Define zoom parameters, page 3-109



Acquisition Modes

The acquisition system lets you select ways to convert analog data into digital form. You can select from the acquisition mode, whether or not to permit equivalent time sampling, and a means of stopping acquisitions.

Operation

To operate the acquisition modes, perform the following steps:

Acquisition Mode

The available acquisition modes are sample, peak detect, hi res, average and envelope.

The sample, peak detect, and hi res acquisition modes are useful in examining real-time signals.

- *Sample* mode (default) saves one sample during each acquisition interval. It is useful for acquiring fast signals.
- *Peak detect* mode saves the minimum and maximum samples over two acquisition intervals.
- *Hi res* mode averages all samples taken during an acquisition interval.

The average and envelope modes are useful for acquiring repetitive signals.

- *Average* mode reduces the random noise of a displayed waveform and provides a cleaner display. The digitizing oscilloscope presents a waveform that is an average of several accumulated waveform records. (Each point in a record is numerically averaged with the same point in all other records.)
- *Envelope* mode shows the cumulative effect of noise over a period of time. It resembles averaging in that the oscilloscope accumulates several waveform records and displays a combined result. An enveloped waveform shows the maximum excursions of the individual waveform records. This often results in a “thicker” waveform that shows the variations of the signal.

To set the acquisition mode:

- Step 1:** Press the **ACQUIRE MENU** button (**SHIFT** and then **RUN/STOP**) to bring up the Acquire menu (Figure 3-1).
- Step 2:** On the Acquire menu, select **Mode** from the main menu and then select the mode (**Sample**, **Peak Detect**, **Hi Res**, **Envelope**, or **Average**) from the side menu.
- Step 3:** If you select **Envelope** or **Average**, you can enter the number of acquisitions to use from the keypad or with the general purpose knob.

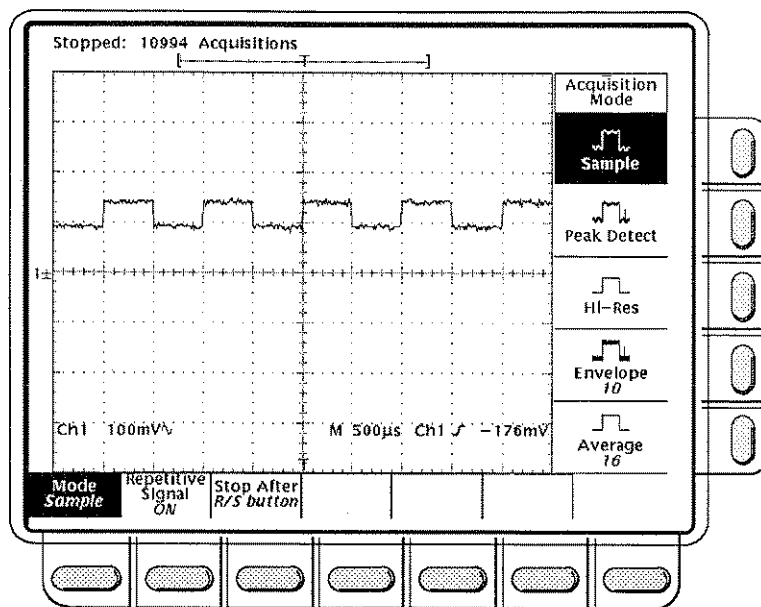

Figure 3-1: Acquire Menu

Repetitive Signal

To select the repetitive signal, use the Acquire menu as selected above.

- Step 1:** Press **Repetitive Signal** from the main menu.
- Step 2:** If desired, press **ON (Enable ET)** from the side menu. This will let you use both the real time and the equivalent time features of the digitizing oscilloscope.
- Step 3:** If desired, press **OFF (Real Time Only)** from the side menu. This will permit you to use real time sampling only. If you request the oscilloscope to acquire samples at a faster speed than possible in real time, the instrument will use the interpolation method chosen in the Display menu to fill in missing points. That is, it can use a linear or a $\sin(x)/x$ algorithm.

Stop After

To select the stop mode, use the Acquire menu as selected above.

- Step 1:** Press **Stop After** from the main menu.
- Step 2:** If desired, press **RUN/STOP** from the side menu. This will let you stop and start acquisitions using the from panel **RUN/STOP** button. Pressing it once will stop the acquisitions and the Acquisition readout will resemble the one shown in Figure 3-2. Pressing it again will restart taking acquisitions.

- Step 3:** If desired, press **Single Acquisition Sequence** from the side menu. This will let you run a single sequence of acquisitions. If you select sample, peak detect, or hi res, this means the instrument will respond to the first valid trigger event and stop. If you select envelope or average, the instrument will acquire number of acquisitions necessary to complete the defined averaging or enveloping tasks.

Acquisition Readout

The Acquisition readout at the top of the display shows the state of the acquisition system (running or stopped). The “running” state also shows the sample speed and acquisition mode. The “stopped” state shows the number of acquisitions since the prior stop.

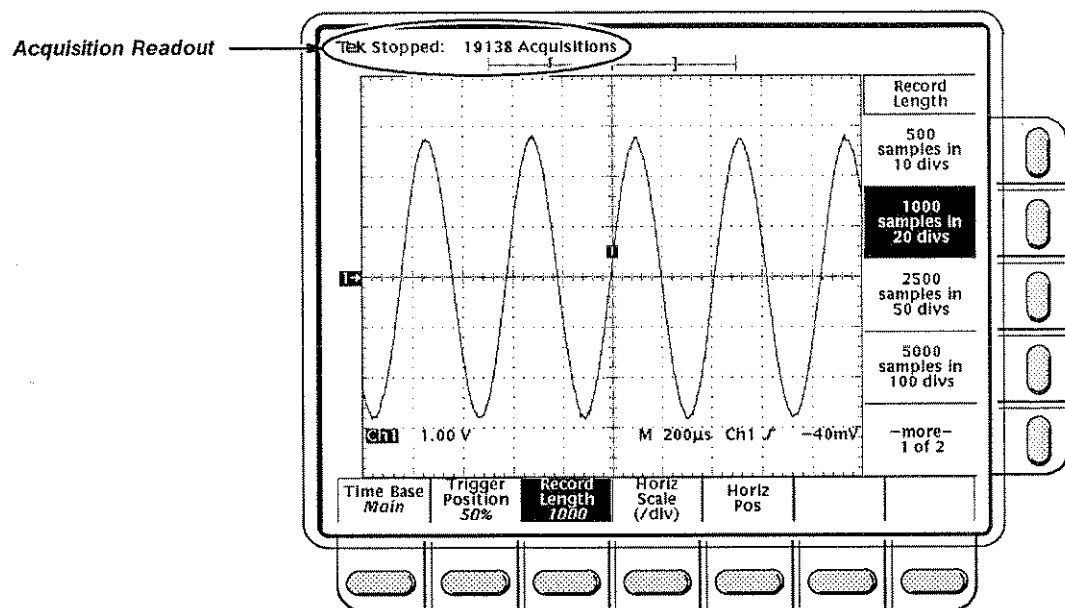

Figure 3-2: Acquisition Readout Shows Acquisition Status

**For More
Information**

See *Acquisition*, on page 2-19.





Autoset

The autoset function lets you quickly obtain and display a stable waveform of usable size. Autoset automatically sets up the front panel controls based on the signal's characteristics. This is faster than manual control-by-control setup.

Autoset makes adjustments in these areas:

- Acquisition
- Display
- Horizontal
- Trigger
- Vertical

Operation

When you want the digitizing oscilloscope to quickly adjust itself to produce a stable signal display, press the **AUTOSET** button.

- Step 1:** Attach a source (probe or BNC connector) to one of the input channels (such as **CH 1**).
- Step 2:** Connect the source to the signal you wish to measure on your device under test.
- Step 3:** Press the Channel Selection button corresponding to your input channel to make it active (such as **CH 1**).
- Step 4:** Press **AUTOSET**.

Algorithms

Autoset works as follows:

If you use autoset when one or more channels are displayed, the digitizing oscilloscope selects the lowest numbered channel for horizontal scaling. All channels in use are vertically scaled.

If you use autoset when no channels are displayed, the digitizing oscilloscope will turn on channel one (**CH 1**) and scale it. If there's no signal, the default settings are 50 mV/div and 100 μ s/div.

Table 3-1 lists the autoset defaults.

Table 3-1: Autoset Defaults

Control	Changed by Autoset to
Selected channel	Numerically lowest of the displayed channels
Acquire Mode	Sample
Acquire Repetitive Signal	On
Acquire Stop After	RUN/STOP button only
Display Style	Vectors
Display Intensity – Overall	If less than 50%, set to 75%
Display Format	YT
Horizontal Position	Centered within the graticule window
Horizontal Scale	As determined by the signal frequency
Horizontal Time Base	Main Only
Horizontal Record Length	Unchanged
Trigger Position	No change
Trigger Type	Edge
Trigger Source	The selected channel – as defined by Autoset
Trigger Slope	Positive
Trigger Coupling	DC
Trigger Holdoff	0
Vertical Scale	As determined by the signal level
Vertical Coupling	DC unless AC was previously set. AC remains unchanged.
Vertical Bandwidth	Full
Vertical Offset	0 volts
Zoom	Off

Cursor Measurements

You may want to measure the difference between two waveform locations. For example, you might want to find the time or the voltage difference between two events. The events may be on the same waveform or may be on different waveforms.

One way to make such measurements is with cursors. Cursors are markers that you position using the knobs. Once you position the cursors, readouts in the screen display show the absolute location of the selected cursor and the difference between the selected and non-selected cursor. Two cursor types are vertical bar and horizontal bar (Figure 3-3).

- *Vertical bar cursors* consist of two vertical bars. The position of the selected cursor and the horizontal distance between the selected and non-selected cursor are shown in horizontal axis units.
- *Horizontal bar cursors* consist of two horizontal bars. The position of the selected cursor and the vertical distance between the selected and non-selected cursor are shown in vertical axis units.

Operation

To take cursor measurements do the following:

- Step 1:** Press the **CURSOR** button to display the Cursor menu (Figure 3-4).
- Step 2:** Select **Function** from the main menu.
- Step 3:** From the side menu, select **H Bars** to display horizontal bars, **V Bars** to display vertical bars, or **Off** to remove any existing cursor bars.
- Step 4:** Use the general purpose knob to move the selected (active) cursor. Use the **TOGGLE** button to change which cursor to move (that is, to select the active cursor). A solid line indicates the active cursor and a dashed line shows the inactive (set) cursor.

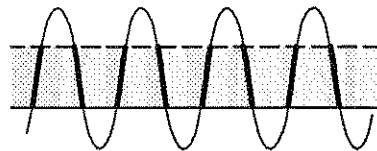

Horizontal Bar Cursors measure between two horizontal bars.

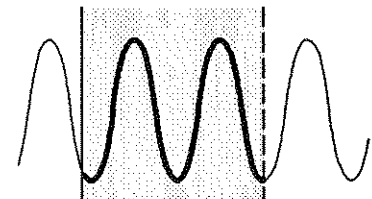

Vertical Bar Cursors measure between two vertical bars.

Figure 3-3: Cursor Types

Cursor Measurements

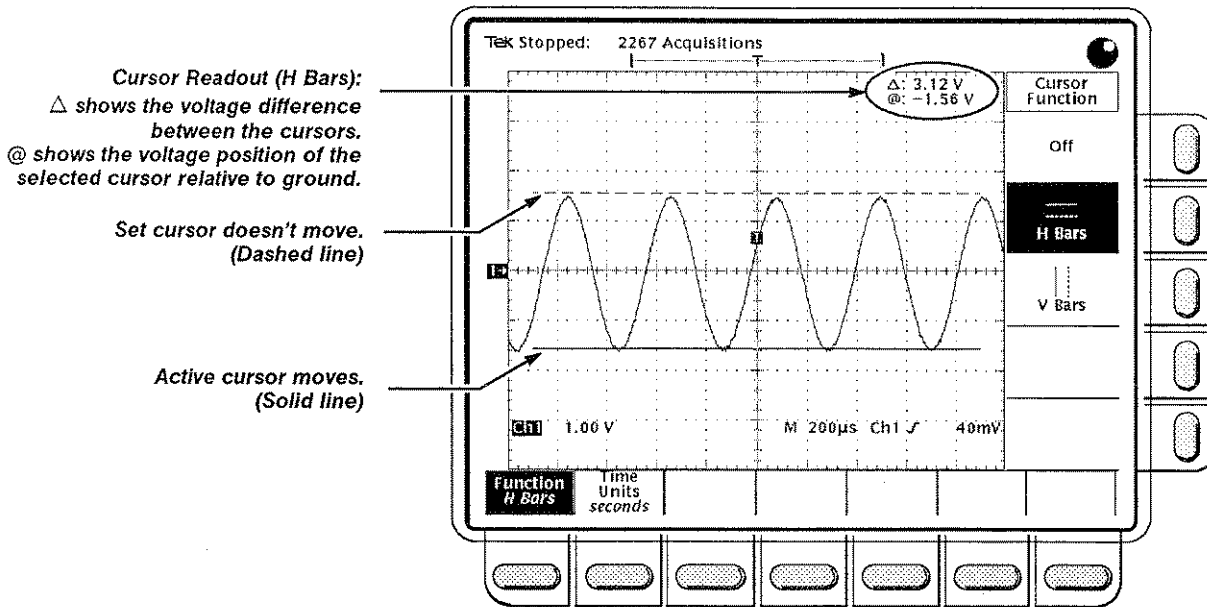

Record View shows position of vertical bar cursors relative to the display and the waveform record (particularly useful for locating cursors outside the display).

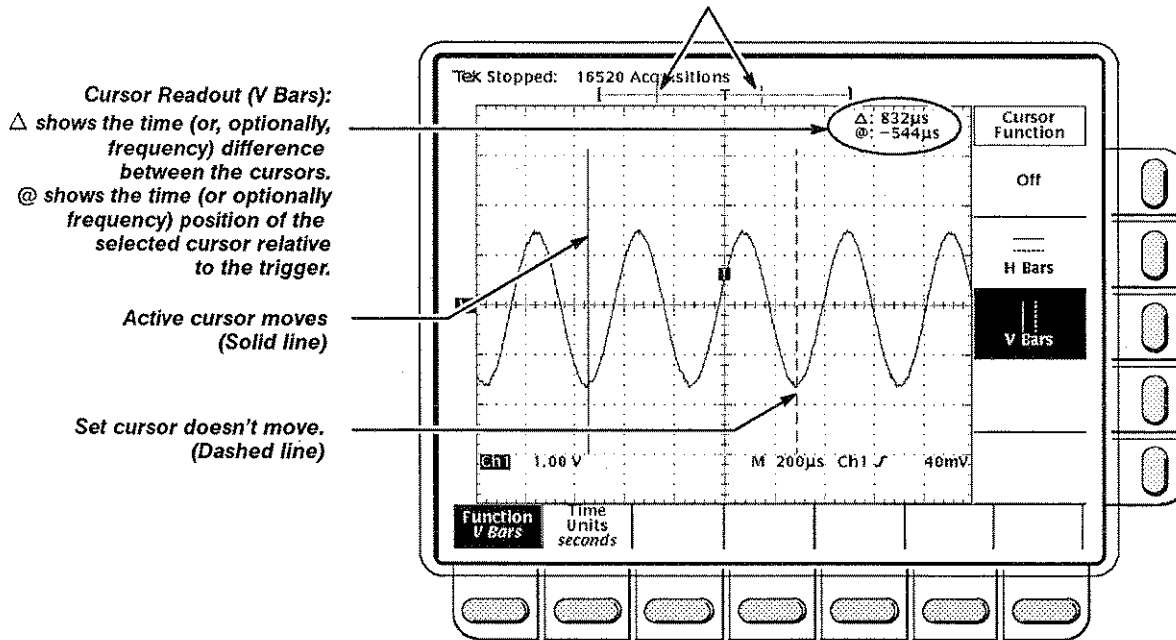

Figure 3-4: Cursor Menu and Cursor Readouts

Time Units

You can choose to display vertical bar cursor results in units of elapsed time (seconds) or frequency (Hertz). Do this as follows:

- Step 1:** From the Cursor main menu, select the **Time Units** item.
- Step 2:** From the side menu, select **seconds** or **1/seconds (Hz)**.

Speed Up

You can increase the response of the general purpose knob operation about 8X by pressing **SHIFT** before turning the general purpose knob. That is, the same knob turn will produce a much greater movement of the cursor when the **SHIFT** button is in its lighted ON state. This feature is particularly useful when moving V Bar cursors around waveforms with long record lengths.

For More Information

See *Measurements*, on page 2-27.



Delayed Triggering

The TDS 500 Series oscilloscopes provide a main time base and a delayed time base. Delayed triggering affects the delayed time base.

There are two types of delayed triggering.

- *Delayed Runs After Main* waits for a main trigger, then waits a user-defined time, then triggers.
- *Delayed Triggerable* waits for a main trigger, then waits a user-defined time or number of delayed trigger events, then looks for a delayed trigger event.

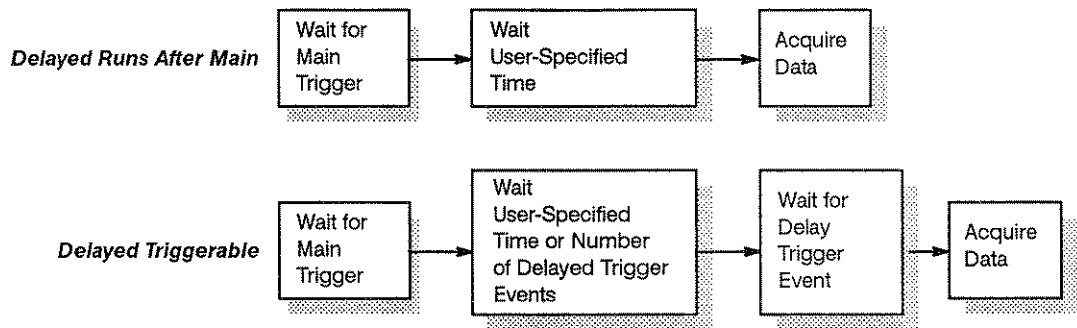

Figure 3-5: Delayed Triggering

The digitizing oscilloscope provides only a conventional Edge trigger for the delayed time base. The delayed time base cannot be triggerable if the main trigger type (as defined in the Main Trigger menu) is Logic, if the main trigger type is Edge with its source set to Auxiliary (TDS 540), or if the main trigger type is Pulse with the Runt trigger class selected.

Operation

To set up and use delayed triggering, do the following:

Delayed Triggerable

- Step 1:** Press the **DELAYED TRIG** button (**SHIFT** and **TRIGGER MENU** buttons) to bring up the Delayed Trigger menu (Figure 3-6).

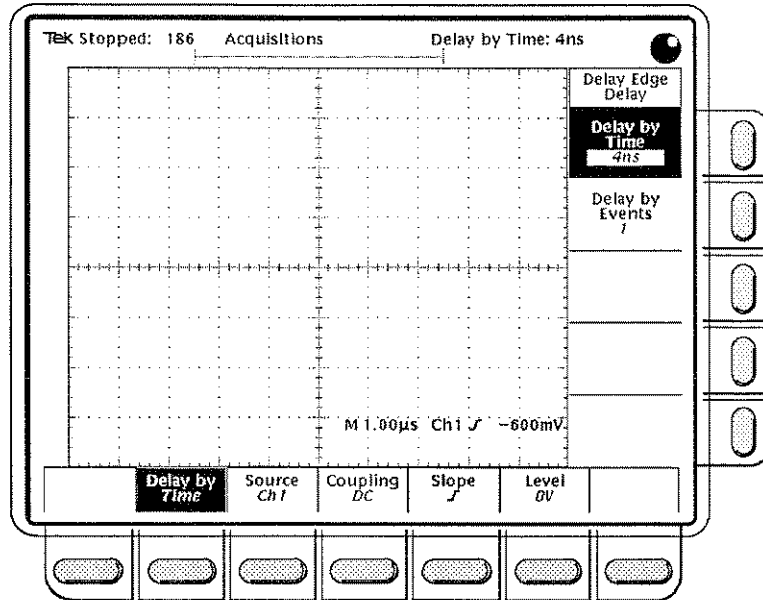

Figure 3-6: Delayed Trigger Menu

- Step 2:** Press the main menu **Delay by** item to select, from the side menu, a time (**Delay by Time**) or an event-based (**Delay by Events**) delay (Figure 3-6).
- Step 3:** Press the main menu **Source** item to select the delayed trigger source. From the side menu, select **Ch1**, **Ch2**, on the TDS 540, **Ch3**, **Ch4**, or **Auxiliary (Rear Panel)**, and, on the TDS 520, **Ax1** or **Ax2**.

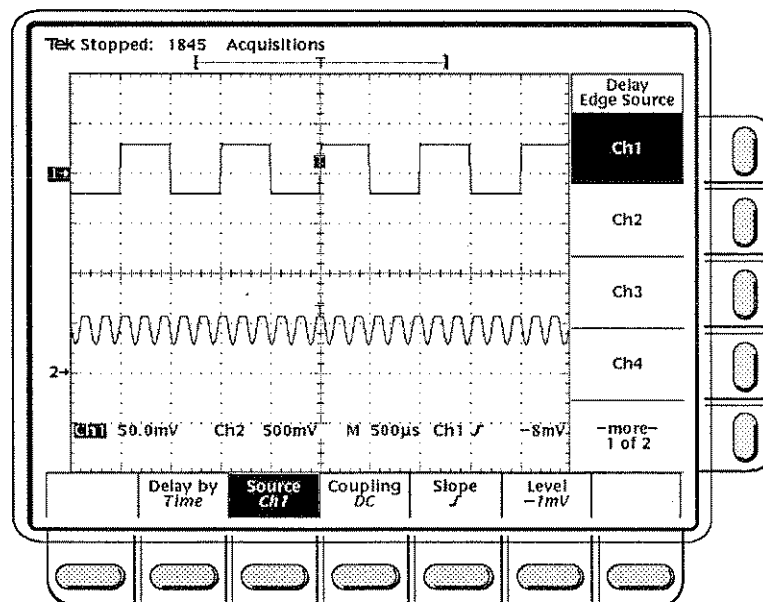

Figure 3-7: Delayed Trigger Menu – Source

- **Step 4:** Press the main menu **Coupling** item to define how to couple the input signal to the delayed trigger. From the side menu, choose **DC**, **AC**, **HF Rej**, **LF Rej**, or **Noise Rej**. See *Triggering* on page 2-12 for descriptions of these coupling types.

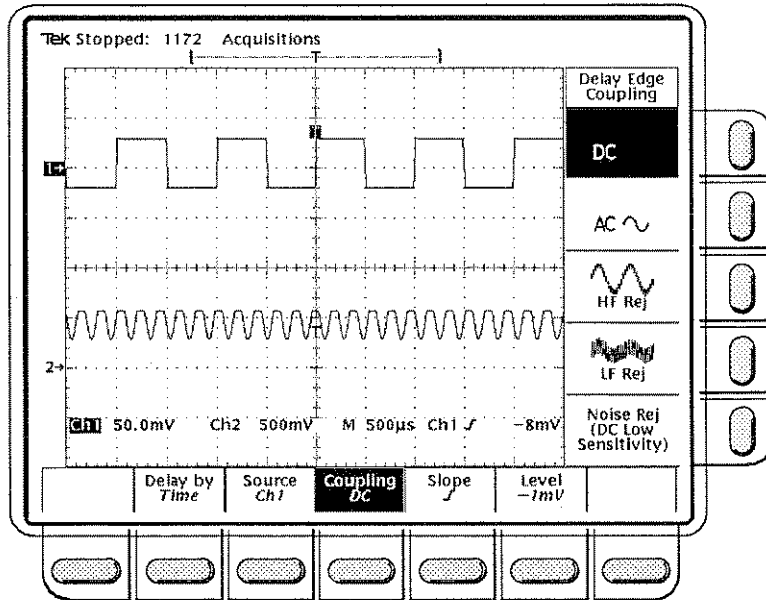

Figure 3-8: Delayed Trigger Menu – Coupling

- **Step 5:** Press the main menu **Slope** item to select the slope that the delayed trigger will occur on (Figure 3-9). Alternatives are rising edge and falling edge slopes.

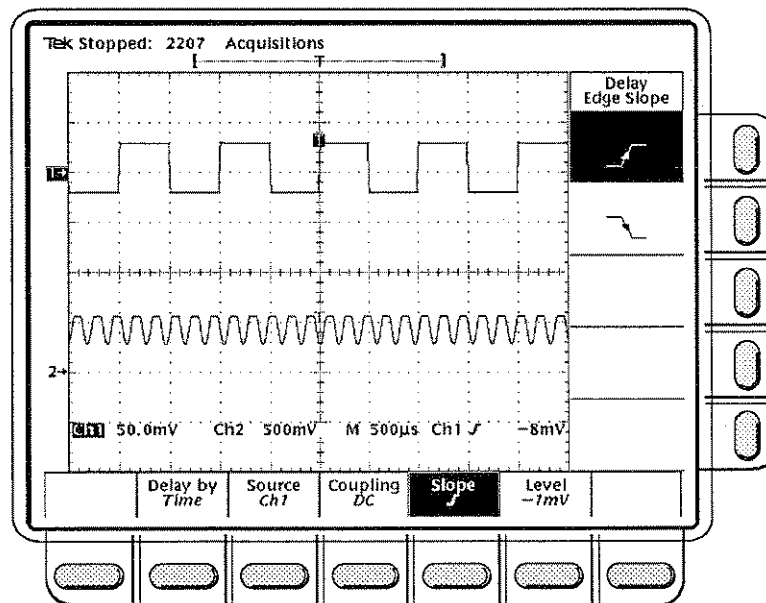

Figure 3-9: Delayed Trigger Menu – Slope

- **Step 6:** Press the main menu **Level** item to bring up a side menu of alternative ways to enter the delayed trigger level. Press the side menu **Level** item and use the general purpose knob or the keypad to enter a user definable voltage level.

You can also choose from side menu preset values using the **Set to TTL** and **Set to ECL** items.

NOTE

The oscilloscope will reduce the TTL or ECL trigger level as you increase the vertical sensitivity (decrease the volts/div) beyond a certain level. That's because the trigger level range is set at ± 12 divisions from the center. Thus, the effective trigger level range in volts can shrink as you increase the vertical sensitivity. This will bound the trigger level to a smaller value than the typical TTL or ECL level. As you decrease the sensitivity (increase the volts/div), the desired TTL or ECL value will return.

Finally, you can select **Set to 50%**. This sets the delayed trigger level to 50% of the peak-to-peak value of the delayed trigger source signal.

NOTE

*You should select the delayed trigger from the Horizontal menu before using **Set to 50%**.*

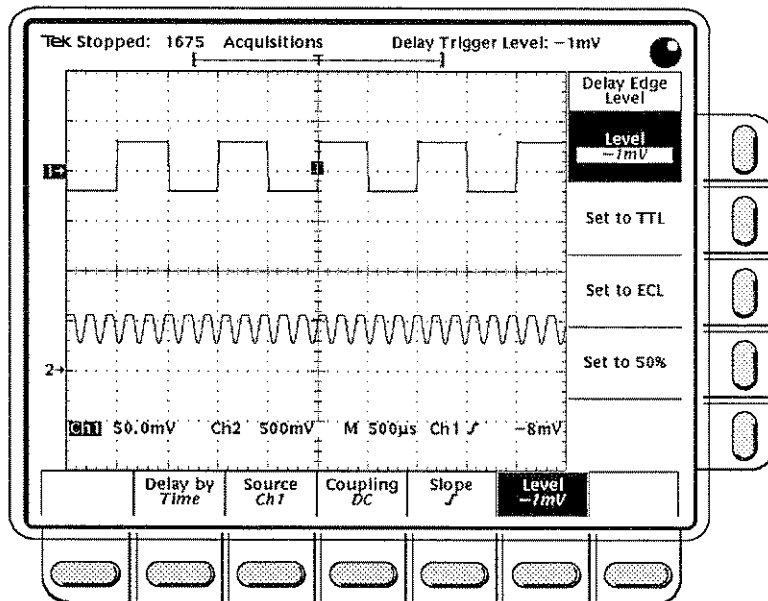

Figure 3-10: Delayed Trigger Menu – Level

- Step 7:** You can optionally display an intensified zone that shows where the delayed trigger record length **COULD** occur relative to the main trigger. Do this as follows:

Press the **HORIZONTAL MENU** button to bring up the Horizontal menu. Then, press **Time Base** from the main menu to select the time base to view. Press **Intensified** to view the delayed time base's position as a more intensified portion of each time base's waveform than the rest of that waveform. This will help you see when the delay trigger might be enabled. To review how to define the intensity level of the normal and intensified waveform, see the *Display Modes* task reference on page 3-31. Finally, press **Delayed Triggerable** to enable the delayed trigger as defined in the Delayed Trigger menu.

The start of the intensified zone corresponds to the possible start point of the delayed trigger record length. The end of the zone is at the end of the record because the delay trigger has no set time to occur.

Delayed Runs After Main

Use the Horizontal menu's **Time Base** item to define the Delayed Runs After Main mode and to ensure proper activation of delayed triggering in general .

- Step 8:** Press the **HORIZONTAL MENU** button to bring up the Horizontal menu.
- Step 9:** Press **Time Base** from the main menu to select the time base to view. To define the Delayed Runs After Main mode, choose the **Delayed Runs After Main** item from the side menu. This will enable the delayed trigger to occur a set time (the delay) after the main trigger. Use the general purpose knob or the keypad to actually adjust the delay time.
- Step 10:** You can optionally display an intensified zone that shows where the delayed trigger record length occurs relative to the main trigger. Do this as follows:

Press **Intensified** to view the delayed time base's position as a more intensified portion of each time base's waveform than the rest of that waveform. This will help you see when the delay trigger might be enabled. To review how to define the intensity level of the normal and intensified waveform, see the *Display Modes* task reference on page 3-31. Finally, press **Delayed Runs After Main** to enable the delayed trigger to occur a set time (the delay) after the main trigger. Use the general purpose knob or the keypad to actually adjust the delay time.

The start of the intensified zone corresponds to the possible start point of the delayed trigger record length. The end of the zone corresponds to the end of the delayed trigger record.

Note: In addition to using the time-base side menu to view the intensified zone, you can use it to view just the main trigger's time base (press **Main Only**) or to view only the delayed time base (press **Delayed Only**).

NOTE

The delay time in the Delay Runs After Main mode is independent from the delay time in the Delayed Triggerable mode. The times do not track each other.

Delay Runs After – set delay from the Horizontal menu (Time base).

Delayed Triggerable – set delay from the Delayed Trig menu (Delay by).

**For More
Information**

See *Triggering*, on page 2-5.



Display Modes

You may want the oscilloscope to present information in a particular way. For example, you may want to use variable persistence for time-jitter analysis. You can adjust the oscilloscope's display style, intensity level, graticule or format.

Display Options

Display options include:

Style

The display style includes a choice of vectors or dots and of variable or infinite persistence.

Vectors versus Dots – The oscilloscope can display waveforms as dots which represent the sample points or show vectors (lines) that connect these points. This is a display control which does not affect the waveform data points.

Variable Persistence versus Infinite Persistence – The oscilloscope can display points so that they accumulated on screen over many acquisitions and remain displayed only for a specific time interval (variable persistence). You can also set persistence to be infinite, in which case points accumulate until some control change (such as a change of scale factor) occurs to cause erasure.

Intensity

Intensity lets you set overall, text/graticule, and waveform intensity (brightness) levels. You can also set the contrast between a normal waveform and the intensified portion of that waveform that shows the delay.

All intensity adjustments operate over an arbitrary range from 20% (close to fully off) to 100% (fully bright).

Contrast operates over a range from 100% (waveform and intensified portion look the same) to 250% (intensified portion is at full brightness).

NOTE

If the waveform intensity is set to 100%, it will be at full brightness and will look just like the intensified portion.

Readout Options

Readout options control whether the trigger indicator appears on the display.

Filter Types

The display filter types are $\sin(x)/x$ interpolation and linear interpolation. Interpolation is used only when the oscilloscope is in its real time interpolated sampling mode (as when Acquire menu's **Repetitive Signal** choice is set to **OFF**).

$\sin(x)/x$ interpolation does a curve fit to fill in missing data points. It provides a smooth approximation to many waveforms, but can introduce overshoot into waveforms with fast rise times.

Linear interpolation uses straight lines to connect the waveform data points.

Graticule Types

Graticule types are full, grid, frame, and crosshair.

Format

YT format is the normal time (on the horizontal axis) versus voltage (on the vertical axis) format. XY format displays voltages of two waveforms against each other.

Operation

Press the **DISPLAY** button to show the Display menu. Each main menu item (**Style**, **Intensity**, **Graticule**, and **Format**) displays a secondary side menu.

Display Style

You can select how to display waveforms with the **Style** menu item (Figure 3-11).

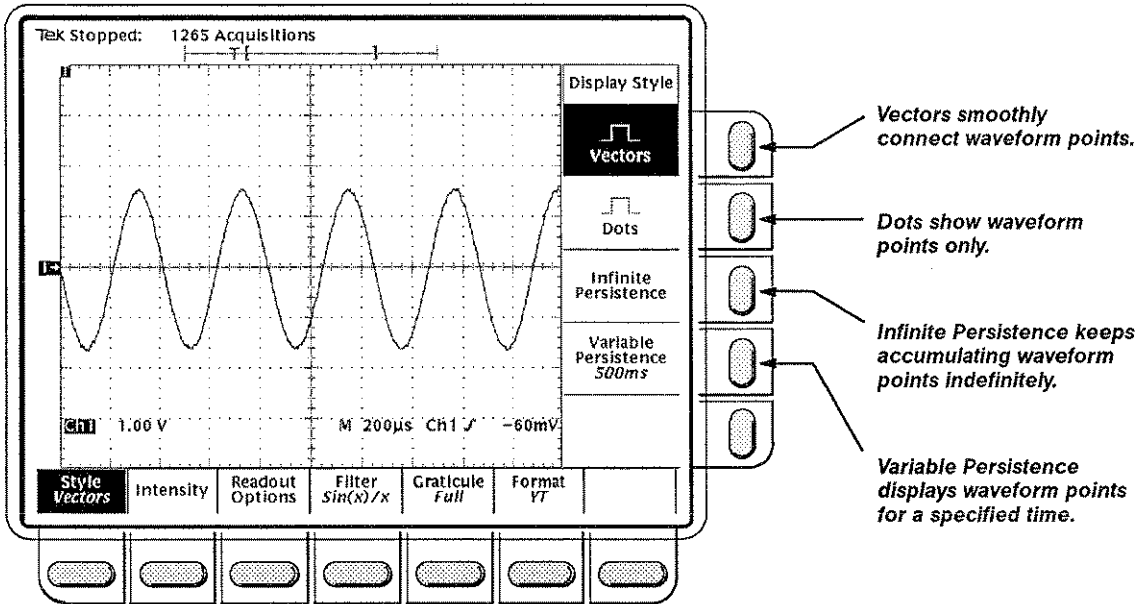

Figure 3-11: Display Menu – Style Selected

Intensity

You can set overall screen intensity, fractional waveform intensities and the intensity of text and the graticule with the **Intensity** menu item (Figure 3-12). The values are in percent. 100% is full brightness; 20% is almost fully off.

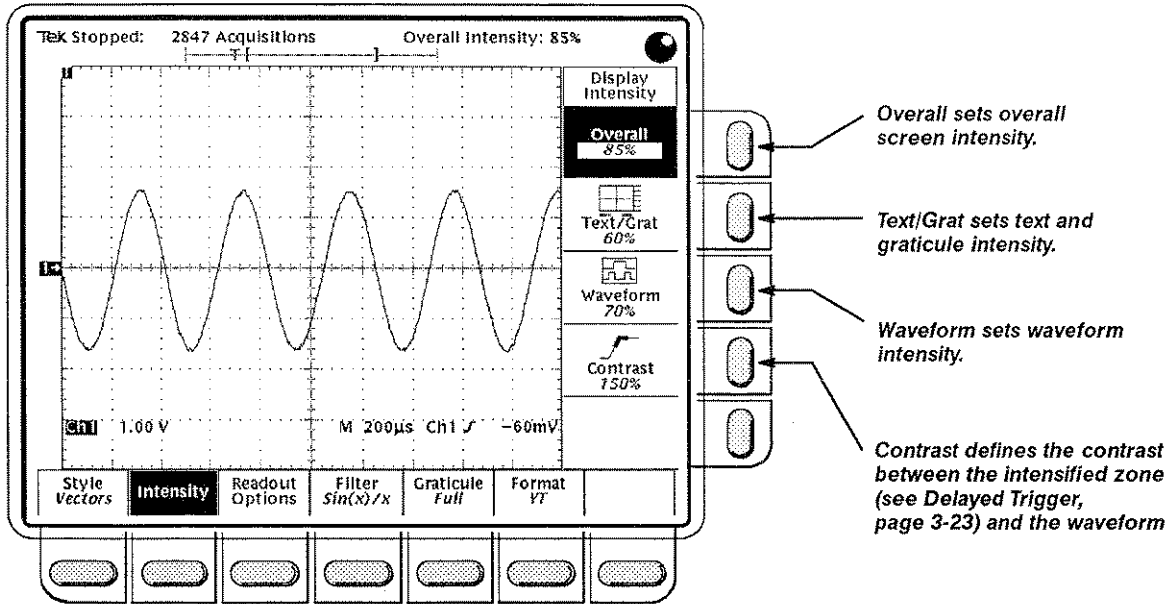

Figure 3-12: Display Menu – Intensity Selected

Display Readout

You can define the display readout with the **Readout** menu item as follows:

- Step 1:** Press **Readout** from the main menu.
- Step 2:** Toggle the side menu **Display 'T' @ Trigger Point** to select whether or not to display a 'T' to indicate the trigger point. You can select **ON** or **OFF**.

Filter Type

You can define an interpolation filter with the **Filter** menu item as follows:

- Step 1:** Press **Filter** from the main menu.
- Step 2:** Select either **Sin(x)/x Interpolation** or **Linear Interpolation** from the side menu.

Graticule Type

Select one of four graticule types using the **Graticule** menu item (Figure 3-13).

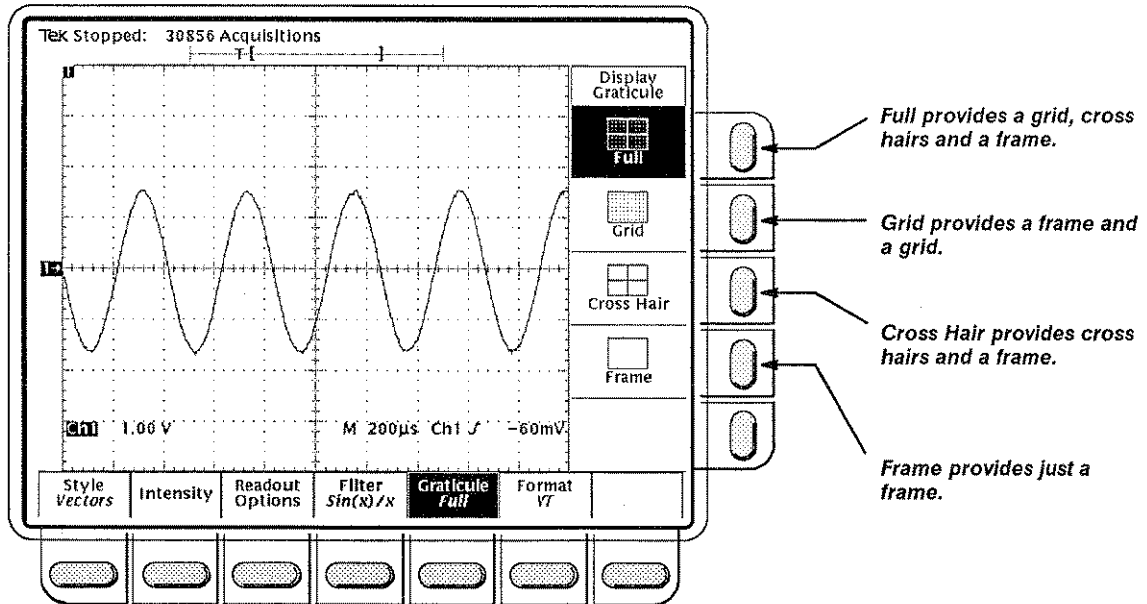

Figure 3-13: Display Menu – Graticule Selected

Format

Typical oscilloscope displays show a signal voltage (the vertical axis) as it varies over time (the horizontal axis). You can also create a display that shows how two signals' voltage levels compare with each other independent of time values. That is, the digitizing oscilloscope can display a graph of the voltage of one signal against the voltage of another signal. This mode is particularly useful for studying phase relationships.

To set the display axis format:

- Step 1:** You can set the display axis format with the main menu **Format** item (Figure 3-14).



- Step 2:** Choose **XY** from the side menu to display a graph of the voltage of one signal against the voltage of another signal.

or



Choose **YT** to display the more typical voltage-over-time waveform.

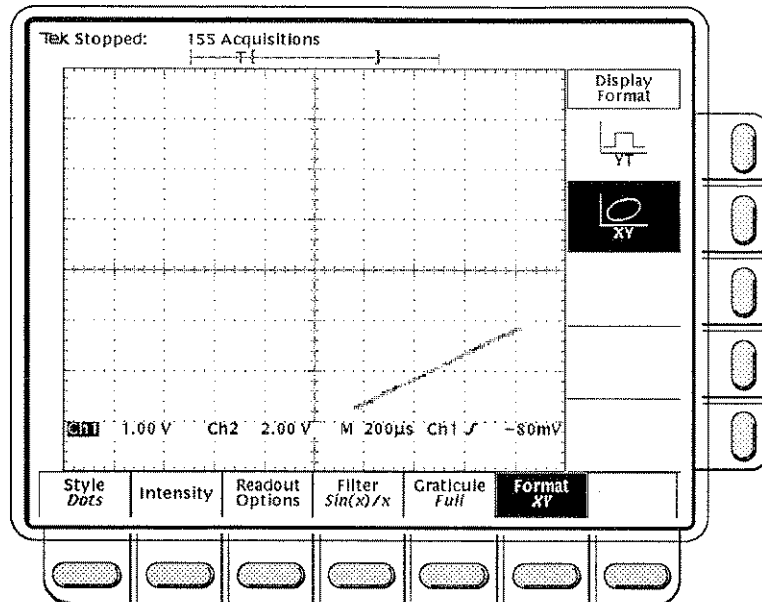

Figure 3-14: Display Menu — Format Selected

When you choose XY, the channels that can make up an XY waveform are fixed as shown in Table 3-2.

Table 3-2: XY Format Pairs

X-Axis Channel	Y-Axis Channel
Ch 1	Ch 2
Ch 3 (TDS 540) (Aux 1 on the TDS 520)	Ch 4 (TDS 540) (Aux 2 on the TDS 520)
Ref 1	Ref 2
Ref 3	Ref 4

This means that if you press the **CH 1** channel selector button, the digitizing oscilloscope will display a graph of Channel 1's voltage levels on the X-axis against channel 2's voltage levels on the Y-axis. This will occur whether or not you were displaying channel 2's waveform when in YT format. If, while channel 1 is selected, you press the **WAVEFORM OFF** button, the digitizing oscilloscope will delete the XY graph of channel 1 versus channel 2.

Since the YT/XY choice is a display choice only, the horizontal and vertical scale and position controls will usually control the same parameters with either selection. Specifically, in XY format, the horizontal scale will continue to control the time base and the horizontal position will continue to control which portion of the waveforms are displayed.

XY format is a dot-only display, although it can have persistence. The **Vector** and **Intensified Samples** style selections have no effect when you select XY format. They become the same as the **Dots** selection.

You cannot display Math waveforms in XY format. They will disappear from the display when you select XY. You can still adjust them, however, even though they are not displayed.



Glitch Triggering

A *glitch* is a pulse narrower in width than some specified time. The glitch trigger feature allows triggering on glitches of either polarity. Alternatively, you can set the glitch trigger to reject glitches of either polarity.

You may want to use the glitch as your trigger event. For example, imagine you're testing a product with a glitch in the power supply. However, the glitch only appears once a day. Instead of sitting by and waiting for this glitch to appear, you can use the glitch trigger to automatically capture your data.

You can define a glitch source, polarity, trigger on, or filter out, set mode (auto or normal), set voltage levels, and set holdoff times.

Operation

To trigger on a glitch:

- Step 1:** Press the **TRIGGER MENU** button to bring up the Main Trigger menu (Figure 3-15).

Then, use the Main Trigger menu options to define glitch trigger parameters to look for:

- Step 2:** Press the **Type** main menu button until you select **Pulse** from the pop-up menu.
- Step 3:** Press the **Class** button until you select **Glitch** from the pop up menu.
- Step 4:** Choose the glitch source, by selecting the main menu **Source** item and then one of the four available channels in the side menu (**Ch1**, **Ch2**, **Ch3 (Ax1 on the TDS 520)**, **Ch4 (Ax2 on the TDS 520)**).
- Step 5:** Define the glitch in terms of polarity (positive, negative, or either) and width. Polarity is shown as icons. Select the **Polarity and Width** item on the main menu, and one of the four choices that appear on the resulting side menu (**Positive**, **Negative**, **Either**, **Width**).



Glitch **Positive** looks at positive-going pulses.



Glitch **Negative** looks at negative-going pulses.



Glitch **Either** looks at both positive and negative pulses.



Glitch **Width** lets you set the glitch width to search for. You enter the actual time value using the general purpose knob or the keypad.

- Step 6:** Specify whether to trigger on glitches or filter out glitches using the **Filter** main menu item and the side menu **Accept Glitch** or **Reject Glitch** items. When **Filter** is **Off (Accept Glitch)**, the oscilloscope will trigger only on pulses narrower than **Width**. When **Filter** is **On (Reject Glitch)**, it will trigger only on pulses wider than **Width**.

- Step 7:** Set the trigger level with the **Level** main menu item (or the front panel trigger **LEVEL** knob), and an appropriate side menu item. From the side menu, you can:
 - select **Level** and enter a value with the general purpose knob or the keypad.
 - select **Set to TTL** to automatically set the trigger level to the TTL switching threshold.
 - select **Set to ECL** to automatically set the trigger level to the ECL switching threshold.
 - select **Set to 50%** to cause the digitizing oscilloscope to search for the point halfway between the peaks of the trigger source signal and set the trigger level to that point.
- Step 8:** Choose between the auto and normal trigger modes. Do this using the **Mode & Holdoff** item in the main menu and the resulting **Auto** and **Normal** side menu items.
- Step 9:** Set the trigger holdoff time. Do this using the **Mode & Holdoff** item in the main menu. Enter the value in % using the general purpose knob or the keypad. The value appears below the **Holdoff** menu item.

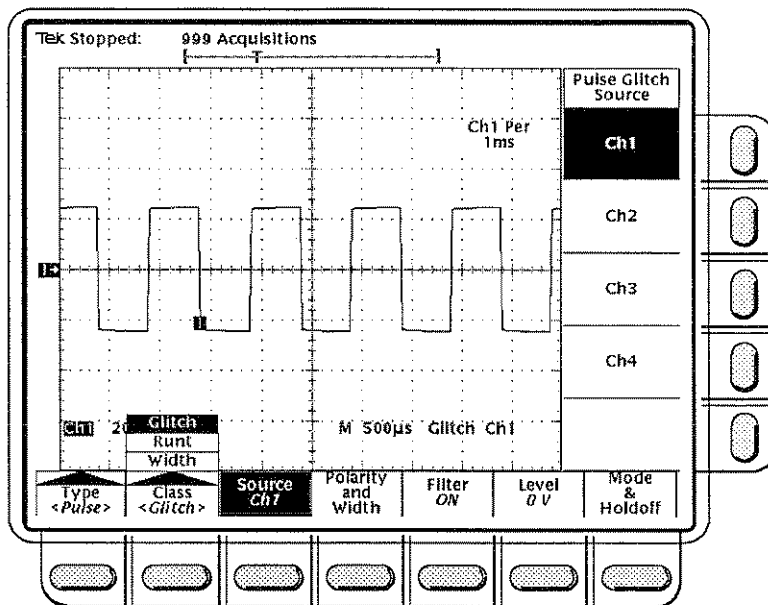

Figure 3-15: Main Trigger Menu – Glitch Class

**For More
Information**

See *Triggering*, on page 2-5.

Hardcopy

You may want to print a copy of what is on the screen. You can get a screen copy using the hardcopy feature. Depending of the output format you select, you can create either an image or a plot. Images are direct bit map representations of the digitizing oscilloscope display. Plots are vector (plotted) representations of the objects on the display.

Operation

Before you make a hardcopy, you need to set up communications and hardcopy parameters.

- Step 1:** Set up the communications parameters:

Press the **UTILITY** button (**SHIFT** and then **DISPLAY**) to show the Utility menu. Then select **I/O** from the **System** main menu pop-up. Choose **Configure** from the main menu. Select the **Hardcopy (Talk Only)** option from the side menu.

- Step 2:** Set up the hardcopy parameters:

Press the shifted **HARDCOPY MENU** button (**SHIFT** and then **HARDCOPY**) to bring up the Hardcopy menu on the display (see Figure 3-16).

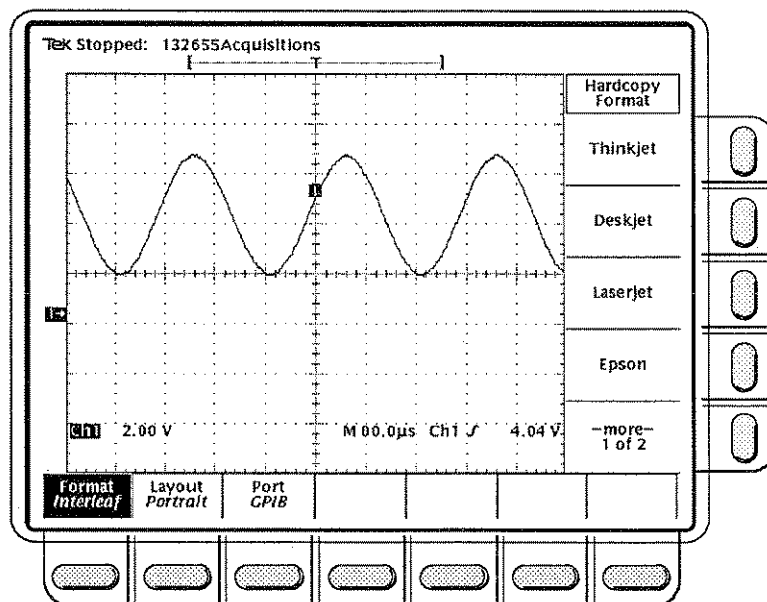

Figure 3-16: Hardcopy Menu – Format Selected

If you want to change the way the oscilloscope will format the hardcopy data, press the main menu **Format** button and select the appropriate side menu item. You can choose **Thinkjet**, **Deskjet**, **Laserjet**, **Epson**, **Interleaf**, **EPS Image** (Postscript) or **HPGL**.

If you want to specify whether to send out hardcopy in landscape or portrait format, press the **Layout** main menu button and select the appropriate side menu item. You can choose **Landscape** or **Portrait**,

The **Port** main menu item lets you specify the output channel to send your hardcopy through. The only choice is **GPIB**.

Step 3: Print the screen copy.

Press the **HARDCOPY** button.

If for some reason you want to stop the hardcopy process, simply press the **HARDCOPY** button on the front panel again.

For More Information

See *Save and Document*, on page 2-31.

See *Remote Communications*, on page 2-35.

See *Remote Communication Tasks*, on page 3-87.

Help

The on-line help system provides brief information about the digitizing oscilloscope's controls.

Operation

To use the on-line help system:

- Step 1:** Press the **HELP** button to provide on-screen information on any front panel button, knob or menu item.

When you press this button, the entire instrument changes mode to support on-line help. Press the **HELP** button again to return to regular operating mode. Whenever the oscilloscope is in help mode, pressing any button (except **HELP** or **SHIFT**), turning any knob, or pressing any menu item displays help text on the screen that discusses that control.

The menu selections that were displayed when **HELP** was first pressed remain on the screen. On-line help is available for each menu selection displayed at the time the **HELP** button was first pressed. If you are in help mode and want to see help on selections from non-displayed menus, you first exit help mode, display the menu you want information on, and press **HELP** again to re-enter help mode.

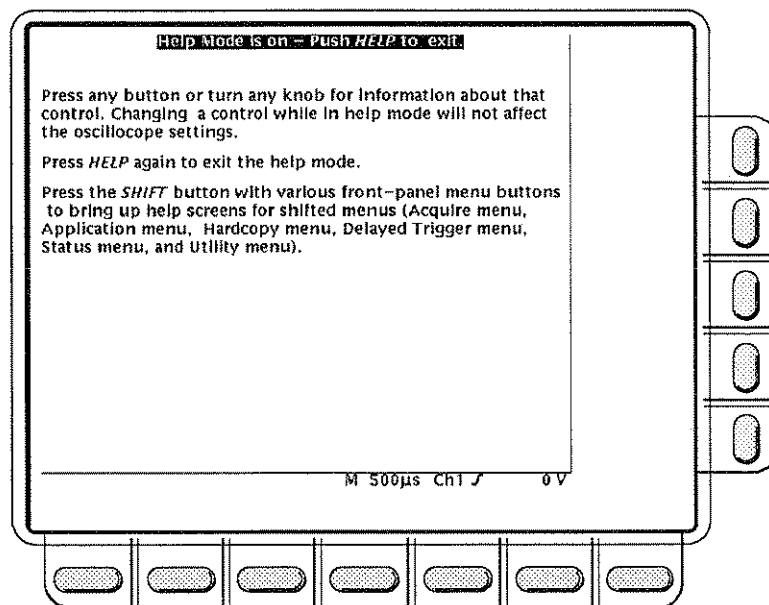

Figure 3-17: Initial Help Screen





Horizontal Scale and Position

By changing the horizontal scale, you can focus on a particular portion of a waveform. By adjusting the horizontal position, you move the waveform right or left to see different portions of it. This is particularly useful when you're using larger record sizes and can't view the entire waveform on one screen.

Operation

To change the horizontal scale and position, use the horizontal **POSITION** and horizontal **SCALE** knobs. The horizontal controls (Figure 3-18) manage the acquisition time base and horizontal waveform positioning on the screen.

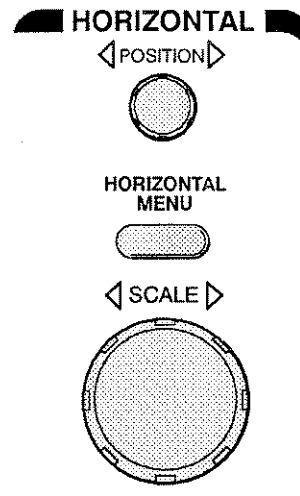

Figure 3-18: Horizontal Controls

Horizontal Menu

Press the **HORIZONTAL MENU** button to bring up the Horizontal menu (Figure 3-19).

The Horizontal menu lets you select either a main or delayed view of the time base for acquisitions, and lets you set the record length and trigger position parameters.

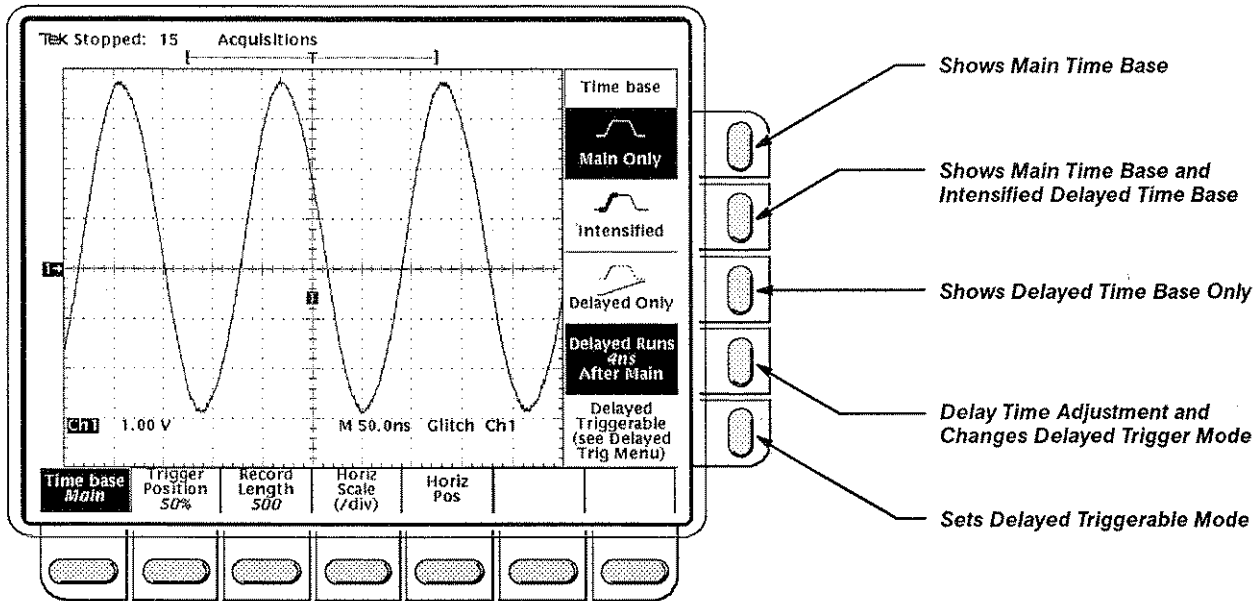

Figure 3-19: Horizontal Menu – Time Base

Main and Delayed Time Base

To select between the Main and Delayed views of the time base, choose the **Time Base** main menu item (Figure 3-19). This selection also lets you see an intensified zone indicating the location of the delayed time base with respect to the main.

For more information on the delayed time base, see *Delayed Triggering* on page 3-23.

Trigger Position

To set the trigger position, select **Trigger Position** from the main menu (Figure 3-20). Then set the trigger position by using the general purpose knob or the keypad. This enters a value into the side menu **Pretrigger** item. You can select presets using the **Set to 10%**, **Set to 50%**, and **Set to 90%** items from the side menu.

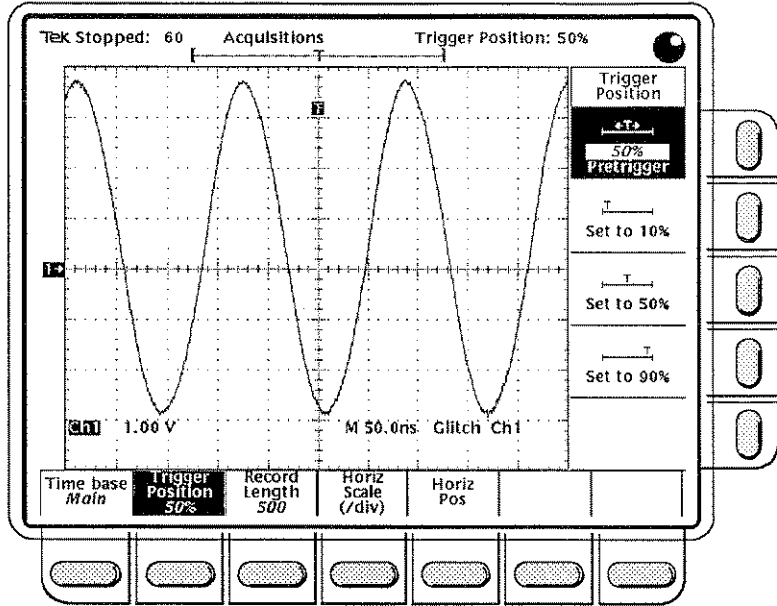

Figure 3-20: Horizontal Menu – Trigger Position

Readouts

At the top of the display, the *Record View readout* shows the size and location of the waveform record and the location of the trigger relative to the display.

The *Time Base readout* at the lower right of the display shows the time/division settings and the time base (main or delayed) being referred to.

The *Channel readout* at the lower part of the display shows each displayed channel (the selected channel is in inverse video), and its volts/division setting.

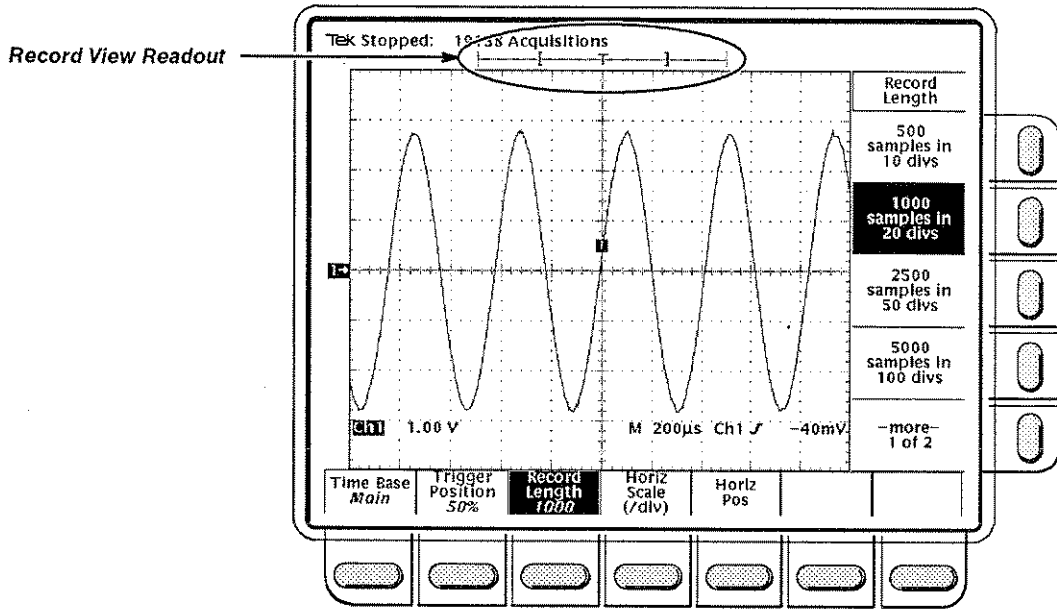

Figure 3-21: Record View Readout

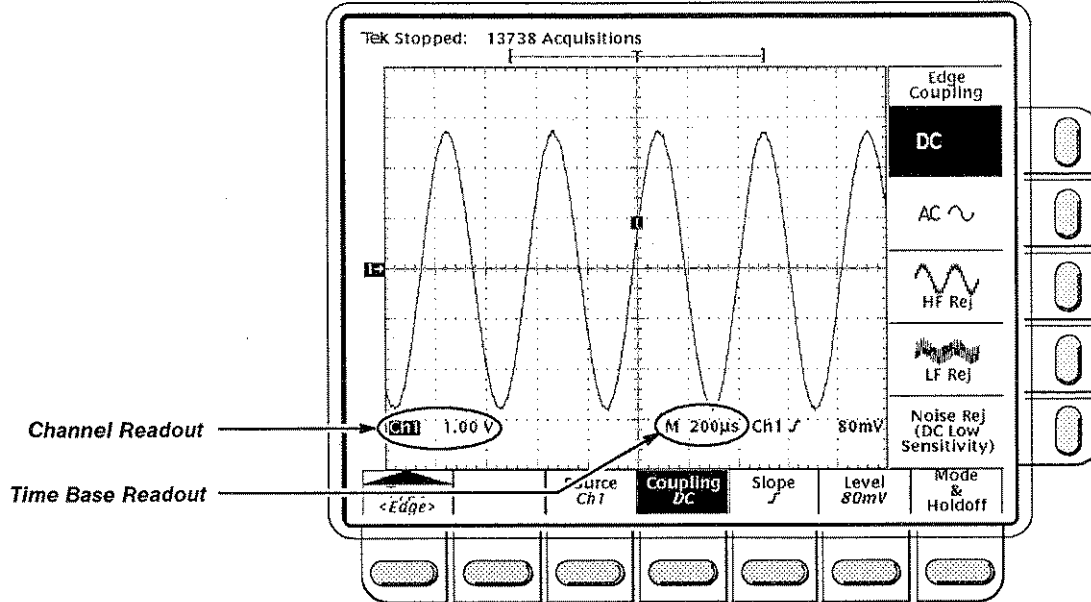

Figure 3-22: Record View, Channel, and Time Base Readouts

Record Length

To set the waveform length, choose the **Record Length** item in the Horizontal main menu (Figure 3-23). The side menu selections of **500 points in 10 divs**, **1000 points in 20 divs**, **2500 points in 50 divs**, **5000 points in 100 divs**, **15000 points in 300 divs** and, with option 1M, **50000 points in 1000 divs** give you a set of discrete record length choices.

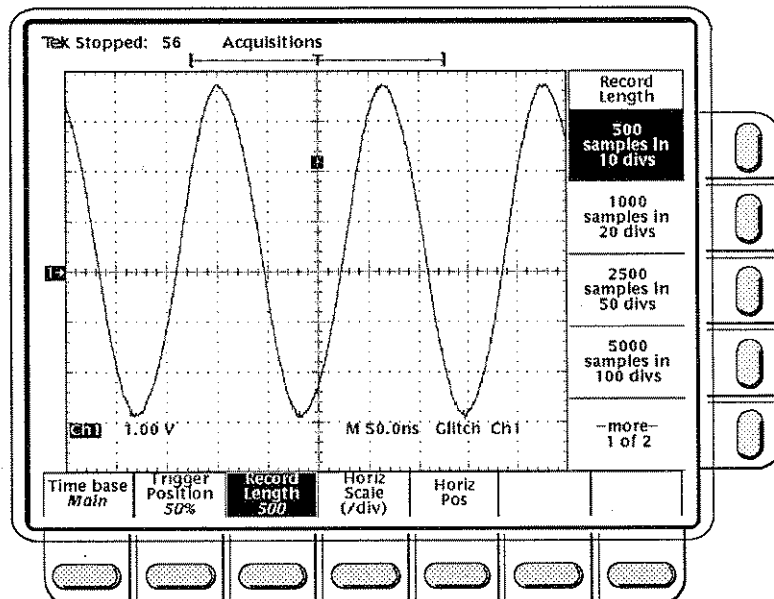

Figure 3-23: Horizontal Menu – Record Length

Horizontal Scale

To change the horizontal scale of either the main or the delayed time base, press the **Horiz Scale** main menu item. On the resulting side menu, press either **Main Scale** or **Delayed Scale** to enable entering the corresponding scale values with the keypad or the general purpose knob.

Horizontal Position

To change the horizontal (left-right) position of the selected waveform and all other waveforms horizontally locked to it, press the **Horiz Pos** main menu item. On the resulting side menu, press the **Set to 10%**, **Set to 50%** or **Set to 90%** buttons to choose how much of the waveform to display to the left of the display center.

For More Information

See *Scaling Waveforms*, on page 2-13.



Logic Triggering

You can set the oscilloscope to trigger on a specified logic state or a logic combination across multiple channels.

Operation

To perform logic triggering:

- Step 1:** Press the **TRIGGER MENU** button to call up the Main Trigger menu (Figure 3-26).
- Step 2:** From the Main Trigger menu, use the **Type** main menu pop-up to set your oscilloscope to trigger on logic signals.
- Step 3:** Set the trigger class.

Use the **Class** main menu pop-up to trigger on **Pattern** or **State**.

NOTE

*Trigger Level has no meaning for the Logic Trigger, and therefore, when **Logic** is selected, the Trigger Level readout will disappear and the **Trigger Level** knob will be inactive.*

- Step 4:** Set the trigger conditions as described in the rest of this section.

Pattern Triggering

When the pattern submenu is selected, the oscilloscope will trigger on a specified logic combination of the four channels. The Logic Pattern menu items are described below.

Define Inputs – Press the main menu **Define Inputs** button to bring up a side menu that lets you set the logic state to be considered TRUE for each of the input channels (**Ch1, Ch2 ...**). The available selections for each channel are: High (**H**), Low (**L**), and Don't Care (**X**). The Logic Pattern Inputs menu is shown in Figure 3-24.

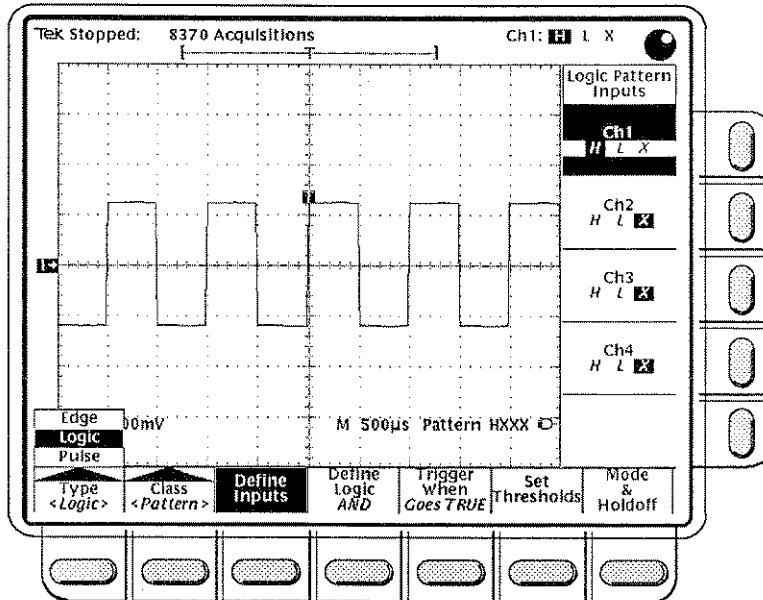

Figure 3-24: Setting Logic Pattern Inputs

Define Logic – Press the main menu **Define Logic** button to bring up a side menu of logic operators to apply to the combinational inputs. Your choices are: **AND**, **OR**, **NAND**, and **NOR** (Figure 3-26).

Step 5: The pattern trigger logic works as follows: Check the combinatorial logic conditions of Ch1, Ch2, Ch3 (Ax1 on the TDS 520), and Ch4 (Ax2 on the TDS 520). If they result in a true, then the trigger occurs.

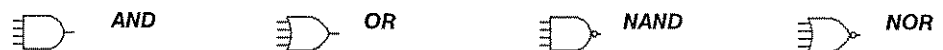

Figure 3-25: Pattern Trigger Logic

Trigger When – Press the main menu **Trigger When** button to bring up a side menu of triggering conditions. Your choices are: **Goes TRUE** and **Goes FALSE**. Press **Goes TRUE** to trigger when the logic condition is met. Press **Goes FALSE** to trigger when the logic condition is no longer met.

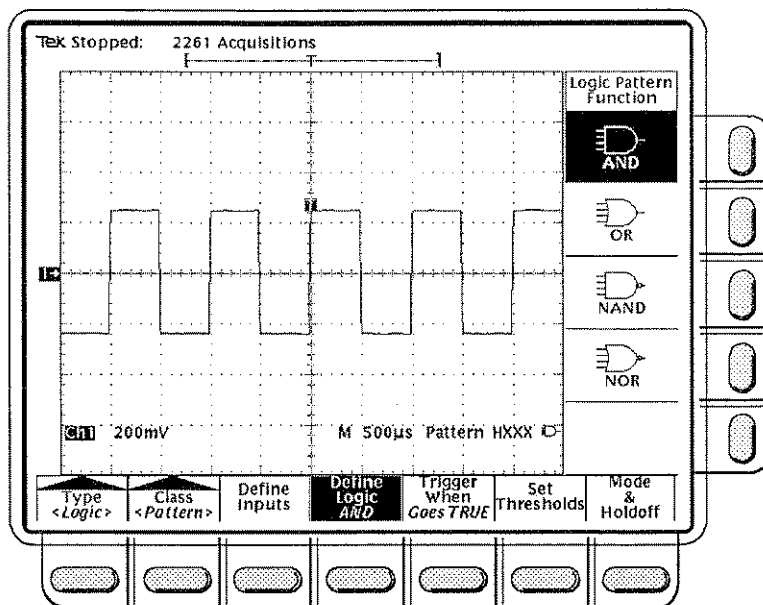

Figure 3-26: Main Trigger Menu – Logic Pattern Function

Set Thresholds – Press the main menu **Set Thresholds** item to enable the general purpose knob and keypad to set the trigger comparator threshold for each channel. The side menu selections are **Ch1** and **Ch2**. On the TDS 540 you can also select **Ch3** or **Ch4**. On the TDS 520 you can also select **Ax1** or **Ax2**.

Mode and Holdoff – Press the main menu **Mode and Holdoff** button to bring up a side menu of **Auto** or **Normal** mode and holdoff %.

State Triggering

The **State** selection preassigns Channel 4 to be used as a clock input to synchronize the pattern defined on the remaining channels.

Define Inputs – Press the main menu **Define Inputs** button to bring up a side menu that lets you set the logic state to be considered TRUE for each of the first three input channels (**Ch1**, **Ch2** and **Ch3** on the TDS 540 and **Ch1**, **Ch2** and **Ax1** on the TDS 520). The available choices are High (H), Low (L), and Don't Care (X). The choices for the **Ch4** (**Ax2** on the TDS 520) edge are rising edge and falling edge.

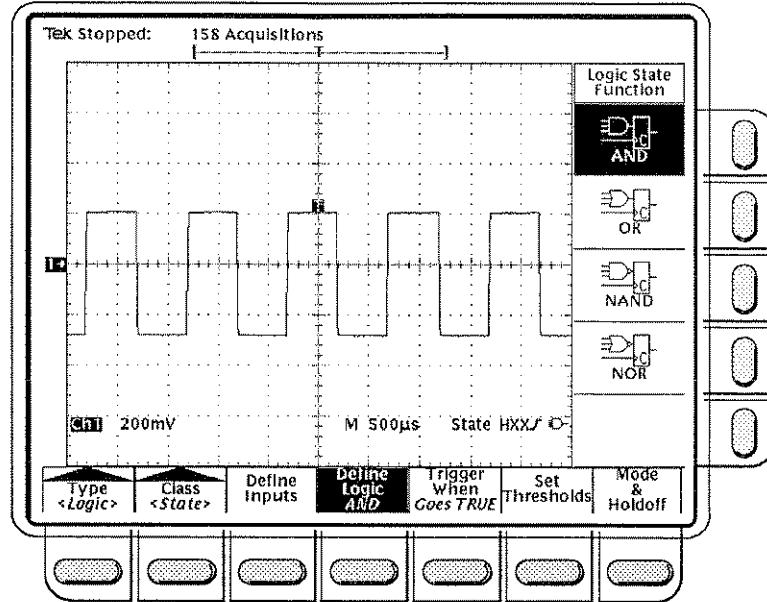

Figure 3-27: Setting the Logic State Function

Define Logic – Operates the same as for the Pattern class described above. The choices are: **AND**, **OR**, **NAND**, and **NOR**. The Logic State Function side menu is shown in Figure 3-27.

The state trigger logic works as follows: Wait until the fourth channel meets the preset slope and voltage threshold, then check the combinatorial logic conditions of the first three channels. If they result in a true, then the trigger occurs.



Figure 3-28: State Trigger Logic

Set Thresholds – Operates the same as for the Pattern class described above.

Mode & Holdoff – Operates the same as for the Pattern class described above.

For More Information

See *Triggering*, on page 2-5.



Measurement System

There are various ways to measure properties of waveforms. You can use graticule, cursor, or automatic measurements. The cursors and graticules are described elsewhere. (See *Cursor Measurements* on page 3-19 and *Measurements* on page 2-27.) This section describes *automatic measurements*. These are generally more accurate and quicker than, for example, manually counting graticule divisions. The oscilloscope will continuously update and display these measurements.

The TDS 500 Series Digitizing Oscilloscopes provide you with 22 automatic measurements: These include: period, frequency, positive width, negative width, rise time, fall time, positive duty cycle, negative duty cycle, delay, burst width, positive overshoot, negative overshoot, high, low, maximum, minimum, peak to peak, amplitude, mean, cycle mean, RMS, and cycle RMS.

Automatic measurements calculate waveform parameters from acquired data. Measurements are made on data for the entire record (where relevant), not just the portion displayed on the screen.

Definitions

The following are brief definitions of the automated measurements in the digitizing oscilloscope (for more details see *Appendix D: Algorithms*, page A-77):

Table 3-3: Measurement Definitions







Name	Definition
 Amplitude	The high value less the low value. Measured over the entire waveform. $\text{Amplitude} = \text{High} - \text{Low}$
 Burst Width	Timing measurement. The duration of a burst. Measured over the entire waveform.
 Cycle Mean	Amplitude (voltage) measurement. The arithmetic mean over the first cycle in the waveform.
 Cycle RMS	The true Root Mean Square voltage over the first cycle in the waveform.
 Delay	Timing measurement. The time between the MidRef crossings of two different traces.
 Fall Time	Timing measurement. Time taken for the falling edge of the first pulse in the waveform to fall from a High Ref value (default = 90%) to a Low Ref value (default = 10%) of its final value.

Table 3-3: Measurement Definitions (Cont.)

















Name	Definition
 Frequency	Timing measurement for the first cycle in the waveform. The reciprocal of the period. Measured in Hertz (Hz) where 1 Hz = 1 cycle per second.
 High	The value used as 100% whenever High Ref, Mid Ref, and Low Ref values are needed as in fall time and rise time measurements. May be calculated using either the min/max or the histogram method. With the min/max method it is the maximum value found. With the histogram method, it refers to the most common value found above the mid point. Measured over the entire waveform.
 Low	The value used as 0% whenever High Ref, Mid Ref, and Low Ref values are needed as in fall time and rise time measurements. May be calculated using either the min/max or the histogram method. With the min/max method it is the minimum value found. With the histogram method, it refers to the most common value found below the mid point. Measured over the entire waveform.
 Maximum	Amplitude (voltage) measurement. The maximum amplitude. Typically the most positive peak voltage. Measured over the entire waveform.
 Mean	Amplitude (voltage) measurement. The arithmetic mean over the entire waveform.
 Minimum	Amplitude (voltage) measurement. The minimum amplitude. Typically the most negative peak voltage. Measured over the entire waveform.
 Negative Duty Cycle	Timing measurement of the first cycle in the waveform. The ratio of the negative pulse width to the signal period expressed as a percentage.
$\text{NegativeDutyCycle} = \frac{\text{NegativeWidth}}{\text{Period}} \times 100\%$	
 Negative Overshoot	Amplitude (voltage) measurement. Measured over the entire waveform.
$\text{NegativeOvershoot} = \frac{\text{Low} - \text{Min}}{\text{Amplitude}} \times 100\%$	
 Negative Width	Timing measurement of the first pulse in the waveform. The distance (time) between MidRef (default 50%) amplitude points of a negative pulse.

Table 3-3: Measurement Definitions (Cont.)

Name	Definition
 Peak to Peak	Amplitude (voltage) measurement. The absolute difference between the maximum and minimum amplitude.
 Period	Timing measurement. Time it takes for the first complete signal cycle to happen. The reciprocal of frequency. Measured in seconds.
 Positive Duty Cycle	Timing measurement of the first cycle in the waveform. The ratio of the positive pulse width to the signal period expressed as a percentage. $PositiveDutyCycle = \frac{PositiveWidth}{Period} \times 100\%$
 Positive Overshoot	Amplitude (voltage) measurement over the entire waveform. $PositiveOvershoot = \frac{Max - High}{Amplitude} \times 100\%$
 Positive Width	Timing measurement of the first pulse in the waveform. The distance (time) between MidRef (default 50%) amplitude points of a positive pulse.
 Rise time	Timing measurement. Time taken for the leading edge of the first pulse to rise from a Low Ref value (default = 10%) to a High Ref value (default = 90%) of its final value.
 RMS	Amplitude (voltage) measurement. The true Root Mean Square voltage over the entire waveform.

Measurement Display

The readout area for measurements is normally the area to the right of the waveform window as shown in Figure 3-29. The digitizing oscilloscope has four areas for measurement readouts. You can simultaneously display and continuously update up to four measurements.

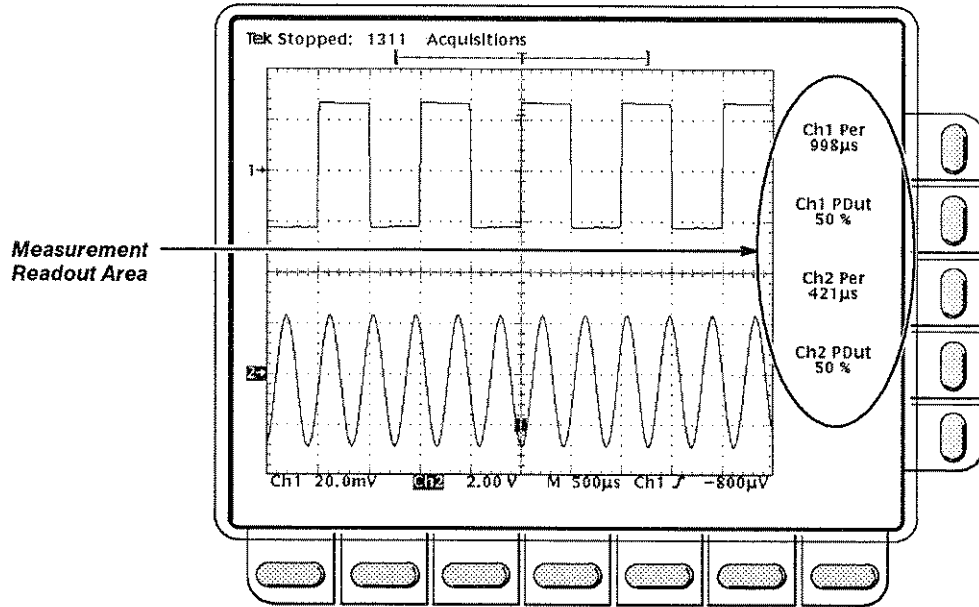

Figure 3-29: Measurement Readouts

Operation

To use the automatic measurements:

- Step 1:** Obtain a stable display of the waveform to be measured. Autoset may help.
- Step 2:** Press the **MEASURE** button to bring up the Measure menu (Figure 3-30).

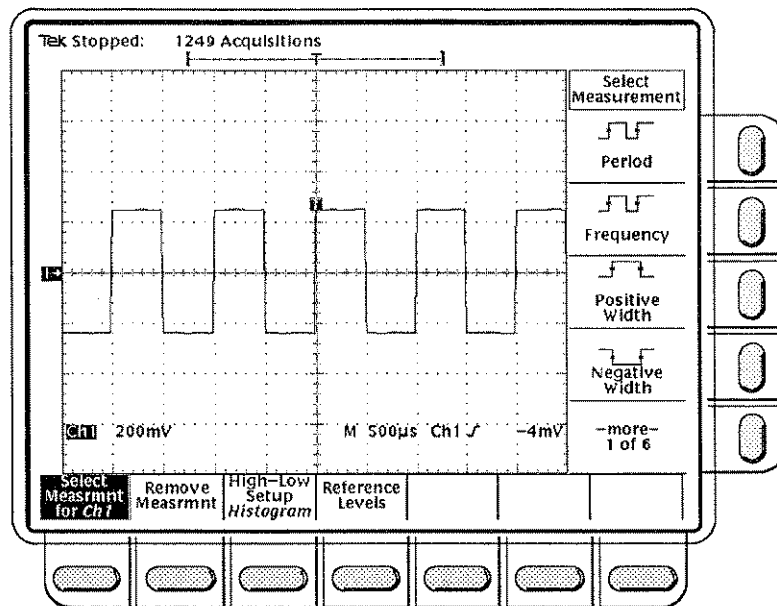

Figure 3-30: Measure Menu

Selecting a Measurement

- Step 3:** Press the main menu **Select Measrmt** button to call up the side menu measurements list.
- Step 4:** Select a measurement from the side menu. When they are created, the oscilloscope can perform four measurements at one time. Measurements use the current selected waveform as their target.

The following are hints on making automatic measurements:

- You can take a maximum of four measurements at a time. If you attempt to create a fifth measurement, the oscilloscope will generate an error message. You must remove one or more of the existing four measurements before you can add another one.
- You can vary the source for measurements. The source waveform for each measurement is simply the waveform that was selected when you created the measurement.
- Measurements are made on data for the entire record, not just the portion displayed on the screen.

- Be careful when taking automatic measurements on noisy signals. You want to ensure that when, for example, you measure frequency on signals where the noise level is relatively high, you measure the frequency of the desired waveform phenomena and not of the noise.

Your digitizing oscilloscope helps identify such situations by presenting low signal amplitude or low resolution warning messages.

You can try to work around noise problems by changing the vertical scale to enlarge the waveform height and make it easier to ignore certain noise. You can also change the acquisition mode. You might use Hi Res mode, which is less susceptible to this type of noise problem, rather than the more susceptible Peak Detect mode.

Removing Measurements

The **Remove Measrmt** selection provides explicit choices for removing measurements from the display according to their readout block position. Measurement 1 is the one in the top readout block. Measurement 2 is below it, and so forth. The fifth menu button provides the choice to remove all the measurements at once. The measurement blocks stay in their positions even when you remove measurements above them.

To remove measurements:

- Step 1:** Press the **MEASURE** button to bring up the Measure menu (Figure 3-31).
- Step 2:** Press the **Remove Measrmt** main menu item (Figure 3-31).
- Step 3:** Select the measurement to remove from the side menu.

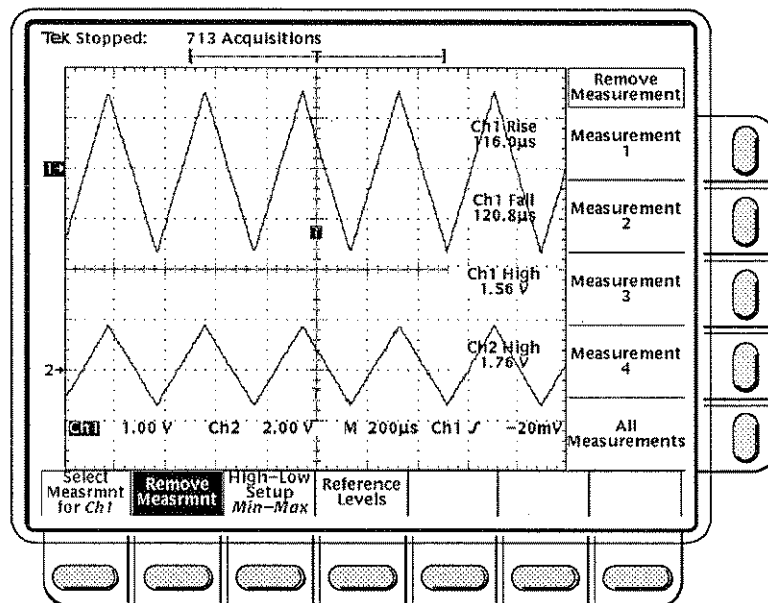

Figure 3-31: Remove Measurement Side Menu

Delay Measurement

The delay measurement measures from the selected waveform to another waveform, which you specify. When you select this measurement, the oscilloscope prompts you for further information by displaying the menu (Figure 3-32). This allows you to specify the parameters needed to complete the delay measurement.

To use:

- Step 1:** Press the Measure menu's **Delay** side menu button. This brings up the Measure Delay menu (Figure 3-32).
- Step 2:** On the Measure Delay menu, press the button below the main menu item called **Delay To**. It provides a side menu with one item: **Measure Delay to** (Figure 3-32). Press the side menu button repeatedly or turn the general purpose knob to choose the Delay to waveform. The choices are: **Ch1**, **Ch2**, **Ch3** and **Ch4** (on the TDS 540), **Ax1** and **Ax2** (on the TDS 520), **Math1**, **Math2**, **Math3**, **Ref1**, **Ref2**, **Ref3**, and **Ref4**.

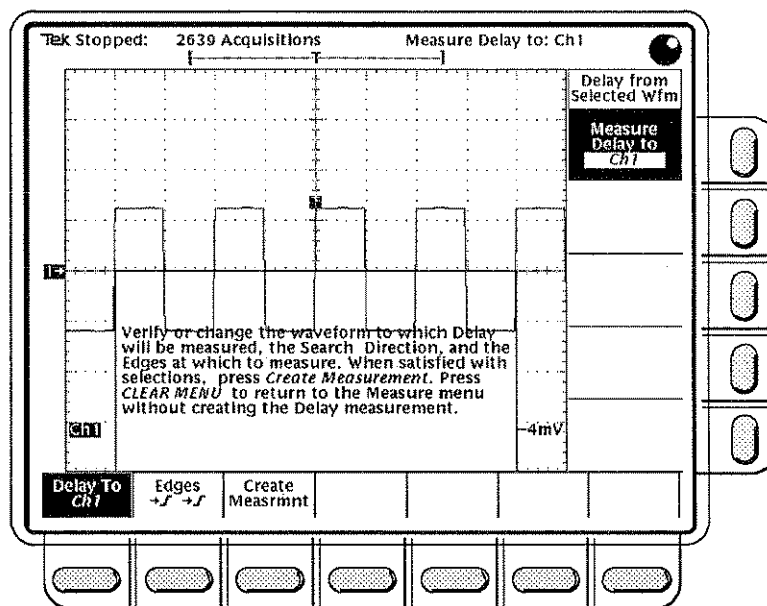

Figure 3-32: Measure Delay Menu – Delay To

- Step 3:** On the Measure Delay menu, press the main menu button with the label **Edges**. A side menu of delay edges and direction will appear (Figure 3-33).

The direction arrows on the choices allow you to specify whether to do a forward search on both waveforms or forward on the selected, (or "from"), waveform and backwards on the "to" waveform. This latter choice is useful for isolating a specific pair of edges out of a stream.

The waveform slopes allow you to specify the slope to be detected on each of the target waveforms. The upper waveform on each icon represents the *from* waveform and the lower one represents to *to* waveform.

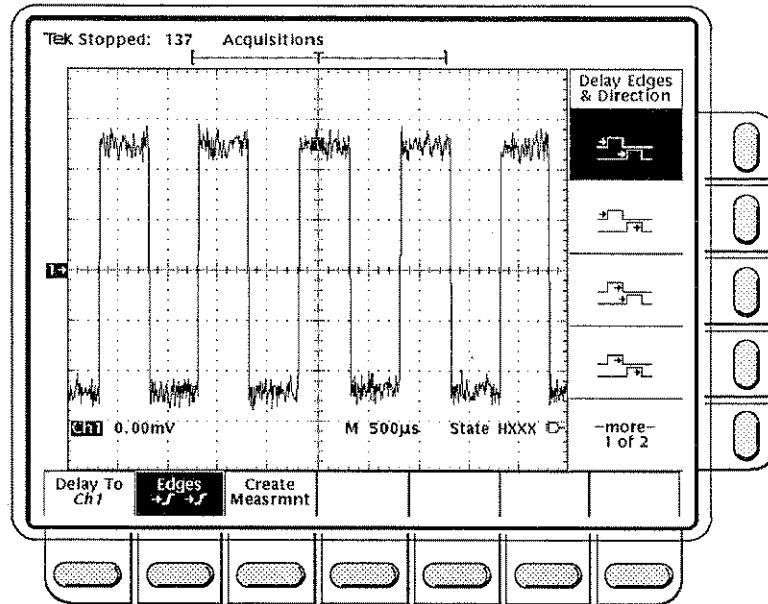

Figure 3-33: Measure Delay Menu – Edges

- Step 4:** Press the main menu **Create Measrmt** button. On the resulting side menu, press: **OK Create Measurement**. This causes the specified delay measurement to be created and returns you to the Measure menu.

To exit the Measure Delay menu without causing the delay measurement to be created, press the **CLEAR MENU** button, which returns you to the Measure menu.

High-Low Setup

The **High-Low Setup** item provides two choices for how the oscilloscope determines the High and Low levels of waveforms. These are: *histogram* and *max/min*. Histogram sets the values statistically. Max/Min uses the reference levels you set with the Reference Level main menu and resulting side menu.

To set the high-low setup type:

- Step 1:** Press the **MEASURE** button to bring up the Measure menu (Figure 3-34).
- Step 2:** Press the **High-Low Setup** main menu item.
- Step 3:** Select either **Histogram (best for pulses)** or **Min-Max (all other waveforms)** from the High-Low side menu. If you select **Min-Max**, you may also want to check and/or revise values using the Reference Levels side menu.

Reference Levels

You can set the vertical reference levels with the **Reference Levels** main menu item. Once you've selected an item with the side menu, you can enter a value with the general purpose knob or key pad. Side menu items are:

Set Levels in % (or) units – Choose whether the References are set in % relative to High (100%) and Low (0%), or set explicitly in units of the target waveform (typically volts). The **units or %** selection applies to all Reference Levels. % is the default selection. It's useful for many general purpose applications. The **units** selection is helpful for setting precise values. For example, if you're trying to measure adherence to published interface specifications on an RS-232-C circuit, then it makes sense to assign the High and Low references to units. In this case you might set those units to equal precise RS-232-C specification voltage values.

High Ref – Set the high reference level. The default is 90%.

Mid Ref – Set the middle reference level. The default is 50%.

Low Ref – Set the low reference level. The default is 10%.

Mid2 Ref – Set the middle reference level used on the second waveform specified in the Delay Measurements. The default is 50%.

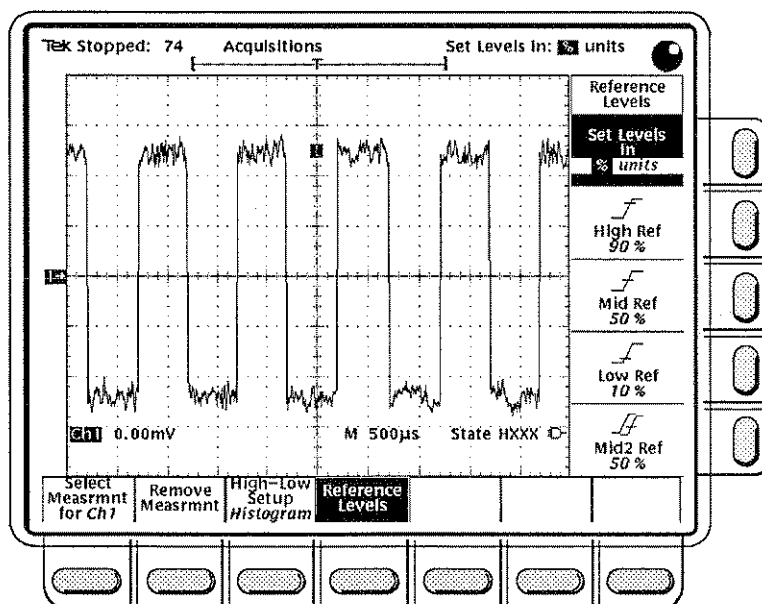

Figure 3-34: Measure Menu – Reference Levels

**For More
Information**

See *Measurements*, on page 2-27.

See *Appendix D: Algorithms*, on page A-77.



Probe Compensation

Passive probes require compensation to ensure maximum distortion-free output and to avoid high frequency amplitude errors.

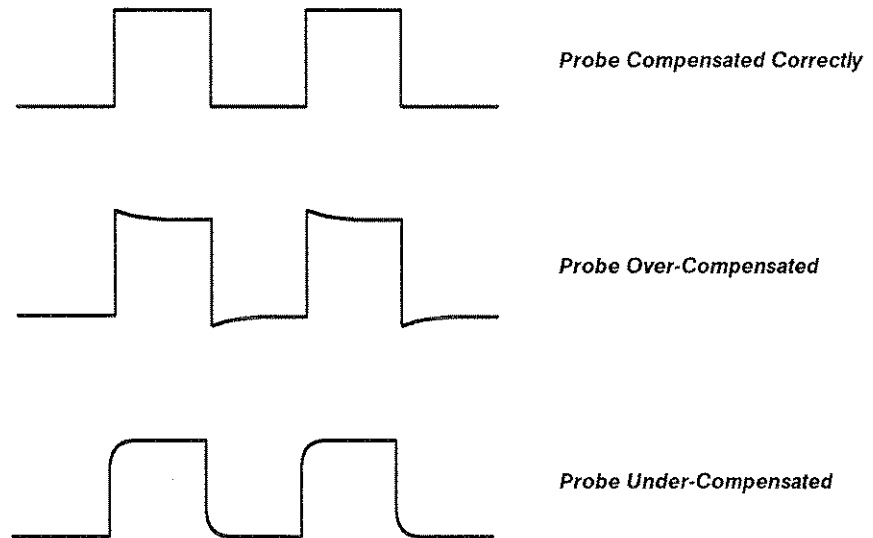

Figure 3-35: How Probe Compensation Affects Signals

Operation

To compensate your probe:

- Step 1:** Connect the probe to the probe compensation signal on the front panel.
- Step 2:** Press **AUTOSET**.
- Step 3:** Adjust the trimmer in the probe until you see a perfectly flat top square wave on the display. Figure 3-36 shows where the adjustment trimmer is located.

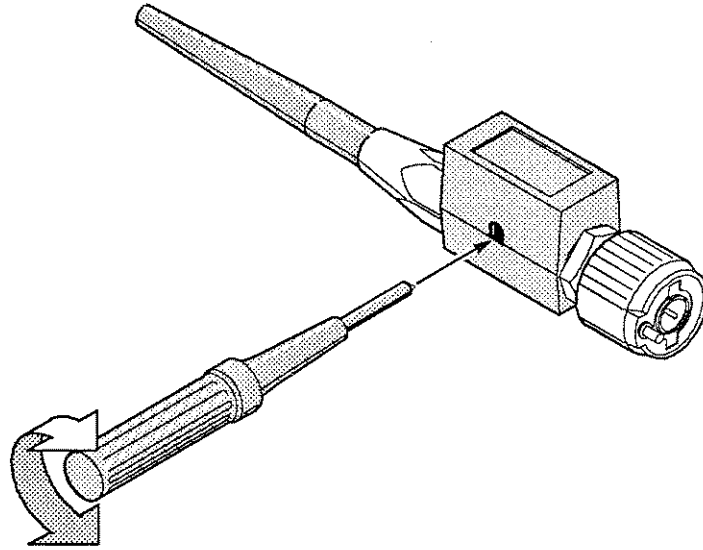

Figure 3-36: P6139A Probe Trimmer Adjustment

**For More
Information**

See *Probe Connection*, on page 3-65.

See *Probe Selection*, on page 3-77.

Probe Connection

The way you attach your probe to a signal source can affect the results you get.

Two important factors that can affect your signal are:

- ground lead inductance (introduced by the probe), and
- the physical layout of your circuit and component devices.

Ground Lead Inductance

In order for an amplitude measurement to be meaningful, you must give the measurement some point of reference. Your probe offers you the capability for referencing the voltage at its tip to ground. Use the ground lead to access the ground reference.

However, when you touch your probe tip to a circuit element, you are introducing new resistance, capacitance, and inductance into the circuit (Figure 3-37).

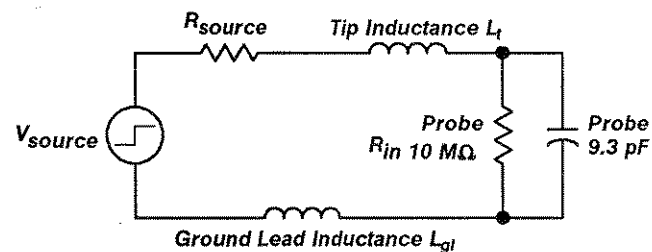

Figure 3-37: A Probe Adds Resistance, Capacitance, and Inductance

For most circuits, the high input resistance of a passive probe has a negligible effect on the signal. The series inductances represented by the probe tip and ground lead, however, can result in a parasitic resonant circuit that may "ring" within the bandwidth of the oscilloscope. Figure 3-38 shows the effect of the same signal through the same probe with different ground leads.

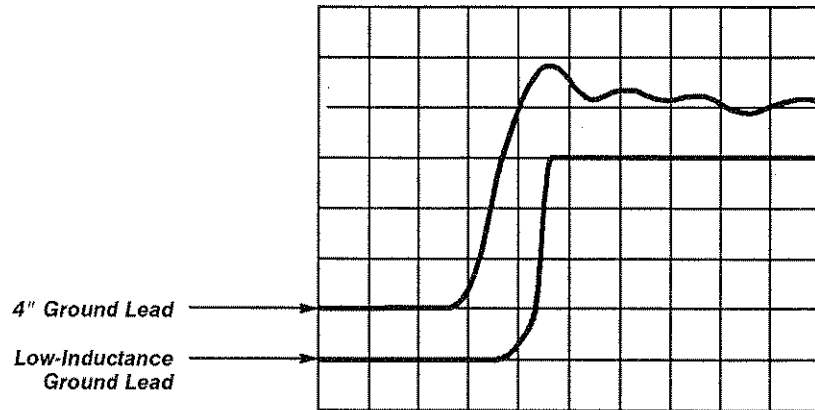

Figure 3-38: Signal Variation Introduced by Probe Ground Lead (1 ns/division)

Ringings and rise time degradation may be hidden if the frequency of the induced ringing is beyond the bandwidth of the oscilloscope. If you know the self-inductance (L) and capacitance (C) of your probe and ground lead, you can calculate the resonant frequency (f_0) at which this parasitic circuit will resonate:

$$f_0 = \frac{1}{2\pi \times \sqrt{LC}}$$

Reducing the ground lead inductance will raise the resonant frequency. Ideally, the inductance is low enough that the resulting frequency is above the frequency at which you want to take measurements. For this purpose, the probes include several accessories to help reduce ground lead inductance.

Probe Accessories Overview

The following descriptions explain how to use many of the accessories that came with your probe as well as optional ones you can order. Figure 3-39 shows the standard and optional probe accessories and how they fit with your probe.

The accessories serve two purposes. Some reduce ground lead inductance, and some are physical adapters to help you connect the probe to your circuit.

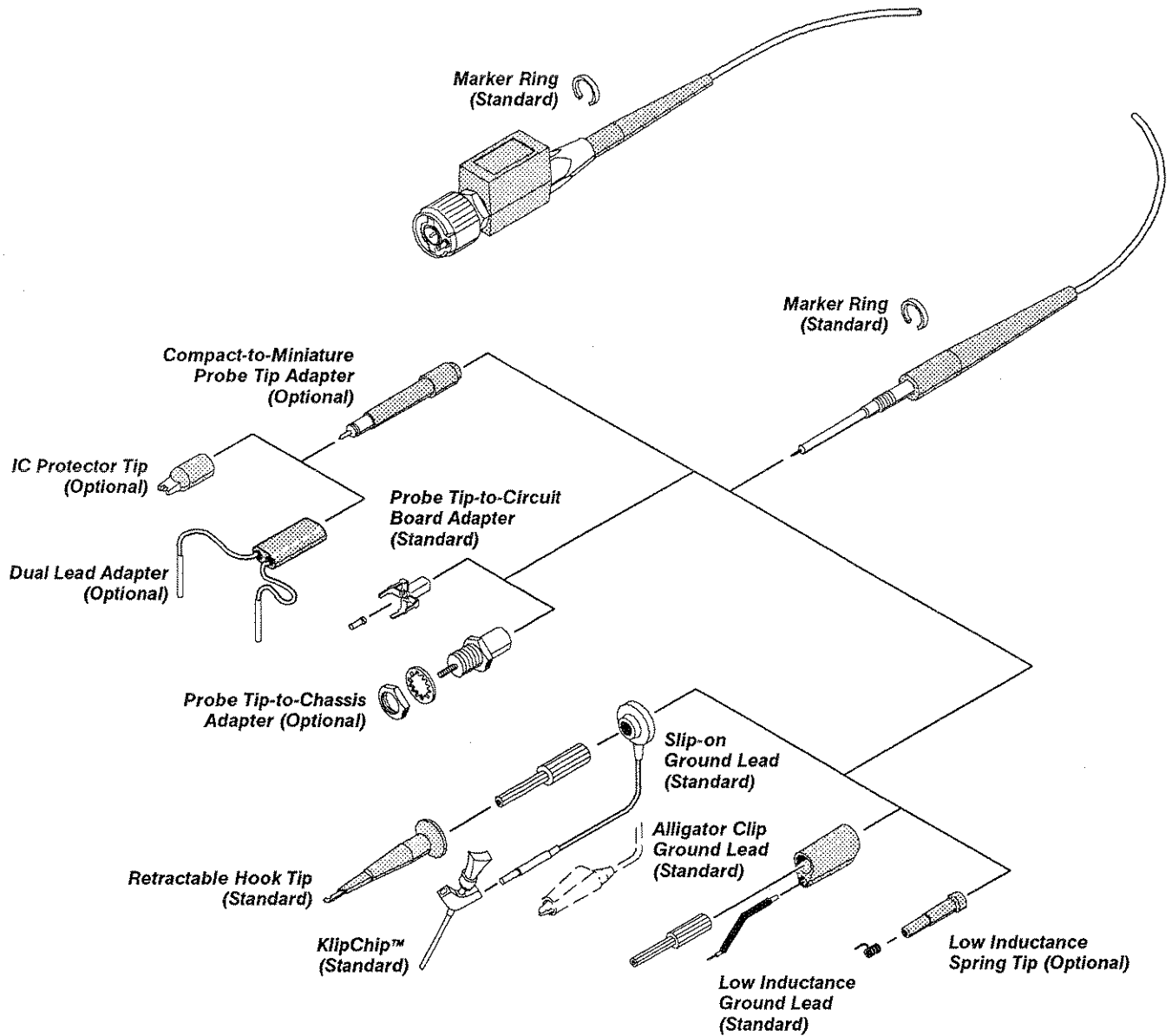

Figure 3-39: Probe Accessories

Standard Probe Accessories

Standard probe accessories include the following:

Retractable Hook Tip

The Retractable Hook Tip attaches to your signal test point for hands-free operation of the probe. The hook tip attaches to components having leads, such as resistors, capacitors, and discrete semiconductors. You can also grip stripped wire, jumpers, busses, and test pins with the retractable hook.

For maximum flexibility with the hook tip, use one of the six-inch ground leads. For precise measurements at high frequency, however, long ground leads may have too much inductance. In these cases you can use one of the low-inductance probe tip configurations instead.

To remove the hook tip, simply pull it off the probe. Reinstall it by pushing it firmly onto the ribbed ferrule of the probe tip (see Figures 3-39 and 3-40).

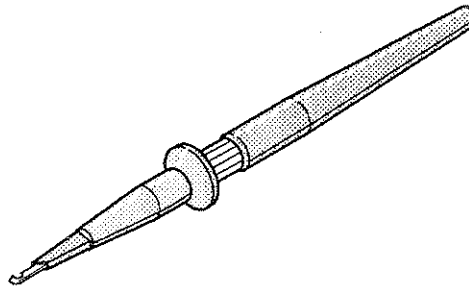

Figure 3-40: Retractable Hook Tip

Marker Rings

The Marker Rings help you keep track of individual probes and signal sources when you have a complicated test setup. Use the marker rings whenever you want to identify a particular probe for any reason.

To make probe identification easy, clip matching colored rings onto the probe cable and probe tip as shown (Figure 3-41).

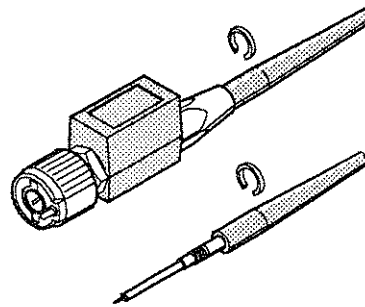

Figure 3-41: Marker Rings

Long Ground Leads

Long Ground Leads help when a long reach is important and high-frequency information is not. Because of the high inductance associated with long ground leads, you should not use them for precise measurements above approximately 30 MHz (or for pulses with rise times less than about 11 ns). Long ground leads are ideal for quick troubleshooting when you are looking for the presence or absence of a signal and are not concerned with the precision of the measurement.

You can choose between a ground lead terminated with an alligator clip and a lead terminated with a square-pin receptacle. To attach the lead, unscrew the ribbed ferrule, slip the ground lead ring over the probe tip, and push it firmly against the molded portion of the cable. Secure the cable by reinstalling the ribbed ferrule (see Figure 3-42).

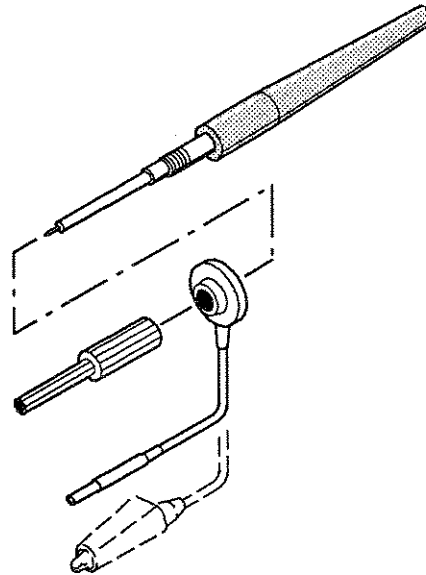

Figure 3-42: Long Ground Leads

Low-Inductance Ground Lead

Low-Inductance Ground Leads substantially reduces ground lead inductance. Compared to a typical six-inch ground lead with an inductance of approximately 140 nH, the low-inductance tip assembly has an inductance of approximately 32 nH. This improved performance means that your measurements will be relatively free of probe-related high-frequency degradation to approximately 250 MHz.

The low-inductance tip has a partially insulated flexible ground pin that allows you to ground the probe and still have a limited amount of reach with the probe tip. Because the ground lead simply contacts the ground reference

(instead of clipping onto it) you can move the probe around your device under test with ease. The assembly is well-suited to densely populated circuit boards and multi-pin connectors.

To attach the low-inductance tip assembly, unscrew the ribbed ferrule and remove the long ground lead, if installed. Slip the plastic adapter onto the probe tip so that the end of the adapter with two holes is nearest the probe tip. Secure the adapter by reinstalling the ribbed ferrule. Insert the receptacle end of the short, black, flexible wire into the remaining hole in the adapter and seat it firmly onto the recessed pin (see Figure 3-43).

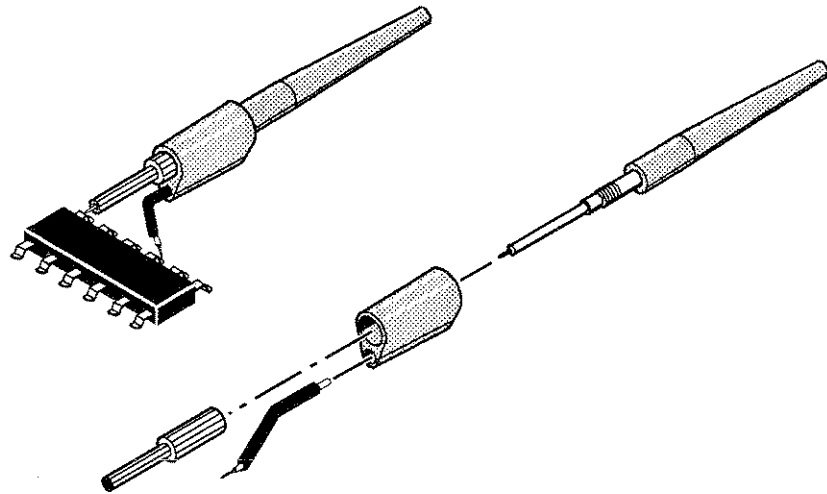

Figure 3-43: Low-Inductance Ground Lead

Probe-Tip-to-Circuit Board Adapters

The Probe-Tip-to-Circuit Board Adapters let you design minimum inductance test points into your next circuit board. With this type of adapter installed, the practical frequency limit of your measurements is determined by system performance specifications and not by ground lead inductance effects.

Instructions for installing the probe tip-to-circuit board adapters are packaged with the adapters. For maximum performance and ease of testing, Tektronix strongly recommends that you incorporate the probe tip-to-circuit board adapters (or the probe tip-to-chassis adapters described below) into your next design.

To use your probe with these adapters, unscrew and remove the ribbed ferrule. Use the probe tip directly with the adapter (see Figure 3-44).

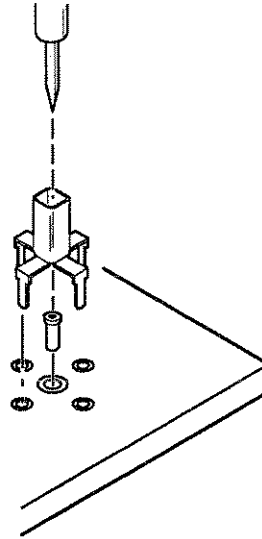

Figure 3-44: Probe-Tip-to-Circuit Board Adapter

SMT KlipChip™

The SMT KlipChip provides hands-free attachment to a physically small signal or ground source (Figure 3-45). The low profile of the KlipChip allows you to grasp surface-mounted devices that the full-size retractable hook tip can't grip.

To use the SMT KlipChip as a ground attachment, use the long ground lead terminated with a pin receptacle (described earlier in this section) and connect the termination to the pin in one of the KlipChip shoulders.

To use the KlipChip as a signal attachment, use a single-lead adapter (similar to the dual-lead adapter described later in this section) and connect the termination to the pin in one of the KlipChip shoulders.

You can use a KlipChip for both ground and signal attachment by combining them with the dual-lead adapter, or by combining the single-lead adapter with the long ground lead.

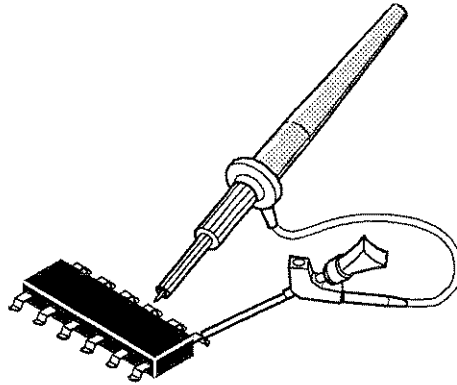

Figure 3-45: SMT KlipChip™

Optional Probe Accessories

Optional probe accessories include the following:

Low-Inductance Spring-Tips

The Low-Inductance Spring-Tips can be used whenever you will be making many measurements of devices with known fixed spacings. The spring-tip is ideal for repetitive production use. Select different length springs to match device spacings on a variety of components, including edge connectors, IC packages, multi-pin connectors and receptacles, and adjacent runs on circuit boards or other devices. Because the spring-tip ground lead simply contacts the ground reference (instead of clipping onto it) you can move the probe around your device-under-test with ease.

To attach the low-inductance spring-tip assembly, remove the ribbed ferrule (and long ground lead) if installed. Slip the smooth plastic ferrule onto the probe tip and push it firmly against the molded portion of the cable. Select a spring tip and push it onto the metal barrel of the probe tip (Figure 3-46).

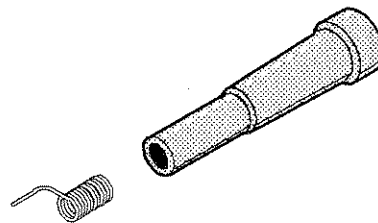

Figure 3-46: Low-Inductance Spring-Tips

Probe-Tip-to-Chassis Adapter

The Probe-Tip-to-Chassis Adapter makes your test point accessible without removing instrument covers or panels. It provides an easy-access, low-inductance test point anywhere on your circuit (Figure 3-47). The probe tip-to-chassis adapter has the same low inductance properties as the probe tip-to-circuit board adapter described previously.

To use your probe with these adapters, unscrew and remove the ribbed ferrule.

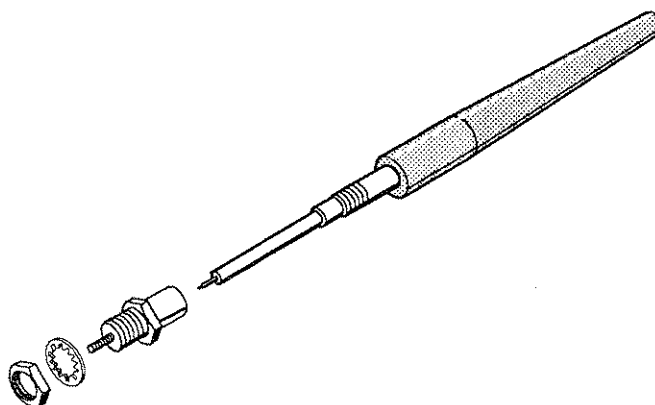

Figure 3-47: Probe-Tip-to-Chassis Adapter

Compact-to-Miniature Probe Tip Adapter

The Compact-to-Miniature Probe Tip Adapter allows you to use accessories that are designed to accept a larger probe tip (Figure 3-48). These accessories include the IC protector tip, single- and dual-lead adapters, and others.

To install the adapter, unscrew and remove the ribbed ferrule and screw the adapter on in its place. (The IC protector tip discussed below is installed on the adapter tip when shipped. Remove the protector tip by pulling it off before using the adapter with other accessories.)

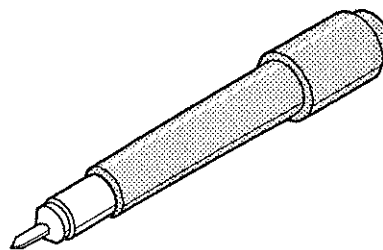

Figure 3-48: Compact-to-Miniature Probe Tip Adapter

IC Protector Tip

The IC Protector Tip simplifies probing inline IC packages (Figure 3-49). The shape of the IC protector guides the probe tip to the IC pin and prevents accidental shorting of pins by the probe tip. It is used with the compact-to-miniature probe tip adapter. When using this tip, the spacing (pitch) between leads should be greater than or equal to 0.100 inches (100 mils).

Because the IC protector tip prevents you from using the low-inductance tips, you will have to use one of the longer ground leads. For this reason you should take into account ground lead inductance effects on measurements at frequencies greater than about 30 MHz.

To attach the IC protector tip, push it firmly onto the end of the metal barrel of the compact-to-miniature probe tip adapter.

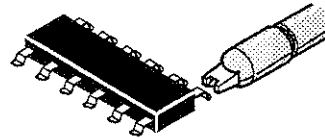

Figure 3-49: IC Protector Tip

Dual-Lead Adapter

The Dual-Lead Adapter makes an easy connection to 0.025 diameter connector pins (Figure 3-50). One lead connects to a ground reference pin and the other to the signal pin. The adapter prevents burring and pin damage that can result when a retractable hook tip is used on soft pins. A single-lead adapter is also available. These adapters can also be used with the SMT KlipChip to provide access to very small signal and ground test points.

Although the dual-lead adapter is an improvement over the long ground leads in terms of added inductance, measurements at frequencies greater than 30 MHz may require using one of the low-inductance ground leads. Because of the length of the signal lead, the dual-lead configuration is also more susceptible to signal crosstalk than other tip configurations.

To use the dual-lead adapter you must first install the optional compact-to-miniature probe tip adapter (or a KlipChip. See Figure 3-45). Remove the ribbed ferrule if it is installed. Screw the compact-to-miniature adapter onto the probe tip. Then insert the miniature probe tip into the dual-lead adapter.

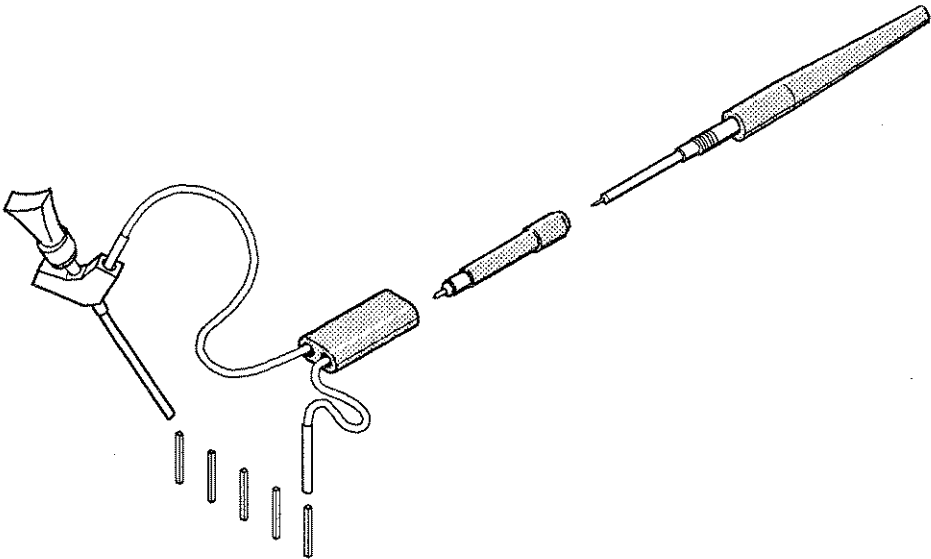

Figure 3-50: Dual-Lead Adapter





Probe Selection

The probes included with your digitizing oscilloscope are useful for a wide variety of tasks. For special measurement situations, you need different probes. This section helps you select the right probe for the job.

Probes by Application

One way to classify probes is by applications. Different applications demand different probes. Use Table 3-4 to select a probe for your application.

Table 3-4: Probes by Application

Typical Applications	Telecommuni- cations & High- Speed Logic	Industrial Electronics	Consumer/ Computer Electronics	High Energy Pulsed Power	Certification, Regulatory, & Compliance Testing
Passive, high-impedance voltage	P6139A ¹ P6101A ¹	P6139A ^{1,2} P6101A ^{1,2}	P6139A ^{1,2,3} P6101A ¹	P6139A ^{1,2,3} P6101A ^{1,2}	P6139A ^{1,2,3} P6101A ^{1,2}
Active, high-speed digital voltage	P6205 ^{2,3} P6204 ^{2,3}	P6205 ^{2,3}	P6205 ^{2,3} P6204 w/1103 power sup- ply ^{2,3}	P6205 ^{2,3}	P6205 ^{2,3}
Low capacitance voltage (Low impedance Zo)	P6156 ^{1,2,3}		P6156 ^{1,2,3}		
Passive, high voltage	P6009 ^{1,2}	P6009 ^{1,2,3} P6015 ^{1,2,3}	P6009 ^{1,2}	P6009 ^{1,2,3} P6015 ^{1,2,3}	P6009 ^{1,2,3} P6015 ^{1,2,3}
Active, differential voltage	P6046 ^{2,3}	P6046 ^{2,3}	P6046 ^{2,3}		
Current	AM 503S ^{2,3} P6021 ^{1,2}	AM 503S ^{2,3} P6021 ^{1,2} CT4 ^{1,2}	AM 503S ^{2,3} P6021 ^{1,2}	AM 503S ^{2,3} P6021 ^{1,2}	AM 503S ^{2,3} P6021 ^{1,2} CT1/2 ^{2,3} CT4 ^{1,2}
Fixtured	A6501 ^{2,3} P6501 ^{2,3}		A6501 ^{2,3} P6501 ^{2,3}		
Optical	P6701A ^{2,3} P6703A ^{2,3} P6711 ^{2,3} P6713 ^{2,3}		P6701A ^{2,3} P6703A ^{2,3} P6711 ^{2,3} P6713 ^{2,3}		P6701A ^{2,3} P6703A ^{2,3} P6711 ^{2,3} P6713 ^{2,3}
Time-to-voltage conver- ter	TVC 501 ^{2,3}	TVC 501 ^{2,3}	TVC 501 ^{2,3}	TVC 501 ^{2,3}	

¹Qualitative signal evaluation — doesn't require a great deal of accuracy, such as in go/no go measurement.

²Functional testing — good for when the device under test is being compared to some standard.

³Quantitative Signal Evaluation — involves detailed evaluation.

Probes can also be classified by type. Figure 3-51 and Table 3-5 show such a breakdown.

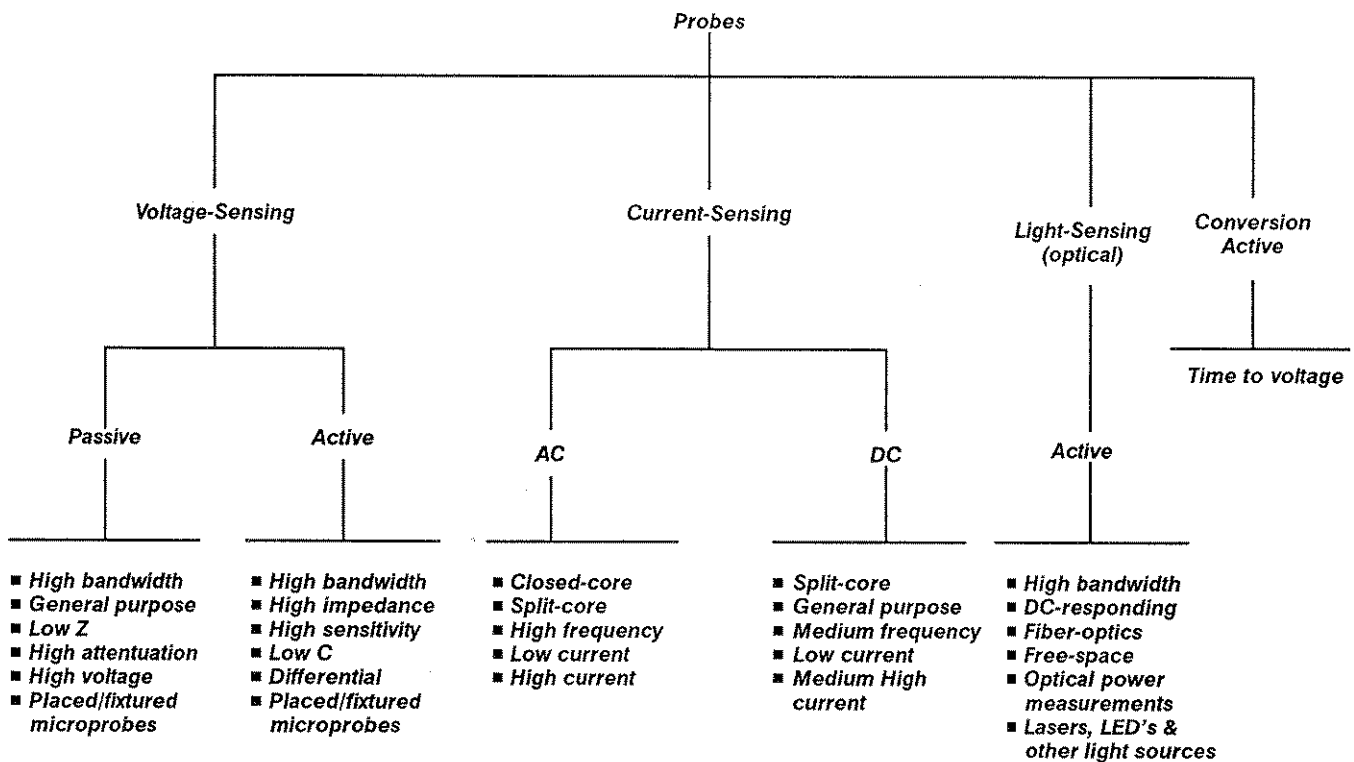

Figure 3-51: Basic Probe Types by Type

Table 3-5: TDS 520/540 Compatible Probes

Probe Type	Tektronix Model #	Description
Passive, high impedance voltage	P6139A (std.) P6101A	10X, 500 MHz 1X, 15 MHz
Passive, low capacitance voltage (low impedance Z_0)	P6156	10X, 3.5 GHz, for 50 Ω inputs (1X, 20X, 100X optional)
Passive, high voltage	P6009 P6015	100X, 1.5 kV, DC + peak AC 1000X, 20 kV, DC + peak AC
Active, high speed voltage	P6205 P6204	DC to 750 MHz FET DC to 1 GHz. DC offset. Needs Tek 1103 TekProbe Power Supply for offset capability.
Active, differential voltage	P6046	1X/10X, DC to 100 MHz
Active, fixtured voltage	A6501 P6501 Opt. 02	Buffer Amplifier, 1 GHz, 1 M Ω , 10X Microprobe with TekProbe Power Cable, 750 MHz, 1 M Ω , 10X
Current	AM 503S AM 503S Opt. 03 P6021 P6022 CT-1/CT-2 CT-4	AC/DC. Uses A6302 Current Probe. AC/DC. Uses A6303 Current Probe. AC. 120 Hz to 60 MHz. AC. 935 kHz to 120 MHz. Designed for permanent or semi-permanent in-circuit installation CT-1: 25 kHz to 1 GHz, 50 Ω input CT-2: 1.2 kHz to 200 MHz, 50 Ω input Current Transformer for use with AM 503S and P6021. Peak pulse 1 kA, 0.5Hz to 20 MHz with AM 503S
Optical (Opto-Electronic Converters)	P6701A P6703A P6711 P6713	500 to 950 nm, DC to 850 MHz, 1 V/mW 1100 to 1700 nm, DC to 1 GHz, 1 V/mW 500 to 950 nm, DC to 250 MHz, 5 V/mW 1100 to 1700 nm, DC to 300 MHz, 5 V/mW
Time-to-Voltage Converter	TVC 501	Time delay, pulse width and period measurements

Passive Voltage Probes

Passive voltage probes measure voltage. They employ passive circuit components such as resistors, capacitors and inductors. Three common classes of passive voltage probes are:

- *General purpose (High input resistance)*
- *Low impedance Z_0*
- *High voltage*

General Purpose (High Input Resistance) Probes

These are considered “typical” oscilloscope probes. The P6139A probes included with the digitizing oscilloscope are passive probes. The high input resistance of passive probes (typically 10 M Ω) provides negligible DC loading. This makes them a good choice for accurate DC amplitude measurements. On the negative side, their 9 pF to 12 pF (over 60 pF for 1X) capacitive loading can distort timing and phase measurements. High input resistance passive probes are preferred for measurements involving:

- device characterization (above 15 V, thermal drift applications)
- maximum sensitivity using 1X high Z passives
- between 15 and 500 V
- qualitative or go/no-go measurements

Low Impedance Z_0 Probes

Low Impedance probes offer more accurate frequency measurement than general purpose probes, but at the tradeoff of less accurate amplitude measurement. They offer a higher bandwidth to cost ratio.

These probes, however, must be terminated in a 50 Ω scope input. Input capacitance is much lower than high Z passive probes, typically 1 pF, but input resistance is also lower (500 to 5000 Ω typically). Though DC loading degrades amplitude accuracy, the lower input capacitance reduces high frequency loading to the circuit under test. This makes Z_0 probes ideal for timing and phase measurements.

Z_0 probes are useful for measurements of up to 40 V.

A low impedance Z_0 probe that works with the TDS 500 Series Digitizing Oscilloscope is the Tektronix P6156 3.5 GHz probe. It comes standard with a 10X (500 Ω) attenuator tip. 1X, 20X, and 100X attenuator tips are also available.

High Voltage Probes

High Voltage probes have attenuation factors in the 100X to 1000X range. The considerations which apply to other passive probes apply equally well to high voltage probes with a few exceptions. The voltage range on high voltage probes varies from 1 kV to 20 kV (DC + peak AC), resulting in probe head

mechanical designs which are larger than their passive probe counterparts. High voltage probes have the added advantage of lower input capacitance, although this is offset by the reduced sensitivity.

The TDS 500 Series Digitizing Oscilloscope works with the Tektronix P6009 and P6015 high voltage probes for 1 M Ω inputs. The P6009 works with a maximum input voltage of 1.5 kV DC + peak AC and the P6015 works with a maximum input voltage of 20 kV DC + peak AC continuous (or 40 kV peak for less than 100 ms).

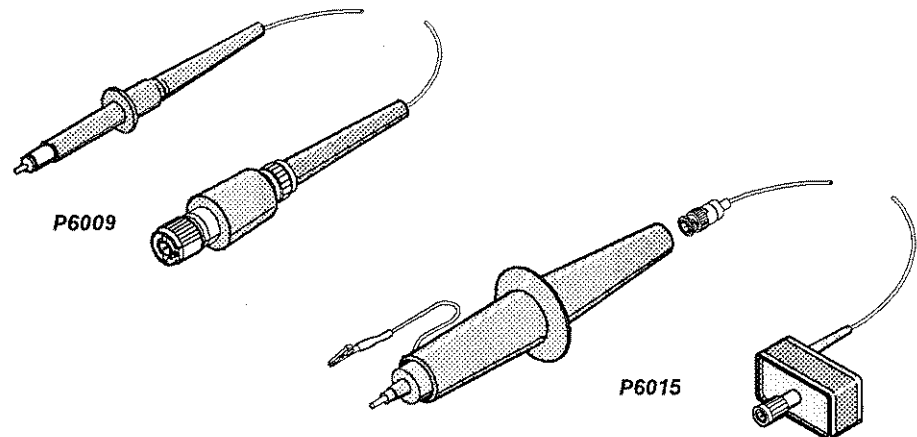

Figure 3-52: The P6009 and P6015 High Voltage Probes

Active Voltage Probes

Active voltage probes use active circuit elements such as transistors. Three common classes of active probes are:

- *High speed active*
- *Differential active*
- *Fixtured active*

Active voltage measuring probes employ active elements in the probe body and compensation box to acquire and process signals from the circuit under test. All active probes require a source of power for their operation. Power is either obtained from an external power supply or from the oscilloscope itself.

Active probes offer low input capacitance (1 to 2 pF typical) while maintaining the higher input resistance of passive probes (10 k Ω to 10 M Ω). Like Zo probes, active probes are useful for making accurate timing and phase measurements, but without the degradation of amplitude accuracy. Active probes typically have a dynamic range of ± 10 to ± 15 V.

Some active probes are also referred to as "FET" probes.

High-Speed Active Probes

Two high speed active probes that work with the TDS 500 Series Digitizing Oscilloscope are the P6204 and P6205. The P6205 has a sufficient linear dynamic range for most logic family applications. The P6204's linear dynamic range can be extended through its offset capability. The P6204 and P6205 probes will automatically set attenuation to 10X and set the coupling to 50 Ω .

NOTE

To use the offset capability of the P6204 probe, you also need the Tektronix 1103 TEKPROBE Power Supply.

Differential Probes

Differential Probes determine the voltage drop between two points in a circuit under test. Differential probes enable you to simultaneously measure two points and to display the difference between the two voltages on your digitizing oscilloscope.

Differential signal processing takes place in the probe itself, resulting in high common-mode signal rejection at higher frequencies. Differential probe-tip signal processing minimizes the measurement errors caused by differences in probes, cable lengths, and input attenuators.

Active differential probes are stand alone products designed to be used with 50 Ω inputs. The same characteristics that apply to active probes apply to active differential probes.

The common mode rejection ratio is a measure of how effectively the probe cancels signals which are common to both inputs while the common mode range indicates the maximum amplitude the common signal can reach before the probe circuitry is saturated.

The TDS 500 Digitizing Oscilloscope works with the Tektronix P6046 Differential Probe. This is a 100 MHz differential amplifier in probe form which connects to one oscilloscope input channel.

Fixtured Active Probes

In some small geometry or dense circuitry applications, such as surface mounted devices (SMD), a hand-held probe is too big to be practical. You can instead use fixtured (or probe card mounted) active probes (or buffered amplifiers) to precisely connect your instrument to your device-under-test. These probes have the same electrical characteristics as high speed, active probes but use a smaller mechanical design.

The TDS 500 Series Digitizing Oscilloscope works with the Tektronix A6501 Buffer Amplifier and the P6501 Microprobe.

Current Probes

Current sensing probes use transformers or a combination of transformers and Hall effect devices to convert flux fields to voltage signals.

Current probes enable you to directly observe and measure current waveforms, which may be very different from voltage signals. Tektronix current probes are unique in that they can measure from DC to 1 GHz.

Two types of current probes are available: one that measures AC current only, and AC/DC probes which utilize the Hall effect to accurately measure the AC or DC components of a DC or mixed AC/DC signal. AC-only current probes use a transformer to convert AC current flux into a voltage signal to the oscilloscope, and have a frequency response from a few hundred Hertz up to 1 GHz. AC/DC current probes include Hall effect semiconductor devices and provide frequency response from DC to 50 MHz.

Use a current probe by clipping its jaws around the wire carrying the current that you want to measure. (This is unlike an ammeter which you must connect in series with the circuit.) Because current probes are non-invasive, with loading typically in the $m\Omega$ to low Ω range, they are especially useful where low loading of the circuit is important. Current probes can also make differential measurements by measuring the results of two opposing currents in two conductors in the jaws of the probe.

The TDS 500 Series Digitizing Oscilloscope works with a wide variety of Tektronix current probes including:

- the AM 503S current probe system, which provides you the capability to measure both AC and DC current with one probe
- the P6021 AC current measurement system
- the P6022, with a small package that makes it well-suited to measure current in compact semiconductor circuits
- the CT-1 and CT-2, which are designed for more permanent in-circuit installation.

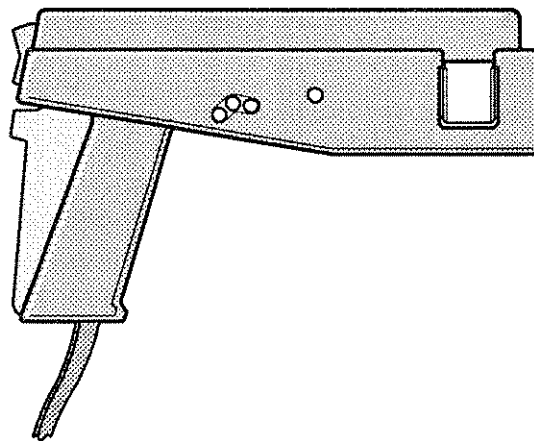

Figure 3-53: A6303 Current Probe Used in the AM 503 Opt. 03

Optical Probes

Optical probes (opto-electronic converters) allow you to acquire optical signals and convert them to electrical signals for convenient analysis on your digitizing oscilloscope.

Optical probes let you blend the functions of an optical power meter with the high-speed analog waveform analysis capability of a traditional oscilloscope. You have the capability of acquiring, displaying and analyzing optical and electrical signals simultaneously.

Applications include measuring the transient optical properties of lasers, LED's, electro-optic modulators, and flashlamps, the development, manufacturing, and maintenance of fiber optic control networks, local area networks (LANs), fiber-based systems based on the FDDI and SONET standard, optical disk devices, and high-speed fiber optic communications systems.

NOTE

TDS Digitizing Oscilloscopes recognize level II active probes as having 10X attenuation. However, Tektronix optical probes actually have 1X attenuation. Thus, the values calculated are really lower than what these oscilloscopes state. Also, the display shows measurements in volts rather than watts as used by optical probes. To convert the result to watts you must use the equation on the side of the probe. For example, the message of the side of the P6701A states that there is 1 V/mW. Table 3-6 shows how you might take a result displayed on the oscilloscope and calculate the corrected value.

Table 3-6: P6701A Optical Probe Measurement Conversion

Measurement on Oscilloscope	Corrected for 1X, not 10X, Attenuation	Expressed in Watts (1 V/mW)
1 V	.1 V	.1 mW
.1 V	.01 V	.01 mW

Time-to-Voltage Converter

The instantaneous time-interval to voltage converter (TVC) continuously converts consecutive timing measurements to a time-interval vs. time waveform.

Timing variations typically appear as left-to-right motion, or jitter, on an oscilloscope. Time base or trigger holdoff adjustments may improve display stability, but they do not show timing dynamics. The TVC untangles the often confusing waveforms in digital systems and delivers a coherent real-time view.

The TVC adds three measurement functions to your oscilloscope's voltage vs. time capability: time delay vs. time, pulse-width vs. time, and period vs. time.

The TVC continuously measures the timing parameter and instantaneously generates a voltage proportional to the measurement. Since the TVC generates voltages proportional to time-intervals, you can set your scope to trigger on timing violations such as a time-delay that exceeds a threshold or an incorrectly narrow pulse or glitch.

The TDS 500 Series Digitizing Oscilloscope works with the Tektronix TVC 501 Instantaneous Time Interval to Voltage Converter.





Remote Communication Tasks

You may want to integrate your oscilloscope into a benchtop or rack system environment. This lets you remotely control your oscilloscope or exchange measurement or waveform data with a computer. You can control your oscilloscope remotely via the IEEE Std 488.2-1987 (GPIB) interface.

Operation

To set up remote communications, you must ensure that your oscilloscope is physically cabled to the controller and that your oscilloscope's parameters are correctly set. Plug an IEEE Std 488.2-1987 GPIB cable (available as Tektronix part number 012-0991-00) into the 24-pin, D-shell, GPIB connector on your oscilloscope's rear panel, and to the GPIB port on your controller.

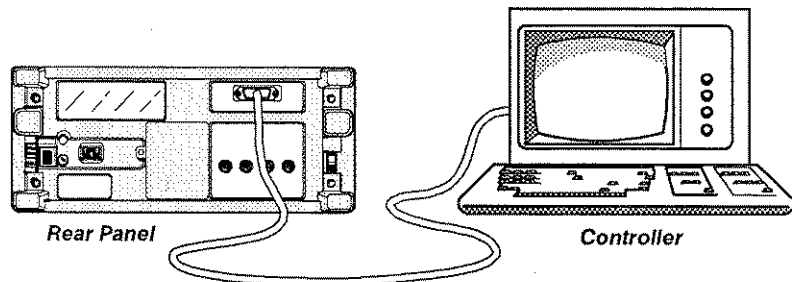

Figure 3-54: Connecting the Digitizing Oscilloscope to a Controller

You set remote communications parameters as follows:

- Step 1:** Press the **UTILITY (SHIFT and then DISPLAY)** button to reach the Utility menu (Figure 3-55).
- Step 2:** Select **System** from the main menu. Choose the **I/O** pop-up item from the resulting pop-up menu.
- Step 3:** Select **Port** from the main menu.
- Step 4:** Select **GPIB** from the Port pop-up menu and **Configure** from the main menu to select the GPIB operating configuration.

The GPIB Configuration side menu, shown below, should appear.

- Step 5:** Select **Talk/Listen Address** for normal, controller-based system operation, **Hardcopy (Talk Only)** for possible use as the instrument's hardcopy port, or **Off Bus**, to disconnect the digitizing oscilloscope from the bus.

The address is defined with the general purpose knob or keypad when **Talk/Listen** is selected.

You may be using GPIB for making hardcopies. The following should happen when you press the hardcopy button:

- If the configuration is **Hardcopy (Talk Only)**, then when the **HARDCOPY** button is pressed, the oscilloscope will send the hardcopy data to any listeners on the bus.
- If the configuration is **Talk/Listen**, then when the **HARDCOPY** button is pressed, an error will occur and you will see a message that the selected hardcopy port is currently unavailable.
- If the configuration is **Off Bus**, then when the **HARDCOPY** button is pressed, an error will occur and you will see a message that the selected hardcopy port is currently unavailable.

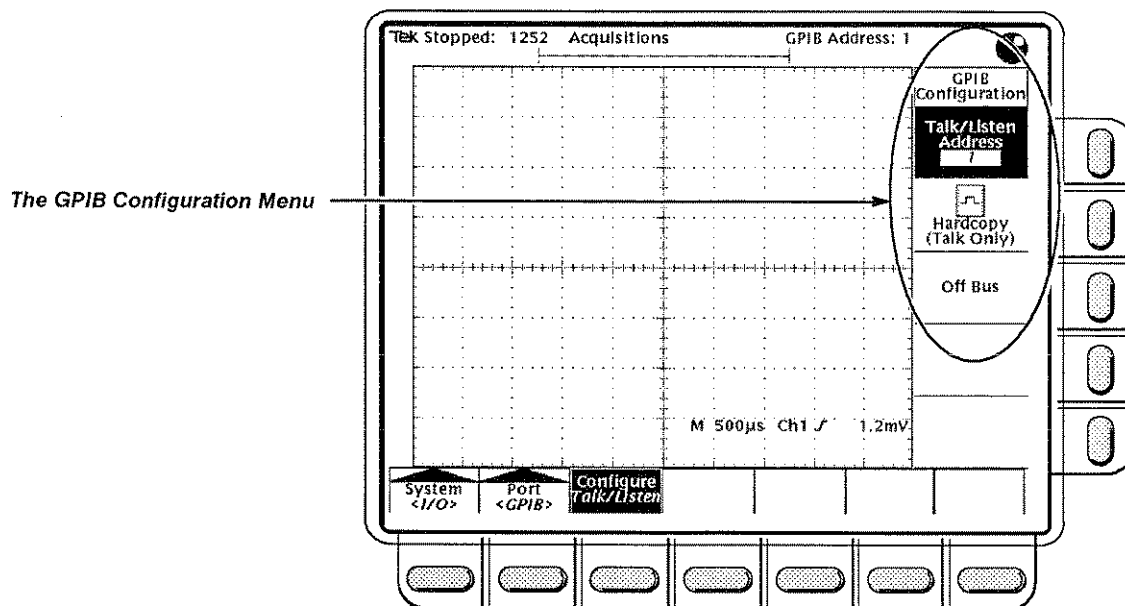

Figure 3-55: Utility Menu

For More Information

See *Remote Communications*, on page 2-35.

See *TDS Digitizing Oscilloscopes Programmer Manual*, Tektronix Part Number 070-8318-00.

Runt Triggering

A runt is a short pulse that crosses one threshold but fails to cross a second threshold before recrossing the first (Figure 3-56). You can set your oscilloscope to detect positive or negative runt pulse crossings.



Figure 3-56: Runt Triggers

Operation

To set up runt triggering:

- Step 1:** Press the **TRIGGER MENU** button to call up the Main Trigger menu (Figure 3-57).
- Step 2:** In the Main Trigger menu, select **Pulse** from the **Type** pop-up menu.
- Step 3:** In the Main Trigger menu, select **Runt** from the **Class** pop-up menu.
- Step 4:** Select the runt source from the four available channels listed in the **Source** side menu (**Ch1**, **Ch2**, **Ch3 (Ax1)** in the TDS 520), or **Ch4 (Ax2)** in the TDS 520)).
- Step 5:** Press **Polarity** on the main menu and define the polarity of the runt (**Positive**, **Negative**, or **Either**) using the **Polarity** side menu.
- Step 6:** Set the upper and lower thresholds for runt detection with the **Thresholds** main menu item, the side menu selections and the keypad or the general purpose knob.
- Step 7:** Set the mode by selecting the **Mode & Holdoff** main menu item and either **Auto** or **Normal** mode from the side menu.
- Step 8:** Set the holdoff by selecting **Mode & Holdoff** from the main menu and **Holdoff** from the resulting side menu. Valid holdoff values are in percent from 0% to 100%. You can use the general purpose knob or the keypad to enter values.

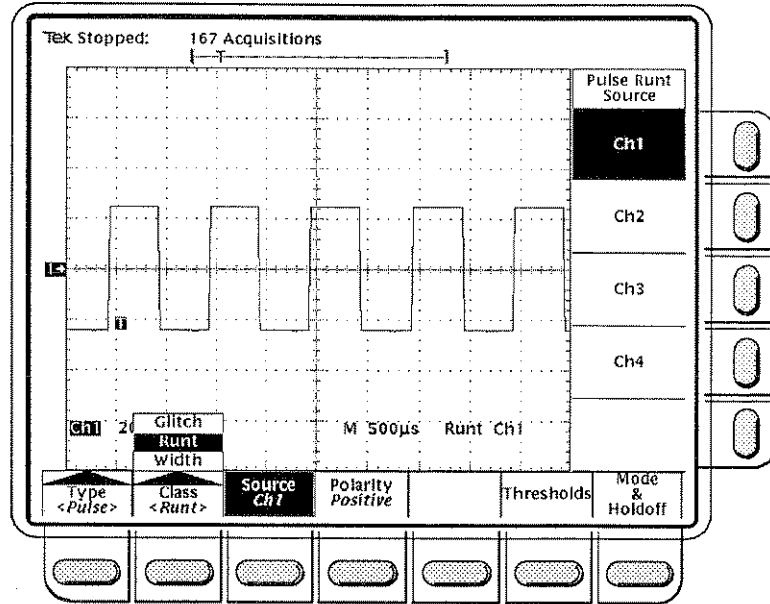

Figure 3-57: Main Trigger Menu – Runt Class

**For More
Information**

See *Triggering*, on page 2-5.



Saving and Recalling Setups

You may want to save and reuse setups for many reasons. For example, after changing the setting during the course of an experiment, you may want to quickly return to your original setup.

You can save and recall up to ten instrument setups from internal oscilloscope memory which retains information even when you turn the oscilloscope power off.

Operation

To operate:

- Step 1:** Press the save/recall **SETUP** button to call up the Save/Recall Setup menu (Figure 3-58).

Saving a Setup

- Step 2:** Press the main menu **Save Current Setup** button. Then press the side menu item corresponding to the reference memory to save to.

This allows direct saving of the current setup into any one of the ten setup storage locations.

Recalling a Setup

- Step 3:** Press the main menu **Recall Saved Setup** button. Then press the side menu item corresponding to the reference memory holding the desired setup (**Recall Setup 1**, **Recall Setup 2** ...).

Recalling a setup will not change the menu that is currently displayed.

Recall Factory Setup

- Step 4:** Press the main menu **Recall Factory Setup** button. Then press the side menu **OK Confirm Factory Init** item.

This allows you to reset your oscilloscope setup to the factory defaults.

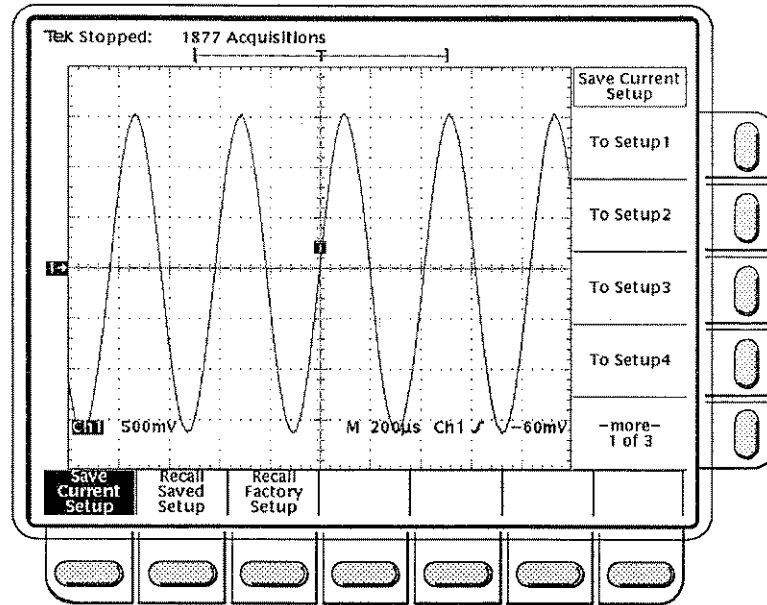

Figure 3-58: Save/Recall Setup Menu

For More Information

See *Tutorial Example 4: Saving Setups*, on page 1-19.

See *Save and Document*, on page 2-31.

See *Factory Initialization Settings*, on page A-91.



Saving and Recalling Waveforms

The digitizing oscilloscope can display up to 11 (9 on the TDS 520) waveforms at one time. This includes four (two on the TDS 520) input channels, four reference memories and three math waveforms.

One example use for storing waveforms is a testing application where you establish a library of known output waveforms from a good device-under-test to compare with a device just off the manufacturing line.

You will find saved waveform descriptions useful when you work with many waveforms and many channels. If you have more waveforms than you want to display, you can save a waveform as a saved description and remove the displayed version. This lets you display another waveform, while keeping the original in a form that you can easily retrieve.

You can store a waveform in one of four internal digitizing oscilloscope memories that remain even when you turn the power off. (This memory is also called non-volatile RAM or NVRAM).

Operation

To operate:

Saving a Waveform

- Step 1:** Press the save/recall **WAVEFORM** button to call up the Save/Recall Waveform menu (Figure 3-59).
- Step 2:** Press the **Save Waveform** main menu button.
- Step 3:** From the side menu, select the reference memory to save the selected waveform to. The side memory lists four references (**To Ref1, To Ref2, To Ref3, To Ref4**).

If you run out of memory when you try to save a waveform, you can choose the **Delete Refs** main menu item and then select the references you no longer need from the side menu (**Delete Ref1, Delete Ref2, Delete Ref3, Delete Ref4** or **Delete All Refs**). You'll know if you run out of memory because the digitizing oscilloscope will display an appropriate message.

The digitizing oscilloscope only lets you save 50,000 points total. Therefore, you can save four 500-, 1000-, 2500-, or 5000-point waveforms. You can save up to three 15000-point waveforms. You can also save combinations of these waveforms providing they contain less than 50000 point total. If you have option 1M, you can save one 50000-point waveform.

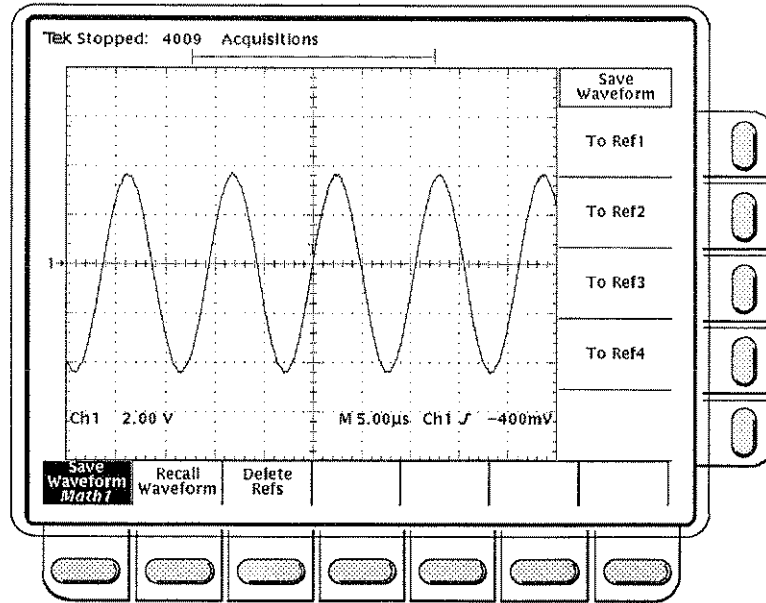

Figure 3-59: Save Waveform Menu

Recalling a Waveform

- Step 1:** Press the **MORE** button to bring up the More menu (Figure 3-60).
- Step 2:** Press the main menu button corresponding to the waveform reference memory to retrieve from (**Ref1, Ref2, Ref3 or Ref4**).

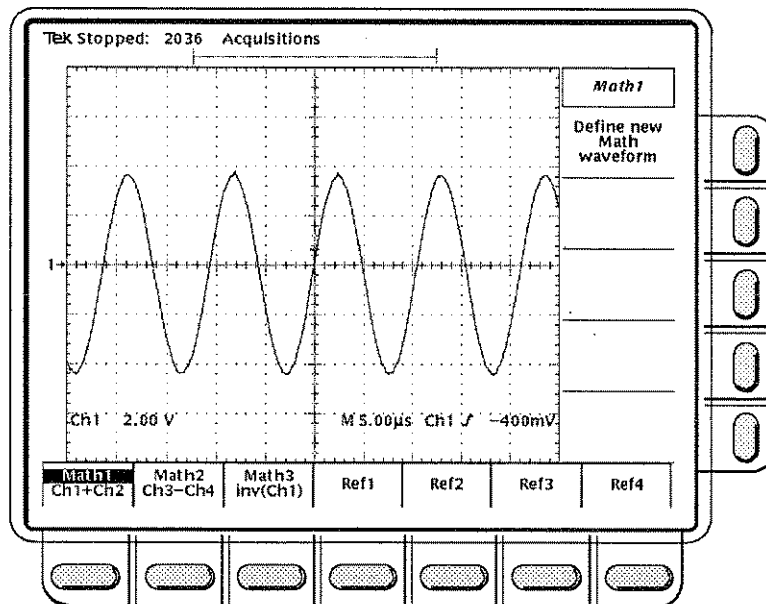

Figure 3-60: More Menu

For More Information

See *Save and Document*, on page 2-31.
 See *Selecting Channels*, on page 3-95.

Selecting Channels

The *selected channel* is the channel that the vertical controls act upon.

Operation

The *channel selection* buttons are on the right of the display and are labeled **CH 1**, **CH 2**, **CH 3 (AUX 1)** on the TDS 520), **CH 4 (AUX 2)** on the TDS 520), and **MORE** (Figure 3-61). They determine which channel is selected for the vertical controls to act upon.

The selected channel is indicated by the lighted LED above each button. The illustration shows Channel 2 as the currently selected channel. The **MORE** button allows you to select virtual channels carrying internally stored *Math* and *Ref* waveforms for display and manipulation.

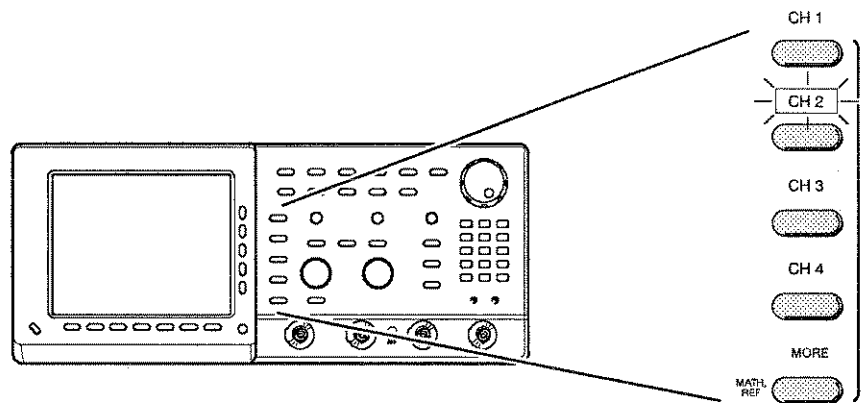

Figure 3-61: Channel Selection Buttons

These buttons are the primary means for pointing to a waveform. Waveform-specific activities, like measurements, are applied to the selected waveform.

Selecting a channel turns it on if it is not already on. This operation is immediate when one of the **CH 1**, **CH 2**, **CH 3 (AUX 1)** on the TDS 520), **CH 4 (AUX 2)** on the TDS 520) buttons is pressed. When you press the **MORE** button, the More menu appears with Math and Ref selections.

Triggering does not use the channel selection buttons. It has its own source selection mechanism embedded in the Main Trigger menu and Delayed Trigger menu.

Removing Waveforms From the Display

The **WAVEFORM OFF** button turns OFF the selected channel's waveform display. This will also turn off any automated measurements on that waveform. You still can, however, use the channel for triggering.

Selecting Channels

When you turn off a waveform, the digitizing oscilloscope automatically selects another waveform. Figure 3-62 shows which waveform will be selected when you turn off a waveform.

You may turn off all waveforms by using the **WAVEFORM OFF** button. The last waveform turned off remains selected.

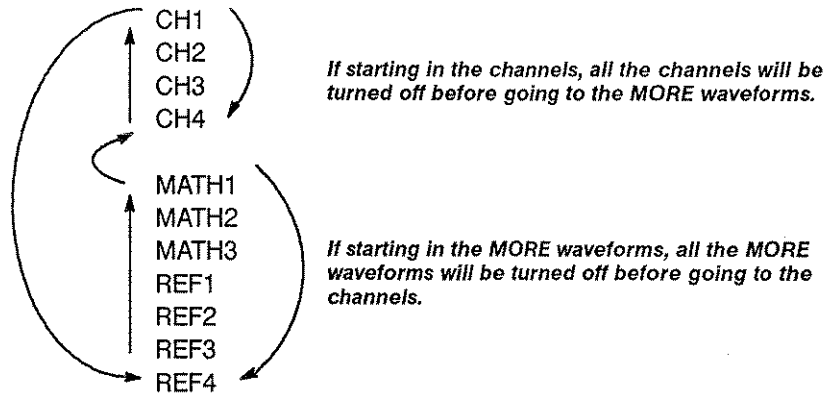

Figure 3-62: Waveform Selection Priority (TDS 540)

Readout

The Channel Readout shows the selected channel in inverse video.

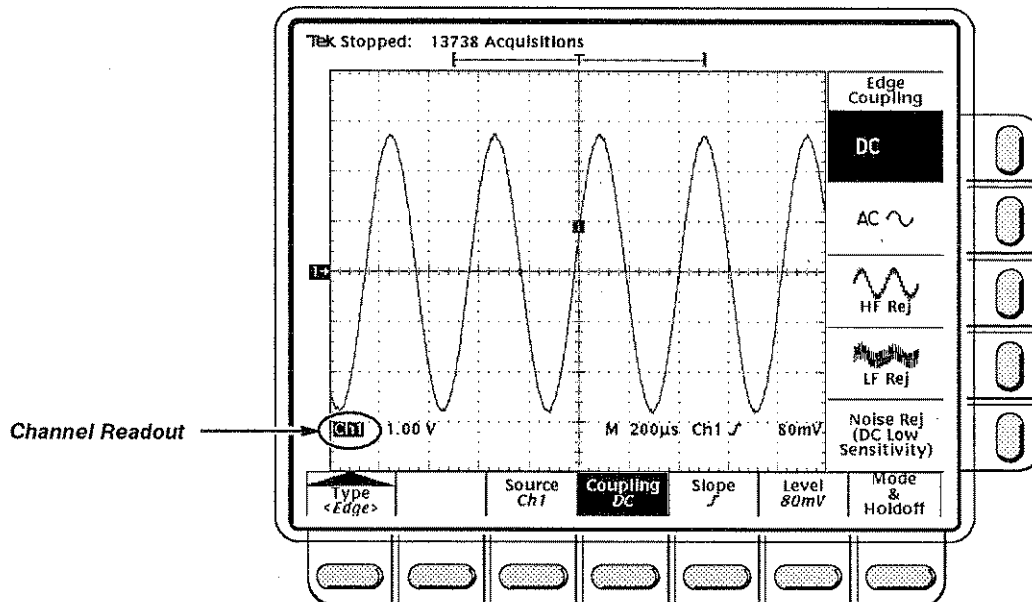

Figure 3-63: The Channel Readout

Status

The status screens provide a snapshot of information about the oscilloscope state. This includes information on settings for triggers, GPIB, waveforms and other systems.

Operation

To operate the status system:

- Step 1:** Press the **STATUS** button (**SHIFT** and **HELP**) to bring up the Status side menu (Figure 3-64).
- Step 2:** Select **System** from the menu to display information about the Horizontal, Zoom, Acquisition, Display, Measure, and Hardcopy systems (Figure 3-64).
- Step 3:** Select **Trigger** from the menu to display information about the parameters of the various triggers (Figure 3-65).
- Step 4:** Select **Waveforms** from the menu to display information about the various waveforms. This includes live, math and reference waveforms (Not shown).
- Step 5:** Select **GPIB** from the menu to display information about the GPIB system (Figure 3-66).

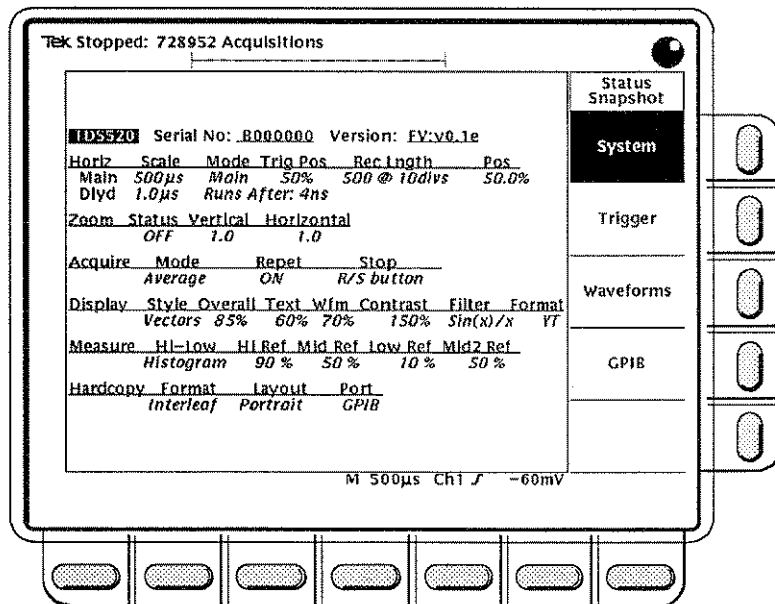

Figure 3-64: Status Menu – System Shown

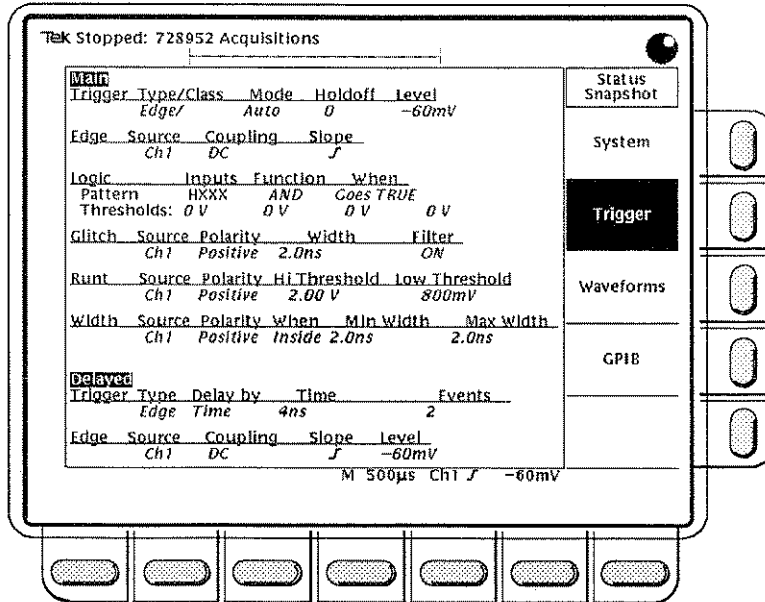

Figure 3-65: Status Menu – Trigger

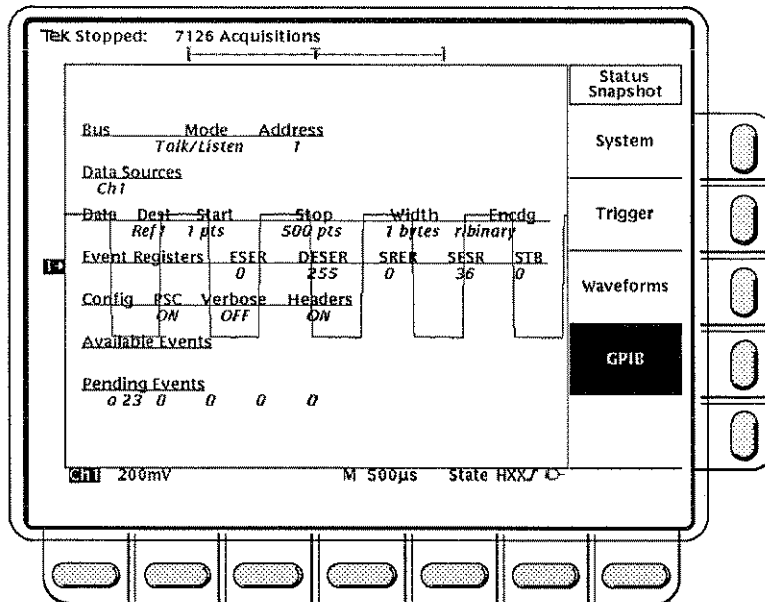

Figure 3-66: Status Menu – GPIB



Trigger Settings

You may want to adjust any of several trigger settings to help you obtain the desired results. These settings include the trigger type, mode, holdoff, and the trigger level.

Type

To select the trigger type:

- Step 1:** Press the **TRIGGER MENU** button to call up the Main Trigger menu.
- Step 2:** Select the appropriate trigger using the main menu **Type (Edge, Logic or Pulse)** and **Class (Pattern, State, Glitch, Runt and Width)** items.
- Step 3:** Select further parameters from the main menu and the resulting side menus.

The trigger types, classes and some related parameters as available on the TDS 500 Series Digitizing Oscilloscopes are:

Table 3-7: Pulse Triggers







Name	Definition
 Glitch positive	Triggering occurs if the scope detects positive spike widths less than the specified glitch time.
 Glitch negative	Triggering occurs if the scope detects negative spike widths less than the specified glitch time.
 Glitch either	Triggering occurs if the scope detects horizontal, positive or negative widths less than the specified glitch time.
 Runt positive	Input values cross one threshold but fail to cross a second threshold before recrossing the first. The crossings detected must be in the increasing direction.
 Runt negative	Input values cross one threshold but fail to cross a second threshold before recrossing the first. The crossings detected must be in the decreasing direction.
 Runt either	Input values cross one threshold but fail to cross a second threshold before recrossing the first. The crossings detected can be in the decreasing or increasing direction.

Table 3-7: Pulse Triggers (Cont.)



Name	Definition
 Width positive	Triggering occurs if the scope finds a positive pulse with a width between, or optionally outside, the user-specified lower and upper time limits.
 Width negative	Triggering occurs if the scope finds a negative pulse with a width between, or optionally outside, the user-specified lower and upper time limits.

Table 3-8: Logic Triggers









Name	Definition
State	The oscilloscope checks for conditions on channels 1, 2 and 3 if channel 4 meets the set condition. If the conditions of 1, 2, and 3 exist then the oscilloscope triggers. (Channels 1,2, and 3 are checked at the time channel 4 goes through its threshold.)
 Clocked AND	Samples the AND combinatorial logic state of inputs from channels 1, 2, and 3 on the specified edge of channel 4's inputs to determine whether to trigger. If ALL the preconditions selected for channels 1, 2, 3 are true, then trigger.
 Clocked NAND	Samples the NAND combinatorial logic state of inputs from channels 1, 2, and 3 on the specified edge of channel 4's inputs to determine whether to trigger. If NOT ALL of the preconditions selected for channels 1, 2, 3 are true then trigger.
 Clocked OR	Samples the OR combinatorial logic state of inputs from channels 1, 2, and 3 on the specified edge of channel 4's inputs to determine whether to trigger. If ANY of the preconditions selected for channels 1, 2, 3 are true then trigger.
 Clocked NOR	Samples the NOR combinatorial logic state of inputs from channels 1, 2, and 3 on the specified edge of channel 4's inputs to determine whether to trigger. If NONE of the preconditions selected for channels 1, 2, 3 are true then trigger.
Pattern	The scope triggers depending on condition of channels 1, 2, 3, and 4.
 AND	If ALL the preconditions selected for channels 1, 2, 3, and 4 are true then trigger.

Table 3-8: Logic Triggers (Cont.)

Name	Definition
 NAND	If NOT ALL of the preconditions selected for channels 1, 2, 3, and 4 are true then trigger.
 OR	If ANY of the preconditions selected for channels 1, 2, 3, and 4 are true then trigger.
 NOR	If NONE of the preconditions selected for channels 1, 2, 3, and 4 are true then trigger.

Mode

You set your trigger mode to *auto* to produce an internal trigger in the absence of other trigger events on the trigger signal. You may also want *normal* mode to make the oscilloscope wait for a valid trigger before acquiring data.

To Set Up Trigger Mode

- Step 1:** Press the **TRIGGER MENU** button to bring up the Main Trigger menu.
- Step 2:** Select the main menu item **Mode & Holdoff**.
- Step 3:** Select the side menu item **Auto** or **Normal**.

Holdoff

Trigger *holdoff* to stabilizes the display. Sometimes you can experience trouble obtaining a meaningful trigger because the signal contains spurious activity between the meaningful activity you want to trigger on. The oscilloscope may trigger on the spurious activity rather than on the meaningful activity. To minimize the chance of this, you can define a blanking or masking time (holdoff) between triggers during which the digitizing oscilloscope will not trigger.

To Set the Holdoff

- Step 1:** Press the **TRIGGER MENU** button to call up the Main Trigger menu.
- Step 2:** Select the main menu item **Mode & Holdoff**.
- Step 3:** Enter the holdoff % into the side menu item labelled **Holdoff** with the general purpose knob or the keypad. Visually check your signal to see it is stable.

Level

To set the trigger level, you can do the following:

To Set An User-Defined Level

You can set the trigger level with the front panel trigger **LEVEL** knob. You can also press the Trigger menu's **Level** main menu item, **Level** from the side menu and enter a value with the general purpose knob or the keypad.

To Set to ECL

You can automatically set the trigger level to the ECL switching threshold by pressing the side menu **Set to ECL** item.

To Set to TTL

You can automatically set the trigger level to the TTL switching threshold by pressing the side menu **Set to TTL** item.

To Set to 50%

When appropriate to the currently defined trigger type, you can press the **SET LEVEL TO 50%** button or the **Set to 50%** side menu item to cause the instrument to search for the point halfway between the peaks of the trigger source signal and set the trigger level to that point. When that is complete, the trigger controls resume their normal operation.

Appropriate trigger types are edge triggers and width or glitch pulse triggers.

NOTE

*The **LEVEL** knob and menu items apply to the main trigger level only. To access the delayed trigger level controls, use the Delayed Trigger menu's **Level** item and corresponding side menu.*

Force Trigger

You force a trigger event if you want the oscilloscope to trigger immediately regardless of whether any other trigger event occurs.

To Force a Trigger Event

Press the **FORCE TRIGGER** front panel button, to cause the oscilloscope to trigger and complete the current acquisition regardless of whether any other triggering event occurs. The oscilloscope recognizes and acts upon **FORCE TRIGGER** even if you press it before the end of pretrigger holdoff.

The **FORCE TRIGGER** button has no effect if the acquisition system is stopped.

If your goal is to wait for and act on the next valid trigger event and stop, as opposed to **FORCE TRIGGER**'s immediate operation, you might want to use the Acquire menu's **Single Acquisition Sequence** option. To use this feature, press the **ACQUIRE MENU** button (**SHIFT** and then **RUN/STOP**) followed by the main menu's **Stop After** selection. Finally, select **Single Acquisition Sequence** from the resulting side menu.

Readouts

The Record View Readout at the top of the display shows the location of the trigger signal in the display and in the waveform record (Figure 3-67).

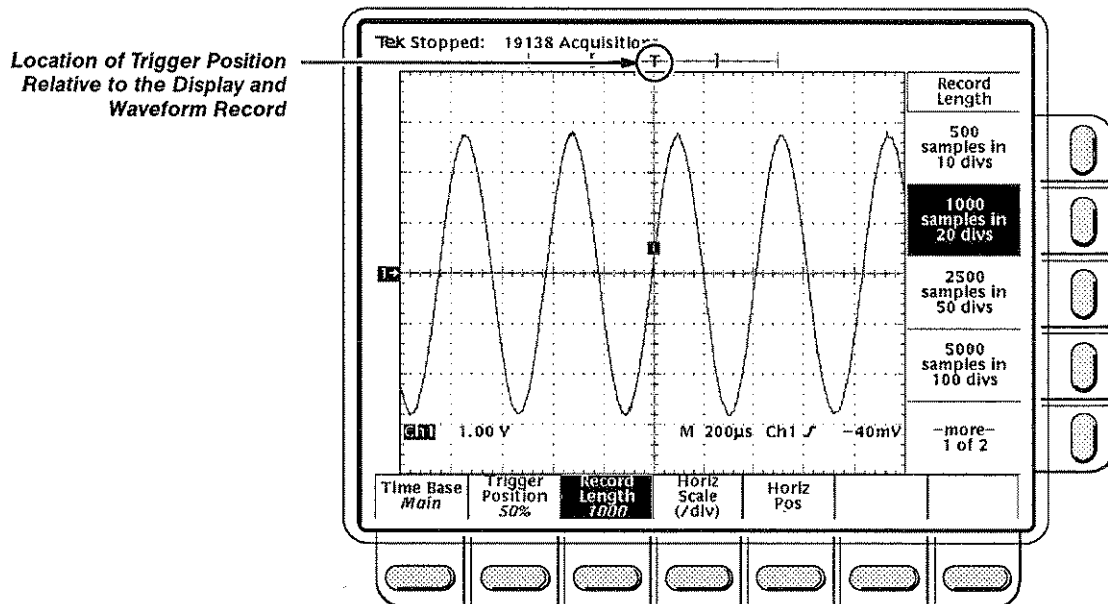

Figure 3-67: Record View Readout Showing Trigger Position

At the bottom of the display, the Trigger readout shows the selected trigger(s) and some key parameters (Figure 3-68).

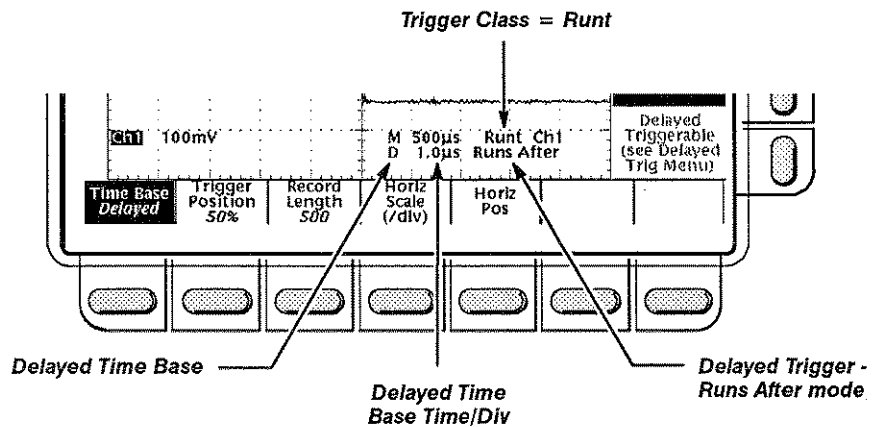
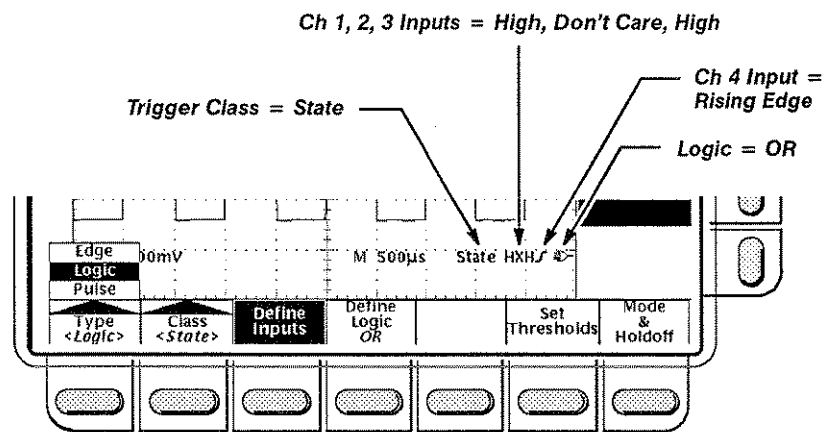
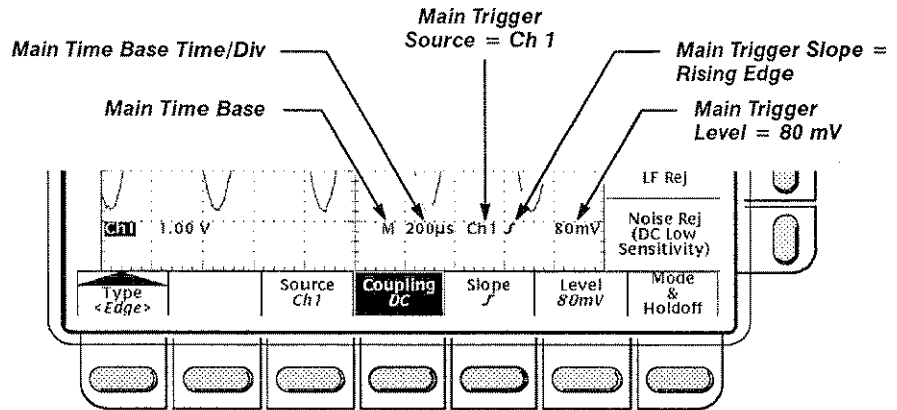

Figure 3-68: Example Trigger Readouts

For More Information

See *Triggering*, on page 2-5.



Vertical Scale and Position

You may want to adjust the vertical size and placement of your displayed waveforms. By changing the size, you can move in or out of a particular portion of a waveform. By adjusting the position, you move the waveform up or down.

The digitizing oscilloscope lets you adjust the position with either the vertical position or the offset controls. Vertical position and offset change where the ground reference point is shown with respect to the graticule. You can use both offset and position interchangeably if you just want to move the waveform up and down on the display.

Position adds screen divisions to the reference point. Adding divisions moves the waveform up and subtracting them moves the waveform down.

Offset adds volts to the reference point. (Adding volts moves the waveform down and subtracting volts moves the waveform up.)

Position is limited to a range of ± 5 divisions. Offset has a wider range. This makes offset useful in cases where a waveform has a DC bias. One example is where you're trying to look at a small ripple on a power supply output. You may be trying to look at a 100 mV ripple on top of a 15 V supply. Offset's range can prove valuable as you try to move and scale the ripple to meet your needs.

Operation

To change the vertical scale and position:

- Step 1:** Select the desired channel to size or position. Do this with the channel selection buttons (to the right of the display).
- Step 2:** Adjust the front-panel vertical **POSITION** and **SCALE** knobs as needed.
- Step 3:** Press the **VERTICAL MENU** button to call up the appropriate vertical menu (Figure 3-69).

This button brings up the menu for the selected waveform. There are two types of vertical menus. One is the Vertical Channel menu, of which there is one for each channel, and the other is the More menu. The menu type depends on the selected waveform.

The More menu is called up either by pressing **MORE** or by pressing **VERTICAL MENU** when the **MORE LED** is lit. The Vertical Channel menu is only directly called up by the **VERTICAL MENU** button. However, if the More menu is already up, pushing any of the **CH1** through **CH4** buttons will switch menus to the appropriate Vertical Channel menu.

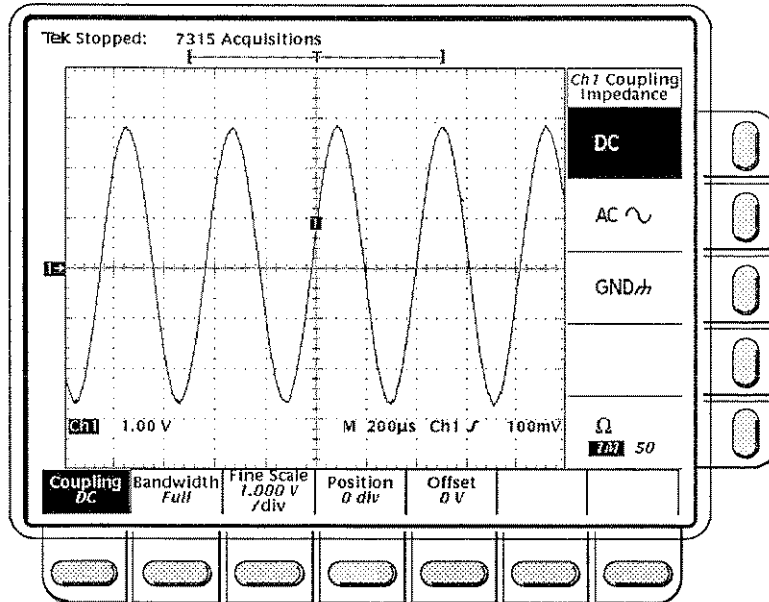

Figure 3-69: Vertical Channel Menu

- Step 4:** Press the main menu **Coupling** item to select the vertical coupling method (from the side menu choices) to attach the input signal to the vertical attenuator. The choices are static and only one is allowed at a time. Also, the side menu allows selection of the input impedance. You can choose 50 Ω or 1 M Ω .
- Step 5:** Press the main menu **Bandwidth** item to select one of the preamp bandwidth filters. Side menu choices are: **Full**, **20 MHz**, and **100 MHz**.
- Step 6:** Press the main menu **Fine Scale** item to attach fine control of the vertical scale to the general purpose knob. Only the top item in the side menu contains an entry. It shows the setting of the **Fine Scale** parameter. The menu readout and the normal scale factor readout of volts/division will reflect the finely calibrated volts/division.
- Step 7:** Press the main menu **Position** to attach control of the vertical **Position** to the general purpose knob. The **Set to Zero** selection is a momentary selection which resets the position to zero.
- Step 8:** Press the main menu **Offset** item to attach control of the vertical **Offset** to the general purpose knob. The **Set to Zero** side menu selection is a momentary selection which resets the offset to zero.

For More Information

See *Scaling Waveforms*, on page 2-13.

Waveform Math

You can mathematically manipulate your waveforms. For example, imagine you had a waveform of interest clouded by background noise and wanted a cleaner waveform. You could obtain the cleaner waveform by subtracting a waveform with just the background noise from your original waveform.

Operation

To perform waveform math:

- Step 1:** Press the **MORE** button to bring up the More menu (Figure 3-70). The More menu allows you to display, define and manipulate three math functions.

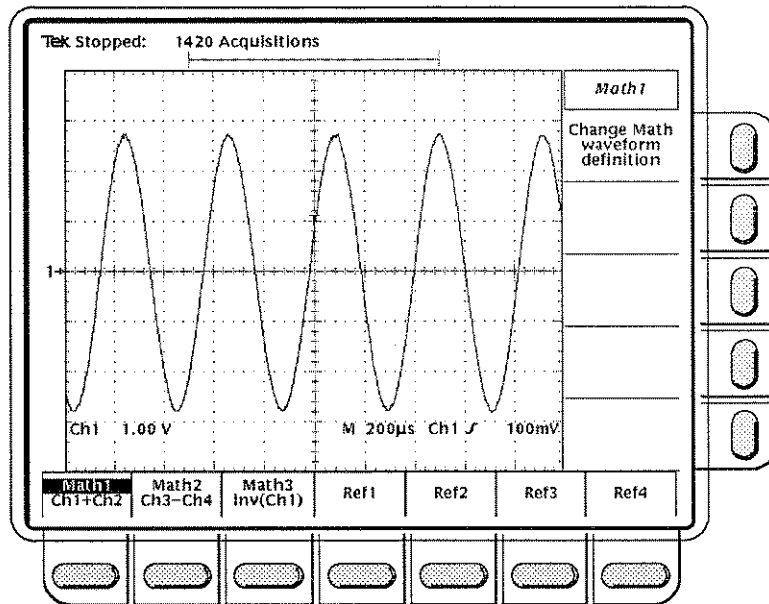

Figure 3-70: More Menu

Math1, Math2, and Math3:

- Step 2:** Press the main menu key corresponding to the math waveform you wish to display or change. You can choose **Math1**, **Math2**, or **Math3** (Figure 3-70).
- Step 3:** Press the side menu **Change Math waveform definition** key to bring up a second set of main and side menus to alter the present math waveform definition (Figure 3-70).

- **Step 4:** Select **Single Wfm Math** or **Dual Wfm Math** from the main menu. Choose the waveform(s) to operate on and the operator to use from the resulting side menus (Figure 3-71).
- For Single Wfm Math, you can select **Set Function to**. The only argument choice is **inv** (inverse). This takes the inverse of the source waveform. You can also define the source waveform by toggling the **Set Single Source to** item or by selecting this item and using the general purpose knob. When you're ready to perform the function, press the **OK Create Math Wfm** item.
- For Dual Wfm Math, you can select the sources with the **Set 1st Source to** and **Set 2nd Source to** items. Enter the sources by toggling the relevant button or by using the general purpose knob. Enter the math operator to use on the sources by selecting the **Set operator to** item. Enter the operator by toggling in the values or turning the general purpose knob. Supported operators are +, -, and *. To perform the function, press the **OK Create Math Wfm** item.

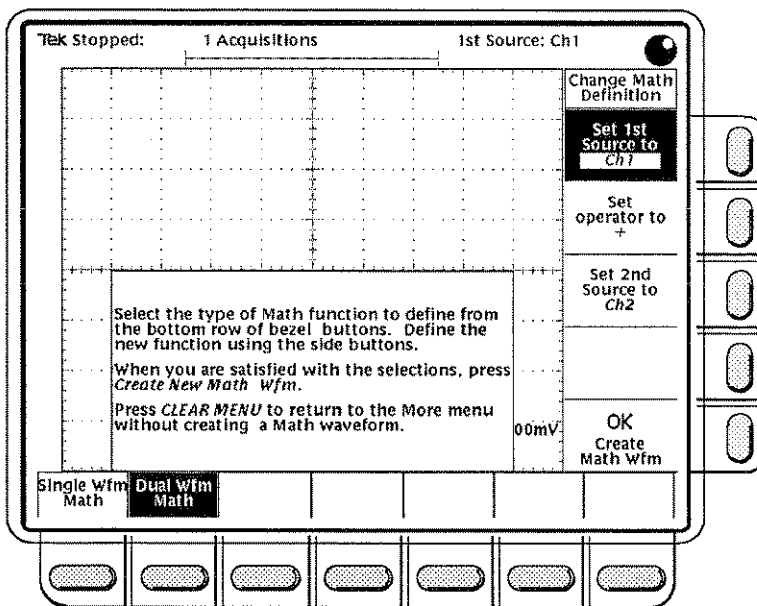

Figure 3-71: Dual Waveform Math Main and Side Menus

Zoom

At times, you may want to expand or contract a waveform on the display without changing the acquisition parameters. You can do this with the zoom feature.

Operation

When you turn on the zoom feature, the vertical and horizontal scale and position controls cease to have any effect on the acquisition hardware. Instead, they control the displayed size and position of waveforms, allowing them to be expanded, contracted, and repositioned on screen.

To use zoom:

- Step 1:** Press the **ZOOM** button. The Zoom side menu will appear (Figure 3-72).

The Zoom menu is unique in that it displays itself totally along the side (vertical) menu. There are no choices at all along the main (horizontal) axis.

Zoom mode selected but no zooming has occurred – the waveforms are still at their pre-zoom size.

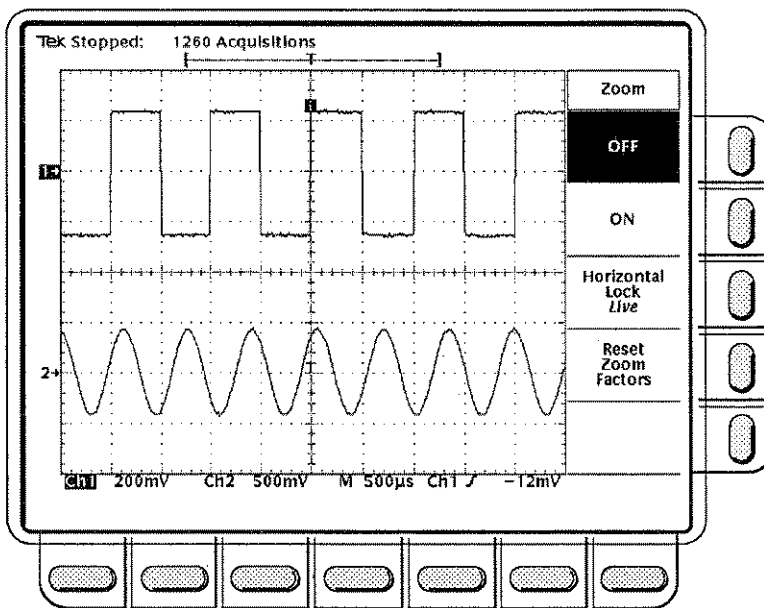

Figure 3-72: Zoom Menu

- Step 2:** Press the side menu **ON** item. The label above the **ZOOM** front-panel button should light.

Horizontal Lock

Toggle **Horizontal Lock** to **None**. In this mode, only the selected waveform is affected by horizontal zoom changes (Figure 3-73). Toggle **Horizontal Lock** to **Live**. In this mode, all acquired waveforms are zoomed together in a locked state. That is, they all have the same zoom parameters. All the waveforms are magnified and positioned together (Figure 3-74).

Reset Zoom

To reset all zoom factors to their defaults, press the **Reset Zoom Factors** side menu choice. The defaults are as follows:

Table 3-9: Zoom Defaults

Parameter	Setting
Zoom Vertical Position	0
Zoom Vertical Gain	1X
Zoom Horizontal Position	Tracking Horizontal Position
Zoom Horizontal Gain	1X

- Step 3:** Press **Zoom Off** to return to normal oscilloscope (non-zoom) operation.

Zoom mode selected with Horizontal Lock set to None and Horizontal Scale knob turned – Only the selected waveform changes size.

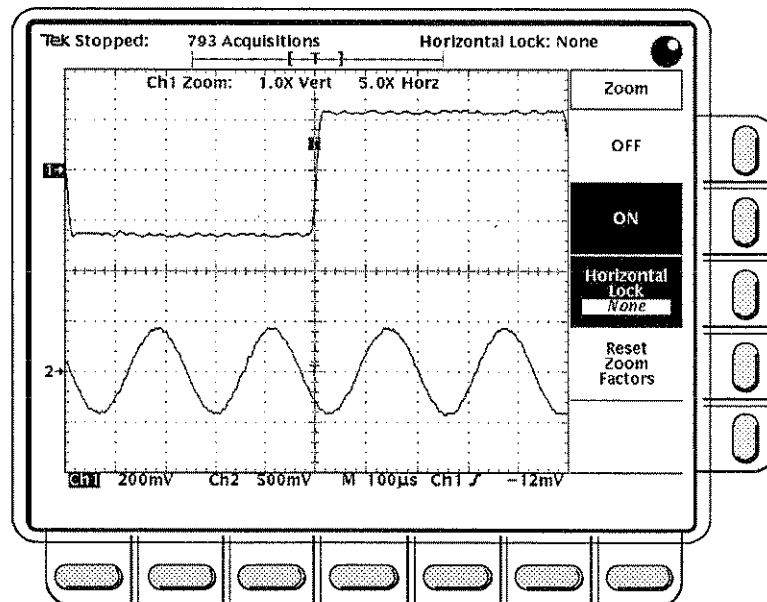

Figure 3-73: Zoom Mode and Horizontal Lock Set to None

Zoom mode selected with Horizontal Lock set to Live and Horizontal Scale knob turned – All the displayed waveforms (except reference ones) change size.

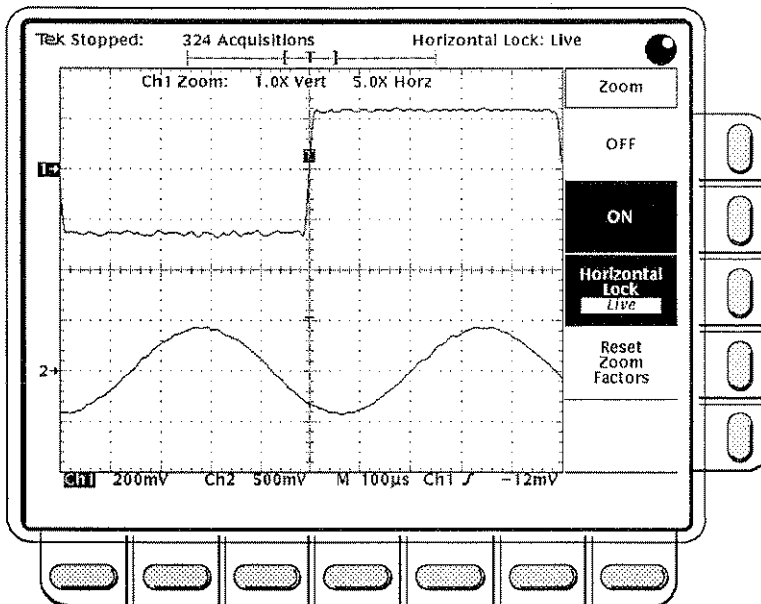

Figure 3-74: Zoom Mode and Horizontal Lock Set to Live





Appendix A: Options and Accessories

This section describes the various options as well as the standard and optional accessories that are available for the TDS 520 and TDS 540 Digitizing Oscilloscopes.

Options

Options include:

Options A1–A5: International Power Cords

Besides the standard North American, 110 V, 60 Hz power cord, Tektronix ships any of five alternate power cord configurations with the oscilloscope when ordered by the customer.

Table A-1: International Power Cords

Option	Power Cord
A1	Universal European – 220 V, 50 Hz
A2	UK – 240 V, 50 Hz
A3	Australian – 240 V, 50 Hz
A4	North American – 240 V, 60 Hz
A5	Switzerland – 220 V, 50 Hz

Option 1M: 50,000 Point Record Length

This option provides a maximum record length of 50,000 points per acquisition (50,000/channel).

Option 1R: Rackmounted Digitizing Oscilloscope

Tektronix ships the digitizing oscilloscope, when ordered with Option 1R, configured for installation in a 19 inch wide instrument rack. Customers with instruments not configured for rackmounting can order a rackmount kit (016-1136-00 for field conversions).

Instructions for rackmounting the digitizing oscilloscope are shipped with the rackmount kit or the option 1R.

Rackmounted instruments include holes in their front panels for mounting connectors. You can route signals found at rear-panel connectors to front-panel connectors you install in use these holes. You must provide the cables and connectors to implement such through-panel access. However, you can order them separately as catalog items from Tektronix, Inc.

Option 22: Additional Probes

With this option, Tektronix ships two additional probes identical to the two standard-accessory P6139A probes normally shipped with the instrument. This provides one probe for each front-panel input.

Option 1P: HC100 4 Pen Plotter

With this option, Tektronix ships a four-color plotter designed to make waveform plots directly from the digitizing oscilloscope without requiring an external controller. It handles A4 and US letter size media.

Option 9C: Certificate of Calibration and Test Data Report

Tektronix ships a Certificate of Calibration which states this instrument meets or exceeds all warranted specifications and has been calibrated using standards and instruments whose accuracies are traceable to the National Institute of Standards and Technology, an accepted value of a natural physical constant or a ratio calibration technique. The calibration is in compliance with US MIL-STD-45662A. This option also includes a test data report for the instrument.

Standard Accessories

The following standard accessories are included with the digitizing oscilloscope:

Table A-2: Standard Accessories

Accessory	Part Number
Tutorial/User Manual	070-8317-00
Programmer Manual	070-8318-00
Quick Reference	070-8316-00
Front Cover	200-3696-00
U.S. Power Cord	161-0230-01
Probes (qty. two) P6139A 10X Passive	P6139A (single unit)

Probe Accessories

These are accessories to the standard probe listed previously (P6139A). Except for the probe-tip-to-circuit board adapter, they can also be ordered separately.

Table A-3: Probe Accessories

Accessory	Part Number
Retractable Hook Tip	013-0107-06
Body shell, tip cover	204-1049-00
Probe-Tip-to-Circuit Board Adapter (qty. two standard, optionally available in package of 25 as 131-5031-00)	No customer orderable part number for double unit
6 Inch Slip-On Ground Lead	196-3113-02
Low Inductance Ground Lead	195-4240-00
Marker Rings Set (qty. eighteen rings which includes two each of nine colors)	016-0633-00
Ground collar	343-1003-01
6 Inch Alligator Clip Ground Lead	196-3305-00
Screwdriver: adjustment tool, metal tip	003-1433-00
SMT KlipChip™	206-0364-00
Accessory pouch	016-0708-00

Optional Accessories

You can also order the following optional accessories:

Table A-4: Optional Accessories

Accessory	Part Number
TDS 520 Service Manual	070-8312-00
TDS 540 Service Manual	070-8314-00
Plotter (GPIB and Centronics Standard)	HC100
Oscilloscope Cart	K218
Rack Mount Kit (for field conversion)	016-1136-00
Oscilloscope Camera	C9
Oscilloscope Camera Adapter	016-1145-00
Soft-Sided Carrying Case	016-0909-01
Transit Case	016-1135-00
GPIB Cable (1 meter)	012-0991-01
GPIB Cable (2 meter)	012-0991-00

Accessory Probes

The following optional accessory probes are recommended for use with your digitizing oscilloscope:

- P6101A 1X, 15 MHz, Passive probe.
- P6156 10X, 3.5 GHz, Passive, low capacitance, (low impedance Zo) probe. Option 25 provides 100X.
- P6009 Passive, high voltage probe, 100X, 1500 VDC + Peak AC
- P6015 Passive extra high voltage probe, 1000X, 20 kVDC + Peak AC (40 kV peak for less than 100 ms)
- P6205 750 MHz probe bandwidth. Active (FET) voltage probe.
- P6204 Active, high speed digital voltage probe. FET. DC to 1 GHz. DC offset. 50 Ω input. Use with 1103 Tekprobe Power Supply for offset control.
- P6046 Active, differential probe, 1X/10X, DC to 100 MHz, 50 Ω input.
- A6501 Buffer Amplifier (active fixtured), 1 GHz, 1 M Ω , 10X.
- P6501 Option 02: Microprobe with TekProbe power cable (active fixtured), 750 MHz, 1 M Ω , 10X.
- AM 503S – DC/AC Current probe system, AC/DC. Uses A6302 Current Probe.
- AM 503S Option 03: DC/AC Current probe system, AC/DC. Uses A6303 Current Probe.
- P6021 AC Current probe. 120 Hz to 60 MHz.
- P6022 AC Current probe. 935 kHz to 120 MHz.
- CT-1 Current probe – designed for permanent or semi-permanent in-circuit installation. 25 kHz to 1 GHz, 50 Ω input.
- CT-2 Current probe – designed for permanent or semi-permanent in-circuit installation. 1.2 kHz to 200 MHz, 50 Ω input.
- CT-4 Current Transformer – for use with the AM 503S (A6302) and P6021. Peak pulse 1 kA. 0.5 Hz to 20 MHz with AM 503S (A6302).
- P6701A Opto-Electronic Converter, 500 to 950 nm, DC to 850 MHz
1 V/mW.
- P6703A Opto-Electronic Converter, 1100 to 1700 nm, DC to 1 GHz
1 V/mW.
- P6711 Opto-Electronic Converter, 500 to 950 nm, DC to 250 MHz 5 V/mW.
- P6712 Opto-Electronic Converter, 1100 to 1700 nm, DC to 300 MHz.
5 V/mW.
- TVC 501 Time-to-voltage converter. Time delay, pulse width and period measurements.

Probe Accessories

The following optional accessories are recommended for use with the standard probe listed under *Standard Accessories*.

Table A-5: Probe Accessories

Accessory	Part Number
Connector, BNC: BNC to Probe Tip Adapter	013-0226-00
Connector, BNC: 50 Ω , BNC to Probe Tip Adapter	013-0227-00
Connector, Probe: Package of 100, compact	131-4244-00
Connector, Probe: Package of 25, compact	131-5031-00
Screwdriver Adjustment Tool, Package of five	003-1433-01
Compact-to-Miniature Probe Tip Adapter	013-0202-02
Probe Tip Holder: (holds three tips)	352-0670-00
3 Inch Slip-On Ground Lead	196-3113-03
Probe Holder: Black ABS	352-0351-00
IC Protector Tip, Package of 10	015-0201-07
IC Protector Tip, Package of 100	015-0201-08
Marker Ring Set: Two each of nine colors	016-0633-00
SMT KlipChip™: 20 Adapters	SMG50
Low-inductance Spring-Tips: Two each of five different springs and insulator	016-1077-00
Probe Tip-to-Chassis Adapter	131-4210-00

NOTE

The next four items below can only be used with the Compact-to-Miniature Probe Tip Adapter.

Dual-Lead Adapter	015-0325-00
BNC-to-Probe Tip Adapter	013-0084-01
G.R.-to-Probe Tip Adapter, 50 Ω	017-0088-00
Bayonet Ground Assembly	013-0085-00

Accessory Software

The following optional accessories are Tektronix software products recommended for use with your digitizing oscilloscope:

Table A-6: Accessory Software

Software	Part Number
EZ-Test Program Generator	S45F030
Wavewriter: AWG and waveform creation	S3FT400
TekTMS: Test management system	S3FT001
LabWindows	S3FG910

Warranty Information

Check for the full warranty statements for this product, the probes, and the products listed above on the back of each product manual's title page.



Appendix B: Specification

This subsection begins with a general description of the traits of the TDS 520 and TDS 540 Digitizing Oscilloscope. Three subsections follow, one for each of three classes of traits: *nominal traits*, *warranted characteristics*, and *typical characteristics*.

General Product Description

The Tektronix TDS 520 and 540 Digitizing Oscilloscopes are both portable, four-channel instruments suitable for use in a variety of test and measurement applications and systems. Key differences between the two models are as follows:

- The TDS 540 supplies four full-featured vertical channels. The TDS 520 supplies two full-featured channels; the remaining two channels are auxiliary channels with fewer vertical scale factors.
- The TDS 540 acquires all four channels simultaneously; the TDS 520 can acquire any two channels at the same time.
- The TDS 540 has a maximum digitizing rate of 1 Gigasample/second with an analog bandwidth of 500 MHz; the TDS 520 has a maximum digitizing rate of 500 Megasample/second with an analog bandwidth of 500 MHz.

Key features they have in common are:

- Selectable record lengths of 500 to 15,000 points. A 50,000-point record length is available with the 1M option.
- Extensive triggering capabilities: such as edge, logic, and glitch.
- Full programmability and printer/plotter output.
- Advanced functions like continuously updated measurements.
- Specialized display modes, such as infinite and variable persistence.
- A unique graphical user interface (GUI), an on-board help mode, and a logical front-panel layout which combine to deliver a new standard in usability.

User Interface

This digitizing oscilloscope uses a combination of front-panel buttons, knobs, and on-screen menus to control its many functions. The front-panel controls are grouped according to function: vertical, horizontal, trigger, and special. Within each group, any function likely to get adjusted often, such as vertical positioning, or the time base setting, is set directly by its own front-panel knob.

Menus

Those functions for which control settings are usually changed less often, such as vertical coupling and horizontal mode, are set indirectly. That is, pressing one (sometimes two) front-panel button, such as vertical menu, displays a menu of functions at the bottom of the screen that are related to that button. (For the button vertical menu, the menu displayed contains the functions such as coupling, bandwidth, etc.) Using the buttons below this *main* menu to select a function, such as coupling, displays a *side* menu of settings for that function, such as AC, DC, or GND (ground) coupling, at the right side of the screen. Use the buttons to the right of the menu to select a setting, such as DC.

Indicators

Several on-screen readouts help you keep track of the settings for various functions, such as vertical and horizontal scale and trigger level. There are also readouts to display the results of measurements made using cursors or using the automatic parameter extraction feature (called measure) and readouts to display the status of the instrument.

General Purpose Knob

Menus can also be used to assign the general purpose knob to adjust a selected parameter function. The method employed is the same as for *selecting* a function, except the final selection in the side menu causes the general purpose knob to *adjust* some function, such as the position of measurement cursors on screen, or the setting for a channel's fine gain.

GUI



The user interface also makes use of a GUI, or Graphical User Interface, to make setting functions and interpreting the display more intuitive. Some menus and status are displayed using iconic representations of function settings such as those shown here for full, 100 MHz, and 20 MHz bandwidth. Such icons allow you to more readily determine status or the available settings.

Signal Acquisition System

TDS 520

The signal acquisition system of the TDS 520 provides four vertical channels: two full-featured vertical channels (CH 1 and CH 2) with calibrated vertical scale factors from 1 mV to 10 V per division, plus two auxiliary channels (AUX 1 and AUX 2) with three calibrated vertical scale factors of 100 mV, 1 V, and 10 V per division. Any two of the four channels can be acquired simultaneously.

Each of the four channels can be displayed, vertically positioned, and offset; CH 1 and CH 2 can also have their bandwidth limited (100 MHz or 20 MHz) and their vertical coupling specified. Fine gain can also be adjusted for CH 1 and CH 2.

TDS 540

The signal acquisition system of the TDS 540 provides four vertical channels. All four channels have calibrated vertical scale factors from 1 mV to 10 V per division; all four channels can be acquired simultaneously.

Each channel can be displayed and/or bandwidth limited (100 MHz or 20 MHz), its vertical position, fine gain, and offset can be adjusted, and its vertical coupling can be specified.

Both Models

Besides the four channels, up to three math waveforms and four reference waveforms are available for display. (A math waveform results when you specify dual waveform operations, such as add, on any two channels; a reference waveform results when you save a live waveform in a reference memory.)

Horizontal System

There are three horizontal display modes: main only, main intensified, and delayed only. You can select among various horizontal record length settings (see Table A-7).

Table A-7: Record Length vs Divisions per Record

Record Length ^{1, 2}	Divisions per Record (50 Points/Division)
50000	1000 divs
15000	300 divs
5000	100 divs
2500	50 divs
1000	20 divs
500	10 divs

¹The 50,000 points in 1,000 division record is only available with Option 1M.

²The maximum record length of 15,000 points (50,000 points with Option 1M) is selectable with all acquisition modes except Hi Res. In Hi Res, the maximum record length is 5,000 points (15,000 points with Option 1M).

Both the delayed only display and the intensified zone on the main intensified display may be delayed by time with respect to the main trigger. Both can be set to display immediately after the delay (delayed runs after main mode); the delayed display can also be set to display at the first valid trigger after the delay (delayed triggerable mode).

The delayed display (or the intensified zone) may also be delayed by a selected number of events. In such a case, the events source is the delayed trigger source. For any events signal, the delayed-trigger system conditions the signal by determining the source, coupling, etc., of that signal.

Trigger System

The triggering system comprises a rich set of features for triggering the signal-acquisition system. Types of trigger signals recognized include:

- **Edge** (main- and delayed-trigger systems): This familiar type of triggering is fully configurable for source, slope, coupling, mode (auto or normal), and holdoff.
- **Logic** (main-trigger system): This type of triggering can be based on pattern (asynchronous) or state (synchronous). In either case, logic triggering is configurable for sources, for Boolean operators to apply to those sources, for logic pattern or state on which to trigger, for mode (auto or normal), and for holdoff.
- **Pulse** (main-trigger system): Pulse triggering is configurable for triggering on runt or glitch pulses, or on pulse widths, or periods inside or outside limits that you specify. It is also configurable for source, polarity, mode, and holdoff.

You can choose where the trigger point is located within the acquired waveform record by selecting the amount of pretrigger data displayed. Presets of 10%, 50%, and 90% of pretrigger data can be selected in the horizontal menu, or the General Purpose knob can be assigned to set pretrigger data to any value within the limits of trigger position resolution.

Acquisition Control

Depending on your measurement requirements, you can specify the mode and manner in which signals are acquired and processed:

- You can select equivalent-time sampling on repetitive signals or interpolation of points sampled on non-repetitive signals. Both can increase the apparent sample rate on the waveform when maximum real-time rates are reached.
- Peak-detect, high-resolution, sample, envelope, and average modes can be used to acquire signals.
- The acquisition can be set to stop after a single acquisition (or sequence of acquisitions if acquiring in average or envelope modes).

On-Board User Assistance

Two features that help you set up this digitizing oscilloscope to make your measurements are help and autoset.

Help

Displays operational information about any front-panel control. When help mode is in effect, manipulating any front-panel control causes the digitizing oscilloscope to display information about that control. When help is first invoked, an introduction to help is displayed on screen.

Autoset

Automatically sets up the digitizing oscilloscope for a viewable display based on the input signal.

Measurement Assistance

Once you have set up to make your measurements, the features cursor and measure can help you quickly make those measurements.

Cursor

Two types of cursors are provided for making parametric measurements on the displayed waveforms. Voltage can be measured between the positions of H Bar (horizontal) cursors and time can be measured between V Bar (vertical) cursors. These are delta measurements; that is, measurements based on the difference between two cursors.

Both V Bar and H Bar cursors can also be used to make absolute measurements – measurements relative to a defined level or event. In the case of the V Bars, either cursor can be selected to read out its voltage with respect to any channel's ground reference level; in the case of the H Bars, its time with respect to the trigger point (event) of the acquisition.

For time measurements, units can be either seconds or Hz (for 1/time).

Measure

Measure can automatically extract parameters from the signal input to the digitizing oscilloscope. Any four out of the more than 20 parameters available can be displayed to the screen. The displayed parameters are extracted continuously and the results updated on-screen as the digitizing oscilloscope continues to acquire waveforms.

Digital Signal Processing (DSP)

An important component of the multiprocessor architecture of this digitizing oscilloscope is Tektronix's proprietary digital signal processor, the DSP. This dedicated processor supports advanced analysis of your waveforms when

doing such compute-intensive tasks as interpolation, waveform math, and signal averaging. It also teams with a custom display system to deliver specialized display modes (See *Display*, later in this description.)

Storage and I/O

Acquired waveforms may be saved in any of four nonvolatile REF (reference) memories. Any or all of the saved waveforms may be displayed for comparison with the waveforms being currently acquired.

The source and destination of waveforms to be saved may be chosen. Assignment can be made to save any of the four channels to any REF memory or to move a stored reference from one REF memory to another. Reference waveforms may also be written into a REF memory location via the GPIB interface.

The digitizing oscilloscope is fully controllable and capable of sending and receiving waveforms over the GPIB interface (IEEE Std 488.1-1987 and IEEE Std 488.2-1987 standard). This feature makes the instrument ideal for making automated measurements in a production or research and development environment that calls for repetitive data taking. Self-compensation and self-diagnostic features built into the digitizing oscilloscope to aid in fault detection and servicing are also accessible using commands sent from a GPIB controller.

Another standard feature is hardcopy. This feature allows you to output waveforms and other on-screen information to a variety of graphic printers and plotters from the digitizing oscilloscope front panel, providing hardcopies without requiring you to put the digitizing oscilloscope into a system-controller environment. The hardcopies obtained are WYSIWYG (What-You-See-Is-What-You-Get), based on what is displayed at the time hardcopy is invoked.

Display

The TDS 540 Digitizing Oscilloscope offers flexible display options. You can customize the following attributes of your display:

The TDS 520 and 540 Digitizing Oscilloscopes offer flexible display options. You can customize the following attributes of your display:

- Intensity: waveforms, readouts, graticule, etc.
- Style of waveform display(s): vectors or dots, intensified or non-intensified samples, and infinite or variable persistence
- Display format: XY or YT and graticule type

Zoom

This digitizing oscilloscope also provides an easy way to focus in on those waveform features you wish to examine up close. By invoking zoom, you can magnify the waveform parameter using the vertical and horizontal controls to expand (or contract) and position it for viewing.

Nominal Traits

This subsection contains a collection of tables that list the various *nominal traits* that describe the TDS 520 and 540 Digitizing Oscilloscopes. (Traits that differ according to model or only apply to one model are preceded by the appropriate model number, TDS 520 or TDS 540, in the tables.) Included are electrical and mechanical traits.

Nominal traits are described using simple statements of fact such as “Four, all identical” for the trait “Input Channels, Number of”, rather than in terms of limits that are performance requirements.

Table A-8: Nominal Traits – Signal Acquisition System

Name	Description								
Bandwidth Selections	20 MHz, 100 MHz, and FULL (500 MHz)								
TDS 540: Digitizers, Number of	Four, all identical								
TDS 520: Digitizers, Number of	Two, both identical								
Digitized Bits, Number of	8 bits ¹								
TDS 540: Input Channels, Number of	Four, all identical								
TDS 520: Input Channels, Number of	Two full-featured (CH 1 and CH 2), plus two limited, auxiliary inputs (AUX 1 and AUX 2)								
Input Coupling ²	DC, AC, or GND								
Input Impedance Selections	1 M Ω or 50 Ω								
TDS 540: Ranges, Offset, All Channels	<table border="1"> <thead> <tr> <th>Volts/Div Setting</th> <th>Offset Range</th> </tr> </thead> <tbody> <tr> <td>1 mV/div–99.5 mV/div</td> <td>± 1 V</td> </tr> <tr> <td>100 mV/div–995 mV/div</td> <td>± 10 V</td> </tr> <tr> <td>1 V/div–10 V/div</td> <td>± 100 V</td> </tr> </tbody> </table>	Volts/Div Setting	Offset Range	1 mV/div–99.5 mV/div	± 1 V	100 mV/div–995 mV/div	± 10 V	1 V/div–10 V/div	± 100 V
Volts/Div Setting	Offset Range								
1 mV/div–99.5 mV/div	± 1 V								
100 mV/div–995 mV/div	± 10 V								
1 V/div–10 V/div	± 100 V								
TDS 520: Ranges, Offset, CH 1 and CH 2	Same as is listed for the TDS 540								
TDS 520: Ranges, Offset, AUX 1 and AUX 2	<table border="1"> <thead> <tr> <th>Volts/Div Setting</th> <th>Offset Range</th> </tr> </thead> <tbody> <tr> <td>50 mV/div & 100 mV/div</td> <td>± 0.5 V</td> </tr> <tr> <td>500 mV/div & 1 V/div</td> <td>± 5.0 V</td> </tr> <tr> <td>5 V/div & 10 V/div</td> <td>± 50 V</td> </tr> </tbody> </table>	Volts/Div Setting	Offset Range	50 mV/div & 100 mV/div	± 0.5 V	500 mV/div & 1 V/div	± 5.0 V	5 V/div & 10 V/div	± 50 V
Volts/Div Setting	Offset Range								
50 mV/div & 100 mV/div	± 0.5 V								
500 mV/div & 1 V/div	± 5.0 V								
5 V/div & 10 V/div	± 50 V								
Range, Position	± 5 divisions								

¹Displayed vertically with 25 digitization levels (DLs) per division and 10.24 divisions dynamic range with zoom off. A DL is the smallest voltage level change that can be resolved by the 8-bit A-D Converter, with the input scaled to the volts/division setting of the channel used. Expressed as a voltage, a DL is equal to 1/25 of a division times the volts/division setting.

²The input characteristics (*Input Coupling, Input Impedance Selections, etc.*) apply to both full-featured and auxiliary inputs except where otherwise specified.

Table A-8: Nominal Traits – Signal Acquisition System (Cont.)

Name	Description								
TDS 540: Range, Sensitivity, All Channels	1 mV/div to 10 V/div ³								
TDS 520: Range, Sensitivity, CH 1 and CH 2	Same as listed for the TDS 540								
TDS 520: Range, Sensitivity, AUX 1 and AUX 2	100 mV/div, 1 V/div, and 10 V/div ⁴								
Rise Time ⁵	<table border="1"> <thead> <tr> <th>Volts/Div Setting</th> <th>Rise Time</th> </tr> </thead> <tbody> <tr> <td>5 mV/div–10 V/div</td> <td>700 ps</td> </tr> <tr> <td>2 mV/div–4.98 mV/div</td> <td>1 ns</td> </tr> <tr> <td>1 mV/div–1.99 mV/div</td> <td>1.2 ns</td> </tr> </tbody> </table>	Volts/Div Setting	Rise Time	5 mV/div–10 V/div	700 ps	2 mV/div–4.98 mV/div	1 ns	1 mV/div–1.99 mV/div	1.2 ns
Volts/Div Setting	Rise Time								
5 mV/div–10 V/div	700 ps								
2 mV/div–4.98 mV/div	1 ns								
1 mV/div–1.99 mV/div	1.2 ns								

³The sensitivity ranges from 1 mV/div to 10 V/div in a 1-2-5 sequence of coarse settings. Between a pair of adjacent coarse settings, the sensitivity can be finely adjusted. The resolution of such a fine adjustment is 1% of the more sensitive of the pair. For example, between 50 mV/div and 100 mV/div, the volts/division can be set with 0.5 mV resolution.

⁴There is no fine adjustment between the three sensitivity selections for AUX 1 and AUX 2.

⁵Rise time is defined by the following formula: $\text{Rise Time (ns)} = \frac{350}{\text{BW (MHz)}}$

Table A-9: Nominal Traits -- Time Base System

Name	Description		
TDS 540: Range, Sample-Rate ^{1,3}	Number of Channels On	Sample-Rate Range	
	1	5 Samples/s–1 GSample/s	
	2	5 Samples/s–500 MSamples/s	
	3 or 4	5 Samples/s–250 MSamples/s	
TDS 520: Range, Sample-Rate ^{1,3}	Input Channel	Number of Channels On	Sample-Rate Range
	CH 1 or CH 2	1	5 Samples/s–500 MSamples/s
	CH 1 or CH 2	2	5 Samples/s–250 MSamples/s
	AUX 1 or AUX 2	Doesn't matter	5 Samples/s–250 MSamples/s
Range, Equivalent Time or Interpolated Waveform Rate ^{2,3}	500 MSamples/s to 100 GSamples/s (2 ns/Sample to 1 ps/Sample)		
Range, Seconds/Division	500 ps/div to 10 s/div		
Range, Time Base Delay Time	4 ns to 250 seconds		
Record Length Selection ⁴	500 points, 1000 points, 2500 points, 5000 points, 15000 points. A record length 50000 points is available with Option 1M.		

¹The range of real-time rates, expressed in samples/second, at which a digitizer samples signals at its inputs and stores the samples in memory to produce a record of time-sequential samples

²The range of waveform rates for equivalent time or interpolated waveform records.

³The Waveform Rate (WR) is the equivalent sample rate of a waveform record. For a waveform record acquired by real-time sampling of a single acquisition, the waveform rate is the same as the real-time sample rate; for a waveform created by interpolation of real-time samples from a single acquisition or by equivalent-time sampling of multiple acquisitions, the waveform rate is faster than the real time sample rate. For all three cases, the waveform rate is $1/(\text{Waveform Interval})$ for the waveform record, where the waveform interval (WI) is the time between the samples in the waveform record.

⁴The maximum record length of 15,000 points (50,000 points with Option 1M) is selectable with all acquisition modes except Hi Res. In Hi Res, the maximum record length is 5,000 points (15,000 points with Option 1M).

Table A-10: Nominal Traits – Triggering System

Name	Description								
Range, Delayed Trigger Time Delay	4 ns to 250 seconds								
Range, Events Delay	2 to 9,999,999								
Range (Time) for Pulse-Glitch or Pulse-Width Triggering	2 ns to 1 s								
Ranges, Trigger Level or Threshold	<table border="1"> <thead> <tr> <th>Source</th> <th>Range</th> </tr> </thead> <tbody> <tr> <td>Any Channel</td> <td>± 12 divisions from center of screen</td> </tr> <tr> <td>Auxiliary (TDS 540 only)</td> <td>± 4 V</td> </tr> <tr> <td>Line</td> <td>± 300 V</td> </tr> </tbody> </table>	Source	Range	Any Channel	± 12 divisions from center of screen	Auxiliary (TDS 540 only)	± 4 V	Line	± 300 V
Source	Range								
Any Channel	± 12 divisions from center of screen								
Auxiliary (TDS 540 only)	± 4 V								
Line	± 300 V								

Table A-11: Nominal Traits – Display System

Name	Description
Video Display Resolution	640 pixels horizontally by 480 pixels vertically in a display area of 5.2 inches horizontally by 3.9 inches vertically
Waveform Display Graticule	Single Graticule: 401 × 501 pixels/8 × 10 divisions, where divisions are 1 cm by 1 cm
Waveform Display Grey Scale	Sixteen levels in infinite-persistence and variable persistence display styles

Table A-12: Nominal Traits – Interfaces, Output Ports, and Power Fuse

Name	Description
Interface, GPIB	GPIB interface complies with IEEE Std 488.1-1987 and IEEE Std 488.2-1987.
Logic Polarity for Main- and Delayed-Trigger Outputs	Negative TRUE. High to low transition indicates the trigger occurred.
Fuse Rating	Either of two fuses ¹ may be used: a .25" × 1.25" (UL 198.6, 3AG): 6 A FAST, 250 V, or a 5 mm × 20 mm, (IEC 127): 5 A (T), 250 V.

¹Each fuse type requires its own fuse cap.

Table A-13: Nominal Traits – Mechanical

Name	Description
Cooling Method	Forced-air circulation with no air filter.
Construction Material	Chassis parts constructed of aluminum alloy; front panel constructed of plastic laminate; circuit boards constructed of glass-laminate. Cabinet is aluminum and is clad in Tektronix Blue vinyl material.
Finish Type	Tektronix Blue vinyl-clad aluminum cabinet.
Weight	<p>Standard digitizing oscilloscope</p> <p>12.3 kg (27 lbs), with front cover. 20.0 kg (44 lbs), when packaged for domestic shipment.</p> <p>Rackmount digitizing oscilloscope</p> <p>12.3 kg (27 lbs) plus weight of rackmount parts, for the rack-mounted digitizing oscilloscope (Option 1R). 20.5 kg (45 lbs), when the rackmounted digitizing oscilloscope is packaged for domestic shipment.</p> <p>Rackmount conversion kit</p> <p>2.3 kg (5 lbs), parts only; 3.6 kg (8 lbs), parts plus package for domestic shipping.</p>
Overall Dimensions	<p>Standard digitizing oscilloscope</p> <p>Height: 236 mm (9.3 in), when feet and accessories pouch are installed. 193 mm (7.6 in), without the accessories pouch installed.</p> <p>Width: 445 mm (17.5 in), with handle.</p> <p>Depth: 432 mm (17.0 in), with front cover installed.</p> <p>Rackmount digitizing oscilloscope</p> <p>Height: 178 mm (7.0 in).</p> <p>Width: 483 mm (19.0 in).</p> <p>Depth: 558.8 mm (22.0 in).</p>

Warranted Characteristics

This subsection lists the various *warranted characteristics* that describe the TDS 540 and 520 Digitizing Oscilloscopes. (Characteristics that differ according to model or only apply to one model are preceded by the appropriate model number, TDS 520 or TDS 540, in the tables.) Included are electrical and environmental characteristics.

Warranted characteristics are described in terms of quantifiable performance limits which are warranted.

NOTE

*In these tables, those warranted characteristics that are checked in the procedure Performance Verification, found in Appendix C, appear in **boldface type** under the column Name.*

As stated above, this subsection lists only warranted characteristics. A list of *typical characteristics* starts on page A-23.

Performance Conditions

The electrical characteristics found in these tables of warranted characteristics apply when the scope has been adjusted at an ambient temperature between +20°C and +30°C, has had a warm-up period of at least 20 minutes, and is operating at an ambient temperature between 0°C and +50°C (unless otherwise noted).

Table A-14: Warranted Characteristics – Signal Acquisition System

Name	Description	
Accuracy, DC Gain	± 1%	
Accuracy, DC Voltage Measurement, Averaged	Measurement Type Average of ≥16 waveforms	DC Accuracy ± (1.0% × (reading – Net Offset ¹) + Offset Accuracy + 0.06 div)
	Delta volts between any two averages of ≥16 waveforms ²	± (1.0% × reading + 0.1 div + 0.3 mV)
TDS 540: Accuracy, Offset	Volts/Div Setting 1 mV/div – 99.5 mV/div	Offset Accuracy ± (0.2% of Net Offset ¹ + 1.5 mV + 0.1 div)
	100 mV/div – 995 mV/div	± (0.2% of Net Offset ¹ + 15 mV + 0.1 div)
	1 V/div – 10 V/div	± (0.2% of Net Offset ¹ + 150 mV + 0.1 div)

¹Net Offset = Offset – (Position × Volts/Div). Net Offset is the voltage level at the center of the A-D converter's dynamic range. Offset Accuracy is the accuracy of this Voltage level.

²The samples must be acquired under the same setup and ambient conditions.

Table A-14: Warranted Characteristics – Signal Acquisition System (Cont.)

Name	Description								
TDS 520: Accuracy, Offset (CH 1 and CH 2)	Same as is listed for the TDS 540								
TDS 520: Accuracy, Offset (AUX 1 and AUX 2)	$\pm (1\% \text{ of Net Offset}^1 + 0.1 \text{ div})$								
Analog Bandwidth, DC-50 Ω Coupled	<table border="0"> <thead> <tr> <th>Volts/Div</th> <th>Bandwidth³</th> </tr> </thead> <tbody> <tr> <td>5 mV/div – 10 V/div</td> <td>DC – 500 MHz</td> </tr> <tr> <td>2 mV/div – 4.98 mV/div</td> <td>DC – 350 MHz</td> </tr> <tr> <td>1 mV/div – 1.99 mV/div</td> <td>DC – 250 MHz</td> </tr> </tbody> </table>	Volts/Div	Bandwidth ³	5 mV/div – 10 V/div	DC – 500 MHz	2 mV/div – 4.98 mV/div	DC – 350 MHz	1 mV/div – 1.99 mV/div	DC – 250 MHz
Volts/Div	Bandwidth ³								
5 mV/div – 10 V/div	DC – 500 MHz								
2 mV/div – 4.98 mV/div	DC – 350 MHz								
1 mV/div – 1.99 mV/div	DC – 250 MHz								
Cross Talk (Channel Isolation)	$\geq 100:1$ at 100 MHz and $\geq 30:1$ at 500 MHz for any two channels having equal volts/division settings								
Delay Between Channels, Full Bandwidth, Equivalent Time	≤ 250 ps for any two channels with equal volts/division and coupling settings								
Input Impedance, DC-1 M Ω Coupled	1 M $\Omega \pm 0.5\%$ in parallel with 10 pF ± 2 pF								
Input Impedance, DC-50 Ω Coupled	50 $\Omega \pm 1\%$ with VSWR $\leq 1.3:1$ from DC – 500 MHz								
Input Voltage, Maximum, DC-1 M Ω , AC-1 M Ω , or GND Coupled	± 400 V (DC + peak AC); derate at 20 dB/decade above 1 MHz								
Input Voltage, Maximum, DC-50 Ω or AC-50 Ω Coupled	5 V rms, with peaks less than or equal to ± 30 V								
Lower Frequency Limit, AC Coupled	≤ 10 Hz when AC-1 M Ω Coupled; ≤ 200 kHz when AC-50 Ω coupled ⁴								

¹Net Offset = Offset – (Position x Volts/Div). Net Offset is the voltage level at the center of the A-D converter's dynamic range. Offset Accuracy is the accuracy of this voltage level.

²The samples must be acquired under the same setup and ambient conditions.

³The limits given are for the ambient temperature range of 0°C to +30°C. Reduce the upper bandwidth frequencies by 2.5 MHz for each °C above +30°C.

⁴The AC Coupled Lower Frequency Limits are reduced by a factor of 10 when 10X, passive probes are used.

Table A-15: Warranted Characteristics – Time Base System

Name	Description										
Accuracy, Long Term Sample Rate and Delay Time	± 25 ppm over any ≥ 1 ms interval										
TDS 540: Accuracy, Delta Time Measurement	<p>For single-shot acquisitions using sample or high-resolution acquisition modes:</p> <table border="1"> <thead> <tr> <th>Channels On/Bandwidth Selected</th> <th>Measurement Accuracy^{1,2}</th> </tr> </thead> <tbody> <tr> <td>1 or 2 channels/100 MHz</td> <td>$\pm (1 \text{ WI} + 25 \text{ ppm of Reading} + 500 \text{ ps})$</td> </tr> <tr> <td>3 or 4 channels/20 MHz</td> <td>$\pm (1 \text{ WI} + 25 \text{ ppm of Reading} + 1.3 \text{ ns})$</td> </tr> </tbody> </table> <p>For repetitive acquisitions using average acquisition mode with ≥ 8 averages:</p> <table border="1"> <thead> <tr> <th>Channels On/Bandwidth Selected</th> <th>Measurement Accuracy^{1,2}</th> </tr> </thead> <tbody> <tr> <td>1 to 4 Channels/Full Bandwidth</td> <td>$\pm (1 \text{ WI} + 25 \text{ ppm of Reading} + 200 \text{ ps})$</td> </tr> </tbody> </table>	Channels On/Bandwidth Selected	Measurement Accuracy ^{1,2}	1 or 2 channels/100 MHz	$\pm (1 \text{ WI} + 25 \text{ ppm of Reading} + 500 \text{ ps})$	3 or 4 channels/20 MHz	$\pm (1 \text{ WI} + 25 \text{ ppm of Reading} + 1.3 \text{ ns})$	Channels On/Bandwidth Selected	Measurement Accuracy ^{1,2}	1 to 4 Channels/Full Bandwidth	$\pm (1 \text{ WI} + 25 \text{ ppm of Reading} + 200 \text{ ps})$
Channels On/Bandwidth Selected	Measurement Accuracy ^{1,2}										
1 or 2 channels/100 MHz	$\pm (1 \text{ WI} + 25 \text{ ppm of Reading} + 500 \text{ ps})$										
3 or 4 channels/20 MHz	$\pm (1 \text{ WI} + 25 \text{ ppm of Reading} + 1.3 \text{ ns})$										
Channels On/Bandwidth Selected	Measurement Accuracy ^{1,2}										
1 to 4 Channels/Full Bandwidth	$\pm (1 \text{ WI} + 25 \text{ ppm of Reading} + 200 \text{ ps})$										
TDS 520: Accuracy, Delta Time Measurement	<p>For single-shot acquisitions using sample or high-resolution acquisition modes on CH 1 and/or CH 2:</p> <table border="1"> <thead> <tr> <th>Channels On/Bandwidth Selected</th> <th>Measurement Accuracy^{1,2}</th> </tr> </thead> <tbody> <tr> <td>1 channel/100 MHz</td> <td>$\pm (1 \text{ WI} + 25 \text{ ppm of Reading} + 500 \text{ ps})$</td> </tr> <tr> <td>2 channels/20 MHz</td> <td>$\pm (1 \text{ WI} + 25 \text{ ppm of Reading} + 1.3 \text{ ns})$</td> </tr> </tbody> </table> <p>For repetitive acquisitions using average acquisition mode with ≥ 8 averages:</p> <table border="1"> <thead> <tr> <th>Channels On/Bandwidth Selected</th> <th>Measurement Accuracy^{1,2}</th> </tr> </thead> <tbody> <tr> <td>1 to 2 Channels/Full Bandwidth</td> <td>$\pm (1 \text{ WI} + 25 \text{ ppm of Reading} + 200 \text{ ps})$</td> </tr> </tbody> </table>	Channels On/Bandwidth Selected	Measurement Accuracy ^{1,2}	1 channel/100 MHz	$\pm (1 \text{ WI} + 25 \text{ ppm of Reading} + 500 \text{ ps})$	2 channels/20 MHz	$\pm (1 \text{ WI} + 25 \text{ ppm of Reading} + 1.3 \text{ ns})$	Channels On/Bandwidth Selected	Measurement Accuracy ^{1,2}	1 to 2 Channels/Full Bandwidth	$\pm (1 \text{ WI} + 25 \text{ ppm of Reading} + 200 \text{ ps})$
Channels On/Bandwidth Selected	Measurement Accuracy ^{1,2}										
1 channel/100 MHz	$\pm (1 \text{ WI} + 25 \text{ ppm of Reading} + 500 \text{ ps})$										
2 channels/20 MHz	$\pm (1 \text{ WI} + 25 \text{ ppm of Reading} + 1.3 \text{ ns})$										
Channels On/Bandwidth Selected	Measurement Accuracy ^{1,2}										
1 to 2 Channels/Full Bandwidth	$\pm (1 \text{ WI} + 25 \text{ ppm of Reading} + 200 \text{ ps})$										

¹For input signals ≥ 5 divisions in amplitude and a slew rate of ≥ 2.0 divisions/ns at the delta time measurement points. Signal must have been acquired at a volts/division setting ≥ 5 mV/division.

²The WI (waveform interval) is the time between the samples in the waveform record. Also, see the footnotes for *Sample Rate Range* and *Equivalent Time or Interpolated Waveform Rates* in Table A-9 on page A-15.

Table A-16: Warranted Characteristics – Triggering System

Name	Description		
Accuracy (Time) for Pulse-Glitch or Pulse-Width Triggering	Time Range	Accuracy	
	2 ns to 1 μ s 1.02 μ s to 1 s	\pm (20% of setting + 1.5 ns) \pm (100 ns + .0025% of setting)	
Accuracy, Trigger Level or Threshold, DC Coupled	Trigger Source	Accuracy	
	Any Channel Auxiliary (TDS 540 only)	\pm (2% of (Setting – Net Offset ¹) + 0.2 div \times volts/div setting + Offset Accuracy) \pm (6% of Setting + 8% of p-p signal + 100 mV)	
Sensitivity, Edge-Type Trigger, DC Coupled ²	Trigger Source	Sensitivity	
	Any Channel Auxiliary (TDS 540 only)	0.35 division from DC to 50 MHz, increasing to 1 division at 500 MHz 0.25 volts from DC to 50 MHz	
Width, Minimum Pulse and Rearm, for Pulse Triggering	Pulse Class	Minimum Pulse Width	Minimum Rearm Width
	Glitch	2 ns	5 ns + 5% of Glitch Width Setting
	Runt	2.5 ns	2.5 ns
	Width	2 ns	5 ns + 5% of Width Upper Limit Setting

¹Net Offset = Offset – (Position \times Volts/Div). Net Offset is the voltage level at the center of the A-D converter's dynamic range. Offset Accuracy is the accuracy of this voltage level.

²The minimum sensitivity for obtaining a stable trigger. A stable trigger results in a uniform, regular display triggered on the selected slope. The trigger point must not switch between opposite slopes on the waveform, and the display must not "roll" across the screen on successive acquisitions. The TRIG'D LED stays constantly lighted when the SEC/DIV setting is 2 ms or faster but may flash when the SEC/DIV setting is 10 ms or slower.

Table A-17: Warranted Characteristics – Output Ports Probe Compensator and Power Requirements

Name	Description	
TDS 540: Logic Levels, Main- and Delayed-Trigger Outputs	Characteristic	Limits
	Vout (HI)	\geq 2.5 V open circuit; \geq 1.0 V into a 50 Ω load to ground
	Vout (LO)	\leq 0.7 V into a load of \leq 4 mA; \leq 0.25 V into a 50 Ω load to ground
Output Voltage and Frequency, Probe Compensator	Characteristic	Limits
	Voltage	0.5 V (base-top) \pm 5% into a 1 M Ω load; 0.25 V (base-top) \pm 7.5% into a 50 Ω load
	Frequency	1 kHz \pm 5%

**Table A-17: Warranted Characteristics –
Output Ports Probe Compensator and Power Requirements (Cont.)**

Name	Description
Output Voltage, Channel 3 Signal Out	20 mV/division $\pm 10\%$ into a 1 M Ω load; 10 mV/division $\pm 10\%$ into a 50 Ω load
Source Voltage	90 to 250 VAC rms, continuous range
Source Frequency	47 Hz to 63 Hz
Power Consumption	≤ 300 W (450 VA)

Table A-18: Warranted Characteristics – Environmental, Safety, and Reliability

Name	Description
Atmospherics	Temperature: 0°C to +50°C, operating; -40°C to +75°C, non-operating Relative humidity: 0 to 95%, at or below +40°C; 0 to 75%, +41°C to 50°C Altitude: To 15,000 ft. (4570 m), operating; to 40,000 ft. (12190 m), non-operating
Dynamics	Random vibration: 0.31 g rms, from 5 to 500 Hz, 10 minutes each axis, operating; 2.46 g rms, from 5 to 500 Hz, 10 minutes each axis, non-operating
Emissions	Meets or exceeds the requirements of the following standards: MIL-STD-461C CE-03, part 4, curve #1, RE-02, part 7 VDE 0871, Category B FCC Rules and Regulations, Part 15, Subpart J, Class A
User-Misuse Simulation	Electrostatic Discharge Susceptibility: Up to 8 kV with no change to settings or impairment of normal operation; up to 15 kV with no damage that prevents recovery of normal operation

Typical Characteristics

This subsection contains tables that lists the various *typical characteristics* that describe the TDS 520 and 540 Digitizing Oscilloscope. (Characteristics that differ according to model or only apply to one model are preceded by the appropriate model number, TDS 520 or TDS 540, in the tables.)

Typical characteristics are described in terms of typical or average performance. Typical characteristics are not warranted.

This subsection lists only typical characteristics. A list of warranted characteristics starts on page A-18.

Table A-19: Typical Characteristics – Signal Acquisition System

Name	Description	
Accuracy, DC Voltage Measurement, Not Averaged	Measurement Type	DC Accuracy
	Any Sample	$\pm (1.0\% \times (\text{reading} - \text{Net Offset}^1) + \text{Offset Accuracy} + 0.13 \text{ div} + 0.6 \text{ mV})$
	Delta Volts between any two samples ²	$\pm (1.0\% \times \text{reading} + 0.26 \text{ div} + 1.2 \text{ mV})$
TDS 540: Frequency Limit, Upper, 100 MHz Bandwidth Limited (All Channels)	100 MHz	
TDS 520: Frequency Limit, Upper, 100 MHz Bandwidth Limited (CH 1 and CH 2 only)	Same as listed for the TDS 540	
TDS 540: Frequency Limit, Upper, 20 MHz Bandwidth Limited (All Channels)	20 MHz	
TDS 520: Frequency Limit, Upper, 20 MHz Bandwidth Limited (CH 1 and CH 2 only)	Same as listed for the TDS 540	

¹Net Offset = Offset - (Position x Volts/Div). Net Offset is the voltage level at the center of the A-D converter's dynamic range. Offset Accuracy is the accuracy of this voltage level.

²The samples must be acquired under the same setup and ambient conditions.

Table A-19: Typical Characteristics – Signal Acquisition System (Cont.)

Name	Description						
Nonlinearity	< 1 DL, differential; ≤ 1 DL, integral, independently based						
TDS 540: Step Response Settling Errors	Volts/Div Setting	Step Amplitude	Settling Error (%) ³				
			20 ns	100 ns	20 ms		
			1 mV/div–99.5 mV/div	≤2 V	≤0.5	≤0.2	≤0.1
			100 mV/div–995 mV/div	≤20 V	≤1.0	≤0.5	≤0.2
			1 V/div–10 V/div	≤200 V	≤1.0	≤0.5	≤0.2
TDS 520: Step Response Settling Errors (CH 1 and CH 2 only)	Same as is listed for the TDS 540						

³The values given are the maximum absolute difference between the value at the end of a specified time interval after the mid-level crossing of the step, and the value one second after the mid-level crossing of the step, expressed as a percentage of the step amplitude.

Table A-20: Typical Characteristics – Time Base System

Name	Description
Aperture Uncertainty	$\leq (50 \text{ ps} + 0.03 \text{ ppm} \times \text{Record Duration})$ rms, for real-time or interpolated records having duration ≤ 1 minute; $\leq (50 \text{ ps} + 0.03 \times \text{WI}^1)$ rms, for equivalent time records

¹The WI (waveform interval) is the time between the samples in the waveform record. Also, see the footnotes for *Sample Rate Range* and *Equivalent Time or Interpolated Waveform Rates* in Table A-9 on page A-15.

Table A-21: Typical Characteristics – Triggering System

Name	Description										
TDS 540: Input, Auxiliary Trigger	The input resistance is $\geq 1.5 \text{ k}\Omega$; the maximum safe input voltage is $\pm 20 \text{ V}$ (DC + peak AC).										
Error, Trigger Position, Edge Triggering	<table border="1"> <thead> <tr> <th>Acquire Mode</th> <th>Trigger-Position Error^{1,2}</th> </tr> </thead> <tbody> <tr> <td>Sample, Hi-Res, Average</td> <td>$\pm (1 \text{ WI} + 1 \text{ ns})$</td> </tr> <tr> <td>Peak Detect, Envelope</td> <td>$\pm (2 \text{ WI} + 1 \text{ ns})$</td> </tr> </tbody> </table>	Acquire Mode	Trigger-Position Error ^{1,2}	Sample, Hi-Res, Average	$\pm (1 \text{ WI} + 1 \text{ ns})$	Peak Detect, Envelope	$\pm (2 \text{ WI} + 1 \text{ ns})$				
Acquire Mode	Trigger-Position Error ^{1,2}										
Sample, Hi-Res, Average	$\pm (1 \text{ WI} + 1 \text{ ns})$										
Peak Detect, Envelope	$\pm (2 \text{ WI} + 1 \text{ ns})$										
Holdoff, Variable, Main Trigger	<p>Minimum: For any horizontal scale setting, <i>minimum</i> holdoff is $10 \times$ that setting, but is never less than $1 \mu\text{s}$ or more than 5 s.</p> <p>Maximum: For any horizontal scale setting, <i>maximum</i> holdoff is at least 2 times the minimum holdoff for that setting, but is never more than 10 times the minimum holdoff for that setting.</p>										
Lowest Frequency for Successful Operation of "Set Level to 50%" Function	50 Hz										
Sensitivity, Edge Trigger, Not DC Coupled ³	<table border="1"> <thead> <tr> <th>Trigger Coupling</th> <th>Typical Signal Level for Stable Triggering</th> </tr> </thead> <tbody> <tr> <td>AC</td> <td>Same as DC-coupled limits⁴ for frequencies above 60 Hz. Attenuates signals below 60 Hz.</td> </tr> <tr> <td>Noise Reject</td> <td>Three and one half times the DC-coupled limits.⁴</td> </tr> <tr> <td>High Frequency Reject</td> <td>One and one half times times the DC-coupled limits⁴ from DC to 30 kHz. Attenuates signals above 30 kHz.</td> </tr> <tr> <td>Low Frequency Reject</td> <td>One and one half times the DC-coupled limits⁴ for frequencies above 80 kHz. Attenuates signals below 80 kHz.</td> </tr> </tbody> </table>	Trigger Coupling	Typical Signal Level for Stable Triggering	AC	Same as DC-coupled limits ⁴ for frequencies above 60 Hz. Attenuates signals below 60 Hz.	Noise Reject	Three and one half times the DC-coupled limits. ⁴	High Frequency Reject	One and one half times times the DC-coupled limits ⁴ from DC to 30 kHz. Attenuates signals above 30 kHz.	Low Frequency Reject	One and one half times the DC-coupled limits ⁴ for frequencies above 80 kHz. Attenuates signals below 80 kHz.
Trigger Coupling	Typical Signal Level for Stable Triggering										
AC	Same as DC-coupled limits ⁴ for frequencies above 60 Hz. Attenuates signals below 60 Hz.										
Noise Reject	Three and one half times the DC-coupled limits. ⁴										
High Frequency Reject	One and one half times times the DC-coupled limits ⁴ from DC to 30 kHz. Attenuates signals above 30 kHz.										
Low Frequency Reject	One and one half times the DC-coupled limits ⁴ for frequencies above 80 kHz. Attenuates signals below 80 kHz.										
Sensitivities, Logic Trigger/Pulse Trigger/Events, DC Coupled ⁵	1.0 division, from DC to 100 MHz with a minimum slew rate of $25 \text{ div}/\mu\text{s}$ at the trigger level or the threshold crossing										
Width, Minimum Pulse and Rearm, for Logic Triggering or Events Delay ⁶	5 ns										

¹The trigger position errors are typically less than the values given here. These values are for triggering signals having a slew rate at the trigger point of $\pm 0.5 \text{ division/ns}$.

²The waveform interval (WI) is the time between the samples in the waveform record. Also, see the footnote for the characteristics *Sample Rate Range and Equivalent Time or Interpolated Waveform Rates* in Table A-9 on page A-15.

³The minimum sensitivity for obtaining a stable trigger. A stable trigger results in a uniform, regular display triggered on the selected slope. The trigger point must not switch between opposite slopes on the waveform, and the display must not "roll" across the screen on successive acquisitions. The TRIG'D LED stays constantly lighted when the SEC/DIV setting is 2 ms or faster but may flash when the SEC/DIV setting is 10 ms or slower.

⁴See the characteristic *Sensitivity, Edge-Type Trigger, DC Coupled* in Table A-16, which begins on page A-21.

⁵The minimum signal levels required for stable logic or pulse triggering of an acquisition or for stable counting of a DC coupled events delay signal. (Stable counting of events is counting that misses no events.)

⁶The minimum pulse width and rearm width required for logic-type triggering or events delaying to occur.

Table A-22: Typical Characteristics – Data Handling and Reliability

Name	Description
Time, Data-Retention, Nonvolatile Memory ^{1,2}	5 years

¹The time that reference waveforms, stored setups, and calibration constants are retained when there is no power to the digitizing oscilloscope.

²Data is maintained by small lithium-thionyl-chloride batteries internal to the memory ICs. The amount of lithium is so small in these ICs that they can typically be safely disposed of with ordinary garbage in a sanitary landfill.

³The average length of time between successive failures, calculated by summing the failure rates of all components and connections in the instrument and taking the reciprocal of that sum.



Appendix C: Performance Verification

Brief Procedures

These procedures verify both the TDS 520 and the TDS 540 Digitizing Oscilloscopes.

The *Self Tests* use internal routines to confirm basic functionality and proper adjustment. No test equipment is required to do these test procedures.

The *Functional Tests* utilize the probe-compensation output at the front panel as a test-signal source for further verifying that the oscilloscope functions properly. A standard-accessory probe, included with this oscilloscope, is the only equipment required.

General Instructions

Besides the *Brief Procedures*, the set of procedures that can be used to verify oscilloscope performance includes the *Performance Tests*, found later in this appendix. You may not need to perform all of these procedures, depending on what you want to accomplish:

- To rapidly confirm that this oscilloscope functions and was adjusted properly, just do the procedures under *Self Tests*, which begin on page A-30.

Advantages: These procedures are quick to do, require no external equipment or signal sources, and perform extensive functional and accuracy testing to provide high confidence that the oscilloscope will perform properly. They can be used as a quick check before making a series of important measurements.

- To further check functionality, first do the *Self Tests* just mentioned; then do the procedures under *Functional Tests* that begin on page A-32.

Advantages: These procedures require minimal additional time to perform, require no additional equipment other than a standard-accessory probe, and more completely test the internal hardware of this oscilloscope. They can be used to quickly determine if the oscilloscope is suitable for putting into service, such as when it is first received.

- If more extensive confirmation of performance is desired, do the *Performance Tests*, beginning on page A-39, after doing the *Functional* and *Self Tests* just referenced.

Advantages: These procedures add direct checking of warranted specifications. They require more time to perform and suitable test equipment is required. (See *Equipment Required* on page A-39.)

If you are not familiar with operating this oscilloscope, read *At a Glance* in section 3 of this manual.

Conventions

Throughout these procedures the following conventions apply:

- Each test procedure uses the following general format:

Title of Test

Equipment Required

Prerequisites

Procedure

- Each procedure consists of as many steps, substeps, and subparts as required to do the test. Steps, substeps, and subparts are sequenced as follows:

1. First Step

a. First Substep

- First Subpart
- Second Subpart

b. Second Substep

2. Second Step

- In steps and substeps, the lead-in statement in italics instructs you what to do, while the instructions that follow tell you how to do it: in the example step below, *“Initialize the oscilloscope”* by doing “Press save/recall **SETUP**. Now, press the main-menu button...”.

Initialize the oscilloscope: Press save/recall **SETUP**. Now, press the main-menu button **Recall Factory Setup**; then the side-menu button **OK Confirm Factory Init**.

- Where instructed to use a front-panel button or knob, or select from a main or side menu, or verify a readout or status message, the name of the button or knob appears in boldface type: “press **SHIFT**; then **ACQUIRE MENU**”, “press the main-menu button **Coupling**”, or “verify that the status message is **Pass**.”



The symbol at the left is accompanied by information you must read to do the procedure properly.

- Refer to Figure A-1. "Main menu" refers to the menu that labels the seven menu buttons under the display; "side menu" refers to the menu that labels the five buttons to the right of the display. "Pop-up menu" refers to a menu that pops up when a main-menu button is pressed.

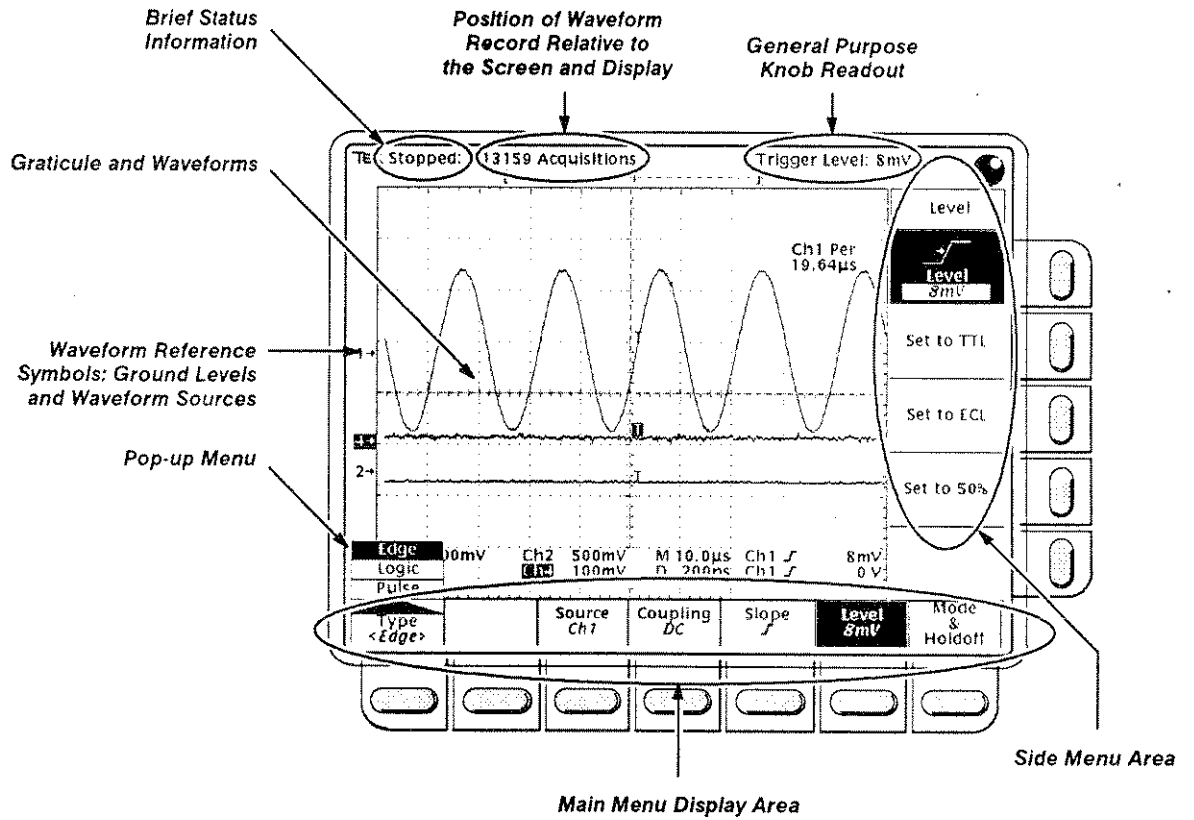

Figure A-1: Map of Display Functions

Self Tests

This procedure uses internal routines to verify that this oscilloscope functions and was adjusted properly. No test equipment or hookups are required.

Verify Internal Adjustment, Self Compensation, and Diagnostics

Equipment Required: None.

Prerequisites: Power up the oscilloscope and allow a 20 minute warm-up before doing this procedure.

Procedure:

1. *Verify that internal diagnostics pass:* Do the following substeps to verify passing of internal diagnostics.
 - a. *Display the System diagnostics menu:*
 - Press **SHIFT**; then press **UTILITY**.
 - Repeatedly press the main-menu button **System** until **Diag/Err** is highlighted in the pop-up menu.
 - b. *Run the System Diagnostics:* Press the main-menu button **Execute**; then press the side-menu button **OK Confirm Run Test**.
 - c. *Wait:* The internal diagnostics do an exhaustive verification of proper oscilloscope function. This verification will take up to two minutes. While it progresses, a "clock" icon (shown at left) is displayed on-screen. When finished, the resulting status will appear on the screen.
 - d. *Confirm no failures are found:* Verify that no failures are found and reported on-screen.
 - e. *Confirm the three adjustment sections have passed status:*
 - Press **SHIFT**; then press **UTILITY**.
 - Press the main menu button **System** until **Cal** is highlighted in the pop-up menu.
 - Verify that the word **Pass** appears in the main menu under the following menu labels: **Voltage Reference**, **Frequency Response**, and **Pulse Trigger**. (See Figure A-2.)

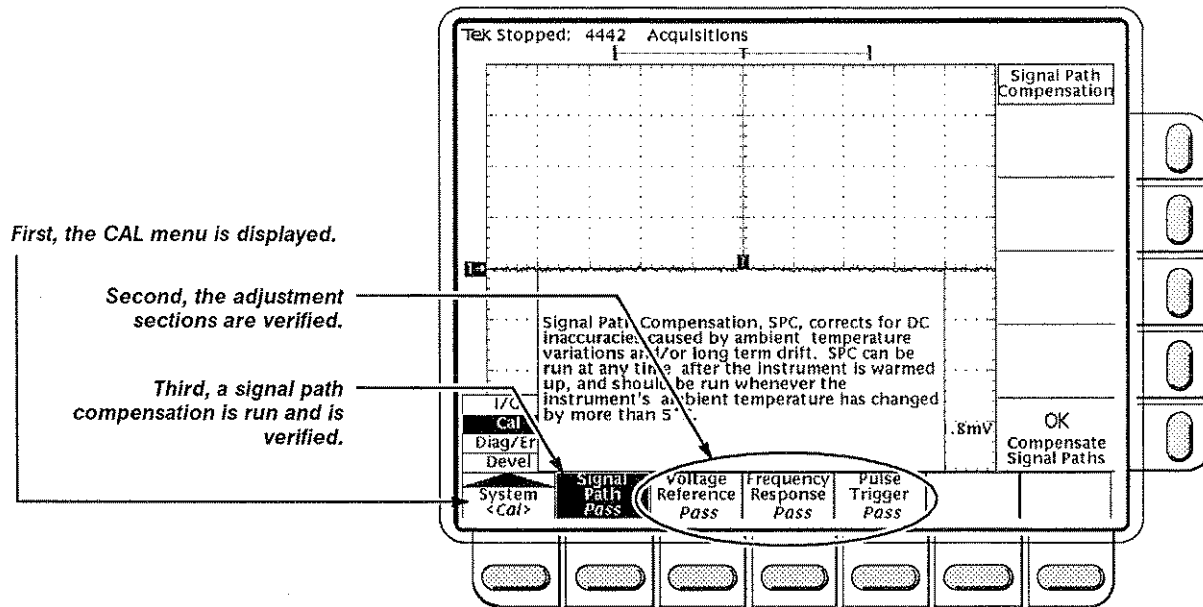

Figure A-2: Verifying Adjustments and Signal-Path Compensation

- f. *Run the signal-path compensation:* Press the main-menu button **Signal Path**; then press the side-menu button **OK Compensate Signal Paths**.
 - g. *Wait:* Signal-path compensation runs in about one to two minutes. While it progresses, a “clock” icon (shown at left) is displayed on-screen. When compensation completes, the status message will be updated to *Pass* or *Fail* in the main menu (see step h).
 - h. *Confirm signal-path compensation returns passed status:* Verify the word *Pass* appears under **Signal Path** in the main menu. (See Figure A-2.)
2. *Return to regular service:* Press **CLEAR MENU** to exit the system menus.

Functional Tests

The purpose of these procedures is to confirm that this oscilloscope functions properly. The only equipment required is one of the standard-accessory probes.



These procedures verify functions; that is, they verify that oscilloscope features *operate*. They do *not* verify that they operate within limits.

Therefore, when the instructions in the functional tests that follow call for you to verify that a signal appears on-screen “that is about five divisions in amplitude” or “has a period of about six horizontal divisions”, etc., do *NOT* interpret the quantities given as limits. Operation within limits is checked in *Performance Tests*, which begin on page A-39.



DO NOT make changes to the front-panel settings that are not called out in the procedures. Each verification procedure will require you to set the oscilloscope to certain default settings before verifying functions. If you make changes to these settings other than those called out in the procedure, you may obtain invalid results. In this case, just redo the procedure from step 1.

When you are instructed to press a menu button, the button may already be selected (its label will be highlighted). If this is the case, it is not necessary to press the button.

Verify: All Input Channels

Equipment Required: One P6139A probe.

Prerequisites: None.

Procedure:

1. *Install the test hookup and preset the oscilloscope controls:*

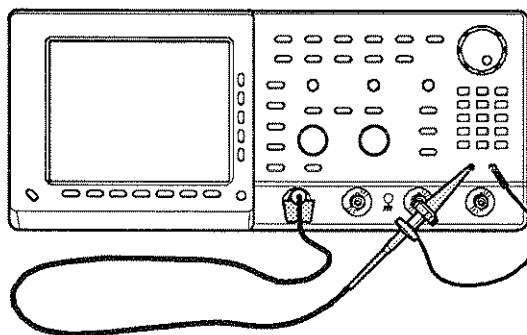

Figure A-3: Universal Test Hookup for Functional Tests

- a. *Hook up the signal source:* Install the probe on **CH 1**. Connect the probe tip to **PROBE COMPENSATION SIGNAL** on the front panel; connect the probe ground to **PROBE COMPENSATION GND**.

b. *Initialize the oscilloscope:*

- Press save/recall **SETUP**.
- Press the main-menu button **Recall Factory Setup**.
- Press the side-menu button **OK Confirm Factory Init**.
- Set the horizontal **SCALE** to 200 μ s. Press **CLEAR MENU** to remove any menu that may be on the screen.

2. *Verify that all input channels operate:* Do the following substeps — test CH 1 first, *skipping substep a since CH 1 is already set up for verification from step 1.*a. *Select an unverified channel:*

- Press **WAVEFORM OFF** to remove from display the channel just verified.
- Press the front-panel button that corresponds to the channel you are to verify.
- Move probe to the channel you selected.

b. *Set up the selected channel:* Press **AUTOSET** to obtain a viewable, triggered display in the selected channel.c. *Verify that the channel is operational:* Confirm that the following statements are true.

- The vertical scale readout for the channel under test shows a setting of 100 mV, and a square-wave probe-compensation signal about five divisions in amplitude is on-screen. (See Figure A-1 on page A-29 to locate the readout.)
- Turning the vertical **SCALE** knob counterclockwise decreases the amplitude of the waveform on-screen, turning the knob clockwise increases the amplitude, and returning the knob to 100 mV returns the amplitude to about five divisions.

d. *Verify that the channel acquires in all acquisition modes:* Press **SHIFT**; then press **ACQUIRE MENU**. Use the side menu to select, in turn, each of the five hardware acquire modes and confirm that the following statements are true. Refer to the icons at the left of each statement as you confirm those statements.

- **Sample** mode displays an actively acquiring waveform on-screen. (Note that there is noise present on the peaks of the square wave.)



- **Peak Detect** mode displays an actively acquiring waveform on-screen with the noise present in Sample mode “peak detected”.



- **Hi Res** mode displays an actively acquiring waveform on-screen with the noise that was present in Sample mode reduced.



- **Envelope** mode displays an actively acquiring waveform on-screen with the noise displayed.

Verify: The Time Base**Equipment Required:** One P6139A probe.**Prerequisites:** None.**Procedure:**

1. *Install the test hookup and preset the oscilloscope controls:*
 - a. *Hook up the signal source:* Install the probe on **CH 1**. Connect the probe tip to **PROBE COMPENSATION SIGNAL** on the front panel; connect the probe ground to **PROBE COMPENSATION GND**. (See Figure A-3 on page A-32.)
 - b. *Initialize the oscilloscope:*
 - Press save/recall **SETUP**.
 - Press the main-menu button **Recall Factory Setup**; then press the side-menu button **OK Confirm Factory Init**.
 - c. *Modify default settings:*
 - Press **AUTOSET** to obtain a viewable, triggered display.
 - Set the horizontal **SCALE** to 200 μ s.
 - Press **CLEAR MENU** to remove the menus from the screen.
2. *Verify that the time base operates:* Confirm the following statements.
 - a. One period of the square-wave probe-compensation signal is about five horizontal divisions on-screen for the 200 μ s horizontal scale setting (set in step 1c).
 - b. Rotating the horizontal **SCALE** knob clockwise expands the waveform on-screen (more horizontal divisions per waveform period), and that counterclockwise rotation contracts it, and that returning the horizontal scale to 200 μ s returns the period to about five divisions.
 - c. The horizontal **POSITION** knob positions the signal left and right on-screen when rotated.
3. *Remove the test hookup:* Disconnect the probe from the channel input and the probe-compensation terminals.

Verify: The Main and Delayed Trigger Systems**Equipment Required:** One P6139A probe.**Prerequisites:** None.**Procedure:**

1. *Install the test hookup and preset the oscilloscope controls:*
 - a. *Hook up the signal source:* Install the probe on **CH 1**. Connect the probe tip to **PROBE COMPENSATION SIGNAL** on the front panel; connect the probe ground to **PROBE COMPENSATION GND**. (See Figure A-3 on page A-32.)

- b. *Initialize the oscilloscope:*
 - Press save/recall **SETUP**.
 - Press the main-menu button **Recall Factory Setup**.
 - Press the side-menu button **OK Confirm Factory Init**.
 - c. *Modify default settings:*
 - Press **AUTOSET** to obtain a viewable, triggered display.
 - Set the horizontal **SCALE** for the **M** (main) time base to 200 μ s.
 - Press **TRIGGER MENU**.
 - Press the main-menu button **Mode & Holdoff**.
 - Press the side-menu button **Normal**.
 - Press **CLEAR MENU** to remove the menus from the screen.
2. *Verify that the main trigger system operates:* Confirm that the following statements are true.
 - The trigger level readout for the main trigger system changes with the trigger **LEVEL** knob.
 - The trigger-level knob can trigger and untrigger the square-wave signal as you rotate it. (Leave the signal *untriggered*.)
 - Pressing **SET LEVEL TO 50%** triggers the signal that you just left untriggered. (Leave the signal triggered.)
 3. *Verify that the delayed trigger system operates:*
 - a. *Select the delayed time base:*
 - Press **HORIZONTAL MENU**.
 - Press the main-menu button **Time Base**.
 - Press the side-menu button **Delayed Triggerable**; then press the side-menu button **Delayed Only**.
 - Set the horizontal **SCALE** for the **D** (delayed) time base to 200 μ s.

- b. *Select the delayed trigger level menu:*
 - Press **SHIFT**; then press **DELAYED TRIG**.
 - Press the main-menu button **Level**; then press the side-menu button **Level**.
 - c. *Confirm that the following statements are true:*
 - The trigger-level readout for the delayed trigger system changes with the general purpose knob.
 - The general purpose knob can trigger and untrigger the square-wave probe-compensation signal as you rotate it. (Leave the signal *untriggered*.)
 - Pressing the side-menu button **Set to 50%** triggers the probe-compensation signal that you just left untriggered. (Leave the signal triggered.)
 - d. *Verify the delayed trigger counter:*
 - Press the main-menu button **Delay by Time**.
 - Use the keypad to enter a delay time of 1 second.
 - Verify that the trigger **READY** indicator on the front panel flashes about once every second as the waveform is updated on-screen.
4. *Remove the test hookup:* Disconnect the standard-accessory probe from the channel input and the probe-compensation terminals.

Performance Tests

This subsection contains a collection of procedures for checking that the TDS 520 and TDS 540 Digitizing Oscilloscopes perform as warranted. Since both models are covered by these procedures, instructions that apply only to one of the models are clearly identified. Otherwise, all test instructions apply to both the TDS 520 and TDS 540.

The procedures are arranged in four logical groupings: *Signal Acquisition System Checks*, *Time Base System Checks*, *Triggering System Checks*, and *Output Ports Checks*. They check all the characteristics that are designated as checked in Section B, *Specification*. (The characteristics that are checked appear in **boldface** type under *Warranted Characteristics* in Appendix B.)



These procedures *extend* the confidence level provided by the basic procedures described on page A-27. The basic procedures should be done first, then these procedures performed if desired.

Prerequisites

The tests in this subsection comprise an extensive, valid confirmation of performance and functionality when the following requirements are met:

- The cabinet must be installed on the digitizing oscilloscope.
- You must have performed and passed the procedures under *Self Tests*, found on page A-30, and those under *Functional Tests*, found on page A-32.
- A signal-path compensation must have been done within the recommended calibration interval and at a temperature within $\pm 5^{\circ}\text{C}$ of the present operating temperature. (If at the time you did the prerequisite *Self Tests*, the temperature was within the limits just stated, consider this prerequisite met.)
- The digitizing oscilloscope must have been last adjusted at an ambient temperature between $+20^{\circ}\text{C}$ and $+30^{\circ}\text{C}$, must have been operating for a warm-up period of at least 20 minutes, and must be operating at an ambient temperature between 0°C and $+50^{\circ}\text{C}$. (The warm-up requirement is usually met in the course of meeting the first prerequisite listed above.)

Related Information – Read *General Instructions and Conventions* starting on page A-27. Also, if you are not familiar with operating this digitizing oscilloscope, read *At a Glance* in Section 3 before doing any of these procedures.

Equipment Required

These procedures utilize external, traceable signal sources to directly check warranted characteristics. The required equipment list follows this introduction.

Table A-23: Test Equipment

Item Number and Description	Minimum Requirements	Example	Purpose
1 Attenuator, 10X (three required)	Ratio: 10X; impedance 50 Ω ; connectors: female BNC input, male BNC output	Tektronix part number 011-0059-02	Signal Attenuation
2 Attenuator, 5X	Ratio: 5X; impedance 50 Ω ; connectors: female BNC input, male BNC output	Tektronix part number 011-0060-02	Signal Attenuation
3 Termination, 50 Ω	Impedance 50 Ω ; connectors: female BNC input, male BNC output	Tektronix part number 011-0049-01	Signal Termination for Channel Delay Test
4 Cable, Precision Coaxial (two required)	50 Ω , 36 in, male to male BNC connectors	Tektronix part number 012-0482-00	Signal Interconnection
5 Connector, Dual-Banana (two required)	Female BNC to dual banana	Tektronix part number 103-0090-00	Various Accuracy Tests
6 Connector, BNC "T"	Male BNC to dual female BNC	Tektronix part number 103-0030-00	Checking Trigger Sensitivity
7 Coupler, Dual-Input	Female BNC to dual male BNC	Tektronix part number 067-0525-02	Checking Delay Between Channels
8 Generator, DC Calibration	Variable amplitude to ± 110 V; accuracy to 0.1%	Data Precision 8200, with 1 kV option	Checking DC Offset, Gain, and Measurement Accuracy
9 Generator, Calibration	500 mV square wave calibrator amplitude; accuracy to 0.25%	PG 506A ¹	Use to check accuracy of the CH 3 Output (TDS 540 Only).
10 Generator, Leveled Sine-Wave, Medium-Frequency	200 kHz to 250 MHz; Variable amplitude from 5 mV to 4 V p-p into 50 Ω	TEKTRONIX SG 503 Leveled Sine Wave Generator ¹	Checking Trigger Sensitivity at low frequencies
11 Generator, Leveled Sine-Wave, High-Frequency	250 MHz to 500 MHz; Variable amplitude from 5 mV to 4 V p-p into 50 Ω ; 6 MHz reference	TEKTRONIX SG 504 Leveled Sine Wave Generator ¹ with its Leveling Head	Checking Analog Bandwidth and Trigger Sensitivity at high frequencies
12 Generator, Time Mark	Variable marker frequency from 10 ms to 10 ns; accuracy within 2 ppm	TEKTRONIX TG 501 Time Mark Generator ¹	Checking Sample-Rate and Delay-time Accuracy
13 Probe, 10X, included with this instrument	A P6139A probe	Tektronix number P6139A	Signal Interconnection

¹Requires a TM 500 or TM5000 Series Power Module Mainframe.

Signal Acquisition System Checks

These procedures check those characteristics that relate to the signal-acquisition system and are listed as checked under *Warranted Characteristics* in *Appendix B: Specification*.

Check: Accuracy of Offset (Zero Setting)

Equipment Required: None.

Prerequisites: The oscilloscope must meet the prerequisites listed on page A-38.

1. *Preset the instrument controls:*
 - a. *Initialize the oscilloscope:*
 - Press save/recall **SETUP**.
 - Press the main-menu button **Recall Factory Setup**.
 - Press the side-menu button **OK Confirm Factory Init**.
 - Press **CLEAR MENU** to remove the menus from the screen.
 - b. *Modify the default settings:*
 - Set the horizontal **SCALE** to 1 ms.
 - Press **SHIFT**; then **ACQUIRE MENU**.
 - Press the main-menu button **Mode**; then press the side-menu button **Hi Res**.
 - Press **DISPLAY**.
 - Press the main-menu button **Graticule**; then press the side-menu button **Frame**.
 - Press **CURSOR**.
 - Press the main-menu button **Function**; then press the side-menu button **H Bars**.
 - Press **CLEAR MENU**.
2. *Confirm input channels are within limits for offset accuracy at zero offset:* Do the following substeps — test CH 1 first, *skipping substep a since CH 1 is already set up to be checked from step 1*.
 - a. *Select an unchecked channel:* Press **WAVEFORM OFF** to remove the channel just confirmed from the display. Then, press the front-panel button that corresponds to the channel you are to confirm.



Follow these rules to match this procedure to the model of the oscilloscope under test:

Model TDS 540 Digitizing Oscilloscope Only — When using Table A-24 to test CH 1 – CH 4; ignore the columns for AUX 1 & AUX 2 settings and limits.

Model TDS 520 Digitizing Oscilloscope Only — Use Table A-24 to test input channels; use the columns for CH 1 – CH 4 when testing CH 1 and CH 2; use the columns for AUX 1 and AUX 2 when testing those channels.

Table A-24: DC Offset Accuracy (Zero Setting)

Vertical Scale Setting		Vertical Position and Offset Setting ¹	Offset Accuracy Limits	
CH 1 – CH 4	AUX 1 & AUX 2		CH 1 – CH 4	AUX 1 & AUX 2
1 mV	100 mV	0	± 1.6 mV	± 10 mV
100 mV	1 V	0	± 25 mV	± 100 mV
1 V	10 V	0	± 250 mV	± 1.0 V

¹Vertical position is set to 0 divisions and vertical offset to 0 V when the oscilloscope is initialized in step 1.

- b. *Set the vertical scale:* Set the vertical **SCALE** to one of the settings listed in Table A-24 that is not yet checked. (Start with the first setting listed.)
- c. *Display the test signal:* The baseline DC test level was initialized for all channels in step 1 and is displayed as you select each channel and its vertical scale. Be sure *not* to use the vertical **POSITION** knob while checking any channel for accuracy of offset, since varying the position invalidates the check.
- d. *Measure the test signal:* Rotate the general purpose knob to superimpose the active cursor over the baseline DC test level. (Ignore the other cursor.)
- e. Read the measurement results at the absolute (@:) cursor readout, not the delta (Δ:) readout on screen.

- f. *Check against limits:* Do the following subparts in the order listed.
 - CHECK that the measurement results are within the limits listed for the current vertical scale setting.
 - Repeat substeps b through f until all vertical scale settings settings listed in Table A-24 are checked for the channel under test.

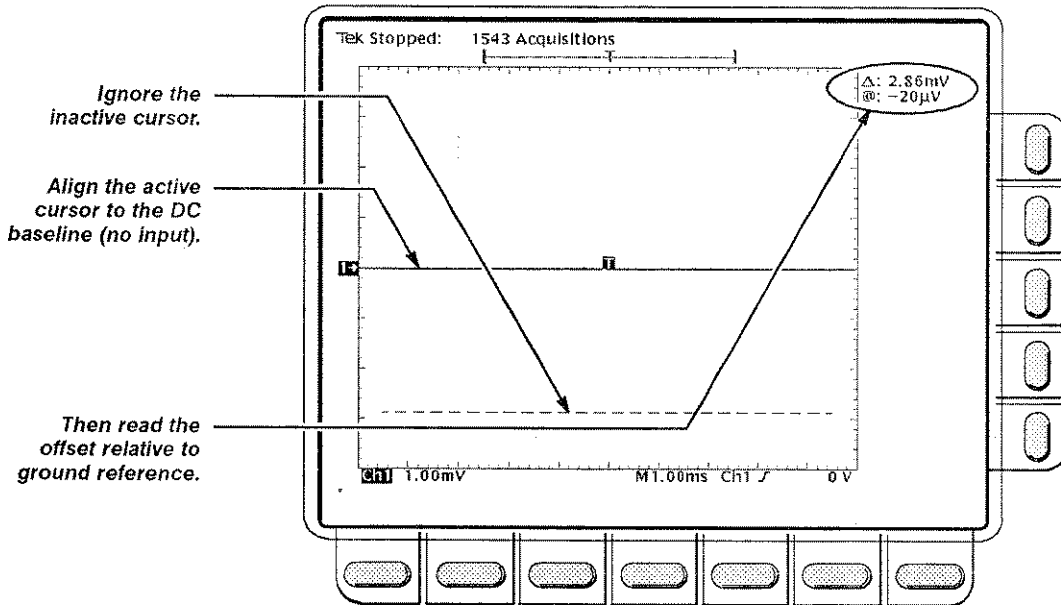

Figure A-4: Measurement of DC Offset Accuracy at Zero Setting

- g. *Test all channels:* Repeat substeps a through f for all input channels.
3. *Disconnect the hookup:* No hookup was required.

Check: DC Gain and Voltage Measurement Accuracy**WARNING**

Performance of this procedure requires input voltages up to 180 VDC. Be sure to set the DC calibration generator to 0 volts before connecting, disconnecting, and/or moving the test hookup during the performance of this procedure.

Equipment Required: Two dual-banana connectors (Item 5), one BNC T connector (Item 6), one DC calibration generator (Item 8), and two precision coaxial cables (Item 4).

Prerequisites: The oscilloscope must meet the prerequisites listed on page A-38.

Procedure:

1. *Install the test hookup and preset the instrument controls:*

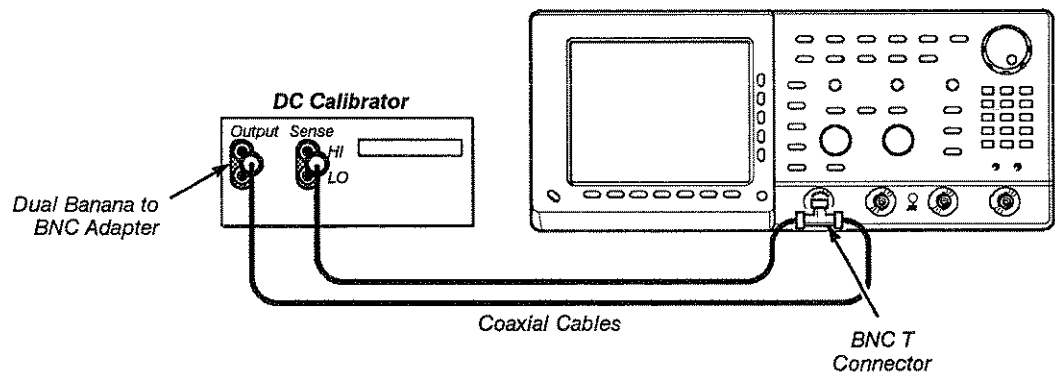

Figure A-5: Initial Test Hookup

- a. *Hook up the test-signal source:*

- Set the output of a DC calibration generator to 0 volts.
- Connect the output of a DC calibration generator through a dual-banana connector followed by a 50 Ω precision coaxial cable to one side of a BNC T connector.
- Connect the Sense output of the generator through a second dual-banana connector followed by a 50 Ω precision coaxial cable to other side of the BNC T connector. Now connect the BNC T connector to **CH 1**.

- b. *Initialize the oscilloscope:*
 - Press save/recall **SETUP**.
 - Press the main-menu button **Recall Factory Setup**.
 - Press the side-menu button **OK Confirm Factory Init**.
 - c. *Modify the default settings:*
 - Press **SHIFT**; then **ACQUIRE MENU**.
 - Press the main-menu button **Mode**; then press the side-menu button **Average 16**.
 - Press **CURSOR**.
 - Press the main-menu button **Function**; then press the side-menu button **H Bars**.
 - Press **DISPLAY**.
 - Press the main-menu button **Graticule**; then press the side-menu button **Frame**.
2. *Confirm input channels are within limits for DC delta voltage accuracy: Do the following substeps — test CH 1 first, skipping substep a since CH 1 is already selected from step 1.*
- a. *Select an unchecked channel:*
 - Set the generator output to 0 V.
 - Press **WAVEFORM OFF** to remove the channel just confirmed from the display.
 - Press the front-panel button that corresponds to the next channel you are to confirm.
 - Move the test hookup to the channel you select.
 - b. *Display the test signal:*
 - Press **VERTICAL MENU**. Press the main-menu button **Position**.
 - Use the keypad to set vertical position to -2.5 divisions (press -2.5, then **ENTER**, on the keypad).
 - c. *Measure the test signal:*
 - Press **CURSOR**. Use the general purpose knob to precisely align the active cursor to the DC baseline level on screen.
 - Set the generator output to 500 mV.
 - Press **TOGGLE**. Use the general purpose knob to precisely align the alternate cursor to the 500 mV DC test level on screen.
 - Press **CLEAR MENU**. Read the measurement results from the delta (Δ :) readout, not the absolute (@:) readout. See Figure A-6 on page A-45.

- d. *Check against limits:* CHECK that the Δ : readout on screen is within 485 mV to 515 mV.

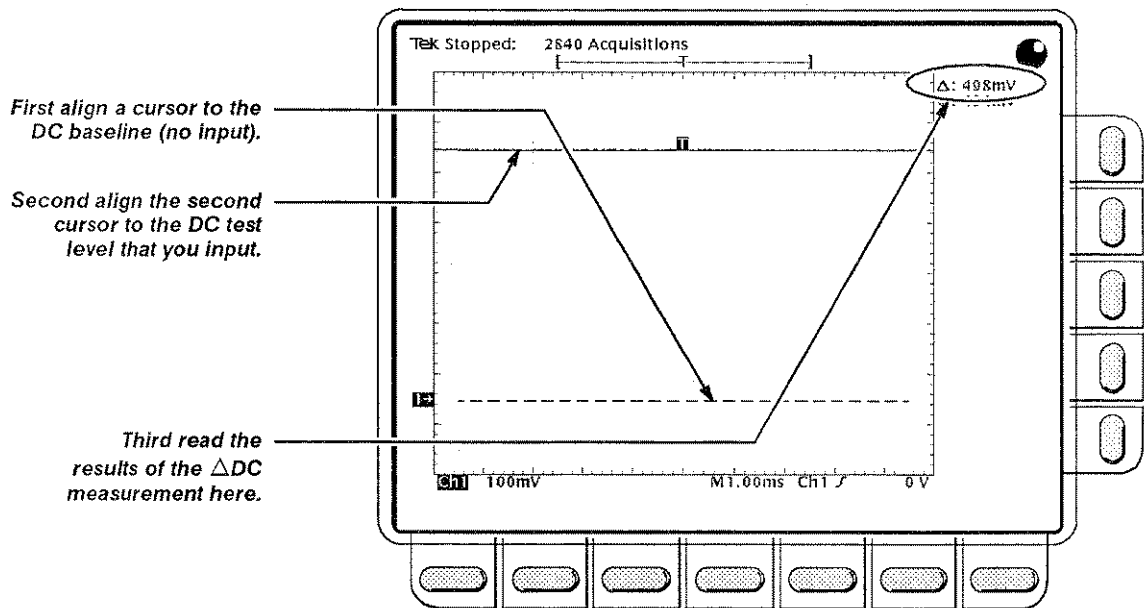

Figure A-6: Measurement of the DC Accuracy for Delta Measurements

- e. *Test all channels:* Repeat substeps a through d for all four channels.
3. *Reestablish the initial test hookup setup:*
- a. *Hook up the test-signal source:*
 - Set the output of a DC calibration generator to 0 volts.
 - Move the BNC T connector back to CH 1.
 - b. *Initialize the oscilloscope:*
 - Press save/recall **SETUP**.
 - Press the main-menu button **Recall Factory Setup**.
 - Press the side-menu button **OK Confirm Factory Init**.
 - c. *Modify the default settings:*
 - Press **SHIFT**; then **ACQUIRE MENU**.
 - Press the main-menu button **Mode**; then press the side-menu button **Average 16**.
 - Press **DISPLAY**.
 - Press the main-menu button **Graticule**; then press the side-menu button **Frame**.

4. *Confirm input channels are within limits for DC accuracy at maximum offset and position:* Do the following substeps – test CH 1 first, skipping substep a since CH 1 is already selected from step 3.

a. *Select an unchecked channel:*

- Press **WAVEFORM OFF** to remove the channel just confirmed from the display.
- Press the front-panel button that corresponds to the channel you are to confirm.
- *Set the generator output to 0 V.*
- Move the test hookup to the channel you select.

b. *Turn on the measurement Mean for the channel:*

- Press **MEASURE**, then press the main-menu button **Select Measurement for CHx**.
- Press the side menu button **more** until the menu label **Mean** appears in the side menu (its icon is shown at the left). Press the side-menu button **Mean**.
- Press **CLEAR MENU**.



Follow these rules to match this procedure to the model of the oscilloscope under test:

Model TDS 540 Digitizing Oscilloscope Only – Use Table A-25 to test CH 1 – CH 4; ignore Table A-26 AUX 1 & AUX 2 settings and limits.

Model TDS 520 Digitizing Oscilloscope Only – Use Table A-25 to test CH 1 and CH 2 only; use Table A-26 to test AUX 1 and AUX 2 only.

c. *Set its vertical scale:* Set the vertical **SCALE** to one of the settings listed in the table matching the channel under test that is not yet checked. (Start with the first setting listed.)

Table A-25: DC Accuracy: CH 1–CH 4

Scale Setting	Position Setting (Divs)	Offset Setting	Generator Setting	Accuracy Limits
5 mV	-5	+1 V	+1.040 V	+1.0355 V to +1.0445 V
	+5	-1 V	-1.040 V	-1.0355 V to -1.0445 V
200 mV	-5	+10 V	+11.6 V	+11.525 V to +11.675 V
	+5	-10 V	-11.6 V	-11.525 V to -11.675 V
1 V	-5	+100 V	+108 V	+107.450 V to +108.550 V
	+5	-100 V	-108 V	-107.450 V to -108.550 V

Table A-26: DC Accuracy: AUX 1–AUX 2

Scale Setting	Position Setting (Divs)	Offset Setting	Generator Setting	Accuracy Limits
100 mV	-5	+0.5 V	+1.3 V	+1.271 V to +1.329 V
	+5	-0.5 V	-1.3 V	-1.271 V to -1.329 V
1 V	-5	+5 V	+13 V	+12.710 V to +13.290 V
	+5	-5 V	-13 V	-12.710 V to -13.290 V
10 V	-5	+50 V	+130 V	+127.10 V to +132.90 V
	+5	-50 V	-130 V	-127.10 V to -132.90 V

d. *Display the test signal:*

- Press **VERTICAL MENU**. Press the main-menu button **Position**.
- Use the keypad to set vertical position to -5 divisions (press **-5**, then **ENTER**, on the keypad.) The baseline level will move off screen.
- Press the main-menu button **Offset**.
- Use the keypad to set vertical offset to the positive-polarity setting listed in the table for the current vertical scale setting. The baseline level will remain off screen.
- Set the generator to the level and polarity indicated in the table for the vertical scale, position, and offset settings you have made. The DC test level should appear on screen. (If it doesn't return, the DC accuracy check is failed for the current vertical scale setting of the current channel.)

- e. *Measure the test signal:* Press **CLEAR MENU**. Read the measurement results at the **Mean** measurement readout. See Figure A-7.

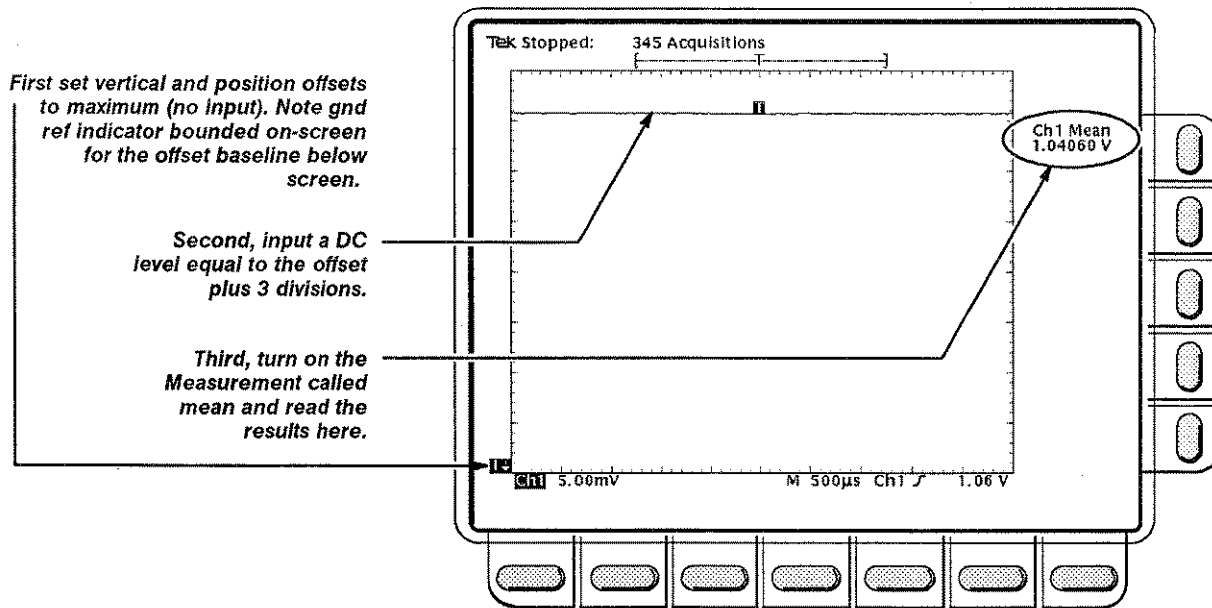

Figure A-7: Measurement of DC Accuracy at Maximum Offset and Position

- f. *Check against limits:*
- CHECK that the readout for the measurement **Mean** readout on screen is within the limits listed for the current vertical scale and position/offset/generator settings.
 - Repeat step d, reversing the polarity of the position, offset, and generator settings as is listed in the table.
 - CHECK that the **Mean** measurement readout on screen is within the limits listed for the current vertical scale setting and position/offset/generator settings.
 - Repeat substeps c through f until all vertical scale settings settings listed in the appropriate table are checked for the channel under test. (Use the table that matches the input under test – CH or AUX.)
- g. *Test all channels:* Repeat substeps a through f for all four channels.
5. *Disconnect the hookup:*
- a. *Set the generator output to 0 V.*
 - b. Then disconnect the cable from the generator output at the input connector of the channel last tested.

Check: Analog Bandwidth

Equipment Required: One high-frequency leveled sine-wave generator and its leveling head (Item 11), plus three 10X attenuators (Item 1).

Prerequisites: See page A-38.

Procedure:1. *Install the test hookup and preset the instrument controls:*a. *Initialize the oscilloscope:*

- Press save/recall **SETUP**.
- Press the main-menu button **Recall Factory Setup**.
- Press the side-menu button **OK Confirm Factory Init**.

b. *Modify the default settings:*

- Set the horizontal **SCALE** to 50 ns.
- Press **SHIFT**; then **ACQUIRE MENU**.
- Press the main-menu button **Mode**; then press the side-menu button **Average 16**.
- Press **Measure**. Now press the main-menu button **High-Low Setup**; then press the side-menu button **Min-Max**.

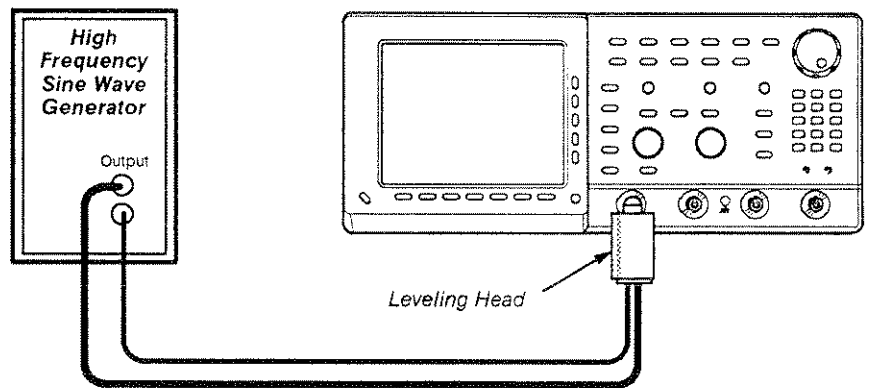

Figure A-8: Initial Test Hookup

- c. *Hook up the test-signal source:* Connect, through its leveling head, the sine-wave output of a high-frequency leveled sine-wave generator to **CH 1**. Set the output of the generator to a reference frequency of 6 MHz.

2. *Confirm the input channels are within limits for analog bandwidth: Do the following substeps – test CH 1 first, skipping substeps a and b since CH 1 is already set up for testing from step 1.*
 - a. *Select an unchecked channel:*
 - Press **WAVEFORM OFF** to remove the channel just confirmed from display.
 - Press the front-panel button that corresponds to the channel you are to confirm.
 - Move the leveling head to the channel you select.
 - b. *Match the trigger source to the channel selected:*
 - Press **TRIGGER MENU**.
 - Press the main-menu button **Source**.
 - Press the side-menu button that corresponds to the channel selected.
 - c. *Set its input impedance:*
 - Press **VERTICAL MENU**; then press the main-menu button **Coupling**.
 - Press the side-menu button Ω to toggle it to the 50 Ω setting.
 - d. *Set the vertical scale: Set the vertical **SCALE** to one of the settings listed in Table A-27 not yet checked. (Start with the 100 mV setting.)*

Table A-27: Analog Bandwidth

Vertical Scale ¹	Attenuators (10X)	Reference Amplitude (at 6 MHz)	Horizontal Scale	Test Frequency	Limits
100 mV	none	600 mV (6 divisions)	1 ns	500 MHz	≥ 424 mV
1 V	none	5 V (5 divisions)	1 ns	500 MHz	≥ 3.535 V
500 mV	none	3 V (6 divisions)	1 ns	500 MHz	≥ 2.121 V
200 mV	none	1.2 V (6 divisions)	1 ns	500 MHz	≥ 848 mV
50 mV	1	300 mV (6 divisions)	1 ns	500 MHz	≥ 212 mV
20 mV	1	120 mV (6 divisions)	1 ns	500 MHz	≥ 84 mV
10 mV	1	60 mV (6 divisions)	1 ns	500 MHz	≥ 42 mV
5 mV	2	30 mV (6 divisions)	1 ns	500 MHz	≥ 21 mV
2 mV	2	12 mV (6 divisions)	2 ns	350 MHz	≥ 8.4 mV
1 mV	2	6 mV (6 divisions)	2 ns	250 MHz	≥ 4.2 mV

¹Only the 100 mV, 1 V, and 10 V vertical scale settings are available for the AUX 1 and AUX 2 input channels. Ignore all other settings listed when checking those channels.

- e. *Display the test signal:* Do the following subparts to first display the reference signal and then the test signal.
- Press **MEASURE**; then press the main-menu button **Select Measurement for CHx**.
 - Now press the side menu button **more** until the menu label **Pk-Pk** appears in the side menu (its icon is shown at the left). Press the side-menu button **Pk-Pk**.
 - Press **CLEAR MENU**.
 - Set the generator output so the CHx Pk-Pk readout equals the reference amplitude in Table A-27 that corresponds to the vertical scale set in substep d.
 - Press the front-panel button **SET LEVEL TO 50%** as necessary to trigger a stable display.
- f. *Measure the test signal:*
- Increase the frequency of the generator output to the test frequency in Table A-27 that corresponds to the vertical scale set in substep d.
 - Set the horizontal **SCALE** to 1 ns. Press **SET LEVEL TO 50%** as necessary.
 - Read the results at the CHx Pk-Pk readout, which will automatically measure the amplitude of the test signal.

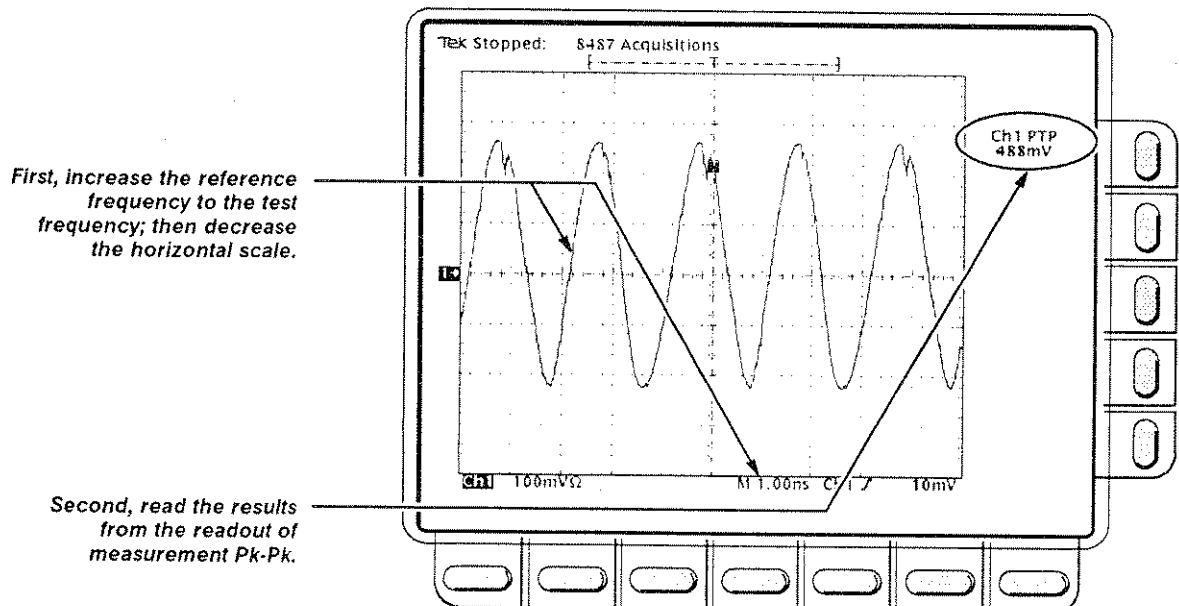

Figure A-9: Measurement of Analog Bandwidth

g. *Check against limits:*

- CHECK that the **Pk-Pk** readout on screen is within the limits listed in Table A-27 for the current vertical scale setting.
- When finished checking, set the horizontal **SCALE** back to the 50 ns setting.



Checking each channel's bandwidth at all vertical scale settings is time consuming and unnecessary. You may skip checking the remaining vertical scale settings in Table A-27 (that is, skip the following substep, h) if this digitizing oscilloscope has performed as follows:

- Passed the 100 mV vertical scale setting just checked in this procedure.
- Passed the *Verify Internal Adjustment, Self Compensation, and Diagnostics* procedure found under *Self Tests*, on page A-30.

NOTE

Passing the signal path compensation confirms the signal path for all vertical scale settings for all channels. Passing the internal diagnostics ensures that the factory-set adjustment constants that control the bandwidth for each vertical scale setting have not changed.

h. *Check remaining vertical scale settings against limits (optional):*

- If desired, finish checking the remaining vertical scale settings for the channel under test by repeating substeps d through g for each of the remaining scale settings listed in Table A-27 for the channel under test.
- When doing substep e, skip the subparts that turn on the CHx Pk-Pk measurement until you check a new channel.
- Install/remove 10X attenuators between the generator leveling head and the channel input as is needed to obtain the six division reference signals listed in the table.

i. *Test all channels:* Repeat substeps a through g for all four channels.

3. *Disconnect the hookup:* Disconnect the test hook up from the input connector of the channel last tested.

Check: Delay Between Channels

Equipment Required: One medium-frequency leveled sine-wave generator (Item 10), one precision coaxial cable (Item 4), one 50 Ω terminator (Item 3), and a dual-input-coupler (Item 7).

Prerequisites: See page A-38.

Procedure:

DO NOT use the vertical position knob to reposition any channel while doing this check. To do so invalidates the test.

1. *Install the test hookup and preset the instrument controls:*
 - a. *Initialize the front panel;*
 - Press save/recall **SETUP**.
 - Press the main-menu button **Recall Factory Setup**.
 - Press the side-menu button **OK Confirm Factory Init**.
 - b. *Modify the initialized front-panel control settings:*
 - Do *not* adjust the vertical position of any channel during this procedure.
 - Set the horizontal **SCALE** to 500 ps.
 - Press **SHIFT**; then press **ACQUIRE MENU**.
 - Press the main-menu button **Mode**, and then press the side-menu button **Average 16**.

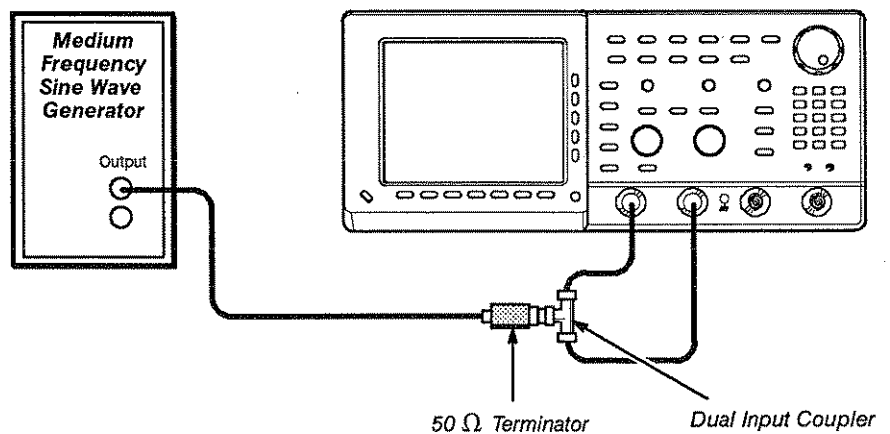

Figure A-10: Initial Test Hookup

c. *Hook up the test-signal source:*

- Connect, through a 50 Ω precision coaxial cable, followed by a 50 Ω termination, the sine wave output of a medium-frequency sine wave generator to a dual-input coupler.
- Connect the coupler to both **CH 1** and **CH 2**.

2. *Confirm CH 1 through CH 4 are within limits for channel delay:*

- a. *Set up the generator:* Set the generator frequency to 250 MHz and the amplitude for about five divisions in CH 1.

Hint: as you are adjusting the generator amplitude, push **SET LEVEL TO 50%** frequently to speed up the updating of the waveform amplitude on screen.



TDS 520 only: Press **CH 2**; then skip to substep e and continue this check. If testing a TDS 540 model, continue with the next substep, b.

- b. *Save a CH 2 waveform:* Press **CH 2**; then press save/recall **WAVEFORM**. Now, press the main-menu button **Save Waveform**; then press the side-menu button **To Ref 2**.

- c. *Save CH 3 waveform:* Move the coupler from **CH 2** to **CH 3**, so that **CH 1** and **CH 3** are driven. Press **CH 3**; then press the side-menu button **To Ref 3**.

d. *Display all test signals:*

- Press **WAVEFORM OFF** twice to remove CH 2 and CH 3 from the display.
- Move the coupler from **CH 3** to **CH 4**, so that CH 1 and CH 4 are driven. Press **CH 4** to display.
- Now, press the front-panel button **MORE**. Press the main-menu buttons **Ref 2** and **Ref 3**.

e. *Measure the test signal:*

- Locate the point on the rising edge of the left-most waveform where it crosses the center horizontal graticule line. This is the *time reference point* for this waveform. Note the corresponding *time reference point* for right-most waveform. See Figure A-11.
- Press **CURSOR**; then press the side-menu button **V Bars**.
- Press **CLEAR MENU**.
- Rotate the General Purpose knob to align one cursor to the *time reference point* of the left-most waveform edge and the other cursor to the *time reference point* of the right-most waveform edge. (Press **TOGGLE** to switch between the two cursors.) See Figure A-11.
- Read the measurement results at the Δ : cursor readout, not the @: readout on screen.

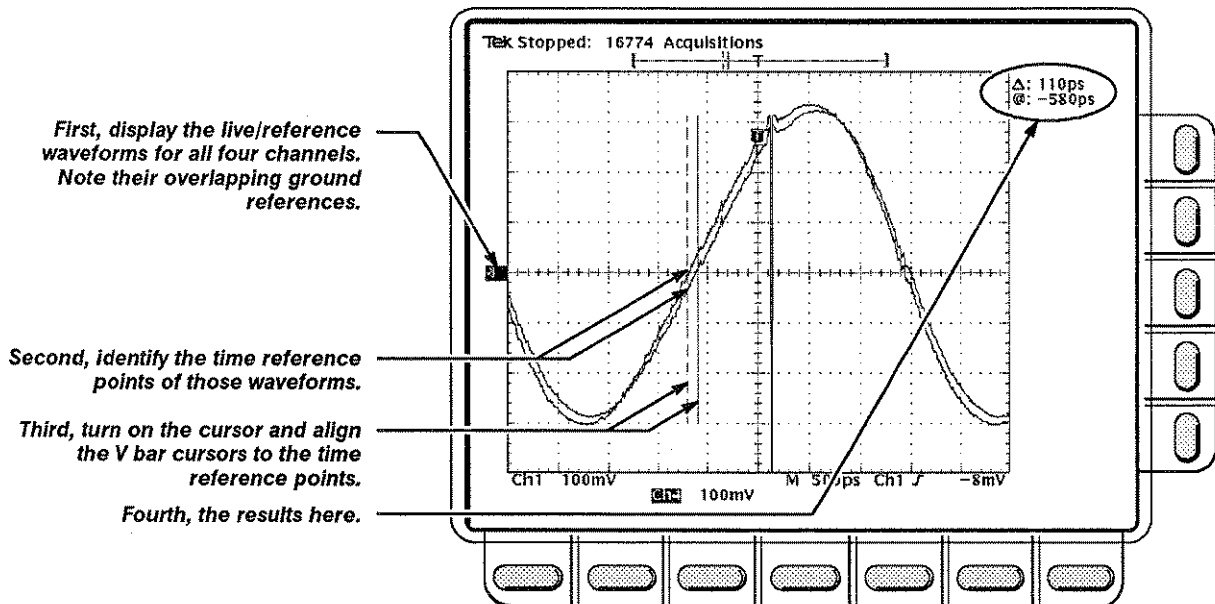

Figure A-11: Measurement of Channel Delay

- f. *Check against limits:* CHECK that the cursor readout on screen is ≤ 250 ps.
3. *Disconnect the hookup:* Disconnect the cable from the generator output at the input connectors of the channels.

Time Base System Checks

These procedures check those characteristics that relate to the Main and Delayed time base system and are listed as checked under *Warranted Characteristics* in *Appendix A: Specification*.

Check: Accuracy for Long-Term Sample Rate, Delay Time, and Delta Time Measurement

Equipment Required: One time-marker generator (Item 12) and one precision coaxial cable (Item 4).

Prerequisites: See page A-38.

Procedure:

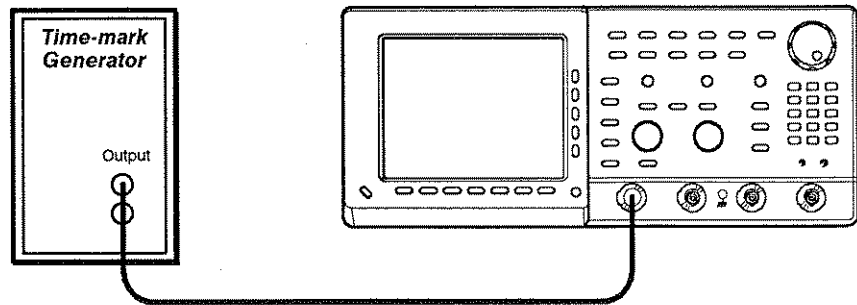

Figure A-12: Initial Test Hookup

1. *Install the test hookup and preset the instrument controls:*
 - a. *Hook up the test-signal source:* Connect, through a 50 Ω precision coaxial cable, the time-mark output of a time-marker generator to **CH 1**. Set the output of the generator for 10 ms markers.
 - b. *Initialize the oscilloscope:*
 - Press save/recall **SETUP**.
 - Press the main-menu button **Recall Factory Setup**.
 - Press the side-menu button **OK Confirm Factory Init**.
 - c. *Modify the initialized front-panel control settings:*
 - Set the vertical **SCALE** to 500 mV.
 - Press **VERTICAL MENU**; then press the main-menu button **Coupling**. Press the side-menu button Ω to **50 Ω** .
 - Press **SET LEVEL TO 50%**.
 - Use the vertical **POSITION** knob to center the test signal on screen.
 - Set the horizontal **SCALE** of the Main time base to 1 ms.

- Press **TRIGGER MENU**; then press the main-menu button **Mode & Holdoff**. Now press the side-menu button **Normal**.
 - Press **SET LEVEL TO 50%**.
 - Press horizontal **MENU**. Press the main-menu button **Record Length**; then press the side-menu button **1000 points in 20 divs**.
 - Press the main-menu button **Trigger Position**. Press the side-menu button **Pretrigger**; then set pretrigger to 20%: press **20**, then **ENTER**, on the keypad.
2. *Confirm Main and Delayed time bases are within limits for accuracies:*
- a. *Display the test signal:*
 - Adjust the horizontal **POSITION** so the trigger T is aligned to the center vertical graticule line.
 - Press the main-menu button **Time Base**
 - Press the side-menu buttons **Delayed Only** and **Delayed Runs After Main**.
 - b. *Measure the test signal:*
 - Set the horizontal **SCALE** of the **D** (delayed) time base to 100 ns.
 - Use the keypad to set delayed time to 10 ms. (Press **10**, then **SHIFT**, then **m** followed by **ENTER**.)

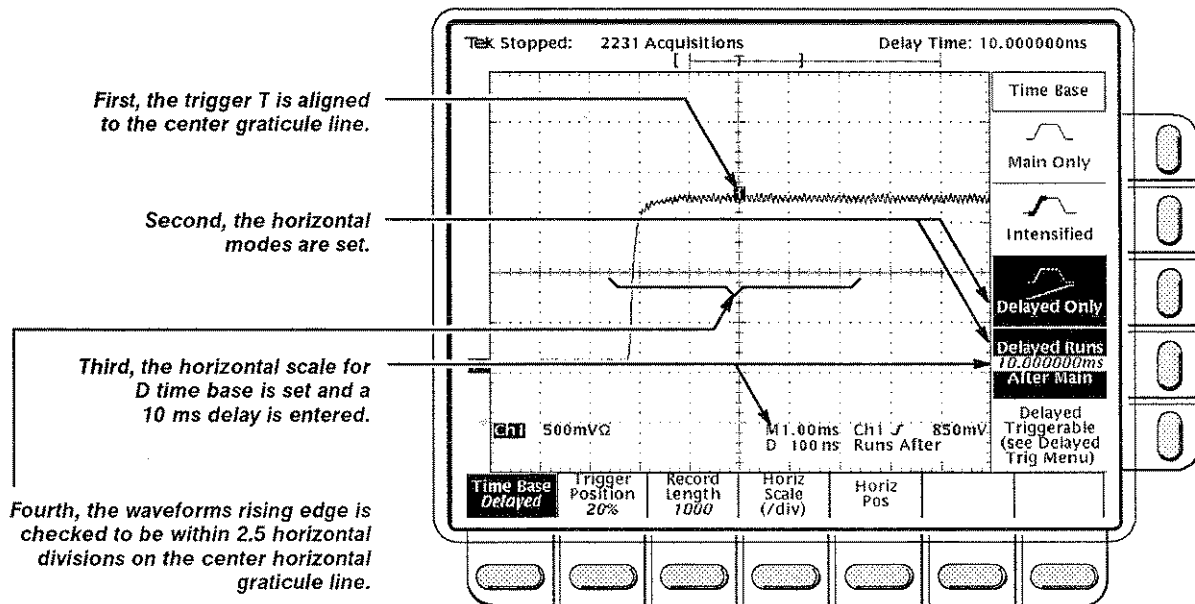

Figure A-13: Measurement of Accuracy -- Long-Term and Delay-Time

- c. *Check long-term sample rate and delay time accuracies against limits:* CHECK that the rising edge of the marker crosses the center horizontal graticule line at a point within ± 2.5 divisions of center graticule.
 - d. *Check delta-time accuracy against limits:*
 - Press the side-menu button **Main Only**. Set horizontal **SCALE** to 2 ns.
 - Set the output of the generator for 20 ns markers.
 - Press **SET LEVEL TO 50%**
 - Press **SHIFT**; then **ACQUIRE MENU**. Now press the main-menu button **Mode**; then press the side-menu button **Average**.
 - Enter **8**, for eight averages, on the keypad.
 - Press **MEASURE**.
 - Press the main-menu button **High-Low Setup**; then press the side-menu button **Min-Max**.
 - Press the main-menu button **Select Measurement for Ch1**.
 - Press the side-menu button **-more-**, until **PERIOD** appears in the side menu. Press **PERIOD**.
 - Press **CLEAR MENU**.
 - CHECK that the readout for **CH 1 Per** is within 19.760 ns to 20.240 ns.
3. *Disconnect the hookup:* Disconnect the cable from the generator output at the input connector of **CH 1**.

Trigger System Checks

These procedures check those characteristics that relate to the Main and Delayed trigger systems and are listed as checked under *Warranted Characteristics* in *Appendix B: Specification*.

Check: Accuracy (Time) for Pulse-Glitch or Pulse-Width Triggering

Equipment Required: One medium-frequency leveled sine-wave generator (Item 10), one 10X attenuator (Item 1), and one precision coaxial cable (Item 4).

Prerequisites: See page A-38.

Procedure:

1. *Install the test hookup and preset the instrument controls:*
 - a. *Initialize the instrument.*
 - Press save/recall **SETUP**.
 - Press the main-menu button **Recall Factory Setup**.
 - Press the side-menu button **OK Confirm Factory Init**.
 - b. *Modify the default setup:*
 - Press vertical **MENU**.
 - Press the main-menu button **Coupling**; then press the side-menu button Ω to select 50 Ω coupling.
 - Set the horizontal **SCALE** to 10 ns.

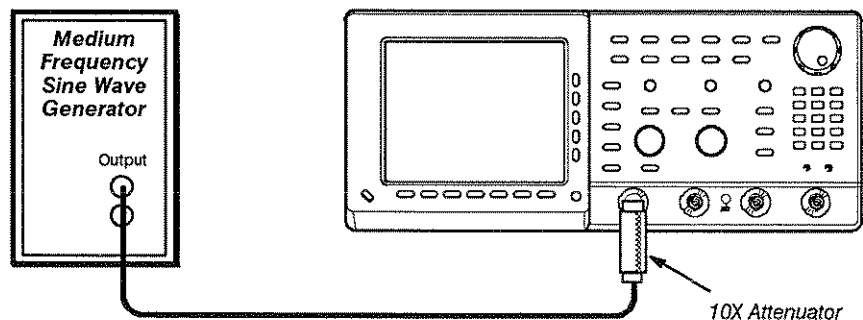

Figure A-14: Initial Test Hookup

- c. *Hook up the test-signal source:* Connect, through a 50 Ω precision coaxial cable, followed by a 10X attenuator, the output of a medium-frequency leveled sine-wave generator (Item 10).

2. *Confirm the trigger system is within time-accuracy limits for pulse-glitch or pulse-width triggering (Horizontal Scale $\leq 1 \mu\text{s}$):*
 - a. *Display the test signal:* Set the output of the sine wave generator for a 100 MHz, five-division sine wave on screen. Press **SET LEVEL TO 50%**.
 - b. *Set the trigger mode:* Press **TRIGGER MENU**. Now press the main-menu button **Mode & Holdoff**; then the side-menu button **Normal**.
 - c. *Set upper and lower limits that ensures triggering:*
 - Press the main-menu button **Type**; then repeatedly press the same button until **Pulse** is highlighted in the menu that pops up.
 - Press the main-menu button **Class**; then repeatedly press the same button until **Width** is highlighted in the menu that pops up.
 - Press the main-menu button **Trig When**; then press the side-menu button **Within Limits**.
 - Press the side-menu button **Upper Limit**. Use the keyboard to set the upper limit to 10 ns: press **10**; then **SHIFT**; then **n**; then **ENTER**.
 - Press the side-menu button **Lower Limit**. Use the keypad to set the lower limit to 2 ns.
 - d. *Check against limits:*
 - Press **SET LEVEL 50%**.
 - While doing the following subparts, monitor the display (it will stop acquiring) and the front-panel light **TRIG** (it will extinguish) to determine when triggering is lost.
 - Use the general purpose knob to *increase* the **Lower Limit** readout until triggering is lost.
 - CHECK that the **Lower Limit** readout is within 2.5 ns to 7.5 ns, inclusive.
 - Use the keypad to return the **Lower Limit** to 2 ns and reestablish triggering.
 - Press the side-menu button **Upper Limit**; then use the general purpose knob to slowly *decrease* the the **Upper Limit** readout until triggering is lost.
 - CHECK that the **Upper Limit** readout is within 2.5 ns to 7.5 ns, inclusive.

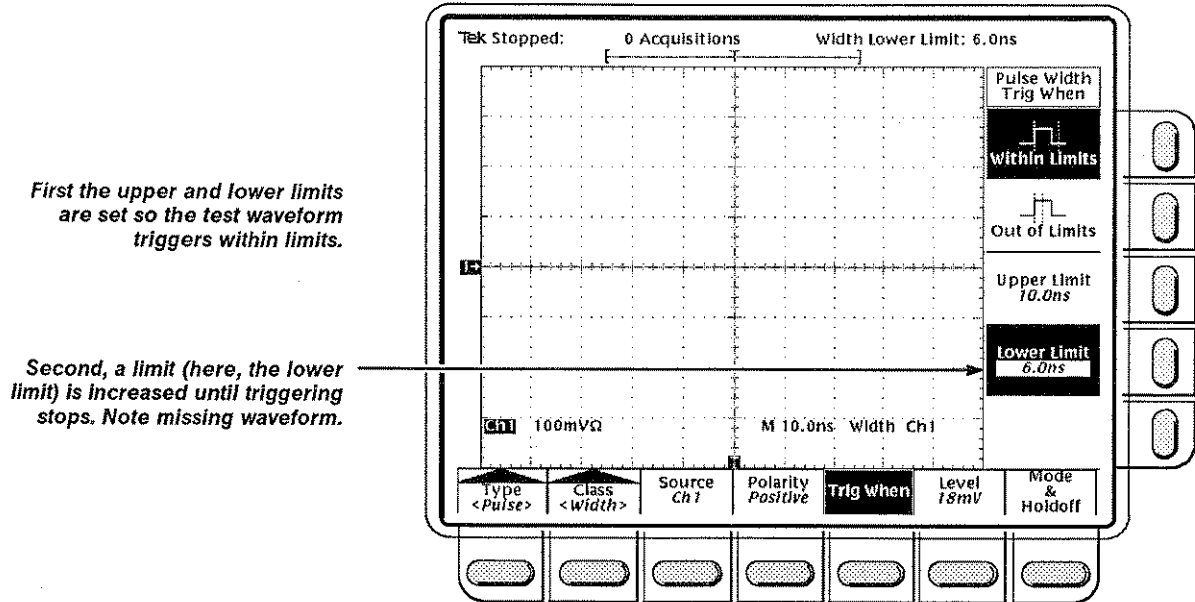

Figure A-15: Measurement of Time Accuracy for Pulse and Glitch Triggering

3. Confirm the trigger system is within time-accuracy limits for pulse-glitch or pulse-width triggering (horizontal scale $> 1 \mu\text{s}$):
 - a. Set upper and lower limits that ensures triggering at 250 kHz:
 - Press the side-menu button **Upper Limit**. Use the keyboard to set the upper limit to 4 μs .
 - Press the side-menu button **Lower Limit**. Use the keypad to set the lower limit to 500 ns.
 - b. Display the test signal:
 - Set the horizontal **SCALE** to 5 μs .
 - Set the output of the sine-wave generator for a 250 kHz, five-division sine wave on screen. Set the vertical **SCALE** to 20 mV (the waveform will overdrive the display).
 - Press **SET LEVEL TO 50%**.
 - c. Check against limits: Do the following subparts in the order listed.
 - Use the general purpose knob to *increase* **Lower Limit** readout until triggering is lost.
 - CHECK that the **Lower Limit** readout is within 1 μs to 3 μs , inclusive.
 - Use the keypad to return the **Lower Limit** to 500 ns and reestablish triggering.

- Press the side-menu button **Upper Limit**; then use the general purpose knob to slowly *decrease* the the **Upper Limit** readout until triggering is lost.
 - CHECK that the **Upper Limit** readout is within 1 μ s to 3 μ s, inclusive.
4. *Disconnect the hookup:* Disconnect the cable from the generator output at the input connector of **CH 1**.

Check: Accuracy, Trigger-level or Threshold, DC Coupled

Equipment Required: One DC calibration generator (Item 8), one BNC T connector (Item 6), and two precision coaxial cables (Item 4).

Prerequisites: The oscilloscope must meet the prerequisites listed on page A-38.

Procedure:

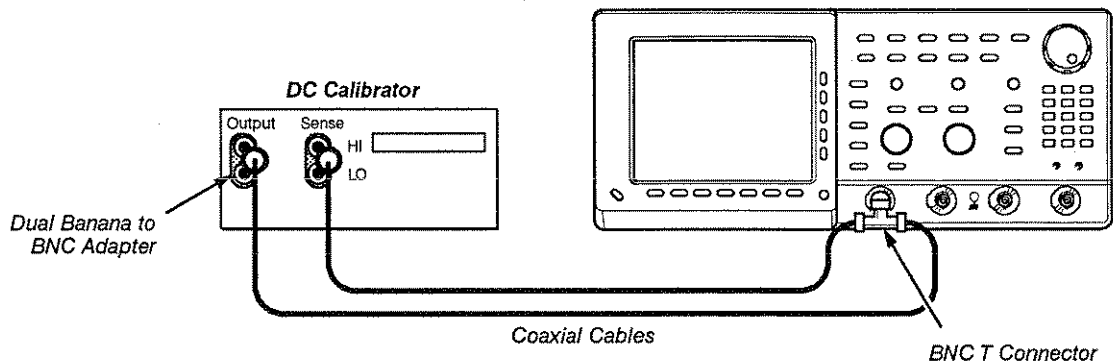

Figure A-16: Initial Test Hookup

1. *Install the test hookup and preset the instrument controls:*
 - a. *Hook up the test-signal source:*
 - Set the output of a DC calibration generator to 0 volts.
 - Connect the output of a DC calibration generator through a dual-banana connector followed by a 50 Ω precision coaxial cable to one side of a BNC T connector.
 - Connect the Sense output of the generator, through a second dual-banana connector followed by a 50 Ω precision coaxial cable, to other side of the BNC T connector. Now connect the BNC T connector to **CH 1**.

- b. *Initialize the oscilloscope:*
 - Press save/recall **Setup**.
 - Press the main-menu button **Recall Factory Setup**.
 - Press the side-menu button **OK Confirm Factory Init**.
2. *Confirm Main trigger system is within limits for Trigger-level/Threshold accuracy:*
 - a. *Display the test signal:*
 - Press **VERTICAL MENU**. Press the main-menu button **Position**.
 - Use the keypad to set vertical position to -3 divisions (press **-3**, then **ENTER**, on the keypad.) The baseline level will move down three divisions.
 - Press the main-menu button **Offset**.
 - Use the keypad to set vertical offset to +10 volts. The baseline level will move off-screen.
 - Set the standard output of a DC calibration generator to +10 volts. The DC test level will appear on screen.
 - b. *Measure the test signal:*
 - Press **SET LEVEL TO 50%**.
 - Press **TRIGGER MENU**.
 - Read the measurement results from the readout below the label **Level** in the menu; not the trigger readout in the graticule area.
 - c. *Check against limits:*
 - CHECK that the **Level** readout in the main menu is within 9.940 V to 10.060 V, inclusive.
 - Press **TRIGGER MENU**. Press the main-menu button **Slope**; then press the side-menu button for negative slope. (See icon at left.) Repeat substep b.
 - CHECK that the **Level** readout in the main menu is within 9.940 V to 10.060 V, inclusive.
3. *Confirm Delayed trigger system is within limits for Trigger-level/Threshold accuracy:*
 - a. *Select the Delayed time base:*
 - Press **HORIZONTAL MENU**.
 - Press the main-menu button **Time Base**.
 - Press the side-menu buttons **Delayed Only** and **Delayed Triggerable**.
 - Set **D** (delayed) horizontal **SCALE** to 500 μ s.

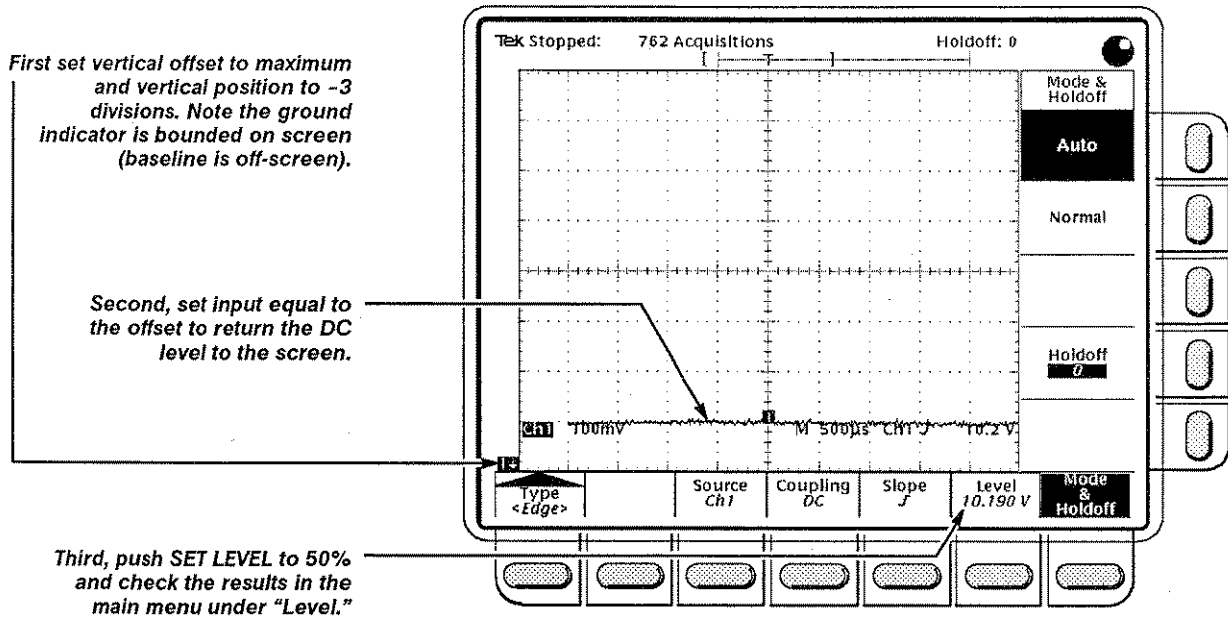

Figure A-17: Measurement of Trigger-Level Accuracy

- b. *Select the Delayed trigger system:*
 - Press **SHIFT**; then press the front-panel button **DELAYED TRIG**.
 - Press the main-menu button **Level**.
 - c. *Measure the test signal:* Press the side-menu button **SET TO 50%**. The **TRIG'D** indicator should be lit. Read the measurement results in the side menu below the label **Level**.
 - d. *Check against limits:* Do the following subparts in the order listed.
 - CHECK that the **Level** readout in the side menu is within 9.940 V to 10.060 V, inclusive.
 - Press the main-menu button **Slope**; then press the side-menu button for negative slope. (See icon at left.) Press the main-menu button **Level**. Repeat substep c.
 - CHECK that the **Level** readout in the side menu is within 9.940 V to 10.060 V, inclusive.
4. *Disconnect the hookup:*
 - a. *First set the output of the DC calibration generator to 0 volts.*
 - b. *Then disconnect the cable from the generator output at the input connector of CH 1.*

Check: Sensitivity, Edge Trigger, DC Coupled

Equipment Required: One medium-frequency leveled sine-wave generator (Item 11), one high-frequency leveled sine-wave generator, one precision 50 Ω coaxial cable (Item 4), and one 10X attenuator (Item 4). When checking the TDS 540 Digitizing Oscilloscope, a BNC T connector (Item 6), a 5X attenuator (Item 2), and a second precision 50 Ω coaxial cable (Item 4) are also required.

Prerequisites: See page A-38.

Procedure:

1. *Install the test hookup and preset the instrument controls:*
 - a. *Initialize the oscilloscope:*
 - Press save/recall **SETUP**.
 - Press the main-menu button **Recall Factory Setup**.
 - Press the side-menu button **OK Confirm Factory Init**.
 - b. *Modify the initialized front-panel control settings:*
 - Set the horizontal **SCALE** for **M** (main) time base to 20 ns.
 - Press **HORIZONTAL MENU**; then press the main-menu button **Time Base**.
 - Press the side-menu button **Delayed Only**; then the side-menu button **Delayed Triggerable**.
 - Set the horizontal **SCALE** for the **D** (delayed) time base to 20 ns; then press the side-menu button **Main Only**.
 - Press **TRIGGER MENU**; then press the main-menu button **Mode & Holdoff**. Now press the side-menu button **Normal**.
 - Press **VERTICAL MENU**; then press the main-menu button **Coupling**. Now press the side-menu button Ω select the 50 Ω setting.
 - Press **SHIFT**; then press **ACQUIRE MENU**. Now press the main-menu button **Mode**; then the side-menu button **Average 16**.
 - c. *Hook up the test-signal source:*

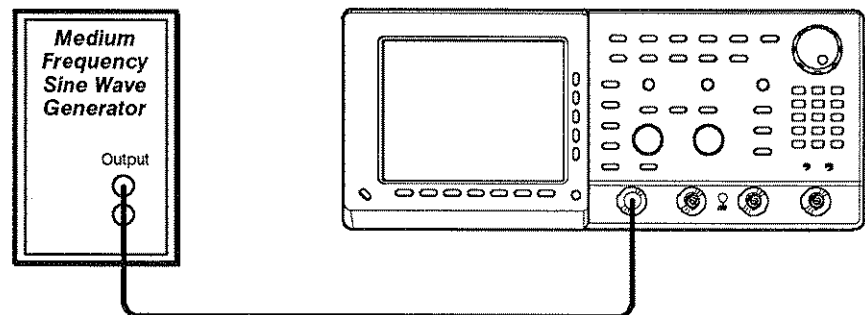

Figure A-18: Initial Test Hookup — TDS 520 Only

- TDS 520 only: Connect, through a 50 Ω precision coaxial cable, the signal output of a medium-frequency sine wave generator to **CH 1**. See Figure A-18.

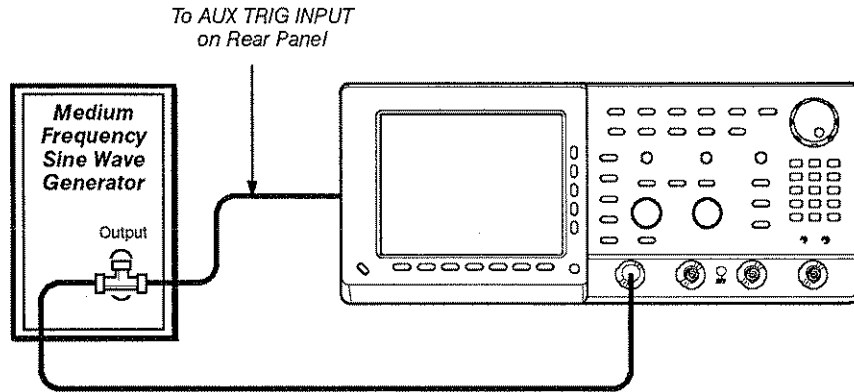

Figure A-19: Initial Test Hookup – TDS 540 Only

- TDS 540 only: Connect the signal output of a medium-frequency sine wave generator to a BNC T connector. Connect one output of the T connector to **CH 1** through a 50 Ω precision coaxial cable; connect the other output of the T connector to the **AUX TRIG INPUT** at the rear panel. See Figure A-19.
2. *Confirm Main and Delayed trigger systems are within sensitivity limits (50 MHz):*
 - a. *Display the test signal:*
 - Set the generator frequency to 50 MHz.
 - Press **MEASURE**.
 - Press the main-menu button **High-Low Setup**; then press the side-menu button **Min-Max**.
 - Press the main-menu button **Select Measurement for Ch 1**.
 - Press the side-menu button **–more–** until **Amplitude** appears in the side menu (its icon is shown at the left). Press the side-menu button **Amplitude**.
 - Press **SET LEVEL TO 50%**.
 - Press **CLEAR MENU**.
 - Set the test signal amplitude for about three divisions on screen. Now fine adjust the generator output until the **CH 1 Amplitude** readout indicates the amplitude is 350 mV. (Readout may fluctuate around 350 mV.)
 - Disconnect the 50 Ω precision coaxial cable at **CH 1** and reconnect it to **CH 1** through a 10X attenuator.



- b. Check for Main trigger system for stable triggering at limits:
- Read the following definition: A stable trigger is one that is consistent; that is, one that results in a uniform, regular display triggered on the selected slope (positive or negative). This display should *not* have its trigger point switching between opposite slopes, nor should it “roll” across the screen. At horizontal scale settings of 2 ms/division and faster, **TRIG'D** will remain constantly lit. It will flash for slower settings.
 - Press **TRIGGER MENU**; then press the main-menu button **Slope**.
 - Press **SET LEVEL TO 50%**. CHECK that a stable trigger is obtained for the test waveform on both the positive and negative slopes. (Use the side menu to switch between trigger slopes; use the **TRIGGER LEVEL** knob to stabilize the trigger if required.)
 - Leave the Main trigger system triggered on the positive slope of the waveform before continuing to the next step.

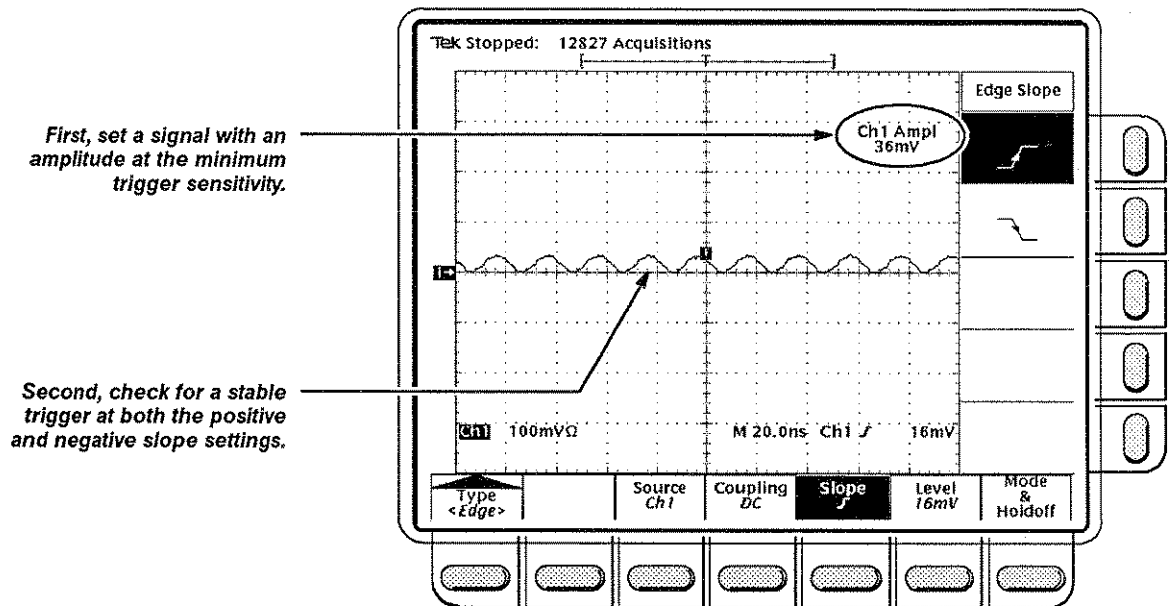

Figure A-20: Measurement of Trigger Sensitivity

- c. Check delayed trigger system for stable triggering at limits Do the following subparts in the order listed.
- Press **HORIZONTAL MENU**; then press the main-menu button **Time Base**. Now press the side-menu button **Delayed Only**.
 - Press **SHIFT**; then press **DELAYED TRIG**. Press the main-menu button **Level**.

- Press the *side-menu* button **SET TO 50%**. CHECK that a stable trigger is obtained for the test waveform for both the positive and negative slopes of the waveform. (Use the General Purpose knob to stabilize the trigger if required.) Press the main-menu button **Slope**; then use the side menu to switch between trigger slopes.
- Leave the delayed trigger system triggered on the positive slope of the waveform before continuing to the next step. Also, return to the main time base: Press **HORIZONTAL MENU**; then press the main-menu button **Time Base**. Now press the side-menu button **Main Only**.



TDS 520 only: Skip to step 4 since the TDS 520 is not equipped with an AUX Trigger input. If testing the TDS 540, continue with step 3.

3. *Confirm the AUX Trigger input:*

a. *Display the test signal:*

- Remove the 10X attenuator and reconnect the cable to **CH 1**.
- Set the test signal amplitude for about 2.5 divisions on screen.
- Now fine adjust the generator output until the **CH 1 Amplitude** readout indicates the amplitude is 250 mV. (Readout may fluctuate around 250 mV.)

b. *Check for AUX trigger source for stable triggering at limits:* Do the following in the order listed.

- Use the definition for stable trigger from step 2.
- Press **TRIGGER MENU**; then press the main-menu button **Source**.
- Press the side-menu button **-more-** until the side-menu label **Auxiliary** appears; then press **Auxiliary**.
- Press **SET LEVEL TO 50%**. CHECK that a stable trigger is obtained for the test waveform on both the positive and negative slopes. Press the main-menu button **Slope**; then use the side menu to switch between trigger slopes. Use the **TRIGGER LEVEL** knob to stabilize the trigger if required.
- Leave the Main trigger system triggered on the positive slope of the waveform before proceeding to the next check.
- Press the main-menu button **Source**; then press the side-menu button **-more-** until **CH 1**. Press **CH 1**.

4. *Confirm that the Main and Delayed trigger systems are within sensitivity limits (500 MHz):*

- a. *Hook up the test-signal source:* Disconnect the hookup installed in step 1. Connect, through its leveling head, the signal output of a high-frequency leveled sine-wave generator to **CH 1**.

- b. *Set the Main and Delayed Horizontal Scales:*
 - Set the horizontal **SCALE** to 500 ps for the **M** (Main) time base.
 - Press **HORIZONTAL MENU**.
 - Press the main-menu button **Time base**; then press the side-menu button **Delayed Triggerable**.
 - Press the side-menu button **Delayed Only**.
 - Set the horizontal **SCALE** to 500 ps for the **D** (Delayed) time base. Press the side-menu button **Main Only**.
 - c. *Display the test signal:*
 - Set the generator frequency to 500 MHz.
 - Set the test signal amplitude for about five divisions on screen. Now fine adjust the generator output until the **CH 1 Amplitude** readout indicates the amplitude is 500 mV. (Readout may fluctuate around 500 mV.)
 - Disconnect the leveling head at **CH 1** and reconnect it to **CH 1** through a 5X attenuator.
 - d. Repeat step 2, substeps b and c only, since only the 500 MHz frequency is to be checked here.
5. *Confirm that the Main and Delayed trigger systems couple trigger signals from all channels:* If you have not done the procedure *Check Analog Bandwidth*, which begins of page A-49, do so after finishing this procedure. See the following note.

NOTE

Steps 1 through 4 confirmed trigger sensitivity for the Main and Delayed triggering systems using the CH 1 input. Doing the procedure Check Analog Bandwidth ensures that trigger signals are coupled from all four channels.

6. *Disconnect the hookup:* Disconnect the cable from the generator output at the input connector of the channel last tested.

Output Signals Checks

These procedures check those characteristics that are available at the various output ports on the oscilloscope and are listed as checked under *Warranted Characteristics* in *Appendix B: Specification*.

Check: Outputs – CH 3, Main and Delayed Trigger, and Probe Compensator

Equipment Required:

- TDS 520 and TDS 540: One standard-accessory 10X probe (Item 13).
- TDS 540 only: Two 50 Ω precision cables (Item 4), and one calibration generator (Item 9).

Prerequisites: See page A-38. Also, this digitizing oscilloscope must have passed *Check Accuracy – Long-Term Sample Rate, Delay time, Time Measurement* on page A-56 and *Check Accuracy for DC Gain and Voltage Measurements* on page A-43.



The TDS 520 Digitizing Oscilloscope does not have rear-panel outputs; therefore, when testing the TDS 520 skip the steps that check those outputs where instructed to do so.

Procedure:

1. *Install the test hookup and preset the instrument controls*

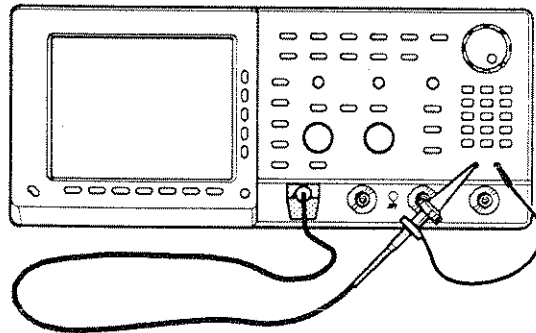

Figure A-21: Initial Test Hookup (TDS 520)

- a. *Hook up test-signal source 1 (both TDS 520 and TDS 540):* Install the standard-accessory probe to **CH 1**. Connect the probe tip to **PROBE COMPENSATION SIGNAL** on the front panel; connect the probe ground to **PROBE COMPENSATION GRD.**

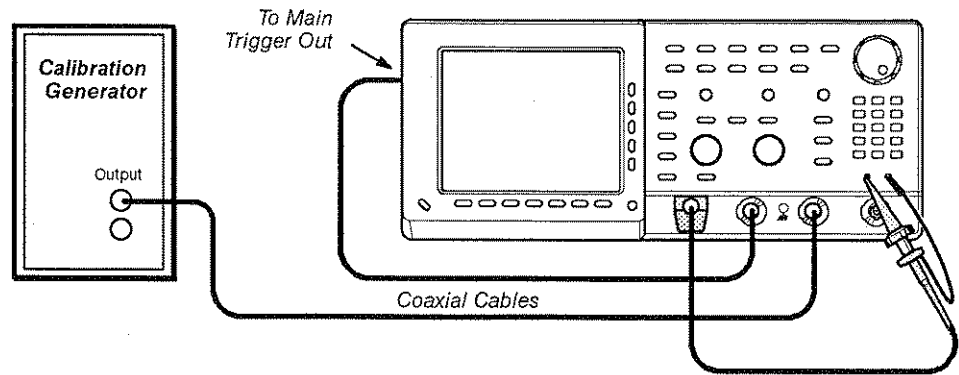

Figure A-22: Initial Test Hookup (TDS 540)

b. *Hook up test-signal source 2 (TDS 540 only):*

- Connect the standard amplitude output of a calibration generator through a 50 Ω precision coaxial cable to **CH 3**.
- Set the output of the calibration generator to 0.500 V.

c. *Hook up test-signal source 3 (TDS 540 only):* Connect the **Main Trigger Out** at the rear panel to **CH 2** through a 50 Ω precision cable.

d. *Initialize the oscilloscope:*

- Press save/recall **SETUP**.
- Press the main-menu button **Recall Factory Setup**.
- Press the side-menu button **OK Confirm Factory Init**.

e. *Modify the initialized front-panel control settings:*

- Press **AUTOSET**. Set the horizontal **SCALE** to 200 μ s.
- Press **SHIFT**; then press **ACQUIRE MENU**.
- Press the main-menu button **Mode**; then press the side-menu button **Hi Res**.

2. *Confirm that the Probe Compensator signal is within limits for amplitude and frequency:*

a. *Measure amplitude and frequency of the probe compensation signal:*

- Press **MEASURE**; then press the main-menu button **Select Measurement for Ch 1**.
- Repeatedly press the side-menu button **-more-** until **Frequency** appears in the side menu (its icon is shown at the left). Press the side-menu button **Frequency**.
- Now repeatedly press the side-menu button **-more-** until **Amplitude** appears in the side menu (its icon is shown at the left). Press the side-menu button **Amplitude**.



- Press **CLEAR MENU** to remove the menus from the display. See Figure A-23.

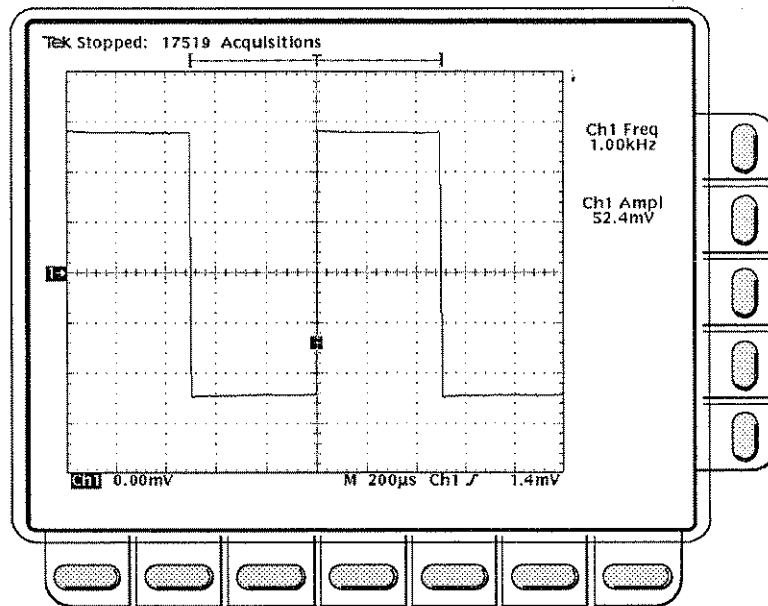

Figure A-23: Measurement of Probe Compensator Limits

- b. *Check against limits:* CHECK that the **CH 1 Freq** readout is within 950 Hz to 1.050 kHz, inclusive, and that the readout for **Ch 1 Ampl** is within 475 mV to 525 mV, inclusive.



TDS 520 only: Checking the probe compensator concludes this test. Skip to step 5 to disconnect the test hookup.

3. *Confirm Main and Delayed Trigger outputs are within limits for logic levels:*
 - a. *Display the test signal:*
 - Press **WAVEFORM OFF** to turn off CH 1.
 - Press **CH 2** to display that channel.
 - Set the vertical **SCALE** to 1 V.
 - Use the vertical **POSITION** knob to center the display on screen.
 - b. *Measure logic levels:*
 - Press **MEASURE**; then press the main-menu button **Select Measurement for Ch 2**.
 - Repeatedly press the side-menu button **-more-** until **High** and **Low** appear in the side menu (their icons are shown at the left). Press both side-menu buttons **High** and **Low**.



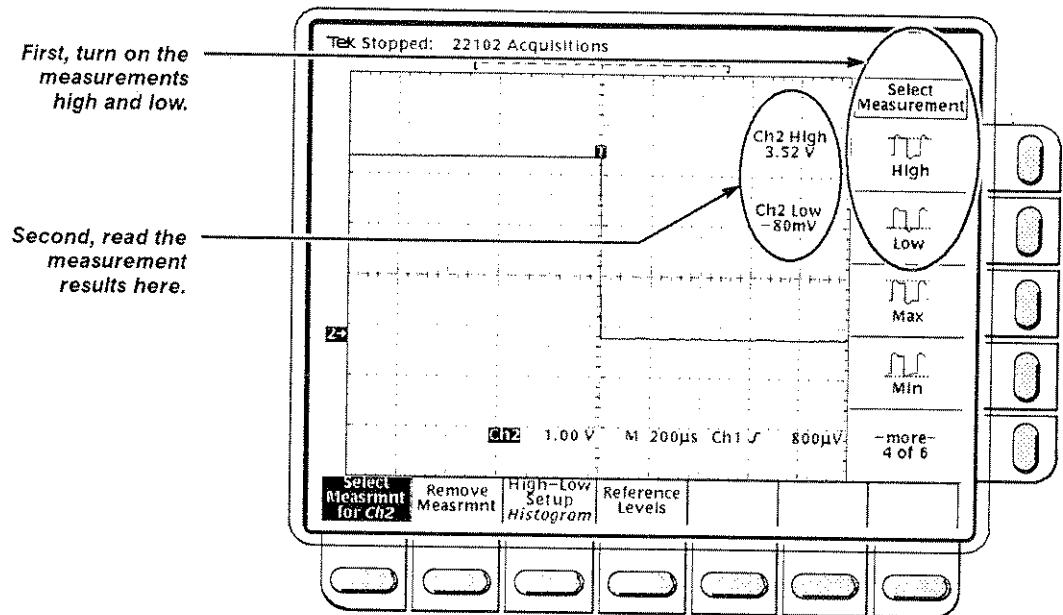

Figure A-24: Measurement of Main Trigger Out Limits

- c. *Check Main Trigger output against limits:*
 - CHECK that the **Ch 2 High** readout is ≥ 2.5 volts and that the **Ch 2 Low** readout is ≤ 0.7 volts.
 - Press **VERTICAL MENU**; then press the main-menu button **Coupling**. Now press the side-menu button Ω to toggle it to the 50 Ω setting.
 - CHECK that the **Ch 2 High** readout is ≥ 1.0 volts and that the **Ch 2 Low** readout ≤ 0.25 volts.
- d. *Check Delayed Trigger output against limits:*
 - Move the precision 50 Ω cable from the **Main Trigger Output** BNC to the **Delayed Trigger Output** BNC.
 - CHECK that the **Ch 2 High** readout is ≥ 1.0 volts and that the **Ch 2 Low** readout ≤ 0.25 volts.
 - Press the side-menu button Ω select the 1 M Ω setting.
 - Press **CLEAR MENU**.
 - CHECK that the **Ch 2 High** readout is ≥ 2.5 volts and that the **Ch 2 Low** readout is ≤ 0.7 volts.
4. *Confirm CH 3 output is within limits for gain:*
 - a. *Measure gain:*
 - Move the precision 50 Ω cable from the **DELAYED TRIGGER OUTPUT** BNC to the **CH 3 OUTPUT** BNC.
 - Press **SHIFT**; then press **DELAYED TRIG**.



- Press the main-menu button **Source**; then press the side-menu button **Ch 3**.
 - Press **HORIZONTAL MENU**.
 - Press the main-menu button **Time Base**; then press the side-menu button **Delayed Triggerable**.
 - Set vertical **SCALE** to 100 mV.
 - Press **MEASURE**; then press the main-menu button **Select Measurements for Ch 2**.
 - Repeatedly press the side-menu button **-more-** until **Pk-Pk** appears in the side menu (its icon is shown at the left). Press the side-menu button **Pk-Pk**.
 - Press **CLEAR MENU**.
- b. *Check against limits:*
- CHECK that the readout **Ch 2 Pk-Pk** is between 90 mV and 110 mV, inclusive.
 - Press **VERTICAL MENU**; then press the side-menu button Ω to toggle to the 50 Ω setting.
 - Press **CLEAR MENU**.
 - CHECK that the readout **Ch 2 Pk-Pk** is between 45 mV and 55 mV, inclusive.
5. *Disconnect the hookup:* Disconnect the cable from the generator output at the input connector of the channel last tested.



Appendix D: Algorithms

The Tektronix TDS Series Digitizing Oscilloscope can take 22 automatic measurements. By knowing how the instrument makes these calculations, you may better understand how to use your instrument and how to interpret your results.

Measurement Variables

The TDS Series Digitizing Oscilloscope uses a variety of variables in its calculations. These include:

High, Low

High is the value used as the 100% level in measurements such as fall time and rise time. For example, if you request the 10% to 90% rise time, then the oscilloscope will calculate 10% and 90% as percentages with *High* representing 100%.

Low is the value used as the 0% level in measurements such as fall time and rise time.

The exact meaning of *High* and *Low* depends on which of two calculation methods you choose from the Measure menu's **High-Low Setup** item. These are *Min-max* and *Histogram*.

Min-Max Method — defines the 0% and the 100% waveform levels as the lowest amplitude (most negative) and the highest amplitude (most positive) samples. The min-max method is useful for measuring frequency, width, and period for many types of signals. Min-max is sensitive to waveform ringing and spikes, however, and does not always measure accurately rise time, fall time, overshoot, and undershoot.

The min-max method calculates the High and Low values as follows:

$$High = Max$$

and

$$Low = Min$$

Histogram Method — attempts to find the highest density of points above and below the waveform's midpoint. It attempts to ignore ringing and spikes when determining the 0% and 100% levels. This method works well when measuring square waves and pulse waveforms.

The oscilloscope calculates the histogram-based *High* and *Low* values as follows:

1. It makes a histogram of the record with one bin for each digitizing level (256 total).

2. It splits the histogram into two sections at the halfway point between *Min* and *Max* (also called *Mid*).
3. The level with the most points in the upper histogram is the *High* value, and the level with the most points in the lower histogram is the *Low* value. (Choose the levels where the histograms peak for *High* and *Low*.)

If *Mid* gives the largest peak value within the upper or lower histogram, then return the *Mid* value for both *High* and *Low* (this is probably a very low amplitude waveform).

If more than one histogram level (bin) has the maximum value, choose the bin farthest from *Mid*.

This algorithm does not work well for two-level waveforms with greater than about 100% overshoot.

HighRef, MidRef, LowRef

The user sets the various reference levels, through the Measure menu's **Reference Level** selection. They include:

HighRef — the waveform's high reference level. Used in fall time and rise time calculations. Typically set to 90%. You can set it from 0% to 100%.

MidRef — the waveform's middle reference level. Typically set to 50%. You can set it from 0% to 100%.

LowRef — the waveform's low reference level. Used in fall and rise time calculations. Typically set to 10%. You can set it from 0% to 100%.

Mid2Ref — the middle reference level for a second waveform. Used in delay time calculations. Typically set to 50%. You can set it from 0% to 100%.

Other Variables

The oscilloscope also measures several values itself that it uses to help calculate measurements.

RecordLength — is the number of data points in the time base. You set it with the Horizontal menu **Record Length** item.

Start — is the location of the start of the measurement zone (X-value). It is always 0.0 samples.

End — is the location of the end of the measurement zone (X-value). It is always (*RecordLength* - 1.0) samples.

Hysteresis – is 10%. It is used in *MCross1*, *MCross2*, and *MCross3* calculations.

MCross Calculations

MCross1, MCross2, and MCross3 – refer to the first, second, and third *MidRef* Cross times, respectively. See Figure A-25.

Note that the polarity of the crossings does not matter for these variables, but the crossings will alternate in polarity; i.e., *MCross1* could be a positive or negative crossing, but if *MCross1* is a positive crossing, *MCross2* will be a negative crossing.

The oscilloscope calculates these values as follows:

1. Find the first *MidRefCrossing* in the measurement zone. This is *MCross1*.
2. Continuing from *MCross1*, find the next *MidRefCrossing* in the measurement zone of the opposite polarity of *MCross1*. This is *MCross2*.
3. Continuing from *MCross2*, find the next *MidRefCrossing* in the measurement zone of the same polarity as *MCross1*. This is *MCross3*.

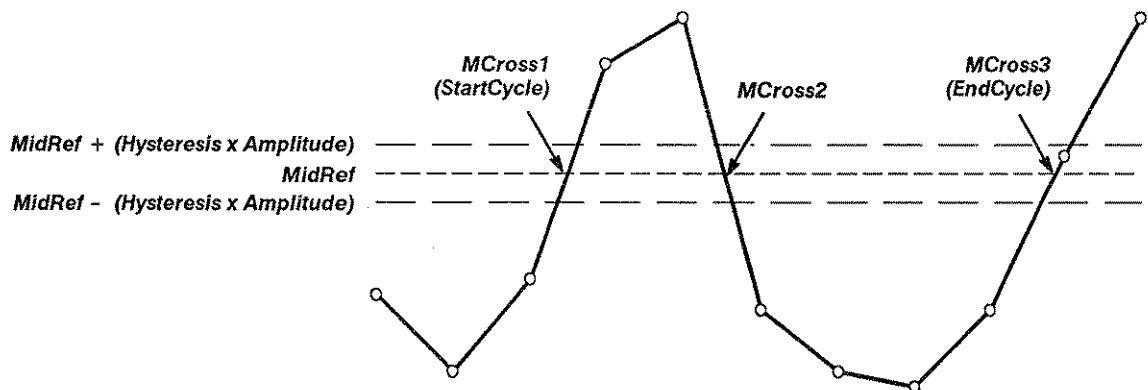

Figure A-25: MCross Calculations

MCross1Polarity – is the polarity of first crossing (no default). It can be rising or falling.

StartCycle – is the starting time for cycle measurements. It is a floating-point number with values between 0.0 and (*RecordLength* - 1.0), inclusive.

$$\text{StartCycle} = \text{MCross1}$$

EndCycle – is the ending time for cycle measurements. It is a floating-point number with values between 0.0 and (*RecordLength* - 1.0), inclusive.

$$\text{EndCycle} = \text{MCross3}$$

Waveform[<1 ... **RecordLength**>] – holds the acquired data.

TPOS – is the location of the sample just before the trigger point (the time reference zero sample). In other terms, it contains the domain reference location. This location is where time = 0.

TSOFF – is the offset between *TPOS* and the actual trigger point. In other words, it is the trigger sample offset. Values range between 0.0 and 1.0 samples. This value is determined by the instrument when it receives a trigger. The actual zero reference (trigger) location in the measurement record is at (*TPOS* + *TSOFF*).

Measurement Algorithms



The automated measurements are defined and calculated as follows:

Amplitude

$$\text{Amplitude} = \text{High} - \text{Low}$$



Burst Width

Timing measurement. The duration of a burst.

1. Find $MCross1$ on the waveform. This is $MCrossStart$.
2. Find the last $MCross$ (begin the search at $EndCycle$ and search toward $StartCycle$). This is $MCrossStop$. This could be a different value from $MCross1$.
3. Compute $BurstWidth = MCrossStop - MCrossStart$



Cycle Mean

Amplitude (voltage) measurement. The mean over one waveform cycle. For non-cyclical data, you might prefer to use the Mean measurement.

If $StartCycle = EndCycle$ then return the (interpolated) value at $StartCycle$.

$$\text{CycleMean} = \frac{\int_{StartCycle}^{EndCycle} \text{Waveform}(t) dt}{(EndCycle - StartCycle) \times \text{SampleInterval}}$$



Cycle RMS

The true Root Mean Square voltage over one cycle.

If $StartCycle = EndCycle$ then $CycleRMS = \text{Waveform}[Start]$.

Otherwise,

$$\text{CycleRMS} = \sqrt{\frac{\int_{StartCycle}^{EndCycle} (\text{Waveform}(t))^2 dt}{(EndCycle - StartCycle) \times \text{SampleInterval}}}$$



Delay

Timing measurement. The time between the $MidRef$ crossings of two different traces.

Delay measurements are actually a group of measurements. To get a specific delay measurement, you must specify the target and reference crossing polarities, and the reference search direction.

$Delay$ = the time from one $MidRef$ crossing on the source waveform to the $Mid2Ref$ crossing on the second waveform.

Fall Time

Timing measurement. The time taken for the falling edge of a pulse to drop from a *HighRef* value (default = 90%) to a *LowRef* value (default = 10%).

Figure A-26 shows a falling edge with the two crossings necessary to calculate a Fall measurement.

1. Searching from *Start* to *End*, find the first sample in the measurement zone greater than *HighRef*.
2. From this sample, continue the search to find the first (negative) crossing of *HighRef*. The time of this crossing is *THF*. (Use linear interpolation if necessary.)
3. From *THF*, continue the search, looking for a crossing of *LowRef*. Update *THF* if subsequent *HighRef* crossings are found. When a *LowRef* crossing is found, it becomes *TLF*. (Use linear interpolation if necessary.)
4. $FallTime = TLF - THF$

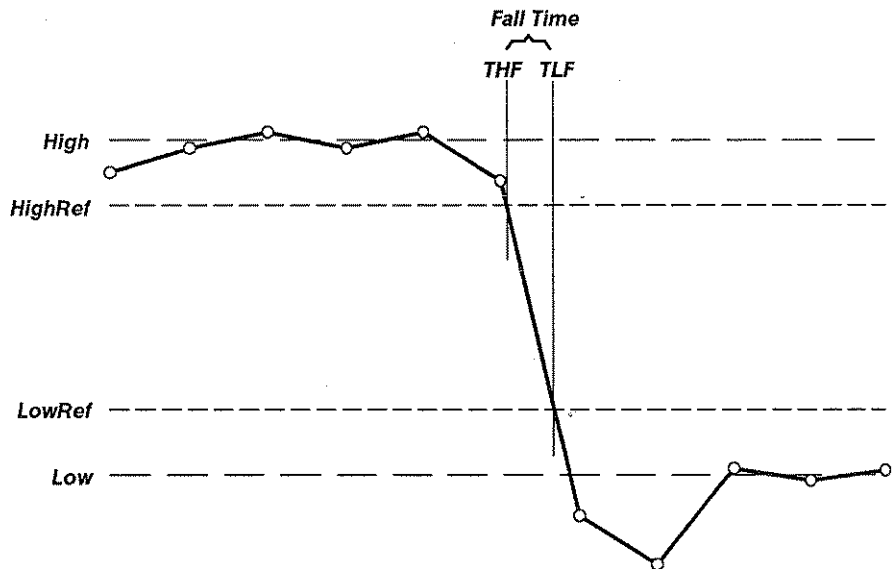

Figure A-26: Fall Time

Frequency

Timing measurement. The reciprocal of the period. Measured in Hertz (Hz) where 1 Hz = 1 cycle per second.

If *Period* = 0 or is otherwise bad, return an error.

$$Frequency = 1/Period$$

High

100% (highest) voltage reference value. (See “High, Low” earlier in this section)

Using the min-max measurement technique:

$$High = Max$$

Low

0% (lowest) voltage reference value calculated. (See “High, Low” earlier in this section)

Using the min-max measurement technique:

$$Low = Min$$

Maximum

Amplitude (voltage) measurement. The maximum voltage. Typically the most positive peak voltage.

Examine all *Waveform[]* samples from *Start* to *End* inclusive and set *Max* equal to the greatest magnitude *Waveform[]* value found.

Mean

The arithmetic mean for one waveform. Remember that one waveform is not necessarily equal to one cycle. For cyclical data you may prefer to use the cycle mean rather than the arithmetic mean.

if *Start = End* then return the (interpolated) value at *Start*.

Otherwise,

$$Mean = \frac{\int_{Start}^{End} Waveform(t) dt}{(End - Start) \times SampleInterval}$$

Minimum

Amplitude (voltage) measurement. The minimum amplitude. Typically the most negative peak voltage.

Examine all *Waveform[]* samples from *Start* to *End* inclusive and set *Min* equal to the smallest magnitude *Waveform[]* value found.



Negative Duty Cycle

Timing measurement. The ratio of the negative pulse width to the signal period expressed as a percentage.

NegativeWidth is defined in **Negative Width**, below.

If *Period* = 0 or undefined then return an error.

$$\text{NegativeDutyCycle} = \frac{\text{NegativeWidth}}{\text{Period}} \times 100\%$$



Negative Overshoot

Amplitude (voltage) measurement.

$$\text{NegativeOvershoot} = \frac{\text{Low} - \text{Min}}{\text{Amplitude}} \times 100\%$$

Note that this value should never be negative (unless High or Low are set out-of-range).



Negative Width

Timing measurement. The distance (time) between *MidRef* (default = 50%) amplitude points of a negative pulse.

If *MCross1Polarity* = '-'

then

$$\text{NegativeWidth} = (\text{MCross2} - \text{MCross1})$$

else

$$\text{NegativeWidth} = (\text{MCross3} - \text{MCross2})$$



Peak to Peak

Amplitude measurement. The absolute difference between the maximum and minimum amplitude.

$$\text{PeaktoPeak} = \text{Max} - \text{Min}$$

Period



Timing measurement. Time taken for one complete signal cycle. The reciprocal of frequency. Measured in seconds.

$$Period = MCross3 - MCross1$$

Positive Duty Cycle



Timing measurement. The ratio of the positive pulse width to the signal period, expressed as a percentage.

PositiveWidth is defined in **Positive Width**, following.

If *Period* = 0 or undefined then return an error.

$$PositiveDutyCycle = \frac{PositiveWidth}{Period} \times 100\%$$

Positive Overshoot



Amplitude (voltage) measurement.

$$PositiveOvershoot = \frac{Max - High}{Amplitude} \times 100\%$$

Note that this value should never be negative.

Positive Width



Timing measurement. The distance (time) between *MidRef* (default = 50%) amplitude points of a positive pulse.

If *MCross1Polarity* = '+'

then

$$PositiveWidth = (MCross2 - MCross1)$$

else

$$PositiveWidth = (MCross3 - MCross2)$$

Rise Time

Timing measurement. Time taken for the leading edge of a pulse to rise from a *LowRef* value (default = 10%) to a *HighRef* value (default = 90%).

Figure A-27 shows a rising edge with the two crossings necessary to calculate a Rise Time measurement.

1. Searching from *Start* to *End*, find the first sample in the measurement zone less than *LowRef*.
2. From this sample, continue the search to find the first (positive) crossing of *LowRef*. The time of this crossing is the low rise time or *TLR*. (Use linear interpolation if necessary.)
3. From *TLR*, continue the search, looking for a crossing of *HighRef*. Update *TLR* if subsequent *LowRef* crossings are found. If a *HighRef* crossing is found, it becomes the high rise time or *THR*. (Use linear interpolation if necessary.)
4. $RiseTime = THR - TLR$

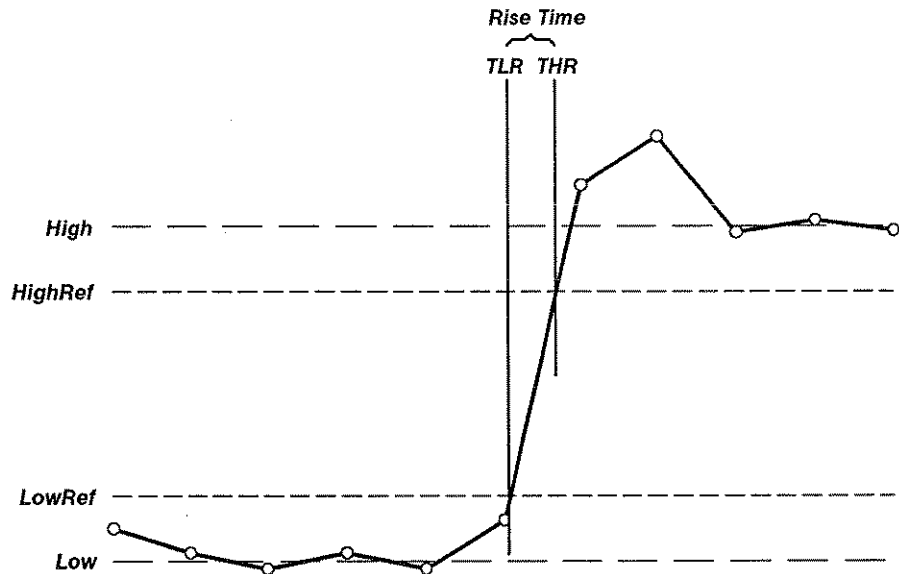

Figure A-27: Rise Time

RMS:

Amplitude (voltage) measurement. The true Root Mean Square voltage.

If $Start = End$ then $RMS =$ the (interpolated) value at $Waveform[Start]$.

Otherwise,

$$RMS = \sqrt{\frac{\int_{Start}^{End} (Waveform(t))^2 dt}{(End - Start) \times SampleInterval}}$$

Measurements on Envelope Waveforms

Time measurements on envelope waveforms must be treated differently from time measurements on other waveforms, because envelope waveforms contain so many apparent crossings. Unless otherwise noted, envelope waveforms use either the minima or the maxima (but not both), determined in the following manner:

1. Step through the waveform from *Start* to *End* until the sample min and max pair **DO NOT** straddle *MidRef*.
2. If the pair $> MidRef$, use the minima, else use maxima.

If all pairs straddle *MidRef*, use maxima. See Figure A-28.

The Burst Width measurement always uses both maxima and minima to determine crossings.

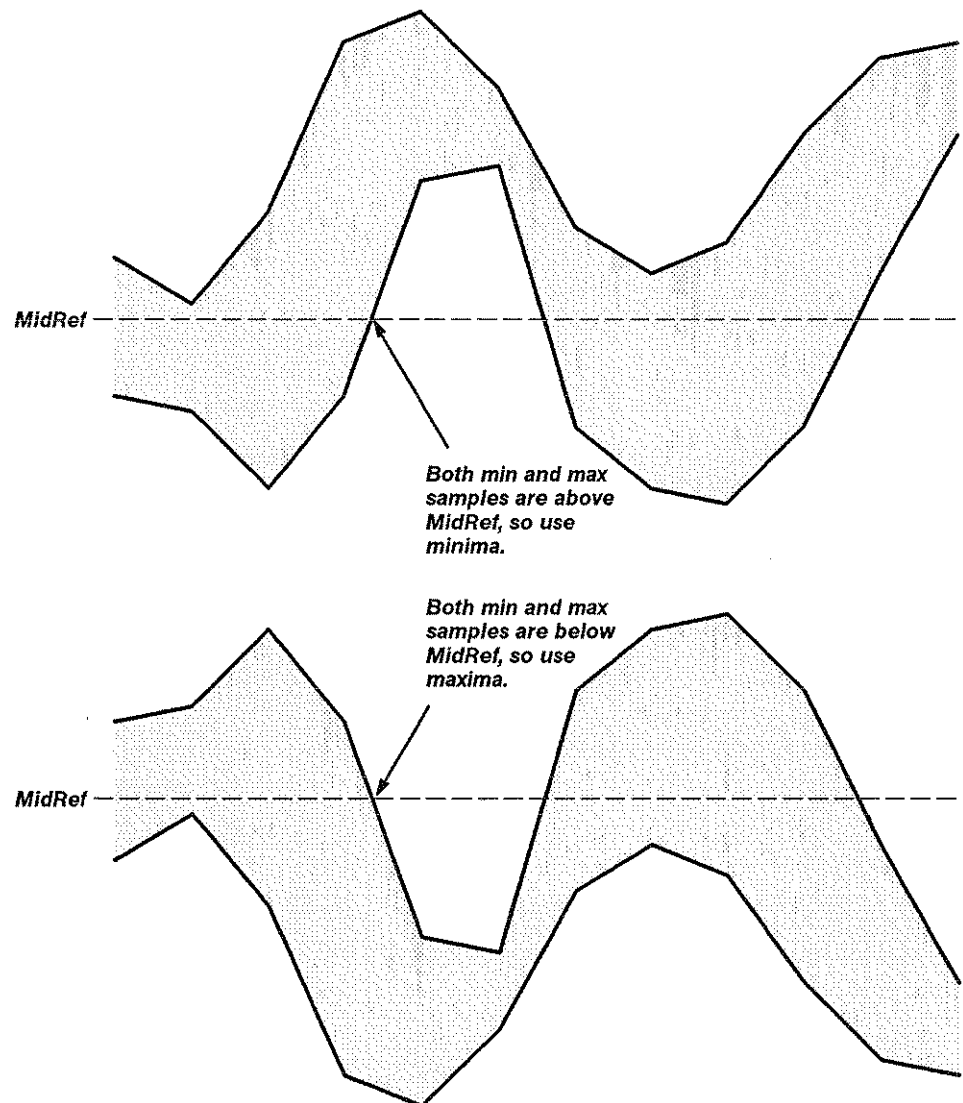

Figure A-28: Choosing Minima or Maxima to Use for Envelope Measurements

Missing or Out-of-Range Samples

If some samples in the waveform are missing or off-scale, the measurements will linearly interpolate between known samples to make an “appropriate” guess as to the sample value. Missing samples at the ends of the measurement record will be assumed to have the value of the nearest known sample.

When samples are out of range, the measurement will give a warning to that effect (for example, “CLIPPING”) if the measurement could change by extending the measurement range slightly. The algorithms assume the samples recover from an overdrive condition instantaneously.

For example, if *MidRef* is set directly, then *MidRef* would not change even if samples were out of range. However, if *MidRef* was chosen using the % choice from the Measure menu’s **Set Levels in % Units** selection, then *MidRef* could give a “CLIPPING” warning.



Appendix E: Packaging for Shipment

If you ship the digitizing oscilloscope, pack it in the original shipping carton and packing material. If the original packing material is not available, package the instrument as follows:

- Step 1:** Obtain a corrugated cardboard shipping carton with inside dimensions at least 15 cm (6 in) taller, wider, and deeper than the digitizing oscilloscope. The shipping carton must be constructed of cardboard with 375 pound test strength.
- Step 2:** If you are shipping the digitizing oscilloscope to a Tektronix field office for repair, attach a tag to the digitizing oscilloscope showing the instrument owner and address, the name of the person to contact about the instrument, the instrument type, and the serial number.
- Step 3:** Wrap the digitizing oscilloscope with polyethelene sheeting or equivalent material to protect the finish.
- Step 4:** Cushion the digitizing oscilloscope in the shipping carton by tightly packing dunnage or urethane foam on all sides between the carton and the digitizing oscilloscope. Allow 7.5 cm (3 in) on all sides, top, and bottom.
- Step 5:** Seal the shipping carton with shipping tape or an industrial stapler.





Appendix F: Factory Initialization Settings

The factory initialization settings function provide you a known state for the digitizing oscilloscope.

Settings

Factory initialization sets values as shown in Table A-28.

Table A-28: Factory Initialization Defaults

Control	Changed by Factory Init to
Acquire mode	Sample
Acquire repetitive signal	ON (Enable ET)
Acquire stop after	RUN/STOP button only
Acquire # of averages	16
Acquire # of envelopes	10
Channel selection	Channel 1 on, all others off
Cursor H Bar 1 position	10% of graticule height (-3.2 divs from the center)
Cursor H Bar 2 position	90% of the graticule height (+3.2 divs from the center)
Cursor V Bar 1 position	10% of the record length
Cursor V Bar 2 position	90% of the record length
Cursor function	Off
Cursor time units	Seconds
Delayed edge trigger coupling	DC
Delayed edge trigger level	0 V
Delayed edge trigger slope	Rising
Delayed edge trigger source	Channel 1
Delay trigger average #	16
Delay trigger envelope #	10

Table 3-10: Factory Initialization Defaults(Cont.)

Control	Changed by Factory Init to
Delay time, delayed runs after main	4.0 ns
Delay time, delayed triggerable after main	4.0 ns
Delay events, triggerable after main	2
Delayed, delay by ...	Delay by Time
Delayed, time base mode	Delayed Runs After Main
Display format	YT
Display graticule type	Full
Display intensity – contrast	125%
Display intensity – text	60%
Display intensity – waveform	80%
Display intensity – overall	85%
Display interpolation filter	Sin(x)/x
Display style	Vectors
Display trigger “T”	On
Display variable persistence	500 ms
Edge trigger coupling	DC
Edge trigger level	0.0 V
Edge trigger slope	Rising
Edge trigger source	Channel 1
Horizontal – delay trigger position	50%
Horizontal – delay trigger record length	500 points (10 divs)
Horizontal – delay trigger time/div.	50 μ s
Horizontal – main trigger position	50%
Horizontal – main trigger record length	500 points (10 divs)
Horizontal – main trigger time/div.	500 μ s
Horizontal – time base	Main only

Table 3-10: Factory Initialization Defaults(Cont.)

Control	Changed by Factory Init to
Logic pattern trigger Ch4 (Ax2) input	X (don't care)
Logic state trigger Ch4 (Ax2) input	Rising edge
Logic trigger input (pattern and state)	Channel 1 = H (high), Channels 2 & 3 (Ax1) = X (don't care)
Logic trigger threshold (all channels) (pattern and state)	1.4 V (when 10X probe attached)
Logic trigger class	Pattern
Logic trigger logic (pattern and state)	AND
Logic trigger triggers when ... (pattern and state)	Goes TRUE
Main trigger holdoff	0%
Main trigger mode	Auto
Main trigger type	Edge
Math function (single wfm)	Invert (Inv)
Math operator (dual wfm)	+ for math1 and math3, - for math2
Math source 1 (single and dual)	Channel 1 (Ch1)
Math source 2	Channel 2 (Ch2)
Math type	Dual Wfm Math
Measure Delay to	Channel 1 (Ch1)
Measure Delay edges	Both rising and forward searching
Measure High-Low Setup	Histogram
Measure High Ref	90% and 0 V (units)
Measure Low Ref	10% and 0 V (units)
Measure Mid Ref	50% and 0 V (units)
Measure Mid2 Ref	50% and 0 V (units)
Pattern trigger Ch4/Ax2 input	X (don't care)
Pulse glitch trigger polarity	Positive
Pulse runt high threshold	2.0 V
Pulse runt low threshold	0.0 V

Table 3-10: Factory Initialization Defaults(Cont.)

Control	Changed by Factory Init to
Pulse runt trigger polarity	Positive
Pulse trigger class	Glitch
Pulse trigger filter state	On (Reject glitch)
Pulse trigger glitch width	2.0 ns
Pulse trigger level	0.8 V
Pulse trigger source (Glitch, runt, and width)	Channel 1 (Ch1)
Pulse width trigger when ...	Within limits
Pulse width upper limit	2.0 ns
Pulse width lower limit	2.0 ns
Pulse width trigger polarity	Positive
Saved setups	No change
Saved waveforms	No change
Vertical bandwidth (all channels)	Full
Vertical coupling (all channels)	DC
Vertical impedance (termination) (all channels)	1 M Ω
Vertical offset (all channels)	0 V
Vertical position (all channels)	0 divs.
Vertical volts/div. (all channels)	100 mV/div.
Zoom horizontal (all channels)	1.0X
Zoom horizontal lock	Live
Zoom horizontal position (all channels)	50% = .5 (the middle of the display)
Zoom state	Off
Zoom vertical (all channels)	1.0X
Zoom vertical position (all channels)	0 divs.

AC 

AC coupling

A type of signal transmission that blocks the signal's DC component but uses the signal's dynamic (AC) component. Useful for observing an AC signal that is normally riding on a DC signal.

Accuracy

The closeness of the indicated value to the true value.

Acquisition

The process of sampling signals from input channels, digitizing the samples, processing the resulting samples into data points, and assembling the data points into a waveform record. The waveform record is stored in memory.

Acquisition interval

The time duration of the waveform record divided by the record length. The digitizing oscilloscope displays one data point for every acquisition interval.

Active cursor

The cursor that moves when you turn the general purpose knob. The @ readout on the display shows the position of the active cursor.

Aliasing

A false representation of the signal's waveform due to insufficient sampling of high frequencies or fast transitions. That is, a condition that occurs when a digitizing oscilloscope digitizes at an effective sampling rate that is too slow to reproduce the input signal. The waveform displayed on the oscilloscope may have a lower frequency than the actual input signal. Can cause excessive measurement and other errors.



Amplitude

The High waveform value less the Low waveform value.



AND

A logic (Boolean) function in which the output is true when and only when all the inputs are true. On the digitizing oscilloscope, this is a trigger logic pattern and state function.

Attenuation

The degree of reduction in amplitude as a signal passes through an attenuating device such as a probe or attenuator. That is, the ratio of the input measure to the output measure. For example, a 10X probe will attenuate, or reduce, the input signal's voltage by a factor of 10.

Automatic trigger mode

A trigger mode that causes the system to automatically acquire if triggerable events are not detected within a specified time period. Useful for displaying a waveform even though the oscilloscope has not been triggered.

Autoset

A function of the oscilloscope that produces a stable waveform of usable size. Autoset automatically sets up front-panel controls based on the characteristics of the active waveform. A successful autoset will set the volts/div, time/div, and trigger level to produce a coherent and approximately centered waveform display.

**Average acquisition mode**

A mode in which the oscilloscope acquires and displays a waveform that is the averaged result of several acquisitions. This reduces the apparent noise. The oscilloscope acquires data as in the sample mode and then averages it according to the number of averages that you specify.

**Bandwidth**

The highest frequency signal the oscilloscope can acquire with no more than 3 dB ($\times .707$) attenuation of the original (reference) signal.

**Burst width**

Timing measurement. The duration of a burst.

Channel

One of the oscilloscope's inputs for signal acquisition. The TDS 540 has four channels; the TDS 520 has two. It is the internal path from a signal input connector to the digitizer. It includes input coupling, termination, signal conditioning, sampling and associated controls.

Coupling

The association of two or more circuits or systems in such a way that power or information may be transferred from one to the other. The trigger and vertical systems have several coupling options.

Cursors

Paired markers that you use to make measurements between two waveform locations. You can use them for visual comparison with waveform features. The oscilloscope displays a readout of the cursor positions and the distance between them (expressed in volts or time).

**Cycle mean**

Amplitude (voltage) measurement. The arithmetic mean over one cycle.

**Cycle RMS**

The true Root Mean Square voltage over one cycle.

DC

DC coupling

Mode that passes both AC and DC signal components to the circuit. Available for both the trigger system and the vertical system.

**Delay measurement**

timing measurement. The time between the middle reference crossings of two different waveforms.

Delay time

The time between the trigger event and the acquisition of data.

Display system

The oscilloscope system that shows waveforms, measurements, menu items, status, and other parameters.

**Envelope acquisition mode**

A mode in which the oscilloscope acquires and displays a waveform that shows the variation extremes of several acquisitions.

Equivalent time sampling (ET)

Sampling mode in which the oscilloscope acquires signals over many repetitions of the event. The TDS 500 Series Digitizing Oscilloscopes use a type of equivalent time sampling called *random equivalent time sampling*. It utilizes an internal clock that runs asynchronously with respect to the input signal and the signal trigger. The oscilloscope takes samples continuously, independent of the trigger position, and displays them based on the time difference between the sample and the trigger. Although the samples are taken sequentially in time, they are random with respect to the trigger.

**Fall time**

Measurement of the time it takes for a pulse's trailing edge to fall from a HighRef value (typically 90%) to a LowRef value (typically 10%) of its amplitude.

**Frequency**

Timing measurement. The reciprocal of the period. Measured in Hertz (Hz) where 1 Hz = 1 cycle per second.

**General purpose knob**

The large front-panel knob with the indentation. You can use it to increase or decrease the value of the assigned parameter.

**Glitch positive trigger**

Triggering occurs if the oscilloscope detects positive spike widths less than the specified glitch time.

**Glitch negative trigger**

Triggering occurs if the oscilloscope detects negative spike widths less than the specified glitch time.

**Glitch either trigger**

Triggering occurs if the oscilloscope detects either positive or negative spike widths less than the specified glitch time.

**GPIB (General Purpose Interface Bus)**

An interconnection bus and protocol that allows you to connect multiple instruments in a network under the control of a controller. Also known as IEEE 488 bus. Transfers data with eight parallel data lines, five control lines, and three handshake lines.

**Graticule**

A grid on the display screen that serves as horizontal and vertical scales. You can use it to visually measure waveform parameters.

**Ground (GND) coupling**

Coupling option that disconnects the input signal from the vertical system.

**Hardcopy**

A copy, in a format useable by a printer or plotter, of the display.

**Hi res acquisition mode**

An acquisition mode in which the digitizing oscilloscope averages all samples taken during an acquisition interval. This average (a boxcar, or blocking average) results in a higher-resolution, lower-bandwidth waveform. This mode works with real-time/non-interpolated sampling only.

**High**

The value used as 100% in automated measurements (whenever high ref, mid ref, and low ref values are needed as in fall time and rise time measurements). May be calculated using either the min/max or the histogram method. With the min/max method (most useful for general waveforms), it is the maximum value found. With the histogram method (most useful for pulses), it refers to the most common value found above the mid point. See *Appendix D: Algorithms* for details.

Holdoff, trigger

The time after a trigger signal that must elapse before the trigger circuit will accept another trigger signal.

**Horizontal bar cursors**

Two horizontal bars that you can position vertically. The oscilloscope displays the voltage value represented by the active (moveable) cursor and the vertical distance between the bars.

Interpolation

The way the digitizing oscilloscope assigns values to points in its time base (interpolates) when you ask the oscilloscope to sample in real time at rates faster than the oscilloscope can acquire in real time. The digitizing oscilloscope has two interpolation options: *linear* or *sin(x)/x interpolation*.

Linear interpolation works by assigning values in a straight-line fit between the actual values acquired. Sin(x)/x works by assigning values in a curve fit between the actual values acquired. It assumes all the interpolated points fall in their appropriate point in time on that curve.

Intensity

Display brightness.

Interleaving

The way the digitizing oscilloscope attains high digitizing speeds by combining the efforts of several channels' digitizers. For example, if you want to digitize on all channels at one time (four on the TDS 540 and two on the TDS 520), each of those channels can digitize at a maximum real-time speed of 250 megasamples per second.

Knob

A rotary control.

**Logic state trigger**

The oscilloscope checks for defined combinatorial logic conditions on channels 1, 2, and 3 on a transition of channel 4 that meets the set slope and threshold conditions. If the conditions of channels 1, 2, and 3 are met then the oscilloscope triggers.

**Logic pattern trigger**

The oscilloscope triggers depending on combinatorial logic the condition of channels 1, 2, 3, and 4. Allowable conditions are AND, OR, NAND, NOR.

**Low**

The value used as 0% in automated measurements (whenever high ref, mid ref, and low ref values are needed as in fall time and rise time measurements). May be calculated using either the min/max or the histogram method. With the min/max method (most useful for general waveforms), it is the minimum value found. With the histogram method (most useful for pulses), it refers to the most common value found below the mid point. See *Appendix D: Algorithms* for details.

Main menu

A menu that the oscilloscope displays across the bottom of the screen. A group of related controls for a major oscilloscope function.

Main menu buttons

Bezel buttons aligned with the main menu.

**Maximum**

Amplitude (voltage) measurement. The maximum amplitude. Typically the most positive peak voltage.

**Mean**

Amplitude (voltage) measurement. The arithmetic mean over the entire waveform.

**Minimum**

Amplitude (voltage) measurement. The minimum amplitude. Typically the most negative peak voltage.

**NAND**

A logic (Boolean) function in which the output of the AND function is complemented (true becomes false, and false becomes true). On the digitizing oscilloscope, this is a trigger logic pattern and state function.

**Negative duty cycle**

Timing measurement. The ratio of the negative pulse width to the signal period, expressed as a percentage.

**Negative overshoot measurement**

Amplitude (voltage) measurement.

$$\text{NegativeOvershoot} = \frac{\text{Low} - \text{Min}}{\text{Amplitude}} \times 100\%$$

**Negative width**

Timing measurement. The distance (time) between two amplitude points — falling-edge MidRef (default 50%) and rising-edge MidRef (default 50%) — on a negative pulse.

Normal trigger mode

A mode on which the oscilloscope does not acquire unless a valid trigger event occurs. That is, it waits for a valid trigger event before acquiring waveform data.

**NOR**

A logic (Boolean) function in which the output of the OR function is complemented (true becomes false, and false becomes true). On the digitizing oscilloscope, this is a trigger logic pattern and state function.

**OR**

A logic (Boolean) function in which the output is true if any of the inputs are true. Otherwise the output is false. On the digitizing oscilloscope, this is a trigger logic pattern and state function.

Oscilloscope

An instrument for making a graph of two factors. These are typically voltage versus time.

**Peak Detect acquisition mode**

A mode in which the oscilloscope acquires and displays a waveform that shows the variation extremes over all samples in an acquisition interval. This is the same as envelope mode with a single time period selected. For many glitch-free signals, this mode is indistinguishable from the sample mode. (This mode works with real-time, non-interpolation sampling only.)

**Peak-to-Peak**

Amplitude (voltage) measurement. The absolute difference between the maximum and minimum amplitude.

**Period**

Timing measurement. Time it takes for one complete signal cycle. The reciprocal of frequency. Measured in seconds.

Pixel

A visible point on the display. The TDS 520/540 display is 640 pixels wide by 480 pixels high.

Pop-up Menu

A sub-menu of a main menu. Pop-up menus temporarily occupy part of the waveform display area and are used to present additional choices associated with the main menu selection. You can cycle through the options in a pop-up menu by pressing the main menu button repeatedly.

**Positive duty cycle**

Timing measurement. The ratio of the positive pulse width to the signal period, expressed as a percentage.

**Positive overshoot**

Amplitude (voltage) measurement.

$$\text{PositiveOvershoot} = \frac{\text{Max} - \text{High}}{\text{Amplitude}} \times 100\%$$

**Positive width**

Timing measurement. The distance (time) between two amplitude points — rising edge *MidRef* (default 50%) and falling edge *MidRef* (default 50%) — on a positive pulse.

Posttrigger

The part of the waveform record data that occurs after the trigger event.

Pretrigger

The part of the waveform record data that occurs before the trigger event.

Probe

An oscilloscope input device.

Probe compensation

Adjustment that improves a probe's low-frequency response.

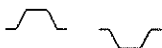
**Pulse trigger**

A trigger mode in which triggering occurs if the oscilloscope finds a pulse, of the specified polarity, with a width between, or optionally outside, the user-specified lower and upper time limits.

Real-time sampling

Sampling where the digitizing oscilloscope operates fast enough to completely fill a waveform record from a single trigger event. Use real-time sampling to capture single-shot or transient events.

Record length

The number of samples in a waveform.

Reference memory

Memory in a oscilloscope used to store waveforms or settings. You can use the waveform data for later processing. Non-volatile reference memory, as in your digitizing oscilloscope, saves data even after the oscilloscope's external power is turned off.

**Rise time**

The time it takes for a pulse's leading edge to rise from a *LowRef* value (typically 10%) to a *HighRef* value (typically 90%) of its amplitude.

**RMS**

Amplitude (voltage) measurement. The true Root Mean Square voltage.

Runt trigger

A mode in which the oscilloscope triggers on a runt. A runt is a pulse that crosses one threshold but fails to cross a second threshold before recrossing the first. The crossings detected can be positive, negative, or either.

**Sample acquisition mode**

The oscilloscope saves one sample during each acquisition interval. It uses these points to construct a waveform record without further processing. This is the TDS 520/540 default mode.

Sample interval

The time interval between successive samples in a time base.

Sampling

The process of converting a portion of the input signal to digital form for display and processing. Two general methods of sampling are: *real-time sampling* and *equivalent-time sampling*.

Selected waveform

The waveform on which all measurements are performed, and which is affected by vertical position and scale adjustments. The light over one of the channel selector buttons indicates the current selected waveform.

Side menu

Menu that appears on the right side of the display. These selections expand on main menu selections.

Side menu buttons

The buttons to the right of the display that operate the side menu.

Slope

The direction at a point on a waveform. You can calculate the direction by computing the sign of the ratio of change in the vertical quantity (Y) to the change in the horizontal quantity. The two allowable values are rising and falling.

Time base

The parameter set which defines, at the user interface level, the time and horizontal axis attributes of any single record as it exists in waveform memory. All time domain waveforms have these time domain parameters. The time base determines when and how long to acquire signal data points.

Toggle button

A button that when pressed to let you select which of the two cursors displayed is active.

Trigger

An event that marks time zero in the waveform record. It also results in acquisition and display of the waveform.

Trigger level

The vertical level the trigger signal must cross to generate a trigger (on edge mode).

Vertical bar cursors

Two vertical bars that you can position horizontally. The oscilloscope displays the horizontal position of the active (moveable) cursor and the horizontal distance between the bars.



Waveform

The shape or form (visible representation) of a signal.

Waveform interval

The time interval between samples as displayed and as used in automated measurements.

**XY format**

A display of two signals plotted against each other. That is, both the horizontal and vertical position of the displayed points reflect signal data.

**Yt format**

A display where the vertical position of the displayed data points reflects signal level and the horizontal position reflects time.



Numbers

- 1/seconds (Hz), Acquire menu, 3-21
- 100 MHz, Vertical menu, 3-106
- 1000 points in 20 divs, Horizontal menu, 3-47
- 15000 points in 300 divs, Horizontal menu, 3-47
- 20 MHz, Vertical menu, 3-106
- 2500 points in 50 divs, Horizontal menu, 3-47
- 500 points in 10 divs, Horizontal menu, 3-47
- 5000 points in 100 divs, Horizontal menu, 3-47
- 50000 points in 1000 divs, Horizontal menu, 3-47

A

- AC coupling, 2-12, 2-14, G-1
- AC line voltage, trigger input, 2-6
- AC, Delayed Trigger menu, 3-25
- Accept Glitch, Main Trigger menu, 3-37
- Accessories, A-1—A-6
 - Optional, A-3
 - Probes, A-2, A-4—A-6
 - Software, A-6
 - Standard, A-2, A-5, A-6
- Accuracy, G-1
- Acquire menu, 3-13
 - Average, 3-13
 - Envelope, 3-13
 - Hi Res, 3-13
 - Mode, 3-13
 - OFF (Real Time Only), 3-14
 - ON (Enable ET), 3-14
 - Peak Detect, 3-13
 - Repetitive Signal, 3-14
 - RUN/STOP, 3-14
 - Sample, 3-13
 - Single Acquisition Sequence, 3-15, 3-103

- Stop After, 3-14, 3-103
- ACQUIRE MENU button, 3-13
- Acquisition, 2-19—2-26, 3-17, G-1
 - Interval, G-1
 - Modes
 - Average, 3-13
 - Envelope, 3-13
 - Hi res, 3-13
 - Peak detect, 3-13
 - Sample, 3-13
 - Readout, 3-15
 - Waveform, A-10
- Active cursor, G-1
- Active voltage probes, 3-81—3-82
- Algorithms, A-75—A-86
- Aliasing, 2-16, G-1
- Amplitude, 3-53, G-1
- AND, G-1
- AND, Main Trigger menu, 3-50, 3-52
- Application menu, 3-10
- Attenuation, G-1
- Auto trigger mode, 3-101
- Auto, Main Trigger menu, 3-38, 3-51, 3-52, 3-89, 3-101
- Automated measurements, 1-13, 2-29, 3-53
- Automatic trigger mode, 2-11, G-1
- Autoset, 1-6, 2-18, 3-17—3-18, G-2
- AUTOSET button, 1-6, 3-17
- Auxiliary trigger, 2-6
- Average acquisition mode, 2-25, 3-13, G-2
- Average, Acquire menu, 3-13

B

- Bandwidth, v, 2-14, G-2
- Bandwidth, Vertical menu, 3-106
- Button
 - ACQUIRE MENU, 3-13
 - AUTOSET, 1-6, 3-17

- CLEAR MENU, 1-4, 1-14, 3-4, 3-9, 3-60
- CURSOR, 3-19
- DELAYED TRIG, 2-9, 3-23
- DISPLAY, 2-20, 3-31
- FORCE TRIGGER, 3-103
- HARDCOPY, 3-39
- HELP, 3-41
- HORIZONTAL MENU, 2-9, 3-27, 3-44
- MEASURE, 1-13, 2-29, 3-57
- MORE, 3-94, 3-95, 3-105, 3-107
- ON/STBY, x, 3-4
- Save/recall SETUP, 1-2, 1-19, 2-32, 3-91
- Save/recall WAVEFORM, 2-31, 3-93
- SET LEVEL TO 50%, 3-102
- SHIFT, 1-17
- STATUS, 3-97
- TOGGLE, 2-28, 3-19, G-8
- TRIGGER MENU, 3-37, 3-49, 3-89, 3-99, 3-101
- UTILITY, 2-37, 3-39, 3-87
- VERTICAL MENU, 1-10, 3-105
- WAVEFORM OFF, 2-29, 3-34, 3-95, 1-12
- ZOOM, 2-17, 3-109

Buttons

- CH1, CH2 ..., 3-95
- Channel selection, 1-9, 3-95
- Main menu, 3-4
- Side menu, 3-4

C

- Cables, 2-36, 3-87
- CAUTION
 - statement in manuals, vii
 - statement on equipment, vii
- Certificate of Calibration and Test Data Report, A-2
- CH1, CH2 ... buttons, 3-95
- Ch1, Ch2 ..., Delayed Trigger menu, 3-24
- Ch1, Ch2 ..., Main Trigger menu, 3-37, 3-49, 3-51, 3-89

Change Math waveform definition,
More menu, 3-107

Channel, 3-95—3-96, G-2
Readout, 3-96
Selection buttons, 3-95
Trigger input, 2-5

Channel ground reference indicator,
3-7

Channel readout, 3-7

Channel selection buttons, 1-9

Circuit loading, G-2

Class, Main Trigger menu, 3-37, 3-49,
3-89, 3-99

CLEAR MENU button, 1-4, 1-14, 3-4,
3-9, 3-60

Compact-to-miniature probe tip
adapter, 3-73, A-5

Compensation, 3-63

Configure, Utility menu, 3-39, 3-87

Connector
BNC, A-5
GPIB, 2-36, 3-6

Contrast, Display menu, 3-32

Coupling, 1-11
AC, 2-12, 2-14
DC, 2-12, 2-14
Ground, 2-14, G-3
Trigger, 2-12

Coupling, Delayed Trigger menu,
3-25

Coupling, Vertical menu, 3-106

Create Measrmt, Measure Delay
menu, 3-60

Cross Hair, Display menu, 3-33

Current probes, 3-83

Cursor
Horizontal bar, 2-28
Measurements, 2-28
Vertical bar, 2-28

CURSOR button, 3-19

Cursor menu, 3-10, 3-19
1/seconds (Hz), 3-21
Function, 3-19
H Bars, 3-19
Off, 3-19
seconds, 3-21
Time Units, 3-21
V Bars, 3-19

Cursors, 2-27, 3-19—3-22, G-2

Cycle mean, 3-53, G-2

Cycle RMS, 3-53, G-2

D

DANGER, statement on equipment,
vii

DC coupling, 2-12, 2-14, G-2

DC, Delayed Trigger menu, 3-25

Define Inputs, Main Trigger menu,
3-49, 3-51

Define Logic, Main Trigger menu,
3-50, 3-52

Delay by Events, Delayed Trigger
menu, 3-24

Delay by Time, Delayed Trigger
menu, 3-24

Delay by, Delayed Trigger menu, 3-24

Delay measurement, 3-59

Delay time, G-2

Delay To, Measure Delay menu, 3-59

Delayed Runs After Main, 2-9—2-10,
3-23

Delayed Runs After Main, Horizontal
menu, 3-27

Delayed Scale, Horizontal menu,
3-48

DELAYED TRIG button, 2-9, 3-23

Delayed trigger, 2-9—2-12, 3-23—3-28

Delayed Trigger menu, 3-10,
3-23—3-28

AC, 3-25

Ch1, Ch2 ..., 3-24

Coupling, 3-25

DC, 3-25

Delay by, 3-24

Delay by Events, 3-24

Delay by Time, 3-24

Falling edge, 3-25

HF Rej, 3-25

Intensified, 3-27

Level, 3-26

LF Rej, 3-25

Noise Rej, 3-25

Rising edge, 3-25

Set to 50%, 3-26

Set to ECL, 3-26

Set to TTL, 3-26

Slope, 3-25

Source, 3-24

Delayed Triggerable, 2-9—2-10, 3-23

Delayed Triggerable, Horizontal
menu, 3-27

Delete Refs, Save/Recall Waveform
menu, 3-93

Deskjet, 2-32

Deskjet, Hardcopy menu, 3-40

Differences - TDS 520 and TDS 540,
v

Differential active probes, 3-82

Digitizing rate, *v*

Display, 3-7, 3-17
Options, 3-29—3-36
Readout, 3-32
System, G-3

Display 'T' @ Trigger Point, Display
menu, 3-32

DISPLAY button, 2-20, 3-31

Display menu, 2-20, 3-10, 3-31

Contrast, 3-32

Cross Hair, 3-33

Display 'T' @ Trigger Point, 3-32

Dots, 3-31

Filter, 3-32

Format, 3-33

Frame, 3-33

Full, 3-33

Graticule, 3-32—3-33

Grid, 3-33

Infinite Persistence, 3-31

Intensity, 3-31—3-32

Linear interpolation, 3-32

Overall, 3-32

Readout, 3-32

Sin(x)/x interpolation, 3-32

Style, 3-31

Text/Grat, 3-32

Variable Persistence, 3-31

Vectors, 3-31

Waveform, 3-32

XY, 3-33

YT, 3-33

Dots, 3-29

Dots, Display menu, 3-31

Dual Wfm Math, More menu, 3-108

Dual-lead adapter, 3-74

Duty cycle, 1-14, G-5, G-6

E

Edge trigger, 2-6
Edge, Main Trigger menu, 3-99
Edges, Measure Delay menu, 3-59
Either, Main Trigger menu, 3-37, 3-89
Envelope acquisition mode, 2-25, 3-13, G-3
Envelope, Acquire menu, 3-13
EPS Image, Hardcopy menu, 3-40
Epson, 2-32
Epson, Hardcopy menu, 3-40
Equivalent time sampling, 2-15, 2-21, G-3

F

Factory initialization settings, A-89 – A-92
Factory setup, 1-3
Fall time, 3-53, G-3
Falling edge, Delayed Trigger menu, 3-25
Falling edge, Main Trigger menu, 3-51
Filter, Display menu, 3-32
Filter, Main Trigger menu, 3-37
Fine Scale, Vertical menu, 3-106
Fixtured active probes, 3-82
FORCE TRIGGER button, 3-103
Format, Display menu, 3-33
Format, Hardcopy menu, 3-40
Frame, Display menu, 3-33
Frequency, 1-14, 3-54, G-3
Front panel, 3-3, 3-5
Full, Display menu, 3-33
Full, Vertical menu, 3-106
Function, Acquire menu, 3-19
Fuse, *ix*, 3-6

G

General purpose (high input resistance) probes, 3-80
General purpose knob, 1-16, 3-8, G-3
Glitch trigger, 2-7, 3-37, 3-99, G-3
Glitch, Main Trigger menu, 3-37, 3-99
Goes FALSE, Main Trigger menu, 3-50, 3-52
Goes TRUE, Main Trigger menu, 3-50, 3-52
GPIO, 2-35 – 2-38, 3-6, 3-87, G-3
GPIO, Hardcopy menu, 3-40
GPIO, Status menu, 3-97
GPIO, Utility menu, 3-87
Graticule, 3-30, 3-32, G-3
 Definition, 2-27
 Measurements, 2-28
Graticule, Display menu, 3-32 – 3-33
Grid, Display menu, 3-33
Ground coupling, 2-14, G-3
Ground lead inductance, 3-65

H

H Bars, Acquire menu, 3-19
Hardcopy, 2-32, 3-39 – 3-40, 3-88, G-4
Hardcopy (Talk Only), Utility menu, 3-39
HARDCOPY button, 3-39
Hardcopy menu, 3-10
 Deskjet, 3-40
 EPS Image, 3-40
 Epson, 3-40
 Format, 3-40
 GPIO, 3-40
 HPGL, 3-40
 Interleaf, 3-40
 Landscape, 3-40
 Laserjet, 3-40
 Layout, 3-40

Port, 3-40
Portrait, 3-40
Thinkjet, 3-40

Hardcopy, Utility menu, 3-87, 3-88
HELP button, 3-41
Help system, 3-41
HF Rej, Delayed Trigger menu, 3-25
Hi res acquisition mode, 2-24, 3-13, G-4
Hi Res, Acquire menu, 3-13
High, 3-54, G-4
High frequency rejection, 2-12
High Ref, Measure menu, 3-61
High speed active probes, 3-82
High voltage probes, 3-80 – 3-81
High-Low Setup, Measure menu, 3-60
Histogram, Measure menu, 3-60
Holdoff, Main Trigger menu, 3-38, 3-51, 3-52, 3-89
Holdoff, trigger, 2-8, 3-101, G-4
Horiz Pos, Horizontal menu, 3-48
Horiz Scale, Horizontal menu, 3-48
Horizontal, 3-17
 Bar cursors, 2-28, G-4
 Menu, 2-9
 POSITION knob, 2-15
 SCALE knob, 1-5, 2-15
 Scaling and positioning, 3-43 – 3-48
 System, 1-5, 2-15, A-9
Horizontal Lock, Zoom menu, 3-110
Horizontal menu, 3-10, 3-27, 3-44
 1000 points in 20 divs, 3-47
 15000 points in 300 divs, 3-47
 2500 points in 50 divs, 3-47
 500 points in 10 divs, 3-47
 5000 points in 100 divs, 3-47
 50000 points in 1000 divs, 3-47
 Delayed Runs After Main, 3-27
 Delayed Scale, 3-48
 Delayed Triggerable, 3-27
 Horiz Pos, 3-48
 Horiz Scale, 3-48

Intensified, 3-27
Main Scale, 3-48
Pretrigger, 3-45
Record Length, 3-47
Set to 10%, 3-45, 3-48
Set to 50%, 3-45, 3-48
Set to 90%, 3-45, 3-48
Time Base, 3-27, 3-44
Trigger Position, 3-45

HORIZONTAL MENU button, 2-9,
3-27, 3-44

Horizontal **POSITION** knob, 3-43

Horizontal **SCALE** knob, 3-43

HPGL, 2-32

HPGL, Hardcopy menu, 3-40

I

I/O, Utility menu, 3-39, 3-87

IC protector tip, 3-74

Icons, v

Infinite Persistence, Display menu,
3-31

Input, Impedance, 2-14

Installation, ix

Intensified zone, 3-27

Intensified, Delayed Trigger menu,
3-27

Intensified, Horizontal menu, 3-27

Intensity, 3-29, 3-31, G-4

Intensity, Display menu, 3-31 – 3-32

Interleaf, 2-32

Interleaf, Hardcopy menu, 3-40

Interleaving, 2-20, G-4

Interpolation, 2-20, 3-30, G-4

K

Keypad, 1-16, 3-8

Knob, G-4

General purpose, 1-16, 3-8, G-3

Horizontal **POSITION**, 1-5, 2-15,
3-43

Horizontal **SCALE**, 1-5, 2-15, 3-43

Trigger **MAIN LEVEL**, 1-5, 2-11

Vertical **POSITION**, 1-5, 2-13,
3-105

Vertical **SCALE**, 1-5, 2-14, 3-105

L

Landscape, Hardcopy menu, 3-40

Laserjet, 2-32

Laserjet, Hardcopy menu, 3-40

Layout, Hardcopy menu, 3-40

Level, Delayed Trigger menu, 3-26

Level, Main Trigger menu, 3-38, 3-102

LF Rej, Delayed Trigger menu, 3-25

Linear interpolation, 2-20, 3-30

Linear interpolation, Display menu,
3-32

Logic trigger, 2-7, 3-100

Pattern, 3-100, G-5

State, 3-100, G-5

Logic triggering, 3-49 – 3-52

Logic, Main Trigger menu, 3-99

Long ground leads, 3-69

Low, 3-54, G-5

Low frequency rejection, 2-12

Low impedance Zo probes, 3-80

Low Ref, Measure menu, 3-61

Low-inductance ground lead, 3-69

Low-inductance spring-tips, 3-72, A-5

M

Main menu, G-5

Main menu buttons, 3-4, G-5

Main Scale, Horizontal menu, 3-48

Main Trigger menu, 2-11, 3-10, 3-11,
3-37, 3-49, 3-89, 3-99, 3-101

Accept Glitch, 3-37

AND, 3-50, 3-52

Auto, 3-38, 3-51, 3-52, 3-89, 3-101

Ch1, Ch2 ..., 3-37, 3-49, 3-51, 3-89

Class, 3-37, 3-49, 3-89, 3-99

Define Inputs, 3-49, 3-51

Define Logic, 3-50, 3-52

Edge, 3-99

Either, 3-37, 3-89

Falling edge, 3-51

Filter, 3-37

Glitch, 3-37, 3-99

Goes FALSE, 3-50, 3-52

Goes TRUE, 3-50, 3-52

Holdoff, 3-38, 3-51, 3-52, 3-89,
3-101

Level, 3-38, 3-102

Logic, 3-99

Mode & Holdoff, 3-38, 3-51, 3-52,
3-89, 3-101

NAND, 3-50, 3-52

Negative, 3-37, 3-89

NOR, 3-50, 3-52

Normal, 3-38, 3-51, 3-52, 3-89,
3-101

OR, 3-50, 3-52

Pattern, 3-49, 3-99

Polarity, 3-89

Polarity and Width, 3-37

Positive, 3-37, 3-89

Pulse, 3-37, 3-89, 3-99

Reject Glitch, 3-37

Rising edge, 3-51

Runt, 3-89, 3-99

Set Thresholds, 3-51

Set to 50%, 3-38, 3-102

Set to ECL, 3-38, 3-102

Set to TTL, 3-38, 3-102

Source, 3-37, 3-89

State, 3-49, 3-51, 3-99

Thresholds, 3-89

Trigger When, 3-50, 3-52

Type, 3-37, 3-49, 3-89, 3-99

Width, 3-37

Marker rings, 3-68, A-5

Math waveforms, 3-107

Math1/2/3, More menu, 3-107

Maximum, 3-54, G-5

Mean, 3-54, G-5

MEASURE button, 1-13, 2-29, 3-57

Measure Delay menu, 3-59

Create Measrmnt, 3-60

Delay To, 3-59

Edges, 3-59

Measure Delay To, 3-59

OK Create Measurement, 3-60

Measure Delay To, Measure Delay
menu, 3-59

Measure menu, 2-29, 3-11, 3-57

- High Ref, 3-61
- High-Low Setup, 3-60
- Histogram, 3-60
- Low Ref, 3-61
- Mid Ref, 3-61
- Mid2 Ref, 3-61
- Min-Max, 3-60
- Reference Levels, 3-61
- Remove Measrmt, 3-58
- Select Measrmt, 3-57
- Set Levels in % units, 3-61

Measurement

- Amplitude, 3-53, G-1
- Burst width, 3-53, G-2
- Cycle mean, 3-53, G-2
- Cycle RMS, 3-53, G-2
- Delay, 3-59
- Duty cycle, 1-14, G-5, G-6
- Fall time, 3-53
- Frequency, 1-14, 3-54, G-3
- High, 3-54, G-4
- Low, 3-54, G-5
- Maximum, 3-54, G-5
- Mean, 3-54, G-5
- Minimum, 3-54, G-5
- Negative duty cycle, 3-54
- Negative overshoot, 3-54
- Negative width, 3-54
- Overshoot, G-7
- Peak to peak, 3-55, G-6
- Period, 3-55, G-6
- Positive duty cycle, 3-55
- Positive overshoot, 3-55
- Positive width, 3-55
- Propagation delay, 3-53, G-2
- Readout, 3-56, 3-57
- Reference levels, 1-15
- Rise time, 1-14, 3-55, G-7
- RMS, 3-55, G-7
- Undershoot, G-5
- Width, 1-14, G-6, G-7

Measurements, 2-27–2-30,

3-53–3-62

- Algorithms, A-75–A-86
- Automated, 1-13, 2-29
- Cursor, 2-28, 3-19
- Graticule, 2-28

Memory, Waveform, 2-31, 3-93

Menu

- Acquire, 3-13
- Application, 3-10
- Cursor, 3-10, 3-19
- Delayed Trigger, 3-10, 3-23–3-28
- Display, 2-20, 3-10, 3-31
- Hardcopy, 3-10

- Horizontal, 2-9, 3-10, 3-27, 3-44
- Main, 3-7
- Main Trigger, 2-11, 3-10, 3-11, 3-37, 3-49, 3-89, 3-99, 3-101
- Measure, 2-29, 3-11, 3-57
- Measure Delay, 3-59
- More, 2-31, 3-11, 3-94, 3-107
- Operation, 3-8
- Pop-up, 3-9, G-6
- Save/Recall, 3-91
- Save/Recall Setup, 2-32, 3-11
- Save/Recall Waveform, 3-11, 3-93
- Setup, 1-2
- Status, 3-97–3-98
- status, 3-11
- Utility, 2-37, 3-12, 3-39, 3-87
- Vertical Channel, 3-12, 3-105
- Zoom, 3-109
- zoom, 3-12

Mid Ref, Measure menu, 3-61

Mid2 Ref, Measure menu, 3-61

Min-Max, Measure menu, 3-60

Minimum, 3-54, G-5

Mode

- Auto trigger, 3-101
- Normal trigger, 3-101

Mode & Holdoff, Main Trigger menu, 3-38, 3-51, 3-52, 3-89, 3-101

Mode, Acquire menu, 3-13

Mode, Main Trigger menu, 3-101

Model number location, 3-4

MORE button, 3-94, 3-95, 3-105, 3-107

More menu, 2-31, 3-11, 3-94, 3-107

Change Math waveform definition, 3-107

Dual Wfm Math, 3-108

Math1/2/3, 3-107

OK Create Math Waveform, 3-108

Set 1st Source to, 3-108

Set 2nd Source to, 3-108

Set Function to, 3-108

Set operator to, 3-108

Set Single Source to, 3-108

Single Wfm Math, 3-108

Negative duty cycle, 3-54

Negative overshoot, 3-54

Negative width, 3-54

Negative, Main Trigger menu, 3-37, 3-89

Noise Rej, Delayed Trigger menu, 3-25

NOR, G-6

NOR, Main Trigger menu, 3-50, 3-52

Normal trigger mode, 2-11, 3-101, G-6

Normal, Main Trigger menu, 3-38, 3-51, 3-52, 3-89, 3-101

O

OFF (Real Time Only), Acquire menu, 3-14

Off Bus, Utility menu, 3-87, 3-88

Off, Acquire menu, 3-19

Offset, Vertical, 2-14, 3-105

Offset, Vertical menu, 3-106

OK Confirm Factory Init, Save/Recall Setup menu, 3-91

OK Create Math Wfm, More menu, 3-108

OK Create Measurement, Measure Delay menu, 3-60

ON (Enable ET), Acquire menu, 3-14

On, Zoom menu, 3-109

ON/STBY button, x, 3-4

Optical probes, 3-84

Options, A-1–A-6

OR, G-6

OR, Main Trigger menu, 3-50, 3-52

Oscilloscope, G-6

Overall, Display menu, 3-32

Overshoot, G-7

P

Packaging, A-87

Passive voltage probes, 3-80–3-81

Pattern trigger, 2-7, 3-49—3-51
Pattern, Main Trigger menu, 3-49, 3-99
 Peak detect acquisition mode, 2-24, 3-13, G-6
Peak Detect, Acquire menu, 3-13
 Peak to peak, 3-55, G-6
 Period, 3-55, G-6
 Persistence, 3-29
 Pixel, G-6
 Plotter, HC100, A-2
Polarity and Width, Main Trigger menu, 3-37
Polarity, Main Trigger menu, 3-89
 Pop-up menu, 3-9, G-6
Port, Hardcopy menu, 3-40
Port, Utility menu, 3-87
Portrait, Hardcopy menu, 3-40
 Position, Vertical, 2-14, 3-105
Position, Vertical menu, 3-106
 Positive duty cycle, 3-55
 Positive overshoot, 3-55
 Positive width, 3-55
Positive, Main Trigger menu, 3-37, 3-89
 Postscript, 2-32
 Posttrigger, G-7
 Power connector, *ix*
 Power cords, A-1
 Power off, *x*
 Power on, *x*
 Pretrigger, G-7
Pretrigger, Horizontal menu, 3-45
 Principal power switch, *x*, 3-6
 Probe accessories

- Compact-to-miniature probe tip adapter, 3-73, A-5
- Dual-lead adapter, 3-74
- IC protector tip, 3-74
- Long ground leads, 3-69
- Low-inductance ground lead, 3-69
- Low-inductance spring-tips, 3-72, A-5
- Marker rings, 3-68, A-5
- Probe tip-to-chassis adapter, 3-73, A-5

Probe tip-to-circuit board adapters, 3-70
 Retractable hook tip, 3-68
 SMT KlipChip, 3-71, A-5
 Probe tip-to-chassis adapter, 3-73, A-5
 Probe tip-to-circuit board adapters, 3-70
Probes

- Accessories, 3-67—3-76, A-2, A-4—A-6
- Active voltage, 3-81—3-82
- Additional, A-2
- By applications, 3-77
- Compensation, 1-5, 3-63, G-7
- Connection, 1-1, 3-65—3-76
- Current, 3-83
- Definition, G-7
- Differential active, 3-82
- Fixtured active, 3-82
- General purpose (high input resistance), 3-80
- High speed active, 3-82
- High voltage, 3-80—3-81
- Low impedance Z_0 , 3-80
- Optical, 3-84
- Passive, 3-63
- Passive voltage, 3-80—3-81
- Selection, 3-77—3-86
- Time-to-voltage converter, 3-85

 Propagation delay, 3-53, G-2
 Pulse trigger, 2-6, 3-99
Pulse, Main Trigger menu, 3-37, 3-89, 3-99

R

Rack mounting, A-1
Readout

- Acquisition, 3-15
- Channel, 3-7, 3-96
- Display, 3-32
- General purpose knob, 3-7
- Measurement, 2-29, 3-56, 3-57
- Record View, 3-46, 3-103
- Time base, 3-7
- Trigger, 3-7, 3-103, 3-104

 Readout options, 3-30
Readout, Display menu, 3-32
 Real time sampling, 2-15, 2-20, G-7
 Rear panel, 3-3, 3-6, 3-87

Recall, Setups, 3-91—3-92
Recall Factory Setup, Save/Recall Setup menu, 3-91
Recall Saved Setup, Save/Recall Setup menu, 3-91
 Recalling, Waveforms, 3-93
 Record length, *v*, 2-17, 2-20, 3-47, A-1, G-7
Record Length, Horizontal menu, 3-47
 Record View readout, 3-46, 3-103
Ref1, Ref2, Ref3, Ref4, Save/Recall Waveform menu, 3-94
 Reference levels, 1-15, 3-61
Reference Levels, Measure menu, 3-61
 Reference memory, 2-31, G-7
Reject Glitch, Main Trigger menu, 3-37
 Remote communication, 3-87—3-88
Remove Measrmnt, Measure menu, 3-58
Repetitive Signal, Acquire menu, 3-14
Reset Zoom Factors, Zoom menu, 3-110
 Retractable hook tip, 3-68
 Rise time, 1-14, 3-55, G-7
 Rising edge, Delayed Trigger menu, 3-25
 Rising edge, Main Trigger menu, 3-51
 RMS, 3-55, G-7
RUN/STOP, Acquire menu, 3-14
 Runt trigger, 2-6, 3-89, 3-99, G-7
Runt, Main Trigger menu, 3-89, 3-99

S

Safety, *vii*
 Symbols, *vii*
 Sample acquisition mode, 2-24, 3-13, G-8
 Sample interval, G-8
Sample, Acquire menu, 3-13

Sampling, 2-20, G-8
 Sampling and acquisition mode, 2-25
 Save, Setups, 3-91 – 3-92
Save Current Setup, Save/Recall Setup menu, 3-91
Save Waveform, Save/Recall Waveform menu, 3-93
 Save/recall **SETUP** button, 1-2, 1-19, 2-32, 3-91
 Save/Recall Setup menu, 2-32, 3-11, 3-91
 OK Confirm Factory Init, 3-91
 Recall Factory Setup, 3-91
 Recall Saved Setup, 3-91
 Save Current Setup, 3-91
 Save/recall **WAVEFORM** button, 2-31, 3-93
 Save/Recall Waveform menu, 2-31, 3-11, 3-93
 Delete Refs, 3-93
 Ref1, Ref2, Ref3, Ref4, 3-94
 Save Waveform, 3-93
 To Ref ..., 3-93
 Saving, Waveforms, 3-93
 Saving and recalling setups, 1-19, 2-32, 3-91
 Saving and recalling waveforms, 2-31, 3-93
seconds, Acquire menu, 3-21
 Security bracket, 3-6
Select Measrmnt, Measure menu, 3-57
 Selected waveform, G-8
 Selecting channels, 3-95
 Self test, x
Set 1st Source to, More menu, 3-108
Set 2nd Source to, More menu, 3-108
Set Function to, More menu, 3-108
SET LEVEL TO 50% button, 3-102
Set Levels in % units, Measure menu, 3-61
Set operator to, More menu, 3-108
Set Single Source to, More menu, 3-108
Set Thresholds, Main Trigger menu, 3-51
Set to 10%, Horizontal menu, 3-45, 3-48

Set to 50%, Delayed Trigger menu, 3-26
Set to 50%, Horizontal menu, 3-45, 3-48
Set to 50%, Main Trigger menu, 3-38, 3-102
Set to 90%, Horizontal menu, 3-45, 3-48
Set to ECL, Delayed Trigger menu, 3-26
Set to ECL, Main Trigger menu, 3-38, 3-102
Set to TTL, Delayed Trigger menu, 3-26
Set to TTL, Main Trigger menu, 3-38, 3-102
Set to Zero, Vertical menu, 3-106
 Setup menu, 1-2
 Setups, Save and recall, 3-91 – 3-92
SHIFT button, 1-17
 Shipping, A-87
 Side menu, G-8
 Side menu buttons, 3-4, G-8
 Sin(x)/x interpolation, 2-20, 3-30
Sin(x)/x interpolation, Display menu, 3-32
Single Acquisition Sequence, Acquire menu, 3-15, 3-103
Single Wfm Math, More menu, 3-108
 Slope, G-8
Slope, Delayed Trigger menu, 3-25
 SMT KlipChip, 3-71, A-5
 Software, v
Source, Delayed Trigger menu, 3-24
Source, Main Trigger menu, 3-37, 3-89
 Start up, ix
 State trigger, 2-7, 3-51 – 3-52
State, Main Trigger menu, 3-49, 3-51, 3-99
STATUS button, 3-97
 Status menu, 3-11, 3-97 – 3-98
 GPIO, 3-97
 System, 3-97
 Trigger, 3-97
 Waveforms, 3-97

Stop After, Acquire menu, 3-14, 3-103
 Style, 3-29
Style, Display menu, 3-31
 Switch, Principal power, x
 Switch, Principal power, 3-6
System, Status menu, 3-97
System, Utility menu, 3-39, 3-87

T

Talk/Listen Address, Utility menu, 3-87, 3-88
 TDS 520 and 540 differences, v
Text/Grat, Display menu, 3-32
 Thinkjet, 2-32
Thinkjet, Hardcopy menu, 3-40
Thresholds, Main Trigger menu, 3-89
 Time base, 2-17, G-8
Time Base, Horizontal menu, 3-27, 3-44
Time Units, Acquire menu, 3-21
 Time-to-voltage converter, 3-85
To Ref ..., Save/Recall Waveform menu, 3-93
TOGGLE button, 2-28, 3-19, G-8
 Trigger, 2-5 – 2-12, 3-17, G-8
 Auxiliary, 2-6
 Coupling, 2-12
 Delay, 2-9
 Delayed, 3-23 – 3-28
 Edge, 2-6
 Glitch, 2-7, 3-37, 3-99, G-3
 Holdoff, 2-8, 3-101
 Level, 2-11, G-8
 Logic, 2-7, 3-49 – 3-52, 3-100
 Mode, 2-11
 Pattern, 2-7, 3-49 – 3-51
 Position, 2-17, 3-45
 Pulse, 2-6, 3-99
 Readout, 3-103, 3-104
 Runt, 2-6, 3-89, 3-99, G-7
 Slope, 2-5, 2-11
 Source, 2-5
 State, 2-7, 3-51 – 3-52
 System, A-10

Types, 3-99–3-104
Width, 2-6
Trigger **MAIN LEVEL** knob, 1-5, 2-11
TRIGGER MENU button, 3-37, 3-49,
3-89, 3-99, 3-101
Trigger **Position**, Horizontal menu,
3-45
Trigger **When**, Main Trigger menu,
3-50, 3-52
Trigger, Status menu, 3-97
Type, Main Trigger menu, 3-37, 3-49,
3-89, 3-99

U

Undershoot, G-5
UTILITY button, 2-37, 3-39, 3-87
Utility menu, 2-37, 3-12, 3-39, 3-87
 Configure, 3-39, 3-87
 GPIB, 3-87
 Hardcopy, 3-87, 3-88
 Hardcopy (Talk Only), 3-39
 I/O, 3-39, 3-87
 Off Bus, 3-87, 3-88
 Port, 3-87
 System, 3-39, 3-87
 Talk/Listen Address, 3-87, 3-88

V

V Bars, Acquire menu, 3-19
Variable Persistence, Display menu,
3-31
Vectors, 3-29

Vectors, Display menu, 3-31
Vertical, 3-17
 Bar cursors, 2-28, G-8
 Channel menu, 3-105
 Offset, 2-14, 3-105
 POSITION, 3-105
 Position, 2-14, 3-105
 POSITION knob, 2-13
 Scale, 3-105
 SCALE knob, 1-5, 2-14, 3-105
 Scaling and positioning,
 3-105–3-106
 System, 1-5, 2-13

Vertical Channel menu, 3-12

Vertical menu

100 MHz, 3-106
 20 MHz, 3-106
 Bandwidth, 3-106
 Coupling, 3-106
 Fine Scale, 3-106
 Full, 3-106
 Offset, 3-106
 Position, 3-106
 Set to Zero, 3-106

VERTICAL MENU button, 1-10, 3-105

W

WARNING, statement in manual, *vii*

Waveform, G-9
 Acquisition, A-10
 Interval, G-9
 Math, 3-107–3-108
 Off priority, 3-96

Waveform memory, 2-31, 3-93

WAVEFORM OFF button, 1-12, 2-29,
3-34, 3-95

Waveform, Display menu, 3-32
Waveforms, Math, 3-107
Waveforms, Status menu, 3-97
Width, 1-14, G-6, G-7
 Burst, 3-53
Width trigger, 2-6
Width, Main Trigger menu, 3-37

X

XY, Format, 3-30, 3-33–3-36, G-9
XY, Display menu, 3-33

Y

YT, Format, 3-30, 3-33–3-36, G-9
YT, Display menu, 3-33

Z

Zoom, 3-109–3-112
ZOOM button, 2-17, 3-109
Zoom menu, 3-12, 3-109
 Horizontal Lock, 3-110
 On, 3-109
 Reset Zoom Factors, 3-110
 Zoom Off, 3-110
Zoom Off, Zoom menu, 3-110