

Programmer Manual



TDS 820 Digitizing Oscilloscope 070-8513-01

Please check for change information at the rear of this manual.

First Printing: February 1993





List of Tables

2-1	Table 2-1: BNF Symbols and Meanings
2-2	Table 2-2: Command Message Elements
2-3	Table 2-3: Comparison of Header Off and On Responses
2-11	Table 2-4: Acquisition Commands
2-11	Table 2-5: Alias Commands
2-12	Table 2-6: Application Menu Commands
2-13	Table 2-7: Calibration and Diagnostic Commands
2-13	Table 2-8: Cursor Commands
2-14	Table 2-9: Display Commands
2-15	Table 2-10: Graphics Commands
2-16	Table 2-11: Hard Copy Commands
2-16	Table 2-12: Horizontal Commands
2-17	Table 2-13: Limit Test Commands
2-18	Table 2-14: Measurement Commands
2-20	Table 2-15: Miscellaneous Commands
2-21	Table 2-16: Save and Recall Commands
2-22	Table 2-17: Status and Error Commands
2-23	Table 2-18: Trigger Commands
2-24	Table 2-19: Vertical Commands
2-27	Table 2-20: Waveform Commands
2-29	Table 2-21: Zoom Commands
2-52	Table 2-22: Commands that Affect BUSY? Response
2-53	Table 2-23: Calibration Error Codes
2-83	Table 2-24: DATA and WFMPre Parameter Settings
2-101	Table 2-25: XY Format Pairs
2-182	Table 2-26: Commands that Generate an Operation Complete Message
2-219	Table 2-27: Additional WFMPre Commands
3-2	Table 3-1: SESR Bit Functions
3-3	Table 3-2: SBR Bit Functions
3-13	Table 3-3: No Event Messages
3-13	Table 3-4: Command Error Messages—CME Bit 5
3-14	Table 3-5: Execution Error Messages—EXE Bit 4
3-17	Table 3-6: Device Error Messages—DDE Bit 3
3-17	Table 3-7: System Event Messages
3-18	Table 3-8: Execution Warning Messages—EXE Bit 4
3-19	Table 3-9: Internal Warning Messages

A-1 Table A-1: The TDS Character Set

A-2 Table A-2: The ASCII & GPIB Code Chart

C-2 Table C-1: Digitizing Oscilloscope Standard Interface Messages ...

D-1 Table D-1: Factory Initialization Defaults



2-1 Command Syntax 2-1

2-1 Command and Query Structure 2-1

2-4 Clearing the Digitizing Oscilloscope 2-4

2-4 Command Entry 2-4

2-6 Constructed Mnemonics 2-6

2-8 Argument Types 2-8

2-10 Syntax Diagrams 2-10

2-11 Command Groups 2-11

2-11 Acquisition Commands 2-11

2-11 Alias Commands 2-11

2-12 Application Menu Commands 2-12

2-12 Calibration and Diagnostic Commands 2-12

2-13 Cursor Commands 2-13

2-14 Display Commands 2-14

2-15 Graphics Commands 2-15

2-16 Hard Copy Commands 2-16

2-16 Horizontal Commands 2-16

2-17 Limit Test Commands 2-17

2-18 Measurement Commands 2-18

2-20 Miscellaneous Commands 2-20

2-21 Save and Recall Commands 2-21

2-22 Status and Error Commands 2-22

2-23 Trigger Commands 2-23

2-24 Vertical Commands 2-24

2-24 Waveform Commands 2-24

2-29 Zoom Commands 2-29

2-31 Command Descriptions 2-31

Syntax and Commands

1-1 Getting Started 1-1

1-1 This Manual 1-1

1-4 Setting Up Remote Communications 1-4

Getting Started



Glossary and Index

Appendices

A-1 Appendix A: Character Charts

B-1 Appendix B: Reserved Words

C-1 Appendix C: Interface Specifications

C-1 GPIB Function Subsets

C-2 Interface Messages

D-1 Appendix D: Factory Initialization Settings

Programming Examples

4-1 Programming Examples

4-2 Compiling the Example Programs

Status and Events

3-1 Status and Events

3-1 Registers

3-5 Queues

3-6 Event Handling Sequence

3-7 Synchronization Methods

3-13 Messages

This Manual

This manual includes the following sections.

- *This Manual* describes the major sections in this manual.
- *Setting Up Remote Communications* describes remote control. This includes connecting the oscilloscope and setting the appropriate front panel controls.

This section covers the following:

You can write computer programs that remotely set the oscilloscope front panel controls or take measurements and read those measurements for further analysis or storage.

Syntax and Commands

The *Syntax and Commands* section (Section 2) describes the structure and content of the messages your program sends to the digitizing oscilloscope. Figure 1-1 shows a syntax diagram and command parts as described in the *Command Syntax* subsection.

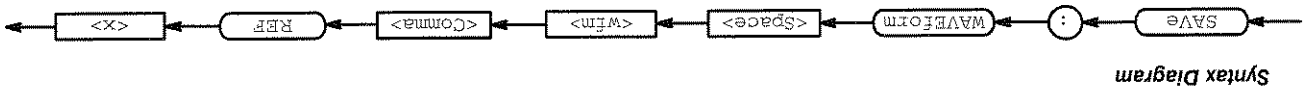
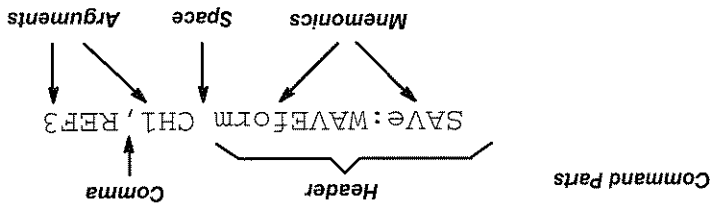

Figure 1-1: Common Message Elements

Section 2 also describes each command's effect and provides examples of how you might use it. The *Command Groups* subsection provides a list by functional area. The *Command Descriptions* subsection arranges commands alphabetically (Figure 1-2).

Getting Started



Figure 1-3: Service Requests (SRQ's) Provide for Event (Interrupt) Driven Programs

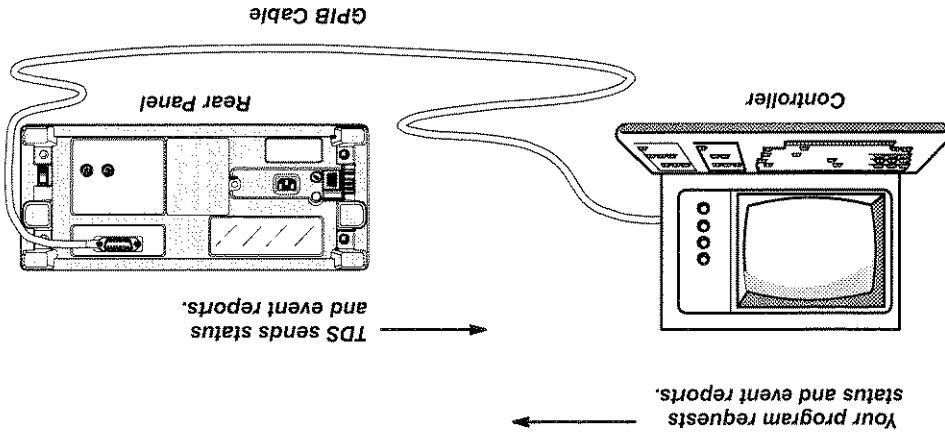

The program requests information from the oscilloscope. The oscilloscope provides information in the form of status and error messages. Figure 1-3 illustrates the basic operation of this system.

The *Status and Events* section (Section 3) starting on page NO TAG describes how to use service requests (SRQ's) and various event messages in your programs.

Status and Events

Figure 1-2: Functional Groupings and an Alphabetical List of Commands

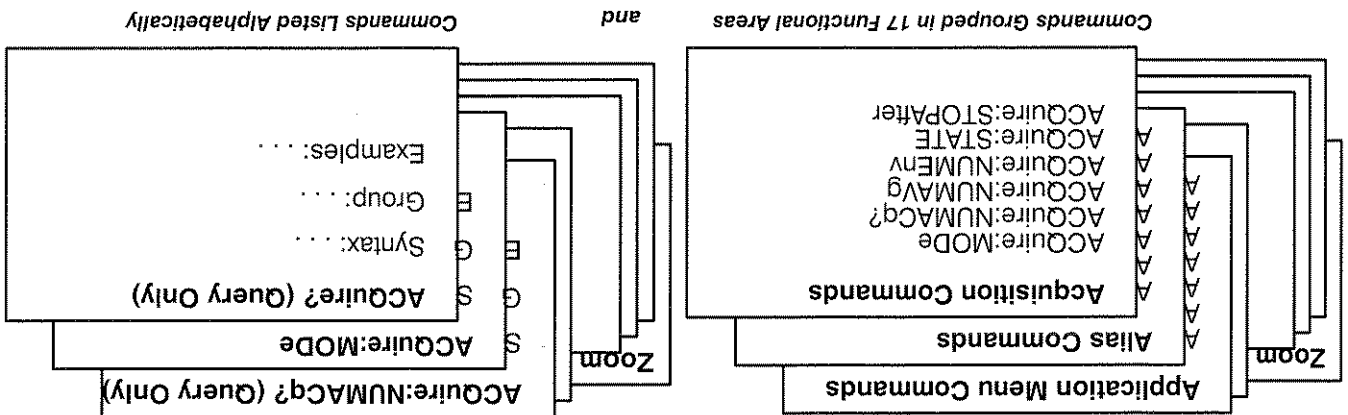

Programming Examples

The *Programming Examples* section (Section 4) starting on page 4-1 describes some example digitizing oscilloscope programs and how to compile them. The disks that come with this manual (Figure 1-4) have an executable and a Microsoft QuickBASIC 4.5 and a Microsoft QuickC 2.5 source code version of each program.

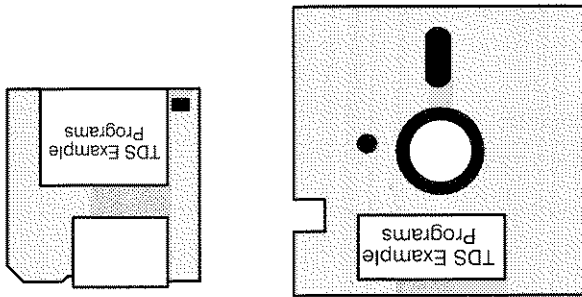

Figure 1-4: The Disks That Accompany This Manual

Setting Up Remote Communications

Even the best instrument control program will not do much if the instrument is not connected to the controller.

The digitizing oscilloscope has a 24-pin **GPB** connector on its rear panel, as shown in Figure 1-5. This connector has a D-type shell and conforms to IEEE Std 488.1-1987.

Attach an IEEE Std 488.1-1987 GPB cable (available from Tektronix as part number 012-0991-00) to this connector.

GPB Connector Port

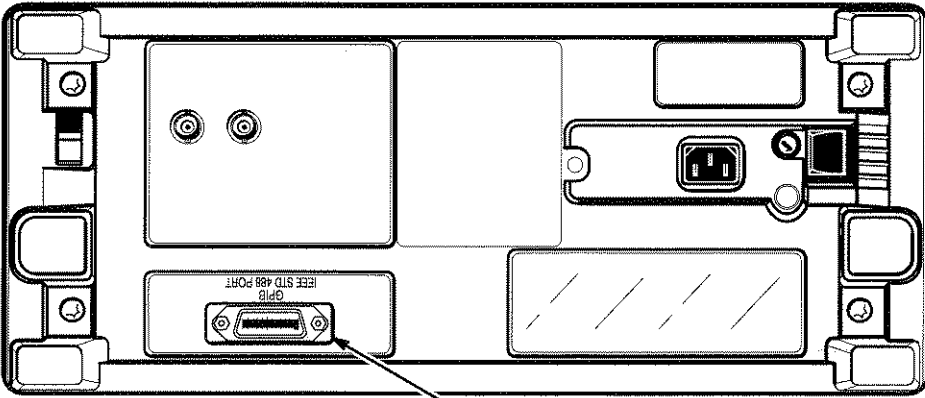

Figure 1-5: GPB Connector Location

If needed, you can stack GPB connectors as shown in Figure 1-6.

- Observe these rules when you use your digitizing oscilloscope with a GPIB network:
- Assign a unique device address to each device on the bus. No two devices can share the same device address.
 - Do not connect more than 15 devices to any one bus.
 - Connect one device for every 2 meters (6 feet) of cable used.
 - Do not use more than 20 meters (65 feet) of cable to connect devices to a bus.
 - Turn on at least two-thirds of the devices on the network while using the network.
 - Connect the devices on the network in a star or linear configuration as shown in Figure 1-7. Do not use loop or parallel configurations.

GPIB Requirements

Figure 1-6: How to Stack GPIB Connectors

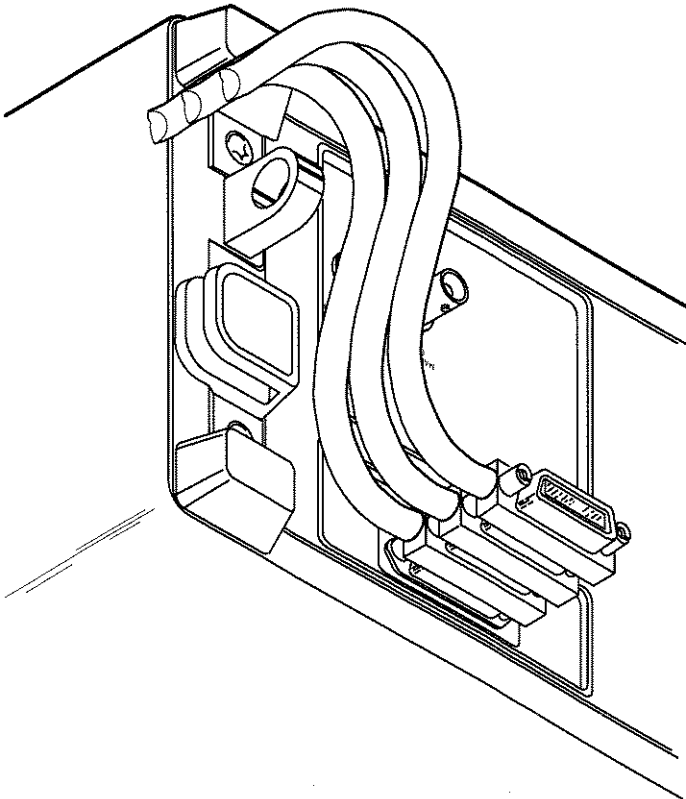
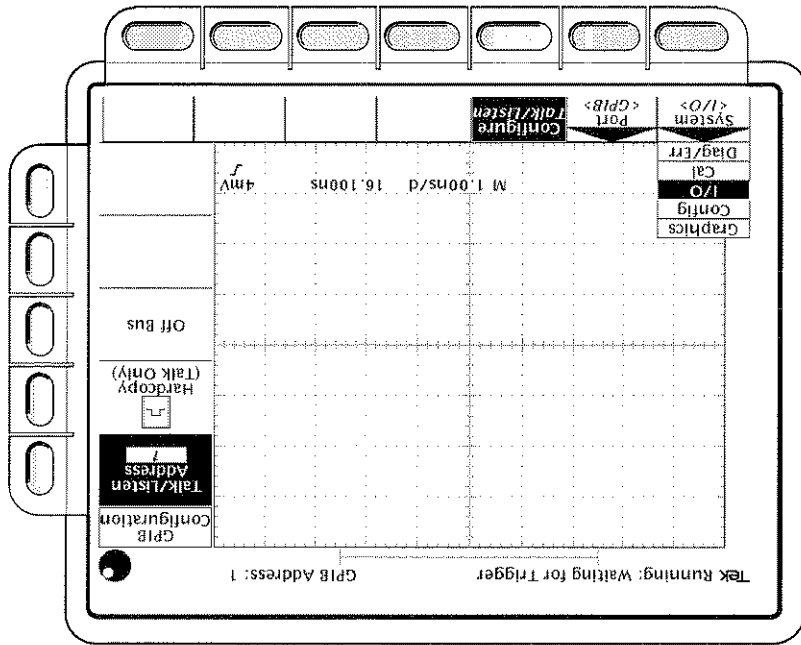

Figure 1-8: Selecting the I/O System in the Main Menu



Step 2: Press the **System** button in the main menu until it highlights the I/O selection in the pop-up menu (See Figure 1-8).

Step 1: Press the **UTILITY (SHIFT DISPLAY)** button to display the Utility menu.

You need to set the GPIB parameters of the digitizing oscilloscope to match the configuration of the bus. Once you have set these parameters, you can control the digitizing oscilloscope through the GPIB interface.

Setting the GPIB Parameters

Appendix C: Interface Specifications, gives more information on the GPIB configuration of the digitizing oscilloscope.

Figure 1-7: Typical GPIB Network Configurations

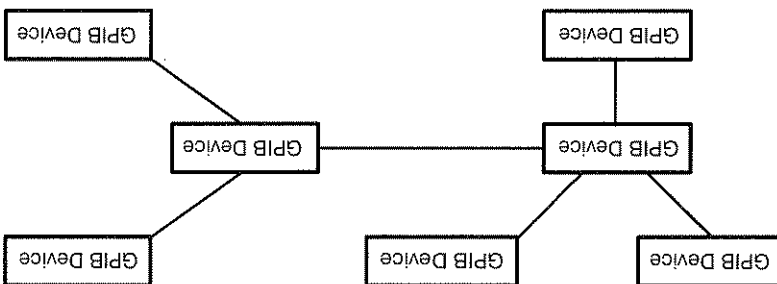

- Press the **Hardcopy** side menu button to have the digitizing oscilloscope send hard copy information only when you press the **HARDCOPY** button (and accept a **HARDCOPY ABORT** command).
 - Press the **Off Bus** side menu button. This disables all communication with the controller.
- If you wish to enter a special mode of operation to communicate directly with non-488.2 hard copy devices:
- The digitizing oscilloscope is set up for bidirectional communication with your controller. If you wish to isolate the digitizing oscilloscope from the bus:

Figure 1-9: Selecting the GPIB Address in the GPIB Configuration Side Menu

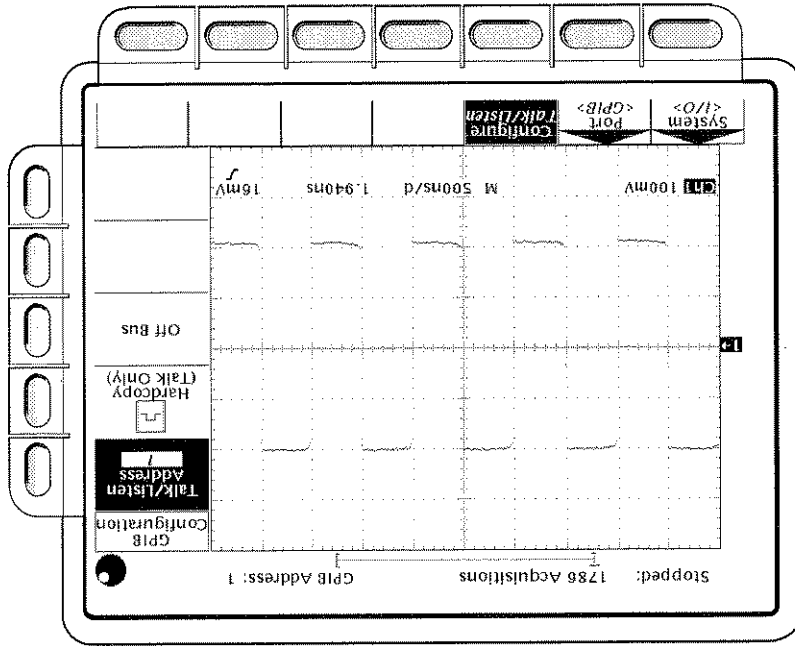

- Step 3:** Press the **Port** button in the main menu until it highlights the **GPIB** selection in the pop-up menu (See Figure 1-9).
- Step 4:** Press the **Configure** button in the main menu to display the GPIB Configuration side menu (See Figure 1-9).
- Step 5:** Press the **Talk/Listen Address** side menu button, and set the GPIB address using either the general purpose knob or the keypad.



You can control the digitizing oscilloscope through the GPIB and RS-232-C interfaces using commands and queries. This section describes the syntax these commands and queries use. It also describes the conventions the digitizing oscilloscope uses to process them. The next section, entitled *Commands*, lists the commands and queries themselves.

You transmit commands to the digitizing oscilloscope using the enhanced American Standard Code for Information Interchange (ASCII) character encoding. Appendix A on page A-1 contains a chart of the ASCII character set.

This manual describes commands and queries using Backus-Naur Form (BNF) notation and syntax diagrams.

This manual uses the following BNF symbols:

Table 2-1: BNF Symbols and Meanings

Symbol	Meaning
<	Defined element
::=	Is defined as
	Exclusive OR
{ }	Group; one element is required
[]	Optional; can be omitted
..	Previous element(s) may be repeated
()	Comment

Command and Query Structure

Commands consist of set commands and query commands (usually simply called commands and queries). Commands modify instrument settings or tell the digitizing oscilloscope to perform a specific action. Queries cause the digitizing oscilloscope to return data and information about its status.

Most commands have both a set form and a query form. The query form of the command differs from the set form by its question mark on the end. For example, the set command `ACQUIRE:MODE` has a query form `ACQUIRE:MODE?`. Not all commands have both a set and a query form. Some commands have set only and some have query only.

A command message is a command or query name followed by any information the digitizing oscilloscope needs to execute the command or query. Command messages may contain five element types, defined in Table 2-2 and shown in the example in Figure 2-1.

Table 2-2: Command Message Elements

Symbol	Meaning
<Header>	The basic command name. If the header ends with a question mark, the command is a query. The header may begin with a colon (;) character. If the command is concatenated with other commands, the beginning colon is required. Never use the beginning colon with command headers beginning with a star (*).
<Mnemonic>	A header sub-function. Some command headers have only one mnemonic. If a command header has multiple mnemonics, a colon (;) character always separates them from each other.
<Argument>	A quantity, quality, restriction, or limit associated with the header. Some commands have no argument while others have multiple arguments. A <Space> separates arguments from the header. A <Comma> separates arguments from each other.
<Comma>	A single comma between arguments of multiple argument commands. It may optionally have white space characters before and after the comma.
<Space>	A white space character between command header and argument. It may optionally consist of multiple white space characters.

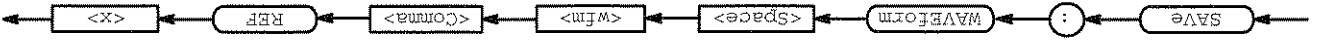
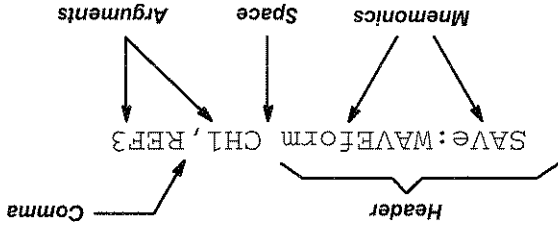

Figure 2-1: Command Message Elements

Query	Header Off Response	Header On Response
APPMENU:TITLE? "Test Setup"	APPMENU:TITLE "Test Setup"	
ACQUIRE:NUM-MAVG?	100	ACQUIRE:NUMAVG 100

Table 2-3: Comparison of Header Off and On Responses

You can control whether the digitizing oscilloscope returns headers as part of the query response. Use the `HEADER` command to control this feature. If header is on, the query response returns command headers and formats itself as a valid set command. When header is off, the response includes only the values. This may make it easier to parse and extract the information from the response. Table 2-3 shows the difference in responses.

Headers in Query Responses

You can specify a query command at any level within the command tree unless otherwise noted. These branch queries return information about all the mnemonics below the specified branch or level. For example, `MEASURE-ment:MEAS<x>:DELAY:DIrection?` returns the starting point and direction of the edge of a delayed measurement, while `MEASURE-ment:MEAS<x>:DELAY?` returns the current settings of all delayed measurement parameters, and `MEASUREment:MEAS<x>?` returns all the measurement parameters for the specified measurement.

- `[:] <Header>? [<Space> <Argument> [<Comma> <Argument>] . . .]`
- `[:] <Header>?`

Queries cause the digitizing oscilloscope to return information about its status or settings. Queries have the structure:

Queries

A command header consists of one or more mnemonics arranged in a hierarchical or tree structure. The first mnemonic is the base or root of the tree and each subsequent mnemonic is a level or branch off the previous one. Commands at a higher level in the tree may affect those at a lower level. The leading colon (:) always returns you to the base of the command tree.

- `[:] <Header> [<Space> <Argument> [<Comma> <Argument>] . . .]` or change one of its settings. Commands have the structure:

Commands

Clearing the Digitizing Oscilloscope

You can clear the Output Queue and reset the digitizing oscilloscope to accept a new command or query by using the Device Clear (DCL) GPIB command.

Command Entry

- You can enter commands in upper or lower case.
- You can precede any command with white space characters. White space characters include any combination of the ASCII control characters 00 through 09 and 0B through 20 hexadecimal (0 through 9 and 11 through 32 decimal).
- The digitizing oscilloscope ignores commands consisting of any combination of white space characters and line feeds.

Abbreviating Commands

You can abbreviate many digitizing oscilloscope commands. Each command's listing in the *Commands* section shows the abbreviations in capitals. For example, you can enter the command `ACQUIRE:NUMAVG` simply as `ACQ:NUMA` or `acq:numa`.

If you use the `HEADER` command to have command headers included as part of query responses, you can further control whether the returned headers are abbreviated or are full-length. The `VERBOSE` command lets you control this.

Concatenating Commands

You can concatenate any combination of set commands and queries using a semicolon (;). The digitizing oscilloscope executes concatenated commands in the order received.

When concatenating commands and queries, you must follow these rules:

1. Separate completely different headers by a semicolon and by the beginning colon on all commands but the first. For example, the commands `TRIGGER:MODE NORMAL;ACQUIRE:NUMAVG 10` would be concatenated into a single command:

```
TRIGGER:MODE NORMAL;ACQUIRE:NUMAVG 10
```

2. If concatenated commands have headers that differ by only the last mnemonic, you can abbreviate the second command and eliminate the beginning colon. For example, you can concatenate the commands `ACQUIRE:MODE ENVELOPE` and `ACQUIRE:NUMAVG 10` into a single command:

```
ACQUIRE:MODE ENVELOPE;NUMAVG 10
```

The longer version works equally well:

```
Acquire:MODE ENVELOPE;ACQUIRE:NUMAVG 10
```

3. Never precede a star (*) command with a colon:

```
Acquire:MODE ENVELOPE;*TRG
```

Any commands that follow will be processed as if the star command was not there so

```
Acquire:MODE ENVELOPE;*TRG;NUMAVG 10
```

will set the acquisition mode to envelope and set the number of acquisitions for averaging to 10.

4. When you concatenate queries, the responses to all the queries are concatenated into a single response message. For example, if the display intensity for text is 80% and for the waveform it is 90%, the concatenated query

```
Display:INTENSITY:TEXT?;WAVEFORM?
```

will return either: DISPLAY:INTENSITY:TEXT 80; DISPLAY:INTENSITY:WAVEFORM 90 if header is on or 80; 90 if header is off.

5. Set commands and queries may be concatenated in the same message. For example,

```
Acquire:MODE NORMAL;NUMAVG?;STATE?
```

is a valid message that sets the acquisition mode to normal, then queries the number of acquisitions for averaging, and the acquisition state. Concatenated commands and queries are executed in the order received.

Here are some invalid concatenations:

```
Display:INTENSITY:TEXT 80;ACQUIRE:NUMAVG 10  
(no colon before ACQUIRE)
```

```
Display:INTENSITY:TEXT 80;:WAVEFORM 90
```

(extra colon before WAVEFORM—could use DISPLAY:INTENSITY:WAVEFORM instead)

```
Display:INTENSITY:TEXT 80;:*TRG  
(colon before a star (*) command)
```

```
APMenu:LABEL:BOTTOM1 "foo";LABEL:BOTTOM2 "fee"  
APMenu:LABEL:BOTTOM1 "foo";LABEL:BOTTOM2 "fee"  
(levels of the mnemonics are different—either remove the second use of LABEL: or place: APMenu: in front of LABEL:BOTTOM2)
```

Message Terminators

This manual uses <EOM> (End of message) to represent a message terminator.

The end-of-message terminator may be the END message (EOL asserted concurrently with the last data byte), the ASCII code for line feed (LF) sent as the last data byte, or both. The digitizing oscilloscope always terminates messages with LF and EOL. It allows white space before the terminator. For example, it allows CR LF.

Symbol	Meaning
<EOM>	Message terminator

Constructed Mnemonics

Some header mnemonics specify one of a range of mnemonics. For example, a channel mnemonic can be CH1, or CH2. You use these mnemonics in the command just as you do any other mnemonic. In the command descriptions, this list of choices is abbreviated CH<x>.

Application Menu Mnemonics

When the application menu is displayed, commands may specify which menu button to use.

Symbol	Meaning
BOTTOM<x>	A main menu button selector; <x> is 1, 2, 3, 4, 5, 6, or 7. Main menu buttons are located along the bottom of the display and are numbered left to right, starting with 1.
RIGHT<x>	A side menu button selector; <x> is 1, 2, 3, 4, or 5. Side menu buttons are located along the right side of the display and are numbered top to bottom, starting with 1.

Cursor Position Mnemonics

When cursors are displayed, commands may specify which cursor of the pair to use.

Symbol	Meaning
POSITION<x>	A cursor selector; <x> is either 1 or 2.

Measurement Specifier Mnemonics

Commands can specify which measurement to set or query as a mnemonic in the header. Up to four automated measurements may be displayed with each displayed waveform. The displayed measurements are specified in this way:

Symbol	<code><wfm></code>
Meaning	Can be CH<x>, MATH<x> or REF<x>

In some commands, you can specify a waveform regardless of whether it is a channel waveform, a math waveform, or a reference waveform. Specify such a waveform as follows:

Waveform Mnemonics

Symbol	<code>REF<x></code>
Meaning	A reference waveform specifier; <x> is either 1, 2, 3, or 4.

Commands can specify the reference waveform to use as a mnemonic in the header:

Reference Waveform Mnemonics

Symbol	<code>MATH<x></code>
Meaning	A math waveform specifier; <x> is 1, 2, or 3.

Commands can specify the mathematical waveform to use as a mnemonic in the header:

Math Waveform Mnemonics

Symbol	<code>CH<x></code>
Meaning	A channel specifier; <x> is either 1, or 2.

Commands specify the channel to use as a mnemonic in the header:

Channel Mnemonics

Symbol	<code>MEAS<x></code>
Meaning	A measurement specifier; <x> is either 1 [top], 2, 3, or 4 [bottom].

Argument Types

The argument of a command may be in one of several forms. The individual descriptions of each command tell which argument types to use with that command.

Numeric Arguments

Many digitizing oscilloscope commands require numeric arguments. The syntax shows the format that the digitizing oscilloscope returns in response to a query. This is also the preferred format when sending the command to the digitizing oscilloscope though any of the formats will be accepted. This manual represents these arguments as follows:

Symbol	Meaning
<NR1>	Signed integer value
<NR2>	Floating point value without an exponent
<NR3>	Floating point value with an exponent

Most numeric arguments will be automatically forced to a valid setting, either by rounding or truncating, when an invalid number is input unless otherwise noted in the command description.

Quoted String Arguments

Some commands accept or return data in the form of a quoted string, which is simply a group of ASCII characters enclosed by a single quote (') or double quote ("). For example:

"this is a quoted string"

Symbol	Meaning
<QString>	Quoted string of ASCII text

Follow these rules when you use quoted strings:

1. A quoted string can include any character defined in the 7-bit ASCII character set. (See Appendix A on page A-1).
2. Use the same type of quote character to open and close the string: "this is a valid string"
3. You can mix quotation marks within a string as long as you follow the previous rule: "this is an 'acceptable' string"
4. You can include a quote character within a string simply by repeating the quote. For example, "here is a " " mark"

Figure 2-2: Block Argument Example

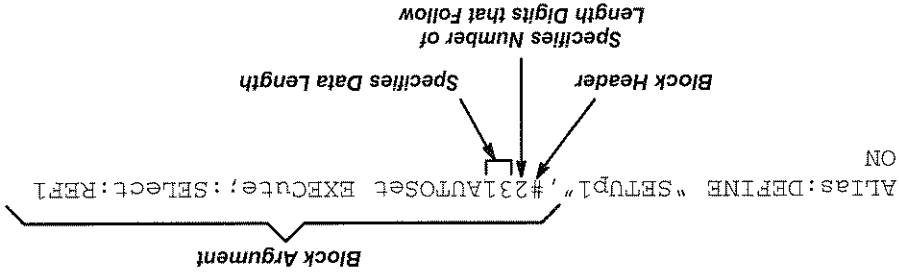

<NZDig> specifies the number of <Dig> elements that follow. Taken together, the <Dig> elements form a decimal integer that specifies how many <DChar> elements follow.

Symbol	Meaning
<NZDig>	A non-zero digit character, in the range 1–9
<Dig>	A digit character, in the range 0–9
<DChar>	A character with the hex equivalent of 00 through FF hexadecimal (0 through 255 decimal)
<Block>	A block of data bytes, defined as: <pre><Block> ::= { #<NZDig><Dig> [<Dig>...] [<DChar>...] #0 [<DChar>...] <terminator> }</pre>

Several digitizing oscilloscope commands use a block argument form:

Block Arguments

- "test<EOI>" (termination character is embedded in the string)
- "Invalid string argument" (quotes are not of the same type)

Here are some invalid strings:

- Strings can have upper or lower case characters.
- If you use a GPIB network, you cannot terminate a quoted string with the END message before the closing delimiter.
- A carriage return or line feed imbedded in a quoted string does not terminate the string, but is treated as just another character in the string.
- The maximum length of a quoted string returned from a query is 1000 characters.

Syntax Diagrams

The syntax diagrams in this manual use the following symbols and notation:

- Circles and ovals contain literal elements. You must send most elements exactly as shown. The command mnemonics are shown in both upper and lower case to distinguish between complete and abbreviated spellings. These elements are not case sensitive. You can omit the lower case portion of the mnemonic.
- Boxes contain the defined elements described earlier in this section, such as `<NR3>` or `<Qstring>`.
- Elements are connected by arrows that show the allowed paths through the diagram and, thus, the orders in which you can send the elements. Parallel paths show that you must take one and only one of the paths. A path around a group of elements shows that those elements are optional.
- Loops show elements that you can repeat.

Figure 2-3 shows the structure of a few typical syntax diagrams.

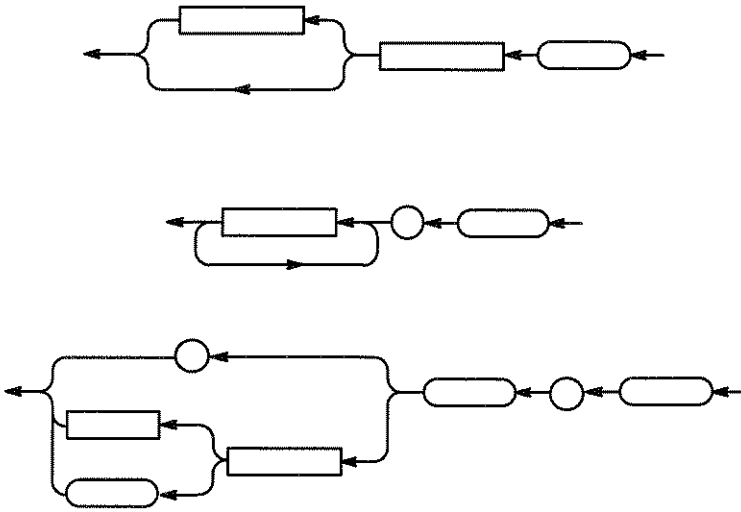

Figure 2-3: Typical Syntax Diagrams



Command Groups

This section lists Digitizing Oscilloscope commands in two ways. It first presents them by functional groups, and then lists them alphabetically. The functional groups are shown in Tables 2-4 through 2-21. The alphabetical list provides more detail on each command and starts on page 2-31.

The TDS 820 GPIB interface conforms to Tektronix standard codes and formats and IEEE 488.2-1987 except where noted.

Acquisition Commands

Acquisition commands affect the acquisition of waveforms. These commands control mode, averaging, enveloping, and single-waveform acquisition. (Persistence controls are in the Display commands section on page 2-98)

Table 2-4: Acquisition Commands

Header	Description
ACquire?	Return acquisition parameters
ACquire:MODE	Acquisition mode
ACquire:NUMAcq?	Number of acquisitions obtained query
ACquire:NUMAVg	Number of acquisitions for average
ACquire:NUMENV	Number of acquisitions for envelope
ACquire:STATE	State of acquisition system
ACquire:STOPAfter	Single-waveform acquisition control

Alias Commands

Alias commands let you define your own commands as a sequence of standard commands. This feature is useful when you use the same commands each time you perform a certain task, such as setting up the digitizing oscilloscope to take a measurement.

Table 2-5: Alias Commands

Header	Description
Alias	Turns the alias state on and off
Alias:CATalog?	Return a list of aliases

Calibration and Diagnostic Commands

Calibration and Diagnostic commands let you initiate the self-calibration and diagnostic routines that are built into the digitizing oscilloscope. The diagnostic test operation includes selecting the test sequence, executing the sequence, and then examining the results.

Header	Description
APPMenu	Display the application menu
APPMenu: LABEL	Return or remove all application menu button labels
APPMenu: LABEL: BOTTOM<x>	Label for a bottom menu button
APPMenu: LABEL: RIGHT<x>	Label for a side menu button
APPMenu: TITLE	Create a title for the application menu

Table 2-6: Application Menu Commands

Application menu commands let you define special-purpose menus for the digitizing oscilloscope. You can define labels for both the main and side menus as well as a side menu title. You can display an Application menu by either pressing the front-panel **APPLICATION** button or sending the APPMe- nu ACTivate command.

When the Application menu is displayed and a front-panel button is pressed, an event is generated that tells the controller which button was pressed. The event reporting system can also be set up so that a Service Request is generated when a menu button is pressed.

Application Menu Commands

Header	Description
Alias: DEFINE	Create a new alias
Alias: DELETE	Remove an alias
Alias: DELETE: ALL	Remove all aliases
Alias: DELETE: NAME	Remove a named alias
Alias: STATE	Turn the alias state on and off

Table 2-5: Alias Commands (Cont.)

Header	Description
CURSOR?	Returns cursor settings
CURSOR:FUNCTION	Turn cursors on or off; select cursor type
CURSOR:HBAR?	Return H bar settings
CURSOR:HBAR:DELTA?	Vertical distance between cursors
CURSOR:HBAR:POSITION<x>	Position a horizontal cursor
CURSOR:HBAR:SELECT	Set which cursor the knob controls
CURSOR:MODE	Set cursor tracking mode
CURSOR:PAIRED	Position paired cursors

Table 2-8: Cursor Commands

Cursor Commands

Cursor commands provide control over cursor (calliper) display and readout.

Header	Description
*CAL?	Perform an internal self-calibration and return the result
CALIBRATE:ALL	Perform an internal self-calibration or return the result
CALIBRATE:ALL:STATUS?	Results of the self-calibration
DIAG:RESULT:FLAG?	Status of diagnostic tests
DIAG:RESULT:LOG?	Results of last diagnostic test sequence
DIAG:SELECT:ACQUISITION	Acquisition system diagnostic test sequence
DIAG:SELECT:ALL	Diagnostic test sequence for Acquisition, Processor, Display, and Front panel
DIAG:SELECT:CPU	Processor diagnostic test sequence
DIAG:SELECT:DISPLAY	Display system diagnostic test sequence
DIAG:SELECT:FPanel	Front panel diagnostic test sequence
DIAG:STATE	Control of diagnostic tests

Table 2-7: Calibration and Diagnostic Commands

Display Commands

Display commands let you change the graticule style, change the displayed intensities, display messages, and clear the menu. When you turn off waveform display, waveforms are acquired and transmitted but not displayed. The update rate is much faster when waveform display is off.

Table 2-9: Display Commands

Header	Description
CLEARMenu	Clear menus from display
Display?	Returns display settings
Display:CLOCK	Controls the display of the date/time stamp
Display:FILTER	Displayed data interpolation
Display:FORMAT	Y-t or X-Y display
Display:GRATICULE	Graticule style

Header	Description
CURSOR:PAIRED:HDELTA?	Return distance between horizontal paired cursors
CURSOR:PAIRED:HPOS1?	Return horizontal position of first paired cursor
CURSOR:PAIRED:HPOS2?	Return horizontal position of second paired cursor
CURSOR:PAIRED:POSITION1	Set vertical position of first paired cursor
CURSOR:PAIRED:POSITION2	Set vertical position of second paired cursor
CURSOR:PAIRED:SELECT	Select the active paired cursor
CURSOR:PAIRED:VDDELTA?	Return the vertical distance between paired cursors
CURSOR:VBARS	Position vertical bar cursors
CURSOR:VBARS:DELTA?	Horizontal distance between cursors
CURSOR:VBARS:POSITION<x>	Position a vertical cursor
CURSOR:VBARS:SELECT	Set which cursor the knob controls
CURSOR:VBARS:UNITS	Set vertical cursors to period or frequency

Table 2-8: Cursor Commands (Cont.)

Graphics Commands

The Graphics commands let you draw lines and polygons on the instrument display.

Table 2-10: Graphics Commands

Header	Description
Graphics?	Returns graphics display status and collection of move and draw points.
Graphics: MOVE	Move to a new position
Graphics: DRAW	Draw a line from the current position to a new position
Graphics: DISPLAY	Graphics display status
Graphics: DELETE	Delete all points
Graphics: NUMPOINTS?	Number of graphics points query

Table 2-9: Display Commands (Cont.)

Header	Description
Display: INTENSITY?	Returns intensity settings
Display: INTENSITY: CONTRAST	Waveform intensified zone brightness
Display: INTENSITY: OVERALL	Main brightness
Display: INTENSITY: TEXT	Text brightness
Display: INTENSITY: WAVEFORM	Waveform brightness
Display: PERSISTENCE	Variable persistence decay time
Display: STYLE	Waveform dots, line, infinite or variable persistence
Display: TRIGGER	Included for compatibility only
Display: TRIGGER	Controls the display of the trigger bars on screen
Message	Remove text from the message window
Message: BOX	Set size and location of message window
Message: SHOW	Remove and display text in the message window
Message: STATE	Control display of message window

Header	Description
HORIZONTAL?	Return horizontal settings
HORIZONTAL:DELAY?	Return delay time base settings
HORIZONTAL:DELAY:SCALE	Delay time base time per division
HORIZONTAL:DELAY:SECDIV	Same as HORIZONTAL:DELAY:SCALE
HORIZONTAL:DELAY:TBPOSITION	Time from the trigger to the first point in the record in delay mode
HORIZONTAL:DESKEW:CH<X>	Sets deskew for specified channel
HORIZONTAL:MAIN:SCALE	Main time base time per division
HORIZONTAL:MAIN?	Return main time base settings

Table 2-12: Horizontal Commands

Horizontal commands control the time bases of the digitizing oscilloscope. You can set the time per division (or time per point) of both the main and delay time bases. You can also set the record lengths. SECdiv may be substituted for SCALE in the horizontal commands. (This provides program compatibility with earlier models of Tektronix digitizing oscilloscopes.)

Horizontal Commands

Header	Description
HARDCOPY	Start or terminate hard copy
HARDCOPY:FORMAT	Hard copy output format
HARDCOPY:LAYOUT	Hard copy orientation
HARDCOPY:PORT	Hard copy port for output

Table 2-11: Hard Copy Commands

The hard copy commands let you control the format of hard copy output, and control the initiation and termination of hard copies.

Hard Copy Commands

Header	Description
GRAPHICS:POINTS	Set or return the entire collection of move and draw points

Table 2-10: Graphics Commands (Cont.)

Header	Description
LIMIT:BEL1	Sound an audio signal if a signal exceeds the limits of the reference waveform
LIMIT:COMPARE:<CHx>	Compare reference waveform to acquired waveform
LIMIT:HARDCOPY	Hardcopy if a signal exceeds the limits of the reference waveform
LIMIT:STATE	Turn limit testing on or off
LIMIT:TEMPLATE	Create a waveform to use as a reference
LIMIT:TEMPLATE:DESTINATION	Specify the destination in which to store the reference waveform
LIMIT:TEMPLATE:SOURCE	Specify the source of the waveform to use as the reference
LIMIT:TEMPLATE:TOLERANCE	Horizontal tolerance when making template from other waveform

Table 2-13: Limit Test Commands

Limit Test commands add limit test capability to the acquisition commands. These commands let you define signal conditions under which acquisition should or should not take place.

Limit Test Commands

Header	Description
HORIZONTAL:MAIN:SCALE	Same as HORIZONTAL:MAIN:SCALE
HORIZONTAL:TBPOSITION	Time from the trigger to the first point in the record in main mode
HORIZONTAL:MODE	Select main or delayed time base mode
HORIZONTAL:POSITION	Portion of waveform to display
HORIZONTAL:RECORDLENGTH	Number of points in waveform record
HORIZONTAL:SCALE	Same as HORIZONTAL:MAIN:SCALE
HORIZONTAL:SECdiv	Same as HORIZONTAL:MAIN:SCALE
HORIZONTAL:TBPOSITION	Set the main time base position

Table 2-12: Horizontal Commands (Cont.)

Header	Description
MEASUREMENT: CLEARSNAPSHOT	Take down measurement snapshot
MEASUREMENT: GATING	Set or query measurement gating
MEASUREMENT: IMMEDIATE?	Return immediate measurement parameters
MEASUREMENT: IMMEDIATE? DELAY?	Return information on immediate delay measurement
MEASUREMENT: IMMEDIATE: DELAY: DIRECTION	Search direction to use for delay measurements
MEASUREMENT: IMMEDIATE: DELAY: EDGE1	Which waveform edge to use for delay measurements
MEASUREMENT: IMMEDIATE: DELAY: EDGE2	Which waveform edge to use for delay measurements
MEASUREMENT: IMMEDIATE: SOURCE1	Channel to take measurement from

Table 2-14: Measurement Commands

Measurement commands control the automated measurement system. Up to four automated measurements can be displayed on the screen of the digitizing oscilloscope. In the commands, these four measurement readouts are named MEAS<x>, where <x> can be 1, 2, 3, or 4. In addition to the four displayed measurement readouts, the measurement commands let you specify a fifth measurement, IMMEDIATE. The immediate measurement has no front-panel equivalent, and immediate measurements are never displayed. Because they are computed only when they are needed, immediate measurements slow the waveform update rate less than displayed measurements.

Whether you are using displayed or immediate measurements, you use the VALUE? query to obtain measurement results.

Several measurement commands set and query measurement parameters. Some parameters, such as waveform sources, can be assigned differently for each measurement readout. Other parameters, such as reference levels, have only one value, which applies to all measurements.

Measurement Commands

Header	Description
LIMIT: TEMPLATE: TOLERANCE:	Vertical tolerance when making
VERTICAL	template from other waveform

Table 2-13: Limit Test Commands (Cont.)

Header	Description
MEASUREMENT:IMMED:SOURCE2	Second channel to take measurement from (delay or "to" channel)
MEASUREMENT:IMMED:TYPE	The measurement to be taken
MEASUREMENT:IMMED:UNITS?	Units of the measurement result
MEASUREMENT:IMMED:VALUE?	Measurement result query
MEASUREMENT:MEAS<x>?	Return parameters on measurement
MEASUREMENT:MEAS<x>:DELAY?	Return delay measurement parameters.
MEASUREMENT:MEAS<x>:DELAY:Direction	Search direction to use for delay measurements
MEASUREMENT:MEAS<x>:DELAY:EDGE1	Which waveform edge to use for delay measurements
MEASUREMENT:MEAS<x>:DELAY:EDGE2	Which waveform edge to use for delay measurements
MEASUREMENT:MEAS<x>:SOURCE1	Channel to take measurement from
MEASUREMENT:MEAS<x>:SOURCE2	Second channel to take measurement from (delay or "to" channel)
MEASUREMENT:MEAS<x>:STATE	Turn measurement display on or off
MEASUREMENT:MEAS<x>:TYPE	The measurement to be taken
MEASUREMENT:MEAS<x>:UNITS?	Units to use for measurement
MEASUREMENT:MEAS<x>:VALUE?	Measurement result query
MEASUREMENT:METHOD	Method for calculating reference levels
MEASUREMENT:REFLEVEL?	Return reference levels
MEASUREMENT:REFLEVEL:ABSOLUTE:HIGH	The top level for risetime (90% level)
MEASUREMENT:REFLEVEL:ABSOLUTE:LOW	The low level for risetime (10% level)
MEASUREMENT:REFLEVEL:ABSOLUTE:MID	Mid level for measurements
MEASUREMENT:REFLEVEL:ABSOLUTE:MID2	Mid level for delay measurements
MEASUREMENT:REFLEVEL:METHOD	Method to assign levels: either % or absolute volts

Table 2-14: Measurement Commands (Cont.)

Header	Description
AUTOset	Automatic instrument setup
BELL	Audio alert
*DATE	Set date
*DDT	Define group execute trigger (GET)
FACTORY	Reset to factory default
HDR	Same as HEADER
HEADER	Return command header with query
*IDN?	Identification
*LRN?	Learn device setting
LOCK	Lock front panel (local lockout)
NEWpass	Change password for User Protected Data
PASSword	Access to change User Protected Data

Table 2-15: Miscellaneous Commands

Miscellaneous commands are a group of commands that do not fit into any other category. Several commands and queries used with the digitizing oscilloscope are common to all devices on the GPIB bus. These commands and queries are defined by IEEE Std 488.2-1987 and Tek Standard Codes and Formats 1989, and begin with a star (*) character.

Miscellaneous Commands

Header	Description
MEASUREMENT:RFFLevel:PERCENT:HIGH	The top level for rise/fall time (90% level)
MEASUREMENT:RFFLevel:PERCENT:LOW	The low level for rise/fall time (10% level)
MEASUREMENT:RFFLevel:PERCENT:MID	Mid level for measurements
MEASUREMENT:RFFLevel:PERCENT:MID2	Mid level for delay measurements
MEASUREMENT:SNAPShot	Displays measurement snapshot

Table 2-14: Measurement Commands (Cont.)

Table 2-15: Miscellaneous Commands (Cont.)

Header	Description
REM	No action; remark only
RS232?	Query RS-232 parameters
RS232:BAUD	Set RS-232 baud rate
RS232:HARDFlagging	Set RS-232 hard flagging
RS232:PARTY	Set RS-232 parity
RS232:SOFTFlagging	Set RS-232 soft flagging
RS232:STOPbits	Set # of stop bits for RS-232
*RST	Return most settings to factory default
SET?	Same as *LRN?
TEKSecure	Initialize waveforms and setups
*TIME	Set time
*TRG	Perform group execute trigger (GET)
*TST?	Self-test
UNLOCK	Unlock front panel (local lockout)
VERBOSE	Return full command name or minimum spellings with query

Save and Recall Commands

Save and Recall commands allow you to store and retrieve internal waveforms and settings. When you "save a setting," you save all the settings of the digitizing oscilloscope. When you then "recall a setting," the digitizing oscilloscope restores itself to the state it was in when you originally saved that setting.

Table 2-16: Save and Recall Commands

Header	Description
ALLOCATE?	Number of allocated data points query
ALLOCATE:WAVEFORM?	Number of allocated data points query
ALLOCATE:WAVEFORM:FREE?	Number of unallocated data points query

Header	Description
ALLEN?	Return all events
BUSY?	Scope busy query
*CLS	Clear status
DESE	Device event status enable
*ESE	Standard event status enable
*ESR?	Standard event status register
EVEN?	Event query
EVMsg?	Event message query
EVQRY?	Number of events query
ID?	Identification
*OPC	Operation complete
*PSC	Power-on status clear

Table 2-17: Status and Error Commands

Table 2-17 lists the status and error commands the digitizing oscilloscope supports. These commands let you determine the status of the digitizing oscilloscope and control events.

Several commands and queries used with the digitizing oscilloscope are common to all devices on the GPIB bus. IEEE Std 488.2-1987 defines these commands and queries. They begin with an asterisk (*) character.

Status and Error Commands

Header	Description
ALLOCATE:WAVEFORM:REF<x>	Specify the number of allocated data points
DELETE:SETUP	Delete stored setup
DELETE:WAVEFORM	Delete stored waveform
*RCL	Recall setting
RECALL:SETUP	Recall saved instrument setting
*SAV	Save setting
SAVE:SETUP	Save instrument setting
SAVE:WAVEFORM	Save waveform

Table 2-16: Save and Recall Commands

Trigger Commands

Trigger commands control all aspects of digitizing oscilloscope triggering. Triggering lets you display a waveform just after the point where the signal passes through a voltage level of your choosing.

Table 2-18: Trigger Commands

Header	Description
TRIGGER	Set the trigger level to midrange
TRIGGER:HOLDOFF:ACTUAL?	Query the actual trigger holdoff
TRIGGER:HOLDOFF:VALUE	Requested trigger holdoff value
TRIGGER:INTRATE	Internal clock rate for internal clock trigger source
TRIGGER:LEVEL	Trigger level
TRIGGER:MAIN	Same as TRIGGER
TRIGGER:MAIN:EDGE:INTRATE	Same as TRIGGER:INTRATE
TRIGGER:MAIN:EDGE:SLOPE	Same as TRIGGER:SLOPE
TRIGGER:MAIN:EDGE:SOURCE	Same as TRIGGER:SOURCE
TRIGGER:MAIN:HOLDOFF:AC-TUAL?	Same as TRIGGER:HOLDOFF:AC-TUAL
TRIGGER:MAIN:HOLDOFF:VALUE	Same as TRIGGER:HOLDOFF:VAL-NE
TRIGGER:MAIN:LEVEL	Same as TRIGGER:LEVEL
TRIGGER:MAIN:MAXSAMPLE	Same as TRIGGER:MAXSAMPLE
TRIGGER:MAIN:MODE	Same as TRIGGER:MODE
TRIGGER:MAXSAMPLE?	Trigger maximum sample rate query
TRIGGER:MODE	Trigger mode

Table 2-17: Status and Error Commands (Cont.)

Header	Description
*PUD	Query or set User Protected Data
*RST	Reset
*SRE	Service request enable
*STB?	Read status byte
*WAI	Wait to continue

Waveform Commands

Waveform commands let you transfer waveform data points to and from the digitizing oscilloscope. Waveform data points are a collection of values that define a waveform. One data value usually represents one data point in the

Header	Description
CH<x>:PROBEFuncT:EXTAttEn	Set external attenuation factor (as a factor)
CH<x>:PROBEFuncT:EXTDBAttEn	Set external attenuation factor (in dB)
CH<x>:SCALE	Channel volts/div
CH<x>:VOLTS	Same as CH<x>:SCALE
MATH<x>?	Return definition of specified math waveform
MATH<x>:DEFINE	Math waveform
SElect:<wfM>	Set selected waveform
SElect:CONTROL	Front-panel channel selector

Table 2-19: Vertical Commands

Vertical commands control the display of channels and of main and reference waveforms. The `SElect:<wfM>` command also selects the waveform to be used by many commands in other command groups. (This provides program compatibility with earlier models of Tektronix digitizing oscilloscopes.)

Vertical Commands

Header	Description
TRIGGER:SLOPE	Trigger slope
TRIGGER:SOURCE	Trigger source
TRIGGER:STATE?	Trigger system status

Table 2-18: Trigger Commands (Cont.)

Up to 15,000 data points can be transferred for each waveform record. You can transfer a portion of the waveform or you can transfer the entire record. The DATA:START and DATA:STOP commands let you specify the first and last data points of the waveform record.

When transferring data into the digitizing oscilloscope you must specify the location of the first data point within the waveform record. For example, when DATA:START is set to 1, data points will be stored starting with the first point in the record, and when DATA:START is set to 500, data will be stored starting at the 500th point in the record. DATA:STOP will be ignored when

Waveform Data/Record Lengths

Binary is signed integer where the most significant byte is transferred first, and RPBinary is positive integer where the most significant byte is transferred first. SRBinary and SRPBinary correspond to RBinary and RPBinary respectively but use a swapped byte order where the least significant byte is transferred first. The byte order is ignored when DATA:WIDTH is set to 1.

The defined binary formats also specify the order in which the bytes are transferred giving a total of four binary formats: RBinary, RPBinary, SRBinary, and SRPBinary.

Binary data—can be represented by signed integer or positive integer values. The range of the values depends on the byte width specified. When the byte width is one, signed integer data ranges from -128 to 127, and positive integer values range from 0 to 255. When the byte width is two, values range from -32768 to 32767.

```
CURVE<space>-110,-109,-110,-110,-109,-107,-109,-107,-109,-107,-107,-107,-106,-105,-103,-100,-97,-90,-84,-80
```

An example ASCII waveform data string may look like this:

ASCII data—is represented by single byte, signed integer values in the range -128 to 127. Each data point value consists of up to three ASCII characters for the value and one for the minus sign if the value is negative. Data points are separated by commas. The DATA:WIDTH command is ignored when using ASCII format since the byte width is always one.

The digitizing oscilloscope can transfer waveform data in either ASCII or binary format. You specify the format with the DATA:ENCDg command.

Acquired waveform data uses two 8-bit data bytes to represent each data point. The DATA:WIDTH command lets you specify the number of bytes per data point when transferring data to and from the digitizing oscilloscope.

Waveform Data Formats

When working with enveloped waveforms, each data value is either the min or max of a min/max pair. Before waveform data can be transferred, you must specify the data format, record length, and waveform locations.

- You can transfer waveforms from the digitizing oscilloscope to an external controller using the following sequence:
- Step 1:** Select the waveform source(s) using the DATA:SOURCE command. If you want to transfer multiple waveforms, select more than one source.
 - Step 2:** Specify the waveform data format using the DATA:ENCODG command.
- ### Transferring Waveform Data from the Digitizing Oscilloscope

Once the waveform data has been transferred to the controller, the waveform data points can be converted into voltage values for analysis using information from the waveform preamble.

Scaling Waveform Data

Each waveform that is transferred has an associated waveform preamble that contains information such as the horizontal scale, the vertical scale, and other settings in place when the waveform was created. Refer to the WFM:PRE command starting on page 2-21 for more information about the waveform preamble.

Waveform Preamble

Only one waveform can be transferred to the digitizing oscilloscope at a time. Waveforms sent to the digitizing oscilloscope are always stored in one of the four reference memory locations. The reference memory location can be specified by the DATA:DESTINATION command. The memory size for the specified location must be defined before the data can be stored. The ALLOCATE:WAVEFORM:REF <x> command lets you specify the memory size for each reference location.

The DATA:SOURCE command specifies the location of the data when transferring waveforms from the digitizing oscilloscope. Multiple waveforms can be transferred at one time by specifying more than one source.

Waveform Data Locations and Memory Allocation

When transferring data from the digitizing oscilloscope, you must specify the first and last data points in the waveform record. Setting DATA:START to 1 and DATA:STOP to the record length will always return the entire waveform. You can also use the vertical bar cursors to delimit the portion of the waveform that you want to transfer. DATA:START and DATA:STOP can then be set to the current cursor positions by sending the command DATA:SNAP.

transferring data into the digitizing oscilloscope as the digitizing oscilloscope will stop reading data when there is no more data to read or when the specified record length has been reached.

Header	Description
CURVE	Transfer waveform data
DATA	Copy VBAR cursor positions to DATA:START and DATA:STOP, and initialize data variables
DATA:DESTINATION	Destination for waveforms sent to the digitizing oscilloscope
DATA:ENCODG	Waveform data encoding method
DATA:SOURCE	Source of CURVE? data
DATA:START	Starting point in waveform record for CURVE?

Table 2-20: Waveform Commands

- You can transfer waveform data to one of the four reference memory locations in the digitizing oscilloscope using the following sequence:
- Step 1:** Specify the reference memory location for the waveform using the DATA:DESTINATION command.
 - Step 2:** Specify the memory size for the reference location specified in the previous step using the ALLOCATE:WAVEFORM:REF<x> command.
 - Step 3:** Specify the waveform data format using the DATA:ENCODG command.
 - Step 4:** Specify the number of bytes per data point using the DATA:WIDTH command.
 - Step 5:** Specify the location of the first data point in the waveform record using the DATA:START command.
 - Step 6:** Transfer waveform preamble information using the WFM:PRE:<wfm> command.
 - Step 7:** Transfer the waveform data to the digitizing oscilloscope using the CURVE command.

Transferring Waveform Data to the Digitizing Oscilloscope

- Step 3:** Specify the number of bytes per data point using the DATA:WIDTH command.
- Step 4:** Specify the portion of the waveform that you want to transfer using the DATA:START and DATA:STOP commands.
- Step 5:** Transfer waveform preamble information using the WFM:PRE? query.
- Step 6:** Transfer the waveform data from the digitizing oscilloscope using the CURVE? query.

Table 2-20: Waveform Commands (Cont.)

Header	Description
DATA:STOP	Ending point in waveform record for CURVE?
DATA:TARGET	Same as DATA:DESTINATION
DATA:WIDTH	Byte width of waveform points
WAVFrm?	Returns both the waveform preamble and curve data
WAVPre?	Returns waveform format data
WFMPre:BIT_Nr	Preamble bit width of waveform points
WFMPre:BN_Fmt	Preamble binary encoding type
WFMPre:BYT_Nr	Preamble byte width of waveform points
WFMPre:BYT_Or	Preamble byte order of waveform points
WFMPre:CRVChk	Preamble checksum of waveform points
WFMPre:ENCDg	Preamble encoding method
WFMPre:NR_Pt	Number of points in the curve
WFMPre:PT_Fmt	Format of curve points
WFMPre:PT_Off	Trigger position
WFMPre:WFIId	Curve identifier
WFMPre:XINcr	Horizontal sampling interval
WFMPre:XMULt	Horizontal scale factor
WFMPre:XOFF	Horizontal offset
WFMPre:XUNIt	Horizontal units
WFMPre:XZERo	Horizontal origin offset
WFMPre:YMULt	Vertical scale factor
WFMPre:YOFF	Vertical offset
WFMPre:YUNIt	Vertical units
WFMPre:YZERo	Offset voltage
WFMPre:ZMULt	Z-axis scale factor
WFMPre:ZOFF	Z-axis offset

Header	Description
ZOOM	Resets zoom parameters to defaults
ZOOM:HORIZONTAL:LOCK	Horizontal zoom lock
ZOOM:HORIZONTAL:POSITION	Horizontal zoom position
ZOOM:HORIZONTAL:SCALE	Horizontal zoom scale
ZOOM:STATE	Turn zoom mode on or off
ZOOM:VERTICAL:POSITION	Vertical zoom position
ZOOM:VERTICAL:SCALE	Vertical zoom scale

Table 2-21: Zoom Commands

Zoom commands let you expand and position the waveform display horizontally and vertically without changing the time base or vertical settings.

Zoom Commands

Header	Description
WFMPRE:ZUNITS	Z-axis units
WFMPRE:ZZERO	Z-axis origin offset
WFMPRE:NR_PT	Number of points in the curve
WFMPRE:PT_FMT	Format of curve points
WFMPRE:PT_OFF	Trigger position
WFMPRE:WFID	Curve identifier
WFMPRE:XINCR	Horizontal sampling interval
WFMPRE:XUNITS	Horizontal units
WFMPRE:XZERO	Horizontal origin offset
WFMPRE:YMULT	Vertical scale factor
WFMPRE:YOFF	Vertical offset
WFMPRE:YUNITS	Vertical units
WFMPRE:YZERO	Offset voltage

Table 2-20: Waveform Commands (Cont.)

You can use commands either 1) to set instrument features or 2) to query instrument values. You can use some commands to do both, some to only set, and some to only query. This manual marks set only commands with the words "No Query Form" included with the command name. It marks query only commands with a question mark appended to the header, and includes the words "Query Only" in the command name.

This manual spells out headers, mnemonics, and arguments with the minimal spelling shown in upper case. For example, to use the abbreviated form of the ACQUIRE:MODE command just type ACQ:MOD.

ACQUIRE? (Query Only)

Returns all the current acquisition parameters.

Group: Acquisition

Syntax: ACQUIRE?

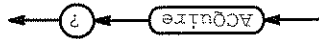

Examples: ACQUIRE?
 might return the string : ACQUIRE: STOPAFTER RUNSTOP; STATE 1; MODE NORMAL; NUMENV 10; NUMAVG 16; for the current acquisition parameters.

ACQUIRE:MODE

Sets or queries the acquisition mode of the digitizing oscilloscope. This affects all live waveforms. This command is equivalent to setting **Mode** in the Acquire menu.

Waveforms are the data point values taken from acquisition intervals. Each acquisition interval represents a time duration that is determined by the horizontal scale (time per division).

The acquisition mode, which you set using this ACQUIRE:MODE command, determines how the final value of the waveform is generated from the many data samples.

Group: Acquisition

Related Commands: ACQUIRE:NUMAVG, ACQUIRE:NUMENV, CURVE?, DATA:WIDTH

Syntax: ACQUIRE:MODE { NORMAL | AVERAGE | ENVELOPE }
ACQUIRE:MODE?

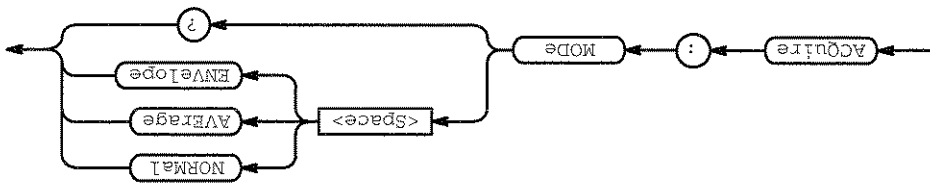

Arguments:

NORMAL specifies that the data point value is the value that was acquired with no averaging, enveloping, or other processing. **NORMAL** is the default mode.

Average specifies averaging mode, where the resulting waveform shows an average of data points from several separate waveforms. The number of waveform records that go into making up the average waveform is set or queried using the ACQUIRE:NUMAVG command.

ENVELOPE specifies envelope mode, where the resulting waveform shows the maximum and minimum range of data points from several separate waveform records. The number of waveform records that go into making up the envelope waveform is set or queried using the ACQUIRE:NUMENV command.

Examples:

ACQUIRE:MODE AVERAGE
sets the acquisition mode to display a waveform that is an average of many individual waveform records.

ACQUIRE:MODE?
might return ENVELOPE when the digitizing oscilloscope is in envelope mode.

ACQUIRE:NUMAcq? (Query Only)

Indicates the number of acquisitions that have taken place since starting acquisition. This value is reset to zero when any Acquire, Horizontal, or Vertical arguments that affect the waveform are modified. The maximum number of acquisitions that can be counted is $2^{30}-1$. Counting stops when this number is reached. This is the same value that is displayed in the upper left corner of the screen when RUN/STOP is pressed.

Group: Acquisition

Related Commands: ACQUIRE:STATE

Syntax: ACQUIRE:NUMAcq?

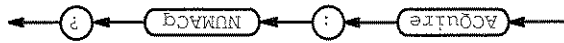

Returns: <NR1>

Examples: ACQUIRE:NUMAcq? might return 350, indicating that 350 acquisitions took place since an ACQUIRE:STATE RUN command was executed.

ACQUIRE:NUMAVG

Sets the number of waveform acquisitions that make up an averaged waveform. This is equivalent to setting the **Average** count in the Acquire Mode side menu.

Group: Acquisition

Related Commands: ACQUIRE:MODE

Syntax: ACQUIRE:NUMAVG <NR1>

ACQUIRE:NUMAVG?

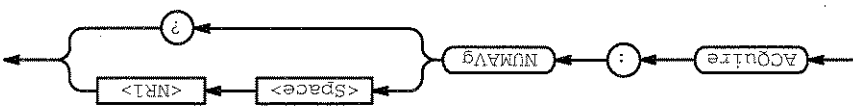

Arguments:

<NR1> is the number of waveform acquisitions, from 2 to 10,000. Most changes in instrument settings will cause the average to restart (for example, changes in horizontal or vertical settings).

Examples:

ACQUIRE:NUMAVG 10 specifies that an averaged waveform will show the result of combining 10 separately acquired waveforms.

ACQUIRE:NUMAVG?

might return 75, indicating that there are 75 acquisitions specified for averaging.

ACQUIRE:NUMENV

Sets the number of waveform acquisitions that make up an envelope waveform. This is equivalent to setting the **Envelope** count in the Acquire Mode side menu.

Group: Acquisition

Related Commands: ACQUIRE:MODE

Syntax: ACQUIRE:NUMENV { <NR1> | INFINITE }

ACQUIRE:NUMENV?

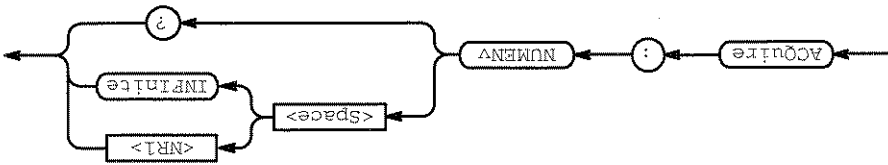

Arguments: <NR1> ≠ 0 is the number of waveform acquisitions, from 1 to 2000. Most changes in instrument settings will cause the envelope to restart. INFINITE or <NR1> = 0 specifies continuous enveloping.

NOTE

If you set the acquisition system to single sequence, envelope mode, and set the number of envelopes to infinity, the digitizing oscilloscope will envelope a maximum of 2001 acquisitions.

Examples: ACQUIRE:NUMENV 10 specifies that an enveloped waveform will show the result of combining 10 separately acquired waveforms.

ACQUIRE:NUMENV? might return 0, indicating that acquisitions are acquired infinitely for enveloped waveforms.

ACQUIRE:STATE

Starts or stops acquisitions. This is the equivalent of pressing the front-panel **RUN/STOP** button. If **ACQUIRE:STATE** is set to **LIMIT** or **SEQUENCE**, other signal events may also stop acquisition.

Group: Acquisition

Related Commands: **ACQUIRE:NUMACQ?**, **ACQUIRE:STOPAfter**

Syntax: **ACQUIRE:STATE** { **OFF** | **ON** | **RUN** | **STOP** | **<NR1>** } **ACQUIRE:STATE?**

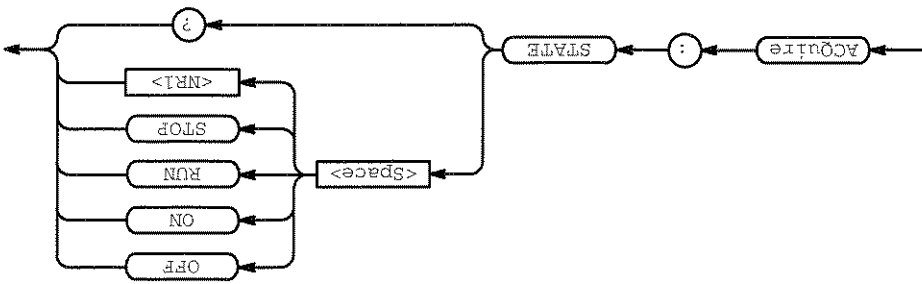

Arguments: **OFF** or **STOP** or **<NR1> = 0** stops acquisitions.

ON or **RUN** or **<NR1> ≠ 0** starts acquisition and display of waveforms. If the command was issued in the middle of an acquisition sequence (for instance averaging or enveloping), **RUN** restarts the sequence, discarding any data accumulated before the **STOP**. It also resets the number of acquisitions.

Examples:

ACQUIRE:STATE:RUN
starts acquisition of waveform data and resets the number of acquisitions count (**NUMACQ**) to zero.

ACQUIRE:STATE?
returns either 0 or 1, depending on whether the acquisition system is running.

ACQUIRE:STOPAFTER

Tells the digitizing oscilloscope when to stop taking acquisitions. This is equivalent to setting **Stop After** in the Acquire menu.

Group: Acquisition

Related Commands: ACQUIRE:MODE, ACQUIRE:STATE

Syntax: ACQUIRE:STOPAFTER { RUNSTOP | LIMIT | SEQUENCE }

ACQUIRE:STOPAFTER?

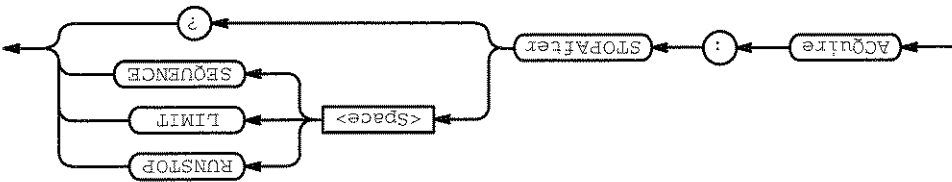

Arguments:

RUNSTOP specifies that the run and stop state should be determined by the user's pressing the front-panel RUN/STOP button.

LIMIT specifies that the oscilloscope will stop if waveform data exceeds the limits set by the limit test commands.

SEQUENCE specifies single sequence operation, where the digitizing oscilloscope stops after it has acquired enough waveforms to satisfy the conditions of the acquisition mode. For example, if the acquisition mode is set to normal, then the digitizing oscilloscope will stop after acquiring a single record. However, if the acquisition mode is set to average 100 waveforms, then the digitizing oscilloscope will stop only after all 100 waveforms have been acquired. The ACQUIRE:STATE command and the front-panel RUN/STOP button will also stop acquisition when the digitizing oscilloscope is in single sequence mode.

NOTE

If you set the acquisition system to single sequence, envelope mode, and set the number of envelopes to infinity, the digitizing oscilloscope will envelope a maximum of 2001 acquisitions.

Examples:

ACQUIRE:STOPAFTER RUNSTOP

sets the scope to stop acquisition when the user presses the front-panel RUN/STOP button.

ACQUIRE:STOPAFTER?

might return SEQUENCE.

Alias

Turns command aliases on or off. This command is identical to the Alias:STATE command.

Group: Alias

Syntax: Alias { OFF | ON | <NR1> }

Alias?

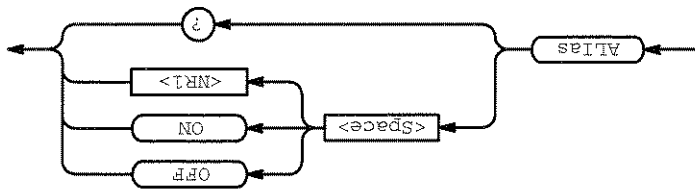

Arguments:

OFF or <NR1> = 0 turns alias expansion off. If a defined alias label is sent when Alias is OFF, an execution error (102, "Syntax error; illegal use of alias") will be generated.

ON or <NR1> ≠ 0 turns alias expansion on. When a defined alias is received, the specified command sequence is substituted for the alias and executed.

Examples:

Alias ON

turns the alias feature on.

Alias?

returns 1 when the aliases are on.

Alias:CATalog? (Query Only)

Returns a list of the currently defined alias labels, separated by commas. If no aliases are defined, the query returns the string " ".

Group: Alias

Syntax: Alias:CATalog?

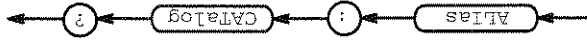

Returns:

<QString> [, <QString> ...]

Examples:

Alias:CATalog?

might return the string " SETUP1 ", " TESTMENU1 ", " DEFAULT ", showing there are 3 aliases named SETUP1, TESTMENU1, and DEFAULT.

Assigns a sequence of program messages to an alias label. These messages are then substituted for the alias whenever it is received as a command or query provided Alias:STATE has been turned ON. The Alias:DEFINE? query returns the definition of a selected alias.

Up to 10 aliases can be defined at one time. Aliases can be recursive. That is, aliases can include other aliases with up to 10 levels of recursion.

Group: Alias

Syntax: Alias:DEFINE <QString><Comma>{ <QString> | <Block> }

Alias:DEFINE? <QString>

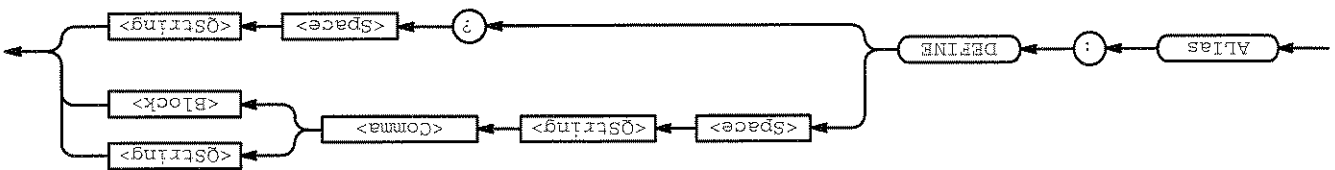

Arguments:

The first <QString> is the alias label. This label cannot be a command name. Labels must start with a letter, and can contain only letters, numbers, and underscores; other characters are not allowed. The label must be ≤12 characters.

The second <QString> or <Block> is a complete sequence of program messages. The messages can contain only valid commands that must be separated by semicolons and must follow all rules for concatenating commands (see page 2-4). The sequence must be ≤80 characters.

NOTE

Attempting to give two aliases the same name causes an execution error. To give a new alias the name of an existing alias, you must first delete the existing alias.

Examples:

```
Alias:DEFINE "ST1", " :RECALL:SETUP 5 ; AUTOSSET ; SELECT:CH1 ON"
Alias:DEFINE? "ST1"
might return :ALIAS:DEFINE "ST1",#239:RECALL:SETUP 5 ; AU-
TOSSET ; SELECT:CH1 ON
```

defines an alias named "ST1" that sets up the digitizing oscilloscope.

Alias:DELETE (No Query Form)

Removes a specified alias. This command is identical to Alias:DELETE:NAME.

Group: Alias

Syntax: Alias:DELETE <QString>



Arguments: <QString> is the name of the alias you want to remove. Using Alias:DELETE without specifying an alias causes an execution error. <QString> must be a previously defined alias.

Examples: Alias:DELETE "SETUP1" deletes the alias named SETUP1.

Alias:DELETE:ALL (No Query Form)

Deletes all existing aliases.

Group: Alias

Syntax: Alias:DELETE:ALL

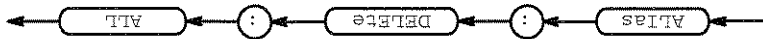

Examples: Alias:DELETE:ALL deletes all aliases.

Alias:STATE

Turns aliases on or off. This command is identical to the Alias command.

Group: Alias

Syntax: Alias:STATE { OFF | ON | <NRL> }

Alias:STATE?

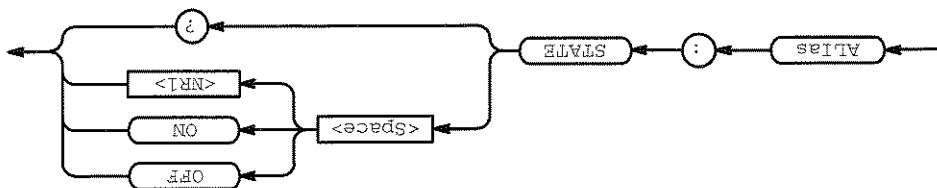

Arguments:

OFF or <NRL> = 0 turns alias expansion off. If a defined alias is sent when Alias:STATE is OFF, a command error (102) will be generated.

ON or <NRL> ≠ 0 turns alias expansion on. When a defined alias is received, the specified command sequence is substituted for the alias and executed.

Examples:

Alias:STATE OFF

turns the command alias feature off.

Alias:STATE?

returns 0 when alias mode is off.

Alias:DELETE:NAME (No Query Form)

Removes a specified alias. This command is identical to Alias:DELETE.

Group: Alias

Syntax: Alias:DELETE:NAME <QString>



Arguments: <QString> is the name of the alias to remove. Using Alias:DELETE:NAME without specifying an alias causes an execution error. <QString> must be a previously defined alias.

Examples: Alias:DELETE:NAME "STARTUP" deletes the alias named STARTUP.

ALLEV? (Query Only)

Causes the digitizing oscilloscope to return all events and their messages, and removes the returned events from the Event Queue. The messages are separated by commas. Use the *ESR? query to enable the events to be returned. For a complete discussion of the use of these registers, see page 3-1. This command is similar to repeatedly sending *EVMsg? queries to the instrument.

Group: Status and error

Related Commands: *CLS, DESE, *ESE, *ESR?, EVENT?, EVMsg?, EVQTY, *SRE, *STB?

Syntax: ALLEV?



Returns: The event code and message in the following format:

```
<Event Code><Comma><QString>[<Comma><Event Code>
<Comma><QString>...]
```

<Command> is the command that caused the error and may be returned when a command error is detected by the digitizing oscilloscope. As much of the command will be returned as possible without exceeding the 60 character limit of the <Message> and <Command> strings combined. The command string is right-justified.

Examples:

ALLEV?
 might return the string: ALLEV 2225,"Measurement error, No waveform to measure; ",420,"Query UNTERMINATED; ".

ALLOCATE? (Query Only)

Returns the number of data points allocated for all four reference memory locations.

Group: Save and Recall

Syntax: ALLOCATE?



Examples: ALLOCATE?

might return: ALLOCATE:WAVEFORM:REF1 50000;REF2 0;REF3 0;REF4 0; indicating that all 50000 data points are allocated to reference memory location 1.

ALLOCATE:WAVEFORM? (Query Only)

Returns the number of data points allocated for all four reference memory locations.

Group: Save and Recall

Syntax: ALLOCATE:WAVEFORM?



Examples: ALLOCATE?

might return: ALLOCATE:WAVEFORM:REF1 500;REF2 500;REF3 500;REF4 0; indicating that 500 data points are allocated to each of the first three reference memory locations.

ALLOCATE:WAVEFORM:FREE? (Query Only)

Returns the approximate number of data points that have not been allocated.

Group: Save and Recall

Syntax: ALLOCATE:WAVEFORM:FREE?



Returns: <NR1> is the approximate number of data points available.

Examples: ALLOCATE:WAVEFORM:FREE?
might return 520 indicating that there are approximately 500 data points available for allocation. The extra 20 are used for administration purposes.

ALLOCATE:WAVEFORM:REF<x>

Sets or queries the number of waveform data points for the specified reference location. If an attempt is made to allocate memory when it is not available, an execution error is generated and the memory is not allocated.

Group: Save and Recall

Syntax: ALLOCATE:WAVEFORM:REF<x> <NR1>

ALLOCATE:WAVEFORM:REF<x>?

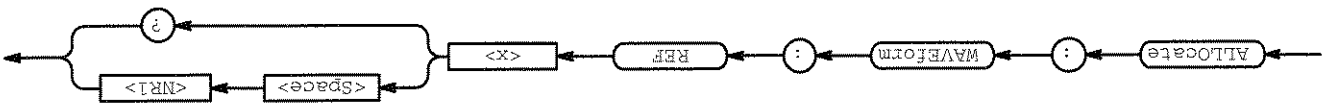

Arguments: <NR1> = 0 is returned when the reference location is empty.

<NR1> ≠ 0 specifies the number of data points, and can be 500, 1000, 2500, 15000, or 50000. All invalid values less than 50000 will be forced to the next highest valid value, and those higher than 50000 will be forced to 50000. For example, 15002 will cause 50000 points of data to be allocated for the reference. The memory size of the four reference locations combined cannot exceed 50000 data points.

Examples:

ALLOCATE:WAVEFORM:REF2 15000
 reserves 15,000 data points for REF2.
 ALLOCATE:WAVEFORM:REF1 ?
 might return 500

APPMenu

Displays the user-definable Application menu and the query returns the current Application menu labels and title. This is equivalent to pressing the front-panel **APPLICATION** button.

Group: Application Menu

Related Commands: CLEARMenu, *ESR, EVENT?

Syntax: APPMenu ACTivate

APPMenu?

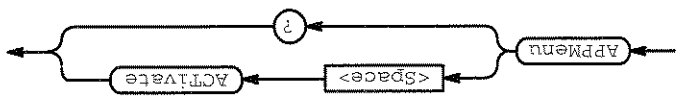

Arguments:

ACTivate displays the Application menu. Use the CLEARMenu command to deactivate the Application menu.

Once the Application menu is activated, whenever a front-panel menu button is pressed an event is generated that tells which button was pressed. See page 3-17 for event codes.

Menu button presses will also generate Service Requests when the URC bit is enabled in DESER and ESR, and the ESB bit is enabled in SRR. See page 3-1 for a complete discussion of the use of these registers.

Examples:

APPMenu ACTivate

displays the application menu.

The label is displayed on a single line and is centered, both vertically and horizontally, within the label area. A line feed character can be embedded in the string to position the label on multiple lines. You can also use white space tab characters to position the label within a line.

The label is displayed on a single line and is centered, both vertically and horizontally, within the label area. A line feed character can be embedded in the string to position the label on multiple lines. You can also use white space tab characters to position the label within a line.

Arguments:

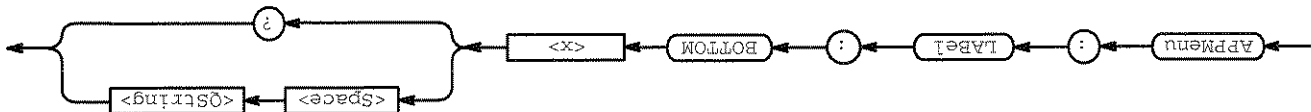

Syntax: APPMenu:LABEL:BOTTOM<x> <String> APPMenu:LABEL:BOTTOM<x> ?

Group: Application Menu

Defines a label for the main menu button that is specified by `<x>`. Main menu buttons are located along the bottom of the display, and are numbered from 1 to 7 starting with the left-most button.

APPMenu:LABEL:BOTTOM<x>

clears the user-defined menu labels from the display.

Examples: APPMenu:LABEL CLEAR

Arguments: CLEAR removes the main and side menu labels from the display. Front-panel bezel button presses will continue to generate events.

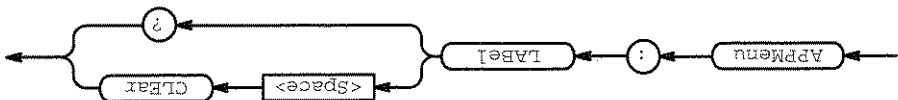

Syntax: APPMenu:LABEL CLEAR APPMenu:LABEL ?

Group: Application Menu

Removes all user-defined Application menu button labels from the display. The `APPMenu:LABEL?` query returns all the current label settings.

APPMenu:LABEL

A tab can be sent by sending a tab character (decimal 9) followed by two numeric characters that specify the pixel column relative to the left margin of the label area.

The ESC @ character turns reverse video on and off, and can be embedded in the label string. The first ESC @ character displays all text following the ESC @ in reverse video until another ESC @ character is found in the string.

NOTE

The use of any undocumented codes may produce unpredictable results.

The label area is 45 pixels high and 90 pixels wide. The length of the label that fits in the label area depends on the contents of the label, because the width of characters varies. The label area is about 10 characters wide and 3 lines high. For a complete list of character widths in pixels, see Table A-1 on page A-1.

If the label exceeds the limits of the label area, either horizontally or vertically, the portion of the label that exceeds the limits will not be displayed. Note that the label itself is not altered. The entire label can be returned as a query response regardless of what is displayed.

Examples:

```
APPMENU: LABEL: BOTTOM3 " SETUP1 "
```

assigns the label "SETUP1" to the third main menu button.

APPMenu:LABEL:RIGHT<X>

Defines a label for the side menu button that is specified by <X>. Side menu buttons are located on the right side of the display, and are numbered from 1 to 5 starting with the top-most button.

Group: Application Menu

Syntax: APPMenu:LABEL:RIGHT<X> <QString>

APPMenu:LABEL:RIGHT<X>?

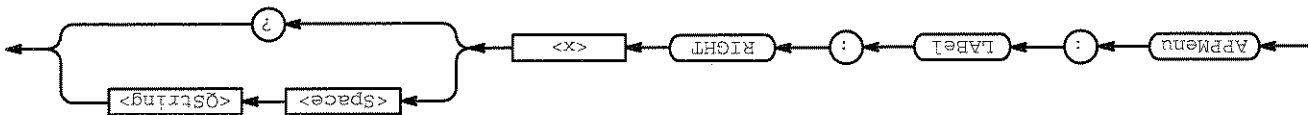

Arguments:

<QString> is the menu button label and can include any of the characters shown in the TDS Character Chart in Appendix C. The maximum length of the label is 1000 characters. The label is displayed in the area to the left of the specified side menu button.

The label area is 40 pixels high and 112 pixels wide. The length of the label that fits in the label area depends on the contents of the label, because the width of characters varies. The label area is about 12 characters wide and 2 lines high. For a complete list of character widths in pixels, see Table A-1 on page A-1.

Examples:

APPMenu:LABEL:RIGHT1 "TEST ON" displays the label "TEST ON" next to the top side menu button.

APPMenu:TITLE

Command Descriptions

Sets or queries the user-defined application menu title. The title is displayed above the side menu.

Group: Application Menu

Related Commands: APPMenu, APPMenu:LABEL

Syntax: APPMenu:TITLE <QString>

APPMenu:TITLE?

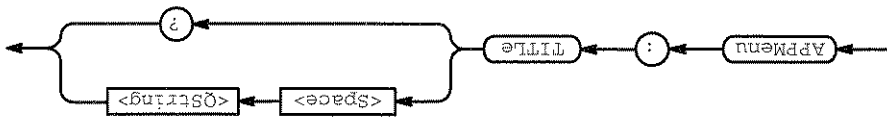

Arguments:

<QString> is the side menu title and can include any of the characters shown in the TDS Character Chart in Appendix C. The maximum length of the title is 1000 characters. All rules that apply to menu labels also apply to the menu title. The APPMenu:LABEL:BOTTOM<x> command on page 2-47 provides information on defining menu labels.

The label area is 40 pixels high and 112 pixels wide. The length of the label that fits in the label area depends on the contents of the label, because the width of characters varies. The label area is about 12 characters wide and 2 lines high. For a complete list of character widths in pixels, see Table A-1 on page A-1.

Examples:

APPMenu:TITLE "Custom Menu" displays the title "Custom Menu" on the screen.
APPMenu:TITLE? might return "Test Setup" for the current application menu title.

AUTOSET (No Query Form)

Causes the digitizing oscilloscope to adjust its vertical, horizontal, and trigger controls to provide a stable display of the selected waveform. This is equivalent to pressing the front-panel **AUTOSET** button. For a detailed description of the autoset function, see Autoset in the In Detail section of the Tutorial/User Manual for your instrument.

NOTE

The AUTOSET command does not return control to the instrument controller until the autoset operation is complete.

Group: Miscellaneous

Syntax: AUTOSET EXECUTE

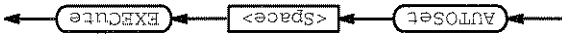

Arguments: EXECUTE initiates the autoset.

BELL (No Query Form)

Beeps the audio indicator of the digitizing oscilloscope.

Group: Miscellaneous

Syntax: BELL



Examples: BELL
rings the bell.

BUSY? (Query Only)

Returns the status of the digitizing oscilloscope. This command allows you to synchronize the operation of the digitizing oscilloscope with your application program. Synchronization methods are described on page 3-7.

Group: Status and error

Related Commands: *OPC, *WAI

Syntax: BUSY?

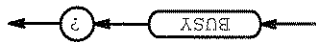

Returns:

<NR1> = 0 means that the digitizing oscilloscope is not busy processing a command whose execution time is extensive. These commands are listed in Table 2-22.

<NR1> = 1 means that the digitizing oscilloscope is busy processing one of the commands listed in Table 2-22.

Table 2-22: Commands that Affect BUSY? Response

Operation	Command
Single sequence acquisition	ACQUIRE:STATE ON or ACQUIRE:STATE RUN (when ACQUIRE:STOPAfter is set to SEQUENCE)
Limit test comparison	LIMIT
Hardcopy output	HARDCOPY START

Examples: BUSY?
might return 1, indicating that the instrument is busy.

***CAL? (Query Only)**

Instructs the digitizing oscilloscope to perform an internal self-calibration and return its calibration status. Terminate signals to all channels before you calibrate the instrument. This is equivalent to executing Calibrate All in the Cal pop-up menu of the **System I/O** item in the Utility menu.

NOTE

The self-calibration can take 15 seconds or more to respond. No other commands will be executed until calibration is complete. All channels should be inactive before you issue this command; active channels can cause calibration errors.

Group: Calibration and Diagnostic

Related Commands: CALIBRATE

Syntax: *CAL?

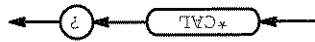

Returns: <NR1> = 0 indicates that the calibration completed without any errors detected. <NR1> ≠ 0 indicates that the calibration did not complete successfully or completed with errors. See Table 2-23 for error code meanings.

Table 2-23: Calibration Error Codes

<NR1>	Meaning
0	no error
-1	the calibration has failed

Examples: *CAL? performs an internal self-calibration and might return 0 to indicate that the calibration was successful.

CALIBRATE:ALL

The CALIBRATE:ALL command instructs the digitizing oscilloscope to calibrate all channels and the horizontal time base. Terminate signals to all channels before you calibrate the instrument. This is equivalent to executing Calibrate All in the Cal pop-up menu of the **System I/O** item in the Utility menu. The calibration can take 15 seconds or more to respond. No other commands will be executed until calibration is complete.

NOTE

All channels should be inactive before you issue this command, active channels can cause calibration errors.

Group: Calibration and Diagnostic

Related Commands: *CAL?, CALIBRATE:ALL:STATUS?

Syntax: CALIBRATE:ALL START

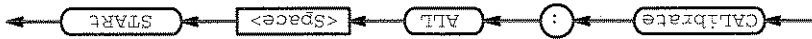

Arguments: START starts the internal self-calibration.

Examples: CALIBRATE:ALL START performs the internal self-calibration.

CALIBRATE:ALL:STATUS? (Query Only)

CALIBRATE:ALL:STATUS? queries the digitizing oscilloscope for the results of the self-calibration.

NOTE

All channels should be inactive before you issue this command, active channels can cause calibration errors.

Group: Calibration and Diagnostic

Related Commands: *CAL?, CALIBRATE:ALL

Syntax: CALIBRATE:ALL:STATUS?

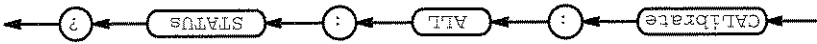

Returns: PASS means that the digitizing oscilloscope is properly calibrated.

FAIL means that the digitizing oscilloscope is not properly calibrated. Look at the error log to determine the specific error. Use the Diag/Err pop-up menu item of the **System I/O** item in the Utility menu.

INIT means that the digitizing oscilloscope has been restored to its initial defaults, and must be calibrated before it is used.

Examples: CALIBRATE:ALL:STATUS?
might return PASS, indicating that the instrument is calibrated properly.

CH<x>? (Query Only)

Returns the vertical parameters. Because CH<x>:SCALE and CH<x>:VOLTS are identical, only CH<x>:SCALE is returned.

Group: Vertical

Syntax: CH<x>?



Examples: CH1?

might return the string :CH1:SCALE 10.0E-3
POSITION 0.0E+0;OFFSET 0.0E+0; for channel 1.

CH<X>:OFFSET

Sets or queries the offset, in volts, that is subtracted from the specified input channel before it is acquired. The greater the offset, the lower on the display the waveform appears. This is equivalent to setting **Offset** in the Vertical menu.

Group: Vertical

Related Commands: CH<X>:POSITION

Syntax: CH<X>:OFFSET <NR3>

CH<X>:OFFSET?



Arguments:

<NR3> is the desired offset in volts. The range depends on whether delay lines are present as well as the probe attenuation factor. With no probe or using a 1X probe, the offset is ± 1 V when delay lines are absent (instruments with Option 1D) and ± 2 V when delay lines are present.

When using probes with an attenuation factor greater than 1X, multiply these numbers by the probe attenuation factor to get the offset. For example, if you are using 10X probes, the offset is ± 10 V when delay lines are absent and ± 20 V when delay lines are present. For 5X probes, the offset is ± 5 V without delay lines and ± 10 V with delay lines.

If you are using a probe with probe tip offset capability, your probe determines the maximum and minimum offset values. Consult the documentation that came with your probe for these values.

Examples:

CH1:OFFSET 0.5E+00

lowers the channel 1 displayed waveform by 0.5 volts.

CH1:OFFSET?

might return 5.00E-3, indicating that the current channel 1 offset is 0.5 volts.

CH<x>:POSITION

Sets or queries the vertical position of the specified channel. The position voltage value is applied to the signal before digitization. This is equivalent to setting **Position** in the Vertical menu or adjusting the front-panel **Vertical Position** knob.

Group: Vertical

Related Commands: CH<x>:OFFSET

Syntax: CH<x>:POSITION <NR3>

CH<x>:POSITION?



Arguments: <NR3> is the desired position, in divisions from the center graticule. The range is ± 5 divisions.

Examples: CH2:POSITION 1.3E+00 positions the channel 2 input signal 1.3 divisions above the center of the display.
CH1:POSITION? might return -1.3E+00, indicating that the current position of channel 1 is at -1.3 divisions.

CH<x>:PROBE? (Query Only)

Returns the attenuation factor of the probe that is attached to the specified channel.

Group: Vertical

Syntax: CH<x>:PROBE?



Returns: <NR3>

Examples: CH2:PROBE? might return 100.0E-3 for a 10x probe.

CH<x>:PROBEFunct:EXTAtten

Sets or queries the channel external attenuation factor.

External channel attenuation enables you to enter a number representing the external attenuation of a channel. Once the number has been entered (1 is the default), the digitizing oscilloscope then uses the total attenuation factor in scaling measurement results. Note that the attenuation factor is also applied to vertical size and if a vertical channel is the trigger source, the trigger level.

The probe attenuation of an active probe attached to a channel and the external attenuation for that channel are multiplied. The external attenuation factor is displayed in the **VERTICAL MENU** → **Probe Functions** (main) → **External Attenuation** (side) menu.

Negative or fractional attenuation factors indicate gain, rather than attenuation.

Group: Vertical

Syntax: CH<x>:PROBEFunct:EXTAtten <NR3>

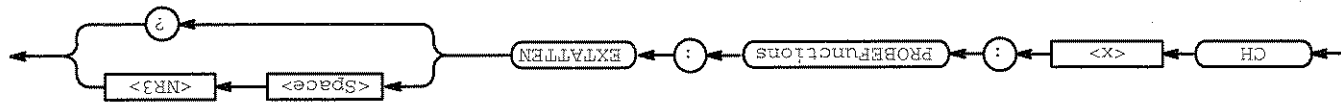

Arguments: <NR3> is the external attenuation factor, from 1E+6 to 1E-6.

Examples: CH2:PROBEFunct:EXTAtten 1E+3 sets the external attenuation to 1000X (and recalculates the dB level).

CH1:PROBEFunct:EXTAtten? might return 1.00E-3, indicating 1x external attenuation.

CH <x>:PROBEFunct:EXTDBatten

Sets or queries the channel external attenuation factor in dB units.

Group: Vertical

Syntax: CH <x>:PROBEFunct:EXTDBatten <NR3>

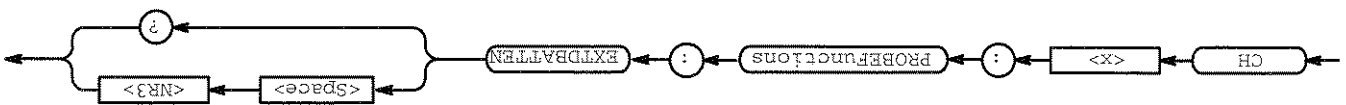

Arguments:

<NR3> is the external attenuation factor in decibels, from -120 dB to 120 dB.

Examples:

CH2:PROBEFunct:EXTDBatten 30

sets the external attenuation to 30 dB (and recalculates the attenuation factor).

CH1:PROBEFunct:EXTDBatten?

might return -10, indicating -10 dB external attenuation.

CH<X>:SCALE

Sets or queries the vertical gain of the specified channel. This is equivalent to setting **Fine Scale** in the Vertical menu or adjusting the front-panel **Vertical SCALE** knob.

Group: Vertical

Related Commands: CH1:VOLTS

Syntax: CH<X>:SCALE <NR3>

CH<X>:SCALE?

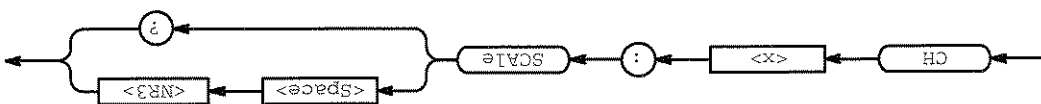

Arguments: <NR3> is the gain, in volts per division. The range is 10 V/div to 1 mV/div when using a 1x probe.

Examples: CH2:SCALE 100E-03
sets the channel 2 gain to 100 mV/div.

CH2:SCALE?
might return 500.0E-3, indicating that the current V/div setting of channel 2 is 500 mV/div.

CH<X>:VOLTS

Sets or queries the vertical gain of the specified channel. This command is identical to the CH<X>:SCALE command and is included for compatibility purposes. Only CH<X>:SCALE is returned in response to a CH<X>? query.

Group: Vertical

Related Commands: CH1:SCALE

Syntax: CH<X>:VOLTS <NR3>

CH<X>:VOLTS?

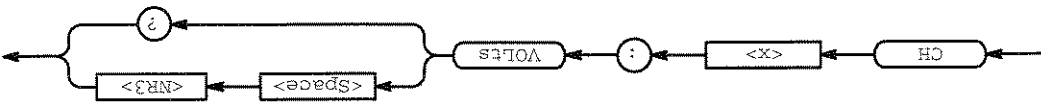

CLEARMENU (No Query Form)

Clears the current menu from the display. This command is equivalent to pressing the **CLEAR MENU** button on the front panel.

Group: Display

Syntax: CLEARMENU

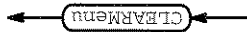

Examples: CLEARMENU

clears the menu from the display.

*CLS (No Query Form)

Clears the digitizing oscilloscope status data structures.

Group: Status and Error

Related Commands: DESE, *ESE, *ESR?, EVENT?, EVMSG?, *SRE, *STB?

Syntax: *CLS



The *CLS command clears the following:

- the Event Queue
- the Standard Event Status Register (SESR)
- the Status Byte Register (except the MAV bit; see below)

If the *CLS command immediately follows an <EOI>, the Output Queue and MAV bit (Status Byte Register bit 4) are also cleared. MAV indicates information is in the output queue. The device clear (DCL) GPIB control message will clear the output queue and thus MAV. *CLS does not clear the output queue or MAV. (A complete discussion of these registers and bits, and of event handling in general, begins on page 3-1.)

*CLS can suppress a Service Request that is to be generated by an *OPC. This will happen if a limit test comparison, hard copy output, or single sequence acquisition operation is still being processed when the *CLS command is executed.

CURSOR? (Query Only)

Returns all current cursor settings.

Group: Cursor

Syntax: CURSOR?

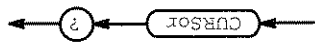

Examples: CURSOR?

```

might return: CURSOR:FUNCTION OFF;VBARS:UNITS SECONDS;
POSITION1 500.0E-6;POSITION2 4.50E-3;SELECT CURSOR1;
:CURSOR:HBAKS:POSITION1 3.20E+0;POSITION2 -3.20E+0;
SELECT CURSOR1 as the current cursor settings.

```

CURSOR:FUNCTION

Selects and displays the cursor type. Cursors are attached to the selected channel. This command is equivalent to setting **Function** in the Cursor menu.

Group: Cursor

Related Commands: SELECT:CONTROL

Syntax: CURSOR:FUNCTION { HBARS | OFF | VBARS | PAIRED }
CURSOR:FUNCTION?

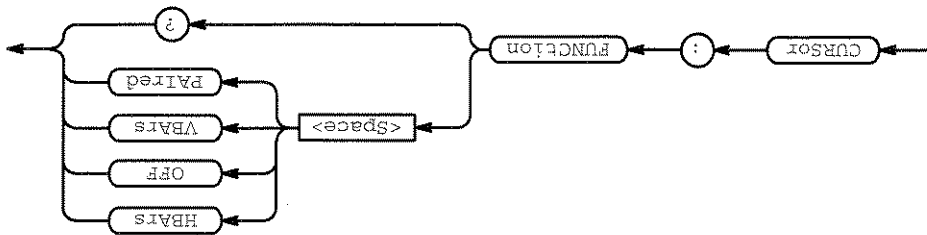

Arguments: HBARS specifies horizontal bar cursors that measure volts.

OFF removes the cursors from the display.

VBARS specifies vertical bar cursors that measure time.

PAIRED specifies paired cursors that show both time and volts.

Examples: CURSOR:FUNCTION VBARS
selects vertical bar type cursors.

CURSOR:HBAR:DELTA? (Query Only)

Returns the voltage difference between the two horizontal bar cursors. The difference is also indicated in a readout at the top right of the screen after executing the **HBars** side menu item of the Cursor menu.

The difference reported is related to the position of the cursors in display pixels, not to the volts per division settings. If you turn the horizontal cursor function off, the results of a query will be the last difference in effect, even if you have since changed the volts per division.

Group: Cursor

Syntax: CURSOR:HBAR:DELTA?

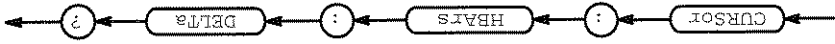

Returns: <NR3>

Examples: CURSOR:HBAR:DELTA? might return 5.08E+0 for the voltage difference between the two cursors.

CURSOR:HBAR? (Query Only)

Returns the current settings for the horizontal bar cursors. The units used are volts. The range depends on the volts per division, vertical position, and vertical offset. The position is also indicated in a readout at the top right of the screen after executing the **HBars** side menu item of the Cursor menu.

The settings reported are related to the position of the cursors in display pixels, not to the volts per division settings. If you turn the horizontal cursor function off, the results of a query will be the last settings in effect, even if you have since changed the volts per division.

Group: Cursor

Syntax: CURSOR:HBAR?



Examples: CURSOR:HBAR? might return CURSOR:POSITION1 0;SELECT CURSOR1.

CURSOR:HBARS:POSITION<x>

Positions a horizontal bar cursor. The position is also indicated in a readout at the top right of the screen after executing the **HBars** side menu item of the Cursor menu.

The position reported is related to the position of the cursors in display pixels, not to the volts per division settings. If you turn the horizontal cursor function off, the results of a query will be the last difference in effect, even if you have since changed the volts per division.

Group: Cursor

Syntax: CURSOR:HBARS:POSITION<x> <NR3>

CURSOR:HBARS:POSITION<x>?



Arguments: <NR3> specifies the cursor position relative to ground, in volts.

Examples: CURSOR:HBARS:POSITION1 25.0E-3

positions one of the horizontal cursors at 25.0 mV.

CURSOR:HBARS:POSITION2?

might return -64.0E-3, indicating that one of the horizontal bar cursors is at -64.0 mV.

CURSOR:HBAR:SELECT

Selects which horizontal bar cursor is active for front-panel control. The active cursor will be displayed as a solid horizontal line and can be moved using the general purpose knob when the cursor menu is active. The unselected cursor will be displayed as a dashed horizontal line. This command is equivalent to pressing the **TOGGLE** button on the front panel when the Cursor menu is displayed.

Group: Cursor

Syntax: CURSOR:HBAR:SELECT { CURSOR1 | CURSOR2 }
CURSOR:HBAR:SELECT?

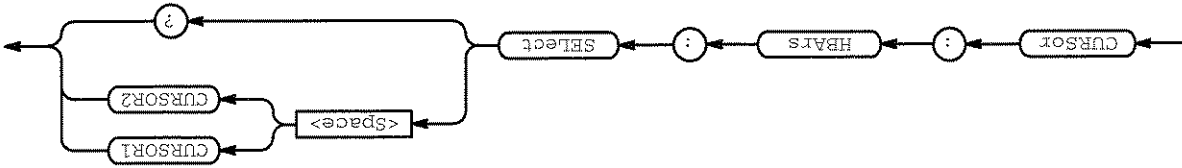

Arguments: CURSOR1 selects the first horizontal bar cursor.
CURSOR2 selects the second horizontal bar cursor.

Examples: CURSOR:HBAR:SELECT CURSOR1
selects the first horizontal bar cursor as the active cursor.

CURSOR:HBAR:SELECT?
returns CURSOR1 when the first cursor is the active cursor.

CURSOR:MODE

Selects whether the two cursors move together in unison or separately from each other.

Group: Cursor

Related Commands: CURSOR:FUNCTION

Syntax: CURSOR:MODE{TRACK | INDEPENDENT }

CURSOR:MODE?

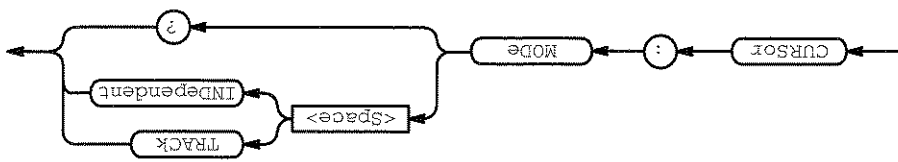

Arguments:

TRACK ties the two cursors together as you move the general purpose knob. This argument is valid only for "cursor" (leftmost vertical cursor and top-most horizontal cursor).

INDEPENDENT frees the two cursors to move separately of each other.

Examples:

CURSOR:MODE TRACK

specifies that the cursors move in unison.

CURSOR:MODE?

might return : TRACK showing the two cursors move in unison.

CURSOR:PAIRED

Positions the paired cursors and the CURSOR:PAIRED? query returns the current paired cursor settings for position and cursor selection.

Group: Cursor

Related Commands: DATA:START, DATA:STOP, MEASUREMENT:GATING

Syntax: CURSOR:PAIRED SNAP

CURSOR:PAIRED?

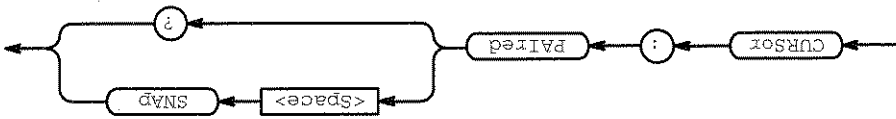

Arguments: SNAP positions the paired (vertical bar) cursors at DATA:START and DATA:STOP

Examples: CURSOR:PAIRED SNAP

specifies that the cursors positions are the same as the current DATA:START and DATA:STOP values.

CURSOR:PAIRED?

might return :CURSOR:PAIRED:POSITION1 1.00E-6;POSITION2 9.00E-6;SELECT CURSOR2.

CURSOR:PAIRED:HDELTA (Query Only)

Queries the distance (voltage) between the first and second paired cursor. This is the absolute value of the first cursor's vertical position minus the second cursor's vertical position.

Group: Cursor

Related Commands: CURSOR:FUNCTION

Syntax: CURSOR:PAIRED:HDELTA?

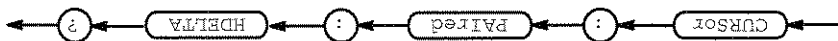

Examples: CURSOR:PAIRED:HDELTA?
might return 5.08E+0 for the voltage difference between the two cursors.

CURSOR:PAIRED:HPOST (Query Only)

Queries the horizontal bar (voltage) position of the first paired cursor.

Group: Cursor

Related Commands: CURSOR:FUNCTION

Syntax: CURSOR:PAIRED:HPOST?



Examples: CURSOR:PAIRED:HPOST?
might return -64.0E-3, indicating that the first cursor is at -64.0 mV.

CURSOR:PAIRED:HPOS2 (Query Only)

Queries the horizontal bar position (voltage) of the second paired cursor.

Group: Cursor

Related Commands: CURSOR:FUNCTION

Syntax: CURSOR:PAIRED:HPOS2?

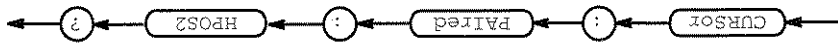

Examples: CURSOR:PAIRED:HPOS2? might return $-64.0E-3$, indicating the second cursor is at -64.0 mV.

CURSOR:PAIRED:POSITION1

Sets or queries the vertical bar position of the first paired cursor.

Group: Cursor

Related Commands: CURSOR:FUNCTION

Syntax: CURSOR:PAIRED:POSITION1<NR3>

CURSOR:PAIRED:POSITION1?

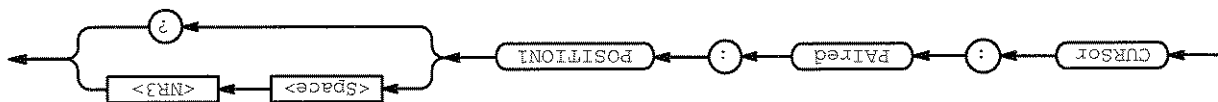

Arguments: <NR3> specifies the position of the first paired cursor.

Examples: CURSOR:PAIRED:POSITION1 9.00E-6 specifies the first paired cursor is at 9 μ s.

CURSOR:POSITION1? might return $1.00E-6$, indicating that the first paired cursor is at 1 μ s.

CURSOR:PAIRED:POSITION2

Sets or queries the vertical bar position of the second paired cursor.

Group: Cursor

Related Commands: CURSOR:FUNCTION

Syntax: CURSOR:PAIRED:POSITION2 <NR3>

CURSOR:PAIRED:POSITION2?

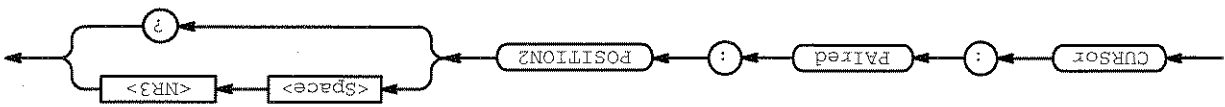

Arguments: <NR3> specifies the position of the second paired cursor.

Examples: CURSOR:POSITION2
might return 1.00E-6, indicating that the second paired cursor is at
1 μs.

CURSOR:PAIRED:SELECT

Selects the active paired cursor. The active cursor appears as a solid vertical line. The unselected cursor appears as a dashed vertical line. This command is equivalent to pressing the **TOGGLE** button on the front panel when the Cursor menu is displayed.

Group: Cursor

Syntax: CURSOR:PAIRED:SELECT { CURSOR1 | CURSOR2 }

CURSOR:PAIRED:SELECT?

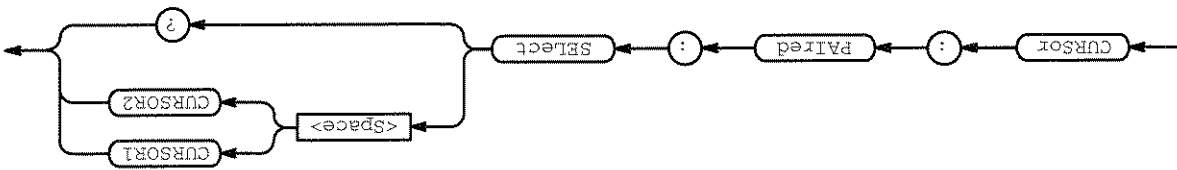

Arguments: CURSOR1 specifies the first paired cursor. CURSOR2 specifies the second paired cursor.

Examples: CURSOR:PAIRED:SELECT CURSOR2

selects the second paired cursor as the active cursor.

CURSOR:PAIRED:SELECT?

returns CURSOR1 when the first paired cursor is the active cursor.

CURSOR:PAIRED:VDelta (Query Only)

Queries the horizontal distance between paired cursors. It returns the absolute value of the first cursor's less the second cursor's horizontal positions.

Group: Cursor

Related Commands: CURSOR:FUNCTION

Syntax: CURSOR:PAIRED:VDelta?

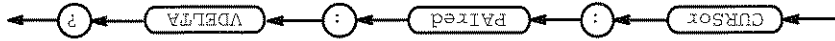

Examples: CURSOR:PAIRED:VDelta? might return 1.064E+00, indicating that the time between the paired cursors is 1.064 seconds.

CURSOR:VBARS

Positions the vertical bar cursors and the CURSOR:VBARS? query returns the current vertical bar cursor settings for horizontal position, delta, cursor selection, and unit. The units used are seconds or Hertz, as indicated by the CURSOR:VBARS:UNITS command. The settings are also indicated in a readout at the top right of the screen after executing the **VBARS** side menu item of the Cursor menu.

The settings reported are related to the position of the cursors in display pixels, not to the seconds per division settings. If you turn the vertical cursor function off, the results of a query will be the last settings in effect, even if you have since changed the seconds per division.

Group: Cursor

Related Commands: DATA:START, DATA:STOP

Syntax: CURSOR:VBARS SNAP

CURSOR:VBARS?

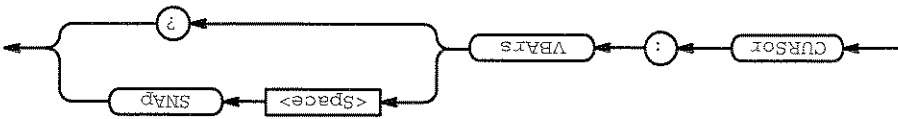

Arguments: SNAP positions the vertical bar cursors at DATA:START and DATA:STOP

Examples: CURSOR:VBARS SNAP
 specifies that the cursors' positions are the same as the current
 DATA:START and DATA:STOP values.

CURSOR:VBARS?

might return: CURSOR:VBARS:UNITS SECONDS, POSITION1
 1.00E-6; POSITION2 9.00E-6; SELECT CURSOR2.

CURSOR:VBARS:DELTA? (Query Only)

Returns the time or frequency between the two vertical bar cursors. The units, seconds or Hertz, are specified by the CURSOR:VBARS:UNITS command. The difference is also indicated in a readout at the top right of the screen after executing the **VBARS** side menu item of the Cursor menu. The difference reported is related to the position of the cursors in display pixels, not to the seconds per division settings. If you turn the vertical cursor function off, the results of a query will be the last difference in effect, even if you have since changed the seconds per division.

Group: Cursor

Related Commands: CURSOR:VBARS:UNITS

Syntax: CURSOR:VBARS:DELTA?

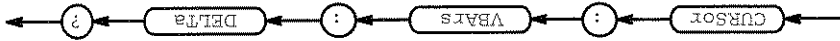

Returns: <NR3>

Examples: CURSOR:VBARS:DELTA?
 might return 1.064E+00, indicating that the time between the vertical bar cursors is 1.064 seconds.

CURSOR:VBARS:POSITION <x>

Positions a vertical bar cursor. The units are specified by the CUR-
SOR:VBARS:UNITS command. The position is also indicated in a readout at the
top right of the screen after executing the **VBARS** side menu item of the
Cursor menu.
The position reported is related to the position of the cursors in display
pixels, not to the seconds per division settings. If you turn the vertical cursor
function off, the results of a query will be the last position in effect, even if
you have since changed the seconds per division.

Group: Cursor

Related Commands: CURSOR:VBARS:UNITS

Syntax: CURSOR:VBARS:POSITION<x> <NR3>

CURSOR:VBARS:POSITION<x>?



Arguments:

<NR3> specifies the cursor position in the units specified by the CUR-
SOR:VBARS:UNITS command. The position is relative to the trigger position.

Examples:

CURSOR:VBARS:POSITION2 9.00E-6
positions one of the vertical bar cursors at 9 μseconds.

CURSOR:VBARS:POSITION1 ?
might return 1.00E-6, indicating that one of the vertical bar cursors is
at 1 μsecond.

CURSOR:VBARS:SELECT

Selects which vertical bar cursor is active. The active cursor will be displayed as a solid vertical line and can be moved using the general purpose knob when the cursor menu is active. The unselected cursor will be displayed as a dashed vertical line. This command is equivalent to pressing the **TOGGLE** button on the front panel when the Cursor menu is displayed.

Group: Cursor

Syntax: CURSOR:VBARS:SELECT { CURSOR1 | CURSOR2 }

CURSOR:VBARS:SELECT?

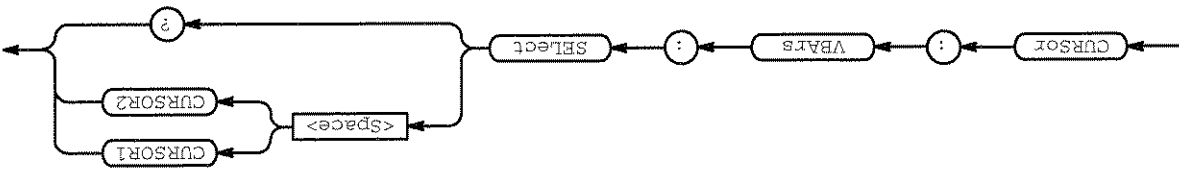

Arguments: CURSOR1 specifies the first vertical bar cursor.

CURSOR2 specifies the second vertical bar cursor.

Examples:

CURSOR:VBARS:SELECT CURSOR2

selects the second vertical bar cursor as the active cursor.

CURSOR:VBARS:SELECT?

returns CURSOR1 when the first vertical bar cursor is the active cursor.

CURSOR:VBARS:UNITS

Sets or queries the units for the vertical bar cursors. This is equivalent to setting **Time Units** in the Cursor menu.

Group: Cursor

Related Commands: CURSOR:VBARS:DELTA?, CURSOR:VBARS:POSITION<x>

Syntax: CURSOR:VBARS:UNITS { SECONDS | HERTZ }

CURSOR:VBARS:UNITS?

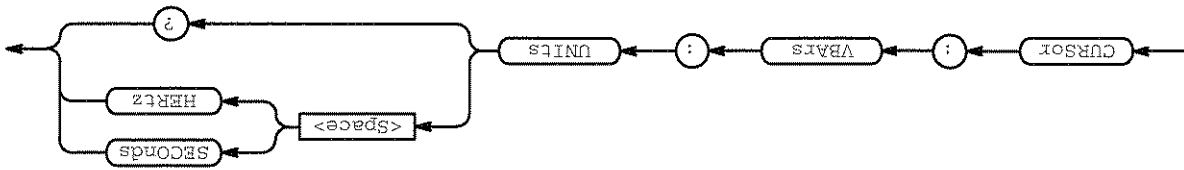

Examples: CURSOR:VBARS:UNITS SECONDS
sets the units for the vertical bar cursors to seconds.

CURSOR:VBARS:UNITS?
returns HERTZ when the vertical bar cursor units are Hertz.

Transfers waveform data to and from the digitizing oscilloscope in binary or ASCII format. Each waveform that is transferred has an associated waveform preamble that contains information such as data format and scale. Refer to the WFMPre command starting on page 2-21 for information about the waveform preamble. The data format is specified by the DATA:ENCDg and DATA:WIDTH commands.

The CURVe? query transfers data from the instrument. The data source is specified by the DATA:Source command. If more than one source is specified, a comma separated list of data blocks is returned. The first and last data points that are transferred are specified by the DATA:START and DATA:STOP commands.

The CURVe command transfers waveform data to the instrument. The data is stored in the reference memory location specified by DATA:DESTINATION starting with the data point specified by DATA:START. Only one waveform can be transferred at a time. The waveform will only be displayed if the reference is displayed.

A description of the waveform transfer process starts on page 2-26.

Group: Waveform

Related Commands: DATA, WFMPre

Syntax: CURVE { <Block> | <asc curve> }

CURVe?

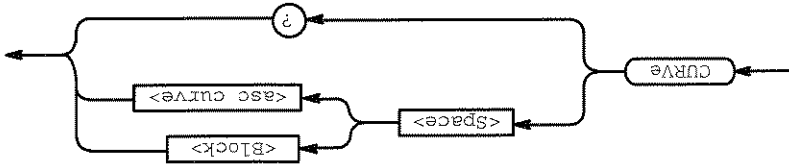

Arguments:

<Block> is the waveform data in binary format. The waveform is formatted as: #<x><yyy><data><newline> where <x> is the number of bytes. For example, if <yyy> = 500, then <x> = 3. <yyy> is the number of bytes to transfer including checksum. If width is 1 then all bytes on the bus are single data points. If width is 2 then all bytes on the bus are 2-byte pairs. Use the DATA:WIDTH command to set the width. <data> is the curve data. <newline> is a single byte newline character at the end of the data. See the GETWFM.C or GETWFM.BAS examples in the accompanying disk for more specifics.

<asc curve> is the waveform data in ASCII format. The format for ASCII data is <NR1> [, <NR1> . . .] where each <NR1> represents a data point.

DATA

Sets or queries the format and location of the waveform data that is transferred with the CURVE command. Since DATA:DESTINATION and DATA:TAR- get are equivalent, only DATA:DESTINATION is returned by the DATA? query.

Group: Waveform

Related Commands: CURVE, WAVEFORM

Syntax: DATA { INIT | SNAP }

DATA?

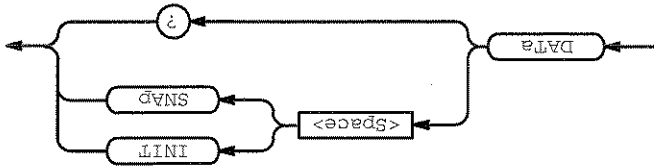

Arguments:

INIT initializes the waveform data parameters to their factory defaults. SNAP sets DATA:START and DATA:STOP to match the current vertical bar cursor positions.

Examples:

DATA SNAP

assigns the current position of the vertical bar cursors to DATA:START and DATA:STOP

DATA?

might return the string :DATA:ENCDG RPBINARY,DESTINATION REF4; SOURCE REF4;START 1;STOP 500;WIDTH 2

Examples:

CURVE?

might return :CURVE 0,0,0,-1,1,0,-1,0,0,-1,0,0,-1,0,-1,0,-1,1,0,0,0,-1,0,0,-1,0,0,1,1,0,-1,0,0,-1,0,0,-1,0,0

DATA:DESTINATION

Sets or queries the reference memory location for storing waveform data that is transferred into the digitizing oscilloscope by the CURVE command. This command is identical to the DATA:TARGET command.

Group: Waveform

Syntax: DATA:DESTINATION REF<x>

DATA:DESTINATION?

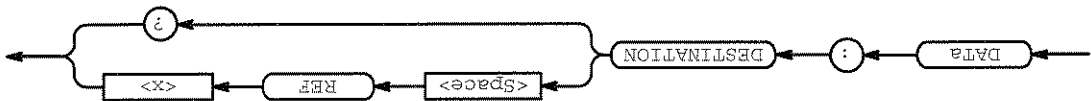

Arguments: <x> is the reference memory location where the waveform will be stored.

Examples: DATA:DESTINATION REF3 stores incoming waveform data in reference memory 3.

DATA:DESTINATION? might return REF2 as the reference memory location that is currently selected.

DATA:ENCdG

Sets or queries the format of the waveform data. This command is equivalent to setting WFMPre:ENCdG, WFMPre:BN_Fmt, and WFMPre:BYT_Or as shown in Table 2-24. Setting the DATA:ENCdG value causes the corresponding WFMPre values to be updated and vice versa.

Group: Waveform

Related Commands: WFMPre:ENCdG, WFMPre:BN_FMT, WFMPre:BYT_Or

Syntax: DATA:ENCdG { ASCII | ASCII | RIBinary | RPBinary | SRBinary | SRPBinary } DATA:ENCdG?

DATA:ENCdG?

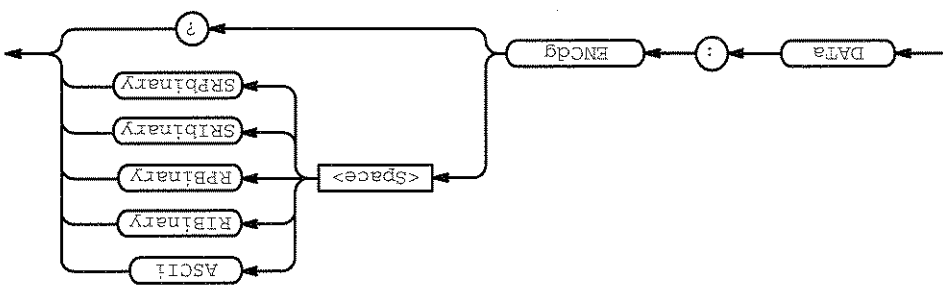

Arguments:

ASCII specifies the ASCII representation of signed integer (RIBinary) data. If this is the value at power-on, the WFMPre values for BN_Fmt, BYT_Or, and ENCDG are set as RI, MSB, and ASC respectively.

RIBinary specifies signed integer data-point representation with the most significant byte transferred first. This format results in the fastest data transfer rate when DATA:WIDTH is set to 2.

The range is -128 to 127 when DATA:WIDTH is 1. Zero is center screen. The range is -32768 to 32767 when DATA:WIDTH is 2. The upper limit is one division above the top of the screen and the lower limit is one division below the bottom of the screen.

RPBinary specifies positive integer data-point representation with the most significant byte transferred first.

The range is 0 to 255 when DATA:WIDTH is 1. Center screen is 127. The range is 0 to 65,535 when DATA:WIDTH is 2. The upper limit is one division above the top of the screen and the lower limit is one division below the bottom of the screen.

SRBinary is the same as RIBinary except that the byte order is swapped, meaning that the least significant byte is transferred first. This format is useful when transferring data to IBM compatible PCs.

Data:ENCdG Setting		WFMPre Settings	
	:ENCdG	:BN_Fmt	:BYT_Or
ASCII	ASC	N/A	N/A
RIBinary	BIN	RI	MSB
RPBinary	BIN	RP	MSB
SRIBinary	BIN	RI	LSB
SRBinary	BIN	RP	LSB

Table 2-24: Data and WFMPre Parameter Settings

SRBinary is the same as RPBinary except that the byte order is swapped, meaning that the least significant byte is transferred first. This format is useful when transferring data to IBM compatible PCs.

Examples:

DATA:ENCdG RPBINARY sets the data encoding format to be positive integer where the most significant byte is transferred first.
 DATA:ENCdG? might return SRPBINARY for the format of the waveform data.

DATA:SOURCE

Sets or queries the location of the waveform data that is transferred from the instrument by the CURVE? query. The source data is always transferred in a predefined order regardless of the order they are specified using this command. The predefined order is CH1 through CH2, MATH1 through MATH3, then REF1 through REF4.

Group: Waveform

Syntax: DATA:SOURCE <wfM> [<Comma><wfM>] . . .

DATA:SOURCE?

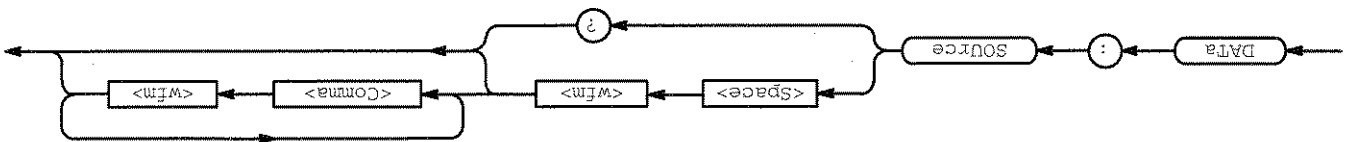

Arguments:

<wfM> is the location of the waveform data that will be transferred from the digitizing oscilloscope to the controller.

Examples:

DATA:SOURCE REF2, CH2, MATH1, CH1 specifies that four waveforms will be transferred in the next CURVE? query. The order that the data will be transferred is CH1, CH2, MATH1, then REF2.

DATA:SOURCE?

might return REF3, indicating the source for the waveform data that is transferred using a CURVE? query.

DATA:START

Sets or queries the starting data point for waveform transfer. This command allows for the transfer of partial waveforms to and from the digitizing oscilloscope.

Group: Waveform

Related Commands: CURVE?, DATA SNAP, DATA:STOP

Syntax: DATA:START <NR1>

DATA:START?

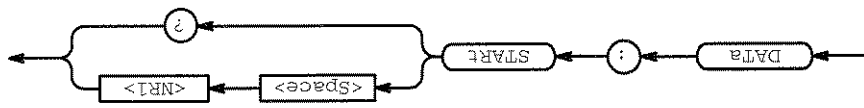

Arguments:

<NR1> ranges from 1 to the record length, and is the first data point that will be transferred. Data will be transferred from <NR1> to DATA:STOP or the record length, whichever is less. If <NR1> is greater than the record length then no data will be transferred. When DATA:STOP is less than DATA:START, the values will be swapped internally for the CURVE? query.

Examples:

DATA:START 10

specifies that the waveform transfer will begin with data point 10.

DATA:START?

might return 214 as the first waveform data point that will be transferred.

DATA:STOP

Sets or queries the last data point that will be transferred when using the CURVE? query. This allows the transfer of partial waveforms to the controller. When using the CURVE command, the digitizing oscilloscope will stop reading data when there is no more data to read or when the specified record length has been reached. This command is therefore ignored under those circumstances.

Group: Waveform

Related Commands: CURVE?, DATA SNAP

Syntax: DATA:STOP <NR1>

DATA:STOP?

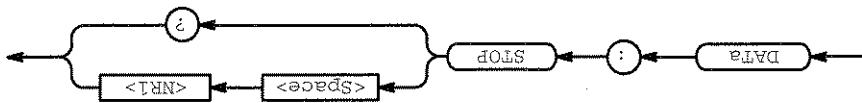

Arguments:

<NR1> ranges from 1 to the record length, and is the last data point that will be transferred. If <NR1> is greater than the record length then data will be transferred up to the record length. If both DATA:START and DATA:STOP are greater than the record length, an execution error occurs. When DATA:STOP is less than DATA:START, the values will be swapped internally for the CURVE? query.

If you always want to transfer complete waveforms, just set DATA:START to 1 and DATA:STOP to the maximum record length.

Examples:

DATA:STOP 15000

specifies that the waveform transfer will stop at data point 15000.

DATA:STOP?

might return 14900 as the last data point that will be transferred.

DATA:TARGet

Sets or queries the location for storing waveform data transferred to the instrument using the CURVe command. This command is equivalent to the DATA:DESTINATION command and is included here for compatibility with older Tektronix instruments.

Group: Waveform

Related Commands: CURVe

Syntax: DATA:TARGet REF<X>

DATA:TARGet?



DATA:WIDTH

Sets the number of bytes per data point in the waveform transferred using the CURVE command.

Group: Waveform

Related Commands: CURVE, WFMPre:BIT_Nr, WFMPre:BYT_Nr

Syntax: DATA:WIDTH <NR1>

DATA:width?

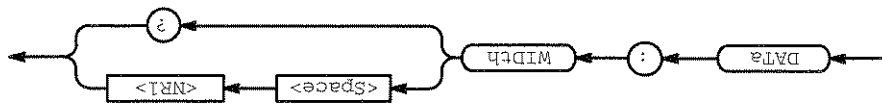

Arguments:

<NR1> = 1 specifies that there is 1 byte (8 bits) per point. The low order byte is not transmitted. Any data over 8 bits is truncated.

<NR1> = 2 specifies that there are 2 bytes (16 bits) per point. This format reports the maximum amount of precision. This is the default.

If DATA:WIDTH is set to 2, the block will be twice as long as if it were 1. The length or number of bytes in the block can be calculated by ((DATA:STOP - DATA:START) + 1) * DATA:WIDTH. If DATA:START and/or DATA:STOP extend beyond the limits of the waveform the number of bytes will be less.

Examples:

DATA:width 1

sets the data width to 1 byte per data point for CURVE data.

DATE

Sets or queries the date that the digitizing oscilloscope can display.

Group: Miscellaneous

Related Commands: DISPLAY: CLOCK, TIME

Syntax: DATE <QString>

DATE?



Arguments:

<QString> is a date in the form "YYYY-mm-dd".
 mm refers to a two-digit month number from 01 to 12.
 dd refers to a two-digit day number in the month.
 YYYY refers to a four-digit year number.
 There must a dash (-) after the YYYY and after the mm.
 Examples: DATE "1993-01-24"
 specifies that the date is set to January 24, 1993.

*DDT

Command Descriptions

Allows the user to specify a command or a list of commands that are executed when the instrument receives a *TRG command or the GET GPIB interface message. This is just a special alias that *TRG uses.

Group: Miscellaneous

Related Commands: ALIAS:DEFINE, *TRG, Get GPIB interface message

Syntax: *DDT { <Block> | <QString> }

*DDT?

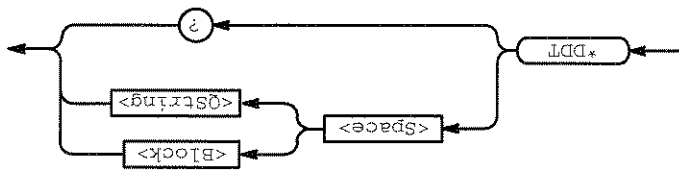

Arguments:

<Block> or <QString> is a complete sequence of program messages. The messages can contain only valid commands that must be separated by semicolons and must follow all rules for concatenating commands (see page 2-4). The sequence must be ≤ 80 characters. <Block> format is always returned as a query response.

Examples:

```
*DDT #0ACQUIRE:STATE RUN,BELL<EOI>
```

specifies that the acquisition system will be started and the bell rings each time a *TRG command is sent.

DELETE:SETUP (No Query Form)

Removes stored setups from memory and initializes the location with the factory default setup.

NOTE

The setup information cannot be recovered once it has been deleted.

Group: Save and Recall

Related Commands: *RCL, RECALL:SETUP, *RST, *SAV, SAVE:SETUP

Syntax: DELETE:SETUP { <NR1> | ALL }

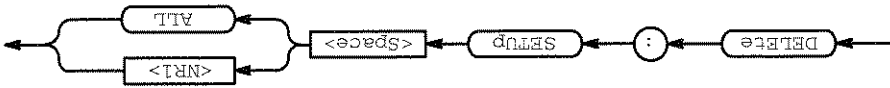

Arguments:

<NR1> is a value in the range 1 to 10, and specifies a setup storage location. Using an out-of-range value causes an execution error. ALL specifies all the stored setups.

Examples:

DELETE:SETUP ALL
removes all stored setups. All ten storage locations are initialized to the factory default setup.

DELETE:WAVEFORM (No Query Form)

Command Descriptions

Deletes one or all the stored reference waveforms from memory. The memory allocated for the reference location is then available for reallocation. Memory must be reallocated for the deleted references before any waveform data can be stored in the reference location. This command is equivalent to pressing the **Delete Refs** menu item in the Save/Recall Waveform menu.

NOTE

The waveform data is not actually cleared from the reference location.

Group: Save and Recall

Related Commands: RECALL:WAVEFORM, SAVE:WAVEFORM

Syntax: DELETE:WAVEFORM { REF<x> | ALL }

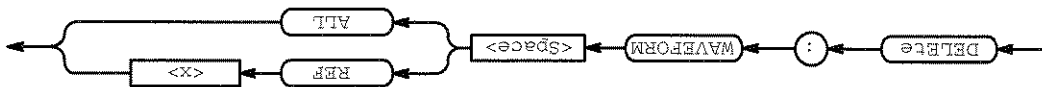

Arguments: <x> = 1 to 4, and specifies one of the reference memory locations. ALL specifies all the stored waveforms.

Examples: DELETE:WAVEFORM ALL
removes all the waveforms stored in reference memory.

DELETE:WAVEFORM REF2
removes the waveform stored at REF2.

Sets and queries the bits in the Device Event Status Enable Register (DESER). The DESER is the mask that determines whether events are reported to the Standard Event Status Register (SESR), and entered into the Event Queue. For a complete discussion of the use of these registers, see page 3-1.

Group: Status and Error

Related Commands: *CLS, *ESE, *ESR?, EVENT?, EVMsg?, *SRE, *STR?

Syntax: DESE <NR1>

DESE?



Arguments:

<NR1> is a value in the range from 0 to 255. The binary bits of the DESER are set according to this value. For example, DESE 209 sets the DESER to the binary value 11010001 (that is, the most significant bit in the register is set to 1, the next most significant bit to 1, the next bit to 0, etc.).

The power-on default for DESER is all bits set if *PSC is 1. If *PSC is 0, the DESER maintains its value through a power cycle.

NOTE

Setting the DESER and the ESER to the same value allows only those codes to be entered into the Event Queue and summarized on the ESB bit (bit 5) of the Status Byte Register. Use the *ESE command to set the ESER. A complete discussion of event handling is on page 3-1.

Examples:

DESE 209

sets the DESER to binary 11010001, which enables the PON, URQ, EXE, and OPC bits.

DESE?

might return the string :DESE 186, showing that the DESER contains the binary value 10111010.

DIAG:RESULT:FLAG? (Query Only)

Returns the pass/fail status from the last diagnostic test. The DIAG:RE-
SULT:LOG? query can be used to determine which test(s) has failed.

Group: Calibration and Diagnostic

Related Commands: DIAG:RESULT:LOG?

Syntax: DIAG:RESULT:FLAG?

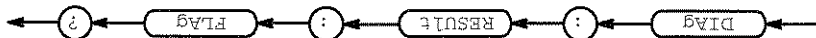

Returns: PASS indicating that all the selected diagnostic tests have passed.

FAIL indicating that at least one of the selected diagnostic tests have failed.

Examples: DIAG:RESULT:FLAG?
returns either PASS or FAIL.

DIAG:RESULT:LOG? (Query Only)

Returns the internal results log from the last diagnostic test. The list contains all modules and module interfaces that were tested along with the pass/fail status of each.

Group: Calibration and Diagnostic

Related Commands: DIAG:RESULT:FLAG?

Syntax: DIAG:RESULT:LOG?

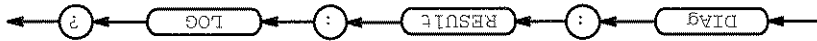

Returns: <QString> in the following format:

<Status>,<Module name>[,<Status>,<Module name>...]

Examples:

```
DIAG:RESULT:LOG? might return
:DIAG:RESULT:LOG "pass -- Processor
FAIL ++ Cal Initialization (see error log)
pass -- RP/Proc Interface
pass -- Acq/Proc Interface
pass -- Acquisition
pass -- Front Panel"
```

DIAG:SELECT:ACQUISITION (No Query Form)

Selects the acquisition system test sequence that will be run when the DIAG:STATE EXECUTE command is sent. This command is equivalent to setting **Acquisition** in the Utility menu when **System** is set to Diag/Err.

Group: Calibration and Diagnostic

Syntax: DIAG:SELECT:ACQUISITION ALL



Arguments: ALL selects functional, memory and register tests.

DIAG:SELECT:ALL (No Query Form)

Specifies that all system test sequences will be run when the DIAG:STATE EXECUTE command is sent. This command is equivalent to setting **All** in the Utility menu when **System** is set to Diag/Err.

Group: Calibration and Diagnostic

Syntax: DIAG:SELECT:ALL ALL



Arguments: ALL selects functional, memory, and register tests for the acquisition, processor and display systems, and self diagnostics for the front panel.

DIAG:SELECT:CPU (No Query Form)

Selects the processor system test sequence that will be run when the DIAG:STATE EXECUTE command is sent. This command is equivalent to setting **Processor** in the Utility menu when **System** is set to Diag/Err.

Group: Calibration and Diagnostic

Syntax: DIAG:SELECT:CPU ALL



Arguments: ALL selects functional, memory and register tests.

DIAG:SELECT:DISPLAY (No Query Form)

Selects the display system test sequence that will be run when the DIAG:STATE EXECUTE command is sent. This command is equivalent to setting **Display** in the Utility menu when **System** is set to Diag/Err.

Group: Calibration and Diagnostic

Syntax: DIAG:SELECT:DISPLAY ALL

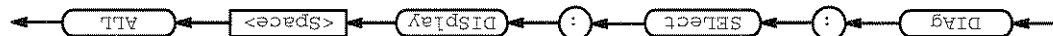

Arguments: ALL selects functional, memory and register tests.

DIAG:STATE (No Query Form)

Arguments: ALL selects self diagnostic tests.

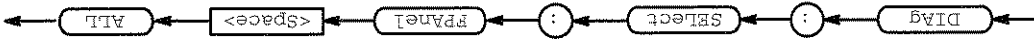

Syntax: DIAG:SELECT:FPanel ALL

Group: Calibration and Diagnostic

Selects the front-panel test sequence that will be run when the DIAG:STATE EXECUTE command is sent. This command is equivalent to setting **Front Panel** in the Utility menu when **System** is set to Diag/Err.

DIAG:SELECT:FPanel (No Query Form)

Executes the diagnostic tests that have been specified with the DIAG:SELECT commands.

When the test sequence has completed any of the modules or module interfaces that failed diagnostics are displayed on the screen and stored in an internal log file. The pass/fail status will be returned by the DIAG:RE-SUIT:FLAG? query and the internal log will be returned by the DIAG:RE-SUIT:LOG? query. This command is equivalent to running Extended Diagnostics by selecting **Execute** in the Utility menu when **System** is set to Diag/Err.

NOTE

The DIAG:STATE EXECUTE command can take 30 seconds or more to respond. This command performs a warm boot and does not return control to the instrument controller until diagnostics are complete.

Group: Calibration and Diagnostic

Syntax: DIAG:STATE EXECUTE

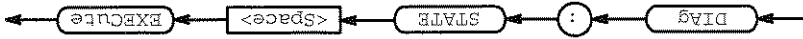

Arguments: EXECUTE runs the diagnostic test sequences specified by the DIAG:SELECT commands. When complete, the digitizing oscilloscope will return to the state it was in just before the test. If the PON event was enabled before

Display? (Query Only)

Returns the current display settings.

Group: Display

Syntax: Display?

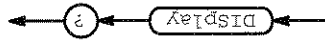

Examples: Display?

might return: DISPLAY:FORMAT YF;STYLE VECTORS;FILTER
 SINX;PERSISTENCE 500.0E-3;GRATICULE FULL;TRIGT 1;IN-
 TENSITY:OVERALL 85;WAVEFORM 70;TEXT 60;CONTRAST 150

Examples:

Diag:STATE EXECUTE

executes all the diagnostic tests that have been selected.

- *PSC 0
- *SRE 32
- *ESE 128
- DESE 128

To enable a power-on event to generate a Service Request, send the following commands before running diagnostics:

- the Event Queue
- the Input Queue
- the Status Registers (SESR and SBR)

The DIAG:STATE EXECUTE command clears the following:

running the tests, a Service Request will be generated. When the Service Request has been received, the pass/fail status of the tests can be returned by executing the DIAG:RESULT:FLAG? query.

Display:CLOCK

Controls the display of the date and time. This is equivalent to setting the **Display Date/Time** in the Readout Options side menu. The query form returns an ON (1) or an OFF (0).

Group: Display

Syntax: Display:CLOCK { OFF | ON | <NR1> }

Display:CLOCK?

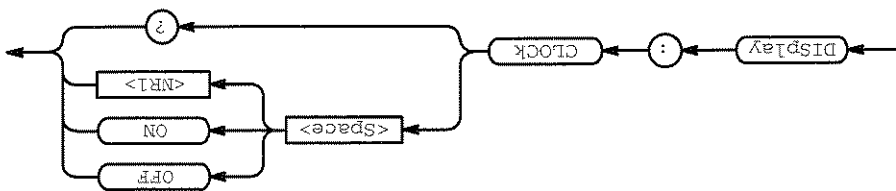

Arguments: OFF or <NR1> = 0 removes the clock from the display.

ON or <NR1> ≠ 0 displays the clock on the display.

Examples:

Display:CLOCK ON

sets the display to show time and date.

Display:CLOCK?

might return 1 indicating that the display shows time and date.

DISPLAY:FILTER

Sets or queries the type of interpolation to use for the display when the DISPLAY:STYLE is VECTORS. This command is equivalent to setting **Filter** in the Display menu.

Group: Display

Related Commands: DISPLAY:STYLE

Syntax: DISPLAY:FILTER { LINEAR | SINX }
 DISPLAY:FILTER?

DISPLAY:FILTER?

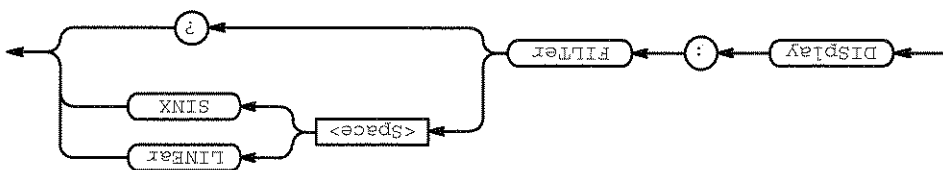

Arguments:

LINEAR specifies linear interpolation where acquired points are connected with straight lines.

SINX specifies $\sin(x)/x$ interpolation where acquired points are fit to a curve.

Examples:

DISPLAY:FILTER LINEAR

sets the interpolation filter type to linear.

DISPLAY:FILTER?

returns either LINEAR or SINX, indicating the type of interpolation filter.

Display:FORMAT

Sets or queries the display format. This command is equivalent to setting **Format** in the Display menu.

Group: Display

Syntax: Display:FORMAT { XY | YT }

Display:FORMAT?

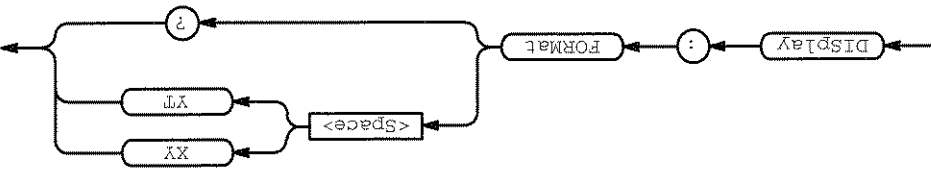

Arguments:

XY displays the voltage of one waveform against the voltage of another. The sources that make up an XY waveform are predefined and are listed in Table 2-25. Displaying one source causes its corresponding source to be displayed.

Table 2-25: XY Format Pairs

X-Axis Source	Y-Axis Source
Ch 1	Ch 2
Ref 1	Ref 2
Ref 3	Ref 4

YT sets the display to a voltage versus time format and is the normal mode.

Examples:

DISPLAY:FORMAT YT

selects a voltage versus time format for the display.

DISPLAY:FORMAT?

might return XY for the display format.

Display:GRATICULE

Selects the type of graticule that will be displayed. This command is equivalent to setting **Graticule** in the Display menu.

Group: Display

Syntax: Display:GRATICULE { CROSSHAIR | FRAME | FULL | GRID }

Display:GRATICULE?

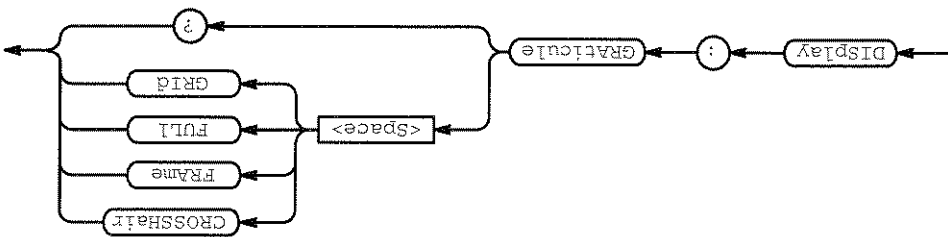

Arguments: CROSSHAIR specifies a frame and cross hairs.

FRAME specifies just a frame.

FULL specifies a frame, a grid, and cross hairs.

GRID specifies a frame and a grid.

Examples: Display:GRATICULE GRID
 sets the graticule type to display a frame and a grid.

Display:GRATICULE?

returns FULL when all graticule elements (grid, frame, and cross hairs) are selected.

Display:INTENSITY? (Query Only)

Returns the current intensity settings for different parts of the display.

Group: Display

Syntax: Display:INTENSITY?

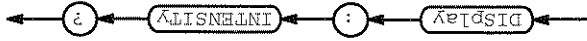

Examples: Display:INTENSITY?

might return : DISPLAY:INTENSITY:OVERALL 85;WAVEFORM
 70;TEXT 60;CONTRAST 150

Display:INTENSITY:CONTRAST

Sets the intensity of the intensified zone on a waveform. This command is equivalent to setting **Contrast** in the Display Intensity side menu.

Group: Display

Related Commands: Horizontal:MODE

Syntax: Display:INTENSITY:CONTRAST <NR1>
Display:INTENSITY:CONTRAST?

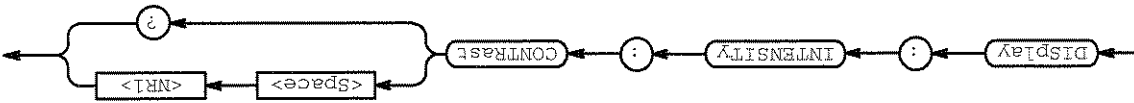

Arguments: <NR1> ranges from 100 to 250 percent.

Examples: DISPLAY:INTENSITY:CONTRAST 140
sets the intensity of the intensified portion of a waveform.

Display:INTENSITY:OVERALL

Sets the intensity of the entire display. This command is equivalent to setting **Overall** in the Display Intensity side menu.

Group: Display

Syntax: Display:INTENSITY:OVERALL <NR1>
Display:INTENSITY:OVERALL?

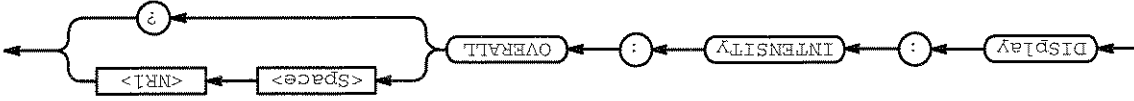

Arguments: <NR1> ranges from 20 to 100 percent.

Examples: Display:INTENSITY:OVERALL 50
sets the intensity of the display to the middle of the range.
Display:INTENSITY:OVERALL?
might return 75 as the overall display intensity.

Display:INTENSITY:TEXT

Sets the intensity of the text, any lines drawn using the GRAPHICS commands, and the graticule. This command is equivalent to setting **Text/Grat** in the Display Intensity side menu.

Group: Display

Syntax: Display:INTENSITY:TEXT <NR1>

Display:INTENSITY:TEXT?

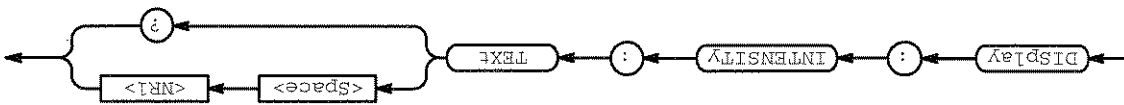

Arguments: <NR1> ranges from 20 to 100 percent.

Examples: Display:INTENSITY:TEXT 100
sets the intensity of the text to the brightest level.

Display:INTENSITY:WAVEFORM

Sets the intensity of the waveforms. This command is equivalent to setting **Waveform** in the Display Intensity side menu.

Group: Display

Syntax: Display:INTENSITY:WAVEFORM <NR1>

Display:INTENSITY:WAVEFORM?

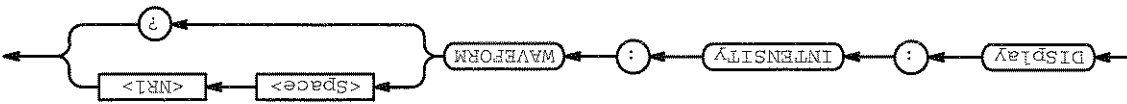

Arguments: <NR1> ranges from 20 to 100 percent.

Examples: Display:INTENSITY:WAVEFORM?
might return 60 as the intensity of the waveform.

Display:PERSISTENCE

Sets the length of time that data points are displayed when DISPLAY:STYLE is set to VARPERSIST. This affects the display only and is equivalent to setting Variable Persistence in the Display Style side menu.

Group: Display

Related Commands: DISPLAY:STYLE

Syntax: DISPLAY:PERSISTENCE <NR3>

DISPLAY:PERSISTENCE?

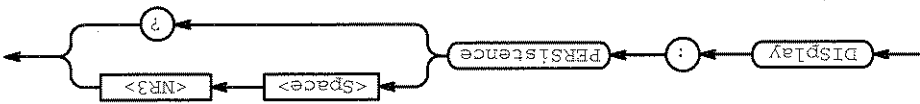

Arguments: <NR3> specifies the length, in seconds, that the waveform points are displayed on the screen. The range is 250 ms to 10 s.

Examples: DISPLAY:PERSISTENCE 3
specifies that the waveform points are displayed on the screen for 3 seconds before they fade.

Display:STYLE

Selects how the data is displayed. This command is equivalent to selecting **Style** in the Display menu.

Group: Display

Related Commands: Display:PERSISTENCE

Syntax: Display:STYLE { DOTS | INFPERLIST | INTENSIFIED | VARPERLIST | VECTORS }

Display:STYLE?

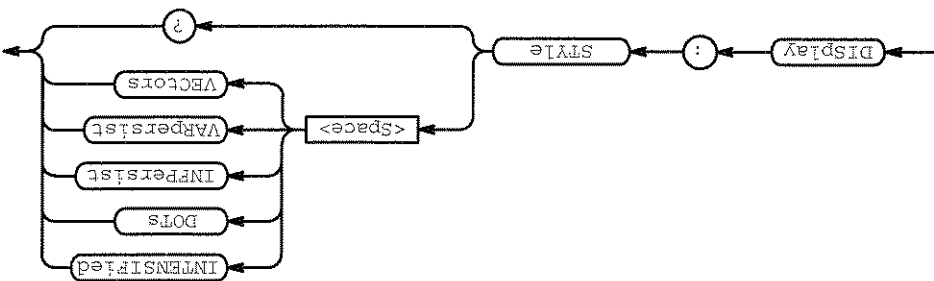

Arguments:

DOTS displays individual data points.
INFPERLIST accumulates data points on the display indefinitely. The display is reset when the style or acquisition is reset.
INTENSIFIED displays non-interpolated data points brighter than other data points.
VARPERLIST leaves acquired data points on the display for a period of time specified by **Display:PERSISTENCE**.
VECTORS connects adjacent data points. Old points are immediately replaced by new ones.

Examples:

Display:STYLE INFPERLIST
sets the display to indefinitely accumulate data points on the screen.

Display:STYLE?
might return **DOTS** indicating that the display shows individual waveform data points.

Display:TRIGBar

Controls the display of the trigger bar indicator/s. The bar indicates where the trigger will occur, in voltage.
 The digitizing oscilloscope will only display the bar if the trigger source is also displayed. The bar will not appear if the instrument is using an external trigger.

Group: Display

Syntax: Display:TRIGBar { OFF | SHORT | LONG }
 Display:TRIGBar?

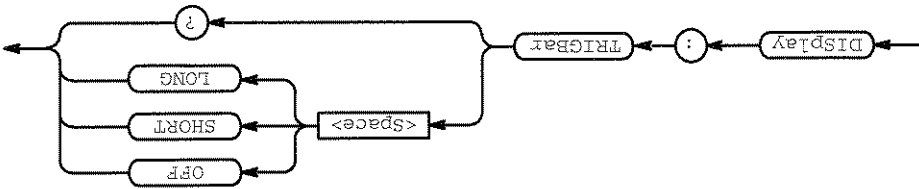

Arguments:

OFF removes the trigger bar indicator from the display.
 SHORT displays a short arrow at the right side of the graticule
 LONG displays a horizontal line in the center of the graticule

Examples:

DISPLAY:TRIGBAR LONG
 sets the display to show long trigger bar indicator (or indicators).

Display:TRIGT

This command has no effect and is included for compatibility.

Syntax: Display:TRIGT { OFF | ON | <NR1> }
 Display:TRIGT?

*ESE

Sets and queries the bits in the Event Status Enable Register (ESER). The ESER prevents events from being reported to the Status Byte Register (STB). For a complete discussion of the use of these registers, see page 3-1.

Group: Status and Error

Related Commands: *CLS, DESE, *ESR?, EVENT?, EVMsg?, *SRE, *STB?

Syntax: *ESE <NR1>

*ESE?



Arguments: <NR1> is a value in the range from 0 through 255. The binary bits of the ESER are set according to this value.

The power-on default for ESER is 0 if *PSC is 1. If *PSC is 0, the ESER maintains its value through a power cycle.

NOTE

Setting the DESE and the ESER to the same value allows only those codes to be entered into the Event Queue and summarized on the ESB bit (bit 5) of the Status Byte Register. Use the DESE command to set the DESE. A complete discussion of event handling is on page 3-1.

Examples:

*ESE 209 sets the ESER to binary 11010001, which enables the PON, URQ, EXE, and OPC bits.

*ESE?

might return the string *ESE 186, showing that the ESER contains the binary value 10111010.

EVENT? (Query Only)

Returns from the Event Queue an event code that provides information about the results of the last *ESR? read. EVENT? also removes the returned value from the Event Queue. A complete discussion of event-handling is on page 3-1.

Group: Status and Error

Related Commands: ALLEV?, *CLS, DESE, *ESE, *ESR?, EVMSG?, *SRE, *STB?

Syntax: EVENT?

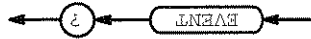

Examples: EVENT?

might return the response : EVENT 110, showing that there was an error in a command header.

*ESR? (Query Only)

Returns the contents of the Standard Event Status Register (SESR). *ESR? also clears the SESR (since reading the SESR clears it). For a complete discussion of the use of these registers, see page 3-1.

Group: Status and Error

Related Commands: ALLEV?, *CLS, DESE, *ESE, EVENT?, EVMSG?, *SRE, *STB?

Syntax: *ESR?

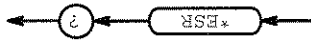

Examples: *ESR?

might return the value 213, showing that the SESR contains binary 11010101.

EVMsg? (Query Only)

Removes from the Event Queue a single event code associated with the results of the last *ESR? read, and returns the event code along with an explanatory message. A complete discussion of event handling is on page 3-1.

Group: Status and Error

Related Commands: ALLEV?, *CLS, DESE, *ESE, *ESR?, EVENT?, *SRE, *STB?

Syntax: EVMsg?

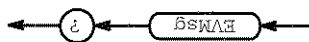

Returns: The event code and message in the following format:

```
<Event Code><Comma><Qstring>[<Event Code><Com-  
ma><Qstring>...]
```

```
<Qstring>:: = <Message>[:[<Command>]
```

where <Command> is the command that caused the error and may be returned when a command error is detected by the digitizing oscilloscope. As much of the command will be returned as possible without exceeding the 60 character limit of the <Message> and <Command> strings combined. The command string is right-justified.

Examples: EVMsg?
might return the message: EVMMSG 110,"Command header
error!..."

EVQTY? (Query Only)

Returns the number of event codes that are in the Event Queue. This is useful when using the ALLEV? query since it lets you know exactly how many events will be returned.

Group: Status and Error

Related Commands: ALLEV?, EVENT?, EVMSG?

Syntax: EVQTY?

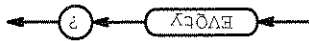

Returns: <NRL>

Examples: EVQTY?
might return 3 as the number of event codes in the Event Queue.

FACTORY (No Query Form)

Resets the digitizing oscilloscope to its factory default settings. This command is equivalent to selecting **Recall Factory Setup** in the Setup Save/Recall menu.

Group: Miscellaneous

Related Commands: *PSC, *RCL, RECALL:SETUP, *RST, *SAV, SAVE:SETUP

Syntax: FACTORY



Setting the digitizing oscilloscope to factory default includes:

- Clears the Event Status Enable Register.
- Clears the Service Request Enable Register.
- Sets the Device Event Status Enable Register to 255.
- Sets the Power On Status Clear Flag to TRUE
- Purges all defined aliases.
- Enables all Command Headers (HEADER ON).
- Set the macro defined by *DDT to a "zero-length field."
- Clear the pending operation flag and associated operations.
- Change various user-settable parameters such as horizontal, vertical, and trigger settings.

The FACTORY command does not alter the following:

- The state of the RS-232-C or GPIB (IEEE 488.1) interfaces.
- The selected GPIB address.
- Calibration data that affects device specifications.
- Protected user data.
- Stored settings.
- The current password (if implemented).
- Hardcopy parameters.

GRAPHICS:DELETE (No Query Form)

Deletes the entire collection of points added with the GRAPHICS:MOVE and GRAPHICS:DRAW commands. This command is equivalent to executing **Delete All Points** in the Graphics pop-up menu of the Utility System I/O side menu.

Group: Graphics

Related Commands: GRAPHICS?:GRAPHICS:DISPLAY, GRAPHICS:MOVE, GRAPHICS:DRAW, GRAPHICS:NUMPOINTS?, GRAPHICS:POINTS

Syntax: GRAPHICS:DELETE ALL



Examples: GRAPHICS:DELETE ALL

deletes the entire collection of move and draw points.

GRAPHICS? (Query Only)

Returns the status of the graphics display and the collection of move and draw points.

Group: Graphics

Related Commands: GRAPHICS:DELETE, GRAPHICS:DISPLAY, GRAPHICS:MOVE, GRAPHICS:DRAW, GRAPHICS:NUMPOINTS?, GRAPHICS:POINTS, MESSAGE:BOX

Syntax: GRAPHICS?



Examples: GRAPHICS?

might return GRAPHICS:DISPLAY 1; POINTS -122,132,200,210, indicating that the graphics display is on, and the instrument is displaying a line between the two points specified.

GRAPHICS:DISPLAY

Turns the graphics display on or off, or queries its status. This command is equivalent to setting **Line Display On or Line Display Off** in the Graphics pop-up menu of the Utility System I/O side menu.

Group: Graphics

Related Commands: GRAPHICS?, GRAPHICS:DELETE, GRAPHICS:MOVE, GRAPHICS:DRAW, GRAPHICS:NUMPOINTS?, GRAPHICS:POINTS

Syntax: GRAPHICS:DISPLAY { OFF | ON | <NR1> }

GRAPHICS:DISPLAY?

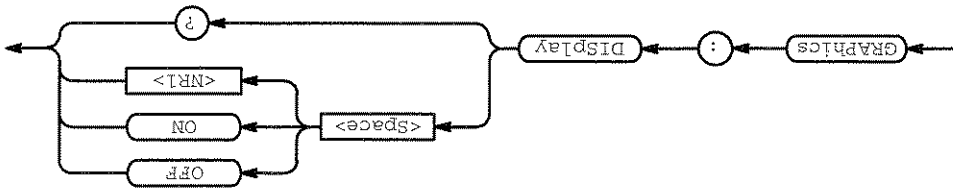

Arguments:

ON or <NR1> ≠ 0 allows the display of lines drawn with the graphics commands. OFF or <NR1> = 0 clears these lines from the screen, although they can be redisplayed at any time. The query returns 0 or 1.

To clear the lines from the instrument's memory, use the GRAPHICS:DELETE command.

Examples:

GRAPHICS:DISPLAY ON
 GRAPHICS:DISPLAY ON
 displays the lines drawn using the GRAPHICS:DRAW command.

might return 0, indicating that the graphics display is off.

GRAPHICS:DRAW (No Query Form)

Draws a line to the specified coordinate from the current position. The specified coordinate then becomes the current position. If this is the first draw or move command, it is treated as a move command and no line is drawn. This command is equivalent to executing **Draw To Crosshair** in the Graphics pop-up menu of the Utility System I/O side menu.

The instrument can hold up to 100 points. If points have been specified when a setting is saved, they are saved with the setting.

Group:

Graphics

Related Commands:

GRAPHICS?:DELETE, GRAPHICS:DISPLAY, GRAPHICS:MOVE, GRAPHICS:NUMPOINTS?, GRAPHICS:POINTS

Syntax:

GRAPHICS:DRAW <NR1>,<NR1>

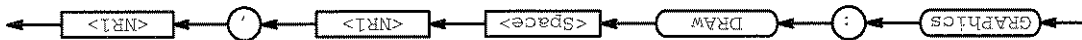

Arguments:

<nr1>,<nr1> are the X and Y coordinates, respectively, of the point to which to draw a line. Points must be contained within the graticule. The range for the X coordinate is 24–524. The range for the Y coordinate is 34–434.

The upper left corner of the graticule is 24,34. The lower right corner of the graticule is 524,434.

Examples:

GRAPHICS:DRAW 200,210
 draws a line from the current position to the point at X coordinate 200 and Y coordinate 210.

GRAPhics:MOVE (No Query Form)

Moves the current position to the specified coordinate without drawing a line. This command is equivalent to executing **Move To Crosshair** in the Graphics pop-up menu of the Utility System I/O side menu.

The instrument can hold up to 100 points. If points have been specified when a setting is saved, they are saved with the setting.

Group:

Graphics

Related Commands:

GRAPhics?, GRAPhics:DELETE, GRAPhics:DISPLAY, GRAPhics:DRAW, GRAPhics:NUMPoints?, GRAPhics:Points

Syntax:

GRAPhics:MOVE <NR1>, <NR1>



Arguments:

<nr1>, <nr1> are the X and Y coordinates, respectively, of the point to which to move. Points must be contained within the graticule. The range for the X coordinate is 24–524. The range for the Y coordinate is 34–434. The upper left corner of the graticule is 24,34. The lower right corner of the graticule is 524,434.

Examples:

GRAPhics:MOVE 132,420
 moves the current position to the point at X coordinate 32 and Y coordinate 420.

Graphics:NUMPoints? (Query Only)

Returns the number of points currently in the collection added with the GRAPHICS:MOVE, GRAPHICS:DRAW, or GRAPHICS:POINTS commands.

Group: Graphics

Related Commands: GRAPHICS?, GRAPHICS:DELETE, GRAPHICS:DISPLAY, GRAPHICS:DRAW, GRAPHICS:MOVE, GRAPHICS:POINTS

Syntax: GRAPHICS:NUMPoints?



Examples: GRAPHICS:NUMPoints?
might return GRAPHICS:NUMPOINTS 21, indicating that 21 points are currently in the collection of move and draw points.

GRAPHICS:POINTS

Deletes all the points in the current collection of move and draw points, and creates a new collection of points based on the specified X and Y coordinates. The query returns the current collection of move and draw points as a set of X,Y coordinate pairs.

If an X coordinate is negative, the point is moved to, not drawn to; a line does not appear between that point and the previous one.

Group: Graphics

Related Commands: GRAPHICS:DELETE, GRAPHICS:DISPLAY, GRAPHICS:DRAW, GRAPHICS:MOVE, GRAPHICS:NUMPOINTS?

Syntax: GRAPHICS:POINTS <NR1>,<NR1>[,<NR1>,<NR1>]*

GRAPHICS:POINTS?

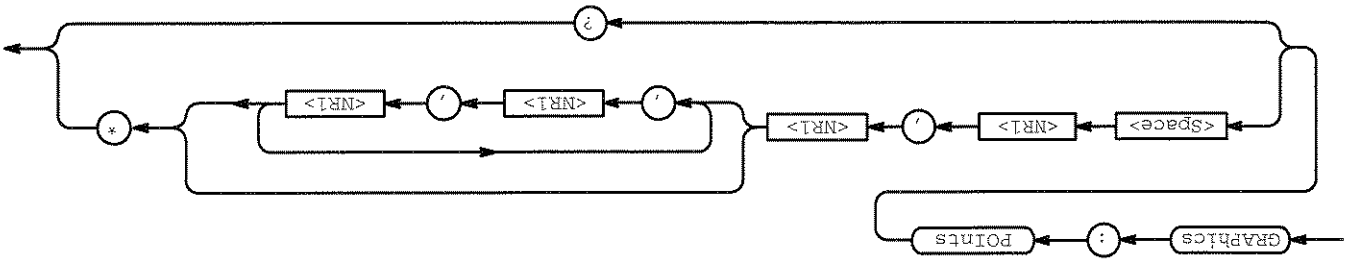

Arguments: <NR1>,<NR1> are the X and Y coordinates, respectively, of the point to add to the collection of move and draw points. Points must be contained within the graticule. The range for the X coordinate is 24–524. The range for the Y coordinate is 34–434. This command can accept up to 100 coordinate pairs.

Examples:

GRAPHICS:POINTS -100,110,42,80,-40,35,200,22
 deletes the points presently in the collection and adds four points. Two lines are drawn; a line is not drawn between the second and the third point, because the X coordinate of the third point is negative.

GRAPHICS:POINTS?
 might return -44, 42, 100, 100, -114, 224, 80, 70, specifying the current collection of move and draw points.

HARDCOPY

Sends a copy of the screen display followed by and EOI to the port specified by HARDCOPY:PORT. The format and layout of the output is specified with the HARDCOPY:FORMAT and HARDCOPY:LAYOUT commands. This command

is equivalent to pressing the front-panel **HARDCOPY** button. Aborting this command is equivalent to pressing the front-panel **HARDCOPY** button twice.

The **HARDCOPY?** query returns format, layout and port information.

NOTE

This command is NOT IEEE Std 488.2-1987 compatible.

Group: Hardcopy

Syntax: `HARDCOPY { ABORT | CLEARSPPOOL | START }`

`HARDCOPY?`

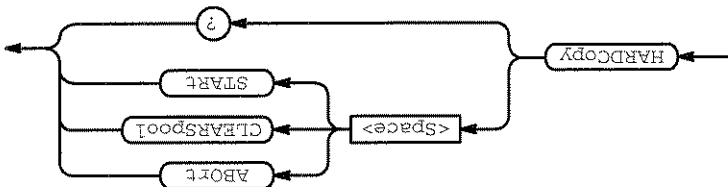

Arguments: `ABORT` terminates the hardcopy output in process.

NOTE

DCL does NOT clear the output queue once a hardcopy is in process. The only way to abort the hardcopy process is to send the `HARDCOPY ABORT` command. The output queue can then be cleared using DCL.

`CLEARSPPOOL` clears the printer output spool.

`START` initiates a screen copy that is sent to the port where it can be stored in a file or sent to a printing device.

NOTE

*Use the `*WAI` command between `HARDCOPY START` commands to ensure that the first hardcopy is complete before starting another.*

Examples:

`HARDCOPY ABORT`

stops any hardcopy output that is in process.

HARDCOPY:FORMAT

Selects the output data format for hard copies. This is equivalent to setting **Format** in the Hardcopy menu.

Group: Hardcopy

Syntax: HARDCOPY:FORMAT { BMP | DESKJET | EPSCOLOR | EPSIMAGE | EPSMONO | EPSON | HPGL | INTERLEAF | LASERJET | PCX | THINKJET | TIFF }
HARDCOPY:FORMAT?

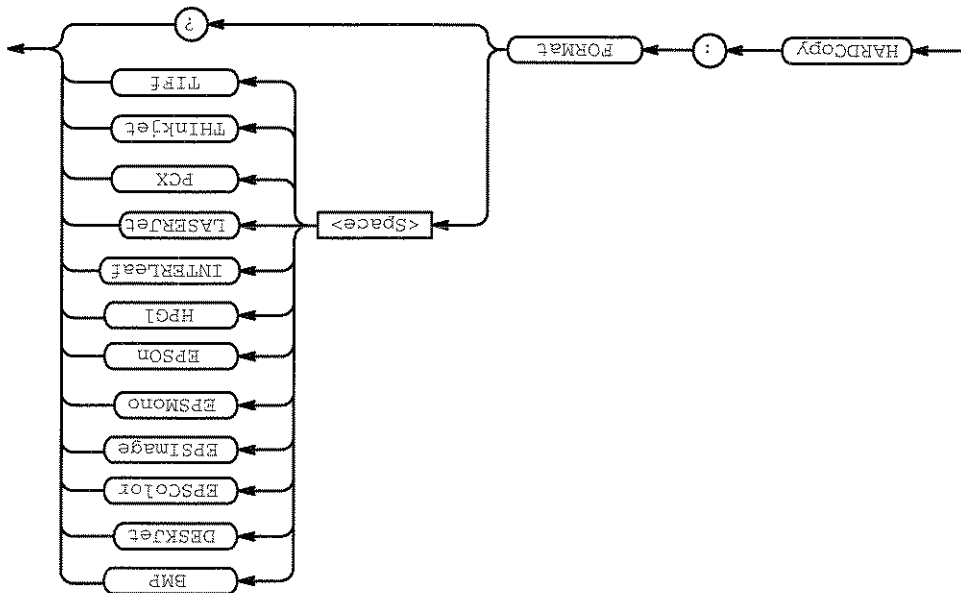

Examples: HARDCOPY:FORMAT HPGL sets the hardcopy output format to HPGL.

HARDCOPY:FORMAT? might return INTERLEAF as the final hardcopy output format.

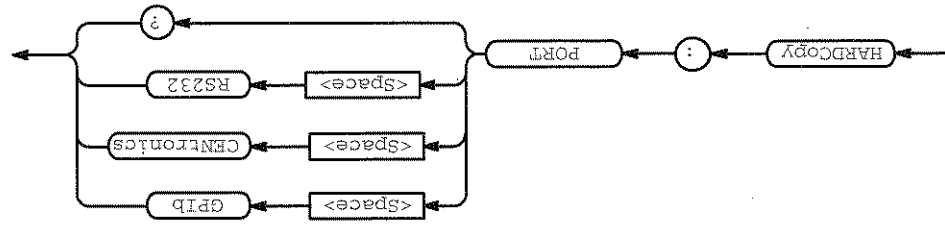

HARDCopy:PORT?

Syntax: HARDCopy:PORT { GPIB | CENTronics | RS232 }

Related Commands: HARDCopy

Group: Hardcopy

Hardcopy menu.

Selects the output port for the printer. This is equivalent to setting **Port** in the

HARDCopy:PORT

output.
might return **PORTrait** as the page layout format of the hardcopy

Examples: HARDCopy:LAYOut?

of the page. This is the standard format.
PORTrait specifies that the bottom of the hardcopy is along the short side

side of the page.
LANDscape specifies that the bottom of the hardcopy is along the longest

Arguments:

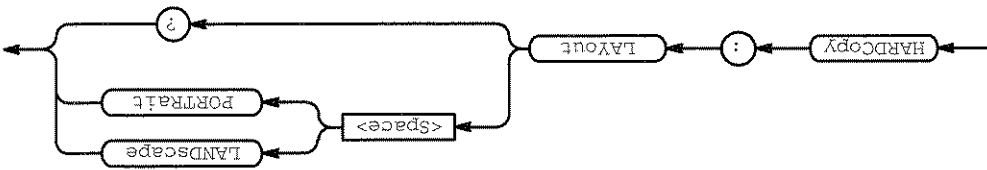

HARDCopy:LAYOut?

Syntax: HARDCopy:LAYOut { LANDscape | PORTrait }

Group: Hardcopy

Hardcopy menu.

Selects the printing orientation. This is equivalent to setting **Layout** in the

HARDCopy:LAYOut

HDR

This command is identical to the HEADer query and is included for compatibility with older Tektronix instruments.

Group: Miscellaneous

Syntax: HDR { OFF | ON | <NR1> }
HDR?

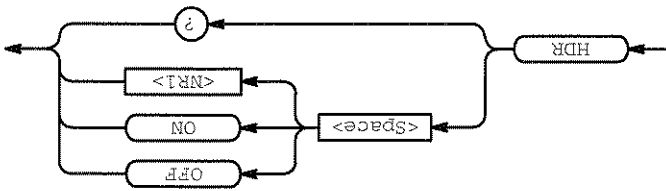

Sets and queries the Response Header Enable State that causes the digitizing oscilloscope to either include or omit headers on query responses. This command does not affect IEEE Std 488.2-1987 Common Commands (those starting with an asterisk); they never return headers.

Group: Miscellaneous

Related Commands: VERbose

Syntax: HEADER { OFF | ON | <NR1> }

HEADER?

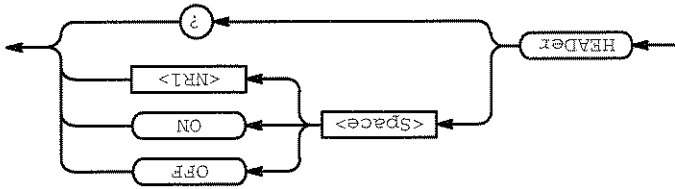

Arguments: ON or <NR1> ≠ 0 sets the Response Header Enable State to true. This causes the digitizing oscilloscope to include headers on applicable query responses. You can then use the query response as a command. OFF or <NR1> = 0 sets the Response Header Enable State to false. This causes the digitizing oscilloscope to omit headers on query responses, so that only the argument is returned.

Examples: HEADER OFF

causes the digitizing oscilloscope to omit headers from query responses.

HEADER?

might return the value 1, showing that the Response Header Enable State is true.

HORIZONTAL? (Query Only)

Returns all settings for the horizontal commands. The commands HORIZONTAL:SCALE, HORIZONTAL:MODE?, HORIZONTAL:DELAY:SCALE, and HORIZONTAL:DELAY:MODE? are equivalent so HORIZONTAL:MAIN:SCALE is the only value that is returned.

Group: Horizontal

Syntax: HORIZONTAL?

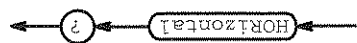

Examples: HORIZONTAL?

might return the string : HORIZONTAL:MODE MAIN;RECORDLENGTH 500; POSITION 50.0E+0; MAIN:SCALE 1.000E-9;TBPOSITION 17.650E-9; :HORIZONTAL:DELAY:SCALE 1.000E-12; TBPOSITION 15.000E-9; :HORIZONTAL:DHSKEM:CH1 1.0E-12; CH2 0.0E+0

HORIZONTAL:DELAY? (Query Only)

Returns all horizontal delayed time base parameters. The commands HORIZONTAL:DELAY:SCALE and HORIZONTAL:DELAY:SCALE are identical so only HORIZONTAL:DELAY:SCALE will be returned.

Group: Horizontal

Related Commands: HORIZONTAL?, HORIZONTAL:DELAY:MODE?, HORIZONTAL:DELAY:SCALE?, HORIZONTAL:DELAY:SCALE?, HORIZONTAL:DELAY:TIME?

Syntax: HORIZONTAL:DELAY?

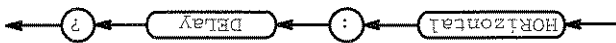

Examples: HORIZONTAL:DELAY?
 might return the delay parameters : HORIZONTAL:DELAY:SCALE 1.000E-12; TBPOSITION 15.000E-9

HORIZONTAL:DELAY:SCALE

Sets the time per division for the delayed time base. This is equivalent to setting **Delayed Fine Scale** in the Horizontal Fine Scale side menu.

Group: Horizontal

Related Commands: HORIZONTAL:DELAY:SECDIV

Syntax: HORIZONTAL:DELAY:SCALE <NR3>

HORIZONTAL:DELAY:SCALE?

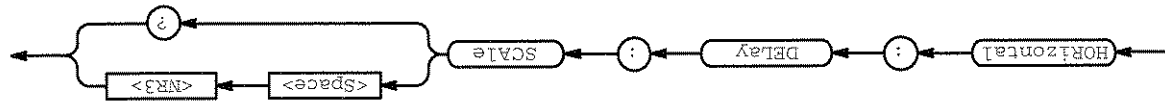

Arguments: <NR3> is the time per division. The range is 500 ms to 20 ps per division. Values are rounded to the nearest 10 ps.

Examples: HORIZONTAL:DELAY:SCALE 2.0E-6
 sets the delay scale to 2 μ s per division.

HORIZONTAL:DELAY:SCALE?

might return 1.0E-3, indicating that the delay time is 1 ms per division.

HORIZONTAL:DELAY:SECDIV

This command is identical to the HORIZONTAL:DELAY:SCALE command. It is provided to maintain program compatibility with some older models of Tektronix digitizing oscilloscopes.

Group: Horizontal

Syntax: HORIZONTAL:DELAY:SECDIV <NR3>

HORIZONTAL:DELAY:SECDIV?

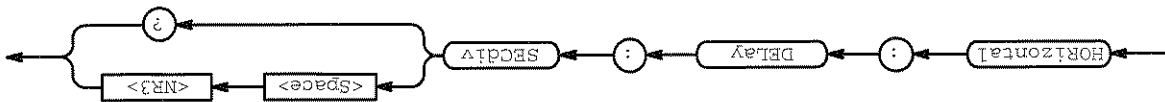

HORIZONTAL:DELAY:TbPosition

Sets or queries the delayed time base position. The time base position is the time from the trigger to the first sample of the record. The delay time base provides an additional window to view your record. This command is equivalent to setting **Delayed Position** in the Time Base Position side menu of the Horizontal menu.

Group: Horizontal

Syntax: HORIZONTAL:DELAY:TbPosition <NR3>
HORIZONTAL:DELAY:TbPosition?

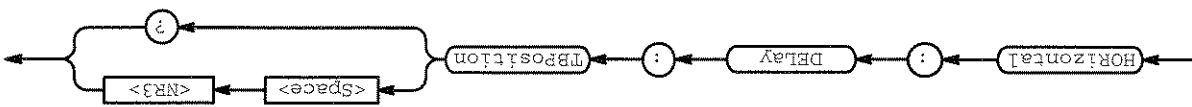

Arguments:

For instruments with delay lines, the valid range for <NR3> is -1.5 ns to 50 ms in increments of 1 ps. For instruments without delay lines (Option 1D), the valid range for <NR3> is 16 ns to 50 ms in increments of 1 ps.

Examples:

HORIZONTAL:DELAY:TbPosition?
might return: HORIZONTAL:DELAY:TbPosition 15.000E-9 indicating a delay of 15 ns.

HORIZONTAL:MAIN? (Query Only)

Returns the time per division of the main time base. The commands HORIZONTAL:MAIN:SECDiv and HORIZONTAL:MAIN:SCALE are identical so only HORIZONTAL:MAIN:SCALE will be returned.

Group: Horizontal

Related Commands: HORIZONTAL:SCALE, HORIZONTAL:SECDiv, HORIZONTAL:SCALE

Syntax: HORIZONTAL:MAIN?



Examples: HORIZONTAL:MAIN?

might return: HORIZONTAL:MAIN:SCALE 1.0E-6.

HORIZONTAL:DESKew:CH<x>

Sets or queries deskew for the specified channel. Deskew allows you to align signals from both channels precisely with each other. It allows you to compensate for the fact that the signals may be coming in from cables of different lengths. This command is equivalent to setting **Manual Deskew** for a selected channel in the Horizontal menu.

Group: Horizontal

Syntax: HORIZONTAL:DESKew:CH<x> <NR3>

HORIZONTAL:DESKew:CH<x>?

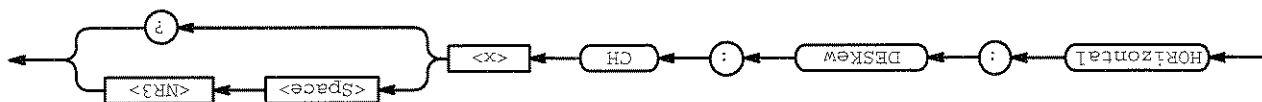

Arguments: The valid range for <NR3> is 0 to 10 ns in increments of 1 ps.

sets the deskew for channel 1 to 1.4 ns.

Examples: HORIZONTAL:DESKew:CH1 1.4E-9

HORIZONTAL:MAIN:SCALE

Sets the time per division for the main time base. This command is equivalent to HORIZONTAL:SCALE and is included for compatibility.

Syntax: HORIZONTAL:MAIN:SCALE <NR3>
HORIZONTAL:MAIN:SCALE?

HORIZONTAL:MAIN:SECDIV

Sets the time per division for the main time base. This command is identical to the HORIZONTAL:SECDIV command and is included for compatibility.

Syntax: HORIZONTAL:MAIN:SECDIV <NR3>
HORIZONTAL:MAIN:SECDIV?

HORIZONTAL:MAIN:TPOSITION

Sets the time base position for the main time base. This command is identical to the HORIZONTAL:TPOSITION command and is included for compatibility.

Syntax: HORIZONTAL:MAIN:TPOSITION <NR3>
HORIZONTAL:MAIN:TPOSITION?

HORIZONTAL:MODE

Selects whether the horizontal display uses the main or delayed time base or both. This command is equivalent to setting **Time Base** in the Horizontal menu.

Group: Horizontal

Related Commands: DISPLAY:INTENSITY:CONTRAST

Syntax: HORIZONTAL:MODE { DELAYED | INTENSIFIED | MAIN }
HORIZONTAL:MODE?

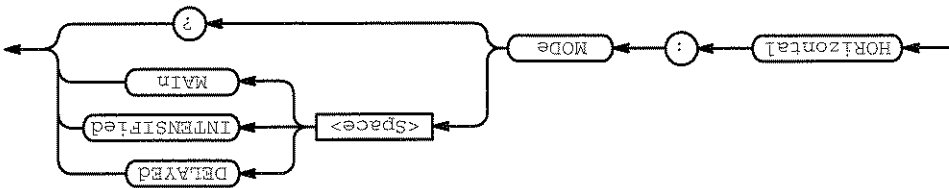

Arguments: DELAYED means that the selected waveform is horizontally scaled relative to the delayed time base.

INTENSIFIED uses the both the main and delay scales to display the waveform. The portion of the waveform that would be displayed in DELAYED mode is intensified. The intensity level is set by the DISPLAY:INTENSITY:CONTRAST command.

MAIN means that the waveform is horizontally scaled relative to the main time base.

Examples: HORIZONTAL:MODE DELAYED
uses the delayed horizontal scale to display the waveform.

HORIZONTAL:MODE?
might return INTENSIFIED, indicating that the waveform is displayed using both the main and delayed time base scale.

HORIZONTAL:POSITION

Positions the waveform horizontally on the display. This is used for both main and delayed time bases. This command is equivalent to adjusting the front-panel **Horizontal Position** knob or setting the position in the Horiz Pos side menu.

Group: Horizontal

Syntax: HORIZONTAL:POSITION <NR3>

HORIZONTAL:POSITION?

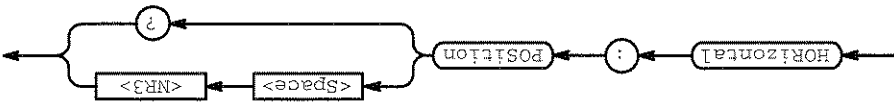

Arguments: <NR3> is from 0 to 100, and is the percentage of the waveform that is displayed left of the center graticule.

Examples:

HORIZONTAL:POSITION 10

sets the horizontal position of the waveform such that 10% of the waveform is to the left of screen center.

HORIZONTAL:RECORDLENGTH

Sets the number of data points that are acquired for each record. This is equivalent to setting **Record Length** in the Horizontal menu.

Group: Horizontal

Syntax: HORIZONTAL:RECORDLENGTH <NR1>

HORIZONTAL:RECORDLENGTH?



Arguments: <NR1> is 500, 1000, 2500, 5000, or 15000.

Examples:

HORIZONTAL:RECORDLENGTH 2500

specifies that 2500 data points will be acquired for each record.

HORIZONTAL:RECORDLENGTH?

might return 15000 as the number of data points per record.

HORIZONTAL:SECDIV

Sets the time per division for the main time base. This command is identical to the HORIZONTAL:SCALE command. It is provided to maintain program compatibility with some older models of Tektronix digitizing oscilloscopes.

Group: Horizontal

Related Commands: HORIZONTAL:DELAY:SCALE, HORIZONTAL:DELAY:SECDIV, HORIZONTAL:SCALE

Syntax: HORIZONTAL:SECDIV <NR3>

HORIZONTAL:SECDIV?

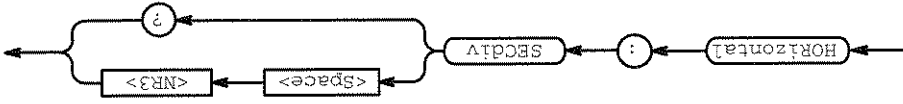

HORIZONTAL:SCALE

Sets the time per division for the main time base. This command is equivalent to setting **Main Fine Scale** in the Horizontal Fine Scale side menu.

Group: Horizontal

Related Commands: HORIZONTAL:DELAY:SCALE, HORIZONTAL:DELAY:SECDIV

Syntax: HORIZONTAL:SCALE <NR3>

HORIZONTAL:SCALE?

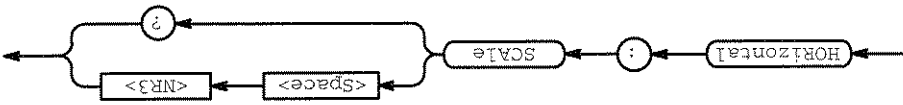

Arguments: <NR3> is the time per division. The range is 500 ms to 20 ps per division. Values are rounded to the nearest 10 ps.

Examples: HORIZONTAL:SCALE 2E-6
sets the main scale to 2 μs per division.

HORIZONTAL:TBPosition

Sets or queries the main time base position. The time base position is the time from the trigger to the first sample of the record. This command is equivalent to setting **Main Position** in the Time Base Position side menu of the Horizontal menu.

Group: Horizontal

Syntax: HORIZONTAL:TBPosition <NR3>

HORIZONTAL:TBPosition?

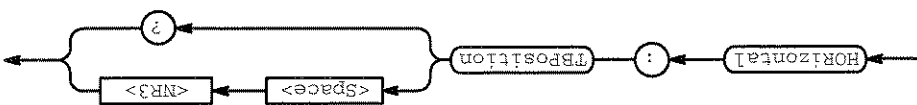

Arguments:

For instruments with delay lines, the valid range for <NR3> is -1.5 ns to 50 ms in increments of 1 ps. For instruments without delay lines (Option 1D), the valid range for <NR3> is 16 ns to 50 ms in increments of 1 ps.

Examples:

HORIZONTAL:TBPosition?
 might return: HORIZONTAL:TBPOSITION 17.000E-9 indicating a
 delay of 17 ns.

*IDN? (Query Only)

Returns the digitizing oscilloscope's unique identification code. This is equivalent to executing the **System** side menu item in the Status menu.

Group: Miscellaneous

Related Commands: ID

Syntax: *IDN?

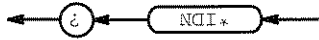

Returns: The instrument id in the following format:

```
ID TEK/<model number>,0,CF:91.1CT,FV:<<firmware version number>
```

Examples: *IDN?

might return the response
TEKTRONIX,TDS820,0,CF:91.1CT,FV:2.0

ID? (Query Only)

Returns identifying information about the instrument and its firmware. This is equivalent to executing the **System** side menu item in the Status menu.

Group: Status and Error

Related Commands: *IDN?

Syntax: ID?

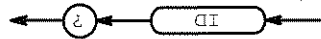

Returns: The instrument id in the following format:

```
ID TEK/<model number>,0,CF:91.1CT,FV:<<firmware version number>
```

Examples: ID?

might return ID TEK/TDS820,0,CF:91.1CT,FV:2.0

LIMIT:BELL

Rings the bell when the waveform data exceeds the limits set in the limit test, if the limit state is on.

Group: Limit Test

Related Commands: LIMIT:COMPARE:CH<x>, LIMIT:STATE

Syntax: LIMIT:BELL { OFF | ON | <NR1> }

LIMIT:BELL?

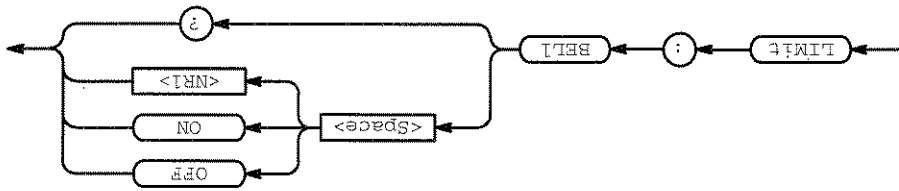

Arguments: OFF or <NR1> = 0 turns off ringing the bell when any waveform data exceeds the limits set by the limit test.

ON or <NR1> ≠ 0 turns on ringing the bell.

Examples: LIMIT:BELL ON specifies that the bell is to ring when any waveform data exceeds the limits specified in the limit test.

LIMIT:BELL? returns either 0 or 1, indicating whether the bell is to ring when any waveform data exceeds the limits specified in the limit test.

LIMIT:COMPARE:CH<x>

Sets or queries the template against which to compare the waveform acquired through the specified channel. The template can be a waveform saved in any of the reference locations REF1 through REF4, or none.

Group: Limit Test

Related Commands: CURVE, LIMIT:TEMPlate, LIMIT:TEMPlate:DESTINATION, LIMIT:TEMPlate:SOURCE, WFMPre

Syntax: LIMIT:COMPARE:CH<x> { NONE | REF<x> }

LIMIT:COMPARE:CH<x>?

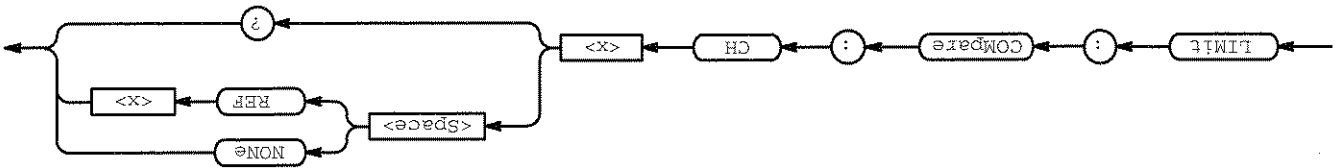

Arguments: REF<x> is a reference waveform.

NONE specifies that no template testing is to be done for the specified channel.

Examples: LIMIT:COMPARE:CH1 REF1 specifies REF1 as the template waveform against which to compare waveforms acquired using CH1.

LIMIT:COMPARE:CH2?

might return LIMIT:COMPARE:CH2 REF4, indicating that waveforms acquired using CH2 will be compared to the template waveform stored in REF4.

LIMIT:HARDCOPY

Executes a hard copy operation on the waveform when any waveform data exceeds the limits set in the limit test, if the limit state is on. The hard copy operation uses the port, and prints in the format and layout, specified using the HARDCOPY commands.

Group: Limit Test

Related Commands: LIMIT:COMPARE:CH<x>, LIMIT:STATE, HARDCOPY

Syntax: LIMIT:HARDCOPY { OFF | ON | <NR1> }

LIMIT:HARDCOPY?

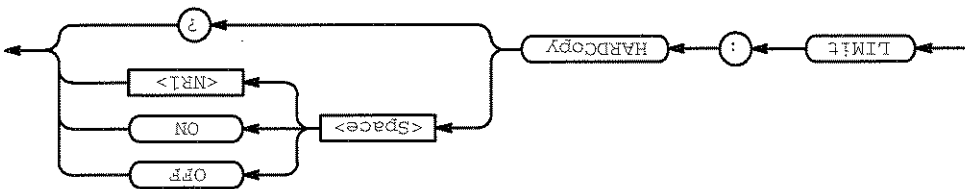

Arguments: ON or <NR1> ≠ 0 turns on the hardcopy operation for the waveform when any waveform data exceeds the limits set by the limit test.

OFF or <NR1> = 0 turns off the hardcopy operation.

Examples: LIMIT:HARDCOPY ON specifies that the hardcopy operation occurs for the waveform when any waveform data exceeds the limits specified in the limit test.

LIMIT:HARDCOPY?

returns either 0 or 1, indicating whether the hardcopy operation occurs for the waveform when any waveform data exceeds the limits specified in the limit test.

LIMIT:STATE

Turns limit testing on or off, or queries whether limit testing is in effect.

Group: Limit Test

Related Commands: CURVE, LIMIT:BELL, LIMIT:COMPARE:CH<x>, LIMIT:HARDCOPY, LIMIT:TEMP-PLATE, WFMPre, ACQUIRE:STOPAfter LIMIT

Syntax: `LIMIT:STATE { OFF | ON | <NR1> }`
`LIMIT:STATE?`

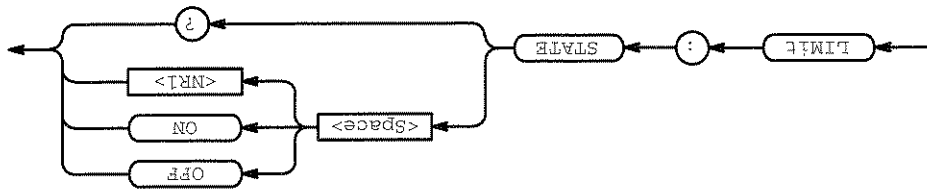

Arguments: OFF or <NR1> = 0 turns off limit testing.

ON or <NR1> ≠ 0 turns on limit testing.

Examples:

`LIMIT:STATE ON`

specifies that limit testing of waveforms is in effect.

`LIMIT:STATE?`

returns either 0 or 1, indicating whether limit testing of waveforms is in effect.

LIMIT:TEMPLATE (No Query Form)

Sets or queries the template against which to compare the waveform acquired through the specified channel. The template can be a waveform saved in any of the reference locations REF1 through REF4, or none.

Group: Limit Test

Related Commands: LIMIT:TEMPLATE:DESTINATION, LIMIT:TEMPLATE:SOURCE, LIMIT:TEMPLATE:TOLERANCE

Syntax: LIMIT:TEMPLATE STORE



Arguments: STORE creates a template with the specified source waveform and tolerances, and stores it in the destination reference waveform to be used in limit testing comparisons.

Examples: LIMIT:TEMPLATE STORE creates a template with the specified source waveform and tolerances, and stores it in the destination reference waveform to be used in limit testing comparisons.

LIMIT:TEMPLATE:DESTINATION

Sets or queries the destination reference waveform in which to store the template waveform to use in limit tests. The LIMIT:TEMPLATE STORE command must be executed for this to take effect.

Group: Limit Test

Related Commands: LIMIT:COMPARE:CH<x>, LIMIT:TEMPLATE, LIMIT:TEMPLATE:SOURCE

Syntax: LIMIT:TEMPLATE:DESTINATION REF<x>

LIMIT:TEMPLATE:DESTINATION?



Arguments: REF<x> specifies the reference waveform destination in which the template waveform is to be stored.

Examples: LIMIT:TEMPLATE:DESTINATION REF2
 specifies that the template waveform referred to with the LIMIT:TEMPLATE STORE command is stored as the REF2 waveform.

LIMIT:TEMPLATE:SOURCE

Sets or queries the channel, math waveform, or reference waveform to use as the source of the template waveform for limit tests. The LIMIT:TEMPLATE STORE command must be executed for this to take effect.

Group: Limit Test

Related Commands: LIMIT:COMPARE:CH<x>, LIMIT:TEMPLATE, LIMIT:TEMPLATE:DESTINATION

Syntax: LIMIT:TEMPLATE:SOURCE { CH<x> | MATH<x> | REF<x> }

LIMIT:TEMPLATE:SOURCE?

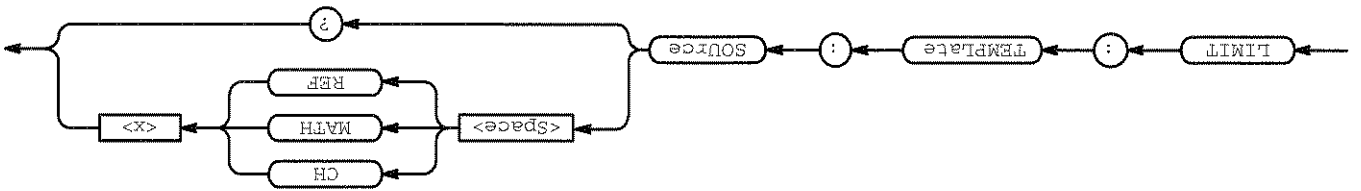

Arguments:

CH<x> specifies that the template waveform is the waveform currently being acquired using the specified channel.

MATH<x> specifies that the template waveform is the waveform currently stored as the specified math waveform.

REF<x> specifies that the template waveform is the waveform currently stored as the specified reference waveform.

Examples:

LIMIT:TEMPLATE:SOURCE CH2
 specifies that the template waveform for limit tests is the waveform currently acquired using channel 2.

LIMIT:TEMPLATE:SOURCE?
 might return MATH3, specifying that the template waveform for limit tests is the waveform currently stored as the MATH3 waveform.

LIMIT:TEMPLATE:Tolerance:HORIZONTAL

Sets or queries the amount by which the tested waveform can vary, in units of horizontal divisions, when comparing the current waveform to the template waveform for limit tests. The LIMIT:TEMPLATE:STORE command must be executed for this to take effect.

Group: Limit Test

Related Commands: LIMIT:COMPARE:CH<x>

Syntax: LIMIT:TEMPLATE:Tolerance:HORIZONTAL <NR3>

LIMIT:TEMPLATE:Tolerance:HORIZONTAL?

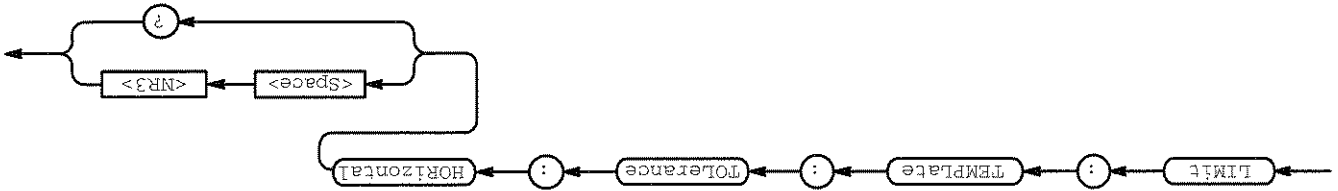

Arguments:

<NR3> is the amount, in horizontal divisions, by which the current waveform is allowed to deviate from the template waveform without being deemed to have exceeded the limits set in the limit test.

Examples:

LIMIT:TEMPLATE:Tolerance:HORIZONTAL 1.0

Specifies that the current waveform is deemed to be close enough to the template waveform if it is within ± 1.0 horizontal division.

LIMIT:TEMPLATE:Tolerance:HORIZONTAL?

Might return 1.0, specifying that the current waveform is deemed to be close enough to the template waveform if it is within ± 1.0 horizontal division.

LIMIT:TEMPLATE:TOLERANCE:VERTICAL

Sets or queries the amount by which the tested waveform can vary, in units of vertical divisions, when comparing the current waveform to the template waveform for limit tests. The LIMIT:TEMPLATE:STORE command must be executed for this to take effect.

Group: Limit Test

Related Commands: LIMIT:COMPARE:CH<X>

Syntax: LIMIT:TEMPLATE:TOLERANCE:VERTICAL <NR3>

LIMIT:TEMPLATE:TOLERANCE:VERTICAL?

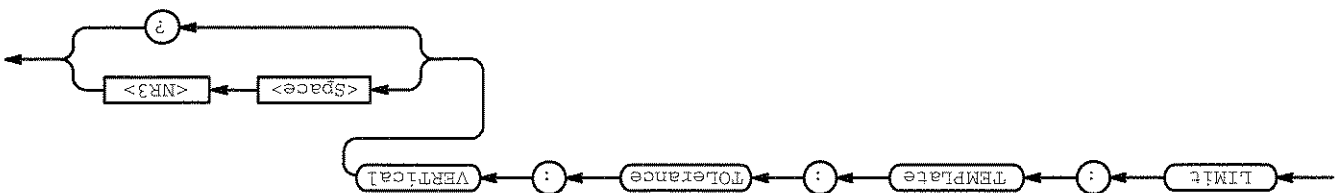

Arguments: <NR3> is the amount, in vertical divisions, by which the current waveform is allowed to deviate from the template waveform without being deemed to have exceeded the limits set in the limit test.

Examples: LIMIT:TEMPLATE:TOLERANCE:VERTICAL 1.0 specifies that the current waveform is deemed to be close enough to the template waveform if it is within ± 1.0 vertical division from the template waveform.

LIMIT:TEMPLATE:TOLERANCE:VERTICAL? might return 1.0, specifying that the current waveform is deemed to be close enough to the template waveform if it is within ± 1.0 vertical division.

LOCK

Enables and disables all front panel buttons and knobs. There is no front-panel equivalent.

Group: Miscellaneous

Related Commands: UNLock, Remote Enable Group, Local Lockout Group

Syntax: LOCK { ALL | NONE }

LOCK?

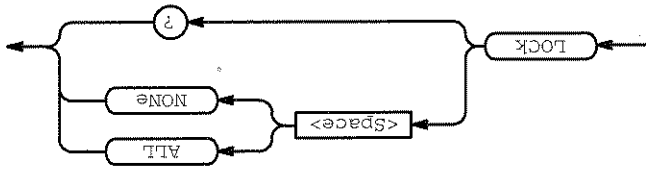

Arguments: ALL disables all front panel controls.

NONE enables all front panel controls. This is equivalent to the UNLock ALL command.

NOTE

If the digitizing oscilloscope is in the Remote With Lockout State (RWLS), the LOCK NONE command has no effect. For more information, see the ANSI IEEE Std. 488.1-1987 Standard Digital Interface for Programmable Instrumentation, section 2.8.3 on RL State Descriptions.

Examples:

LOCK ALL

locks the front panel controls.

LOCK?

returns NONE when the front panel controls are enabled by this command.

***LRN? (Query Only)**

Returns a string listing the digitizing oscilloscope's settings, except for configuration information for the calibration values. You can use this string to return the digitizing oscilloscope to the state it was in when you made the *LRN? query.

Group: Miscellaneous

Related Commands: HEADER, SET?, VERBOSE

Syntax: *LRN?

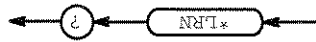

NOTE

The *LRN? query always returns a string including command headers, regardless of the setting of the HEADER command. This is because the returned string is intended to be sent back to the digitizing oscilloscope as a command string. The VERBOSE command can still be used normally to specify whether the returned headers should be abbreviated.

Examples:

*LRN?

a partial response might look like this:
 ACQUIRE:STATE 1;MODE NORMAL;NUMENV 10;NUMAVG 16;
 STOPAFTER RUNSTOP;DIAG:LOOP:OPTION ONCE;
 COUNT 1;DIAG:STATE HALT;HEADER 1;VERBOSE 1;
 CURSOR:FUNCTION OFF;VBARS:UNITS SECONDS;
 POSITION1 1.00E-6;POSITION2 9.00E-6;SELECT CURSOR1;

MATH<x>? (Query Only)

Returns the definition for the math waveform specified by <x>.

Group: Vertical

Syntax: MATH<x>?

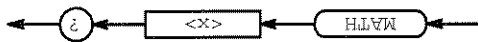

MATH<x>:DEFINE

Allows the user to define new waveforms using mathematical expressions. This is equivalent to selecting **Change Math waveform definition** in the Math<x> side menu.

Group: Vertical

Syntax: MATH<x>:DEFINE <QString>

MATH<x>:DEFINE?



Arguments:

<QString> contains the mathematical expression. The expression can include any amount of white space. Expressions can be either single or dual waveform expressions. <src> and <function> elements are case independent.

The format for a single waveform expression is:

<function>(<src>)

The format for a dual waveform expression is:

<src><operator><src>

where:

<function> ::= INV | DIFF | FFT | INT

■ INV (for invert): inverts the defined waveform.

■ DIFFerentiate: takes the derivative of the selected waveform.

- FFT provides an FFT of the selected waveform. It uses the format: "FFT(<source>, <window>, <scaling>, <phase suppression>)" where the window, scaling, and phase suppression arguments in the parentheses are optional. You can specify these arguments in any order. <source> refers to a signal channel. Valid choices are: CH1, CH2, REF1, REF2, REF3, or REF4. <window> refers to an FFT window. Valid choices are: RECTangular, HANNing, HANNing, or BLACKmanharris. <scaling> provides vertical scaling. Valid choices are: LOGrms, LINear, Nearrms, DEGreessphase, or RADianSpHase. <Phase suppression> is of the range: -100 dB to 100 dB.

- INTEGRate: takes the integral of the selected waveform.

```
<operator> ::= { + | - | * }
<src> ::= { CH<x> | REF<x> }
```

Examples:

```
MATH2:DEFINE "CH1 + CH2"
adds channel 1 and channel 2, and stores the result in MATH2.

MATH1:DEFINE "INV(REF4)"
inverts the waveform stored in reference memory location 4 storing the result in MATH1.

MATH1:DEFINE?
might return "CH2*REF2" as the expression that defines MATH1.
```

MEASUREMENT:CLEARNAPSHOT

Takes down the measurement snapshot display.

Group: Measurement

Syntax: MEASUREMENT:CLEARNAPSHOT



Examples: MEASUREMENT:CLEARNAPSHOT

Examples: MEASUREMENT?
 might return: MEASUREMENT:MEAS1:STATE 0;TYPE PERIOD;UNITS
 "s";SOURCE1 CH1;SOURCE2 CH1;DELAY:EDGE1 RISE;EDGE2
 RISE;DIRECTION FORWARDS;MEASUREMENT:MEAS2:STATE
 0;TYPE PERIOD;UNITS "s";SOURCE1 CH1;SOURCE2
 CH1;DELAY:EDGE1 RISE;EDGE2 RISE;DIRECTION FOR-
 WARDS;MEASUREMENT:MEAS3:STATE 0;TYPE PERIOD;UNITS
 "s";SOURCE1 CH1;SOURCE2 CH1;DELAY:EDGE1 RISE;EDGE2
 RISE;DIRECTION FORWARDS;MEASUREMENT:MEAS4:STATE
 0;TYPE PERIOD;UNITS "s";SOURCE1 CH1;SOURCE2
 CH1;DELAY:EDGE1 RISE;EDGE2 RISE;DIRECTION FOR-
 WARDS;MEASUREMENT:IMMED:TYPE PERIOD;UNITS "s";SOURCE1
 CH1;SOURCE2 CH1;DELAY:EDGE1 RISE;EDGE2 RISE;DIRECTION
 FORWARDS;GATING 0;MEASUREMENT:METHD HISTOGRAM;REFLE-
 VEL:METHD PERCENT;ABSOLUTE:HIGH 0.0E+0;LOW 0.0E+0;MID
 0.0E+0;
 MID2 0.0E+0;;MEASUREMENT:REFLEVEL:PERCENT:HIGH
 90.0E+0;LOW 10.0E+0;MID 50.0E+0;MID2 50.0E+0

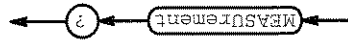

Syntax: MEASUREMENT?

Group: Measurement

Returns all measurement parameters.

MEASUREMENT? (Query Only)

MEASUREMENT:GATING

Sets or queries measurement gating. This command is equivalent to setting **Gating** in the Measure menu.

Group: Measurement

Syntax: MEASUREMENT:GATING { OFF | ON | <NR1> }
 MEASUREMENT:GATING?

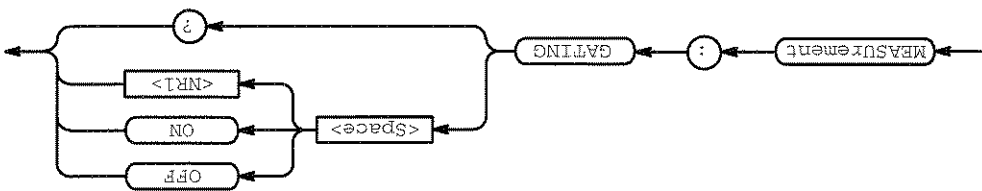

Arguments: ON or <NR1> ≠ 0 turns on measurement gating.

OFF or <NR1> = 0 turns off measurement gating.

Examples: MEASUREMENT:GATING?
 might return: MEASUREMENT:GATING 1, indicating that measurement gating is on.

MEASUREMENT:IMMED:DELAY? (Query Only)

Returns information about the immediate delay measurement.

Group: Measurement

Syntax: MEASUREMENT:IMMED:DELAY?



Examples: MEASUREMENT:IMMED:DELAY?
 might return: MEASUREMENT:IMMED:DELAY:EDGE1 RISE,EDGE2 RISE, DIRECTION FORWARDS

MEASUREMENT:IMMED? (Query Only)

Returns all immediate measurement setup parameters.

Group: Measurement

Syntax: MEASUREMENT:IMMED?

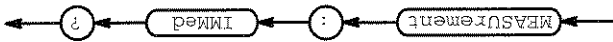

Examples: MEASUREMENT:IMMED?
 might return: MEASUREMENT:IMMED:TYPE PERIOD,UNITS "s"; SOURCE1 CH1;SOURCE2 CH1;DELAY:EDGE1 RISE,EDGE2 RISE, DIRECTION FORWARDS

MEASUREMENT:IMMED:DELAY:Direction

Command Descriptions

Sets or queries the starting point and direction that determines the delay "to" edge when taking an immediate delay measurement. Use the MEASUREMENT:IMMED:SOURCE2 command to specify the delay "to" waveform.

Group: Measurement

Syntax: MEASUREMENT:IMMED:DELAY:Direction { Backwards | Forwards }

MEASUREMENT:IMMED:DELAY:Direction?

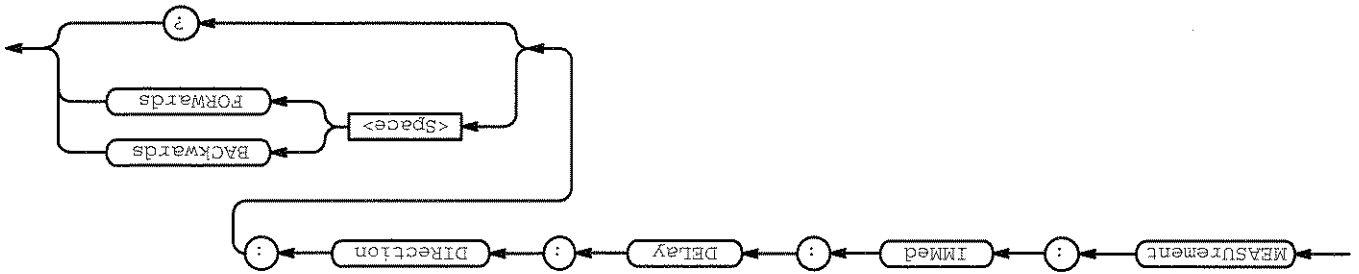

Arguments:

Backwards means that the search starts at the end of the waveform and looks for the last rising or falling edge in the waveform. The slope of the edge is specified by MEASUREMENT:IMMED:DELAY:EDGE2.
Forwards means that the search starts at the beginning of the waveform and looks for the first rising or falling edge in the waveform. The slope of the edge is specified by MEASUREMENT:IMMED:DELAY:EDGE2.

Examples:

MEASUREMENT:IMMED:DELAY:Direction FORWARDS
starts searching from the beginning of the waveform record.
MEASUREMENT:IMMED:DELAY:Direction? returns either BACKWARDS or FORWARDS.

MEASUREMENT:IMMED:DELAY:EDGE1

Sets or queries the slope of the edge that is used for the delay "from" waveform when taking an immediate delay measurement. The waveform is specified by MEASUREMENT:IMMED:SOURCE1.

Group: Measurement

Related Commands: MEASUREMENT:IMMED:SOURCE1

Syntax: MEASUREMENT:IMMED:DELAY:EDGE1 { FALL | RISE }
MEASUREMENT:IMMED:DELAY:EDGE1 ?

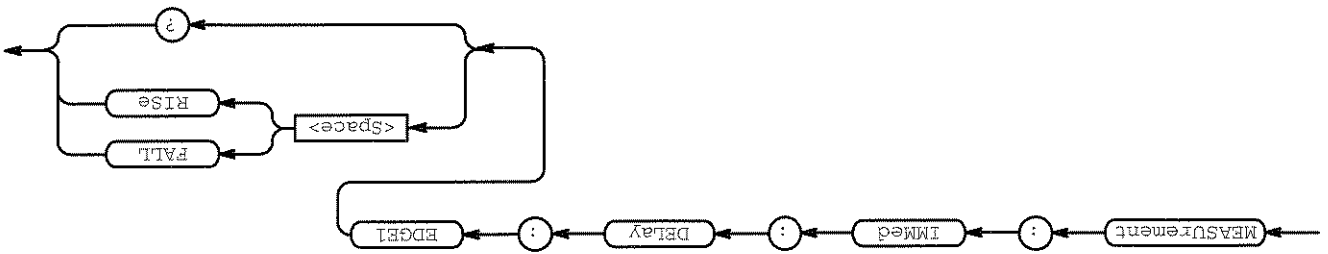

Arguments: FALL specifies the falling edge.
RISE specifies the rising edge.

Examples: MEASUREMENT:IMMED:DELAY:EDGE1 RISE
specifies that the rising edge be used for the immediate delay measurement.

MEASUREMENT:IMMED:DELAY:EDGE1 ?
returns either RISE or FALL.

MEASUREMENT:IMMED:DELAY:EDGE2

Sets or queries the slope of the edge that is used for the delay "to" waveform when taking an immediate delay measurement. The waveform is specified by MEASUREMENT:IMMED:SOURCE2.

Group: Measurement

Related Commands: MEASUREMENT:IMMED:SOURCE2

Syntax: MEASUREMENT:IMMED:DELAY:EDGE2 { FALL | RISE }

MEASUREMENT:IMMED:DELAY:EDGE2?

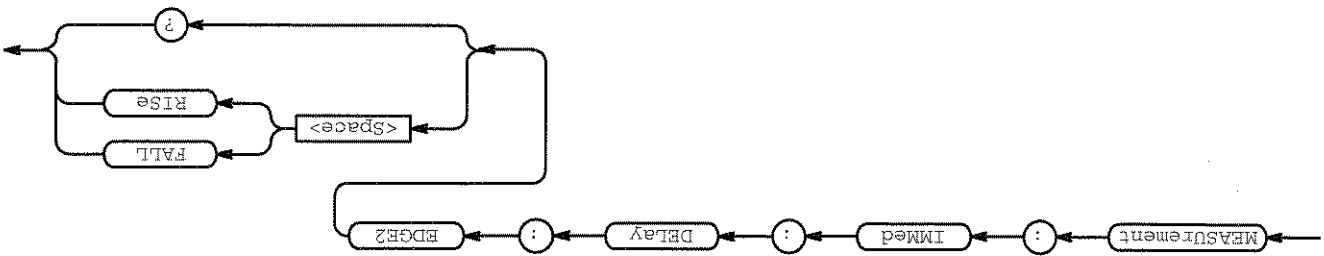

Arguments: FALL specifies the falling edge.

RISE specifies the rising edge.

Examples:

MEASUREMENT:IMMED:DELAY:EDGE2 RISE

specifies that the rising edge be used for the immediate delay measurement.

MEASUREMENT:IMMED:DELAY:EDGE2?

returns FALL showing that the falling or negative edge of the waveform is used for the immediate delay measurement.

MEASUREMENT:IMMED:SOURCE[1]

Sets or queries the source for all single channel immediate measurements and specifies the source to measure from when taking an immediate delay measurement.

Group: Measurement

Syntax: MEASUREMENT:IMMED:SOURCE[1] { CH<x> | MATH<x> | REF<x> }
 MEASUREMENT:IMMED:SOURCE[1] ?

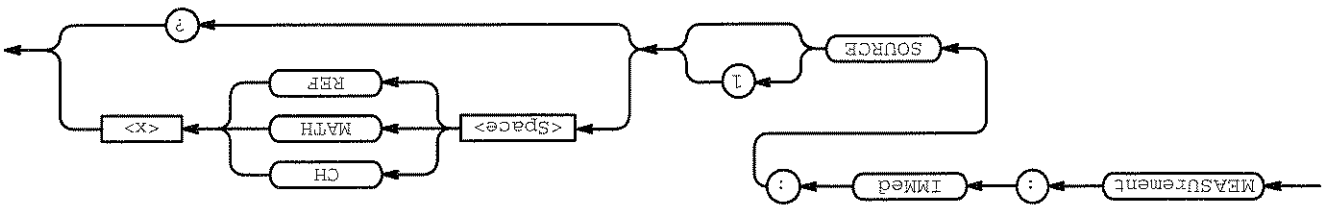

Arguments: CH<x> is an input channel.

MATH<x> is a math waveform.

REF<x> is a reference waveform.

Examples: MEASUREMENT:IMMED:SOURCE MATH1 specifies MATH1 as the immediate measurement source.

MEASUREMENT:IMMED:SOURCE2

Specifies the source to measure to when taking an immediate delay measurement.

Group: Measurement

Syntax: MEASUREMENT:IMMED:SOURCE2 { CH<x> | MATH<x> | REF<x> }
 MEASUREMENT:IMMED:SOURCE2?

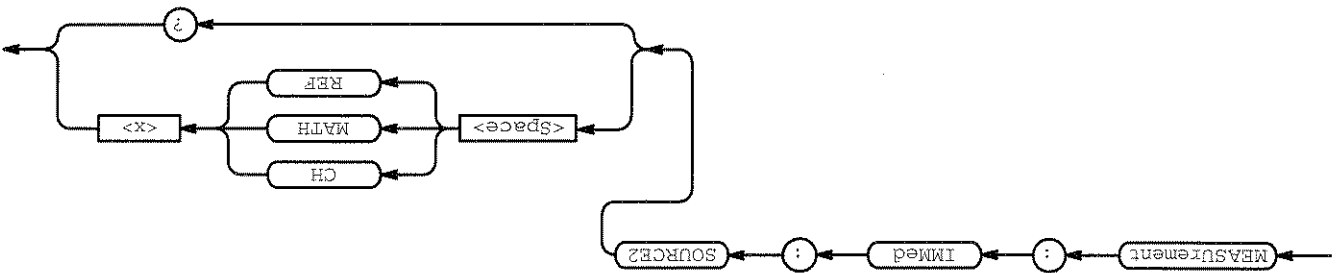

Arguments: CH<x> is an input channel.

MATH<x> is a math waveform.

REF<x> is a reference waveform.

Examples: MEASUREMENT:IMMED:SOURCE2 REF3
 sets the waveform in reference memory location 3 as the delay "to" source when making delay measurements.
 MEASUREMENT:IMMED:SOURCE2?
 might return MATH1.

MEASUREMENT:IMMED:TYPE

The MEASUREMENT:IMMED:TYPE command specifies the immediate measurement.

Group: Measurement

Syntax: MEASUREMENT:IMMED:TYPE { AMPLITUDE | AREA | BURST | CAREA | CMean | CRMS | DELAY | FALL | FREQUENCY | HIGH | LOW | MAXimum | MEAN | MINimum | NCross | NDUTY | NOVershoot | NMWidth | PCross | PDUTY | PERIOD | PHASE | PK2pk | POvershoot | PWidth | RISE | RMS }

Arguments: AMP1 tude is the high value minus the low value.
 AREA is the area between the curve and ground over the entire waveform.
 BURSt is the time from the first MidRise crossing to the last MidRise crossing.
 CARea (cycle area) is the area between the curve and ground over one cycle.
 CMEan is the arithmetic mean over one cycle.
 CRMS is the true Root Mean Square voltage over one cycle.
 DELay is the time between the MidRise crossings of two different waveforms.

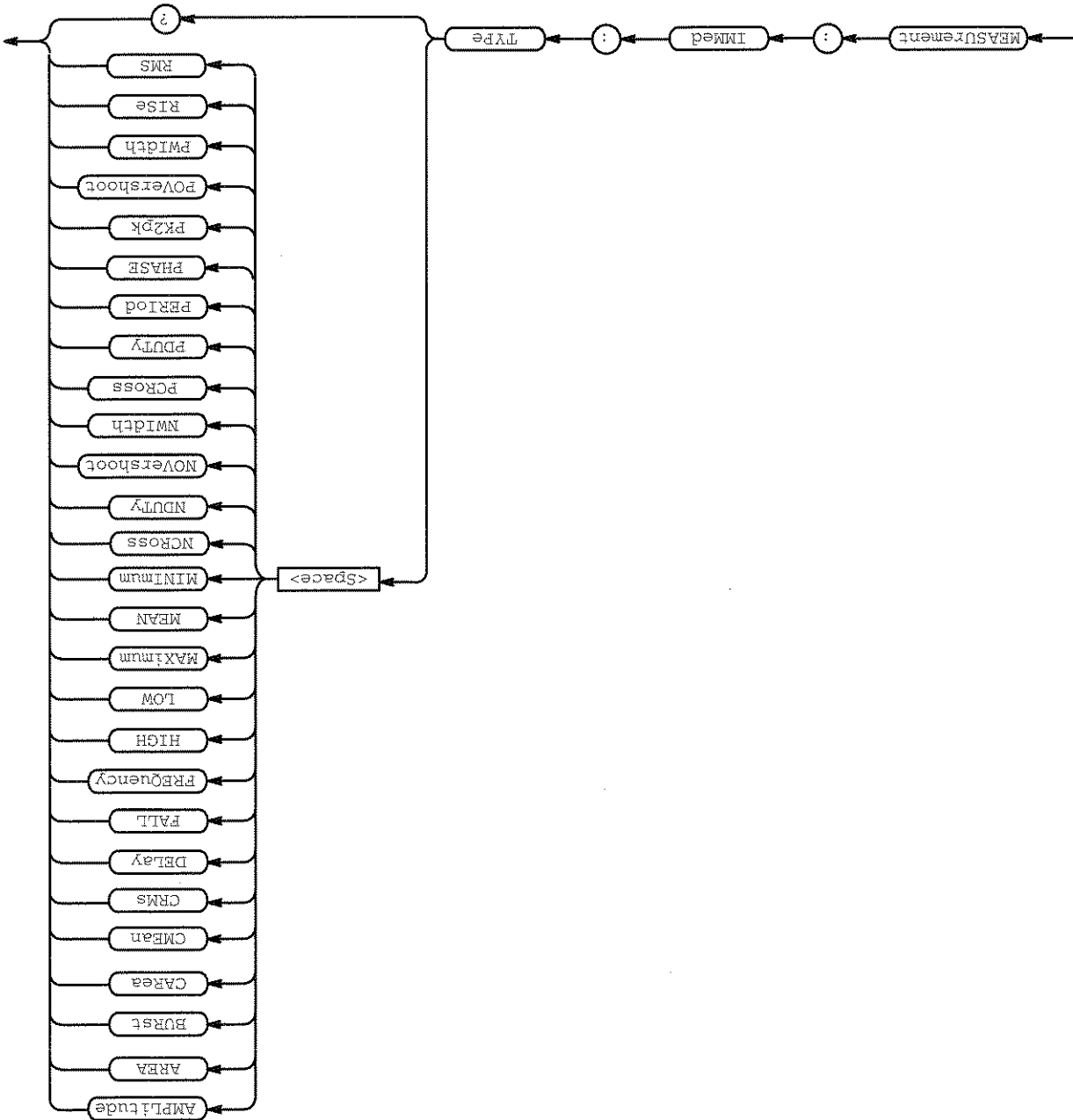

Command Descriptions

FALL is the time that it takes for the falling edge of a pulse to fall from a HighRef value to a LowRef value of its final value.

FREQUENCY is the reciprocal of the period measured in Hertz.

HIGH is the 100% reference level.

LOW is the 0% reference level.

MAXIMUM is the highest amplitude (voltage).

MEAN is the arithmetic mean over the entire waveform.

MINIMUM is the lowest amplitude (voltage).

NCROSS is the time from the trigger to the point in the waveform that crosses the midlevel with a negative slope. This time can be less than zero if the instrument has no delay lines (Option 1D).

NDUTY is the ratio of the negative pulse width to the signal period expressed as a percentage.

NOVERSHOOT is the negative overshoot, expressed as:

$$NOVERSHOOT = 100 \times \left(\frac{Amplitude}{Low - Minimum} \right)$$

NWIDTH is the distance (time) between MidRef (usually 50%) amplitude points of a negative pulse.

PCROSS is the time from the trigger to the point in the waveform that crosses the midlevel with a positive slope. This time can be less than zero if the instrument has no delay lines (Option 1D).

PDUTY is the ratio of the positive pulse width to the signal period expressed as a percentage.

PERIOD is the time, in seconds, it takes for one complete signal cycle to happen.

PHASE is the phase difference from the selected waveform to the designated waveform.

PR2PK is the absolute difference between the maximum and minimum amplitude.

POVERSHOOT is the positive overshoot, expressed as:

$$POVERSHOOT = 100 \times \left(\frac{Amplitude}{Maximum - High} \right)$$

PWIDTH is the distance (time) between MidRef (usually 50%) amplitude points of a positive pulse.

RISE is the time that it takes for the leading edge of a pulse to rise from a low reference value to a high reference value of its final value.

RMS is the true Root Mean Square voltage.

MEASUREMENT:IMMED:VALUE? (Query Only)

Immediately executes the immediate measurement specified by the MEASUREMENT:IMMED:TYPE command. The measurement is taken on the source(s) specified by the SELECT:CH<X> command.

Group: Measurement

Syntax: MEASUREMENT:IMMED:VALUE?

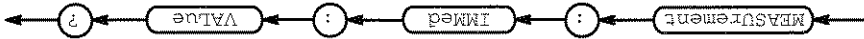

Returns: <NR3>

Examples: MEASUREMENT:IMMED:UNITS?

might return "s", indicating that the units for the immediate measurement are seconds.

Returns: <string> returns "V" for volts, "s" for seconds, "HZ" for hertz, "VV" for volts², "%" for percent, or "dB" for decibels.

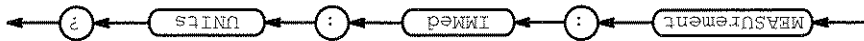

Syntax: MEASUREMENT:IMMED:UNITS?

Related Commands: MEASUREMENT:IMMED:TYPE

Group: Measurement

Returns the units for the immediate measurement.

MEASUREMENT:IMMED:UNITS? (Query Only)

defines the immediate measurement to be a frequency measurement.

Examples: MEASUREMENT:IMMED:TYPE FREQUENCY

MEASUREMENT:MEAS<x>? (Query Only)

Returns all measurement parameters for the displayed measurement specified by <x>.

Group: Measurement

Syntax: MEASUREMENT:MEAS<x>?

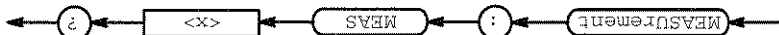

Examples:

MEASUREMENT:MEAS3 ?
might return: MEASUREMENT:MEAS3:STATE 0;TYPE PERIOD;
UNITS "s";SOURCE1 CH1;SOURCE2 CH2;DELAY:EDGE1 RISE;
EDGE2 RISE;DIRECTION FORWARDS.

MEASUREMENT:MEAS<x>:DELAY? (Query Only)

Returns the delay measurement parameters for the measurement specified by <x>.

Group: Measurement

Syntax: MEASUREMENT:MEAS<x>:DELAY?



Examples:

MEASUREMENT:MEAS3:DELAY ?
might return: MEASUREMENT:MEAS3:DELAY:EDGE1 RISE;
EDGE2 RISE;DIRECTION FORWARDS.

MEASUREMENT:MEAS<X>:DELAY:Direction

Sets or queries the starting point and direction that determines the delay "to" edge when taking a delay measurement. The waveform is specified by MEASUREMENT:MEAS<X>:SOURCE2. This command is equivalent to setting the direction in the Delay Edges & Direction side menu.

Group: Measurement

Syntax: MEASUREMENT:MEAS<X>:DELAY:Direction { Backwards | Forwards }

MEASUREMENT:MEAS<X>:DELAY:Direction?

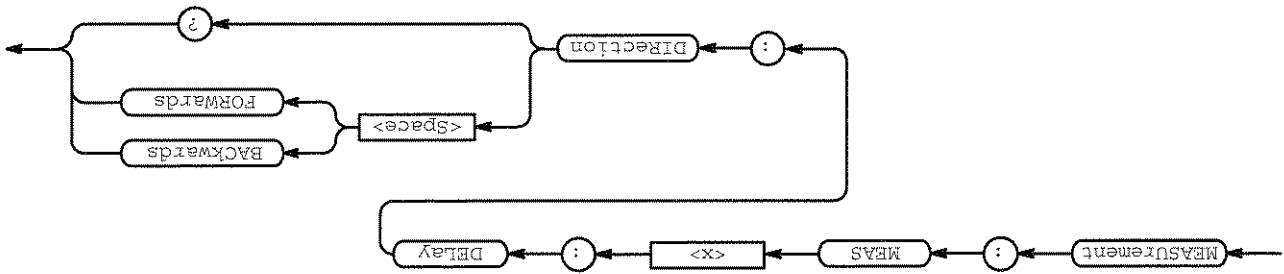

Arguments:

Backwards means that the search starts at the end of the waveform and looks for the last rising or falling edge in the waveform. The slope of the edge is specified by MEASUREMENT:MEAS<X>:DELAY:EDGE2.

Forwards means that the search starts at the beginning of the waveform and looks for the first rising or falling edge in the waveform. The slope of the edge is specified by MEASUREMENT:MEAS<X>:DELAY:EDGE2.

Examples:

MEASUREMENT:MEAS1:DELAY:Direction BACKWARDS
 starts searching from the end of the waveform record.

MEASUREMENT:MEAS3:DELAY:Direction
 might return FORWARDS for the search direction.

MEASUREMENT:MEAS<x>:DELAY:EDGE1

Sets or queries the slope of the edge that is used for the delay "from" waveform when taking a delay measurement. The waveform is specified by MEASUREMENT:MEAS<x>:SOURCE1. This command is equivalent to selecting the edges in the Delay Edges & Direction side menu.

Group: Measurement

Syntax: MEASUREMENT:MEAS<x>:DELAY:EDGE1 { FALL | RISE }

MEASUREMENT:MEAS<x>:DELAY:EDGE1 ?

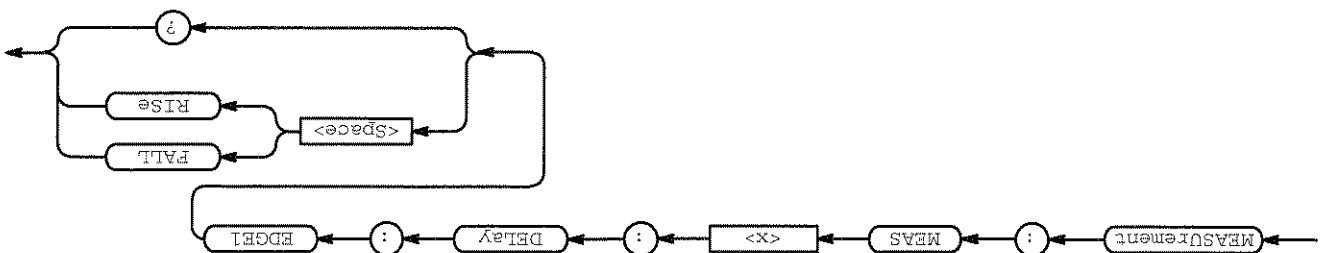

Arguments: FALL specifies the falling edge.

RISE specifies the rising edge.

Examples:

MEASUREMENT:MEAS3:DELAY:EDGE1 RISE

specifies that the rising edge be used for measurement 3.

MEASUREMENT:MEAS1:DELAY:EDGE1 ?

returns either RISE or FALL for measurement 1.

MEASUREMENT:MEAS<x>:DELAY:EDGE2

Sets or queries the slope of the edge that is used for the delay "to" waveform when taking a delay measurement. The waveform is specified by MEASUREMENT:MEAS<x>:SOURCE2. This command is equivalent to selecting the edges in the Delay Edges & Direction side menu.

Group: Measurement

Syntax: MEASUREMENT:MEAS<x>:DELAY:EDGE2 { FALL | RISE }

MEASUREMENT:MEAS<x>:DELAY:EDGE2?

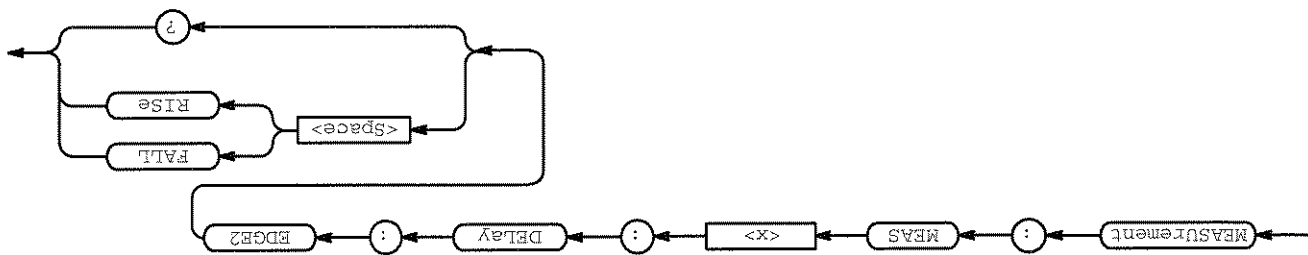

Arguments: FALL specifies the falling edge.

RISE specifies the rising edge.

Examples: MEASUREMENT:MEAS2:DELAY:EDGE2 RISE
 specifies that the rising edge be used for the second delay measurement.

MEASUREMENT:MEAS2:DELAY:EDGE2?
 might return FALL showing that the falling or negative edge of the waveform is used for the second measurement.

MEASUREMENT:MEAS<x>:SOURCE[1]

Sets or queries the source for all single channel measurements and specifies the source to measure "from" when taking a delay measurement.

Group: Measurement

Syntax: MEASUREMENT:MEAS<x>:SOURCE[1] { CH<x> | MATH<x> | REF<x> }

MEASUREMENT:MEAS<x>:SOURCE[1] ?

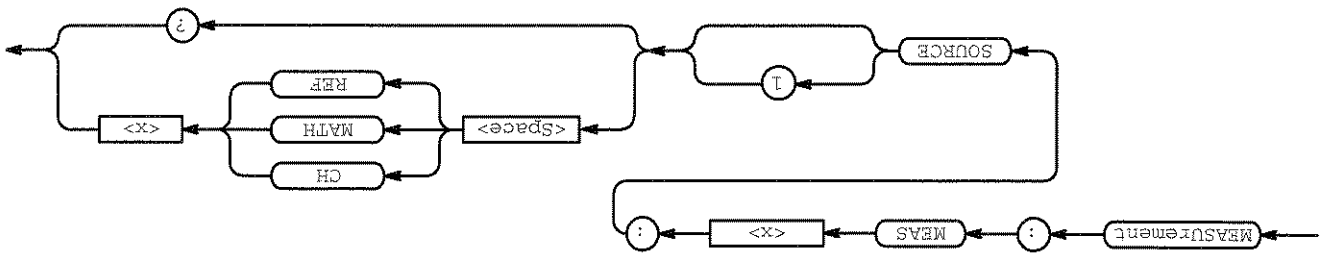

Arguments: CH<x> is an input channel.

MATH<x> is a math waveform.

REF<x> is a reference waveform.

Examples: MEASUREMENT:MEAS2:SOURCE1 MATH1 specifies MATH1 as the measurement 2 source.

MEASUREMENT:MEAS<x>:SOURCE2

Sets or queries the source to measure "to" when taking a delay measurement. This is equivalent to setting the source in the Delay from Selected Wfm side menu.

Group: Measurement

Syntax: MEASUREMENT:MEAS<x>:SOURCE2 { CH<x> | MATH<x> | REF<x> }

MEASUREMENT:MEAS<x>:SOURCE2?

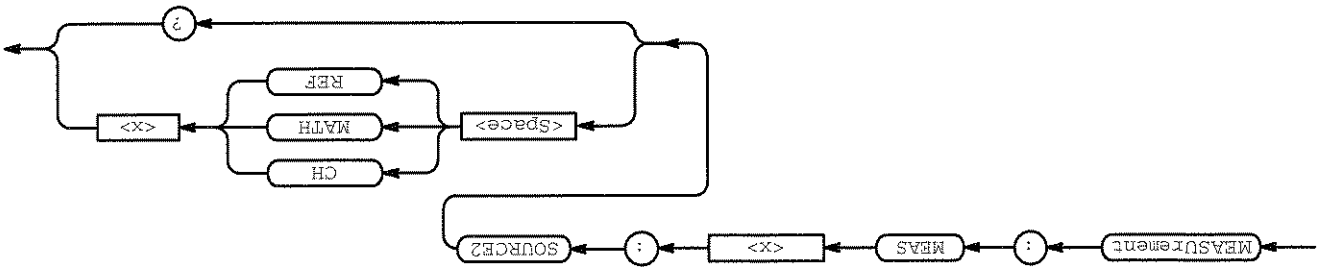

Arguments: CH<x> is an input channel.

MATH<x> is a math waveform.

REF<x> is a reference waveform.

Examples: MEASUREMENT:MEAS4:SOURCE2 CH<x>
sets channel 1 as the delay "to" source when making delay measurements.

MEASUREMENT:MEAS2:SOURCE2?
might return MATH1.

MEASUREMENT:MEAS<x>:STATE

Controls the measurement system. The source specified by MEASUREMENT:MEAS<x>:SOURCE1 must be selected for the measurement to be displayed. The source can be selected using the SELECT:CH<x> command.

Group: Measurement

Syntax: MEASUREMENT:MEAS<x>:STATE { OFF | ON | <NR1> }

MEASUREMENT:MEAS<x>:STATE?

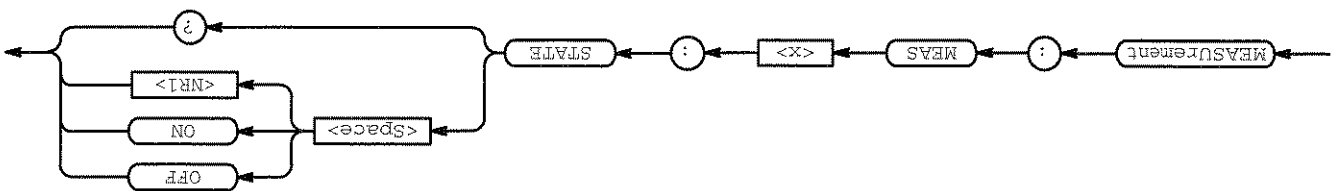

Arguments:

OFF or <NR1> = 0 turns measurements off. You can also turn the state off by deselecting the source.

ON or <NR1> ≠ 0 turns measurements on.

Examples:

MEASUREMENT:MEAS1:STATE ON

turns measurement defined as MEAS1 on.

MEASUREMENT:MEAS4:STATE?

returns either 0 or 1, indicating the state of MEAS4.

MEASUREMENT:MEAS<x>:TYPE

The MEASUREMENT:MEAS<x>:TYPE command sets or queries the measurement type for the measurement specified by <x>. This is equivalent to selecting the measurement in the Select Measurement side menu.

Group: Measurement

Syntax:

MEASUREMENT:MEAS<x>:TYPE { AMPLITUDE | AREA | BURST | CAREA | CMEAN | CRMS | DELAY | FALL | FREQUENCY | HIGH | LOW | MAXIMUM | MEAN | MINIMUM | NCROSS | NDUTY | NOVERSHOOT | NWIDTH | PCROSS | PDUTY | PERIOD | PHASE | PK2PK | POWERSHOOT | PWIDTH | RISE | RMS }

Arguments: AMPLitude is the high value minus the low value or HIGH - LOW.
 AREA is the area between the curve and ground over the entire waveform.
 BURSt is the time from the first MidRef crossing to the last MidRef crossing.
 CARea (cycle area) is the area between the curve and ground over one cycle.
 CMean is the arithmetic mean over one cycle.
 CRMS is the true Root Mean Square voltage over one cycle.
 DELay is the time between the MidRef crossings of two different waveforms.

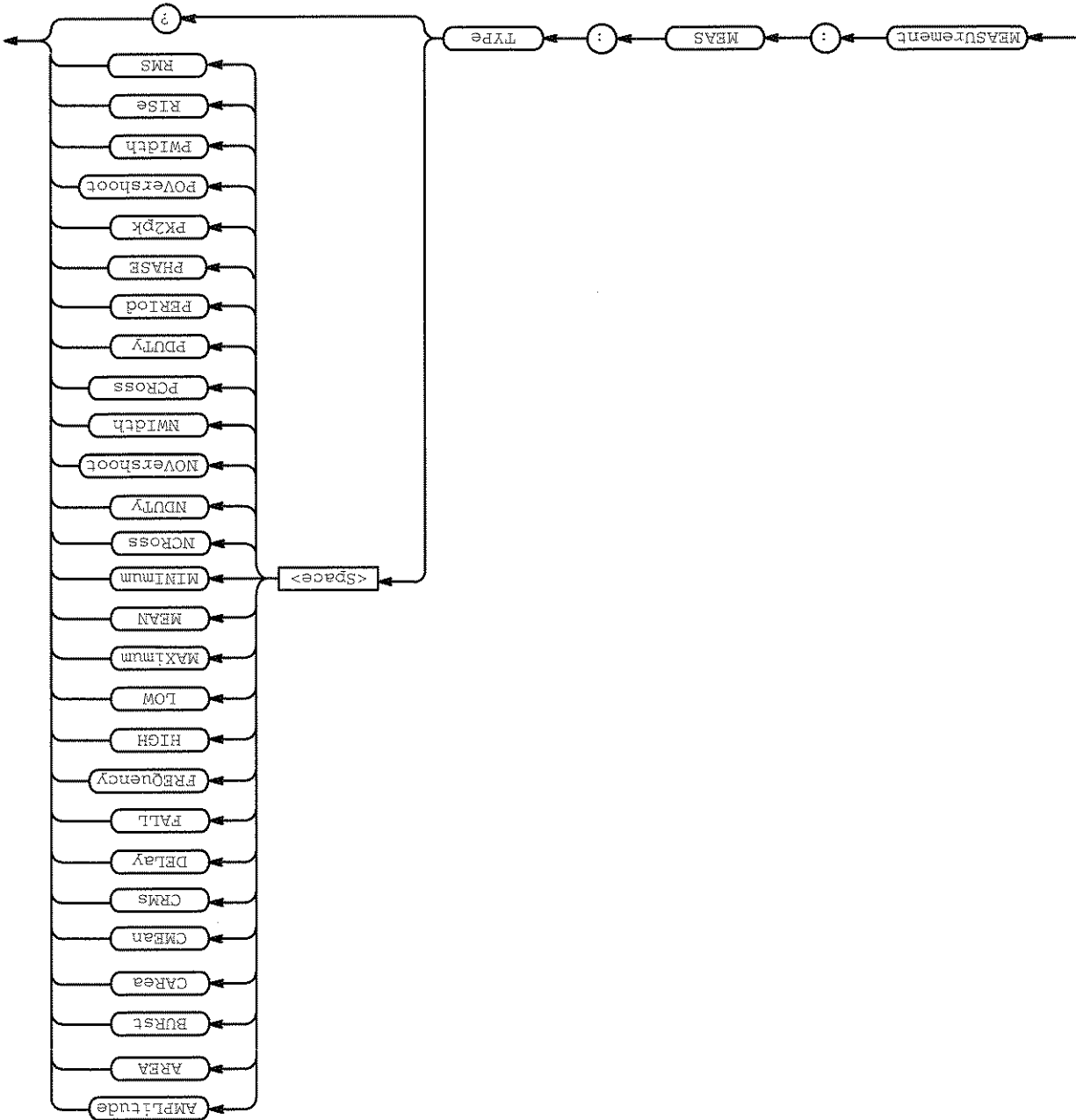

Command Descriptions

FALL is the time that it takes for the falling edge of a pulse to fall from a HighRef value to a LowRef value of its final value.

FREQUENCY is the reciprocal of the period measured in Hertz.

HIGH is the 100% reference level.

LOW is the 0% reference level.

MAXimum is the highest amplitude (voltage).

MEAN is the arithmetic mean over the entire waveform.

MINimum is the lowest amplitude (voltage).

NCRoss is the time from the trigger to the point in the waveform that crosses the midlevel with a negative slope. This time can be less than zero if the instrument has no delay lines (Option 1D).

NDUTY is the ratio of the negative pulse width to the signal period expressed as a percentage.

NOVershoot is the negative overshoot, expressed as:

$$NOVershoot = 100 \times \left(\frac{Amplitude}{Low - Minimum} \right)$$

NWIDth is the distance (time) between MidRef (usually 50%) amplitude points of a negative pulse.

PCross is the time from the trigger to the point in the waveform that crosses the midlevel with a positive slope. This time can be less than zero if the instrument has no delay lines (Option 1D).

PDUTY is the ratio of the positive pulse width to the signal period expressed as a percentage.

PERIOD is the time, in seconds, it takes for one complete signal cycle to happen.

PHASE is the phase difference from the selected waveform to the designated waveform.

PK2pk is the absolute difference between the maximum and minimum amplitude.

POVershoot is the positive overshoot, expressed as:

$$POVershoot = 100 \times \left(\frac{Amplitude}{Maximum - High} \right)$$

PWIDth is the distance (time) between MidRef (usually 50%) amplitude points of a positive pulse.

RISE is the time that it takes for the leading edge of a pulse to rise from a low reference value to a high reference value of its final value.

RMS is the true Root Mean Square voltage.

Returns: <NR3>



Syntax: MEASUREMENT:MEAS<x>:VALUE?

Group: Measurement

This value is a display value and will be updated every 1/3 of a second.

NOTE

Returns the value that has been calculated for the measurement specified by <x>.

MEASUREMENT:MEAS<x>:VALUE? (Query Only)

Examples: MEASUREMENT:MEAS3:UNITS? might return "%", indicating the units for Measurement 3 are percent.

Returns: <String> returns "V" for volts, "s" for seconds, "HZ" for hertz, "V" for volts², "%" for percent, or "dB" for decibels.



Syntax: MEASUREMENT:MEAS<x>:UNITS?

Group: Measurement

Returns the units for the measurement specified by MEASUREMENT:MEAS<x>:TYPE.

MEASUREMENT:MEAS<x>:UNITS? (Query Only)

Examples: MEASUREMENT:MEAS3:TYPE RMS specifies MEAS3 to calculate the Root Mean Square voltage.

MEASUREMENT:METHOD

Sets or queries the method used to calculate the 0% and 100% level. This is equivalent to setting the **High-Low Setup** in the Measure menu.

Group: Measurement

Syntax: MEASUREMENT:METHOD { Histogram | MINMAX }

MEASUREMENT:METHOD?

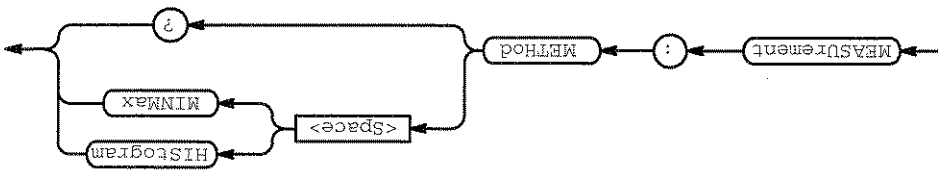

Arguments:

Histogram sets the high and low waveform levels statistically using a histogram algorithm.

MINMAX sets the high and low waveform levels to MAX and MIN, respectively.

Examples:

MEASUREMENT:METHOD HISTOGRAM

specifies that the high and low levels are set statistically.

MEASUREMENT:METHOD?

returns MINMAX when the high and low levels are set to MIN and MAX.

MEASUREMENT:REFLEVEL? (Query Only)

Returns the reference levels.

Group: Measurement

Syntax: MEASUREMENT:REFLEVEL?

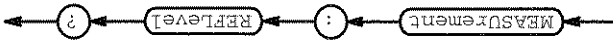

MEASUREMENT:REFLEVEL:ABSOLUTE:HIG

Sets or queries the high reference level, and is the 90% reference level when MEASUREMENT:REFLEVEL:METHOD is set to ABSOLUTE. This command is equivalent to setting the **Reference Levels** in the Measure menu.

Group: Measurement

Syntax: MEASUREMENT:REFLEVEL:ABSOLUTE:HIG <NR3>

MEASUREMENT:REFLEVEL:ABSOLUTE:HIG?

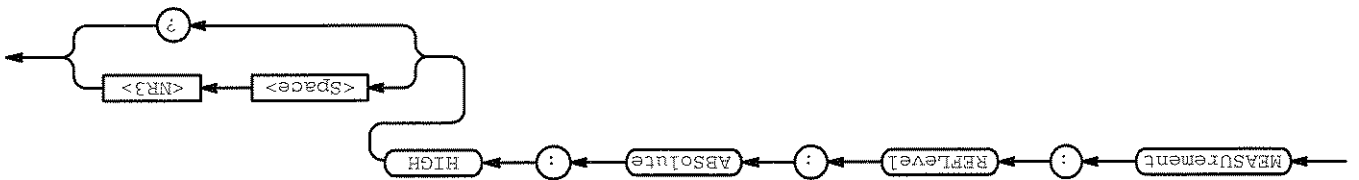

Arguments: <NR3> is the high reference level, in volts. The default is 0.0 V.

Examples: MEASUREMENT:REFLEVEL:ABSOLUTE:HIG 1.71

sets the high reference level to 1.71 V.

MEASUREMENT:REFLEVEL:ABSOLUTE:LOW

Sets or queries the low reference level, and is the 10% reference level when MEASUREMENT:REFLEVEL:METHOD is set to ABSOLUTE. This command is equivalent to setting the **Reference Levels** in the Measure menu.

Group: Measurement

Syntax: MEASUREMENT:REFLEVEL:ABSOLUTE:LOW <NR3>

MEASUREMENT:REFLEVEL:ABSOLUTE:LOW?

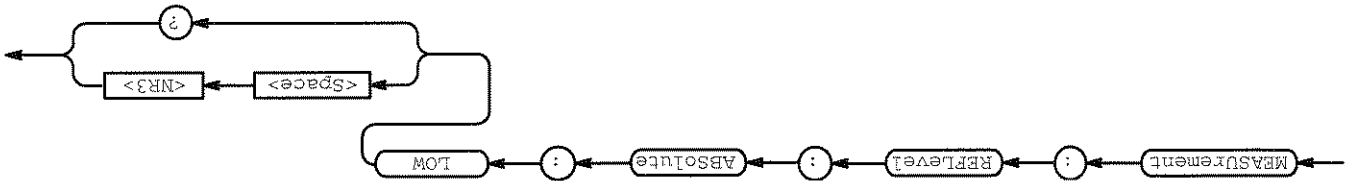

Arguments: <NR3> is the low reference level, in volts. The default is 0.0 V.

Examples: MEASUREMENT:REFLEVEL:ABSOLUTE:LOW?
might return 0.0E+0 as the low reference level.

MEASUREMENT:REFLEVEL:ABSOLUTE:MID

Sets or queries the mid reference level, and is the 50% reference level when MEASUREMENT:REFLEVEL:METHOD is set to ABSOLUTE. This command is equivalent to setting the **Reference Levels** in the Measure menu. The mid reference level is used in the PCROSS and NCROSS arguments and in the "from" waveform when taking a delay measurement.

Group: Measurement

Syntax: MEASUREMENT:REFLEVEL:ABSOLUTE:MID <NR3>

MEASUREMENT:REFLEVEL:ABSOLUTE:MID?

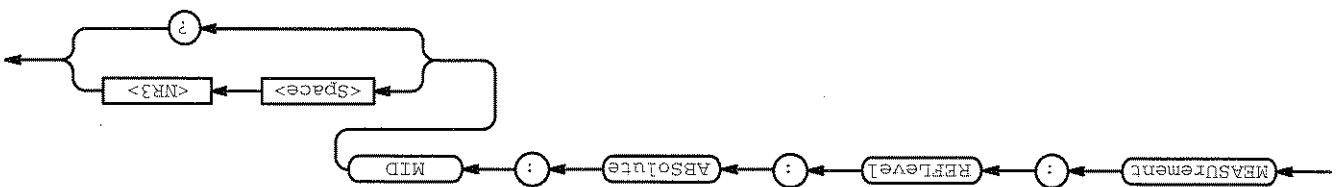

Arguments: <NR3> is the mid reference level, in volts. The default is 0.0 V.

Examples: MEASUREMENT:REFLEVEL:ABSOLUTE:MID .71
sets the mid reference level to .71 volts.

MEASUREMENT:REFLEVEL:ABSOLUTE:MID2

Sets or queries the mid reference level for the "to" waveform when taking a phase or delay measurement, and is the 50% reference level when MEASUREMENT:REFLEVEL:METHOD is set to ABSOLUTE. This command is equivalent to setting the **Reference Levels** in the Measure menu.

Group: Measurement

Syntax: MEASUREMENT:REFLEVEL:ABSOLUTE:MID2 <NR3>

MEASUREMENT:REFLEVEL:ABSOLUTE:MID2?

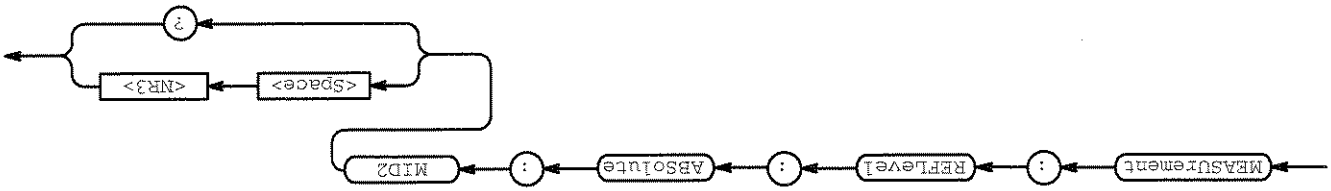

Arguments: <NR3> is the mid reference level, in volts. The default is 0.0 V.

Examples: MEASUREMENT:REFLEVEL:ABSOLUTE:MID2 0.5
sets the mid reference level for the delay waveform to 0.5 volts.

MEASUREMENT:REFLEVEL:METHOD

Specifies which reference levels are used for measurement calculations. This command is equivalent to setting the levels in the Reference Levels side menu.

Group: Measurement

Syntax: MEASUREMENT:REFLEVEL:METHOD { Absolute | Percent }

MEASUREMENT:REFLEVEL:METHOD?

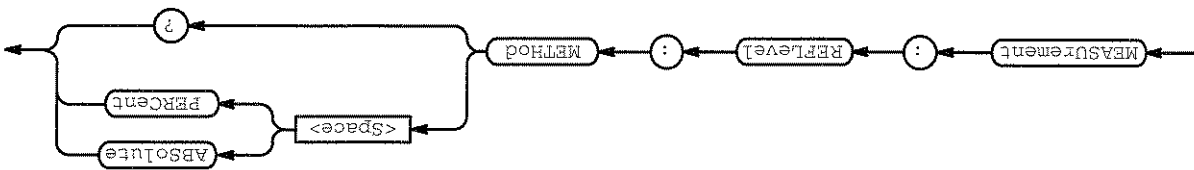

Arguments:

Absolute specifies that the reference levels are set explicitly using the MEASUREMENT:REFLEVEL:ABSOLUTE commands. This method is useful when precise values are required. For instance, when designing to published interface specifications such as RS-232-C.

Percent specifies that the reference levels are calculated as a percent relative to HIGH and LOW. The percentages are defined using the MEASUREMENT:REFLEVEL:PERCENT commands.

Examples:

MEASUREMENT:REFLEVEL:METHOD Absolute
 specifies that explicit user-defined values are used for the reference levels.

MEASUREMENT:REFLEVEL:METHOD?
 returns either Absolute or PERCENT, indicating the reference levels used.

MEASUREMENT:REFLEVEL:PERCENT:HIGH

Sets or queries the percent, relative to HIGH, that is used to calculate the high reference level when MEASUREMENT:REFLEVEL:METHOD is set to PERCENT. This command is equivalent to setting the **Reference Levels** in the Measure menu.

Group: Measurement

Syntax: MEASUREMENT:REFLEVEL:PERCENT:HIGH <NR3>

MEASUREMENT:REFLEVEL:PERCENT:HIGH?

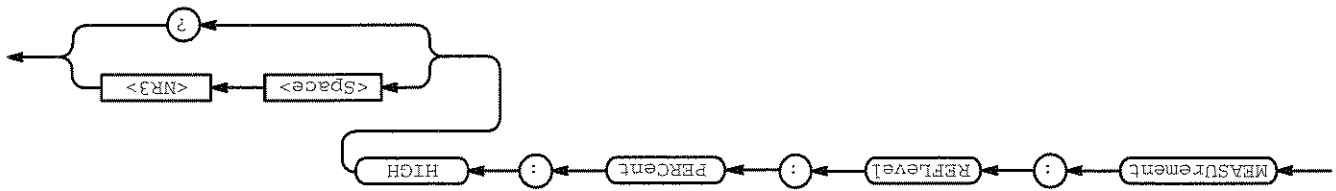

Arguments: <NR3> ranges from 0 to 100 percent, and is the high reference level. The default is 90%.

Examples: MEASUREMENT:REFLEVEL:PERCENT:HIGH 95
 specifies that the high reference level is set to 95% of HIGH.

MEASUREMENT:REFLEVEL:PERCENT:LOW

Sets or queries the percent, relative to LOW, that is used to calculate the low reference level when MEASUREMENT:REFLEVEL:METHD is set to PERCENT. This command is equivalent to setting the **Reference Levels** in the Measure menu.

Group: Measurement

Syntax: MEASUREMENT:REFLEVEL:PERCENT:LOW <NR3>

MEASUREMENT:REFLEVEL:PERCENT:LOW?

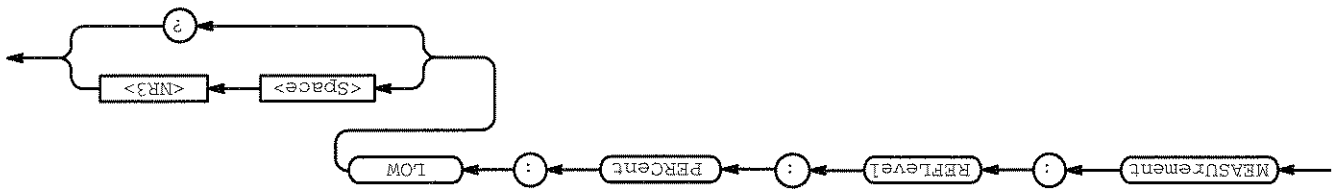

Arguments: <NR3> ranges from 0 to 100 percent and is the low reference level. The default is 10%.

Examples: MEASUREMENT:REFLEVEL:PERCENT:LOW? might return 15, meaning that the low reference level is 15% of LOW.

MEASUREMENT:REFLEVEL:PERCENT:MID

Sets or queries the percent, relative to HIGH, that is used to calculate the midreference level when MEASUREMENT:REFLEVEL:METHOD is set to PERCENT. This command is equivalent to setting the **Reference Levels** in the Measure menu.

Group: Measurement

Syntax: MEASUREMENT:REFLEVEL:PERCENT:MID <NR3>

MEASUREMENT:REFLEVEL:PERCENT:MID?

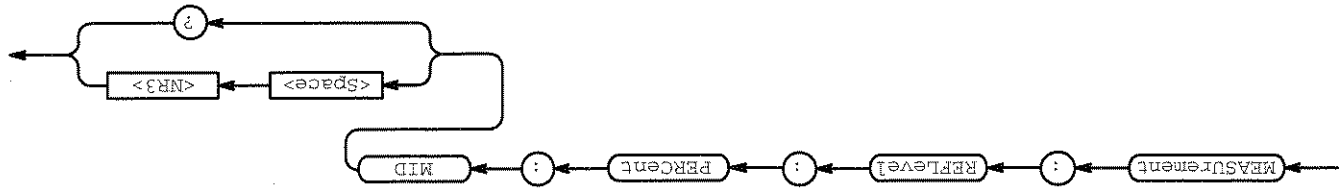

Arguments: <NR3> ranges from 0 to 100 percent and is the midreference level. The default is 50%.

Examples: MEASUREMENT:REFLEVEL:PERCENT:MID 60 specifies that the midreference level is set to 60% of HIGH.

MEASUREMENT:REFLevel:PERCent:MID2

Sets or queries the percentage, relative to HIGH, that is used to calculate the mid reference level for the second waveform specified when taking a delay or phase measurement. This command is equivalent to setting the **Reference Levels** in the Measure menu.

Group: Measurement

Syntax: MEASUREMENT:REFLevel:PERCent:MID2 <NR3>

MEASUREMENT:REFLevel:PERCent:MID2?

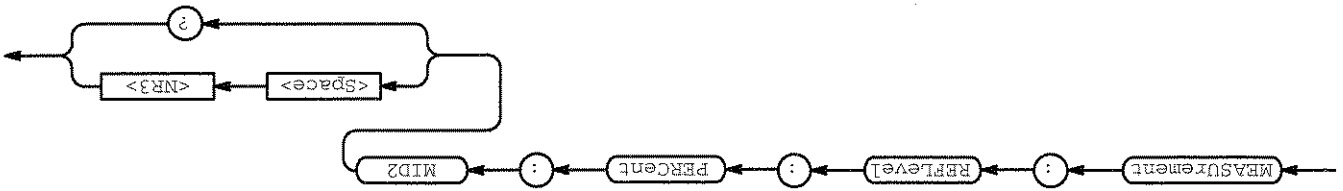

Arguments: <NR3> ranges from 0 to 100 percent, and is the mid reference level. The default is 50%.

Examples: MEASUREMENT:REFLevel:PERCent:MID2 40 specifies that the mid reference level is set to 40% of HIGH.

MEASUREMENT:SNAPShot

Displays the measurement snapshot.

Group: Measurement

Related Commands: MEASUREMENT:CLIPARSnapShot

Syntax: MEASUREMENT:SNAPShot



Examples: MEASUREMENT:SNAPSHOT

MESSAGE

Clears the message window and the MESSAGE? query returns the current message parameters.

Group: Display

Syntax: MESSAGE CLEAR

MESSAGE?

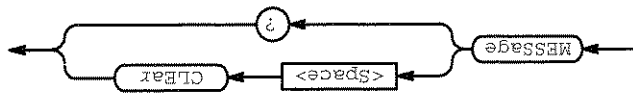

Arguments: CLEAR removes the message from the message window. This is equivalent to sending MESSAGE SHOW " " .

Examples: MESSAGE CLEAR
clears the message from the window.

MESSAGE:BOX

Defines the size and position of the message window. This command does not display the window unless MESSAGE:STATE is ON.

Group: Display

Syntax: MESSAGE:BOX <X1>, <Y1>, <X2>, <Y2>

MESSAGE:BOX?

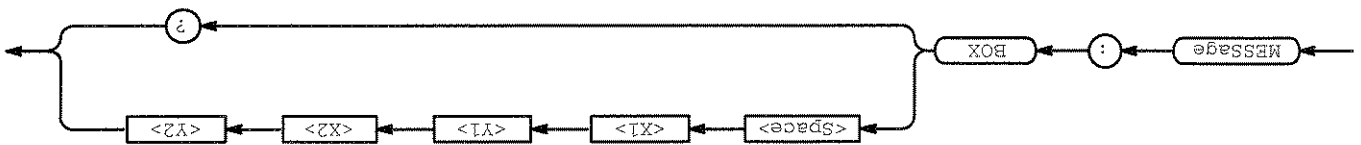

Arguments:

<X1> and <X2> = 0 to 640, and are pixel positions along the horizontal axis. <X1> defines the left side of the window. <X2> defines the right side of the window.

<Y1> and <Y2> = 0 to 480, and are pixel positions along the vertical axis. <Y1> defines the top of the window. <Y2> defines the bottom of the window. The reserved height of all characters is 15 pixels so the height of the window must be at least 15 pixels before any characters can be fully displayed. If the window is smaller, the characters will be clipped. For a complete list of character widths in pixels, see Table A-1 on page A-1.

The origin of the coordinate system is the upper left corner of the screen. The coordinate system, relative to the screen, is shown in Figure 3-1.

Arguments: <QString> is the message and can include any of the characters shown in the TDS Character Chart in Appendix C. The maximum length of the message is 1000 characters. The message is left-justified, and is displayed on a single line starting with the top most line in the window. A line feed character can be embedded in the string to position the message on multiple lines. You can also use white space and tab characters to position the message within a line.

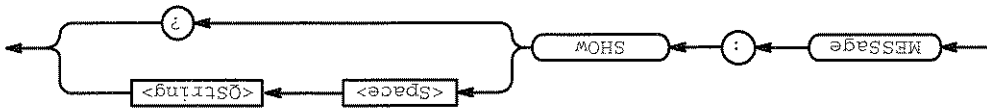

MESSAGE:SHOW?

Syntax: MESSAGE:SHOW <QString>

Group: Display

Clears the contents of the message window and displays the new message in the window.

MESSAGE:SHOW

Figure 2-4: Message Window Coordinates

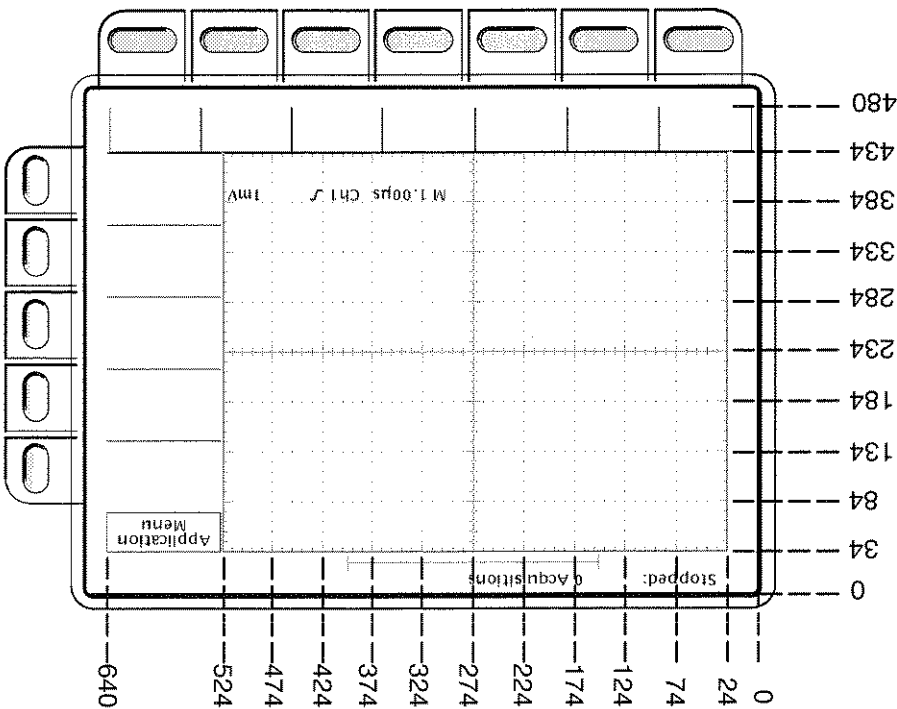

Examples: MESSAGE:SHOW "Hello world" displays "Hello world" in the upper left corner of the box. (You can define the box size with the MESSAGE:BOX command.)

MESSAGE:SHOW "Hello world" displays "Hello world ... hello" in the upper left corner of the box. The world "world" is displayed in inverse video. In this example, ♦ stands for the ESC character. The ESC character may appear differently to you depending on your controller and your GPIB talker-listener program.

The label area is the height and width you have set using the MESSAGE:BOX command. The length of the label that fits in the label area depends on the contents of the label, because the width of characters varies. For a complete list of character widths in pixels, see Table A-1 on page A-1.

If the message exceeds the limits of the window, either horizontally or vertically, the portion of the message that exceeds the limits will not be displayed. Note: the message string itself is not altered. The entire message can be returned as a query response regardless of what is displayed in the window.

The use of any undocumented codes may produce unpredictable results.

NOTE

A tab can be sent by sending a tab character (decimal 9) followed by two numeric characters that specify the pixel column relative to the left margin of the message window.

The ESC character followed by the @ character turns inverse video on and off, and can be embedded in the message string. The first ESC character followed by the @ character displays all the text that follows in inverse video until another ESC character followed by the @ character is found in the string.

NEWPASS (No Query Form)

Changes the password that enables access to password protected data. The PASSWORD command must be successfully executed before using this command or an execution error will be generated.

Group: Miscellaneous

Related Commands: PASSWORD, *PUD

Syntax: NEWPASS <QString>



Arguments: <QString> is the new password. The password can include up to 10 characters.

Examples: NEWPASS "mypassword" creates a new password for accessing the user protected data.

ON or <NR1> ≠ 0 displays the message window and its contents on the screen. The size of the window is defined by MESSAGE:BOX.

Arguments: OFF or <NR1> = 0 removes the message window from the screen.

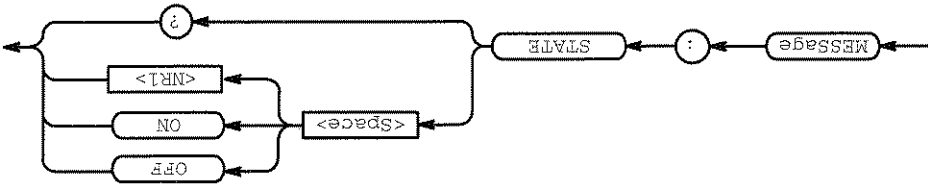

MESSAGE:STATE?

Syntax: MESSAGE:STATE { OFF | ON | <NR1> }

Group: Display

Controls the display of the message window.

MESSAGE:STATE

***OPC**

Command Descriptions

Generates the operation complete message in the Standard Event Status Register (SESR) when all pending operations finish. The *OPC? query places the ASCII character "1" into the output queue when all pending operations are finished. The *OPC? response is not available to read until all pending operations finish. For a complete discussion of the use of these registers and the output queue, see page 3-1.

Group: Status and Error

Related Commands: BUSY?, *WAI

Syntax: *OPC

*OPC?



The *OPC command allows you to synchronize the operation of the digitizing oscilloscope with your application program. Synchronization methods are described starting on page 3-7.

Table 2-26: Commands that Generate an Operation Complete Message

Operation	Command
Automatic scope adjustment	AUTOset EXECute
Internal self-calibration	*CAL
Single sequence acquisition	ACQUIRE:STATE ON or ACQUIRE:STATE RUN (when ACQUIRE:STOPAfter is set to SEQUence)
Hardcopy output	HARDCopy STArT

PASSWord (No Query Form)

Enables the *PUD and NEWpass commands. Sending PASSWord without any arguments disables these same commands. Once the password is successfully entered, the *PUD and NEWpass commands are enabled until the digitizing oscilloscope is powered off, or until the FACTory command, the PASSWord command with no arguments, or the *RST command is issued. The digitizing oscilloscope remembers the password even if you turn it off. When you turn it on again you must use the PASSWord command to prove you know the password. Then you can use the NEWpass and *PUD commands.

Group: Miscellaneous

Related Commands: NEWpass, *PUD

Syntax: PASSWord [<QString>]



Arguments: <QString> is the password and can include up to 10 characters. The factory default password is "XYZZY" and is always valid.

Sets and queries the power-on status flag that controls the automatic power-on handling of the DESER, SRER, and ESER registers. When *PSC is true, the DESER register is set to 255 and the SRER and ESER registers are set to 0 at power-on. When *PSC is false, the current values in the DESER, SRER, and ESER registers are preserved in non-volatile memory when power is shut off and are restored at power-on. For a complete discussion of the use of these registers, see page 3-1.

Group: Status and Error

Related Commands: DESE, *ESE, FACTORY, *RST, *SRE

Syntax: *PSC <NRL>

*PSC?



Arguments:

<NRL> = 0 sets the power-on status clear flag to false, and disables the power-on clear and allows the digitizing oscilloscope to possibly assert SRQ after power-on.

<NRL> ≠ 0 sets the power-on status clear flag true. Sending *PSC 1 therefore enables the power-on status clear and prevents any SRQ assertion after power-on. Using an out-of-range value causes an execution warning.

Examples:

*PSC 0

sets the power-on status clear flag to false.

*PSC?

might return the value 1, showing that the power-on status clear flag is set to true.

*PUD

Sets or queries a string of Protected User Data. This data is protected by the PASSWORD command, and can only be modified by entering the correct password. The password is not necessary to query the data.

Group: Miscellaneous

Related Commands: PASSWORD

Syntax: *PUD <Block>

*PUD?

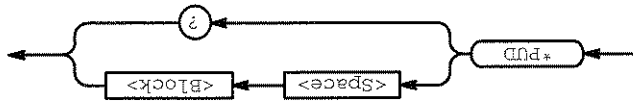

Arguments: <Block> is a string containing up to 100 characters.

Examples: *PUD #229This instrument belongs to me

stores the string "This instrument belongs to me" in the user protected data area.

*PUD?

might return #221Property of Company X.

*RCL (No Query Form)

Restores the state of the digitizing oscilloscope from a copy of its settings stored in memory. (The settings are stored using the *SAV command.) This command is equivalent to RECALL:SETUP, and performs the same function as the **Recall** item in the front-panel Save/Recall Setup menu.

Group: Save and Recall

Related Commands: DELETE:SETUP, FACTORY, *LRN?, RECALL:SETUP, *RST, *SAV, SAVE:SETUP

Syntax: *RCL <NR1>

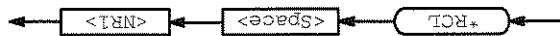

Arguments: <NR1> is a value in the range from 1 to 10, and specifies a setup storage location. Using an out-of-range value causes an execution error (222, "Data out of range").

Examples: *RCL 3
restores the digitizing oscilloscope from a copy of the settings stored in memory location 3.

RECALL:SETUP (No Query Form)

Restores a stored or factory front-panel setup of the digitizing oscilloscope. This command is equivalent to selecting **Recall Saved Setup** or **Recall Factory Setup** in the Save/Recall Setup menu.

Group: Save and Recall

Related Commands: DELETE:SETUP, FACTORY, *RCL, *RST, *SAV, SAVE:SETUP

Syntax: RECALL:SETUP { FACTORY | <NRL> }

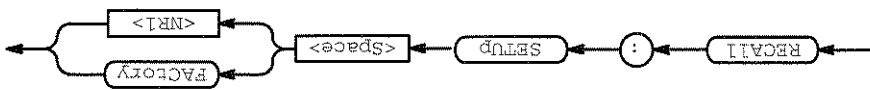

Arguments: FACTORY selects the factory setup.

<NRL> is a value in the range from 1 to 10 and specifies a setup storage location. Using an out-of-range value causes an execution error (222, "Data out of range").

Examples: RECALL:SETUP FACTORY
 recalls the front panel setup to its factory defaults.

REM (No Query Form)

Specifies a comment. This line is ignored by the instrument.

Group: Miscellaneous

Syntax: REM <Qstring>

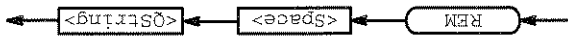

Arguments: <Qstring> is a string that can have a maximum of 80 characters.

Examples: REM "This is a comment"
 is ignored by the instrument.

*RST (No Query Form)

(Reset) Returns the digitizing oscilloscope to a known set of instrument settings, but does not purge any aliases or stored settings.

Group: Status and Error

Related Commands: FACTORY, *PSC, *RCL, RECALL:SETUP, *SAV, SAVE:SETUP

Syntax: *RST



*RST does the following:

- Returns the instrument settings to the factory defaults (see Appendix D).
- The *RST command does not alter the following:

- The state of the RS-232-C or IEEE 488.1 interfaces.
- The selected IEEE Std 488.1-1987 address of the digitizing oscilloscope.
- Calibration data that affect device specifications.
- The Output Queue.
- The Service Request Enable Register setting.
- The Standard Event Status Enable Register setting.
- The Power-on status clear flag setting.
- Alias definitions.
- Stored settings.
- Hardcopy settings.
- The *PUD? response.

RS232? (Query Only)

Queries the RS232 settings.

Group: Miscellaneous

Related Commands: RS232: BAUD, RS232: HARDFlagging, RS232: PARity, RS232: SOFTFlagging, RS232: STOPBits

Syntax: RS232?

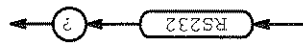

Arguments: None

Examples: RS232? queries for RS232 settings.

It might return:

```
RS232 BAUD: 9600, SOFTFLAGGING: OFF, HARDFLAGGING: ON,  
PARITY: NONE, STOPBITS: 1
```

RS232:BAUD

Sets or queries RS-232-C interface transmission speed.

Group: Miscellaneous

Related Commands: RS232:HARDFlagging, RS232:PARITY, RS232:SOFTFlagging, RS232:STOP-Bits, RS232?

Syntax: RS232:BAUD <NR1>

RS232:BAUD?

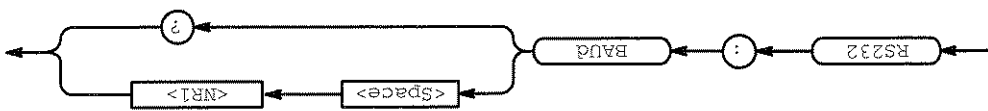

Arguments: <NR1> where <NR1> can be 300, 600, 1200, 4800, 9600 or 19200.

Examples: RS232:BAUD 9600

sets the transmission rate to 9600 baud.

RS232:HARDFlagging

Sets or queries the input and output hard flagging over the RS-232 port. It uses the RFR (Ready For Receive) and CTS (Clear To Send) lines to control data transmission. On output, the instrument transmits data only when CTS is asserted. When CTS is not asserted, the instrument stop transmitting data. On input the digitizing oscilloscope asserts RFR until the receive queue is full. Then it unasserts RFR to stop transmission from an external printer. CTS remains unasserted until the receive queue is not full. Then CTS is asserted again to restart transmission.

Group: Miscellaneous

Related Commands: RS232:BAUD, RS232:PARITY, RS232:SOFTFlagging, RS232:STOPBits, RS232?

Syntax: RS232:HARDFlagging { ON | OFF | <NR1> }
 RS232:HARDFlagging?

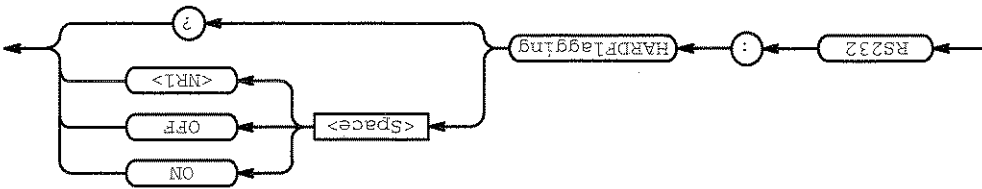

Arguments: ON or <NR1> ≠ 0 turn on hardflagging.
 OFF or <NR1> = 0 turn off hardflagging.

Examples: RS232:HARDFlagging ON
 turns on hard flagging.

RS232:PARity

Sets or queries the parity used for all RS-232-C data transfers. When parity is odd or even, the digitizing oscilloscope generates the selected parity on output and checks all input against the selected parity. When parity is none, the digitizing oscilloscope performs no input parity error checks and generates no output parity.

Group: Miscellaneous

Related Commands: RS232:BAUD, RS232:HARDFlagging, RS232:SOFTFlagging, RS232:STOP-Bits, RS232?

Syntax: RS232:PARity { EVEN | NONE | ODD }
RS232:PARity?

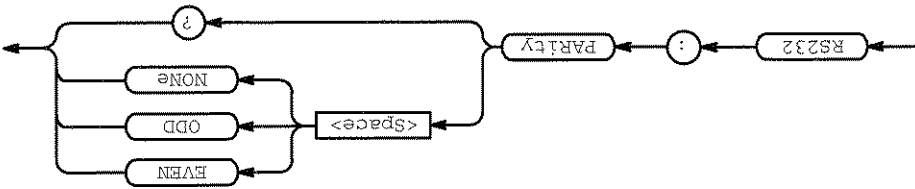

Arguments: EVEN even parity.

ODD odd parity.

NONE no parity.

Examples: RS232:PARity EVEN
sets the parity to be even.

RS232:SOFTFlagging

Sets or queries the input and output soft flagging over the RS-232 port. It stops transmitting data any time it receives an XOFF (DC3) character. It sends an XOFF character when its 512 byte input buffer has 80 free bytes. The digitizing oscilloscope begins transmitting data again when it receives an XON (DC1) character. It sends XON when its input buffer is has 100 free bytes.

Group: Miscellaneous

Related Commands: RS232:BAUD, RS232:HARDFlagging, RS232:PARity, RS232:STOPbits, RS232?

Syntax: RS232:SOFTFlagging { ON | OFF | <NRL> }
RS232:SOFTFlagging?

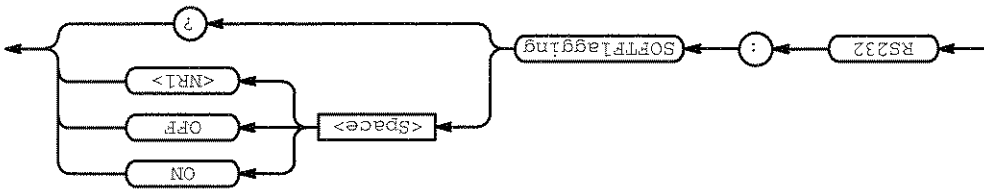

Arguments: ON or <NRL> ≠ 0 turn on softflagging.

OFF or <NRL> = 0 turn off softflagging.

Examples: RS232:SOFTFlagging ON
turns on soft flagging.

RS232:STOPbits

Sets or queries the number of transmission stop bits sent with each character to identify the end of data for that character.

Group: Miscellaneous

Related Commands: RS232:BAUD, RS232:HARDFlagging, RS232:PARity, RS232:SOFTflagging, RS232?

Syntax: RS232:STOPbits <NRL>

RS232:STOPbits?

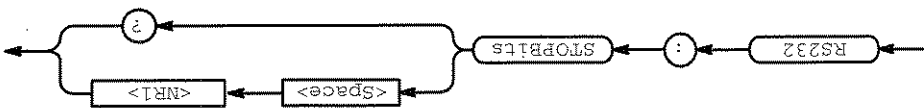

Arguments: <1> use one stop bit.

<2> use two stop bits.

Examples: RS232:STOPbits 1 sets the number of stop bits to 1.

*SAV (No Query Form)

(Save) Stores the state of the digitizing oscilloscope into a specified memory location. You can later use the *RCL command to restore the digitizing oscilloscope to this saved state. This is equivalent to selecting the **Save Current Setup** in the Save/Recall Setup menu.

Group: Save and Recall

Related Commands: DELETE:SETUP, FACTory, *RCL, RECALL:SETUP, SAVE:SETUP

Syntax: *SAV <NRL>

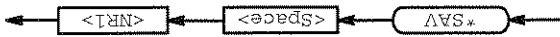

Arguments: <NRL> is a value in the range from 1 to 10 and specifies a location. Using an out-of-range value causes an execution error. Any settings that have been stored previously at this location will be overwritten.

Examples: *SAV 2

saves the current settings in memory location 2.

SAVE:SETUP (No Query Form)

Saves the current front-panel setup into the specified memory location. This is equivalent to selecting the **Save Current Setup** in the Save/Recall Setup menu.

Group: Save and Recall

Related Commands: DELETE:SETUP, RECALL:SETUP, *RCL, *SAV

Syntax: SAVE:SETUP <NR1>

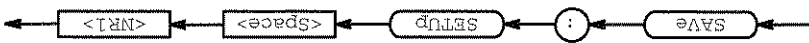

Arguments: <NR1> is a value in the range from 1 to 10 and specifies a location. Using an out-of-range value causes an execution error. Any settings that have been stored previously at this location will be overwritten.

Examples: SAVE:SETUP 5
saves the current front-panel setup in memory location 5.

SAVE:WAVEFORM (No Query Form)

Stores a waveform in one of four reference memory locations. This command is equivalent to selecting the **Save Waveform** item in the Save/Recall Waveform menu.

Group: Save and Recall

Related Commands: DELETE:WAVEFORM

Syntax: SAVE:WAVEFORM <wfm><Comma>REF<x>



Arguments: <wfm> is CH<x>, MATH<x>, or REF<x>, and is the waveform that will be saved.

REF<x> is the location where the waveform will be stored.

Examples: SAVE:WAVEFORM MATH2,REF1
saves the math 2 waveform in reference memory location 2.

SELECT? (Query Only)

Returns the selected waveform and the display status of all waveforms.

Group: Vertical

Syntax: SELECT?

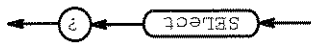

Examples:

```
SELECT?
might return: SELECT:CH1 1;CH2 0;MATH1 0;
              MATH2 0;MATH3 0;REF1 0;REF2 0;REF3 0;REF4 0
```

SELECT:<wfm>

Controls the display and selection of waveforms. There can be up to eleven waveforms displayed at one time but only one waveform can be selected at a time. The selected waveform is the waveform that was most recently turned on. This command is equivalent to pressing a front-panel **CH** or **MORE** button. <wfm> can be CH<x>, MATH<x>, or REF<x>.

Group: Vertical

Syntax: SELECT:<wfm> { OFF | ON | <NR1> }

SELECT:<wfm>?

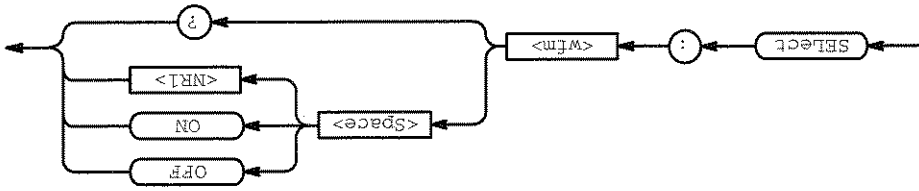

Arguments:

OFF or <NR1> = 0 turns off the display of the specified waveform.
 ON or <NR1> ≠ 0 turns on the display of the specified waveform. The waveform also becomes the selected waveform.

Examples:

```
SELECT:CH2 ON
turns the channel 2 display on and selects channel 2.

SELECT:REF1?
returns either 0 or 1, indicating whether the REF1 waveform is selected.
```

SELECT:CONTROL

Sets or queries the waveform that is currently affected by the cursor and vertical commands.

Group: Vertical

Syntax: SELECT:CONTROL <wfm>

SELECT:CONTROL?

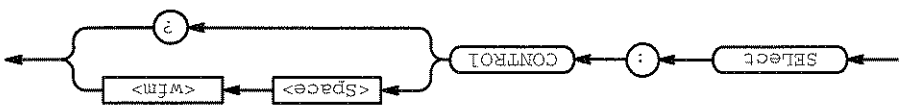

Arguments: <wfm> is CH<x>, MATH<x>, or REF<x>, and is the selected waveform.

Examples: SELECT:CONTROL?
might return CH1 as the selected waveform.

```

10;NUMAVG 16;APPMENU:TITLE "Application Menu";LA-
BEL:BOTTOM1 "";BOTTOM2 "";BOTTOM3 "";BOTTOM4 "";BOT-
TOM5 "";BOTTOM6 "";BOTTOM7 "";RIGHT1 "";RIGHT2 "";
RIGHT3 "";RIGHT4 "";RIGHT5 "";:HEADER 1;:VERBOSE 1;
ALIAS:STATE 0;:DISPLAY:FORMAT Y7;STYLE VECTORS;FILTER
SINK;PERSISTENCE 500.0E-3;GRATICULE FULL;TRIG 1;IN-
TENSITY:OVERALL 85;WAVEFORM 75;TEXT 60;CONTRAST
150;:MESSAGE:SHOW "hello";STATE 1;BOX
74,84,475,135;:LOCK NONE;:HARDCOPY:FORMAT EPSI-
MAGE;PORT GPIB;LAYOUT PORTRAIT;

```

a partial return string may look like this:

Examples: SET?

The SET? query always returns a string with command headers, regardless of the setting of the HEADER command. This is because the returned string is intended to be able to be sent back to the digitizing oscilloscope as a command string. The VERBOSE command can still be used to specify whether the returned headers should be abbreviated or full length.

NOTE

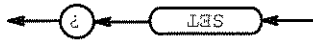

Syntax: SET?

Related Commands: HEADER, *LRN?, VERBOSE

Group: Miscellaneous

Returns a string listing the digitizing oscilloscope's settings, except for configuration information for the calibration values. You can use this string to return the digitizing oscilloscope to the state it was in when you made the SET? query. This command is identical to the *LRN? command.

SET? (Query Only)

***SRE**

(Service Request Enable) sets and queries the bits in the Service Request Enable Register (SRE). For a complete discussion of the use of these registers, see page 3-1.

Group: Status and Error

Related Commands: *CLS, DESE, *ESE, *ESR?, EVENT?, EVMSG?, FACTORY, *PSC, *STB?

Syntax: *SRE <NR1>

*SRE?

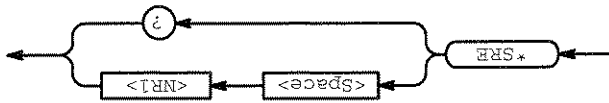

Arguments:

<NR1> is a value in the range from 0 to 255. The binary bits of the SRE are set according to this value. Using an out-of-range value causes an execution error. The power-on default for SRE is 0 if *PSC is 1. If *PSC is 0, the SRE maintains its value through a power cycle.

Examples:

*SRE 48

sets the bits in the SRE to 00110000 binary.

*SRE?

might return a value of 32, showing that the bits in the SRE have the binary value 00100000.

TEKSecure

Initializes both waveform and setup memories. This overwrites any previously stored data. It writes 0's in all waveform reference memory regardless of selected record length and puts all setups in the factory init state. It then verifies that the waveform and setup memory are in the desired state. It displays a pass or a fail notifier on completion.

Group: Miscellaneous

Syntax: TEKSecure

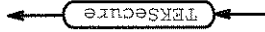

*STB? (Query Only)

The *STB? (Read Status Byte) query returns the contents of the Status Byte Register (SBR) using the Master Summary Status (MSS) bit. For a complete discussion of the use of these registers, see page 3-1.

Group: Status and Error

Related Commands: *CLS, DESE, *ESE, *ESR?, EVENT?, EVMSG?, FACTORY, *SRE

Syntax: *STB?

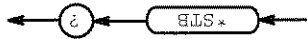

Returns: <NR1>

Examples: *STB? might return the value 96, showing that the SBR contains the binary value 01100000.

TIME

Command Descriptions

Sets or queries the time that the digitizing oscilloscope can display.

Group: Miscellaneous

Related Commands: DATE, DISPLAY: CLOCK

Syntax: TIME <QString>

TIME?

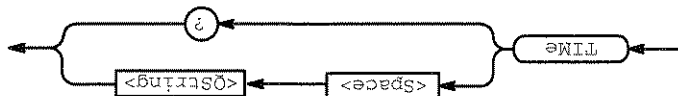

Arguments:

<QString> is a date in the form "hh:mm:ss".

hh refers to the hour number from 1 to 24.

mm refers to the minute number in the hour from 0 to 59.

ss refers to the seconds number in the minute from 0 to 59.

There must be a colon after the hh and after the mm.

Examples:

TIME "01:24:00"

specifies that the time is set to 01:24 AM.

Sets the trigger level and returns the current trigger parameters.

Group: Trigger

Syntax: TRIGGER SETTLEVEL

TRIGGER?



Arguments: SETTLEVEL sets the main trigger level to halfway between the MIN and MAX amplitudes of the trigger source input. This is equivalent to pressing the front-panel **SET LEVEL TO 50%** button.

Examples:

TRIGGER SETTLEVEL

sets the trigger level midway between MAX and MIN.

TRIGGER?

might return : TRIGGER:MAIN:MODE AUTO;LEVEL 0.0E+0;HOLD-OFF:VALUE 15.0000E-6;:TRIGGER:MAIN:EDGE:SOURCE EXTERNAL; SLOPE RISE;INTRATE 500.000E+3

TRIGGER:HOLDoff:ACTUAL (Query Only)

Queries the actual trigger holdoff—the minimum time between triggers. The minimum possible trigger holdoff is 15 μ s, but it is also affected by certain time base settings. If the time per division is large (for main or delayed time base), the record length is long, the time base position is large (for main or delayed time base), or the deskew setting is large, the actual trigger holdoff may need to be longer than the requested holdoff to accommodate these settings.

Group: Trigger

Syntax: TRIGGER:HOLDoff:ACTUAL?

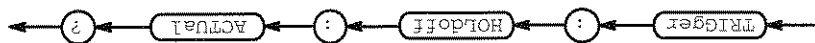

Examples:

TRIGGER:HOLDoff:ACTUAL?

might return 15.0000E-6, indicating that the actual trigger holdoff is 15 μ s.

TRIGGER:HOLDoff:VALUE

Sets or queries the requested trigger holdoff—the minimum time between triggerers. The minimum possible trigger holdoff is 15 μ s. You can use trigger holdoff to ignore some signals that would otherwise cause the instrument to trigger. This is equivalent to setting **Holdoff** in the Mode & Holdoff side menu.

Group: Trigger

Syntax: TRIGGER:HOLDoff:VALUE <NR3>

TRIGGER:HOLDoff:VALUE?

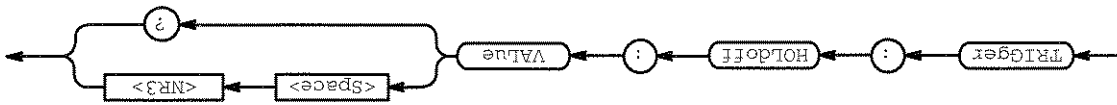

Arguments:

<NR3> sets the requested trigger holdoff in fractions of seconds. The minimum possible trigger holdoff is 15 μ s. The maximum is 2 s. Trigger holdoff is also affected by certain time base settings. If the time per division is large (for main or delayed time base), the record length is long, the time base position is large (for main or delayed time base), or the deskew setting is large, the actual trigger holdoff may need to be longer than the requested holdoff to accommodate these settings.

Examples:

TRIGGER:HOLDoff:VALUE 40E-6

sets the requested holdoff value to 40 μ s.

TRIGGER:HOLDoff:VALUE?

might return 40.0000E-6, indicating that the requested trigger holdoff is 40 μ s.

TRIGGER:INTRATE

Sets or queries the internal clock rate, which can be used as a trigger source. This command is equivalent to setting **Internal Clock** on the Source side menu of the Trigger menu.

Group: Trigger

Syntax: TRIGGER:INTRATE <NR3>

TRIGGER:INTRATE?

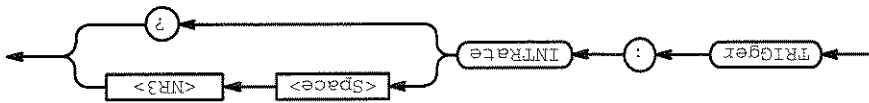

Arguments:

<NR3> sets the internal clock rate. The minimum possible value is 10 Hz. The maximum possible value is 500 kHz. The internal clock rate can be set to any value in a 1,2,5 sequence.

Examples:

TRIGGER:INTRATE 500.000E+3
sets the internal clock rate to 500 kHz.

TRIGGER:INTRATE?
might return 200.000E+3, indicating that the internal clock rate is 200 kHz.

TRIGGER:LEVEL

Sets the trigger level. This command is equivalent to adjusting the front-panel TRIGGER LEVEL knob.

Group: Trigger

Syntax: TRIGGER:LEVEL <NR3>

TRIGGER:LEVEL?

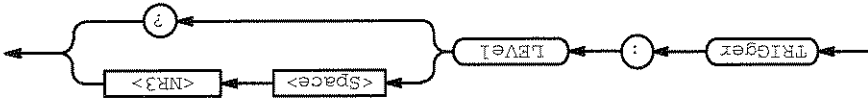

Arguments:

<NR3> is the trigger level in volts.

Examples:

TRIGGER:LEVEL?
might return 0.0, indicating that the trigger is set to 0 V.

TRIGGER:MAIN

Sets the trigger level to halfway between the MIN and MAX amplitudes of the trigger source input and returns the current trigger parameters. This command is identical to the TRIGGER and is included for compatibility.

Syntax: TRIGGER:MAIN SETLevel

TRIGGER:MAIN?

TRIGGER:MAIN:EDGE? (Query Only)

Returns the trigger source, slope, and intrate for the trigger. This query is identical to TRIGGER? and is included for compatibility.

Syntax: TRIGGER:MAIN:EDGE?

TRIGGER:MAIN:EDGE:SLOPE

Selects a rising or falling slope for the trigger. This command is identical to TRIGGER:SLOPE and is included for compatibility.

Syntax: TRIGGER:MAIN:EDGE:SLOPE { FALL | RISE }

TRIGGER:MAIN:EDGE:SOURCE

Sets or queries the source for the trigger. This command is identical to TRIGGER:SOURCE and is included for compatibility.

Syntax: TRIGGER:MAIN:EDGE:SOURCE { CH<x> | EXTERNAL | INTLOCK }

TRIGGER:MAIN:EDGE:SOURCE?

TRIGGER:MAIN:HOLDOFF? (Query Only)

Returns the actual and requested trigger holdoff values. This command is identical to TRIGGER:HOLDOFF:ACTUAL? and TRIGGER:HOLDOFF:VALUE? and is included for compatibility.

Syntax: TRIGGER:MAIN:HOLDOFF?

TRIGGER:MAIN:HOLDoff:VALUE

Sets or queries the requested trigger holdoff value. This command is identical to TRIGGER:HOLDoff:VALUE and is included for compatibility.

Syntax:
 TRIGGER:MAIN:HOLDoff:VALUE <NR1>
 TRIGGER:MAIN:HOLDoff:VALUE?

TRIGGER:MAIN:LEVEL

Sets the main trigger level. This command is equivalent to TRIGGER:LEVEL and is included for compatibility.

Syntax:
 TRIGGER:MAIN:LEVEL { <NR3> }
 TRIGGER:MAIN:LEVEL?

TRIGGER:MAIN:MODE

Sets or queries the trigger mode. This command is equivalent to TRIGGER:MODE and is included for compatibility.

Syntax:
 TRIGGER:MAIN:MODE { AUTO | NORMAL }
 TRIGGER:MAIN:MODE?

TRIGGER:MAXSampleRate (Query Only)

Queries the maximum sample rate—the fastest rate at which points can be sampled and placed in the waveform record. If the trigger source is external or either channel, the maximum sample rate is the inverse of the actual trigger holdoff. If the trigger source is the internal clock, the maximum sample rate is either the internal clock rate or the inverse of the actual trigger holdoff, whichever is slower.

Group: Trigger

Syntax: TRIGGER:MAXSampleRate?



Examples: TRIGGER:MAXSampleRate?
 might return 75.000E+3, indicating that the maximum sample rate is 75 KHZ.

TRIGGER:SLOPE

Selects a rising or falling slope for the trigger. This is equivalent to setting **Slope** in the Trigger menu.

Group: Trigger

Syntax: TRIGGER:SLOPE { FALL | RISE }

TRIGGER:SLOPE?

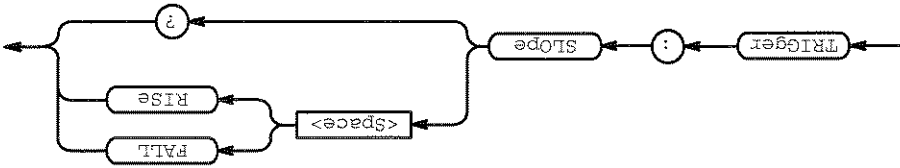

Arguments: FALL specifies to trigger on the falling or negative edge of a signal. RISE specifies to trigger on the rising or positive edge of a signal.

Examples: TRIGGER:SLOPE RISE

sets the main edge trigger to occur on the rising slope.

TRIGGER:MODE

Sets or queries the trigger mode. This command is equivalent to selecting **Mode** in the Trigger menu.

Group: Trigger

Syntax: TRIGGER:MODE { AUTO | NORMAL }

TRIGGER:MODE?

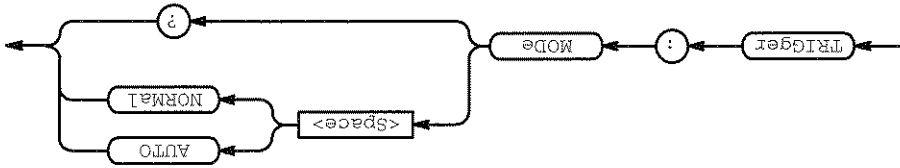

Arguments: AUTO forces acquisition of a record if a trigger is not detected within 50 ms. NORMAL waits for valid trigger events.

Examples: TRIGGER:MODE AUTO

specifies that a waveform record is automatically acquired.

TRIGGER:SOURCE

Sets or queries the source for the trigger. This is equivalent to setting **Source** in the Trigger menu.

NOTE

If you have an instrument without delay lines (Option 1D), you cannot set the trigger source to be either of the two channels. Doing so causes a parameter error.

Group: Trigger

Syntax: TRIGGER:SOURCE { CH<x> | EXTERNAL | INTLOCK }
 TRIGGER:SOURCE?

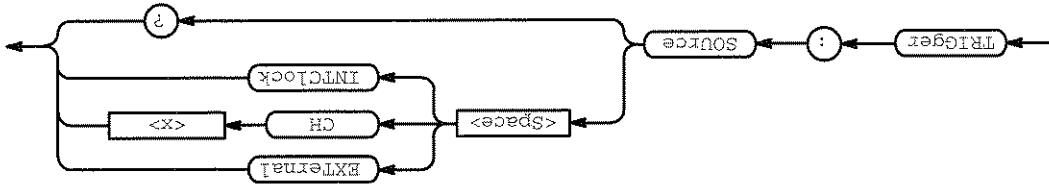

Arguments: EXTERNAL specifies an external trigger using the Auxiliary Trigger Input connector that is located on the rear panel of the instrument. CH<x> specifies one of the input channels. INTLOCK specifies the internal clock. Its rate can be specified using the TRIGGER:INTRate command.

Examples: TRIGGER:SOURCE INTLOCK
 specifies the internal clock as the trigger source.

TRIGGER:SOURCE?
 might return CH2, indicating that the signal acquired using channel 2 is the trigger source.

TRIGGER:STATE? (Query Only)

Returns the current state of the triggering system. This is equivalent to viewing which LEDs are lighted on the front panel.

Group: Trigger

Syntax: TRIGGER:STATE?



Returns: READY indicates that the instrument is ready to accept a trigger. TRIGGER indicates that the instrument is seeing triggers and is acquiring the waveform record. SAVE indicates that the instrument is in save mode and is not acquiring data. AUTO indicates that the instrument is in auto mode and acquires data even in the absence of a trigger. TRIGGER:STATE? might return READY, indicating that the instrument is ready to accept a trigger.

Examples:

TRIGGER:STATE?

TRIGGER:STATE? might return READY, indicating that the instrument is ready to accept a trigger.

*TRG (No Query Form)

(Trigger) Executes commands that are defined by *DTI.

The Group Execute Trigger (GET) interface message has the same effect as the *TRG command.

Group: Miscellaneous

Related Commands: Alias commands, *DDT

Syntax: *TRG

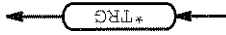

Examples:

*TRG

Immediately executes all commands that have been defined by *DTI.

***TST? (Query Only)**

(Self-Test) Tests the GPIB interface and returns a 0.

Group: Miscellaneous

Syntax: *TST?

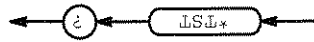

Returns: <NR1> and is always 0.

UNLOCK (No Query Form)

Unlocks the front panel. This command is equivalent to LOCK NONE.

NOTE

If the digitizing oscilloscope is in the Remote With Lockout State (RWLS), the UNLOCK command has no effect. For more information see the ANSI IEEE Std. 488.1-1987 Standard Digital Interface for Programmable Instrumentation, section 2.8.3 on RL State Description.

Group: Miscellaneous

Related Commands: LOCK

Syntax: UNLOCK ALL

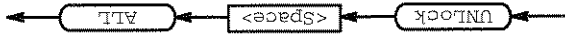

Arguments: ALL specifies all front-panel buttons and knobs.

VERBOSE

Sets and queries the Verbose State that controls the length of keywords on query responses. Keywords can be both headers and arguments. This command does not affect IEEE Std 488.2-1987 Common Commands (those starting with an asterisk).

Group: Miscellaneous

Related Commands: HEADER, *LRN?, SET?

Syntax: VERBOSE { OFF | ON | <NR1> }

VERBOSE?

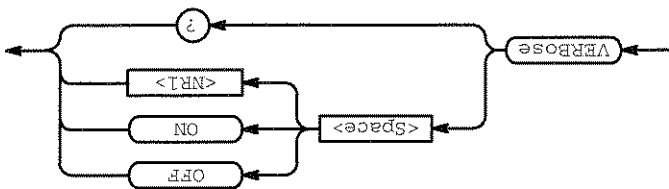

Arguments: ON or <NR1> ≠ 0 sets the Verbose State true, which returns full-length keywords for applicable setting queries.

OFF or <NR1> = 0 sets the Verbose State false, which returns minimum-length keywords for applicable setting queries.

Examples: VERBOSE ON

sets the Verbose State true.

VERBOSE?

might return the value 1, showing that the Verbose State is true.

*WAI (No Query Form)

(Wait) Prevents the digitizing oscilloscope from executing further commands or queries until all pending operations finish. This command allows you to synchronize the operation of the digitizing oscilloscope with your application program. Synchronization methods are described on page 3-7.

Group: Status and Error

Related Commands: BUSY?, *OPC

Syntax: *WAI



```

BYT_Nr <NR1> ; BIT_Nr <NR1> ; ENCDg { ASC | BIN } ;
BN_Fmt { RI | RP } ; BYT_Or { LSB | MSB } ;
<Wfm> : WfID <Qstring> ; NR_PT <NR1> ; XUNt <Qstring> ;
XINcr <NR3> ; PT_Off <NR1> ; YUNt <Qstring> ; YMUt <NR3> ;
YOFF <NR3> ; YZErO <NR3> [ ; <Wfm> : WfID <Qstring> ;
NR_PT <NR1> ; XUNt <Qstring> ; XINcr <NR3> ;
XZErO <NR3> ; PT_Off <NR1> ; YUNt <Qstring> ; YMUt <NR3> ;
YOFF <NR3> ; YZErO <NR3> ... ]
    
```

Returns: The format of the response is:



Syntax: WFMPRe?

Related Commands: WAFVrm?

Group: Waveform

Returns the waveform formatting data for the waveform specified by the DATA:SOURCE command. All channel and math waveforms must be displayed.

WFMPRe? (Query Only)



Syntax: WAFVrm?

Related Commands: CURVe?, DATA:SOURCE, WFMPRe?

Group: Waveform

Returns WFMPRe? and CURVe? data for the waveform specified by the DATA:SOURCE command. This command is equivalent to sending WFMPRe?; CURVe?.

WAFVrm? (Query Only)

WFMPre:BIT_Nr

Returns the number of bits per binary waveform point for the waveform specified by the DATA:SOURCE command. The WFMPre:BIT_Nr command is ignored on input.

Group: Waveform

Related Commands: DATA:WIDTH, WFMPre:BYT_Nr

Syntax: WFMPre:BIT_Nr <NR1>

WFMPre:BIT_Nr?

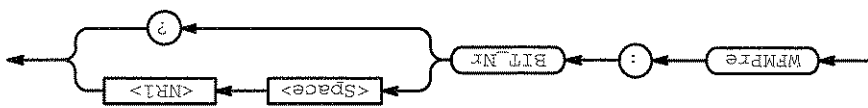

Arguments: <NR1> is either 8 or 16, and is equivalent to WFMPre:BYT_Nr * 8.

Examples: WFMPre:BIT_Nr? might return 8, indicating that there are 8 bits per waveform point.

WFMPre:BN_Fmt

Sets or queries the format of binary data for the waveform specified by the DATA:SOURCE command.

Group: Waveform

Related Commands: DATA:ENCdg, WFMPre:BYT_Or, WFMPre:ENCdg

Syntax: WFMPre:BN_Fmt { RI | RP }
WFMPre:BN_Fmt?

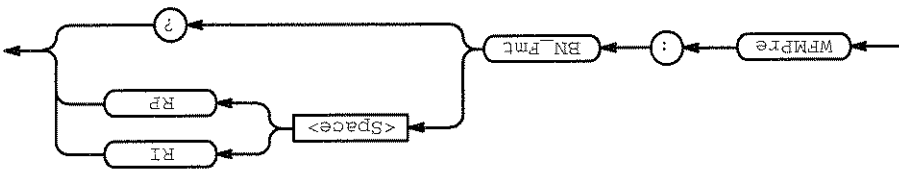

Arguments: RI specifies signed integer data-point representation.

RP specifies positive integer data-point representation.

Examples:

WFMPre:BN_Fmt RP

specifies that the binary waveform data are positive integer data-points.

WFMPre:BN_Fmt?

returns either RI or RP as the current waveform data format.

WFMPre:BYT_Nr

Sets or queries the binary field data width for the waveform specified by the DATA:SOURCE command. This command is equivalent to the DATA:WIDTH command.

Group: Waveform

Related Commands: DATA:WIDTH, WFMPre:BIT_Nr

Syntax: WFMPre:BYT_Nr <NR1>

WFMPre:BYT_Nr?

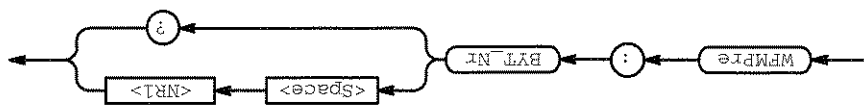

Arguments: <NR1> is the number of bytes per point and can be 1 or 2.

Examples: WFMPre:BYT_Nr 2
specifies that there are 2 bytes per waveform data point.

WFMPre:BYT_OR

Selects which byte of binary waveform data is transmitted first during a waveform data transfer when DATA:WIDTH (or WFMPre:BYT_NR) is set to 2.

Group: Waveform

Related Commands: DATA:ENCdg, WFMPre:BN_Fmt, WFMPre:ENCdg

Syntax: WFMPre:BYT_OR { LSB | MSB }

WFMPre:BYT_OR?

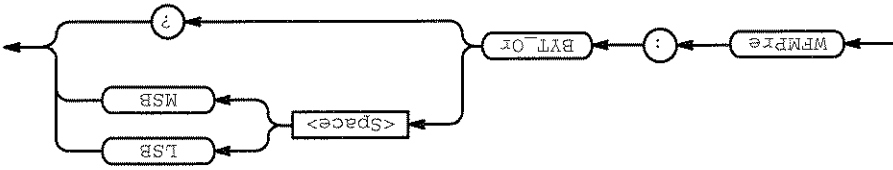

Arguments: LSB selects the least significant byte to be transmitted first.

MSB selects the most significant byte to be transmitted first.

Examples:

WFMPre:BYT_OR MSB

specifies that the most significant byte in the waveform data will be transferred first.

WFMPre:BYT_OR?

returns either MSB or LSB depending on which data byte is transferred first.

WFMPre:ENCdg

Sets or queries the type of encoding for waveform data transferred with the CURVE command.

Group: Waveform

Related Commands: DATA:ENCdg, WFMPre:BYT_Or, WFMPre:BN_Fmt

Syntax: WFMPre:ENCdg (ASC | BIN)

WFMPre:ENCdg?

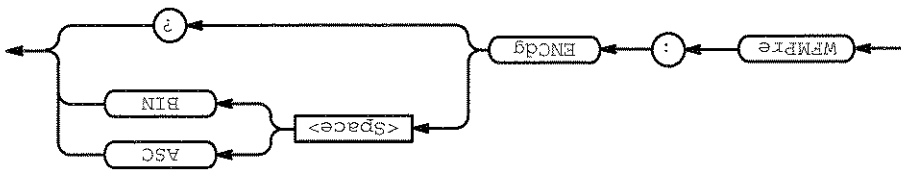

Arguments: ASC specifies ASCII curve data.

BIN specifies binary curve data.

Examples: WFMPre:ENCdg ASC specifies that the waveform data is in ASCII format.

WFMPre:ENCdg?

might return BIN, indicating that the waveform data is in binary format.

WFMPRE:PT_Fmt (No Query Form)

Selects the point format of the waveform data for the waveform specified by the DATA:SOURCE command.

Group: Waveform

Syntax: WFMPRE:PT_Fmt { ENV | Y }

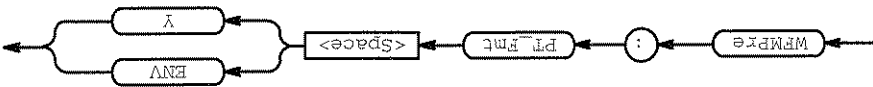

Arguments:

ENV specifies that the waveform is transmitted as maximum and minimum point pairs. Only y values are explicitly transmitted. Absolute coordinates are given by:

$$X_n = 0 + XINcr (n - PT_Off)$$

$$Y^{nmax} = YZERO + YMULT (Y^{nmax} - YOFF)$$

$$Y^{nmin} = YZERO + YMULT (Y^{nmin} - YOFF)$$

Y specifies a normal waveform where one ASCII or binary data point is transmitted for each point in the waveform record. Only y values are explicitly transmitted. Absolute coordinates are given by:

$$X_n = 0 + XINcr (n - PT_Off)$$

$$Y_n = YZERO + YMULT (Y_n - YOFF)$$

Examples:

WFMPRE:PT ENV

sets the waveform data point format to enveloped.

WFMPRE:XINcr (No Query Form)

Specifies the horizontal sampling interval for the reference waveform specified by the DATA:DESTINATION command.

Group: Waveform

Syntax: WFMPRE:XINcr <NR3>

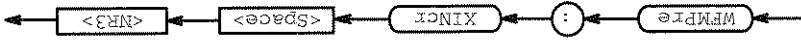

Arguments: <NR3> is the sampling interval, in seconds per point.

WFMPre:XZERO (No Query Form)

Sets the time base position of the waveform data for the reference waveform specified by the DATA:DESTINATION command.

Group: Waveform

Syntax: WFMPre:XZERO <NR3>



Arguments: <NR3> specifies the time base position in seconds.

Examples: WFMPre:XZERO -1.500E-9
sets the time base position to -1.5 ns.

WFMPre:YMULT (No Query Form)

Specifies the vertical scale factor for the reference waveform specified by the DATA:DESTINATION command.

Group: Waveform

Syntax: WFMPre:YMULT <NR3>



Arguments: <NR3> is the vertical scale factor, in YUNits (usually volts) per division.

WFMPre:YOFF (No Query Form)

Specifies the offset of the vertical component for the reference waveform specified by the DATA:DESTINATION command.

Group: Waveform

Syntax: WFMPre:YOFF <NR3>



Arguments: <NR3> is the vertical offset in digitizing levels.

Command	Argument	Description
WFMPre:CRVchk	{CHKSM0 NONE}	Binary curve error check
WFMPre:NR_PT	<NR1>	Number of waveform points
WFMPre:PT_OFF	<NR1>	Trigger point
WFMPre:WfId	<QString>	Waveform identifier
WFMPre:XUNIt	<QString>	Horizontal units
WFMPre:XMULt	<NR3>	Horizontal (X-axis) scale factor
WFMPre:XOFF	<NR3>	Horizontal (X-axis) offset
WFMPre:YUNIt	<QString>	Vertical units
WFMPre:ZMULt	<NR3>	Z-axis scale factor
WFMPre:ZOFF	<NR3>	Z-axis offset
WFMPre:ZUNIt	<QString>	Z-axis units
WFMPre:ZZERO	<NR3>	Z-axis origin offset

Table 2-27: Additional WFMPre Commands

These commands do not support a query form and all information is ignored.

NOTE

Table 2-27 lists additional WFMPre commands that are included for compatibility purposes.

Arguments: <NR3> is of the offset, in YUNIts (usually volts).

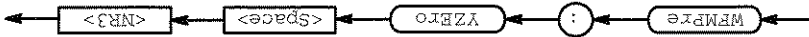

Syntax: WFMPre:YZERO <NR3>

Group: Waveform

Specifies the offset voltage for the reference waveform specified by the DATA:DESTINATION command.

WFMPre:YZERO (No Query Form)

WFMPRE:<wfm? (Query Only)

When returning WFMPRE:<wfm> information from the oscilloscope, <wfm> specifies the waveform source (CH<x>, MATH<x>, or REF<x>). The source must also be set using the Data:Source command. When sending WFMPRE:<wfm> information to the scope, the <wfm> specification is ignored and the reference location specified by Data:Destination is used instead.

Returns the waveform formatting data for the waveform specified by the Data:Source command. Channel and math waveforms must be displayed before they can be queried. Querying an invalid reference waveform generates an execution error.

Group: Waveform

Syntax: WFMPRE:<wfm?>

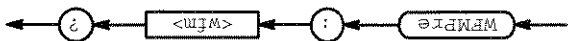

Returns: The format of the response is:

```
<wfm>:WFID<Qstring>;NR_PT<NR1>;XUNIt<Qstring>;
XINCr<NR3>;PT_OFF<NR1>;YUNIt<Qstring>;YMUlt<NR3>;
YOFF<NR3>;YZErO<NR3>[;<wfm>:WFID<Qstring>;
NR_PT<NR1>;XUNIt<Qstring>;XINCr<NR3>;
XZErO<NR3>;PT_OFF<NR1>;YUNIt<Qstring>;
YMUlt<NR3>;YOFF<NR3>;YZErO<NR3>...]
```

NOTE

WFMPRe:<wfm>:NR_Pt

Sets or queries the number of points that are in the transmitted waveform record for the waveform specified by the DATA:SOURCE command. This value is ignored on input.

Related Commands: DATA:DESTINATION

Group: Waveform

Syntax: WFMPRe:<wfm>:NR_Pt <NR1>

WFMPRe:<wfm>:NR_Pt?

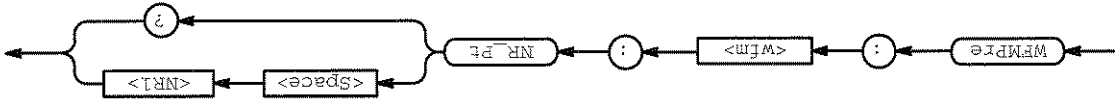

Arguments: <NR1> is the number of data points. If DATA:WIDTH is 2 then there are twice as many bytes.

<NR1> = 0 means that the waveform record is of an unspecified length.

Examples:

WFMPRe:CH1:NR_Pt?

might return 5000 as the number of data points in the waveform record transferred from channel 1.

WFMPRE:<wfm>:PT_Fmt

Selects the point format of the waveform specified by the DATA:SOURCE command. On input <wfm> always defaults to the reference location specified by DATA:DESTINATION regardless of what is sent.

Group: Waveform

Related Commands: DATA:DESTINATION

Syntax: WFMPRE:<wfm>:PT_Fmt { ENV | Y }

WFMPRE:<wfm>:PT_Fmt?

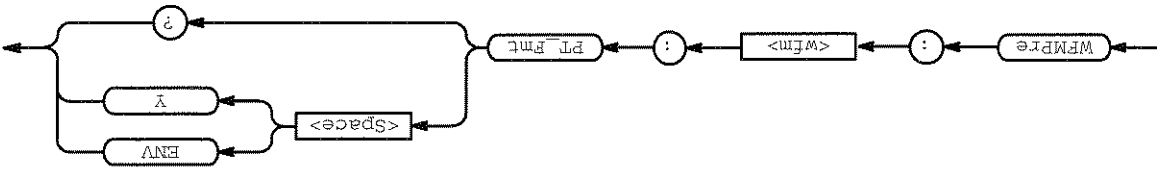

Arguments:

ENV specifies that the waveform is transmitted as maximum and minimum point pairs. Only y values are explicitly transmitted. Absolute coordinates are given by:

$$X_n = 0 + XINcr (n - PT_Off)$$

$$Y_n^{max} = YZERO + YMULT (V_n^{max} - YOFF)$$

$$Y_n^{min} = YZERO + YMULT (V_n^{min} - YOFF)$$

x specifies a normal waveform where one ASCII or binary data point is transmitted for each point in the waveform record. Only y values are explicitly transmitted. Absolute coordinates are given by:

$$X_n = 0 + XINcr (n - PT_Off)$$

$$Y_n = YZERO + YMULT (V_n - YOFF)$$

Examples:

WFMPRE:MATH1:PT_Fmt?

might return ENV, indicating that the MATH1 waveform data format is enveloped.

WFMPre:<wfm>:WfId

Returns information about the waveform specified by the DATA:SOURCE command, such as volts per division, time per division, time base position, acquisition mode, and record length.

The WFMPre:<wfm>:WfId command is ignored on input.

Group: Waveform

Syntax: WFMPre:<wfm>:WfId <QString>

WFMPre:<wfm>:WfId?

Arguments: <QString> is the waveform identifier string.

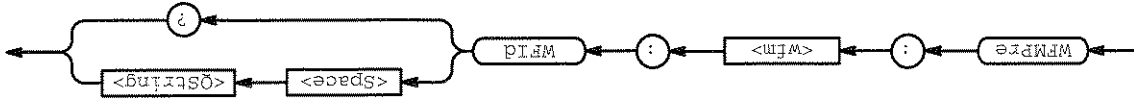

WFMPre:<wfm>:PT_Off

Returns 0. This command is ignored on input and is included for compatibility.

Group: Waveform

Syntax: WFMPre:<wfm>:PT_Off <NR1>

WFMPre:<wfm>:PT_Off?

Arguments: <NR1> = 0.

Examples: WFMPre:CH1:PT_Off? returns 0.

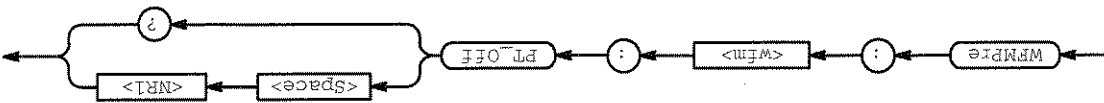

WFMPRe:<wfm>:XINcr

Command Descriptions

Sets or queries the horizontal sampling interval for the waveform specified by the DATA:Source command. On input <wfm> always defaults to the reference location specified by DATA:DESTination regardless of what is sent.

Group: Waveform

Syntax: WFMPRe:<wfm>:XINcr <NR3>

WFMPRe:<wfm>:XINcr?

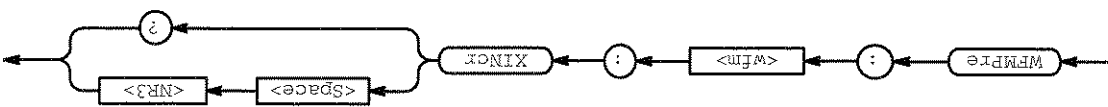

Arguments: <NR3> is the sampling interval.

WFMPRe:<wfm>:XUNIt

Returns the horizontal (X-axis) units of the waveform data at the time of creation, for the waveform specified by the DATA:Source command.

The WFMPRe:<wfm>:XUNIt command is ignored on input.

Group: Waveform

Syntax: WFMPRe:<wfm>:XUNIt <QString>

WFMPRe:<wfm>:XUNIt?



Arguments: <QString> is "s" for seconds or "Hz" for Hertz, and specifies the units.

Examples: WFMPRe:CH1:XUNIt? might return "s", indicating that the horizontal units for channel 1 are seconds.

WFMPRe:<wfm>:YMUIt

Sets or queries the vertical scale factor, in YUnit per unscaled data point value, for the waveform specified by the DATA:SOURCE command. On input <wfm> always defaults to the reference location specified by DATA:DESTINATION regardless of what is sent.

Group: Waveform

Syntax: WFMPRe:<wfm>:YMUIt <NR3>

WFMPRe:<wfm>:YMUIt?

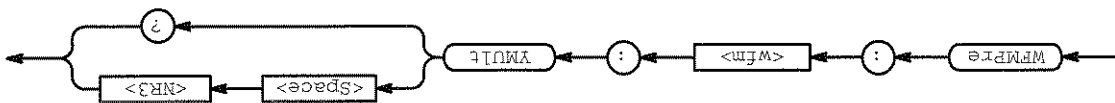

Arguments: <NR3> is the scale factor, in YUnits (usually volts) per digitizing level.

WFMPRe:<wfm>:XZEro

Sets or queries the time base position of the waveform data for the waveform specified by the DATA:SOURCE command.

Group: Waveform

Syntax: WFMPRe:<wfm>:XZEro <NR3>

WFMPRe:<wfm>:XZEro?

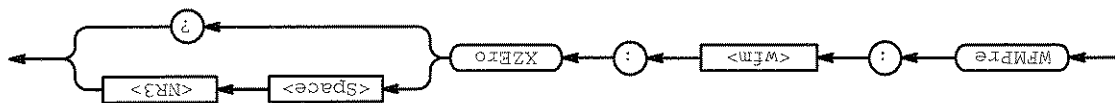

Arguments: <NR3> specifies the time base position in seconds.

Examples: WFMPRe:CH1:XZEro? might return -0.500E-9 ns, indicating that the time base position for channel 1 is -0.5 ns.

WFMPRe:<wfm>:YOFF

Sets or queries the vertical position of the waveform, for the waveform specified by the DATA:SOURCE command. On input <wfm> always defaults to the reference location specified by DATA:DESTINATION regardless of what is sent.

Group: Waveform

Syntax: WFMPRe:<wfm>:YOFF <NR3>

WFMPRe:<wfm>:YOFF?

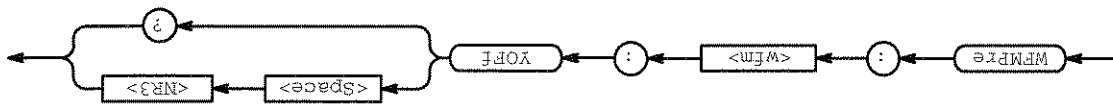

Arguments: <NR3> is the position in digitizing levels.

WFMPRe:<wfm>:YUNIT

Returns the vertical (Y-axis) units of the waveform data at the time of creation, for the waveform specified by the DATA:SOURCE command. The WFMPRe:<wfm>:YUNIT command is ignored on input.

Group: Waveform

Syntax: WFMPRe:<wfm>:YUNIT <QString>

WFMPRe:<wfm>:YUNIT?

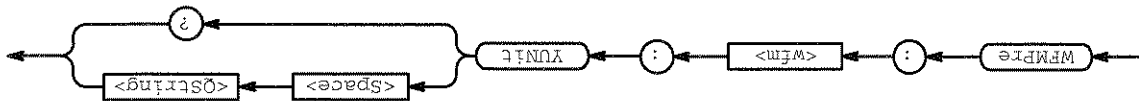

Arguments: <QString> is "V" for volts, "VV" for volts², or "dB" for decibels, and specifies the units.

Examples: WFMPRe:CH2:YUNIT? might return "V", meaning that the units for the vertical component of the channel 2 waveform data are volts.

ZOOM

Resets the display to its normal state, and resets all Zoom parameters to their factory default settings. The ZOOM query returns the current vertical and horizontal positioning and scaling of the display. This command is equivalent to selecting **Reset Zoom Factors** in the Zoom menu.

Group: Zoom

Syntax: ZOOM RESET

ZOOM?

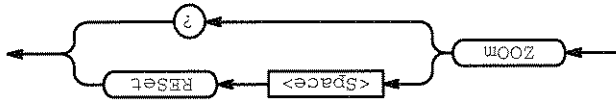

Arguments:

RESET sets the horizontal and vertical positions to zero, and the horizontal and vertical scale to one.

Examples:

ZOOM?
 might return : ZOOM:STATE 0;HORIZONTAL:SCALE 1.00E+0;POSITION
 500.0E-3;LOCK LIVE;;ZOOM:VERTICAL:SCALE 1.0E+0;POSITION
 0.0E+0.

WFMPRe:<wfm>:YZERo

Sets or queries the vertical (Y-axis) offset voltage, for the waveform specified by the DATA:SOURCE command. On input <wfm> always defaults to the reference location specified by DATA:DESTINATION regardless of what is sent.

Group: Waveform

Syntax: WFMPRe:<wfm>:YZERo <NR3>

WFMPRe:<wfm>:YZERo?

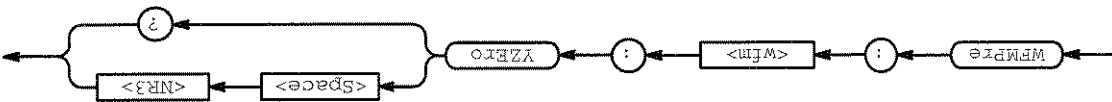

Arguments:

<NR3> is the offset in YUNits (usually volts).

ZOOM:HORIZONTAL:LOCK

Specifies the waveforms that the horizontal zoom parameters affect. This is equivalent to setting **Horizontal Lock** in the Zoom side menu.

Group: Zoom

Syntax: ZOOM:HORIZONTAL:LOCK { ALL | LIVE | NONE }

ZOOM:HORIZONTAL:LOCK?

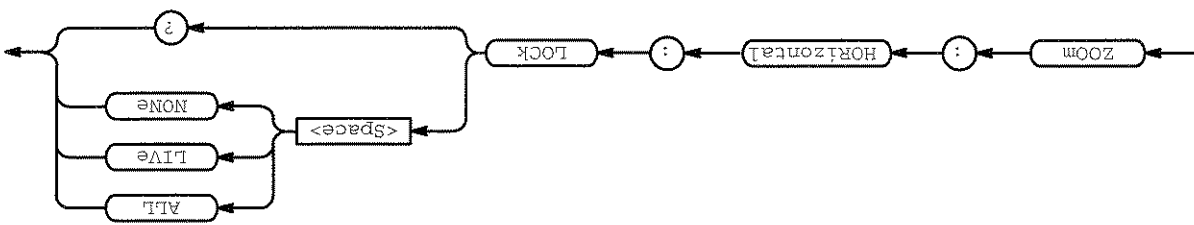

Arguments:

LIVE specifies that all live (CH<x>) waveforms will be horizontally positioned and scaled together.

NONE specifies that only the selected waveform is positioned and scaled using the horizontal zoom parameters.

ALL specifies that all (CH<x>, Ref<x>, Math<x>) waveforms will be horizontally positioned and scaled together.

Examples:

ZOOM:HORIZONTAL:LOCK LIVE

specifies that all live waveforms are positioned and scaled together.

ZOOM:HORIZONTAL:LOCK?

returns either LOCK or NONE.

ZOOM:HORIZONTAL:SCALE

Sets or queries the horizontal expansion factor. This command is equivalent to using the front-panel **Horizontal Scale** knob when Zoom is on.

Group: Zoom

Syntax: ZOOM:HORIZONTAL:SCALE <NR3>

ZOOM:HORIZONTAL:SCALE?

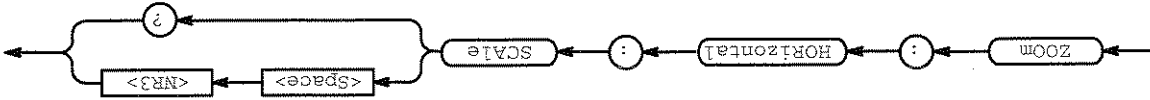

Arguments: <NR3> is the amount of expansion in the horizontal direction.

Examples: ZOOM:HORIZONTAL:SCALE? might return 1.00E+0 as the horizontal scale factor.

Group: Zoom

Syntax: ZOOM:HORIZONTAL:POSITION <NR3>

ZOOM:HORIZONTAL:POSITION?

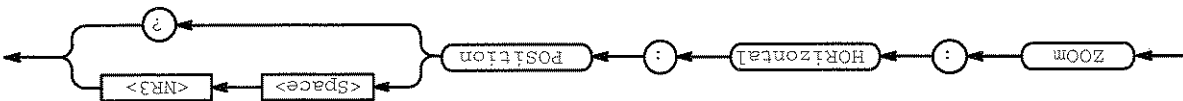

Arguments: <NR3> is from 0 to 100, and is the percentage of the waveform that is to the left of screen center.

Examples: ZOOM:HORIZONTAL:POSITION 50 centers the waveform on the display.

Sets or queries the horizontal position of waveforms. If ZOOM:HORIZONTAL:LOCK is set to LIVE then all waveforms are affected otherwise only the selected waveform is affected.

ZOOM:STATE

Turns Zoom mode on and off. When Zoom mode is on, the horizontal and vertical position and scale commands affect the waveform display not the acquisition. This is the only way to position and scale math and reference waveforms. This command is equivalent to turning **Zoom** on and off in the Zoom side menu.

Group: Zoom

Syntax: ZOOM:STATE { OFF | ON | <NR1> }

ZOOM:STATE?

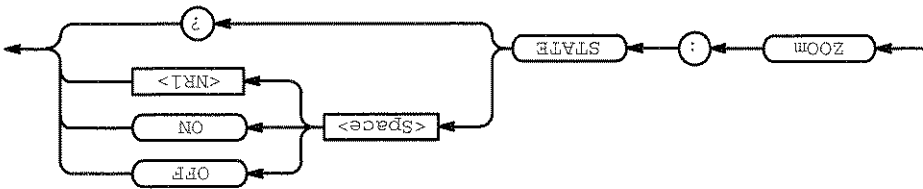

Arguments: OFF or <NR1> = 0 turns Zoom mode off.

ON or <NR1> ≠ 0 turns Zoom mode on.

Examples:

ZOOM:STATE ON

enables the Zoom feature.

ZOOM:STATE?

returns either 0 or 1 depending on the state of Zoom mode.

ZOOM:VERTICAL:SCALE

Sets or queries the vertical expansion and compression factor.

Group: Zoom

Related Commands: ACQUIRE:MODE

Syntax: ZOOM:VERTICAL:SCALE <NR3>

ZOOM:VERTICAL:SCALE?

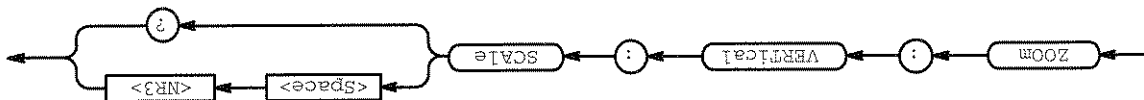

Arguments: <NR3> is the amount of vertical expansion or compression.

Examples: ZOOM:VERTICAL:SCALE?

might return : ZOOM:VERTICAL:SCALE 1.0E+0

ZOOM:VERTICAL:POSITION

Sets or queries the vertical position of waveforms.

Group: Zoom

Syntax: ZOOM:VERTICAL:POSITION <NR3>

ZOOM:VERTICAL:POSITION?

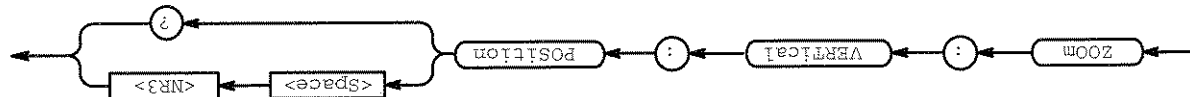

Arguments: <NR3> is the vertical position, in divisions.

Examples: ZOOM:VERTICAL:POSITION?

might return : ZOOM:VERTICAL:POSITION 0

Status and Events

The digitizing oscilloscope provides a status and event reporting system for the GPIB and RS-232-C interfaces. This system informs you of certain significant events that occur within the digitizing oscilloscope. The digitizing oscilloscope status handling system consists of five 8-bit registers and two queues. This section describes these registers and components. It also explains how the event handling system operates.

Registers

The registers in the event handling system fall into two functional groups:

- Status Registers contain information about the status of the digitizing oscilloscope. They include the Standard Event Status Register (SESR) and the Status Byte Register (SBR).
- Enable Registers determine whether selected types of events are reported to the Status Registers and the Event Queue. They include the Device Event Status Enable Register (DESER), the Event Status Enable Register (ESER), and the Service Request Enable Register (SREER).

Status Registers

The Standard Event Status Register (SESR) and the Status Byte Register (SBR) record certain types of events that may occur while the digitizing oscilloscope is in use. IEEE Std 488.2-1987 defines these registers.

Each bit in a Status Register records a particular type of event, such as an execution error or service request. When an event of a given type occurs, the digitizing oscilloscope sets the bit that represents that type of event to a value of one. (You can disable bits so that they ignore events and remain at zero. See the Enable Registers section on page 3-3.) Reading the status registers tells you what types of events have occurred.

The Standard Event Status Register (SESR)—The SESR, shown in Figure 3-1, records eight types of events that can occur within the digitizing oscilloscope. Use the *ESR? query to read the SESR register. Reading the register clears the bits of the register so that the register can accumulate information about new events.

7	PON	6	URQ	5	CME	4	EXE	3	DDE	2	QYE	1	RQC	0	OPC
---	-----	---	-----	---	-----	---	-----	---	-----	---	-----	---	-----	---	-----

Figure 3-1: The Standard Event Status Register (SESR)

Figure 3-2: The Status Byte Register (SBR)

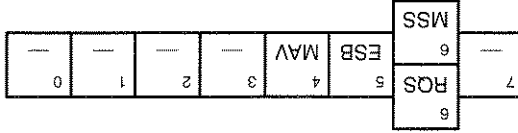

The Status Byte Register (SBR)—shown in Figure 3-2, records whether output is available in the Output Queue, whether the digitizing oscilloscope requests service, and whether the SESR has recorded any events. Use a Serial Poll or the *STB? query to read the contents of the SBR. The bits in the SBR are set and cleared depending on the contents of the SESR, the Event Status Enable Register (ESER), and the Output Queue. When you use a Serial Poll to obtain the SBR, bit 6 is the RQS bit. When you use the *STB? query to obtain the SBR, bit 6 is the MSS bit. Reading the SBR does not clear the bits.

Table 3-1: SESR Bit Functions

Bit	Function
7 (MSB)	PON (Power On). Shows that the digitizing oscilloscope was powered on. The completion of the diagnostic tests also sets this bit.
6	URQ (User Request). Shows that an Application menu button was pressed.
5	CME (Command Error). Shows that an error occurred while the digitizing oscilloscope was parsing a command or query. Command error messages are listed in Table 3-4 on page 3-13.
4	EXE (Execution Error). Shows that an error occurred while the digitizing oscilloscope was executing a command or query. Execution error messages are listed in Table 3-5 on page 3-14.
3	DDE (Device Error). Shows that a device error occurred. Device error messages are listed in Table 3-6 on page 3-17.
2	QYE (Query Error). Shows that either an attempt was made to read the Output Queue when no data was present or pending, or that data in the Output Queue was lost.
1	RQC (Request Control). Not used.
0 (LSB)	OPC (Operation Complete). Shows that the operation is complete. This bit is set when all pending operations complete following a *OPC command.

Figure 3-3: The Device Event Status Enable Register (DESER)

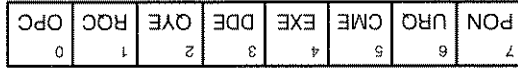

The Device Event Status Enable Register (DESER)—is shown in Figure 3-3. This register controls which types of events are reported to the SESR and the Event Queue. The bits in the DESER correspond to those in the SESR, as described earlier.

Use the DESER command to enable and disable the bits in the DESER. Use the DESER? query to read the DESER.

DESER, ESER, and SRES allow you to select which events are reported to the Status Registers and the Event Queue. Each Enable Register acts as a filter to a Status Register (the DESER also acts as a filter to the Event Queue) and can prevent information from being recorded in the register or queue.

Each bit in an Enable Register corresponds to a bit in the Status Register it controls. In order for an event to be reported to its bit in the Status Register, the corresponding bit in the Enable Register must be set to one. If the bit in the Enable Register is set to zero, the event is not recorded.

Various commands set the bits in the Enable Registers. The Enable Registers and the commands used to set them are described below.

Enable Registers

Bit	Function
7 (MSB)	Not used.
6	RQS (Request Service), obtained from a serial poll. Shows that the digitizing oscilloscope requests service from the GPIB controller.
6	MSS (Master Status Summary), obtained from *STB? query. Summarizes the ESER and MAV bits in the SBR.
5	ESB (Event Status Bit). Shows that status is enabled and present in the SESR.
4	MAV (Message Available). Shows that output is available in the Output Queue.
3 – 0	Not used.

Table 3-2: SBR Bit Functions

To enable the PON (Power On) event to generate a Service Request, send *PSC 0, use the DESe and *ESE commands to enable PON in the DESER and ESER, and use the *SRE command to enable bit 5 in the SREr. Subsequent power-on cycles will generate a Service Request.

NOTE

Sending *PSC 0 lets the Enable Registers maintain their values in non-volatile memory through a power cycle.

- DESER 255 (equivalent to a DESe 255 command)
- ESER 0 (equivalent to an *ESE 0 command)
- SREr 0 (equivalent to an *SRE 0 command)

The *PSC command controls the Enable Registers contents at power-on. Sending *PSC 1 sets the Enable Registers at power on as follows:

The Enable Registers and the *PSC Command

Figure 3-5: The Service Request Enable Register (SREr)

7	6	5	4	3	2	1	0
—	—	ESB	MAV	—	—	—	—

The Service Request Enable Register (SREr)—is shown in Figure 3-5. It controls which bits in the SBR generate a Service Request and are summarized by the Master Status Summary (MSS) bit. Use the *SRE command to set the SREr. Use the *SRE? query to read it. The RQS bit remains set to one until either the Status Byte Register is read with a Serial Poll or the MSS bit changes back to a zero.

Figure 3-4: The Event Status Enable Register (ESER)

7	6	5	4	3	2	1	0
PON	URQ	OME	EXE	DDE	QVE	RQC	OPC

Use the *ESE command to set the bits in the ESER. Use the *ESE? query to read it.

The Event Status Enable Register (ESER)—is shown in Figure 3-4. It controls which types of events are summarized by the Event Status Bit (ESB) in the SBR.

The digitizing oscilloscope status and event reporting system contains two queues: the Output Queue and the Event Queue.

The Output Queue

The digitizing oscilloscope stores query responses in the Output Queue. It empties this queue each time it receives a new command or query message after an <EOM>. The controller must read a query response before it sends the next command (or query) or it will lose responses to earlier queries.

WARNING

When a controller sends a query, an <EOM>, and a second query, the digitizing scope normally clears the first response and outputs the second while reporting a Query Error (QYE bit in the ESR) to indicate the lost response. A fast controller, however, may receive a part or all of the first response as well. To avoid this situation, the controller should always read the response immediately after sending any terminated query message or send a DCL (Device Clear) before sending the second query.

The Event Queue

The Event Queue stores detailed information on up to 20 events. If more than 20 events stack up in the Event Queue, the 20th event is replaced by event code 350, "Too many events."

Read the Event Queue with the EVENT? query (which returns only the event number), with the EVMSG? query (which returns the event number and a text description of the event), or with the ALLEV? query (which returns all the event numbers along with a description of the event). Reading an event removes it from the queue.

Before reading an event from the Event Queue, you must use the *ESR? query to read the summary of the event from the SESR. This makes the events summarized by the *ESR? read available to the EVENT? and EVMSG? queries, and empties the SESR.

Reading the SESR erases any events that were summarized by previous *ESR? reads but not read from the Event Queue. Events that follow an *ESR? read are put in the Event Queue but are not available until *ESR? is used again.

Event Handling Sequence

Figure 3-6, on page 3-6, shows how to use the status and event handling system. In the explanation that follows, numbers in parentheses refer to numbers in Figure 3-6.

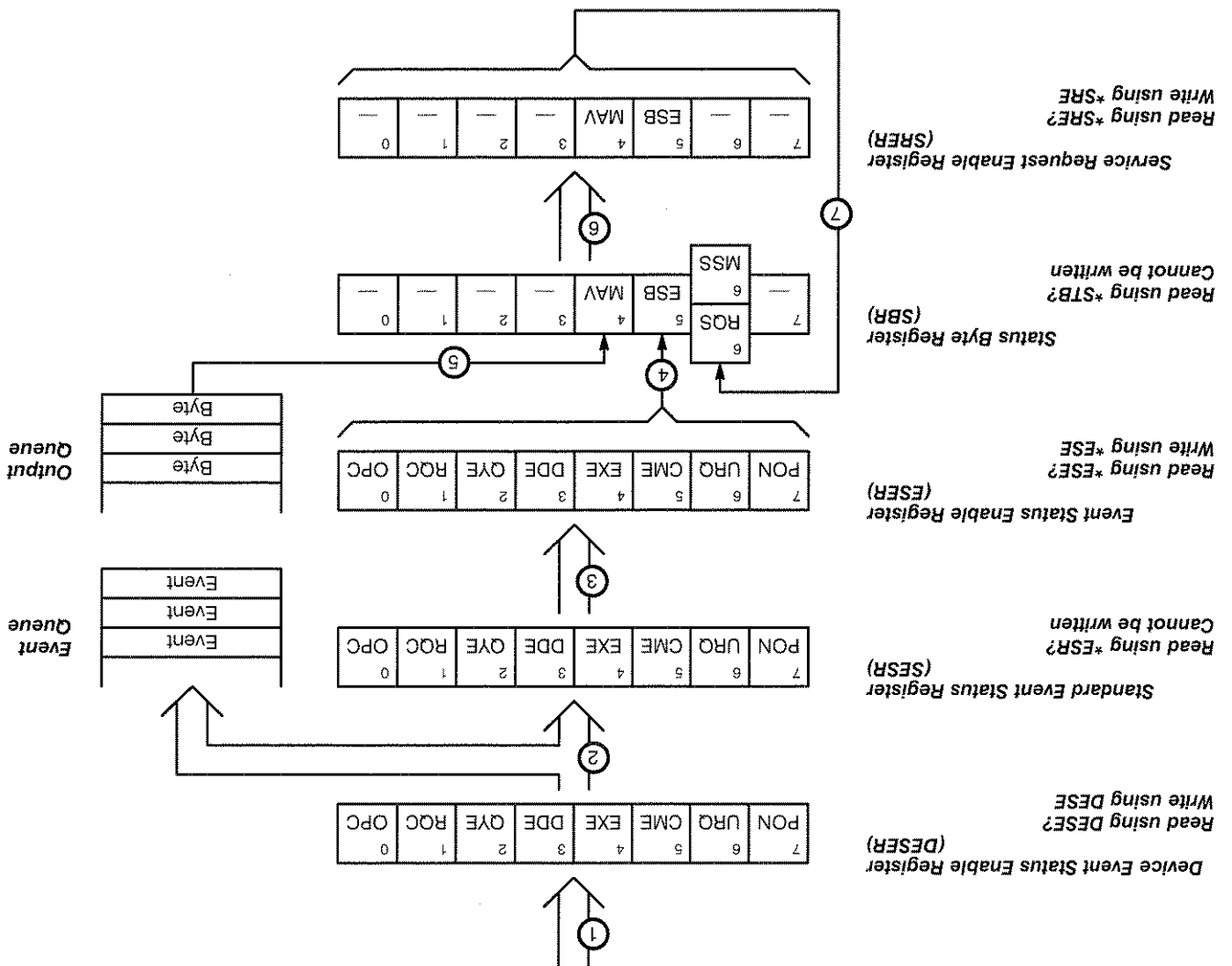

Figure 3-6: Status and Event Handling Process

When an event occurs, a signal is sent to the DESER (1). If that type of event is enabled in the DESER (that is, if the bit for that event type is set to one), the appropriate bit in the SESR is set to one and the event is recorded in the Event Queue (2). If the corresponding bit in the ESER is also enabled (3), then the ESB bit in the SBR is set to one (4).

When output is sent to the Output Queue, the MAV bit in the SBR is set to one (5).

Synchronization Methods

When a bit in the SBR is set to one and the corresponding bit in the SFR is enabled (6), the MSS bit in the SBR is set to one and a service request is generated (7).

Although most GPIB commands are completed almost immediately after being received by the digitizing oscilloscope, some commands start a process that requires more time. For example, once a HARDCOPY START command is executed it may be a few seconds before the hardcopy operation is complete. Rather than remain idle while the operation is in process, the digitizing oscilloscope will continue processing other commands. This means that some operations will not be completed in the order that they were sent.

Sometimes the result of an operation depends on the result of an earlier operation. A first operation must complete before the next one gets processed. The digitizing oscilloscope's status and event reporting system provide ways to do this.

For example, a typical application might involve acquiring a single-sequence waveform then taking a measurement on the acquired waveform. You could use the following command sequence to do this:

```
/** Set up single-sequence acquisition **/  
SELECT:CH1 ON  
HORIZONTAL:RECORDLENGTH 500  
ACQUIRE:MODE NORMAL  
ACQUIRE:STOPAFTER SEQUENCE  
/** Acquire waveform data **/  
ACQUIRE:STATE ON  
/** Set up the measurement parameters **/  
MEASUREMENT:IMMED:TYPE AMPLITUDE  
MEASUREMENT:IMMED:SOURCE CH1  
/** Take amplitude measurement on acquired data **/  
MEASUREMENT:IMMED:VALUE?
```

The acquisition of the waveform requires extended processing time. It may not finish before the digitizing oscilloscope takes an amplitude measurement (See Figure 3-7). This can result in an incorrect amplitude value.

```

/* Set up the measurement parameters */
MEASUREMENT:IMMED:TYPE AMPLITUDE
MEASUREMENT:IMMED:SOURCE CH1
ACQUIRE:STATE ON
/* Acquire waveform data */
ACQUIRE:STOPAFTER SEQUENCE
ACQUIRE:MODE NORMAL
HORIZONTAL:RECORDLENGTH 500
SELECT:CH1 ON
/* Set up single-sequence acquisition */

```

The same command sequence using the *WAI command for synchronization looks like this:

You can force commands to execute sequentially by using the *WAI command. This command forces completion of the previous commands before processing new ones.

Using the *WAI Command

You can use four commands to synchronize the operation of the digitizing oscilloscope with your application program: *WAI, BUSY?, *OPC, and *OPC?

Figure 3-8: Processing Sequence With Synchronization

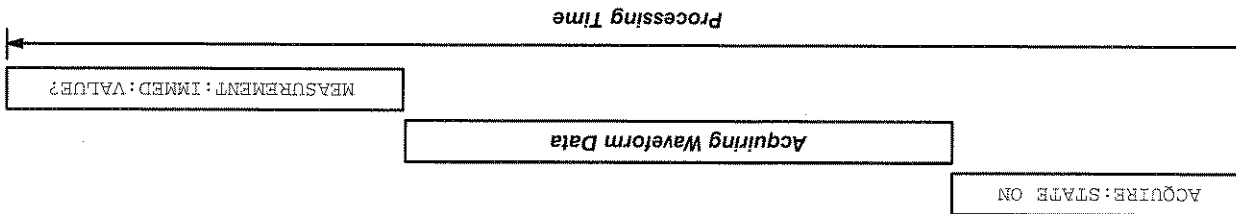

To ensure the digitizing oscilloscope completes waveform acquisition before taking the measurement on the acquired data, you can synchronize the program. Figure 3-8 shows the desired processing sequence.

Figure 3-7: Command Processing Without Using Synchronization

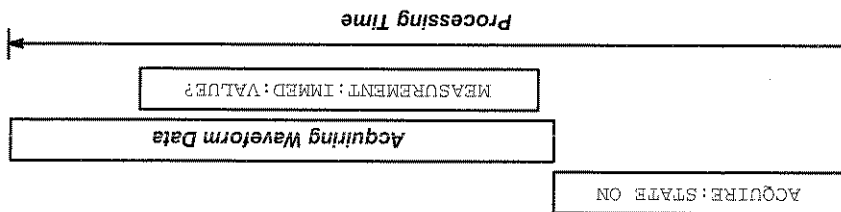

```
/* Wait until the acquisition is complete before taking the measurement
```

```
*/
```

```
/* Take amplitude measurement on acquired data */
```

```
MEASUREMENT:IMMED:VALUE?
```

Though *WAI is one of the easiest way to achieve synchronization, it is also the most costly. The processing time of the digitizing oscilloscope is slowed since it is processing a single command at a time. This time could be spent doing other tasks.

The controller can continue to write commands to the digitizing oscilloscope's input buffer, but the commands will not be processed by the digitizing oscilloscope until all operations in process are complete. If the input buffer becomes full, the controller will be unable to write more commands to the buffer. This can cause a time-out.

Using the BUSY Query

The BUSY? query allows you to find out whether the digitizing oscilloscope is busy processing a command that has an extended processing time such as single-sequence acquisition.

The same command sequence using the BUSY? query for synchronization looks like this:

```
/* Set up single-sequence acquisition */
```

```
SELECT:CH1 ON
```

```
HORIZONTAL:RECORDLENGTH 500
```

```
ACQUIRE:MODE NORMAL
```

```
ACQUIRE:STOPAFTER SEQUENCE
```

```
/* Acquire waveform data */
```

```
ACQUIRE:STATE ON
```

```
/* Set up the measurement parameters */
```

```
MEASUREMENT:IMMED:TYPE AMPLITUDE
```

```
MEASUREMENT:IMMED:SOURCE CH1
```

```
/* Wait until the acquisition is complete before taking the measurement
```

```
*/
```

```
while BUSY? keep looping
```

```
/* Take amplitude measurement on acquired data */
```

```
MEASUREMENT:IMMED:VALUE?
```

This sequence lets you create your own wait loop rather than using the *WAI command. The BUSY? query helps you avoid time-outs caused by writing too many commands to the input buffer. The controller is still tied up, though, and the repeated BUSY? query will result in more bus traffic.

Using the *OPC Command

If the corresponding status registers are enabled, the *OPC command sets the OPC bit in the Standard Event Status Register (SESR) when an operation is complete. You achieve synchronization by using this command with either a serial poll or service request handler.

Serial Poll Method—Enable the OPC bit in the Device Event Status Register (DESER) and the Event Status Enable Register (ESER) using the DESE and *ESE commands. When the operation is complete, the OPC bit in the Standard Event Status Register (SESR) will be enabled and the Event Status Bit (ESB) in the Status Byte Register will be enabled. The same command sequence using the *OPC command for synchronization with serial polling looks like this:

```

/* Set up single-sequence acquisition */
SELECT:CH1 ON
HORIZONTAL:RECORDLENGTH 500
ACQUIRE:MODE NORMAL
ACQUIRE:STOPAFTER SEQUENCE
/* Enable the status registers */
DESE 1
ESE 1
SRE 0
/* Acquire waveform data */
ACQUIRE:STATE ON
/* Set up the measurement parameters */
MEASUREMENT:IMMED:TYPE AMPLITUDE
MEASUREMENT:IMMED:SOURCE CH1
/* Wait until the acquisition is complete before taking the measurement.
*/
*OPC
while serial poll = 0, keep looping
/* Take amplitude measurement on acquired data */
MEASUREMENT:IMMED:VALUE?

```

This technique requires less bus traffic than did looping on BUSY?

Service Request Method—Enable the OPC bit in the Device Event Status Enable Register (DESER) and the Event Status Enable Register (ESER) using the DESE and *ESE commands. You can also enable service requests by setting the ESB bit in the Service Request Enable Register (SREER) using the *SRE command. When the operation is complete, a Service Request will be generated.

The same command sequence using the *OPC command for synchronization looks like this:

```

/* Set up single-sequence acquisition */
SELECT:CH1 ON
HORIZONTAL:RECORDLENGTH 500
ACQUIRE:MODE NORMAL
ACQUIRE:STOPAFTER SEQUENCE
/* Enable the status registers */
DESE 1
*ESE 1
*SRE 32
/* Acquire waveform data */
ACQUIRE:STATE ON
/* Set up the measurement parameters */
MEASUREMENT:IMMED:TYPE AMPLITUDE
MEASUREMENT:IMMED:SOURCE CH1

```

```

/* Wait until the acquisition is complete before taking the measurement
*/
*OPC

```

```

Program can now do different tasks such as talk to
other devices. The SRQ, when it comes, interrupts
those tasks and returns control to this task.
/* Take amplitude measurement on acquired data */
MEASUREMENT:IMMED:VALUE?

```

This technique is more efficient but requires more sophisticated programming.

Using the *OPC? Query

The *OPC? query places a 1 in the Output Queue once an operation is complete. A timeout could occur if you try to read the output queue before there is any data in it.

The same command sequence using the *OPC? query for synchronization looks like this:

```

/* Set up single-sequence acquisition */
SELECT:CH1 ON
HORIZONTAL:RECORDLENGTH 500
ACQUIRE:MODE NORMAL
ACQUIRE:STOPAFTER SEQUENCE
/* Acquire waveform data */
ACQUIRE:STATE ON
/* Set up the measurement parameters */
MEASUREMENT:IMMED:TYPE AMPLITUDE
MEASUREMENT:IMMED:SOURCE CH1
/* Wait until the acquisition is complete before taking the measurement
*/
*OPC?
Wait for read from Output Queue.
/* Take amplitude measurement on acquired data */
MEASUREMENT:IMMED:VALUE?

```

This is the simplest approach. It requires no status handling or loops. However, you must set the controller time-out for longer than the acquisition operation.

Tables 3-3 through 3-9 list all the programming interface messages the digitizing oscilloscope generates in response to commands and queries.

For most messages, a secondary message from the digitizing oscilloscope gives more detail about the cause of the error or the meaning of the message. This message is part of the message string, and is separated from the main message by a semicolon.

Each message is the result of an event. Each type of event sets a specific bit in the SESR, and is controlled by the equivalent bit in the DESER. Thus, each message is associated with a specific SESR bit. In the message tables that follow, the associated SESR bit is specified in the table title, with exceptions noted with the error message text.

Table 3-3 shows the messages when the system has no events or status to report. These have no associated SESR bit.

Table 3-3: No Event Messages

Code	Message
0	No events to report – queue empty
1	No events to report – new events pending *ESR?

Table 3-4 shows the error messages generated by improper command syntax. Check that the command is properly formed and that it follows the rules in the Command Syntax chapter starting on page 2-1.

Table 3-4: Command Error Messages—CME Bit 5

Code	Message
100	Command error
102	Syntax error
103	Invalid separator
104	Data type error
105	GPI not allowed
108	Parameter not allowed
110	Command header error
111	Header separator error
112	Program mnemonic too long
113	Undefined header

Table 3-5 lists the execution errors that are detected during execution of a command. In these error messages, you should read "macro" as "alias."

Code	Message
200	Execution error
201	Invalid while in local
210	Trigger error
211	Trigger ignored
212	Arm ignored
220	Parameter error
221	Settings conflict
222	Data out of range
223	Too much data
224	Illegal parameter value
230	Data corrupt or stale
240	Hardware error
241	Hardware missing
242	Hardware configuration error
243	Hardware I/O device error
260	Expression error
261	Math error in expression
2200	Measurement error, Measurement system error
2201	Measurement error, Zero period
2202	Measurement error, No period found
2203	Measurement error, No period, second waveform
2204	Measurement error, Low signal amplitude
2205	Measurement error, Low amplitude, second waveform
2206	Measurement error, Invalid gate
2207	Measurement error, Measurement overflow
2208	Measurement error, Waveform does not cross Mid Ref
2209	Measurement error, No second Mid Ref crossing
2210	Measurement error, No Mid Ref crossing, second waveform
2211	Measurement error, No backwards Mid Ref crossing

Table 3-5: Execution Error Messages—EXE Bit 4

Code	Message
2212	Measurement error, No negative crossing
2213	Measurement error, No positive crossing
2214	Measurement error, No crossing
2215	Measurement error, No crossing, second waveform
2216	Measurement error, No crossing, target waveform
2217	Measurement error, Constant waveform
2218	Measurement error, Unused
2219	Measurement error, No valid edge – No arm sample
2220	Measurement error, No valid edge – No arm cross
2221	Measurement error, No valid edge – No trigger cross
2222	Measurement error, No valid edge – No second cross
2223	Measurement error, waveform mismatch
2224	Measurement error, WAIT calculating
2225	Measurement error, No waveform to measure
2226	Null Waveform
2227	Positive and Negative Clipping
2228	Measurement error, Positive Clipping
2229	Measurement error, Negative Clipping
2230	Measurement error, High Ref < Low Ref
2235	Math error, Invalid math description
2236	Math error, Reference waveform is invalid
2237	Math error, Out of acquisition memory
2240	Invalid password
2241	Waveform request is invalid
2242	Data start and stop > record length
2243	Waveform requested is not a data source
2244	Waveform requested is not turned on
2245	Saveret error, Selected channel is turned off
2246	Saveret error, Selected channel data invalid

Table 3-5: Execution Error Messages—EXE Bit 4 (Cont.)

Code	Message
2247	Saveret error, Out of reference memory
2248	Saveret error, Source reference data invalid
2249	Reference deletion error, Waveform in use for math
2250	Calibration error, Strobe delay meas failed
2251	Calibration error, HLLUT entry out of bounds
2252	Calibration error, HLLUT corrections not working
2253	Calibration error, Excessive amplitude on DC measurement
2254	Calibration error, Excessive offset on DC measurement
2255	Calibration error, Incorrect forward gain at sampler
2256	Calibration error, VLLUT underrange cannot be calculated
2257	Calibration error, VLLUT overrange cannot be calculated
2260	Calibration error
2261	Calibration error, VCO coarse DAC out of bounds
2262	Calibration error, VCO coarse DAC nonfunctional
2263	Calibration error, VCO coarse DAC did not converge
2264	Calibration error, VCO fine DAC nonfunctional
2265	Calibration error, VCO fine DAC did not converge
2266	Calibration error, VCO tcgain DAC out of bounds
2267	Calibration error, VCO frequency measurement failed
2268	Calibration error, Diagnostic A/D timed out
2269	Calibration error, VCO wrap delay out of bounds
2270	Alias error
2271	Alias syntax error
2272	Alias execution error
2273	Illegal alias label
2274	Alias parameter error
2275	Alias definition too long
2276	Alias expansion error
2277	Alias redefinition not allowed

Table 3-5: Execution Error Messages—EXE Bit 4 (Cont.)

Code	Message
400	Query event
401	Power on (PON bit 7 set)

Table 3-7: System Event Messages

Table 3-7 lists the system event messages. These messages are generated whenever certain system conditions occur.

Code	Message
300	Device-specific error
310	System error
311	Memory error
312	PUD memory lost
313	Calibration memory lost
314	Save/recall memory lost
315	Configuration memory lost
350	Queue overflow (does not set DDE bit)

Table 3-6: Device Error Messages—DDE Bit 3

Table 3-6 lists the device errors that can occur during digitizing oscilloscope operation. These errors may indicate that the oscilloscope needs repair.

Code	Message
2278	Alias header not found
2279	Alias label too long
2280	Alias table full
2285	TekSecure@ Pass
2286	TekSecure@ Fail
2290	Limit error, reference in use
2291	Limit error, reference data invalid
2292	Limit error, out of reference memory
2293	Limit error, selected channel is turned off
2301	Cursor error, off-screen

Table 3-5: Execution Error Messages—EXE Bit 4 (Cont.)

Code	Message
500	Execution warning
510	String data too long, truncated
525	Parameter underrange
526	Parameter overrange

Table 3-8: Execution Warning Messages—EXE Bit 4

Table 3-8 lists warning messages that do not interrupt the flow of command execution. These notify you that you may get unexpected results.

Code	Message
402	Operation complete (OPC bit 0 set)
403	User request (URQ bit 6 set)
404	Power fail (DDE bit 3 set)
405	Request control
410	Query INTERRUPTED (QYE bit 2 set)
420	Query UNTERMINATED (QYE bit 2 set)
430	Query DEADLOCKED (QYE bit 2 set)
440	Query UNTERMINATED after indefinite response (QYE bit 2 set)
450	Right menu button #1 pushed (URQ bit 6 set)
451	Right menu button #2 pushed (URQ bit 6 set)
452	Right menu button #3 pushed (URQ bit 6 set)
453	Right menu button #4 pushed (URQ bit 6 set)
454	Right menu button #5 pushed (URQ bit 6 set)
460	Bottom menu button #1 pushed (URQ bit 6 set)
461	Bottom menu button #2 pushed (URQ bit 6 set)
462	Bottom menu button #3 pushed (URQ bit 6 set)
463	Bottom menu button #4 pushed (URQ bit 6 set)
464	Bottom menu button #5 pushed (URQ bit 6 set)
465	Bottom menu button #6 pushed (URQ bit 6 set)
466	Bottom menu button #7 pushed (URQ bit 6 set)

Table 3-7: System Event Messages (Cont.)

Code	Message
600	Internal warning
620	Internal warning, Bad thermistor
630	Internal warning, 50 Ω overload

Table 3-9: Internal Warning Messages

Table 3-9 shows internal errors that indicate an internal fault in the digitizing oscilloscope.

Code	Message
527	Parameter rounded
528	Parameter out of range
530	Data stop > stop, Values swapped internally
531	Data stop > record length, Curve truncated
532	Curve data too long, curve truncated
540	Measurement warning
541	Measurement warning, Low signal amplitude
542	Measurement warning, Unstable histogram
543	Measurement warning, Low resolution
544	Measurement warning, Uncertain edge
545	Measurement warning, Invalid in minmax
546	Measurement warning, Need 3 edges
547	Measurement warning, Clipping positive/negative
548	Measurement warning, Clipping positive
549	Measurement warning, Clipping negative

Table 3-8: Execution Warning Messages—EXE Bit 4 (Cont.)

Programming Examples

The example programs illustrate methods you can use to control the digitizing oscilloscope from the GPIB interface. The diskettes that come with this manual contain listings for these programs written in Microsoft QuickBASIC 4.5 and Microsoft QuickC 2.5.

The programs run on a PC-compatible system equipped with a Tektronix (National Instruments) GPIB board and associated drivers. For example, the programs will work with a Tektronix S3FG210 (National Instruments GPIB-PCI/IIA) GPIB package (See Figure 4-1).

All the example programs assume that the GPIB system recognizes the digitizing oscilloscope as DEV1 and the PC (controller) as GPIB0. You can use the `IBCONF . EXE` program to assign these names.

The example software includes:

- MEAS: automatically measures waveform parameters.
- COMM: shows communication between controller and oscilloscope.
- GETWFM: reads a waveform from an oscilloscope and stores it in a file.
- CURSOR: uses cursors to measure waveform parameters.
- TL: a talker-listener program.

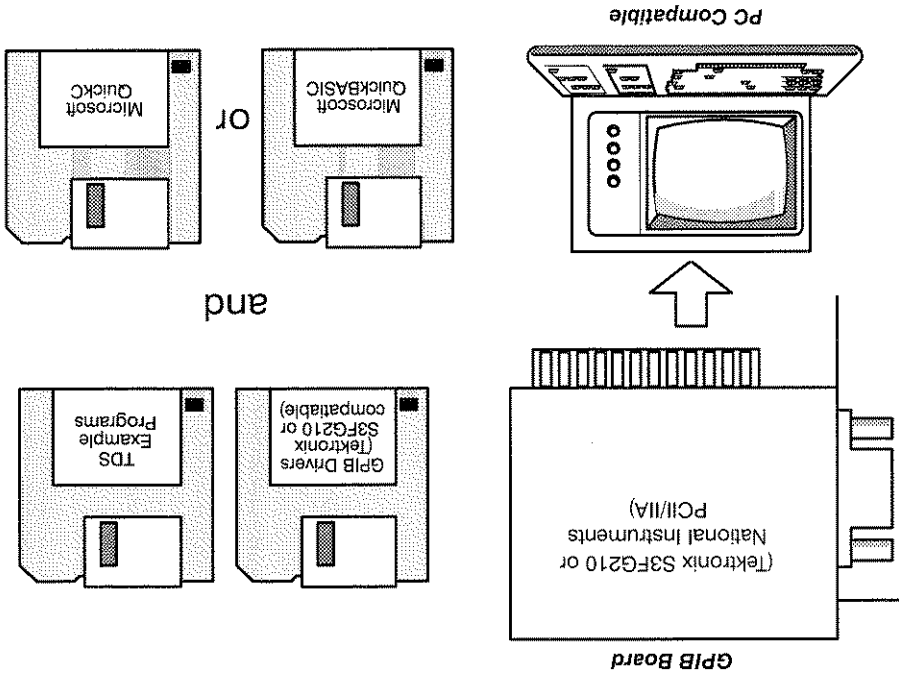

Figure 4-1: Equipment Needed to Run the Example Programs

Compiling the Example Programs

The example programs diskette contains programs written in Microsoft QuickBASIC 4.5 and Microsoft QuickC 2.5.

Executable versions of the programs are in the PROGRAMS directory. Source versions are in the SOURCES directory. Within this directory, the QuickBASIC programs are in the Q-BASIC subdirectory and the QuickC programs are in the QUICK-C subdirectory.

A README file in each directory explains how to build executable code from the source files provided.

The QuickC directory also comes with sample MAKE files and sample executable files. These have the suffix .MAK.

If you wish to develop code, you will need to use files that come with the GPIB system. Specifically, the QuickBASIC programs use QBDECL.BAS and GPIB.OBJ. The QuickC programs use DECL.H and MCIB.OBJ.

NOTE

The programs you compile in the Sources directory work with the Tektronix S3FG210 (National Instruments GPIB-PCII-IIA) GPIB system. It may take extra steps or changes to get them to work with older Tektronix GURU and other GPIB systems.

To make an executable for any example, perform the following:

Step 1: Install QuickC. Select the SMALL memory model. Be sure to set up your path so DOS can access the QuickC directory.

Step 2: Install the Tektronix S3FG210 (National Instruments GPIB-PCII-IIA) GPIB board and drivers. Remember to identify the GPIB device as DEV1. You can use the IBCONF.EXE program to do this.

Step 3: Copy the files from the examples diskette to your hard disk. You might also create a special directory to store them. For example, if the current drive is hard disk C, you want to store the examples in drive C and the examples diskette is in drive B, you might type:

```
mkdir examples
```

```
cd examples
```

```
copy B:\quick-c\*.*
```

Step 4: For this installation, you will also want to copy DECL.H and MCIB.OBJ from your Tektronix S3FG210 (National Instruments GPIB-

PCII-IIA) GPIB drivers directory to this directory. For example, if the GPIB drivers are in the gpiib-pc directory and you are in the example programs directory, you would type:

```
copy \gpiib-pc\decl.h .
```

```
copy \gpiib-pc\mcib.obj .
```

Compiling And Linking Your Example QuickBASIC Programs

To make an executable for any of the following files, perform the following:

Step 1: Install QuickBASIC.

Step 2: Install the Tektronix S3FG210 (National Instruments GPIB-PCII/IIA) GPIB board and drivers. Remember to reboot your PC to initialize the GPIB drivers.

Step 3: Copy the files from the examples diskette to your hard disk. You might also create a special directory to store them. For example, if the current drive is hard disk C, you want to store the examples in drive C and the examples diskette is in drive B, you might type:

```
mkdir examples
```

```
cd examples
```

```
copy b:\q-basic\*.*
```

Step 4: For this installation, you will also want to copy QBDECL.BAS and QBIB.OBJ from your Tektronix S3FG210 (National Instruments GPIB-PCII/IIA) GPIB drivers directory to the directory your example programs are in. For example, if the GPIB drivers are in the gp1b-pc directory and you are in the example programs directory, you would type:

```
copy \gp1b-pc\qbdecl.bas .
```

```
copy \gp1b-pc\qb1b.obj .
```

Step 5: To compile and link your TDS sample C programs, simply type:

```
make <file name>.mak
```

where <file name> refers to the name of the example program you wish to compile and link. Specifically:

To compile and link MEAS.C, type: `make meas.mak`

To compile and link COMM.C, type: `make comm.mak`

To compile and link GETWFM.C, type: `make getwfm.mak`

To compile and link CURSOR.C, type: `make cursor.mak`

To compile and link TL.C, type: `make tl.mak`

Step 6: Run the program by simply typing the program name.

To run meas, type: `meas`

To run comm, type: `comm`

To run getwfm, type: `getwfm`

To run cursor, type: `cursor`

To run tl, type: `tl`

The example programs disable front-panel operation while they are running, and reenable it when they terminate. If your program terminates prematurely, front-panel operation may remain disabled. To reenable front-panel operation, do one of the following: cycle power on the digitizing oscilloscope or send the GPIB command UNLOCK ALL to unlock the front panel. You can send the UNLOCK ALL command with the TL program included in your sample programs disk.

NOTE

To run meas, type: meas
 To run comm, type: comm
 To run getwfm, type: getwfm
 To run cursor, type: cursor
 To run tl, type: tl

Step 6: Run the program by simply typing the program name.

GPIBIO.BAS is a collection of input/output routines used by the other programs and is included for proper file compilation.

To link MEAS.OBJ, type: link meas.obj+qblb.obj;
 To link COMM.OBJ, type: link comm.obj+qblb.obj;
 To link GETWFM.OBJ, type: link getwfm.obj+qblb.obj;
 To link CURSOR.OBJ, type: link cursor.obj+qblb.obj;
 To link TL.OBJ, type: link tl.obj+qblb.obj;
 where <file> is one of the above program names.
 link <file>.obj+qblb.obj;

2) Link the compiled program with the qblb.obj module to create the executable program (file.EXE) by using the following command:

bc /o <file>.bas;
 where <file> is one of the example program names.
 To compile MEAS.BAS, type: bc /o meas.bas;
 To compile COMM.BAS, type: bc /o comm.bas;
 To compile GETWFM.BAS, type: bc /o getwfm.bas;
 To compile CURSOR.BAS, type: bc /o cursor.bas;
 To compile TL.BAS, type: bc /o tl.bas;

Step 5: Perform the following two steps for example programs:

1) Compile the program by using the following command:

Appendix A: Character Charts



These characters are available for the digitizing oscilloscope. Numbers in the lower left corners are character widths in pixels.

Table A-1: The TDS Character Set

	0	1	2	3	4	5	6	7
0	NUL	√	space	0	@	P	,	p
1	Ω	Ω	i	1	A	Q	a	q
2	?	△	”	2	B	R	b	r
3	Ĉ	BW	#	3	C	S	c	s
4	..	√	\$	4	D	T	d	t
5	,	√	%	5	E	U	e	u
6	ƒ	√	&	6	F	V	f	v
7	,	˘	,	7	G	W	g	w
8	!	—	(8	H	X	h	x
9	HT	—)	9	I	Y	!	y
A	LF	∞	*	:	J	Z	!	z
B	,	ESC	+	:	K	[k	}
C	±	x	,	<	L	\	l	
D	CR	≠	—	=	M]	m	}
E	-	~	.	>	N	˘	n	~
F	•	•	/	?	O	-	o	

Table A-2: The ASCII & GPIB Code Chart

	ADDRESS COMMANDS	UNIVERSAL COMMANDS	LISTEN ADDRESSES	TALK ADDRESSES	SECONDARY ADDRESSES OR COMMANDS
0	NUL	DLE	SP	@	P
1	SOH	DC1	i	A	Q
2	STX	DC2	"	B	R
3	ETX	DC3	#	C	S
4	EOT	DC4	\$	D	T
5	ENQ	NAK	%	E	U
6	ACK	SYN	&	F	V
7	BEL	ETB	,	G	W
8	BS	CAN	(H	X
9	HT	EM)	I	Y
A	LF	SUB	*	J	Z
B	VT	ESC	+	K	[
C	FF	FS	,	L	\
D	CR	GS	-	M]
E	SO	RS	.	N	^
F	SI	US	/	O	_

KEY octal 25 PPU **NAK** hex 15 21 decimal

GPIB code
ASCII character
decimal

Appendix B: Reserved Words

The following is a list of the reserved words of the digitizing oscilloscope. Do not use these words for aliases.

MEASUREMENT	HDELTA	DESTINATION	BOTTOM4
MEG	HDR	DIAG	BOTTOM5
MESSAGE	HEADER	DIRECTION	BOTTOM6
METHOD	HERTZ	DISPLAY	BOTTOM7
MID	HFRJ	DIVISIONS	BOX
MID2	HFRJ	DOTS	BURST
MINIMUM	HIGH	DRAW	BUSY
MINMAX	HISTOGRAM	EDGE	BYT_Nr
MODE	HOLDOFF	EDGE1	BYT_Or
MONO	HORIZONTAL	EDGE2	CALIBRATE
MOVE	HPGI	ENCODG	CATALOG
MSB	HPOS1	ENV	CAREA
NAME	HPOS2	ENVELOPE	CENTRONICS
NCROSS	HYSTeresis	EPSCOLOR	CH1
NDUTY	ID	EPsImAge	CH2
NEWPass	IMMED	EPsMOnO	CHKsm0
NEXT	INDEPENDENT	EPSON	CLEAR
NONE	INFINITE	ERRLOG	CLEARMENU
NORMAL	INFPERSIST	EVEN	CLEARSNAPSHOT
NOVERSHOOT	INIT	EVMG	CLOCK
NR_PT	INTENSIFIED	EXECUTE	CMEAN
NUMAVG	INTERNAL	EXERCISER	COMPARE
NUMENv	INTERNAL	EXTATTEN	CONTRAST
NUMPOINTS	LABEL	EXTDBATTEN	CONTROL
NWIDTh	LANDSCAPE	EXTERNAL	COUNT
ODD	LASERJET	FACTORY	CPU
OFF	LAYOUT	FALL	CR
OFFBUS	LEVEL	FILTER	CRLT
OFFSET	LF	FIRST	CRMS
ON	LFCR	FLAG	CROSSHAIR
ONCE	LIMIT	FORMAT	CROSSLEVEL
OPTION	LINEAR	FORWARDS	CRVCHK
OVERALL	LIVE	FPPANEL	CURSOR
PAIRED	LOCK	FRAME	CURSOR1
PARITY	LOG	FREE	CURSOR2
PARTIAL	LOW	FREQUENCY	CURVE
PASS	LSB	FULL	DATA
PASSWORD	MAIN	FUNCTION	DATE
PCROSS	MATH1	GATING	DEFINE
PCX	MATH2	GPIB	DELAY
PDUty	MATH3	GRAPHICS	DELETED
PERCENT	MAXIMUM	GRATICULE	DELTA
PERIOD	MEAN	GRID	DESE
PERSISTENCE	MEAS1	HALL	DESKJET
PHASE	MEAS2	HARDCOPY	DESKW
PK2pk	MEAS3	HARDFLAGGING	BOTTOM2
POINTS	MEAS4	HBAR	BOTTOM3

WAVFrm	TEMPLate	SINX	RIGHT1	PORT
WAVFid	TEXT	SLOPe	RIGHT2	PORTRait
WFMPre	THInkJet	SNAP	RIGHT3	POSITIon
WIDth	TIFf	SNAPShot	RIGHT4	POSITIon1
XINcr	TIME	SOFTfLagging	RIGHT5	POSITIon2
XMUIT	TITLe	SOUrcE	RISE	POVershoot
XOFF	TOLerance	SOUrcE1	RMS	PROBE
XUNIt	TRACk	SOUrcE2	RP	PROBEFunc
XY	TRIGBar	SRIbInary	RPBInary	PT_Fmt
XYZ	TRIGger	SRIbInary	RS232	PT_Off
XZerO	TRIGT	SRO	RUN	PWIDth
Y	TRIPe	STARt	RUNStOp	RECAll
YMUIT	UNITS	STATe	SAVE	RECOrdlength
YOFF	UNLOCK	STATUS	SCALE	REF1
YT	VALUe	STOP	SECdIV	REF2
YUNIt	VARPERSist	STOPAtter	SECOnds	REF3
YZ	VBARs	STOPBIts	SELEct	REF4
YZerO	VDELTA	STORe	SELFdiag	REFLevel
ZMUIT	VECTors	STYle	SEQUence	REMI
ZOFF	VERBOse	TALkLIsten	SET	RESEt
ZOOM	VERTICal	TARget	SETLevel	RESULt
ZUNIt	VOLts	TBPosition	SETUP	RI
ZZerO	WAVEform	TEKSecure	SHOW	RIBInary

Appendix C: Interface Specifications



This appendix describes details of the GPIB remote interface of the digitizing oscilloscope. Normally, you will not need this information to use the digitizing oscilloscope, but the information is useful when connecting to controllers of unusual configuration.

GPIB Function Subsets

The digitizing oscilloscope supports many GPIB function subsets, as listed below. Some of the listings describe subsets that the digitizing oscilloscope does not support.

- SH1 (Source Handshake). The digitizing oscilloscope can transmit multiline messages across the GPIB.
- AH1 (Acceptor Handshake). The digitizing oscilloscope can receive multiline messages across the GPIB.
- T5 (Talker). The digitizing oscilloscope becomes a talker when its talk address is sent with the ATN (Attention) line asserted. It can send both response data and status information when responding to a serial poll. It ceases to be a talker when another device's talk address is sent with ATN asserted. The digitizing oscilloscope has talk-only capability for hardcopy operation.
- L4 (Listener). The digitizing oscilloscope becomes a listener when its listen address is sent with the ATN (Attention) line asserted. The digitizing oscilloscope does not have listen-only capability.
- SR1 (Service Request). The digitizing oscilloscope asserts an SRQ (Service Request) line to notify the controller when it requires service. (Remote/Local). The digitizing oscilloscope responds to both the GTL (Go To Local) and LLO (Local Lock Out) interface messages.
- PP0 (Parallel Poll). The digitizing oscilloscope has no parallel poll capability. It does not respond to the following interface messages: PFC, PPD, PPE, and PPU. The digitizing oscilloscope does not send out a status message when the ATN (Attention) and EOI (End or Identify) lines are asserted simultaneously.
- DC1 (Device Clear). The digitizing oscilloscope responds to the DCL (Device Clear) and, when made a listener, the SDC (Selected Device Clear) interface messages.
- DT1 (Device Trigger). When acting as a listener, the digitizing oscilloscope responds to the GET (Group Execute Trigger) interface message.
- C0 (Controller). The digitizing oscilloscope cannot control other devices.
- E2 (Electrical). The digitizing oscilloscope uses tristate buffers to provide optimal high-speed data transfer.

Interface Messages

Table C-1 shows the standard interface messages that are supported by the digitizing oscilloscope.

Table C-1: Digitizing Oscilloscope Standard Interface Messages

Message	GPIOB
DCL	Yes
GET	Yes
GTL	Yes
LLO	Yes
PPC	No
PPD	No
PPE	No
PPU	No
SDC	Yes
SPD	Yes
SPE	Yes
TCT	No
UNL	Yes
UNT	Yes
Listen Addresses	Yes
Talk Addresses	Yes

Control	Changed by Factory Init to
Acquire mode	Normal
Acquire stop after	RUN/STOP button only
Acquire # of averages	16
Acquire # of envelopes	10
Channel selection	Channel 1 on, all others off
Cursor H Bar 1 position	10% of graticule height (-3.2 divs from the center)
Cursor H Bar 2 position	90% of the graticule height (+3.2 divs from the center)
Cursor V Bar 1 position	10% of the record length
Cursor V Bar 2 position	90% of the record length
Cursor function	Off
Cursor mode	Independent
Cursor time units	Seconds
Delayed time base position without delay lines	16 ns
Delayed time base position with delay lines	-1.5 ns
Delayed time per division	100 ps
Display format	YT
Display graticule type	Full
Display intensity – contrast	150%

Table D-1: Factory Initialization Defaults

Factory initialization sets values as shown in Table D-1.

Settings

The factory initialization settings provide a known state for the digitizing oscilloscope.

Appendix D: Factory Initialization Settings



Table D-1: Factory Initialization Defaults (Cont.)

Control	Changed by Factory Init to
Display intensity – text	60%
Display intensity – waveform	75%
Display intensity – overall	85%
Display interpolation filter	Sin(x)/x
Display style	Dots
Display trigger “T”	On
Display variable persistence	500 ms
Horizontal – main position	50%
Horizontal – record length	500 points (10 divs)
Horizontal – time base	Main only
Main time base position without delay lines	16 ns
Main time base position with delay lines	–1.5 ns
Main time per division	1 ns
Math function (single wfm)	Invert (Inv) for math3
Math operator (dual wfm)	+ for math1, – for math2
Math source 1 (single and dual)	Channel 1 (Ch1)
Math source 2	Channel 2 (Ch2)
Math type	Dual Wfm Math for math1 and math2, single for math3
Measure Delay to	Channel 1 (Ch1)
Measure Delay edges	Both rising and forward searching
Measure High-Low Setup	Histogram
Measure High Ref	90% and 0 V (units)
Measure Gating	Off
Measure Low Ref	10% and 0 V (units)
Measure Mid Ref	50% and 0 V (units)
Measure Mid2 Ref	50% and 0 V (units)
Message Window coordinates	74, 84, 475, 135
Saved setups	No change

Control	Changed by Factory Init to
Saved waveforms	No change
Trig Bar	Short
Trig Bar internal clock rate	100 kHz
Trig Bar holdoff	15 μ s
Trig Bar level	0.0 V
Trig Bar mode	Auto
Trig Bar slope	Rising
Trig Bar source	External
Vertical offset (all channels)	0 V
Vertical position (all channels)	0 divs.
Vertical volts/div. (all channels)	100 mV/div.
Zoom horizontal (all channels)	1.0X
Zoom horizontal lock	All
Zoom horizontal position (all channels)	50% = .5 (the middle of the display)
Zoom state	Off
Zoom vertical (all channels)	1.0X
Zoom vertical position (all channels)	0 divs.

Table D-1: Factory Initialization Defaults (Cont.)

A computer language (distributed by Microsoft) that is based on the Beginner's All-Purpose Symbolic Instruction Code.

QuickBASIC

Acronym for the Institute for Electrical and Electronic Engineers.

IEEE

Acronym for General Purpose Interface Bus, the common name for the communications interface system defined in IEEE Std 488.

GPB

A sampling mode in which the oscilloscope acquires signals over many repetitions of the event. The TDS 820 Digitizing Oscilloscope uses a type of equivalent time sampling called *sequential equivalent time sampling*. With this method, the oscilloscope acquires one sample for each trigger event. At the first trigger, the oscilloscope samples the voltage at the time after the trigger event specified by the time base position. Each subsequent trigger increases the delay interval before acquisition of the next sample, so that each successive sample represents voltage later in the input waveform. The oscilloscope constructs a waveform record using the samples from multiple acquisitions.

Equivalent-time sampling (ET)

A generic acronym referring to the end-of-message terminator. The end-of-message terminator can be either an EOI or the ASCII code for line feed (LF).

EOM

A mnemonic referring to the control line "End or Identify" on the GPB interface bus. One of the two possible end-of-message terminators.

EOI

A computer or other device that sends commands to and accepts responses from the digitizing oscilloscope.

Controller

A standard notation system for command syntax diagrams. The syntax diagrams in this manual use BNF notation.

Backus-Naur Form (BNF)

A 7-bit code that identifies an instrument on the communication bus. The digitizing oscilloscope must have a unique address for the controller to recognize and transmit commands to it.

Address

Acronym for the American Standard Code for Information Interchange. Controllers transmit commands to the digitizing oscilloscope using ASCII character encoding.

ASCII

QuickC

A computer language (distributed by Microsoft) that is based on C.

TEKSecure

A Tektronix custom command that initializes both waveform and setup memories. This overwrites any previously stored data.

- Quoted string, 2-8
- Command Descriptions, 1-1
- Command group
 - Acquisition, 2-11
 - Application menu, 2-12
 - Calibration and diagnostic, 2-12
 - Cursor, 2-13
 - Display, 2-14, 2-29
 - Graphics, 2-15
 - Hardcopy, 2-16
 - Horizontal, 2-16
 - Limit test, 2-17
 - Measurement, 2-18
 - Miscellaneous, 2-20
 - Save and recall, 2-21
 - Status and error, 2-22
 - Trigger, 2-23
 - Vertical, 2-24
 - Waveform, 2-24
- Command Groups, 1-1
- Command mnemonic
- Channel, 2-7
- CH<x>, 2-7
- Cursor position, 2-6
- Math waveform, 2-7
- MATH<x>, 2-7
- Measurement specifier, 2-6
- MEAS<x>, 2-6
- POSITION<x>, 2-6
- Reference waveform, 2-7
- REF<x>, 2-7
- Waveform, 2-7
- <wfm>, 2-7
- Command syntax, 2-1
- BNF (Backus-Naur form), 2-1
- Commands, 1-1
- Parts of, 1-1
- Syntax diagrams, 1-1
- Common command, 2-20, 2-22
- Common GPIB commands
 - *CAL?, 2-53
 - *CLS, 2-62
- Concatenating, command, 2-4
- Configuration, command query, 2-133
- Controller, Definition of, *Glossary-1*
- Cursor command group, 2-13
- Cursor commands
 - CURSOR?, 2-63
 - CURSOR:FUNCTION, 2-64
 - CURSOR:HBAARS?, 2-65
 - CURSOR:HBAARS:DELTA?, 2-65
- Cursor position, command mnemonic, 2-6
- CURSOR?, 2-63
- CURSOR:FUNCTION, 2-64
- CURSOR:HBAARS?, 2-65
- CURSOR:HBAARS:DELTA?, 2-65
- CURSOR:HBAARS:POSITION<x>, 2-66
- CURSOR:HBAARS:SELECT, 2-67
- CURSOR:MODE, 2-68
- CURSOR:PAIRED, 2-69
- CURSOR:PAIRED:HDELTA, 2-70
- CURSOR:PAIRED:HDELTA, 2-70
- CURSOR:PAIRED:HPOST, 2-70
- CURSOR:PAIRED:HPOS2, 2-71
- CURSOR:PAIRED:POSITION1, 2-71
- CURSOR:PAIRED:POSITION2, 2-72
- CURSOR:PAIRED:SELECT, 2-73
- CURSOR:PAIRED:VDDELTA, 2-73
- CURSOR:VBARS, 2-74
- CURSOR:VBARS:DELTA?, 2-75
- CURSOR:VBARS:POSITION<x>, 2-76
- CURSOR:VBARS:SELECT, 2-77
- CURSOR:VBARS:UNITS, 2-78
- CURVE, 2-79
- Cursor position, command mnemonic, 2-66
- CURSOR:HBAARS:POSITION<x>, 2-66
- CURSOR:HBAARS:SELECT, 2-67
- CURSOR:MODE, 2-68
- CURSOR:PAIRED, 2-69
- CURSOR:PAIRED:HDELTA, 2-70
- CURSOR:PAIRED:HDELTA, 2-70
- CURSOR:PAIRED:HPOST, 2-70
- CURSOR:PAIRED:HPOS2, 2-71
- CURSOR:PAIRED:POSITION1, 2-71
- CURSOR:PAIRED:POSITION2, 2-72
- CURSOR:PAIRED:SELECT, 2-73
- CURSOR:PAIRED:VDDELTA, 2-73
- CURSOR:VBARS, 2-74
- CURSOR:VBARS:DELTA?, 2-75
- CURSOR:VBARS:POSITION<x>, 2-76
- CURSOR:VBARS:SELECT, 2-77
- CURSOR:VBARS:UNITS, 2-78
- DATA, 2-80
- DATA:DESTINATION, 2-81
- DATA:ENCDG, 2-82
- DATA:SOURCE, 2-84
- DATA:START, 2-85
- DATA:STOP, 2-86
- DATA:TARGET, 2-87
- DATA:WIDTH, 2-88
- DATE, 2-89
- DCL, C-2
- *DDI, 2-90
- DELETE:SETUP, 2-91
- DELETE:WAVEFORM, 2-92
- DESE command, 2-93, 3-3
- DESER register, 2-93, 2-184, 3-3
- Device Clear, 2-4, C-2
- DIAG:RESULT:FLAG?, 2-94
- DIAG:RESULT:LOG?, 2-95
- DIAG:SELECT:ACQUISITION, 2-95
- DIAG:SELECT:ALL, 2-96
- DIAG:SELECT:CPU, 2-96
- DIAG:SELECT:DISPLAY, 2-96
- DIAG:SELECT:FPANEL, 2-97
- DIAG:STATE, 2-97
- Diagram, syntax, 2-10
- Disks included with this manual, 1-3
- Display command group, 2-14, 2-29
- Display commands
 - CLEARMENU, 2-62
 - DISPLAY?, 2-98
 - DISPLAY:CLOCK, 2-99
 - DISPLAY:DATE/TIME. *See DIS-PLAY:CLOCK*
 - DISPLAY:FILTER, 2-100
 - DISPLAY:FORMAT, 2-101
 - DISPLAY:GRATICULE, 2-102
 - DISPLAY:INTENSITY?, 2-102
 - DISPLAY:INTENSITY:CONTRAST, 2-103
- Display commands
 - Cursor commands
 - Display command group, 2-14, 2-29
 - Disks included with this manual, 1-3
 - Diagram, syntax, 2-10
 - DIAG:STATE, 2-97
 - DIAG:SELECT:FPANEL, 2-97
 - DIAG:SELECT:DISPLAY, 2-96
 - DIAG:SELECT:CPU, 2-96
 - DIAG:SELECT:ALL, 2-96
 - DIAG:SELECT:ACQUISITION, 2-95
 - DIAG:RESULT:LOG?, 2-95
 - DIAG:RESULT:FLAG?, 2-94
 - Device Clear, 2-4, C-2
 - DESER register, 2-93, 2-184, 3-3
 - DESE command, 2-93, 3-3
 - DELETE:WAVEFORM, 2-92
 - DELETE:SETUP, 2-91
 - *DDI, 2-90
 - DCL, C-2
 - DATE, 2-89
 - DATA:WIDTH, 2-88
 - DATA:TARGET, 2-87
 - DATA:STOP, 2-86
 - DATA:START, 2-85
 - DATA:SOURCE, 2-84
 - DATA:ENCDG, 2-82
 - DATA:DESTINATION, 2-81
 - DATA, 2-80

L

Limit test command group, 2-17

Limit Test commands

LIMIT:BELL, 2-134

LIMIT:COMPARE:CH<X>, 2-135

LIMIT:HARDCOPY, 2-136

LIMIT:TEMPLATE:MODE, 2-129

HORIZONTAL:MAIN:TBPOSITION, 2-128

HORIZONTAL:MAIN:SCALE, 2-128

HORIZONTAL:MAIN:SECDIV, 2-128

HORIZONTAL:RECORDLENGTH, 2-130

HORIZONTAL:SCALE, 2-131

HORIZONTAL:SECDIV, 2-131

HORIZONTAL:TBPOSITION, 2-132

LIMIT:STATE, 2-137

LIMIT:HARDCOPY, 2-136

LIMIT:COMPARE:CH<X>, 2-135

LIMIT:TEMPLATE:TOLERANCE:VERTICAL, 2-142

LIMIT:TEMPLATE:TOLERANCE:HORIZONTAL, 2-141

LIMIT:TEMPLATE:TOLERANCE:VERTICAL, 2-142

LIMIT:TEMPLATE:DESTINATION, 2-139

LIMIT:TEMPLATE:SOURCE, 2-140

LIMIT:BELL, 2-134

LIMIT:COMPARE:CH<X>, 2-135

I

IEEE, Glossary-1

IEEE Std 488.2-1987, 1-4, 2-1, 2-20, 2-22

Interface message, C-2

Instrument setup, 1-4

ID?, 2-133

*IDN?, 2-133

M

Manual trigger, simulation with command, 2-208

Manuals, Other TDS 820, v

Math waveform, command mnemonic, 2-7

MATH<X>, command mnemonic, 2-7

Measurement command group, 2-18

Measurement commands

MEASUREMENT:CLEARSNAPSHOT, 2-147

MEASUREMENT?, 2-147

MEASUREMENT:IMMED:DELAY, 2-153

SOURCE1, 2-153

MEASUREMENT:IMMED:SOURCE2, 2-154

MEASUREMENT:IMMED:DELAY?, 2-149

SOURCE2, 2-154

MEASUREMENT:IMMED:DELAY?, 2-149

MEASUREMENT:IMMED:DELAY, 2-149

MEASUREMENT:IMMED:DELAY, 2-151

EDGE1, 2-151

MEASUREMENT:IMMED:DELAY, 2-152

EDGE2, 2-152

MEASUREMENT:IMMED:TYPE, 2-154

MEASUREMENT:IMMED:UNITS?, 2-157

MEASUREMENT:IMMED:VALUE?, 2-157

MEASUREMENT:MEAS<X>?, 2-158

Manual trigger, simulation with command, 2-208

Manuals, Other TDS 820, v

Math waveform, command mnemonic, 2-7

MATH<X>, command mnemonic, 2-7

Measurement command group, 2-18

Measurement commands

MEASUREMENT:CLEARSNAPSHOT, 2-147

MEASUREMENT?, 2-147

MEASUREMENT:IMMED:DELAY, 2-153

SOURCE1, 2-153

MEASUREMENT:IMMED:SOURCE2, 2-154

MEASUREMENT:IMMED:DELAY?, 2-149

SOURCE2, 2-154

MEASUREMENT:IMMED:DELAY?, 2-149

MEASUREMENT:IMMED:DELAY, 2-149

MEASUREMENT:IMMED:DELAY, 2-151

EDGE1, 2-151

MEASUREMENT:IMMED:DELAY, 2-152

EDGE2, 2-152

MEASUREMENT:IMMED:TYPE, 2-154

MEASUREMENT:IMMED:UNITS?, 2-157

MEASUREMENT:IMMED:VALUE?, 2-157

MEASUREMENT:MEAS<X>?, 2-158

MEASUREMENT:MEAS<X>, 2-158

MEASUREMENT:MEAS<X>:DELAY?, 2-158

MEASUREMENT:MEAS<X>:STATE, 2-164

MEASUREMENT:MEAS<X>:TYPE, 2-164

MEASUREMENT:MEAS<X>:UNITS?, 2-167

MEASUREMENT:MEAS<X>:VALUES?, 2-167

MEASURE-
LIMIT:TEMPLATE:SOURCE, 2-140

MEASURE-
LLO, C-2

Local lock out, C-2

LOCK, 2-143

*LRN?, 2-144

MEASURE-
HORIZONTAL:SCALE, 2-131

MEASURE-
HORIZONTAL:SECDIV, 2-131

MEASURE-
HORIZONTAL:TBPOSITION, 2-132

MEASURE-
MENT:MEAS<X>:DELAY, 2-161

EDGE2, 2-161

MEASURE-
MENT:MEAS<X>:DELAY, 2-160

EDGE1, 2-160

MEASURE-
MENT:MEAS<X>:DELAY, 2-159

DIRECTION?, 2-159

MEASURE-
MENT:MEAS<X>:DELAY, 2-162

SOURCE1, 2-162

MEASURE-
MENT:MEAS<X>:DELAY, 2-163

SOURCE2, 2-163

MEASUREMENT:METHOD, 2-168

MEASUREMENT:REFLEVEL?, 2-168

MEASUREMENT:REFLEVEL, 2-168

MEASUREMENT:REFLEVEL:ABSOLUTE:HIGH, 2-169

MEASUREMENT:REFLEVEL:ABSOLUTE:LOW, 2-169

MEASUREMENT:REFLEVEL:ABSOLUTE:MID, 2-170

MEASUREMENT:REFLEVEL:ABSOLUTE:MID2, 2-171

MEASUREMENT:REFLEVEL:METHOD, 2-172

MEASUREMENT:REFLEVEL:PERCENT:HIGH, 2-173

MEASUREMENT:REFLEVEL:PERCENT:LOW, 2-174

MEASUREMENT:REFLEVEL:PERCENT:MID, 2-175

MEASUREMENT:REFLEVEL:PERCENT:MID2, 2-176

PERCENT:MID2, 2-176

MEASUREMENT:SNAPSHOT, 2-176

Measurement specifier, command mnemonic, 2-6

MEASUREMENT?, 2-147

MEASUREMENT:CLEARSNAPSHOT, 2-147

MEASUREMENT:GATING, 2-148

MEASUREMENT:IMMED?, 2-149

N

NEWPASS, 2-181

Numeric, command argument, 2-8

O

*OPC, 2-182

Operation complete command, 2-182

Operation complete wait, 2-210

Output queue, 3-5

P

MESSAGE:BOX, 2-178

MESSAGE:SHOW, 2-179

MESSAGE:STATE, 2-181

Messages, Status and error, 1-2

Miscellaneous, LOCK, 2-143

Miscellaneous command group, 2-20

Miscellaneous commands

AUTOSET, 2-51

BELL, 2-51

DATE, 2-89

*DDT, 2-90

FACTORY, 2-112

HDR, 2-122

HEADER, 2-123

*IDN?, 2-133

*LRN?, 2-144

NEWPASS, 2-181

PASSWORD, 2-183

*PUD, 2-185

REM, 2-186

RS232?, 2-188

RS232:BAUD, 2-189

RS232:HARDFLAGGING, 2-190

RS232:PARITY, 2-191

RS232:SOFTFLAGGING, 2-192

RS232:STOPBITS, 2-193

SET, 2-197

TEKSECURE, 2-199

TIME, 2-200

*TRG, 2-208

UNLOCK, 2-209

VERBOSE, 2-210

Mnemonic, command, 2-2

Query command, 2-1

Query, header in query response, 2-123, 2-210

Q

*PUD, 2-185

*PSC command, 3-4

*PSC, 2-184

Programming Examples, 1-3

PPU, C-2

PPE, C-2

PPD, C-2

PPC, C-2

Power-on status clear command, 2-184

ic, 2-6

POSITION<x>, command mnemonic

Performance verification, Manual, v

PASSWORD, 2-183

Parts of commands, 1-1

Parallel poll, C-2

Paired cursors, 2-69

Queue
Event, 3-5
Output, 3-5

QuickBASIC, *Glossary-1*
QuickC, *Glossary-1*
Quoted string, command argument, 2-8

R

*RCL, 2-185
Recall setting command, 2-185
RECALL:SETUP, 2-186
Reference waveform, command mnemonic, 2-7
REF<x>, command mnemonic, 2-7
Register
DESER, 2-93, 2-184, 3-3
ESER, 2-108, 2-184, 3-4
SBR, 2-199, 3-2
SESR, 2-62, 2-109, 2-182, 3-1
SRER, 2-184, 2-198, 3-4
Related manuals, v
REM, 2-186
Reset
Command, 2-187
Factory, 2-112
RS232?, 2-188
RS232:BAUD, 2-189
RS232:HARDFLAGGING, 2-190
RS232:PARITY, 2-191
RS232:SOFTFLAGGING, 2-192
RS232:STOPBITS, 2-193
*RST, 2-187
Rules, command forming, 2-1

S

*SAV, 2-193
Save and recall command group, 2-21
ALLOCATE?, 2-43
ALLOCATE?, 2-43
Save and recall commands
ALLOCATE:WAVEFORM?, 2-43

ALLOCATE:WAVEFORM:FREE?, 2-44
ALLOCATE:WAVEFORM:REF<x>, 2-45
DELETE:SETUP, 2-91
DELETE:WAVEFORM, 2-92
*RCL, 2-185
RECALL:SETUP, 2-186
*SAV, 2-193
SAVE:SETUP, 2-194
SAVE:WAVEFORM, 2-194
Save setting command, 2-193
SAVE:SETUP, 2-194
SAVE:SETUP, 2-194
SBR register, 2-199, 3-2
SDC, C-2
SELECT?, 2-195
SELECT:<wfm>, 2-195
SELECT:CONTROL?, 2-196
Selected device clear, C-2
Self test, 2-209
Separator, command, 2-2
Serial poll, 3-2
Disable, C-2
Enable, C-2
Service, Manual, v
Service request enable command, 2-198
Service request enable register, 2-198
Service Requests, 1-2
SESR register, 2-62, 2-109, 2-182, 3-1
Set command, 2-1
SET?, 2-197
Setting
Command query, 2-144
Query, 2-144
Recall command, 2-185
Save command, 2-193
Setup, instrument preparation, 1-4
SPD, C-2
SPE, C-2
*SRE command, 2-198, 3-4
SRER register, 2-184, 2-198, 3-4
SRQ, 1-2
Status, 3-1

Status and error command group, 2-22
Status and error commands
ALLEV?, 2-42
BUSY?, 2-52
*CLS, 2-62
DESE, 3-3
*ESE, 2-108, 3-4
*ESR?, 2-109, 3-1
EVENT?, 2-109
EVMMSG?, 2-110
EVQTY?, 2-111
ID?, 2-133
*OPC, 2-182
*PSC, 2-184, 3-4
*RST, 2-187
*SRE, 3-4
*STB?, 2-199, 3-2
*WAI, 2-210
Status and Events, 1-2
*STB?, 2-199
*STB? query, 3-2
Syntax
BNF (Backus-Naur form), 2-1
Command, 2-1
Diagram, 2-10
Syntax and Commands, 1-1
Syntax diagrams, 1-1

T

Table, programming message, 3-13
TCT, C-2
Tek Standard Codes and Formats
1989, 2-20, 2-22
TEKSECURE, 2-199
TEKSecure, *Glossary-1*
Terminator, command message, 2-5
TIME, 2-200
Time base, Manual trigger simulation, 2-208
*TRG, 2-208
TRIGGER, 2-201
Trigger command group, 2-23
Trigger commands

