

User Manual

Tektronix

**VM700T Video Measurement Set
Option 01 (NTSC) & Option 11 (PAL)**

070-9647-01

CE

Copyright © Tektronix, Inc. All rights reserved. Licensed software products are owned by Tektronix or its suppliers and are protected by United States copyright laws and international treaty provisions.

Use, duplication, or disclosure by the Government is subject to restrictions as set forth in subparagraph (c)(1)(ii) of the Rights in Technical Data and Computer Software clause at DFARS 252.227-7013, or subparagraphs (c)(1) and (2) of the Commercial Computer Software – Restricted Rights clause at FAR 52.227-19, as applicable.

Tektronix products are covered by U.S. and foreign patents, issued and pending. Information in this publication supercedes that in all previously published material. Specifications and price change privileges reserved.

Printed in the U.S.A.

Tektronix, Inc., P.O. Box 1000, Wilsonville, OR 97070-1000

TEKTRONIX and TEK are registered trademarks of Tektronix, Inc.

Portions of the software in this instrument are copyrighted by Stanford University.

WARRANTY

Tektronix warrants that the products that it manufactures and sells will be free from defects in materials and workmanship for a period of one (1) year from the date of shipment. If a product proves defective during this warranty period, Tektronix, at its option, either will repair the defective product without charge for parts and labor, or will provide a replacement in exchange for the defective product.

In order to obtain service under this warranty, Customer must notify Tektronix of the defect before the expiration of the warranty period and make suitable arrangements for the performance of service. Customer shall be responsible for packaging and shipping the defective product to the service center designated by Tektronix, with shipping charges prepaid. Tektronix shall pay for the return of the product to Customer if the shipment is to a location within the country in which the Tektronix service center is located. Customer shall be responsible for paying all shipping charges, duties, taxes, and any other charges for products returned to any other locations.

This warranty shall not apply to any defect, failure or damage caused by improper use or improper or inadequate maintenance and care. Tektronix shall not be obligated to furnish service under this warranty a) to repair damage resulting from attempts by personnel other than Tektronix representatives to install, repair or service the product; b) to repair damage resulting from improper use or connection to incompatible equipment; c) to repair any damage or malfunction caused by the use of non-Tektronix supplies; or d) to service a product that has been modified or integrated with other products when the effect of such modification or integration increases the time or difficulty of servicing the product.

THIS WARRANTY IS GIVEN BY TEKTRONIX IN LIEU OF ANY OTHER WARRANTIES, EXPRESS OR IMPLIED. TEKTRONIX AND ITS VENDORS DISCLAIM ANY IMPLIED WARRANTIES OF MERCHANTABILITY OR FITNESS FOR A PARTICULAR PURPOSE. TEKTRONIX' RESPONSIBILITY TO REPAIR OR REPLACE DEFECTIVE PRODUCTS IS THE SOLE AND EXCLUSIVE REMEDY PROVIDED TO THE CUSTOMER FOR BREACH OF THIS WARRANTY. TEKTRONIX AND ITS VENDORS WILL NOT BE LIABLE FOR ANY INDIRECT, SPECIAL, INCIDENTAL, OR CONSEQUENTIAL DAMAGES IRRESPECTIVE OF WHETHER TEKTRONIX OR THE VENDOR HAS ADVANCE NOTICE OF THE POSSIBILITY OF SUCH DAMAGES.

Table of Contents

| | |
|------------------------------|-----|
| General Safety Summary | vii |
| Preface | ix |

Getting Started

| | |
|---|------------|
| Installation | 1-3 |
| Power Requirements | 1-3 |
| Changing Line Voltage Range and Fuse | 1-3 |
| Power Cord | 1-3 |
| Power Up Diagnostics | 1-4 |
| Calibrating the Touch Screen | 1-5 |
| Setting the Power Up Mode | 1-7 |
| Function Playback on Power Up | 1-8 |
| Serial Port Configuration | 1-9 |
| RS-232C Interface Information | 1-9 |
| Connecting Serial Printers | 1-12 |
| Connecting an EPSON LQ Printer | 1-12 |
| Connecting an Apple LaserWriter | 1-13 |
| Connecting a Serial Interface HP LaserJet, DeskJet, or ThinkJet | 1-14 |
| Connecting an ASCII Printer | 1-15 |
| Connecting Parallel Printers | 1-16 |
| Configuring the VM700T for Parallel Printers | 1-16 |
| VGA Output Connector | 1-16 |

Operating Basics

| | |
|---|------------|
| Front Panel Operation | 2-1 |
| Touch Screen | 2-1 |
| Manual and Auto Operational Mode Buttons | 2-2 |
| Freeze, Source Selection, and Average Functions | 2-3 |
| Support Functions | 2-3 |
| Control Knob | 2-4 |
| Equipment/Signal Sources Required | 2-5 |
| Bandwidth | 2-5 |
| Connecting Inputs and Outputs | 2-5 |
| Configuring the VM700T Video Measurement Set | 2-7 |
| Configure Operations | 2-9 |
| The Configure Directory Structure | 2-9 |
| Supplied Directories and Files | 2-11 |
| Creating and Deleting Files | 2-11 |
| Editing Files | 2-14 |
| Printing Files | 2-16 |

| | |
|--|------|
| Setting the Internal Clock | 2-17 |
| Directory Structure | 2-18 |
| Source_Selection~Video (File) | 2-18 |
| Video_Source~Files (Directory) | 2-21 |
| Auto_Limit Files (Directory) | 2-22 |
| Communication Setup (File) | 2-23 |
| Diagnostic Errors (File) | 2-27 |
| Diagnostics Selection (File) | 2-27 |
| Measure_Limit Files (Directory) | 2-28 |
| Measurement Locations (Directory) | 2-29 |
| Measurement Results (Directory) | 2-29 |
| Password (File) | 2-30 |
| Selected Measurements (Directory) | 2-32 |
| Timed Events (Directory) | 2-32 |
| Video Source Identification (File) | 2-36 |

Reference

| | |
|---|------------|
| Waveform Mode | 3-1 |
| Display | 3-1 |
| Waveform | 3-1 |
| Graticule | 3-1 |
| Line Identification | 3-2 |
| Horizontal Reference Line | 3-2 |
| Status Lines | 3-3 |
| Control Knob | 3-3 |
| Freeze | 3-4 |
| Menu | 3-4 |
| Cursors | 3-4 |
| Sync | 3-6 |
| Noise [0 dB - 30.10 dB] | 3-7 |
| Extra Functions | 3-7 |
| Filter Select | 3-8 |
| Clamp Couple | 3-8 |
| Select Line | 3-9 |
| System Line | 3-10 |
| Cursors | 3-10 |
| Cursor Appearance | 3-10 |
| Cursor Status Lines | 3-11 |
| Moving Cursors-Lock Left, Lock Right, Center Left, and Center Right ... | 3-11 |
| Using Cursors to Measure Timing | 3-11 |
| Using Cursors to Measure Frequency | 3-14 |
| Using Cursors to Measure Amplitude | 3-14 |

| | |
|---|-------------|
| Vector Mode | 3-17 |
| Display | 3-17 |
| Control Knob | 3-18 |
| Menu | 3-18 |
| Select Line | 3-20 |
| Measure Mode | 3-21 |
| Measure Mode Menu Operation | 3-21 |
| Video Option Measurement Menu Operation | 3-22 |
| Picture Mode | 3-23 |
| Auto Mode | 3-25 |
| Auto Mode Display | 3-25 |
| Measurement Identification | 3-25 |
| Violated Limits Indication | 3-25 |
| Comments Column | 3-26 |
| Timed Events | 3-26 |
| Violated Limits Logging | 3-26 |
| Remote Operation | 3-26 |
| Configuring Auto Mode | 3-26 |
| Setting Alarm Limits | 3-27 |
| Defining Measurement Locations | 3-28 |
| Selecting a Group of Measurements | 3-28 |
| Setting Event Times | 3-29 |

Appendices

| | |
|---|------------|
| Appendix A: Specification | A-1 |
| Electrical Characteristics | A-1 |
| Physical Characteristics | A-3 |
| Power Requirements | A-3 |
| Environmental | A-3 |
| Optional Accessory | A-7 |
| Appendix B: Performance Verification | B-1 |
| Self Diagnostics | B-1 |
| Test Equipment Required | B-2 |
| System Verification Procedures | B-2 |
| Measure Squarewave | B-3 |
| Measure Sinewave | B-4 |
| Measure the Burst Frequency | B-5 |
| Appendix C: Adding Options | C-1 |
| Ordering | C-1 |
| Activating the New Options | C-2 |

Index

List of Figures

| | |
|--|------|
| Figure 1-1: Rear-panel fuse, power connector, ON/OFF switch and Line selector | 1-4 |
| Figure 1-2: VM700T Startup menu | 1-5 |
| Figure 1-3: Touch screen calibration (display) | 1-6 |
| Figure 1-4: Touch screen calibration (panel) | 1-6 |
| Figure 1-5: Panel calibration values | 1-7 |
| Figure 1-6: Diagnostic configuration menu | 1-7 |
| Figure 1-7: Set diagnostics power up mode menu | 1-8 |
| Figure 1-8: VM700T rear panel | 1-9 |
| | |
| Figure 2-1: VM700T front panel | 2-1 |
| Figure 2-2: VM700T keypad | 2-2 |
| Figure 2-3: Main Configure menu | 2-8 |
| Figure 2-4: Configure Directory | 2-10 |
| Figure 2-5: Creating a new file | 2-12 |
| Figure 2-6: File naming keyboard | 2-13 |
| Figure 2-7: Time Configure menu | 2-17 |
| Figure 2-8: How the VM700T Video Measurement Set gets parameter information | 2-20 |
| Figure 2-9: Communication Setup file with Copy Format selected to edit | 2-25 |
| Figure 2-10: Communication Setup file after edit is accepted | 2-26 |
| Figure 2-11: Diagnostic selection file | 2-28 |
| Figure 2-12: Diagnostic selection file showing an unselected choice ... | 2-28 |
| Figure 2-13: DIP switch setting to enable Password | 2-31 |
| | |
| Figure 3-1: Typical NTSC Waveform display | 3-2 |
| Figure 3-2: Waveform menu tree | 3-5 |
| Figure 3-3: Left cursor locked to 90% point of sync edge, right cursor to 10% point | 3-13 |
| Figure 3-4: Color burst aligned with horizontal reference line | 3-14 |
| Figure 3-5: Cursors mode indicating color burst amplitude | 3-15 |
| Figure 3-6: Vector display of a color bar signal | 3-17 |
| Figure 3-7: Vector mode menu | 3-18 |
| Figure 3-8: Measure Mode menu choices | 3-21 |
| Figure 3-9: Measure menu of Camera Video Option | 3-22 |
| | |
| Figure C-1: Main configure menu | C-1 |
| Figure C-2: Option Key control menu | C-2 |
| Figure C-3: Error message for invalid Option Key | C-4 |

List of Tables

| | |
|---|------|
| Table 1-1: Serial port protocol | 1-10 |
| Table 1-2: Typical VM700T RS-232C cable connections | 1-11 |
| Table 1-3: VM700T 9-pin to PC 25-pin null modem cable for remote control | 1-12 |
| Table 1-4: Epson LQ serial cable connections | 1-13 |
| Table 1-5: Apple LaserWriter serial connections | 1-14 |
| Table 1-6: HP LaserJet cable connections | 1-15 |
| | |
| Table A-1: Input characteristics | A-1 |
| Table A-2: Digitizer | A-2 |
| Table A-3: Synchronization | A-2 |
| Table A-4: Physical characteristics | A-3 |
| Table A-5: Power requirements | A-3 |
| Table A-6: Environmental specification | A-3 |
| Table A-7: EMC compliance | A-4 |
| Table A-8: Safety standards | A-5 |
| Table A-9: Safety certification compliance | A-6 |
| Table A-10: Rear panel signal connectors | A-6 |
| Table A-11: Optional power cords | A-7 |
| Table A-12: Certifications and compliances | A-8 |
| | |
| Table B-1: Test equipment required for verification | B-2 |

General Safety Summary

Review the following safety precautions to avoid injury and prevent damage to this product or any products connected to it.

Only qualified personnel should perform service procedures.

To avoid potential hazards, use this product only as specified.

To Avoid Fire or Personal Injury

Use Proper Power Cord. Use only the power cord specified for this product and certified for the country of use.

Use Proper Voltage Setting. Before applying power, ensure that the line selector is in the proper position for the power source being used.

Connect and Disconnect Properly. Do not connect or disconnect probes or test leads while they are connected to a voltage source.

Ground the Product. This product is grounded through the grounding conductor of the power cord. To avoid electric shock, the grounding conductor must be connected to earth ground. Before making connections to the input or output terminals of the product, ensure that the product is properly grounded.

Observe All Terminal Ratings. To avoid fire or shock hazard, observe all ratings and markings on the product. Consult the product manual for further ratings information before making connections to the product.

Do not apply a potential to any terminal, including the common terminal, that exceeds the maximum rating of that terminal.

Do Not Operate Without Covers. Do not operate this product with covers or panels removed.

Use Proper Fuse. Use only the fuse type and rating specified for this product.

Avoid Exposed Circuitry. Do not touch exposed connections and components when power is present.

Do Not Operate With Suspected Failures. If you suspect there is damage to this product, have it inspected by qualified service personnel.

Do Not Operate in Wet/Damp Conditions.

Do Not Operate in an Explosive Atmosphere.

Provide Proper Ventilation. To prevent product overheating, provide proper ventilation.

Symbols and Terms

Terms in this Manual. These terms may appear in this manual:



WARNING. Warning statements identify conditions or practices that could result in injury or loss of life.



CAUTION. Caution statements identify conditions or practices that could result in damage to this product or other property.

Terms on the Product. These terms may appear on the product:

DANGER indicates an injury hazard immediately accessible as you read the marking.

WARNING indicates an injury hazard not immediately accessible as you read the marking.

CAUTION indicates a hazard to property including the product.

Symbols on the Product. The following symbols may appear on the product:



WARNING
High Voltage



Protective Ground
(Earth) Terminal



CAUTION
Refer to Manual



Double
Insulated

Preface

This manual describes the front panel operation of the VM700T Video Measurement Set. Those features that generally apply across the full range of possible options are explained. For specific information on the installed options, see the applicable option manual supplied with this manual set. User and Programmer manuals for the measurement set and its options now include:

- VM700T Video Measurement Set User Manual
- Option 01 NTSC Measurements User Manual
- Option 11 PAL Measurements User Manual
- Option 1G Echo and Rounding Error Measurements User Manual
- Option 20 Teletext Measurements User Manual
- Option 21 Camera Measurements User Manual
- Option 30 Component Measurements User Manual
- Option 40/41/42 Audio Measurements User Manual
- Option 48 GPIB Interface Programmer Manual
- VM700T RS-232 Interface Programmer Manual

Your manual set includes the *VM700T Video Measurement Set Option 01 & Option 11 User Manual*, the *VM700T RS-232 Interface Programmer Manual*, and the applicable option user manuals for the other options in your instrument.

Here are some additional software packages that may be of special interest to you:

- VMBKUP. Software to assist in backing up the VM700T user-created files. These files can be reloaded to the same instrument or to another VM700T to generate a common set of configuration files.
- VMRMGR. This software aids you in handling the graphic displays and transferring them to a personal computer for filing, display, or printing.
- VMTerminal. This useful software package assists in remote control of the VM700T and remote file capture using a personal computer.

The VM700T Video Measurement Set manuals also apply to the VM700A Video Measurement Sets with the VMTB or VMTX upgrade and any option upgrades that are ordered with the VMTB or VMTX upgrade.



Getting Started

Getting Started

The VM700T Video Measurement Set is a multifunction television test and measurement device with an easy-to-use interface. The VM700T combines the functions of a waveform monitor, vectorscope, automatic measurement set, and noise measurement set in a single instrument. Input signals can be obtained from live TV broadcast or generated by test equipment. The VM700T can be operated by using its front-panel controls or by using one of the rear-panel RS-232C ports, or the GPIB port if Option 48 is installed, to send it commands.

The measurement set can be operated as an NTSC-standard instrument (Option 01), a PAL-standard instrument (Option 11), or as a dual-standard instrument when both options are included.

The measurement set functions as a waveform monitor when its Waveform front-panel button is pressed. Waveform monitor operation is described *Waveform Mode* on page 3-1.

The measurement set functions as a vectorscope when its Vector front-panel button is pressed. Vectorscope operation is described in *Vector Mode* on page 3-17.

When the Measure front-panel button is pressed, a list of available measurements is displayed. A general description of Measure mode operation is given in *Measure Mode* on page 3-21. Detailed information about individual measurements is included in the *VM700T Option 01 NTSC Measurements User Manual* and the *VM700T Option 11 PAL Measurement User Manual*. Consult either of those manuals for more information about individual measurements. Measurement provided with additional installed options are described in the user manuals supplied for the options.

When the Picture front-panel button is pressed, the VM700T functions as a low-resolution picture monitor. This display is to assist you in identifying the input source for other operational modes. Picture mode operation is described in *Picture Mode* on page 3-23.

When the Auto front-panel button is pressed, the VM700T cycles through the selected set of automated measurements. Refer to page 3-25 for a general description of Auto mode operation. Detailed information about individual auto-mode measurements is included in the *VM700T Option 01 NTSC Measurements User Manual* and the *VM700T Option 11 PAL Measurements User Manual*. Consult either of those manuals for more information about individual measurements.

The VM700T Video Measurement Set features the ability to record sequences of operations (functions) and execute them by touching a soft key on the front panel. See the *VM700T RS-232 Interface Programmer Manual* for details on how to record, edit, and execute functions. The functions can also be called remotely once they have been created.

The measurement set is capable of being remotely controlled. You can operate the instrument using a computer or terminal connected through a rear-panel RS-232C port. See the *VM700T RS-232 Interface Programmer Manual* for information on remote programming and operation. If Option 48, the GPIB interface, is also installed, the measurement set may be operated remotely through the GPIB port. See the *VM700T Option 48 GPIB Interface Programmer Manual* for information about GPIB remote control.

An added display option is available for the VM700T. Option 74 provides a display module with a white phosphor CRT instead of the standard green phosphor when a VM700T is ordered with the option.

The display can be viewed on an external VGA monitor connected to the rear panel VGA output connector.

The user manuals for the VM700T Video Measurement Set and its options are applicable to the VM700A with either the VMTB or the VMTX turbo upgrade installed.

Installation

This section contains information about preparing the VM700T Video Measurement Set for operation.

Power Requirements

The measurement set operates with line frequencies of 50 Hz or 60 Hz, over two line voltage ranges. The nominal setting of the low voltage range is 115 VAC. The nominal setting of the high voltage range is 230 VAC.

There are two power switches on the measurement set; one is on the rear panel above the power cord receptacle, and one is on the front panel. **Both must be on** to operate the instrument. The rear-panel switch is the master power switch. The switch on the front panel remotely enables the voltage supply outputs.



WARNING. *Dangerous voltages are present within the Power Supply module when the rear-panel power switch is on, regardless of the position of the front-panel power switch. Do not operate the measurement set with any covers removed. Refer all servicing of the instrument to a qualified service person.*

Changing Line Voltage Range and Fuse

The voltage range selection switch and fuse holder are located in the lower left corner of the rear panel (see Figure 1-1). The measurement set is shipped from the factory set for the operating voltage of the destination nation (115 VAC or 230 VAC). If the setting is not correct as received, it must be changed before connecting the power cord to the power source. Simply set the voltage range selection switch (located on the rear panel of the measurement set) to the correct position for operation.



CAUTION. *When changing the line voltage selector switch you must also change the fuse to provide proper protection for the operating voltage in use. The 3A slow-blow fuse provides the proper protection in the 230 VAC range and the 6A slow-blow fuse provides protection for operation in the 115 VAC range.*

Power Cord

A detachable three-wire power cord with a three-contact plug is provided with each instrument for connecting to both the power source and protective ground. The protective-ground connector in the plug connects (through the protective-ground conductor) to the accessible metal parts of the instrument. For electrical-shock protection, insert this plug only into a power-source outlet that has a properly grounded protective-ground contact.

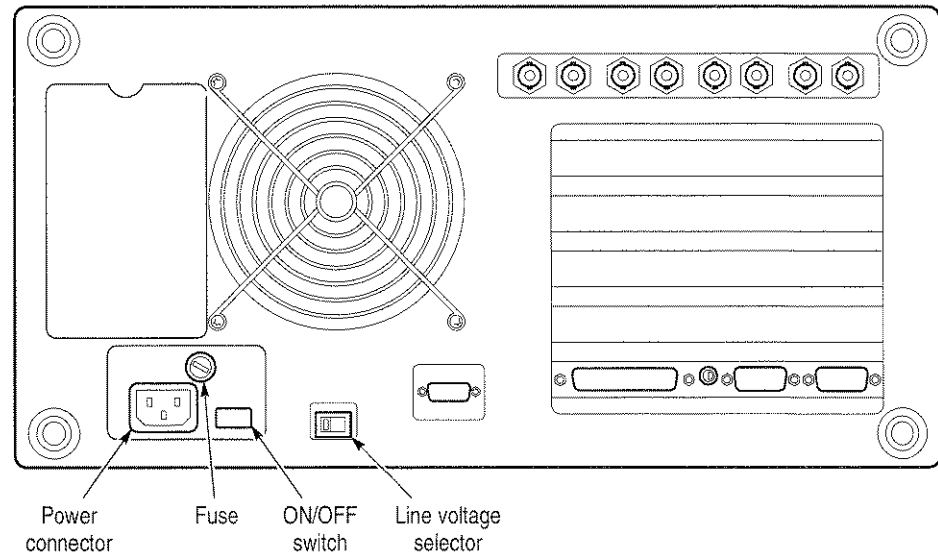

Figure 1-1: Rear-panel fuse, power connector, ON/OFF switch and Line selector

Instruments are shipped with the power cord required for the country of destination. Available power-cord option information is given in *Appendix A: Specification* on page A-7. Contact your Tektronix representative or local Tektronix field office for additional power-cord information.

Power Up Diagnostics

The measurement set, as received from the factory, is configured to skip diagnostics at power on, and it starts up in the quick start mode with the Waveform application running. When configured to skip the diagnostics, you can run diagnostics at power on by pressing and holding in the Menu button while turning on the front-panel power switch. The measurement set then starts up in the low-level diagnostics mode with the VM700T startup menu as shown in Figure 1-2. Use the following procedure to force an auto reset. All the diagnostics then run at power on regardless of the power on diagnostic configuration.

1. Turn off the measurement set.
2. Hold down the **Menu** button and use the front panel STBY/ON switch to power on the instrument.
3. After the instrument beeps twice, release the **Menu** button. The VM700T displays the VM700T Startup Menu.
4. In the menu, use the control knob to select R ... INSTRUMENT RUN MODES, and press the **Select Line** button. A second diagnostic menu is then displayed.

5. In this menu, select A ... AUTO RESET, and press the **Select Line** button. This runs the full set of internal diagnostics. Check that all tests pass as they run.

After the diagnostics complete, the measurement set initializes in the Waveform mode unless there is a powerup function file (refer to Function Playback on Power Up on page 1-8). If any of the diagnostic tests fail, refer your instrument to a qualified service person.

As a user, there are two things you may wish to do in the diagnostics mode. These are setting the power on run mode (either to run the diagnostics at power on or to skip them for a quick start) and calibrating the touch screen.

Calibrating the Touch Screen

The touch screen is fully calibrated when shipped from the factory. Although it will seldom be necessary, the touch screen can easily be recalibrated.

To calibrate the touch screen:

1. Switch off power to the measurement set at the front panel.
2. Press and hold the **Menu** button while turning on the power.
3. After the measurement set beeps twice to acknowledge the startup mode, release the **Menu** button. The VM700T then initializes directly into the Low Level Diagnostics Interface with the VM700T startup menu as shown in Figure 1-2.

Low Level Diagnostic Interface
(knob moves cursor, "Select Line" inputs selection)

```

--- VM700T STARTUP MENU ---
Key   Selection
-----
R ... Instrument -RUN MODES- Menu
U ... -UTILITIES- Menu
D ... Low Level -DIAGNOSTICS- Menu
C ... Diagnostics -CONFIGURATION- Menu
H ... Diagnostics -HELP- Menu
T ... Calibrate -TOUCH PANEL INTERFACE-
-----
= ... Reprint           @ ... Abort Menu
-----

Input your selection:

```

Figure 1-2: VM700T Startup menu

4. In the startup menu, use the large control knob to highlight the T in the Calibrate Touch Panel Interface line.
5. Press the **Select Line** button to make the selection to calibrate. The first touch screen calibration instructions are then displayed as shown in Figure 1-3.
6. Follow the written directions. Pressing AUTO aborts the calibration process and returns you to the VM700T startup menu. Pressing any other button stores the setting in NVRAM and brings up the next touch screen calibration menu.

After making the adjustment requested and storing the current setting, a second set of instructions are displayed as shown in Figure 1-4. Follow the directions given in the screen.

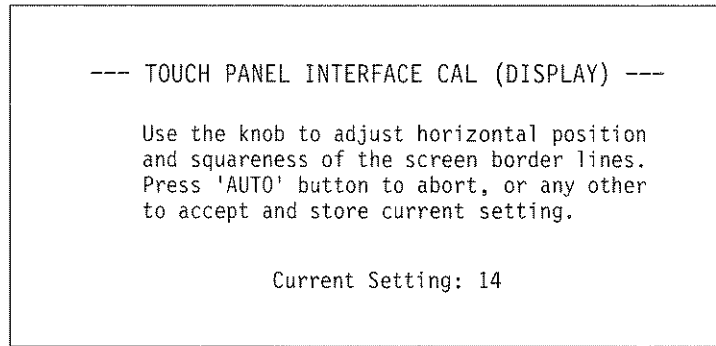

Figure 1-3: Touch screen calibration (display)

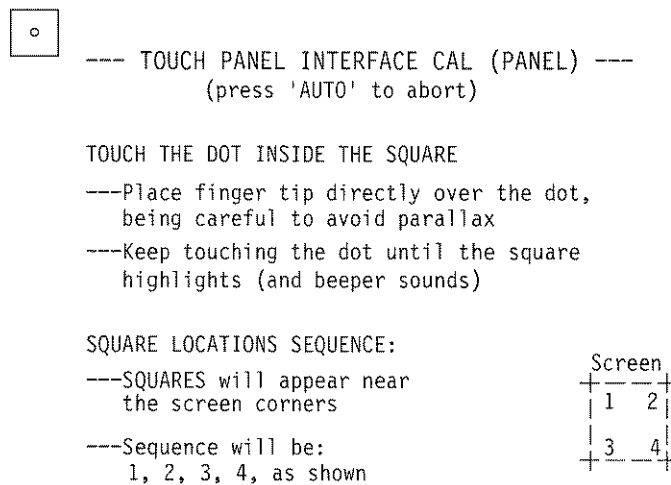

Figure 1-4: Touch screen calibration (panel)

After the dots at all four corners have been touched, a screen displaying the panel calibration factors is displayed as shown in Figure 1-5. From that screen, you can press any key to return to the VM700T startup menu.

```

--- PANEL CALIBRATION VALUES ---

XSCALE = 471      XOFFSET = 292
YSCALE = -398    YOFFSET = 231

-#- Press Any Key to Continue -#-

```

Figure 1-5: Panel calibration values

Setting the Power Up Mode

You may configure the instrument to always skip the powerup diagnostics or to always run them at powerup. Use the following procedure to access the diagnostics menus and make changes to the diagnostic power-on mode:

1. Press and hold in the **Menu** button while turning on the power to display the VM700T Startup menu shown previously in Figure 1-2.
2. In the VM700T Startup menu, highlight the C in the Diagnostic Configuration line and press the **Select Line** button. This brings up the Diagnostics Configuration menu shown in Figure 1-6.

```

          Low Level Diagnostic Interface
(knob moves cursor, "Select Line" inputs selection)

--- DIAGNOSTICS CONFIGURATION MENU ---
Key   Selection
-----
P ... Set Diagnostics -POWERUP MODE-
I ... Set Diagnostics -INTENSITIES-
B ... Set Low Level Diagnostics -BAUD RATE-
-----
= ... Reprint           @ ... Abort Menu
-----

Input your selection:

```

Figure 1-6: Diagnostic configuration menu

3. In Diagnostic configuration menu, highlight and select P in the Set Diagnostics Powerup Mode line to bring up the powerup mode choices shown in Figure 1-7.

In the Set Diagnostics Powerup Mode menu, highlight and select Q to have the instrument skip diagnostics on power up or highlight and select P to have the instrument run the diagnostics on power up. The remaining choices are used in diagnostic testing in manufacturing and factory service. When a selection is made, the choice is stored in the diagnostics NVRAM, and the Diagnostics Configuration menu returns. At this point, the quickest way to start the instrument for normal operation is to turn off the VM700T and turn it back on again.

```

Low Level Diagnostic Interface
(knob moves cursor, "Select Line" inputs selection)

--- SET DIAGNOSTICS POWERUP MODE ---

Select a Powerup Mode from the list below. The mode selected will be
stored in Diag NVRAM and will be effective for -NORMAL- powerups
(ie: Boot Switches in NORMAL position). The current Powerup Mode
setting is -STARTUP MENU-.

Key   Selection
-----
Q ... QUICK START ..... Skip Diagnostics, start Instrument
M ... STARTUP MENU ..... Goto VM700T Startup Menu
P ... POWERUP DIAGS ..... Do Diagnostics, start Instrument
L ... LOW LEVEL DIAGS LOOP ..... Loop on Low Level Diagnostics
H ... HIGH LEVEL DIAGS LOOP ..... Loop on High Level Diagnostics
-----
= ... Reprint                                     @ ... Abort Menu
-----

Input your selection:
    
```

Figure 1-7: Set diagnostics power up mode menu

Function Playback on Power Up

If there is a state or measurement mode you want the VM700T to be in or a series of measurements that need to be done after power is either turned on or restored after a power loss, you can create a special powerup function file to perform the required steps. The “powerup” or “PowerUp” function file is looked for by the measurement set as part of the initialization process. If the file is found it is played back immediately after initialization has finished. The powerup function file is created in exactly the same manner as other function files. How to create a function file is explained in the *VM700T RS-232 Interface Programmers Manual*.

Serial Port Configuration

The following text provides information on the serial ports and the cabling requirements to make interconnections between the VM700T and a terminal and to the various printers supported by the VM700T for output of screen displays, measurement results, and diagnostic information. The rear panel connectors are shown in Figure 1–8.

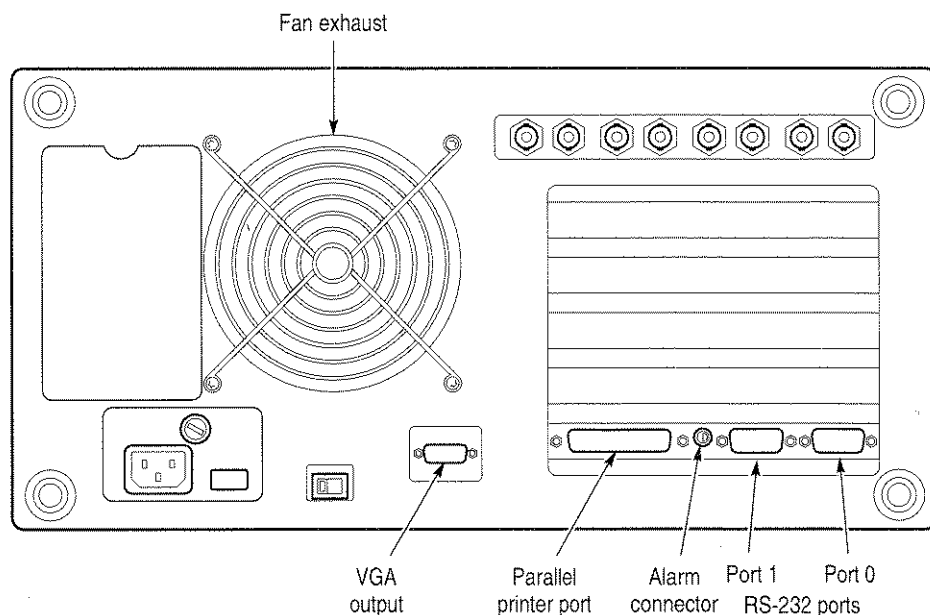

Figure 1–8: VM700T rear panel

RS-232C Interface Information

The Port 0 and Port 1 communication ports may be configured as serial RS-232C DTE ports. These are DB-9 male connectors. The serial interface parameters given in Table 1–1 are user selectable using menu control. If you are connecting the port to another terminal, you will need a null modem connector to make the appropriate connections. You must supply an appropriate printer cable to make the connection between the VM700T and your printer.

Table 1–1: Serial port protocol

| Capabilities | Description |
|------------------------------------|--|
| Serial ports | |
| Port 0 and Port 1 | RS-232C |
| Connector | DB-9, male; configured as DTE ports |
| Serial Interface Parameters | |
| RS-232C | |
| Baud Rate | User selectable: 300, 600, 1200, 2400, 4800, 9600, 19200, and 38400. |
| Flow Control | XON/XOFF, CTS/RTS, and None. |
| Signal Bits | 7 or 8 |
| Stop Bits | 1 or 2 |
| Parity | Odd, Even, and None |

RS-232C Connections. The two RS-232C DTE ports of the VM700T are used to output graphics and reports to a printer, as well as for remote operation using a modem or direct serial connection. Both connectors are accessible on the rear panel. The Communications Setup file is found in the Configure Files directory (press Configure and then touch the Configure Files soft key). The file contains parameter settings for both serial ports. Configuring the Communication Setup file is covered in *Configuring the VM700T* on page 2–23.

The following list describes the signals the VM700T outputs and the input signals required on all the active pins of the serial ports:

Pin 1 - DCD (Data Carrier Detect).

This signal typically comes from a modem and indicates that a phone connection is made.

Pin 2 - RD (Receive Data).

The VM700T receives data on this pin.

Pin 3 - TD (Transmit Data).

The VM700T transmits data on this pin.

Pin 4 - DTR (Data Terminal Ready).

This pin is always high when the VM700T is turned on. Modems typically require this signal to be a high level or they won't answer the phone.

Pin 5 - SG (Signal Ground).

Pin 6 - DSR (unused in the VM700T).

Pin 7 - RTS (Request To Send data to the VM700T).

With hardware flow control (CTS/RTS selected), normally RTS connects to the CTS line of a terminal, and the line is active when the VM700T is ready to receive data. When the receive buffers of the VM700T are nearing capacity, RTS goes inactive, indicating to the sending device to stop transmitting data.

With software flow control (XON/XOFF selected) or None selected, RTS is always active.

Pin 8 - CTS (Clear To Send).

With Flow Control (CTS/RTS selected), the VM700T is enabled to transmit data by a high level on pin 8, and is disabled by a low level. It is normally connected to the RTS line of a terminal.

With Flow Control (None or XON/XOFF selected), the VM700T transmits data regardless of the CTS level.

Pin 9 - RI (Unused).

Table 1–2 gives cable configurations that should work in most instances. The pin numbers given for the Terminal (DTE) are the most common locations for the corresponding signals on DB-9 and DB-25 connectors. Note that there is considerable deviation from this “common” configuration, and not all devices use control lines in the manner described under this topic. Refer to the instruction manual of the equipment you are connecting to the VM700T to determine exactly how it should be connected.

Note also that both ends of the DTE to DTE cable are typically female connectors. The DTE to DCE cable is female on the VM700T (DTE) end, and typically male on the modem (DCE) end.

Table 1–2: Typical VM700T RS-232C cable connections

| VM700T (DTE) to terminal (DTE) (null modem) | | | VM700T (DTE) to modem (DCE) | | |
|---|----------------------------|-----------------------------|-----------------------------|-------------------------|--------------------------|
| VM700T pin no. (DB-9) | Terminal pin no. (DB-9) | Terminal pin no. (DB-25) | VM700T pin no. (DB-9) | Modem pin no. (DB-9) | Modem pin no. (DB-25) |
| | | | 1 (DCD) | 1 | 6 (DSR), 8 (DCD) |
| 2 (RD) | 3 (TD) | 2 (TD) | 2 (RD) | 2 | 3 (RD) |
| 3 (TD) | 2 (RD) | 3 (RD) | 3 (TD) | 3 | 2 (TD) |
| 4 (DTR) | 1 (DCD) | 8 (DCD), 6 (DSR) | 4 (DTR) | 4 | 20 (DTR) |
| 5 (Chassis GND) | 5 (Chassis GND) | 7 (SG) | 5 (Chassis GND) | 5 | 7 (SG) |
| 7 (RTS) | 8 (CTS) | 5 (CTS) | 7 (RTS) | 7 | 4 (RTS) |
| 8 (CTS) | 7 (RTS) | 4 (RTS) | 8 (CTS) | 8 | 5 (CTS) |

Table 1–3 shows the minimum pin configuration for a cable connecting the 9-pin male connector of the VM700T to a 25-pin connector on a PC or terminal. Refer to the *VM700T RS-232 Interface Programmer Manual* for more information on connecting the VM700T for remote operation.

Table 1–3: VM700T 9-pin to PC 25-pin null modem cable for remote control

| VM700T cable end (9-pin female) | PC cable end (25-pin female) |
|---------------------------------|------------------------------|
| 2 (RD) | 2 – Transmit Data (TD) |
| 3 (TD) | 3 – Receive Data (RD) |
| 5 (SG) | 7 – Signal Ground (SG) |
| 7 (RTS) | 5 – Clear to Send (CTS) |
| 8 (CTS) | 4 – Request to Send (RTS) |

Connecting Serial Printers

This section discusses connecting a serial EPSON LQ-570, Apple LaserWriter, HP LaserJet, HP DeskJet, HP ThinkJet, or generic ASCII printer. Both serial and parallel format printers are supported.

Connecting an EPSON LQ Printer

The default configuration files are set for use with the EPSON LQ-570 letter quality printer with serial interface C 823051. The default configuration of the LQ-570 printer is adequate for use with the VM700T. Refer to the user's manual for the printer for information on any changes you might wish to make to the printer setup.

With the VM700T and printer power off, connect the serial printer cable from the 25-pin DB-25 female connector on the printer rear panel to PORT 1 on the back of the VM700T (a 9-pin DB-9 male connector). If you have not changed the factory default values in the Communication Setup file, all you need to do now is turn on the VM700T and the printer. If you have changed some factory default values, be sure the file contains the values shown in the following example.

The following partial listing shows the values that should be set in the Communications Setup file in order to use an Epson LQ-570 serial printer.

| | | | |
|---------------|---------------|-----------------|---------|
| Copy | | Port 1 | |
| Port: | Serial Port 1 | Protocol: | None |
| Format: | Epson LQ | Baud Rate: | 9600 |
| Report | | Flow Control: | CTS/RTS |
| Port: | Serial Port 1 | Character Size: | 8 |

Format: Epson LQ Parity: None
Log Reset Character: None
 Port: None Carrier Detect: disabled
 Format: Epson LQ
Remote
 Port: None/Serial Port 0

Making Your Own Serial LQ Cable. If the correct serial printer cable is not readily available, one can be easily constructed. A male 25-pin DB-25 connector, a female DB-9 connector, and an appropriate length of four-conductor cable are the materials needed for the cable. Table 1-4 lists the wiring connections for making a cable to use with an Epson LQ serial printer.

Table 1-4: Epson LQ serial cable connections

| Male DB-25 connector pin number (Epson LQ end) | Female DB-9 connector pin number (VM700T end) |
|---|--|
| 1 (shield ground) | shield ground |
| 3 (RD) | 3 (TD) |
| 20 (DTR) | 8 (CTS) |
| 7 (signal ground) | 5 (signal ground) |

Connecting an Apple LaserWriter

In Configure mode make the following VM700T setups when connecting a serial interface Apple LaserWriter to one of the VM700T serial ports. Set the Copy Port and Report Port to Serial Port 0 or Serial Port 1 as appropriate for the printer that will be used.

| | |
|--------------------------|--------------------------|
| Copy | Port 1 |
| Port: Serial Port 1 | Protocol: None |
| Format: PostScript | Baud Rate: 9600 |
| Report | Flow Control: XON/XOFF |
| Port: Serial Port 1 | Character Size: 8 |
| Format: PostScript | Parity: None |
| Log | Reset Character: ^D |
| Port: None | Carrier Detect: Disabled |
| Format: PostScript | |
| Remote | |
| Port: None/Serial Port 0 | |

Setting up the LaserWriter with Serial Interface. Set the rear-panel switch on the LaserWriter to the 9600 position.

The serial cable connecting the VM700T and the LaserWriter should be wired as described in Table 1-5. The cable must have a female DB-9 connector on the VM700T end and a male DB-25 connector on the LaserWriter end.

Table 1-5: Apple LaserWriter serial connections

| Male DB-25 connector pin number (Apple LaserWriter end) | Female DB-9 connector pin number (VM700T end) |
|--|--|
| 1 (shield GND) | shield GND |
| 3 (RD) | 3 (TD) |
| 2 (TD) | 2 (RD) |
| 5 (CTS) | 7 (RTS) |
| 4 (RTS) | 8 (CTS) |
| 7 (signal GND) | 5 (signal GND) |

Connecting a Serial Interface HP LaserJet, DeskJet, or ThinkJet

In Configure mode, set the Copy Format, Report Format, and Log Format in the Communication Setup file to HP LaserJet, HP DeskJet, or HP ThinkJet as appropriate for your printer/plotter. Set the Copy Port and Report Port to Serial Port 0, Serial Port 1, or Parallel Printer as needed for your application.

With a serial printer, set the Baud Rate for the selected port to any value from 300 to 19200 (9600 is recommended), set Protocol to None, Flow Control to XON/XOFF, Reset Character to None, Parity to None, Character Size to 8, and Carrier Detect to Disabled. An example of settings is shown below. Again, when using a parallel printer, no special settings are needed.

| Copy | | Port 1 | |
|---------------|--------------------|------------------|----------|
| Port: | Serial Port 1 | Protocol: | None |
| Format: | HP LaserJet | Baud Rate: | 9600 |
| Report | | Flow Control: | XON/XOFF |
| Port: | Serial Port 1 | Character Size: | 8 |
| Format: | HP LaserJet | Parity: | None |
| Log | | Reset Character: | None |
| Port: | None | Carrier Detect: | Disabled |
| Format: | HP LaserJet | | |
| Remote | | | |
| Port: | None/Serial Port 0 | | |

Setting up the HP LaserJet, ThinkJet, or DeskJet with Serial Interface. Set the baud rate to the same as the VM700T. Refer to the appropriate user manual for the printer setups. Connect the serial printer cable between the VM700T and the printer. An optional accessory printer cable is available from Tektronix. Should you want, you may wire your printer cable for the HP to VM700T connection. The necessary wiring information is provided in Table 1–6.

Making Your Own Serial Printer Cable. Table 1–6 lists the wiring connections for making a cable to use with an HP LaserJet, ThinkJet, or DeskJet printer/plotter. The cable must have a female DB-9 connector on the VM700T end and a male DB-25 connector on the printer/plotter end.

Table 1–6: HP LaserJet cable connections

| Male DB-25 connector pin number (HP printer end) | Female DB-9 connector pin number (VM700T end) |
|---|--|
| 1 (shield GND) | shield GND |
| 3 (RD) | 3 (TD) |
| 2 (TD) | 2 (RD) |
| 7 (signal GND) | 5 (signal GND) |
| 20 (DTR) | 8 (CTS) ¹ |

¹ The pin 20 to pin 8 connections is used for hardware flow control. It can be omitted for XON/XOFF flow control.

Connecting an ASCII Printer

The VM700T can also be configured to operate with a generic serial ASCII printer. In the Communication Setup file, set the Report Format and Log Format to ASCII Printer. A generic ASCII printer is assumed to only print text; graphic functions are not supported.

NOTE. When Copy Format is set to ASCII Printer, the Copy function is disabled in Waveform, Vector, Picture, and Measure modes; only the text from Auto mode, text from Measurement Results files in Configure mode, and the Print File soft key function in Configure mode are enabled.

Connecting Parallel Printers

The printer port of the VM700T is a Centronics-compatible parallel printer connection. A standard parallel printer connector with a DB25 pin connector on the VM700T end and a Centronics parallel printer connector on the printer end is needed.



WARNING. *The VM700T and any printers, modems, or monitors connected to the VM700T must be properly grounded to prevent possible damage to the internal circuitry of the VM700T Video Measurement Set.*

Configuring the VM700T for Parallel Printers

In Configure mode, set the Copy Format, Report Format, and Log Format in the Communication Setup file to what is appropriate for your parallel printer. Set the Copy Port and Report Port to Parallel. Parallel interface printers usually do not require special settings to operate with the VM700T.

VGA Output Connector

The output permits viewing the VM700T display on a VGA monitor. The VGA Video output connector provides drive signals to provide a VGA copy of the display of the VM700T screen to an external monitor. Use the Display and Graticule brightness controls for the VM700T display to set contrast between those two areas of the display. Use the brightness and contrast controls of the attached monitor to set the display as needed for overall brightness and contrast of the external display.



Operating Basics

Operating Basics

This first part of this section provides information about operating the VM700T Video Measurement Set and describes the user interface features. The second part describes how to configure the Video Measurement Set and the system file structure.

Front Panel Operation

The VM700T Video Measurement Set front panel (Figure 2-1) consists of a touch screen and a 20-button keypad with a control knob.

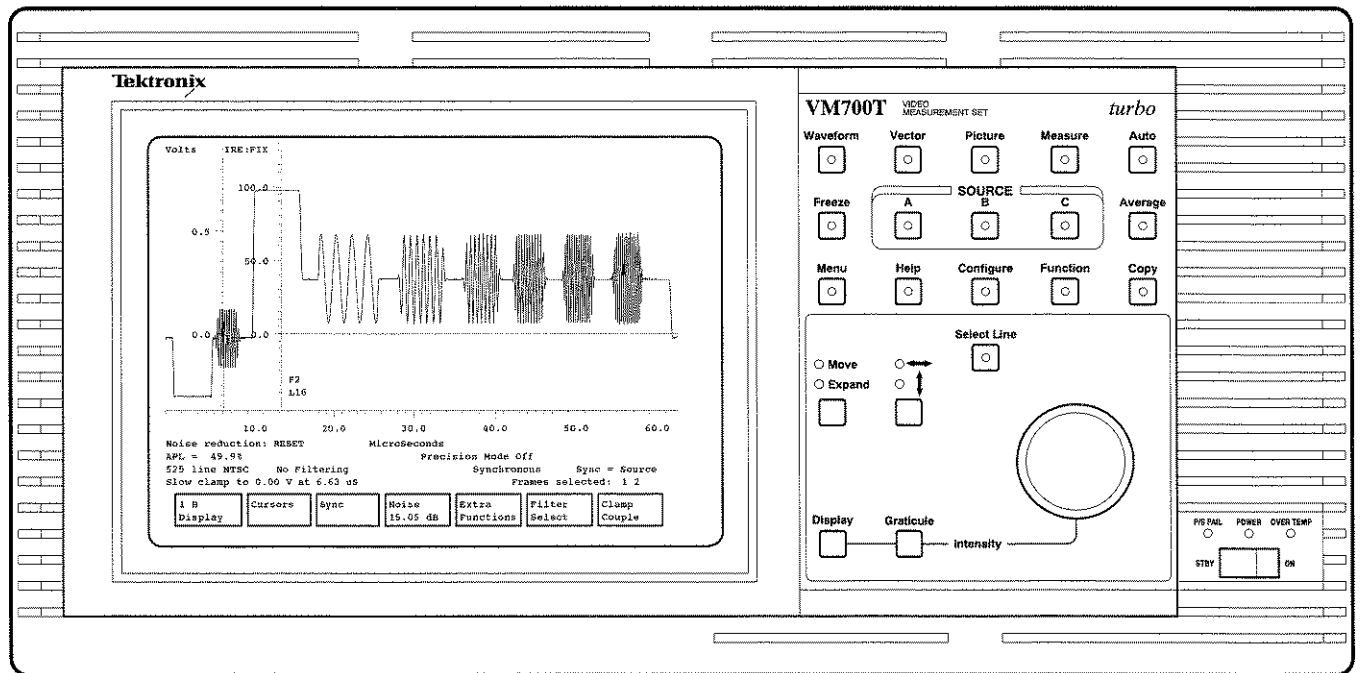

Figure 2-1: VM700T front panel

Touch Screen

The display (CRT) area of the VM700T is also a touch screen for user input. The screen displays input waveform signals, the digital vectorscope, a low-resolution television picture of the input signal, graphic measurement displays, and automatic measurement results. Many operations are performed by selecting soft keys (menu-controlled touch screen controls) at the bottom of the display; when applicable, selection values are changed by rotating the control knob.

Manual and Auto Operational Mode Buttons

The top row of buttons shown in Figure 2-2 controls the operational modes (the major functions). The VM700T has five operational modes: four “manual” modes and Auto mode. The manual modes are Waveform, Vector, Picture, and Measure. The power-on default mode is Waveform.

The manual modes perform the specified operation and provide a graphic display with digital readouts plus status information. Auto mode makes measurements automatically and provides a tabular listing of the measurement results. Reporting of measurement results can be performed in both manual and Auto mode.

Parameters such as clamping, sync source, and the displayed line (system line) are common for all the manual modes of operation. However, *manual mode parameters do not carry over to Auto mode*. Parameters for both Auto mode and the manual modes are set through the directory and file structure accessed through the Configure button.

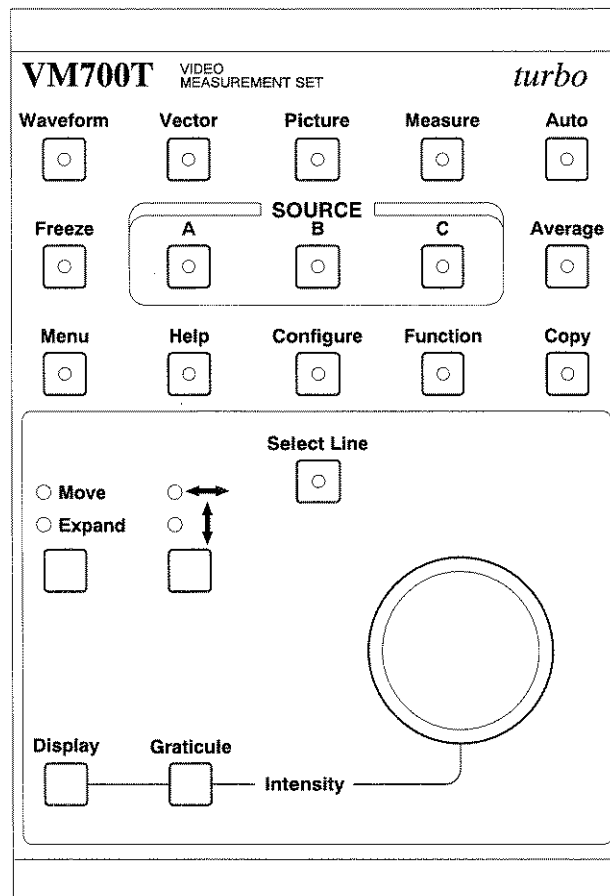

Figure 2-2: VM700T keypad

Freeze, Source Selection, and Average Functions

The second row down in the keypad contains the Freeze button, the input channel selection buttons (grouped as SOURCE A, B, and C), and the Average button.

Freeze. When Freeze is selected, signal acquisition is halted. The frozen display may be repositioned or resized according to the application, as described below under Control Knob, but the display is not updated. Starting a new measurement or operation unfreezes the display.

Source and Polarity Selection. For all operational modes, one of the input sources is always selected. Selected sources are indicated by a lighted LED in the panel button.

For some modes, an input source can be *inverted*. This feature may be used to invert a positive-sync video signal to obtain the correct polarity for measurement by the VM700T. To invert a single source, press and hold the source button approximately one second, until the instrument beeps. When a source is inverted, the LED on the source button blinks. To invert a second source and add it to another, press and hold the normal (non-inverted) source and, while holding it, quickly press and release the inverted source. The LED on the inverted source will flash.

In Waveform and Vector modes, an inverted source can be the sole input or it can be added to another input. In Measure mode, an inverted source can only be added to another source.

Average. The Average button enables noise reduction (averaging) on the signal in Waveform, Vector, and Measure modes. The amount of noise reduction (up to 30.10 dB) is set with the **Noise** soft keys. The number of averages (up to 256) is set with the **Average Num** soft keys.

Support Functions

The third row down in the keypad contains support functions: Menu, Help, Configure, Function, and Copy. Turn any of these functions on by pressing the associated front-panel button. Of these, Copy turns off either after the copy is sent or after pressing the Cancel soft key that appears in the Configure menu when a copy is pending. Help is turned off by pressing the Help button a second time. The remaining functions are turned off either by pressing the button a second time or by selecting a different operational mode in the top row.

Menu. The Menu button displays a menu of soft keys on screen. In some cases, touching a soft key displays a submenu of additional soft keys when it is selected.

Help. The Help button activates the Help function. When Help is turned on, pressing a button or selecting a soft key displays a brief explanation of the button or soft key; all buttons and soft keys, except Help, lose their normal function. The LED on the Help button flashes while Help is active. Help is turned off by pressing the Help button a second time.

Configure and Function. The Configure button and its usage are discussed in *Configuring the VM700T* starting on page 2–7. The Function button and its usage are discussed in the *VM700T RS-232 Interface Programmer Manual*.

Copy. The Copy button sends a copy of the display to the print spooler (temporary memory space) to queue for printing. The LED in the Copy button will flash as long as the copy remains in the spooler. To delete the copy from the spooler, press the Configure button while the Copy LED is flashing and select the **Cancel Copy** soft key. This soft key only appears in the Configure menu when a copy is pending in the spooler.

Control Knob

The specific functions of the control knob in each mode are described in the relevant sections of this manual as the function of the control knob depends on the current mode of operation. Its general operation is described here.

Waveform Expansion and Positioning. In Waveform mode, rotating the control knob affects horizontal or vertical movement of the display or horizontal or vertical expansion of the display, depending on the selections of the Move/Expand button and the Horizontal/Vertical button. In Expand mode, the normal expansion (horizontal or vertical, depending on the arrow button selection) is around the center of the display. A specific point for expansion is selected by touching the screen at the expansion point wanted. Expansion or contraction is around the touched point while the screen is touched. It reverts to the center of the screen when your finger is removed from the touch screen.

Select Line. The Select Line button assigns the function of the control knob to video signal line selection. The LED in the Select Line button is on when Select Line is active. To scroll through the field line by line, press the Select Line button and rotate the control knob. Depending on the operational mode, a menu of soft keys may also appear. The **Select Line** soft keys and the specific control knob functions are described in the relevant sections of this manual.

Display and Graticule Intensity Control. To change the intensity of the display or the graticule, hold down the Display or Graticule button and rotate the control knob.

| | |
|--|--|
| Equipment/Signal Sources Required | Most VM700T measurements can only be done using either off-air (live) signals or signals from a generator that have the appropriate test signals in the vertical interval. Without the correct signal being applied, the displays contain no useful information. |
| Bandwidth | The bandwidth of the VM700T is from 0 Hz (DC) to approximately 6.8 MHz. |
| Connecting Inputs and Outputs | <p>The VM700T has three video loop-through inputs, one external sync loop-through, two RS-232C DTE ports, a Centronics-compatible printer port, and a VGA output connector on the rear panel. The audio options (40 and 41) add appropriate connectors for application of the audio signals to the option circuitry. The GPIB Interface (Option 48) add a standard GPIB connector for remote control and GPIB hardcopy output.</p> <p>Any video signal (of the appropriate format) may be connected to any video input for normal operation. The serial ports (Port 0 and Port 1) may be used for output to serial printers or for remote control of the VM700T. A printer output port supports Centronics-compatible parallel printers. A standard parallel printer cable is required. The monochrome VGA output provides support for viewing the VM700T display on a remote VGA monitor. Certain options, Camera and Component being examples, require connections to specific inputs for correct operation. Refer to the option manual when connecting signals to make those option measurements.</p> |

Configuring the VM700T Video Measurement Set

The Configure button brings up a display (shown in Figure 2–3) that provides access to utilities that allow you to edit files that control many aspects of the VM700T Video Measurement Set operating environment and information on the firmware installed in your instrument. This section describes the use of these utilities.

The measurement set gets important operating information from configuration files stored in its nonvolatile memory. These files are arranged in a directory structure accessed using the front-panel Configure button and the touch screen menu choice. These files control such areas of measurement set operation as the following:

- which measurements are performed in Auto mode
- what measurement limits should be in effect for Auto mode and Measure mode measurements (for example, what values should be used as upper and lower bounds before a caution or alarm is triggered)
- the timing of Auto mode reports and timed functions
- which line(s) each Auto or Measure mode measurement will be made on, and (where applicable) at what position within the line(s)
- which output ports to send printouts, screen dumps, periodic reports, or error logs to, and in what formats
- the password (if any) that must be used for controlling access to the configuration files
- the option configuration choices

The Configure button provides access to utilities that allow you to edit files that control these and other aspects of the measurement set operating environment. Pressing the Configure button brings up the main Configure display seen in Figure 2–3. A bar graph shows the amount of nonvolatile memory used and the amount still free (in bytes) and four soft keys (menu-controlled touch panel controls). These soft keys are labeled Time, Configure Files, Function Keys, and Option Key. (If a copy is queued for printing in the printer spooler, another soft key labeled Cancel Copy is also displayed.)

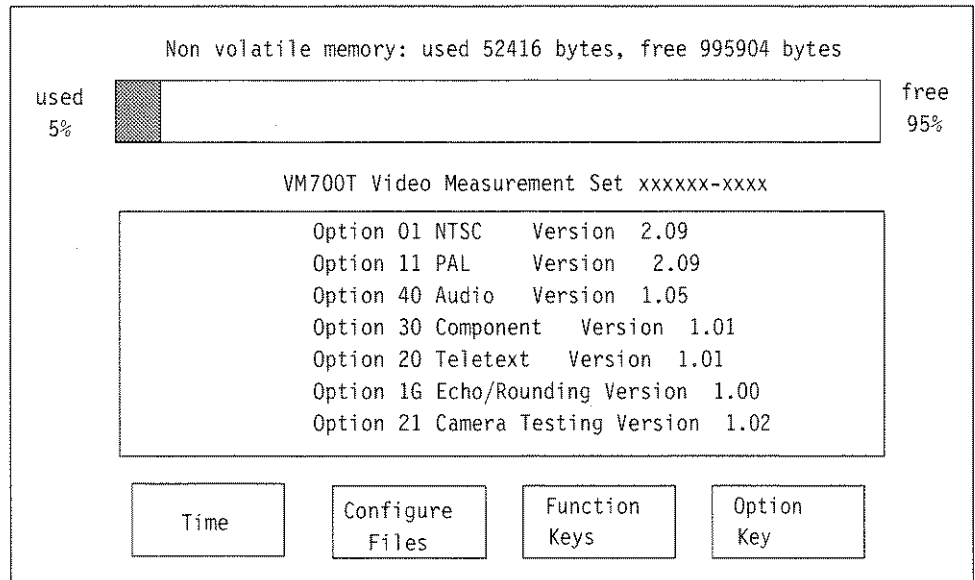

Figure 2-3: Main Configure menu

These soft keys are defined as follows:

- **Time:** Pressing this soft key brings up a display and submenu that allows you to set the internal clock of the measurement set. Refer to page 2-17 for the procedure.
- **Configure Files:** Pressing this soft key brings up a display of the /nvramØ/ ConfigFiles directory, which gives you access to files and directories that control the measurement set operations.
- **Function Keys:** Pressing this soft key brings up a display of the /nvramØ/ FunctionKeys directory, along with a submenu that lets you create, rename, edit, delete, and print out function keys. (Use of the Function Keys feature is fully explained in the *VM700T RS-232 Interface Programmer Manual*.)
- **Option Key:** Pressing this soft key brings up the control screen containing information on the instrument identification number, the software identification, and the option authorization key. Refer to *Appendix C: Adding Options* for information on the use of this soft key and firmware upgrades.
- **Cancel Copy:** Pressing this soft key clears all copies in the spooler.

The Cancel Copy soft key appears as a choice in the Configure menu only if there are files in the printer queue. Touching it deletes the files from the queue.

Configure mode, like other modes, may be selected at any time with the following exceptions: when in remote and during function playback. When the Configure button is pressed again to deselect Configure, the measurement set returns to the mode or application (for example, measurement) that was active when Configure was selected.

The remainder of this section is divided into two parts. The first part describes the operations available in Configure mode; it tells you how to create or delete files in a directory, how to edit files, and so on. The second part describes the Configure mode directory structure and the files it contains.

Configure Operations

This section covers basic information on how to traverse directories and edit files in Configure mode.

The Configure Directory Structure

After you press the Configure button and touch the Configure Files soft key, the measurement set displays the files and sub-directories in the /nvram0/Config-Files directory (see Figure 2–4). Files and directories are displayed as icons enclosing the file or directory name. Directory icons consist of two overlapping rectangles; file icons consist of single rectangles. Below the directory display is the path line, indicating the location of the displayed directory in the directory structure, and two soft keys, Print File and Leave Directory. A dual-standard instrument also has the additional soft key of Switch NTSC/PAL displayed with the selected choice identified as either NTSC Files or PAL Files.

If there are more directories or files than can be displayed in the window area of the screen designated for directory icon displays, use the control knob to scroll up or down to display the remaining choices. The exact number of directories and their names depends on the installed options. All the directories are given in alphabetical order from left to right, top to bottom. Each of the VM700T option manuals provides details on configuring the files for the options.

If you are unfamiliar with the terms **file** and **directory**, the following may help: A file is a collection of information. A directory is a structure that can contain zero or more files or other directories.

Directories are organized in a “tree” structure. Touching the icon of a directory displayed in a window opens that directory. This is also known as “going down the directory tree.” Pressing the Leave Directory soft key closes the directory and displays the next higher directory in the directory structure. This is also known as “climbing up the directory tree.”

To Enter a Directory. Touch the icon showing the name of the directory you wish to enter.

Whenever a directory is open, another soft key, labeled Leave Directory, appears below the directory window.

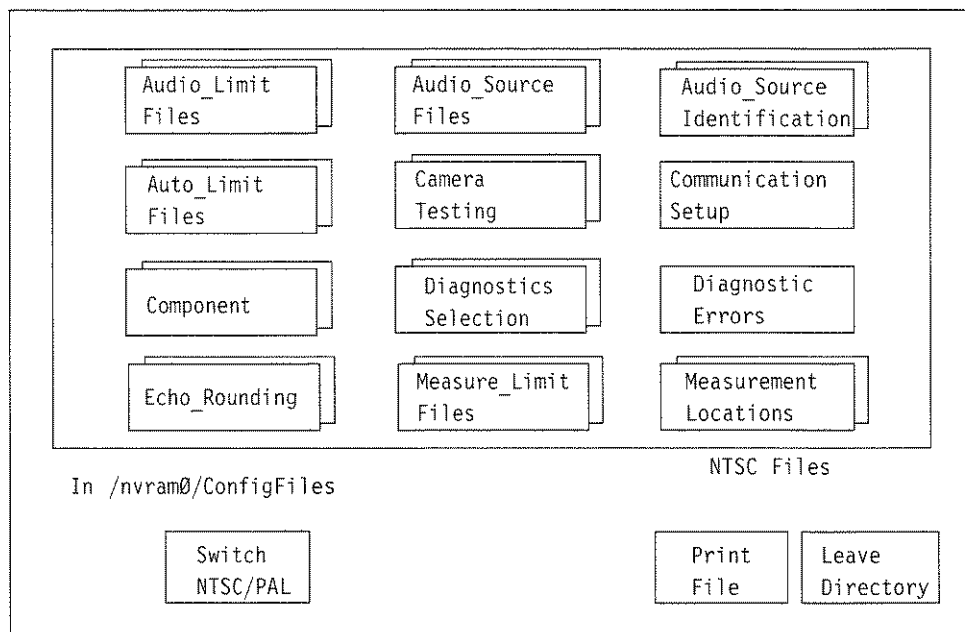

Figure 2-4: Configure Directory

To Leave a Directory. Select the Leave Directory soft key. This closes the current directory and opens the next higher directory in the directory structure.

When you open a directory, a line appears below the directory window (but above the soft keys), indicating the path (the directory or file location in the directory structure) to the displayed directory. For example, if you were viewing the contents of the Measure_Limit~Files directory, the path line would read:

In /nvram0/ConfigFiles/Measure_Limit~Files

This indicates that the path from the “root” of the directory structure (designated by the initial '/') goes through directory nvram0, then through a subdirectory of nvram0 named ConfigFiles, to the current directory, which is a sub-directory of ConfigFiles named Measure_Limit~Files.

When editing a limits file for the Measure mode named “User’s_Measure~Limits_File,” the path line would read:

Editing User’s_Measure~Limits_File

The ~ (tilde) in a directory or file name represents a carriage return, and is used to join the first and second lines of directory, function key, or file names.

VM700T Video Measurement Sets equipped with both Option 01, NTSC, and Option 11, PAL (dual-standard) provide a soft key labeled Switch NTSC/PAL in many of the Configure mode menus. Touching this key toggles between the NTSC and PAL configuration file structures. A readout below the directory window indicates which standard (NTSC or PAL) files you are currently viewing or editing.

Supplied Directories and Files

All the directories and most of the files supplied with the measurement set are read-only; they cannot be edited, renamed, or deleted. However, files can be copied to create new, editable files. Only files that you have created can be renamed or deleted.

You can view supplied read-only files by selecting them. This displays the file contents. All read-only files are stored in ROM, while all editable files are stored in nonvolatile memory (NVRAM).

Six files supplied with the measurement set can be edited without first copying them. Five of these are in the main Configure Files directory: Communication Setup, Diagnostics Selection, Password (if enabled in hardware), Video_Source Identification, and Video Source. The sixth file is the IpConfig file in the /nvrामØ directory, one level higher than the main Configure Files directory. The IpConfig file contains system addresses used for remote file transfer (FTP) and is discussed in the *VM700T RS-232 Interface Programmer Manual*.

Creating and Deleting Files

You create a file in the Configure Files directory by copying the contents of one file to another named file. Since the factory-installed default files are not editable, you must create your own file to make a configuration change.

To Create a File. Enter the Configure Files directory by pressing the **Configure** button, followed by the Configure Files soft key, then touch the icon corresponding to the directory in which you want to add the new file. In a new file system the only file you will see is System Default. The System Default file is not editable, but it is the template to be used to create an editable file. Once you have created other files, you can edit them or choose to copy one of them as the template for a new file (see Figure 2-5).

4. Press the **Create File** soft key. Doing so displays the prompt “Please select a file as template” at the top of the display. Touch the icon corresponding to the file you want to copy (normally System Default). This copies the contents of the selected file. To allow you to name the new copy, a box appears in the center of the directory window and a keyboard appears below it as shown in Figure 2-6. The characters you select (type) appear in this box.

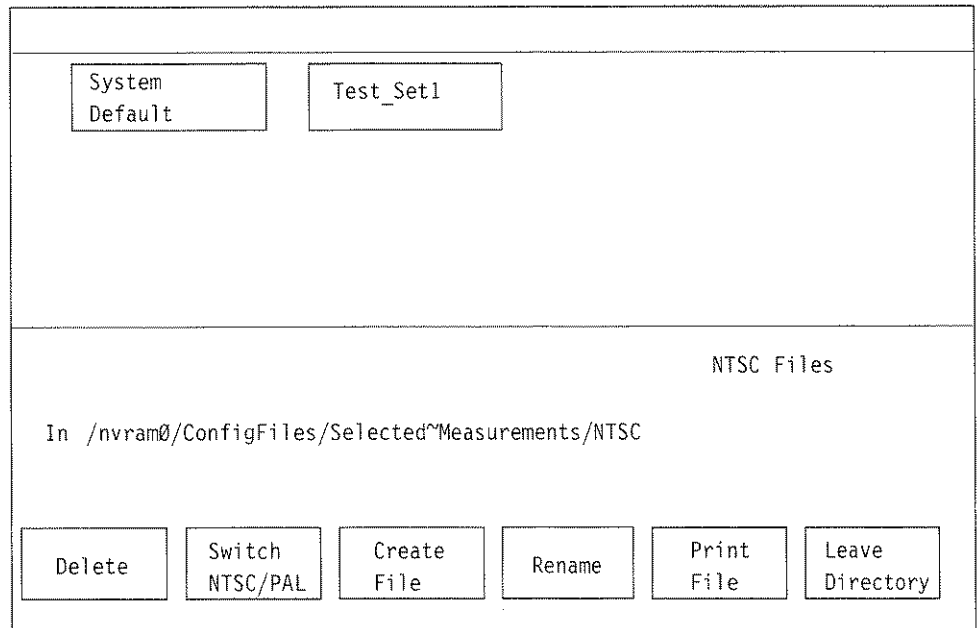

Figure 2-5: Creating a new file

5. Type the new file name, observing the following rules and noting the special uses of some characters and keys:
 - Spaces are not allowed in file or directory names; use an _ (underline) or . (dot) to separate words in a name.
 - Forward slash (/) and reverse slash (\) are not permitted in the file name.
 - When neither Set1 nor Set2 is highlighted, you can type lowercase and uppercase English alphabet characters. The lowercase Set1 character set allows you to enter numerals and punctuation characters. The uppercase Set1 and the Set2 character set allow you to enter various special characters and accented characters for use in non-English language file names.

Both the Set1 and Set2 character keys and the Shift soft key “lock” when selected. Set1 and Set2 are unlocked by touching the same key again or touching the unselected key of the pair. Shift is unlocked by touching Shift again.

Please enter file name (max 31 characters)

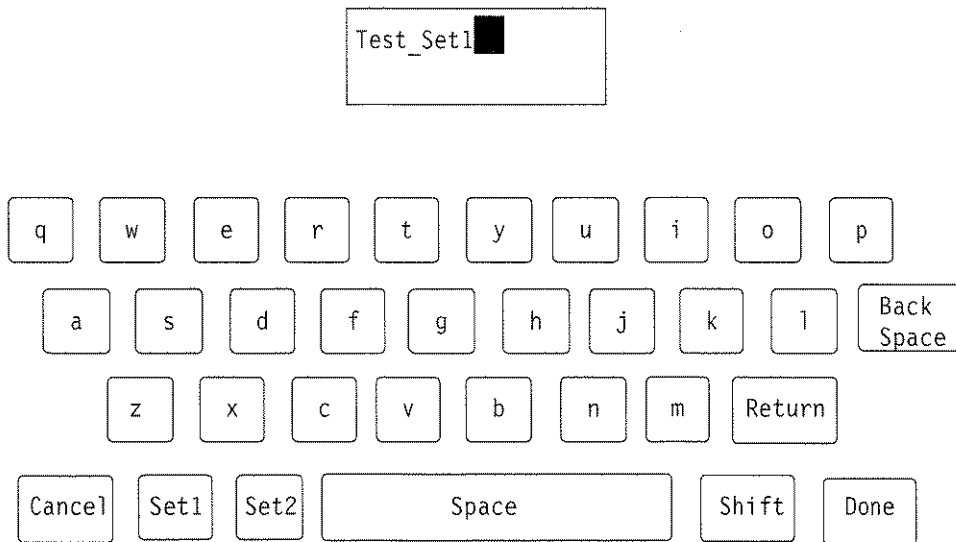

Figure 2-6: File naming keyboard

- A maximum of 31 characters are allowed in a file or directory name.
- Use only uppercase and lowercase letters, numbers, and the following punctuation characters: _ (underline), . (dot), — (minus sign), + (plus sign), : (colon), and ~ (tilde) in names. Avoid using punctuation characters other than those mentioned above in a directory or file name.
- Multi-line directories and file names can be entered using the RETURN key. Touch RETURN on the touch-screen keyboard to get to the second line.
- When the measurement set is in remote mode, the return character becomes a tilde (~) character for purposes of file name reference. Thus, a directory whose name is displayed as:

```

JOHN
SMITH
    
```

in the directory display becomes JOHN~SMITH when referred to in a remote operation.

6. After typing the name, touch **Done** to complete the creation of the file, or press **Cancel** to quit the process and not create the file.

To Delete a File. Press the **Delete** soft key. The measurement set prompts you to select a file.

Select (touch) the icon corresponding to the file to be deleted. Note: only user-created files can be deleted.

The icon containing the name of the selected file switches to reverse video and begins to disintegrate from the display, while the measurement set beeps at one second intervals. The disintegration/deletion process lasts six seconds. It can be stopped by touching the screen inside the directory window or by touching the Delete soft key a second time. Halting the deletion process before its completion has no effect on the file.

Editing Files

To edit a file, simply touch the icon corresponding to the file you wish to edit. This displays the contents of the file for editing. Within the file there are only certain fields that a user may change the value of (edit). You may be able to edit a line, edit a selected parameter, or make a choice of selected or not selected for a measurement or diagnostic. You can view the complete contents of the file by rotating the control knob to scroll the file lines up or down. The line in the center of the window should appear highlighted. If it is not, increase the Display Intensity until it is brighter than the other lines.

To edit a line within an editable file, turn the control knob until the item you wish to edit is highlighted, then touch the line on the screen. There are four possible responses to this touch:

- If the item that you touch is not editable, the measurement set produces a clicking sound, but the screen is not changed.
- If the item that you touch is to be edited alphabetically, a keyboard appears on the lower half of the display screen (see Figure 2-6).
- If you are to choose a new value for the item that you touch from a limited number of choices, such as the *Communication Setup* file, a box appears around the element to be edited. You can then cycle through the available choices by turning the control knob. Refer to *Communication Setup (File)* on page 2-23 for an example of this type of editing.
- If you are editing a file that specifies whether elements are selected or unselected, such as the *Diagnostic~Selections* file, you edit the file by touching the screen next to an element to place the element in the selected or unselected group. Refer to *Diagnostics Selection (File)* on page 2-27 for an example of this type of editing.

NOTE. *The first line of a file is often a title line. You may edit this line to provide a more descriptive identifier about the content or purpose of the file you are creating. Editing the title line of a file does not change the file name.*

To Change a Text Line. Touch the line. A box appears around the line and the soft key keyboard appears below the directory window (see Figure 2–6).

1. Type the new text, keeping the following things in mind:
 - Typing always inserts characters at the cursor position. The cursor can be moved left or right by turning the control knob.
 - To delete characters, move the cursor to the right of the character to be deleted, then press the Back Space key.
 - Pressing the Set1 soft key allows you to enter numerals and punctuation characters. Pressing the Set2 soft key allows you to enter various special characters. Pressing the Shift key allows you to enter uppercase characters or more punctuation characters (in the case of the shifted versions of Set1). Both the Set1 and Set2 character keys and the Shift key lock when selected. Set1 and Set2 are unlocked by touching the same key again or touching the unselected key of the pair. Shift is unlocked by touching Shift again.
2. Touch **Cancel** to quit the editing process without entering the new text, or touch **Done** when you are finished to enter the new title line text.

To Change a Parameter in a File. Use the control knob to scroll the line containing the parameter use wish to change to the center of the display window. The active line to edit is highlighted (made brighter). Refer to *Communication Setup (File)* on page 2–23 for an example of this type of editing.

1. Touch the parameter in the highlighted line you wish to change. A box appears around the selected parameter.
2. Rotate the control knob to scroll through the values or selections available for that parameter.
3. Touch the **Accept Input** soft key, or touch the screen anywhere inside the directory window, to accept the new selection.

NOTE. *In the Selected Measurements file(s) and the Diagnostics Selection file, parameters are either Selected (on the left side of the display) or Not Selected (on the right side of the display).*

To Select/Unselect a Parameter. Touch the line that the parameter appears on, on either the Selected (left) or Unselected (right) side of the display. Refer to *Diagnostics Selection (File)* on page 2–27 for an illustration of this selection process.

To Save Changes to a File and Exit. Touch the **Update & Exit** soft key.

To Exit Without Saving Changes. Touch the **No Change & Exit** soft key. If the file has been modified, a message box appears, warning you that the file has been modified. Press **No Change & Exit**, or any hard key, to exit without saving the file; press **Update & Exit** to save changes to the file and exit the edit session.

Printing Files

Any measurement set file can be printed by selecting the **Print File** soft key and selecting the file. The file is printed from the port (either serial or parallel) designated as the Copy Port. The LED in the Copy button lights continuously while the measurement set creates a print file, and flashes until the entire print file has been sent to the printer.

To Start File Printing:

1. Display the directory containing the file you want to print.
2. Press the **Print File** soft key.
3. Press the icon containing the name of the file you want to print.

To Stop File Printing:

1. Press the **Configure** button twice.
2. Touch the **Cancel Copy** soft key. This soft key only appears when the Copy button LED is flashing. Touching this soft key cancels printouts in progress and deletes all files queued for printing (including printouts generated by pressing the Copy button or the Print File soft key).

To View the Contents of the Spooler:

1. From the main Configure directory, touch **Leave Directory** twice to move to the top directory window.
2. Select the **Spooler** directory. If any copies are pending, they will appear as numbered files.
3. Touch the icon representing the file to view it on the display. The file cannot be edited, but can be scrolled through using the control knob.

Setting the Internal Clock

The Time function allows you to set the measurement set internal calendar and clock (shown in Figure 2–7) to the current time and date. The time and date are placed on all printouts generated by the measurement set. Perform any or all the following steps to enter the correct time and date into your measurement set.

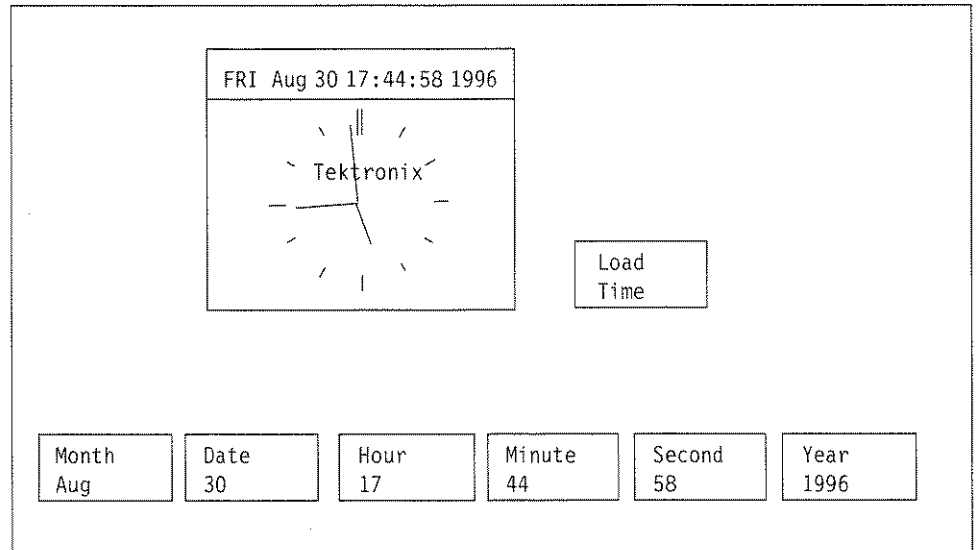

Figure 2–7: Time Configure menu

To Set the Time and Date:

1. Select (touch) the **Time** soft key to display the measurement set calendar and clock. The clock continues to run, but the numbers in the soft keys do not advance with the time and display the time that was present when the Time Configure menu was selected.
2. Select the **Year**, **Month**, **Date**, **Hour**, **Minute**, or **Second** soft key. Rotate the control knob to set the year, month, date, hour, minute, or second.
3. Set the minute and second time (30 seconds or so) slightly ahead of the reference clock time so that you can set the time exactly to your reference time.
4. Select the **Load Time** soft key to enter the new time and date at the exact time you have set for the clock. This enters the time and restarts the clock at that time.
5. After the new time and date have been loaded, press the **Configure** button to exit the Time display and return to the mode previously in effect. Press **Configure** again to return to the top Configure display.

Directory Structure

VM700T Video Measurement Set operations are controlled by means of a hierarchy of files and directories that starts with the Video Source file in the /nvramØ/ConfigFiles directory, and extends to other files in sub-directories of /nvramØ/ConfigFiles. You can customize the operation of the measurement set to suit your specific measurement requirements, and switch quickly between setups as needed to perform different operations by varying the contents of these files and sub-directories.

All ConfigFiles subdirectories, except Measurement Results, contain a file named System Defaults. System Defaults files are used as templates to create new files in a directory. (For more information about creating customized files for a directory, see the discussion of *Configure Operations* starting on page 2–9 in this section.)

The following pages describe the /nvramØ/ConfigFiles hierarchy and how it controls the operation of the measurement set. The Source_Selection~Video file and the Video_Source~Files subdirectory are discussed first. This is followed by a description of the contents and function of the other files and sub-directories in /nvramØ/ConfigFiles.

Source_Selection~Video (File)

The Source_Selection~Video file assigns a file in the Video_Source Files directory to each of the measurement set signal sources (A, B, and C). When a given source is selected (that is when its front-panel Source button is on), the measurement set gets parameter information from the file in the Video_Source Files directory pointed to by the corresponding entry in the Source_Selection~Video file. Figure 2–8 illustrates the relationship between the current signal source (as indicated on the measurement set front panel), the Source_Selection~Video file, and the contents of the Video_Source~Files directory.

The following text is an example of a typical Source_Selection~Video file:

```
Station XYZ's video source file

Channel A Video Source:  tx1
Channel B Video Source:  tx2
Channel C Video Source:  studi01

Timed Events: My_Events
```

With the text of the example Source_Selection~Video file, the measurement set reads the file named “tx1” in the Video_Source~Files directory for parameter information when Channel A is selected, the file “tx2” when Channel B is selected, and the file “studi01” when Channel C is selected. The occurrence of timed events (periodically scheduled reports and functions) is determined by the contents of file “My_Events” in the Timed Events subdirectory.

When the VM700T Video Measurement Set is shipped, all three channel parameters and the Timed Events parameter are set to System Default.

For a dual-standard measurement set (those equipped with both Option 01, NTSC, and Option 11, PAL), the Source_Selection~Video file is a little different. For each channel, it indicates the current standard in effect, along with a separate file from the Video_Source~Files directory for each of NTSC and PAL.

When the NTSC standard is in effect, the file listed under the NTSC column is used; when the PAL standard is in effect, the file listed under the PAL standard is used. To change the standard in effect for a channel, rotate the control knob until that channel's line is highlighted (intensified), then select the entry under the "Video Std." column by touching it. Rotate the control knob until the desired standard appears. Touch the Update & Exit soft key to enter the change into the file.

In Figure 2-8, the current video source (as indicated by the front-panel Source button) determines which entry is read from the Source_Selection~Video file. This, in turn, determines which file is read from the Video_Source~Files directory. This file determines which files are used to get operating information from each of several directories.

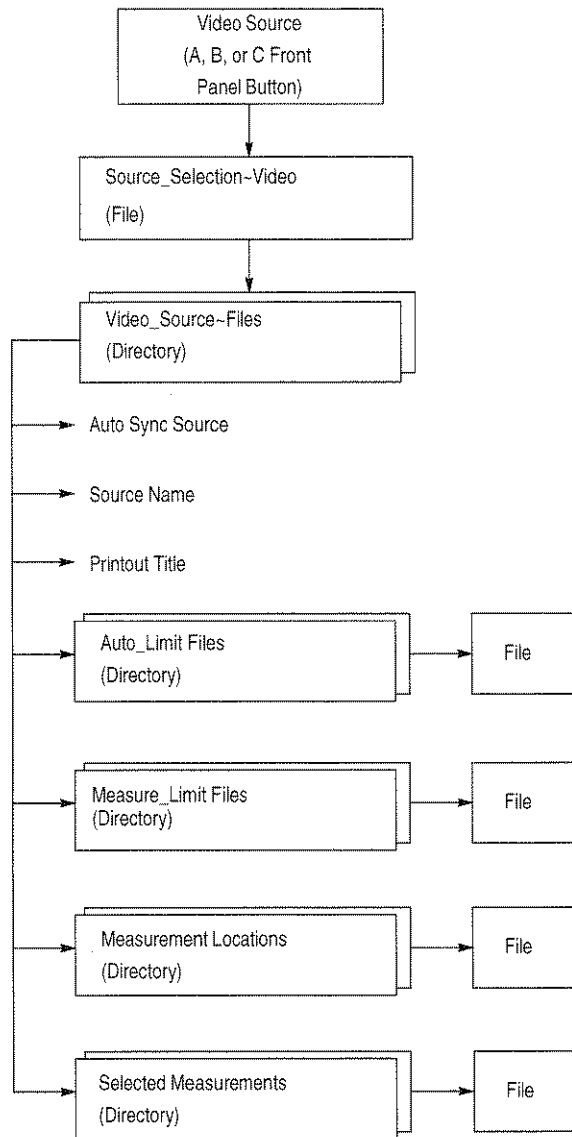

Figure 2-8: How the VM700T Video Measurement Set gets parameter information

**Video_Source~Files
(Directory)**

Files in the Video_Source~Files directory tell the measurement set where to find important parameter information. These files contain the following entries:

- **Auto Limits File:** the file in the Auto_Limit directory that specifies the limits used for Auto mode measurements.
- **Measure Limits File:** the file in the Measure_Limits directory that specifies the limits used for Measure mode measurements.
- **Measurements Location File:** the name of the file in the Measurements_Location directory that specifies the default frame lines and intra-line positions from which to make measurements, as well as other measurement-related information.
- **Selected Measurements File:** the file in the Selected Measurements directory that defines which measurements are to be monitored (measurements that potentially generate Caution and Alarm messages) when the measurement set is in Auto mode.
- **Auto Sync Source:** specifies the synchronization source for Auto mode. Possible values are: Channel A, Channel B, Channel C, External, or Locked to Source. The first four use the specified sources for synchronization; Locked to Source uses whichever source is selected when the measurement set goes into Auto mode.
- **Source Name:** specifies text to be printed across the top of printouts generated by Auto mode or the Copy button. This text may be set to any appropriate string (up to 33 characters) that helps identify the source.
- **Printout Title:** specifies text to be printed (above the Source Name text) across the top of printouts generated by pressing Copy. This text may be set to any appropriate string (up to 49 characters) that helps identify the source.

Taken together, the file names and parameter values contained in files in the Video_Source Files directory define a complete measurement and reporting environment. This environment is usually associated with a particular configuration of equipment being monitored. Thus, for example, you might create a file in the Video_Source Files directory called “tx1,” which would define a measurement environment associated with the signal from your primary transmitter. To avoid confusion, you should give all the files associated with this environment the same name. (They reside in different directories, so there is no risk of name collision.)

This arrangement, whereby the file in the Video_Source Files directory defines the measurement environment while the Video Source file assigns the environment to a channel, gives the measurement set maximum flexibility in meeting a variety of signal monitoring needs. Pre-defining a number of different environments (one for each configuration of equipment to be monitored) allows you to set up the measurement set for different assignments by simply changing entries in the Video Source file.

Auto_Limit Files (Directory)

The Auto_Limit Files directory contains limit files used by Auto mode. A limit file lists all the measurements available for the Auto mode. Each measurement has limits that, when exceeded, produce Caution or Alarm messages on the display and can generate error logging. Both Caution and Alarm limits can be set for every measurement.

The Auto Limits file in use is specified by the active file in the Video_Source Files directory. A file from the Selected Measurements directory is used in conjunction with a file from the Auto_Limits Files directory to provide Auto mode with a list of measurements to be made, as well as the limits for those measurements.

The first line of each file in the Auto_Limit Files directory is the title line for identification of the file. The second line sets the number of consecutive times the measurement set must find a value outside either of its Alarm limits before sending a report of the error to the Log Port.

NOTE. *All Cautions and Alarms encountered in Auto mode are displayed on the measurement set screen, but only Alarms equal to or exceeding the consecutive errors number specified in the active Auto Limits file are sent to the Log port.*

To Change the Consecutive Error(s) Before Logging Value:

1. Rotate the control knob to scroll the screen until the “consecutive error(s) before logging” line is highlighted.
2. Touch the number at the front of the line.
3. Rotate the control knob to select either 1, 2, or 3.
4. Select the **Accept Input** soft key or touch the screen anywhere inside the directory window to return the control knob to its scrolling function.

The next two lines after the “consecutive errors before logging” line contain noneditable label information. Each line of the rest of the file lists the name of an Auto mode measurement, along with its lower and upper Caution limits and its lower and upper Alarm limits.

To Change the Lower or Upper Limit of a Caution or Alarm:

1. Rotate the control knob to scroll the screen until the line with the limit you wish to change is highlighted.
2. Touch the limit you wish to change or remove.
3. Scroll the control knob to display the desired value or select Make it undefined if you wish to remove the limit.

4. Select the **Accept Input** soft key or touch the screen anywhere inside the directory window to return the control knob to its scrolling function.

Setting a pair of limits “backwards” (setting an upper limit lower than its lower limit) always generates an alarm flag on the Auto mode display.

Alarm limits may be set inside Caution limits, but then only Alarm limit violations are flagged.

Communication Setup (File)

The measurement set has two RS-232-C serial ports and a parallel printer port. Either serial port can be attached to an ASCII, Epson, HP LaserJet, or PostScript printer, or to a modem or terminal for serial communication during remote operation. The parallel printer port may be used for any printer having a Centronics-compatible parallel printer interface. The Communication Setup file tells the measurement set how the RS-232-C ports are configured. The factory default settings are the proper settings for a serial Epson LQ-570 printer connected to Serial Port 1.

NOTE. *Option 48, the GPIB Interface option, adds a parallel GPIB port. Any or all of the logical ports may be set to GPIB when the option is installed.*

Port and Format Assignments. The standard VM700T Video Measurement Set has the following three physical ports:

- Serial Port 0
- Serial Port 1
- Parallel Printer Port

NOTE. *The GPIB Interface, Option 48, adds GPIB to the available port list for Copy, Log, Report, and Remote.*

It has the following five logical ports:

- **Copy:** the port to which screen dumps generated by pressing the Copy button, as well as printouts generated by the Configure mode Print File soft key, are sent. The physical port may be either of the serial ports or the parallel printer port.
- **Report:** the port to which Timed Event reports are sent. Again, the physical port may be either of the serial ports or the parallel printer port.

- **Log:** the port to which error reports are sent. Errors are logged when the measurement set, running in Auto mode, measures a parameter as being out of specification for more than the number of consecutive times designated in the active Auto Limits file. As with Copy and Report, the Log port may be either serial port or the parallel printer port.
- **Control:** the port used to connect a device to be controlled by the measurement set. A typical example is the ASG 100 Audio Signal Generator under control of the measurement set running Function Key commands that generate test signals for the Option 40 audio measurements. Either of the serial ports may be selected. Neither the parallel printer port nor the GPIB port is selectable as a Control port.
- **Remote Control:** the port used to connect the measurement set to a modem, terminal, or PC for remote operation. See the *VM700T RS-232 Interface Programmer Manual* for details on remote operation. Refer to the *VM700T GPIB Interface Programmer Manual* when using the GPIB port for remote control. Copy/Report/Log Format should be set to match to type of printer connected. Either of the serial ports may be selected. The parallel printer port is not selectable as a Remote Control port.

The first five groups of lines of the Communication Setup file (after the title line) assign a physical port and a format to each logical port.

Possible Port settings for the Copy, Report, Log, Control, and Remote Control ports are Serial Port 0, Serial Port 1, and None. Copy, Report, and Log may also be set to Parallel when using a parallel interface printer. Control and Remote Control are not possible through the parallel port. Giving a port a setting of None disables the logical port's function (e.g., setting the Copy port to None means that no screen dump will be produced when you press the Copy button).

The measurement set supports either serial or parallel interface printers. Possible format settings for the Copy, Report, Log, and Remote Control ports are Epson LQ, PostScript, ASCII Printer, HP LaserJet, HP DeskJet, and HP ThinkJet. If you have an Epson LQ, PostScript-compatible, or HP LaserJet printer, you can use the Copy function to capture any measurement set display from the Waveform, Vector, Picture, Measure, or Auto modes.

If you have only an ASCII printer available, set Copy Format to ASCII Printer. Then the Copy function is enabled only in Auto mode, which displays only text. If the Copy button is pressed in Waveform, Vector, Picture, or Measure modes when Copy Format is set to ASCII Printer, the measurement beeps to indicate that the Copy function is not available.

To change a Port or Format Assignment:

1. Select the parameter you wish to change by rotating the knob until the parameter is highlighted, then touching the screen over the parameter value. A box appears around the item to edit (see Figure 2-9).

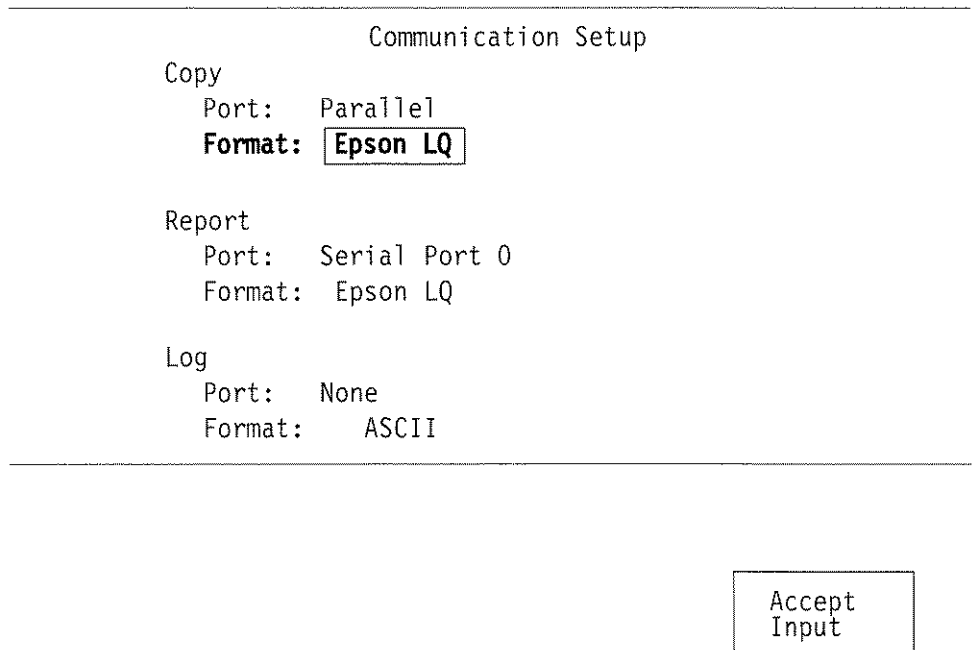

Figure 2–9: Communication Setup file with Copy Format selected to edit

2. Rotate the control knob until the desired parameter value appears in the box.
3. Press the **Accept Input** soft key or touch the screen anywhere inside the window (between the two light horizontal lines).
4. Press the **Update & Exit** soft key to save the changes (see Figure 2–10).

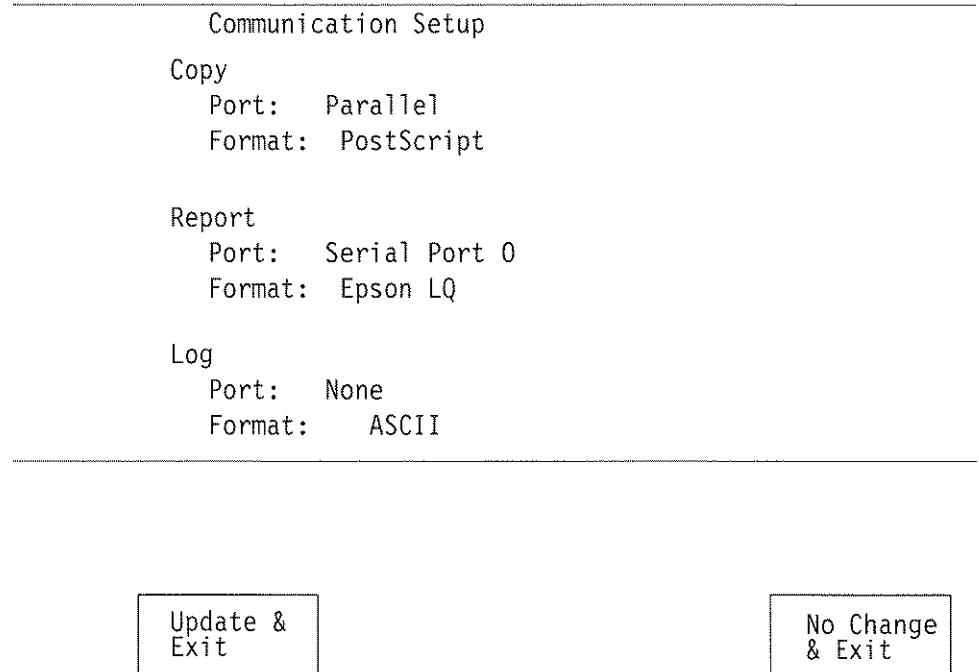

Figure 2–10: Communication Setup file after edit is accepted

Parallel Printer Port. The parallel printer port is a Centronics-compatible output port. No special configuration settings are required beyond setting the printer type and selecting Parallel for the Copy, Log, or Report port.

Serial Port Configuration. Two groups of eight lines appear in the Communication Setup file after the lines that control port and format assignments. These two groups constitute the serial port configuration lines of the Communication Setup file. These lines control the formatting of data when the measurement set is being operated remotely and when it is being used to control a remote device on the Control port.

The configuration parameters for Serial Port 0 and Serial Port 1 and their possible values are as follows:

- **Protocol:** can be set to None or SLIP (serial line internet protocol).
- **Baud Rate:** can be set to 300, 600, 1200, 2400, 4800, 9600, 19200, or 38400.
- **Flow Control:** can be set to XON/XOFF (software handshaking to control data flow), CTS/RTS (hardware handshaking to control data flow) or NONE (no flow control).
- **Character Size:** can be set to 7 or 8 bits.

- **Parity:** can be set to None, Odd, Even, Zero, or One.
- **Reset Character:** can be set to None or Ctrl-A through Ctrl-Z. (Note: the Reset Character for an Apple LaserWriter is Ctrl-D.)
- **Carrier Detect:** can be enabled or disabled.

The default Port 1 settings are suitable for a serial Epson LQ-570 printer.

To Change a Port Configuration Parameter Value:

1. Select the parameter you wish to change by rotating the knob until the parameter is highlighted, then touching the screen over the parameter value. A box appears around the item to edit.
2. Rotate the control knob until the desired parameter value appears in the edit box.
3. Either press the **Accept Input** soft key or touch the screen anywhere inside the window.
4. Press the **Update & Exit** soft key to save the changes.

Diagnostic Errors (File)

When high-level diagnostics are run, any errors detected are written to the Diagnostic Errors file. The contents of this file can be printed using the Print File soft key, or the file can be deleted using the Delete soft key.

If diagnostic errors appear, refer to the servicing information found in the *VM700T Video Measurement Set Service Manual*.

The maximum capacity for the Diagnostic Errors file is 100 lines in a circular file (scrolling past the last entry returns to the top line of the file). If the number of errors detected causes the file to exceed this length, the earlier results are scrolled out of the file buffer. When this occurs, the Diagnostic Errors file includes a message stating that some of the text has been scrolled out of the file.

Diagnostics Selection (File)

The Diagnostics Selection file lists the diagnostics the measurement set can perform at power on. If installed options require additional diagnostics, those are also listed. As received from the factory, all diagnostics are selected, but bypassed by default for a quick startup. Refer to *Setting the Power Up Mode* on page 1–7 for information on reconfiguring the measurement set to run diagnostics at power on. Any diagnostic can be deselected by rotating the control knob until the diagnostic is highlighted (see Figure 2–11, then touching the right side of the highlighted line (above the words Not Selected). To return the choice to selected, highlight the choice and touch the screen on the left side (above the word Selected).

| Power Up Diagnostics Selection | | |
|--------------------------------|--------|--|
| Genlock~Diagnostic | | |
| Controller~Diagnostic | | |
| Acquisition~Diagnostic | | |
| ADC~Diagnostic | | |
| AnalogInput~Diagnostic | | |
| FilterBoard~Diagnostic | | Rotate control knob to highlight the selection to be made. |
| GPIB~Diagnostic | | |
| AudioProcessor~Diagnostic | | |
| AudioAnalog~Diagnostic | | |
| Selected | Line 8 | Not Selected |

Figure 2–11: Diagnostic selection file

As shown in Figure 2–12, the FilterBoard Diagnostic routine is in the Not Selected column and will not be performed.

| Power Up Diagnostics Selection | | |
|--------------------------------|--------|------------------------|
| Genlock~Diagnostic | | |
| Controller~Diagnostic | | |
| Acquisition~Diagnostic | | |
| ADC~Diagnostic | | |
| AnalogInput~Diagnostic | | |
| | | FilterBoard~Diagnostic |
| GPIB~Diagnostic | | |
| AudioProcessor~Diagnostic | | |
| AudioAnalog~Diagnostic | | |
| Selected | Line 8 | Not Selected |

Figure 2–12: Diagnostic selection file showing an unselected choice

Measure_Limit Files (Directory)

The Measure_Limit Files directory contains limit information for Measure mode (manual) measurements. The limits in these files perform the following two functions:

- they place graphic limit markers on the screen in measurements (where applicable)
- they appear on printouts from the Measurement Results directory when the measurement exceeds the limits

The measurement limits file used by Measure mode is designated in the active file in the Video_Source Files directory.

Measurement Locations (Directory)

The file(s) in the Measurement Locations directory contain information used by both Auto and Measure modes. The measurement locations file for each channel is designated in the active file in the Video_Source Files directory.

For PAL, the SIS Present parameter tells the measurement set whether Sound in Sync is present (yes) or absent (no). When SIS Present is yes, measurements are made using Synchronous sampling. The Measure mode parameter determines whether manual measurements are made with Asynchronous (the default) or Synchronous sampling.

NOTE. *Measure mode (manual) measurements normally use Asynchronous sampling. Auto measurements always use Synchronous sampling. Synchronous sampling is available for manual measurements in the case of very noisy signals, negative-going pulses, or other conditions that prevent using Asynchronous sampling. However, Synchronous sampling cannot be used to measure VCR/VTR devices.*

The Line parameter contains the default line on which the measurement is made. The Line value is used in the Default Line Sel. soft key in the Select Line menu in Measure mode. For PAL, the Time offset from leading edge of sync parameter defines the actual measurement position. The numeric Line values and Time values can be changed by highlighting the desired line and selecting the parameter you want to change. Rotate the control knob to obtain the new value, then select the **Accept Input** soft key or touch the screen anywhere inside the directory window. Finish by selecting the **Update & Exit** soft key.

For PAL, two of the measurement descriptions can also be modified. The 20T value on the Modulated Pulse (F) HAD line can be changed to 10T by selecting the parameter and rotating the control knob. The 40% value of the 5-Riser Chroma Amplitude line can be changed to 20% by selecting the parameter and rotating the control knob.

Measurement Results (Directory)

Files are written into the Measurement Results directory in the following circumstances:

- when you exit a measurement in Measure mode
- when you exit Auto mode (assuming that Auto mode has had time to go through one complete cycle of selected measurements)
- when a **getresults** command has been sent from a remote
- when a **getresults** request is part of a Function Key operation

One file with an appropriate name (“Auto,” “Bar LineTime,” etc.) is written for each Measure mode measurement or for Auto mode when it is exited. If a file with that name existed previously, the old file is overwritten.

Once a Measurement Results file contains results, it can be printed (by selecting the Print File soft key), renamed, deleted, or viewed.

Password (File)

The measurement set can be configured to require a password for permission to create, rename, edit and delete directories, function keys, and files. When the Password function is enabled, a Password file appears in the Configure_Files directory.

To Initially Set a Password:

1. Select (touch) the Password file.
2. Touch the screen to the right of the text “Password.”
3. Type in the new password (up to 15 characters).
4. Press **Return** or **Done** and select the **Update & Exit** soft key to put the new password into effect, or press **Cancel** or **Exit** to leave without changing the new password.

NOTE. *Enabling the Password function requires partial removal of the right side cover of the measurement set. Refer the instrument to a qualified service person to either change the Password enabled/disabled state or to reset the password should it become unknown for some reason.*

To Enable or Reset the Password Function. Turn the measurement set off and remove the holding screws for the right side panel. Slide the right side cover off the measurement set to access the 8-section DIP switch on the right rear corner of CPU (A5) circuit board. The switch is located at rear, outer corner of the CPU board when viewed facing the right side of instrument and looking down at the CPU board. You can see this switch without removing the right side board retainer plate.

In Figure 2–13, the DIP switch is shown with switch 6 set to Open to enable the Password function. The factory setting at shipment is with all switches set to the CLOSED position (pushed in at top). To enable Password, set switch 6 (third switch from the back of the DIP switch) to Open. When power is turned on again, the Password function is enabled, and you can set a password using the procedure given previously.

To either reset the password, if it should become unknown for some reason, or disable the function, set position 6 of the DIP switch to the Closed position, turn on the measurement set, and let it complete its power-on routine.

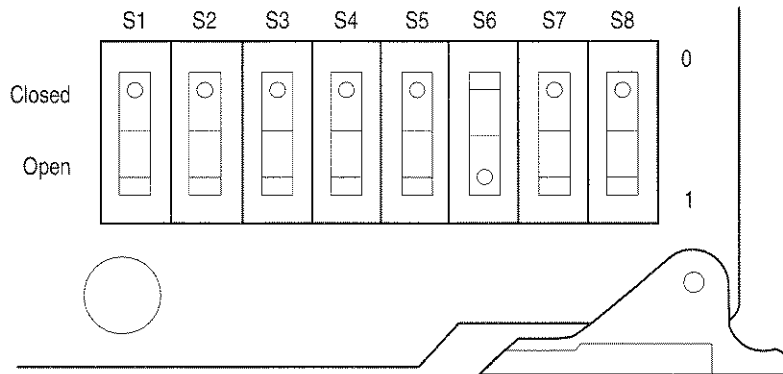

Figure 2–13: DIP switch setting to enable Password

The Password function is now disabled, and the unknown password is visible in the Password file and can be edited. To re-enable Password, turn off the measurement set and switch position 6 of the DIP switch to Open. Replace the side panel and replace the holding screws for the panel.

To Change the Current Password:

1. Select (touch) the Password file icon.
2. Type in the current password and press **Done** or **Return**.
3. Touch the current password.
4. Type in the new password (up to 15 characters).
5. Press **Return** or **Done** and select the **Update & Exit** soft key to put the new password into effect, or press **Cancel** or **No Change & Exit** to keep the old password.

When the Password function is first enabled, the default password is null; no password is needed to Update & Exit, Rename, Delete, or Create a directory or file. Once a password is set, it will be requested when you attempt to Update & Exit, Rename, Delete, or Create a directory or file (that is, every time you change the contents of nonvolatile memory).

If the correct password is entered, the requested action is completed. The measurement set allows three unsuccessful attempts to enter a password before displaying the message “No Password, no access!” and canceling the requested

action. Changing the password to null has the same effect as disabling the Password function with the DIP switches.

Selected Measurements (Directory)

File(s) in the Selected Measurements directory contain a list of all the measurements Auto mode can perform. They allow you to select a subset of measurements for the measurement set to perform. The current Selected Measurements file provides Auto mode with a list of measurements to perform, while the current Auto Limit file provides the limits at which those measurements generate Caution and Alarm messages.

The Selected Measurements System~Default file is the only file available for selection when the instrument is shipped. This file cannot be edited and all the measurements within it are Selected. You must use the Create File function to copy the contents of the System Default file into a new file, and then select the new file before you can select a subset from the measurements available.

To Select or Unselect a Measurement:

1. Open the **Selected Measurements** file for editing by touching its icon in the display of the /nvramØ/ConfigFiles/Selected_Measurements directory.
2. Scroll the file using the knob until the desired measurement is highlighted. Note that the labels **Selected** and **Not Selected** are printed below the directory window. An example of the selection procedure is shown in the *Diagnostic~Selection* file discussion on page 2-27.
3. Touch the highlighted line on the **Selected** side of the screen to select the measurement, or on the **Not Selected** side of the screen to deselect the measurement.

If you wish to select only a small subset of the available measurements, press the **Select None** soft key and then make your measurement selections.

If you wish to unselect only a small subset of the available measurements, press the **Select All** soft key, then unselect the measurements you do not want to make.

Timed Events (Directory)

Files in the Timed Events directory provide a facility for producing scheduled reports of Auto mode measurements, and performing operations (in the form of functions to be played back) at specified times. Events occur at times specified by the current Timed Events file. The Report Port setting in the Communication Setup file must be set to Port 0, Port 1, or Parallel (not None) for reports to be generated.

Consider the following lines from a user-generated Timed Events file named “daily_events”:

Timed Events File: daily_events

| Time | Type | Channel | Standard | Selected File Name |
|-------|----------|---------|----------|--------------------|
| 9:30 | function | | | mid_morn |
| 15:30 | report | B | NTSC | mid_pm |

Timed Events files use a 24-hour clock to specify event occurrences. When this file is the current Timed Events file, the following events are set to occur daily:

- a function called “mid_morn” is executed at 9:30 a.m.
- a report is generated at 3:30 p.m., using the Video Source file named “mid_pm”

Two kinds of timed events can occur: a report can be generated (designated as event type “report” in the Timed Events file), or a function can be executed (designated as event type “function” in the Timed Events file). For “report” events, the measurement set looks in the /nvrāmØ/ConfigFiles/Video_Source~Files directory for the file named in the Timed Events file.

For function events, the measurement set looks for the function named in the Timed Events file in directory /nvrāmØ/FunctionKeys/Timed~Functions. The function selected as a Timed function must reside in the Timed~Functions subdirectory (displayed by the Function Keys soft key in the Configure menu). The parameters for the Auto report (selected measurement limits, measurement locations, etc.) are specified by the selected file in the Source_Selection~Video file.

When a report time occurs, the measurement set screen shows the Timed Report display (unless the measurement set is in remote mode; see note below). The Timed Report display includes a status line showing the channel and the Selected Measurements file in use, a soft key labeled Cancel Report, and the measurements being made. Pressing the Cancel Report soft key halts the timed report execution. Once the report is complete, the measurement set returns to the mode it was in when the report began. The Copy button flashes until the report is either printed or canceled with the Cancel Copy soft key in the initial Configure menu.

When a function time occurs, the measurement set executes the function. When the function has been executed, the measurement set remains in the state specified by the body of the function; it does not return to the state it was in when function execution began.

NOTE. *If the measurement set is in remote mode during a scheduled timed event, the scheduled event is not performed.*

To Create a Timed Events File:

1. Press the **Configure** button.
2. Touch the **Configure Files** soft key.
3. Touch the icon for **Timed Events**.
4. Touch the **Create File** soft key.
5. Touch the icon of an existing file to use as a template.
6. Give the new file a name using the on-screen keyboard.
7. Press **Done** when you have finished entering the name.

The contents of the new file appear on the screen, ready for editing.

To Setup Timed Events:

1. Create a Timed Events file.
2. If any reports are to be generated, make sure the Report Port in the Communication Setup file has a value other than “None.”
3. If a function is to execute a screen copy, make sure that the Copy Port in the Communication Setup file has a value other than “None.”

To Delete a Timed Events File:

1. Press the **Configure** button.
2. Touch the **Configure Files** soft key.
3. Touch the icon for **Timed Events**.
4. Touch the **Delete File** soft key.
5. Touch the icon containing the name of the file you wish to delete.

The icon of the selected file “disintegrates” over a period of five seconds. To stop file deletion, touch the screen anywhere inside the directory window before the disintegration completes. Stopping the disintegration part way through has no effect on the file.

To Add a Report or Function to a Timed Events File. Touch the icon of the file to display it for editing, if it is not displayed already. With the file opened, turn the knob so that the insertion point of the file is highlighted; touch either the **Enter Report** or **Enter Function** soft key as required.

The measurement set inserts a copy of the selected type above the highlighted line. That may then be edited for the new event or function to be timed.

To Remove an Event From a Timed Events File. Touch the icon of the file to display it for editing, if it is not displayed already; turn the knob to highlight the line you wish to delete; then press the **Delete Line** soft key.

To Edit an Event in a Timed Events File:

1. Touch the icon of the file to display it for editing, if it is not displayed already.
2. Turn the knob to highlight the line you wish to edit.
3. Touch the item (time, type, channel, standard, or file name) on the line you wish to edit.
4. Turn the knob until the desired value appears.
5. Press the **Accept Input** soft key or touch the screen anywhere within the window.

You can enter a time of “Undefined” for an event by pressing the Enter undefined soft key when the event’s time field is highlighted. An event with an undefined time is ignored. This function is handy when you want to skip an event temporarily, but do not want to re-enter its associated values later.

To Create a Function for Timed Execution:

1. Press the **Configure** button.
2. Press the **Function Keys** soft key.
3. Press the **Timed-Functions** icon.
4. Press the **Create Function** soft key.
5. Give the new function a name using the on-screen keyboard.
6. Press **Done** when you have finished entering the name.

From this point, you can define a timed function. The steps for defining a timed function are found in the *VM700T RS-232 Interface Programmer Manual*. Basically, creating a function is a learn mode operation that records into the named file, all the front-panel button presses, soft key presses, and delay times used to create the function. Once created, the Function Key file is then available for playback.

NOTE. *If a command line in a function key file is edited incorrectly or somehow becomes unknown in anyway, the measurement set can hang when that bad command line is reached in running a function.*

To Cancel a Timed Report in Progress. Press the **Cancel Report** soft key.

To Cancel a Timed Function Execution in Progress. Press the **Function** button. This leaves the measurement set in whatever state it was in during function execution when you pressed the button.

Video Source Identification (File)

The Video Source Identification file contains a series of number and text string pairs used to identify signal sources in Auto mode. The number is encoded in binary format onto the line of the frame specified by the Source ID line in the Measurement Locations file; the default Source ID video line is line 16.

During Auto mode operation, if an encoded ID number is found on the Source ID line, the measurement set decodes the number and searches the Video Source Identification file for a matching number entry. If a match is found, the accompanying text string is printed on the line labeled Source ID in the Auto mode display. If no match is found, the message "Not Found" is printed.

The Video Source Identification file can contain multiple lines. The range for identifying numbers is 0 to 16383 (14 bits). The text string that accompanies each number can be up to 20 characters long.

Inserting a Video Source Identification Number. The Video Source Identification number is inserted using a VITS 200 NTSC Generator and Inserter, a VITS 201 PAL Insertion Generator, or similar vertical interval test signal generator.

Pulses 1 μ s wide and 1 μ s apart represent binary 1's. For PAL signals, the encoding begins with a start bit (pulse) at the default location of 26 μ sec after the leading edge of sync. (You can change the start value in the Measurement Locations file, but it should be an even number between 26 μ s and 52 μ s.) When a start pulse is found, the measurement set checks that no part of the waveform preceding the start pulse is more than one-half the bar amplitude. If part of the waveform preceding the start pulse is more than one-half the bar amplitude, the encoded number is rejected. Encoding always ends with a stop pulse whose trailing edge is at 57 μ s.

The start and stop pulses are not used in the encoding scheme. There are a maximum of 14 pulses between the start pulse and end pulse, which are used to represent a binary number. The pulse following the start pulse is the least significant bit and the pulse preceding the stop pulse is the most significant bit.



Reference

Waveform Mode

This section describes the capabilities of the VM700T Video Measurement Set as a waveform monitor and how the user interface controls its operation. It is divided into three topics:

- *Display* features discusses basic characteristics of a Waveform mode display.
- *Menu* contains information on all the functions and controls accessed through the Menu button.
- *Select Line* describes the operation of the digital line selection feature.

Display

Figure 3–1 shows a typical Waveform display. Refer to this figure as you read the descriptions that follow.

Waveform

The Waveform mode can present a real-time Waveform display (with 30 updates per second) when a video line or less is displayed. With a greater number of lines, a very full display, or a display of VITS on the first field in a frame, the display is slowed slightly from real-time.

For NTSC, the measurement set may display any part of the two frames of two fields each. Select the frame displayed by selecting Field 1 or Field 2 for frame 1 or Field 3 or Field 4 for frame 2. The default display is both frames. Use the Select Line menu (discussed later in this section) to move to the desired field within a frame.

For PAL, the measurement set may display any part of the four frames of an eight-field color sequence. You can select which frames are displayed in the Select Line menu; the default is all four frames displayed. There is no implicit field selection. Again, use the Select Line menu (discussed later in this section) to move to the desired field within a frame.

Graticule

The Waveform mode graticule scale tracks as the waveform expands, contracts, or moves in both the horizontal and vertical directions. This ensures the graticule scale is always calibrated regardless of the gain (expansion) factor.

The Waveform mode vertical graticule scale is in mV or Volts, depending on the vertical gain setting.

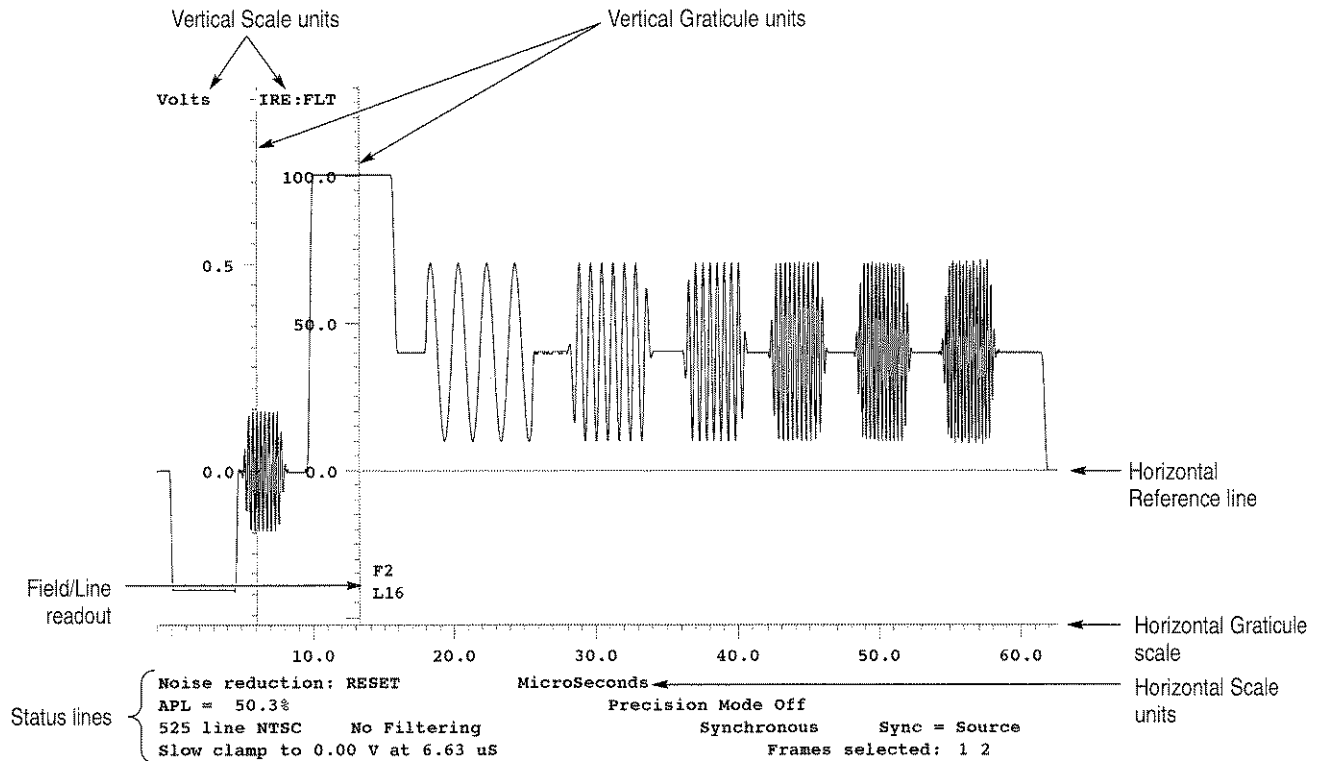

Figure 3-1: Typical NTSC Waveform display

The horizontal graticule scale is calibrated in μs (microseconds) or ns (nanoseconds), as appropriate for the horizontal gain setting. The horizontal scale units indication is centered in the topmost status line, just below the horizontal scale.

Line Identification

A readout of the displayed line number is always shown. If a single line or a fraction of a line of video is displayed, the readout is located just above the horizontal graticule scale and somewhere to the right of the vertical scale, wherever it fits best. If more than one line is displayed, the indicator is found to the right of sync tip for each line.

When multiple lines are displayed, the leftmost line number is the system line. The system line is the line that will be displayed when switching between the manual modes (Waveform, Picture, Measure, and Vector mode when System Line is selected).

Horizontal Reference Line

The horizontal reference line is a stationary line across the display provided for checking and comparing signal levels. It also provides a reference for measuring amplitudes in Cursors mode, and can be used to get a quick measure of tilt on a bar top.

Status Lines The lines of text directly below the horizontal graticule scale are referred to as the status lines. The first line of text displays the units for the horizontal graticule scale (microseconds or nanoseconds). This line also indicates when the measurement set is performing self-calibration. The second line gives the APL (Average Picture Level), and the on/off status of Precision mode and Sound-In-Sync (PAL only). The third line shows the television standard in use, the type of Filtering in effect or No Filtering if none is in effect, the method of sampling in use (Synchronous/Asynchronous), and the selected Sync source. The fourth line describes the clamping status and which frames are currently selected. Two additional lines appear with cursors showing the cursor measurements. Any menu called up will appear below the status lines and will cause the status lines to move upward to make room for the menu selections.

Control Knob The control knob is used with the toggling Move/Expand and Vertical/Horizontal buttons to control waveform positioning and gain and with the Graticule and Display Intensity buttons to set the brightness of the display. When the end of range for a control knob assignment is reached, a slight clicking noise will be heard if the knob rotation is continued in the out-of-range direction. Display and Graticule intensity adjustment is controlled by the knob only when either of those buttons is held. When the intensity buttons are released, the control knob assignment reverts back to the Move/Expand positioning function.

Move/Expand. When entering Waveform mode, the control knob's default function is Horizontal Move (positions left and right). When Expand is selected by pressing the Move/Expand button, the waveform expands around the center of the screen. Expand is also selected when the active area of the screen is touched. (The active area of the screen is that area above the horizontal graticule scale line.) The point touched becomes the point about which the display expands. To move or expand the display vertically, be sure the direction button indicator is Vertical and then rotate the control knob.

Note that selecting Expand with the button is only necessary for one-handed operation. Using the two-hand "touch and zoom" method is much easier. The "touch and zoom" method makes use of the switching to Expand from Move feature. Leave the Move/Expand choice in Move and select the direction, either vertical or horizontal. Move the waveform to the point of interest, then touch the screen at the point about which you wish the waveform to expand or compress. The function of the control knob switches to Expand while the screen is touched and defaults back to Move when you lift your finger from the screen.

Expand (Gain) Range. The horizontal gain of the default 1H Waveform display can be continuously compressed or expanded to display from 10 ns to 704 μ s (11 lines) across the screen. Vertically, the Volts scale ranges from 5 mV full scale to 8 V full scale. The calibrated graticule scale tracks the waveform as it expands, compresses, or moves, both vertically and horizontally.

NOTE. *Using the Expand function to change the display gain does not affect the analog processing of the signal. Signals of up to 4V peak-to-peak may be viewed.*

Display and Graticule Intensity. Display and Graticule intensity adjustments are also made with the control knob. While the Display button is depressed, the control knob varies the intensity of the waveform, menu information, and any other text on the display not associated with the graticule. While the Graticule button is held in, the control knob varies only the intensity of the graticule and the background text displays.

Freeze When Freeze is selected by pressing the Freeze button, the measurement set acquires consecutive frames of 50 lines each and holds that information in the display memory. Therefore, it is not possible to scroll through the entire field when Freeze is selected, only the acquired lines may be displayed.

Menu

Pressing the Menu button while in the Waveform mode displays a row of soft keys along the bottom of the display. This row of soft keys is known as the Waveform menu. The entire Waveform mode menu tree is shown in Figure 3-2.

Pressing the Menu button when the measurement set is in Waveform mode displays the Waveform menu, which is structured as follows:

[1-11] H Display: resets the Waveform display to fit a specified number of lines [1 to 11] into the display. When possible, it aligns the front porch of the system line to the left edge of the display, and 0 volts is aligned with the horizontal reference line. To select the number of lines to display, hold the soft key while turning the knob.

Cursors This choice provides a set of cursors centered on the waveform display. To position the cursors, move the waveform over the cursor and lock the cursor to the desired point of the waveform. When cursors are on, the lower part of the display contains three additional status lines for cursor measurement results.

Pressing the Cursors soft key brings up the following submenu:

Center Left/Right: centers the left or right vertical cursor on the screen. If the cursor is locked to the waveform, the two will move together. If the left and right cursors overlie each other, they appear together as a single dotted line. The vertical amplitude reference marker positions are reset if the cursor is unlocked.

Waveform Menu

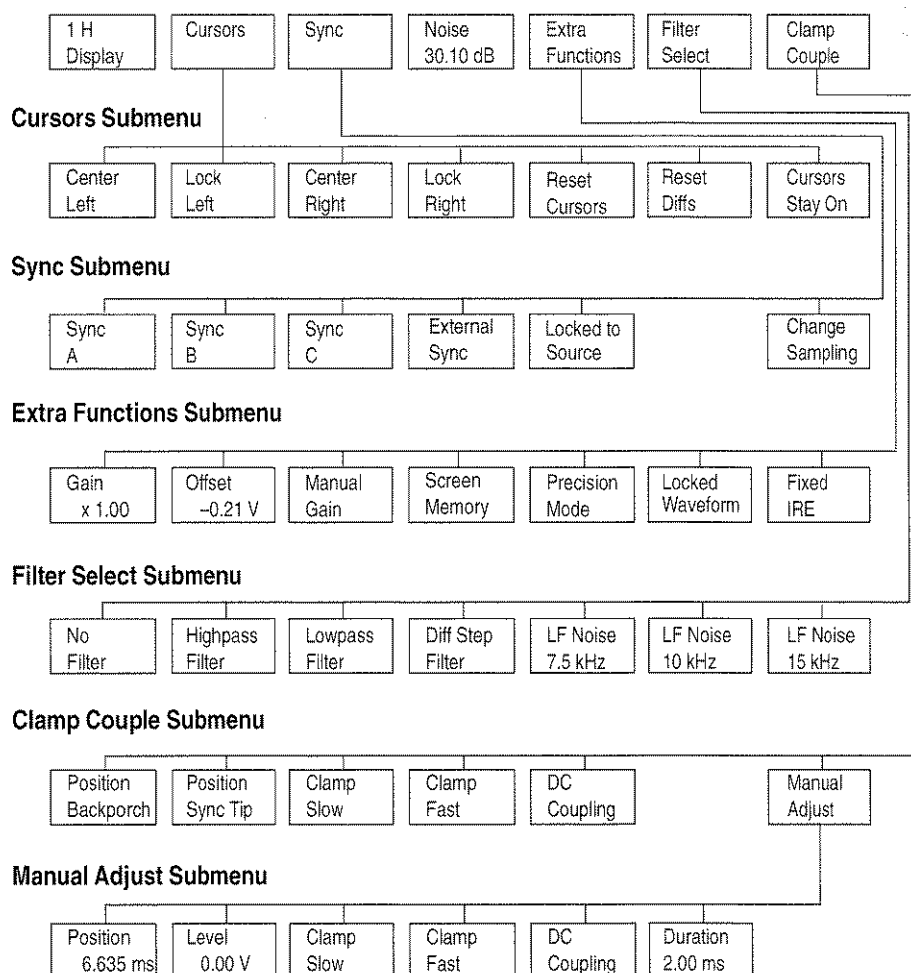

Figure 3-2: Waveform menu tree

NOTE. The LED in the Menu button is on when the Waveform menu is displayed. If the Menu button is pressed when the Menu LED is on, the menu is unselected (removed from the display), and the Menu LED goes off.

Lock Left/Right: locks the left or right vertical cursor to the waveform so that the cursor and waveform move together. The cursor may be moved anywhere within a frame. The “Time from L to R:” reading indicates the time interval between the left (solid) cursor and right (dashed) cursor. The frequency reading is the reciprocal of the time (1/T) and is useful when the cursors are aligned to exactly one period of a waveform. The amplitude reference markers associated with the cursors are not displayed when both cursors are locked to the waveform.

NOTE. *If you position the left (solid) cursor to the right of the right (dashed) cursor, you will be measuring the time from one frame to the next.*

Reset Cursors: unlocks the left and right vertical cursors from the waveform, and positions both at the center of the display. The amplitude reference markers are also reset, so moving the waveform to the 0% and 100% positions of the waveform again pushes the amplitude reference markers back to those positions on the waveform. You can then adjust the cursor on the waveform to the “% point” (as indicated by the % of waveform readout) between the 0 and 100% points required for the cursor measurement (for example, 50% or 10% and 90%).

Reset Diffs: resets the Vertical Delta readout to 0.0 at the current vertical position. Any subsequent vertical displacement from the knob is displayed. This capability is useful for measuring signal amplitudes. The horizontal marker line (across the middle of the active waveform area) provides a useful reference level to align the waveform for voltage difference measurements.

Cursors Stay On: keeps the cursor graphics up even when not in the Cursors submenu. This is useful for keeping up sine-wave measurement results, which measure the amplitude, frequency, and offset of a sine wave in the center of the displayed area.

Sync This choice allows selection of Sync source: A, B, C, External or “Locked to Source” sync mode. Also selects Sound in Sync mode and genlock mode selection between synchronous, asynchronous, and free-run modes. If incorrectly set for the input signal, the waveform display may be replaced by the message “<Loss of sync>”.

Pressing the Sync soft key brings up the following submenu:

Sync A/B/C: sets the sync source to input channel A, B, or C, and clears (unhighlights) the Locked to Source soft key.

NOTE. *If the **Locked to Source** soft key is not highlighted, the sync source will NOT change with changing input selections. The result is erratic behavior if the relative timing between the two inputs is not close.*

External Sync: sets the sync source to external sync. This input cannot be displayed or measured.

Locked to Source: when highlighted, indicates that the sync source and the input source are the same. Changing the signal source also switches the sync to the new signal source.

Sound in Sync (PAL only, not shown in Figure 3–2): enables the measurement set to lock or sync to signals that contain digitally-encoded sound information in the sync pulse. When sound information is contained in the sync pulse, Sound In Sync must be selected or else the measurement set will display the message “Loss of sync.” When Sound In Sync is selected, less of the sync pulse is available for synchronization, which makes the signal timing more susceptible to noise and jitter.

The Sound In Sync soft key only affects Waveform mode. For all other manual modes, Sound In Sync is enabled with the SIS Present “yes” parameter in the active Measurement Locations file.

Change Sampling: toggles between synchronous, asynchronous, and free-run sampling. For a stable source, use synchronous mode; for an unstable source (a VCR for example), first use asynchronous mode. If this does not work, use free-run mode. In free-run mode, line or field syncs are not used, and you lose TV timing references.

Noise [0 dB - 30.10 dB]

The Noise choice sets the decibel value for noise reduction. Highlight the soft key and rotate the knob to change the decibel value. Noise reduction is enabled with the Average button. Noise reduction up to 30.1 dB in 3.01-dB steps is available. Larger noise reduction settings require a longer settling period.

Extra Functions

Pressing the Extra Functions soft key brings up the following submenu:

Gain: allows direct control of the hardware used in acquisition. Gains of 0.25 to 7.75 in steps of 0.25 are available. A larger gain gives a smaller input range, but more resolution. The input range is indicated by two horizontal cursors. Signals beyond these cursor levels are clipped.

Offset: used to bring the signal inside the cursors that appear when the Manual Gain mode is on. Otherwise, hard clipping may occur.

Manual Gain: selects control of the input gain and offset used from the other soft keys in this submenu. When deselected, normal automatic gain control is in effect. When highlighted, two horizontal cursors appear in the waveform area, showing the limits of the input range before hard clipping occurs.

Screen Memory: when highlighted, causes screen erasures to cease, allowing a “build-up” of displayed waveforms. This is useful for looking at eye-heights, jitter, or abnormal excursions of the signal over a period of time. The screen is cleared if the waveform is moved by the knob.

NOTE. Calibration is suppressed in Screen Memory mode.

Precision Mode: provides a higher-accuracy display for waveforms with rise times between 5 MHz and 6 MHz. However, the system update rate is slowed when Precision mode is on. This mode is useful for cursor measurement of fast edges as found on 1T pulses.

Locked Waveform: when highlighted, this key disengages knob movement. Moving the knob resets the calculation when accumulating averages, and resets the screen when in Screen Memory mode. This soft key prevents this from happening accidentally. It also changes cursor mode to make the knob move the cursors if they are unlocked from the waveform.

Fixed IRE (NTSC Only): When highlighted, overrides the Zero Carrier Pulse and Bar Reference selections in the current Measurement Locations file, and fixes the IRE scale to 0 IRE = 0 Volts, 140 IRE per Volt.

Filter Select

This choice provides soft keys to select any of six filter characteristics or no filter. When filters are engaged, measurement or timing information may become less reliable.

Pressing the Filter Select soft key brings up the following submenu:

No Filter: displays the waveform without any filtering (default).

High-pass Filter: removes luminance from the signal. The pass band is approximately 2.5 MHz to 6 MHz.

Low-pass Filter: removes chrominance from the signal. The pass band is approximately 0 MHz to 1 MHz.

Diff Step Filter: removes chrominance from the signal, then displays the direction and relative size of signal transitions.

LF Noise 7.5 kHz/10 kHz/15 kHz: removes all signal information above the specified frequency.

Clamp Couple

Pressing the Clamp Couple soft key brings up the following submenu:

Position Backporch: sets the clamp position to the back porch and the clamp level to 0.0 Volts.

Position Sync Tip: sets the clamp position to the sync tip and the clamp level to -0.3 Volts (-0.29 V for NTSC).

Clamp Slow: selects slow clamp speed. This allows hum effects to be visible, but is useful for coping with large DC offsets on an input signal.

Clamp Fast: selects fast clamp speed. This removes DC offset, hum, and bounce effects from the signal.

DC Coupling: selects DC coupling (no clamping).

Manual Adjust: brings up the following submenu:

Position: adjusts the horizontal clamp position within a line.

Level: adjusts the clamp voltage level from -1.28 V to 1.27 V in 10 mV steps. Adjustments outside ± 300 mV may cause APL measurement problems.

Clamp Slow: selects slow clamp speed. This allows hum effects to be visible, but is useful for coping with large DC offsets on an input signal.

Clamp Fast: selects fast clamp speed. This removes DC offset, hum, and bounce effects from the signal.

DC Coupling: selects DC coupling (no clamping).

Duration: selects 0.5 ms, 0.67 ms, 1.0 ms, or 2.0 ms clamp gating widths. Wide gating widths provide better noise immunity, but signal distortions may not provide a wide enough sustained level.

Select Line

In Waveform mode, pressing the Select Line button switches the control knob to a digital line select function. When either no menu or the Waveform menu is displayed, pressing Select Line also displays the Select Line menu, which is structured as follows:

Field Toggle: toggles the system line to the other field (for PAL, $+313$ lines if the system line was from 1 to 313 , -313 lines if the system line was from 314 to 625). In freeze mode, the change is limited to the acquired area.

Field n Line nn (NTSC)/Line nn (PAL): displays the system line specified by the soft key. To change the line number, select and hold the soft key to be changed, turn the knob until the new line number is found, and release the soft key. In Freeze mode, the change is limited to the acquired area.

Field 1 or 2/Field 3 or 4 (NTSC): when selected (the default), color frame 1 (fields 1 or 2) or color frame 2 (fields 3 or 4) are displayed.

Frame 1/2/3/4 (PAL): when selected, the corresponding frame is included in the display. The default is all four frames selected.

Although the Select Line button responds in all submenus, the Select Line menu will not replace any submenus, only the main Waveform menu. Select Line always disables the Move/Expand function of the control knob, but it does not disable the Display and Graticule Intensity control functions.

System Line

Changing the displayed line in Waveform mode or any of the manual modes (Waveform, Vector, Picture, and Measure), changes the current line for all the manual modes. This line is referred to as the “system line.” The leftmost line number on the display is the system line.

However, both Vector mode and Measure mode can operate independently of the system line. In Vector mode, you can select an independent Vector Line (found in the Select Line menu in Vector mode). See *Vector Mode*, beginning on page 3–17, for more information on the Vector Line. In individual measurements, the Default Line Sel. soft key changes the displayed line to the measurement line specified in the Measurement Locations file.

Cursors

The measurement set provides a set of cursors that enable you to make custom measurements manually with a high degree of accuracy. You can use the cursors to perform the following tasks:

- measure time duration
- measure frequency
- measure luminance or chrominance amplitudes
- measure rise or fall times
- toggle quickly between any two points in a frame

Primarily, cursors are used to make measurements that are not automatically made in Auto mode or Measure mode. They can also be used to verify some of the automated measurements, should the need arise. Cursor measurement accuracy is limited by the one percent vertical accuracy of the measurement set display. Accuracy may be improved (at the expense of update speed) if Precision mode is on.

Cursor Appearance

The cursors, which are displayed when the Cursors soft key is selected, are two vertical bars. The left cursor is a solid vertical line and the right cursor is a dashed vertical line. When both cursors are on the same point, they appear as a dotted vertical line. The default position for the cursors is the center of the display.

Each cursor has a pair of horizontal amplitude reference markers that extend from the cursor to the furthest left or right point the cursor touched on the waveform. The anchor point of each amplitude reference marker is a short vertical line on the waveform. The amplitude reference markers are cleared and reset when the Reset Cursors, Center Left, or Center Right soft keys are selected.

Amplitude reference markers are used to establish 0% and 100% reference levels so that the cursor can be positioned at a specific level (for example, 50%) as needed for a measurement.

Cursor Status Lines

Selecting the Cursors soft key displays the cursors and the submenu shown in Figure 3-3. When cursors are on, the following three additional status lines appear:

- Sine pk-pk (mV), freq (MHz), and offset (mV)
- Time from L to R, and Vertical Delta
- Frequency (1/T), and % point (% point appears as UNDEFINED point when cursors are first turned on or when the Reset Cursors soft key is touched.)

The values in the first Cursor status line are measured at the center of the display. The message — **Sine wave at middle of screen has frequency above 1.5 x Subcarrier: not measurable** — is displayed when no sine wave is found at the center. This condition occurs when measuring noise and when the signal frequency is actually too high to measure. The following formula is used for calculating the Sine pk-pk (mV), freq (MHz), and offset (mV) values:

$$f(t) = A \sin(\Sigma t) + B$$

where $A = \text{pk-pk}/2$, $\Sigma = 2\pi\text{freq}$, and $B = \text{offset}$. The second and third cursor status lines display values relative to the cursor positions and to the horizontal reference line.

Moving Cursors-Lock Left, Lock Right, Center Left, and Center Right

When cursors are displayed, a cursor can be moved from its default position in the middle of the display by locking it to a point on the waveform. Use the control knob to position the waveform under the cursors, then lock one of the cursors with the Lock Left or Lock Right soft key. You can now move both the cursor and the waveform horizontally.

If the Left or Right cursor is moved off the screen and lost from view, it can be easily brought back on the display by selecting the Center Left or Center Right soft key, as appropriate. With a cursor locked to the waveform, selecting the corresponding Center soft key will horizontally center the cursor and the point on the waveform to which it is locked. This technique may be used to toggle between any two points in a frame.

Using Cursors to Measure Timing

Cursors can help you make extremely accurate time measurements over short or very long intervals. For example, you can measure rise times or the length of up to two fields of video. To familiarize you with cursors, the following text explains how to measure the rise time of the leading edge of horizontal sync. While learning to use cursors, you'll find it much easier to use the stable output of a test signal generator than live video. You can also select Freeze to stabilize the signal.

Note that the measurement set bandwidth limits the signal to 6 MHz. To accurately display rise times of signals with significant frequency components between 5 MHz and 6 MHz, select Precision mode.

To Use Cursors to Measure a Rise Time. First, use the control knob and the Vertical/Horizontal buttons to position the leading edge of a sync pulse in the center of the screen and then expand the sync edge to fill about 80% of the screen. Select the Reset Cursors soft key to center the cursors, reset the amplitude reference markers, and turn off any previously selected cursor Lock soft keys.

Attach the left amplitude reference marker to a stable spot on the blanking level prior to the leading edge of sync by moving the waveform to the right until the blanking level reaches the cursor. This establishes the 100% point of sync. Then attach the right amplitude reference marker to a stable spot on the sync tip by moving the waveform to the left until the sync tip reaches the cursor. This establishes the 0% point of sync. Live video may require moving the sync edge a little further in both directions to find an average or stable level for the 100% and 0% points. When the sync edge is now moved past the cursors, the % point readout is calibrated, and indicates the sync edge % point that intersects the cursors.

NOTE. *If the waveform point that the amplitude reference marker is attached to is moved off the display, the amplitude reference marker does not remain attached to the waveform. Instead, it locks to the vertical scale at the point where the waveform left the display.*

So, if the level of the signal at the point where the amplitude reference marker was formerly anchored (which is now off screen) changes, the amplitude reference marker will not track that change. It may sometimes be necessary to decrease the horizontal expansion to keep both amplitude reference markers on the display when trying to find a stable point on live video to anchor them.

Position the sync edge under the cursors so the % point readout is 90% and select the Lock Left soft key. This locks the left cursor to the 90% point of the sync edge. Now when you move the sync edge horizontally the left cursor moves with it. Notice that the left cursor is a solid vertical line, and the right cursor, which is still centered in the display, is a dashed line. Now simply move the waveform so the % point readout indicates 10%. The Time from L to R readout now indicates the rise time of the leading edge of sync. Figure 3-3 illustrates the right cursor sitting at the 10% point and the left cursor locked to the 90% point of the sync edge.

Note that touching either the Center Left or Center Right soft key will move the corresponding cursor to the center of the display.

From this point, to measure sync width from the leading edge 90% point (10% down from blanking) to the trailing edge 90% point (10% down from blanking), you will need to locate the 90% point on the trailing edge by repeating the above procedure. First, move the waveform to the left until the trailing edge of sync is in the center of the screen. Next touch the Center Right soft key. Move the waveform to the left and right to position the amplitude reference markers on the 100% point and 0% point of sync. Position the trailing sync edge so the % point readout indicates 90%. The Time from L to R: readout now indicates sync width from the 10% point of the leading edge of sync to the 10% point on the trailing sync edge.

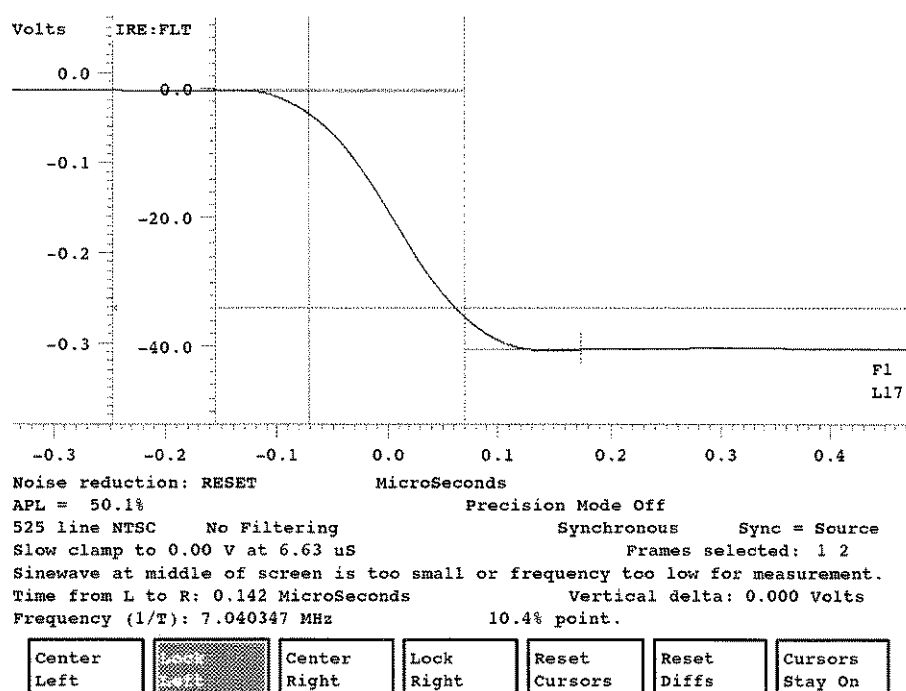

Figure 3-3: Left cursor locked to 90% point of sync edge, right cursor to 10% point

NOTE. Always make sure the Left cursor is to the left of the Right cursor. If it is not, the Time from L to R: readout will indicate the time duration of a frame of video minus the time interval between the cursors. Also, measuring time durations with cursors is not limited to a single line width or a field. Cursors can measure up to one full frame before they wrap around.

Using Cursors to Measure Frequency

Sine-wave frequencies can be easily measured with cursors. The following procedure produces the best accuracy using asynchronous sampling and with averaging on to reduce the noise.

To Measure a Sine-Wave Frequency. Expand the desired sine wave (for example, color burst) so two cycles fill the majority of the screen.

Position the sine-wave zero crossings to occur at the horizontal reference line.

Select the Cursors soft key and position a zero crossing on the cursors.

Select Lock Left and move the waveform to the left one full cycle (two zero crossings) and position the zero crossing on the right cursor. Select Lock Right. The sine wave frequency is now displayed in the Frequency (1/T) readout. Compare this value with the freq (MHz) = value in the first cursor status line (third line from the bottom in the status area).

Using Cursors to Measure Amplitude

The Cursors mode provides a quick tool to make amplitude measurements and indicates measurement results in the same units as the vertical scale, to three decimal places. The following example discusses the Vertical delta readout and its use in measuring amplitude of the color burst.

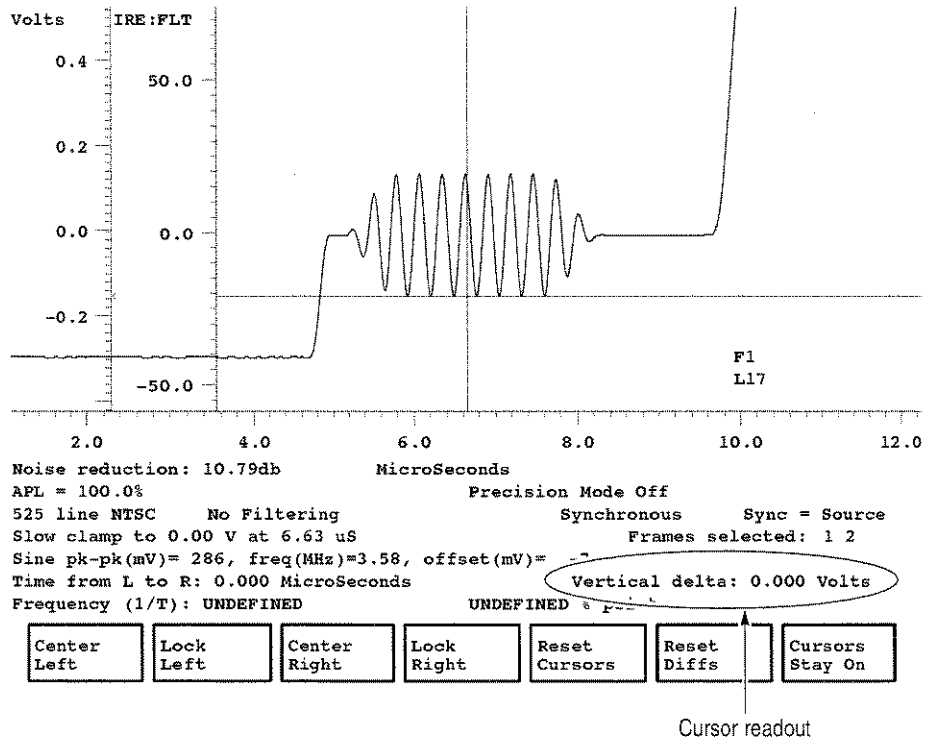

Figure 3-4: Color burst aligned with horizontal reference line

To Make an Amplitude Measurement. Vertically expand the desired portion of the signal to give adequate resolution.

Use the control knob to position the bottom (or top) of the portion of the waveform to be measured on the horizontal reference line. See Figure 3-4.

Select the Reset Diffs soft key to reset the Vertical delta: readout to 0.000 Volts.

Use the control knob to position the top of the portion of the waveform to be measured on the horizontal reference line. See Figure 3-5.

The Vertical delta readout now indicates the absolute amplitude of the waveform.

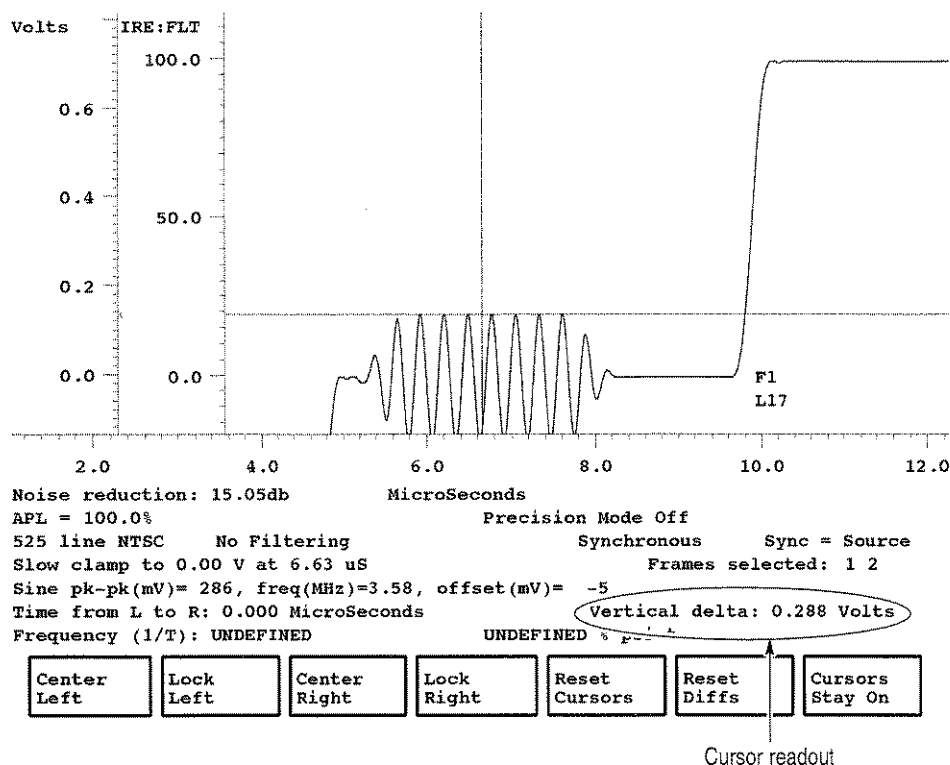

Figure 3-5: Cursors mode indicating color burst amplitude

Vector Mode

This section provides a detailed description of the capabilities of Vector mode and tells how to operate the VM700T as a vectorscope.

Display

Vector mode provides a conventional vector display. Because the display is digitally derived, a single line is displayed with full brightness. The Vector mode has an electronic graticule accompanied by digital readouts of the line selection mode (System Line or Vector Line—refer to page 3-20), displayed field and line number, phase Angle (in degrees), Gain (in both dB and times gain), APL level, and Setup level. Figure 3-6 shows a typical color bar signal on a vertical interval line of an NTSC test signal.

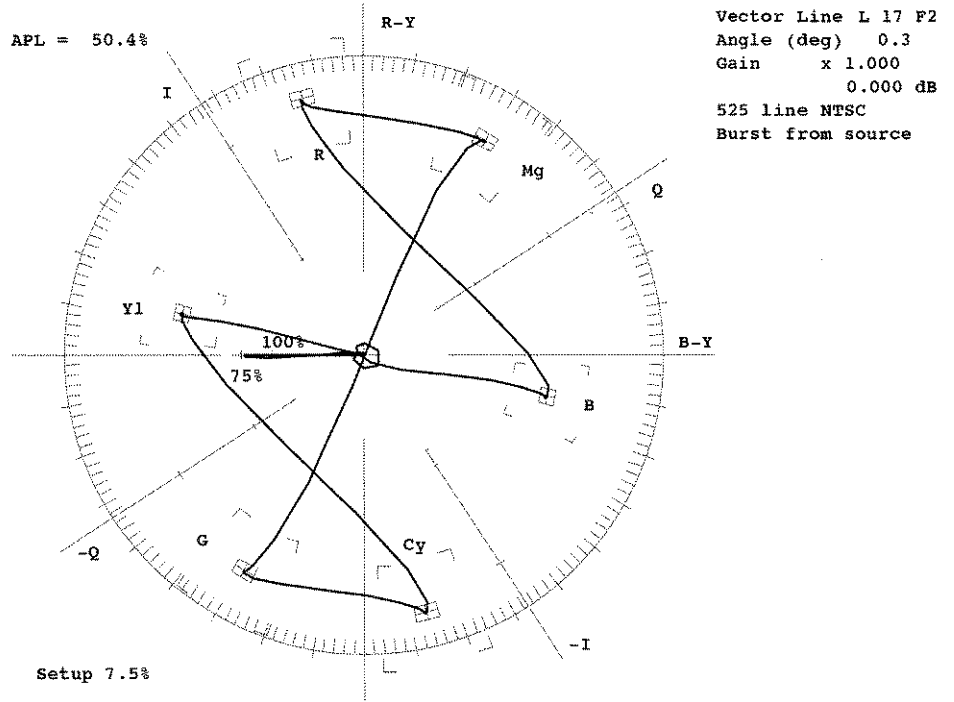

Figure 3-6: Vector display of a color bar signal

Additional information is included on the left side of the display to indicate the noise reduction if Average is on; and, for the PAL vector display, if Sound-in-Sync is ON or OFF. Also, for the PAL vector display, there is a line added to the information on the right side of the display to indicate the V-axis being displayed.

Control Knob

The control knob is used in conjunction with the Move/Expand button to vary the display phase Angle and Gain, and with the Display and Graticule buttons to set the display's Intensity. When the Select Line button is pressed, the control knob performs a digital line select function.

Display Phase Angle. When entering Vector mode, the default function of the control knob is to vary the display phase Angle (the Move LED is on). As a phase shifter, the control knob rotates the display in one-tenth degree increments, as indicated by the Angle (deg) readout in the upper right corner of the display.

Expand (Gain) Range. When the Expand button is pressed, the control knob becomes a calibrated vector Gain control. Expand is also temporarily selected when the screen is touched inside or near the graticule. The Gain readout in the upper right corner of the display indicates the current Gain setting with a multiplier (x) and in dB.

The default Vector Gain is x1.000 (0.000 dB), and can be compressed or expanded from x0.250 (-12.195 dB) to x50.000 (34.055 dB) in 0.023 dB increments.

Display and Graticule Intensity. Display and graticule intensity adjustments are also made with the control knob. While the Display button is held in, the control knob varies the intensity of the vector, menu information, and any other text on the display not associated with the graticule. While the Graticule button is held in, the control knob varies only the intensity of the graticule.

Menu

Pressing the Menu button either displays the Vector menu or toggles it off (if it is already displayed). The Vector Menu is shown in Figure 3-7.

V-Axis Switch (PAL only): inverts the vector around the V-axis for a line with a -V-axis burst. It has no effect on lines with a +V-axis burst.

Display Select V (PAL only): toggles between display of lines with a +V-axis, a -V-axis, or both axes (default).

Vector Menu

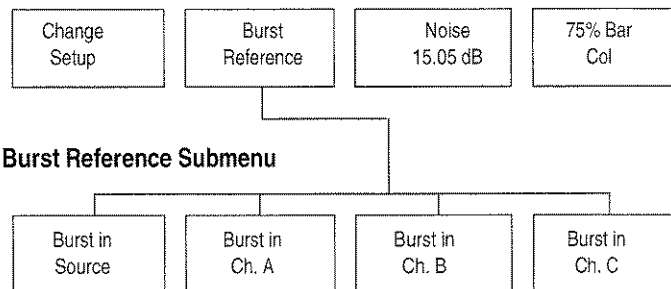

Figure 3-7: Vector mode menu

Change Setup (NTSC only): toggles the graticule for a proper display of a color bar signal with either 7.5% setup (Setup 7.5%) or no setup (Setup 0%).

Burst Reference: brings up the following submenu to select the reference source for color burst:

Burst in Source: sets the color burst reference to the current signal source.

Burst in Ch. A/B/C: the color burst reference is set to the specified channel.

When a color burst reference is set to a channel other than the source channel, an additional readout is provided at the top of the vector display screen. The timing difference between the two channels is provided in time and degrees. The two channels must have a common burst reference to provide any useful information about the time difference between channels. A typical readout in this case is:

ChA after ChB: xx ns
(degrees) xx

where xx represents the measured timing difference.

Noise: sets the amount of noise reduction in decibels when the Average button is pressed. For PAL, each V-axis is averaged separately. The higher the noise reduction requested, the longer it takes to settle.

75% Bar Cal: Rotating the knob in Vector mode changes the gain or phase angle, which can leave the VM700T uncalibrated for angle or amplitude. Touching this soft key returns Vector mode to a default calibrated state, with phase angle set to 0.0 degrees, gain to 1.000 (0.0 dB).

Select Line

In the Vector mode, pressing the Select Line button changes the control knob function to digital line select and displays the following menu:

Field Toggle: displays the system line in the other field. For PAL, if the current line is between 1 and 313, it adds 313; if the current line is between 314 and 625, it subtracts 313.

Find Colorbars: searches from the system line through the frame for a line containing color bars, and displays it if found.

Vector Line: when highlighted, changes the Vector mode line independently of the system line.

Field n Line nn (NTSC)/Line n (PAL): displays the line specified by the soft key. To change the line number, select and hold the soft key to be changed, turn the knob until the new line number is found, and release the soft key.

Measure Mode

Pressing the Measure button on the front panel puts the VM700T into Measure mode. In this mode, the VM700T provides interactive control of measurement parameters, as well as graphical display and digital readouts of measurement results.

Measure Mode Menu Operation

Measure mode is used for making interactive measurements of NTSC and PAL signal properties, and accessing the measurements of any installed options as shown in Figure 3–8. This is different from Auto Mode, which is used for automatic, non-interactive, and continuous execution of user-specified measurements.

NTSC and PAL video measurements available through Measure mode are described in detail in the *VM700T Option 01 (NTSC) Measurements User Manual* and the *VM700T Option 11 (PAL) Measurement User Manual*. The Video Option and Audio Option measurements are described in the individual option user manuals.

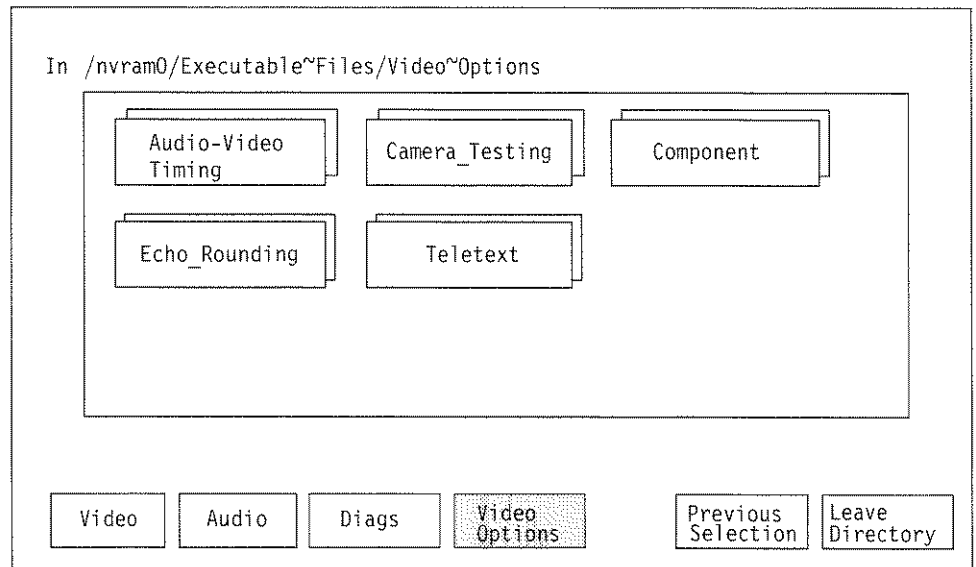

Note: In the first Measure mode menu display, the Video soft key is visible when Video Options are selected, and the Video Options soft key is visible when Video is selected. The Audio soft key is seen only if Audio Options are installed.

Figure 3–8: Measure Mode menu choices

Video Option Measurement Menu Operation

Figure 3–8 shows the Measure mode menu with Video Options selected. Notice that a directory for each installed Video option is displayed. The option menu arrangement separates the option measurements so you can make a selection from the shorter list of measurements for a single option as illustrated in Figure 3–9, rather than all the possible option measurement choices.

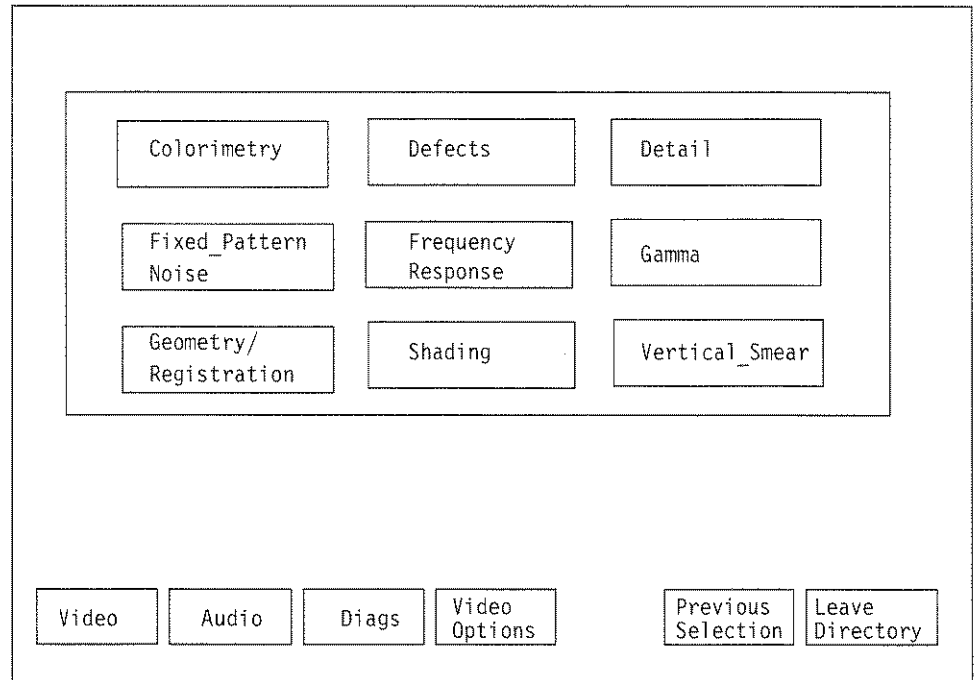

Figure 3–9: Measure menu of Camera Video Option

The menu choice of Previous Selection returns to the previously selected measurement. The menu choice of Leave Directory displays the next higher level of the menu hierarchy. The directories and files in the higher-level menu displays are not accessed using this route in normal operation. They are normally accessed by the appropriate front panel button or soft key as needed for the application in use.

Picture Mode

Picture mode is intended solely to assist in input source identification of TV video (picture) signals. If non-picture test signals are viewed, the signal patterns are displayed, but no meaningful information may be extracted from the display.

Pressing the Picture button brings up a low-resolution TV display with a software generated pseudo-gray-scale. The number of the system line is always displayed, and Select Line is always on. A bright line indicates the position of the system line on the display. You may quickly set the line selection to a visual reference point in the picture display and then switch to the waveform, vector, or measure mode to view or make measurements on the contents of that line.

Two soft keys are available for use in adjusting the display. When Picture mode is active, the Display and Graticule hard keys change their action. Turning the knob while holding the Display button in adjusts the picture brightness. When the Graticule hard key is held in, turning the control knob adjusts the picture contrast. Both brightness and contrast can be reset to their default values using the Adjust/Default Brightness and Adjust/Default Contrast soft keys.

Auto Mode

Auto mode of the VM700T Video Measurement Set executes a configurable list of continuously performed measurements. Whereas Measure mode makes individual measurements that are graphically displayed, Auto mode performs all the selected measurements and generates the measurement results in tabular format. The measurements to be made and the limits to measure to are obtained from the configuration files. The Auto mode measurements provide a large amount of information about the signals being measured and indications of violations of user-selectable measurement limits. This section discusses Auto mode operation and how to configure it.

Auto Mode Display

When you press the Auto button, the VM700T displays the measurements being made in Auto mode. Due to the large number of measurements made by Auto mode, not all of them can be displayed on the screen at once. Use the control knob to scroll the display to view all of the list of measurements and results. As each measurement is made, the measurement's name, the measured value, the measurement units, and the limit values for the measurement are highlighted. When the complete list of measurements has been made, the highlighted text returns to normal display.

The Auto mode measurements are not affected by the sync and clamping parameters set in Waveform mode for the manual measurements.

Measurement Identification

In Auto mode, the VM700T lists measurement names on the left-hand side of the display. Each name is followed by the measurement result, and a notation of the measurement's reference where applicable.

Violated Limits Indication

When the user definable limits are violated, the violated limits are printed on the screen, and an indicator appears between the measurement result readout and the Violated Limits — Lower column. If the indicator is a single "*" (asterisk), a Caution Limit has been violated. If the indicator is a "**" (double asterisk), an Alarm Limit has been violated.

If a measurement cannot be made for some reason, the result readout is replaced with a line of dashes and is considered a limit violation.

Setting the Caution and Alarm Limits is discussed later in this section.

Comments Column Beyond the Violated Limits columns, Auto mode prints messages primarily for measurements that cannot be performed. The comment describes the nature of the problem the VM700T has in making the measurement to assist you in rectifying the problem. If the measurement is one that will not normally be available from the signal being measured, a new Selected Measurement file can be created to customize the measurements list to those of interest in your application.

Timed Events Auto mode has a utility for generating reports of specified measurements at specified times, or for automatically executing functions at specified times. The report is in the same format as the Auto mode display. Configuring the report generation/function execution process is discussed in detail later in this section.

Violated Limits Logging The VM700T can be set to log (print) limit violations. A one-line report from the Auto mode display is logged any time a measurement result crosses the Alarm Limit boundary a specified consecutive number of times, both when the measurement goes outside the limit or comes back within the limit.

Enabling/Disabling Logging. The automatic logging of violated limits can be enabled or disabled by setting the Serial And Printer Setup file (found in Configure mode) Log Port entry to Port 0 or Port 1 (enabled) or None (disabled, the default setting). If the Option 48 GPIB Interface is installed, the logging port may be set to GPIB.

Remote Operation

The VM700T Auto mode measurements may be executed individually or as reports while in remote operation. Details of making Auto mode measurements remotely are discussed in the *VM700T RS-232 Interface Programmer Manual*.

Configuring Auto Mode

Each input SOURCE (channels A, B, and C) has a file assigned to it in the Video_Source Files directory that specifies other files to use for defining measurement limits, measurement signal locations, and selected measurements.

System default files are provided that may be used as templates to create customized measurement configuration files. Basic information on each of these files and how to use the Configure mode directory structure is found in *Configuring the VM700T Video Measurement Set* beginning on page 2-9.

The following aspects of Auto mode can be configured by the user:

- Caution and Alarm Limits (Auto Limit Files)
- locations of test signals on VITS lines and presence of zero carrier (Measurement Locations file).
- a subset of the available measurements (Selected Measurements file)
- times for reports to be generated and the Selected Measurements file to be used at each report time (Timed Events file)

Setting Alarm Limits

Limit files for Auto mode are located in the Auto_Limit Files directory. This directory is accessed by pressing the Configure button, selecting the Configure Files soft key, and then selecting the Auto_Limit Files directory. There are five limits file in the directory when the instrument is shipped from the factory.

Each limit file contains a list of all the measurements available for the Auto mode. Each measurement can have limits that, when exceeded, produce caution or alarm messages on the display. Both Caution and Alarm Limits can be set for each measurement. The supplied limit files cannot be edited. Their contents can be viewed by selecting (touching) a file. Only the Exit soft key is available to close these files. Use the Create File soft key to copy the contents of one of the supplied files to create a limit file you can customize.

The first line of the file is the title line. The second line of the file, "2 consecutive error(s) before reporting," sets the number of consecutive measurements that find a value that is outside the Alarm Limits before logging the error to the printer.

To change the consecutive error(s) before reporting value:

1. Rotate the control knob to scroll the screen and highlight the 2 consecutive error(s) before reporting line.
2. Touch the number at the front of the line.
3. Rotate the control knob to select either 1, 2, or 3.
4. Select the Accept Input soft key or touch the screen inside the directory window other than the selected parameter box to return the control knob to its scrolling function.

To change a Caution or Alarm Lower or Upper Limit:

1. Rotate the control knob to scroll the screen and highlight the line with the limit you wish to change.
2. Touch the limit you wish to change or remove.

3. Scroll the control knob to display the desired value or select “Make it undefined” if you wish to remove the limit.
4. Select the Accept Input soft key or touch the screen anywhere inside the directory window other than the selected parameter box to return the control knob to its scrolling function.

Note that setting a pair of limits backward (setting an upper limit lower than its lower limit) will always display an error flag on the Auto mode display. Alarm Limits may be set inside Caution Limits, but then only Alarm Limit violations will be flagged.

The limit file used by Auto mode is designated in the configuration file (Channel_A/B/C Configuration) for each channel. A file from the Selected Measurements directory is used in conjunction with a file from the Auto_Limit Files directory to provide Auto mode with a list of desired measurements and limits for those measurements.

Defining Measurement Locations

You can specify the zero carrier pulse location and/or whether or not you wish to use it as a reference and define the locations of test signals on VITS lines (or in a full field signal) within a file in the Measurement Locations directory. The files found in this directory contain information used by both Auto and Measure modes. The measurement locations file used by Auto and Measure modes is designated in the configuration file (Channel_A/B/C Configuration) for each channel. The System Default file is the only file available for selection when the instrument is shipped. Any additional files you create to customize your applications will be available for selection.

Selecting a Group of Measurements

The files used to designate which subset of measurements you wish Auto mode to perform are found in the Selected Measurements directory.

The files found in this directory contain a list of all the measurements Auto mode can perform. The purpose of the files is to allow you to select a subset of measurements you wish to perform from the entire list of measurements available. A selected measurements file is used in conjunction with an auto limit file to provide Auto mode with a list of desired measurements and the limits at which those measurements generate caution and alarm messages.

Note that the mnemonic of each measurement name used in remote operation is listed to the left of the measurement name.

The Selected Measurements system default file is the only file available for selection when the instrument is shipped. Use the Create File soft key to create a new file you can customize.

Selecting or deselecting a particular measurement is simple. After opening the desired file, use the control knob to scroll the file so the desired measurement is highlighted. Note that the labels Selected and Not Selected are printed below the directory window. Touch the highlighted line on the Selected side of the screen to select a measurement, or on the Not Selected side of the screen to deselect a measurement.

If you wish to select a small subset of the available measurements, select the Select None soft key and then make your measurement selections. Touching the Select All soft key selects all measurements.

Setting Event Times

Files in the Timed Events directory provide a facility for producing scheduled reports of Auto mode measurements, or executing functions at specified times. Reports consist of a set of measurements designated by a selected measurements file. A few lines from a user-generated New Timed Events file follow:

New Timed Events file:

| Time | Type | Channel | Standard | Selected File Name |
|-------|----------|---------|----------|--------------------|
| 12:00 | report | A | NTSC | System~Default |
| 23:00 | function | B | PAL | Night_reset |

The active Timed Events file is specified on the last line of the Video Source file. When the VM700T senses an event time specified in the active Timed Events file, it does one of two things:

- If the event is a report, it selects the channel and standard, then runs the measurements included in the Selected Measurements file specified by the active Timed Events file.
- If the event is a function, it selects the channel and standard, then executes the function specified by the active Timed Events file.

The Report Time is entered in 24-hour format. Any file in the Selected Measurements directory may be specified at any Report Time.

At any Event Time, regardless of what mode it is in, the VM700T screen will blank and display a message indicating that a Timed Event is occurring. You will see the LED in a SOURCE (channel) button light when measurements are being made for a report on that channel. Report generation can also be overridden only by entering Remote Operation mode.

The Event Times System Default file is the only file available for selection when the instrument is shipped. Any additional files you create to provide time events for your application are also available for selection.



Appendices

Appendix A: Specification

The performance limits in this specification are valid with the following conditions:

- This instrument must have been calibrated/adjusted at an ambient temperature between +20° C and +30° C.
- The instrument must be in an environment with temperature, altitude, humidity, and vibration within the operating limits described in this specification.
- The instrument must have had a warm-up period of at least 20 minutes.
- The instrument must have had its signal-path-compensation routine last executed after at least a 20 minute warm-up period at an ambient temperature within $\pm 5^\circ$ C of the current ambient temperature.

Any conditions that are unique to a particular characteristic are expressly stated as part of that characteristic.

Electrical Characteristics

Table A-1: Input characteristics

| Characteristic | Performance requirement | Supplemental information |
|----------------------------|--|--|
| Channel A, B, and C | | User selectable. Differential A – B, A – C, B – A, B – C, C – A, and C – B may also be digitized for parallel component testing. |
| Input Type | Loop-through BNC connectors | |
| Return Loss (75 Ω) | Greater than 46 dB from 0 to 5 MHz | Channels A, B, and C are loop-through terminated in 75 Ω in use or not; power on or off. |
| Input Signal Range | +3, –6 dB with respect to 1 V_{p-p} nominal video (1.41 V_{p-p} to 0.5 V_{p-p}) terminated in 75 Ω | |
| Coupling | | DC, AC, Clamp |
| Clamp | | Independently programmable on each channel as follows: 1. Timing with respect to sync 2. Clamp pulse width 3. Clamp reference level 4. Clamp time constant |

Table A-1: Input characteristics (cont.)

| Characteristic | Performance requirement | Supplemental information |
|-----------------------------------|---|---|
| Hum Rejection | | |
| Fast | Greater than 24 dB | |
| Slow | Less than 1 dB | |
| External Sync | | Provided through a rear panel input |
| Crosstalk Between Channels | | Greater than 70 dB isolation between channels. Measured at F_{sc} between A, B, C, and EXT SYNC |
| Residual Noise Level (0 to 5 MHz) | Better than -80 dB with respect to $0.714 V_{p-p}$ active video | |

Table A-2: Digitizer

| Characteristic | Performance requirement | Supplemental information |
|----------------------------------|-------------------------|---|
| Distortions | | |
| 2nd Harmonic | | -70 dB or less; with 2.5 MHz, -1 dBfs signal |
| Noise | | -60 dBfs _{RMS} , typical; with 5 MHz, -50 dBfs input |
| Anti-aliasing filter attenuation | | |
| At 7.16 MHz (NTSC) | 35 dB or greater | |
| At 8.86 MHz (PAL) | 40 dB or greater | |

Table A-3: Synchronization

| Characteristic | Performance requirement | Supplemental information |
|----------------|--|---|
| Modes | | Video input or external (Sound-in-syncs and PCM2 capable without jumper options.) |
| Amplitudes | | |
| Internal | | |
| Minimum | -14 dB with respect to 286 mV nominal sync amplitude | |
| Maximum | +12 dB with respect to 286 mV nominal sync amplitude | |
| External | | |
| Minimum | -8 dB with respect to 286 mV nominal sync amplitude | Composite sync |
| Maximum | 8 V peak-to-peak | Composite sync |

Physical Characteristics

Table A–4: Physical characteristics

| Characteristic | Description |
|------------------------|---|
| Dimensions (W × H × D) | 19.0 in × 8.75 in × 21.9 in (483 mm × 222 mm × 556 mm) |
| Weight | 45 lb (20 kg) |
| Shipping Weight | Approximately 71 lb (33 kg) |

Power Requirements

Table A–5: Power requirements

| Characteristic | Description |
|-------------------|--|
| Mains Voltage | 90 VAC to 132 VAC (115 VAC nominal) |
| | 180 to 250 VAC (230 VAC nominal) |
| Mains Frequency | 50 or 60 Hz |
| Power Consumption | 250 Watts (400 VA maximum) |
| Fuse Rating | |
| Low Input Range | 6A slow blow |
| High Input Range | 3A slow blow |
| Cooling Method | Forced-air circulation |

Environmental

Table A–6: Environmental specification

| Characteristic | Performance requirement |
|----------------|-------------------------------|
| Temperature | |
| Operating | 0° C to +50° C |
| Nonoperating | –55° C to +75° C |
| Altitude | |
| Nonoperating | To 50,000 feet (15240 meters) |
| Operating | To 15,000 feet (4572 meters) |

Table A-6: Environmental specification (cont.)

| Characteristic | Performance requirement |
|-----------------------------|---|
| Sine Vibration Operating | 10 Hz – 55 Hz, 0.015 inch peak-to-peak, 15 minutes total cycling time per axis for three axes followed by a 10 minute dwell at the identified resonance frequency or at 33 Hz if none is found. |
| Shock Nonoperating | 50 g's, 1/2 sine, 11 ms duration, 3 shocks per surface (18 shocks) |
| Transportation | Qualified under NTSB Test Procedure 1A, Category II (30 inch drop) |
| Humidity Operating | Up to 95% at or below 50° C |
| Nonoperating | Up to 95% at or below 60° C |

Table A-7: EMC compliance

| Characteristic | Description |
|--|---|
| EMC Requirements | <p>Emissions shall be within the limits specified by the following requirements.</p> <p>Enclosure EN55022 Class B limits for radiated emissions</p> <p>AC Mains EN55022 Class B limits for conducted emissions</p> <p>To ensure compliance with the above requirements, only high-quality shielded interface cable should be attached to this instrument. High-quality cables have a reliable, continuous outer shield (braid and foil) that has low impedance connections to shielded connector housings at both ends.</p> |
| Immunity, Enclosure, Electrostatic Discharge (ESD) | Up to 8 kV with no loss of stored data, change to control settings, degradation of performance, or temporary loss of function. |
| Immunity, Enclosure, Radio Frequency Electromagnetic Field | No degradation of performance when the instrument is subjected to a 3 V/M electromagnetic field over the frequency range of 27 MHz to 500 MHz. |

Table A-7: EMC compliance (cont.)

| Characteristic | Description | | | | | | | | | | | | | | | | |
|--|--|-------------------|-------------------|---------------------|---------------------|------------------|-----|------|---|----------|-----|------|---|----------|-----|------|---|
| Immunity, Fast Transients, Common Mode | No loss of stored data, change to control settings, degradation of performance, or temporary loss of function will occur when the instrument is subjected to transients as described below. | | | | | | | | | | | | | | | | |
| | <table border="1"> <thead> <tr> <th>Port</th> <th>Peak Voltage (kV)</th> <th>Tr/Th (ns)</th> <th>Rep Frequency (kHz)</th> </tr> </thead> <tbody> <tr> <td>Signal & Control</td> <td>0.5</td> <td>5/50</td> <td>5</td> </tr> <tr> <td>DC Power</td> <td>0.5</td> <td>5/50</td> <td>5</td> </tr> <tr> <td>AC Power</td> <td>1.0</td> <td>5/50</td> <td>5</td> </tr> </tbody> </table> | Port | Peak Voltage (kV) | Tr/Th (ns) | Rep Frequency (kHz) | Signal & Control | 0.5 | 5/50 | 5 | DC Power | 0.5 | 5/50 | 5 | AC Power | 1.0 | 5/50 | 5 |
| | Port | Peak Voltage (kV) | Tr/Th (ns) | Rep Frequency (kHz) | | | | | | | | | | | | | |
| | Signal & Control | 0.5 | 5/50 | 5 | | | | | | | | | | | | | |
| | DC Power | 0.5 | 5/50 | 5 | | | | | | | | | | | | | |
| AC Power | 1.0 | 5/50 | 5 | | | | | | | | | | | | | | |
| | | | | | | | | | | | | | | | | | |
| | | | | | | | | | | | | | | | | | |
| FCC | <p>The instrument complies with the radiated and conducted emissions requirements of FCC Code of Federal Regulation 47, Part 15, Subpart B, Class A limits.</p> <p>To ensure compliance with the above requirements, only high-quality shielded interface cable should be attached to this instrument. High-quality cables have a reliable, continuous outer shield (braid and foil) that has low impedance connections to shielded connector housings at both ends.</p> | | | | | | | | | | | | | | | | |

Table A-8: Safety standards

| Category | Description |
|---|---|
| U.S. Nationally Recognized Testing Laboratory Listing | UL3111-1 – Standard for Electrical and Electronic Measuring and Testing Equipment |
| Canadian Certification | CAN/CSA C22.2 No. 1010.1 – Safety Requirements for Electrical Equipment for Measurement, Control and Laboratory Use |
| European Declaration of Conformity | <p>Compliance was demonstrated to the following specification as listed in the Official Journal of European Communities:</p> <p>Low Voltage Directive 73/23/EEC; amended by 93/68/EEC: EN61010-1/A2 1995 – Safety Requirements for Electrical Equipment for Measurement, Control, and Laboratory Use</p> |
| Additional Compliance | <p>ANSI/ISA S82.02.01 – Safety Standard for Electrical and Electronic Test, Measuring, Controlling, and Related Equipment, 1994</p> <p>IEC1010-1 – Safety Requirements for Electrical Equipment for Measurement, Control, and Laboratory Use</p> |

Table A-9: Safety certification compliance

| Category | Description |
|---------------------------------------|---|
| Temperature (operating) | +5° C to +40° C |
| Altitude (maximum operating) | 2000 Meters |
| Relative Humidity (maximum operating) | 80% for temperatures up to 31° C, decreasing linearly to 50% to at 40° C |
| Equipment Type | Test and Measuring |
| Safety Class | Class I (as defined in IEC 1010-1, Annex H) – grounded product |
| Overvoltage Category | Mains – Overvoltage Category II (as defined in IEC 1010-1, Annex J). Local-level mains, appliances, portable equipment |
| Pollution Degree | Pollution Degree 2 (as defined in IEC 1010-1). Do not operate in environments where conductive pollutants may be present. Note – Rated for indoor use only |

Table A-10: Rear panel signal connectors

| Characteristic | Description |
|---|---|
| Port 0 and Port 1 Connectors | DB-9, male connectors, configured as RS-232C DTE ports to provide hardcopy output to serial printers and remote control |
| GPIB Connector (Option 48) | Meets electrical specifications described in IEEE-488 for parallel GPIB connectors |
| VGA Connector | 15 pin, D-type. Outputs monochrome VGA signals |
| Parallel Printer Connector | Centronics-compatible connector and signals |
| Remote Contact Closure Relay (Alarm) | Contacts are not debounced |
| Maximum Current | 50 mA |
| Maximum Voltage | 30 VAC _{RMS} or 30 VDC |
| Control Logic | set GRLY 1 closes the relay set GRLY 0 opens the relay |
| CH A, CH B, CHC, and Ext Sync Feed-Through Connectors | BNC. 75 Ω Termination is required when not used as feed-through signal path. |

Table A-11: Optional power cords

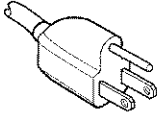
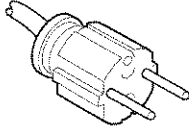
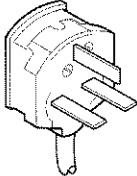
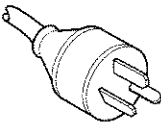
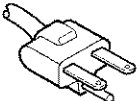
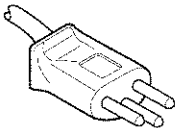
| Plug configuration | Normal usage | Option number |
|---|---|---------------|
|  | North America 125 V/15A Plug NEMA 5-15P | Standard |
|  | Europe 230 V | A1 |
|  | United Kingdom 230 V | A2 |
|  | Australia 230 V | A3 |
|  | North America 230 V | A4 |
|  | Switzerland 230 V | A5 |

Optional Accessory

Printer cable for Hewlett-Packard LaserJet, ThinkJet, or DeskJet with serial interface. Tektronix part number 012-1285-00.

Table A-12: Certifications and compliances

| | |
|-------------------------------------|---|
| <p>EC Declaration of Conformity</p> | <p>Meets intent of Directive 89/336/EEC for Electromagnetic Compatibility and Low Voltage Directive 73/23/ECC for Product Safety. Compliance was demonstrated to the following specifications as listed in the Official Journal of the European Communities:</p> <p>EN 50081-1 Emissions: EN 55022 Class B Radiated and Conducted Emissions</p> <p>EN 50082-1 Immunity: IEC 801-2 Electrostatic Discharge Immunity IEC 801-3 RF Electromagnetic Field Immunity IEC 801-4 Electrical Fast Transient/Burst Immunity</p> <p>Low Voltage Directive 73/23/EEC; amended by 93/68/EEC: EN 61010-1/A2 1995 Safety requirements for electrical equipment for measurement, control, and laboratory use</p> |
| <p>EMC Compliance</p> | <p>Meets the intent of Directive 89/336/EEC for Electromagnetic Compatibility when it is used with the product(s) stated in the specifications table. Refer to the EMC specification published for the stated products. May not meet the intent of the Directive if used with other products.</p> |
| <p>FCC Compliance</p> | <p>Emissions comply with FCC Code of Federal Regulations 47, Part 15, Subpart B, Class A Limits</p> |

Appendix B: Performance Verification

The Verification procedures in the this section are done with the covers on. The procedures are used to verify the operation of the VM700T Video Measurement and to determine if there is a need for readjustment. Performance of the Video Measurement Set to published specifications for measurement accuracy is verified by other methods during a factory calibration.

Self Diagnostics

The measurement set is configured at the factory to bypass the diagnostics at power on to provide a quicker startup. Refer to *Setting the Power Up Mode* on page 1–7 if you want to change the configuration to run the diagnostics at power on. The diagnostic routines of the measurement set check the operation of the digital hardware. Passing the diagnostics is part of the performance verification procedure. Use the following procedure to force an auto reset. All the diagnostics then run at power on regardless of the power-on diagnostic configuration.

1. Turn off the measurement set.
2. Hold down the **Menu** button and use the front panel STBY/ON switch to power on the instrument.
3. After the instrument beeps twice, release the **Menu** button. The measurement set displays the VM700T Startup Menu.
4. In the menu, use the control knob to select R ... INSTRUMENT RUN MODES, and press the **Select Line** button. A second diagnostic menu is then displayed.
5. In this menu, select A ... AUTO RESET, and press the **Select Line** button. This runs the full set of internal diagnostics. Check that all tests pass as they run.

After the diagnostics complete, the measurement set should initialize in the Waveform mode.

Check that all tests pass as they run. If a test fails, refer to the *VM700T Video Measurement Set Service Manual* for further actions you can take to determine which board or boards may be at fault.

To check for soft errors (possible intermittent operation), enter the Configure files and set the Diagnostic Selection file to run all diagnostics. If you see a Diagnostic Errors file, either use the Delete soft key to erase it (if it is not needed), or check it for the last error saved and note its time for reference. Select Measure mode by pressing the Measure hard key, and set the diagnostics to loop continuously (DiagsLoop).

NOTE. The measurement set requires a 20 minute warm-up period before starting the verification procedures.

Run the diagnostics while you let the measurement set warm up for 20 minutes before starting the verification checks. The diagnostics can be looped as long as desired to more rigorously check for intermittent errors. Use the Abort Diagnostic soft key to halt diagnostic looping. Return to the Configure menu and check the Diagnostic Errors file for new errors.

Test Equipment Required

The test equipment to use for performing the verification procedures is shown in Table B–1. Test equipment suggestions for use in doing the verification procedure are given in the example column. The examples given are based on the test equipment that many customers and the Tektronix service centers have installed for supporting the VM700 family of video measurement sets. Substitute test equipment may be used if available. Refer to the Minimum Specification column to determine the key specifications needed to verify the accuracy of the VM700T Video Measurement Set. If you do not have the required test equipment, you can return your instrument to a Tektronix service center for the accuracy verification.

Table B–1: Test equipment required for verification

| Test equipment | Minimum specification | Purpose | Example |
|-------------------------------|--|---|---|
| Video amplitude calibrator | Square wave 0.0 mV to 999.9 mV peak; accuracy 0.05%, resolution 0.1 mV | Reference standard for amplitude verification | Tektronix 067-0916-00 (not currently available for purchase) ¹ |
| Leveled sine-wave generator | 75 Ω output impedance; output flat within ±0.025 dB (±0.3%) to 6 MHz | Measure sine wave, check filter flatness | Hewlett-Packard 3336C Sine-wave generator with option 005 ² |
| Television signal generator | NTSC, full field and burst capability, accurate to ±1 Hz | NTSC test signal source | Tektronix TSG-170A or equivalent |
| Television signal generator | PAL, full field and burst capability, accurate to ±1 Hz | PAL test signal source | Tektronix TSG-271 or equivalent |
| Coaxial cable, BNC connectors | 75 Ω impedance, high-quality noise free; 1-meter length | Signal interconnections | Tektronix part number 012-0074-00 |
| Termination | 75 Ω precision, BNC connectors | Signal termination | Tektronix part number 011-0102-01 |

¹ The example amplitude calibrator requires a TEGAM TM500 or TM5000 series power module.

² The flatness accuracy required of the leveled sine-wave generator is only to the bandwidth needed to perform the measurement set verification and adjustments. It is not specified to be that flat over the entire bandwidth of the generator.

System Verification Procedures

NOTE. *If the results yielded by the verification procedures in this section are within the limits specified, further adjustment is not necessary and is not recommended. Adjusting the measurement set unnecessarily (for example, to get a “better” reading on a calibration result that is within limits) can introduce errors into a functional instrument.*

Measure Squarewave

This procedure checks the amplitude accuracy of the instrument. An externally applied precision reference signal is used to check the complete signal path through the instrument.

Test Equipment Required

- Video amplitude calibration fixture (VAC).
- Coaxial cable, 75 Ω high-quality noise free; 1-meter length.

Procedure: Measure Squarewave

1. Connect the VAC to channel A of the measurement set (leave the input unterminated).
2. Set the controls of the VAC for NTSC, +LUM, and 700.0 mV.
3. On the measurement set, press the Measure key, the Diags soft key (if not already in Diagnostics mode), and the Measure Squarewave soft key.
4. Check the measurement set for a reading of 700 mV \pm 2.1 mV.

NOTE. *If the voltage measured in step 4 is out of the specified limits, your calibration DAC may need readjustment. Refer your instrument to a qualified service person.*

5. Move the test signal and select the appropriate channel to repeat the check for channel B and channel C.
6. Disconnect the VAC from the measurement set.

Measure Sinewave

This procedure is to be used as a check for proper system level adjustment of the measurement set. It checks the frequency response flatness over the operating frequency range.

Test Equipment Required

- Leveled sine-wave generator.
- Termination, 75 Ω precision BNC.
- Coaxial cable, 75 Ω high-quality noise free; 1-meter length.

Procedure: Measure Sinewave

1. Connect the leveled sine-wave generator output to the measurement set channel to be tested (start with channel A). Terminate the channel loop-through output connection in 75 Ω .
2. Set the leveled sine-wave generator for 50 kHz at an output level of 500 mV into 75 Ω .

NOTE. If the example leveled sine-wave generator is being used, the output level should be set for -3.81 dBm.

3. Press the Measure hard key; then, if necessary, display the measurement set Diagnostics directory by pressing the Diags soft key. In diagnostics, run the sine-wave measurement application by pressing the Measure~Sinewave soft key.
4. After the measurement application has initialized, turn averaging on by pressing the Average hard key until the Average hard key light is lit. When the display stabilizes, press the Freeze hard key. The Delta Amp reading should remain at 0. If the Delta Amp reading changes, press the Freeze key again, as many times as needed, until the Delta Amp reading remains at 0. This is now the reference to which all other measurements are compared.
5. Set the leveled sine-wave generator for a frequency of 4.43 MHz; do not change the output level.
6. To speed up the response to the frequency change, toggle the Average hard key off. Turn averaging on again after the display has re-stabilized.
7. Check that the amplitude is within $\pm 0.5\%$ (Delta Amp of $\pm 0.5\%$ or less) of the 50 kHz reference level stored in step 4.
8. Set the leveled sine-wave generator for 5.8 MHz; do not change the output level.

9. Again, to speed up the response to the frequency change, toggle the Average hard key off. Turn averaging on again after the display has re-stabilized.
10. Check that the amplitude is within $\pm 0.55\%$ of the reference level stored in step 4.
11. Change the TV Standard parameter from PAL to NTSC by pressing the XY Arrow hard key. Change the filter selection from No Filter to the NTSC bandwidth limiting filter by pressing the Move/Expand hard key until the filter displays NTSC BW Lim.
12. Return the leveled sine-wave generator to 50 kHz; do not change the output level.
13. To speed up the response to the frequency change, toggle the Average hard key off. Turn averaging on again after the display has re-stabilized.
14. Check that the amplitude is within $\pm 0.5\%$ of the reference level stored in step 4.
15. Reset the leveled sine-wave generator for 3.6 MHz; do not change the output level.
16. To speed up the response to the frequency change, toggle the Average hard key off. Turn averaging on again after the display has re-stabilized.
17. Check that the amplitude is within $\pm 0.5\%$ of the reference level stored in step 4.
18. Change the Filter parameter from NTSC BW Lim to Chroma BP by pressing the Move/Expand hard key. Don't change the settings on the leveled sine-wave generator.
19. To speed up the response to the filter change, toggle the Average hard key off. Turn averaging on again after the display has re-stabilized.
20. Check that the amplitude is within $\pm 0.5\%$ of the reference level stored in step 4.
21. Change the TV standard parameter to PAL by pressing the XY Arrow hard key.
22. Change the leveled sine-wave generator frequency to 4.43 MHz; do not change the output level.
23. To speed up the response to the frequency change, toggle the Average hard key off. Turn averaging on again after the display has re-stabilized.
24. Check that the amplitude is within $\pm 0.5\%$ of the reference level stored in step 4.
25. Repeats steps 1 through 7 for channel B and channel C.

26. Disconnect the test equipment from the measurement set.

NOTE. *If the response on channel A is out of limits, your measurement set may need readjustment of the system response. Refer your instrument to a qualified service person.*

If either channel B or channel C does not pass but channel A does, the Analog input board may need replacement. Check with your nearest Tektronix representative or factory service for assistance and board replacement information.

Measure the Burst Frequency

This procedure checks the calibration of the internal oscillator using a signal source of known frequency.

NOTE. *To successfully run this procedure, the internal oscillator of the measurement set must be completely stable. Power on the measurement set at least 20 minutes before performing this procedure.*

Test Equipment Required

- Television signal generator (NTSC or PAL) with full field and burst capability, accurate to ± 1 Hz.
- Coaxial cable, 75 Ω high-quality noise free; 1-meter length.
- Termination, 75 Ω precision BNC.

Specification Checked

Burst frequency accurate to ± 10 Hz using the internal frequency reference.

NOTE. *The frequency of the signal generator used must be accurate to ± 1 Hz to ensure a valid limit check reference on the burst frequency measurement.*

Procedure: Measuring Burst Frequency

1. Disconnect all signal inputs from the measurement set.
2. Press the Measure hard key and touch the Video soft key, if necessary, to recall the Video measurement menu.
3. Touch the Burst Frequency soft key. With no signal applied, the measurement set displays a warning message that tells you to check the signal source because a signal cannot be found. The burst frequency measurement starts automatically after 3 seconds (the Loss of Sync indicator blinks).

4. Press the Menu hard key and touch the Reference soft key in the menu display.
5. Touch the Zero Set soft key to set the measurement reference for the internal oscillator.
6. Connect the signal generator (full field and burst) to the channel A input (terminate the Ch A loop through with a $75\ \Omega$ BNC termination).
7. Check that the burst frequency measurement is 0 ± 10 Hz using the internal frequency reference.

Appendix C: Adding Options

The following instructions tell you how to order an option upgrade and how to activate the new option configuration in your measurement set.

Ordering an Option Upgrade

First you must locate the current option authorization key for your VM700T Video Measurement Set. If your set is not running, turn it on and wait for the system initialization to complete. Use the following procedure to locate the option key.

1. Press the **Configure** front panel button to display the menu shown in Figure C-1.

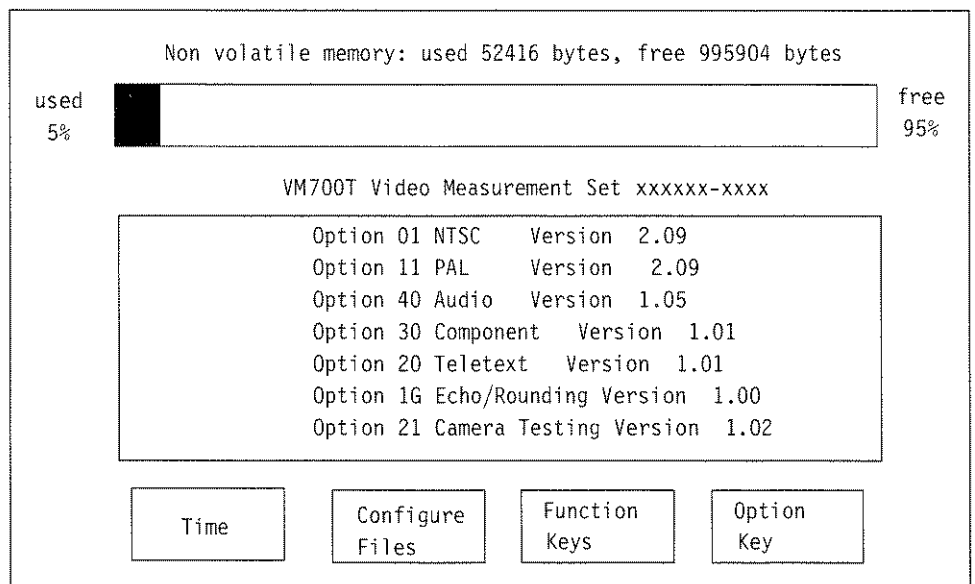

Figure C-1: Main configure menu

2. Touch the **Option Key** soft key. This brings up the Option Key control screen as shown in Figure C-2. Several lines of information are shown related to the instrument identification number, the software identification number, and the option authorization key for your instrument. Note the option authorization key and record it for use when placing an order for a firmware upgrade.

3. Contact your local Tektronix representative to place your order for the new option. You will be asked for the option authorization key of your measurement set as part of the order process.

Tektronix Identification #: xxxxxxxx

Software Identification Number: xxxxxx

Current Option Key: xxxx-xxxx-xxxx

New Option Key:

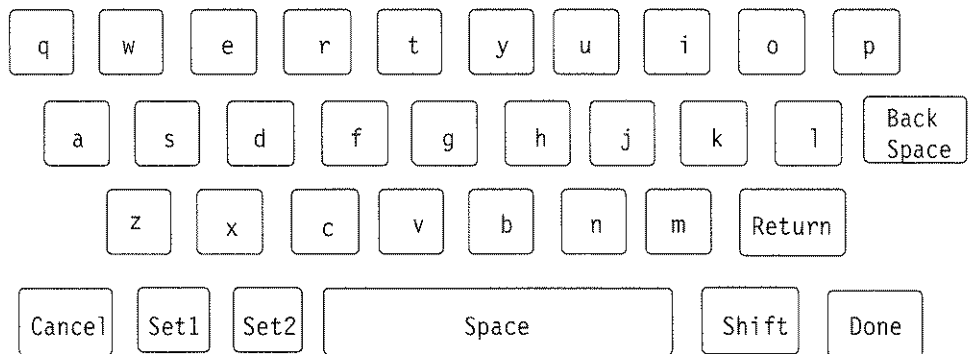

Figure C-2: Option Key control menu

After your order is processed, you will be sent the firmware upgrade kit with your new option authorization key. The firmware upgrade kit includes a new manual for the ordered option. When an option upgrade requires additional circuit boards, those are also in the upgrade kit with instructions for installation.

Activating the New Options

The following procedure explains how to activate your new option configuration after you receive a new option key. If the option upgrade requires addition circuit boards (two examples are the Audio Option and the GPIB Interface Option) install the new hardware before upgrading the firmware. Follow the installation instructions received with the firmware upgrade kit. After that installation is completed, use the following steps to upgrade the firmware.

NOTE. *As a precaution against the loss of files, you should back up the file system of the measurement set using the Tektronix VMBKUP software accessory. It is not a requirement to do this, only a precaution.*

1. Turn the measurement set on and wait for the system initialization to complete.
2. Press the **Configure** button.
3. Touch the **Option Key** soft key. This will display the option key control menu (see Figure C-2).
4. Touch the **New Option Key** edit field.
5. Type in the new option key; the hyphens are not needed and lower case letters only are used. Note the following information about typing in characters:
 - Typing always inserts characters at the cursor position. The cursor can be moved left or right by turning the control knob.
 - To delete characters, move the cursor to the right of the character to be deleted, then press the Back Space key.
6. When you have finished entering the new option key, touch the **Done** soft key. If you have entered a valid Option Key, a list of the options authorized by the option key is displayed. Verify that this is the set of options you wanted with your firmware upgrade. You will have two soft keys in the display: Continue and Cancel.

If you made a typing mistake or entered an invalid option key for your instrument, an error message appears in the display (see Figure C-3). Follow the directions given in the message.

Tektronix Identification #: xxxxxxxx

Software Identification Number:xxxxxx

Current Option Key: xxxx-xxxx-xxxx

New Option Key:

Error: New Option not valid for this instrument.
Please verify the Key and try again.
Touch the screen to continue.

Figure C-3: Error message for invalid Option Key

7. Touch the **Continue** soft key if the list of options is correct. If the list of options is not correct, touch **Cancel** to prevent the new option configuration from taking place. Verify that you used the new Option Key rather than another that may be valid for your instrument. This might occur if you have Option Key numbers from previous firmware upgrades.

When Continue is pressed, the VM700T Video Measurement Set reconfigures its firmware and files structure to the new option list. Some internal files will have new lines added where needed for the new options. When reconfiguring finishes, the measurement set runs the complete set of instrument diagnostics before the system is initialized.



Index

Index

Symbols

[1-11] H Display, 3-4

Numbers

20T value, 2-29

5-Riser Chroma Amplitude, 2-29

A

Accept Input softkey, 2-15

activating an option, C-2

Alarm Limit, 3-25

alarm limits, 2-22

amplitude measurement, 3-14

amplitude reference markers, 3-10

Apple LaserWriter, 1-13

ASCII Printer, 1-15

Auto

Alarm Limit, 3-25

Caution Limit, 3-25

Comments Column, 3-26

logging, 3-26

Measurement Identification, 3-25

Timed Events, 3-26

Violated Limits Indication, 3-25

Violated Limits Logging, 3-26

Auto Limit File

lines, 2-22

title, 2-22

Auto Limits File, 2-21

Auto Mode

Configuration, 3-26

Remote Operation, 3-26

Auto mode display, 3-25

Auto Sync Source, 2-21

Auto_Limit Files, 3-27

Auto_Limit Files directory, 2-22

Average, 2-3, 3-17

B

Bandwidth, 2-5

Baud Rate, 2-26

C

calendar and clock, 2-17

Cancel Copy, 2-8

Cancel Copy soft key, 2-16

Carrier Detect, 2-27

Caution Limit, 3-25

Centronics Printer Port, 1-16

Centronics-compatible printer, 2-23

Changing a Caution limit, 3-27

Changing a File Parameter, 2-16

changing a port configuration parameter, 2-27

changing a port or format assignment, 2-24

Changing an Alarm limit, 3-27

Character Size, 2-26

Clamp Couple, 3-8

Clamp Fast, 3-8

Clamp Slow, 3-8

clock, 2-8

Communication Setup file, 1-10, 2-23

Configure button, 2-4, 2-7

Configure Files, 2-8

Configure Files directory, 1-10

Configuring the VM700T, configuration, 2-7

Connecting Printers, 1-12

Connecting VM700T to a PC/Terminal, 25-pin cable,
1-12

Connector, Port 0 and Port 1, 1-9

Connectors, VGA, 1-16

consecutive alarms, 2-22

Control Knob, 2-4, 3-3

Control port, 2-24

Copy button, 2-4

Copy Port, 2-16

Copy port, 2-23

Creating and Deleting Files, 2-11

Cursor Appearance, 3-10

Cursors, 3-4, 3-10

Center Left/Right, 3-4

Cursors Stay On, 3-6

Lock Left/Right, 3-5

Reset Cursors, 3-6

Reset Diffs, 3-6

cursors

amplitude measurement, 3-14

Center Right, 3-13

- frequency measurement, 3-14
- Lock Left, 3-11
- Lock Right, 3-11
- rise time measurement, 3-12
- status lines, 3-11
- time measurement, 3-11

D

- DC Coupling, 3-8
- Diagnostic Errors, 2-27
- Diagnostic Errors file, 2-27
- Diagnostics Selection, 2-27
- Diff Step Filter, 3-8
- directory, 2-9
 - entering, 2-10
 - leaving, 2-10
- Directory Structure, 2-9, 2-18
- directory tree, 2-9
- Display, 3-1
- Display and Graticule Intensity, 3-18
- Display Intensity, 2-4, 3-4
- Display Phase Angle, 3-18
- DTE to DCE cable, 1-11
- DTE to DTE cable, 1-11

E

- editable files, 2-11
 - creating, 2-11
 - storage, 2-11
 - supplied, 2-11
- editing a file, 2-14
- editing keyboard, 2-14
- EMC Compliance, A-4
- Enabling/Disabling Logging, 3-26
- EPSON LQ-570 printer, 1-12
- Event Time, 3-29
- Exit a File Without Change, 2-16
- Expand, 3-3
- Expand (Gain) Range, 3-3
- Expand Range, 3-18
- Expand while the screen is touched, 3-3
- Expansion, Waveform, 2-4
- Expansion point, 2-4
- External VGA monitor, 1-16
- Extra Functions, 3-7

F

- Field 1 or 2/Field 3 or 4 (NTSC), 3-9

- Field n Line nn (NTSC)/Line nn (PAL), 3-9
- Field Toggle, 3-9
- file, 2-9
- files
 - creating, 2-11
 - deleting, 2-14
 - editing a line, 2-14
 - Editing Files, 2-14
 - editing keyboard, 2-14
 - rules for naming, 2-12
 - saving changes to a file, 2-16
 - start printing, 2-16
 - stop printing, 2-16
- Filter Select, 3-8
- firmware upgrades, C-1
- Fixed IRE (NTSC Only), 3-8
- Flow Control, 1-11, 2-26
- Format, changing assignment, 2-24
- Frame 1/2/3/4 (PAL), 3-9
- Freeze, 2-3, 3-4
- frequency measurement, 3-14
- front panel, 2-1
- Function button, 2-4
- Function Keys, 2-8
- Function playback, PowerUp, 1-8
- Functions, playback from front panel, 1-8
- Fuse, 1-3

G

- Gain, 3-7
- gating widths, 3-9
- Graticule, 3-1
- Graticule Intensity, 2-4, 3-4
- graticule scale, 3-2

H

- Help button, 2-4
- high-level diagnostics, 2-27
- High-pass Filter, 3-8
- Horizontal Reference Line, 3-2

I

- inputs, 2-5
- Instrument Specifications, A-1
- intensity, 2-4
- internal calendar and clock, setting, 2-17
- inverted source, 2-3

K

keyboard
 character set shifting, 2–11
 Set1, 2–12
 Set2, 2–12

L

Leave Directory soft key, 2–9
 LF Noise 7.5 kHz/10 kHz/15 kHz, 3–8
 line frequencies, 1–3
 Line Identification, 3–2
 line number display, 3–2
 Line parameter, 2–29
 Line Voltage Range Switch, 1–3
 line voltage ranges, 1–3
 Load Time soft key, 2–17
 Lock Left, 3–11
 Lock Right, 3–11
 Locked to Source, 2–21
 Locked Waveform, 3–8
 Log port, 2–24
 logging
 enabling/disabling, 3–26
 violated limits, 3–26
 logical ports, 2–23
 loop-through inputs, 2–5
 Low-pass Filter, 3–8

M

Manual Adjust, 3–9
 Clamp Fast, 3–9
 Clamp Slow, 3–9
 DC Coupling, 3–9
 Duration, 3–9
 Level, 3–9
 Position, 3–9
 Manual Gain, 3–7
 Manual Overview, ix
 Measure Limits File, 2–21
 Measure_Limit Files directory, 2–28
 measurement
 deselection, 2–32
 selection, 2–32
 Measurement Locations, Defining, 3–28
 Measurement Locations directory, 2–29
 Measurement Results directory, 2–29
 measurement subset, selecting, 3–28
 Measurements Location File, 2–21
 Menu button, 2–3

Mode Buttons, 2–2
 Move, 3–3
 Move/Expand, 3–3

N

No Filter, 3–8
 Noise [0 dB - 30.10 dB], 3–7
 noise reduction, 3–19

O

Offset, 3–7
 Option 48, 1–2
 Option 74, 1–2
 Option Key, 2–8, C–1
 Option Power Cord Data, A–7
 option upgrade orders, C–1
 outputs, 1–10

P

Parallel Printer, 2–24
 Parallel Printer port, 2–23
 parallel printer port, 1–16
 parameter, change in a file, 2–15
 Parity, 2–27
 password
 changing, 2–31
 default, 2–31
 enabling, 2–30
 resetting, 2–30
 setting, 2–30
 Password file, 2–30
 physical ports, 2–23
 Picture Mode, 3–23
 Port, changing assignment, 2–24
 Port and Format Assignments, 2–23
 port configuration, 2–26
 Position Backporch, 3–8
 Position Sync Tip, 3–8
 Power Cord, 1–3
 power cord, A–7
 Power Requirements, 1–3
 power switches, 1–3
 PowerUp, function playback, 1–8
 Precision Mode, 3–8
 Print File softkey, 2–16
 printer
 Apple LaserWriter, 1–13
 ASCII, 1–15

- HP DeskJet, 1–14
- HP LaserJet, 1–14
- HP ThinkJet, 1–14
 - parallel, 1–16
- printer cable, A–7
- printer cable configurations, 1–11
- Printer Connections, 1–12
- Printer port, 2–23
- printers, 2–24
 - factory default, 2–23
- Printing Files, 2–16
- printout source text string, 2–21
- Printout Title, 2–21
- Protocol, 2–26

R

- read-only directories and files, 2–11
- read-only directories, viewing, 2–11
- rear panel, 2–5
- Remote Control port, 2–24
- Remote Control Relay, A–6
- Remote Operation, Auto Mode, 3–26
- Report port, 2–23
- Report Time, 3–29
- Reset Character, 2–27
- rise time measurement, 3–12
- root directory, 2–10
- RS–232–C serial ports, 2–23
- RS–232C DTE ports, 2–5

S

- safety standards, A–5
- sampling
 - asynchronous, 2–29
 - synchronous, 2–29
- scheduled reports, 2–32
- Screen Memory, 3–7
- Select Line, 2–4, 3–1, 3–9
- Selected Measurements, 2–32
 - default file, 3–28
- Selected Measurements File, 2–21
- Serial Interface Parameters, 1–9
- Serial Port 0, 2–23
- Serial Port 1, 2–23
- Setting Alarm Limits, 3–27
- Setting Event Times, 3–29
- Setting the Internal Clock, 2–16
- signal sources (A, B, and C), 2–18
- Sound in Sync, 2–29, 3–6
- Source and Polarity Selection, 2–3

- Source Name, 2–21
- Source_Selection~Video file, 2–18
- specifications, A–1
- spooler, 2–16
- Status Lines, 3–3
- Support Functions, 2–3
 - Configure and Function, 2–4
 - Copy, 2–4
 - Help, 2–4
 - Menu, 2–3
- Sync
 - Change Sampling, 3–7
 - External Sync, 3–6
 - Locked to Source, 3–6
 - Sound in Sync (PAL only), 3–7
 - Sync A/B/C, 3–6
 - Sync source, 3–6
- sync loop-through, 2–5
- system line, 3–2, 3–20

T

- tilde, 2–11
- Time, 2–8, 2–17
- time and date setting, 2–17
- Timed Events, 2–32, 3–29
 - file, 3–29
- timed events file
 - creating, 2–34
 - deleting, 2–34
- timed execution, 2–35
- touch and zoom, 3–3
- Touch Screen, Calibrating, 1–5
- touch screen, 2–1
- tree, 2–9

U

- upgrades, C–1

V

- Vector
 - 75% Bar Cal, 3–19
 - Angle (deg) readout, 3–18
 - Burst in Ch. A/B/C, 3–19
 - Burst in Source, 3–19
 - Burst Reference, 3–19
 - calibrated state, 3–19
 - Change Setup (NTSC only), 3–19
 - color bar signal, 3–17

Display Select V (PAL only), 3–18
Field n Line nn (NTSC)/Line n (PAL), 3–20
Field Toggle, 3–20
Find Colorbars, 3–20
Menu, 3–18
Noise, 3–19
V–Axis Switch (PAL only), 3–18
Vector Line, 3–20
Vector Gain, 3–18
Vector mode display, 3–17
VGA monitor connector, 1–16
Video Source, 2–18
Video Source Identification Number, inserting, 2–36
Violated Limits, 3–25

Volts scale, 3–3

W

Waveform, 3–1
waveform expansion, 2–4
Waveform mode menu, 3–4
Waveform Positioning, 2–4

Z

zero carrier pulse, 3–28

