

This site uses frames. If you don't see the menus on the left, click [here](#)

Presentation

I started electronics around 10 years old with the help of my father. At that time, Tektronix oscilloscopes were the benchmark.

During my studies, the school lab was equipped with Tektronix oscilloscopes and TM500 racks. My final project was to design and build a variable phase generator that was contained in a double drawer TM500. When I visited the components fair every year, I dreamed of all these measuring devices that were too expensive, especially for a young student. As soon as I could, I bought a Tektronix oscilloscope which I still have and which works very well. I bought last year in a secondhand market a TM503 rack which made me want to manufacture the measuring devices that I lack in the form of modules.

I found a few other drawers and accessories on Ebay. My initial idea was to find HS modules to take the box and put my own electronics. But it's not easy to find HS modules and disassemble working modules, it's a shame. So I decided to build the module from scratch. It's work but not infeasible. The following paragraph describes in detail its manufacture. But before doing the presentation:

The TM500 series.

In the 1970s, Tektronix brought a series of modular measuring devices to the market.

There are reference devices TM50x which includes the power supply and the box that can receive from 1 to 6 modules and different drawers, function generator, pulse generator, power supply, etc ...

This is what it looks like:



Module photo taken on the Internet

For those who want more photos and info click [HERE](#) , [HERE](#) , or [LA](#) .

These modules are well designed. Each drawer has 2 [galvanically isolated](#) 25V alternating power supplies , one of 11.5v direct and another symmetrical of + and - 35v. DC power supplies are common to all drawers. Each drawer also has numerous inputs and outputs on its rear connector and it is possible to connect the modules together by placing connecting wires. Each location also offers 2 power transistors, one NPN and one PNP, using the box as a radiator. Modules typically use them to regulate their internal power.

Here is the pinout of the connectors:

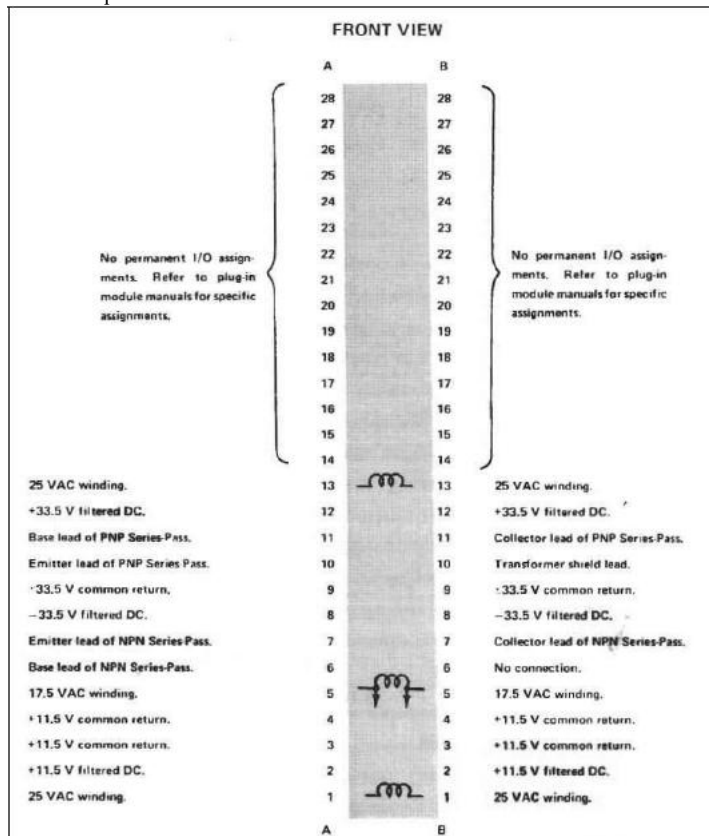

At the time Tektronix had the good idea to provide with each module the complete schemas, calibration procedure etc. We find on Ebay these manuals at more or less prohibitive prices or even free by searching well ([here for example](#)). In any case, these diagrams are invaluable for repairing or adjusting modules.

In the years that followed, Tektronix created the TM5000 series, these devices were controllable via a GPIB Bus. Then, in the 90s, they sold the license back to another company ([TEGAM](#)) and manufacturing ceased.

NOTE : The 500 series drawers work in 5000 power supplies, but the opposite is not true.

Here are my realizations related to the TM500 series

- [-One Test drawer for the TM500 series](#)
- [-An extension for drawer](#)
- [-Improvement of a TM503B](#)
- [-Reduction of the noise of a TM506 -An Adapter for repairing the TM500 drawers -Repair and restoration of the drawers](#)
- [-A Test speaker in a Tektronix TM500 drawer](#)
- [-A signal to trace in a Tektronix TM500 drawer -Display repair DC503](#)
- [-CP0109 A Tektro TM500 drawer AC503 lab power supply](#)

A test plugin for TM500 Series

The first drawer that I decided to build is a drawer to check that the power supply is working properly, and also to debug or troubleshoot the modules. The specifications are therefore:

- Using LEDs to visualize the presence of each supply voltage
- Have an isolated voltmeter to measure the voltage of each supply or an external voltage.
- Be able to start or stop the module during the test without having to cut the general power supply.
- Be able to test the 2 internal transistors and try a module with transistors easier to change than those of the power supply module

I am using a small liquid crystal voltmeter module, powered by a DC / DC converter recovered from a PC network card for galvanic isolation.

Relays make it possible to cut or not the power supply to the module during the test. (I could have used a single 5 contact relay, but not having one, I used 3 relays with the coils in parallel.

2 other 3 RT relays, allow either to test the module on the power supply transistors, or to connect it to test transistors. In this case, the transistors of the power supply are connected to a "Rustic" tester making it possible to visualize their correct operation.

Here is a photo of the "Beast":



The connector at the bottom right makes it possible to connect the drawer to the drawer under test.

Here are some pictures of the construction stages:

To start, cut with a jigsaw the top and the bottom of the module in 6mm thick aluminum. It's long and very long ...



After squaring the faces, I clamp on the milling machine and adjust the parallelism with a comparator

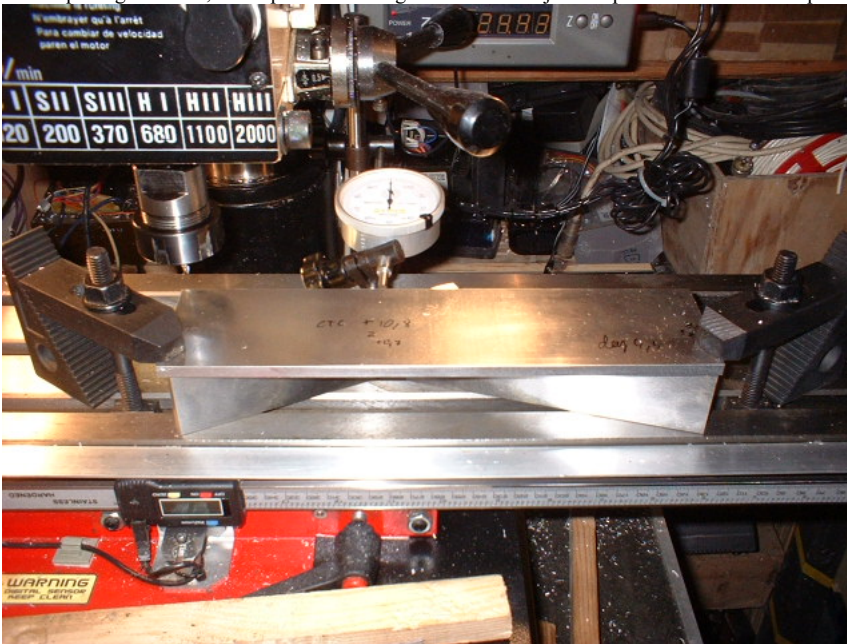

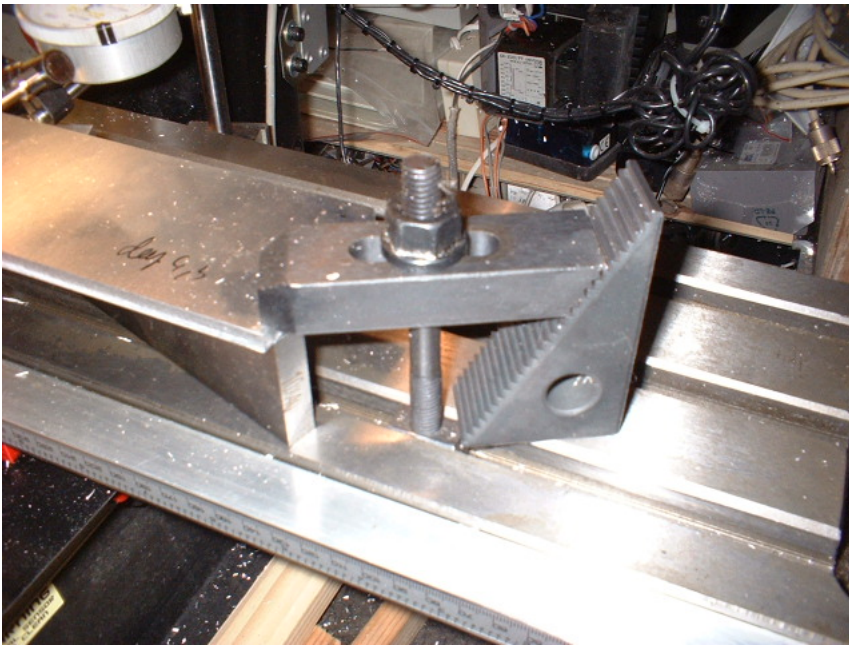
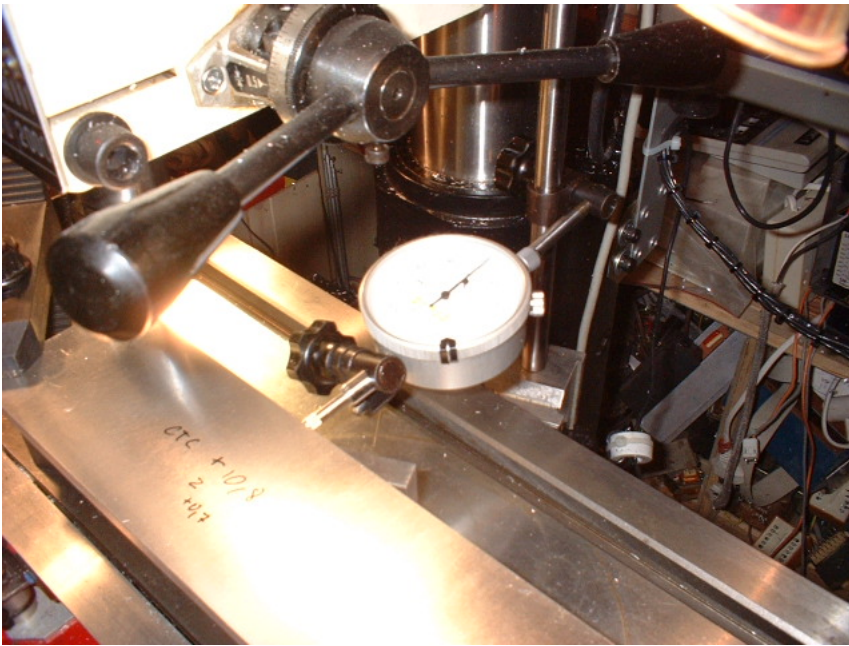

Then milling the guide grooves



Then drilling and tapping of the front and rear face fasteners



Connector fabrication



It's starting to take shape, next to a "Real" Tektronix module for comparison

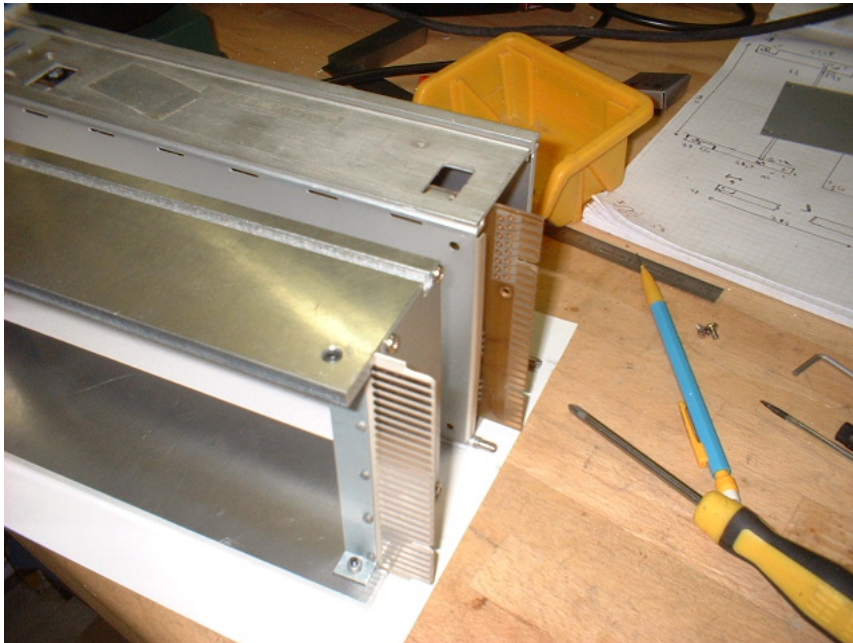

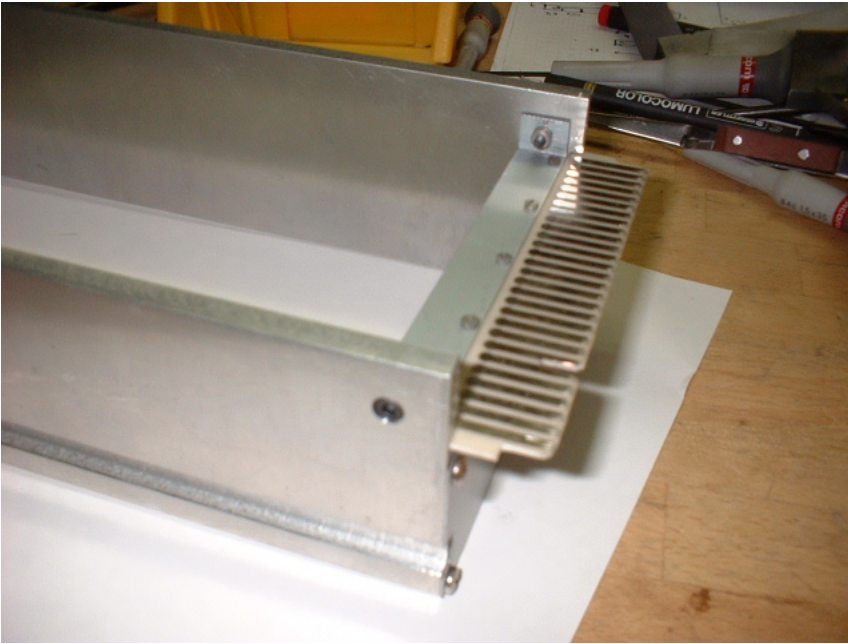

The module in place in the power supply, we can see the power transistors

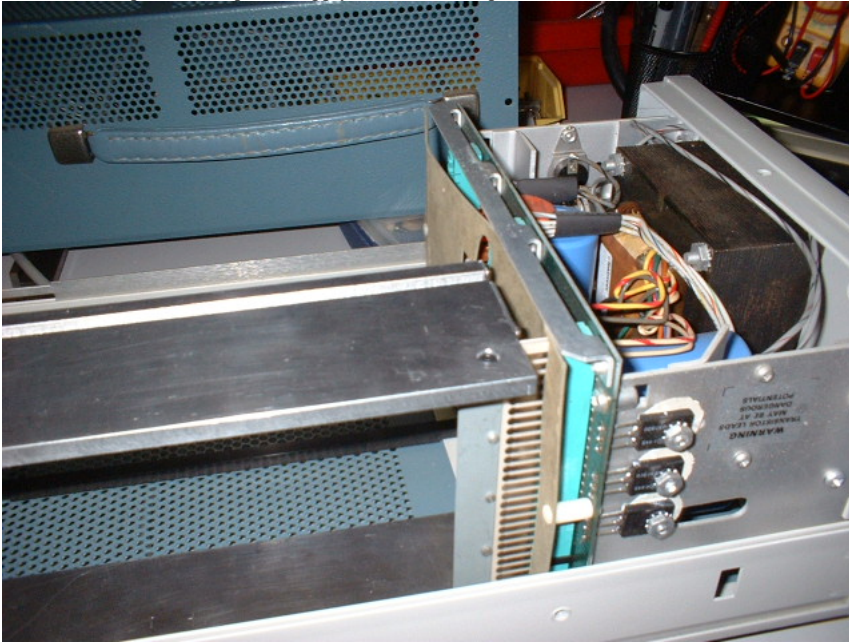

The Tekro locking system is not easy to reproduce, so I designed another "Rotary" type.

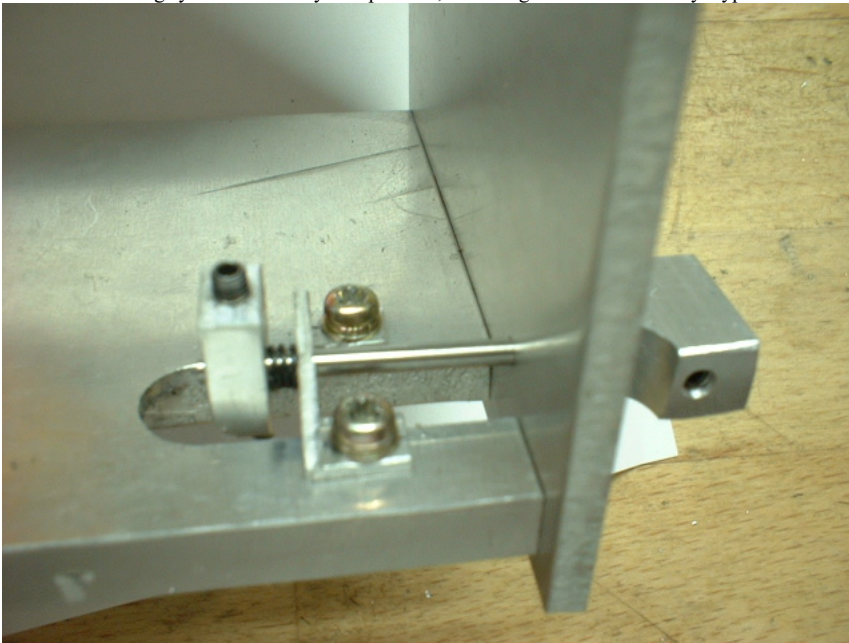

Now machining of the front face in 3mm thick aluminum



For information, here is the right way to mount this type of switch



You have to drill a small hole to put the anti-rotation tab

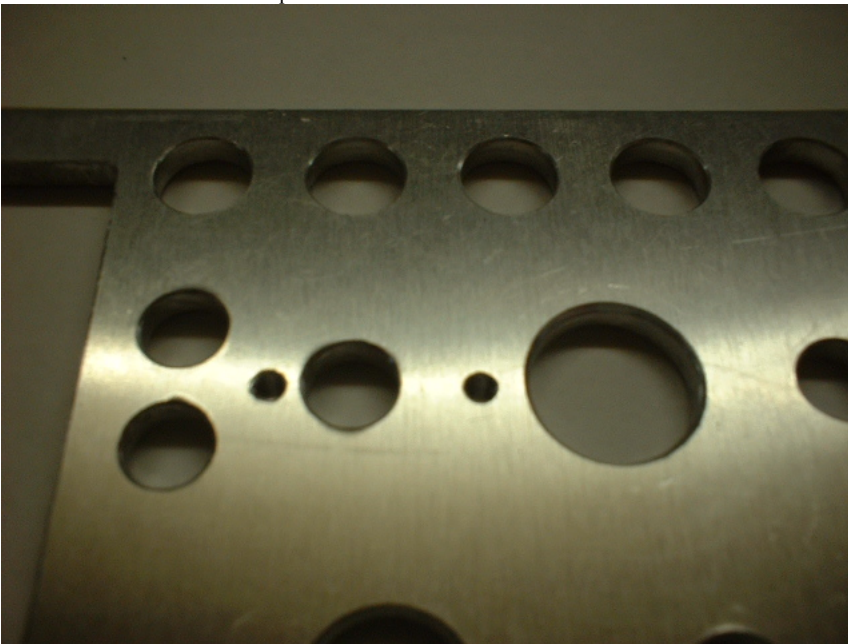

And hop, we adjust so that the front face nut is ok and we use the rear nut, so that we do not risk scratching the beautiful front face

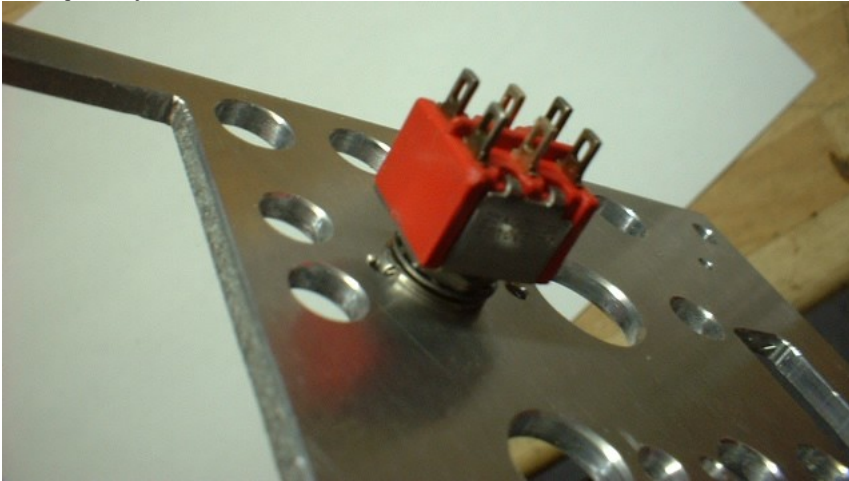

As I don't want a screw on the front face, I fix it with countersunk screws and then I glue the beautiful front face generated with the pécé!

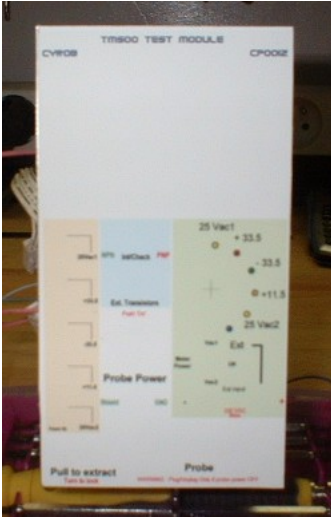

Then we cut the holes with a sharp cutter (we see it on the right)



Then we fix all the elements.



Fixing the frame:

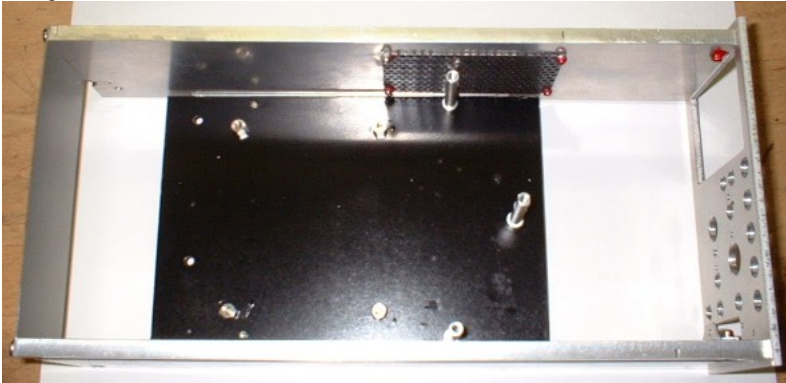

A little sheet metal for the 24V power supply



And machining of a recuperation radiator to fix the test transistors and their switching relays



The circuit, mounted on an experiment board as usual, includes the various components, the voltmeter DC converters (mounted vertically for lack of space), the flashing circuit of the probe's power-on indicator (mounted on it also vertically), the power supply of the converter, the switching relays of the probe, the transistor tester, plus a few miscellaneous "guts".

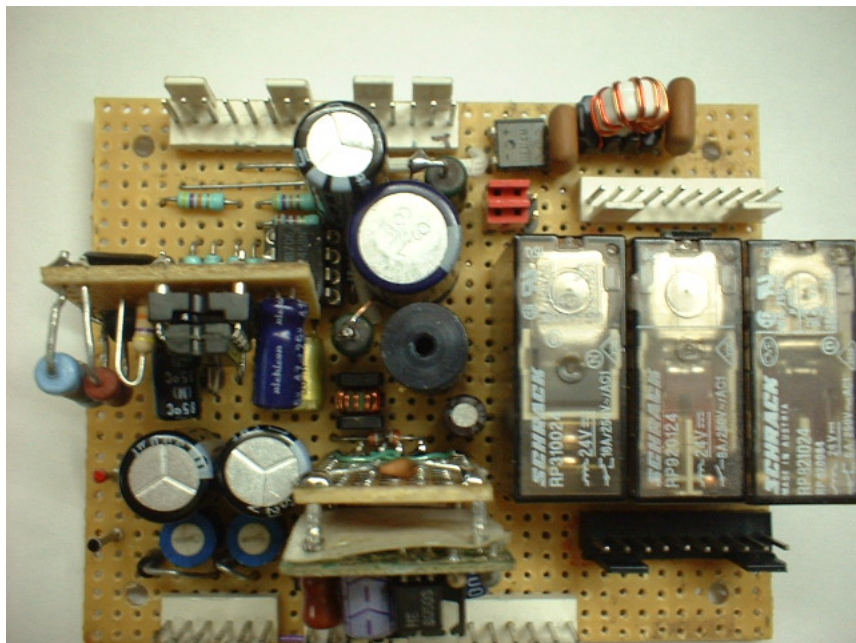

The DC / DC converter is really "noisy" as the English say and filtering is necessary. It is effective not far from 15db of attenuation of rapasites!

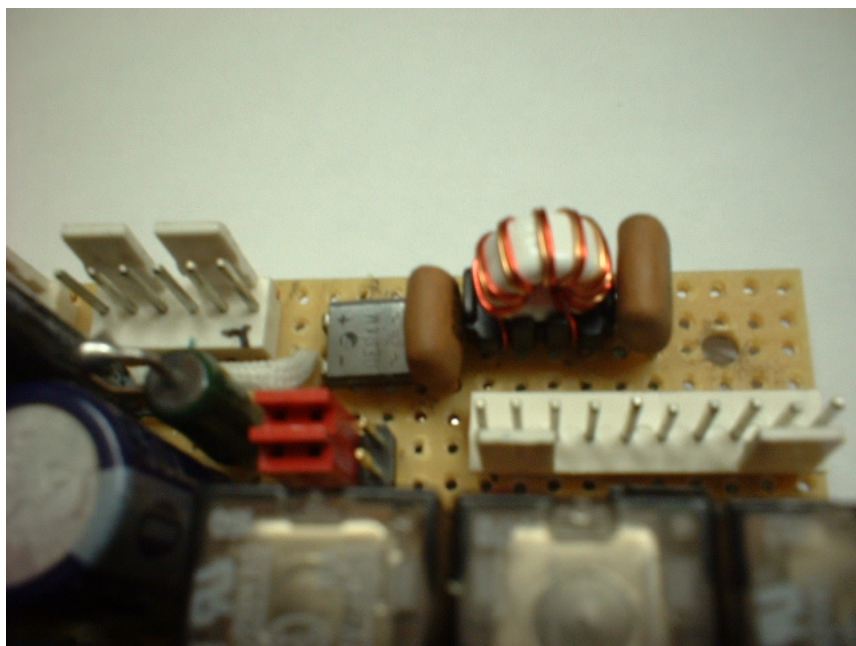

Close-up of the converter. For information, Ethernet networks must be galvanically isolated from the PC, in part to avoid ground loop problems, in part for safety and protection of people and electronics. The isolated part needing energy, network cards often integrate a small DC / DC converter like 5V to 9V which come in different shapes and brands, the ones I have seen the most are black cubes which look like this:



As I ran out of space, I used an un-molded one. It's practical, inexpensive because I recovered dozens of them on reform boards, and perfect for powering my LCD voltmeter module in 'floating'

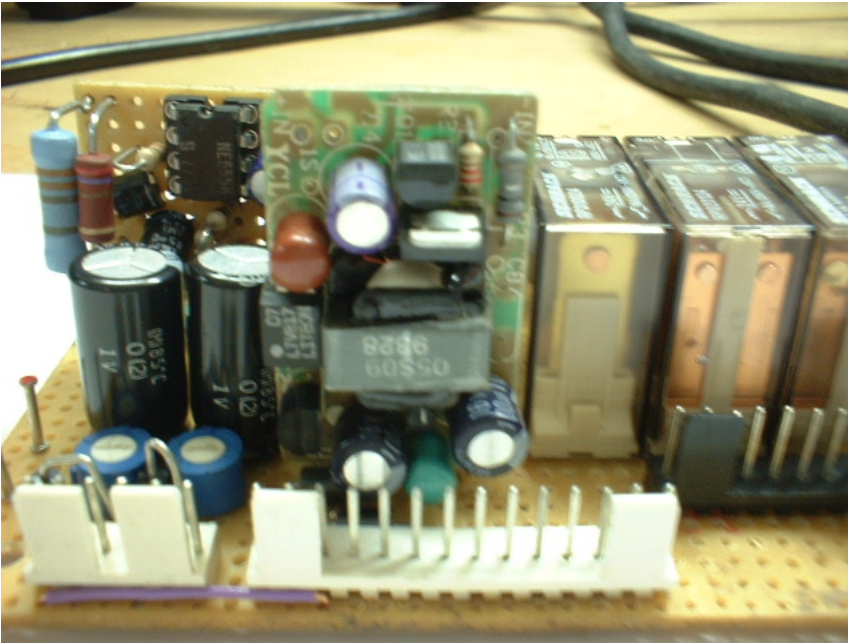

Here is the machine side stack ...

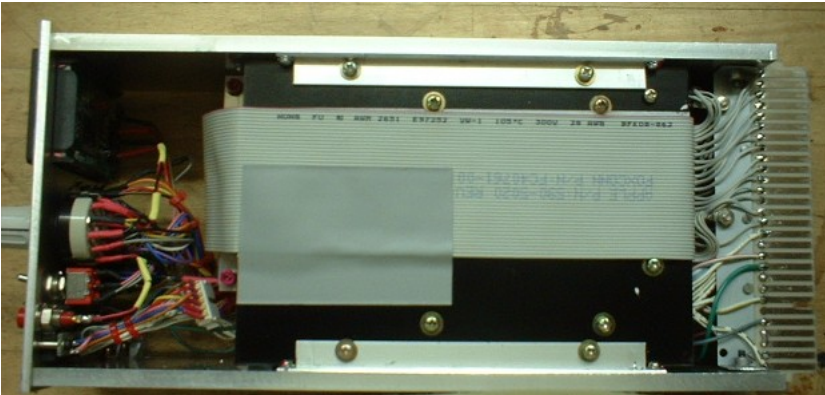

and face ...

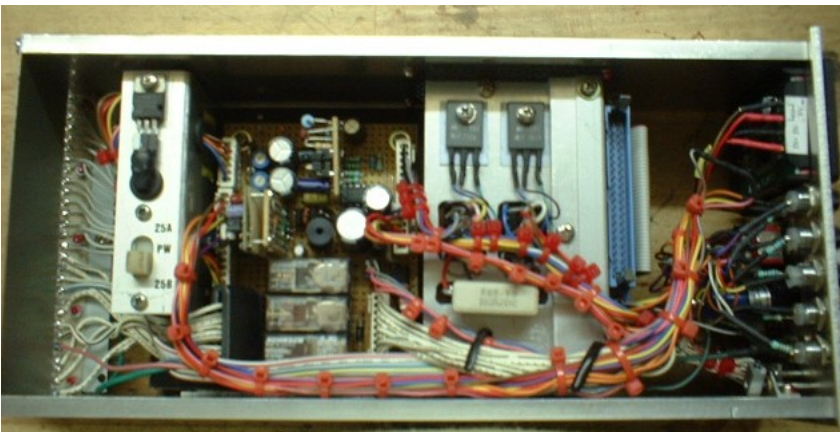

We can see the HE10 connector for the possible "Signals" extension, possibly allowing the connection of the inputs / outputs of the module under test. You can also see here the test transistors mounted on the heatsink, the heatsink also serving as a maintenance for the 2 3 R / T switching relays allowing the permutation of the Real / Test transistors.

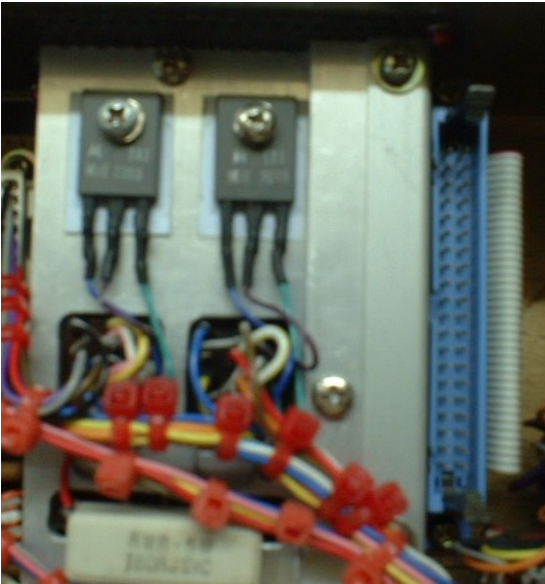

And There you go !! it works !!



In fact, it didn't work on its own, I encountered some debugging issues:

- The DC / DC converter converted from 5V to 12V. So I had to convert the 25V AC power supply to 5V DC. I had put a classic diode bridge, followed by RC filtering and then an old LM309 from recovery, nothing but classic. In fact when I plug in to test, the consumption is much higher than expected, the voltage at the input of the converter is almost zero, the regulator heats up hard, and the voltage at the output of the converter is fluctuating and low. Quecoletchu? as they say here in Vendée. At first I suspected the converter, I tested it on a lab power supply, it works! I tell myself that there is a wiring error, but everything looks good and the regulator connected to a load equivalent to that of the converter is OK. I think there is an HF hook somewhere, but damn it !. I go to bed that night saying that this thing is pumping my air! After a few days of doing something else, I get back to the problem with the "New Eye" and after intense reflection, I have a lead. I reconnect the biniou and put my 5v power supply on the input terminals of the converter apparently short-circuited and the miracle it works! I got it, it's a kind of "Latch-up", this phenomenon well known to the first op-amps, in particular the famous $\mu A709$. In my case the pb does not come from a "Parasite" thyristor as in the 709 but from the strong current inrush when the converter starts. The series resistors upstream of the regulator cause too much voltage drop and the converter locks up in this "Batard" operating mode. How can we all remedy it while keeping these limiting resistances? The solution is simple, I put a big chemical condo which bypasses them during the few milliseconds necessary to start the converter. 2 or 3 tries and I find the value that is fine.
Great, the problem is solved, but it's not over ...

- I start to try the integrated transistor tester and quickly realize that it works very badly, the leds are almost permanently supplied and in addition seem inverted. The problem of the inversion is a wiring error quickly repaired. On the other hand that does not solve anything. I put test transistors in place of those of the power supply module and do some measurements. Now, I was quick on the original design scheme and overlooked some predictable leakage currents. Fortunately it is easy to correct and the addition of 2 zener diodes judiciously placed fixes the problem. The tester works CANON! I go back and try, the PNP transistor seems OK but the NPN messes up. I tell myself that it may be dead on the case and I'm trying another location. The same. I re-test all the wiring, everything is OK, you lose your Latin. And then suddenly, I have the explanation, an error on my diagram and I reversed the collector and the emitter. It is not symmetrical a transistor, and especially not a big heavy load of power with basic control calculated to saturate it to death. So I put the red thread on the red button, and the blue on the blue as the excellent Robert Lamoureux said and ... and especially not a big heavy powerhouse with basic control calculated to saturate it to death. So I put the red thread on the red button, and the blue on the blue as the excellent Robert Lamoureux said and ... and especially not a big heavy powerhouse with basic control calculated to saturate it to death. So I put the red thread on the red button, and the blue on the blue as the excellent Robert Lamoureux said and ...

I test thoroughly and everything works. Still !! It's better than computers, electronics, we always have funny surprises, while the programs are always the same bullshit well, you have to live well.

All I have to do is make the probe and it's done.

The probe

The purpose of this probe is to make the interface between the flat cable of the HE10 connector which must be very short because it does not support the maximum current, to allow the measurement of the current delivered by each power supply, to be able to put a probe on the pins of the power transistors and finally, to protect the power supplies with good old fuses. I used an aluminum box which served as a network interface:



then i machined it to fit my specs:

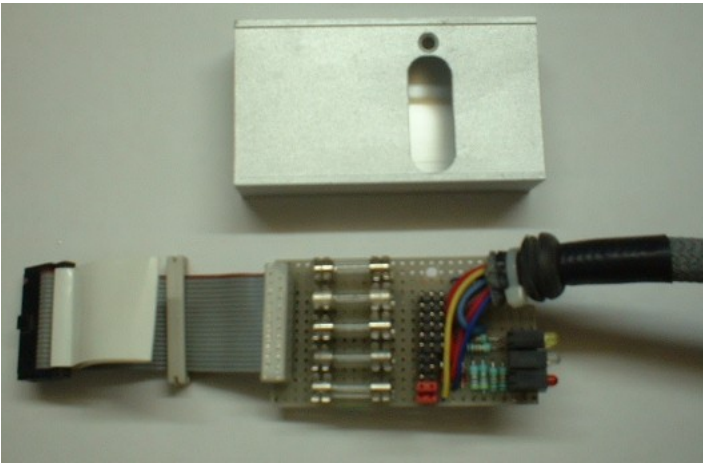

Here is the CI of the box. The low consumption type LEDs (2mA!) Are used to visualize the possible failure of a fuse. You can see the pins supporting the short circuit jumpers that can be removed to measure the current.

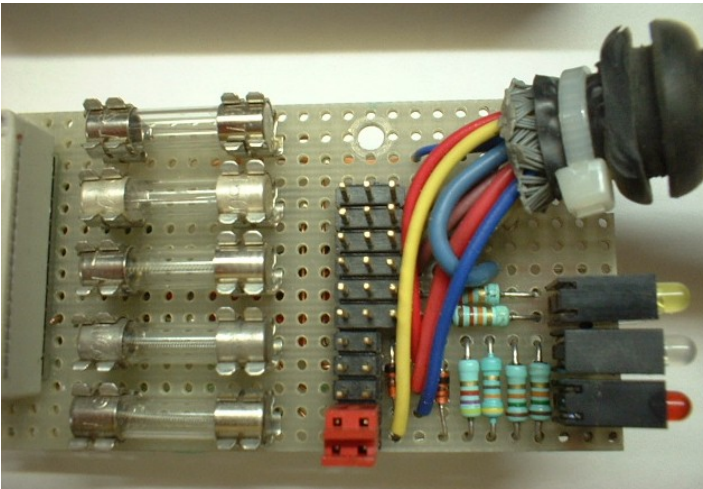

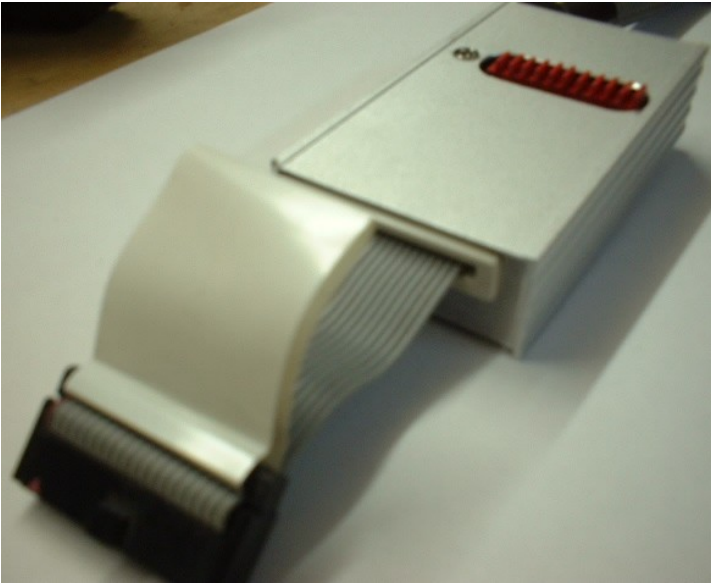

And here is the final connector, The switch makes it easy to turn the module on or off.
The relay cuts the 17.5 VAC because some module uses it. The cable optionally allows the control signals to be connected.

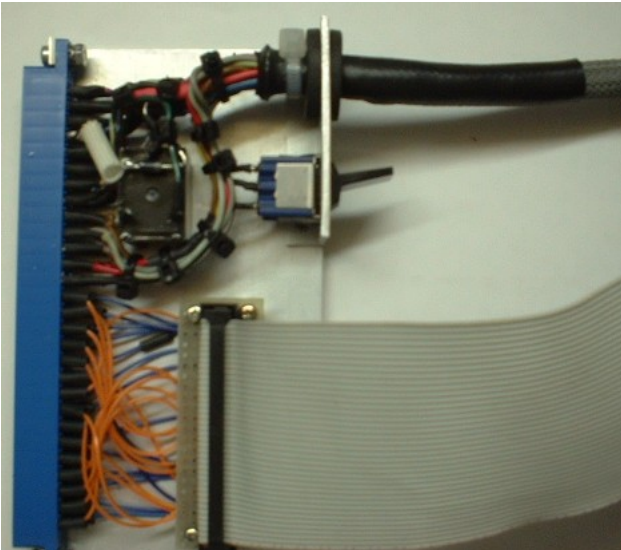

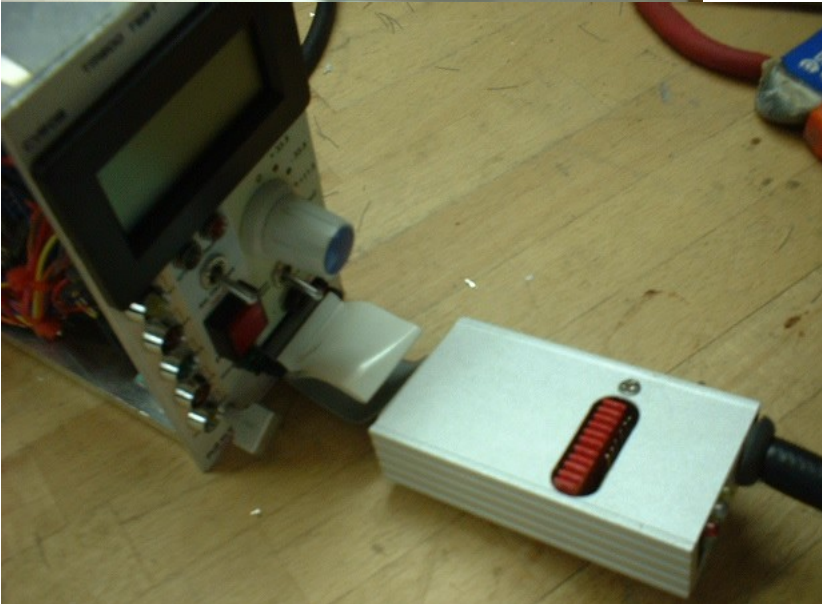
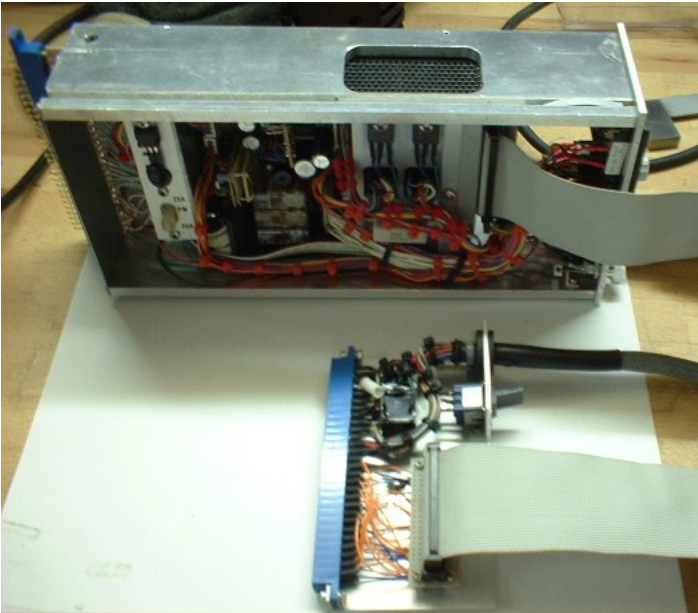

And here is the biniou connected to a real module, everything works nominal!

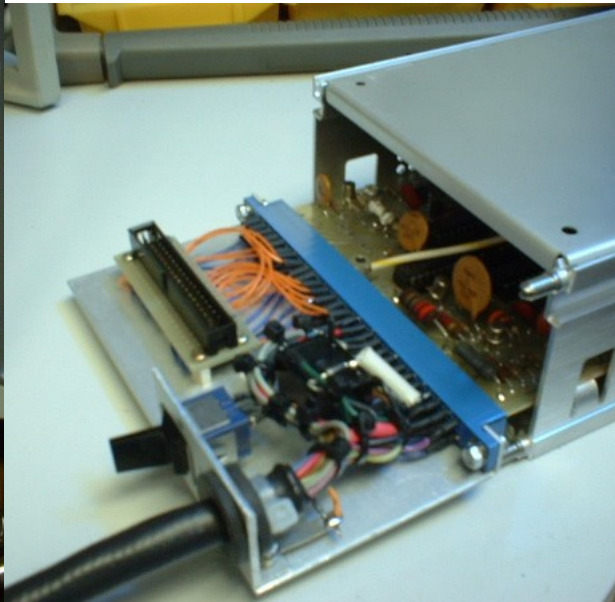

I'm really happy to have finished because this project took me a lot longer than expected and I have a lot of other things to do ... Finally, I decided to finish what I am starting ... so I finished.

This module will allow me to develop new modules (I have lots of ideas !!, much more than time) and especially to adjust and recalibrate some of my modules which really need it!

If some people ask, I would try to put the diagram online, at least a scanned manual diagram, I'm not sure I have the courage to make a nice diagram with the PC.

A surfer asked me for the diagram of the transistor tester, here it is:

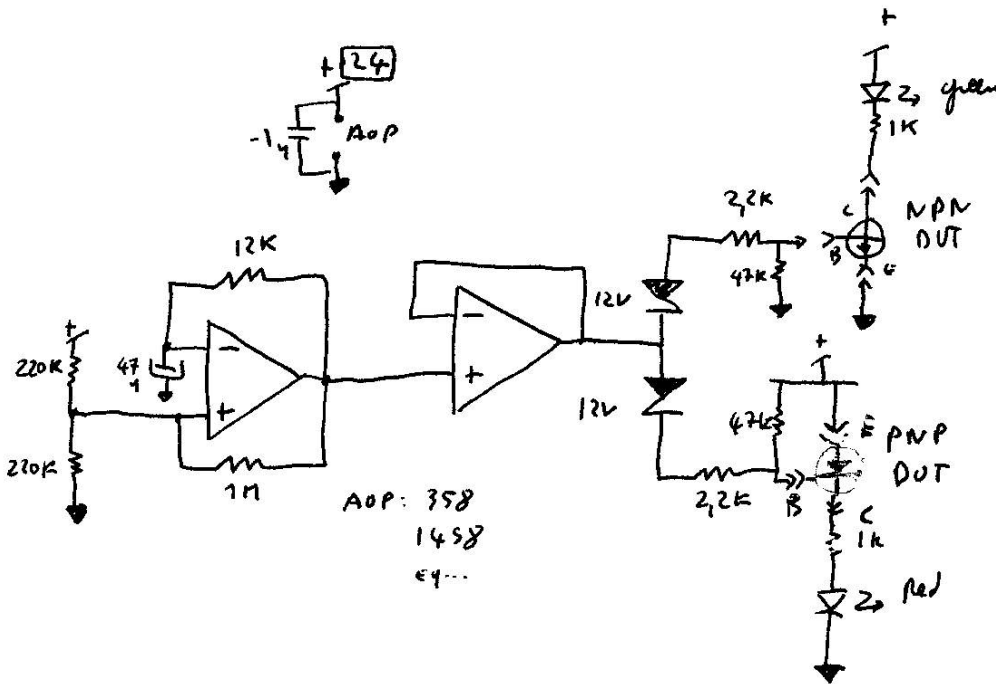

It is amazingly simple, powered by 24 Volt. A double op amp, (any model can do the trick, like LM358 or JFet), the first is mounted as an astable multivibrator at a frequency of around 2Hz, the second as a voltage follower (In fact a simple amp would probably suffice but there are 2 in the box so you might as well use them). If the 2

transistors work, the green LED for the NPN and Red for the PNP must flash alternately, if one of them does not flash or is always on, this indicates that the transistor is out of order. The diode should light up or go out clearly.

This tester can be used as a stand-alone fixture.

One drawer extension

We are in 2009 and several years have passed since the manufacture [of the test drawer](#) described above.

This has done me a lot of service, but in use it is not always convenient for calibrating and repairing drawers.

This is already what led me to build an [adapter](#).

In addition, the cable between the plugin and the test drawer is a bit short, which is not always great.

So an extension beast would not be bad. Tektronix sold one but it almost impossible to find and costs the skin of the ...

Here is a picture of the beast:



So I decided to make one for myself, of course you have to have the male and female connector and by looking on the net I found a [kit](#).

It's not too expensive, I buy 2.

At reception, the cable they provide is really (Really !!) short, and then it seems really impractical to insert it in a mainframe, so ...

So I do nothing at the moment, I put them 2 kit in a drawer and I put it off ...

Water is going under the bridges and while I'm in the middle of a big project (A water pump supervisor that I would put online when finished) I have a frequency meter drawer that breaks, so I put it on my [test drawer](#) to repair it and ... after I do not know what manipulation, the 11.5v is no longer present ...

I naturally suspect one of the probe's fuses and I open it (not without difficulty, I tell me it's not very practical) and in addition the fuse is .. still alive (Like Robert's duck !!) Arrrrrrrrrg, the test drawer is broken, and nothing to test it, what do I do?

In theory I have set myself to always finish the current projects before attacking others but ...

- I would like to repair my frequency meter (I have others but I don't like to have breakdown)
- I'm very upset that my test drawer is down and I would like to know why
- I'm a little fed up with the ongoing project which drags on
- The rules are made to have exceptions
- And then m ..e it's still me who does what I want, no but sometimes ..

So I say to myself: this is a golden opportunity to make the drawer extension of your dreams, and I take the kit out of the drawer. Well the supplied cable is too short, not flexible and I do not like it then, I tell myself that I will put the best. Then, to facilitate insertion into the mainframe and in order to make the assembly resistant, I said to myself that the male connector must be mounted on a plate, but this plate, it risks leveraging and damaging the connector, then he must be prevented from faltering.

Then I tell myself that it is a shame to make an extension for the power transistors, if they are near the drawer, it will be better from all points of view (and in addition in case of wrong manipulation, they will be a thousand times easier to change than those of the mainframe)

Speaking of the mainframe, it might be good to protect it with fuses, for example. As long as I am at it, it would be great to visualize the presence of the voltages and to be able to easily start or stop the drawer under test.

And here it is, with a simple trick, I'm going to make a gas plant again, it's stronger than me, it always has to be like daddy mum, but hey after that I would have the rolls of extenders. I think about it a little and I start ...

To start, I cut the frame out of a sheet metal:

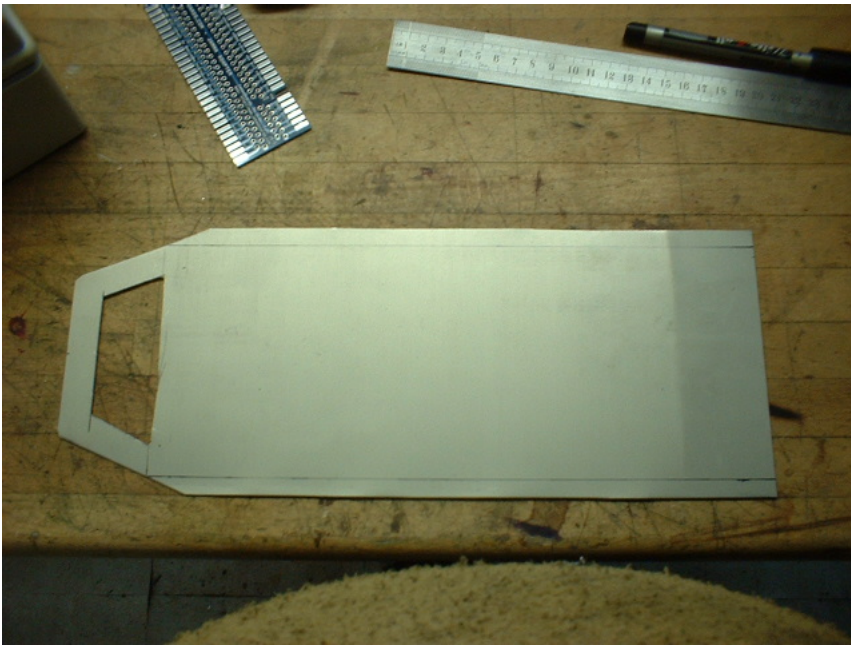

I bend the edges to stiffen it and then drill all the mounting holes.

And I paint gray with yellow stripes (aviation style) and it's a disaster, it's raining and I can't paint outside like I'm used to, my spray paint is old and the nozzle sucks. Anyway, I'm not good at painting (and I HATE IT !!) but this is really a failure. Well I will do with it.

Then, with a milling machine, I machine a scrap of aluminum to make the small guide which will keep the bouzin aligned in the connector.



then I tackle the plate which will have to support the fuses and the death switch (you have to cut the 2 Ac power supplies, the + and - 33v and the 11.5v) Not easy to find but I find one in the recuperation of an old Tektro oscillo drawer (We stay in family!) Of course it is not the standard step (2.54 mm 1/10 of an inch). As in addition it will pass fairly strong current, I decide to make myself a small printed circuit. With a pen, like in the good old days:

Calcium implant, drilling, and indelible felt-tip drawing on copper

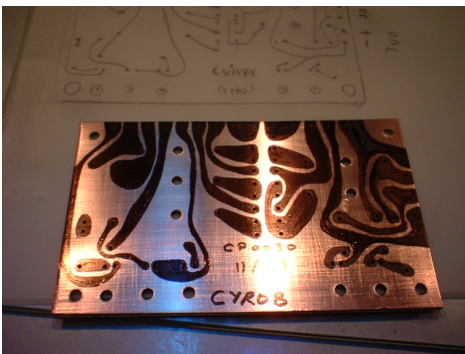

Engraving, and force insertion of the connection pads. (Like that when we weld them, they don't move)

(**Note** : there is another method, it is to use a solder which melts at a higher temperature than the normal solder. We solder the pads with it and when we solder the wires on it with the normal solder, it will not come off. will not desolder !! it is not beautiful ..)

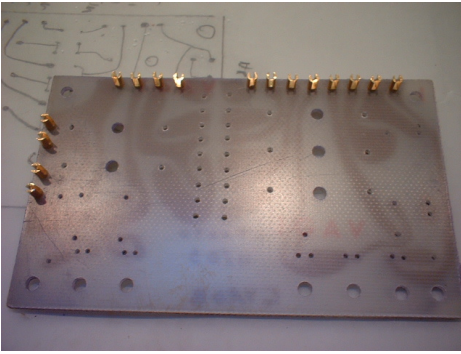

And then wiring the different components ...

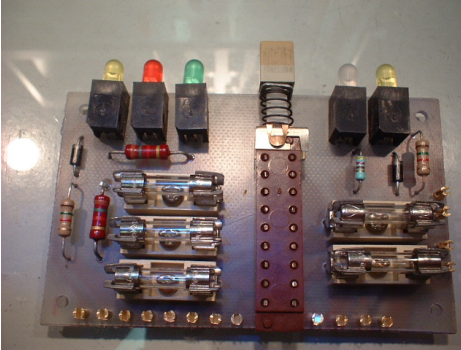

Well now, I rivet the connector on the sheet:

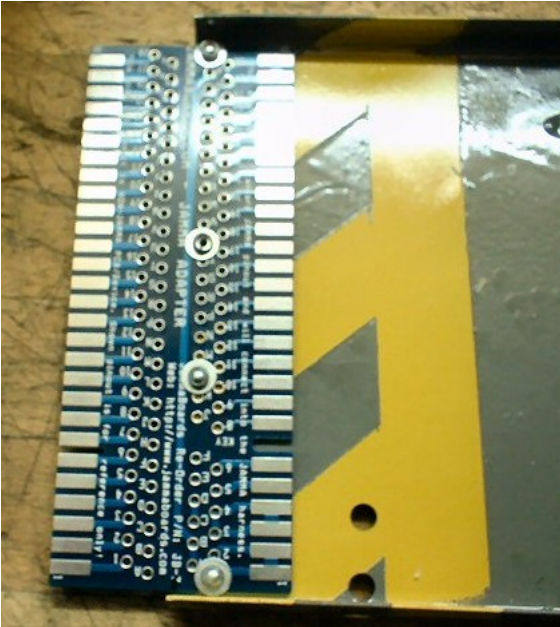

and I attach the probe (The part that will plug into the drawer to be tested)

I machine the edges in the aluminum square, then I cut the blanks in the sheet metal of reccup (cover of VCR)



I fix the 2 pépères on the sheet with radiators outside so that they are not too hot ...
It is of course also necessary to ensure [the galvanic isolation](#) .

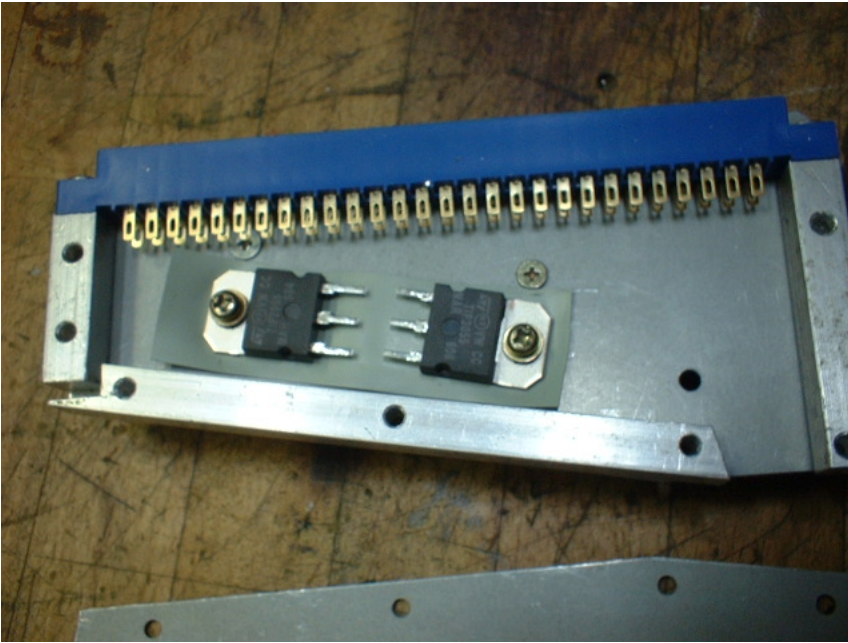

And then I cable everything
Note the fixing of the cable, I want beefy !!

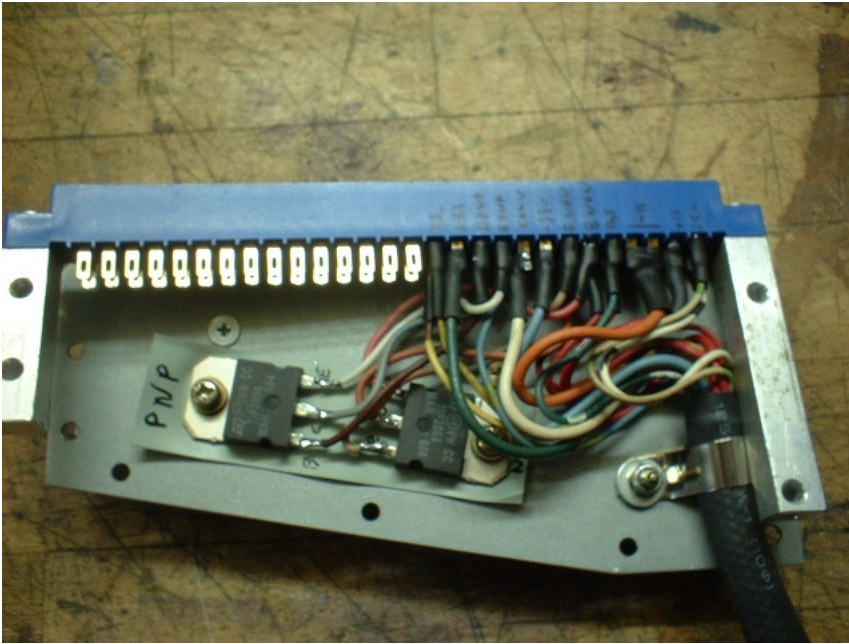

I stick on the beautiful stickers that I made with the pécé and here is:

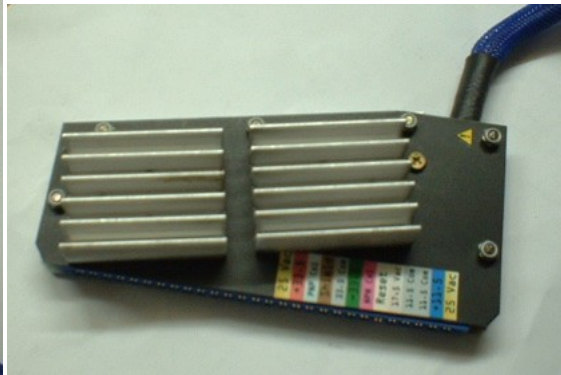
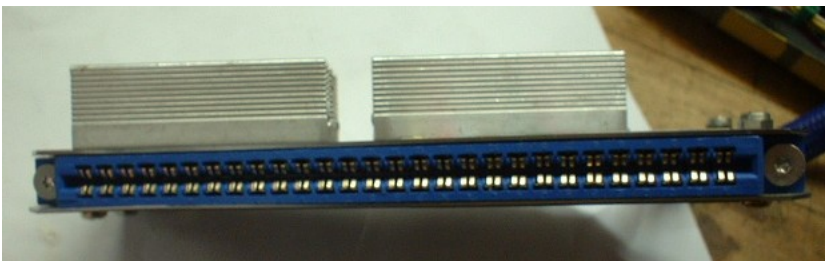

The exact location of the connector pins will be of great help in use.

It only remains to wire everything and here is the finished beast:

Battery side



Face side

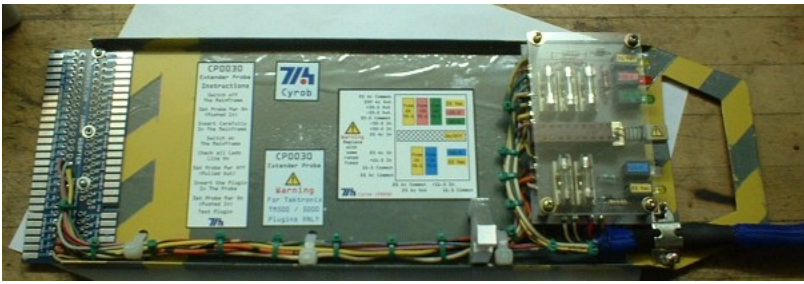

the connector

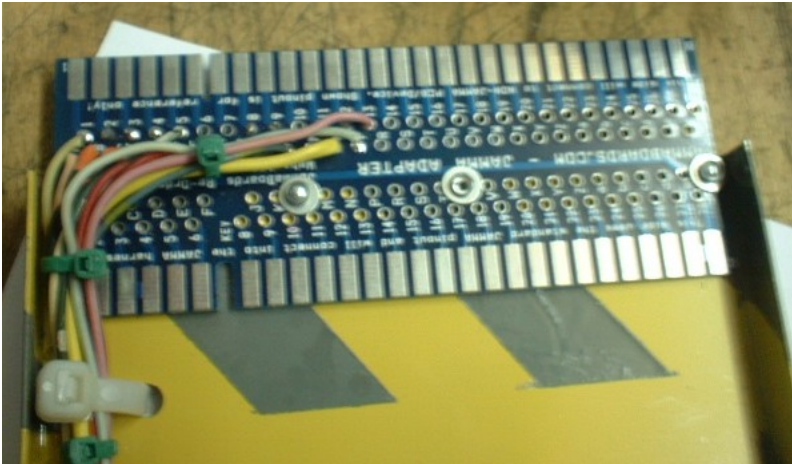

the front part

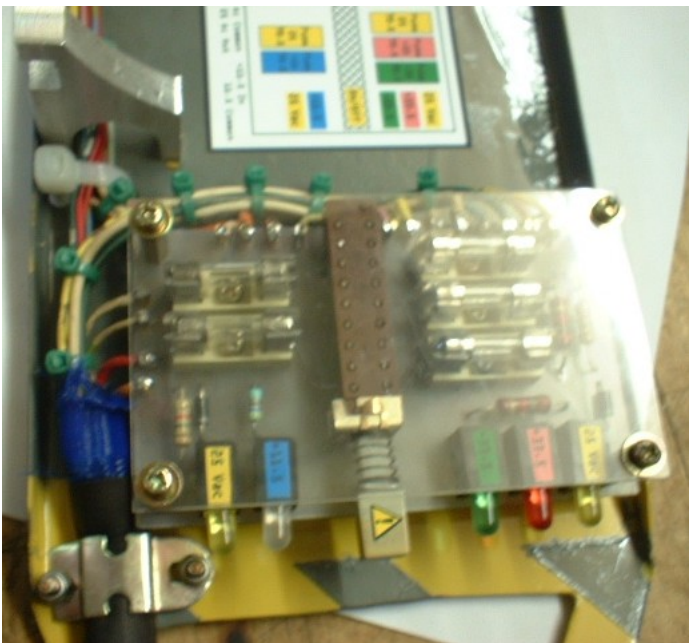

Here again, the cable is firmly fixed

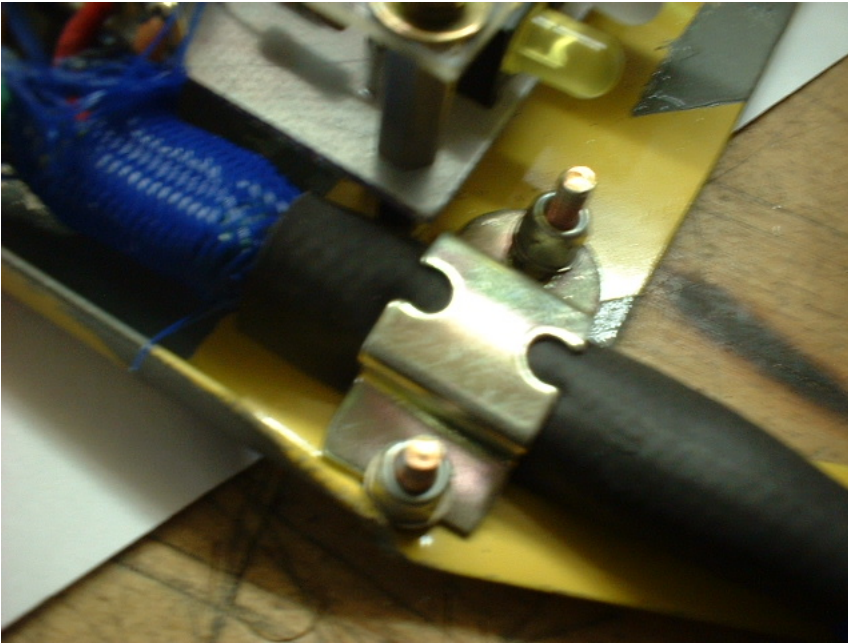

Yes I know, I'm doing a little too much with my labels, but it's so much better with the information under the nose ...

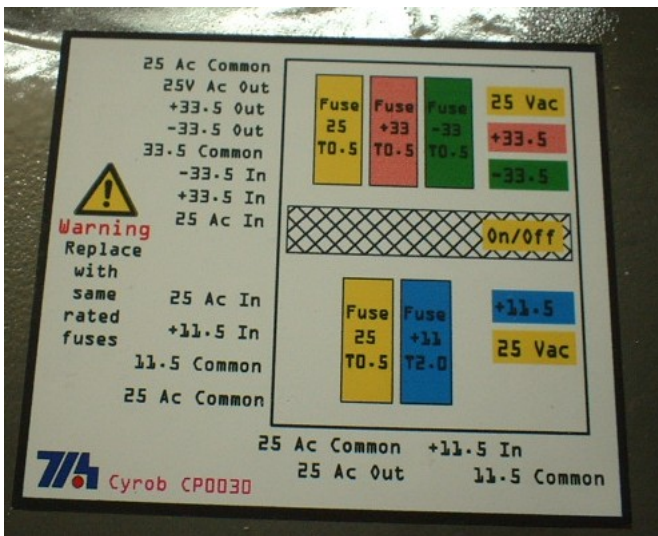

Well I test the biniou with different drawers and it's a real success, with this thing, I am equipped for the winter

So, I test the test module:

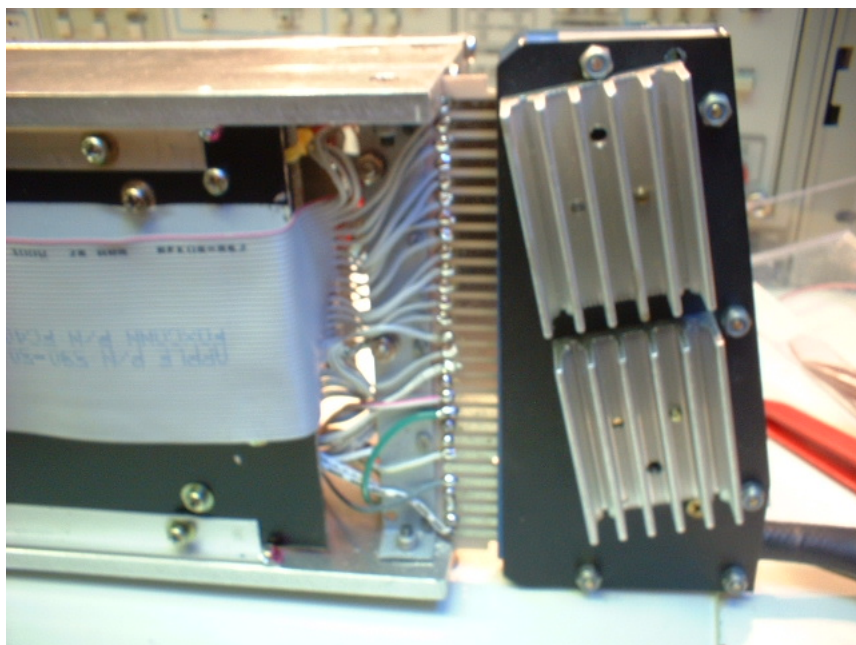

and after much research, here is the cause of the misfortune:

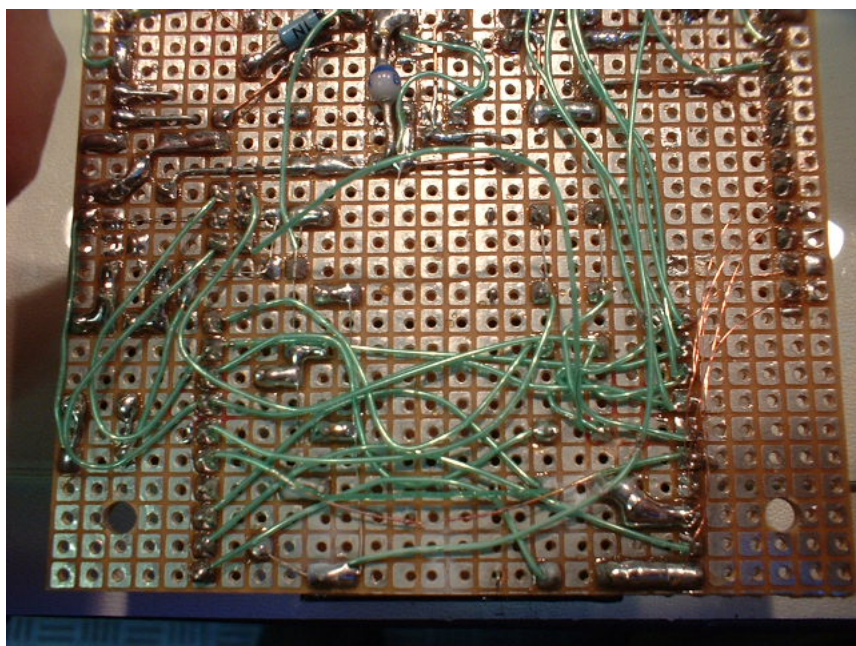

As you can see at the bottom of the map, one of the warping sons, suffering from a sudden attack of schizophrenia, it is taken for a fuse and he died !! rest in peace. After investigation and careful consideration, I do not have a satisfactory explanation to explain this failure, (Maybe a blow from the Aliens, I call Mulder !!) Finally, it's fixed.

I will therefore be able to get back to my current project

Improved 7-segment display

Many drawers use 7-segment displays as their display.

Here are 2 ways to display the 6 and the 9 on such displays:

Original way (Without flags)



Modified way (With flags)



As can be seen, on the 6 and 9 an additional segment is lit in the latter case. This segment is sometimes called "Flag" or 'Queue'.

Like in a famous spaghetti western, the world is divided into 3 categories:

- Those who prefer without a flag
- Those who prefer with
- Those who don't mind like their first panties ...

If you fall into this third category, this article is not for you and you can go back to going about your business ...

If you are part of the first, we do not have the same values but this may interest you, why not remove the flags where there are ...

If, like me, these bastard displays annoy you, this article will certainly fascinate you ...

The principles set out here are also valid for all instruments of all brands.

We can roughly summarize the display techniques by 7 segments in the following categories:

1. One decoding IC per display
2. A single decoding IC for a multiplexed display
3. A specialized IC or μ Controller which controls the segments
4. "Intelligent" displays with their own decoding logic

In cases 3 and 4, it is not very easy to modify the decoding but in the first 2 it is easier.

In fact, case 2 is most often used, particularly in the TM500 drawers. Multiplexing in fact reduces consumption, the number of ICs, the number of tracks and connections, etc.

One of the first ICs available to decode binary in 7 Segments was the SN7447, designed to directly drive Common Anode displays. For reasons that escape me, some talk about saving the number of logic gates, this circuit does not display the flags. in the CMOS family, the 4511 is also one of the great standards, it even has the luxury of integrating a "Latch" but still no flags ...

There is also the 74C48, and more bizarre ones like the 8T06 used by the SG503, which bypasses the segments to be switched off

Tracks released later generally display the flag ...

In some cases there is the pin / pin compatible choice, the SN74LS247 is identical to the 74LS47 but displays the flags.

For the 4511, I have not found 100% compatible but the 4513, which has 2 more pins (DIP18) is compatible at the cost of shorting 2 pins.

WARNING : It seems that some old datasheet su 4513 indicates a flagless decoding, while others do. I don't know if it's just a printing error but the 4513 I had in my hands displays it well (A big thank you to Jean-Jacques who informed me of this info, I don't had not chosen the 4513 solution because I had the wrong datasheet !!)

For the other circuits, I did not really research, for the 74C48 of the DM501A and the 8T06 of the SG503, it does not seem obvious ...

We can always do a decoding in addition to the mano with diodes and transistors see make a more complex assembly but it becomes expensive for just a little comfort ...

So let's summarize:

- For all devices that use 7447 or 74LS47, replacing with a 74LS247 solves the problem :)
- For all devices that use 4511, replacing with a 4513 by shorting pins 8 and 9 solves the problem:)

The circuits are rarely on support, once carefully desoldered, I recommend putting one which allows you to put the circuits that you want easily after.

Here is the manipulation on the DC503A, made easier because the IC was already on support ...

Before:

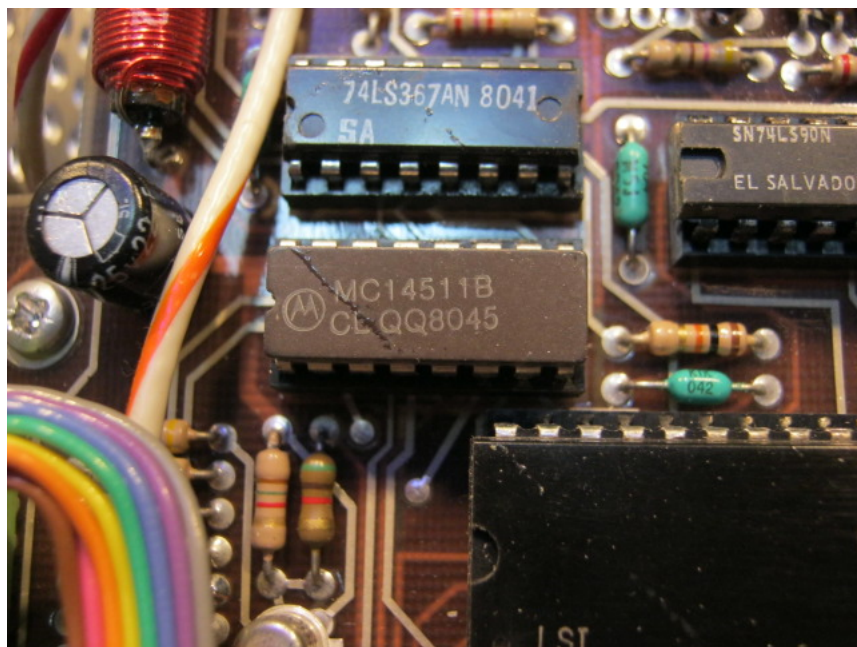

Afterwards: note the solder bridge between tabs 8 and 9

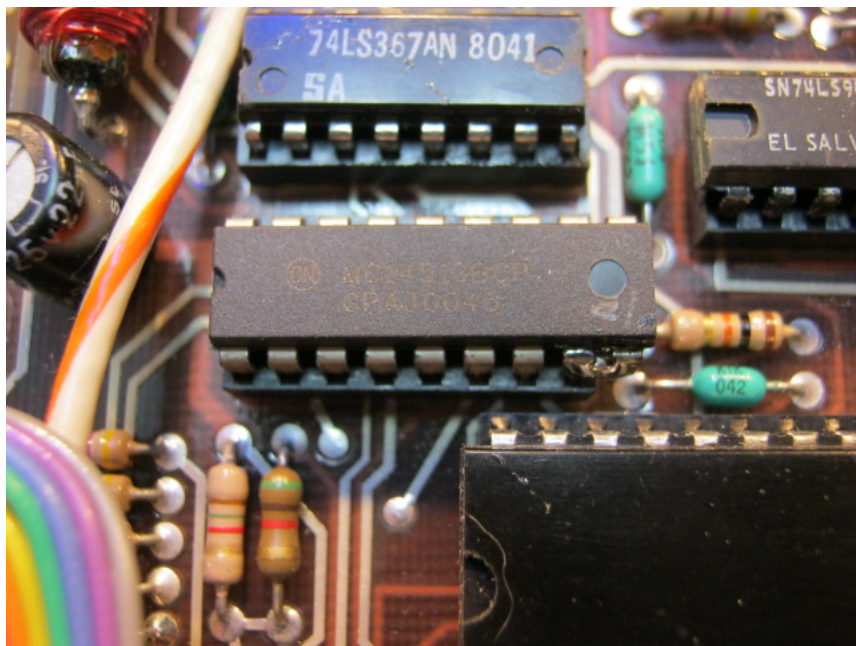

Here we are, we can easily find LS247 on Ebay,

For the 4513s, it's trickier but I found 8 for \$ 22 including postage on eBay.

I intend to gradually convert all my eligible drawers ...

It's probably a point of detail but really I don't like displays without flags ...

Upgrade a TM503B

I dreamed about it, Tektronix didn't. For once they did not do much at Tektro, to save 4 under the latest versions of TM503 do not have an ON / OFF switch accessible from the front.

This is really the kind of detail that annoys me. The earlier versions had a pull tab allowing them to be started from the front. So having bought a TM503b in the States, I still had to tinker.

To begin with, I rummaged through my reserves and found a big slide switch. I made a small hole in the head with a thread:



Then I made a square:

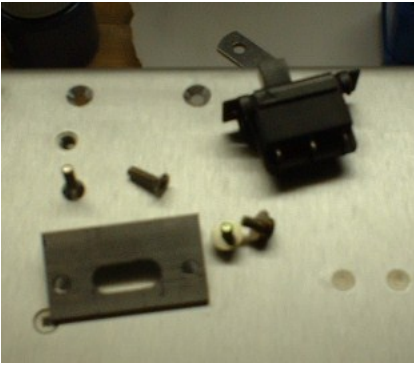

Then I mounted everything in the back of the case:

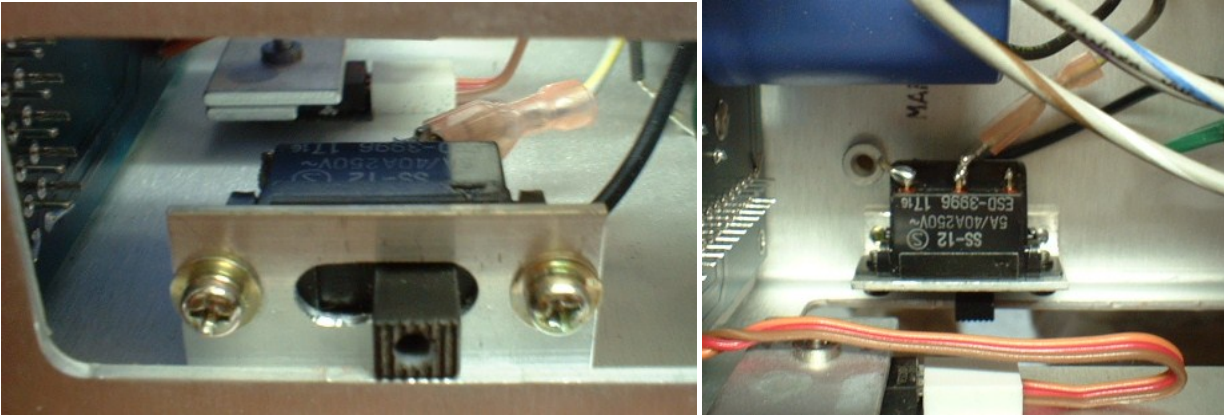

With the hole that goes well in the body:

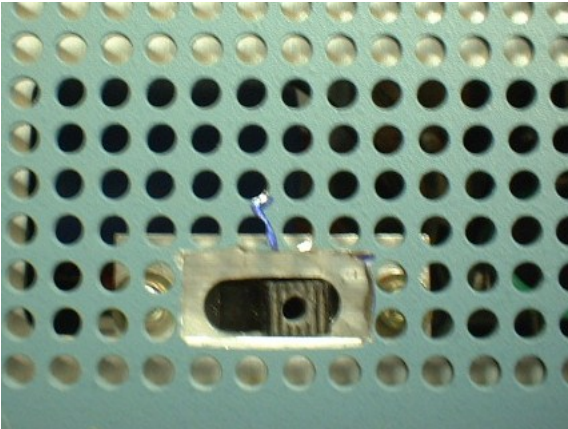

All that remained was to mill a small piece of plastoc to hold the rod

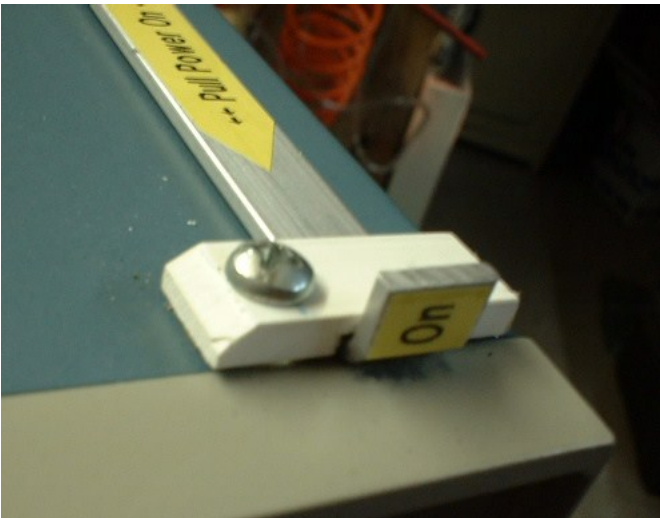

And here it is:



Now I can switch the gadget without going rummaging in the depths ...

Universalize an AFG 5501 into TM503

Tektronix has marketed a number of drawers in 2 forms:

- As a standard 5000 series drawer
- As a complete stand-alone 5500 series device

In fact, the 5500 is a drawer with a hacked TM503b 'Mainframe'.

I bought myself an AFG 5031 (arbitrary functions generator) for Christmas and I quickly saw the trick. The drawer is fixed to the power supply by a screw which, once removed, allows it to be extracted normally. This drawer is three units wide, so the power supply appears to be a TM503b. But in fact, I quickly noticed that there are differences:

- There are not the 3 plastic guide rails at the bottom.
- Only the location on the right to the 2 external complementary transistors.
- The middle location only has the NPN transistor and it is used!

This is surely due to an economic logic, they had to manufacture TM503b and customize them on demand. On the other hand, why put the unused connectors? Mystery?

Unable to find any documentation, so I reverse engineer and discover that the IC allows using the strap to use the NPN transistor in the middle as a pre-regulator of the 11.5V power supply, bringing it back to 8, 5V, standard voltage for TM5000 modules.

CAUTION : The transistor in question is connected normally to the middle connector and putting a spool directly in it can damage it.

In addition, the power supply being a TM503b, it has the same defect as I described above, namely the inability to start it from the front. So I decided to modify the bouzin so that it could be used by the other modules and to be able to switch it from the front.

So I start by modifying the IC a little by removing 2 straps, cutting 2 tracks and installing a connector in order to externalize the pre-regulator transistor, thus making the NPN its role as external transistors.

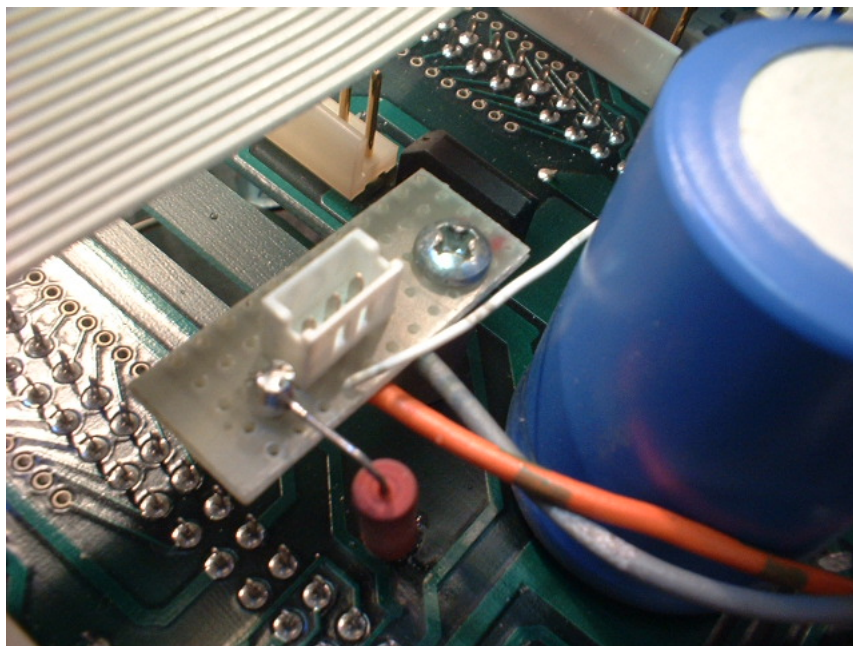

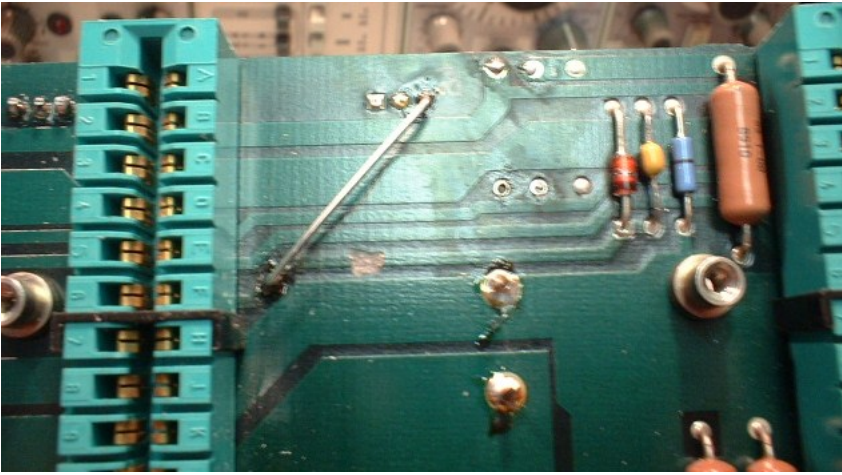

Next, I machine the missing radiator for the 2 external straight transistors and I mount them.

Note : they must be isolated from the radiator, so I use silicone insulation plates, insulating barrels and thermal paste.

I also add the missing PNP for the central drawer

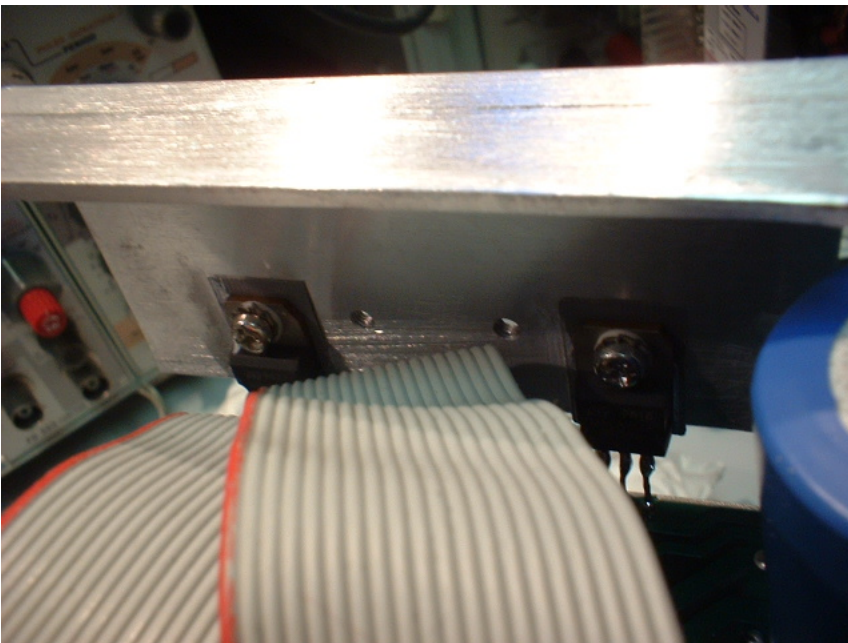

Then I modify a recuperating radiator, put an old 2N4111 on the bottom of the drawer (insulated of course too!)
For the pre-regulate.

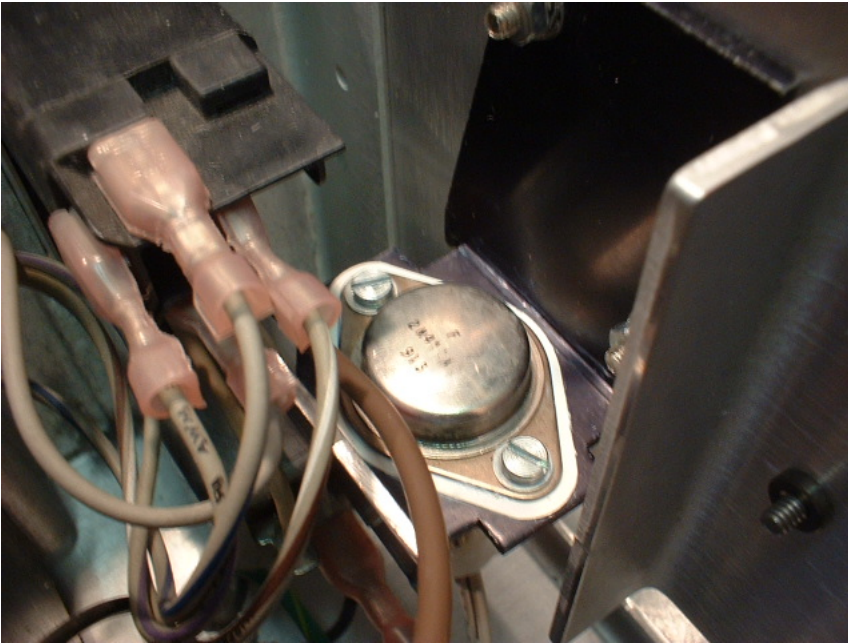

Then, as for the first TM503b, I mount a 2mm threaded switch



This blow, I take an aluminum rod, which I heat to bright red in order to flatten it with a hammer.



and, I make a nice zipper with a turn, plus the part that is well machined in a piece of angle iron.

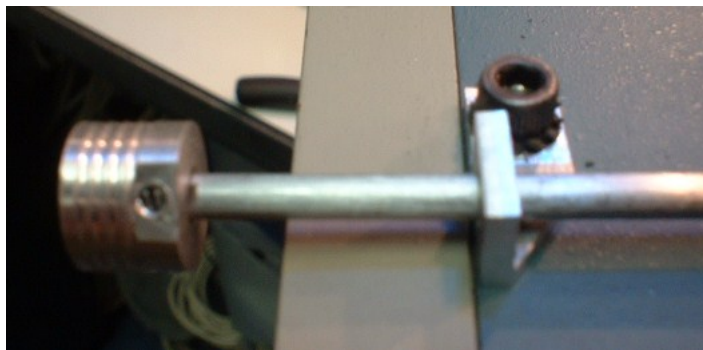

And voila, I test and everything works fine, I machined plastic bars to replace the missing rails.

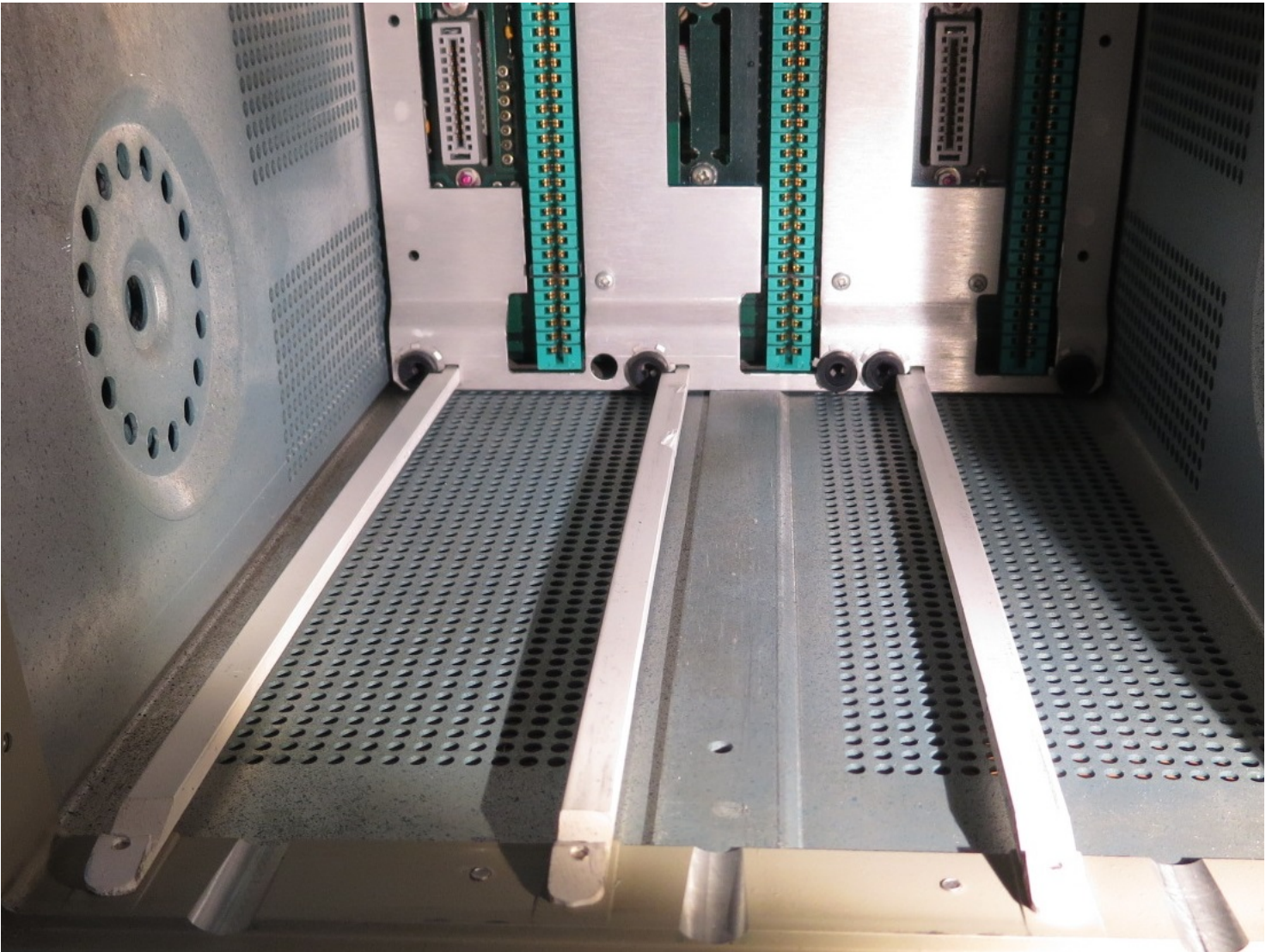

Reduce the noise of a TM506

I recently bought a TM506 "Mainframe" which can accommodate up to 6 basic modules.



This works very well but is particularly noisy because of the fan. So I added in series with this one a small thermal switch like "Klixon". I mounted it on the aluminum plate serving as a heat sink for the external power transistors of the modules.



I put a layer of heat-conducting silicone cream in order to have good thermal contact.

Silence has since returned. It never tripped but it must be said that I did not use it for hours ...

Adapter for repairing TM500 drawers

I bought some broken modules on Ebay. So I used my [super test drawer](#) to fix them.

Unfortunately, the failure was, as often, one of the power supplies short-circuited. The protection being done by fuses, my stock was quickly exhausted!

I quickly realized that while my test drawer was very useful for testing and calibrating modules, it was not great for repair.

I got away with replacing the faulty power supply with a current limited lab power supply, but it wasn't practical.

It is rare for a module to use all the power supplies available on the connector, and very often the 25 Volt AC is rectified by a Graetz bridge which allows a DC voltage to be applied. The idea is to troubleshoot the modules with a current limited lab power supply. This also avoids components that destroy each other 'in cascade'. Immediately said, immediately done, so I decided to make a connector suitable for handling. It is also of course necessary that the 2 power transistors normally on the mainframe be provided. (I found on Ebay a lot of TIP2955 and TIP3055 at canon price, these transistors replace the MJxxx normally used advantageously) A quick crobar, I make a chassis,

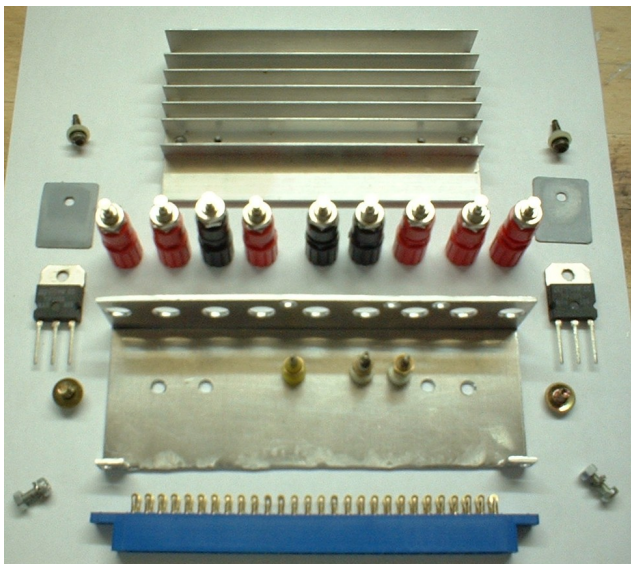

All that remains is to set up the mess .. and here is the result:

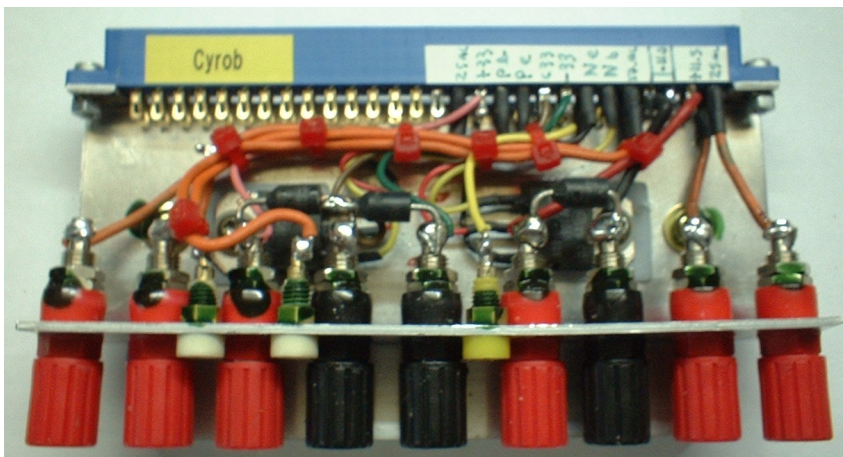

I put protective diodes on the DC power supplies, for the times where I make a mistake ...

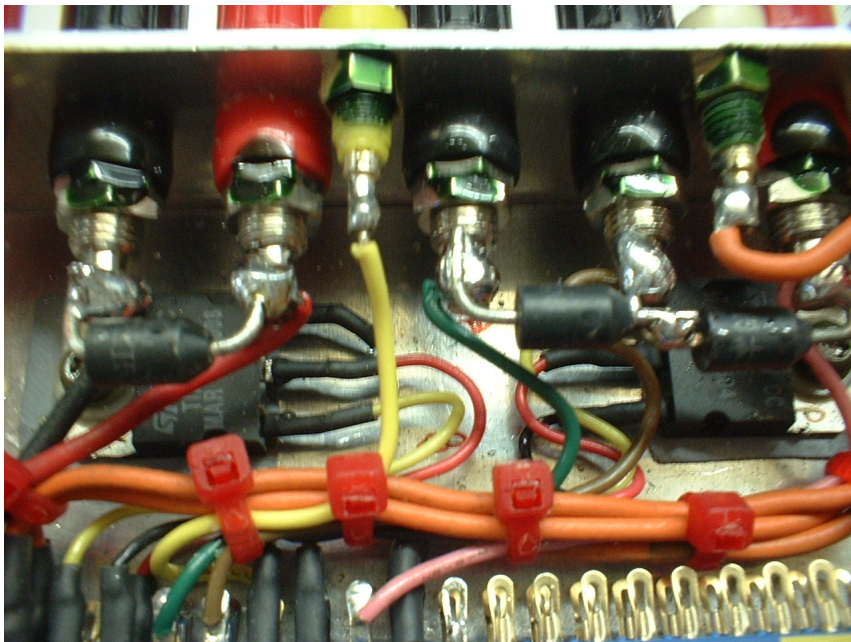

We can also see the 2 power peperes, electricly isolated from the radaiateur by siliconed fabrics specially designed for. I put locking varnish on the nuts of the banana sockets.



And here is the biniou at work on a badly damaged PS503:

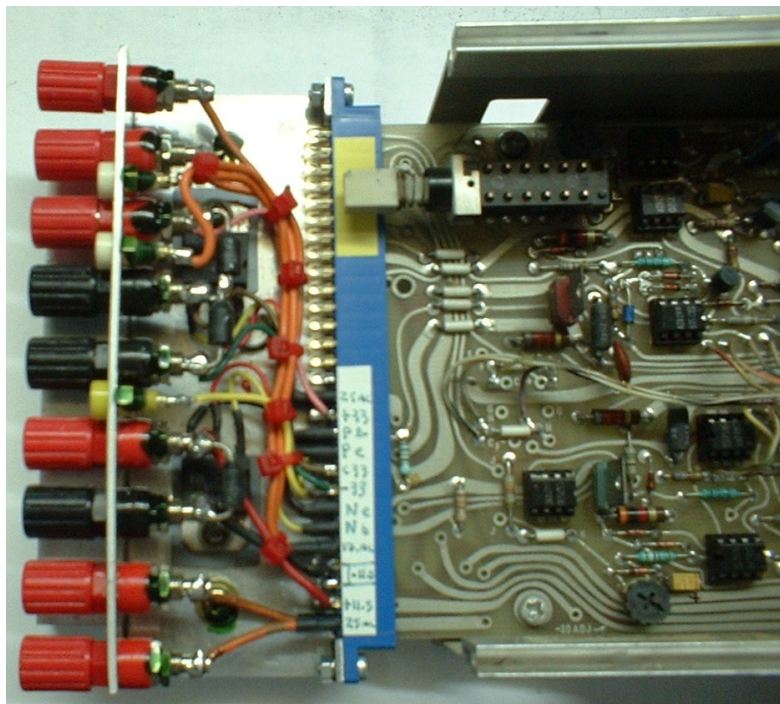

Repair and restoration of drawers

The drawers are electronic devices like any other and as such, all the rules and troubleshooting procedures apply. However, it can be interesting to emphasize certain specific points. (Which can for some of course also apply to many other devices)

So far, the main problems I have encountered with the drawers have been:

- Electro-mechanical problem, bad contacts, oxidation, etc ...
- Short-circuit supply problem
- Aging of the components making adjustment impossible
- HS components

Electro-mechanical problems are resolved with the usual methods: Contact spray, Light brushing, Isopropyl alcohol. Tektro rotary switches are very often composed of a block of plastic cams actuating small gold contacts soldered on the printed circuit. These contacts can be changed individually quite easily.

For the electronic part, the first point is to examine the diagram carefully and to understand the operation. The Tektro manuals are fairly well detailed but in English (yet another proof that mastering this language is almost essential for electronics and computers).

If you do not have the documentation, the task will be much more difficult, or even impossible in certain cases.

As the documents are often available in PDF format, it is practical to print the diagram or certain enlarged parts.

Warning : The docs often indicate differences depending on the version. It is important to identify the version concerned, (most often by the serial number)

If it is an 'unknown' drawer, a visual examination (possibly using a magnifying glass) is important. Locate all traces of burnt or damaged components.

Then, if possible, you plug into a protected power supply, you listen and you feel, at the slightest suspicious sign, you unplug!

If it smokes or heats up, he'll have to find out why. And it is not obvious, especially if the failure of one component is propagated and damaged others in cascade ...

If the power supply is short-circuited, here are some ideas:

- First the damn tantalum capacitors. These capacitors have a peculiarity: If they are not energized for a certain time (the army standard is 3 years), they will short-circuit. (Usually a good short circuit, less than an ohm to an ohmmeter) As the modules are old and have very often been stored without working for a long time, this is a very frequent failure. (By the way, remember to turn on all your devices if possible once a year, this is enough to prevent the capas from being damaged)
- The solution: locate and unsolder them one by one, test them and change them as needed. Note that I often take this opportunity to change them as a preventive measure.
- CAUTION: if you change them with tantalum stored for a long time, even new, test them with a laboratory power supply at their maximum operating voltage. I have plenty of them at home that do not stand up to the test !! In many cases, it is possible to replace tantalum with electrochemical Alu.

Another solution is sometimes to cut certain tracks in order to proceed by elimination.

Sometimes you see amazing stuff: An SG502 bought from an amateur radio club was supposed to be in good condition. I plug it in and it works well, except that it gives me an almost square signal !! For a sinus gen known for its very low distortion (-0.035% !!) it's not great. I plug the devil's beast (As my wife says) on the test clappoteur and I take some measurements looking at the diagram. All seem to show that the AGC intended to moderate the heat of the oscillator amp is not doing its job. I quickly suspect the FET in charge of regulating the gain, unsolder it and see that it is a 2N2907 (A PNP bipolar transistor) !! Funny FET !! The guy who fiddled with this drawer before me must either be very tired or still have some knowledge to learn.

(To be continued...)

PCB for DC503

A surfer had dead displays on a DC503 drawer, as they are nowadays impossible to find, he redesigned a PCB which he kindly made public. You can see the result here



The data and the gerbers are available here: [File.rar](#)

A big thank you to TL for this great work and this sharing.