

INSTRUCTION MANUAL

TYPE 134

CURRENT PROBE AMPLIFIER

SN 6620 and up



MANUFACTURERS OF CATHODE-RAY OSCILLOSCOPES

INSTRUCTION MANUAL

Serial Number _____

TYPE 134
CURRENT PROBE AMPLIFIER
SN 6620 and up

Tektronix, Inc.

S.W. Millikan Way • P. O. Box 500 • Beaverton, Oregon 97005 • Phone 644-0161 • Cables: Tektronix

070-0990-00

369



WARRANTY

All Tektronix instruments are warranted against defective materials and workmanship for one year. Tektronix transformers, manufactured in our own plant, are warranted for the life of the instrument.

Any questions with respect to the warranty mentioned above should be taken up with your Tektronix Field Engineer.

Tektronix repair and replacement-part service is geared directly to the field, therefore all requests for repairs and replacement parts should be directed to the Tektronix Field Office or representative in your area. This procedure will assure you the fastest possible service. Please include the instrument Type and Serial or Model Number with all requests for parts or service.

Specifications and price change privileges reserved.

Copyright © 1966, new material copyright, 1969 by Tektronix, Inc., Beaverton, Oregon. Printed in the United States of America. All rights reserved. Contents of this publication may not be reproduced in any form without permission of the copyright owner.

CONTENTS

Section 1	Specification
Section 2	Operating Instructions
Section 3	Circuit Description
Section 4	Maintenance
Section 5	Performance Check/Calibration Procedure
Section 6	Electrical Parts List
Section 7	Mechanical Parts List
Section 8	Diagrams
	Mechanical Parts List Illustrations

Abbreviations and symbols used in this manual are based on or taken directly from IEEE Standard 260 "Standard Symbols for Units", MIL-STD-12B and other standards of the electronics industry. Change information, if any, is located at the rear of this manual.

SEE PARTS LIST FOR SEMICONDUCTOR TYPES

SERIES M MODEL 1, 2, 3

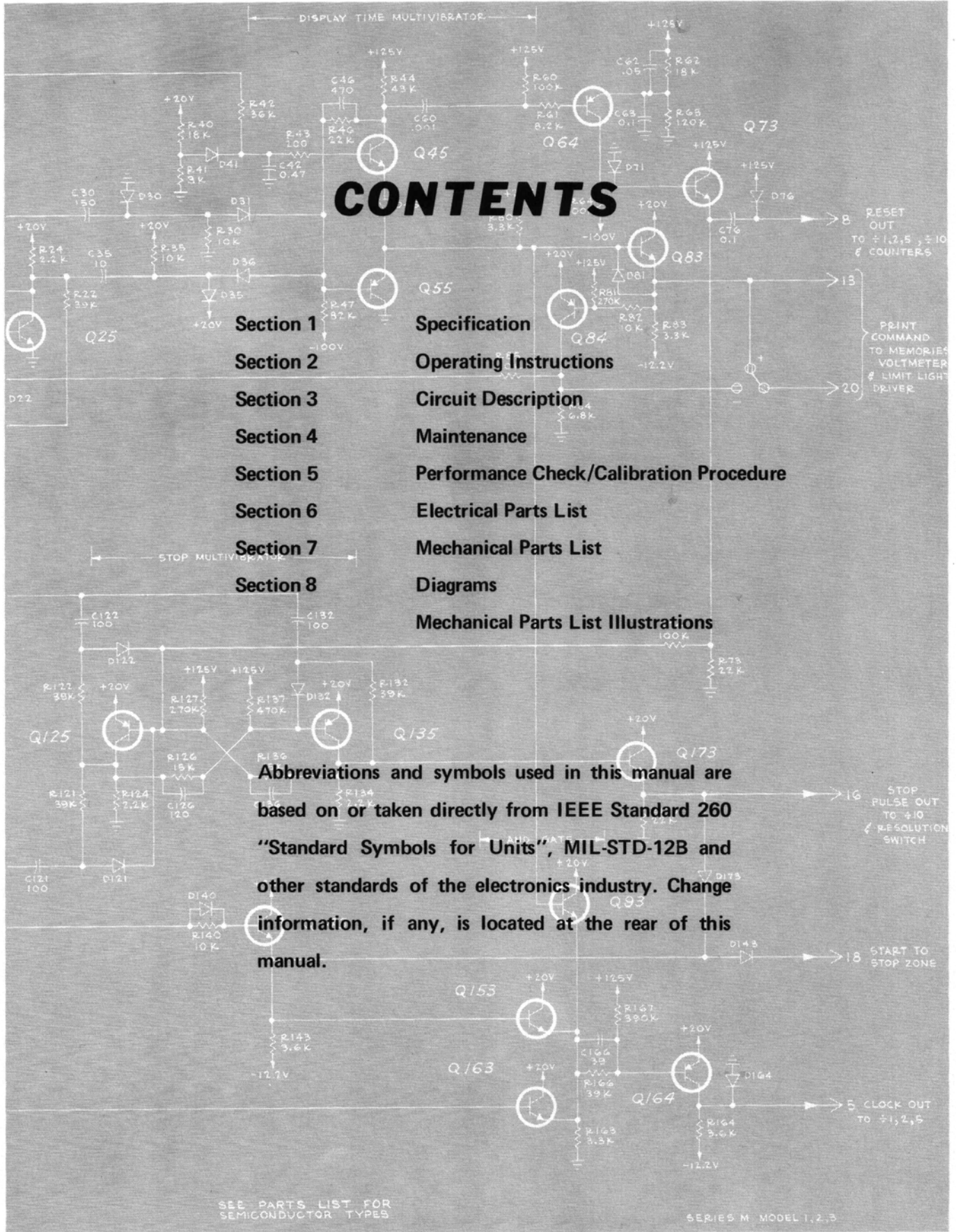

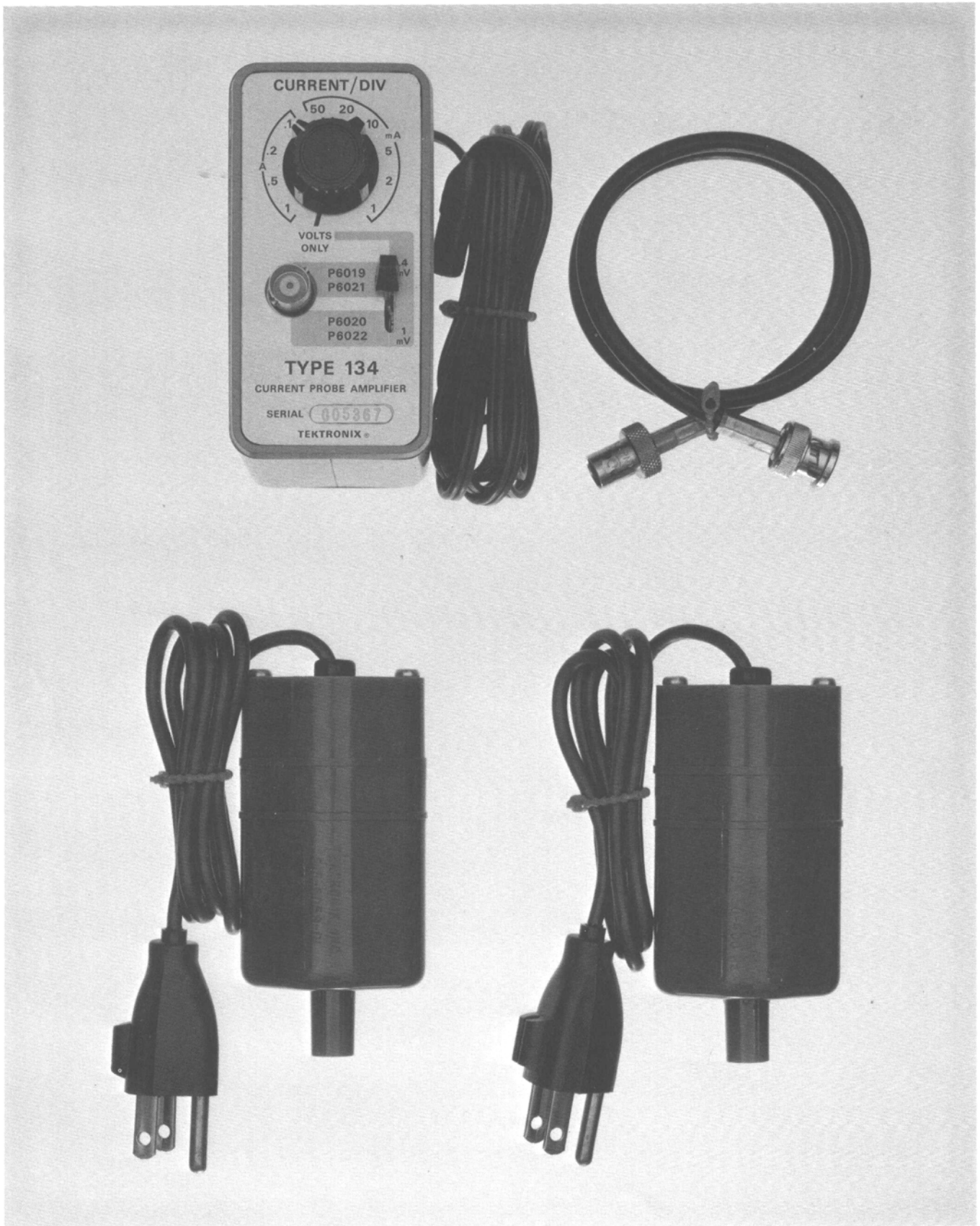

Fig. 1-1. Type 134 Current Probe Amplifier and accessories.

SECTION 1

TYPE 134 SPECIFICATION

Change information, if any, affecting this section will be found at the rear of the manual.

Introduction

The Type 134 Current Probe Amplifier is designed primarily for use with Tektronix current probes. When used with an oscilloscope, the amplifier and current probe form a complete alternating current measuring system. The Type 134 may also be used as a 50-ohm input voltage amplifier, with a gain of 50 or 125, set by a front-panel selector switch. Power for the amplifier is supplied by a separate power supply, available for either 115 volts or 230 volts.

Unless otherwise stated, the specifications listed below pertain only to the Type 134 Current Probe Amplifier and current probe and do not include the effects of the test oscilloscope.

ELECTRICAL CHARACTERISTICS

Characteristics	Type 134 With P6021 Probe			Type 134 With P6022 Probe		
Deflection Factor (with 50 mV/div oscilloscope setting)	Switched current amplifier steps from 1 mA/div to 1 A/div. Accuracy $\pm 3\%$.			Switched current amplifier steps from 1 mA/div to 1 A/div. Accuracy $\pm 3\%$.		
High-Frequency Response (-3 dB)	580-series	Type 453	Type 547/1A1	Type 454	647-series	580-series
	≥ 35 MHz	≥ 28 MHz	≥ 28 MHz	≥ 59 MHz	≥ 54 MHz	≥ 51 MHz
Low-Frequency Response (-3 dB)	≤ 12 Hz (see Fig. 1-2 and 1-3).			≤ 100 Hz		
Aberrations (does not include circuit effects of plug-in or oscilloscope)	$\leq +5\%$, -5% (total of 5% p-p) from 1 mA to 20 mA, $\leq +6\%$, -6% (total of 6% p-p) from 50 mA to 1 A, within 50 ns of step; $\leq +1\%$, -1% (total of 2% p-p) thereafter.			$\leq +5\%$, -5% (total of 5% p-p) from 1 mA to 20 mA, $\leq +6\%$, -6% (total of 6% p-p) from 50 mA to 1 A, within 50 ns of step; $\leq +2\%$, -2% (total of 2% p-p) thereafter.		

Tilt (does not include effects of plug-in or oscilloscope)	$\leq 3\%$ during first 400 μs of step.	$\leq 3\%$ during first 80 μs of step.
Noise	$\leq 150 \mu\text{A}$ referred to input.	$\leq 150 \mu\text{A}$ referred to input.
Maximum Current	15 A peak to peak continuous wave (see Fig. 1-4).	6 A peak to peak continuous wave (see Fig. 1-5).
Maximum Voltage	600 V	600 V

VOLTS ONLY

Characteristics	Selector Set to P6019/P6021	Selector Set to P6020/P6022
Deflection factor (with 50 mV/div Oscilloscope setting)	0.4 mV/div (gain of 125). Accuracy $\pm 3\%$.	1 mV/div (gain of 50). Accuracy $\pm 3\%$.
Risetime	≤ 11.7 ns	≤ 6.5 ns
High-Frequency Response (-3 dB)	≥ 30 MHz	≥ 54 MHz
Low-Frequency Response (-3 dB)	≤ 10 Hz	≤ 8 Hz
Aberrations	$\leq +5\%$, -5% (total of 5% p-p) within 50 ns of step; $\leq +1\%$, -1% (total of 2% p-p) thereafter.	$\leq 5\%$, -5% (total of 5% p-p) within 50 ns of step; $\leq +2\%$, -2% (total of 2% p-p) thereafter.
Tilt	$\leq 3\%$ during first 500 μs of step.	$\leq 3\%$ during first 600 μs of step.

Specification—Type 134

POWER SUPPLY

Characteristics	115 Volt Power Supply	230 Volt Power Supply
Line voltage Range	103.5 to 126.5 V AC	207 to 253 V AC
Line Frequency Range	50 to 400 Hz	50 to 400 Hz
Output Voltage	+13.25 to +15.25 V DC	+13.25 to +15.25 V DC
Regulation	≤0.5 volts change	≤0.5 volts change
Ripple	≤2 mV	≤2 mV

MECHANICAL SPECIFICATIONS

Construction—Aluminum-alloy wrap-around cover and circuit board chassis. Die cast end plates.

Connectors—Front panel input connector is BNC type; rear panel output connector is locking type BNC.

Finish—Anodized front panel with blue vinyl wrap-around cover.

Dimensions—3 5/8 inches high, 1 7/8 inches wide, 6 3/16 inches deep (includes connectors).

Optional Accessories

Battery Adapter (013-0050-00)—To connect battery to power cord. (Use a 16 to 33 volt, 70 mA battery such as a Mercury E302580 or equivalent.)

BNC/UHF Adapter (103-0015-00)—For use with oscilloscopes having UHF input connector.

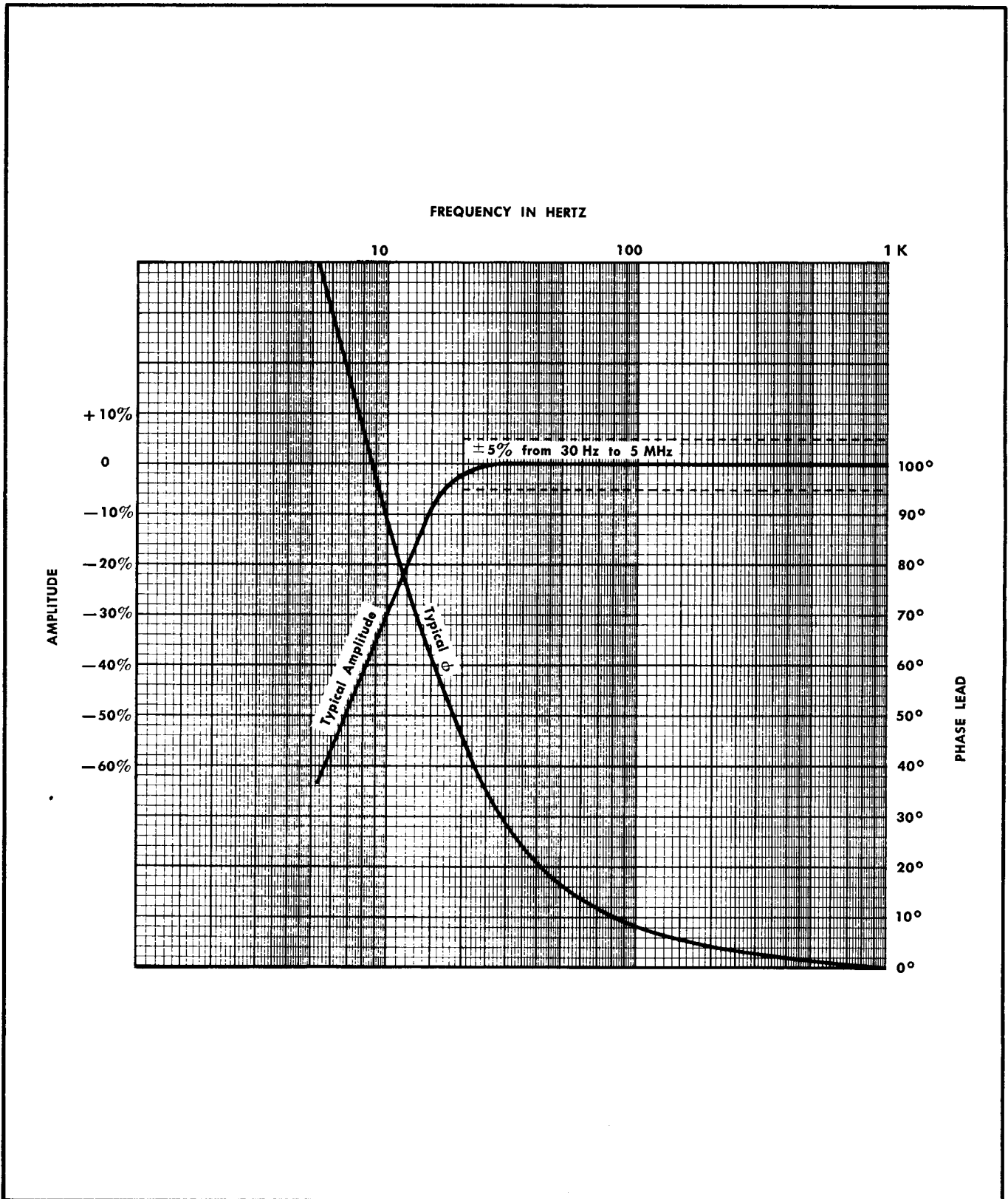

Fig. 1-2. Type 134 and P6021 amplitude and phase vs frequency.

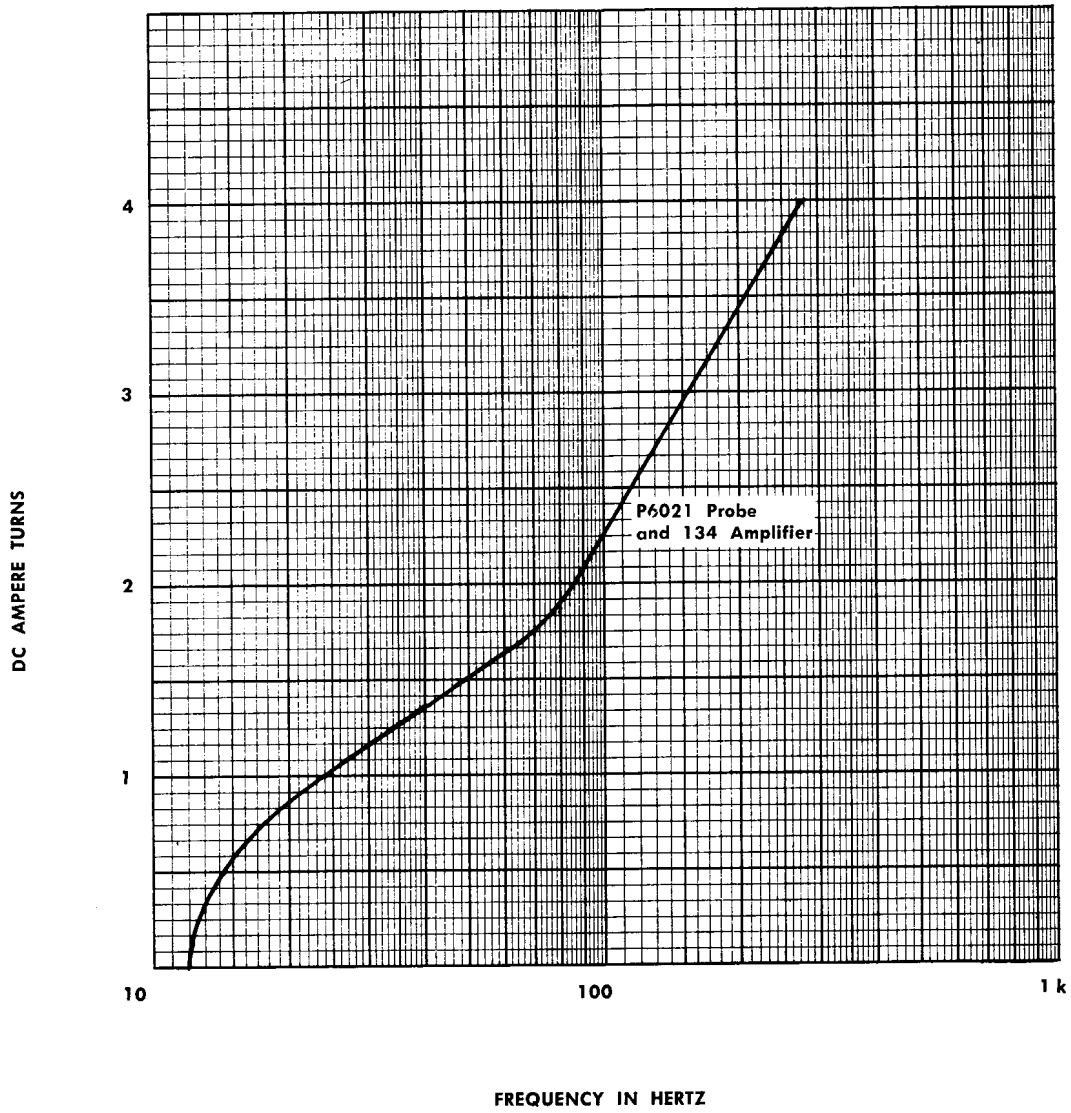

Fig. 1-3. Type P6021 low-frequency-3 dB point vs DC-ampere turns.

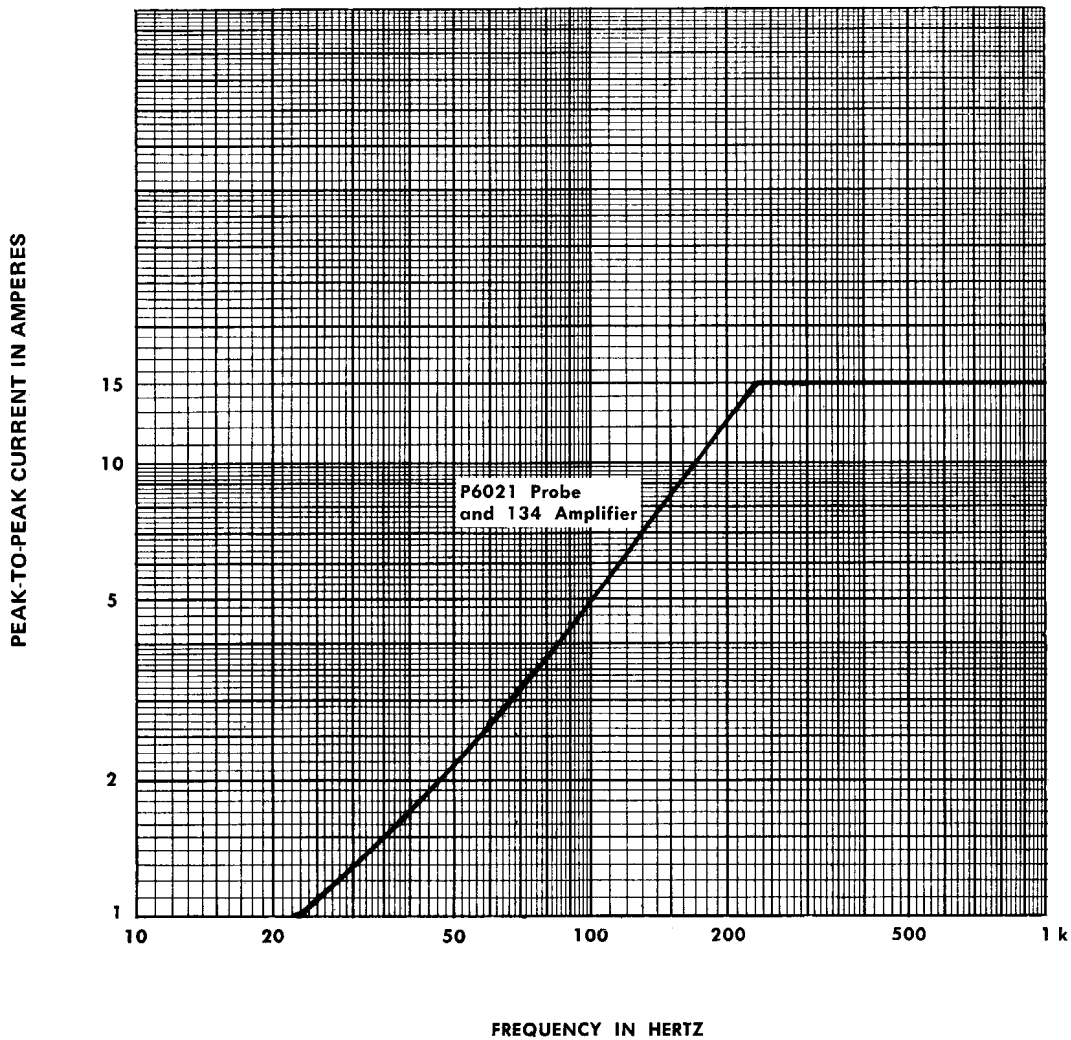

Fig. 1-4. Type P6021 low frequency response vs peak-to-peak current. At the low-frequency end detectable sine-wave distortion occurs as a result of core saturation. Although the probe distorts low-frequency current waveforms when the core starts to saturate, any high-frequency waveforms or short-duration microsecond pulses present at the same time are unaffected. At the high-frequency end, current rating may be exceeded under conditions indicated on the graph.

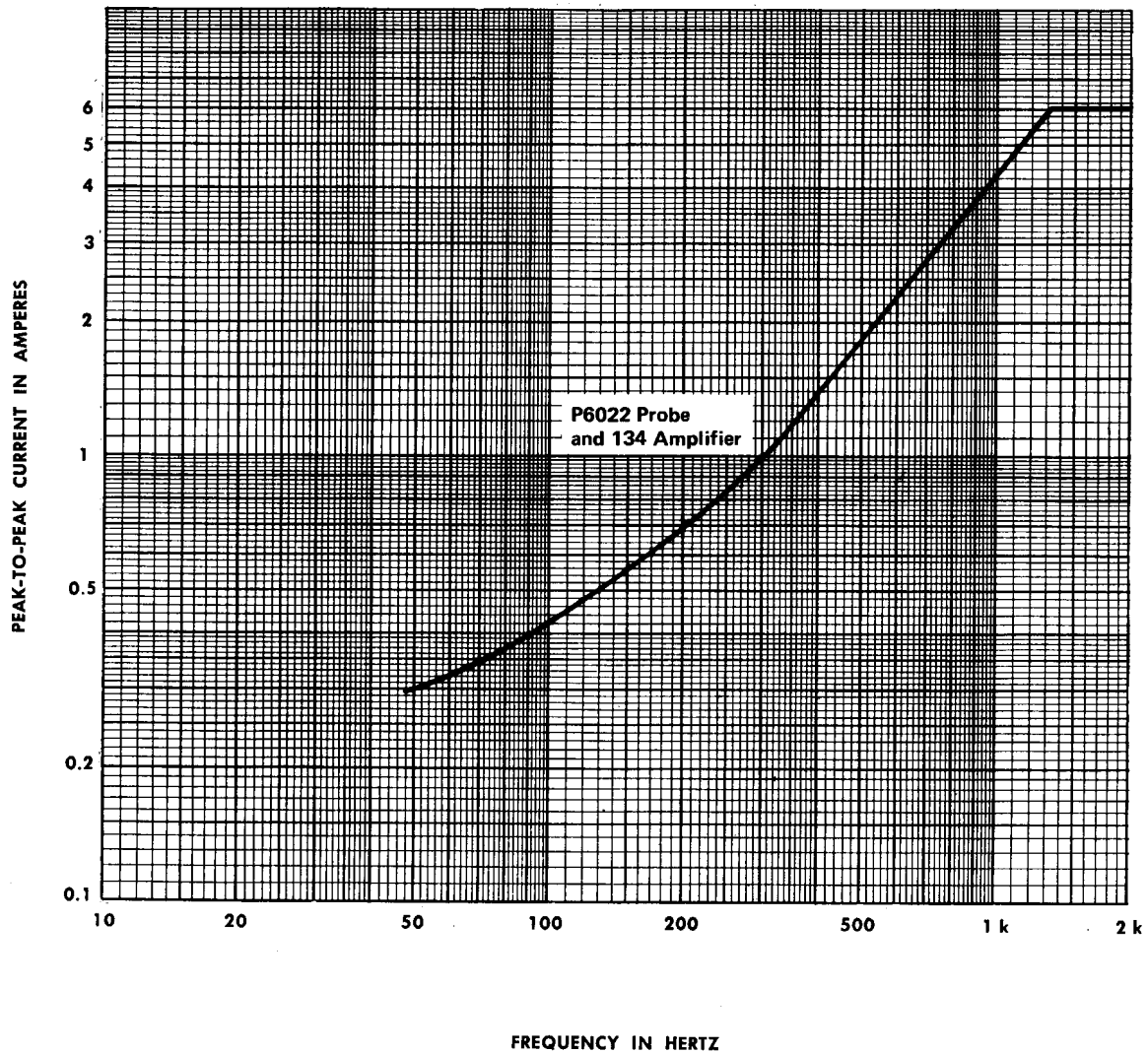

Fig. 1-5. Type P6022 low frequency response vs peak-to-peak current. At the low-frequency end detectable sine-wave distortion occurs as a result of core saturation. Although the probe distorts low-frequency current waveforms when the core starts to saturate, any high-frequency waveforms or short-duration microsecond pulses present at the same time are unaffected. At the high-frequency end, current ratings may be exceeded under conditions indicated on the graph.

SECTION 2

OPERATING INSTRUCTIONS

Change information, if any, affecting this section will be found at the rear of the manual.

General

The Type 134 Current Probe Amplifier operates with a Tektronix current probe and an oscilloscope to form a complete alternating current measuring system. To effectively use the Type 134, the operation and capabilities of the instrument should be known. This section describes the operation of the front-panel controls and connectors, gives first-time operating information, and lists some basic applications of the instrument.

Installation

The Type 134 is designed to connect to the vertical input of Tektronix oscilloscopes, either directly or through the 18-inch BNC female-to-male cable. When connecting directly, loosen the locking BNC output connector, plug into the vertical input connector, and tighten down until the Type 134 is rigidly supported. The Type 134 may also be fastened to the side of the instrument, using the hanger assembly supplied in the accessory kit. (Refer to Section 4 for hanger installation instructions.) In this case, connect the output of the Type 134 to the female end of the 18-inch cable and connect the male end of the cable to the vertical input connector.

Connect the appropriate (115-volt or 230-volt) power unit to the power source. Connect the power cord from the Type 134 to the power unit.

CONTROLS AND CONNECTORS

The controls required for the operation of the Type 134 are located on the front panel and right side of the unit. To make full use of this instrument, the operator should be familiar with the function and use of each of these controls. A brief description of the function or operation of each control follows:

CURRENT/DIV Selects the vertical deflection factor from 1 mA/Div to 1 A/DIV in 1-2-5 sequence. CURRENT/DIV control is calibrated only when oscilloscope vertical deflection factor is set to 50 mV/div and the variable is in the calibrated position. The VOLTS ONLY position of the CURRENT/DIV switch changes the current probe amplifier to a 50-ohm input impedance voltage amplifier.

Probe Selector Lever switch provides the appropriate gain and peaking to correspond with the current probe being used. The low-frequency probes require more gain than

do the high-frequency probes, due to the difference in turns ratios. The probes also require different peaking circuits in the amplifier. When the CURRENT/DIV switch is set to VOLTS/ONLY, the voltage gain of the amplifier is 125 with the selector set to P6019/P6021, resulting in a deflection factor of 0.4 mV/div (oscilloscope set to 50 mV/div). The gain in the P6020/P6022 position is 50, and the deflection factor is 1 mV/div

Input Connector BNC type connector. Input for current probes when operating in current mode; 50-ohm signal input when operating in voltage mode.

LF COMP Adjusted for optimum response when probe is first connected, or when changing from one probe to another.

GAIN P6020/P6022—Adjusts gain of amplifier when the front-panel selector switch is set to P6020/P6022.

P6019/P6021—Adjusts gain of amplifier when the front-panel selector switch is set to P6019/P6021.

FIRST-TIME OPERATION

General

The following steps demonstrate the basic operation of controls and connectors of the Type 134. It is recommended that this procedure be followed completely for familiarization with the instrument.

Current Measurement

1. Connect the Type 134 Amplifier to the vertical input of an oscilloscope. DC-couple the oscilloscope input and set the deflection factor to 50 mV/div, calibrated.

2. Plug the Type 134 power unit into the power source. Connect the power cord from the instrument to the power unit.

3. Connect a current probe to the input connector. Set the front-panel selector switch to correspond with the probe being used.

Operating Instructions—Type 134

4. Slide the thumb-controlled portion of the probe back, place the probe around the oscilloscope calibrator current loop (or Calibrator adapter, Tektronix Part No. 013-0092-00), and push the slider forward into the locked position (see Fig. 2-1).

5. Set the CURRENT/DIV control and the oscilloscope time-base controls to display the calibrator square wave.

6. Adjust LF COMP for a flat top on the displayed square wave.

NOTE

When connecting the current probe to the Type 134 for the first time, or when changing from one probe to another, the LF COMP must be adjusted.

7. Check the vertical deflection of the displayed square wave. There are two gain adjustments on the side of the Type 134 which correspond with the two positions of the front-panel selector switch. If gain adjustment is necessary, adjust the appropriate control.

Voltage Measurement

1. Connect the Type 134 Amplifier to the vertical input of an oscilloscope. Set the oscilloscope input to 50 mV/div, DC-coupled.

2. Plug the Type 134 power unit into the power source. Connect the power cord from the instrument to the power unit.

3. Set the CURRENT/DIV switch to VOLTS ONLY. In this position, the Type 134 becomes a voltage amplifier with an input impedance of 50 ohms.

4. Connect the signal source to the input connector. (Attenuator probes designed for use with 50-ohm systems, such as the P6034 10X Probe or the P6035 100 X Probe may be used).

NOTE

The Type 134 Current Probe Amplifier must be driven by a source having a DC return. Otherwise, the two capacitors in the input stage, C110 and C112, will be charged to the level of the signal and no signal will be passed (depending upon the duty cycle of the input signal).

5. With the front-panel selector switch in the P6019/P6021 position, the deflection factor is 0.4 mV/div (gain = 125). The deflection factor in the P6020/P6022 position is 1 mV/div (gain = 50). Set the selector switch to the desired position.

If an oscilloscope deflection factor other than 50 mV/div is used, the overall deflection factor must be calculated. The following is an example:

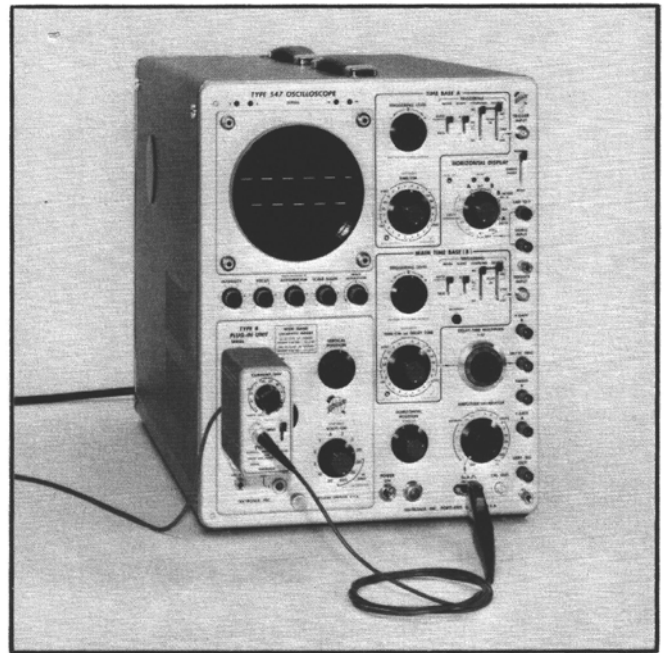

Fig. 2-1. Type Type 134 Current Probe Amplifier and current probe connected to an oscilloscope.

Attenuation ratio of the probe – 10X
Gain of the Type 134 (P6020/P6022 position) – 50
Oscilloscope deflection factor – 0.1 V/div

$$\frac{10}{50} \times \frac{0.1 \text{ V}}{\text{div}} = 20 \text{ mV/div}$$

6. Connect the voltage probe to the calibrator output. Set the oscilloscope controls to display the calibrator square wave.

7. Adjust LF COMP for a flat top on the displayed square wave.

8. Check the vertical deflection of the displayed square wave. There are two gain adjustments on the side of the Type 134 which correspond with the two positions of the front-panel selector switch. If gain adjustment is necessary, adjust the appropriate control.

GENERAL OPERATING INFORMATION

Current Probe Selection

The current probes recommended for use with the Type 134 are Tektronix Types P6019, P6020, P6021 and P6022. Generally, the P6019 or P6021 should be used when measuring current waveforms in the low- to medium-frequency range, while the P6020 or P6022 should be used for medium- or high-frequency measurements. The current probes require different gain and peaking to provide an accurate representation of the current signal. These circuit changes are made by the front-panel selector switch.

Ground Clip Leads

Ground clip leads are furnished with the probe to ground the shield around the probe transformer at the probe end of the cable when desired. Normally the ground lead is not used in the 1, 2, 5, and 10 mA positions of the CURRENT/DIV switch, due to undesirable chassis currents which may appear in the more sensitive positions. When observing high-frequency waveforms, use the short ground clip lead to avoid ringing.

Direction of Current Flow

Direction of conventional current flow, as opposed to electron flow, is plus to minus. Conventional current flowing in the direction of the arrow on the probe produces a positive deflection of the waveform on the CRT (see Fig. 2-2).

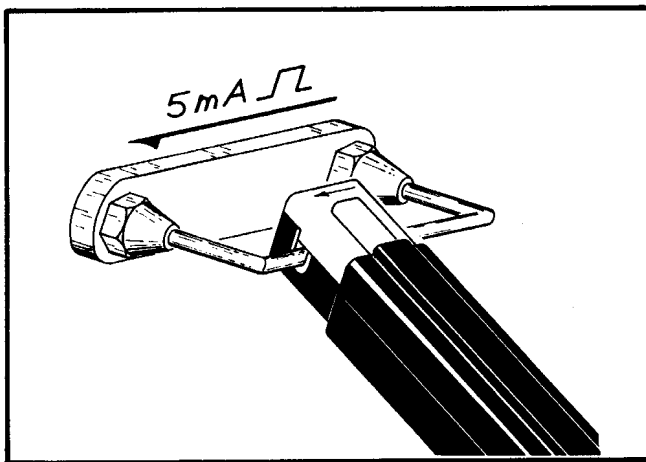

Fig. 2-2. Current flow in a conductor.

Loading Effect

To minimize loading effect of critical circuits, whenever possible clamp the probe at the low or ground end of a component lead. Also, less noise or spurious signal interference will be seen when the probe is connected near ground.

High Currents

When measuring high currents, do not leave the current probe clamped around the conductor while disconnecting the probe cable from the amplifier. With the probe cable unterminated under this condition, a high voltage is developed in the secondary winding which may damage the current probe transformer.

BASIC APPLICATIONS

Increasing the Sensitivity

The current sensitivity of the Type 134 and current probe can be increased by increasing the number of turns passing through the core of the probe. For example, if the conductor is looped through the probe two times, a two-turn primary winding is formed, increasing the secondary current by a factor of two. (The ratio of current in a trans-

former is inversely proportional to the turns ratio.) With the Type 134 CURRENT/DIV switch set to 1 mA, the deflection factor is actually reduced by a factor of two to 0.5 mA/division.

Remember, however, that the impedance reflected into the primary (circuit being measured) from the secondary (probe winding) varies as the square of the primary turns. When observing high-frequency current waveforms or fast-rise pulses, the inductance added to the primary circuit by the additional turns may be significant.

Probe Shielding

The current probe is shielded to minimize the effect of external magnetic fields. However, strong fields may interfere with a current signal being measured. If you suspect that an external field is interfering with your measurement, remove the probe from the conductor and place it in the vicinity of the original measurement. If you obtain appreciable deflection, attempt to measure the conductor current at another point away from the magnetic field source.

If current measurements must be made in the presence of a strong external field, the external field interference may be minimized by the use of two current probes and a differential-input oscilloscope. Both current probes must be the same type, and both must be connected to the oscilloscope inputs in the same manner, through two Type 134 Amplifiers.

With both probes connected to a differential-input oscilloscope, clamp one probe around the conductor in which the current is to be measured, and place the other probe near the first, with the slider closed. By setting the oscilloscope controls for common-mode rejection, the undesirable current signal induced in one probe can be minimized by the induced current in a second probe. Adjust the positions of the probes for best results. Complete cancellation of the undesirable signal may be difficult to obtain due to probe characteristics and time differences between the two probes and amplifiers.

Tracing Magnetic fields

The Type 134 and current probe can be used to trace magnetic fields, such as those produced by chassis currents, to their source. This is most easily accomplished by holding the probe slider open, and scanning about the chassis. The increased sensitivity of the unshielded transformer permits the maximum field current to be induced in the probe.

Balancing Currents

The Type 134 and current probe can be used to balance currents in a push-pull circuit. This can be accomplished by clamping the probe around both cathode or emitter leads in the push-pull stage. Algebraic addition of the two currents can then be displayed on the oscilloscope. Adjustments can be made in the device under test until the two currents produce a null display.

Operating Instructions—Type 134

Simultaneous Current and Voltage Measurements

Simultaneous current and voltage measurements can be obtained using the Type 134, a current probe, a voltage probe, and a dual-trace oscilloscope.

1. Connect the Type 134 Current Probe amplifier to one of the vertical input connectors on the oscilloscope. DC-couple the oscilloscope input and set the deflection factor to 50 mV/div, calibrated. Connect a current probe to the Type 134.

2. Connect the voltage probe to the other vertical input connector.

3. Connect the current probe around the conductor at the point where the signal is to be measured. (Use a ground lead if necessary.)

4. Connect the voltage probe tip to the point where the signal is to be measured. (Use a ground lead if necessary.)

5. Set the CURRENT/DIV switch and the oscilloscope controls for suitable displays. Obtain the current and voltage readings from the respective displays on the CRT.

SECTION 3

CIRCUIT DESCRIPTION

Change information if any, affecting this section, will be found at the rear of the manual.

Introduction

This section of the manual contains a description of the circuitry used in the Type 134. The description begins with a discussion of the amplifier, both as a current probe amplifier and as a voltage amplifier. The operation of the power supply is then described. Complete diagrams are given in the Diagrams section. Refer to these diagrams throughout the following circuit description for electrical values and relationship.

Type 134 Current Probe Amplifier

Current Positions of CURRENT/DIV Switch

The first stage of the amplifier (see AMPLIFIER circuit diagram), formed by Q114 and Q124, is a feedback amplifier, with the parallel combination of C118 and R118 providing the negative feedback loop. The value of C118 determines the frequency and amplitude of the negative feedback, thus providing high frequency compensation. The input impedance of Q114 is approximately two ohms. The input stage is AC-coupled by C110 and C112.

The input signal from the current probe (see ATTENUATORS circuit diagram) is terminated by R60, L60 and the two ohms input impedance of Q114 in the 1 mA through 20 mA positions of the CURRENT/DIV switch. C51-C52-R51, C53-R53, and C55-R55 are input impedance compensation networks. In the 50 mA through 1 AMP positions, the input signal is terminated by L62-R62, and the two ohms input impedance of Q114.

To achieve the desired 1-2-5 deflection factor sequence in the ten current positions of the CURRENT/DIV switch, four gain-setting networks are switched into the emitter of Q134, and the input signal is attenuated in the 20 mA through 1 AMP positions. In the 1 mA position, the $\div 1$ network, R91-C92-R92-C98-C99-R138, is switched into the emitter of Q134. In the 2 mA position, the $\div 2$ network, R94-C95-R95-C98-C99-R138, is switched in. In the 5 mA position, the $\div 5$ network, C98-C99-R99-R138, is switched in. In the 10 mA position, the $\div 10$ emitter resistor, R138 is switched in. In the 20 mA through .5 AMP positions, the $\div 5$ network is switched in and the input signal is attenuated through R70-R71-LR71, C69-R69-C73-R73, C75-R75, R77 and R79 in the CURRENT/DIV switch. In the 1 AMP position, the $\div 10$ resistor is switched in, and the input signal is attenuated through R81.

The gain of Q124 is set by the ratio of the collector circuit to emitter resistors R120-R121. Resistor R121 is bypassed by C121 to provide a high frequency boost. Emitter peaking circuits to correspond with the requirements of

the current probe being used are selected by the Probe Selector switch, SW130. With SW130 in the P6019/P6021 position, C131 and R131 are connected from the emitter of Q124 to ground. In the P6020/P6022 position, R131-C132-R132 are switched in. Separate gain adjustments in the collector of Q124 are also provided by SW130. The wiper of R125 or R128, depending upon the position of SW130, is AC-grounded through C125. This AC-grounding provides gain adjustments without affecting the DC level of Q124. The parallel combination of LR126 prevents high frequency ringing of the circuit.

The signal at the collector of Q124 is AC-coupled through C130 to the base of Q133. Resistor R130 is a parasitic suppressor. Resistors R133-R134 set the bias for Q133. This emitter follower circuit isolates the collector load of Q124 from Q134 so that switching Q134 emitter resistor networks (see previous description) does not affect the gain of Q124. Resistors R137 and R140 are parasitic suppressors which prevent Q134 from oscillating. The parallel combination of LR136 provides high frequency peaking for Q134.

The signal at the collector of Q134 is AC-coupled through C140 to the output stage. Peaking circuit C139-R139 is connected from the base of Q143 to ground only in the P6020/P6022 position of SW130. Transistor Q143 isolates the base of Q154 from the collector of Q134. Peaking circuit C156-R156-R157-C158 is connected between ground and the emitter of Q154 only in the P6019/P6021 position of SW130. Variable capacitor C158 is adjusted to shape the front corner response when using the low frequency probe. Emitter peaking is provided by C160-R160-C161. Variable capacitor C160 is adjusted to shape the high frequency response with either current probe. Resistor R159 is the emitter load for Q154. The connections between pins D and G of the circuit board assembly and the Probe Selector switch are made with two twisted pairs of wires to reduce the inductance. The ground for this switch must be made at pin G, near the ground end of R159, to avoid ground currents.

A low-pass filter, in the negative feedback loop of the Q143-Q154 operational amplifier, is formed by C146-R146-R147. This stabilizes the DC operating point of Q154 as the emitter impedance changes with the switching of SW130. A low-frequency boost network is formed by C151-R151-R153-R154-C163. At high frequencies, the reactance of C163 is low; therefore, the output signal is developed across R150. At low frequencies, the reactances of C151 and C163 rise, and the signal is then developed across R150 and R151, resulting in a low frequency boost.

Circuit Description—Type 134

The low frequency signal is compensated by R154. Toroid T164 is switched out of the circuit in the current positions of the CURRENT/DIV switch. The output signal is AC-coupled through C165.

VOLTS ONLY Position of the CURRENT/DIV Switch

In the VOLTS ONLY position of the CURRENT/DIV switch, R67, LR83, and the input impedance of Q114 form a 50-ohm termination for the input signal. High frequency compensation is provided by C68-R68 to maintain the 50 ohms impedance at high frequencies. Since the input of the amplifier is AC-coupled, the driving source must have a DC return. If not, C110 and C112 charge and no signal is passed (depending upon the duty cycle of the input signal).

The emitter peaking for Q124, required for the current probes, is removed in the VOLTS ONLY position. The gain of the amplifier is set by the collector circuit of Q124 as previously described. The $\div 1$ network, R91-C92-R92-C98-C99-R138, is switched into the emitter of Q134 in the VOLTS ONLY position. Capacitor C163, the low frequency boost capacitor in the output stage, is bypassed in the VOLTS ONLY position. Toroid T164 isolates the capacitance of the CURRENT/DIV switch from the output of the amplifier.

Type 134 Power Supply

The power plug portion of the power supply consists of

a transformer with a diode bridge in the secondary, which supplies unfiltered DC to the amplifier circuit board where it is filtered and regulated. The primary of the transformer is wound for 115 volts in both the 115-volt and the 230-volt power units. The 230-volt power unit has a resistor in each side of the line (R101 and R102) between the AC power cord and the primary of the transformer to reduce the line voltage to 115 volts. The frequency range of the power supply is 50 to 400 hertz.

The filter circuit, located in the amplifier portion of the power supply, is formed by C105-C106-C107-R105-R106. A 15-volt zener diode, D107, supplies a fixed voltage to the base of Q107, the power transistor. This produces a +14-volt supply at the emitter of Q107. Capacitor C107 eliminates any zener noise from D107.

To avoid shock hazard should the transformer windings short, the ground side of the secondary is held near ground by D105 and D106. (No other ground exists when the power cord is disconnected from the oscilloscope.) Neither diode will conduct unless a potential difference of more than 0.5 volt is present, therefore avoiding a ground loop. Should the transformer windings short, the primary fuse F101 will open before D105 or D106 are damaged. However, F101 will not open if the two sides of the diode bridge (power unit output) are shorted together.

SECTION 4

MAINTENANCE

Change information, if any, affecting this section will be found at the rear of the manual.

Introduction

This section of the manual contains maintenance information for use in preventive maintenance, corrective maintenance and troubleshooting of the Type 134 Current Probe Amplifier and Power Supply.

PREVENTIVE MAINTENANCE

General

Preventive maintenance consists of cleaning, visual inspection, lubrication, etc. Preventive maintenance performed on a regular basis may prevent instrument breakdown and will improve the reliability of this instrument. The severity of the environment to which the Type 134 is subjected determines the frequency of maintenance. A convenient time to perform preventive maintenance is preceding recalibration of the instrument.

Remove the Type 134 Cover

1. Unscrew the plastic portion of the locking BNC connector (output to the oscilloscope), and remove.
2. Remove the two screws on either side of the connector.
3. Remove the rear panel and wrap-around cover.

Cleaning

The Type 134 should be cleaned as often as operating conditions require. Accumulation of dirt in the instrument can cause overheating and component breakdown. Dirt on components act as an insulating blanket and prevent efficient heat dissipation. It also provides an electrical conduction path.

Exterior. Loose dirt accumulated on the outside of the Type 134 can be removed with a soft cloth or small paint brush. The paint brush is particularly useful for dislodging dirt on and around the front-panel controls. Dirt which remains can be removed with a soft cloth dampened in a mild detergent and water solution. Abrasive cleaners should not be used.

Interior. Dust in the interior of the instrument should be removed occasionally due to its electrical conductivity under high-humidity conditions. The best way to clean the interior is to blow off the accumulated dust with dry, low-velocity air. Remove any dirt which remains with a soft paint brush or cloth dampened with a mild detergent and

water solution. A cotton-tipped applicator is useful for cleaning in narrow spaces.

Lubrication

The reliability of potentiometers, switches and other moving parts can be maintained if they are kept properly lubricated. Do not over lubricate. A lubrication kit containing the necessary lubricants and instructions is available from Tektronix, Inc. Order Tektronix Part No. 003-0342-01.

Visual Inspection

The Type 134 should be inspected occasionally for such defects as broken connections, broken or damaged circuit boards, improperly seated transistors, and heat-damaged parts.

The corrective procedure for most visible defects is obvious; however particular care must be taken if heat-damaged components are found. Overheating usually indicates other trouble in the instrument; therefore, it is important that the cause of overheating be corrected to prevent a recurrence of the damage.

Transistor Checks

Periodic checks of the transistors in the Type 134 are not recommended. The best check of transistor performance is its actual operation in the instrument. More details on checking transistor operation is given under Troubleshooting.

Recalibration

To ensure accurate measurements, check the calibration of this instrument after each 1000 hours of operation or every six months if used infrequently. In addition, replacement of components may necessitate recalibration of the affected circuits. Complete calibration instructions are given in Section 5.

The Performance Check/Calibration Procedure can also be helpful in localizing certain troubles in the instrument. In some cases, minor troubles may be revealed and/or corrected by calibration.

TROUBLESHOOTING

Introduction

The following information is provided to facilitate troubleshooting of the Type 134. Information contained in

Maintenance—Type 134

other sections of this manual should be used along with the following information to aid in locating the defective component. An understanding of the circuit operation is very helpful in locating troubles. See the Circuit Description section for complete information.

Troubleshooting Aids

Diagrams. Circuit diagrams are given on foldout pages in Section 8. The component number and electrical value of each component in this instrument are shown on the diagrams. Important voltages are also shown on the diagrams.

Wiring Color-Code. All insulated wire and cable used in the Type 134 is color-coded to facilitate circuit tracing. Signal carrying leads are identified with one or two stripes.

Resistor Color-Code. In addition to the brown composition resistors, some metal-film resistors are used in the Type 134. The resistance values of composition resistors and metal-film resistors are color-coded on the components (some metal film resistors may have the value printed on the body) with EIA color-code. The color-code is read starting with the stripe nearest the end of the resistor. Composition resistors have four stripes which consist of two significant figures, a multiplier and a tolerance value (see

Fig. 4-1). Metal-film resistors have five stripes consisting of three significant figures, a multiplier and a tolerance value.

Capacitor Marking. The capacitance values of common disc capacitors and small electrolytics are marked in microfarads on the side of the component body. The white ceramic capacitors used in the Type 134 are color-coded in picofarads using a modified EIA code (see Fig. 4-1).

Diode Color-Code. The cathode end of each glass-enclosed diode is indicated by a stripe, a series of stripes or a dot. For most silicon or germanium diodes with a series of stripes, the color-code also indicates the type of diode or identifies the Tektronix Part Number using the resistor color-code system (e.g., a diode color-coded blue or pink-brown-gray-green indicates Tektronix Part Number 152-0185-00). The cathode and anode end of metal-encased diodes can be identified by the diode symbol marked on the body.

Troubleshooting Equipment

The following equipment is useful for troubleshooting the Type 134.

1. Transistor Tester

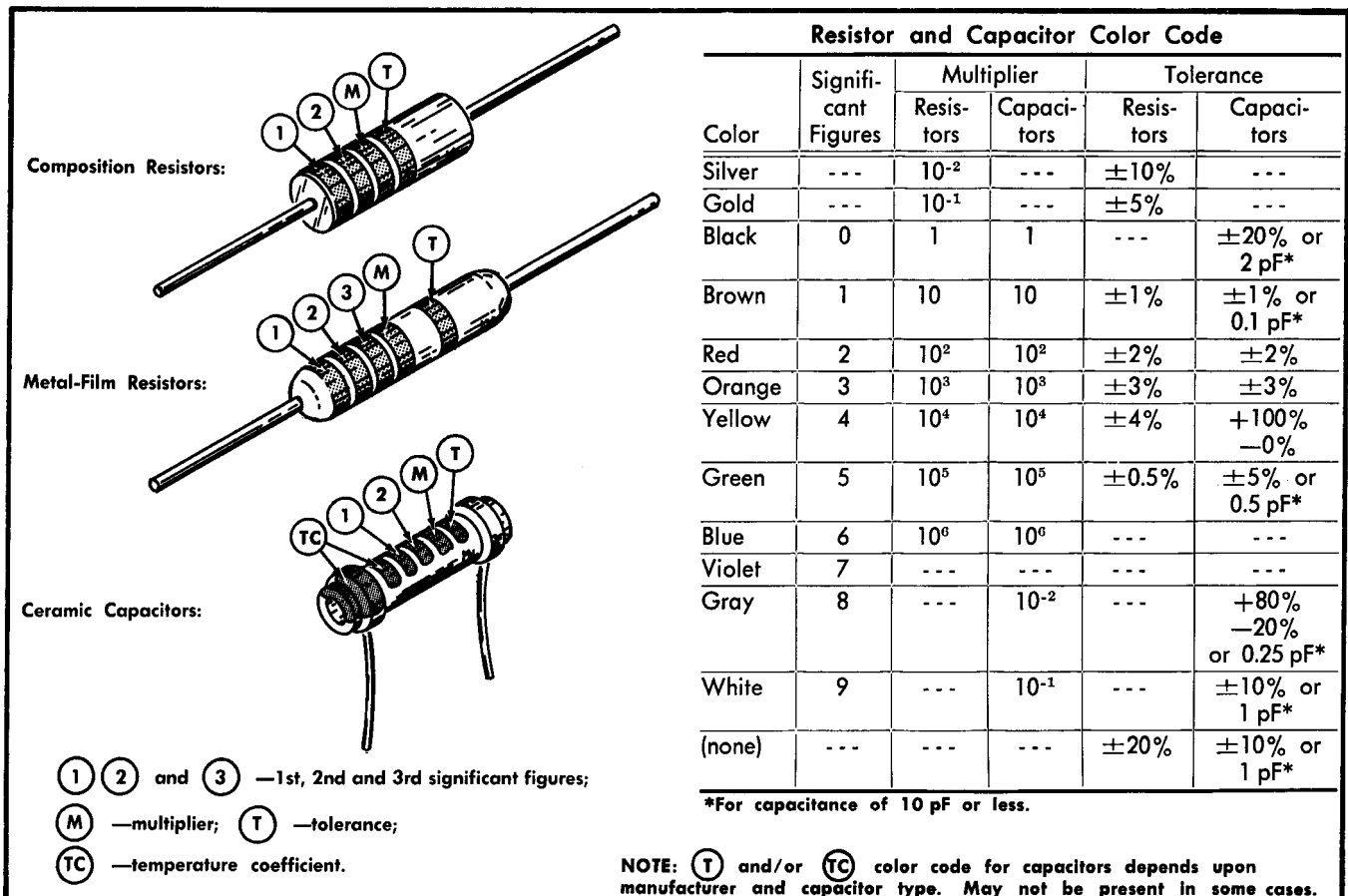

Fig. 4-1. Color-code for resistors and ceramic capacitors.

Description: Tektronix Type 576 Transistor-Curve Tracer or equivalent.

Purpose: To test the semiconductors used in this instrument.

2. Volt-ohmmeter

Description: 20,000 ohms/volt. 0-500 volts DC. Accurate within 3%. Test probes must be insulated.

Purpose: To measure voltages and resistances.

Troubleshooting Techniques

This troubleshooting procedure is arranged in an order which checks the simple trouble possibilities before proceeding with extensive troubleshooting. The first few checks ensure proper connection, operation and calibration. If the trouble is not located by these checks, the remaining steps aid in locating the defective component. When the defective component is located, it should be replaced following the replacement procedures given under Corrective Maintenance.

1. Check Control Setting. Incorrect control settings can indicate a trouble that does not exist. If there is any question about the correct function or operation of any control, see the Operating Instructions section of this manual.

2. Check Associated Equipment. Before proceeding with troubleshooting of the Type 134, check that the equipment used with this instrument is operating correctly. Check that the signal is properly connected and that the probe is not defective. The oscilloscope can be checked for proper operation by substituting another which is known to be operating properly.

3. Check Instrument Calibration. Check the calibration of this instrument, or the affected circuit if the trouble exists in one circuit. The apparent trouble may only be a result of misadjustment or may be corrected by calibration. Complete calibration instructions are given in Section 5.

4. Visual Check. Visually check the portion of the instrument in which the trouble is located. Many troubles can be located by visible indications such as unsoldered connections, broken wires, damaged components, etc.

5. Isolate Trouble to a Circuit. To isolate a trouble to a circuit, note the trouble symptom. The symptom often indicates the circuit in which the trouble is located.

6. Check Voltages. Often the defective component can be located by checking for the correct voltage in the circuit. Typical voltages are given on the diagrams.

NOTE

Voltages given on the Amplifier diagram are not absolute and may vary slightly between instruments. To obtain operating conditions similar to those used to take these readings, see the note on the Amplifier diagram.

7. Check Individual Components. The following procedures describe methods of checking individual components in the Type 134. Components which are soldered in place are best checked by disconnecting one end. This isolates the measurement from the effects of surrounding circuitry.

A. TRANSISTORS. The best check of transistor operation is actual performance under operating conditions. If a transistor is suspected of being defective, it can best be checked by substituting a new component or one which has been checked previously. However, be sure that circuit conditions are not such that a replacement transistor might also be damaged. If substitute transistors are not available, use a dynamic tester (such as Tektronix Type 576).

B. DIODES. A diode can be checked for an open or shorted condition by measuring the resistance between terminals. With an ohmmeter scale having an internal source of between 800 millivolts and 3 volts, the resistance should be very high in one direction and very low when the leads are reversed.

CAUTION

Do not use an ohmmeter scale that has a high internal current. High currents may damage the diode.

C. RESISTORS. Resistors can be checked with an ohmmeter. Check the Electrical Parts List for the tolerance of the resistors used in this instrument. Resistors normally do not need to be replaced unless the measured value varies widely from the specified value.

D. INDUCTORS. Check for open inductors by checking continuity with an ohmmeter. Shorted or partially shorted inductors can usually be found by checking the waveform response when high-frequency signals are passed through the circuit. Partial shorting often reduces high-frequency response (roll-off).

E. CAPACITORS. A leaky or shorted capacitor can best be detected by checking the resistance with an ohmmeter on the highest scale. Do not exceed the voltage rating of the capacitor. The resistance reading should be high after initial charge of the capacitor. An open capacitor can best be detected with a capacitance meter or by checking whether the capacitor passes AC signal.

8. Repair and Readjust the Circuit. If any defective parts are located, follow the replacement procedures given in this section. Be sure to check the performance of any circuit that has been repaired or that has had any electrical components replaced.

CORRECTIVE MAINTENANCE

General

Corrective maintenance consists of component replacement and instrument repair. Special techniques required to replace components in this instrument are given here.

Obtaining Replacement Parts

Standard Parts. All electrical and mechanical part replacements for the Type 134 can be obtained through your local Tektronix Field Office or representative. However, many of the standard electronic components can be obtained locally in less time than is required to order them from Tektronix, Inc. Before purchasing or ordering replacement parts, check the parts list for value, tolerance, rating and description.

NOTE

When selecting replacement parts, it is important to remember that the physical size and shape of a component may effect the performance in the instrument, particularly at high frequencies. All replacement parts should be direct replacements unless it is known that a different component will not adversely affect instrument performance.

Special Parts. In addition to the standard electronic components, some special parts are used in the Type 134. These parts are manufactured or selected by Tektronix, Inc. to meet specific performance requirements, or are manufactured for Tektronix, Inc. in accordance with our specifications. These special parts are indicated in the parts list by an asterisk preceding the part number. Most of the mechanical parts used in this instrument have been manufactured by Tektronix, Inc. Order all special parts directly from your local Tektronix Field Office or representative.

Ordering Parts. When ordering replacement parts from Tektronix, Inc., include the following information:

1. Instrument Type.
2. Instrument Serial Number.
3. A description of the part (if electrical, include circuit number).
4. Tektronix Part Number.

Soldering Techniques.

WARNING

Disconnect the instrument from the power source before soldering.

Circuit Board. The components mounted on the circuit board in the amplifier can be replaced using normal circuit board soldering techniques. Keep the following points in mind when soldering on the circuit boards:

1. Use a pencil-type soldering iron with a power rating from 15 to 50 watts.
2. Apply heat from the soldering iron quickly to the junction between the component and the circuit board.
3. Heat-shunt the lead of the component by means of a pair of long-nosed pliers.

4. Avoid excessive heating of the junction with the circuit board, as this could separate the circuit board wiring from the laminate.

5. Use electronic grade 60-40 tin-lead solder.

6. Clip off any excess lead length extending beyond the circuit board and clean off any residual flux with a flux-removing solvent. Be careful that the solvent does not remove any printing from the circuit board.

CAUTION

If possible, avoid soldering in the area of R64, a 2.1 Ω disc resistor. This resistor is extremely heat-sensitive, and if overheated will greatly affect the attenuation ratios in the 50 mA through 1 AMP positions of the CURRENT/DIV switch.

Metal Terminals. When soldering metal terminals (e.g., switch terminals, potentiometers, etc), use 60-40 tin-lead solder and a 15 to 50 watt soldering iron. Observe the following precautions when soldering metal terminals:

1. Apply only enough heat to make the solder flow freely.
2. Apply only enough solder to form a solid connection. Excess solder may impair the function of the part.
3. If a wire extends beyond the solder joint, clip off the excess.
4. Clean the flux from the solder joint with a flux removing solvent.

Transistor Replacement

Transistors should not be replaced unless actually defective. If removed from their sockets during routine maintenance, return them to their original sockets. Unnecessary replacement of transistors may affect the calibration of this instrument. When transistors are replaced, check the operation of that part of the instrument which may be affected.

Replacement transistors should be of the original type or a direct replacement. Remount the transistors in the same manner as the original. Fig. 4-2 shows the lead configurations of the transistors used in this instrument. This view is as seen from the bottom of the transistor. When replacing transistors, check the manufacturer's basing diagram for correct basing.

Repairing the Type 134 Amplifier

Removing the Front Panel and Subpanel

1. Remove the CURRENT/DIV switch knob, using a 1/16 inch hexagonal wrench.
2. Remove the probe selector switch knob.

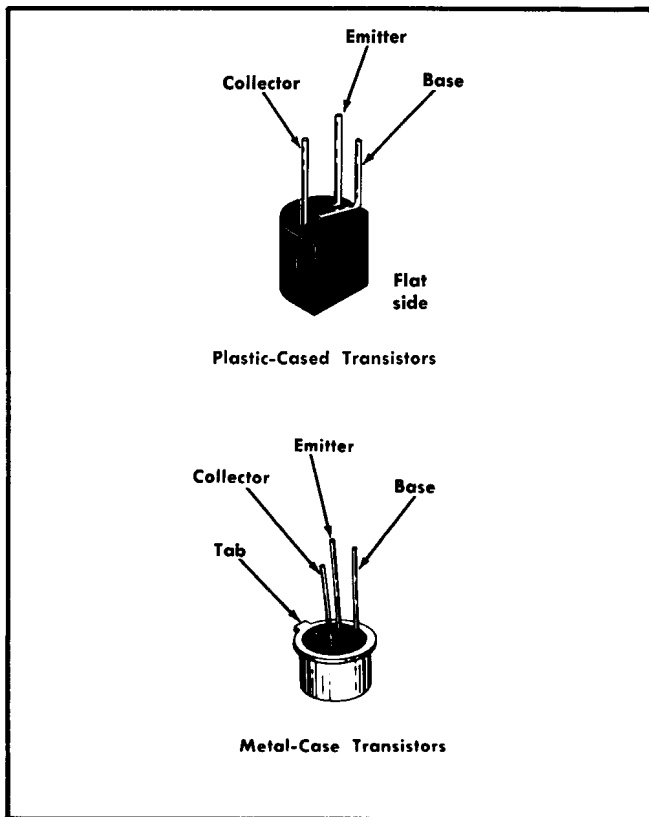

Fig. 4-2. Electrode configuration for transistors in Type 134.

3. Remove the 7/16-inch hexagonal nut from the CURRENT/DIV switch and remove the front panel.

4. Remove the six screws holding the subpanel to the chassis selector switch, and input connector, and remove the subpanel.

Removing the Probe Selector Switch

1. Disconnect the three solderless connectors from pins O, Q, and R of the circuit board.

2. Unsolder the leads from pins D and G of the circuit board.

3. Unsolder C125, and 150 μ F capacitor between the switch and the circuit board.

4. Unsolder the connections to the feed-through tie points in the shield, and remove the switch.

Removing the CURRENT/DIV Switch

1. Disconnect the seven solderless connectors from pins A, B, C, E, I, N, and P of the circuit board.

2. Unsolder the strap from the CURRENT/DIV switch to the two 180 μ F capacitors on the circuit board.

3. Remove the screw from the center of the shield.

4. Turn the amplifier over and unsolder the ground straps between the switch and the circuit board.

5. Remove the switch, input connector, and shield intact.

6. Unsolder the connections to the shield, and to the feed-through tie points in the shield.

7. Unsolder the selector switch portion of the shield from the CURRENT/DIV switch.

8. Unsolder the input BNC connector.

Removing the Circuit Board Assembly

1. After the switches have been removed, remove the five remaining solderless connectors from pins F, H, K, L and M of the circuit board.

2. Unsolder the ground side of the power cord from the circuit board.

3. Remove the two screws from the corners of the circuit board, and remove the circuit board from the chassis.

Repairing the Power Unit

Removing the Cover

Remove the cover by removing the two screws on either side of the AC power cord.

Replacement of the Diodes

Use a heat sink when removing and replacing the diodes. Also, when replacing the diodes, observe the polarity.

CAUTION

Use care and minimum heat when soldering on the power transformer terminals. Overheating can cause the fine wire used in the transformer windings to break loose from the terminals.

Replacement of the Amplifier Power Connector

1. Using a heat sink, unsolder the connections to the diode bridge.

2. Remove the connector from the power unit chassis.

3. Replace the connector and resolder the diode connections.

Replacement of the AC Power Cord

1. Unsolder the connections at the power unit end of the power cord.

2. Remove the power cord from the cover plate.

3. Insert the new power cord into the cover plate.

4. Resolder the power cord connections.

Maintenance—Type 134

Replacement of the Transformer

1. Remove the amplifier power connector and the AC power cord as previously described.
2. Unsolder the two diodes between the transformer and the power unit chassis.
3. Remove the transformer from the chassis.
4. Remove the diode bridge from the secondary and the remaining components from the primary.
5. Replace the transformer by reversing the above procedure.

Installing the Type 134 Hanger

Supplied with the Type 134 is a hanger that may be used to mount the amplifier on the side of the oscilloscope, rather than connecting directly to the vertical input.

1. Using the screws supplied with the hanger, fasten the large portion of the hanger to the right side of the Type 134 (see Fig. 4-3).

2. Position the Type 134 on the left side of the oscilloscope and mark the location of the hanger. The Type 134 should be mounted so that the front panel controls extend beyond the front of the oscilloscope for ease of operation.

3. Drill two 1/8-inch holes in line vertically and separated 1/2 inch.

4. Fasten the small portion of the hanger to the oscilloscope cabinet.

5. Replace the Type 134 in position and connect the amplifier output to the input of the oscilloscope, using the 18-inch BNC male to female cable.

Recalibration After Repair

After any electrical component has been replaced, the performance of that particular circuit should be checked, as well as the performance of other closely related circuits. The Performance Check procedure in Section 5 provides a quick and convenient means of checking instrument operation.

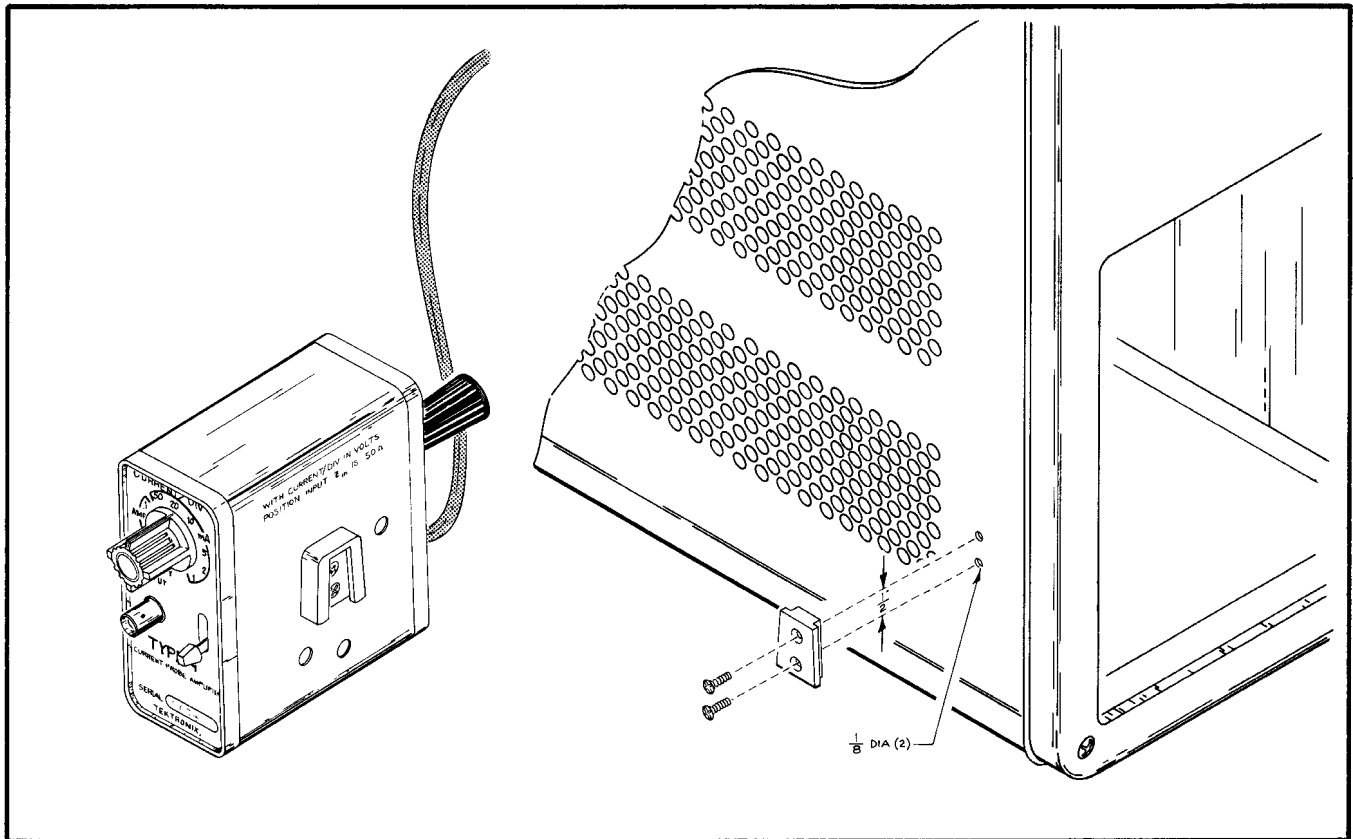

Fig. 4-3. Hanger installation.

SECTION 5

PERFORMANCE CHECK/CALIBRATION

Change information, if any, affecting this section will be found at the rear of the manual.

Introduction

This section provides procedures to be used in checking the performance or in calibrating the Type 134. Limits, tolerances, and waveforms in this section are given as calibration guides and are not necessarily instrument specifications.

To ensure measurement accuracy, check the calibration of the Type 134 every 1000 hours of operation, or every six months if used infrequently. Before calibration, thoroughly clean and inspect the instrument as outlined in the Maintenance section.

Completion of each step in the Calibration Procedure checks this instrument to the original performance standards and gives the procedure to set each adjustment to its optimum setting. Where possible, instrument performance is checked before an adjustment is made. For best overall

instrument performance make each adjustment to the exact setting even if the CHECK is within the allowable tolerance. (See Fig. 5-1 for location of adjustments.)

Short Form Procedure

The Short-Form Procedure lists the step numbers and titles of the complete Performance Check/Calibration Procedure and gives the page on which each step begins. Therefore, the Short-Form Procedure can be used as an index to the steps in the complete procedure.

The Short-Form Procedure lists the adjustments necessary for each step and/or the applicable tolerance for correct calibration. The experienced calibrator who is familiar with the calibration of this instrument can use this procedure to facilitate checking or calibrating this instrument.

The Short-Form Procedure can be reproduced and used

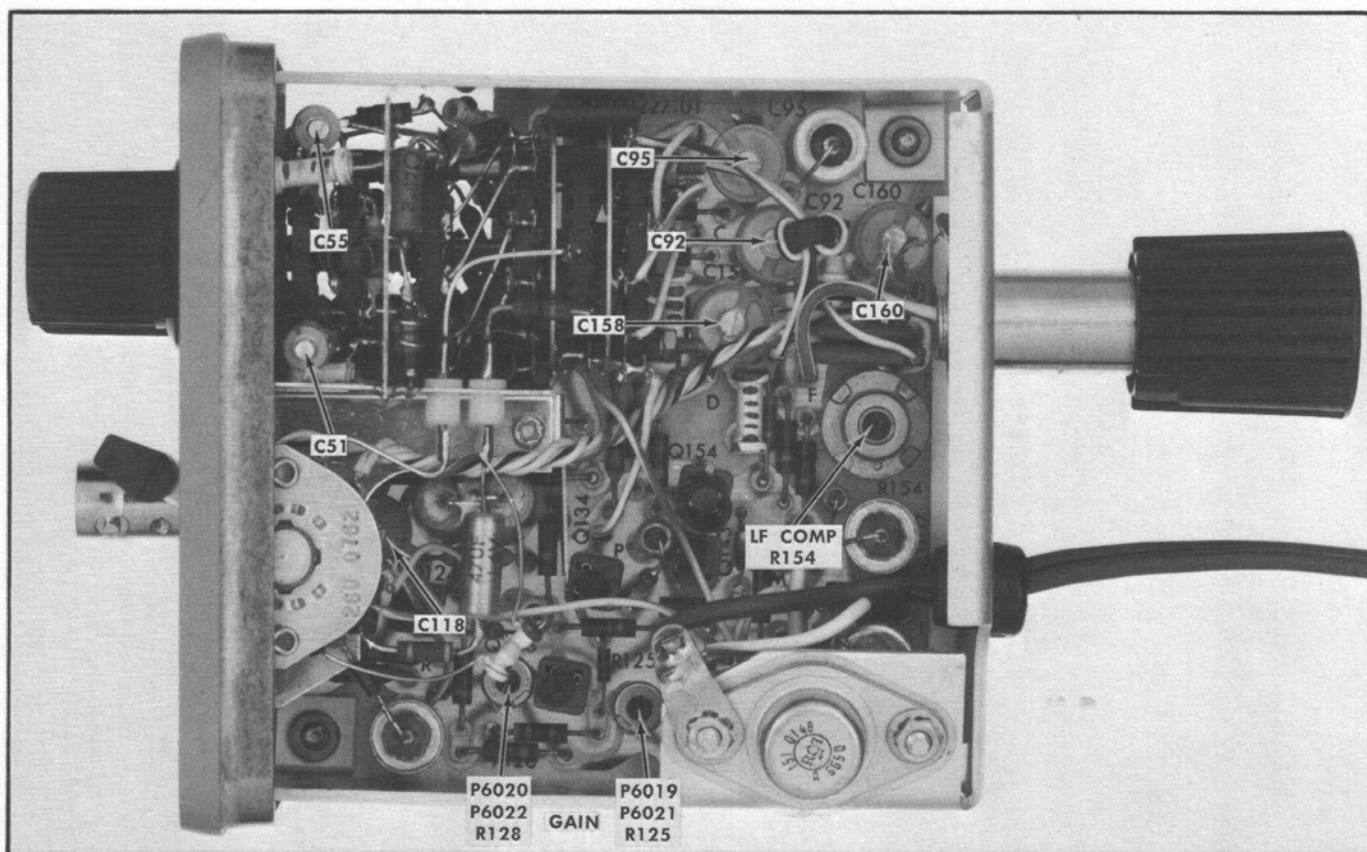

Fig. 5-1. Location of adjustments.

Performance Check/Calibration—Type 134

as a permanent record of instrument calibration. Spaces are provided to record performance data for this instrument or to check off steps as they are completed.

Performance Check

The Calibration Procedure can be used as a performance checkout procedure by completing all portions except the ADJUST— part of a step (with the exception of the LF COMP adjustment). This checks the Type 134 to the original performance without removing the instrument cover.

EQUIPMENT REQUIRED

General

The following items are required for complete calibration of the Type 134. Specifications given are the minimum necessary for accurate calibration. All test equipment is assumed to be correctly calibrated and operating within the given specifications. If equipment is substituted, it must equal or exceed the specifications of the recommended equipment.

For the quickest and most accurate calibration, special Tektronix calibration fixtures are used where necessary. These special calibration fixtures are available from Tektronix, Inc. Order by part number through your local Tektronix Field Office or representative.

1. Test oscilloscope. Bandwidth, DC to 75 MHz; deflection factor, .01 V/cm to .05 V/cm; sweep rate, .05 μ sec/cm to 10 msec/cm. Tektronix 580-series Oscilloscope with Type 86 plug-in unit and P6011 Probe recommended.

2. Square wave generator. Frequency, 60 Hz and 1 kHz; output amplitude, 10 mA to 20 mA when terminated into 50 ohms. Tektronix Type 106 Square Wave Generator recommended.

3. Pulse generator. Risetime, 0.25 nanosecond or less; repetition rate, 550 to 720 pulses/second; output amplitude, variable to 50 mA when terminated into 50 ohms. Tektronix Type 109 Pulse Generator recommended.

4. Constant amplitude sine-wave generator. Frequency, 350 kHz to 54 MHz; reference frequency 50 kHz; output amplitude, 16 mV to 1 V (20 mA into 50 ohms). Tektronix Type 191 Constant Amplitude Signal Generator recommended.

5. Low frequency sine wave generator. Frequency, 2 Hz to 20 kHz; output amplitude, 16 mV to 1 V (20 mA into 50 ohms). For example, General Radio 1310—A Oscillator (use a General Radio Type 274QBJ Adapter to provide BNC output).

6. Variable autotransformer. Output amplitude, variable from 103.5 VAC to 126.5 VAC (207 VAC to 253 VAC). For example, General Radio W10MT3W Metered Variac Autotransformer.

7. DC voltmeter. Impedance, 20,000 ohms/volt. For ex-

ample, Triplett 630—NA.

8. Current probe. Tektronix P6021 (P6019 may be used) and/or P6022 (P6020 may be used) Current Probes.

9. Charge line. Impedance, 50 ohms; electrical length, 60 nanoseconds; connectors, GR. Tektronix Type 113 Delay Cable recommended.

10. Cable (2). Impedance, 50 ohms; type, RG213/U; electrical length, 5 nanoseconds; connectors, GR. Tektronix Part No. 017-0502-00.

11. Cable. Impedance, 50 ohms; Type, RG58/U; length, 42 inches; connectors, BNC. Tektronix Part No. 012-0057-01.

12. High frequency test fixture. Description, 50-ohm terminating current loop; connector, GR. Tektronix Part No. 067-0559-00.

13. Calibrator adapter. Converts 100 mV calibrator square wave output to 4 mA current source; connector, BNC. Tektronix Part No. 013-0092-00.

14. 10X attenuator. Impedance, 50 ohms; connectors, BNC. Tektronix Part No. 011-0059-00.

15. Adapter. Description, GR to BNC male. Tektronix Part No. 017-0064-00.

16. Resistor. Description, -1000 Ω , 1%, 1/4 W. Tektronix Part No. 322-0193-00.

17. Non-conducting adjustment tool. Handle and insert. Tektronix Part Nos. 003-0307-00 and 003-0334-00.

SHORT—FORM PROCEDURE

Type 134, Serial No. _____

Calibration date _____

Calibrated by _____

1. Check Regulation

REQUIREMENT: Power supply output +13.25 to +15.25 VDC at pin L as line voltage is varied between 103.5 and 126.5 VAC (207 and 253 VAC).

PERFORMANCE: Correct _____;
not correct _____.

2. Check Ripple

REQUIREMENT: Power supply ripple of \leq 2 mV.

PERFORMANCE: _____ mV.

Current Mode

3. Adjust LF COMP

REQUIREMENT: LF COMP must adjust for a straight but tilted top on the displayed square wave.

PERFORMANCE: Correct _____; not correct _____.

4. Check Tilt

Type 134 and P6021 Probe

REQUIREMENT: $\leq 3\%$ deviation from horizontal during first 400 μsec of displayed square wave.

PERFORMANCE: Correct _____; not correct _____.

Type 134 and P6022 Probe

REQUIREMENT: $\leq 3\%$ deviation from horizontal during first 80 μsec of displayed square wave.

PERFORMANCE: Correct _____; not correct _____.

5. Check/Adjust GAIN

Type 134 and P6021 Probe (R125)

REQUIREMENT: Correct deflection, $\pm 3\%$.

PERFORMANCE: Correct _____; not correct _____.

Type 134 and P6022 Probe (R128)

REQUIREMENT: Correct deflection, $\pm 3\%$.

PERFORMANCE: Correct _____; not correct _____.

6. Check/Adjust High Frequency Compensation (C118, C160, C95, C92, C51, C53, C55, C158)

REQUIREMENT: Aberrations $\leq 5\%$ (not including effects of test oscilloscope).

PERFORMANCE: Correct _____; not correct _____.

7. Check High Frequency Response

Type 134 and P6021 Probe

REQUIREMENT: High frequency re-

sponse ≥ 35 MHz (with 580-series test oscilloscope).

PERFORMANCE: _____ MHz.

Type 134 and P6022 Probe

REQUIREMENT: High frequency response ≥ 51 MHz (with 580-series test oscilloscope).

PERFORMANCE: _____ MHz.

8. Check Low Frequency Response

Type 134 and P6021 Probe

REQUIREMENT: Low frequency response ≤ 12 Hz.

PERFORMANCE: _____ Hz.

Type 134 and P6022 Probe

REQUIREMENT: Low frequency response ≤ 100 Hz.

PERFORMANCE: _____ Hz.

9. Check Noise

Type 134 and P6021 Probe

REQUIREMENT: Probe and amplifier noise ≤ 150 μA referred to the probe input.

PERFORMANCE: _____ μA .

Type 134 and P6022 Probe

REQUIREMENT: Probe and amplifier noise ≤ 150 μA referred to the probe input.

PERFORMANCE: _____ μA .

Voltage Mode

10. Check Deflection Factor

Selector switch set to P6019/P6021 position

REQUIREMENT: Correct deflection, $\pm 3\%$.

PERFORMANCE: Correct _____; not correct _____.

Selector switch set to P6020/P6022 position

Performance Check/Calibration—Type 134

REQUIREMENT: Correct deflection, $\pm 3\%$.

PERFORMANCE: Correct ____ ;
not correct ____ .

11. Check High Frequency Response

Selector switch set to P6019/P6021 position

REQUIREMENT: High frequency response ≥ 30 MHz.

PERFORMANCE: ____ MHz.

Selector switch set to P6020/P6022 position

REQUIREMENT: High frequency response ≥ 54 MHz.

PERFORMANCE: ____ MHz.

12. Check Low Frequency Response

Selector switch set to P6019/P6021 position

REQUIREMENT: Low frequency response ≤ 10 Hz.

PERFORMANCE: ____ Hz.

Selector switch set to P6020/P6022 position

REQUIREMENT: Low frequency response ≤ 8 Hz.

PERFORMANCE: ____ Hz.

PERFORMANCE CHECK/CALIBRATION PROCEDURE

General

The following procedure is arranged so that the Type 134 can be calibrated with the least interaction of adjustments and reconnection of equipment. The Current Mode portion of the procedure may be completed with either a P6021 Probe (a P6019 may be used) or a P6022 Probe (a P6020 may be used) or both. The performance of the Type 134 as a voltage amplifier is checked after the internal adjustments are made. Each step continues from the equipment setup and control settings used in the preceding step(s) unless otherwise noted. External controls or adjustments of the Type 134 referred to in this procedure are capitalized (e.g., CURRENT/DIV). Internal adjustments are referred to by circuit number only.

All waveforms shown in this procedure were taken with a Tektronix Oscilloscope Camera System. The following procedure uses the equipment listed under Equipment Required. If equipment is substituted, control settings or equipment setup may need to be altered to meet the requirements of the equipment used. Detailed operating instructions for the test equipment is not given in this procedure. If in doubt as to the correct operation of any of the test equipment, refer to the instruction manual for that unit.

NOTE

This instrument should be calibrated at an ambient temperature of $+25^{\circ}\text{C}$, $\pm 5^{\circ}\text{C}$. The performance of this instrument can be checked at any temperature within 0°C to $+40^{\circ}\text{C}$ range.

Preliminary Procedure for Performance Check Only

a. Connect the Type 134 power unit to the line voltage source.

b. Connect the power cable from the amplifier to the power unit.

c. Proceed directly to step 3, omitting steps 1 and 2.

Preliminary Procedure for Complete Calibration

a. Remove the cover from the Type 134 as described on page 4-1.

b. Set the variable line voltage source to 115 volts AC (230 volts AC).

c. Connect the Type 134 power unit to the variable line voltage source.

d. Connect the power cable from the amplifier to the power unit.

CALIBRATION PROCEDURE

1. Check Regulation

a. Connect the DC voltmeter between the emitter of Q107 (pin L of the circuit board) and ground.

b. CHECK—DC voltmeter reading between $+13.25$ and $+15.25$ volts.

c. Vary the line voltage between the limits of 103.5 and 126.5 VAC (207 and 253 VAC).

d. CHECK—DC voltmeter reading between $+13.25$ and $+15.25$ volts. Remove the voltmeter.

e. Return the variable line voltage source to 115 VAC (230 VAC).

2. Check Ripple

- a. Connect the 1X probe from the test oscilloscope to the emitter of Q107 (pin L of the circuit board). Use a ground lead.
- b. CHECK—Power supply ripple of ≥ 2 millivolts peak to peak. Remove the probe.

CURRENT MODE

3. Adjust LF COMP

Type 134 and P6021 Probe

- a. Connect the Type 134 to the input of the test oscilloscope.
- b. Set the test oscilloscope input to DC, and the deflection factor to .05 V/cm, calibrated. Set the sweep rate to 10 msec/cm.
- c. Connect the high-frequency test fixture to the Hi Amplitude output connector of the square wave generator. Set the square wave generator to 60 Hz.
- d. Connect the P6021 probe from the Type 134 input to the high-frequency test fixture (see Fig. 5-2).
- e. Set the Type 134 CURRENT/DIV switch to 5 mA, and the probe selector to the P6019/P6021 position.

- f. Adjust the square wave generator amplitude for two centimeters of deflection.
- g. Set the test oscilloscope triggering controls for a stable display.
- h. ADJUST—LF COMP (R154) for a straight but tilted top on the displayed square wave (see Fig. 5-3).

Type 134 and P6022 Probe

- a. Connect the Type 134 to the input of the test oscilloscope.
- b. Set the test oscilloscope input to DC, and the deflection factor to .05 V/cm, calibrated. Set the sweep rate to 0.5 msec/cm.
- c. Connect the high-frequency test fixture to the Hi Amplitude output connector of the square wave generator. Set the square wave generator to 1 kHz.
- d. Connect the P6022 probe from the Type 134 input to the high-frequency test fixture (similar to Fig. 5-2).
- e. Set the Type 134 CURRENT/DIV switch to 5 mA, and the probe selector to the P6020/P6022 position.

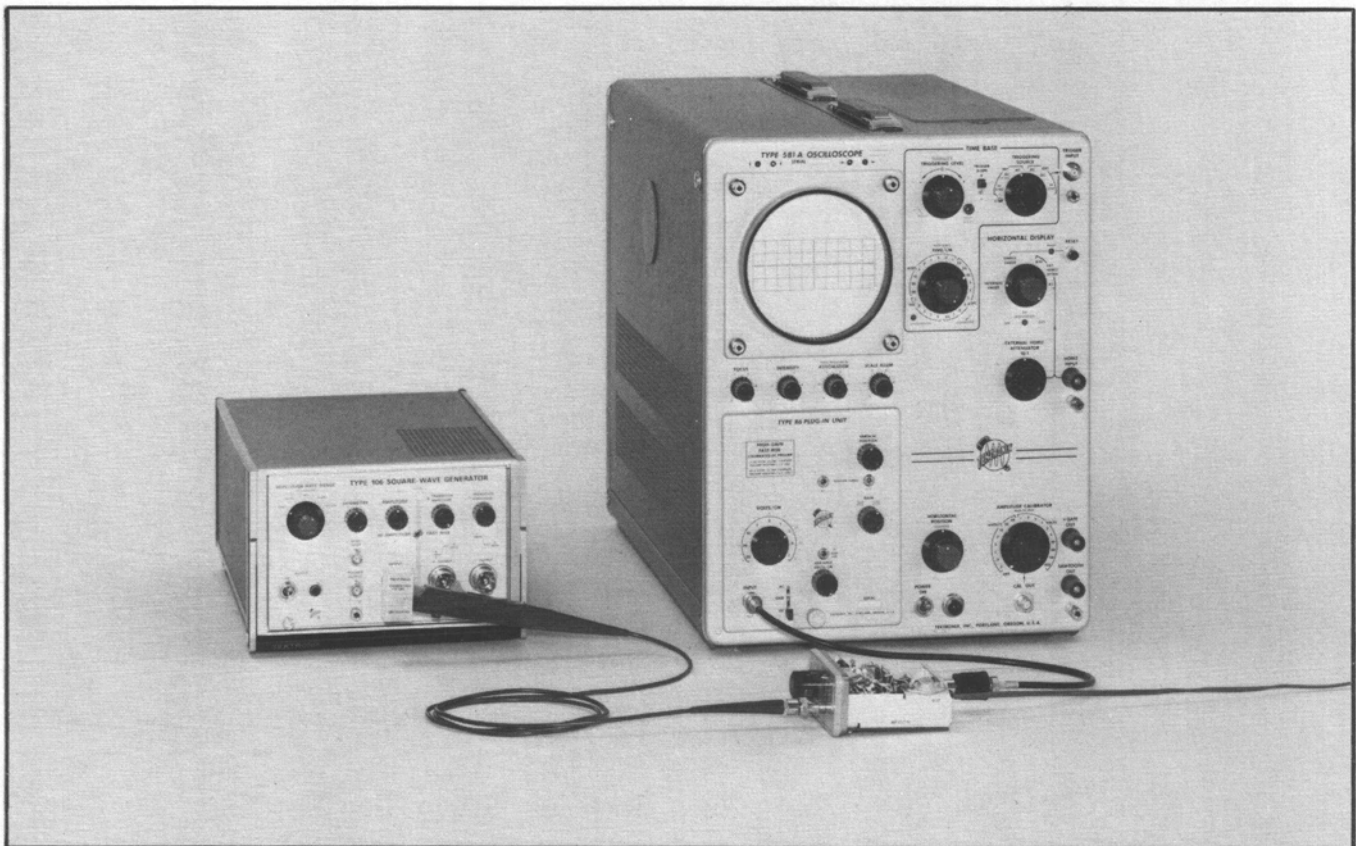

Fig. 5-2. Test setup for LF COMP adjustment.

Performance Check/Calibration—Type 134

f. Adjust the square wave generator amplitude for two centimeters of deflection.

g. Set the test oscilloscope triggering controls for a stable display.

h. ADJUST—LF COMP (R154) for a straight but tilted top on the displayed square wave (similar to Fig. 5-3).

NOTE

When changing from one current probe to another, readjust LF COMP and set the probe selector switch to correspond with the current probe being used.

4. Check Tilt

Type 134 and P6021 Probe

a. Adjust the square wave generator amplitude for four centimeters of deflection (see Fig. 5-4A).

b. Set the test oscilloscope sweep rate to 50 $\mu\text{sec}/\text{cm}$ and position the top of the square wave on the center horizontal line.

c. CHECK—CRT trace of ≤ 0.12 centimeter deviation from horizontal in first eight centimeters, or $\leq 3\%$ deviation from horizontal during first 400 μsec of displayed square wave (see Fig. 5-4B).

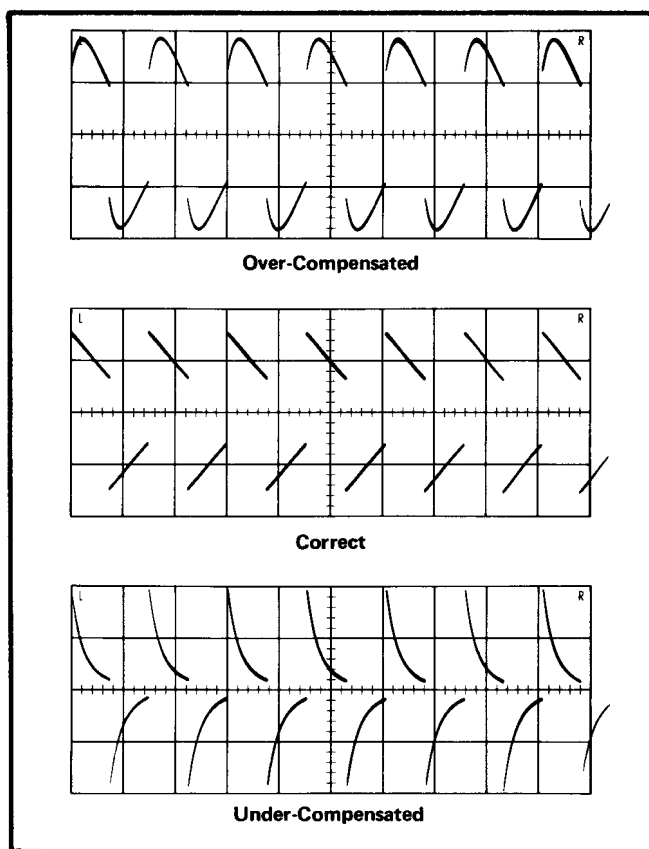

Fig. 5-3. Adjustment of LF COMP.

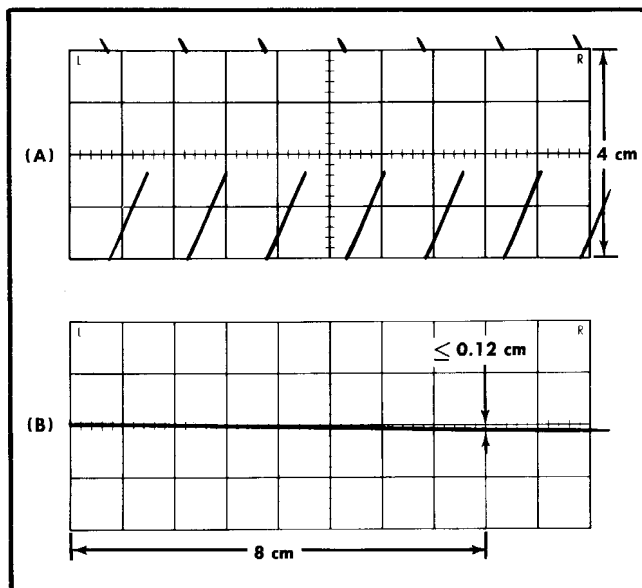

Fig. 5-4. Tilt measurement, showing (A) four-centimeters of deflection and (B) eight-centimeter measurement area.

Type 134 and P6022 Probe

a. Adjust the square wave generator amplitude for four centimeters of deflection (see Fig. 5-4A).

b. Set the test oscilloscope sweep rate to 10 $\mu\text{sec}/\text{cm}$ and position the top of the square wave on the center horizontal line.

c. CHECK—CRT trace of ≤ 0.12 centimeter deviation from horizontal in first eight centimeters, or $\leq 3\%$ deviation from horizontal during first 80 μsec of displayed square wave (see Fig. 5-4B).

5. Check/Adjust GAIN

Type 134 and P6021 Probe

Using Calibrator Adapter (013-0092-00)

a. Connect the calibrator adapter to the calibrator output connector.

b. Set the calibrator to the 100-volt square wave position. In this position, the calibrator adapter produces a 4 mA square wave.

c. Connect the P6021 probe to the calibrator adapter.

d. Set the CURRENT/DIV switch to 1 mA, and the sweep rate to 0.5 msec/cm.

e. CHECK—CRT display of 4 centimeters of deflection, $\pm 3\%$ (not including calibrator error).

f. ADJUST—P6019/P6021 GAIN (R125) for 4 centimeters of deflection.

Using Amplitude Calibrator 5 mA Current Loop

- a. Connect the P6021 probe to the calibrator 5 mA current loop.
- b. Set the calibrator to the 5 mA square wave position.
- c. Set the CURRENT/DIV switch to 2 mA, and the sweep rate to 0.5 msec/cm.
- d. CHECK—CRT display of 2.5 centimeters of deflection, $\pm 3\%$ (not including calibrator error).
- e. ADJUST—P6019/P6021 GAIN (R125) for 2.5 centimeters of deflection.

Type 134 and P6022 Probe

Using Calibrator Adapter (013-0092-00)

- a. Connect the calibrator adapter to the calibrator output connector.
- b. Set the calibrator to the 100-volt square wave position. In this position, the calibrator adapter produces a 4 mA square wave.
- c. Connect the P6022 probe to the calibrator adapter.
- d. Set the CURRENT/DIV switch to 1 mA, and the sweep rate to 0.5 msec/cm.
- e. CHECK—CRT display of 4 centimeters of deflection, $\pm 3\%$ (not including calibrator error).
- f. ADJUST—P6020/P6022 GAIN (R128) for 4 centimeters of deflection.

Using Amplitude Calibrator 5 mA Current Loop

- a. Connect the P6022 probe to the calibrator 5 mA current loop.
- b. Set the calibrator to the 5 mA square wave position.
- c. Set the CURRENT/DIV switch to 2 mA, and the sweep rate to 0.5 msec/cm.
- d. CHECK—CRT display of 2.5 centimeters of deflection, $\pm 3\%$ (not including calibrator error).
- e. ADJUST—P6020/P6022 GAIN (R128) for 2.5 centimeters of deflection.

6. Check/Adjust High Frequency Compensation**NOTE**

When performing calibration with both P6021 and P6022 probes, first complete parts a through r using the P6022. Then perform parts s through w using the P6021. If only one probe type is used, complete the entire step with that probe.

- a. Connect the delay cable to the pulse generator charge line connectors, using the two five-nanosecond coaxial cables.

- b. Connect the high frequency test fixture to the pulse generator output.

- c. Connect the P6022 probe from the Type 134 to the test fixture (see Fig. 5-5).

- d. Set the test oscilloscope sweep rate to .05 $\mu\text{sec/cm}$.

- e. Set the CURRENT/DIV switch to 5 mA and adjust the triggering controls and the pulse generator amplitude for a stable four-centimeter display.

- f. CHECK—Front corner square wave aberrations $\leq 5\%$, not including the effects of the test oscilloscope.

- g. ADJUST—C118 and C160 for best front corner on displayed square wave.

- h. Recheck the display of the 50 mA position of the CURRENT/DIV switch. If the front corner has fast overshoot, readjust C118 and C160 for the best compromise between the 5 mA and 50 mA positions.

- i. Set the CURRENT/DIV switch to 2 mA and adjust the pulse generator for a four-centimeter display.

- j. CHECK—Front corner square wave aberrations of $\leq 5\%$, not including the effects of the test oscilloscope.

- k. ADJUST—C95 for best front corner on displayed square wave.

- l. Set the CURRENT/DIV switch to 1 mA and adjust the pulse generator for a four-centimeter display.

- m. CHECK—Front corner square wave aberrations of $\leq 5\%$, not including the effects of the test oscilloscope.

- n. ADJUST—C92 and C51 for best front corner on displayed square wave.

- o. Set the CURRENT/DIV switch to 20 mA and adjust the pulse generator for a four-centimeter display.

- p. CHECK—Front corner square wave aberrations of $\leq 5\%$, not including the effects of the test oscilloscope.

- q. Set the CURRENT/DIV switch to 5 mA and adjust the pulse generator for a four-centimeter display.

- r. CHECK—Front corner square wave aberrations of 5%, not including the effects of the test oscilloscope.

- s. ADJUST—C55 for minimum aberrations.

NOTE

When checking the 20 mA setting, LR71 may need positioning for best response. Use a short ground lead on the probe when checking the positions from 20 mA to 1 A.

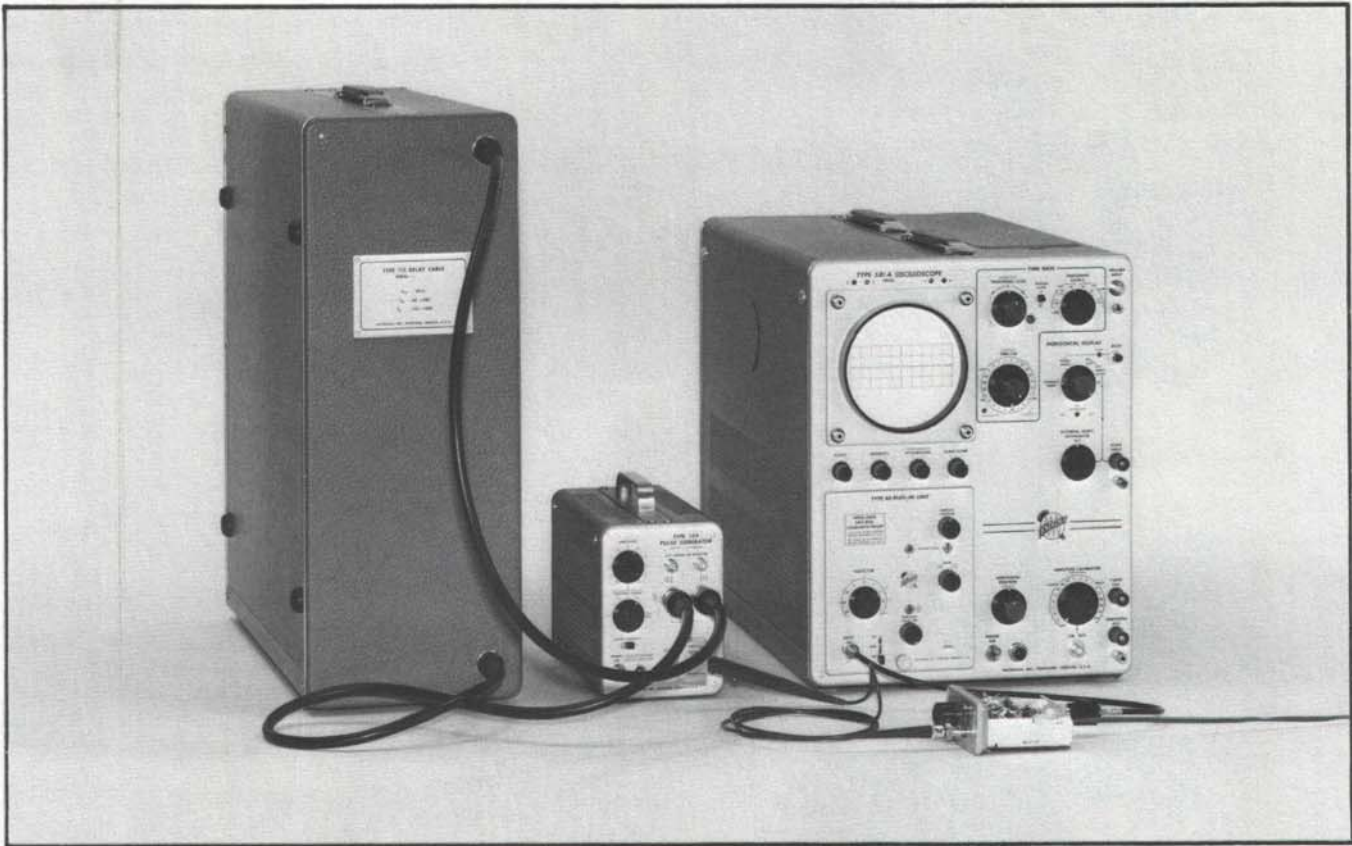

Fig. 5-5. Test setup for high-frequency compensation adjustments.

t. Recheck the 1 mA through 1 A positions of the CURRENT/DIV switch for shape and risetime of the waveform.

u. Connect a P6021 probe to the Type 134, set the probe selector switch to the P6019/P6021 position, and check LF COMP. Connect the probe to the pulse generator output.

v. Set the CURRENT/DIV switch to 5 mA and adjust the pulse generator for a four-centimeter display.

w. CHECK—Front corner square wave aberrations of $\leq 5\%$, not including the effects of the test oscilloscope.

x. ADJUST—C158 for best front corner on displayed square wave.

y. Check compensation in all positions of the CURRENT/DIV switch. If the 1 mA position has overshoot, readjust C92 and recheck with the P6022.

7. Check High Frequency Response

Type 134 and P6021 Probe

a. Connect the high-frequency test fixture to the output of the constant amplitude signal generator.

b. Connect the P6021 probe from the Type 134 to the test fixture (see Fig. 5-6).

c. Set the CURRENT/DIV switch to 5 mA and the sweep rate to 20 $\mu\text{sec}/\text{cm}$.

d. Set the constant amplitude signal generator to KHz and adjust the output amplitude for four centimeters of deflection (see Fig. 5-7A).

e. Increase the frequency of the signal generator until the display reduces in amplitude to 2.8 centimeters (see Fig. 5-7B).

f. CHECK—Frequency setting of constant amplitude signal generator of ≥ 35 MHz (with 580-series test oscilloscope. Refer to Section 1 for other examples).

g. Remove the probe and test fixture from the signal generator output.

Type 134 and P6022 Probe

a. Connect the high-frequency test fixture to the output of the constant amplitude signal generator.

b. Connect the P6022 probe from the Type 134 to the test fixture (similar to Fig. 5-6).

c. Set the CURRENT/DIV switch to 5 mA and the sweep rate to 20 $\mu\text{sec}/\text{cm}$.

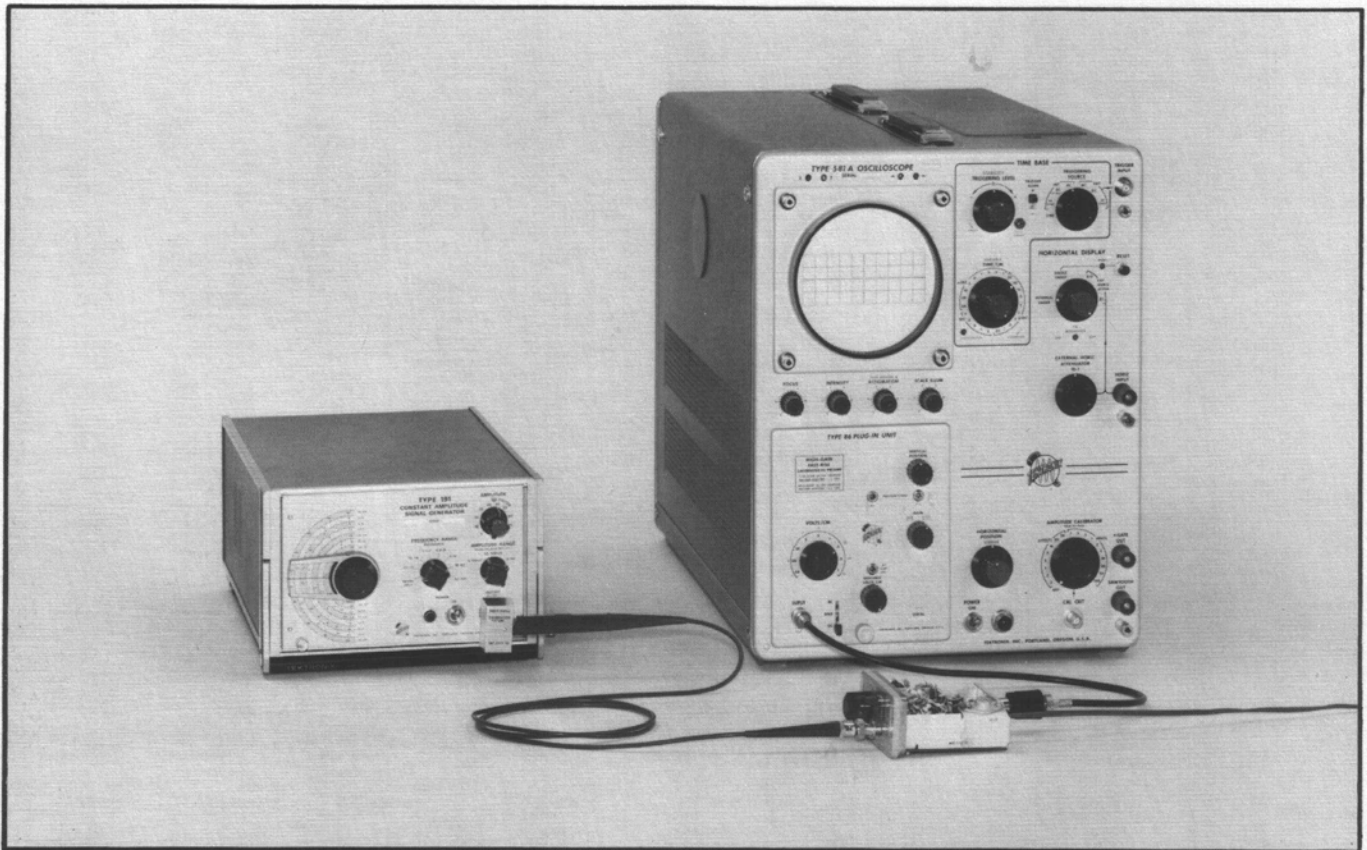

Fig. 5-6. Test setup for high-frequency response check.

d. Set the constant amplitude signal generator to 50 kHz and adjust the output amplitude for four centimeters of deflection (see Fig. 5-7A).

e. Increase the frequency of the signal generator until the display reduces in amplitude to 2.8 centimeters (see Fig. 5-7B).

f. CHECK—Frequency setting of constant amplitude signal generator of ≥ 51 MHz (with 580-series test oscilloscope. Refer to Section 1 for other examples).

g. Remove the probe and test fixture from the signal generator output.

8. Check Low Frequency Response

Type 134 and P6021 Probe

a. Connect the high-frequency test fixture to the output of the low-frequency sine wave generator.

b. Connect the P6021 probe from the Type 134 to the test fixture (see Fig. 5-8).

c. Set the test oscilloscope sweep rate to 50 $\mu\text{sec}/\text{cm}$.

d. Set the frequency of the sine wave generator to 20 kHz and adjust the output amplitude for four centimeters of deflection (see Fig. 5-9A).

e. Reduce the frequency of the sine wave generator until the display reduces in amplitude to 2.8 centimeters. Set the test oscilloscope sweep rate as required (see Fig. 5-9B).

f. CHECK—Sine wave generator frequency setting of ≤ 12 Hz.

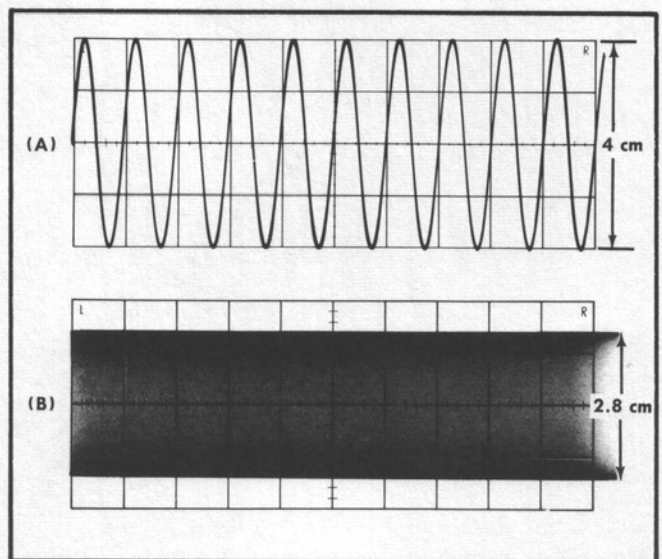

Fig. 5-7. High-frequency response check, showing (A) 4-centimeter display and (B) 2.8-centimeter display.

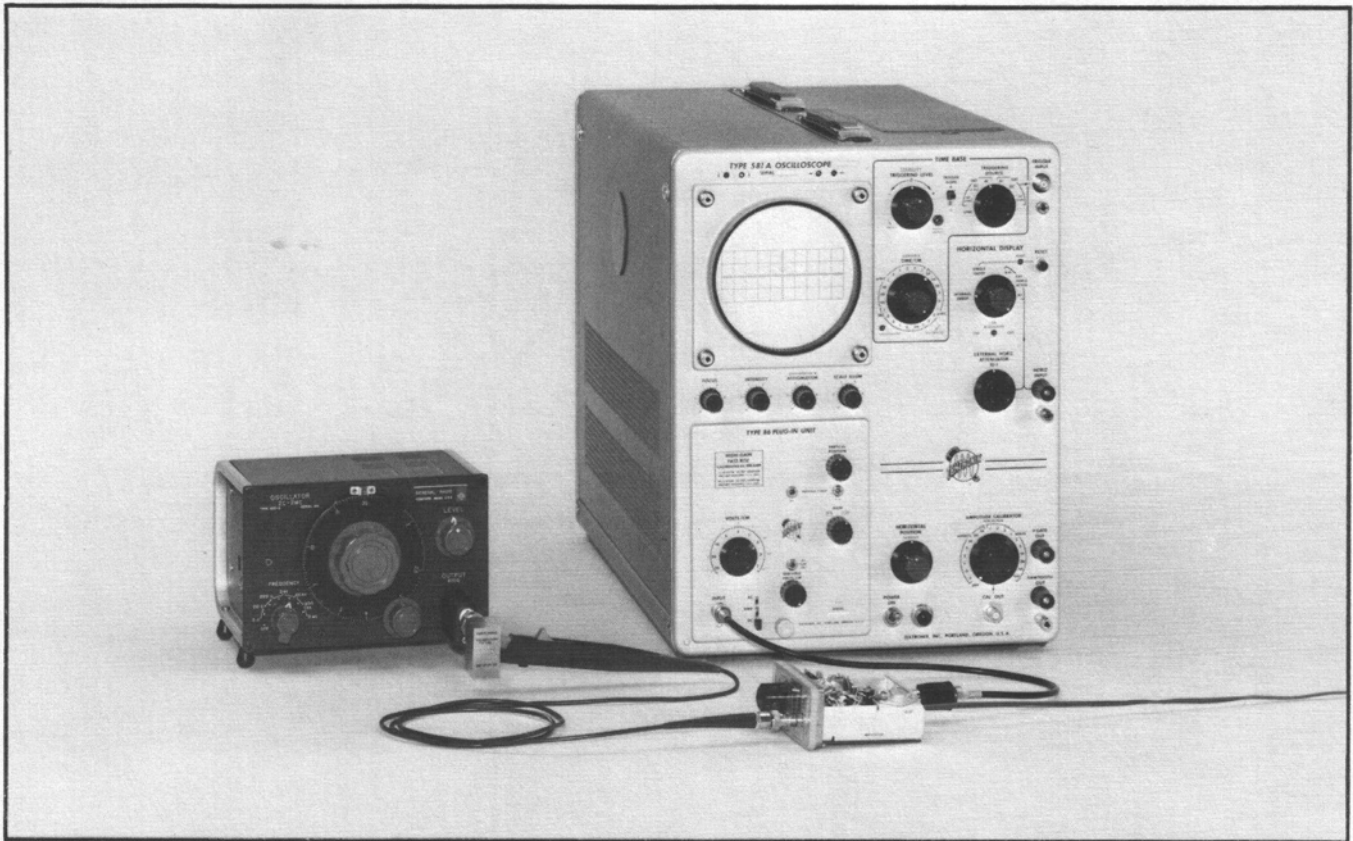

Fig. 5-8. Test setup for low-frequency response check.

g. Remove the probe and test fixture from the sine wave generator output.

Type 134 and P6022 Probe

a. Connect the high-frequency test fixture to the output of the low-frequency sine wave generator.

b. Connect the P6022 probe from the Type 134 to the test fixture (similar to Fig. 5-8).

c. Set the test oscilloscope sweep rate to 50 $\mu\text{sec}/\text{cm}$.

d. Set the frequency of the sine wave generator to 20 kHz and adjust the output amplitude for four centimeters of deflection (see Fig. 5-9A).

e. Reduce the frequency of the sine wave generator until the display reduces in amplitude to 2.8 centimeters. Set the test oscilloscope sweep rate as required (see Fig. 5-9B).

f. CHECK—Sine wave generator frequency setting of ≤ 100 Hz.

g. Remove the probe and test fixture from the sine wave generator output.

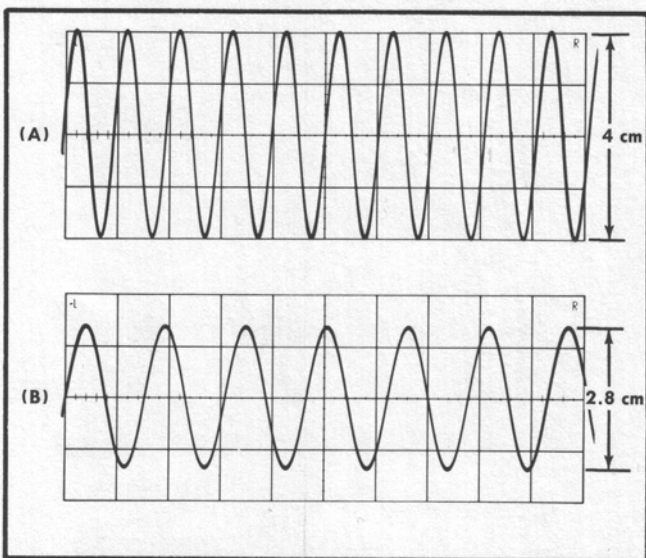

Fig. 5-9. Low-frequency response check, showing (A) 4-centimeter display and (B) 2.8-centimeter display.

9. Check Noise

Type 134 and P6021 Probe

a. Set the test oscilloscope deflection factor to .01 V/cm, and the sweep rate to 50 $\mu\text{sec}/\text{cm}$.

b. Set the CURRENT/DIV switch to 1 mA.

c. Close the P6021 probe slider.

- d. CHECK—CRT noise display of ≤ 0.75 centimeter peak to peak ($\leq 150 \mu\text{A}$ referred to the probe input).
- e. Remove the P6021 probe from the Type 134 input.

Type 134 and P6022 Probe

- a. Set the test oscilloscope deflection factor to .01 V/cm, and the sweep rate to 50 $\mu\text{sec/cm}$.
- b. Set the CURRENT/DIV switch to 1 mA.
- c. Close the P6022 probe slider.
- d. CHECK—CRT noise display of ≤ 0.75 centimeter peak to peak ($\leq 150 \mu\text{A}$ referred to the probe input).
- e. Remove the P6022 probe from the Type 134 input.

VOLTAGE MODE

10. Check Deflection Factor

- a. Set the test oscilloscope deflection factor to .05 V/cm and the sweep rate to 0.5 msec/cm.
- b. Set the CURRENT/DIV switch to VOLTS ONLY, and the probe selector switch to the P6019/P6021 position.
- c. Set the 580-series calibrator to 20 mV output.
- d. Connect the calibrator output through the 1000-ohm resistor to the Type 134 input.
- e. CHECK—CRT deflection of 2 centimeters, $\pm 3\%$ (gain set by R125 in step 5).
- f. Set the calibrator to 50 mV output.
- g. Set the probe selector switch to the P6020/P6022 position.
- h. CHECK—CRT deflection of 2 centimeters, $\pm 3\%$ (gain set by R128 in step 5).

11. Check High Frequency Response

- a. Connect the output of the constant amplitude signal generator, through a 10X attenuator, to the Type 134 input.
- b. Set the probe selector switch to the P6019/P6021 position.
- c. Set the sweep rate to 20 $\mu\text{sec/cm}$.
- d. Set the constant amplitude signal generator to 50 kHz and adjust the output amplitude for four centimeters of deflection.

e. Increase the frequency of the signal generator until the display reduces in amplitude to 2.8 centimeters.

f. CHECK—Frequency setting of constant amplitude signal generator ≥ 30 MHz.

g. Set the probe selector switch to the P6020/P6022 position

h. Set the constant amplitude signal generator to 50 kHz and adjust the output amplitude for four centimeters of deflection.

i. Increase the frequency of the signal generator until the display reduces in amplitude to 2.8 centimeters.

j. CHECK—Frequency setting of the constant amplitude signal generator ≥ 54 MHz.

12. Check Low Frequency Response

- a. Connect the output of the low-frequency constant amplitude sine wave generator, through the 10X attenuator, to the Type 134 input.
- b. Set the probe selector switch to the P6019/P6021 position.
- c. Set the sweep rate to 20 $\mu\text{sec/cm}$.
- d. Set the sine wave generator to 20 kHz and adjust the output amplitude for four centimeters of deflection.
- e. Reduce the frequency of the sine wave generator until the display reduces in amplitude 2.8 centimeters. Set the test oscilloscope sweep rate as required.
- f. CHECK—Sine wave generator frequency setting ≤ 10 Hz.
- g. Set the probe selector switch to the P6020/P6022 position.
- h. Set the sweep rate to 20 $\mu\text{sec/cm}$.
- i. Set the sine wave generator to 20 kHz and adjust the output amplitude for four centimeters of deflection.
- j. Reduce the frequency of the sine wave generator until the display reduces in amplitude to 2.8 centimeters. Set the test oscilloscope sweep rate as required.
- k. CHECK—Sine wave generator frequency setting ≤ 8 Hz.
- l. Remove all test equipment.

PARTS LIST ABBREVIATIONS

BHB	binding head brass	int	internal
BHS	binding head steel	lg	length or long
cap.	capacitor	met.	metal
cer	ceramic	mtg hdw	mounting hardware
comp	composition	OD	outside diameter
conn	connector	OHB	oval head brass
CRT	cathode-ray tube	OHS	oval head steel
csk	countersunk	PHB	pan head brass
DE	double end	PHS	pan head steel
dia	diameter	plstc	plastic
div	division	PMC	paper, metal cased
elect.	electrolytic	poly	polystyrene
EMC	electrolytic, metal cased	prec	precision
EMT	electrolytic, metal tubular	PT	paper, tubular
ext	external	PTM	paper or plastic, tubular, molded
F & I	focus and intensity	RHB	round head brass
FHB	flat head brass	RHS	round head steel
FHS	flat head steel	SE	single end
Fil HB	fillister head brass	SN or S/N	serial number
Fil HS	fillister head steel	SW	switch
h	height or high	TC	temperature compensated
hex.	hexagonal	THB	truss head brass
HHB	hex head brass	thk	thick
HHS	hex head steel	THS	truss head steel
HSB	hex socket brass	tub.	tubular
HSS	hex socket steel	var	variable
ID	inside diameter	w	wide or width
incd	incandescent	WW	wire-wound

PARTS ORDERING INFORMATION

Replacement parts are available from or through your local Tektronix, Inc. Field Office or representative.

Changes to Tektronix instruments are sometimes made to accommodate improved components as they become available, and to give you the benefit of the latest circuit improvements developed in our engineering department. It is therefore important, when ordering parts, to include the following information in your order: Part number, instrument type or number, serial or model number, and modification number if applicable.

If a part you have ordered has been replaced with a new or improved part, your local Tektronix, Inc. Field Office or representative will contact you concerning any change in part number.

SPECIAL NOTES AND SYMBOLS

- | | |
|--------------------------|---|
| ×000 | Part first added at this serial number |
| 00× | Part removed after this serial number |
| *000-0000-00 | Asterisk preceding Tektronix Part Number indicates manufactured by or for Tektronix, Inc., or reworked or checked components. |
| Use 000-0000-00 | Part number indicated is direct replacement. |
| ⓘ | Screwdriver adjustment. |
| <input type="checkbox"/> | Control, adjustment or connector. |

SECTION 6

ELECTRICAL PARTS LIST

Values are fixed unless marked Variable.

Ckt. No.	Tektronix Part No.	Serial/Model No. Eff Disc	Description			
Capacitors						
Tolerance $\pm 20\%$ unless otherwise indicated.						
C51	281-0123-00		5-25 pF, Var	Cer	100 V	
C52	281-0657-00		13 pF	Cer	500 V	2%
C53	281-0564-00		24 pF	Cer	500 V	5%
C55	281-0123-00		5-25 pF, Var	Cer	100 V	
C57	281-0612-00		5.6 pF	Cer	200 V	± 0.5 pF
C66	281-0603-00		39 pF	Cer	500 V	5%
C68	283-0054-00		150 pF	Cer	200 V	5%
C73	281-0651-00		47 pF	Cer	200 V	5%
C75	281-0617-00		15 pF	Cer	200 V	
C92	281-0092-00		9-35 pF, Var	Cer		
C95	281-0091-00		2-8 pF, Var	Cer		
C98	283-0059-00		1 μ F	Cer	25 V	+80%—20%
C99	290-0326-00		820 μ F	EMT	6 V	10%
C105	290-0273-00		68 μ F	EMT	60 V	10%
C106	290-0296-00		100 μ F	EMT	20 V	
C107	290-0296-00		100 μ F	EMT	20 V	
C108	290-0267-00		1 μ F	EMT	35 V	
C110	290-0139-00		180 μ F	EMT	6 V	
C112	290-0139-00		180 μ F	EMT	6 V	
C114	290-0167-00		10 μ F	EMT	15 V	
C118	281-0092-00		9-35 pF, Var	Cer		
C121	290-0138-00		330 μ F	EMT	6 V	
C125	290-0248-01		150 μ F	EMT	15 V	
C130	290-0297-00		39 μ F	EMT	10 V	10%
C131	281-0616-00		6.8 pF	Cer	200 V	
C132	290-0114-00		47 μ F	EMC	6 V	
C139	281-0546-00		330 pF	Cer	500 V	10%
C140	290-0134-00		22 μ F	EMT	15 V	
C146	290-0246-00		3.3 μ F	EMT	15 V	10%
C151	281-0589-00		170 pF	Cer	500 V	5%
C156	281-0528-00		82 pF	Cer	500 V	10%
C158	281-0092-00		9-35 pF, Var	Cer		
C160	281-0092-00		9-35 pF, Var	Cer		
C161	281-0650-00		18 pF	Cer	200 V	10%
C163	283-0026-00		0.2 μ F	Cer	25 V	
C165	283-0059-00		1 μ F	Cer	25 V	+80%—20%

Electrical Parts List—Type 134

Diodes

Ckt. No.	Tektronix Part No.	Serial/Model No. Eff	Disc	Description
D101	*152-0107-00		Silicon	Replaceable by 1N647
D102	*152-0107-00		Silicon	Replaceable by 1N647
D103	*152-0107-00		Silicon	Replaceable by 1N647
D104	*152-0107-00		Silicon	Replaceable by 1N647
D105	*152-0107-00		Silicon	Replaceable by 1N647
D106	*152-0107-00		Silicon	Replaceable by 1N647
D107	152-0243-00		Zener	1N965B, 0.4 W, 15 V, 5%

Fuse

F101	159-0056-00		0.1 A	Fast-Blo, (115 V Power Supply Only)
------	-------------	--	-------	-------------------------------------

Connectors

J51	131-0278-00		BNC, 2 hole mounted
J169	131-0319-00		BNC, locking male cable end

Inductors

L60	*108-0395-00		Toroid, 64 μ H
L62	*108-0395-00		Toroid, 64 μ H
L79	276-0543-00		Core, Ferrite
L81	276-0543-00		Core, Ferrite
LR57	*108-0330-00		0.4 μ H (wound on a 56 Ω , 1/4 W, 5% resistor)
LR71	*108-0399-00		0.03 μ H (wound on a 5.6 Ω , 1/4 W, 5% resistor)
LR83	*108-0398-00		0.4 μ H (wound on a 16 Ω , 1/4 W, 5% resistor)
LR126	*108-0423-00		0.17 μ H (wound on a 56 Ω , 1/8 W, 5% resistor)
LR136	*108-0268-01		0.1 μ H (wound on a 36 Ω , 1/8 W, 5% resistor)

Transistors

Q107	*151-0148-00		Silicon	Selected RCA 40250
Q114	*151-0195-00		Silicon	Replaceable by MPS-6515
Q124	*151-0195-00		Silicon	Replaceable by MPS-6515
Q133	*151-0198-00		Silicon	Replaceable by MPS-918
Q134	*151-0198-00		Silicon	Replaceable by MPS-918
Q143	*151-0192-00		Silicon	Replaceable by MPS-6521
Q154	*151-0109-00		Silicon	Selected from 2N918

Resistors

Ckt. No.	Tektronix Part No.	Serial/Model No. Eff	Disc	Description	
Resistors are fixed, composition, $\pm 20\%$ unless otherwise indicated.					
R51	317-0750-00		75 Ω	$\frac{1}{8}$ W	5%
R53	317-0910-00		91 Ω	$\frac{1}{8}$ W	5%
R55	317-0820-00		82 Ω	$\frac{1}{8}$ W	5%
R60	321-0079-00		64.9 Ω	$\frac{1}{8}$ W	Prec 1%
R62	321-0079-00		64.9 Ω	$\frac{1}{8}$ W	Prec 1%
R64	307-0097-00		2.1 Ω	1 W	1%
R66	317-0620-00		62 Ω	$\frac{1}{8}$ W	5%
R67	321-0066-01		47.5 Ω	$\frac{1}{8}$ W	Prec $\frac{1}{2}\%$
R68	317-0151-00		150 Ω	$\frac{1}{8}$ W	5%
R70	325-0013-00		6 Ω	$\frac{1}{2}$ W	Prec 1%
R71	325-0012-00		2.67 Ω	$\frac{1}{2}$ W	Prec 1%
R73	321-0023-01		16.9 Ω	$\frac{1}{8}$ W	Prec $\frac{1}{2}\%$
R75	321-1056-01		37.9 Ω	$\frac{1}{8}$ W	Prec $\frac{1}{2}\%$
R77	321-1087-01		79.6 Ω	$\frac{1}{8}$ W	Prec $\frac{1}{2}\%$
R79	321-0127-01		205 Ω	$\frac{1}{8}$ W	Prec $\frac{1}{2}\%$
R81	321-0127-01		205 Ω	$\frac{1}{8}$ W	Prec $\frac{1}{2}\%$
R91	321-0078-01		63.4 Ω	$\frac{1}{8}$ W	Prec $\frac{1}{2}\%$
R92	315-0510-00		51 Ω	$\frac{1}{4}$ W	5%
R94	321-0114-01		150 Ω	$\frac{1}{8}$ W	Prec $\frac{1}{2}\%$
R95	315-0910-00		91 Ω	$\frac{1}{4}$ W	5%
R99	321-0173-01		619 Ω	$\frac{1}{8}$ W	Prec $\frac{1}{2}\%$
R101	308-0291-00		2 k Ω	3 W	WW 5% (230 V Pwr. Supply only)
R102	308-0230-00		2.7 k Ω	3 W	WW 5% (230 V Pwr. Supply only)
R105	315-0911-00		910 Ω	$\frac{1}{4}$ W	5%
R106	315-0561-00		560 Ω	$\frac{1}{4}$ W	5%
R111	315-0622-00		6.2 k Ω	$\frac{1}{4}$ W	5%
R114	321-0207-00		1.4 k Ω	$\frac{1}{8}$ W	Prec 1%
R115	321-0173-01		619 Ω	$\frac{1}{8}$ W	Prec $\frac{1}{2}\%$
R118	315-0153-00		15 k Ω	$\frac{1}{4}$ W	5%
R119	321-0126-00		200 Ω	$\frac{1}{8}$ W	Prec 1%
R120	315-0560-00		56 Ω	$\frac{1}{4}$ W	5%
R121	315-0181-00		180 Ω	$\frac{1}{4}$ W	5%
R124	315-0151-00		150 Ω	$\frac{1}{4}$ W	5%
R125	311-0622-00		100 Ω , Var		
R127	315-0101-00		100 Ω	$\frac{1}{4}$ W	5%
R128	311-0622-00		100 Ω , Var		
R129	315-0201-00		200 Ω	$\frac{1}{4}$ W	5%
R130	315-0151-00		150 Ω	$\frac{1}{4}$ W	5%
R131	315-0750-00		75 Ω	$\frac{1}{4}$ W	5%
R132	315-0471-00		470 Ω	$\frac{1}{4}$ W	5%

Electrical Parts List—Type 134

Resistors (Cont)

Ckt. No.	Tektronix Part No.	Serial/Model No. Eff	Disc	Description	
R133	315-0113-00		11 k Ω	1/4 W	5%
R134	315-0822-00		8.2 k Ω	1/4 W	5%
R135	315-0332-00		3.3 k Ω	1/4 W	5%
R136	315-0221-00		220 Ω	1/4 W	5%
R137	317-0101-00		100 Ω	1/8 W	5%
R138	321-0174-01		634 Ω	1/8 W	Prec 1/2%
R139	315-0432-00		4.3 k Ω	1/4 W	5%
R140	315-0560-00		56 Ω	1/4 W	5%
R142	315-0562-00		5.6 k Ω	1/4 W	5%
R144	315-0271-00		270 Ω	1/4 W	5%
R146	315-0562-00		5.6 k Ω	1/4 W	5%
R147	315-0562-00		5.6 k Ω	1/4 W	5%
R150	315-0510-00		51 Ω	1/4 W	5%
R151	315-0301-00		300 Ω	1/4 W	5%
R153	315-0202-00		2 k Ω	1/4 W	5%
R154	311-0624-00		200 k Ω , Var		
R156	317-0101-00		100 Ω	1/8 W	5%
R157	315-0430-00		43 Ω	1/4 W	5%
R159	315-0510-00		51 Ω	1/4 W	5%
R160	317-0430-00		43 Ω	1/8 W	5%

Switches

	Wired or Unwired		
SW10	Wired *262-0765-01	Rotary	CURRENT/DIV
SW10	260-0761-00	Rotary	CURRENT/DIV
SW130	260-0762-00	Lever	PROBE SELECTOR

Transformers

T101	*120-0436-00	Power
T164	276-0557-00	Core, Toroid

FIGURE AND INDEX NUMBERS

Items in this section are referenced by figure and index numbers to the illustrations which appear on the pullout pages immediately following the Diagrams section of this instruction manual.

INDENTATION SYSTEM

This mechanical parts list is indented to indicate item relationships. Following is an example of the indentation system used in the Description column.

Assembly and/or Component
Detail Part of Assembly and/or Component
mounting hardware for Detail Part
Parts of Detail Part
mounting hardware for Parts of Detail Part
mounting hardware for Assembly and/or Component

Mounting hardware always appears in the same indentation as the item it mounts, while the detail parts are indented to the right. Indented items are part of, and included with, the next higher indentation.

Mounting hardware must be purchased separately, unless otherwise specified.

PARTS ORDERING INFORMATION

Replacement parts are available from or through your local Tektronix, Inc. Field Office or representative.

Changes to Tektronix instruments are sometimes made to accommodate improved components as they become available, and to give you the benefit of the latest circuit improvements developed in our engineering department. It is therefore important, when ordering parts, to include the following information in your order: Part number, instrument type or number, serial or model number, and modification number if applicable.

If a part you have ordered has been replaced with a new or improved part, your local Tektronix, Inc. Field Office or representative will contact you concerning any change in part number.

Change information, if any, is located at the rear of this manual.

ABBREVIATIONS AND SYMBOLS

For an explanation of the abbreviations and symbols used in this section, please refer to the page immediately preceding the Electrical Parts List in this instruction manual.

INDEX OF MECHANICAL PARTS LIST ILLUSTRATIONS
(Located behind diagrams)

FIG. 1 TYPE 134 EXPLODED VIEW

FIG. 2 115 V POWER SUPPLY

FIG. 3 230 V POWER SUPPLY

SECTION 7

MECHANICAL PARTS LIST

FIG. 1 TYPE 134 EXPLODED VIEW

Fig. & Index No.	Tektronix Part No.	Serial/Modal No.		Q † Y	Description
		Eff	Disc		
1-1	015-0057-01			1	TYPE 134 CURRENT PROBE AMPLIFIER
	- - - - -			-	amplifier includes:
-1	333-0931-02			1	PANEL, front
-2	200-0327-02			1	COVER, box
-3	366-0322-01			1	KNOB, charcoal—CURRENT/DIV
	- - - - -			-	knob includes:
	213-0004-00			1	SCREW, set, 6-32 x 3/16 inch, HSS
-4	262-0765-01			1	SWITCH, wired—CURRENT/DIV
	- - - - -			-	switch includes:
	260-0761-00			1	SWITCH, unwired—CURRENT/DIV
	- - - - -			-	mounting hardware: (not included w/switch)
-5	210-0840-00			1	WASHER, flat, 0.390 ID x 9/16 inch OD
-6	210-0590-00			1	NUT, hex., 3/8-32 x 7/16 inch
-7	366-0215-01			1	KNOB, charcoal—PROBE SELECTOR
-8	260-0762-00			1	SWITCH, lever—PROBE SELECTOR
	- - - - -			-	mounting hardware: (not included w/switch)
-9	211-0101-00			2	SCREW, 4-40 x 1/4 inch, 100° csk, FHS
-10	210-0004-00			2	LOCKWASHER, internal, #4
-11	210-0406-00			2	NUT, hex., 4-40 x 3/16 inch
-12	131-0158-00			2	CONNECTOR, feed thru
-13	337-0820-00			1	SHIELD, probe selector switch
	- - - - -			-	mounting hardware: (not included w/shield)
	213-0055-00			1	SCREW, thread forming, 2-32 x 3/16 inch
-14	131-0278-00			1	CONNECTOR, coaxial, 1 contact, BNC
	- - - - -			-	mounting hardware: (not included w/connector)
-15	211-0038-00			2	SCREW, 4-40 x 5/16 inch, 82° csk, FHS
-16	210-0586-00			2	NUT, keps, 4-40 x 1/4 inch
-17	407-0227-00			1	BRACKET, frame
	- - - - -			-	mounting hardware: (not included w/bracket)
-18	211-0101-00			2	SCREW, 4-40 x 1/4 inch, 100° csk, FHS
-19	- - - - -			1	TRANSISTOR
	- - - - -			-	mounting hardware: (not included w/transistor)
-20	386-0143-00			1	WASHER, mica
-21	211-0012-00			2	SCREW, 4-40 x 3/8 inch, PHB
	210-0054-00			2	LOCKWASHER, split #4
-22	210-0849-00			2	WASHER, fiber, shouldered, #4
	210-0994-00			2	WASHER, flat, 0.125 ID x 0.250 inch OD
-23	210-0004-00			1	LOCKWASHER, internal, #4
-24	210-0201-00			1	LUG, solder, SE #4
-25	210-0406-00			2	NUT, hex., 4-40 x 3/16 inch

FIG. 1 TYPE 134 EXPLODED VIEW (Cont)

Fig. & Index No.	Tektronix Part No.	Serial/Modal Eff	No. Disc	Q					Description
				y	1	2	3	4	
1-26	131-0319-00			1					CONNECTOR, BNC, locking
	- - - - -			-					connector includes:
	- - - - -			1					NUT
-27	- - - - -			1					COVER, BNC
-28	670-0227-01			1					ASSEMBLY, circuit board
	- - - - -			-					assembly includes:
-29	131-0344-00			2					CONNECTOR, bifurcated feed thru
-30	136-0220-00			6					SOCKET, transistor, 3 pin
	132-0119-00			4					DISC, Plastic
-31	337-0828-00			1					SHIELD, input
	388-0697-00			1					BOARD, circuit
	- - - - -			-					board includes:
	388-0697-01			1					BOARD, circuit
-32	214-0506-00			15					PIN, connector, straight
-33	214-0693-00			1					HEAT SINK, transistor
	- - - - -			-					mounting hardware: (not included w/assembly)
-34	211-0116-00			2					SCREW, sems, 4-40 x 5/16 inch, PHB
-35	358-0091-00			1					BUSHING, strain relief
-36	161-0020-00			1					CORD, power, connector one end
-37	380-0095-01			1					HOUSING, amplifier, wrap around
-38	200-0327-01			1					COVER, box, aluminum cast
	- - - - -			-					mounting hardware: (not included w/cover)
-39	211-0071-00			2					SCREW, 4-40 x 3/8 inch, PHS
-40	210-0270-00			1					LUG, terminal
-41	175-0680-00			1					LEAD, electrical
	- - - - -			-					lead includes:
-42	131-0371-00			1					CONNECTOR, pin
-43	131-0371-00			14					CONNECTOR, pin
-44	124-0124-00			1					STRIP, brass
STANDARD ACCESSORIES									
	070-0990-00			2					MANUAL, instruction (not shown)

FIG. 2 CURRENT PROBE AMPLIFIER POWER SUPPLY (115 V)

Fig. & Index No.	Tektronix Part No.	Serial/Model No.		Q † y	Description
		Eff	Disc		
2-	015-0058-01			1	POWER SUPPLY, current probe amplifier (115 V)
	- - - - -			-	power supply includes:
-1	200-0246-03			1	COVER, power supply (115 V)
-2	131-0190-01			1	CONNECTOR, molded assembly
-3	407-0226-00			1	BRACKET, transformer
-4	214-0696-00			2	COLLAR, transformer
-5	387-0265-00			1	PLATE, cover
-6	210-0261-00			1	LUG, solder, HV
-7	211-0007-00			2	SCREW, 4-40 x 3/16 inch, PHS
-8	200-0957-00			1	COVER, rear
-9	386-1541-00			1	PLATE, rear
-10	213-0206-00			2	SCREW, 6-32 x 1.250 inches, THS
-11	358-0091-00			1	BUSHING, strain relief
-12	161-0035-01			1	CABLE ASSEMBLY, power cord
	- - - - -			-	cable assembly includes:
	334-1205-00			1	SLEEVE, cable marker (not shown)

Mechanical Parts List—Type 134

FIG. 3 CURRENT PROBE AMPLIFIER POWER SUPPLY (230 V)

Fig. & Index No.	Tektronix Part No.	Serial/Model No.		Q					Description		
		Eff	Disc	t	Y	1	2	3		4	5
3-	015-0059-01				1						POWER SUPPLY, current probe amplifier (230 V)
	- - - - -				-						power supply includes:
-1	200-0246-04				1						COVER, power supply (230 V)
-2	131-0190-01				1						CONNECTOR, molded assembly
-3	407-0226-00				1						BRACKET, transformer
-4	214-0696-00				2						COLLAR, transformer
-5	387-0265-00				1						PLATE, cover
-6	210-0261-00				1						LUG, solder, HV
-7	211-0007-00				2						SCREW, 4-40 x 3/16 inch, PHS
-8	200-0957-00				1						COVER, rear
-9	386-1541-00				1						PLATE, rear
-10	213-0206-00				2						SCREW, 6-32 x 1.250 inches, THS
-11	358-0091-00				1						BUSHING, strain relief
-12	161-0035-01				1						CABLE ASSEMBLY, power cord
	- - - - -				-						cable assembly includes:
	344-1205-00				1						SLEEVE, cable marker (not shown)

SECTION 8

DIAGRAMS

The following symbols are used on the diagrams:

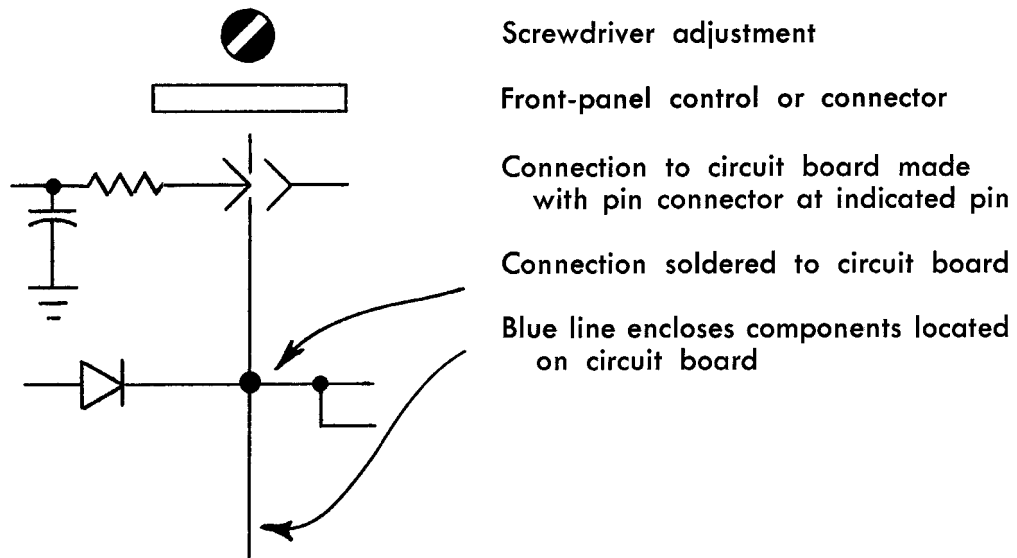

ATTENUATORS

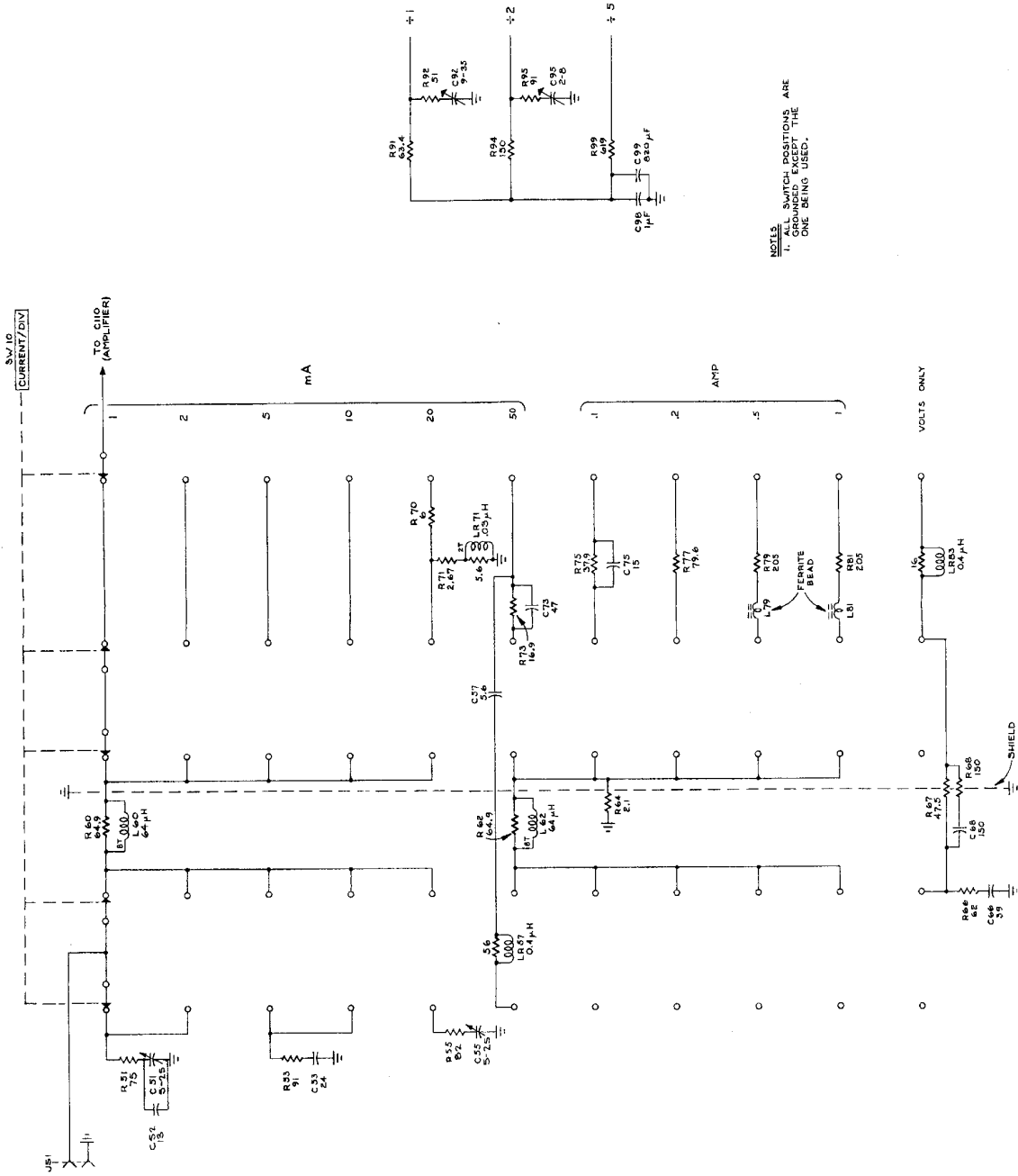

NOTE:
1. ALL SWITCH POSITIONS ARE TO BE USED.

269
ATTENUATORS
S/N 6620 UP

TYPE 134

AMPLIFIER

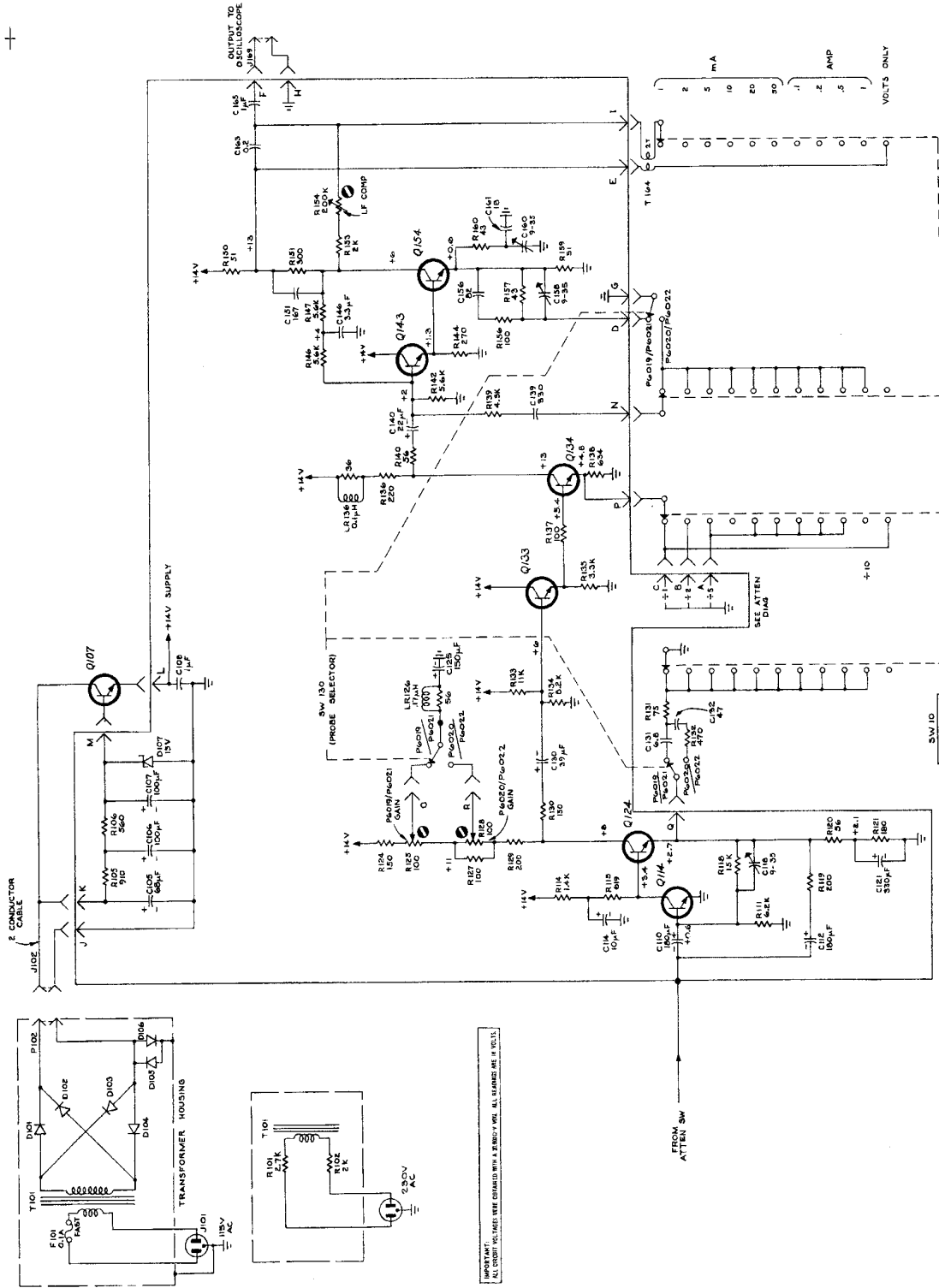

269
CURRENT PROBE AMPLIFIER
S/N 6620 UP

TYPE 134

FIG. 1

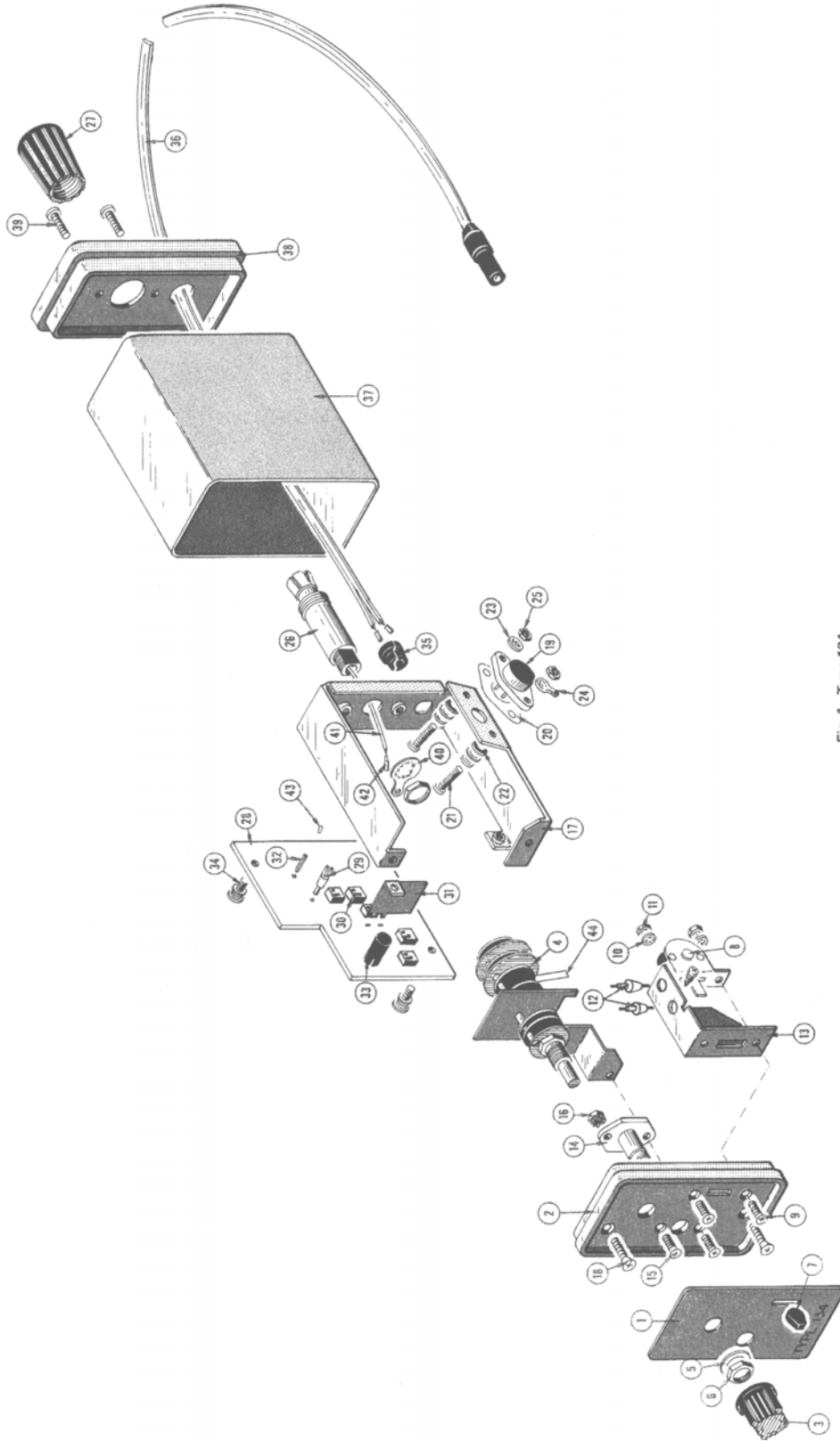

FIG. 1

Fig. 1. Type 134
Exploded View

A

+

FIG. 3

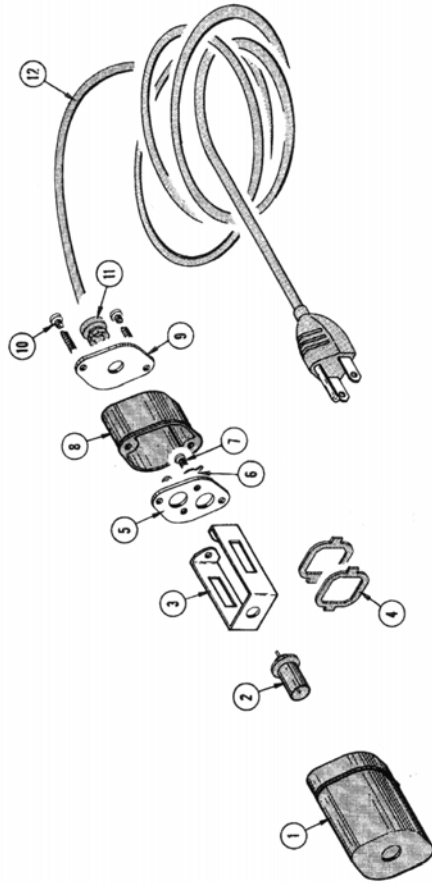

Fig. 3. 230-Volt Power Supply
Exploded View

FIG. 2

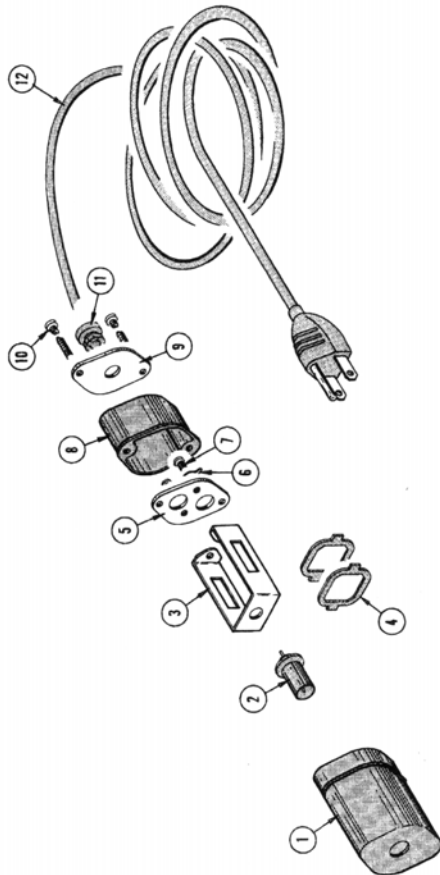

Fig. 2. 115-Volt Power Supply
Exploded View

FIG. 2 & FIG. 3

MANUAL CHANGE INFORMATION

At Tektronix, we continually strive to keep up with latest electronic developments by adding circuit and component improvements to our instruments as soon as they are developed and tested.

Sometimes, due to printing and shipping requirements, we can't get these changes immediately into printed manuals. Hence, your manual may contain new change information on following pages.

A single change may affect several sections. Sections of the manual are often printed at different times, so some of the information on the change pages may already be in your manual. Since the change information sheets are carried in the manual until ALL changes are permanently entered, some duplication may occur. If no such change pages appear in this section, your manual is correct as printed.

TYPE 134

ELECTRICAL PARTS LIST CORRECTION

CHANGE TO:

LR83

108-0593-00

0.4 μ H (wound on a 12 Ω , 1/4 W, 5% resistor)

TYPE 134

TEXT CORRECTION

Section 1 Specification

Page 1-6 Fig. 1-5

CHANGE: Curve label in center of graph to read:

P6022 Probe and 134 Amplifier

C5/569

TYPE 134

TEXT CORRECTION

Section 5 Performance Check/Calibration

Page 5-8 Second column, Step 7 d, Type 134 and P6021 Probe

CHANGE: part d to read:

d. Set the constant amplitude signal generator to 50 kHz and adjust the output amplitude for four centimeters of deflection (see Fig. 5-7A).

C6/569

TEXT CORRECTION

Section 3 Circuit Description

Page 3-1 First Column, Type 134 Current Probe Amplifier, third paragraph

CHANGE: line 13 to read:

through R70-R71-LR71, C69-R69-C73-R73, C75-R75, R77 and R79

Page 3-2 First Column, VOLTS ONLY Position of the CURRENT/DIV Switch,
first paragraph

CHANGE: line 4 to read:

compensation is provided by C68-R68 to main-

Section 5 Performance Check/Calibration

Page 5-3 First column, Current Mode, Step 6

CHANGE: line 2 to read:

(C118, C160, C95, C92, C51, C53, C55, C158)

Page 5-7 Step 6 Check/Adjust High Frequency Compensation

ADD: new part q to read:

q. Set the CURRENT/DIV switch to 5 mA and adjust the pulse generator for a four-centimeter display.

ADD: new part r to read:

r. CHECK-Front corner square wave aberrations of 5%, not including the effects of the test oscilloscope.

RELETTER: old part q and the remaining parts in alphabetical sequence starting with the letter s.

ELECTRICAL PARTS LIST CORRECTION

REMOVE :

C57	281-0612-00	5.6 pF	Cer	200 V	±0.5 pF
C66	281-0603-00	39 pF	Cer	500 V	5%
LR57	108-0330-00	0.4 μH (wound on a 56 Ω, 1/4 W, 5% resistor).			
R66	317-0620-00	62 Ω	1/8 W		5%

CHANGE TO:

C53	281-0123-00	5-25 pF, Var			
C73	283-0060-00	100 pF	Cer	200 V	5%
C139	281-0524-00	150 pF	Cer	500 V	±30 pF
C156	283-0095-00	56 pF	Cer	200 V	10%
LR126	108-0582-00	0.19 μH (wound on a 91 Ω, 1/4 W, 5% resistor)			
LR136	108-0575-00	0.6 μH (wound on a 100 Ω, 1/4 W, 5% resistor)			
R92	315-0430-00	43 Ω	1/4 W		5%
R95	315-0161-00	160 Ω	1/4 W		5%
R139	315-0912-00	9.1 kΩ	1/4 W		5%
R156	317-0511-00	510 Ω	1/8 W		5%

ADD:

C69	281-0516-00	39 pF	Cer	500 V	
C141	281-0523-00	100 pF	Cer	350 V	
R69	315-0100-00	10 Ω	1/4 W		5%
R141	315-0133-00	13 kΩ	1/4 W		5%

SCHEMATIC CORRECTIONS

