

Tektronix®

**TM 515
FIVE COMPARTMENT
PORTABLE
POWER MODULE**

Français Deutsch 日本語

INSTRUCTION MANUAL



**PLEASE CHECK FOR CHANGE INFORMATION
AT THE REAR OF THIS MANUAL.**

**TM 515
FIVE COMPARTMENT
PORTABLE
POWER MODULE**

Francais Deutsch 日本語

INSTRUCTION MANUAL

**Tektronix, Inc.
P.O. Box 500
Beaverton, Oregon 97077**

Serial Number _____

070-2020-02
Product Group 75

First Printing SEP 1975
Revised JUL 1988

Copyright © 1975, 1980 Tektronix, Inc. All rights reserved. Contents of this publication may not be reproduced in any form without the written permission of Tektronix, Inc.

Products of Tektronix, Inc. and its subsidiaries are covered by U.S. and foreign patents and/or pending patents.

TEKTRONIX, TEK, SCOPE-MOBILE, and  are registered trademarks of Tektronix, Inc.

Printed in U.S.A. Specification and price change privileges are reserved.

Copyright © 1975, 1980 durch Tektronix, Inc. Alle Rechte vorbehalten. Der Inhalt dieser Publikation darf ohne Genehmigung von Tektronix, Inc. nicht weitergegeben werden.

Produkte von Tektronix, Inc. und seinen Tochtergesellschaften sind durch US- und Auslandspatente und/oder schwebende Patente abgedeckt.

TEKTRONIX, TEK, SCOPE-MOBILE und  sind geschützte Warenzeichen von Tektronix, Inc.

Gedruckt in U.S.A. Spezifikations- und Preisänderungen bleiben vorbehalten.

Copyright © 1975, 1980 TEKTRONIX INC. Tous droits réservés. Le contenu de ce manuel ne peut être reproduit sous quelque forme que ce soit sans l'accord de Tektronix Inc.

Tous les produits TEKTRONIX sont brevetés US et Etranger et les logotypes TEKTRONIX, TEK SCOPE MOBILE,  sont déposés.

Imprimé aux USA. TEKTRONIX se réserve le droit de modifier : caractéristiques et prix dans le cadre de développements technologiques.

© 1975, 1980 年著作権所有テクトロニクス社。不許複製。

TEKTRONIX、TEK、SCOPE-MOBILE、 はテクトロニクス社の登録商標です。

米国にて印刷。仕様及び価格は予告なく変更する場合があります。

INSTRUMENT SERIAL NUMBERS

Each instrument has a serial number on a panel insert, tag, or stamped on the chassis. The first number or letter designates the country of manufacture. The last five digits of the serial number are assigned sequentially and are unique to each instrument. Those manufactured in the United States have six unique digits. The country of manufacture is identified as follows:

B000000	Tektronix, Inc., Beaverton, Oregon, USA
100000	Tektronix Guernsey, Ltd., Channel Islands
200000	Tektronix United Kingdom, Ltd., London
300000	Sony/Tektronix, Japan
700000	Tektronix Holland, NV, Heerenveen, The Netherlands

TABLE OF CONTENTS

	Page
LIST OF ILLUSTRATIONS	ii
LIST OF TABLES	ii
OPERATORS SAFETY SUMMARY	iii
SERVICE SAFETY SUMMARY	v

OPERATORS PART

Section 1 SPECIFICATION	1-1
Introduction	1-1
Instrument Description	1-1
Performance Conditions	1-1
Electrical Characteristics	1-1
Physical Characteristics	1-3

OPERATORS PART—ENGLISH

Section 2 OPERATING INSTRUCTIONS	2-1
General	2-1
Installation	2-1
Power Source	2-1
Power Usage	2-1
Operating Temperatures	2-1
Plug-in Modules	2-1
Module Installation	2-1
Turn-on Procedure	2-2
Building a System	2-2
Family Compatibility	2-2
Customizing the Interface	2-2
Installation and Pre-Turn On Procedure	2-3
Front and Rear Cover Removal	2-3
Use of Bail	2-3
Line Voltage Selector and Fuse	2-5

OPERATORS PART—FRENCH

Chapitre 2 INSTRUCTIONS D'UTILISATION

Installation	2-1
Source d'alimentation	2-1
Consommation	2-1
Température de fonctionnement	2-1
Tiroirs	2-1
Installation du module	2-1
Mise en service	2-2
Conception d'un système	2-2
Compatibilité	2-2
Conception de l'interface selon les besoins spécifiques du client	2-2
Installation et mise en service préli- minaire	2-3
Démontage des capots avant et arrière	2-3
Utilisation de la barre d'inclinaison	2-5
Sélecteur de la tension réseau et fusible	2-5

OPERATORS PART—GERMAN

Kapitel 2 BEDIENUNGSANLEITUNG

Einführung	2-1
Einbau	2-1
Netzspannung	2-1
Leistungsaufnahme	2-1
Betriebstemperaturen	2-1
Einschübe	2-1
Einschubeinbau	2-1
Einschaltvorgang	2-2
Aufbau eines Meßsystems	2-2
Kompatibilität	2-2
Anwenderbezogenes Interface	2-2
Einbau und Anleitung vor der Inbetriebnahme	2-3
Entfernen der vorderen und hinteren Abdeckhauben	2-3
Gebrauch des Standbügels	2-3
Netzspannungswahl und Sicherungen	2-5

TABLE OF CONTENTS (cont)

	Page
OPERATORS PART—JAPANESE	
第2章 取扱説明.....	2-1
取付け.....	2-1
電源.....	2-1
消費電力.....	2-1
動作温度.....	2-1
プラグイン.....	2-1
プラグインの取付け.....	2-1
電源投入の手順.....	2-2
システム構成.....	2-2
互換性.....	2-2
インターフェイス.....	2-2
機器の組み立て.....	2-3
前面および後部カバーの取りはずし.....	2-3
底部金具の使用.....	2-3
電源電圧セレクト及びヒューズ.....	2-5

SERVICE PART



THE FOLLOWING SERVICING INSTRUCTIONS ARE FOR USE BY QUALIFIED PERSONNEL ONLY. TO AVOID PERSONAL INJURY, DO NOT PERFORM ANY SERVICING OTHER THAN THAT CONTAINED IN OPERATING INSTRUCTIONS UNLESS YOU ARE QUALIFIED TO DO SO.

	Page
Section 3 MAINTENANCE	3-1
General	3-1
Introduction	3-1
Cabinet Removal	3-1
Cleaning	3-1
Preventive Maintenance	3-1
Calibration	3-2
Troubleshooting Aids	3-2
Troubleshooting Techniques	3-2
Parts Ordering and Replacing	3-4
Packaging Information	3-8
Section 4 OPTIONS	4-1
Option 5	4-1
Option 6	4-1
Option 7	4-1
Section 5 REPLACEABLE ELECTRICAL PARTS	5-1
Section 6 DIAGRAMS AND CIRCUIT BOARD ILLUSTRATIONS	
Power Module Interface Pin Assignments	
Detailed Block Diagram	
Schematic Diagram	
Parts Location Grid and Reference Tables	
Option 6 Parts Location	
Section 7 REPLACEABLE MECHANICAL PARTS	7-1
Exploded View	
Accessories	

CHANGE INFORMATION

LIST OF ILLUSTRATIONS

Figure		Page
	TM 515 Five Compartment Power Module..	vi
1-1	Dimensional Diagram	1-4
2-1	Interface Board	2-2
2-2	End Clamp Detail	2-3
2-3	Bail Usage and Storage	2-4
2-4A	Rear View	2-5
2-4B	Front View	2-6
2-5	Line Voltage Selector and Fuse	2-7
3-1	Reassembly Guide-Pin Alignment	3-1
3-2	Semiconductor device lead configurations found in the TM 500 family	3-5
3-3	Light-emitting diode (LED) lead orientation..	3-7

LIST OF TABLES

Table		Page
1-1	SUPPLIES	1-1
1-2	SERIES PASS TRANSISTORS	1-2
1-3	SOURCE POWER REQUIREMENTS ...	1-2
1-4	MISCELLANEOUS	1-3
1-5	ENVIRONMENTAL	1-3
1-6	MECHANICAL	1-3

OPERATORS SAFETY SUMMARY

The general safety information in this part of the summary is for both operating and servicing personnel. Specific warnings and cautions will be found throughout the manual where they apply, but may not appear in this summary.

TERMS

In This Manual

CAUTION statements identify conditions or practices that could result in damage to the equipment or other property.

WARNING statements identify conditions or practices that could result in personal injury or loss of life.

As Marked on Equipment

CAUTION indicates a personal injury hazard not immediately accessible as one reads the marking, or a hazard to property including the equipment itself.

DANGER indicates a personal injury hazard immediately accessible as one reads the marking.

SYMBOLS

In This Manual



This symbol indicates where applicable cautionary or other information is to be found.

As Marked on Equipment



DANGER — High voltage.



Protective ground (earth) terminal.



ATTENTION — refer to manual.

Power Source

This product is intended to operate from a power source that will not apply more than 250 volts rms between the supply conductors or between either supply conductor and ground. A protective ground connection by way of the grounding conductor in the power cord is essential for safe operation.

Grounding the Product

This product is grounded through the grounding conductor of the power cord. To avoid electrical shock, plug the power cord into a properly wired receptacle before connecting to the product input or output terminals. A protective ground connection by way of the grounding conductor in the power cord is essential for safe operation.

Danger Arising From Loss of Ground

Upon loss of the protective-ground connection, all accessible conductive parts (including knobs and controls that may appear to be insulating) can render an electric shock.

Use the Proper Power Cord

Use only the power cord and connector specified for your product.

Use only a power cord that is in good condition.

Refer cord and connector changes to qualified service personnel.

Use the Proper Fuse

To avoid fire hazard, use only the fuse of correct type, voltage rating and current rating as specified in the parts list for your product.

Refer fuse replacement to qualified service personnel.

Do Not Operate in Explosive Atmospheres

To avoid explosion, do not operate this product in an explosive atmosphere unless it has been specifically certified for such operation.

Do Not Remove Covers or Panels

To avoid personal injury, do not remove the product covers or panels. Do not operate the product without the covers and panels properly installed.

Do Not Operate Without Covers (for TM 500 plug-ins only)

To avoid personal injury, do not operate this product without covers or panels installed. Do not apply power to the plug-in via a plug-in extender.

SERVICE SAFETY SUMMARY

FOR QUALIFIED SERVICE PERSONNEL ONLY

Refer also to the preceding Operators Safety Summary.

Do Not Service Alone

Do not perform internal service or adjustment of this product unless another person capable of rendering first aid and resuscitation is present.

Use Care When Servicing With Power On

Dangerous voltages exist at several points in this product. To avoid personal injury, do not touch exposed connections and components while power is on.

Disconnect power before removing protective panels, soldering, or replacing components.

Power Source

This product is intended to operate from a power source that will not apply more than 250 volts rms between the supply conductors or between either supply conductor and ground. A protective ground connection by way of the grounding conductor in the power cord is essential for safe operation.

CONSIGNES DE SECURITE

Ce rappel des consignes générales de sécurité s'adresse à la fois aux utilisateurs et au personnel de maintenance. Avertissements et précautions à respecter sont annotés au long de ce manuel à chaque fois que l'utilisation du TM 515 l'exige. Il est à noter que ceux-ci peuvent ne pas figurer dans cette rubrique de rappel.

TERMES

Dans ce manuel

Les paragraphes intitulés ATTENTION identifient les circonstances ou opérations pouvant entraîner la détérioration de l'appareil ou de tout autre équipement.

Les paragraphes intitulés AVERTISSEMENT indiquent les circonstances dangereuses pour l'utilisateur (danger de mort ou risque de blessure).

Repères gravés sur l'appareil

CAUTION (ATTENTION) : ce mot identifie les zones de risque non immédiatement perceptibles ou un risque éventuel de détérioration de l'appareil.

DANGER (DANGER) : ce mot indique les zones de risque immédiat pouvant entraîner blessures ou mort.

SYMBOLES

Dans ce manuel



Ce symbole signifie «se reporter au manuel».

Gravés sur l'appareil



DANGER – Haute tension



Borne de masse de protection (terre)



ATTENTION – se reporter au manuel

Source d'alimentation

L'appareil est conçu pour fonctionner à partir d'une source d'alimentation maximale de 250 V efficaces entre les conducteurs d'alimentation ou entre chaque conducteur d'alimentation et la terre. Pour utiliser l'appareil en toute sécurité, une connexion à la masse, réalisée au moyen d'un conducteur prévu dans le cordon d'alimentation est indispensable.

Mise à la masse de l'appareil

Une fois installé dans le châssis d'alimentation, l'appareil est relié à la masse à l'aide d'un conducteur du cordon d'alimentation. Pour éviter tout choc électrique, insérer la prise du cordon d'alimentation dans une prise de distribution correspondante avant de connecter l'entrée ou les sorties de l'appareil.

En cas de coupure de la connexion de masse, tous les éléments conducteurs accessibles (y compris boutons et commandes apparaissant isolants) peuvent provoquer un choc électrique.

Utiliser le fusible approprié

Pour éviter tout risque d'accident (incendie...) n'utiliser que le fusible recommandé pour votre appareil.

Le fusible de remplacement doit toujours correspondre au fusible remplacé : même type, même tension et même courant. Un remplacement de fusible ne doit être effectué que par un personnel qualifié.

Ne pas utiliser l'appareil en atmosphères explosives

Pour éviter toute explosion, ne pas utiliser cet appareil dans une atmosphère de gaz explosifs.

Ne pas démonter les capots ou les panneaux

Pour éviter toute blessure, ne pas ôter les capots ou les panneaux. N'utiliser l'appareil que si ceux-ci ont été correctement remis en place.

Ne pas utiliser l'appareil sans les capots de protection

Pour éviter tout risque de blessure, ne pas utiliser cet appareil alors que les capots ou panneaux n'ont pas été installés. Ne pas appliquer les alimentations au tiroir par l'intermédiaire d'un prolongateur.

SICHERHEITSAANGABEN FÜR DEN ANWENDER

Die allgemeinen Sicherheitsinformationen in diesem Teil der Angaben dienen dem Anwender- und Servicepersonal. Spezielle Warnungen und Hinweise sind überall im Handbuch zu finden, müssen jedoch in diesen Angaben nicht erscheinen.

BEGRIFFE

In diesem Handbuch

VORSICHTSHINWEISE erläutern Bedingungen, die zur Zerstörung des Gerätes oder anderer Gegenstände führen könnten.

WARNUNGSHINWEISE erläutern Bedingungen, die zu Personenschäden führen können oder lebensgefährlich sind.

Markierungen auf dem Gerät

CAUTION – VORSICHT weist darauf hin, daß durch zufälliges Berühren an einer nicht unmittelbar zugänglichen Stelle Personenschaden entstehen kann, oder Schaden am Gerät selbst.

DANGER – GEFAHR weist darauf hin, daß durch zufälliges Berühren an einer zugänglichen Stelle Personenschaden entstehen kann.

SYMBOLE

In diesem Handbuch



Dieses Symbol zeigt an, wo Vorsicht walten zu lassen ist, oder wo Informationen zu finden sind.

Markierungen auf dem Gerät



GEFAHR – Hochspannung.



Schutzerdungskontakt.



ACHTUNG – beziehen Sie sich auf das Handbuch.

Netzspannungsversorgung

Die Betriebsspannung für dieses Gerät darf $250 V_{eff}$ nicht überschreiten und ist an die Versorgungsleitungen bzw. an eine Versorgungsleitung und Masse anzulegen. Innerhalb des Netzanschlußkabels muß ein Schutzleiter vorhanden sein, der mit Gerätemasse verbunden ist.

Masseanschluß des Gerätes

Dieses Gerät wird über den Schutzleiter der Versorgungseinheit mit Erdpotential verbunden. Zur Vermeidung von elektrischen Schlägen ist vor der Beschaltung der Ein- und Ausgänge der Netzstecker in eine korrekt verdrahtete Steckdose einzustecken. Verwenden Sie den Schutzleiter nicht als einzige Verbindung zwischen zwei oder mehreren Geräten. Zur Vermeidung von elektrischen Schlägen sind die Geräte untereinander mit separaten Leitungen zu verbinden.

Verwendung einer richtigen Sicherung

Zur Vermeidung von Brandschäden sind nur Sicherungen zu verwenden, die in den Teilelisten dieses Gerätes aufgeführt sind und die in Spannungs- und Stromwert entsprechend sind. Ersatz von Sicherungen ist nur von geschultem Personal vorzunehmen.

Arbeiten Sie nicht in explosiver Umgebung

Zur Vermeidung von Explosionen ist die Inbetriebnahme dieses Gerätes in explosiver Umgebung zu unterlassen, wenn das Gerät nicht dafür geeignet ist.

Entfernen Sie keine Gehäuseabdeckungen

Zur Vermeidung von Personenschäden sind keine Gehäuseteile zu entfernen. Auch ist das Gerät ohne Gehäuse nicht in Betrieb zu nehmen.

Arbeiten Sie nicht ohne Gehäuseabdeckung

Zur Vermeidung von Personenschäden ist das Gerät nicht ohne Gehäuse in Betrieb zu nehmen. Der Einschub sollte nicht über einen Verlängerungsadapter betrieben werden.

ご使用の前に

この章では操作する方およびサービス・エンジニアの方に安全にお取扱いいただくための注意事項が述べられています。

用語

マニュアル中の用語

注意の項は本機器または他の接続機器に損傷を及ぼす恐れのある場合の注意です。

警告の項は人体に損傷を与えたり生命に危険を及ぼす恐れのある場合の注意です。

機器上に記されている用語

CAUTIONは人体および本機器または周辺機器に損傷を及ぼす恐れがある部分を示しています。

DANGERは人体に損傷を及ぼしたり生命に危険を与える恐れがある部分を示しています。

記号

この取扱説明書に出てくる記号



このマークは適切な注意、または他の項目を参照する必要がある場合を指示しています。

機器に記された記号



危険——高電圧



保護用接地ターミナル



注意——取扱説明書参照

電源

本機器は電源コードの線間、あるいは電源コードとグラウンド間が250Vrms以内の範囲の電源で作動します。安全のために電源コードのアース線で接地して下さい。

機器の接地

本機器は電源コードのアース線で接地されます。電氣的ショックを避けるために、電源コードをコンセントに差し込んでから、機器の入、出力端子への接続を行って下さい。電源コード中のアース線は必ず接地して下さい。接地が行われていないと、導体の部品（絶縁処理されたノブおよびコントロールつまみを含む。）により電氣的ショックを受けることもあります。

ヒューズ

危険防止のため、マニュアルに記載されている仕様に適合するヒューズをご使用下さい。

ヒューズの交換に関する詳細は、当社フィールド・エンジニアにおたずね下さい。

爆発防止

危険防止のため、爆発性のガスが周囲にあるような所では作動させないで下さい。

カバー、パネルについて

プラグインのカバーやパネルを取りはずしたまま作動させないで下さい。

機器使用に際して

人体への危険を防止するため、カバーやパネルを取りはずしたまま作動させないで下さい。またプラグイン・エクステンダでプラグインと電源を接続しないで下さい。

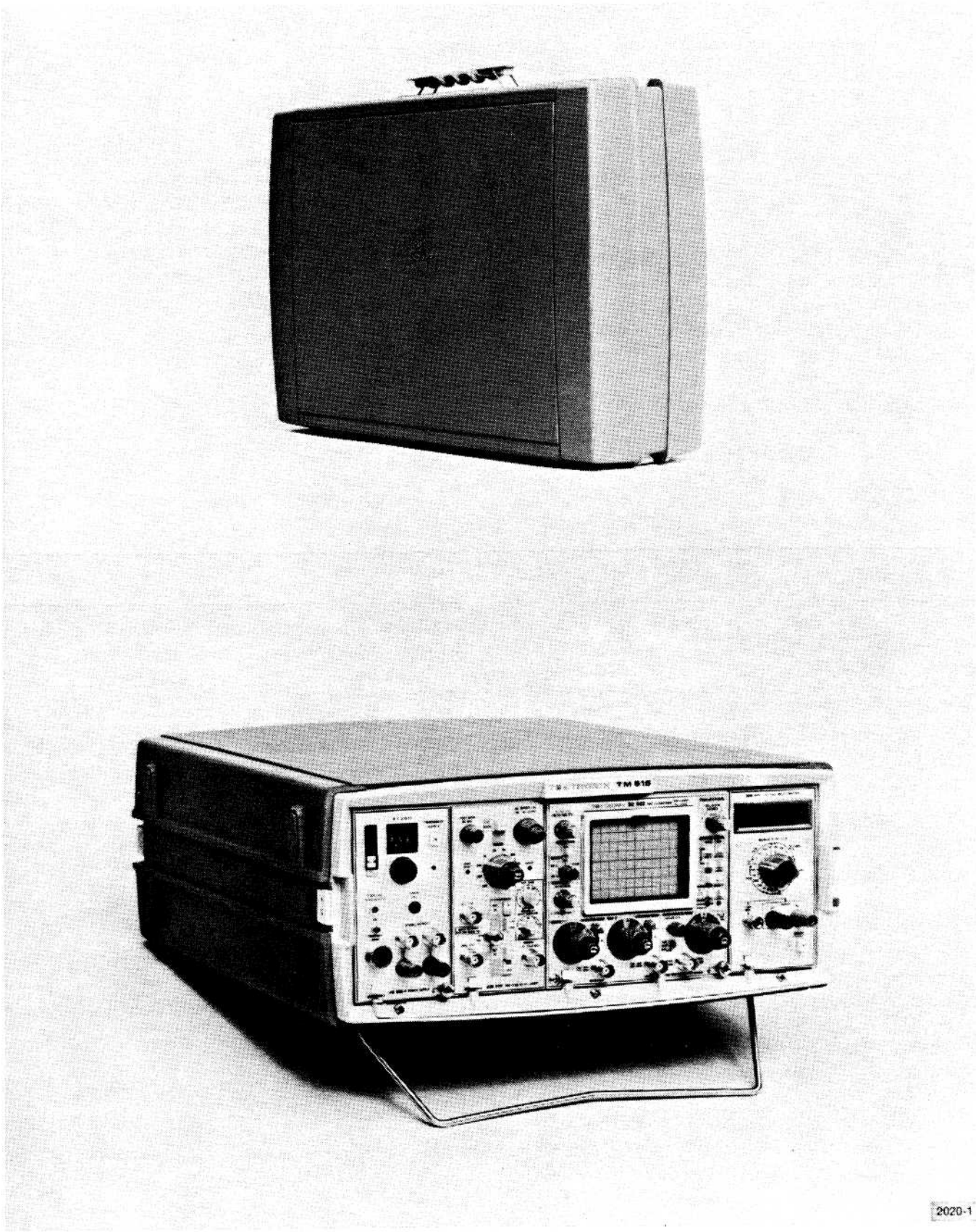

2020-1

TM 515 Five Compartment Portable Power Module.

SPECIFICATION

INTRODUCTION

Instrument Description

The TM 515 is a five-wide power module compatible with most TM 500 plug-ins. It provides unregulated ac and dc supplies and nondedicated power transistors for use by the plug-ins. This mainframe does not have a high-power compartment but does feature forced-air cooling.

Available options allow the rear interface to be customized (Option 5), operation from power sources with a line frequency of up to 400 Hz (Option 6), and specific interconnections for specialized plug-ins (Option 7).

Performance Conditions

The values listed below are valid only when the instrument is operated at an ambient temperature between 0°C and +50°C.

ELECTRICAL CHARACTERISTICS

Table 1-1
SUPPLIES

Characteristics	Performance Requirements	Supplemental Information
+33.5 Vdc		
Tolerance ^a		+23.7 V to +40.0 V
PARD (Periodic and Random Deviation)		≤2.5 VPP
Maximum load		350 mA
Maximum load di/dt		10 mA/μs
-33.5 Vdc		
Tolerance ^a		-23.7 V to -40.0 V
PARD		≤2.5 VPP
Maximum load		350 mA
Maximum load di/dt		10 mA/μs
+11.5 Vdc		
Tolerance ^a		+7.6 V to +16.0 V
PARD		≤2.5 VPP
Maximum load		1.3 A
Maximum load di/dt		20 mA/μs
25 Vac (2 each)		
Range		25.0 Vrms +10%; -15%
Maximum load		25 VA
Maximum floating V		350 V _{peak}

Table 1-1 (cont)

Characteristics	Performance Requirements	Supplemental Information
17.5 Vac		
Range		20.5 Vrms +10%; -20% grounded center tap
Maximum load		30 VA
Maximum Plug-in Power draw from mainframe ^b		35 Wdc or 75 VAac
Combined Power Draw sharing limitation ^b		VAac + 2.1 Wdc ≤75
Fuse Data		
+33.5 Vdc		2.5 A, 3 AG, fast blow
-33.5 Vdc		2.5 A, 3 AG, fast blow
+11.5 Vdc		7.5 A, 3 AG, fast blow

^a Worst case; low line-full load and high line-no load values including PARD.

^b At nominal line voltage.

Table 1-2

SERIES PASS TRANSISTORS

Characteristics	Performance Requirements	Supplemental Information
Type		One each NPN and PNP per compartment.
Maximum dissipation		7.5 W each, 15 W total.

Table 1-3

SOURCE POWER REQUIREMENTS

Characteristics	Performance Requirements	Supplemental Information
Voltage ranges		Selectable 100 V, 110 V, 120 V, 200 V, 220 V, and 240 V nominal line, ±10%.
Line frequency		48 Hz to 60 Hz
Option 6		48 Hz to 400 Hz
Maximum power consumption		240 W
Fuse data		
100 V, 110 V, 120 V ranges		3A, 3 AG, slow blow
200 V, 220 V, 240 V ranges		3A, 3 AG, slow blow

Table 1-4
MISCELLANEOUS

Characteristics	Performance Requirements	Supplemental Information
Maximum recommended plug-in power dissipation		
One-wide		10 to 15 W
Two-wide		25 to 35 W

PHYSICAL CHARACTERISTICS

Table 1-5
ENVIRONMENTAL^a

Characteristics	Information
Overall	Meets or exceeds MIL-T-28800B, class 5 requirements with exception for EMC.
Temperature	
Operating	0°C to 50°C
Non-operating	-55°C to +75°C
Humidity	90 to 95% R.H. for five days cycled to +50°C
Altitude	
Operating	4.6 km (15,000 ft.)
Non-operating	15 km (50,000 ft.)
Vibration	0.38 mm (0.015 in.), 10 Hz to 55 Hz, 75 minutes
Shock	30 g. (1/2 sine), 11 ms, 18 shocks
Bench handling	45°, 4 in., or equilibrium, whichever occurs first
Transportation	Qualified under National Safe Transit Association Preshipment Test Procedures 1A-B-1 and 1A-B-2.

^a With plug-ins; some plug-ins require additional limitations.

Table 1-6
MECHANICAL

Characteristics	Information
Net weight	10.2 kg (22.5 lbs)
Overall dimensions	Height—17.3 cm (6.8 in.) Width—38.1 cm (15.0 in.) Length—50.8 cm (20.0 in.)

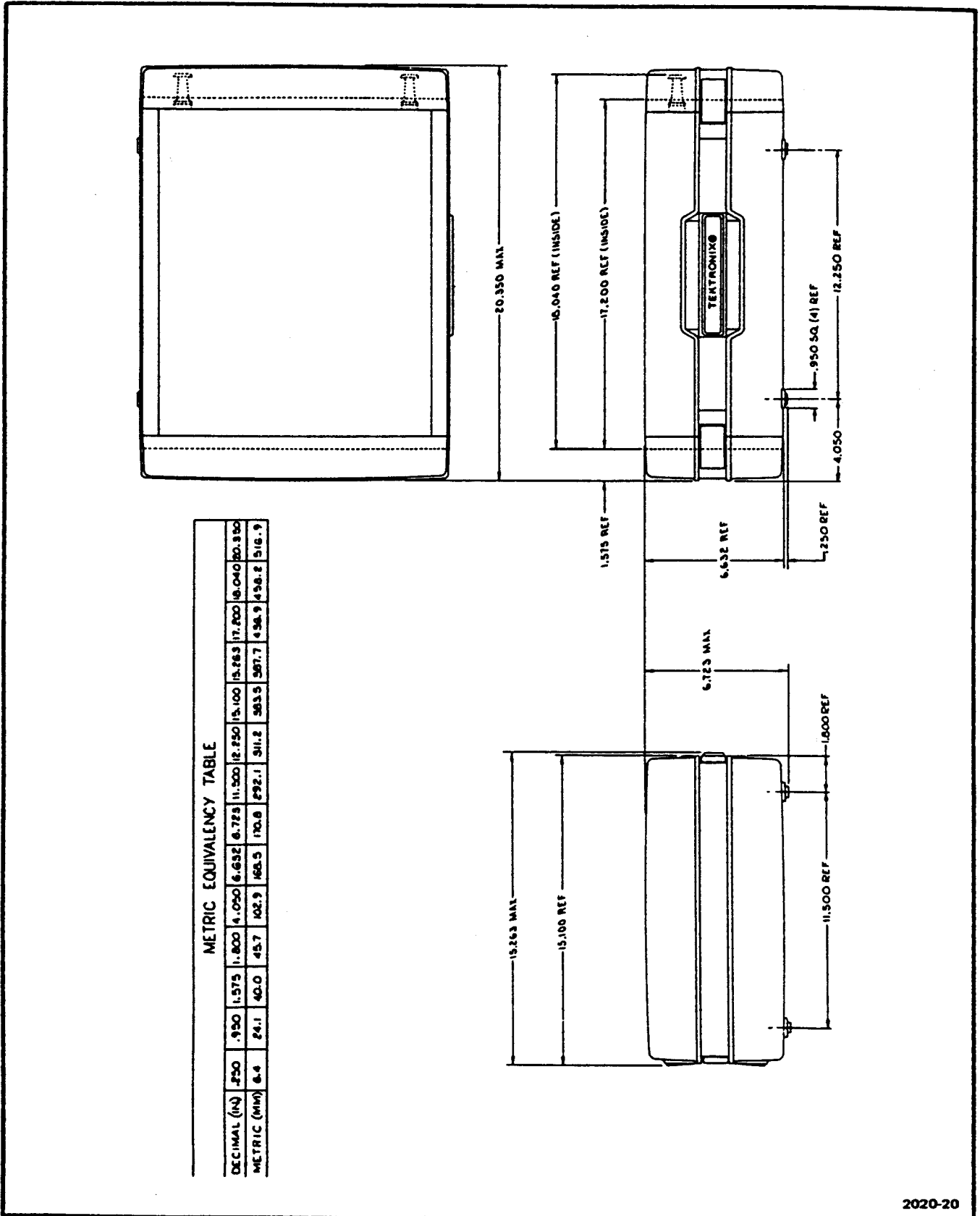

2020-20

Fig. 1-1 Dimensional Diagram.

OPERATING INSTRUCTIONS

GENERAL

Installation

For full installation instructions refer to the procedure at the end of this section.

Power Source

The TM 515 is designed to operate from a power source with its neutral at or near earth (ground) potential with a separate safety-earth conductor. It is not intended for operation from two phases of a multi-phase system. The standard instrument has a 48 Hz to 60 Hz line frequency range for fan operation. Option 6 extends the upper limit of this range to 400 Hz.

Power Usage

With five plug-ins installed, the TM 515 may require up to 240 watts at the upper limits of the high line voltage ranges. Actual power consumption depends on the particular plug-in configuration and operating modes selected.

Loading Considerations. The power capability of the TM 515 can best be used by carefully planning the plug-in configuration, the external loads, and the resulting power distributions. Optimum conditions may be obtained by:

1. Having equal loads in all compartments.
2. Dissipating as much power as possible in the external loads.
3. Operating the system in an ambient temperature near 25°C.

The TM 515 has no high-power compartment, so care should be taken in selecting plug-ins, since some units may not operate at full capability in this module. For instance, some TM 500 power supply type plug-ins will not produce maximum rated current when powered from this module. Combinations of other plug-ins also may not operate at full capability. An example here might be three units rated at 75 watts maximum power dissipation each. All plug-ins working at their maximum rating would probably blow the line fuse, if the thermal cut-out didn't operate first.

Each plug-in is provided access to a pair of heat-sinked, series-pass transistors, one NPN and the other PNP. These transistors enable the plug-ins to operate in power ranges not possible if the power were to be dissipated in the plug-ins themselves.

Operating Temperatures

The TM 515 can be operated in an ambient air temperature of 0°C to 50°C. Thermal cutout devices protect the system by disconnecting the power to the TM 515 Power Module when internal temperatures rise above a safe operating level. These devices automatically return power to the unit when the internal temperatures return to a safe level.

Since the TM 515 can be stored in temperatures between -40°C and +75°C, allow the instrument's chassis to return to within the operating limits before applying power.

Plug-in Modules

It is not necessary that all the plug-in compartments be filled in order to operate the Power Module. The only modules needed are those necessary to accomplish the task.

CAUTION

The TM 515 should be turned off before inserting or removing any plug-ins as arcing may occur and result in circuit damage.

Module Installation

1. Check the location of the plastic barriers on the TM 515 interconnecting jack to ensure that their locations match the slots in the edge of the plug-in circuit board.
2. Take off the PLUG-IN RETAINER by unscrewing the three bolts holding it in place on the lower side of the front aperture.

Operating Instructions—TM 515

3. Align the plug-in chassis with the upper and lower guides of the selected compartment. Insert the plug-in and press firmly to the circuit board in the interconnecting jack. (Remove the plug-in by pulling on the white release latch in the lower left corner of the front panel.)

4. Replace the PLUG-IN RETAINER removed in step 2.

Turn-on Procedure

Press the POWER switch, found on the rear panel of the TM 515, to its ON position. Some plug-ins have independent power switches, usually labeled OUTPUT, controlling application of module power to the plug-in. Press these switches to activate these plug-ins once the Modular Power is turned on.

BUILDING A SYSTEM

Family Compatibility

Mechanically, the plug-ins are very similar to other Tektronix products. However, they are not electrically compatible. Therefore, the TM 515 interface has barrier keys on the mating connectors between pins 6 and 7 to ensure that incompatible plug-ins cannot be inserted. See Fig. 2-1. A compatible plug-in will have a matching slot

between pins 6 and 7 of its main circuit board edge connector. This slot and barrier combination is the primary keying assignment.

TM 500-compatible plug-ins are also identified by the white color of the release latch.

Customizing the Interface

The modularity of this instrumentation system provides for many different functions to be performed by the plug-in modules. Specific functions are grouped into families or classes, of which there may be several plug-in module members (e.g., Power Supplies, Signal Sources, and Measurement). Each modular member of a functional family will have a second slot unique to its family located in its edge connector. The TM 515 user can "program" one or more compartments to accept only members of that family by installing a second barrier key in the interface connector to match the module's slot location. An entire TM 515 can be modified in this manner to set instruction systems for specific work functions. To order extra barrier keys refer to the Mechanical Parts list.

Jumper wires can be used to further specialize the interface. Compartments can be made to "talk" to each other by connecting jumpers on the front side of the

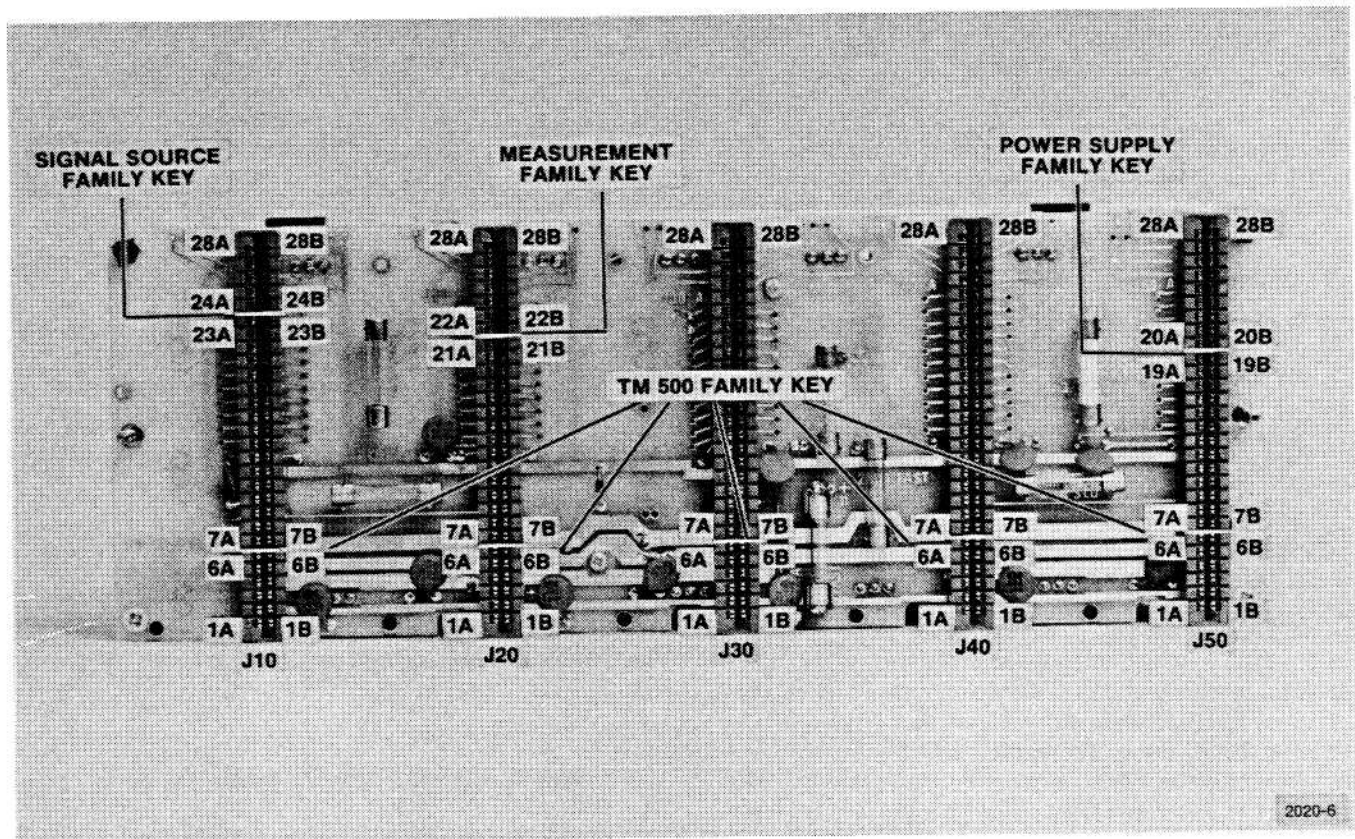

Fig. 2-1. Interface Board.

interface board, using pins 14 through 28 (both A and B sides) of the interconnecting jacks. For a further description of this see Option 5 in the Options Section of this manual. Also refer to each plug-in's manual for the I/O assignments of each pin at the rear interface. Once having made interconnections of a specialized nature, it is recommended that barrier keys be installed to ensure module compatibility with the wiring.

To release them, simply pull the leading edges (left and right) out away from the case.

Pull the rear edge of each clamp clear of its pressure ridge and the end cover comes off (see Fig. 2-2).

INSTALLATION AND PRE-TURN ON PROCEDURE

Front & Rear Cover Removal

The white plastic pieces located left and right toward both ends of this cabinet are the clamps that hold the covers in place.

USE OF BAIL

The Single Angle Bail Wire used to hold this cabinet of instruments at a convenient viewing angle is stored inside the front cover. If desirable, remove it from storage mounts and install according to the viewing angle desired for this package. (See Fig. 2-3.)

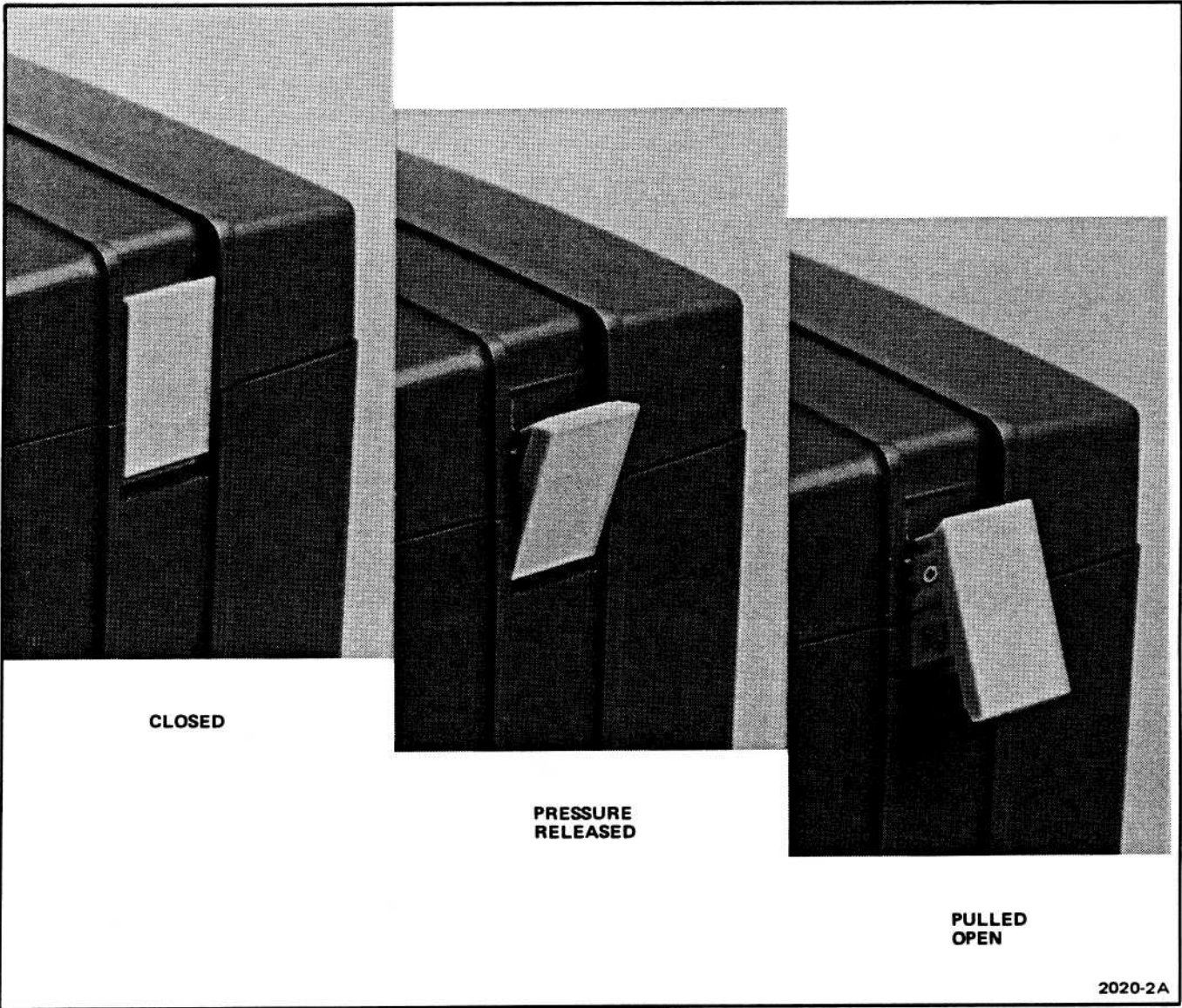
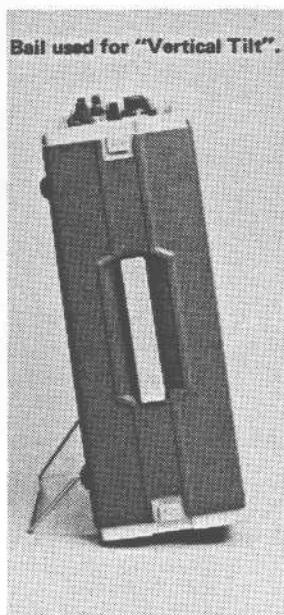
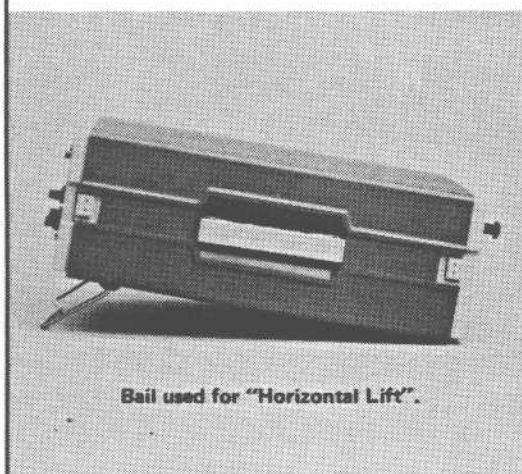
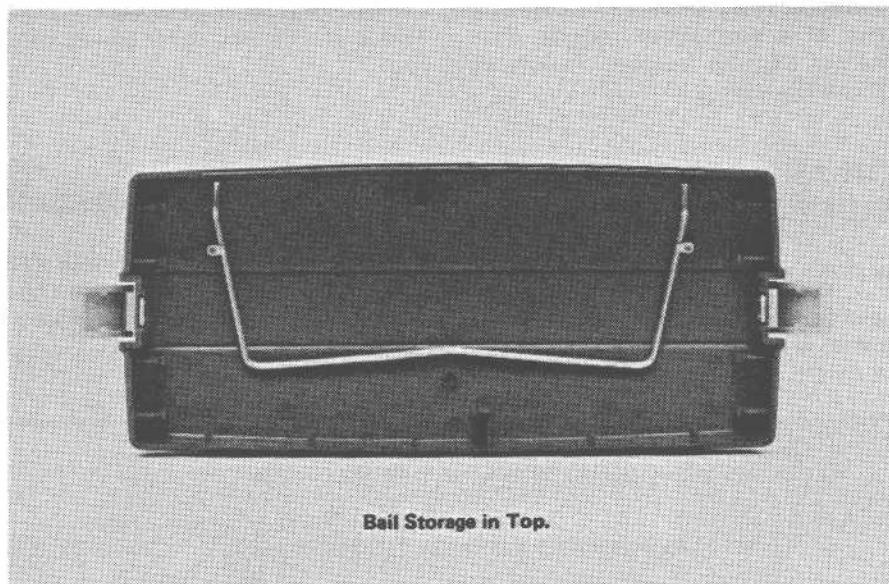

Fig. 2-2. End Clamp Detail.



2020-3A

Fig. 2-3. Bail Usage and Storage.

LINE VOLTAGE SELECTOR & FUSE

AFTER REMOVING THE REAR COVER AND BEFORE PLUGGING LINE CORD IN:

1. Check, through the clear plastic cover, that the appropriate Line Selector Block is in the In-Service position for the line voltage you expect to use this instrument on. Also check that the proper Fuse is in the Line Fuse Holder that screw mounts into the rear of this instrument (Fig. 2-4A).

2. If a change is needed, follow these steps:

- a. Remove the two hold-down screws on the clear plastic line selector cover and lift it off. This gives easy access to the Line Selector Blocks located on the rear of this instrument. See Figs. 2-4 and 2-5.
- b. Remove Improper Block and then install Proper Block for Low, Medium, or High line voltage expected. Install Improper Block on the storage pins so it doesn't get lost, and replace the Clear Plastic Cover.

c. Turn the Fuse Holder Knob in the direction of the arrow and pull it clear of the instrument. Remove improper Fuse and install proper one. (Alternate & Spare Fuses are stored in blank holders on the Main Interface Board. It will be necessary to remove the Power Supply from the cabinet to obtain these fuses. See Cabinet Removal directions under Maintenance, Section 4 of this manual.)

3. Pull the ac Power Cord clear of the Fan-Exhaust Housing.

4. If necessary, change the line cord Power Plug to match the power source receptacle or use an adapter. **Also** make sure the Power Switch on the back is OFF.

5. Plug the cord into the power source.

6. Insert the desired plug-ins.

7. This completes Installation and Pre-Turn On.

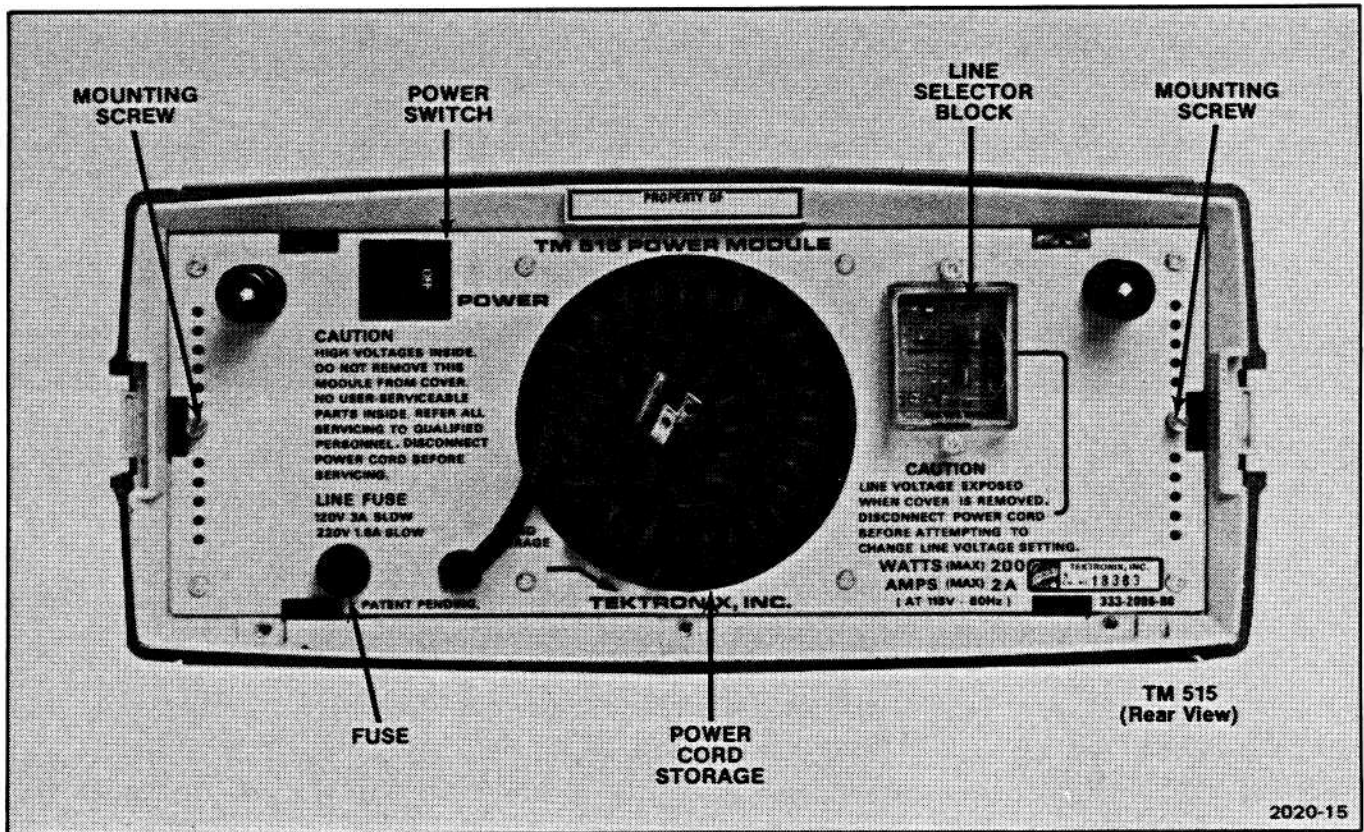

Fig. 2-4A. Rear View.

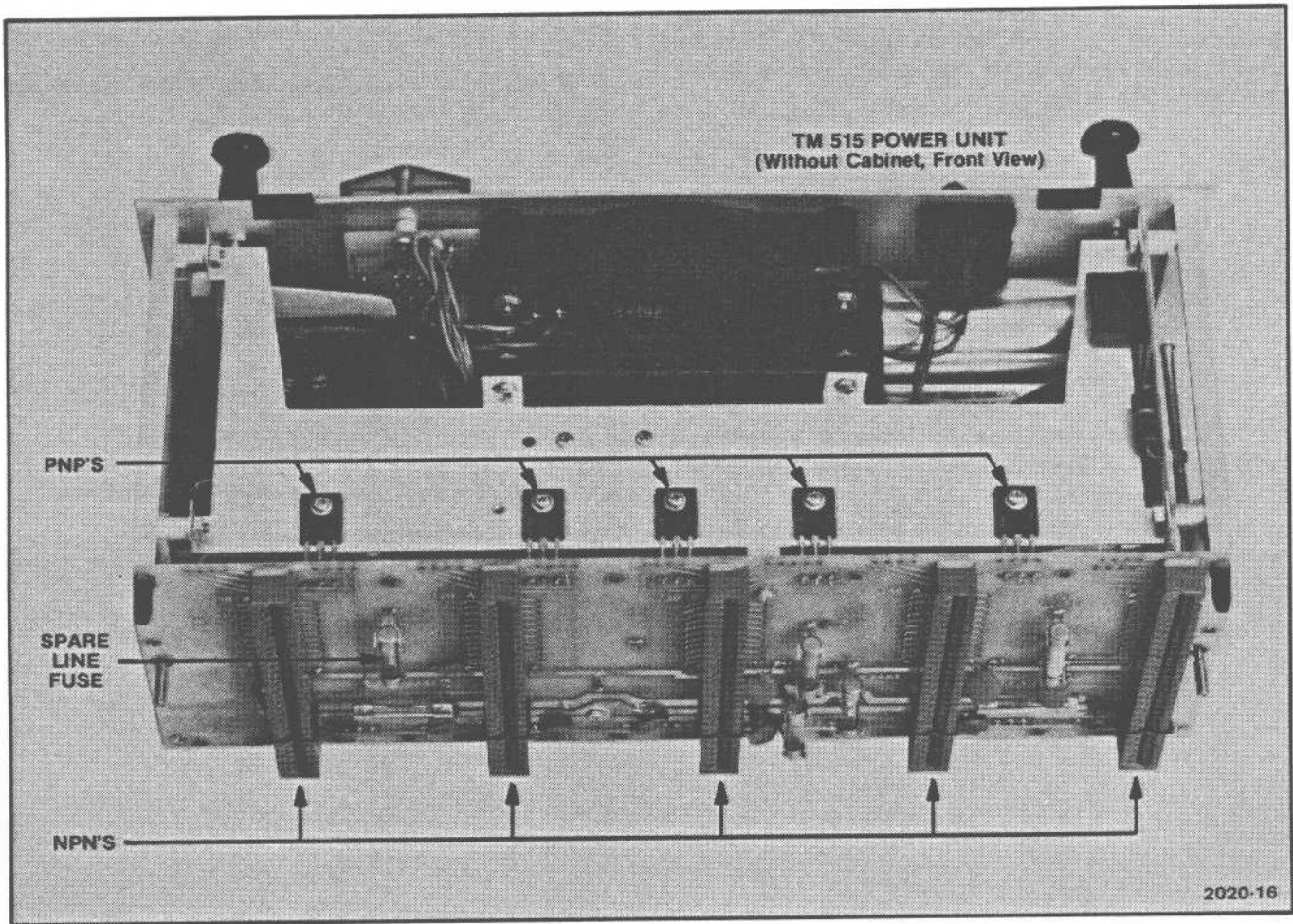
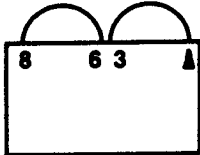
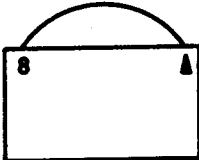

Fig. 2-4B. Front View.

Universal Transformer		
Line Selector Block Position	Regulating Ranges	
	120 Volts Nominal	220 Volts Nominal
L	90 VAC to 100 VAC	180 VAC to 220 VAC
M	99 VAC to 121 VAC	198 VAC to 242 VAC
H	108 VAC to 132 VAC	216 VAC to 268 VAC
Line Fuse Data	3 A Slow-blow	1.6 A Slow-blow
Selector Block	 <p>Brown</p>	 <p>Red</p>

2020-5A

Fig. 2-5. Line Voltage Selector and Fuse.

INSTRUCTIONS D'UTILISATION

Installation

Les instructions complètes d'installation figurent à la fin de ce chapitre.

Source d'alimentation

Cet appareil est conçu pour fonctionner à partir d'une source d'alimentation dont le neutre se trouve au potentiel de la terre ou en est très peu différent, avec un conducteur de protection mis à la terre et séparé. Il n'a pas été prévu pour fonctionner entre deux phases d'un réseau multiphasé.

L'appareil standard fonctionne dans une plage de fréquence réseau de 48 Hz à 60 Hz (ventilateur). L'option 06 porte la limite supérieure de cette plage à 400 Hz.

Consommation

Avec cinq tiroirs installés dans le châssis d'alimentation, le TM 515 peut nécessiter jusqu'à 240 W de puissance dans la gamme supérieure de la tension réseau. La consommation effective est fonction des caractéristiques du tiroir et du mode d'utilisation sélectionnés.

Considérations de charge. Afin d'employer au mieux la capacité de puissance du TM 515, il faut déterminer avec grand soin la configuration des tiroirs, les charges externes ainsi que les consommations respectives. Une utilisation optimale consiste :

1. A répartir des charges égales dans les cinq compartiments.
2. A consommer le maximum de puissance dans les charges extérieures.
3. A utiliser l'ensemble à une température ambiante d'environ 25°C.

Le TM 515 ne possède pas de compartiment forte puissance. La sélection des tiroirs doit donc être soigneusement effectuée, puisque certains appareils ne fonctionnent pas selon leurs pleines possibilités dans ce module. Par exemple, certains tiroirs d'alimentation de la série TM 500 ne fournissent pas leur courant maximal lorsqu'ils sont alimentés par ce module. Des combinaisons avec d'autres tiroirs peuvent également empêcher une utilisation à capacité maximale. Supposons trois tiroirs consommant une puissance maximale de 75 W chacun. Tous ces tiroirs travaillant selon leurs pleines possibilités peuvent détruire le fusible réseau si le disjoncteur thermique ne se met pas en action auparavant.

Le TM 515 alimente chaque tiroir par l'intermédiaire d'une paire de transistors (un NPN et un PNP) montés sur châssis servant de radiateur. Ces transistors, montage série, permettent d'abaisser les tensions d'alimentation nécessaires au tiroir utilisé sans dissiper de puissance dans les tiroirs eux-mêmes.

Température de fonctionnement

Le TM 515 peut être utilisé à une température ambiante comprise entre 0°C et 50°C. Un disjoncteur thermique protège l'ensemble en déconnectant la source d'alimentation du TM 515 lorsque la température interne dépasse un seuil de fonctionnement de sécurité. Ce dispositif rétablit automatiquement l'alimentation de l'appareil lorsque la température interne est redevenue normale.

Puisque le TM 515 peut être stocké à une température comprise entre -40°C et +75°C, il faut laisser au châssis le temps d'atteindre la température normale d'utilisation avant de mettre l'appareil sous tension.

Tiroirs

Il n'est pas nécessaire d'utiliser tous les compartiments pour faire fonctionner le châssis d'alimentation. Les seuls modules nécessaires sont ceux requis pour réaliser une fonction.

ATTENTION

Couper l'alimentation du TM 515 avant l'insertion ou l'extraction de tout tiroir, des arcs électriques risquant de détériorer les circuits.

Installation du module

1. Vérifier que les détrompeurs en plastique situés sur les connecteurs du TM 515 correspondent aux encoches du circuit imprimé du tiroir utilisé.
2. Retirer le dispositif de retenue (PLUG IN RETAINER) maintenant les tiroirs en place, en dévissant les trois vis situées au bas de l'ouverture frontale.
3. Aligner les rainures supérieures et inférieures du tiroir avec les guides du compartiment sélectionné. Insérer le tiroir et le pousser à fond pour que le circuit imprimé se place

correctement dans le connecteur (pour extraire le tiroir, tirer sur la tirette de verrouillage située au coin inférieur gauche du panneau avant).

4. Remettre en place le dispositif « PLUG IN RETAINER ».

Mise en service

Appuyer sur le commutateur POWER, situé sur le panneau arrière du TM 515, pour le placer sur la position ON. Certains tiroirs sont munis de commutateurs de mise en service indépendants, normalement dénommés OUTPUT. Ceux-ci transmettent les alimentations du châssis d'alimentation vers le tiroir sélectionné. Appuyer sur ces boutons pour mettre ces tiroirs en service une fois que le commutateur POWER est sur ON.

CONCEPTION D'UN SYSTEME

Compatibilité

Mécaniquement, les tiroirs modulaires de la série TM 500 sont très similaires aux autres familles de produits Tektronix. Cependant, ils ne sont pas compatibles électriquement. Par conséquent, l'interface du TM 515 est muni de détrompeurs

situés sur les connecteurs correspondants, entre les broches 6 et 7. Cette conception empêche l'insertion de tout tiroir qui ne serait pas compatible. Se reporter à la figure 2-1. Un tiroir compatible doit posséder une encoche correspondante au détrompeur entre les broches 6 et 7 sur le connecteur de son circuit imprimé principal. L'association d'une encoche et de son détrompeur permet l'identification de la fonction et assure la compatibilité des tiroirs.

La tirette de sécurité de couleur blanche est un autre moyen d'identifier la compatibilité des tiroirs de la série TM 500.

Conception de l'interface selon les besoins spécifiques du client

La modularité de ce système permet de réaliser une multitude de fonctions à l'aide des tiroirs. Des fonctions spécifiques sont regroupées par familles ou catégories, chacune de ces familles pouvant comprendre plusieurs tiroirs, par exemple, les familles d'alimentations, de générateurs de signaux, d'instruments de mesures, etc... Chaque tiroir modulaire, membre d'une famille réalisant la même fonction et située sur l'extrémité du connecteur. L'utilisateur du TM 515 peut donc « programmer » un ou plusieurs compartiments afin que ceux-ci n'acceptent que les membres d'une même famille. Pour cela, il suffit d'installer un second détrompeur sur le

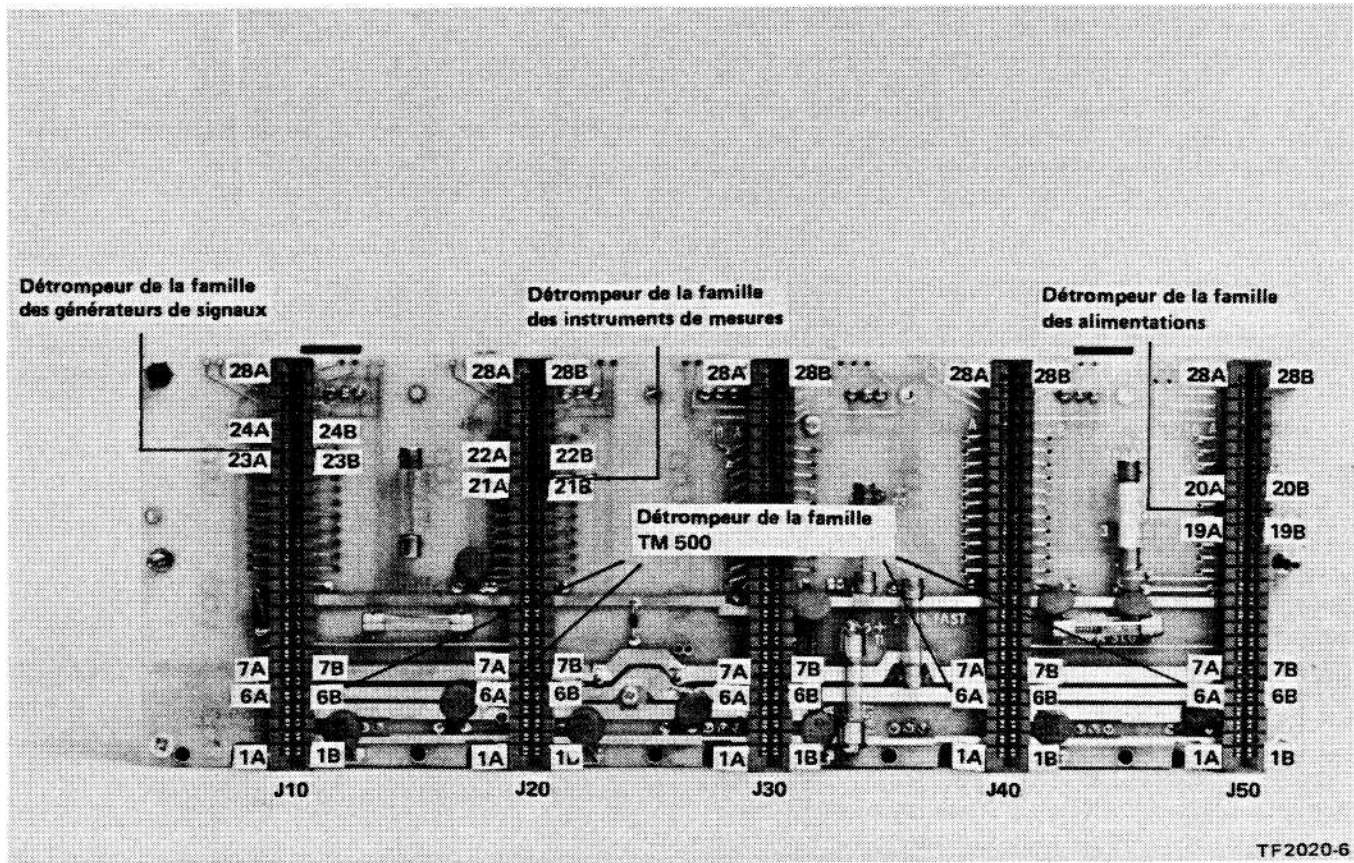

Fig. 2-1. Carte d'interface.

connecteur d'interface en face de l'encoche correspondante. Un appareil TM 515 complet peut être personnalisé de cette manière, permettant d'établir le système d'instructions pour des fonctions spécifiques. Pour obtenir des détrompeurs supplémentaires, se référer à la liste des pièces mécaniques de rechange contenues dans le manuel en anglais.

Des cavaliers câblés peuvent spécialiser l'interface. Des compartiments peuvent ainsi « se parler » en connectant des cavaliers du côté frontal de la carte d'interface par l'intermédiaire des broches d'interconnexions 14 à 28 (côtés A et B ensemble). Pour de plus amples informations, se reporter au chapitre des options du manuel en anglais, rubrique « option 05 ». Se reporter également à chaque manuel de tiroir pour connaître l'assignation de chaque broche I/O (entrée/sortie) placée sur l'interface arrière. Après avoir réalisé les interconnexions pour

une utilisation spécialisée, il est recommandé d'installer les détrompeurs de telle sorte qu'ils garantissent la compatibilité du module avec le câblage effectué.

INSTALLATION ET MISE EN SERVICE PRELIMINAIRE

Démontage des capots avant et arrière

Les pièces en plastique blanc, situées à gauche et à droite, aux extrémités du châssis sont les fixations qui maintiennent les capots en place. Pour les libérer, il suffit d'écarter du boîtier les extrémités avancées des fixations (gauche et droite). Tirer sur le champ arrière de chaque fixation et le couvercle peut être ôté (voir Fig. 2-2).

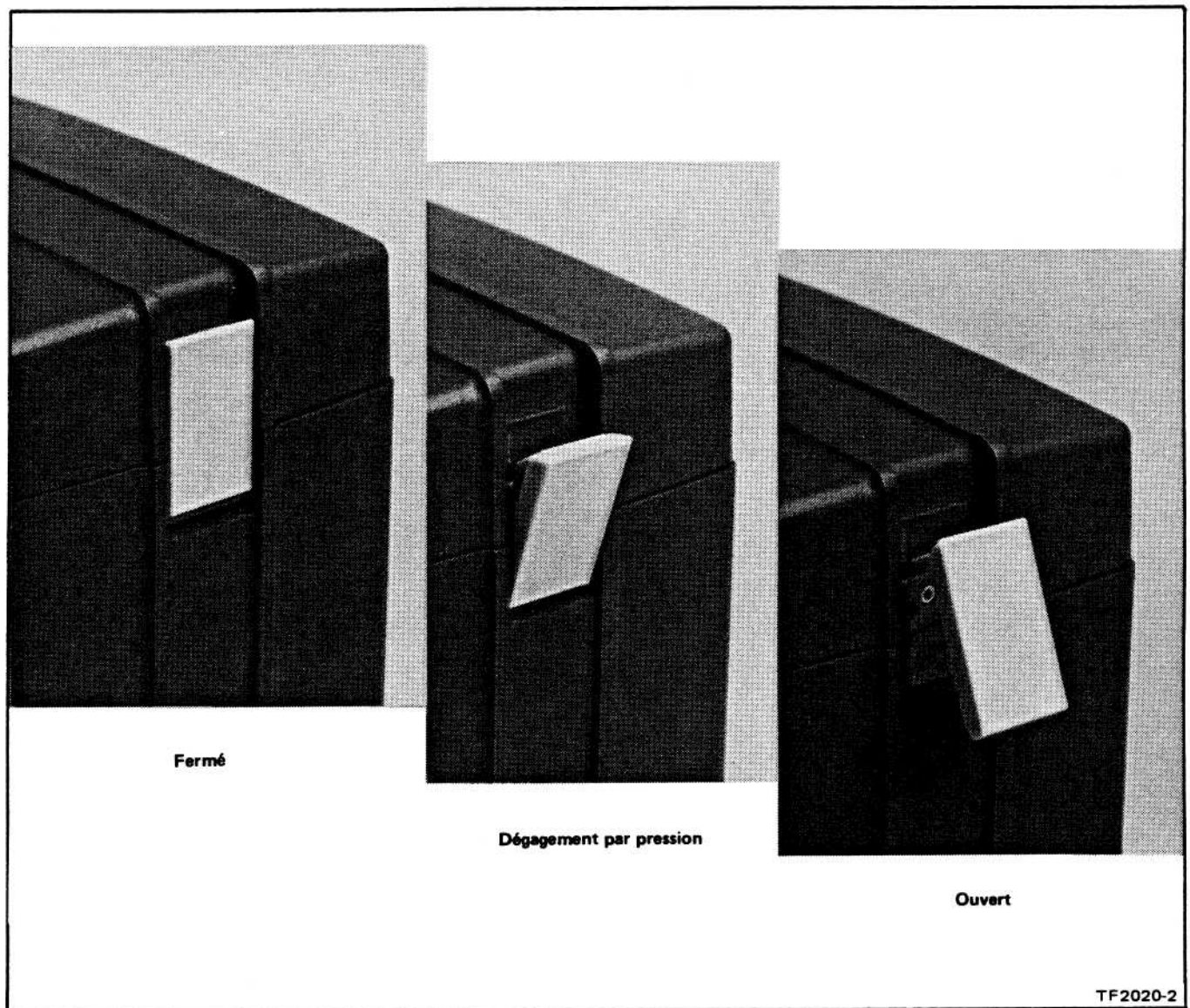
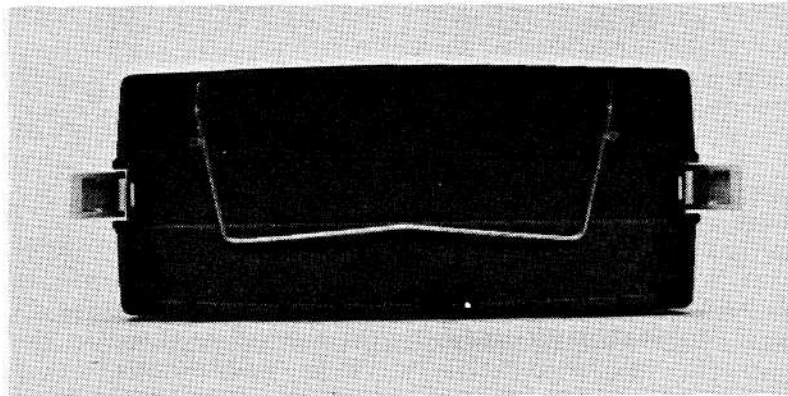
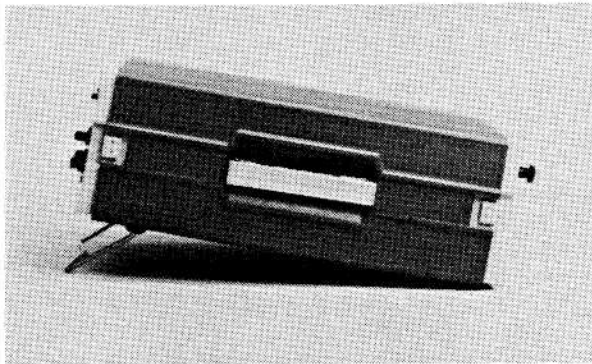

Fig. 2-2. Système de fixation.



Barre d'inclinaison rangée en haut



Barre utilisée pour une inclinaison horizontale

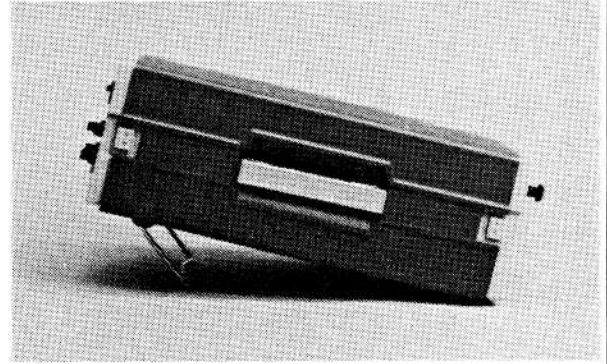

Barre utilisée pour une inclinaison horizontale

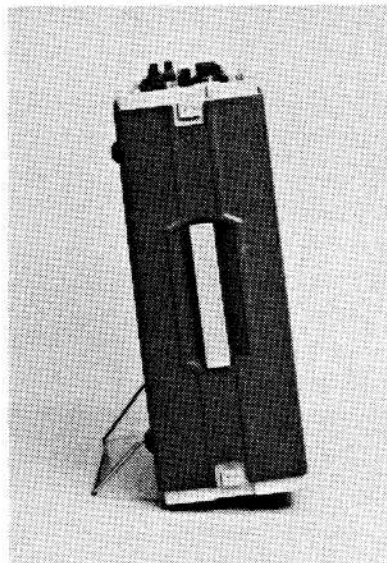

Barre utilisée pour une inclinaison verticale

TF2020-3

Fig. 2-3. Utilisation et rangement de la barre d'inclinaison.

UTILISATION DE LA BARRE D'INCLINAISON

La barre d'inclinaison destinée à maintenir l'appareil selon un angle de visualisation approprié est rangée à l'intérieur du capot avant. Si nécessaire, la sortir de son logement et l'installer conformément à l'angle de visualisation souhaité (Fig. 2-3).

SELECTEUR DE LA TENSION RESEAU ET FUSIBLE

APRES DEMONTAGE DU CAPOT ARRIERE ET AVANT BRANCHEMENT DU CORDON D'ALIMENTATION :

1. Vérifier, à travers le capot de plastique transparent, que le connecteur de sélection de la tension réseau est positionné sur la tension réseau que vous comptez appliquer à l'appareil. Vérifier également que le porte fusible, monté à l'arrière de l'appareil à l'aide d'un écrou, contient bien le fusible approprié (voir Fig. 2-4A).
2. Si l'on doit procéder à une modification, agir de la manière suivante.
3. Dégager le cordon d'alimentation secteur du trou de logement du ventilateur.

a. Desserrer les deux vis de fixation situées sur le capot du sélecteur et démonter le capot. Ceci permet d'accéder aisément aux connecteurs de sélection situés sur l'arrière de l'appareil (voir Fig. 2-4 et 2-5).

b. Démontez le connecteur qui ne convient pas et installez le connecteur correct pour la plage de tension désirée : faible (LOW), moyenne (M) et haute (HIGH). Afin de ne pas l'égarer, placez le connecteur remplacé sur les broches de stockage. Remettez en place le capot de plastique transparent.

c. Tourner le bouton du porte fusible en direction de la flèche et le dégager de l'appareil. Otez le fusible ne convenant pas et mettez en place le fusible approprié. (Des fusibles de rechange sont rangés sur des supports nus sur la carte principale d'interface. Il est nécessaire de séparer l'alimentation du châssis pour accéder à ces fusibles. Se reporter aux instructions de démontage du châssis figurant au chapitre 4 concernant la maintenance, dans le manuel en anglais).

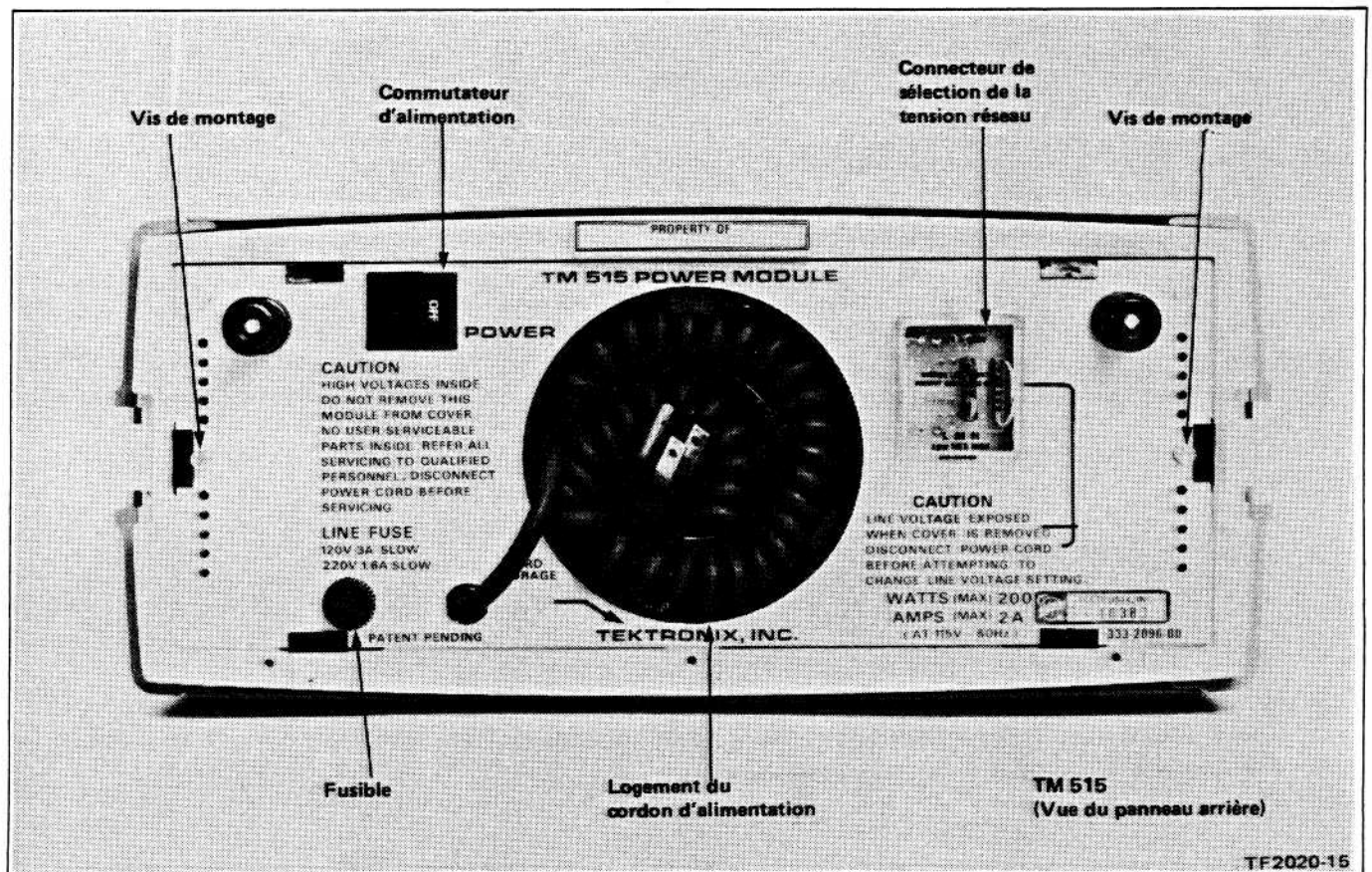

Fig. 2-4A. Panneau arrière.

Instructions d'utilisation - TM 515

4. Si nécessaire, remplacer la prise et le cordon secteur ou utiliser un adaptateur. S'assurer également que le commutateur POWER est sur OFF (hors service).
5. Connecter la prise à la source d'alimentation.
6. Insérer les tiroirs voulus.
7. Les opérations d'installation et de mise en route préliminaire sont alors achevées.

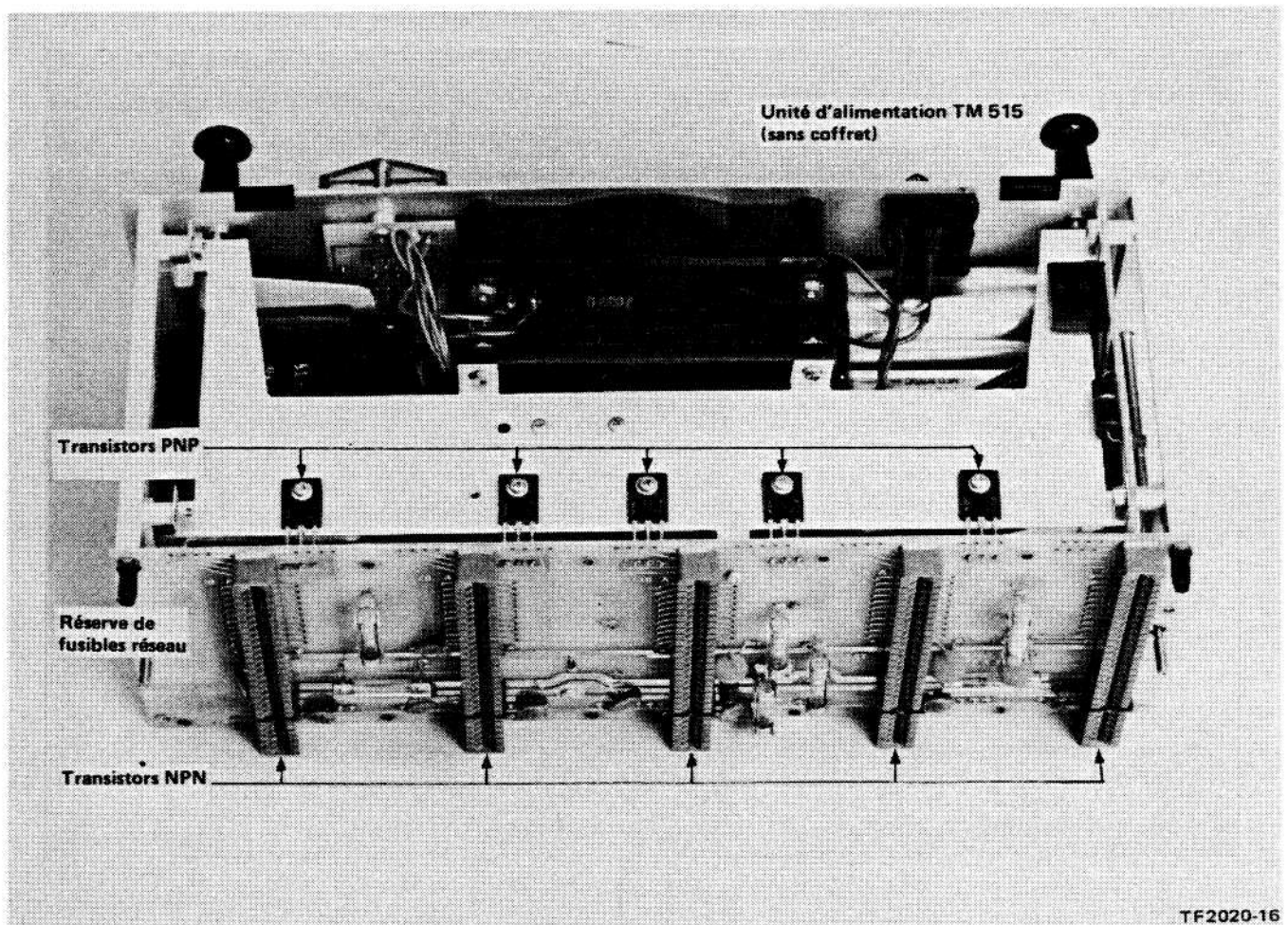



Fig. 2-4B. Vue de face.

Transformateur universel		
Position du connecteur de sélection de la tension réseau	Plages de régulation	
	120 V nominaux	220 V nominaux
L (basse)	90 V alternatifs à 110 V alternatifs	180 V alternatifs à 220 V alternatifs
M (moyenne)	99 V alternatifs à 121 V alternatifs	198 V alternatifs à 242 V alternatifs
H (haute)	108 V alternatifs à 132 V alternatifs	216 V alternatifs à 268 V alternatifs
Fusible réseau	3A fusion lente	1,6 A fusion lente
Sélecteur de tension	 marron	 rouge

TF2020-5

Fig. 2-5. Sélecteur de la tension réseau et fusible.

BEDIENUNGSANLEITUNG

Einbau

Die gesamten Einbauanweisungen finden Sie am Ende dieses Kapitels.

Netzspannung

Die Versorgungseinheit TM 515 muß an ein Lichtnetz mit neutralem oder geerdetem separatem Nulleiter angeschlossen werden. Sie ist nicht für den Anschluß an Zwei- oder Mehrphasennetze geeignet. In der Standardausführung benötigt die Versorgungseinheit 48 Hz bis 60 Hz Netzfrequenz für den Ventilator. Option 6 erhöht den Netzfrequenzbereich auf 400 Hz.

Leistungsaufnahme

Bestückt mit 5 Einschüben nimmt die Versorgungseinheit TM 515 bis zu 240 W an einem 220 V Netz auf. Die tatsächliche Leistungsaufnahme hängt von der Kombination der einzelnen Einschübe und deren momentanen Betriebsarten ab.

Belastungsmöglichkeiten. Der optimale Leistungsverbrauch der Versorgungseinheit TM 515 kann durch Planung der Einschubzusammensetzung, der externen Lasten und der resultierenden Verlustwärme bestimmt werden. Optimale Bedingungen werden erhalten durch:

1. Gleiche Belastung aller Einschubkanäle.
2. Verbrauch von soviel Leistung wie möglich in den externen Lasten.
3. Betrieb des Systems in einer Umgebungstemperatur von etwa 25°C.

Die TM 515-Versorgungseinheit verfügt über kein Einschubfach für erhöhte Leistungsentnahme, es ist daher die Einschubbestückung zu beachten, besonders dann, wenn einige Einschübe nicht mit voller Leistungsentnahme in der Versorgungseinheit betrieben werden dürfen. Einige der TM 500-Seriennetzteile z. B. liefern nicht den maximalen Strom, wenn sie von der TM 515 versorgt werden. Auch gibt es Einschubkombinationen, bei denen die Einschübe nicht die volle Leistung abgeben dürfen. Ein Beispiel wäre die Bestückung mit drei Einschüben, die über eine Verlustleistung von je 75 W verfügen. Wenn alle die Einschübe in ihrer max. Leistung betrieben werden, wird wahrscheinlich die Netzsicherung auslösen, wenn nicht schon vorher die Thermosicherung angesprochen hat.

Jeder Einschub hat Zugriff zu einem, auf ein Kühlblech montierten Leistungstransistorpaar (als Längstransistoren arbeitend). Diese Transistoren, je ein NPN- und PNP-

Typ, ermöglichen den Einschüben in Leistungsbereichen zu arbeiten, die nicht erreichbar wären, würde die Verlustleistung innerhalb der Einschübe abfallen.

Betriebstemperaturen

Die TM 515 kann in einem Umgebungstemperaturbereich von 0°C bis 50°C arbeiten. Die Geräte sind durch thermische Abschaltvorrichtungen, die bei hohen Temperaturen ansprechen, wirkungsvoll geschützt. Nach der Wiederherstellung der Betriebstemperatur schaltet sich die TM 515 automatisch wieder ein.

Die Lagerung der TM 515 kann in einem Temperaturbereich von -40°C bis +75°C erfolgen. Die Inbetriebnahme hat jedoch in den vorgeschriebenen Temperaturgrenzen zu erfolgen.

Einschübe

Für die Inbetriebnahme der TM 515-Versorgungseinheit ist es nicht zwingend, alle Einschubfächer zu bestücken, es sind nur die Einschübe einzubauen, die für die Anwendung erforderlich sind.

VORSICHT

Die Versorgungseinheit TM 515 sollte vor Einfügen oder Herausnahme eines Einschubs ausgeschaltet werden, da Funkenbildung entstehen und die Schaltkreise beschädigen könnte.

Einschubeinbau

1. Überprüfen Sie, ob der Plastiksteg in der rückwärtigen Buchsenleiste der TM 515-Versorgungseinheit so positioniert ist, daß er mit der Aussparung in der Steckerleiste der Einschübe übereinstimmt.

2. Entnehmen Sie die Einschubrückhaltung an der unteren Einschuböffnung durch Aufschrauben der 3 Halterungen.

3. Setzen Sie den Einschub in die obere und untere Führung der Versorgungseinheit und schieben Sie ihn bis er in der hinteren Buchsenleiste einrastet. (Entfernen Sie den Einschub durch Ziehen an der weißen Entriegelungsklinke in der linken unteren Ecke jedes Frontpanels.)

4. Ersetzen Sie die unter Punkt 2 entfernte Einschubrückhalterung.

Einschaltvorgang

Zum Einschalten ist der Netzschalter auf der Rückseite der TM 515 in die Position ON (Ein) zu drücken. Einige Einschübe verfügen über einen eigenen Schalter, der nach dem Einschalten der TM 515-Versorgungseinheit zu betätigen ist.

AUFBAU EINES MESSSYSTEMS

Kompatibilität

Mechanisch sind die Einschübe anderen Tektronix-Produkten sehr ähnlich, jedoch elektrisch nicht kompatibel. Aus diesem Grund besitzt die TM 515 in den Buchsenleisten zwischen den Stiften 6 und 7 Sperriegel, wodurch das Einsetzen eines falschen Einschubes verhindert wird.

Siehe Abb. 2-1. Ein kompatibler Einschub verfügt in seiner Steckerleiste zwischen den Stiften 6 und 7 über eine Aussparung. Diese Kombination von Riegel und Aussparung ist die grundsätzliche Verschlüsselung zwischen Einschüben und Versorgungseinheiten.

Darüber hinaus sind die kompatiblen TM 500-Einschübe durch einen weißen Entriegelungshebel zum Herausnehmen gekennzeichnet.

Anwenderbezogenes Interface

Durch die Modularität dieses Gerätesystems ergibt sich je nach Kombination eine vielseitige Funktionserfüllung. Die speziellen Funktionen sind in Familien bzw. Klassen zusammengefaßt, denen verschiedene Einschübe zugeordnet sind, z.B. Netzteile, Signalgeneratoren und Meßgeräte. Jeder Einschub verfügt daher je nach Familienzugehörigkeit über eine weitere Aussparung in seiner hinteren Steckeranschlußleiste, die ihn klassifiziert. Dem Anwender wird hierdurch ermöglicht, durch Einbau von weiteren Isolierstegen seine Versorgungseinheit so zu programmieren, daß die Einschubfächer nur Einschübe mit bestimmten Funktionen aufnehmen. Beziehen Sie sich bei der Bestellung weiterer Isolierstege auf die Einsatzzeillisten für mechanische Teile.

Zur weiteren Spezialisierung des Interface sind Drahtbrücken zu verwenden, die eine Kommunikation der einzelnen Einschubfächer untereinander gestatten. Hierzu sind die Stifte 14 bis 28 der A- und B-Seiten zu verwenden. Eine Beschreibung hiervon ist unter Option 5 dem Kapitel 4 dieses Handbuches zu entnehmen. Darüber hinaus ist in jeder Einschubbeschreibung die Stiftbelegung der Steckerleiste zu beachten. Sind solche Zwischenverbindungen hergestellt, so ist es zwingend, auch Isolierstege einzubauen, die die Kompatibilität in der Verdrahtung sicherstellen.



Abb. 2-1. Interface-Platine.

EINBAU UND ANLEITUNG VOR DER INBETRIEBNAHME

wonach sie sich aus den Verriegelungen herausklappen lassen (siehe Abb. 2-2).

Entfernen der vorderen und hinteren Abdeckung

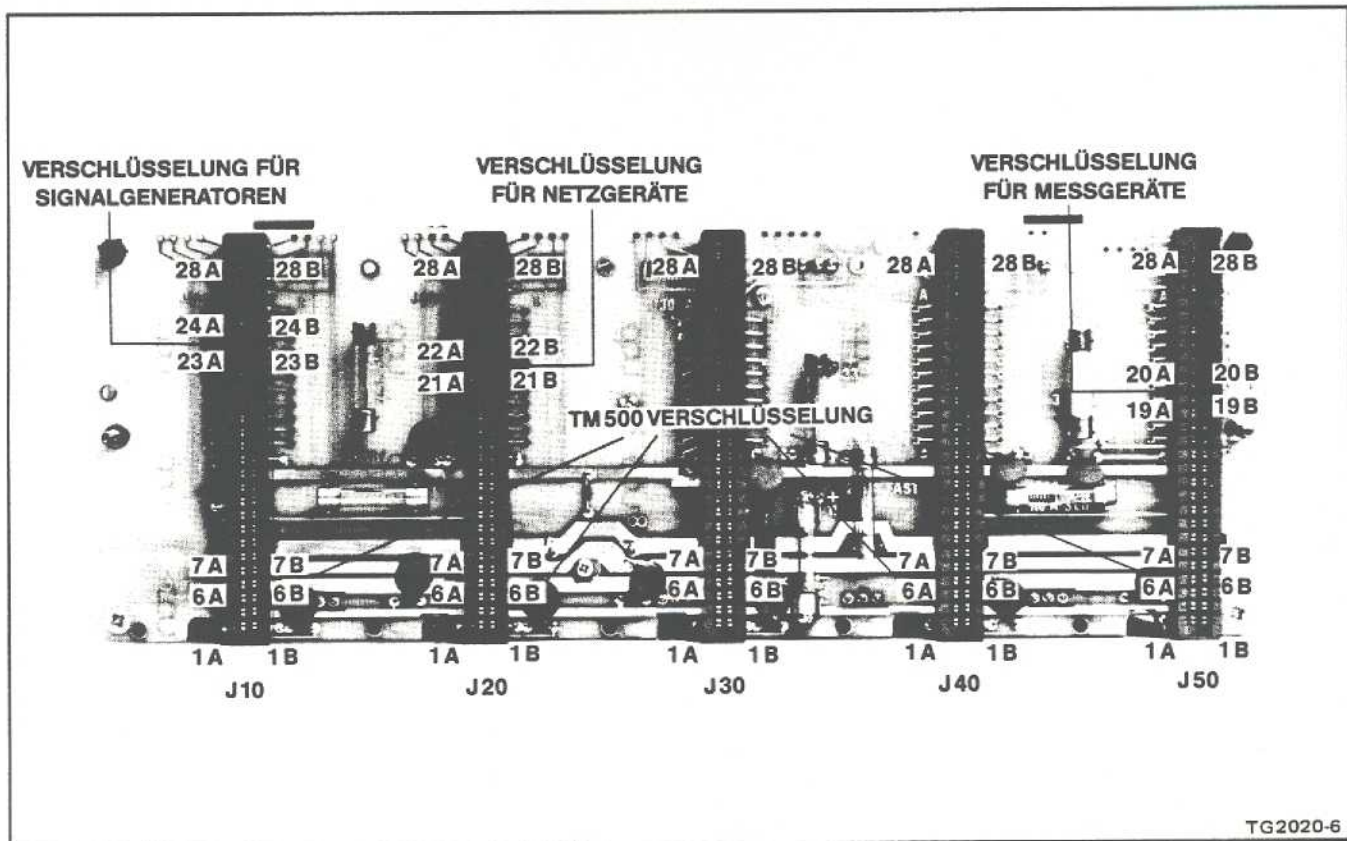
Die weißen, links und rechts am Gehäuse angebrachten Plastikteile sind die Halteklammern der Abdeckhauben.

Zum Entfernen der Abdeckungen sind die Halteklammern an ihren Kanten einfach nach außen zu drücken,

GEBRAUCH DES STANDBÜGELS

Der Standbügel, zur Aufstellung des Gerätes in einem günstigen Betrachtungswinkel, ist in der Frontabdeckung des Gerätes untergebracht. Falls gewünscht, kann der Bügel aus der Halterung in der Frontabdeckung entfernt und entsprechend dem gewünschten Betrachtungswinkel montiert werden.



Abb. 2-2. Halteklammern.



**Standbügel Aufbewahrung in
der Frontabdeckung**

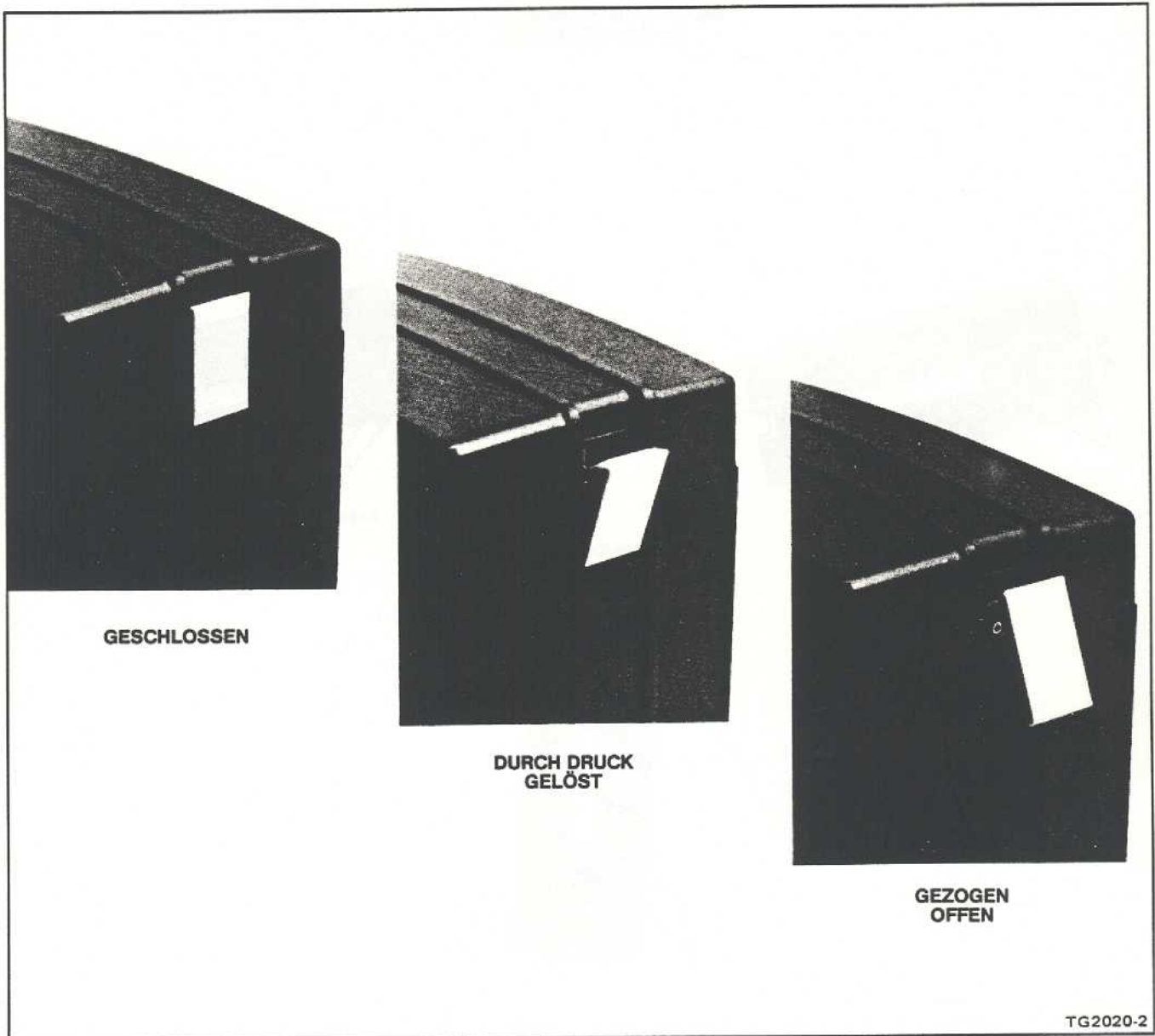
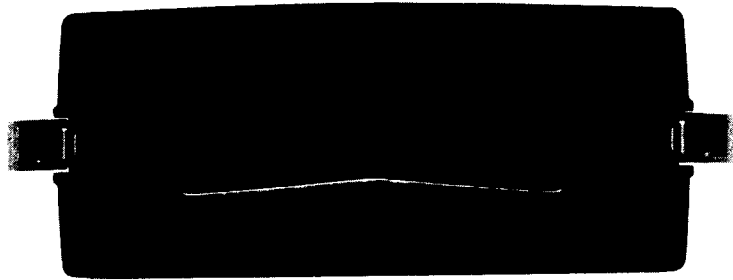
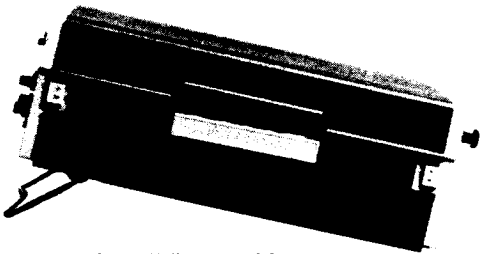

**Standbügelposition zur
Anhebung im Horizontalbetrieb**

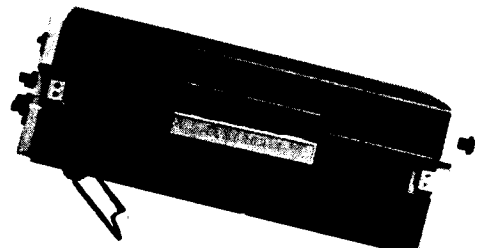

**Standbügelposition zur
Anhebung im Horizontalbetrieb**

**Standbügelposition zur
Neigung im Vertikalbetrieb**

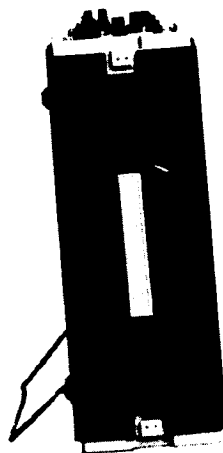

TG2020-3

Abb. 2-3. Gebrauch und Aufbewahrung des Standbügels.

NETZSPANNUNGSWAHL UND SICHERUNGEN

NACH DEM ENTFERNEN DER HINTEREN ABDECKHAUBE UND VOR DEM ANSCHLUSS AN DIE NETZSPANNUNG:

1. Prüfen Sie durch die Plastikabdeckung hindurch, ob sich der entsprechende Netzspannungswahlstecker in der Betriebsposition für die zu erwartende Netzspannungshöhe befindet und ob die richtige Sicherung im Sicherungshalter eingesetzt ist, dessen Schraube auf der Rückseite des Gerätes installiert ist (siehe Abb. 2-4A).

2. Wenn ein Umwechseln erforderlich ist, ist folgendermaßen vorzugehen:

a. Entfernen Sie die zwei Halteschrauben der Plastikabdeckung des Netzspannungswählers und heben Sie die Abdeckung ab. Sie haben jetzt Zugang zu den Netzspannungswahlsteckern, die auf der Rückseite des Gerätes liegen. Siehe Abb. 2-4 und 2-5.

b. Entfernen Sie den unzutreffenden Spannungswahlstecker und ersetzen Sie ihn durch den der richtigen Netzspannungshöhe entsprechenden Stecker. Damit der nicht benötigte Stecker nicht verloren-

geht, stecken Sie ihn bitte auf die dafür vorgesehenen Aufbewahrungsstifte. Dann montieren Sie die Plastikabdeckung wieder mit den Halteschrauben.

c. Drehen Sie den Sicherungshalter in Pfeilrichtung und ziehen Sie ihn heraus. Ersetzen Sie die unpassende Sicherung durch eine passende. (Wechsel- und Ersatzsicherungen werden in Blindhaltern auf der Hauptinterfaceplatte aufbewahrt. Um an die Sicherungen zu gelangen, ist es nötig, das Netzteil aus dem Gehäuse herauszunehmen. Hierzu siehe Gehäuseentfernung unter Kapitel 4 Wartung des Gerätes.)

3. Ziehen Sie die Netzleitung aus dem Lüftergehäuse heraus.

4. Falls nötig, ersetzen Sie den Netzanschlußstecker durch einen passenden, oder benutzen Sie einen Adapter. Prüfen Sie, daß der Netzschalter in Position OFF (Aus) ist.

5. Stecken Sie den Netzstecker ein.

6. Setzen Sie die gewünschten Einschübe ein.

7. Dies beendet den Einbau und die Vorbereitung.



Abb. 2-4A. Rückansicht.



Abb. 2-4B. Vorderansicht.

Universal-Transformator

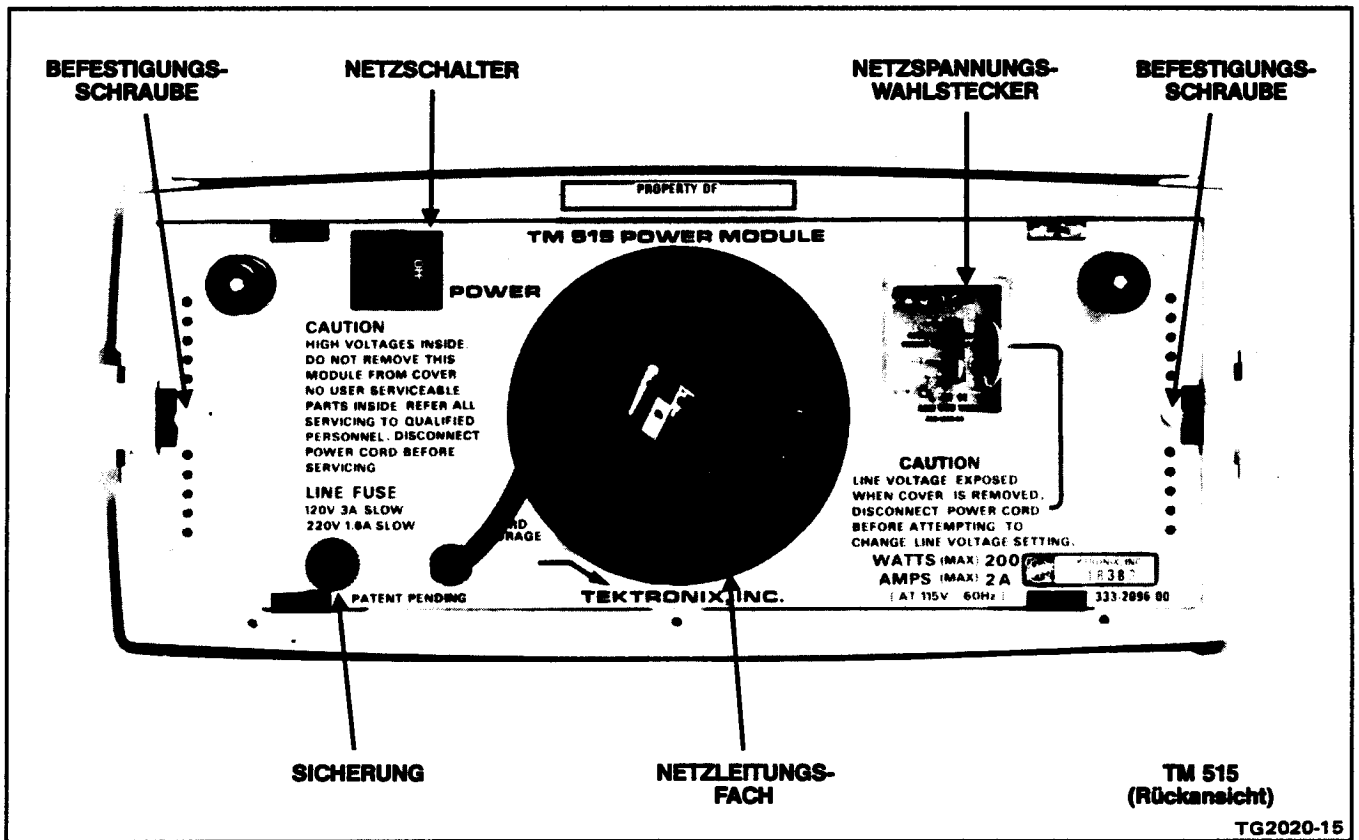
Netzspannungswahlsteckerposition	Regelbereiche	
	120 V Nennwert	220 V Nennwert
L	90 V bis 100 V	180 V bis 220 V
M	99 V bis 121 V	198 V bis 242 V
H	108 V bis 132 V	216 V bis 268 V
Netzsicherungsdaten	3 A träge	1,6 A träge
Netzspannungswahlschalter	 <p>Braun</p>	 <p>Rot</p>

TG2020-5

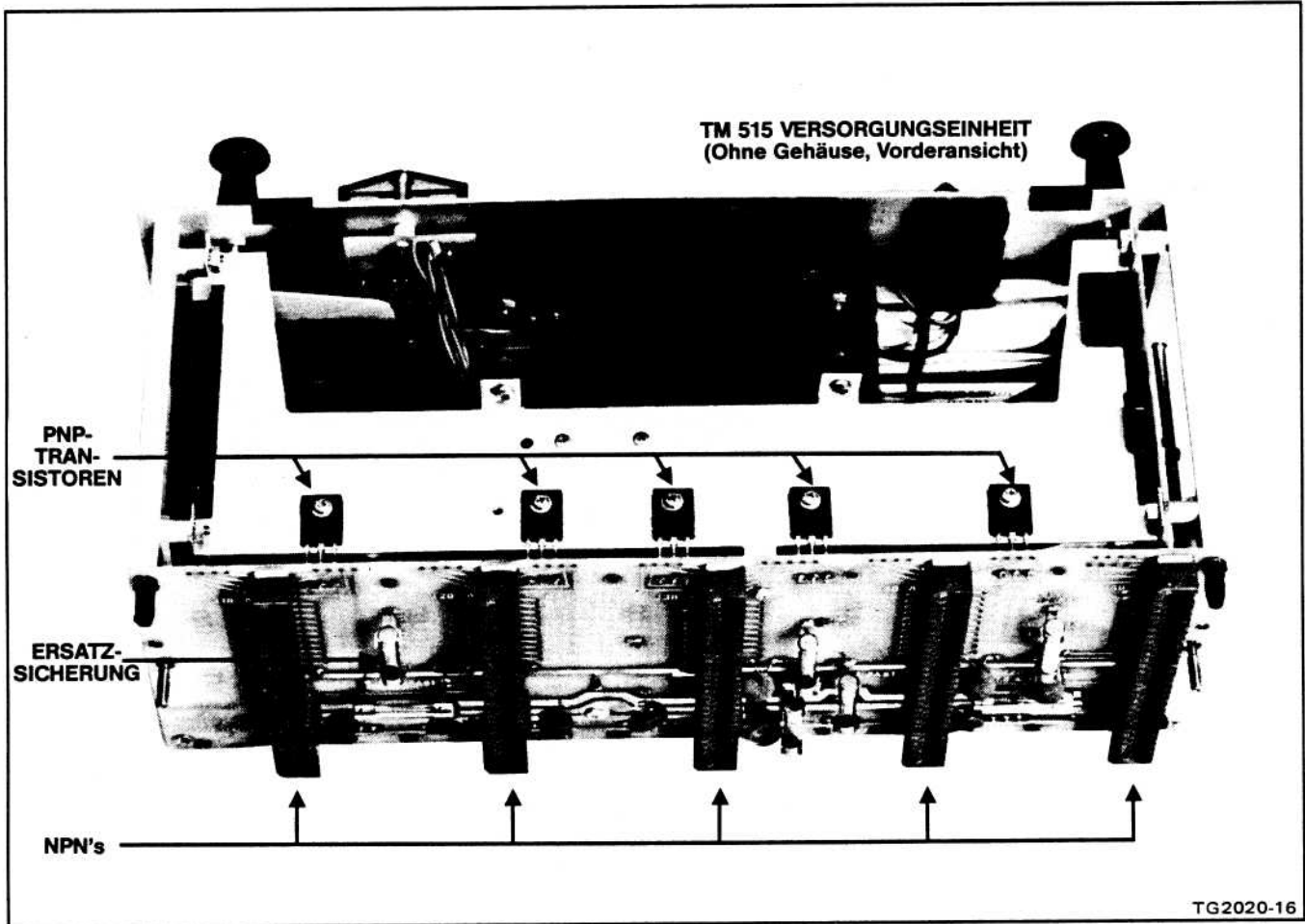
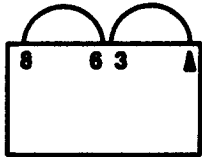
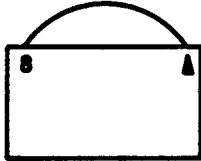
Abb. 2-5. Netzspannungswähler und Sicherung.

取扱説明

取付け

取付け手順に関しては本章の最後の部分に述べられています。

電源

本機器はアース電位の中性点を持った電源で使用するように設計されています。多相システムの2相または単相3線システムの2線で動作させることはできません。標準型の機器はファンが作動するので、周波数範囲は48～60 Hzです。オプション06型は400 Hzまで使用することができます。

消費電力

5台のプラグインが組み込まれた場合、TM515型は高い方の動作電圧で最高240Wの電力を必要とします。実際の消費電力はプラグインの組み合わせや動作状態によって変わります。

負荷について 電力はプラグインの機能的な組合せ、外部負荷、各々のプラグインの消費電力に注意して効率よくご使用下さい。

最適の状態とは、

- (1) 5つのプラグイン・ホールがすべて同じ負荷であること。
- (2) 電力はできる限り外部負荷で消費すること。
- (3) 約25℃の周囲温度で使用すること。

TM515型には高電力プラグイン・ホールがありませんので、プラグインの選択にはご注意ください。プラグインの中には、この電源本体では使用できないものもあります。たとえばTM500シリーズのパワー・サプライはこの本体では最大定格電流を供給できません。他のプラグインの組み合わせでも十分な機能を発揮できないこともあります。最大消費電力がそれぞれ75Wのプラグインを3つ使用した場合、すべてのプラグインが最大定格で動作したならば、サーマル・カットアウトが作動するか、そうでない時はヒューズが切れます。

TM515型には、各プラグイン・ホールに対し各1対ずつ割り合えられたPNP、NPNトランジスタがあります。プラグインの電源はこのトランジスタを通して供給されます。安定化回路はプラグイン内にありますが、熱を十分放散できるようにシリーズ・トランジスタは本体側にあります。

動作温度

TM515型は0～50℃の周囲温度で動作することができます。内部温度が安全動作温度以上に上がった場合には、サーマル・カットアウト装置により自動的に電源が切断し、TM515型を保護します。この装置は内部温度が安全動作温度に復帰すれば再び電源を接続します。

TM515型の格納温度は-40℃～+75℃までですが、機器のシャーシが動作温度範囲内に戻ってから電源を投入して下さい。

プラグイン

本体を動作させるのにすべてのプラグイン・ホールにプラグインを組み込む必要はありません。必要なプラグインのみ組み込んで下さい。

注意

プラグインを抜き差しする場合にはTM515型の電源を切ってから行って下さい。切らずに抜き差ししますとアークが生じ、中の回路に悪影響を与えます。

プラグインの取付け

1. TM515型のコネクタ内にはいつているプラスチックの位置決めスペーサとプラグインのエッジ・コネクタのカット部分が一致していることを確認します。
2. 機器の前面下部についている3本のボルトをはずしてPLUG-IN RETAINERを取りはずします。
3. プラグイン・ホールの上下のガイドに沿ってプラグインを差し込み、さらにコネクタにプラグインのエッジ・コネクタがしっかりと固定されるまで押して下さい。プラグインを取りはずす場合には、左下隅にあるつまみを引っぱりそのまま引き抜きます。
4. PLUG-IN RETAINERを取り付けます。

電源投入の手順

TM515型の後部パネルのPOWERスイッチをONの位置にします。プラグインの中には独立した電源スイッチを持っているものもあり通常OUTPUTと書かれています。プラグインを動作させるにはこのボタンを押します。これによってプラグインへの電源供給をコントロールすることができます。プラグインを作動させるには、本体の電源を入れてから、このスイッチを入れます。

システム構成

互換性

当社のプラグインは外観上、他のシリーズのプラグインと類似しています。しかし電気的には互換性がありません。ですから他のシリーズのプラグインと組み合わせができないよう、TM515型のインターフェイス・コネクタのピン6と7に位置決めスペーサがはいています。(1-1図参照) TM500シリーズのプラグインはメインのプリント基板上のピン6と7の部分がかットされています。このスペーサとカット部分が一致していることを確認します。

TM500シリーズのプラグインには白色のつまみがありますので簡単に識別できます。

インターフェイス

TM500シリーズはプラグイン方式になっていますので多くの異なる機能を持たせることが可能です。またTM500シリーズを信号源、電源、測定器などいくつかの群に分けることができ、それらの同種のプラグインに特定のプラグイン・ホールを割り当てるため、別に位置決めスペーサを挿入することもできます。この位置決めスペーサの追加によって、同種のプラグイン群のみ使用可能なプラグイン・ホールをプログラムすることができます。この方法でTM515型のすべてのプラグイン・ホールに特定の機能を持たせることができます。位置決めスペーサの部品番号はメカニカル・パーツ・リストをご参照下さい。

さらにジャンパ線を使ってインターフェイスを容易にすることが可能です。内部コネクタのA面とB面のピン14~28を使って、インターフェイス・ボードの後側をジャンパ線で接続することによりプラグインの信号を内部でやりとりすることができます。オプション02型の説明の項をご参照下さい。後部インターフェイスの各ピンのI/Oの割り当てについては各プラグインの取扱説明書をお読み下さい。一旦特殊目的用にジャンパ線を接続したら内部インターフェイス・コネクタに位置決めスペーサを取付けて、ジャンパ線の配線に合わせたプラグインの適合性を保持するようにします。

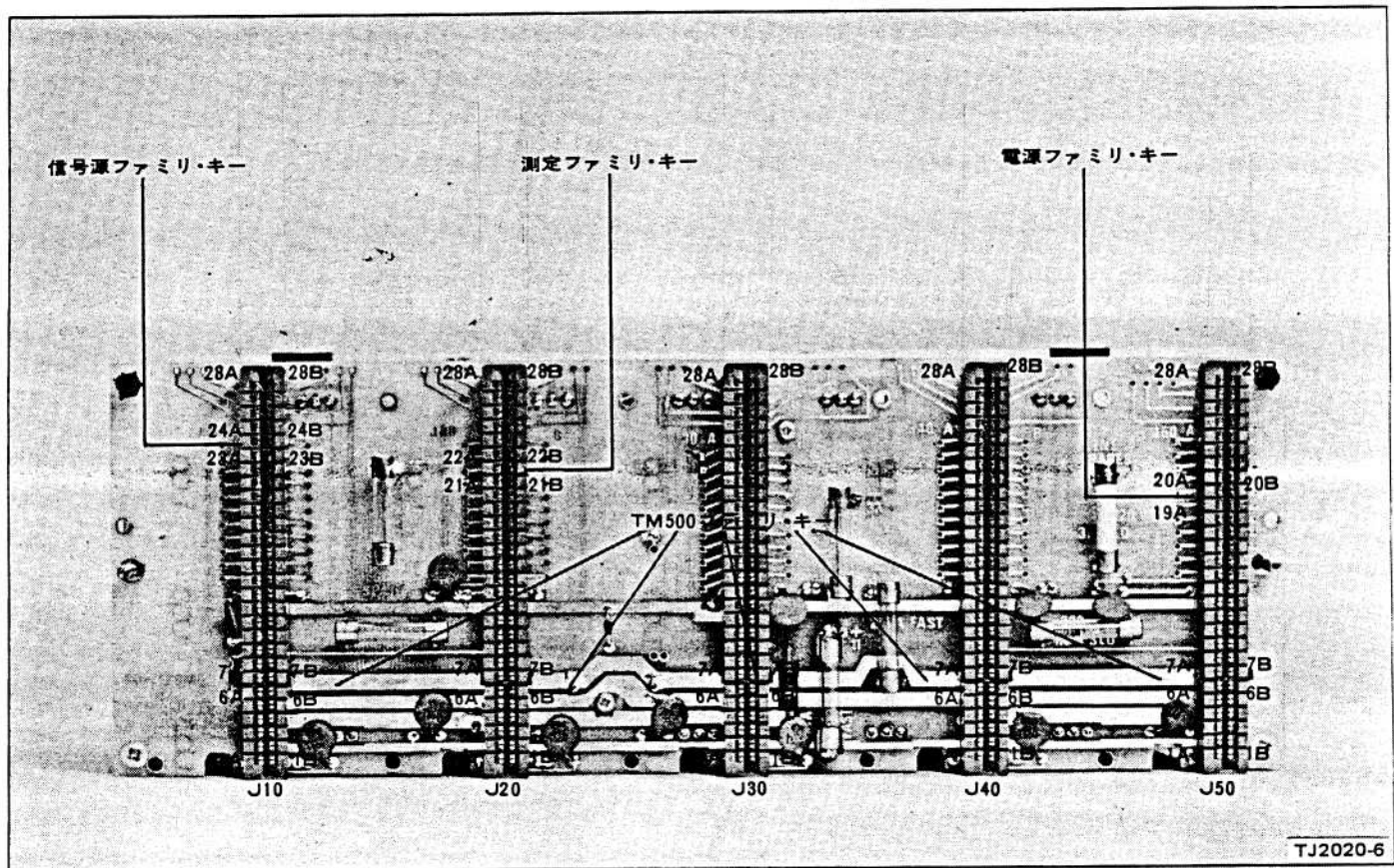

2-1図 インターフェイス・ボード

機器の組み立て

前面および後部カバーの取りはずし

キャビネットの左右両端に、カバーがはずれないように固定しておく白いプラスチックのとめ具がついています。

これらをはずすには、とめ具の上端をケースから離れるように押し広げます。

次にとめ具の他端をはずしカバーをとりはずします。
(2-2図参照)

底部金具の使用

前面カバー内に、測定に便利のように機器を適当な角度に保つための金具が付属しています。必要な場合には、この金具を収納部分から取りはずして、ご希望の角度で観測できるように取り付けて下さい。2-3図参照。

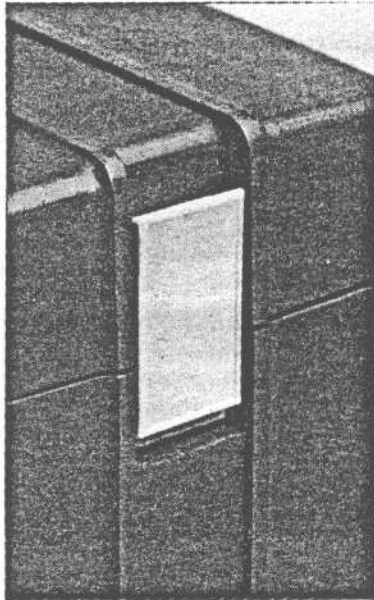

閉じている時

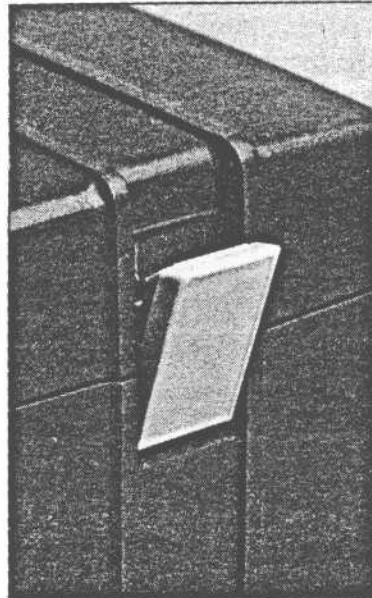

とめ具がはずれかけた状態

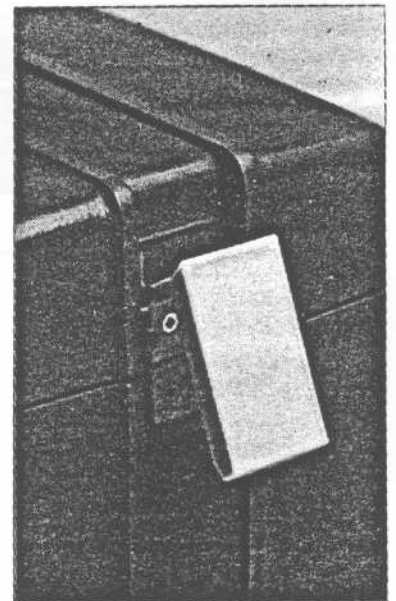

開いた時

TJ2020-2

2-2図 とめ具のはずし方

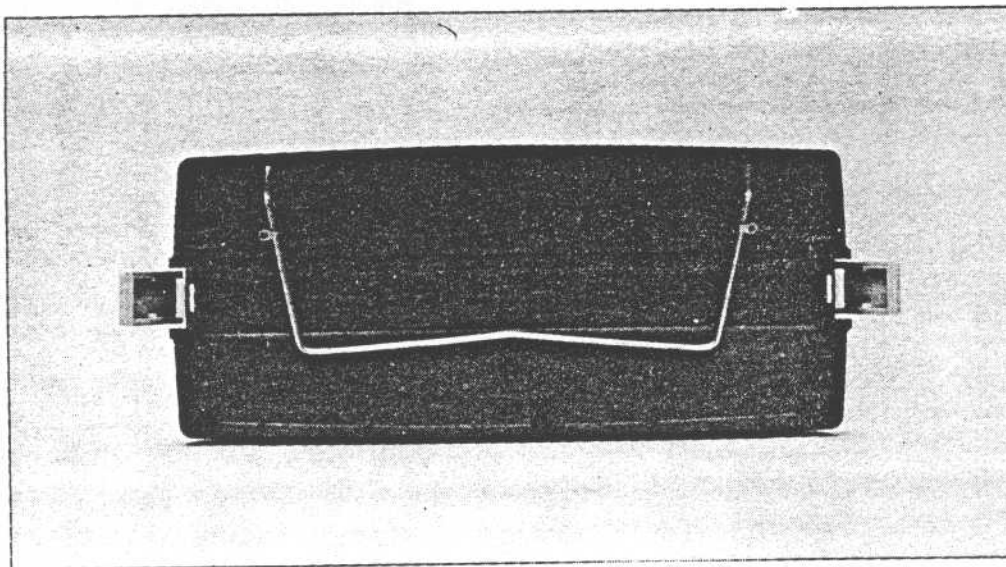

底部金具は前面カバー内に収納されています

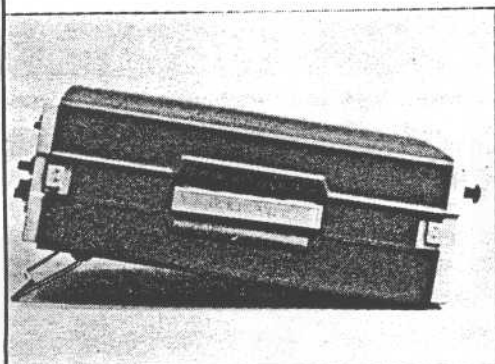

水平に使う場合

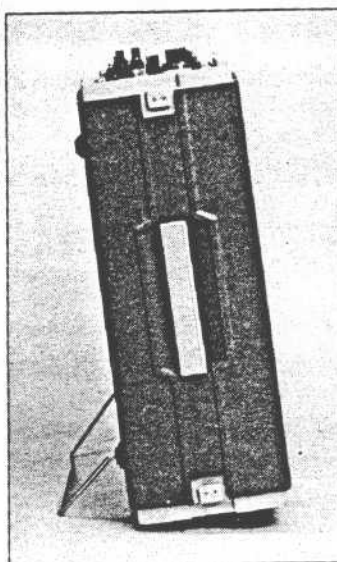

垂直に立てる場合

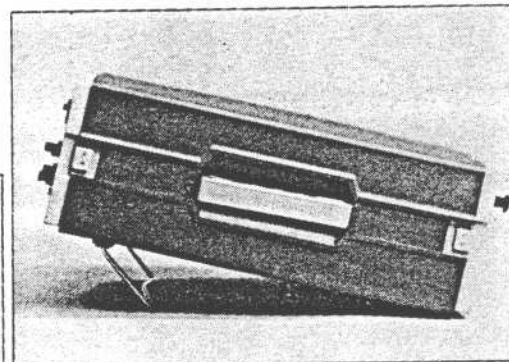

水平に使う場合

TJ2020-3

2-3図 底部金具の使用法と収納

電源電圧セクタ及びヒューズ

後部カバーを取りはずしてから電源を入れるまで

- (1) 機器を使用するにあたって適切な電源電圧が選択されているかどうかを透明プラスチック・カバーを通して確認します。また機器の後部にねじどめされている、ライン・ヒューズ・ホルダに、電源電圧に合ったヒューズが取り付けられているか調べます。(2-4図)
- (2) ヒューズの交換が必要な場合は次の手順に従います。
 - (a) 2個のとめねじをはずし、透明プラスチックの電源電圧セクタ・カバーを取りはずします。(2-4図、2-5図参照。)
 - (b) 不適当なブロックをはずし、L、M、Hのうち希望する電源電圧のブロックを取り付けます。不適当なブロックはストレージ・ピンに取り付け、なくさないようにします。透明プラスチック・カバーを再び取り付けます。
 - (c) ヒューズ・ホルダ・ノブを回して、機器から離れるように引っぱります。不適当なヒューズを取りはずし、適切なものを取り付けます。(交換用ヒューズはメイン・インターフェイス・ボード上のブランク・ホルダに収納されています。ヒューズを取り出す際には、必ず電源を取りはずして下さい。この取扱説明書中の第2章をご参照下さい。)
- (3) 電源コードを収納部分から引き出します。
- (4) 必要であれば電源差し込みプラグを変更するか、交換アダプタを使用します。さらに電源スイッチがOFFになっていることを確かめます。
- (5) 電源コードを差し込みます。
- (6) プラグインを差し込みます。
- (7) プラグインの取付けが完了したら、電源を入れることができます。

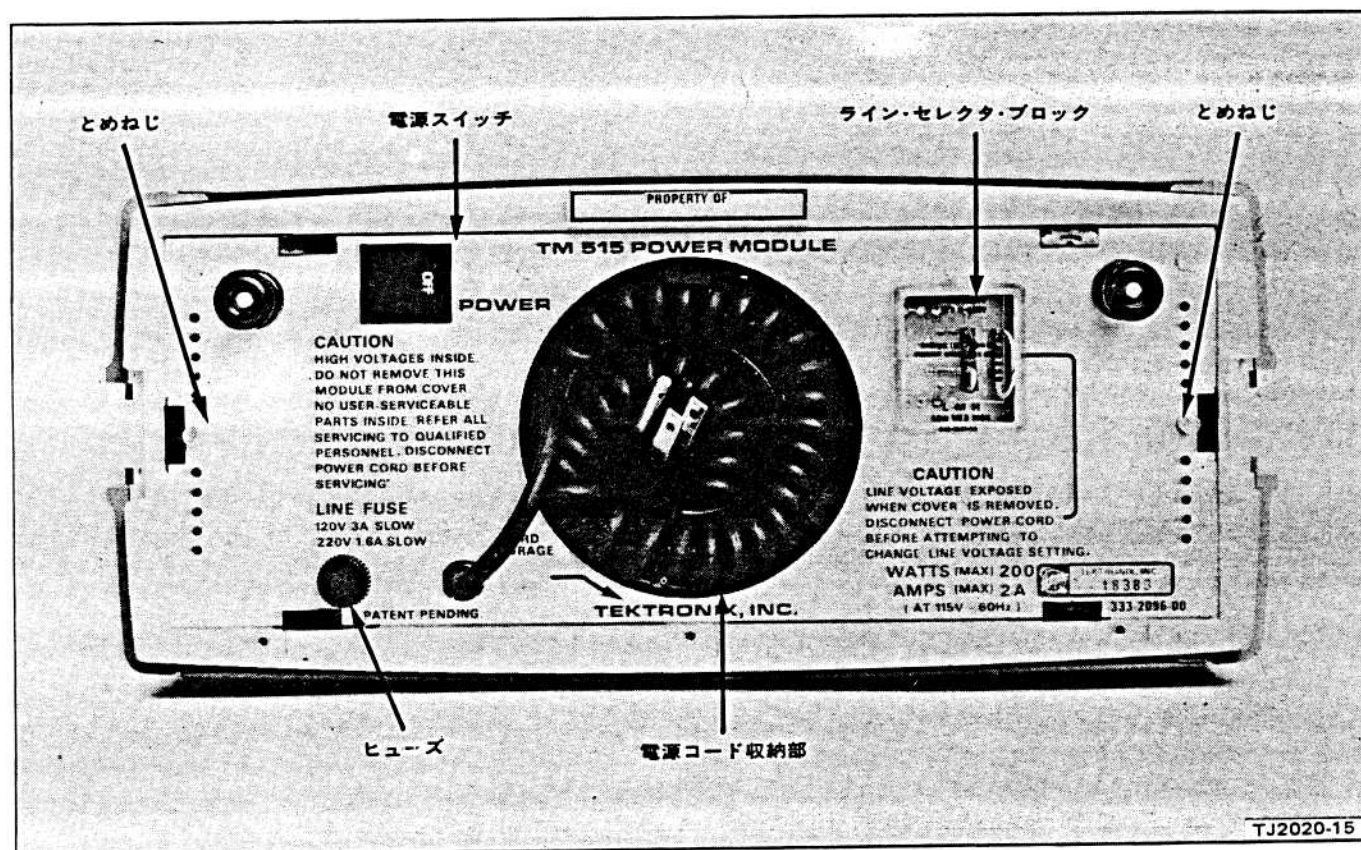

2-4 A 図 後部

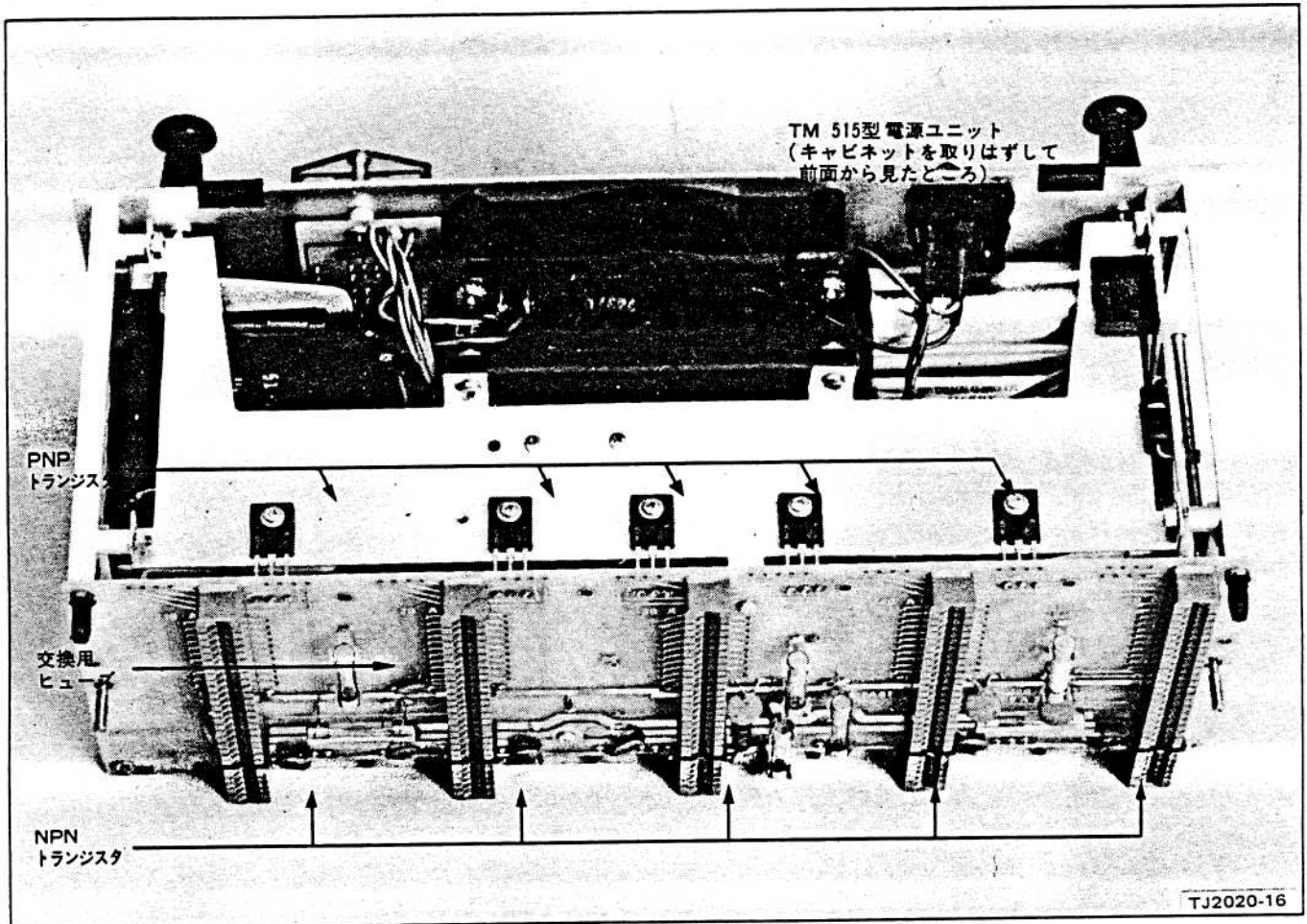

2-4B図 前面

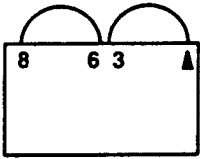
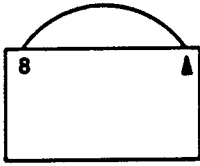
電源電圧レンジ		
ライン・セレクタ・ ブロック位置	電圧レンジ	
	120 V	220 V
L	90 VAC ~ 110 VAC	180 VAC ~ 220 VAC
M	99 VAC ~ 121 VAC	198 VAC ~ 242 VAC
H	108 VAC ~ 132 VAC	216 VAC ~ 268 VAC
ライン・ヒューズ	3 A	1.6 A
セレクタ・ブロック	 <p>茶色</p>	 <p>赤</p>

TJ2020-5

2-5 図 電源電圧セレクタ及びヒューズ

WARNING

THE FOLLOWING SERVICING INSTRUCTIONS ARE FOR USE BY QUALIFIED PERSONNEL ONLY. TO AVOID PERSONAL INJURY, DO NOT PERFORM ANY SERVICING OTHER THAN THAT CONTAINED IN OPERATING INSTRUCTIONS UNLESS YOU ARE QUALIFIED TO DO SO. REFER TO OPERATORS SAFETY SUMMARY AND SERVICE SAFETY SUMMARY PRIOR TO PERFORMING ANY SERVICE.

MAINTENANCE

GENERAL

Introduction

This section of the manual is meant to support the entire TM 500-Series family of modules with a general coverage of the most commonly-needed service information pertinent to preventive maintenance, troubleshooting, ordering parts, and replacing components and sub-assemblies.

Cabinet Removal

WARNING

Dangerous potentials exist at several points throughout the system. When the system must be operated with the cabinet removed, do not touch exposed connections or components. Some transistors have voltage present on their cases. Disconnect power before cleaning the system or replacing parts.

Two screws on the rear panel secure the case to the TM 515 Power Unit. Unscrew them and lift the power unit straight up to take the two apart. Do not operate the system with the case removed any longer than necessary for troubleshooting and calibration. Re-install the power unit to protect the interior from dust and to remove personnel shock hazards, as well as provide proper ventilation.

When reinstalling the power unit in the case, care should be taken to align the Power Supply mounts with their respective holes in the Chassis (Support) Assembly. You may find it easier to fit the case to the supply. Look down through the front end of the open case to make sure the mounts align with their respective holes in the assembly. Then, carefully holding the two units together, invert the whole assembly and screw the two mounting bolts into place. See Fig. 3-1.

Cleaning

CAUTION

Avoid using chemical cleaning agents that might damage plastic parts. Avoid chemicals containing benzene, toluene, xylene, acetone, or similar solvents.

Exterior. Loose dust may be removed with a soft cloth or a dry brush. Water and a mild detergent may be used. Abrasive cleaners should not be used.

Interior. Cleaning the interior of any unit should precede calibration since the cleaning process could alter the settings of calibration adjustments. Use low-velocity compressed air to blow off accumulated dust. Hardened dirt can be removed with a soft brush, cotton-tipped swab, or a cloth dampened in a solution of water and mild detergent.

Preventive Maintenance

Preventive maintenance steps performed on a regular basis will improve the reliability of the instrumentation systems. However, periodic checks of the semiconductors in the absence of a malfunction are not recommended as preventive maintenance measures. See Semiconductor Checking information under Troubleshooting Techniques which follow. A convenient time to perform preventive maintenance is just before instrument calibration.

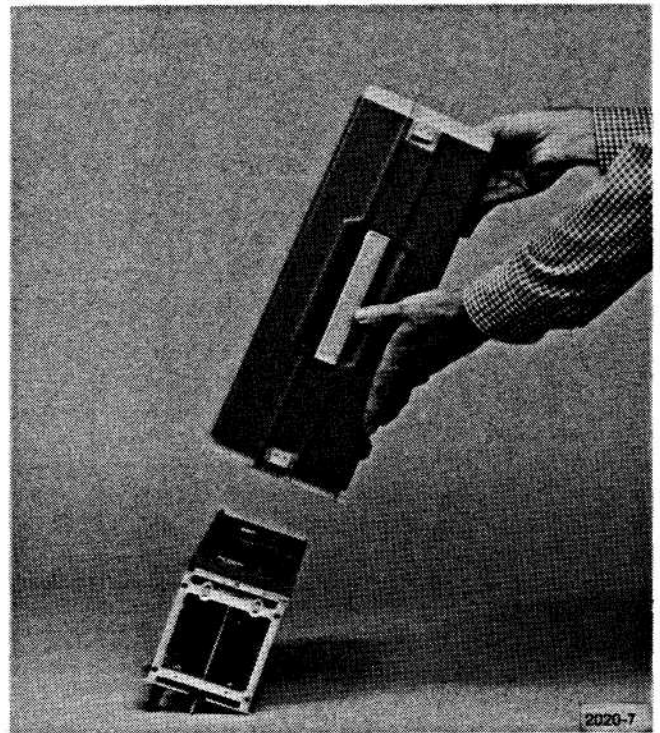

Fig. 3-1. Reassembly Guide-Pin Alignment.

Calibration

To ensure accurate signal generation and measurement, the performance of individual units composing the system should be checked periodically. Refer to the instruction manual for each unit for complete calibration and verification procedures.

TROUBLESHOOTING AIDS

Introduction

The following is provided to augment information contained elsewhere in this and other TM 500-Series manuals when troubleshooting becomes necessary.

Circuit Description

Each manual has a section devoted to explaining circuit operating theory. Used conjointly with the schematics, this can be a powerful analytic tool.

Diagrams

Block diagrams and detailed schematic diagrams are located on foldout pages in the Service section of most of the TM 500-Series manuals. The schematic diagrams show the component values and assigned circuit reference numbers of each part necessary to the circuit design. Usually the first page of the Diagram section defines the the circuit symbols and reference designators used in that particular instrument. Major circuits are usually identifiable by a series of component numbers. Important waveforms and voltages may be shown within the diagrams or on adjoining aprons. Those portions of the circuits located on circuit boards are enclosed with a blue or gray outline.

Circuit Board Illustrations

Illustrations showing component locations keyed with a grid scheme for each circuit board are usually placed on the back of a foldout page and sequenced as close as possible to an associated schematic. The GRID LOC columns, located near the Parts Location Grid, keys each component to easy location on the board.

Component and Wiring Color Codes

Colored stripes or dots on electrical components signify electrical values, tolerances, etc., according to EIA standards. Components not color-coded usually have information printed on the body. The wiring coding follows the same EIA standards, except as follows:

Power Cord Conductor Identification

Conductor	Color	Alternate Color
Ungrounded (Line)	Brown	Black
Grounded (Neutral)	Blue	White
Grounding (Earthing)	Green-Yellow	Green-Yellow

Testing Equipment

Generally, a wide-band oscilloscope, a probe, and a multimeter are all that is needed to perform basic waveform and voltage checks for diagnostic purposes on units in this module. The calibration procedures in the manual for each plug-in lists specific test equipment and the features necessary to adequately check out that particular unit.

TROUBLESHOOTING TECHNIQUES

Introduction

This troubleshooting procedure is arranged in an order that checks the simple possibilities before proceeding to extensive troubleshooting.

Control Settings

Incorrect control settings can indicate a trouble that does not exist. If there is any question about the correct function of any control, see the Operating Instructions section of the manual for the instrument involved.

System and Associated Equipment

Before proceeding with troubleshooting the TM 500-Series system, check that the instruments in the system are operating correctly. Check for proper interconnection between the power module and the plug-ins. Check the line voltage at the power source. Check that the signal is properly connected and that the interconnecting cables and signal source are not defective.

Cam Switch Charts

Cam switches shown on the diagrams are coded on comprehensive charts to locate the cam number of the switch contact in the complete switch assembly, counting from the front, or knob end, toward the rear of the switch. The charts also indicate with a solid dot when each contact is closed. Some contacts are momentarily closed between detent positions and these are identified through the use of a triangular dot between detents in the contact drawing.

The associated plug-ins can be checked for proper operation quickly by substituting other like units known to be operating properly. If the trouble persists after substitution, then the power module is probably at fault. Moving a properly operating plug-in from one appropriate compartment to another might help determine if one or more compartments have a problem.

Visual Check

Inspect the portion of the system in which the trouble is suspected. Many troubles can be located by visual clues such as unsoldered connections, broken wires, damaged circuit boards, damaged components, etc.

Instrument Calibration

Check the calibration of the suspected plug-in or the affected circuit if the trouble is obviously in a certain circuit. The trouble may only be a result of misadjustment or may be corrected by re-calibration. Complete calibration instructions are given in the manual for each instrument in the system.

Circuit Isolation

Note the trouble symptoms. These often identify the circuit in which the trouble is located. When trouble symptoms appear in more than one circuit, check the affected circuits by making waveform and voltage measurements.

Incorrect operation of all circuits often means trouble in the power supplies. Using a multimeter, check first for correct voltages of the individual regulated supplies according to the plug-in schematics and calibration procedures. Defective components elsewhere in the instruments can appear as power supply problems. In these instances, suspected circuits should be disconnected from apparently bad power supplies one at a time to narrow the search.

Voltages and Waveforms

Often, defective components can be located by using waveform and voltage indications when they appear on the schematic or in the calibration procedures. Such waveforms and voltage labels are typical indications and will vary between instruments. To obtain operating conditions similar to those used to take these readings, refer to the first diagram in the service section of the plug-in manuals.

Component Checking

If a component cannot be disconnected from its circuit, then the effects of the associated circuitry must be considered when evaluating the measurement. Except for soldered-in transistors and integrated circuits, most components can be lifted at one end from the circuit board.

Transistors and IC's

Turn the POWER switch OFF before removing or replacing any semiconductor.

A good check of transistor operation is actual performance under operating conditions. A transistor can most effectively be checked by substituting a new component for it (or one which has been checked previously). However, be sure that circuit conditions are not such that a replacement transistor might also be damaged.

If substitute transistors are not available, use a dynamic tester. Static-type testers are not recommended, since they do not check operation under simulated operating conditions. A suction-type desoldering tool must be used to remove soldered-in transistors; see Component Replacement procedure for details.

Integrated circuits can be checked with a voltmeter, test oscilloscope, or by direct substitution. A good understanding of the circuit description is essential to troubleshooting circuits using IC's. Operating waveforms, logic levels, and other operating information for the IC's are given in the Circuit Description section of the appropriate manual. Use care when checking voltages and waveforms around the IC's so that adjacent leads are not shorted together. A convenient means of clipping a test probe to the 14- and 16-pin in-line IC's is with an integrated circuit test clip. This device also doubles as an extraction tool.

Diodes

Do not use an ohmmeter that has a high internal current. High currents may damage the diode.

A diode may be checked for an open or shorted condition by measuring the resistance between terminals. When an ohmmeter scale having an internal source of between 800 mV and 3 V, the resistance should be very high in one direction and very low when the leads are reversed.

Resistors

Check the resistors with an ohmmeter. Resistor tolerances are given in the Electrical Parts List in every manual. Resistors do not normally need to be replaced unless the measured value varies widely from the specified value.

Capacitors

A leaky or shorted capacitor can be detected by checking resistance with an ohmmeter on its highest scale. Use an ohmmeter that will not exceed the voltage rating of the capacitor. The resistance reading should be high after initial charge of the capacitor. An open capacitor can best be detected with a capacity meter, or by checking whether it passes ac signals.

PARTS ORDERING AND REPLACING

Obtaining Replacement Parts

Most electrical and mechanical parts can be obtained through your local Tektronix field office or representative. However, you should be able to obtain many of the standard electronic components from a local commercial source in your area. Before you purchase or order a part from a source other than Tektronix, Inc., please check the electrical parts list for the proper value, rating, tolerance, and description.

Special Parts. Some parts are manufactured or selected by Tektronix, Inc., to satisfy particular requirements, or are manufactured for Tektronix, Inc., to meet our specifications. Most of the mechanical parts used in this system have been manufactured by Tektronix, Inc. Order all special parts directly from the local Tektronix Field Office or representative.

Ordering Procedure. When ordering replacement parts from Tektronix, Inc., please include the following minimum information:

1. Instrument Type (PS 501, SG 502, DC 501, etc.).
2. Instrument Serial Number (for example, B010251).
3. A description of the part (if electrical, include the circuit number).
4. Tektronix part number.

Please do not return any instruments or parts before receiving directions from Tektronix, Inc.

A listing of Tektronix Field Offices, Service Centers, and representatives can be found in the Tektronix Product Catalog and Supplements.

Replacing Parts

The exploded view drawing associated with the Mechanical Parts List, located to the rear of most manuals, may be especially helpful when disassembling or reassembling individual components or sub-assemblies.

Circuit Boards. If a circuit board is damaged beyond repair, the entire assembly, including all soldered-on components, can be replaced.

To remove or replace a board, proceed as follows:

1. Disconnect all leads connected to the board (both soldered lead connections and solderless pin connections).
2. Remove all screws holding the board to the chassis or other mounting surface. Some boards may be held fast by plastic mounting clips around the board edges. For these, push the mounting clips away from the circuit board edges to free the board. Also, remove any knobs, etc., that would prevent the board from being lifted out of the instrument.
3. Lift the circuit board out of the unit. Do not force or bend the board.
4. To replace the board, reverse the order of removal. Use care when replacing pin connectors. If forced into place incorrectly positioned, the pin connectors may be damaged.

Transistors and IC's. Transistors and IC's should not be replaced unless they are actually defective. If removed from their sockets during routine maintenance, return them to their original sockets. Unnecessary replacement or switching of semiconductor devices may affect the calibration of the instruments. When a transistor is replaced, check the operation of the part of the instrument that may be affected.

Replacement semiconductors should be of the original type or a direct replacement. Figure 3-2 shows the lead configurations of the semiconductors used in this instrument system. When removing soldered-in transistors, use a suction-type desoldering tool to remove the solder from the holes in the circuit board.

An extracting tool should be used to remove the 14- and 16-pin integrated circuits to prevent damage to the pins. This tool is available from Tektronix, Inc. Order Tektronix Part No. 003-0619-00. If an extracting tool is not available, use care to avoid damaging the pins. Pull slowly and evenly on both ends of the IC. Try to avoid having one end of the IC disengage from the socket before the other end.

To replace one of the power transistors mounted on the power module chassis adjacent to the interface circuit board, first unsolder the leads. Then, loosen the nuts which clamp the transistor to the chassis. Remove the defective transistor. When replacing the transistor, use a mica washer on the metal tap with silicone grease to increase heat transfer from the transistor to the chassis.

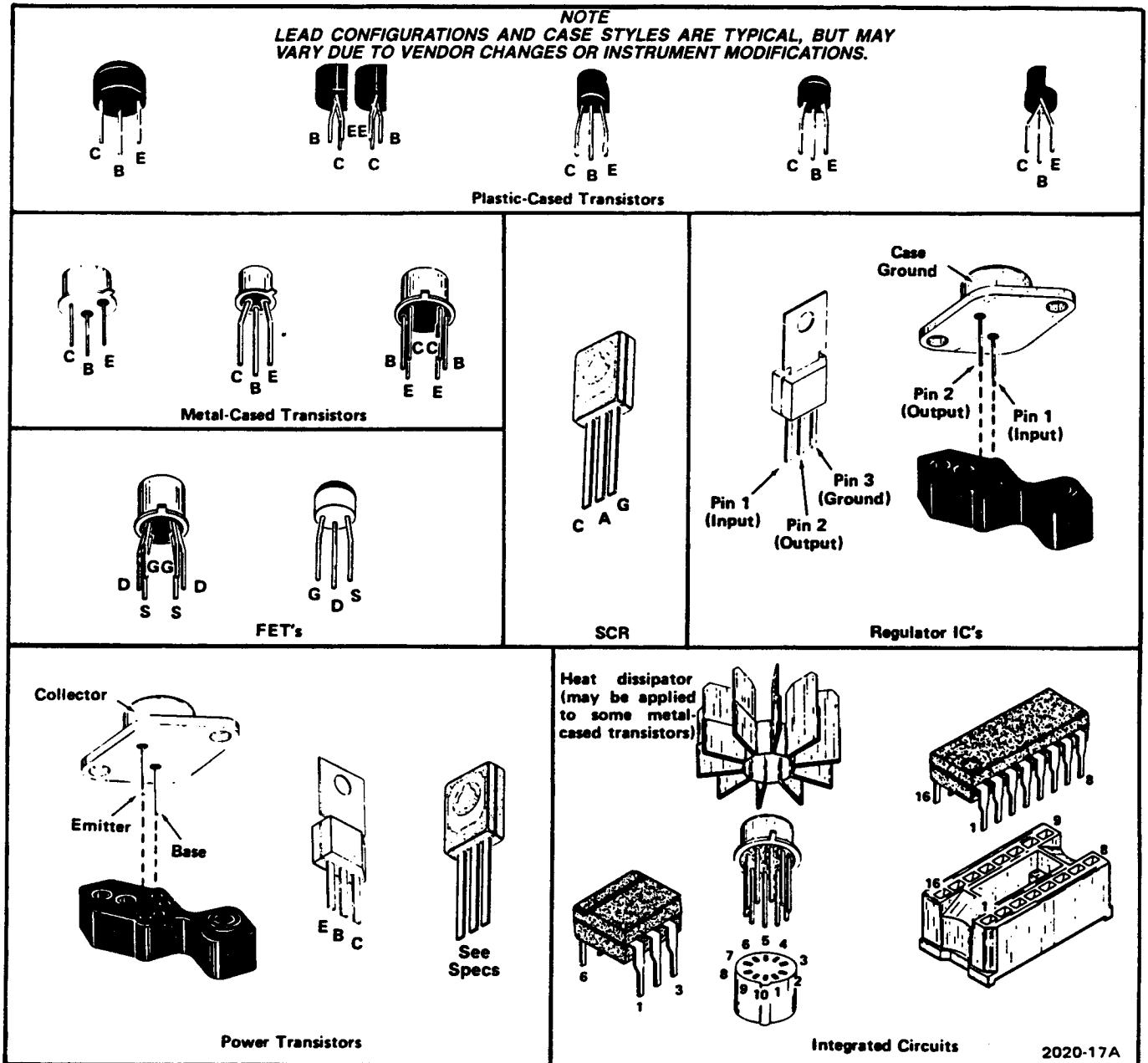

Fig. 3-2. Semiconductor device lead configurations found in the TM 500 family.

This instrument contains semiconductor devices that are susceptible to damage from static discharge. Most semiconductor devices can be easily damaged by static discharge when they are not installed in a circuit and they can also be damaged in the circuit when a low-impedance path does not exist. The following categories are especially susceptible to static discharge damage: MOS or CMOS microcircuits or discreets, linear microcircuits with MOS inputs, ECL, Schottky signal diodes, Schottky TTL, high frequency bipolar transistors, JFETS, linear microcircuits, low power Schottky TTL, and TTL.

The probability of damage increases with the level of static discharge and with the number of times that the device is subjected to a static discharge. The accumulative damage may not be apparent for several months. Levels of static discharge that can cause damage varies with device types and may be as low as 100 V or less. The use of some suction-type solder removers, walking across carpeted floors, and other activities in a technical environment can develop static charges of thousands of volts.

Some precautions against static discharge damage are: 1. drain body static buildup with a wrist bracelet through a 100 k Ω resistor to earth ground; 2. use a grounded non-metallic conductive bench top such as special anti-static polyethylene sheeting; 3. always store and ship circuit boards and semiconductors in their original anti-static type shipping materials (avoid non-conductive plastic and styrofoam material); 4. minimize handling of static sensitive components and keep component leads shorted together when the device is not in the circuit (handle by component body, not leads).

Interconnecting Pins

To replace a pin that is mounted on a circuit board, first disconnect any pin connectors. Then, unsolder the damaged pin and pull it out of the board with a pair of pliers. Be careful not to damage the wiring on the board with too much heat.

Ream out the hole in the circuit board with a 0.031-inch drill. Remove the ferrule from the new interconnecting pin and press the new pin into the hole in the circuit board. Position the pin in the same manner as the old pin and resolder. If the old pin was bent at an angle to mate with a connector, bend the new pin to match the associated pins.

NOTE

A pin replacement kit including necessary tools, instructions, and replacement pins is available from Tektronix, Inc.

Option 5

This factory-installed option adds 25-mil square-pin connectors to the interconnecting jacks at all pin locations from pins 14A and B through pins 28A and B. These pins are installed for convenient intermodule connections of a specialized nature. This will keep the interface flexible by making it easy and fast to change customized wiring using prepared wires with square-pin receptacles and long-nose pliers or tweezers. It also protects the circuit board from damage by repeated soldering and unsoldering of jumper wires. For more information concerning this option see Section 2, Operating Instructions.

Option 7

The following described bus wires and keys are added to the connector boards of the TM 515 Power Module to provide rear interface connections between the TM 500 Counter Plug-in containing Option 7, the TR 502, and the SW 503.

Bus Wires. Six-conductor ribbon cable (Tektronix Part No. 175-0829-00) is used to make bus connections between the following points:

B14 on J10, J20, and J30
B15 on J10, J20, and J30
B16 on J10, J20, and J30
B17 on J10, J20, and J30
B18 on J10, J20, and J30
A18 on J10, J20, and J30

Barrier Keys. Plastic barrier keys (Tektronix Part No. 214-1593-02) are inserted between pins 21 and 22 on J10, between pins 23 and 24 on J20, and between pins 17 and 18 on J30.

Once the above bus connections are made and barrier keys inserted, the three connectors are system dedicated and the three slots should only be used for system-dedicated plug-ins.

Cam Switches

Repair of cam-type switches should be undertaken only by experienced maintenance personnel. Switch alignment and spring tension of the contacts must be carefully maintained for proper operation of the switch. For assistance, contact your local Tektronix Field Office or representative.

NOTE

A cam-type switch repair kit including necessary tools, instructions, and replacement contacts is available from Tektronix, Inc. Order Tektronix Part No. 040-0541-00.

The cam-type switches consist of rotating cam drums which are turned by front-panel knobs, and sets of spring-leaf contacts mounted on adjacent circuit boards. The contacts are actuated by lobes on the cams. These switches can be disassembled for inspection, cleaning, repair, or replacement as follows:

1. Remove the screws which hold the metal cover on the switch, and lift the cover off the switch. The switch is now open for inspection or cleaning.

2. To completely remove a switch from the circuit board, first remove any knobs or shaft extensions. Loosen the coupling at the potentiometer at the rear of the switch, and pull the long shaft out of the switch assembly.

3. Remove the screws (from the opposite side of the circuit board) that hold the cam drum to the board.

4. To remove the cam drum from the front support block, remove the retaining nut from the shaft on the front of the switch and slide the cam drum out of the support block. Be careful not to lose the small detent roller.

5. To replace defective switch contacts, follow the instructions given in the switch repair kit.

6. To re-install the switch assembly, reverse the above procedure.

Pushbutton Switches

The pushbutton switches are not repairable and should be replaced as a unit if defective. Use a suction-type desoldering tool to remove solder from the circuit board when removing these switches.

Incandescent Bulbs

Most of these light bulbs are mounted on the sub-panel using plastic sleeve stand-offs. Unsolder the lead wires and pull the bulb out of the sleeve from the rear of the sub-panel. Extreme care should be exercised to keep from melting the plastic.

Light-Emitting Diodes

LED's used as indicators are mounted on the sub-panels with plastic sleeve sockets similar to the incandescent bulb mountings or they are soldered directly to a sub-assembly and so mounted that they protrude through holes in the panel. In these cases, the sub-assembly must be exposed and the anode and cathode lead orientations carefully noted before unsoldering the defective LED. See Fig. 3-3 for LED lead identifying information.

Power Transformer

Replace the transformer only with a Tektronix direct replacement transformer. Refer to the exploded view drawing at the rear of this manual for disassembly necessary to expose the power transformer. Refer to the schematic diagram color-coding and lead identification information for correct wiring. After replacement, check out the power supply voltages before installing a plug-in.

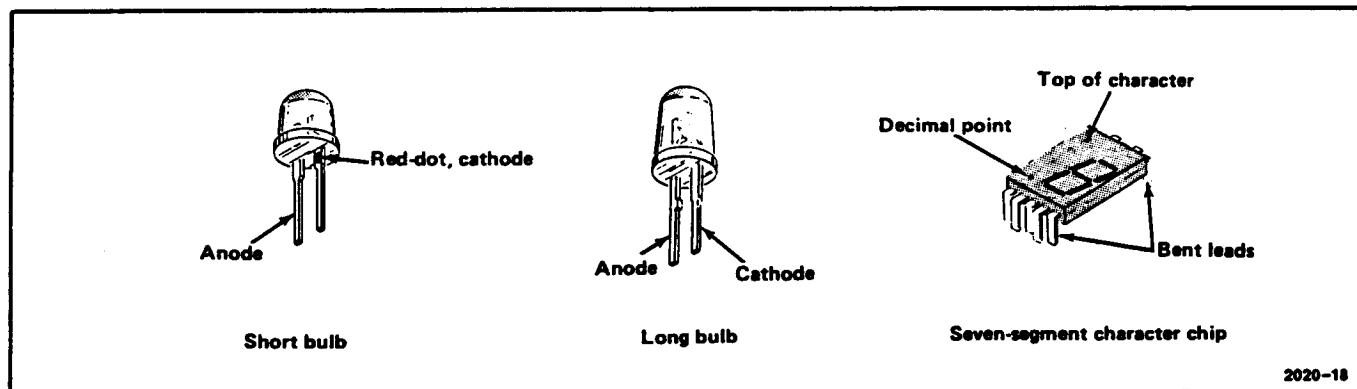

Fig. 3-3. Light-emitting diode (LED) lead orientation illustration.

Packaging Information

A list of standard accessories (and part numbers) is located in the Replaceable Mechanical Parts list.

If the Tektronix instrument is to be shipped to a Tektronix Service Center for service or repair, attach a tag showing owner (with address) and the name of an individual at your firm that can be contacted. Include the complete instrument serial number and a description of the service required.

Save and re-use the package in which your instrument was shipped. If the original packaging is unfit for use or not available, repackage the instrument as follows:

Surround the instrument with polyethylene sheeting to protect the finish of the instrument. Obtain a carton of corrugated cardboard of the correct carton strength and having inside dimensions of no less than 6 inches more than the instrument dimensions. Cushion the instrument by tightly packing 3 inches of dunnage or urethane foam between carton and instrument on all sides. Seal the carton with shipping tape or an industrial stapler.

The carton test strength for this instrument is 275 pounds per square inch.

OPTIONS

Your instrument may be equipped with one or more of the following options. This section directs the reader to where the option is documented.

Option 5

Information concerning this option may be found in Section 2, Operating Instructions; and Section 3, Maintenance.

Option 6

Information concerning this option may be found in Section 1, Specifications; Section 2, Operating Instructions; Section 3, Maintenance; and Section 6, Diagrams.

Option 7

Information concerning this option may be found in Section 3, Maintenance.



Digitally signed by
<http://www.aa4df.com>

REPLACEABLE ELECTRICAL PARTS

PARTS ORDERING INFORMATION

Replacement parts are available from or through your local Tektronix, Inc. Field Office or representative.

Changes to Tektronix instruments are sometimes made to accommodate improved components as they become available, and to give you the benefit of the latest circuit improvements developed in our engineering department. It is therefore important, when ordering parts, to include the following information in your order: Part number, instrument type or number, serial number, and modification number if applicable.

If a part you have ordered has been replaced with a new or improved part, your local Tektronix, Inc. Field Office or representative will contact you concerning any change in part number.

Change information, if any, is located at the rear of this manual.

ITEM NAME

In the Parts List, an Item Name is separated from the description by a colon (:). Because of space limitations, an Item Name may sometimes appear as incomplete. For further Item Name identification, the U.S. Federal Cataloging Handbook H6-1 can be utilized where possible.

ABBREVIATIONS

ACTR	ACTUATOR	PLSTC	PLASTIC
ASSY	ASSEMBLY	QTZ	QUARTZ
CAP	CAPACITOR	RECP	RECEPTACLE
CER	CERAMIC	RES	RESISTOR
CKT	CIRCUIT	RF	RADIO FREQUENCY
COMP	COMPOSITION	SEL	SELECTED
CONN	CONNECTOR	SEMICOND	SEMICONDUCTOR
ELCTLT	ELECTROLYTIC	SENS	SENSITIVE
ELEC	ELECTRICAL	VAR	VARIABLE
INCAND	INCANDESCENT	WW	WIREWOUND
LED	LIGHT EMITTING DIODE	XFMR	TRANSFORMER
NONWIR	NON WIREWOUND	XTAL	CRYSTAL

CROSS INDEX - MFR. CODE NUMBER TO MANUFACTURER

Mfr. Code	Manufacturer	Address	City, State, Zip Code
01121	ALLEN-BRADLEY CO	1201 SOUTH 2ND ST	MILWAUKEE WI 53204-2410
04009	COOPER INDUSTRIES INC	103 HAWTHORN ST	HARTFORD CT 06101
04713	ARROW HART DIV MOTOROLA INC SEMICONDUCTOR PRODUCTS SECTOR	5005 E MCDOWELL RD	PHOENIX AZ 85008-4229
14752	ELECTRO CUBE INC	1710 S DEL MAR AVE	SAN GABRIEL CA 91776-3825
14936	GENERAL INSTRUMENT CORP DISCRETE SEMI CONDUCTOR DIV	600 W JOHN ST	HICKSVILLE NY 11802
31781	EDAC INC	20 RAILSIDE RD	DON MILLS ONT CAN M3A 1A4
56289	SPRAGUE ELECTRIC CO WORLD HEADQUARTERS	92 HAYDEN AVE	LEXINGTON MA 02173-7929
59660	TUSONIX INC	7741 N BUSINESS PARK DR PO BOX 37144	TUCSON AZ 85740-7144
71400	BUSSMANN DIV OF COOPER INDUSTRIES INC	114 OLD STATE RD PO BOX 14460	ST LOUIS MO 63178
80009	TEKTRONIX INC	14150 SW KARL BRAUM DR PO BOX 500 MS 53-111	BEAVERTON OR 97077
82877	ROTRON INC CUSTOM DIV	7 HASBROUCK LN	WOODSTOCK NY 12498-1807
93410	ESSIX GROUP INC CONTROLS DIV LEXINGTON PLANT	45-55 PLYMOUTH ST P O BOX 1007	LEXINGTON OH 44904

Component No.	Tektronix Part No.	Serial/Assembly No. Effective	Discont	Name & Description	Mfr. Code	Mfr. Part No.
A1	670-4021-00	B010100	B021809	CIRCUIT BD ASSY:INTERFACE	80009	670-4021-00
A1	670-4021-01	B021810		CIRCUIT BD ASSY:INTERFACE	80009	670-4021-01
A1	670-4364-00	B010100	B020769	CIRCUIT BD ASSY:INTERFACE	80009	670-4364-00
				(OPT 05 ONLY)		
A1	670-4364-01	B020770		CIRCUIT BD ASSY:INTERFACE	80009	670-4364-01
				(OPT 05 ONLY)		
A2	670-4022-00	B010100	B021809	CIRCUIT BD ASSY:FILTER	80009	670-4022-00
A2	670-4022-01	B021810		CIRCUIT BD ASSY:FILTER	80009	670-4022-01
A3	670-4220-00	B010100	B022719	CIRCUIT BD ASSY:LINE SELECTOR	80009	670-4220-00
A3	670-4220-01	B022720		CIRCUIT BD ASSY:LINE SELECTOR	80009	670-4220-01
A3	670-4220-00	B010100	B022719	CIRCUIT BD ASSY:LINE SELECTOR	80009	670-4220-00
				(OPT 06 ONLY)		
A3	670-5204-00	B022720		CIRCUIT BD ASSY:LINE SELECTOR	80009	670-5204-00
				(OPT 06 ONLY)		
A1	670-4021-00	B010100	B021809	CIRCUIT BD ASSY:INTERFACE	80009	670-4021-00
A1	670-4021-01	B021810		CIRCUIT BD ASSY:INTERFACE	80009	670-4021-01
A1	670-4364-00	B010100	B020769	CIRCUIT BD ASSY:INTERFACE	80009	670-4364-00
				(OPT 05 ONLY)		
A1	670-4364-01	B020770		CIRCUIT BD ASSY:INTERFACE	80009	670-4364-01
				(OPT 05 ONLY)		
A2	670-4022-00	B010100	B021809	CIRCUIT BD ASSY:FILTER	80009	670-4022-00
A2	670-4022-01	B021810		CIRCUIT BD ASSY:FILTER	80009	670-4022-01
A3	670-4220-00	B010100	B022719	CIRCUIT BD ASSY:LINE SELECTOR	80009	670-4220-00
A3	670-4220-01	B022720		CIRCUIT BD ASSY:LINE SELECTOR	80009	670-4220-01
A3	670-4220-00	B010100	B022719	CIRCUIT BD ASSY:LINE SELECTOR	80009	670-4220-00
				(OPT 06 ONLY)		
A3	670-5204-00	B022720		CIRCUIT BD ASSY:LINE SELECTOR	80009	670-5204-00
				(OPT 06 ONLY)		
B104	119-0026-00	B010100	B021179	FAN,VENTILATING:115V,6W,1750 RPM,50 CFM	82877	WR2A1
				(STANDARD ONLY)		
B104	119-0721-00	B021180		FAN,VENTILATING:75CFM,115VAC,50/60HZ	82877	WR2H1
				(STANDARD ONLY)		
B104	119-0026-00	B010100	B021299	FAN,VENTILATING:115V,6W,1750 RPM,50 CFM	82877	WR2A1
				(OPTION 05 ONLY)		
B104	119-0721-00	B021300		FAN,VENTILATING:75CFM,115VAC,50/60HZ	82877	WR2H1
				(OPTION 05 ONLY)		
B104	119-0036-00			FAN,VENTILATING:115V,50-400 HZ	82877	778YF (033503)
				(OPT 06 ONLY. SEE RMPL FOR MOUNTING HARDWAR		
C100	283-0022-00			CAP,FXD,CER DI:0.02UF,+100-0%,1400V	59660	3888531Z5U0203Z
C110	283-0004-00			CAP,FXD,CER DI:0.02UF,+80-20%,150V	59660	855-558Z5V0203Z
C111	290-0637-00			CAP,FXD,ELCTLT:5000UF,+75-10%,50V	56289	68D10527
C112	290-0637-00			CAP,FXD,ELCTLT:5000UF,+75-10%,50V	56289	68D10527
C120	283-0004-00			CAP,FXD,CER DI:0.02UF,+80-20%,150V	59660	855-558Z5V0203Z
C121	290-0637-00			CAP,FXD,ELCTLT:5000UF,+75-10%,50V	56289	68D10527
C122	290-0637-00			CAP,FXD,ELCTLT:5000UF,+75-10%,50V	56289	68D10527
C130	283-0004-00			CAP,FXD,CER DI:0.02UF,+80-20%,150V	59660	855-558Z5V0203Z
C131	283-0004-00			CAP,FXD,CER DI:0.02UF,+80-20%,150V	59660	855-558Z5V0203Z
C132	283-0004-00			CAP,FXD,CER DI:0.02UF,+80-20%,150V	59660	855-558Z5V0203Z
C133	290-0508-00			CAP,FXD,ELCTLT:18000UF,+100-10%,15V	56289	68D10444
C135	290-0508-00			CAP,FXD,ELCTLT:18000UF,+100-10%,15V	56289	68D10444
C139	283-0004-00			CAP,FXD,CER DI:0.02UF,+80-20%,150V	59660	855-558Z5V0203Z
C140	283-0004-00			CAP,FXD,CER DI:0.02UF,+80-20%,150V	59660	855-558Z5V0203Z
C141	283-0004-00			CAP,FXD,CER DI:0.02UF,+80-20%,150V	59660	855-558Z5V0203Z
C142	283-0004-00			CAP,FXD,CER DI:0.02UF,+80-20%,150V	59660	855-558Z5V0203Z
C143	283-0004-00			CAP,FXD,CER DI:0.02UF,+80-20%,150V	59660	855-558Z5V0203Z
C144	283-0004-00			CAP,FXD,CER DI:0.02UF,+80-20%,150V	59660	855-558Z5V0203Z
C150	283-0004-00			CAP,FXD,CER DI:0.02UF,+80-20%,150V	59660	855-558Z5V0203Z

Replaceable Electrical Parts - TM 515

Component No.	Tektronix Part No.	Serial/Assembly No. Effective	Dscont	Name & Description	Mfr. Code	Mfr. Part No.
C600	285-1122-00			CAP,FXD,PLASTIC:0.25UF,10%,120V (OPT 06 ONLY)	14752	C2340
CR112	152-0462-00			SEMICON DVC,DI:RECT,SI,200V,2.5A	14936	KBU4D
CR130	152-0274-00			SEMICON DVC,DI:RECT,SI,100V,12A	04713	SR1901
CR132	152-0274-00			SEMICON DVC,DI:RECT,SI,100V,12A	04713	SR1901
CR140	152-0040-00			SEMICON DVC,DI:RECT,SI,600V,1A,DO-41	80009	152-0040-00
CR150	152-0040-00			SEMICON DVC,DI:RECT,SI,600V,1A,DO-41	80009	152-0040-00
F102	159-0005-00			FUSE,CARTRIDGE:3AG,3A,250V,30SEC,CER	71400	MSL-3
F120	159-0126-00			FUSE,CARTRIDGE:3AG,2.5A,250V,0.65SEC	71400	AGC-CW-2 1/2
F122	159-0126-00			FUSE,CARTRIDGE:3AG,2.5A,250V,0.65SEC	71400	AGC-CW-2 1/2
F135	159-0096-00			FUSE,CARTRIDGE:3AG,7.5A,32V,0.5SEC	71400	AGC-7.5
J10	131-1078-00			CONN,RCPT,ELEC:CKT BD,28/56 CONTACT	31781	303-056-520-301
J20	131-1078-00			CONN,RCPT,ELEC:CKT BD,28/56 CONTACT	31781	303-056-520-301
J30	131-1078-00			CONN,RCPT,ELEC:CKT BD,28/56 CONTACT	31781	303-056-520-301
J40	131-1078-00			CONN,RCPT,ELEC:CKT BD,28/56 CONTACT	31781	303-056-520-301
J50	131-1078-00			CONN,RCPT,ELEC:CKT BD,28/56 CONTACT	31781	303-056-520-301
Q110	151-0373-00			TRANSISTOR:PNP,SI,TD-127	04713	SJE925
Q112	151-0436-00			TRANSISTOR:NPN,SI,SEL,TO-172	04713	SJE966
Q120	151-0373-00			TRANSISTOR:PNP,SI,TD-127	04713	SJE925
Q122	151-0436-00			TRANSISTOR:NPN,SI,SEL,TO-172	04713	SJE966
Q130	151-0373-00			TRANSISTOR:PNP,SI,TD-127	04713	SJE925
Q132	151-0436-00			TRANSISTOR:NPN,SI,SEL,TO-172	04713	SJE966
Q140	151-0373-00			TRANSISTOR:PNP,SI,TD-127	04713	SJE925
Q142	151-0436-00			TRANSISTOR:NPN,SI,SEL,TO-172	04713	SJE966
Q150	151-0373-00			TRANSISTOR:PNP,SI,TD-127	04713	SJE925
Q152	151-0436-00			TRANSISTOR:NPN,SI,SEL,TO-172	04713	SJE966
R120	306-0102-00	B010100	B021809	RES,FXD,CMPSN:1K OHM,10%,2W (STANDARD ONLY)	01121	HB1021
R120	303-0182-00	B021810		RES,FXD,CMPSN:1.8K OHM,5%,1W (STANDARD ONLY)	01121	GB1825
R120	306-0102-00	B010100	B020651	RES,FXD,CMPSN:1K OHM,10%,2W (OPTION 05 ONLY)	01121	HB1021
R120	303-0182-00	B020652		RES,FXD,CMPSN:1.8K OHM,5%,1W (OPTION 05 ONLY)	01121	GB1825
R120	306-0102-00	B010100	B021499	RES,FXD,CMPSN:1K OHM,10%,2W (OPTION 06 AND 07 ONLY)	01121	HB1021
R120	303-0182-00	B021500		RES,FXD,CMPSN:1.8K OHM,5%,1W (OPTION 06 AND 07 ONLY)	01121	GB1825
R122	306-0102-00	B010100	B021809	RES,FXD,CMPSN:1K OHM,10%,2W (STANDARD ONLY)	01121	HB1021
R122	303-0182-00	B021810		RES,FXD,CMPSN:1.8K OHM,5%,1W (STANDARD ONLY)	01121	GB1825
R122	306-0102-00	B010100	B020651	RES,FXD,CMPSN:1K OHM,10%,2W (OPTION 05 ONLY)	01121	HB1021
R122	303-0182-00	B020652		RES,FXD,CMPSN:1.8K OHM,5%,1W (OPTION 05 ONLY)	01121	GB1825
R122	306-0102-00	B010100	B021499	RES,FXD,CMPSN:1K OHM,10%,2W (OPTION 06 AND 07 ONLY)	01121	HB1021
R122	303-0182-00	B021500		RES,FXD,CMPSN:1.8K OHM,5%,1W (OPTION 06 AND 07 ONLY)	01121	GB1825
R130	303-0102-00	B010100	B021809	RES,FXD,CMPSN:1K OHM,5%,1W (STANDARD ONLY)	01121	GB1025
R130	303-0182-00	B021810		RES,FXD,CMPSN:1.8K OHM,5%,1W (STANDARD ONLY)	01121	GB1825
R130	303-0102-00	B010100	B020651	RES,FXD,CMPSN:1K OHM,5%,1W (OPTION 05 ONLY)	01121	GB1025
R130	303-0182-00	B020652		RES,FXD,CMPSN:1.8K OHM,5%,1W (OPTION 05 ONLY)	01121	GB1825
R130	303-0102-00	B010100	B021499	RES,FXD,CMPSN:1K OHM,5%,1W (OPTION 06 AND 07 ONLY)	01121	GB1025
R130	303-0182-00	B021500		RES,FXD,CMPSN:1.8K OHM,5%,1W (OPTION 06 AND 07 ONLY)	01121	GB1825

Component No.	Tektronix Part No.	Serial/Assembly No. Effective	Discort	Name & Description	Mfr. Code	Mfr. Part No.
R135	303-0511-00	B010100	B021809	(OPTION 06 AND 07 ONLY) RES, FXD, CMPSN: 510 OHM, 5%, 1W (STANDARD ONLY)	01121	GB5115
R135	303-0182-00	B021810	B026759	RES, FXD, CMPSN: 1.8K OHM, 5%, 1W (STANDARD ONLY)	01121	GB1825
R135	303-0511-00	B026760		RES, FXD, CMPSN: 510 OHM, 5%, 1W (STANDARD ONLY)	01121	GB5115
R135	303-0511-00	B010100	B020651	RES, FXD, CMPSN: 510 OHM, 5%, 1W (OPTION 05 ONLY)	01121	GB5115
R135	303-0182-00	B020652	B026839	RES, FXD, CMPSN: 1.8K OHM, 5%, 1W (OPTION 05 ONLY)	01121	GB1825
R135	303-0511-00	B026840		RES, FXD, CMPSN: 510 OHM, 5%, 1W (OPTION 05 ONLY)	01121	GB5115
R135	303-0511-00	B010100	B021499	RES, FXD, CMPSN: 510 OHM, 5%, 1W (OPTION 06 AND 07 ONLY)	01121	GB5115
R135	303-0182-00	B021500	B027059	RES, FXD, CMPSN: 1.8K OHM, 5%, 1W (OPTION 06 AND 07 ONLY)	01121	GB1825
R135	303-0511-00	B027060		RES, FXD, CMPSN: 510 OHM, 5%, 1W (OPTION 06 AND 07 ONLY)	01121	GB5115
S102	260-1583-00	B010100	B028879	SWITCH, ROCKER: DPST, 10A, 125VAC	04009	2600-TBA
S102	260-1583-02	B028880		SWITCH, ROCKER: DPST, 10A, 125VAC	04009	2600-51E718
S103	260-0907-00			SWITCH, THRMSTC: NC, OPEN 97.8, CL 75.6, 10A	93410	430-349
S104	260-0907-00			SWITCH, THRMSTC: NC, OPEN 97.8, CL 75.6, 10A	93410	430-349
T100	120-1031-00			XFMR, PWR, STPDN:	80009	120-1031-00

DIAGRAMS AND CIRCUIT BOARD ILLUSTRATIONS

Symbols

Graphic symbols and class designation letters are based on ANSI Standard Y32.2-1975.

Logic symbology is based on ANSI Y32.14-1973 in terms of positive logic. Logic symbols depict the logic function performed and may differ from the manufacturer's data.

The overline on a signal name indicates that the signal performs its intended function when it is in the low state.

Abbreviations are based on ANSI Y1.1-1972.

Other ANSI standards that are used in the preparation of diagrams by Tektronix, Inc. are:

- Y14.15, 1966 Drafting Practices.
- Y14.2, 1973 Line Conventions and Lettering.
- Y10.5, 1968 Letter Symbols for Quantities Used in Electrical Science and Electrical Engineering.

American National Standard Institute
1430 Broadway
New York, New York 10018

Component Values

Electrical components shown on the diagrams are in the following units unless noted otherwise:

Capacitors = Values one or greater are in picofarads (pF).
Values less than one are in microfarads (μF).

Resistors = Ohms (Ω).

————— The information and special symbols below may appear in this manual. —————

Assembly Numbers and Grid Coordinates

Each assembly in the instrument is assigned an assembly number (e.g., A20). The assembly number appears on the circuit board outline on the diagram, in the title for the circuit board component location illustration, and in the lookup table for the schematic diagram and corresponding component locator illustration. The Replaceable Electrical Parts list is arranged by assemblies in numerical sequence; the components are listed by component number *(see following illustration for constructing a component number).

The schematic diagram and circuit board component location illustration have grids. A lookup table with the grid coordinates is provided for ease of locating the component. Only the components illustrated on the facing diagram are listed in the lookup table. When more than one schematic diagram is used to illustrate the circuitry on a circuit board, the circuit board illustration may only appear opposite the first diagram on which it was illustrated; the lookup table will list the diagram number of other diagrams that the circuitry of the circuit board appears on.

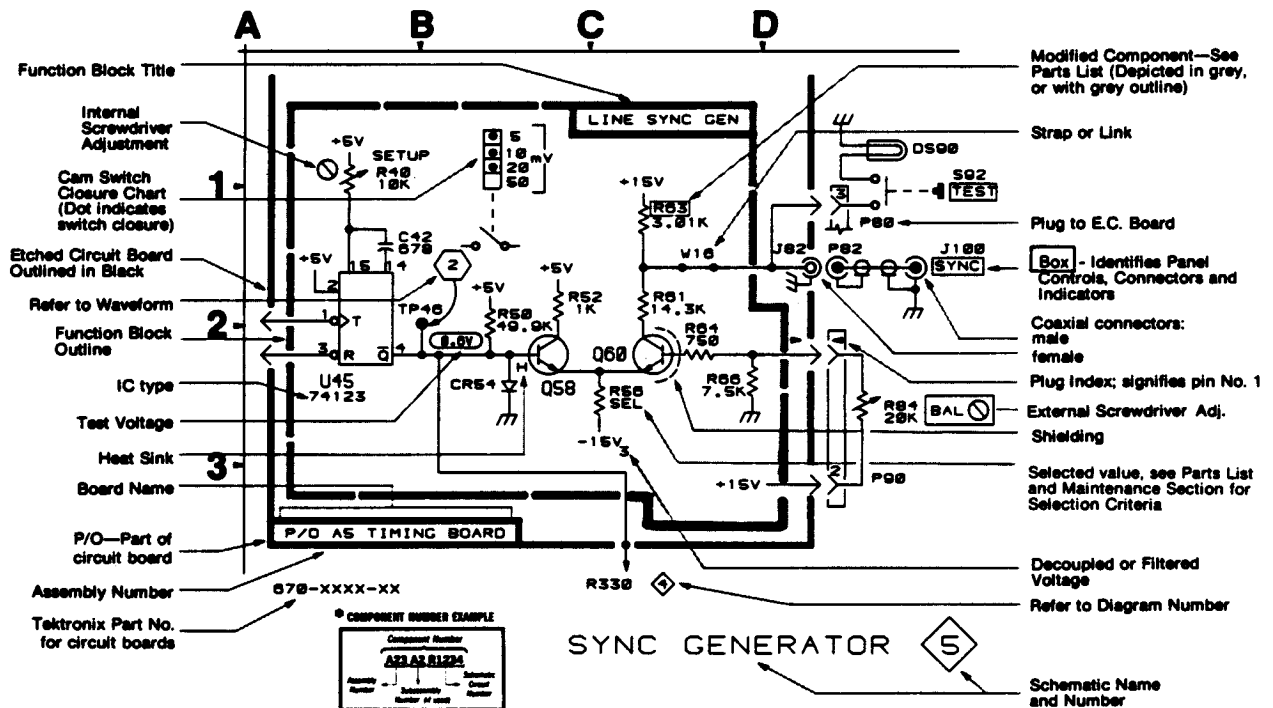

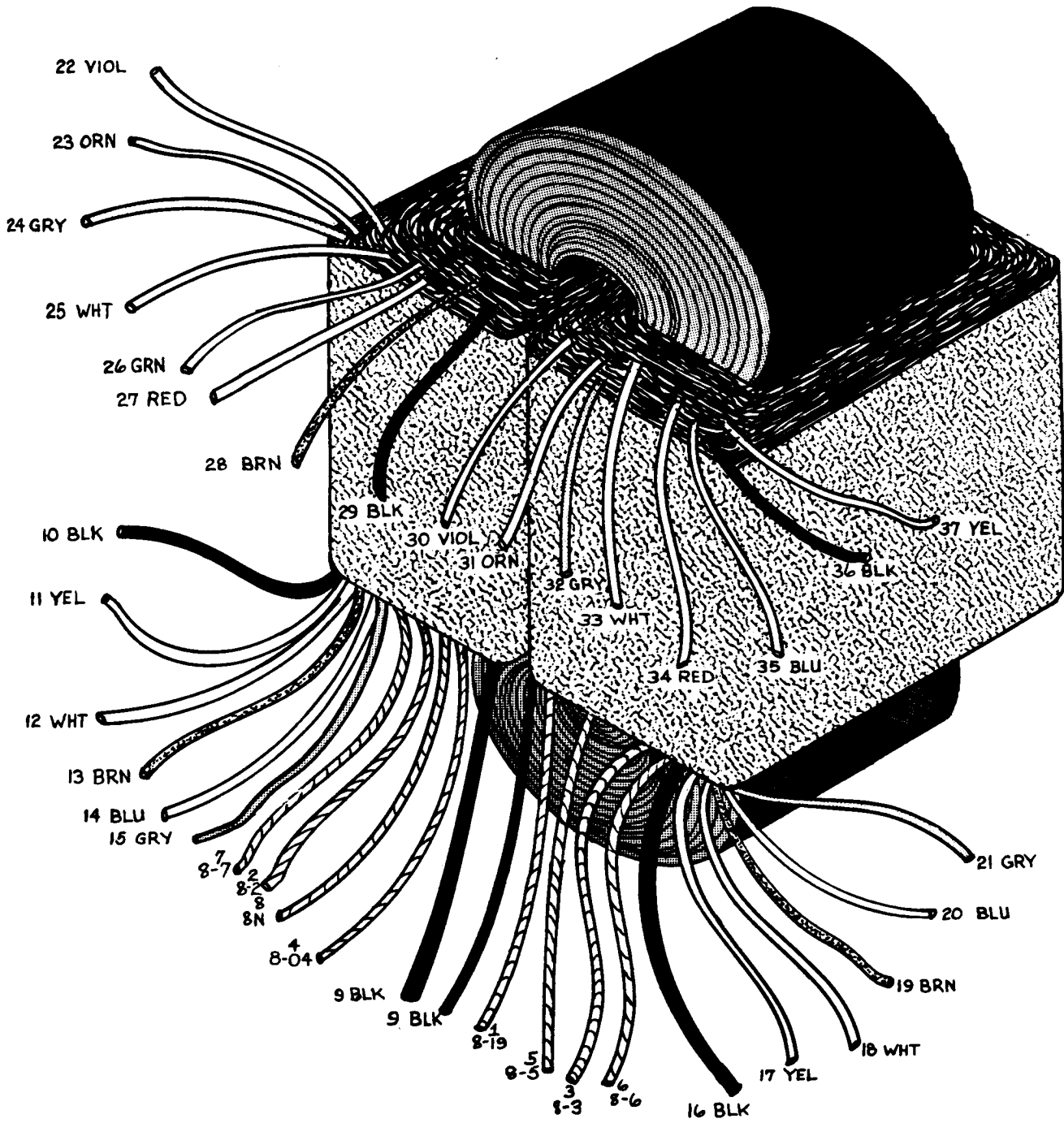

PARTS LOCATION GRID

R-4488-01 TM 515 Interface Board

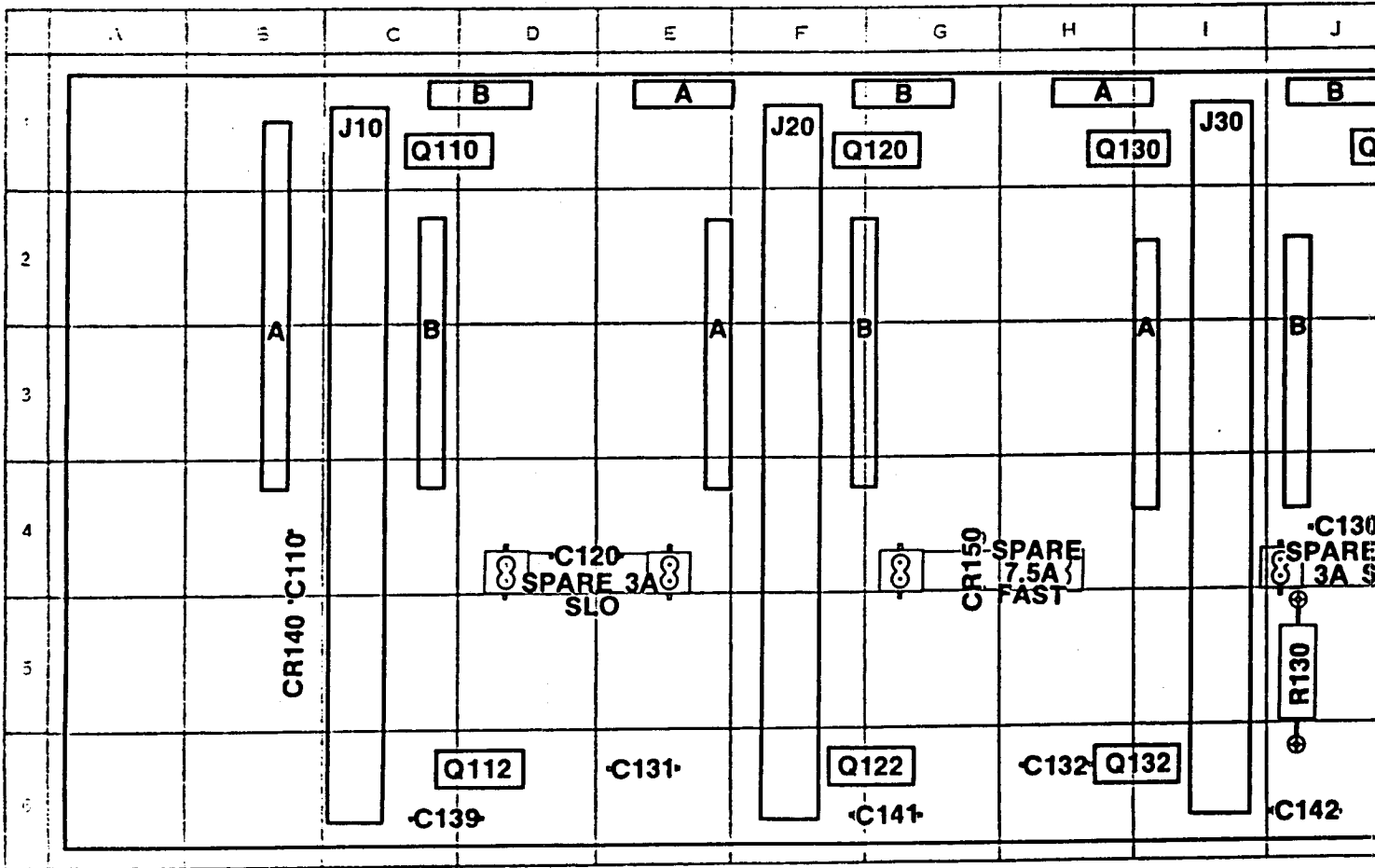

N GRID

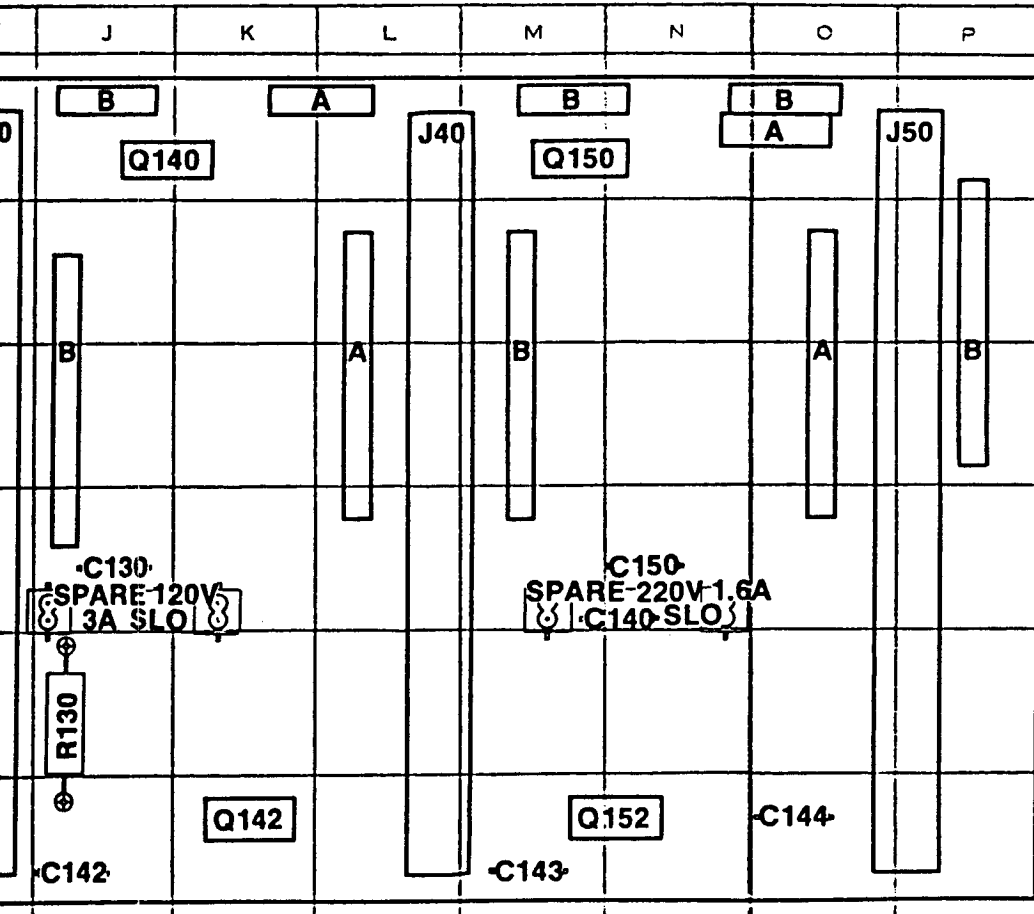

Line Selector Board: Parts List:	
C110	B4
C120	D4
C130	J4
C131	E6
C132	H6
C139	C6
C140	N4
C141	G6
C142	J6
C143	M6
C144	O6
C150	N4
CR140	B5
CR150	G4
SPARE 3A	
SPARE 7.5A	
SPARE 120 V 3A	
SPARE 220 V 1.6A	
J10	C1
J20	F1
J30	I1
J40	L1
J50	P1
Q110	C1
Q112	D6
Q120	G1
Q122	G6
Q130	H1
Q132	I6
Q140	J1
Q142	K6
Q150	M1
Q152	N6
R130	J5
	D4
	H4
	J4
	N4

DETAILED BLOCK DIAGRAM

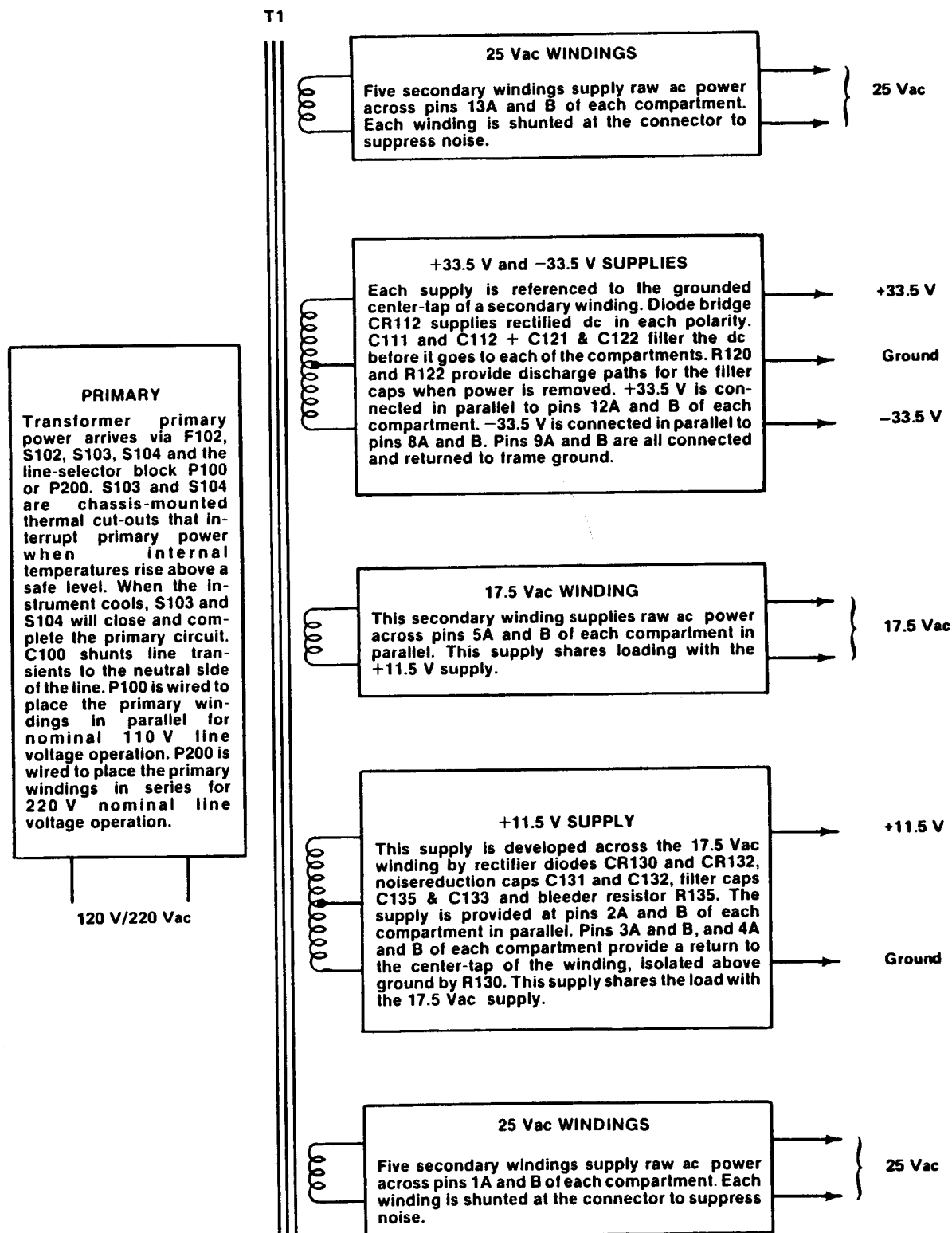

2020-10

POWER MODULE INTERFACE PIN ASSIGNMENTS FRONT VIEW

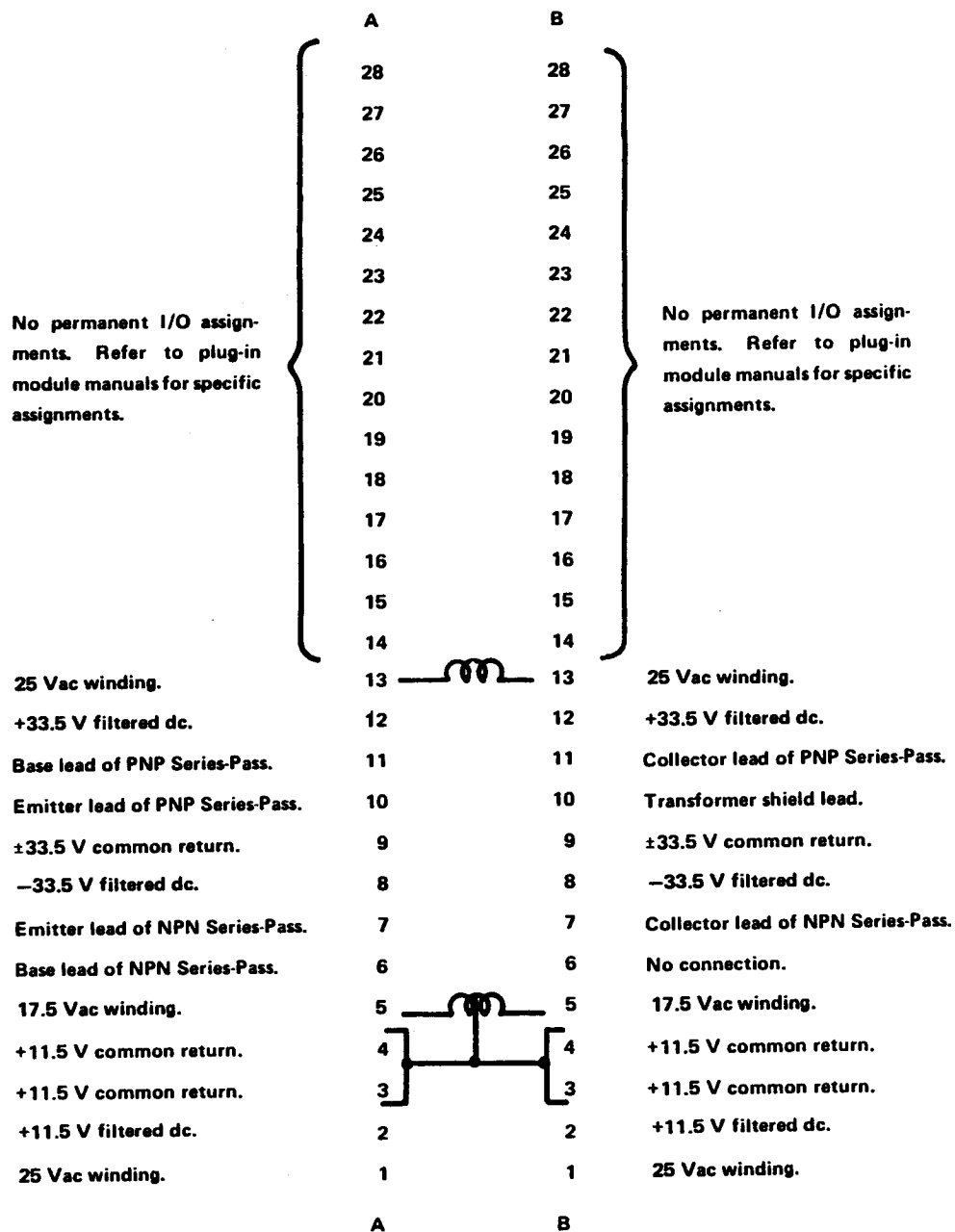

PARTS LOCATION GRID

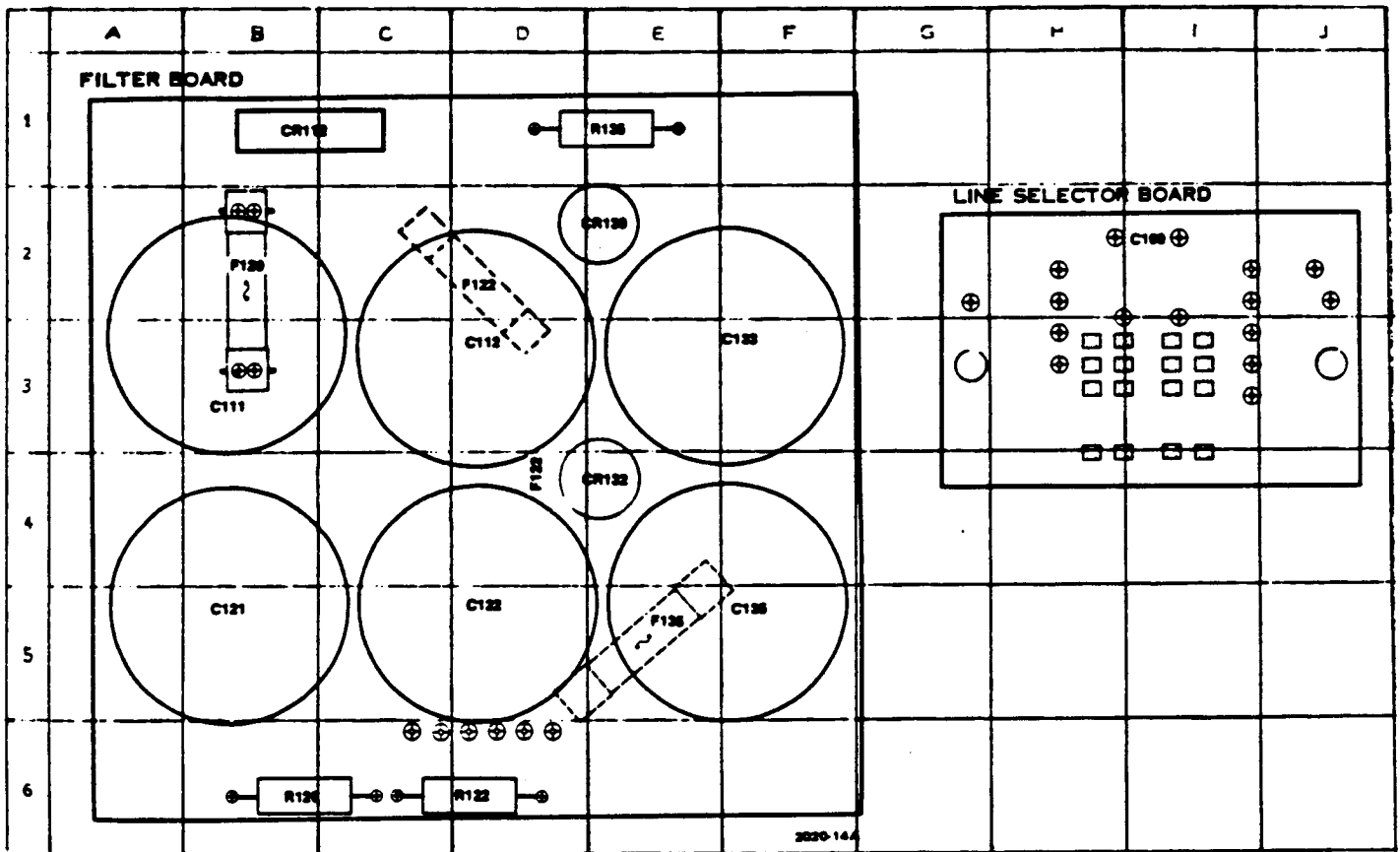

Filter and Line Selector circuit board assemblies.

Interface Board Parts List:	
C100	02
Filter Board: Parts List:	
C111	03
C112	03
C121	05
C122	05
C130	03
C132	05
CR112	01
CR120	02
CR132	04
F120	02
F122	02
F130	03
R110	05
R120	05
R130	01

§ Located on back of board.

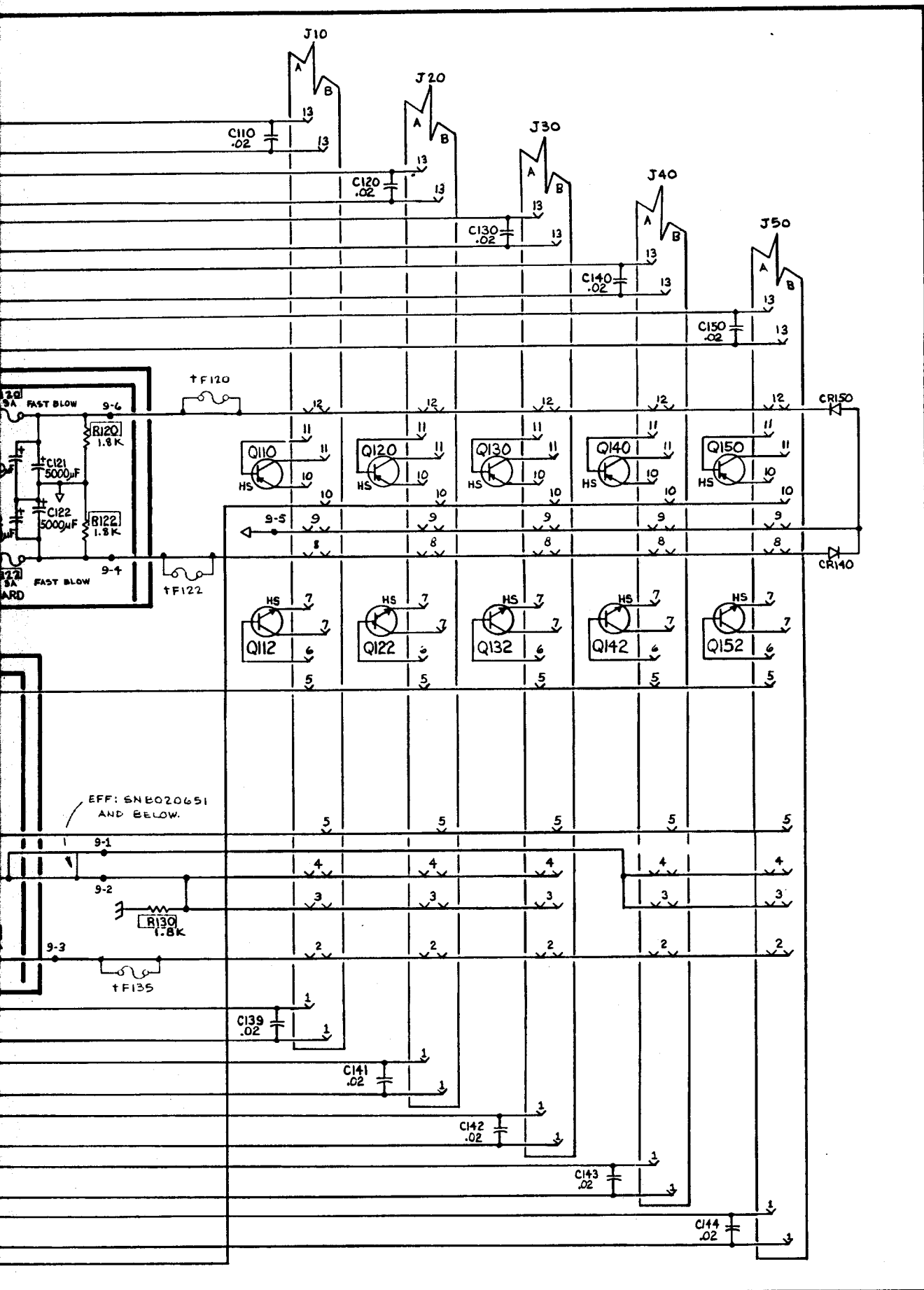

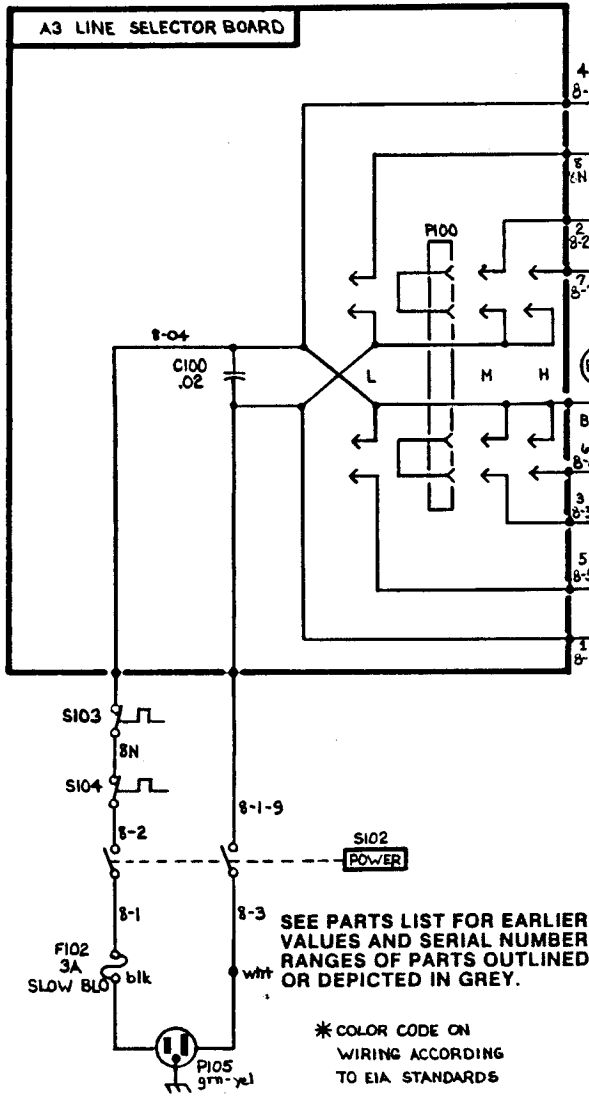

SEE PARTS LIST FOR EARLIER VALUES AND SERIAL NUMBER RANGES OF PARTS OUTLINED OR DEPICTED IN GREY.

* COLOR CODE ON WIRING ACCORDING TO EIA STANDARDS

† SNEB020651 & BELOW. F120, F122 & F135 ARE LOCATED ON THE A1 INTERFACE BOARD.

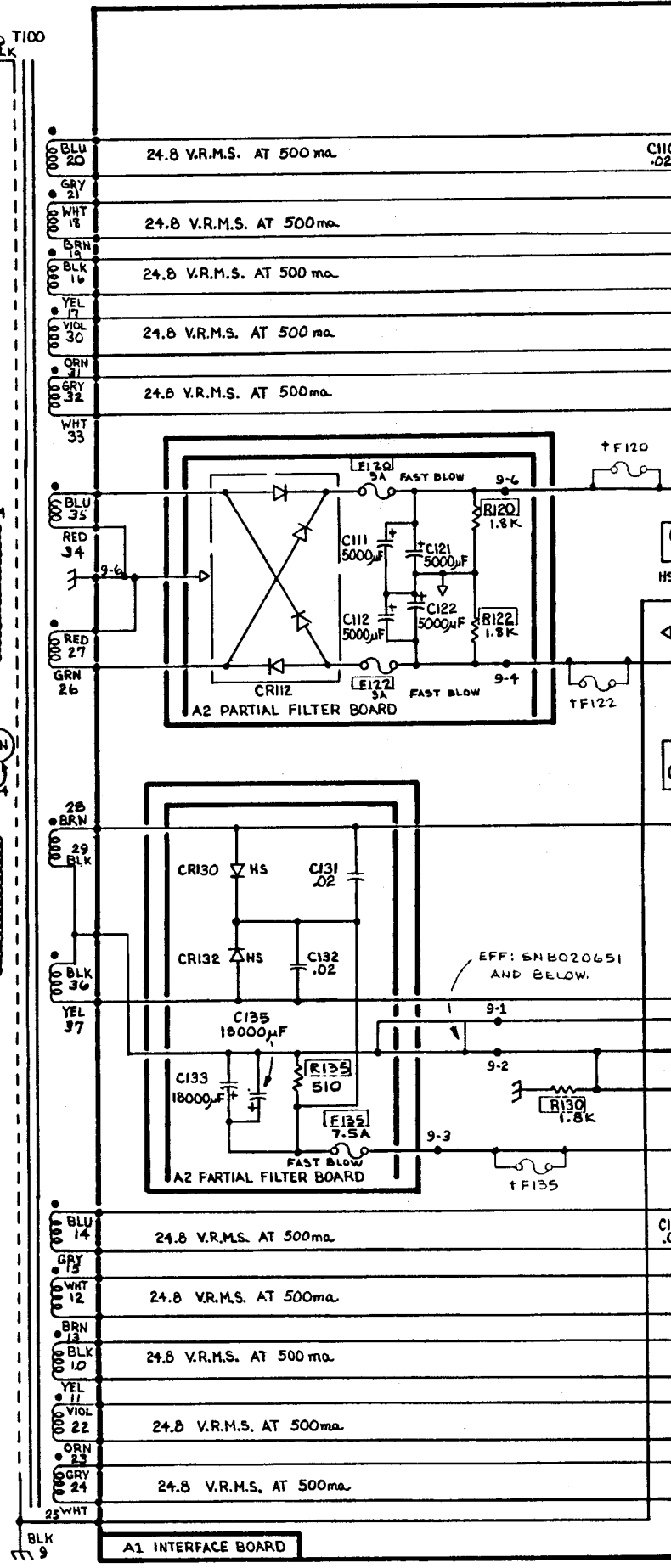

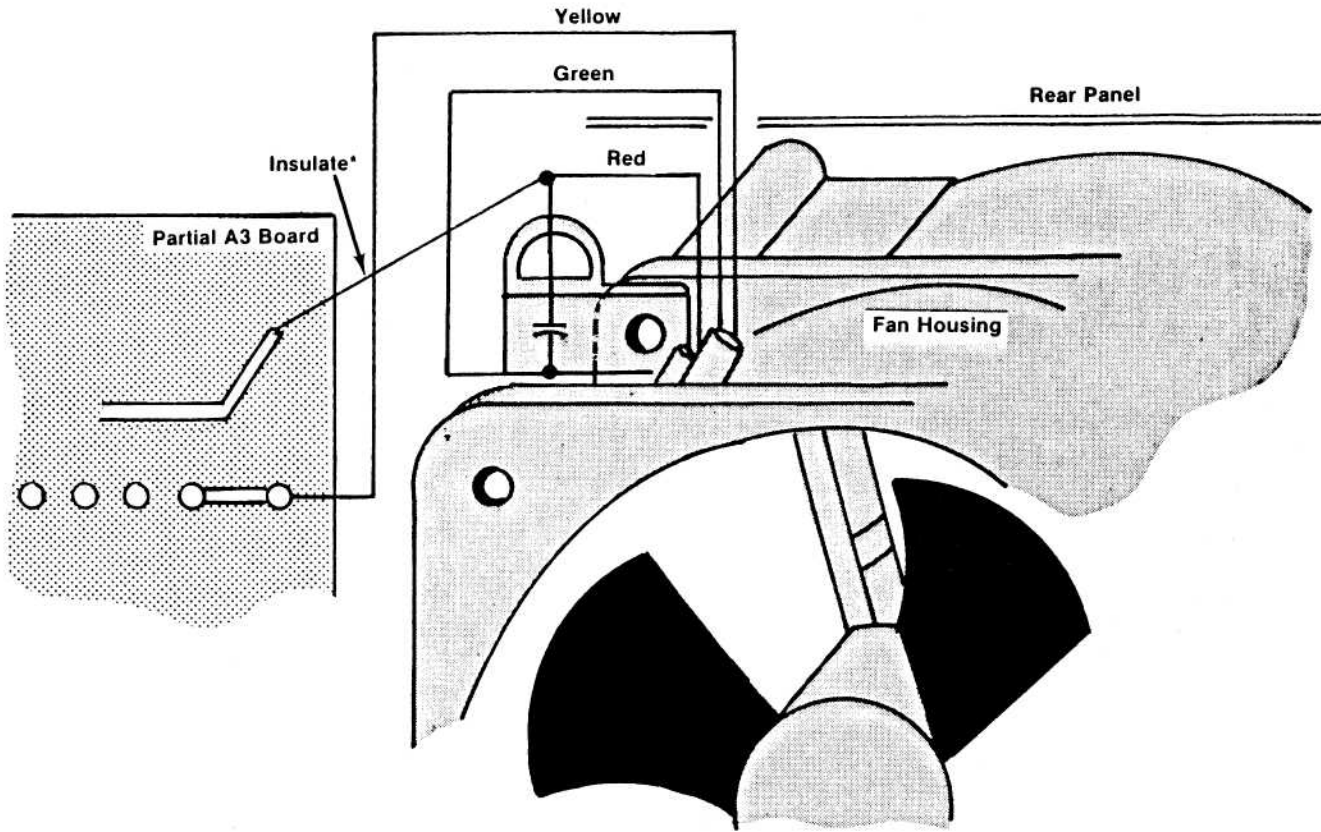

*Insulate this lead from the capacitor with Tektronix Part No. 162-0026-00.

2020-19

REPLACEABLE MECHANICAL PARTS

PARTS ORDERING INFORMATION

Replacement parts are available from or through your local Tektronix, Inc. Field Office or representative.

Changes to Tektronix instruments are sometimes made to accommodate improved components as they become available, and to give you the benefit of the latest circuit improvements developed in our engineering department. It is therefore important, when ordering parts, to include the following information in your order: Part number, instrument type or number, serial number, and modification number if applicable.

If a part you have ordered has been replaced with a new or improved part, your local Tektronix, Inc. Field Office or representative will contact you concerning any change in part number.

Change information, if any, is located at the rear of this manual.

ITEM NAME

In the Parts List, an Item Name is separated from the description by a colon (:). Because of space limitations, an Item Name may sometimes appear as incomplete. For further Item Name identification, the U.S. Federal Cataloging Handbook H6-1 can be utilized where possible.

FIGURE AND INDEX NUMBERS

Items in this section are referenced by figure and index numbers to the illustrations.

INDENTATION SYSTEM

This mechanical parts list is indented to indicate item relationships. Following is an example of the indentation system used in the description column.

```

1 2 3 4 5           Name & Description
Assembly and/or Component
Attaching parts for Assembly and/or Component
-----
Detail Part of Assembly and/or Component
Attaching parts for Detail Part
-----
Parts of Detail Part
Attaching parts for Parts of Detail Part
-----

```

Attaching Parts always appear in the same indentation as the item it mounts, while the detail parts are indented to the right. Indented items are part of, and included with, the next higher indentation. The separation symbol - - - - - indicates the end of attaching parts.

Attaching parts must be purchased separately, unless otherwise specified.

ABBREVIATIONS

INCH	ELECTRN	ELECTRON	IN	INCH	SE	SINGLE END
NUMBER SIZE	ELEC	ELECTRICAL	INCAND	INCANDESCENT	SECT	SECTION
ACTR	ELCTLT	ELECTROLYTIC	INSUL	INSULATOR	SEMICON	SEMICONDUCTOR
ADPTR	ELEM	ELEMENT	INTL	INTERNAL	SHLD	SHIELD
ALIGN	EPL	ELECTRICAL PARTS LIST	LPHLDR	LAMPHOLDER	SHLDR	SHOULDERED
AL	EOPT	EQUIPMENT	MACH	MACHINE	SKT	SOCKET
ASSEM	EXT	EXTERNAL	MECH	MECHANICAL	SL	SLIDE
ASSY	FIL	FILLISTER HEAD	MTG	MOUNTING	SLFLKG	SELF-LOCKING
ATTEN	FLEX	FLEXIBLE	NIP	NIPPLE	SLVGG	SLEEVING
AWG	FLH	FLAT HEAD	NON WIRE	NOT WIRE WOUND	SPR	SPRING
BD	FLTR	FILTER	OB	ORDER BY DESCRIPTION	SO	SQUARE
BRKT	FR	FRAME or FRONT	OD	OUTSIDE DIAMETER	SST	STAINLESS STEEL
BRS	FSTNR	FASTENER	OVH	OVAL HEAD	STL	STEEL
BRZ	FT	FOOT	PH BRZ	PHOSPHOR BRONZE	SW	SWITCH
BSHG	FXD	FIXED	PL	PLAIN or PLATE	T	TUBE
CAB	GSKT	GASKET	PLSTC	PLASTIC	TERM	TERMINAL
CAP	HDL	HANDLE	PN	PART NUMBER	TMD	THREAD
CER	HEX	HEXAGON	PNH	PAN HEAD	THK	THICK
CHAS	HEX HD	HEXAGONAL HEAD	PWR	POWER	TNSG	TENSION
CKT	HEX SOC	HEXAGONAL SOCKET	RCPT	RECEPTACLE	TPG	TAPPING
COMP	HLCPS	HELICAL COMPRESSION	RES	RESISTOR	TRH	TRUSS HEAD
CONN	HLEXT	HELICAL EXTENSION	RGD	RIGID	V	VOLTAGE
COV	HV	HIGH VOLTAGE	RLF	RELIEF	VAR	VARIABLE
CPLG	IC	INTEGRATED CIRCUIT	RTNR	RETAINER	W	WITH
CRT	ID	INSIDE DIAMETER	SCH	SOCKET HEAD	WSHR	WASHER
DEG	IDNT	IDENTIFICATION	SCOPE	OSCILLOSCOPE	XFMR	TRANSFORMER
DWR	IMPLR	IMPELLER	SCR	SCREW	XSTR	TRANSISTOR

CROSS INDEX - MFR. CODE NUMBER TO MANUFACTURER

Mfr. Code	Manufacturer	Address	City, State, Zip Code
06540	MITE CORP	446 BLAKE ST	NEW HAVEN CT 06515-1238
06915	AMATOM ELECTRONIC HARDWARE DIV		
07416	RICHO PLASTIC CO	5825 N TRIPP AVE	CHICAGO IL 60646-6013
12327	NELSON NAME PLATE CO	3191 CASITAS	LOS ANGELES CA 90039-2410
16428	FREEWAY CORP	9301 ALLEN DR	CLEVELAND OH 44125-4632
	COOPER BELDEN ELECTRONIC WIRE AND CA	NW N ST	RICHMOND IN 47374
22526	SUB OF COOPER INDUSTRIES INC		
	DU PONT E I DE NEMOURS AND CO INC	515 FISHING CREEK RD	NEW CUMBERLAND PA 17070-3007
	DU PONT CONNECTOR SYSTEMS		
24618	DIV MILITARY PRODUCTS GROUP		
24995	TRANSCON MFG. CO.	2655 PERTH ST.	DALLAS, TX 75220
	ECS COMPOSITES	3560 ROGUE RIVER HWY	GRANTS PASS, JOSEPHINE OR 97526
		PO BOX 188	
28520	HEYCO MOLDED PRODUCTS	750 BOULEVARD	KENILWORTH NJ 07033-1721
		P O BOX 160	
31781	EDAC INC	20 RAILSIDE RD	DON MILLS ONT CAN M3A 1A4
70485	ATLANTIC INDIA RUBBER WORKS INC	571 W POLK ST	CHICAGO IL 60607
71468	ITT CANNON	666 E DYER RD	SANTA ANA CA 92702
	DIV OF ITT CORP		
71785	CINCH CONNECTORS	1501 MORSE AVE	ELK GROVE VILLAGE IL 60007-5723
72228	AMCA INTERNATIONAL CORP	459 MT PLEASANT	NEW BEDFORD MA 02742
	CONTINENTAL SCREW CO DIV		
73743	FISCHER SPECIAL MFG CO	111 INDUSTRIAL RD	COLD SPRING KY 41076-9749
75915	LITTELFUSE INC	800 E NORTHWEST HWY	DES PLAINES IL 60016-3049
	SUB TRACOR INC		
77900	ILLINOIS TOOL WORKS	ST CHARLES RD	ELGIN IL 60120
	SHAKEPROOF DIV		
78189	ILLINOIS TOOL WORKS INC	ST CHARLES ROAD	ELGIN IL 60120
	SHAKEPROOF DIV		
80009	TEKTRONIX INC	14150 SW KARL BRAUN DR	BEAVERTON OR 97707-0001
		PO BOX 500	
81041	HOWARD INDUSTRIES	1 NORTH DIXIE HWY	MILFORD IL 60953
	DIV OF MSL INDUSTRIES INC	PO BOX 287	
82877	ROTRON INC	7 HASBROUCK LN	WOODSTOCK NY 12498-1807
	CUSTOM DIV		
83309	ELECTRICAL SPECIALITY CO	345 SWIFT AVE	SOUTH SAN FRANCISCO CA 94080-6206
	SUB OF BELDEN CORP		
83385	MICRODOT MFG INC	3221 W BIG BEAVER RD	TROY MI 48098
	GREER-CENTRAL DIV		
86928	SEASTROM MFG CO INC	701 SONORA AVE	GLENDALE CA 91201-2431
91500	ASHEVILLE-SCHDONMAKER MICA CO	910 JEFFERSON AVE	NEWPORT NEWS VA 23607-6120
		P O BOX 318	
93410	ESSEX GROUP ING	45-55 PLYMOUTH ST	LEXINGTON OH 44904
	CONTROLS DIV	P O BOX 1007	
93907	LEXINGTON PLANT		
	TEXTRON INC	600 18TH AVE	ROCKFORD IL 61108-5181
	CAMCAR DIV		
95987	BRADY/WECKESSER MFG CO	4444 WEST IRVING PARK RD	CHICAGO IL 60641
TK0435	LEWIS SCREW CO	4300 S RACINE AVE	CHICAGO IL 60609-3320
TK0512	P H C INDUSTRIES INC	1643 HADDON AVE	CAMDEN NJ 08101-3109
TK0588	UNIVERSAL PRECISION PRODUCTS	1775 NW 216TH	HILLSBORO OR 97123
TK1287	ENOCH MFG CO	14242 SE 82ND DR	CLACKAMAS OR 97015
		PO BOX 98	
TK1319	MORELLIS Q & D PLASTICS	1812 16-TH AVE	FOREST GROVE OR 97116

Fig. & Index No.	Tektronix Part No.	Serial/Assembly No.		Qty	12345 Name & Description	Mfr.	
		Effective	Discont			Code	Mfr. Part No.
1-1	348-0191-00			2	FOOT, CABINET: BLACK POLYCARBONATE (ATTACHING PARTS)	80009	348-0191-00
-2	211-0553-00			2	SCREW, MACHINE: 6-32 X 1.5, PNH, STL (END ATTACHING PARTS)	TK0435	ORDER BY DESCR
-3	129-0598-00			2	SPACER, SLEEVE: 0.3 L X 0.188 ID, AL	80009	129-0598-00
-4	348-0479-00			6	MOUNT, RESILIENT: POWER SUPPLY	TK1319	N/A
-5	213-0726-00			2	SCREW, RETAINING: 6-32 X 6.0, SST, PSVT	TK0588	87231-000
-6	166-0031-00	B020583		2	SPACER, SLEEVE: 0.25 L X 0.18 ID, AL	80009	166-0031-00
-7	200-1905-00			1	COV, LINE V SEL: (ATTACHING PART)	80009	200-1905-00
-8	211-0541-00			2	SCREW, MACHINE: 6-32 X 0.25, FLH, 100 DEG, STL (END ATTACHING PARTS)	93907	ORDER BY DESCR
-9	-----			1	SWITCH, TOGGLE: POWER (SEE S102 REPL)		
-10	161-0046-00			1	CABLE ASSY, PWR, :3, 18AWG, 125V, 60.0 L (ATTACHING PARTS)	16428	KH8390
-11	358-0161-00			1	BSHG, STRAIN RLF: U/W 0.29 DIA CABLE, STRAIGHT SAFETY CONTROLLED (END ATTACHING PARTS)	28520	1147 SR-5P-4
-12	352-0362-01	B010100	B020582	1	FUHLR, EXTR POST: 3AG, 20A, 300V	75915	345613 W/901002
	352-0362-00	B020583		1	FUHLR, EXTR POST: 3AG, 20A, 300V	75915	345603W/901-002
-13	131-0022-00			1	TERMINAL BOARD: SINGLE CONTACT (ATTACHING PARTS)	71785	332-11-02-001
-14	210-0586-00			2	NUT, PL, ASSEM WA: 4-40 X 0.25, STL CD PL	78189	211-041800-00
-15	210-0201-00			1	TERMINAL, LUG: 0.12 ID, LOCKING, BRZ TIN PL (END ATTACHING PARTS)	86928	A373-157-2
-16	-----			1	CKT BOARD ASSY: LINE SELECTOR (SEE A3 REPL) (ATTACHING PARTS)		
-17	211-0578-00	B010100	B020582	2	SCREW, MACHINE: 6-32 X 0.438, PNH, STL	93907	ORDER BY DESCR
	211-0511-00	B020583		2	SCREW, MACHINE: 6-32 X 0.5, PNH, STL	TK0435	ORDER BY DESCR
-18	166-0093-00			2	SPACER, SLEEVE: 0.188 L X 0.196 ID, AL (END ATTACHING PARTS) CKT BOARD ASSY INCLUDES:	80009	166-0093-00
-19	131-1895-00	B010100	B030308	1	.BUS, CONDUCTOR: 8, 22 AWG, 1.5L	80009	131-1895-00
	131-1895-01	B030309		1	.LEAD, ELECTRICAL: 22 AWG, 1.5 L, 8-2	80009	131-1895-01
-20	131-1896-00			1	.BUS, CONDUCTOR: 8, 22 AWG, 1.5 L	80009	131-1896-00
-21	131-0608-00	B010100	B022719	16	.TERMINAL, PIN: 0.365 L X 0.025 BRZ GLD PL	22526	48283-036
	131-0608-00	B022720		20	.TERMINAL, PIN: 0.365 L X 0.025 BRZ GLD PL	22526	48283-036
-22	343-0088-00	B010100	B020582	2	.CLAMP, CABLE: 0.062 DIA, PLASTIC (OPTION 07 ONLY)	80009	343-0088-00
	006-0531-00	B020583		2	STRAP, TIEDOWN, E: BLUE PLASTIC BEADED	24618	700-3688
	334-1377-00			1	MARKER, IDENT: MKD IDENTIFICATION NO.	80009	334-1377-00
-23	333-2096-00			1	PANEL, REAR: (ATTACHING PARTS)	80009	333-2096-00
-24	211-0504-00			4	SCREW, MACHINE: 6-32 X 0.250, PNH, STL	TK0435	ORDER BY DESCR
-25	211-0553-00			4	SCREW, MACHINE: 6-32 X 1.5, PNH, STL	TK0435	ORDER BY DESCR
-26	210-0457-00	B010100	B010399	4	NUT, PL, ASSEM WA: 6-32 X 0.312, STL CD PL	78189	511-061800-00
	210-0407-00	B010400		4	NUT, PLAIN, HEX: 6-32 X 0.25, BRZ CD PL	73743	3038-402
	210-0006-00	B010400		4	WASHER, LOCK: #6 INTL, 0.018 THK, STL (END ATTACHING PARTS)	77900	1206-00-00-0541C
-27	214-0762-00	B010100	B028969	1	GRILLE, METAL:	82877	476042
	200-2222-00	B028970		1	GUARD, FAN:	81041	6-182-033
-28	214-2364-00			1	SHROUD, FAN:	80009	214-2364-00
-29	-----			1	FAN, AXIAL: (SEE B104 REPL) (ATTACHING PARTS)		
-30	211-0511-00			4	SCREW, MACHINE: 6-32 X 0.5, PNH, STL	TK0435	ORDER BY DESCR
-31	210-0457-00			4	NUT, PL, ASSEM WA: 6-32 X 0.312, STL CD PL (END ATTACHING PARTS)	78189	511-061800-00
	343-0013-00	B010100	B010240	1	CLAMP, LOOP: 0.375 ID, PLASTIC (OPT 06 ONLY)	06915	ORDER BY DESCR
	343-0004-00	B010241	B022719	1	CLAMP, LOOP: 0.312 ID, PLASTIC (OPT 06 ONLY)	06915	ORDER BY DESCR
	210-0863-00	B010100	B022719	1	WSHR, LOOP CLAMP: 0.187 ID U/W 0.5 W CLP (OPT 06 ONLY)	95987	C191
-32	260-0907-00			1	SWITCH, THERMSTC: NC, OPEN 97.8, CL 75.6, 10A (ATTACHING PARTS)	93410	430-349
-33	211-0007-00	B010100	B022719	2	SCREW, MACHINE: 4-40 X 0.188, PNH, STL	93907	ORDER BY DESCR
	211-0008-00	B022720		2	SCREW, MACHINE: 4-40 X 0.25, PNH, STL	93907	ORDER BY DESCR
-34	210-0586-00	B010100	B022719	2	NUT, PL, ASSEM WA: 4-40 X 0.25, STL CD PL	78189	211-041800-00

Replaceable Mechanical Parts - TM 515

Fig. & Index No.	Tektronix Part No.	Serial/Assembly No. Effective	Discort	Qty	12345 Name & Description	Mfr. Code	Mfr. Part No.
1-					(END ATTACHING PARTS)		
-35	-----			5	TRAN:(SEE Q110,Q120,Q130,Q140,Q150 REPL)		
					(ATTACHING PARTS)		
-36	211-0097-00	B010100	B023569	5	SCREW,MACHINE:4-40 X 0.312,PNH,STL	93907	ORDER BY DESCR
	211-0275-00	B023570		5	SCREW,SHOULDER:4-40 X 0.375,PNH,STL CD PL	93907	R80-20380-024
-37	210-1122-00	B010100	B023569	5	WASHER,LOCK:0.12 ID,DISHED,0.025 THK,STL	86928	ORDER BY DESCR
	210-0071-00	B023570		5	WASHER,SPR TNSN:0.148 ID X 0.025 THK,STL	78189	4706-05-01-0531
					(END ATTACHING PARTS)		
-38	342-0163-00	B010100	B010250	5	INSULATOR,PLATE:TRANSISTOR,MICA	80009	342-0163-00
	342-0136-00	B010251		5	INSLTR,WSHR:0.19ID X 0.0025THK,MICA,0.812	91500	B52600F013
	348-0003-00	B022720		2	GROMMET,RUBBER:BLACK,ROUND,0.219 ID	70485	141186040
-39	214-2366-00			1	HEAT SINK,XSTR:LOWER	80009	214-2366-00
					(ATTACHING PARTS)		
-40	211-0599-00			4	SCREW,MACHINE:6-32 X 0.750,FILH,SST	93907	ORDER BY DESCR
-41	210-0457-00			4	NUT,PL,ASSEM WA:6-32 X 0.312,STL CD PL	78189	511-061800-00
-42	211-0007-00	B010100	B022119	1	SCREW,MACHINE:4-40 X 0.188,PNH,STL	93907	ORDER BY DESCR
	211-0008-00	B022120		1	SCREW,MACHINE:4-40 X 0.25,PNH,STL	93907	ORDER BY DESCR
	211-0007-00	B010100	B022219	1	SCREW,MACHINE:4-40 X 0.188,PNH,STL	93907	ORDER BY DESCR
					(OPTION 05 ONLY)		
	211-0008-00	B022220		1	SCREW,MACHINE:4-40 X 0.25,PNH,STL	93907	ORDER BY DESCR
					(OPTION 05 ONLY)		
	211-0007-00	B010100	B022379	1	SCREW,MACHINE:4-40 X 0.188,PNH,STL	93907	ORDER BY DESCR
					(OPTION 06 ONLY)		
	211-0008-00	B022380		1	SCREW,MACHINE:4-40 X 0.25,PNH,STL	93907	ORDER BY DESCR
					(OPTION 06 ONLY)		
					(END ATTACHING PARTS)		
-43	-----			1	TRANSFORMER:POWER(SEE T100 REPL)		
					(ATTACHING PARTS)		
-44	407-1174-00	B010100	B022719	2	BRACKET,XFMR:ALUMINUM	80009	407-1174-00
	407-1174-01	B022720		2	BRACKET,XFMR:ALUMINUM	80009	407-1174-01
-45	212-0543-00	B022720		1	SCREW,MACHINE:10-32 X 3.75 HEX HD,STL	93907	ORDER BY DESCR
-46	220-0410-00	B022720		1	NUT,PL,ASSEM WA:10-32 X 0.375 HEX,STL CD PL	78189	511-101800-50
-47	210-0805-00	B022720		1	WASHER,FLAT:0.204 ID X 0.438 OD X 0.032,STL	12327	ORDER BY DESCR
-48	210-0813-00	B022720	B031139	2	WASHER,SHLDR:0.196 X 0.438 X 0.062 THK,FBR	83309	ORDER BY DESCR
	210-0812-00	B031140		2	WASHER,FLAT:0.188 ID X 0.375 OD X 0.31	83309	ORDER BY DESCR
-49	166-0229-00	B022720		1	INSUL SLVG,ELEC:0.187 ID X 3.25 L,MYLAR	80009	166-0229-00
-50	212-0008-00	B010100	B020582	2	SCREW,MACHINE:8-32 X 0.5,PNH,STL	83385	ORDER BY DESCR
	212-0033-00	B020583	B022719	2	SCREW,MACHINE:8-32 X 0.75,PNH,STL	93907	ORDER BY DESCR
	212-0020-00	B022720		2	SCREW,MACHINE:8-32 X 1.0,PNH,STL	83385	ORDER BY DESCR
	210-0008-00	B020583	B022719	2	WASHER,LOCK:#8 INTL,0.02 THK,STL	77900	1208-00-00-0541C
-51	210-0458-00	B022720		2	NUT,PL,ASSEM WA:8-32 X 0.344,STL CD PL	78189	511-081800-00
-52	212-0033-00	B010100	B020582	2	SCREW,MACHINE:8-32 X 0.75,PNH,STL	93907	ORDER BY DESCR
	212-0020-00	B020583		2	SCREW,MACHINE:8-32 X 1.0,PNH,STL	83385	ORDER BY DESCR
-53	210-0409-00	B010100	B020582	2	NUT,PLAIN,HEX:8-32 X 0.312,BRS CD PL	73743	3046-402
	210-0458-00	B020583		2	NUT,PL,ASSEM WA:8-32 X 0.344,STL CD PL	78189	511-081800-00
-54	210-0008-00	B020483		2	WASHER,LOCK:#8 INTL,0.02 THK,STL	77900	1208-00-00-0541C
-55	210-0007-00	B020583		2	WASHER,LOCK:#8 EXT,0.02 THK,STL	78189	1108-00-00-0541C
					(END ATTACHING PARTS)		
-56	342-0028-00			2	INSULATOR,PLATE:TRANSFORMER,ANODIZED AL	80009	342-0028-00
-57	361-0769-00			2	SPACER,BAR:TRANSFORMER	80009	361-0769-00
-58	260-0907-00			1	SWITCH,THRMSTC:NC,OPEN 97.8,CL 75.6,10A	93410	430-349
					(ATTACHING PARTS)		
-59	211-0007-00	B010100	B022719	2	SCREW,MACHINE:4-40 X 0.188,PNH,STL	93907	ORDER BY DESCR
	211-0008-00	B022720		2	SCREW,MACHINE:4-40 X 0.25,PNH,STL	93907	ORDER BY DESCR
-60	210-0586-00	B010100	B022719	2	NUT,PL,ASSEM WA:4-40 X 0.25,STL CD PL	78189	211-041800-00
					(END ATTACHING PARTS)		
-61	-----			5	TRAN:(SEE Q112,Q122,Q132,Q142,Q152 REPL)		
					(ATTACHING PARTS)		
-62	211-0097-00	B010100	B023569	5	SCREW,MACHINE:4-40 X 0.312,PNH,STL	93907	ORDER BY DESCR
	211-0275-00	B023570		5	SCREW,SHOULDER:4-40 X 0.375,PNH,STL CD PL	93907	R80-20380-024
-63	210-1122-00	B010100	B023569	5	WASHER,LOCK:0.12 ID,DISHED,0.025 THK,STL	86928	ORDER BY DESCR
	210-0071-00	B023570		5	WASHER,SPR TNSN:0.148 ID X 0.025 THK,STL	78189	4706-05-01-0531
					(END ATTACHING PARTS)		
-64	342-0163-00	B010100	B010250	5	INSULATOR,PLATE:TRANSISTOR,MICA	80009	342-0163-00
	342-0136-00	B010251		5	INSLTR,WSHR:0.19ID X 0.0025THK,MICA,0.812	91500	B52600F013
-65	214-2366-00			1	HEAT SINK,XSTR:LOWER	80009	214-2366-00
					(ATTACHING PARTS)		
-66	211-0599-00			4	SCREW,MACHINE:6-32 X 0.750,FILH,SST	93907	ORDER BY DESCR

Fig. & Index No.	Tektronix Part No.	Serial/Assembly No.		Qty	12345 Name & Description	Mfr.	
		Effective	Discnt			Code	Mfr. Part No.
1-67	210-0457-00			4	NUT, PL, ASSEM WA: 6-32 X 0.312, STL CD PL	78189	511-061800-00
-68	211-0007-00	B010100	B022119	1	SCREW, MACHINE: 4-40 X 0.188, PNH, STL	93907	ORDER BY DESCR
	211-0008-00	B022120		1	SCREW, MACHINE: 4-40 X 0.25, PNH, STL	93907	ORDER BY DESCR
	211-0007-00	B010100	B02219	1	SCREW, MACHINE: 4-40 X 0.188, PNH, STL (OPTION 05 ONLY)	93907	ORDER BY DESCR
	211-0008-00	B022220		1	SCREW, MACHINE: 4-40 X 0.25, PNH, STL (OPTION 05 ONLY)	93907	ORDER BY DESCR
	211-0007-00	B010100	B022379	1	SCREW, MACHINE: 4-40 X 0.188, PNH, STL (OPTION 06 ONLY)	93907	ORDER BY DESCR
	211-0008-00	B022380		1	SCREW, MACHINE: 4-40 X 0.25, PNH, STL (OPTION 06 ONLY)	93907	ORDER BY DESCR
-69	210-1011-00	B010100	B020651	1	WASHER, FLAT: 0.13 ID X 0.375 OD X 0.01, NYLON (END ATTACHING PARTS)	83309	ORDER BY DESCR
-70	-----			1	CKT BOARD ASSY: FILTER (SEE A2 REPL)		
-71	-----			2	.SEMICONV DEVICE: W/HDR (SEE CR130, CR132 REP		
-72	220-0410-00	B021810		2	.NUT, PL, ASSEM WA: 10-32 X 0.375 HEX, STL CD PL	78189	511-101800-50
-73	344-0154-00	B021810		4	.CLIP, ELECTRICAL: FUSE, CKT BD MT	80009	344-0154-00
-74	344-0286-00	B021810		2	.CLIP, ELECTRICAL: FUSE, SPR BRS	75915	102074
-75	426-1278-01			2	MOUNT, XFMR: (ATTACHING PARTS)	80009	426-1278-01
-76	212-0002-00	B010100	B022119	4	SCREW, MACHINE: 8-32 X 0.25, FLH, 100 DEG, STL	83385	ORDER BY DESCR
	212-0004-00	B022120		4	SCREW, MACHINE: 8-32 X 0.312, PNH, STL	TK0435	ORDER BY DESCR
	212-0002-00	B010100	B022219	4	SCREW, MACHINE: 8-32 X 0.25, FLH, 100 DEG, STL (OPTION 05 ONLY)	83385	ORDER BY DESCR
	212-0004-00	B022220		4	SCREW, MACHINE: 8-32 X 0.312, PNH, STL (OPTION 05 ONLY)	TK0435	ORDER BY DESCR
	212-0002-00	B010100	B022379	4	SCREW, MACHINE: 8-32 X 0.25, FLH, 100 DEG, STL (OPTION 06 ONLY)	83385	ORDER BY DESCR
	212-0004-00	B022380		4	SCREW, MACHINE: 8-32 X 0.312, PNH, STL (OPTION 06 ONLY)	TK0435	ORDER BY DESCR
-77	351-0472-00	B010100	B020582	2	GUIDE, PWR SPLY: W/SHOCK MOUNT, POLYURETHANE, B LACK	TK1319	N/A
	426-1350-01	B020583		2	MOUNT, PWR SPLY: FINISHED (END ATTACHING PARTS)	TK1319	N/A
-78	-----			1	CKT BOARD ASSY: INTERFACE (SEE A1 REPL)		
-79	131-1078-00			5	.CONN, RCPT, ELEC: CKT BD, 28/56 CONTACT	31781	303-056-520-301
-80	214-1593-02			5	.KEY, CONN PLZN: CKT BOARD CONN	80009	214-1593-02
	214-1593-02			15	.KEY, CONN PLZN: CKT BOARD CONN (OPTION 05 ONLY)	80009	214-1593-02
	214-1593-02			3	.KEY, CONN PLZN: CKT BOARD CONN (OPTION 07 ONLY)	80009	214-1593-02
-81	344-0154-00	B010100	B021809	12	.CLIP, ELECTRICAL: FUSE, CKT BD MT	80009	344-0154-00
	344-0154-00	B021810		8	.CLIP, ELECTRICAL: FUSE, CKT BD MT	80009	344-0154-00
-82	344-0286-00	B010100	B020651	2	.CLIP, ELECTRICAL: FUSE, SPR BRS	75915	102074
	131-0608-00			84	.TERMINAL, PIN: 0.365 L X 0.025 BRZ GLD PL (OPTION 05 ONLY)	22526	48283-036
	131-1806-00			2	.TERM SET, PIN: 1 X 31, 0.025 SQ ON 0.15 CTR (OPTION 05 ONLY)	22526	65595-131
	131-1939-00	B010100	B020582	2	.TERM SET, PIN: 1 X 14, 0.15 SPACING (OPTION 05 ONLY)	22526	65561-114
	131-1939-00	B020583	B020774	3	.TERM SET, PIN: 1 X 14, 0.15 SPACING (OPTION 05 ONLY)	22526	65561-114
	131-1806-00	B020583		4	.TERM SET, PIN: 1 X 31, 0.025 SQ ON 0.15 CTR (OPTION 05 ONLY)	22526	65595-131
	006-0531-00			5	.STRAP, TIEDOWN, E: BLUE PLASTIC BEADED (OPTION 05 ONLY)	24618	700-3688
	020-0181-00			1	.COMPONENT KIT: WIRE & CONNECT ORS (OPTION 05 ONLY)	80009	020-0181-00
	352-0425-00	B010350	B020582	1	.FUSEHOLDER: (1)3AG	80009	352-0425-00
-83	006-0531-00	B010100	B022119	4	STRAP, TIEDOWN, E: BLUE PLASTIC BEADED	24618	700-3688
	006-0531-00	B022120		5	STRAP, TIEDOWN, E: BLUE PLASTIC BEADED	24618	700-3688
	006-0531-00	B010100	B022194	4	STRAP, TIEDOWN, E: BLUE PLASTIC BEADED (OPTION 05 ONLY)	24618	700-3688
	006-0531-00	B022220		5	STRAP, TIEDOWN, E: BLUE PLASTIC BEADED (OPTION 05 ONLY)	24618	700-3688
	006-0531-00	B010100	B022379	4	STRAP, TIEDOWN, E: BLUE PLASTIC BEADED (OPTION 06 ONLY)	24618	700-3688
	006-0531-00	B022380		5	STRAP, TIEDOWN, E: BLUE PLASTIC BEADED	24618	700-3688

Replaceable Mechanical Parts - TM 515

Fig. & Index No.	Tektronix Part No.	Serial/Assembly No. Effective	Discnt	Qty	12345 Name & Description	Mfr. Code	Mfr. Part No.
1-	016-0643-00			1	(OPTION 06 ONLY)	24995	CR338-5052
	198-2315-00	B010100	B028879	1	CASE, CARRYING:	80009	198-2315-00
	198-2315-01	B028880		1	WIRE SET, ELEC:	80009	198-2315-01

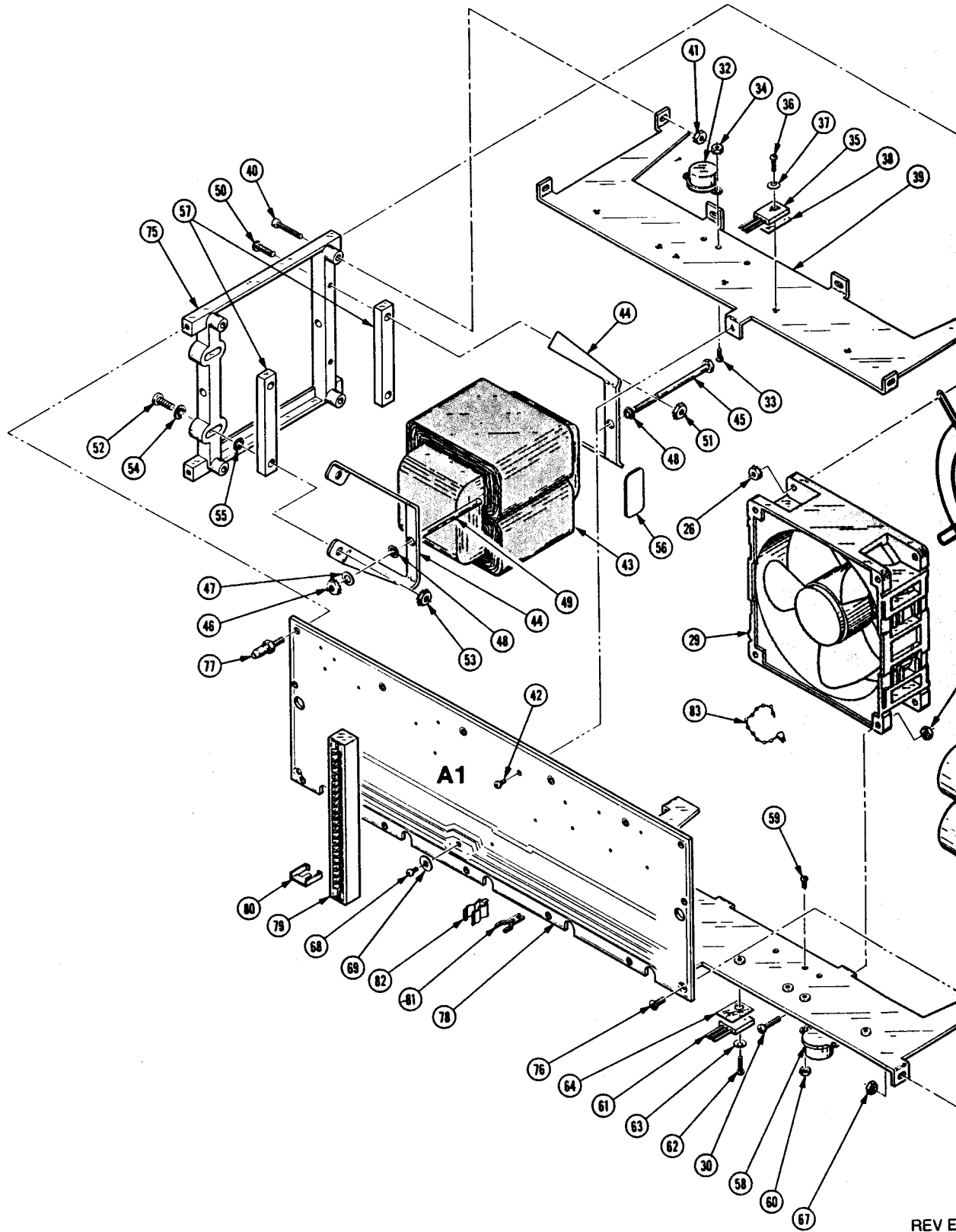

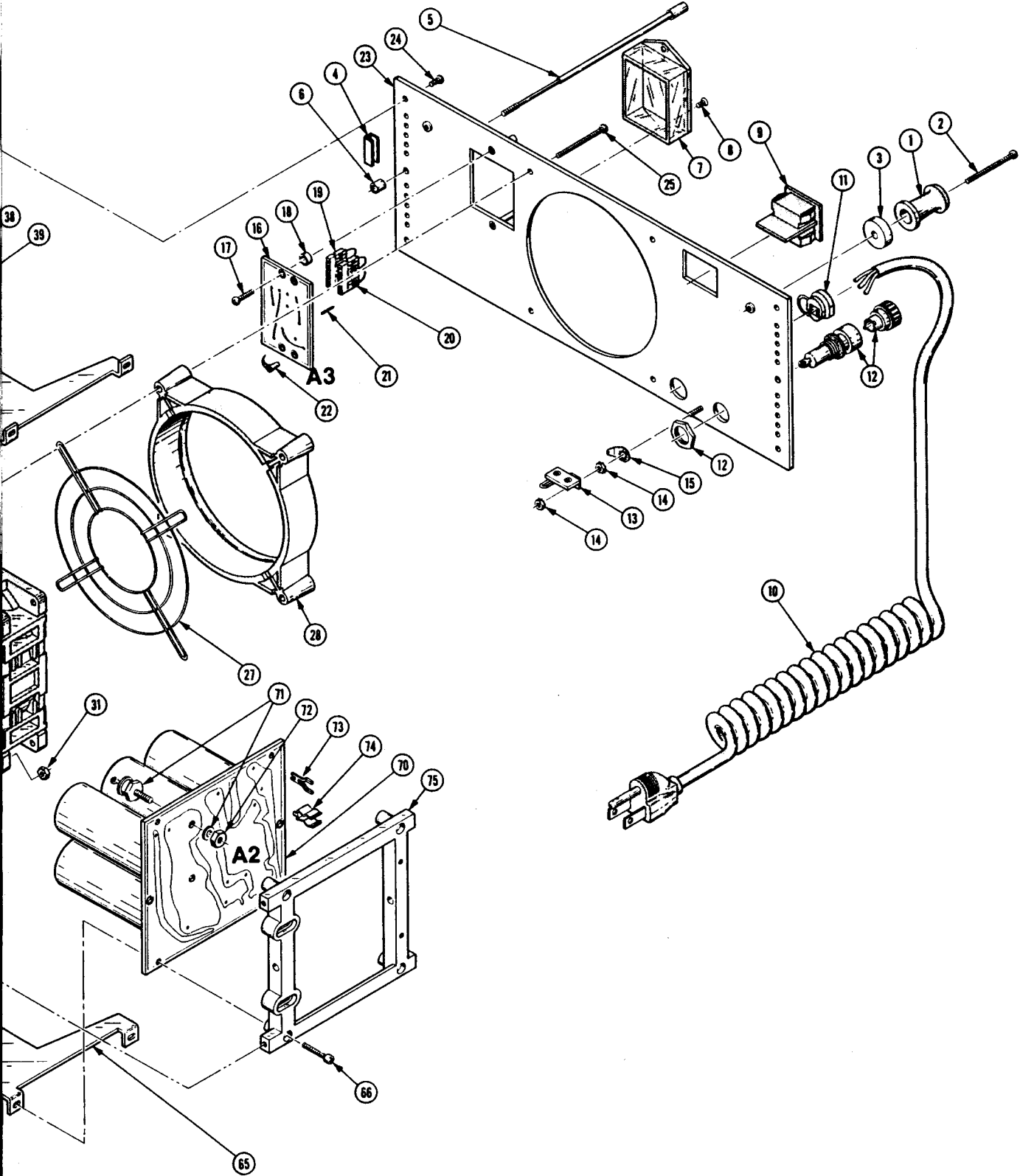
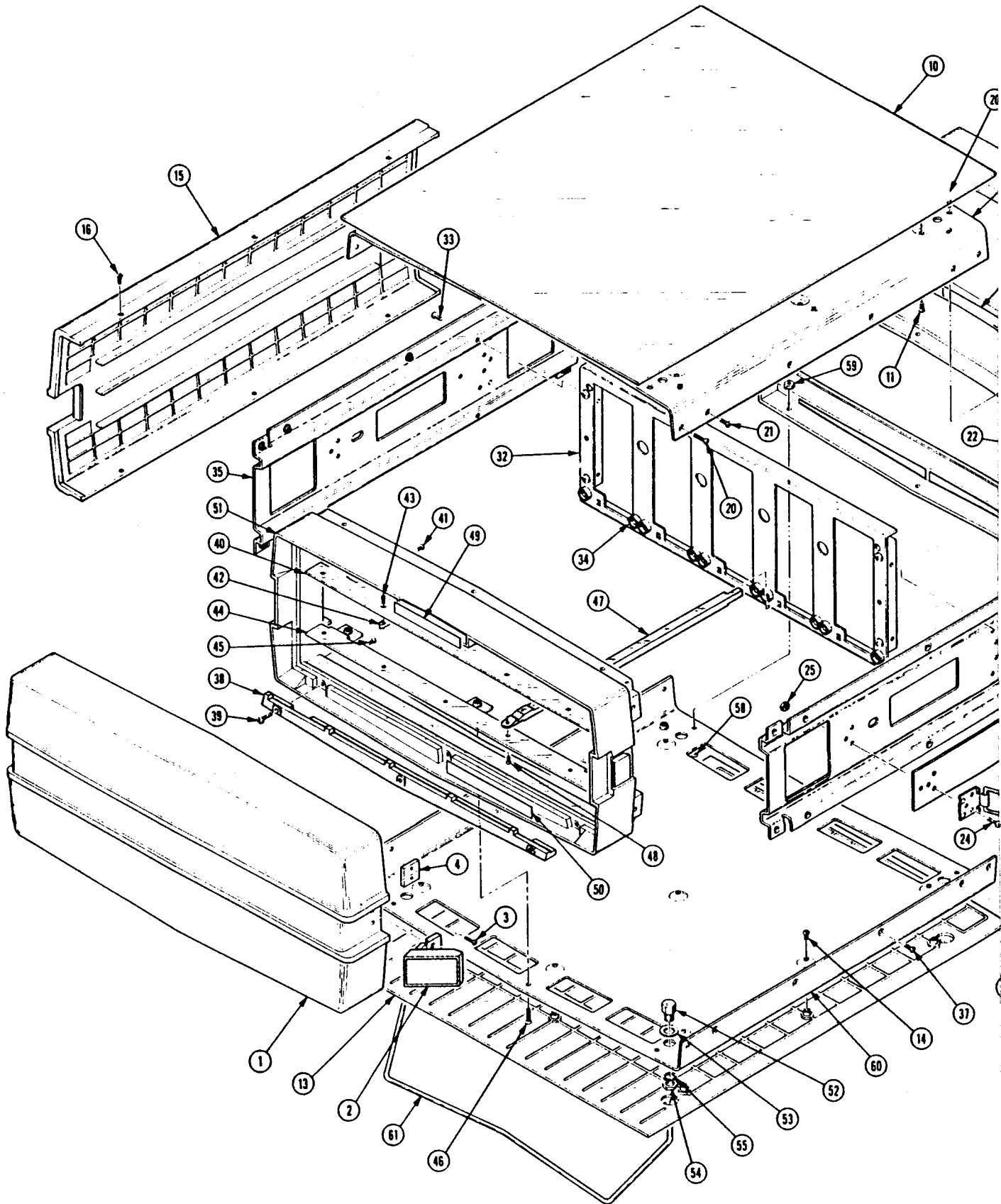
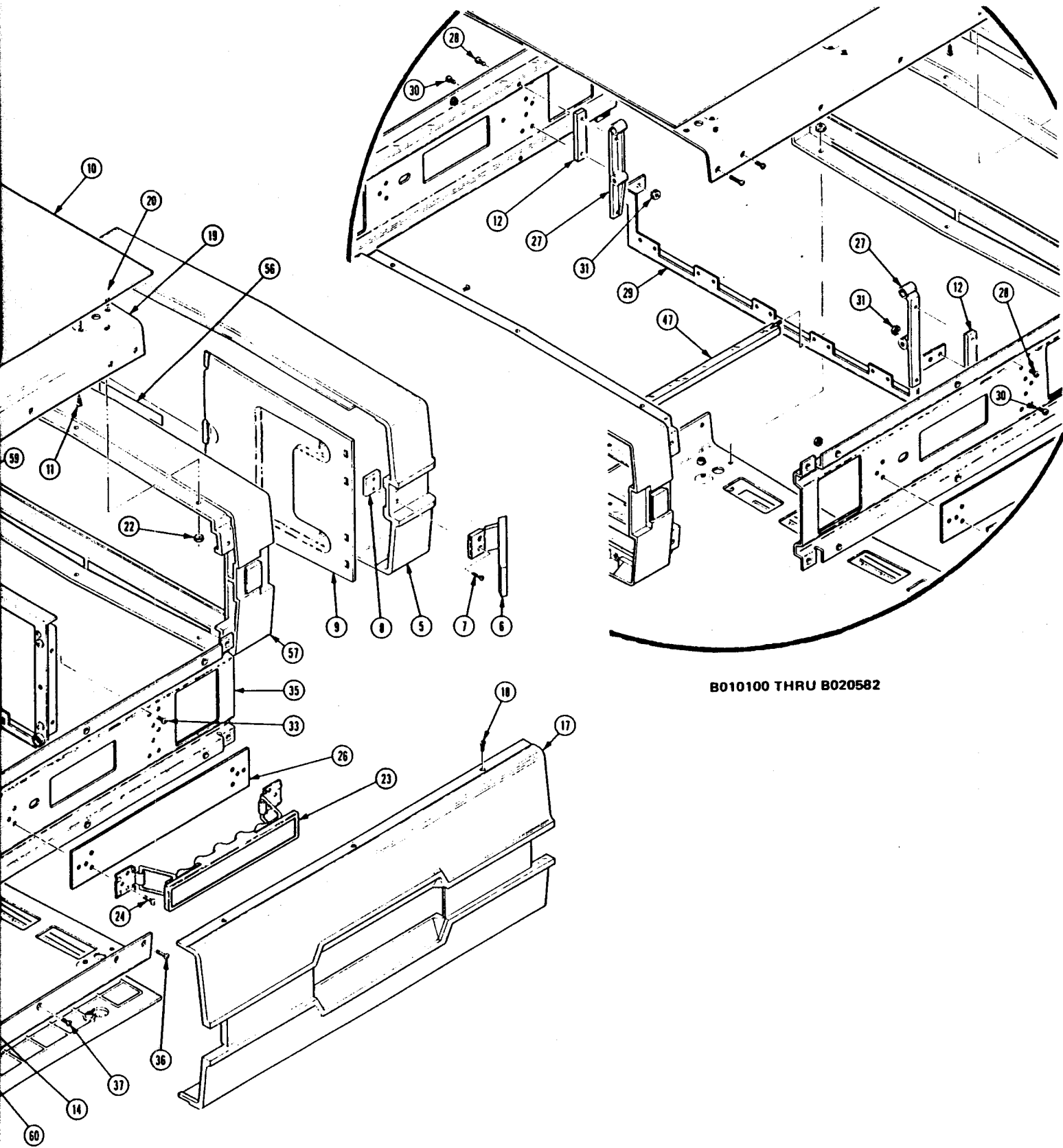

Fig. 2. Cabinet & Mainframe





B010100 THRU B020582

Fig. & Index No.	Tektronix Part No.	Serial/Assembly No.		Qty	12345 Name & Description	Mfr.	
		Effective	Decort			Code	Mfr. Part No.
2-1	390-0529-00			1	CAB., POWER SPLY:	80009	390-0529-00
	200-1901-01			1	.COV, END, PWR SUP: FRONT	80009	200-1901-01
-2	105-0707-00			2	.CATCH, CLAMPING: PLASTIC, SILVER GRAY	80009	105-0707-00
					.(ATTACHING PARTS)		
-3	211-0025-00			4	.SCREW, MACHINE: 4-40 X 0.375, FLH, 100 DEG, STL	TK0435	ORDER BY DESCR
-4	220-0763-00			2	.NUT PLATE: 4-40 X 0.646 SQ, AL	80009	220-0763-00
					.(END ATTACHING PARTS)		
-5	200-1901-00			1	.COV, END, PWR SUP:	80009	200-1901-00
-6	105-0707-00			2	.CATCH, CLAMPING: PLASTIC, SILVER GRAY	80009	105-0707-00
					.(ATTACHING PARTS)		
-7	211-0025-00			4	.SCREW, MACHINE: 4-40 X 0.375, FLH, 100 DEG, STL	TK0435	ORDER BY DESCR
-8	220-0763-00			2	.NUT PLATE: 4-40 X 0.646 SQ, AL	80009	220-0763-00
					.(END ATTACHING PARTS)		
-9	200-1914-00			2	.COV, ACCESS. BOX:	80009	200-1914-00
-10	200-1898-01			1	.COVER, PWR SPLY: UPPER	80009	200-1898-01
					.(ATTACHING PARTS)		
-11	211-0503-00	B010100	B020582	9	.SCREW, MACHINE: 6-32 X 0.188, PNH, STL	93907	ORDER BY DESCR
	211-0504-00	B020583	B022119	8	.SCREW, MACHINE: 6-32 X 0.250, PNH, STL	TK0435	ORDER BY DESCR
	211-0614-00	B022120		8	.SCR, ASSEM WSHR: 6-32 X 0.250, PNH, STL, CD PL	83385	ORDER BY DESCR
	211-0503-00	B010100	B020651	9	.SCREW, MACHINE: 6-32 X 0.188, PNH, STL	93907	ORDER BY DESCR
					.(OPTION 05 ONLY)		
	211-0504-00	B020652	B022219	8	.SCREW, MACHINE: 6-32 X 0.250, PNH, STL	TK0435	ORDER BY DESCR
					.(OPTION 05 ONLY)		
	211-0614-00	B022220		8	.SCR, ASSEM WSHR: 6-32 X 0.250, PNH, STL, CD PL	83385	ORDER BY DESCR
					.(OPTION 05 ONLY)		
	211-0503-00	B010100	B020659	9	.SCREW, MACHINE: 6-32 X 0.188, PNH, STL	93907	ORDER BY DESCR
					.(OPTION 06 ONLY)		
	211-0504-00	B020660	B022379	8	.SCREW, MACHINE: 6-32 X 0.250, PNH, STL	TK0435	ORDER BY DESCR
					.(OPTION 06 ONLY)		
	211-0614-00	B022380		8	.SCR, ASSEM WSHR: 6-32 X 0.250, PNH, STL, CD PL	83385	ORDER BY DESCR
					.(OPTION 06 ONLY)		
	210-0005-00	B020583	B022119	8	.WASHER, LOCK: #6 EXT, 0.02 THK, STL	78189	1106-00
	210-0005-00	B020652	B022219	8	.WASHER, LOCK: #6 EXT, 0.02 THK, STL	78189	1106-00
					.(OPTION 05 ONLY)		
	210-0005-00	B020660	B022379	8	.WASHER, LOCK: #6 EXT, 0.02 THK, STL	78189	1106-00
					.(OPTION 06 ONLY)		
					.(END ATTACHING PARTS)		
-12	361-0797-00	B010100	B020582	1	.SPACER, PLATE: 0.016 X 3.324 X 0.312, AL	80009	361-0797-00
	361-0797-01	B010100	B020582	1	.SPACER, PLATE: 0.025 X 3.324 X 0.312, AL	80009	361-0797-01
-13	200-1898-02			1	.COVER, PWR SPLY: LOWER	80009	200-1898-02
					.(ATTACHING PARTS)		
-14	211-0503-00	B010100	B020582	9	.SCREW, MACHINE: 6-32 X 0.188, PNH, STL	93907	ORDER BY DESCR
	211-0504-00	B020583	B022119	8	.SCREW, MACHINE: 6-32 X 0.250, PNH, STL	TK0435	ORDER BY DESCR
	211-0614-00	B022120		8	.SCR, ASSEM WSHR: 6-32 X 0.250, PNH, STL, CD PL	83385	ORDER BY DESCR
	211-0503-00	B010100	B020651	9	.SCREW, MACHINE: 6-32 X 0.188, PNH, STL	93907	ORDER BY DESCR
					.(OPTION 05 ONLY)		
	211-0504-00	B020652	B022219	8	.SCREW, MACHINE: 6-32 X 0.250, PNH, STL	TK0435	ORDER BY DESCR
					.(OPTION 05 ONLY)		
	211-0614-00	B022220		8	.SCR, ASSEM WSHR: 6-32 X 0.250, PNH, STL, CD PL	83385	ORDER BY DESCR
					.(OPTION 05 ONLY)		
	211-0503-00	B010100	B020659	9	.SCREW, MACHINE: 6-32 X 0.188, PNH, STL	93907	ORDER BY DESCR
					.(OPTION 06 ONLY)		
	211-0504-00	B020660	B022379	8	.SCREW, MACHINE: 6-32 X 0.250, PNH, STL	TK0435	ORDER BY DESCR
					.(OPTION 06 ONLY)		
	211-0614-00	B022380		8	.SCR, ASSEM WSHR: 6-32 X 0.250, PNH, STL, CD PL	83385	ORDER BY DESCR
					.(OPTION 06 ONLY)		
	210-0005-00	B020583	B022119	8	.WASHER, LOCK: #6 EXT, 0.02 THK, STL	78189	1106-00
	210-0005-00	B020652	B022219	8	.WASHER, LOCK: #6 EXT, 0.02 THK, STL	78189	1106-00
					.(OPTION 05 ONLY)		
	210-0005-00	B020660	B022379	8	.WASHER, LOCK: #6 EXT, 0.02 THK, STL	78189	1106-00
					.(OPTION 06 ONLY)		
					.(END ATTACHING PARTS)		
-15	200-1899-00			1	.COVER, PWR SPLY: LEFT	80009	200-1899-00
					.(ATTACHING PARTS)		
-16	211-0538-00			6	.SCREW, MACHINE: 6-32 X 0.312, FLH, 100 DEG, STL	93907	ORDER BY DESCR
					.(END ATTACHING PARTS)		
-17	200-1900-00			1	.COVER, PWR SPLY: RIGHT	80009	200-1900-00
					.(ATTACHING PARTS)		

Replaceable Mechanical Parts - TM 515

Fig. & Index No.	Tektronix Part No.	Serial/Assembly No. Effective Discort		Qty	12345 Name & Description	Mfr. Code	Mfr. Part No.
2-18	211-0538-00			6	.SCREW,MACHINE:6-32 X 0.312,FLH,100 DEG,STL .(END ATTACHING PARTS)	93907	ORDER BY DESCR
-19	386-3450-00			1	.STIFFENER,COVER: .(ATTACHING PARTS)	80009	386-3450-00
-20	211-0512-00	B010100	B020582	10	.SCREW,MACHINE:6-32 X 0.5,FLH,100 DEG,STL	TK0435	ORDER BY DESCR
	211-0512-00	B020583		4	.SCREW,MACHINE:6-32 X 0.5,FLH,100 DEG,STL	TK0435	ORDER BY DESCR
	211-0559-00	B020583		6	.SCREW,MACHINE:6-32 X 0.375,FLH,100 DEG	TK0435	1593-300
-21	211-0538-00			8	.SCREW,MACHINE:6-32 X 0.312,FLH,100 DEG,STL	93907	ORDER BY DESCR
-22	210-0457-00			3	.NUT,PL,ASSEM WA:6-32 X 0.312,STL CD PL .(END ATTACHING PARTS)	78189	511-061800-00
-23	367-0215-00			1	.HANDLE,CARRYING:6.0 L,SIL GY,PP .(ATTACHING PARTS)	TK0512	367-0215-398
-24	211-0507-00			6	.SCREW,MACHINE:6-32 X 0.312,PNH,STL	83385	ORDER BY DESCR
-25	210-0457-00			6	.NUT,PL,ASSEM WA:6-32 X 0.312,STL CD PL .(END ATTACHING PARTS)	78189	511-061800-00
-26	386-3447-00			1	.PLATE,HDL MTG:	80009	386-3447-00
-27	386-3445-01	B010100	B020582	2	.SPRT,PWR SUPPLY:RIGHT .(ATTACHING PARTS)	80009	386-3445-01
-28	211-0504-00	B010100	B020582	4	.SCREW,MACHINE:6-32 X 0.250,PNH,STL .(END ATTACHING PARTS)	TK0435	ORDER BY DESCR
-29	351-0470-00	B010100	B020582	1	.GUIDE,PL-IN RET: .(ATTACHING PARTS)	80009	351-0470-00
-30	211-0507-00	B010100	B020582	4	.SCREW,MACHINE:6-32 X 0.312,PNH,STL	83385	ORDER BY DESCR
-31	210-0457-00	B020200	B020582	4	.NUT,PL,ASSEM WA:6-32 X 0.312,STL CD PL .(END ATTACHING PARTS)	78189	511-061800-00
-32	441-1355-00	B020583	B031367	1	.CHASSIS ASSY:SUPPORT	80009	441-1355-00
	441-1355-01	B031368		1	.CHASSIS ASSY: .(ATTACHING PARTS)	80009	441-1355-01
-33	212-0008-00	B020583		4	.SCREW,MACHINE:8-32 X 0.5,PNH,STL	83385	ORDER BY DESCR
	210-0008-00	B020583		4	.WASHER,LOCK:#8 INTL,0.02 THK,STL .(END ATTACHING PARTS)	77900	1208-00-00-0541C
-34	348-0509-00	B020583	B031367	10	.GROMMET,PLASTIC:BLACK,ROUND,0.188 ID	80009	348-0509-00
	348-0640-00	B031368		10	.GROMMET,PLASTIC:BLACK,ROUND,0.188 ID	80009	348-0640-00
-35	426-1279-00			2	.FRAME SECT,CAB.:SIDE .(ATTACHING PARTS)	80009	426-1279-00
-36	211-0512-00			4	.SCREW,MACHINE:6-32 X 0.5,FLH,100 DEG,STL	TK0435	ORDER BY DESCR
-37	211-0538-00			8	.SCREW,MACHINE:6-32 X 0.312,FLH,100 DEG,STL .(END ATTACHING PARTS)	93907	ORDER BY DESCR
-38	343-0596-00	B010100	B022119	1	.RTNR,PL-IN UNIT:FRONT,NYLON SIL GRAY	80009	343-0596-00
	343-0596-01	B022120		1	.RTNR,PL-IN UNIT:FRONT,NYLON SIL GRAY	80009	343-0596-01
	343-0596-00	B010100	B022219	1	.RTNR,PL-IN UNIT:FRONT,NYLON SIL GRAY .(OPTION 05 ONLY)	80009	343-0596-00
	343-0596-01	B022220		1	.RTNR,PL-IN UNIT:FRONT,NYLON SIL GRAY .(OPTION 05 ONLY)	80009	343-0596-01
	343-0596-00	B010100	B022379	1	.RTNR,PL-IN UNIT:FRONT,NYLON SIL GRAY .(OPTION 06 ONLY)	80009	343-0596-00
	343-0596-01	B022380		1	.RTNR,PL-IN UNIT:FRONT,NYLON SIL GRAY .(OPTION 06 ONLY)	80009	343-0596-01
-39	211-0598-00	B010100	B022119	3	.THUMBSCREW:6-32 X 0.375,0.226 OD SST	06540	6232SS0632
	213-0133-00	B022120		3	.SCREW,CAP:6-32 X 0.75,SST,SLOT	TK1287	ORDER BY DESCR
	211-0598-00	B010100	B022219	3	.THUMBSCREW:6-32 X 0.375,0.226 OD SST .(OPTION 05 ONLY)	06540	6232SS0632
	213-0133-00	B022220		3	.SCREW,CAP:6-32 X 0.75,SST,SLOT .(OPTION 05 ONLY)	TK1287	ORDER BY DESCR
	211-0598-00	B010100	B022379	3	.THUMBSCREW:6-32 X 0.375,0.226 OD SST .(OPTION 06 ONLY)	06540	6232SS0632
	213-0133-00	B022380		3	.SCREW,CAP:6-32 X 0.75,SST,SLOT .(OPTION 06 ONLY)	TK1287	ORDER BY DESCR
-40	386-3448-00	B010100	B022119	1	.PLATE,SUPPORT:UPPER GUIDE	80009	386-3448-00
	386-3708-00	B022120		1	.PLATE,SUPPORT:GUIDE	80009	386-3708-00
	386-3448-00	B010100	B022219	1	.PLATE,SUPPORT:UPPER GUIDE .(OPTION 05 ONLY)	80009	386-3448-00
	386-3708-00	B022220		1	.PLATE,SUPPORT:GUIDE .(OPTION 05 ONLY)	80009	386-3708-00
	386-3448-00	B010100	B022379	1	.PLATE,SUPPORT:UPPER GUIDE	80009	386-3448-00

Fig. & Index No.	Tektronix Part No.	Serial/Assembly No. Effective	Discont	Qty	12345 Name & Description	Mfr. Code	Mfr. Part No.
2-	386-3708-00	B022380		1	.(OPTION 06 ONLY) .PLATE,SUPPORT:GUIDE	80009	386-3708-00
-41	211-0007-00	B010100	B022119	2	.(OPTION 06 ONLY) .(ATTACHING PARTS) .SCREW,MACHINE:4-40 X 0.188,PNH,STL	93907	ORDER BY DESCR
	213-0119-00	B022120		2	.SCREW,TPG,TF:4-24 X 0.375,TYPE B,PNH,STL	83385	ORDER BY DESCR
	211-0007-00	B010100	B022219	2	.SCREW,MACHINE:4-40 X 0.188,PNH,STL	93907	ORDER BY DESCR
	213-0119-00	B022220		2	.SCREW,TPG,TF:4-24 X 0.375,TYPE B,PNH,STL	83385	ORDER BY DESCR
	211-0007-00	B010100	B022379	2	.SCREW,MACHINE:4-40 X 0.188,PNH,STL	93907	ORDER BY DESCR
	213-0119-00	B022380		2	.SCREW,TPG,TF:4-24 X 0.375,TYPE B,PNH,STL .(END ATTACHING PARTS)	83385	ORDER BY DESCR
-42	351-0379-01			5	.GUIDE,PL-IN UNI:UPPER,AL .(ATTACHING PARTS)	80009	351-0379-01
-43	211-0087-01			5	.SCREW,MACHINE:2-56 X 0.188,FLH,82 DEG,STL .(END ATTACHING PARTS)	TK0435	ORDER BY DESCR
-44	386-3449-00	B010100	B022119	1	.PLATE,SUPPORT:LOWER GUIDE	80009	386-3449-00
	386-3708-00	B022120		1	.PLATE,SUPPORT:GUIDE	80009	386-3708-00
	386-3449-00	B010100	B022219	1	.PLATE,SUPPORT:LOWER GUIDE .(OPTION 05 ONLY)	80009	386-3449-00
	386-3708-00	B022220		1	.PLATE,SUPPORT:GUIDE .(OPTION 05 ONLY)	80009	386-3708-00
	386-3449-00	B010100	B022379	1	.PLATE,SUPPORT:LOWER GUIDE .(OPTION 06 ONLY)	80009	386-3449-00
	386-3708-00	B022380		1	.PLATE,SUPPORT:GUIDE .(OPTION 06 ONLY) .(ATTACHING PARTS)	80009	386-3708-00
-45	211-0007-00	B010100	B022119	2	.SCREW,MACHINE:4-40 X 0.188,PNH,STL	93907	ORDER BY DESCR
	213-0119-00	B022120		2	.SCREW,TPG,TF:4-24 X 0.375,TYPE B,PNH,STL	83385	ORDER BY DESCR
	211-0007-00	B010100	B022219	2	.SCREW,MACHINE:4-40 X 0.188,PNH,STL	93907	ORDER BY DESCR
	213-0119-00	B022220		2	.SCREW,TPG,TF:4-24 X 0.375,TYPE B,PNH,STL	83385	ORDER BY DESCR
	211-0007-00	B010100	B022379	2	.SCREW,MACHINE:4-40 X 0.188,PNH,STL	93907	ORDER BY DESCR
	213-0119-00	B022380		2	.SCREW,TPG,TF:4-24 X 0.375,TYPE B,PNH,STL	83385	ORDER BY DESCR
-46	211-0512-00			3	.SCREW,MACHINE:6-32 X 0.5,FLH,100 DEG,STL .(END ATTACHING PARTS)	TK0435	ORDER BY DESCR
-47	351-0286-04	B010100	B020582	5	.GUIDE,PL-IN UNI:LOWER,BLACK NYLON	80009	351-0286-04
	351-0286-06	B020583	B024139	5	.GUIDE,PL-IN UNI:LOWER,BLACK NYLON	80009	351-0286-06
	351-0286-08	B024140		5	.GUIDE,PL-IN UNI:LOWER,NYLON .(ATTACHING PARTS)	80009	351-0286-08
-48	211-0105-00	B010100	B024139	5	.SCREW,MACHINE:4-40 X 0.188,FLH,100 DEG	TK0435	ORDER BY DESCR
	213-0815-00	B024140		5	.SCREW,TPG,TF:4-24 X 0.188L,PLASTITE,FLH,STL .(END ATTACHING PARTS)	72228	ORDER BY DESCR
	334-3379-01	B023320		1	.MARKER,IDENT:MARKED GROUND SYMBOL	80009	334-3379-01
-49	334-2658-00			1	.MARKER,IDENT:MKD TEKTRONIX TM515	80009	334-2658-00
-50	334-2709-00			1	.MARKER,IDENT:MKD CAUTION	80009	334-2709-00
-51	426-1280-01			1	.FRAME SECT,CAB.:	80009	426-1280-01
-52	214-2363-00			4	.RECEPTACLE,BAIL: .(ATTACHING PARTS)	80009	214-2363-00
-53	210-1025-00	B010100	B02058	4	.WASHER,FLAT:0.312 ID X 0.469 OD X 0.031,BRS	12327	ORDER BY DESCR
-54	220-0415-00			4	.NUT,PLAIN,HEX:0.312-32 X 0.438,BRS CD PL	73743	2X-28046-402
-55	210-0048-00			4	.WASHER,LOCK:0.32 ID INTL,0.015 THK,STL .(END ATTACHING PARTS)	78189	1218-04
-56	334-2659-00			1	.MARKER,IDENT:MKD PROPERTY OF	07416	ORDER BY DESCR
-57	426-1280-01			1	.FRAME SECT,CAB.: .(ATTACHING PARTS)	80009	426-1280-01
-58	211-0512-00			3	.SCREW,MACHINE:6-32 X 0.5,FLH,100 DEG,STL	TK0435	ORDER BY DESCR
-59	210-0457-00			3	.NUT,PL,ASSEM WA:6-32 X 0.312,STL CD PL .(END ATTACHING PARTS)	78189	511-061800-00
-60	386-3450-00			1	.STIFFENER,COVER:	80009	386-3450-00
-61	348-0476-00			1	.FLIP-STAND,CAB.:3.565 H,SST	80009	348-0476-00
	016-0643-00			1	CASE,CARRYING:	24995	CR338-5052

Replaceable Mechanical Parts - TM 515

Fig. & Index No.	Tektronix Part No.	Serial/Assembly No. Effective	Discont	Qty	12345 Name & Description	Mfr. Code	Mfr. Part No.
3-					STANDARD ACCESSORIES		
	070-2020-02			1	MANUAL, TECH: INSTR	80009	070-2020-02
					OPTION 05 ACCESSORIES		
-1	175-3301-00			6	CABLE ASSY, RF: 50 OHM COAX, 15.0 L, 9-4	80009	175-3301-00
-2	195-0993-00			6	LEAD, ELECTRICAL: 22 AWG, 15.0 L, 9-4	80009	195-0993-00
-3	214-1593-02			20	KEY, CONN PLZN: CKT BOARD CONN	80009	214-1593-02
-4	131-1319-00			1	SHLD, ELEC CONN:	71468	DD51216
-5	131-1345-00			1	CONN, RCPT, ELEC: D SERIES, 50 CONT, FEMALE	71468	DD-50S
					OPTIONAL ACCESSORIES		
	386-3657-00	B020583	B023849	16	SUPPORT, PLUG-IN:	80009	386-3657-00
	386-3657-01	B023850		16	SUPPORT, PLUG-IN:	93907	ORDER BY DESCR
	210-1270-00	B020583		16	WASHER, FLAT: 0.141 ID X 0.219 OD X 0.04, AL	80009	210-1270-00

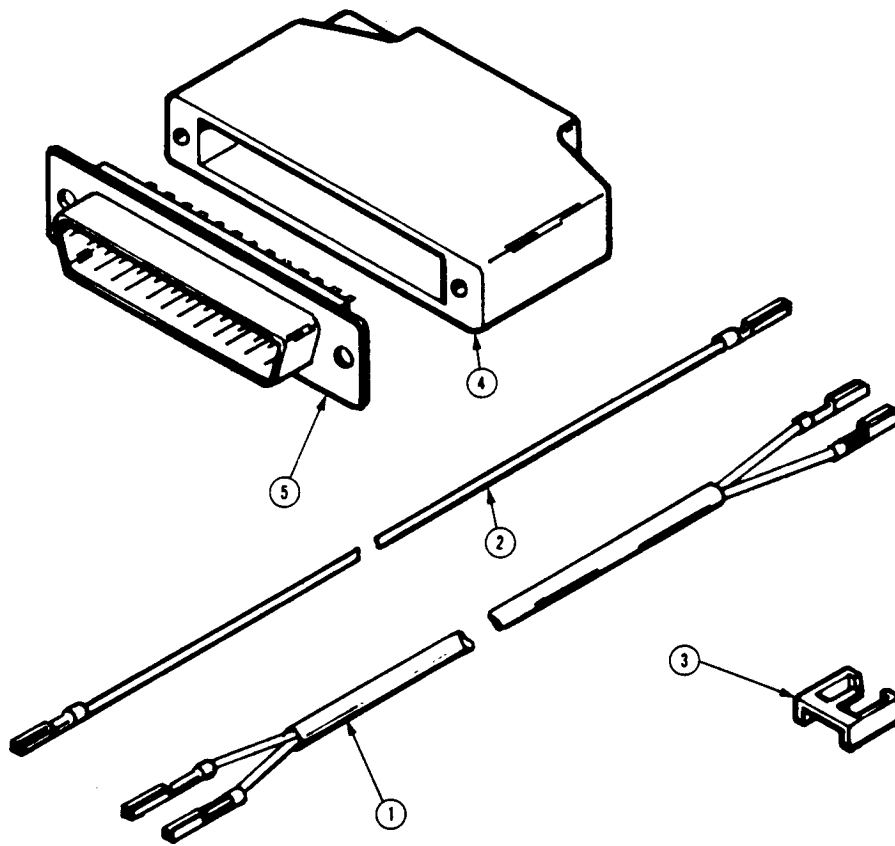

REV APR 1985

MANUAL CHANGE INFORMATION

At Tektronix, we continually strive to keep up with latest electronic developments by adding circuit and component improvements to our instruments as soon as they are developed and tested.

Sometimes, due to printing and shipping requirements, we can't get these changes immediately into printed manuals. Hence, your manual may contain new change information on following pages.

A single change may affect several sections. Since the change information sheets are carried in the manual until all changes are permanently entered, some duplication may occur. If no such change pages appear following this page, your manual is correct as printed.

Description

The following changes should be made to the Replaceable Electrical Parts List of the Instruction Manual.

Replaceable Electrical Parts (partial)

Component No.	Tektronix Part Number	Serial/Assembly No. Effective	Discont	Name and Description	Mfr. Code	Mfr. Part No.
A1	670-4021-01	B021810	B031589	CIRCUIT BD ASSY: INTERFACE	80009	670-4021-01
A1	670-4021-02	B031590		CIRCUIT BD ASSY: INTERFACE	80009	670-4021-02
A1	670-4364-01	B020770	B031589	CIRCUIT BD ASSY: INTERFACE (OPT 05 ONLY)	80009	670-4364-01
A1	670-4364-02	B031590		CIRCUIT BD ASSY: INTERFACE (OPT 05 ONLY)	80009	670-4364-02
F120	159-0005-00			FUSE, CARTRIDGE: 3AG, 3A,250V, 30 SEC, CER	71400	MSL-3
F122	159-0005-00			FUSE, CARTRIDGE: 3AG, 3A,250V, 30 SEC, CER	71400	MSL-3
Q110	151-0373-00	B010100	B031589	TRANSISTOR: PNP, SI, TO-127	04713	SJE925
Q110	151-0938-00	B031590		TRANSISTOR: PNP, SI, TO-220	04713	MJF2955
Q112	151-0436-00	B010100	B031589	TRANSISTOR: NPN, SI, SEL TO-172	04713	SJE966
Q112	151-0937-00	B031590		TRANSISTOR: NPN, SI, TO-220	04713	MJF3055
Q120	151-0373-00	B010100	B031589	TRANSISTOR: PNP, SI, TO-127	04713	SJE925
Q120	151-0938-00	B031590		TRANSISTOR: PNP, SI, TO-220	04713	MJF2955
Q122	151-0436-00	B010100	B031589	TRANSISTOR: NPN, SI, SEL TO-172	04713	SJE966
Q122	151-0937-00	B031590		TRANSISTOR: NPN, SI, TO-220	04713	MJF3055
Q130	151-0373-00	B010100	B031589	TRANSISTOR: PNP, SI, TO-127	04713	SJE925
Q130	151-0938-00	B031590		TRANSISTOR: PNP, SI, TO-220	04713	MJF2955
Q132	151-0436-00	B010100	B031589	TRANSISTOR: NPN, SI, SEL TO-172	04713	SJE966
Q132	151-0937-00	B031590		TRANSISTOR: NPN, SI, TO-220	04713	MJF3055
Q140	151-0373-00	B010100	B031589	TRANSISTOR: PNP, SI, TO-127	04713	SJE925
Q140	151-0938-00	B031590		TRANSISTOR: PNP, SI, TO-220	04713	MJF2955
Q142	151-0436-00	B010100	B031589	TRANSISTOR: NPN, SI, SEL TO-172	04713	SJE966
Q142	151-0937-00	B031590		TRANSISTOR: NPN, SI, TO-220	04713	MJF3055
Q150	151-0373-00	B010100	B031589	TRANSISTOR: PNP, SI, TO-127	04713	SJE925
Q150	151-0938-00	B031590		TRANSISTOR: PNP, SI, TO-220	04713	MJF2955
Q152	151-0436-00	B010100	B031589	TRANSISTOR: NPN, SI, SEL TO-172	04713	SJE966
Q152	151-0937-00	B031590		TRANSISTOR: NPN, SI, TO-220	04713	MJF3055

The following changes should be made to the Replaceable Mechanical Parts List of the Instruction Manual.

Replaceable Mechanical Parts (partial)

Fig. & Index No.	Tektronix Part Number	Serial/AssemblyNo. Effective	Dscont	Qty	Name and Description	Mfr. Code	Mfr. Part No.
1-38	342-0136-00	B010251	B031589	5	INSLTR, WSHR: 0.19 ID X 0.0025 THK, MICA	91500	B52600F013
1-38	342-0902-00	B031590		5	INSLTR, PLATE, TRANSISTOR, Q PAD II, TO-220, ALUM	55285	QII AC-54
1-64	342-0136-00	B010251	B031589	5	INSLTR, WSHR: 0.19 ID X 0.0025 THK, MICA	91500	B52600F013
1-64	342-0902-00	B031590		5	INSLTR, PLATE, TRANSISTOR, Q PAD II, TO-220, ALUM	55285	QII AC-54
2-1	390-0529-00	B010780	B031367	1	CABINET, POWER SUPPLY: TM515	80009	390-0529-00
2-1	390-0529-01	B031368		1	CABINET, POWER SUPPLY: TM515	OJR05	ORDER BY DESCR

The following item should be deleted from the Replaceable Mechanical Parts List of the Instruction Manual.

Replaceable Mechanical Parts (partial)

Fig. & Index No.	Tektronix Part Number	Serial/AssemblyNo. Effective	Dscont	Qty	Name and Description	Mfr. Code	Mfr. Part No.
1-6	166-0031-00	B031367		1	DELETE		

Add the following entry to the Mfr. Code Number to Manufacturer Cross Index:

Mfr. Code	Manufacturer	Address	City, State, Zip
OJR05	Triquest Corp.	3000 Lewis and Clark Hwy	Vancouver, WA 98661-2999
55285	The Berquist Co., Inc.	5300 Edina Industrial Blvd	Minneapolis, MN 55435-3707