



Service Scope

USEFUL INFORMATION FOR USERS OF TEKTRONIX INSTRUMENTS

NUMBER 30

PRINTED IN U.S.A

FEBRUARY 1965

SOME BASIC SAMPLING CONCEPTS REVIEWED

Patrick B. Gee

Tektronix Field Maintenance Engineer

Editor's Notes

The basic concepts reviewed in this article apply to all sampling instruments. The information, however, as it is presented here was developed around the calibration of the Tektronix Type 4S1 Dual-Trace Sampling Unit. It is directed principally toward those who, when exposed to sampling techniques, feel the need for a bit more support. By developing a fuller understanding of these important features of fundamental concern, the author hopes to supply this support and to dispel the needless fear of sampling that seems to hover in the minds of some.

This article has been prepared for those involved in the calibration of the Tektronix Sampling Units, with the Type 4S1 Dual-Trace Sampling Unit being used as an example. It is intended to dissolve a few ordinary misgivings about approaching the unit and to outline an orderly and effective method of system diagnosis and treatment. You should make an effort to thoroughly understand what each adjustment accomplishes. Once you attain this objective, you will no longer need to rely on detailed instructions to calibrate the instrument. You should find it possible to perform all the necessary adjustments on a Type 4S1 in a very few minutes. Performing all the checks that insure the instrument meets original specifications may, however, take an hour or more.

	RISETIME	SAMPLING EFFICIENCY	LOOP GAIN	DOT TRANSIENT RESP.	NOISE	SCALING DRIFT	ATTENUATOR BALANCE	BRIDGE DYNAMIC RANGE
SNAP-OFF CURRENT	X	X		X	X			
MEMORY GATE WIDTH			X	X	X			
"A" BRIDGE VOLTS	A	A		A	A	A		A
"B" BRIDGE VOLTS	B	B		B	B	B		B
AC AMP GAIN (A)	A		A	A	A			
AC AMP GAIN (B)	B		B	B	B			
"A" BRIDGE BALANCE							A	A
"B" BRIDGE BALANCE							B	B
"A" SMOOTHING			A	A	A			
"B" SMOOTHING			B	B	B			
"A" SMOOTHING BAL							A	
"B" SMOOTHING BAL							B	
"A" DC OFFSET							A	A
"B" DC OFFSET							B	B

TABLE I

Excellent performance should not be expected from random adjustments. Rather, an orderly and systematic approach must be taken to restore the Type 4S1 to its proper characteristics. Adjustment is neither a difficult nor an extremely simple thing to do. A few adjustments, because they have an effect on several different characteristics (all of which we wish to hold within specified limits), confound the recalibration. The chart (see Table 1) shows the adjustments that have an effect on several dif-

ferent characteristics. Your principal objective should be to first diagnose the ills by knowing the symptoms, select the most suitable remedy, and then perform the operation you have selected.

Let's review some basic sampling concepts with the intent of learning what characteristics are changed by each adjustment within the sampling "head". First of all we should have a good understanding about *sampling efficiency* which is a measure of signal transfer across the bridge diodes sampling gate. Consider the diagram shown in Figure 1. Our purpose in opening the sampling gate is to permit the sampling capacitance (C_1) to "see" the input signal for a small period of time, the duration of the sample being a limiting factor of system risetime. (Instrument risetime can be no faster than the length of time the sampling gate is open.) We know that it invariably takes some time to fully charge a capacitor because the source and current path have impedance. The pre-amplifier input capacitance (frequently called the sampling capacitance) in the Type 4S1 will charge to

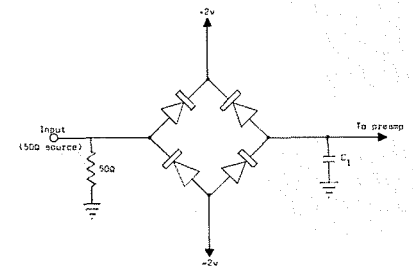

Figure 1. Schematic of a simplified sampling-bridge gate.

only about 25% of the difference in voltage across the sampling gate in 0.35 nanoseconds. This percentage is referred to as the sampling efficiency.

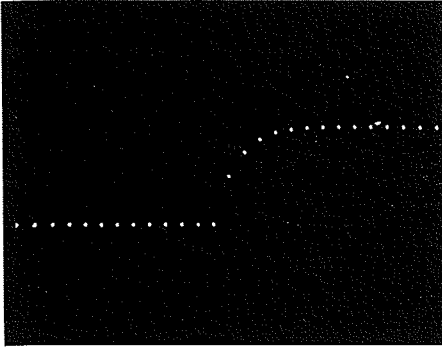

Figure 2. Waveform of the exponential increase in the sampling-capacitance charge with each successive sample, when very few samples/division are taken.

Since this capacitance will not be discharged between samples, we would expect the charge to increase exponentially with each successive sample as shown in Figure 2. Our system would then reconstruct a pulse with severe rolloff even from an infi-

nitely fast step function if very few samples per division were taken. The rolloff would become less obvious, of course, if more samples per division of horizontal deflection were taken. For example, if 10 samples were required to fully charge the sampling capacitance, the rolloff would be evident for 1 division at 10 samples per division. But with 100 samples per division the rolloff would take place in less than one-tenth of a division and would be less apparent.

But let's suppose that the oscilloscope operator should choose to decrease the time required to complete a display of low rate signals. He may do this by reducing the number of samples taken per trace (fewer samples/div). Since under these circumstances a fast rising step function may go from zero volts to its maximum voltage between samples, we must somehow cause the sampling capacitance to become

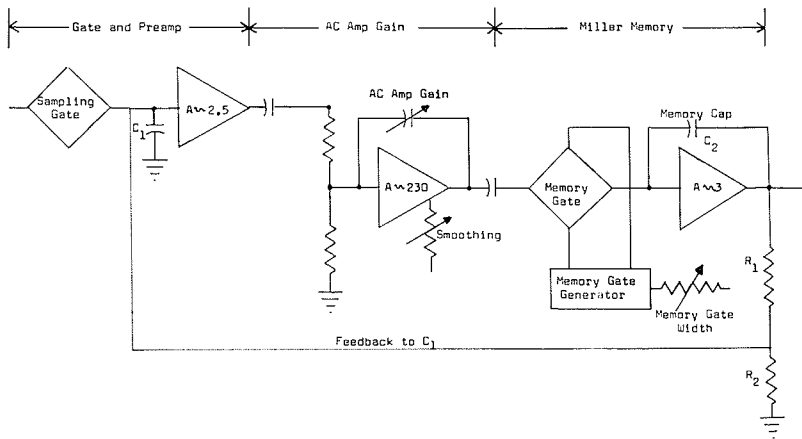

Figure 3. Tektronix slide-back, feed-back sampling system.

should remain the same. We could say, then, that our "dot transient response" is correct since we have a gain of exactly one through the entire loop when referred to the input signal. (Remember, though, that this required a gain of four when referred to the charge on the sampling capacitance.)

But let's suppose that the oscilloscope operator should choose to decrease the time required to complete a display of low rate signals. He may do this by reducing the number of samples taken per trace (fewer samples/div). Since under these circumstances a fast rising step function may go from zero volts to its maximum voltage between samples, we must somehow cause the sampling capacitance to become

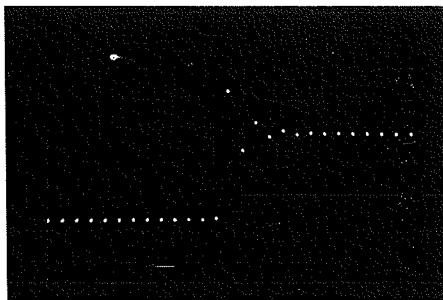

Figure 4. Waveform of overshoot due to the product of sampling efficiency and the amplified feed-back signal being greater than unity.

Obviously then, anything that we do within the sampling loop that changes either sampling efficiency or gain within the loop will also change dot transient response. In other words, dot transient response is a function of both sampling efficiency and loop gain.

Suppose that the product of sampling efficiency and the amplified feedback signal were to equal more than unity. Our presentation would then appear to have overshoot and/or ringing as shown in Figure 4. This is just as undesirable as the rolloff presentation shown in Figure 2.

The four-diode sampling gate performs a few functions which require further explanation. During quiescent conditions the gate is closed so that the signal cannot pass through. To do this, we back-bias the gate with a positive and negative dc voltage of approximately two volts. The dynamic range of the gate is limited by the magnitude of this holdoff bias (BRIDGE VOLTS); a signal greater than two volts might overcome the holdoff bias and improperly charge the sampling capacitance. A trigger pulse from the timing unit initiates the generation of the strobe pulse (to open the sampling gate) and the memory gate pulse (to open the memory gate). The amplitude of the narrow strobe pulse must be sufficient to rise above the holdoff bias for a period of time T, thus forward biasing the bridge diode gate as shown in Figure 5. An increase of strobe amplitude will usually cause an increase in sampling efficiency because the sampling capacitance has longer exposure to the input signal and therefore can charge to a

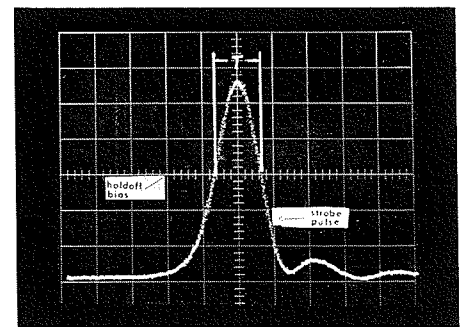

Figure 5. The narrow strobe pulse rises above holdoff bias for a period of time "T" to forward bias the bridge-diode gate.

higher voltage. Also, a higher strobe amplitude will cause the diodes to exhibit a lower impedance during the sampling interval. The gain required through the amplifiers and feedback attenuators to yield a loop gain of unity (correct dot transient response) is the reciprocal of sampling efficiency, so we would need to reduce loop gain to compensate for an increase in sampling efficiency if we were to maintain proper dot transient response. Note that a reduction of BRIDGE VOLTS (keeping strobe amplitude constant) could cause a similar change in sampling efficiency.

A few words are in order concerning the generation of strobe pulses. A trigger pulse from the 5T1A timing unit causes the normally forward-biased snap-off diode to become reverse biased by a reverse current of high and relatively constant amplitude. A peculiar characteristic of the snap-off diode is that this large reverse current ends very abruptly (within a few picoseconds) and the snap-off diode becomes a very high impedance. The reverse current that was flowing down the 50- Ω shorted transmission (clip) line in trying to continue to flow, produces a voltage pulse of short duration that overcomes the back bias on the sampling gate and causes the diodes to conduct. When all the bridge diodes are conducting, they represent a low impedance path for the input signal to get to the input preamplifier. When the voltage pulse is reflected (after about 0.35 nanoseconds) due to current traveling in the shorted clip-line, the sampling gate is returned to its reverse-bias condition thus locking out the input signal once again. The combined snap-off diode and clip-line action produces a very fast rising and falling pulse of a very short controlled duration. Amplitude of reverse current in the clip-line is determined by the stored charge in the diode which is a function of forward SNAP-OFF CURRENT. Reverse current must be sufficient in magnitude so that the voltage created while it travels in the 50- Ω clip line is more than enough to overcome the holdoff bias on the sampling gate.

Let's refer again to Figure 3 and review some of the primary objectives here which are: (1) charge C_1 to the amplitude of the input signal as much as possible during the useable period of the strobe pulse to increase sampling efficiency, (2) feed back an amplified version of this signal between samples to charge C_1 to the full level of the input signal, (3) simultaneously charge C_2 to a value proportional to the input signal level and permit C_2 to retain this charge long enough for us to observe low rep-rate signals.

The voltage on the Memory Capacitor is proportional to the input signal and is used to drive the scope's vertical amplifier. To deflect the dot a given distance with a larger signal at the input requires attenuation of the larger signal before it is applied to the Memory. In other words, the Memory output signal will normally always be proportional to the deflection it causes. Stray capacitance and other factors prohibit using a switched attenuator at the input connector for reducing the deflection sensitivity. It is more feasible to use an attenuator at the pre-amplifier output to limit the signal coupled to the high gain ac amplifier and also prevent overdriving this stage. But we must maintain loop gain close to unity. This requires a second attenuator in the feedback path from the Memory Capacitor

to the pre-amplifier input capacitance—one that will track with the ac amplifier attenuator. This will increase the feedback applied to the sampling capacitance as the ac amplifier signal is decreased (as referred to the signal applied to the 4S1 input connector) with less sensitive settings. R_1 and R_2 make up the second attenuator. (Attenuation is reduced here when it is increased between amplifiers with both attenuators operated by the same control knob). The resistor divider ratio of this pair determines the basic calibration of the sampling loop.

Another diode gate precedes the Memory stage. When the fast, narrow strobe pulse is generated, a relatively wide (250-350 nanosecond) pulse is also generated to open the memory gate. The paramount functions of the memory gate circuits are to: (1) control the in-phase feedback to the sampling capacitance and prevent the memory from responding to this regenerative feedback signal, (2) insure maximum coupling of the amplified error signal to C_2 , and (3) limit memory capacitor discharge between samples. (Leakage of the charge in this capacitor causes vertical deflection of the dots between samples and is called Memory Slash.) It limits the maximum permissible time between samples for a useful display. This leakage is caused by Memory Amplifier grid current or diode gate leakage.

A cursory analysis of the system as shown in Figure 3 reveals that the following controls all have a direct effect on dot transient response:

1. Those that control *sampling efficiency* are
 - a. SNAP-OFF CURRENT—common to both sampling gates
 - b. BRIDGE VOLTS—one for each sampling gate
2. Those that control *loop gain* are
 - a. AC AMPLIFIER GAIN—one for each sampling gate
 - b. MEMORY GATE WIDTH—common to both memories
 - c. SMOOTHING—a front panel control for each ac amplifier

The primary purpose of the SMOOTHING control is to reduce random noise by reducing gain of the ac amplifier. Since this is within the feedback loop, it necessarily follows that dot transient response will be effected corresponding to the amount of smoothing used, but may not be apparent when using lots of samples.

Your preparation for recalibration and/or repair should include the following additional presets on the Type 4S1:

MV/CM SWITCH 200
 VARIABLE Calibrated

VERTICAL POSI- Midrange (dot to 12
 TIONING o'clock)
 SMOOTHING Normal (Maximum
 loop gain)
 DC OFFSET Adjust for zero volts
 ± 100 mv at the
 DC OFFSET
 MONITOR jack

With a free-running sweep, both traces should be well within the central graticule area of a properly adjusted instrument. Severity of imbalance is often indicated in this display and your observations here may help in the diagnosis. If the presentation looks other than normal, first perform steps 3 and 4 of the recalibration guide which follows this article and then start back with step number 1.

Several methods, each having its own merits, may be used to show dot transient response error. A most useful method is to apply a step-function to the input and use a sweep speed that will display no more than two or three samples on the leading edge of the pulse (low vertical dot density) at 100 or more samples per division. Should the pulse shape or transient response change when switching from 100 to 10 or fewer samples, *then dot transient response is not correct*. Quite often in using only 10 samples/div an important part of the trace may be missing and the overshoot or undershoot that appeared with 100 samples/div will not be displayed because it occurred between dots in the presentation. Therefore, when operating at few samples/div you may need to relocate the dots along different portions of the trace or "slide" them back and forth to simulate a solid trace by rotating either the TIME POSITION or VARIABLE TIME/CM control. (The slow sweep speed required for low vertical dot density usually places the beginning of the pulse towards the left edge of the crt. Using the VARIABLE TIME/CM control is generally more desirable for this situation since it moves the trace to the right, towards the center of the screen.)

Another method requires a generator of the mercury-pulsar variety (Tektronix Type 109 or Type 110) with a small charge line on one side of the switch and no charge line on the other side. Here the sampling gate is opening on the two inputs alternately. The sampling capacitance most of the time must alternately charge from the amplitude extremes between the voltage at the top of the pulse input and the zero volts from the other input. Response with each sample is manifested in the display. Proper DTR (dot transient response) would give a presentation that should look like Figure 6a. Low loop gain would give a presentation that should look like Figure 6b, and exces-

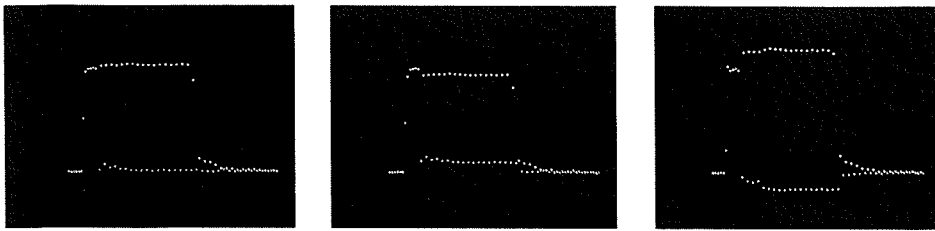

Fig. 6. Waveforms of: (a) correct DTR, (b) low loop gain, (c) excessive loop gain, using a small charge line on one side of the switch and none on the other.

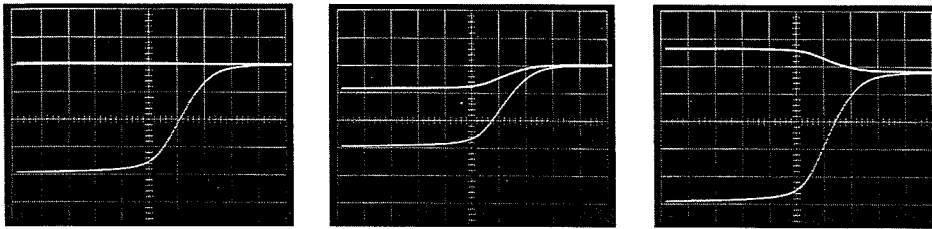

Figure 7. Waveforms of: (a) correct DTR, (b) low loop gain, (c) excessive loop gain, with the 5T1A set up for + INTERNAL triggering at a sweep speed of about 2 NSEC/CM and using a TU-5 Pulser/Adapter operated by a 25-kc square wave from a Type 105 Square-Wave Generator to drive the Type 4S1.

sive loop gain would give a presentation that should look like Figure 6c.

Low repetition rates inherent with mercury-pulsers are sufficiently annoying to warrant investigating other ways of obtaining a similar "twosies" type of display. One such way follows, but requires dc internal triggering: Using a Type 5T1A Timing Plug-In Unit set up for + INTERNAL triggering at a sweep speed of about 2 NSEC/CM, obtain a normal display of the leading edge of a pulse from a Tektronix Type TU-5 Pulser operated by a 25kc square wave from the Tektronix Type 105 Square Wave Generator. Switching the 4S1 triggering switch from ac to dc trigger coupling should produce a display similar to those shown in Figure 7. Here the trigger circuit is alternately responding to the leading edge and pulse top. Triggering on the pulse top occurs because the pulse top is still more positive than the THRESHOLD setting after trigger recovery takes place making the Type 5T1A ready to trigger again whenever the THRESHOLD level is exceeded. Pulse amplitude after the next recovery cycle will be below the THRESHOLD level which will prevent the trigger circuit from responding until the next positive excursion through the THRESHOLD level setting. The sampling capacitance must therefore charge to the pulse amplitude extremes during the first few centimeters of display with each successive sample.

The chart shown in Table 1 is another useful tool during recalibration. Use it to increase your understanding of the interaction between the various amplifiers and controls.

TYPE 4S1 RECALIBRATION GUIDE

Field recalibration is usually a relatively

simple process if previous calibration settings have not since been misadjusted. The following method may be used to perform routine recalibration. This is *not* a complete recalibration procedure, but should serve as a useful reference in conjunction with the regular recalibration procedure in the instruction manuals.

1. Adjust MEMORY GATE WIDTH for maximum loop gain (i.e., maximum overshoot when observing DTR—dot transient response).

NOTE: Before adjusting SNAP-OFF CURRENT or BRIDGE VOLTS, first determine which adjustments need to be made by application of the following concepts:

2. Check DTR on both channels.
 - a. If the same DTR error exists on both channels, adjust SNAP-OFF CURRENT for correct DTR on both channels.
 - b. If Channel A DTR is poor and Channel B DTR is good, adjust Channel A BRIDGE VOLTS for proper DTR on Channel A.
 - c. If Channel B is poor and Channel A is good, adjust Channel B BRIDGE VOLTS for proper DTR on Channel B.
 - d. If both channels exhibit DTR errors in opposite directions (one showing too much loop gain and the other showing insufficient loop gain), perform the following steps:

- (1) Adjust BRIDGE VOLTS on both channels to maximum clockwise positions.
- (2) Adjust SNAP-OFF CURRENT for proper DTR on the channel that has the highest loop gain as indicated by the most overshoot when samples/cm is changed.

- (3) Adjust BRIDGE VOLTS on the *other* channel for proper DTR.

3. Adjust BRIDGE BALANCE on both channels so that the trace remains on the screen throughout MV/CM settings. (DC OFFSET must be zero volts). Be sure not to brush the DC OFFSET control as you rotate MV/CM.
4. Adjust SMOOTHING BALANCE for no trace shift while rotating SMOOTHING—both channels.
5. Apply a known amplitude to B Channel and adjust B GAIN ADJUST for proper deflection.
6. Apply a known amplitude to A Channel and adjust A-B BALANCE (on the front panel) for proper deflection.
7. Adjust INVERTER ZERO on both channels for less than 2mm trace shift when switching from NORMAL to INVERTED (DC OFFSET MUST BE ZERO).

This completes the adjustments for the Type 4S1, leaving only a series of checks that should be performed to insure that the instrument is functioning properly. The most important considerations include:

- a. RISETIME—less than 0.35 nanoseconds computed.
- b. NOISE—less than 1mv (consider 90% of the dots).
- c. BASELINE SHIFT—less than 3mv base-line shift between 50 cps and 100 kc rep-rates. (This is a shift of the dc reference level or base-line with changes of rep-rate. It may come from several sources including improper adjustments, and is usually greatest between 90 kc to 100 kc. Scaling drift is checked by observing a trace with no signal applied and triggering the sweep from 10 cps to 100kc using a Type 111 Pulse Generator or equivalent.)
- d. MEMORY SLASH—less than 1/2 cm vertical trace slash at 10 cps.
- e. OVERSHOOT or UNDER-SHOOT—3% maximum.
- f. DOT TRANSIENT RESPONSE—correct for both positive and negative going signals of less than $\pm 1/2$ v in amplitude.

If risetime is adequate but noise and/or scaling drift are excessive, decrease BRIDGE VOLTS and readjust SNAP-OFF CURRENT for proper dot transient response, then repeat steps 2, 3 and 4 above. Make sure that BRIDGE VOLTS is at least 2 volts above and below ground for your final setting.

NOTE—Refer to your instruction manual or recalibration procedure for other checks to be performed.

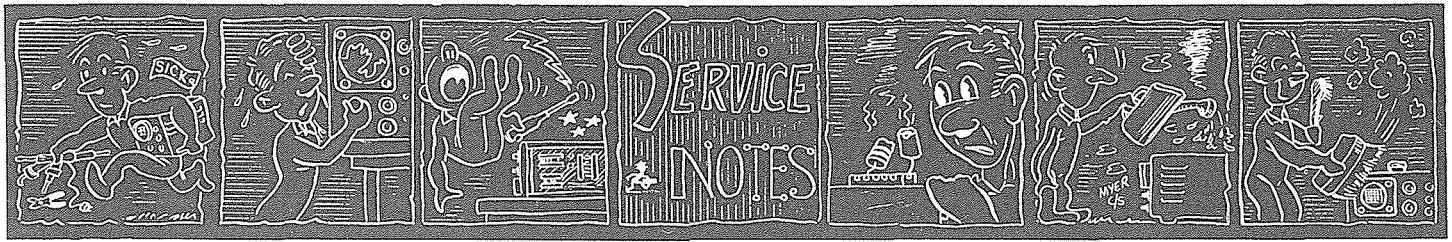

TYPE 575 TRANSISTOR CURVE TRACER — NOISE ON HORIZONTAL AND VERTICAL ATTENUATOR SWITCHES

Under extreme environmental conditions, foreign material can build up on switch contacts and cause excessive electrical noise. This noise can be particularly objectionable.

The application of a *thin* film of Cramolin cleaner and lubricant (Tektronix part number 006-197) will solve this problem. Usage of Cramolin will result in approximately 40 times improvement in reducing noise and wear, over a dry switch.

Cramolin should be applied with a small artist-type camel-hair brush. Just a drop placed on the brush and then applied to the switch contacts and rotor will give good results. After application, rotate the switch back and forth through its range several times. This aids the cleaning and lubrication action. Avoid the use of excessive amounts of Cramolin. Anything more than a thin film will only detract from the neatness of your work and will neither hasten nor aid the cleaning and lubricating action.

Cramolin may be obtained through your local Tektronix Field Engineer, Representative, Field Office or Distributor.

TEKTRONIX INSTRUMENTS WITH FORCED-AIR VENTILATION — FAN MOTOR SALVAGE

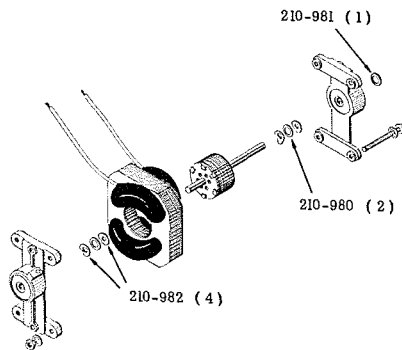

Figure 4. Exploded drawing of fan motor, part number 147-001.

Many Tektronix instruments employing forced-air ventilation use the same type fan motor. Tektronix part number for this motor is 147-001. When these motors begin to display signs of wear (normally

after extended periods of service) they may be salvaged to give many more hours of use. Indications of wear can be a noisy motor, and/or excessive end play of the motor shaft. (You should note here that a bent or out of balance fan blade can vibrate and give the appearance of a noisy motor. Check your fan blade before finally assessing the cause of noise.)

The cause of noise or shaft end play in a 147-001 motor is wear on the seven washers shown in Figure 4. To replace the washers shown in this exploded drawing you will need:

Qty.	Part #	
2 each	210-980	steel washers
4 each	210-982	beryllium washers
1 each	210-981	fiber washer

These parts may be ordered through your local Tektronix Field Engineer, Representative, Field Office or Distributor.

The Mechanical parts list in the Instruction Manual for your instrument gives the Tektronix part number for the fan motor. We remind you, the information given here applies only to instruments using fan motors part numbered 147-001.

TYPE 661 SAMPLING OSCILLOSCOPE — DELAYED PULSE MODIFICATION

Here is a do-it-yourself modification that will protect the Tunnel diode D992 (in the Delayed Pulse circuit) from excessive current during the warm-up time of V694 and V814. The modification routes the current supply through relay K601 until the instrument is warmed up, at which time normal supply current is restored. This modification applies to Type 661 instruments serial numbers 101 through 2219.

The following instructions should aid in rewiring the relay:

IMPORTANT: Use silver-bearing solder when soldering to ceramic strips.

- () 1. Unsolder from relay K601:
 - () white-violet wire
 - () sleeving-covered wire
 - () gray-red-red wire
- () 2. Replace the sleeving-covered wire with a piece of wire and sleeving that is $\frac{1}{8}$ " longer.

- () 3. Solder the new sleeving-covered wire and the white-violet wire to the terminals shown in Figure 1.

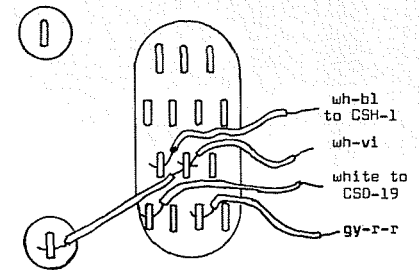

Figure 1. Diagram showing solder terminals on relay K601.

- () Solder the gray-red-red wire to the terminal shown in Figure 1.
- () 4. Solder a 10" piece of #22 white-black wire and a 6" piece of white wire to the terminals shown in Figure 1.
- () 5. Solder the other end of the white-black wire to CSH-1 (locate in Figure 2).

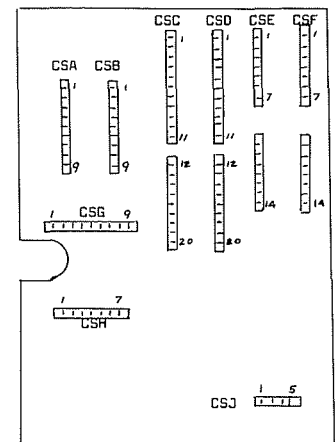

Figure 2. Diagram showing layout of ceramic strip terminals referred to in Delayed Pulse Modification.

- () 6. Solder the other end of the white wire to CSD-19 (locate in Figure 2). This completes the modification.
- () 7. Check wiring for accuracy and change Interconnecting Sockets dia-

gram in the Type 661 Instruction Manual to agree with Figure 3.

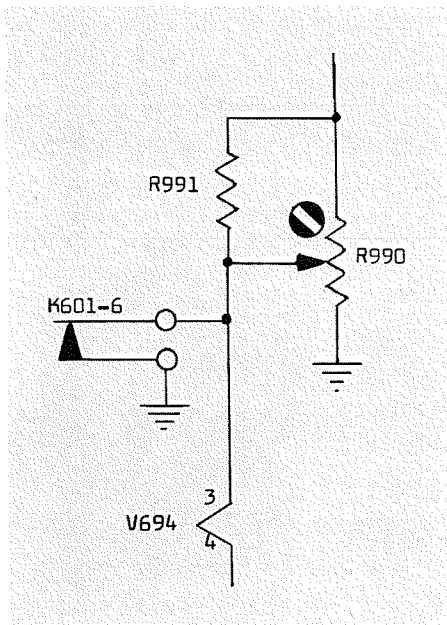

Figure 3. Schematic of K601 relay after performing Delayed Pulse Modification.

TYPE 575 TRANSISTOR CURVE TRACER—VIEWING FIELD EFFECT TRANSISTORS' CURVES

Normally, a Type 575 Transistor Curve Tracer is limited in displaying a family of curves for an FET (field effect transistor). When the STEP SELECTOR control of the Type 575's Base Step Generator is set to the maximum (200 ma) position it will not completely cutoff the FET.

A simple modification is to place a 10 k, ½ w, 1% precision resistor between the base and emitter terminals of the Type 575

and then set the Base Step Generators STEP SELECTOR control to 0.05 ma. This gives an IR drop between the gate and source terminals of the FET of 0.5 volts per step. This is sufficient to view the complete family of curves from zero to cutoff.

TYPE 530, TYPE 530A, TYPE 540, TYPE 540A, TYPE 540B, TYPE 550, TYPE 585 AND TYPE 585A OSCILLOSCOPES — EXCESSIVE DELAY BEFORE CRT BEAM COMES ON

Time-delay relays used in the above oscilloscopes delay their operation for approximately 45 seconds after the power switch is turned on. This brief delay allows the tubes to warm up to near their operating temperature before the dc operating voltages are applied. At the end of this delay period the cathode-ray beam should appear on the face of the crt.

A more lengthy delay (two or more minutes — or up to 30 minutes in aggravated cases) can very often be traced to low emission by one or both of the 5642 tubes in the crt grid supply and the crt high-voltage cathode supply. Or, it may be due to low emission in the crt itself.

To determine if the 5642 tubes are at fault, remove the ground strap from the crt-cathode connector located on the rear panel of the oscilloscope. Patch a cord from the calibrator output to the crt-cathode connector and feed in 10 volts of calibrator signal. With the sweep free running you should now see a modulated trace on the face of the crt. Advance the calibrator control through the 20, 50, and 100 volts positions. If the modulated trace remains on the crt face the 5642 tubes are most probably functioning properly.

To check for low emission in the crt, remove the calibrator signal from the crt-cathode connector and reconnect the ground strap. Adjust the FOCUS and ASTIGMATISM controls for largest diameter spot. With the sweep turned off, adjust the INTENSITY control to where the de-focused spot on the crt face has a very slight halo. Remove the left-hand side panel from the oscilloscope. Then, with the tip of a magnetized screw driver, touch the base of the crt near where it joins the glass neck. While moving the tip of the screw driver around the available circumference of the crt base, check for dark areas within the defocused spot on the crt face. If dark areas are observed the crt is suffering from low emission.

If either the 5642's or the crt are low in emission they should be replaced.

TYPE CA PLUG-IN UNIT — LACK OF DUAL-TRACE DURING WARM UP

Type CA Plug-In Units, serial numbers 101 through 34790, may exhibit a lack of dual trace during the period when the instrument is warming up. The problem is caused by V3382. This 6AL5 tube in the switching circuitry has its cathodes returned to the -150 volt supply through a 1.8 meg resistor in the oscilloscope via pin 16 of the interconnecting plug. The 1.8 meg resistor provides a current source for the 6AL5 that tends to balance the multivibrator plates (V3375) in the CA unit; both halves saturate and prevent multivibrator action.

A 330 k, ¼ w, 10%, composition resistor (Tektronix part number 316-334) added between pin 5 of V3382 and +225 volts will cure the problem.

NEW FIELD MODIFICATION KITS

TYPE 111 PRETRIGGER PULSE GENERATORS—PULSE WAVEFORM IMPROVEMENTS

This modification reduces overshoot, ringing, and other aberrations in the pulse waveform. It also improves the risetime of the negative pulse.

Primarily, the modification consists of replacing the Avalanche transistor (Q84) and reworking the associated circuitry on the etched circuit board. New "transition pieces" are used to connect the Charge Line and Output Polarity coaxial cables to the board.

Parts Replacement Kit 050-216 is also included to replace the OUTPUT POLARITY switch and Charge Line cable.

This modification applies to Type 111 instruments with serial numbers below 800. Order through your Tektronix Field Engineer, Field Representative, Field Office or Distributor. Specify Tektronix Part Number 040-392.

TYPE 4S2 DUAL-TRACE SAMPLING UNITS—TRANSIENT RESPONSE IMPROVEMENTS

This modification improves the transient response and reduces ringing on fast-rise signals in the Type 4S2:

1. Replacing Gate (bridge) diodes with closer-matched and lower-capacitance diodes.
2. Making the sampling bridge compensation networks adjustable.
3. Substituting 200 Ω resistors for the ferrite beads between sampling bridge and Nuistor grid.
4. Terminating the strobe pulse lines with 100 Ω resistors.
5. Adding grid-bias balancing potentiometers for each Nuistor.
6. Decoupling the -100 and +300 voltages to the Sampler and Gate-Generator circuits.

This modification applies to Type 4S2 instruments with serial numbers below 301.

Order through your local Tektronix Field Engineer, Field Representative, Field Office or Distributor. Specify Tektronix part number 040-379.

TYPE 53/54C AND TYPE CA DUAL-TRACE PLUG-IN UNITS—SLAVE TO AUTOMATIC DISPLAY SWITCHING

This modification allows Channels A and B of either Type 53/54C, serial numbers 3710-up, or Type CA, serial numbers 101 through 64009, to be slaved to the respective sweeps of the Type 547 Oscilloscope, when the Type 547 is operated in A ALT B mode. The modification does not change the operation of the Type 53/54C or Type CA when operated in any other instrument.

Order through your local Tektronix Field Engineer, Field Representative, Field Office or Distributor. Specify Tektronix part number 040-391.

RELAY RACK CRADLE ASSEMBLY

Three new Field Modification Kits provide a rear support cradle for installing rack-mounted instruments in a backless relay rack by the use of slide-out tracks. The slide-out tracks are not included in the modification kits and must be ordered separately.

Slide-out tracks allow the instrument to be pulled out like a drawer. When pulled out, the instrument can be locked in one of seven positions: horizontal, or 45°, 90°, or 105° above and below horizontal.

Order through your local Tektronix Field Engineer, Field Representative, Field Office or Distributor from the following information.

Field Modification Kit, Tektronix part number 040-344, applies to the following instruments:

Type 127	serial numbers	309 - up
Type RM15	serial numbers	101 - up
Type 526	serial numbers	101 - up
Type RM561	serial numbers	101 - up
Type RM561A	serial numbers	5000 - up
Type RM564	serial numbers	100 - up
Type RM647	serial numbers	100 - up

Order slide-out track assemblies separately, as follows:

Types 127, RM15, and RM647 1 ea. 351-006

Types RM561, RM561A,
RM564 1 ea. 351-050

Type 526 1 ea. 351-001
1 ea. 351-011

Field Modification Kit, Tektronix part number 040-346, applies to the following instruments:

Type RM565	serial numbers	101 - up
Type RM567	serial numbers	101 - up

Order slide-out track assemblies, Tektronix part number 351-055 (1 pr.), separately for these instruments.

Field Modification Kit, Tektronix part number 040-345 applies to the following instruments:

Type RM16	serial numbers	101 - up
Type RM17	serial numbers	101 - up

Order slide-out track assemblies, Tektronix part number 351-083 (1 pr.), separately for these instruments.

TYPE 3T77 SAMPLING PLUG-IN UNITS, S/N'S 840 TO 1999 — IMPROVED SINE-WAVE TRIGGERING

This modification imparts a greater stability to the display during triggering on high-frequency sine waves. A trigger-circuit change allows switching to a lock-on type of operation when displaying high-frequency sine waves and eliminates display break-up caused by drift in recovery time.

A new push-pull Recovery control replaces the old control.

Pulling the control to the ON position synchronizes the circuit on sine waves above approximately 30 Mc. With the control pushed in the instrument triggers on signals below 30 Mc. Order through your local Tektronix Field Engineer, Field Office or Representative. Specify Tektronix Part Number 040-366.

SCOPEMOBILE® CART ADAPTER

This modification adapts the Type 202, Type 202-1, Type 202-2 and Type 204 Scopemobile carts for use with a Type 502 or Type 502A Oscilloscope. Two adapter plates fasten to the Scopemobile cart and prevent the oscilloscope from shifting sideways. Order through your local Tektronix Field Engineer, Field Office or Representative. Specify Tektronix Part Number 040-365.

TYPE 502 AND TYPE 502A OSCILLOSCOPES—SAWTOOTH AND +GATE OUT

This modification installs two UHF output connectors (one for the direct coupled Sawtooth and one for the +Gate Out waveforms) on the rear panel of the Type 502 or Type 502A Oscilloscopes. The +Gate Out waveform is 40 volts and of the same duration as the +150-volt Sawtooth waveform. The waveforms are dc coupled to the connector via a dual cathode-follower assembly which mounts on the Time/CM switch bracket.

Order through your local Tektronix Field Engineer, Field Office or Representative. Specify Tektronix Part Number 040-312.

TYPE 502 OSCILLOSCOPE—SILICON RECTIFIER

This modification replaces the selenium rectifier (SR642) used in the Type 502 with silicon rectifiers which offer more reliability and longer life. Order through your local Tektronix Field Engineer, Field Office or Representative. Specify Tektronix Part Number 040-383.

TYPE 108 FAST-RISE MERCURY PULSER — SILICON RECTIFIER

This modification replaces the original selenium rectifiers (SR3A,B) with silicon rectifiers which offer more reliability and longer life.

The modification is applicable to all Type 108 Mercury Pulsers.

Order through your Tektronix Field Engineer or local Field Office. Specify Tektronix part number 040-388.

TYPE 527 WAVEFORM MONITOR—LINE SELECTOR

This modification installs a prewired Video Output-Amplifier chassis in the Type 527 to allow a picture monitor to be connected directly to the Type 527 and to display the signal, being displayed on the Type 527, on the picture monitor.

The modification also installs a prewired Line-Selector chassis circuit for detailed observation of any one TV line in a frame. A Field-Shift circuit provides line selection from either the odd or the even field. A Line-Intensification circuit rapidly identifies the line being observed and the selected line is intensified on the picture monitor via the Video-Output connector of the Type 527 Waveform Monitor.

Order through your local Tektronix Field Engineer, Field Office or Representative.

Specify for:

Type	S/n's	Tektronix Part Number
527	151-579	040-356
RM527	151-979	040-354
527	580 and up	040-359
RM527	980 and up	040-358



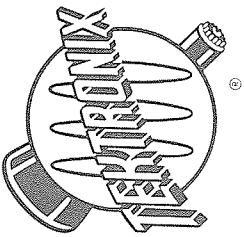

Tektronix, Inc.
P. O. Box 500
Beaverton, Oregon

Service Scope

USEFUL INFORMATION FOR

USERS OF TEKTRONIX INSTRUMENTS

CMR

Gordon Marsh, Engineer
Department of Transport
Maint. & Operations Dept.
Temporary Building #3
Ottawa, Ontario, Canada

9/63

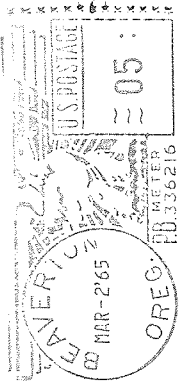



Service Scope

USEFUL INFORMATION FOR USERS OF TEKTRONIX INSTRUMENTS

NUMBER 31

PRINTED IN U.S.A.

APRIL 1965

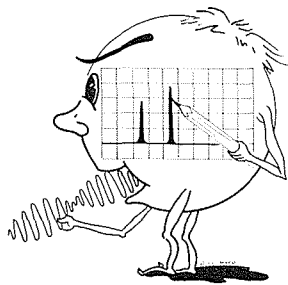

GETTING ACQUAINTED WITH SPECTRUM ANALYZERS

by Russ Myer
Tektronix Advertising Dept.

This article forms a conceptual basis for the understanding of Spectrum Analysis, thus preparing the reader for the several advanced works available on the subject written on the Engineering level.

Part I

WHAT IS A SPECTRUM ANALYZER?

At any given moment, there is an incredible amount of activity within that portion of the Electromagnetic Spectrum that we call the Radio Frequency Bands. These bands range in frequency from about 15 kc to 750,000 Mc.

Assume you have a special radio receiver capable of tuning over this entire range. At the lower end, you'll find maritime ship-to-shore, aircraft point-to-point, high-powered government and commercial transoceanic signals. Tuning higher in frequency, within the familiar 540-to-1600 kc broadcast band, dozens of commercial radio stations compete for your attention. Above these, you'll find more ship-to-shore, and, confined to relatively small portions of the spectrum, thousands of "ham" radio operators pursue their electronic endeavors. Also, interspaced throughout this short-wave band, you will hear much air-ground activity, government point-to-point, many foreign broadcast stations, the Voice of America (and Moscow!), police radio broadcast stations, and some experimental work.

Still higher in frequency, you'll find television stations, starting at 54 Mc, FM stations above 88 Mc and more television above 174 Mc. The area above 400 Mc, once considered experimental, produces myriad signals: microwave, telemetry and others.

These radio transmissions take various electronic configurations, ranging from single-frequency carriers to complex signals produced by changing these carriers in amplitude, frequency and phase.

Regardless of the shape of these signals and how they were produced, or "modulated", each one can be separated into individual sine waves. Each sine wave represents a single frequency. To examine the composition and quality of a signal, you would find it very helpful to extract each individual sine wave that it contains and display it alone on an oscilloscope. Seeing all the sine waves in a "group" picture, each standing alone, would enable you to analyze the complex signal. The instrument that performs this task for you is called a Spectrum Analyzer.

To use an example of a familiar but complex waveform which could be reduced to individual sine waves for analysis, consider an AM radio station. A broadcast transmitter radiates a single carrier frequency from its antenna. Intelligence (speech, music, tones, etc.) is superimposed on this carrier, varying its amplitude at an audio rate. Assume the station is transmitting a 1000-cycle test tone. The carrier frequency of the station is 1 Mc. This carrier is combined in the final stage of the transmitter with the 1000-cycle tone. The antenna, however, through the process of "modulation", is broadcasting not two, but *three* signals. Viewed on a conventional scope,

the signal might look like figure 1a.

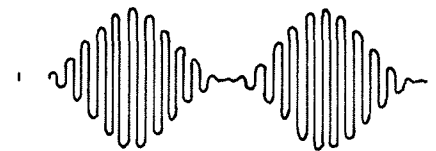

Figure 1a. Conventional oscilloscope display of 1000 kc carrier modulated by a 1000 cps tone.

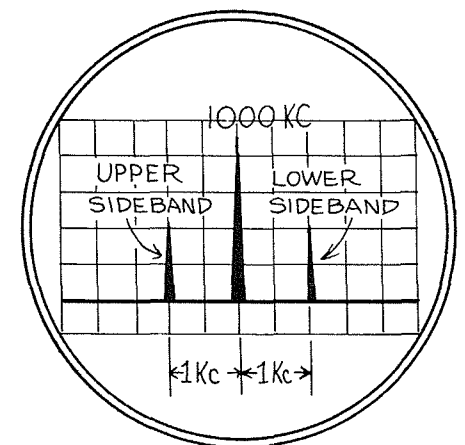
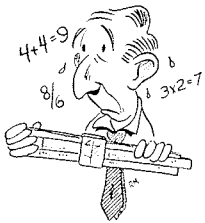

Figure 1b. Display of same signal using Spectrum Analyzer.

Electrically, the carrier is still occupying the 1-Mc spot in the spectrum. Exactly 1000 cycles below this frequency, however,

at 999 kc, you will find a new signal, called the "lower sideband". 1000 cycles above the 1-Mc spot, at 1,001 kc, you'll find another signal, identical to the one at 999 kc, called the "upper sideband". The separation is exactly equal to the modulating frequency — the 1000 cycle tone. The Spectrum Analyzer is capable of displaying these three frequencies, individually, on the screen of a cathode-ray tube. Thus, the component frequencies may be individually studied, or "analyzed". Figure 1b shows how the Spectrum Analyzer would display them.



There is nothing difficult about the overall operation of the analyzer. The signals which we will use as examples, however, must be followed in detail through the different sections shown in the block diagram. To understand the conversion of input signals to signals of lower frequencies, you will find it helpful to perform the simple arithmetical computations dealing with the mixer and i.f. (intermediate frequency) sections.

There are several ways that a signal can be broken down into component sine waves. One method is to introduce the signal to a stack of filters, the inputs of which are paralleled. Each filter is tuned, in succession, to a slightly different frequency than the others. The output of each filter will contain only that portion of the input which corresponds to the frequency it was tuned to. The drawback here is that for most complex signals, you would need hundreds of filters — a costly mechanical burden. Too, it is difficult to design filters with narrow bandwidths to produce good resolution between closely-related signal components.

The prism is also a simple spectrum analyzer. It takes the visible portion of the electromagnetic spectrum and breaks it up into its component frequencies, each representing a familiar color. There are chemical analogies, also, such as the chemist's ability to reduce complex compounds into their individual ingredients. The Tektronix Spectrum Analyzer performs an analysis by purely electronic means.

HETERODYNING

To continue our discussion of the analyzer, we will review, briefly, the principle of heterodyning. Years ago, Armstrong and his colleagues created the "superhet" receiver. They discovered that it was possible to feed two separate single-frequency signals into a non-linear device, usually a vacuum tube, and get *four* signals out! Using suitable filters, they found that besides the two original frequencies, they had a 3rd

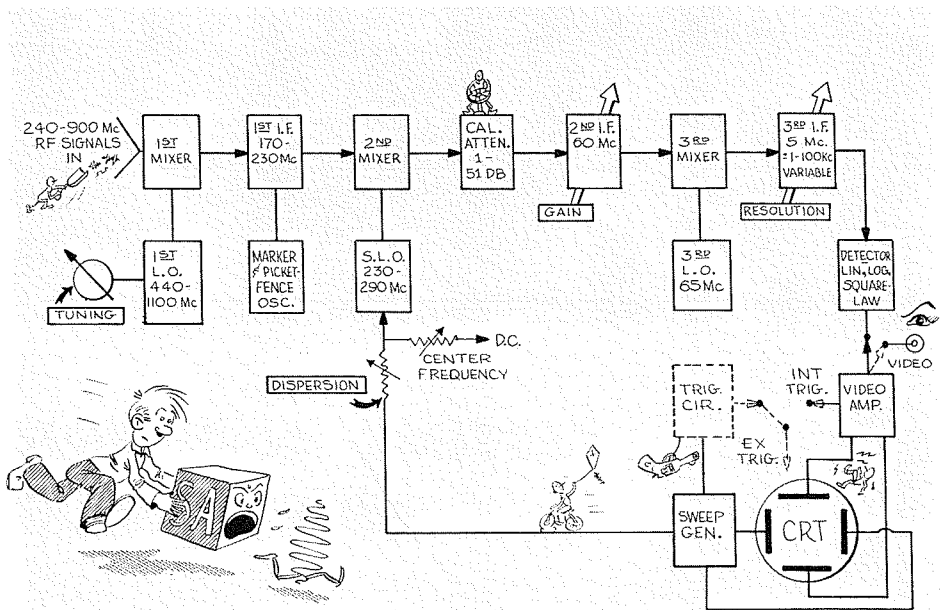

Block diagram of typical Tektronix Plug-In Spectrum Analyzer.

frequency that was equal to the mathematical difference of the input signals. Also, they found a 4th frequency in the output — one equal to the sum of the two original signals. They applied this principle to the superheterodyne receiver, like one you probably have in your home today. The following example illustrates this concept, so necessary to the understanding of Spectrum Analyzers.

Tune in a radio station that has, let us say, a carrier frequency of 1080 kc. This frequency enters the front end of your radio and into a "mixer" tube. A local oscillator in your set, which follows the main tuning, generates a frequency of 1535 kc. This oscillator frequency also is fed into the mixer tube. In the output of this tube, as in the days of Armstrong, you have the two original frequencies *plus* the two new frequencies mentioned before: 2615 kc and 455 kc. The latter, 455 kc, is the one accepted by the tuned circuits of the intermediate-frequency stages of your receiver.

As we tune across the band, we simultaneously tune the local oscillator to a frequency exactly 455 kc above the frequency of the station tuned in. Thus, a highly-efficient i.f. stage can be designed which is responsive to a single frequency — the 455-kc difference between the local oscillator and the frequency present at the front end.

HOW THE ANALYZER WORKS

Tektronix Spectrum Analyzers, built as plug-in accessories for existing oscilloscopes, cover various frequency ranges. Currently, these cover frequencies from 1 Mc to 10.4 Gc (Gigacycles). One of these,

the Type L-20, will analyze frequencies from 10 Mc to 4 Gc, in 5 bands. We will consider the range of frequencies covered by band 2 of the Type L-20, roughly 230 Mc to 900 Mc.

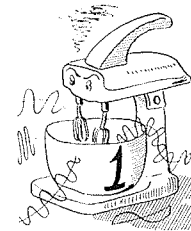

Refer to the block diagram of the analyzer. Incoming signals are introduced directly into the first mixer. As in your radio receiver, there is a local oscillator associated with the mixer. This oscillator is tuned by the front-panel control which also rotates the tuning dial indicating the frequency of the incoming signal. It tunes through a frequency range of 440 Mc to 1100 Mc. The output of the mixer is fed into the first i.f. stage. This stage is fixed-tuned to 200 Mc.

Therefore, any input signal that will mix with the local-oscillator frequency in the mixer stage and produce a difference frequency of 200 Mc will pass through the 1st i.f. For example, when the local oscillator (abbreviated L.O.) is tuned to its lowest frequency, 440 Mc (the main tuning dial reading 240 Mc), an input signal of 240 Mc will "beat" with this frequency in the mixer and produce the desired i.f. output of 200 Mc. Tuning the L.O. to 600 Mc means that there has to be an input signal of 400-Mc to produce a 200-Mc difference. The highest setting of the L.O., 1100 Mc, allows a signal of 900 Mc to produce the 200-Mc difference and appear in the first i.f. You will see that *any* signal tuned in from 240 Mc to 1100 Mc will produce the same 200-Mc difference.

The first i.f. is tuned to a center frequency of 200 Mc. The bandwidth of this circuit is fixed at 60 Mc. Therefore, any signals 30 Mc above or below the 200 Mc difference frequency will also pass through the i.f. This is important to the operation of the Spectrum Analyzer.

We will now follow 3 input signals through the analyzer. Their frequencies are: 280 Mc, 300 Mc, and 320 Mc. Assume you have set the tuning dial on 300 Mc, calling it the "Center Frequency". Actually, you have tuned the L.O. to 500 Mc. This produces a 200-Mc difference between the L.O. and the 300-Mc center frequency. This 200-Mc "beat" frequency falls in the middle of the i.f. tuned circuit. The input frequency of 280 Mc also is beating with the established L.O. frequency of 500 Mc. It produces an output from the mixer stage of 220 Mc. This falls within the 60 Mc bandpass of the i.f. stage. The input of 320-Mc also produces a frequency (180 Mc) that falls within the bandpass of the i.f. stage. You will see, therefore, that at the output of the first i.f. stage, all three input signals are present. They have the same 20-Mc separation but are reduced in frequency. Although converted in frequency, their relationship to one another has not been changed. It is important to realize one difference, however: The 180-Mc i.f. signal represents the *highest-frequency* input signal, 320 Mc. The 220-Mc i.f. signal represents the *lowest-frequency* (280 Mc) input signal. In other words, there is a reversal of relative frequency.

The three signals at the output of the first i.f. stage are now fed into a second mixer. See block diagram. This mixer is also associated with a local oscillator, and the output is fed into a 2nd i.f. stage. This stage is actually tuned to 59 Mc, but to simplify our example, consider that it is tuned to 60 Mc. The 2nd local oscillator is also tuned and covers a frequency range of 230 Mc to 290 Mc. The tuning is accomplished by electronic means, however. The oscillator frequency is "swept" through this frequency range by the application of an external sawtooth.

The inputs to the 2nd mixer stage always exist within the range of 170 Mc to 230 Mc. No other signals can get through the first i.f. Note that the 2nd local oscillator (Swept Local Oscillator — S.L.O.) sweeps through a range of 60 Mc — the band-width of the 1st i.f. Therefore, any signal from 170 Mc to 230 Mc, when combined with the 230-Mc to 290-Mc "sweep" of the S.L.O. will produce a 60-Mc difference frequency. The 2nd i.f. has a relatively narrow bandwidth and is sensitive only to this 60-Mc difference.



To illustrate how a swept oscillator produces the 60-Mc i.f. frequency, consider the 3 input signals to the 2nd mixer stage. The S.L.O. begins its normal sweep, starting at 230 Mc. To produce the desired i.f. frequency of 60 Mc there would have to be a 170-Mc signal present at the 2nd detector input. There is none, thus no i.f. frequency is produced. The S.L.O. continues its sweep and passes through the frequency of 240 Mc. This mixes with the 180-Mc input and produces the 60-Mc i.f. frequency. As it sweeps through 260 Mc and 280 Mc, it mixes with the other two inputs and also produces the 60-Mc i.f. frequency.

Thus, by using a local oscillator that sweeps a certain range of frequencies, input signals to the mixer can be made to enter the 2nd i.f. stage *one by one*, separated in time. *This is the important thing to remember about the operation of the analyzer.*

Skipping the 3rd mixer and i.f. for a moment, assume you have fed the output of the 2nd i.f. into a detector. As the signals appear one by one at the output of the 2nd i.f., they are rectified, giving positive pulses which will cause vertical deflection on the face of a crt. In our typical spectrum analyzer, the sawtooth that causes the the S.L.O. to sweep through its frequency range is the same one that drives the horizontal circuits of the oscilloscope in which it is used. Thus, you will observe the three input signals on the crt, with the horizontal axis representing frequency. Study the following example, referring to Fig. 2.

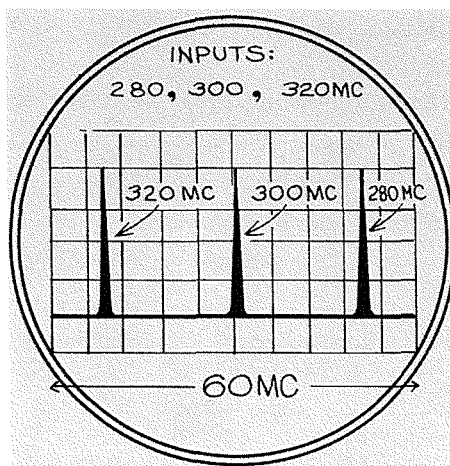

Figure 2. Crt display of output of 2nd i.f. (detected). Each cm = 6 Mc. Note that frequency is read from right to left on Spectrum Analyzer displays.

The crt spot begins its sweep at the 0 centimeter mark at the left-hand side of the graticule. The S.L.O., in step with the crt spot, is now at the low-end of its frequen-

cy range, or 230 Mc. No output is observed, as discussed above; the spot is not deflected vertically. The S.L.O. sweeps through a range of 60 Mc. Thus, a complete sweep of the horizontal represents 60 Mc also, and each major graticule line represents 6 Mc (assuming a normal 10-cm scan, of course). When the beam reaches a point 1.4 cm from the left-hand side, the S.L.O. is sweeping through 240 Mc. This produces an output corresponding to the 180-Mc input signal and the crt beam is deflected vertically. The beam then passes through the 5-cm mark at which time the S.L.O. passes through its mid-range, or 260 Mc. At this time, the crt beam is deflected again, indicating the 200-Mc input signal on the crt. Likewise, the 220-Mc signal is displayed at the 8.6-cm graticule line. The sweep is repetitive in normal operation and the result is a display similar to Figure 2. Note that the highest-frequency signal appears on the left-hand side. Frequency is read from *right to left*.



The previous example considered the S.-L.O. sweeping through a 60-Mc range. This affords a "look"

at a 60-Mc piece of the electromagnetic spectrum. The S.L.O. was set at maximum *dispersion* (range of frequencies swept by S.L.O.). The portion of the spectrum under analysis can also be narrowed. This is accomplished by decreasing the dispersion. If we set the dispersion at 20 Mc, the S.L.O. will sweep from 250 Mc to 270 Mc. Note that its center frequency is *still* 260 Mc, as before. Figure 3 shows the display obtained on the simplified spectrum analyzer, using this dispersion.

When the S.L.O. begins its sweep at the dispersion setting of 250 Mc, the 180-Mc signal at the input of the 2nd mixer is heterodyned to a frequency of 70 Mc. This falls outside of the bandpass of the 2nd

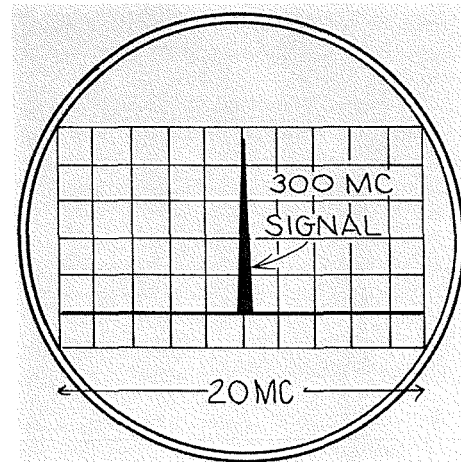

Figure 3. Dispersion, or bandwidth, set at 20 Mc. Each cm = 2 Mc.

i.f., which is tuned to 60 Mc. The 200-Mc signal produces a 50-Mc difference and is not accepted by the 2nd i.f., either. The 220-Mc signal produces an even lower beat; 30 Mc, which is well outside the bandpass of the i.f. As the S.L.O. passes through 260 Mc, the 200-Mc signal from the 1st i.f. produces the 60-Mc beat signal which is accepted by the 2nd i.f. The S.L.O. sweeps to 270 Mc and the same arithmetic proves that no other signal is displayed. Thus, of the original three signals, only one is displayed. The other two fall outside the area "scanned" by the S.L.O. In effect, we have narrowed the "window", through which we observe a portion of the spectrum, in order to take a closer look at it. (A good analogy would be a zoom movie camera that closes in on a subject.) As the dispersion of the S.L.O. is narrowed to sweep a smaller range of frequencies, we "close in" on the center portion of the output of the first i.f. As the observed portion still fills the entire horizontal sweep of the oscilloscope, the signal is spread out more. This gives better resolution in the case of closely-associated sine waves.

Figure 4 represents a display with the dispersion set at 10 Mc. Note that an upper and a lower side-band are beginning to emerge. Although at first we could not see them, these sidebands were associated with the 200-Mc signal all along. With a wide dispersion, the resolution was so poor, they all blended together. The following circuitry of the analyzer can spread, or resolve, these signals even more.

A front-panel vernier labeled "Center Frequency", controls a dc voltage to the S.L.O. This provides a slight shift of the S.L.O. center frequency. This is useful

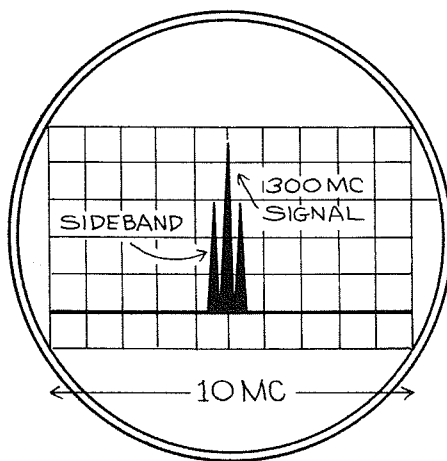

Figure 4. Dispersion set at 10 Mc. Note emergence of sidebands.

for lining up the display with a desired graticule line for subsequent measurement.

Because of the wide range of possible input voltages, a 1 to 51-db attenuator network is inserted between the 2nd mixer and the second i.f. In addition, the second i.f. also has a "Variable Gain" control on the front-panel.

A THIRD I.F. IS ADDED

The output of the 60-Mc 2nd i.f. is still too broad for resolution of closely-associated signals. So we convert a 3rd time! A 3rd L.O., operating at a fixed frequency of 65 Mc, beats in the 3rd mixer with the 60-Mc output and produces an i.f. frequency of 5 Mc. This signal is fed into the 3rd i.f. which is fixed-tuned to 5 Mc. This i.f. has variable bandwidth and can be changed from 1 kc to 100 kc. Therefore, we can vary the resolution by changing the

actual bandwidth of the i.f. stage. The output of the 3rd i.f. is fed to the detector.

THE DETECTOR CIRCUIT

All signals appearing at the input of the detector circuit are both positive and negative. We have no need to display the entire signal because one-half of it would simply mirror the other. So the signals are detected, or rectified, and passed on to a video amplifier.

The detector circuit provides three different outputs: LINEAR, LOGARITHMIC, AND SQUARE-LAW. We'll consider each in turn.

The LINEAR output increases proportionally as the input increases. In other words, if an input voltage to the detector causes a crt deflection of 4 cm, doubling the input will cause a crt deflection of 8 cm.

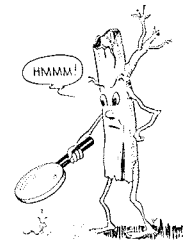

The LOGARITHMIC output reflects a decrease in the gain of the detector circuit as the input is increased. This has the effect of compressing the larger input signals and increasing the dynamic range of the detector input. The output is proportional to the log of the input signal to the detector. The crt vertical deflection increases as the square root of the input voltage. This is equal to the db gain of the display. Increasing the input amplitude by a factor of 4 only doubles the height of the vertical display.

(Part 2, which concludes this article, will appear in the forthcoming June, 1965 issue of SERVICE SCOPE.)

TEKTRONIX PART-NUMBERING SYSTEM EXPANDED

We, at Tektronix, Inc., recently expanded our part-numbering system from six to nine-digit numbers. Several factors necessitated this change. One factor given major consideration was our desire to give ever more effective support to our customers. The expanded part-numbering system will work to that end.

What we've done is merely to expand the existing part number. The change won't require much getting used to on the part of the customer. (For example, parts categories will remain as they are.)

If a customer's original purchase order used six-digit numbers, here's how he can check his parts against the new numbering system:

Here is the familiar Tektronix part number as our customers know it:

524-268

All we've done is move the description digits (the three digits following the hyphen) one place to the right:

524- 268

Drop in a zero:

524-0268

and add a two-digit suffix:

524-0268-00

That's all there is to it.

This method will work for all Tektronix six-digit part numbers except those few having an alphabetical suffix — 154-058A for example. For help in converting these to the new nine-digit part numbers, please consult your local Tektronix Field Office, Field Engineer or Representative.

During the transition period to our new system, the numbers on the parts customers receive may not jibe with those on the invoice we send. When this happens, by just applying the above simple steps in reverse the customer will find it was the same old part number all the time.

We hope this information helps. In the meantime, we appreciate our customers' cooperation and thank them for their patience while we make this necessary change.

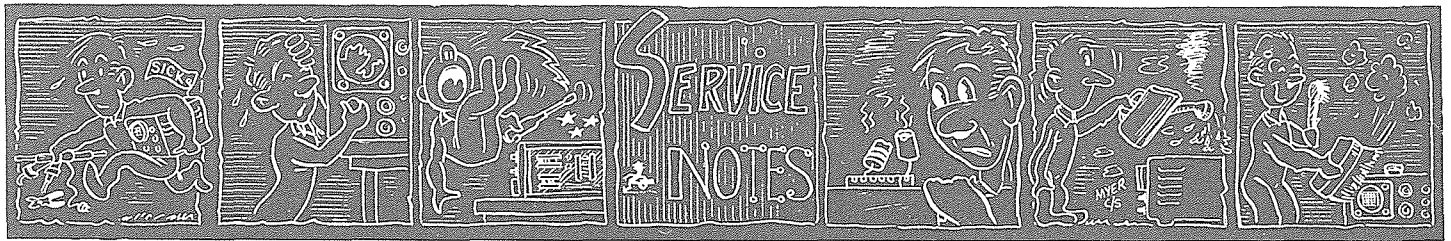

SILICONE GREASE FOR TRANSISTOR HEAT-SINK USE

The need for the use of silicone grease in mounting heat-sinked transistors is apparently not well known.

The maximum power which may be dissipated in a transistor is limited by its junction temperature, T_j . An important factor in determining junction temperature is the ability to conduct heat away from it. There are several "thermal resistances" to be considered in series with heat transfer from junction to ambient air.* Figure 1

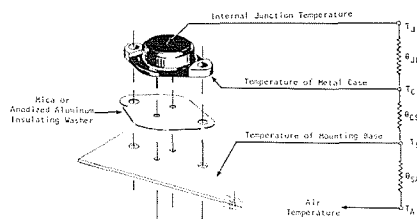

Figure 1. Electrical analog of heat path in a heat-sinked transistor. θ_{jc} = Thermal resistance of junction to case bond. (Controlled by manufacturing process only.) θ_{cs} = Thermal resistance of mounting. (Silicone grease can improve surface contact between transistor and mounting surface.) θ_{sa} = Thermal resistance of "heat sink" or mounting base. (Usually a designed in factor after other elements have been optimized.)

shows an electrical analogy of these separate "resistances". One of these θ_{cs} , is the thermal resistance from case to heat sink and is influenced by the method of mounting. If a mica insulating washer is used dry, the junction temperature rise per watt of power dissipated is about 1.0°C due to θ_{cs} alone. This is mainly due to irregularities in the surface resulting in dead air spaces which do not readily transfer heat. See Figure 2. One way to over-

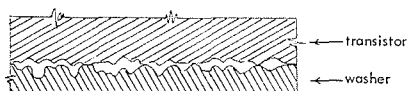

Figure 2. How a magnified cross-section view of the surface might look.

come this difficulty is to fill the dead air spaces with a substance superior to dead air in thermal conduction. Nearly anything is better than dead air, but silicone

grease has the advantage of being a good electrical insulator while readily conducting heat. The use of ordinary silicone grease (like Dow-Corning DC-4) can reduce the above mentioned 1.0°C rise per watt of power to about half, and some of the new types of grease bearing metallic oxides claim reductions to the area of $0.1^\circ\text{C}/\text{w}$. As an example, this would mean a difference of 22.5°C in the junction temperature of a power transistor dissipating 25 watts.

Of the many readily available silicone dielectric compounds, we recommend Dow Corning Type 4 or Type 5 Silicone Compound for heat-sink use in current Tektronix instruments. These types of silicone grease we know will meet the thermal conductivity requirements and temperature range requirements of our "environmental" instruments.

As previously mentioned, there are some other types of silicone greases containing metallic oxides which increase thermal conductivity. However, we haven't fully tested the special metal oxide-bearing "Silicone Heat Sink Compounds" so we are not sure that they will meet our environmental temperature range requirements. This is, the

A CORRECTION

In the article "Some Basic Sampling Concepts Reviewed" which appeared in the February, 1965 issue of SERVICE SCOPE, one line is missing.

On page two at the bottom of column one, the line "... fully charged to the error voltage across ..." should be added. Properly corrected the sentence, which begins five lines up from the bottom and in the center of the column, should read: "Since under these circumstances a fast rising step function may go from zero volts to its maximum voltage between samples, we must somehow cause the sampling capacitance to become fully charged to the error voltage across the gate with one sample".

The type was set correctly but somehow in the mechanics of production this line was lost in the shuffle.

Our sincere apologies to the author and our readers for this omission from an otherwise excellent article.

The Editor.

ability to retain the desired fluid consistency from the lowest (storage) to the highest temperature range that any of our instruments are specified to operate over; and, the range of temperatures that could occur at the point in the instrument where the grease is used.

A practical general rule is to use silicone grease whenever replacing *any* heat-sink-mounted transistor. Apply a thin film of silicone grease between the transistor case and the heat sink. The error, if any, in the amount used should be on the generous side. (The excess that squeezes out when the mounting bolts are tightened can be neatly wiped off.)

If a mica or other type electrically-insulating washer is used between the transistor and heat sink, apply a thin film of grease to both sides of the insulating washer as well.

In some cases (such as the Type 547 Oscilloscope Vertical-Amplifier output transistors), the transistor is electrically insulated from the chassis by a white beryllium oxide disk. If you remove the heat-sink disk, you should also apply silicone grease where the disk contacts the chassis.

The Dow Corning Type 4 Silicone Compound is available in 2 oz. and 8 oz. tubes through electrical and electronic supply houses.

*For a more complete analysis of thermal characteristics, see "MOTOROLA POWER TRANSISTOR HANDBOOK", copyright 1961.

C12, C13, C19 and C27 TRACE-RECORDING CAMERAS—CLEANING AGENT FOR FOCUS PLATE

Any of the liquid dishwashing detergents (Joy, Vel, Lux, Swan, etc.) performs effectively as a cleaning agent for the focus-plate assembly supplied with these cameras. Used in fairly concentrated form, these readily-available detergents will easily remove oily residues as well as ordinary dust and dirt.

As a rule of thumb, you should avoid most all organic solvents such as Focotal, Social, flux remover, trichlor, etc. These agents will attack either the Plexiglass plate or the silk-screening. One which you can use without harm, however, is DuPont Freon TF. This is available locally from your chemical supply house.

TYPE 262 PROGRAMMER — RESISTOR KITS

The Type 262 Programmer Instruction manual, on page 2-8, tells how to place the No-Go Limits on a program card by soldering resistors to the NO-GO LIMITS terminals. On this same page Table 2-1 lists the required resistor values and the corresponding numbers.

The resistor values listed are available in a kit. Each kit contains a total of 176 resistors. These are $\frac{1}{4}$ w, 1%, precision (Std Mil-Bel) resistors in the following quantities and values:

Quantity	Value	Number
36	887 Ω	0
25	1.58 k	1
20	2.26 k	2
20	3.01 k	3
10	3.83 k	4
25	4.64 k	5
10	5.49 k	6
10	6.34 k	7
10	7.15 k	8
10	8.06 k	9

These kits are available through your Tektronix Field Engineer, Representative, local Field Office or Distributor. Ask for Tektronix part number 016-0056-00.

TYPE 3T77 SAMPLING SWEEP UNIT AND TYPE 3S76 DUAL-TRACE SAMPLING UNIT — TRIGGER-TO-VERTICAL KICKBACK

Sometimes, when a Type 3S76 Dual-Trace Sampling Unit is set to trigger internally from either A or B Channel, a certain amount of sweep gating voltage from the Type 3T77 Sampling Sweep Unit gets coupled into the vertical channel.

This voltage will appear on the displayed waveform. You can detect the aberrations with the sweep free running at 5 nanoseconds per division and sensitivity set at 2 mv per division. Their amplitude is affected by what might be connected to the input and is least with no signal applied.

An additional decoupling capacitor placed between the base of Q14 (the trigger input isolator in the Type 3T77) and ground will usually reduce the amplitude of the aberrations to a negligible amount. We recom-

mend a 500 pf capacitor (Tektronix part number 283-0025-00). Solder the capacitor in place without leads (if possible) right at the point where the base lead of Q14 transistor socket emerges from the socket. A word of caution here. Too long leads on the capacitor or a sloppy soldering job will aggravate rather than relieve the difficulty. Perform your work carefully, neatly and with a critical eye.

BEER-CAN OPENER WEARS TWO HATS

The so-called "church key" type beer-can opener makes a handy tool for removing the large copper-clad staples used to close and secure the cartons in which Tektronix instruments are shipped. A carelessly used pliers or screw-driver employed to remove these staples can eject them with sufficient force to endanger the eyes or appearance of surrounding personnel. The bottle-top opening end of the ubiquitous beer-can opener works almost as well as a commercial staple-removing tool. It eliminates the hazard of flying staples and—the price recommends it. Our thanks to Rick Le Forge, Field Engineer with our Van Nuys Field Office, for passing on this information.

NEW FIELD MODIFICATION KITS

TYPE 5T1 TIMING UNITS — TIME-EXPANDER AND GENERAL IMPROVEMENTS

This modification improves the performance and versatility of the Type 5T1, s/n's 101 through 996, to nearly correspond with that of the Type 5T1A. The modification adds to the SAMPLES/CM switch a '1000' position for greater display resolution; and, a TIMED slow-scan position for use with a Y-T recorder. A new front-panel, screw-driver adjusted potentiometer adjusts the TIMED scan speed between the limits of 5 to 8 sec/cm (approx.).

The modification adds a TIME-EXPANDER control which provides X1, X10, X20, X50 and X100 sweep 'magnification' but does not affect the number of samples per centimeter.

A TIME-POSITION control replaces the old TIME-DELAY control. This new control supplies a variable time-delay for positioning the signal display when the TIME-EXPANDER switch is in the X1 position. In the expanded positions, the TIME-POSITION control moves the time 'window' anywhere within the original range displayed in the X1 position of the TIME-EXPANDER switch.

A new Fast-Ramp board with improved linearity for the Fast-Ramp waveform replaces the original Fast-Ramp board.

Order through your local Tektronix Field Engineer, Field Representative, Field Office or Distributor. Specify Tektronix part number 040-0311-00.

TYPE 5T1 AND TYPE 5T1A TIMING UNITS — IMPROVED SINE-WAVE TRIGGERING

By providing a high-frequency mode of operation, this modification reduces jitter and improves stability when triggering on high-frequency sine waves. The operating procedure for the instrument is not altered. To synchronize on high frequencies, the THRESHOLD control is simply advanced into the free-running portion of its range. Both positive and negative trigger circuits are modified for improved performance.

This modification applies to Type 5T1 Units, s/n's 101 through 996 and Type 5T1A Units, s/n's 997 through 2089. Order through your local Tektronix Field Engineer, Field Representative, Field Office or Distributor. Specify Tektronix part number 040-0390-00.

TYPE 2A61 DIFFERENTIAL PLUG-IN UNIT — INCREASED DYNAMIC RANGE

This modification replaces C437, a 13000 μ f capacitor, and its protective diodes, D437 and D438, with a larger non-polarized capacitor. It also adds tube shields to V484 and V584 to prevent negative feedback caused by capacitor-tube coupling. The net

result is an increase in the range of the Type 2A61's dynamic "window" from ± 90 mv to better than ± 300 mv. The improvement is in the 0.01, MV/DIV through the 0.5-MV/DIV attenuator positions.

(Please note: The increased value of C437 increases the time constant of the circuit to a dc input.)

This modification is applicable to Type 2A61 Units, s/n's 100 through 986. Order through your local Tektronix Field Engineer, Field Representative, Field Office or Distributor. Specify Tektronix part number 040-0361-00.

TYPE 2A61 DIFFERENTIAL PLUG-IN UNITS—NOISE AND DRIFT REDUCTION

This modification minimizes drift and reduces low-frequency noise and microphonics when the plug-in is used in the differential mode.

By replacing the floating preamplifier chassis with one that utilizes nuvistors in special, heat-stabilizing shields, and changing the circuitry to permit greater stability of the DIFF BAL control, the modification accomplishes its purpose.

This modification applies to Type 2A61 Units, s/n's 100 through 986. Order through your local Tektronix Field Engineer, Field Representative, Field Office or Distributor. Specify Tektronix part number 040-0397-00.

**TORONTO TRAFFIC CONTROL
SYSTEM
USES TEKTRONIX OSCILLOSCOPE**

At the new Traffic-Control Center in Toronto, Canada, a Tektronix Oscilloscope aids the engineer in preventive maintenance. This new automatic traffic-control installation uses thousands of printed circuit cards in the UNIVAC 1107 Thin-Film Memory Computer.

In the larger photo on this page, an engineer observes waveform displays on a Tektronix Oscilloscope. The waveforms are from a printed circuit board undergoing tests in the card analyzer shown to the left of the oscilloscope. This is a preventive maintenance test accomplished quickly and reliably with a card analyzer and Tektronix Oscilloscope. The tests give the engineer added assurance of computer proficiency in daily work of traffic simulation and analysis.

The smaller photo, taken at City Hall in Toronto, shows the UNIVAC 1107 Computer (left), the special-purpose Traffic Control Computer (center), and the card analyzer featured in the larger photo (right). Here the engineer is checking the console of the control computer which accumulates data at high speeds from traffic-detector sensors in metropolitan Toronto's new traffic-control system.

The computer-based system, which was designed by the UNIVAC Division of Sperry Rand Corporation, continuously and automatically analyzes movement of vehicles within a controlled area of intersections. It will, sometime in 1965, control traffic flow at over 1000 intersections.

**GRATICULE SWITCHING
A PROBLEM?
TRY THIS**

Mr. Edward G. Morgis, Maintenance supervisor at Trans Canada Telemeter, offers a suggestion that will interest oscilloscope users who must interchangeably use graticules scribed as regular rasters and in Percentage of Modulation.

Mr. Morgis uses a 6 x 10-cm graticule (Tektronix part number 331-0037-00) and a TV graticule (Tektronix part number 331-0009-00) sandwiched in between the green filter and the bezel. He positions the two graticule lights so that one lights the front graticule, the other the rear graticule.

He replaces the scale-illumination potentiometer with a 75-ohm wire-wound potentiometer. By electrically placing the potentiometer between the two graticule lights with the center tap connected to 6.3 volts, the control acts like a "fader". Full rota-

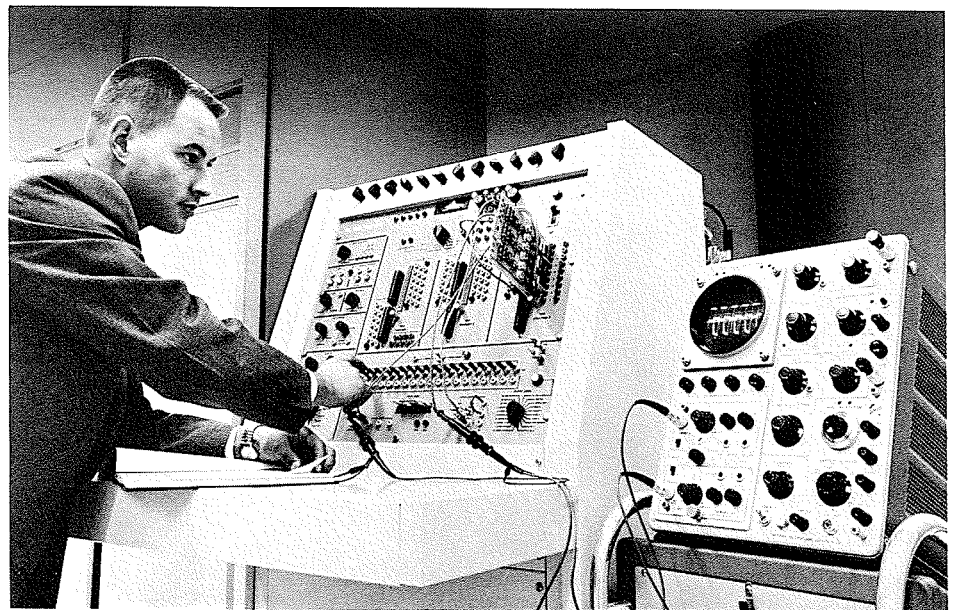
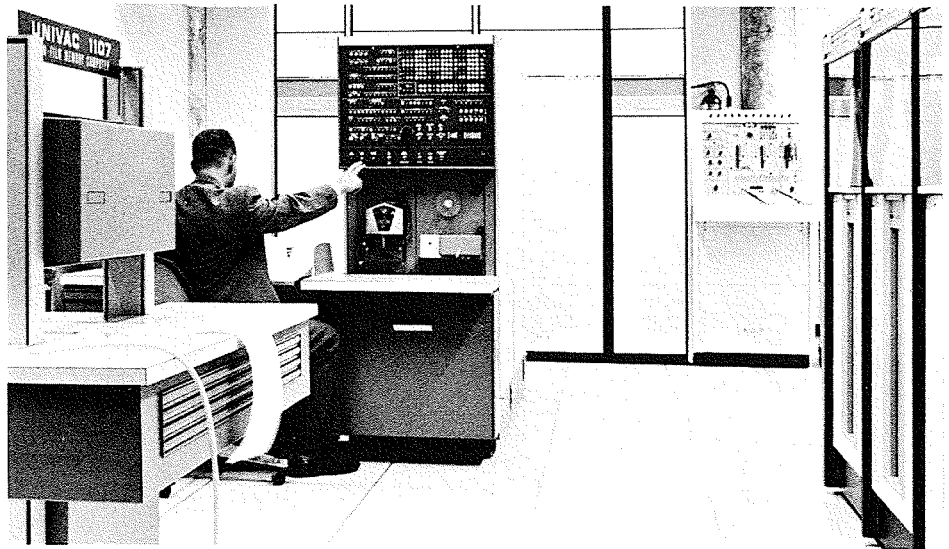

tion to either end of the control will illuminate one graticule leaving the other invisible.

Naturally, illumination of either graticule by only one light will not afford as even a raster as using both. Also, some increase in parallax will be apparent when using the front graticule. But if your work requires you to change graticules often, these negative features may be a minor consideration compared to the convenience Mr. Morgis' modification affords.

USED INSTRUMENTS FOR SALE

The University of Alberta Hospital in Edmonton, Alberta offers the following instruments for sale:

- 1—Type 551 Oscilloscope, s/n 002951
- 1—Type CA Plug-In Unit, s/n 026921
- 1—Type Q Plug-In Unit, sn 00525

Equipment is in very good condition. Contact: Mr. R. M. Allen, Asst. Purchasing Agent. Telephone: 439-5911.

TO OUR READERS

Do you have an item of local origin or interest that you would like to see in Service Scope? If you have send the information to Mr. E. C. von Clemm, General Manager, Tektronix Canada Ltd., 5050 Sorel Street, Room 12, Montreal 9, Quebec.

Items, in general, should relate to oscilloscopes and associated instruments. Ways and means that you have found helpful in using and maintaining your instruments may aid someone else to do a better job. Unique applications are often interesting, also.

We can not guarantee that all items received will be used in Service Scope. We can assure that all items will be thoughtfully considered and those that we feel have a broad appeal will be used. The decision as to which articles meet these objectives must be the responsibility and prerogative of the editor.

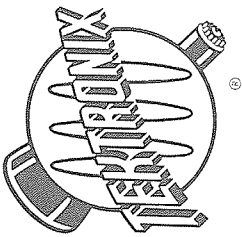

Tektronix, Inc.
P. O. Box 500
Beaverton, Oregon

Service Scope

USEFUL INFORMATION FOR

USERS OF TEKTRONIX INSTRUMENTS

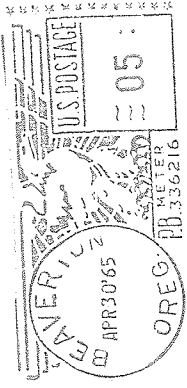

Gordon Marsh, Engineer
Department of Transport
Maint. & Operations Dept.
Temporary Building #3
Ottawa, Ontario, Canada

9/63

RETURN REQUESTED



Service Scope

USEFUL INFORMATION FOR USERS OF TEKTRONIX INSTRUMENTS

NUMBER 32

PRINTED IN U.S.A.

JUNE 1965

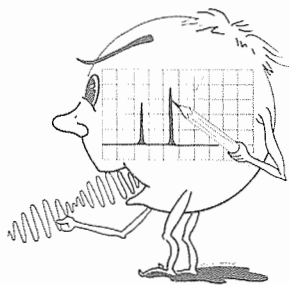

GETTING ACQUAINTED WITH SPECTRUM ANALYZERS

by Russ Myer
Tektronix Advertising Dept.

This is the second and concluding half of an article intended to form a conceptual basis for the understanding of Spectrum Analysis. The first half of the article appeared in the April, 1965 issue of SERVICE SCOPE.

Editors Note:

Part 1 of this article, presented the author's thoughts on Spectrum Analysis to as far as the detector circuit of a spectrum analyzer. Part 1 concluded with a short explanation of two of the detector circuit's three outputs—the linear output and the logarithmic output.

Here in the June, 1965 issue of SERVICE SCOPE, Part 2 begins with a brief review of decibels. This is intended to give the reader a better understanding of the logarithmic output.

We suggest that a refresher reading of Part 1 *before* continuing on to Part 2 will allow the reader to more readily associate himself with the author's thoughts presented here in the second half of the article.

Part II

DECIBELS

To give you a better understanding of the logarithmic output, let's briefly review decibels.

A decibel is one-tenth of a bel. A bel is the same thing as a power of ten. Thus: 50 db is equal to 5 bels. This is the same as 10 to the 5th power, or 10^5 .

If we increase the power level of a signal by 60 db, we increase it 10^6 times—a gain of 1,000,000. Increasing a one-watt signal by 60 db increases it to one million watts!

Remember that db merely expresses the difference between two power levels. By itself, it means nothing, nor does it represent any actual quantity of power. If the example above were 1 micro-watt, a 60 db gain would bring the power up to 1 watt. So the same 60 db expressed a difference of almost 1 million watts in the first example and only 1 watt in the second!

Gains of whole bels, 1, 2, 3, etc. . . . can easily be calculated in the head. 1 bel (10 db), for example, means a power gain of 10^1 , or ten. 2 bels, (20 db), means a power gain of 10^2 , or one hundred. And so on.

Unfortunately, gain is not always expressed in even numbers of bels. What about a gain of 33 db? This is a gain of 3.3 bels, or $10^{3.3}$. Reviewing math, this means 10^3 times $10^{.3}$. 10^3 is easy: 1000. What about $10^{.3}$? For this, you'll have to refer to the table of fractional exponents. See Fig. 5. From the table, you'll see that 0.3 corresponds to 2. So $10^{.3}$, or 1000, is multiplied by 2. A 33 db gain, therefore, is equal to a gain of two thousand.

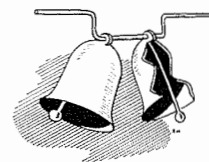

Assume that an amplifier has an input of 200 milliwatts. The gain is 33 db. The output, in watts, would be 400 watts. ($0.2 \times 10^{3.3}$)

Db's are also used to express a loss. We can still consider, in the case of our example, that the difference between two signals is 33 db, but as we now desire to express a loss in power, the figure of 2000 must be divided into 1 to obtain its reciprocal. In this second case, our initial power of 200 milliwatts must be multiplied not by 2000, but 1 divided by 2000, or 0.0005. This reduces our 200 milliwatts to 100 microwatts.

To express a difference in voltage levels, more commonly used in oscilloscope work, the number of bels used as exponents, is divided by 2. Example: a voltage gain of 44 db gives an exponent of $10^{.4}$. Dividing

EXPONENT	MULTIPLY BY	EXPONENT	MULTIPLY BY
.1	1.25	.6	4.0
.2	1.6	.7	5.0
.3	2.0	.8	6.3
.4	2.5	.9	8.0
.5	3.16		

Figure 5. Fractional Exponent Multipliers.

the exponent by 2 gives a new number: $10^{2.2}$. This is $10^2 \times 10^{.2}$, or 100×1.6 , or 160. Increasing any voltage level (RMS) by a factor of 160 produces an increase in power of about 25,000 times. This is proved by the relationship $E^2/R(160^2)$.

The power formula, $P = E^2/R$ indicates that power increases as the square of the voltage (resistance remaining the same, of course). The oscilloscope is a voltage-operated device; therefore, increasing a vertical signal by a factor of 2 requires a signal 4 times the power of the original.

So much for decibels. Let us return now to the detector circuit and its 3rd or SQUARE-LAW output.

To expand vertical signals, the analyzer's detector is operated in the SQUARE-LAW mode. In this manner, the output voltage is the *square* of the input voltage. Doubling the input causes the output to increase *four* times. Tripling the input causes the output to increase 9-fold!

The advantage of this circuit can easily be seen. Input signals of nearly the same amplitude are expanded and can be measured more accurately on the crt. Also, the crt now measures relative input *power*. Doubling the input power doubles the vertical deflection. Thus, the square-law mode causes the output to behave exactly the opposite of the logarithmic mode.

THE VIDEO AMPLIFIER

The detector circuit is followed by the Video Amplifier. Signals are fed into the amplifier and applied, push-pull, to the crt vertical-deflection plates. To increase the versatility of the spectrum analyzer, video signals can be fed directly into the amplifier, by-passing the i.f. and detector portions of the instrument. This allows an oscilloscope display of ordinary time-based signals.

IMAGES AND OTHER SPURIOUS SIGNALS

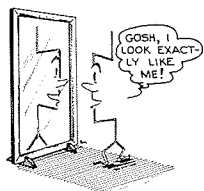

Until now, we have assumed that only the signals appearing in the area of the center frequency are presented on the crt display. Unfortunately, this is not always the case. Other signals also sneak through the analyzer and are displayed.

Assume you have set the tuning dial at 300 Mc to observe a signal of that frequency on the crt. Since 300 Mc is the center-frequency signal, it will appear at the center graticule line. Assume further that along with the 300-Mc input, another signal with a frequency of 700 Mc is present at the input.

Since the first L.O. operates 200 Mc higher than the desired input signal, it will be oscillating at 500 Mc. This frequency beats with the 300-Mc input to produce the 200-Mc difference which is allowed to pass through the 1st i.f.

But . . . the difference between the 500-Mc L.O. and the 700-Mc input is *also* 200 Mc! So, it too is introduced into the 1st i.f. and, as you would expect, appears on the crt — exactly super-imposed on the 300-Mc signal at the center graticule line. Now, set the dial slightly to either side of the 300-Mc center frequency. This causes the signals to move from the center graticule area. However, each signal goes in the *opposite* direction!! A little arithmetic will prove why.

Moving the L.O. to 530 Mc, for example, (tuning dial reading 330 Mc, of course) produces a beat of 230 Mc for the desired input signal of 300 Mc. As the output of the 2nd i.f. is swept through its range of 170 Mc to 230 Mc, it's obvious that the true signal now will appear on the extreme right of the crt. The L.O. frequency of 530 Mc also beats with the 700-Mc input and produces a difference frequency, or beat frequency, of 170 Mc. This causes it to appear to the extreme left of the crt.

This illustrates an important rule: Tuning the L.O. (main tuning dial) to a higher frequency causes the true signal to move to the right of the crt; unwanted signals move to the left. These undesired responses are called "images," or "spurious" responses.

As signals above and below the center frequency of the 1st L.O. can produce beat frequencies, either of the two could be called the "true" signal, depending upon how we labeled the tuning dial. We simply choose to call signals below the frequency of the L.O. *true responses* and all signals above it, the image signals. The i.f., of course, doesn't know the difference.

Another type of spurious response that shows up on the crt is caused by input signals that fall within the bandpass of the first i.f. Any input signal falling within the range of 170 Mc to 230 Mc will be displayed. This is called *i.f. feedthrough*. This type of spurious signal is the easiest to identify. Moving the tuning dial either direction does not shift the display on the crt. This is because the 1st L.O. does not beat with any input signal to produce the response.

Figure 6 shows two unknown signals on the crt of the scope. Note their positions on the graticule. The dispersion is set at 50 Mc. Thus, each graticule line represents 5 Mc. First attending to signal A, move it to the center graticule line. This will determine the center frequency of the signal as read on the tuning dial. Assume that

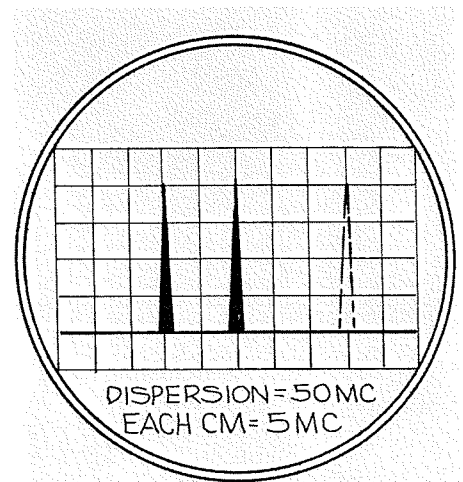
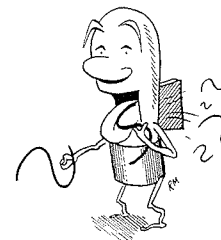

Figure 6. Display after shifting image to center of graticule. This illustrates how two signals, separated by 390 Mc, show up only 10 Mc apart on the crt.

it was necessary to tune the dial higher in frequency. The signal moved higher in frequency, also (towards the left). This identifies signal A as a spurious, or image, response. Reading the tuning dial gives us a figure of 205 Mc. We know the L.O. is operating 200 Mc above the tuning-dial reading, so it must be oscillating at 405 Mc. The image, therefore, is 200 Mc above that, or 605 Mc!

Signal B was moved to the right (down in frequency) to be located at the center graticule line. The tuning dial would now read 215 Mc, which is the frequency of the true input signal.

HARMONIC SPURII



When the operation of the Spectrum Analyzer is considered, remember that any complex waveform is the algebraic sum of a number of pure sine waves. The analyzer permits the display of these individual sine waves on an oscilloscope. The horizontal sweep represents some continuous frequency range.

Any sine wave passed through a non-linear device, such as a tube or a transistor, will be accompanied in the output by a new set of frequencies called *harmonics*. These frequencies will be exact multiples of the original, but of decreasing amplitude. The second harmonic, for example, of a 200-Mc signal, is 400 Mc; the 3rd, 600 Mc, etc.

Here is where we can get into trouble with our typical spectrum analyzer. Originally, we spoke of all the signals present at the output of the first mixer: the original L.O. frequency, the original input signal, the sum of the two, and the difference, which was the one selected for i.f. amplification. We also learned that any signal

170-Mc to 230-Mc *higher* than the L.O. frequency would also produce a beat that fell within the bandpass of the first i.f. And, finally, there was i.f. feedthrough.

But, unfortunately, there are other spuri which can show up on the crt screen.

The mixer will produce harmonics of its two input signals, (original signal and L.O.) which are present in the output. Harmonics of the L.O. are of particular interest to us now. For example, assume the L.O. could be set at 300 Mc to show a 100-Mc input signal on the crt. The second harmonic of the L.O. is 600 Mc. If there were a 400-Mc signal of equal strength at the input of the analyzer, it, too, would produce a 200-Mc difference and be displayed on the crt! Because of the decreased amplitude of the harmonic, however, the crt presentation would be less than that of a true-response presentation. (Bear in mind, however, that the 400-Mc signal could have a signal strength several times that of the true signal and show up as a larger amplitude presentation than the true one).

Also, an 800-Mc signal, if present at the input, would beat with the 2nd harmonic of the L.O. and produce the 200-Mc i.f. difference signal. Likewise, the 3rd harmonic of the L.O. — 900 Mc — could beat with a 700-Mc input, or a 1,100-Mc input and produce the 200-Mc i.f. frequency!

Fortunately, these harmonic-caused spuri can be easily recognized. Increasing the L.O. frequency by 100 Mc, for example, increases the 2nd harmonic by 200 Mc, and the 3rd by 300 Mc. Thus, harmonic spuri move across the screen faster than true response or images.

Assume inputs of 700, 400 and 100 Mc. The L.O. is set at 300 Mc to display the 100-Mc signal at the center of the crt. The dispersion is set at 10 Mc, each centimeter representing 1 Mc on the crt. At the center of the crt, only one signal is observed. Actually, three signals are present — the true signal which is L.O. minus the input frequency of 100 Mc, $2 \times$ L.O. minus the input frequency of 400 Mc and $3 \times$ L.O. minus the input frequency of 700 Mc. All these differences are exactly 200 Mc! See Figure 7.

Tuning the L.O. up 1 Mc in frequency will shift the true signal, 100-Mc, exactly 1 division to the right (remember that tuning higher in frequency shifts true signals towards the minus-frequency or right hand side of the crt). The 1-Mc shift upward caused the 2nd harmonic to increase 2 Mc, and this moved the 400-Mc input *two* divisions to the right! The 3rd harmonic increased by 3 Mc, and the 700-Mc signal appeared three divisions to the right of center. Assuming inputs of equal signal strength, the 2nd harmonic signal would be less than the amplitude of the true response and the 3rd harmonic signal amplitude would be

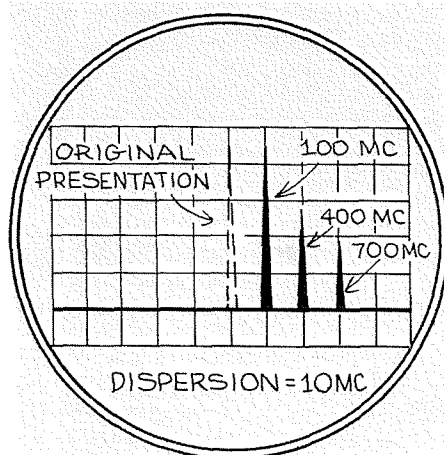

Figure 7. Display showing effects of moving tuning dial up 1 Mc to recognize and separate spuri from true response.

less than the second. Observe that, unlike images, moving the L.O. up in frequency causes these harmonic spuri to move in the same direction as true responses.

MARKER OSCILLATOR

A feature of the spectrum analyzer is the Marker Oscillator. It generates a 200-Mc signal which is fed into the 1st i.f. of the analyzer. You can use it to determine relative frequency or frequency difference of signals observed on the crt.

You'll remember that the center frequency of the 1st i.f. is 200 Mc. The marker frequency of 200 Mc is injected into the i.f. and will exist at the center of the bandpass of the i.f. You can say, therefore, that the 200-Mc marker indicates the center frequency of the i.f. and is displayed at the center graticule line of the crt. The marker appears as a spike, or "pip", much like the time marks used to calibrate oscilloscopes.

A front-panel control, the "Frequency-Difference Control," allows the marker to be tuned to either side of its 200-Mc mid-range, usually plus or minus 30 Mc (170 Mc to 230 Mc). Figure 8 gives an example of the use of the marker.

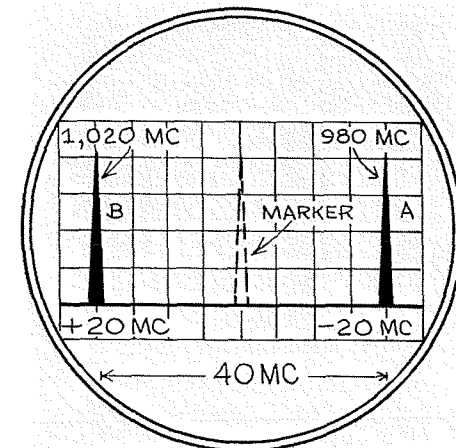
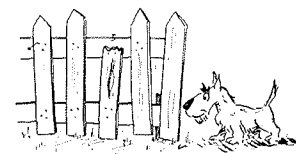

Figure 8. Dispersion is 50 Mc. Each cm = 5 Mc. Marker reads frequency difference.

First, line up the marker "pip" and the signal at "A". The control reads -20 Mc. Moving the marker over to signal "B" and lining them up, the control reads $+20$ Mc. The frequency difference is 40 Mc and that is the frequency difference between signals "A" and "B". Assume the main-tuning dial is tuned to 1,000 Mc. The dispersion is set at 50 Mc. Each graticule mark now represents 5 Mc. No signal appears at the center graticule line, which represents the center frequency. Therefore, no input at 1000 Mc is present at the input of the analyzer. However, there is a signal 4 graticule lines to the left of the center one. This signal is 20 Mc less than the 200-Mc center frequency, or 180 Mc, and corresponds to an original input of 1,020 Mc. The signal on the right, "B", is 20 Mc greater than 200 Mc and is produced by an input of 980 Mc. Remember to read frequency from right to left!

As we have seen previously, spurious inputs will also produce similar signals on the crt. An input of 1,380 Mc will produce a signal similar to "A" and an input of 1,420 Mc will produce one similar to "B". Note that in the case of these and any images, frequency is read from left to right, in the normal fashion. You can, of course, identify true signals by shifting the main-tuning dial and observing which way the signals move on the crt.



The marker-oscillator output can be frequency-modulated, also. Two modulating frequencies are

available on this typical analyzer: 1 Mc and 100 kc. When modulated, the 200-Mc marker signal now becomes a complex waveform which the analyzer will break down into individual sine-wave components (which is what our analyzer does to all complex waveforms!). These are displayed on the crt as pips, spaced equally apart. These pips extend to the right and left of the marker center-frequency displayed on the crt. The separation between the pips is equal to the modulating frequency that caused them. In other words, with a dispersion of 10 Mc and the marker set on 200 Mc, a modulating frequency of 1 Mc will create a "pip" at each graticule line. These pips are called the "picket fence."

VERTICAL AMPLITUDE MEASUREMENTS

Look at the graphical view of the bandwidth of the 1st i.f. (Figure 9). The center frequency is 200 Mc. The bandwidth limits are 170 Mc to 230 Mc and is expressed in db variation, usually ± 3 db. The figure shows that the flat portion of the curve can vary between minus 3 db and plus 3 db. This is a 6-db variation! Per-

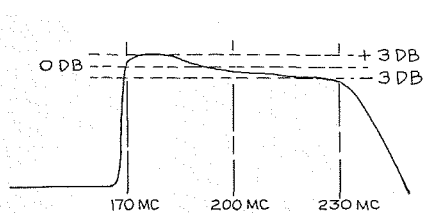

Figure 9. Bandwidth of 1st i.f., reproduced on crt by sweeping constant input signal over 60 Mc range. Note that despite constant input, there is a 6 db variation between 170 Mc and 230 Mc.

haps at the 170-Mc point, the response is +3 db. At the 230-Mc point, it could be -3 db. A single, constant-input signal, swept from 170 to 230 Mc, will produce an output to the detector that varies between +3 db and -3 db. Obviously, this same signal viewed on the crt would assume a varying vertical deflection at different points along the horizontal axis although the input had not changed at all. Therefore, it is important that all measurements using the Spectrum Analyzer be made with the signal under measurement lined up at the center graticule line. Thus, a constant output from the detector is assured.

To measure relative differences in amplitude of signals displayed on the crt, we use the calibrated attenuator of the analyzer.

Assume you have a crt display of two signals of different amplitudes. The detector is in the linear mode. The largest signal is reduced, with the attenuator, to the original amplitude of the second signal. The difference is noted on the attenuator. This is the relative difference. For signals of greatly different amplitude, the log mode of detection may be used. If the input signals were nearly the same amplitude, the square-law detection mode could be used.

This discussion has presented the overall operation of a typical Tektronix Spectrum Analyzer. Although the company's product line features several different models covering other portions of the electromagnetic spectrum, some of which operate a little differently than explained here, they all do one basic thing. They break down complex waveforms and display them on an oscilloscope as individual sine waves on a frequency time base.

The End

The Author wishes to acknowledge the help received from pertinent articles and material supplied by the following Tektronix personnel: Arnold Frisch, Project Manager, and Morris Engelson, Design Engineer of the Spectrum Analyzer group in the Instrument Engineering Department,

Fred Davey, Education and Training Program Director, and Fred Beville Field Engineer; also the assistance of others who aided in the editing of this material . . . Russ Myer

About the Author—

Russ Myer received his training in basic electronics at the Venezuela Communication School in Caracas, Venezuela.

He later took service with the U.S. Federal Aviation Agency and during his tenure studied electronic engineering at their University of the Air in Oklahoma City, Oklahoma.

He followed this with a stint as teacher of electronics at Port Arthur College in Port Arthur, Texas.

Russ has also had five years of experience as a broadcast engineer, holding the position of chief engineer at each of the several stations employing him.

He came to Tektronix, Inc. in April of 1962 and worked in the Test and Calibration and Customers Service departments before transferring, recently, to the Advertising Dept. as a technical writer.

The Editor.

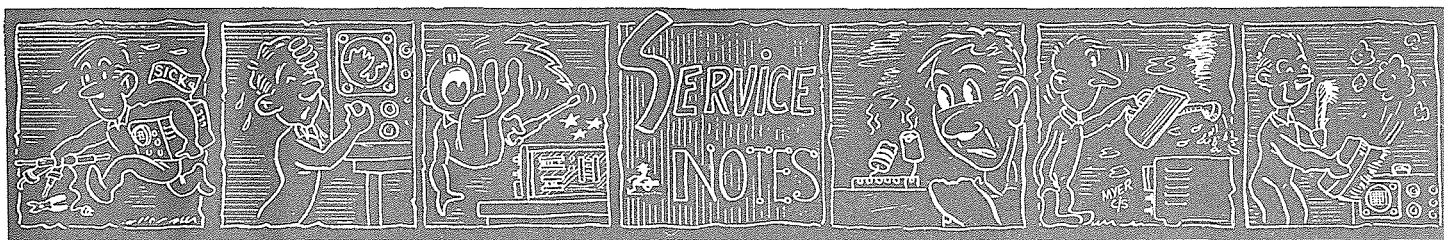

TYPE L-20 PLUG-IN-UNIT SPECTRUM ANALYZER—APPLICATIONS ABOVE ITS SPECIFIED FREQUENCY RANGE

The Type L-20 Spectrum Analyzer's specified upper frequency is 4Gc. You can, however, use the instrument for applications up to 12Kmc, at reduced sensitivities. You will need to compute the dial setting for any input frequency from a knowledge of the local oscillator frequency; and, you can compute the local oscillator frequency from the dial setting on Band 2 (fundamental operation) using this equation:

$$\frac{F_{rr} + 200}{n} = F_d + 200$$

Where

F_{rr} = Input signal rf frequency

200 = IF Frequency

n = harmonic number of local oscillator,

Band 2 Dial Reading	n = 5 Kmc	sens - dbm	n = 6	n = 7	n = 8	n = 9	n = 10	n = 11
			sens -80 dbm Kmc	sens -75 dbm Kmc	sens -70 dbm Kmc	sens -66 dbm Kmc	sens -63 dbm Kmc	sens -60 dbm Kmc
230	1.95	-85	2.38	2.81	3.24	3.67	4.10	4.53
240	2.00	-85	2.44	2.88	3.32	3.76	4.20	4.64
250	2.05	-85	2.50	2.95	3.40	3.85	4.30	4.75
260	2.10	-85	2.56	3.02	3.48	3.94	4.40	4.86
270	2.15	-85	2.62	3.09	3.56	4.03	4.50	4.97
280	2.20	-85	2.68	3.16	3.64	4.12	4.60	5.08
290	2.25	-85	2.74	3.23	3.72	4.21	4.70	5.19
300	2.30	-85	2.80	3.30	3.80	4.30	4.80	5.30
320	2.40	-85	2.92	3.44	3.96	4.48	5.00	5.52
340	2.50	-85	3.04	3.58	4.12	4.66	5.20	5.74
360	2.60	-85	3.16	3.72	4.28	4.84	5.40	5.96
380	2.70	-85	3.28	3.86	4.44	5.02	5.60	6.18
400	2.80	-85	3.40	4.00	4.60	5.20	5.80	6.40
450	3.05	-85	3.70	4.35	5.00	5.65	6.30	6.95
500	3.30	-85	4.00	4.70	5.40	6.10	6.80	7.50
550	3.55	-85	4.30	5.05	5.80	6.55	7.30	8.05
600	3.80	-85	4.60	5.40	6.20	7.00	7.80	8.60
650	4.05	-85	4.90	5.75	6.60	7.45	8.30	9.15
700	4.30	-85	5.20	6.10	7.00	7.90	8.80	9.70
750	4.55	-85	5.50	6.45	7.40	8.35	9.30	10.25
800	4.80	-85	5.80	6.80	7.80	8.80	9.80	10.80
850	5.05	-85	6.10	7.15	8.20	9.25	10.30	11.35
900	5.30	-85	6.40	7.50	8.60	9.70	10.80	11.90

Chart 1. Chart for determining the value for n in the equation $\frac{F_{rr} + 200}{n} = F_d + 200$.

for F_r between 4 Kmc and 12 Kmc is 5 to 11 (for Type L-20)

F_a = Band 2 dial settings

Sensitivities are estimated—we make no production measurements, nor do we guarantee performance in this frequency range. Engineering tests do, however, indicate that the Type L-20 exceeds the estimated sensitivities in most cases.

NOTE: You should always operate at the lowest harmonic possible so as to achieve best sensitivity. Also, on Chart 1 below, those numbers to the right and below the mid-chart line do not appear on the dial of the Type L-20 Spectrum Analyzer. Those numbers above and to the left of the mid-chart line do appear on the dial at a low order of harmonic.

TYPE 545B AND TYPE RM545B OSCILLOSCOPES—IMPROVED VERTICAL AMPLIFIER HF RESPONSE

You can improve the high frequency response of the Type 545B (s/n's 101-1079) and the Type RM545B (s/n's 101-219) Oscilloscopes by replacing C551, a fixed 7.5 pf capacitor, with a 5-25 pf variable capacitor (Tektronix part number 281-0075-00). C551 is located on the lower Vertical Amplifier chassis. You will need to rearrange the components on the ceramic strips to accommodate the larger replacement

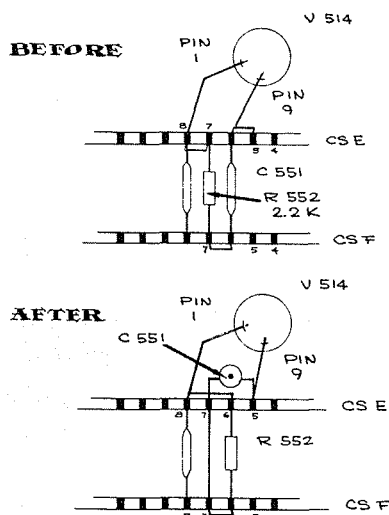

Figure 1. "Before" and "After" sketch showing the placement of components on the ceramic strips when making the modification to improve the vertical amplifier high frequency response in the Type 545B and Type RM545B Oscilloscopes.

capacitor. Figure 1 shows a "BEFORE" and "AFTER" sketch of this modification.

Remove C551 from the ceramic strips, located on the lower Vertical Amplifier, just above the two TA1938 transistors Q513 and Q523. Follow the BEFORE and AFTER drawings and rewire the ceramic

strips to accommodate the new C555 capacitor. Refer to your Instruction Manual's Calibration section and recheck the Vertical Adjustment, adding C551 to the procedure as necessary. Don't neglect to change the parts list and schematic values in your Instruction Manual to agree with the new capacitor.

TYPE 2B67 TIME-BASE UNIT—RASTER

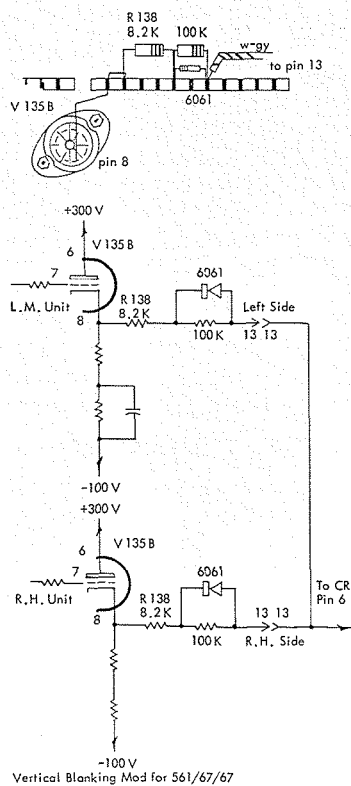

Figure 2. Partial schematic and sketch of component placement on the involved ceramic strips when making the vertical blanking modification to the Type 2B67 Time-Base Unit.

When two Type 2B67 Time-Base Units are used for raster applications in a Type 561A or Type 564 Oscilloscopes the left-hand unit will not blank the vertical retrace. A slight modification to the two Type 2B67's will allow the left-hand 2B67 to blank the vertical retrace. Figure 2 shows the circuit modification in schematic form. With this circuit, if either time base says "off" the beam turns off. That way it's off during each retrace of the horizontal and off during vertical retrace, too. This circuit works well with moderately slow sweeps. It will not work at very fast sweeps; there just isn't enough current in the Type 2B67 system to pull these plates around very rapidly.

There are four steps involved in the modification and here they are:

1. On the bottom ceramic strip of each of the two 2B67's, remove the white-

grey lead from the end of R138 (8.2k) resistor and move it two notches to the rear.

2. Connect a 100k, ½ w resistor (Tektronix part number 302-0104-00) between the 8.2k resistor (R138) and the white-grey wire moved in Step 1.
3. Shunt the 100k resistor installed in Step 2 with a 6061 diode (Tektronix part number 152-0061-00). Connect the cathode end of the diode to the junction of the 8.2k and 100k resistors.
4. On the Type 561A (or Type 564) Oscilloscope, run a lead from pin 13 of the right-hand interconnecting socket to pin 13 of the left-hand interconnecting socket.

That's all there is to it.

TYPE 545B AND TYPE RM545B OSCILLOSCOPES — ELIMINATING TIME-BASE 'B' TRIGGER JITTER

In some of these instruments, trigger jitter may be apparent when Time-Base 'B' is triggered with the MODE switch in the —EXT position. Should this be objectionable, replacing R92, a 22k, 1w, 5% resistor, with a 20k, 1w, 5% resistor, (Tektronix part number 303-0203-00) will eliminate the jitter.

R92 is located on the 'B' sweep chassis between the center two ceramic strips, with one end connected to L424, a 225 μh inductor, which is directly over V424, a 6AU6 tube. Be sure to note the changed value for R92 in your Instruction Manual's part list and schematic when you make this modification.

TYPE Q TRANSDUCER & STRAIN GAGE PLUG-IN UNIT—POSSIBLE TEMPERATURE/GAIN PROBLEM

Some Type Q Units within the serial number range of 101 through 1629 will exhibit a temperature/gain problem. The problem manifests itself as a change in gain with a change in temperature and is most likely to occur during warm up of the Q Unit. It can result in a significant measurement error. Two 0.02 μf discaps in the amplifier cause the instability. Replacing these with 0.022 μf, 200 v, PTM capacitors (Tektronix part number 285-0566-00) will assure stable operation during and after warm up.

With the Q unit turned upside down on the bench and the front panel facing you, C5724 and C5755 are located on the four-notch ceramic strips directly behind the front panel and under the μ STRAIN/DIV. switch.

After making this modification, correct the parts list and schematic in your Type Q Unit Instruction Manual to agree with the work you have done.

TYPE 519 OSCILLOSCOPE — POSSIBLE SHORT DAMAGE IN HV SUPPLY

Accidentally grounding the HV supply of the Type 519 Oscilloscope (s/n's below 560) may cause C841, an 0.01 μ f-500 v capacitor, to short. This short will, in turn, damage V800, the 6AU5 oscillator tube in the HV circuit.

Replacing C841 with a capacitor having a higher voltage rating will protect against this damage. The replacement should be an 0.01 μ f, 1 kv capacitor (Tektronix part number 283-0013-00). C841 is located in the HV supply between pin 7 of V814 (a 12AU7 error-signal-amplifier tube) and ground—consult the CRT CIRCUIT schematic in your Type 519 manual. Be sure to note the changed value for C841 in the schematic and parts list of your manual.

TYPE 519 OSCILLOSCOPE — REPLACEMENT CAPACITOR COVER

Installation of a new type capacitor cover on C655 will offer more protection against arcing of this capacitor in the Type 519 Oscilloscope. C655 is a 2 x 1000 μ f, 450 v, EMF capacitor in the 6.3-v crt-heater circuit of the Type 519's power supply. Under the proper atmospheric conditions and at 4000 foot elevations, pins 16, 17 and 26 of T601 and the can of C655 may arc to ground. Should this occur, the two diodes, D655 and D656 may be destroyed and 601

damaged. Normal age deterioration of the original capacitor cover will enhance the possibilities of this arcing.

The new capacitor cover (Tektronix part number 200-0293-00) is molded of a recently available plastic, highly resistant to age deterioration and with very effective insulating abilities.

TYPE 160A POWER SUPPLY—EXCESSIVE RIPPLE ON +225-SUPPLY

Under conditions of high-load demand at the output and a low-line supply at its power source the Type 160A Power Supply (s/n's 101 through 9049) may exhibit ripple on the +225-v supply that exceeds specifications. Changing R33 from a 1 meg to a 1.5 meg $\frac{1}{2}$ w, 10% resistor will assure that ripple on the +225-v supply remains within specifications. R33 is located on the Type 160A chassis between pin 5 of V33 (a 6AU6 tube) and pin 2 of V35 (a 6080 tube). Tektronix part number for the 1.5 meg resistor is 302-0155-00. After you make the replacement, note the changed value for R33 in the parts list and on the schematic of your Type 160A's Instruction Manual.

REPRINTS AVAILABLE

Reprints of two articles written by Tektronix personnel and which appeared in technical magazines recently are available.

The March, 1965 issue of THE MICRO-WAVE JOURNAL contained an article on

spectrum analyzers. Title of the article is "Oscilloscope Plug-In Spectrum Analyzers". Three Tektronix design engineers, Arnold Frisch, Project Manager, and Larry Weiss and Morris Engelson, Design Engineers with the Spectrum Analyzer group in our Instrument Engineering Department, collaborated to produce this article. It deals primarily with the plug-in type of spectrum analyzers designed for use with the Tektronix Type 530, 540, 550 and 580 Oscilloscopes.

Following a brief rundown on the principles of a spectrum analyzer's performance, the article explains how the plug-in analyzer uses to advantage certain oscilloscope characteristics; such as, the calibrated sweep, the expanded sweep, intensity modulation and (as in the case of the Type 555 Oscilloscope) dual beam presentation.

The January, 1965 issue of ELECTRO-TECHNOLOGY carried an article on sampling oscilloscopes entitled "Nanosecond Measurements with a Sampling Oscilloscope". The author is H. Allen Zimmerman, Project Engineer with the Tektronix, Inc. Instrument Design Department. This article describes the sampling process and discusses the usefulness and versatility of a sampling oscilloscope.

Reprints of either or both of these articles can be obtained from your local Tektronix Field Office, Field Engineer, Field Representative or Distributor.

A NEW TELEVISION WAVEFORM MONITOR THE TEKTRONIX TYPE RM529

The Tektronix Type RM529 is a new television waveform monitor with capabilities for precise measurement of Vertical Interval Test Signals (VIT).

VIT signals have been in use in Europe and Canada for the past ten years. Their use on the North American continent was pioneered by the Canadian Broadcasting Corporation. The United States government authorized the use of VIT signals in that country as far back as 1956. They have, however, only recently come into common use there.

The Type RM529 is designed for use with the 525/50 line scanning rate used in the United States and here in Canada. This instrument can be obtained (on special order) with minor modifications to the sweep and vertical amplifiers that adapt it to other systems currently in use, including 405/50, 819/50 or high-resolution closed circuit systems. Tektronix, Inc. also produces a television waveform monitor, the Type RM529 MOD 158E, that is designed specifically for the CCIR system. This instrument is of interest, primarily to tele-

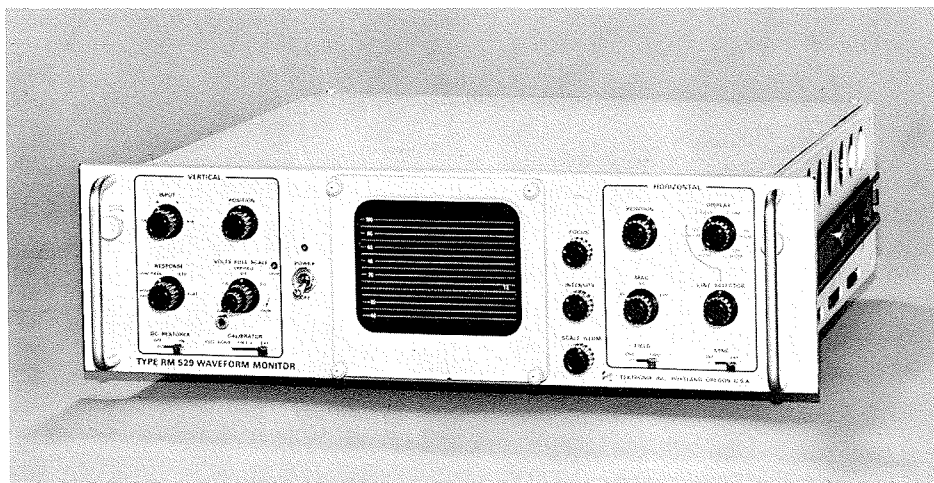

vision authorities, engineers and technicians in areas other than the North American continent.

The wide bandwidth of the Type RM529—flat to 8 MHz—assures excellent waveform fidelity and makes the instrument ideally suited for sine-squared testing.

A new highly efficient 12.7 cm aluminumized mono-accelerator crt operating at an increased accelerating potential, assures brighter waveform displays in line-selector operation. Viewing area is 7 x 10 cm.

The electrical design of the instruments incorporates the best of both solid state and vacuum tube circuitry, thus assuring extra high reliability and longer component life. Except for the two power transistors all 45 transistors are socket mounted to enhance serviceability. The two power transistors are bolted to the heat sink on the rear panel of the instrument. Vacuum tubes (there are only seven in the instrument) have been used in but a few circuits, and then, only when they offered superior performance or

better reliability over presently available semiconductor devices. Total power consumption is only 80 watts and this low power consumption precludes the need for a fan. The result is cleaner operation and complete freedom from mechanical noise.

The design of the Type RM529 is compact. The instrument fits in a standard 19" rack and requires only 5 1/4" of vertical rack space. It is designed for mounting with the Conrac picture monitor, or other commercial picture monitors in a standard console or relay rack installation.

A positive field selector is incorporated in the Type RM529 and is ideal for monitoring VIT signals.

A video signal is composed of frames (complete pictures) occurring at a 30 Hz rate. Each frame is divided into two fields—Field One and Field Two. Each field contains 262 1/2 lines, making up a complete frame of 525 horizontal lines. The two fields interlace; that is, Field One lines occur between those of Field Two. Close inspection shows that a full line of video precedes Field One; while only one-half line of video precedes Field Two. These two identifying features occur *immediately* before the vertical blanking pulse which precedes the field in question. (See Figure 1,

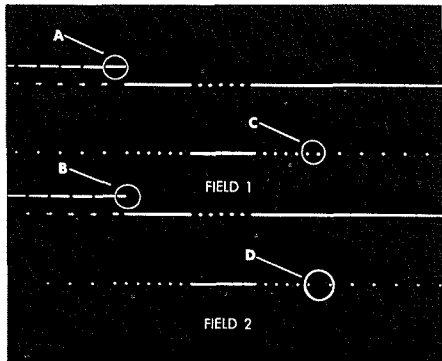

Figure 1. shows the differences between Field One and Field Two. (Double exposure photograph)

point a and b.) Careful inspection of the vertical-blanking pulse reveals another difference between Field One and Field Two—a difference in the time relationship between the last equalizing pulse and the first horizontal-sync pulse. (See Figure 1, points c and d.) This difference enables electronic circuits to identify individual fields.

A prime feature of the Type RM529 is the ability to distinguish between Field One and Field Two. Through the use of appropriate delay circuitry to interrogate the vertical blanking interval, the Type RM529 can generate a trigger which *positively* locks the Field Trigger Generator to Field One or to Field Two. Hence, triggers initiating a sweep at the start of either Field One or Field Two can be selected with a front-panel switch. *After a noise transient*

or temporary loss of video, this circuit will always return to the proper field.

By introducing a delay between these triggers and the start of the sawtooth, *any* line of the TV raster can be inspected individually. Horizontal magnification allows more detailed inspection of the signal on the line selected.

Bright waveform displays are another important feature of the Type RM529. A single line displayed at a frame rate is inherently dim. The Line Selector circuitry in the Type RM529 furnishes a brightening pulse to the crt grid (ac-coupled). This feature makes it unnecessary for the operator to re-adjust the intensity control in line-selector operation. It also limits the normal intensity range, thus preventing accidental burning of the crt phosphor; particularly in the event of sweep circuit failure. The net result is waveforms—exceptionally bright and sharp—that are clearly viewed or photographed.

The Type RM529 has four vertical-amplifier-response positions: high pass, low pass, IEEE and flat.

The high-pass or chroma position is often used to remove low-frequency components from the staircase. With these removed, amplitude of the 3.58 MHz modulation is more easily measured and differential gain determined. Adequate reserve gain exists to expand the subcarrier signal for accurate measurements.

The low-pass position is used to attenuate the high-frequency bursts on the multiburst signal when making axis-shift measurements. It will limit the 0.5 MHz-modulation to approximately 20% of the original amplitude. Modulation is scarcely detectable on the 2-MHz portion of the burst and negligible at the higher frequencies. (This response position is also useful when it is necessary to observe a waveform in the presence of extreme amounts of white noise.)

The IEEE position is the standard response designated by the broadcast industry in Canada and the U.S.A. for making amplitude measurements. It removes the chrominance signal from video containing color in-

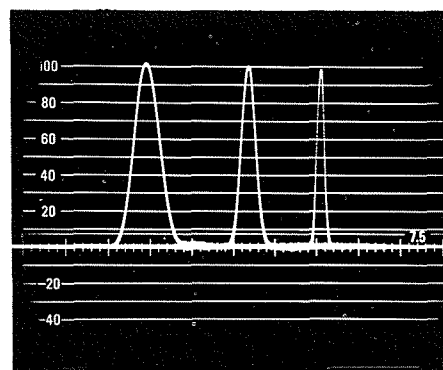

Figure 2. 2T Signal. Multiple exposure. Left: 2T. Center: T. Right: 1/2 T Sine².

formation, and eliminates high frequency noise which is often present.

The flat response position is usually used when making measurements with multiburst and sine² pulses. It will not significantly attenuate a T pulse and it provides good reproduction of the 50 nsec 1/2 T pulse, see Figure 2. This position is also useful for making signal-to-noise-ratio measurements because it readily passes all white noise present in the system. A calibrated 14 db increase in sensitivity over the 1.0 v full-scale calibrated sensitivity is provided for such purposes.

DC RESTORATION

A dc restorer on-off switch is incorporated in the Type RM529 to facilitate its use as a modulation monitor. In normal use, the dc restorer serves the function of clamping the video signal to a reference level so that it will not change position with varying average voltage level (brightness). The dc restorer normally clamps to the back porch of the video signal. Black level is usually set to 7.5 IEEE units above the back porch, and the white level to 100 units. The bottom of the sync tip is normally set to -40 IEEE units. Studio signals are usually measured at the 1 v level and 1 v equals 140 IEEE units in normal signal.

When the dc restorer is turned off, the input capacitor of the Type RM529 may be shorted out. All following stages are dc-coupled, making it possible to use the Type RM529 in conjunction with a diode detector for % of modulation measurements. Signals which are not video, such as found in tape recorders, may also be measured. DC coupling is also useful for measuring hum and bounce in the video system. With the dc restorer disabled, and the input of the Type RM529 ac-coupled (normal), the low frequency 3-db down point is approximately 0.32 Hz.

Both the back porch (blanking level) and the sync tip represents stable reference levels in the video signal. Back-porch clamping has in the past been objectionable because it interfered with color burst. Design considerations in the Type RM529 make this objection invalid. Back-porch clamping has the advantage that there is a more direct relationship between the blanking level (back porch) and picture black level than there is to the sync tip level. (A simple modification of the Type RM529 circuitry will adapt the instrument for sync-tip clamping. This modification is described in the Type RM529 Instruction Manual.)

Change in blanking level due to the presence of color burst is well under 1%. No aberrations to the color burst are caused by the clamping circuit.

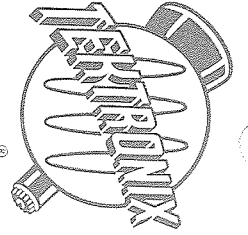

Tektronix, Inc.
P. O. Box 500
Beaverton, Oregon

Service Scope

USEFUL INFORMATION FOR

USERS OF TEKTRONIX INSTRUMENTS

E. F. Porter, Des. & Const. Div.
Department of Transport
Telecommunications Div.
#3 Temporary Bldg., Room B193
Ottawa, Ontario, Canada 4/62

RETURN REQUESTED

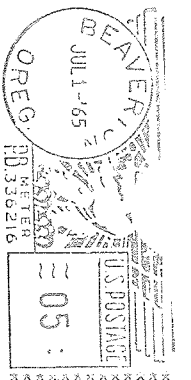



Service Scope

USEFUL INFORMATION FOR USERS OF TEKTRONIX INSTRUMENTS

NUMBER 33

PRINTED IN U.S.A.

AUGUST 1965

INTRODUCTION TO OSCILLOSCOPE DIFFERENTIAL AMPLIFIERS

by

Joseph E. Nelson

Tektronix Product Technical Information Group

This article describes oscilloscope differential amplifiers in terms of their application to measurements. Characteristics such as common-mode rejection ratio, voltage range, and frequency range are explained, and typical figures are given. In addition, the effect of probes and filters as well as the importance of source impedance are discussed and pointed up as factors that can affect measurement capability.

What Is It?

The word "differential" in the amplifier name can be misleading. To some it suggests a relationship to differential calculus while others think of a differentiating network. It is neither of these, but simply a *difference* amplifier. By definition: An oscilloscope differential amplifier is a device that amplifies and displays the voltage difference that exists at *every* instant between signals applied to its two inputs.

With this definition as a departure point, one can get some idea of the oscilloscope display that will result from a variety of input signals. For example, two pulses that differ in both amplitude and coincidence that are applied to a differential amplifier will cause the oscilloscope display to be a complex waveform that represents the instantaneous difference between the two pulses. On the other hand, two signals that are *identical* in every respect will cause no output on the CRT screen (limitations to this statement will be described under *Common-Mode Rejection*).

Several examples of input waveforms as applied to a differential amplifier and the resultant output waveforms are shown in Figures 1, 2 and 3.

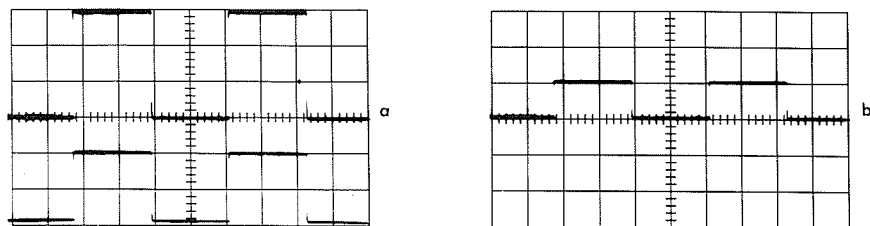

Figure 1. a, Input signals of different amplitude (same phase) applied to a differential amplifier. b, The resultant output signal.

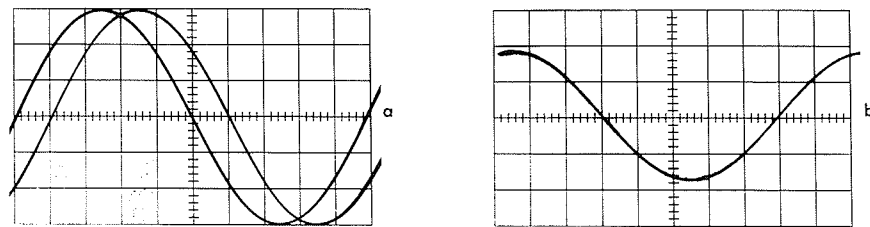

Figure 2. a, Two signals of equal amplitude but of different phase (approx. 35°) applied to a differential amplifier. b, The resultant signal seen on the crt.

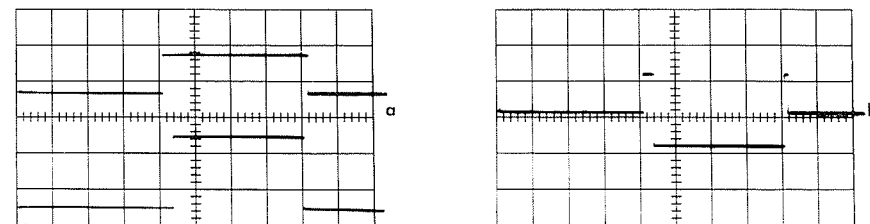

Figure 3. a, Two square waves of different amplitude and coincidental applied to a differential amplifier. b, the difference waveform seen on the crt.

Common-Mode Rejection

The definition of the term differential amplifier implies a rejection of equal amplitude, coincident signals. This implication is correct. However, the degree of rejection depends primarily on the symmetry of the amplifier inputs. Unfortunately, the design and construction of two exactly symmetrical inputs to a differential amplifier cannot be accomplished in practice. Small differences in resistor and capacitor values result in deviations from the theoretical input attenuation ratio. In addition, the capacitance of active elements may not remain the same for each input and this can cause a difference voltage, especially at the higher frequencies. The net result of these variations in component values is an unbalance that causes a *difference* signal, even though the amplifier is driven by identical input signals. The amount of difference signal that one can expect from a particular amplifier is documented with a mathematical relationship that is called the common-mode rejection ratio (CMRR). This ratio and associated terms are defined as follows:

Common-Mode: Refers to signals that are identical with respect to both amplitude and time. Also used to identify the respective parts of two signals that are identical with respect to amplitude and time.

Common-Mode Rejection: The ability of a differential amplifier to reject common-mode signals.

Common-Mode Rejection Ratio (CMRR): The ratio between the amplitude of the common-mode input signal to the difference input signal which would produce the same deflection on the CRT screen.

NOTE: Since the differential amplifier in this discussion (and throughout this article) is part of an oscilloscope, the output signal used to calculate the CMRR is measured in the usual way from the CRT screen and volts-per-division switch setting.

Thus, a differential amplifier that produces a .005-volt output when driven by 5.0 volts of common-mode signal has a CMRR of 5/.005 or 1000:1.

Measurements made with a differential amplifier should contain an allowance for the output voltage that is due to common-mode signal. For example, if an amplifier with a CMRR of 1000:1 is used to measure the difference between two similar five-volt signals, the output seen on the oscilloscope screen is the result of two voltages: (1) the *actual* difference between the input signals, and (2) the difference voltage that results from the common-mode signal. Because of this combination, the

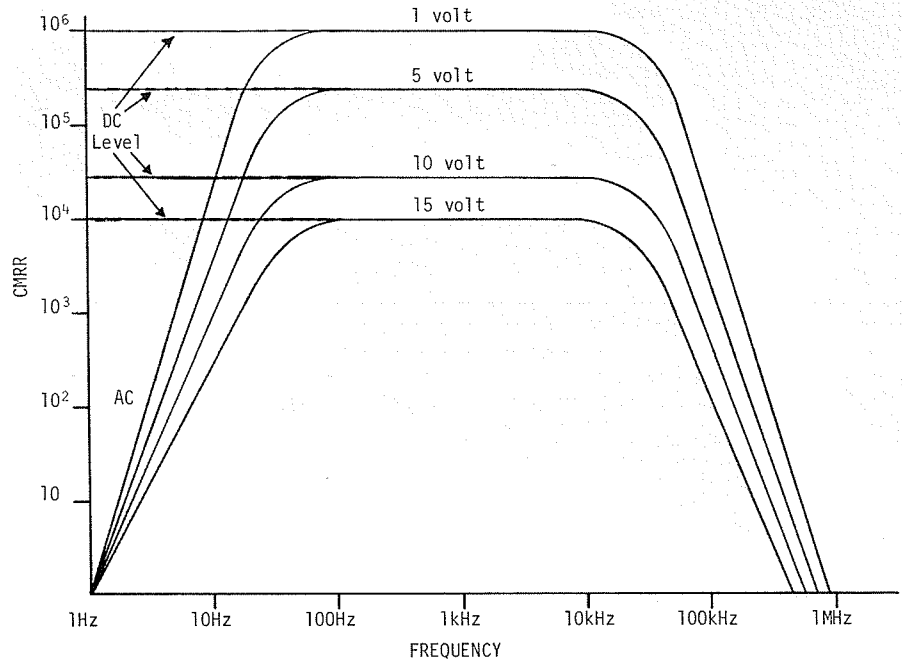

Figure 4. The common-mode rejection ratio related to frequency, voltage level, and input coupling of a typical differential amplifier.

COMMON-MODE REJECTION¹ 0.1 MV/CM to 10 MV/CM²

	Referred to Input Connectors		Referred to Input of Properly Adjusted P6023 Probes	
	DC-Coupled Input	AC-Coupled Input With Low-Z Source	DC-Coupled Input	AC-Coupled Input With Low-Z Source
DC to 100kHz	50,000:1			
500kHz	1,000:1	1,000:1		
DC to 10Hz			50,000:1	
15 Hz		500:1		
60 Hz		2,000:1		
100 Hz			10,000:1	
1 to 10 kHz			1,000:1	1,000:1
100 kHz		50,000:1	500:1	500:1
20 MV/CM to 10 V/CM ³				
DC to 1kHz	10,000:1			
DC to 100kHz	1,000:1			
500 kHz	500:1	500:1		
15 Hz		500:1		
60 Hz		2,000:1		

¹For ground-referenced sine-wave common-mode signals.
²With 10 volts peak-to-peak or less in common mode at input connectors.
³With common-mode amplitude at input connectors of 100 volts peak-to-peak or less from 20 mv/cm to 0.1 v/cm, and with 600 volts peak-to-peak or less from 0.2 v/cm to 10 v/cm.
 These common-mode signals will not overdrive the amplifier:
 0.1 mv/cm to 10 mv/cm, ±20 v from gnd (40 v pk-to-pk ac)
 20 mv/cm to 0.1 v/cm, ±200 v from gnd (400 v pk-to-pk ac)
 0.2 v/cm to 10 v/cm, ±600 v from gnd (1200 v pk-to-pk ac)

Figure 5. Chart for the Tektronix Type 3A3 Differential-Amplifier Unit that outlines the parameters under which certain common-mode rejection ratios can be achieved.

actual difference voltage cannot be *exactly* measured. Therefore, the voltage measured on the CRT screen should include a tolerance that is equal to the computed, or measured, output voltage due to the common-mode signal.

In the above example, the CMRR of 1000:1 means that the common-mode portion of the five-volt signals will cause an output of 5.0 volt/1000 or .005 volt. If a voltage of, say .015 was measured on the

CRT screen, it should be noted as .015 ±.005 volt.

Amplitude, Frequency and Input Coupling

To this point, no mention has been made of common-mode rejection in terms of amplitude, frequency, or type of input coupling. The importance of these factors is graphically illustrated in Figures 4 and 5. From these figures one can formulate some general rules as to expected changes

in common-mode rejection when amplitude, frequency or input coupling are changed.

1. The specified common-mode rejection becomes *lower* as the common-mode signal amplitude is *increased*.
2. The specified common-mode rejection becomes *lower* as the input attenuators (within the amplifier) are switched into the amplifier input circuit.
3. The specified common-mode rejection becomes *lower* as the frequency of the common-mode signal increases. (Exception: with AC-coupled input the CMRR can become higher as frequency is increased within the 1 Hz to 100 Hz range).
4. Generally, the addition of components such as probes, attenuators, or even extra cable to the amplifier inputs will lower the *apparent* common-mode rejection. (Note: the actual CMRR of the instrument cannot be changed by added external components.)

Where precise quantitative data is needed, one should measure the CMRR of the instrument at the specific frequency or repetition rate and amplitude of the signals being used and use this measured CMRR as a tolerance figure in difference measurements.

Amplitude and Common-Mode Rejection

In the text to follow, the term *maximum common-mode input voltage* means the maximum voltage that will not overdrive the amplifier. This should not be confused with the *maximum non-destructive input voltage* which is related to the breakdown limits of the amplifier components.

Figure 4 shows that the CMRR decreases as the input voltage increases. If the voltage applied to the input is raised beyond the maximum common-mode input voltage specified for the amplifier, at some point the input circuit will be overdriven and the common-mode rejection ratio becomes meaningless. Once this occurs, further increase of the common-mode voltage will cause a disproportionate increase in the amplitude of the CRT display.

This discussion of input voltage also applies to pulses and square-waves as well as sine-waves. But because these waveforms contain components of many frequencies, it is difficult to predict the shape of the resultant waveform that a differential amplifier may display.

Probes and Common-Mode Rejection

Attenuator probes extend the usable voltage range of a differential amplifier by reducing the input signals to a level that is below the *maximum common-mode input voltage*. In doing this, however, the probes

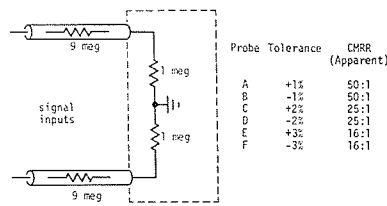

Figure 6. Simplified input circuit and table that shows the change in CMRR (apparent) due to X10 probes that are within 1, 2, and 3% of their attenuation value.

may cause a reduction in the *apparent* CMRR due to component value differences within the probes. For example, Figure 6 illustrates the change in CMRR (apparent) due to X10 probes that are within 1, 2, and 3% of their attenuation value. Bear in mind that the reduction in apparent CMRR can also be caused by different values of the input resistor. Also, probes with cables of different length may introduce enough signal delay between them to cause a difference voltage at the inputs. A good rule, especially with probes, is to try to make conditions at both inputs identical.

A typical test was run on four Tektronix Type 6006 probes to illustrate what might be expected in practice. The differential amplifier was a Tektronix Type 3A3 Dual-Trace Differential Amplifier in a Tektronix Type 561A Oscilloscope and the source voltage was from a Tektronix Type 190B Sine-Wave Generator set at 1 kHz.

Probes	CMRR
Probes 1 and 2	56:1
Probes 1 and 3	40:1
Probes 2 and 3	68:1
Probes 4 and 1	8:1
Probes 4 and 2	7:1
Probes 4 and 3	8:1

This test pointed out two additional features of probe use: (1) by reversing the probe connections to the amplifier inputs the CMRR was changed. For instance, when probes 1 and 2 were reversed, the CMRR changed from 56:1, as shown above, to 46:1; and (2) the test showed probe number 4 to be defective, as indicated by the low CMRR (8:1).

In measurements where attenuator probes must be used because of voltage levels, and at the same time a high (above 1000:1) CMRR must also be achieved, the Tektronix Type P6023 Probe is suggested. This is a X10 low capacitance probe with variable attenuator ratio that is adjustable over a $\pm 2.5\%$ range. As pointed out earlier in Figure 5, these probes, when used with a Tektronix Type 3A3 Differ-

ential-Amplifier Unit, can be adjusted for CMRR's of 50,000 at certain frequencies.

Filters and Common-Mode Rejection

Some differential amplifiers use filters, but this technique is not considered to be common-mode rejection since difference signals are also rejected by filters. In effect, the filters set the bandwidth of the amplifier and reject signals that are above or below the filter passband. For example, a 60 Hz sine-wave modulated by high-frequency noise can be "cleaned up" considerably by using a filter whose passband centers on 60 Hz. Conversely, to eliminate line-frequency hum, a filter that restricts the hum frequency should be used.

Several differential amplifiers, such as the Tektronix Type 2A61 Low-Level Differential Amplifier and Tektronix Type 1A7 High-Gain Differential Amplifier, have a series of internal filters that are adjusted by frequency-response controls on the instrument front panel. These controls allow the amplifier passband to be centered on the frequency of the desired signal. One note of caution—too severe restriction of the passband may cause distortion of non-sinusoidal signals.

Signal Source Impedance and Common-Mode Rejection

The common-mode rejection ratio specified for a differential amplifier is obtained by applying the same signal to both inputs. Since the signals are from the same generator, the source impedance of the signals is the same. (In the discussion that follows, the signals are 100 Hz sine waves.)

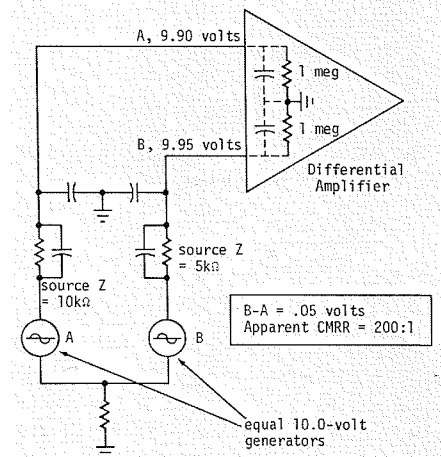

Figure 7. Schematic that shows the relationship of test-point source impedance to the amplifier input impedance, and also shows the apparent CMRR caused by large value difference between test-point impedances.

If the two inputs to a differential amplifier are connected to circuits that do not have the same source impedances, the *apparent* CMRR will be lower than expected, even though the voltages from both sources are the same. (Note: This assumes a finite resistance such as 1 megohm from grid to ground at each input of the differential amplifier). The reason for this lower CMRR is: the source impedance of the circuit under test and the amplifier input impedance form a divider (both R and C) and the ratio between these two impedances determines the amount of signal presented to the grids.

For example, in Figure 7, the source impedance of generator A is 10 kilohms and the input impedance of input A is 1 megohm. The actual voltage present at the input A is 99.0% of the source or 9.90 volts.

Generator B has a source impedance of 5 kilohms which is in series with the 1 megohm input impedance of input B. This results in 99.5% or 9.95 volts applied to input B.

With 9.90 volts applied to input A and 9.95 volts applied to input B, the net difference between the two inputs is 0.05 volt. This difference voltage of 0.05 volt would be amplified and appear on the CRT screen. If one considered this voltage as the result of a common-mode 10.0-volt signal the ratio would be 200:1. However, as the illustration shows, the difference voltage of 0.05 volt was present at the input to the amplifier and because of this, cannot be considered as a common-mode voltage. In addition, the illustration shows that the difference voltage present at the amplifier input was a direct result of the difference in source impedance of the two signal sources.

One way to reduce inaccuracy due to

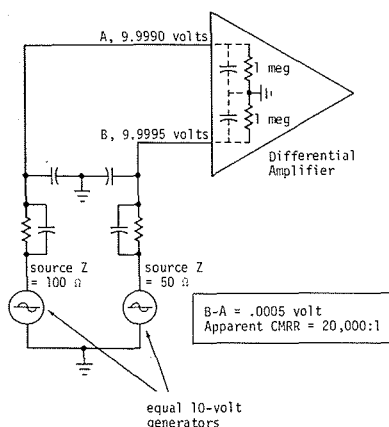

Figure 8. Schematic that shows the small effect on CMRR caused by low-impedance test points compared to that of Figure 7.

different source impedance is to select test points with low source impedance. Figure 8 shows a difference voltage of .0005 volt applied to a differential amplifier when the source voltage is 10.0 volts and the source impedances are 50 Ω and 100 Ω respectively. In this case, the apparent CMRR is 20,000:1 (assumes infinite CMRR of the amplifier).

If a measurement must be made from two different high impedance points the source impedances can be calculated and allowance made for the difference voltage although this calculation can be quite difficult. A second way to handle this measurement is to use a differential amplifier with an infinite input resistance. The Tektronix Type W Plug-In Unit can be set by a front panel control to have 10,000 megohms input resistance. The remaining input capacitance of 20 pf will present approximately 80 megohms to the 100 Hz signal. When two dividers are calculated between 80 megohms and the 5-k and 10-k source impedances, the difference voltage from a 10-v signal is .0006 v.

As the frequency of signals increases, the error due to different source impedances also increases. There is really no solution to this problem other than to avoid the conditions that produce it. Thus, one should: (1) select low source impedance test points whenever possible, and (2) where high impedance test points must be used, try to use points of equal source impedance.

Ground Connections

Because differential amplifiers are capable of measuring difference signals at microvolt levels they are also sensitive to unwanted signals that may be present in the instrument environment. Proper grounding can often reduce these unwanted signals to a point where they do not interfere with a measurement. Figures 9a, b, and c illustrate the right and wrong way to connect a differential amplifier into a circuit.

Figure 9a is wrong because each probe shield acts much like an antenna in picking up stray signals from the environment. These signals will differ in both phase and amplitude between the two probe shields and will induce currents in the center conductors which result in small signal differences at the input to the amplifier. Figure 9b is wrong since a ground connection between the junction of the probe shields and the instrument under test would allow ground currents to flow through the shields. The presence of these ground currents increases the possibility of erroneous measurement due to resultant voltage differences applied to the inputs of the amplifier.

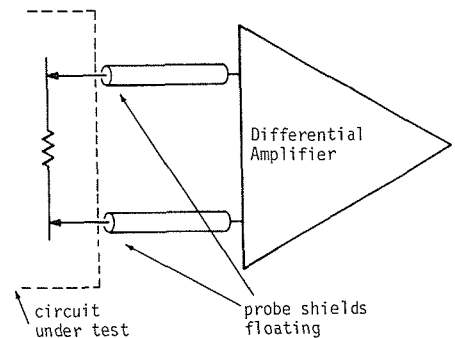

Fig. 9a. Wrong

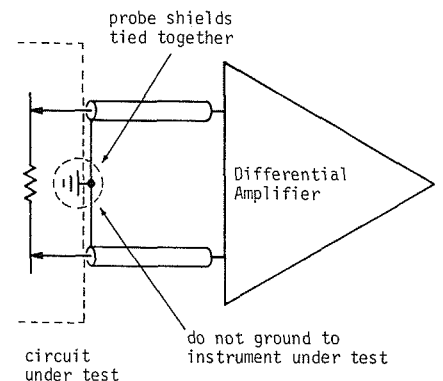

Fig. 9b. Wrong

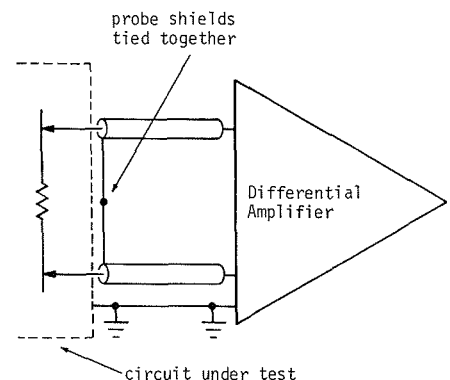
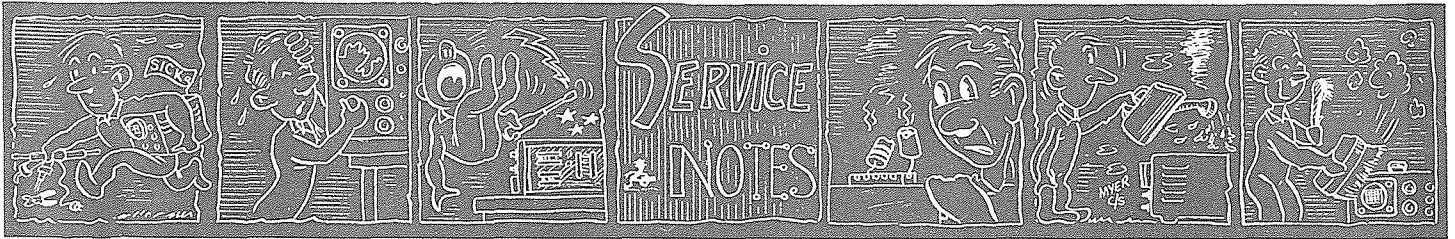

Fig. 9c. Right

Figure 9. The right and wrong way to connect a differential amplifier into a circuit. The ground shown in c is for safety purposes and not essential to the measurement.

Figure 9c shows that the correct way to connect the probes is to couple the shields together at the probe body (but not to instrument ground). This reduces interference by (1) reducing the impedance of the loop formed by the shield, and (2) equalizing the currents through the loop to allow the CMR of the amplifier to reject them. The chassis ground shown in Figure 9c is provided for safety between instruments; it is not essential to the measurement.

(Part 2, which concludes this article, will appear in the forthcoming October, 1965 issue of SERVICE SCOPE.)



TYPE 543B AND TYPE 545B OSCILLOSCOPES — IMPROVEMENT OF AUTOMATIC INTERNAL AND EXTERNAL TRIGGER TRIGGER

	TRIGGER MODE	TRIGGER REQUIREMENTS
INTERNAL	AC	2-mm deflection from 150 cps to 10 Mc, increasing to 1 cm at 30 Mc. Will trigger below 150 cps with increased deflection.
	AC LF REJECT	2-mm deflection from 30 kc to 10 Mc, increasing to 1 cm to 30 Mc. Will trigger below 30 kc with increased deflection.
	DC	6-mm deflection to 10 Mc.
	AUTOMATIC	5-mm deflection at 150 cps. With increasing deflection, to 10 Mc. Will trigger to 50 cps with increased deflection.
EXTERNAL	AC	0.2 v from 150 cps to 10 Mc, increasing to 1 v at 30 Mc. Will trigger below 150 cps with increased signal.
	AC LF REJECT	0.2 v from 30 kc to 10 Mc, increasing to 1 v at 30 Mc. Will trigger below 30 kc with increased signal.
	DC	0.2 v to 10 Mc, increasing to 1 v at 30 Mc.
	AUTOMATIC	0.5 v at 150 cps. With increasing deflection, to 10 Mc. Will trigger to 50 cps with increased deflection.

Chart 1. Manual specifications of trigger requirements for Type 543B and Type 545B (Time Base A only) Oscilloscopes.

Some Type 543B and Type 545B Oscilloscopes, both conventional and RM models, offer a difficulty in meeting the 5mm and 0.5v Manual specifications, respectively on automatic internal and external trigger. (In the Type 545B Oscilloscope the difficulty is confined to the Time Base "A" trigger circuit). A non-symmetrical trigger-output signal when the TRIGGER MODE control is in the AUTO position, will cause erratic auto triggering. Changing the resistor R38 from a value of 12k to 18k (1w, 5%—Tektronix part number 303-0183-00) will improve the sym-

metry of the signal and allow stable triggering on the latest Manual specifications. See Chart 1.

After making the change, be sure to note the new value for R38 in the parts list and on the schematic in the Instruction Manual for the instrument.

This improvement is applicable to Type 545B Oscilloscopes, s/n 101 to 1235; Type RM545B Oscilloscopes, s/n 101 to 247; Type 543B Oscilloscopes, s/n 101 to 267; and Type RM543B Oscilloscopes, s/n 101 to 120.

TYPE G PLUG-IN UNIT — INTERMITTENT OSCILLATIONS IN TYPE 544, TYPE 546, AND TYPE 547 OSCILLOSCOPES

Some Type G Plug-In Units will, on occasion, exhibit intermittent oscillation when used in some Type 544, 546, and 547 Oscilloscopes.

A cure for this problem is the addition of two 0.01 μ h ferrite cores (Tektronix part number 276-0528-00); one to the lead of L3977 (an 0.18 μ h inductor) located between pin 1 of the Type G Unit's amphenol connector and ceramic strip #2, and the other to the lead of L4977 (an

0.18 μ h inductor) located between pin 1 of the amphenol connector and ceramic strip #4. Install the ferrite cores on the leads that run between the ceramic strip and the inductors. Give the designation L3978 to the ferrite core added to the lead of L3977. Give the designation L4978 to the ferrite core added to the lead of L4977. Be sure to make the necessary corrections to the schematic and parts list in your Type G Unit's Instruction Manual.

TWO TYPE 3A1 PLUG-IN UNITS X-Y — POWER SUPPLY UNDER-LOAD AT HIGH LINE

Type 3A1 Plug-In Units (s/n below 7930 only) will, under certain conditions shunt a little more current around the -100 v power-supply series regulator than the plug-in can actually use.

With two 3A1's installed, the -100 v in the Type 561, Type 561A or Type 564 Oscilloscopes (either conventional or rack mount versions) may fail to regulate when the power source (line voltage) exceeds 115 v. The Type 3A1/Type 3A1 is the only plug-in combination where the under-load is significant.

Replacing the wire strap between pin 22 of the Type 3A1's amphenol connector and ground with a 1k, 2w, 10% resistor (Tektronix part number 306-0102-00) will reduce the power supply shunting to a level which will allow the use of Two Type 3A1's X-Y. Designate the new resistor R393 and make the necessary addition to the parts list and correct the schematic in your Type 3A1 Instruction Manual.

Generally speaking, two 3A1's is a rather unusual combination for dual-trace X-Y presentations. Type 3A1's have no facility for channel pairing,* phase characteristics do not match for the entire band-pass and the X-axis unit is limited to 8 cm scan (6 cm in units with serial number below 7930). However, in X-Y applications where these limitations are not serious, Type 3A1's below serial number 7930 will operate satisfactorily if modified as noted above. Type 3A1 Units with serial numbers 7930 and higher incorporate the modification.

*For single-trace X-Y presentations or for dual-trace X-Y presentations using a common signal applied to only one channel of one of the axis units, the lack of channel pairing does not present a problem.

INPUT TIME-CONSTANT STANDARDIZER — USE OF UHF-TO-BNC ADAPTERS NOT RECOMMENDED

Tektronix input Time-Constant Standardizers are available for standardizing the input time constant of plug-in having a nominal capacitance of 12 pf, 15 pf, 20 pf, 24 pf, and 47 pf. The individual standardizers for each time constant (except 15 pf X 1 meg) can be obtained with either

UHF or BNC connectors; the standardizer for 15 pf X 1 meg time constant is available with BNC connectors only.

The use of a UHF-to-BNC adapter with a Tektronix Time-Constant Standardizer equipped with UHF connectors will add one or two picofarads of capacitance to the plug-in input. This additional capacitance will have an effect on the accuracy of high frequency measurements. The higher the frequency of the applied signal the greater the effect of the additional capacitance.

Use a standardizer of the correct time constant equipped with connectors that match those of the plug-in whose input time constant you wish to standardize.

Listed below are the available Tektronix Time-Constant Standardizers:

Tektronix Part #		
Input Cap.	UHF	BNC
12 pf X 1 meg	011-0051-00	011-0065-00
15 pf X 1 meg		011-0073-00
20 pf X 1 meg	011-0022-00	011-0066-00
24 pf X 1 meg	011-0029-00	011-0067-00
47 pf X 1 meg	011-0030-00	011-0068-00

TYPE 544, TYPE 546, TYPE 547 OSCILLOSCOPES — MODIFICATION FOR BETTER COMPATIBILITY WITH TYPE W HIGH-GAIN DIFFERENTIAL-COMPARATOR* AND TYPE Z DIFFERENTIAL COMPARATOR PLUG-IN UNITS

The Type W and Type Z Units are capable of more signal-output swing than other plug-in units used with these oscilloscopes.

Off screen signals saturate one or more of the two delay-line-driver transistors (Q1014 or Q1024). This raises the emitter voltage to an excessive level. When the

signal waveform comes back on screen, a transient oscillation occurs in the lumped LC formed by L1018, C1035 and C1153. The oscillation-energy excursion diverts emitter current from the delay-line drivers and causes amplifier distortion as shown in Figure 1. The size of the aberration depends on the vertical position of the waveform.

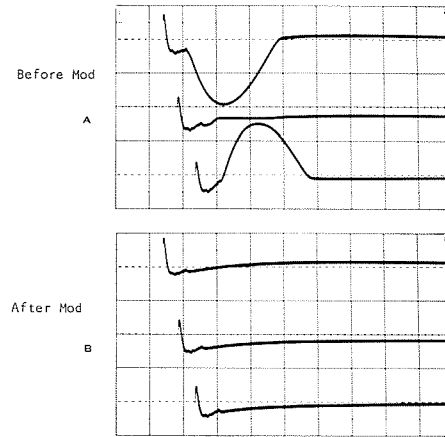

Figure 1. A—Waveform aberration before addition of R1020. B—After addition. Signal Source: 1 Volt Cal, Sweep Rate 1 μs/cm. Type W Unit Control Settings: Vc + 11, INPUT ATTEN 1, DISPLAY A-Vc, MILLIVOLTS/CM 5. (Triple exposure photos.)

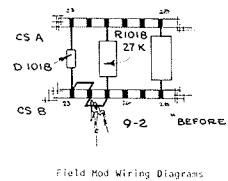

Figure 2. "Before" and "After" sketches showing how to install the 330 Ω resistor R1020.

NEW FIELD MODIFICATION KITS

TYPE 310 OSCILLOSCOPES — SILICON RECTIFIERS

This modification replaces the selenium rectifiers SR601 or SR660 and SR630 with silicon rectifiers, offering more reliability and longer life.

The modification involves the removal of the old selenium rectifiers and the installation of a new silicon rectifier assembly. The new assembly includes three resistors (R601, R630, and R660), which compensates for a lower voltage drop across the twelve silicon diodes in the new assembly.

This modification is applicable to Type 310 Oscilloscopes, serial numbers 101-10000. Order through your local Tektronix Field Office, Field Engineer, Field Representa-

tive or Distributor. Specify Tektronix part number 040-0195-00.

TYPE 551 OSCILLOSCOPE—SILICON RECTIFIERS

This modification replaces the selenium rectifiers with silicon diodes which offer more reliability and longer life.

The modification involves the removal of selenium stacks SR690, SR660, SR640, SR700 and SR740 and the installation of a new silicon rectifier assembly. The new assembly includes resistors which compensate for a lower voltage drop across the 20 silicon diodes in the new assembly.

This modification is applicable to Type 551 Oscilloscopes, serial numbers 101-2357.

Order through your local Tektronix Field Office, Field Engineer, Field Representa-

A 330 Ω, ¼ w, 10% resistor (Tektronix part number 316-0331-00) connected effectively between the junction of the inductor, L1018, and the two capacitors, C1035 and C1153, will act as an oscillation damper and overcome this problem. The "Before" and "After" sketches in Figure 2 show how to install the 330 Ω resistor.

Designate this new resistor R1020 and make the necessary corrections to the parts list and on the schematic of your instrument's Instruction Manual.

This modification is applicable to the following instruments:

TYPE	SERIAL NUMBER
544	101-210
RM544	101-210
546	101-449
RM546	101-150
547	101-940
RM547	101-180

*In conjunction with this modification, Type W Units with serial numbers 101 through 169 will require the addition of an 0.1 μf discap (Tektronix part number 283-0057-00). Type W Units with serial numbers 170 and up have the additional capacitor installed at the factory.

The new capacitor is installed in parallel with R283, a 2-k, 5-w, wire-wound resistor.

To install the new capacitor, turn the Type W Unit upside down on the bench with the front panel facing you. R283 is located on the rear of the chassis to the left and just under the Amphenol connector. Solder one lead of the new 0.1 μf capacitor to the top lug of R283. Solder the other lead to the bottom lug of R283.

Designate the new capacitor C283 and add it to the parts list and schematic of the Type W Unit's Instruction Manual.

tentative or Distributor. Specify Tektronix part number 040-0206-00.

TYPE 551 OSCILLOSCOPES—MULTI-TRACE COMPATIBILITY

This modification assures compatibility between the Type 551 Oscilloscopes and Multi-Trace plug-ins (i.e., 53C, 53/54C, C, CA, M, 1A1, 1A2, etc).

The "Multi-Trace Units Sync Amplifier" V154 (a 6AU6 tube) is replaced with a 6DJ8 duo-triode which supplies Alternate Trace sync pulses to each plug-in.

The isolation of the two sync pulses prevents the differences in the plug-in Alternate-Trace switching circuitry and input impedances from locking up the switching circuitry in one or both of the plug-ins when they are in the Alternate Mode.

This modification is applicable to Type 551 Oscilloscopes, serial numbers 101-5953. A few instruments in the serial number range 5575-5950 were factory modified. Instruments within this range should be checked before the modification is ordered. If V154 is a 6DJ8, the instrument has been modified.

Order through your local Tektronix Field Office, Field Engineer, Field Representative or Distributor. Specify Tektronix part number 040-0398-00.

TYPE 524D TELEVISION OSCILLOSCOPES — HIGH-VOLTAGE POWER SUPPLY

This modification includes a new High-Voltage Power Supply which has been redesigned mechanically on a larger chassis.

With the new chassis, one can replace a defective part rather than replace the

TYPE 540 SERIES AND TYPE 551 OSCILLOSCOPES — VERTICAL AMPLIFIER BIAS

This modification increases the bias on the 6DK6 tubes in the distributed amplifiers. This imparts a greater reliability to the tubes and a better stability to the Vertical Amplifier.

It is applicable to the following instruments:

Type	Serial Numbers
541	6475 - 7022
543	101 - 181
545	9292 - 11691
RM41	101 - 142
RM45	101 - 205
551*	101 - 291

* The Type 551 instrument has two identical main amplifiers. Order two modification kits for this instrument.

Order through your local Tektronix Field Office, Field Engineer, Representative, or Distributor. Specify Tektronix Part Number 040-0191-00.

entire supply and the new layout provides greatly improved ventilation.

The modification is applicable to Type 524D instruments, serial numbers 101-1429.

Order through your local Tektronix Field Office, Field Engineer, Field Representative or Distributor. Specify Tektronix part number 040-0058-00.

TYPE 524AD OSCILLOSCOPES — PROBE POWER

This modification supplies the instructions and components for converting the Probe Power Supply in the Type 524AD from AC to DC filament voltage. The DC filament voltage reduces hum to a minimum when the instrument is used with a P500CF cathode-follower probe.

The modification is applicable to Type 524AD instruments, serial numbers 1843-6649.

TYPE RM567 OSCILLOSCOPES — IMPROVED FRAME PLATES

This modification supplies improved frame plates for the Type RM567 Oscilloscopes. The new left-hand frame plate contains a removable panel for ease of access to the Vertical plug-in unit during calibration. The new right-hand frame plate provides better access to the 6R1A Digital Unit's plug-in cards and their Bendix connectors.

Please note that, in order to accommodate the above improvements, the chassis tracks are relocated on both frame plates. The rack-mounted portion of the tracks must be relocated in the rack in order to maintain the same position of the instrument in the rack.

This modification is applicable to Type RM567 instruments with s/n's 101-2029.

Order through your local Tektronix Field Office, Field Engineer, Representative, or distributor. Specify Tektronix Part Number 040-0378-00.

Order through your local Tektronix Field Office, Field Engineer, Field Representative or Distributor. Specify Tektronix part number 040-0274-00.

TYPE 531 AND TYPE 535 OSCILLOSCOPES — B+ DELAY RELAY CONVERSION

This modification provides long-term reliability for K701, the B+ Delay Relay, by installing a more expensive relay designed around tighter specifications.

The modification is applicable to Type 531 Oscilloscopes, serial numbers 101-1280 and Type 535 Oscilloscopes, serial numbers 101-1703.

Order through your local Tektronix Field Office, Field Engineer, Field Representative or Distributor. Specify Tektronix part number 040-0085-00.

TYPE 524D AND TYPE 524AD OSCILLOSCOPE — IRE RESPONSE NETWORK

In this modification a new IRE Response Network installed in the oscilloscope changes the roll-off characteristics to conform with the Revised Standard '58 IRE 23.1 as amended July 1, 1961.

This modification kit is applicable to Type 524D Oscilloscopes, s/n's 1400 - 1842 and Type 524AD Oscilloscopes, s/n's 1843 - 6835. It is also suitable for Type 524D's with s/n's below 1400 that have the four-position VERTICAL RESPONSE switch installed (Tektronix Field Mod Kit 040-057). It is *not* for use with instruments which have Tektronix Field Mod Kit 040-271 (Four-Position Vertical Selector Switch) installed.

Order through your local Tektronix Field Office, Field Engineer, Representative, or Distributor. Specify Tektronix Part Number 040-0343-00.

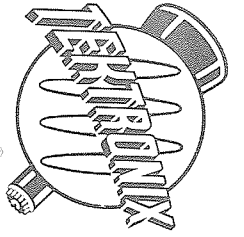

Tektronix, Inc.
P. O. Box 500
Beaverton, Oregon

Service Scope

USEFUL INFORMATION FOR

USERS OF TEKTRONIX INSTRUMENTS

E. F. Porter, Des. & Const. Div.
Department of Transport
Telecommunications Div.
#3 Temporary Bldg., Room B193
Ottawa, Ontario, Canada 4/62

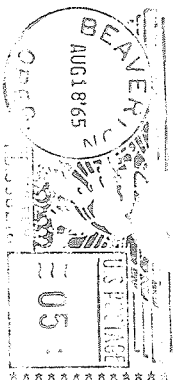



Service Scope

USEFUL INFORMATION FOR USERS OF TEKTRONIX INSTRUMENTS

NUMBER 34

PRINTED IN U.S.A.

OCTOBER, 1965

INTRODUCTION TO OSCILLOSCOPE DIFFERENTIAL AMPLIFIERS

by

Joseph E. Nelson

Tektronix Product Technical Information Group

This is the second and concluding half of an article describing oscilloscope differential amplifiers. The first half, which appeared in the August, 1965 issue of SERVICE SCOPE, discussed differential amplifier characteristics such as common mode rejection ratio, voltage range, frequency range, etc. The effect of probes and filters as well as the importance of source impedance was also discussed.

This second half of the article presents several applications that either require a differential amplifier or can more effectively be performed with a differential amplifier.

Part II Applications

Differential Measurements

A differential input measurement is one in which the two inputs to a differential amplifier are connected to two points in a circuit under test and the amplifier displays the difference voltage between the points. In this type of measurement each input of the amplifier acts as a reference for the other and ground connections are only used for safety reasons. (Note: The term "differential input" is synonymous with "floating input".)

One application in which differential input was used to advantage concerned the power source of an electric railroad engine. This was a 3-phase transformer system with a solid-state controller that consisted of strings of silicon-controlled rectifiers. The measurement problem was to examine the individual rectifier switching characteristics and note risetime, ringing, and point of occurrence. The circuit (simplified) is shown in Figure 10.

The voltage across the silicon controlled rectifiers before switching was approximately 250 volts; however, the entire system was several kV off ground. Because of

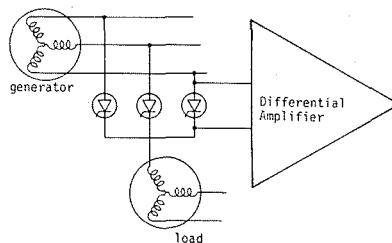

Figure 10. A differential amplifier connected for a differential input measurement in the power system of an electric train.

this latter voltage, two P6013 high-voltage X1000 probes connected to a differential amplifier were used. With this arrangement, the amplifier sensitivity was increased to a point where the switching transients could be seen and photographed.

Slideback Technique

Slideback can be defined as the technique of applying a dc voltage to one input of a differential amplifier in order to change the vertical position on the crt screen of the signal applied to the other input. For example, if an oscilloscope differential amplifier is set for a vertical sensitivity of 0.01 V/cm (trace on-screen) and a +1 volt dc voltage is applied to input A, the trace will

be deflected upward off screen. If a +1 volt dc voltage is now applied to input B, the trace will return on screen. One might say that the signal *slides back* on-screen as a result of the voltage (slide-back voltage) applied to input B. Also, and this is the principle of operation, the dc voltage applied to input B is common-mode with that of input A, and thus, both are rejected by the amplifier.

A measurement problem often encountered is the need to examine a pulse (say 0.01 volt height) that is superimposed on a dc level (say +1 volt), and make the measurement with the oscilloscope's amplifier decoupled.

If this composite signal is applied to input A of a differential amplifier and a +1 volt dc voltage (slideback voltage) is applied to input B, the two dc levels are common-mode and thus rejected, and only the pulse remains. In this situation, the vertical sensitivity could be increased to 5 mV/cm where the pulse would have a height of 2 centimeters.

Because the dc level of the composite signal in this example can be any voltage up to the maximum common-mode input voltage specified for the amplifier, the slideback voltage should be adjustable from

zero volts up to this maximum common-mode input voltage level. With this source in a separate black box, an arrangement similar to that shown in Fig. 11 can be set up.

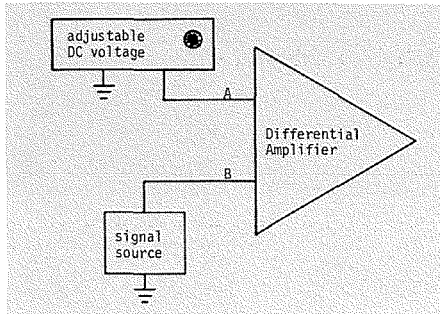

Figure 11. Circuit connections for the slideback technique described in the text.

A second example of slideback technique concerns the detailed examination of small amounts (1 millivolt) of modulation superimposed on a pulse or square wave of +1.0 volt pulse height. If this pulse is applied to input A of a differential amplifier (at 0.2 V/cm) and the "black box" slideback voltage source applied to input B, the pulse displayed on the crt screen can be moved vertically by varying the slideback voltage. If the sensitivity is now increased to 1 mV/cm, the top of the pulse will go off-screen. It can be returned on-screen by adjusting the slideback voltage. Since the sensitivity remained at 1 mV/cm, the sought-for modulation on top of the pulse should occupy one vertical centimeter. (See over-scan limitations later in text).

This example introduces the concept of *effective* crt screen height. A 1 volt pulse was displayed on the crt screen at a sensitivity of 1 mV/cm. Through use of the slideback voltage any portion of the pulse could have been brought on-screen. Since the pulse height was 1 volt and the sensitivity 1 mV/cm, the effective screen height was 1000 cm. The formula for finding the effective screen height is:

$$\frac{\text{Slideback Voltage}}{\text{Vertical Sensitivity}} = \text{Effective screen height}$$

Applying this formula to the Tektronix Type W High-Gain Differential Comparator Plug-In Unit comes out as follows:

$$\frac{\pm 11,000 \text{ V dc}}{.001 \text{ V/cm}} = 11,000 \text{ cm maximum}$$

Differential Comparator

Carrying the slideback technique one step further by making the slideback voltage a calibrated supply with a precision dial and building this into the amplifier makes the device a differential comparator. This instrument, sometimes called a slideback voltmeter, can make both ac and dc voltage measurements. The precision of these measurements in terms of a \pm percent can be calculated from the differential comparator

specifications (attenuator accuracy, comparison voltage accuracy, etc.; see example later in text).

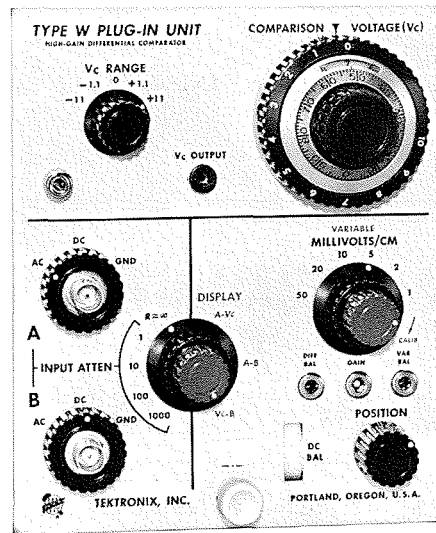

Figure 12. The Tektronix Type W High-Gain Differential Comparator Plug-In Unit.

Operation of the differential comparator as a precision voltmeter consists of applying the signal to be measured to input A with the front panel controls set for a comparison measurement. This internally connects the comparison (slideback) voltage (V_c) to input B. Figure 12 shows the front panel of the Type W High-Gain Differential Comparator Plug-In Unit. Note that the V_c range switch not only changes the range but also can change the polarity of the comparison voltage. This allows comparisons with both positive-going and negative-going signals.

In dc voltage measurements the signal-carrying cable is connected to the A input connector with the input attenuator at 1, but with the input coupling switch set to GND. The display switch is set to A-Vc which means a comparison between whatever signal is present at input A and the comparison voltage. The precision dial is set to zero and the position control used to move the trace (free-run) to the center vertical reference graticule line. This zero voltage line is the start and finish point of a measurement. All that remains is to turn the coupling switch of input A to dc, which allows the trace to disappear off-screen; then slide the trace back on-screen to the reference line with the precision dial. The value of the unknown voltage is the reading of the precision dial.

AC voltage measurements that use ac input coupling have signals that pass through both polarity. To measure peak-to-peak, the comparison voltage dial is adjusted to bring one peak to a graticule reference line and the dial reading is noted. Then the V_c range switch is turned to the opposite polarity and again the precision dial

is used to move the peak to the same graticule reference line. The dial reading is noted, and this reading, added to the first dial reading, equals the peak-to-peak voltage.

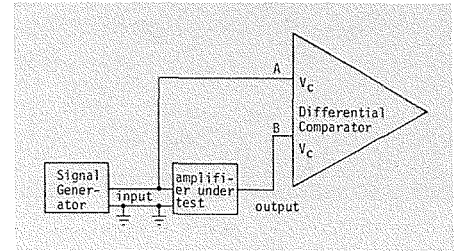

Figure 13. Test setup to measure amplifier gain.

An application in which the two inputs to a differential comparator are used to advantage is the gain setting of low-frequency amplifiers. Figure 13 shows a suggested arrangement in which input A of the comparator is used to measure the input signal (A- V_c Display) and then input B of the comparator is used to measure the output (B- V_c Display).

A second application is the measurement of transmitter carrier power. In the following description, correction must be made for carrier frequencies that are above the flat response portion of the amplifier passband. In addition, since this is a voltage measurement, the transmission line should be terminated so as to minimize standing waves. A "Tee" connector is inserted in the output transmission line and used to couple the input of the differential comparator, through attenuator probes, to the line center conductor. Figure 14 shows the connections.

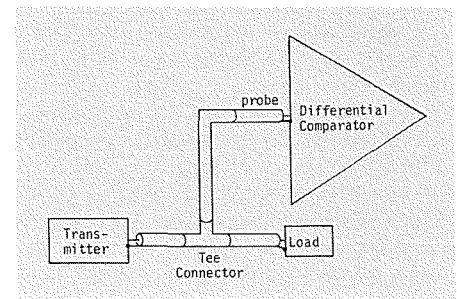

Figure 14. Test setup to measure transmitter power with a differential comparator.

The peak-to-peak sine wave carrier is measured with the differential comparator and the results used in the following formula:

$$\frac{\left[\frac{\text{P-P Voltage}}{2} \times 0.707 \right]^2}{Z \text{ of System}} = \text{Power}$$

For example, if 200 volts peak-to-peak carrier voltage is measured with a differential comparator and the transmission system is 50 Ω , the power is:

$$\frac{\left[\frac{200}{2} \times 0.707 \right]^2}{50 \Omega} = \frac{70.7^2}{50 \Omega} = \frac{4998.5}{50 \Omega} = 99.97 \text{ W}$$

At low power, as in this example, the signal can be connected directly into the comparator, but at higher power levels attenuator probes must be used and the tolerance of these probes should be included in the power computation.

Limitations of Differential Comparators

Overscan Recovery is a characteristic of differential comparators that states the time required for the amplifier to recover to within some amount of voltage after a return to the screen. For example, in the discussion of effective screen height, the top of a pulse was brought on-screen by use of the slideback voltage. When the pulse falls and rises again, the rapid change causes peaking and ringing of the pulse leading edge. The overscan recovery specifications state that this ringing will reduce to within 10 millivolts after 300 nanoseconds (W unit). Because of this, measurements should not be made in the first 300 nanoseconds after the leading edge of the pulse reappears on the screen.

Rate of Rise is a specification of some differential amplifiers (Tektronix Type Z Differential Comparator Plug-In Unit) that is specified in volts per time. For instance, the maximum rate of rise of the Z unit is 1 volt in 7 nanoseconds. Signals that exceed this rate will cause grid current and subsequent waveform distortion. Similarly, rate of fall of the Z unit is 1 volt in 5 nanoseconds.

Recovery from the conditions caused by pulses that exceed these rates takes an amount of time that is proportional to the pulse amplitude. For example, a 10.0 volt pulse that exceeds the rate of rise specification (say 1.0 volt per 7 nanoseconds) would cause the first 70.0 nanoseconds, measured from the start of the rise, to be unusable.

Differential Comparator Measurement Accuracy

The accuracy of a differential comparator measurement depends on several characteristics of the amplifier. These are: comparison voltage (V_c) and linearity accuracy, CMRR, drift, and input attenuator accuracy. In addition to these characteristics which affect *all* measurements, certain other factors must be considered when measuring pulse amplitude. These include: errors due to amplifier recovery, shift in reference level, and input attenuator compensation.

Each of these characteristics, where applicable, can influence the overall accuracy of a measurement. By adding the tolerance figures of each characteristic, a "worst case" figure can be obtained for any particular comparator measurement. For example, the overall accuracy of a dc level measurement of approximately 25 volts (2.5 volts after X10 input attenuation) using a W unit would be:

Operator resolution (1 mm at 10 mV/cm)	0.04 %
--	--------

V_c supply accuracy	0.15 %
V_c readout linearity (0.05% of 11.0 volt range)	0.22 %
CMRR (20,000:1)	0.005%
Reference drift (1 mV)	0.04 %
Input attenuator accuracy	0.05 %

Overall accuracy	0.505%
------------------	--------

A pulse measurement in which the signal was approximately 25 volts (2.5 volts after X10 input attenuation) with a width of 0.75 microseconds would be:

Operator resolution (1 mm at 10 mV/cm)	0.04 %
V_c supply accuracy	0.15 %
V_c readout linearity (0.05% of 11.0 volt range)	0.22 %
CMRR (20,000:1)	0.005%
Reference drift (1 mV)	0.04 %
Input attenuator accuracy	0.05 %
Input attenuator compensation (1% with 20 microseconds time constant)	1.00 %
Recovery offset (10 mV)	0.40 %
Reference level shift (5 mV)	0.20 %

Overall accuracy	2.105%
------------------	--------

The large influence of the input attenuator compensation (1%) in this example is due to the narrow width of the signal. When this width is increased to 100 microseconds, the overall accuracy figure is 0.958%.

The tolerance figures used to compute the overall figures can be obtained from the instrument instruction manual. The following formulas should be used to convert these figures to percentages where necessary.

$$V_c \text{ readout linearity} = \frac{V_c \text{ linearity (\%)} \times \text{range in volts}}{V_c}$$

CMRR error is the reciprocal of the CMRR expressed as a percentage
 $CMRR \text{ error (\%)} = 1/CMRR$

$$\text{Reference drift} = \frac{\text{drift (volts)}}{V_c} \times 100\%$$

$$\text{Error due to amplifier recovery} = \frac{\text{offset (volts)}}{V_c} \times 100\%$$

In the above formula, offset refers to the voltage that remains due to overdrive recovery at the time a measurement is made.

$$\text{Error due to reference shift} = \frac{\text{shift (volts)}}{V_c} \times 100\%$$

Measuring Potentiometer Conformity

A differential amplifier combined with a storage oscilloscope and test jig can be used to measure linearity, tracking, and backlash of potentiometers. The test setup is similar for all three measurements and is shown in Figure 15.

Linearity (independent): This term is defined as the maximum deviation, expressed as a percent of the total applied voltage, of the actual function characteristic from a

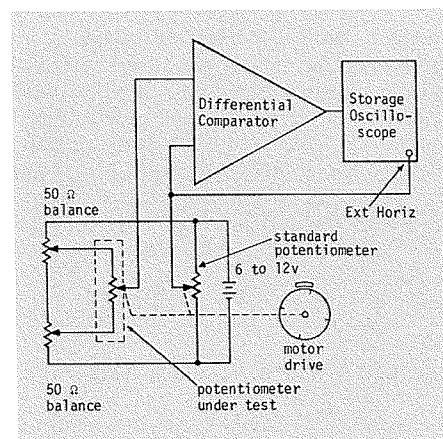

Figure 15. Test setup to check potentiometers for linearity, tracking, and backlash.

straight reference line with its slope and position chosen to minimize the maximum deviation over the actual electrical travel, or any specified portion thereof*.

The test for linearity is a comparison between a standard and unknown. A standard potentiometer and the potentiometer to be tested are connected in the test circuit with their shafts mechanically coupled together. Both controls are set at the end of their shaft rotation (zero volts out) and the differential amplifier and the oscilloscope are adjusted to position the start of the trace at the vertical midline. Since the horizontal trace is driven by the voltage from the standard potentiometer, the horizontal amplifier should be adjusted to make the complete rotation of the potentiometers correspond to degrees, i.e., degrees per horizontal centimeter. Thus, deviations in linearity can be described in terms of voltage excess at specific points of shaft rotation. For example, a report on a test could read "20 mV beyond tolerance at 200° from ccw end."

With both potentiometers coupled together and connected to the amplifier, it only remains to determine the sensitivity setting of the amplifier before the actual test is run. This setting depends on the tolerance of the potentiometer under test. For example, $\pm 0.1\%$ linearity would mean that the difference voltage between standard and unknown should not exceed 0.1% of the total voltage applied across the controls. With 10.0 volts as a source voltage, the allowable deviation is ± 0.010 volt. With the differential amplifier sensitivity set to 5 mV/cm, the tolerance is ± 2 vertical centimeters from the midline.

The test is completed by turning the two controls throughout their range, either by hand or driven by a slow-speed motor. The interpretation of the trace is simply whether it is within the tolerance limits prescribed.

*From: *Wirewound Precision Potentiometers*, an Industry Standard published by the Precision Potentiometer Manufacturers Assn.

At this point the backlash** of the potentiometer can be checked by reversing the rotation of the control shafts and returning them to their starting point. If no backlash is present, the new trace will exactly superimpose over the first. But with backlash, the new trace will be shifted, and the amount of this shift is a measure of the backlash. This same check can be made after the tracking measurement described below:

Tracking: This term is defined as the difference at any shaft position between the output ratios of any two commonly actuated similar electrical elements expressed as a percentage of the single total voltage applied to them.

In tracking, the measurement is: how closely do two or more ganged potentiometers have the same output voltage as they are rotated throughout their range? The test setup is the same as that shown in Figure 15. The specification is usually given as: should track within some percentage such as 1.0%. With this specification and 10 volts applied across the potentiometers

**Backlash: Defined as the maximum difference in a shaft position that occurs when the shaft is moved to the same actual output ratio point from opposite directions. This measurement excludes the effect of resolution and contact width.

under test, the difference voltage should not exceed 1% of 10 volts or 0.1 volt. At these figures, the sensitivity of the differential amplifier should be set to 0.05 V/cm. This corresponds to ± 2 vertical cm.

Backlash can also be checked as described above under linearity. However, in this case the results are total backlash for both controls.

About the Author

Joseph E. Nelson originally trained as a biochemist at Massachusetts Institute of Technology while a member of the U.S. Army. This was concurrent with 6 years as a clinical chemist in army laboratories during World War II.

At the conclusion of World War II, he entered electronics with stress on communications. During the fifties, while with Northrop Aircraft he became associated with standards and measurement techniques. He has published several articles on primary and secondary standards and their relationship to the calibration laboratory.

With Tektronix he has served as a technical writer of instruction manuals and currently as an engineering writer of technical application and instructional articles.

Drawing on his original training as a chemist, he is now active in seeking ways to apply electronic instruments such as differential amplifiers to the field of analytical chemistry.

—The Editor

ERRATA

Figure 9 in Part I of Introduction to Oscilloscope Differential Amplifiers published in the August 1965 issue of Service Scope is incorrectly drawn. The probe shields, in all cases, should be shown grounded to the differential amplifier chassis as follows:

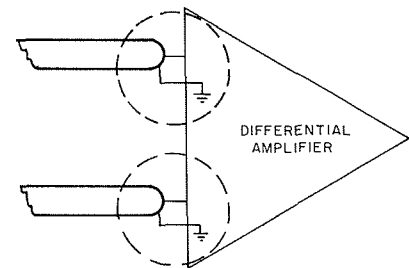

Also in the article, Introduction to Oscilloscope Differential Amplifiers under the heading Probes and Common-Mode Rejection, 2nd paragraph, page 3, the statement, "Tektronix Type 190B Sine-wave Generator at 1 kHz," should read, "General Radio Type 1210C Sine-Wave Generator set to 1 kHz."

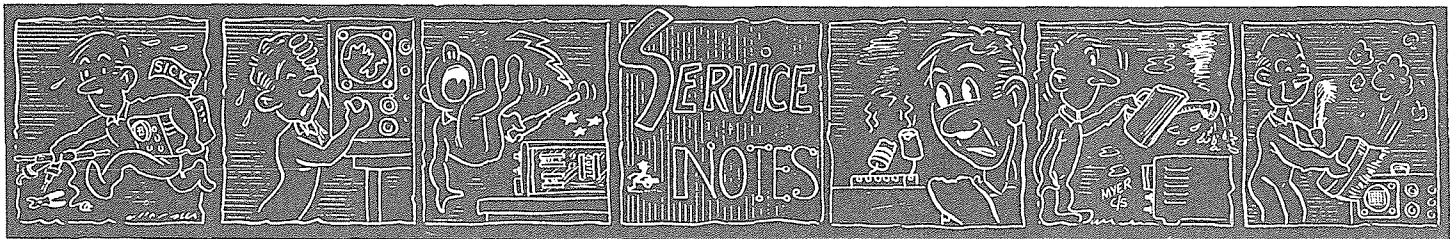

IEEE STANDARD SYMBOLS FOR UNITS

In this issue of SERVICE SCOPE we initiate our use of the IEEE STANDARD SYMBOLS FOR UNITS. Future issues of SERVICE SCOPE will continue to use this standard.

The IEEE publication *IEEE Transactions on ENGINEERING WRITING AND SPEECH*, Volume EWS-8, No. 1, June 1965, presented the Symbols in an article entitled "IEEE Standard Symbols for Units". The Symbols first appeared in the publication "IEEE Standard Symbols for Units, No. 260 (Revision of Part

of 51 IRE 21 S1), January 1965".* The Standard Symbols for Units was compiled by the Abbreviations Subcommittee of the IEEE Symbols Committee. It represents four years of careful consideration, thorough discussion and plain hard work by many people. It is consistent with the recommendations of the International Organization for Standardization (ISO) and with the current work of the International Electrotechnical Commission (IEC).

Tektronix, Inc. has decided to follow the lead of the IEEE and adopt the Sym-

bols for Units as a standard for use in our texts, equations, in graphs and diagrams, on the panels and name plates. In so doing, we admit, along with the IEEE, that the Symbols for Units is not perfect. We do believe, however, that the potentialities it offers for better, unambiguous communication are great.

* Reprints are available (\$1.00 for IEEE members; \$3.00 for nonmembers) from IEEE headquarters, 345 East 47 Street, New York, N.Y. 10017.

TEKTRONIX PARTS REPLACEMENT KIT 050-0226-00 — ATTENTION U.S. AIR FORCE INSTRUMENT-CALIBRATION AND REPAIR PERSONNEL

The instruction sheet for parts replacement kit 050-0226-00 contains an error. This kit replaces the selenium rectifier stack SR741 or SR701 in the Type 180A Time-Mark Generator, or SR460 in the Type 315D Oscilloscope with a silicon rectifier bridge. The kit was produced as a special order for the U.S. Air Force.

The error in the instruction sheet is important only when the kit is used to replace SR701 in the +350-V supply of the Type 180A Time-Mark Generator.

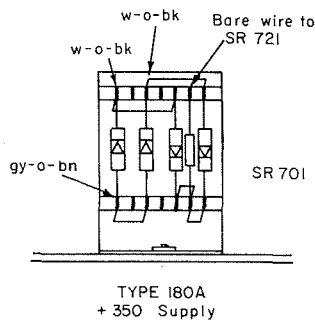

Figure 1 (a).

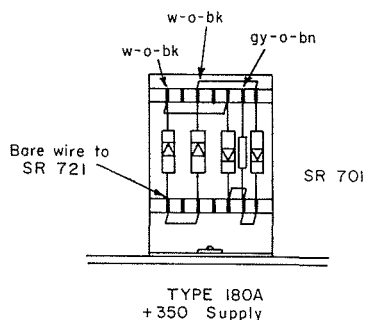

Figure 1 (b).

Figure 1 (a) is a reproduction of the SR701 rectifier diagram as it appears in the instruction sheet. Here the plus (gy-o-bn wire) and minus (bare wire strap) leads are called out incorrectly. With SR701 connected in this manner, the resistor R701 will smoke and burn. Figure 1 (b) shows SR701 connected properly. Notice that the plus and minus leads are connected the reverse of the way shown in Figure 1 (a).

Our thanks to Sgt. Haist of the Portland Air Force Base for calling this error to our attention.

TYPE 1A1 DUAL-TRACE UNIT—VAR. ATTEN. BAL. CONTROL REPLACEMENT

The following information applies to Type 1A1 Dual-Trace Units with serial numbers below 360.

R130 (Channel 1) and R230 (Channel

2) are the parts list and schematic designations for the potentiometers that serve as the VAR. ATTEN. BAL. controls for Channel 1 and Channel 2 in the Type 1A1 Unit.

Starting with serial number 360, these potentiometers were replaced with a more-serviceable potentiometer (Tektronix part number 311-0459-00). This is the potentiometer you should order when replacing R130 or R230 in units with serial numbers below 360. You should also order an adapter nut (Tektronix part number 220-0420-00) for each replacement potentiometer. The nut used to hold the original potentiometer will not fit the replacement.

TYPE 555 DUAL-BEAM OSCILLOSCOPE — FAILURE OF INTENSITY CONTROL TO TURN OFF BEAM

The Type 555 Oscilloscope has two INTENSITY controls—one for the Upper Beam and one for the Lower Beam. Inability of one of these controls to turn off its associated beam may be caused by failure of the type 5642 vacuum tube in the INTENSITY control's circuit. Schematic designation of this tube is V822 in the Upper Beam's INTENSITY control circuit or V922 in the Lower Beam's INTENSITY control circuit. Replacement of the defunct 5642 tube will generally clear up the problem.

TYPE M FOUR-TRACE PLUG-IN UNIT—CHANNELS A, B, C, AND D: CROSS-TALK REDUCED

The addition of four 0.01 μ F capacitors (Tektronix part number 283-0050-00) will eliminate high-frequency cross-talk (approximately 0.5% at 20 MHz) in early Type M Four-Trace Units, serial numbers 101-3120.

To add the capacitors, install a #2 solder lug (Tektronix part number 210-0001-00) under the socket-mounting screw nearest pin 2 of each V5323 tube socket. V5323 is a type 7586 vacuum tube and there are four of them—one for each channel—in a Type M Unit. Solder an 0.01 μ F capacitor between pin 2 of the tube socket and the newly installed solder lug of each V5323 tube.

Designate the capacitor C5323 and add it to the parts list and schematic of the Type M Unit's Instruction Manual.

Type M Units, serial numbers 3120 and up have this modification installed at the factory.

TYPE 3A3 DUAL-TRACE DIFFERENTIAL AMPLIFIER — UNSTABLE TRACE AND DC SHIFT

Some Type 3A3 Dual-Trace differential amplifier units within the serial number range 101-969, will sometimes exhibit an unstable trace and evidence of dc shift

when the attenuator POSITION control is adjusted. This, when it occurs in Channel 1, is caused by oscillations in transistor Q143 and (or) Q243, and, when it occurs in Channel 2, by oscillations in transistors Q343 and (or) Q443.

The cure is the addition of 4 ferrite cores (Tektronix part number 267-0532-00). Install a ferrite core on the #22 wire strap that runs between the emitter pin and the ceramic strip of each of the four transistors, Q143, Q243, Q343, and Q443. Designate the cores L143, L243, L343, and

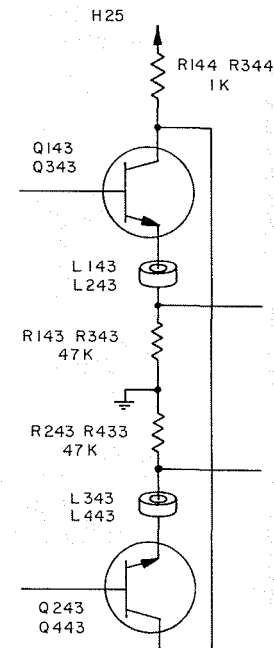

Figure 2. Partial schematic showing installation of ferrite cores to emitter leads of Q143, Q243, Q343, and Q443 in the Type 3A3 Unit.

L443 as shown in Figure 2. Add them to the parts list and to the Channel 1 Input Amplifier and the Channel 2 Input Amplifier schematics in your Type 3A3 Instruction Manual.

TYPE 3A74 FOUR-TRACE PLUG-IN UNIT — PROTECTION AGAINST LARGE POSITIVE TRANSIENTS

The addition of a 1k, $\frac{1}{2}$ W, 10% resistor (Tektronix part number 302-0102-00) in early Type 3A74 Plug-In Units reduces the possibility of a failure of the Channel 1 trigger-amplifier transistor, Q503, caused by a large positive transient at the input connector. The new resistor replaces the wire strap between the collector and ground of the trigger-amplifier transistor Q503.

Designate this new resistor R501 and add it to the parts list and schematic in the Type 3A74 Instruction Manual.

This improvement is applicable to Type 3A74 Units, serial numbers 101-1309. In Units with serial numbers 1310 and up the protection is installed at the factory.

TYPE 2B67 TIME-BASE UNIT—PROTECTION FOR DIODE D126

A grid-to-plate short in V135 (a 6DJ8 vacuum tube) in the Type 2B67 Time-Base Unit, can cause damage to the diode D126, when the MODE switch is in the NORMAL position.

Changing R137, a 100 Ω 1/2 W, 10% resis-

tor, to a 220 k, 1/2 W, 10% resistor (Tektronix part number 302-0224-00) and paralleling it with a 68 pF, 500 V speed-up capacitor (Tektronix part number 281-0549-00) will protect D126 against this damage.

R137 is located between pins 1 and 7 of V135.

Designate the new capacitor C137 and add it to the parts list and schematic in your

Type 2B67 Instruction Manual. Note also, in these sections of the Instruction Manual, the changed value for R137.

This information is applicable to Type 2B67 Units with serial numbers below 15380. Instruments with higher serial numbers have the new-value resistor and paralleling capacitor installed at the factory.

NEW FIELD MODIFICATION KITS

TYPE 544, TYPE 546, and TYPE 547 OSCILLOSCOPES — VERTICAL-OUTPUT AMPLIFIER PROTECTION

This modification protects the output transistors Q1114 and Q1134 in the Vertical Amplifiers of the above instruments (both conventional and rackmount versions) from excessive collector voltage. The excessive voltage is caused primarily by grid-to-cathode shorts in V707, a type 6080 series-regulator tube, in the +225 V supply.

The protective circuit consists of a new transistor, Q1109, in series with the collector supply of the output-amplifier transistors Q1114 and Q1134. The base of Q1109 is returned to +100 V through a new 105 V zener diode (D1109). Should the +225 V supply go out of regulation, the fixed base voltage of Q1109 limits the output transistors collector voltage to approximately 205 V.

The new transistors and associated circuitry are all mounted on a small sub-chassis. This sub-chassis mounts near the rear of the input Vertical-Amplifier chassis using an existing hole in this chassis.

This modification is applicable to the following instruments:

TYPE	SN's
544	101-374
RM544	100-119
546	100-449
RM546	100-149
547	100-2343
RM547	100-259

Order through your local Tektronix Field Office, Field Engineer, Field Representative or Distributor. Specify Tektronix part number 040-0405-00.

ALTERNATE/CHOPPED COMPATIBILITY REWORK

This modification kit is applicable to Type 531, Type 535, Type 541 and Type 545 Oscilloscopes, sn's 101-20000, that have had Field Modification Kit 040-0403-00 (see SERVICE SCOPE, issue #5, December, 1960) installed; and, Type RM31, Type RM35, Type RM41 and Type RM45, sn's 101-1000, that have had Field Modification Kit 040-0198-00-01 (see SERVICE SCOPE, issue #5, December, 1960) installed.

Installation of the Alternate/Chopped Compatibility Rework field modification kit

gives to these instruments the ability to utilize the Alternate-Trace feature of the Type 1A1 and Type 1A2 Dual-Trace Plug-In Units.

These plug-in units require an alternate-trace sync pulse at pin 8 of the oscilloscope's plug-in interconnecting socket. This pulse is not available in the oscilloscopes listed above.

The Alternate-Trace/Chopped Compatibility Rework field modification kit corrects this situation by replacing the 6J6 tube in the V78 position with a 6DJ8 tube and changing the oscilloscope's Multi-Trace sync and Chopped-Blanking circuitry to conform to that in the Type 531A, Type 535A, Type 541A, Type 545A/B, Type 546, Type 547, etc., oscilloscopes.

To install the 6DJ8 tube it is necessary to enlarge the socket-mounting hole and replace the original socket for the V78 position with a 9-pin type.

Order through your local Tektronix Field Office, Field Engineer, Field Representative or Distributor. Specify Tektronix part number 040-0404-00.

12 KV HIGH VOLTAGE

This modification is applicable to the following oscilloscopes:

TYPE	SN's
541	101-20000
RM41	101-1000
541A	20000-up
RM41A	1001-up
543	101-3000
RM43	101-1000
543A	3001-up
RM43A	1001-up
545	101-20000
RM45	101-1000
545A	20000-up
RM45A	1001-up
581	101-3974
581A	3975-4999*
585	101-5968
585A	5969-8999*
RM85A	101-999*

The modification replaces the original 10-kV high-voltage transformer with a 12-kV transformer, thus increasing the crt accelerating potential to provide greater intensity at fast sweep speeds.

The vertical and horizontal deflection sensitivities of the crt are reduced approxi-

mately 15%; a special graticule (supplied with the kit) is used to compensate for this reduction. All front panel and manual references to "CM" should be interpreted as "DIV". For example, read "TIME/CM" as "TIME/DIV".

Order through your local Tektronix Field Office, Field Engineer, Field Representative or Distributor. Specify Tektronix part number 040-0176-00.

*NOTE: This kit can be installed in instruments above these serial numbers provided they have external-graticule crt's. It can also be installed in those instruments above these serial numbers provided the instrument is first converted to an external-graticule crt.

The external-graticule crt must be ordered separately as follows:

Crt, external grat. P31 phosphor (T5810-31), Tektronix part number 154-0354-00.

Crt, external grat. P11 phosphor (T5810-11), Tektronix part number 154-0230-00.

Steps 17 through 22 on page 4 of the modification's instruction sheet tell how to remove the internal-graticule crt and install the external-graticule crt replacement.

TYPE 530 AND TYPE 540 SERIES OSCILLOSCOPES — DC FAN MOTOR

This modification supplies a dc fan motor to enable the following instruments to operate on 50-400 cycle power lines.

TYPE	SN's
531	5001-20000
RM31	101-1000
533	101-3000
RM33	101-1000
535	5001-20000
RM35	101-1000
541	5001-20000
RM41	101-1000
543	101-3000
RM43	101-1000
545	5001-20000
RM45	101-1000

Order through your local Tektronix Field Office, Field Engineer, Field Representative or Distributor. Specify Tektronix part number 040-0255-00.

THE TEKTRONIX TYPE 453 DUAL-TRACE DC-TO-50 MHz PORTABLE OSCILLOSCOPE

Until rather recently, the need for a sophisticated oscilloscope offering DC to 50 MHz bandpass and versatile capabilities was, for the most part, confined to the laboratory. The need today however, for an instrument with these qualities, extends beyond the laboratory into many areas of servicing, research and development. Examples of these areas are: computer installations, radar and guidance systems, telemetry and microwave equipment, commercial aircraft, aerospace work, and defense systems.

In addition to the capabilities stated above, an instrument designed for use outside the laboratory must be capable of withstanding a wide range of environmental conditions, be ruggedly constructed and compactly contained in a highly portable package. The Type 453 Dual-Trace, DC to 50 MHz Oscilloscope is just such an instrument in just such a package. It provides the highest performance compatible with cost and portability. It possesses rather extended environmental capabilities and delivers information with laboratory accuracy.

The vertical amplifier system of the Type 453 Oscilloscope combines in one oscilloscope many features normally available only in a plug-in type instrument using several different plug-in units. These features amongst others are: (a) high gain, low bandwidth; (b) medium gain, high bandwidth; (c) low gain, high bandwidth; (d) medium gain, medium bandwidth, dc coupled; (e) dual trace, low gain, high bandwidth; and, to a not inconsiderable degree, differential input capability.

Here, briefly, are some of this instrument's characteristics:

- 1). Dual-Trace Vert.
- 2). Signal Delay
- 3). 50 MHz basic Vert. bandwidth
- 4). 5 mV/div basic Vert. sensitivity
- 5). 1 mV/div maximum Vert. sensitivity at reduced bandwidth (One Channel only—Ch 1 and Ch 2 cascaded).
- 6). 5 sec/div minimum sweep rate
- 7). 10 nsec/div maximum sweep rate (with X10 magnifier).
- 8). Full bandwidth triggering
- 9). Normal sweep plus delayed sweep
- 10). 6×10 div* (4.8 x 8 cm) vert. and hor. crt display size
- 11). 10 kV crt accelerating voltage
- 12). Only 100 W power consumption
- 13). 31 lbs weight complete with accessories

The Type 453 maintains its full bandwidth of 50 MHz to a sensitivity of 20 mV/div, and drops to 45 MHz and 40 MHz at 10 mV/div and 5 mV/div respectively.

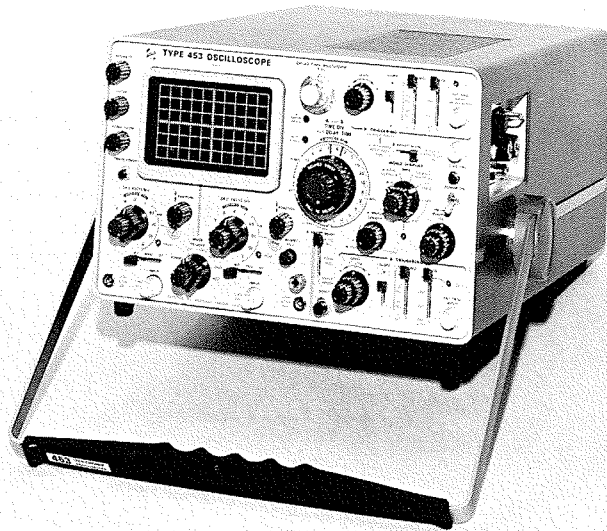

It presents the usual five vertical display modes of dual-trace instruments—CH 1, CH 2, ALT, CHOP, and ADDED. CH 2 has polarity selection to provide some differential amplifier performance in the ADD Mode. Sampling rate for the CHOP Mode is 0.5 MHz rather than 1 MHz—a relaxation that reduces the loss of brightness due to chopped transient blanking.

Internal triggering may be selected between either the displayed signal or that of a single channel. The latter selection enables stable triggering when observing time related events in either of the dual-trace modes.

The input impedance of 1 megohm paralleled by 20 picofarad is compatible to previous laboratory instruments.

All previous passive probes adjustable to this input capacitance are applicable to the Type 453 Oscilloscope. However, a new 10X probe, the P6010, was designed specifically to provide a smaller tip for use with the increasingly compact equipment that it is anticipated this oscilloscope will service. This new probe's tip is pencil size and free of adjustment.

Capacitance compensation is accomplished at the scope end of the probe. Two of these probes are shipped with each Type 453 Oscilloscope. Bandwidth figures quoted here include the effect of the P6010 probe.

The Type 453 utilizes a four-inch, rectangular-faced crt which features an internal graticule illuminated with edge lighting. The significantly improved display contrast of this crt provides enhanced viewing under high ambient light conditions. In addition, a fine mesh filter, placed in front of the crt, attenuates bothersome external reflections for easier viewing.

The Type 453 will operate on either 115 V or 230 V nominal power-line sup-

plies; and, without the need to make internal wiring changes. Two power cords are shipped with the instrument, one for 115 V line supplies and one for 230 V line supplies. Selection of the correct power cords automatically adapts the instrument's power supply to the available line supply. The oscilloscope power supply automatically operates at either nominal voltage, when the appropriate power cord is inserted. A rear-panel switch permits operation on line voltage above or below nominal: high range—103 to 137 volts or 206 to 274 volts, low range—96 to 127 volts or 192 to 254 volts (when line contains less than 2% total harmonic distortion).

The Type 453 will accept the recently-announced Tektronix Type C30 Camera, thus assuring those whose applications require it the capability of trace photography.

Many will find that in the laboratory (where, incidentally, it requires a minimum of bench space) the Type 453 delivers all the oscilloscope capability they require. In addition, it will provide them with an easily transported instrument—remember it weighs only 31 pounds—for servicing equipment or maintenance or research work in the field. This can be a mighty important consideration, particularly for those who must operate on limited budgets.

The Type 453 Dual-Trace DC to 50 MHz Portable Oscilloscope offers many other features not described here. Full appreciation of this advanced example of the state-of-the-art in portable oscilloscopes requires a demonstration of the instrument.

May we suggest you call your Tektronix Field representative or distributor to arrange one. He'll be pleased to accommodate you—no obligation on your part, of course.

* 1 div = 0.8 cm

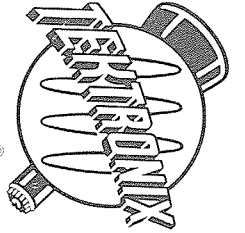

Service Scope

USEFUL INFORMATION FOR

USERS OF TEKTRONIX INSTRUMENTS

Tektronix, Inc.
P.O. Box 500
Beaverton, Oregon, U.S.A. 97005

2777

Mr. Dave Yule
Department of Transport
Maintenance & Operations Div.
Temporary Building #3
Ottawa, Ontario, Canada 8-61

RETURN REQUESTED

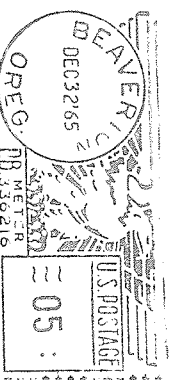



Service Scope

USEFUL INFORMATION FOR USERS OF TEKTRONIX INSTRUMENTS

NUMBER 35

PRINTED IN U.S.A.

DECEMBER 1965

THE FATAL CURRENT

Strange as it may seem, most fatal electric shocks happen to people who should know better. Here are some electro-medical facts that should make you think twice before taking that last chance.

It's The Current That Kills

Offhand it would seem that a shock of 10,000 volts would be more deadly than 100 volts. But this is not so! Individuals have been electrocuted by appliances using ordinary house currents of 110 volts and by electrical apparatus in industry using as little as 42 volts direct current. The real measure of shock's intensity lies in the amount of current (amperes) forced through the body, and not the voltage. Any electrical device used on a house wiring circuit can, under certain conditions, transmit a fatal current.

While any amount of current over 10 milliamps (0.01 amp) is capable of producing painful to severe shock, currents between 100 and 200 mA (0.1 to 0.2 amp) are lethal.

Currents above 200 milliamps (0.2 amp), while producing severe burns and unconsciousness, do not usually cause death if the victim is given immediate attention. Resuscitation, consisting of artificial respiration, will usually revive the victim.

From a practical viewpoint, after a person is knocked out by an electrical shock it is impossible to tell how much current passed through the vital organs of his body. Artificial respiration must be applied immediately if breathing has stopped.

The Physiological Effects of Electric Shock

Chart 1 shows the physiological effect of various current densities. Note that voltage is not a consideration. Although it takes a voltage to make the current flow, the

amount of shock-current will vary, depending on the body resistance between the points of contact.

As shown in the chart, shock is relatively more severe as the current rises. At values as low as 20 milliamps, breathing becomes labored, finally ceasing completely even at values below 75 milliamps.

As the current approaches 100 milliamps, ventricular fibrillation of the heart occurs—an uncoordinated twitching of the walls of the heart's ventricles.

Above 200 milliamps, the muscular contractions are so severe that the heart is forcibly clamped during the shock. This clamping protects the heart from going into ventricular fibrillation, and the victim's chances for survival are good.

Danger — Low Voltage!

It is common knowledge that victims of high-voltage shock usually respond to artificial respiration more readily than the victims of low-voltage shock. The reason may be the merciful clamping of the heart, owing to the high current densities associated with high voltages. However, lest these details be misinterpreted, the only reasonable conclusion that can be drawn is that 75 volts are just as lethal as 750 volts.

The actual resistance of the body varies depending upon the points of contact and the skin condition (moist or dry). Between the ears, for example, the internal resistance (less than skin resistance) is only 100 ohms, while from hand to foot it is closer to 500 ohms. The skin resistance may vary from 1000 ohms for wet skin to over 500,000 ohms for dry skin.

When working around electrical equipment, move slowly. Make sure your feet are firmly placed for good balance. Don't

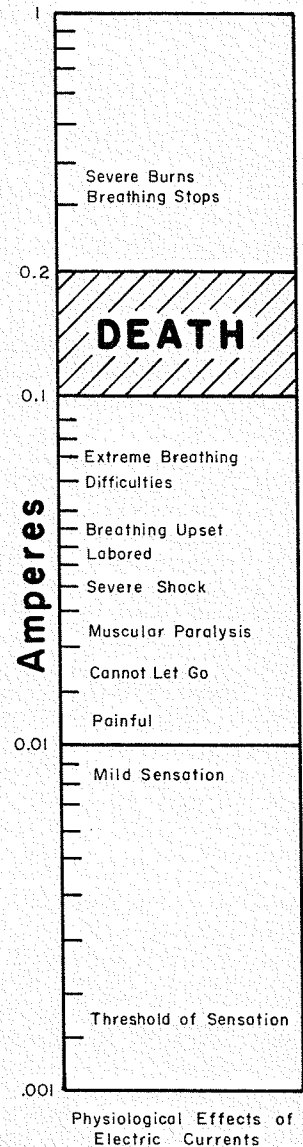

lunge after falling tools. Kill all power, and ground all high-voltage points before touching wiring. Make sure that power cannot be accidentally restored. Do not work on underground equipment.

Don't examine live equipment when mentally or physically fatigued. Keep one hand in pocket while investigating live electrical equipment.

Above all, do not touch electrical equipment while standing on metal floors, damp concrete or other well grounded surfaces. Do not handle electrical equipment while wearing damp clothing (particularly wet shoes) or while skin surfaces are damp.

Do not work alone! Remember the more you know about electrical equipment, the

more heedless you're apt to become. Don't take unnecessary risks.

What To Do For Victims—

Cut voltage and/or remove victim from contact as quickly as possible—but without endangering your own safety. Use a length of dry wood, rope, blanket, etc., to pry or pull the victim loose. Don't waste valuable time looking for the power switch. The resistance of the victim's contact decreases with time. The fatal 100 to 200-milliamper level may be reached if action is delayed.

If the victim is unconscious and has stopped breathing, start artificial respiration at once. *Do not stop resuscitation until*

medical authority pronounces the victim beyond help. It may take as long as eight hours to revive the patient. There may be no pulse and a condition similar to rigor mortis may be present; however these are the manifestations of shock and are not an indication the victim has succumbed.

—Printed through the
courtesy of
Fluid Controls Co. Inc.,
Cliffside, New Jersey,
University of California
Information Exchange
Bulletin and Safer
Oregon.

THE READERS' CORNER

Some readers have indicated an interest in articles written by Tektronix personnel. For these readers' information, we list here the title of the article, the author, the author's title, the publication in which the article appeared and the date of the issue. We include also, a thumb-nail sketch of the article's content.

Reprints of these articles are available through your local Tektronix Field Office, Field Engineer, Field Representative or Distributor.

They are offered on a first-come, first-serve basis. When quantities are exhausted they will not be reordered. Another possible source for the articles is the back-issue file (in a public or company library) of the magazine in which the article originally appeared.

"Straight Scoop on Sampling Scopes", Cliff Moulton, Project Engineer (former employee). *MICROWAVES*, February, 1963. An early explanation of the sampling oscilloscope. What it is, how it works, how the various circuits differ from the conventional oscilloscope.

"Pulse Reflections Pin Down Discontinuities", Gordon Long, Design Engineer. *ELECTRONIC DESIGN*, May 10, 1963. Using a sampling oscilloscope to obtain high resolution measurements when using a pulse-reflection technique to test transmission lines.

"The Cathode Ray Oscilloscope", Will Marsh, Staff Engineer. *MACHINE DESIGN*, June 6, 1963. Using an oscilloscope to obtain precise (and sometimes otherwise unobtainable) information in the field of mechanical design.

"Storage to Picoseconds—a Survey of the Art", C. N. Winningstad, Manager, Display Devices Development. *ELECTRONIC INDUSTRIES*, June, 1963. A comparison of the sampling oscilloscope with the conventional oscilloscope in a series of topics including risetime, sensitivity, display modes, system interaction and interference, and continuing accent on tubes.

"Understanding Operational Amplifiers", Geoffery Gass, Staff Engineer. *ELECTRONIC INDUSTRIES*, February, 1964. An explanation of operational amplifiers and how they work.

"The Sophisticated Oscilloscope", John Kobbe, Manager, Advanced Circuitry Department. *INDUSTRIAL RESEARCH*, March, 1964. A discussion of present-day oscilloscopes and the techniques employed to record oscilloscope data.

"How To Get More Out of Your Spectrum Analyzer", A. Frisch and M. Engelson, Project Managers, *MICROWAVES*, May, 1963. Describes five useful microwave measurements that can be performed with a spectrum analyzer.

"Measuring the Cost of Programmed Instruction", Fred Davey and Jerry Foster, Programmed Instruction Group. *ADMINISTRATIVE MANAGEMENT*, September, 1964. Some guide lines for companies considering the feasibility of writing their own programs.

"How To Measure High-Current Recovery Times in Signal Diodes", C. C. Edgar, Design Engineer. *EEE (Electrical Equipment Engineer)*, October, 1964. A technique for pulsing a diode on and off with cur-

rent of 1 amp or higher and observing the current through the diode for the recovery time.

"Nanosecond Measurements with a Sampling Oscilloscope", H. Allen Zimmerman, Project Engineer. *ELECTRO-TECHNOLOGY*, January, 1965. A description of the sampling process and a discussion of the usefulness and versatility of a sampling oscilloscope.

"Oscilloscope Plug-In Spectrum Analyzers", Weis, Engelson, and Frisch, Project Engineers. *MICROWAVE JOURNAL*, March, 1965. Discusses the advantage of a plug-in spectrum analyzer as compared to a conventional spectrum analyzer.

"Design of Transistorized DC Amplifiers with Reduced Thermal Drift", Jerry Foster, Programmed Instruction Group. *ELECTRONICS AND COMMUNICATIONS (Canada)*, March, 1965. A discussion of one of the prime considerations during the design stage of semiconductor/dc amplifier circuits — thermal compensation.

"Using a Transistor-Curve Tracer", Ralph Show, Instrument Engineering. *ELECTRONICS WORLD*, September, 1965. An explanation of the operation principles of the transistor-curve tracer. The method of interpreting curves to obtain parameters is also covered.

"The Sampling Oscilloscope", compiled from information supplied by Tektronix, Inc. *EDN (Electrical Design News) Test Instrument Reference issue*, 1965. How a sampling system works. How it buys sensitivity at the price of time. Some application techniques.

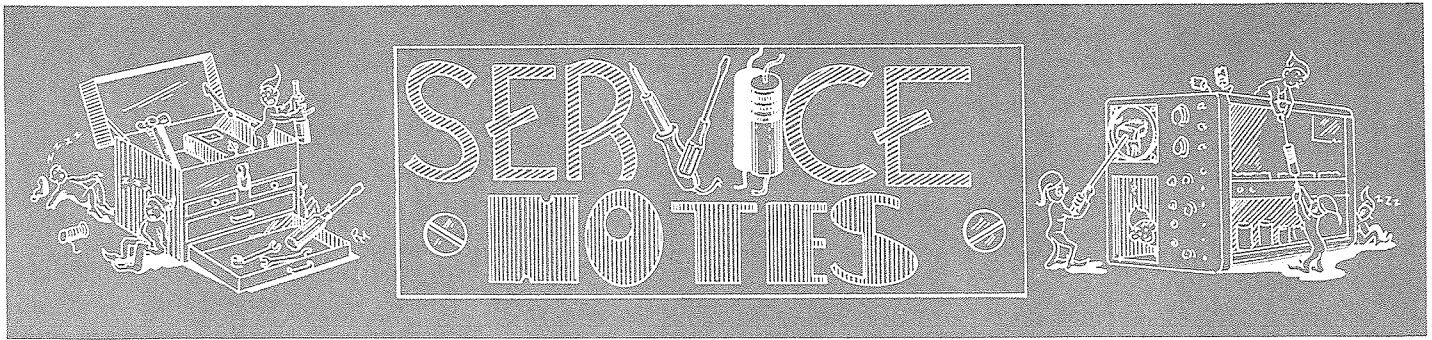

TYPE 1A1 WIDE-BAND DUAL-TRACE UNITS — OSCILLATIONS IN THE "ADD" MODE

Sometimes at turn on, an oscilloscope with a Type 1A1 Unit plugged into the vertical amplifier compartment will display a 10 MHz oscillation on the crt. See Figure 1.

This only occurs when the oscilloscope is turned on with the *MODE* control in the *ADD* position. The phenomena is normal and occurs because: with the *MODE* control in the *ADD* position, both halves of the channel-switching multivibrator (Q305 and Q315) are normally biased on. However, during the oscilloscope turn-on cycle, when the power relay (K601) pulls in, the resulting power-supply transients may turn off one side of the multivibrator and it will go into oscillation.

Switching the *MODE* switch out of *ADD* kills the oscillation and it will not come back unless you repeat the oscilloscope turn-on cycle with the Type 1A1 in the *ADD* mode.

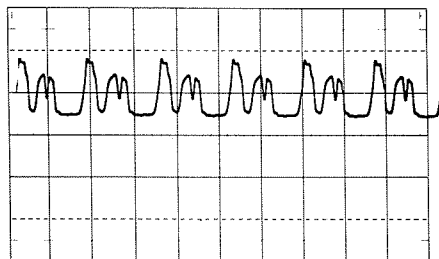

Figure 1. Typical oscillation waveform, caused by conditions described in text, displayed on a Type 547 Oscilloscope. Sweep rate $0.1 \mu\text{s}/\text{cm}$. Waveform will be different on Type 545 (A), (B) Oscilloscopes but fundamental frequency will still be about 10 MHz.

TYPE RM529 WAVEFORM MONITOR —TERMINOLOGY

Early Type RM529 Waveform Monitors, sn's 101-399, use the terms *ODD* and *EVEN* to designate the two positions of the *FIELD SHIFT* switch. Subsequent to the introduction of the Type RM529, the Federal Communications Commission

(FCC) chose to designate these fields as *Field One* and *Field Two*. This new system of designating the fields may be related to the *ODD* and *EVEN* terminology as follows: *Field Two* corresponds to the *ODD* position and *Field One* corresponds to the *EVEN* position of the *FIELD SHIFT* switch on the early Type RM529 instruments.

Beginning with serial number 400 in the Type RM529 we changed the front panel terminology. The designation for the *FIELD SHIFT* switch became *FIELD* and the two positions of this switch were relabeled to conform to the FCC's designation for fields of *ONE* and *TWO*.

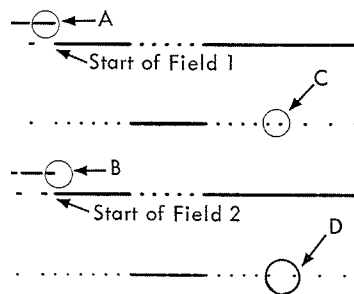

Figure 2. Waveform display showing that *Field One* is preceded by a full line of video (A) and *Field Two* by a $\frac{1}{2}$ line of video (B). (C) and (D) indicate the equalizer pulses in the vertical blanking interval that determine correct instrument triggering.

Notice in the display shown in Figure 2, that *Field One* is preceded by a full line of video and *Field Two* by $\frac{1}{2}$ line of video. (A and B in photo).

The Type RM529 actually uses the position of the first sync pulse after the last equalizer in the vertical blanking interval to determine correct instrument triggering. (See C and D in photo). The *FIELD SHIFT* (*FIELD*) switch selects and indicates the field which will initiate the sweep in all modes of operation. Hence, with the switch set to *ONE*, the vertical sync group seen at mid screen is the start of *Field Two*. Note the $\frac{1}{2}$ line of video that precedes this group.

TYPE 544, TYPE 546 AND TYPE 547 OSCILLOSCOPES — USING THE AMPLITUDE CALIBRATOR WITH A TYPE 1S1 SAMPLING PLUG-IN UNIT

Amplitude Calibrator circuits in Tektronix instruments prior to the Type 544, Type 546 and Type 547 Oscilloscopes, were not intended to be loaded with anything less than 1 megohm. Consequently no effort was made to design the calibrator circuits to have a constant impedance. For the Type 544, Type 546 and Type 547 Oscilloscopes, however, we designed an Amplitude Calibrator circuit that, within the 0.2 millivolt to 0.2 volt range, delivers voltages having a constant 50 ohm source impedance. The development of the Type 1S1 Sampling Plug-In Unit which has a 50 ohm input impedance made such a calibrator desirable.

Here is a word of explanation for those using a Type 1S1 in a Type 544, Type 546 or Type 547 Oscilloscope and looking at the calibrator with the *AMPLITUDE CALIBRATOR* control set to one of the 0.2 millivolt to 0.2 volt (50 Ω constant source impedance) positions.

If you are checking the gain of the Type 1S1 (remember, it has a 50 Ω input impedance) you will find that the gain of the Type 1S1 appears to be 50% low. This is normal—the calibrator voltage indicated by the *AMPLITUDE CALIBRATOR* control will be twice the voltage available at the input of the Type 1S1. In other words, given a voltage with a 50 Ω source impedance and a 50 Ω load, the voltage across the load will be one-half the voltage of the generator.

One can look at it as shown in Figure 3, with the Amplitude Calibrator acting as

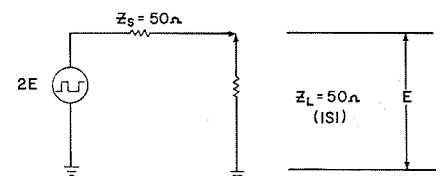

Figure 3. Simplified equivalent circuit representing the Amplitude Calibrator of a Type 544, Type 546, or Type 547 Oscilloscope and a Type 1S1 Sampling Unit.

the generator with a source impedance of $50\ \Omega$ and the Type 1S1 with an input impedance of $50\ \Omega$ acting as the load. If the Amplitude Calibrator open circuit voltage is $2E$, then the voltage across the load will be E . So, if the Amplitude Calibrator is set for 0.2 volts one should read 100 millivolts on the Type 1S1.

We might mention here that when using the Amplitude Calibrator of a Type 544, Type 546 or Type 547 Oscilloscope in conjunction with a plug-in unit or other device having a high input impedance, the voltage delivered at the input of the plug-in or device will agree with the value indicated by the AMPLITUDE CALIBRATOR control setting.

TEST SET UP CHARTS

We would like to bring our readers up to date on the Test Set Up Charts now available.

As you may recall, the charts offer a ready means of recording instrument control settings for any given test or production set-up. For the laboratory this means that in so far as the oscilloscope is concerned, one need no longer rely on memory if the need to repeat the test should occur at a later date. Once the experiment or test has been performed, the oscilloscope control settings can be recorded on the test set up chart, a facsimile of the waveform resulting from the test drawn on the chart graticule (or a photograph of the waveform attached to the chart) and pertinent data recorded on the chart.

For production testing, an engineer generally devises the test procedure required to attain the desired result. He then designates the control settings on the chart and draws a picture of the display on the chart graticule, outlining the limits for acceptance or rejection. The production-test facility takes over at this point and performs the test with speed and accuracy. Often a non-technical person can handle this phase and release a highly trained person for more important work.

We know of several instances where girls from the production test line who had little or no experience with an oscilloscope, set up the oscilloscope and successfully performed the test required. These girls were able to do this using a previously prepared Test Set Up Chart and they required only a minimum of additional instruction.

Listed below are the oscilloscopes for which we now have Test Set Up Charts:

OSCILLOSCOPE	TEKTRONIX PART NUMBER
Type 262	070-0491-00
Type 422	070-0513-00
Type 453	070-0529-00
Type 502	070-0482-00
Type 502A	070-0488-00
Type 503	070-0483-00
Type 531	070-0492-00
Type 532	070-0493-00
Type 541	070-0494-00
Type 545A/CA	070-0481-00
Type 545A/R	070-0485-00
Type 545A/Z	070-0486-00
Type 547/1A1	070-0479-00
Type 561A/2A60/ 2B67	070-0540-00
Type 567	070-0487-00
Type 567/262	070-0490-00
Type 570	070-0484-00
Type 575	070-0480-00
Type 575 (MOD122C)	070-0489-00

Order through your local Tektronix Field Office, Field Engineer, Field Representa-

TYPE 125 POWER SUPPLY—EXCESSIVE RIPPLE IN +135 V SUPPLY

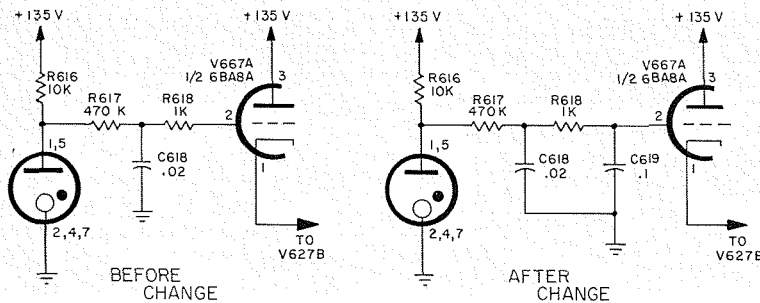

Figure 4. Before and After schematics showing installation of 0.1 discap in the +135 V supply of the Type 125.

In some Type 125 Power Supplies, ripple on the +135 V supply may exceed specifications (3 mV max). This is generally due to stray pick-up at the grid of V667A, one half of a Type 6BA8A tube that forms half a comparator circuit (V6278 and its circuitry form the other half). The solution to the problem is the addition of an 0.1 mFd, 200 V discap (Tektronix part

number 283-0057-00) from the grid, pin 2, of V667A to the ground lug of the V667 tube socket. See Figure 4.

Designate the new capacitor C619 and add it to the parts list and schematic in your Type 125 Instruction Manual.

This modification is applicable to Type 125 Power Supplies, serial numbers 101-2169.

TYPE 1A2 DUAL-TRACE PLUG-IN UNIT—NEW SHAFT COUPLER IMPROVES VARIABLE VOLTS/CM POTENTIOMETER RELIABILITY

If you should have occasion to replace the Variable Volts/CM potentiometer in your Type 1A2 Dual-Trace Plug-In Unit, we suggest you also replace the control shaft and coupler. We now have a new style flexible shaft-coupler that secures with set screws and a new control rod to connect the potentiometer with the front panel control. Tektronix part numbers for the new parts are:

Coupler	376-0054-00
Control Rod	384-0276-00

The nylon pot-coupler formerly used requires a hard push to force the coupler sleeve onto the potentiometer shaft. The exercise of too much force here can cause damage to the potentiometer. The new type coupler and control shaft eliminate this hazard.

This information applies to Type 1A2 instruments with serial numbers below 1160.

TYPE 2B67 TIME-BASE UNIT — STABILITY ADJUSTMENT RANGE MADE LESS CRITICAL

In the early 2B67 Time-Base Units (below sn 10630), it was sometimes hard to find a compromise Stability Adjustment setting for both the NORMAL and SINGLE SWEEP operating modes. Changing resistor R126 from 220 k to a 680 k, $\frac{1}{2}$ W, 10% resistor (Tektronix part number 302-0684-00) usually solves the problem. The original value of the resistor was chosen to compensate for the "spec" leakage in the transistor Q124, but few if any of the transistors ever develop this much leakage, resulting in overcompensation.

R126 is located in the front notches of the pair of ceramic strips that bracket the sweep-length potentiometer R176. After converting R126 to the new (680 k) value, be sure to note the new value in the schematic and parts list of your Type 2B67 Instruction Manual.

All Type 2B67 Time-Base Units, sn's 10630 and up have the modification installed at the factory.

tive or Distributor. The Test Set Up Charts come in pads of 100.

TYPE 545B AND TYPE RM545B OSCILLOSCOPES — TIMING ERROR AT SLOW SWEEP RATES

In some Type 545B and Type RM545B instruments, a timing error may occur in the Time Base B Generator. The error, when it occurs, affects only the slow sweep rates. It is caused by shield-to-cathode current leakage in V252, the dual-triode 12AL5 tube that serves as the disconnect diodes in the Time Base B Generator.

To cure the problem, disconnect, at ground, the #22 bare wire strap that runs from pin 6 of V252 to ground and reconnect it to pin 7 of V252.

This information applies to Type 545B instruments with serial numbers below 2021 and to Type RM545B instruments with serial numbers below 410.

TYPE 525 WAVEFORM MONITOR — PROTECTION FOR THE HIGH VOLTAGE TRANSFORMER

High line voltage or excessive line transients can cause failure of the High Voltage Transformer (T940) in the Type 525 Waveform Monitor. As protection against this hazard, we suggest the installation of

a 390 Ω , 2 W, 10% resistor (Tektronix part number 306-0391-00). Install the resistor between the primary center tap of T940 and the +unregulated dc (360 V) supply.

This information applies to Type 525 instruments, all serial numbers.

TYPE RM561A OSCILLOSCOPE — HIGH VOLTAGE RIPPLE IN THE +125 V SUPPLY

Should you be troubled with high voltage ripple in the +125 V supply of a Type RM561A Oscilloscope, check C642 (A, B), a 160 μ Fd x 10 μ Fd, EMC capacitor in the power supply of the Type RM561A. Be sure that the twist tabs on this capacitor have a good low-resistance contact with the capacitor flange—and that they are securely soldered to the flange.

Failure of these twist tabs to make a good low-resistance contact with the flange may cause the Type RM561A to develop excessive high-frequency (HV oscillator) ripple in the +125 V supply. Amplitude of the ripple may measure up to 20 or 30 millivolts as against one or two millivolts normally. Actual ripple values and the effects on the display will vary considerably among instruments, with time and various plug-in type.

Because of a temporary change in assembly procedure, Type RM561A Oscilloscopes

within the serial number range of 7800-8020 are more prone to the problem described here than other Type RM561A instruments.

TYPE 567 AND TYPE RM567 DIGITAL READOUT OSCILLOSCOPES—INSTALLATION OF IMPROVED CALIBRATOR MOD KIT

The calibration procedure for the Improved Calibrator Modification Kit (Tektronix part number 040-0380-00. See Service Scope #32, June, 1965) calls out a procedure to check the ground side of the square wave. This should be within 0.001 V of ground. Measuring this with a Fluke voltmeter you will find this tolerance cannot be met. The reading will typically be 50-100 mV or higher. The cause appears to be a pulse that is coupled through, even with Q925 removed, which affects the reading of the Fluke voltmeter.

Measuring the base line with a Type W High-Gain Differential Comparator Unit you will find the base line within 0.5 mV with a pulse riding on it of some 4.5 V amplitude and a microsecond or so wide at the 50% point. You will need to either make this measurement with the Type W Unit or to remove Q914 as well as Q925. This eliminates the pulse and allows the Fluke voltmeter to give an accurate reading.

NEW FIELD MODIFICATION KITS

TYPE 67, TYPE 2B67, TYPE 3B1, TYPE 3B3 AND TYPE 3B4 TIME BASE UNITS — SAWTOOTH DRIVE FOR TYPE 3L10 SPECTRUM ANALYZERS

This modification provides a sawtooth signal at pin 18 of the interconnecting plug of the above time-base units. This sawtooth signal is required by the Type 3L10 Spectrum Analyzer Plug-In Units to drive the analyzer's Swept Oscillator.

The sawtooth signal is a standardized current ramp of 66 μ A/cm (nominal) fed from the sawtooth cathode follower of the time-base unit via a standardizing resistor to pin 18 of the time base interconnecting plug.

The current signal will drive a low-impedance circuit, such as the minus input of an operational amplifier or the emitter of a transistor, with a positive-going linear ramp of current. It will not drive two circuits (e.g. 3L10 and sawtooth out) at the same time, nor will it successfully serve as a "voltage" signal source—especially at faster sweep rates. The high source impedances of this signal prevent excessive cross-talk of the sweep signal into vertical plug-ins in which pin 18 of the interconnecting plug is open.

The sawtooth is provided by adding the standardizing resistor to the ceramic strips above the time base Sawtooth Cathode Follower. The standardizing resistor is connected between the cathode of the Sawtooth Cathode Follower and a length of coaxial cable. The other end of the coaxial cable is connected to pins 18 and 19 of the time-base interconnecting plug.

This modification is applicable to the following time base units:

Type	SN
67	101-5000
2B67	5001-15179
3B1	101-4039
3B3	100-4269
3B4	100-739

Order through your local Tektronix Field Office, Field Engineer, Field Representative or Distributor. Specify Tektronix Part Number 040-0413-00.

CRADLE MOUNT — FOR LISTED OSCILLOSCOPES

This modification kit supplies a cradle-mount assembly that allows the instruments listed below to be rackmounted in

a standard 19-inch relay rack. A vertical front panel space of 17½ inches is required.

The modification kit is applicable to the following Tektronix Oscilloscopes: Type 524AD, 531, 532, 535, 541, 545 and 570; serial numbers 5001 and up. Also, to Type 531A, 533, 533A, 535A, 536, 541A, 543, 543A, 543B, 544, 545A, 545B, 546, 547, 575, 581, 581A, 585, 585A and 661, all serial numbers.

Order through your local Tektronix Field Office, Field Engineer, Field Representative or Distributor. Specify Tektronix Part Number 040-0281-00.

TYPE 180 TIME-MARK GENERATOR SILICON RECTIFIER

This modification kit replaces the selenium rectifier SR401 in the Type 180 with a silicon rectifier. Silicon rectifiers offer more reliability and longer life.

The modification kit also adds a series resistor to compensate for the lower voltage loss through the new silicon rectifier.

Order through your local Tektronix Field Office, Field Engineer, Field Representative or Distributor. Specify Tektronix Part Number 040-0213-00.

DC FAN MOTOR — FOR LISTED OSCILLOSCOPES

This modification installs a DC fan motor assembly, a transformer and rectifier assembly, and a neon bulb assembly to allow the oscilloscope to operate on a 50-400 cycle power line supply. It is applicable to the following instruments:

TYPE	PART NUMBER
531A	22074-up
RM31A	1508-up
533A	3001-up
RM33A	1001-up
535A	24350-up
RM35A	1851-up
541A	21455-up
RM41A	1190-up
543A	3001-up
RM43A	1001-up
545A	27703-up
RM45A	1893-up

It is also applicable to instruments which have the DC Relay Field Modification Kit (Tektronix Part Number 040-258) installed.

Order through your local Tektronix Field Office, Field Engineer, Field Representative or Distributor. Specify Tektronix Part Number 040-0233-00.

TYPE 1A1 DUAL-TRACE PLUG-IN UNIT — ETCHED CIRCUIT CARDS IMPROVEMENT

This modification involves the Etched Circuit cards (Channel 1 Input Amplifier, Channel 2 Input Amplifier and the Output Amplifier) and the 14 wires that connect these boards with other parts of the Type 1A1.

Original equipment employed a jack-type connector on the etched circuit board and a pin-type connector on the associated interconnecting wire. This modification reverses the procedure. It installs interconnecting wires employing an improved jack-type connector on the etched-circuit-board end of the wire and installs pin-type connectors at the associated locations on the etched circuit board. Four of these locations use 45°-angle pin-type connectors. This is to prevent the bending or breaking of the connector in the event the etched circuit board is removed without disconnecting these connectors. The other ten locations use a straight pin-type connector.

The improved jack-type connectors reduce the failures caused by faulty contact in the old connectors. The new connectors also realize a reduction in noise caused by intermittent contact between pin and jack in the old connector.

This modification is applicable to Type 1A1 instruments with serial numbers 101 through 3179 that have the following etched circuit cards installed:

Channel 1 Input Amplifier — Models 1 & 2

Channel 2 Input Amplifier — Models 1 & 2

Output Amplifier — Models 1 through 7.

Order through your local Tektronix Field Office, Field Engineer, Field Representative or Distributor. Specify Tektronix part number 040-0402-00.

TYPE 531, TYPE 535, TYPE 541, TYPE 545 OSCILLOSCOPES — CHOPPING-TRANSIENT BLANKING

This modification provides a means of eliminating switching transients from the crt display by applying a blanking voltage to the crt cathode. Switching transients occur when a multiple-trace plug-in unit is operated in the chopped mode. The blanking voltage is applied by means of a crt CATHODE SELECTOR switch installed on the rear panel of the oscilloscope.

A 6DJ8 tube replaces the 6AU6 tube in the V78 position of the multi-trace unit's Sync-Amplifier circuit. One half of the new tube is used as the Sync Amplifier; the other half is used to generate the blanking pulse.

Installation of the modification involves replacing the old 7-pin socket for V78 with a 9-pin socket to accommodate the new 6DJ8 tube. Also, the addition of a crt CATHODE-SELECTOR switch to rear panel of the oscilloscope plus other minor circuit changes. The instructions divide the modification into several parts to facilitate the installation in the specific instrument at hand.

This modification is applicable to the Type 531, 535, 541 and 545 Oscilloscopes with serial numbers 101 through 19999 and Type RM31, RM35, RM41, and RM45 Oscilloscopes with serial numbers 101 through 999.

Order through your local Tektronix Field Office, Field Engineer, Representative or Distributor. Specify Tektronix Part Number 040-0403-00.

TYPE 180A TIME-MARK GENERATOR — SILICON RECTIFIERS

This modification kit replaces the selenium rectifiers in the Type 180A Time-mark generator with silicon rectifiers which offer more reliability and longer life. It is applicable to Type 180A instruments, sn's 5001-6385 with the exception of sn's 6380 and 6381. These two instruments were modified at the factory.

Order through your local Tektronix Field Office, Field Engineer, Field Representative or Distributor. Specify Tektronix part number 040-0214-00.

TYPE 531, TYPE 535, TYPE 541 AND TYPE 545 OSCILLOSCOPES — TRIGGER IMPROVEMENTS

This modification installs the PRESET STABILITY and fully automatic TRIGGER MODE capabilities in the following oscilloscopes:

Type	SN
531	608-6019
535	1075-6044
541	101-5414
545	101-5945

Setting the STABILITY control to the PRESET position establishes an optimum setting for correct triggering in most applications. Normally the control will require no further adjustment.

In the Improved AC AUTO Trigger Mode, the STABILITY and TRIGGERING LEVEL controls do not function and triggering becomes fully automatic.

Order through your local Tektronix Field Office, Field Engineer, Field Representative or Distributor. Specify Tektronix Part Number 040-0152-00.

TYPE 515, TYPE 515A, AND TYPE RM15 OSCILLOSCOPE — SILICON RECTIFIERS

This modification replaces the selenium rectifiers in the Type 515, Type 515A and Type RM15 Oscilloscopes with silicon rectifiers. The new rectifiers offer better reliability and longer life.

The installation consists of removing the original selenium rectifiers and installing a new silicon-rectifier bracket assembly and three additional resistors. The three resistors compensate for the lower voltage loss occasioned by the new rectifiers.

Order through your local Tektronix Field Office, Field Engineer, Representative, or Distributor. Specify for:

Type	Serial Number	Tektronix Part Number
RM15	101-1000	040-0205-00
515	1001-4029	040-0205-00
515A	101-755	040-0208-00

TYPE 315D OSCILLOSCOPES — SILICON RECTIFIERS

This modification kit replaces the selenium rectifiers in the Type 315D Oscilloscope with silicon rectifiers which offer more reliability and longer life. It is applicable to Type 315D Oscilloscopes, all serial numbers.

Order through your local Tektronix Field Office, Field Engineer, Field Representative or Distributor. Specify Tektronix part number 040-0220-00.

SOLVING POWER LINE PROBLEMS FOR BETTER OSCILLOSCOPE PERFORMANCE

Tektronix oscilloscopes are designed to accommodate line-voltage variations up to roughly $\pm 10\%$ from design center without loss of stability or accuracy; however, variation beyond these limits causes loss of accuracy and often, severe instability.

The problems reported seem to fall into three main categories: (1) continuously high or low line voltage; (2) fluctuation between high and low line voltage; and, (3) serious waveform distortion, giving the effect of low line voltage. Here are some suggested solutions to these problems:

(1) Many Tektronix oscilloscopes are supplied with multi-tap transformers. These transformers allow selection of a tap with a voltage rating close to that of the available power line supply. Each selectable tap will operate at line voltages within $\pm 10\%$ of its design center.

Other Tektronix oscilloscopes have transformers with either 115 (117) volt or 230 (234) volt taps and no additional taps to allow selection. In either case, it may be necessary to provide some type of external step-down transformer to supply the necessary operating voltage to the oscilloscope.

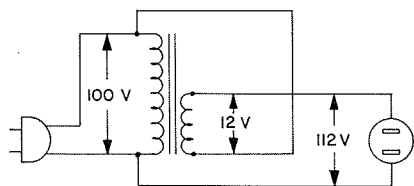

Fig. A. Low-cost line voltage boost or drop circuit, using a filament transformer. Connect as shown for 12 V boost; reverse secondary connections for 12 V drop. Filament winding must have a minimum rating sufficient to carry the oscilloscope load.

A variable autotransformer of the "Variac" or "Powerstat" type is particularly useful in accommodating a wide range of input voltages. An inexpensive filament transformer may also be used as an autotransformer in cases where the line voltage is consistently high or low. The filament transformer should be procured locally; they are not available from Tektronix. For an oscilloscope whose normal operating range is 105 to 125 volts, a 12-volt filament transformer will allow it to have an operating range of from 93 to 113 volts, thus making it compatible with 100 volt power line systems. Reconnected as shown in Figure A, the transformer's secondary voltage is added to or subtracted from the incoming line voltage to bring it within range. Be sure to check the oscilloscope specifications and then select a filament transformer with a current rating adequate to carry the oscilloscope load. For

example: a Type 321 Oscilloscope, drawing 20 W will require a filament transformer rated to handle only $\frac{1}{4}$ amp, while a Type 517(A) Oscilloscope (drawing 1250 W) will require a filament transformer rated to handle 15 amps.

(2) The second problem is a little more difficult. Although slow periodic fluctuations in power-line voltage can be conveniently handled with a variable autotransformer, as above, there are many areas where wide line-voltage variations are so frequent that a constant-voltage-transformer type of regulator appears to be the only solution. However, for proper operation of the oscilloscope power supplies, it is extremely important that the regulator does not cause waveform distortion. The electronically-regulated power supplies in Tektronix oscilloscopes require not so much a certain rms voltage on which to operate, as a certain minimum pp (peak-to-peak) voltage. Many regulating transformers of the saturable-reactance type regulate primarily by limiting the peaks of the incoming sine waves. Either an rms or average-reading ac voltmeter (most voltmeters are of the latter type) may indicate the proper rms voltage for scope operation. However, the actual pp voltage supplied by most of the common "constant-voltage" transformers is insufficient for proper operation of the scope's power supplies. Under these circumstances excessive ripple, jitter, and instability will result. An increase of the pp voltage is not a solution in this case because this would increase the rms voltage also. While these regulated power supplies are dependent upon pp, the tube filaments are dependent upon rms. The power-line waveform must retain a sinusoidal form. Therefore, it is important to use only a low-distortion type of regulator—one having less than, say 5% distortion at the highest expected incoming line voltage under full oscilloscope load conditions. Regulators of this type are available through commercial channels, though at some increase in cost over the models without waveform correction.

The third major problem—serious waveform distortion—is the most difficult to overcome, since general-purpose correction systems are not always immediately available. To determine whether waveform distortion will seriously affect the performance of your instrument, an adapter such as that illustrated in Figure B can be used with a voltmeter to obtain pp measurement of the line waveform at moderate construction cost. An oscilloscope equipped for accurate differential voltage measurements in the 300-350 volt range can, through the use of a pair of P6023 probes, be used to make the pp voltage measurement directly

from the power line. It is not recommended that a scope be used "single ended" to measure its own power line voltage because of possible measurement errors and serious shock and damage hazards. The oscilloscope power supplies should continue to regulate properly down to 295 volts pp. If the pp line voltage is less than 295 volts for an rms reading of 105 volts, but the scope power supplies do regulate correctly at 295 pp volts, then the trouble is mostly in the power-line waveform, and power-supply waveform; and, power-supply components are probably in good condition.

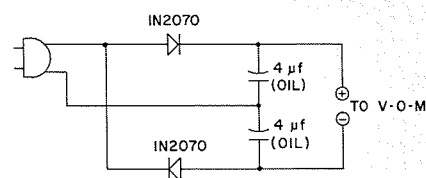
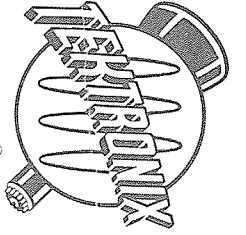

Figure B. Peak-to-peak reading adapter for 20,000 ohm/volt V-O-M. The use of silicon diodes and oil-filled (or Mylar, or paper) capacitors assures accurate voltage output.

RMS	Peak-to-Peak
105 V	297 V
117 V	331 V
125 V	354 V

If power-line waveform distortion exists on the power lines into your building, the easiest solution may be to have the local power company correct the waveform for you. However, if it's caused by in-plant equipment (any high-current, nonlinear load will cause some distortion), it may be necessary to apply your own waveform-correction, using a filter of appropriate design and a transformer (to compensate for filter losses) between the power line and the oscilloscope. In extreme cases where severe fluctuations and transients are also involved, it may be necessary to employ a motor-generator set to obtain a steady, sinusoidal waveform. As before, be sure that the current rating of the filter or motor-generator is adequate for oscilloscope operation.

Incidentally, it should be mentioned that a step-up transformer alone should not be used where waveform distortion is the primary cause of power-supply regulation problems. If the pp voltage of a seriously flattened power-line waveform is increased sufficiently to obtain good power-supply regulation, the unregulated filament lines in the oscilloscope will rise to excessive levels, causing premature tube failures from increased dissipation, gas, leakage, and filament burn-outs.



Service Scope

USEFUL INFORMATION FOR

USERS OF TEKTRONIX INSTRUMENTS

Tektronix, Inc.
P.O. Box 500
Beaverton, Oregon, U.S.A. 97005

Frank L. Greenwood
Department of Transport
Telecommunications, Attn: CMO
Room 1217, 3 Temporary Buildings
Ottawa, Ontario, Canada 9/65

RETURN REQUESTED

