



# TEKSCOPE



**TEKTRONIX®**  
committed to  
technical excellence

Customer Information from Tektronix, Inc.,  
Beaverton, Oregon 97077

Editor: Gordon Allison  
Ass't. Editor: John Mulvey

## Contents

### 3 **A 5 MHz digitally controlled spectrum analyzer.**

A new concept for front panel controls, coupled with two custom MOS processors, yields new operating ease and measurement capability.

### 8 **Transition counting with an oscilloscope**

A powerful new technique for troubleshooting digital circuitry speeds servicing by even relatively inexperienced technicians.

### 12 **Storage expands your oscilloscope measurement capabilities.**

An assist in choosing the storage scope best-suited to your application.

### 16 **A potpourri of modifications and service notes.**

Some simple modifications to enhance the usefulness of your TEKTRONIX instruments for particular applications, and service hints on several products.

### 18 **New Products**

A new section of Tekscope providing a brief description of products recently introduced by Tektronix.

Cover: The digital character of the 7L5 Spectrum Analyzer is reflected in the background showing a portion of the digital section in the 7L5.

## To our Tekscope readers:

Beginning with this issue, a new section entitled "New Products" will appear in Tekscope. It includes the information formerly contained in the New Product Supplement that accompanied Tekscope. To simplify printing and distribution, product prices are shown on the attached inquiry card rather than as a part of the product description. We invite you to use the card for further information or a demo of any of the products discussed.

The "Classified Ad Supplement" that accompanied, or appeared as an integral part of, Tekscope is also available through the use of the inquiry card. We plan, by this means, to give you more up-to-date information on TEKTRONIX instruments our customers wish to buy or sell.

We trust these changes will increase the value of Tekscope to you, and welcome your comments.

Sincerely,

Gordon R. Allison  
Tekscope Editor

# A 5 MHz digitally controlled spectrum analyzer

Digital control of instrumentation is rapidly coming into vogue. Besides being the popular thing to do, what are the advantages to users of spectrum analyzers? One important advantage is the operating ease achieved by simplified controls, and the ability to place those controls for maximum operator convenience. But there is much more.

The *more* includes an automatic start-up mode that switches in full attenuation to protect against inadvertent overloads damaging the input mixer, and sets the center frequency at zero with the 0-Hertz marker displayed on-screen for a quick operational check. *More* also includes new capabilities to measure signals masked by noise, and more precise measurements made with greater ease. These are just a few of the benefits in store for users of the 7L5 Spectrum Analyzer. Others will be apparent as we discuss the 7L5 in greater detail.

The 7L5 is a 0 to 5 MHz spectrum analyzer designed to operate in any 7000-Series mainframe having crt readout. It occupies two plug-in compartments, leaving the other two compartments in a 4-hole mainframe available for time shared time domain measurements. A unique plug-in front end overcomes the performance limitations imposed by trying to accommodate a wide range of input impedances, and permits an 80 dB dynamic window over a

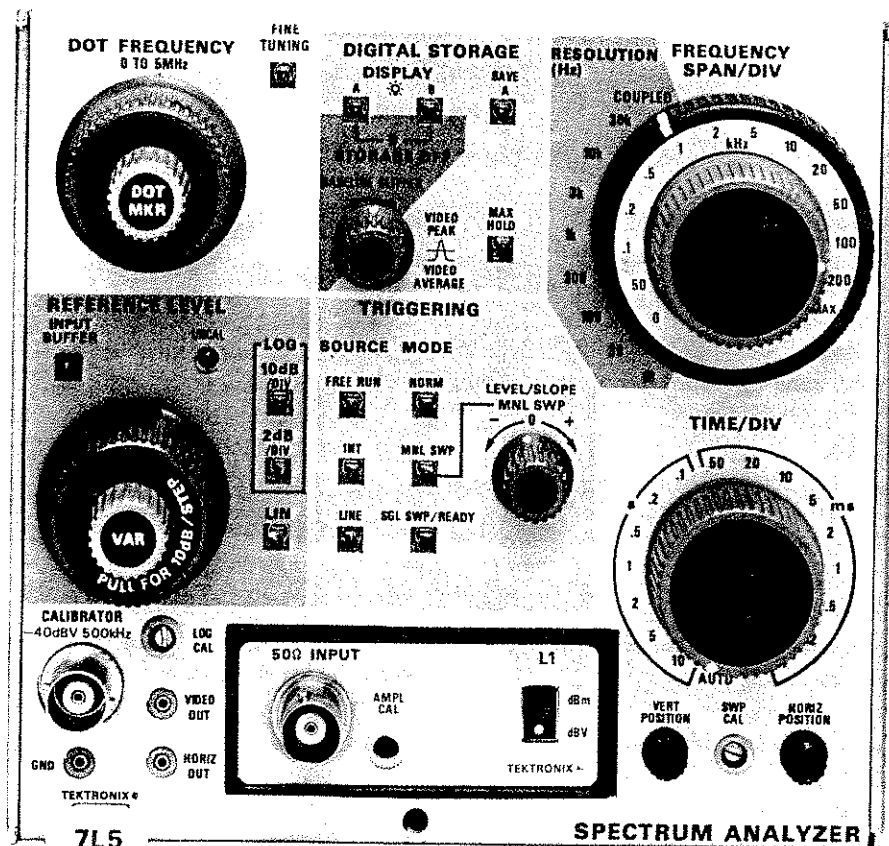

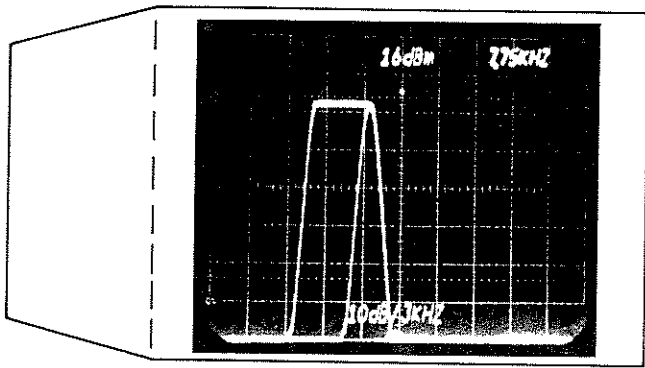

Fig. 1. Signal drift is easily observed using the max hold function. Split memory is used to display frequency excursion over time interval, and frequency at time photo was taken.

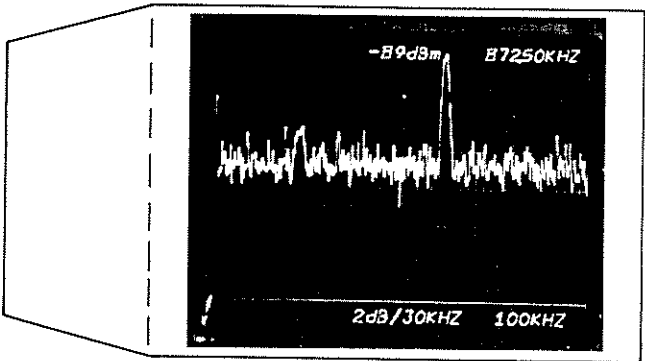

Fig. 2. Two small signals in presence of noise with no digital averaging.

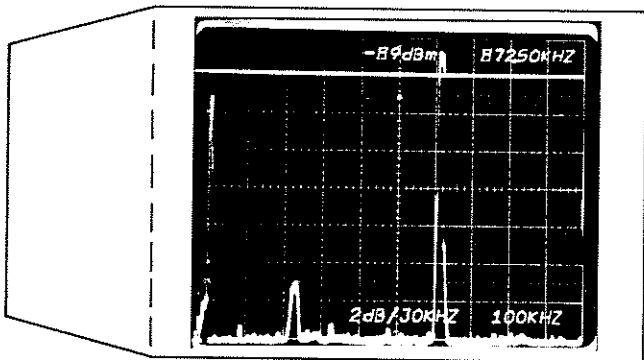

Fig. 3. Same signals as in Fig. 2 with the signals below the sweep cursor digitally averaged. Noise is greatly reduced and true small signal amplitude of  $-102$  dBm is indicated.

reference level range of  $-128$  dBm to  $+21$  dBm. Calibrated displays are maintained for both dBm and dBV measurements, selected by a front-panel switch.

#### Front-panel controls

The uncluttered front panel of the 7L5 gives the impression that the unit is easy to operate. And it is. Digital controls yield many benefits in the design, manufacture, and usability of the instrument. They allow placing the controls for operator convenience, and give a much wider range than is usually available with conventional analog controls. For example, the Reference

Level control has a range of 149 dB in 1 dB and 10 dB steps, and the Dot Frequency control covers a range of 0 to 4999.75 kHz in 250 Hz and 10 kHz steps. Digital operation also simplifies the coupling of two or more controls, eliminating expensive and complex mechanical configurations. With the Resolution control in the COUPLED position and the TIME/DIV in AUTO, optimum sweep rate and resolution are automatically selected for each position of the FREQUENCY SPAN/DIV control, giving one-knob control of these three functions for many applications.

One of the factors that makes the 7L5 easy to operate is familiar nomenclature and function for the front-panel controls. The major function that may be unfamiliar to you is digital storage, so let's take a look at this section first.

#### Digital storage

Four pushbuttons and one variable control handle the digital storage functions of the 7L5. With none of the pushbuttons actuated, the unit operates as a conventional analyzer. With either DISPLAY A or B actuated, the digital storage section is activated, and the bright, steady displays and measurement capabilities afforded by digital storage come into play. The memory is split into two sections of 256 X-axis locations each. When both A and B pushbuttons are actuated, the sections are interlaced allowing updating of all 512 horizontal locations. Information in both memory sections is updated every sweep unless the SAVE A pushbutton is actuated. With SAVE A and DISPLAY A actuated, data in A memory are displayed, but not updated, serving as a reference against which the contents of B memory can be compared.

A maximum hold function is available by actuating the MAX HOLD control. In this mode, the maximum amplitude stored in every horizontal position of the memory is displayed. The information is updated every sweep, with the resultant display a cumulative envelope as a progression of time. Figure 1 shows such a display. Using split memory, the flat top pedestal shows the frequency excursion of an oscillator as it shifted about one and one half divisions across the screen, while the second half of the memory displays the oscillator frequency at the time the photo was taken. This function is useful in checking for signal drift as in Figure 1, or for unattended monitoring for the presence of short-duration signals.

A unique feature of the 7L5 digital storage is the ability to digitally average the amplitude of the displayed signal. The threshold for averaging is continually adjustable from the bottom of the display, for no averaging, to the top of the display, for averaging all displayed signals. The averaging threshold selected is indicated by a sweep cursor displayed on the crt (Fig. 2, 3). The cursor control serves as a baseline clipper

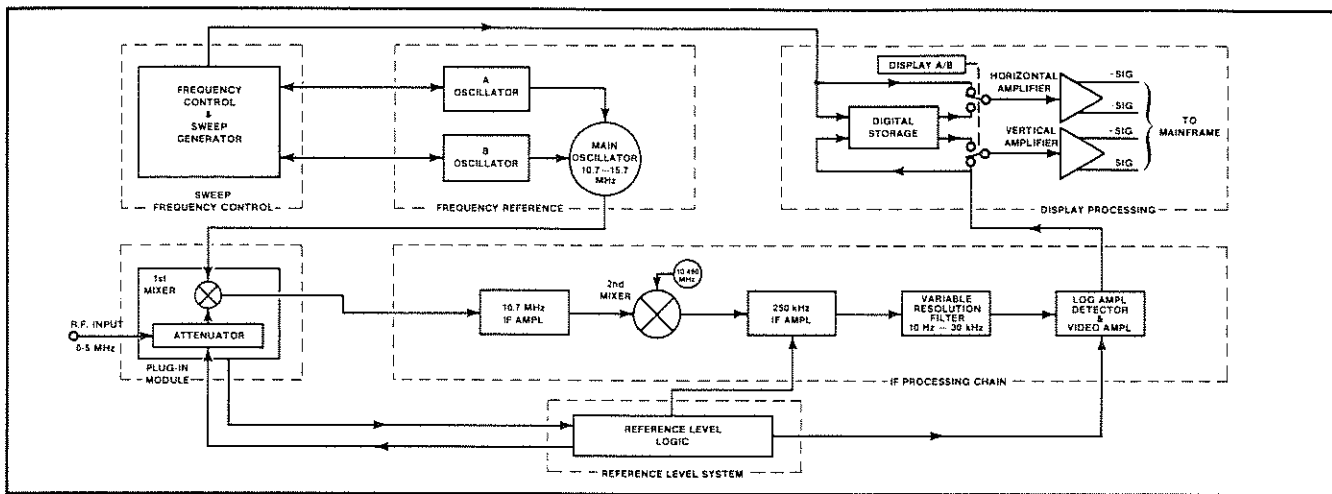

Fig. 4. Simplified functional block diagram of the 7L5.

control in the non-storage mode. The averaging circuitry has a bandwidth equivalent to a 2.5 Hz to 12.5 kHz filter, as a function of the sweep speed selected, and sweep rates are not as limited as with conventional video filters.

Now let's consider the conventional functions of the 7L5.

#### Processor control simplifies operation

Two custom MOS processors developed by Tektronix control the frequency tuning (horizontal axis) and reference level (vertical axis) functions. These chips decode the front-panel controls and serve as an interface to the remainder of the circuitry.

The vertical processor detects which plug-in front end is in use and selects the proper dynamic window and the appropriate vertical readouts. It decodes the reference level selected and chooses the appropriate attenuation and gain settings. Four attenuators are available: 4, 8, 16, and 32 dB. These are selected in conjunction with gain steps of 1, 2, 4, 8, 16, another 16, and a post variable resolution gain of 60 dB, to achieve the desired reference levels. For example, to select a 1 dB change in gain, (above a reference level of  $-29$  dBm), we insert 4 dB of attenuation and 3 dB of gain.

The Reference Level control is a 16-position,  $360^\circ$  rotating switch consisting of two circuit-board switch sections having eight pads each. The output of these two sections generates two square waves  $90^\circ$  out of phase developing what we call a 4-level, 2-bit gray code; a gray code being a binary number which changes one bit at a time. Whether the number increases or decreases depends on which direction the knob is turned. The output of the Reference Level control is fed into an 8-bit up-down counter that, in conjunction with other inputs, provides the 8-bit code for the vertical processor to set the reference level. A ROM contains attenuation and gain information for each reference

level selected, and switches attenuation in or out by means of TEK-made relays. Gain is inserted or removed by CMOS analog switches in the IF, Variable Resolution (VR), and post-VR stages.

The front panel INPUT BUFFER pushbutton provides a quick, easy check for intermodulation (IM) distortion and reduces the likelihood of IM products. Activating the input buffer inserts 8 dB of attenuation at the analyzer front end, and compensates by inserting 8 dB of post-VR gain to maintain a constant display amplitude for input signals. It also provides a cleaner 50-ohm termination (than a mixer) at the input, for those applications requiring it.

#### Frequency selection

The frequency control system combines a synthesizer with digital techniques that permits setting the frequency with six-digit resolution and excellent stability immediately after turn-on. A dot is displayed on-screen to indicate the point on the display that corresponds to the 6-digit readout. With the DOT MKR control fully counterclockwise the dot is at center screen. The dot can be positioned to the left side of the screen to operate in a "start" mode, with the readout always displaying the frequency at the dot position.

The 1st L.O. consists of three phase-locked oscillators. Two of the oscillators (A and B) control a third oscillator to generate a digitally stepped, or synthesized, 10.7 to 15.7 MHz output. The A and B Oscillators use divide-by-N synthesizer loops to generate 100 kHz and 10 kHz signal steps respectively. In addition, the B Oscillator output frequency is divided by 40, thus generating steps of 250 Hz. The A and B Oscillators are swept by the shaped sawtooth input to generate a swept frequency output across the full frequency span. To achieve an 80 dB dynamic window and exceptionally low residual FM, A Oscillator is swept when using frequency spans of 500 kHz/div to 5 kHz/div, and B Oscil-

lator when using spans of 2 kHz/div to 50 Hz/div. High stability is maintained by phase-locking the system during sweep retrace, or every 100 seconds when operating in a non-sweeping mode.

The output of the 1st L.O. goes to the 1st Mixer located in the front-end plug-in module. The resultant 10.7 MHz signal is fed to the 1st IF Located in the main plug-in. There it is amplified and then mixed with the 10.45 MHz signal from the phase-locked 2nd L.O., giving a 2nd IF frequency of 250 kHz. Passing through the 250 kHz gain switched amplifier, the Variable Resolution circuitry, and the Log Amp, which provides up to 60 dB of switched gain, the signal is then detected and passed to the logic circuitry for display along with the frequency dot and the averaging cursor (Fig. 4).

Careful attention to design at every stage yields excellent intermodulation performance with IM products for two on-screen  $-40$  dBm signals down at least 80 dB. Internally generated spurious signals are  $-130$  dBm, or less, referred to the input mixer. Noise specifications are equally impressive:  $-105$  dBm at 30 kHz resolution and improving to  $-135$  dBm, or less, at 10 Hz.

Now let's turn our attention to the mechanical aspects of the 7L5.

#### Mechanical innovation

The design goals for the 7L5 provided challenge and opportunity for many mechanical innovations. One of the major goals was to develop front panel controls to satisfy a concept of instrument architecture having a plug-on front panel for ease of manufacturing, assem-

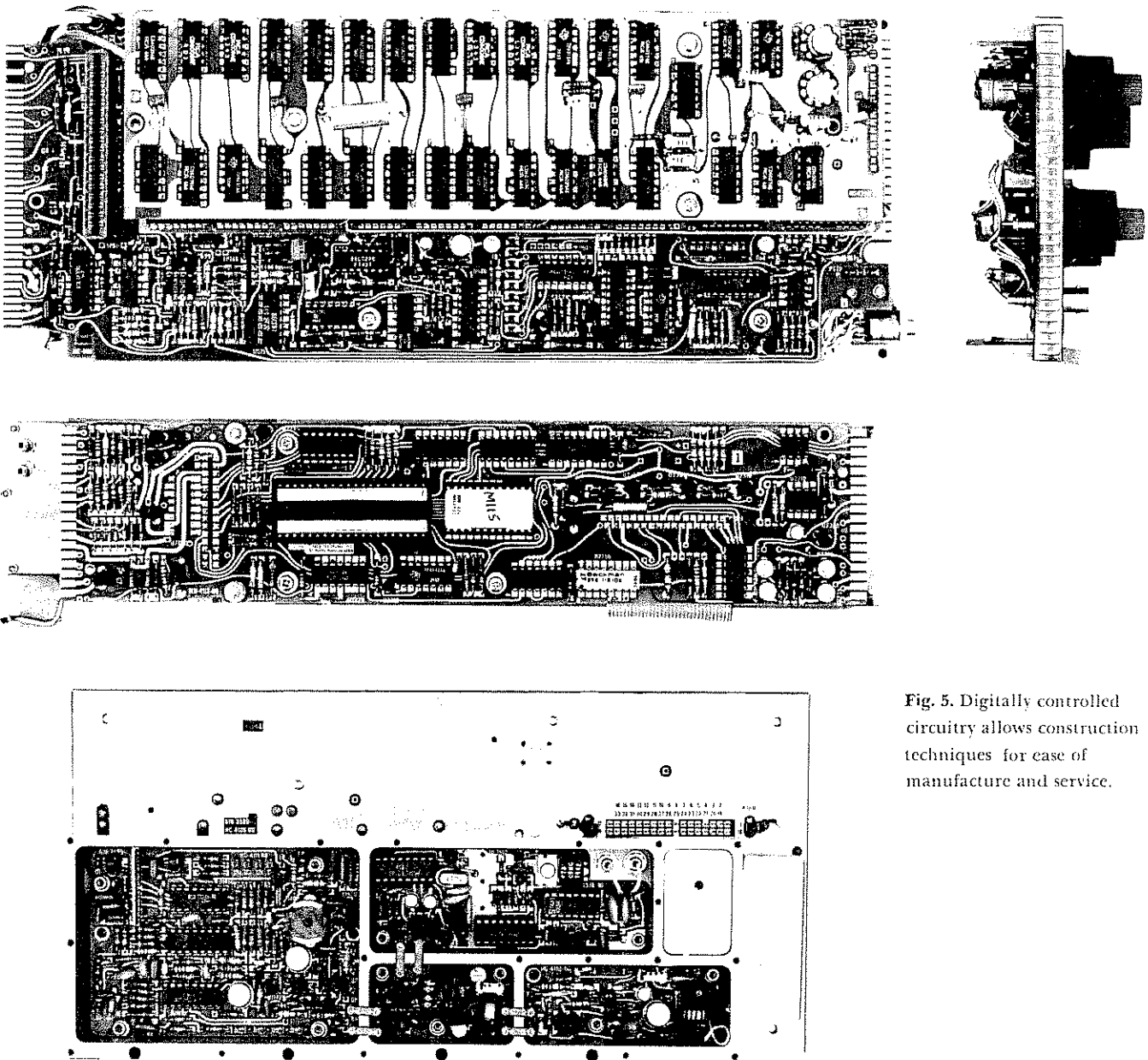

Fig. 5. Digitally controlled circuitry allows construction techniques for ease of manufacture and service.

bly, and servicing. To meet this need, a rotary switch using optoelectronic concepts (no mechanical contacts) was developed. The switching elements were to be localized in the knob, and the entire assembly was to plug into the front panel. Further requirements dictated a minimum of 30 positions, smallest possible size, capability of mass production, high reliability and ease of repair. The end result of many designs is a switch contained in a knob shell 1" in diameter and  $\frac{3}{4}$ " long. The separate parts of the switch are shown in Figure 6. Basically the switch consists of a detent mechanism, a 5-element LED light source, a slotted shutter wheel, and a 5-element phototransistor assembly. The 5-element optoelectronic array gives a capability of  $2^5$ , or 32 switch positions.

Both the LED's and the phototransistors had to be positioned very accurately in relation to one another and in relation to the shutter wheel. A package was developed for them with the five LED's in series instal-

controls are identical except for the number of positions. They generate a 4-level, 2-bit, gray code as discussed previously.

Other mechanical techniques contributing to the outstanding performance of the 7L5 include numerical-controlled milling of the honeycomb chassis, and chemical milling of mumetal gaskets for effective shielding of some areas. A unique U-shaped feedthrough device reduces cost and complexity by coupling signals between compartments without the need for cables and connectors.

The outboard chassis on the left side of the 7L5 swings out, providing easy access for servicing without extension boards or cables. The entire unit can be disassembled in minutes, into the major components pictured in Figure 5.

### Summary

The 7L5 combines frequency synthesis with digital technology to produce a 0 to 5 MHz spectrum analyzer with exceptional accuracy and frequency stability. Crt readout of measurement parameters and simplicity of operating controls assures easy, error-free operation. Digital storage provides a bright display, and averaging techniques that allow peak levels and averaged signals to be displayed together. Plug-in front-end modules yield low-noise levels and an 80 dB dynamic display range. Digital controls give precise selection of measurement parameters, simplify mechanical construction, and speed servicing.

### Acknowledgments

Fendall Winston was Project Leader for the 7L5 and along with Craig Bryant and Steve Morton, provided much of the electrical design. Bill Benedict and Don Kirkpatrick did the digital circuitry. Steve Skidmore coordinated mechanical design, with Carlos Beek doing the optoelectronic switch-in-a-knob. Morris Engelson provided overall engineering direction for the program. Our thanks to these and many others who provided material and assistance in writing this article. 

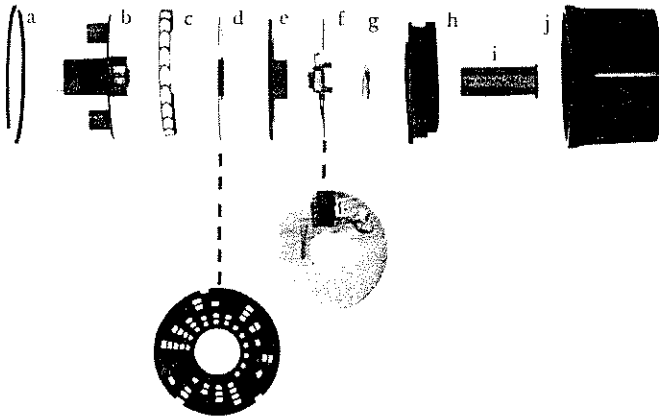

Fig. 6. Elements of the optoelectronic switch-in-a-knob that generates a 5-bit code for control of time/div and frequency span. (a) retainer ring, (b) phototransistor holder assembly, (c) spacer ring, (d) shutter, (e) light baffle, (f) LED array holder assembly, (g) spring washer, (h) detent assembly, (i) shaft assembly, (j) knob shell.

led on a lead frame, and encapsulated in transparent epoxy with integrally molded focusing lenses. The phototransistor chips are also mounted on a lead frame, wired in parallel, and encapsulated in the same manner as the LED's. The shutter wheel is chemically milled for economic precision production.

The output of the switch is a 5-bit code at a level which interfaces directly with CMOS logic. Two switches of this type are used in the 7L5. They are the TIME/DIV and FREQUENCY SPAN/DIV Controls.

The RESOLUTION, DOT FREQUENCY, AND REFERENCE LEVEL controls also are knob switches, but of a different type. They are circuit board switches, with the switching elements located inside the knob. The DOT FREQUENCY and REFERENCE LEVEL



Bob Beville

## Transition counting with an oscilloscope

Many people involved with troubleshooting digital circuits are continually looking for a better way to do the job. And people building instruments to test digital circuits are likewise looking for better ideas so their instruments may do a better job. A very powerful technique called transition counting has been used by some manufacturers of circuit board test equipment, and a transition counter has now been combined with the most popular Tektronix oscilloscope, the 465, for servicing digital circuits. This technique and this instrument are undoubtedly just the kind of "better way" many people have been looking for. The time-saving, money-saving potential is vast. We would like to tell you about the technique, how we have combined a transition counter with an oscilloscope, and what that can do for two groups of people.

The first group is comprised of those who are concerned about the great expense of their inventory of replacement circuit boards, the long shipping delay for repaired boards, or, perhaps, the red-tape and delay uncertainty through Customs when exchanging boards between countries. The second group: those people who are concerned about the high percentage of training time required to keep their highly qualified technicians familiar with new equipment.

### Truth tables vs count comparison

Most engineers and technicians become familiar with truth tables when they first learn about logic circuits. In school you get a pretty strong impression that the state of an output is dependent on the combination of HIGH or LOW states on the various inputs. That is a way of envisioning the operation of a logic circuit that is like taking a snapshot . . . it freezes the action. Although we are aware that the inputs normally change states, and that the outputs normally change states as a consequence, there is little point in trying to envision the action. The action of going from a LOW to a HIGH, or

from a HIGH to a LOW, is simply called a transition. If you go from LOW to HIGH and back to LOW, you have had two transitions.

A simple two-input AND gate which has one input repeatedly going between HIGH and LOW should have an output which goes through an equal number of transitions during any interval when the second input remains at the asserted level.

By using the signal at the second input to gate a digital counter, the transitions at the output and at the first input may be counted and the numbers compared. If the AND gate is functioning properly the two will be the same. In other words, with the right digital counter and a suitable set of input signals, you can determine whether the AND gate is functioning properly by counting transitions.

This principle does not seem very important until you realize it applies to complex IC's and large sections of digital circuits, as well as to individual gates and flip-flops. Using the principle, entire circuit boards may be tested, and faults isolated to the component causing the trouble.

If a circuit board is tested and found to be faulty what then? The trouble may be isolated and the faulty element identified and replaced on the spot, using the same transition counting technique. You don't have to be testing boards; you may be troubleshooting a portion of a board, or the entire equipment the board is used in.

The main data needed when counting transitions is a set of numbers showing the proper number of transitions to expect at any point. Such data may be written on the circuit diagrams adjacent to the corresponding points. Figure 2 shows a circuit diagram labeled for using the transition counter technique of troubleshooting.

For the numbers to be valid, the time intervals during which transitions are counted must be identified. In most cases such intervals correspond to either the period of one cycle of the signal at some point in the circuits being tested, or the width of a pulse at that point. When a probe is connected to the identified point, and the counter set to recognize the proper gating interval from the signal there, only one other probe is needed: the troubleshooting probe. With that probe you may check counts at any other point.

For the gating intervals to be correct and the numbers to be valid, the equipment must be operated in the proper mode. For some equipment the proper mode may be a special diagnostic routine. For other equipment it may be merely how the controls and switches are set. Either way, a few informative sentences, or a set-up procedure, can identify the mode.

So transition counting depends on knowing three things: (1) the right number of counts to expect, (2) the right count-gating time intervals to select, and (3) the



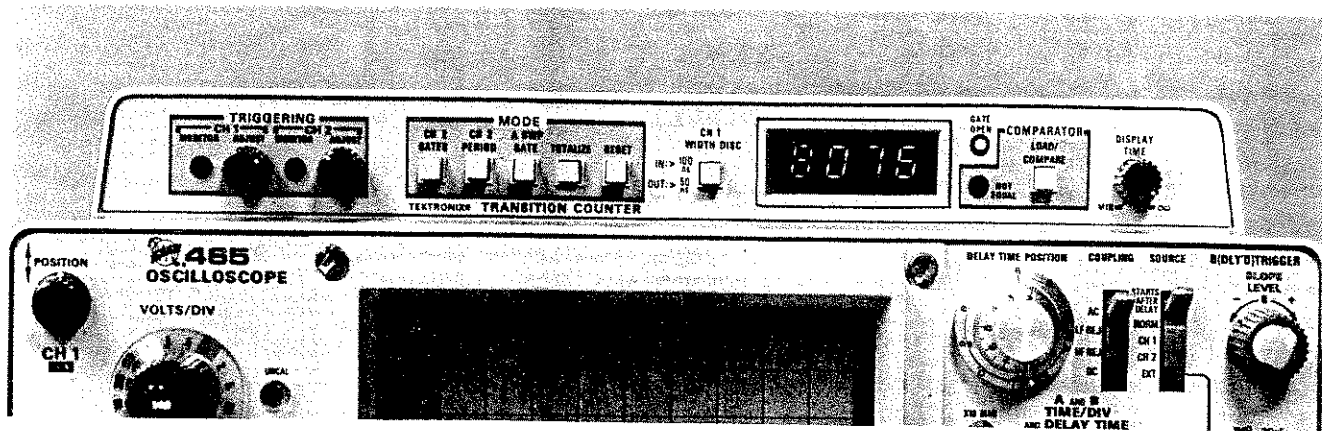

Fig. 1. The top of a 465 MOD 719A Oscilloscope, showing the controls and display window of a built-in digital counter. The oscilloscope probes may be used with the counter at the same time they are used for the scope. Input attenuators for the scope reduce the

right mode of operating the equipment containing the circuits being tested. The equipment designer is probably in the best position to supply this information because of his familiarity with the various operating modes and circuit functions. When the designer has a TEKTRONIX 465 Oscilloscope Mod 719A, it is no chore at all for him to compile the information. He merely picks an appropriate operating mode to exercise most, if not all, inputs, identifies the count-gating signal, measures the counts with his 465 at all the various points, and logs the counts on a circuit diagram. Forever after, troubleshooting is fast, simple, and convenient for anyone who has a 465 Mod 719A.

The information does not have to be supplied by the designer. A skilled service technician can do a comparable job. Nor does the information have to be compiled at the time the equipment is designed. It will pay many service organizations to compile such information as a supplement to the service manuals they presently use. It will also pay equipment manufacturers to compile and furnish such data on equipment introduced years ago, if it is still being supplied and posing a service problem.

Making a transition counter part of an oscilloscope makes good sense. Very little extra room or cost is required because many of the circuits are common. That says the price for the combination can be less than a separate counter and oscilloscope. Of equal importance to most people is the convenience of having one piece of service equipment that will do most jobs. Even the scope probes serve a double role. See Figure 1 for how we combined a transition counter with the 465.

#### Capturing the counts

The vertical input signals are routed internally to the transition counter circuits, as well as to the scope circuits. The transition counter always looks at the signal that arrives at channel 1 on the dual-trace scope. Transi-

signals to the right size for the counter when they are the right size for the crt screen. MOD 719A counts signal transitions not signal cycles. Signal cycles will be one half of the number indicated.

tions of that signal are what you count. The signal that arrives at channel 2 may be used to gate the counter on and off whenever the CH2 GATED pushbutton, or the CH2 PERIOD pushbutton, is pressed.

When the A SWP pushbutton is selected, counting is enabled during those time intervals when the A sweep is moving the crt beam. And when the TOTALIZE pushbutton is pushed, counting is enabled each time the RESET button is pressed.

To count transitions of the signal at channel 1, you trigger the counter on that signal. To gate the counter on and off with the signal at channel 2, you trigger the counter gating circuits with that signal. Proper triggering for each channel is indicated by a monitor light located next to each TRIGGERING ADJUST control.

The scope sweeps don't have to be triggered except when the A SWP GATE is used for the count gate. But when they are triggered, you can display the signal being counted, the signal doing the count-gating, or both. The channel 1 and channel 2 VOLTS/DIV controls govern the amplitude of the displayed signals and, also, the amplitude of the signals arriving at the counter trigger circuits. The scope may always be used as a signal monitor if count-triggering should be difficult or unstable.

Transition counting can be done using the A sweep gating signal as the count-gating signal by pushing the A SWP GATE pushbutton. That allows you to use only one probe anytime you can be sure that every transition you want to count is displayed on a particular sweep. A continually variable count-gating signal may be simulated by varying the length (duration) of the A sweep. The length is controlled with the 10-turn DELAY TIME POSITION control when the B ENDS A mode is selected. The duration may also be controlled with the VAR (Variable) TIME/DIV control.

When the equipment is not apt to have a count-

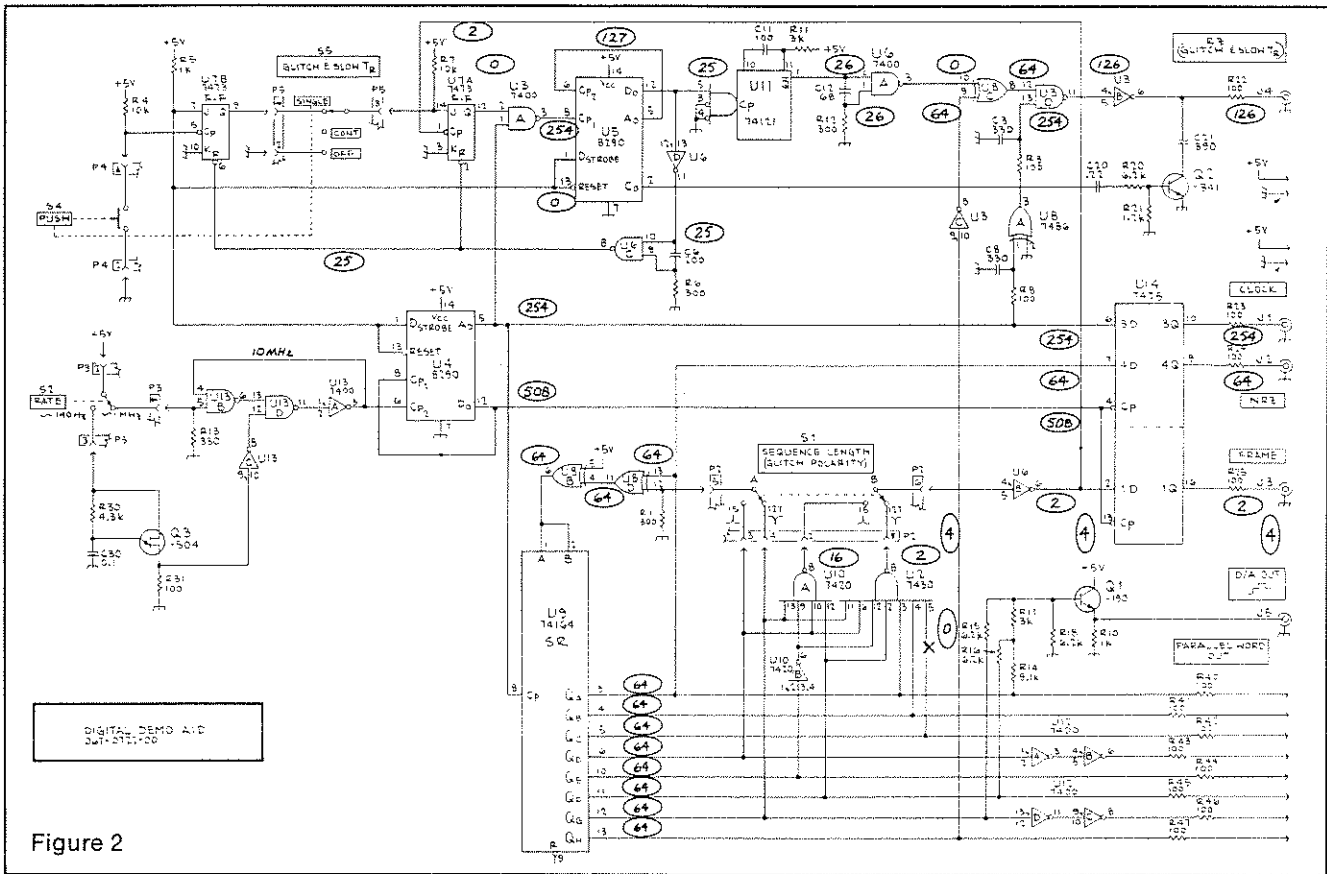

Figure 2

By labeling each signal lead on a circuit diagram with the number of transitions that should occur on that lead during identified time intervals, the cause of a wrong number may be traced to its source. Wrong counts are traced to the source of error back along any signal path where there is also an erroneous count. Any path where there is a correct count is ignored.

The proper time intervals during which transitions are to be counted must be identified. That is sometimes done by indicating the source of the gating signal, and what portion of the signal corresponds to the correct intervals. If the time interval signals in your equipment are apt to be faulty you may simulate the right interval with the scope.

The scope sweep gate signal may be used to gate the counter when the pulses occur in easily recognized groups. Or the sweep gate signal may be set to have a duration determined by a given number of clock signal transitions. You merely trigger on the clock signal, count clock signal transitions, and vary the sweep length until the right number of transitions are indicated. That sweep gate signal is then used for all the rest of the transition counts.

You can simulate a faulty IC in the equipment shown in the above diagram by lifting pin 5 of U2. The result will be an erroneous count of 4 at its output, that appears at all points along the path to the FRAME signal output. Anyone that can use an oscilloscope and follow a circuit diagram can find the fault in a matter of minutes even without knowing what the equipment is supposed to do, or how to operate it.

Troubleshooting Instructions might read like this:

**Equipment Operating Mode:**

Set the three toggle switches to position shown on diagram.

**Oscilloscope Operating Mode:**

Horizontal . . . B Sweep at .05  $\mu$ S/DIV, A Sweep at 20  $\mu$ S/DIV, A INTENS pushbutton in.

Triggers . . . A Trigger in NORM mode, AC Coupled, CH2 source, + Slope, Holdoff in B ends A position.

B (DLY'D) Trigger AC Coupled, CH2 Source, + Slope.

Vertical . . . CH1 Mode, 1 V/DIV with probe, AC Coupled.

Probes . . . Troubleshooting probe on CH1, triggering probe on CH2, both connected to resistor R8, the clock signal.

Control Settings . . . Set A TRIGGER LEVEL near middle of triggered range as indicated by the TRIG light.

Set B (DLY'D) TRIGGER LEVEL near middle of triggered range for triggered B sweep, as indicated by a shortened sweep when DELAY TIME POSITION control is moved to about mid range. Set Delay Time Position control and CH1 Triggering Adjust for a displayed count of 254.

**Troubleshooting**

All points may now be checked for the proper number of transitions indicated on the circuit diagram, using only the troubleshooting probe.

gating signal that is much more trouble-free than signals in other parts of the equipment, a reliable gating signal may be simulated in the scope by varying the sweep length. You do that by counting a specified number of signal cycles in the equipment, usually clock signal cycles. An example is the equipment shown in Figure 2. The FRAME signal output from that circuit would normally make an ideal gating signal, because the period of one cycle (2 transitions) is properly related to all the other inputs and outputs. But nearly any fault, including the one introduced by lifting pin 5 of IC U2, changes that signal period and therefore makes it unsuitable. Instead, the scope is operated in such a way that a gating signal of equal length is produced in the scope. You know it's the right length when you set it to give you the right count of clock signal transitions.

It is important to note that the particular defect chosen would not have been detectable with a logic probe because no output was locked up HIGH or LOW.

Transition counting can also be done on a one-shot basis by selecting the TOTALIZE pushbutton and pushing the RESET pushbutton each time a count is ready to be made. This mode is very useful for troubleshooting non-repetitive signals, such as you may find in a calculator when a particular calculation is in error. With this mode only one probe is required.

The DISPLAY TIME control will hold and display any count indefinitely, or enable fresh counting to occur frequently.

Noise spikes as wide as 50 ns or 100 ns may be ignored by a count-pulse width discriminator pushbutton.

A very unique and useful feature is a count COMPARATOR mode of operating the 465 Mod 719A. Many times circuit troubles are intermittent, so erroneous counts only occur occasionally and, therefore, only occasionally may be recognized. By storing a correct count once for a particular point, all subsequent counts for that point may be compared electronically. Any discrepancy between a new count and the stored count will immediately be indicated by a NOT EQUAL light on the 465 Mod 719A, and the erroneous count will be displayed until intentionally replaced.

Even if you have never used transition counting as a troubleshooting technique for digital circuits its simplicity and speed will be apparent once you understand the principle. The main bottleneck most people perceive is compiling the count data and getting the information included in their service manuals and circuit diagrams. Once you try the 465 Mod 719A for acquiring that data you can see how much more time and money will be saved servicing the equipment, compared to the investment in acquiring the data.

Complex digital equipment deserves special attention in the design and early production stages to profit most from transition counting principles. Here are the things to consider doing:

1. Add sockets, connectors, or special circuits to accommodate jumper cables, resistors, ROM's, etc., that are to be part of the diagnostic plan.
2. Characterize the product's performance early in the first production stages, with transition signatures recorded while the product is exercised according to the diagnostic routine.
3. Document the signatures on the circuit diagrams and in troubleshooting procedures.
4. Start a fault-and-repair reporting system.
5. Build a library of erroneous counts and associated faults.
6. Document any new signature which is caused by a circuit modification.

#### **SPECIFICATIONS 465 MOD 719A**

**Display:** 4 digits: up to 9999 counts.

**Input signal amplitude, CH 1 or CH 2:** 10 mV p-p or greater when displayed over 2 divisions or more.

**Input signal frequency:** 10 MHz or less.

**Time between transitions:** At least 50 ns or 100 ns depending on WIDTH DISCRIMINATOR selected.

**Gating signal:** Channel 2 signal period or pulse width; A SWP GATE duration; manual RESET (TOTALIZE).

**Count Comparator:** Detects intermittent fault by storing and indicating any count that is not equal to the pre-loaded correct count.

**Triggering Monitor Lights:** Indicate when the counter is triggered on the CH 2 count-gating signal and triggered on CH 1 signal transitions. 



Dave McCullough

# Storage expands your oscilloscope measurement capabilities

**F**ast moving events—how do you view them? If the events are electrical signals, the best way is to use an oscilloscope. For convenient viewing on a conventional oscilloscope the signal must have a fairly high repetition rate. But what if you want to view single events, or slowly changing signals such as those created by a difference in temperature? Then the conventional oscilloscope alone isn't your solution. You could use a camera, or you could take advantage of a storage oscilloscope.

Storage, in an oscilloscope, is the ability to retain the image of an electrical event on the cathode ray tube, after that event ceases to exist. Image retention may be for only a few seconds, or for weeks, depending on the type of storage. Different applications often require different types of storage. To ensure full coverage of your measurement applications Tektronix provides three types of storage:

- Bistable
- Variable Persistence
- Fast Transfer

Each type has advantages and limitations that make one more suitable than the other for a particular application. A look at the different storage types applied to typical applications may help you select the one best suited to your needs.

## **Bistable storage**

The most important characteristic of Bistable storage is long retention or view time. View times range from one hour to weeks, depending on the technique used to achieve Bistable storage. Long view times allow extended signal analysis without fear of losing the display. They also extend your ability to compare signals. Two or more repetitive signals occurring at essentially the same time can be easily compared, but when there is a considerable time lag between the two signals, one must be stored until the other occurs. A typical application is the need to compare signals before and after making circuit design changes or adjustments. In such cases, we need to keep the reference signal stored, while repeatedly storing and erasing the signal we're adjusting. For these applications Bistable Split-Screen storage is available. In this type, the phosphor storage screen is divided into two independent sections, upper and lower, with independent storage controls allowing you to erase either half of the screen without affecting the other half. This split-screen capability is unique to Bistable storage where the phosphor is the storage medium. It is not available in the Bistable storage discussed later, where the storage medium is a mesh.

If you need to display waveforms of slow, repetitive signals with fast risetimes, that appear as a slow-moving spot traveling across the crt, you should choose Bistable storage. Such a signal is displayed in Figures 4 and 5 using two different types of storage. When the spot velocity of the risetime portion of this type of signal is approximately twenty times the horizontal spot velocity, you will find it difficult to get a satisfactory display using Variable Persistence storage (see Fig. 4). Adjusting the Variable Persistence storage controls will only cause the horizontal line to bloom more (at one extreme) or cause the risetime to disappear or fade quickly (at the other extreme).

If your application fits into one of the following categories and you want storage that is the lowest cost, most rugged and easiest to operate, your choice is Bistable storage:

- Comparing signals that occur at greatly differing times
- Viewing non-repetitive events
- Displaying slow moving waveforms, or
- Requires the split-screen versatility.

Now let's consider another type of storage.

### Variable Persistence storage

Producing high contrast displays is the most outstanding capability of Variable Persistence storage. This allows you to view signals that are beyond the display capabilities of conventional (non-storage) or Bistable storage instruments. The dim conventional oscilloscope displays produced by fast, low rep rate signals (see Fig. 6) can be converted to bright, easy to view displays with Variable Persistence storage (see Fig. 7).

The high contrast ratio (stored image to background brightness ratio) of Variable Persistence provides much greater contrast than the 4:1 best-case contrast ratio of Bistable storage. This high contrast ratio comes at the cost of view time. While Bistable storage techniques provide up to weeks of view time, Variable Persistence is limited to a few minutes. View time available is proportional to the stored writing speed needed, as illustrated in Figure 2. Also, as shown in Figure 2 you can increase view time by using the SAVE mode of operation.

For many applications, limited view time offers a measurement advantage. With Variable Persistence, once a signal is stored it automatically starts to fade away. This characteristic automatically erases the display. It also illustrates the sequence in which the events occurred (Fig. 8). A persistence control allows you to choose the rate at which the stored signal fades. The controllable range varies from the specified view time at maximum writing speed (see Fig. 2), to almost instant disappearance.

Here are some typical applications where the ability to control the persistence, or view time, is a valuable aid to measurement.

- Identifying the order in which signals occurred (Fig. 8)
- Observing the change in the signal while making calibration adjustments (Fig. 9)
- Suppressing signal noise
- Producing bright displays (Fig. 7).

If one of these categories describes your measurement needs, Variable Persistence storage is your best bet.

### Fast storage

A third type of storage is provided by Tektronix to meet your needs for viewing very fast, low repetition rate or non-recurring signals. It is called Fast storage.

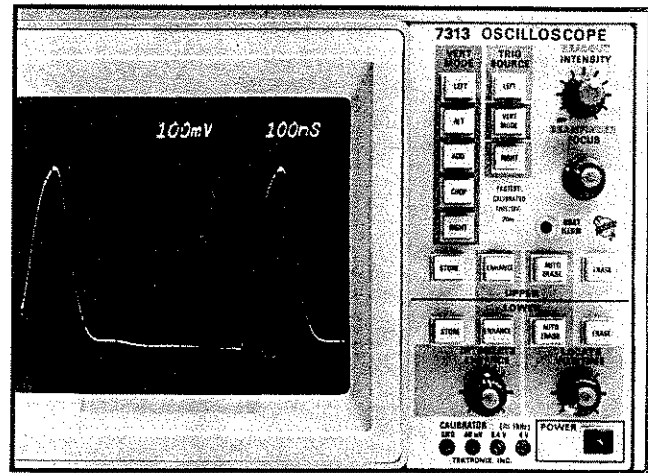

Fig. 1. Portion of split-screen Bistable storage oscilloscope front panel showing storage controls.

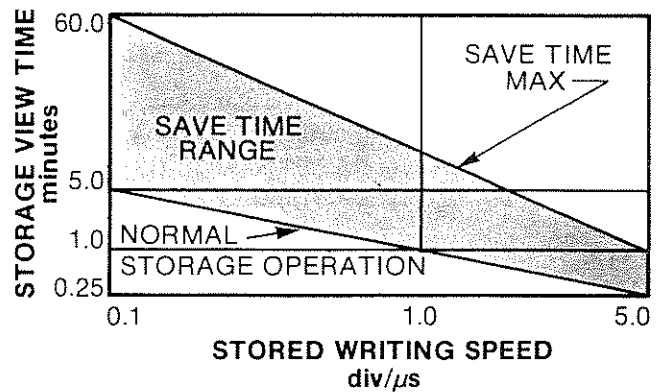

Fig. 2. Graph showing extended view time available in SAVE mode. The higher the stored writing speed needed, the shorter the view time.

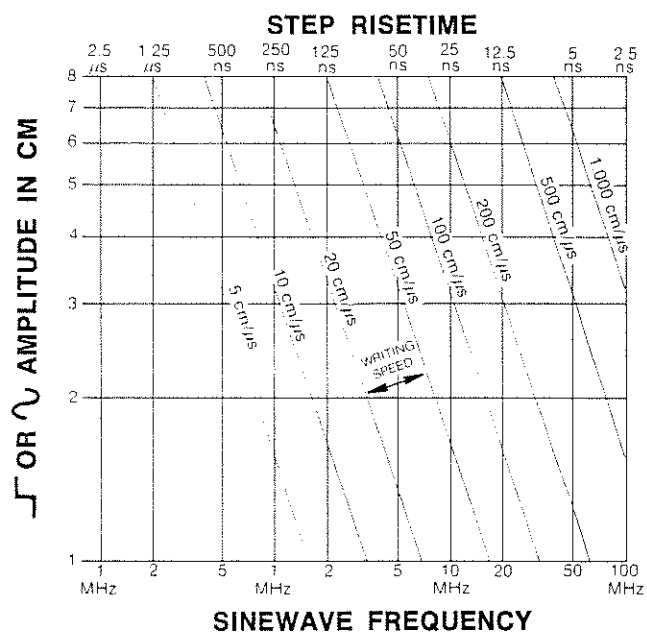

Fig. 3. Graph showing the stored writing speed needed to display a given sinewave or step risetime at a given amplitude.

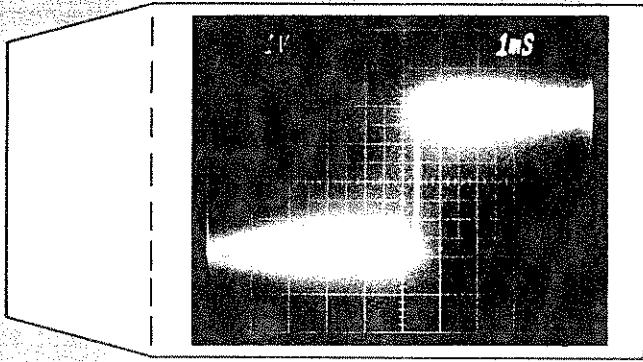

Fig. 4. Slow repetitive signals with fast risetimes are difficult to display using Variable Persistence storage as in this photo.

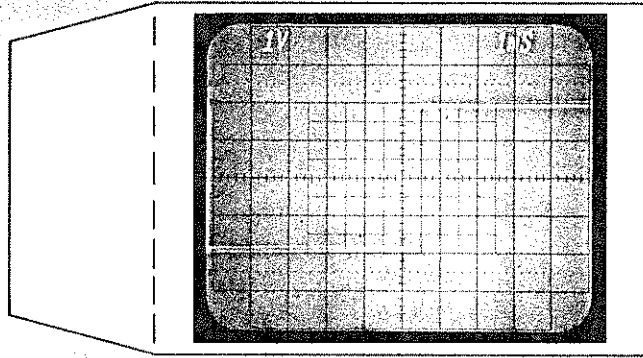

Fig. 5. The same waveform as in Fig. 4 displayed using Bistable storage.

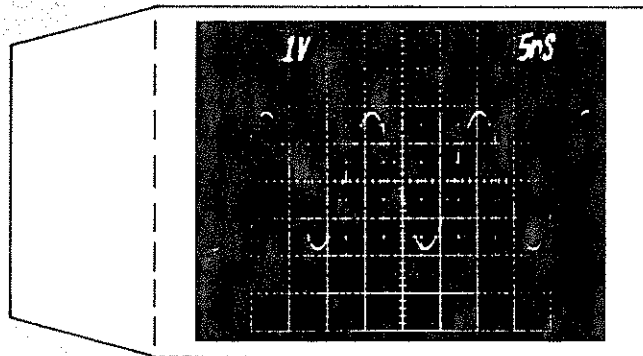

Fig. 6. Fast, low rep rate signals are difficult to view with a conventional (non-store) oscilloscope.

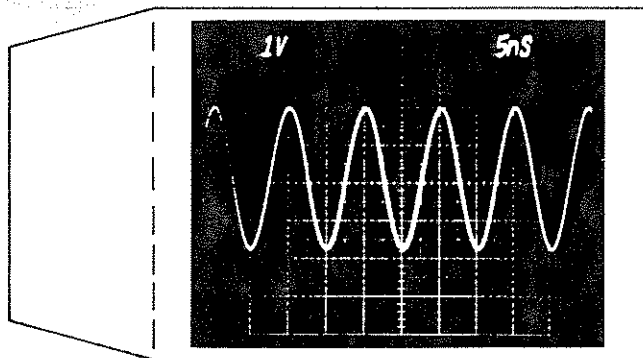

Fig. 7. The same signal as in Fig. 6 displayed using Variable Persistence storage.

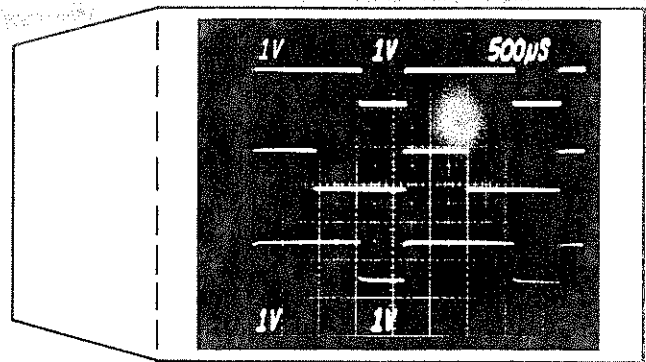

Fig. 8. Sequence of events is handily displayed by the fading characteristic of Variable Persistence storage displays.

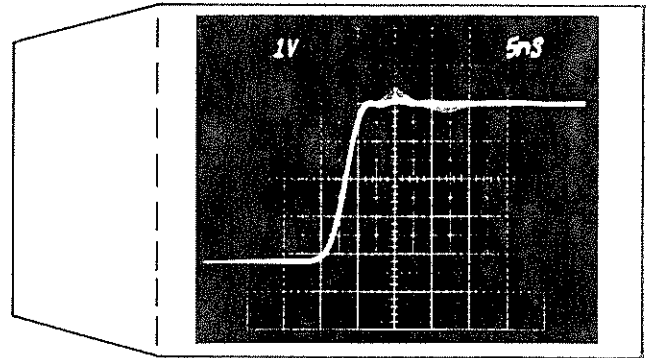

Fig. 9. Changes in the waveform as calibration adjustments are made are readily discernible in this Variable Persistence display.

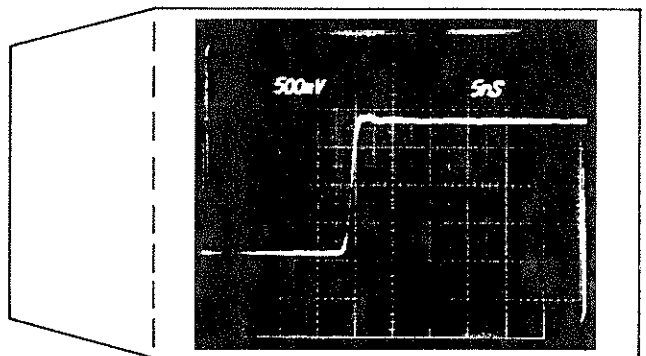

Fig. 10. The outstanding stored-writing capability of Fast Variable Persistence is dramatically illustrated in this photo of a single event having a risetime of 3.5 ns.

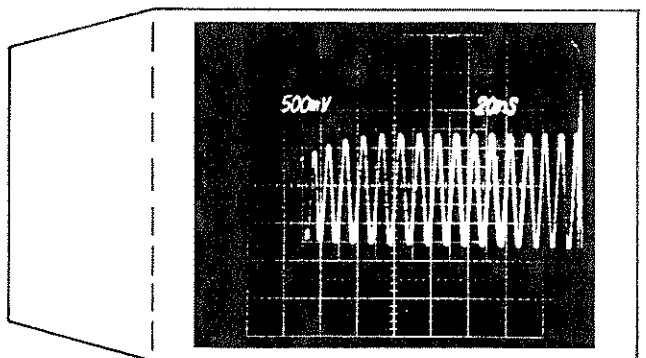

Fig. 11. A single burst of 100 MHz noise is captured by Fast Variable Persistence storage.

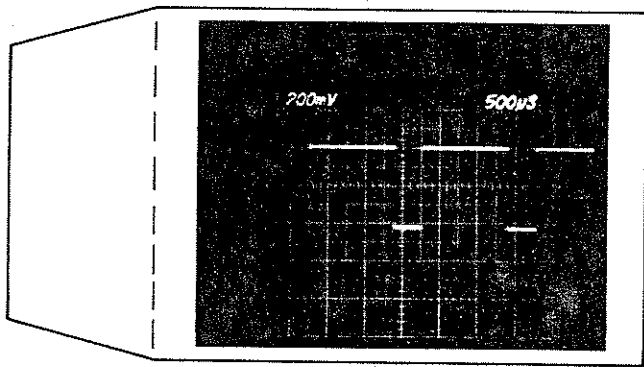

Fig. 12. Signal displayed using Variable Persistence storage. Note rising and falling portions are not visible.

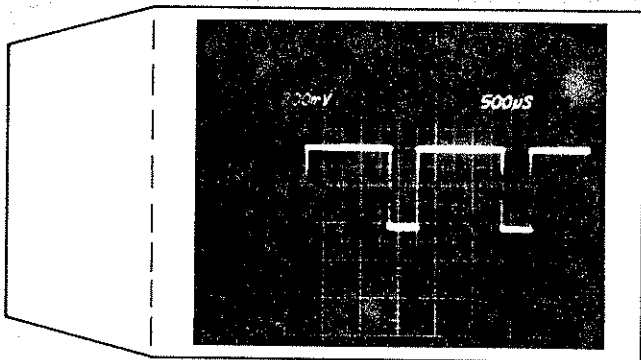

Fig. 13. Same signal as in Fig. 12 displayed using Fast Variable Persistence. Rise and fall times are clearly visible.

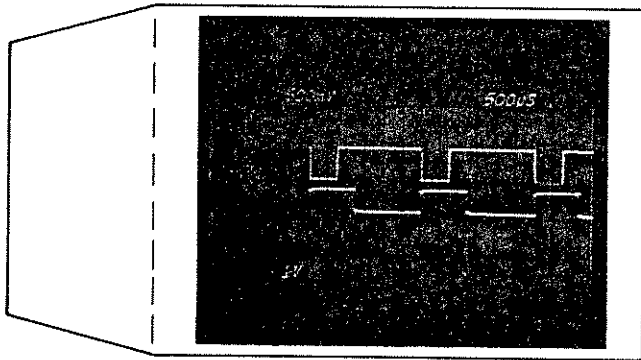

Fig. 14. Two fast signals occurring one minute apart are easily displayed using Fast Bistable storage.

In this type of storage the signal is first stored on a mesh in the crt, that is optimized to achieve maximum writing speed. The signal on this mesh is then transferred to a second mesh which can be operated in either a Bistable or Variable Persistence mode. These two modes are called Fast Bistable and Fast Variable Persistence.

Writing speed is the most important consideration for choosing Fast storage, and stored writing speed is increased up to  $1350 \text{ cm}/\mu\text{s}$  using Fast Variable Persistence. The Tektronix Bistable and Variable Persistence storage types discussed earlier have approximately the same writing speed ( $5 \text{ cm}/\mu\text{s}$ ), so writing speed was

not a consideration for selecting one type over the other. However, in Fast Bistable and Fast Variable Persistence, that writing speed relationship is no longer true. Fast Variable Persistence can exceed Fast Bistable capabilities by more than seven times. The same basic trade offs, long view time in Bistable and high contrast displays in Variable Persistence, are still true for the Fast Bistable and Fast Variable Persistence modes.

The nomograph in Figure 9 is useful for selecting the writing speed needed to display a given sine wave or step risetime ( $t_r$ ) at a certain amplitude. For example, to display a 16 ns risetime signal three centimeters in amplitude requires a writing speed of  $180 \text{ cm}/\mu\text{s}$ .

Figures 10 and 11 show the ability of Fast Variable Persistence to store a single event having a risetime of 3.5 ns, or a single burst of 100 MHz noise. A comparison of the ability of Variable Persistence and Fast Variable Persistence to display the same waveform is shown by Figures 12 and 13. Two fast signals occurring one minute apart are displayed in Figure 14 using Fast Bistable storage.

If these are typical of your measurement needs, your choice should be fast storage.

#### Summary

Each type of storage has advantages and limitations that make one more suitable than the others for a particular measurement application. *Bistable storage* offers long view times, a low cost, and rugged, split-screen operation. *Variable Persistence* provides high contrast and the ability to display different stored intensities. *Fast storage* offers increased Bistable and Variable Persistence writing speeds. Only at Tektronix will you find all three types of storage, and they're available in the plug-in oscilloscope or portable oscilloscope that's right for you. If you can't choose, we have multi-mode oscilloscopes that include the best of all three types. 

# Servicescope

## A potpourri of modifications and service hints

### THREE EASY MODIFICATIONS TO MAKE YOUR 465 OSCILLOSCOPE DO SOME JOBS BETTER

When the 465 was designed, some special performance features were omitted because they would be of little or no value to most customers. But for those who need the features and are able to make the mods themselves we can offer parts and instructions. Mod descriptions follow:

#### Equalize X-Y Phase to 2 MHz

By adding two resistors, two capacitors, and a small variable inductor you can modify the horizontal deflection circuits so the phase difference between the horizontal and vertical deflection circuits may be adjusted to be less than 3 degrees to 2 MHz. The circuit card where the parts are installed comes with holes to make it easy to install the additional components. The components are located next to the X Gain adjustment pot, R1215. Resistor R1211, in the original circuit, is removed and discarded. The changed section of the circuit diagram is shown in Fig. 1. Following is the list of required parts:

- 1-321-0077-00, Resistor, 62  $\Omega$ , 1%, 1/8 watt
- 1-283-0594-00, Capacitor, 1000 pF, 1%, 100V, mica
- 1-114-0278-00, Inductor, 4.5 to 12  $\mu$ H, variable
- 1-283-0672-00, Capacitor, 200 pF, 1%, mica
- 1-317-0151-00, Resistor, 150  $\Omega$ , 5%, 1/8 watt

#### 1 kHz Calibrator Frequency Made Accurate to $\pm 1\%$

This mod requires adding a small potentiometer and changing five resistors and one capacitor to have a different value, tolerance, or temperature stability. The amplitude calibrator signal may then be set to precisely 1 kHz and used as a timing reference for sweep calibra-

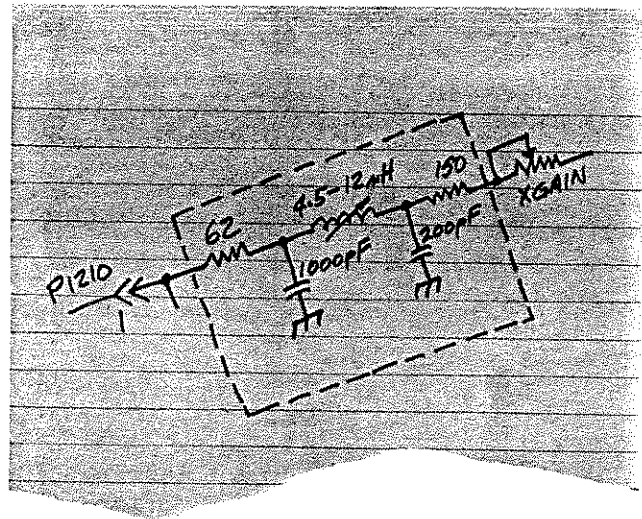

Fig. 1. Components within dashed lines replace R1211 on original diagram.

tion checks as well as a voltage reference for vertical deflection checks. The following capacitors and resistors are needed and used to replace those used in the original circuits:

- 1-285-0758-00, Capacitor C1592, .05  $\mu$ F, 2%, 400 V Poly carb
- 1-321-0365-09, Resistor R1591, 61.9 k $\Omega$ , 1%, 1/8 watt
- 1-321-0381-00, Resistor R1592, 90.9 k $\Omega$ , 1%, 1/8 watt
- 1-321-0268-09, Resistor R1593, 6.04 k $\Omega$ , 1%, 1/8 watt
- 1-321-0385-00, Resistor R1594, 100 k $\Omega$ , 1%, 1/8 watt
- 1-317-0622-00, Resistor R1596, 6.2 k $\Omega$ , 5%, 1/8 watt

One component, a small potentiometer, must be added:  
1-311-1224-00, 500  $\Omega$  Variable resistor, 0.5 watt

When R1593 is soldered into place the bottom end should not be connected to ground as shown in the original circuit diagram but wired in series with the 500  $\Omega$  variable resistor. The bottom end of the variable resistor is connected to the +5 volt supply instead of ground. Varying the resistor sets the calibrator signal frequency.

#### Dual Trace Chopping Rate Increased to 1 MHz

This mod requires eight parts, three of which replace original components. It reduces trace brightness somewhat in the chopped mode.

Capacitors C356 and C368, and resistor R356, should be replaced with ones shown in the parts list below. These parts are shown on the Vertical Switching diagram in the service manual (070-1861-00). R370 should be removed and not replaced.

Now modify the CRT Circuit diagram in your service manual according to the partial diagram in Fig. 2. The remaining five parts should be soldered into the circuit according to the diagram.



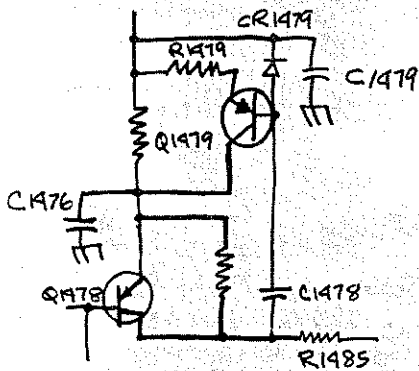

Fig. 2. Circuit changes to increase chopping rate to 1 MHz.

Here are the parts you will need:

- 1-281-0629-00, Capacitor, C356, 33 pF, 5%, 600 V
- 1-283-0100-01, Capacitor, C368, 0.0047  $\mu$ F, 10%, 200 V
- 1-315-0303-00, Resistor, R356, 30 k $\Omega$ , 5%, 0.25 watt
- 1-281-0557-00, Capacitor, C1478, 1.8 pF, 500 V, NPO
- 1-283-0057-00, Capacitor, C1479, 0.1  $\mu$ F, +80% -20%
- 1-315-0470-00, Resistor, R1479, 47  $\Omega$ , 5%, 0.25 watt
- 1-152-0141-02, Diode, CR1479, 1N4152
- 1-151-0301-00, Transistor, Q1479, 2N2907

#### CHANGE YOUR 5L4N TO HAVE A 20 Hz TO 20 kHz LOG SPAN

The log span is normally 100 Hz to 100 kHz for the 5L4N Spectrum Analyzer. But it is easy to change the span to cover 20 Hz to 20 kHz to fit the audio frequency spectrum. Here is what to do if your 5L4N has a Serial Number below B030313:

1. Change R1204 to 1.01 k $\Omega$ ,  $\frac{1}{8}$  w, metal film (321-0222-00)
2. Change R1202 to 11 k $\Omega$ ,  $\frac{1}{8}$  w, metal film (321-0293-00)
3. Change R1200 to a 2 k $\Omega$ , 0.5 w, 10%, trimmer, (311-1265-00)
4. Adjust R1200 for the proper span at 20 Hz.

You can change the span by adding or removing a jumper wire if your 5L4N has a serial number higher than B030312.

#### PLUG-IN EXTENDER CABLE PRECAUTION

You can save hours of repair time by observing two simple precautions when using plug-in extender cables.

1. Be sure power is turned off when connecting either end of the extender.
2. Be sure both ends of the extender are connected properly.

#### 7300, 7400, 7600 SERIES — 50 V SUPPLY FAILURES

There has been a higher than normal number of failures of transistor Q896 in the power supply of scopes in the above series. By adding a diode between the base of Q896 and ground it will be protected. A silicon diode is installed in parallel with diode CR894 with its anode grounded. We use a diode having the characteristics of a 1N4152, part number 152-0141-02.

#### 464, 465, AND 466 ERRATIC TRIGGERING

When a display is sometimes erratic when triggering on low amplitude signals it may be caused by part of the sweeps being triggered from the opposite slope than the one selected. The condition can be corrected by changing four tunnel diodes from one type to another. Diodes CR550, CR552, CR650, and CR652 should be changed from a type having part number 152-0125-00 to a type having the part number 152-0125-01. A good way to recognize diodes having the right part number is that the letters GE appear on them.

#### 575, 576, 577 CURVE TRACERS

When the brushes on the variable transformer (used to control the peak collector voltage) wear out they may be replaced with new brushes for about 1/10th the cost of a new transformer. For the 575 or 576 use a brush with part number 118-0032-00. For the 577 use part number 118-0033-00.

#### TM 504 GROUND LOOP

When TM 504 mainframes with serial numbers below B011370 are used to power an SG 502 signal generator the signal distortion may exceed normal limits. The problem appears on the SG 502 only when the signal frequency is an even multiple of the line voltage frequency but may appear on other plug-ins as very low level hum. To prevent the condition remove the top and bottom cover of the TM 504. Locate the section of the circuit card shown below and cut through two circuit board conductors as shown. Remove the connection between the  $\pm 33$  V COMMON and chassis ground (at the junction of C-20 and C-22 via a solder lug). Connect the junction of C-20 and C-22 of the circuit board at the point between J10 and J20 marked COM.

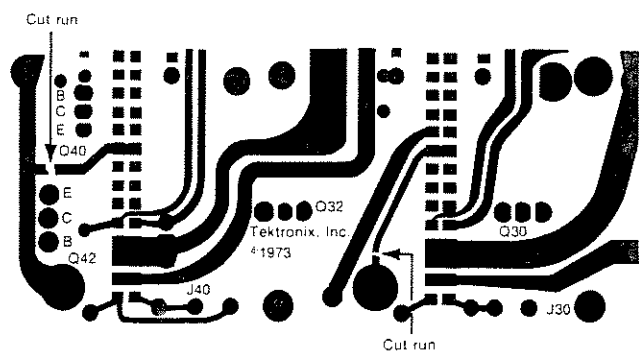
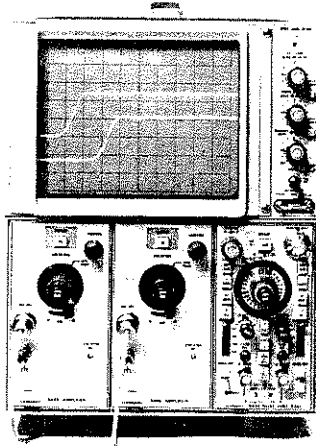

Fig. 3. TM 504 circuit board changes to remove ground loops.

# New products New products New products

---



## 5444 Dual-Beam Oscilloscope

The 5444 Dual-Beam Oscilloscope is a new member of the 5000 Series. Used with the 5B44 Dual Time Base plug-in and two plug-in vertical amplifiers, it is virtually two oscilloscopes in one. Both beams can write anywhere on the 8 by 10-division screen.

The 5444 will display a one-shot signal at two sweep speeds or two one-shot signals at any sweep speed. Only a dual-beam scope with two sets of horizontal deflection plates can do this.

If you need to compare more than two signals, the 5444 can display up to four repetitive waveforms in the alternate or chopped mode, or up to 8 at reduced bandwidth. Four single-shot events may be displayed at sweep speeds up to 100  $\mu\text{s}/\text{div}$  in the chopped mode.

The crt provides a bright display, has an illuminated parallax-free internal graticule, and provides readout that automatically documents the sweep speed and vertical deflection factor for each beam. A user-addressable readout option allows you to write up to two 10-character words of your choice to identify the photograph, the device under test, etc. The TEKTRONIX C-27 Option I Camera with 10,000 speed film and the Writing Speed Enhancer (or P-11 phosphor option) make it possible to photograph a one-shot display to the full 60 MHz bandwidth of the system.

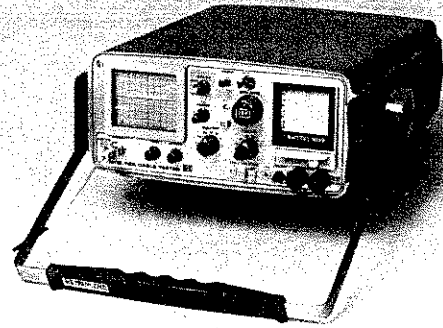

## 1502 and 1503 TDR Cable Testers

The 1500 Series meets the most stringent environmental specifications for flight-line rated test equipment. These portable TDR Cable Testers are at home operating in a deluge or a sand storm. January in Alaska or August in Texas doesn't bother them. Bouncing around in an off-the-road repair vehicle or being doused with salt spray on board ship doesn't stop them either. They're small, self-contained, rugged, and battery operated.

The two Cable Testers use TDR, a proven technique, to pinpoint faults to a fraction of an inch in short lines. In longer lines they resolve faults to within a yard as far away as 50,000 feet, depending on the cable characteristics. What can you test with this series? Just about any cable assembly from lamp cord to coax, plus a variety of broadband components (antennas, connectors, equalizers, sensors, etc.)

The 1502, for lines up to 2000 feet, provides fractional inch resolution. It uses a 110 ps step test signal into 50 ohms. The 1503 works out to 50,000 feet. It uses an impulse test signal into 50, 75, 93, or 125 ohms. Both versions are equipped for recording a "signature" of line characteristics using most any external X-Y Recorder. Signatures can be checked on a routine basis allowing problems to be identified and corrected before catastrophic failures can occur. An optional plug-in strip chart recorder is available (option 4).

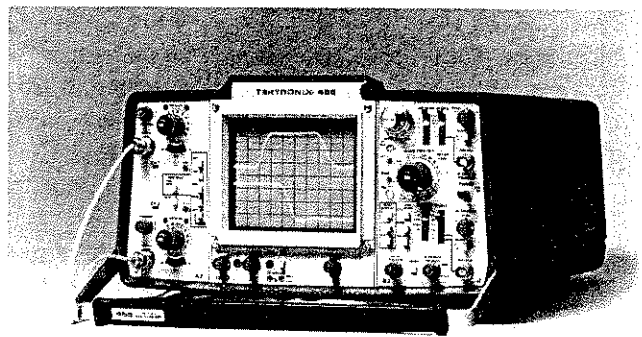

### 455 Portable 50-MHz Oscilloscope

The 455 combines 50-MHz bandwidth, dual traces, and delayed sweep in a rugged, value-leading portable oscilloscope. This instrument provides a cost-effective means of bringing needed performance features and accuracy to field service applications and to many production applications as well.

Accuracy and measurement range of the 455 are suitable for virtually all servicing of digital and analog equipment. Vertical sensitivity ranges to 5 mV/div with  $\pm 3\%$  accuracy (1 mV/div with channels cascaded). Sweep rates extend to 5 ns/div (2% accuracy for 50 ns/div and slower, 3% for 5 ns/div, 10 ns/div, and 20 ns/div). Differential time measurement accuracy is  $\pm 1.5\%$ .

In addition, the 455 offers features designed to make measurements faster, easier, and more error free. These include: lighted deflection factor indicators, trigger view, variable trigger holdoff, color-coded modular probes, modular construction for easy serviceability, and an easily understood color-coded control panel. To further enhance its use in service and industrial environments, the 455 is housed in a rugged, shock resistant plastic case. Optional battery operation frees the 455 from dependence on ac lines.

The 455 is an ideal choice for servicing small to medium scale computers, computer peripherals, industrial control equipment, military or commercial communications gear, office machines, and point-of-sale terminals.

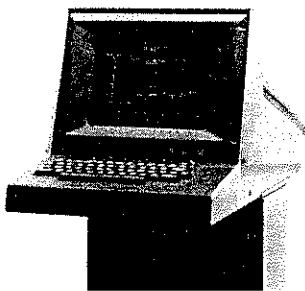

### E4010 and E4010-1 Graphic Display Terminals

These two terminals are economy models of the popular TEKTRONIX 4010 computer graphics terminal and have all the 4010's features except for the traditional thumbwheels to control the cross-hair cursor. Graphic input is through the keyboard. The E4010, and its hard-copy compatible version, the E4010-1, have 11-inch flicker-free storage tubes, 63-character ASCII set (upper case), and 1024 x 1024 addressable points. All TEKTRONIX interfaces, options and peripherals are compatible with the terminals, including the graphics tablets and disc memory units.

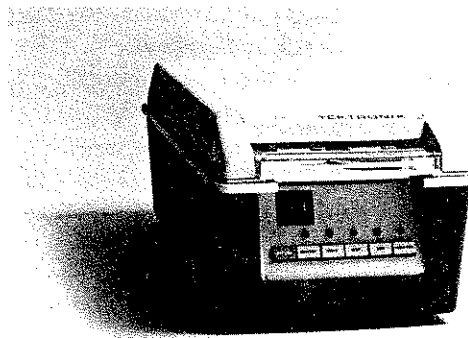

### The 4923 Digital Cartridge Tape Reader

The 4923 Digital Tape Reader is the perfect storage device to team up with the TEKTRONIX 4010 family of Computer Display Terminals or the 4023 Terminal. In fact, any product using RS-232-C data communications lines can be used with the 4923 Option 1.

Information is stored on a DC300A 3M Data Cartridge with a data capacity of 200,000 8-bit bytes. Data format is 128 8-bit byte records with variable length files. The standard model operates up to 10K baud, depending on the terminal environment. Option 1 lets you select a baud rate from 110 to 9600.

Operating the 4923 is as simple as one, two, three. You have front panel controls for Reverse, Write, Stop, Run and Forward.

The computer can access START READ (DC1) and STOP READ (DC3). During a READ operation the 4923 provides a line-turn-around character if a DC3 is encountered in the data. Once a DC3 is read, the following stored character is read and sent, and the unit stops.

---

### 2701 and 2703 Step Attenuators

The 2701 and 2703 Step Attenuators are small, laboratory-quality, wideband bench-top instruments for attenuating large value radio- and video-frequency signals. The 2701 is a 50 ohm attenuator particularly useful in making receiver sensitivity and distortion measurements. Its range of attenuation is 0 to 79 dB, in 1 dB steps. A front-panel slide switch selects dc (direct coupling), ac (protects against dc offsets), or dc TERM (a 50 ohm precision termination).

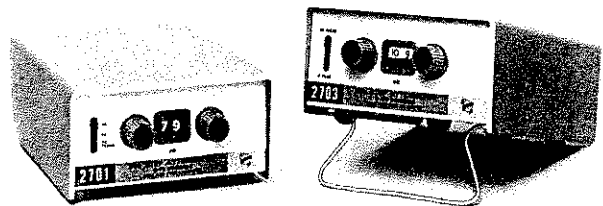

The 2703 is a 75 ohm attenuator for television, CATV, telephone, and radio applications. A front-panel switch extends the range from 79 dB to 109 dB, making an ideal accessory for wide-range measurements of cross modulation, signal-to-noise ratio, receiver sensitivity, etc. Attenuation can be selected in 1 dB steps with tens and units cam switches. The value selected is shown in the display window. A block has been incorporated on both rear panel ports to protect against accidental burnout from high dc offsets or ac power on center conductors.



#### 1° Luminance Probe

The J6523 1° Luminance Probe is the newest probe for the J16 Photometer/Radiometer. The J6523 is especially useful for measuring a very small spot or a small, distant area of light.

Now you can take a precision light-measurement tool into the field and make measurements in difficult situations. The J16/J6523 is tough, compact, light (about 5.5 pounds), battery operated, and stabilized for reliable indoor or outdoor use.

The J6523 has a measurement range of 0.1 to 19,900 foot-lamberts (1 to 199,900 nits for the metric version), will measure a spot as small as 0.23 inch (smaller with commercially available close-up lenses), and has an optical sighting system with a 9-degree field of view. Its

rugged, stable silicon photodetector incorporates accurate photopic spectral correction.

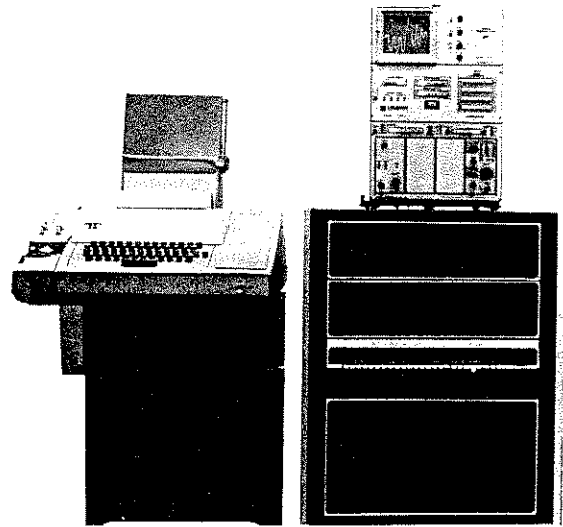

#### WP 1205 Digital Processing Oscilloscope (DPO)

The WP 1205 DPO is a low-priced starting package for customers with a restricted budget. The package includes one 7A16 vertical plug-in, one 7B70 time base plug-in, a CP1151 controller with a 16k memory, a modified ASR-33 teletype, and paper tape DPO TEK BASIC software.

The WP1205 has an internal 1k semiconductor memory, adequate to acquire and display one waveform with scale factors. But a standard option is available providing a 4k memory. The CP1151 controller with 16k memory provides adequate program space for most user applications since specific software routines may be selected when initially loading DPO TEK BASIC software.

Option 02 deletes plug-ins, option 08 substitutes a 4k processor memory for the 1k memory, and option 09 changes the line voltage connections for 230-V operation.

Most of the products pictured here are making their initial appearance in Tekscope. Others have been announced by Tektronix in the last few months and are included here because of their wide range of

application. We invite you to use the inquiry card accompanying Tekscope if you would like more complete information on any of these products.

A-3169

**TEKTRONIX, INC.**  
P.O. BOX 500  
BEAVERTON, OR. 97005

**BULK RATE  
U.S. POSTAGE  
PAID  
Tektronix, Inc.**

0544304  
MR FRANK CAPELLUPO  
NEW YORK TELEPHONE CO  
8898 75TH AVE  
GLENDALE NY 11227