

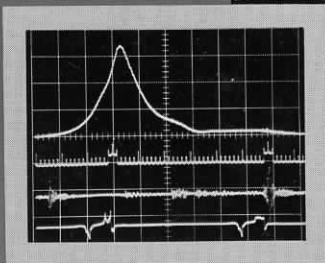

Engine Analysis Measurements

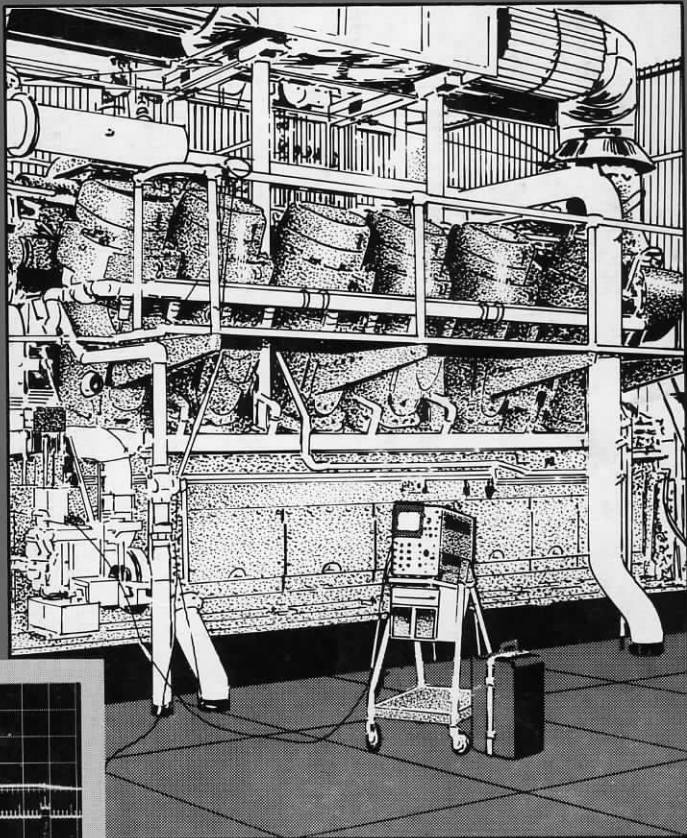

Measurement Concepts Series

ENGINE ANALYSIS

BY
JIM THURMAN

ILLUSTRATIONS
BY
DICK WILSON



MEASUREMENT CONCEPTS

ENGINE
ANALYSIS

FIRST EDITION SECOND PRINTING MARCH 1970
062-1074-00
PRICE \$1.00

TREATMENT CONCEPTS

© 1969, TEKTRONIX, INC.
BEAVERTON, OREGON
ALL RIGHTS RESERVED



CONTENTS

	INTRODUCTION	1	
1	IGNITION SYSTEMS	3	
2	IGNITION WAVEFORM ANALYSIS	17	
3	MAGNETIC TRANSDUCER	41	
4	ROTATIONAL FUNCTION GENERATOR	49	
5	VIBRATION TRANSDUCER	63	
6	PRESSURE TRANSDUCER	71	
	APPENDIX A	101	
	APPENDIX B	113	
	INDEX	119	

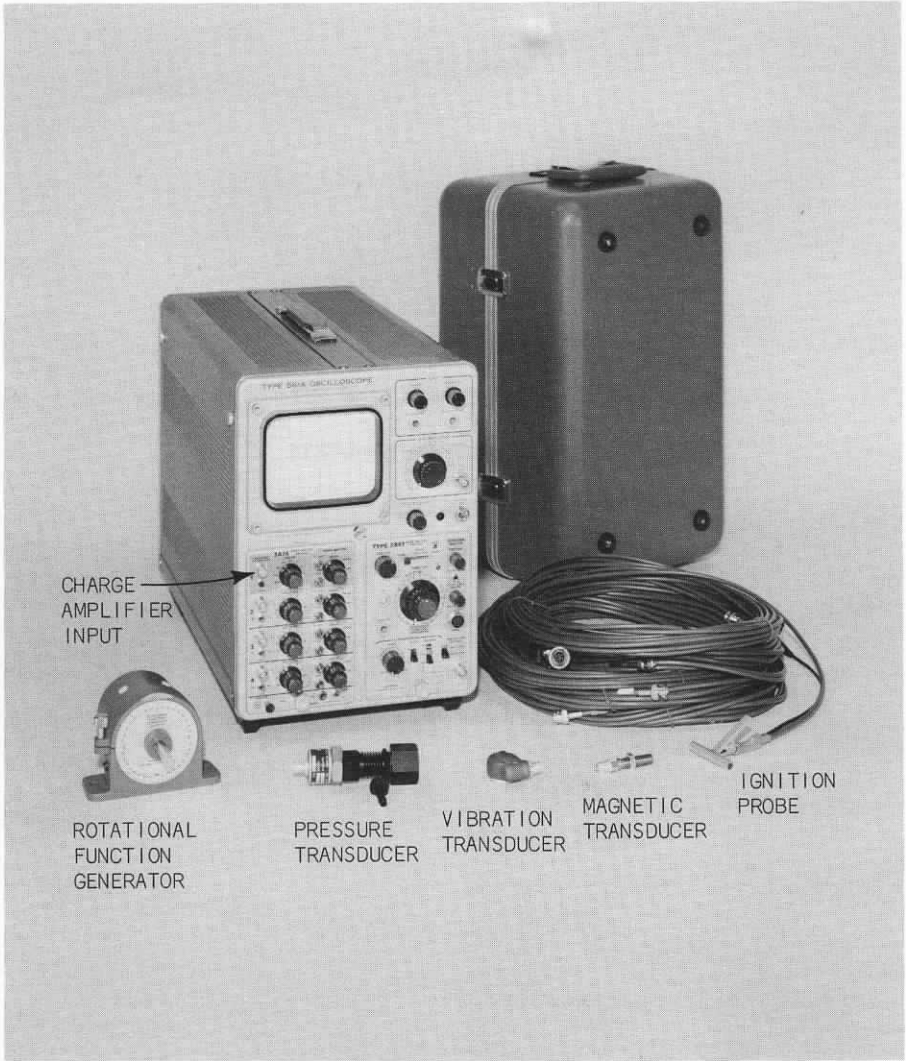

INTRODUCTION

The Tektronix Engine Analyzer is capable of displaying five waveforms; ignition, crank angle markers, magnetic pulses, vibration, and pressure waveforms. The ignition waveform is obtained with the Ignition Probe, the crank angle markers are provided by the Rotational Function Generator, the magnetic pulses are generated by the Magnetic Transducer, the vibration waveforms by the Vibration Transducer, and the pressure waveforms are generated by the Pressure Transducer and are displayed through the Charge Amplifier (Channel 1 of the 3A74 Engine Analyzer Amplifier).

These waveforms can be most useful in determining the condition of the mechanical and electrical components of the engine. Each of the waveforms will be discussed individually, as much as is practical, in the first part of this text. The latter part will be devoted to a discussion of the display and analysis of all the waveforms simultaneously.

It is not the intent of this text to illustrate waveforms for any particular malfunction relating to a specific engine. It is, instead, the intent to illustrate basic concepts that can be applied to any engine.

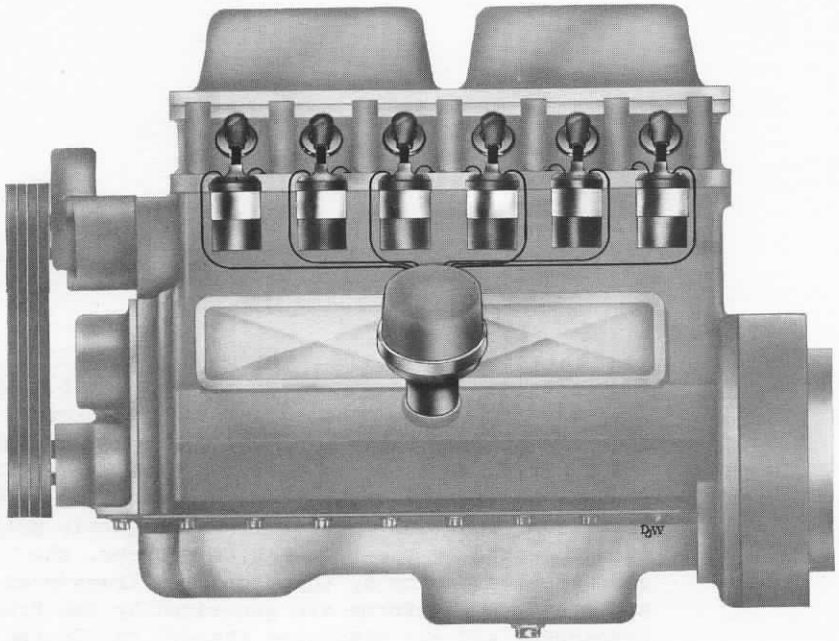

Fig. 1-1. Low-tension ignition system.

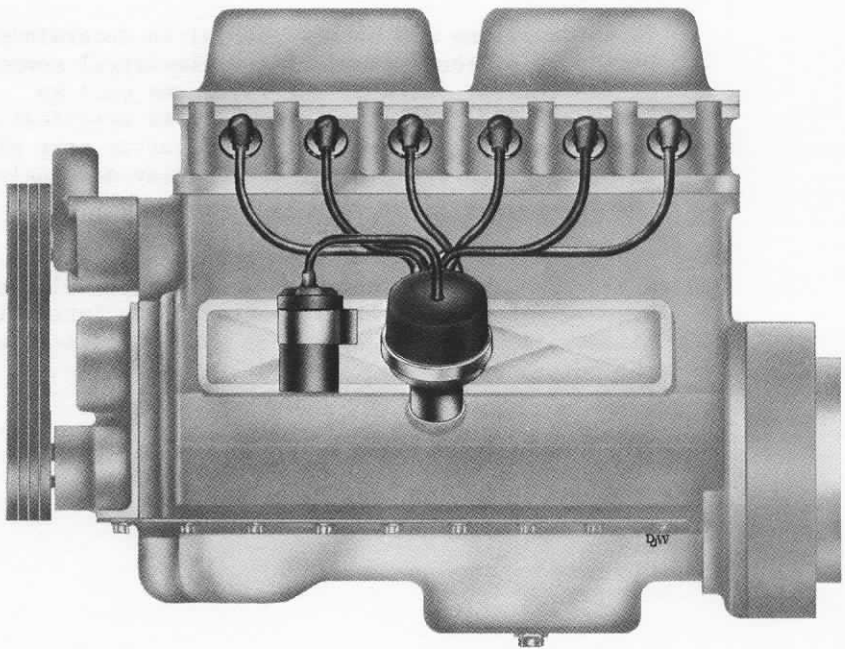

Fig. 1-2. High-tension ignition system (high-voltage distribution).

1

IGNITION SYSTEMS

The purpose of an ignition system on a spark-ignited engine is to deliver an arc at the spark plug electrode gap at the precise moment it is needed to begin the burning or combustion process in the cylinder.

high tension
low tension

Ignition systems are divided into two basic groups: High-tension and low-tension (refer to Figs. 1-1 and 1-2). The terms refer to a voltage level at the time of distribution. In a high-tension system, the energy is distributed to the spark plugs as a high voltage and usually uses a single transformer. In a low-tension system the energy is distributed as a low voltage and is transformed into high voltage at or near the individual spark plugs, thus requiring multiple transformers.

Several different schemes have been used over the years to achieve the basic purpose of the system. One system that probably has been used more than any other is the "standard" inductive storage system that is used on most automobiles. Other types of ignition systems in use today are magneto, transistor, pulse generator and capacitive discharge.

INDUCTIVE STORAGE

Because of its wide-spread use the inductive storage system will be discussed first.

current
creates
magnetic
field

In the inductive storage system, when the spark plug is not being fired, the points are closed (refer to Figs. 1-3 and 1-4). With the points closed, the system is effectively a short circuit to ground and, therefore, a high current flows in the primary windings of the transformer (coil). The current is usually on the order of four or five amperes. The high current in the primary of the transformer causes a rather large field to be present.

When it is time to fire the spark plug, the points are opened by a lobe on the distributor cam, breaking the current path to ground. With the disruption of the primary current flow, the magnetic field present in the transformer begins to collapse.

high
voltage
generated

The high rate of change of the magnetic field will generate a high voltage in the secondary due to the 100:1 turns ratio of the transformer.

This voltage is directed to the proper spark plug by the rotor and distributor cap electrodes.

spark
gap
ionization

When the potential reaches sufficient amplitude to ionize the atmosphere present at the spark plug gap, an arc will begin. With ionization of the gap the resistance of the current path is much lower and therefore the voltage will drop back to a lower value.

The arc will be sustained until the secondary no longer has enough energy to maintain the arc across the gap. At this time the arc will cease and the energy remaining will be dissipated in the form of oscillations in the "tank" or resonant circuit between the capacitor and the primary of the transformer (refer to Fig. 1-4).

Sometime later the points are allowed to close as the cam lobe continues its rotation and the cycle begins again.

Fig. 1-4 is a drawing of the waveform as it is generated in the secondary circuit of the inductive-storage high-tension system. Fig. 1-3 is a simplified schematic diagram of such a system.

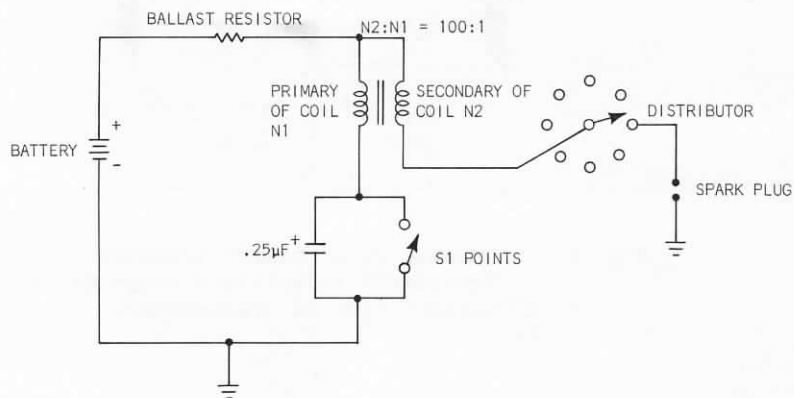

Fig. 1-3. Simplified schematic for "standard" inductive storage system.

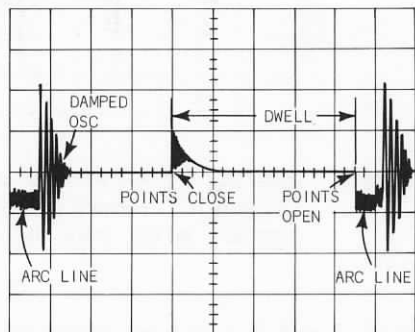

Fig. 1-4. Drawing of secondary waveform of "standard" inductive storage system.

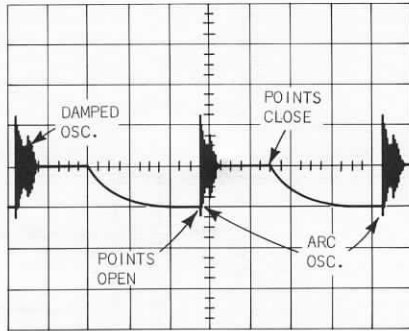

Fig. 1-5. Drawing of a primary waveform of "standard" inductive storage system at battery side of transformer.

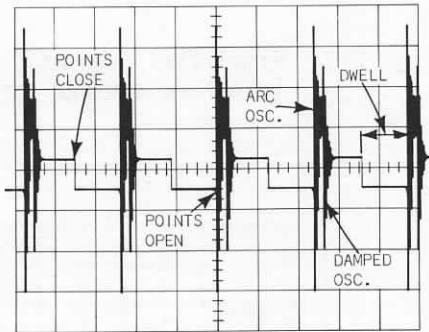

Fig. 1-6. Drawing of a primary waveform of "standard" inductive storage system at contact point side of transformer.

Figs. 1-5 and 1-6 are drawings of the waveforms that are generated in the primary circuit of the inductive storage system with their characteristic features indicated in the illustration.

MAGNETOS

Magnetos generally fall into the low-tension group--generating and distributing a low-voltage current to the transformers.

The magneto can be divided into two sections--the voltage-generating section and the distributing section (refer to Fig. 1-7).

voltage
generation

The voltage-generating section consists of a stationary coil and a rotating permanent magnet. A voltage is generated in the coils as the lines of flux pass over them. The amplitude of the generated voltage is, of course, a function of how rapidly the flux passes over the conductors of the coils. The voltage output of the magneto will increase as a linear function as the RPM is increased. Therefore, the magneto efficiency is much greater at higher RPM's than it is at lower RPM's. This section also contains a single set of contact points with an operating cam and a capacitor.

voltage
distribution

The distributing section consists of another operating cam with a set of contact points for each cylinder.

The system as depicted in Fig. 1-7 functions as follows: When a cylinder is soon to be fired, the contacts for that cylinder will be closed in the distributing section and the points in the generating section will be open, providing a current path from the voltage generator through the primary of the transformer. When it is time to fire that cylinder, the points in the generating section will close and the field in the transformer will collapse. The collapsing field induces a high voltage in the secondary--firing that spark plug.

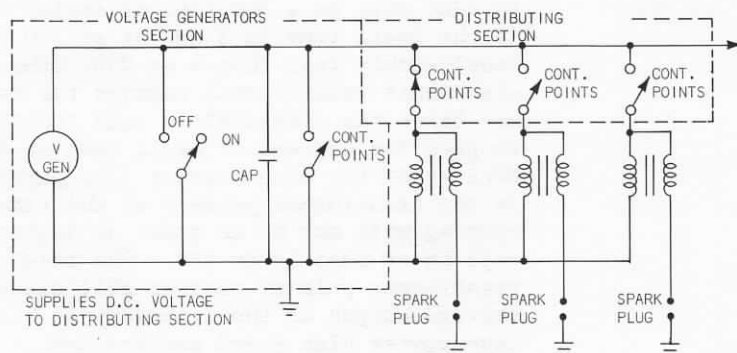

Fig. 1-7. Simplified schematic of low-tension magneto system.

The distributor points that have been closed will now open and the points to the next cylinder to be fired will be closed--the points in the generator will open so that a field can be built in the next transformer, and the cycle begins again.

The shorting ON-OFF switch is normally a part of the ignition switch.

transformers Frequently the transformers are single units mounted near each spark plug. However, dual transformers are also used (one transformer firing two spark plugs on one cylinder) and occasionally the transformers are mounted directly over the spark plug in the cylinder head recess; thus eliminating the need for secondary leads (refer to Fig. 1-8).

TRANSISTOR

It can readily be seen that the contact points carry all the transformer primary current, therefore "dwell" or point-closure time is most important. If the points are left closed for too long a time period the high current will overheat them--if they are not closed for enough time there will not be enough current built up in the primary circuit and the transformer field will not be strong enough to deliver sufficient voltage to fire the spark plug at higher RPM.

Dwell of the contact points is a function of crankshaft rotation and therefore, it can be related to time only as a function of engine RPM. That is, if the dwell time is X amount at 500 RPM it will be considerably less than X at 2000 RPM, even though the crankshaft relationship remains the same, because it now takes the crankshaft a much shorter period of time to pass the degrees of dwell than it did previously. Because of the much shorter time period, the current in the transformer primary at the time of the points opening will not be as great at higher RPM's as it will be at some lower RPM. The resultant lower transformer primary current will cause a much lower voltage output at the secondary at higher RPM's and thus poorer high speed performance.

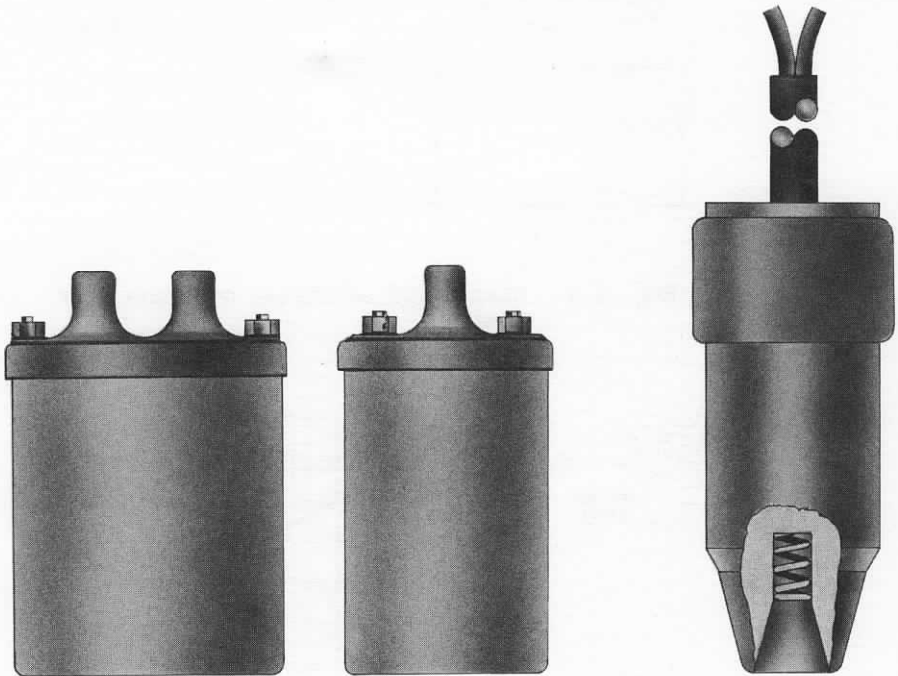

DUAL SINGLE
High or Low Tension

OVER-SPARK PLUG
Low Tension
System Only

Fig. 1-8. Transformers.

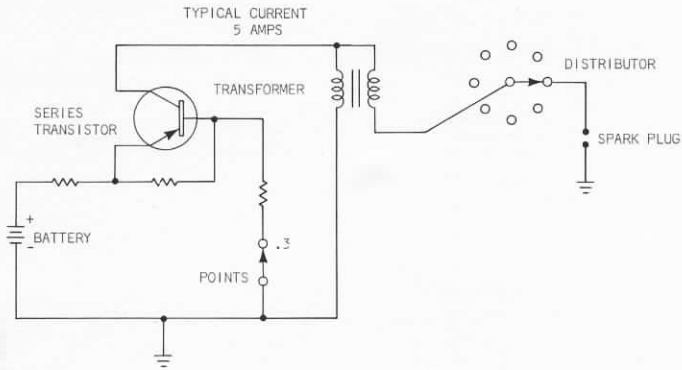

Fig. 1-9. Simplified schematic of transistor system.

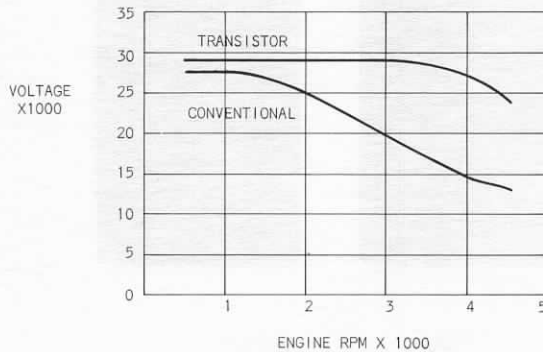

Fig. 1-10. Available voltage chart.

The development of the transistor ignition system (refer to Fig. 1-9) was an effort to rid the contact points of the damaging high current of the transformer primary and, at the same time, gain more current for the primary circuit for better high-speed performance. This was accomplished by using the transistor as the current switch and using the contact points as a switch to turn the transistor on and off. In this way the contact points carry the small base current of the transistor. The transistor carries all the primary current and since there is no longer a danger of failure due to burned points the dwell time can be

voltage
vs RPM

lengthened and the primary current increased to achieve better high-speed performance. Fig. 1-10 is a graph showing available voltage vs RPM of both the conventional and the transistor ignition systems.

early
transistor
system
shortcomings

These things the system accomplished. However, the base current of the transistor, usually about 300 mA or less, was not enough to keep the points from contaminating (approximately 1A is needed) and difficulty was still experienced with them. A high turns-ratio (200:1) transformer was developed (low primary inductance) to minimize the inductive kick-back that was damaging the early semiconductors. A resistive divider was designed into the base-point circuit to provide the additional current for the contacts. The addition of the divider and the low-inductance transformer has presumably made the transistorized ignition system reliable.

transistor
system
operation

The system functions as follows: When the spark plug is not being fired, the contact points are closed. This turns the transistor on. The transistor conducts hard to ground, building the field in the transformer primary. When it is time for the spark plug to be fired, the contact points are opened, turning the transistor off and breaking the current path. Without the sustaining current flow in the transformer primary the magnetic field collapses and induces the high voltage necessary in the secondary to fire the spark plug.

Some time later the points are allowed to close, turning the transistor on and the cycle starts again.

PULSE GENERATOR

The pulse generator is the result of a continued effort to get rid of the problems associated with contact points and generally upgrade the performance of the ignition system.

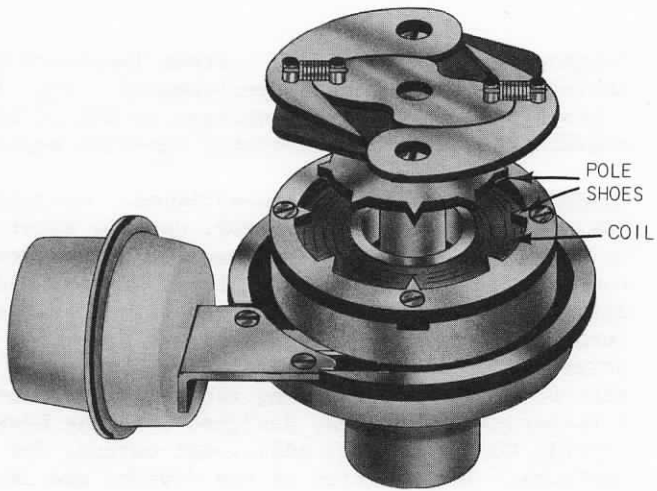

Fig. 1-11. Pulse generator.

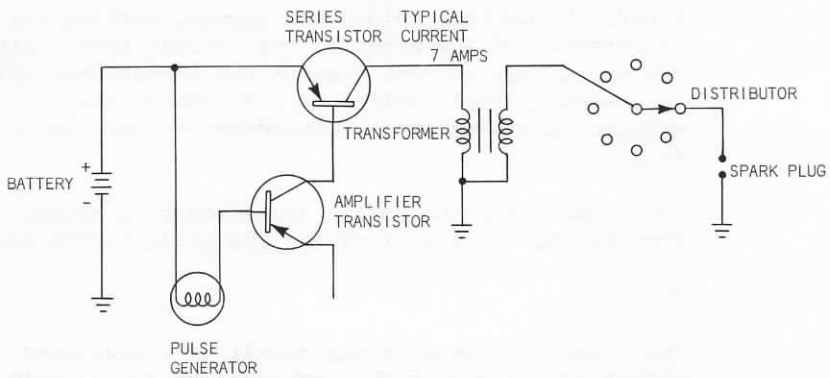

Fig. 1-12. Simplified schematic of pulse generator system.

electro-
magnetic
pulse

The usual approach in high-tension systems is to generate a pulse electromagnetically. This is accomplished by using a stationary coil and magnet with a rotating core in the distributor. Fig. 1-11 is an example of such a generator. The core has protrusions that coincide with the number of cylinders in the engine, as does the stationary pole piece. As the rotating core points line up with the pole-piece points, the permeability of the flux path will go up greatly--resulting in a pulse being generated in the coil. The pulse is then used as a gating waveform for a transistor which, in turn, makes and breaks the transformer current. This system eliminates parts wearing and getting out of adjustment.

The pulse generator system (refer to Fig. 1-12), in a high tension configuration, is essentially the same as a transistor system, except that the current transistor is gated on and off with a generated pulse rather than a set of contact points.

In low-tension systems the pulse is sometimes generated by a rotating coil and a stationary magnet and, of course, the pulse distributed to the appropriate transformer.

CAPACITIVE DISCHARGE

The capacitive discharge system uses a pulse generator, as a gating signal source. However, beyond this there is little similarity between it and other systems.

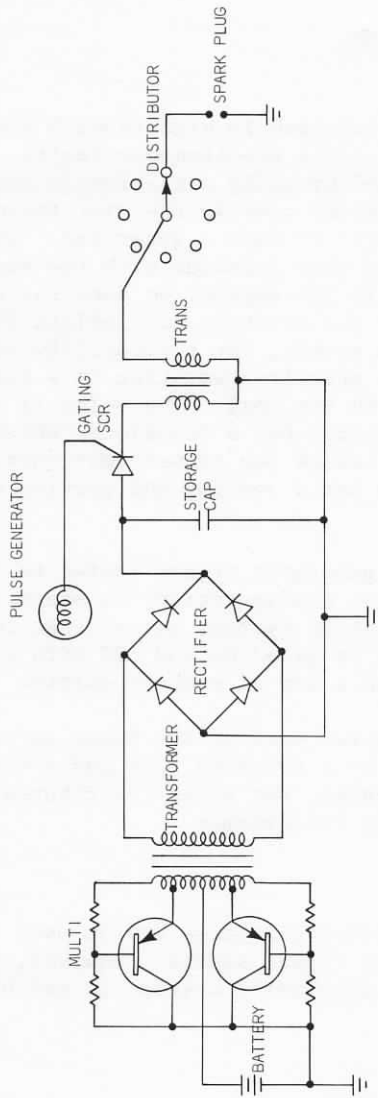

Fig. 1-13. Simplified schematic of capacitive discharge system.

gated
multi-
vibrator

The simplified schematic diagram in Fig. 1-13 shows that the source of charge voltage for the storage capacitor is the secondary of a transformer--the primary of which is driven by a multivibrator that may operate on as little as 4 volts. It is evident from this that battery voltage, or charge state, has little effect on the power output of the system, making this system very desirable on hard-to-start engines or in a cold ambient environment where battery efficiency drops considerably.

high voltage
with short
falltime

The charge on the storage capacitor is held or released by the SCR, which is gated by the pulse generator. The amount of energy released into the ignition transformer primary is dependent upon the size of the capacitor (perhaps 1.5 μ Fd) and the voltage across it, which is frequently as much as 300 V or 400 V. Releasing this much energy into the special low-induction ignition-transformer primary gives not only a very high secondary voltage output due to the rapid expansion of the transformer primary field and the transformer having a high turns-ratio, but also a much shorter falltime in the secondary voltage. Falltimes on the order of 3 or 4 μ s are not unusual, as compared to as much as 130 or 140 μ s for an inductive storage system.

The higher energy level, faster falltime and lack of sustaining oscillations have a number of advantages. The arc line width is reduced to cut down spark plug erosion while still maintaining positive ignition of the fuel/air mixture. The faster falltime will fire spark plugs that are deposit or temperature fouled and would not otherwise fire. It also allows the use of wider spark plug gaps--assisting in ignition of the mixture.

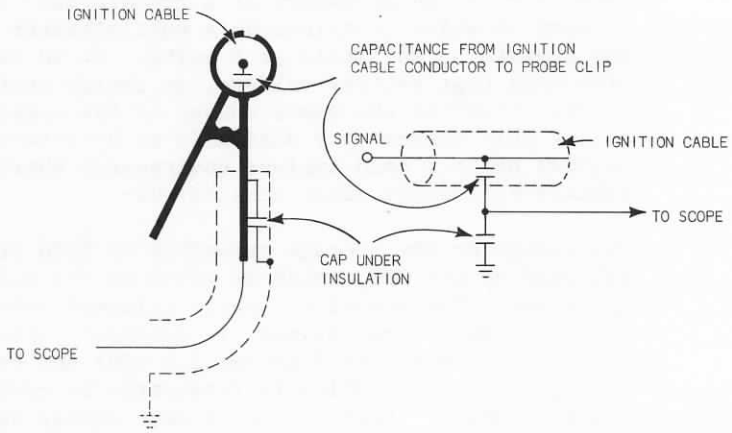

Fig. 2-1. Electrical configuration of ignition probe.

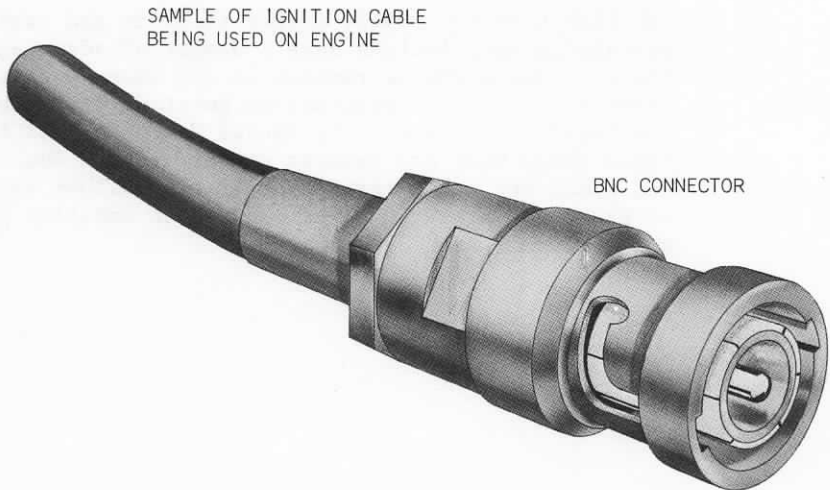

Fig. 2-2. Ignition calibration cable.

2

IGNITION WAVEFORM ANALYSIS

capacitive
pick-off

The Tektronix Engine Analyzer uses a clip-on capacitive pick-off as an ignition probe to gain access to the secondary or high-tension ignition waveform. The clip that fastens on the secondary cable, by virtue of the capacitance from the center conductor of the secondary cable to the clip of the probe, forms a capacitor that is half of a capacitive divider. The other half of the divider is a capacitor that is located under the insulation at the clip base and is connected between the clip and ground through the shield of the probe coax. Fig. 2-1 shows the physical and electrical configurations. The divider is approximately 1000:1 so that the instrument sensitivity can be read in kilovolts.

calibrating
the system

If absolute voltage amplitudes are desired, the 40 V position of the CALIBRATOR of the instrument should be checked with a precision voltmeter (refer to Calibration Procedure in the manual of the instrument) to assure CALIBRATOR accuracy. The calibration cable described later and illustrated in Fig. 2-2, should be attached to CAL OUT connector, the CALIBRATOR set to the 40 V position, and the Ignition Probe connected to the cable. If the vertical gain of the plug-in has been accurately set the attenuation factor of the Ignition Probe can be

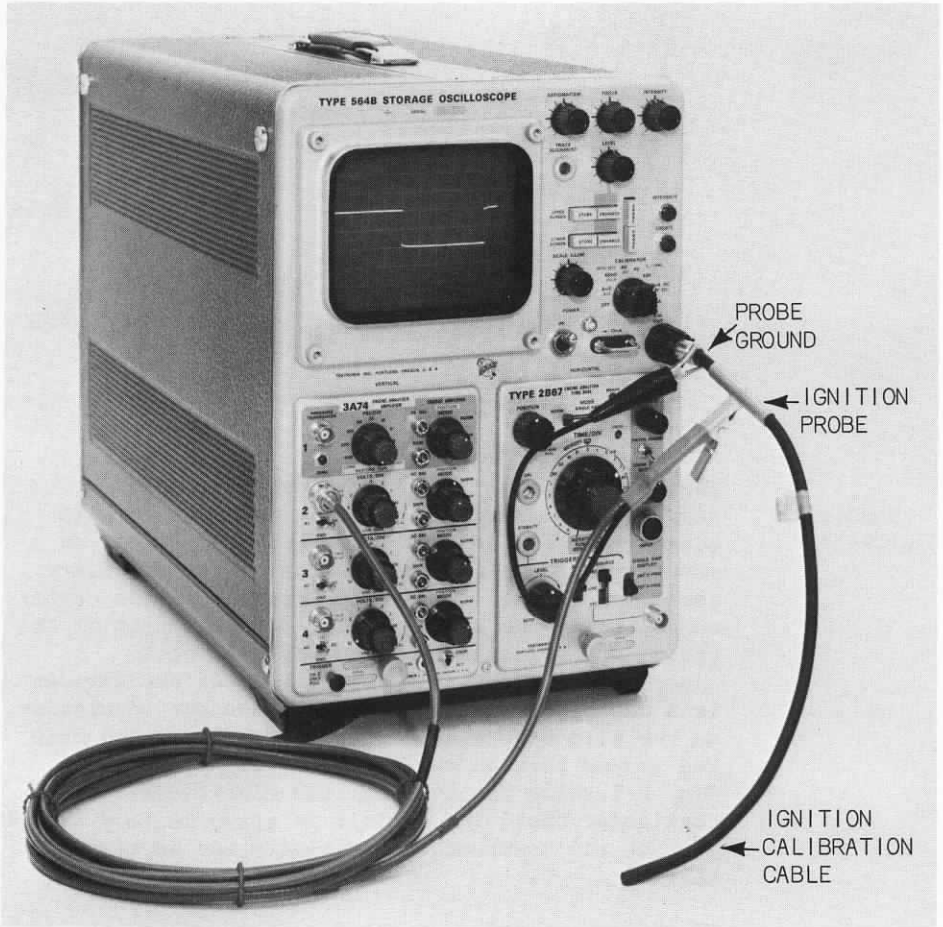

Fig. 2-3. Checking attenuation ratio of ignition probe.

read on the CRT. If this factor is used and considered in reading waveform amplitudes, actual voltage values can be determined. The calibration set-up is illustrated in Fig. 2-3.

The calibration cable is simply a length of high-tension cable of the same type used on the ignition system with a BNC connector fixed on one end for convenience in connecting to the CAL OUT.

Fig. 2-4 is a drawing of a typical waveform using this procedure. In this case the ignition probe has an attenuation factor of 1000:1, giving a 40 mV output for a 40 V input.

The attenuation factor of the ignition probe can be changed to a wide range of values by simply changing or selecting the capacitor value located under the clip's protective cover.

probe
connection

To view the waveform of only one cylinder on a high tension system, the ignition probe should be clipped on the spark plug lead for that cylinder. However, to observe all cylinders, the probe should be clipped on the lead between the transformer secondary and the distributor cap center tower.

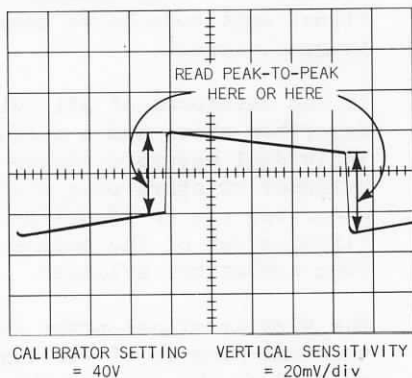

Fig. 2-4. Typical waveform for ignition probe connected to calibrator.

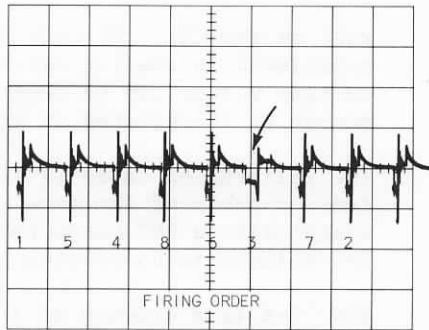

Fig. 2-5. Drawing showing typical waveform while locating malfunctioning spark plug.

triggering

In the case of viewing all the cylinder waveforms it is helpful to use an additional probe on the number one cylinder spark plug lead connected to the EXT TRIGGERING input of the time base unit of the instrument. In this way the instrument can be triggered on the number one cylinder and the waveforms following will be for the remaining cylinders presented in the firing order of the engine.

If an additional probe is used for triggering, an attenuation factor of 2000:1 to 2500:1 is desirable, for use on a high-tension system, to reduce the signal amplitude to an acceptable level for the trigger circuit.

cylinder
identifica-
tion

If the waveforms of all cylinders are "paraded" as described above and a malfunction is noted on an individual waveform (refer to Fig. 2-5), the cylinder or spark plug where the malfunction is occurring can be identified by counting down the firing order of the engine to the offending waveform from number one cylinder.

single
cylinder
analysis

The viewing signal probe which is connected to the vertical plug-in of the instrument can then be changed to the lead of the offending spark plug, the display expanded and examined in greater detail to determine the cause of the malfunction. When viewing the signal of only one particular spark plug (as above) it will probably be helpful to change the TRIGGERING SOURCE from EXT to INT so that the

instrument will be triggered from the signal that is being viewed rather than from number one cylinder. Fig. 2-6 is a drawing of a waveform of a "standard" inductive storage system, taken in such a manner with the various characteristics noted.

Close examination of an actual waveform taken of the system used on an engine can reveal a great deal about the performance of the system, both electrical and mechanical.

Because of the popularity of the system, the following discussion will be about the "standard" inductive storage system. There are, however, many similarities between this and other systems and, therefore, many of the analyses, theories and practices used here can be applied to other systems.

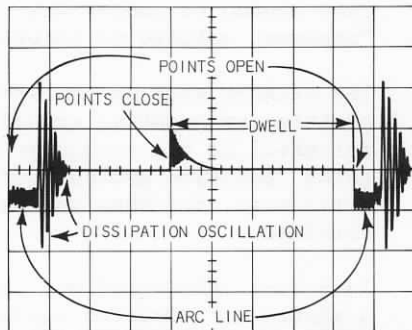

Fig. 2-6. Drawing of typical secondary waveform.

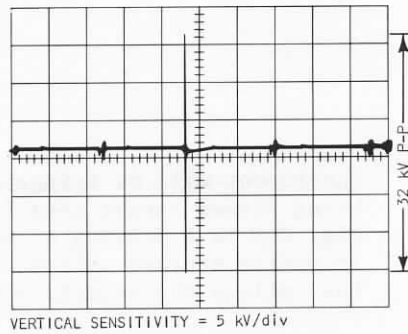

Fig. 2-7. Drawing of typical waveform while checking generating potential.

generating
potential

Probably of first order importance on an ignition system is the generating potential. This can be checked rather easily by removing a high-tension lead from the spark plug and isolating it from ground. Fig. 2-7 is a waveform taken under these conditions. The vertical scale is 5 kV/div, showing a total generating potential of 32 kV peak to peak.

The difference between the generating potential and that needed to ionize the spark gap can be considered "reserve" voltage to insure firing of the spark plug.

polarity

The primary side of the system may have either a positive or negative ground, but the generating potential in the secondary should always be negative going (positive ground), if maximum ignition system efficiency, and thus engine performance, is to be obtained.

To better understand why this is, refer to Fig. 2-8, a sketch of a mounted spark plug. It can be seen that the center (negative) electrode will be the hotter of the two electrodes in a positive ground configuration. Thus, because electrons are negative, and can be excited into conduction by temperature as well as electrical pressure, the air gap can be ionized with 20-40% less voltage with the positive ground system than it can be with a negative ground system. The voltage in the primary is insignificant compared to the generating potential, even though they may be of opposite polarities.

ionizing
potential

Refer to Fig. 2-9. The first negative peak (the INTENSITY may have to be turned up to make these peaks visible) of each waveform is the voltage or potential necessary to overcome the various resistances in the secondary current path. This is the point at which the spark plug gap begins to conduct current and combustion should begin.

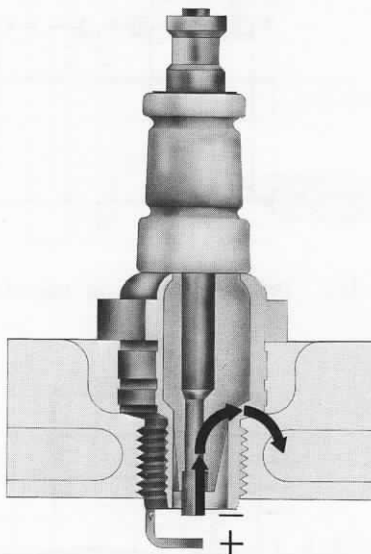

Fig. 2-8. Typical mounted spark plug showing cooling path.

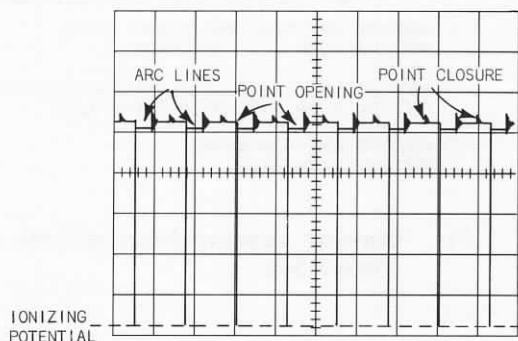

Fig. 2-9. Drawing showing ionizing potential of cylinders.

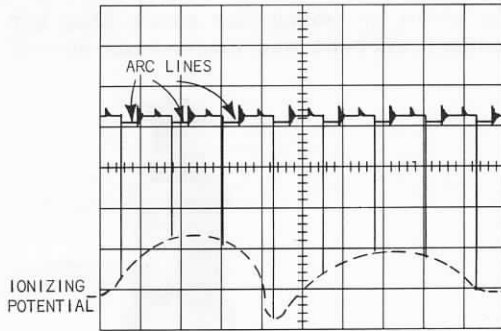
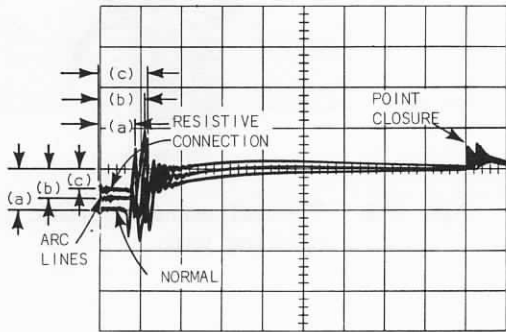

Fig. 2-10. Drawing showing unbalanced fuel mixture.



- (a) ARC LINE AMPLITUDE GREATER THAN NORMAL.
ARC LINE WIDTH LESS THAN NORMAL.
- (b) ARC LINE AMPLITUDE A LITTLE GREATER THAN NORMAL.
ARC LINE WIDTH A LITTLE LESS THAN NORMAL.
- (c) ARC LINE AMPLITUDE NORMAL.
ARC LINE WIDTH NORMAL.

Fig. 2-11. Drawing showing intermittent secondary connection.

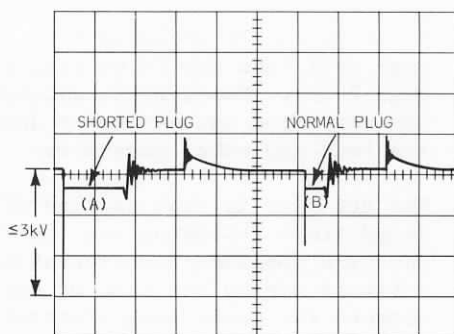

Fig. 2-12. Drawing showing ionizing potential of rotor-to-cap gap by shorting spark plug.

The potential necessary depends upon many things--the amount of pressure (PSI), the air/fuel ratio, the amount of cylinder air turbulence, the temperature at the electrodes, the resistance of the associated circuitry (including the spark plug), the air gap of the spark plug and the amount of air gap elsewhere in the circuit, such as the rotor-to-cap gap in a high-tension system.

The ionizing voltage value can be of interest for many reasons. A varying voltage, such as that in Fig. 2-10, can mean that the fuel/air ratio is unbalanced from one cylinder to another, that the spark plug gaps are not uniform, that some secondary leads have higher resistance than others, and in a high-tension system, the distributor cap is worn or the rotor is worn or wobbling due to a bent shaft or bearing wear.

Should the peaks be sufficiently uniform, but excessively high, the cause may be excessive spark plug gap, broken or high-resistance secondary leads, excessive rotor-to-cap gap, or a lean fuel mixture. A high ionizing potential will be accompanied by an arc line that is both higher in amplitude and shorter in length than usual (refer to Fig. 2-11).

rotor-to-cap
air gap

In a high-tension system (assuming no excessive resistance elsewhere in the system) the rotor-to-cap gap can be checked by shorting out the lead at the spark plug. The waveform will be similar to that of Fig. 2-12 and negative peak now seen will be representative of that air gap and, generally, should not exceed 3 kV.

It is generally accepted that the normal ionizing peak amplitude should be between 5-10 kV (refer to Fig. 2-13). However, it should be noted that this can vary from one engine to another depending upon its load and other parameters.

arc line

The arc line is that portion of the waveform immediately following the ionizing peak and is, as the name implies, representative of the voltage activity during the time of current conduction between the spark plug electrodes.

As the atmosphere at the spark plug electrodes ionizes and begins to conduct current, the resistance of the gap drops to a much lower value and the voltage in the lead will drop back to a lesser value during the time of current conduction. There are two characteristics of this portion of the waveform that are of interest: (1) Amplitude, and (2) Duration. The two characteristics are inversely related to each other. That is, if the arc line amplitude is high, then the duration will be short and if the duration is long, then the amplitude will be low. This is apparent when comparing Fig. 2-14 with Fig. 2-12. In Fig. 2-14 the amplitude of the arc line is high due to resistance deliberately placed in the circuit. Fig. 2-12 is a waveform taken with the spark plug shorted. Note that the arc line width for the shorted plug waveform is much longer than that of the resistive waveform.

It can be seen by the above comments and by referring to the waveforms that the amplitude and duration of the arc line can disclose quite a lot about the condition of the spark plugs, leads and other components in the system. For example, if the arc-line amplitude keeps getting greater from one time of measurement to another, this would be ample reason to suspect electrode gap growth in the spark plug. Also, if the arc-line amplitude decreases as the engine warmed up, this might indicate temperature fouling of the spark plug. If the arc-line amplitude decreases with time it might very well indicate deposit fouling of the spark plug. If the amplitude jitters up and down as in Fig. 2-11 the cause is likely to be an unbalanced fuel mixture. If the arc-line amplitude of the waveforms remain fairly constant, but the width grows shorter with time it could indicate that the output energy of the system is

becoming less with time and therefore probably points to a failing transformer or capacitor. If this is true there will probably be a decreasing number of oscillations appearing at the end of the arc line.

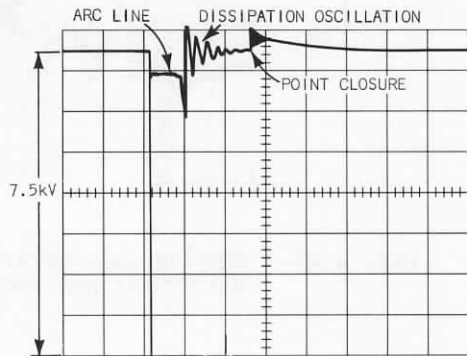

Fig. 2-13. Drawing showing ionizing potential of an individual cylinder.

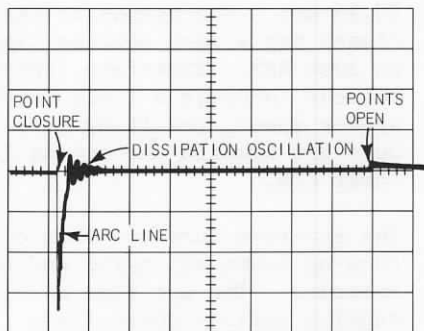

Fig. 2-14. Drawing showing arc line of very resistive spark plug.

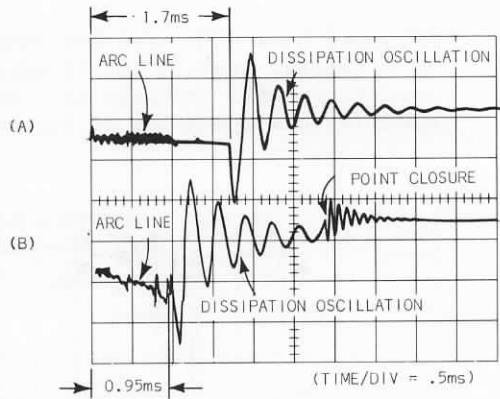

Fig. 2-15. Drawing showing arc-line duration at 500 RPM(A) and 2000 RPM(B).

In the case of flexible engine applications the arc line will become increasingly short as engine RPM increases. Fig. 2-15A is an arc duration with the engine running at 500 RPM. Fig. 2-15B is the arc-line with the same engine running at 2000 RPM. It can be seen that the arc duration has decreased considerably from 500 RPM (1.7 ms) to 2000 RPM (0.95 ms). The reason is that the contact points are closed for a much shorter time with the engine running at 2000 RPM. Therefore, there is less time for the current to build a field in the transformer at the higher speed, resulting in a lower energy output which does not sustain the arc as long as it does at the lower RPM.

The arc-line duration should be checked just after a tune-up (when all parts and adjustments are good) and recorded. The arc time should then be checked at regular periods thereafter. If it is noticed that the arc-line duration grows shorter with time it should be noted whether or not the dwell time has decreased for any reason.

damped
oscillation

The damped oscillation appearing at the end of the arc line is a good indicator of the condition of the transformer and capacitor. It was mentioned earlier that these two components compose the "tank" or resonant circuit that is used to generate the high secondary voltage. If these components are in good condition the voltage oscillations generated during the time of the arc and dissipated at the end of the arc line will be representative of the energy in the system. If one of these components is defective the voltage oscillation (both generated and dissipated) will be much shorter.

Fig. 2-16A shows an example of a defective transformer--in this case, shorted turns in the primary. Note that there are very few oscillations appearing at the end of the arc line and that the oscillations at point closure have practically disappeared. The oscillation at the point closure is a function of the inductance of the transformer and the interwinding capacitance of the transformer. Therefore, when these oscillations are minimized it is sufficient reason to suspect a faulty transformer. Fig. 2-16B is the waveform as it appeared after the transformer had been replaced. Again note the number of oscillations appearing at both the end of the arc line and at point closure.

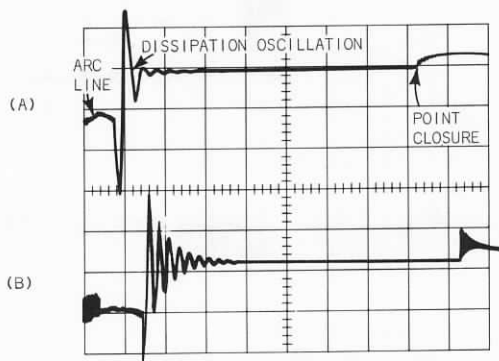

Fig. 2-16. Drawing showing defective transformer waveform.

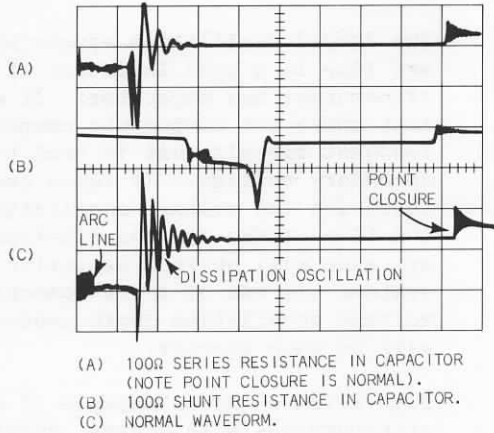

Fig. 2-17. Drawing showing defective capacitor waveform.

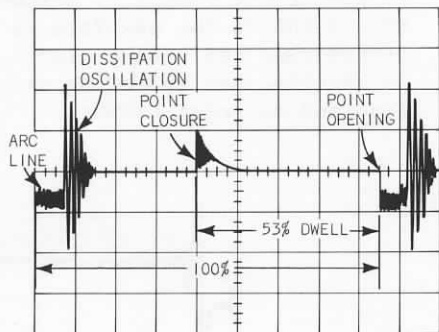

Fig. 2-18. Drawing showing checking contact-point dwell.

Figs. 2-17A and 2-17B show examples of series and shunt resistance in the capacitor. Fig. 2-17A is a drawing of a waveform taken with 100 Ω resistance in series with the capacitor to simulate a near-open circuit or resistive-connection condition. Note the number of oscillations at the end of the arc line

are considerably reduced. However, also note that the point closure portion of the waveform is not affected.

Fig. 2-17B is a drawing of a waveform taken with 100 Ω resistance in shunt with the capacitor to simulate a shorted-capacitor condition. Note the disappearance of oscillations at the end of the arc line and again, the nearly normal point closure.

point
closure

The point closure portion of the ignition waveform can disclose a number of helpful things about the system's performance in addition to those already mentioned.

dwll--
percent vs
crank angle

If the operational cycle of a set of contact points is considered to be from one contact opening to the next, dwell time could be described as being that time, during the operational cycle, during which the contacts are closed. For example, if the overall waveform is considered as being 100%, the dwell in Fig. 2-18 is 53%. Frequently, however, contact dwell is expressed in crankshaft angle in degrees. These two different ways of expressing the same thing can easily be related so that degrees can be converted into percentages, which is more easily used on the oscilloscope. The reference when using degrees is 360°. Now take the number of cylinders and divide 360° by it. For example, if the engine has eight cylinders you would divide the 360° of a circle by 8 (the number of cylinders in the engine) and get a result of 45° ($360^\circ/8 = 45^\circ$). The result, or 45°, could be considered to be the reference crankshaft degrees for the total operational cycle of the contact points. On a 6 cylinder engine the 100% will represent 60° ($360^\circ/6 = 60^\circ$), and for a 4 cylinder engine the 100% will represent 90° ($360^\circ/4 = 90^\circ$).

As an example, Fig. 2-18 is a waveform taken from an 8 cylinder engine, so 100% is 45°. Therefore, the 53% dwell shown on this waveform is 23.85° because 53% of 45° is equal to 23.85°.

As mentioned earlier, percentage of dwell is quite easily read on the CRT. For example, if the waveform is adjusted, with time-base's POSITION and the VARIABLE TIME/DIV, so that one waveform just fills the 10-division graticule, the percentage of dwell can be determined by counting off the number of

divisions between the point closure and the right hand graticule edge. Each division now equals 10%. To refer this back to crankshaft rotation, all that is needed is to multiply the percentage by the reference degrees and the degrees of dwell is obtained. For example, a waveform shows 70% dwell on an 8 cylinder engine. $70\% \cdot 45^\circ$ (45° = reference number for an 8 cylinder engine) = 31.5° of contact dwell.

resistive
point
closure

The point closure portion of the waveform can be indicative of mechanical, as well as, electrical component problems. For example, in Fig. 2-19 note that the first oscillation of the point closure is not full amplitude as it is in the normal waveform. This is an indication that the contacts are contaminated or burned and are not making good contact immediately upon closing. By referring to Fig. 2-20 it can be seen that this problem can occur on some of the waveforms and not on others, indicating that the problem is intermittent.

waveform
"stacking"

In a high-tension system if the probe is placed between the transformer tower and the distributor cap center terminal and the instrument triggered internally, the individual ignition waveforms can be "stacked" and viewed superimposed on the CRT. This has the advantage of showing the variations from one waveform or cylinder to another. Fig. 2-21 is such a waveform. In this particular instance there is little variation from one firing of one cylinder to another. However, if the point closure portion of the waveform is observed, it will be noted that there is a variation here. In this particular instance the reason is the lack of uniformity in the distributor cam lobes. However, worn distributor bearings, bent shaft or many other things could have caused the same kind of display. These variations should be kept within the manufacturer's tolerance.

Probably the best way to measure this is to adjust the time base's POSITION and VARIABLE TIME/DIV so that the waveform just fills the 10 divisions of the graticule. The "spread" of the waveform can be measured in percentage of the overall waveform.

This method of "stacking" the waveforms is also good for checking uniformity or balance of fuel mixture and other variations in the overall system's performance.

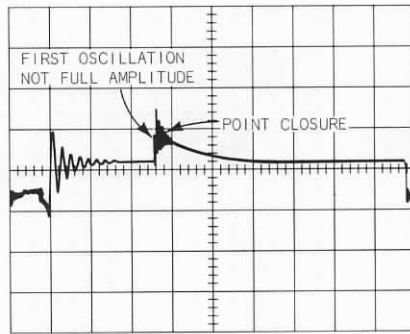

Fig. 2-19. Drawing showing resistive point closure.

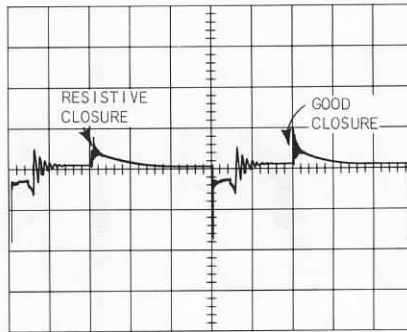

Fig. 2-20. Drawing showing intermittent resistive point closure.

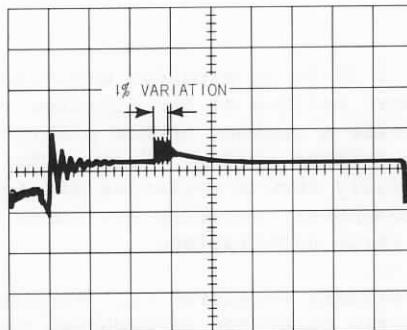

Fig. 2-21. Drawing showing mechanical variations in distributor.

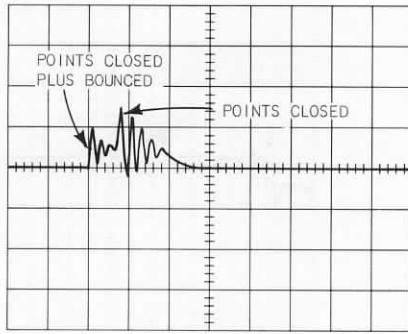

Fig. 2-22. Drawing showing contact point bounce.

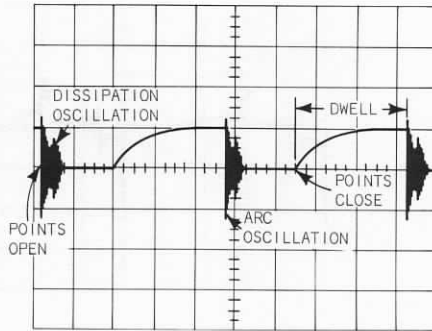

Fig. 2-23. Drawing showing primary waveform at battery side of transformer.

contact
bounce

Fig. 2-22 is an expanded waveform of the point-closure portion of the ignition waveform and it exhibits a contact bounce problem resulting from a weak contact spring. Notice that the contacts initially show a resistive closing and then approximately three cycles later close again, causing the large oscillations.

primary
waveforms

The primary waveforms can frequently be most helpful in early detection of problems that if allowed to go uncorrected can cause unnecessary shutdown of the engine or breakdown of components.

The graphic results of certain events are far more pronounced in the primary than are their reflections in the secondary. Fig. 2-23 is an example of the primary as viewed from the battery side of the transformer primary and Fig. 2-24 is an example of the waveform that appears at the distributor side of the transformer primary.

Referring to Fig. 2-23 the first event seen is the oscillation that occurs during the arc time in the secondary. Next is the dissipation oscillations at the end of the arc. The beginning of the slope is the point at which the contacts are closed. The slope, of course, is representative of the current build-up in the primary circuit.

Referring to Fig. 2-24 it can be seen that the same series of events are presented a little differently. First are the two oscillations as before but now the point closure is not as vague as before--allowing any malfunction in this area to appear more pronounced. Conversely, as will be shown later, malfunctions relating to the primary current build-up are more pronounced in the waveform that appears on the battery side of the transformer (Fig. 2-23).

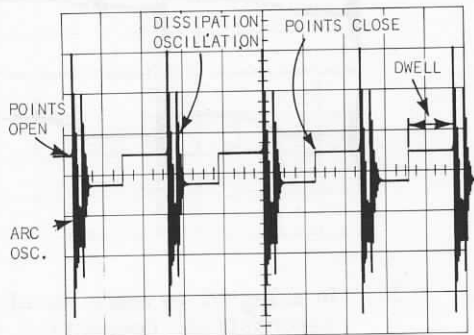

Fig. 2-24. Drawing showing primary waveform at contact points side of transformer.

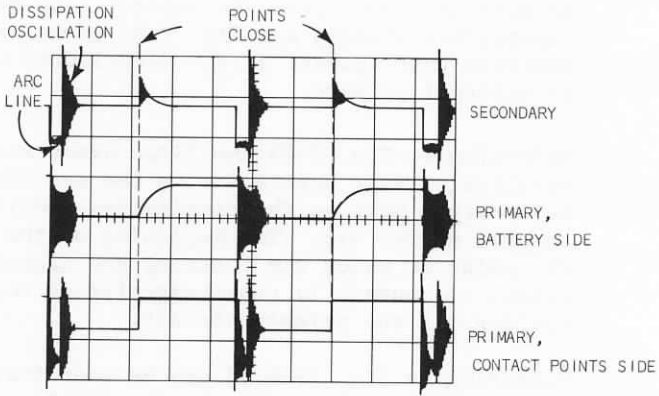

Fig. 2-25. Drawing showing simultaneous display of secondary and primary waveforms.

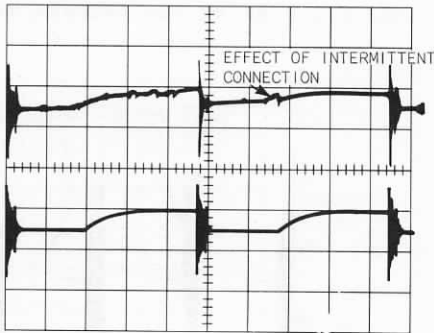

Fig. 2-26. Drawing of primary waveform showing intermittent connection on battery side of transformer.

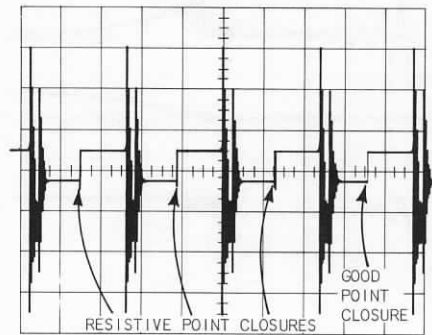

Fig. 2-27. Drawing showing intermittent resistive point closure.

Fig. 2-25 is an example of a simultaneous display of both primary and secondary waveforms illustrated here for the sake of showing the relationship of the various portions of the individual waveforms.

intermittent
primary
connection

The aberrations on Fig. 2-26 were caused by a loose connection in the primary between ignition switch and transformer.

resistive
point
closure

Fig. 2-27, taken from the contact points side of the transformer, shows the effect of poor contact on closing. Note, again, that the condition is intermittent as it does not appear on every waveform.

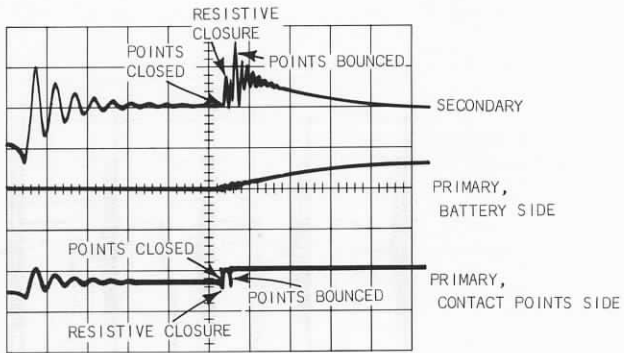

Fig. 2-28. Drawing showing effects of bouncing points.

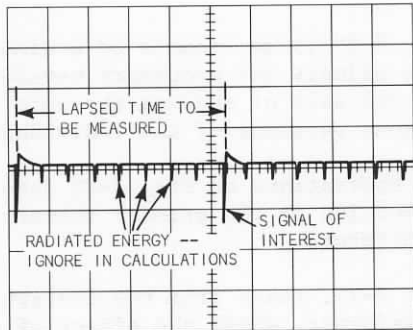

Fig. 2-29. Drawing showing checking engine RPM (time = 50 ms/div).

contact
bounce

Fig. 2-28 is an expanded display of both secondary and primary waveforms showing the effects of bouncing contact points. (Notice the two point-closure waveforms.) Note that, even though it is quite apparent from the secondary waveform that something is wrong, that by viewing the primary waveforms simultaneously that the cause for the secondary aberrations is clearly seen.

RPM
determination

In the absence of a tachometer, or other means of determining the speed of the engine, the ignition waveform can be used to verify or check the RPM. This is done by connecting the ignition probe to the lead of one spark plug and measuring the time interval between firings of the spark plug.

Fig. 2-29 is an example of this technique. The time base is 50 ms/div and it can be seen that the time interval is approximately 260 milliseconds (ignore the smaller waveforms present in the illustration as these are the result of radiated energy from nearby leads). Because the engine used here is a four-cycle engine it has made two revolutions during the time interval. Therefore, the engine has made one revolution in approximately 130 milliseconds.

The next step in converting this interval to RPM is to apply the equation $RPM = 60/T_{sec}$. Since T (time) = .130 seconds, then $60/.130$ equals 461.53. Therefore, the engine is running at a rate of 461.53 RPM.

If the engine had been a two-cycle engine the initial time interval would have been used instead of dividing it by two. The resulting RPM would have been twice that of the four-cycle engine.

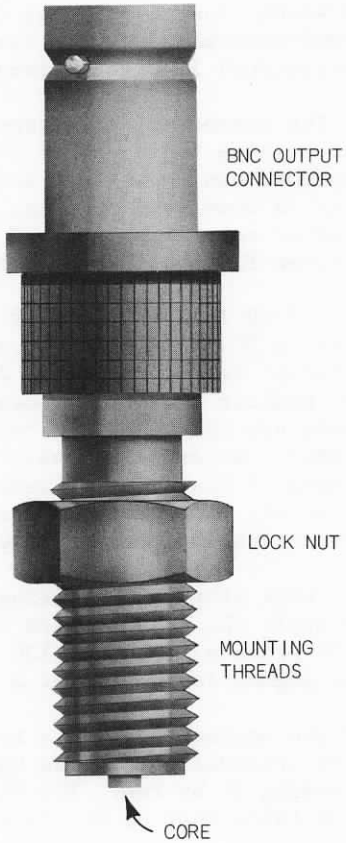

Fig. 3-1. Magnetic transducer.

3

MAGNETIC TRANSDUCER

A magnetic transducer is furnished with the Tektronix Engine Analyzer as a part of the standard accessories. It is used to generate signals which may be used as a rotational reference for the oscilloscope display.

changing
magnetic
field

The transducer consists of a coil wound on a magnetic core, and has an output of 15 V at 1000 inches/second with a 20-pitch, 30-tooth gear having a .005-inch clearance. When the transducer is placed near a ferrous metal, there will be a change in the magnetic field present in the coil--this change in the field will cause a voltage to be generated in the coil.

pulse
polarity

The polarity of the generated pulse will depend on the direction of the change in the field--that is, whether the field increased or decreased. If there is an increase in the flux (additional ferrous metal such as a brad, rivet or screw passing under the transducer)--the pulse will have a positive polarity, and if there is a decrease in the flux (a reduction in metal passing under the transducer, such as a drilled hole), the pulse polarity will be negative. A screw or brad made of a nonferrous metal (brass, copper, aluminum, etc.) will have the same effect (negative-polarity pulse) as that of just a hole as a metal of this type has a magnetic μ of less than 1.

transducer
mounting

The transducer is cylindrical in shape with a threaded body (refer to Fig. 3-1). It is suggested that a

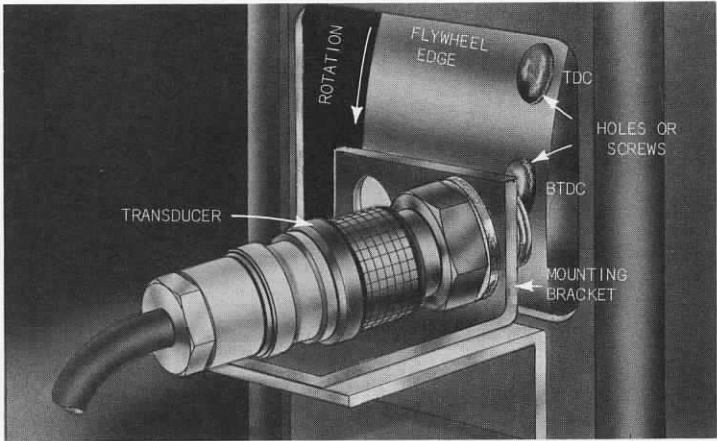

(A)

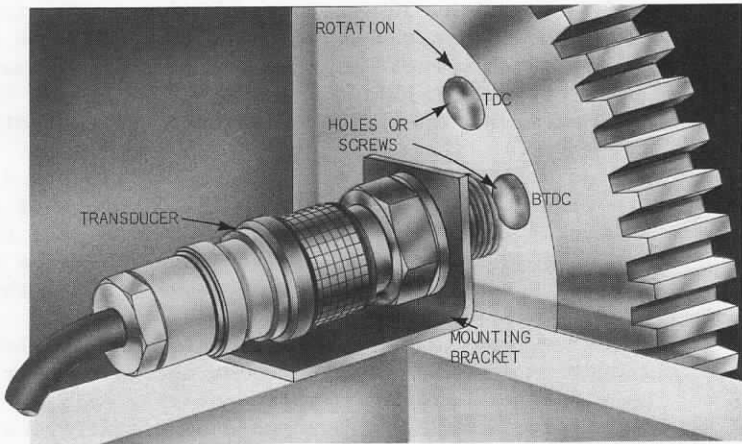

(B)

Fig. 3-2. Transducer mounting techniques.

permanent bracket, similar to that shown in Fig. 3-2, of sufficient thickness to be threaded (perhaps $3/8''$), be mounted on the engine in such a manner to assure alignment of the transducer center magnet with the holes or screws in the flywheel. The transducer is furnished with a lock nut so that when proper adjustment is achieved, the transducer can be held in position without danger of changing the adjustment due to vibration.

magnetic
marker
installation

Fig. 3-2B is an example of a typical installation with the screws inserted in the face of the flywheel, and Fig. 3-2A is an example with the screws inserted in the edge of the flywheel. Fig. 3-2A also shows a bracket that provides for two transducers. In this case, the transducers have outputs for the reference cylinders of each bank.

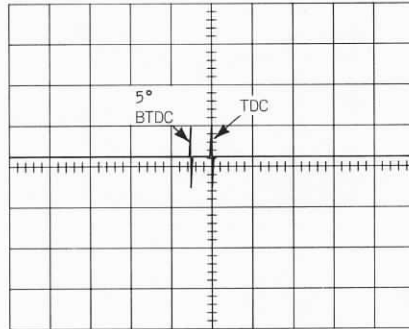

Fig. 3-3. Drawing of typical waveform with screws inserted for timing and TDC marking.

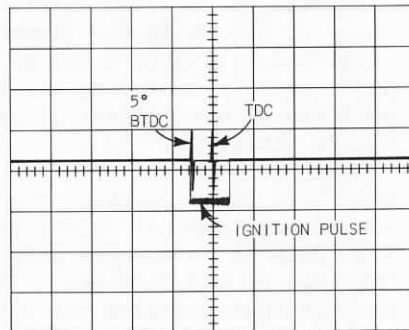

Fig. 3-4. Drawing of typical waveform with timing pulse aligned with ignition pulse.

The screws are usually inserted (or the holes drilled in the flywheel) and the transducer mounted to correspond with the number one piston Top-Dead-Center (TDC) position and/or to correspond with the crankshaft position at which ignition is supposed to occur. For example, if ignition is supposed to occur 5° BTDC (Before Top-Dead-Center) two screws might be inserted in the flywheel--one at the TDC position, and one at the 5° BTDC position. Such an arrangement will produce two pulses (refer to Fig. 3-3)--one at the TDC position and one at the 5° BTDC position.

ignition
timing

The magnetic pulse appearing at the timing position can be used to align the ignition pulse or time the ignition. Fig. 3-4 is an example of such a technique. In this case, the magnetic pulse is connected to Channel 2 and the ignition waveform is connected to Channel 3. The vertical POSITION has been adjusted so that the traces appear to be superimposed for the sake of improving resolution.

RPM
measurements

Either timing or TDC pulses can be used to check engine RPM. In making the RPM check, make use of the same lapsed-time technique that was used in making the RPM check with the ignition waveform. When the magnetic transducer is used, there is no need to differentiate between a 2 cycle or a 4 cycle engine as the time lapse between pulses will be that of one revolution only, regardless of engine type. Care should be taken to use the same pulses in the reference, i.e., if the timing pulse (BTDC) is used as a first reference point, the timing pulse (BTDC) must be again used to measure the lapsed time. It would be erroneous to measure the time between a timing pulse (BTDC), and a TDC pulse.

Fig. 3-5 is an example of this measurement. The time-lapse is 310 ms which is 3.226 revolutions per second. Multiplying this by 60, gives a product of 193.56 which is the RPM of the engine.

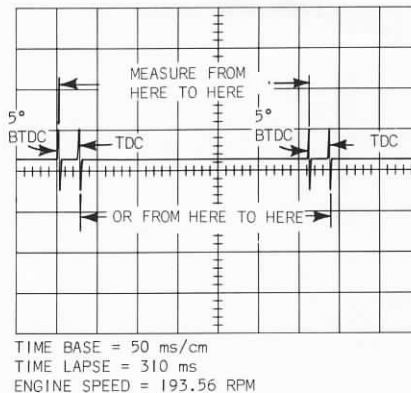

Fig. 3-5. Drawing showing RPM measurement.

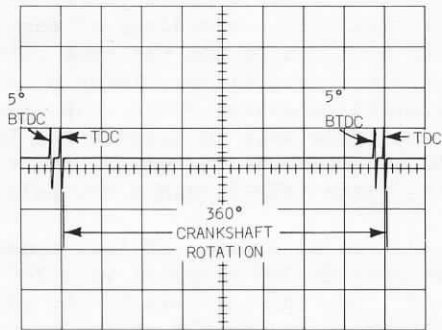

Fig. 3-6. Drawing showing technique of relating time and crankshaft rotation.

crank angle
measurements

The TDC pulses can also be used to assist in determining crank angle. In Fig. 3-6 the VARIABLE TIME/DIV has been adjusted so that there are exactly 8 divisions between pulses, therefore, each division represents 45° of crank angle. This technique, of course, is only applicable on cylinders where there is a pulse available for the TDC for the particular cylinder under examination.

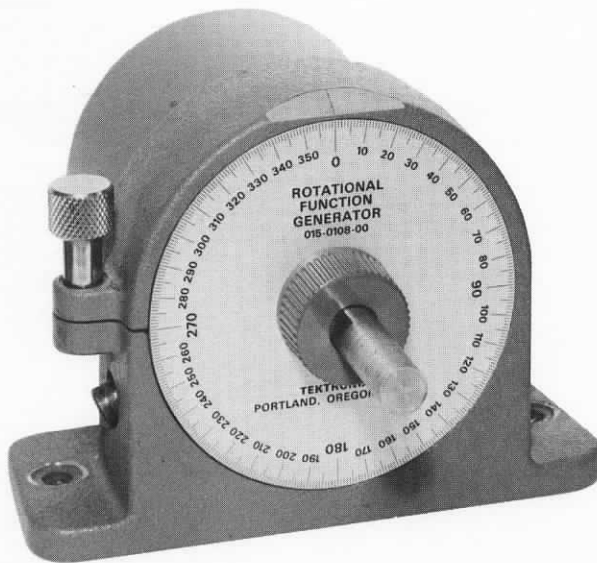

Fig. 4-1. Rotational function generator.

4

ROTATIONAL FUNCTION GENERATOR

Vibration and pressure waveforms need to be related in some way to the crankshaft angle or rotation as referred to a power cylinder or compressor, as the case may be. The Rotational Function Generator (Fig. 4-1) furnished with the Tektronix Engine Analyzer provides the ability, when properly aligned, to relate portions of the waveform to crank angle.

output
waveforms

The Rotational Function Generator (RFG) has three waveform outputs (Fig. 4-2): (1) Markers every 10° of crankshaft rotation, with larger markers every 60° of crankshaft rotation, and the 0° (360°) marker on a 20° wide pedestal; (2) a voltage ramp for plotting the vertical display versus crankshaft angle; and (3) a modified sine wave for plotting the vertical display versus cylinder volume.

The waveforms are generated in the RFG by means of light sources, a rotating film disc and photo transistors.

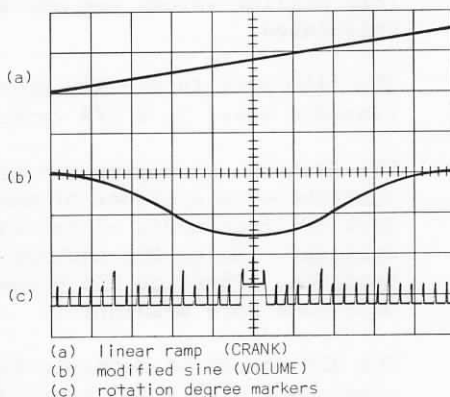

Fig. 4-2. Drawing of RFG output waveforms.

modified
sinewave

Please note that the sinewave generated for plotting the cylinder volume is not a true sinewave but a modified sinewave. The reason for this is that the cylinder volume does not change with respect to the crankshaft rotation as a true sine function. The connecting-rod length of the engine would have to be infinite for the cylinder volume to change as a sine function. The cylinder volume, however, does change at a rate that is dependent on the L/R ratio of the engine. Referring to Fig. 4-3 it can be seen that L represents the center-to-center length of the connecting rod and R represents the radius of the circle described by the crankshaft. Table 4-4 shows the variations of percentage of stroke as compared to crankshaft degree for L/R ratios from 3:1 to 5:1 in 0.5:1 steps.

L/R ratio

By referring to Fig. 4-3 it can be seen that using the equation,

$$X = R + L - (R \cos \theta + L \cos \phi) \quad \text{where:}$$

X = Piston displacement,

ϕ = The angle described by the connecting rod and the center line through the wrist-pin center and crankshaft center,

θ = The angle described by the crankshaft throw and the line through the wrist-pin center and crankshaft center,

R = The radius of the circle described by the crankshaft, and,

L = The length of the connecting rod,

that similar values for any given L/R ratio can be calculated.

The film disc in the RFG generates a modified sinewave based on a L/R ratio of 4:1.

The markers, when properly aligned with the TDC position of a cylinder of the engine, can be used to mark off increments of crankshaft rotation for that cylinder. Using the markers as a reference the ignition, vibration and pressure waveforms can be made much more meaningful.

coupling
ratio

The RFG should be mechanically coupled to the crankshaft with a 1:1 ratio when using it as a reference for ignition or pressure waveforms for either two-cycle or four-cycle engines, and as a reference for vibration waveforms on a two-cycle engine.

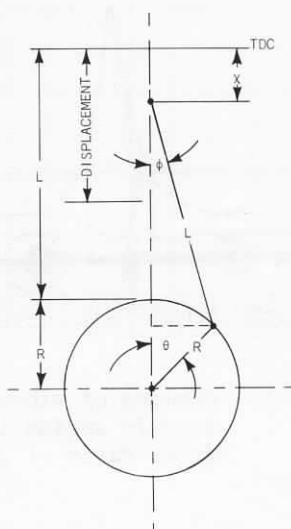

Fig. 4-3. Geometrical illustration showing relationship between cylinder volume and crankshaft angle.

θ , deg from top center	L/R 3.0	L/R 3.5	L/R 4.0	L/R 4.5	L/R 5.0
0	0.0	0.0	0.0	0.0	0.0
10	1.0	1.0	1.0	0.9	0.9
20	4.0	3.8	3.7	3.7	3.6
30	8.8	8.5	8.3	8.1	8.0
40	15.2	14.5	14.2	14.0	13.8
50	22.8	22.1	21.5	21.1	20.8
60	31.4	30.3	29.7	29.1	28.8
70	40.5	39.2	38.4	37.8	37.4
80	49.6	48.2	47.4	46.7	46.2
90	58.6	57.2	56.3	55.6	55.1
100	67.0	65.7	64.7	64.1	63.6
110	74.7	73.4	72.6	72.0	71.5
120	81.4	80.4	79.7	79.1	78.8
130	87.1	86.4	85.8	85.4	85.1
140	91.8	91.4	90.8	90.6	90.4
150	95.4	95.1	94.9	94.7	94.6
160	98.0	97.8	97.7	97.6	97.6
170	99.5	99.5	99.4	99.4	99.4
180	100.0	100.0	100.0	100.0	100.0

Table 4-4. Percentage of cylinder displacement as a function of crankshaft angle and various L/R ratios.

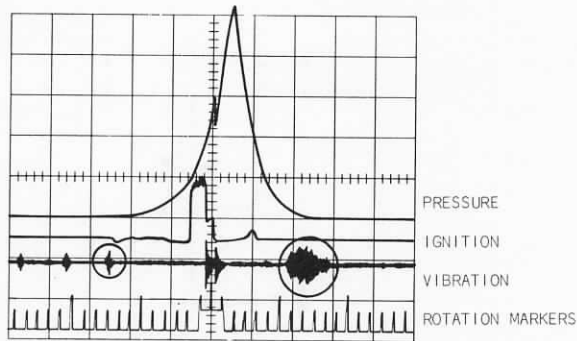

Fig. 4-5. Drawing of vibration waveform of a 4-cycle engine taken with an RFG drive-ratio of 1:1.

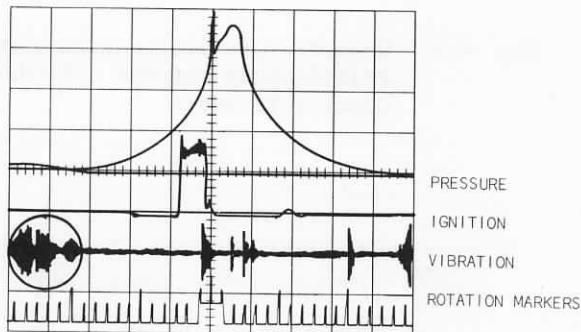

Fig. 4-6. Drawing of vibration waveform of a 4-cycle engine taken with an RFG drive-ratio of 2:1.

4-cycle
vibration
waveform

However, when using it (the RFG) as a reference for vibration on a four-cycle engine, a 2:1 reduction (engine crankshaft rotating twice for one rotation of the RFG's) must be employed to prevent "stacking" the vibration waveforms of the power and exhaust strokes over the intake and compression strokes on the graticule and rendering the waveforms very difficult, if not impossible, to interpret. For example, Fig. 4-5 is a pressure versus crank angle drawing of a four-cycle engine with the RFG

connected with a 2:1 ratio and Fig. 4-6 is a similar drawing with a 1:1 ratio on the same engine. Note that the vibration that appears approximately 150° after-top-dead-center on Fig. 4-5 (with 2:1 ratio, the markers appear each 20° of shaft rotation, instead of each 10° of rotation) appears after bottom-dead-center on Fig. 4-6, and it cannot be determined from the photo if the vibration occurred at the beginning of the compression stroke, or at the beginning of the exhaust stroke. However, when referring to Fig. 4-5, it becomes quite apparent that the vibration occurred approximately at the beginning of the exhaust stroke of the engine. Also notice that the vibration that appears at approximately 185° BTDC on Fig. 4-5 is not visible on Fig. 4-6, because it occurred during the trace flyback time.

coupling
methods

The 1:1 coupling can be accomplished several different ways. The RFG is furnished with extension shafts and a friction pad, similar to that used on hand-held tachometers, to assist in the hook-up. A tripod, available as an optional accessory, can be used to mount the RFG. A mounting adapter plate needed to attach the RFG to the tripod is a part of the standard accessories package for the analyzer.

This equipment can be used to mount and drive the RFG from the flywheel hub (if accessible), accessory drive hub, or any backlash-free shaft that turns at the desired rate. However, chain drive with an arbor shaft or any of several other ways will be satisfactory, as long as the method accomplishes the desired ratio between the crankshaft and the RFG, and does not place undue stress on the RFG shaft (10 pounds maximum, on both axes).

Figs. 4-7 through 4-9 are examples of what may be typical hook-ups. The 2:1 hook-up may be made through a gear reduction box similar to that in Fig. 4-10. After the RFG has been adequately mounted and connected to the engine, it should be aligned. It is usually aligned with the number-one cylinder. The TDC pulse generated by the magnetic transducer can be very useful in aligning the 0°/360° marker of the RFG.

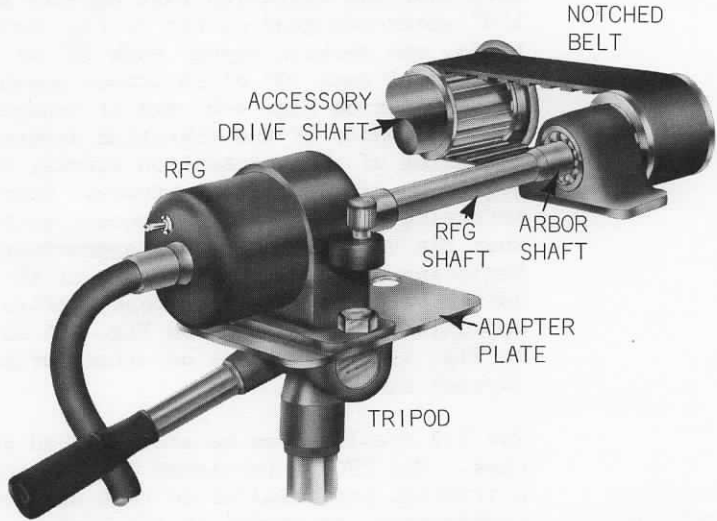

Fig. 4-7. Notched belt and arbor shaft RFG drive.

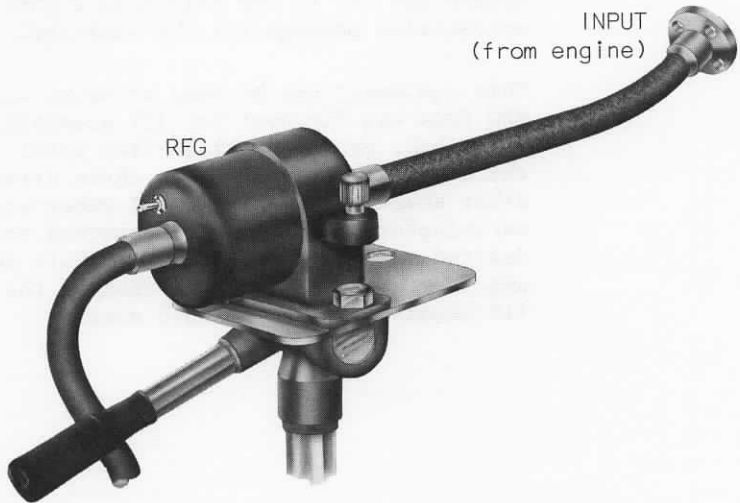

Fig. 4-8. Flexible RFG drive shaft.

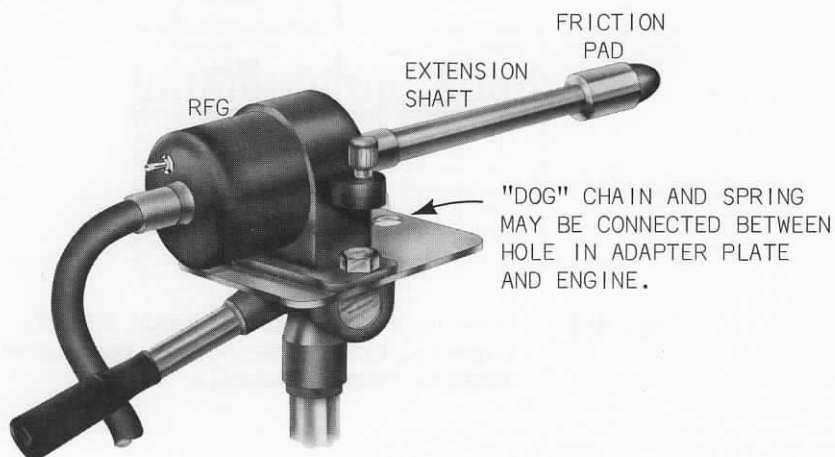

Fig. 4-9. Friction pad and extension shaft RFG drive.

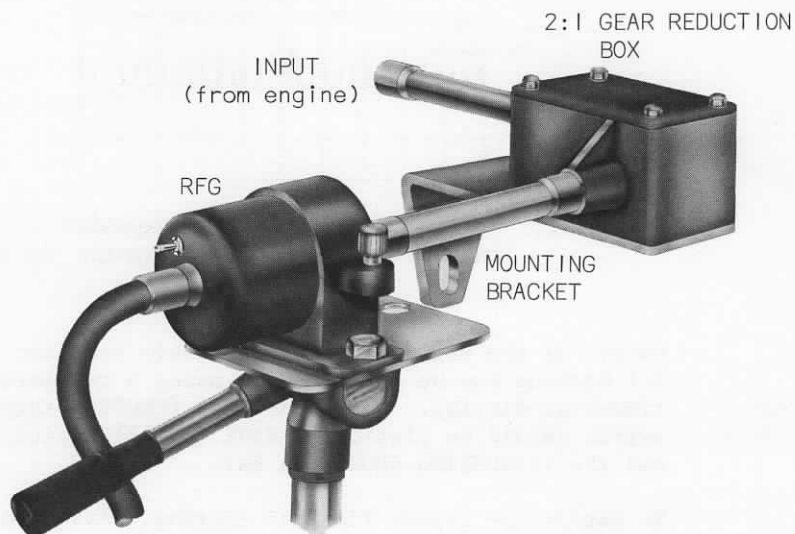

Fig. 4-10. Possible 2:1 reduction drive for vibration waveforms on a 4-cycle engine.

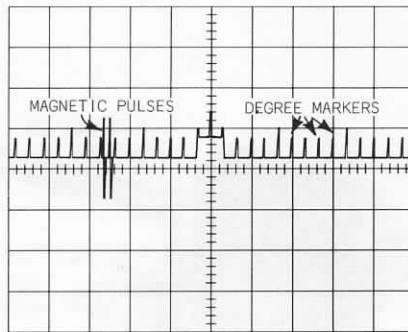

Fig. 4-11. Drawing showing misalignment of RFG magnetic transducer output and degree markers (superimposed).

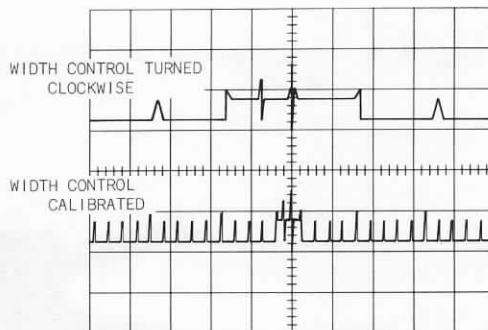

Fig. 4-12. Drawing showing markers expanded to improve resolution for aligning the RFG.

2:1
rotation
simulation

Note: If the engine RPM is relatively constant, the 2:1 hook-up may be simulated by using a triggered time-base display. The ROTATIONAL FUNCTION toggle switch should be placed in CRANK (ANGLE) position and the TRIGGERING SOURCE in EXT.

To obtain the proper TIME/DIV setting, divide the RPM into 12. This gives the maximum TIME/DIV setting to display 720° of crank angle. About 20% of the sweep time is required for internal sweep reset of the Type 2B67. Therefore, set the TIME/DIV switch to a position that is between 50 to 80% of the value calculated above.

You will now see about 50 to 80% of the functional cycle. The crank angle markers may be used to identify the number of degrees displayed. By adjusting the TRIGGERING LEVEL control, any (50 to 80%) portion of the functional cycle may be observed.

RFG
alignment

It is not likely that the RFG will be properly aligned when first connected to the engine, and therefore, the magnetic pulses will probably appear somewhere other than at TDC on the display, as in Fig. 4-11. If difficulty is experienced in locating the magnetic pulse when it is first connected, the problem is likely to be the VOLTS/DIV setting. The voltage output of the magnetic transducer is a function of distance and flywheel velocity. Therefore the output can be predicted only under prescribed, or controlled, conditions. These conditions will not be the usual case when utilizing the Engine Analyzer and therefore, it will probably be necessary to adjust the amplifier sensitivity for the desired pulse amplitude. If, with the amplifier at maximum sensitivity, the pulse amplitude is still not great enough, it will be necessary to move the transducer closer to the flywheel. This can be done by loosening the lock nut, and screwing the transducer into the bracket a little farther. The adjustment should be made very carefully and slowly to avoid contact with the flywheel and possible damage to the transducer.

The alignment of the RFG can be accomplished by loosening the clamping screw located on the side of the mounting flange casting, and rotating the body of the RFG. The screw should then be retightened.

improving
alignment
resolution

To improve resolution during the alignment of the RFG, the WIDTH control on the Type 2B67 can be turned fully clockwise, so that the markers are magnified. The upper waveform on Fig. 4-12 is an example of the technique, and it can be seen from this photo that the resolution is much improved. The WIDTH control should then be set for whatever display width is desired by the operator. The lower waveform on Fig. 4-12 is how the waveform will appear when the display WIDTH has been adjusted to 10 divisions for measurement use.

If a magnetic transducer is being used that has sufficient output amplitude (30 - 40 V) an alternate method that can be used is to Z-axis modulate the instrument CRT (using connection on the back of the instrument) with the magnetic transducer output. This superimposes a bright spot on the RFG marker output that corresponds with the magnetic transducer pulse or pulses. As can be seen in Fig. 4-13, this method tends to improve resolution so that the alignment is, perhaps, made easier.

It should be noted that if a storage oscilloscope is being used the instrument should be used in nonstore mode if Z-axis modulation is being used. It is not that instrument damage will result from the modulation, it is simply that due to the bistable nature of the stored image, the modulation will not appear on the screen when viewing the stored waveform and it is possible that the modulation will blotch the display due to the heavy current density at that point on the waveform.

With the magnetic pulse connected to the Z-axis input of the instrument, resolution can be improved to the point that the falltime of the ignition waveform can be allowed for, thus assuring that the combustion begins at precisely the right moment. Fig. 4-14 is an example of this technique.

The magnetic transducer waveform, connected to the Z-axis input, can also be useful when viewing the PV (cylinder Pressure versus cylinder Volume) curve, and cylinder pressure versus crankshaft angle plots. These applications will be discussed in a later chapter.

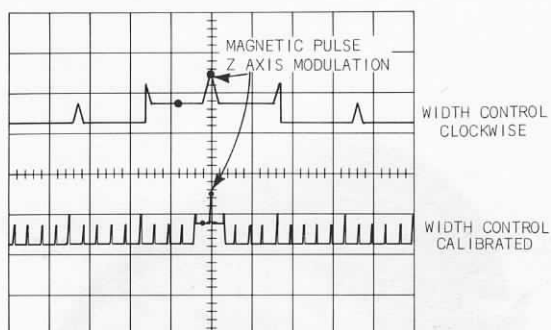

Fig. 4-13. Drawing showing Z-axis magnetic pulse modulation.

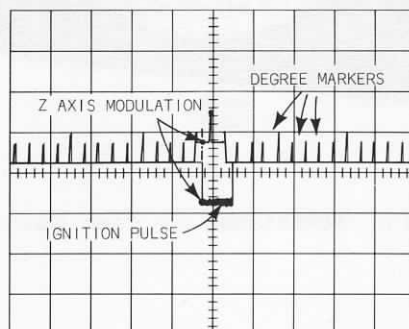

Fig. 4-14. Drawing showing Z-axis modulation used to align ignition pulse and allowing for falltime of ignition pulse.

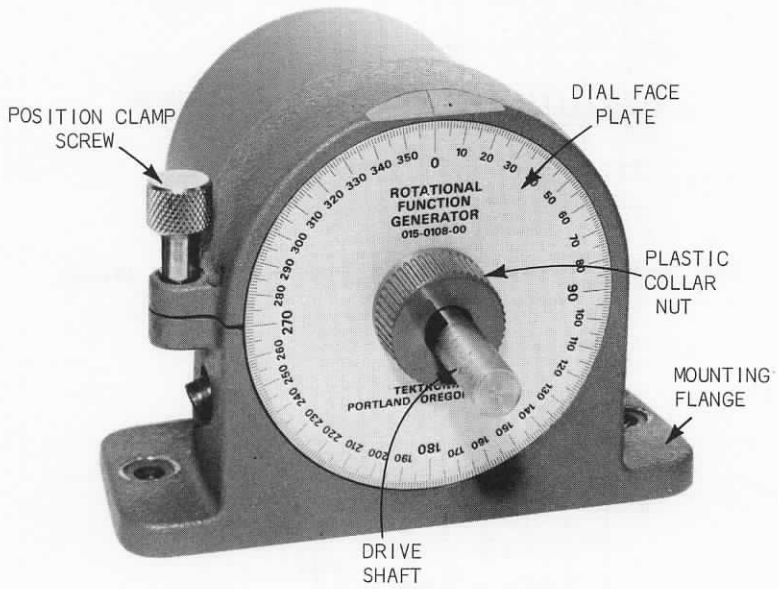

Fig. 4-15. Rotational function generator.

alignment
to other
than
reference
cylinder

If it is wished to align the RFG with a cylinder other than the reference cylinder for which the magnetic pulses are generated, the angular offset for that cylinder, as referred to the reference cylinder, must be known. For example, if number-one cylinder was the cylinder used as reference when aligning the RFG and the cylinder to be examined is offset from that cylinder by 90° it will be first necessary to align the 0° mark on the dial faceplate of the RFG (Fig. 4-15) with the mark on the top of the RFG mounting flange casting. This can be done by loosening the plastic collar nut, aligning the dial faceplate to 0° , and retightening the collar nut. Then by rotating the body of the RFG so that the 90° (or 270°) mark on the dial faceplate is aligned with the housing mark, the Rotational Function Generator will be aligned with the desired cylinder.

This procedure can be followed to align with any of the cylinders of the engine as long as the angular offset from the reference cylinder is known.

It is recommended that the RFG be driven at a 1:1 ratio with the crankshaft during the alignment procedure.

check
rotation
direction

The toggle switch on the back of the transducer should be in the position indicating the direction of the shaft rotation. This assures proper polarity of the voltage ramp driving the instrument horizontal deflection in CRANK (angle) mode.

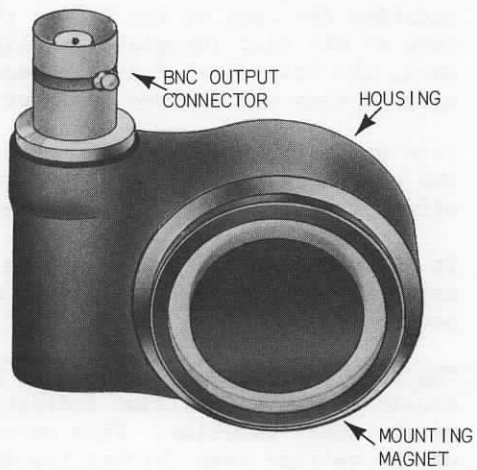

Fig. 5-1. Vibration transducer.

5

VIBRATION TRANSDUCER

A vibration transducer is furnished as a part of the standard accessories for the Tektronix Engine Analyzer (Fig. 5-1).

piezo-
electric
crystal

The transducer is essentially a piezoelectric crystal mounted in a housing which includes permanent magnet for easy attachment of the unit to any ferrous-metal surface.

A piezoelectric crystal has the unique ability to generate an electrical charge when placed under mechanical pressure or stress. Conversely, it will also warp and bend if an electrical pressure (voltage) is applied to it.

It is the first characteristic that is used in the vibration transducer, i.e., the crystal, by virtue of the engine vibration, is subjected to mechanical stress, and, therefore, generates an electrical charge proportional (within limits) to the amount of stress.

It is well-known that sound and vibration are related. Therefore, because it is vibration that causes the transducer to have an electrical output, it might be well to investigate just how these vibrations relate to the sounds that concern the engine operator.

sounds as
related to
waveshapes

There are basically two kinds of sound that are of concern to the engine operator - a hammering or sharp sound, and a leaking or hissing sound. Fig. 5-2 is an example of a display of a sharp or hammering sound, and Fig. 5-3 is an example of a hissing or leaking sound. Notice that the hammering sound has a very steep wavefront, whereas the leaking sound has a much more sloping wavefront. The shape of the wavefront can be most revealing as to the cause and nature of the vibration. For example, the leaking sound can be caused by leaking valves or rings, and the hammering sound can be caused by piston slap, loose wrist pins, excessive valve spring pressure, excessive valve tappet clearance, etc.

For many years, operating engineers have used a long rod (pointed on one end and rounded on the other) or a large screwdriver or pipe wrench (clamped on a tube or pipe) to listen to the various sounds of an engine, or other equipment, in an attempt to detect excessive wear or a part defect before it caused catastrophic breakdown. This method has proven itself to be a very valuable tool to the operator. However, this technique has two disadvantages. First, it is virtually impossible for the operator to relate the sounds heard to the angle of the crankshaft at the time of the occurrence. Second, the human ear is not calibrated or particularly sensitive. Therefore, small progressive changes in a sound heard from one time to another will, for the most part, go unnoticed and frequently when a sound is loud enough to be heard damage to the engine has already resulted.

It is now possible to bypass the lossy sound path of the rod or tool and to use a more sensitive "hearing" instrument than the ear. The vibration transducer is such an instrument, and by connecting the transducer directly to the mass of the engine, the signal strength that would normally be lost through propagation in the tool and its poor connection to the engine, is now regained. The combination of additional signal strength and more sensitive instrumentation allows sounds to be detected that have heretofore gone unnoticed. With photographs, the signals can be recorded and their progress watched, and because the instruments are calibrated, the amplitude of the sounds can be measured. The frequency response of the instruments also allows identification of the noise by type (leaking or hammering). The use of an RFG also allows the noise to be related to crankshaft angle.

The combination of all these advantages allow the operator to identify the sound as to type, cause, and amplitude in sufficient time for corrective action to be taken before damage to the engine results.

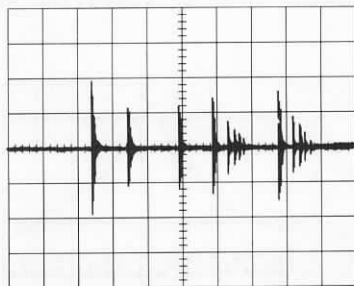
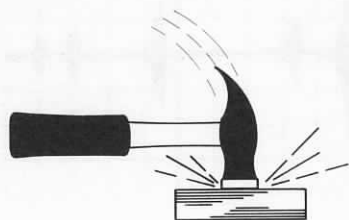

Fig. 5-2. Drawing showing hammering-type sound and resulting visual display.

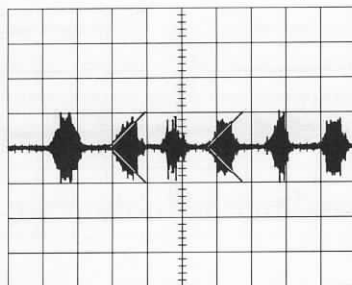
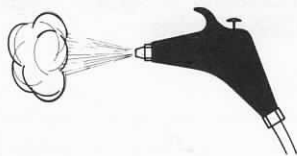

Fig. 5-3. Drawing showing leaking-type sound and resulting visual display.

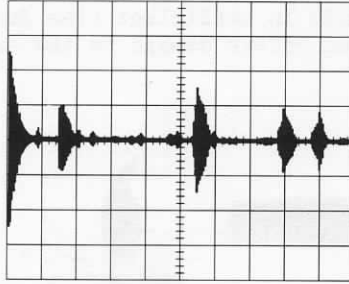

Fig. 5-4. Drawing showing vibration waveform alone.

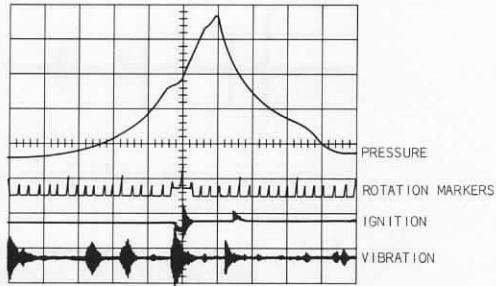

Fig. 5-5. Simultaneous display--Type 2B67 in RFG and CRANK modes.

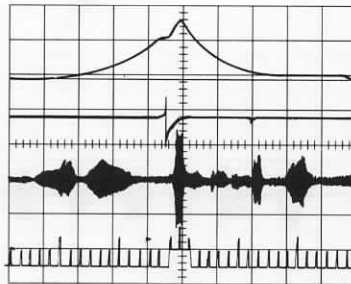

Fig. 5-6. Drawing showing piston-slap condition.

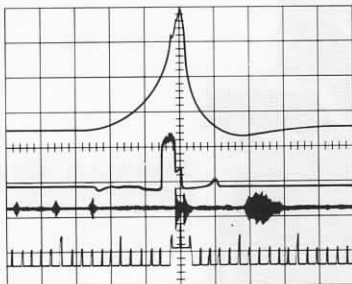

Fig. 5-7. Drawing showing leaking valve condition.

Examination of Fig. 5-4 will show that the vibration waveform alone is not very meaningful, as there is no indication, or reference, to what causes the individual vibrations or at what crank angle they occurred.

Fig. 5-5 is a simultaneous display of the pressure, rotation markers, vibration, and ignition waveforms with the Type 2B67 TIME/DIV switch in the ROTATIONAL FUNCTION GENERATOR position. Note that the display begins at BDC (Bottom-Dead-Center).

graticule
scaling

If a Rotational Function Generator is being used, the graticule will, of course, be scaled by the fact that the RFG drives the analyzer's horizontal deflection. As mentioned earlier, care should be taken to drive the RFG at a 2:1 ratio if analyzing a four-cycle engine.

With the Engine Analyzer, the display represents exactly one functional cycle of the cylinder of interest and with the user's knowledge of the internal sequence of events, the vibration waveforms should be meaningful and considerable information can be gleaned from them as to the condition of the rings, piston, cylinder, valves and/or ports.

piston
slap

leaking
valve

Fig. 5-6 is an example of what a piston slap condition might look like. Again notice that the wavefront is quite steep. Fig. 5-7 is an example of a leaking valve condition and, again, notice the sloping wavefront of the valve closure.

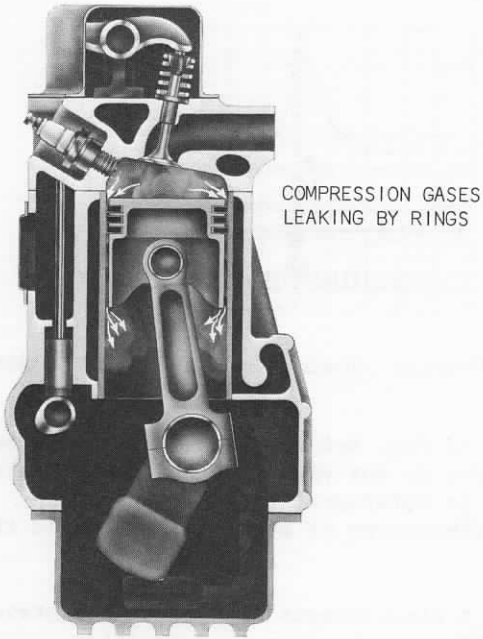

Fig. 5-8. Drawing showing "blowby".

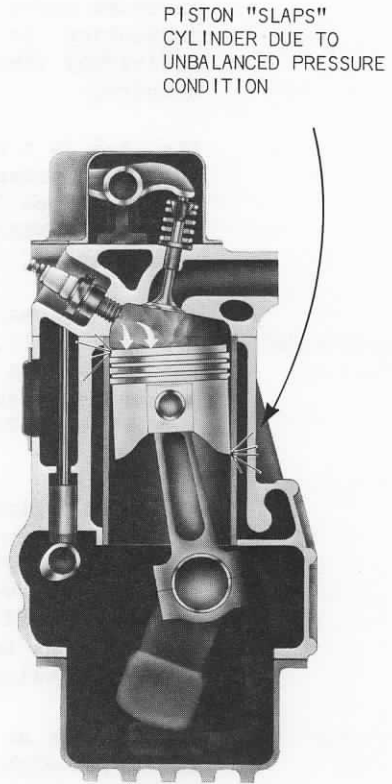

Fig. 5-9. Drawing showing piston-slap.

The vibration transducer can also be used to good advantage in detecting worn turbine bearings and leaking compressor valves. These measurements are all relative and a knowledge of them must be obtained through experience.

transducer
location

Care must be taken to *always* place the transducer in the same place on the same cylinder each time a vibration measurement is made. The reason for this is, of course, that the waveforms will not necessarily appear the same at one location on the cylinder as another. This is because the metal of the cylinder is the propagation medium for the sound and as it is not a perfect sound conductor it will attenuate sounds transmitted through it. If one signal is greater in amplitude, it may appear smaller than the others because it is further away. It is best to experimentally locate a position where all signals of interest can be seen and always use that location. In this way a change in the waveform will, indeed, mean a change in a function relating to that portion of the waveform.

blowby

As further illustration of the types of engine noise and relating them to occurrences in the engine Fig. 5-8 shows one possible source of the leaking sound. In this example piston ring blowby has been used. The condition is usually caused by either worn rings or excessive clearance between rings and piston grooves. It is an undesirable condition, as it results in power loss (due to pressure escape), dilutes the lubricating oil with fuel and therefore increases the possibility of crankcase explosion.

piston slap

Fig. 5-9 illustrates what is believed to be the cause of piston slap. It is felt that as the flame front progresses across the piston there is a pressure difference generated in the combustion chamber. This pressure difference will cause an ill-fitting piston to pivot on the wrist pin, thereby "slapping" the cylinder wall. If the vibration waveform of an engine with this condition is observed simultaneously with the pressure waveform it will be noticed that as the rate of pressure rise after ignition increases, the "slapping" waveform amplitude will also increase. Such a fast rate-of-rise pressure waveform would imply a greater-than-normal pressure-difference on the piston head, causing the piston to "slap" harder.

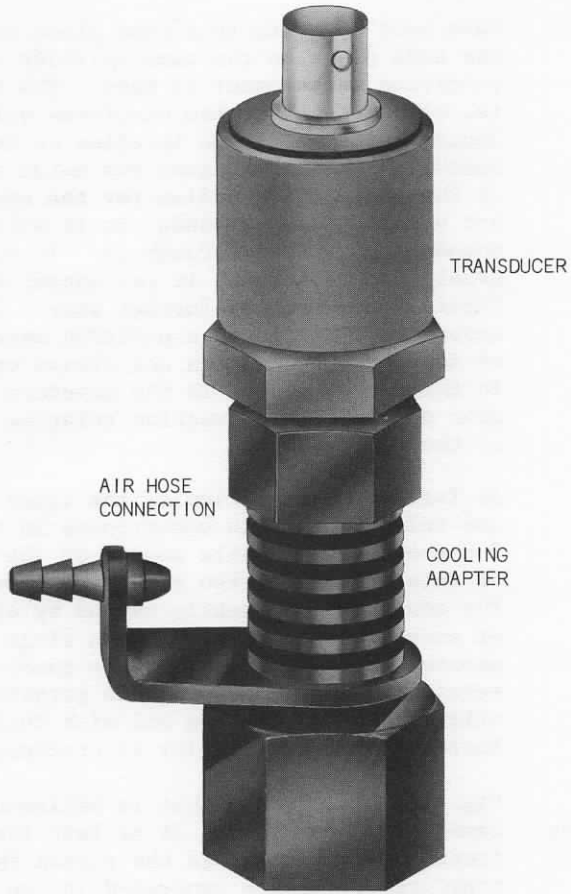

Fig. 6-1. Pressure transducer and cooling adapter.

6

PRESSURE TRANSDUCER

The combustion chamber pressure activity in an engine can be a very interesting study. It is the pressure developed here that must provide sufficient horsepower to overcome the internal friction of the engine itself and to accomplish whatever work is demanded of the engine in the form of a "load".

There are two most common and generally accepted ways of measuring the pressure variations in a combustion chamber. One is to use a balanced pressure indicator and the other is to use a piezoelectric transducer with an oscilloscope.

balanced
pressure
indicator

The balanced pressure indicator is actually a form of pressure sampling. Fig. 6-2 is a simplified diagram of a balanced pressure device. A known pressure is connected to one side of the diaphragm and as soon as the unknown pressure becomes slightly greater than the known pressure, contact is made with the internal electrode. When the unknown pressure drops to a point of being equal to that of the known pressure the contact is broken.

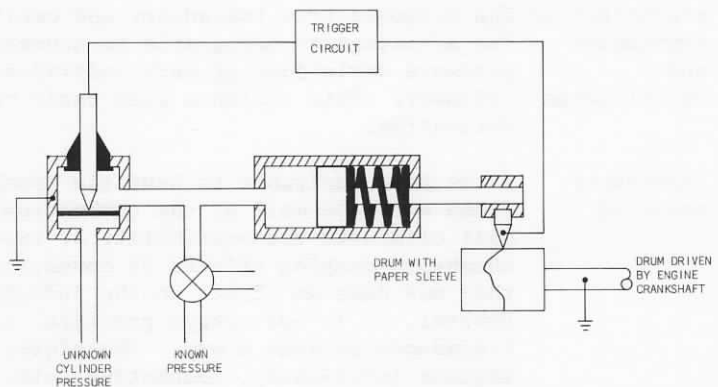

Fig. 6-2. Simplified schematic of balanced pressure indicator.

The indicator will cause a spark to be discharged from the pointer to the driven drum in either event, causing a small hole to be burned in the paper. The known pressure also controls the position of the pointer on the paper. After each cycle the known pressure must be adjusted to a point of either greater or less pressure. If the known pressure is regulated over a sufficient range, a pressure-vs-crankshaft-angle diagram of the cylinder will be plotted on the drum paper which is driven by the engine crankshaft.

The balanced pressure indicator has the advantage of being as accurate as the known pressure. This statement, of course, assumes that the inertia of the device, hysteresis of the diaphragm, etc. are negligible. It has the disadvantage of being a "sampler" and, therefore, is incapable of showing the characteristics of any one cycle as it averages over a period of many cycles of the cylinder. Being a mechanical device it does have some inertia and this prevents it from responding to rapid changes in the cylinder pressure, such as detonation. Further, since the scale accuracy is dependent upon the balance of the known pressure and the spring in the drum-pointer mechanism, spring calibration and linearity are an important part of the accuracy of the device. Therefore, it will probably not be as accurate with a heavy spring (high pressure) as it is with a light spring (low pressure).

piezoelectric transducer and oscilloscope

The piezoelectric transducer and oscilloscope have the advantage of being able to accurately follow the pressure variations of each individual cycle of the cylinder. This includes such rapid variations as detonation.

transducer mounting

It is most desirable to have the transducer mounted flush with the wall of the combustion chamber. This will eliminate the possibility of extra resonance chambers, damping effects of connecting tubes, etc. that may have an effect on the indicated waveform. However, it is not always practical to mount the transducer in such a way. Therefore, on large engines (stationary, locomotive, etc.) both diesel and gas fueled, the transducer is usually mounted on an existing combustion-chamber access tube. On smaller spark-ignited engines special adaptive spark

plugs are frequently used (Fig. 6-3). There is no known easy combustion-chamber access on smaller diesel engines such as those used in trucks, tractors, etc. However, pressure monitoring of the fuel injection system of these engines can be most useful.

transducer
sensitivity

The pressure transducer furnished with the Tektronix Engine Analyzer is a ceramic piezoelectric crystal with a typical charge sensitivity of 200 picocoulombs per pound per square inch of pressure (200 pC/PSI). The pressure transducer should be connected to Channel 1 of the Type 3A74 of the analyzer, which is a charge amplifier designed specifically for use with transducers with a charge sensitivity range of 100 pC/PSI to 300 pC/PSI.

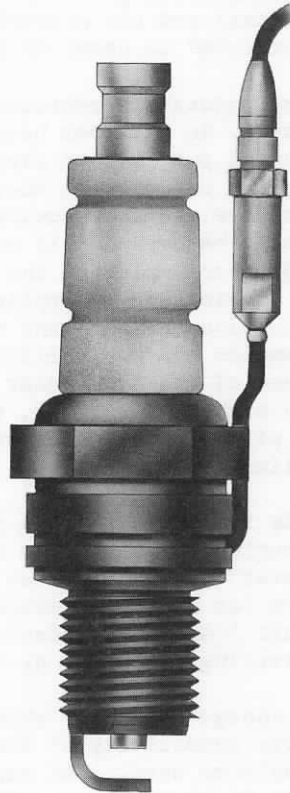

Fig. 6-3. Special adapter spark plug used for access to combustion chamber for small spark-ignited engines.

It was mentioned earlier that a piezoelectric crystal will have an electrical output if it is placed under mechanical stress. The quantity of the charge will be a direct function of the amount of stress placed upon the crystal and, in the case of a quality crystal, will be a linear function of the pressure applied.

If a crystal's electrical output is measured, under laboratory conditions, as a function of pressure applied, it will be found that there is a linear range for the applied pressure versus voltage output, i.e., there would be a uniform unit of additional charge output per additional pound of applied pressure. With an increase in pressure beyond the linear range there would not be a uniform unit of additional charge output. The crystal would then be nonlinear and the pressure applied could no longer be interpreted in terms of its electrical output.

temperature
consider-
ations

Every practical precaution is taken in mounting a crystal, in whatever housing is suitable for its intended purpose, to avoid undue mounting stresses. However, the crystal must be mounted firmly. Therefore, if the housing in which the crystal is mounted becomes hot it will expand with the temperature, placing the crystal under stress. If the combination of applied pressure (from the combustion chamber) and stress due to housing expansion reaches sufficient magnitude the electrical output of the transducer will become nonlinear. At very high temperatures, the crystal begins to lose its piezoelectric characteristic, causing further nonlinearity.

air
cooling

It is for these reasons that the transducer is connected to the engine cylinder via a cooling adapter (Fig. 6-1). The transducer should be kept below its maximum temperature rating by connecting an air line to the adapter that is capable of delivering 30-50 PSI at the adapter.

Charge
Amplifier
Calibrator

The charge amplifier should be calibrated to the charge sensitivity of the particular pressure transducer used. The amplifier GAIN has sufficient range to cover the sensitivity range of the transducers. To calibrate the amplifier, use the Charge Amplifier Calibrator furnished with the analyzer.

The Charge Amplifier Calibrator contains a .004 microfarad, $\pm 1\%$ capacitor. The equation for calculating the charge output of the capacitor for any applied voltage is

$$Q = CE \quad \text{where:}$$

Q = Charge (in coulombs)
 C = Capacitance (in farads), and
 E = The applied voltage.

Since the C , or capacitance, is fixed at 4×10^{-9} , if a 1-volt signal is applied to the capacitor, the charge output will be $1 \times 4 \times 10^{-9} = 4 \times 10^{-9}$ coulombs, or 4000 picoCoulombs (4000×10^{-12}).

calibration
procedure

As stated on the name plate, the Charge Amplifier Calibrator has a charge output of 4000 pC/volt. That is, if a 0.4-volt signal, from the instrument CAL OUT is connected to the Charge Amplifier Calibrator the latter will have a charge output of $4000 \times .4 = 1600$ pC. To calibrate the amplifier, connect the Charge Amplifier Calibrator to the Channel 1 input, using the short coax cable furnished with the analyzer and connect the instrument CALIBRATOR (set to .4 volt) to the Charge Amplifier Calibrator. Now check the charge sensitivity of the pressure transducer to be used (a transducer with a charge sensitivity of 200 pC/PSI will be assumed in this example). Divide 1600 (the Charge Amplifier Calibrator has an output of 4000 pC/volt) by 200 (the charge sensitivity of the transducer). 1600 divide by 200 equals 8 (this number represents the number of pounds-per-square-inch of pressure required to be exerted for the transducer to have an output of 1600 pC).

Now, divide the result by the PSI/Div setting of the amplifier (2 will be used here, assuming that the amplifier has been set to the 2 PSI/DIV position). The result (4) is the number of divisions of deflection that should be seen on the CRT of the analyzer. If the deflection of the signal is greater or less than what it should be, the Channel 1 GAIN should be adjusted for the correct signal size. Care should be taken to use only the rising or falling portion of the signal for amplitude measurement or error can result.

A simple formula can be written for use when calibrating the charge amplifier to a pressure transducer of any charge sensitivity (within the limits of the range of the amplifier gain). Such a formula might be

$$1600/CS/DF = \text{Div} \quad \text{where:}$$

- 1600 = Charge output with a 0.4 volt input,
 CS = Charge sensitivity of the transducer,
 DF = Deflection factor of the amplifier,
 and
 Div = Divisions of deflection.

The pressure waveform can be displayed three ways: (1) pressure versus time, (2) pressure versus crankshaft angle, and (3) pressure versus cylinder volume.

pressure
 versus
 time

It is difficult to have a true pressure versus time display and relate it very accurately to crankshaft angle. One technique that can be used on a spark-ignited engine is to trigger the instrument on the ignition waveform of the cylinder that fires just preceding the cylinder of interest. That is, if cylinder number two is of interest on an engine that fires 1-3-4-2, the instrument would be triggered from the ignition waveform of cylinder number four. This technique will allow sufficient time for the instrument trace to be part of the way across the CRT before the cylinder of interest fires, thereby showing the rise and fall of the pressure waveform of the cylinder of interest. However, as mentioned before, the cylinder and ignition angular displacements would cause it to be difficult to relate the waveform to crank angle.

The pressure versus time display is very useful, however, when the analyzer is operated at slower TIME/DIV settings for checking for pressure variations due to an unbalanced fuel/air mixture, leaking valves, faulty ignition, etc. Such a display is illustrated in Fig. 6-4.

A plot of the cylinder pressure as it relates to crankshaft angle through the complete functional cycle of the engine is shown in Fig. 6-5. This diagram is quite easy to achieve with the use of the RFG. The 2B67 is simply put in RFG mode and the toggle switch put in the CRANK position with the pressure transducer connected to the Channel 1 input.

Referring to Fig. 6-5 it can be seen that the pressure is near atmosphere as the piston begins the compression stroke. As the piston progresses up the cylinder with all valves closed, the pressure begins to increase. This increase in pressure continues until at some point, usually BTDC, the mixture in the cylinder is ignited, or in the case of a diesel engine, the fuel is injected. From the point of ignition, the pressure rises rather rapidly to a peak value and then, as the piston continues on the power stroke, decays to a pressure near that of the atmosphere again after the exhaust valves open.

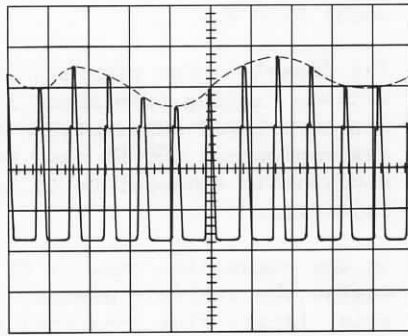

Fig. 6-4. Drawing of pressure display showing variations in peak pressure.

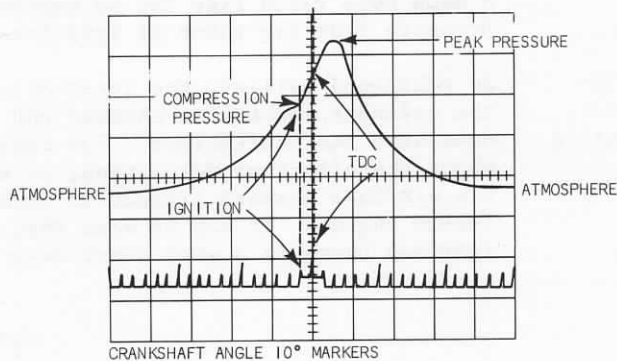

Fig. 6-5. Drawing showing characteristics of pressure waveform.

auto-
ignition

An ignition system is necessary in the case of a gas or gasoline fueled engine because of the temperatures necessary to ignite the fuels. The compression ratios on such engines (usually no higher than 12:1) are not sufficient for the temperature resulting from compression alone to ignite the fuel/air mixture. The autoignition temperatures of gasoline usually begin at approximately 850°F. The autoignition temperature of natural gas is much higher, probably about 1200°F.

The diesel engine with its much higher compression ratios, ranging from about 15:1 to about 25:1, and its much lower autoignition temperature fuel (approximately 600°F) does have sufficient cylinder atmospheric temperature to ignite the fuel upon injection.

In the combustion chamber of a gas or gasoline fueled engine the fuel/air mixture is ignited at a given point (spark plug location) and a flame front propagates across the cylinder with an accompanying rise in cylinder pressure. On a diesel engine, however, the fuel is injected, in spray or mist form, directly into the hot cylinder-air atmosphere and ignites spontaneously at several points. Therefore, a much more rapid rise can be expected in cylinder pressure from the point of ignition.

ignition
in inter-
connecting
tube

As mentioned earlier, the interconnecting tube between the cylinder combustion chamber and the transducer, does have its limitations. For example, Fig. 6-6 shows the effect of detonation, or autoignition, of the air/fuel mixture trapped in such a tube on a gas-fueled engine. It can be seen that shortly after ignition there is a very short duration pressure peak

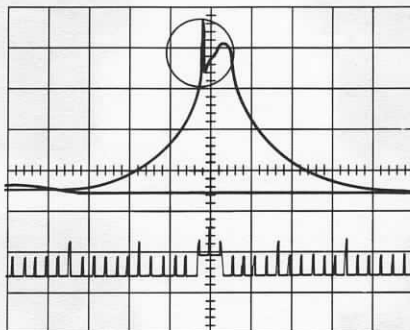

Fig. 6-6. Drawing showing the effect of detonation in interconnecting tube.

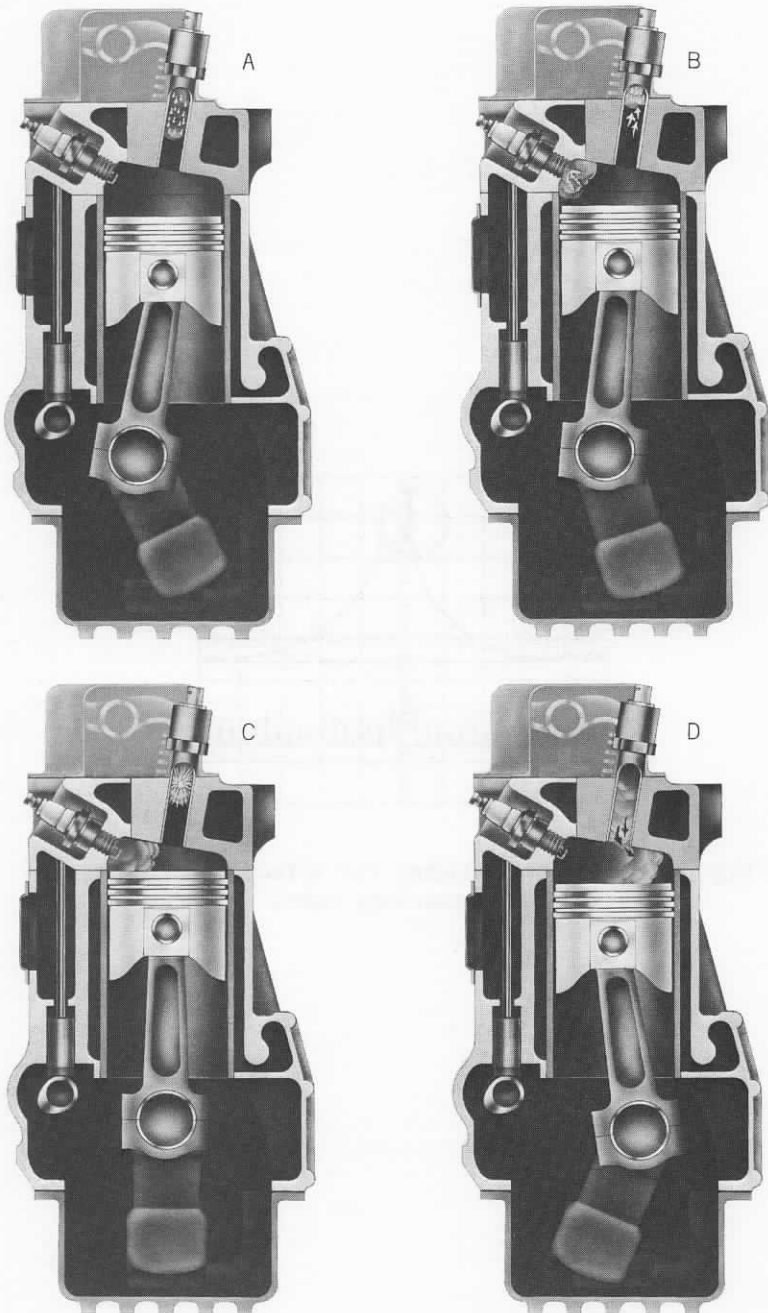

Fig. 6-7. Sequence of events causing interconnecting-tube detonation.

and then the pressure "settles" back to combustion chamber pressure and continues to plot the pressure of the cylinder. The existence of this condition does not destroy the usefulness of the waveform, but it should be understood why it is there and that it is not an occurrence in the combustion chamber itself. Fig. 6-7 illustrates what is believed to be the sequence of events leading up to the occurrence.

First the fuel/air mixture is under pressure and some of it is forced into the interconnecting tube (A). The mixture is then ignited (B), causing a local high pressure area. This causes the mixture in the tube to be compressed under high pressure in a small area. The temperature of the mixture, resulting from the compression and the temperature of the compressing wavefront, reaches the point of autoignition and burns (C), causing combustion to occur in the tube itself.

Because there is only a small amount of the mixture present, the burning will be of short duration and the pressure peak will be high due to the small confines within which the combustion takes place. However, this high pressure cannot survive long under these conditions because of the "connection" to the combustion chamber of the cylinder and therefore, the pressures will equalize themselves due to the passage of the higher pressure gasses into the lower pressure area (D). It is felt that this condition can be minimized by keeping the interconnecting tube short and the internal dimension small so that the volume of the mixture contained within the tube is minimized.

resonance
in inter-
connecting
tube

Another condition that can occur with the interconnecting tube is resonance of the gas column in the tube. This effect is sometimes called "organ pipe effect". Visually, this condition will cause a ringing, or oscillation, to appear on the waveform. The resonance is caused by the combustion pressure wave in the cylinder shocking or exciting the gas column. It is not expected that this condition is likely to cause much of a problem but is mentioned here as a possibility if the interconnecting tube is long enough with an internal dimension large enough.

The wavelength of a sound wave of sufficient frequency to cause a gas column to oscillate to any appreciable degree can be found with the equation,

$$\lambda = C/F \quad \text{where:}$$

λ = Wavelength,
 C = Propagation velocity of the wave, and
 F = Frequency of the wave.

The resonance frequency of a given length of tubing can also be found with the equation,

$$F = C/4L \quad \text{where:}$$

F = Frequency,
 C = Propagation velocity of the wave, and
 L = Length of tube.

inter-
connecting
tube
dimensions

This effect can also be minimized by keeping the inside diameter of the tubing down to the smallest practical dimension.

It is commonly understood that the friction between the air or gas column and the walls of the tube will offer resistance to any movement in the column. This resistance is analogous to the resistance of an electrical circuit inasmuch as it tends to damp out any oscillations occurring in the column and offers resistance to the transmission of pressure waves within the column. The resistance is a function of the area of the resistive surface versus volume of the column.

Therefore, the smaller the tube the greater the resistance and the larger the tube the less the resistance. It is for this reason that the tube must not be made too small. If the tube becomes too small there will be an apparent phase shift between the crankshaft angle and the pressure waveform. This effect should be avoided to the degree possible.

The appearance of resonant "ringing" on the pressure waveform does not defeat the usefulness of the waveform for maintenance purposes. However, in an effort to keep the effect to a minimum, a maximum RPM specification of 1000 has been placed on the Tektronix Engine Analyzer when using the pressure transducer and cooling adapter on a standard shut-off valve.

pressure
waveforms

Because it is the pressure developed in the cylinder of an engine that is the source of energy being developed, the pressure waveform can be most useful in the analysis of an engine. Fig. 6-8 is typical of a diesel engine idling under a no-load condition. Notice that the energy being developed is only sufficient to overcome the friction horsepower of the engine and therefore the positive loop of the PV diagram appears to have no area. Fig. 6-9 is typical of the same engine under a light load condition.

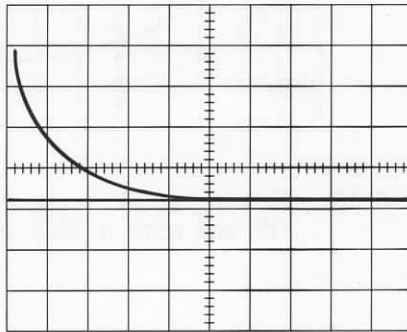

Fig. 6-8. Drawing of PV curve with engine idling and no load.

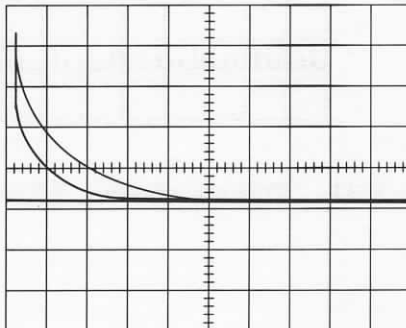

Fig. 6-9. Drawing of PV curve with engine running at medium RPM and with a light load.

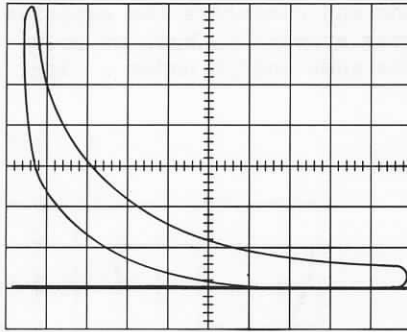

Fig. 6-10. Drawing of PV curve with engine at full RPM and with a full load.

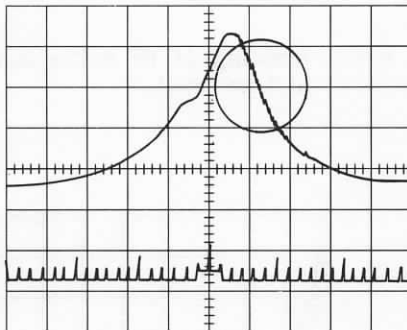

Fig. 6-11. Drawing showing effect of detonation.

Notice that the peak pressure has increased slightly and that the area of the positive loop has increased somewhat. Fig. 6-10 is typical of the same engine under full RPM and full load conditions. Notice that the peak pressure has increased considerably and that the area of the positive loop has proportionally increased.

detonation

Detonation is quite harmful to an engine, as well as robbing it of developed energy, and can be identified quite easily from the pressure waveform. The oscillations on Fig. 6-11 are the result of detonation. The cause of detonation is thought to be premature ignition of the fuel/air mixture. It can be caused by the ignition timing being set too early, improper fuel, by glowing carbon, or, in the case of a diesel engine by early fuel injection into the combustion chamber. It can be readily seen that it is most desirable to have the pressure reach a peak just after the piston has passed through TDC. In this way the engine does not have to overcome the pressure caused by the rapid expansion of the burning fuel and thus expend energy that might otherwise be available to accomplish work external to the engine itself.

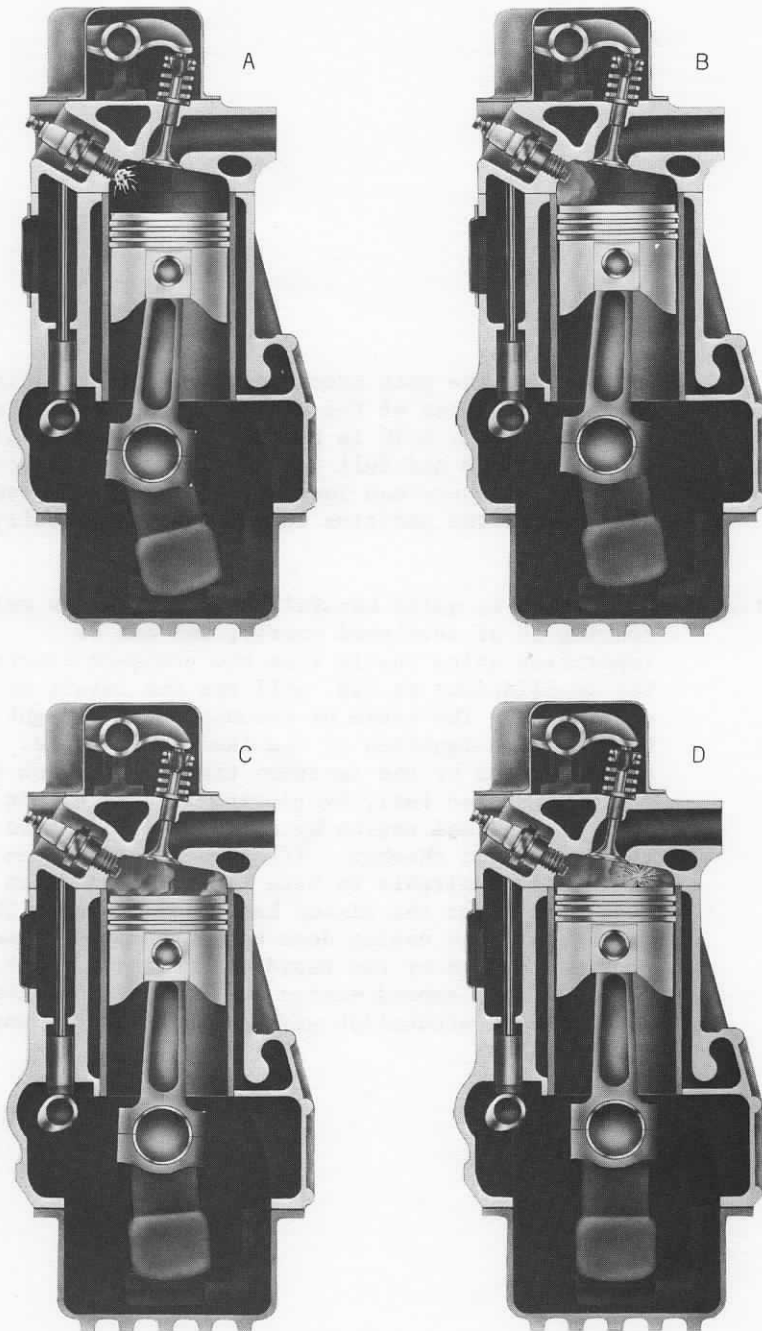

Fig. 6-12. Drawing showing possible cause of detonation resulting in excessive chamber temperature and loss of power.

Therefore, the timing of the cylinder (ignition or fuel injection) should be such that, as the fuel/air mixture burns, the peak pressure is reached after TDC. If, for some reason, this precise timing of the start of the mixture burning is not accomplished and the burning is started early (Fig. 6-12A) it can be seen that as the piston continues on up it will have to compress the burning as well as the still-unburned portion of the mixture (Fig. 6-12B). The pressure will cause an elevated temperature in the unburned mixture and autoignition will result (Fig. 6-12C). The presence of two or more flame and pressure fronts in the cylinder (Fig. 6-12D) will cause variations in the pressure waveform. The frequency of the oscillation will be a function of the sound propagation velocity of the medium and the diameter of the cylinder.

indicated
horsepower

The PV (pressure versus volume) diagram must be used to determine the indicated horsepower (IHP) developed by a cylinder or engine (if the IHP of all cylinders are assumed to be equal). To plot a PV diagram, the Type 2B67 is put in RFG position and the toggle switch put in the PISTON (VOLUME) position. This allows the RFG to drive the instrument horizontal deflection with the modified sinewave instead of the linear ramp as it does in the CRANK (ANGLE) position.

It is suggested that the SINGLE SWP MODE be used. Place the TRIGGERING SOURCE switch to EXT and if the engine is a two-cycle, select the 360° position of the slide switch and if it is a four-cycle engine, select the 720° position. In the case of the four-cycle engine, this allows the horizontal to sweep twice so that both the negative and positive loops of the diagram are plotted. Note: When making a PV diagram the RFG should be driven at a 1:1 ratio with the crankshaft for both two- and four-cycle engines.

In describing the formation of the PV diagram the piston shall be assumed to start at TDC and just before beginning the intake stroke (Fig. 6-13A). It can be seen that as the piston goes down on the intake stroke, with the intake valves open, that there will be only a slight negative pressure present. This is due to the restriction of the induction system to the passage of air, the resulting increase in air velocity and thus, a drop in pressure. Somewhere near BDC the intake valves close and the piston begins to come up on the compression stroke with all valves closed. The compression rise in pressure results (Fig. 6-13B). Sometime BTDC the fuel/air mixture is ignited or the fuel injected. The fuel/air ignition results in a rather steep rise in pressure just after TDC with the piston going down on the power stroke of the cycle.

Sometime just before BDC, again, the exhaust valves open and the pressure drops (Fig. 6-13C) but not immediately, due to the restriction of the exhaust system and the continuous reduction of the cylinder volume as the piston rises on the exhaust stroke. Finally the pressure does return to atmosphere as the piston approaches TDC again (Fig. 6-13D) and the cycle begins again.

Mean
Effective
Pressure

The PV diagram is used to derive the Indicated Mean Effective Pressure for use in one of the horsepower equations. The Mean Effective Pressure (MEP) is the theoretical constant pressure that would have had to be applied during the time of the cylinder functional cycle to develop the same energy that was developed by the varying pressure cycle of the cylinder.

Probably the most practical method of arriving at the MEP is to photograph the CRT display and measure the area of the loop or loops of the diagram. The four-cycle PV is slightly more difficult to calculate than the two-cycle, because of the negative loop, and will be used here as an example.

planimeter

The area of the loops can be determined by weighing, counting squares, or by using a planimeter (mechanical integrator). The planimeter will be used in the example due to its simplicity and ease of use. Fig. 6-14 is a picture of the planimeter used. The dials are zeroed and the outline of the loops followed with the pointer. When the operator has returned to the starting point the area of the loop can be read from the dials. It is, perhaps, more convenient if the planimeter reads out directly in square inches.

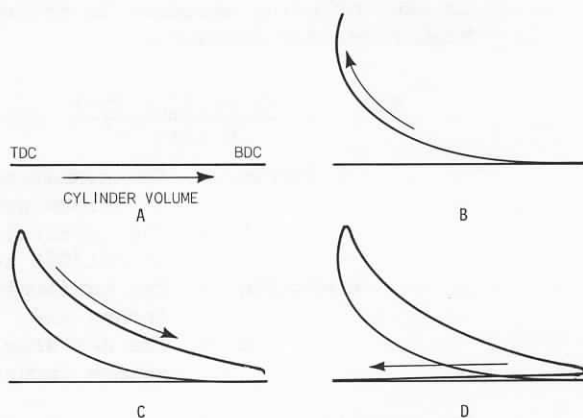

Fig. 6-13. Drawing showing relationship of PV curve formation and cylinder function.

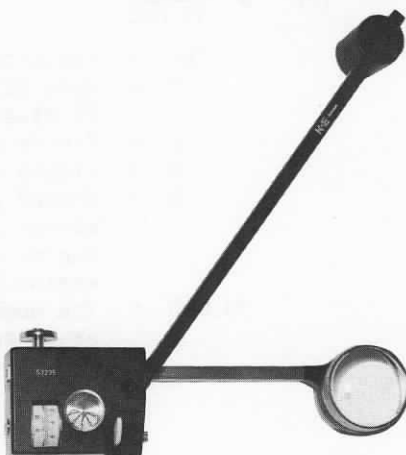

Fig. 6-14. Planimeter.

After the area of the two loops has been determined, the area of the lower, negative loop should be subtracted from that of the upper, positive loop. The result is representative of the net energy developed by the cylinder during that cycle.

The net area of the loop or loops can then be applied to the following equation to derive the Indicated Mean Effective Pressure.

$$\text{MEP}_i = \frac{(V \text{ div/in}) (DF)}{(H \text{ size/in})} (A) \quad \text{where:}$$

- V div/in = The number of vertical divisions per inch,
- DF = The vertical deflection factor or PSI/DIV setting of Channel 1,
- H size/in = The horizontal display size in inches and,
- A = The net area of the loops in square inches.

The equation for calculating the IHP of an individual cylinder is

$$\text{IHP} = \frac{\text{PLAN}}{33,000} \quad \text{where:}$$

- IHP = Indicated Horsepower,
- P = Mean Effective Pressure of the PV diagram,
- L = Piston stroke in feet,
- A = Piston area in square inches,
- N = Number of power strokes per minute (RPM/2 for a four-cycle engine or RPM for a two-cycle engine or compressor) and
- 33,000 = The number of ft-lbs per minute equal to one horsepower.

The equation for calculating the horsepower for an entire engine is, of course, just a slight variation of that for a single cylinder. It is

$$\text{IHP} = \left(\frac{\text{PLAN}}{33,000 (12)} \right) \left(\frac{n}{x} \right) \quad \text{where:}$$

- IHP = Indicated Horsepower
- P = Mean Effective Pressure
- L = Piston stroke in inches
- A = Piston area in square inches
- N = RPM
- n = Number of cylinders
- 33,000 = Number of ft-lbs per minute equal to one horsepower
- 12 = Converts stroke inches to feet
- x = 1 if the engine is a two-cycle or 2 if the engine is a four-cycle.

It should be noted here that these computations are all related to *indicated* quantities. That is, the MEP derived here is the *indicated* MEP and the horsepower equations are for deriving *indicated* HP and are not to be confused with Brake Mean Effective Pressure or Brake Horsepower.

brake
horsepower

Brake horsepower is that power delivered by the engine to a brake or dynamometer and is always less than the indicated quantity. That is, the brake horsepower of an engine is equal to the indicated horsepower less the friction horsepower ($\text{HP}_b = \text{HP}_i - \text{HP}_f$). The friction horsepower is the energy absorbed within the engine itself due to bearing friction, etc. The Brake Mean Effective Pressure (MEP_b) is, of course, that theoretical constant pressure that would need to be applied during each power stroke to produce the brake horsepower of the engine.

L/R ratio
of 4

The disc in the RFG generates a modified sinewave based on a L/R ratio of 4. This waveform is used to drive the horizontal deflection of the instrument when plotting a PV curve and is representative of the cylinder volume as referred to crank angle.

other L/R ratios

There has been much discussion about the effects of various L/R ratios on the waveshape and the effect on resulting horsepower calculations. Figs. 6-15 through 6-18 are computer-drawn composite waveforms superimposing a true sinewave and modified sinewaves that represent L/R ratios from 2:1 through 6:1 in 0.5:1 steps. It will be noticed that the true sinewave and the waveform representing an L/R ratio of 4:1 appear on each of the figures for easy reference.

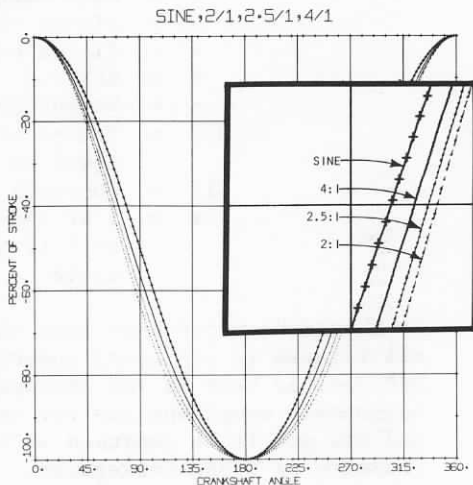

Fig. 6-15. Sine, 2:1, 2.5:1, 4:1 L/R-ratio curves.

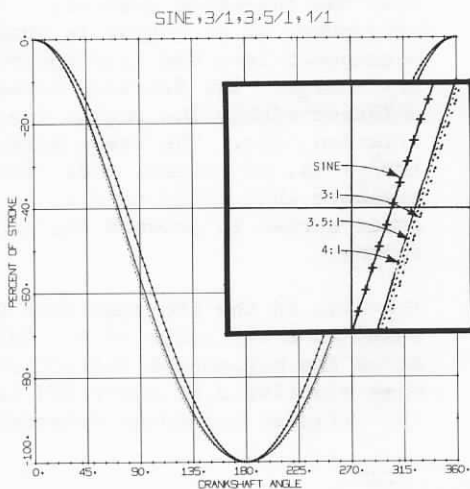

Fig. 6-16. Sine, 3:1, 3.5:1, 4:1 L/R-ratio curves.

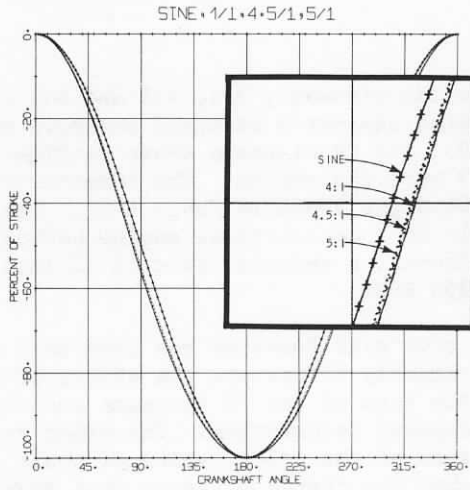

Fig. 6-17. Sine, 4:1, 4.5:1, 5:1 L/R-ratio curves.

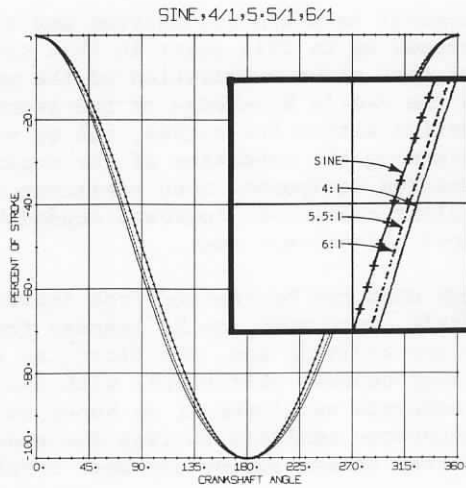

Fig. 6-18. Sine, 4:1, 5.5:1, 6:1 L/R-ratio curves.

resultant
errors

When the sinewave, 3:1, 4:1 and 5:1 functions were plotted against a standard pressure waveform (Fig. 6-19), the PV diagrams shown in Figs. 6-20 through 6-23 were the result. The computer-calculated results are shown in Table 6-24. The PV diagrams apply to a hypothetical engine having a stroke of 17 inches, a cylinder bore of 12 inches and operating at 350 RPM.

The true sine function has been used here only to graphically illustrate the effect of the waveshapes on the area of the PV diagrams and the resulting horsepower calculation. The other ratios are used because of the practicality of their application and to show the degree of error that might be expected for L/R ratios other than the 4:1 generated by the RFG.

It is not expected that these errors will prove significant enough to give difficulty in the practical use of the instrument as a maintenance tool.

Individual waveform acquisition and analysis have been discussed up to this point in this text. It has been shown that close examination of the waveform, coupled with the user's knowledge of the sequence of events occurring within the engine, can be very useful in determining the condition of the engine and its associated equipment, thus assisting in maintaining efficient operation, improved dependability, and reduced maintenance cost.

simultaneous
waveform
analysis

Though much can be learned from individual waveform analysis, much more can be learned from simultaneous waveform analysis and, therefore, as soon as the operator becomes comfortable with the analysis of the separate waveforms it is hoped that he will begin simultaneous analysis to reap the greater benefits of better understanding and more complete analysis.

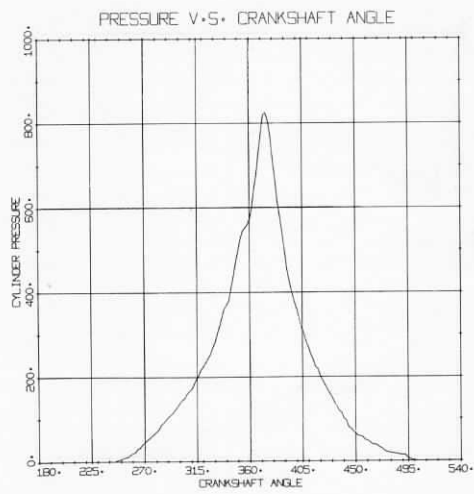

Fig. 6-19. Pressure versus crankshaft angle.

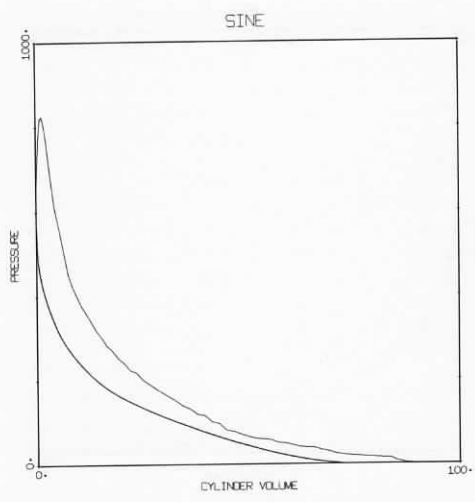

Fig. 6-20. Sine PV curve.

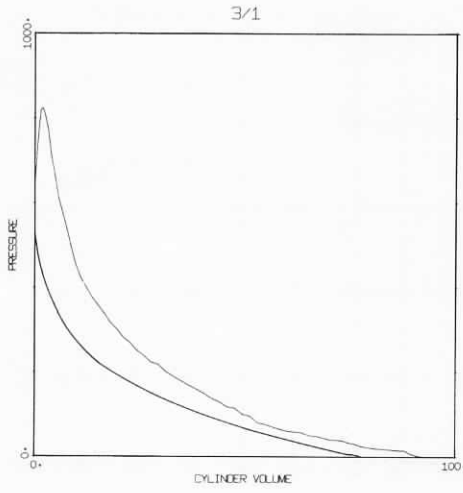

Fig. 6-21. 3/1 PV curve.

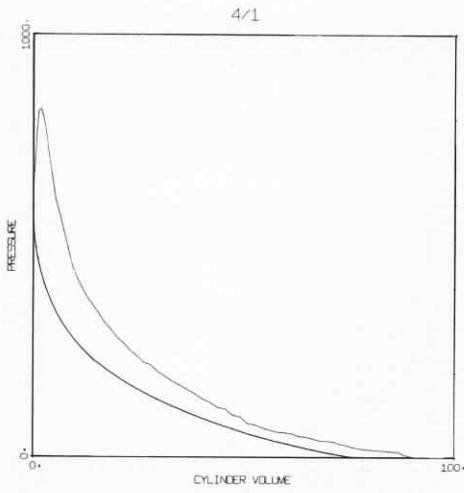

Fig. 6-22. 4/1 PV curve.

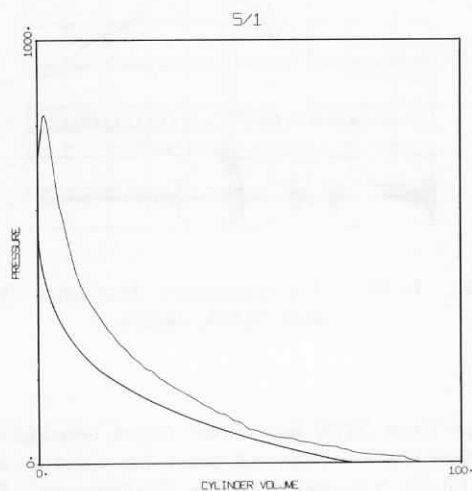

Fig. 6-23. 5/1 PV curve.

L/R RATIO	IMEP	IHP	HP % ERROR FROM 4:1 -
TRUE SINE	59.11	103.17	≈ 12.65
2:1	76.74	133.95	≈ 13.32
2.5:1	72.98	127.39	≈ 7.8
3:1	70.58	123.19	≈ 4.25
3.5:1	68.95	120.35	≈ 1.71
4:1	67.69	118.16	0
4.5:1	66.73	116.48	≈ 1.42
5:1	65.96	115.14	≈ 2.57
5.5:1	65.33	114.03	≈ 3.49
6:1	64.81	113.13	≈ 4.25

Table 6-24. Computation of IHP error for engines have L/R ratios other than 4:1.

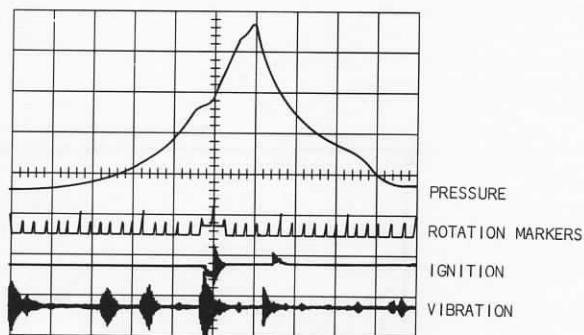

Fig. 6-25. Simultaneous display--Type 2B67 in RFG and CRANK modes.

input
connections

The Type 3A74 has four input amplifiers. The pressure transducer must be connected to the Channel 1 input because of the charge-amplifier configuration. However, beyond this the choice of transducer/channel connections is largely up to the operator. One possible display combination is shown in Fig. 6-25. In this photo Channel 1 displays the cylinder pressure, Channel 2 displays the crankshaft degree markers (connected internally from the 2B67). Channel 3 is displaying the ignition probe output, and the vibration transducer output is shown on Channel 4. The horizontal axis is driven from the voltage ramp (crank) from the RFG. The 3A74 CHOP/ALT switch is in CHOP.

simultaneous
display

In this display, the reference, (crankshaft degree markers) is almost centered, minimizing the need for a straight edge to reference the waveforms. The advantages to the simultaneous display in analyzing the waveforms are apparent. The crankshaft angle at practically any occurrence is available without difficulty. For example, if there is a particular portion of the pressure waveform that is of interest, it is a simple matter to position the markers up to the area of interest so that the angle can be determined. For the ignition and vibration waveforms the markers can easily be positioned downward so that they may be related to the crankshaft angle. Ignition timing, valve timing, and pressure peak can now all be checked at a glance.

With this type of display it is again recommended that the RFG be driven at 2:1 ratio with the crankshaft on a four-cycle engine. This eliminates the difficulty in interpreting the vibration waveform. If the magnetic pulses are connected to the Z axis, they will appear on *all* waveforms and the occurrences at these two points on all waveforms are immediately apparent without further adjustment.

The simultaneous display is unique to the Tektronix Engine Analyzer. Now it is possible to see the results of an ignition malfunction on all other waveforms. This can be especially advantageous when the malfunction is of an intermittent nature. Also, the simultaneous effects of detonation can be viewed as well as that of the effect of a sharp rise in pressure (for example, this might cause a piston slap to show). If there is a drop in the pressure peak on a particular cycle, but the ignition waveform was normal, the probable cause was a fuel imbalance rather than an ignition failure. If ignition failure was the cause that can be seen also.

Careful study of the waveforms at the time that the analyzer is connected to the engine and application of the concepts of this text when coupled with the operator's knowledge of the occurrences of the engine (the related crankshaft degree at which a certain valve opens or closes, for example) allow the operator to isolate and analyze even an intermittent malfunction.

It is recommended that the operator keep and study pictorial records of the waveforms taken from the engine. Such a record can be especially beneficial when involved in long-term analysis.

A continuous and conscientious engine analysis program can eliminate the costly and time-consuming maintenance program where engines are routinely taken down when nothing is wrong. Conversely, engines have been allowed to run too long, the result being a costly catastrophic failure.

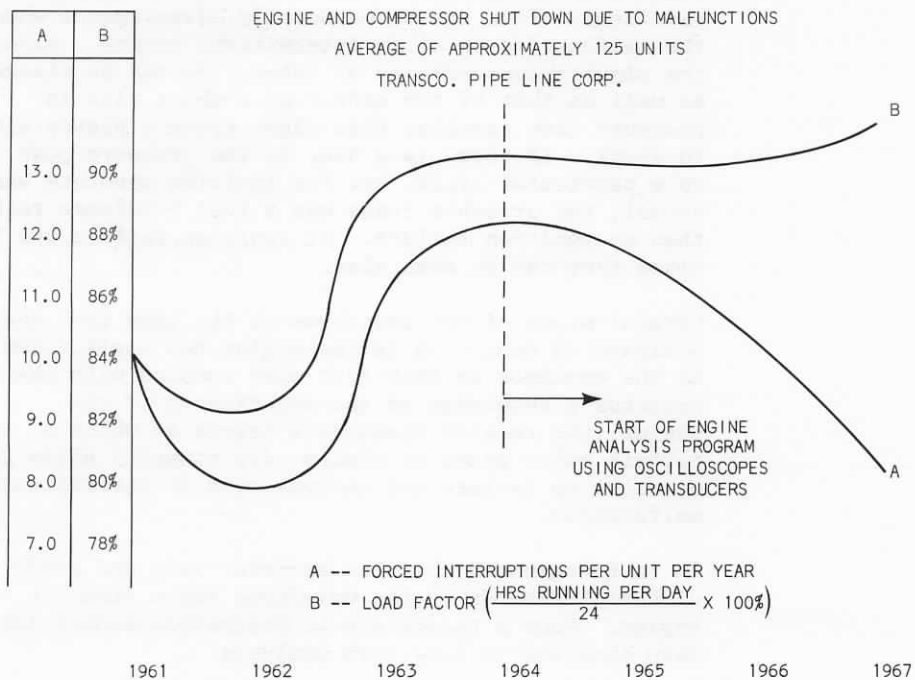

APPENDIX A

ENGINE AND COMPRESSOR MALFUNCTIONS

The Tektronix Engine Analyzer system is used to detect malfunctions inside engines and their accessories by measuring pressures, vibration, ignition voltages and rotation. When displaying these quantities on an oscilloscope so they can be related to crankshaft rotation, the cause of the malfunction can be determined. Also, the moment when the malfunction happens as well as the shape of waveform are used to diagnose the cause.

Listed below are some malfunctions that were detected by our customers on their engines--mostly large stationary engines--utilizing an oscilloscope and various transducers. Some of these malfunctions are shown on the following pages.

<i>VIBRATION:</i>	Piston blowby Leaking valves Ring damage Groove damage Port damage Pits in cylinder walls Carbon build-up Broken ring land	Ridges worn in cylinder wall Worn valve-cams New or overhauled engine run-in Worn blower ball bearings Loose bearings Bad governor gear
<i>PRESSURE:</i>	Preignition Detonation Low compression Late firing Misfiring Irregular firing	Horsepower (from PV diagram) Cylinder pressure balancing Peak firing pressures
<i>IGNITION:</i>	Peak firing voltage Duration of arc Duration of dwell Loose connections Bad coils, transformers or condenser	Wobbling distributor camshaft Bouncing points Condition of sparkplugs Timing

ENGINE AND COMPRESSOR VIBRATION PATTERNS

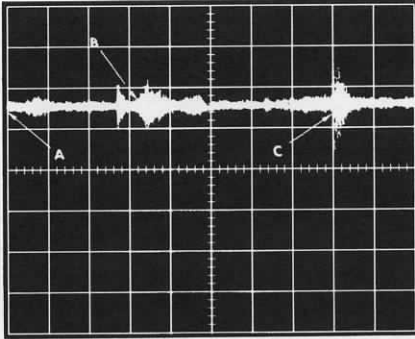

Typical two-cycle vibration pattern

- A - Ignition
- B - Port Opening
- C - Fuel Valve Closure

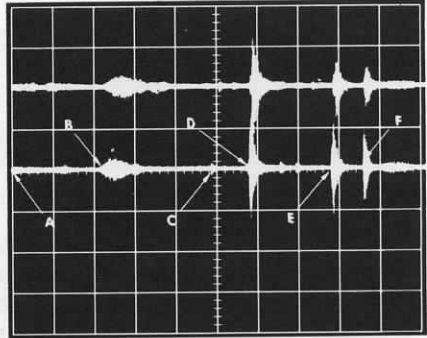

Typical four-cycle vibration pattern

- A - Ignition
- B - Exhaust Valve Opens
- C - Inlet Valve Opens
- D - Exhaust Valve Closes
- E - Inlet Valve Closes
- F - Fuel Valve Closes

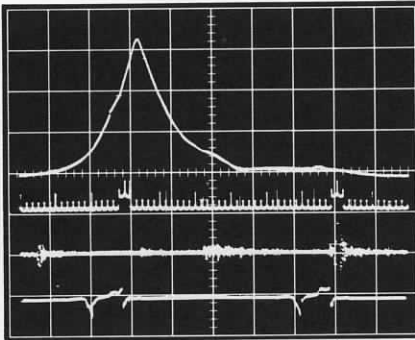

↑ EXH open ↑ EXH closes

Single Cylinder Briggs & Stratton
4 cycle, light load, magneto ignition

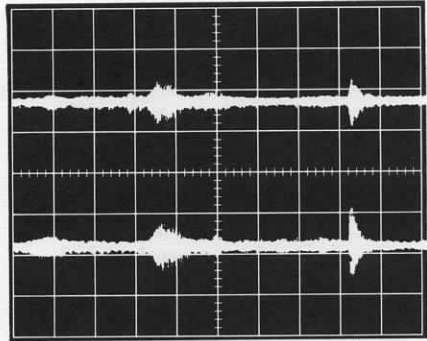

↑ Slight Blowby ↑ Exhaust open ↑ Fuel Valve Closing

C-B, GMWC Engine (2 cycle)

Top pattern normal. Bottom pattern shows slight blowby on power stroke. 10 ms/div. (Uncal.) 5 mV/div. Triggering from ignition.

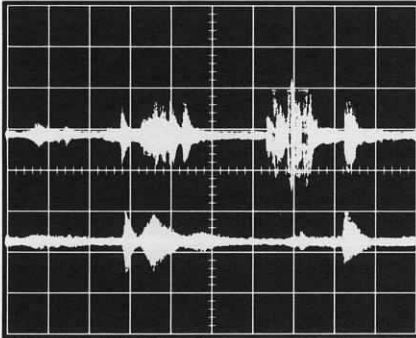

↑
ign

C-B, GMWC Engine

Top pattern shows wear ridge below ports. Bottom pattern shows indication of ring side clearance. 10 ms/div. (Uncal) 5 mV/div. Triggering from ignition.

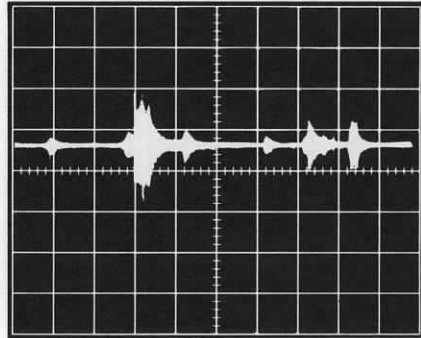

↑
ign

C-B, GMW Engine (2 cycle)

Power Cylinder Vibration, Broken ring.

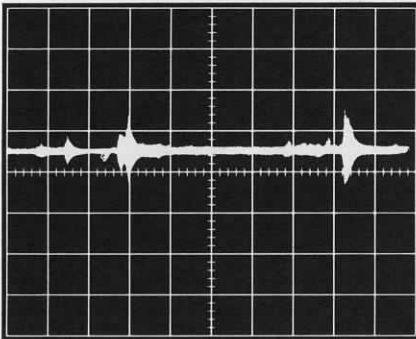

C-B, GMW Engine

Power Cylinder Vibration. After replacing broken ring (see preceding picture)

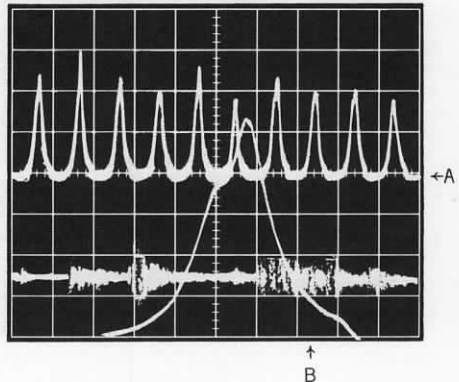

Clark TCV-16

Notice the increased amplitude on the vibration pattern and that the compression has stayed good.

A - 200 PSI/DIV

B - Cylinder scorching caused by sand that entered cylinder accidentally.

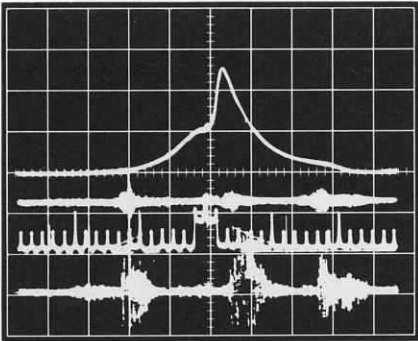

Cooper Bessemer - 250 rpm
Excessive Top Ring Clearance - Blowby

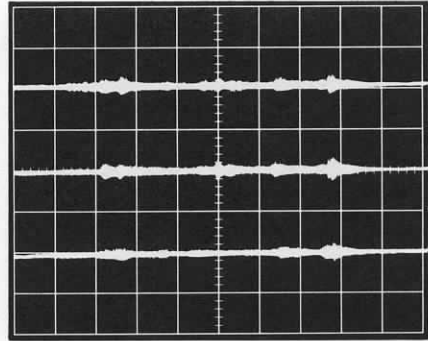

TDC Headend
Compressor Valve Vibration
Normal

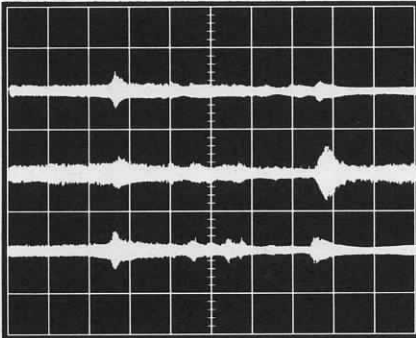

Compressor Valve Vibration
Center trace shows leaking valve.

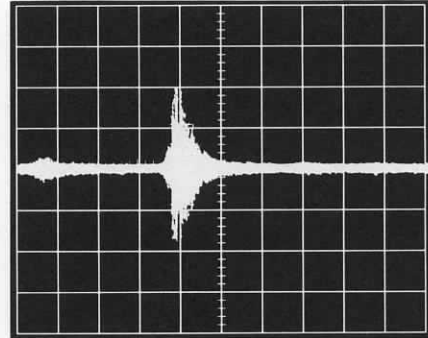

Compressor Cylinder Vibration
Defective compressor rings.

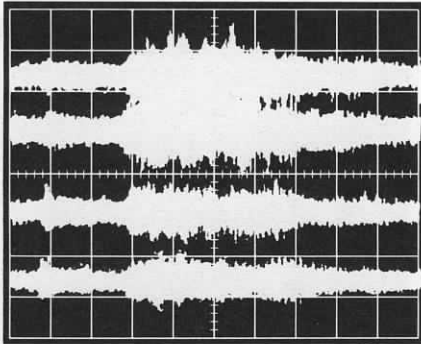

Compressor Cylinder Vibration
Bad rings and bad valves.

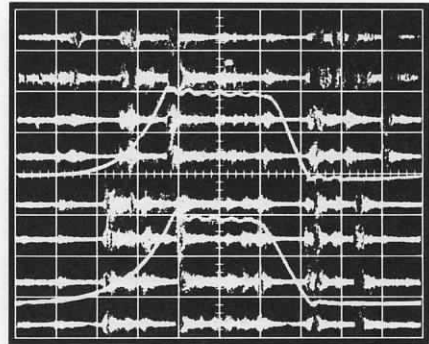

Before

Clark RA5 (50 PSI/DIV)
Pockets closed. $P_s = 150$, $P_d = 320$
Valves were dirty and coked up.

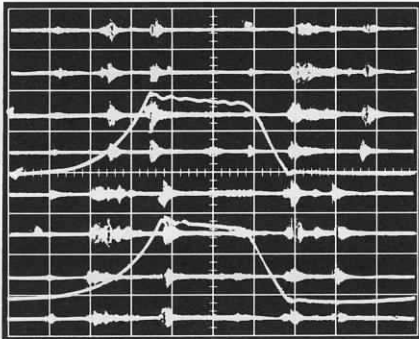

After

Clark RA5
Same as previous picture after
new valve installed.

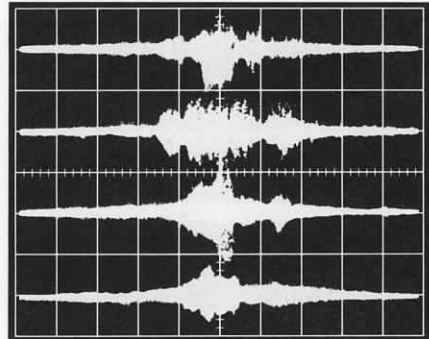

Worthington SUTC
Crank and Compressor vibration
patterns. Valve leaking.

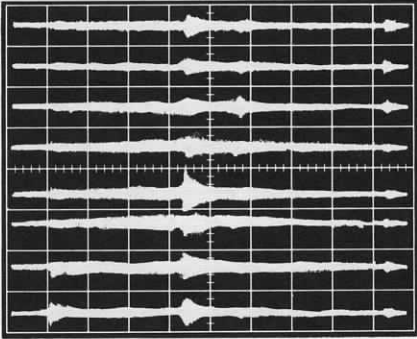

Head-end and Crank-end vibration patterns from above compressor after changing one valve.

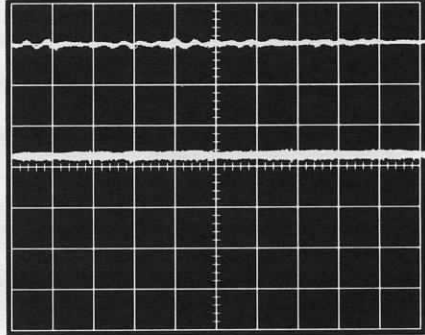

C-B, GMWC
Vibration pattern of new ball bearing in centrifugal blower.

10 V/div
5 ms X5 (top pattern)
10 ms Uncal (bottom)

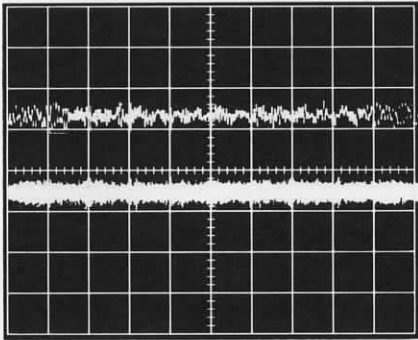

C-B, GMWC-10
Vibration pattern of ball bearing in centrifugal blower as of 7/13/65.

10 mV/div.
5 ms X 5 (top pattern)
10 ms Uncal (bottom)

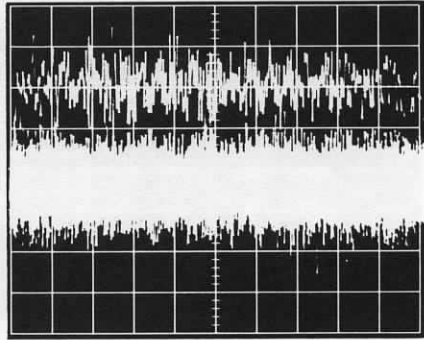

Same as previous picture.
Vibration pattern of ball bearing in centrifugal blower as of 8/17/65.
The noise was audible.

10 mV/div 5 ms X 5 (top pattern)
10 ms Uncal (bottom)

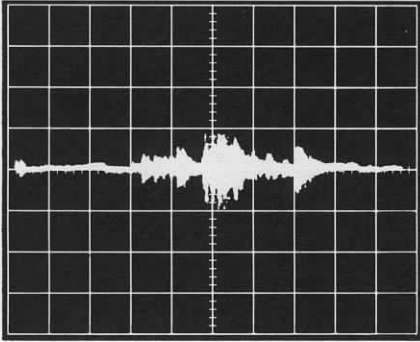

BMW engine

Bad governor drive gear. 12 gear teeth sheared off, other teeth were badly worn. Noise was audible at the flywheel end of engine. Pick-up was on the small crankcase door in the area of the gear.

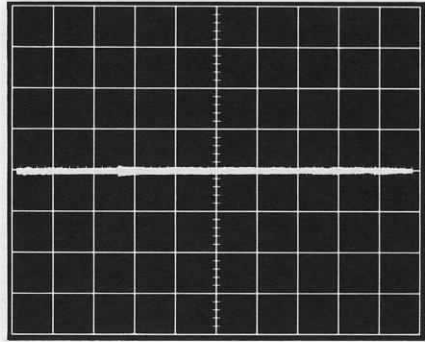

Same engine after replacing gear.

ENGINE AND COMPRESSOR PRESSURE WAVEFORMS

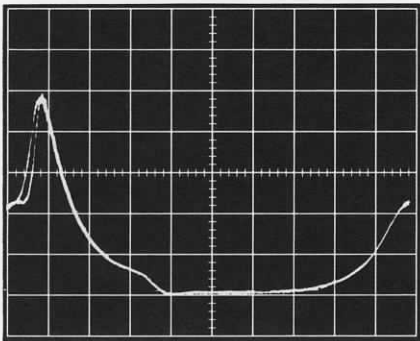

↑
ign

Normal Pressure-Time Diagram of two-cycle power cylinder.

0.1 V/div or 100 psig/div
10 ms/div Uncal.

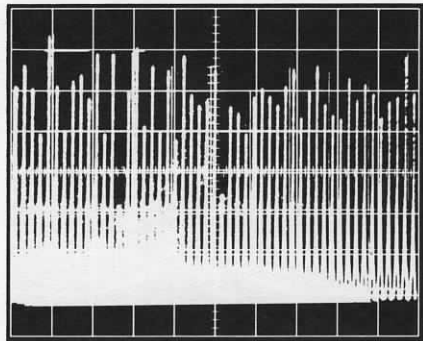

Pressure-Time Diagrams used to give a "Bacharach" type peak firing pressures.

0.1 V/div or 100 psig/div
0.5 s/div

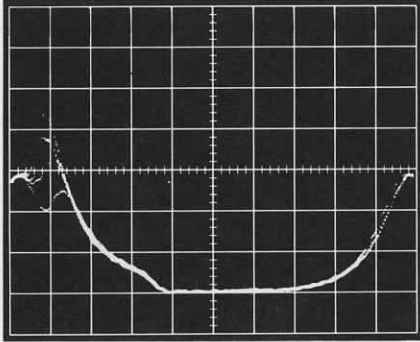

Clark BA-8-T
Abnormal power cylinder
Pressure-Time diagrams
0.1 V/div or 100 psig/div
10 ms/div. Uncal.

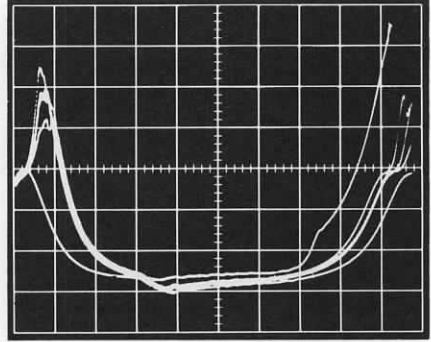

Pre-ignition as seen on two-cycle
Pressure-Time diagram.

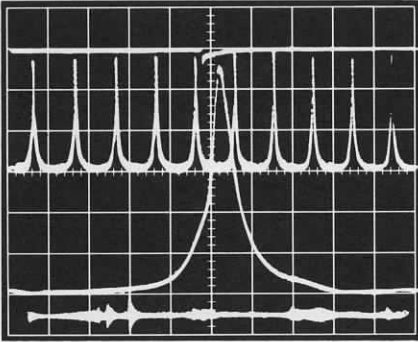

IR XVG Ingersoll Rand
Good power cylinder
50 lbs/cm on compression

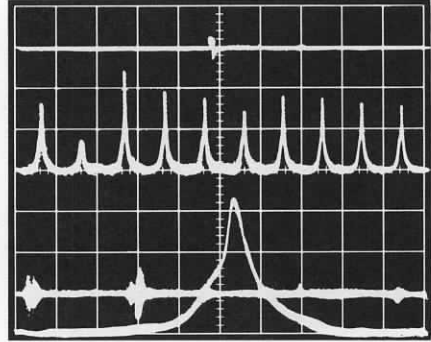

IR XVG
Low compression head - only one
on 8-cylinder engine. Valve guide
worn. 50 lbs/cm on compression.

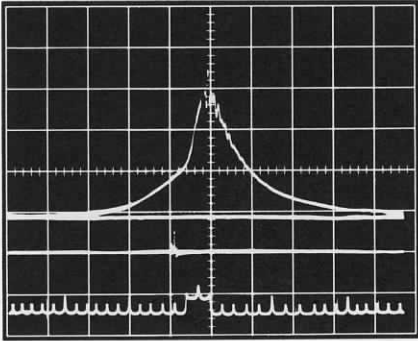

Ingersoll Rand
Knock in pipe to transducer

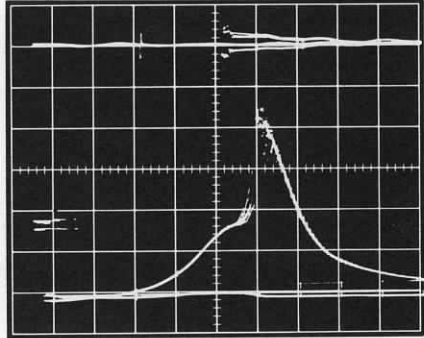

Variations in combustion timing.
Secondary ignition voltage changes
polarity alternately.

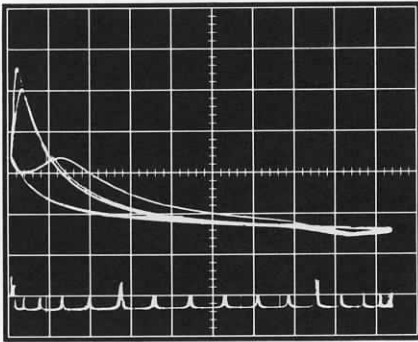

P-V Diagram 200 PSI/DIV
Cooper Bessemer (2-cycle engine)
3 successive cycles.

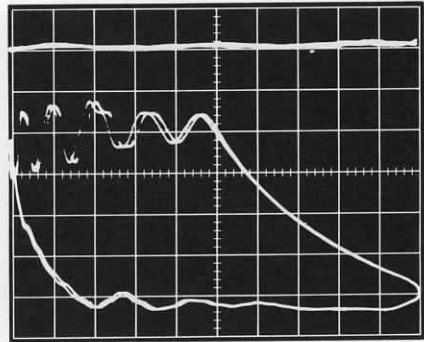

P-V Diagram 10 PSI/DIV
1st Stage of air compressor.

IGNITION WAVEFORMS

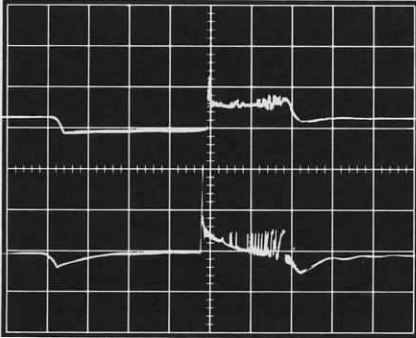

C-B GMW (Cooper Bessemer)
 Pulse-tronic. Normal primary - top pattern. Normal secondary - bottom pattern. ~300 rpm 2 ms/div

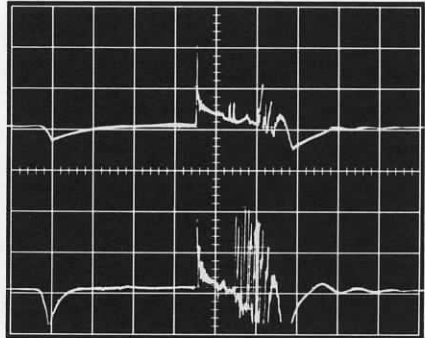

C-B GMW
 Pulse-tronic (secondary). Normal connection - top pattern. Ungrounded connection - bottom pattern.

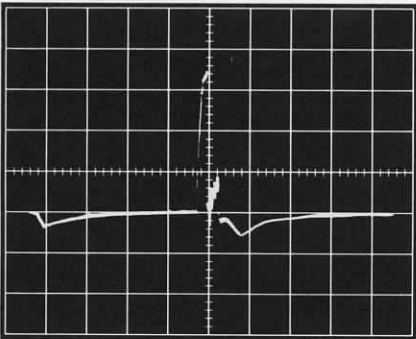

C-B V-250
 Pulse-tronic (secondary). Bad transistor.

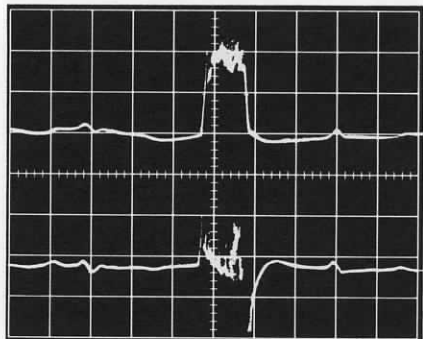

Pulse Generator Primary
 Normal. 10 ms CAL/DIV, 20 V/DIV
 Pulse Generator Secondary, Normal
 10 ms CAL/DIV, 20 V/DIV

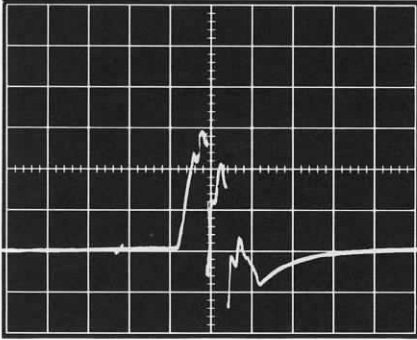

C-B GMWC

Pulse Generator Secondary. Note abnormal firing pattern. Plug wire grounding internally in the transformer. +input. 10 ms, 5X Mag, 20 V/DIV

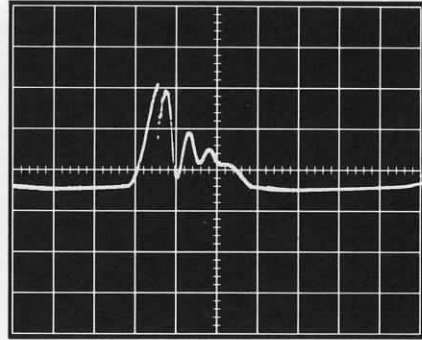

Pulse Generator Primary.

Defective pulse generator.

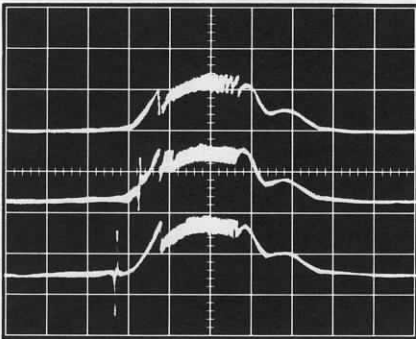

↑A

Pulse Generator.

Timing pulse. Top - correct.

Middle - 2° Retarded.

Bottom - 4° Retarded.

A - Magnetic transducer signal superimposed on ignition trace.

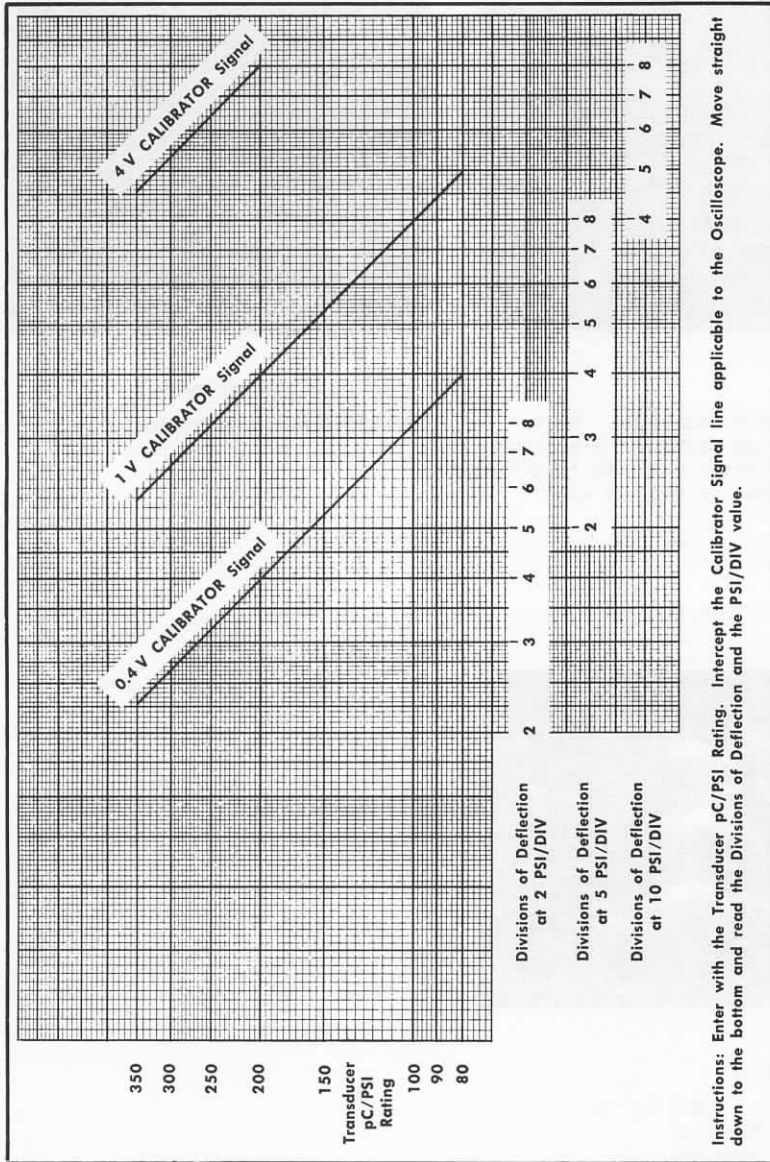

Fig. 1. Gain calibration chart for calibrating the 3A74 Channel 1 Charge Amplifier, using the 4000 pF Charge Amplifier Calibrator.

APPENDIX B

USE WITH OTHER PRESSURE TRANSDUCERS

The charge amplifier (channel 1 of the 3A74 Engine Analyzer Amplifier) is normally calibrated to the charge sensitivity of the particular pressure transducer used. Fig. 1 simplifies the task (for transducers with sensitivity ratings from 80 to 350 pC/PSI) of converting the pressure transducer's sensitivity to the appropriate amount of screen deflection with various PSI/Div settings on the charge amplifier. The correct calibration is achieved by using the Charge Amplifier Calibrator and oscilloscope internal Calibrator signal.

There may be instances where you desire to use pressure transducers with sensitivity values that are not directly listed in Fig. 1. The wide variances that may be encountered are typified on Table 1. These "other" values of transducers are easily adaptable to the EAS and Fig. 1 may still be used for convenience of calibration by:

1. Determining a multiplying factor necessary to equate the transducer's charge sensitivity to a value that will fall between 80 pC/PSI to 350 pC/PSI.
2. Use the multiplied value and Fig. 1 to set charge amplifier gain.
3. Use multiplying factor times the PSI/Div setting to determine *actual* PSI/Div to be used with the transducer selected.

Therefore, for example, if you attempted to use a transducer with a pC/PSI rating of 1 into the normal charge amplifier of the engine analyzer, only the front panel PSI/Div would be off. (1 PSI/Div setting would actually be reading 100 PSI/Div). Calibration steps would remain the same: .4 V would create 8 divisions of deflection with multiplying factor of 100 giving 200 PSI/Div, using the 4000 pC/V charge amplifier calibrator. Quite obviously, however, our reduced sensitivity (100 PSI/Div versus 1 PSI/Div) may create a minor irritation and some simple way to increase the gain would be desirable. Let's briefly review the basic amplifier and determine how we can overcome some of this decrease.

The Type 3A74 Charge Amplifier (channel 1) contains an operational amplifier before the standard amplifier normally associated with the Type 3A74. Decade gain changes are accomplished by switching in feedback capacitors: .004 μF at 1 PSI/Div, .04 μF at 10 PSI/Div and .4 μF at 100 PSI/Div. Refer to Fig. 2.

Using the basic formula covered earlier, we find that to arrive at a charge sufficient to drive the standard amplifier sensitivity of .02 V/Div, at a front panel setting of 1 PSI/Div, requires $Q = CE$.

$$Q = CE$$

$$Q = (.004 \mu\text{F}) .02 \text{ V}$$

$$Q = 80 \times 10^{-12} \text{ or } 80 \text{ pC/Div}$$

The amplifier can be adjusted within a range of 80 pC/Div to 350 pC/Div. Then, using a pressure transducer with a charge sensitivity between 80 to 350 pC/PSI, we can set gain, or Charge/Div, and thus the front panel can be read in PSI/Div. For example, if a pressure of 1 PSI is applied to a transducer with a charge sensitivity of 100 pC/PSI and the amplifier is set for a gain of 100 pC/Div, then screen deflection would be 1 division.

If we now attempted to use a transducer with 1 pC/PSI rating into the amplifier set for 100 pC/Div gain, a pressure of 10 PSI would only produce 1/10 a division of deflection on the CRT screen at a front panel setting of 1 PSI/Div (actually reading 100 PSI/Div), because of the multiplying factor.

A more adequate sensitivity range can be acquired quite easily by changing the appropriate feedback capacitor. A X10 gain increase for the charge amplifier would allow the Charge/Div (gain) to be set at 10 pC/Div (versus 100 pC/Div), and the front panel control would be read as 10 PSI/Div rather than 1 PSI/Div. (Ideally, a X100 increase could be achieved but stability problems limit us in practice.) *Fig. 1 should now be modified by a factor of 10, to reduce confusion with multiplying factors and values for calibration.*

Information concerning the detailed procedure for installing the X10 amplifier gain modification may be obtained from your local Tektronix Field Representative.

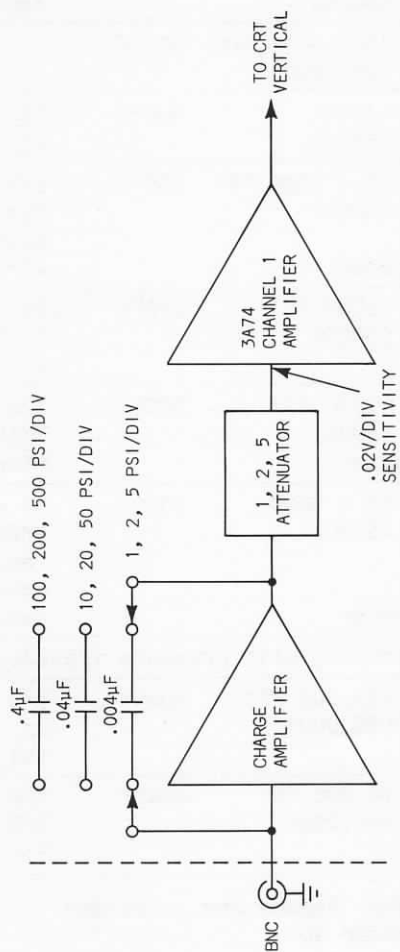

Fig. 2.

MODEL	SENSITIVITY pC/PSI	RANGE PSI (MAX OVERPRESS)	MAX TEMP	PHYSICAL DESCRIPTION
Manufacturer: <i>Kistler, Clarence, N.Y.</i>				
601A	1	10 - 3000 PSI (5000)	500°F	.25 dia x 0.6, .08 oz, 4mm thread
601H	1	1000 - 15,000 (20,000)	500°F	"
603A	.35	-3000 (5000)	500°F	.25 dia x .45", .06 oz, M4mm thread
409	2.4	10 - 3000 PSI (5000)	400°F	5/8 dia x 1.6", 1 oz, M14 - 1.25 metric thd, Microdot connector, Air cooled
Special engine transducer				
606A	5	-3000 PSI (5000)	450°F	.56 dia x 1.25", .7 oz, 1/2" - 20 thd, Microdot connector
609	.35	-2000 PSI (3000)	500°F	3/8 dia x 1.91", 3/8" mounting thd, Microdot connector
Special engine transducer				
618	1	10 - 3000 (5000)	500°F	.56 x 2" 1/2" - 20 mounting thd, 7/16 -28 TNC connector (no cooling needed)
Special engine transducer				
640/601A As 601A Sparkplug with pressure transducer				
607B	.15	-70,000 PSI (75,000)	400°F	3/8 dia x 1.18", .4 oz, 3/8 -24 mounting thd, Microdot
607F	.15	10,000 PSI (60,000)	400°F	3/8 dia x 1.45, 3/8 -24 mounting thd, Microdot connector
Fuel injection TRDCR				
Manufacturer: <i>AVL (Rep. Segamo Inc., Chicago Vibrometer AG</i>				
6QP	.42 - .56	0 - 7100 PSI	200°C	.32 x .62", 2 1/2 gram mounting thd, M6 - .5 or no thd, 6QP 500 fits sparkplug 6ZP10
7QP	.28	0 - 17,000	200°C	.3 x .61", 2.4 gram mounting: adapter

MODEL	SENSITIVITY pC/PSI	RANGE PSI (MAX OVERPRESS)	MAX TEMP	PHYSICAL DESCRIPTION
Manufacturer: <i>AVL (Rep. Segamo Inc., Chicago)</i> <i>Vibrometer AG - continued</i>				
12QP 500 C	2.1	0 - 17,000	200°C	.63 x 1.5", 30 gram M14 - 1.25 thread
AVL 104	1.05	0 - 71,000	200°C	.63 x 1.5", 40 gram M14 - 1.25 thread
8QP 500	.56	0 - 71,000	200°C	.54 x 2.4", 14 gram M10 - 1 thread
8QP 10,000	.15	0 - 14,200	200°C	.54 x 9mm, 11 gram M10 - 1 thread
Manufacturer: <i>Columbia Research Labs Inc., Woodlyn, Pa.</i>				
100-P	100 ±25%	4000 (6000)	230°F	.750 x .625" 15-1/2 grams, thd 9/16" x 24, Connector 10-32
200-P	100 ±25%	4000 (6000)	230°F	.625 x .565", 9 grams thd 7/16" x 28 Connector 10-32
Manufacturer: <i>Endevo, Pasadena, California</i>				
2501 2000	35 ±25%	2000 (3000)	230°F	.750 x .750", Thd 9/16" x 24, Connector 10-32
Manufacturer: <i>Metrix, Houston, Texas</i>				
5016	200 ±50%	3000 (9000)	Max 400°F Oper. 300°F	1.25 x 2.25", 5.5 oz thd 1/2" - 20, Connector BNC
Manufacturer: <i>Piezotronics Inc., Buffalo, N.Y.</i>				
111A	.4	3000	≈ 400°F	.25 dia x .6
112A	1	3000	≈ 400°F	"
112A03	1	10,000	≈ 400°F	"
118A	.14	40,000	≈ 400°F	.28 x .5

Table 1. Piezo-Electric Pressure Transducers

NOTES

INDEX

- Arc line (defined), 26
 Autoignition, 78
 Balanced pressure indicator,
 71-72
 BDC (defined), 67
 Blowby, 69
 Brake horsepower, 91
 BTDC (defined), 44
 Capacitive discharge ignition
 system, 13-15
 Capacitor, 4-8, 13-15, 27,
 29-31
 failure, 27, 29-31
 Charge amplifier calibrator,
 74-76
 Crank angle measurement, 31,
 47, 98
 Cylinder identification, 20
 Detonation, 85-87
 Distributor, 4-15, 32-33
 failure, 32-33
 Dwell, 8, 31-32
 Fuel mixture, 24-26, 76
 Generating potential, 22
 High tension (defined), 3
 Ignition probe, 16-39
 attenuation factor, 19
 calibration, 17-19
 connection of, 19-20
 Ignition timing, 98
 IHP, *see* Indicated horsepower
 Indicated horsepower, 87-88
 Inductive storage ignition
 system, 3-8, 21-39
 Ionizing potential, 23-26
 Leaking valve, 67-69, 76
 Low tension (defined), 3
 L/R ratio (defined), 50
 ratios other than, 4:1,
 94-97
 Magnetic transducer, 41-47,
 54, 57-61
 mounting, 41-44
 used to align RFG, 54,
 57-61
 Mean effective pressure,
 88-91
 MEP, *see* Mean effective pressure
 Piston slap, 66-69, 99
 Planimeter, 89
 Point closure time, *see* Dwell
 Points, 4-15, 32-34, 37-39
 bounce, 34, 39
 contamination, 11, 32-33, 37
 Polarity, 22
 Pressure transducer, 70-99
 calibration, 74-76
 mounting, 72-73, 78-82
 sensitivity, 73
 temperature considerations, 74
 Pressure waveform analysis,
 82-99
 Pulse generator ignition
 system, 11-13
 PV curve (defined), 58
 Rotational function generator,
 49-61, 65-67, 86-99
 alignment, 57
 coupling methods, 53-56
 coupling ratio, 50-53, 67
 rotation direction, 61
 Rotor-to-cap air gap, 25
 RPM determination, 39, 45
 Single cylinder analysis, 20-21
 Sparkplug, 4-15, 25-27
 fouling, 26
 gap, 26
 resistive, 26-27
 TDC (defined), 44
 Transformer, 4-15, 27, 29-31
 failure, 27, 29-31
 Transistor ignition system, 8-11
 Triggering, 20-21, 76
 Valve timing, 98-99
 Vibration transducer, 63-69
 location, 69
 Worn bearings, 69

BOOKS IN THIS SERIES:

CIRCUIT CONCEPTS

<i>title</i>	<i>part number</i>
Digital Concepts	062-1030-00
Horizontal Amplifier Circuits	062-1144-00
Oscilloscope Cathode-Ray Tubes	062-0852-01
Oscilloscope Probe Circuits	062-1146-00
Oscilloscope Trigger Circuits	062-1056-00
Power Supply Circuits	062-0888-01
Sampling Oscilloscope Circuits	062-1172-00
Spectrum Analyzer Circuits	062-1055-00
Storage Cathode-Ray Tubes and Circuits	062-0861-01
Sweep Generator Circuits	062-1098-00
Television Waveform Processing Circuits	062-0955-00
Vertical Amplifier Circuits	062-1145-00

MEASUREMENT CONCEPTS

Automated Testing Systems	062-1106-00
Engine Analysis	062-1074-00
Information Display Concepts	062-1005-00
Probe Measurements	062-1120-00
Semiconductor Devices	062-1009-00
Spectrum Analyzer Measurements	062-1070-00
Television System Measurements	062-1064-00