

INSTRUCTION MANUAL

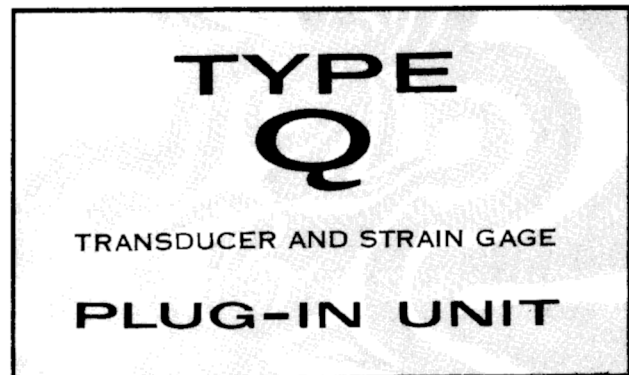

Tektronix, Inc.

S.W. Millikan Way ● P. O. Box 500 ● Beaverton, Oregon 97005 ● Phone 644-0161 ● Cables: Tektronix

070-199



WARRANTY

All Tektronix instruments are warranted against defective materials and workmanship for one year. Tektronix transformers, manufactured in our own plant, are warranted for the life of the instrument.

Any questions with respect to the warranty mentioned above should be taken up with your Tektronix Field Engineer.

Tektronix repair and replacement-part service is geared directly to the field, therefore all requests for repairs and replacement parts should be directed to the Tektronix Field Office or Representative in your area. This procedure will assure you the fastest possible service. Please include the instrument Type and Serial number with all requests for parts or service.

Specifications and price change privileges reserved.

Copyright © 1959. New material copyright © 1962 by Tektronix, Inc., Beaverton, Oregon. Printed in the United States of America. All rights reserved. Contents of this publication may not be reproduced in any form without permission of the copyright owner.



CONTENTS

Section 1	Specifications
Section 2	Operating Information
Section 3	Applications
Section 4	Theory of Operation
Section 5	Maintenance
Section 6	Internal Adjustments
	Abbreviations and Symbols
	Parts Ordering Information
Section 7	Electrical Parts List
Section 8	Mechanical Parts List

Abbreviations and symbols used in this manual are based on or taken directly from IEEE Standard 260 "Standard Symbols for Units", MIL-STD-12B and other standards of the electronics industry. Change information, if any, is located at the rear of this manual.



TYPE Q PLUG-IN UNIT
SERIAL

TRANSDUCER AND STRAIN GAGE PREAMP
RISETIME = 60 μSEC BANDWIDTH = DC TO 6 KC

BRIDGE BALANCE

FINE RESISTANCE

FINE CAPACITANCE

EXT. ARMS

EXTERNAL BRIDGE ARMS

CALIBRATE

VERTICAL POSITION

UNCALIBRATED

NON-OPERATE

VARIABLE

POLARITY FUNCTION

NORMAL BALANCE INST. ZERO INVERTED OPERATE

μ STRAIN/DIV.

GAIN ADJ.

PHASE ADJ.

PORTLAND, OREGON, U.S.A.

TEKTRONIX, INC.

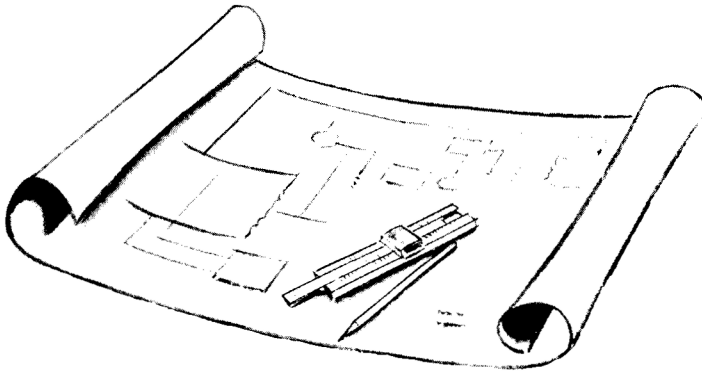

SPECIFICATIONS

General Information

The Type Q Plug-In Unit permits any Tektronix 530-, 540-, or 550-series oscilloscope to be operated with strain gages and other transducers. The unit is completely self contained and requires no external equipment other than the strain gages or transducers operated with it. Excitation voltages for the strain gages and transducers are provided by the plug-in unit. The unit provides high gain, low noise, and extremely low drift.

Frequency Response and Risetime

DC to 6 kc; approximately 60 μ seconds.

Carrier Frequency

25 kc.

Modulation

Suppressed carrier amplitude modulation produced by unbalancing an ac bridge with the strain gages or other transducers. A phase sensitive demodulator is used to produce the proper direction of trace deflection.

Strain Sensitivity

Ten calibrated steps from 10 microstrain (microinches per inch) per major graticule division to 10,000 microstrain per division. The sensitivity is continuously variable between steps. These values apply when the unit is used with a single strain gage with a gage factor of approximately 2. With active strain gages (gage factor 2) inserted into all four arms of the bridge, the maximum sensitivity is 2.5 μ strain per division.

Drift

The amplification system is essentially drift free. Overall system drift is primarily a function of the stability of the external transducer.

Input Bridge

A 5-position switch allows selection of any number of external bridge arms from zero to four. The zero position allows a check of the instrument for normal operation without an external transducer. Total bridge voltage is approximately 5 volts rms. Standard plug-in resistance supplied with the instrument is 120 ohms.

Capacitance Balance Range

Up to 250 μ mf across any one of the bridge arms.

Resistance Balance Range

Sufficient to accommodate standard transducers and strain gages. Range of adjustment can easily be selected by changing one internal resistor.

Transducer Cable Requirements

Three- or four-conductor shielded microphone cable.

Phase Adjustment

Phase Adjust control has sufficient range to allow for use of either resistive or reactive transducers.

Range of Gage Resistances

For cable lengths up to 100 feet the range of useful gage resistances extends from 50 ohms to over 2,000 ohms. For optimum performance and ease of operation the recommended range of gage resistances is from 120 ohms to 500 ohms. Long-lead applications require the use of either two or four bridge arms at the transducer end of the cable.

Gage Factor Calibration

The gage factor calibration is easily and accurately accomplished by increasing or decreasing the amplifier gain proportionately when calibrating. No special gage factor dial is provided.

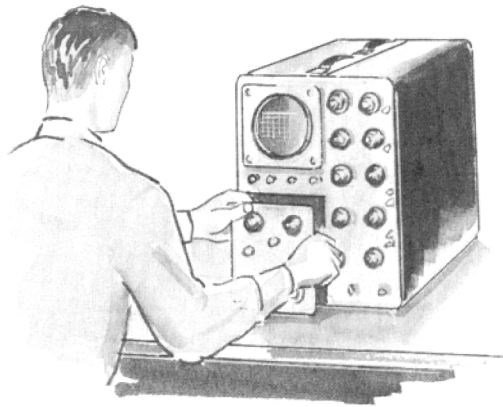

SECTION 2

OPERATING INFORMATION

General Information

The Type Q Plug-In Unit permits any Type 530-, 540-, or 550-series oscilloscopes to be operated with strain gages and other transducers. This allows the oscilloscope to be used for strain analysis, quality control, and measurement of such physical quantities as force, acceleration, and pressure. The usefulness of the unit is limited only by the imagination of the user.

This section of the manual outlines the basic Q Unit operating procedures. In order to obtain maximum utility of the instrument, it is necessary that you become thoroughly familiar with the effects and operation of each control. Much of this familiarity will come only with actual use of the unit.

In this section of the manual, operation of the unit is described mainly in conjunction with resistance type strain gages. Other types of transducers may be treated in a similar manner. The unit contains a completely self contained bridge circuit which can also be used to check certain operational procedures without requiring external connections.

Selecting the Strain Gages

In preparing the Q Unit for operation, it is first necessary to select the strain gages which are to be used with the unit. Although the unit can be made to operate with virtually any type of strain gage, certain strain gage resistances and

gage factors produce optimum performance and ease of operation. Whenever possible, strain gages which satisfy these requirements should be chosen.

When shipped, the Q Unit is calibrated for use with 120 ohm strain gages with gage factors of 2.00. A change in either the strain gage resistance or the gage factor will necessitate one or two short calibration steps. These steps can be made in a matter of seconds providing that the necessary calibration and bridge resistors are available.

When strain gages are used with lead lengths up to 100 feet, the resistance range of strain gages is from 50 ohms to over 2000 ohms. However, if possible, strain gages with resistances between 120 and 500 ohms should be chosen. This will insure optimum operational ease and performance. Since the Q Unit is calibrated for 120 ohm gages, this value is easiest to use. However, if it is necessary to use a different value of resistance, the unit can quickly be set up for this value.

To calibrate the unit for a different strain gage resistance, it may be necessary to change a plug-in calibration resistor. The proper value for the calibration resistor can be determined using the information contained in this section entitled "Selecting the Calibration Resistor". The calibration resistor can be plugged into the unit or attached to convenient binding posts. Depending upon the number of external arms used, it may also be necessary for you to change one of the internal bridge resistors. This is necessary only if one external arm is used. The internal resistor plugs in and

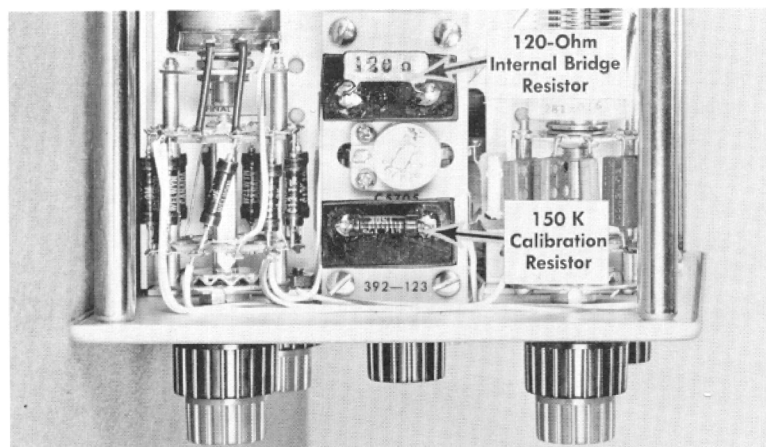

Fig. 2-1. Location of the plug-in calibration and internal bridge resistors. Resistors may either be plugged in as shown, or connected to the binding posts that are provided.

Operating Information — Type Q

can be easily removed. Another resistor can then be plugged in or attached to the binding posts that are provided. The nominal value of the internal bridge resistor must be the same as the resistance of the strain gage used in the external arm. If desired, another strain gage may be attached to the binding posts to serve as the internal bridge resistance. The unit can then be balanced and calibrated as usual in the manner described later in this section.

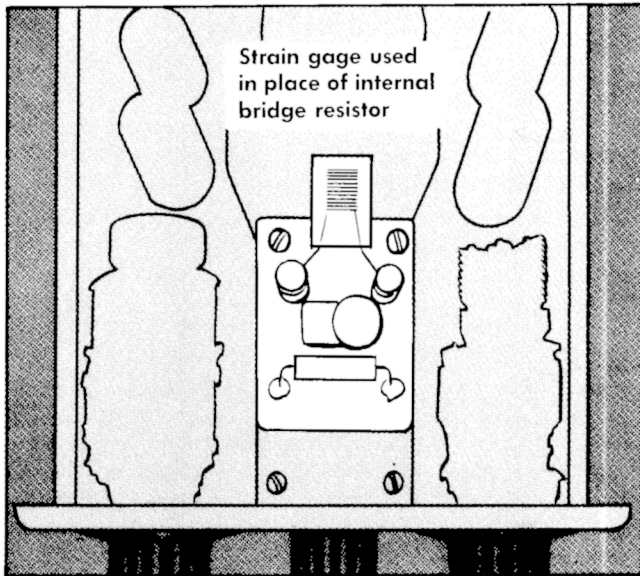

Fig. 2-2. Connecting a strain gage to the binding posts to serve as the internal bridge resistor.

The second factor in the choice of a strain gage is the gage factor. Optimum ease of operation and performance is obtained with a gage factor of 2.00. When gage factors other than 2.00 are used, it is necessary to reset the GAIN ADJ. control to compensate for the change. This can be done as described under the heading "Setting the Gain Adjust Control". The range of adjustment of the GAIN ADJ. control permits gage factors of from approximately 1 to 6 to be used without changing the range steps of the μ STRAIN/DIV. control. Strain gages with gage factors outside of this range can be used by changing the panel markings for ranges of the μ STRAIN/DIV. control. This is described later in this section. It should be remembered that the gage factor is in effect a measure of the strain gage sensitivity. When extremely high sensitivity is required, it is desirable to use a strain gage with a high gage factor. Unfortunately it is frequently true that a high degree of temperature instability accompanies a high gage factor. Because the Q-Unit is capable of high amplification, you will seldom need to use gage factors higher than 2.

Selecting the Number of External Arms

The simplest type of strain-gage application involves the use of only one external arm. The use of only one external arm, however, limits the operation in long lead applications. Leads running from the strain gage to the Q-Unit effectively add resistance to one arm of the bridge only. If the leads are sufficiently long, the added resistance may un-

balance the bridge beyond the range of the bridge balance controls.

Two or four external arms should be used whenever possible, and must be used with leads longer than approximately 20 feet. When two (or four) external arms are used, approximately equal values of resistance are contained in each arm. This permits the bridge to be balanced easily. Using more than one external arm also permits you to obtain greater sensitivity when the strain gages can be mounted to aid each other. Maximum sensitivity can be obtained with four active external arms.

An additional advantage in using two or four external arms is stability. Environmental changes (primarily temperature) which produce changes in resistance of one strain gage, produce approximately the same change in the other strain gages. Bridge unbalance that could be produced as a result of these changes are thereby nulled out. It is not necessary when using either two or four external arms for all arms to be active. Strain gages can be connected into one or more of the external arms without actually being mechanically attached to the equipment under test. If dummy strain gages are used, they should be connected at the strain gage end of the interconnecting cable and placed in approximately the same environmental conditions as the active arms. This will provide the same stability as though all external arms were active and will permit the bridge to be balanced in long lead applications.

When any number of external arms except 4 are used, switch contacts are in series with at least one of the bridge arms. These switch contacts provide a source of possible variance in resistance due to the contact resistance of the switch. In the most sensitive range of the Q Unit, a resistance change in one arm of approximately .0025 ohms will produce one division of deflection of the associated oscilloscope. It can readily be seen that any slight change in contact resistance could produce considerable deflection of the trace. When four external arms are used, the switch contacts are out of the circuit thereby eliminating this possible source of difficulty.

When one, two or four external arms are used, any strain gage resistance value above 50 ohms can be used. If one external arm is used, however, it is necessary to change the plug-in bridge resistor to a value equal to the resistance of the strain gage used. When two external arms are used, the two arms must have nearly equal impedances. When three external arms are used, any value of strain gage resistance can be used in arms 1 and 2 so long as the impedance in the two arms is approximately the same. The strain gage used in arm 3 must be 120 ohms unless the arm 4 internal resistor is unsoldered and replaced by a value equal to the resistance of the arm 3 strain gage. Any strain gage resistance can be used with four external arms. The strain gage resistances in arms 1 and 2 can be the same or different from the strain gage resistances in arms 3 and 4. Electrical connections for any number of external arms are shown in Fig. 2-3.

Actual selection of the number of external arms by the Q Unit is made with the EXT. ARMS switch. In the zero position of this switch, the internal bridge circuit of the Q Unit is used. This position can be used for checks of instrument operation without requiring external connections provided that the 120 ohm internal bridge resistor is inserted in the terminals provided.

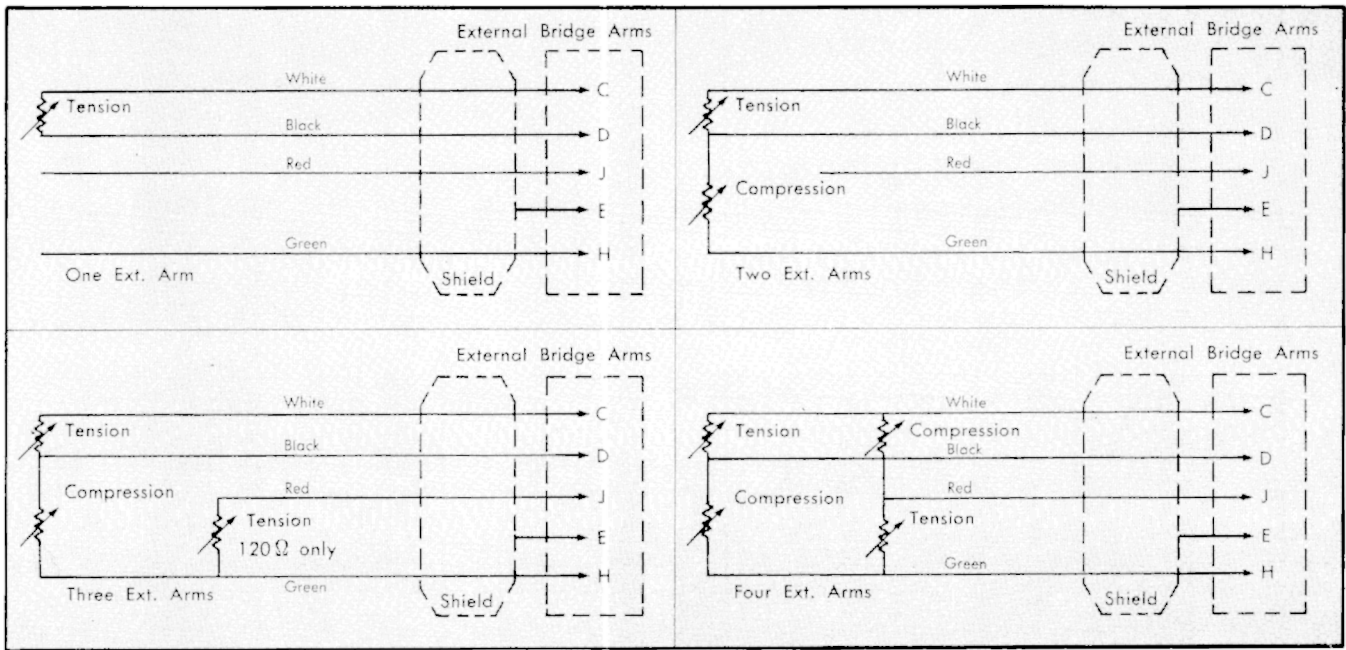

Fig. 2-3. Circuit connections for resistive transducers and strain gages using four-conductor microphone cable. Strain gages mounted so that the tension and compression is as shown will produce maximum upward displacement of the oscilloscope trace when the POLARITY switch is at NORMAL.

Selecting the Interconnecting Cable

A large variety of shielded cables are suitable for use with the Q Unit. The purpose here is to outline the relative merits of specific types to aid you in the selection of the best cable for your application. Individual requirements may favor one cable type over another for a particular measurement. The ability of the Q Unit to reject many interfering signals simplifies the grounding and shielding problems usually associated with high gain amplifiers. In general, unshielded cabling is not recommended although many short connections will work satisfactorily if the unshielded leads are laced together carefully to avoid lead crossovers. The discussion here is limited to the types of shielded leads particularly suited to the Q Unit.

Four-conductor shielded microphone cable. Four-conductor shielded cable can be considered the general purpose cable applicable to all measurements regardless of the external circuit configuration. Using the circuit connections shown in Figure 2-3, you can secure excellent results in all applications using just one type of cable. Connections to the input bridge circuit are made in such a way that the interlead capacities tend to maintain a balanced bridge regardless of the length of the interconnecting cable. This means that the Q Unit Capacitance balance controls need only correct for minor irregularities.

One important precaution has to be observed when you are soldering the cable leads to the connector. Failure to connect the cable leads properly will result in a large capacitance unbalance that cannot be balanced out with

the Capacitance balance controls. Figure 2-4 shows the arrangement of four conductors inside the shield of a typical cable. The capacitance between adjacent pairs of leads (C and D for example) is much greater than the capacitance between diagonal pairs (D and J for example). This is a property of four-conductor cable that is not encountered

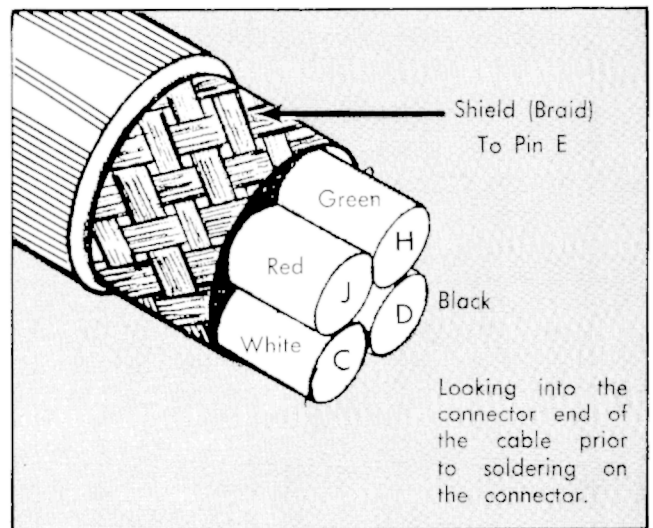

Fig. 2-4. Typical four-conductor shielded microphone cable. Letters on the wires indicate the corresponding connector pins. The lead sequence shown should be maintained to insure proper capacitive balance of the cable.

Operating Information — Type Q

using cables having fewer than four conductors. Difficulties from this source can be avoided by making connections as follows:

1. Solder the shield lead to pin E of the connector.
2. Looking at the end of the cable, select the lead you wish to use for a ground and solder it to pin D.
3. Avoiding any lead crossover, connect the remainder of the leads to pins C, J, and H while maintaining the lead sequence shown in Figure 2-4. Figure 2-3 shows the electrical connections for any number of external arms.

If you wish, you can use the clockwise sequence obtained by interchanging leads C and H. However, this creates an unnecessary mechanical lead crossover during the soldering operation. Where the opposite lead color sequence is desired it is better to interchange the cable end-for-end. When a number of cables are to use a particular lead color code, they will have to be fabricated from shielded cables having the lead colors in the same sequence because the choice of leads is not arbitrary.

Three-conductor shielded microphone cable. For all applications not requiring more than two external bridge arms, three conductor shielded cable is recommended. Three conductor cable is inherently balanced capacitively so that no special precautions are required in making the lead connections. Except that the lead from connector pin J is omitted, three conductor cable is used in the same circuit configurations shown for four-conductor cable (where applicable).

Two-conductor shielded microphone cable. Figure 2-5 shows the circuit connection using two external resistive bridge arms and a two-conductor shielded cable. Notice that the shield braid is used as one of the signal leads in this circuit. If the braid is grounded at the test site, differences of potential between the test-site ground and the oscilloscope ground can appear at the Q-Unit input. Except in extreme cases, this connection does not introduce an objectionable amount of interference or hum. Generally, three-conductor cable is to be preferred in this application.

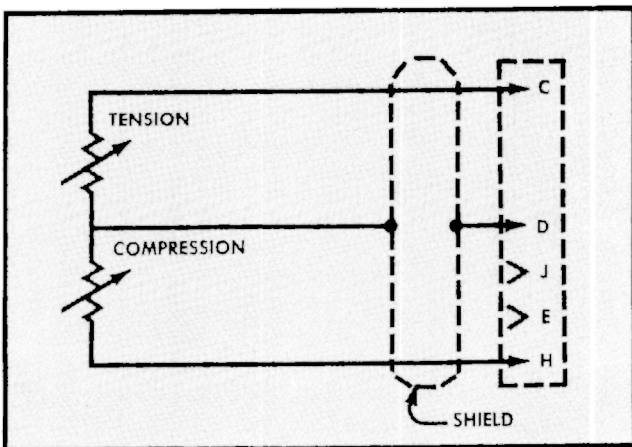

Fig. 2-5. Electrical connections for resistive transducers and strain gages using two-conductor shielded cable.

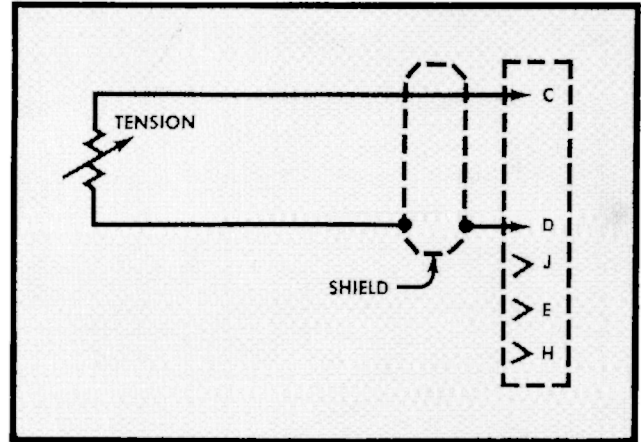

Fig. 2-6. Electrical connections for one external arm using single-conductor shielded (coaxial) cable.

Single-conductor shielded microphone or coaxial cable. Measurements involving the use of one external bridge arm naturally suggests the use of a single-conductor shielded cable. Connections for this type of installation are shown in Fig. 2-6. The capacitance of a single-conductor cable typically varies from $10 \mu\mu\text{f}$ per foot to $100 \mu\mu\text{f}$ per foot depending upon the specific design. Since all of this cable capacitance is in parallel with only one arm of the input bridge, the Q-Unit CAPACITANCE controls have to compensate for the entire cable capacitance. If an appreciable length of single-conductor cable is to be used, a capacitor whose capacitance approximately equals the total cable capacitance (within 250 mmfd) must be added in parallel with the internal plug-in bridge arm resistor. This brings the circuit within the range of the CAPACITANCE control. The binding posts provided facilitate the installation of this capacitor. From the convenience standpoint, single conductor cable should not be used when multiple-conductor cable is readily available.

Other cable types and circuit configurations. All of the possible cable and circuit combinations have not been outlined above. For example, cable having more than four conductors may be available though not specifically prepared for Q-Unit use. In making non-standard circuit connections, select the mechanical lead configurations that keep the bridge-circuit shunt capacitances balanced. This may involve leaving the extra leads floating in the cable (or perhaps grounded). The mechanical symmetry of the leads gives a clue to the proper circuit connection.

Connecting the Cable to the Amphenol Connector

The method for preparing the cable and making the solder connections is shown here in outline form. See the section entitled "Selecting the Interconnecting Cable" for the circuit connections to be used. The procedure is as follows:

1. Remove the protective insulating jacket from the end of the cable as shown in Figure 2-7. The insulating jacket should be stripped back 2 inches or more.

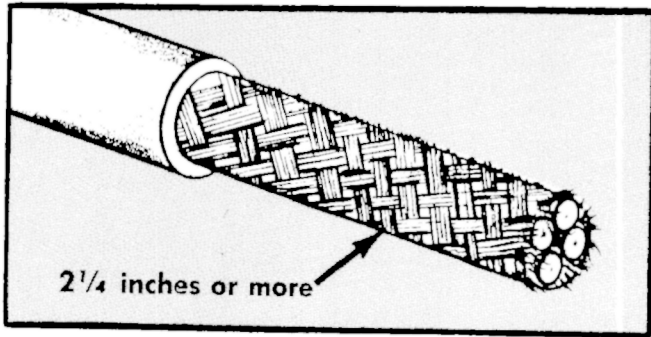

Fig. 2-7. Preparing the cable for installation in the connector. First cut the insulated outer sheath back as shown.

2. Disassemble the connector and place all the parts except the connector body and connector insert on the cable in their sequence.
3. Push the shield braid down over the wires as shown in Figure 2-8.

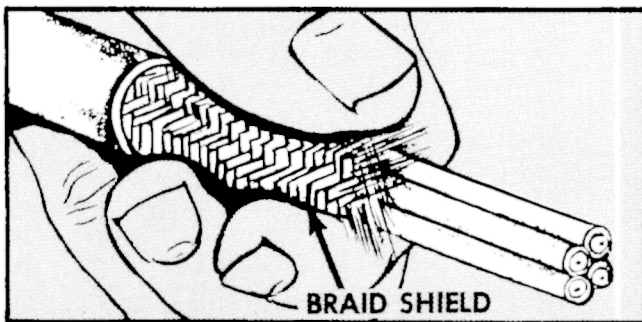

Fig. 2-8. After removal of the insulated outer sheath, pull the braid shield back as shown.

4. Select the lead that you wish to use for a ground lead (pin D of the connector). Using a pointed (but not sharp)

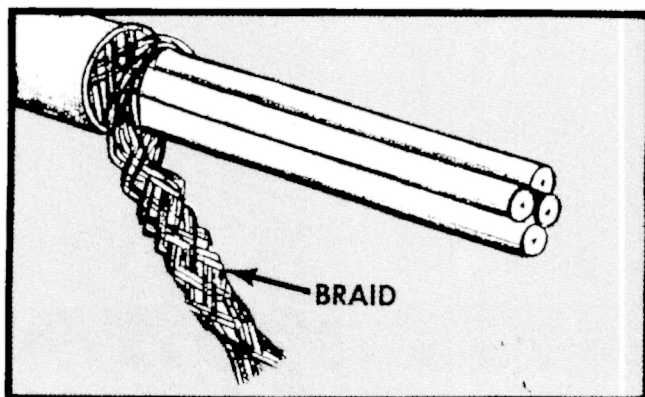

Fig. 2-9. Using a pointed tool, pull each wire out through the side of the braid shield. Then stretch the braid shield out to form a pigtail.

tool, spread the braid wires apart on the opposite side of the cable from the ground lead at a point close to the end of the insulating jacket. Through this opening in the braid, reach in behind one of the leads with your pointed tool and gradually work the lead out through the opening. Repeat for the other leads and packing string until the braid is empty. Stretch the braid out to form a pigtail. Refer to Figure 2-9.

5. Loop a piece of tinned bare wire over the braid approximately $\frac{1}{8}$ inch from the point where the leads are brought out through the shield. Crimp the wire lightly and then solder using a freshly tinned iron and rosin core solder. Heat the braid rapidly and briefly during the soldering operation to avoid melting the lead-wire insulation. Cut off the excess pigtail. (See Fig. 2-10.)

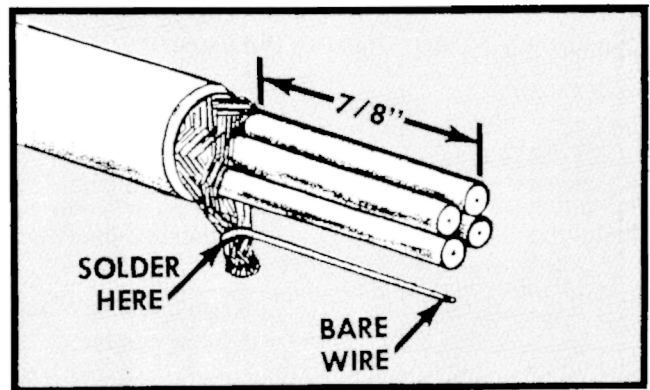

Fig. 2-10. Solder a tinned bare wire to the pigtail formed by the braid shield. Shorten all leads as shown.

6. Cut the excess lead length off as shown in Figure 2-10 including the bare wire. Strip each lead back $\frac{1}{4}$ inch being careful not to cut the stranded wires.

7. Cut $\frac{1}{2}$ inch lengths of spaghetti tubing (available from most radio supply houses) to go over the ends of the leads. Number 12 spaghetti is usually about right for the average microphone cable wire. Slip the tubing back over the leads as far as it will go. A small amount of wire insulation should protrude so that the leads can be identified. No spaghetti is required on the braid extension lead.

8. Clamp the molded connector insert in a bench vise or other support. Clamp lightly to avoid breakage. The solderpot openings should be up. Work from the bottom upwards in soldering the leads.

9. After all the leads are soldered, inspect each joint carefully to see that there are no rosin or frosty solder joints. Also, at this time double check to see that the leads are properly connected. Cut off any free strands that may be present.

10. Push the spaghetti up over the solder pots until each piece is flush with the molded insert. Secure the spaghetti in position with vinyl plastic insulating tape. Depending on whether or not you use a special compression gland to adapt your cable to the diameter of the connector compression fitting, you may wish to build the diameter of the insulating sheath up to slightly less than $\frac{3}{8}$ inch so that the compression gland can be effective. Use tape for this purpose.

Operating Information — Type Q

11. Assemble the connector being careful that the insert is engaged in the keyway and is pushed all the way in. Do not tighten excessively.
12. Check the insulation resistance of each wire to ground to be sure that no grounds have occurred. Also check the insulation between each wire and every other wire. Use an ohmmeter for this test.
13. Four or more conductor cable should be checked to see that the leads are capacitively balanced prior to connecting to the transducer. To do this, connect the lead to the Q Unit input and balance the bridge with the EXT. ARMS switch in the 0 position. (The 120 ohm internal bridge resistor must be connected to the terminals provided.) A miswired cable of appreciable length will not balance.

Connecting Strain Gages to the Unit

When the proper strain gages have been selected, it is necessary to attach them mechanically to the equipment to be instrumented. Actual techniques for attaching strain gages to instrumented equipment is beyond the scope of this manual. However, a number of excellent texts are available which present this information. In addition, information generally accompanies strain gages to aid in their installation.

Strain gages must be soldered to the proper leads of the interconnecting cable. It is important that good solder joints

be made in order to prevent erratic operation. Soldered connections on the Q-Unit end of the interconnecting cable should be made to an Amphenol 165-14 connector as described in the previous section. This connector is then mated with the EXTERNAL BRIDGE ARMS connector on the front panel of the Q Unit. The EXT. ARMS switch must be placed in the position which will provide the correct number of external arms.

Balancing the Input Bridge Circuit

Insert the Q Unit into the plug-in compartment of the associated oscilloscope and turn on the power. Connect the strain gages to the unit and allow several minutes of warm-up time for the unit to stabilize. Adjust the oscilloscope for automatic internal triggering. Set the POLARITY switch at NORMAL and the FUNCTION switch at INST. ZERO. Using the VERTICAL POSITION control, center the trace on the oscilloscope screen. Then place the FUNCTION switch at BALANCE and set the μ STRAIN/DIV. control at 2000. With the FINE RESISTANCE and FINE CAPACITANCE controls set at mid range, rotate first the RESISTANCE, then the CAPACITANCE switches for minimum vertical deflection. Adjust the FINE RESISTANCE and FINE CAPACITANCE controls for minimum vertical deflection. Increase the strain sensitivity to 100 μ strain per division and readjust the balance controls for minimum vertical deflection. Increase the strain sensitivity

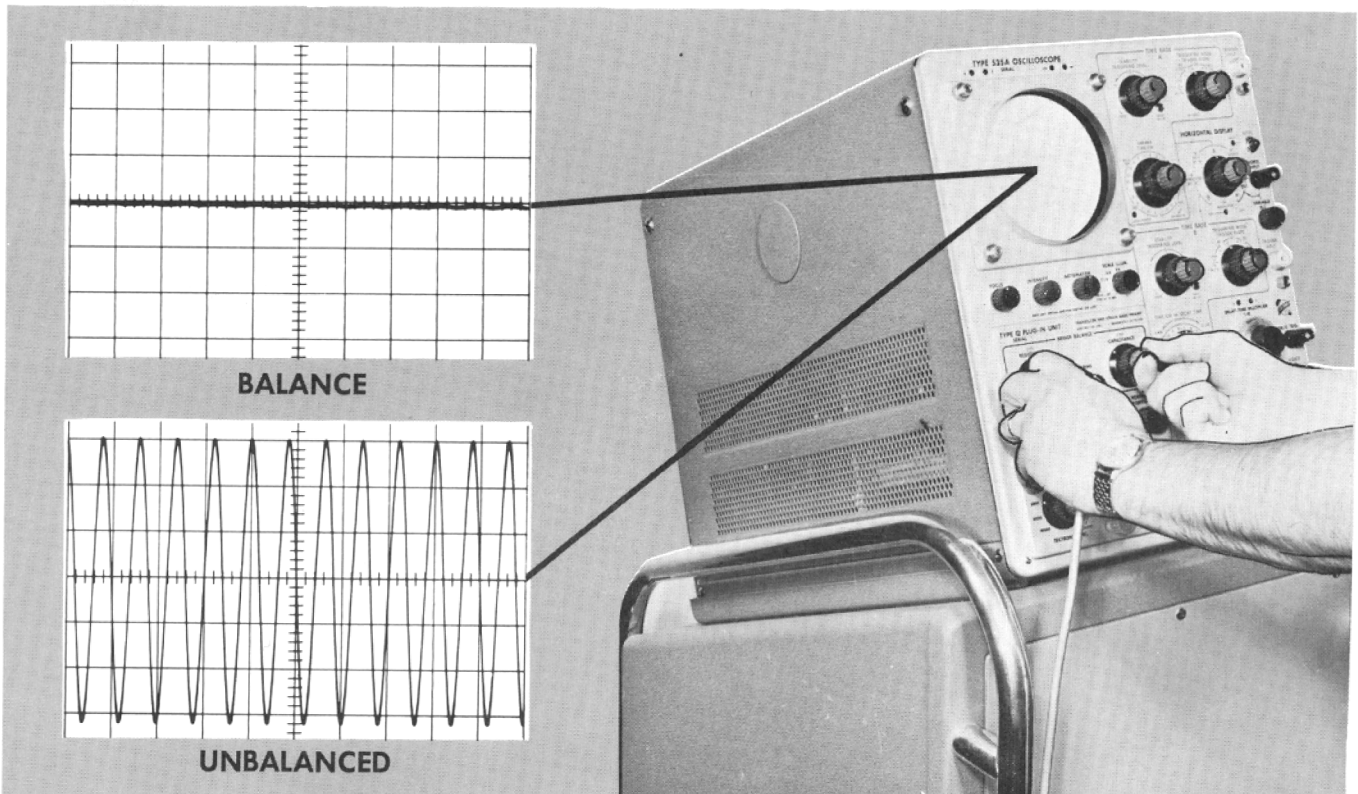

Fig. 2-11. Balancing the input bridge circuit. Adjust the BALANCE controls in conjunction with each other to obtain the BALANCE waveform on the oscilloscope. The UNBALANCED waveform will be observed with control settings on either side of the balanced position.

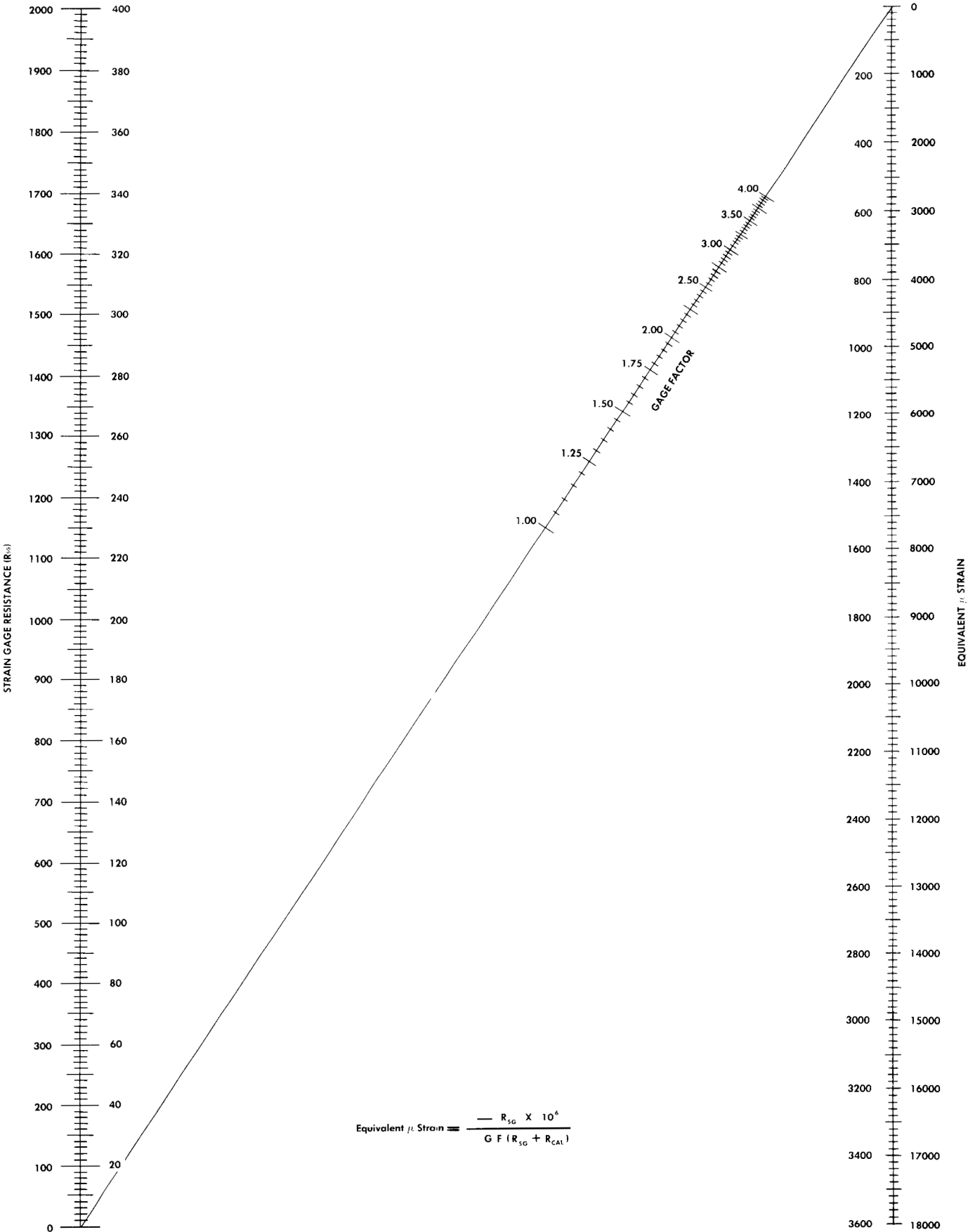

Fig. 2-12. Nomograph for the 150 k calibrator resistor. This nomograph can be used to find the equivalent μ strain produced by the 150 k calibration resistor when the unit is used with strain gages with various resistances and gage factors.

Operating Information — Type Q

to 10 μ strain per division and again adjust the balance controls for minimum deflection. The bridge will now be in proper balance. Set the FUNCTION switch at OPERATE and the μ STRAIN/DIV. switch at the desired strain sensitivity.

With the strain gages in an unstressed condition, the bridge can be checked for proper balance at any time by placing the FUNCTION switch in the BALANCE position. If the bridge is correctly balanced, no signal should appear on the oscilloscope trace. An optional method of checking the bridge balance involves use of the INST. ZERO position of the FUNCTION switch. With the strain gages unstressed, virtually no shift of the trace should occur as the FUNCTION switch is switched between the OPERATE and INST. ZERO positions. If significant shift of the trace is observed, the bridge should be rebalanced. A slight amount of trace shift is normal on the most sensitive positions of the μ STRAIN/DIV. switch.

Adjusting the PHASE ADJ. Control

The PHASE ADJ. control allows the use of either resistive or reactive transducers. When the control is adjusted properly, maximum overall sensitivity of the Q Unit is obtained for a particular type of transducer impedance variation. The control must be readjusted each time that a different transducer circuit is used. The control should also be checked periodically when the unit is used continually with the same transducer circuit. The control has sufficient range for either resistive or reactive transducers to be used.

With the strain gages connected and the bridge balanced, place the μ STRAIN/DIV. control at 100. Place the POLARITY switch at NORMAL and position the oscilloscope trace to the top of the screen. Set the FUNCTION switch at OPERATE and depress the CALIBRATE button. Adjust the PHASE ADJ. control for maximum downward deflection of the trace.

Selecting the Calibration Resistor

Depressing the CALIBRATE button on the Q Unit front panel connects a calibration resistor in parallel with one arm of the input bridge. The calibration resistor supplied with the Q Unit simulates a -400μ strain unbalance of the bridge. This simulated strain is produced when a 120 ohm strain gage with a gage factor of 2 is used. The resulting deflection of the trace is used to set the GAIN ADJ. control as described in the next section.

If the strain gage resistance or gage factor is changed from 120 ohms and 2, respectively, the calibration resistor supplied with Q Unit no longer simulates a -400μ strain unbalance. You must therefore either change the calibration resistor or allow for the change in calibration strain, when adjusting the GAIN ADJ. control. It is not usually necessary to change the calibration resistor if only the gage factor is different. Adjustment of the GAIN ADJ. control permits you to compensate for gage factors between approximately 1 and 6 without changing the calibration resistor. It should be emphasized however, that if a gage factor other than 2 is used, the calibration resistor will not simulate a -400μ strain unbalance. The simulated strain produced by the calibration resistor will depend on the

gage factor used. The simulated strain produced by the 150 k calibration resistor with various strain gage resistances and gage factors is shown graphically in Figure 2-12.

There are essentially three possible reasons for changing the calibration resistor. They are: (1) use of strain gages with resistances other than 120 ohms; (2) use of gage factors other than 2 (changing the calibration resistor is not required unless you want the calibration to be -400μ strain or some other even value); and (3) a requirement for a calibration point at some value other than -400μ strain (for example, -1000μ strain). Regardless of the cause for changing the calibration resistor, the proper value can be found from the following equation.

$$(1) R_{CAL} = \frac{R_{SG}}{-(G.F.) (Strain)} - R_{SG}$$

In the preceding equation, R_{CAL} is the value of the required calibration resistor, R_{SG} is the strain gage resistance, G.F. is the gage factor, and Strain represents the simulated strain produced by the calibration resistor. The $-R_{SG}$ term in equation 1 is very small in comparison with the other terms and can usually be ignored. This approximation with normal strain gages will introduce an error of less than 0.5%. The equation then reduces to the following:

$$(2) R_{CAL} = \frac{R_{SG}}{-(G.F.) (Strain)}$$

Using equation 2, the proper value for the calibration resistor can be found. Assuming a gage factor of 2, a strain gage resistance of 120 ohms, and a calibration strain of -400μ strain, the calibration resistor is found as follows:

$$(3) R_{CAL} = \frac{120 \text{ ohms}}{-(2) (-400 \times 10^{-6})} = 150,000 \text{ ohms}$$

The value of the calibration resistor from equation 3 is 150 k. This is the value supplied with the Q Unit when the unit is shipped. A more precise value can be found from equation 1 as follows:

$$(4) R_{CAL} = \frac{120 \text{ ohms}}{-(2) (-400 \times 10^{-6})} - 120 \text{ ohms} = 149,880 \text{ ohms}$$

It can be seen that the difference in values found in equations 3 and 4 is only 120 ohms. Under these conditions then, use of a 150 k resistor introduces an error of less than 0.1%. This is probably much less than the error introduced due to the tolerance of the resistor used.

NOTE

In equations 1 through 4, it is assumed that transducer leads are short and that the resistance of the leads is negligible. For a discussion of the effects of lead resistance on the effective gage factor, refer to "Correcting for Lead Resistance".

After selection of the required calibration resistor, it is necessary to connect the resistor into the unit. The calibration resistor supplied with the unit plugs into special holders as shown in Figure 2-2. This resistor can be removed by unplugging it from the holder. The new calibration resistor can then be plugged into the holders or attached to the binding posts that are provided. If the new calibration resistor provides calibration at something other than -400μ strain, a small tag can be fastened in the plastic holder over the -400μ STRAIN marking on the front panel to indicate the new calibration point.

Setting the GAIN ADJ. Control

The GAIN ADJ. control must be adjusted to provide the strain sensitivity indicated by the μ STRAIN/DIV. switch. The control is adjusted by using the CALIBRATE switch to produce a simulated strain. Using the calibration strain, the GAIN ADJ. control is then adjusted for the corresponding amount of trace deflection. Before adjusting the GAIN ADJ. control, you must balance the bridge and set the PHASE ADJ. control.

NOTE

In this adjustment procedure it is assumed that resistance of leads is negligible. This is the case when leads are short. However, with leads longer than approximately 15 feet, the resistance of leads is not negligible. A correction should be made when setting the GAIN ADJ. control if long leads are used. This is discussed in the paragraphs entitled "Correcting for Lead Resistance".

To set the GAIN ADJ. control, place the μ STRAIN/DIV. switch at 100, the VARIABLE control at CALIBRATED, and the FUNCTION switch at OPERATE. Depress the CALIBRATE button and adjust the GAIN ADJ. control for the proper amount of vertical trace deflection. The correct amount of trace deflection depends on the value of the calibration resistor, strain gage resistance, and gage factor. Using 120 ohm strain gages with a gage factor of 2 and the calibration resistor supplied with the unit, the GAIN ADJ. control should be set for exactly 4 divisions of vertical deflection. If the 150 k calibration resistor is used with different strain gage resistances or gage factors, Fig. 2-12 can be used to find the amount of simulated strain produced. The setting of the μ STRAIN/DIV. control can then be changed, if required, to allow you to make an accurate setting of the GAIN ADJ. control. The calibration resistor supplied with the unit can, if necessary, be used for virtually all strain gages, regardless of resistance and gage factor. The calibration strain for 120 ohm strain gages can be found from either the following equation, or from Fig. 2-12.

$$(5) \text{ Calibration Strain} = \frac{800 \times 10^{-6}}{\text{Gage Factor}}$$

The calibration strain should be marked on a small tag and mounted over the -400μ STRAIN front panel marking. The proper amount of trace deflection can then be found from equation 6 and used to set the GAIN ADJ. control.

$$(6) \text{ Divisions of Trace Deflection} = \frac{\text{Calibration Strain}}{\mu \text{ STRAIN/DIV. Setting}}$$

If a calibration resistance other than 150 k is substituted for the resistor supplied with the unit, the correct amount of vertical deflection can be found as follows:

1. Using the strain gage resistance and gage factor, and the calibration resistance, compute the calibration strain using equation 2. This calibration strain should be marked on a small tag and mounted over the -400μ STRAIN marking on the front panel using the plastic holder provided.

2. From equation 6, find the correct amount of trace deflection.

3. Adjust the GAIN ADJ. control for the correct amount of trace deflection.

The GAIN ADJ. control has sufficient range to compensate for gage factors between approximately 1 and 8. If the strain gage you are using is outside of this range, it will be necessary for you to change the range steps of the μ STRAIN/DIV. control before adjusting the GAIN ADJ. control. The range steps of the μ STRAIN/DIV. control can be changed by removing the knobs and nut to place a plate marked with the new range steps over the shafts. The plate can then be held in place by replacing the nut and knob. The GAIN ADJ. control can then be set to agree with these steps. The required calibration resistor can be found from equation 2.

As an example, assume that a hypothetical 120 ohm strain gage with a gage factor of 20 is used. The sensitivity steps of the μ STRAIN/DIV. control could be changed to run from 1 to 1000 μ strain per division. The GAIN ADJ. control would then be set to provide the correct amount of deflection on some convenient range.

Correcting for Lead Resistance

The resistance of leads connecting the strain gage to the Q Unit is in series with the strain gage resistance. Since the lead resistance does not change when stress is applied to the strain gage, the effect is the same as though the gage factor were reduced. Consequently the effective gage factor is less than the gage factor of the strain gage used. This effective change in gage factor is not unique to strain gage installations involving use of the Q Unit. The same change occurs in any other type of strain gage installation involving long leads but it is often ignored. To make accurate measurements, however, a correction should be made to compensate for the change. This correction is made when the GAIN ADJ. control is adjusted. The effective gage factor can be found from the following equation.

$$(7) GF_{\text{eff}} = \frac{GF R_{SG}}{R_{SG} + 2\rho L} = \frac{GF R_{SG}}{R_{SG} + 2R}$$

In equation 7, GF_{eff} is the effective gage factor, GF is the gage factor of the strain gage, R_{SG} is the strain gage resistance, ρ is the resistance per unit length of lead, L is the lead length, and R is the resistance of one lead. The values of ρ or R, if they are not known, will have to be determined experimentally for the cable you are using. Their value will depend on the wire size used, and the composition of the wire.

It can be seen from equation 7 that the change in effective gage factor with short leads is negligible. However when leads longer than about 15 feet are used, the change in effective gage factor may be as much as several percent. To compensate for the change, it is necessary to use the effective gage factor when setting the GAIN ADJ. control. Using the effective gage factor, the GAIN ADJ. control is set in the same manner as described in the previous paragraphs.

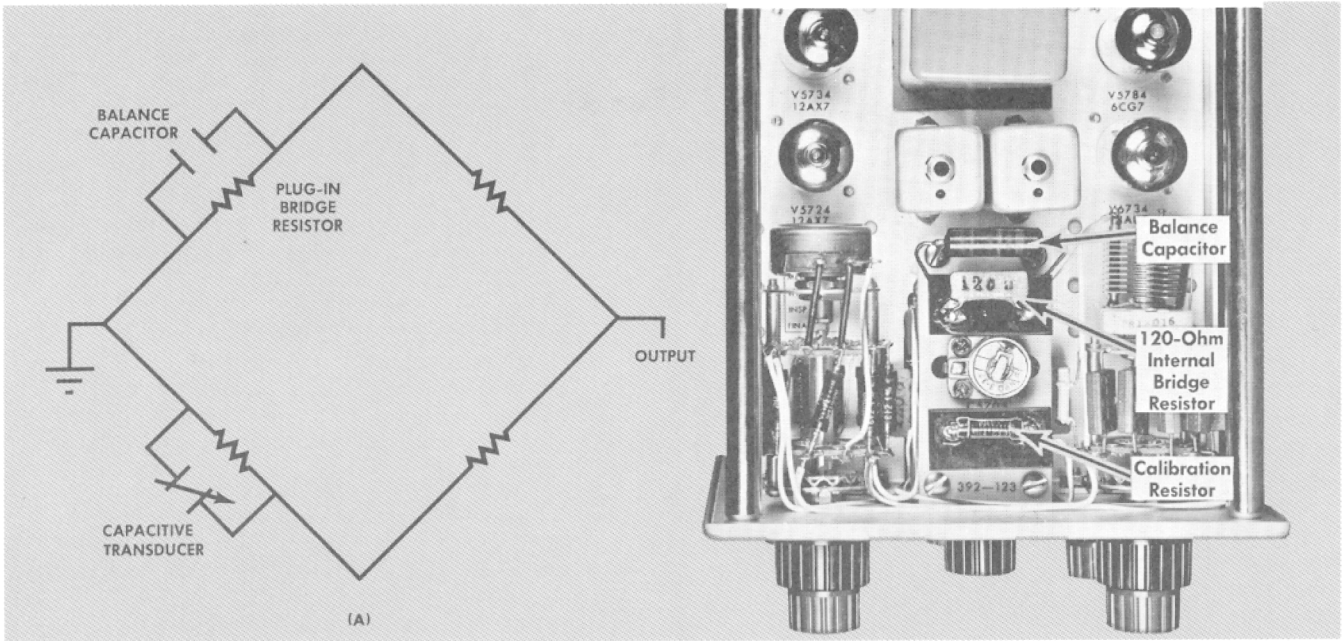

Fig. 2-13. Connecting a capacitor into the bridge circuit to compensate for large capacitive unbalances which are beyond the range of the internal balance controls. In (a) the electrical connections are shown while (b) shows the actual physical connections of the capacitor.

Using Reactive Transducers

The ac bridge used in the Q Unit senses impedances changes in the bridge arms. Consequently either resistive or reactive transducers can be used with the unit. Changes in impedance of the transducers produce vertical deflections of the oscilloscope trace.

Reactive transducers are connected to the Q Unit in much the same manner as strain gages. The major difference is that capacitive transducers are usually connected in parallel with one or more of the internal arms of the bridge. The EXT. ARMS switch is set at 0. Inductive transducers can be connected in the same manner as resistive transducers or connected in parallel with the internal bridge resistors. If connection of the transducer produces an unbalance in the bridge that cannot be eliminated using the balance controls, it is necessary to produce balance using additional elements of the same type as the transducer in other arms of the bridge (see Figure 2-13). When the bridge has been balanced, the PHASE ADJ. and GAIN ADJ. controls are adjusted in a manner similar to the adjustment with strain gages.

In addition to the slight changes in connections, additional factors are also involved in the use of reactive transducers. In general, you will not be attempting to measure strain with a reactive transducer. This means that the Q Unit's calibration in strain will be meaningless. If a capacitive transducer is used, it would be much more meaningful to have the Q Unit calibrated in, for example, $\mu\mu\text{f}/\text{DIV}$. Under these conditions you could change the title of the $\mu\text{ STRAIN}/\text{DIV}$.

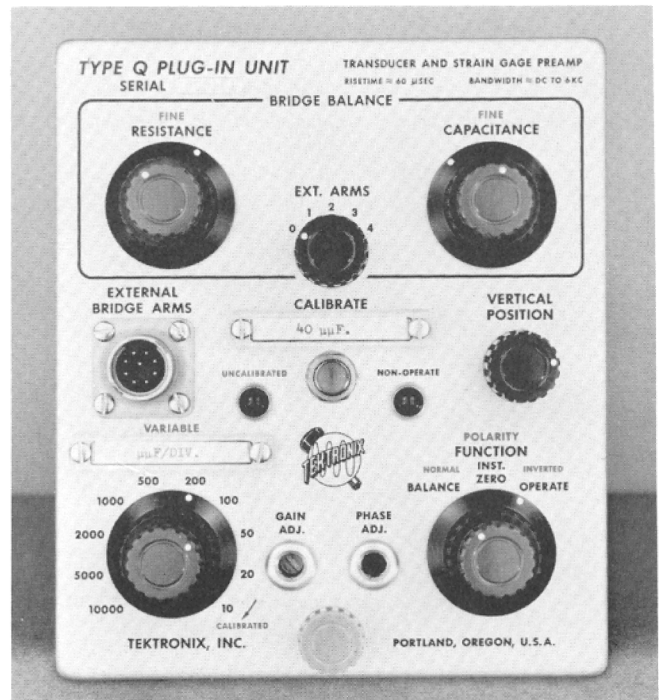

Fig. 2-14. Front panel view of the Type Q Plug-In Unit. The $400\ \mu\text{ STRAIN}$ and $\mu\text{ STRAIN}/\text{DIV}$. front panel markings have been changed to $40\ \mu\mu\text{f}$. and $\mu\mu\text{f}/\text{DIV}$. respectively by means of small tags placed in the small plastic holders. In this case the scale markings of the control must be divided by 10 to obtain the correct scale factors.

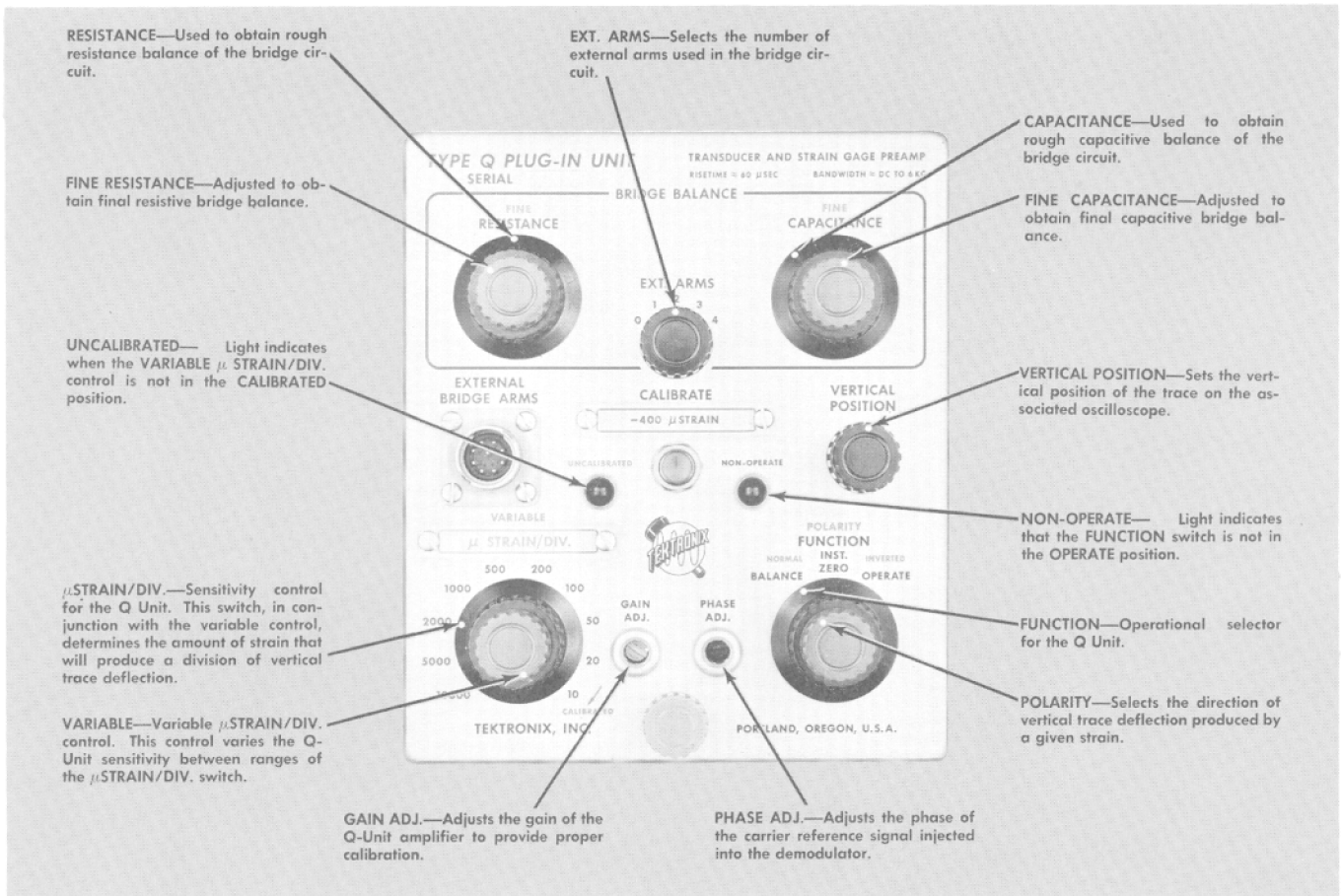

Fig. 2-15. Functions of Type Q Plug-In Unit front panel controls.

switch to $\mu\mu f$ /DIV. This can be done by mounting a small tag over the μ STRAIN/DIV. title using the plastic holder provided. The ranges of the switch can also be changed by removing the knobs and nut and mounting a plate on the shafts with the required range steps. If the capacitive transducer is installed to detect motion, the μ STRAIN/DIV. switch could be labeled INCHES/DIV., for example. Ranges of the control could be changed accordingly. The title and ranges of the μ STRAIN/DIV. switch will depend entirely on the transducer installation.

The second major factor involved in use of a reactive transducer is the calibration. Obviously if a capacitive transducer is used, a calibration resistor will not produce the desired calibration signal. Similarly, if an inductive transducer is used, a calibration capacitor will not produce the required calibration signal. The calibration element must correspond to the type of transducer used. The value and type of Calibration element will depend on the transducer installation. For example, assume that a capacitive transducer is used, and that the title of the μ STRAIN/DIV. control is changed to $\mu\mu f$ /DIV. to correspond to this transducer. The calibration element would then be a capacitor. Assuming that a calibration point is desired on the 10 $\mu\mu f$ /DIV. range, a 40 $\mu\mu f$ calibration capacitor would produce exactly 4 centimeters of vertical deflection. The -400 μ STRAIN marking on the front panel could then be covered with a plate to indicate a calibration of 40 $\mu\mu f$.

When the proper calibration element has been selected, it should be mounted in place of the calibration resistor supplied with the unit. This then allows you to set the GAIN ADJ. and PHASE ADJ. controls to provide the proper calibration for the μ STRAIN/DIV. switch. Changes in bridge arm impedance can then be read directly from the trace deflection.

SPECIALIZED BRIDGE CIRCUITS

Figure 2-3 shows the bridge circuits most often used in transducer and strain gage measurements. To these we can add the schematics shown in Figures 2-16 and 2-17. In making these connections, please note that the wiring at the Q-Unit end of the cables is not the same as for the "standard" circuits. Also the EXT. ARMS switch must be set as indicated to provide proper operation.

Gages in opposite bridge arms

When we wish to measure the average longitudinal tensile or compression strains in a member without measuring the effects of any bending strains that may be present, the circuit of Figure 2-16 is useful. An application of this type arises when we wish to measure the total longitudinal force in a structural member. If the gages are

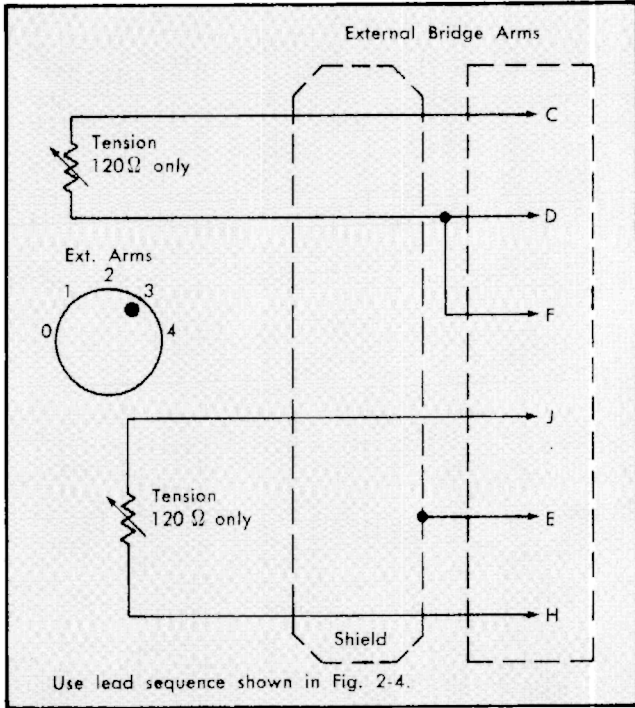

Fig. 2-16. Circuit connections for strain gages connected in opposite arms of the bridge. With the POLARITY switch at NORMAL, tensile strains in the gages will produce an upward deflection of the trace.

cemented on diametrically opposite sides of the member with their strain sensitive elements parallel to the longitudinal axis, they will both be subject to the same kind of longitudinal strain. The longitudinal components due to bending are of opposite sign on opposite sides of the member so that they cancel (if the beam is uniform) using the circuit of Fig. 2-16. Where temperature changes occur during the measurement we recommend the use of a standard four arm bridge with "dummy" gages. Another method is to use the Poisson mounting for the other two bridge arms. Although the circuit of Fig. 2-16 is limited to short lead applications it is often very convenient.

"Three wire connection" for lead temperature compensation

Internally compensated strain gages allow you to make strain measurements over a wide temperature range without the use of a compensating dummy gage at the test site.

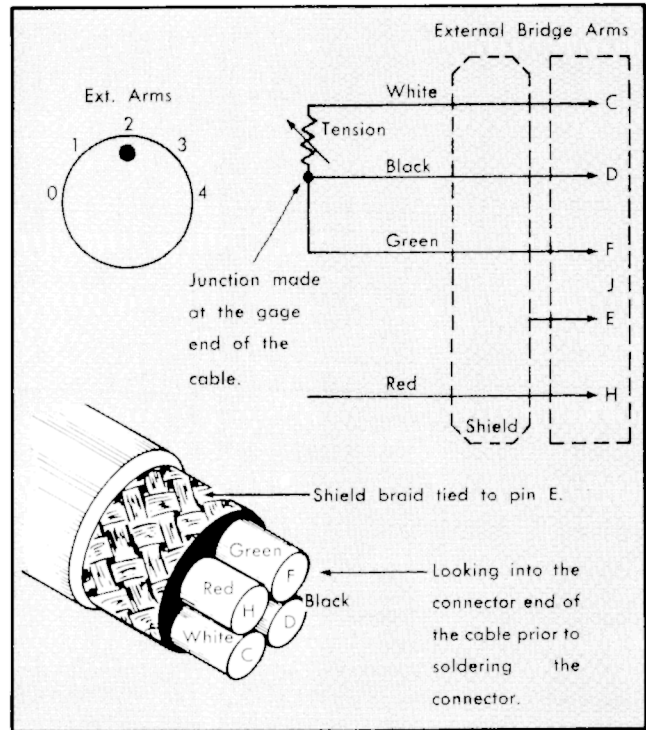
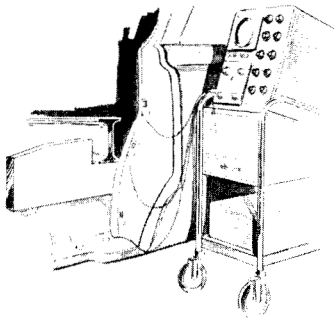

Fig. 2-17. Circuit connections for lead compensation (temperature and length). With the POLARITY switch at NORMAL, tensile strains in the gage will produce an upward deflection of the trace. The EXT. ARMS switch must be set as shown to obtain the proper lead compensation.

Unfortunately the simple One External Arm connection shown in Fig. 2-3 does not provide for temperature compensation of the leads connecting to the gage. Changes in lead resistance and inductance can cause the bridge balance to drift although the strain gage itself may be stable. The circuit of Figure 2-17 is a lead compensation hook-up suitable for use with the Q-Unit carrier amplification system. The connection to pin "F" places a lead in series with the internal bridge arm "2". This provides an inherent balance compensation for changes in lead temperature and/or lead length. The lead length compensation feature become important for long-lead applications with low gage resistances. Although the term "three wire connection" is used to identify the circuit with the equivalent d-c bridge circuit, a fourth wire to pin "H" is required to provide cable capacitance balance. In soldering the connector to the cable you are cautioned to use the exact cable lead sequence shown in Fig. 2-17.



SECTION 3

APPLICATIONS

General

Information presented in this section of the manual has been selected to aid you in instrumenting your mechanical measurements. We attempt here to answer those questions most frequently encountered in actual experience. The total range of application is as broad as the mechanical field itself. Clearly it is beyond the scope of this manual to give a comprehensive coverage. Since the Q Unit bridges the gap between mechanical engineering and electronic instrumentation, the material is presented in considerable detail. Our objective is to make the information understandable to a specialist in either field.

In general, it may be stated that any mechanical quantity can be measured by the Q Unit providing that the quantity can be converted to a change in resistance, capacitance, or inductance through use of a suitable transducing device. In many cases this involves only the connection of a commercially available transducer to the device to be instrumented. In other cases however, it may be necessary to build a simple transducer specially for the application. Information is given later in this section to aid in constructing simple capacitive transducers.

Strain and Gage Factor Definitions

Two of the common terms associated with strain-type instrumentation are easily defined yet are often inexactly understood. A discussion of these defining terms affords an opportunity to explain basic strain-gage theory and to place subsequent explanations on a firm basis.

Suppose that we have a straight piece of metallic wire with a "free length" L . By free length we mean the length of the wire when it is lying on a flat surface and subject to no external forces. Now, if we pull on each end of the wire as indicated by the force F in Figure 3-1, the wire will lengthen slightly. This is indicated in the figure by the dotted length ΔL . For most structural materials, the amount of elongation is too small to be readily detected by the human eye but is easily measured by sensitive equipment. The ratio of ΔL to the unstressed length (L , a measure of the deformation of the molecular bonds in the material, is called the strain. Since ΔL and L are both length units, their ratio is a pure number having no units. A particular strain value is numerically the same whether it is expressed in the English system or the metric system. Just as an electrical engineer finds it convenient to express small time intervals in microseconds the mechanical engineer expresses small strain values in micro-inches/inch or more simply μstrain .

So far we have only considered a long piece of metallic wire, however, the basic strain definition is applicable to

all solid materials and all physical shapes. In many objects subject to external forces the strain is not everywhere the same. In these cases we may refer to the strain at a particular point in the material or to the average strain over a specified interval. Strain measurements using strain gages measure the average strain over the length of the gage wires. Gages are commercially available with gage lengths as small as 1/16 inch.

The electrical resistance of a piece of wire is given by the equation:

$$\text{resistance} = \frac{(\text{resistivity of the material}) (\text{length})}{(\text{cross-sectional area})}$$

For the wire stretched in Figure 3-1, the length increased with the application of the force F . From the defining equation for resistance, we see that the resistance increases. This is the basis for the action of the strain gages in converting mechanical signals to electrical signals. In addition to the increase in wire length, the cross-sectional area of the wire decreases with tensile loading. This also contributes to the increase in the wire resistance. The resistivity of the wire usually changes with the strain but the factor may either increase or decrease depending upon the properties of the material. Most materials subject to stretching or tensile forces increase their resistivity.

Electrical variations in resistance are easily converted into electrical voltage variations. Consequently, we can dis-

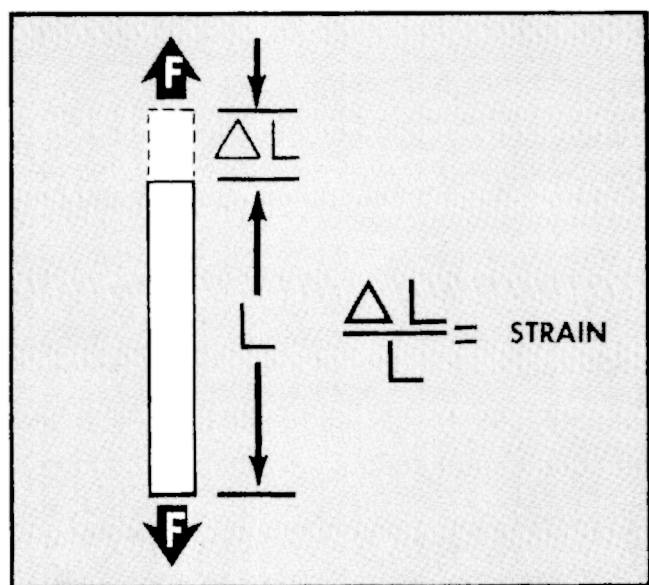

Fig. 3-1. Basic factors entering into the definition of strain.

Applications — Type Q

play strain variations using a cathode-ray oscilloscope in much the same way that we display electrical voltage variations. Before we can get quantitative data we need to know how the strain changes are related to the resistance changes. Fortunately, over a very wide range, the change in resistance is proportional to the strain.

Let ΔR be the change in wire resistance corresponding to a change in length ΔL . Then:

$$\frac{\Delta R}{R} = (G.F.) \frac{\Delta L}{L}$$
$$= (\text{gage factor}) (\text{strain})$$

From this defining equation, we see that the gage factor (G.F.) is merely a proportionality factor between the strain and the decimal change in resistance. A knowledge of the gage factor allows us to make quantitative strain measurements with a cathode-ray oscilloscope.

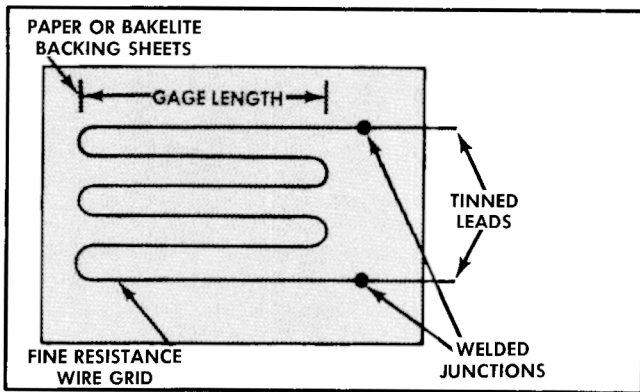

Fig. 3-2. Construction details of a resistance wire strain gage.

Practical strain gages most often take the form shown in Figure 3-2. A length of fine resistance wire is doubled back and forth to form a resistive grid. Tinned leads are welded to the resistance wire to facilitate soldering. The grid is then cemented between two layers of paper or other suitable material. This sandwich can be cemented to the surface of a structural material to be subjected to strain. In cementing the gage, the longitudinal axis of the wires are placed along the direction that we wish to measure strain. As the material stretches and compresses, the gage wire is stretched and compressed in direct proportion.

Strain gages are manufactured in large quantities under controlled conditions so that the gage factor does not vary appreciably from gage to gage in a particular lot. The manufacturer determines the average value for the gage factor as well as the total deviation from the average—usually less than $\pm 2\%$. This information is supplied to the consumer and is used in calibrating the Q-Unit for strain measurements as outlined in the operating instructions.

Temperature Compensation

Strain gages are usually fabricated from materials with low temperature coefficients of resistance. Consequently, their resistance is only slightly affected by changes in temperature. Even though the resistance variations are very small,

they may not be negligible in comparison to the resistance variations resulting from the minute strains being measured. Zero drift errors due to temperature changes do occur. In addition to the temperature induced resistance changes within the gage itself, there is a change in the strain-gage resistance due to the difference in the temperature coefficient of expansion between the strain-gage material and to the structural material to which it is cemented.

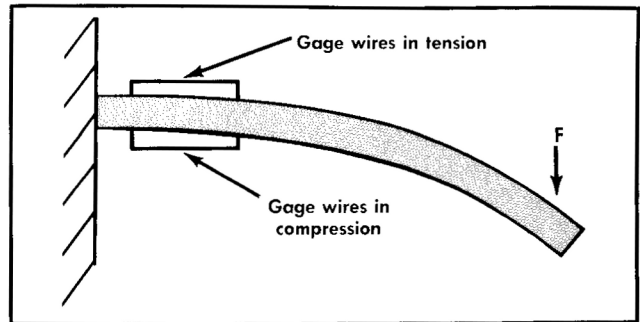

Fig. 3-3. Simple cantilever beam arranged to give self compensation for temperature effects.

One of the simpler methods used to minimize temperature effects is to employ two gages mounted to the structure and arranged electrically so that they are in adjacent arms of the Q-Unit bridge. A simple application where this is possible is shown in Figure 3-3. Here, the gages are mounted on opposite sides of a beam subject to a bending force. Under these conditions one strain gage will be subject to tensile strain while the other experiences a compressive strain. Both gages are affected by temperature in the same manner, maintaining the bridge "zero" with variations in temperature.

Self compensating bridge circuits are very convenient in transducer applications. However, in most strain measurements you cannot find two gage locations having equal and opposite strains. It may be necessary to employ a dummy gage cemented to a metal plate that sees nearly the same temperature environment but is unstressed. Mount the dummy gage on the same type material as the active gage for best results.

Another temperature compensation method uses special strain gages manufactured for use on specified materials. By designing these gages to have the same thermal expansion as the material for which they are compensated, the gage manufacturer minimizes the temperature errors. Gages of this type are customarily used only when the temperature variations are a part of or are incidental to the test. Using ordinary gages, temperature zero drift due to variations in room temperature is usually negligible unless the test is of relatively long duration and the Q-Unit is operated at high sensitivity.

Force Measurement with Longitudinally Stressed Members

In terms of the calculations required, longitudinal force measurements represent one of the simplest transducer applications of the Q-Unit in conjunction with strain gages. The

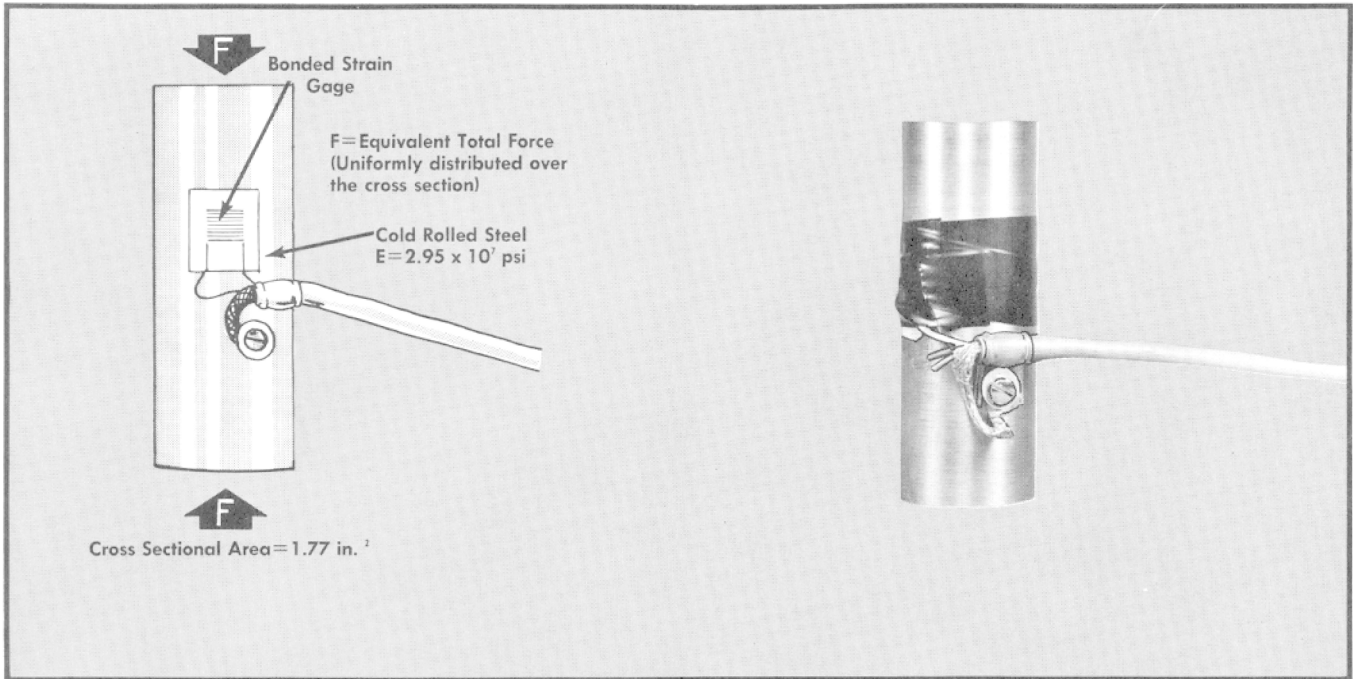

Fig. 3-4. Construction details of a simple force transducer.

measurements described in the following paragraphs represent, in a single example, the determination of strain, stress and force in a compression member. Calculations and measurement methods are applicable to tension members as well. Here, we describe the construction and calibration of a simple force transducer. Since many machines and structures incorporate longitudinal force members in their design, the methods of this section may be applied quite generally.

Figure 3-4 shows a short length of cold rolled steel bar stock with a strain-gage mounted near the center. In cementing the gage, the strain-sensing axis of the gage was oriented parallel to the longitudinal axis of the bar. When a uniformly distributed compression load F is applied to the ends of the bar, all parts of the bar are shortened in proportion to the force. Since the material strain is proportional to the force, the deflection appearing on the oscilloscope screen is likewise proportional to the force. Using the Q-Unit calibration technique for strain measurements explained in the Operating Instructions, we will now relate the strain calibration to the force calibration by simple calculations.

The stress in a structural material is defined to be the force per unit area at a particular point in the material. In this example, the stress is constant throughout the bar due to the nature of the loading and the bar geometry. In most materials the relationship between the stress and strain is nearly linear over a wide strain range. A typical curve for structural material is shown in Figure 3-5. The slope of the curve is a measure (modulus) of the deformation of the material under load (elasticity). Hence the name "modulus of elasticity" for the constant of proportionality between stress and strain. The modulus of elasticity (E) for all grades of carbon steel is very nearly 2.95×10^7 psi. Let us suppose that we have the Q-Unit calibrated for $100 \mu\text{strain/division}$. From the definition of the modulus of elasticity, we know:

$$\text{Stress} = (E) (\text{Strain})$$

$$\begin{aligned} \text{also, } \text{Stress/Div.} &= (E) (\text{Strain/Div.}) \\ &= (2.95 \times 10^7) (100 \times 10^{-6}) \\ &= 2,950 \text{ psi/division} \end{aligned}$$

We now have an oscilloscope calibration directly in terms of the material stress. It is only necessary to multiply the stress by the cross-sectional area of the bar to obtain the calibration directly in terms of the force. Stated mathematically:

$$\begin{aligned} \text{Force/Div.} &= \left(\frac{\text{Stress}}{\text{Div.}} \right) \text{Area} \\ &= \left(2,950 \frac{\text{lbs.}}{\text{in.}^2 \text{ div.}} \right) (1.77 \text{ in.}^2) \\ &= 5,220 \text{ pounds/division} \end{aligned}$$

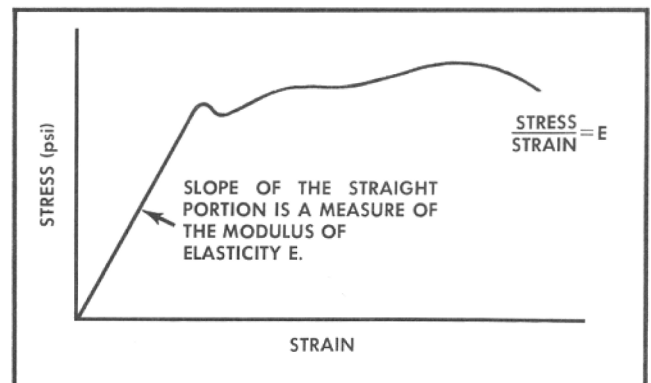

Fig. 3-5. Typical stress-strain diagram for structural steel.

Applications — Type Q

When using the Q-Unit in a non-strain application, you may desire to have the calibration per graticule division be an integral multiple of the quantity being measured. This is easily accomplished by adjusting the gain proportionately during the Q-Unit calibration. In the example, 5000 pounds per division would be a convenient value to use. This calibration can be made by applying a known force to the bar and adjusting the gain for the proper trace deflection. Alternatively, you can select a calibration resistor which corresponds to an integral force value. The calibration resistor can then be used to set the gain. Starting with the force per division you want, you can calculate first the corresponding stress per division, then the corresponding strain per division for the bar. Then use the equations outlined in the Operating Instructions to determine the value of the special calibrator resistor.

The simple strain-gage installation of Figure 3-4 is satisfactory in an application where the strain is known to be evenly distributed over the member cross section. In a uniform member subject to bending stresses as well as longitudinal stresses, the longitudinal stresses can be measured independently by cementing two active strain gages on opposite sides of the member and connecting them in arms "2" and "4" of the bridge. This connection will give twice the sensitivity as well as measuring the average longitudinal strain. Circuit connections are accomplished using the Q-Unit in the 4 EXT. ARMS position and completing the bridge circuit with two unstressed (dummy) arms. An easy way to do this is to mount two additional strain gages on a separate piece of metal to form the dummy arms. The dummy arms should be physically located in the same temperature environment as the active arms. The dummy arms can also be cemented to the force measuring bar at right angles to the longitudinal axis. Unfortunately, due to Poisson's effect there exists a tensile strain along the transverse circumference of the bar. The magnitude of the tensile strain is approximately $\frac{1}{4}$ as large as the longitudinal compressive strain. Unless Poisson's ratio for the metal is precisely known, the transverse strain cannot be calculated accurately. Also the axis of zero strain cannot be located accurately. This presents no problem when equipment for calibrating the load cell against a standard is available. Some of the commercial force measuring transducers use this method for locating the dummy arms. The four-arm arrangement will give excellent temperature stability. Use of four external arms also avoids possible difficulties resulting from switch or connect or contact resistance since critical connections in the bridge circuit can be soldered directly. Temperature stability is discussed in more detail elsewhere in this section of the manual.

Resistive Transducers

Most of the commercial transducers useful in conjunction with the Q-Unit operate on the resistance variation principle. The number of transducer types and manufacturers is very large so we will not attempt to discuss them in detail.

It is now common practice for the manufacturer to supply information regarding the shunt calibration resistor that corresponds to a specific transducer calibration. This allows you to use the calibration system built into the Q-Unit. In some cases, a correction for lead length may

have to be applied. The best results are obtained when the transducer and Q Unit are calibrated with the proper length lead connected. The transducer can be calibrated experimentally by applying a known amount of the transduced quantity to the unit and observing the resulting trace deflection on the oscilloscope. By setting the GAIN ADJ. control, the trace deflection can be made an integral number of graticule divisions. The calibration resistor can then be selected experimentally to produce the same amount of trace deflection. When calibration is made in this manner, the lead effect correction is automatically included. Where convenient, you may wish to use the 2 point calibration system.

As an example of a resistive transducer application, we will discuss a dynamic blood pressure measurement. A commercial transducer is available for this purpose using a four-arm resistive bridge. The transducer has built-in venting valves to allow entrapped air from the pressure system to be freed. In this application, the proper connections would be made from the transducer to the Q Unit through a suitable cable and connector. A resistor corresponding to a known pressure is then connected to the calibration-resistor binding posts within the Q-Unit. The pressure system should be filled with fluid and the trapped air removed. The transducer and needle should be in approximately their normal position while the Q-Unit bridge is being balanced. Using the Q-Unit in the 4 external arms position, the bridge is balanced to establish the zero or atmospheric pressure calibration point. Next the Q-Unit gain is adjusted to give a specific deflection sensitivity in terms of mm of Hg/Dv. Finally, when the needle attached to the transducer is inserted into a blood vessel, the vertical deflection of the oscilloscope trace is directly proportional to the instantaneous pressure being measured.

Note that it is convenient to re-label the CALIBRATE button and the μ STRAIN/DIV. control in terms of pressure so that the oscilloscope calibration is direct reading in terms of the transduced quantity. Possible errors in reading are thereby minimized.

Capacitive Transducers

Transducers based on the variation of the capacitance with the transduced quantity are less frequently encountered in commercial design than are resistive transducers. However, the extreme simplicity of the capacitive design makes it convenient for transducers specially designed for particular applications. Capacitive devices can be made to transduce most of the mechanical quantities, however, they are most frequently useful in the measurement of mechanical displacements. In addition to the electrical variation of capacitance in semi-conductor devices, three general forms of mechanical-capacitance devices find general application.

The first mechanical arrangement of capacitor plates to be discussed in this section consists of two or more flat metallic plates arranged so that their plane surfaces are parallel. If one plate is connected to ground through connector pin "D" and the other is connected to pin "C", then you will get an oscilloscope trace deflection proportional to the area of the plate overlap provided the areas are great enough to minimize edge effects. It is only necessary to connect each set of plates mechanically to two points in a machine where the relative displacement is to be measured

to complete the installation. Naturally the plates connected to pin "C" will have to be insulated from ground. In some cases, extreme electrical interference (brush noise in a series motor for example) may require electrostatic shielding or the elimination of the source of interference.

When the relative motion does not occur along a straight line, the transducer plates will have to be specially shaped and/or spaced to provide a linear relationship between the trace deflection and the transduced motion.

A second mechanical arrangement may conveniently take the form of coaxial-concentric cylinders. Cylindrical devices are relatively easy to manufacture and are inexpensive. Using devices of this kind, it is very easy to measure straight-line displacements even when the amount of travel is very great. If the transducer capacitance corresponding to "zero" displacement is greater than 250 mmfd, you will have to add a fixed capacitor across R5702 (use the binding posts for this purpose) to bring the bridge capacitance within the range of the CAPACITANCE balance control. Use a capacitor value within 250 mmfd of the transducer "zero" capacitance including the effect of any lead unbalance. You can measure the "zero" capacitance with the Q-Unit or determine the proper value experimentally. Use a mica capacitor or other temperature insensitive capacitor to achieve the best long term temperature stability.

The third form of mechanical capacitance variation finds application in measuring very small displacements where the total range may be in the order of a few thousandths of an inch or less. In this case, it is convenient to change the spacing of the two metal plates for the capacity variation. Alternatively, one of the plates may be a machine surface and the other may be a test probe of relatively small diameter. Figure 3-6 shows how the capacitance varies with the spacing for a 1/4 inch diameter probe. Since the capacitance is a nonlinear function of the spacing, a correction must be applied to the results unless the range is selected for approximately linear operation by changing the probe spacing relative to the amount of motion.

Capacitive transducers may be calibrated by artificial means using a calibration capacitor connected inside the Q Unit as explained previously. Also, you can secure two static calibration points by moving the machine or device by hand allowing you to adjust the Q-Unit gain to correspond to a known displacement. Usually you will want to make one of the calibration points the end of the travel or "zero" point so that later you can reestablish a reference balance for checking thermal drift. The amount of capacity variation likely to be encountered in transducer work is small enough that nonlinearity due to excessive bridge unbalance will not occur.

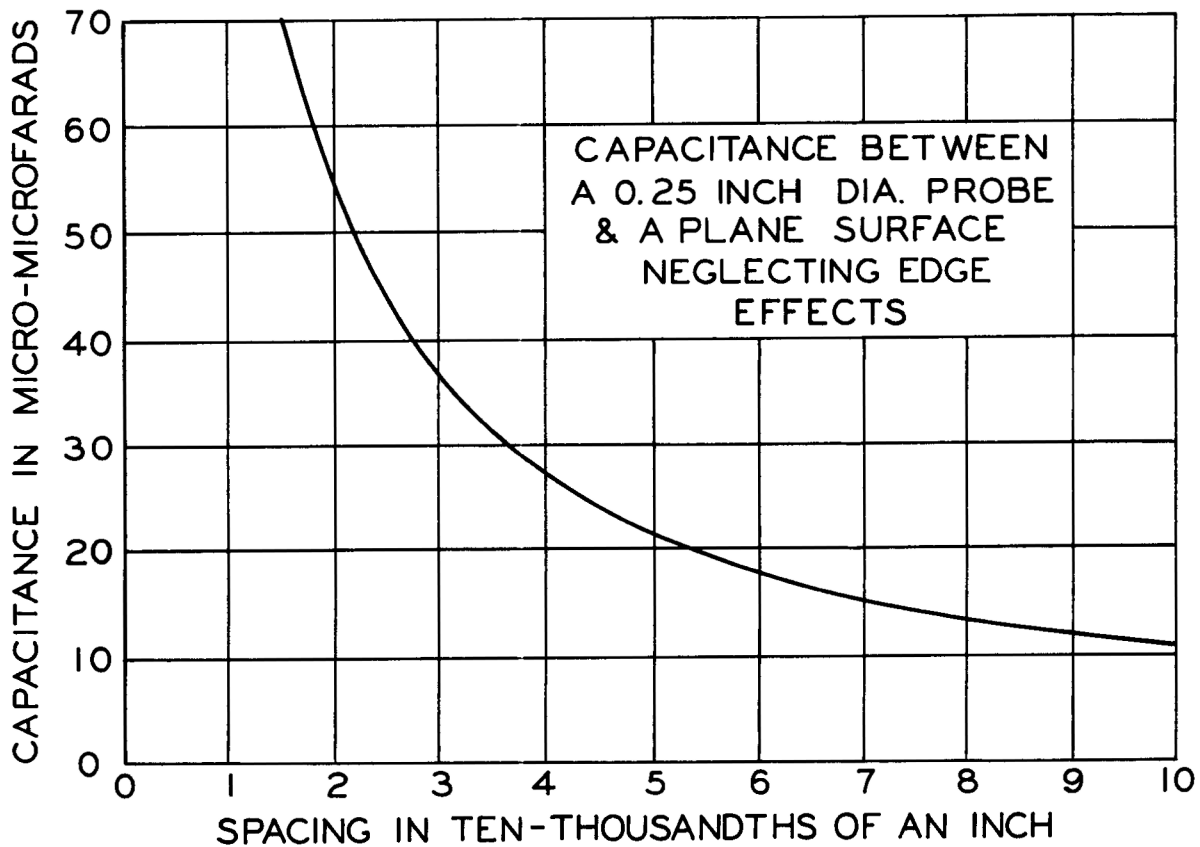

Fig. 3-6. Graphical display of capacitance variation versus spacing for a 1/4 inch diameter probe.

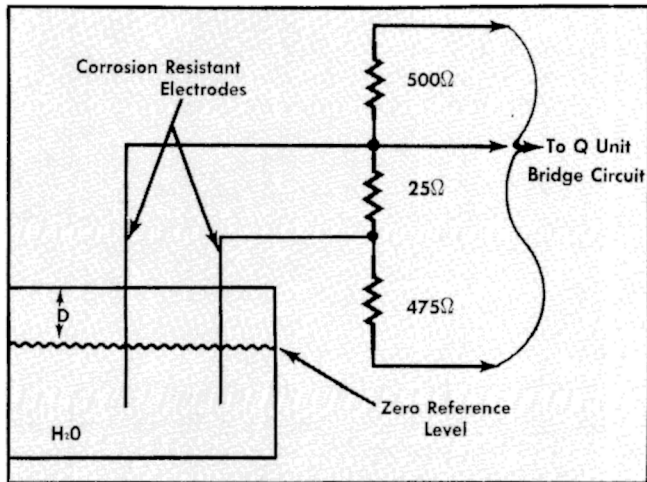

Fig. 3-7. Diagram of a simple transducer for measuring water-wave actions in hydraulic model studies.

Special Transducers

Measurement problems occasionally arise where transducers are not commercially available to meet special requirements. It is often possible to design a transducer to meet your needs. As an example, we will describe the construction of a transducer designed to measure the water-wave action in hydraulic models.

Referring to Figure 3-7, we show a transducer of two electrodes inserted into a fluid (tap water in this example). As the water rises and falls relative to the fixed transducer, the total resistance of the water between the electrodes changes. Even with relatively pure water the change in resistance for moderate depth changes (D) is more than enough to operate the Q-Unit. Actually, to avoid non-linearity difficulties it is best to bridge only a portion of the resistive arm with the water conduction path as shown in the sketch. Direct calibration is accomplished by moving the transducer a known amount relative to the water and adjusting the Q-Unit gain accordingly.

Note that if the water contains soluble impurities there will be no electrolytic deposition because the a-c bridge excitation reverses the current flow each half cycle. If the electrodes are totally immersed, the device will measure changes in solution conductivity or temperature.

Capacitance Measurement

A useful secondary application for the Q Unit is the direct measurement of capacitance. Although not primarily intended for this purpose, the unit is very convenient for measuring and selecting capacitors in the range from 5 to 10,000 mmfd. The connection to the capacitor under test can be made with a short length of shielded lead terminated in alligator clips or you can assemble a special test jig to meet your individual needs. Use pins C and D of the EXTERNAL BRIDGE ARMS connector to make connections to the capacitor being measured. Use pin D for the ground lead.

Other than the test lead or fixture, no additional equipment is needed external to the Q-Unit. Make sure the in-

ternal 120 ohm resistor (R5702) is in place and set the EXT. ARMS switch to the "0" position. Replace the calibration resistor (R5705) with an accurate capacitor suitable for securing a calibration point in the range that you want to make capacitance measurements. Using the internal resistive bridge, the normal sensitivity of the amplifier is such that the number of mmfd per division will be one-tenth of the calibration numerals on the μ STRAIN/DIV. switch. For example, when you are set 100 μ strain/div. the Q-Unit will conveniently calibrate to 10 mmfd/div. Suppose that you select an accurate 40 mmfd capacitor for calibration purposes. Then in the "100" position of the μ STRAIN/DIV. switch you should rotate the GAIN ADJ. control to get a trace deflection of 4 divisions when the CALIBRATE button is depressed. The PHASE ADJ. control will have to be rotated until the trace deflection is a maximum for a capacitive-type bridge unbalance before completing the gain adjustment. If additional capacitance sensitivity is required, you can use an external 1,000 ohm four-arm bridge to extend the useful range to .2 mmfd per major graticule division.

Within the accuracy limits of the STRAIN/DIV. switch, you can now make measurements up to 1,000 mmfd without recalibration as you change ranges. The deflection on the oscilloscope screen is directly proportional to the unknown capacitance. Above 1,000 mmfd the output of the bridge is slightly nonlinear with capacitance changes. In the range above 1,000 mmfd, the error due to non-linearity would typically be 2% or less for a total range to 10,000 mmfd if you calibrate at or near full scale. For measurements and calibration at lower values the error will decrease. A typical curve of capacitance vs. oscilloscope trace deflection is shown in Figure 3-8. Here, we calibrated using an 8,000 mmfd capacitor and set the gain for eight major graticule divisions deflection (Type 536 Oscilloscope). The curve shows only slight deviation from non-linearity up to 4,000 mmfd. The maximum error due to bridge non-linearity is approximately 2%. Errors caused by resistive losses in the capacitor are negligible for capacitors of good commercial design. The Q-Unit output is relatively insensitive to changes in the resistive component when correctly adjusted for capacitive measurements.

General information outlined in this section is applicable to measurements where a variable-capacitance device is used as a transducer.

How to Reduce the Q-Unit Bandwidth

The need for changing the Q-Unit bandpass characteristic rarely arises. When you are using your unit at maximum sensitivity, residual circuit noise originating in the input stage is amplified sufficiently to appear on the crt screen. Some of this noise can be eliminated by reducing the overall system bandwidth. The most convenient place to reduce bandwidth is in the RC circuit preceding the output cathode follower tube, V6734.

If you place additional capacitance in parallel with C6724, the bandwidth will be reduced in proportion to the total capacitance. Adding .001 μ fd in parallel with C6724 will double the total capacitance and reduce the bandwidth from 6 kc to 3 kc, etc. Alternatively, you can decrease the bandwidth by increasing the value of R6724. Doubling the value of this resistor halves the bandwidth. You should use caution in using your instrument at reduced bandwidth to avoid errors due to frequency discrimination.

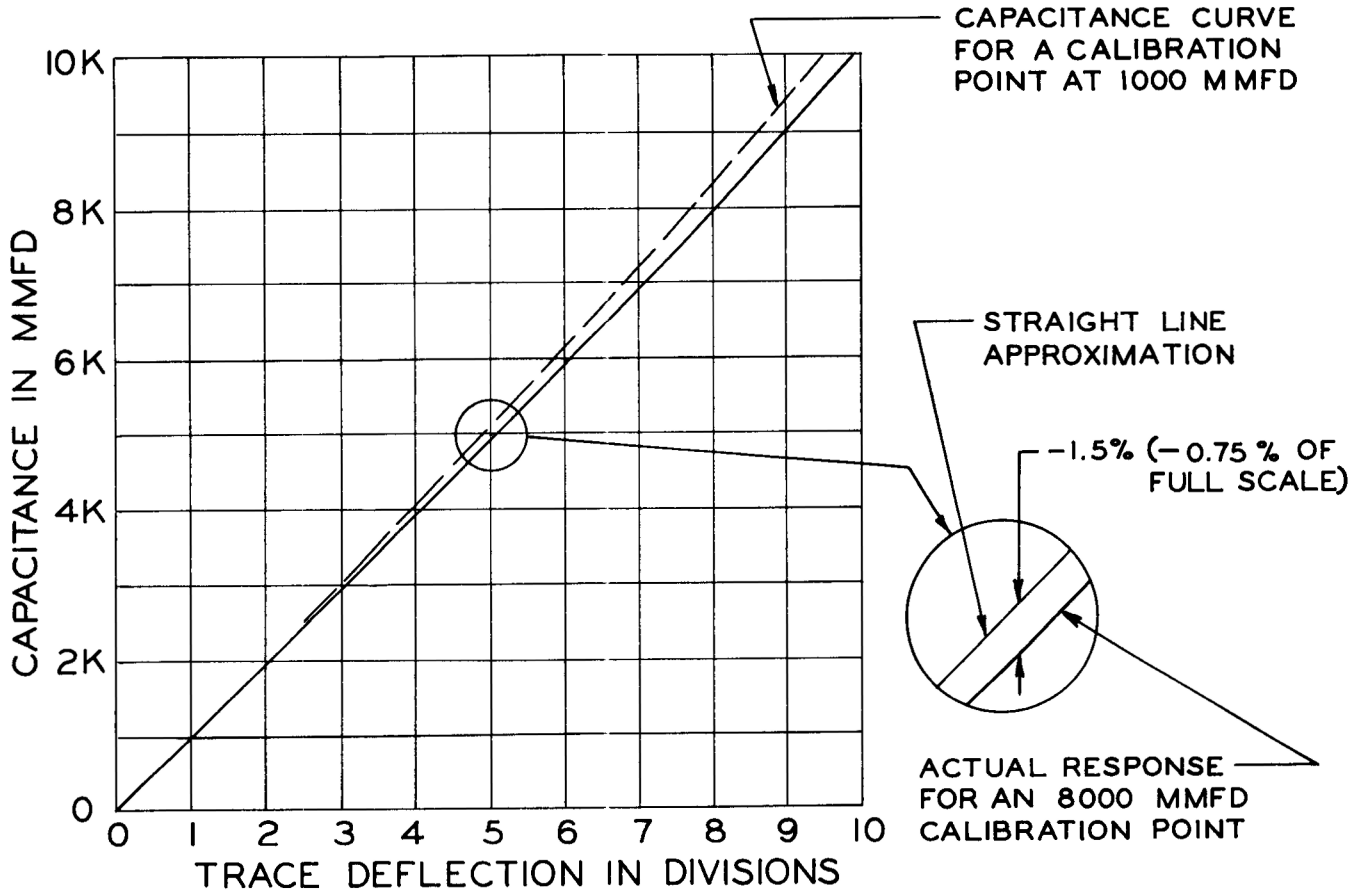
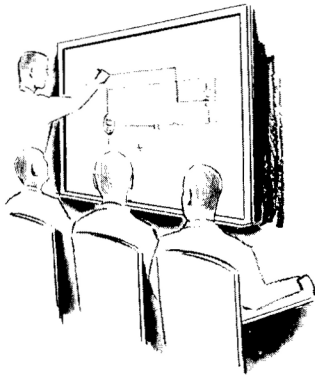

Fig. 3-8. Typical curve of capacitance versus oscilloscope trace deflection.



SECTION 4

THEORY OF OPERATION

General

The carrier system used within the Q Unit provides many desirable characteristics which are not easily attained with a dc system. Since only ac voltages need be amplified an ac-coupled amplifier is used which provides the necessary high gain with essentially no drift. The modulation system provides an effective frequency response of from dc to 6 kc with the ac-coupled amplifier, permitting the unit to be used to measure both static and dynamic strain. The carrier system also allows the amplifier to be designed to pass only the desired frequencies. In this way most of the pickup is eliminated from the output of the unit. In addition to the other advantages of the system, the ac carrier system allows reactive transducers to be used with the unit.

Block Diagram

The block diagram for the Type Q Plug-In Unit is shown in Figure 4-1. The input circuit for the unit is an ac bridge with the external transducer connected into one or more of the bridge arms. Excitation voltage for the bridge is obtained from a 25-kc oscillator.

In operation, the bridge circuit modulates the 25 kc carrier in accordance with the bridge unbalance produced by

the transducer. Under no-signal conditions, the bridge is balanced and the carrier is suppressed. The amplitude of the output signal from the bridge is determined by the amount of unbalance. The phase of the output is determined by the direction and type of unbalance (resistive or reactive). The bridge produces suppressed-carrier amplitude modulation.

The modulation sidebands from the bridge circuit are applied to an ac-coupled amplifier where the desired sidebands are amplified while unwanted frequencies are rejected. An attenuator and the GAIN ADJ. control located in the amplifier, determine the overall sensitivity of the unit.

The amplified modulation sidebands are applied to the phase-sensitive demodulator. In the demodulator an artificial carrier is added to the sidebands. A phase shifting network between the oscillator and the demodulator insures that the carrier is added in the proper phase. The added carrier permits only the desired phase to be demodulated.

The output of the demodulator circuit is applied to a filter network where the undesirable modulation components are eliminated. The output from the filter is then applied to the associated oscilloscope through the interconnecting plug. The signal applied to the oscilloscope corresponds exactly to the signal applied to the input bridge circuit by the external transducer.

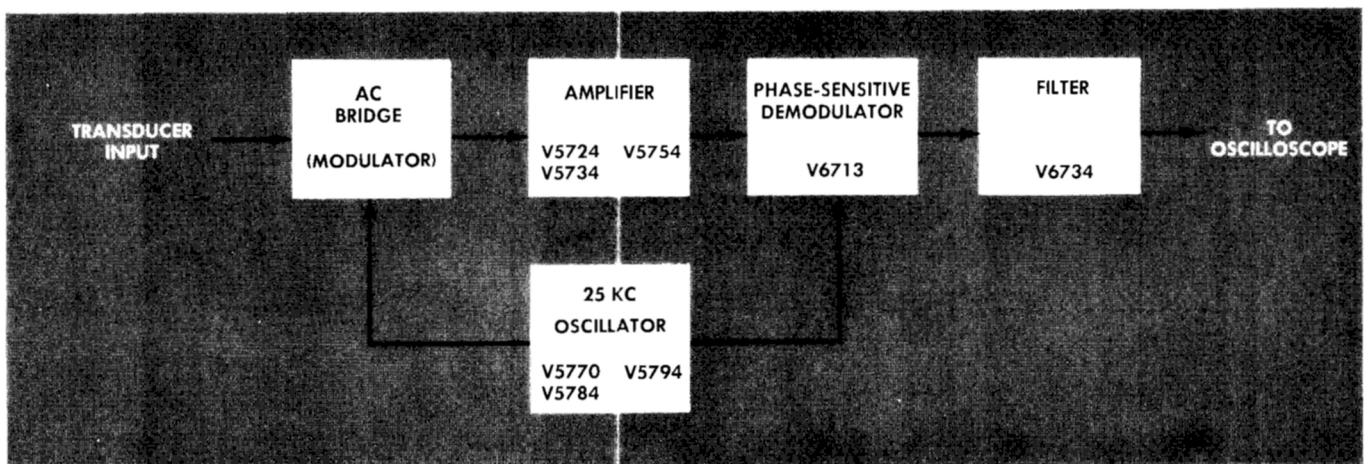

Fig. 4-1. Type Q Plug-In Block Diagram.

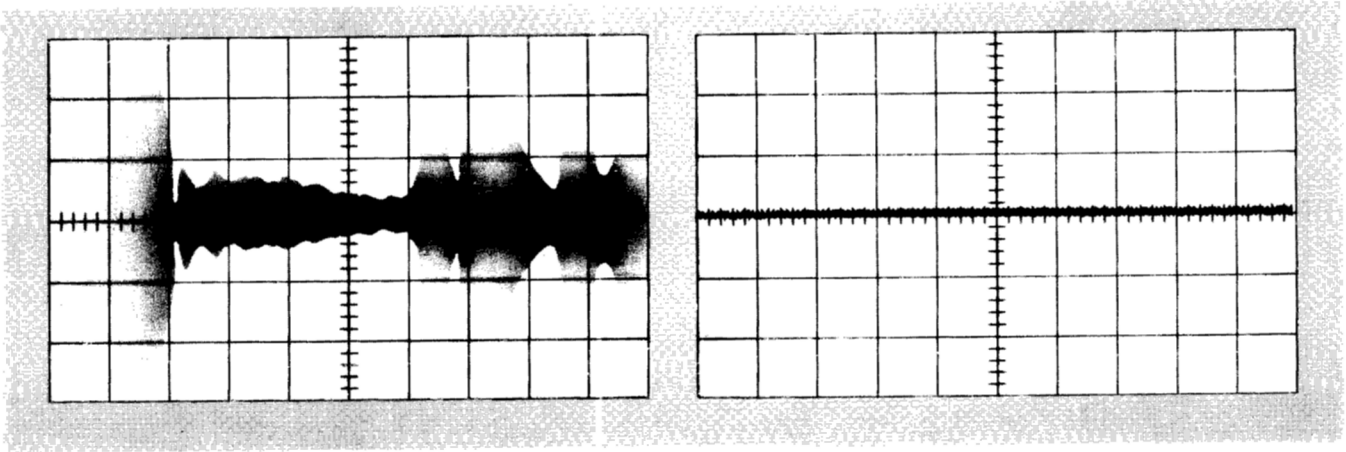

Fig. 4-2. Output waveforms obtained from the bridge circuit. One waveform shows the modulation envelope produced by dynamic strain. The other waveform shows the output when the bridge circuit is balanced.

Input Bridge Circuit

Input signals to the Q Unit are applied to the input bridge circuit in the form of impedance changes. These impedance changes are produced by the external transducer in accordance with variations in the quantities the transducer is designed to measure. The input bridge is an impedance sensing device which produces an electrical output signal corresponding to the changes in impedance.

The external transducer used with the unit is connected into one or more of the bridge arms. Impedance changes

by the transducer thereby affect the bridge balance. The amplitude of the output signals depends on the amount of unbalance.

Excitation voltage for the bridge circuit is obtained from the 25 kc oscillator. Under no-signal conditions, the bridge is balanced and the 25 kc signal suppressed at the output of the bridge. Due to the ac excitation voltage, both resistive and reactive balance circuits are required to produce complete balance of the bridge. The resistive balance circuit permits you to compensate for small resistance differences between transducers and for resistance in leads. The resis-

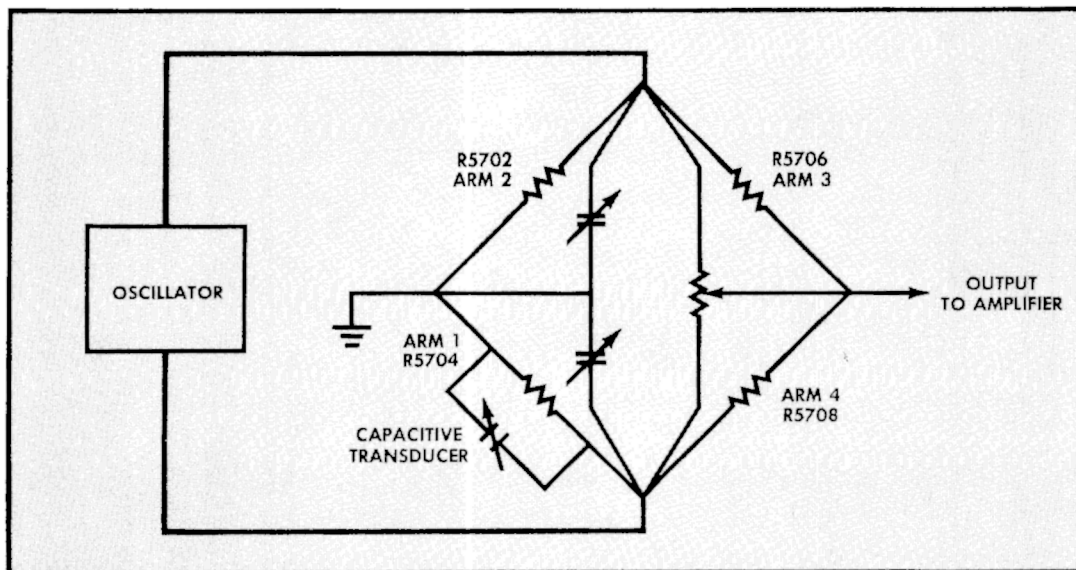

Fig. 4-3. Simplified schematic diagram of the bridge showing the bridge balance circuits.

tance balance circuit does not allow you to compensate for unbalanced reactances however. This is because the output from the bridge resulting from a reactive unbalance is 90 degrees out of phase with respect to the signal resulting from a resistive unbalance. A separate capacitive balance circuit compensates for any capacitive unbalance. It is necessary to balance inductive transducers externally. An inductive balance circuit is not included in the unit.

Referring to the simplified schematic diagram of figure 4-3, it can be seen that in order for the bridge to balance resistively, the ratio of R5702 to R5704 must equal the ratio of R5706 to R5708. The resistance balance controls adjust the ratio of R5706 to R5708 to produce the required balanced condition.

Again referring to the simplified schematic diagram of Figure 4-3, it can be seen that in order to obtain capacitive balance, the ratio of the arm 2 capacitance to the arm 1 capacitance must equal the ratio of the arm 3 capacitance to the arm 4 capacitance. The capacitance balance controls adjust the ratio of capacitances in the left side of the bridge to equal the ratio of capacitances in the right side of the bridge.

Under perfect balance conditions, the 25 kc carrier is suppressed and no output is obtained from the bridge. When the transducer is activated, however, impedance changes cause the bridge to unbalance and modulate the 25 kc carrier. This produces an output. Since the carrier is suppressed, only the sidebands are obtained as an output.

The bridge circuit of the Q Unit produces amplitude modulation. The amplitude of the modulation is determined by the amount of bridge unbalance. The phase of the output is determined by the type of unbalance. Capacitive unbalance

produces an output which is approximately 90 electrical degrees out of phase with the output resulting from resistive unbalance. Under normal operating conditions resistive and reactive unbalance do not occur simultaneously. The phase angle of the output signal is therefore usually 0, 90, 180, or 270 degrees with respect to the carrier. The upper and lower modulation sidebands at the output of the bridge are applied to the amplifier through C5720.

In order to produce a definite amount of bridge unbalance for purposes of calibration, a special calibration circuit is used. The calibration circuit consists of the CALIBRATE switch SW5705, resistor R5705, and capacitor C5705. When the CALIBRATE switch is depressed, R5705 is connected in parallel with external arm 1 (see Fig. 4-4). This produces a resistance change in the bridge arm that corresponds to a -400μ strain signal. This unbalances the bridge slightly and produces an output signal. The output signal resulting from the bridge unbalance is used to set the GAIN ADJ. and PHASE ADJ. controls. When reactive transducers are used, corresponding reactive elements may be used in place of R5705 to produce the correct calibration signal.

When the CALIBRATE switch is depressed, a small amount of stray capacitance is also connected in parallel with external arm 1. This stray capacitance produces an undesirable capacitive unbalance in addition to the desired resistive unbalance. To eliminate this effect, C5705 is connected in parallel with the arm when the switch is released. This variable capacitor is adjusted so that the same amount of capacitance exists in both positions of the switch. The small amount of capacitance is then balanced out with the capacitance balance controls. Since the same amount of capacitance exists in both positions of the switch, no capacitive unbalance is introduced when the CALIBRATE switch is depressed. The bridge then sees a pure resistive unbalance.

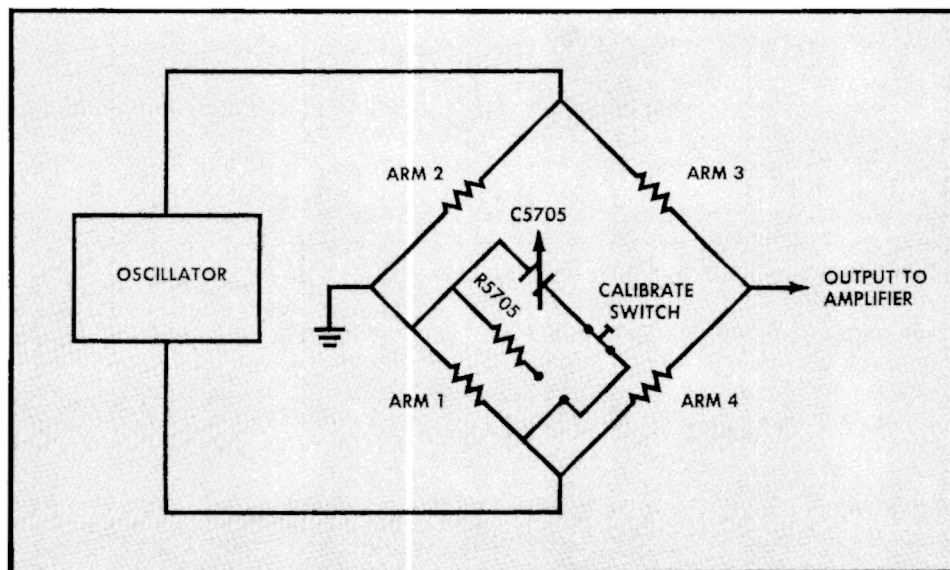

Fig. 4-4. Simplified schematic diagram of the calibration circuit.

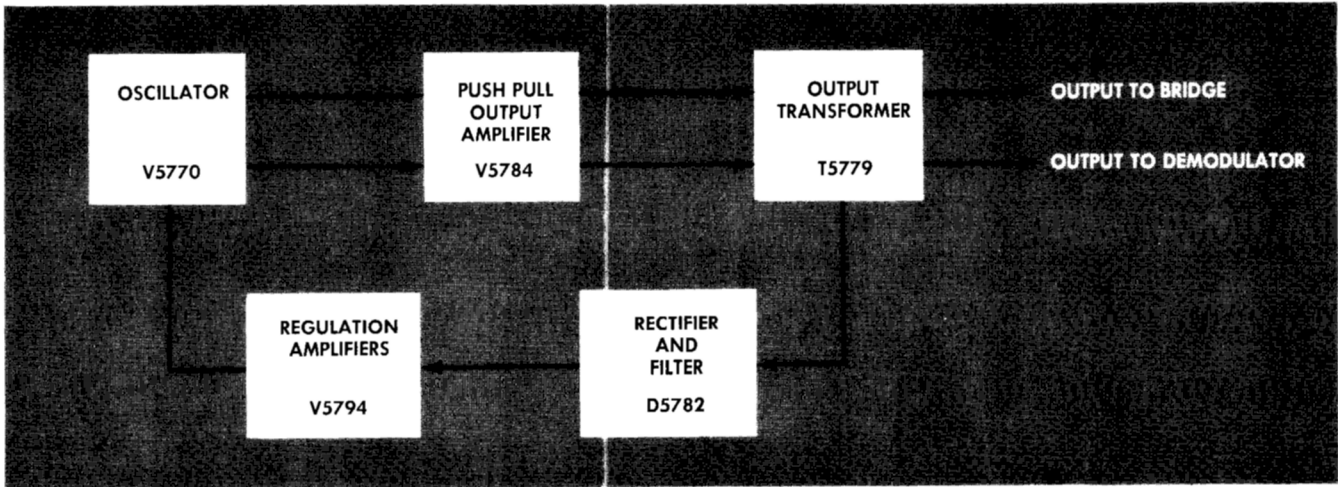

Fig. 4-5. Oscillator circuit block diagram.

Oscillator Circuit

The oscillator circuit produces the excitation voltage for the bridge and the carrier voltage for the phase sensitive demodulator. The oscillator stage is V5770. As the tube originally goes into conduction during warmup, a voltage drop is produced across R5771. This voltage drop is applied through C5772 and R5772 to the tank circuit consisting of L5773 and C5773. The voltage drop shocks the tank circuit into oscillations. These oscillations are then fed back through C5774 to the grid of the oscillator tube. The tube amplifies the signals and applies the output from the plate to the tank circuit to maintain oscillations.

The oscillator circuit has two characteristics which make it especially suitable for use in the Q Unit. First, it produces an excellent sine wave output which is low in undesirable harmonics. Second, the oscillator provides a push-pull output which is used to drive the output amplifier directly.

The push-pull output of the oscillator is applied directly to the grids of the push-pull output amplifier, V5784A and V5784B. The output of the amplifier is then applied across the primary winding of transformer T5779. One secondary winding of T5779 supplies the excitation voltage for the bridge circuit. The other secondary winding applies an output through a phase shifting network to the phase sensitive demodulator.

A regulation circuit is used to maintain the output of the oscillator circuit at a constant amplitude. Changes in the output voltage are sensed, amplified, and used to control the screen voltage of the oscillator tube. This, in turn, controls the amplitude of oscillations.

A sample of the output from a secondary winding of T5779 is applied through C5783 to diode D5782. The diode rectifies the ac voltage and produces a dc voltage across R5785 and C5794 which is proportional to the secondary voltage of T5779. This voltage is subtracted from the positive voltage at the junction of R5780 and R5781 and the resulting voltage is applied to the grid of V5794B. The voltage at the grid of V5794B is then dependent on the output of the oscillator circuit.

Capacitor C5794 serves as a filter capacitor for the rectifier circuit thereby bypassing high frequency components at the output of the rectifier to ground. Ripple at the output of D5782 is further reduced at the plate of V5794B due to the action of C5793. Ripple at the plate of V5794B is fed back to the grid through C5793. This greatly reduces the high frequency gain of the stage. Essentially, only changes in dc level are amplified by V5794B.

The output of V5794B is applied to the grid of V5794A where it is amplified and connected to the screen grid of the oscillator tube, V5770. The screen voltage of V5770 is therefore controlled by the output of V5794A. The screen voltage in turn controls the output amplitude of the oscillator. Variations in the output of the oscillator are therefore nearly eliminated by the regulator circuit.

Amplifier Circuit

Modulation side bands from the bridge are applied through C5720 to the input of the amplifier. The short time constant of C5720 and R5720 tends to reject 60 and 120 cycle pickup applied to the amplifier input. Modulation sidebands are applied to the grid of V5724A with very little attenuation.

Output signals from the bridge circuit are frequently quite small in amplitude. Consequently, a step attenuator for the μ STRAIN/DIV. control cannot be inserted in front of V5724A or the signal would be attenuated into the noise level. Instead the signal is applied directly to the grid of V5724A where it is amplified well above the noise level. The output of V5724A is then applied to the grid of cathode follower V5724B. The μ STRAIN/DIV. attenuator is connected in the cathode circuit of V5724B. The μ STRAIN/DIV. switch, SW5730A selects the signal amplitude applied to the grid of V5734A.

The output from the plate of V5734A is further amplified by V5734B and applied through C5737 to the grid of V5734A. The signal at the grid of V5754A is developed across a Twin-T Band Rejection Filter which presents a low transmission to the sideband frequencies and a high transmis-

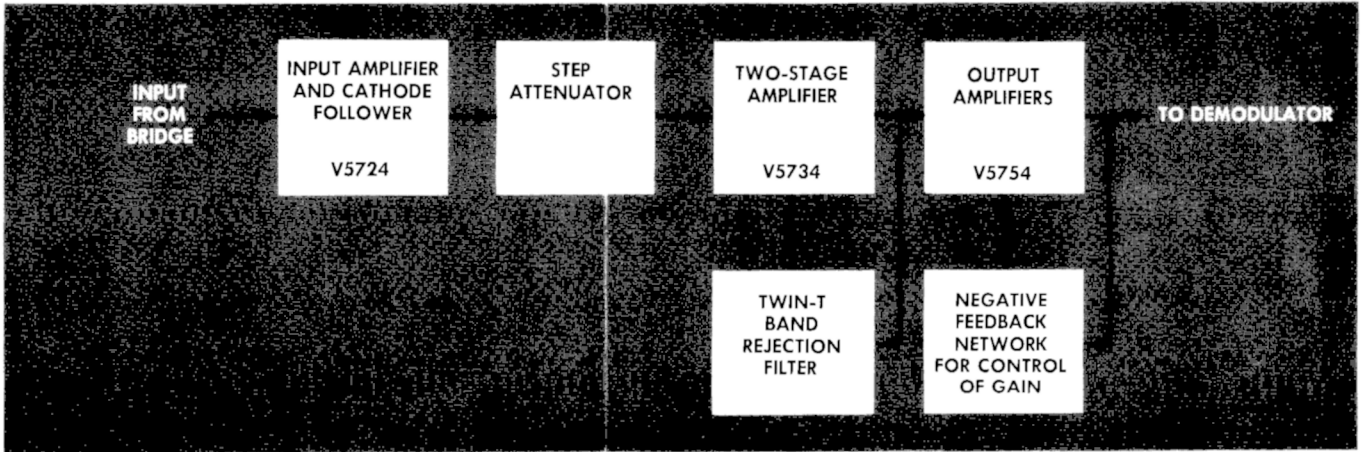

Fig. 4-6. Amplifier block diagram.

sion to other frequencies. Frequencies which are below or above the sideband frequencies are applied through the filter to the cathode circuit of V5734A as inverse feedback. This reduces the gain of the amplifier for all frequencies other than the sideband frequencies.

The output from the plate of V5754A is further amplified by V5754B and connected through C5757 at the output of the amplifier, to the phase sensitive demodulator. A degenerative feedback network is connected from the output of V5754B to the cathode circuit of V5754A. The reactance of C5755 is quite low at 25 kc so that at this frequency the capacitor bypasses R5756 to ground. Consequently, the amount of inverse feedback depends largely on the ratio of R5761 and R5760 in series to the parallel resistance of R5754 and R5756. Both the VARIABLE control, R5754 and the GAIN ADJ. control, R5761 affect this ratio and consequently the amount of inverse feedback. The VARIABLE control produces an additional effect on the gain of V5754A by setting the cathode resistance of the stage. The GAIN ADJ. and VARIABLE controls, by setting the gain of V5754A and V5754B, control the output of the amplifier.

Phase Sensitive Demodulator

In the demodulator, the carrier is first added to the sideband frequencies. The resulting modulation envelope is then demodulated and applied through a filter circuit to the input of the associated oscilloscope. The sidebands are applied from the output of the amplifier, while the carrier is applied from the oscillator through a phase-shifting network.

The sidebands from the output of the amplifier are connected through cathode follower V6713A to the primary winding of T6715A. An output from the oscillator is applied through cathode follower V6713B to the primary winding of T6715B.

The 25 kc carrier voltage is applied to the demodulator circuit through two phase-shifting circuits. The first network consists of R5779 and C5779. The phase of the output from this network is variable through approximately 170 degrees by adjustment of the PHASE ADJ. control. Figure 4-8 shows the phasor diagram of this network for two settings of the PHASE ADJ. control. It can be seen that the phasor for the voltage across R5779 must at all times be 90 degrees

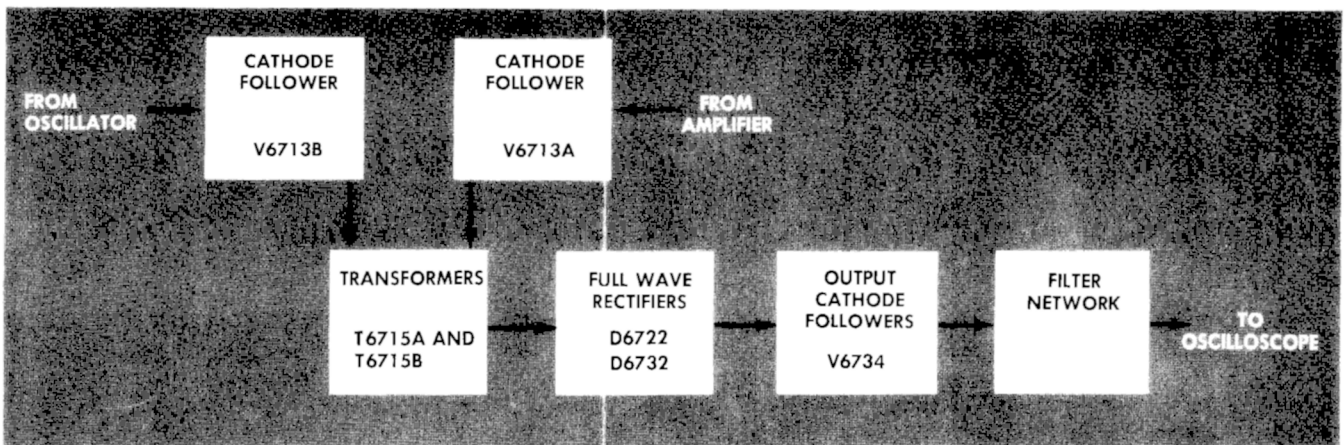

Fig. 4-7. Demodulator and filter block diagram.

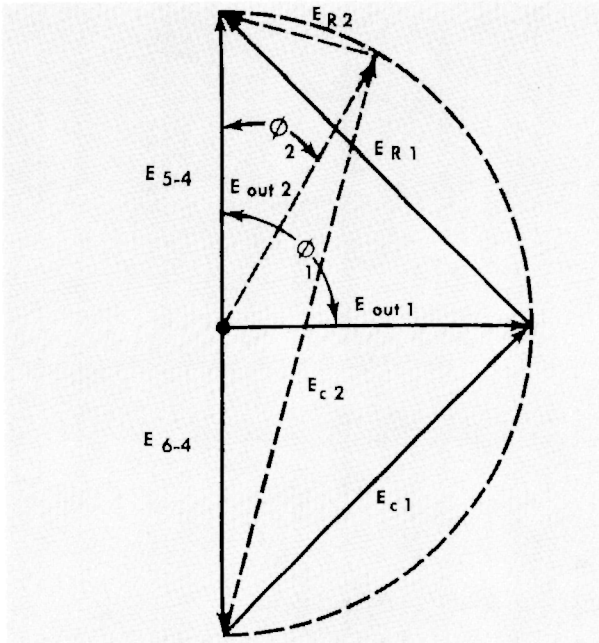

Fig. 4-8. Phasor diagram for the adjustable phase shifting network. E_C is the phasor representing the voltage across C5779, E_R is the phasor for R5779, and E_{OUT} is the output of the network. The phase of the output is represented by θ and is referenced to the voltage between terminals 5 and 4 of T5779. Adjustment of R5779 rotates E_{OUT} through the semi-circle shown dotted in the diagram.

out of phase with the phasor for the voltage across C5779. Also the phasor sums of the voltages must equal the source voltage. The locus of all points which satisfy these conditions is the semi-circle shown in the phasor diagram. Consequently the amplitude of the output phasor is constant regardless of the actual output phase. The phase of the output can be shifted through virtually the entire semi-circle.

The output of the first phase-shifting network is applied to the grid of V6713B through the second phase-shifting network. The second network, consisting of R6716 and C6716, produces a fixed phase shift of approximately 30 degrees which is used to place the output of the first network in the proper range of adjustment. The output from the second network is applied to the second primary winding of T6715 through cathode follower V6713B.

The carrier is recombined with the sideband frequencies in the secondary windings of the transformers. The secondary windings are connected in series so that the sidebands add to the carrier on one output from the transformers (terminals 5 and 6 for example) and subtract from the carrier on the other output (terminals 7 and 8). The resulting modulation signals are then applied to separate full-wave bridge rectifier circuits.

Under balance conditions, no signal is applied from the amplifier to the demodulator. The carrier, then, is the only signal appearing at the secondary windings of T6715. The carrier is rectified by D6722 and D6732. The resulting dc difference voltage appearing between the grids of cathode followers V6734A and V6734B is therefore zero. The outputs from the cathode followers are applied through a filter cir-

cuit where any remaining carrier and harmonic frequencies are eliminated. The dc components are applied through the filter to the oscilloscope input. Since both output voltages are equal and opposite, no deflection of the trace results.

When the bridge is unbalanced, sideband frequencies are applied to the demodulator. These sideband frequencies add and subtract from the carrier as shown in the phasor diagram in Figure 4-9(a). It can be seen from Figure 4-9 that in order to obtain maximum addition and subtraction, the carrier must in phase or 180 degrees out of phase with the resultant phasor of the two sidebands. Under these conditions the carrier has the same phase relationship to the signal as the carrier signal originally modulated by the bridge circuit. The proper phase relationship is established by adjusting the PHASE ADJ. control for maximum output. When the PHASE ADJ. control is properly set, the phasor relationships shown in Figure 4-9(a) exist.

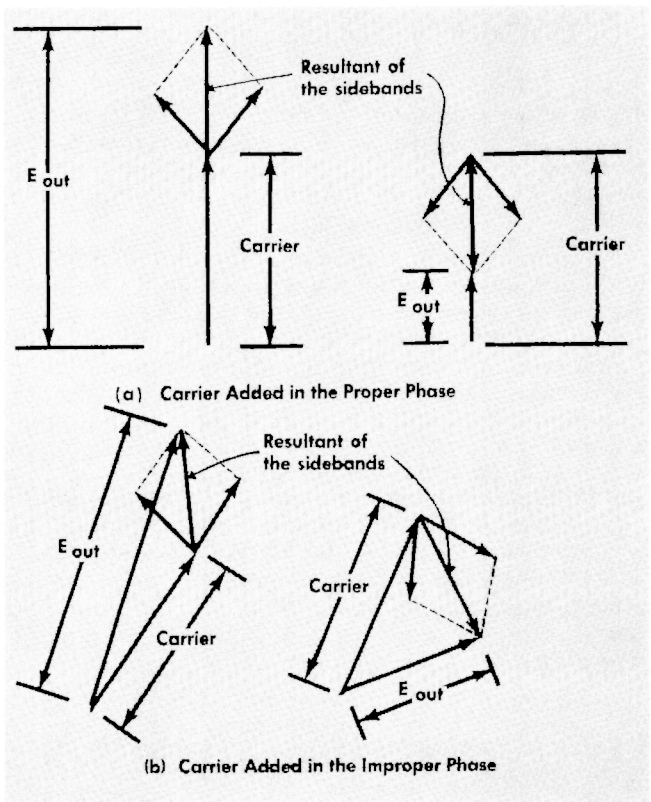

Fig. 4-9. Phasor diagrams for the outputs of T6715A and T6715B. The carrier combines with the resultant of the sidebands to form the output, E_{OUT} . When the carrier is added in the proper phase, the relationships shown in (a) exist. The PHASE ADJ. control allows you to obtain this relationship.

Any time that the bridge is unbalanced, the modulation signals at the two outputs of T6715A and T6715B are unequal. The direction of bridge unbalance determines which of the two outputs is greater. The modulation envelopes are applied to the two full-wave rectifier circuits. The outputs of the rectifiers are also unequal, and consequently a voltage difference exists between the signal applied to V6734A and the signal applied to V6734B. The amount of voltage difference depends on the amount of bridge un-

balance. The polarity of the voltage difference depends on the direction of the input bridge unbalance. The essential point to observe is that the voltage differential at the grids of the two cathode followers corresponds to the instantaneous bridge unbalance.

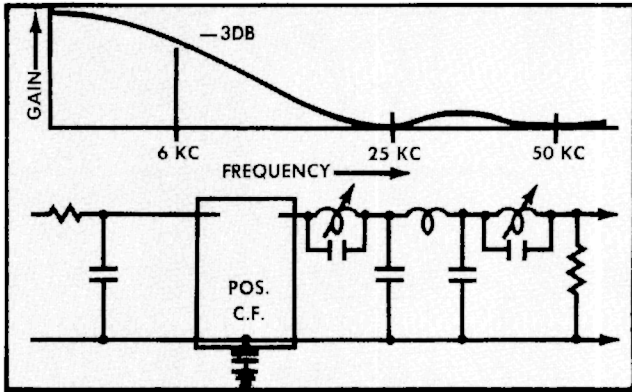

Fig. 4-10. Response curve and simplified schematic diagram for the filter network.

The voltage difference at the grids of V6734A and V6734B also appears at the cathodes and is applied through a filter circuit to the input of the oscilloscope. This causes the trace to deflect vertically in accordance with bridge unbalance produced by variations in the impedance of external transducers. A tuned circuit consisting of L6741 and C6741 blocks 50 kc signals produced by full wave rectification of the 25 kc carrier. Following the 50 kc tuned circuit is a prototype filter section which helps to eliminate all high frequency signals. A second tuned circuit consisting of C6745 and L6745 removes any 25 kc signals remaining due to rectifier unbalance. The filter circuit permits only signal voltages originating in the input bridge circuit to be applied to the

oscilloscope.

Two controls determine the vertical position of the trace on the associated oscilloscope. Both of these controls position the trace by unbalancing the conduction by V6734A and V6734B. The VERTICAL POSITION control, R6735 sets the cathode resistance of the two tubes thereby determining their relative conduction. The VERT. POS. RANGE control, R6726 adjusts the dc voltage applied to the grids of V6734A and V6734B. This control is used to put the VERTICAL POSITION control within the proper adjustment range.

When the FUNCTION switch, SW6711A is placed in the INST. ZERO position, the output from the amplifier is disconnected from the demodulator. This produces a simulated bridge balance condition. With no signal to the demodulator, you can determine the position of the trace under no signal conditions even though the bridge circuit is not balanced at the time the check is made. You can then establish a reference position of the trace. This is particularly useful when it is not convenient to zero the transducer to check the zero point of the trace. This only permits you to check and correct for drift in the demodulator, output cathode followers, and oscilloscope, however. It does not permit you to check for unbalance in the bridge circuit produced by thermal drift.

When the FUNCTION switch is in the BALANCE position, the demodulator is bypassed and signals from the amplifier are connected directly to the oscilloscope through the interconnecting plug. Consequently the output of the amplifier is displayed on the oscilloscope. By adjusting the bridge balance controls, while observing the output of the amplifier on the oscilloscope, the bridge can be accurately balanced. When the bridge is balanced properly, minimum signal is displayed on the oscilloscope. In order to prevent interfering demodulator signals from also being displayed on the oscilloscope, C6740 is connected between the cathodes of V6734A and V6734B. This eliminates the signal voltages while permitting the dc positioning voltages to be applied to the oscilloscope.

SECTION 5

MAINTENANCE

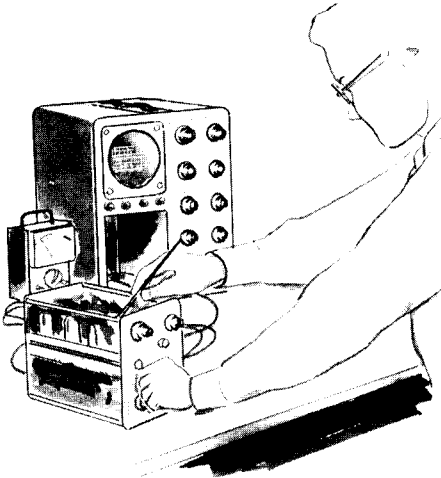

PREVENTIVE MAINTENANCE

Calibration

The Type Q Plug-In Unit will require complete calibration very infrequently. However, to insure that the unit is operating properly at all times, we suggest that you check the calibration of the instrument after each 500-hour period of operation (or every six months if the unit is used intermittently). A complete step-by-step procedure for calibrating the unit and checking its operation is given in the Internal Adjustments section of this manual. The accuracy of measurements made with the Q Unit depends not only on the accuracy of the Q Unit calibration, but on the associated oscilloscope calibration as well. Therefore, it is essential that the oscilloscope be maintained in proper calibration.

Due to many variable conditions which can affect operation of the Q Unit, it will be necessary for you to check the settings of the GAIN ADJ. and PHASE ADJ. control each time that the unit is used. The settings of these controls

should also be checked occasionally while the instrument is in use. Procedures are given in the Operating Information section of this manual for adjusting these controls.

Visual Inspection

Many potential and existent troubles can be detected by a visual inspection of the unit. For this reason, you should perform a complete visual check every time the instrument is calibrated or repaired. Apparent defects may include loose or broken connections, damaged connectors, improperly seated tubes, scorched or burned parts, broken terminal strips, as well as many others. The remedy for these troubles is readily apparent except in the case of heat-damaged parts. Damage of parts due to heat is often the result of other less apparent troubles in the unit. It is essential that you determine the cause of overheating before replacing the damaged parts.

COMPONENT REPLACEMENT

The procedures for replacing most parts in the Q Unit are obvious. Detailed instructions for their removal are therefore not required. In some cases, additional information will aid in the replacement of parts. This information is given in the following paragraphs. Because of the nature of the instrument, replacement of certain parts will require that you calibrate portions of the instrument to insure proper operation. Refer to the Internal Adjustments section of this manual.

Switches

Methods for removal of defective switches are, for the most part, obvious and only a normal amount of care is required. Single wafers are normally not replaced on the switches used in the Q Unit, and if one wafer is defective, the entire switch should be replaced. Switches may be ordered from Tektronix either with the parts wired in place or unwired, as desired.

Soldering Precautions

In the production of Tektronix instruments, a special silver-bearing solder is used to establish a bond to the ceramic terminal strips. This bond may be broken by repeated use of ordinary tin-lead solder, or by the application of too much heat. Occasional use of ordinary solder will not break the bond if too much heat is not applied.

If you frequently perform work on Tektronix instruments, it is advisable that you have a stock of solder containing about 3% silver. This type of solder is used quite often in printed circuitry and should be readily available. It may also be purchased directly from Tektronix in one-pound rolls (part number 251-514).

Because of the shape of the terminals on the ceramic terminal strips, you may wish to use a wedge-shaped tip on your soldering iron. A tip such as this allows you to apply heat directly to the solder in the terminals and reduces the amount of heat required. It is important to use as little heat as is possible.

REPLACEMENT PARTS

Standard Parts

Replacements for all parts used in the Type Q Plug-In Unit can be purchased directly from Tektronix at current net prices. However, since most of the components are standard electronic parts, they can generally be obtained locally in less time than is required to obtain them from the factory. Before ordering or purchasing a part, be sure to consult the parts list to determine the tolerances and ratings required. The parts list gives the values, tolerances, ratings, and Tektronix part numbers for all components used in the instrument.

Special Parts

In addition to the standard electronic components mentioned in the previous paragraphs, special parts are also used. These parts are manufactured or selected by Tektronix to satisfy particular requirements, or are manufactured especially for Tektronix by other companies according to Tektronix specifications. These parts and most mechanical parts should be ordered directly from Tektronix since they are normally difficult or impossible to obtain from other sources. All parts may be obtained either directly from the factory or through the local Tektronix Field Engineering Office.

Parts Ordering Information

Each part in the Q Unit has a 6-digit Tektronix part number. This number and a description of the part, will be found in the parts list. When ordering parts, be sure to include both the description of the part and the part number. For example, if the serial number of your unit is 1145, a certain resistor would be ordered as follows: R5760, 100 k, 1/2 watt, fixed, precision, 1%, part number 309-045, for Type Q Plug-In Unit, Serial Number 1145. When parts are ordered in this manner, we are able to fill your orders promptly, and delays that might result from transposed numbers in the part number are avoided.

Since the production of your instrument, some of the parts may have been superseded by improved components. In such cases, the part numbers of these new components will not be listed in your manual. However, if you order a part from Tektronix and it has been superseded by an improved component, the new part will be shipped in place of the part ordered. Your local Tektronix Field Engineering Office has knowledge of these changes and may call you if a change in your purchase order is necessary.

Replacement information sometimes accompanies the improved components to aid in their installation.

NOTE

Always include the instrument Type and Serial Number in any correspondence concerning this or any other Tektronix instrument.

TROUBLESHOOTING

This section is included to provide you with information about the Q Unit that will enable you to more efficiently troubleshoot the unit in the event that a trouble develops. During troubleshooting work, you should correlate information contained in this section with information obtained from other sections in this manual. We have not attempted to give detailed step-by-step procedures for finding the cause of specific troubles. We have, instead, attempted to outline a general troubleshooting guide which can be used to locate any trouble which may occur in the instrument. This guide provides a means for determining the cause of a trouble from symptoms observed rather than from detailed voltage or resistance measurements.

In general, a troubleshooting procedure can be thought of as consisting of two parts, circuit isolation and circuit troubleshooting. The first step involves isolating a trouble to a definite circuit. When the trouble has been isolated, detailed checks will then allow you to determine which part or parts are causing the trouble. Both circuit isolation and circuit troubleshooting are covered in detail in the following paragraphs.

In the following troubleshooting procedures, it is assumed that the oscilloscope used with the Q Unit is operating correctly. This is not always the case. If you are in doubt, you

should check operation of the oscilloscope before attempting to troubleshoot the Q Unit. Troubles occurring in the oscilloscope can usually be detected by substituting another plug-in unit for the Q Unit and checking for proper operation.

A schematic diagram of the Q Unit is contained in the rear portion of this manual together with a block diagram. The reference designation of each section is shown on the circuit diagrams as well as important voltages and waveforms. These voltages and waveforms should be used as troubleshooting aids.

Switch wafers shown on the schematic diagram are coded to indicate the position of the wafer on the actual switch. The number portion of the code refers to the wafer number on the switch assembly, wafers being numbered from the front of the switch to the rear. The letters F and R indicate whether the front or the rear of the wafer is used to perform the particular switching function.

All wiring used in the Q Unit is color coded to facilitate circuit tracing. In addition, filament and power-supply leads are distinguishable by specific color codes. All power supply leads follow the standard RETMA code. For example, the —150-volt lead is coded brown-green-brown. The widest stripe identifies the first color of the code.

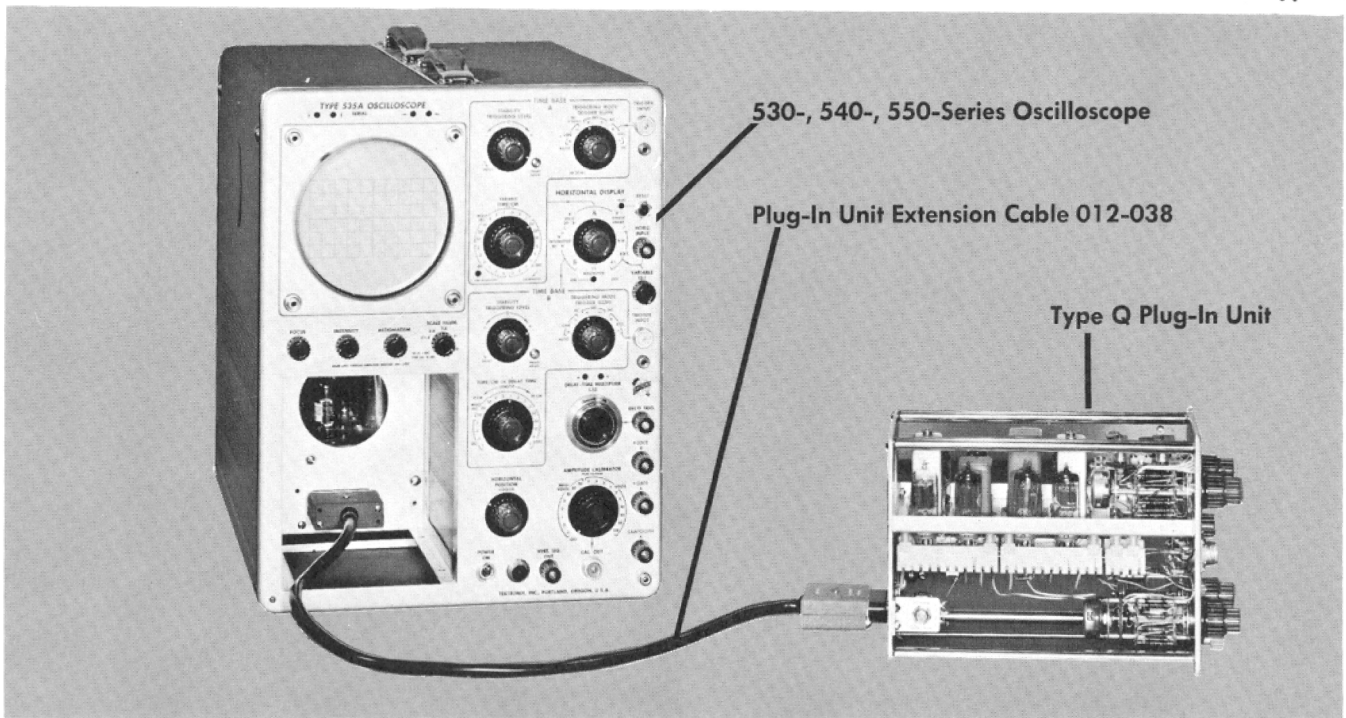

Fig. 5-1. Bench setup for maintenance or calibration of the Q Plug-In Unit.

Before attempting any troubleshooting work, you should check all front panel controls for proper settings. If all controls are set properly, insure that the transducer is connected to the Q Unit according to the information given in the Operating Information section of this manual. If there

is any doubt that the transducer is connected properly, disconnect the transducer and check operation of the Q Unit using the internal bridge circuit. Before making this check, be certain that the 120 ohm internal bridge resistor is in place.

CIRCUIT ISOLATION

A good procedure to follow when troubles occur in the Q Unit is to make a careful visual check of the unit and external connections. Many troubles can be detected most easily by visual means. If a visual check of the unit does not indicate the cause of trouble, reinsert the unit in the oscilloscope and adjust the front panel controls to see the effect of each. The normal or abnormal operation of each control will allow you to firmly establish the trouble symptoms in your mind. Once the symptoms are clearly determined, the faulty circuit can usually be detected without much difficulty.

The Q Unit consists basically of the circuits shown in the block diagram at the rear of this manual. Each of these circuits performs a specific part of the unit's overall operation. If any circuit should fail, a definite symptom of this failure will be apparent. It is the purpose of this portion of the troubleshooting procedure to allow you to localize the trouble to one of the blocks on the block diagram. After locating the defective circuit, additional checks will enable you to isolate the trouble to a particular part.

To isolate the trouble to a circuit, first look for the obvious indications. Check that the front panel indicators light when the controls are operated; feel for any irregularities in the operation of the controls; and check that the tubes are heating. The type of trouble will generally indicate the

checks to make. If these checks fail to isolate the trouble, use the internal bridge circuit to check operation of the unit.

Due to the nature of the Q Unit, most troubles which may occur can be isolated immediately to a circuit by using the trouble symptoms. If some doubt remains as to which circuit is defective, check the output of each suspected circuit in accordance with the information given below.

Oscillator Circuit

The output of the oscillator circuit should be checked at the two secondary windings of T5779. Voltages and waveforms are shown on the schematic diagram at the rear of the manual. The output of the oscillator should be a pure sine wave with amplitudes as shown on the schematic diagram. To check regulation of the circuit, connect a test oscilloscope to terminal 6 of T5779. Switch the EXT. ARMS switch between positions 0 and 4 while observing the output waveform on a test oscilloscope. There should be essentially no change in the amplitude of the oscillator output.

Input Bridge and Amplifier

Since signal voltages out of the bridge circuit are frequently very low in amplitude, it is inconvenient to check the bridge circuit alone. Consequently the bridge circuit and the

Maintenance — Type Q

amplifier should be checked together. By placing the FUNCTION switch in the BALANCE position, the output of the amplifier circuit is displayed on the screen of the oscilloscope used with the unit.

To check the bridge and amplifier, first check to see if the bridge will balance using the BALANCE controls. With the bridge balanced, virtually no signal should be displayed on the associated oscilloscope. Indications observed will indicate whether the trouble is in either the bridge or the amplifier. If the bridge does not balance, the bridge circuit is probably defective. If no signal is observed on the oscilloscope with any settings of the BALANCE controls, the amplifier is probably at fault.

Unbalance the bridge circuit a slight amount using the BALANCE controls and observe the sine wave at pin 6 of V5754B using a test oscilloscope. Any distortion of the sine wave will indicate a trouble in the amplifier circuit. Next run through all ranges of the μ STRAIN/DIV. control while observing the sine wave amplitude on the oscilloscope used with the Q Unit. Start at the 10 μ strain per division range and adjust the balance controls for an even number of divisions of trace deflection. Switch to the 20 μ strain per division and check to see that the deflection is halved. Readjust the balance controls to obtain 5 divisions of deflection then switch to the 50 μ strain per division range and check to see that there is 2 divisions of trace deflection. Again readjust the balance controls and check the next range step.

Continue in this manner until all of the range steps of the attenuator have been checked.

Demodulator and Filter

Troubles which do not show up in checks on the oscillator, bridge, and amplifier, probably are located in either the demodulator or the filter circuit. It will be apparent which of the two circuits is causing the difficulty. If you desire to double-check however, you can check operation of the demodulator as follows.

To check the demodulator, place the FUNCTION switch in the INST. ZERO position and center the trace on the screen. Using a dc voltmeter, measure the voltage across R6721 and R6723. The voltage across each of the resistors should be approximately 2.25 volts dc. Place the FUNCTION switch in the BALANCE position and unbalance the bridge resistively until a small signal is displayed on the associated oscilloscope. Place the FUNCTION switch at OPERATE and observe the trace. The trace should shift vertically as the switch is positioned, but should remain on the screen. While observing the position of the trace, adjust the PHASE ADJ. control. As the control is adjusted, the trace should move to a maximum or minimum point and then start to return. If any of these normal indications do not occur, the demodulator is operating incorrectly.

CIRCUIT TROUBLESHOOTING

The most common cause of troubles in the Q Unit is vacuum tube failures. For this reason, the first step in troubleshooting a circuit is to check for defective tubes—preferably by direct substitution. Do not depend on tube testers to adequately indicate the suitability of a tube for use in the unit. The criterion for usability of a tube is whether or not it works satisfactorily in the instrument. Be sure to return any tubes found to be good to their original sockets.

If tube substitution does not correct the trouble, you will have to perform detailed troubleshooting of the circuit. Information for troubleshooting each circuit is contained in the following paragraphs.

Oscillator Circuit

The oscillator circuit consists of two sections, the oscillator section (V5770 and V5784) and the regulator section (V5794 and D5782). Troubles in the oscillator section or the regulator section can be detected by checking the voltage and waveform at terminal 6 of T5779. Usually troubles which affect the amplitude of the output from the oscillator will be located in the regulator section. However, if the output is zero or very low, the trouble may also be in the oscillator section. Distortion of the output waveform generally results from troubles in the oscillator section.

If no output is obtained from the oscillator circuit, check the signal at the grids of V5784A and V5784B. Then if necessary check across the primary of T5779.

If the output of the oscillator circuit is abnormally high or low, check to see that the oscillator is regulating. This can be done as described in the Circuit Isolation portion of the troubleshooting procedure. If the circuit regulates, but not at the proper output voltage, check resistors R5780 and R5781 and diode D5782. If the circuit does not regulate, check the components associated with V5794A and V5794B.

Bridge Circuit

Troubles in the bridge circuit are generally indicated by a failure of the bridge to balance. If this occurs, first check to see that the EXT. ARMS switch is in the 0 position. Then make sure that the 120 ohm internal resistor R5702, is in place. If the unbalance still occurs, check operation of the BALANCE controls with the FUNCTION switch in the BALANCE position. This will generally indicate whether the resistance or capacitance balance circuits are inoperative. The defective part or parts can be found by ohmmeter checks.

Calibration signals for the Q Unit are produced by shunting one of the bridge resistors with a calibration resistor. If the calibration signal is incorrect, it will cause you to make an improper setting of the amplifier GAIN ADJ. control. If you experience any difficulty in adjusting the gain, check the value of the 150k calibration resistor.

Amplifier Circuit

Probably the best way to localize troubles in the amplifier is to observe the input and output of each stage on a test oscilloscope.

At the input stages, signal levels may be too low for you to observe on your test oscilloscope. In this case operation of the stages can be checked by comparing voltage measurements against dc voltages marked on the schematic diagram. By observing the input and output waveforms and voltages of each stage, the faulty stage can be determined. The defective part or parts can then be found by voltage and resistance measurements.

In order to apply a signal voltage to the amplifier, it is necessary to unbalance the bridge by a slight amount. This is done most easily using the BALANCE controls or the CALIBRATE button. The resulting signal can be checked at the output of each stage against the waveforms shown on the schematic diagram.

The attenuator and gain controls should be checked by observing the amplifier output displayed on the oscilloscope used with the Q Unit. This can be done by placing the FUNCTION switch at BALANCE. Each attenuator step should be checked by rotating the μ STRAIN/DIV. switch through all ranges while observing the displayed signal. The BALANCE controls can be adjusted to provide the proper amount of signal for each range. The GAIN ADJ. and VARIABLE controls can both be checked using the calibration signal. Both controls should smoothly vary the amplitude of the amplifier output signal.

Demodulator Circuit

The best way to troubleshoot the demodulator circuit is to follow the signal flow through the circuit. The first step should be to introduce a signal voltage to the demodulator by unbalancing the bridge. This can be done most easily by placing the FUNCTION switch at OPERATE and adjusting the RESISTANCE BALANCE controls.

The input cathode followers, V6713A and V6713B, should be checked by observing the signal at their cathodes. If these voltages are normal, place the FUNCTION switch at INST. ZERO and check the voltage across R6721 and R6723. The voltage across each resistor should be approximately 2.25 volts dc. If the voltages are not normal, check T6715 and rectifiers D6722 and D6732. Next place the FUNCTION switch at OPERATE and check the voltage between the grids of V6734A and V6734B while rotating the RESISTANCE BALANCE controls through the balance position. The voltage between the grids of V6734A and V6734B should decrease, pass through zero, then increase in the opposite polarity. This voltage change will normally be in the order of tenths of volts. If the proper voltages are not observed, check transformer T6715 and the rectifier, D6722 and D6732.

The voltage and voltage differential at the cathodes of V6734A and V6734B should be approximately equal to the grid voltages. Approximately the same voltages should also appear between pins 1 and 3 of the interconnecting plug. If ripple is observed on the oscilloscope trace, make sure that the two tuned circuits in the filter are tuned properly.

SECTION 6

INTERNAL ADJUSTMENTS

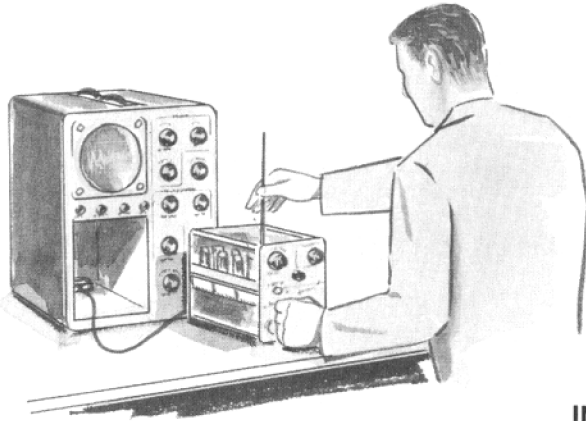

INTRODUCTION

Information contained in this section of the manual is provided as an aid to calibrating and checking the operation of the Type Q Plug-In Unit. In addition, this section may be used as an aid to isolating troubles occurring in the unit.

Apparent troubles in the unit are occasionally the result of improper calibration of one or more circuits. Consequently, calibration checks should be an integral part of any troubleshooting procedure. Abnormal indications occurring during calibration checks will often aid in isolating troubles to a definite circuit or stage.

In the instructions that follow, the steps are arranged in the proper sequence for a complete calibration of the unit. Each numbered step contains the information required to make one check or adjustment. The steps are arranged to avoid unnecessary repetition of checks or adjustments.

In each calibration step only the required information is given. Detailed instructions pertaining to normal operation of the instrument are not included. If you are in doubt as to the proper operation of controls, refer to the Operating Information section of this manual.

EQUIPMENT REQUIRED

The following equipment or its equivalent is required to perform a complete calibration of the Type Q Plug-In Unit.

1. Tektronix Type 530-, 540-, or 550-Series Oscilloscope. The oscilloscope must be properly calibrated.
2. One 150 k calibration resistor (supplied with the unit).
3. One 120 ohm internal bridge resistor (supplied with the unit).
4. Test oscilloscope. Virtually any oscilloscope with calibrated vertical deflection factors may be used.
5. Flexible plug-in extension cable, Tektronix Part Number 012-038.
6. DC Voltmeter.

7. Resistance Bridge (required only if you wish to check the accuracy of the attenuator resistors).

8. Adjustment tools shown in Fig. 6-1.

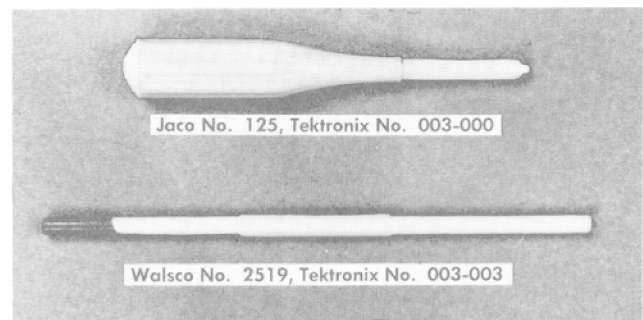

Fig. 6-1. Suggested calibration tools.

PRELIMINARY PROCEDURE

Connect the 150 k calibration resistor and the 120 ohm internal bridge resistor to the terminals provided. Using the flexible plug-in extension cable, connect the Q Unit to the oscilloscope. Turn on the power and allow at least 15 min-

utes of warm up time. Adjust the oscilloscope controls for automatic triggering and a sweep speed of 20 microseconds per centimeter.

ADJUSTMENT PROCEDURE

1. VERT. POS. RANGE

This adjustment is made to bring the VERTICAL POSITION control into proper range. To make the adjustment, place the FUNCTION switch at INST. ZERO and set the VERTICAL POSITION control at midrange. Adjust the VERT. POS. RANGE control to vertically center the trace on the oscilloscope screen.

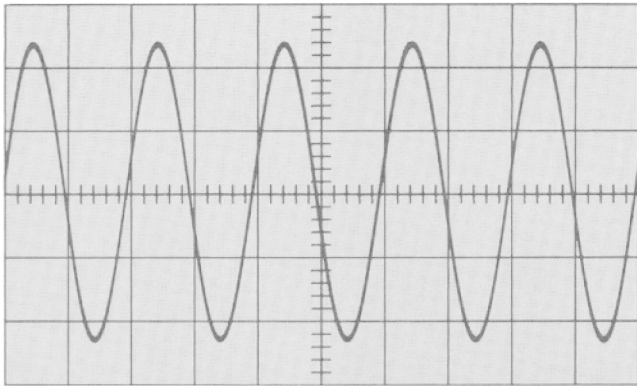

Fig. 6-2. Adjustment of the oscillator frequency. When the oscillator frequency is 25 kc and the oscilloscope sweep is set at 20 microseconds per division, there will be five complete cycles per 10 divisions as shown in the waveform above.

2. Oscillator Frequency

The frequency of the Q Unit Oscillator is adjusted by means of L5773. When the coil is properly adjusted, the oscillator frequency is approximately 25 kc.

Place the FUNCTION switch at BALANCE, and adjust the BRIDGE BALANCE controls for approximately 3 divisions of vertical deflection. Adjust L5773 to obtain 5 cycles per 10 centimeters on the oscilloscope. It may be necessary to reset the BRIDGE BALANCE controls as this adjustment is made to maintain the desired signal amplitude.

3. Check the Oscillator Output and Regulation

The output voltage from the oscillator to the bridge circuit should be checked for proper amplitude and regulation. The amplitude of the oscillator output can be checked at terminal 6 of T5779 using the test oscilloscope. The regulation of the output can be checked by observing the output on the test oscilloscope while varying the load on the output.

Connect the test oscilloscope to pin 6 of T5779. The voltage at this point should be approximately 20 volts peak-to-peak. While observing this voltage, rotate the EXT. ARMS switch through all of its positions. There should be no appreciable change in the signal amplitude. Return the EXT. ARMS switch to the 0 position.

4. PHASE ADJ.

Complete instructions for setting the PHASE ADJ. control are contained in the Operating Information section of this manual. However, for convenience, a portion of this procedure is repeated here. Under normal conditions, the PHASE ADJ. control is set with the actual transducer con-

nected to the unit. The procedure described here is only for use with the internal bridge circuit.

The primary reason for setting the PHASE ADJ. control is to insure that the carrier is added to the sidebands in the demodulator circuit in the proper phase. This adjustment must be made before adjusting the filter traps in the following steps.

Place the FUNCTION switch at BALANCE, and balance the bridge. Set the μ STRAIN/DIV. controls at 100, CALIBRATED, and place the FUNCTION switch at OPERATE. Depress the CALIBRATE button, and adjust the PHASE ADJ. control to obtain maximum negative vertical deflection of the oscilloscope trace.

5. Check Demodulator Balance

To check the demodulator for proper balance, place the FUNCTION switch at INST. ZERO. Using a dc voltmeter check the voltage across resistor R6721 and R6723 (see Fig. 6-3). The voltage across each resistor should be approximately 2.25 volts.

6. Check Demodulator and Oscilloscope Linearity

This procedure is intended to check the linearity of the demodulator output. However, since the output of the demodulator is applied to the vertical deflection system of the associated oscilloscope, the procedure checks the linearity of both the demodulator and the oscilloscope.

To make the check, first balance the bridge circuit. Place the FUNCTION switch at OPERATE and the POLARITY switch at NORMAL. Center the trace on the oscilloscope screen then push the CALIBRATE button. Adjust the μ STRAIN/DIV. controls until the trace is at the bottom of the

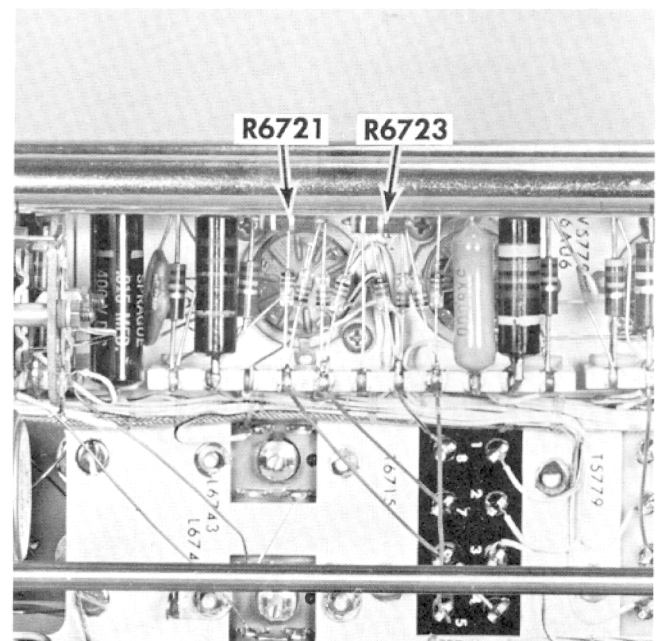

Fig. 6-3. Bottom view of the plug-in unit showing the locations of R6721 and R6723.

screen. Set the POLARITY switch at INVERTED and check that the trace is at the top of the screen. The trace should be the same distance from the centerline in both positions of the POLARITY switch.

7. Prototype Filter Section

The inductance of the prototype filter section is adjusted with the slug of L6743. The adjustment is made by running the slug almost completely into the coil to provide maximum inductance. Since the position of the slug is not critical, the adjustment should not be necessary unless the slug is accidentally rotated out of the coil. It is not necessary to adjust the coil each time the unit is calibrated.

8. 50Kc Filter Trap

The 50 kc filter trap consists of L6741 and C6741. Adjustment of L6741 is made to tune the circuit to resonance at 50 kc, thereby blocking undesirable 50 kc signals which would otherwise be applied to the oscilloscope.

Rotate the VERTICAL POSITION control fully counterclockwise and set the FUNCTION switch at OPERATE. Set the POLARITY switch at NORMAL, and adjust the RESISTANCE BALANCE controls to position the trace to the center of the oscilloscope screen. Set the oscilloscope for a sweep speed of .1 milliseconds per division. Adjust L6741 and L6745 to eliminate, as nearly as possible, all ripple appearing on the oscilloscope screen.

9. 25Kc Filter Trap

To eliminate 25 kc components appearing in the output of the Q Unit, a 25 kc filter consisting of L6745 and C6745 is used. The circuit is tuned by means of L6745 to a resonant point at 25 kc.

Place the FUNCTION switch at BALANCE and adjust the BRIDGE BALANCE controls to produce approximately 3 divisions of vertical deflection. Adjust L6745 to obtain maximum displayed signal. If necessary, readjust the BRIDGE BALANCE controls to keep the deflection on screen as the adjustment is made.

10. GAIN ADJ.

Complete information for setting the GAIN ADJ. control is contained in the Operating Information section of this manual and only adjustment with the internal bridge circuit will be covered here. In this procedure calibration is made for a 120 ohm strain gage with a gage factor of 2.

The GAIN ADJ. control is set to provide the correct amount of vertical trace deflection for a given amount of strain. To make the adjustment, place the μ STRAIN/DIV. controls at 100 CALIBRATED, and set the PHASE ADJ. control as described in step 4. Depress the CALIBRATE button and adjust the GAIN ADJ. control for exactly 4 major divisions of vertical trace deflection.

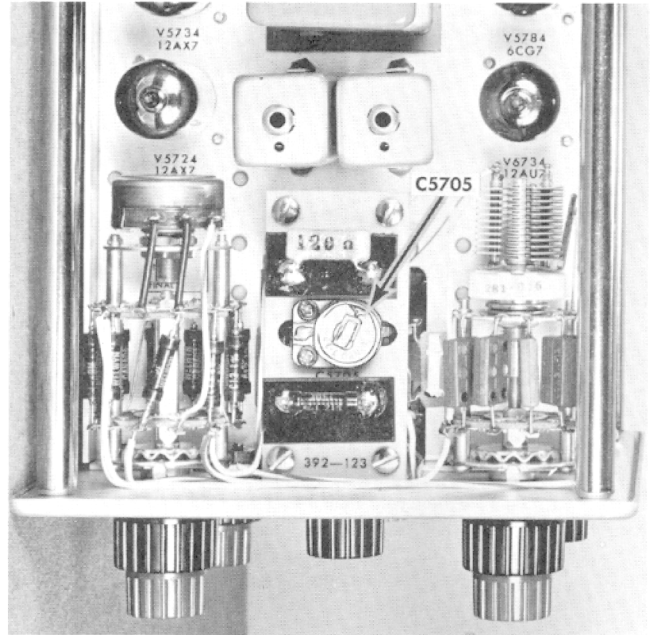

Fig. 6-4. Top view of the plug-in unit showing the location of C5705.

11. C5705

Capacitor C5705 is used to insure that no unwanted capacitive bridge unbalance is introduced when the calibrate button is depressed. When properly adjusted, equal amounts of capacitance will be introduced in one bridge arm in either position of the switch.

Remove the calibration resistor from the unit and balance the bridge circuit. With the μ STRAIN/DIV. controls at 10, CALIBRATED, depress the CALIBRATE button. Adjust C5705 until a minimum of vertical trace shift occurs between the CALIBRATE switch positions. It is normal for the trace to shift slightly in the intermediate switch position. Disregard this and observe only the position of the trace when the CALIBRATE button is fully depressed and fully released.

PARTS LIST ABBREVIATIONS

BHB	binding head brass	int	internal
BHS	binding head steel	lg	length or long
cap.	capacitor	met.	metal
cer	ceramic	mtg hdw	mounting hardware
comp	composition	OD	outside diameter
conn	connector	OHB	oval head brass
CRT	cathode-ray tube	OHS	oval head steel
csk	countersunk	PHB	pan head brass
DE	double end	PHS	pan head steel
dia	diameter	plstc	plastic
div	division	PMC	paper, metal cased
elect.	electrolytic	poly	polystyrene
EMC	electrolytic, metal cased	prec	precision
EMT	electrolytic, metal tubular	PT	paper, tubular
ext	external	PTM	paper or plastic, tubular, molded
F & I	focus and intensity	RHB	round head brass
FHB	flat head brass	RHS	round head steel
FHS	flat head steel	SE	single end
Fil HB	fillister head brass	SN or S/N	serial number
Fil HS	fillister head steel	SW	switch
h	height or high	TC	temperature compensated
hex.	hexagonal	THB	truss head brass
HHB	hex head brass	thk	thick
HHS	hex head steel	THS	truss head steel
HSB	hex socket brass	tub.	tubular
HSS	hex socket steel	var	variable
ID	inside diameter	w	wide or width
incd	incandescent	WW	wire-wound



PARTS ORDERING INFORMATION

Replacement parts are available from or through your local Tektronix, Inc. Field Office or representative.

Changes to Tektronix instruments are sometimes made to accommodate improved components as they become available, and to give you the benefit of the latest circuit improvements developed in our engineering department. It is therefore important, when ordering parts, to include the following information in your order: Part number, instrument type or number, serial or model number, and modification number if applicable.

If a part you have ordered has been replaced with a new or improved part, your local Tektronix, Inc. Field Office or representative will contact you concerning any change in part number.

SPECIAL NOTES AND SYMBOLS

- ×000 Part first added at this serial number
- 00× Part removed after this serial number
- *000-0000-00 Asterisk preceding Tektronix Part Number indicates manufactured by or for Tektronix, Inc., or reworked or checked components.
- Use 000-0000-00 Part number indicated is direct replacement.
-  Screwdriver adjustment.
-  Control, adjustment or connector.

SECTION 7

ELECTRICAL PARTS LIST

Values are fixed unless marked Variable.

Ckt. No.	Tektronix Part No.	Serial/Model No. Eff Disc	Description		
Bulbs					
B5730	150-0018-00		GE 12 Uncalibrated		
B6711	150-0018-00		GE 12 Non-Operate		
Capacitors					
Tolerance $\pm 20\%$ unless otherwise indicated.					
C5705	281-0007-00		3-12 pF, Var	Cer	
C5710	281-0046-00		5-80 pF, Var	Cer	
C5711A	283-0503-00		56 pF	Mica	10%
C5711C	283-0503-00		56 pF	Mica	10%
C5711E	283-0503-00		56 pF	Mica	10%
C5711G	283-0503-00		56 pF	Mica	10%
C5711J	283-0503-00		56 pF	Mica	10%
C5711L	281-0515-00		27 pF	Cer	500 V
C5720	283-0000-00		0.001 μ F	Cer	500 V
C5723	283-0068-00	X1510	0.01 μ F	Cer	500 V
C5724	Use 285-0566-00		0.022 μ F	PTM	200 V
C5728	283-0002-00		0.01 μ F	Cer	500 V
C5736	283-0002-00		0.01 μ F	Cer	500 V
C5737	283-0002-00		0.01 μ F	Cer	500 V
C5738	283-0006-00		0.02 μ F	Cer	500 V
C5742	281-0546-00		330 pF	Cer	500 V
C5743	281-0546-00		330 pF	Cer	500 V
C5746	281-0546-00		330 pF	Cer	500 V
C5747	281-0546-00		330 pF	Cer	500 V
C5755	Use 285-0566-00		0.022 pF	PTM	200 V
C5757	283-0002-00		0.01 μ F	Cer	500 V
C5758	283-0006-00		0.02 μ F	Cer	500 V
C5772	283-0000-00		0.001 μ F	Cer	500 V
C5773	Use 285-0627-00		0.0033 μ F	PTM	100 V
C5774	283-0000-00		0.001 μ F	Cer	500 V
C5775	281-0623-00	X2250	650 pF	Cer	500 V
C5778	283-0004-00		0.02 μ F	Cer	150 V
C5779	283-0001-00		0.005 μ F	Cer	500 V
C5783	283-0000-00		0.001 μ F	Cer	500 V
C5793	283-0002-00		0.01 μ F	Cer	500 V

Electrical Parts List—Type Q

Capacitors (Cont)

Ckt. No.	Tektronix Part No.	Serial/Model No.		Description		
		Eff	Disc			
C5794	283-0002-00			0.01 μ F	Cer	500 V
C5798	283-0002-00			0.01 μ F	Cer	500 V
C6711	283-0000-00			0.001 μ F	Cer	500 V
C6716	281-0546-00			330 pF	Cer	500 V
C6718	283-0008-00			0.1 μ F	Cer	500 V
						10%
C6724	285-0501-00			0.001 μ F	PTM	600 V
C6736	Use 283-0057-00			0.1 μ F	Cer	200 V
C6740	Use 283-0057-00			0.1 μ F	Cer	200 V
C6741	285-0501-00			0.001 μ F	PTM	600 V
C6742	285-0512-00			0.015 μ F	PTM	400 V
C6743	285-0512-00			0.015 μ F	PTM	400 V
C6745	285-0506-00			0.0047 μ F	PTM	400 V
C6760	290-0025-00			6.25 μ F	Elect	300 V
C6761	283-0002-00			0.01 μ F	Cer	500 V
C6765	283-0002-00			0.01 μ F	Cer	500 V

Diodes

D5782	152-0008-00		T12G
D6722A	152-0008-00		T12G
D6722B	152-0008-00		T12G
D6722C	152-0008-00		T12G
D6722D	152-0008-00		T12G
D6732A	152-0008-00		T12G
D6732B	152-0008-00		T12G
D6732C	152-0008-00		T12G
D6732D	152-0008-00		T12G

Inductors

L5773	114-0123-00		6-12 mH, Var	Core not available separately
L6741	114-0123-00		6-12 mH, Var	Core not available separately
L6743	114-0123-00		6-12 mH, Var	Core not available separately
L6745	114-0123-00		6-12 mH, Var	Core not available separately
L6747	276-0507-00	X1310	0.6 μ H	Ferramic Suppressor
L6748	276-0507-00	X1310	0.6 μ H	Ferramic Suppressor

Resistors

Resistors are fixed, composition, $\pm 10\%$ unless otherwise indicated.

R5702 ¹	*310-0561-00		120 Ω	$\frac{1}{2}$ W	Prec	1%
R5704	*310-0561-00		120 Ω	$\frac{1}{2}$ W	Prec	1%
R5705 ²	Use *323-0649-00		150 k Ω	$\frac{1}{2}$ W	Prec	$\frac{1}{2}\%$
R5706	*310-0561-00		120 Ω	$\frac{1}{2}$ W	Prec	1%
R5708	*310-0561-00		120 Ω	$\frac{1}{2}$ W	Prec	1%

¹Located on Plug-in Resistor Board (013-0025-00).

²Located on Plug-in Resistor Board (013-0078-00).

Resistors (Cont)

Kct. No.	Tektronix Part No.	Serial/Model No. Eff	No. Disc	Description			
R5712A	309-0030-00			1.8 k Ω	1/2 W	Prec	1%
R5712C	309-0030-00			1.8 k Ω	1/2 W	Prec	1%
R5712E	309-0030-00			1.8 k Ω	1/2 W	Prec	1%
R5712G	309-0030-00			1.8 k Ω	1/2 W	Prec	1%
R5712J	309-0030-00			1.8 k Ω	1/2 W	Prec	1%
R5712L	309-0030-00			1.8 k Ω	1/2 W	Prec	1%
R5712N	309-0030-00			1.8 k Ω	1/2 W	Prec	1%
R5712Q	309-0030-00			1.8 k Ω	1/2 W	Prec	1%
R5712S	309-0030-00			1.8 k Ω	1/2 W	Prec	1%
R5712U	309-0030-00			1.8 k Ω	1/2 W	Prec	1%
R5714	311-0049-00			5 k Ω , Var			
R5716	309-0182-00			3 k Ω	1/2 W	Prec	1%
R5720	302-0473-00			47 k Ω	1/2 W		
R5722	316-0103-00	X1510		10 k Ω	1/4 W		
R5723	302-0273-00			27 k Ω	1/2 W		
R5724	302-0104-00			100 k Ω	1/2 W		
R5728	302-0104-00			100 k Ω	1/2 W		
R5730A	309-0100-00	101	2309	10 k Ω	1/2 W	Prec	1%
R5730A	323-0289-01	2310		10 k Ω	1/2 W	Prec	1/2%
R5730C	309-0099-00	101	2309	6 k Ω	1/2 W	Prec	1%
R5730C	323-0608-01	2310		6 k Ω	1/2 W	Prec	1/2%
R5730E	309-0098-00	101	2309	2 k Ω	1/2 W	Prec	1%
R5730E	323-0222-01	2310		2 k Ω	1/2 W	Prec	1/2%
R5730G	309-0115-00	101	2309	1 k Ω	1/2 W	Prec	1%
R5730G	323-0193-01	2310		1 k Ω	1/2 W	Prec	1/2%
R5730J	309-0097-00	101	2309	600 Ω	1/2 W	Prec	1%
R5730J	323-0607-01	2310		600 Ω	1/2 W	Prec	1/2%
R5730L	309-0073-00	101	2309	200 Ω	1/2 W	Prec	1%
R5730L	323-0126-01	2310		200 Ω	1/2 W	Prec	1/2%
R5730N	309-0112-00	101	2309	100 Ω	1/2 W	Prec	1%
R5730N	323-0097-01	2310		100 Ω	1/2 W	Prec	1/2%
R5730Q	309-0067-00	101	2309	60 Ω	1/2 W	Prec	1%
R5730Q	323-0606-01	2310		60 Ω	1/2 W	Prec	1/2%
R5730S	309-0064-00	101	2309	20 Ω	1/2 W	Prec	1%
R5730S	323-0030-01	2310		20 Ω	1/2 W	Prec	1/2%
R5730U	309-0064-00	101	2309	20 Ω	1/2 W	Prec	1%
R5730U	323-0030-01	2310		20 Ω	1/2 W	Prec	1/2%
R5733	Use 316-0104-00			100 k Ω	1/4 W		
R5734	302-0222-00			2.2 k Ω	1/2 W		
R5736	302-0562-00			5.6 k Ω	1/2 W		
R5737	302-0473-00			47 k Ω	1/2 W		
R5738	302-0184-00			180 k Ω	1/2 W		
R5741	301-0473-00			47 k Ω	1/2 W		5%
R5742	301-0303-00			30 k Ω	1/2 W		5%
R5743	301-0303-00			30 k Ω	1/2 W		5%

Electrical Parts List—Type Q

Resistors (Cont)

Ckt. No.	Tektronix Part No.	Serial/Model No. Eff	No. Disc	Description			
R5747	301-0153-00			15 kΩ	1/2 W		5%
R5753	302-0104-00			100 kΩ	1/2 W		
R5754	311-0175-00			5 kΩ, Var			
R5755	302-0274-00			270 kΩ	1/2 W		
R5756	302-0102-00			1 kΩ	1/2 W		
R5757	302-0473-00			47 kΩ	1/2 W		
R5758	302-0184-00			180 kΩ	1/2 W		
R5760	302-0332-00			3.3 kΩ	1/2 W		
R5761	311-0023-00			50 kΩ, Var			
R5771	302-0473-00			47 kΩ	1/2 W		
R5772	302-0683-00			68 kΩ	1/2 W		
R5775	302-0105-00			1 MΩ	1/2 W		
R5778	308-0052-00			6 kΩ	5 W	WW	5%
R5779	311-0016-00			10 kΩ, Var			
R5780	309-0193-00			25 kΩ	1/2 W	Prec	1%
R5781	309-0201-00	101	2689	2.85 kΩ	1/2 W	Prec	1/4%
R5781	323-0237-00	2690		2.87 kΩ	1/2 W	Prec	1%
R5784	309-0049-00			150 kΩ	1/2 W	Prec	1%
R5785	309-0093-00			4 MΩ	1/2 W	Prec	1%
R5793	302-0474-00			470 kΩ	1/2 W		
R5797	304-0184-00			180 kΩ	1 W		
R5798	302-0104-00			100 kΩ	1/2 W		
R6711	302-0104-00			100 kΩ	1/2 W		
R6714	302-0152-00			1.5 kΩ	1/2 W		
R6716	302-0103-00			10 kΩ	1/2 W		
R6718	306-0223-00			22 kΩ	2 W		
R6721	302-0392-00			3.9 kΩ	1/2 W		
R6723	302-0392-00			3.9 kΩ	1/2 W		
R6724	302-0183-00			18 kΩ	1/2 W		
R6726	311-0009-00	101	2679	2.25 kΩ, Var			
R6726	311-0474-00	2680		2 kΩ, Var			
R6727	302-0683-00			68 kΩ	1/2 W		
R6728	302-0683-00			68 kΩ	1/2 W		
R6734	304-0103-00			10 kΩ	1 W		
R6735	311-0016-00			10 kΩ, Var			
R6736	304-0103-00			10 kΩ	1 W		
R6745	302-0103-00			10 kΩ	1/2 W		
R6747	301-0182-00			1.8 kΩ	1/2 W		5%
R6748	302-0184-00			180 kΩ	1/2 W		
R6760	302-0101-00			100 Ω	1/2 W		

Switches

Wired or Unwired

SW5705		260-0016-00	CALIBRATE
SW5710	Wired	*262-0253-00	EXT. ARMS
SW5710		260-0289-00	EXT. ARMS
SW5711	Wired	*262-0252-00	CAPACITANCE
SW5711		260-0288-00	CAPACITANCE

Switches (Cont)

Ckt. No.		Tektronix Part No.	Serial/Model Eff	No. Disc	Description
SW5712	Wired	*262-0251-00			RESISTANCE
SW5712		260-0287-00			RESISTANCE
SW5730	Wired	*262-0254-00			μSTRAIN/DIV.
SW5730		260-0290-00			μSTRAIN/DIV.
SW6711	Wired	*262-0255-00			FUNCTION and POLARITY
SW6711		260-0291-00			FUNCTION and POLARITY

Transformers

T5779		*120-0146-00			Power Amp
T6715		*120-0147-00			Demodulator

Vacuum Tubes

V5724		154-0043-00			12AX7
V5734		154-0043-00			12AX7
V5754		154-0043-00			12AX7
V5770		154-0022-00	101	2269	6AU6
V5770		154-0022-07	2270		8425
V5784		154-0134-00			6CG7
V5794		154-0043-00			12AX7
V6713		154-0041-00			12AU7
V6734		154-0041-00			12AU7

SECTION 8

MECHANICAL PARTS LIST

A list of abbreviations and symbols used in this section will be found immediately preceding Section 7. Parts ordering information is also located immediately preceding Section 7.

FRONT

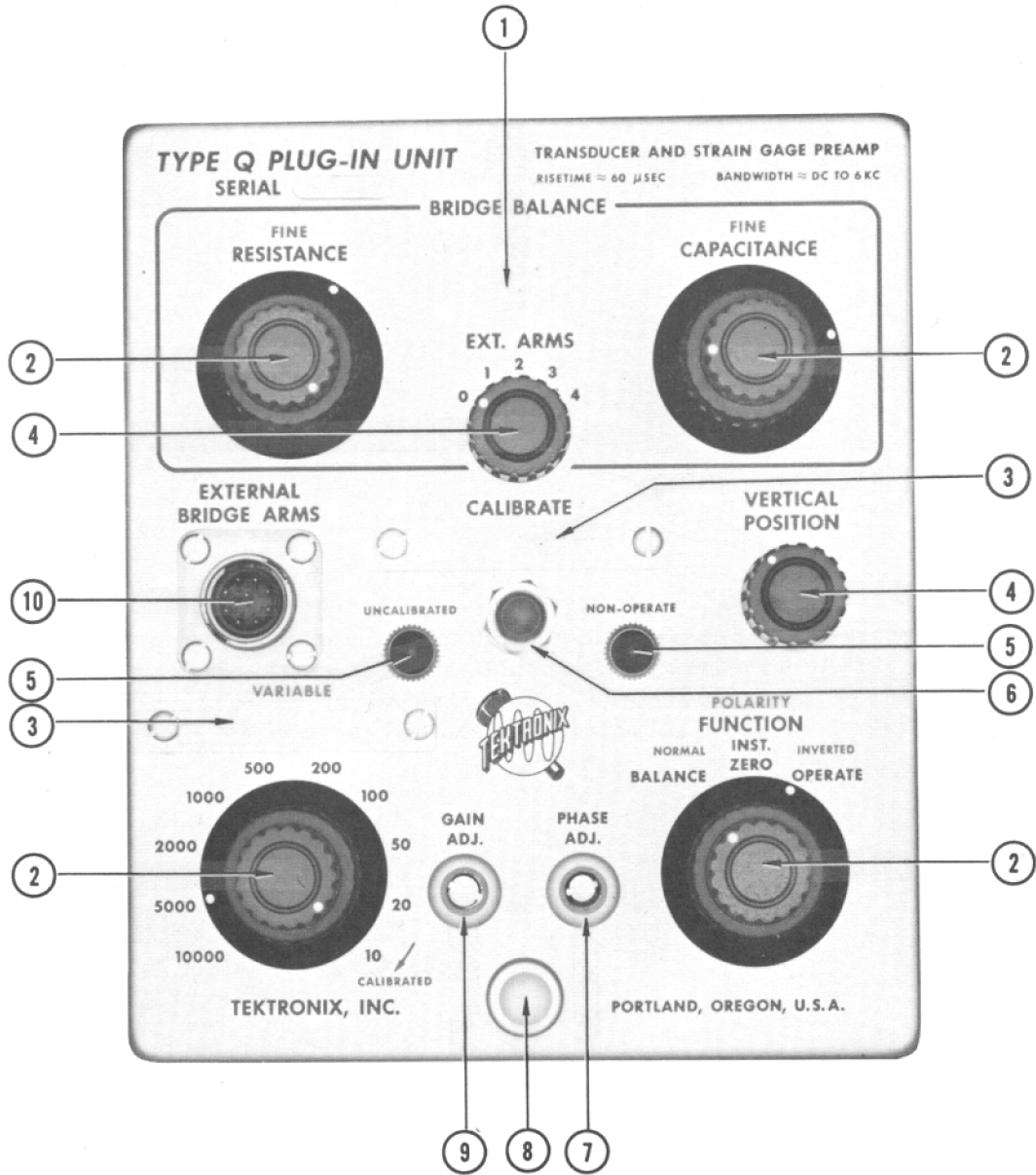

FRONT

REF. NO.	PART NO.	SERIAL/MODEL NO.		QTY.	DESCRIPTION
		EFF.	DISC.		
1	333-0570-00 386-0977-00			1	PANEL, front
2	366-0040-00 366-0160-00 366-0038-00 210-0413-00 210-0840-00 210-0012-00 210-0013-00	101 2040	2039	1 4 4 4 4 4 3 1	PLATE, subpanel, alum. KNOB, large black KNOB, large black KNOB, small red NUT, hex, 3/8-32 x 1/2 inch WASHER, .390 ID x 9/16 OD x .020 inch LOCKWASHER, external #2 LOCKWASHER, internal 3/8 x 11/16 inch
3	387-0006-00 211-0011-00			2	PLATE, cover title, clear plastic
4	366-0044-00 366-0113-00 210-0413-00 210-0840-00 210-0207-00 210-0012-00	101 2040 X2680	2039	2 2 2 2 1 1 1 1 2	KNOB, small black KNOB, small black NUT, hex, 3/8-32 x 1/2 inch WASHER, .390 ID x 9/16 OD x .020 LUG, solder, pot, plain, 3/8 inch LOCKWASHER, internal, 3/8 x 1/2 inch SOCKET, light, w/#14L red jewel assembly
5	136-0047-00			1	NUT, hex, 3/8-32 x 1/2 inch
6	210-0413-00 210-0840-00 210-0012-00 210-0207-00			1 1 1 1	WASHER, .390 ID x 9/16 OD x .020 inch LOCKWASHER, pot, internal 3/8 x 1/2 inch LUG, solder, SE10, long
7	358-0010-00 210-0013-00 385-0158-00			1 1 1	BUSHING, alum., 3/8-32 x 9/16 x .412 inch LOCKWASHER, internal 3/8 x 11/16 inch ROD, alum., hex, 1/2 x 1 5/16 inch
8	366-0056-00 366-0125-00 210-0894-00	101 570	569	1 1 1	KNOB, small gray KNOB, plug-in securing, alum. WASHER, polyethylene, .190 ID x 7/16 OD x 1/32 inch
9	358-0010-00 210-0013-00 210-0494-00			1 1 1	BUSHING, alum., 3/8-32 x 9/16 x .412 inch LOCKWASHER, internal 3/8 x 11/16 inch NUT, hex, 3/8-32 x 1/2 x 11/16 inch
10	136-0077-00 211-0012-00 210-0004-00 210-0201-00 210-0406-00			1 4 3 1 4	SOCKET, 9 pin SCREW, 4-40 x 3/8 inch, BHS LOCKWASHER, internal #4 LUG, solder, SE4 NUT, hex, 4-40 x 3/16 inch

LEFT SIDE

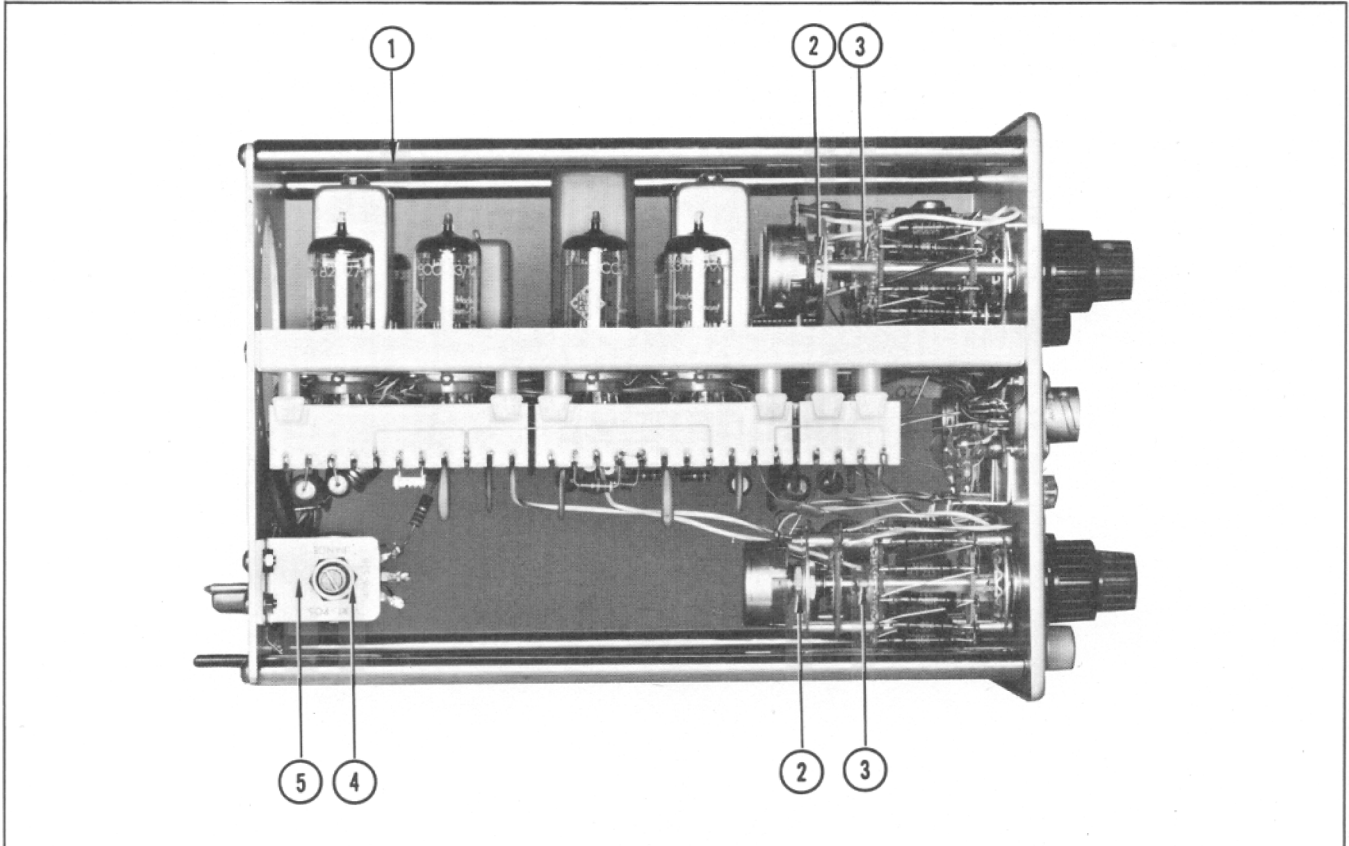

REF. NO.	PART NO.	SERIAL/MODEL NO.		QTY.	DESCRIPTION
		EFF.	DISC.		
1	384-0508-00	101	1769	4	ROD, frame, 3/8 x 8 7/8 inch
	384-0631-00	1770		4	ROD, frame, 3/8 x 8 7/8 inch
	212-0043-00	101	1859X	4	SCREW, 8-32 x 1/2 inch, FHS, phillips, 100°
2	212-0044-00			4	SCREW, 8-32 x 1/2 inch, FHS, phillips
	210-0413-00			4	NUT, hex, 3/8-32 x 1/2 inch
3	210-0012-00			1	LOCKWASHER, pot, internal 3/8 x 1/2 inch
	384-0100-00			2	ROD, extension, 1/8 x 3 inch
4	376-0014-00			2	COUPLING, pot, wire
	210-0413-00			1	NUT, hex, 3/8-32 x 1/2 inch
5	210-0840-00			1	WASHER, .390 ID x 9/16 OD x .020 inch
	406-0528-00			1	BRACKET, alum.
	211-0507-00			2	SCREW, 6-32 x 5/16 inch, BHS
	210-0006-00			2	LOCKWASHER, internal #6
	210-0407-00			2	NUT, hex, 6-32 x 1/4 inch

REAR

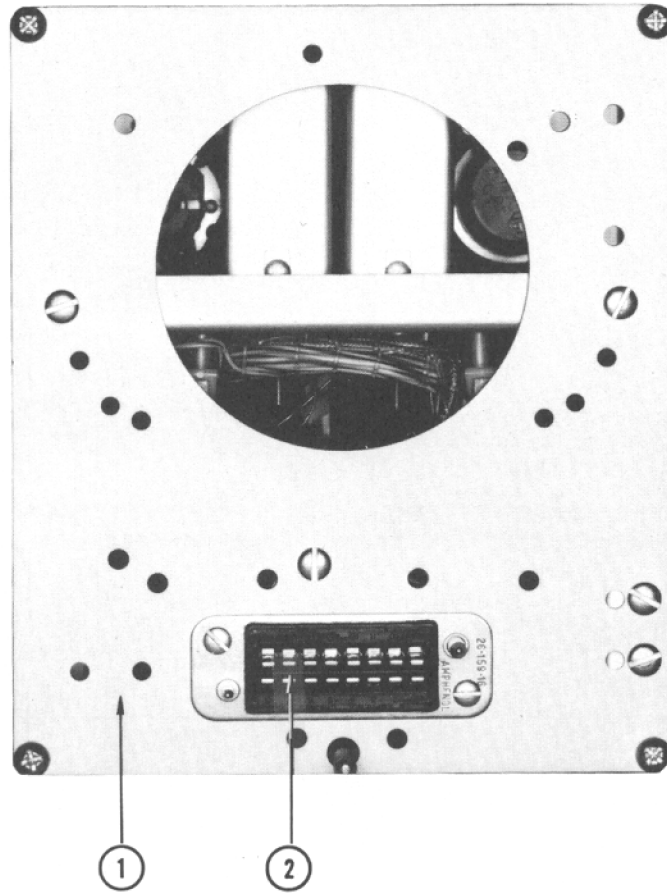

REF. NO.	PART NO	SERIAL NO.		QTY.	DESCRIPTION
		EFF.	DISC.		
1	387-529			1	PLATE, alum., rear, 5 ¹¹ / ₃₂ x 6 ¹¹ / ₃₂ inch
2	131-017			1	CONNECTOR, chassis mount, 16 pin
	211-008			2	SCREW, 4-40 x 1/4 inch, BHS
	210-201			2	LUG, solder, SE4
	210-406			2	NUT, hex, 4-40 x 3/16 inch

Mechanical Parts List—Type Q

TOP

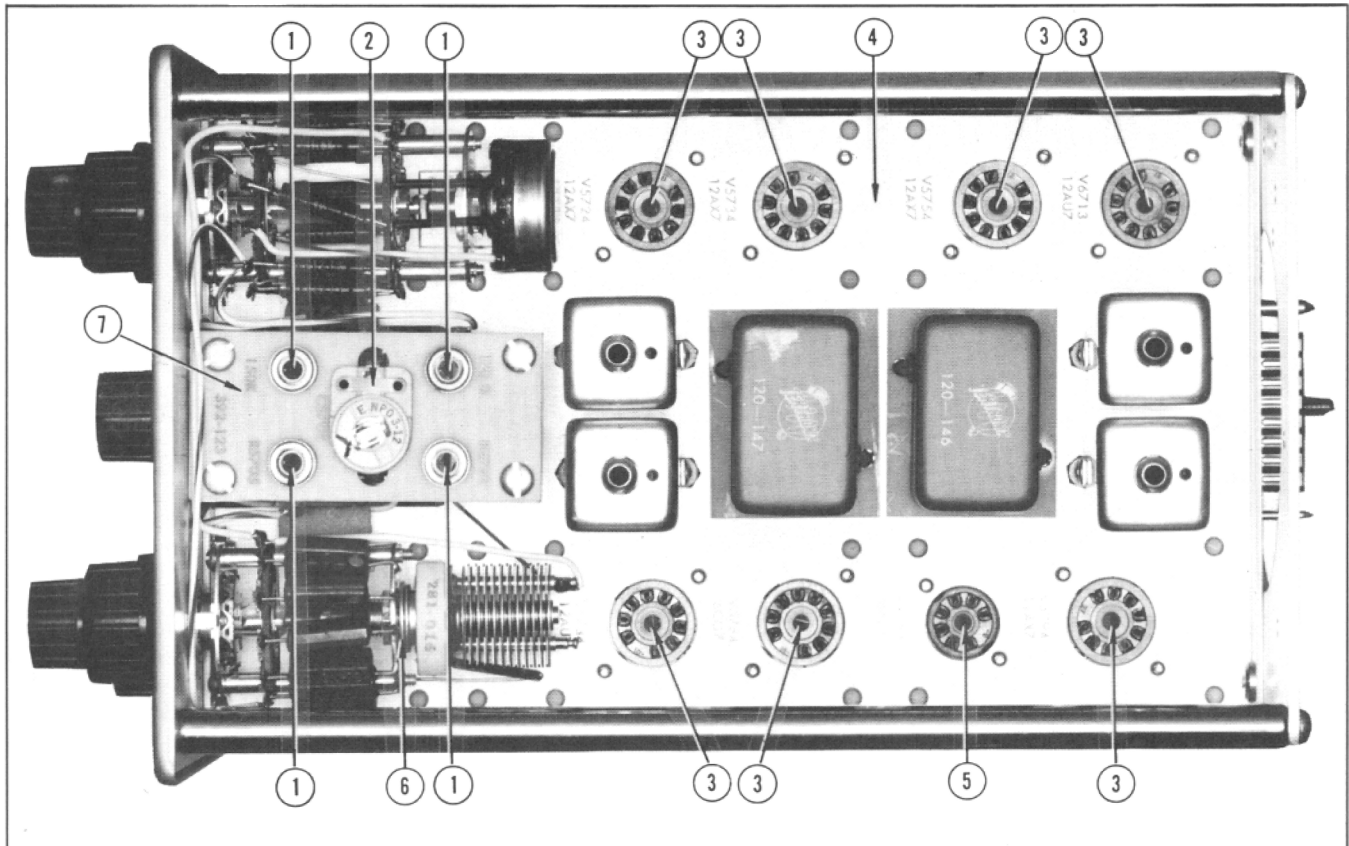

REF. NO.	PART NO.	SERIAL/MODEL NO.		QTY.	DESCRIPTION
		EFF.	DISC.		
1	129-0053-00 355-0507-00 200-0103-00 210-0011-00 210-0223-00 210-0455-00 013-0025-00 013-0026-00 013-0078-00	101 1770	1769	4 - 1 1 4 4 8 1 1 1	POST, binding, assembly - Includes: STEM, binding post CAP, binding post LOCKWASHER, , internal 1/4 inch LUG, solder, lock, 1/4 inch hole NUT, hex, 1/4-28 x 3/8 x 3/32 inch FASTENER, snap, double pronged PLUG-IN RESISTOR BOARD, 120 Ω (not shown) PLUG-IN RESISTOR BOARD, 150 k (not shown)
2	214-0153-00			1	PLUG-IN RESISTOR BOARD, 150 k (not shown)
3	136-0015-00 213-0044-00			7 14	SOCKET, STM9G SCREW, thread cutting, 5-32 x 3/16 inch, PHS, phillips
4	441-0278-00 211-0559-00 210-0457-00 211-0504-00			1 4 4 2	CHASSIS SCREW, 6-32 x 3/8 inch, FHS, phillips, 100° CSK NUT, keps, 6-32 x 5/16 inch SCREW, 6-32 x 1/4 inch, BHS
5	136-0008-00 213-0044-00			1 2	SOCKET, STM7, shielded SCREW, thread cutting, 5-32 x 3/16 inch, PHS, phillips
6	210-0413-00 210-0018-00 210-0807-00			1 1 1	NUT, hex, 3/8-32 x 1/2 inch LOCKWASHER, 5/16 inch WASHER, 5/16 ID x 5/8 OD x .050 inch
7	392-0123-00 406-0512-00 406-0530-00 211-0507-00 210-0006-00 210-0407-00 211-0507-00 210-0202-00			1 1 1 4 4 1 2 1	BOARD, terminal, 3/32 x 27/8 x 1 3/8 inch BRACKET, alum., switch mounting BRACKET, alum., switch SCREW, 6-32 x 5/16 inch, BHS LOCKWASHER, internal #6 NUT, hex, 4-40 x 3/16 inch SCREW, 6-32 x 5/16 inch, BHS LUG, solder, SE6, w/2 wire holes

BOTTOM

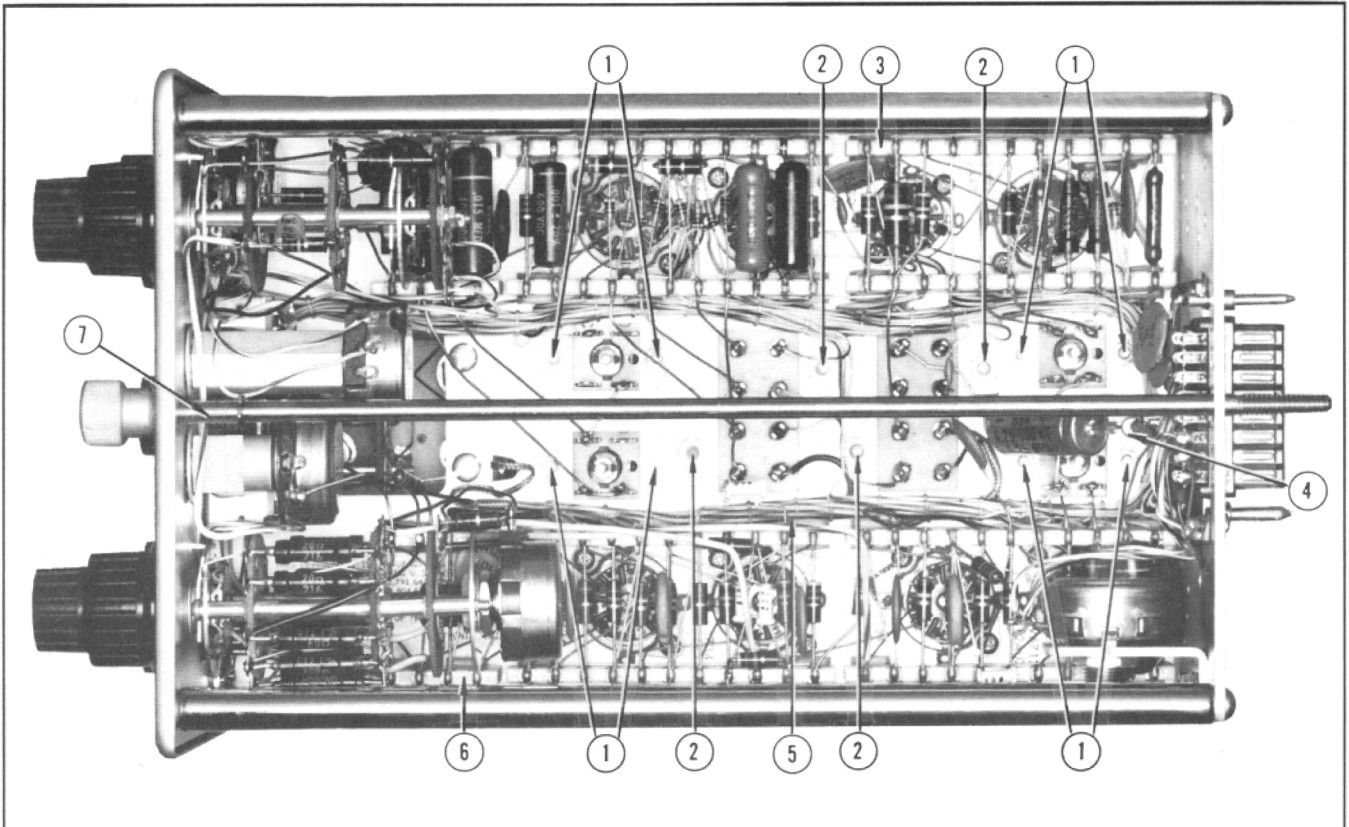

REF. NO.	PART NO.	SERIAL/MODEL NO.		QTY.	DESCRIPTION
		EFF.	DISC.		
1	210-0406-00 210-0004-00			8	NUT, hex, 4-40 x 3/16 inch
2	210-0407-00 210-0006-00 210-0202-00			8 4 3	LOCKWASHER, internal #4 NUT, hex, 6-32 x 1/4 inch LOCKWASHER, internal #6
3	124-0091-00 361-0009-00			1 8	LUG, solder, SE6, w/2 wire holes STRIP, ceramic, 3/4 inch x 11 notches, clip mounted
4	131-0022-00 211-0507-00 210-0006-00 210-0407-00			16 1 1 1	SPACER, nylon, for ceramic strip CONNECTOR, terminal, tie point, 1 point SCREW, 6-32 x 5/16 inch, BHS LOCKWASHER, internal #6
5	179-0373-00			1	NUT, hex, 6-32 x 1/4 inch CABLE, harness
6	124-0088-00 361-0009-00			4 8	STRIP, ceramic, 3/4 inch x 4 notches, clip mounted SPACER, nylon, for ceramic strip
7	384-0510-00 - - - - - 354-0025-00			1 - 1	ROD, securing rod includes: RING, retaining, #18 securing

STANDARD ACCESSORIES

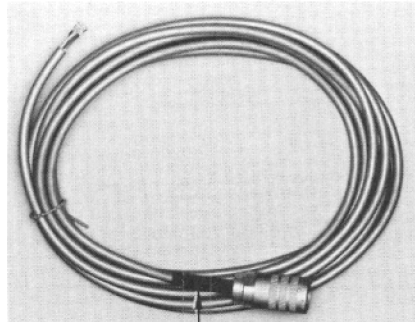

1

REF. NO.	PART NO.	SERIAL/MODEL NO.		QTY.	DESCRIPTION
		EFF.	DISC.		
1	012-0040-00			1	INTERCONNECTING CABLE, 4 cond.
--	070-0199-00			2	MANUAL, instruction (not shown)

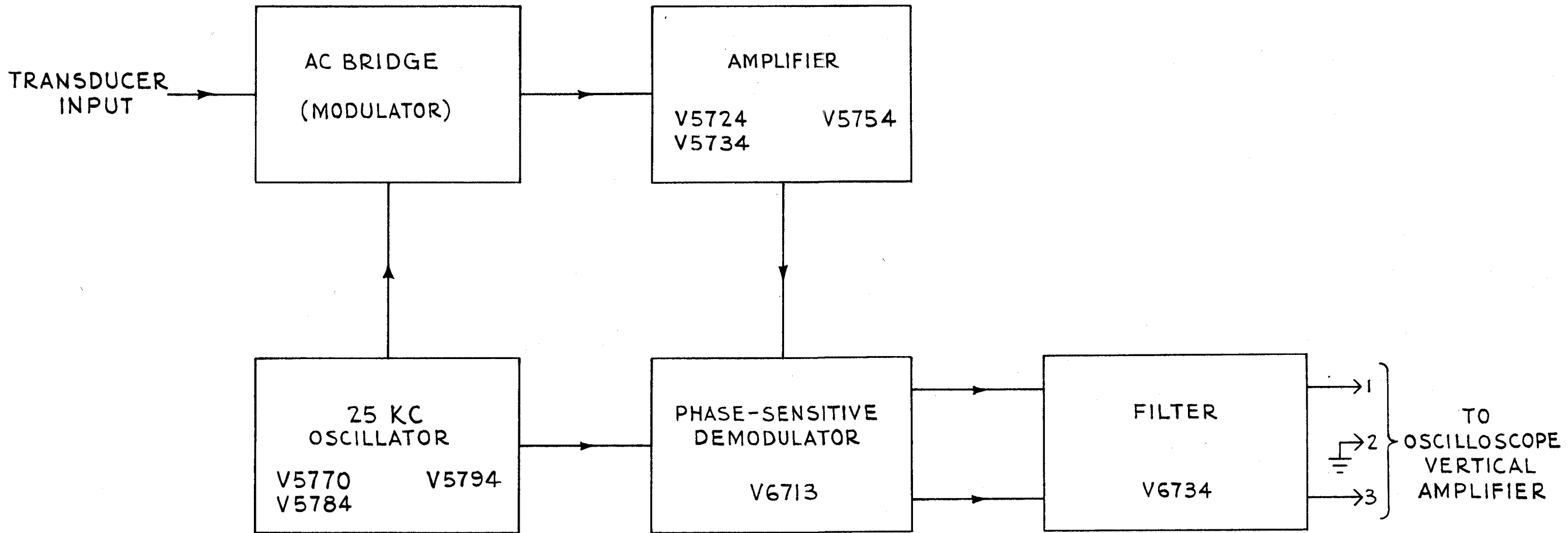

9-25-59
RBH

TYPE Q PLUG-IN UNIT

A₁

BLOCK DIAGRAM

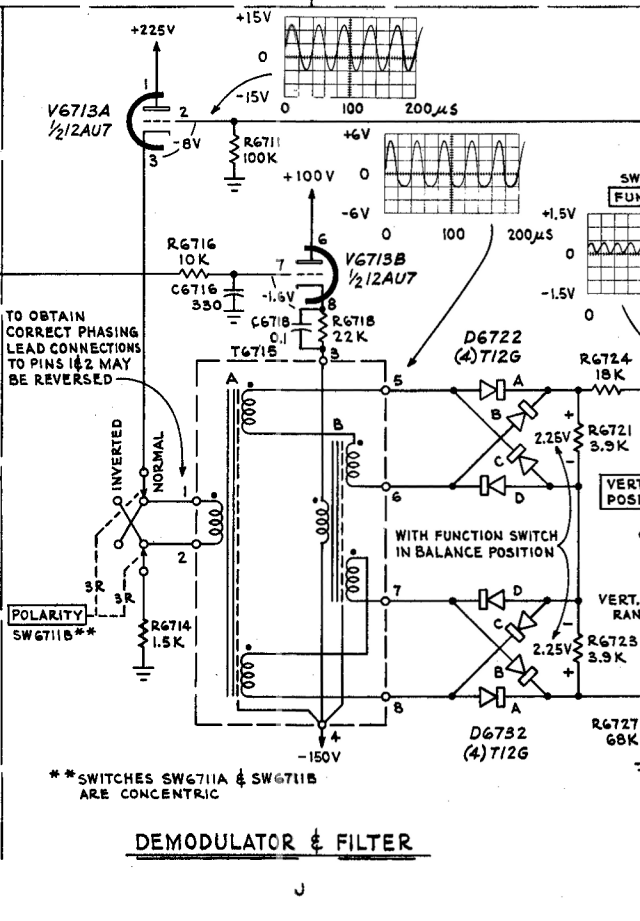
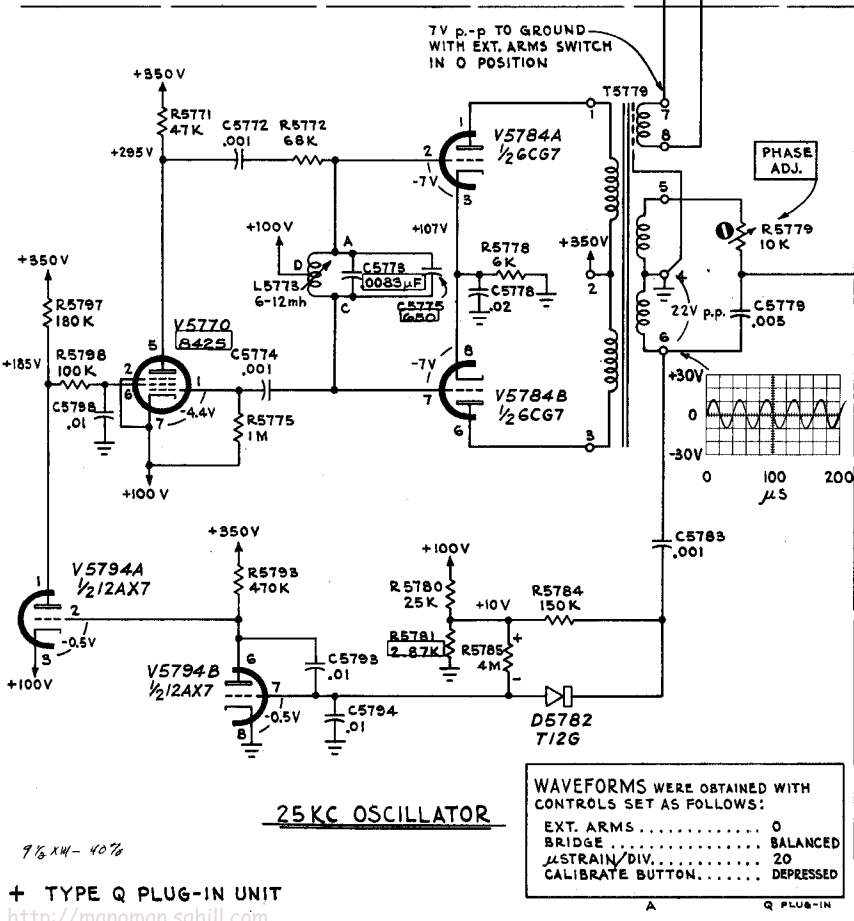
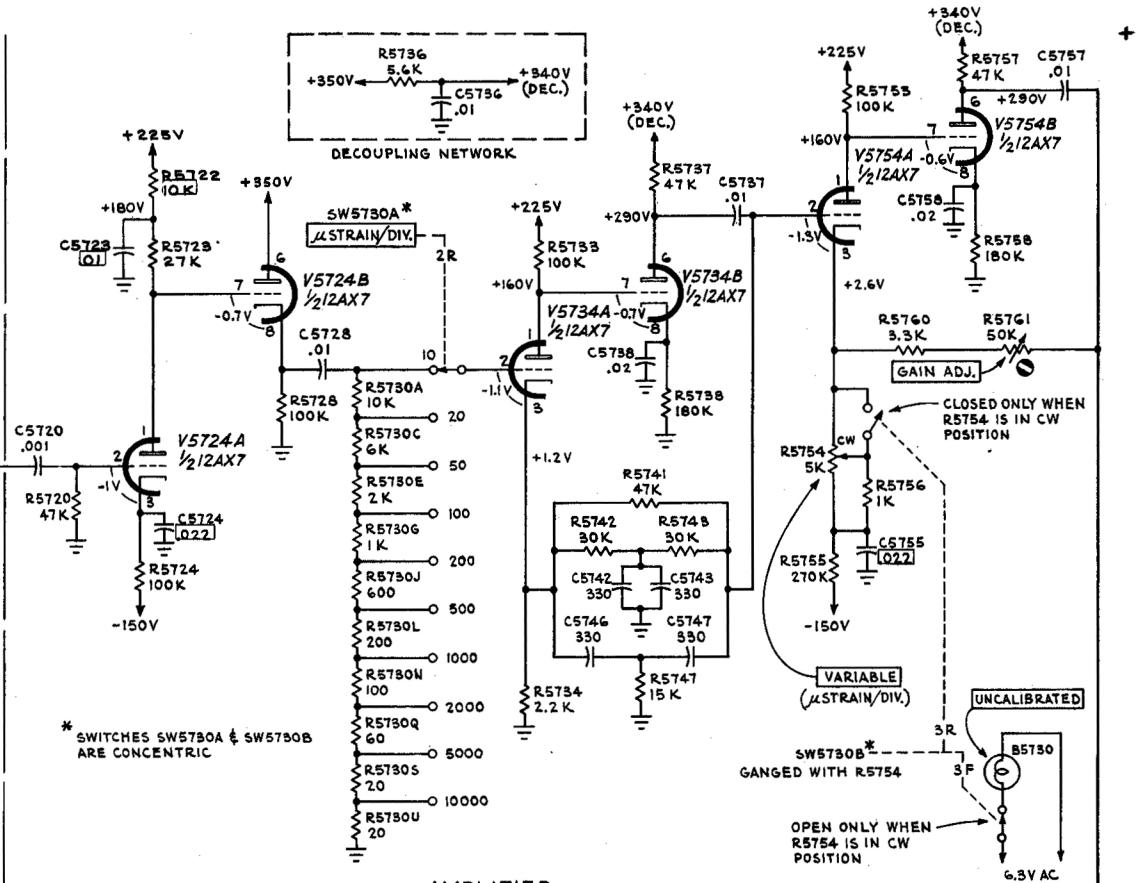
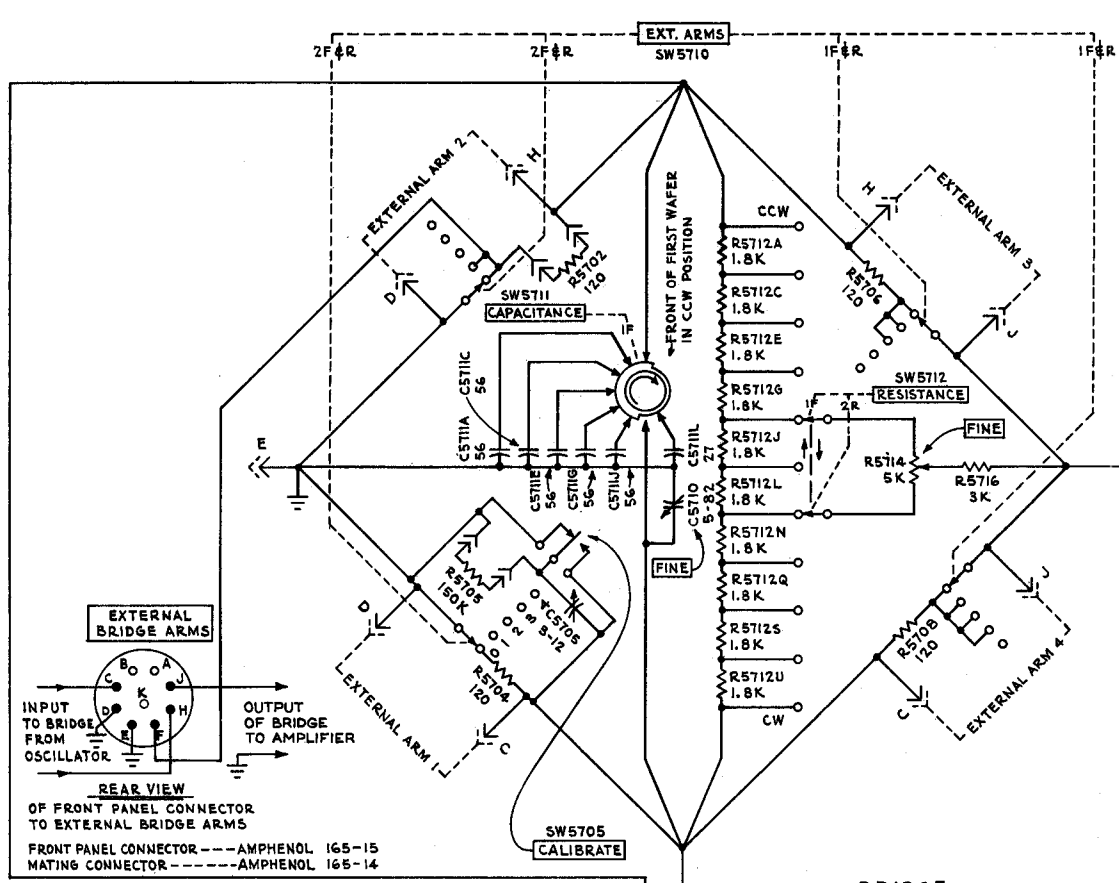

MANUAL CHANGE INFORMATION.

At Tektronix, we continually strive to keep up with latest electronic developments by adding circuit and component improvements to our instruments as soon as they are developed and tested.

Sometimes, due to printing and shipping requirements, we can't get these changes immediately into printed manuals. Hence, your manual may contain new change information on following pages.

A single change may affect several sections. Sections of the manual are often printed at different times, so some of the information on the change pages may already be in your manual. Since the change information sheets are carried in the manual until ALL changes are permanently entered, some duplication may occur. If no such change pages appear in this section, your manual is correct as printed.

TYPE Q TENT SN 2680

ELECTRICAL PARTS LIST CORRECTION

CHANGE TO:

R6726 311-0474-00 2 ~~k~~ Ω , Var

M13,964/768

TYPE Q TENT SN 2690

ELECTRICAL PARTS LIST CORRECTION

CHANGE TO:

R5781	323-0237-00	2.87 k Ω	1/2 W	1%
-------	-------------	-----------------	-------	----

M13,978/968