

TEK

PART NO. 070-6960-00  
PRODUCT GROUP 45

# SCD1000/SCD5000 OPERATORS

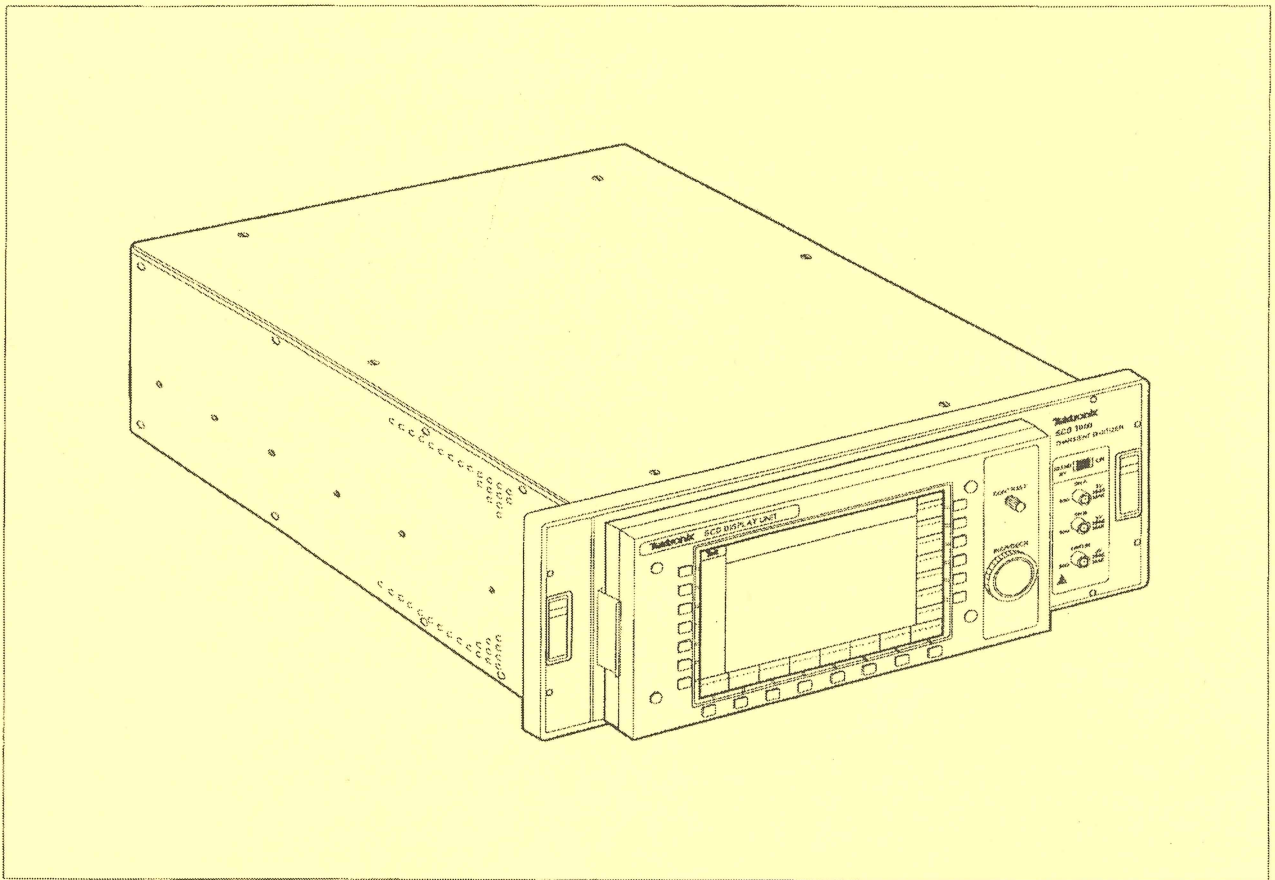

**Tektronix**  
COMMITTED TO EXCELLENCE

# User Manual

**Tektronix**

## **SCD1000 & 5000 Transient Waveform Recorders**

**070-6960-02**

This document applies for firmware version  
V1.80.

**Please check for change information at the  
rear of this manual.**

First Printing: September 1992  
Revised Printing: November 1992

### **Instrument Serial Numbers**

Each instrument manufactured by Tektronix has a serial number on a panel insert or tag, or stamped on the chassis. The first letter in the serial number designates the country of manufacture. The last five digits of the serial number are assigned sequentially and are unique to each instrument. Those manufactured in the United States have six unique digits. The country of manufacture is identified as follows:

B010000	Tektronix, Inc., Beaverton, Oregon, USA
E200000	Tektronix United Kingdom, Ltd., London
J300000	Sony/Tektronix, Japan
H700000	Tektronix Holland, NV, Heerenveen, The Netherlands

Instruments manufactured for Tektronix by external vendors outside the United States are assigned a two digit alpha code to identify the country of manufacture (e.g., JP for Japan, HK for Hong Kong, IL for Israel, etc.).

Tektronix, Inc., P.O. Box 500, Beaverton, OR 97077

Printed in U.S.A.

Copyright © Tektronix, Inc., 1990, 1991, 1992. All rights reserved. Tektronix products are covered by U.S. and foreign patents, issued and pending. The following are registered trademarks: TEKTRONIX, TEK, TEKPROBE, and SCOPE-MOBILE

Microsoft is a registered trademark of Microsoft Corporation.

IBM is a registered trademark of International Business Machines.

DEC is a registered trademark of Digital Equipment Corporation

HP is a registered trademark of Hewlett Packard Corporation.

## WARRANTY

Tektronix warrants that this product will be free from defects in materials and workmanship for a period of one (1) year from the date of shipment. If any such product proves defective during this warranty period, Tektronix, at its option, either will repair the defective product without charge for parts and labor, or will provide a replacement in exchange for the defective product.

In order to obtain service under this warranty, Customer must notify Tektronix of the defect before the expiration of the warranty period and make suitable arrangements for the performance of service. Customer shall be responsible for packaging and shipping the defective product to the service center designated by Tektronix, with shipping charges prepaid. Tektronix shall pay for the return of the product to Customer if the shipment is to a location within the country in which the Tektronix service center is located. Customer shall be responsible for paying all shipping charges, duties, taxes, and any other charges for products returned to any other locations.

This warranty shall not apply to any defect, failure or damage caused by improper use or improper or inadequate maintenance and care. Tektronix shall not be obligated to furnish service under this warranty a) to repair damage resulting from attempts by personnel other than Tektronix representatives to install, repair or service the product; b) to repair damage resulting from improper use or connection to incompatible equipment; or c) to service a product that has been modified or integrated with other products when the effect of such modification or integration increases the time or difficulty of servicing the product.

**THIS WARRANTY IS GIVEN BY TEKTRONIX WITH RESPECT TO THIS PRODUCT IN LIEU OF ANY OTHER WARRANTIES, EXPRESSED OR IMPLIED. TEKTRONIX AND ITS VENDORS DISCLAIM ANY IMPLIED WARRANTIES OF MERCHANTABILITY OR FITNESS FOR A PARTICULAR PURPOSE. TEKTRONIX' RESPONSIBILITY TO REPAIR OR REPLACE DEFECTIVE PRODUCTS IS THE SOLE AND EXCLUSIVE REMEDY PROVIDED TO THE CUSTOMER FOR BREACH OF THIS WARRANTY. TEKTRONIX AND ITS VENDORS WILL NOT BE LIABLE FOR ANY INDIRECT, SPECIAL, INCIDENTAL, OR CONSEQUENTIAL DAMAGES IRRESPECTIVE OF WHETHER TEKTRONIX OR THE VENDOR HAS ADVANCE NOTICE OF THE POSSIBILITY OF SUCH DAMAGES.**



# Welcome

This is the Operator Manual for the SCD1000 and SCD5000 Series Waveform Recorders.

*Section 1 — Introduction* contains an instrument description, a list of standard accessories, and a list of optional accessories.

*Section 2 — Preparation For Use* contains installation instructions, including power, switch settings, signal cabling, diagnostics, incoming inspection, and packaging for reshipment.

*Section 3 — Operating Instructions* contains three major sections. The first describes controls, connectors, and indicators. The second contains initial power-up instructions and instrument familiarization. The third section contains information about the Display Unit.

*Section 4 — Specification* contains information on the environmental, electrical, and physical characteristics of the instrument.

*Section 5 — Options* lists and describes instrument options.

*Section 6 — Programmer Manual* explains the necessary details of operating the instrument over the GPIB interface. It includes:

- Setting up the instrument for GPIB operation
- Introduction to the GPIB standard
- Complete GPIB command set used to operate the instrument
- GPIB command reference table
- SRQ and Event tables
- Programming examples

---

## Related Manuals

Other documentation available for the SCD1000 and SCD5000 includes:

- Programmer Manual (Tektronix Part No 070–7315–02)
- Quick Reference Guide (Tektronix Part No 070–7316–01)
- Service Manual (Tektronix Part No. 070–6963–00)



# Contents

<b>Safety</b> .....	<b>xiii</b>
---------------------	-------------

---

## General Information

<b>General Information</b> .....	<b>1-1</b>
<b>Product Overview</b> .....	<b>1-1</b>
<b>Features</b> .....	<b>1-2</b>
<b>Accessories</b> .....	<b>1-4</b>

---

## Preparation For Use

<b>Preparation for Use</b> .....	<b>2-1</b>
<b>Operating Power Information</b> .....	<b>2-1</b>
Safety .....	2-1
Line Voltage .....	2-1
Line Fuse .....	2-2
Power Cord .....	2-3
<b>Environmental Considerations</b> .....	<b>2-5</b>
Instrument Cooling .....	2-5
Temperature .....	2-5
Humidity .....	2-5
<b>Rackmounting</b> .....	<b>2-6</b>
<b>Switch Settings</b> .....	<b>2-6</b>
<b>External Interfacing</b> .....	<b>2-6</b>
Signal Cabling .....	2-6
Signal Inputs .....	2-7
External Trigger Input .....	2-7
Arm Input .....	2-7
Video Output .....	2-7
IEEE 488 Cabling .....	2-8
<b>Incoming Inspection</b> .....	<b>2-9</b>
Internal Diagnostics and Internal Calibration .....	2-10
Required Equipment .....	2-11
<b>Test 1 Diagnostics</b> .....	<b>2-12</b>
Setup .....	2-12
Procedure .....	2-12
<b>Test 2 Cal Time Frequency</b> .....	<b>2-14</b>
Setup .....	2-14
Procedure .....	2-16
Reference Voltage .....	2-16



Setup .....	2-17
Procedure for SCD1000: .....	2-17
Procedure for SCD5000: .....	2-19
<b>Test 3 Internal Calibration .....</b>	<b>2-21</b>
Setup .....	2-21
Procedure .....	2-21
<b>Packaging for Shipment .....</b>	<b>2-22</b>

---

## Operating Instructions

<b>Instrument Familiarization .....</b>	<b>3-1</b>
<b>Front Panel Controls, Connectors, and Indicators .....</b>	<b>3-1</b>
Controls .....	3-1
Connectors .....	3-1
Indicators .....	3-2
<b>Rear Panel Controls, Connectors, and Indicators .....</b>	<b>3-4</b>
Controls .....	3-4
Connectors .....	3-5
<b>Initial Instrument Setup .....</b>	<b>3-9</b>
<b>Power On .....</b>	<b>3-9</b>
<b>Power Off .....</b>	<b>3-9</b>
<b>Self-Test and Diagnostics .....</b>	<b>3-10</b>
<b>Initialization .....</b>	<b>3-11</b>
<b>Operator's Procedures .....</b>	<b>3-13</b>
<b>Display Unit Overview .....</b>	<b>3-13</b>
Removing/Replacing Display Unit .....	3-14
<b>Display Unit Operation .....</b>	<b>3-15</b>
Display Zones .....	3-15
Keys .....	3-19
Using the Mode and Function Keys .....	3-21
Key Labels .....	3-21
Waveforms .....	3-22
Record Number .....	3-22
Time Stamp .....	3-23
Ground Potential Indicator .....	3-23
Cursors .....	3-23
Record Bar .....	3-23
Display Graticule .....	3-23
<b>Examples .....</b>	<b>3-25</b>
<b>Initial Setup .....</b>	<b>3-25</b>
<b>Acquiring a Signal .....</b>	<b>3-26</b>
<b>Making Cursor Measurements .....</b>	<b>3-27</b>
Items to Note .....	3-27
<b>SCD Scanning Setup .....</b>	<b>3-28</b>
Items to Observe .....	3-28

<b>Saving and Recalling Stored Instrument Setups</b> .....	<b>3-30</b>
Saving Stored Instrument Setups .....	3-30
Recalling Stored Instrument Setups .....	3-30
Items to Note .....	3-30
<b>Using Auto-Advance Recording</b> .....	<b>3-31</b>
Items to Note .....	3-31
<b>Acquisition Concepts</b> .....	<b>3-33</b>
<b>Scan Conversion</b> .....	<b>3-33</b>
Writing the Data .....	3-34
Reading the Data .....	3-36
<b>Linear and Reference Arrays</b> .....	<b>3-37</b>
<b>Centroid Processing</b> .....	<b>3-37</b>
<b>Geometry Correction</b> .....	<b>3-39</b>
Geometry Distortion Characterization .....	3-40
Vertical Correction .....	3-42
Using Geometry Correction .....	3-45
Turning Correction On/OFF .....	3-45
Conclusion .....	3-46
<b>Acquiring Data</b> .....	<b>3-47</b>
Defects .....	3-47
Interpolation .....	3-48
Linear Array Overflow .....	3-48
Intensity Adjustment .....	3-49
Focus Adjustment .....	3-51
CRT Background .....	3-51
<b>Acquisition/Display Model</b> .....	<b>3-53</b>
<b>Acquisition Process</b> .....	<b>3-54</b>
<b>Vertical Size and Offset</b> .....	<b>3-55</b>
<b>Horizontal Size, Resolution, and Position</b> .....	<b>3-57</b>
<b>Multiple Record Acquisition</b> .....	<b>3-59</b>
<b>Averaging</b> .....	<b>3-59</b>
<b>Timestamping</b> .....	<b>3-59</b>
<b>Display Process</b> .....	<b>3-60</b>
<b>GPIB Waveform Data Transmission</b> .....	<b>3-62</b>
GPIB Port .....	3-62
Number of Records .....	3-62
Starting Record .....	3-62
Starting Point .....	3-62
Number of Points .....	3-63
Waveform Preamble Information .....	3-63
Initiation of Data Transfer .....	3-63
Partial Data Transfer .....	3-63
<b>HPGL</b> .....	<b>3-65</b>
<b>HPGL Plotter Support</b> .....	<b>3-65</b>
<b>Stand Alone Operation</b> .....	<b>3-66</b>

Measurement Model .....	3-67
Measurement System and Environment Options .....	3-70
Operation of Measurement System .....	3-74
Measurement Termination Errors .....	3-76
Measurement System Specifics .....	3-78
Extra Information Available Over the GPIB Interface .....	3-83
Instrument Function Reference .....	3-85
Vertical Functions .....	3-93
Vertical Mode (SCD1000 Only) .....	3-94
Vertical Channel Select (SCD1000 Only) .....	3-95
Vertical Range .....	3-96
Vertical Offset .....	3-97
Vertical Coupling (SCD1000 Only) .....	3-99
Vertical Channel Invert (SCD1000 Only) .....	3-100
Acquisition Functions .....	3-101
Acquisition Mode .....	3-102
Acquisition Time Window .....	3-104
Acquisition Record Length .....	3-105
Acquisition Start Record .....	3-106
Number of Records to Average .....	3-107
Number of Records to Acquire .....	3-108
Acquisition Hold Next .....	3-109
Geometry Correction .....	3-110
Set Geometry Correction .....	3-111
Trigger Functions .....	3-113
Trigger Mode .....	3-114
Trigger Source .....	3-115
Trigger Level .....	3-116
Trigger Slope .....	3-118
Trigger Coupling (SCD1000 Only) .....	3-119
Trigger Delay .....	3-120
Trigger Arm .....	3-121
Display Functions .....	3-123
Number of Windows Displayed .....	3-124
Window Select .....	3-126
Record Selection for Selected Window .....	3-128
Horizontal/Vertical Expansion Point .....	3-129
Vertical Expansion Factor .....	3-130
Horizontal Expansion Mode .....	3-131
Horizontal Expansion Factor .....	3-132
Cursor Functions .....	3-133
Cursors On/Off .....	3-134

<b>Cursor 1 Window Location</b> .....	3-136
<b>Cursor 2 Window Location</b> .....	3-137
<b>Cursor 1 Position</b> .....	3-138
<b>Cursor 2 Position</b> .....	3-139
<b>Graticule On/Off</b> .....	3-140
<b>Save/Recall Functions</b> .....	3-141
<b>Save Settings Selection</b> .....	3-142
<b>Save Current Settings</b> .....	3-143
<b>Recall Settings Selection</b> .....	3-144
<b>Recall Settings</b> .....	3-145
<b>Recall Status Messages</b> .....	3-146
<b>Initialize</b> .....	3-147
<b>Secure</b> .....	3-148
<b>Utility Functions</b> .....	3-149
Utility Menu 1 .....	3-149
Utility Menu 2 .....	3-150
Utility Menu 3 .....	3-151
Utility Menu 4 .....	3-151
Utility Menu 5 (SCD1000 Only) .....	3-151
Utility Menu 5 (SCD5000 Only) .....	3-152
<b>Display Threshold</b> .....	3-153
<b>CRT Beam Intensity</b> .....	3-154
<b>CRT Beam Focus</b> .....	3-155
<b>Set Reference Data</b> .....	3-156
<b>CRT Background</b> .....	3-157
<b>Calibration Mode Selection</b> .....	3-159
<b>Initiate Calibration</b> .....	3-160
<b>View Settings of All or Selected Areas</b> .....	3-161
<b>Beeper ON/OFF</b> .....	3-164
<b>KNOB Beeper ON/Off</b> .....	3-165
<b>Debug Mode</b> .....	3-166
<b>Instrument Self-Test</b> .....	3-167
<b>Processor Self-Test</b> .....	3-168
<b>Front Panel Self-Test</b> .....	3-169
<b>Acquisition Self-Test</b> .....	3-170
<b>Options Self-Test</b> .....	3-171
<b>Date/Time Functions</b> .....	3-172
<b>Channel Calibration Signals (SCD1000)</b> .....	3-173
<b>External Calibrator Signal</b> .....	3-174
<b>Calibrator Signal Amplitude</b> .....	3-175
<b>Calibrator Signal Period</b> .....	3-176
<b>Calibrator Out Signal (SCD5000)</b> .....	3-177
<b>Measurement Functions</b> .....	3-179
Measurement Menu 1 .....	3-179

Measurement Menu 2 .....	3-180
Measurement Menu 3 .....	3-180
<b>Measure On/Off .....</b>	<b>3-181</b>
<b>Measure Selection .....</b>	<b>3-182</b>
<b>Measure Enter .....</b>	<b>3-183</b>
<b>Measure Display Window .....</b>	<b>3-184</b>
<b>Measure Waveform .....</b>	<b>3-185</b>
<b>Measure Zone .....</b>	<b>3-186</b>
<b>Base Mode .....</b>	<b>3-188</b>
<b>Top Mode .....</b>	<b>3-189</b>
<b>Area Zone .....</b>	<b>3-190</b>
<b>Level Mode .....</b>	<b>3-191</b>
<b>Distal Level .....</b>	<b>3-192</b>
<b>Mesial Level .....</b>	<b>3-193</b>
<b>Proximal Level .....</b>	<b>3-194</b>

---

## Specifications

<b>Specifications .....</b>	<b>4-1</b>
<b>Performance Conditions .....</b>	<b>4-1</b>
Specifications .....	4-1
Characteristics .....	4-1
Recommended Calibration Interval .....	4-1
<b>Electrical Specifications .....</b>	<b>4-2</b>
<b>Electrical Characteristics .....</b>	<b>4-5</b>
<b>Physical Characteristics .....</b>	<b>4-11</b>
<b>Environmental Characteristics .....</b>	<b>4-12</b>

---

## Options

<b>Options .....</b>	<b>5-1</b>
<b>Option 2F .....</b>	<b>5-2</b>
High Speed Data Output (HSDO) .....	5-2
Connectors .....	5-2
Dump Continuous Mode .....	5-3
Handshake Transfer Mode .....	5-4
GPIB Commands .....	5-5
GPIB Query Commands .....	5-6
<b>Option 9E (SCD5000 Only) .....</b>	<b>5-13</b>
Rear Panel Inputs .....	5-13

---

## Change Information

# List of Figures

Figure 2-1: Line Voltage Selector, Line Fuse, Power Cord Receptor .	2-2
Figure 2-2: Power-Cord Plug Identification .....	2-4
Figure 2-3: Video Connector Pinout (Factory Configuration) .....	2-8
Figure 2-4: Adapting the Rear Panel Connector to a VGA Monitor Connector .....	2-8
Figure 2-5: Internal Clock Frequency Test Setup .....	2-15
Figure 3-1: SCD1000 Front Panel Controls, Connectors, and Indicators .....	3-3
Figure 3-2: SCD5000 Front Panel Controls, Connectors, and Indicators .....	3-4
Figure 3-3: SCD1000 Rear Panel Controls, Connectors, and Indicators .....	3-5
Figure 3-4: SCD5000 Rear Panel Controls, Connectors, and Indicators .....	3-6
Figure 3-5: SCD5000 Option 9E Rear Panel Controls, Connectors, and Indicators .....	3-6
Figure 3-6: Instrument Switches .....	3-7
Figure 3-7: SCD1000 Waveform Recorder With Display Unit Attached .....	3-13
Figure 3-8: Securing the Display Unit .....	3-14
Figure 3-9: Display Unit Display Zones .....	3-15
Figure 3-10: Single Waveform Displayed .....	3-17
Figure 3-11: Two Waveforms Displayed .....	3-17
Figure 3-12: Four Waveforms Displayed .....	3-18
Figure 3-13: Waveform Zone Indicators .....	3-18
Figure 3-14: Display Unit Key Types and Knob .....	3-19
Figure 3-15: The Scan Converter Tube used in the SCD1000 .....	3-34
Figure 3-16: Reading and Writing Beam Interaction on Target .....	3-35
Figure 3-17: Reading Gun Scans Target Vertically .....	3-36
Figure 3-18: Data Storage and Processing .....	3-38
Figure 3-19: The Acquisition Process .....	3-40
Figure 3-20: Vertical Dividing of Target for Distortion Characterization .....	3-41
Figure 3-21: Corrected and Uncorrected Baselines Shown With Horizontal Divisions .....	3-42
Figure 3-22: Definition of Bilinear Interpolation .....	3-43
Figure 3-23: Duration of Linear Array Overflow .....	3-49
Figure 3-24: Blooming on a Step Transition .....	3-50
Figure 3-25: Under Estimation of Trace Peak Due to Blooming .....	3-50
Figure 3-26: Typical Input Signal .....	3-53
Figure 3-27: SCD Processes .....	3-53
Figure 3-28: Acquisition Parameters & Acquisition Window .....	3-54

Figure 3-29: Effect of Increasing Vertical Offset .....	3-56
Figure 3-30: Effect of Decreasing Vertical Offset .....	3-56
Figure 3-31: Effect of Time Window on Horizontal Size .....	3-57
Figure 3-32: Effect of Trigger Delay on Horizontal Position .....	3-58
Figure 3-33: Auto Advance Acquisitions .....	3-59
Figure 3-34: Effect of Vertical Expansion on Display .....	3-61
Figure 3-35: Effect of Horizontal Expansion on Display .....	3-61
Figure 3-36: Measurement Block Diagram .....	3-75
Figure 3-37: Timing Measurement Interval .....	3-80
Figure 3-38: ID View .....	3-162
Figure 3-39: Acquire View .....	3-162
Figure 3-40: Display View .....	3-163
Figure 5-1: Handshake Mode Timing Diagram .....	5-4
Figure 5-2: Synchronous Mode Timing Diagram .....	5-4
Figure 5-3: Location of HSDO Rear Panel Connector (SCD1000) ...	5-7
Figure 5-4: Location of HSDO Rear Panel Connector (SCD5000) ...	5-8
Figure 5-5: Location of Option 9E Rear Panel Connectors (SCD5000 only) .....	5-14

# List of Tables

Table 1-1: SCD Waveform Recorders Overview .....	1-2
Table 1-2: Standard Accessories .....	1-4
Table 1-3: Optional Accessories .....	1-4
Table 2-1: Line Voltage Ranges & Fuses .....	2-2
Table 2-2: Lists of Tests for Incoming Inspection .....	2-9
Table 2-3: List of Required Equipment for Incoming Inspection .....	2-11
Table 2-4: Test List .....	2-12
Table 2-5: Calibrator Timing Measurements .....	2-16
Table 2-6: SCD1000 Calibrator Voltage Limits .....	2-17
Table 2-7: SCD1000 Calibrator $\Delta$ Voltage Limits .....	2-18
Table 2-8: SCD5000 Calibrator Voltage Limits .....	2-19
Table 2-9: SCD5000 Calibrator $\Delta$ Voltage Limits .....	2-20
Table 3-1: Acquisition Status Indicators .....	3-2
Table 3-2: Active Interface Indicators .....	3-2
Table 3-3: Interface Status Indicators .....	3-2
Table 3-4: System Status Indicators .....	3-3
Table 3-5: Required Equipment .....	3-25
Table 3-6: Geometry Correction Array .....	3-44
Table 3-7: Horizontal Location of Geometry Calibration Constants ..	3-45
Table 3-8: Measurement Terms .....	3-67
Table 3-9: List of Measurements .....	3-70
Table 3-10: Measurement Environment Selections .....	3-72
Table 3-11: Measurement Termination Errors .....	3-76
Table 3-12: CROSS? Query Links .....	3-83
Table 3-13: Vertical Functions .....	3-86
Table 3-14: Acquisition Functions .....	3-87
Table 3-15: Trigger Functions .....	3-87
Table 3-16: Display Functions .....	3-88
Table 3-17: Cursor Functions .....	3-88
Table 3-18: Save/Recall Functions .....	3-89
Table 3-19: Utility Functions .....	3-89
Table 3-20: Measurement Functions .....	3-91
Table 3-21: Vertical Offset Ranges .....	3-97
Table 4-1: Electrical Specifications .....	4-2
Table 4-2: Electrical Characteristics .....	4-5
Table 4-3: Physical Characteristics .....	4-11
Table 4-4: Environmental Characteristics .....	4-12



Table 5-1: SCD Digitizer Power Options .....	5-1
Table 5-2: SCD1000 Digitizer Options .....	5-1
Table 5-3: SCD Series to DEC DRV11-B Cabling .....	5-9
Table 5-4: SCD Series to HP GPIO Cabling .....	5-11



# Safety

Please take a moment to review these safety precautions. They are provided for your protection and to prevent damage to the SCD1000 and SCD5000. This safety information applies to all operators and service personnel.

---

## Symbols and Terms

These two terms appear in manuals:

-  statements identify conditions or practices that could result in damage to the equipment or other property.
-  statements identify conditions or practices that could result in personal injury or loss of life.

These two terms appear on equipment:

- *CAUTION* indicates a personal injury hazard not immediately accessible as one reads the marking, or a hazard to property including the equipment itself.
- *DANGER* indicates a personal injury hazard immediately accessible as one reads the marking.

This symbol appears in manuals:



Static-Sensitive Devices

These symbols appear on equipment:



DANGER  
High Voltage



Protective  
ground (earth)  
terminal



ATTENTION  
Refer to  
manual

---

## **Specific Precautions**

Observe all of these precautions to ensure your personal safety and to prevent damage to either the SCD1000 and SCD5000 or equipment connected to it.

### **Power Source**

The SCD1000 and SCD5000 is intended to operate from a power source that will not apply more than 250 V<sub>RMS</sub> between the supply conductors or between either supply conductor and ground. A protective ground connection, through the grounding conductor in the power cord, is essential for safe system operation.

### **Grounding the SCD1000 and SCD5000**

The SCD1000 and SCD5000 is grounded through the power cord. To avoid electric shock, plug the power cord into a properly wired receptacle where earth ground has been verified by a qualified service person. Do this before making connections to the input or output terminals of the SCD1000 and SCD5000.

Without the protective ground connection, all parts of the SCD1000 and SCD5000 are potential shock hazards. This includes knobs and controls that may appear to be insulators.

### **Use the Proper Power Cord**

Use only the power cord and connector specified for your product. Use only a power cord that is in good condition.

### **Use the Proper Fuse**

To avoid fire hazard, use only the fuse specified in the parts list for your product, matched by type, voltage rating, and current rating.

### **Do Not Remove Covers or Panels**

To avoid personal injury, do not operate the SCD1000 and SCD5000 without the panels or covers.

### **Do Not Operate in Explosive Atmospheres**

The SCD1000 and SCD5000 provides no explosion protection from static discharges or arcing components. Do not operate the SCD1000 and SCD5000 in an atmosphere of explosive gases.

### **Electric Overload**

Never apply to a connector on the SCD1000 and SCD5000 a voltage that is outside the range specified for that connector.

# General Information

# General Information

---

## Product Overview

The SCD1000 and SCD5000 Waveform Recorders are designed to capture low nanosecond and picosecond single shot events. Whether the application involves Laser, ESD, EMP, Particle Accelerators or other high speed single shot phenomena, SCD series waveform recorders can capture the event of interest with excellent fidelity and resolution.

The maximum acquisition rate of 200 giga samples-per-second provides time resolution to 5 picoseconds. With time windows from 5 nsec to 100  $\mu$ s, the SCD Series recorders provide flexible acquisition. The SCD1000 and SCD5000 Option 01 delay lines give approximately 2.5 ns of pretrigger information.

The SCD1000 and SCD5000 are single channel waveform recorders. The SCD5000 uses direct access with input sensitivity of 5 volts with an offset range of  $\pm 4.0$  volts. Signals are DC coupled. The SCD1000 provides input signal conditioning with 100 mV to 10 V full scale input ranges, offset capability, signal invert and AC or DC coupling. There are two input channels which can be configured to multiplex two signals or algebraically add two input signals to the single channel waveform recorder.

The waveform record length is selectable between 256, 512 or 1024 waveform data points, with 11 bits of vertical resolution (2048 levels). With 16 built-in waveform locations (the first four use nonvolatile memory), multiple trigger events can be stored into separate storage locations using Auto-advance acquisition mode. Averaging acquisition mode allows up to 1024 acquisitions to be averaged for an improved signal-to-noise ratio. Each record is time and date stamped for later comparison. There are 10 non-volatile settings storage locations for quick instrument setup.

The SCD waveform recorders can be controlled over the IEEE-488 interface or from the display unit attached to the front of the instrument. The display unit provides the ability to control operating parameters, view up to 4 waveforms at one time, make cursor measurements on any displayed waveform and view status of instrument operation. It can also be used as operator display device with 2 user-definable buttons and up to 16 lines of text that can be printed on the screen.

A number of options are available for the SCD1000 and SCD5000 Waveform Recorders:

- Option 01, available only for the SCD5000, provides a delay line and internal trigger pickoff.
- Option 1E, available only for the SCD1000, provides a TEKPROBE™ interface. This interface allows connection of active and other specialized probes with the proper scaling of the input range and control of probe offset.

- Option 1P, Fast Waveform Capture, increases the acquisition rate from about one to ten 512 point waveforms per second.
- Option 2E provides SMA-type connectors on the front panel (N connectors are standard).
- Option 2F adds a high speed (16-bit) data output as an alternative to the GPIB output. It also adds nonvolatile storage of Linear Array data (battery backup).
- Option 9E relocates the Input, Calibrator Output, and Trigger Input connectors to the rear panel.
- With Option 20 the instrument is supplied without the LCD display unit that allows manual operator control. Control with Option 20 is possible only over the GPIB interface.

## Features

Table 1-1 is a brief list of SCD1000 and SCD5000 features. See *Specifications*.

**Table 1-1: SCD Waveform Recorders Overview**

Feature	Description	
	SCD1000	SCD5000
<b>Inputs</b>		
Number of Acquisition Channels	1 channel	1 channel
Vertical Modes	1 channel (Ch A or Ch B) or algebraic sum of both (Add and Invert)	1 channel
Input Voltage Range	Programmable from 100 mV to 10.0 V Full-scale in a 1, 2, 5 sequence	5 V Full-scale (fixed) (10 V with Option 01)
Input Offset Range	±250% of input voltage range	±4 V (±8 V with Option 01)
Input Coupling	AC, DC, or OFF	DC only
Bandwidth	1 GHz	4.5 GHz (3 GHz with Option 01)
<b>Timebase &amp; Memory</b>		
Time Windows	5 ns to 100 µs	5 ns to 100 µs
Programmable Record Lengths	256, 512, 1024 points	256, 512, 1024 points
Maximum Number of Records	16; record 0 reserved for text only (records 1–4 nonvolatile)	16; record 0 reserved for text only (records 1–4 nonvolatile)

**Table 1-1: SCD Waveform Recorders Overview (Cont.)**

Feature	Description	
	SCD1000	SCD5000
<b>Triggering</b>		
Triggering Sources	Any vertical mode, external (Analog) input, GPIB command, or <i>Display Unit Key</i>	External input, internal time calibrator signal, GPIB command, or <i>Display Unit Key</i> (Internal trigger with Option 01)
Trigger Level	External: AC coupling: $\pm 0.5$ V; Internal: AC coupling: $\pm 100\%$ of full-scale range; DC coupling: $\pm 50\%$ of full-scale range	External: AC coupling only, $\pm 50\%$ of vertical range Internal (with Option 01): DC coupling only +100% of vertical range
Trigger Delay	Up to 5 times the time window; programmable in percent or seconds. Approximately 2.5 ns of pretrigger information is displayed with 0 delay setting	Option 01: Approximately 2.5 ns of pretrigger information is displayed with 0 delay setting
Trigger Level Units	Selectable as % of full-scale input range (internal only) or volts	
Trigger Slope	Positive or Negative	
<b>Miscellaneous</b>		
Internal calibration	Automatic adjustment of Vertical, Horizontal, Trigger, and CRT circuitry	
Factory Initialization Settings	Stored in ROM. All instrument and GPIB settings can be initialized to their factory settings at any time.	

---

## Accessories

The SCD Waveform recorders have the following Standard and Optional Accessories:

**Table 1-2: Standard Accessories**

Quantity	Description	Tektronix Part Number
1	Power Cord, 3-wire, 2.5 meter; U.S. 120 V, 15 A, 60 Hz	161-0066-12
1	User Manual	070-6960-02
1	Programmer Manual	070-7315-02
1	Quick Reference Guide	070-7316-01
2	Rack Rail Sets	351-0375-01
4	Screws	212-0672-00
4	Washers	210-0910-00
4	Nut Assemblies	220-0805-00

**Table 1-3: Optional Accessories**

Description	Tektronix Part Number
Technical Reference Manual	070-6963-00
GPIB Cables, Double Shielded, Low EMI	
1 meter	012-0991-01
2 meters	012-0991-00
4 meters	012-0991-02
Type N male to SMA male adapter	015-1009-00
SMA female to female adapter	015-1012-00
Type N male to BNC female adapter	103-0045-00
Type N male to GR adapter	017-0021-00

The instrument options are discussed in the *Options* section of this manual. See page 5-1.



# Preparation For Use

# Preparation for Use

---

## Operating Power Information

### Safety

Refer to the Safety summary at the front of this manual for power source, grounding, and other safety considerations pertaining to the use of the instrument. Before connecting the instrument to a power source, read both this section and the Safety summary.

### Line Voltage

The SCD1000 and SCD5000 operate from either a 120 V or 240 V nominal AC power source with a line frequency ranging from 48 Hz to 440 Hz. The line voltage selector on the rear panel indicates the voltage source required by the waveform recorder (Figure 2-1). Before connecting the power cord to a power source, check that the voltage at the power source falls within the selected voltage range listed on the label near the line voltage selector. If the line voltage of the instrument needs to be changed, use a small-blade screwdriver to switch the line voltage selector on the rear panel.



*This instrument may be damaged if operated from a power source line voltage outside the range shown on the label near the line voltage selector on the rear panel. Damage may also occur if the wrong size power input line fuse is installed in the rear panel of the instrument. If the instrument is set for 120 operation and is connected to a 220 power source, an internal line fuse will blow. It should be replaced only by a qualified service person.*

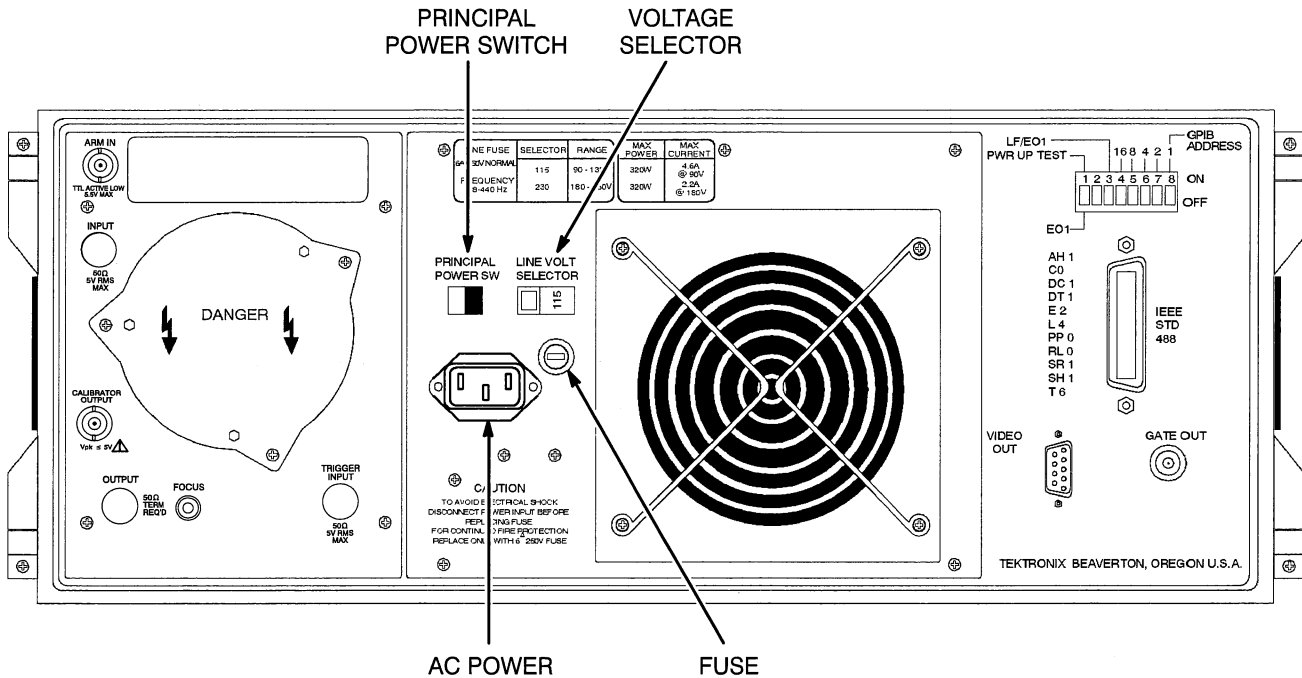

**Figure 2-1: Line Voltage Selector, Line Fuse, Power Cord Receptor**

## Line Fuse

To verify the proper value of the instrument's power input line fuse, perform the following:

1. Unplug the instrument from line voltage.
2. Press in the fuse-holder cap and release it with a counterclockwise rotation.
3. Pull the cap (with the attached fuse inside) out of the fuse holder.
4. Verify the proper fuse value (Table 2-1).
5. Install the proper fuse, if required, and reinstall the fuse-holder cap by carefully pushing it in while rotating it clockwise (CW).
6. Plug the instrument into line voltage receptacle.

**Table 2-1: Line Voltage Ranges & Fuses**

Line Voltage Indicator	Voltage Range	Line Fuse
115 V, nominal	90–132 VAC	6A, 250 V, normal blow
230 V, nominal	180–250 VAC	6A, 250 V, normal blow

## Power Cord

This instrument has a detachable three-wire power cord with a three-contact plug for connection to both the power source and protective ground (Figure 2-1). The protective ground contact on the plug connects (through the power cord protective grounding conductor) to the accessible metal parts of the instrument. For electrical shock protection, insert this plug into a power source outlet that has a properly grounded protective-ground contact.

### **WARNING**

*This instrument operates from a single-phase power source, and has a detachable three-wire power cord with a two-pole, three-terminal grounding-type plug. The voltage to ground (earth) from either pole of the power source must not exceed the maximum rated operating voltage of 250 volts.*

*Before making connection to the power source, be sure that the voltage selector is set to match the voltage of the power source and that the power source receptacle has a suitable plug (two pole, three-terminal, grounding type). Do not defeat the grounding connection. Any interruption of the grounding connection can create an electric shock hazard.*

*Instruments are shipped with the required power cord as ordered by the customer. Information on the available power cords is presented in Figure 2-2. Part numbers are listed in Options, page 5-1.*

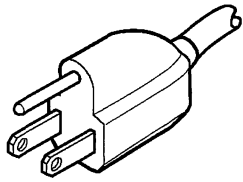

**Standard\***  
North American  
115V

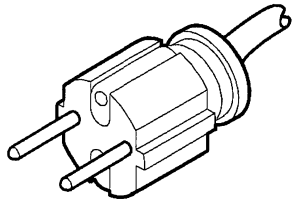

**Option A1**  
Universal Euro  
230V

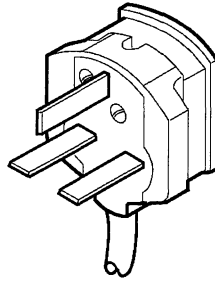

**Option A2**  
UK  
230V

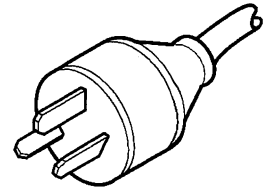

**Option A3**  
Australian  
230V

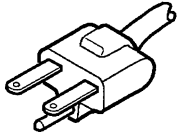

**Option A4\***  
North American  
230V

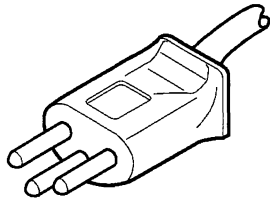

**Option A5**  
Switzerland  
230V

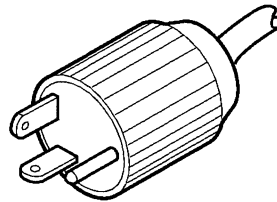

**Option 1A\***  
North American  
115V/High Power

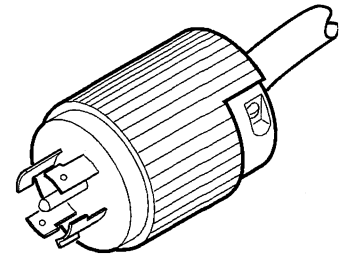

**Option 1B**  
North American  
3-Phase

*\* Canadian Standards Association certification includes these power plugs for use in the North American power network*

**Figure 2-2: Power-Cord Plug Identification**

---

## Environmental Considerations

### Instrument Cooling

To prevent instrument damage from overheating, adequate internal airflow must be maintained. A clearance of 2 inches on the side and 1 inch on the rear must be maintained for proper cooling to take place.

Before turning on the instrument, be sure that the air intake and exhaust holes on the instrument are free from any obstructions to airflow. The SCD Waveform Recorders typically generate 700 Btu/hour (based on 250 Watts typical power). An internal fan moves 100 cfm of air for cooling. Cooling is automatically regulated according to the power supply temperature.

### Temperature

The SCD Waveform Recorders can be operated in an environment where the ambient temperature is between +5° C (0° without display) and +40° C. For storage lengths over an hour, the temperature should be between -20° C and +60° C. After storage at temperatures outside the operating limits, allow the chassis to reach a normal operating temperature before applying power.



*Storage in temperatures below -20° C will damage the Liquid Crystal Display (LCD).*

### Humidity

The SCD Waveform Recorders can be operated in 30% to 85% relative humidity (non-condensing). The instrument can be stored in 20% to 90% relative humidity, (non-condensing).

If condensation occurs on the instrument or any circuitry following storage at low temperatures, allow all condensation to evaporate before applying power to the instrument.

---

## Rackmounting

Refer rack selection and actual installation of rackmounting hardware to qualified service personnel.

The instrument should be mounted using the slides provided with the instrument in the recommended rackmounting configuration, anchoring both front and rear chassis tracks:

- rack height: 7 inches
- rack depth: 30 inches
- rack width: 19 inches
- instrument weight: approximately 55 pounds. (See *Specifications*, on page 4-1.)

---

## Switch Settings

A set of eight switches on the waveform recorder's rear panel set the SCD's GPIB operation and Power-Up Self-Test execution. See the Programmer Manual for setting these switches before operation.

---

## External Interfacing

### Signal Cabling

The SCD Waveform Recorders allow connection of the following input and output cables. Some channel input parameters vary depending on the model of the waveform recorder. These differences are described below.

#### SCD1000

- Two signal inputs (front panel connectors)
- External trigger input (front panel connector)
- IEEE-488.1 bus using a standard GPIB connector (rear panel connector)
- calibrator signal output (rear panel connector)
- VGA video output (rear panel connector)
- Gate signal output (rear panel connector)
- Arm signal input (rear panel connector)

#### SCD5000

- One signal input (front panel connector)
- External trigger input (front panel connector)
- Calibrator signal output (front panel connector)
- IEEE-488.1 bus using a standard GPIB connector (rear panel connector)

- VGA video output (rear panel connector)
- Gate signal output (rear panel connector)
- Arm signal input (rear panel connector)

## Signal Inputs

The SCD1000 includes two input channels. (Either of the two signal inputs can be selected or they can be added.) The SCD5000 includes one input channel. Input cables are connected to front panel connectors. The signal inputs have a 50  $\Omega$  impedance on both waveform recorder models.

On the SCD1000, input signals can be AC or DC coupled. On the SCD5000, only DC coupling is provided.

Observe the maximum input voltage and power described in *Electrical Characteristics*, Table 4-2.



*When AC coupling signals greater than 25 VDC, set the input coupling to OFF (SCD1000 only) to allow the input capacitor to pre-charge.*

## External Trigger Input

An external trigger signal can be connected to the front panel EXT TRIG connector. The DC component of the SCD1000 trigger signal must not exceed 100 V. The AC component should be limited to 0.2 watts average or 25 V<sub>p-p</sub>. The input impedance is nominally 50  $\Omega$ .

## Arm Input

External arming allows an externally applied signal to enable trigger recognition when the acquisition state is Hold Next or Running. The arming signal is applied to the rear panel Arm In connector. To enable, select External Arm from the Trigger menu or issue the appropriate GPIB command. A trigger will not be recognized until the arming signal (ground or TTL low) is received.

## Video Output

The SCD's are configured at the factory to provide video signals compatible with VGA video monitors (640  $\times$  400 lines resolution). See Figures 2-3 and 2-4 for pinout configuration. Internal jumpers on the MPU circuit board can be set to alter the signal pinout and polarity for monochrome displays and video copy processors. See the Service Manual for additional information.



<u>PIN</u>	<u>SIGNAL</u>
1	Ground
2	N/C
3	Video
4	Video
5	Video
6	Horizontal Sync
7	N/C
8	Vertical Sync
9	N/C

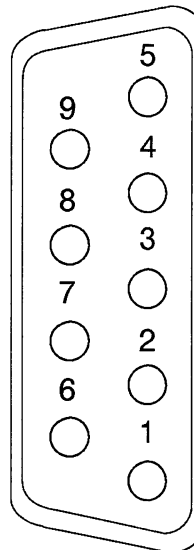

**Figure 2-3: Video Connector Pinout (Factory Configuration)**

<u>SCD Rear Panel</u>	<u>MULTISYNC TTL (DIGITAL) INPUT COLOR MONITOR 15 PIN D CONNECTOR</u>
1	5 (Ground)
2	
3	1 (Video)
4	2 (Video)
5	3 (Video)
6	13 Horiz. Sync.
7	
8	14 Vert. Sync.
9	

**Figure 2-4: Adapting the Rear Panel Connector to a VGA Monitor Connector**

### IEEE 488 Cabling

The IEEE-488.1 (GPIB) connector on the rear panel allows waveform recorder control over the GPIB. Connect the IEEE-488 cable (available as an optional accessory) between the rear panel connector and the bus controller or the nearest instrument on the bus. More information on the GPIB is provided in the Programmer Manual. GPIB cabling and interconnection conventions must be observed for proper operation.

---

## Incoming Inspection

The tests in this section should be run in the order indicated. After the instrument has had power applied for 20 minutes, Test 1 (Diagnostics) should be run to ensure that the instrument is in general working order. If diagnostics fails, the instrument should be returned to an authorized service center for servicing. After diagnostics has passed, Test 2 (Cal Time Frequency) should be run to ensure that the internal standards are within specification. If they are outside the limits, the performance of the instrument cannot be guaranteed, and the instrument should be returned to an authorized service center for servicing. Test 3 (Internal Calibration) should then be run before proceeding with instrument operation.

### NOTE

*This procedure is only intended to verify the general operation of the instrument. It DOES NOT verify that the instrument meets all specifications. In order to verify that the instrument meets all specifications, use the Performance Verification Procedure in the SCD1000/SCD5000 Service Manual (part number 070-6963-00).*

If at any time during the tests the instrument fails to meet a test limit, then it should be returned to an authorized service center for servicing, identifying the test failed and limits exceeded.

The test should be run in a stable environment with the temperature between 20° C and 30° C and provisions made for adequate airflow to the instrument (i.e. the ventilation ports on the rear, sides, and front should be unobstructed). The ambient temperature should not change by more than 5° C during the tests.

Line supply should lie within the limits of 90 to 132 V<sub>RMS</sub> or 180 to 250 V<sub>RMS</sub>.

Table 2-2 lists the tests to be run.

**Table 2-2: Lists of Tests for Incoming Inspection**

Test Number	Test Name	Description
1	Diagnostics	Verifies general operating condition of the instrument
2	Calibrator	Checks internal calibration reference signals
3	Self-Cal	Performs verification of internal timing, vertical gain and offset, and trigger level circuitry of the instrument

## Internal Diagnostics and Internal Calibration

Diagnostics and Internal Calibration can be run either from the IEEE–488 interface or the display unit. See the Programmer Manual, for more information on the associated GPIB commands. See *Section 3, Operating Procedures*, for information about how to invoke Diagnostics and Internal Calibration from the Utility Mode menu.

The internal diagnostics test the following:

- **PROCESSOR SYSTEM**, including system ROM, RAM, NVRAM, GPIB system, and system timer module
- **FRONT PANEL**, including the LCD, front panel circuitry, and MPU front panel interface
- **ACQUISITION SYSTEM**, including functioning of the digital acquisition control and data path
- **OPTIONS**, Option 1P

Internal calibration performs the following:

- **VERTICAL**
  - SCD1000** — Sets the gain and offset range, and the Normal and Invert offset zero level for Channels A, B, and Add.
  - SCD5000** — Sets the input range, offset range, and the offset zero level.
- **HORIZONTAL**

Sets Window timing accuracy and Trigger Delay minimum and maximum values.
- **TRIGGER**
  - SCD1000** — For DC coupling, sets the internal level range and offset for both slope settings; for internal and external.
  - SCD5000** — Sets trigger level and slope for external trigger.
- **CRT**

For each window size, sets the CRT intensity and focus to be used when an instrument initialize is performed. The initialized intensities are also used to set the current operating intensity for each window size after the CRT cal is run. Sets the orthogonality of the CRT's Write Gun with relation to the Read Gun.

## Required Equipment

Table 2-3 lists the required equipment to complete the incoming inspection procedures

**Table 2-3: List of Required Equipment for Incoming Inspection**

<b>Instrument Name</b>	<b>Recommended or Equivalent</b>
5½ digit Digital Multimeter (DMM)	Tektronix DM 5120
250 MHz Digital Counter	Tektronix DC 5010
1 MHz Signal Generator	Tektronix SG 503
Instrument Controller with IEEE-488 interface	
<b>Miscellaneous Parts</b>	
<b>SCD1000</b>	
Qty. 1: 50 Ω coaxial cable (3 ft long)	Tektronix part number 012-0482-00
Qty. 2: N to BNC adapters	Tektronix part number 103-0045-00
<b>SCD5000</b>	
Qty. 1: 50 Ω coaxial cable (3 ft long)	Tektronix part number 012-0482-00
Qty. 1: 50 Ω coaxial cable (8 in long)	Tektronix part number 012-0118-00
Qty. 2: N to BNC adapters	Tektronix part number 103-0045-00
50 Ω terminator with BNC feed-through	Tektronix part number 011-0049-01

---

## Test 1 Diagnostics

The general operating condition of the instrument is ascertained by running the internal diagnostic routines.

### Setup

Apply power to the waveform recorder.

### NOTE

*Allow 20 minutes for warm-up.*

### Procedure

1. Invoke the internal diagnostic routines via IEEE–488 by sending the instrument the commands:

INIT ALL

TEST SYS:ALL

or

Invoke the internal diagnostic routines via the optional display unit by selecting the Utility Mode menu. In the function menu which appears when the Utility Mode menu is selected, select the Next Menu function. This will cause an alternate function menu to appear. In this menu select the InstTest function. This will invoke a self-test of the entire instrument.

2. If the self-test routines fail, return the instrument to an authorized service center for servicing.

**Table 2-4: Test List**

Number	Name	Subsystem	Description
1	Real-time Clock	MPU	Checks for proper operation of the clock used to set the waveform time stamps.
2	GPIB	MPU	Confirms operation of the GPIB system excluding the bus drivers.
3	Bus Error	MPU	Forces a MPU bus error to confirm the bus error detection circuitry is operational.
4	Timer	MPU	Tests the timer used by the operating system for operation at the proper interrupt rate.
5	ROM0 part number	MPU	Checks the MPU board EPROM location and does check-sum test.
6	ROM1 part number	MPU	Same as test 5.
7	ROM2 part number	MPU	Same as test 5.
8	ROM3 part number	MPU	Same as test 5.

**Table 2-4: Test List (Cont.)**

<b>Number</b>	<b>Name</b>	<b>Subsystem</b>	<b>Description</b>
9	Display Unit ROM part number	MPU	Check for the proper EPROM on the Front Panel circuit board.
10	NVRAM	MPU	Checks the NVRAM on the MPU board.
11	Video	FP	Checks the RAM on the MPU board used for the LCD display.
12	Button	FP	Checks the push button logic on the Front Panel board.
13	Front Panel Communication	FP	Confirms the link between the MPU and the Display's Front Panel circuit board.
14	Digital Acquisition With Memory Test	DIG	Checks the waveform recorder's control system.
15	Digital Acquisition Without Memory Test	DIG	Checks the waveform recorder's control system and memory.
16	Serial Bus	DIG	Confirms the internal serial communications bus is operational.
17	Options	OPT	Check Option 1P and Option 2F memory if installed.
18	DSP Option Communication	OPT	Checks Option 1P host port communication.

---

## Test 2 Cal Time Frequency

The accuracy of the internal calibration reference signal is verified using a digital counter.

### Setup

Refer to Figure 2-5 for proper connections. Connect the Calibrator Output connector on the rear of the SCD1000 or the front of the SCD5000 through a 50  $\Omega$  coax cable to the DC5010 Counter/Timer.

### Digitizer

Cal Out	Time
Cal Time	4 ns

### Counter

Mode	Frequency
Trigger Level	Auto (680 mV for SCD1000 or 2.1 V for SCD5000)
Trigger Slope	+
Coupling	DC
Attenuation	X1 (SCD1000) X5 (SCD5000)
Termination	50 $\Omega$

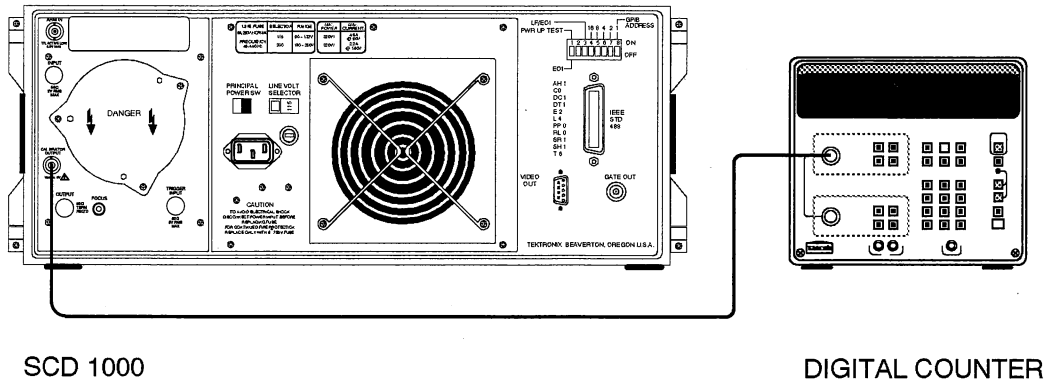
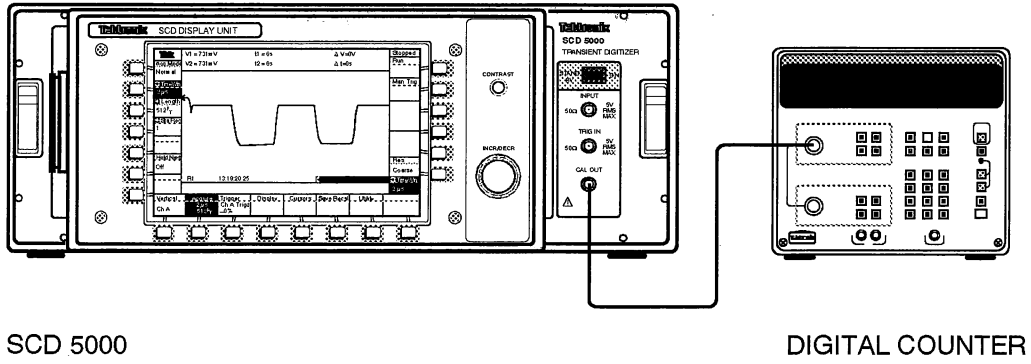

Figure 2-5: Internal Clock Frequency Test Setup



## Procedure

1. Set the counter averaging to AUTO (or highest accuracy setting possible).
2. From the Utility menu (5th level), select EXT CAL (CAL OUT on SCD5000) to Time.
3. Adjusting CAL TIME settings from 4 ns to 80  $\mu$ s according to the steps in the following table.
4. Verify that the measured period (or frequency) matches the SCD CAL TIME readout value for all settings (4 ns to 80  $\mu$ s), within 0.1% tolerance:

**Table 2-5: Calibrator Timing Measurements**

Cal Range	Frequency	Tolerance
4 ns	250.000 MHz	$\pm$ 250 kHz
8 ns	125.000 MHz	$\pm$ 125 kHz
16 ns	62.500 MHz	$\pm$ 62.5 kHz
40 ns	25.000 MHz	$\pm$ 25 kHz
80 ns	12.500 MHz	$\pm$ 12.5 kHz
160 ns	6.250 MHz	$\pm$ 6.25 kHz
400 ns	2.500 MHz	$\pm$ 2.5 kHz
800 ns	1.250 MHz	$\pm$ 1.25 kHz
1.6 $\mu$ s	625.0 kHz	$\pm$ 625 Hz
4 $\mu$ s	250.0 kHz	$\pm$ 250 Hz
8 $\mu$ s	125.0 kHz	$\pm$ 125 Hz
16 $\mu$ s	62.50 kHz	$\pm$ 62.5 Hz
40 $\mu$ s	25.00 kHz	$\pm$ 25 Hz
80 $\mu$ s	12.50 kHz	$\pm$ 12.5 Hz

## Reference Voltage

The amplitude of the internal voltage reference is verified using a digital multimeter

## Setup

**SCD1000** — Connect a Tek DM5120 DMM through a 50  $\Omega$  coax cable directly to the Calibrator output connector on the rear panel.

**SCD5000** — Connect a 50  $\Omega$  termination directly to the Calibrator output connector on the front panel. Connect the DM5120 through a 50  $\Omega$  coax cable to the 50  $\Omega$  termination.

### Digitizer

Cal Out	Ampl
Cal Ampl	2.50 V

### DMM

Mode	DC Volts
Range	Auto

### Procedure for SCD1000:

1. From the Utility menu (5<sup>th</sup> menu level), select EXT CAL to AMPL.
2. While adjusting CAL AMPL according to the following table, check the calibrator voltage to  $\pm(0.1\% + 1 \text{ mV})$  accuracy on all ranges:

**Table 2-6: SCD1000 Calibrator Voltage Limits**

Calibrator Ampl.	Measurement (min)	Measurement (max)
+2.5 V	2.4965 V	2.5035 V
+2.0 V	1.997 V	2.003 V
+800 mV	0.7982 V	0.8018 V
+400 mV	0.3986 V	0.4014 V
+200 mV	198.8 mV	201.2 mV
+80 mV	78.92 mV	81.08 mV
+40 mV	38.96 mV	41.04 mV
0.0 V	-1.0 mV	+1.0 mV
-40 mV	-38.96 mV	-41.04 mV
-80 mV	-78.92 mV	-81.08 mV
-200 mV	-198.8 mV	-201.2 mV
-400 mV	-0.3986 V	-0.4014 V

**Table 2-6: SCD1000 Calibrator Voltage Limits (Cont.)**

Calibrator Ampl.	Measurement (min)	Measurement (max)
-800 mV	-0.7982 V	-0.8018 V
-2.0 V	-1.997 V	-2.003 V
-2.5 V	-2.4965 V	-2.5035 V

3. Adjust CAL AMPL to the first of the two values given in the first column of the table below.
4. Mark down the amplitude measured by the DVM = A1.
5. Adjust the CAL AMPL to the second of the two values given in the first column of the table. Mark down the amplitude measured on the DVM = A2.
6. Add the absolute values of A1 and A2 for the  $\Delta$ Volts measurement:  $|A1| + |A2| = \Delta$ Volts.
7. Check the calibrator voltage  $\Delta$ Volts accuracy to within the specification limits given in the table below.
8. Repeat steps 3 through 7 above for all the rows of the table below.

**Table 2-7: SCD1000 Calibrator  $\Delta$  Voltage Limits**

Calibrator Ampl.	$\Delta$ V Measurement (min)	$\Delta$ V Measurement (max)
+2.5 V, -2.5 V	4.990 V	5.010 V
+2.0 V, -2.0 V	3.992 V	4.008 V
+800 mV, -800 mV	1.597 V	1.603 V
+400 mV, -400 mV	798.4 mV	801.6 mV
+200 mV, -200 mV	399.2 mV	400.8 mV
+80 mV, -80 mV	159.7 mV	160.3 mV
+40 mV, -40 mV	79.84 mV	80.16 mV

### Procedure for SCD5000:

1. From the Utility menu (5th menu level), select CAL OUT to AMPL.
2. While adjusting CAL AMPL according to the following table, check the calibrator voltage to  $\pm(0.1\% + 1 \text{ mV})$  accuracy on all ranges:

**Table 2-8: SCD5000 Calibrator Voltage Limits**

Calibrator Ampl.	Measurement (min)	Measurement (max)
+4 V	+3.995 V	+4.005 V
+3 V	+2.996 V	+3.004 V
+2 V	+1.997 V	+2.003 V
+1 V	+0.998 V	+1.002 V
+800 mV	+798.2 mV	+801.8 mV
+400 mV	+398.6 mV	+401.4 mV
+200 mV	+198.8 mV	+201.2 mV
+100 mV	+98.9 mV	+101.1 mV
0.0 V	+1.0 mV	-1.0 mV
-100 mV	-98.9 mV	-101.1 mV
-200 mV	-198.8 mV	-201.2 mV
-400 mV	-398.6 mV	-401.4 mV
-800 mV	-798.2 mV	-801.8 mV
-1 V	-0.998 V	-1.002 V
-2 V	-1.997 V	-2.003 V
-3 V	-2.996 V	-3.004 V
-4 V	-3.995 V	-4.005 V

3. Adjust CAL AMPL to the first of the two values given in the first column of the table below.
4. Mark down the amplitude measured by the DVM = A1.
5. Adjust the CAL AMPL to the second of the two values given in the first column of the table. Mark down the amplitude measured on the DVM = A2.
6. Add the absolute values of A1 and A2 for the  $\Delta$  Volts measurement:  
 $|A1| + |A2| = \Delta \text{ Volts}$
7. Check the calibrator voltage  $\Delta$  Volts accuracy to within the specification limits given in Table 2-9.

8. Repeat steps 3 through 7 above for all of the rows in the table.

**Table 2-9: SCD5000 Calibrator  $\Delta$  Voltage Limits**

<b>Calibrator Ampl.</b>	<b><math>\Delta V</math> Measurement (min)</b>	<b><math>\Delta V</math> Measurement (max)</b>
+4 V, -4 V	7.984 V	8.016 V
+3 V, -3 V	5.988 V	6.012 V
+2 V, -2 V	3.992 V	4.008 V
+1 V, -1 V	1.996 V	2.004 V
+800 mV, -800 mV	1.597 V	1.603 V
+400 mV, -400 mV	798.4 mV	801.6 mV
+200 mV, -200 mV	399.2 mV	400.8 mV
+100 mV, -100 mV	199.6 mV	200.4 mV

---

## Test 3 Internal Calibration

Internal timing, vertical gain, offset gain, and trigger level gain of the instrument are verified by running the internal calibration routines. A calibration in process may be terminated by pressing any front-panel key or sending any GPIB command.

### Setup

Apply power to the waveform recorder.

### Procedure

1. Invoke CRT calibration routines via IEEE-488 by sending the instrument the command:

CALIBRATE CRT

After intensity is calibrated (which takes approximately 2 minutes), the waveform recorder will prompt the user. At this time, connect a 1 MHz 80 mV<sub>p-p</sub> signal from the SG503 to the CHA input connector of the SCD1000. If an SCD5000 is being calibrated, connect a 1 MHz 3 V<sub>p-p</sub> signal from the SG503 to the input connector of the instrument. Press any front panel button for the CRT calibration to continue.

The instrument will wait approximately 1 minute for the user to connect the proper signal and press any menu button. If the instrument times out

(>1 minute), it will report a calibration failure for the CRT. If this happens, run CRT calibration again, making sure to connect the proper signal within the time limit. (The user will hear the bell “ticking” while waiting for the user to connect the signal and press a button. The “ticking” speeds up as timeout approaches.)

2. For SCD5000's connect the calibrator output to the signal input using the 8" cable.
3. Run system calibration routines via IEEE-488 by sending the instrument the command:

CALIBRATE ALL

The instrument will wait approximately 1 minute for the user to connect the proper signal and press any menu button. If the instrument times out

(>1 minute), it will report a calibration failure for the CRT. If this happens, run CRT calibration again, making sure to connect the proper signal within the time limit. (The user will hear the bell “ticking” while waiting for the user to connect the signal and press a button. The “ticking” speeds up as timeout approaches.)

4. If the calibration routines fail, return the instrument to an authorized service center for servicing.

---

## Packaging for Shipment

It is recommended that the original carton and packing material be saved for shipping the waveform recorder. If the original materials are unfit or not available, package the instrument as follows:

1. Use a corrugated cardboard shipping carton having a test strength of at least 275 pounds and with an inside dimension of at least six inches greater than the instrument dimensions.
2. If the instrument is being shipped to a Tektronix Service Center, enclose the following information:
  - the owner's address,
  - name and phone number of a contact person,
  - type and serial number of the instrument,
  - reason for return,
  - a complete description of the service required.
3. Completely wrap the instrument with polyethylene sheeting, or an equivalent, to protect the instrument case and to prevent entry of harmful substances into the instrument.
4. Cushion the instrument on all sides using three inches of padding material or urethane foam, tightly packed between the carton and the instrument.
5. Seal the shipping carton with an industrial stapler or strapping tape.
6. If the instrument is being shipped to a Tektronix service center, mark the address of the Tektronix Service Center and also your own return address on the shipping carton in two clearly visible locations.

# Operating Instructions



# Instrument Familiarization

---

## Front Panel Controls, Connectors, and Indicators

The SCD1000 and SCD5000 can be controlled either over the GPIB using the waveform recorder's command set, or from the Display Unit. The command set follows the IEEE–488.1 GPIB protocol and is described in the Programmer Manual. Frequent references in this section of the manual are made to the command set. Refer to the Programmer Manual for more information when necessary. Control of the instrument from the Display Unit is described in this section.

Front panel controls and indicators of the SCD1000 and SCD5000 waveform recorders are located around the Display Unit. The Display Unit can be removed from the instrument as described in *Removing/Replacing Display Unit* on page 3-14. Controls and indicators of the Display Unit are described, starting on page 3-19.



*Removal and installation of the Display Unit must be done with the instrument power turned off.*

The following descriptions cover both the SCD1000 (Figure 3-1) and SCD5000 (Figure 3-2) waveform recorders. A description that applies to only one of the instruments is noted in the description.

### Controls

**ON/STANDBY Switch** turns the instrument ON and OFF when the rear panel principal power switch is ON.

### Connectors

**DISPLAY UNIT** connects to the Display Unit when attached. This is the signal and power interface between the waveform recorder and the Display Unit.

**CHA/CHB (SCD1000 Only)** provides input connections for signal acquisition. Input impedance is 50  $\Omega$  when the waveform recorder is turned on. Impedance is 500 k $\Omega$  when the power is turned off.

**INPUT (SCD5000 Only)** provides input connections for signal acquisition. Input impedance is 50  $\Omega$  when power is on or off.

**CAL OUT (SCD5000 Only)** outputs the calibrator signal selected from the Utility Menu or GPIB. On the SCD5000, this signal must be physically connected to the input connector using a cable when calibrating the instrument. On the SCD1000, the CAL OUT connector is located on the rear panel, but an internal signal path to the inputs is provided for calibration. A cable is not required.

**EXT TRIG** provides connection for triggering on an external signal.

**Indicators**

The following indicators are located on the mainframe’s front panel, behind the Display Unit.

**Table 3-1: Acquisition Status Indicators**

<b>Name</b>	<b>Color</b>	<b>Description</b>
RUN	Green	Lights to indicate the waveform recorder is running, digitizing, and storing data.
STOP	Red	Lights to indicate no digitization is in process. An acquisition has taken place, but no further acquisitions will take place until the waveform recorder is started again.
HOLD NEXT	Yellow	Lights to indicate the waveform recorder is in the HoldNext state.

**Table 3-2: Active Interface Indicators**

<b>Name</b>	<b>Color</b>	<b>Description</b>
GPIB	Green	Lights to indicate the GPIB interface is active.
OPTION	Yellow	Reserved for future use.

**Table 3-3: Interface Status Indicators**

<b>Name</b>	<b>Color</b>	<b>Description</b>
TALK	Green	Lights to indicate the waveform recorder is TALK addressed.
SRQ	Red	Lights to indicate the waveform recorder has asserted the GPIB Service Request Line.
LISTEN	Yellow	Lights to indicate the waveform recorder is LISTEN addressed.

**Table 3-4: System Status Indicators**

Name	Color	Description
ON	Green	Lights when the waveform recorder has been turned on (both the rear panel principal power and front panel ON/STANDBY switches are on).
FAULT	Red	Lights to indicate that a fault condition has occurred during the power-up self-test.
TEST	Yellow	Lights to indicate the waveform recorder's internal test routines are in process.

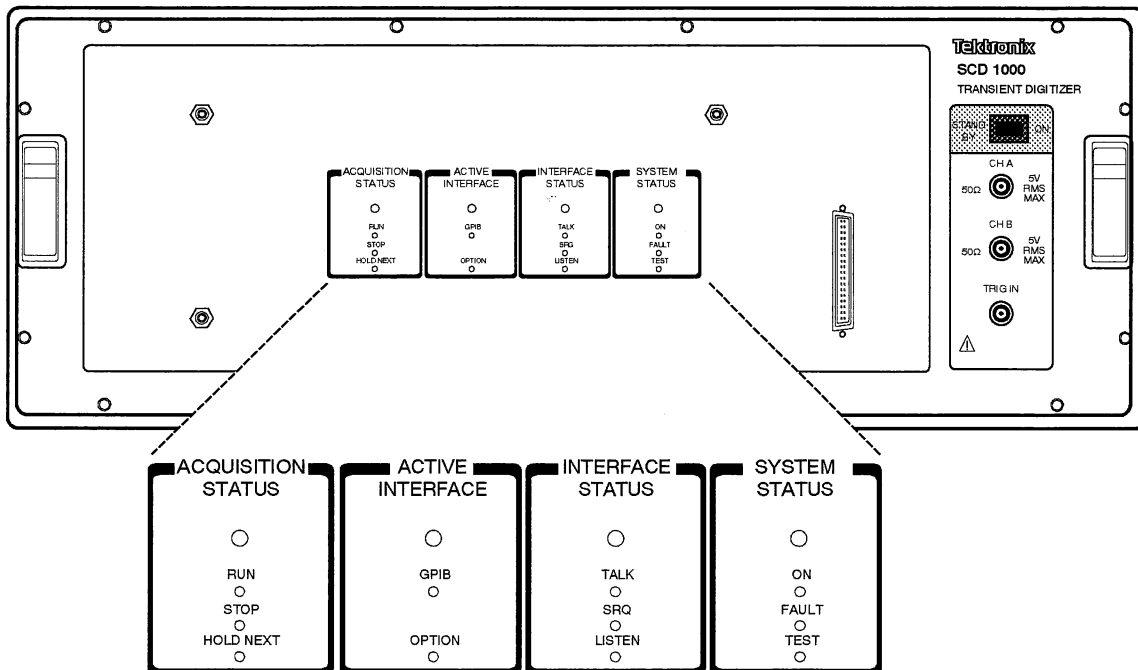

**Figure 3-1: SCD1000 Front Panel Controls, Connectors, and Indicators**

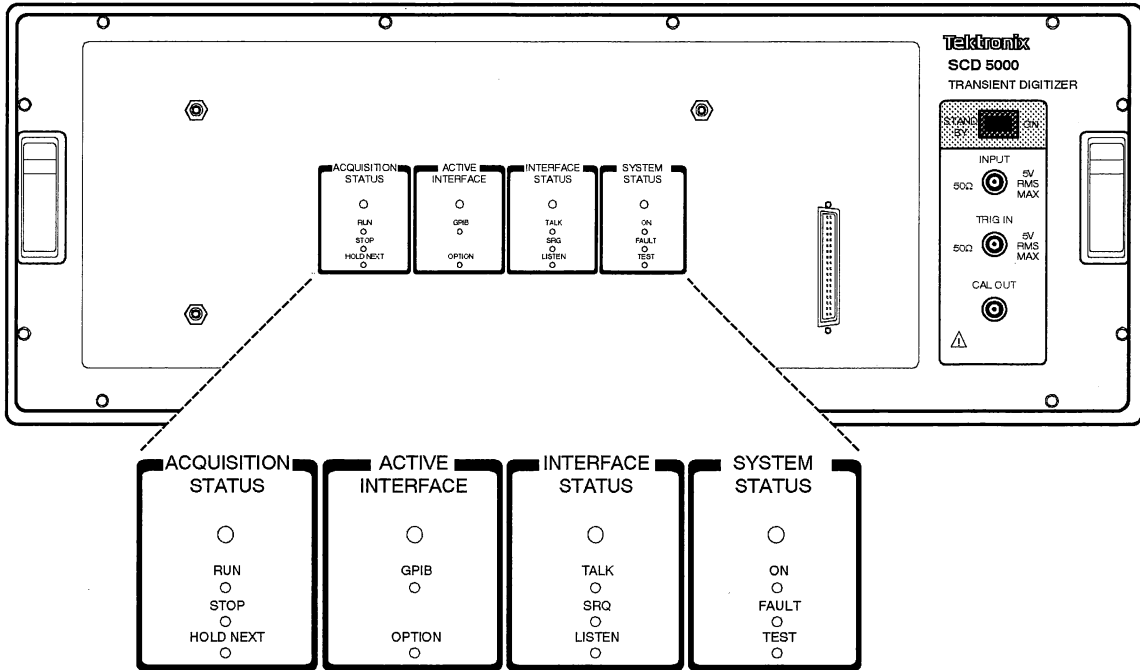

Figure 3-2: SCD5000 Front Panel Controls, Connectors, and Indicators

## Rear Panel Controls, Connectors, and Indicators

The SCD1000 and SCD5000 rear panels differ slightly. The SCD1000 rear panel contains the CAL OUT connector, while the SCD5000 has the connector on the front panel. Otherwise the rear panels are identical. Rear panel controls, connectors, and indicators are shown in Figure 3-3 (SCD1000) and Figure 3-4 (SCD5000).

### Controls

**PRINCIPAL POWER SW** turns AC power to the waveform recorder on and off. This switch must be ON to turn on the waveform recorder.

**LINE VOLT SELECTOR** selects the AC line voltage to be either 120 V or 220 V nominal.

**Rear Panel Focus** does not require adjustment. See the Service Manual for information.

**Instrument Switches** set various waveform recorder operating parameters, including Power-up test bypass, GPIB terminator, and GPIB address. Figure 3-6 illustrates these switches.

The address switches are binary-encoded switches (1, 2, 4, 8, and 16). Setting the switch to ON is equivalent to its binary value of 1. The sum of the values equals the GPIB address. Addresses 0 through 30 are valid operating addresses. The factory-set address for the SCD1000 is 4; the SCD5000 address is 5. Address 31 is equivalent to OFF BUS.

Refer to the Programmer Manual for more information on switch settings.

### Connectors

**AC POWER INPUT** accepts 98 to 250 V nominal power source from 48 to 440 Hz.

**FUSE HOLDER** contains the AC line fuse (6 A, 250 V, normal blow for 115 V or 230 V operation).

**GPIB CONNECTOR** is compatible with IEEE–488.1 cable connector.

**VIDEO OUT** supplies VGA-compatible video signal for connection to a monitor or hardcopy unit.

**GATE OUT** supplies a TTL-level signal that goes HIGH when the acquisition sweep begins to write the input signal onto the target.

**CALIBRATOR OUT (SCD1000 Only)** outputs calibrator signal. See CAL OUT (SCD5000 Only) on page 3-2.

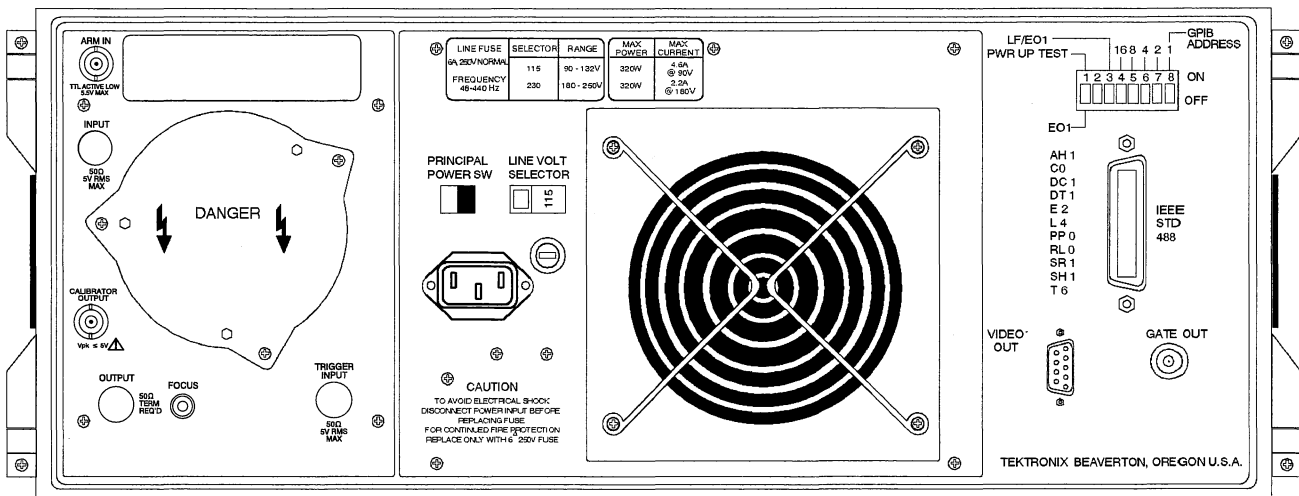

Figure 3-3: SCD1000 Rear Panel Controls, Connectors, and Indicators

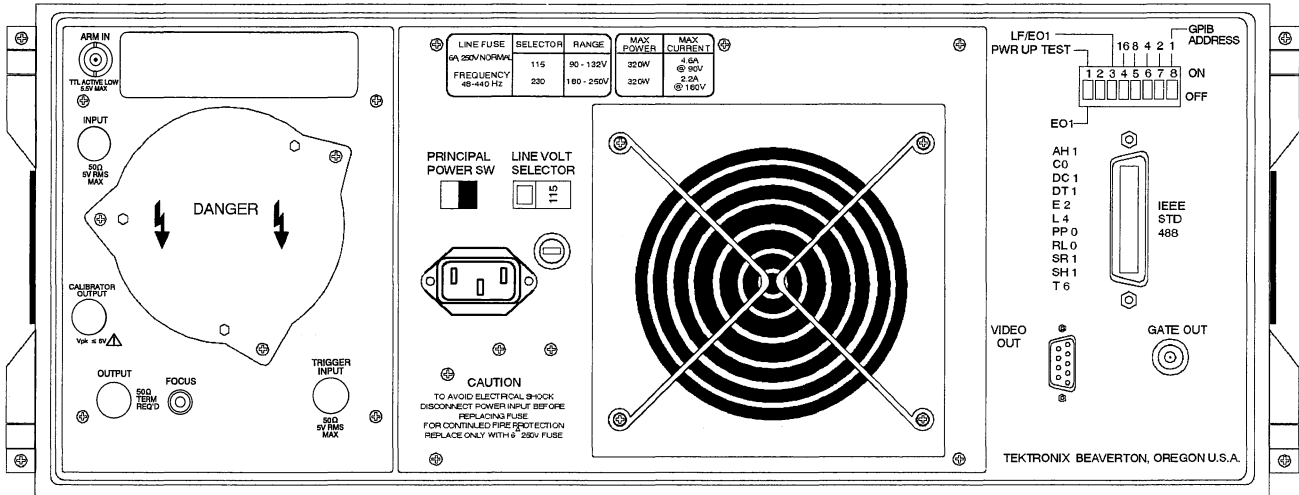

Figure 3-4: SCD5000 Rear Panel Controls, Connectors, and Indicators

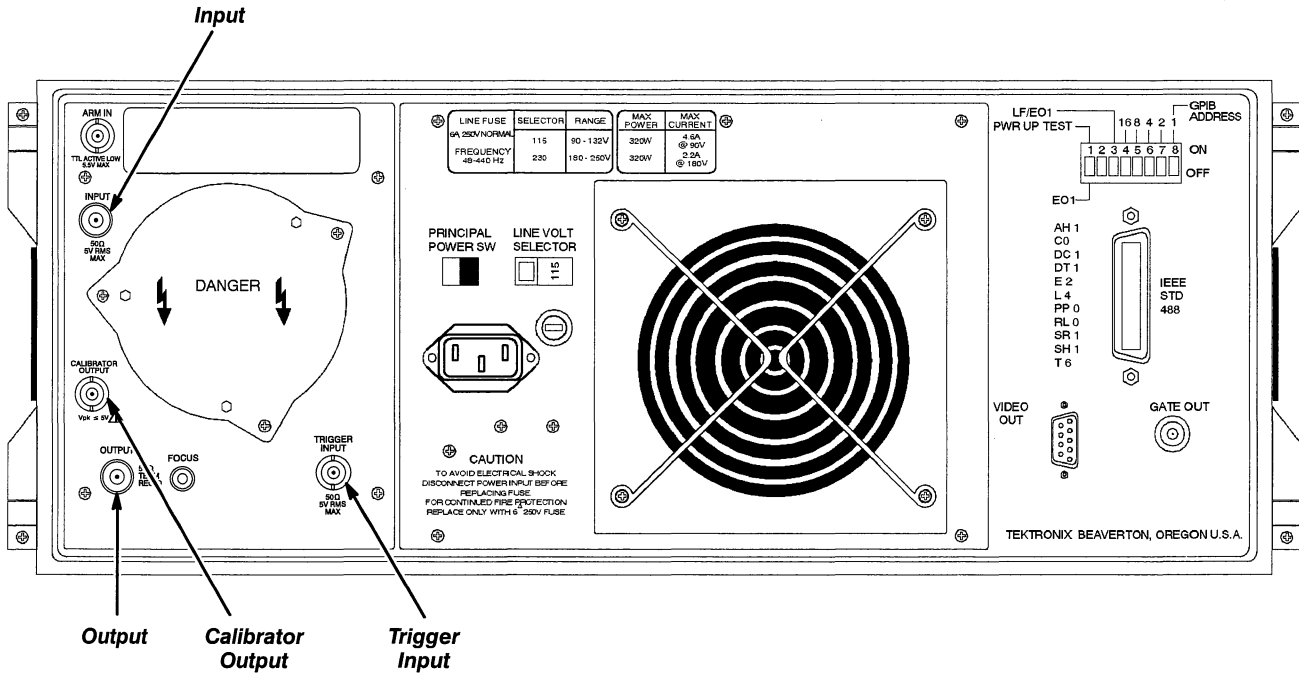

Figure 3-5: SCD5000 Option 9E Rear Panel Controls, Connectors, and Indicators

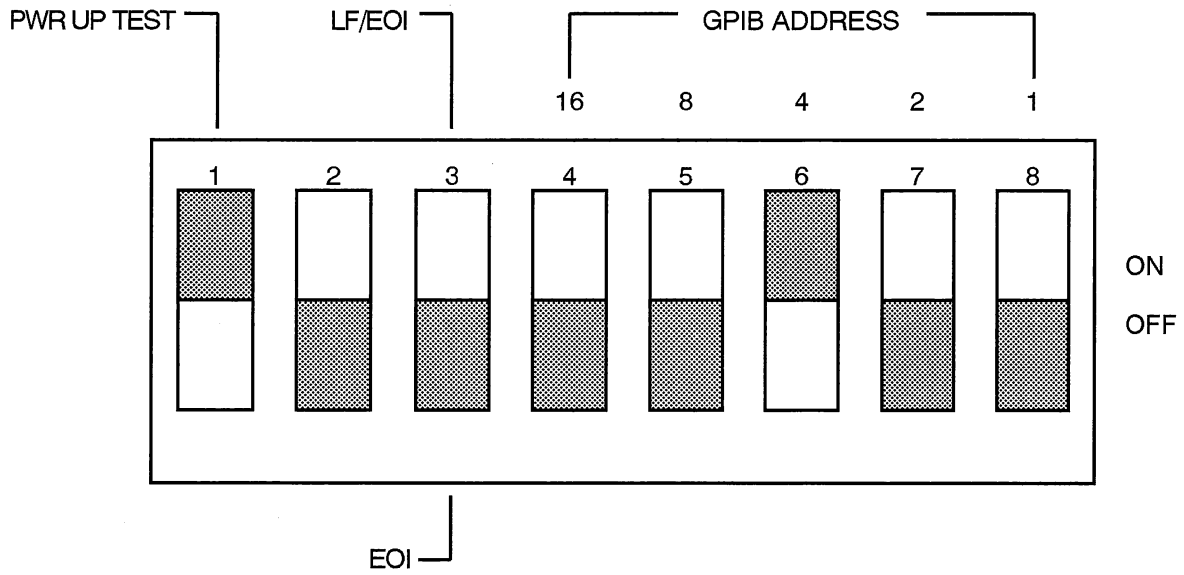

Figure 3-6: Instrument Switches





# Initial Instrument Setup

---

## Power On

Before turning on the power for the first time, be sure to read the Safety summary at the front of this manual and *Preparation for Use*, on page 2-1.



*If the waveform recorder has been stored in an environment outside its specified operating temperature, do not turn on the power until the instrument has stabilized to an ambient temperature within its specified operating temperature range. If moisture has collected on the instrument, allow the moisture to evaporate before powering up.*

The waveform recorder has two power switches: the PRINCIPAL POWER switch (on the rear panel) and the ON/STANDBY switch (on the front panel). To power up the instrument, first make sure the rear panel PRINCIPAL POWER switch is ON and turn on the front-panel ON/STANDBY switch.

---

## Power Off

To turn the waveform recorder completely off, first set the front-panel ON/STANDBY switch to STANDBY, then turn off the rear-panel PRINCIPAL POWER switch.

Before powering off during a normal power-off sequence, the waveform recorder stores, in non-volatile memory, the current instrument settings, and the waveforms in records 1 through 4. Settings are reestablished when the waveform recorder is later powered up. If power is turned off or interrupted during a self-test or while performing a normal operation, the instrument may not properly save these settings. The settings are then set to factory default.

In addition to saving the current settings, up to 10 different instrument settings can be saved in non-volatile memory for quick recall. Saving settings can be done over the GPIB (SAVE command) or from the Display Unit. Refer to the Programmer Manual for more information on the SAVE command.

---

## Self-Test and Diagnostics

The SCD Waveform Recorders perform internal self-test routines each time the instrument is powered up. The power-up self-test can be bypassed by setting the rear-panel PWR UP TEST switch OFF. Power-up self-test routines require no user interaction.

### **NOTE**

*Instrument warm-up can take 20 minutes.*

If any test fails, the following occur:

- the instrument attempts to run while reporting an Internal Error event code over the GPIB (See the Programmer Manual for Event Codes)
- the front-panel FAULT indicator (beneath the Display Unit) lights to indicate a fault
- A descriptive message is displayed in the Message/Measurements Zone of the Display Unit

The power-up self-test consists of two parts: the Kernel Tests and the Essential Diagnostics Tests. Kernel tests include the microprocessor, processor RAM and ROM, and the GPIB communication system tests. These tests verify that all the resources needed by the operating system are working. Once the kernel tests have passed, the operating system is activated.

The first task of the operating system is to execute the Essential Diagnostics tests, which assure that all basic subsystems properly function. No kernel or essential diagnostics are performed with Power-up test off.

Self-test can also be initiated over the GPIB (using the TEST command) or from the Display Unit. See the Programmer Manual for more information on the TEST command.

The SCD Waveform Recorders also provide calibration routines for the following subsystems. These routines are only initiated from the Display Unit or over the GPIB, and are not part of the power-on sequence.

**CALIBRATE HORIZONTAL:** Performs self-calibration of the horizontal sweep circuits.

**CALIBRATE TRIGGER:** Performs self-calibration of trigger circuits.

**CALIBRATE VERT:** Performs self-calibration of Gain and Offset vertical circuits.

**CALIBRATE CRT:** Performs self-calibration of the CRT circuits.

**CALIBRATE ALL:** Executes all calibration routines.

Refer to the Programmer Manual for more information on the CALIBRATE command.

---

## Initialization

Once the power-up self-test has successfully completed, the SCD Waveform Recorders automatically returned to the settings that existed prior to the power being turned off. If initialization to factory default settings is desired, initialization can be invoked from the Display Unit or over the GPIB. Over the GPIB, the instrument settings (Panel), the GPIB (GPIB), or both can be initialized. From the Display Unit menus, any mode, function, or the entire instrument (Panel) can be initialized.

The Programmer Manual lists the factory default settings for the SCD Waveform Recorders.

## Initial Instrument Setup

# Operator's Procedures

## Display Unit Overview

The SCD waveform recorders can be controlled over the GPIB or from the Display Unit (shown in Figure 3-7 attached to a waveform recorder). The instrument's GPIB command set is described in the Programmer Manual. The Display Unit is described in the remainder of this section.

The Display Unit provides instrument control and display of digitized waveform data and instrument status on a high-resolution Liquid Crystal Display (LCD). Instrument control is through several "soft keys" around the perimeter of the LCD. Key functions change depending on the operating mode of the instrument and the soft keys previously pressed. A label displayed on the LCD next to a key defines the current function of that key.

The Display Unit plugs into the waveform recorder. It is easily removed as described in *Removing/Replacing Display Unit* on page 3-14.

The LCD is a backlit, high-resolution display (640 × 400 pixels). Up to 64 characters by 16 rows of text can be displayed on the screen. A CONTRAST adjustment knob allows changes in contrast for comfortable viewing over a wide range of ambient lighting.

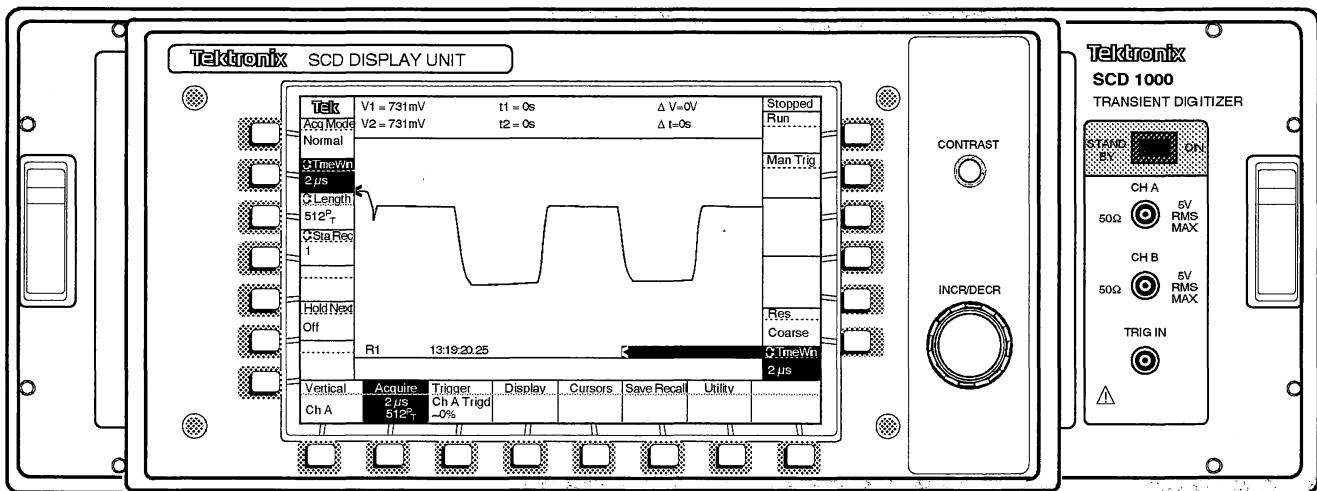

Figure 3-7: SCD1000 Waveform Recorder With Display Unit Attached

### Removing/Replacing Display Unit

The Display Unit is a removeable device. It is attached to the waveform recorder front panel by four "clasps" that engage posts on the instrument's front chassis. The clasps are engaged and disengaged by the handle on the left side of the Display Unit (see Figure 3-8). By firmly pulling the handle to the left, the clasps are disengaged. The Display Unit can then be removed by pulling the unit forward, away from the waveform recorder.

When re-installing the Display Unit, make sure the handle is completely pulled out. Place the Display Unit onto the waveform recorder, making sure the display connector properly mates. Slide the handle to the right to engage the clasps and secure the Display Unit to the waveform recorder.

**CAUTION**

*Make sure the handle is pressed all the way in. If the handle is not pressed in all the way, the Display Unit is not secured to the instrument, and it may fall off. The yellow "Latch Open" warning label will be totally hidden when the latch is fully engaged.*

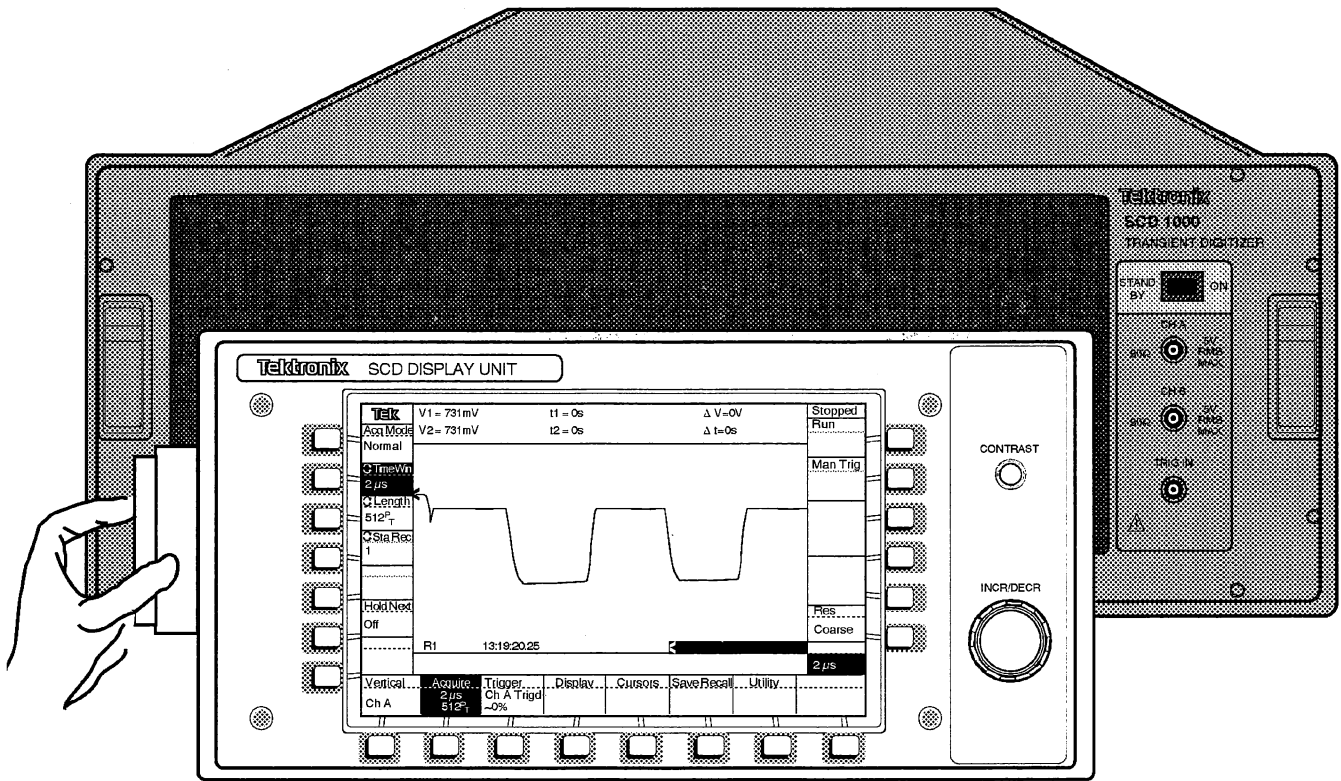
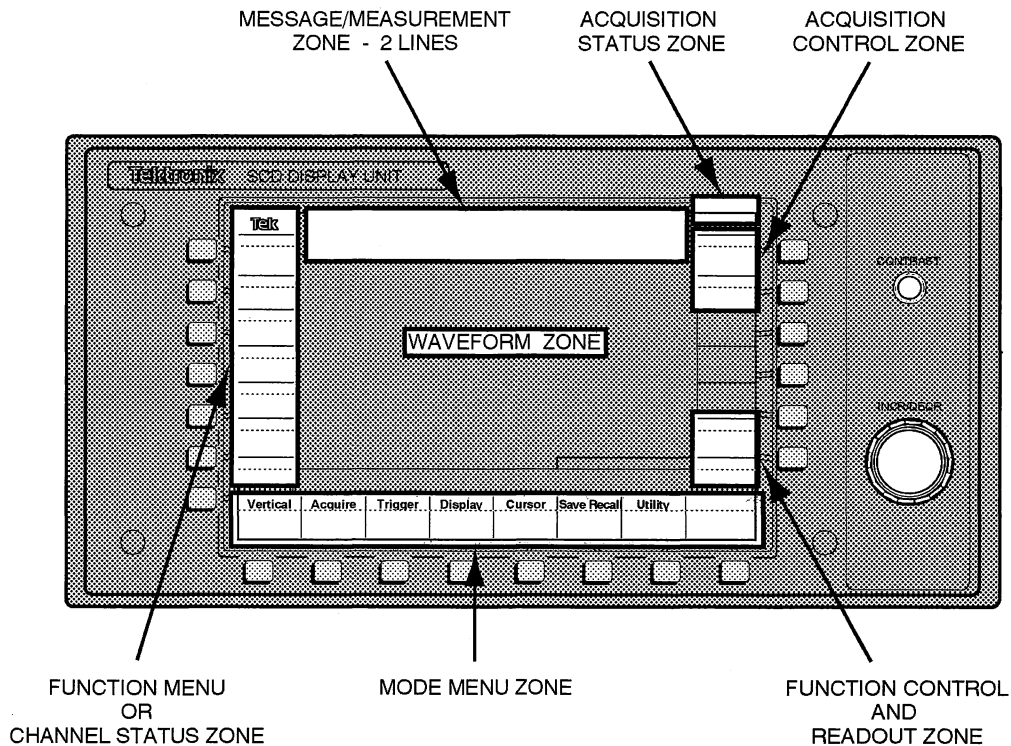

Figure 3-8: Securing the Display Unit

## Display Unit Operation

### Display Zones

The Display Unit includes six display zones, as illustrated in Figure 3-9. These zones contain soft key menus and settings, waveform data, messages, and waveform recorder status information.



**Figure 3-9: Display Unit Display Zones**

**Mode Menu Zone** — The mode menu zone is always displayed when the Display Unit is on. Mode menu labels are described starting on page 3-19.

**Function Menu/Channel Status Zone** — This zone displays the function key labels when a mode is active or vertical channel status information when no mode is active. Each channel's status includes the vertical mode (Ch A, Ch B, or Add), vertical range and coupling, offset value, and the vertical expansion factor.

**Acquisition Status Zone** — This zone displays the current state of the waveform recorder:

- Stopped indicates the system has stopped acquiring data.
- Running indicates the system is acquiring data.
- HoldNext indicates the system is waiting for an acquisition to complete and the HoldNext acquisition mode is on.

**Knob Readout Zone** — This zone displays the last parameter that was set by the knob and its current value. Turning the knob affects the value in this zone.

**Message/Measurements Zone** — This zone displays error messages, warning messages, or measurement results from the two cursors or expansion point. When any error or warning occurs from the front panel or the GPIB, an appropriate error/warning message is written in the message zone. This message remains until a new message replaces the current one, or until a cursor position is changed or the Cursors mode key is activated. The last 20 messages are saved in nonvolatile memory and can be recalled using the Recall Status function.

Cursors must be turned on for measurement information to be displayed.

**Cursors** — Cursor measurements include absolute time and voltage for each cursor and the  $\Delta t$  (or  $1/t$ ) and  $\Delta$  amplitude between the cursors. The cursors can be assigned to the same display window or different display windows.

This zone is shared amongst all functions that use it, so the information displayed here is a result of the last function that used it. None of the functions has priority over any other function; this means if an error message is displayed in the area and the cursor function is requested, the cursor will display its readout in the area, overwriting the error message.

**Waveform Zone** — This zone displays waveform data in 1, 2, or 4 windows. Each window can display one waveform and several indicators. Waveform displays with one window, two windows, and four windows are shown in Figures 3-10, 3-11, and 3-12. Waveform zone indicators are shown in Figure 3-13.

The horizontal axis for each window covers 512 pixels. The vertical axis for each window covers 256 pixels (1 window), 128 pixels (2 windows), or 64 pixels (4 windows).



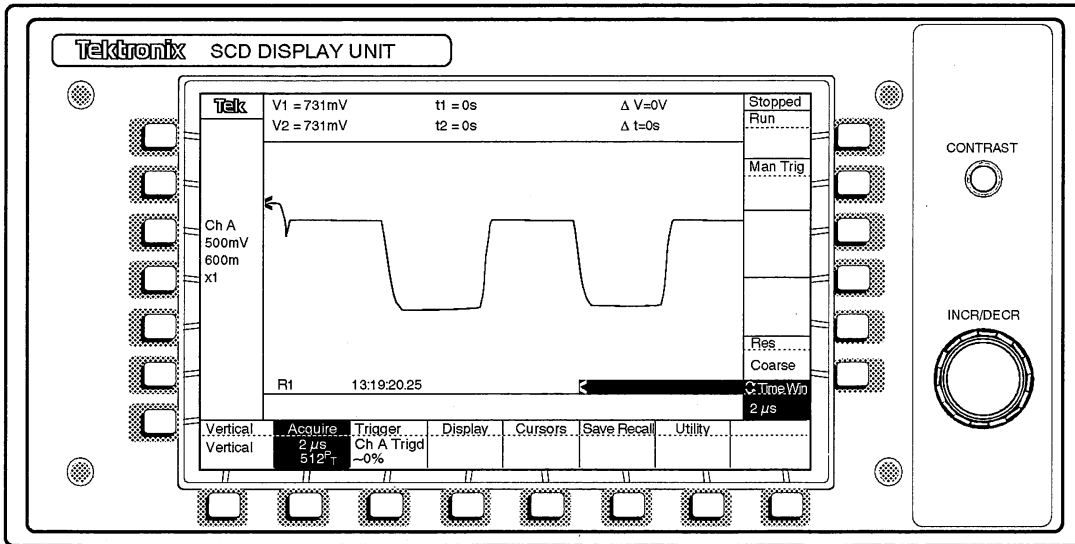

Figure 3-10: Single Waveform Displayed

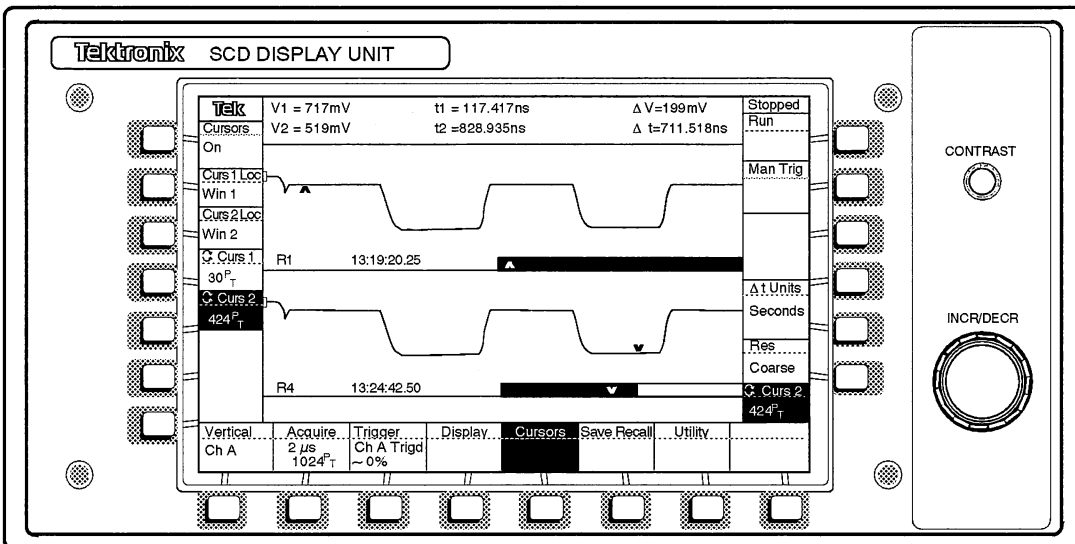

Figure 3-11: Two Waveforms Displayed

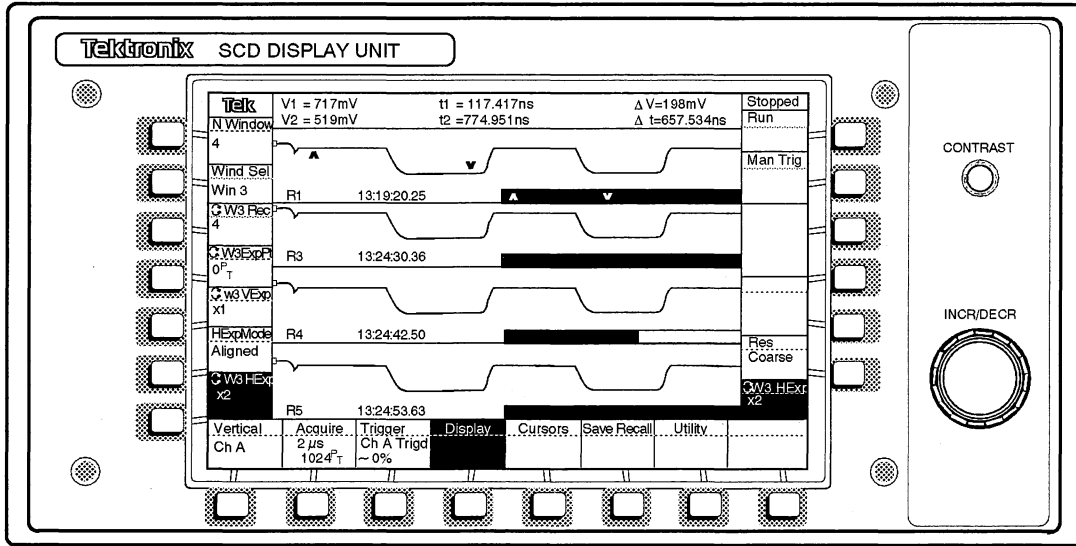

Figure 3-12: Four Waveforms Displayed

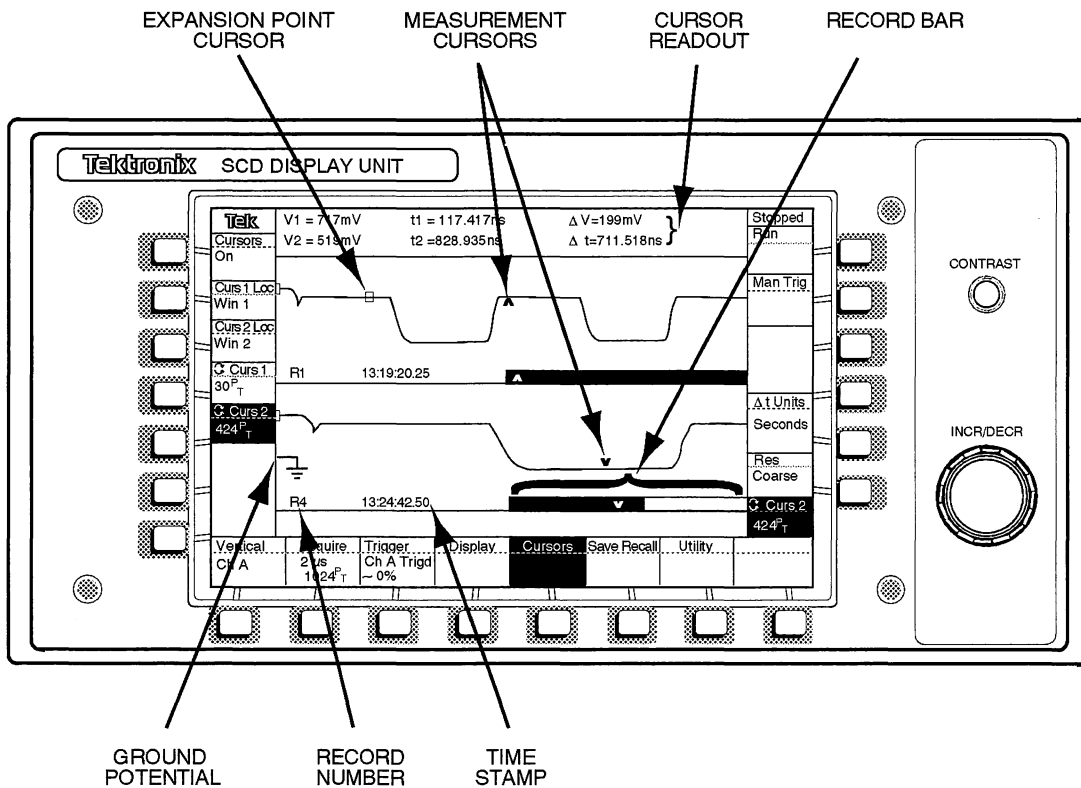

Figure 3-13: Waveform Zone Indicators

## Keys

Keys around the display are labeled on the LCD to indicate what a key will do when pressed. Keys are grouped into different functional groups. In addition, a large knob allows quickly setting numeric parameters accessed by some soft keys as explained later. Figure 3-14 identifies the key types and knob.

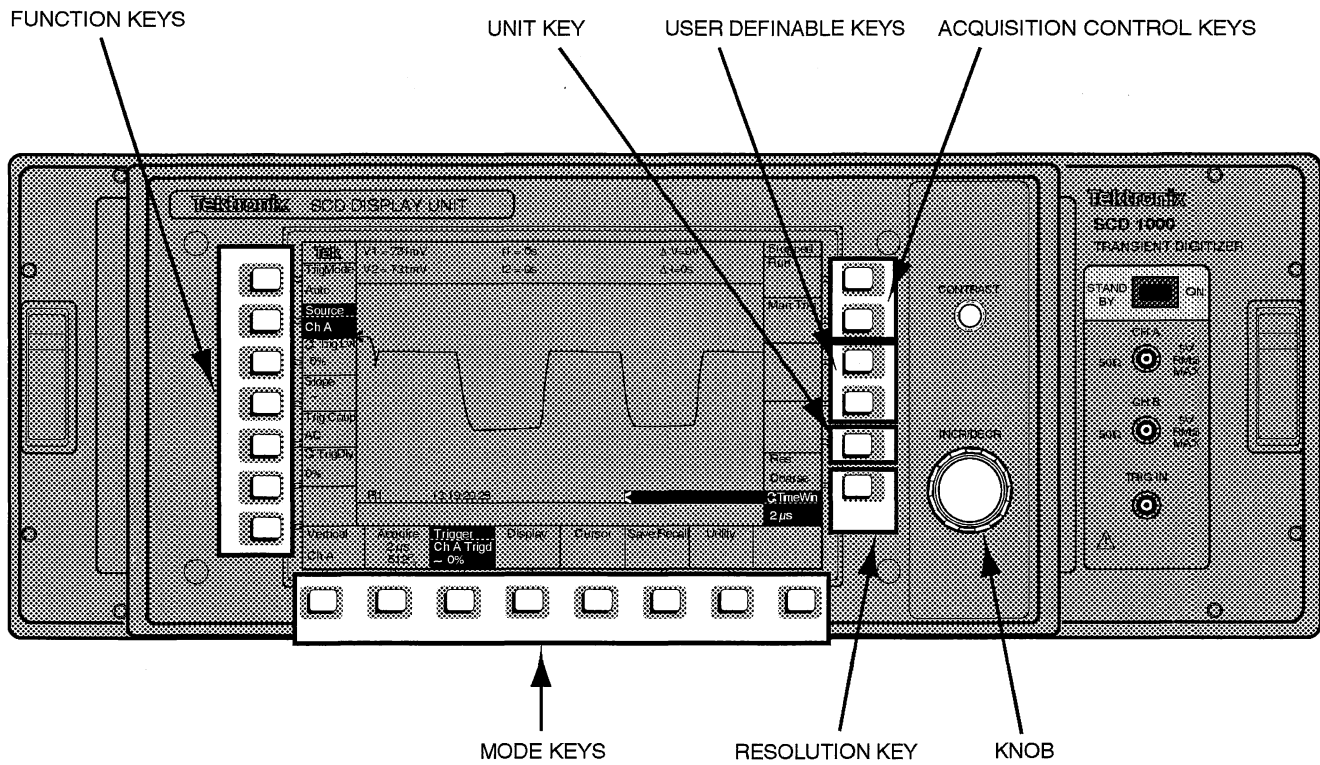

Figure 3-14: Display Unit Key Types and Knob

### Acquisition Control Keys —

- **Manual Trig:** Forces the acquisition to complete in the absence of a trigger. The waveform recorder must be in the Run or HoldNext state for manual trigger to initiate an acquisition.
- **Run/Stop:** Immediately stops any acquisition in progress. “Stopped” appears above the key label. If stopped, pressing the key causes the system to reset and begin the acquisition process, displaying “Running” above the key label. If the acquisition state is HoldNext, the label above the key displays “HoldNext” when the waveform recorder is ready to acquire data and awaits a valid trigger. When acquisition is completed, the stopped state is entered. Instrument control from the Display Unit is more responsive when acquisition is stopped.

**Mode Keys** — The mode keys along the bottom of the Display Unit select one of the setup modes (Vertical, Acquire, Trigger, Display, Cursors, SaveRecall, Measurements, and Utility). The mode keys allow changing waveform recorder parameters associated with a common group of functions such as the vertical input parameters, trigger parameters, etc. Modes are described in Function Reference in this section.

When a mode key is pressed, the label is displayed in reverse video (white text on a black background) to indicate the mode is active. If a mode key is active, a function menu appears along the left side of the LCD next to the soft keys (Function Keys). When no mode is active, the area next to the function keys displays waveform vertical status information (see Display Zones, on page 3-15).

The function keys select a single parameter to be changed. When a function key is pressed, the label is displayed in reverse video to indicate it has been selected. Usually, if the parameter has a numeric value, the value is changed using the knob.

**Function Keys** — Although there are seven function keys, the number of functions depends on the selected mode. Some modes, such as SaveRecall, use all seven function keys. Other modes, such as Utility, have more than seven functions. When more than seven functions are required, a NextMenu key selects the next group of functions. Function key menu labels are always replaced with Channel Vertical Status information when no mode key is active.

**User-Programmable Keys** — User-programmable keys can be defined (both labels and functions) by the user. The key labels and functions are programmed by GPIB USER commands. When a user-programmable key is pressed, it generates a unique SRQ and Event Report over the bus.

When the SCD is set up for HPGL plotting in the talk only mode, (See HPGL Plotting, on page ) the user-programmable keys take on special functions.

The buttons used for plotter control are buttons #3 and #4 from the top on the right side of the Display Unit. Button #3 is labeled PLOTTER and the selections are STOPPED and PLOTTING. Normally Button #3 will indicate STOPPED. When the button is pushed the indication will change to PLOTTING. This means that the process has started and further button pushes will not have an effect until either the plotting has completed or the process has been aborted using button #4. Button #4, labeled CANCEL PLOT, can be used to abort the plotting process and return control to the Display Unit.

See the Programmer Manual for more information on user programmability.

**Units Key** — The units key changes the units for some of the numeric values adjusted using the knob. For example, when the cursor 1 position key is selected, the cursor can be positioned with the knob in terms of seconds or points. The units key selects the units used.

**Resolution Key** — The resolution key selects the size of step when incrementing or decrementing a numeric value. The step size varies with the parameter. The selections are Coarse (large step) or Fine (small step).

**Knob (Incr/Decr)** — The knob increments or decrements a waveform recorder parameter with a numeric value, such as Time Window, Record Number, Start Record, etc. or selects from a list of parameters. A readout to the left of the knob indicates the function being adjusted and its current value. As the knob is turned, the value increments or decrements depending on the direction the knob is turned. A click sounds for every increment or decrement step if the knob beeper is turned on.

The knob always affects the most recently selected function that uses the knob. Although another function that does not use the knob is selected after the knob has been used, the knob can still change the function labelled next to the knob. This allows the user to adjust parameters such as cursor placement, after changing parameters such as input coupling.

## Using the Mode and Function Keys

The following steps describe how to change a parameter using the mode and function keys:

1. Select a mode by pressing one of the mode keys.

The selected mode label is displayed in reverse video. To deselect a mode, press the key again or press another mode key. Appropriate function keys appear in the function key zone when a mode is active. Each function key label includes its current value.

2. Select a function to change by pressing the desired function key.

If the functional parameter value is indicated by text (e.g., AC), change it by pressing the function key repeatedly until the desired value is displayed.

If the functional parameter value is a numeric (indicated by a knob icon  in the label), turn the knob to increment or decrement the value. Press the Units key if available to change the units of the values. Press the Resolution key to change the step size of the value.

## Key Labels

Function keys are identified by labels when a mode is activated. When no mode is active, the function key labels are removed, and waveform vertical status information is displayed in place of the labels.

Function key labels include the function key name with the current functional setting shown below the name. As the setting is changed, either with the function key or knob, the setting changes. (If the setting is changed with the knob, the setting also appears next to the knob.)

Mode key labels are not removed. They always identify the group of functions the mode keys affect. In addition to the mode name, some mode key labels include some settings of the mode as follows:

- Vertical displays the current vertical mode (Ch A, Ch B, Add, or External). (SCD1000 only.)
- Acquire displays the current time window setting and the current record length (256, 512, or 1024 points).
- Trigger displays the source, slope, and delay of the trigger event.
- Display is blank.
- Cursor is blank.
- SaveRecall is blank.
- Utility is blank.
- Measure is blank.

Typical mode key values displayed in the menu label are shown in Figures 3-10 and 3-11.

### Waveforms

Waveforms can be captured horizontally as 256, 512, or 1024 sample points. The acquisition record length determines the number of sample points used to capture the waveform. All waveforms are digitized to 2048 levels of vertical resolution. Since the window's horizontal axis is 512 sample points, waveforms captured with 256 sample points will cause every other horizontal pixel column in the waveform area of the display to be illuminated.

Waveforms can be expanded vertically and horizontally to show the sampled data in more detail. However, only waveforms captured with 1024 sample points can be expanded horizontally by a factor of 2. When vertical and horizontal expansion factors are 1, the waveform is scaled to fit within the display window. The number of windows displayed and the vertical expansion factor affect the ratio of displayed points to sampled points along the vertical axis (amplitude). See the expansion descriptions in Function Reference later in this section for more information.

The expanded waveform display is changed when repositioning the waveform as the expansion point is moved off screen. The display repositions the expansion point back approximately 10% from the display edge.

### Record Number

The record number identifies the currently displayed record. The record is selected by a function key (Wx Rec) in the Display mode.

## Time Stamp

The time stamp indicates the time of day the data was acquired. The date/time clock of the waveform recorder is used to determine the acquisition time. The date/time clock is set using the Utility mode functions.

## Ground Potential Indicator

The small ground symbol is used to indicate ground potential. If the vertical offset is greater than the vertical range of the window, the ground indicator will not be displayed in the window.

## Cursors

If turned on, cursors are identified by "v" and "^" symbols. Cursors do not have to be placed in the same window.

## Record Bar

The record bar provides an approximate indication of the current display and the cursor locations relative to the entire record. The portion of the record that is currently displayed is shown as a black band in the record bar. If the entire record is shown on screen, the rectangle is completely black. Only when a 1024 sample record is horizontally expanded will the record bar indicate a partial record display.

Cursor locations in the record bar are indicated by the "v" and "^" symbols.

## Display Graticule

SCD's with firmware version 1.5 or greater have a graticule display mode capability. The purpose of this capability is to allow faster and easier visual interpretation of waveform data. The cursors still offer a more accurate measurement capability.

This is a 10 × 10 graticule that is displayed in each waveform window when the function is turned on. The corresponding amplitude and time per division is shown near the time stamp area for each window. The amplitude and time per division tracks with the display expansion or contraction of the waveform. If the graticule mode is turned on and a plot is generated the graticule is also on the resulting plot. Graticule is ON or OFF for all waveform display windows this function is not individually selectable for each waveform display window.

This mode does not affect how input range and time window are selected. The acquisition characteristics are still set as full scale input and time window.

Interface to this capability from the display unit is through the Cursors Mode menu selection.





# Examples

The following examples are provided to help the new user become familiar with some of the basic functions of the SCD waveform recorders.

In addition to the SCD waveform recorder you will need the following:

**Table 3-5: Required Equipment**

Quantity	Description
1	SCD1000 or SCD5000 transient waveform recorder with display unit
1	PG502 Pulse Generator in Tektronix TM500 mainframe or equivalent
2	Type N male to BNC female adapter, Tektronix part number 103-0045-00
2	BNC cables

---

## Initial Setup

In this section the instrument is powered up and initialized to a known state.

1. Verify the principal power switch located on the rear of the instrument is off. Verify that the **ON/STANDBY** switch located on the front panel is set to STANDBY.
2. Plug the power cord into an appropriate AC power source outlet supplying the correct nominal voltage (check the line voltage switch on the rear panel). Verify that the PWR UP TEST dip switch (switch number 8) is on (set to 1).
3. Set the principal power switch ON. Press the **ON/STANDBY** switch to the ON position. The SCD1000/SCD5000 will perform a self test. If the self test fails, an error message is displayed on the display unit.
4. Allow the instrument to warm up for at least 20 minutes.
5. Press the **Save Recall** button located on the bottom of the display unit. Press the **INIT** button twice to reset the instrument to a predefined state. You should see a ground trace on the display unit.

---

## Acquiring a Signal

The following instructions show how to acquire and display a signal from a pulse generator. A Tektronix PG502 Pulse Generator (risetime <1 ns) is recommended for this tutorial. If a PG502 is unavailable, use a generator with a fast risetime.

### NOTE

*This example assumes that the instrument is starting from default settings.*

- Step 1:** For the SCD1000, connect the PG502 output to the SCD1000 CHA input. For the SCD5000, connect the PG502 output to the SCD5000 CH input and connect trigger out to EXT TRIG in.
- Step 2:** Set the PG502 250 MHz pulse generator as follows:
  - Output (Volts): Low level: -2 V, High level: 2 V
  - Period:  $\leq 4.5$  ns (Set variable X5, about 12 noon position)
  - Pulse Duration:  $\leq 2$  ns  
(Set variable fully counter clockwise, X1)
  - Back Term: Out
- Step 3:** For the SCD1000, press **Vertical**, then set **Range** to 5 V.
- Step 4:** Press **Acquire**, then set **Timewin** to 5 ns.
- Step 5:** Press **Trigger**, then set **MODE** to Normal, **TrigLvl** to 15%, and **TrigDly** to 1.000 ns.
- Step 6:** If SCD is not acquiring, press Run/Stop button (upper right button).
- Step 7:** Now that a signal is being display, some of the advanced features of the SCD waveform recorder can be utilized.

---

## Making Cursor Measurements

The following instructions show how to take a cursor measurement. The cursors are used to bracket the portion of the waveform that the measurement will be taken on.

- Step 1:** If SCD is acquiring, press Run/Stop button (upper right button) to enter the Stopped state.
- Step 2:** Press Cursors button, then Curs 1 to select cursor 1 then turn the INCR/DECR knob to move cursor to desired location (for example, 178 pt.).
- Step 3:** Press Curs 2 button to select cursor 2 then turn the INCR/DECR knob to move cursor to desired location (for example, 326 pt.).
- Step 4:** The top of the display has absolute voltage (V1 and V2), absolute time (t1 and t2) and relative time and voltage ( $\Delta t$  and  $\Delta V$ ) measurements.

### Items to Note

- The user can select the type of timing measurement, either time,  $\Delta$  time or  $1/\Delta$  time (frequency). This is selected by pressing the UNITS button (lower right side) near the INCR/DECR knob.
- If more than one window is displayed, the cursors can be placed in any window. For example, cursor 1 can be in window 1 and cursor 2 can be in window 4. Each window can display a different record.
- For best efficiency for cursor measurements, it is best to place the waveform recorder in the Stopped state before executing cursor measurements.
- Cursors must be turned off to run Debug mode.

---

## SCD Scanning Setup

The scan converter tube must properly be set up for accurate capture of all waveforms, especially for fast transient events. Acquiring Data, on page 3-47 explains the concepts and reasons for proper adjustment. Without proper adjustment, the write beam can over-write the target, producing erroneous waveform data, or fast waveform transitions can be missed.

Two adjustments are provided for setup: Intensity and Focus. Both of these parameters are set at the factory for optimum waveform capture at the fastest writing speed. However, user adjustment of Intensity may be necessary according to the waveform being recorded.

Extremely fast waveform events, such as fast transients and short risetimes may require a higher beam intensity to capture the waveform. Adjustments should be done using a waveform identical or similar to the one being captured.

The Utility menu function, Inten, allows adjustment of intensity and viewing of the CRT's target image without centroid processing. The Thresh (Threshold) function and unprocessed target image aids in detecting excessive intensity. Threshold adjustment allows determining how hard the target has been written.

- Step 1:** Acquire a waveform that is identical or similar to the one to be acquired for final capture.
- Step 2:** Press the **Utility** mode key to select utility functions.
- Step 3:** Press the **NextMenu** function key until the top function key is **Thresh**.

### Items to Observe

- The Display Unit displays the acquired waveform data as stored in the linear array.
- Notice that all waveform points stored for each horizontal position, instead of the just the centroided data, are shown on the display against a graticule.
- If the intensity is too high, the waveform will appear too thick because of too much waveform data.

- Step 4:** Press the **Intens** function key to adjust the intensity then re-acquire the waveform.
- Step 5:** Turn the knob slightly to change the intensity setting. The intensity range is from 0 to 100%. Proper intensity adjustment allows the entire waveform to be clearly written on the Display Unit without the waveform appearing too thick. This adjustment may take some experimenting to optimize scan conversion capture capabilities and the requirements of the waveform.

- Step 6:** Press the **Thresh** function to adjust the displayed representation of the target. By adjusting the threshold with the knob, the thickness of the written trace can be seen to vary. With a high threshold setting (63) a very thin trace or possibly missing portions of the trace can be seen. With a threshold setting of 0 an uninterrupted waveform should be seen. The 0 threshold setting is useful for detecting linear array overflow. Optimum intensity setting occurs when a uniform but thin trace of the waveform is visible using a threshold setting of 63 without blooming of linear array overflow indications when using a threshold setting of 0.

**NOTE**

*THRESH is a display function only and does not impact other display modes or the waveform data.*

Under most circumstances, Crt Bkg in the Utility menu should be set to 0%. See the Utility functions in the Function Reference section.

- Step 7:** To return to normal waveform display, press the **NextMenu** function key or any mode key.

---

## Saving and Recalling Stored Instrument Setups

This example shows how to Save and Recall Stored Instrument Setups.

### Saving Stored Instrument Setups

Up to ten instrument setups can be stored in nonvolatile storage.

- Step 1:** Press Save/Recall button, then Savesel button.
- Step 2:** Select the setting location (1 to 10) with the INCR/DECR knob.
- Step 3:** Press Save Set to store the settings in the selected location.
- Step 4:** Press the INIT button twice to reset the instrument to factory defaults. Now recall the stored settings using the procedure below.

### Recalling Stored Instrument Setups

- Step 1:** Press Save/Recall button, then Rcl Sel button.
- Step 2:** Turn the INCR/DECR knob to select the setting to be recalled.
- Step 3:** Press Rcl Set to recall settings from the selected location. If the SCD is not acquiring, press Run/Stop button to enter the RUN state.

### Items to Note

- In the Save/Recall menu, there is a button labeled Secure. When this button is pressed twice, it erases all settings and waveform memory, and sets the instrument to its factory defaults.
- The Init button can initialize all settings by pressing Init twice. An individual mode (vertical, acquire, etc.) can be initialized by pressing the **Initl** key followed by the desired mode key.

---

## Using Auto-Advance Recording

Auto-Advance sequentially fills up to 16 records as fast as the waveform recorder is ready to acquire the waveforms. Auto-Advance can be useful when repetitive, but unique signals (such as laser pulses) need to be quickly captured.

- Step 1:** If the SCD is acquiring, press RUN/STOP button (upper right button) to enter the STOPPED state.
- Step 2:** Press **Acquire** button, then set **Acq Mode** to Auto Adv.
- Step 3:** Verify that StaRec (start record) is set to 1 (it should be after an Init). If not, press STAREC and use INCR/DECR knob to set to 1.
- Step 4:** Press **N Rec** button
- Step 5:** Turn the INCR/DECR knob until the number 16 is displayed.
- Step 6:** Press **HoldNext** button until ON is displayed. This instructs the SCD to enter the STOPPED state when all 16 records are filled.
- Step 7:** Press Run/Stop button (upper right button) to start acquiring the data. When all 16 events have been captured, the SCD will enter the STOPPED state.
- Step 8:** Press **Display** button, then press **W1Rec**.
- Step 9:** Turn the INCR/DECR knob to view the contents of records 1 through 16.

### Items to Note

- SCD Waveform Recorders allow the user to select where a waveform is acquired (using **StaRec**). This means that acquisition into different records can also be done manually by changing the starting record while in the Normal mode (1 record acquisition).
- The start record for Auto-Advance can be any record.
- Option 1P (Fast Waveform Capture option) increases the capture rate from about 2 waveforms/sec to 10 waveforms per second using a 512 point waveform.

**Examples**



# Acquisition Concepts

---

## Scan Conversion

Scan conversion is a method of quickly storing a fast analog signal so that it can be digitized at a slower rate. It is one of the methods of the Fast In, Slow Out (FISO) concept, where a fast signal is captured and held in some analog storage buffer and then slowly read out for digitization.

One simple scan conversion method is to take a picture of the faceplate of a CRT as the trace sweeps. The fast signal now has been captured on film, and one can take a long time to slowly read out the trace deflection versus time. Using film can be expensive and time consuming; this led to another type of scan conversion becoming popular in the 1950s, when the first "true" scan converters consisted of TV cameras pointed at the faceplates of oscilloscopes. This scheme allowed the capture and display of fast signals at TV rates (1/30 sec) provided the trace on the phosphor was bright enough. Unfortunately, the lack of sufficient trace intensity for most measurements kept the scheme from being widely used.

In the Tektronix SCD Series Waveform Recorders, intensity problems are surmounted by writing the signal directly on a semiconductor diode target at a high rate by a special high bandwidth electron gun. The gaussian charge distribution corresponding to the trace location is stored on the target until read out by a different electron gun at a slower rate. It is the levels detected by the read gun, from the opposite side of the target, that are converted to digital values of the charge level sensed. This avoids all the losses inherent in converting electron energy into light in the phosphor, imaging the light from the phosphor with a lens system, converting the light into a charge distribution on a photosensitive target in a TV camera, and then converting the information into a digital representation of the signal.

The scan-converter tube used in the SCD1000 is shown in Figure 3-15. It consists of two facing electron guns with a silicon diode target array positioned between them. This is conceptually the same as two CRT's joined at a common faceplate. The read and write beams scan regions on opposite sides of the target. The target consists of diodes at a density of about 1,000,000 diodes per square centimeter. The input signal is applied to the high-bandwidth deflection structure of the writing gun which is similar to a high-performance oscilloscope CRT.

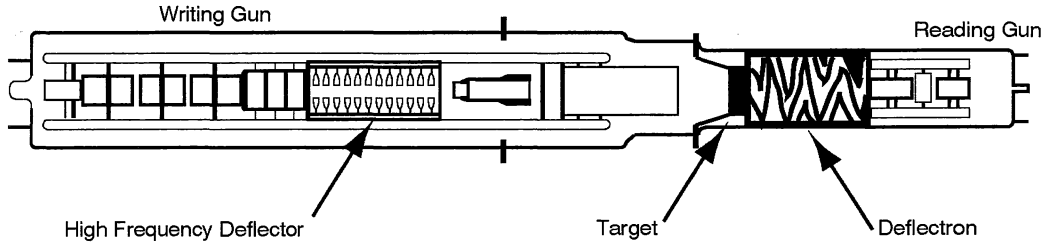

Figure 3-15: The Scan Converter Tube used in the SCD1000

### Writing the Data

The SCD1000 writing gun has a 1 GHz bandwidth with a helical deflection structure driven by the amplified input signal and the horizontal plates driven by a triggered sweep ramp from the time base. The reading gun operates as a high speed video camera, scanning the target using a rectangular raster.

The SCD5000 writing gun is identical to the SCD1000 writing gun, except for a state-of-the-art high bandwidth 50 Ω helical deflection structure directly driven by the input signal. The deflection structure for the SCD5000 has a nongaussian frequency response which allows faster risetime performance than the analog bandwidth usually would suggest. In most instruments, risetime is directly related to the analog bandwidth using the formula:

$$t_{rise} = \frac{350}{\text{Bandwidth (GHz)}} \text{ [psec]}$$

If you measure the SCD5000 analog bandwidth using sine waves, the -3 dB point is ≥ 4.5 GHz. This gives a calculated gaussian response for the risetime of about 78 psec. If you measure the risetime using a fast step, it typically will be < 65 psec. This is because the SCD5000 writing gun attenuates high frequency signals at a slower rate than would be expected with a gaussian response. The deflection structure maintains pulse characteristics without over peaking of the high frequency signal components. The result is a clean step response for extremely fast risetime events.

The silicon diode array target is shown in Figure 3-16. The low-speed reading beam continuously scans the target from top to bottom, left to right as shown in Figure 3-17. This scanning reverse biases each diode in the array.

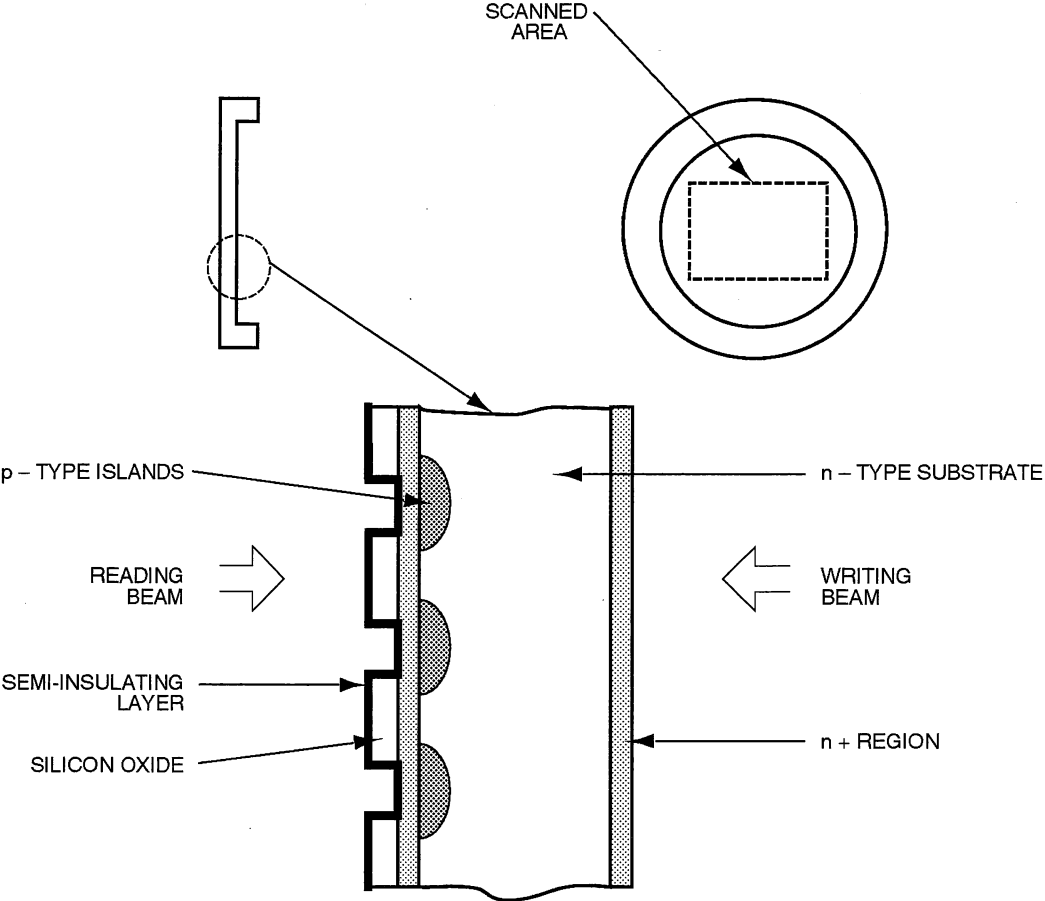

Figure 3-16: Reading and Writing Beam Interaction on Target

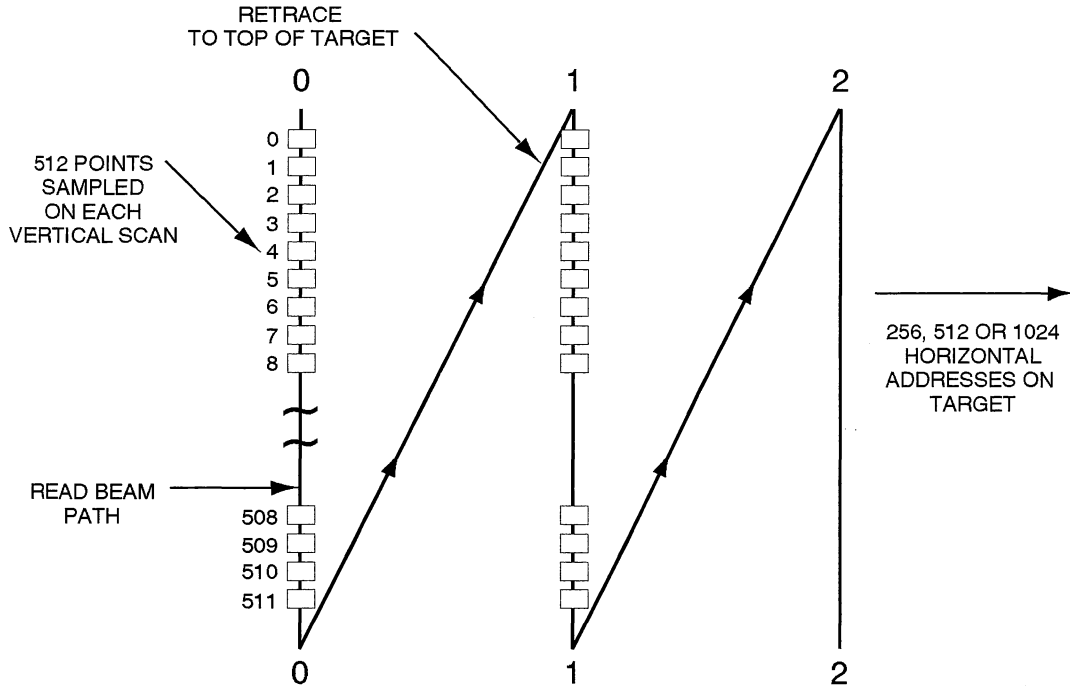

Figure 3-17: Reading Gun Scans Target Vertically

### Reading the Data

When a high-speed input signal is applied to the SCD Series, the writing gun writes the waveform on the target by discharging the target diodes. Then, as the reading gun scans one of these “written” diodes, read gun beam current flows to reverse bias the diode. The beam current returning to the target is digitized during the vertical scan every 20 nanoseconds to one of sixty-four current levels.

The resulting lower speed digital signal is used to reconstruct the high-speed input signal. This arrangement of shared target between a fast writing gun and a slower reading gun results in a fast input, slow output waveform recorder which allows high analog bandwidth (up to 4.5 GHz) with high amplitude and time resolution of fast transient events.

The horizontal scan step increment is determined by the selected number of points (either 256, 512, 1024). The larger the number of points, the smaller the horizontal increment of the vertical scan.

---

## Linear and Reference Arrays

The digitized charge data is stored in a 256K buffer called the linear array after a reference array (which contains background target information) is subtracted point by point from the raw digitized data. The reference array provides a map of the diode target that allows correction for differences in target element charge capability (see Defects on page 3-47). The reference array is set at the factory, but can be reset by the user. If an aberration in the target causes problems, the reference array can be updated at any time from the display unit or via GPIB. When the SETREF RUN command is sent via GPIB or the **Set Ref** button is pushed in the Utility menu, the SCD Waveform Recorder scans the diode target and updates the reference array.

The linear array and reference array data is available via the GPIB using the LINARRAY? and REFARRAY? queries. The reference array correction can be turned on and off using the SETREF ON|OFF command.

---

## Centroid Processing

The electron writing beam and the diode response to the beam is gaussian by nature. Therefore, when a single vertical line is scanned, the charge distribution across that scan will have a gaussian distribution of charge. Centroid processing takes the charge data stored in the linear array and processes the data to find the center of charge resulting in a single vertical value for each horizontal element.

The entire scan conversion process is illustrated in Figure 3-18. In the illustration, the pixels charged from a single vertical scan are digitized using an A/D converter. If the difference between the digitized data from the diode target and the corresponding value from the reference array is greater than the noise floor, then the digitized data is stored in the linear array along with a location tag. The linear array data is then centroid processed and stored into one of sixteen waveform locations.

The reference array, linear array and centroid data are available over the GPIB. Linear array (without centroid processing, it is referred to as the target image) and centroid data is available for viewing on the display unit. The reference array can be displayed on the display unit by, for example, sending the commands:

1. Save the current settings: SAVE # (where # is one of the stored setting locations)
2. INIT the instrument: INI
3. Recall the saved settings: RECA#
4. Use the ABStouch command to select the Utility Mode menu: ABS 6,8
5. Select the reference array: RAW REFA

## Acquisition Concepts

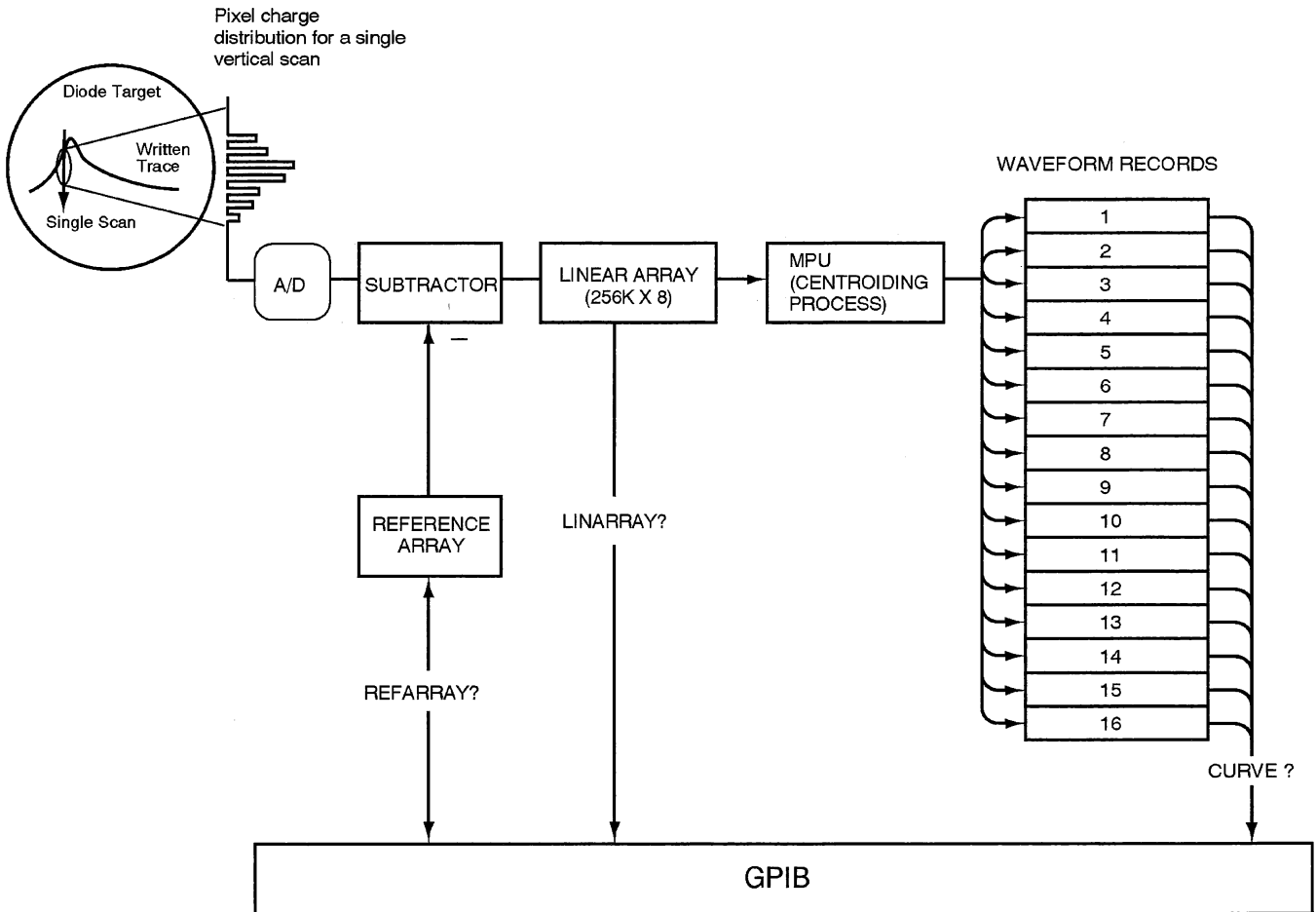

**Figure 3-18: Data Storage and Processing**

Centroid processing within the SCD functions on a single vertical scan line at a time. The algorithm is a weighted average calculation that transforms X data (current scan line number), Y data (vertical location) and Z data (charge) into a single YT waveform array coordinate. Because the charge distribution is gaussian, a weighted average yields an accurate determination of the peak charge on the vertical scan with the peak representing the center of the trace. The basic algorithm is:

$$Y[X] = \frac{\sum_{i=1}^n Y_i \times Z_i}{\sum_{i=1}^n Z_i}$$

*n* = number of data points in a vertical scan

A minimum threshold charge (Z) level is used to provide rejection of low level noise that may appear in the system. This cutoff (Z charge) is calculated as a percentage of the peak for each scan line. The typical value for the threshold is about 30 percent.

The waveform capture rate is largely determined by the time it takes to centroid the linear array data. Option 1P, Fast Waveform Capture, provides specialized hardware to reduce the time it takes to centroid the linear array.

---

## Geometry Correction

The SCD1000 and SCD5000 Waveform Recorders use scan conversion technology to achieve phenomenal single shot acquisition capability. The scan converter is essentially a very high bandwidth cathode ray tube (CRT) similar to that found in analog oscilloscopes. The CRT writes an electron beam onto a storage media (a diode matrix in the SCD).

Geometry distortion is caused by two distinct mechanisms, the scan conversion CRT write gun and read gun electron-optics. Although both guns contribute to geometry distortion, they do so in different ways.

The write gun geometry distortion manifests itself as a “bowing” or “pincushion” effect, whereby the rectangular shape of the written area becomes either compressed or expanded. This form of distortion alters both the vertical and horizontal axis, and increases in a non-linear fashion as the beam position is moved from the center point of the target out towards any of the “edges”.

The read gun geometry distortion manifests itself primarily as “S-curve” distortion. A flat baseline written by the write-gun is twisted at both ends to resemble an “S”. The S-curve distortion of the read gun primarily affects the vertical axis.

Data quality is improved by reducing the effects of geometric distortion. SCD Waveform Recorders accomplish correction of vertical geometry distortion in two distinct stages:

- Distortion Characterization
- Vertical Correction

The characterization phase occurs during vertical geometry calibration. The calibration process builds a two-dimensional array which represents the amount of vertical distortion induced on a data sample at evenly spaced intervals of the target.

The correction process occurs as a part of the acquisition task. The sequence of events during an acquisition is as shown in Figure 3-19.

- For best results geometry correction characterization should be executed at the same record length that the waveform data will be captured.
- Geometry correction, if enabled, only corrects centroided data. It does not affect the linear array data.

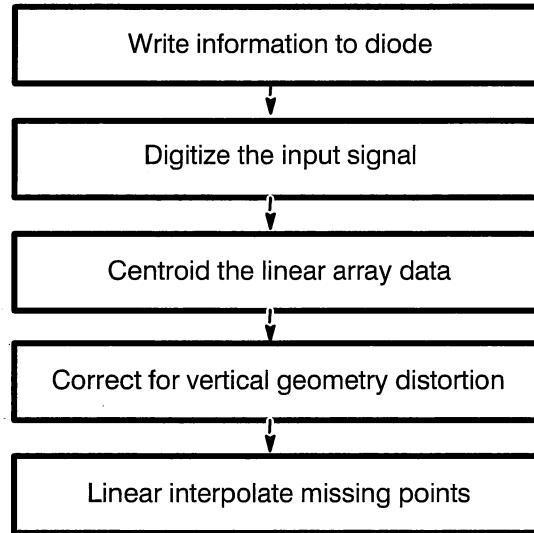

**Figure 3-19: The Acquisition Process**

The method of correcting for geometry distortion utilizes the grid produced during calibration along with a bilinear interpolation equation.

### **Geometry Distortion Characterization**

Vertical geometry calibration produces a two-dimensional grid that represents the amount of vertical correction needed at any given point on the target. It is not necessary to compute correction coefficients for each of the target locations. Therefore, the target is subdivided into a finite number of vertical and horizontal sections.

The process of tabulating these correction constants is accomplished by digitizing baselines positioned at different vertical offsets. For each captured record the error due to distortion is computed at defined intervals within the waveform. The quantitative measure of distortion at each of these points is the difference between the ideal value for the given baseline position and the value read. The correction values are computed on averaged acquisitions to limit the effects of noise and to obtain a better representation of distortion.

Each baseline position represents a row within the two-dimensional correction array. The number of rows needed to adequately characterize the distortion is arbitrary to a certain degree. The trade-off being: greater resolution, (i.e. more accurate correction of the data), vs. size of the internally stored array and time it takes to characterize geometry.

Dividing the target into 9 equally-spaced vertical sections, (requires characterizing 10 baselines), provides sufficient vertical resolution for correcting the data. Figure 3-20 illustrates subdividing the target vertically.



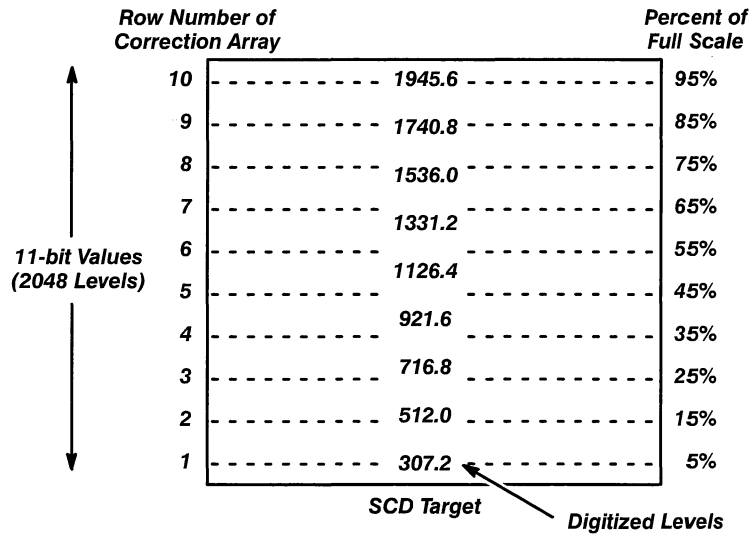

**Figure 3-20: Vertical Dividing of Target for Distortion Characterization**

The columns of the correction array represent the offset into the waveform at which the error due to distortion was recorded. The process of sectioning the target horizontally is more flexible in the number and placement of the dividing lines than the vertical subdividing. The horizontal divisions are determined by which data points within the waveform are examined for geometry distortion.

Dividing the waveform into 29 columns in the 2-dimensional grid characterizes the vertical geometry distortion. Figure 3-21 shows the horizontal spacing of the columns. The final product of distortion characterization is a 10 × 29 array of correction constants. This grid is utilized by a bilinear interpolation equation to calculate the amount of correction needed of any digitized point on the target. Figure 3-21 also shows example baselines captured single shot at the top of the digitizing range. There are four curves displayed. The first is the uncorrected baseline captured at 256 points. The maximum geometry error is less than 2% of full scale (in this example, 2048 Least Significant Bits or LSBs). The second baseline is a corrected waveform where the characterization was performed using 1024 points. You will notice an improvement in the baseline but it still has about 0.5% error due to geometry distortion. The third baseline was captured where the characterization was performed at the same record length (in this case, 256 points). The error caused by geometry distortion is reduced to less than one tenth of a percent. An ideal baseline is shown as a reference.

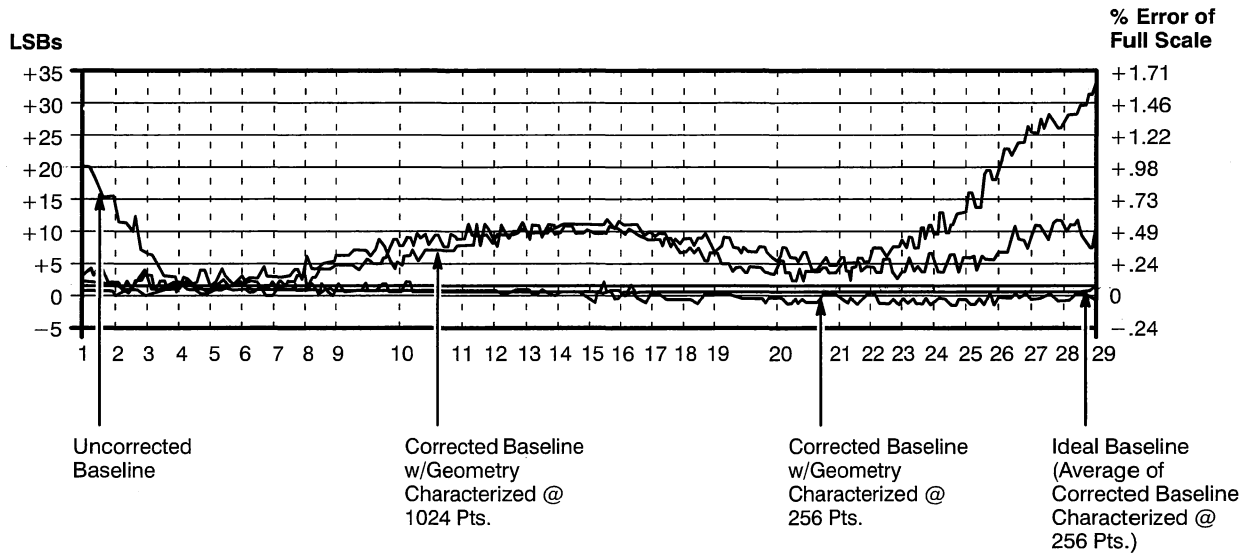

Figure 3-21: Corrected and Uncorrected Baselines Shown With Horizontal Divisions

### Vertical Correction

As described earlier, the process of performing vertical geometry correction is done as part of the acquisition task and occurs after the linear array data is centroid processed.

The method of compensating for vertical geometry distortion at each data point in the record is a three-step process. First, the cell of the 2-dimensional grid which the point lies within is determined. Second, the data point is normalized to the vertical and horizontal resolution of the array. Finally, the coordinates of the data point, along with the 4 vertices defining the rectangle, are substituted into a bilinear interpolation equation.

The result of the equation is the amount of vertical correction needed at the data point as a function of its location and the values of the coefficients defining the block. The equations used to perform the two-dimensional interpolation are illustrated in Figure 3-22.

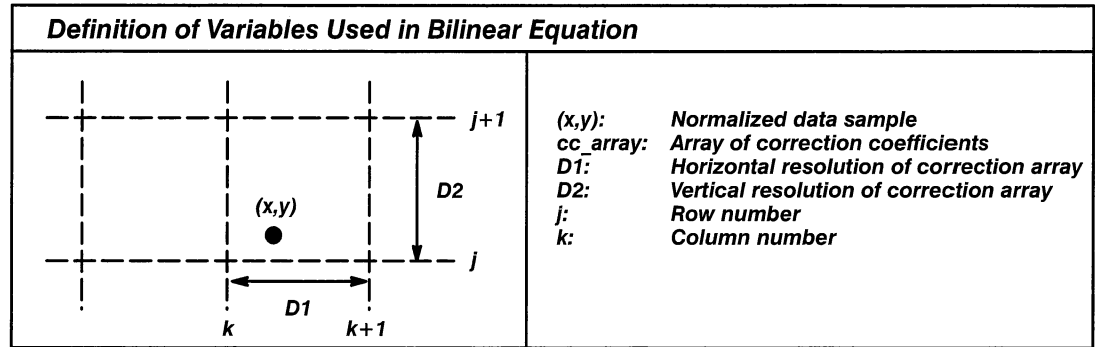

**Figure 3-22: Definition of Bilinear Interpolation**

E1, E2, E3, E4 — Values from the 2-D correction array.

D1 — Difference in horizontal location between the two nearest correction values.

D2 — Difference in vertical location between the two nearest correction values.

$(x,y)$  values that are above 95% of full scale use only the E3 and E4 correction terms (E1 and E2 = 0).

$(x,y)$  values that are below 5% of full scale use only the E1 and E2 correction terms (E3 and E4 = 0).

The following steps transform  $(x,y)$  into  $(x,y')$ , where  $y'$  represents the geometry corrected vertical position.

Let C = Vertical geometry correction needed at  $(x,y)$

$$t = x / D1$$

$$u = y / D2$$

$$c = [(1-t)*(1-u)*E1/16] + [t*(1-u)*E2/16] + [t*u*E3/16] + [(1-t)*u*E4/16]$$

$$(x,y') = (x,y+c)$$

The "GEOMARRAY?" data is output from the instrument as 16-bit signed integers using the "DL" format. The correction array is referenced by the order in which it is sent from the instrument, and applies to the target area as shown in Table 3-6.

**Table 3-6: Geometry Correction Array**

				<b>% of Full Scale</b>
262, 263	. . . . .	. . . . .	289, 290	95%
233, 234	. . . . .	. . . . .	260, 261	85%
204, 205	. . . . .	. . . . .	231, 232	75%
175, 176	. . . . .	. . . . .	202, 203	65%
146, 147	. . . . .	Scan Target Area	173, 174	55%
117, 118	. . . . .	. . . . .	144, 145	45%
88, 89	. . . . .	. . . . .	115, 116	35%
60, 61	. . . . .	. . . . .	86, 87	25%
30, 31	. . . . .	. . . . .	57, 58	15%
1, 2	. . . . .	. . . . .	28, 29	5%

The value of each constant has been scaled up by a value of 16. This was done to improve precision with the correction algorithm (i.e., a value of 8 in the correction array indicates an error correction requirement of 0.5 LSBs or  $(8/16 = .5 \text{ LSBs})$ )

Table 3-7 shows the horizontal location, normalized to a 1024 point record, for the geometry calibration constants in each column of constants. The position values for 512 point waveforms may be found by dividing the horizontal position in the table by 2. Values for 256 point waveforms may be found by dividing by 4. The 29<sup>th</sup> constant is always placed at the end of the curve data.

**Table 3-7: Horizontal Location of Geometry Calibration Constants**

Constant #	Horizontal Position	Location #	Horizontal Location
1	0	15	512
2	32	16	544
3	64	17	576
4	96	18	608
5	128	19	640
6	160	20	704
7	192	21	768
8	224	22	800
9	256	23	832
10	320	24	864
11	384	25	896
12	416	26	928
13	448	27	960
14	480	28	992
		29	1023

### Using Geometry Correction

Geometry characterization and correction can be controlled from the display unit or over the GPIB as explained in the next sections.

**When Geometry Should be Characterized** — Geometry distortion varies with the time window and record length used and should be characterized whenever these parameters are changed to maximize the quality of the acquired waveform data.

**Initializing Geometry Characterized** — From the display unit, the geometry correction table can be updated by entering the **Acquire** menu and pressing the **NextMenu** button until the **Set Geom** button is displayed. When this button is pressed, the status will change from STOP to RUN. Characterization takes approximately two minutes to run without Option 1P (Fast Waveform Capture option).

Over the GPIB, the ACQUIRE GEOMETRY:SET command initiates geometry characterization.

### Turning Correction On/OFF

Geometry correction can be turned on or off. The reason to turn off correction is to increase waveform capture rate. There is approximately a 20% decrease in waveform capture rate with geometry correction on. Turn geom-

etry correction off to increase the responsiveness of the instrument when setting up for a measurement. Then correction can be characterized and turned on before an important measurement.

From the display unit, geometry correction is turned on and off by entering the **Acquire** menu and pressing the **NextMenu** button until the **Geometry** button is displayed. When this button is pressed, the status will change from ON or OFF. Over the GPIB, the ACQUIRE GEOMETRY:ON|OFF command can be used.

### Conclusion

Geometry correction results in more accurate conversion of analog waveform data. It characterizes the response and distortion of a scan converter tube and uses this information to correct for geometry distortion inherent in any analog CRT technology.

Because this capability can be turned on or off conveniently, using geometry correction is up to the individual needs of the user. The trade-off of waveform capture throughput vs absolute data quality.

---

## Acquiring Data

The SCD's operate much like other cathode ray oscilloscopes for viewing waveforms with the centroided display or with the target image. Although this similarity carries over to acquiring data in most respects, some further considerations apply.

### Defects

A portion of the scan converter target that is read as data whether or not it is struck by the writing beam is called a defect. While the ideal is no defects, a few may be present on the target (see CRT target specifications), especially near maximum specified ambient temperatures.

Defects can be caused by burns that result from too high intensity levels for extended periods. Protective hardware and firmware reduce the possibility of burning, but care should be taken to avoid on-going acquisition of identical signals at high intensity levels. Apparent defects can be caused by improper calibration. Refer calibration to qualified service personnel for adjustment of the instrument within the limits stated in the service manual. Attempts to enhance performance by adjusting the instrument outside these limits can degrade performance, causing such problems as apparent defects, reduced writing rate and inaccurate centroiding.

Defects are normally removed from the target data automatically. The automatic removal can be turned off with the GPIB command SETREF OFF. When on, any areas detected when SETREF was last run are removed. Defects are removed to prevent their interfering with the centroiding process. A defect that falls on a written portion of the target will be subtracted resulting in a void in that small portion of the waveform. The void is not visible on the displayed centroided waveform because as part of the centroiding process any missing points are interpolated. The voids are visible if the target image is viewed using the CRT Setup Utility Mode menu. The areas detected as defects that will produce voids are viewable on the display using, for example, the following GPIB commands:

1. Save the current settings: SAVE # (where # is one of the stored setting locations).
2. INIT the instrument: INI.
3. Recall the saved settings: RECA #.
4. Use the ABStouch command to select the CRT set-up Utility Mode menu: ABS 6, 8.
5. Select the reference array: RAW REFA.

A listing of the defect is obtainable using the REFLIST? command.

The type of signal being captured along with the intensity, focus, amplitude, CRT background, and time window setting affect the displayed waveform. These factors interact requiring some understanding of their interdependence to obtain best results.

## Interpolation

Insufficient write beam intensity will result in portions of the target not being written. This may be the result of too low an intensity or incorrect focus setting, or an abrupt change in the signal as might occur when a fast-edge square wave is captured using a long time window. When a portion of the target is not written, centroiding will interpolate between the previous and next written points with a straight line. Small numbers of missing points will not be noticeable. Large numbers of missing points can produce distorted waveform data. Waveform data contained in the GPIB curve is flagged if the point was interpolated by setting bit 15 (2<sup>nd</sup> most significant bit) to 1. Acquisitions containing missing points produce an error message. This error message is always generated for acquisitions containing missing points when the acquire mode is Hold Next. If Hold Next is off, the error will only be generated on the first occurrence after the acquire state is set to run. It may be impossible to prevent missing points on some waveforms. By limiting the posting of the missing points error message, other messages such as cursor measurements are not interfered with.

Missing points are also caused if the beam is driven out of the vertical window by an input signal that exceeds the vertical range. In this condition, interpolation may produce unexpected results. For example, a square wave with one level on screen and the other level off screen may be displayed as a straight line at the on-screen level. (See Figure 3-24.)

## Linear Array Overflow

Excessive intensity and/or under sampled signal can produce a linear array overflow error. This occurs when more than  $\frac{1}{4}$  of a read scan line detects written data on the target. The most common cause of this error is when a waveform or portion of a waveform contains a large number of transitions in a small enough time that for the current time window setting the individual transitions can not be resolved. The linear array overflow message will be generated and centroiding will produce a line through the center of the area causing overflow. Overflow can be confirmed by viewing the target image with the CRT set-up Utility menu. See Figure 3-23. Like the missing point error message, linear array overflow error messages will always be generated when Hold Next is on, but will only appear after the first occurrence when Hold Next is off.



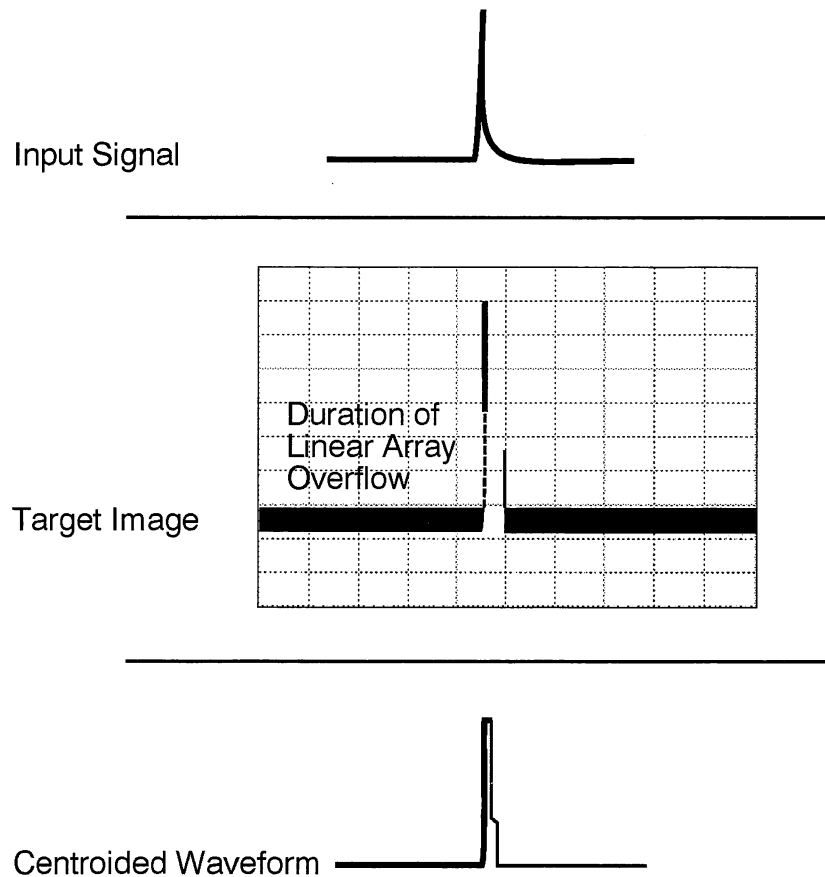

**Figure 3-23: Duration of Linear Array Overflow**

### Intensity Adjustment

The critical parameter in acquiring data with the scan converter is writing intensity. This is affected by the intensity and focus controls, sweep speed (set by the time window), CRT background, instrument operating temperature and trace slope (caused by changes in amplitude of the input signal).

A step transition can result in missing data during the transition or blooming before and after the transition (or both). If intensity is set too low, a portion of the trace is missing as shown in Figure 3-24. If intensity is set too high, the trace blooms where it travels more slowly, and the top and bottom portions of the waveform overlap. The solution is to increase the sweep rate, reducing the slope of the transition, and to increase the intensity enough to write the transition.

The Intensity control requires careful attention when digitizing a waveform with a fast transition. Although blooming on the slow portion (top and bottom) of the trace should be avoided.

Another waveform that requires a careful balance between intensity and sweep speed is shown in Figure 3-25. If the intensity is increased to capture the abrupt transition at the top and bottom of the waveform as shown in part b of the figure, blooming causes the peak value to be underestimated when the top and bottom of the trace are centroided. Increasing the sweep speed to reduce the number of cycles for less abrupt transitions will improve the data.

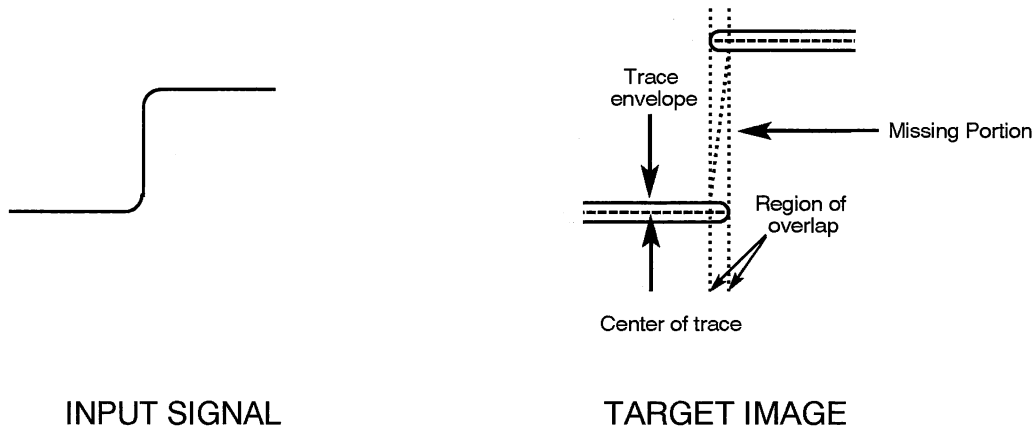

Figure 3-24: Blooming on a Step Transition

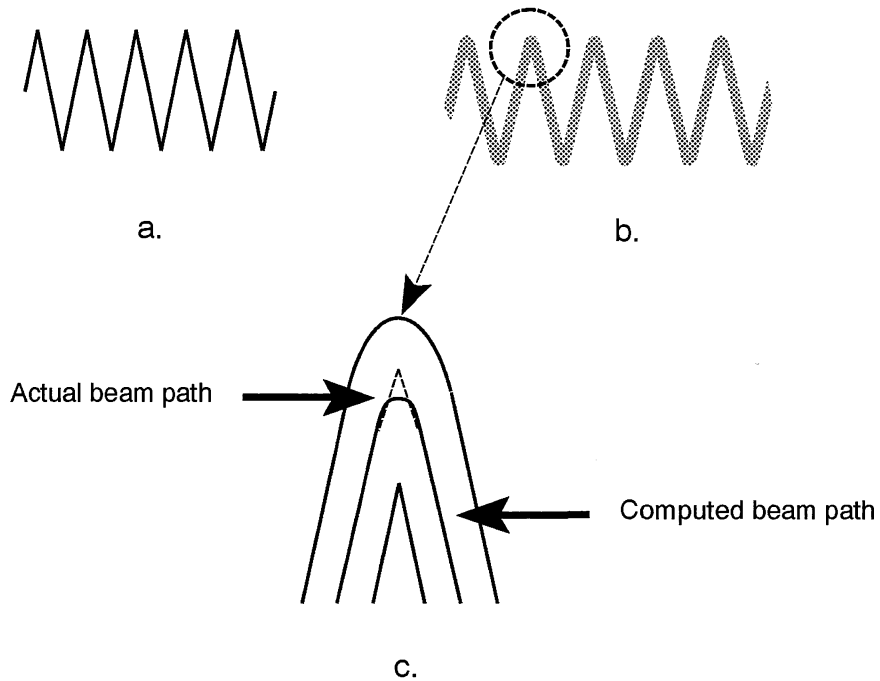

Figure 3-25: Under Estimation of Trace Peak Due to Blooming

The highest quality digitization will be accomplished by setting the intensity using a signal identical or similar to the one to be captured. Adjustment of intensity is best set using the Threshold (Thresh) function in the Utility menu. Intensity should be set to produce a narrow and uniform trace with a Threshold setting as high as possible. Signals filling a small portion of the digitizer vertical range require lower intensity setting than signals that cover the full range, so an intensity adjustment may be necessary after a change in vertical range. For most Time windows this will be a setting of a 63. For the shortest time windows it may need to be reduced. For most signals, on the fastest window (5 ns) the intensity can simply be set to 100%.

### Focus Adjustment

Focus determines the concentration of the writing beam and is slightly dependent on the intensity setting. Each time window maintains its own focus and intensity settings so adjustment of focus is not normally required. Adjustment of focus is not critical for the longer time windows, but it is critical to achieve the best writing of the target on the fastest (5 and 10 ns) time windows. To insure the focus is optimum, it should be set with a signal that is at the writing limit of the CRT. For the SCD1000 a 1 GHz signal, amplitude 80% of vertical range, and 5 ns time window should be used to adjust focus of equally written rising and falling slopes of the sinewave. For the SCD5000 a 4.5 GHz sinewave should be used.

### CRT Background

CRT Background allows adjustment of target sensitivity. Under most conditions increased sensitivity is not necessary and a setting of 0% is appropriate. Signals with extremely fast transitions, amplitudes greater than 25% of the Input Range for the SCD5000 or conditions requiring operation of the instrument near its lower limit of operating temperature may benefit by a setting other than 0%.

In general, when the writing of the target, as seen on the display when the Utility menus containing CRT Bkg is selected, is not sufficient (with Inten at 100%), CRT Bkg can be increased. At some point the target image will show improved writing of the waveform. Increasing CRT Bkg further will cause excess sensitivity adding background noise. A small amount of background noise will be ignored by the centroiding process, but it is best to set CRT Bkg below the point where noise is seen (with the Display Threshold set to 0) because increased target temperature due to instrument warm-up or increased ambient temperature also increases the target sensitivity adding noise that may affect centroiding. Because the enhancement of the writing rate is temperature sensitive, adjustment should only be made after the instrument has been operating for at least 30 minutes to allow time for the CRT to reach normal operating temperature.

## Acquisition Concepts

Excessive enhancement will cause a noisy background to appear on the target image along with the error message "linear array overflow". At high temperatures, enhancement is not necessary. If left set high from operating at lower temperatures, a noisy background or linear array overflow may occur. Reduce CRT Background until a noise-free background is seen for several acquire cycles.

# Acquisition/Display Model

This section describes the concepts of signal acquisition and display using the SCD1000 and SCD5000 Waveform Recorders. Figure 3-26 illustrates a typical input signal.  $V_{+pk}$  and  $V_{-pk}$  represent the maximum and minimum amplitudes, while  $V_{ss}$  represents the steady state value of the input signal.

In order to capture and display a portion of this input signal, the signal must go through several processes illustrated in Figure 3-26. These processes are the acquisition process, storage process, centroiding process, and display process.

The acquisition process defines the portion of the signal to be captured and stored in acquisition memory. The storage process assures integrity of the captured waveform data by removing false data from the waveform data due to digitized aberrations of the target diodes. The resultant data is placed in the linear array. (Once the input signal has been stored, it is available for display or transmission to an external device via the GPIB port.) The centroiding process mathematically processes the data to achieve a single waveform data point on the vertical axis for every point on the horizontal axis. The display process defines all or part of the acquired waveform to be displayed.

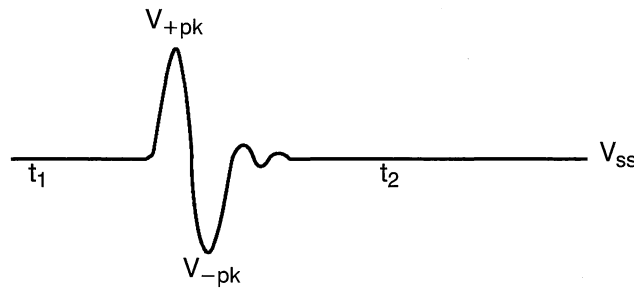

Figure 3-26: Typical Input Signal

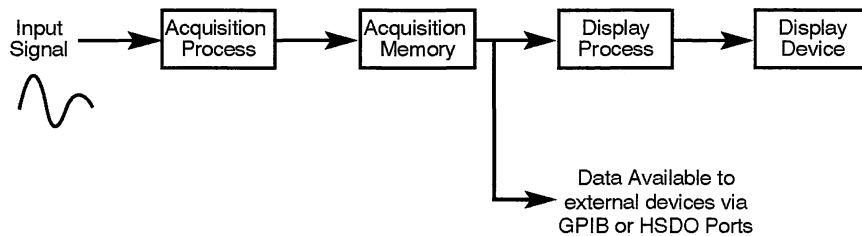

Figure 3-27: SCD Processes

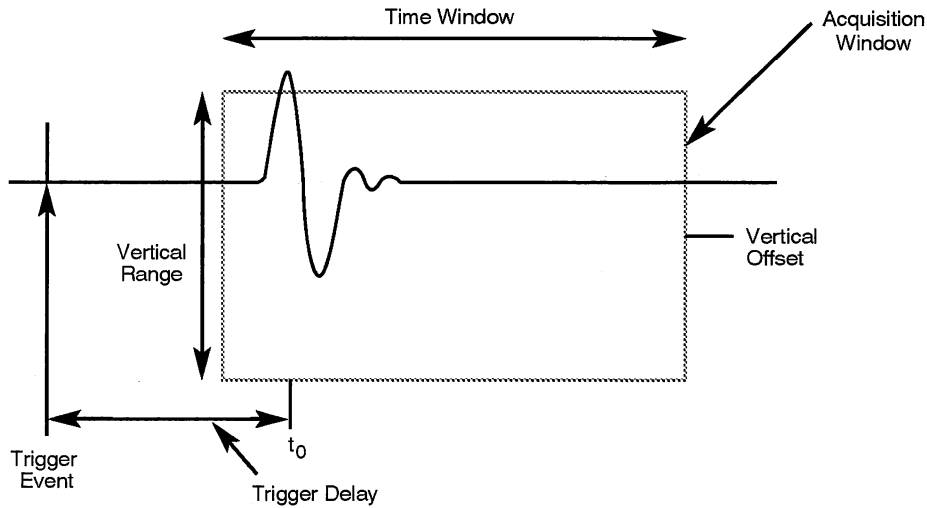

Figure 3-28: Acquisition Parameters & Acquisition Window

## Acquisition Process

The acquisition process can be illustrated as a window through which is “seen” a portion of the signal (Figure 3-28). Only the portions of the input signal that are seen through the acquisition window are acquired. Through the various waveform recorder functional parameters, the user defines window parameters, such as height, width, and position, in order to select the portion of the signal to be captured.

An acquisition process is the filling of all required records with waveform data. The process consists of a sequence of events (the acquisition sequence) which is repeated for each record to be filled. The following acquisition sequence must occur in the listed order for a record to be filled:

- recognition of the trigger event
- recording of time of acquisition (time stamp)
- expiration of the trigger delay
- writing of the input signal on the target
- reading of the target
- removing target defects
- storing the data in memory (linear array)
- centroid processing
- interpolation of missing points
- geometry correction
- storage

The sequence is repeated for each record to be filled. Records are consecutively filled from a specified start record through the specified number of records (up to 16) set by the acquisition system functions. The number of records to be filled could be only one, or it could be all 16 records.

If an acquisition process is started after a previous one finishes, previously filled records are overwritten.

---

## Vertical Size and Offset

The vertical size and offset of the acquisition window determine the vertical portions of the waveform that are captured. These two parameters allow the user to capture the entire waveform's peak-to-peak swing, or a portion of the waveform's swing. Care must be taken to avoid waveform distortion due to amplifier overload when only a portion of the vertical range of a signal is acquired. (The SCD5000 does not use an amplifier, so overload distortion will not occur). When the signal exceeds the target in either vertical direction for centroided data the missing points are interpolated as a linear function from the last point captured prior to the excess excursion to the first point captured after the signal returns to the target area.

The vertical size of the acquisition window is set by the waveform recorder's Vertical Range function of the vertical mode. The larger the vertical range, the greater the acquisition window's vertical size and thus the larger (in amplitude) the signal that can be acquired.

The SCD1000's vertical range is from 100 mV to 10 V; SCD5000 vertical range is fixed at 5 V (10 V for Option 01). Because the SCD5000 has a fixed vertical range, it is necessary to attenuate any signal that exceeds its input range limit. Attenuation is also necessary when attempting to capture signals that exceed the maximum adjustable limit of the SCD1000.

The vertical center of the acquisition window is set by the waveform recorder's Vertical Offset function of the vertical mode. The vertical offset value is defined as the center of the acquisition window, allowing the center of the acquisition window to be at other than ground potential (within the limits of the waveform recorder's offset limits).

Notice that if  $V_{SS}$ , the average DC level of the signal, (see Figure 3-29) is other than ground potential, it is necessary to include  $V_{SS}$  in the Vertical Range setting or to adjust the Vertical Offset setting.

Increasing vertical offset moves the window up (Figure 3-29); decreasing the vertical offset moves the window down (Figure 3-30). (Note that it is the window being positioned, not the waveform.) If  $V_{SS}$  is +500 mV, adjusting the Vertical Offset positively from 0 volts moves the window up. The signal offset remains at +500 mV. SCD1000 vertical offset can be from  $\pm 250$  mV to  $\pm 25$  V; SCD5000 vertical offset limits are  $\pm 4$  V. ( $\pm 8$  V for Option 01)

Vertical offset to center the signal in the acquisition window is calculated as

$$\text{Vertical Offset} = (V_{+pk} + V_{-pk})/2$$

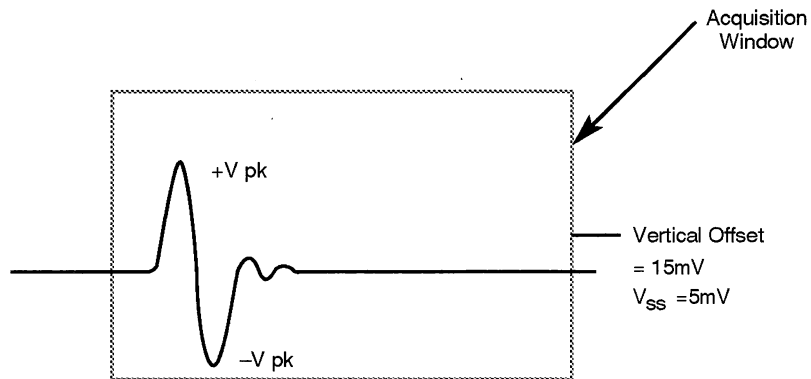

Figure 3-29: Effect of Increasing Vertical Offset

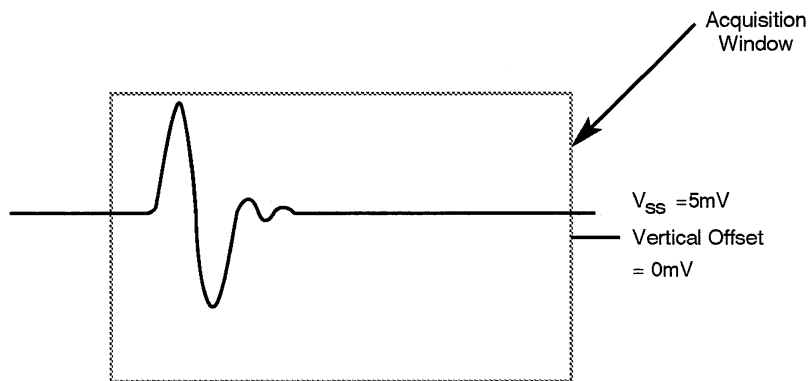

Figure 3-30: Effect of Decreasing Vertical Offset



## Horizontal Size, Resolution, and Position

The horizontal size of the acquisition window determines the amount of the waveform captured along the time axis. The larger the size, the more of the waveform that can be captured. The waveform recorder's Time Window function of the acquisition mode controls the horizontal size.

The Time Window function sets the sweep rate of the CRT's write gun. The faster the sweep rate, the smaller the time window. (Figure 3-31.) A slow-moving signal requires a time window longer than a fast-moving signal. The time window can be set from 5 ns to 100  $\mu$ s.

Once the signal has been written, the scanning resolution is determined by the number of sample intervals to digitize. The waveform recorder's Record Length function of the acquisition mode controls this parameter. Record lengths are 256, 512, or 1024 sample points. Increasing the sample points increases the number of digitized intervals along the time axis.

The horizontal positioning of the acquisition window is dependent on the trigger event. The Trigger Delay function of the Trigger mode controls this parameter.

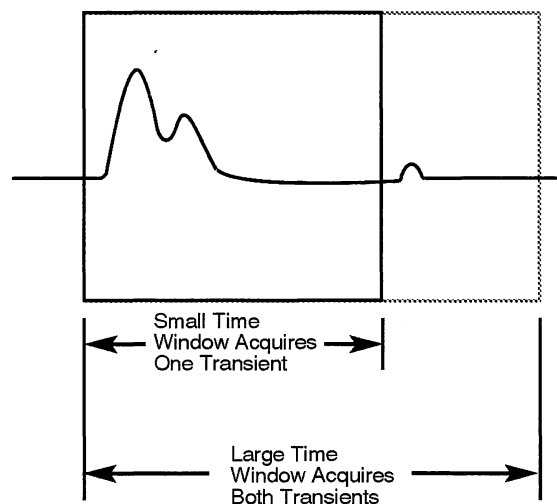

**Figure 3-31: Effect of Time Window on Horizontal Size**

The trigger event occurs at a time,  $t_0$ , when the trigger signal reaches a specified voltage level or a specified percentage of the selected vertical range. If the signal to be captured occurs after the trigger event, an amount of trigger delay (Figure 3-32) is necessary to delay waveform recording until the delay time has expired. SCD delay setting can be from 0 to 500% the size of the time window.

The SCD write gun's sweep subsystem contains 45 ns of delay. If an input signal is simultaneously applied to the vertical deflection and internal trigger subsystems, waveform data would be recorded approximately 45 ns after trigger. To offset the sweep delay, the SCD1000 has an internal 47.5 ns delay in the vertical deflection signal path. This results in approximately

## Acquisition/Display Model

2.5 ns pretrigger information being recorded with internally triggered signals. For example, if a waveform is recorded in a 5 ns time window with a 0 trigger delay setting, one-half of the waveform record will include information prior to the trigger event. This applies only to internal triggering, which is available on the SCD1000 and SCD5000 Option 01.

To capture a desired waveform event using external triggering, an external delay must be added prior to the SCD signal input. If a delay is not introduced, waveform recording will start 45 ns after the trigger event.

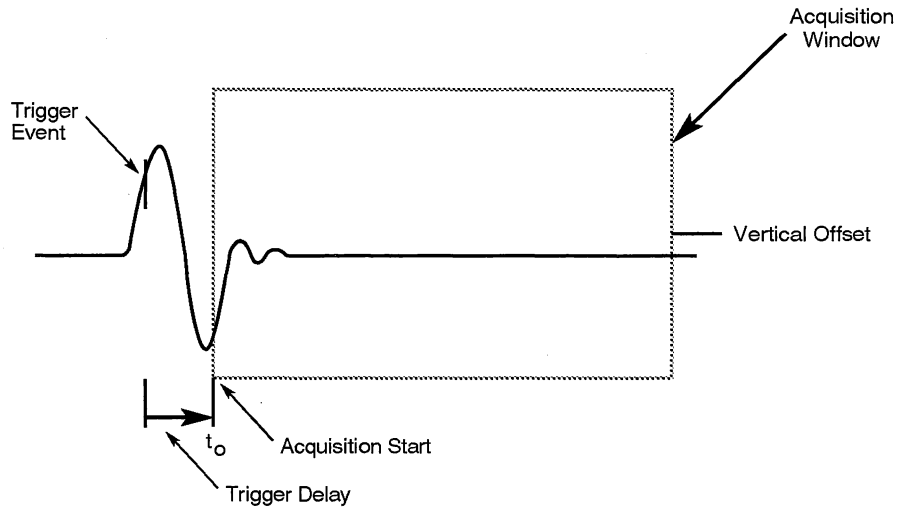

**Figure 3-32: Effect of Trigger Delay on Horizontal Position**

## Multiple Record Acquisition

Up to 16 records can sequentially be filled using the Auto Advance Acquire mode. This acquisition mode causes the waveform recorder to fill a beginning record and repeat the acquisition sequence for each record to be filled, up to 16 records. The first record is called the start record and is set by the **Sta Rec** function of the Acquisition mode. The number of records filled is set by the **N Rec** function of the Acquisition mode. Records 1, 2, 3, and 4 are stored in nonvolatile memory.

While a signal is being scanned and digitized, other input signals are ignored. After the signal data has been stored, the waveform recorder is reset and waits for the next trigger event to occur. Figure 3-33 illustrates Auto Advance acquisition concepts.

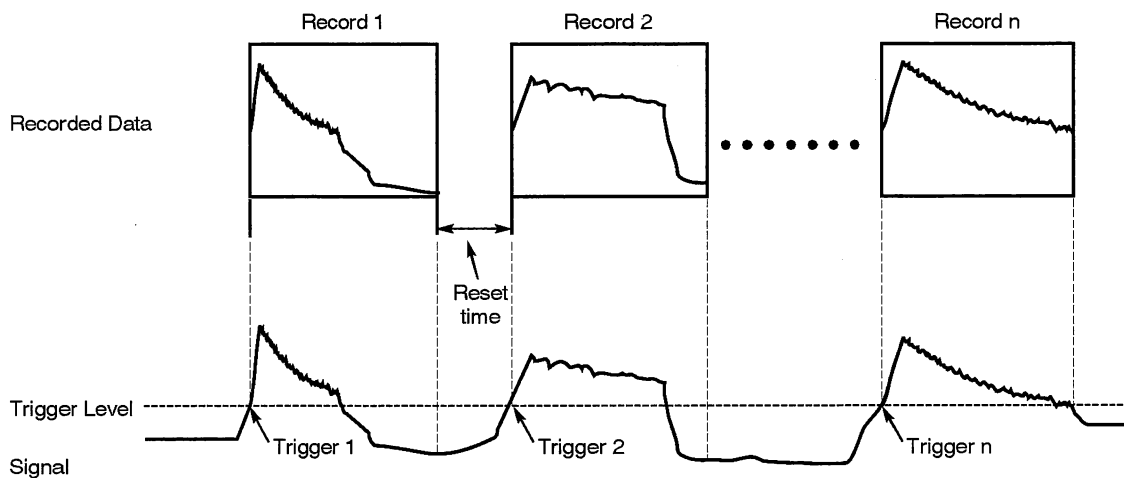

Figure 3-33: Auto Advance Acquisitions

## Averaging

Up to 1024 averages can be done using the Average Acquire mode. This acquisition mode causes the waveform recorder to perform the set number of averages as one acquire. The number of averages is set with the N Avg function which is visible when the Acquire mode is set to Average. While averaging is in process, the display is updated about every five seconds.

## Timestamping

Each record is stamped with the time of day the signal was acquired. A date/time clock in the SCD Waveform Recorder provides the time. The date/time clock is set using the Utility mode or over the GPIB. The time clock's resolution is 10 ms.

---

## Display Process

Like the acquisition process, the display process can be illustrated as a window in which appears all or a portion of the acquired signal stored in the record. The simplest display process consists of one record displayed on the Display Unit in a display window. Up to four windows can be displayed at one time, but each window can contain only one record. The number of windows displayed is selected using the display mode's *N Window* function. All windows can display the same waveform, portions of the same waveform, or all or portions of different waveforms. The record displayed is selected using the display mode's *Wx Rec* function (*x* indicates the currently selected window). The user defines what portion of the waveform is seen by setting the expansion functions of the display mode. Expansion functions allow the user to "zoom" in on the waveform to see more detail.

Expansion functions include the expansion factors and the expansion point. The horizontal and vertical expansion factors determine how much of a waveform is displayed. The expansion point determines what part of the waveform is displayed.

Vertical expansion factors are 1, 2, 4, 8, or 16. Horizontal expansion factors are 1 and 2. An expansion factor of 1 displays the entire record in the window. Only records with 1024-sample record length can be expanded horizontally. The default expansion factor is 1. Expansion factors are selected using the display mode's *Wx VExp* (vertical expansion) and *Wx HExp* (horizontal expansion). The expansion point is selected using the display mode's *Wx ExpPt* function. (The *x* indicates the currently selected window to be expanded.)

An expansion point is selected by activating the *Wx ExpPt* function of the display mode, and turning the knob. An expansion point indicator (a small box) moves across the waveform as the knob is turned. The sample point on which the expansion indicator rests is displayed in the display mode menu label and next to the knob. The  $\Delta$ time from the trigger to the expansion point indicator is displayed in the message/measurements zone. Expansion takes place when the vertical or horizontal expansion factor function key is activated and the knob turned to select the desired expansion factor.

Figure 3-34 illustrates vertical expansion. Figure 3-35 illustrates horizontal expansion.

If more than one window is displayed and horizontal expansion is selected, all waveforms can be expanded at the same time (aligned) or independently expanded. The display mode's *HExp Mode* function is used to select Aligned or Independent horizontal expansion.

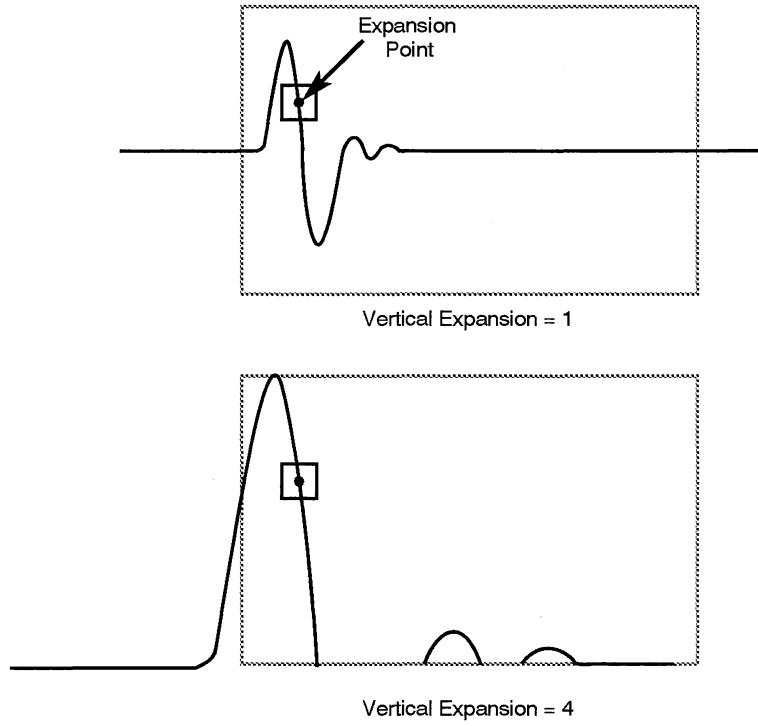

Figure 3-34: Effect of Vertical Expansion on Display

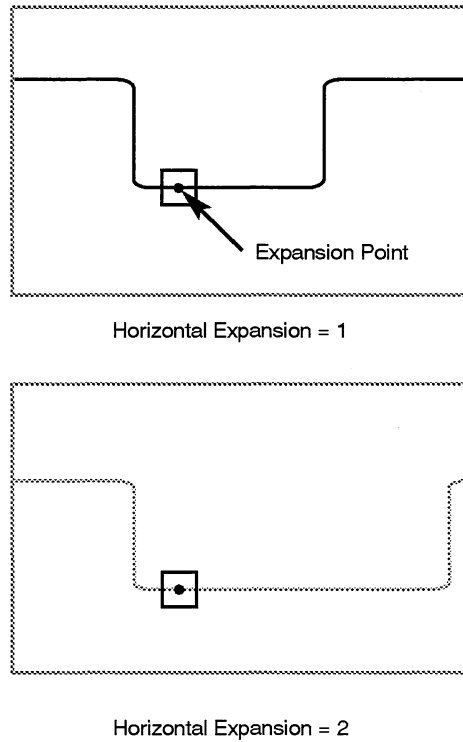

Figure 3-35: Effect of Horizontal Expansion on Display

## **GPIB Waveform Data Transmission**

The acquired waveform data can be transmitted over the GPIB to a computer for analysis, plotting, graphing, storage, etc. To transmit the acquired data, the data must be requested by a bus controller.

The following characteristics of data transmission may be defined before data transmission (see the Programmer Manual for detailed descriptions of each of the GPIB commands associated with data transfer):

- number of records to be transferred
- starting record to be transferred
- starting point in the selected record(s)
- number of points in the records to be transferred
- type of data to be transferred: linear array data (LINARRAY? command), reference array data (REFARRAY? command), or centroided data (CURVE? command)

### **GPIB Port**

The GPIB port uses an 8-bit-parallel, byte-serial binary data format which has a maximum transmission rate of 500 Kbytes/sec for data transmission. See the Programmer Manual for more information about the GPIB port.

### **Number of Records**

The SCD Waveform Recorders can transfer multiple consecutive records (up to 16) in one data transfer. The number of records to be transferred is selected using the DATA CNTRECORD command. A selection of 0 records causes all 16 records to be transferred. See the Programmer Manual for detailed information about the DATA CNTRECORD command.

### **Starting Record**

The first record to be transferred in a data transfer is selected using the DATA STRECORD command. Once a transfer is initiated, data will be transferred starting with the specified start record and ending when the specified number of records has been transferred. Records are transmitted consecutively; it is not possible to transfer non-consecutive records in a single data transmission. See the Programmer Manual for detailed information about the DATA STRECORD command.

### **Starting Point**

The SCD Waveform Recorders can transfer all or only specified portions of a data record. Specifying a starting point other than the beginning of a record is done using the DATA START command. A starting point within the limits of 1 to the record length may be specified. If multiple records are transferred,

each record transmission will begin at the same starting point in each record. See the Programmer Manual for detailed information about the DATA START command.

### **Number of Points**

Once a starting point for data transmission has been selected, the number of data points to be transferred may also be selected using the DATA COUNT command. If 0 is selected, the entire record will be transferred. If multiple records are transferred, the same number of points will be transferred for each record. See the Programmer Manual for detailed information about the DATA COUNT command.

### **Waveform Preamble Information**

The waveform preamble contains scaling, encoding, timestamp, and other information to be used by the controller in re-constructing the acquired waveforms from their data. The WFMPRE? query command causes the waveform recorder to transmit all available preamble information. See the Programmer Manual for a detailed description of this command.

### **Initiation of Data Transfer**

Once all of the data transmission parameters have been specified, the data transfer can be initiated using the CURVE? query. Once initiated, data will be transferred in the specified manner. See the Programmer Manual for detailed information about the CURVE query.

### **Partial Data Transfer**

If a transfer is not completed (i.e. the controller does not read all data), further GPIB activity is prevented. Sending any command or query will return normal GPIB operation.





---

## HPGL Plotter Support

SCD's with firmware version 1.5 or greater have direct and computer initiated HPGL plotter support capability using the IEEE-488 interface. This provides a plotter copy of the waveform data and text information on the display unit.

A plotter can be connected to the instrument in a GPIB talk/listen environment when a controller is in the system, and DIP switch #2 on the rear panel of the instrument is set to the "talk/listen" position (OFF). Plotter commands are sent from the instrument in response to the PLOT? query, which may be captured by the controller, or routed directly to a plotter addressed to listen. In this mode, there are no front panel functions to control plotting.

A plotter can also be connected to the instrument in GPIB "talk only" mode, when there is no controller in the system. DIP switch #2 should be set to the "talk only" position (ON). The plotter should be set to the appropriate GPIB address for "listen only" (usually address 31). Plotter output is controlled by the front panel buttons as assigned to the plotting functions.

The plot title can be changed using the PTitle command with a quoted string argument up to 50 characters long. If a null string (PTitle "") is entered or if nothing is changed from ROM defaults, the plot title will match the ID? query response for the instrument. To completely eliminate the title from a plot, send the PTitle command with a single blank as an argument.

The current date can also be displayed as part of the plot with the PDAtE (ON/OFF) command. If PDAtE is ON, the data acquisition date is displayed in a "yy-mm-dd" format. Turning PDAtE OFF excludes the current date from the plot.

At the beginning of each plot the instrument sends the command to initialize the plotter (DF) and scales the plotting area into user units (SC). The actual size of the plotting area (determined by the scaling points P1 and P2, which are set either from the plotter's front panel or by the IP command via the bus) is not initialized, allowing you to independently select the physical size of the plot. The paper and pens are assumed to be ready to plot before the first command reaches the plotter. Text is scaled as a percentage of physical plot size.

When using the plotting capability with computer control over the IEEE-488 interface to a plotter the following sequence of instructions is required. Send the PLOT? to the SCD; listen address the plotter; talk address the SCD, and when the plot is complete untalk/unlisten the bus. During the transfer it may be necessary to assure that the interface in the computer is not also listen addressed. The end of the plotting sequence can be determined by the controller detecting that EOI has been set.

---

## Stand Alone Operation

Operation of the plotter support capability is possible without the use of a computer. This mode of operation is selected by connecting the SCD to a HPGL compatible plotter using the IEEE-488 interface and using the rear panel dips switch to select "Talk Only" operation for the SCD. To set the SCD in this mode, set rear panel switch #2 to the ON position. The plotter must also be set to "Listen Only" in order to support this stand alone capability. This mode of operation is not available if the Display Unit is not attached.

When switch #2 on the rear panel of the SCD is set to the ON position, output to the plotter is controlled from the display. The operation is via two labeled buttons on the right side of the Display Unit. The plotting control indications are only present when rear panel dip switch #2 is in the ON position. When switch #2 is in the OFF position, these buttons are used for the USER1 and USER2 commands.



*For Firmware Versions 1.5 through 1.72 the instrument may lockup while using the Plotter output function. This problem will be corrected with a later firmware version.*

*To prevent the instrument from locking-up while using the plotter output, perform the following sequence: Press the CANCEL PLOT button. Then press the PLOTTER button.*

# Measurement Model

Firmware Versions 1.6 and later provide time and amplitude measurement capabilities, allowing the user control of where and how the measurements are made. You can make 21 measurements on a single waveform of which 8 measurements at a time can be displayed on the Display Unit. All measurements are available over the IEEE – 488 interface.

The following information provides a definition of the measurement terms and an explanation of how the measurements are made. The control of measurements is also explained and provides the information to allow making the required measurement in the most appropriate manner.

**Table 3-8: Measurement Terms**

<b>Term</b>	<b>Description</b>
Measurement Zone	The segment of the waveform data over which measurements will be made. The choices are full waveform, any of the four windows, or between cursors to define the beginning and end points (inclusive) of the measurement zone. The factory setting is full waveform. Area has a further bounding selection of between proximal levels, mesial levels, or distal levels.
Measurement Waveform	All measurements are made on only one record (a maximum of 16 records can be stored in the SCD). Factory setting is Record 1.
Measurements are computed	When enabled, the measurements are computed and made available with each new acquisition or when the front panel manual measurement button is pushed.
Measurement Display Window	Up to 8 of the 21 available measurements can be displayed on the SCD Display Unit at one time. Where these measurements are displayed can be assigned to any one of the 4 waveform display windows. The display window used can contain the waveform, but if the waveform display function is turned off for that window, only the measurements will be displayed.
Proximal Level	The user selected value, in either percent of Base–Top or Absolute Value, used as crossing level closest to the Base Line value. This is one of the levels used for determining rise and fall times and slew rates. It also can be used to bound an Area measurement. The factory setting is 10% of Base–Top.
Distal Level	The user selected value, in either percent of Base–Top or Absolute Value, used as crossing level closest to the Top Line value. This is one of the levels used for determining rise and fall times and slew rates. It also can be used to bound an Area measurement. The factory setting is 90% of Base–Top.
Mesial Level	The user selected value, in either percent of Base–Top or Absolute Value, used as crossing level between the Proximal and Distal level values. This is the level used for determining width, period, and frequency. It also can be used to bound an Area measurement. The factory setting is 50% of Base–Top.
Base Mode Method	The user selected technique to determine the Base Line value of the measurement zone. The choices are Histogram, Histogram Mean, Minimum Value, or Absolute Value. The factory setting is Histogram.

Table 3-8: Measurement Terms (Cont.)

Term	Description
Top Mode Method	The user selected technique to determine the top line value of the measurement zone. The choices are Histogram, Histogram Mean, Max/Min Value, or Absolute Value. The factory setting is Histogram.
Using Different Base and Top	Depending on waveshape there may be value in using different methods to determine Base and Top Line values. For example a positive going gaussian pulse might best be measured using Histogram to determine Base Line and Maximum value to determine Top Line.
Relationship Levels and Lines	Base < Proximal < Mesial < Distal < Top
Absolute	User entered values in vertical units that can be used for setting values for Proximal, Mesial, and Distal Levels. It can also be used to set Base and Top Line values. For example, the measurement might require setting crossing levels at specific voltages to determine the proper operation of a digital device. Absolute is individually selectable for each Level or Value.
Histogram	Histogram uses the most common occurring value in the lower half (for Base Line) or upper half (for Top Line) of the vertical range of data to determine the Base or Top Line value. Typically this works well for pulses even with ringing and overshoot.
Histogram Mean	Histogram Mean uses the weighted value of occurrence value in the lower half (for Base Line) or upper half (for Top Line) of the vertical range of data to determine the Base or Top Line value. Typically this works well for signals that do not have a level Top or Bottom, such as transformer pulses with droop or sag.
Minimum Amplitude	The value of the minimum amplitude signal in the measurement zone. This is one of the measurements available and can also be used to set the Base Line. The measurement unit is in vertical units.
Maximum Amplitude	The value of the maximum amplitude signal in the measurement zone. This is one of the measurements available and can also be used to set the Top Line. The measurement unit is in vertical units.
Peak to Peak	This is equal to Maximum Value — Minimum Value. The measurement unit is in vertical units.
Top Line	This is the amplitude of the value determined by the Top Mode Method and is also used to determine Top Line to Base Line Amplitude. The measurement unit is in vertical units.
Base Line	This is the amplitude of the value determined by the Base Mode Method and is also used to determine Top Line to Base Line Amplitude. The measurement unit is in vertical units.
Top Line to Base Line Amplitude	Base-Top is equal to Top Line — Base Line and is also used for percentage calculations of Proximal, Mesial, and Distal Levels. The measurement unit is in vertical units.
Top Line to Maximum Amplitude	Top Aberrations is equal to Maximum Value — Top Line and is an indication of overshoot when Top Line is determined using a method other than Maximum Value. The measurement unit is in vertical units.

Table 3-8: Measurement Terms (Cont.)

Term	Description
Base Line to Minimum Amplitude	Base Aberrations is equal to Base Line — Minimum Value and is an indication of undershoot when Base Line is determined using a method other than Minimum Value.
Edge Qualified	A technique which assures that the proper crossings are used for making timing measurements. See discussion later in this section.
Rise Time	A measure of the time interval from the Proximal Level to the Distal Level for a positive going qualified edge in the measurement zone. The unit of measure is seconds.
Fall Time	A measure of the time interval from the Distal Level to the Proximal Level for a negative going qualified edge in the measurement zone. The unit of measure is seconds.
Rise Slew Rate	Equals (Distal Amplitude — Proximal Amplitude)/Rise Time. The unit of measure is vertical units per nanosecond.
Fall Slew Rate	Equals (Distal Amplitude — Proximal Amplitude)/Fall Time. The unit of measure is vertical units per nanosecond.
Width	This is the measure of time between two consecutive edge qualified crossings of the Mesial Level in the measurement zone. It equals the absolute value of mesial crossing on the rising edge — mesial crossing on the falling edge. The width is measured based on the first qualified edges found in the measurement zone. The unit of measure is seconds.
Period	This is the measure of time between the first and third crossing of the 3 consecutive edge qualified crossings of the Mesial Level in the measurement zone. The unit of measure is seconds.
Frequency	This is best described as the repetition rate within the measurement zone. Frequency is equal to 1/Period. The unit of measure is Hertz.
Area	The Area under the curve in the measurement zone. This is calculated using the trapezoidal rule with the zero (0) amplitude line as the reference. Thus Area can have negative and positive components. The unit of measure is vertical units seconds.
<b>NOTE</b>	
<i>The Area measurement can also be bounded by Proximal, Mesial, and Distal Level crossings. An integer number of sine waves symmetrical about zero (0) volts has an Area of zero (0).</i>	
Mean	The mean (sum of all values/number of values) of all the values in the measurement zone. The unit of measure is vertical units.
RMS	The RMS (Root Means Square) of all the values in the measurement zone. The unit of measure is vertical units. This is an AC+DC measurement.
Cross	An array of the interpolated array indices from which all timing measurements are made; plus the integer array indexes of the first location of the minimum and maximum values. See the additional discussion in this section. This array of measurements is available only over the IEEE-488 interface.

## Measurement System and Environment Options

The measurement system provides the user with the ability to generate 22 different results. Additionally, each result has a user controllable environment under which it can be calculated. The table below illustrates each with its availability, units and return value (when not found).

### NOTE

*NAN means Not A Number and is used to indicate an invalid result such as when measurement results are not available. NAN is shown on the display, (2.0E+308) is shown over the GPIB.*

**Table 3-9: List of Measurements**

Measurement	Availability	Units	Return Value If Not Found
Minimum amplitude value	Front Panel GPIB command: RESUIts?MINIum	Vertical units of the measured waveform	NAN(2.0E+308)
Maximum amplitude value	Front Panel GPIB command: RESUIts?MAXIum	Vertical units of the measured waveform	NAN(2.0E+308)
Peak-to-peak amplitude of data in the measurement zone	Front Panel GPIB command: RESUIts?PK_pk	Vertical units of the measured waveform	NAN(2.0E+308)
Topline	Front Panel GPIB command: RESUIts?TOP	Vertical units of the measured waveform	NAN(2.0E+308)
Baseline	Front Panel GPIB command: RESUIts?BASE	Vertical units of the measured waveform	NAN(2.0E+308)
Topline to baseline amplitude	Front Panel GPIB command: RESUIts?BASETop	Vertical units of the measured waveform	NAN(2.0E+308)
Topline to maximum amplitude	Front Panel GPIB command: RESUIts?TOPAber	Vertical units of the measured waveform	NAN(2.0E+308)
Baseline to minimum amplitude	Front Panel GPIB command: RESUIts?BASEAber	Vertical units of the measured waveform	NAN(2.0E+308)
Proximal measurement reference level	Front Panel GPIB command: RESUIts?PROXIal	Vertical units of the measured waveform	NAN(2.0E+308)
Mesial measurement reference level	Front Panel GPIB command: RESUIts?MESIal	Vertical units of the measured waveform	NAN(2.0E+308)

Table 3-9: List of Measurements (Cont.)

Measurement	Availability	Units	Return Value If Not Found
Distal measurement reference level	Front Panel GPIB command: RESUIts?DISTAI	Vertical units of the measured waveform	NAN(2.0E+308)
Rise Time	Front Panel GPIB command: RESUIts?RISE	Seconds	NAN(2.0E+308)
Rise Slew Rate	Front Panel GPIB command: RESUIts?RISESlew	Vertical Units per nanosecond	NAN(2.0E+308)
Fall Time	Front Panel GPIB command: RESUIts?FALL	Seconds	NAN(2.0E+308)
Fall Slew Rate	Front Panel GPIB command: RESUIts?FALLSlew	Vertical Units per nanosecond	NAN(2.0E+308)
Period	Front Panel GPIB command: RESUIts?PERIod	Seconds	NAN(2.0E+308)
Width	Front Panel GPIB command: RESUIts?WIDth	Seconds	NAN(2.0E+308)
Frequency	Front Panel GPIB command: RESUIts?FREquency	Hertz	NAN(2.0E+308)
Area	Front Panel GPIB command: RESUIts?AREA	Vertical Units-Seconds	NAN(2.0E+308)
Mean	Front Panel GPIB command: RESUIts?MEAN	Vertical units of measured waveform	NAN(2.0E+308)
RMS	Front Panel GPIB command: RESUIts?RMS	Vertical units of measured waveform	NAN(2.0E+308)
Cross locations used by the measurement system for timing measurements	GPIB command: CROss?	No units	-1.0

## Measurement Model

There are also user selectable controls that alter the environment under which measurements are run. Contained in the following table is a brief description of each of these controls along with a list of the measurements that depend upon them.

**Table 3-10: Measurement Environment Selections**

Control	Header and Link	Arguments	Dependent Measurements	Default Value
Measurement results can be displayed in any of the four windows on the front panel	MEASUre WINDow:	WIN1 WIN2 WIN3 WIN4	Any measurements whose results have been selected for display	WIN1
The zone of the waveform over which measurements are taken can be the entire waveform or between the cursors inclusively	MEASUre MEASZone:	FULI CURSors WIN1 WIN2 WIN3 WIN4	All measurements depend upon this with the exception of Area whose zone can be further narrowed by the AREAZone command	FULI
Any of the 16 SCD waveforms can be selected for measurement	MEASUre WAVfrm:	<NRx>	All measurements depend upon this	1
Measurements can be enabled or disabled	MEASUre FUNction:	ON OFF	All measurements depend upon this	OFF
Individual measurements can be enabled or disabled for results display	MSList<mslist>: <mslist> can be any of the measurement links shown in the previous table	ON OF	All measurements depend upon this	OFF (All measurements are off)
All measurements can be disabled for display	MSList	CLEar	All measurements depend upon this	Does not apply
Baseline can be calculated from a histogram as an average or a max count. It can also be set to the minimum or as an absolute level	BASEMode METHod:  LEVEL:	HISTO- Gram HIS- TOMean MINIum ABSOLute <NRx>	Baseline, Base to Top, and Base Aberration are dependent upon this	HISTOGRAM
Topline can be calculated from a histogram as an average or a max count. It can also be set to the maximum or as an absolute level.	TOPMode METHod:  LEVEL:	HISTO- Gram HIS- TOMean MAXIum ABSOLute <NRx>	Topline, Base to Top, and Top Aberration are dependent upon this	HISTOGRAM
The reference levels can be settable as an absolute level or as a percentage of the topline and baseline difference from the front panel	LEVMode	PERCent ABSOLute	The proximal, mesial, and distal levels are dependent upon this	PERCent



Table 3-10: Measurement Environment Selections (Cont.)

Control	Header and Link	Arguments	Dependent Measurements	Default Value
The reference levels can be set as absolute levels or as a percentage of the topline to baseline amplitude over the bus	PROXLevel		This affects the proximal, mesial, and distal reference levels as well as all the measurements that use the crossing points	PERCent:10
	PERCent: LEVEL:	<NRx> <NRx>		
	MESLevel			PERCent:50
	PERCent: LEVEL:	<NRx> <NRx>		
DISTLevel		PERCent:90		
PERCent: LEVEL:	<NRx> <NRx>			
The area zone can be specified as reference level crossings or the same as the measurement zone	AREAZone	PROXimal MESial DISTal MEASZone	This only affects the Area measurement	MEASZone

## Operation of Measurement System

This section describes the operation of the measurement system. Figure 3-36 shows a diagram outlining the order in which the measurements occur when the system is invoked. It represents a complete run of the system with the assumption that no errors were encountered forcing a premature exit. Errors causing exits will be discussed in a subsequent section.

The measurements are run in a specific order. This allows information generated in previous steps to be passed on rather than recalculated in subsequent steps. Please note that each of the blocks has been numbered. There will be references made to these numerical designators in later sections.

First it should be noted that measurements can only operate on one record at a time. Second, when invoked, the measurement system makes all the measurements (provided there are no errors) regardless of what has been enabled via the front panel. In reality, the measurements highlighted in the front panel selection menu (of which there can only be eight) are merely enabling the display of specific results upon completion. However, over the bus, all results will be available after execution.

Measurements can be enabled or disabled from the front panel or GPIB interface bus. When enabled, measurements are run after each acquisition cycle any time the waveform area of the front panel is redrawn or, provided that the instrument is not in the process of an acquisition cycle, when the **Man Meas** button is pushed.

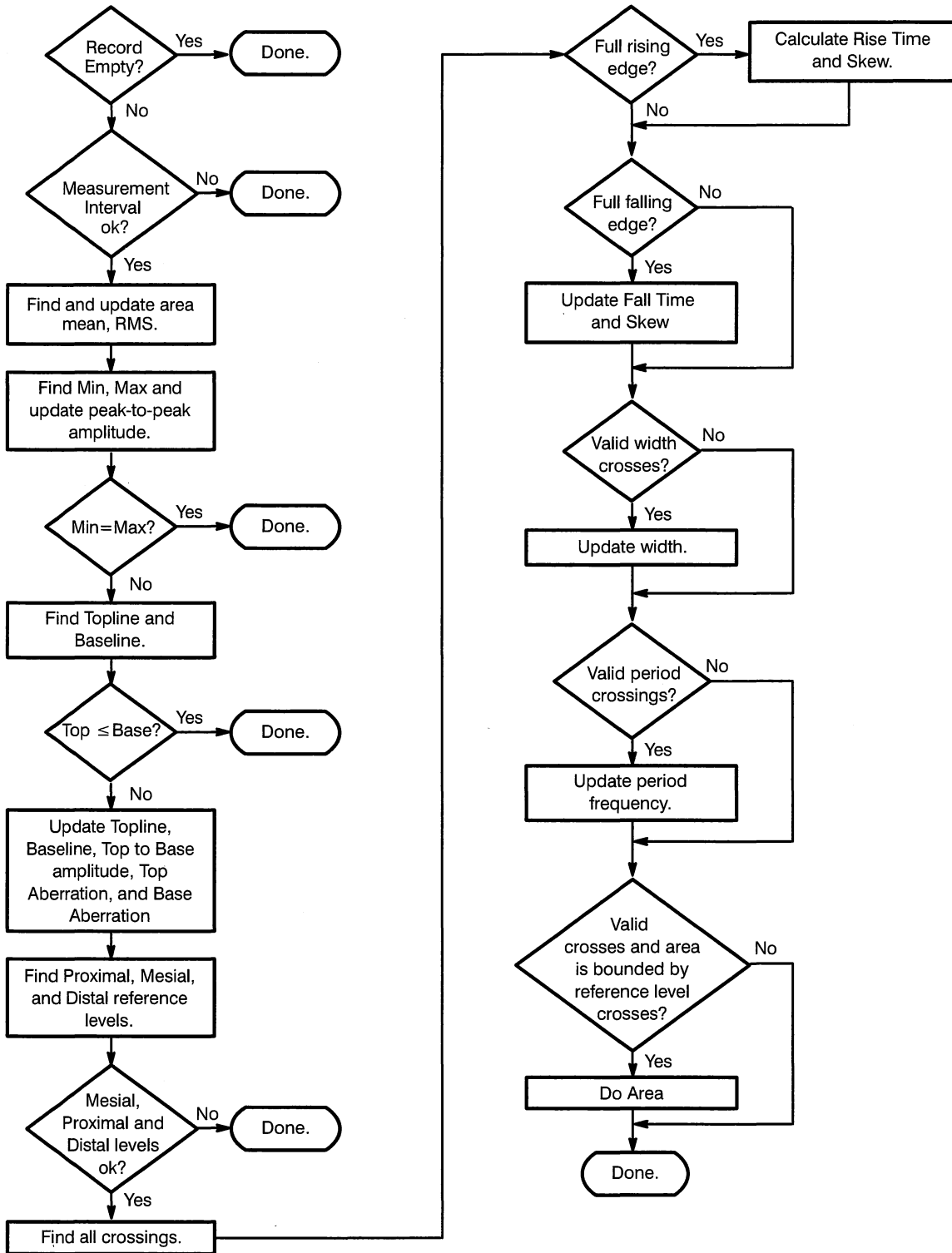

Figure 3-36: Measurement Block Diagram

## Measurement Termination Errors

Error checking in the measurement system only occurs once the measurements have been invoked. When the measurement system encounters a setup or situation that it cannot resolve, it terminates the current measurement and, in some cases, all further measurements.

The flow of information through the system has been designed in such a way that later measurements depend on information generated from previous ones. As a result, the system always measures as much as it possibly can. To indicate that a requested measurement was not completed, the system will set its result equal to NAN (“Not A Number”) instead of a numerical value. Over the bus, this value will be reported as a very large number (i.e. 2.0E+308) whereas the front panel will display it as “NAN”. The cross locations available via the bus however, are an exception to the rule. Since a cross value represents an interpolated position in the waveform, its value can never be less than 0. Therefore a simpler value, -1, was chosen as the invalid result.

There are approximately 9 errors that are trapped in the measurement system. Each has been tabulated in the following table, along with its location in the block diagram, the action it takes, and the effect generated over the front panel or GPIB bus.

**Table 3-11: Measurement Termination Errors**

Exit Point	Location	Cause	Effect
1	block 1	The record is empty	No measurements will be made
2	block 2	An invalid measurement interval has been chosen	No measurements will be made
3	block 5	The max value equals the min value	Only the min, max, and peak-to-peak measurements will be made
4	block 7	Topline $\leq$ Baseline	Only the min, max, peak-to-peak measurements will be made
5	block 10	Distal $\leq$ Mesial or Proximal $\leq$ Mesial or Distal $\leq$ Proximal	Only the min, max, peak-to-peak, topline, baseline, top to base, top aberration and base aberration measurements will be made. Additionally, if the area interval has been set to proximal, mesial or distal, the area measurement will not be made either.
6	block 12	The rising edge distal or proximal crossing was not found	No rise time, rise slew, frequency, and width measurements will be made. Additionally, if the area interval has been set to proximal, mesial or distal, the area measurement will not be made either.
7	block 14	The falling edge distal or proximal crossing was not found	No fall time, fall slew, frequency, and width measurements will be made. Additionally, if the area interval has been set to proximal, mesial or distal, the area measurement will not be made either.

Table 3-11: Measurement Termination Errors (Cont.)

Exit Point	Location	Cause	Effect
8	block 16	Two consecutive mesial crossings were not found on edges of opposite polarity	No width measurement will be made. Additionally, if the area interval has been set to proximal, mesial or distal, the area measurement will not be made either.
9	block 18	Two consecutive mesial crossings were not found on edges of the same polarity.	No period or frequency measurement will be made. Additionally, if the area interval has been set to proximal, mesial or distal, the area measurement will not be made either.

---

## Measurement System Specifics

This section covers the specifics of how results are calculated in the measurement system. Before actually calculating any results, the system first establishes the interval over which the measurements will take place. The user can select whether the entire waveform or some subsection of it bounded by the cursors is measured. If the cursors are selected, the measurements will include their vertical values in the interval along with the data residing between. Also, attention is paid only to the relative magnitude of the cursors. Thus, the cursor with the smallest index in the waveform becomes the lower (leftmost) bound and the cursor with the largest becomes the upper (rightmost) bound.

Once the interval has been bounded, the minimum, maximum, and peak-to-peak amplitude values are calculated. To find the min and max in the waveform, each data point in the interval is examined, and its minimum and maximum is saved along with their locations. Only the first occurrence of the minimum and maximum are saved. Repeated values are ignored. The peak-to-peak measurement is the minimum subtracted from the maximum.

The next set of results calculated are based on a topline and baseline which can be set as explicit levels via the bus or front panel, can be set to the maximum or minimum, respectively, or can be calculated automatically. When internally generated, the instrument must first make a histogram of the vertical values within the interval boundaries. And from that, the levels can be computed. The following steps illustrate how this is done.

1. A histogram bucket is allocated for each digitizer level that was used in the digitized signal. In other words, the histogram is built for all values between the minimum and maximum calculated previously.
2. The frequency of occurrence of each digitizer level is saved in its appropriate bucket.
3. The range of levels used in the histogram is then divided into two equal halves with the upper half being used to calculate topline and the lower half being used to calculate baseline.
4. Based on a user selection, the halves can be used in one of two ways to come up with a value for topline and baseline.
  - a. The maximum occurrence in each half can be found and assigned to topline and baseline. This method corresponds to the user selection of HistMode. In this case, the histogram is searched from the extremes toward the center for each section and only the first occurrence of a maximum is saved. Thus, if a dominant peak is not encountered in either section, the topline will remain the extreme value (maximum of the waveform) of the top half, and the baseline will remain the extreme value (minimum of the waveform) of the bottom half.

or,
  - b. The average of each half can be calculated and assigned to the topline and baseline. This method corresponds to the user selection of HistMean.

Once topline and baseline have been found, the following results are updated with the values shown below. Please note that all values (topline, min, max, baseline, base to top, top aberration, and base aberration) are in the vertical units of the channel on which the measurements were made.

- top to base = topline – baseline
- top aberration = max – topline
- base aberration = baseline – min

With the exception of area, mean, and rms, the remaining measurements require the determination of crossing locations to complete successfully. When the area interval is set to proximal, distal, or mesial, it too will depend on valid crossings of both a rising and falling edge. Finding the cross locations is simply a matter of locating the closest pair of points in either the forward or reverse direction whose vertical values bound the crossing point of interest on both sides. The leftmost horizontal bounding value can have a vertical value that is equal to the cross value. The rightmost horizontal bounding value can be greater than or less than but never equal to the cross value. Once the bounding values have been located, the horizontal crossing location from which the timing measurements are made is then linearly interpolated between them based on the formula shown below.

$V_C$  = value of the cross location in vertical units

$V_L$  = value of the leftmost bounding point in vertical units

$V_R$  = value of the rightmost bounding point in vertical units

$H_L$  = horizontal position in the waveform of  $V_L$  (no associated units)

$H_C$  = interpolated horizontal position in the waveform of  $V_C$  (no associated units)

$$H_C = H_L + (V_C - V_L)/(V_R - V_L)$$

The order in which the crossing values are found determines which edges are qualified for a particular measurement. All the crossing measurements are made starting from the first full signal edge which can be rising or falling. To find and classify a full edge the instrument executes the following steps.

1. The first mesial crossing is found.
2. It then looks forward from the mesial point for the next distal and proximal crossing. If the proximal crossing occurs first, the edge is classified as falling, or if the distal crossing occurs first, it is classified as rising.
3. If the edge is rising, the instrument will then search backward from the mesial point for a proximal crossing. If the edge is falling, it will search backward for a distal crossing. If either crossing is found, the edge is then considered full.
4. If a failure occurs in finding a full edge from the first mesial crossing, the instrument will attempt to find another from the next mesial crossing. This will go on until an edge is found or until the end of the measurement interval is reached.

Once the first full edge is found, the proximal, mesial, and distal crossings of the next edge of opposite polarity are located beginning with the mesial. And, finally, if these three crossings are found, a third mesial crossing is located which should be on an edge of the same polarity as the first. Outlined in Figure 3-37 is the general order of search that characterizes the timing measurement interval in the three cases described previously.

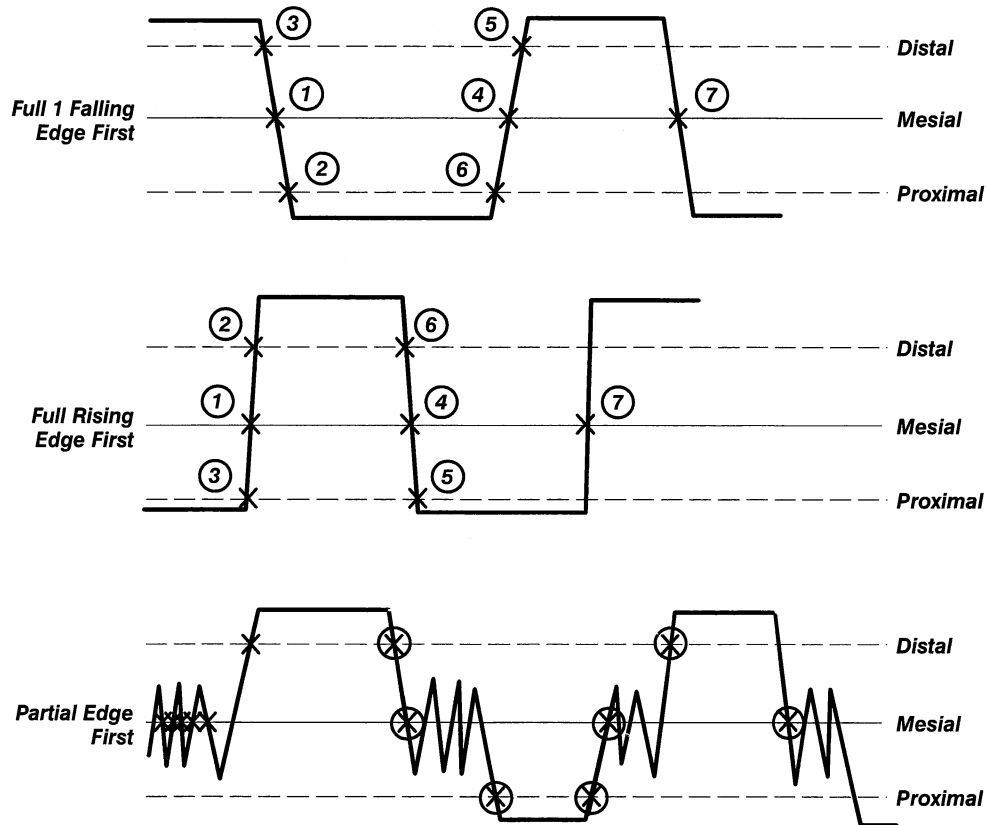

**Figure 3-37: Timing Measurement Interval**

Even though many more can be taken, there are 7 crossings located and used to make a full set of timing measurements: a rising edge proximal (RP), a rising edge mesial (RM), a rising edge distal (RD), a falling edge proximal (FP), a falling edge mesial (FM), a falling edge distal (FD), and a final mesial made for the period measurement (PM). These values represent interpolated horizontal position values in the waveform data and as such they have no units. To calculate the time results, the positions are subtracted from each other and then scaled by the sample interval. The slew measurement is calculated using the difference between the proximal and distal levels (which are scaled in vertical units) divided by the time generated previously. The actual manner in which the results are generated from the values has been detailed below.

- rise time = (RD – RP) \* sample interval
- fall time = (FP – FD) \* sample interval



- rise slew = (distal – proximal) / rise time
- fall slew = (distal – proximal) / fall time

Period and width are treated in a different fashion than the other measurements because their ultimate result must take into consideration the polarity of the edges used as well as the sequence in which these edges are encountered. For period measurements, the mesial crossings of the first full edge and the next consecutive edge of the same polarity are used. For the width measurement, the mesial crossings of the first full edge and the next consecutive edge of the opposite polarity are used. To generate a result for period and width when the leading edge is rising, the following formulas are used.

- period = (PM – RM) \* sample interval
- width = (FM – RM) \* sample interval

To generate a result for period and width when the leading edge is falling, the following formulas are used.

- period = (PM – FM) \* sample interval
- width = (RM – FM) \* sample interval
- frequency = 1 / period

Mean, RMS and area are the last measurements that will be described.

Mean is a sum of the signed vertical values of the points contained in the measurement interval divided by the number of points summed.

RMS first sums the squares of the signed vertical values of all the points contained in the measurement interval. It divides that value by the number of values summed and then takes its square root.

Fundamentally, area uses a modified trapezoidal approximation algorithm. This approach uses the signed vertical value of each data point as the height and the sample interval as the width of a rectangle. This implies that the difference between positive and negative area is being reported. The area result is computed in two steps as shown in the formula below.

Step 1 truncates the interpolated area bounds to discrete values and then sums the area of all the rectangles included between. However, the sum does not include the discrete end points; they are treated separately. Because the data points essentially bisect the rectangles parallel to the vertical axis, extra information (the rectangle halves hanging over each end) will get included into the final area measurement. This has been taken care of by including only half the area of each end point rectangle into the sum.

Once step 1 has been completed, Area is equal to a value calculated from truncated discrete end points (not processing the end points originally specified for the measurement). When the measurement interval is selected as the area interval, the Area in step 1 is the final result. However, if one of the reference level crosses is selected to bound the interval, the final area is

generated by adding and subtracting the information that the truncation procedure ignored or included, respectively. Thus, step 2 of the formula performs this correction.

**Step 1:**

start = TRUNCATE(lower area bound)  
 stop = TRUNCATE(upper area bound)

$$Area = \frac{waveform[start] + waveform[stop]}{2} * sample\ interval + \sum_{i=start+1}^{stop-1} waveform[i] * sample\ interval$$

**Step 2:**

$V_L$  = interpolated vertical value of the leftmost bound point  
 $V_R$  = interpolated vertical value of the rightmost bound point  
 $V_{START}$  = vertical value of the truncated leftmost bound point  
 $V_{STOP}$  = vertical value of the truncated rightmost bound point  
 $H_L$  = interpolated horizontal crossing location of the leftmost bound point  
 $H_R$  = interpolated horizontal crossing location of the rightmost bound point

$$H_{IGNORED} = (H_R - stop) * sample\ interval$$

$$H_{EXTRA} = (H_L - start) * sample\ interval$$

$$V_{IGNORED} = (V_{STOP} + V_R) / 2.0$$

$$V_{EXTRA} = (V_{START} + V_L) / 2.0$$

$$Area = Area + (H_{IGNORED} * V_{IGNORED}) - (H_{EXTRA} * V_{EXTRA})$$

From the GPIB and front panel, additional and separate control over the area interval has been provided. When the measurement interval, "Meas-Zone", is selected as the area interval, the area will be taken over the entire waveform or between the cursors following the same rules as the rest of the measurement system. However, if "Distal" is chosen, the area measurement will be taken between the distal crossings located that are on the first two full edges. This implies that when any of the crosses are bounding the area interval, the measurement will not be run in their absence and will be subject to exit points 6, 7, and 8. When "Proximal" (proximal crossings) or "Mesial" (mesial crossings) are chosen as the bounds, they will work analogously.

## Extra Information Available Over the GPIB Interface

Extra information has been provided over the bus that may prove useful in determining where the measurements have taken place or how they generated the results they did. This information is accessed via the CROSS? query. It responds with the horizontally interpolated locations corresponding to the 7 crossings used in the timing measurements as well as the explicit locations of the minimum and maximum used in the vertical measurements. In the table below there is a description of each link. Please note that the values returned are not scaled in time, but represent positions along the horizontal axis of the waveform record. They represent interpolated data locations (in the case of the timing crosses) or explicit data locations (in the case of the minimum and maximum locations) in the data array being measured. In the event that a cross was not found, it will be set to -1.

**Table 3-12: CROSS? Query Links**

Header	Link	Description
CROss	PRlse	The interpolated rising edge proximal crossing.
CROss	PFAll	The interpolated falling edge proximal crossing.
CROss	DRlse	The interpolated rising edge distal crossing.
CROss	DFAll	The interpolated falling edge distal crossing.
CROss	MRlse	The interpolated rising edge mesial crossing.
CROss	MFAll	The interpolated falling edge mesial crossing.
CROss	MPEriod	The interpolated third mesial crossing used to generate the period and frequency values.
CROss	MINLoc	The explicit location of the minimum in waveform data.
CROss	MAXLoc	The explicit location of the maximum in waveform data.

Also available over the bus are the unit strings associated with each measurement. To get all the unit strings, one should issue the command, "UNITS?" over the bus. To get the units for an individual measurement, one should issue the units query with a measurement link attached (example – "UNITS?MAXIMUM").

Numerical results in the measurement system are expressed to a certain number of significant figures. For the horizontal measurements (rise time, fall time, period, and width), the resolution is 1/5 percent of the time window. Rise and fall slew rate has a fixed precision of 4 digits, cross uses a fixed resolution of 0.01, and period uses a resolution of 1/ $\Delta$  time. For the vertical measurements (those measurements remaining), the resolution is calculated as 10 times the resolution of the digitizer, or one digit less of precision than the vertical resolution of the digitizer.



# Instrument Function Reference

The remainder of this section provides reference information for SCD Waveform Recorder modes and functions.

Tables 3-13 through 3-20 summarize all the modes and functions described on the following pages. The tables list all modes and functions (function name and function key label), the range of functional settings, the factory default setting, and whether the setting is affected by the function key or knob. Function key names are shown as they appear on the Display Unit (limited to eight characters). An “x” in a key label indicates the channel or window that the function affects. For example, Wx Rec is a function key that assigns a record to the currently selected window (selected by another function key). The currently selected window number (1, 2, 3, or 4) replaces the x in the key label.

Some functions are dependent on the waveform recorder’s model: SCD1000 or SCD5000. Model dependencies are noted in the tables and the descriptions. Since only seven function keys can be active at one time, modes with more than seven functions have more than one level of function key labels. These additional levels are accessed by pressing the **NextMenu** function key (the bottom function key). The NextMenu label is displayed only when additional levels are available. The following tables indicate the different levels of functions provided (if any) in each mode.

In this functional reference, functions are described according to the mode in which they appear. Vertical mode functions are explained first, followed by Acquisition functions, Trigger functions, Display functions, Cursor functions, Save/Recall functions, and Utility functions. Each function is described with various important aspects of the function. A brief description of each function of the mode is provided prior to the detailed descriptions of each function.

Changing a function setting while an acquisition is in process stops the acquisition, selects the new function setting, and restarts the acquisition system. For example, if the waveform recorder is in the “Running” acquisition state, after the function setting is changed, the waveform recorder returns to the Running state, continuously acquiring data. If AutoAdvance acquisition mode is selected, HoldNext is on, and the waveform recorder state is “Running”, after a change to the function setting, the AutoAdvance acquisition is restarted; the waveform recorder starts storing data into the specified start record.

For each function, the following information (if applicable) is provided:

- **Function Name** lists the descriptive title of the function. A representation of the mode menu is shown with the appropriate mode key highlighted. If the function is dependent on the waveform recorder model (SCD1000 or SCD5000), it is noted in the function name.

- **Key Presses** indicates the sequence of keys to be pressed to arrive at the desired function. The **Selector** column next to the key presses indicates the control (function key just pressed or the knob) that further defines the value of the selection.
- **Description** provides a detailed description of the function.
- **Values** includes all available settings for the function. If the value is numeric, the numeric range is provided. The factory setting is also listed, showing the value assumed when the instrument is initialized to the factory settings.
- **Interactions** lists any functions that are affected by or affect the function being described.
- **GPIB Command** lists the command or commands that perform the equivalent function over the GPIB. Not all GPIB functions are available on the Display Unit. (Furthermore, the Display Unit may provide capabilities that are not available over the GPIB.)

Only the long form of the GPIB command is given here. Most commands have an abbreviated form that can be used instead. For more information regarding GPIB commands listed in this reference section, see the Programmer Manual.

**Table 3-13: Vertical Functions**

Function	Label	Selector	Selections	Factory Setting
Vertical Mode (SCD1000 only)	VertMode	Function Key	Ch A; Ch B; Add	Ch A
Channel Select (SCD1000 only)	Chan Sel	Function Key	Ch A; Ch B	Ch A
Range (SCD1000 only)	Range	Knob	100 mV to 10 V	1 V
Offset (Volts)	Offset	Knob	SCD1000: $\pm(2.5 \times \text{Range})$ SCD5000: $\pm 4.5 \text{ V}$	0 V
Offset (%)	Offset	Knob	SCD1000: $\pm 250\%$ of Range SCD5000: $\pm 80\%$ of Range	NA
Coupling (SCD1000 only)	Coup	Function Key	AC; DC; OFF	DC
Channel Invert (SCD1000 only)	Invert	Function Key	Off or On	Off

Table 3-14: Acquisition Functions

Function	Label	Selector	Selections	Factory Setting
Mode	Mode	Function Key	Normal, Auto Adv Average	Normal
Time Window	TimeWin	Knob	5 ns to 100 $\mu$ s	1 ms
Record Length	Length	Knob	256; 512; 1024	512
Start Record	Sta Rec	Knob	1 to 16	1
Number of Records Acquired (normal acquire mode)	N Rec	Knob	1 to 16	1
Number of Averages Acquired (average acquire mode)	N Avg	Knob	1 to 1024	16
Hold Next	HoldNext	Function Key	Off or On	Off
<b>Next Menu</b>				
Use Geometry Correction	Geometry	Function Key	Off or On	On (SCD5000) Off (SCD1000)
Set Geometry Correction	Set Geom	Function Key	Running or stopped	Stopped

Table 3-15: Trigger Functions

Function	Label	Selector	Selections	Factory Setting
Mode	TrigMode	Function Key	Normal or Auto	Auto
Source	Source	Function Key	SCD1000: Ch A; Ch B; Add; External SCD5000: External or Cal	SCD1000:a Ch A SCD1000: Ch A SCD5000: EXT
Level (Internal/ Volts)	TrigLvl	Knob	$\pm$ (Vertical Range/2) + Offset	0 V
Level (Internal/%)	TrigLvl	Knob	$\pm$ 100%	0%
Level (External)	TrigLvl	Knob	SCD1000: $\pm$ 0.5 V SCD5000: $\pm$ 1.0 V	0 V
Slope	Slope	Function Key	+ or -	+
Coupling	TrigCoup	Function Key	AC or DC	SCD1000: AC SCD5000: DC
Delay	TrigDly	Knob	0 to 5 times the time window (% or seconds)	0 %
Arming	Arming	Function Key	Internal or External	Internal

Table 3-16: Display Functions

Function	Label	Selector	Selections	Factory Setting
Number of Window	N Window	Function Key	1; 2; 4	1
Window Select	Wind Sel	Function Key	1; 2; 3; 4	1
Record Selection for Selected Window	Wx Rec	Knob	0 to 16	1
Horizontal/Vertical Expansion Point	WxExpPt	Knob	0 to (Record Length – 1)	0
Vertical Expansion Factor	Wx VExp	Knob	1 to 4	1
Horizontal Expansion Mode	HExpMode	Function Key	Independent or Aligned	Independent
Horizontal Expansion Factor	Wx HExp	Knob	1 or 2 (1024 point waveform only)	1

Table 3-17: Cursor Functions

Function	Label	Selector	Selections	Factory Setting
Cursors On/Off	Cursors	Function Key	On or Off	On
Cursor 1 Window	Curs1Loc	Function Key	Any displayed window (1 to 4)	Win 1
Cursor 2 Window	Curs2Loc	Function Key	Any displayed window (1 to 4)	Win 1
Cursor 1 Position	Curs 1	Knob	0 to (Record Length – 1)	0
Cursor 2 Position	Curs 2	Knob	0 to (Record Length – 1)	0
Graticules On/Off	Grat	Function Key	On or Off	Off



Table 3-18: Save/Recall Functions

Function	Label	Selector	Selections	Factory Setting
Save Settings Selection	SaveSel	Knob	1 to 10	1
Save Current Settings	Save Set	None	None	None
Recall Settings Selection	Rcl Set	Knob	1 to 10	1
Recall Settings	Rcl Set	None	None	None
Recall Status Messages	Rcl Stat	Function Key	Stat 1 to Stat 10	Stat 1
Initialize Digitizer	Init	Function Key	None	None
Secure Digitizer	Secure	Function Key	None	None

Table 3-19: Utility Functions

Function	Label	Selector	Selections	Factory Setting
Target Threshold	Thresh	Knob	0 to 63	0
Time Window	Timewin	Knob	5 $\mu$ s to 100 $\mu$ s	1 ms
CRT Beam Intensity	Inten	Knob	0% to 100%	Set by time window
CRT Beam Focus	Focus	Knob	0% to 100%	Set by time window
Set Target Reference Data	Set Ref	Function Key	None	None
Trigger Delay	Trig Dly	Function Key	0% to 500%	0%
<b>Next Menu (2<sup>nd</sup> Level)</b>				
Calibration Mode Selection	Cal Mode	Function Key	System; Vertical; Horizontal; Trigger; CRT; Geometry	System
Initiate Calibration	Cal	Function Key	None	None
View Setup	View	Function Key	ID; Acquire; Display	ID
Beeper On/Off	Beeper	Function Key	On or Off	On
Knob Beeper On/Off	KnobBeep	Knob	On or Off	On
Debug Mode	Debug	Function Key	On or Off	Off

Table 3-19: Utility Functions (Cont.)

Function	Label	Selector	Selections	Factory Setting
<b>Next Menu (3<sup>rd</sup> Level)</b>				
Instrument Self Test	Inst Test	Function Key	Stopped; running	Stopped
Processor Board Test	MPU Test	Function Key	Stopped; running	Stopped
Front Panel Test	FP Test	Function Key	Stopped; running	Stopped
Acquisition System Test	Acq Test	Function Key	Stopped; running	Stopped
<b>Next Menu (4<sup>th</sup> Level)</b>				
Set Timestamp Year	Year	Knob	1989 – 2010	year of calibration
Set Timestamp Month	Month	Knob	1 – 12	month
Set Timestamp Day	Day	Knob	1 – 31	day (PDT)
Set Timestamp Hour	Hour	Knob	0 – 23	hour
Set Timestamp Minute	Minute	Knob	0 – 59	minute
Enter Timestamp Info Into NV RAM	Enter	Function Key	N/A	N/A
<b>Next Menu (5<sup>th</sup> Level)</b>				
Channel Calibration Signals (SCD1000)	Ch A Cal Ch B Cal	Function Key	Time; Ampl into 0; Ampl into 450; Off	Off
Calibrator Output Signal (SCD5000)	Cal Out	Function Key	Time; Ampl into 0; Ampl into 450; Off	Off
External Calibrator Signal (SCD1000)	Ext Cal	Function Key	Time; Amplitude	Time
Calibrator Signal Amplitude	CalAmpl	Knob	SCD1000: 0 V to $\pm 2.5$ V; SCD5000: $\pm 2.5$ V	+2.5 V
Calibrator Signal Period	CalTime	Knob	4 ns to 8 ms	0.8 ms

Table 3-20: Measurement Functions

Function	Label	Selector	Selections	Factory Setting
Measurements On/Off	Measure	Function Key	On or Off	Off
Measurement Function	Select	Knob	Max Value; Top Level; Distal Level; Mesial Level; Proximal Level; Base Level; Min Value; Peak-Peak Amp; Base-Top Amp; Top Aberrations; Base Aberrations; Rise Time; Rise Slew Rate; Fall Time; Fall Slew Rate; Width; Period; Frequency; Area; Mean; RMS	
Add or Delete Measurement	Enter	Function Key	On or Off	
Measurement Window Select	Disp Win	Function Key	1; 2; 3; 4	1
Waveform Source	Wfm #	Knob	1 through 16	1
Select Waveform Area	MeasZone	Function Key	Cursors or Full Wfm	Full Wfm
<b>Next Menu</b>				
Select Proximal, Mesial, and Distal Units	LevelMod	Function Key	Percent; Absolute	Percent
Distal Level	Distal	Knob	Percent: 0 to 100; Absolute: -1000 to +1000	Percent: 90 Absolute: 0
Mesial Level	Mesial	Knob	Percent: 0 to 100; Absolute: -1000 to +1000	Percent: 50 Absolute: 0
Proximal Level	Proximi	Knob	Percent: 0 to 100; Absolute: -1000 to +1000	Percent: 10 Absolute: 0
<b>Next Menu</b>				
Base Level Measurement	BaseMode	Function Key	HistMode; HistMean; MinValue; AbsLevel	HistMode
Top Mode Measurement	TopMode	Function Key	HistMode; HistMean; MinValue; AbsLevel	HistMode
Area Measurement	AreaZone	Function Key	Proximi; Mesial; Distal; Measzone	Measzone



# Vertical Functions

Vertical Functions affect the active acquisition channel and the input signal conditioning for the channel. These functions are selected by pressing the **Vertical** mode key. Vertical selections are (with function key labels in parentheses):

**Vertical Mode (VertMode)** — (SCD1000 only) Selects the active channel(s) (Ch A, Ch B, or Add) for an acquisition. Either of the two input channels can be selected, or the algebraic sum of the two inputs can be selected.

**Channel Select (Chan Sel)** — (SCD1000 only) Selects the channel for which signal conditioning parameters are to be adjusted (range offset, coupling, and invert). These parameters can be independently set for each acquisition channel. When a channel is selected, the channel indicator (A or B) appears in other menu labels.

**Vertical Range (Range x)** — Sets the full-scale input range for the selected channel. (SCD5000 range is fixed at 5 volts.)

**Vertical Offset (Offset x)** — Sets a DC offset for the selected channel. Offset can be specified in terms of volts or percent of the full-scale range.

**Vertical Coupling (Coup x)** — (SCD1000 only) Selects the input coupling (DC, AC, or OFF) to the input amplifiers. DC selects the waveform recorder's entire bandwidth limit. (SCD5000 coupling is fixed at DC.) AC coupling attenuates signal components below 1 kHz. OFF effectively provides an open circuit (500 k $\Omega$ ) to the input signal path.

**Invert Signal (Invert)** — (SCD1000 only) Inverts the signal from the selected input channel. If Vertical Mode is set to ADD, the Invert function can be used to obtain the difference between two signals.

## Vertical Mode (SCD1000 Only)

The Vertical Mode function selects the input channel(s) to be used for acquisition. Either of the input channels, or the algebraic sum of both channels, can be selected.

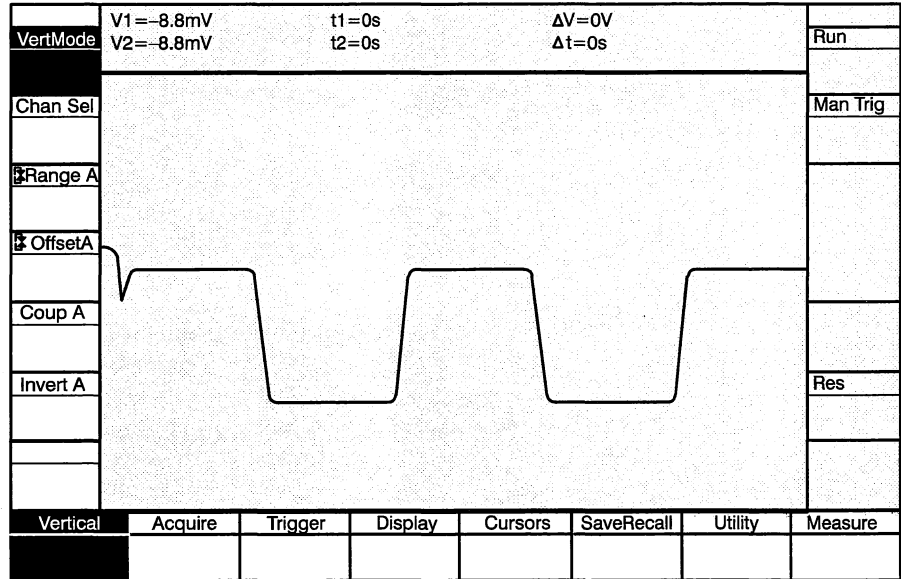

**Values:** Ch A, Ch B, Add

**Initial Value:** Ch A

**Interactions:** None

**GPIB Command:** VMODE { CHA | CHB | ADD }  
VMODE?

## Vertical Channel Select (SCD1000 Only)

The Vertical Channel Select function selects the channel on which vertical parameters are to be changed: range, offset, coupling, and signal invert. Each of these functions can independently be set on each acquisition channel.

As this function key is pressed to select the next channel, the menu label of each of the vertical parameters (range, offset, coupling, and invert) displays the current settings for the selected channel. The label also indicates the channel for which the settings are made.

Whether or not the channel selected with Chan Sel function key is being used for acquisition, parameters for the selected channel can be adjusted. This allows setup of input parameters prior to selecting a channel for acquisition. It also allows setting signal conditioning parameters of an input signal that is not acquired but is being used as a trigger source.

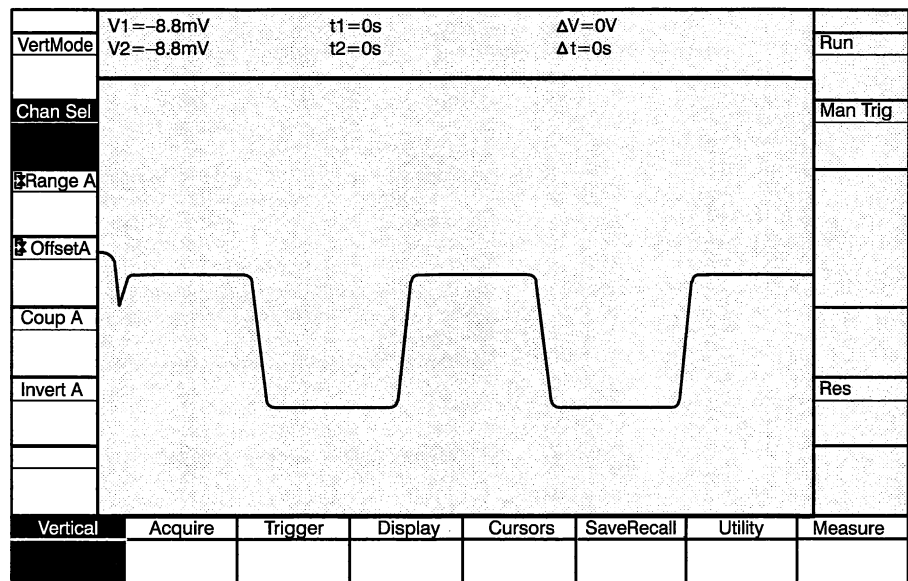

**Values:** Ch A, Ch B

**Initial Value:** Ch A

**Interactions:** None

**GPIB Command:** No direct equivalent. The vertical channel is specified together with one of the other vertical functions (Range, Offset, Offset Type, Coupling, or Invert) as follows:

```
CH<x> { RANGE | OFFSET | TYPEOFFSET | COUPLING }:<NRx>
CH? { RANGE | OFFSET | TYPEOFFSET | COUPLING } :
CH<x>?
CH?
```

## Vertical Range

The Vertical Range function sets the full-scale (peak-to-peak) dynamic range of the vertical acquisition window. Range is set only for the channel selected with the Vertical Channel Selection function. Vertical range values are adjusted with the variable knob. (Vertical range for the SCD5000 is fixed at 5 volts peak-to-peak.)

When no mode is active, the vertical range is displayed in the waveform vertical status information to the left of the waveform zone.

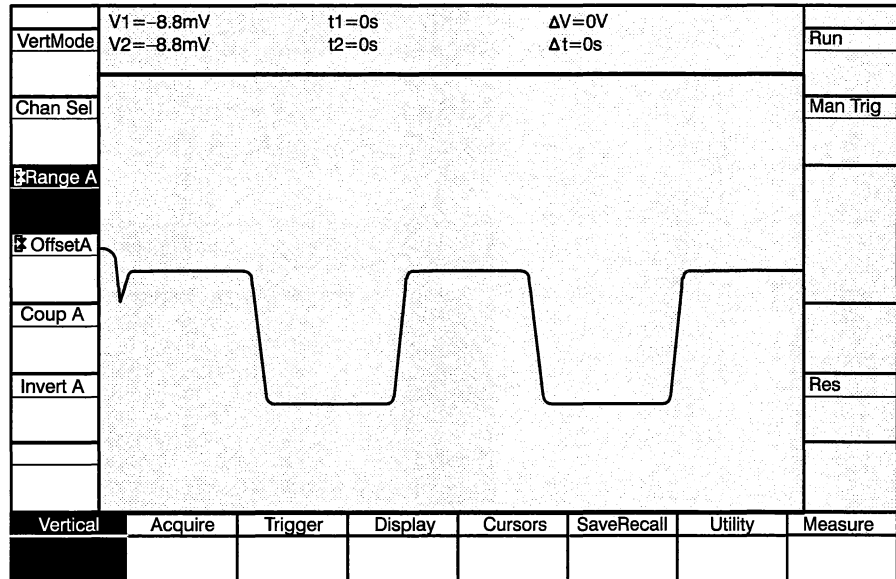

**Values:** SCD1000 Only: 100 mV, 200 mV, 500 mV, 1 V, 2 V, 5 V, 10 V

**Initial Value:** 1 V for both channels

**Interactions:** The Vertical Range selection affects the following other functions:

- **Vertical Offset :** The offset is coerced to the closest valid setting if the current setting is invalid for the selected range. For example, if the offset is set to +5 volts for a 10 volt range and the range is changed to 500 mV, the offset is automatically set to +1.25 V.
- **Trigger Level:** If the trigger source is the channel being changed and the trigger level is set in volts, the trigger level is automatically recalculated, adjusted, and the trigger level readout changed to the appropriate value.

**GPIB Command:** CH<x> RANGE  
CH<x>? RANGE



## Vertical Offset

The Vertical Offset function adjusts the vertical position of the acquisition window. The offset value corresponds to the voltage value at the center of the acquisition window. Increasing the offset moves the acquisition window upward; decreasing the offset moves the acquisition window *downward*. When offset is *increased*, the resultant waveform appears to move downward (and vice versa); this is because the window is being positioned, not the waveform.

Offset units are selected with the Units key (% or volts). Offset value is adjusted with the variable knob. Knob resolution is selectable as Coarse or Fine.

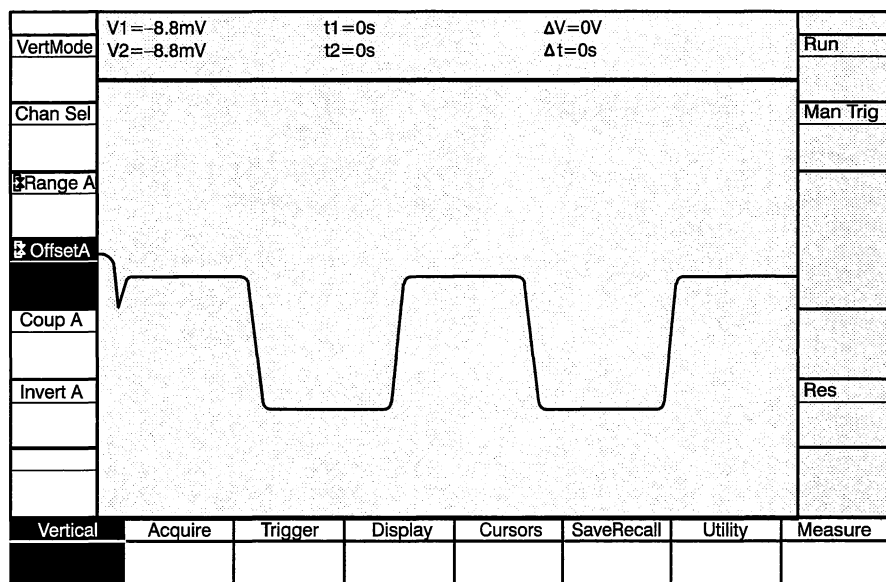

**Values:** The offset values differ between the SCD1000 and SCD5000. See Table 3-21.

**Table 3-21: Vertical Offset Ranges**

Offset Parameter	SCD1000	SCD5000
Max. Negative Offset (Volts)	$-2.5 \times \text{Range}$	$-4.5 \text{ V}$
Max. Positive Offset (Volts)	$+2.5 \times \text{Range}$	$+4.5 \text{ V}$
Resolution (Volts)	5% of Range (both Coarse and Fine)	5% of Range (both Coarse and Fine)
Max. Negative Offset (%)	$-250\% \text{ of Range}$	$-80\% \text{ of Range}$
Max. Positive Offset (%)	$+250\% \text{ of Range}$	$+80\% \text{ of Range}$

Table 3-21: Vertical Offset Ranges (Cont.)

Offset Parameter	SCD1000	SCD5000
Resolution	5% of Range (both Coarse and Fine)	5% of Range (both Coarse and Fine)
Initialized Value	0 V	0 V

**Interactions:** The Vertical Offset selection affects the following other functions:

**Trigger Level:** If the trigger source is the channel being changed and the trigger level is set in volts, the trigger level is automatically recalculated, adjusted, and the trigger level readout changed to the appropriate value.

**GPIB Command:** CH<x> OFFSET: <NRx>  
 CH<x>? OFFSET  
 CH<x> TYPEOFFSET: { VOLTS | PERCENT }  
 CH<x>? TYPEOFFSET

## Vertical Coupling (SCD1000 Only)

The Vertical Coupling function selects how the input signal is coupled to the input amplifiers. The selections are AC, DC, and OFF. DC couples all signal components within the waveform recorder's bandwidth. AC couples all components from 1 kHz to the waveform recorder's upper bandwidth limit. OFF disconnects the input from the signal, providing an effective open circuit to the input signal ( $\leq 500 \text{ k}\Omega$  input impedance) and grounding the input amplifiers.

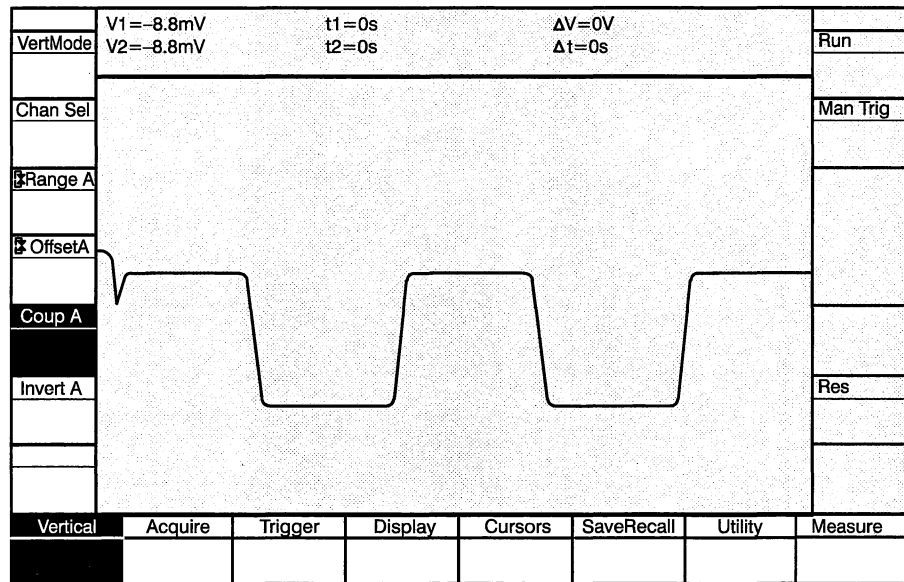

**Values:** AC, DC, OFF

**Initial Value:** DC

**Interactions:** None

**Calibration:** When an internal calibration signal is used as the channel input, the input coupling is set to OFF. If the input coupling is changed from OFF, the calibration signal is turned off.

**GPIO Command:** CH<x> COUPLING: { AC | DC | OFF }  
CH<x>? COUPLING

## Vertical Channel Invert (SCD1000 Only)

The Vertical Channel Invert function inverts the signal to the input amplifiers and trigger circuitry (if the signal is also the trigger source). If the vertical mode is set to Add and one of the channels is inverted, the resulting input signal will be the difference between the two signals.

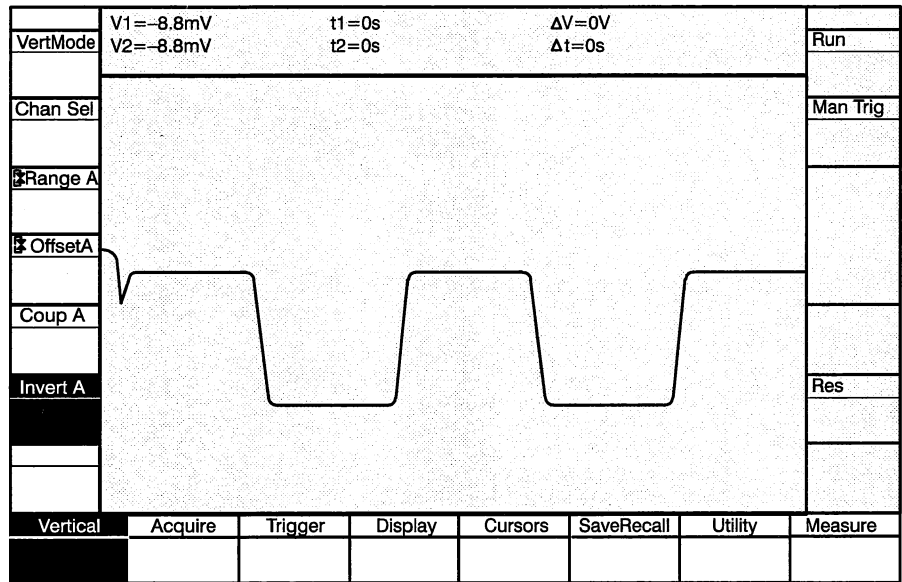

**Values:** Off, On

**Initial Value:** Off

**Interactions:** None

**GPIB Command:** CH<x> INVERT: { ON | OFF }  
 CH<x>? INVERT

# Acquisition Functions

Acquisition functions control how the input signal is acquired and stored. These functions are selected by pressing the **Acquire** mode key. The acquisition selections are (with menu abbreviations in parentheses):

**Acquisition Mode (Acq Mode)** — Selects the type of acquisition (Normal, Auto Advance, or Average). In normal mode, a single record is acquired and stored into the specified start record. In Auto Advance mode, up to 16 records can be acquired. In Average mode 1 to 1024 averages can be done as an acquire.

**Time Window (TimeWin)** — Selects the duration of the acquisition window from 5 ns to 100  $\mu$ s. This parameter controls the sweep speed of the CRT write gun.

**Acquisition Record Length (Length)** — Sets the record length of the record(s) to be filled.

**Start Record (Sta Rec)** — Selects the first record to be filled (Auto Advance acquisition mode) or selects the only record to be filled for the current acquisition(s) (Normal acquisition mode).

**Number of Acquisition Records (N Rec)** — Sets the number of records to acquire when the Acquisition Mode is set to Auto Advance. This function is only available when the acquisition mode is Auto Advance.

**Number of Averages (N Avg)** — Sets the number of averages to acquire when the acquisition mode is Average. This function is available when the acquisition mode is Average.

**Acquisition Hold Next (HoldNext)** — When On, sets the waveform recorder to stop acquiring data after filling the current record (in Normal acquisition mode) or the final record (in Auto Advance acquisition mode). When Off, the waveform recorder continuously acquires data until manually stopped, or until no trigger events are detected.

**Use Geometry Correction (Geom)** — When on, centroided waveforms will be processed to remove distortions produced by non-linearities in the scan converter CRT. When off, the distortions will remain uncorrected. See Geometry Correction on page 3-39.

**Set Geometry Correction (Set Geom)** — When run, a series of acquisitions will be done to map the distortion due to the scan converter CRT. The map is used to reduce vertical non-linearity when Geometry Correction is on. See Geometry Correction on page 3-39.

## Acquisition Mode

The Acquisition Mode function determines whether one or many records will be acquired. The selections are Normal, Auto Advance, and Average.

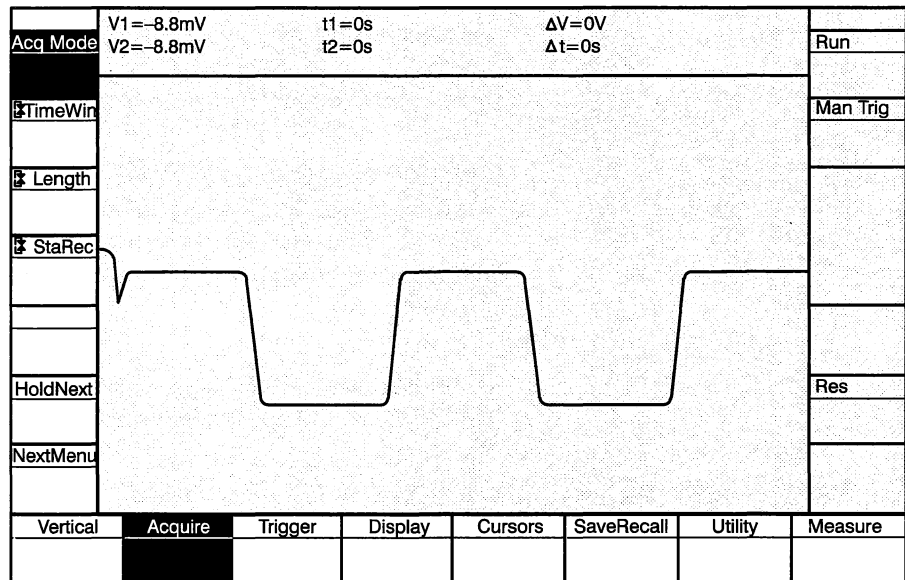

**Values:** Normal, Auto Advance, Average

In Normal mode, acquired data is stored in the specified start record. If Hold Next is off, the waveform recorder continuously acquires data and stores it into the specified start record. Any data in the record is overwritten for each acquisition. This continues until the acquisition process is manually stopped (using the Display Unit key), no more triggers occur, or stopped via a GPIB command. If Hold Next is on, the waveform recorder fills the specified start record and stops acquisition.

In Auto Advance mode, multiple acquisitions of the input signal can be done, filling up to 16 records. Records are filled starting with the specified start record through the specified number of records to be filled. If Hold Next is off, the waveform recorder continuously acquires data and stores it into the specified record(s). Any data in the record(s) is overwritten for each acquisition. This continues until the acquisition process is manually stopped, stopped via a GPIB command, or no more triggers occur. If Hold Next is on, the waveform recorder fills the specified record(s) and stops acquisition.

In Auto Advance mode, if the number of records to be filled causes the waveform recorder to advance beyond record 16, record 1 is filled next with subsequent records filled, if necessary.

In Average mode, the input signal is averaged the number of times set by N Avg. While averaging, the display is updated every five seconds. Curve queries will not be answered until the averaging is complete. Changing any setting while an averaged acquire is in progress will restart the average.

The time the waveform recorder takes to acquire data and recycle for the next acquisition depends on the record length, type of signal and intensity of the waveform on the target. This recycle time determines how many acquisitions can be accomplished per second. With the Display turned off (GPIB command: DISPLAY OFF), for 256 sample records, the recycle time is 250 ms (or 4 Hz); for 512 sample records, the recycle time is 480 ms (or 2 Hz); for 1024 sample records, the recycle time is 700 ms (or 1.1 Hz). With the fast waveform Capture Option, (Option 1P), the capture rate increases to 10 Hz for 512 point waveforms.

**Initial Value:** Normal

**Interactions:** The Acquisition Mode selection affects the following other functions:

- Number of Records to Advance (N Rec)
- Number of Records to Average (N Avg)
- The N Rec function key label appears only when Auto-Advance mode is selected.
- The N Avg function key label appears only when Average mode is selected.

**GPIB Command:** ACQUIRE MODE: { NORMAL | ADVANCE | AVERAGE }  
ACQUIRE? MODE

## Acquisition Time Window

The Time Window function sets the duration of the acquisition. The quality of the waveform written onto the CRT is affected by the time window setting and the CRT settings (intensity and focus). See Acquiring Data starting on page 3-47 and the CRT Utility Functions later in this section.

The time window value is adjusted with the knob.

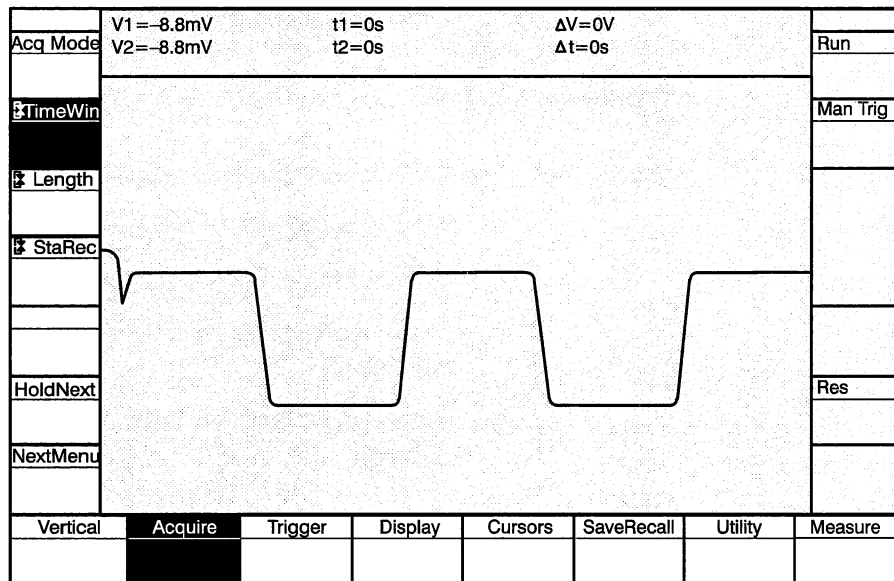

**Values:** 5 ns, 10 ns, 20 ns, 50 ns, 100 ns, 200 ns, 500 ns, 1 μs, 2 μs, 5 μs, 10 μs, 20 μs, 50 μs, 100 μs

**Initial Value:** 1 μs

**Interactions:** None

**GPIB Command:** ACQUIRE TIME: <NRx>  
ACQUIRE? TIME



## Acquisition Record Length

The Record Length function sets the record length of all records to be filled in the next acquisition. Record length can be 256, 512, or 1024 sample points. The value is adjusted with the knob.

Since the waveform zone's width is 512 pixels, 512-sample waveforms are horizontally mapped 1 display pixel to 1 waveform sample. 256-sample waveforms are mapped 1 waveform sample to every other pixel. Only one half of the display pixels along the horizontal axis are illuminated. 1024-sample waveforms are mapped 2 display pixels on the same vertical column per 2 adjacent waveform samples. The mapping uses a min-max algorithm with two pixels in one column connected by a line. Because the 1024-sample record contains twice as many samples as available pixels, only this size record can be horizontally expanded (2 times).

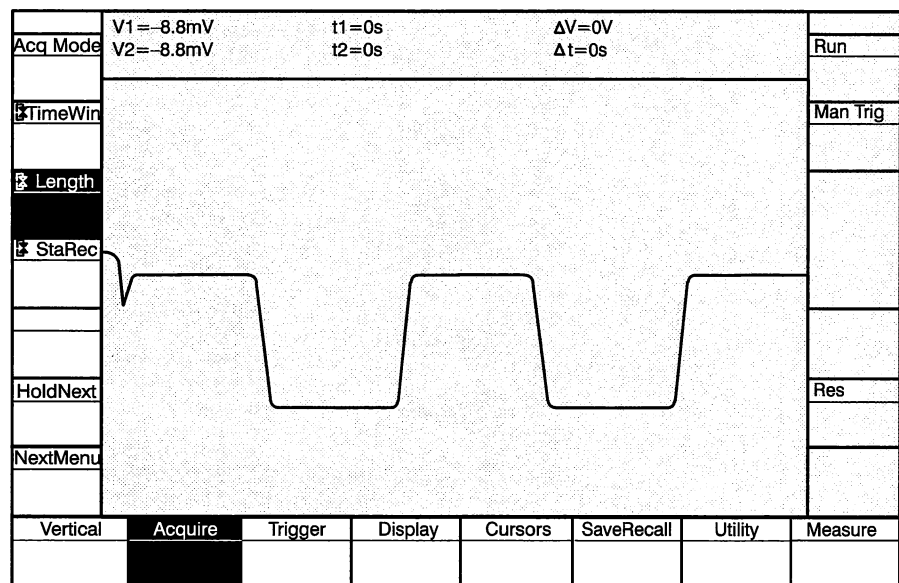

**Values:** 256, 512, 1024

**Initial Value:** 512

**Interactions:** The record length affects the following parameters:

**Cursors and Expansion Point:** The expansion point and cursor position settings are affected by the selected record length. If these settings are currently set outside the new record length, the settings will be coerced to a value within the record length for the next acquisition cycle. The following relationship is maintained for the acquisition cycle after the change in the record length:

$$1 \leq \text{parameter setting} \leq \text{record length}$$

**GPIB Command:** ACQUIRE LENGTH:<NRx>  
ACQUIRE? LENGTH

## Acquisition Start Record

The Start Record function selects the only record to be filled (for Normal acquisition mode) or the first record to be filled (for Auto Advance acquisition mode). The start record can be from record 1 to record 16. The setting is selected with the knob.

Records 1, 2, 3 and 4 are stored in non-volatile memory and will be present across power-downs.

If Auto Advance acquisition mode is used, and the start record and number of records are set such that record 16 is filled, the next record to be filled will be record 1. Further acquisitions will fill subsequent records until the specified number of records are filled.

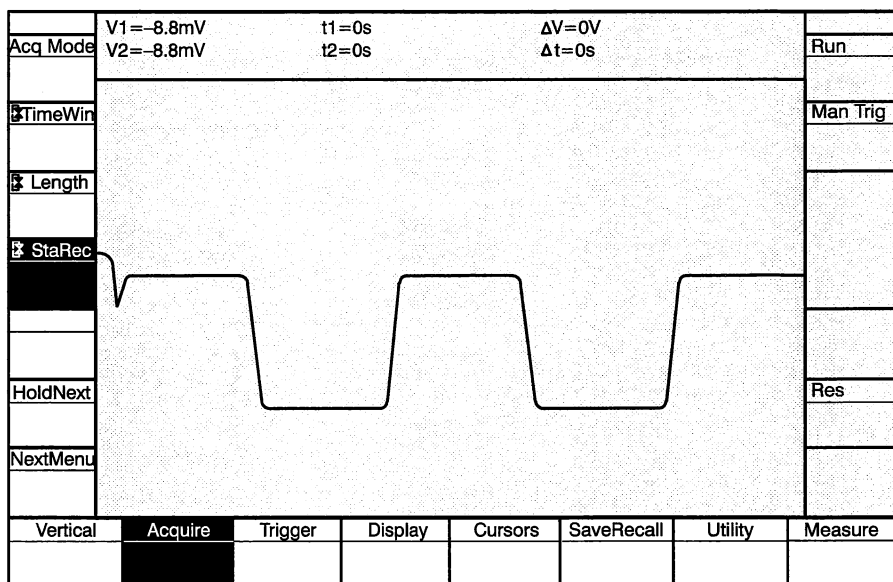

**Values:** Range is from 1 to 16

**Initial Value:** 1

**Interactions:** None

**GPIB Command:** ACQUIRE START:<NRx>  
ACQUIRE? START

## Number of Records to Average

The Number of Records to Average function sets the number of averages to be performed when Acquisition Mode is set to Average. The setting can be from 1 to 1024.

The value is adjusted with the variable knob.

The menu label is displayed only when Acquisition Mode is set to Average.

The number of averages composed is displayed below N Avg.

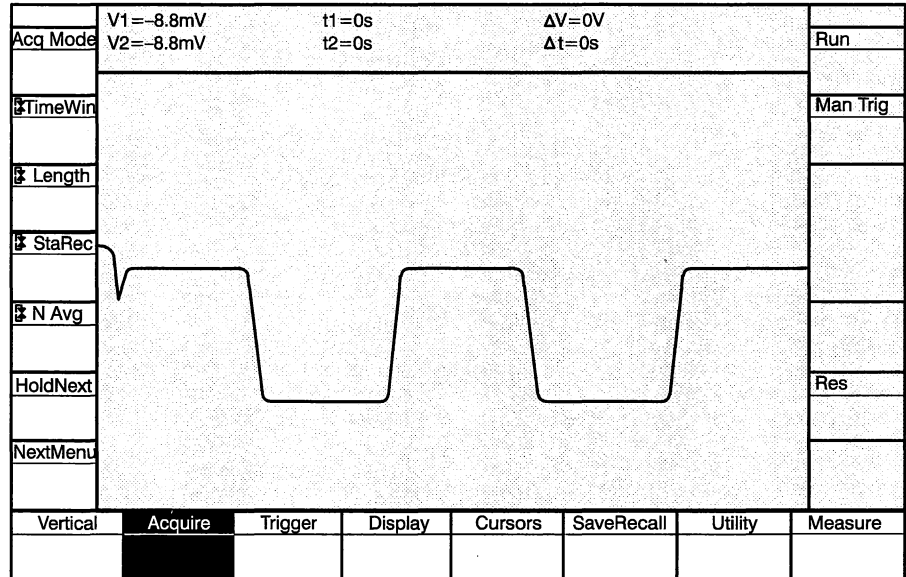

**Values:** Range is from 1 to 1024

**Initial Value:** 16

**Interactions:** None

**GPIB Command:** ACQUIRE AVERAGE: <NRx>  
ACQUIRE? AVERAGE

## Number of Records to Acquire

The Number of Records to Acquire function sets the number of records to acquire when Acquisition Mode is set to Auto Advance. The setting can be from 1 to 16.

The value is adjusted with the variable knob.

The menu label is displayed only when Acquisition Mode is set to Auto Advance. If the number of records to acquire and the start record settings are such that record 16 is filled, the next record to be filled will be record 1. Further acquisitions will fill subsequent records until the specified number of records are filled.

The number of records acquired is displayed below N Adv.

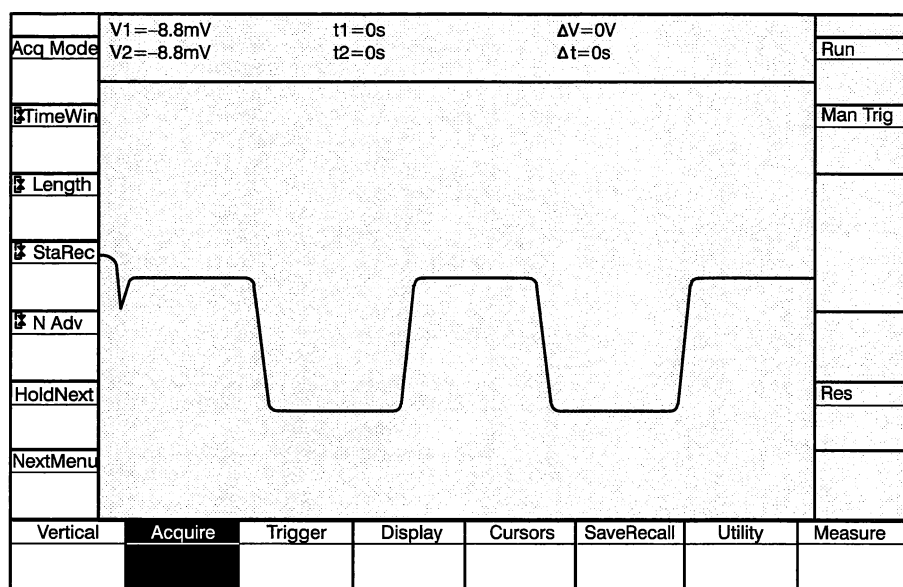

**Values:** Range is from 1 to 16

**Initial Value:** 1

**Interactions:** None

**GPIB Command:** ACQUIRE NRECORD: <NRx>  
ACQUIRE? NRECORD

## Acquisition Hold Next

The Hold Next function turns the Hold Next state off and on. When Hold Next is on, the waveform recorder stops acquiring data after the final record is filled. Triggers are accepted until the waveform recorder fills all required records (whether one record, as in Normal acquisition mode, or several records as in Auto Advance acquisition mode). Once all required records are filled, additional trigger events are ignored until the acquisition process is again initiated.

When Hold Next is off, the waveform recorder continuously acquires data until the acquisition is manually stopped, stopped by a GPIB command, or trigger events are no longer detected.

When an acquisition is running with Hold Next turned ON, the acquisition status label displays *HoldNext*, and the HoldNext function key label displays *On*. When the acquisition has finished, the acquisition status label displays *Stopped*. The HoldNext function label continues to display the Hold Next selection (*On*).

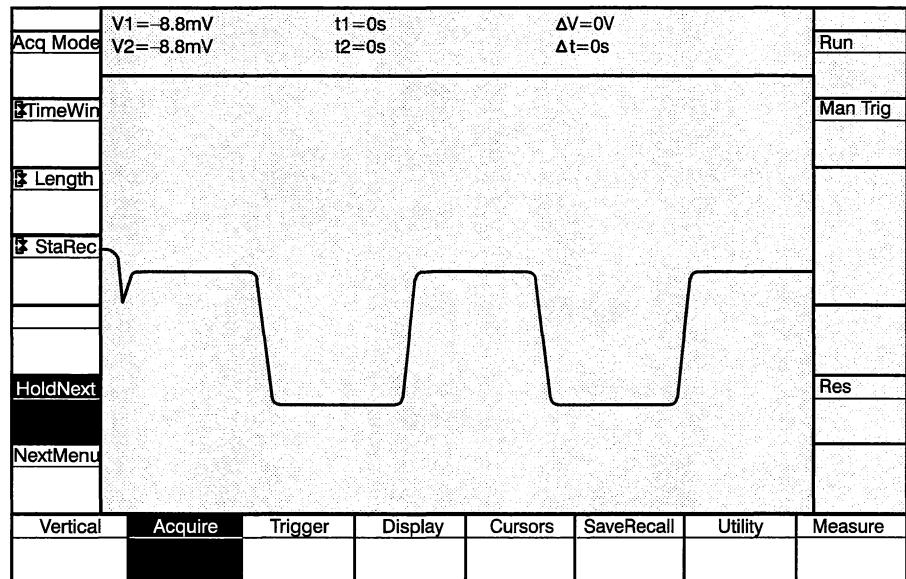

**Values:** On, Off

**Initial Value:** Off

**Interactions:** None

**GPIB Command:** ACQUIRE STATE: { STOP | RUN | HLDNXT }  
 ACQUIRE? STATE  
 HOLDNEXT: { ON | OFF }

## Geometry Correction

Geometry correction processes centroided waveforms to remove distortions produced by non-linearities in the scan converter CRT.

When off, the distortions will remain uncorrected.

See Geometry Correction on page 3-39 for more information.

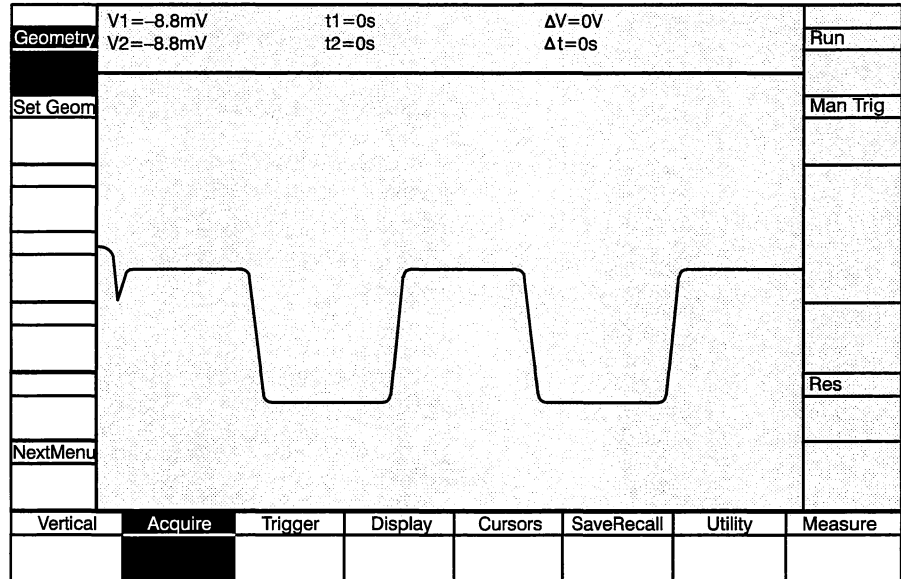

**Values:** On, Off

**Initial Value:** SCD1000: Off  
SCD5000: On

**Interactions:** None

**GPIB Command:** ACQUIRE GEOMETRY: { ON | OFF | RUN }  
ACQUIRE? GEOMETRY

## Set Geometry Correction

When run, a series of acquisitions will be done to map the distortion due to the scan converter CRT. The map is used to reduce vertical non-linearity when Geometry Correction is on.

See Geometry Correction on page 3-39 for more information.

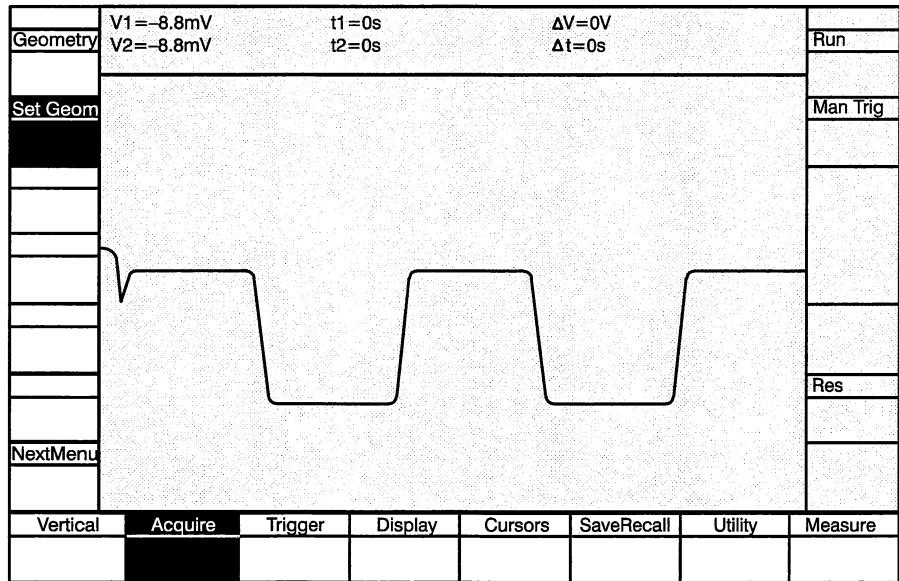

**Values:** Running, Stopped

**Initial Value:** Stopped

**Interactions:** None

**GPIB Command:** ACQUIRE GEOMETRY: { ON | OFF | RUN }  
ACQUIRE? GEOMETRY





# Trigger Functions

The Trigger Functions control when the acquisition begins. These functions are selected by pressing the **Trigger** mode key. The selections are (with menu abbreviations in parentheses):

**Trigger Mode (TrigMode)** — Selects the trigger mode as Normal or Auto. Auto trigger mode is typically used while setting up the waveform recorder. In this mode, the waveform recorder triggers either when a trigger event occurs or 360 ms after the start of an acquisition sequence. In Normal mode, the waveform recorder triggers only when a valid trigger event occurs, the Trigger button on the Display Unit is pressed, or a trigger command is sent over the GPIB.

**Trigger Source (Source)** — Selects the source of the trigger signal. The selections for this function differ between the SCD1000 and the SCD5000. The SCD1000 allows selection of Ch A, Ch B, Add, or an external signal as the trigger source. The SCD5000 allows selection of either an external signal or the Calibrator Time signal as the trigger source. If Option 01, Delay Line option, has been installed in an SCD5000, the trigger can also be internally from the delay-line. In the SCD1000, the vertical mode's Invert function inverts the signal to the trigger circuitry.

**Trigger Level (TrigLvl)** — Sets the signal amplitude at which a trigger will be recognized. Depending on the trigger source and coupling method, the level can be specified in either volts or percentage of the triggering channel's full-scale vertical range. Both positive and negative values can be specified. If the trigger source is from an inverted channel, inversion does not affect the level setting.

**Trigger Slope (Slope)** — Selects the slope of the waveform to be triggered on. The slope can be rising (plus) or falling (minus). If the trigger source is from an inverted channel, the slope is not affected by the inversion.

**Trigger Coupling (TrigCoup)** — Selects the coupling method of the trigger signal (AC or DC) if internally triggered (SCD1000 only). Only AC coupling for external triggering is allowed.

**Trigger Delay (TrigDly)** — Sets the amount of delay from the trigger event to the beginning of waveform data storage. Delay can be as late as 5 times the acquisition time window's setting. Delay can be specified in percentage of the time window or in seconds. If the time window value is changed after a delay is specified, the amount of delay remains the same (as a percentage of the time window), even if the delay is specified in seconds.

**Trigger Arming (Arm)** — Allows selection of internal or external arming. When External arm is selected, triggering of an acquisition will not occur unless the external arm input is low. The external arm input has no effect when internal arming is selected, or Auto Trigger mode is implemented.

## Trigger Mode

The Trigger Mode function determines if the waveform recorder is triggered only by a valid trigger event (Normal) or automatically triggered even if a valid trigger event does not occur (Auto). If Auto is selected, the waveform recorder waits 360 ms until after the start of the acquisition sequence and automatically produces a trigger if no valid trigger event occurs. This mode is useful for setting up the waveform recorder before acquiring input signal data for analysis. If Normal is selected, the waveform recorder triggers only if a valid trigger event occurs.

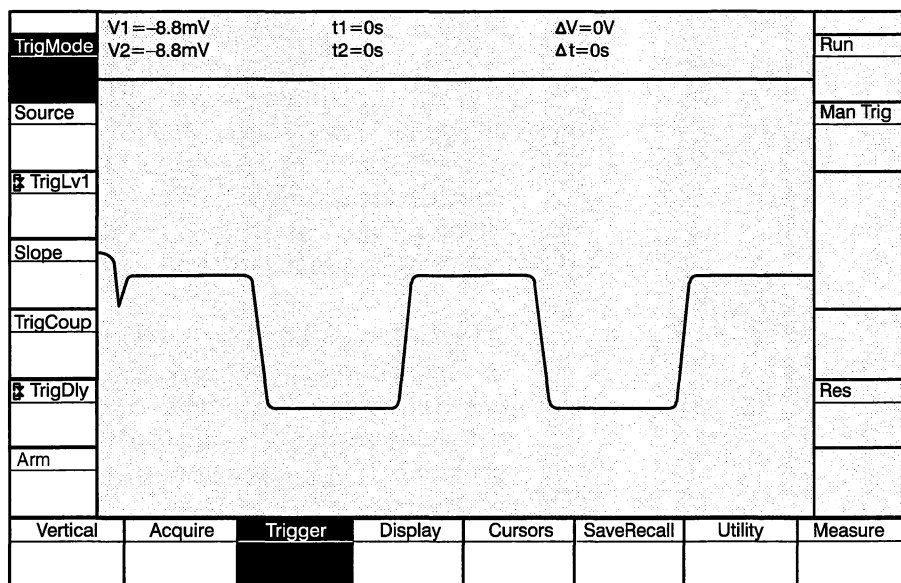

**Values:** Normal, Auto

**Initial Value:** Auto

**Interactions:** None

**GPIB Command:** TRIGGER MODE: { AUTO | NORMAL }  
TRIGGER? MODE and TRIGGER?

## Trigger Source

The Trigger Source function selects from where the trigger signal is received. For the SCD1000, this setting can be any of the vertical mode settings (Ch A, Ch B, or Add), or from the external trigger input connector. For the SCD5000 this setting can be from the external input connector or from an internal time calibrator signal.

In the SCD1000, if the source is from an internal vertical channel that has been inverted, the trigger signal is also inverted. Inversion affects the signal, but has no effect on trigger slope or level settings.

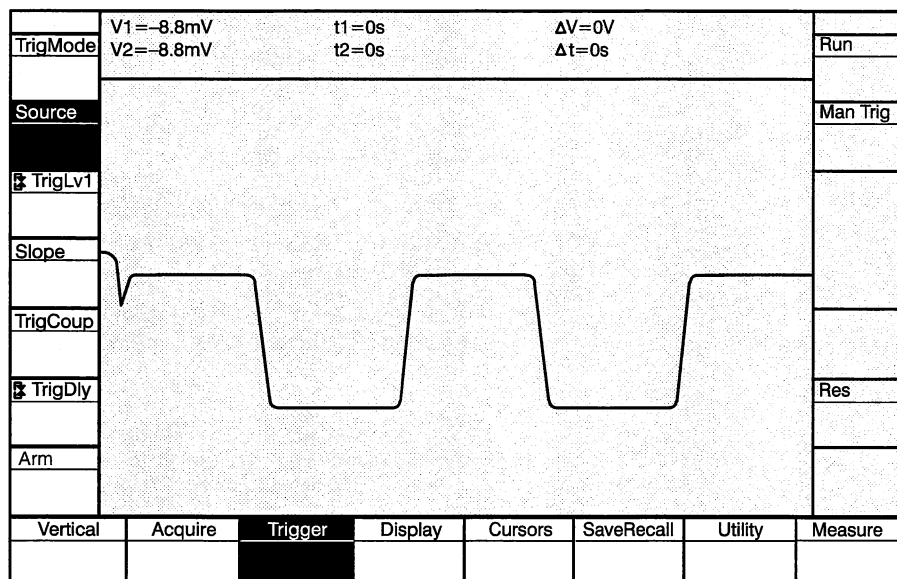

**Values:** SCD1000: Ch A, Ch B, Add, External  
 SCD5000: External, Call (Time Calibrator Signal)

**Initial Value:** SCD1000: Ch A  
 SCD5000: External

**Interactions:** The Trigger Source selection interacts with the following other functions:

- Trigger Level:** As the trigger source is changed, the trigger level readout is adjusted according to the following relationship:  

$$\text{trigger level} = \text{trig\%} * \text{vertical range} + \text{offset}$$
- Trigger Level Units:** Trigger level units are forced to volts if the source is changed to external.

**GPIB Command:** TRIGGER SOURCE: { CHA | CHB | ADD | EXTERNAL } (SCD1000)  
 TRIGGER SOURCE: { CALIBRATOR | EXTERNAL } (SCD5000)  
 TRIGGER? SOURCE

## Trigger Level

The Trigger Level function sets the trigger level in either volts or as a percentage of the selected channel's vertical full-scale range. The *Units* key allows selection of the different units. The *Units* key is active only when the source is internal. If the source is external, the trigger level can be specified only as voltage.

The trigger level is adjusted with the variable knob.

Trigger level is determined by the following relationship:

$$\text{trigger level} = \text{trig\%} * \text{vertical range} + \text{offset}$$

Once the trigger level is set, it remains constant as a percentage of the full-scale acquisition window. If the vertical range or offset (of an internal trigger source) is adjusted, the trigger level is recalculated and the level readout is updated, but the position of the trigger level within the acquisition window does not change.

For example, if trigger level is set to the center of the acquisition window (0%) and the range or offset is changed, the trigger level will remain in the center of the window. The level's position changes only when the trigger level is changed. When the coupling is AC, a "~" (tilde) character is appended to the trigger level readout.

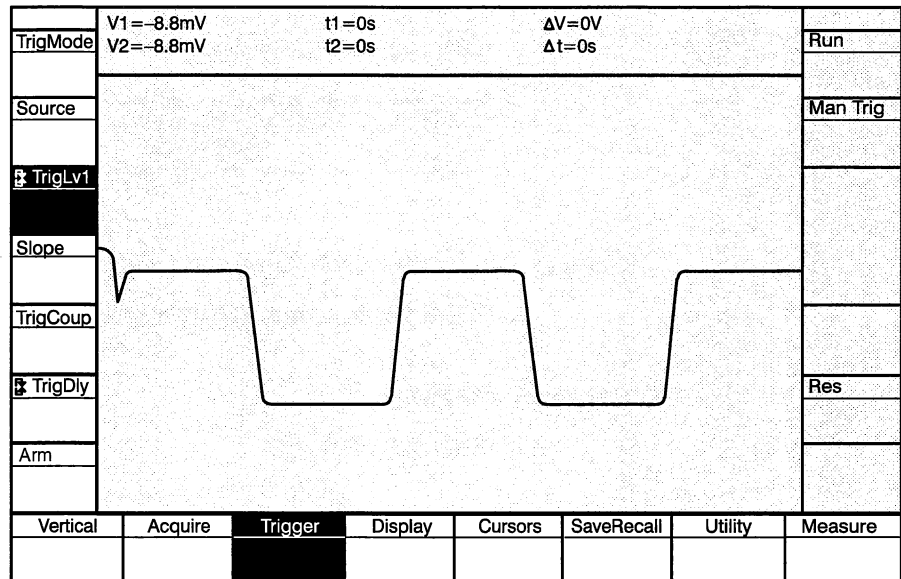

**Values:**

Source	Units*	Min	Max	Init Value
Int	Volts	–(Vertical Range/2 + Offset**)	+(Vertical Range/2 + Offset**)	0 V
Int	%	–100%	+100%	0%
Ext	Volts only	–0.5 V –1.0 V	+0.5 V (SCD5000) +1.0 V (SCD1000)	0 V

\*Units are initialized at volts.

\*\*Offset is included in the calculation only if the coupling is DC for both vertical and trigger modes. Otherwise, Offset is not included.

**Interactions:** Trigger Level is affected by adjustment of the following other functions:

**Trigger Source:** If the trigger source is changed from internal to external, the level units will automatically change to volts.

**Vertical Channel Parameters:** If the vertical range or vertical offset is changed, the trigger level voltage readout is adjusted, but the actual trigger level % of vertical range remains constant.

**GPIB Command:** TRIGGER LEVEL: <NRx>  
 TRIGGER TYPELEVEL:{ PERCENT | VOLTS }  
 TRIGGER? LEVEL  
 TRIGGER? TYPELEVEL  
 TRIGGER SLOPE

## Trigger Slope

The Trigger Slope function selects the slope of the signal that triggers an acquisition. Slope can be either a rising edge (+) or falling edge (-). If the trigger source is an inverted internal channel, the slope is not affected by the signal inversion.

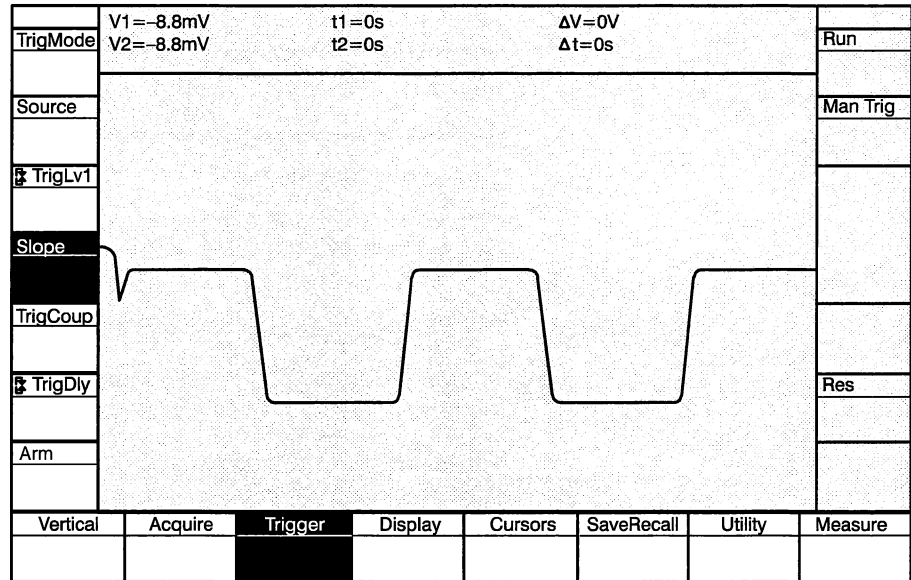

**Values:** +, -

**Initial Value:** +

**Interactions:** None

**GPIB Command:** TRIGGER SLOPE: { PLUS | MINUS }  
 TRIGGER? SLOPE and TRIGGER?

## Trigger Coupling (SCD1000 Only)

The Trigger Coupling function selects how the trigger signal is coupled to the trigger circuitry. The selections are DC and AC. (AC coupling only is allowed when the trigger source is external.) DC coupling allows all signal components within the waveform recorder's bandwidth to be coupled to the trigger circuitry. AC coupling attenuates frequencies below 1 kHz.

Only AC coupling is allowed on the SCD5000.

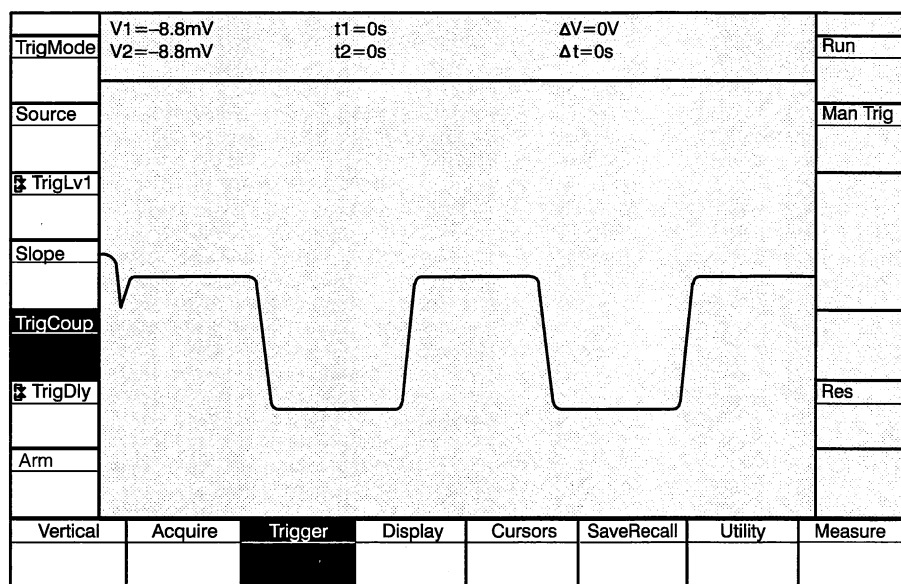

**Values:** AC, DC

**Initial Value:** DC

**Interactions:** The Trigger Coupling selection interacts with other functions as follows:

**Trigger Level:** If coupling is set to AC, the “~” (tilde) character is appended to the level value readout.

**Trigger Source:** If the trigger source is changed from internal to external, the coupling automatically changes to AC.

**GPIB Command:** TRIGGER COUPLING: { AC | DC }  
TRIGGER? COUPLING and TRIGGER?

## Trigger Delay

The Trigger Delay function sets how long to wait (up to 9 times the time window) after a valid trigger event before writing the signal onto the target. Delay can be specified in % of the time window or seconds. Knob resolution can be Coarse or Fine. Coarse resolution is 10% of the time window, Fine is 0.4%. Resolution is set with the *Resolution* key. The value is set with the knob.

If the time window value is changed after a delay is specified, the amount of delay remains the same (as a percentage of the time window), even if the delay is specified in seconds.

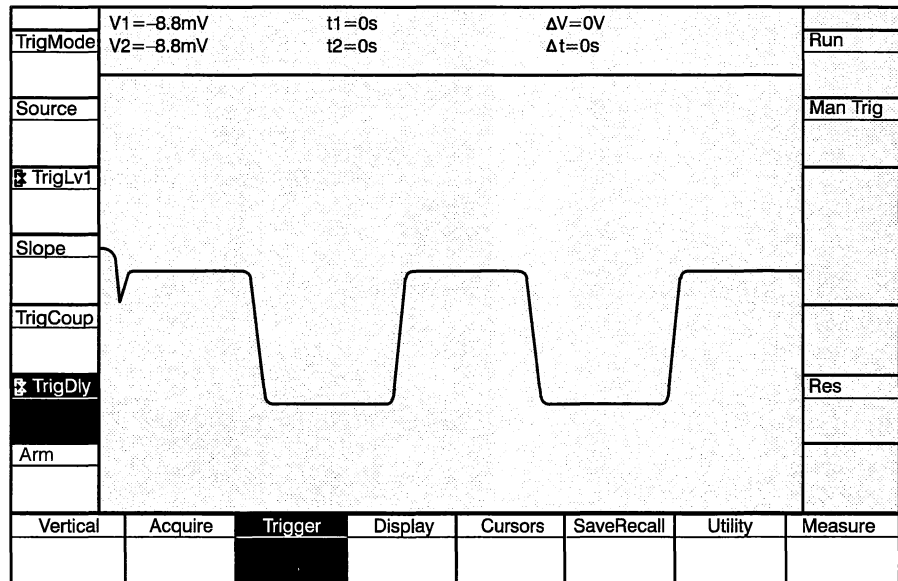

**Values:** Range is 0 to 9 times the Time Window

**Initial Value:** 0%

**Interactions:** Trigger Position is affected by the following other functions:

**Time Window:** If the time window value is changed, the delay remains constant as a percentage of the time window, even if specified in seconds.

**GPIB Command:** TRIGGER POSITION: <NRx>  
 TRIGGER TYPEPOSITION: { PERCENT | SECOND }  
 TRIGGER? POSITION  
 TRIGGER? TYPEPOSITION



## Trigger Arm

External arming allows an externally applied signal to enable trigger recognition when the acquisition state is Hold Next or Running. The arming signal is applied to the rear panel ARM IN connector. To enable, select External Arm from the Trigger menu or issue the appropriate GPIB command. A trigger will not be recognized until the arming signal (ground or TTL low) is received.

The Trigger menu provides selection of internal or external arming. When External Arm is selected, triggering of an acquisition will not occur unless the external arm input is low. Arming is level sensitive but a temporary low transition is sufficient to enable triggering. If ARM IN is held low, the trigger rearms after each acquisition, allowing continuous acquisition without transitioning the arm input high and low again.

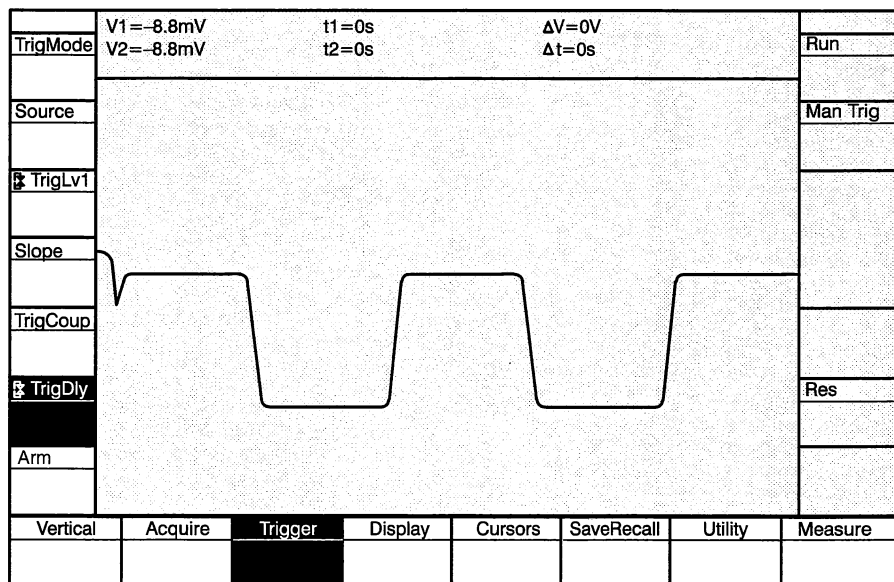

**Values:** Internal, External

**Initial Value:** Internal

**Interactions:** The external arm input has no effect when internal arming is selected, or Auto Trigger mode is implemented (internal arm is forced).

**GPIB Command:** ARM {INTERnal | EXTERNAL}  
ARM?

**Trigger Functions**

# Display Functions

Display functions control how the acquired waveform is displayed on the Display Unit. These functions are selected by pressing the **Display** mode key. The display selections are (with menu abbreviations in parentheses):

**Number of Windows Displayed (N Window)** — Selects 1, 2, or 4 windows to be displayed simultaneously in the Waveform Zone.

**Window Select (Wind Sel)** — Selects the active display window for the record select and waveform expansion functions. When a window is selected, the window number (1, 2, 3, or 4) appears in other function key labels

**Record Selection for Current Window (Wx Rec)** — Selects the record to be displayed in the currently-selected window (x indicates the window selected by the **Wind Sel** key).

**Horizontal/Vertical Expansion Point (WxExpPt)** — Sets the sample point around which horizontal and vertical expansions occur in the currently-selected window (x indicates the window selected by the **Wind Sel** key).

**Vertical Expansion Factor (Wx VExp)** — Sets the vertical expansion factor for the selected window (x indicates the window selected by the **Wind Sel** key).

**Horizontal Expansion Mode (HExpMode)** — Selects whether horizontal expansion is done for all windows at the same time (Aligned mode) or only upon the selected window (Independent mode).

**Horizontal Expansion Factor (Wx HExp)** — Sets the horizontal expansion factor for the selected window (x indicates the window selected by the **Wind Sel** key).

## Number of Windows Displayed

The Number of Windows function selects the number of windows to be displayed at one time (1, 2, or 4) in the waveform zone. Each window can display one waveform record and its related data. More than one window can display the same, or portions of the same, record. A window can display a special text window designated record number 0. See *Record Selection For Selected Window* later in this Display Function reference. If a window has been displayed and then is removed from the screen, the current parameters remain defined. If the window is again displayed, it is displayed with the same parameters.

The entire vertical display axis is 256 pixels. As the waveform zone is divided, the number of pixels per window changes. One window is 256 pixels high. Two windows are each 128 pixels high. Four windows are each 64 pixels high.

The number of windows (along with the vertical expansion factor) affects the ratio of sample points to display pixels (number of waveform sample points displayed per one display pixel). The ratios (at a vertical expansion factor of 1) are as follows: one window = 8:1; two windows = 16:1; four windows = 32:1. As vertical expansion is changed, the ratio changes as described in *Vertical Expansion Factor* later in this reference.

The horizontal display axis is 512 pixels. The number of windows does not affect waveform display on this axis. However, the record length does affect how data is displayed. See *Acquisition Record Length* earlier in this functional reference.

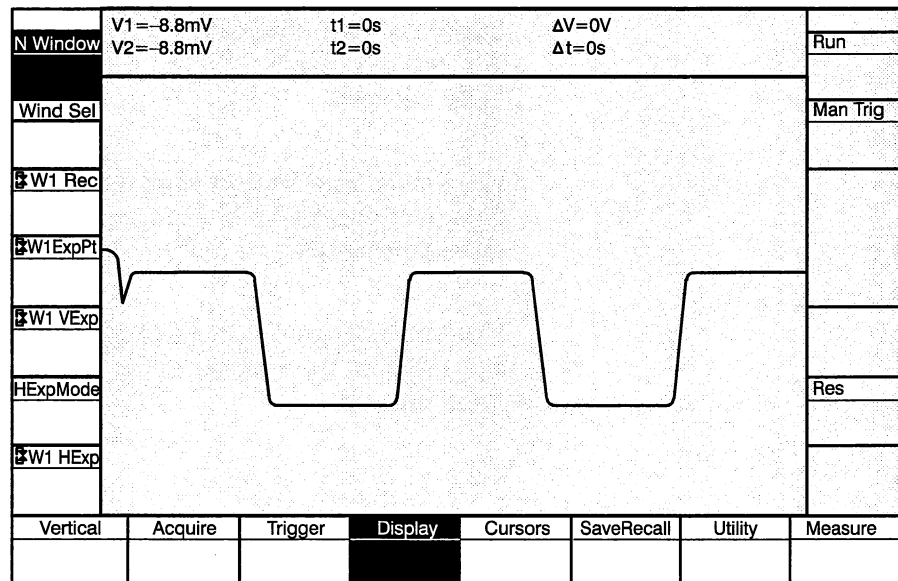

**Values:** 1, 2, or 4

**Initial Value:** 4

**Interactions:** The number of windows affects the displayed resolution of the vertical waveform data as explained above.

**GPIB Command:** NWIN { 1 | 2 | 4 }  
NWIN?

## Window Select

The Window Select function selects one of the four windows in order to change its record selection, horizontal/vertical expansion point, vertical expansion factor, and horizontal expansion factor. When a window is selected, the window number appears in other display function key labels.

Window selection is limited to the number of windows currently displayed.

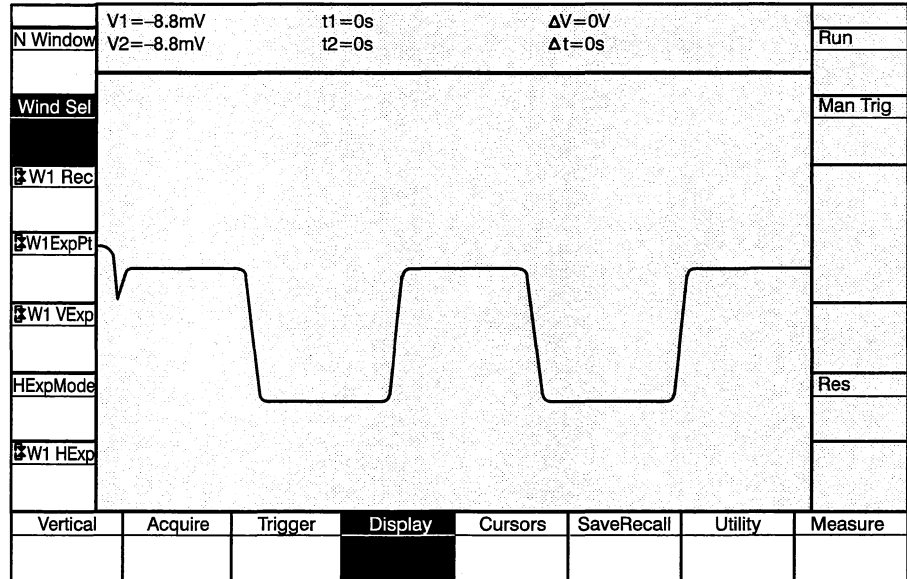

**Values:** 1, 2, 3, or 4

**Initial Value:** 1

**Interactions:** Window selection affects the following parameters:

**Display Parameters:** The selected window affects record selection, vertical/horizontal expansion point, and the vertical and horizontal expansion factors for the currently selected window. The setting displayed in the key label of each of these parameters changes to indicate the current setting for the selected window.

The selected window is affected by the following parameters:

**Number of Windows:** Window selection is limited to the number of windows currently displayed. If one window is displayed, the only window selection is 1. If two windows are displayed, window selection can be 1 or 2. If four windows are displayed, window selection can be 1, 2, 3, or 4.

**GPIB Command:** No direct equivalent. The active window selection is part of other display function GPIB commands.

See WIN<ui> CHANNEL: { RECORD: | EXPNT: | VEXPND: | HEXPND: }

WIN<ui> RECORD: <NRx>

WIN<ui> EXPNT: <NRx>

WIN<ui> VEXPND: <NRx>

WIN<ui> HEXPND: <NRx>

WIN<ui>?

WIN?

## Record Selection for Selected Window

The Record Selection function displays a record in the currently selected window. Records 0 to 16 can be selected. Records 1 to 16 are the waveform records; record 0 is a special empty record in which waveform data cannot be stored. (Record 0 is not selectable from the Acquire function menu.)

Text only can be written anywhere on the Display Unit using the GPIB TEXT command. The text appears over any waveform data currently displayed. By selecting record 0, text can be displayed without waveform data.

The function is adjusted with the variable knob.

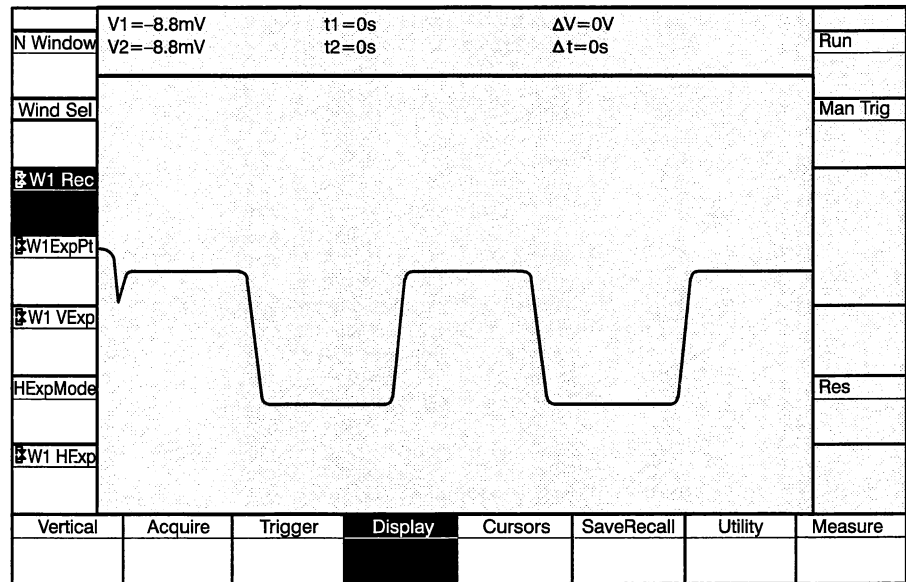

**Values:** Range is 0 to 16

**Initial Value:** 1

**Interactions:** Record selection is affected by the following parameters:

**Window Select:** As the currently selected window is changed, the record selection readout is automatically updated to indicate the record assigned to the window.

**GPIB Command:** WIN<ui> RECORD:<NRx>  
WIN<ui>? RECORD



## Horizontal/Vertical Expansion Point

The Expansion Point function selects the sample point in the record of the currently selected window around which vertical and horizontal expansions occur. An expansion point cursor (“x” surrounded by a box) indicates the current expansion point. As the waveform is expanded, the cursor remains in the same position on the display.

When the Display mode is activated or when an expansion function is activated, the message/measurements zone displays the time from the trigger point to the current expansion point and the voltage from the ground reference to the current expansion point. The measurements remain until another message/measurements indicator is selected (such as cursors or status messages).

Positioning the expansion point beyond the left, right, top, or bottom display boundary results in the waveform being scrolled in the appropriate direction by 75% of the screen’s height or width (if possible).

The setting is adjusted with the variable knob. The *Resolution* key selects the number of sample points the knob moves the expansion point cursor.

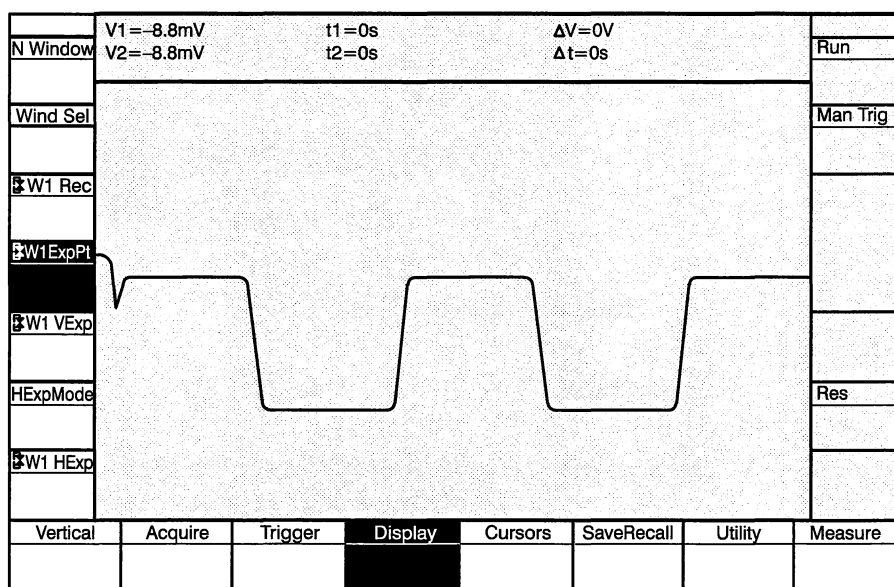

**Values:** Range is 0 to Record Length – 1

**Initial Value:** Point 0

**Interactions:** The expansion point setting is affected by the following parameters:

**Record Length:** The maximum expansion point setting is limited to the record length.

**GPIB Command:** WIN<ui> EXPNT: <NRx>  
WIN<ui>? EXPNT

## Vertical Expansion Factor

The Vertical Expansion factor sets the expansion factor along the vertical axis. Vertical expansion factors are 1, 2, 4, 8, and 16. An expansion factor of 1 displays the entire waveform. Vertical expansion is allowed on all record lengths.

The expansion factor is adjusted with the variable knob. Expansion is around the expansion point.

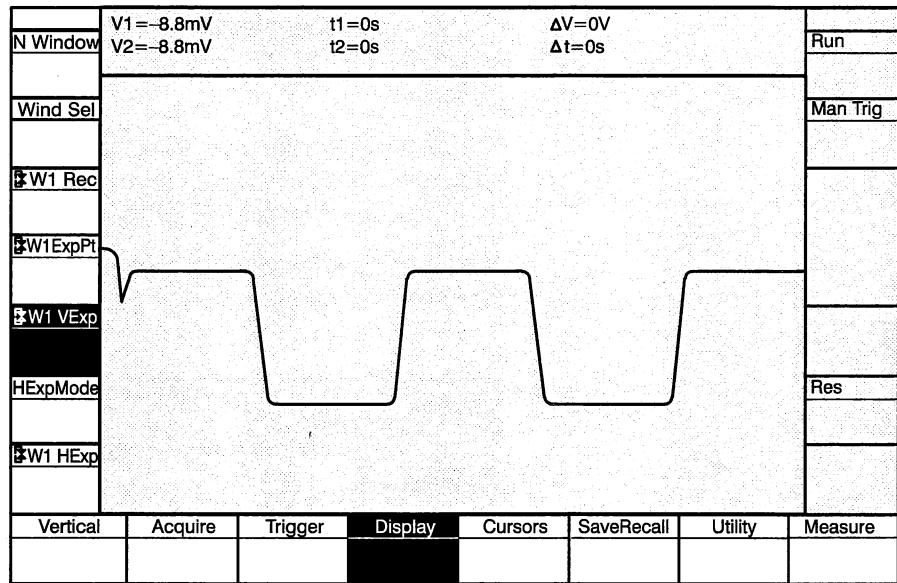

**Values:** Range is 1 to 16

**Initial Value:** 1

**Interactions:** **Number of Windows:** The apparent vertical expansion is affected by the number of windows displayed as listed in the table above.

**GPIB Command:** WIN<ui> VEXPND: <NRx>  
WIN<ui>? VEXPND

## Horizontal Expansion Mode

The Horizontal Expansion Mode function controls how expansion is accomplished when more than one window is displayed. Independent mode expands each window independently of the others. In Aligned mode, all windows are expanded according to the expansion point and horizontal expansion factor of the currently selected window. If Aligned is selected and the selected window is changed, the expansion factors of the newly selected window are used, and expansion is re-executed.

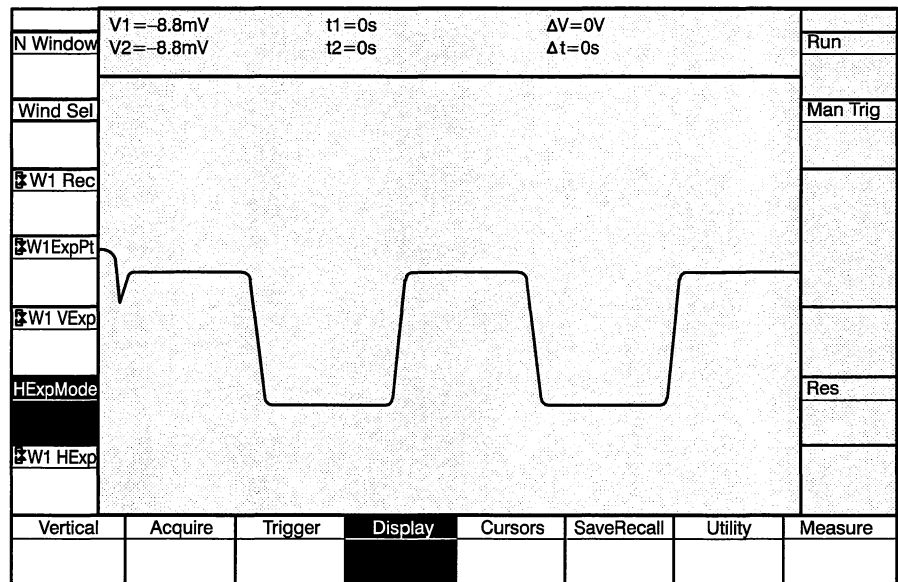

**Values:** Independent, Aligned

**Initial Value:** Independent

**Interactions:** None

**GPIB Command:** HEXPMD{ ALIGNED | INDEP }  
HEXPMD?

## Horizontal Expansion Factor

The Horizontal Expansion Factor sets the expansion along the horizontal axis of the selected window. Expansion factors are 1, 2, 4 and 8. A factor of 1 displays the entire waveform length in the window.

The horizontal expansion factor is adjusted with the variable knob. Expansion is around the expansion point.

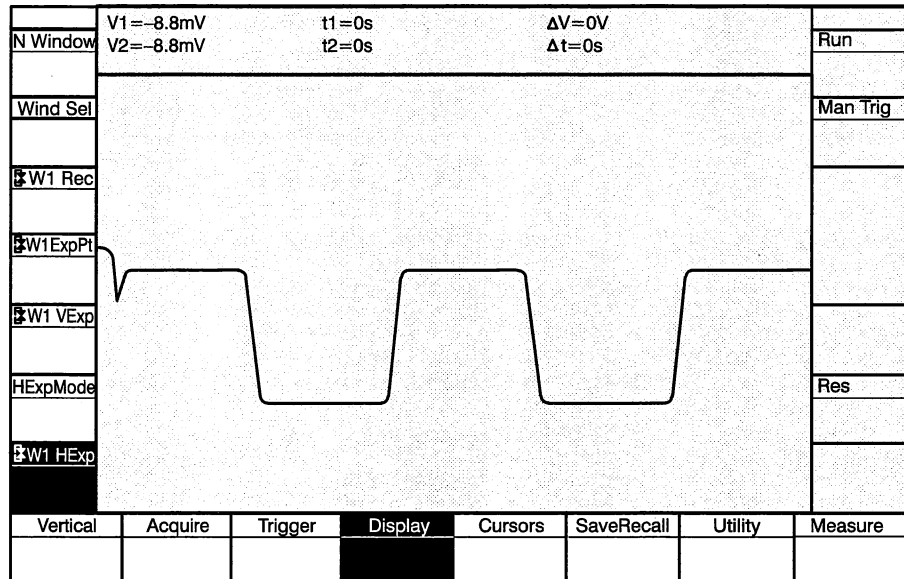

**Values:** 1, 2, 4, or 8

**Initial Value:** 1

**Interactions:** The horizontal expansion factor is affected by the following parameters:

**Record Length:** Expanded waveform display is being enhanced to support greater horizontal expansion of displayed waveforms.

1024 and 512 point waveforms may be expanded by 1X, 2X, 4X, 8X.

256 point waveforms may be expanded 1X, 2X, 4X.

When fewer waveform points are displayed than the display has resolution for the display is filled by linearly interpolating between the actual waveform points. Cursors will only move to waveform data points not the interpolated display points.

**Expansion Mode:** If the expansion mode is Aligned, the currently selected window determines the expansion factor for all other windows. If the expansion factor is 8, any windows with record lengths of 256 are only expanded 4. If the currently selected window's record length is 256, the expansion factor is forced to 4 (even if other window record lengths are 512 or 1024).

**GPIB Command:** WIN<ui> HEXPND: <NRx>  
WIN<ui>? HEXPND

# Cursor Functions

Cursor functions control the placement of Cursor 1 and Cursor 2. These functions are selected using the **Cursor** mode key. The cursor selections are (with menu abbreviations in parentheses):

**Cursors ON/OFF (Cursors)** — Turns the cursors ON and OFF. The cursors must be on to move them and to take measurements.

**Cursor 1 Window Location (Curs1Loc)** — Selects the window in which Cursor 1 will appear.

**Cursor 2 Window Location (Curs2Loc)** — Selects the window in which Cursor 2 will appear.

**Cursor 1 Position (Cursor 1)** — Positions Cursor 1 on a sample point in the selected window.

**Cursor 2 Position (Cursor 2)** — Positions Cursor 2 on a sample point in the selected window.

**Unit (Units Key)** — Selects units of  $\Delta$ time measurements as Hertz or seconds.

**Graticule ON/OFF (Grat)** — Turns the graticule ON and OFF.

## Cursors On/Off

The Cursors function turns the cursors ON or OFF. Cursors are indicated on the waveform and in the record bar as the symbols “v” (Cursor 1) and “^” (Cursor 2). The cursors allow time,  $\Delta$ time, voltage, and  $\Delta$ voltage measurements.

Delta measurements are made by measuring from the beginning of the record to each cursor and calculating the difference between the values: (Curs 1 Location – record start) – (Curs 2 Location – record start). To obtain meaningful measurement data cursors should be placed in records with similar acquisition settings.

Measurement information is displayed in the message/measurements zone above the waveform zone.

Measurement information is first displayed when the Cursors mode key is activated and the cursors are turned on. (The cursors must be turned on to display cursor positions in the menu labels and measurement information in the message/measurements zone.) The cursor measurement information is removed from the message/measurements zone if another function that uses this zone, such as expansion point, is activated. The cursor information returns when a cursor function (including rotating the knob to move a cursor) is used (if the cursors are on).

Turning the cursors off removes the measurements from the message/measurement zone and removes the cursor symbols from the waveform display and the record bar indicator. Cursor position and window location are still displayed in the key labels. These parameters can be changed, but measurement information and the cursor symbols are not displayed.

If a waveform on which cursors are placed is expanded and the cursors are no longer visible, the cursor position readout in the menu label and the cursor measurement information is still displayed.

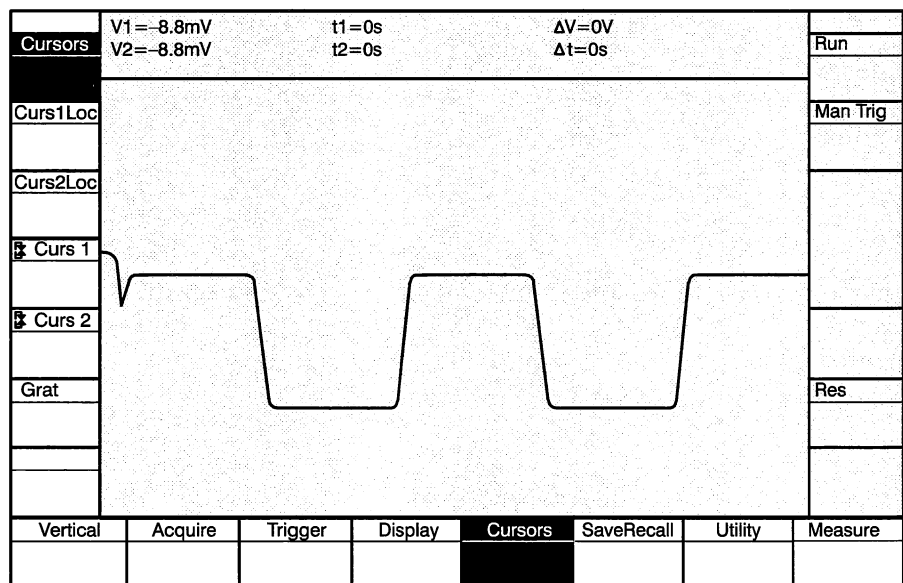

**Values:**

Function	Choices	Init Value
Cursors	On	On
	Off	
Units	Second	Seconds
	Hertz	

**Interactions:** The Cursors On/Off function affects the following parameters:

**Measurement Information:** Turning cursors on or off add or remove the measurement information in the message/measurements zone and the cursor symbols in the waveform zone. Cursors can still be manipulated, but measurement information is not displayed when cursors are off.

**Debug Mode:** The cursor measurements take precedence over debug information, therefore cursors must be off when the GPIB Debug function (of the Utility mode) is turned on.

**GPIB Command:** CURSORS { ON | OFF }  
CURSORS?

## Cursor 1 Window Location

The Cursor 1 Window Location selects the window in which Cursor 1 will appear. Only one of the windows currently displayed can be selected.

Both Cursors can be placed in the same window.

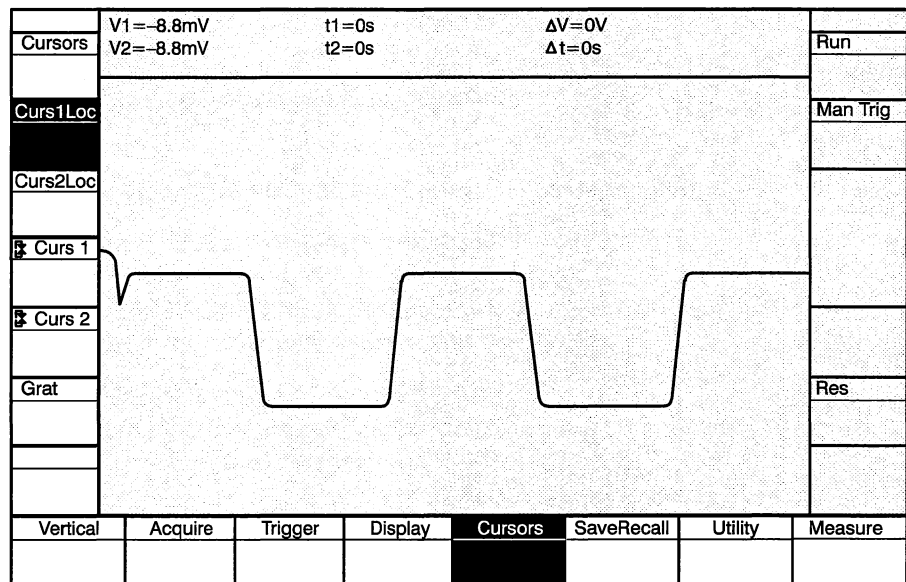

**Values:** Win1, Win2, Win3, Win4

**Initial Value:** Win1

**Interactions:** Cursor 1 Location is affected by the following parameters:

**Number of Windows:** If a window in which a cursor is located is removed, the cursor readout becomes undefined.

**GPIB Command:** CRS1 LOCTN: WIN<ui>  
CRS1? LOCN



## Cursor 2 Window Location

The Cursor 2 Window Location selects the window in which Cursor 2 will appear. Only one of the windows currently displayed can be selected.

Both Cursors can be placed in the same window.

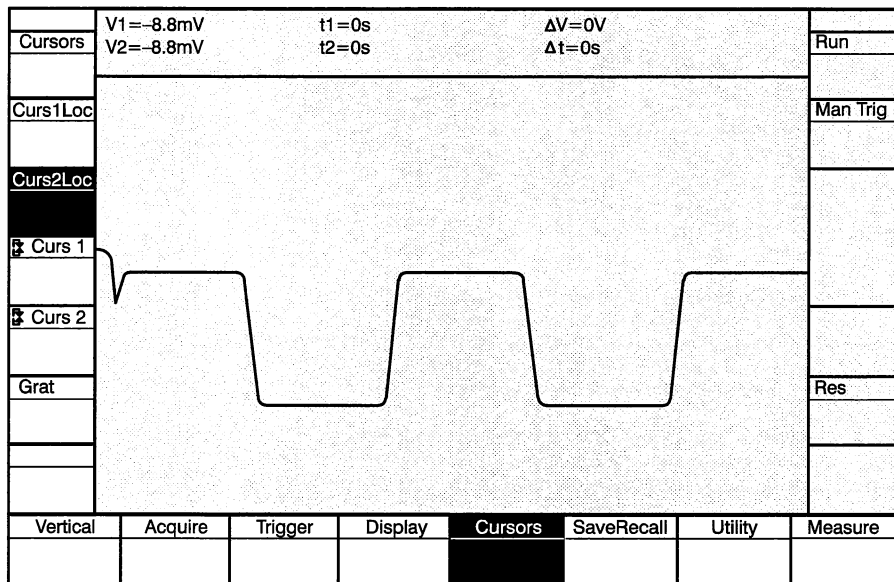

**Values:** Win1, Win2, Win3, Win4

**Initial Value:** Win1

**Interactions:** Cursor 2 Location is affected by the following parameters:

**Number of Windows:** If a window in which a cursor is located is removed, the cursor readout becomes undefined.

**GPIB Command:** CRS2 LOCTN: WIN<ui>  
CRS2? LOCN

## Cursor 1 Position

The Cursor 1 Location function positions Cursor 1 on a sample point of the record in the selected window. The cursor position value is adjusted with the variable knob.

The *Units* and *Resolution* keys can be used to select the  $\Delta$ time units and the step size of cursor movement.

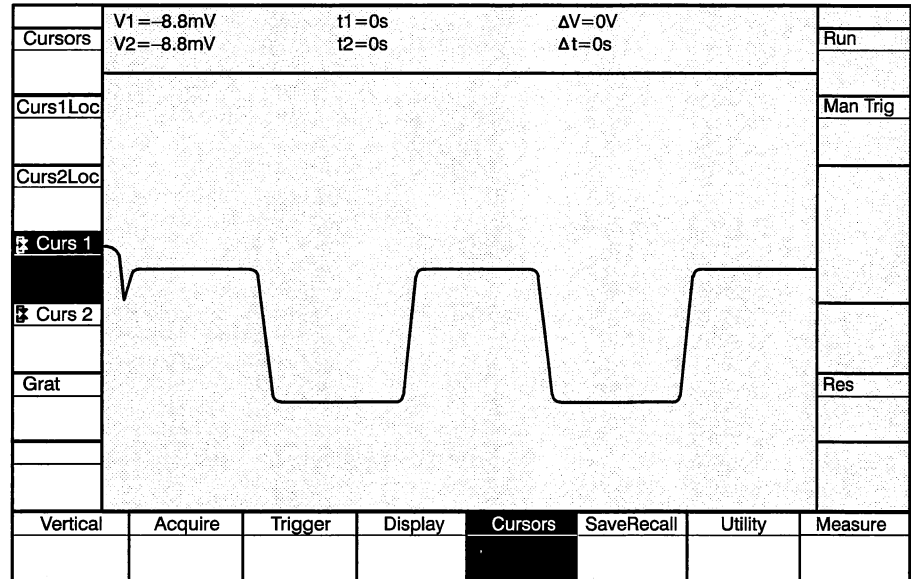

**Values:** Range is 0 to Record Length – 1

**Initial Value:** 0

**Interactions:** Cursor 1 Position is affected by the following parameters:

**Record Length:** The cursor position is limited to the number of points in the record.

**Number of Windows:** If a window in which a cursor is located is removed, the cursor readout becomes undefined.

**GPIB Command:**

```

CRS1 XPOINT: <NRx>
CRSD TYPETIME: { HZ | SECOND }
CRS1? XPOINT
CRSD? TYPETIME
CRS1? XTIME
CRS1? YCOORD
CRS1?
CRS?
CRSD? T
CRSD? V
CRSD?
    
```

## Cursor 2 Position

The Cursor 2 Location function positions Cursor 2 on a sample point of the record in the selected window. The cursor position value is adjusted with the variable knob.

The *Units* and *Resolution* keys can be used to select the  $\Delta$ time units and the step size of cursor movement.

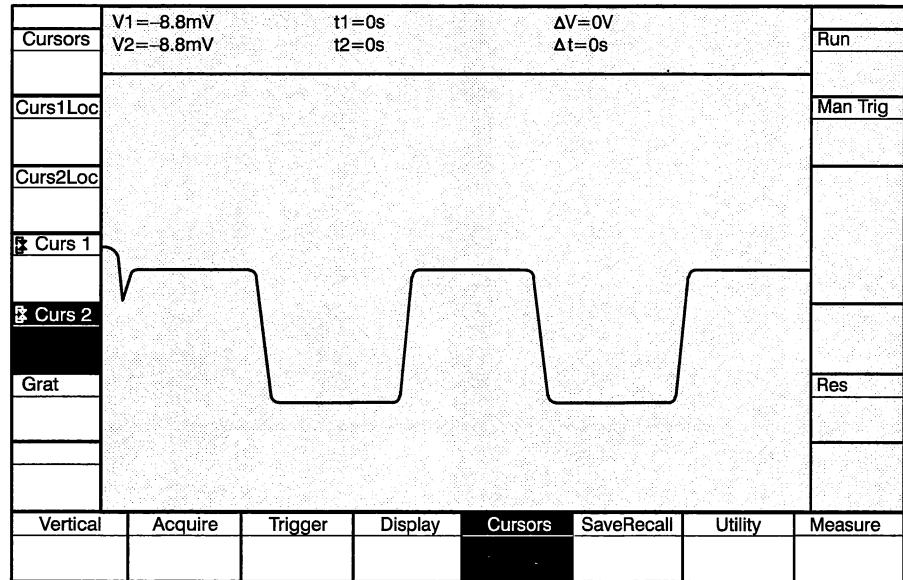

**Values:** Range is 0 to Record Length – 1

**Initial Value:** 0

**Interactions:** Cursor 2 Position is affected by the following parameters:

**Record Length:** The cursor position is limited to the number of points in the record.

**Number of Windows:** If a window in which a cursor is located is removed, the cursor readout becomes undefined.

**GPIB Command:** CRS2 XPOINT: <NRx>  
 CRSD TYPETIME: { HZ | SECOND }  
 CRS2? XPOINT  
 CRSD? TYPETIME  
 CRS2? XTIME  
 CRS2? YCOORD  
 CRS1?  
 CRS?  
 CRSD? T  
 CRSD? V  
 CRSD?

## Graticule On/Off

The Graticule function turns the graticule ON or OFF.

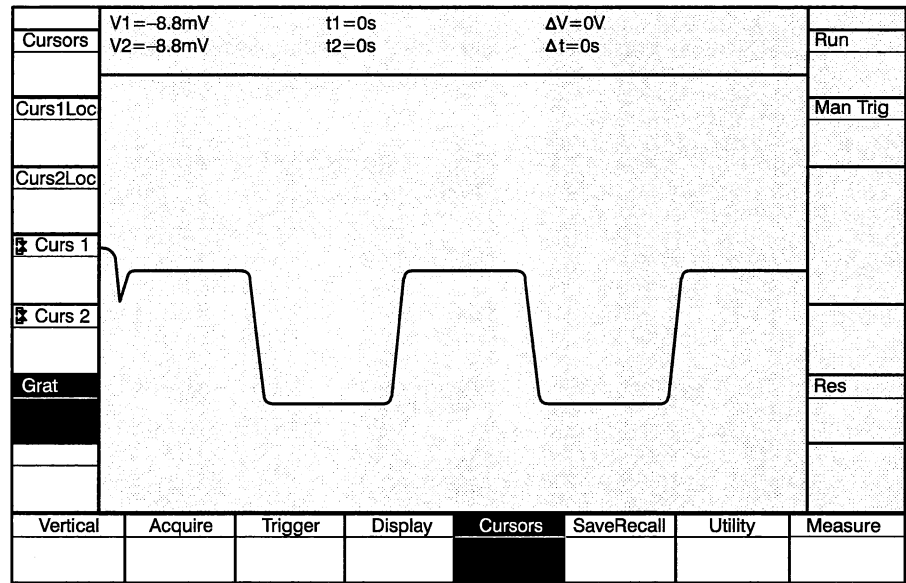

**Values:** On or Off

**Initial Value:** Off

**GPIB Command:** GRATICULE { ON | OFF }  
GRATICULE?

# Save/Recall Functions

Save/Recall functions control nonvolatile storage and retrieval of instrument settings and display of status messages. The waveform recorder can also be “secured” from the Save/Recall function menu. These functions are selected by pressing the **Save/Recall** mode key. The selections are (with menu abbreviations in parentheses):

**Save Settings Selection (Save Sel)** — Selects a storage location (1 to 10) where the current settings will be saved.

**Save Current Settings (Save Set)** — Saves all current settable parameters in the location specified by the Save Settings Selection function.

**Recall Settings Selection (Rcl Sel)** — Selects a storage location (1 to 10) from which to recall saved settings.

**Recall Settings (Rcl Set)** — Recalls settable parameters from the location specified with the Recall Settings Selection function.

**Recall Status Messages (Rcl Stat)** — Recalls any one of the last ten status messages for display in the message/measurements zone.

**Secure Instrument (Secure)** — Initializes all instrument settings and clears all waveform, settings, and status memory. To prevent unwanted erasure of memory, this function requires a double key press, allowing function cancellation before the second press.

## Save Settings Selection

The Save Settings function selects one of the ten memory locations for saving current front panel settings. The location value is selected with the variable knob.

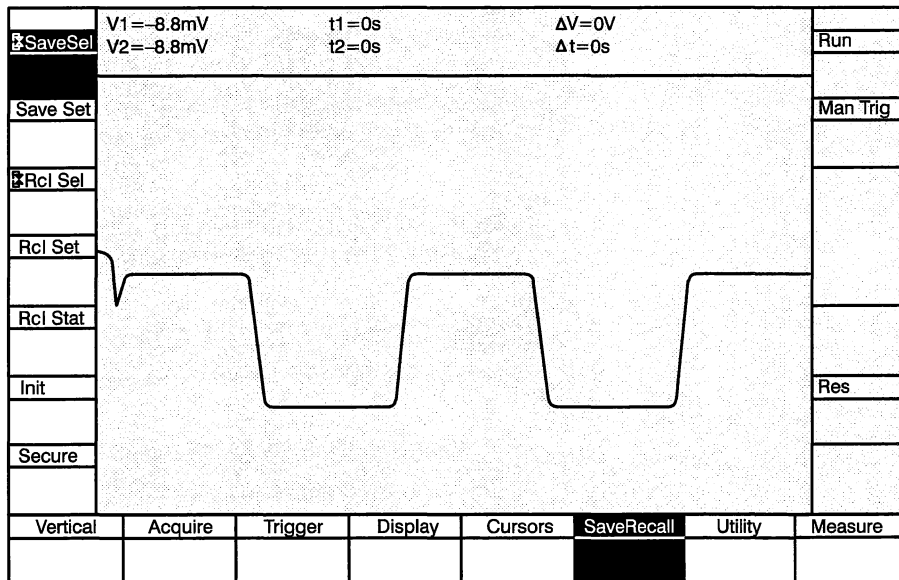

**Values:** Range is 1 to 10

**Initial Value:** 1

**Interactions:** None

**GPIB Command:** SAVE <NRx> (see also the LLSET <bblock> and ERASE <NRx> commands)

SET? (see also the LLSET? command)

The SAVE <NRx> command also executes the equivalent of the Save Current Settings function. The SET? and LLSET? command queries for all current instrument settings. The GPIB controller can then read them for use at a later time.

## Save Current Settings

The Save Settings function saves all current settable parameters in the location selected by the Save Settings Selection. The function is executed when selected, and presents no options.

Waveform data is not part of the front panel settings; it is not saved using the SaveRecall functions.

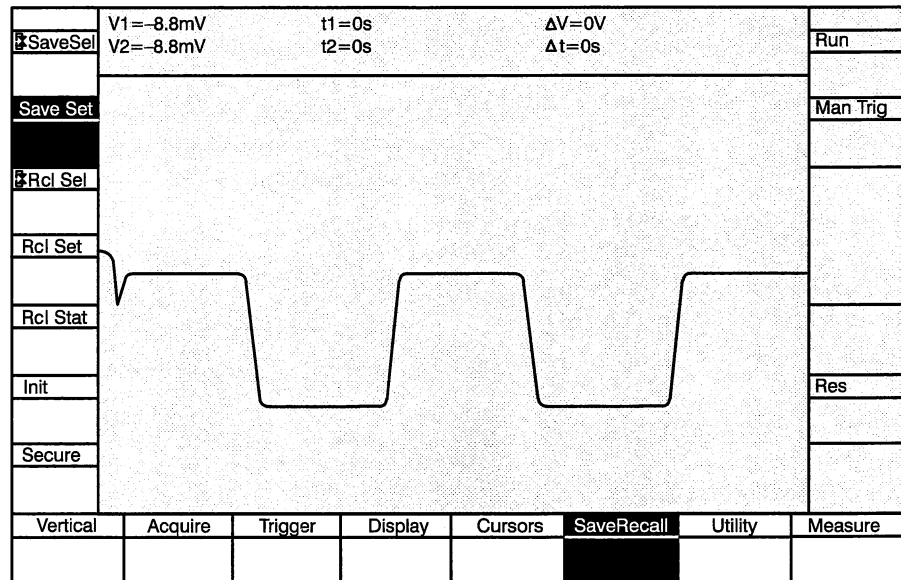

**Values:** None

**Interactions:** None

**GPIB Command:** SAVE <NRx> (see also the LLSET <bblock> and ERASE <NRx> commands)

SET? (see also the LLSET? command)

The SAVE <NRx> command also executes the equivalent of the Save Current Settings function. The SET? command queries for all current instrument settings.

## Recall Settings Selection

The Recall Settings function selects one of the ten memory locations from which to recall current front panel settings. The location value is selected with the variable knob.

### NOTE

*Certain waveform recorder functions, such as cursor positions, expansion point, etc., rely on the current contents of acquisition memory for legal boundaries. Under some circumstances, the contents of acquisition memory at the time of recall can force settings to legal boundaries that differ from the saved value. To avoid this, recall the settings, perform the acquisition, then recall the settings again.*

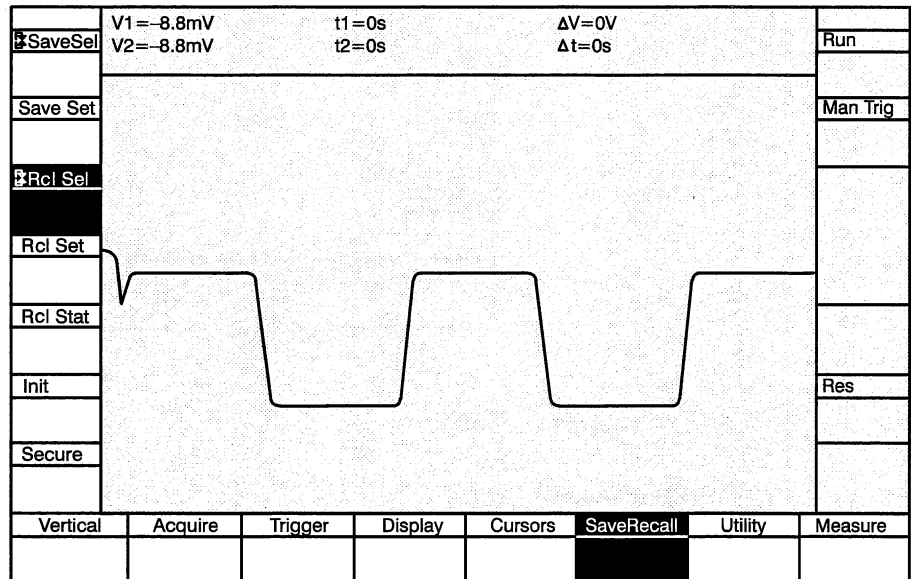

**Values:** Range is 1 to 10

**Initial Value:** 1

**Interactions:** None

**GPIB Command:** RECALL SAVE <NRx> (see also the LLSET <bblock> and ERASE <NRx> commands)

SET? (see also the LLSET? command)

The RECALL <NRx> command also executes the equivalent of the Recall Current Settings function. The SET? command queries for all current instrument settings.



## Recall Settings

The Recall Settings function recalls all current settable parameters in the location selected by the Recall Settings Selection. The function is executed when selected, and presents no options.

### NOTE

*Certain waveform recorder functions, such as cursor positions, expansion point, etc., rely on the current contents of acquisition memory for legal boundaries. Under some circumstances, the contents of acquisition memory at the time of recall can force settings to legal boundaries that differ from the saved value. To avoid this, recall the settings, perform the acquisition, then recall the settings again.*

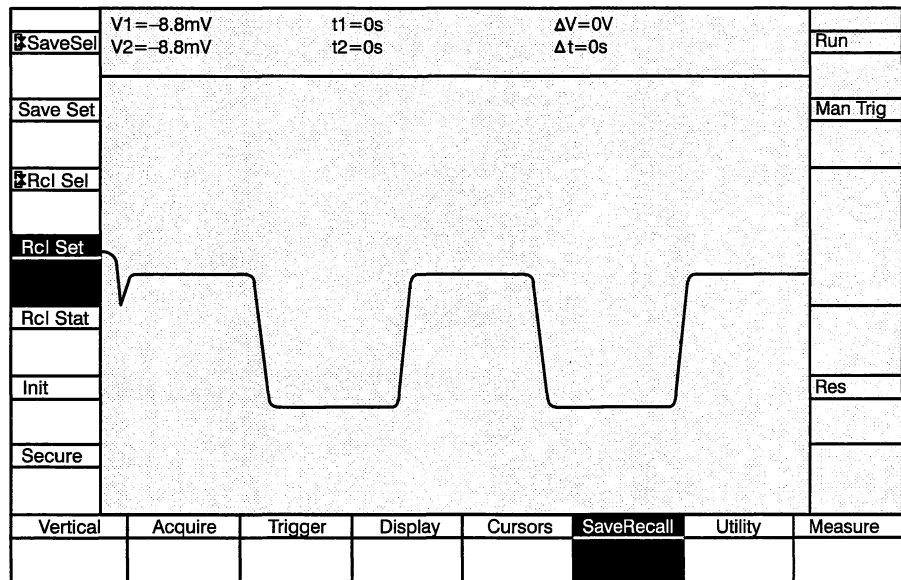

**Values:** None

**Interactions:** None

**GPIB Command:** RECALL <NRx> (see also the LLSET <bblock> and ERASE <NRx> commands)

SET? (see also the LLSET? command)

The RECALL <NRx> command also executes the equivalent of the Recall Current Settings function. The SET? command queries for all current instrument settings.

## Recall Status Messages

The Recall Status Messages function recalls any of the last ten status messages for display in the message/measurements zone. Only one message can be displayed at a time.

The status messages are part of the waveform recorder firmware. The messages are the same messages reported over the GPIB when an event is reported to the GPIB controller. See Section 6 in the *SCD1000 & SCD5000 Programmer Manual* for a list of event codes.

If Debug mode is turned on, the last 10 status messages saved include any GPIB traffic information to this instrument.

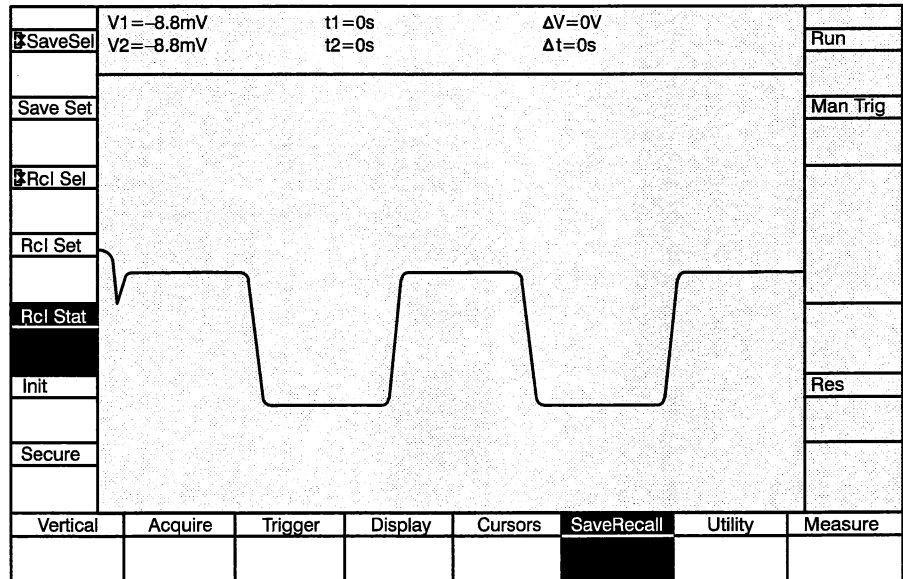

**Values:** Stat 1 (Current), Stat 2, Stat 3, Stat 4, Stat 5, Stat 6, Stat 7, Stat 8, Stat 9, Stat 10

**Initial Value:** Stat 1 (Current)

**Interactions:** None

**GPIB Command:** None

## Initialize

The Initialize function initializes any mode or the entire instrument to the factory settings stored in ROM. Pressing a mode key after pressing **Init** initializes the selected mode. Pressing the **Init** key twice initializes all waveform recorder parameters, including GPIB parameters. To prevent unwanted initialization of the entire instrument, the **Init** key must be pressed twice to execute complete waveform recorder initialization. Pressing the **Cancel** key before pressing **Init** a second time cancels the operation.

Tables 3-20 and 3-21 in the *SCD1000 & SCD5000 Programmer Manual* lists the factory default settings assumed upon initialization.

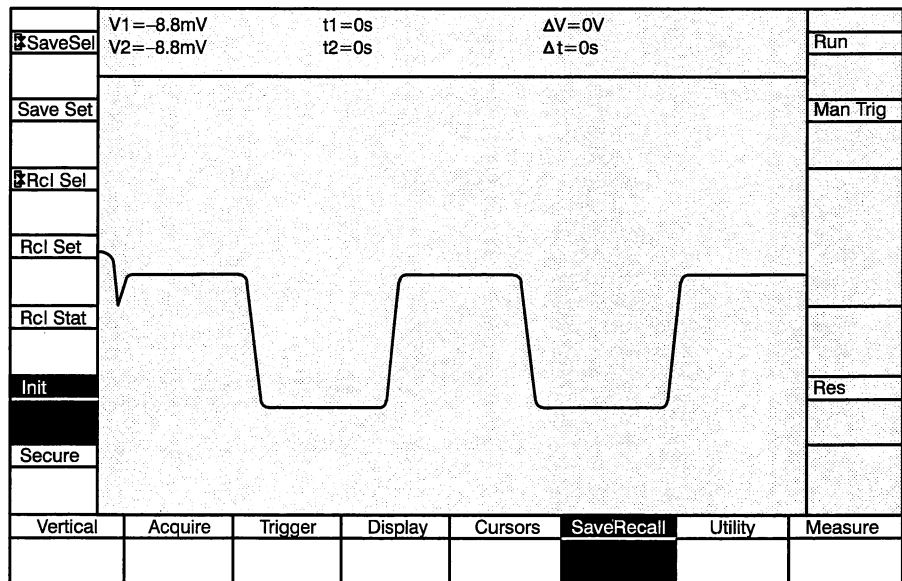

**Values:** None

**Interactions:** If a mode key is pressed after **Init** is pressed, **Init** affects all mode parameters. If **Init** is pressed twice, **Init** affects all waveform recorder parameters.

**GPIB Command:** INIT PANEL  
INIT GPIB  
INIT

## Secure

The Secure function sets all instrument parameters to their factory settings and erases all stored settings, waveforms, and status memory.

To prevent unwanted erasure of data and settings, the **Secure** function must be pressed a second time before this function is executed. The **Cancel** function key is pressed to cancel the operation.

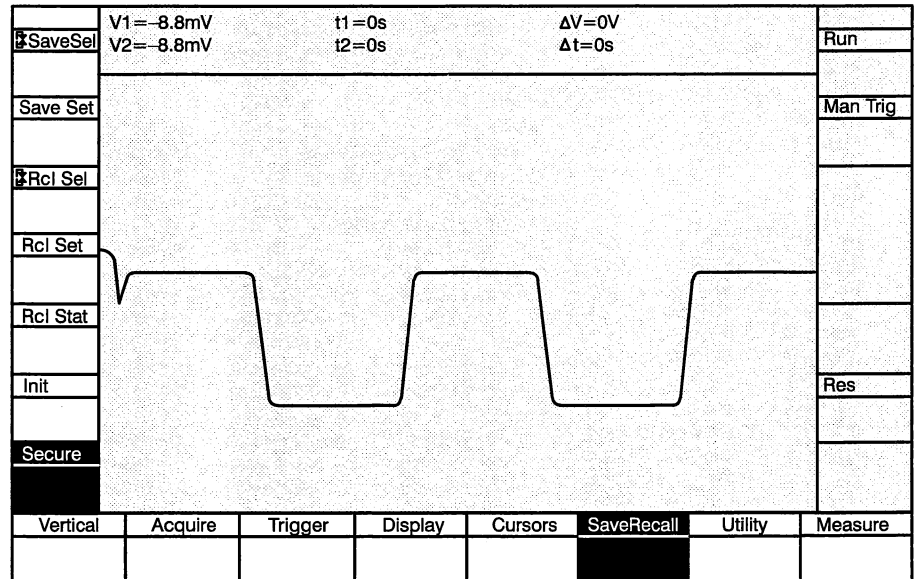

**Values:** Secure, Cancel

**Initial Value:** N/A

**Interactions:** This function affects all settable parameters and waveform memory in the waveform recorder.

**GPIB Command:** SAFEGUARD SECURE

# Utility Functions

Utility functions control beam-writing parameters, test functions, date/time clock setting functions, and SCD calibrator functions. These functions are selected by pressing the **Utility** mode key. Because of the numerous selections, the functions are divided into four menus. A **NextMenu** key selects the next menu in the sequence. When the last menu in the sequence is displayed, pressing **NextMenu** selects the first menu in the sequence. The following list describes the menus in the order they appear after initializing the Utility mode or the entire instrument, or after the instrument has been secured (using the **Secure** key in the SaveRecall mode). The selections are (with menu abbreviations in parentheses).

## Utility Menu 1

This menu allows setting up the CRT for signal capture. When Utility Menu 1 is selected, the Display Unit displays the target image (linear array) for the last acquired waveform. Centroiding is not done. If Gpib Setref Off has been sent to the SCD, the reference array data is not subtracted from the raw target data; any target aberrations will be seen.

Using a signal identical to or similar to the one to be captured, the write gun's beam intensity can be properly set for recording. If the SCD is not properly set up, "linear array overflow" can occur. This condition results in a "checkerboard" pattern being displayed as the waveform is written on the display. See SCD Scanning Setup and Acquiring Data earlier in this section for more information on how to properly set up the SCD Waveform Recorders.

**Display Threshold (Thresh)** — Sets the threshold above which any object written on the target is displayed as the target image. The Display Threshold setting is only valid when this Utility function menu is displayed. See Acquiring Data earlier in this section.

**CRT Intensity (Intens)** — Sets the intensity for the write gun. This setting is similar to an oscilloscope's CRT intensity setting. This value should be set prior to capturing a signal. CRT Intensity settings are individually maintained for each window size.

### NOTE

*For an accurate waveform capture, it is important to adjust the intensity setting prior to capturing the final waveform. Adjustment should be done at the time window and delay settings used for final capture and with an identical or similar waveform that will be the final captured waveform. See Acquiring Data earlier in this section for instructions on how to set up this parameter.*

**CRT Focus (Focus)** — Sets the focus for the write gun. Focus normally does not need adjustment. This setting is similar to an oscilloscope's CRT focus setting. CRT focus settings are individually maintained for each window size.

**Acquisition Time Window (TimeWin)** — Same as acquisition time window setting. This function is provided in this menu to select the time window to be used for final waveform capture. See Acquisition Functions in this reference section.

**Trigger Delay (TrigDly)** — Same as trigger delay setting. This function is provided in this menu to select the trigger delay to be used for final waveform capture. See Trigger Functions in this reference section.

**Set Target Reference Data (Set Ref)** — Analyzes the target for aberrations. This data is used as a target reference when digitizing waveforms. The aberrations are subtracted from waveform data before the data is stored in the Linear Array. See SCD Acquisition Concepts earlier in this section.

**CRT Background** — CRT Background allows adjustment of target sensitivity. Under most conditions increased sensitivity is not necessary; a setting of 0% is appropriate. Signals with extremely fast transitions (for the SCD5000 amplitudes greater than 25% of the Input Range), or instrument operation near the lower temperature limit, setting CRT background to greater than 0% is not beneficial. In general, it is not necessary to increase CRT Bkg until the adjustment of Display Intensity exceeds 100%.

## Utility Menu 2

**Calibration Mode Selection (Cal Mode)** — Selects one or all of the SCD subsystems to automatically calibrate. The subsystems are: System, Horizontal, Vertical, CRT, Trigger, and Geometry. The CRT calibration process requires an input signal and provides on-display instructions in the message/measurements zone. System calibration does not include CRT calibration.

**Initiate Calibration (Cal)** — Starts automatic calibration of the system or selected subsystem. The state of the calibration operation is displayed in the menu label.

**View Settings of All or Selected Areas (View)** — Displays various system and mode information. There are three view displays: ID, Acquire, and Display.

**Beeper ON/OFF (Beeper)** — Turns ON and OFF the audio feedback for button presses.

**Knob Beeper ON/OFF (KnobBeep)** — Turns ON and OFF audio feedback for knob clicks.

**Debug Mode (Debug)** — Turns ON and OFF the Debug mode. When Debug is ON, all commands received at the GPIB port for this waveform recorder are displayed in the screen. Cursors must be turned off to use the Debug mode.

**Select Next Menu (Next Menu)** — Advances to the next menu in the sequence. This function appears in all utility menus.

### Utility Menu 3

**Instrument Tests (Inst Test, MPU Test, FP Test, Acq Test)** — Executes self tests of the entire waveform recorder, the processor subsystem, the Display Unit, and the acquisition subsystem.

### Utility Menu 4

**Date/Time Functions (Year, Month, Day, Hour, Minute)** — Set the waveform recorder's date/time clock. After each parameter is set, pressing **Enter** sets the date/time clock. The date/time clock is used to determine waveform acquisition time, which is stored with the waveform data (timestamp).

**Enter Date/Time Values (Enter)** — Enters the currently selected date/time values into the waveform recorder's date/time clock.

### Utility Menu 5 (SCD1000 Only)

**Channel A Calibrator Signal (Ch A Cal)** — Connects the internal calibrator signal to Channel A and selects the signal type (time, amplitude into 0  $\Omega$ , amplitude into 450  $\Omega$ , or off).

**Channel B Calibrator Signal (Ch B Cal)** — Connects the internal calibrator signal to Channel B and selects the signal type (time, amplitude into 0  $\Omega$ , amplitude into 450  $\Omega$ , or off).

**External Calibrator (Ext Cal)** — Connects the calibrator signal to the CAL OUT connector on the SCD1000 rear panel.

**Calibrator Signal Amplitude (CalAmpl)** — Sets the calibrator signal's amplitude.

**Calibrator Signal Period (CalTime)** — Sets the calibrator signal's period.

### Utility Menu 5 (SCD5000 Only)

**Calibrator Signal (Cal Out)** — Selects the type of signal connected to the CAL OUT connector on the front panel: time, amplitude into 0  $\Omega$ , or amplitude into 450  $\Omega$ .

**Calibrator Signal Amplitude (CalAmp)** — Sets the calibrator signal's amplitude.

**Calibrator Signal Period (CalTime)** — Sets the calibrator signal's period.



## Display Threshold

The Threshold function sets the display threshold value, above which data from the CRT will be visible on the Display Unit. The value is adjusted with the knob. This setting is usually set to 0 during normal operation.

A setting of 63 is used for critical adjustment of intensity. See *Acquiring Data* earlier in this section.

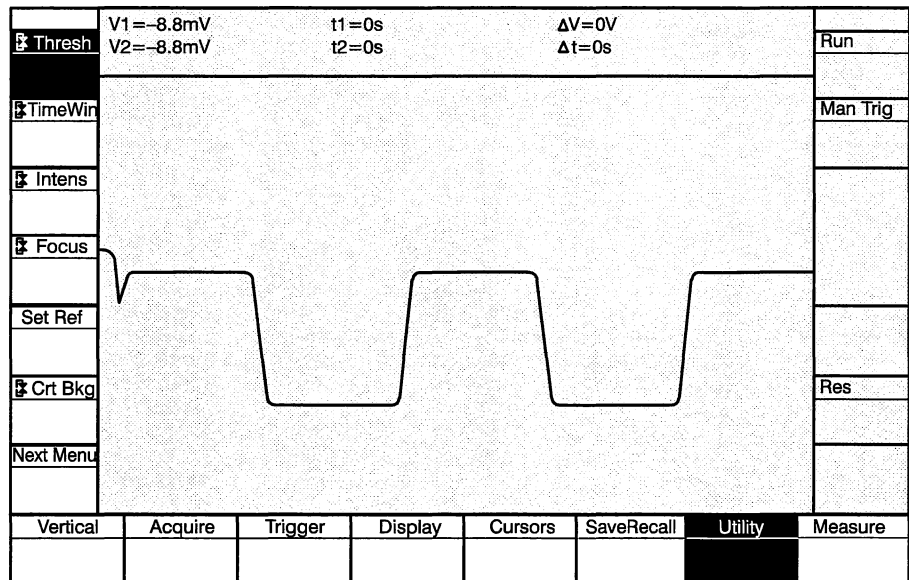

**Values:** Range is 0 to 63

**Initial Value:** 0

**Interactions:** None

**GPIB Command:** None

## CRT Beam Intensity

The Intensity function sets the CRT's write gun intensity (like an oscilloscope's intensity) for the current time window setting. The intensity affects the quality of the waveform written onto the target and thus the digitized waveform. Beam intensity varies over the beam's sweep rates. Therefore, intensity should be set for a specific time window and checked (and changed if necessary) for other time window settings.

The value is set with the knob.

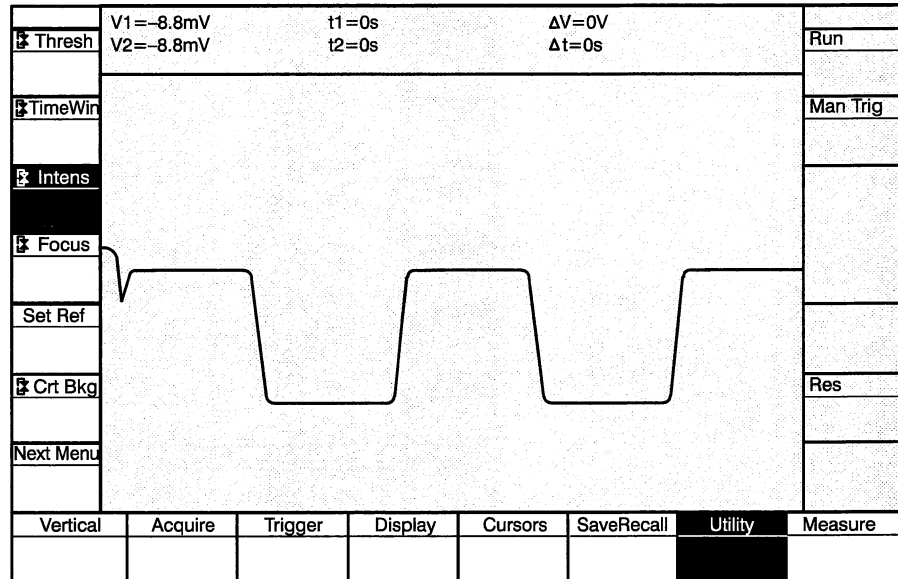

**Values:** Range is 0 to 100%

**Interactions:** The setting of Intensity affects the quality of the waveform to be digitized.

**GPIB Command:** INTENSITY <NRx>  
INTENSITY?

## CRT Beam Focus

The Focus function sets the CRT's write gun focus on the target (like an oscilloscope's focus adjustment) for the current time window setting. Focus is set at the factory and should not need to be changed. See *Acquiring Data* earlier in this section.

The focus affects the quality of the waveform written onto the target and thus the digitized waveform.

The value is set with the knob.

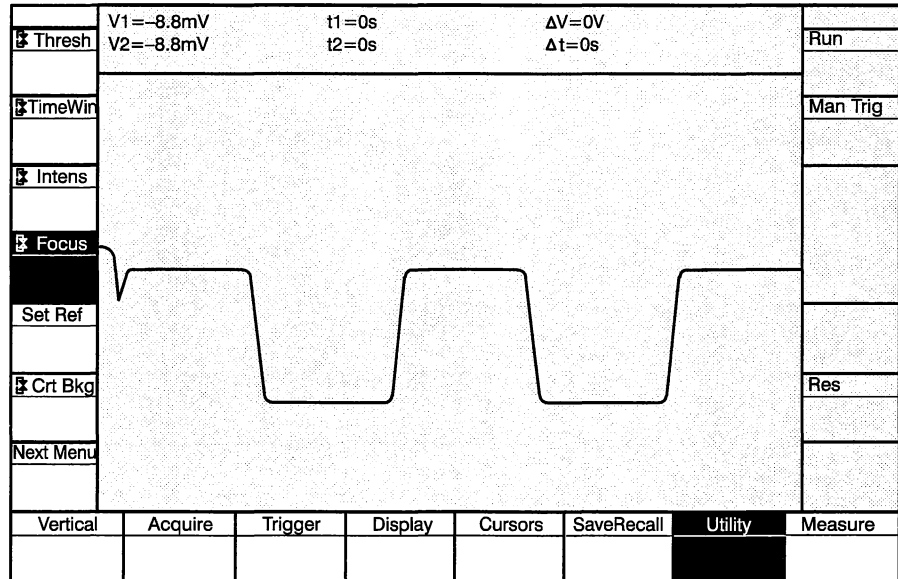

**Values:** Range is 0 to 100%

**Interactions:** The setting of focus affects the quality of the digitized waveform.

**GPIB Command:** FOCUS <NRx>  
FOCUS?

## Set Reference Data

The Target Reference function digitizes a blank target, analyzing it for aberrations. These aberrations stored in memory (reference array) and are subtracted from actual digitized waveform data before being stored in the linear array

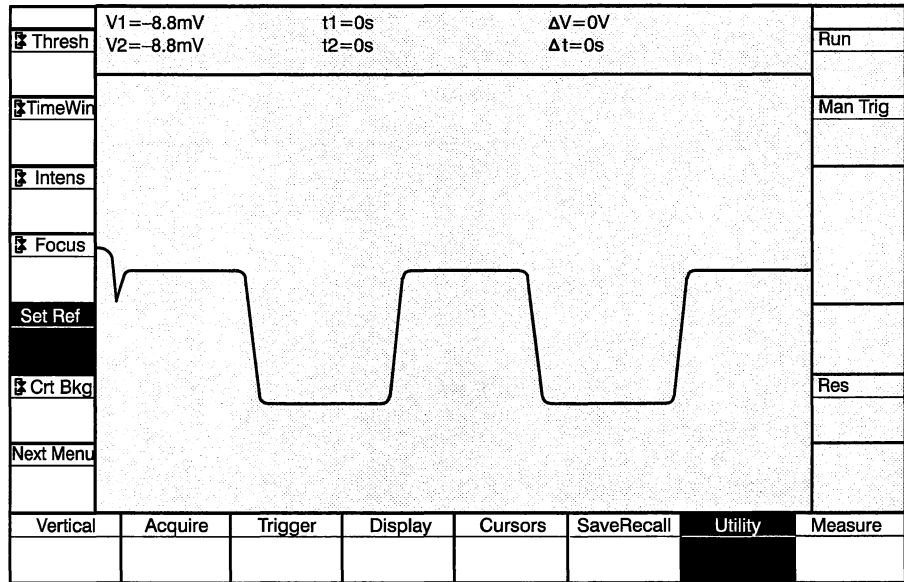

**Values:** None

**Interactions:** The result of the reference data affects the digitized waveform data.

**GPIB Command:** SERFEF RUN. The contents of the reference array can be transmitted over the GPIB using the REFARRAY? command. Use RAW REF ARRAY to view reference array data while in Utility Menu 1.

The SETREF ON/OFF command allows turning a reference array correction on and off.

## CRT Background

CRT Background allows adjustment of target sensitivity. Under most conditions increased sensitivity is not necessary; a setting of 0% is appropriate. Signals with extremely fast transitions (for the SCD5000 amplitudes greater than 25% of the Input Range), or instrument operation near the lower temperature limit, setting CRT background to greater than 0% is not beneficial. In general, it is not necessary to increase CRT Bkg until the adjustment of the display intensity exceeds 100%.

At some point the target image will show improved writing of the waveform. Increasing CRT Bkg further will cause excess sensitivity adding background noise. A small amount of background noise will be ignored by the centroiding process, but it is best to set CRT Bkg below the point where noise is seen (with the Display Threshold set to 0) because increased target temperature due to instrument warm-up or increased ambient temperature also increases the target sensitivity adding noise that may affect centroiding. Because the enhancement of the writing rate is temperature sensitive, adjustment should only be made after the instrument has been operating for at least 30 minutes to allow time for the CRT to reach normal operating temperature.

Excessive enhancement will cause a noisy background to appear on the target image along with the error message "linear array overflow". At high temperatures, enhancement is not necessary. If left set high from operating at lower temperatures, a noisy background or linear array overflow may occur. Reduce CRT Background until a noise-free background is seen for several acquire cycles.

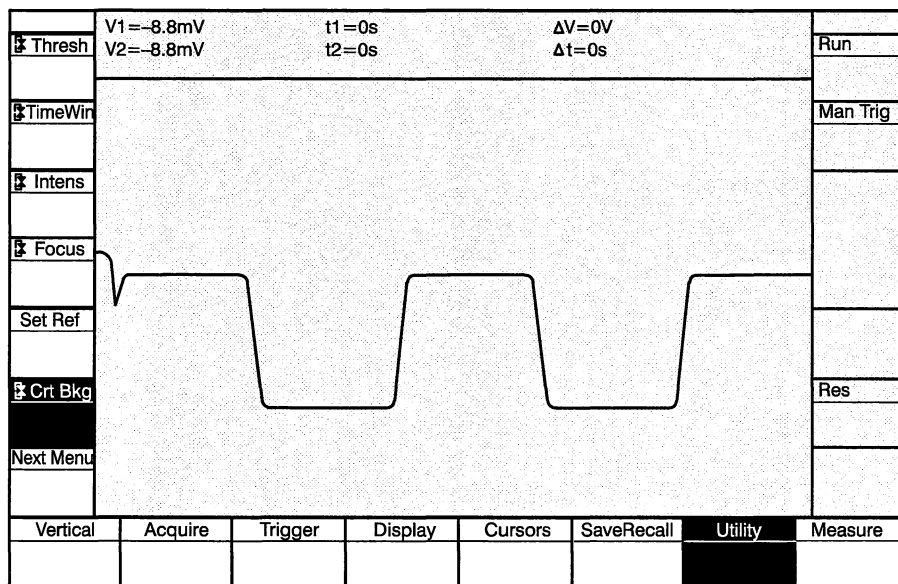

**Values:** Range is 0 to 100%

**Interactions:** The setting of CRT Bkg affects the quality of waveform digitization.

## Utility Functions

**GPIB Command:** CRTbkgnd <NRx>  
CRTbkgnd?

## Calibration Mode Selection

The Cal Mode function selects calibration of the entire waveform recorder or a subsystem. Calibration is controlled through system software. It is performed to establish a functional reference. The vertical, horizontal, CRT, and trigger subsystems can be calibrated. Results and messages related to calibration are displayed in the message/measurements zone.

The CRT calibration requires input of an external signal, therefore it is not included in the system calibration. During CRT calibration, a message appears instructing the user to connect a calibration signal (approximately 1 MHz @ 3 V<sub>p-p</sub> for SCD5000; 1 MHz @ 80 mV<sub>p-p</sub> for SCD1000) to the input connector.

The SCD5000 requires connecting the CAL OUT to the signal input for any cal mode other than CRT.

Internal calibration does not replace periodic calibration performed by a qualified calibration technician or metrology laboratory.

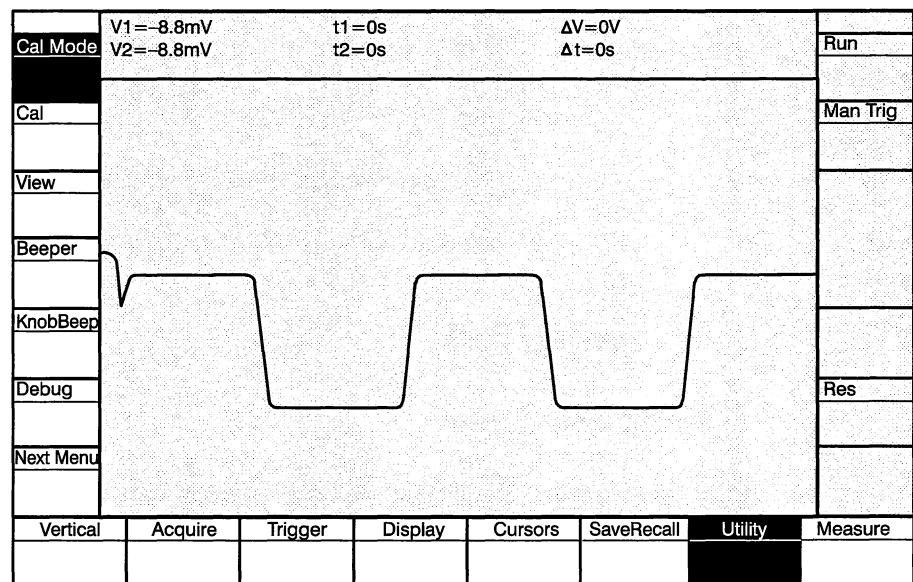

**Values:** System, Vertical, Horizontal, Trigger, CRT, Geometry

**Initial Value:** System

**Interactions:** None

**GPIB Command:** CALIBRATE {HORIZONTAL|VERTICAL|TRIGGER|CRT|GEOMETRY|ALL}  
 CALIBRATE? (see also the CCONSTANT? <ui>, CCONSTANT?, and CCDATE? commands)

The GPIB CALIBRATE command also executes the equivalent of the Initiate Calibration function.

## Initiate Calibration

The Initiate Calibration function starts the calibration process specified with the Calibration Mode Selection. The function is executed when selected, and presents no options.

Once initiated, calibration runs to completion. GPIB activity is suspended and the display is shut off until calibration is complete.

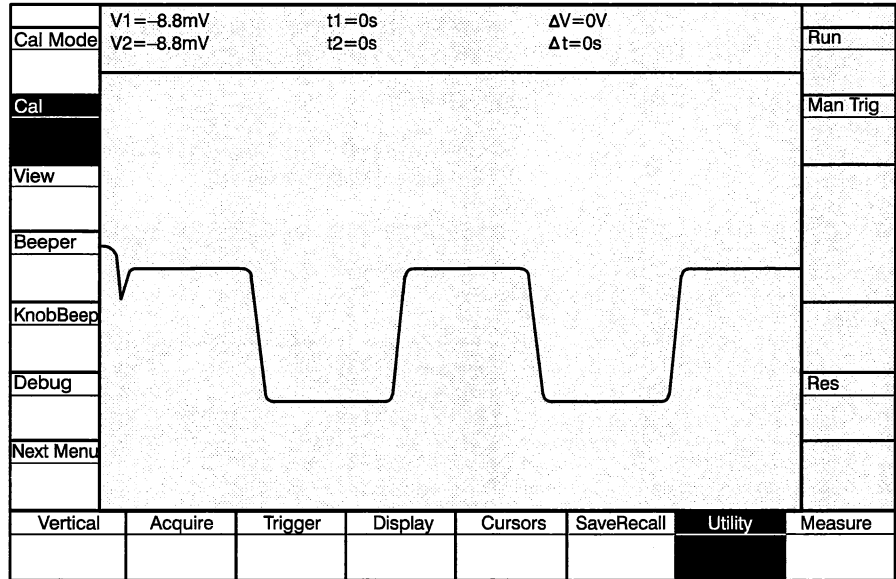

**Values:** None

**Interactions:** None

**GPIB Command:** CALIBRATE { TIME | TRIGGER | VERT | ALL }  
 CALIBRATE? (see also the CCONSTANT?<ui>, CCONSTANT?, and CCDATE? commands)

**NOTE**

*The GPIB CALIBRATE command also executes the equivalent of the Calibrate Mode Selection function.*



## View Settings of All or Selected Areas

The View function displays system and mode information. It enables the user to view the entire instrument's settings at a glance. The function is forced off when the Utility mode is exited.

There are three view selections: ID, Acquire, and Display.

The ID selection displays the front panel and instrument version number, instrument options, GPIB address, termination, SRQ status, SRQ Mask, Event Code, calibration date, optional interface parameters, and instrument serial number. Figure 3-38 illustrates the ID view.

The Acquire and Display choices allow all the current settings of the Acquire and Display modes to be viewed. These views are illustrated in Figure 3-39 and Figure 3-40.

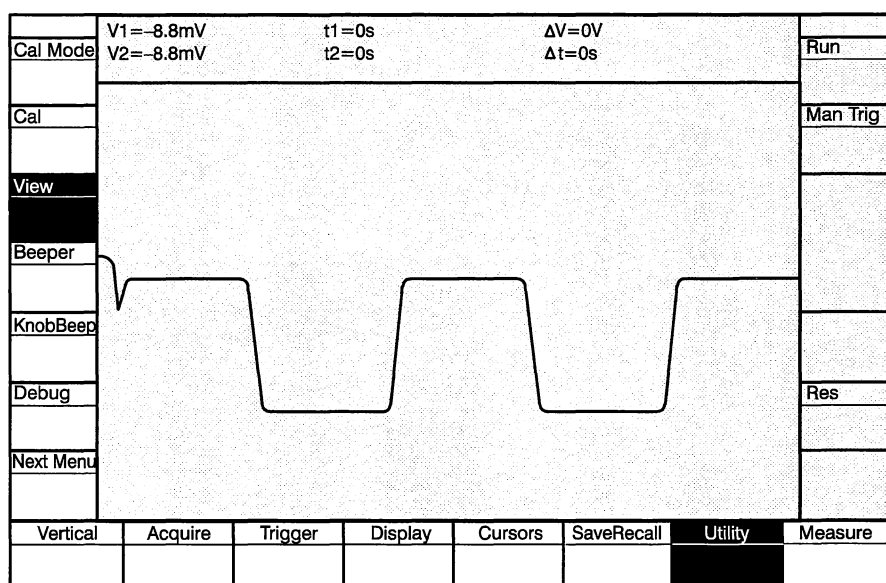

**Values:** ID, Acquire, Display, Off

**Initial Value:** ID

**Interactions:** None

**GPIB Command:** No direct equivalent. This function performs the equivalent of the GPIB SET?, EVENT?, ID?, RQS?, SRQMASK, OPTION?, and CCDATE commands.

	V1 = -2.500V					ΔV=0V	Stopped
Cal Mode	V2 = -2.500V					Δt=0s	Run
System	SCD 5000	IEEE 488.1 Port					
Cal	ID: B040234	Version: V81.1	RQS: On				
Stopped	Dig FW Ver: 1.8	Address: 7	OPCMPL: On				Man Trig
View	Dsp FW Ver: 3.00	Terminator: EOI	CMDERR: On				
ID	Options: None	Mode: Talk/Listen	EXERR: On				
Beeper	Safeguards	Debug: Off	INERR: On				
On	PowerUpTst: Off	Longform: On	EXWARN: On				
KnobBeep	InptProtct: Off	Path: On	INWARN: On				
On	AcqProtect: Off	Device Trig: Off	ABSTOUCH: Off				
KnobBeep	Miscellaneous	Data Output					
On	BattDate: yy-mm-dd	Start Record: 1					
Debug	LastFacCal: yy-mm-dd	Record Count: 1					Res
Off	Ref Array: On	Start Point: 1					Coarse
NextMenu		Point Count: 0					TimeWin
		Byte Order: MSB First					1μs
		Interp Flag: On					
Vertical	Acquire	Trigger	Display	Cursors	SaveRecall	Utility	Measure
	1μs	Ext Trigd					
	512Pt	0V~					

Figure 3-38: ID View

	V1 = -2.500V					ΔV=0V	Stopped
Cal Mode	V2 = -2.500V					Δt=0s	Run
System	Vertical Settings						
Cal							
Stopped	Range: 5V						Man Trig
View	Offset: 0V						
Acquire							
Beeper							
On							
KnobBeep							
On							
Debug							Res
Off							Coarse
NextMenu							TimeWin
							1μs
Vertical	Acquire	Trigger	Display	Cursors	SaveRecall	Utility	Measure
	1μs	Ext Trigd					
	512Pt	0V~					

Figure 3-39: Acquire View

	V1=-717mV	t1=117.417ns	ΔV=87mV	Stopped			
Cal Mode	V2=-630mV	t2=1.65949μs	Δt=1.54207μs	Run			
System	Display Settings						
Cal	N Window: 1						
Stopped	Window Sel: Window 1	Window 2	Window 3	Window 4			
View	Chan Sel: Ch A	Ch A	Ch A	Ch A			
Display	Rec Sel: 1	4	4	5			
Beeper	ExpPoint: 0 <sub>Pt</sub>	0 <sub>Pt</sub>	0 <sub>Pt</sub>	0 <sub>Pt</sub>			
On	Vert Exp: 1	1	1	1			
	Horiz Exp: 1	2	2	1			
KnobBEEP	HExpMode: 1						
			Utility Settings				
Debug	Cursor Settings		Beeper: On				
	Cursors: On		KnobBEEP: On				
NextMenu	Curs1Loc: Win 1		Cal Mode: System				
	Curs2Loc: Win 1		Date: 90-03-07	Res			
	Cursor 1: 30 <sub>Pt</sub>		Time: 13:30:52	Coarse			
	Cursor 2: 424 <sub>Pt</sub>		Ch A Cal: Time	TimeWin			
			Ch B Cal: Off				
			Ext Cal: Ampl				
			Cal Amp: 2.5V				
			Cal Period: 800ns				
Vertical	Acquire	Trigger	Display	Cursors	SaveRecall	Utility	Measure
Ch A	2μs 1024 <sub>Pt</sub>	Ch A Trigd ~0%					

Figure 3-40: Display View

## Beeper ON/OFF

The Beeper function turns the button beeper ON or OFF. The button beeper provides audio feedback for button presses.

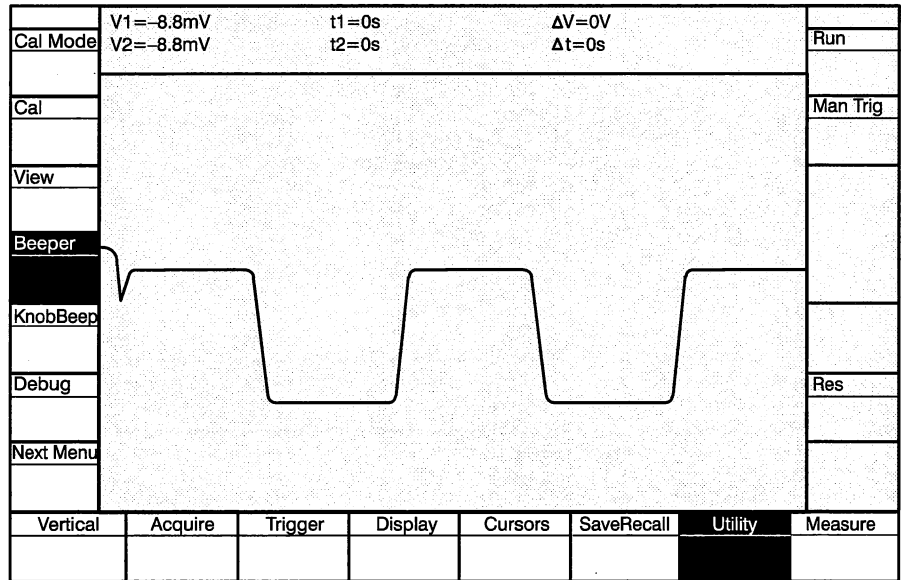

**Values:** On, Off

**Initial Value:** On

**Interactions:** None

**GPIB Command:** BELL BUTTON: { ON | OFF }  
 BELL? BUTTON  
 BELL?

## KNOB Beeper ON/Off

The Knob Beeper function turns the knob beeper ON or OFF. The knob beeper provides audio feedback for variable knob actions.

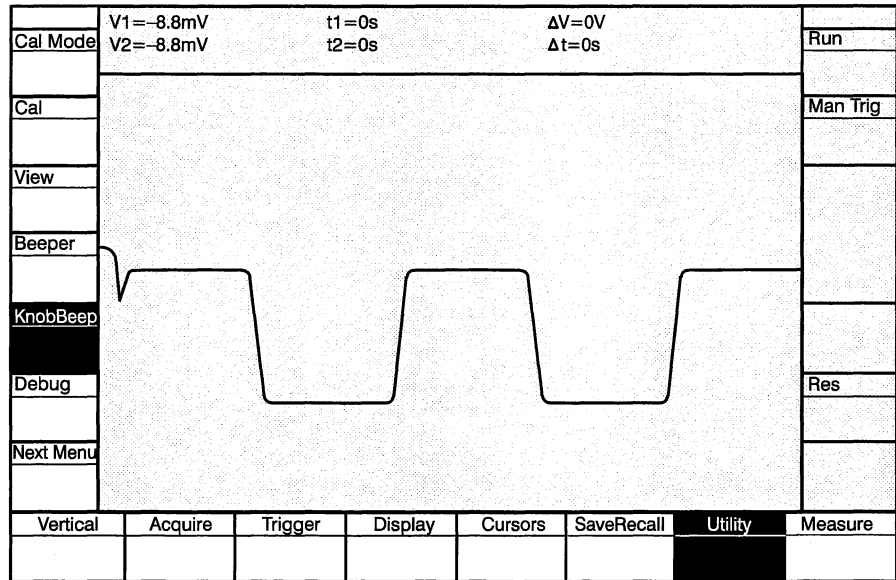

**Values:** On, Off

**Initial Value:** On

**Interactions:** None

**GPIB Command:** BELL KNOB: { ON | OFF }  
 BELL? KNOB  
 BELL?

## Debug Mode

The Debug function initiates or cancels the Debug mode. In Debug mode, all commands and errors being received at the GPIB port for this waveform recorder are displayed on the screen in the message area.

The Debug function is useful when developing instrument control programs over the GPIB. The display shows all commands, control characters, and errors, making program debugging easier.

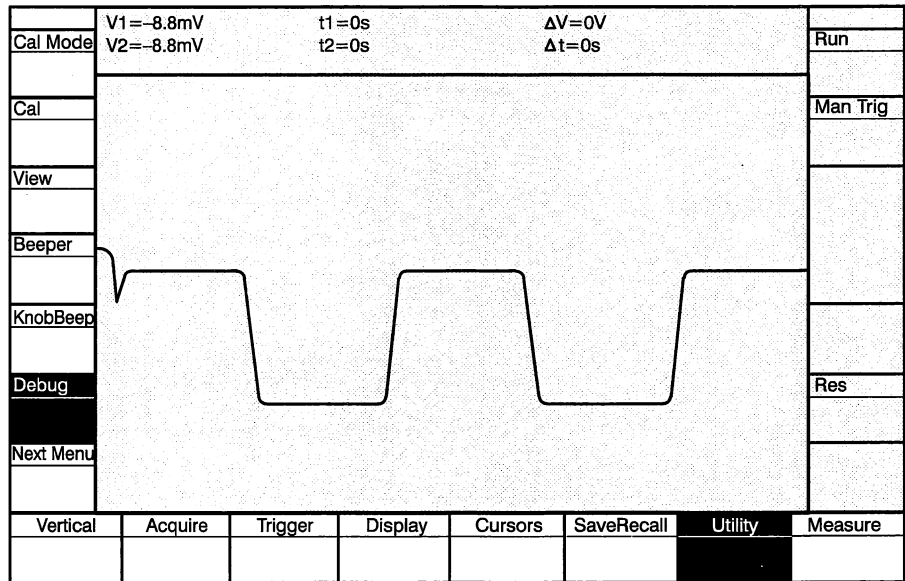

**Values:** On, Off

**Initial Value:** Off

**Interactions:** The Debug mode is affected by the following parameters:

**Cursors:** Cursors must be off to view the debug display, because cursor measurements over-ride the debug mode display.

**GPIB:** When Debug is on, GPIB operation is slowed and binary data is not shown.

**GPIB Command:** DEBUG GPIB: { ON | OFF }  
DEBUG?

## Instrument Self-Test

The Instrument Test function initiates a self-test of the entire waveform recorder. When the test is executing, the status indicates such (i.e., "Running"). The test results are displayed in the message/measurements area.

The function is executed when selected, with no options presented.

If power is turned off during self-test, settings are returned to the factory default.

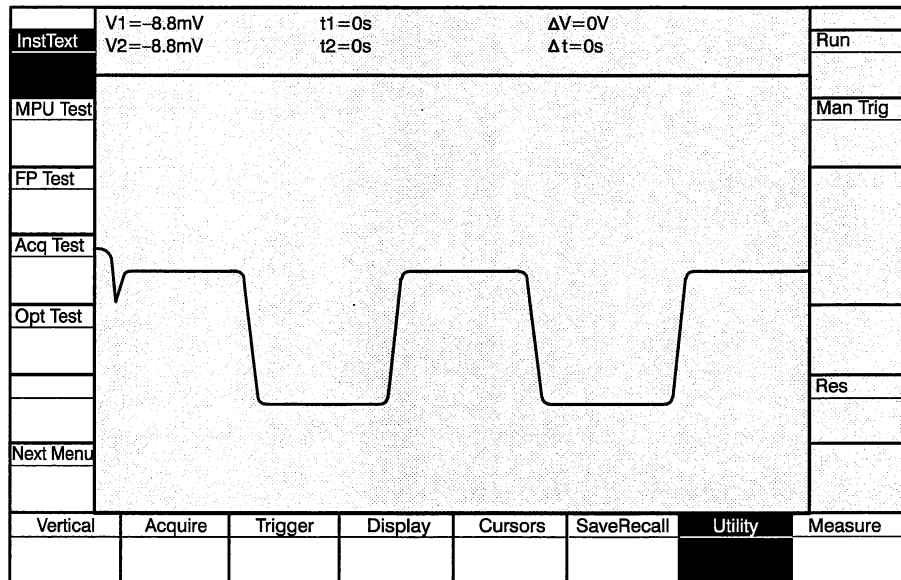

**Values:** None

**Interactions:** None

**GPIB Command:** TEST SYS: [ALL] (see also TEST LOOP: command)  
 TEST? SYS  
 TEST?  
 DIAG? (see also TEST VERBOSE: command)

## Processor Self-Test

The MPU Test function initiates a self-test of the processor board subsystem. When the test is executing, the status indicates such (i.e., "Running"). The test results are displayed in the message/measurements area.

The function is executed when selected, with no options presented.

For information on testing specific components and assemblies of the processor subsystem, refer to the TEST NUM: <NRx> command description in Section 2 and the Programmer Manual.

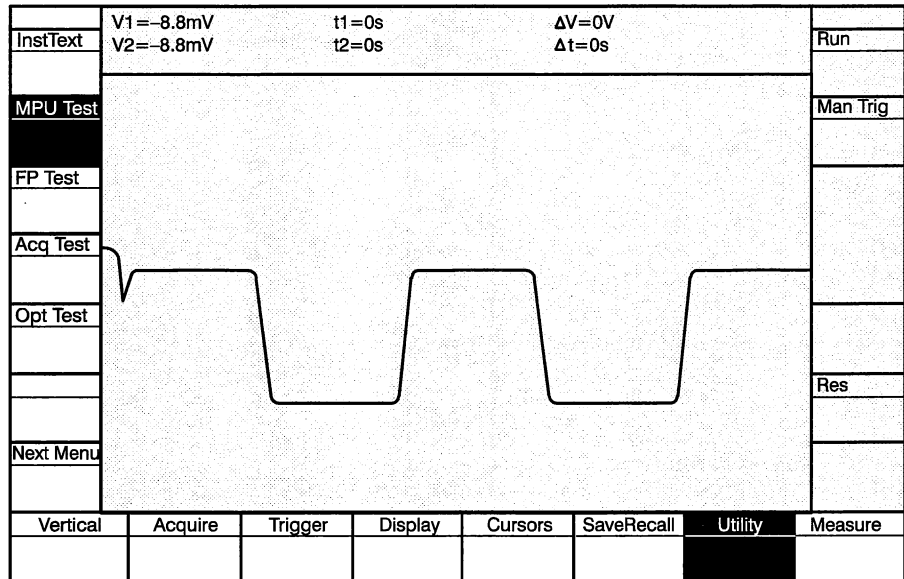

**Values:** None

**Interactions:** None

**GPIB Command:** TEST SYS: PROSYS (see also the TEST LOOP: and TEST NUM: <NRx> commands)  
 TEST? SYS  
 TEST?DIAG? (see also TEST VERBOSE: command)



## Front Panel Self-Test

The FP Test function initiates a self-test of the Display Unit. When the test is executing, the status indicates such (i.e., "Running"). The test results are displayed in the message/measurements area.

The function is executed when selected, with no options presented.

For information on testing specific components and assemblies of the acquisition memory subsystem, refer to the TEST NUM: <NRx> command description in Section 2 and the Programmer Manual.

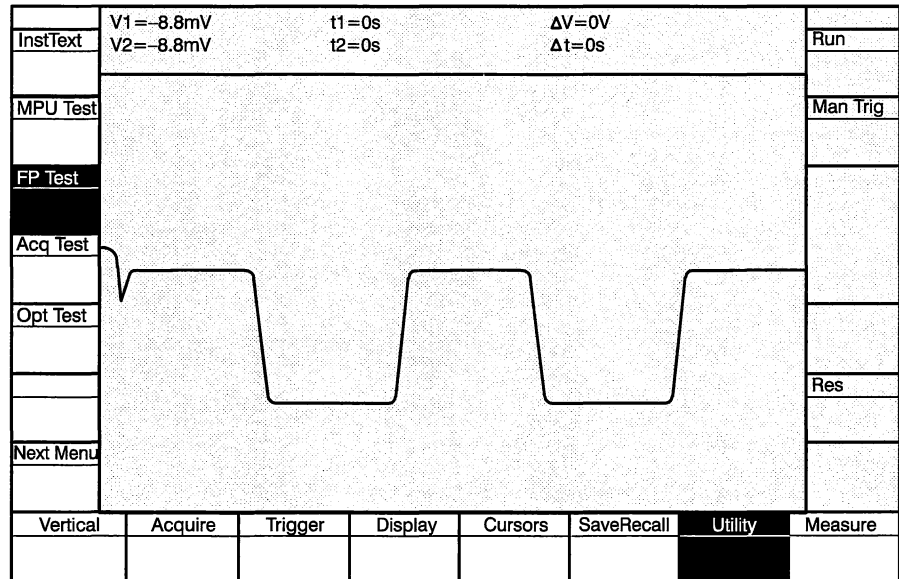

**Values:** None

**Interactions:** None

**GPIB Command:** TEST SYS: FP (see also the TEST LOOP: and TEST NUM: <NRx> commands)  
 TEST? FP  
 TEST?DIAG? (see also the TEST VERBOSE: command)

## Acquisition Self-Test

The Acquisition Test function initiates a self-test of the acquisition subsystem. When the test is executing, the status indicates such (i.e., "Running"). The test results are displayed in the message/measurements area.

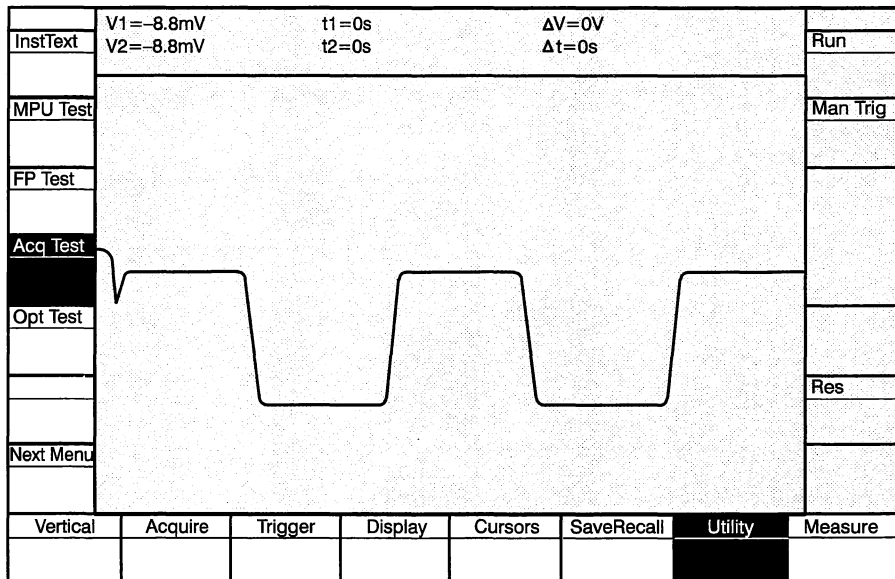

**Values:** None

**Interactions:** None

**GPIB Command:** TEST SYS: FP (see also the TEST LOOP: and TEST NUM: <NRx> commands)  
 TEST? FP  
 TEST?DIAG? (see also the TEST VERBOSE: command)

## Options Self-Test

The Option Test function initiates a self-test of the HSDO and/or Fast WFM capture option subsystem. When the test is executing, the status indicates such (i.e., "Running"). The test results are displayed in the message/measurements area.

The function is executed when selected, with no options presented.

For information on testing specific components and assemblies of the acquisition subsystem, refer to the TEST NUM: <NRx> command description in Section 2 and the Programmer Manual.

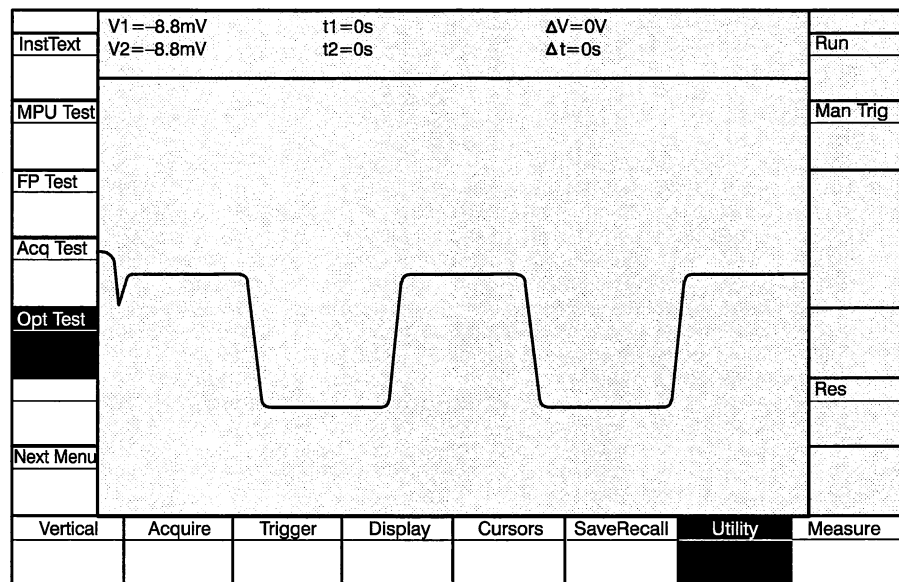

**Values:** None

**Interactions:** None

**GPIB Command:** TEST? SYS  
 TEST?  
 DIAG? (see also the TEST VERBOSE: command)

## Date/Time Functions

The Date/Time functions set the waveform recorder's date/time clock. The date/time clock is used to determine waveform acquisition time. These settings are selected with the knob. When the date/time settings are correct, the **Enter** key sets the current values into the date/time clock.

The date/time clock is set to the shipping date when it leaves the factory.

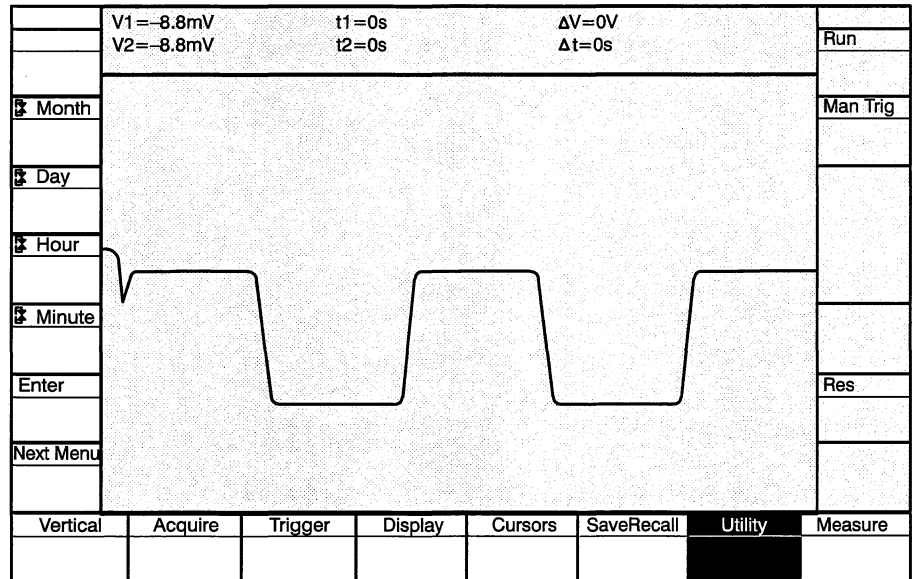

**Values:**

Parameter	Min	Max
Year	1989	2010
Month	1	12
Day	1	31
Hour	0	23
Minute	0	59

**Interactions:** None

**GPIB Command:** CLOCK DATE:<qstring>  
 CLOCK TIME:<qstring>  
 CLOCK? DATE  
 CLOCK? TIME  
 CLOCK?

## Channel Calibration Signals (SCD1000)

The Channel Calibration function selects the signal that is internally connected to the channel inputs (Ch A Cal connects the calibrator to channel A; Ch B Cal connects the calibrator to channel B). The calibrator can be one of three types: Time, Amplitude from 0  $\Omega$ , or Amplitude from 450  $\Omega$ . The calibrator can also be turned off. If the calibrator is Time, the period can be set with the CalTime function (described later in this functional reference).

If a calibrator signal is selected, the trigger source is automatically set to internal. If the trigger source is set to external, the calibrator is automatically turned off.

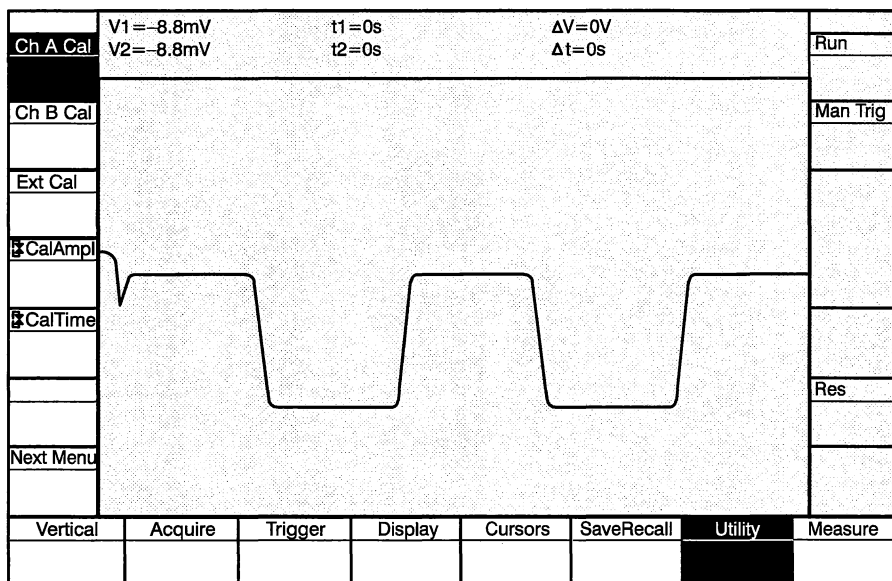

**Values:** Time, Ampl from 0  $\Omega$ , Ampl from 450  $\Omega$ , Off

**Initial Value:** Off

**Interactions:** The calibrator affects and is affected by the following parameters:

**Trigger Source:** If a calibrator signal is selected, the trigger source is automatically set to internal. If the trigger source is set to external, the calibrator is automatically turned off.

**GPIB Command:** CALOUT CH{ A | B } : { TIME | AMPL | AMPL450 | OFF }  
 CALIBRATOR { AMPLITUDE | TIME } <NRx>  
 CALOUT? CH{A|B}  
 CALOUT?  
 CALIBRATOR? { AMPLITUDE | TIME }  
 CALIBRATOR?

## External Calibrator Signal

The External Calibrator function connects the internal calibrator signal to the CAL OUT connector and selects the type of calibrator signal: time or amplitude.

If the calibrator is Time, the period can be set with the **CalTime** function (described later in this functional reference). If the signal is amplitude (DC voltage level), the amplitude can be set with the **CalAmpl** function (described later in this functional reference).

When **Ext Cal** is selected, both channels A and B are turned off.

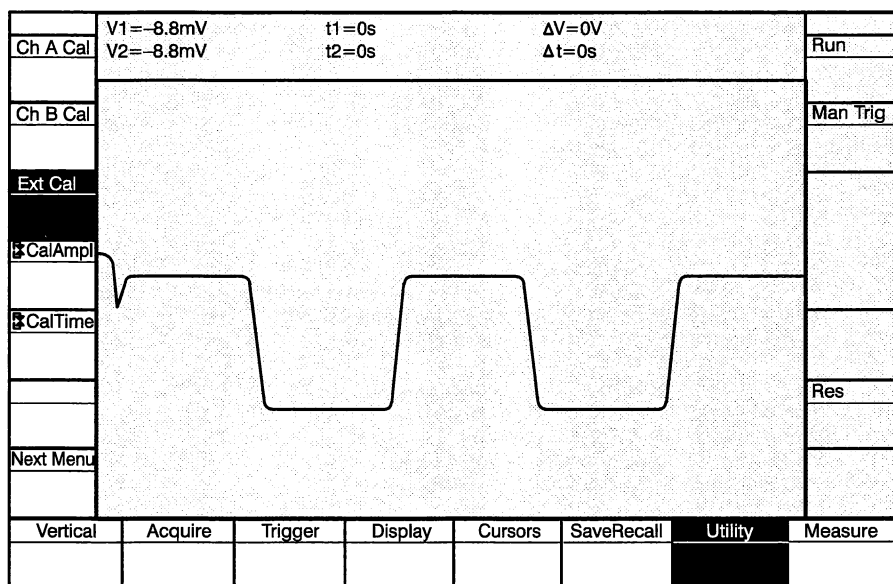

**Values:** Time, Amplitude

**Initial Value:** Time

**Interactions:** The External Calibrator function affects the following function:

**Vertical Mode:** When External Calibrator is selected, both channels are turned off.

**GPIB Command:**

```

CALOUT EXTERNAL: { TIME | AMPL }
CALIBRATOR: { AMPLITUDE | TIME } <NRx>
CALOUT? EXTERNAL
CALOUT?
CALIBRATOR? { AMPLITUDE | TIME }
CALIBRATOR?
    
```

## Calibrator Signal Amplitude

The Calibrator Signal Amplitude function sets the DC level of the calibrator signal.

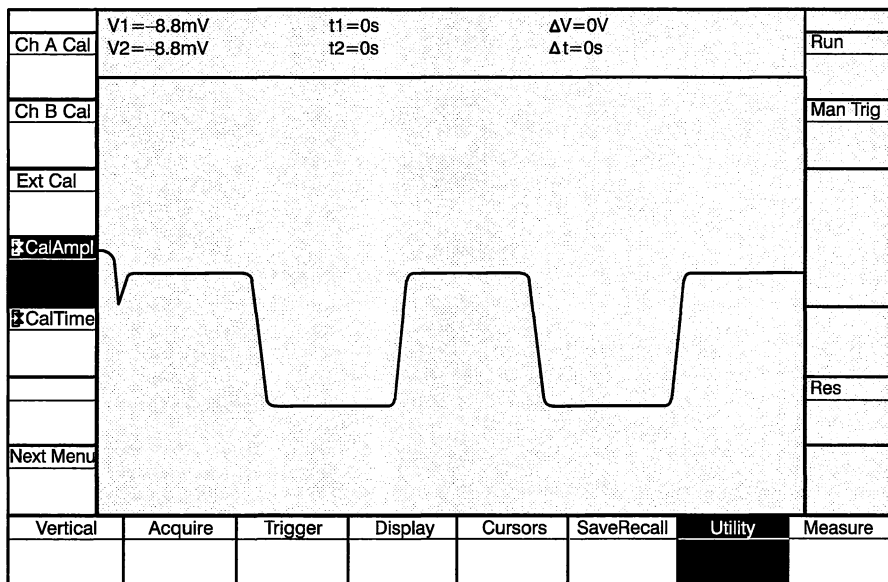

**Values:**

Choices SCD1000	Init	Choices SCD5000	Init
-2.5 V,+2.5 V	+2.5 V	-4.0 V,+4.0 V	+2.0 V
-2.0 V,+2.0 V		-3.0 V,+3.0 V	
-0.8,+0.8 V		-2.0 V,+2.0 V	
-0.4 V,+0.4 V		-1.0 V,+1.0 V	
-0.2 V,+0.2 V		-0.5 V,+0.5 V	
-0.080 V,+0.080 V		0 V	
-0.040 V,+0.040 V			
0 V			

**Interactions:** None

**GPIB Command:** CALIBRATOR AMPLITUDE:<NRx>  
 CALIBRATOR? AMPLITUDE  
 CALIBRATOR?

## Calibrator Signal Period

The Calibrator Signal Period function sets the period of the calibrator signal. The amplitude is automatically set to 800 mV with a 600 mV offset.

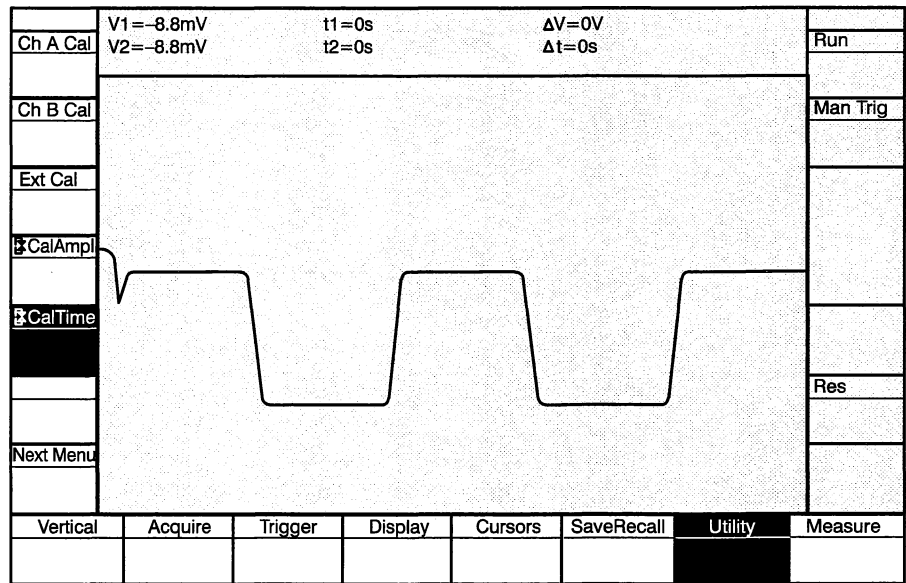

**Values:**

Min	Max	Step Sequence	Init
4 ns	80 μs	4, 8, 16, 40	0.8 μs

**Interactions:** None

**GPIB Command:** CALIBRATOR TIME: <NRx>  
CALIBRATOR? TIME  
CALIBRATOR?



## Calibrator Out Signal (SCD5000)

The Calibrator Out function selects the signal that is connected to the CAL OUT connector on the front panel. The calibrator can be either amplitude or time. The SCD5000 requires a cable to be connected from the CAL OUT connector to the INPUT connector.

If the calibrator is Time, the period can be set with the **CalTime** function (described later in this functional reference). If the signal is amplitude, the DC level can be set with the **CalAmpl** function (described later in this functional reference).

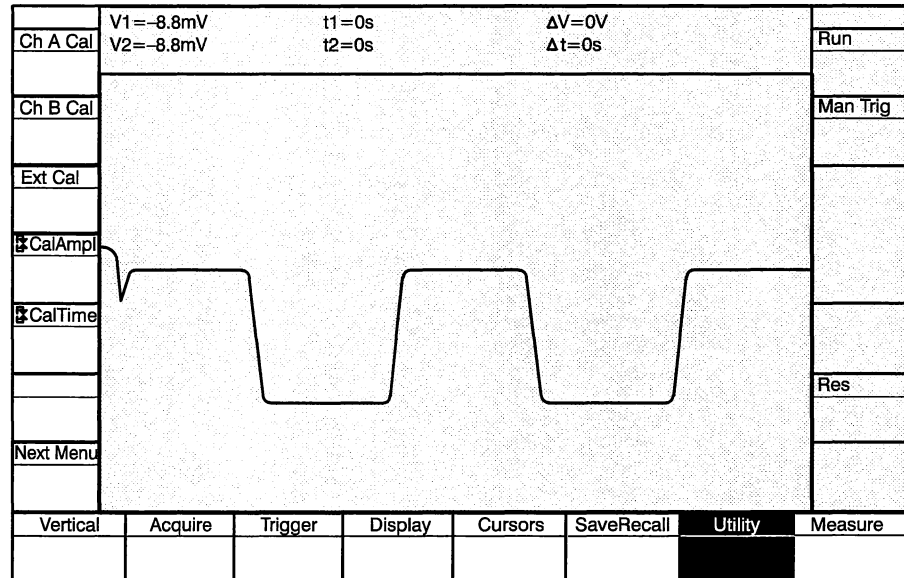

**Values:** Time, Amplitude

**Initial Value:** Time

**Interactions:** None

**GPIB Command:** CALOUT EXTERNAL: { TIME | AMPL }  
 CALIBRATOR { AMPLITUDE | TIME } <NRx>  
 CALOUT? EXTERNAL  
 CALOUT?  
 CALIBRATOR? { AMPLITUDE | TIME }  
 CALIBRATOR?



# Measurement Functions

The SCD has a built-in waveform measurement system which allows you to make a wide variety of measurements and report the results to the display or over the GPIB.

The quantity and types of measurements displayed, as well as the bounding parameters of the measurement system are controlled by the measurement functions. The primary measurement menu is selected by the **Measure** mode key. Additional menus in the measurement menu sequence are accessible through the **NextMenu** function key (available in all measurement related menus). When the last menu in the sequence is displayed, pressing the **NextMenu** function key will display the first menu in the sequence. The following list describes the measurement menus in the order they appear.

## Measurement Menu 1

This is the primary measurement menu for enabling/disabling the measurement system, display and choosing the data to use in the calculations.

**Measure** — This key globally enables and disables measurement calculations. Note that ALL measurements are calculated if measurements are enabled, but only those measurements which are selected will show results on the display.

**Select** — Pressing this key assigns the measurement selection function to the knob. The measurement type currently selected by the knob appears in inverse video on the display. The currently selected measurement is added to the measurement display list using the **Enter** function key.

**Enter** — This key adds or deletes the measurement type currently selected on the display (see **Select** above) to the measurement display list. When a measurement is added to the display list a small square appears to the left of the measurement name on the selection display. A maximum of eight measurements can be included in the display list.

**Disp Win** — This key selects the waveform window in which measurement results will be displayed. Possible selections are 1, 2, 3, or 4. Note that the display configuration must accommodate this selection if measurement results are to be shown. See the **N windows** key under DISPLAY FUNCTIONS above regarding configuration of waveform windows on the display.

**Wfm #** — This key selects the data (by record number) on which the measurements are to be executed. Note that selecting an empty record will cause all measurement results to be invalid (NAN).

**MeasZone** — The end points of the waveform data used in measurement calculations can be selected with the cursors. Selecting **Cursors** with this key enables this feature. Selecting **Full Wfm** disables this feature; the measurement calculations ignore the cursor positions and use the first and last acquired point in the record as end points.

## Measurement Menu 2

**BaseMode** — This key selects which method to use in determining base level. There are four possible selections. **HistMode** calculates the base level from a regular histogram. **HistMean** calculates the base level from a mean histogram. **MinValue** takes the minimum data point as the base level. Lastly, an arbitrary base level can be input with **AbsLevel**. With this last selection, an additional function key is defined (**BasLevel**), assignable to the knob, to select the user's desired base level.

**TopMode** — This key selects which method to use in determining top level. There are four possible selections. **HistMode** calculates the top level from a regular histogram. **HistMean** calculates the top level from a mean histogram. **MaxValue** takes the maximum data point as the top level. Lastly, an arbitrary top level can be input by the user with **AbsLevel**. With this last selection an additional function key is defined (**TopLevel**), assignable to the knob, to select the user's desired top level.

The other three sets, **Proximi**, **Mesial**, and **Distal** use end points established by the first two adjacent proximal, mesial, or distal crossing points on the waveform, respectively.

## Measurement Menu 3

**LevelMod** — This key selects the units for the proximal, mesial, and distal selection functions. Units can be either **Percent** or **AbsLevel**.

**Proximi** — The selected proximal level influences the result of other measurements, and therefore proximal level is user selectable. This key assigns the proximal level selection function to the knob. Units are determined by the **LevelMod** key.

**Mesial** — The selected mesial level influences the result of other measurements, and therefore mesial level is user selectable. This key assigns the mesial level selection function to the knob. Units are determined by the **LevelMod** key.

**Distal** — The selected distal level influences the result of other measurements, and therefore distal level is user selectable. This key assigns the distal level selection function to the knob. Units are determined by the **LevelMod** key.

## Measure On/Off

This button globally enables/disables measurement calculations. Note that one or more specific measurements must be selected (see buttons for **Measure Selection** and **Measure Enter** below) for any measurement results to appear on the display.

When measurements are enabled and an acquisition is NOT running, the button usually assigned to **Manual Trigger** is assigned to **Manual Measure**. This allows the user to do repeated measurement calculations on acquired data, while making adjustments with the cursors.

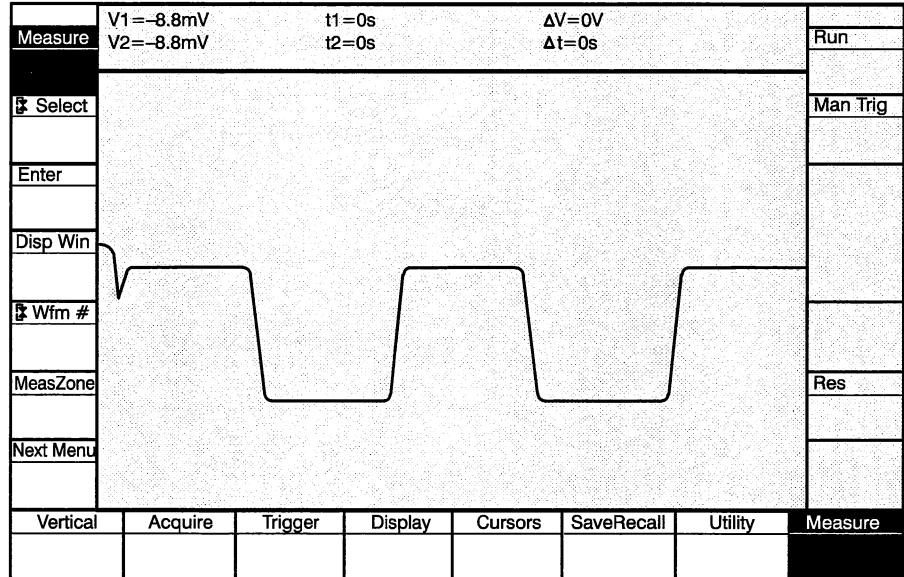

**Values:** On or Off

**Initial Value:** Off

**Interactions:** If an acquisition is in progress, or measurements are globally disabled, the **Manual Measure** button is not available.

**GPIB Command:** MEASURE FUNCTION: { ON | OFF }  
 MEASURE?FUNCTION  
 MEASURE MANMEAS

## Measure Selection

This key assigns the measurement selection function to the knob. The currently selected measurement type is highlighted on the display in inverse video. The measurement is added to or deleted from the selected measurement list by the **Measure Enter** function key (see below).

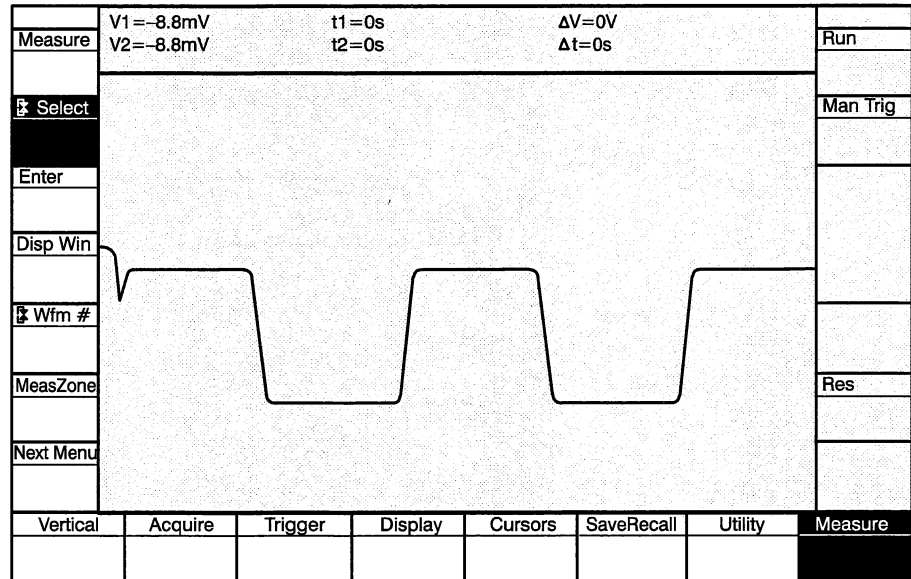

<b>Values:</b>	Max Value	Peak-to-Peak Amp	Fall Slew Rate
	Top Level	Base-Top Amp	Period
	Distal Level	Top Aberrations	Frequency
	Mesial Level	Base Aberrations	Area
	Proximal Level	Rise Time	Mean
	Base Level	Rise Slew Rate	RMS
	Min Value	Fall Time	Width

**Interactions:** A maximum of eight measurements can be selected at one time.

**GPIB Command:** MSLIST CLEAR

MSLIST<mslist>:{ON|OFF}[,<mslist>:{ON|OFF}.....]

MSLIST?

<mslist> ::= { MAXIMUM | TOP | DISTAL | MESIAL | PROXIMAL | BASE  
| MINIMUM | PK\_PK | BASEABER | TOPABER | RISE |  
RISESLEW | FALL | FALLSLEW | WIDTH | PERIOD |  
FREQUENCY | AREA | BASETOP | MEAN | RMS }

### NOTE

*If an MSLIST query is returned to the instrument without first clearing the measurement list, measurements would be selected until the maximum of eight measurements was exhausted; all subsequent selections would generate errors and be ignored. To avoid this problem, CLEAR is always generated as the first link in the MSLIST? response in the context of a SET? query.*

## Measure Enter

This button adds/deletes the measurement type currently selected on the display (by inverse video) to/from the list of currently selected measurements (see **Measure Selection** above). A box appears to the left of the measurement title when the measurement is included in the measurement list.

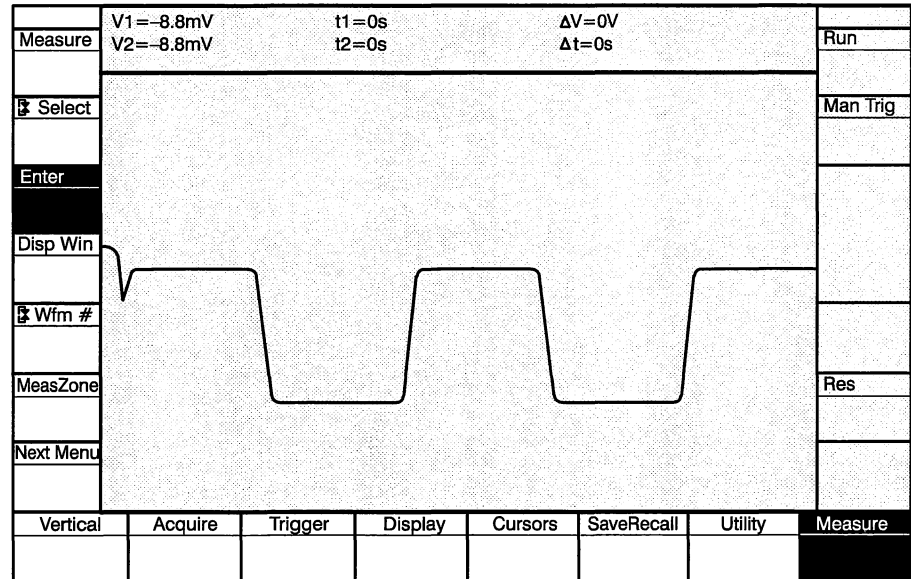

**Values:** On or Off

**Interactions:** A maximum of eight measurements can be selected at one time.

**GPIB Command:** MSLIST CLEAR

MSLIST<mslist>:{ON|OFF}[,<mslist>:{ON|OFF}]  
MSLIST?

<mslist> ::= { MAXIMUM | TOP | DISTAL | MESIAL | PROXIMAL | BASE  
| MINIMUM | PK\_PK | BASEABER | TOPABER | RISE |  
RISESLEW | FALL | FALLSLEW | WIDTH | PERIOD |  
FREQUENCY | AREA | BASETOP }

### NOTE

*If an MSLIST query is returned to the instrument without first clearing the measurement list, measurements would be selected until the maximum of eight measurements was exhausted; all subsequent selections would generate errors and be ignored. To avoid this problem, CLEAR is always generated as the first link in the MSLIST? response in the context of a SET? query.*

## Measure Display Window

This button selects the waveform window in which the measurement results will be displayed. Note that the display must be set up to show the correct number of waveform windows, i.e., if window 3 is selected to be the measurement display window, the display must be configured to display 4 windows if measurement readouts are to be seen.

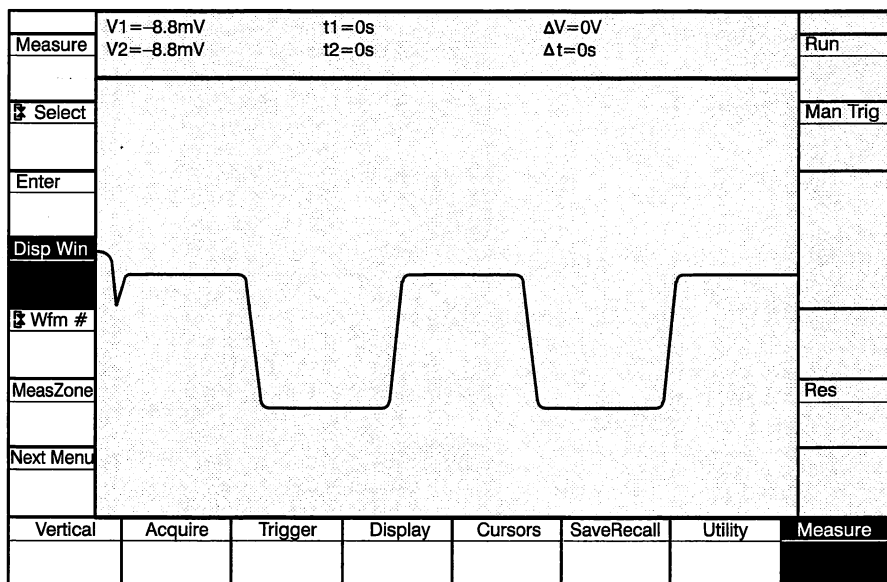

**Values:** 1, 2, 3, or 4

**Initial Value:** 1

**Interactions:** None

**GPIB Command:** MEASURE WINDOW:{ WIN1 | WIN2 | WIN3 | WIN4 }  
MEASURE?WINDOW



## Measure Waveform

This button assigns the waveform selection function to the knob, allowing records 1 through 16 to be selected as the source data from which measurements are to be calculated.

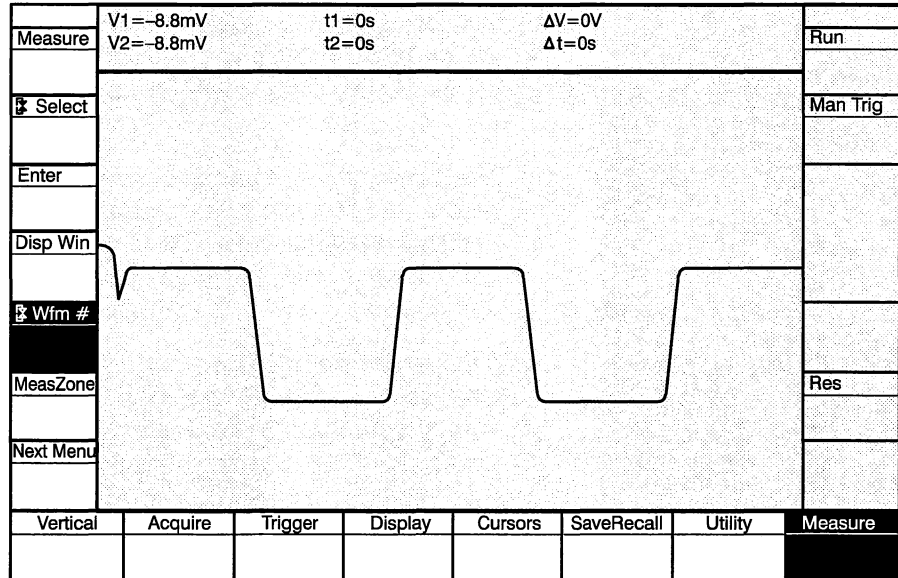

**Values:** Range is 1 through 16

**Initial Value:** 1

**Interactions:** The data for the selected waveform (record) must exist for measurement calculations to complete. Lack of data results in NAN being displayed for all selected measurements. This can happen if the last acquisition was done in Normal Acquisition Mode and the currently selected measurement waveform is not the same as the start record (see Acquire Functions above).

**GPIB Command:** MEASURE WAVFRM: <NRx>  
MEASURE?WAVFRM

## Measure Zone

There are three choices for selecting the portion of a waveform on which measurement calculations can be done. Full Wfm selects the entire waveform. When Cursors are selected, they set the endpoints of the measurement zone. Using the Window selection, endpoints displayed in any of the four possible windows can be used to select the measure zone. If the window used for selecting the measure zone is horizontally expanded, the waveform points that the edges of the displayed portion of the waveform will set the portion of the measured waveform that calculations are performed on.

The cursor and measurement zone window are not tied to the measured record. The measurement record and the record displayed in the measurement zone window do not have to be the same. The measurement zone window simply defines endpoints that are then applied to the measurement record.

If the selected measurement zone does not fall on the measure waveform, the result returned from the measurement will be NAN (Not A Number). Such conditions can occur when a combination of waveform size and horizontal expansion select a portion of a waveform that does not exist on the measured waveform (i.e., selecting the last half of a 1024 point waveform as the measurement zone of a 256 point waveform). NAN will also be returned if the conditions for the measurement are not met on the measured waveform although they might be met in the window that sets the measure zone.

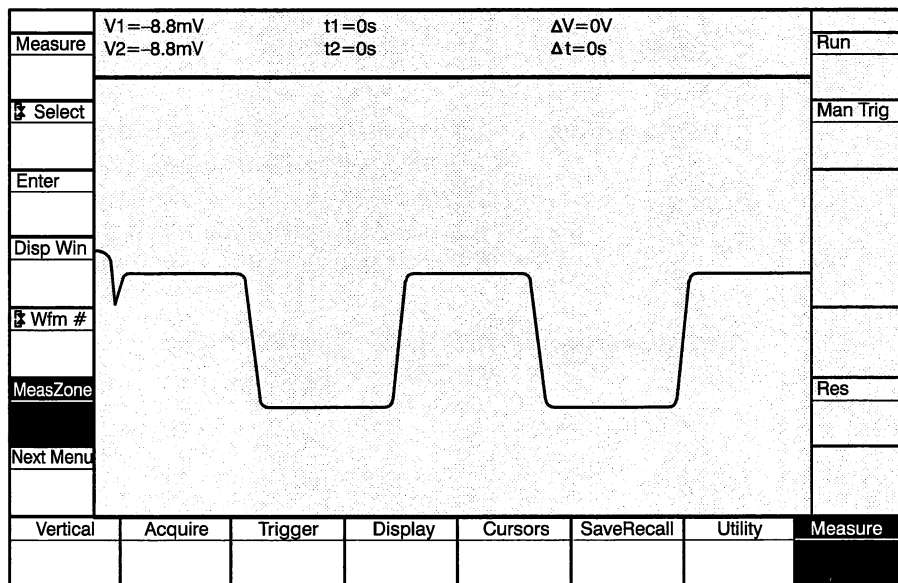

**Values:** Cursors, Full Wfm, Window1, Window2, Window2, Window4

**Initial Value:** Full Wfm

**Interactions:** None

**GPIB Command:** MEASURE MEASZONE: { FULL | CURSORS } | WIN1 | WIN2 | WIN3 |  
WIN4  
MEASURE? MEASZONE

## Base Mode

The base level measurement can be calculated according to several parameters. This button selects which one is to be used. There are four selections.

1. HistMode calculates the base level from a regular histogram.
2. HistMean calculates the base level from a mean histogram.
3. MinValue takes the minimum data point as the base level.
4. An arbitrary base level can be input by the user with Abslevel. With this last selection, an additional function key (BasLevl) is defined, assignable to the knob, to select the user's desired base level.

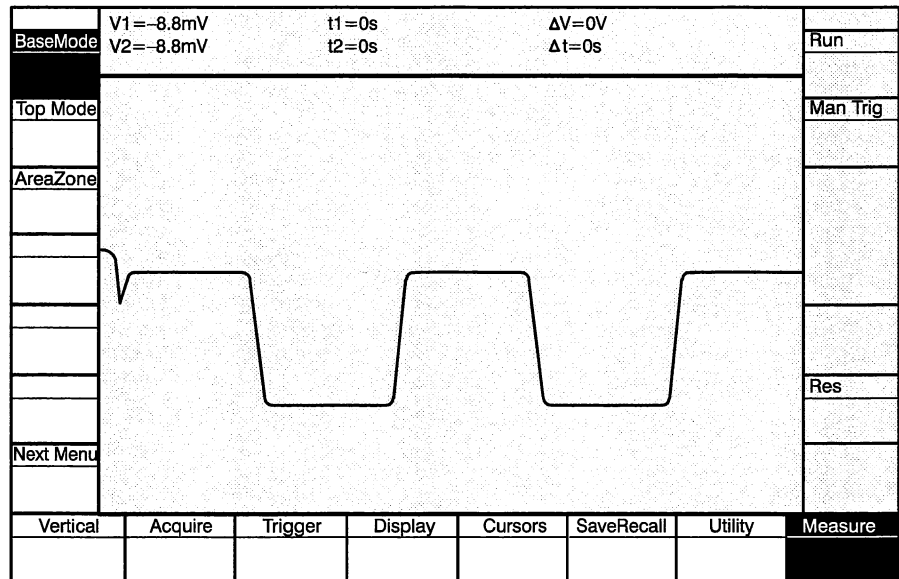

**Values:** HistMode, HistMean, MinValue, AbsLevel

**Initial Value:** HistMode

**Interactions:** None

**GPIB Command:** BASEMODE METHOD: { HISTOGRAM | HISTOMEAN | MINIMUM | ABSOLUTE }  
 BASEMODE LEVEL: <NRx> (\*)  
 BASEMODE?  
 BASEMODE? METHOD  
 BASEMODE? LEVEL

(\*) active only when METHOD:ABSOLUTE is selected

## Top Mode

The top level measurement can be calculated according to several parameters. This button selects which one is to be used. There are four selections.

1. HistMode calculates the top level from a regular histogram.
2. HistMean calculates the top level from a mean histogram.
3. MinValue takes the maximum data point as the base level.
4. An arbitrary top level can be input by the user with AbsLevel. With this last selection, an additional function key (Top Level) is defined, assignable to the knob, to select the user's desired top level.

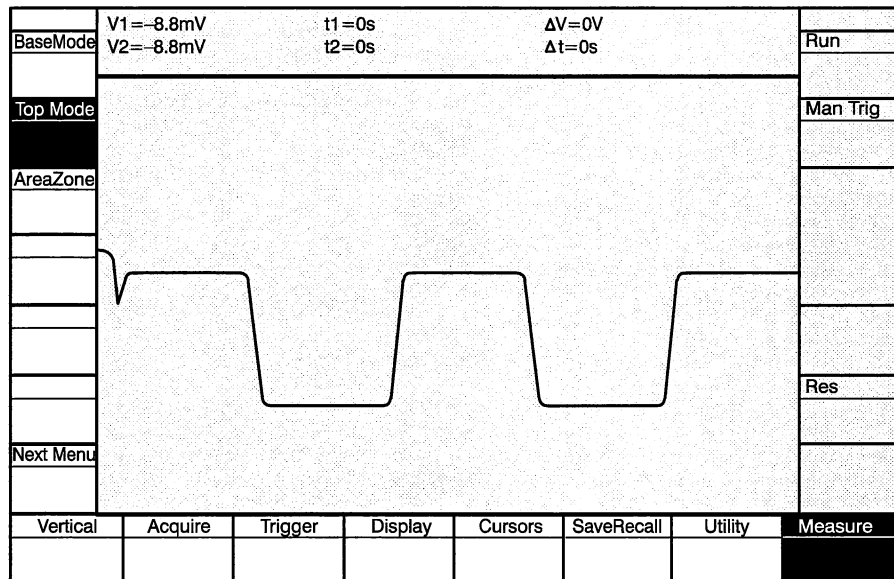

**Values:** HistMode, HistMean, MaxValue, AbsLevel

**Initial Value:** HistMode

**Interactions:** None

**GPIB Command:** TOPMODE METHOD:{ HISTOGRAM | HISTOMEAN | MAXIMUM | ABSOLUTE}  
 TOPMODE LEVEL: <NRx> (\*)  
 TOPMODE?  
 TOPMODE? METHOD  
 TOPMODE? LEVEL

(\*) active only when METHOD:ABSOLUTE is selected

## Area Zone

The area measurement can be calculated using several different sets of parameters. This button selects one of four possible sets.

One set (MeasZone) causes the area measurement to be based upon the setting determined by the **MeasZone** button (see above). With this selection, the endpoints of the data are determined by either the first and last acquired point in the record (Full Wfm), or by the points selected by the cursors (Cursor).

The other three sets, Proximi, Mesial, and Distal use endpoints established by the first two adjacent proximal, mesial, or distal crossing points on the waveform, respectively.

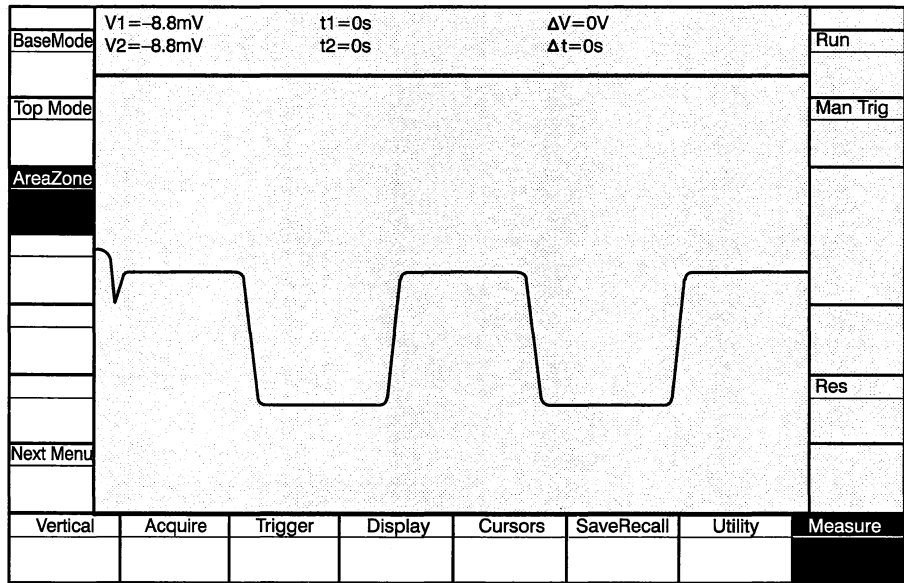

**Values:** Proximi, Mesial, Distal, MeasZone

**Initial Value:** MeasZone

**Interactions:** None

**GPIB Command:** AREAZONE { PROXIMAL | MESIAL | DISTAL | MEASZONE }  
AREAZONE?

## Level Mode

This key selects the units for the proximal, mesial, and distal selection functions (see below). Units can be either Percent or AbsLevel.

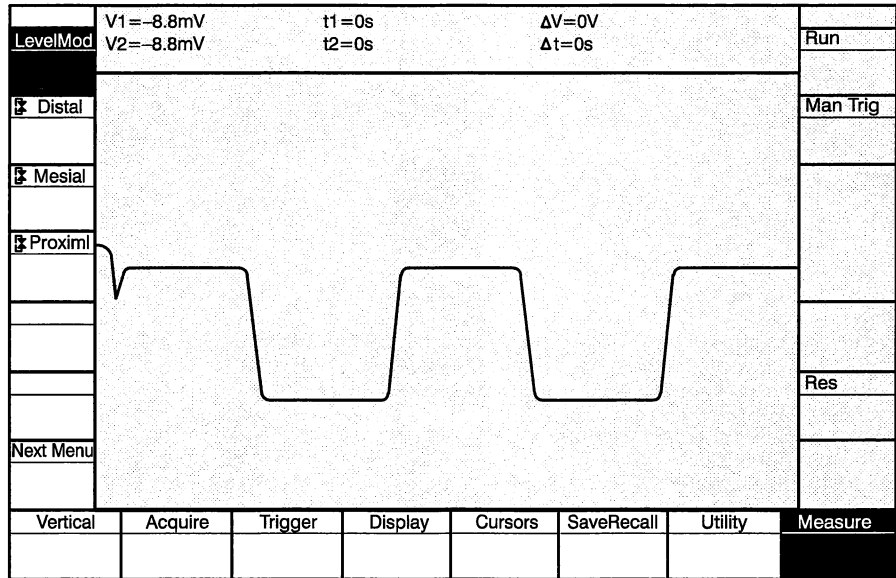

**Values:** Percent or absolute

**Initial Value:** Percent

**Interactions:** Affects the proximal, mesial, and distal selection inputs and readouts.

**GPIB Command:** LEVMODE { PERCENT | ABSOLUTE }  
LEV MODE?

## Distal Level

The selected distal level influences the result of other measurements, and therefore distal level is user selectable. This button assigns the distal level selection function to the knob. Units are determined by the **Level Mode** button (see above).

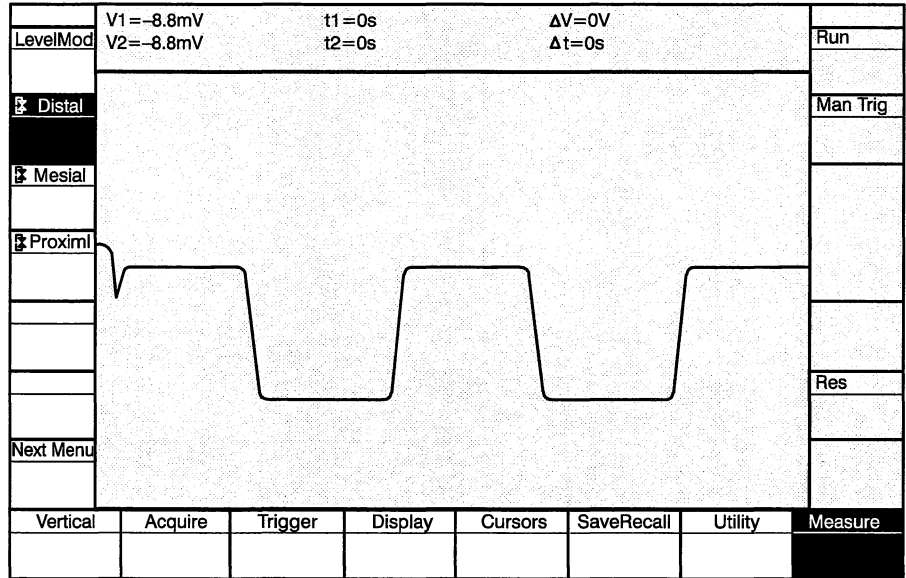

**Interactions:** None

**GPIB Command:** DISTLEVEL PERCENT: <NRx>  
 DISTLEVEL LEVEL: <NRx>  
 DISTLEVEL?  
 DISTLEVEL? PERCENT  
 DISTLEVEL? LEVEL



## Mesial Level

The selected mesial level influences the result of other measurements, and therefore mesial level is user selectable. This button assigns the mesial level selection function to the knob. Units are determined by the **Level Mode** button (see above).

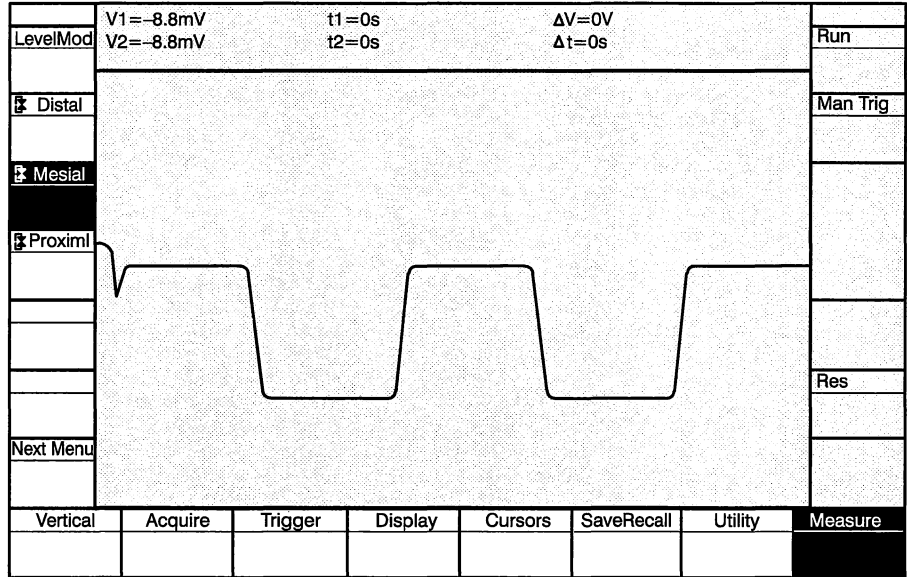

**Values:** percent : 0 to 100  
absolute level : - 1000 to +1000

**Interactions:** None

**GPIB Command:** MESLEVEL PERCENT: <NRx>  
MESLEVEL LEVEL: <NRx>  
MESLEVEL?  
MESLEVEL? PERCENT  
MESLEVEL? LEVEL

## Proximal Level

The selected proximal level influences the result of other measurements, and therefore proximal level is user selectable. This button assigns the proximal level selection function to the knob. Units are determined by the **Level Mode** button (see above).

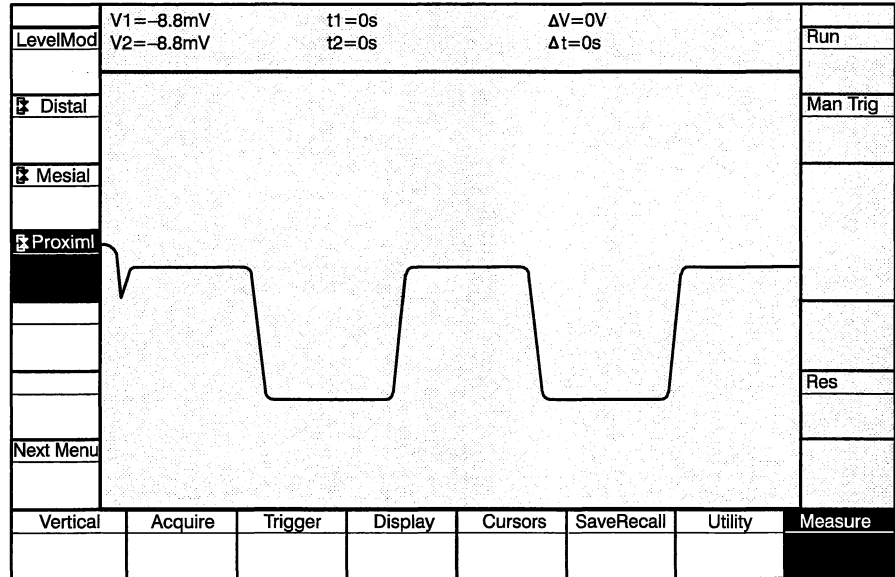

**Values:** percent : 0 to 100  
absolute level : -1000 to +1000

**Interactions:** None

**GPIB Command:** PROXLEVEL PERCENT: <NRx>  
PROXLEVEL LEVEL: <NRx>  
PROXLEVEL?  
PROXLEVEL? PERCENT  
PROXLEVEL? LEVEL

This page contains measurement related GPIB commands that have no front panel counterpart.

```
<mslist> ::= { MAXIMUM | TOP | DISTAL | MESIAL | PROXIMAL | BASE
              | MINIMUM | PK_PK | BASEABER | TOPABER | RISE |
              RISESLEW | FALL | FALLSLEW | WIDTH | PERIOD |
              FREQUENCY | AREA | BASETOP | MEAN | RMS }
```

RESULTS? [<mslist>[,<mslist>...]]

This query only command returns the values of the indicated measurements. If no links are provided, the current results of ALL measurements are returned.

UNITS? [<mslist>[,<mslist>...]]

This query only command returns the units of the indicated measurements. If no links are provided, the current units of ALL measurements are returned.

<mslist>?

The current result of the individual measurement is returned. Note that the query "RESULTS? <mslist>" is equivalent to "<mslist>?".

```
CROSS? [PRISE:<NRx>, PFALL: <NRx>, DRISE: <NRx>,
        DFALL:<NRx>,MRISE <NRx>, MFALL <NRx>, MPERIOD: <NRx>,
        MAXLOC: <NRx>, MINLOC <NRx>]
```

This query only command returns all the crossing values and related information calculated and used in the most recent measurement cycle.

## Measurement Functions

# Specifications

# Specifications

---

## Performance Conditions

This specification applies when the following conditions are true:

- The instrument is calibrated at an ambient temperature between +20° C and +30° C.
- The instrument has been running for at least 20 minutes (minimum warm-up period).

## Specifications

Specifications are verifiable by qualitative or quantitative limits that define the measurement capabilities of the instrument.

For environmental specifications, the test result is highly dependent on the procedure used. For verification of environment performance, refer to the listed government/industry documents for test methods. Tektronix internal verification procedures and in some cases more stringent requirement for performance, are contained in the listed standards. Tektronix standards may be provided upon request.

Under MIL-T-28800D, the instrument is classified as Type III, Class 5, with exceptions. Only those requirements from MIL-T-28800D listed in these specifications apply. Nonoperating specification means the principal power switch on the rear panel is off, or the power cord is disconnected.

## Characteristics

Characteristics qualitatively or quantitatively describe the typical behavior or operation of the instrument.

## Recommended Calibration Interval

To ensure accurate measurements, check the performance of this instrument every 2000 hours of operation or every 12 months, whichever comes first. In addition, replacement of components may necessitate readjustment of the affected circuits.

It is recommended that the internal calibration be performed if the temperature varies more than 5° C since the last internal calibration.

## Electrical Specifications

The electrical specifications for the SCD1000 and SCD5000 are listed in Table 4-1. The specifications apply to both instruments unless stated otherwise.

**Table 4-1: Electrical Specifications**

Feature	Specification
<b>Vertical System (SCD1000)</b>	
$\Delta$ Volts Accuracy (1 kHz or lower)	
10% to 90% full-scale signal	
within $\pm 5^\circ$ C of calibration temperature	$\pm(1\% + 0.003 \times \text{range})$
$0^\circ$ C to $40^\circ$ C; calibrated at $20^\circ$ C to $30^\circ$ C	$\pm(2.5\% + 0.005 \times \text{range})$
Offset Accuracy	$\pm(2.0\% + 0.02 \times \text{input range})$
Low-frequency Linearity	1% full-scale or less, of compression or expansion for a 25% of full-scale center-of-range signal, when the offset is anywhere within 10 to 90% of full-scale range.
Frequency Response (HF $-3$ dB)	At least 71% of 10 MHz gain at 1 GHz
Common Mode Rejection Ratio	
Full-scale sine wave signal on each channel for same range and coupling	At least 20:1 DC to 50 MHz
CHA and CHB RMS Noise (referred to input)	$0.003 \times \text{range}$
ADD (with INVERT off)	$0.006 \times \text{range}$
<b>Vertical System (SCD5000)</b>	
$\Delta$ Volts Accuracy (1 kHz or lower)	
10% to 90% full-scale signal	$\pm 2\%$ of range
Low Frequency Linearity	2% full-scale or less, of compression or expansion for a 25% of full-scale center-of-range signal, when the offset is 10 to 90% of full-scale range.
Offset Accuracy	$\pm(2.0\% + 0.02 \times \text{input range})$
Frequency Response (HF $-3$ dB)	
SCD5000	At least 71% of 10 MHz gain at 4.5 GHz
SCD5000 Opt. 01	At least 71% of 250 MHz gain at 3.0 GHz

**Table 4-1: Electrical Specifications (Cont.)**

<b>Feature</b>	<b>Specification</b>
<b>Horizontal System</b>	
Accuracy	
10% to 90% of time window	
within 5° C of calibration temperature	±3%
0° C to 40° C; calibrated at 20° C and 30° C	±5%
<b>Trigger System</b>	
Sensitivity (sine wave)	
Channel A or B Inputs (SCD1000)	0.05 × range, DC to 250 MHz 0.15 × range, 250 MHz to 1 GHz
Internal Trigger (SCD5000 Opt. 01)	0.05 × range, 50 kHz to 50 MHz 0.15 × range, 50 MHz to 500 MHz 0.35 × range, 500 MHz to 1 GHz
External Input	50 mV, DC to 50 MHz 150 mV, 50 MHz to 500 MHz 350 mV, 500 MHz to 1 GHz
Sensitivity (Pulse)	
0.5 ns half amplitude duration pulse	
External input (SCD5000)	150 mV <sub>p-p</sub>
<b>Calibrator</b>	
Amplitude Accuracy	
Absolute	±(0.1% + 1 mV)
Δ (Delta), for each pair of amplitudes with equal absolute values	±0.2%
Timing Accuracy	±0.1%



**Table 4-1: Electrical Specifications (Cont.)**

Feature	Specification
<b>CRT Operating Parameters</b>	
<b>Writing Speed</b>	
SCD1000 conditions: writes a sine wave of at least 1 GHz in a single sweep after 1 hour of operation with proper adjustment of intensity, focus and CRT background. Performance is derated by 50% below 10° C.	90% full-scale
With CRT background = 0%	80% full-scale
SCD5000 conditions: writes a sine wave of at least 4.5 GHz in a single sweep after 1 hour of operation with proper adjustment of intensity, focus, and CRT background. Performance is derated by 50% below 10° C.	50% full-scale
With CRT background = 0%	25% full-scale
<b>Geometry</b>	
Correction off (10% to 90% of range; 10% to 90% of window)	
SCD1000	±4% of range
SCD5000	±5% of range
Correction on (correction run at current instrument settings)	
	±1% of range

## Electrical Characteristics

The electrical characteristics for the SCD1000 and SCD5000 are listed in Table 4-2. The characteristics apply to both instruments unless stated otherwise.

**Table 4-2: Electrical Characteristics**

Feature	Characteristic
<b>Vertical System (SCD1000)</b>	
Input Range	100 mV to 10 V full-scale in a 1, 2, 5 sequence
Offset Range	$\pm 2.5 \times$ input range
Offset Resolution	$0.05 \times$ input range (101 steps)
Low Frequency Limit ( $-3$ dB)	
AC Coupled	1 kHz or less from $50 \Omega$ source
Step Response	
Calculated from BW	
Rise time	$\leq 0.35$ ns calculated from BW ( $0.35/BW$ )
Channel Isolation	
Test on 100 mV range with other channel driven $0.8 \times$ full-scale on 1 V range. Ratio=Ampl.(driven channel)/Ampl. (undriven channel)	At least 40:1 DC to 1 GHz
Input Characteristics	
Maximum Input Voltage (AC or DC Coupled)	$5 V_{RMS}$ (0.5 W) or 0.25 W-sec pulses not exceeding 25 V peak
Maximum Input Voltage (AC Coupled)	$\pm 100$ V (DC + peak AC). Signals of more than 25 V peak must be connected with coupling OFF so the coupling capacitor precharges.
Input Protection Disconnect Threshold	$5 V_{RMS}$ DC to 100 MHz, typical
Input Resistance	
Power-off & Disconnect	$500 \text{ k}\Omega \pm 10\%$
DC Coupling within $\pm 5^\circ$ C of calibration temperature	$50 \Omega \pm 0.25 \Omega$
AC Coupling	$50 \Omega \pm 1 \Omega$ in series with nominally $2.2 \mu\text{F}$

**Table 4-2: Electrical Characteristics (Cont.)**

<b>Feature</b>	<b>Characteristic</b>
<b>Vertical System (SCD1000) (Cont.)</b>	
VSWR	
100 mV range	< 1.45:1 10 MHz to 1 GHz
200 mV to 10 V range	< 1.25:1 10 MHz to 1 GHz
Input Bias Current	
0 V offset, 100 mV range	≤ 10 μA
0° C to 50° C, calibrated at 20° C to 30° C	≤ 50 μA
Delay match between channels same range and coupling	100 ps
<b>Vertical System (SCD5000)</b>	
Input Range	
SCD5000	5 V full-scale
SCD5000 Opt. 01	10 V full-scale
Offset Range	
SCD5000	±4 V
SCD5000 Opt. 01	±8 V
Offset Resolution	0.05 × input range (33 steps)
Input Characteristics	
Maximum input voltage	5 V <sub>RMS</sub> (0.5 W) or 0.25 W-sec pulses not to exceed 25 V <sub>p-p</sub>
Input Resistance	50 Ω ± 1.0 Ω (Option 01: 50 Ω ± 1.5 Ω)
VSWR	≤ 1.5:1 for frequencies ≤ 3.5 GHz (Option 9E ≤ 1.7:1)
<b>Horizontal System</b>	
Window Range	5 ns to 100 μs in a 1, 2, 5 sequence
Gate Output (BNC connector)	
Output Voltage	2.4 to 5 V high level, 0 to 0.5 V low level
Polarity	Low during sweep
Output Drive	Source 400 μA into 2 V, sink 100 mA

**Table 4-2: Electrical Characteristics (Cont.)**

<b>Feature</b>	<b>Characteristic</b>
<b>Horizontal System (Cont.)</b>	
Trigger to Sweep Start (SCD5000)	≤ 50 ns
Pretrigger Time	
5 ns time window (SCD1000 and SCD5000 Opt. 01)	≥ 2 ns
<b>Trigger System</b>	
Jitter	
500 mV <sub>p-p</sub> square wave, rise time ≤ 1 ns	≤ 30 ps RMS
Trigger Level	
Accuracy	
SCD1000 CHA, CHB, or ADD	±(2% + 0.05 × vertical range)
SCD5000 Option 01 Input	±(10% + 500 mV)
External Input	±(10% + 50 mV)
Range (SCD1000)	
CHA, CHB or ADD (AC)	±vertical range
CHA, CHB or ADD (DC)	±(vertical range/2) + offset
External Input	±1.0 V
Range (SCD5000)	
External Input	±0.5 V
Internal Input (Opt. 01)	±5 V
Resolution (201 steps) SCD1000	
CHA, CHB, or ADD (AC)	0.01 vertical range
CHA, CHB, or ADD (DC)	0.005 vertical range
External Input	10 mV
Resolution (201 steps) SCD5000	
External Input	5 mV
Internal Input (Opt. 01)	50 mV
Slope	Positive or negative

**Table 4-2: Electrical Characteristics (Cont.)**

Feature	Characteristic
<b>Trigger System (Cont.)</b>	
Delay (when operated within 5° C of temperature where internal calibration was last performed)	
Accuracy	±(3% of time window + 1 ns)
Coupling	
Channel A or B (SCD1000)	DC or AC. Triggering sensitivity is reduced below 2 kHz when AC coupled.
External Input	AC
Internal Input (SCD5000 Opt. 01)	DC
External Trigger Input	
Maximum Safe Input	DC component: 100 VDC
SCD1000	AC component: 0.2 watt average, 25 V <sub>p-p</sub> (3 V <sub>RMS</sub> )
SCD5000	AC component: 0.5 watt average, 25 V <sub>p-p</sub> (5 V <sub>RMS</sub> )
Input Impedance	Nominally 0.1 μF in series with 50 Ω ±5%
Delay Range	0 to 900% of the acquired time window
<b>Digitizer System</b>	
Vertical Resolution	11 bits for centroided data (up to 14 with averaging). Raw target (linear data) provides multiple 9 bit resolution data, each with independent 6 bit intensity data for each time increment.
Horizontal Resolution	256, 512, or 1024 points
Maximum Acquisition Recycle Rate Display off, Repeat Mode on	4 acquisitions/second for 256 point waveforms 2 acquisitions/second for 512 point waveforms 1 acquisition/second for 1024 point waveforms
Opt. 1P (≤20% of target pixel area written. Data transfer must be DL mode)	10 acquisitions/second for 512 point waveforms, Auto Advance acquisition mode.
Acquisition Completion Time	Time to recognize a completed acquisition (1024 point waveform with <20% of the target area written): ≤ 160 ms with Option 1P; ≤ 50 ns with Option 2F.

**Table 4-2: Electrical Characteristics (Cont.)**

<b>Feature</b>	<b>Characteristic</b>
<b>Calibrator</b>	
Amplitude Range	
SCD1000	±2.5, ±2.0, ±0.8, ±0.4, ±0.2, ±0.08, ±0.04, 0 VDC
SCD5000	±4.0, ±3.0, ±2.0, ±1.0, ±0.8, ±0.4, ±0.2, ±0.1, 0 VDC
Timing	
Amplitude	
SCD1000	≥ 100 mV <sub>p-p</sub> into 50 Ω, reduced to 50 mV <sub>p-p</sub> at 4 ns period
SCD5000	≥ 2 V <sub>p-p</sub> into 50 Ω; reduced to 1 V <sub>p-p</sub> at 4 ns period
Period	4 ns to 80 μs in a 4-8-16-40 sequence
Offset	
SCD1000	600 mV ±100 mV
SCD5000	1 V ±500 mV
<b>Video Output</b>	
Type	640 × 400 pixel resolution, compatible with TTL input of multi-sync video monitors
<b>Auxiliary Inputs and Outputs</b>	
Rear Panel	
IEEE-488 Connector	24-pin female located on rear panel. Meets specification IEEE-488-1978
Arm In	A negative-going edge input enables triggering when External arm is selected. If Arm is held low, triggering is enabled when the Acquire State is RUNNING. The input is pulled up to +5 V through a 4.7 K resistor.
Input High Level	≥ 3.5 V, ≤ 5.5 V
Input Low Level	≥ 0 V, ≤ 1.0 V
Input Delay	≤ 15 μs (minimum time between arm and trigger)
Pulse Width	Will not arm in ≤ 5 μs. Will arm in ≥ 10 μs
Arm In Connector	BNC type

**Table 4-2: Electrical Characteristics (Cont.)**

<b>Feature</b>	<b>Characteristic</b>
<b>Auxiliary Inputs and Outputs</b>	
Option 2F	(High Speed Data Output)
HSDO Connector	DB37 type. Mating connector 3M 3357–9237; cable 3M 3659/37. Signal level TTL
ACQ–CONT Connector	BNC type. Signal level TTL
Option 9E	(SCD 5000 only)
Input Connector	N Female
Calibration Output Connector	BNC
Trigger Input Connector	N Female
Output Connector	N Female
Termination	N type: 50 $\Omega$ , 2 watt (Tektronix Part No. 015–0647–00)
VSWR	Specification change: $\leq 1.7:1$ DC to 3.5 GHz (with Tektronix 015–0647–00 termination)
<b>Power</b>	
AC Line Power	
Voltage	Selected by rear panel switch 90 to 132 $V_{RMS}$ 180 to 250 $V_{RMS}$
Line Frequency	48 to 440 Hz
Power Consumption	250 W typical
Line Current	4.6 amps maximum at 90 V, 50 Hz line
Fuse Rating	115 V operation: 6 A, 250 VAC, normal blow 230 V operation: 6 A, 250 VAC, normal blow

## Physical Characteristics

The physical characteristics for the SCD1000 and SCD5000 are listed in Table 4-3.

**Table 4-3: Physical Characteristics**

Feature	Characteristic	
Dimensions		
Height	178 mm (7 inches)	
Width	483 mm (19 inches)	
Depth	724 mm (28.5 inches) without display unit	
Recommended rack depth	794 mm (31.25 inches) with display unit	
Weight		
Net	SCD1000	58 lbs
	SCD5000	50 lbs
	SCD5000 with Opt. 01	56 lbs
Shipping	31.75 kg (70 lbs.)	
Cooling Type	Forced air circulation	
Airflow	Internal airflow is approximately 100 CFM at fan voltage (8 V). Airflow direction is intake from sides, exhaust at rear, and is not reversible. Air flow is regulated, based on internal temperature of the power supply.	
Clearance		
Sides	51 mm (2 inches)	
Rear	25 mm (1 inch)	
Top	3 mm (0.125 inches)	
Rear	38 mm (1.5 inches)	



## Environmental Characteristics

The environmental characteristics for the SCD1000 and SCD5000 are listed in Table 4-4. The characteristics apply to both instruments unless stated otherwise.

**Table 4-4: Environmental Characteristics**

<b>Feature</b>	<b>Characteristic</b>
Temperature without Display	
Operating & Nonoperating	Meets MIL-T-28800D, Type III, class 7
Operating	0° C to +40° C
Nonoperating	-40° C to +70° C
Temperature with Display	
Operating & Nonoperating	Meets MIL-T-28800D, Type III, class 7
Operating	+5° C to +40° C
Nonoperating	-20° C to +60° C
Humidity without Display	
Operating & Nonoperating	Meets MIL-T-28800D, Type III, class 5
Operating	Up to 85% relative humidity, noncondensing, up to 40° C
Nonoperating	20% to 90% relative humidity, noncondensing
Humidity with Display	
Operating & Nonoperating	Meets MIL-T-28800D, Type III, class 7
Operating	30% to 85% relative humidity, noncondensing
Nonoperating	20% to 90% relative humidity, noncondensing
Altitude	
Operating & Nonoperating	Exceeds MIL-T-28800D, Type III, class 5
Operating	4.5 km (15,000 ft.) maximum
Nonoperating	15 km (50,000 ft.) maximum
Vibration	
Operating	Meets MIL-T-28800D, Type III, class 5; tested per paragraph 4.5.5.3.1 0.015 in. peak-to-peak, 10 to 55 Hz sine wave; total test time is 75 minutes.

**Table 4-4: Environmental Characteristics (Cont.)**

<b>Feature</b>	<b>Characteristic</b>
<b>Shock</b>	
Nonoperating	Meets MIL-T-28800D type III, class 5; tested per paragraph 4.5.5.4.1 30 g (1/2 sine), 11 ms duration, 3 shocks in each direction along 3 major axes, 18 total shocks
<b>Bench Handling</b>	
Operating	Meets MIL-T-28800D type III, class 5; tested per paragraph 4.5.5.4.3 Withstands 12 drops from 10 cm (4 inches)
<b>Packaged Product</b>	
Vibration	Meets ASTM D999-75, method A, paragraph 3.1g (NSTA Proj. 1A-B-1)
Shock	Meets ASTM D775-61, method 1, paragraph 5 (NSTA Proj. 1A-B-2)
<b>Electrostatic Immunity</b>	
No disruption or degradation of performance	15 kV, 500 pF capacitor discharged in series with 100 Ω resistor
<b>Electromagnetic Compatibility</b>	
U.S.	Within limits of FCC Regulation Part 15, Subpart J, class A. In compliance with: MIL-STD-461B, CE01 Part 2, narrow band. CE03 Part 4; CE07 Part 2; CS01 Part 2. CS02 Part 2; CS06 Part 5; limited to 300 V. RE01 Parts 5 and 6. RS03 Part 2, limited to 1 GHz when tested per MIL-STD-462 test procedures.
Germany	Complies with acceptance criteria of VDE 0871/6.78 class B



# Options

The SCD family has several orderable options. They are listed in Table 5-1. Some of these options are field installable using a Tektronix Field Upgrade Kit available from Tektronix.

The SCD digitizers are shipped with a detachable power cord as ordered by the customer. Descriptive information about the international power cords is provided in *Section 2, Preparation for Use*. Table 5-1 lists the Tektronix part number for the available power cords.

**Table 5-1: SCD Digitizer Power Options**

<b>Option Name</b>	<b>Description</b>	<b>Tektronix Part Number</b>
A1	Universal European Power Cord (2.5 m) 220 V, 16 A, 50 Hz	161-0066-09
A2	United Kingdom Power Cord (2.5 m) 240 V, 13 A, 50 Hz	161-0066-10
A3	Australian Power Cord (2.5 m) 240 V, 10 A, 60 Hz	161-0066-11
A4	North American Power Cord (2.5 m) 240 V, 15 A, 60 Hz	161-0066-12
A5	Switzerland Power Cord (2.5 m) 220 V, 10 A, 50 Hz	161-0154-00

**Table 5-2: SCD1000 Digitizer Options**

<b>Option Name</b>	<b>Description</b>
1E	TEKPROBE™, Level II Interface Input Connectors
01	Delay Line and Internal Trigger Pickoff
1P	Fast Waveform Capture increases waveform captures from one to ten 512 point waveforms per second.
2E	SMA-type input connectors
2F	High speed 16-bit data output (HSDO) & battery backed-up linear array
9E	Rear panel Signal input and output and Trigger input.
20	Delete LCD Display Unit

---

## Option 2F

### High Speed Data Output (HSDO)

Option 2F provides nonvolatile storage (battery backup) of Linear Array Data and is an alternative to GPIB output for Curve and Linear Array Data.

HSDO data encoding is absolute binary. The Option 2F interface allows SCD1000 and SCD5000 instruments to transfer waveform data encoded in 16-bit words at a 2 MHz maximum rate. With the GPIB command HSDO FORmat, the 16-bit words may be transferred 1 byte at a time, high byte first (MSB). The HSDO port is output enabled with the GPIB HSDO STATE and HSDO DUMp: CONTInuous commands, or by a combination of internal and external switch settings.

The HSDO port provides high speed data transfer to the Tektronix 9503/9504 Fast Data Cache system and to interfaces such as Digital Equipment Corporation DRV 11–B or Hewlett Packard GPIO (see special cabling requirements in Tables 3-9 and 5-4). Most computers, including MS-DOS based, support this type of parallel port interface.

### Connectors

---

HSDO	(High Speed Data Output)
Type	DB 37 Mating connector: 3M 3357–9237 Cable: 3M 3659/37
Signal Level	TTL

---

ACQ-CONT	(Acquire Continuous Data)
Type	BNC
Signal Level	TTL

---

## Dump Continuous Mode

Dump Continuous repeatedly outputs acquisition data from the HSDO port until specifically inactivated, or a new acquisition is initiated. This allows external control of the acquisition process. Dump Continuous transfers Linear Array data exclusively, and is activated by the GPIB command HSDO DUMp: CONTInuous. This mode may be implemented manually (by a certified service technician only) as follows. Set DIP switch 2 on the instrument rear panel to closed; set DIP switch 2 to closed and DIP switch 3 to open on the Processor board. If Dump Continuous is activated manually, the instrument will power-up in the Hold Next acquisition state; the HSDO transfer mode will be 1 (Handshake).

When activated, Dump Continuous mode loops continuously, transferring the contents of the Linear Array over the HSDO port. The loop may be interrupted by setting the states on two HSDO pins. Setting HS STAT 3 (pin 28) low causes an acquisition to occur followed by continuous transmission of data; setting HS STAT 2 (pin 27) low restarts continuous transmission of data from its start point.

The rear panel ACQ-CONT BNC allows the same control as HSDO connector HS STAT 3 (pin 28), permitting acquisition control from another source.

Two output pins provide the Controller with digitizer and HSDO transmission status, HS CNTL 0 (pin 20) and HS CNTL 1 (pin 21). HS CNTL 0 is high when data is to be read from the digitizer. HS CNTL 1 toggles for each new data transmission.

The following is an example of how the HS STAT and HS CNTL pins may be used to retransmit or force an acquisition while in Continuous Dump mode.

To Retransmit:

5. Halt HSDO port handshake data
6. Note the state of HS CNTL 1 (pin 21)
7. Set HS STAT 2 (pin 27) low
8. Monitor HS CNTL 1, await toggle state
9. Following HS CNTL 1 toggle, return HS STAT 2 high
10. Resume HSDO port handshake data output

To Reacquire:

1. Halt HSDO port handshake data
2. Set HS STAT 3 (pin 28) low
3. Wait for HS CNTL 0 (pin 20) to transition high (digitizer enabled, ACQUIRE STATE: HLDNxt)
4. Set HS STAT 3 high
5. Wait for HS CNTL 0 to transition low (acquisition complete, ACQUIRE STATE: STOP) and HS CNTL 1 (pin 21) to toggle. The instrument is ready for data transmission.

## 6. Resume HSDO port handshake data output

When an acquisition is initiated (and before the trigger), HS STAT 3 ignores requests for data retransmission and acquisition aborts. Retransmission requests are not accepted until acquisition is complete.

### Handshake Transfer Mode

Two HSDO port communication protocols are available, Handshake and Synchronous.

**Transfer Mode 1 (Handshake)** — Data is output to an external device (the external device initiates the transfer). This mode is full handshake compatible with Digital Equipment Corporation DRV 11–B and Hewlett Packard GPIO.

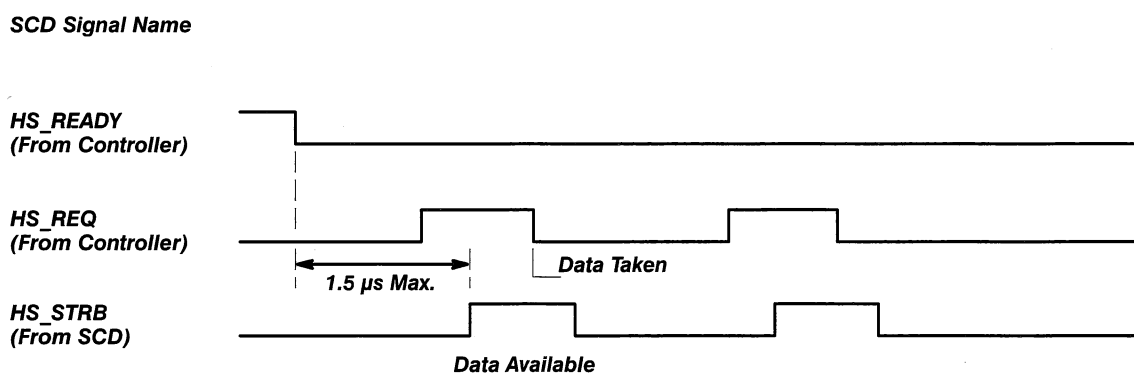

Figure 5-1: Handshake Mode Timing Diagram

**Transfer Mode 2 (Synchronous)** — Data is transferred to a custom interface. The interface accepts data on a clock edge generated by the SCD. No handshake is used.

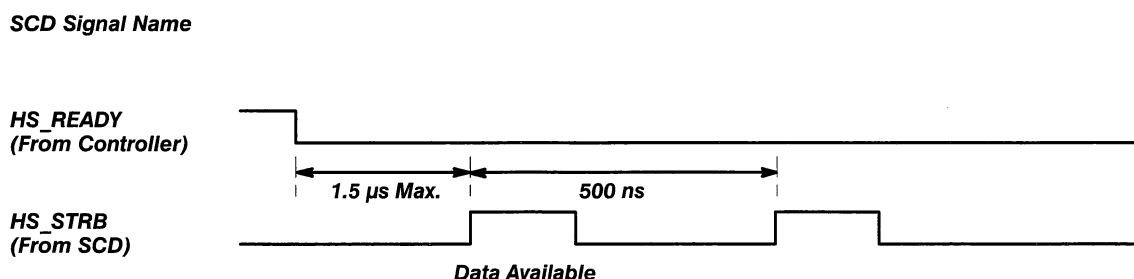

Figure 5-2: Synchronous Mode Timing Diagram

## GPIB Commands

Option 2F adds the following GPIB commands:

Header	Link	Argument	Description
HSDO	DUMp	OFF	Sets the HSDO dump mode to off.
		CONTInuous	Repeatedly outputs acquired data until a new acquisition is requested; following a new acquisition, the new data is repeatedly output, etc. Refer also to the Option 2F alternate interface description in this manual. Factory setting: OFF Example: HSDO DUMp: CONTInuous Interactions: HSDO STATE forced to OFF HSDO MODE forced to 1 (Handshake)
		FORmat: BYTE	HSDO interface outputs one 8-bit byte at a time.
		WORd	All 16 bits of the HSDO interface used for output. Transfers 2 bytes (one waveform data point) at a time. Byte output is in the LSB of the interface, MSB first. Factory setting: WORd Example: HSDO FORmat: WORd
MODE:	<NRx>	NRx = 1: selects HSDO Handshake mode for data output to external devices (DRV 11–B and GPIO). NRx = 2: selects HSDO Synchronous mode for data output to external devices. Data is transferred to a custom interface accepting data on a clock edge generated by the SCD. No handshake used. Limits: 1 or 2 Factory setting: 1 Example: HSDO MODE: 1	
STATe:	OFF	Inactivates the HSDO (the GPIB port is used for waveform transfers).	
	ALL	The HSDO outputs all memory regardless of valid data quantity (262144 bytes fixed data length).	
	VALid	The HSDO outputs only valid data (variable data length depends on information acquired). Factory setting: OFF Example: HSDO STATe: VALid	



## GPIB Query Commands

Option 2F adds the following query selections:

Header	Link	Argument	Description
HSDO?			Returns all HSDO settings. Example: HSDO? Response: HSDO STATE: OFF, MODE: 1, FORMAT: WORD, LENGTH: 12555, DUMP: OFF
	DUMp		Returns HSDO Dump settings. Example: HSDO? DUMp Response: HSDO DUMP: OFF
	FORmat		Returns HSDO Format settings. Example: HSDO? FORmat Response: HSDO FORMAT: WORD
	LENgth		Query only; returns the length of HSDO port data in bytes. If HSDO: STATE is set to VALid, the length of data sent is returned. Example: HSDO? LENgth
	MODe		Returns the HSDO Mode setting. Example: HSDO? MODe Response: HSDO MODE: 1
	STATe		Returns the HSDO State setting. Example: HSDO? STATe Response: HSDO STATE: OFF, MODE: 1, FORMAT: WORD, LENGTH: 12555, DUMP: OFF

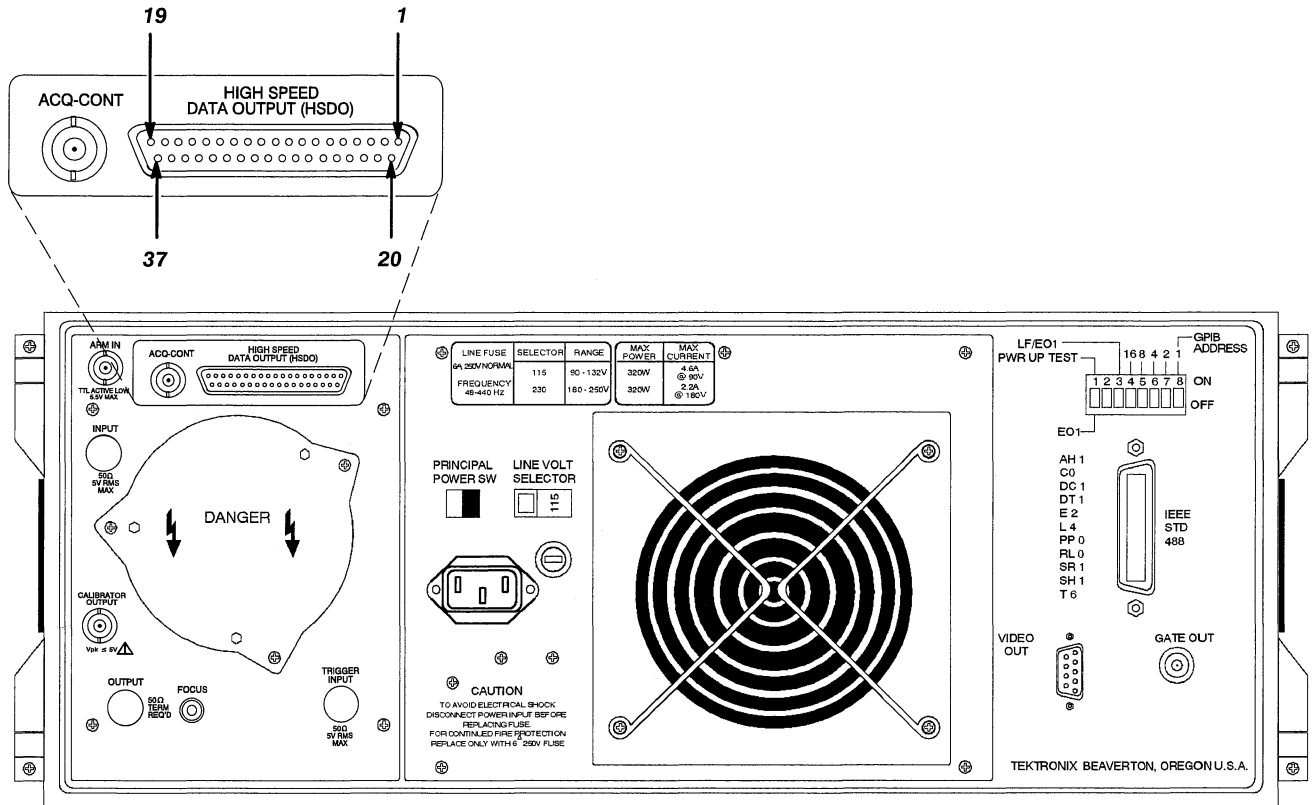

Figure 5-3: Location of HSDO Rear Panel Connector (SCD1000)

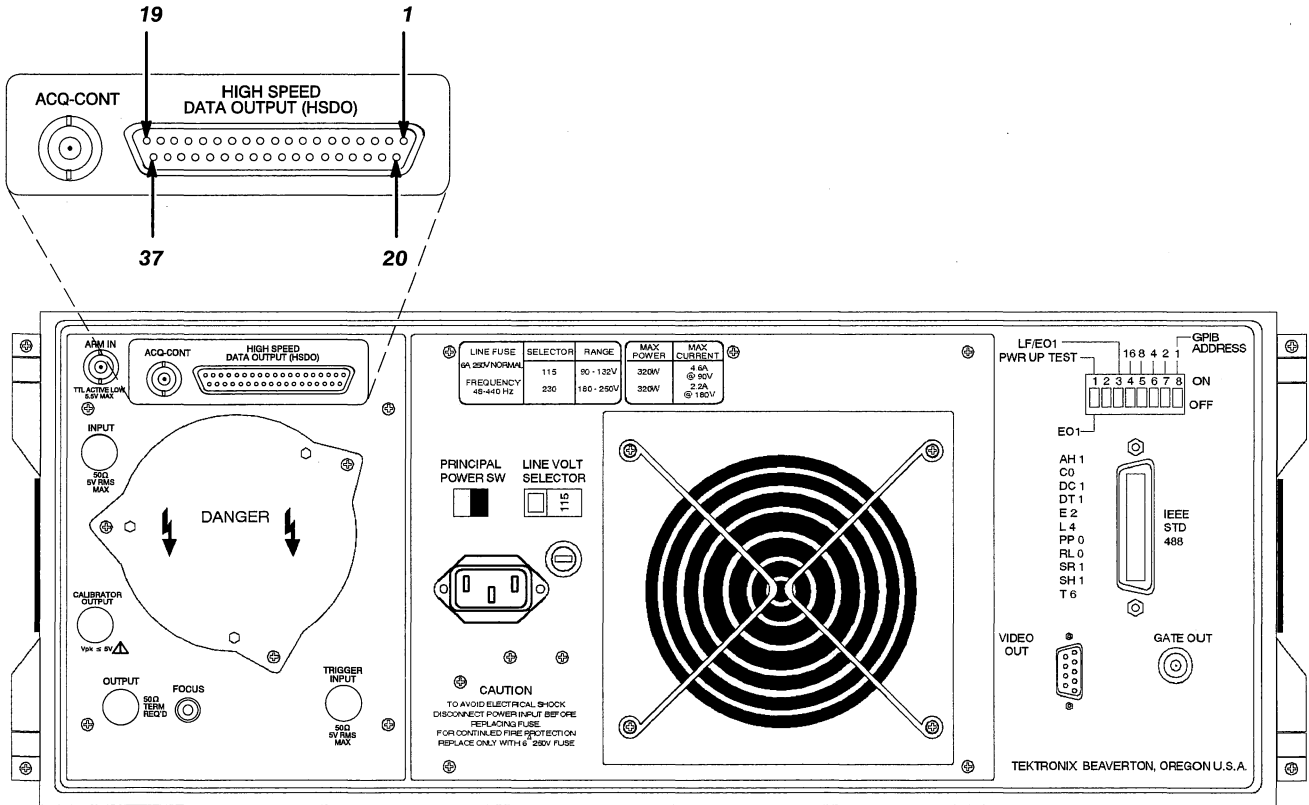

Figure 5-4: Location of HSDO Rear Panel Connector (SCD5000)

**Table 5-3: SCD Series to DEC DRV11-B Cabling**

SCD Pin	Signal Name	Direction (Pin to Pin)	DRV11-B Pin	Signal Name	Description
1	HSDO0	→	J2-UU	00 IN H	LOW BYTE DATA
2	HSDO1	→	J2-SS	01 IN H	LOW BYTE DATA
3	HSDO2	→	J2-PP	02 IN H	LOW BYTE DATA
4	HSDO3	→	J2-MM	03 IN H	LOW BYTE DATA
5	HSDO4	→	J2-KK	04 IN H	LOW BYTE DATA
6	HSDO5	→	J2-HH	05 IN H	LOW BYTE DATA
7	HSDO6	→	J2-EE	06 IN H	LOW BYTE DATA
8	HSDO7	→	J2-CC	07 IN H	LOW BYTE DATA
9	HSDO8	→	J2-DD	08 IN H	HIGH BYTE DATA
10	HSDO9	→	J2-FF	09 IN H	HIGH BYTE DATA
11	HSDO10	→	J2-JJ	10 IN H	HIGH BYTE DATA
12	HSDO11	→	J2-LL	11 IN H	HIGH BYTE DATA
13	HSDO12	→	J2-NN	12 IN H	HIGH BYTE DATA
14	HSDO13	→	J2-RR	13 IN H	HIGH BYTE DATA
15	HSDO14	→	J2-TT	14 IN H	HIGH BYTE DATA
16	HSDO15	→	J2-VV	15 IN H	HIGH BYTE DATA
17	HSREQ	←	J2-B	BUSY H	Request for next word
18	HSREADY	←	J1-F	READY H	LOW indicates DRV11 is ready
19	HS_STRB	→	J1-B	CYCLE REQ H	Latch data on rising edge
20	HS_CNTL 0	→	J1-L	STATUS A	Contains mode of SCD Series instrument
21	HS_CNTL 1	→	J1-R	STATUS B	Contains mode of SCD Series instrument
22	VCC	→	J2-F	A00H	Tied to +5 V through a 1 K resistor
23	HSSYSRES	→	J2-D	ATTN H	Terminates DMA transfers
24	C1	→	J2-T	C1 H	Must be HIGH for DATA transfer to DRV11. Driven high by SCD Series instrument.
25	C0	→	J2-N	C0 H	Must be LOW for DATA transfer to DRV11. Connected to ground by SCD Series instrument.
26	HS_STAT 0	←	J2-V	FNCT 1 H	Not used

**Table 5-3: SCD Series to DEC DRV11-B Cabling (Cont.)**

<b>SCD Pin</b>	<b>Signal Name</b>	<b>Direction (Pin to Pin)</b>	<b>DRV11-B Pin</b>	<b>Signal Name</b>	<b>Description</b>
27	HS_STAT 1	←	J2-R	FNCT 2 H	See Continuous Dump mode
28	HS_STAT 2	←	J2-LK	FNCT 3 H	See Continuous Dump mode
29	HSOK	→			Not used
30	HSATTN	←			Not used
31	DGND				Logic Ground
32	DGND				Logic Ground
33	DGND				Logic Ground
34	DGND				Logic Ground
35	DGND				Logic Ground
36	VCC		J2-J	WC INC EN H	
37	VCC		J2-J	BA INC EN H	

**Table 5-4: SCD Series to HP GPIO Cabling**

SCD Pin	Signal Name	Direction (Pin to Pin)	GPIO Pin	Signal Name	Description
1	HSDO0	→	42	DI0	LOW BYTE DATA
2	HSDO1	→	41	DI1	LOW BYTE DATA
3	HSDO2	→	40	DI2	LOW BYTE DATA
4	HSDO3	→	39	DI3	LOW BYTE DATA
5	HSDO4	→	38	DI4	LOW BYTE DATA
6	HSDO5	→	37	DI5	LOW BYTE DATA
7	HSDO6	→	36	DI6	LOW BYTE DATA
8	HSDO7	→	35	DI7	LOW BYTE DATA
9	HSDO8	→	34	DI8	HIGH BYTE DATA
10	HSDO9	→	33	DI9	HIGH BYTE DATA
11	HSDO10	→	32	DI10	HIGH BYTE DATA
12	HSDO11	→	31	DI11	HIGH BYTE DATA
13	HSDO12	→	30	DI12	HIGH BYTE DATA
14	HSDO13	→	29	DI13	HIGH BYTE DATA
15	HSDO14	→	28	DI14	HIGH BYTE DATA
16	HSDO15	→	27	DI15	HIGH BYTE DATA
17	HSREQ	←	19	PCTL	LOW means not ready. HIGH means request.
18	HSREADY	←		DGND	Not used. From SCD Series instrument pin 35.
19	HS_STRB	→	44	PFLG	Latch data; clear PCTL on rising edge.
20	HS_CNTL 0	→	47	STI0	Contains mode of SCD Series instrument
21	HS_CNTL 1	→	48	STI1	Contains mode of SCD Series instrument
22	VCC	→			Not used
23	HSSYSRES	→	46	EIR	Interrupt host
24	C1	→			Not used
25	C0	→			Not used
26	HS_STAT 0	←	22	CTL0	Not used
27	HS_STAT 1	←	23	CTL1	See Continuous Dump mode

**Table 5-4: SCD Series to HP GPIO Cabling (Cont.)**

<b>SCD Pin</b>	<b>Signal Name</b>	<b>Direction (Pin to Pin)</b>	<b>GPIO Pin</b>	<b>Signal Name</b>	<b>Description</b>
28	HS_STAT 2	←			See Continuous Dump mode
29	HSOK	→	45	PSTS	The HSDO mode is ready and OK
30	HSATTN	←	21	PRESET	Not used
31	DGND	↔	1	LOGIC GND	
32	DGND	↔	18	LOGIC GND	
33	DGND	↔	24	LOGIC GND	
34	DGND	↔	26	LOGIC GND	
35	DGND	↔	49	LOGIC GND	
36	VCC	↔			
37	VCC	↔			
			43	SAFETY GND	
			25	SAFETY GND	

---

## Option 9E (SCD5000 Only)

### Rear Panel Inputs

Option 9E relocates the Input, Calibrator Output, and Trigger Input connectors to the instrument rear panel, providing better cabling in some applications. In addition, the input signal passes through the CRT vertical deflector and appears at the rear panel Output connector. This configuration allows for easy replacement of input termination (should a serious over voltage occur) and cascading of instrumentation. A 50  $\Omega$  termination of the Output connector is required for normal instrument operation (Option 9E instruments are factory configured with a 50  $\Omega$ , 2 watt termination). All SCD specifications for the inputs and Calibrator Output remain unchanged, with the exception of those listed in *Specifications* below.

#### **WARNING**

*Incorrect termination of the OUTPUT connector adversely affects Input VSWR, bandwidth, and transient response.*

### Specifications

---

#### Connectors:

Input	N female
Calibration Output	BNC
Trigger Input	N female
Output	N female

---

Termination	50 ohm, 2 watt, N type (Tektronix part number 015-0647-00)
-------------	--

---

VSWR	With 015-0647-00 termination: $\leq 1.7:1$ DC to 3.5 GHz (SCD5000 specification change)
------	--

---

#### **NOTE**

*Option 9E is available for SCD Series 5000 instruments only, and is not available in combination with Option 01 (Delay Line with Internal Trigger Pick-Off) or Option 2E (SMA connectors).*



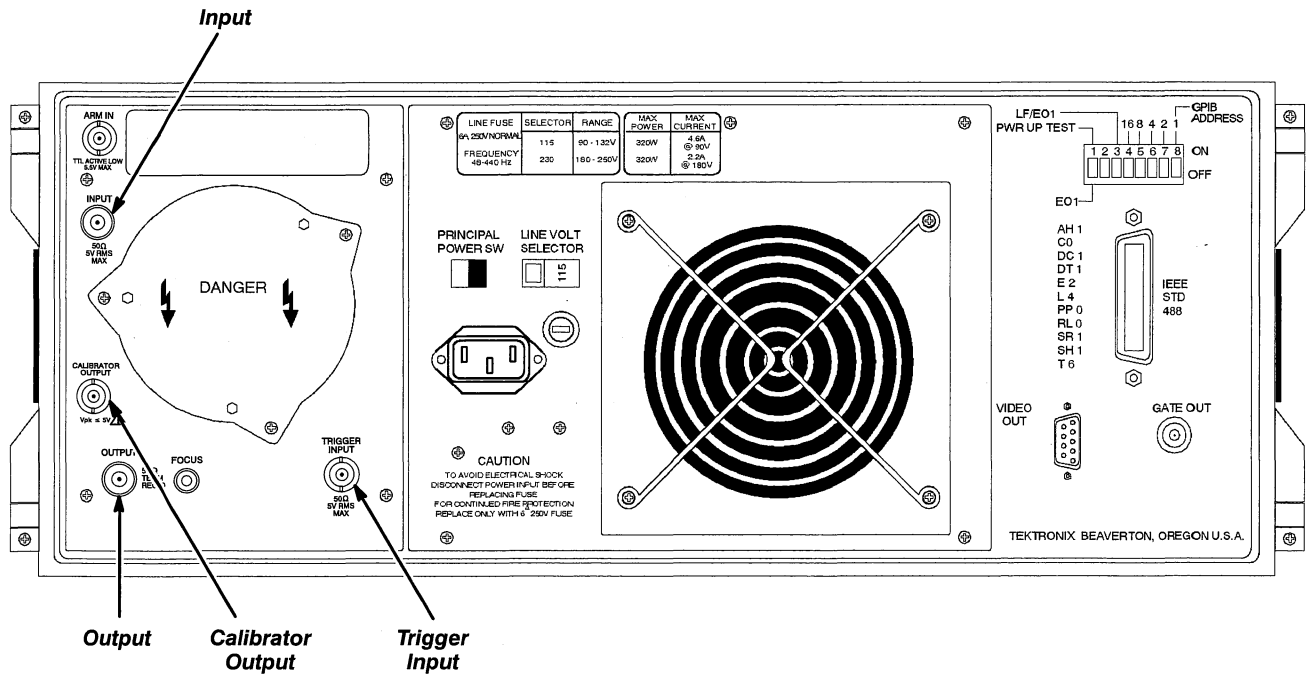

Figure 5-5: Location of Option 9E Rear Panel Connectors (SCD5000 only)

## **MANUAL CHANGE INFORMATION**

At Tektronix, we continually strive to keep up with the latest electronic developments by adding circuit and component improvements to our instruments as soon as they are developed and tested.

Sometimes, due to printing and shipping requirements, we can't get these changes immediately into printed manuals. Hence, your manual may contain new change information on the following pages.

A single change may affect several sections. Since the change information sheets are carried in the manual until all changes are permanently entered, some duplication may occur. If no such change pages appear following this page, your manual is correct as printed.

