TEK DSA 600
SERIES

Part No. 070-8181-00
Product Group 47

THE
DSA 601A
& DSA 602A
DIGITIZING SIGNAL
ANALYZERS

**User
Reference**

*Please check for CHANGE INFORMATION
at the rear of this manual.*

First Printing FEB 1991

Tektronix
COMMITTED TO EXCELLENCE

Instrument Serial Numbers

Each instrument manufactured by Tektronix has a serial number on a panel insert or tag, or stamped on the chassis. The first letter in the serial number designates the country of manufacture. The last five digits of the serial number are assigned sequentially and are unique to each instrument. Those manufactured in the United States have six unique digits. The country of manufacture is identified as follows:

B010000	Tektronix, Inc., Beaverton, Oregon, USA
E200000	Tektronix United Kingdom, Ltd., London
J300000	Sony/Tektronix, Japan
H700000	Tektronix Holland, NV, Heerenveen, The Netherlands

Instruments manufactured for Tektronix by external vendors outside the United States are assigned a two digit alpha code to identify the country of manufacture (e.g., JP for Japan, HK for Hong Kong, etc.).

Tektronix, Inc., P.O. Box 500, Beaverton, OR 97077

Copyright © Tektronix, Inc., 1991. All rights reserved. Tektronix products are covered by U.S. and foreign patents, issued and pending. The following are registered trademarks: TEKTRONIX, TEKPROBE, TEK, SCOPEMOBILE and



Printed in U.S.A.

Centronics® is a registered trademark of Data Computer Corporation.

Epson® is a registered trademark of Epson America, Inc.

HP LaserJet is a product of the Hewlett-Packard Company.

HP ThinkJet is a product of the Hewlett-Packard Company.

IBM® is a registered trademark of International Business Machines Corporation.

Lotus is a registered trademark of Lotus Development Company.

Proprinter® is a registered trademark of International Business Machines Corporation.

About This Manual



This is the front panel reference manual for the DSA 601A and DSA 602A Digitizing Signal Analyzers. If you are a new user, first read the *DSA 601A and DSA 602A Tutorial* to become familiar with the DSA. Use this User Reference to answer specific questions about operation of the DSA.

The first section, *At a Glance*, presents quick get-acquainted information and a map of the various menus. Each menu is accompanied by pointers into the detailed second section, *In Detail*.

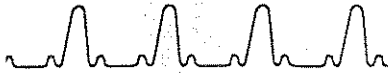

Related Manuals

Other manuals that complete the documentation set for the DSA 601A and DSA 602A Digitizing Signal Analyzers are:

- The *DSA 601A and DSA 602A Tutorial* gives step-by-step instructions that demonstrate basic operation of the DSA.
- The *DSA 601A and DSA 602A QuickStart Package* is a complete learning laboratory, including a signal generating board and a workbook. A videotape for the *DSA 601A and DSA 602A QuickStart Package* is included with your DSA. These show you how to use the power of the DSA to get the types of measurements you need. The QuickStart Package is available at no charge, but you need to mail in the postage-paid card included with the DSA.
- The *DSA 601A and DSA 602A Programmer Reference* describes the commands used to program the DSA through GPIB or RS-232-C interfaces.
- The *DSA 601A and DSA 602A Quick Reference* is a manual that briefly describes how to perform common tasks with your DSA, perform any function available from the front panel, and it includes a listing of programming commands.
- The *DSA 601A and DSA 602A Service Reference* provides information to maintain and service components of the DSA, and provides a complete board-level description of DSA operation.

Contents

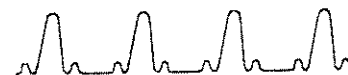

About This Manual	i
At a Glance	1
Front Panel and Plug-in Units	2
Rear Panel	4
Display and Touch Panel	6
Icons	8
Knobs, Knob Menu, and Keypad Menu	10
Major Menu Buttons	12
Waveform Major Menu	14
Trigger Major Menu	16
Measure Major Menu	18
Store/Recall Major Menu	20
Stored Waveform Scan Major Menu	22
Utility 1 Major Menu	24
Utility 2 Major Menu	26
Utility 3 Major Menu	28
In Detail	31
Acquisition	33
Act on Delta	53
Audio Feedback	63
Autoset	65
Averaging and Enveloping	71
Calibrator	77
Color Display	79
Cursors	83
Diagnostics	91
Disk Drive	97
Display Intensity	107
Display Persistence	109
Enhanced Accuracy	111
Fast Fourier Transforms	113
GPIB Parameters	135
Graticules	139
Hardcopy	143
Horizontal Controls	153
Initialization	159
Instrument Configuration	163



Labeling	165
Measurements	173
Plug-in Units	201
Power-On	209
Probes and Cables	213
Record Length	221
RS-232-C Parameters	225
Stored Settings	229
Stored Waveforms	239
Time and Date	251
Triggering	253
Utilities	269
Vectored Waveforms	273
Vertical Controls	277
Waveform Definition and Management	281
Windows	297
XY Waveforms	301
Appendix A: Accessories	305
Appendix B: Specifications	309
Appendix C: Acquisition Operation	319
Appendix D: Algorithms	331
Appendix E: Hardcopy Defaults	371
Appendix F: Messages	373
Appendix G: Safety	375
Glossary	379
Index	391
Change Information	

At a Glance

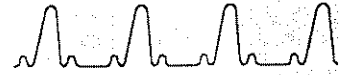

This section presents general operating instructions and a road-map of the menu system. All menus are shown in this section. Once you find a menu of interest, you will be directed to the page in the In Detail section that discusses that feature.

You may want to consult the *DSA 601A and DSA 602A Tutorial* for a complete introduction.

Front Panel and Plug-in Units	2
Rear Panel	4
Display and Touch Panel	6
Icons	8
Knobs, Knob Menu, and Keypad Menu	10
Major Menu Buttons	12
Waveform Major Menu	14
Trigger Major Menu	16
Measure Major Menu	18
Store/Recall Major Menu	20
Stored Waveform Scan Major Menu	22
Utility 1 Major Menu	24
Utility 2 Major Menu	26
Utility 3 Major Menu	28

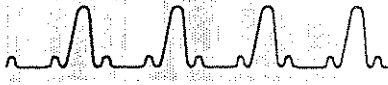

The display shows the waveforms and the menus, which you touch to activate. See page 6.

The major menu buttons let you select the major menu that will appear at the bottom of the display. See page 12.

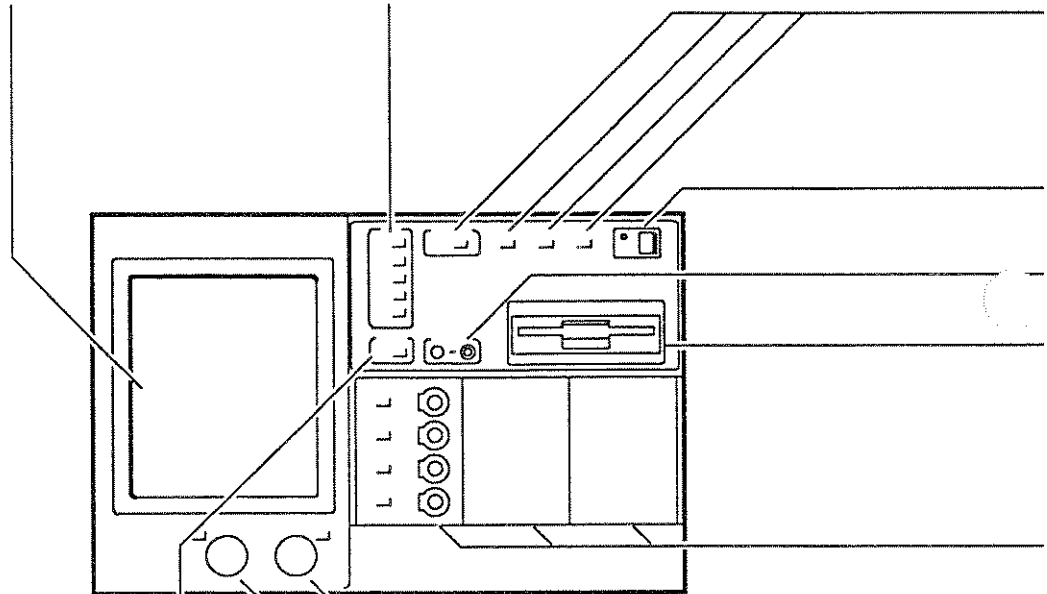

The **TOUCH PANEL ON/OFF** button lets you turn off the touch panel so that you can point to the display without inadvertently making menu selections.

The two knobs control many functions of the DSA. You set the knobs to control specific functions when you make menu selections or touch icons. The knobs are described on page 10.

Front Panel and Plug-in Units

The **DIGITIZER** button stops and starts waveform acquisition – see page 39. The **AUTOSET** button sets the DSA parameters for a waveform display – see page 65. The **HARDCOPY** button prints a copy of the display – see page 143. The **ENHANCED ACCURACY** button calibrates the system for greatest accuracy – see page 111.

Use the **ON/STANDBY** switch as the power switch once the DSA is installed. See page 209.

The **CALIBRATOR** output provides a known signal for calibrating probes and input cables. See page 217.

The **DISK DRIVE** enables storing waveforms and settings to 3.5 inch PC compatible floppy disks. See page 97.

You install plug-in units or blank covers in the plug-in compartments. See page 201.

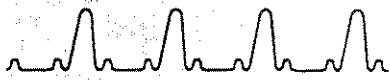

Power line controls include the **LINE VOLTAGE SELECTOR SWITCH**, the fuse, the power connector, and the **PRINCIPAL POWER SWITCH**. See page 209.

The **RS-232-C** connector allows a remote computer to control the DSA through a serial interface. See page 225.

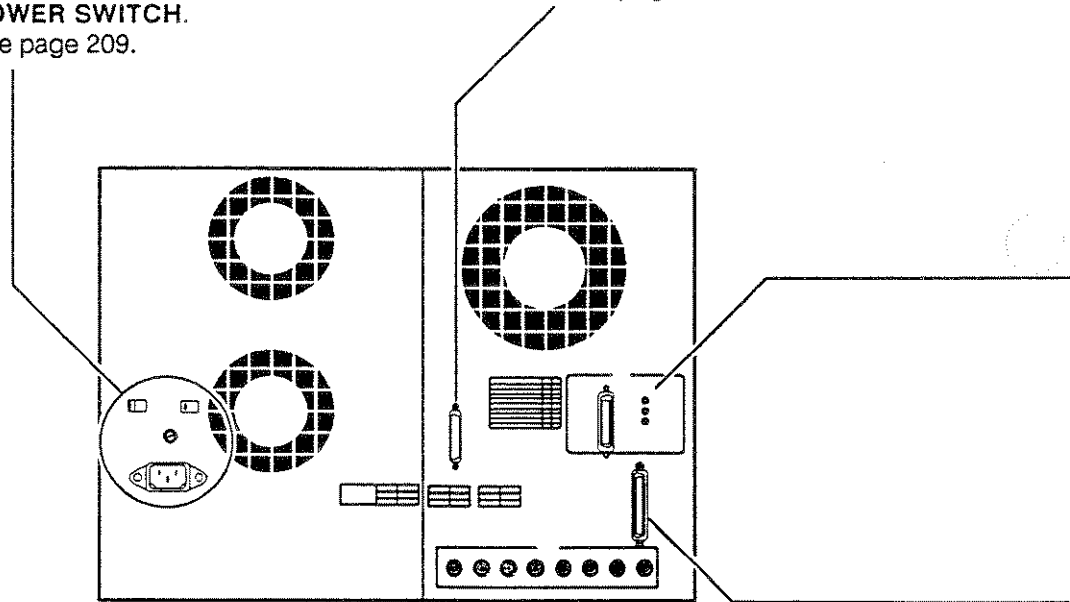

Rear Panel

The **GPIB** connector allows a remote computer to control the DSA through an IEEE STD 488 parallel interface. Three lights show the status of the parallel bus. See page 135.

The **PRINTER** connector lets you attach an Epson FX-80 or compatible printer using a Centronics interface. See page 143.



Selected waveform and unselected waveform. Axis labels and readouts apply to the selected waveform. Waveforms can be selected by touching them. See page 291.

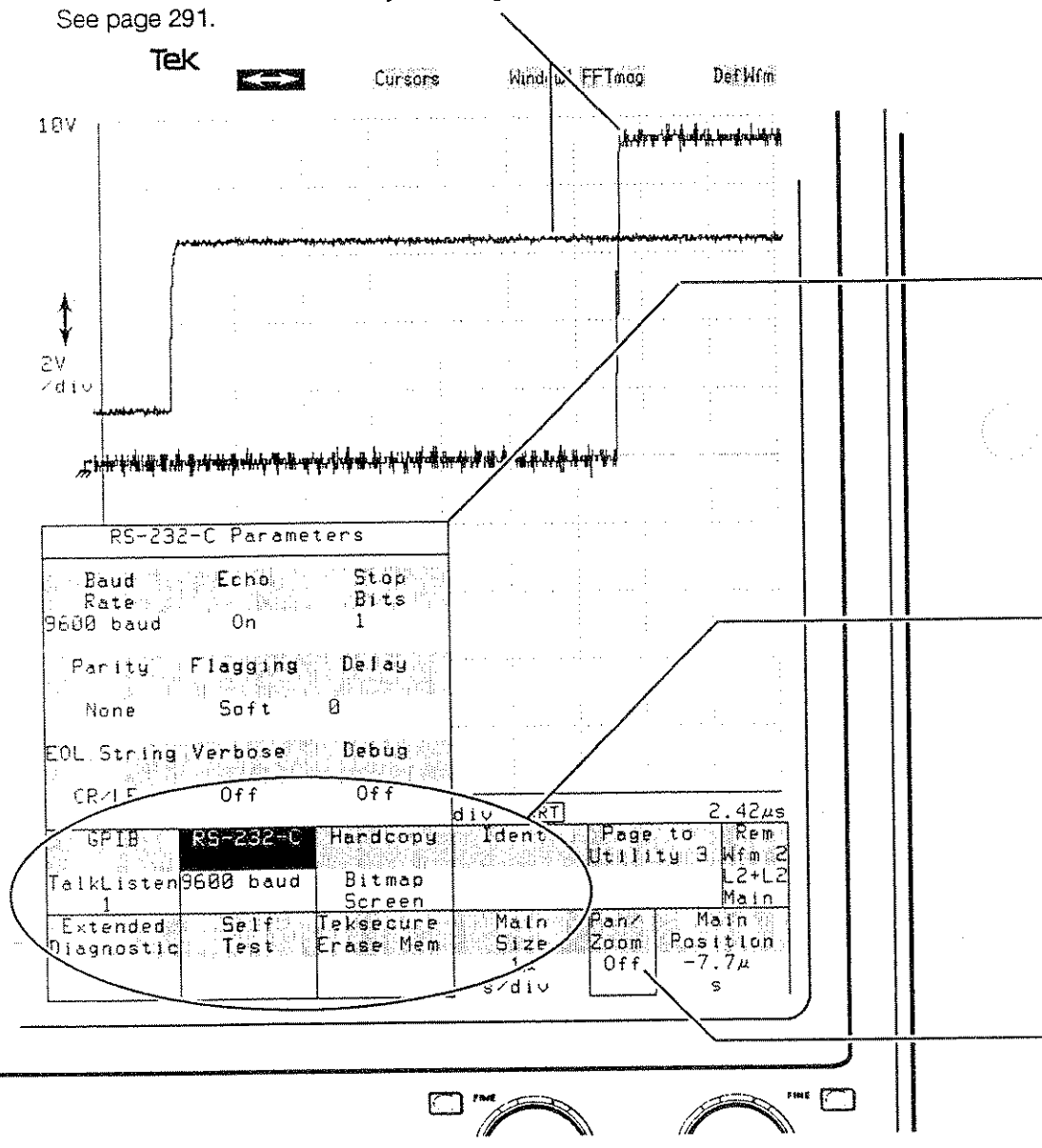

Display and Touch Panel

The display shows the output of the DSA, such as waveforms and measurement information. The display is combined with the touch panel to provide a touch menu system. Touch the selectors that are displayed in the various menus to execute those items. Each menu selector has a shaded top portion that names the selector, and a lower portion that shows the current status of the parameter that the selector controls.

RS-232-C Parameters		
Baud Rate	Echo	Stop Bits
9600 baud	On	1
Parity	Flagging	Delay
None	Soft	0
EOL String	Verbose	Debug
CR/LF	Off	Off

A pop-up menu provides a temporary dialog to let you set specific parameters. This is the **RS232C** pop-up menu, which is accessed by touching the **RS232C** selector in the Utility 2 major menu.

GPiB	RS-232-C	Hardcopy	Ident	Page to Utility 3
Talk Listen	9600 baud	Bitmap Screen		
1				
Extended Diagnostic	Self Test	Teksecure Erase Mem		

Several different major menus are available. You display and use the major menus by pressing the major menu buttons. This is the Utility 2 major menu. Touch the **RS232C** selector to display that pop-up menu. See page 12 for a description of the various major menus.

Main Size	Pan/Zoom	Main Position	Rem. Wfm
1 μ s/div	Off	-7.7 μ s	2
			L2+L2
			Main

The Knob Menu always shows the parameters the knobs are currently assigned to control (top two selectors). You can also use the knob menu to remove waveforms from the display. You can touch the knob labels to see the Keypad Menu, which lets you enter a numeric value for any knob-controlled parameter. See page 10.

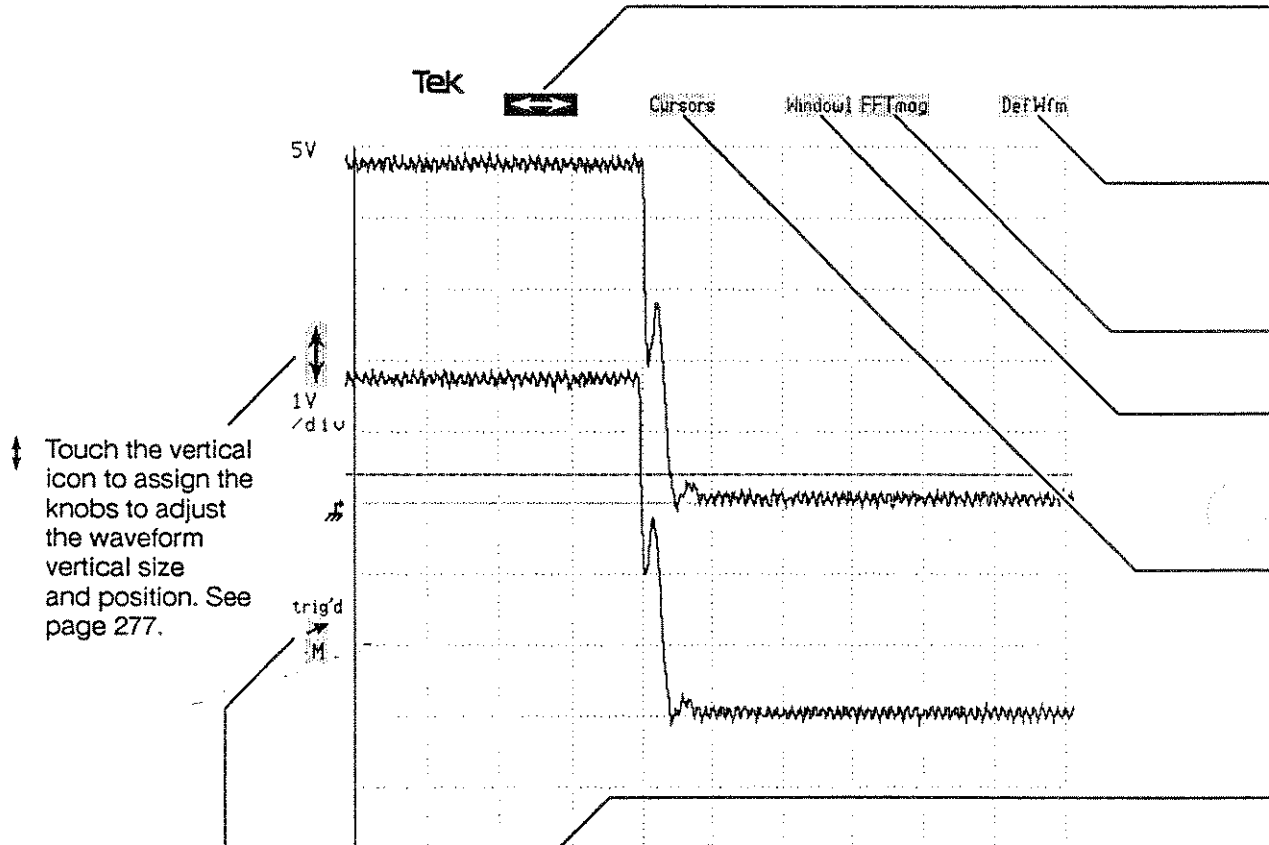

Touch the vertical icon to assign the knobs to adjust the waveform vertical size and position. See page 277.

-916ns	RemAnno	200ns/div	RT	1.084µs
Vertical Desc L2 Fast	Horizontal Desc Main 500MS/sec	Acquire Desc Continuous	Graticules	Page to All Wfms Status
Input Parameters DC 1MΩ/300MHz	FFT Control dBm Rectang	Action Del None	Main Size 200ns/div	Pan/Zoom Off
				Main Position -940ns

Touch the trigger icon to assign the knobs to adjust the trigger level. If the DSA is not triggered, !not! appears above the word trig'd. See page 253.

Touch the RemAnno icon to remove annotations from the display. This icon appears after you define annotations, and remains until they are removed. See page 187.

Icons

————— ↔ Touch the horizontal icon to assign the knobs to adjust the waveform horizontal size and position. See page 153.

————— DefWfm

Touch the define waveform icon to display a pop-up menu that lets you define a new waveform to be displayed. See page 281.

————— FFTmag

Touch the FFT magnitude icon to display the magnitude of the frequency spectrum of the selected waveform. See page 113.

————— Window1 Touch the window icon to create a new waveform that represents an enlarged portion of another waveform. See page 297.

————— Cursors

Touch the cursors icon to display bar or dot cursors for measurements of waveform values. See page 83.

————— RemCurs The **RemCurs** icon appears here after you define cursors, and remains until they are removed. Touch the **RemCurs** icon to remove the cursors from the display. See page 84.

Icons are always available, regardless of the major menu that is displayed.



The knob labels always show the knob assignments, the parameters that the knobs will control. The bottom half of each knob label shows the current value of the parameter. When you turn a knob, you will see the current value change, and you will see the change on the display and on any displayed menus that show the parameter.

This selector lets you remove a waveform from the display. First select the waveform you want removed by touching it, then touch this selector. A pop-up menu will ask you to verify the removal. See page 281.

Touch either knob label to display the Keypad Menu for that parameter.

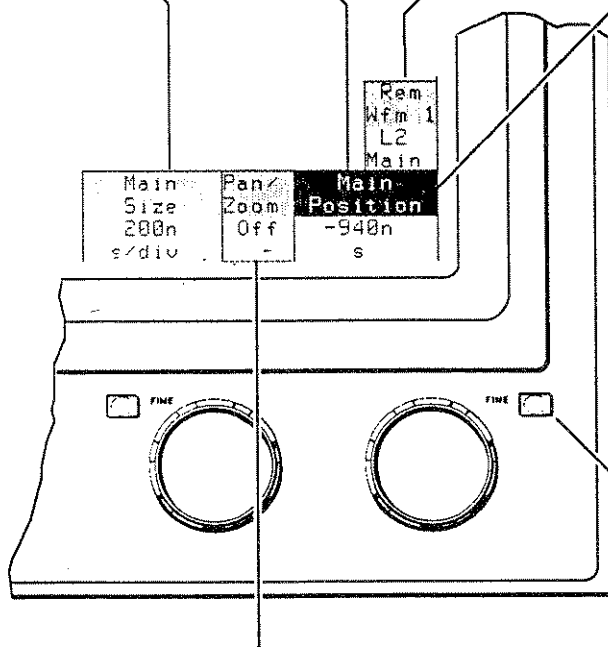

Touch the **FINE** button to change knob resolution. The **FINE** label is lighted when the knob resolution is set to Fine.

The **Pan/Zoom** selector lets you expand any part of a waveform using horizontal magnification. See page 155. When the knobs are assigned to vertical size and offset, this selector may change to provide more vertical control. See page 278.

Knobs, Knob Menu, and Keypad Menu

If you touch the wrong knob label by accident, the top two selectors let you choose the other knob parameter for Keypad Menu manipulation.

You can use the Keypad Menu to enter a numeric value for your parameter instead of turning the knob until the parameter is set. Touch number selectors as if you were typing the number, and end your entry by touching the **Enter** selector. **CHS** changes the sign of your number; **Back Space** lets you correct errors. The **p** (pico), **n** (nano), **μ** (micro), and **m** (milli) selectors let you scale your number.

Numeric Entry				& Knob Res	
Main Size		Main Pos			
Numeric Entry				Knob Res	
7	8	9	p	Coarse	1 μs
4	5	6	n	Medium	200ns
1	2	3	μ	Fine	100ns
0	.	CHS	m	Set to Min	-102.3 μ
Back Space	Enter		Set to Max		
					0
					Rem
					Wfm 1
					L1
					Main
Main Size	Pan/Zoom	Main Position			
10 μ	Off	-21.2 μ			
s/div		s			

The **Coarse**, **Medium**, and **Fine** selectors affect the knob resolution. When set to coarse, each knob click represents a greater change than when set to medium or fine.

The **Set to Min** and **Set to Max** selectors let you quickly set a parameter to either extreme of its range of adjustment.

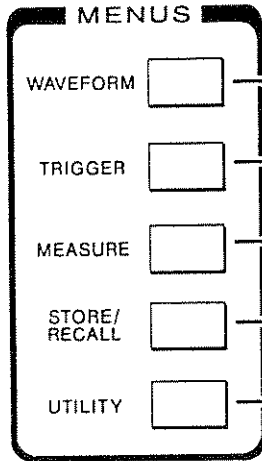

Calibrator	Modes	Probes	Color	Page to Utility 2
Initialize	Time & Date 15:12:43 11-SEP-89	Label		

GPIB	RS-232-C	Hardware	Ident	Page to Utility 3
Full System	9600 baud	Bitmap Screen		
Extended Diagnostic	Self Test	Secure Erase Mem		

The Utility 1 and Utility 2 major menus control general DSA parameters including display colors, GPIB and RS-232-C settings, and the internal clock. See pages 24 and 26.

Cursor	Type	Paired	Page to Previous Menu
1	450.0ns		
2	360.0ns		
3	488.0ns		
4	2.049ns		

The Cursors major menu controls the cursors, which are markers that you position on your waveform to make measurements. Use the **Cursors** icon to display the Cursors major menu. See page 83.

Disk Dos	Directory Dos	File Dos	Page to Utility 1

The Utility 3 major menu controls the Disk Drive including disk directories and files. See page 97.

Major Menu Buttons

Vertical Desc L2 Fast	Horizontal Desc Main 500MS/sec	Acquire Desc Continuous	Statistics	Page to All Wfms Status
Input Parameters DC 1MHz/300MHz	FFT Control dBm Rectang	Act on Delta None		

The Waveform major menu controls waveform definition, acquisition, and the plug-in units. See page 14.

IFLO Main 1V 200ns	2:1:2-3 Main 1V 200ns		Show Full Wfm Desc	Page to Single Waveform
--------------------	-----------------------	--	--------------------	-------------------------

An alternate form of the Waveform major menu, the All Wfms Status menu, can be displayed using the **Page to** selector in the Waveform major menu. Press the Waveform major menu button to alternate between this menu and the Waveform major menu. See page 14.

Trigger Select Main	Source Desc LINE OR L2	Level A Level B 1.0div 400mV	Time Holdoff 20us	Mode Auto
Coupling DC		Timer t1 2ns	Timer t2 1ms	

The Trigger major menu controls triggering. See page 16.

ΔPeak-Peak 4.960 V	ΔOver-Shoot 2.964 V	ΔRise error	Measurements	Page to Statistics Histogram
ΔSpectral Freq 7.991 ns				

The Measure major menu controls the automatic measurement system. See page 18.

Top=4V	Mean=0V	σ1=0%	Page to Measurements Menu
Ptm=-4V	RMS=0V	σ2=0%	
Lft=-71ns	PkPk=0V	σ3=0%	
Par=20ns	Hits=0	Wfms=0	
Histograms	Statistics	Compare	
Continuous	Continuous	Default	

An alternate form of the Measure major menu, the Statistics Histogram menu, can be displayed using the **Page to** selector in the Measure major menu. Press the Measure major menu button to alternate between this menu and the Measure major menu. See page 19.

Store Waveform	Recall Waveform	Delete Waveform	Disk Copy	Page to Stored Wfm Scan
Store Setting	Recall Setting	Delete Setting		

The Store/Recall major menu controls storage and recall of waveform data and DSA settings. See page 20.

Previous ST04	Scan Stop Stopped	Next ST01	Scan Rate 1 wfm/sec	Page to Store/Recall
Scan Using All Wfms	Scan from: 1 to: 4			

The Stored Wfm Scan major menu allows you to visually "scan" through a set of stored waveforms. See page 22.



Vertical Description

L1

Waveform Functions

Stored Waveforms

Adjustable Constants

Enter Desc Back Space Cancel

This pop-up menu lets you modify the waveform description of the selected waveform. See page 283.

MENUS

WAVEFORM

TRIGGER

MEASURE

STORE/RECALL

UTILITY

Vertical Desc	Horizontal Desc	Acquire Desc	Graticules	Page to
L1	Main	Continuous	Main	All Wfms
Fast	500MS/sec		Size	Status
Input Parameters	Control	Action	200n	Wz
DC	dBm	Delta	Zoom	Posi
IMQ/300MHz	Rectang	None	s/div	-94

The Page to selector displays the alternate All Wfms Status major menu. This displays the status of all waveforms on the display. See page 294.

Channel Select

L1	C1	Digitizer Filter
DC	DC	100 MHz
IMQ/300MHz	IMQ/300MHz	Off
C2	C2	
DC	DC	
IMQ/300MHz	IMQ/300MHz	
C3	C3	
DC	DC	
IMQ/300MHz	IMQ/300MHz	
L4	C4	
DC	DC	
IMQ/300MHz	IMQ/300MHz	
Impedance	Coupling	Bandwidth
50Ω	AC	20MHz
IMQ	Off	100MHz
	DC	300MHz

This pop-up menu lets you set the impedance, coupling, and bandwidth limits of plug-in amplifier input channels. See page 204.

FFT Control

FFT Windowing		Average Source Wfm	Magnitude Format
Blackman	Blackman-Harris	Off	dBm V (Linear)
Hamming	Hanning	DC Suppress Off	dBV Vrms (Linear)
Rectang	Triangular	Phase Format Wrap	dBVrms dBfund

This pop-up menu lets you control Fast Fourier Transform parameters. See page 113.

Waveform Major Menu

Display persistence controls. See page 109.

Horizontal Description				
Acquiring Timebase: Main Main Sample Interval: 2ns/point P1 Window Sample Interval: 1ns/point				
Main Record Length 1024 points		Window Record Length 1024 points		
Display Persistence		Digitizer Interleave		
<input checked="" type="checkbox"/> Normal <input type="checkbox"/> Infinite <input type="checkbox"/> Variable <input type="checkbox"/> Persist Time 1s		<input type="checkbox"/> 1GS/sec Realtime <input checked="" type="checkbox"/> Disabled		
XY Display Mode: X-Displayed Waveform				
	Wfm 1	Wfm 2	Wfm 3	Wfm 4
	L2	L2-3	L1	L1
	Main	Main	Main	Main
Displayed Waveforms				
Stored Waveforms				

Record length controls. See page 223.

Digitizer Interleave. See page 37.

XY waveform controls. See page 303.

Acquire Description	
Set S	Stop Acquire After
99%	<input type="checkbox"/> Fill Complete
Set AvgN Average N	
32	<input type="checkbox"/> Off
Set EnvN Envelope N	
32	<input type="checkbox"/> Off
<input checked="" type="checkbox"/> Trigger Subject	Single Trigger Single Sequence
Main Window	
Set Rep Trigger N Create Template	<input checked="" type="checkbox"/> Rep Trigger
1	Next Label
Page To Autostore Parameters Menu	FEPI
	Fun Acquisition
	Continuous

Averaging and enveloping controls: see page 71.
Repetitive single trigger controls: see page 41.

Conditional acquisition control. See page 38.

Delta Description				
	Wfm 1	Wfm 2	Wfm 3	Wfm 4
	L2	L2-3	L1	L1
	Main	Main	Main	Main
Displayed Waveforms				
Cancel				
Delta Actions				
Save As	Repeat	Enzyme	Total Points	Consecutive Points
Stored Wfm			1	1
Next Label	Count			
FEPI	0			
SP0	Hardcopy		Show Delta Points On Test Waveform	Status Display Delts Actions
Current Delta Description				

This pop-up menu lets you define a delta description for Act on Delta "glitch capture." See page 53.

Graticules
Create Second Graticule

Graticule controls. See page 139.



Select the Main or Window Trigger using this selector. See page 256.

Touch these selectors to assign the knobs to control the trigger level and holdoff. See page 259.

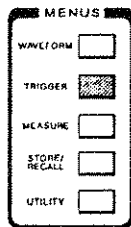

Trigger Select Main	Source Desc LI	Level 2.525V	Time Holdoff 2ns	Mode Auto
Coupling DC	Slope +	Timer t1 2ns	Timer t2 1ms	

Touch this selector to assign the knobs to control timing for extended triggering. See page 264.

Touch this selector to change the trigger slope. See page 259.

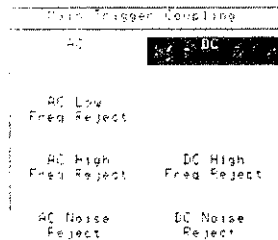

Select the coupling for the trigger signal using this pop-up menu. See page 258.

Trigger Major Menu

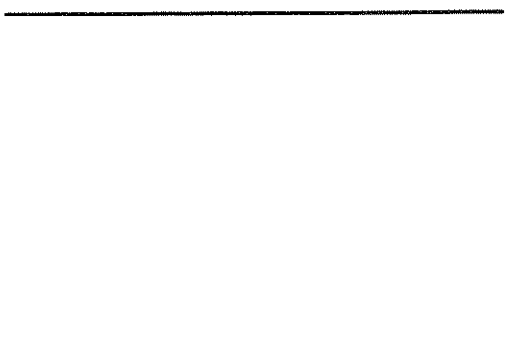

Main Trigger Source Description			
L1	C	P	Boolean Triggering
L2			NOT
			Trigger on Edge
			WHILE at Level
Line		-	Time Qualified Triggering
Trigger Bandwidth = 1 GHz			
Cancel			
Current Main Trigger Description			
L1			

Define the trigger source for the selected trigger using this pop-up menu. See page 256.

Trigger Mode
Auto Level
HUTO
Normal

Select the trigger mode using this pop-up menu. See page 263.



Touch a measurement readout to display a pop-up menu that lets you control the way the measurement is taken. See page 185.

Peak Peak	
Left Limit	Right Limit
0%	100%
-848.088ns	3.24480us
Time Mode	
relative	

Measurements					
Amplitude	Area	Energy	Timing	Frequency	Freq Domain
Max	Area	Energy	Rise	Fall	Spectral Freq
Mid	RMS		Freq- uency	Period	Spectral Mag
Min	Over Shoot		Delay	Prop- Delay	THD
Peak	Under Shoot		Cross	Width	
Gain	Energy		Duty Cycle	Phase	
Area +	Area -		Skew	Main+Win Trig Time	
Exit Menu			Clear All		

Use this pop-up menu to specify which measurements you want to take. As you select measurements, the readouts appear immediately in the unused selectors of the major menu. See page 176.

MENUS	
WAVEFORM	<input type="checkbox"/>
TRIGGER	<input type="checkbox"/>
MEASURE	<input checked="" type="checkbox"/>
STORE/ RECALL	<input type="checkbox"/>
UTILITY	<input type="checkbox"/>

Mean	Peak- Peak	Rise	Measure- Point	Page to
2.274 V	4.578 V	148.3 ns		Statistics Histogram

These six selectors are reserved for readouts of the measurements that you select. This sample menu shows that three measurements are selected. See page 173.

Measure Major Menu

This section shows histogram parameters, status and statistics.

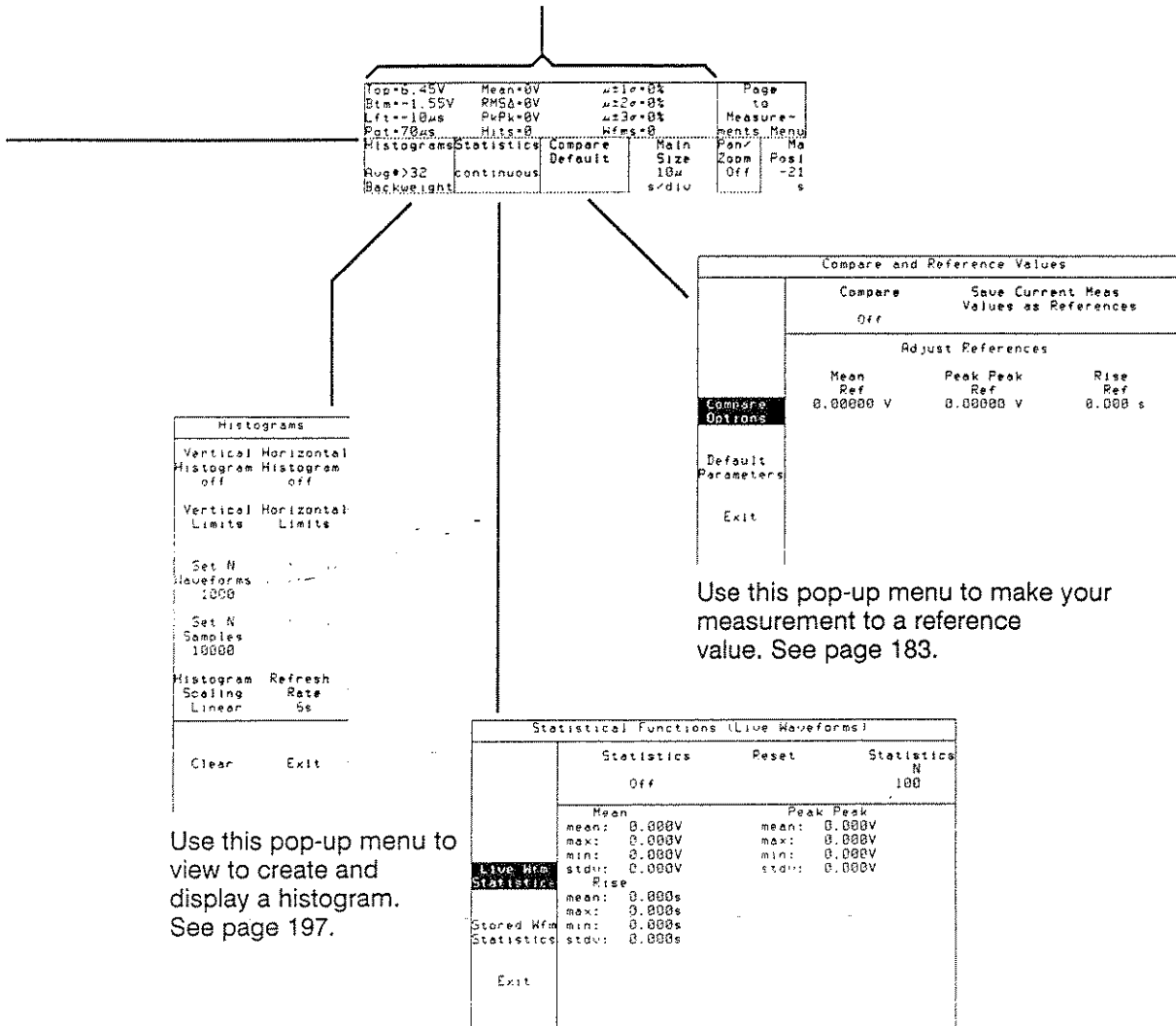

Use this pop-up menu to view to create and display a histogram. See page 197.

Use this pop-up menu to make your measurement to a reference value. See page 183.

Use this pop-up menu to view measurement statistics value. See page 183.

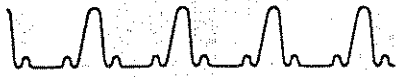

These pop-up menus let you store and recall displayed waveforms. See page 97.

Store Waveform To

RAM DISK

WFB 1

WugL11
Main
Store All Set Next
STO Index
STO1

Free Stored Wfm RAM
470816 bytes

Recall Stored Waveform From **RAM** **WFB**

STO1.WFB	STO2.WFB	STO3.WFB	STO4.WFB
9:42:20 8-OCT-90	9:42:22 8-OCT-90	9:42:22 8-OCT-90	16:09:02 12-OCT-90

MENUS

WAVEFORM

TRIGGER

MEASURE

STORE/RECALL

UTILITY

Store Waveform	Recall Waveform	Delete Waveform	Disk Copy	Page to Stored Wfm Scan
Store Setting	Recall Setting	Delete Setting		

Use the **Page to** selector or the **STORE/RECALL** button to display the Stored Waveform Scan major menu. See page 22.

Store Present Front Panel setting to **RAM** DISK

FPS 1	FPS 2	FPS 3
1	2	3

Menu Displayed with Stored Setting

Waveform	Trigger	Measure	Store/Recall	Utility 1
Single Wfm	Main			
Waveform	Trigger	Cursors	Stored Wfm Scan	Utility 2
W1 Wfm 1	Window			
Store Next	Free NonVolatile RAM	162 bytes	Set Next	FPS Index
FPS				1

This pop-up menu lets you store a DSA setting. See page 231.

Store/Recall Major Menu

Delete Waveforms				
Displayed Waveforms		Stored Waveforms		
Wfm 1	Wfm 2	ST01.WFB	ST02.WFB	ST03.WFB
Aug(L1)	ST05.WFB	9:42:20	9:42:22	9:42:22
Main		8-OCT-90	8-OCT-90	8-OCT-90
Wfm 3		ST04.WFB	ST05.WFB	
L2		16:09:02	10:36:10	
Main		12-OCT-90	23-OCT-90	

RAM **DISK**

All Waveforms

Delete displayed or stored waveforms using this pop-up menu. See page 97.

Use this menu to copy stored waveforms from RAM to DISK or from DISK to RAM. See page 250.

Copy Stored Waveforms to RAM From RAM DISK				
Starting with ST02				
Stored Waveforms		Stored Settings		
ST01.WFB	ST02.WFB	ST03.WFB	ST04.WFB	ST05.WFB
9:42:20	9:42:22	9:42:22	16:09:02	10:36:10
8-OCT-90	8-OCT-90	8-OCT-90	12-OCT-90	23-OCT-90

Set Next STO Index ST02

All Waveforms

Delete Front Panel Setting From RAM DISK		
FPS 1	FPS 2	FPS 3
1	2	3

All Settings

Recall Front Panel Setting From RAM DISK		
FPS 1	FPS 2	FPS 3
1	2	3

Initialize Setting

Sequence Front Panel Settings

Next Setting Initiated By Probe ID Button Or

Off

These pop-up menus let you recall or delete settings. See page 231.

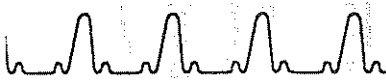

Use this selector to start or stop scanning through a sequence of stored waveforms. See page 246.

Use this selector to display the previous stored waveform in a sequence. See page 246.

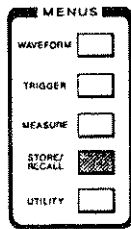

Previous ST03	Scan/Stop Stopped	Next ST01	Scan Rate 1 wfms/sec.	Page to Store/ Recall...
Scan Using All Wfms	Scan from: 1 to: 3			

Use the **Page to** selector or the **STORE/RECALL** button to display the Store/Recall major menu. See page 20.

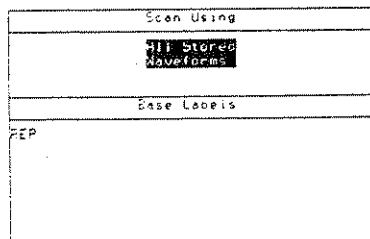

Touch this selector to assign the knobs to control the limits of the sequence of stored waveforms to scan. See page 246.

This pop-up menu lets you select a sequence of waveforms to scan on the display. See page 247.

Stored Waveform Scan Major Menu

Use this selector to display the next stored waveform in a sequence. See page 246.

Touch this selector to assign the knobs to control the rate at which stored waveforms are displayed and replaced in scanning. See page 248.

Touch this selector to create a new waveform that displays the current stored waveform in the scanning sequence. See page 246.



Use this pop-up menu to control the calibrator output. See page 77.

Calibrator BNC	
Frequency	1.024 MHz
Impedance	50 ohm
Output Amplitude	0.5000 V

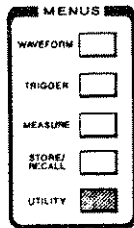

Use this selector to initialize the DSA to a known state. See page 159.

Calibrator	Modes	Probes	Color	Page to Utility 2
Initialize	Time & Date	Label		
	16:48:19			
	11-SEP-89			

Time and Date	
Time:	21:41:57
Date:	2-MAR-89
Ontime:	857.0hrs
Powerups:	565 times
Time	Date
Hours	Month
21	MAR
Minutes	Day
41	2
Seconds	Year
57	89

Use this pop-up menu to set the DSA clock. See page 253.

Probes		
Probe ID Function		
Select/New	Store	
New Item & AutoSet	Waveforms	
To calibrate, deskew, and compensate probes: Connect a probe or input to the calibrator then select the channel from this menu.		
A LEFT channel is required to deskew for maximum sample rate.		
L1	C1	R
L2	C2	
L3	C3	
L4	C4	

Use this pop-up menu to calibrate probes and to set the function of the probe ID button. See page 215.

Use the Page to selector or the UTILITY button to display the Utility 2 major menu. See page 26.

Utility 1 Major Menu

Instrument Modes

Autoset
Vertical Horizontal Undo Last
Pk-Pk Period AutoSet

Miscellaneous
Multitrace Pan/Zoom Averaging Enhanced
Pan/Zoom Pivot Type Accuracy
Off Center Backweight Manual

Zoom Intp Stored Wfm Incremental
Sin(x) x Time Fmt Acquire
Prefilter Date Show Disabled
Audio Feedback Default Cursor
On Paired Dots Hold
Cursor Off

Waveform Scaling Optional
Trigger DC Level Screen

Touch this selector to set the Trigger DC Level mode. See page 260.

Touch this selector to turn the audible beep on or off. See page 63.

Touch this selector to change the format of the stored waveform timestamp. See page 244.

Touch this selector to change the default cursor type. See page 83.

Touch this selector to enable or disable incremental acquisition. See page 45.

Touch this selector to set the Enhanced Accuracy mode. See page 111.

Autoset controls are described on page 65.

Averaging types are discussed on page 71.

Pan/Zoom controls are described on pages 155 through 158.

Turn on or off vectored waveforms with this selector. See page 275.

Set the Zoom Interpolation with this control. See page 277.

Turn on or off vectored waveforms with this selector. See page 275.

Use this pop-up menu to label a waveform or setting. See page 165.

Label				
Unlabeled Waveforms	Stored Waveforms	Stored Settings	Base Label	Text
Wfm 1	Wfm 2	Wfm 3		
Hug(L1) Main	A:ST05.W	L2 Main		
		Mode	Display	Position
		Manual	On	
Upper Case	Numbers	Greek		Exit
Lower Case	Graphics	Other		

Use this pop-up menu to adjust the display colors. See page 79.

Color Selection		
Background	Waveform Color 1	
Graticule/Selectors	Waveform Color 2	
Window Waveform	Waveform Color 3	
Cursors/Meas Zones	Waveform Color 4	
Display Intensity 80%	Previous Colors	[Default Color All]
Selected Wfm Color Wfm 2 Color 2		Color Model Standard



Use this pop-up menu to set GPIB parameters. See page 135.

GPIB Parameters	
C & F VBI.1	
Mode	
Talk/Listen	
Address	
:	
Terminator	
EOI	
Debug	Off

RS-232-C Parameters		
Baud Rate	Echo	Stop Bits
9600 baud	Off	1.5
Parity	Flagging	Delay
None	Soft	0
EOL String	Verbose	Debug
CR/LF	Off	Off

Use this pop-up menu to set RS-232-C parameters. See page 227.

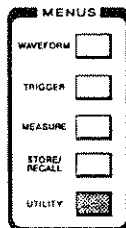

GPIB	RS-232-C	Hardcopy	Ident	Page to Utility 3
Talk/Listen	9600 baud	Bitmap Screen		
Extended Diagnostic	Self Test	Secure Erase Mem		

Use the **Page to** selector or the **UTILITY** button to display the Utility 3 major menu. See page 24.

Use the **Self Test** and **Extended Diagnostic** selectors to operate the diagnostic system and verify that the DSA is operating properly. See page 91.

Utility 2 Major Menu

Hardcopy Parameters			
Printer		Color Map	
8 Pin	24 Pin	index 0	index 1
Tek 4692	Tek 4696	index 6	index 2
Tek 4697	Bitmat Digitizer	index 5	index 3
Alt. InkJet	HPGL	index 7	index 4
Screen Format	Direction Horizontal	Data Format BinHex Compacked	Default ColorMap
Security Option	Off		
Output Port	RS-232-C		Flush Queue

Hardcopy controls are described on page 143.

Instrument Configuration			
Instr	Section	ROM	ID#
DSA 602A	Executive	F2.0	8050116
DSA 602A	Digitizer	F2.0	8050116
DSA 602A	Display	F2.0	8050116
11A34	Left	F3.7	8043417
N7K	Center		
N7K	Right		
Installed Options			
Option 4C - Non-volatile RAM			

This pop-up menu shows DSA and plug-in unit identification, firmware version numbers, and installed options. See page 163.

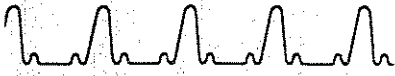

Disk Operations				
A: >>				
	format	label	chkdsk	...
		DISK1		
				Exit

Use this pop-up menu to perform operations that affect the disk. See page 100.

MENUS	
WAVEFORM	<input type="checkbox"/>
TRIGGER	<input type="checkbox"/>
MEASURE	<input type="checkbox"/>
STORE/RECALL	<input type="checkbox"/>
UTILITY	<input checked="" type="checkbox"/>

Disk Ops	Directory Ops	File Ops	Page to Utility 1

Use the **PAGE to** selector or the **UTILITY** button to display the Utility 1 major menu. See page 25.

Utility 3 Major Menu

Directory Operations			
A: >>			
File Type	chdir mkdir rmdir		
File Data	mkdir dir		
A: >>>			
FPS1.FPB	1694	FPS2.FPB	1694
23:49:16	3-FEB-91	23:49:16	3-FEB-91
TEST	<DIR>		
9:07:18	4-FEB-91		
Keyboard File List		Exit	

Use this pop-up menu to perform operations on directories. See page 102.

File Operations			
A: >>			
File Type	attrib rename copy		
File Data	delete prefix		
Format	STO		
HEB			
A: >>>			
FPS1.FPB	1694	FPS2.FPB	1694
23:49:16	3-FEB-91	23:49:16	3-FEB-91
TEST	<DIR>		
9:07:18	4-FEB-91		
Keyboard File List		Exit	

Use this pop-up menu to perform operations on files. See page 104.



In Detail



Acquisition	33
Act on Delta	53
Audio Feedback	63
Autoset	65
Averaging and Enveloping	71
Calibrator	77
Color Display	79
Cursors	83
Diagnostics	91
Disk Drive	97
Display Intensity	107
Display Persistence	109
Enhanced Accuracy	111
Fast Fourier Transforms	113
GPIB Parameters	135
Graticules	139
Hardcopy	143
Horizontal Controls	153
Initialization	159
Instrument Configuration	163
Labeling	165
Measurements	173
Plug-in Units	201
Power-On	209
Probes and Cables	213
Record Length	221
RS-232-C Parameters	225
Stored Settings	229

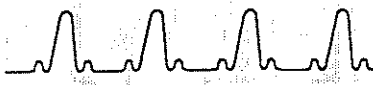

Stored Waveforms	239
Time and Date	251
Triggering	253
Utilities	269
Vectored Waveforms	273
Vertical Controls	277
Waveform Definition and Management	281
Windows	297
XY Waveforms	301

Acquisition

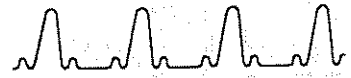

Acquisition is the process of collecting points of data from a signal and assembling them into a waveform record. Waveforms can be acquired continuously or acquisition can be halted after a single trigger event. In continuous acquisition mode, once you create a waveform, the DSA continues to acquire the signal and you see a live waveform on the display. In single trigger mode, the DSA stops acquisition after acquiring a waveform record or partial waveform record based on a single trigger event. Triggering is discussed in detail starting on page 253.

How Waveforms are Acquired

The DSA collects samples from a signal and determines the position of each sampled point with respect to the trigger event on that repetition of the signal. Samples may be taken both before and after the trigger event. This process continues until enough sampled points have been collected to assemble a complete waveform record.

Sampling in Real Time Mode

Real time sampling occurs only when the *selected sample interval*, the time between samples, is at least as great as the time required to take a sample. That is, the sample rate must be low enough that the DSA can acquire a complete waveform record based on a single trigger event.

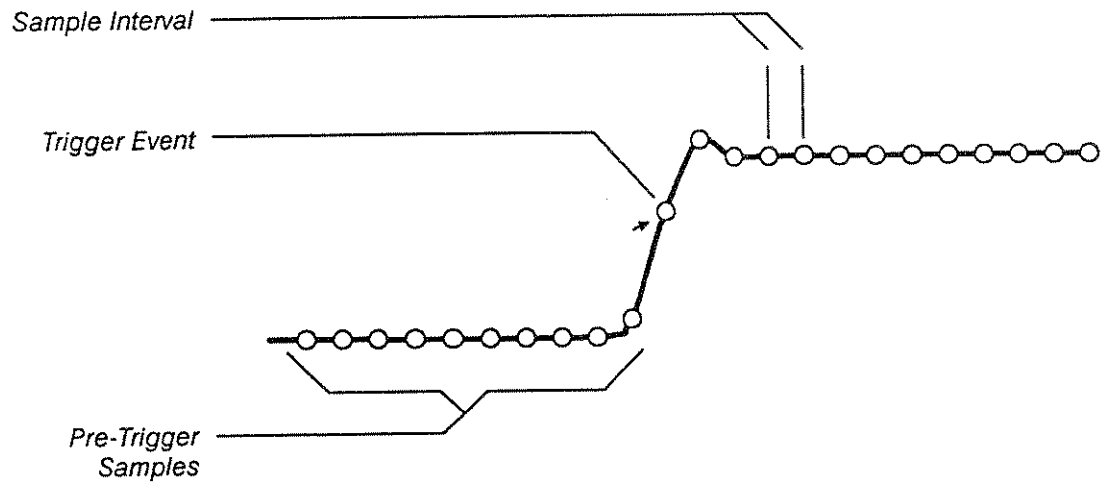
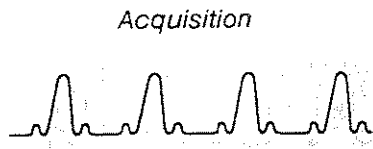

Real Time Acquisition of a Waveform

Non-repetitive events can be captured in real time sampling mode. The maximum sample rate at which real time acquisition will occur is 2 GSample/s for the DSA 602A or 1 GSample/s for the DSA 601A. These sample rates result in sample intervals of 500 ps/point and 1 ns/point, respectively.

Sampling in Equivalent Time Mode

When the DSA cannot acquire a complete waveform record in real time mode, samples from multiple repetitions of a signal will be assembled into a single waveform record. This is called *equivalent time sampling*. The DSA does not acquire the samples in sequential order, but determines the position of each sample in the final waveform record based on the time between the sample and its trigger event. This is sometimes referred to as Random Equivalent-time sampling.

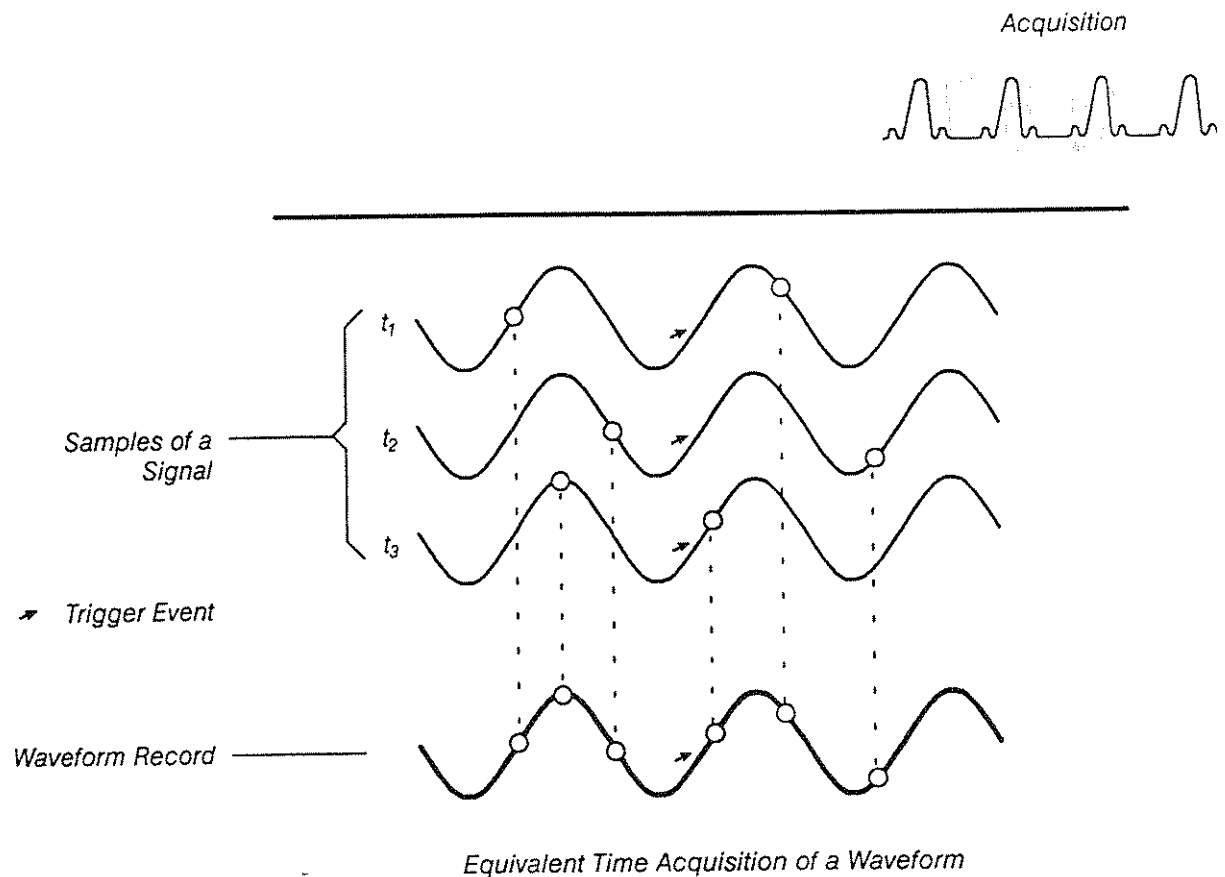

Achieving Real Time Acquisition

For some applications you will want to ensure that acquisition occurs in real time mode. For example, a sequence of laser pulses (repetitive events) may appear similar but exhibit significant pulse to pulse variations when observed as separate single-shot events. Non-repetitive signals (transient events) must be captured in real time mode.

You can tell whether the DSA is acquiring signals in real time or equivalent time mode by observing the **RT** (Real Time) or **ET** (Equivalent Time) indicator that appears below the graticule. The acquisition mode is also reported in the **Horizontal Desc** pop-up menu, shown on the next page. To view this pop-up menu, select **Horizontal Desc** in the Waveform major menu.

Acquisition will occur in real time mode if the selected time between samples is at least as great as the time the DSA takes to sample and digitize a waveform record point. Therefore, real time acquisition can be achieved by increasing the sample interval.

Acquisition

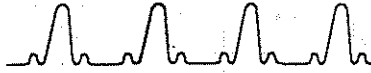

Setting the record length is described in more detail on page 221.

Increasing the Sample Interval

The sample interval is equal to the time period that the waveform record displays divided by the number of points in the waveform record. For example, if you display a waveform at 20 ns per division, a little more than 200 ns of time is displayed. (There are a few points outside the 10-division graticule on either side.) If the waveform has 2048 points, the sample interval is 204.8 ns divided by 2048 points, or 100 ps/point. The current sample interval is reported in the **Horizontal Desc** pop-up menu.

You can increase the sample interval by increasing the *horizontal size* (time per division), the time period the waveform record displays. To set the horizontal size, select the horizontal icon (↔) and use the left knob to adjust the size.

You can also increase the sample interval by decreasing the *record length*, the number of points in a waveform record. To change the record length, select **Main Record Length** or **Window Record Length** in the **Horizontal Desc** pop-up menu and use the knobs to adjust the record length.

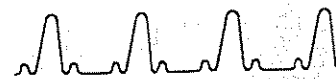

RT/ET Indicators

Horizontal Description					
Acquiring Timebase: Main Main Sample Interval: 500ns/point Window Sample Interval: 50ns/point					
Main Record Length 1024 points			Window Record Length 1024 points		
Display Persistence Normal Infinite Variable Persist Time 1s			Digitizer Interleave 1GS/sec Realtime Disabled		
XY Display Mode: X-Displayed Waveform					
Normal		Wfm 1		Wfm 2	
		L1		L2	
		Main		Main	
Displayed Waveforms					
Stored Waveforms					
RAM					
DISK					
Vertical Desc	Horizontal Desc	Acquire Desc	Graticules	Page to	Rem Wfm
L2	Main	Stopped		All Wfms	L2
Fast	2MS/sec			Status	Main
Input Parameters	FFT Control	Act on Delta	Main Record Len		Window Record Len
DC	dBm	None	1024		1024
1M0/300MHz	Rectang				

The Horizontal Desc Pop-Up Menu

Acquisition



Increasing the Sample Rate

The sample rate is the inverse of the sample interval. When the DSA operates in equivalent time mode, the sample rate is an *equivalent* sample rate. The equivalent sample rate reflects the timing resolution of equivalent time acquisition.

The sample rate is always displayed in the status area of the **Horizontal Desc** selector in the Waveform major menu. To determine whether sampling is occurring in equivalent time or in real time, you can observe the **[ET]** or **[RT]** indicator below the graticule, or you can observe the "ET" or "RT" notation following the sample interval readout in the **Horizontal Desc** pop-up menu.

When the DSA operates in single shot (single trigger) mode, the RT notation in the **Horizontal Desc** pop-up menu may be followed by the notation "< 100%," meaning that the waveform sampled in real time mode will be an incomplete record.

Achieving the Maximum Real Time Sample Rate

You can use the Digitizer Interleave function, which is available from the **Horizontal Desc** pop-up menu, to set the maximum real time sample rate when a single channel is being acquired. Select **2GS/sec Realtime** (1 GS/sec Realtime for the DSA 601A) under **Digitizer Interleave** in the **Horizontal Desc** pop-up menu to enable or disable this function. The DSA 601A has two digitizers which individually allow sample rates of up to 500 million samples per second (500 Msample/s). When Digitizer Interleave is enabled, the two digitizers of the DSA 601A can alternately sample a single channel to provide sample rates of up to 1 GSample per second (1 GSample/s). The DSA 602A has four digitizers, providing a maximum sample rate of up to 2 GSample/s when Digitizer Interleave is enabled.

Probe Calibration
is discussed
on page 217.

After enabling the Digitizer Interleave function, you will need to follow the Probe Calibration procedure. Even if you are not using a probe, the Probe Calibration is necessary to ensure optimum performance. If you are using a subminiature probe, you will need to use the subminiature probe tip-to-BNC adapter provided with the DSA in order to calibrate the system for the maximum sample rate.

Acquisition

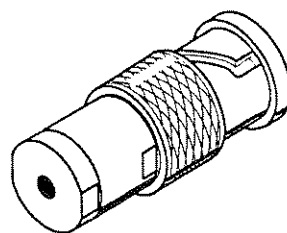

Subminiature Probe Tip-to-BNC Adapter

Controlling Acquisition

You can freeze the waveforms on the display at any time by pressing the **DIGITIZER** button. This button is found above the plug-in compartment, near the column of major menu buttons. This technique lets you stop live waveforms to examine them more closely.

DIGITIZER Button

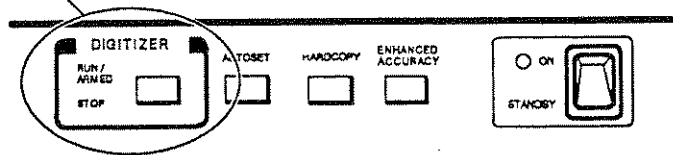

Next to the **DIGITIZER** button are the **RUN/ARMED** and **STOP** lights. One or the other of these lights is always on, telling you whether acquisition is occurring.

The **Acquire Desc** pop-up menu in the Waveform major menu also controls acquisition. Use the selectors in the **Stop Acquire After** section of this pop-up menu to specify that acquisition stops on various conditions. The status area below the **Acquire Desc** selector shows the current acquisition status, for example **Stopped**, **Trig Armed**, or **Continuous**.

Acquisition

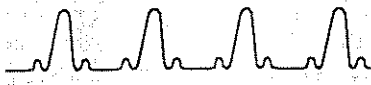

You can remove waveforms at any time using the **Rem Wfm** pop-up menu. To remove a selected waveform, touch the **Rem Wfm** selector above the knob menu and verify that you want to remove the indicated waveform.

% Fill Complete

Select **% Fill Complete** to have equivalent time acquisition stop when the percentage of a complete record specified by the **% Fill** parameter has been reached for each waveform record.

Select **Set %** to set the **% Fill** parameter using the knobs or keypad menus.

Average or Envelope Complete

If you use the averaging or enveloping features, you can select **Average Complete**, **Envelope Complete**, or **Both Avg & Env** to specify that acquisitions stop after enough records have been acquired to provide a complete average and/or envelope.



For details on how to use the **Acquire Desc** pop-up menu to select averaging or enveloping, see **Averaging and Enveloping** on page 71.

Acquire Description	
Set % Fill 99%	Stop Acquire After % Fill Complete
Set Avg N Average N 32 Off	Average Complete Both Avg & Env
Set Env N Envelope N 32 Off	Envelope Complete
Trigger Select Main Window	Single Trigger Single Sequence
Set Rep Create Trigger N Template 1	Rep Trig Delta Complete Next Label REP1
Page To Autostore Parameters Menu	Run Acquisition Continuous

Vertical Desc	Horizontal Desc	Acquire Desc	Graticules	Page to	Rem Wfm 2
L2 Fast	Main 2MS/sec	Stopped		All Wfms Status	L2 Main
Input Parameters DC 1M Ω /300MHz	FFT Control dBm Rectang	Action Delta None	Main Size 50 μ s/div	Pan/ Zoom Off	Main Position -6 μ s

The Acquire Desc Pop-Up Menu

Acquisition

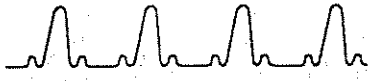

Triggering is discussed in detail starting on page 253.

If the digitizer is stopped, any adjustment of the horizontal, vertical or trigger parameters will clear your waveform since any parameter change will no longer apply to the waveform as captured. However, you can turn on Pan/Zoom and alter the waveform. You can also prevent waveform clearing when altering vertical parameters by initially defining the waveform as high precision. (See Waveform Scaling on page 294.)

Acquisition Control Modes

The Single Trigger, Single Sequence, and Repetitive Single Trigger acquisition modes stop acquisition after acquiring a waveform record or partial waveform record based on a single trigger event or after acquiring a series of such waveform records. Touch a **Trigger Select** selector (Main or Window) in the **Acquire Desc** pop-up menu to select the Main or Window trigger for these functions. The Window trigger can be selected only when a separate Window trigger is defined.

Select **Single Trigger** to stop acquisition when a single Main trigger is detected and the time base duration has expired. In Real Time sampling mode, you can use Single Trigger to acquire a single triggered sweep of a non-repetitive signal. Pressing the **DIGITIZER** button will re-arm the trigger circuit for another Single Trigger acquisition. If the first Single Trigger acquisition did not sample all the active input channels, the next will begin with those channels.

Select **Single Sequence** to have the DSA run a series of Single Trigger acquisitions, stopping when all waveform records are at least partially acquired. Use this mode when not all channels can be acquired with one trigger. When all channels can be acquired with one trigger, the Single Trigger and Single Sequence modes are identical. Press the **DIGITIZER** button to start another Single Sequence acquisition.

Select **Rep Trig Complete** to enable Repetitive Single Trigger acquisition. The DSA will store a series of Single Trigger acquisitions of the selected waveform or waveforms. You can set the number of acquisitions by selecting **Set Rep Trigger N** and adjusting **Rep Trig N** using the knobs. Press the **DIGITIZER** button to begin Repetitive Single Trigger Acquisition. You may notice a brief delay as the DSA prepares to acquire and store waveforms.

You can select **Rep Trig Complete** only when all active channels can be acquired concurrently. See Concurrent Acquisition on page 51 for a description of limitations on concurrent acquisition.

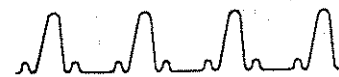

You can store multiple waveforms in Repetitive Single Trigger mode, provided the waveforms can be acquired concurrently. Select **Rep Trig Complete**, then **Page to Autostore Parameters Menu** to display a pop-up menu that allows you to select multiple waveforms. Select the waveforms you want to acquire and save in Repetitive Single Trigger mode by touching their selectors.

The **Wraparound** selector in the **Autostore Parameters** pop-up menu controls memory wrapping. When **Wraparound** is set to Off (the default), the number of acquisitions specified by **Set Rep Trigger N** in the **Acquire Desc** pop-up menu are acquired and stored.

When **Wraparound** is set to On, acquisition continues indefinitely and **Rep Trigger N** is ignored. All available waveform memory will be used for Repetitive Single Trigger acquisitions. When waveform memory is filled, the oldest waveforms stored by Repetitive Single Trigger will be replaced by new acquisitions. This is useful if you want to leave the DSA running for awhile and examine the most recent acquisitions.

Note that when the digitizer is started and wraparound is set to On, all stored waveforms with labels that match the current Base Label will be deleted and that memory space will be used for new acquisitions. If you have previously stored waveforms with a different Base Label, they will be retained.

Acquisition

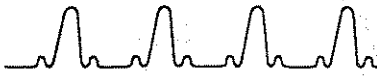

Autostore Parameters					
			Waveforms To Store		
Wraparound Off		Wfm 1			
SRQ Off		L1 Main			
Page To Acquire Description Menu					
Exit					
Vertical Desc L1 Fast	Horizontal Desc Main 10MS/sec	Acquire Desc Stopped	Graticules	Page to All Wfms Status	Rem Wfm 1 L1 Main
Input Parameters DC 1MQ/300MHz	FFT Control dBm Rectang	Act on Delta None	Rep Trig N 1		Rep Trig N 1

The Autostore Parameters Pop-Up Menu

See Labeling on page 165 for more information about labeled waveforms.

In Repetitive Single Trigger mode, each acquired waveform record is stored with a label consisting of a *base label* followed by a number. The numbers are assigned sequentially.

When you acquire multiple waveforms in Repetitive Single Trigger mode, each stored waveform will be labeled with the base label, followed by the acquisition number, a colon, and the waveform number (1 through 8) of that waveform. For example, **REP10:2** identifies the tenth acquisition of waveform 2 in Repetitive Single Trigger mode, using the base label "REP."

Acquisition

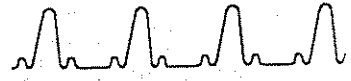

In Repetitive Single Trigger mode, the DSA allocates stored waveform memory when you press the **DIGITIZER** button, before starting acquisition. If memory wraparound is off, enough memory to store N acquisitions (set by **Set Rep Trigger N**) will be allocated. If memory wraparound is on, all available waveform memory will be allocated for Repetitive Single Trigger.

Be aware of the following cautions when using Repetitive Single Trigger mode:

- When you are using memory wraparound, any stored waveforms with labels matching the current base label will be deleted as soon as you initiate Repetitive Single Trigger operation by pressing the **DIGITIZER** button.
- Because waveform memory is allocated before Repetitive Single Trigger acquisition begins, you cannot reset the number of acquisitions while the DSA is acquiring waveforms in this mode. When memory wraparound is off, attempting to change **Rep Trig N** will stop acquisition.
- You should avoid performing other DSA operations while acquiring waveforms in Repetitive Single Trigger mode, because you may slow down or interrupt Repetitive Single Trigger operation. Any DSA operation can stop Repetitive Single Trigger acquisition.
- Stored waveforms that have been allocated for Repetitive Single Trigger acquisitions will have a time stamp of zero hours, minutes, and seconds and the date 00-JAN-00. (The time stamps are updated as acquisitions occur and are stored.) Stored waveform records exist as soon as memory is allocated for them. Therefore, although you cannot select these waveforms in the **Recall Waveform** pop-up menu, you can query them over the RS-232-C or GPIB interface even though they do not contain any valid data.

You can choose to generate a Service Request signal (SRQ) after each Repetitive Single Trigger acquisition. To do this, touch **Rep Trig Complete** then touch **Page to Autostore Parameters Menu** and toggle the **SRQ** selector to on.

Acquisition



See page 53 for more information about Act on Delta.

Incremental Acquisition

Act on Delta

When you have defined a delta description comparing a displayed waveform to an enveloped waveform, you can select **Delta** to enable Act on Delta acquisition. Acquisition in this mode will not begin until you press the **DIGITIZER** button. Delta descriptions and Act on Delta acquisition are discussed in detail on page 53.

Returning to Continuous Acquisition

To resume normal, continuous acquisition after using a Stop Acquisition function, touch the **Continuous** selector under the heading **Run Acquisition**.

Incremental acquisition provides a regular display update for signal acquisition with a sample interval greater than or equal to 5 ms/point. The display of a very slow sweep is updated as soon as a part of the waveform record is acquired. For **Continuous Acquisition** the waveform record is filled from left to right and the acquisition is free-running. That is, sample points are acquired and displayed, but there is no horizontal reference point. Hence, the horizontal scale end points do not relate to waveform features in any absolute way.

If you select **Single Trigger** or **Single Sequence** in the **Acquire Desc** menu the DSA will position the waveform relative to the trigger point after a full record has been acquired. If a trigger does not occur the acquisition will continue to free run, overwriting waveform data. Remember in **Single Trigger** or **Single Sequence** mode you must press the **Digitizer** button to begin an acquisition

When multiple channels are active, the DSA will obtain samples from one channel for a brief time and then switch or "chop" to the next channel. Each channel is briefly sampled on each sweep of the time base.

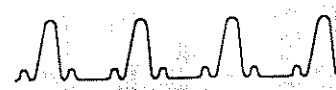

Enabling Incremental Acquire Mode

Touch the **Incremental Acquire** selector in the **Modes** pop-up menu from the **Utility 1** major menu to enable incremental acquisition mode. Incremental acquisition does not begin until the following conditions are met:

- The sample interval is greater than 5 ms/point.
- No window waveforms are displayed.
- No waveform functions are part of the vertical description of a displayed waveform.
- The total sample points of all displayed waveform records does not exceed 32,256 points.
- Act on Delta is not the selected acquisition mode.

Acquisition

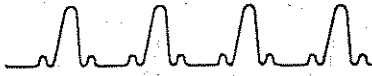

Incremental
Acquire
Selector

Instrument Modes					
Autoset					
Vertical	Horizontal	Undo Last			
Pk-Pk	Period	AutoSet.			
Miscellaneous					
Multitrace	Pan/Zoom	Averaging	Enhanced		
Off	Center	Backweigh	Accuracy		
Vectored	Zoom	Stored Wf	Incremental		
Waveforms	Into	Time Fmt	Acquire		
On	Linear	Show	Disabled		
Waveform	Audio	Default	Cursor		
Scaling	Feedback	Cursor	Hold		
Optional	On	Paired	Off		
Trigger	DC Level				
Screen					
Calibrator	Modes	Probes	Color	Page to	Rem.
				Utility: 2	Wfm 1
					L1
					Main
Initialize	Time &	Label	Main	Pan/	Main
	Date		Size	Zoom	Position
	11:20:19	Disp: On	10μ	Off	-21.2μ
	2-JAN-00	Mode: Man	s/div		s

The Modes Pop-Up Menu

Clearing Waveforms

A waveform may be displayed but not be acquiring new waveform data. This will happen when a waveform becomes untriggered in Normal trigger mode, or if you use the DIGITIZER button or a Stop Acquisition function to stop acquisition.

When the waveform is displayed but is not acquiring data, the waveform record from the last acquisition remains on the display. This is why waveforms appear frozen on the display when you stop acquisition.

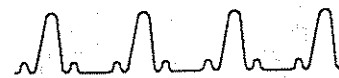

If the digitizer is stopped, any adjustment of the horizontal, vertical or trigger parameters will clear your waveform since any parameter change will no longer apply to the waveform as captured. However, you can turn on Pan/Zoom and alter the waveform horizontally without clearing the waveform. You can also prevent waveform clearing when altering vertical parameters by initially defining the waveform as high precision. (See Waveform Scaling on page 294.)

You can clear waveform data from the display using the Rem Wfm selector above the knobs menu. Touching the **Clear Wfm #** selector in the pop-up menu clears the selected waveform. The selected waveform is identified both by waveform number (Wfm 2 in the illustration below) and by waveform expression and time base (L2 and Main). (The **Clear Wfm #** selector clears acquisition memory but the input channel remains active. The **Remove Wfm #** selector turns off the selected channel.)

Verify Remove/Clear Waveform					
Cancel		Clear All		Clear Wfm 2	
		L2		Main	
		Remove Wfm 2		L2	
		Main		Main	
Calibrator	Modes	Probes	Color	Page to Utility 2	Rem Wfm 2
					L2
					Main
Initialize	Time & Date	Label	Main Size	Pan/Zoom	Main Position
	17:16:30	Disp: On	50μ	Off	-6μ
	8-OCT-98	Mode: Man	s/div		s

The Rem Wfm Pop-Up Menu

The **Clear All** selector lets you clear all continuously acquired waveforms at once.

You cannot clear a waveform that displays only stored waveform data. For example, if you have a waveform that is defined to be **STO1 + STO2**, that waveform will not be selectable in the **Rem Wfm** pop-up menu.

If you clear waveforms that are being acquired (live waveforms on the display), they will blink momentarily and then continue to be displayed as new waveform records are acquired.

Acquisition

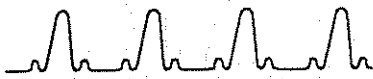

Single-Shot Acquisition Tips

Always run probe calibration when you enable Digitizer Interleave. Probe calibration is necessary to align the DSA's digitizers, even if you are not using probes.

The DSA 601A and DSA 602A offer excellent capabilities for single-shot acquisition. Using the Single Trigger options described earlier in this section, you can capture non-repetitive events in real time at sample rates of up to 1 GSample/s for the DSA 601A or 2 GSample/s for the DSA 602A. You can capture multiple signals concurrently at lower sample rates. To make the best use of these capabilities, you will need to be aware of factors that affect the real time sample rate of the DSA and how to configure your DSA for concurrent acquisition.

If you want the DSA to acquire signals at its maximum real time sample rate, enable Digitizer Interleave and set the Horizontal Size so that the maximum sample rate appears in the **Horizontal Desc** selector. Once you have acquired a waveform record, use Pan/Zoom to horizontally expand the waveform. Horizontal controls and Pan/Zoom are discussed in Horizontal Controls on page 153. The maximum sample rate is determined by the number of input channels acquired concurrently.

Main and Window Single-Shot Acquisition

You can use the DSA's windowing capabilities to acquire two simultaneous records of the same signal. Because the Main and Window time bases acquire signals at different sample rates, you can use a high sample rate to obtain a detailed record of an event on the Window time base while acquiring on the Main time base a less detailed record of a greater span of time surrounding the event. Windows are described on page 297.

For each channel, one waveform on the Main time base and two Window waveforms (waveforms acquired on the Window time base) may be acquired in single-shot mode. The combined record length of the waveforms acquired can generally be up to 10240 points.

Observe the "ET" or "RT" readout in the **Horizontal Desc** pop-up menu when you set parameters for single-shot acquisition. If the qualification "< 100% Fill" appears after "RT," a complete waveform record cannot be acquired at the current sample rate and DSA configuration. A waveform will be acquired in real time mode, but some points in the waveform record will not be acquired.



Concurrent Acquisition

If you wish to acquire multiple channels concurrently, your choice of input channels can affect the sample rate. The DSA 601A can acquire two signals concurrently; the DSA 602A can acquire up to four signals concurrently. The waveform record samples of the signals will be concurrent to within ± 100 ps.

The input channels that can be sampled simultaneously are limited to two channels from the left plug-in compartment and one channel each from the center and right plug-in compartments. For concurrent acquisition, connect your signal sources as follows.

- For four-channel concurrent acquisition, connect two signal sources to channels of the left plug-in amplifier. Connect one signal source to a channel of the center plug-in amplifier, and one to a channel of the right plug-in amplifier.

Four-channel concurrent acquisition is available in the DSA 602A at up to 500 MSample/s, but is not available in the DSA 601A.

- For two-channel concurrent acquisition, connect two signal sources to channels of the left plug-in amplifier, or connect the two sources to channels of two plug-in amplifiers.

Two-channel concurrent acquisition is available in the DSA 602A at up to 1 GSample/s and in the DSA 601A at up to 500 MSample/s.

In any other configuration, the DSA will not acquire all of the input channels concurrently. Instead, the DSA will alternate between channels it cannot sample simultaneously, and some channels will be acquired on separate triggered sweeps of the time base.

Acquisition

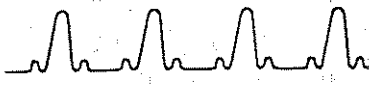

Defining a smoothed waveform is explained in Waveform Definition and Management on page 281.

For maximum single-shot timing accuracy, you can use the SCLOCKD command of the ASCII interface to disable dithering of the sample clock. See the *DSA 601A and DSA 602A Programmer Reference* for more information about this command. Alternatively, you can have a qualified service person connect an internal jumper to disable sample clock dithering. Either method results in greater single-shot accuracy at the expense of equivalent time performance.

High-Resolution Single-Shot Acquisition

The resolution of the DSA's digitizer is 8 bits. You can attain higher single-shot resolution by using the smoothing function.

When you define a smoothed waveform, the DSA computes a running average of several adjacent points in the waveform. High-frequency information is attenuated in the resulting waveform record. The equivalent bandwidth of the smoothing operation is determined by the sample interval and by the number of points to be smoothed. The following table shows the maximum bandwidth available when you use smoothing to increase resolution.

Single-Shot Resolution and Bandwidth with Smoothing

Resolution (in bits)	Points to Smooth	Single-Shot Bandwidth (by Sample Rate)			
		2 GS/s	1 GS/s	500 MS/s	100 MS/s
8	none	1 GHz	500 MHz	250 MHz	50 MHz
9	3	295 MHz	147 MHz	74 MHz	15 MHz
10	5	177 MHz	86 MHz	44 MHz	9 MHz
11	9	98 MHz	49 MHz	25 MHz	5 MHz
12	17	52 MHz	26 MHz	13 MHz	3 MHz
13	33	37 MHz	13 MHz	7 MHz	1 MHz
14	65	14 MHz	7 MHz	3 MHz	680 kHz

See the Algorithm section for the formula which ties points to smooth to bandwidth.

Act on Delta

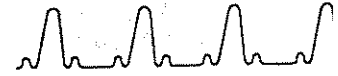

Act on Delta is an acquisition mode in which the DSA monitors a signal for anomalies, or “deltas.” You can create an enveloped waveform that defines the acceptable limits of the signal and have the DSA perform one or more of the following actions when the signal travels outside the acceptable envelope:

- Save the waveform record in which the anomaly occurred
- Make a hardcopy of the waveform record
- Sound an audible alarm (chime)
- Send a signal to a GPIB or RS-232-C controller connected to the DSA

The DSA displays delta points falling outside the enveloped waveform in a color different than the waveform color.

Act on Delta acquisition stops when an anomaly is detected and can be set to restart automatically.

Test Waveform and Reference Waveform

In Act on Delta mode, the DSA compares the *test waveform*, the signal you are studying for anomalies, to a *reference waveform*. The reference waveform defines the acceptable limits of variation of the test waveform and must be an enveloped waveform.

The reference waveform may be a stored waveform or an actively acquired waveform, but in most cases you will probably want to use a stored waveform so that the reference limits do not change while the DSA is monitoring the test signal for variations outside the limits.

For more information on creating an enveloped waveform, see Averaging and Enveloping on page 71.

A simple way to create a reference waveform is to add noise to the test waveform, envelope and store it, then remove the noise and use the stored waveform as the reference waveform.

In order to compare the two waveforms, the record length of the reference waveform must be at least as great as the record length of the test waveform. The DSA considers only the points in the reference waveform record that correspond with points in the test waveform, so increasing the record length of the reference waveform does not affect the Act on Delta comparison.

Act on Delta

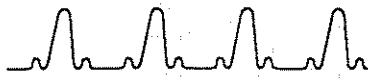

Defining the Delta Event

A *delta event* occurs when points in the test waveform record are outside the bounds of the reference waveform. In addition to setting up the comparison between the test waveform and the reference waveform, you can specify an acceptable degree of variation of the test waveform from the reference waveform.

Defining the Delta Description

Once you have created an enveloped reference waveform, use the top half of the **Act on Delta** pop-up menu in the Waveform major menu to define a *delta description*. A delta description is always of the form **Wfm1 OUTSIDE Wfm2**. **Wfm1**, the test waveform, must be a displayed waveform. **Wfm2**, the reference waveform, must be an enveloped waveform.

To enter a delta description, touch the selectors in the **Delta Description** section of the **Act on Delta** pop-up menu. Only the appropriate selectors are selectable at any point as you enter an expression. Select the active waveform you want to study from the **Displayed Waveforms** shown in the upper section of the pop-up menu, select the operator **OUTSIDE**, and select an enveloped waveform. If you make an error as you enter the description, touch **Back Space** to correct it.

The reference waveform may be an actively acquired waveform or a stored waveform. If the reference waveform is stored in RAM, touch **Env Disp Waveforms** or **Env Stored Waveforms** to display selectors for the available displayed or stored enveloped waveforms, respectively. If the reference waveform is stored on disk, all the waveform files are displayed, not just enveloped waveforms. Selecting a non-enveloped waveform, however, generates an error.

The delta description you enter appears at the top of the **Act on Delta** pop-up menu shown on the next page. If a delta description already exists, it appears on the **Current Delta Description** line at the bottom of the pop-up menu. The new delta description is entered when you select **Enter Desc**. If you select **Cancel** or otherwise remove the **Act on Delta** pop-up menu without entering the description, the existing delta description is retained.

Act on Delta

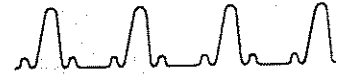

The current delta description will be erased when either the test waveform or the reference waveform in the description is removed, or if the waveform description of the reference waveform is changed so that it is not an enveloped waveform. Changing the description of the test waveform will not affect the delta description, as long as the test waveform is not an XY waveform.

Delta description being entered

Selectors for entering delta description

Existing delta description appears here

Delta Description					
WFM1 OUTSIDE					
Env Disp Waveforms					
Env Stored RAM Waveforms					
DISK					
Enter Desc		Outside		Back Space: Cancel	
Delta Actions					
Save As		Repeat		Chime	
Stored Wfm		Next Label		Event Count	
REP1		SRQ		Hardcopy	
0		Total Points		Consecutive Points	
		1		1	
		Show Delta Points On Test Waveform		Status Display: Delta Actions	
Current Delta Description					
Vertical Desc L2 Fast	Horizontal Desc Main 2MS/sec	Acquire Desc Stopped	Graticules	Page to All Wfms Status	Rem Wfm 1 L2 Main
Input Parameters DC 1M/300MHz	FFI Control dBm Rectang	Act on Delta None	Vertical Size: L2 1 V/div	Chan Sel L2	Vertical Offset: L2 1.5 V

The Act on Delta Pop-Up Menu

Act on Delta

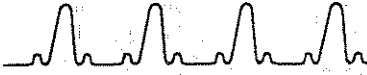

Setting Acceptable Limits of Signal Variation

You can set the number of out-of-bounds waveform record points that constitute an acceptable degree of variation of the test waveform from the reference waveform. You can also define a maximum acceptable length of variation. For example, you might want to ignore "spikes" that take only a few waveform record points out of the limits defined by the reference waveform.

Select **Total Points** and **Consecutiv Points** in the **Act on Delta** pop-up menu to adjust these delta event parameters. These selectors set the left knob to control the total number of out-of-bounds waveform record points and the right knob to control the minimum number of consecutive out-of-bounds record points required for a delta event.

A delta event will occur only when both the total number of points and the number of consecutive points are outside the specified bounds. For example, if you set **Total Points** to fifteen and **Consecutiv Points** to ten, a delta event will occur when there are at least fifteen out-of-bounds points in the test waveform record, at least ten of which occur consecutively.

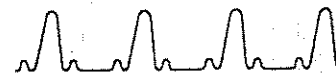

Delta Actions

When the DSA detects a delta event, acquisition stops. In addition, the DSA can perform any of the functions described below. Selectors for these delta actions appear in the **Act on Delta** pop-up menu in the Waveform major menu. You can choose to have the DSA perform any combination of these functions. You can also choose to have a summary of the currently selected delta actions appear in the **Act on Delta** selector in the Waveform major menu. If no delta action is selected, "None" appears in the **Act on Delta** selector in the Waveform major menu.

Repeat

Select **Repeat** to have the DSA automatically restart acquisition in Act on Delta mode after a delta event has caused acquisition to stop. Otherwise, you would restart acquisition by pressing the **DIGITIZER** button.

The **Evnt Count** in the **Repeat** selector lists the number of delta events that have occurred, and is reset to zero when you press the **DIGITIZER** button. This count also appears in the **Acquire Desc** selector when the digitizer is running.

Save As Stored Wfm

Select **Save As Stored Wfm** to have the DSA store the waveform record in which a delta event occurred. Each stored waveform is assigned a label consisting of the current base label (the default base label is **REP**) followed by a sequentially-assigned number. The label that will be assigned to the next waveform stored appears in the **Save as Stored Wfm** selector. This label is not updated while acquisition is occurring and is therefore only valid before you begin Act on Delta acquisition.

You can store a series of waveform records for later study by using **Repeat** and **Save As Stored Wfm** together. The waveform stored is always the "test" waveform unless you override this in the **Autostore Parameters** menu. If the DSA runs out of memory for stored waveforms, it will display a single error message and continue Act on Delta acquisition without storing waveform records. Note that this occurs unless Wraparound is turned on in the **Autostore Parameters** menu. You can also use the **Autostore Parameters** menu to specify which waveforms to store.

Stored waveforms are discussed in detail on page 97. For more information on base labels, see Labeling on page 165.

Act on Delta

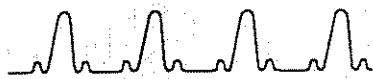

Chime

Select **Chime** to have the DSA produce a single “beep” when a delta event is detected.

SRQ

When **SRQ** is selected, the DSA will send a “Conditional acquire complete” signal request message to the GPIB or RS-232-C controller when acquisition stops on a delta event.

You do not need to select **SRQ** unless you have also selected **Repeat**; the “Conditional acquire complete” message will be sent to the controller at the end of a single Act on Delta acquisition even if **SRQ** is not selected.

In addition, note that the **SRQ** selector in the **Autostore Parameters** menu provides an alternative method of generating an SRQ.

Hardcopy

Select **Hardcopy** to have the DSA create a hardcopy of the display when acquisition stops on a delta event. See Hardcopy on page 143 for more information about making hardcopies of the display.

Do not use the **Hardcopy** and **Repeat** delta actions together if you expect delta events to occur in rapid succession.

Do not use the **Hardcopy** delta action with **Repeat** if you expect the delta events to occur in rapid succession, because hardcopies will only be generated if there is space for them in the hardcopy queue when the delta event occurs. Instead, select **Save As Stored Wfm** and make hardcopies showing the stored waveform records later.

If you do select **Hardcopy** and **Repeat**, you may find that the display “freezes up” when delta events occur too frequently. You might need to press the **DIGITIZER** button to stop acquisition and then press the **HARDCOPY** button to abort the hardcopy being queued. If you do not stop acquisition, a new hardcopy might be started soon after you remove the current one.

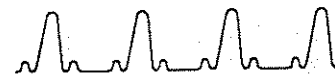

Display Features

You can choose to have either the delta actions or the number of delta points displayed in the status area of the Act on Delta selector. Touch **Status Display** in the **Act on Delta** pop-up menu to toggle between Delta Actions and Number of Delta Points.

You can choose to show the detected delta points on either the test waveform or on the selected waveform. Touch **Show Delta Points** in the **Act on Delta** pop-up menu to toggle between showing delta points on the test or selected waveform.

It is useful to show the delta points on a selected trace that is not "live" like the test waveform. You can recall stored waveforms to see what points of the stored waveform are outside the reference waveform. If Repeat and Save were used during Act on Delta to store a number of waveforms, you can then individually examine the delta points on each of the stored waveforms.

Initiating Act on Delta Acquisition

Once you have defined the delta event and set up the actions you want to occur on a delta event, you can start acquisition in Act on Delta mode by pressing the **DIGITIZER** button. Unless you have selected the **Repeat** delta action, you will need to press this button to restart acquisition after each delta event.

DIGITIZER
Button

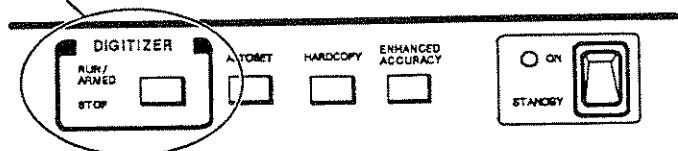

If a delta description already exists, you can also select **Delta** in the **Acquire Desc** pop-up menu in the Waveform major menu to enter Act on Delta acquisition. You must press the **DIGITIZER** button to start acquisition after you select **Delta**. This is an easy way to return to Act on Delta acquisition after doing intervening work in another acquisition mode. The DSA enters **Delta** acquisition mode automatically when you touch **Enter Desc** in the **Act on Delta** pop-up menu.

Act on Delta



Viewing Delta Points

Changing the default colors is discussed on page 79.

Refer to page 155 for information about Pan/Zoom.

Delta points outside the specified bounds are displayed in a color different from the other waveform points. It may be necessary, however, to adjust the color of the delta points by changing the default colors. Making the waveforms dark and the delta points bright may aid in viewing the delta points. Also, it may be easier to see the colored delta points when the **Pan/Zoom** selector is set to **Off** or when **Pan/Zoom** interpolation is **None**. If you zoom in on the test waveform, the DSA will automatically zoom in on the first delta point in the waveform record.

Note that the delta points are displayed only when the Digitizer is stopped. Thus the delta points do not appear when **Repeat** is on.

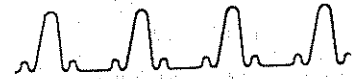

See Acquisition on page 33 for information about the other acquisition modes you can select from the **Acquire Desc** pop-up menu.

Delta Selector

Acquire Description	
Set % 99%	Stop Acquire After % Fill Complete
Set AvgN Average N 32 On	Average Complete Both Avg & Env
Set EnvN Envelope N 32 Off	Envelope Complete
Trigger select Main	Single Trigger
Trigger select Window	Single Sequence
Set Rep Trigger N 1	Rep. Trig. Complete Next Label REP1
Page To Autostore Parameters Menu	Run Acquisition
	Continuous

Vertical Desc	Horizontal Desc	Acquire Desc	Graticules	Page to	Rem Wfm 1
Avg (L1) Fast	Main 2MS/sec	Avg#>32 Backweight		All Wfms Status	Aug(
Input Parameters DC 1MQ/300MHz	FFT Control dBm Rectang	Act on Delta None	Main Size 50μ s/div	Pan/ Zoom Off	Main Position -6μ s

The Acquire Desc Pop-Up Menu

You cannot use Act on Delta acquisition with incremental acquisition or with XY waveforms. Nor is Act on Delta allowed when Histograms are on.

Act on Delta

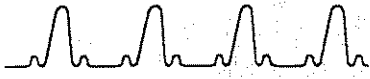

Audio Feedback

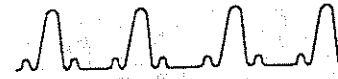

When you select a function on the touch screen, you will hear a beep that means your selection has been noted and is being acted on. The beeper can be turned on or off.

To turn the audio feedback on or off use the **Instrument Modes** pop-up menu in the Utility 1 major menu. Touch the **Audio Feedback** selector in the **Instrument Modes** pop-up menu to turn the beeper off or on.

Audio Feedback
Selector

Instrument Modes					
Autoset					
Vertical	Horizontal	Undo Last			
Pk-Pk	Period	AutoSet			
Miscellaneous					
Multitrace	Pan/Zoom	Averaging	Enhanced		
Pan/Zoom	Pivot	Type	Accuracy		
Off	Center	Backweight	Manual		
Vectored	Zoom	Stored Wfm	Incremental		
On	Intp	Time Fmt	Acquire		
	Sin(x)/x	Show	Disabled		
		Date			
Waveform	Audio	Default	Cursor		
Scaling	Feedback	Cursor	Hold		
Optional	On	Paired	Off		
		Dots			
Trigger					
DC Level					
Screen					
Calibrator	Modes	Probes	Color	Page to	Rem
				Utility 2	Wfm 1
					L1
					Main
Initialize	Time &	Label	Main	Pan/	Main
	Date	Disp: On	Size	Zoom	Position
	14:50:15	Mode: Man	50μ	Off	-6μ
	10-OCT-90		s/div		s

The Modes Pop-Up Menu

Audio Feedback

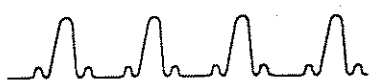

Autoset

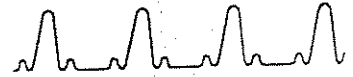

Adjusting a DSA to display a stable waveform of usable size and amplitude is easily accomplished with the Autoset feature.

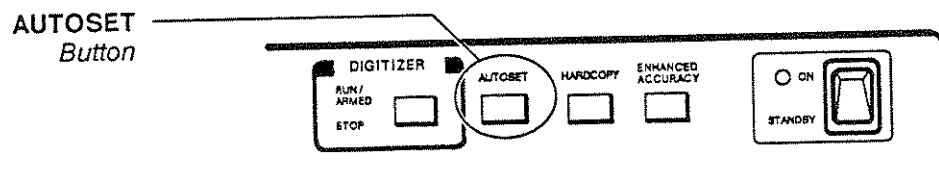

The input channels must be calibrated (Enhanced Accuracy in effect) for Autoset to work properly.

Autoset does not change your selected input coupling, Trigger Source description or Trigger Coupling.

When you press the **AUTOSET** button, you tell the DSA to examine the selected waveform and adjust the following for optimal display:

- **Vertical** gain and offset; for calculated waveforms, vertical size and position
- **Main** and **Window** horizontal size and position
- **Trigger** level

If you press the **AUTOSET** button when no waveforms are defined, the DSA will search the input channels for a signal and display the first signal found. During the search, the plug-in amplifiers will be set to their most sensitive gain settings and to 0 V offset; they will be restored to their previous settings if no signal is found. Plug-in amplifier coupling is not changed, so a signal at an input channel that has coupling turned off will not be detected.

Autoset is also invoked when you press a Probe ID button if you have selected the Probe ID Function **Wfm Select/New Wfm & AutoSet** from the **Probes** pop-up menu of the Utility 1 major menu.

Autoset

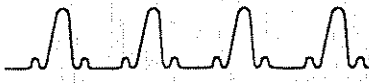

Undoing an Autoset

If you don't like the results of an Autoset, you can restore the status of the DSA by touching the **Undo Last AutoSet** selector in the **Modes** pop-up menu of the Utility 1 major menu.

Instrument Modes					
Autoset					
Vertical	Horizontal	Undo Last		AutoSet	
Pk-Pk	Period				
Miscellaneous					
Multitrace	Pan/Zoom	Averaging	Enhanced		
Pan/Zoom	Pivot	Type	Accuracy		
Off	Center	Backweight	Manual		
Vectorized	Zoom	Stored Wfm	Increment		
Waveforms	Intp	Time Fmt	Acquire		
On	Linear	Show	Disabled		
		Date			
Waveform	Audio	Default	Cursor		
Scaling	Feedback	Cursor	Hold		
Optional	On	Paired	Off		
		Dots			
Trigger					
DC Level					
Absolute					
Calibrator	Modes	Probes	Color	Page to	Rem
				Utility 2	Wfm 1
					L1
					Main
Initialize	Time & Date	Label	Main Size	Pan/Zoom	Main Position
	1:04:14	Disp: On	1n	Off	-2.12n
	9-FEB-91	Mode: Man	s/div		s

The Modes Pop-Up Menu

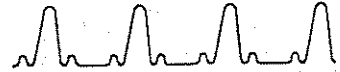

Autoset Options

The **Modes** pop-up menu lets you set several Autoset parameters so that you can tailor the Autoset operation to your needs. In addition to the **Undo Last AutoSet** selector, the **Autoset** section of the **Modes** pop-up menu has two selectors that let you specify independently the vertical and horizontal Autoset characteristics of the DSA.

Vertical Autoset Options

The **Vertical** selector cycles among four values: Peak-to-Peak, TTL, ECL, and Off.

Peak-to-Peak mode—sets the vertical gain and offset so that the waveform will be four to nine divisions high and centered vertically on the graticule. Trigger level will also be set. The trigger source will be set to match the waveform source if the time base becomes untriggered.

TTL and ECL modes—set the vertical gain and offset and trigger level to values appropriate to the TTL and ECL logic families. Both set plug-in amplifier and trigger coupling to DC and set Main trigger mode to Auto and Window trigger mode to Normal.

Vertical Autoset may also be turned Off. If you turn Vertical Autoset off, Horizontal Autoset will not work properly unless the signal is triggered.

Horizontal Autoset Options

The **Horizontal** selector cycles among four values: Period, Pulse, Edge, and Off. With any of the first three selected, Autoset will adjust the Main size and position. Main holdoff will be set to its minimum value of 2 μ s if it is greater than 1 ms when Autoset is invoked. The trigger source will be set to match the signal source if the waveform becomes untriggered.

Horizontal Autoset will not function properly on signals with frequencies below 50 Hz.

Autoset

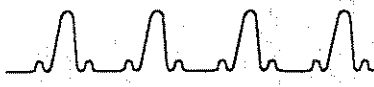

Period mode—adjusts the Main size and position so that at least three cycles of a repetitive signal appear on the graticule. Based on the trigger slope, either a rising edge or a falling edge is placed two divisions from the left of the graticule. The Window horizontal size is set to 1/10 of the main size, with Window1 and Window2 positions set to two and five divisions from the left of the Main graticule. Window holdoff will be set to its minimum if the delay between the Main and Window triggers is more than five times the Main size.

Pulse mode—sets the Main size so that approximately one pulse is displayed across six horizontal divisions of the screen. The trigger slope determines whether a rising or falling edge is placed two divisions from the left edge of the graticule.

Edge mode—sets the Main size to display the edge of a pulse across the entire graticule and sets Main position so that the edge is centered horizontally on the graticule. The trigger slope determines whether a rising or falling edge is displayed.

Horizontal Autoset may be turned off without affecting Vertical Autoset.

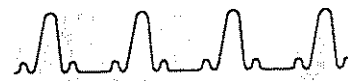

Special Cases

Fast and high precision waveforms are explained in Waveform Scaling on page 294.

Autoset treats certain classes of waveforms differently. If you invoke Autoset with a stored waveform selected, the result will be a vertical scaling of the waveform (unless Vertical Autoset is turned off). If an active Horizontal Autoset mode is selected, Autoset will set the horizontal magnification (Zoom) to 1. Invoking Autoset on a live waveform will cause Pan/Zoom to be turned off.

When the selected waveform is a multi-channel waveform, Vertical Autoset will be applied to each channel, but Horizontal Autoset will be applied only to the first channel in the waveform description. The amplifier gains of the input channels will be matched only if the waveform is defined as a "fast," as opposed to "high precision," waveform.

When Autoset is performed on an XY waveform, the two components of the waveform are autoset individually. If one of the components of the XY waveform is a multi-channel "fast" waveform, both components will be treated as multi-channel waveforms and the amplifier gains for the channels involved will therefore be matched. Horizontal Autoset is executed only on the horizontal component of the XY waveform.

If the selected waveform is on a Window time base, invoking Autoset will cause the Main waveform to be autoset if the Main time base is not triggered. If the Main time base is triggered, Autoset will simply adjust the size and position of the window. If Vertical Autoset is in TTL or ECL mode, the vertical size and position of the window will also be set.

Autoset

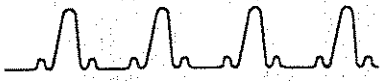

Averaging and Enveloping



The averaging and enveloping functions allow you to examine and manage noisy signals.

Averaging reduces the random noise of a displayed waveform and provides a cleaner display. The DSA presents a waveform that is an average of several accumulated waveform records. Each sample in a record is numerically averaged with the same sample in all the other records. The resulting waveform is displayed.

There are two types of averaging available:

- *Back-weighted averaging* generates an average that is exponentially weighted by previous (back) waveforms. This produces a continuous display during the averaging process and continues to generate an average value after the specified number of averages is reached. Each new average consists of N-1 parts previous average and one part new data, where N is the specified number of averages.
- *Summation averaging* totals a specified number of input waveforms, then divides the total by the specified number. No display accompanies this type of averaging until averaging is complete, and no new waveform data is incorporated into the average once the total is reached.

Enveloping shows the cumulative effect of noise and signal variation over a period of time. It is similar to averaging in that several waveform records are accumulated and a combined result is displayed. An enveloped waveform shows the maximum excursions of the individual waveform records. This often results in a “thicker” waveform that shows the limits of variation of the signal.

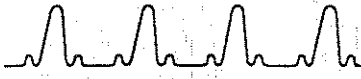

Defining an Averaged or Enveloped Waveform

If you aren't sure how to define a waveform, see *Waveform Definition and Management* on page 281

There are two ways to establish an averaged or enveloped waveform.

- If you are establishing a new waveform you can use the **Avg()** or **Env()** waveform functions as you define your waveform. These can be selected from the **DefWfm** menu. For more information on this method, see *Waveform Definition and Management* on page 281.
- The easiest method is to establish the waveform without averaging or enveloping. Then, after you have the waveform adjusted, you can invoke averaging or enveloping.

The following procedure describes averaging and enveloping using the second method described above.

- Step 1: Create the waveform you want using any method.
- Step 2: If the waveform isn't selected, touch the waveform to select it.
- Step 3: To select the type of averaging, press the **UTILITY** button until the **Utility 1** major menu appears, then touch **Averaging Type** in the **Modes** pop-up menu.
- Step 4: To average the waveform, press the **WAVEFORM** menu button, touch the **Acquire Desc** selector in the major menu, and then touch the **Average N** selector in the pop-up menu. To envelope the waveform, touch the **Envelope N** selector in the pop-up menu.

Selecting **Average N** invokes the average type selected in the **Modes** menu. If you want to change average type you must turn **Average N** off then back on to recognize a change in the **Modes** menu average type.

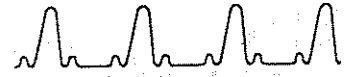

Acquire Description	
Set % 99%	Stop Acquire After % Fill Complete
Set AvgN Average N 32 On	Average Complete Both Aug & Env
Set EnvN Envelope N 32 Off	Envelope Complete
Trigger Select Main	Trigger Select Window
Set Rep Trigger N 1	Single Trigger Single Sequence Rep Trig Complete Next Label REP1
Page To Autostore Parameters Menu	Run Acquisition Continuous

Vertical Desc Avg(L1) Fast	Horizontal Desc Main 2MS/sec	Acquire Desc Avg*32 Backweight	Graticules Main Size 50µ s/div	Page to All Wfms Status	Rem Wfm 1 Aug Main
Input Parameters DC 1MQ/300MHz	FFT Control dBm Rectang	Act on Delta None		Pan/ Zoom Off	Main Position -6µ s

The Acquire Desc Pop-Up Menu

The **Acquire Desc** selector status shows that the average function is now part of the waveform expression. It also shows the type of averaging selected.

Averaging and Enveloping

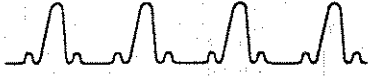

Record Count

Several complete waveform records are combined to form an averaged or enveloped waveform. You can set the number of records that the DSA accumulates and combines.

Use the **Set AvgN** and **Set EnvN** selectors in the **Acquire Desc** pop-up menu to assign the knobs to set the number of records. The left knob sets the number of records to accumulate for an average, and the right knob does the same for enveloping.

Each knob click changes the current value by a multiple of two in the coarse setting or in increments of one when the front panel button is set to **FINE**. You can use the numeric keypad to enter specific values.

Limiting Acquisition

You can have the DSA stop acquiring waveform data when a complete average or envelope is accumulated. When the DSA stops acquiring data the waveform will appear to be frozen on the display. The selectors in the **Stop Acquire After** section of the **Acquire Desc** pop-up menu let you specify **Average Complete**, **Envelope Complete**, or **Both Avg & Env**. (Both Average and Envelope functions must be used in waveform definitions for the **Both Avg & Env** function to be selectable.) When you want to resume normal continuous acquisition, touch the **Continuous** selector.

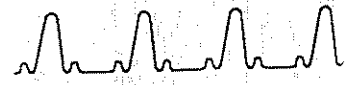

Side Effects of Averaging and Enveloping

Averaging improves the accuracy of some measurements because it reduces the effects of random noise. However, some measurements can be affected adversely by averaging or enveloping. For example, if the signal has horizontal jitter, a rise time measurement taken from the averaged waveform will be slower than the actual rise time. Be cautious when taking measurements of averaged or enveloped waveforms.

If the digitizer is stopped, any adjustment of the horizontal, vertical or trigger parameters will clear your waveform since any parameter change will no longer apply to the waveform as captured. You can, however, turn on Pan/Zoom and alter the waveform horizontally without clearing the waveform. You can also prevent waveform clearing when altering vertical parameters by initially defining the waveform as high precision. (See Waveform Scaling on page 294.)

Terminating Averaging or Enveloping

To turn averaging or enveloping off, toggle the **Average N** or **Envelope N** selector in the **Acquire Desc** pop-up menu.

Averaging and Enveloping

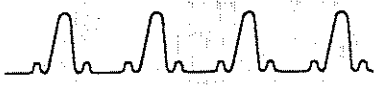

Calibrator

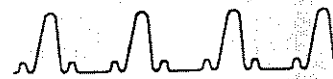

The calibrator provides an accurate voltage/signal source for basic gain and timing applications and provides an accurate signal source for probe calibration. For information on probe calibration, see page 213.

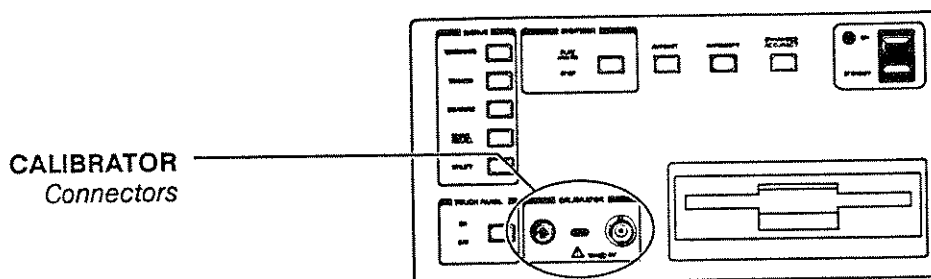

The Calibrator is not available when Enhanced Accuracy, probe calibration, or diagnostics are in progress.

You can select the frequency and output voltage of the calibrator output. To set or determine the parameters of the Calibrator Output, select **Calibrator Output** from the Utility 1 major menu. Then, from the **Calibrator Output** pop-up menu successively touch the **Frequency** selector and note these selections:

- **1.024 MHz** sets the calibrator output to a 1.024 MHz, approximately 560 mV pk-pk square wave signal. The baseline voltage is approximately -60 mV and the series output impedance is 50 Ω .
- **DC** sets the calibrator output to a DC level from -10 V to +10 V. The series output impedance is 450 Ω .

When **DC** is selected, the **Adjust Level** selector can be used to assign both control knobs to **Calibrator Output**. The knob resolution may be set to 250 mV (Coarse), 5.0 mV (Medium), or 0.1 mV (Fine). Coarse and Fine resolution can be selected with the **FINE** button on the front panel. Medium resolution can be set from the **Numeric Entry & Knob Res** pop-up menu.

Calibrator

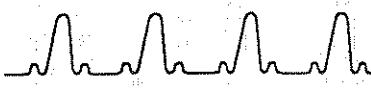

- 1.000 KHz sets the calibrator output to a 1 kHz, 5 V pk-pk square-wave signal. The baseline voltage is 0 V and the series output impedance is 450 Ω.

Calibrator BNC					
Frequency	Adjust				
1.024 MHz	Amplitude				
Impedance	Output				
50 ohm	Amplitude	0.5000 V			
Calibrator	Modes	Probes	Color	Page to	Rem.
				Utility 2	Wfm 1
					L1
					Main
Initialize	Time &	Label	Main	Pan/	Main
	Date	Disp: On	Size	Zoom	Position
	15:33:35	Mode: Man	50μ	Off	-6μ
	10-OCT-90		s/div		s

The Calibrator Output Pop-Up Menu

The Output Amplitude and series output impedance of the calibrator are listed below the Frequency and Adjust Amplitude selectors in the Calibrator Output pop-up menu.

Color Display

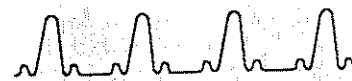

The color display provides a convenient means to identify display items. Specific colors are assigned to the items on the display. The background, graticule and selectors, and cursors and measurement annotations are displayed in distinct colors for easy identification.

The DSA provides two separate color models. In the standard color model, there are up to four colors for waveforms and an additional color for window waveforms. When a window waveform is defined, it is displayed in the window waveform color. When you select a waveform, its color brightens.

In the second color model (called the "original" color model, there is a color for the selected waveform and a different color for unselected waveforms. Similarly, two separate colors distinguish the selected window waveform and the unselected window waveforms.

Color Selection

You can modify the display colors to suit your preferences using the **Color** pop-up menu in the Utility 1 major menu, shown on the next page. You can change the colors displayed and the overall intensity of the display. You can also choose the default or original color model using this pop-up menu.

The upper section of the **Color** pop-up menu has a selector for each display color. Next to each selector is a box the color of that display parameter, and beneath the selector is a readout of the hue, lightness, and saturation values of that color.

- **Hue** is the characteristic associated with a color name, such as red. It is expressed in degrees on a range of 0° to 360°.
- **Lightness** is the intensity of the color, or the amount of light it transmits. Lightness is expressed from 0% (black) to 100% (white).
- **Saturation** is the vividness of the color, or the extent that it differs from gray. Saturation is expressed from 0% (maximum white content) to 100% (fully saturated).

Color Display

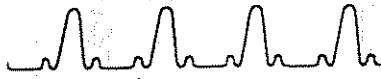

To change the color of a display parameter, select the parameter in the Color pop-up menu. The knobs are automatically assigned to control **Lightness** and **Saturation**; select **Hue** if you want to adjust the hue of the color. Adjust the color using the control knobs.

Color Selection					
Background	Waveform				
H 0	Color 1				
L 0, S 0	H170				
Graticule/	L 67, S 30				
Selectors	Waveform				
H170	Color 2				
L 27, S 10	H130				
Window	L 60, S 55				
Waveform	Waveform				
H290	Color 3				
L 60, S 65	H230				
Cursors	L 55, S 45				
Meas Zones	Waveform				
H120	Color 4				
L 40, S100	H 60				
Hue	L 60, S 30				
	Lightness				Saturation
Display Intensity	Previous Colors				Default Color
60%					All
Selected Wfm Color					Color Model
Wfm 1					Standard
Color 1					
Calibrator	Modes	Probes	Color	Page to Utility 2	Rem Wfm 1
					L1
					Main
Initialize	Time & Date	Label	Main Size	Pan/Zoom	Main Position
	15:46:31	Disp: On	50μ	Off	-6μ
	10-OCT-90	Mode: Man	s/div		s

The Color Pop-Up Menu

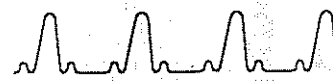

Restoring Colors

Two selectors in the **Color** pop-up menu let you restore colors to their default settings or to the colors previously defined.

- **Previous Colors** restores all eight display parameters to the colors they had when you entered the **Color** pop-up menu.
- **Default Color** sets the selected display parameter to the factory default color.

When no display parameters are selected, the **All** label is displayed below the **Default Color** selector, and touching **Default Color** will set all eight display parameters to the factory default colors.

Setting the Display Intensity

You can adjust the overall intensity, or brightness, of the display. Touch the **Display Intensity** selector in the **Color** pop-up menu to assign the knobs to control the intensity of the display. Overall intensity can be from 0% to 100%.

Selecting the Color Model

Touch the **Color Model** selector to change the color model. The status area of this selector shows which model is currently selected, **Standard** or **Original**. When you touch this selector, the screen clears and is re-drawn based on the other color model. The illustration on the previous page shows the **Color** menu with the **Standard** color parameters.

The Standard Color Model

In the standard color model, the selected waveform is *brightened*.

In the standard color model, four waveform colors are assigned to waveforms in order as they are created. When you select a waveform, its color brightens. You can reassign the color of the selected waveform to any of the four waveform colors using the **Selected Wfm Color** selector at the bottom of the **Color** pop-up menu.

The status area below the **Selected Wfm Color** shows the waveform number of the selected waveform and the number of the color assigned to that waveform, for example **Wfm 1 Color 1**. The box next to the selector displays the color of the waveform.

Color Display

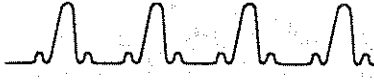

Touch the **Selected Waveform Color** selector to change the color assignment of the selected waveform. As you touch the **Selected Waveform Color** selector, it cycles through the four waveform colors available. If the selected waveform is a window waveform, only one color, the **Window Waveform** color, is available.

The Original Color Model

In the original color model, the selected waveform is displayed in a different color from other waveforms.

In the original color model, the selected waveform on the main time base is displayed in the **Selected Main Waveform** color, and all other waveforms on that time base are shown in the **Unselected Main Waveform** color. The selected waveform on the window time base is displayed in the **Selected Window Waveform** color, and other waveforms on that time base are displayed in the **Unselected Window Waveform** color.

Cursors

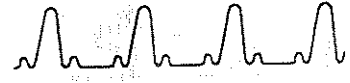

Cursors provide a way to measure the difference between two waveform locations that you specify. Cursors are markers that you position using the knobs. Once the cursors are positioned, readouts in the Cursors major menu show the absolute locations of the two cursors, and the difference (Δ) between them.

- **Vertical Bar** cursors are a pair of vertical bars. The positions of the cursors and the horizontal distance between them are shown in horizontal axis units.
- **Horizontal Bar** cursors are a pair of horizontal bars. The positions of the cursors and the vertical distance between them are shown in vertical axis units.
- **Paired Dot** cursors are a pair of small, diamond-shaped dots resting on the waveform. As you move a dot cursor using the knob, it follows the waveform to the left or right. The cursor readout shows both the vertical and horizontal positions, in the respective axis units.
- **Split Dot** cursors appear similar to paired dots, except the dots may be on different waveforms. The readout indicates both the vertical and horizontal measurements, in the respective axis units.

Consider using the automated measurement system to take measurements instead of using cursors.

You can use cursors to take several measurements. However, the automated measurement system is easier, faster, and more accurate. You can take many common measurements using the Measure major menu. See Measurements on page 173 for more information.

Cursors

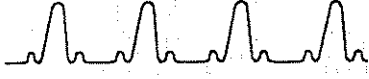

Cursor Operation

The **Cursors** icon functions like a major menu button.

Before you use cursors, display the waveform(s) you want to measure. The waveform should be selected (highlighted). For split-dot cursors, either waveform may be selected.

To invoke the Cursor major menu, touch the **Cursors** icon, located above the graticule containing the selected waveform. This icon operates like one of the menu buttons at the right of the screen: it has its own major menu. When the Cursor menu is displayed, none of the lights of the major menu buttons are lighted.

When you touch the **Cursors** icon, the DSA displays the cursors and their readouts and assigns the knobs to adjust cursor positions.

The **Cursors** major menu has two selectors, the **Cursor Type** selector and the **Page to** (Previous Menu) selector. The rest of the major menu area shows the data readouts associated with the displayed cursors.

The cursors can be set to remain displayed even after exiting the **Cursors** major menu by first getting into the Utility 1 major menu. Touch the **Modes** pop-up menu and press **Cursor Hold**. When in this mode, the **RemCurs** icon appears in the lower left portion of the graticule. This icon appears when cursors are displayed. This icon enables you to remove the cursors at any time without returning to the **Cursors** menu. Cursors are automatically removed when the **Measure** major menu is displayed.



Cursor Type		Move Cursor 2 to		
Vertical Bars	Paired Dots	Wfm 1		
Horizontal Bars	Split Dots	L1 Main		
	Coarse Dots Mode Fixed Interval			
v1 = 4.960V	t1 = -6.000μs	Cursor Type	Page to	Rem Wfm 1
v2 = 0.000V	t2 = 505.5μs	Paired Dots	Previous Menu	L1 Main
Δv = -4.960V	Δt = 511.5μs	Cursor 1		Cursor 2
	1/Δt = 1.955kHz	-6.000μs		505.5μs
	Δv/Δt = -9.697V/ms			

The Cursors Major Menu and Cursor Type Pop-Up Menu

Selecting Cursor Types

At the top of the **Cursor Type** pop-up menu, you can select from four cursor types. If you select **Vertical Bars**, **Horizontal Bars**, or **Paired Dots**, the DSA removes the pop-up menu and shows the selected cursors. The knobs control the cursor positions.

If you select **Split Dots**, the pop-up menu stays on the display and the right half of the pop-up menu becomes active. The right half of the menu shows a selector for each displayed waveform (for example **Wfm 1**, **Wfm 2**). The selector for the selected waveform is highlighted.

At this point, both split-dot cursors are assigned to the selected (highlighted) waveform. To assign the second (right-most) cursor to a different waveform, touch the selector for that waveform. This action removes the pop-up menu and moves the second cursor to the selected waveform.

The default cursor type can be specified by pressing **Default Cursor** in the **Modes** pop-up menu in the Utility 1 major menu.

Cursors

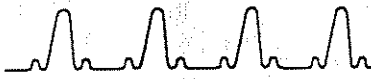

Cursors can be constrained to moved in fixed increments or allowed to jump from one peak to the next.

The **Coarse**, **Medium**, and **Fine** selectors can be found on the Knob pop-up menu.

There is an additional selector, **Coarse Dots Mode** which specifies how the cursors are moved around on a waveform. Touch the **Cursor Type** selector in the **Cursors** major menu and then touch the **Coarse Dots Mode** selector. When the default, Fixed Interval, is selected, the Dots cursors are moved a fixed interval from their previous location with each knob click. The interval is under knob control and its resolution could be coarse, medium, or fine. The + Peak Search Mode will place the cursors on the peaks of the waveform as you turn the knob (each click will move the cursor to the next peak). The knob readout indicates the horizontal position of the cursors. +/- Peak Search Mode will move the cursor from peak to valley and peak again, while - Peak Search Mode will detect the valley points of the waveform. Peak Search mode works only when the knob resolution is set to coarse. (See Knobs on page 10.)

Additional Cursor Facts

- Cursors appear on the selected waveform. If another waveform is selected the cursors move to it.
- Split Dot cursors cannot be used on XY waveforms. Other cursor types operate normally on XY waveforms.
- The horizontal cursor readout includes the inverse of the delta ($1/\Delta t$), which can be used to show frequency. Below that is the slope $\Delta v/\Delta t$, used to measure the slew rate. The cursor readout also shows the absolute values of the cursor locations and the distance between them.
- Dot cursors are positioned on actual waveform points. Bar cursors are referenced to display pixels. Therefore Dot cursors will yield higher resolution and more accurate measurements.

Cursors

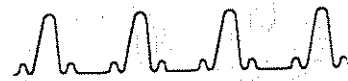

- A dot cursor is displayed as a vertical bar if it is placed on a waveform where waveform data cannot be displayed. This is because without waveform data, there is no known vertical position for the dot.
- If a dot cursor is positioned on a waveform record point that is off the edge of the screen, an arrow appears at the screen edge pointing toward the off-screen cursor.

Cursors

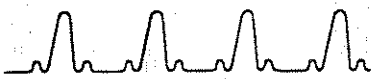

Cursor Examples

Measuring Waveform Amplitude

The following procedure shows how to use cursors to measure waveform amplitude.

- Step 1: Acquire and display a waveform you want to measure. Make sure all of the waveform is within the graticule area, but make the waveform as tall as possible.

OR

- Step 2: Select the waveform you want to measure.
- Step 3: Touch **Cursors**, **Cursor Type**, and **Horizontal Bars**.
- Step 4: Use the knobs to move the cursor positions to the top and bottom of the waveform. Use the **FINE** buttons adjacent to the knobs to increase the resolution of the knobs. This lets you position the cursors more precisely. The Δv readout at the bottom of the display indicates the waveform amplitude.

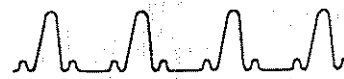

Measuring the Waveform Slew Rate

The following procedure shows how to use cursors to measure waveform slew rate.

- Step 1: Acquire and display the portion of the waveform you want to measure.
- Step 2: Magnify the waveform horizontally, but make sure the portion you want to measure is within the graticule.
- Step 3: Touch **Cursors**, **Cursor Type**, and **Paired Dots**.
- Step 4: Position the cursors on the linear portion of the waveform. Use the **FINE** buttons adjacent to the knobs to increase the resolution of the knobs. This lets you position the cursors more precisely. The $\Delta v/\Delta t$ readout at the bottom of the display indicates the slew rate.

Cursors

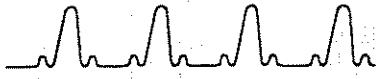

Measuring Time Between Points On Different Waveforms

The following procedure shows how to use cursors to measure time between points on different waveforms.

- Step 1: Create a display of the two waveforms you want to measure. Make sure that the point you want to measure on each waveform is visible on the display. For the most accurate results, use the shortest time per division that shows the points to be measured.
- Step 2: Leave either of these waveforms as the selected waveform, and note the number of the other waveform.
- Step 3: Touch **Cursors**, **Cursor Type**, and **Split Dots**.
- Step 4: Touch the waveform selector of the other waveform that you want to place a cursor on. If you've forgotten its number, the waveform description appears in each selector.
- Step 5: The cursors are now placed, one on each waveform. Use the knobs to move the cursors to the two locations between which you want to measure time difference. Then read the time difference (Δt) at the bottom of the display.

Diagnostics

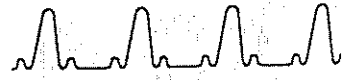

The DSA features a diagnostic system that performs comprehensive tests. This assures you that the DSA is operating correctly. A set of tests is performed automatically whenever the DSA is powered on. You can execute these and additional diagnostic tests at any time.

There are three categories of tests:

The DSA executes the power-on and self-test diagnostics when you turn the power on.

- Power-on Diagnostics are extremely basic functional tests. These ensure that the various microprocessors are running and communicating with each other. The power-on diagnostics take about 5 seconds to execute and are run only at power-on.
- Self-test Diagnostics are a subset of the extended diagnostics and are executed as a group at power-on. You can also execute this group at any time. This group of tests takes about 15 seconds to execute.
- Extended Diagnostics are a complete set of tests that you can execute either individually or as a group at any time. A separate menu system controls the extended diagnostics. Any time the self-test diagnostics encounter a failure, the extended diagnostics menu remains on the screen so that you are notified of the failure.

Do not touch the touch screen or press the front panel buttons during any diagnostic tests. Spurious failures may result.

The extended diagnostics menu is primarily intended as an aid for those servicing the DSA. This manual introduces the menu but does not discuss the extended diagnostics completely. For complete information, see the *DSA 601A and DSA 602A Service Reference*.

Diagnostics



Power-on Diagnostics

Power-on diagnostics execute when you turn the power on. The power-on diagnostics test the most fundamental operations of the microprocessors and the communication paths between microprocessors.

Power-on diagnostics take about 5 seconds to execute. During this time the front panel lights will blink and the display will show the following message.

Diagnostics in Progress

Comm Test in Progress

(If the display is not yet warmed up, you may not be able to see the message.)

You will also hear clicking as the plug-in amplifiers perform their power-on diagnostics.

If the power-on diagnostics are completed successfully, the self-test diagnostics are executed immediately and you will see the message **Self Test in Progress** on the display.

If the power-on diagnostics fail, one or both of the following indications will notify you.

- The DSA freezes and a message appears on the display. For example:

**Dsy Kernel Failure
RAM Data Bit**

- The DSA freezes, with some of the front panel lights turned on, and emits two high-low beeps.

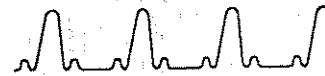

Self-test Diagnostics

The self-test diagnostics execute automatically after the power-on diagnostics are completed successfully.

The self-test diagnostics can also be initiated by touching the **Self Test** selector in the Utility 2 major menu.

The self-test diagnostics take 15 seconds to execute. During this time you will see the message **Self Test in Progress** on the display. You will also see the front panel lights blink on and off, and you will see several test patterns on the display.

If the self-test diagnostics are completed successfully, the DSA will return to the state it was in before the self-test diagnostics ran. In the case where the self-test diagnostics were executed after power-on, the DSA will return to the state it was in when last powered off.

If the self-test diagnostics fail, the extended diagnostic menu is displayed and the failure is noted on the display. You can exit the extended diagnostic system and try to use the DSA, but until the failure is repaired you should not rely on any measurements taken. Call your service person to repair the cause of any failures.

Extended Diagnostics

You can enter the extended diagnostic system by touching the **Extended Diagnostic** selector in the Utility 2 major menu. When self-test diagnostics fail, the extended diagnostic system is entered automatically.

The extended diagnostic system is an independent subsystem of the DSA. While in this system, the front panel buttons will not operate and the Extended Diagnostics menu covers the entire display.

To leave the extended diagnostic system and return to normal DSA operation, touch the **(E) Exit** selector in the Extended Diagnostics menu. The DSA will return to the state it was in before the extended diagnostics were entered. In the case where extended diagnostics were entered after power-on, the DSA will return to the state it was in when last powered off.

Diagnostics

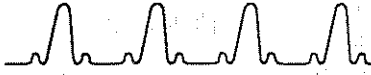

The top portion of the Extended Diagnostics menu shows three columns with the status of the diagnostic tests. The first four blocks are shown below; there are a total of fifteen subsystem test blocks.

<u>BLOCK</u>	<u>INDEX</u>	<u>FAULTS</u>
a) Exec Control	****	
b) Front Panel	****	
c) Internal I/O	****	
d) External I/O	****	

If the extended diagnostic system has been entered because of a test failure, the asterisks in the **INDEX** column will be replaced with a failure index. The three columns of this display have the following meanings:

- **BLOCK** lists the names of the subsystem tests.
- **INDEX** shows the test status for each subsystem. Four asterisks (****) indicate the subsystem tests have yet to be executed. Four dashes (----) indicate the test requires some setup. If a blank appears in this column, the test requires interaction. The word **pass** indicates all tests in this subsystem have executed successfully. If **????** appears in this column, the tests of that particular subsystem are not appropriate for the DSA as it is configured. Any other number or letter sequence indicates a diagnostic failure.
- **FAULTS** shows the number of tests in the subsystem that fail.

If the DSA does not pass the extended diagnostic tests, do not rely on any measurements taken. Call your service person for repair.

Diagnostics



Running all of the extended diagnostic tests takes about a minute. You may execute all the tests from the Extended Diagnostics menu by touching the **(x) All** selector to set the all parameter **On**, and then touching the **(r) Run** selector.

While the diagnostic tests are running, the **(r) Run** selector becomes a **(q) Quit** selector. You can touch this selector to stop execution of diagnostic tests.

When the extended diagnostic tests are complete, the **(r) Run** selector is displayed again, and the test status appears in the **INDEX** and **FAULT** columns.

When you are done with the extended diagnostic tests, touch the **(E) Exit** selector.

Diagnostics

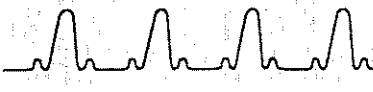

Disk Drive



The DSA 601A and 602A are equipped with a floppy disk drive, so you can store and recall waveforms and front panel settings to and from a 3.5 inch PC-compatible floppy disk.

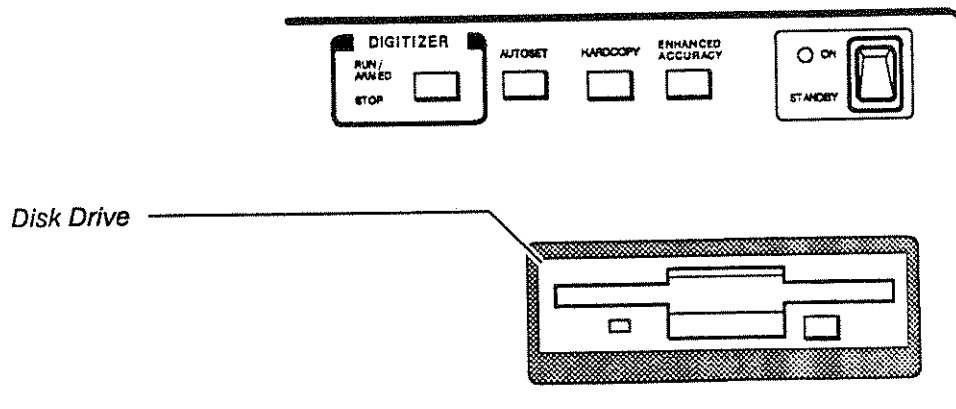

The Disk Drive Location

The Utility 3 major menu contains commands for controlling the floppy disk drive. To enter the Utility 3 major menu, press the **UTILITY** button, then touch the **Page to** selector until the third menu appears. You can also reach the Utility 3 major menu by pressing the **UTILITY** button until the Utility 3 menu appears on the screen.

Disk Ops	Directory Ops	File Ops		Page to Utility 1	Rem Wfm 3 C1 Wind
			Window Size 1 μ s/div	Pan/Zoom Off	Window Position -7.5 μ s

Utility 3 Major Menu

Disk Drive

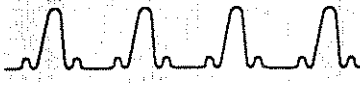

File Types

Note that the binary waveform file format on disk is not the same as the binary waveform format transferred over the GPIB or RS-232-C.

The Utility 3 major menu contains three selectors: **Disk Ops**, **Directory Ops**, and **File Ops**. Each of these selectors provide a pop-up menu. At the top of each pop-up menu is the command line that displays commands as they are entered. Displayed above the File List is the directory that contains the files listed. Also in each pop-up menu are selectors used to enter commands. The commands are equivalent to MS-DOS commands.

The **File Ops** menu contains a **File Type** selector and a **File Data Format** selector.

All *settings* files are stored as binary files and have the extension **.FPB**.

When working with *waveform* files in the **File Ops** pop up menu, you can choose the format in which the data is stored. You can choose between *binary*, *ASCII*, *11k Utility* and *Worksheet*. Each format has a three character file extension assigned to it (**WFB**, **WFA**, **W04**, **WF1**, respectively). The format you choose depends upon the application you will use. For example, if you want to use the file in Lotus 1-2-3, you would set the waveform file data format to *Worksheet* and then *import* the file into 1-2-3. The default waveform file data format is *binary*.

When saving a hardcopy to the disk, be sure to set the **Output Port** selector, after setting the desired printer format, to *Disk* in the **Hardcopy** pop-up menu. (The DSA remembers the output port assigned to each printer format.)



The current directory is shown on this line

File Type Selector
File Data Format Selector

The directory on this line contains the file(s) in the file listing.

File Operations					
A:\>					
File Type	attrib	rename	copy	A:	Enter
waveform					
File Data Format	delete	prefix		D:	
binary		ST0		RAM	
.WFB					
A:*.*					
ST01.WFB	2342	ST02.WFB	2340	PAGE↑	
14:08:48	17-MAR-00	14:09:28	17-MAR-00		
					PAGE↓
					Space
Keyboard	File List	Erase	Backspace	Exit	
Disk Ops	Directory Ops	File Ops		Page to Utility 1	Rem Win 2 L1 Main
			Main Size 10μ s/div	Pan/Zoom Off	Main Position -23μ s

File Ops Pop-Up Menu Showing a File Listing

Disk Drive

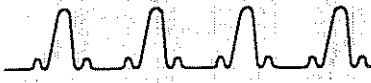

Disk Operations

Status information is displayed in the command entry area as the disk is formatted.

To format, label, or check disks, touch the **Disk Ops** (Disk Operations) selector to enter the **Disk Ops** pop-up menu.

Formatting Disks

The **format** selector operates identically to the MS-DOS **format** command. Formatting sets up a PC compatible floppy disk to accept MS-DOS files. Just as with MS-DOS, formatting a disk that is already formatted results in the irretrievable loss of all data on the disk.

To format a disk, insert a 3.5 inch floppy disk in the disk drive and touch **format,A:**, enter a label if desired and then touch **Enter**. A message will appear at the top of the display indicating the results of the operation. The DSA can use double-sided double-density or double-sided high-density disks.

Labelling Disks

The **label** selector operates identically to the MS-DOS **label** command. You can add, change, or delete the disk label. Touch the **Label** and **A:** selectors, then type a label using the pop-up keyboard. The label identifies a formatted disk in eight characters or less. The label appears below the **Label** selector in the **Disk Ops** pop-up menu.

Checking Disks

The **chkdsk** selector analyzes the disk, just as the MS-DOS **chkdsk /f** command does. It scans the disk, identifies orphan sectors and corrupt structures, and returns unused sectors to the free pool. To identify a corrupt disk, run a diagnostic check by inserting the disk, then touching **chkdsk, A:**, and **Enter**. A message appears at the top of the graticule displaying the results of the operation.

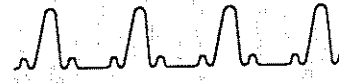

Disk Operations										
A:\>										
File Type	format	label	chkdsk	A:	Enter					
File Data Format					D:					
RAM										
1	2	3	4	5	6	7	8	9	0	.
Q	W	E	R	T	Y	U	I	O	P	>
A	S	D	F	G	H	J	K	L	;	*
2	X	C	V	B	N	M	_	^	~	Space
Keyboard File List				Erase	BackSpace	Exit				
Disk Ops	Directory Ops	File Ops			Page to Utility 1	Mem Wfm				
			Main Size	50μ			Main Position	-6μ	s	

Disk Ops Pop-Up Menu

Disk Drive



Directory Operations

To change directories, make directories, remove directories, rename directories, and list the contents of existing directories on a disk, use the operations in the **Directory Ops** pop-up menu.

Making Directories

To make a subdirectory of the root directory, A:\, touch the **mkdir** selector followed by **A:**, the **Keyboard** selector, and ****. Use the keyboard on the screen to name your directory. Directory names can be up to eight characters in length and can include a three character file extension. After you type in the name, touch **Enter**. To see a list of directories, select **File List** at the bottom of the **Directory Ops** pop-up menu. You can also create subdirectories of subdirectories in the same manner. Example: **mkdir A:\WAVEFORM, ENTER** then **mkdir, A:\WAVEFORM\TEST1, ENTER**. **TEST1** is a subdirectory of **WAVEFORM**.

Changing Directories

You can change the current directory to a specified directory by touching the **chdir** selector. Type in the directory name using the pop-up keyboard. You can also select **chdir**, **File List** and touch the name of the desired directory. Touch the **Enter** selector to implement the change.

Removing Directories

You can remove a specified directory by using the **rmdir** command. Touch **rmdir**, then type the directory name, or select the directory by touching its name in the File List. Touch **Enter**. To verify that the directory was removed, touch **dir, A:**, and **Enter**. The removed directory should not appear in the file list.

Renaming Directories

You can change the name of a directory by using the **ren** command. First select **ren**, followed by the directory you want to rename. Enter a space, type in the new name, and touch **Enter**.

You cannot remove a directory if it contains any files or subdirectories. See File Operations for more information about removing files.



Directory Operations										
A:\>										
File Type	chdir			mkdir			rmdir			A: Enter
File Date Format	renir			dir						D: RAM
1	2	3	4	5	6	7	8	9	0	.
Q	W	E	R	T	Y	U	I	O	P	.
A	S	D	F	G	H	J	K	L	;	'
2	X	C	V	B	N	M	_	^	&	Space
Keyboard		File List		Erase		BackSpace		Exit		
Disk Ops	Directory Ops		File Ops				Page to Utility 1		Rem Win	
					Main Size 50μ s/div				Main Position -6μ s	

Directory Ops Pop-Up Menu

Disk Drive



Listing the Contents of Directories

To display the contents of the current directory, touch the **dir** command then **File List**. To view the contents of another directory, touch the **dir** selector, type in the name of the directory (or select the directory by touching the name in the File List) then touch **File List**.

The wildcards question mark (?) and asterisk (*) work identically, as in MS-DOS, for listing directories and files. ? is a substitute for a single character. * substitutes for more than one character. For example, **dir A:\S*.* Enter** displays a list of all files that begin with the letter S in the root directory of A:.

The pointers period (.) and double period (..) appear in subdirectories and refer to directories. . is a link to the current directory. .. is a pointer to the parent directory. You can select these pointers to simplify path descriptions.

File Operations

Use file operations to change the mode (read only or read and write), rename files, copy files, and delete files. File operations also allow you to specify the format of the data in waveform files (binary, ASCII, 11K Utility, or Worksheet) and to set the default file prefix for each of the file types. For example, you can change **STOmmm.WFA** to **WFMnnn.WFA**.

Changing Attributes

The **attrib** selector toggles between *read only* and *read/write* files. A *read only* file is indicated by a +r in the command line; a read/write file is indicated by a -r. These indicators also appear in the right portion of the file selector in the file list. To change a file attribute, touch **attrib, A:**, and the file you want to change, then touch **Enter**.

Renaming Files

The **rename** selector allows you to change the name of a file to the new name specified. Touch **rename, A:**, the file you want to rename, space, **Keyboard**, the new filename, and finally **Enter**. To verify the change, touch **File List**.



You can also copy files from RAM to DISK and DISK to RAM using the **Disk Copy** selector in the STORE/RECALL major menu. See page 21.

You can also delete files by using the **Delete Waveform** or **Delete Setting** selectors in the STORE/RECALL major menu. See page 21.

Storing Information to Disk

Copying Files

To copy a file to another location on the disk, touch the **copy** selector, select the file you want to copy, a space, the directory, and the new filename. To copy all files in a directory to another directory type in **copy**, **.***, **Space**, and the directory you are copying to.

Deleting Files

You can delete a file by touching **delete**, the file to be deleted, and **Enter**. You can delete more than one file by using wildcards.

Changing Prefixes

You can change the prefix for newly created files for each File Type. Simply select the File Type for which you would like to change the prefix. Select **prefix** and use the pop-up keyboard to type in the new prefix. Then touch the **Enter** selector.

To store waveforms to the disk, set the desired directory path for your waveforms by using the **Directory Ops** pop-up menu in the Utility 3 major menu. Then use the selectors in the **Store Waveform** pop-up menu of the Store/Recall major menu.

To save a waveform or your front panel settings, you need to specify whether to save to RAM or to the floppy disk. To do this, select between the **DISK** and **RAM** icons that appear at the top right of the **Store Waveform** and **Store Setting** pop-up menus. For more information see the Stored Waveforms section on page 239 and the Stored Settings sections on page 229.

Disk Drive

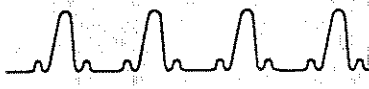

Before storing a file on disk, be sure to specify the disk as the destination of the stored file. To do this:

- Press the **STORE/RECALL** button and select the **Store Waveform** or the **Store Setting** pop-up menu. Select the stored file destination by touching the **DISK** icon. The **RAM** and **DISK** icons toggle between **RAM** and the currently specified directory path on the disk. The directory path is set using the **chdir** command in the **Directory Ops** pop-up menu.

For more information on storing information, see **Stored Settings** on page 229 and **Stored Waveforms** on page 239.

Display Intensity

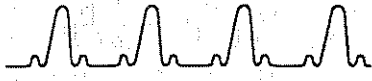

Display Persistence



Normally, a waveform appears “live” on the display because each acquired waveform record replaces the waveform record currently on the display. This is “normal” display persistence.

You can also display a waveform in a mode that shows a history of the waveform. If you select variable persistence, individual samples that compose each waveform record are added to the display as individual dots, and remain on the display for a length of time you specify while new samples are taken and displayed.

Infinite persistence is similar to variable persistence, but displayed waveform samples are not cleared from the display unless you explicitly clear or remove the waveform.

Use the **Horizontal Desc** pop-up menu in the Waveform major menu to change the display persistence of the selected waveform. This menu is shown on the next page. **Normal** selects normal display persistence, **Infinite** selects infinite persistence, and **Variable** selects variable persistence. To set the length of time that waveform points remain on the display in variable persistence mode, select **Persist Time** and adjust the time using the knobs or keypad pop-up menu.

The following restrictions apply to waveforms in variable or infinite persistence modes:

- You cannot perform automated measurements on waveforms displayed in variable or infinite persistence modes.
- Variable or infinite persistence is available only with record lengths up to 2048 points.
- You cannot use both variable and infinite persistence on the same graticule. If you select either **Variable** or **Infinite** persistence for one waveform, any other waveforms on the graticule that are not in normal mode will change to the selected persistence mode.
- All waveforms displayed in variable or infinite persistence mode on the same graticule will be displayed in the same color. Their color will match the color of the most recently selected waveform displayed in variable or infinite persistence mode.

Display Persistence



- XY waveforms are always displayed with either variable or infinite persistence if there is any waveform on the same axis in any of the above modes.

Display Persistence Controls

Horizontal Description					
Acquiring Timebase: Main Main Sample Interval: 500ns/point RT Window Sample Interval: 50ns/point					
Main Record Length 1024 points			Window Record Length 1024 points		
Display Persistence Normal Infinite Variable Persist Time 1s			Digitizer Interleave 1GS/sec Realtime Disabled		
XY Display Mode: X=Displayed Waveform					
Normal Wfm 1 L1 Main		Displayed Waveforms			
Stored Waveforms		RAM DISK			
Vertical Desc	Horizontal Desc	Acquire Desc	Graticules	Page to Status	Rem Wfm 1
L1 Fast	Main 2MS/sec	Continuous		All Wfms	L1 Main
Input Parameters DC 1MΩ/300MHz	FFT Control dBm Rectang	Act on Delta None	Main Size 50μ s/div	Pan/Zoom Off	Main Position -6μ s

The Horizontal Desc Pop-Up Menu

Enhanced Accuracy

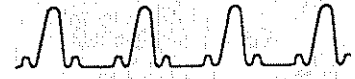

Use Enhanced Accuracy only after a 20-minute warm-up period.

Enhanced Accuracy is an automatic self-calibration that achieves the highest accuracy level (better than 1% vertical accuracy) for the DSA. Enhanced Accuracy calibrates the vertical system from the channel inputs of the plug-in units through the digitizer.

To compensate for differences in propagation delay and achieve best system accuracy, probes and cables should also be calibrated. See Probe Calibration on page 217.

Changes of internal DSA temperature greater than $\pm 5^{\circ}\text{C}$ or configuration changes such as installing new plug-in units or probes will require Enhanced Accuracy calibration. If you choose not to run Enhanced Accuracy calibrations, the DSA will return to normal accuracy, which is typically 3% vertical accuracy or better.

When Enhanced Accuracy is in effect, the Enhanced Accuracy symbol () appears to the left of the graticule. This symbol also appears when the selected waveform is a stored waveform that was acquired with the system in the Enhanced Accuracy state.

Running Enhanced Accuracy

Enhanced accuracy calibration can be initiated either manually or automatically. To manually run Enhanced Accuracy calibration, press the **ENHANCED ACCURACY** button twice during normal operation. The second push confirms that you wish to start calibration. A message on the display will prompt you to run Enhanced Accuracy whenever the system reverts to normal accuracy.

ENHANCED ACCURACY
Button

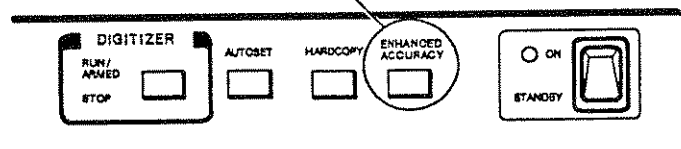

Enhanced Accuracy

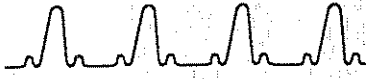

Do not turn the power off while Enhanced Accuracy calibration is in progress.

In automatic Enhanced Accuracy mode, a message on the display tells you that Enhanced Accuracy calibration is needed and is starting.

Enhanced Accuracy calibration takes several minutes to execute. You should not turn off the DSA or change any settings until the calibration is complete.

Setting the Enhanced Accuracy Mode

To set the Enhanced Accuracy mode to **Manual** or **Automatic**, touch the **Enhanced Accuracy Mode** selector in the **Instrument Modes** pop-up menu in the **Utility 1** major menu.

Enhanced Accuracy Mode Selector

Instrument Modes					
Autoset					
Vertical	Horizontal	Undo Last			
Pk-Pk	Period	AutoSet			
miscellaneous					
Multitrace	Pan/Zoom	Averaging	Enhanced Accuracy		
Pan/Zoom	Pivot	Type	Manual		
Off	Center	Backweight			
Vectorized	Zoom	Stored Wfm	Incremental		
Waveforms	Intp	Time Fmt	Acquire		
On	Sin(x)/x	Show	Disabled		
Waveform	Audio	Default	Cursor		
Scaling	Feedback	Cursor	Hold		
Optional	On	Paired	Off		
Trigger					
DC Level					
Screen					
Calibrator	Modes	Probes	Color	Page to	Rem
				Utility 2	Wfm 1
					L1
					Main
Initialize	Time & Date	Label	Main Size	Pan/Zoom	Main Position
	15:10:41	Disp: On	50µ	Off	-6µ
	10-OCT-90	Mode: Man	s/div		s

The Modes Pop-Up Menu

Fast Fourier Transforms

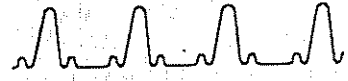

You can use the Fast Fourier Transform (FFT) capability of the DSA to obtain a frequency domain display of a waveform. You can display both the magnitude and the phase of the frequency components of the signal.

There are six FFT magnitude formats available with a linear or decibel vertical scale.

You can perform Fast Fourier Transforms on any arbitrary waveform. The record length of the waveform must be a power of two, up to a maximum of 16384 points.

The DSA can display the real and imaginary components of the FFT. It will also perform the inverse FFT of a real and imaginary pair, from frequency domain to time domain.

The DSA offers a choice of six FFT windowing functions that modify the time domain data to minimize "leakage" of energy across frequency components.

Signal source averaging is available to improve the quality of the FFT display by reducing the effects of random noise.

You can use the automated frequency domain measurements to make magnitude and frequency measurements and you can use cursors to take phase measurements.



Defining an FFT Waveform

Using the **DefWfm** icon to define a waveform is explained on page 282.

You can define an FFT display of a waveform using the **DefWfm** pop-up menu or you can use the **FFTmag** and **FFTpha** icons.

Defining an FFT Display Using the **DefWfm** Pop-up Menu

You can define a waveform that displays the FFT magnitude or FFT phase using the **DefWfm** pop-up menu, which is displayed when you select the **DefWfm** icon. The **FFTmag()** and **FFTphase()** selectors in the **Waveform Functions** can be used to define a display of the magnitude or the phase of the frequency spectrum of a waveform. The part of the waveform description that is within the **FFTmag()** or **FFTphase()** function may be any arbitrary waveform. A list of previously defined waveforms is displayed in the pop-up menu after the function is selected.

Using the same menu, you can also display the real and imaginary components of an FFT using the **FFTreal()** and **FFTimag()** selectors.

The **IFFT()** selector is used for performing an inverse FFT transformation.

Fast Fourier Transforms

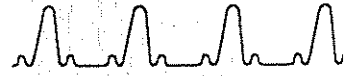

FFTmag and
FFTphase Selectors

Vertical Description					
L1	C1	R1	7	8	9 +
L2	C2	R2	4	5	6 -
L3	C3		1	2	3
L4	C4		0		END
Waveform Functions		Signum()	Smooth()	Sqrt()	Convolve()
Stored	RAM	Correlat()	Dejitter()	Delay()	Pulse()
Adjustable Constants:		FFTmag()	FFTphase()	PAGE↑	PAGE↓
Enter Desc	()	Back Space	Cancel		
Vertical Desc L1 Fast	Horizontal Desc Main 2MS/sec	Acquire Desc Continuous	Graticules Main 50μ s/div	Page to All Wfms Status	Rem Wfm 1 Main
Input Parameters DC 1MQ/300MHz	FFT Control dBm Rectang	Act on Delta None	Main Size 50μ s/div	Pan/Zoom Off	Main Position -6μ s

The DefWfm Pop-Up Menu

Fast Fourier Transforms



Defining an FFT Display Using the FFTmag and FFTpha Icons

You can display the magnitude of the frequency spectrum of a displayed waveform by selecting the waveform and touching the **FFTmag** icon. The DSA will create a second graticule to display the FFT magnitude of the waveform. If the display already shows two graticules, the FFT magnitude will be displayed on the lower graticule.

Once you have created a display of the magnitude of the frequency spectrum, the **FFTpha** icon appears above the lower graticule. Touch this icon to display the phase of the frequency components of the waveform. The FFT phase waveform will appear on the lower graticule.

The FFT values are relative to the center of the time domain trace. The FFT phase waveform can be displayed in either a wrapped or unwrapped format. The wrapped format forces the phase to be displayed between $\pm 180^\circ$. The unwrapped format places no restrictions on the phase display. This format is accessed in the **FFT Control** pop-up menu using the **Phase Format** selector.

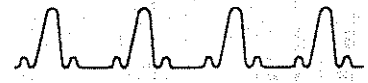

The FFTmag Icon

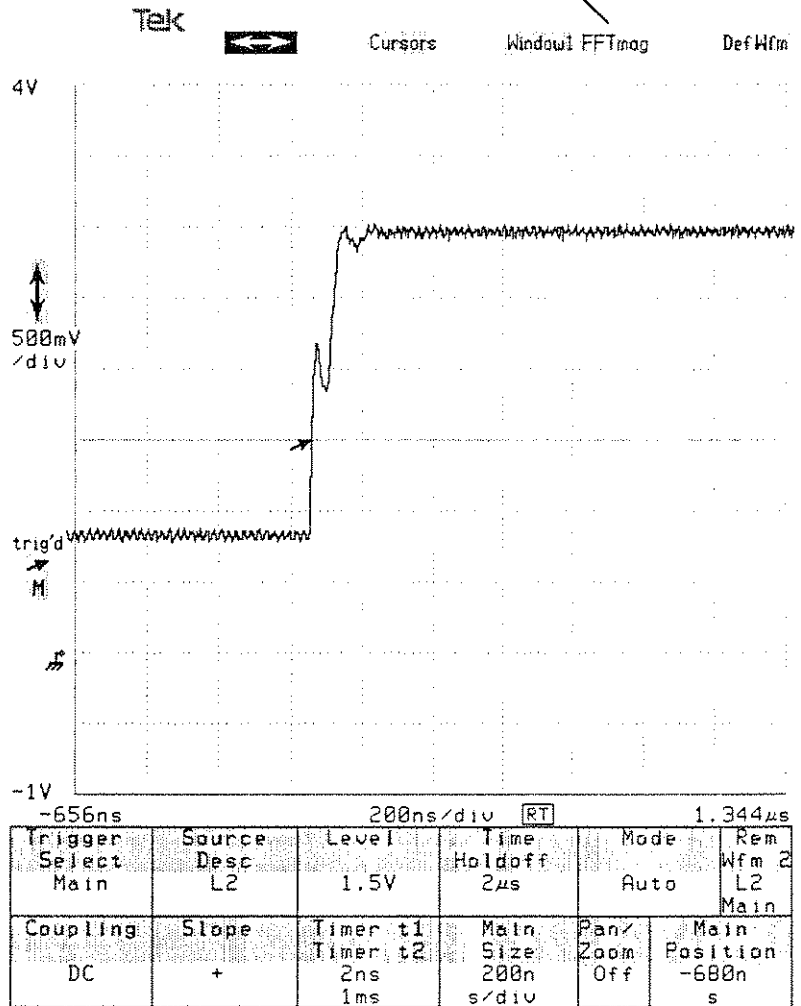

Location of the FFTmag Icon on the Display

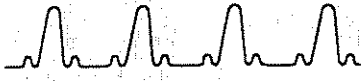

Amplitude Resolution

Amplitude resolution is influenced by the windowing function used and by the vertical adjustment of the time domain waveform. For maximum amplitude resolution, the time domain waveform should be adjusted so that it is centered vertically on the graticule and is as tall as possible without going beyond the graticule, above or below. Setting vertical size and position of waveforms is explained on page 277.

Frequency Range and Resolution

The range and resolution of the frequency spectrum displayed by the DSA are determined by the sample rate and record length of the time domain waveform.

A waveform record of N points in the time domain corresponds to a record of the same number of points in the frequency domain. However, for any real signal, the frequency domain data will be symmetrical about DC, and only the positive part of the spectrum is displayed. Of the displayed points of the FFT waveform, the $N/2$ even-numbered points are the *frequency lines* computed by the FFT; the $N/2$ odd-numbered points are added by interpolation.

The maximum frequency that can be determined by a Fast Fourier Transform is the *Nyquist frequency*, which is equal to one-half the effective sample rate. In fact, the maximum frequency displayed by the DSA, F_{max} , is slightly lower than the Nyquist frequency; it is equal to the Nyquist frequency minus the *frequency interval*, δF , the interval between frequency lines. The *frequency range* displayed is from DC (0 Hz) to F_{max} .

The frequency interval, δF , is equal to the Nyquist frequency divided by the number of frequency lines in the FFT display (half the record length of the time domain waveform). Since the Nyquist frequency is half the sample rate, this works out to the sample rate divided by the record length.

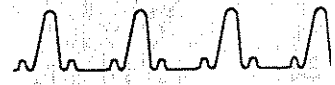

$$\delta F = \frac{\text{sample rate}}{\text{record length}}$$

$$F_{\text{max}} = \frac{\text{sample rate}}{2} - \delta F$$

Equations for Frequency Interval and Frequency Range

For more information on setting horizontal size see page 153. Setting record length is discussed on page 221.

The sample rate is displayed in the status field of the **Horizontal Desc** selector in the Waveform major menu. The record length appears in the **Horizontal Desc** pop-up menu. You can change the frequency interval and frequency range by changing the record length and horizontal size of the time domain waveform. Both record length and horizontal size affect the sample rate.

If the record length increases without a change in the sample rate, frequency resolution improves (δF decreases). When possible, the DSA will automatically modify the sample rate to maintain the current horizontal size when you change the record length. When the sample rate increases, F_{max} and δF both increase, giving the FFT waveform a broader frequency range with less frequency resolution.

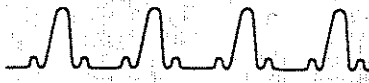

Aliasing

Aliasing occurs when the input signal includes components at frequencies higher than the Nyquist frequency. These frequency components appear in the FFT waveform display as peaks at lower frequencies. The higher-frequency components are reflected around the Nyquist frequency. For example, a frequency component 5 MHz above the Nyquist frequency will appear as a peak 5 MHz below the Nyquist frequency in the FFT waveform display.

You can eliminate aliasing by setting the sample rate to be at least twice the highest frequency in the input signal, or higher than twice the analog bandwidth of the DSA (1 GHz). Increasing the record length or decreasing the horizontal size will increase the sample rate.

The best way to avoid aliasing is to apply a filter to the signal to cut high-frequency components. The plug-in amplifier bandwidth limits and the 100 MHz antialiasing digitizer filter of the DSA provide a limited filtering capability. See Plug-in Units on page 201 for more information on the digitizer filter and on setting plug-in amplifier bandwidth limits.

You can apply backweighted averaging (Number of averages = Set Avg N in the Acquire Desc menu) to the source signal to reduce random noise and prevent aliasing of high-frequency noise in repetitive waveforms. Select **Average Source Wfm** in the FFT Control pop-up menu from the Waveform major menu to have the source waveform averaged prior to FFT computation. The time domain waveform, if it is displayed, is not affected by this averaging.



FFT Control					
FFT Windowing		Magnitude Format			
Blackman	Blackman-Harris	Average Source Wfm	dBm	V	(Linear)
		Off			
Hanning	Hanning	DC Suppress	dBV	Vrms	(Linear)
		Off			
Rectang	Triangular	Phase Format	dBVrms	dBfund	
		Wrap			
Vertical Desc	Horizontal Desc	Acquire Desc	Graticules	Page to	Rem Wfm 1
L1	Main	Continuous		All Wfms	L1
Fast	5MS/sec			Status	Main
Input Parameters	FFT Control	Act on Delta	Main Size	Pan/Zoom	Main Position
DC	dBm	None	20 μ	Off	-42.4 μ
1M Ω /300MHz	Rectang		s/div		s

The FFT Control Pop-Up Menu

FFT Magnitude Format

You can change the vertical scaling of the FFT magnitude display by touching the **Magnitude Format** selector in the **FFT Control** pop-up menu. There are six formats available.

- **dBm**—The display is in dB relative to a 0.316 V peak sine wave on 50 Ω (0 dBm).
- **V (linear)**—This displays the linear magnitude of the peak volts.
- **Vrms**—This displays the linear magnitude of the rms volts rather than peak volts.
- **dBVrms**—For this scale, 0 dB corresponds to a 1 V rms sine wave.

Fast Fourier Transforms

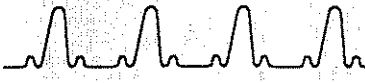

- **dBV**—This displays a scale where 0 dB corresponds to a 1 V peak sine wave.
- **dBfund**—This displays logarithmic magnitudes relative to the fundamental.

If you want to display the FFT magnitude of a waveform in dB relative to a specific reference, you can subtract your reference value from the FFT magnitude of the waveform when you enter the FFT waveform description. For example, enter `FFTmag(L1) - 10` to display the FFT magnitude of the signal at channel one of the left plug-in unit relative to a 10 dB reference.



FFT Windowing Functions

The Fast Fourier Transform operates on the time-domain waveform record acquired by the DSA. The FFT algorithm assumes that the signal is composed of an infinite repetition of this waveform record.

Since the time domain waveform record rarely matches an actual periodicity in the signal, the frequency spectrum displayed will reflect extra frequencies due to discontinuities at the time-domain waveform record edges. These additional frequencies are known as *leakage error*.

The effect of discontinuities at the ends of the time domain waveform record can be limited by choosing an FFT windowing function that tapers near the waveform record ends. The DSA provides a rectangular FFT window, which does not taper the time domain data, and five tapering FFT windows of different shapes.

Each time domain FFT windowing function corresponds to a filter in the frequency domain. Each frequency domain filter has a high central lobe, or passband. The width of this lobe determines how well adjacent frequency components can be resolved. The height of the side lobes surrounding the central lobe determines how much leakage can occur. Leakage is the spreading of energy from one frequency component across the displayed frequency spectrum; low amplitude frequency components can be entirely masked by leakage.

Select an FFT windowing function from the **FFT Window Selection** section of the **FFT Control** pop-up menu. The selected FFT windowing function applies to all FFT waveform displays. The shapes of the FFT windowing functions and their effects on a signal composed of two sine waves are shown in the following discussion; equations for the FFT windowing functions are provided in Appendix D: Algorithms.

Fast Fourier Transforms

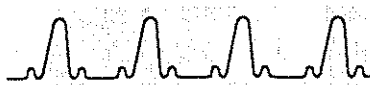

The Rectangular Window

The rectangular window does not taper the time domain data. In the frequency domain, the filter shape is $\text{sinc}(x)/x$. This is the best window to use when you want to examine the frequency spectrum of a non-repetitive signal. The rectangular window should also be used when you want to measure frequency components near DC.

Touch **Rectang** in the FFT Control pop-up menu to select this windowing function.

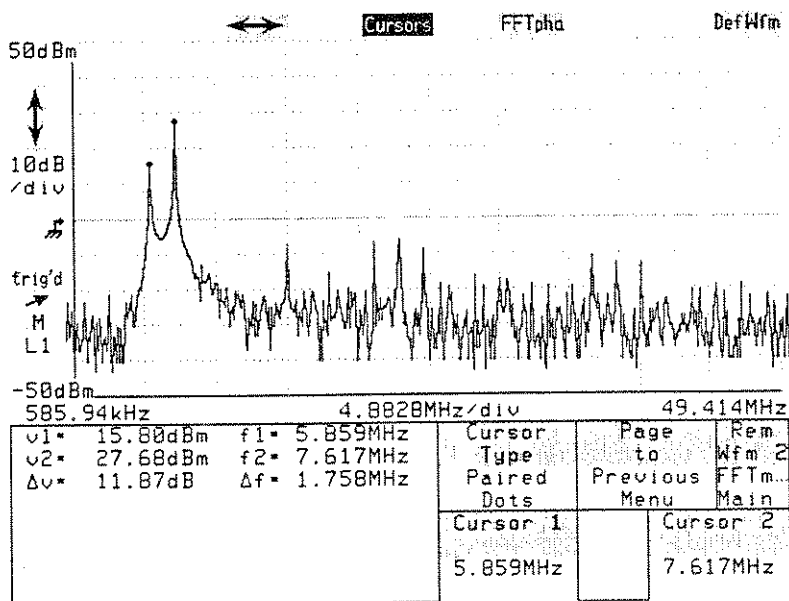
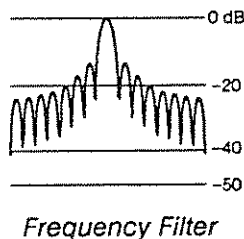

FFT Magnitude Displayed Using Rectangular Window

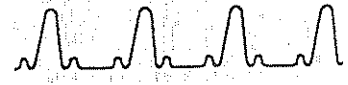

The Triangular Window

The triangular (or Bartlett) window is the convolution of two rectangles half the width of the window, so the frequency spectrum of the triangular window is the product of the rectangular window's spectrum with itself.

Touch **Triangular** in the **FFT Control** pop-up menu to select this windowing function.

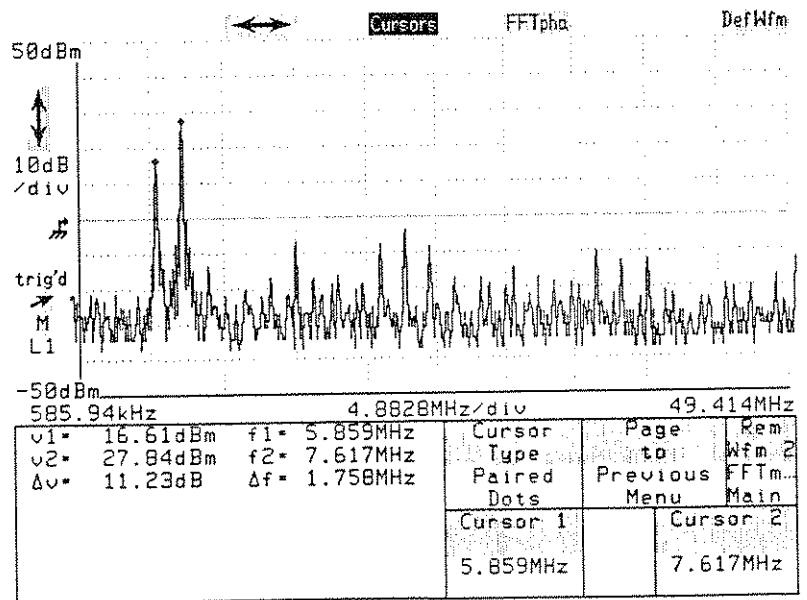
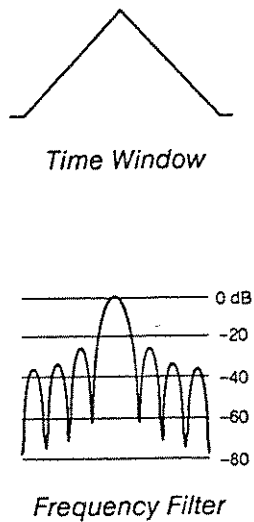

FFT Magnitude Displayed Using Triangular Window

Fast Fourier Transforms



The Hanning Window

The Hanning (or Hann, or cosine) window is derived from a cosine. This window provides reasonably good amplitude accuracy and leakage rejection.

Touch **Hanning** in the **FFT Control** pop-up menu to select this windowing function.

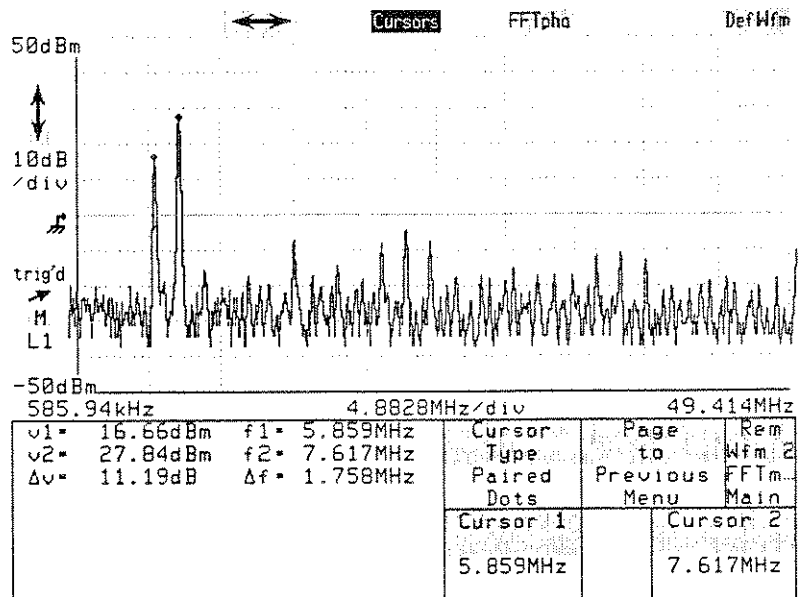
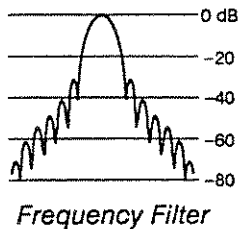

FFT Magnitude Displayed Using Hanning Window



The Hamming Window

The Hamming window is similar to the Hanning window, but is optimized to lower the first side lobe, which is why the separation between the two spikes in the illustration below is greater than in the illustration on the previous page. This window is especially useful for resolution of frequencies that are very close together.

Touch **Hamming** in the **FFT Control** pop-up menu to select the Hamming window.

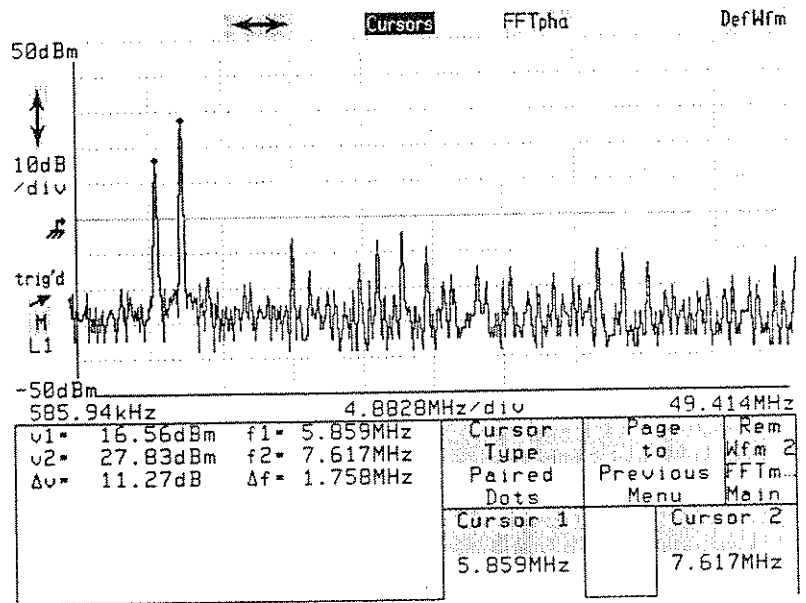
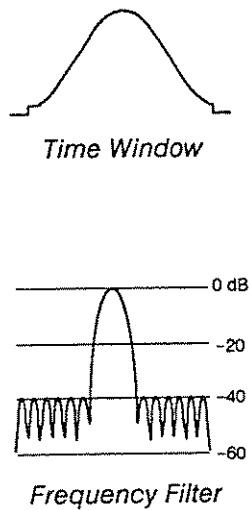

FFT Magnitude Displayed Using Hamming Window

Fast Fourier Transforms

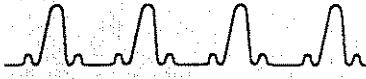

The Blackman Window

The Blackman window reduces leakage better than the Hamming window because of the lower side lobes in the frequency domain, but the resolution of nearby frequencies is diminished.

Touch **Blackman** in the **FFT Control** pop-up menu to select this windowing function.



Time Window

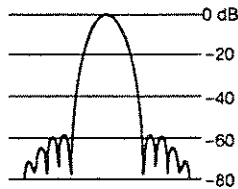

Frequency Filter

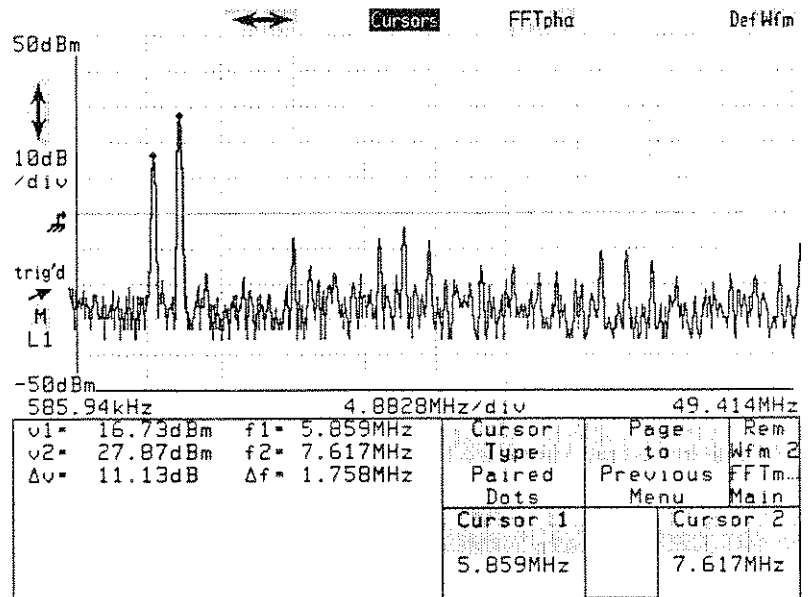

FFT Magnitude Displayed Using Blackman Window



The Blackman-Harris Window

The Blackman-Harris window has the widest pass band (lowest frequency resolution) and lowest side lobes (best elimination of leakage) of the six window functions. This window is especially good for viewing a broad spectrum.

Touch **Blackman-Harris** in the FFT Control pop-up menu to select this windowing function.

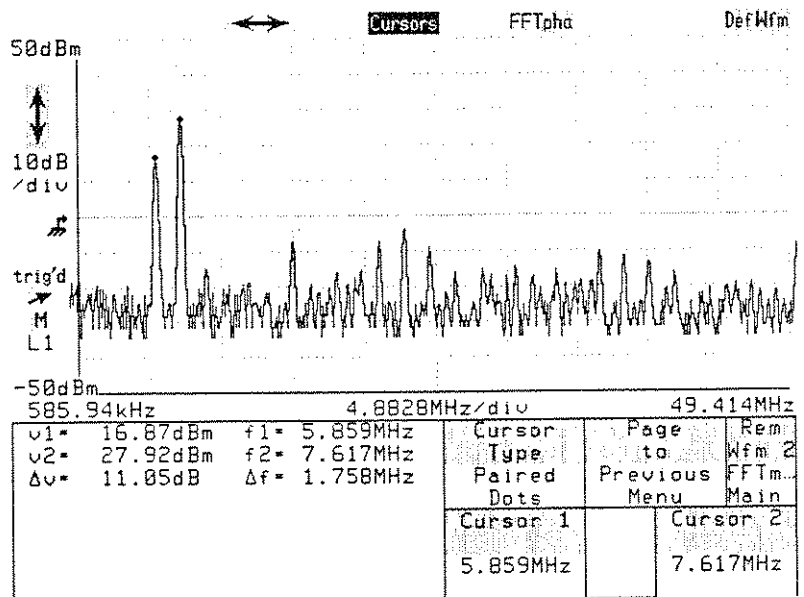
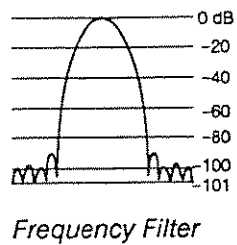
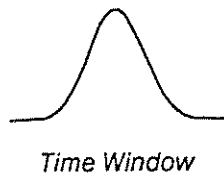

FFT Magnitude Displayed Using Blackman-Harris Window



Making Measurements

You can use the cursors to make measurements on an FFT waveform display or you can use automated frequency domain measurements described on page 175.

Select the FFT waveform and touch the **Cursors** icon to display the **Cursors** major menu. See **Cursors** on page 83 for more information on using cursors.

When making measurements on an FFT waveform, recall that the odd-numbered points in the waveform record are derived by interpolation. The even-numbered record points are the frequency lines; peaks in the FFT magnitude always occur on the even-numbered points. You can see the peaks more clearly by using **Pan/Zoom** to horizontally magnify the FFT waveform as described on the next page.

When you first display cursors on an FFT waveform, paired dot cursors are automatically selected, with one dot cursor placed at DC and the other at F_{\max} . You can use the paired dot cursors to make relative measurements of the peaks of an FFT waveform.

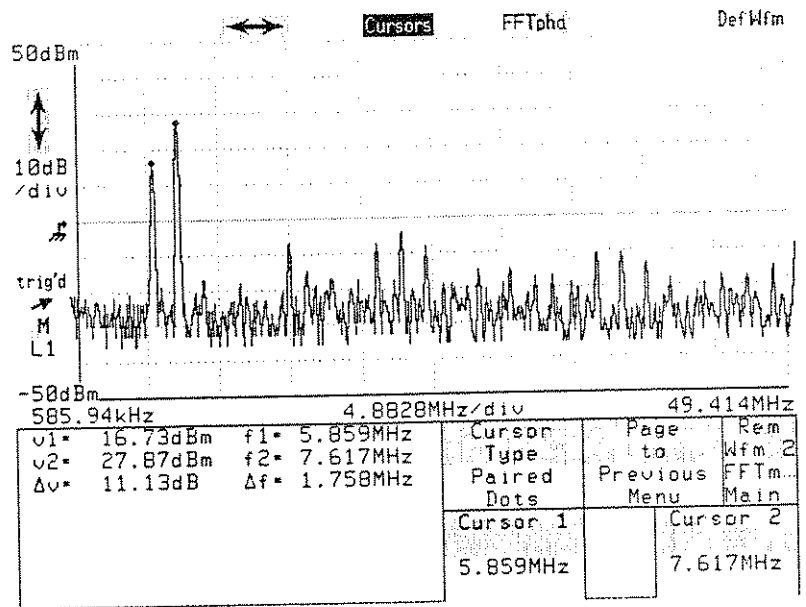
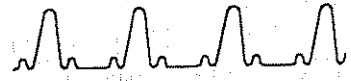

Paired Dots Cursors on an FFT Magnitude Display

The DC value displayed with the FFT magnitude is twice the actual DC amplitude. This value does not include any vertical offset of the plug-in amplifiers. When making measurements near DC, use the rectangular window function. The DC component can be suppressed in the FFT control pop-up menu.

Split dots cursors can be used to make phase measurements. With both the magnitude and the phase of waveform in the frequency domain displayed, you can place one cursor on the FFT magnitude display and the other on the FFT phase display. By adjusting the cursors horizontally so that the Δf readout is 0.000 Hz, you can easily match the phase readout to the corresponding peak in frequency magnitude.

The reference for phase is the center of the screen. A cosine waveform perfectly centered on the screen will display 0° phase for its fundamental spectral component.

Fast Fourier Transforms

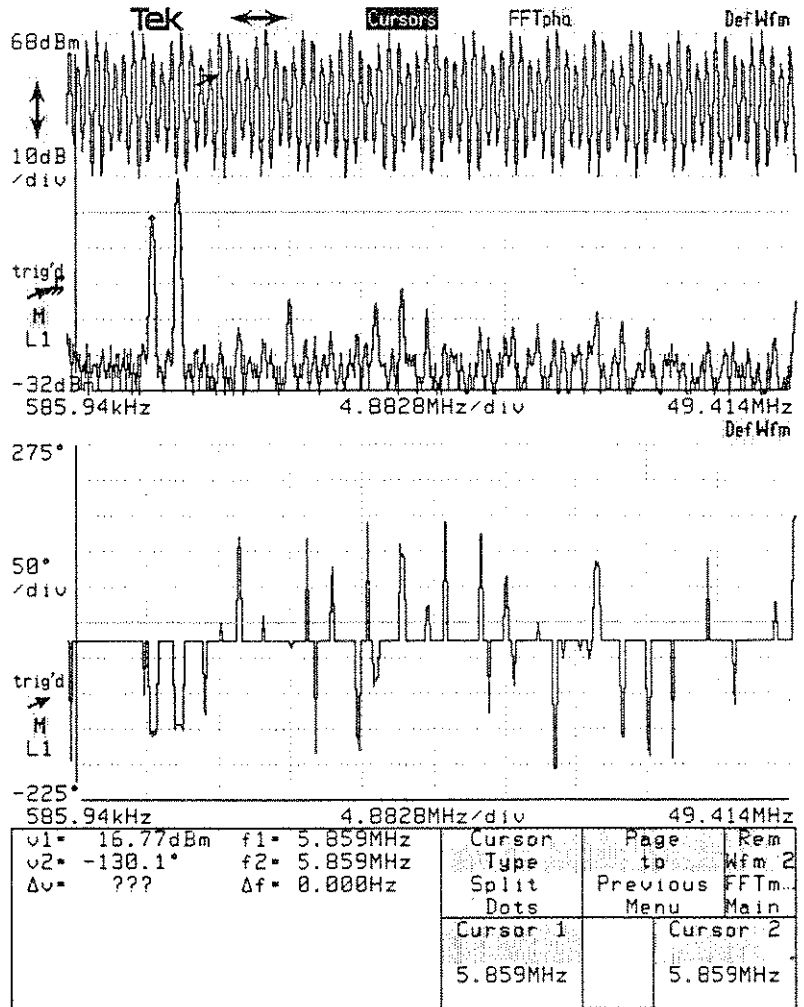

Using Split Dots Cursors to Measure FFT Phase



Changing Vertical and Horizontal Size

You can change the vertical and horizontal size and position of the FFT waveform display by selecting the vertical and horizontal icons and using the knobs to adjust size and position.

When you touch the vertical icon (\updownarrow), the knobs are assigned to control **Vertical Mag: Wfm** and **Vertical Pos: Wfm**, the vertical magnitude and position of the waveform. As with other calculated waveforms, the vertical controls of the FFT waveform affect only the appearance of the waveform. See Vertical Controls on page 277.

With Pan/Zoom off, the knobs are assigned to **Frequency Span/div** and **Frequency Resolution**. The Span/div function changes the frequency range by changing the time domain sample rate. The Frequency Resolution function changes the record length, leaving the sample rate unchanged. When you touch the horizontal icon (\leftrightarrow), the knobs are assigned to control **Horizontal Magnify** (zoom) and **Horizontal Pos Gr** (pan) with Pan/Zoom on. Changing the horizontal magnification and position of an FFT waveform using Pan/Zoom changes the appearance of the waveform, but does not increase the horizontal (frequency) resolution. For more details about Pan/Zoom, including changing the pivot point and using multitrace Pan/Zoom, see page 155.

Fast Fourier Transforms



GPIB Parameters



The DSA can be controlled by a remote computer through one of two interfaces. These interfaces are industry standards IEEE STD 488 and RS-232-C. IEEE STD 488 is also known as the General Purpose Interface Bus or GPIB.

This manual does not discuss the details of connecting a remote computer to the DSA, or the syntax and capabilities of remote commands. That information is found in the *DSA 601A and DSA 602A Programmer Reference*.

GPIB Connection

The cable from your GPIB controller (computer) is connected to the **IEEE STD 488 PORT** connector on the DSA rear panel. Three red lights show the status of specific GPIB signal lines:

- **SRQ** (Service Request) is lighted whenever any device on the bus activates the Service Request line. This indicates to the controller that some device has requested service. You cannot tell which device on the bus has asserted SRQ.
- **NRFD** (Not Ready For Data) is lighted whenever any listener device on the bus is not yet ready for the next data byte. You cannot tell which device on the bus is not ready.
- **NDAC** (Not Data Accepted) is lighted whenever a data byte is on the bus but has not yet been captured by all listener devices.

GPIB Parameters

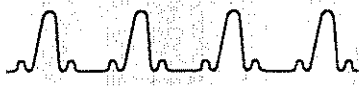

GPIB Area

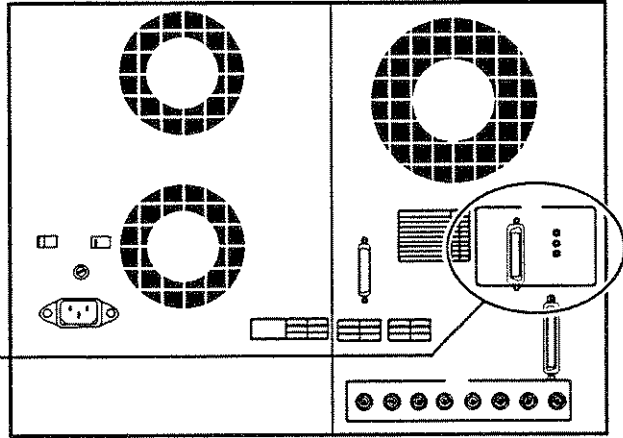

GPIB Rear Panel Connector and Lights

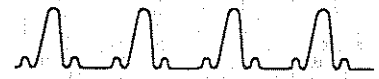

Setting GPIB Parameters

Communication between the devices on a GPIB can occur only if all bus devices are configured in a compatible manner. For example, each device on the bus must have a unique identifying address.

Use the **GPIB Parameters** pop-up menu in the Utility 2 major menu to set these GPIB parameters directly before you attempt to communicate with other devices on the bus.

GPIB Parameters					
C & F V81.1					
Mode					
TalkListen					
Address					
1					
Terminator					
EOI					
Debug					
On					
GPIB	RS-232-C	Hardcopy	Ident	Page to	Rem
TalkListen	9600 baud	Bitmap Screen		Utility 3	Wfm 1
1					L1 Main
Extended Diagnostic	Self Test	Teksecure Erase Mem	Main Size 20μ s/div	Pan/ Zoom Off	Main Position -42.4μ s

The GPIB Parameters Pop-Up Menu

GPIB Parameters are not changed when you initialize the DSA.

The **Mode** selector in the **GPIB Parameters** pop-up menu lets you set the mode to **Talk/Listen**, **Talk Only**, or **Off Bus**. **Off bus** effectively disconnects the DSA from the bus. The DSA must be in talk/listen mode to communicate with the GPIB controller. **Talk Only** may be used to generate display hardcopies on a GPIB printer or plotter.

GPIB Parameters

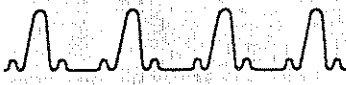

Touching the **Address** selector assigns the knobs to control the GPIB address of the DSA. The GPIB address can be from 0 to 30. No other device on the bus can use the number that you assign to the DSA.

The **Terminator** selector lets you choose between **EOI** and **EOI/LF** message terminators. With either message terminator, the DSA will assert **EOI** (the GPIB End Or Identify) at the end of each output message, and will recognize **EOI** as a message terminator. With the **Terminator** selector set to **EOI/LF**, the DSA will also recognize a Line Feed (LF) character as an input message terminator, and will end each output message with a Carriage Return followed by a simultaneous Line Feed and assert **EOI**. Set the **Terminator** selector to **EOI** to have the DSA recognize only **EOI** as an input message terminator.

The **Debug** selector lets you turn the debugging feature **On** or **Off**. When you turn **Debug On**, the DSA displays each command from the GPIB controller as it is executed. The messages appear at the top of the display. **Debug Off** is the normal mode of operation. Set **Debug On** if you need to watch the result of each DSA command of a controlling program running in the GPIB controller. When debug mode is on it slows the GPIB interface throughput significantly.

Graticules



For more information about choosing display colors, see Color Display on page 79.

You can display two different graticules, each half the height of a single-graticule display. You can choose the colors for the selected waveforms on the Main and Window time bases. In addition, the graticule with the selected waveform has the vertical (\updownarrow) and horizontal (\leftrightarrow) icons.

As with a single-graticule display, the menu selectors affect the selected waveform.

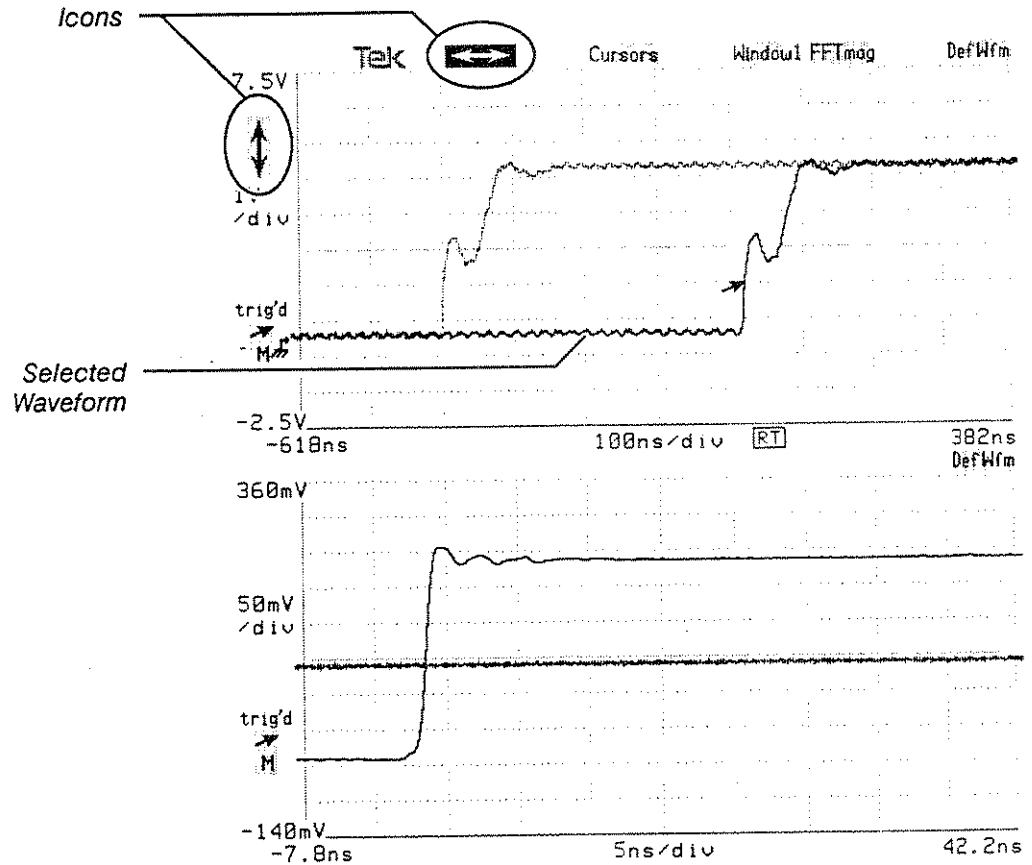

Dual Graticules with Multiple Waveforms

Graticules



Graticules
Reduce to Single Graticule
Create Second Graticule
Move Waveform to Other Graticule

Vertical Desc	Horizontal Desc	Acquire Desc	Graticules	Page to	Rem Wfm 1
L1	Main	Continuous		All Wfms Status	L1 Main
Fast	2MS/sec				
Input Parameters	FFT Control	Act on Delta	Main Size	Pan/Zoom	Main Position
DC	dBm	None	50μ	Off	-6μ
1MQ/300MHz	Rectang		s/div		s

The Graticules Pop-Up Menu

You can make any waveform the selected waveform by touching it. If you select the wrong one because the waveforms are close together, touch again until the desired waveform is selected. Other methods of selecting waveforms are discussed in Waveform Definition and Management on page 281.

You can control the number of graticules and the placement of waveforms on the graticules using the **Graticules** pop-up menu in the Waveform major menu. When dual graticules are displayed, the **Graticules** selector is renamed **Upper Graticule** or **Lower Graticule**, depending on which graticule has the icons and the selected waveform.

Graticules

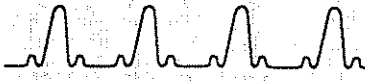

Managing Graticules and Waveforms

When only one graticule is displayed, you can create a dual-graticule display using the **Graticules** pop-up menu from the **Waveform** major menu. Touch the **Create Second Graticule** selector in this pop-up menu. The selected waveform will be placed on the lower graticule. The upper graticule will show all other waveforms.

When two graticules are displayed, you can move the selected waveform from one graticule to the other. Touch the **Move Waveform to Other Graticule** selector to move the waveform. After the waveform is moved, it remains the selected waveform. The horizontal icon (↔) and vertical icon (↕) move to the new graticule.

When two graticules are displayed, you can combine the waveforms from both graticules into a single-graticule display. Touch the **Reduce to Single Graticule** selector to combine the waveforms onto one large graticule. The waveform that was selected before the operation remains the selected waveform on the new single graticule.

If you remove all the waveforms from the lower graticule of a dual-graticule display, the display automatically reverts to a single graticule.

When the **Window1** or **FFTmag** icon is selected while one graticule is displayed, a second graticule is created with the new waveform (window or FFT) displayed on the lower graticule, and all other waveforms will be displayed on the upper graticule.

Hardcopy



A variety of printers and plotters are supported for producing a paper copy of the display. This section will cover how to configure your system for most printers. Also, refer to your printer manual for the proper printer settings.

Installing the Printer

Connect the printer to the DSA. Depending on the printer, you will want to use the **PRINTER** connector, the **GPIB** connector, or the **RS-232-C** connector.

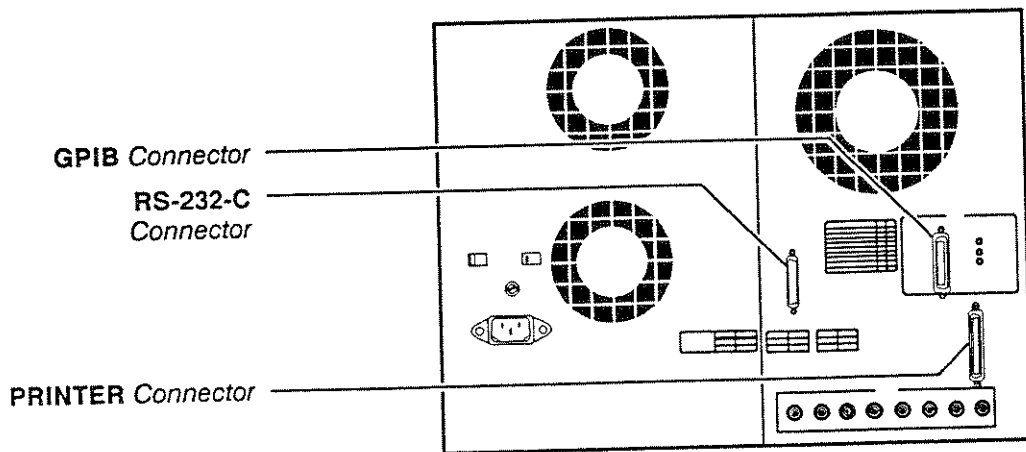

Rear Panel Connectors

- **PRINTER** is the appropriate connector for Centronics-compatible printers. This is the standard interface for the DSA, and no special configuration of the DSA is required.
- **GPIB** is the General Purpose Interface Bus parallel interface connector. Use a standard cable fifteen meters or less in length. If you are not using a controller to initiate the hardcopy, set the GPIB Mode parameter of the DSA to Talk Only and set the printer to Listen Only or Listen Always mode (address 31). Setting GPIB parameters is explained on page 137.

Hardcopy

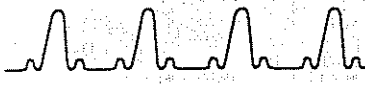

- **RS-232-C** is a serial interface connector. Use a standard, straight-wired cable with male connectors on both ends. Hard flagging is used, so all lines must be connected. Do not use a null modem cable. (The DB-25 to Centronics cable provided with many personal computers *cannot* be used to connect a printer to the DSA, although it appears to match the RS-232-C connector.) The DSA acts as a DCE (Digital Communications Equipment) device. Connecting the DSA to a computer also requires a straight-wired cable, but soft flagging may be used.

The DSA's RS-232-C baud rate, parity, and number of stop bits should be set to match those of the printer or computer. When you connect a printer to the RS-232-C connector, you may also need to set the RS-232-C flagging to Hard. Setting RS-232-C parameters is explained on page 226.

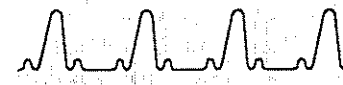

Hardcopy Options

Set the printing properties of the DSA using the **Hardcopy** pop-up menu in the Utility 2 major menu. This menu includes selectors for eight types of printers and for specific options available with some printers.

Hardcopy Parameters			
Printer		Color Map	
8 Pin	24 Pin	Background	Waveform Color 1
		index 0	index 1
Tek 4692	Tek 4696	Graticule	Waveform Color 2
		Selectors	index 2
		index 6	
Tek 4697	Bitmap Dump	Window	Waveform Color 3
		Waveform	index 3
		index 5	
Alt. InkJet	HPGL	Cursors/	Waveform Color 4
		Meas Zones	index 4
		index 7	
Screen Format	Direction Horizontal	Data Format	Set To Default
		BinHex	ColorMap
		Compacted	
Security Option	Graticule Type		
Off			
Output Port		Flush Queue	
RS-232-C			

GPIB	RS-232-C	Hardcopy	Ident	Page to Utility 3	Rem Wfm 1
TalkListen 1	9600 baud	Bitmap Screen			L1 Main
Extended Diagnostic	Self Test	Teksecure Erase Mem	Main Size 50n s/div	Pan/Zoom Off	Main Position -106n s

The Hardcopy Pop-Up Menu

Hardcopy



Printer selection and the associated parameters are not affected by initialization. The factory default settings appear in Appendix E.

Printer Selections

The selectors in the Printer section of the **Hardcopy** pop-up menu determine the printing configuration of the DSA. The settings of the other hardcopy parameters will vary according to the printer that is selected. When you change one of these parameters, you are setting its default value for the selected printer type. These settings are not changed when you initialize the DSA.

- **8 Pin** supports several eight-pin dot-matrix printers, including the Tektronix 4644, Epson FX80 and Epson EX800. The IBM Proprinter and Epson RX80 may also be used, but only the **HiRes** screen format provides useful output. All the supported printers typically use the **PRINTER** connector.

Set the configuration switches on your printer as recommended in its manual except set No Auto Line Feed, No Perf Skip, and Inbuf On.

- **24 Pin** supports the Extended Epson command set for 24-pin dot-matrix printers, including the Epson LQ500, Epson LQ1000, Nec P6, and Nec P7. These printers typically use the **PRINTER** connector.

Set the configuration switches on your printer as recommended in its manual, except set No Auto Line Feed, No Auto-Carriage Return, No Perf Skip, and Inbuf On.

- **Tek 4692** supports the Tektronix 4692 color graphics copier. The Tek 4693DX may also be used when set to 4692 emulation, Full Color, Maximized by Interpolation, and Portrait Mode. These printers typically use the **PRINTER** connector.
- **Tek 4696** supports the Tektronix 4696 and 4695 color inkjet plotters. These printers typically use the **PRINTER** connector.
- **Tek 4697** supports the Tektronix 4697 ColorQuick™ Ink-Jet printer. This printer typically uses the **PRINTER** connector.



- **Bitmap Dump** provides the ability to acquire the screen data for external processing. For example, you can use this option to send the display data to a computer. The format of this information is determined by the **Data Format** selector. (Data format is discussed on page 149.) You will typically want to use the **GPIB** or **RS-232-C** connector for this type of transfer.
- **Alt Inkjet** supports the HP ThinkJet, HP PaintJet, and HP LaserJet printers. The ThinkJet should be used in HP graphics mode, not Epson emulation mode. For the HP ThinkJet, either **Draft** or **HiRes** screen mode may be used, but **HiRes** mode will be very slow. **HiRes** mode also works with the HP LaserJet printer. The Screen mode and Dithered mode may be used with the PaintJet. Either the **PRINTER** connector or the **GPIB** connector may be used.
- **HPGL** supports the HP-GL color plotter command set. An HPGL hardcopy will show graticules, axis labels, and all waveforms. You can choose between cross-hair graticules or full line graticules by pressing **Graticule** in the **Hardcopy** pop-up menu. Cross-hair graticules draw a box with two crossing center lines, each with tic marks as the graticule. Full line graticules draw a box with a set of full length lines for each graticule line. Supported printers include the Tek HC100, HP-7475, and HP-7550. These printers can be connected to the **PRINTER** connector. The HP-7475 and HP-7550 may be connected to the **GPIB** or **RS-232-C** connector.

Color Map

The selections in the **Color Map** section of the menu become available whenever a color printer or plotter is selected. A color selector is available for each display item. To change a color, simply select the item in the menu and then use the control knobs or keypad pop-up menu to adjust the setting. To restore the color map to its factory default settings, touch the **Set to Default Color Map** selector.

Hardcopy

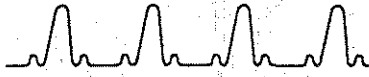

The color selections are expressed in terms appropriate to the selected printer. When **Tek 4692** or **Tek4697** is selected, the colors are expressed as hexadecimal RGB values. For the **Tek 4696** selection, twelve color name selections are available. **HPGL** supports pen numbers 0 to 8.

Specifically for the **Tek 4692** printer, selecting **Set to Screen Color Map** sets the color map to match the display color scheme.

Screen Format

The **Screen Format** selector provides several qualities of hard-copy output. Different format selections are available for different printer types.

- **HiRes** produces an enhanced contrast display on printers with limited gray-scale capability. Selected items, including windows, are highlighted for easy identification. For plotters, **HiRes** produces a hardcopy of the entire screen in which every waveform record point is plotted.
- **Draft** produces hardcopies faster than **HiRes** mode but sacrifices gray-scale capability. For plotters, **Draft** reproduces the screen without the major menu area, and plots only the minimum and maximum points of each waveform record at each horizontal screen location.
- **Reduced** produces low-resolution hardcopies a quarter of the size of **Draft** hardcopies. Advantages are quicker printing and use of less memory.
- **Screen** produces an exact color replica of the screen without reformatting to enhance features (Available for color printers and plotters only). For plotters, **Screen** prints the entire screen, but plots only the minimum and maximum points of each waveform record at each horizontal screen location.
- **Dithered** reduces saturation and increases contrast by dithering icons and selector backgrounds. May be used with **Tek 4696**, **Tek 4692**, **Alt InkJet** and **Bitmap Dump**.

Hardcopy

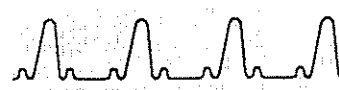

Copy Format

The copy format **Security Option** produces a display of only the graticule and the waveform. This format produces a hardcopy without numbers, text, or menu information.

Direction

The **Direction** selector controls whether information is sent to a printer as horizontal rows or as vertical columns. For most printers, this has the effect of rotating the image by 90°. Some printers will produce an image more quickly in one direction than in the other. When **Direction** is set to **Horizontal**, screen information is sent to the printer by horizontal rows starting at the top left corner of the display. When it is set to **Vertical**, the information is sent by vertical columns starting at the bottom left corner of the display.

Data Format

When **Bitmap Dump** is selected, the screen data is transferred as an ASCII title block followed by a pixel data block. The format of the pixel data is determined by the **Data Format** setting. Touch this selector to cycle through the four available formats.

- **Binary** mode bytes of pixel data are sent as a stream of binary values without delimiters.
- **Binary Compacted** mode pixel data are compressed before being sent. See the discussion of compression, below.
- **BinHex** mode converts every four bits into a hexadecimal character. Each line is terminated by a new-line character.
- **BinHex Compacted** mode pixel data are compressed and then converted into BinHex characters.

Hardcopy

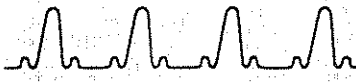

Title Block—consists of three character strings terminated by new-line characters. The first line contains the instrument name and the time and date. The second and third lines give the number of pixels per display line and the number of display lines, respectively. In **Binary mode** the title block is terminated by a NULL character.

Pixel Data Compression—significantly reduces the size of the pixel data block. Without compression, each data byte contains a single three-bit pixel. With compression, two pixels are stored in the six low-order bits of the data byte, and the two high-order bits are a repetition encoding with the following meaning:

Repetition Encodings

Bit 7	Bit 6	Meaning
0	1	Pattern repeats once
1	0	Pattern repeats twice
1	1	Pattern repeats three times
0	0	Following byte(s) contain repetition count

If the second byte of the pixel block has a value in the range 4–255, it is the pattern repetition count. If the value is 1–3 decimal, it is the high order bits of a 10-bit repetition count, and the third byte of the pixel block contains the eight lower-order bits.

Output Port

The **Output Port** selector allows you to choose **GPIB**, **RS232C**, **Centronics** (the **PRINTER** connector), or **Disk**. The selection must match the rear panel connection.



Making a Hardcopy

Once you have installed a printer and configured the DSA properly, you can make a hardcopy of the screen by pressing the **HARDCOPY** button on the front panel.

HARDCOPY
Button

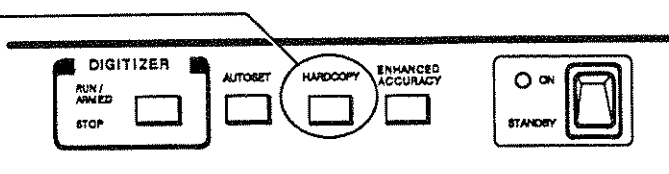

Any displayed messages are removed before the hardcopy process begins. When you press the **HARDCOPY** button, the display freezes for a short time. The shades of intensity on the display may be altered. The printer starts printing immediately.

The length of time that the display is frozen depends on the hardcopy mode, complexity of the display, and memory available for hardcopies. During this pause the DSA formats and buffers the print commands.

After the pause, the DSA returns to normal operation and continues to print the hardcopy. When the display becomes active again, you may operate the DSA without affecting the hardcopy being printed.

You can also initiate a new hardcopy at this point. The DSA will automatically queue multiple screen displays for hardcopy output. The number of hardcopies that can be queued is subject to the amount of available memory.

Do not turn off the DSA or perform diagnostics until the hardcopy is complete.

When the hardcopy is printed, a message is displayed. The hardcopy is not complete until this message appears. You should not turn off the DSA, perform self-test diagnostics, or use the Extended Diagnostics menu until the hardcopy is complete. Any of these actions will terminate the hardcopy.

Hardcopy

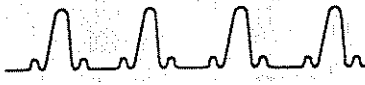

Terminating a Hardcopy In Progress

You can terminate a hardcopy by selecting **Flush Queue**, in the **Hardcopy** pop-up menu. A message will appear stating that the hardcopy has been cancelled. If this message does not appear, the printer may no longer be communicating with the DSA. The **Flush Queue** selector becomes a **Clear Interface** selector until a message is received from the printer. Select **Clear Interface** to abort any hardcopies that have not already been sent to the printer.

You can also terminate the hardcopy while the screen is still frozen by pressing the **HARDCOPY** button a second time.

Horizontal Controls

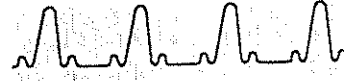

The horizontal controls let you set the horizontal size and placement of your waveforms. Touch the horizontal icon (↔) to access these controls.

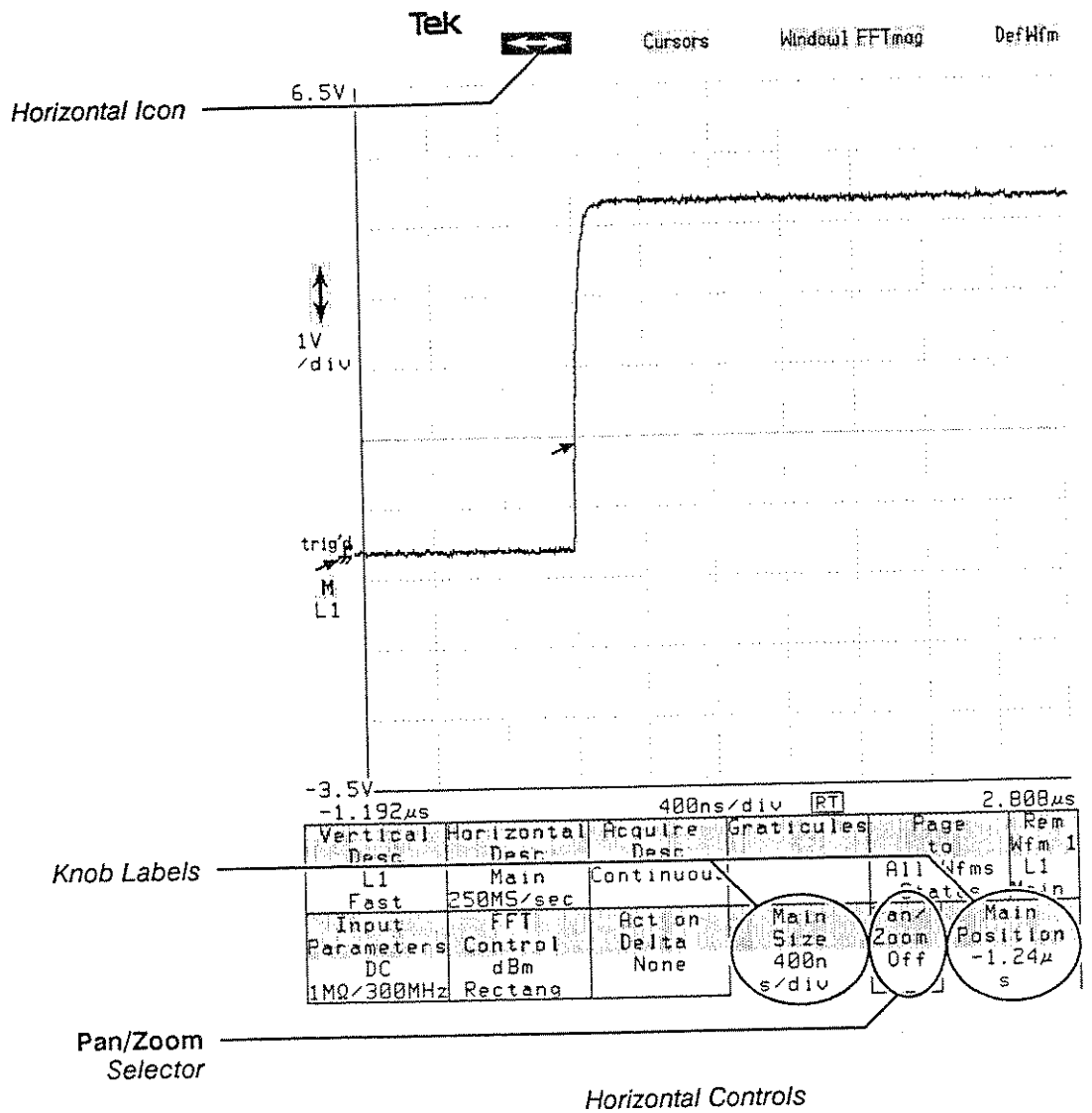

Horizontal Controls

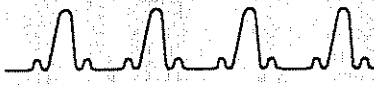

Setting Horizontal Size and Position

Touch a knob label to display the Keypad pop-up menu. This lets you set horizontal size and position numerically, or quickly set them to maximum or minimum limits. It also lets you set the knob resolution.

You can change the horizontal scale factor, or *size*, of a waveform. You can also move the waveform left or right to see different portions of the waveform. This is called adjusting the horizontal position. To do either of these, touch the horizontal (\leftrightarrow) icon. This assigns the knobs to adjust the horizontal size (left knob) and position (right knob) of the selected waveform.

The axis label for the left edge of the graticule is slightly different from the horizontal position of a waveform. This is because waveforms extend slightly beyond the edges of the graticule. The illustration on the previous page shows that the main position (the knob label) is $-1.24 \mu\text{s}$, and the left edge of the graticule is $-1.192 \mu\text{s}$. The reference for these time references is the trigger point of the waveform.

When Pan/Zoom is off and the selected waveform is an FFT and the horizontal units are in Hertz, the left knob is labeled **Frequency Span/Div** and the right knob is labeled **Freq Resolution/Div**. The left knob controls Frequency Span by changing Main Size and the right knob controls the frequency bin width by changing the record length. When Pan/Zoom is on, it operates as before.

Interactions With Other Waveforms

The knob labels tell you whether the selected waveform is from the Main time base or a Window time base.

All waveforms from the Main time base share the same size, position, and record length. If you change the size or position of one main waveform, you will change the size or position of all main waveforms.

All waveforms from Window time bases have the same horizontal size. If you change the horizontal size of one window waveform, you will change the horizontal size of all window waveforms. There are two window time bases; each can have its own horizontal position. All waveforms using the Window1 timebase will have the same horizontal position; all waveforms using the Window2 timebase will have the same horizontal position.

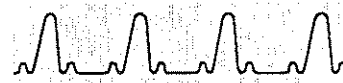

Pan/Zoom

Pan/Zoom does not change the way waveform data are sampled and recorded; it only changes the way the waveform data are displayed.

Pan/Zoom allows you to magnify any portion of the selected waveform to examine it more closely. You can magnify (zoom) the selected waveform to the point where each digitized sample appears on the display, and you can move the magnified waveform left and right (pan) to examine any part of the waveform.

The maximum magnification is determined by the waveform record length, which is described on page 221. You can magnify a waveform until one point is shown for each horizontal division on the graticule. There are 10 horizontal divisions, so you can magnify a 512-point waveform up to 50 times. The greater the record length of a waveform, the greater the maximum available magnification will be.

Whenever the horizontal icon (↔) is highlighted, the **Pan/Zoom** selector appears between the knob labels. Normally, Pan/Zoom is **Off** and the knobs are assigned to horizontal size and position. When you touch the **Pan/Zoom** selector to set it **On**, the knobs are assigned to **Horizontal Magnify (Zoom)** and **Horizontal Pos Gr (Pan)**. The waveform on the next page is the same waveform shown on page 153, but magnified 8 times horizontally.

Use the left knob, **Horizontal Magnify**, to specify how much magnification you want on the selected waveform. Use the right knob, **Horizontal Pos Gr**, to position onto the display the segment of the waveform that you want to view. The knob label status area shows how many waveform data points are not shown because they are off the left end of the screen. When you set **Horizontal Pos Gr** to zero, you display the left-most portion of the waveform.

You can use horizontal magnification to see the exact data points of a waveform record. Turn off waveform vectoring and set the magnification to examine individual acquired points. Waveform vectoring is discussed in *Vectored Waveforms* on page 273.

You can choose between four types of interpolation during the Pan/Zoom mode. Refer to page 275 in *Vectored Waveforms* for details.

When in the Pan/Zoom mode, measurements are performed on the acquired data, not on the product of the Pan/Zooming.

Horizontal Controls

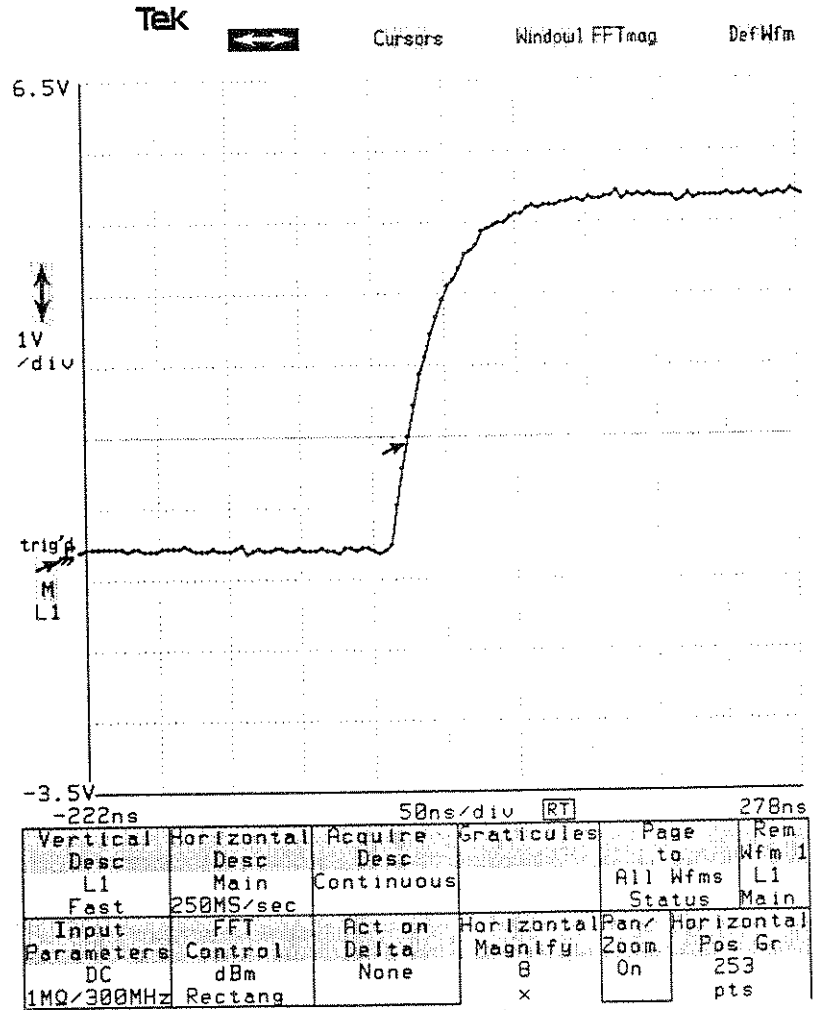

Horizontal Magnification with Pan/Zoom



Pan/Zoom Pivot

When you change the horizontal magnification with Pan/Zoom, the displayed waveform is expanded around a reference point, which remains fixed on the graticule. By entering the Modes pop-up menu of the Utility 1 major menu and touching the Pan/Zoom Pivot selector, you can define this reference point to be the **Left**, **Center**, or **Right** of the graticule. Changing the pivot point will not affect the horizontal magnification or position of waveforms already on the display.

Pan/Zoom Options

Instrument Modes					
Autoset					
Vertical	Horizontal	Undo Last AutoSet			
Pk-Pk	Period				
Miscellaneous					
Multitrace	Pan/Zoom	Averaging	Enhanced		
Pan/Zoom	Pivot	Type	Accuracy		
Off	Center	Backweight	Manual		
Vectorized	Zoom	Stored	Wfm	Incremental	
Waveforms	Intp	Time	Fmt	Acquire	
On	Sin(x)/x	Show	Date	Disabled	
Waveform	Audio	Default	Cursor		
Scaling	Feedback	Cursor	Hold		
Optional	On	Paired	Off		
Trigger					
DC Level					
Screen					
Calibrator	Modes	Probes	Color	Page to	Rem
				Utility 2	Wfm 1
					L1
					Main
Initialize	Time & Date	Label	Main Size	Pan/Zoom	Main Position
	15:10:41	Disp: On	50μ	Off	-6μ
	10-OCT-90	Mode: Man	s/div		s

The Modes Pop-Up Menu

Horizontal Controls



Multitrace Pan/Zoom

Pan/Zoom can be used to position and magnify multiple waveforms. Select **Multitrace Pan/Zoom**, in the **Modes** pop-up menu of the Utility 1 major menu. When you set Pan/Zoom to **On**, you will simultaneously set the horizontal magnification and graphical position of all waveforms that are on the same graticule and have the same record length as the selected waveform.

Turning off Multitrace Pan/Zoom does not change the horizontal magnification and position of displayed waveforms.

Initialization

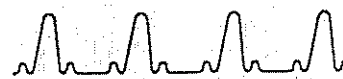

Whenever you begin a new task, you should initialize the DSA so that all settings are at “factory default.” That way you do not get unexpected results from settings that remain from the last use of the DSA.

To initialize the system settings to their defaults, touch the **Initialize** selector in the Utility 1 major menu and select **Initialize** in the displayed pop-up menu to verify the selection.

Verify Selection					
Cancel Initialize					
Calibrator	Modes	Probes	Color	Page to Utility 2	Rem: Wfm 1 L1 Main
Initialize	Time & Date 10:56:01 11-OCT-90	Label Disp: On Mode: Man	Main Size 50n s/div	Pan/ Zoom Off	Main Position -130n s

The Initialize Verify Pop-Up Menu

An alternate initialization method is to select **Initialize Setting** in the **Recall Setting** pop-up menu in the Store/Recall major menu.

The following settings are *not* affected when you initialize:

- Stored settings and stored waveforms
- Hardcopy printer default settings
- Display intensity and display color settings
- The GPIB parameters Address, Debug, Mode, and Terminator
- The RS-232-C parameters Baud Rate, Debug, Echo, Verbose, Stop Bits, Parity, Flagging, Delay, and EOL String

Initialization



Initializing and Erasing Nonvolatile RAM

Extended Diagnostics is entered only if the self test was initiated from the front panel. If the self test was initiated from the GPIB, a status string is returned but the DSA does not enter the Extended Diagnostics menu.

- Time and date
- Current disk directory

There are two methods by which you can erase all information stored in nonvolatile RAM. The first method is by holding down the **WAVEFORM** and **TRIGGER** major menu buttons when you turn on the DSA. Release the buttons when the lights next to the major menu buttons are all off. The second method is by touching **Teksecure Erase Mem** in the Utility 2 major menu. Both methods invoke the Teksecure Erase Memory function.

The Teksecure feature is provided to enable you to ensure that the instrument removes all proprietary information that may be stored in nonvolatile RAM.

The Teksecure Erase Memory function first initiates an instrument self test, which causes all volatile RAM to be erased. After the self test is complete, then Teksecure erases all non-volatile RAM, with the exceptions listed below. When the power-on sequence is complete, the message "Teksecure Status: Erased; Instrument ID, calibration constants, on-time, and number of power-ups retained" will appear on the display.

If the DSA passes its self test but Teksecure does not execute properly, the following message appears "Teksecure Status: Failed; Refer instrument to qualified service personnel." If the DSA fails its self test, it will then enter the Extended Diagnostics menu. The "Teksecure Status..." message appears only after the DSA exits the Extended Diagnostics menu.

After Teksecure completes successfully, partial enhanced accuracy calibration is performed. Also, Enhanced Accuracy will not be available until the warm-up period has expired. See Power-On.

When nonvolatile RAM is erased, the DSA writes over all nonvolatile RAM locations where settings can be stored with the hexadecimal value 0000 and writes the hexadecimal value ABCD over all locations where waveforms can be stored. Any Enhanced Accuracy calibration of the DSA is lost.

Initialization

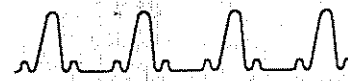

The following information is *not* lost when nonvolatile RAM is erased:

- Serial number of the DSA
- Accumulated time the DSA has been on
- Number of times the DSA has been turned on
- Factory calibration constants, which are established at the factory and cannot be changed by the user or by the DSA
- Time and Date

Initialization



Instrument Configuration

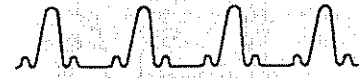

You can determine the configuration of your system by looking at the **Ident** pop-up menu in the Utility 2 major menu.

Instrument Configuration					
Instr	Section	ROM	ID#		
DSA 602A	Executive	F2.0	B050116		
DSA 602A	Digitizer	F2.0	B050116		
DSA 602A	Display	F2.0	B050116		
11A34	Left	F3.7	B043417		
N/7K	Center				
N/7K	Right				
Installed Options					
Option 4C - Non-volatile RAM					
GPIB	R5-232-C	Hardcopy	Ident	Page to	Rem
Talk Only 7	9600 baud	Bitmap Screen		Utility 3	Win
Extended Diagnostic	Self Test	Teksecure Erase Mem	Main Size 20n s/div		Main Position -56n s

The Ident Pop-Up Menu

The upper section of the **Ident** pop-up menu lists the internal processors of the DSA and the contents of its plug-in compartments and displays the version number of the firmware (programming) and the serial number for each component. A notation of N/7K means that the plug-in compartment is empty or contains a 7000-Series plug-in unit.

The lower section of the **Ident** pop-up menu lists any installed options, along with a brief description.

You will need the information from this menu when discussing the DSA with your local Tektronix representative.

Instrument Configuration



Labeling

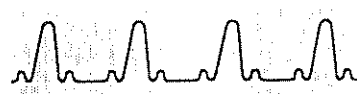

You can label active waveforms, stored waveforms, and stored settings for easier identification. You can also change the *base label*. The base label is assigned automatically to stored waveforms acquired in the Repetitive Single Trigger mode or in the Act on Delta mode. In addition, you can write up to twelve lines of text anywhere on the screen.

A label is a string of up to ten letters, characters, numbers, or spaces. Labels appear in the selector for a waveform or a stored setting and can also be displayed on the screen with active waveforms. The entire DSA character set, including graphic characters, Greek characters, numbers, upper and lower case letters, and other symbols, can be used in labels.

Labeling

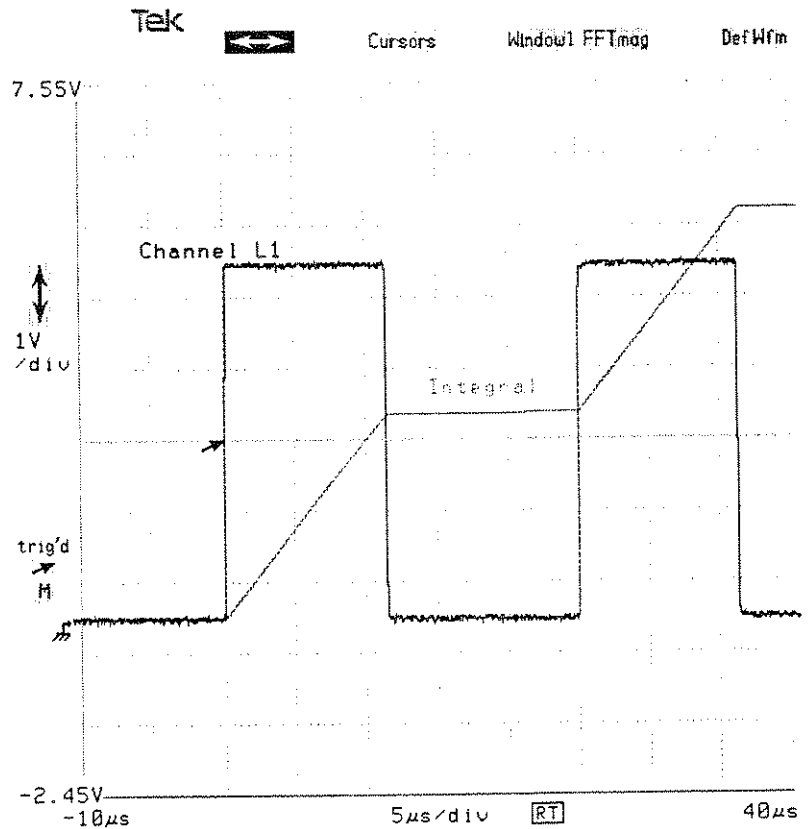

Labels Displayed with Active Waveforms

Creating Labels

You can create and edit labels by using the **Label** pop-up menu, which appears on page 169. Select **Label** in the Utility 1 major menu to display this pop-up menu. The uppermost section of this menu contains selectors for **Displayed Waveforms**, **Stored Waveforms**, **Stored Settings**, **Base Label**, and **Text**. Beneath these selectors, the selectors for individual active waveforms, stored waveforms, or stored settings appear. If there are more stored waveforms or stored settings than can be displayed at once, use the **Page↑** and **Page↓** selectors to scroll through the menu.



To create or change a label, select the item you want to label from the **Label** pop-up menu. For example, select **Stored Waveforms**, then select the stored waveform you want to label. You can then type the label by touching the character selectors in the lower half of the menu. The selectors beneath the characters allow you to choose **Upper Case** letters, **Lower Case** letters, **Numbers** (including punctuation characters), **Graphics**, **Greek** letters, or **Other** symbols (primarily European characters). You can mix any combination of letters, numbers, and symbols within a label. As you type, the label appears in the selector, just below the waveform or setting number.

Use the **Backspace** selector to correct errors as you type a label. Touch the **Erase** selector to completely erase the selected label. Use the **Exit** selector to leave the pop-up menu.

When you store a labeled waveform, or create an active waveform that displays a single stored waveform, the label will be copied to the new waveform.

You can add up to twelve lines of text to any part of the display by selecting **Text**. Use the character selectors in the lower half of the menu to enter the text. Multiple colors of text can be selected by touching the desired color. Color changes to the text appear as escape sequences in the display area. The **Back Space** selector deletes the character to the left of the arrow cursor. If multiple lines of text are displayed, touch a line to select for editing. You can place the text anywhere in the graticule. Touching the **Position** selector assigns the left knob to **Text Vert Pos** and the right knob to **Text Horz Pos**. Simply use the knobs to position the text on the display.

To edit the text, touch the **Edit** selector. In the edit mode, the knobs are assigned to the arrow cursor position. The position of the arrow cursor indicates where the change will occur. Both knobs allow you to move the arrow cursor horizontally along the line of text.

Labeling

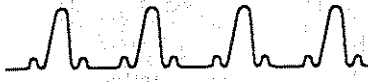

Automatic Waveform Labels

You can have labels automatically specified during waveform definition by changing the **Mode** selector in the **Label** pop-up menu to "Automatic." The label generated consists of the first ten characters of the trace description.

If the trace description changes, the label changes to the new description, unless the new waveform description consists of a single stored waveform. The label of the stored waveform would then replace the active waveform's label.

The default horizontal position of the waveform label depends on the trace number. The left edge of the label is placed a specified number of divisions, equal to the trace number, away from the left edge of the graticule. Thus, the default horizontal position of the label for waveform 1 is 1 division to the right of the left edge of the graticule. The default position of the waveform 4 label is 4 divisions in from the left edge of the graticule.

Note that this
applies only to new
traces

Labeling

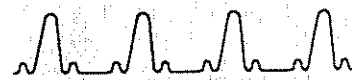

Label					
Displayed Waveforms	Stored Waveforms	Stored Settings	Base Label	Text	
Wfm 1	Wfm 2				
L1	L2				
Main	Main				
		Mode	Display	Position	
		Manual	On		
Q	W	E	R	T	Y
U	I	O	P	\	
A	S	D	F	G	H
J	K	L	:	"	
Z	X	C	V	B	N
M	<	>	?	Space	
Upper Case	Numbers	Greek	Erase	Back	Exit
Lower Case	Graphics	Other		Space	
Calibrator	Modes	Probes	Color	Page to Utility: 2	Rem. Wfm 2 L2 Main
Initialize	Time & Date	Label	Main Size	Pan/Zoom	Main Position
	13:05:25	Disp: On	50n	Off	-130n
	11-OCT-90	Mode: Man	s/div		s

The Label Pop-Up Menu

Labeling

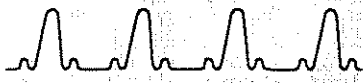

Changing the Base Label

Repetitive Single Trigger mode is discussed on page 44.
Act on Delta is discussed on page 53.

Displaying Labels with Active Waveforms

The current base label is the one that is used whenever acquisition occurs in Repetitive Single Trigger mode or in Act on Delta mode. As each waveform record is acquired, it is stored and labeled with a sequential number appended to the base label. For example, a series of waveform records might be labeled "REP1," "REP2," "REP3," etc. The default base label is "REP," for "repetition."

When multiple waveforms are selected for storing in Repetitive Single Trigger mode or Act on Delta mode, a colon and the waveform number of the acquired waveform are appended to the label. For example, if waveform 1 and waveform 3 are acquired, the first acquisition would produce waveforms labeled "REP1:1" and "REP1:3."

You can change the base label just as you would change any other label. Select **Base Label** in the **Label** pop-up menu. Erase the existing base label and enter a label of your choice. The base label is limited to five characters, so that numbers of up to three digits, a colon, and the waveform number may be appended to the label. Digits may not be entered as part of the base label.

Labels of active waveforms may be displayed on the screen with the waveforms. When **Displayed Waveforms** is selected, **Display** and **Position** selectors appear beneath the waveform selectors in the **Label** pop-up menu. Turning on **Display** will cause the labels to appear with the displayed waveforms. Labels will appear in the selectors for active waveforms whether **Display** is turned on or off.

Labeling



Labels that are displayed on the screen move with the waveforms. You can position each label relative to its waveform. Select **Position** to assign the knobs to set the vertical (left knob) and horizontal (right knob) position of the label. The label position is relative to a specific point on the waveform. By changing the horizontal position of the label, you are changing the point the label will follow. By changing the vertical label position, you can specify the vertical offset of the label from the point. If the waveform record point is out of the range of the graticule, the label will remain at the top or bottom of the graticule. Also, the label cannot be moved off the left edge, even if the waveform point is. However, it will go off the right edge except for the left edge of the leftmost character.

Labeling

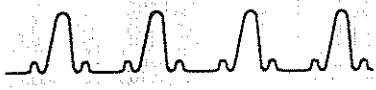

Measurements

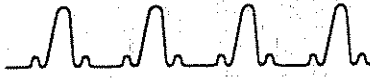

Measurements (Cont.)

Timing
Measurements

Selector	Measures
Rise	The transition time of a rising pulse edge.
Fall	The transition time of a falling pulse edge.
Period	The time taken for one complete signal cycle.
Frequency	The reciprocal of the period.
Width	The time the signal takes to go from one voltage level crossing to the next crossing of opposite slope.
Cross	The time from the trigger point to a specified level crossing.
Delay	The time between the first and last mesial crossings of a waveform within the measurement zone.
PropDelay	The time from the first mesial crossing of the selected waveform to the first mesial crossing of the delayed waveform† within the measurement zone.
Skew	The time from the first mesial crossing of the reference waveform† to the first mesial crossing of the selected waveform within their respective measurement zones.
Duty Cycle	The percentage of a period that a waveform spends above the mesial.
Phase	The phase angle from the reference waveform† to the selected waveform.
Main→Win Trig Time	The time from the Main trigger point to the Window trigger point. This measurement allows much greater precision than other timing measurements, and is discussed in more detail later in this section.

† The delayed waveform is set separately for each waveform, and is used only for the PropDelay measurement. The reference waveform is the same for all selected waveforms; it does not change when you select a new waveform.

Measurements

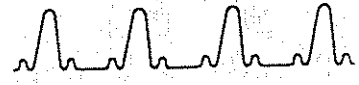

Measurements (Cont.)

	Selector	Measures
Frequency Domain Measurements	Spectral Frequency	This provides frequency tracking for the fundamental and user-specified harmonic as well as spectral peak frequency measurements.
	Spectral Magnitude	This provides amplitude tracking for the fundamental and user-specified harmonic as well as spectral peak amplitude measurements.
	THD	Total harmonic distortion.
Area and Energy Measurements	Area+	The sum of the absolute value of the area under the curve above a reference level and the absolute value of the area under the curve below that reference level.
	Area-	The difference between the absolute value of the area under the curve above a reference level and the absolute value of the area under the curve below that reference level.
	Energy	The energy represented under the curve of a waveform. This integral of the squared voltages can be divided by the resistance of the circuit to yield power measurements.

Setting up a Waveform for Measurements

The %Fill parameter is discussed in Acquisition on page 40.

Measurements are taken from waveform record points. The waveform on which measurements are based must be adjusted so all areas that are needed to take the measurements are visible on the display. No part of the waveform should extend above or below the graticule display area. If a measurement requires a full cycle, as in frequency or period measurements, adjust the horizontal size to show at least two complete cycles of the signal. If a measurement requires a rising or falling edge, as in rise or cross measurements, adjust the horizontal and vertical size and position to show the complete rising or falling edge.

For best accuracy, the %Fill (located in the **Acquire Desc** menu) parameter (located in the **Acquire Desc** menu) should be set to 100. Otherwise, the waveform record may include null points, which will affect the accuracy of the measurements.

Measurements

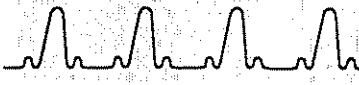

Having an improperly adjusted waveform may result in an error measurement readout. See page 194.

Establishing Measurements

Having an improperly adjusted waveform for a measurement may result in a qualified measurement readout. For example, measurements may be qualified by greater than or equal to (\geq), less than or equal to (\leq), or a question mark (?). An error readout may also result.

The frequency domain measurements are designed to work on FFTmag(w(n)) waveform (the magnitude of the Fast Fourier Transform of waveform w(n)). If the measurements are enabled and the selected waveform is not an FFTmag, the status field will display **FFTmag wfm only**.

Once the waveform display is established, press the **MEASURE** button to display the Measure major menu. Initially, this menu is mostly blank. The six empty selectors are reserved as places for measurement readouts that appear when you select measurements.

			Measure- ments	Page to	Rem Wfm 1
			Main Size 50μ s/div	Pan/ Zoom Off	Statistics L1 &Histogram Main Main Position -6μ s

Measure Major Menu

Note that measurements are performed on linearly interpolated acquired data, regardless of the selected Pan/Zoom interpolation type.

Touch the **Measurements** selector to display a pop-up menu showing the measurement selectors. Touch the individual measurement selectors to take measurements of your waveform. As you select each measurement, the result of the measurement is immediately displayed in one of the selector areas of the Measure major menu.

The illustration on the next page shows the **Measurements** pop-up menu with two measurements, RMS and Frequency, selected. The numeric readouts for these two measurements are in the major menu area.

Measurements



Select measurements here

Measurements					
Amplitude	Area	Energy	Timing	Frequency	Freq Domain
Max	Mean		Rise	Fall	Spectral Freq
Mid	RMS		Freq- uency	Period	Spectral Mag
Min	Over Shoot		Delay	Prop- Delay	THD
Peak- Peak	Under Shoot		Cross	Width	
Gain	Energy		Duty Cycle	Phase	
Area +	Area -		Skew	Main+Win Trig Time	
Exit Menu			Clear All		

Remove the pop-up menu here

View the readouts here

RMS	Freq- uency	Measure- ments	Page to	Rem Wfm 1
2.383 V	41.67 kHz		Statistics & Histogram	Main
		Main Size 50μ s/div	Pan/ Zoom Off	Main Position -6μ s

Measurements Pop-Up Menu with Frequency and RMS Selected

Measurements

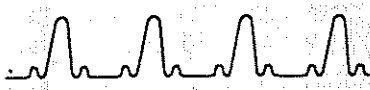

When the measurements you want are selected, you can remove the pop-up menu by touching either the **Exit Menu** selector in the pop-up menu or the **Measurements** selector in the major menu area. This lets you see the waveform as the measurements are taken.

The Main→Window Trigger Time Measurement

Unlike the other timing measurements, which are taken from digitized waveform samples, the Main→Window Trigger Time measurement is taken directly from the signals passing through the trigger circuits. You can use this feature to obtain very precise time interval measurements, similar to the “Time A→B mode” on a counter/timer.

You need to acquire a window waveform in order to use the **Main→Win Trig Time** measurement.

To use the Main→Window Trigger Time measurement, select **Main→Win Trig Time** in the **Measurements** pop-up menu. Since you can set the trigger source, slope, level, and holdoff separately for the Main and Window time bases in the **Trigger** major menu, you can define the Main and Window trigger events so that the time between them represents the time between edges on two different waveforms or on the same waveform, and you can be very specific about the events that define the beginning and end of that time interval.

For more information about triggering, see page 253.

First, define a separate trigger for the Window time base: touch the **Trigger Select** selector in the **Trigger** major menu until **Window** is selected, then select **Window Holdoff: By Time** or **Window Holdoff: By Events** in the **Source Desc** pop-up menu. Window triggering is described fully in the **Window Triggering** section on page 258. Use the **Source Desc** pop-up menu to define the trigger signal for the selected trigger (the one listed in the **Trigger Select** selector).

Selectors for trigger **Level**, **Holdoff**, and **Slope** for both the Main and Window triggers appear in the **Main→Win Trig Time** pop-up menu, which is shown on the next page. Touch the **Main→Win Trig Time** selector to view this pop-up menu. The horizontal lines that appear on the display show the trigger levels. The vertical bars show the location of the trigger events in time and the trigger indicators (↔) show the location of the trigger events on the trigger signals.

Measurements

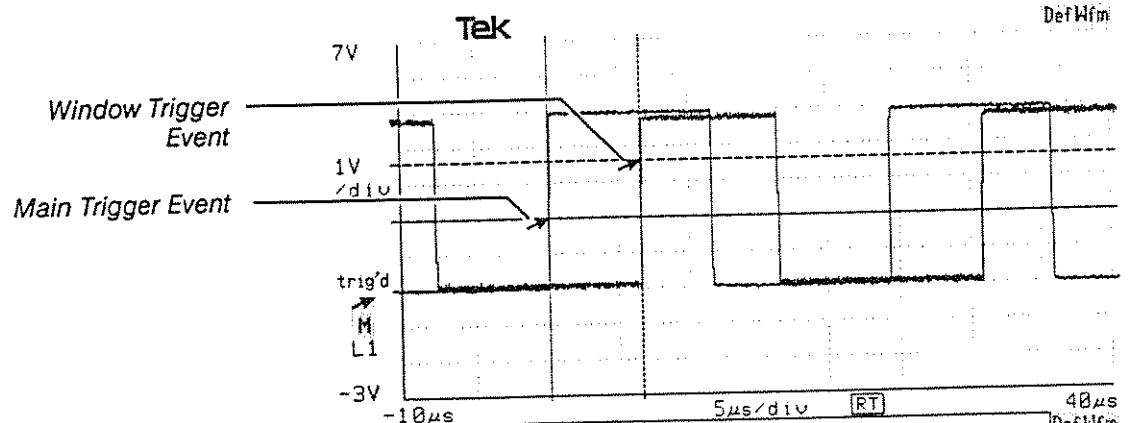

Main Trigger		Window Trigger	Statistics	
Level	2V	Level	Avg 10	Avg 100
Time Holdoff	2µs	Time Holdoff	Avg 1000	Avg Off
Slope	+	Slope	Main→Win Trig Time	
Source Desc	L1	Source Desc	mean: 6.6174300µs	
			max: 6.6184770µs	
			min: 6.6163060µs	
			stdv: 676.56337ps	
XMain→Win Trig Time			Measurements	Page to Wfm 3
6.6174300 µs			Window Size 2µs/div	Statistics C1 Histogram Wind
			Pan/Zoom Off	Window Position 13.25µs

The Main→Win Trig Time Pop-Up Menu

Measurements

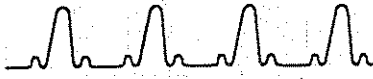

Deleting Measurements

To delete a measurement, touch the **Measurements** selector in the Measure major menu. In the pop-up menu, touch the selectors for the measurements you want to remove. As you touch the measurement selectors, they will turn off highlighting and the measurement readouts will be removed from the major menu area. **Clear All** deletes all measurements. When you are finished removing measurements, touch the **Exit Menu** selector to remove the pop-up menu.

Measurement Statistics

The DSA can collect mean, standard deviation, maximum, and minimum values for all active measurements. To control these statistical functions, go to the **Statistics & Histogram** page of the Measure major menu and select **Statistics**.

Statistical Functions (Live Waveforms)					
	Statistics	Reset	Statistics		
	On		100		
	RMS		Frequency		
	mean: 3.250V		mean: 42.80kHz		
	max: 4.844V		max: 1.334MHz		
	min: 74.83mV		min: 25.64kHz		
	stdv: 565.2mV		stdv: 5.546kHz		
Live Wfm					
Statistics					
Stored Wfm					
Statistics					
Exit					
Top=4V	Mean=0V	$\mu\pm 1\sigma=0\%$	Page	Rem	
Btm=-4V	RMSΔ=0V	$\mu\pm 2\sigma=0\%$	to	Wfm 1	
Lft=50μs	PkPk=0V	$\mu\pm 3\sigma=0\%$	Measure-	L1	
Rat=450μs	Hits=0	Wfms=0	ments Menu	Main	
Histograms	Statistics	Compare &	Main	Pan/	Main
Off	sample *	Defaults	Size	Zoom	Position
	≥100		50μ	Off	-6μ
			s/div		s

Live Wfm Statistics in the Statistics Pop-Up Menu



When the **Statistics** pop-up menu is displayed, you can choose to display the statistical functions of any number of stored waveforms or any live waveforms by touching **Live Wfm Statistics** or **Stored Wfm Statistics**. The stored waveforms must be stored in waveform RAM. Waveforms stored to disk cannot be accessed in this mode.

Touch the **Statistics** selector to turn statistical computation on or off. When statistics are on, the mean values of the measurements appear in the measurement selectors in the Measurements page of the major menu. The symbol \bar{x} , for mean, precedes the name of each measurement. The standard deviation, the mean value, and the maximum and minimum values of each measurement appear in the lower portion of the **Statistics** pop-up menu.

If the DSA encounters an error or an otherwise qualified measurement while computing statistics, the sample that caused the error will be discarded and a question mark (?) will precede the displayed statistics.

Measuring Live Waveforms

When statistics are on, the number of samples that have been used to determine the statistical values appears in the **Statistics** selector in the major menu. You can set the number of samples to be used for statistics by selecting **Statistics N** in the **Statistics** page of the **Statistics** pop-up menu and then setting the value by using the control knobs.

To restart statistics, select **Reset** in the statistical functions page of the **Statistics** pop-up menu. Statistics will also be reset whenever the value of **Statistics N** is changed, when measurement or waveform parameters are changed, or when measurements are turned on or off.

Measurements

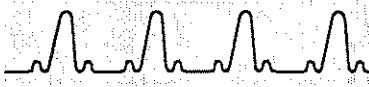

Statistical measurements cannot be taken on waveforms stored on disk.

Reference Waveforms must be displayed waveforms. See page 189.

Measuring Stored Waveforms

To make statistical measurements on stored waveforms, first touch the **Stored Waveform Statistics** selector in the **Statistics** pop-up menu, then touch **Measure** to perform the measurement. A number appears under the **Measure** selector. This number is a running total of the stored waveforms measured and is an indication that something is happening. When finished measuring, the measure selector will revert to "stopped". You can change the group of waveforms used for statistical computation by selecting the *Base Label* of the waveforms you want to measure. Select the **Measure from:/to:** selector to assign the knobs and adjust the **Meas From** and **Meas To** values to further restrict the group of stored waveforms being measured. If you want to use all of the stored waveforms for computing the statistics, touch **All Stored Waveforms**. For more information see page 245.

The display will show the mean, standard deviation and the minimum and maximum values for the specified group of waveforms. The number of the stored waveform responsible for the maximum and minimum values is also displayed in the **STO** column.

Main→Window Trigger Time Statistics

Statistics for the **Main→Win Trig Time** measurement do not appear in the **Statistics** pop-up menu. Instead, the **Main→Win Trig Time** statistics are controlled from the **Main→Win Trig Time** pop-up menu. To view statistics for this measurement, select **Main→Win Trig Time** in the measurement readout area and select **Avg 10**, **Avg 100**, or **Avg 1000** in the **Statistics** section of the pop-up menu to set the number of samples to take to determine the statistical values.

The mean **Main→Win Trig Time** value appears in the status area of the **Main→Win Trig Time** selector, and the maximum, minimum, and standard deviation values appear in the **Statistics** section of the **Main→Win Trig Time** pop-up menu. Select **Avg Off** to terminate statistics for this measurement. Always select **Avg Off** for a **Main→Window Trigger time** measurement in single trigger mode.

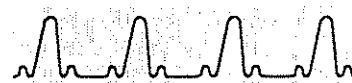

Comparing Measurements to References

You can establish reference values for your measurements and have the DSA display the measurement readouts as the amount of variance from the reference value. For example, if you want to see how much a waveform varies from 0.5 V rms, establish a reference value of 0.5 V rms. Then turn the compare mode on and the DSA displays the difference between the reference value of 0.5 V rms and the rms value of the waveform being measured.

You can save the current measurement readouts as the reference values for those measurements. If you then turn on the compare feature, you can observe how much the signal deviates from those references as you tune the circuit under test.

When the compare mode is on and measurement readouts show difference values, the measurement readouts show a delta (Δ) in the selector label to remind you that difference values are being displayed. For example, the **RMS** measurement readout in the major menu area becomes the **Δ RMS** readout when compare mode is turned on.

The compare feature affects all measurements on all waveforms. When you turn on compare mode, all measurement readouts show Δ comparison values, even if you select a different waveform.

Compare mode is turned on or off by touching **Compare** in the **Compare Options** page of the **Compare & Defaults** pop-up menu in the **Statistics & Histogram** page of the Measure major menu. Select **Compare Options** in the **Compare & Defaults** menu to display this page.

You set the reference values to the current measurement values by touching the **Save Current Meas Values as References** selector. When you touch this selector, all the reference values for measurements established on the selected waveform are copied from the current measurement readouts.

Measurements

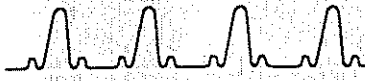

Compare and Reference Values					
Compare Options	Compare		Save Current Measurements as References		
	On				
	Adjust References				
	Peak Peak Ref	5.00000 V	Frequency Ref	76.85kHz	
Default Parameters					
Exit					
Top=6.475V	Mean=0V	$\mu\pm 1\sigma=0\%$	Page to Measure-ments Menu	Rem Wfm 2 L2 Main	
Btm=-1.525V	RMSΔ=0V	$\mu\pm 2\sigma=0\%$			
Lft=-5μs	PkPk=0V	$\mu\pm 3\sigma=0\%$			
Rgt=35μs	Hits=0	Wfms=0			
Histograms	Statistics	Compare & Defaults	Main Size	Pan/Zoom	Main Position
Off	sample * ≥100		5μ s/div	Off	-10.6μ s

Compare Options in the Compare & Defaults Pop-Up Menu

You can use the knobs to set the reference values. A selector appears in the **Adjust References** section of the **Compare & Defaults** pop-up menu for each measurement currently established on the selected waveform. Each of these has the word **Ref** after the measurement name, for example, the **RMS Ref** selector. Touch the reference selector for the measurement reference you want to adjust, and both knobs are set to adjust that reference value. To set the numeric reference value, turn either knob or use the pop-up keypad when you touch the knob selector.



Changing Measurement Parameters

Once you have established a measurement on a waveform, you can find out more information about the measurement and you can control the way the DSA takes the measurement by changing the measurement parameters.

Touch the measurement readout selector in the major menu area to see the additional information. This displays a pop-up menu for the individual measurement. It also displays *annotation lines* that overlay the selected waveform displayed on the graticule. These lines show the value of the *measurement parameters* that pertain to that particular measurement.

In addition to the annotation lines, the portion of the waveform the DSA uses to determine the measurement value is highlighted.

The illustration on the next page shows a typical pop-up menu for a measurement, along with the annotation lines and the highlighted portion of the waveform.

Many of the selectors in the measurement pop-up menu set the knobs to adjust the measurement parameters. As you turn the knob, the annotation lines move to reflect the new value of the measurement parameter. For example, in the **Frequency** pop-up menu, the **Left Limit**, **Right Limit**, **Mesial**, and **S/N Ratio** selectors set the knobs to control those measurement parameters.

When you remove the measurement pop-up menu by touching its selector in the major menu area, the annotation lines remain on the display. The knob settings also remain, so you can set the knobs in the pop-up menu, remove the pop-up menu from the display, and adjust the measurement parameter with the annotation lines on the waveform. Your view of the waveform is not impeded by the measurement pop-up menu.

Measurements

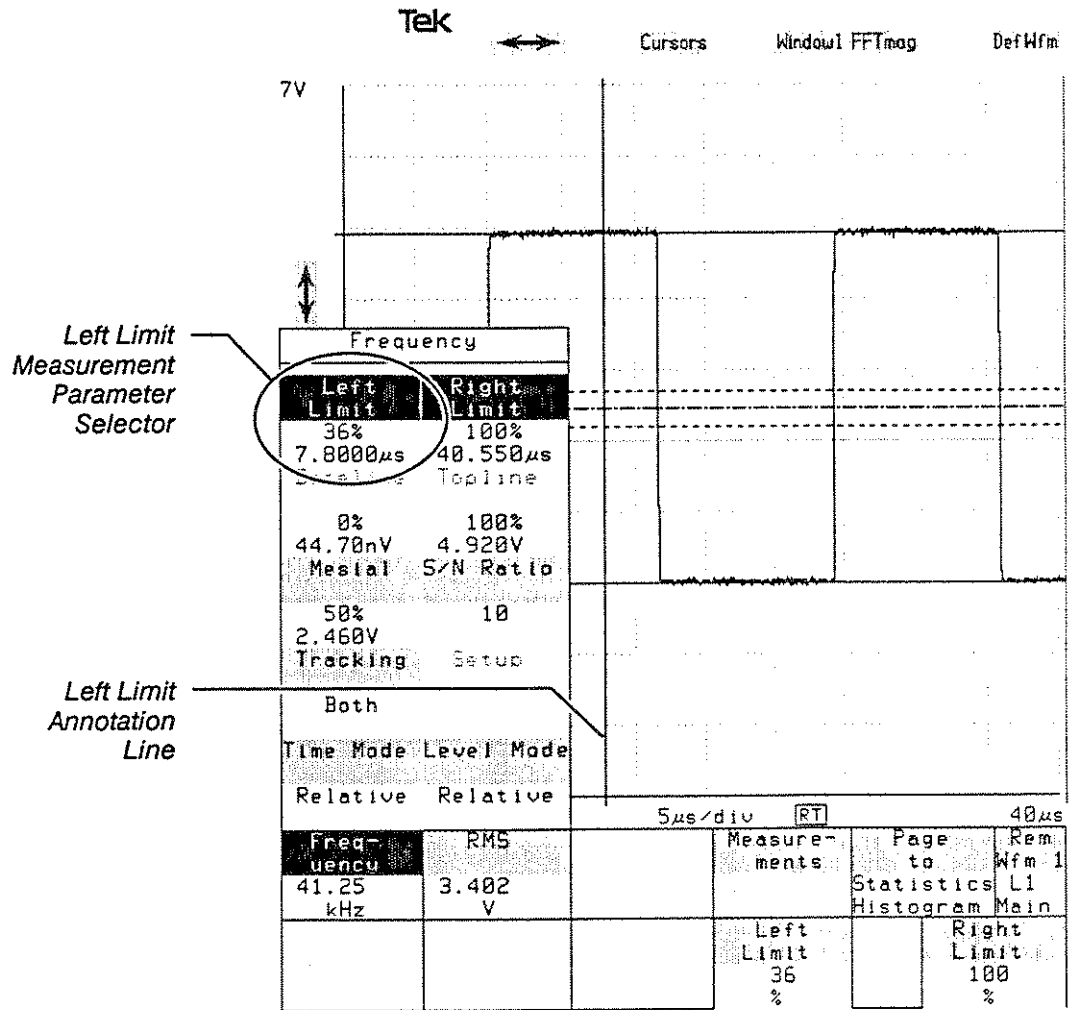

A Typical Individual Measurement Pop-Up Menu

Measurements

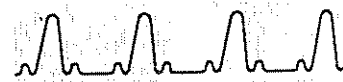

The annotation lines will remain on the display until you leave the Measure major menu even if the knobs are assigned to another function. If you leave the Measure major menu, the annotations will not be displayed but they will return when the menu is re-entered. The annotation lines can be removed at any time by touching the **RemAnno** icon near the lower left corner of the graticule. If trigger annotations are displayed simultaneously, the **RemAnno** icon will remove the lines most recently selected.

In the illustration on the next page, the Left Limit measurement parameter is set to 36%. The left limit vertical line is positioned 36% of the way across the graticule, and the DSA measures the frequency from the first complete cycle to the right of the left limit. The highlighted portion of the waveform shows the area being measured.

Measurements

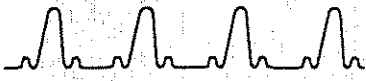

The following table shows the measurement parameters. No pop-up menu for an individual measurement uses all these parameters; only the ones that apply to that particular measurement are shown in the pop-up menu.

Changing a measurement parameter in one measurement changes it in all measurements of the selected waveform that use that parameter, but does not change the parameter for other waveforms.

Measurement Parameters

Name	Definition
Baseline	The baseline value is the 0% level on which proximal, mesial, and distal levels are based. When tracking mode is set to Both or Baseline , the DSA repeatedly determines the baseline and you cannot adjust it. When tracking mode is set to Off or Topline you can set baseline, or you can have the DSA set it once by touching the Setup selector in an individual measurement pop-up menu.
Data Interval	Determines whether the measurement will be taken from one cycle of the waveform within the measurement zone, or from the entire measurement zone. (You can change the measurement zone by changing the Left Limit and Right Limit parameters.)
Distal	The distal (most distant from the origin) reference level. Rise and fall times are measured between the proximal and distal levels, which are typically 10% and 90% of the baseline to topline amplitude.
Left Limit	The beginning of the waveform measurement zone.
Level Mode	Determines how the proximal, distal, mesial, and reference levels are set. In <i>absolute</i> level mode, you set these parameters as absolute values. In <i>relative</i> level mode, you set them in terms of percentages of the baseline to topline distance. In <i>top delta</i> and <i>base delta</i> modes, you set the parameters as offsets to be added to the topline and baseline, respectively.
Mesial	The reference level nearest the middle-amplitude level.

Measurements



Measurement Parameters (Cont.)

UPPER LIMIT, LOWER LIMIT, SLOPE, S/N RATIO, REFERENCE WAVEFORM, DELAYED WAVEFORM, SLOPE, S/N RATIO, REFERENCE WAVEFORM, DELAYED WAVEFORM

Name	Definition
Proximal	The proximal (closest to origin) voltage level. Rise and fall times are measured between the proximal and distal voltage levels, which are typically 10% and 90% of the baseline to topline voltages.
Reference Level	The transition-crossing voltage level.
Right Limit	The end of the waveform measurement zone.
S/N Ratio	The amplitude of a noise rejection or hysteresis band centered on the mesial level. Transitions through the mesial level are qualified by S/N ratio by the requirement that the signal enter the noise rejection band and leave the noise rejection band at the opposite limit with the same slope and with no intermediate values outside the noise rejection band. S/N ratio may be set to any value from 1 to 99. The reciprocal of the number is the fraction of the peak-to-peak signal value that the noise rejection band extends above and below the mesial line. For a 1 V peak-to-peak signal, S/N ratio of 20 creates a noise rejection band 0.05 V above and 0.05 V below the mesial level.
Reference Waveform	The waveform to which the selected waveform is compared for the Gain, Phase, and Skew measurements. There is one reference waveform for all waveforms; it does not change when you select a different waveform.
Delayed Waveform	The waveform compared to the selected waveform for the PropDelay measurement. The delayed waveform is set separately for each selected waveform.
Slope	The direction the waveform must pass through a reference level.

Measurements

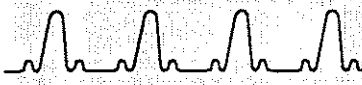

Measurement Parameters (Cont.)

PARAMETERS OF THE MEASUREMENT ZONE

Name	Definition
Search Mode	For frequency domain measurements, Search Mode determines how spectral components are detected. If Search Mode is harmonic, the instrument decides that the first highest peak in the measurement zone is the fundamental frequency component. Setting the harmonic number to n , will move the measurement to the n th harmonic of the input signal. If, by toggling Search Mode, you set the Search Mode to Peak, the spectral components will be treated as simply spectral peaks. A spectral peak is defined as a FFTmag waveform peak higher than a reference level, adjustable from the same pop-up. Peak Index set to n will perform the measurement on the n th spectral peak of the FFT magnitude waveform.
Peak Index	Performs the measurement on the n th spectral peak of the FFT magnitude waveform. Its range of values is from 1 to 1000. (See Search Mode definition).
Harmonic Number	A harmonic number of n moves the measurement to the n th harmonic of the input signal. Its range of values is from 1 to 1000. (See Search Mode definition).

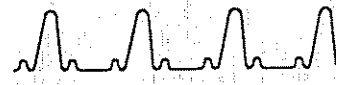

Measurement Parameters (Cont.)

Name	Definition
Time Mode	Determines whether the left limit and right limit are set as absolute values or as percentages of the record length. In <i>absolute</i> time mode, these boundaries are set to absolute values. In <i>relative</i> mode, the boundaries are set as percentages of the record length, and the corresponding absolute values of the limits are displayed along with the percentages in the individual measurement pop-up menu.
Topline	The 100% level on which proximal, mesial, and distal levels are based. When tracking is set to Both or Topline , the DSA repeatedly determines the topline for itself and you cannot adjust it. When tracking is set to Baseline or Off , you can set the topline or you can have the DSA set it once by touching the Setup selector.
Tracking	Determines how the topline and baseline are set. When tracking is set to Both , the topline and baseline are repeatedly determined by the DSA. When tracking is set to Topline , the DSA determines the topline value and you can set the baseline. Similarly, setting tracking to Baseline causes the DSA to set the baseline but allows you to set the topline. When tracking is Off , you set both topline and baseline.

Measurements



Changing Default Parameters

When you define a new waveform, the measurement parameters for that waveform are set to their initial values by copying them from a set of default parameters. The DSA has one set of default parameters. You can set the default parameters to the values you want. This does not change the measurement parameters of any existing waveforms, but it will determine the initial value of the measurement parameters for all new waveforms that you define.

You might want to change the default parameters if you are about to create a number of waveforms and take measurements from them, and know that they will all need the same measurement parameters. Setting the default parameters before creating the waveforms is quicker than changing the measurement parameters of each waveform individually.

To change the default parameters, select **Compare & Defaults** in the **Statistics & Histogram** page of the Measure major menu. Then select **Default Parameters**. The pop-up menu appearing on the next page will show a selector for each measurement parameter.

Touch the selector that names the default you want to set. **Time Mode**, **Level Mode**, **Tracking**, **Slope**, and **Data Interval** cycle through the appropriate values. The other selectors set the knobs to adjust the measurement parameters. To reset the defaults to the values they have when the DSA is initialized, select **Initialize Defaults**.

When you have set the defaults the way you want them, you can change all the measurement parameters of the selected waveform to the default settings by touching the **Copy Defaults to Sel Wfm** selector.

Measurements



Default Parameters				
	Initialize Defaults		Copy Defaults to Sel Wfm	
	LeftLimit	Time Mode	RightLimit	
	0%	Relative	100%	
	Tracking	Level Mode	Slope	
	Both	Relative	+	
Compare Options	Proximal	Distal	Reference Level	
	10%	90%	0	
Default Parameters	Mesial	S/N Ratio	Data Interval	
	50%	10	One Period	
Exit	Baseline		Topline	
	0		0	
Top=4V	Mean=0V	$\mu \pm 1\sigma = 0\%$	Page	Rem
Btm=-4V	RMSΔ=0V	$\mu \pm 2\sigma = 0\%$	to	Wfm 1
Lft=50μs	PkPk=0V	$\mu \pm 3\sigma = 0\%$	Measure-	L1
Rgt=450μs	Hits=0	Wfms=0	ments Menu	Main
Histograms	Statistics	Compare & Defaults	Left	Right
Off	sample *		50μs	450μs
	>100		s	s

Default Parameters in the Compare & Defaults Pop-Up Menu

Measurements

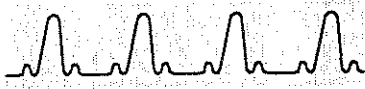

Measurement Errors

When the DSA cannot make an accurate measurement, it displays an error qualifier with the measurement result. Measurement errors usually result from improperly adjusted waveforms (waveform features needed for the measurement are off the graticule or outside the measurement zone) or from incomplete waveform record acquisitions.

The three measurement qualifiers are \geq (greater than or equal to), \leq (less than or equal to), ? (uncertain), and error. These characters are displayed in the measurement readout area.

Greater than or Equal to (\geq) Readouts

A greater than or equal to (\geq) readout can occur:

- On a **Peak-Peak, Amplitude, or Gain** measurement when part of the measured waveform is off the graticule.
- On a **Max, Mean, Mid, or Over Shoot** measurement when the measured waveform is off the top of the graticule.

Less than or Equal to (\leq) Readouts

A less than or equal to (\leq) readout can occur:

- On a **Min, Mean, Mid, or Under Shoot** measurement when the measured waveform is off the bottom of the graticule.

Uncertain (?) Measurement Readouts

The following conditions can result in an uncertain (?) readout:

- The measured waveform contains null (unacquired) values. Set the %Fill parameter to 100 to avoid this condition. See page 40 for details on the %Fill parameter.
- For **Rise, Fall, Frequency, Period, or Width**, the measured waveform is enveloped or includes enveloped components.

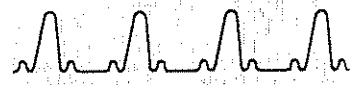

- For **Mean** or **RMS**, the data interval is set to one period and the measured waveform is enveloped or includes enveloped components.

Error (error) Measurement Readouts

The following conditions can result in an error (error) readout:

- For a **Frequency** or **Period** measurement when the measurement zone does not contain a period of the waveform.
- For a **Mean**, **RMS**, **Area+**, **Area-**, or **Energy** measurement, the data interval was set to one period and the measurement zone does not contain a period of the waveform.
- For a **Cross** measurement when no transition of the specified slope is found in the measurement zone.
- For a **Cross** measurement when the reference level does not fall within the Min and Max values for the measurement zone.
- For a **Rise** measurement when the DSA cannot compute a valid Proximal time, followed by a valid Distal time, within the measurement zone.
- For a **Fall** measurement when the DSA cannot compute a valid Distal time, followed by a valid Proximal time, within the measurement zone.
- For a **Width** measurement when two mesial crossings of opposite slope cannot be found within the measurement zone.
- Whenever a measurement is selected with no waveforms displayed.

Measurements



Histograms

The DSA can display histograms constructed from the selected waveform's record data. You can display either a vertical or horizontal histogram. Only one type of histogram can be displayed at a time.

Histograms cannot be displayed for stored waveforms. Histograms can be displayed for calculated waveforms if the calculated waveform contains at least one active waveform (even if the calculated waveform contains a stored waveform).

Histograms are created by using the **Statistics & Histogram** page in the Measure major menu. You can specify the section of the selected waveform used to determine the histogram and set histogram scaling to either linear or logarithmic. You can specify that acquisitions stop after a set number of waveform acquisitions have been acquired or if a specified number of hits are within given limits.

Displaying a Histogram

You create a histogram by using the **Statistics & Histogram** page of the Measure major menu and turning on histograms in the histogram pop-up menu. A rectangular box is displayed when histograms are turned on. This box selects the portion of the waveform used to generate the histogram. If there is more than one waveform on the display, the histogram generated corresponds to the selected waveform. When a vertical or horizontal histogram is selected, the record length of the selected waveform time base is changed to 512 points. The display persistence of the selected waveform is changed to infinite.

Histogram Controls

The histogram display can be affected by several controls. You can specify which part of the selected waveform is used to calculate the histogram. You can stop acquisitions based on the number of waveforms acquired or the number of samples within the specified area. You can set how often the histogram display is updated with new data and you can set scaling of histogram data to logarithmic or linear. All the histogram controls are located in the **Histograms** pop-up menu.



Tek ← Cursors Window Def Wfm

6.25V

Histograms	
Vertical Histogram	Horizontal Histogram
On	Off
Vertical Limits	Horizontal Limits
Set N Waveforms	Stop N Waveforms
1000	
Set N Samples	Stop N Samples
10000	
Histogram Scaling	Refresh Rate
Linear	6s
Clear	Exit

		5μs/div	RT	40.1μs
Top=5.25V	Mean=2.6697V	$\mu\pm 1\sigma=56.023\%$	Page to	Rem Wfm 1
Btm=-2.75V	RMSΔ=2.4558V	$\mu\pm 2\sigma=100\%$	Measure-	L1
Lft=-4.9μs	PkPk=5.3198V	$\mu\pm 3\sigma=100\%$	ments Menu	Main
Rat=35.1μs	Hits=1.73E6	Wfms=4326	Chan Sel	Vertical Offset: L1
Histograms Statistics	Compare & Defaults	Vertical Size: L1	L1	1.25 V
vertical sample *	4	V/div		

The Histograms Pop-up Menu in the Measure Major Menu

Measurements



Changing the Size of the Histogram Box

To change the portion of the selected waveform used to create the histogram, touch either **Vertical Limits** or **Horizontal Limits**. Touching the **Vertical Limits** selector assigns the left knob to upper limit and the right knob to lower limit. Touching **Horizontal Limits** assigns the left knob to left limit and the right knob to right limit. Turning either knob will change the position of the assigned edge of the histogram box, thus limiting the part of the selected waveform used for the histogram.

The vertical and horizontal limits of the histogram box can be set without turning on the histogram display. To set the size and location of the histogram box without turning on the histogram display, just touch either **Vertical Limits** or **Horizontal Limits**. This ability enables you to set up your histogram display before you begin acquiring your data. The histogram box size is an attribute of the waveform; each waveform can have its specified histogram area.

Histogram displays are set separately for each displayed waveform. Because a histogram applies only to the selected waveform, when you select a different waveform, the newly selected waveform histogram will be displayed. (Keep in mind that only one histogram, that of the selected waveform, will be displayed at a time.)

Limiting Acquisition

To stop acquisition after acquiring a set number of waveforms, touch **Set N Waveforms**. This assigns the knobs to limit the number of waveforms acquired. The range for the number of waveforms acquired is 1 to 2^{32} (approximately four billion). Touching the **Stop N Waveforms** selector will start the waveform acquisition count down, as indicated in the histogram selector status field. The number of waveforms left to acquire is shown in the lower left corner of the display under the **Histogram** selector.

Once acquisitions have stopped by reaching the condition set, they can be restarted by pressing the **RUN/STOP** button. To return to a continuous acquisition mode, you can toggle the **Stop N Waveforms** selector or select the **Continuous Acquisition** mode in the **Acquire Desc** pop-up menu in the **Waveform** major menu.

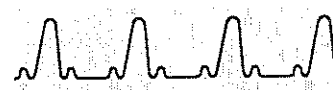

You can also stop acquisition based on the number of samples acquired within the histogram box. To stop acquisition after acquiring a set number of samples, first touch **Set N Samples**. This assigns the knobs to limit the number of samples acquired. Using the knobs, set the number of samples you wish to acquire. The range for the number of samples acquired is 1 to $2^{32} - 1$ (approximately four billion). Touching **Stop N Samples** will start the sample acquisition count down, as indicated in the histogram selector status field. The actual number of hits accumulated into the box can exceed the specified count when many points are acquired on a single acquisition.

For calculated waveforms, the histogram is performed on the calculated data. In equivalent time acquisition mode, all points in the waveform are recalculated, not just the newly acquired points. This means that the number of samples within the histogram box will not reflect the number of actual acquired data points within the box.

Again, if you want to stop or restart a new cycle of the acquisition while still in the acquisition mode, press **RUN/STOP**.

The data that appears in the histogram readout is calculated as waveforms are acquired. The histogram display is updated based on the Refresh Rate.

Changing the Refresh Rate

The rate at which the histogram display is updated can be varied from five seconds to three minutes. To change the time interval of the histogram, touch **Refresh Rate**. You can now turn either of the control knobs to change the time between updates or you can use the knob pop-up menu to enter the time directly.

Changing Scaling

You can set the histogram scaling to either linear or logarithmic. To change the histogram scaling, touch **Histogram Scaling**. Linear scaling better illustrates the relative quantity of various data, while logarithmic scaling provides better detail at the edges of the histogram.

Measurements



Clearing the Histogram Data

To clear the data in the histogram display, touch the **Clear** selector in the **Histogram** pop-up menu.

The Histogram Readout

In the major menu area of the display is a readout of histogram characteristics. Included in the display are the values for the position of each of the sides of the histogram box, statistical values, and measurements.

- **Top, Btm, Lft, and Rgt** represent the position of each of the sides of the histogram box, in appropriate axis units. For example, **Top** and **Btm** values are given in volts; **Lft** and **Rgt** are given in seconds for voltage vs time waveforms.
- **Mean** is the average value of all the acquired points within the histogram box. **Pk Pk** is the difference between the most positive acquired point and the least positive or most negative acquired point, when **Vertical Histogram** is selected. When **Horizontal Histogram** is selected, **Pk Pk** is the difference between the left-most data point and the right-most data point within the histogram box.
- **RMSΔ** is the RMS deviation (also known as standard deviation). $\mu \pm 1\sigma$ represents the percentage of waveform points that fell within one standard deviation from the mean. $\mu \pm 2\sigma$ and $\mu \pm 3\sigma$ represent the percentage of waveform points that fell within two and three standard deviations from the mean, respectively.
- **Wfms** is the number of waveforms that have been acquired since the histogram display was turned on. **Hits** is the number of waveform data points that have fallen inside the histogram box.

Plug-in Units



The DSA has compartments for up to three plug-in units. Several types of plug-in units are available. This section includes general information about plug-in units. For information about a specific plug-in unit, refer to the manual for that unit.

Installing and Removing a Plug-in Unit

CAUTION
Never install or remove a plug-in unit when the DSA power is on. Set the **ON/STANDBY** switch to **STANDBY** first.

Before installing a plug-in unit, set the DSA **ON/STANDBY** switch to **STANDBY**. Align the grooves in the top and bottom of the unit with the guides at the top and bottom of the plug-in compartment. Push the plug-in unit until its front panel is flush with the front panel of the DSA.

To remove a plug-in unit, set the **ON/STANDBY** switch to **STANDBY**, then pull the release latch to disengage the unit and pull the plug-in unit straight out of the compartment.

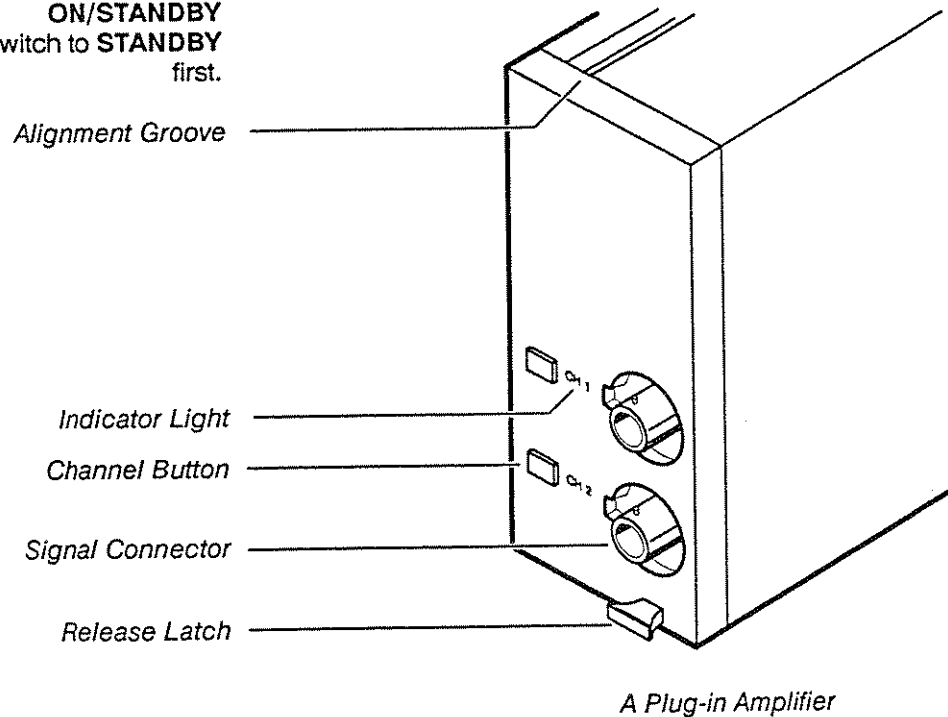

Plug-in Units

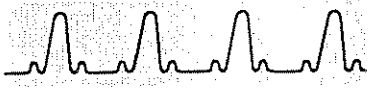

Plug-in settings are initialized when you install a new type of plug-in unit in the compartment. If you replace one plug-in unit with another of the same type, the existing settings are retained.

Display On/Off

A plug-in unit has a signal connector and an associated button and indicator light for each input channel. Buttons are labeled **CH#**, where # is the channel number. Pressing the button turns display of the input channel on or off. The yellow light next to the button will light whenever that channel is displayed.

Display of an input channel may also be turned on or off from the DSA. For example, the display of an input channel of a plug-in amplifier is turned on when you define a waveform expression that includes that channel, and is turned off when all waveforms displaying the channel are removed from the display.

Setting Input Parameters

The operation of a plug-in unit is controlled by the DSA. Some of the input channel controls are determined by selections made in the **Input Parameters** pop-up menu. Select **Input Parameters** in the **Waveform** major menu to display this pop-up menu.

Input parameters are specified individually for each channel. To set the input parameters for a channel, select the channel from the **Channel Select** section of the **Input Parameters** pop-up menu, then use the other selections in the menu to set the parameters.

Plug-in Units

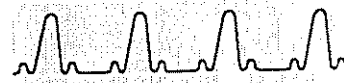

Channel Select					
L1	C1	R1	Digitizer Filter		
DC	DC	DC	100 MHz		
1MΩ/300MHz	1MΩ/300MHz	1MΩ/400MHz	Off		
L2	C2	R2			
DC	DC	DC			
1MΩ/300MHz	1MΩ/300MHz	1MΩ/400MHz			
L3	C3				
DC	DC				
1MΩ/300MHz	1MΩ/300MHz				
L4	C4				
DC	DC				
1MΩ/300MHz	1MΩ/300MHz				
Impedance	+ Coupling -		Bandwidth		
50Ω	AC		20MHz		
1MΩ	Off		100MHz		
	DC		300MHz		
Vertical Desc	Horizontal Desc	Acquire Desc	Lower Graticule	Page to	Rem Win 2
L1	Window	Continuous		All Wfms	L1
Fast	100MS/sec			Status	Wind...
Input Parameters	FFI Control	Act on Delta	Window Size	Pan/Zoom	Window Position
	dBm	None	1μ	Off	-15.8μ
	Rectang		s/div		s

The Input Parameters Pop-Up Menu

Plug-in Units



Channel Impedance

The **Impedance** section of the **Input Parameters** pop-up menu shows the input impedance values available for the selected channel, which are dependent on the type of plug-in unit. Touch a selector in this section of the pop-up menu to select the input impedance.

When you use a probe, the impedance of the plug-in unit should match the impedance of the probe. Active “intelligent” probes will eliminate inappropriate impedance options. Probes are discussed on page 213.

Channel Coupling

You can set the coupling of the selected input channel by making a selection from the **Coupling** section of the **Input Parameters** pop-up menu. The coupling options are different for single-ended and differential plug-in units. For a single-ended channel, three coupling options are available.

AC coupling blocks the DC component of the signal and allows only the AC component of the signal to be displayed. **DC** coupling passes the whole signal to be displayed on the screen. **Off** disconnects the selected channel from the input connector.

Input coupling for a differential channel can be independently selected for the + and – inputs. Differential channels may allow V_c , or voltage comparison coupling, which connects either the + or – input to an internal DC comparison voltage. This mode is also known as slideback comparison, and uses the differential channel as a single-ended input with a wide range DC offset. The Vertical Offset knob controls either differential DC offset, V_c offset, or active probe offsets, depending on the selected coupling. Please refer to the differential amplifier manual for a more detailed explanation.

The use of an active intelligent probe will eliminate the **AC** coupling option.

Plug-in Units



Channel Select					
L1	C1	R1	Digitizer Filter		
DC	DC	+:DC-:DC	100 MHz		
1MΩ/400MHz	1MΩ/400MHz	1MΩ/150MHz	Off		
L2	C2				
DC	DC				
1MΩ/400MHz	1MΩ/400MHz				
Impedance	+ Coupling -		Bandwidth		
50Ω	Off	Off	20MHz		
1MΩ	AC	AC	100MHz		
	DC	DC	150MHz		
	VC	VC			
Vertical Desc Avg(L1) Fast	Horizontal Desc Main 5GS/sec	Acquire Desc Avg* >32	Graticules	Page to All Wfms Status	Rem Wfm 1 Avg Main
Input Parameters DC 1MΩ/400MHz	FFT Control	Act on Delta None	Main Size 20n s/div	Pan/Zoom: Off	Main Position -42.4n s

The Input Parameters Menu with a Differential Channel Selected

Plug-in Units



If the 100 MHz digitizer filter is used, the DSA will not allow real time (RT) operation for 1 GS/s or 2 GS/s interleaved modes.

Vertical Offset and Sensitivity

Channel Bandwidth Limit

You can set the bandwidth limit of the selected channel to reduce the amplitude of unwanted noise or interference at frequencies above the frequency of interest. The bandwidth limits available depend on the type of plug-in unit you are using. Touch one of the selectors in the **Bandwidth** section of the **Input Parameters** pop-up menu to set the bandwidth limit.

Digitizer Filter

A 100 MHz digitizer filter is available and may be turned on or off by touching the 100 MHz selector in the **Digitizer Filter** section of the **Input Parameters** pop-up menu. This filter reduces the effects of noise and signals above 100 MHz. See page 309 in the Appendices for attenuation specifications.

You can get better filtering by using both the digitizer filter and a channel bandwidth limit. The resultant bandwidth will be less than 100 MHz. The DSA will automatically calculate the bandwidth and will display its value in the **Input Parameters** selector.

The vertical offset and sensitivity of a plug-in amplifier are controlled by the vertical settings of the DSA. See **Vertical Controls** on page 277 for information on setting vertical size (sensitivity) and position (offset).

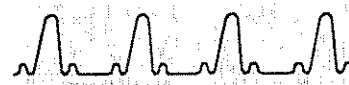

DC Circuit Loading

CAUTION
Use caution when working with voltages in excess of 25 volts.

For several plug-in amplifiers, the input impedance for DC coupling is $50\ \Omega$. This low impedance requires some caution.

When input coupling is set to $50\ \Omega$, a $50\ \Omega$ termination resistance is connected directly from the input connector to ground. Take care that the circuit connected to the input will not be damaged by the $50\ \Omega$ load.

Switching coupling to DC when more than 25 V is present at the input will exceed the peak input voltage specification for some plug-in amplifiers, and thus may damage the input relay. A damaged relay could cause an error in calibration. Refer to the specifications for your plug-in amplifier.

Two ways of unintentionally invoking DC coupling are:

- Pressing the **AUTOSET** button, because the Autoset process starts by searching for a DC voltage
- Recalling a stored setting that specifies DC coupling

Some plug-in amplifiers will automatically disconnect the $50\ \Omega$ termination and display a message on the DSA when the input voltage substantially exceeds 5 V rms. Refer to the manual for your plug-in amplifier.

Plug-in Units

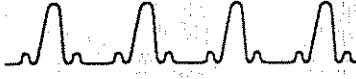

Overdriving

Overdriving occurs whenever a plug-in amplifier is driven out of its linear range. For many of the plug-in amplifiers, this linear range is ± 15 divisions. The *overdrive recovery* of a plug-in amplifier is the time it takes the amplifier to settle to within a stated fraction of the equilibrium value after an input step. Overdriving can be used as a tool for certain measurements with plug-in amplifiers that have fast overdrive recovery.

For example, suppose a signal changes from $+1.7$ V to $+0.8$ V in 1 ns. A plug-in amplifier could be used to determine if the signal stabilized immediately at $+0.8$ V or if it had some small aberration after the transition. By setting the amplifier offset (vertical offset) to $+0.8$ V and the sensitivity (vertical size) to 1 mV/division, aberrations of just 0.1% of the original transition will be 2.5 divisions in amplitude.

Refer to the specifications for your plug-in unit to determine whether its overdrive recovery is fast enough for your application.

HP/86411A - 784.00
HP - MIL CA

COMMERCE
632.00



Power-On

Installation

Before
is completed
follow

be certain that it
involves the
the rear panel:

-
-
- LINE VOLTAGE SELECTOR switch
- PRINCIPAL POWER SWITCH

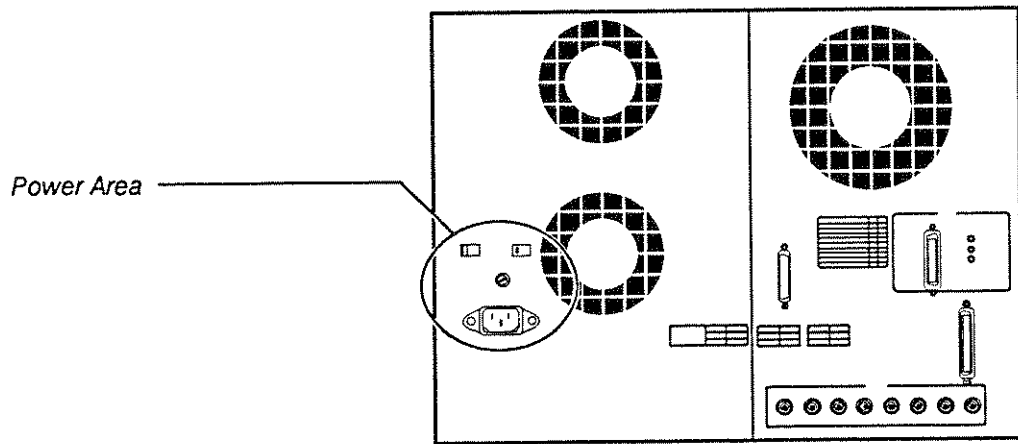

Power Connector, Fuse, and Switches

In addition, you will need to know the location of the ON/STANDBY switch on the front panel.

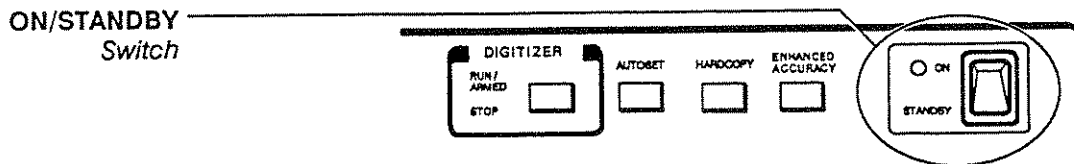

Power-On

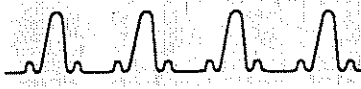

The following steps describe the installation procedure.

- Step 1: Set the **PRINCIPAL POWER SWITCH** to **OFF**.
- Step 2: Set the front panel **ON/STANDBY** switch to **STANDBY**.
- Step 3: Set the **LINE VOLTAGE SELECTOR** to the proper range for your power system.
- Step 4: Check the **FUSE** to be sure it is of the proper type and rating, as printed on the rear panel.
- Step 5: Install one or more plug-in amplifiers in the front panel compartments.

CAUTION
Never install or remove a plug-in unit with the DSA power on.

To install a plug-in unit, align the grooves in the top and bottom of the plug-in unit with the guides at the top and bottom of the plug-in compartment. Push the plug-in unit until its front panel is flush with the front panel of the DSA. Plug-in units are described on page 201.

- Step 6: Connect the power cord from the **POWER** connector to your power system.
- Step 7: Set the **PRINCIPAL POWER SWITCH** to **ON**.

The **PRINCIPAL POWER SWITCH** controls all AC power to the DSA. The **ON/STANDBY** switch controls power to most of the DSA's circuits, but continues to supply power to certain circuits even when set to **STANDBY**.

- Step 8: To operate the DSA, set the front panel **ON/STANDBY** switch to **ON**.

Once the DSA is installed, use the **ON/STANDBY** switch as the power switch.

Power-On

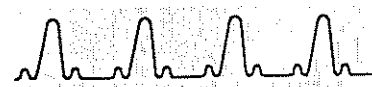

Power-On Sequence

Complete descriptions of the diagnostics are on page 91.

Each time you power on the DSA, it performs a sequence of internal checks and then restores the settings that were established when it was last powered off. The sequence is:

1. The power-on diagnostics are performed, and take about 5 seconds to execute. If these diagnostics fail, the DSA will freeze and you will not be able to operate it.
2. The self-test diagnostics are performed, and take about 15 seconds to execute. If these diagnostics fail, the extended diagnostic system is entered, and the Extended Diagnostic menu is displayed.
3. The system restores all the settings and waveforms that it can. If the configuration of plug-in units has not changed since the last power-down, then the DSA will completely restore to the state it was in when powered down.
4. A partial Enhanced Accuracy calibration is automatically run if the plug-in configuration has changed.

Waveforms that have been stored with the Store Waveform functions are saved *only* if the DSA is equipped with Option 4C, Nonvolatile RAM.

Warm-Up Period

It takes about 20 minutes for the DSA to warm up after power-on. Enhanced Accuracy is available after the DSA warms up and achieves thermal stability. Enhanced Accuracy is described on page 111.

Power-On

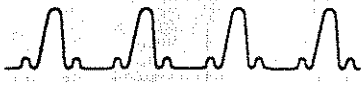

Probes and Cables



You can connect a signal source to the DSA with a probe or with a coaxial cable with a BNC connector. Connect a cable by pushing the BNC connector onto the input channel connector of a plug-in amplifier and turning the connector to secure it. Use an attenuator with the cable when the signal voltage may exceed the capabilities of your plug-in amplifier. In general, it is best to use the shortest cable possible to avoid signal distortion.

When you use a probe, the impedance of the input channel must match the impedance of the probe connected to it. See Channel Impedance on page 204.

For many applications a probe is preferable to a cable connection. Common probe features include small, easily portable signal connectors and attenuation. Special-purpose probes are available for some applications, such as differential probes used for comparison of two signals.

This section concerns properties and functions common to most probes used with 11000 Series plug-in amplifiers. Refer to the documentation for the probe you are using for specific information.

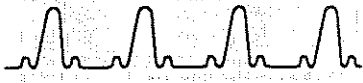

Installing a Probe

The Tektronix product catalog lists TekProbe probes that are recommended for use with 11000 Series plug-in amplifiers and DSAs. These probes have a special connector and are connected both to the input channel and to an interface that provides communication between the probe and the plug-in amplifier. The active probes draw their power from the plug-in amplifier.

To install a probe, place the probe connector over the input connector of the plug-in amplifier. The probe connector must be oriented so that the tab points to the lower left. The prongs around the outer rim of the probe connector will be flush with the interface connector of the plug-in amplifier. Twist the circular plastic casing clockwise to secure the connection.

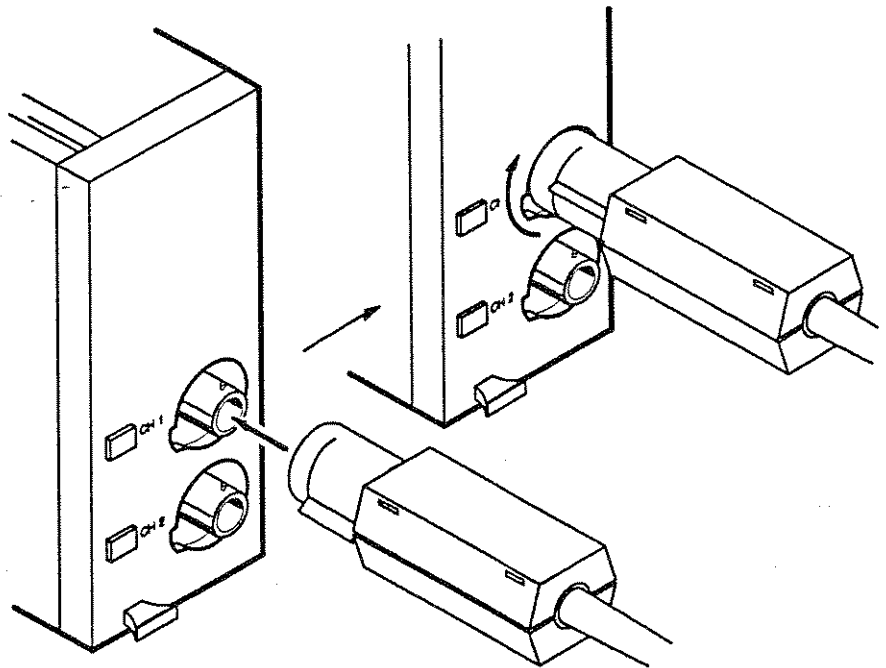

Connecting a Probe to the Input Channel



Probe ID Functions

TekProbe intelligent probes can communicate with the DSA through the plug-in amplifier interface connection. In addition, each probe is equipped with a **Probe ID** button that, when pressed, initiates some action by the DSA.

You can use the **Probe ID** button on a probe to signal the DSA to perform one of four functions. In the **Probes** pop-up menu in the Utility 1 major menu, four selectors determine the action that is initiated when a **Probe ID** button is pressed.

- **Waveform Select/New Wfm** sets the DSA so that pressing the **Probe ID** button will select a waveform displaying the channel the probe is connected to. If no such waveform exists, the DSA will create a new waveform displaying only that channel.
- **Wfm Select/New Wfm & Autoset** sets the DSA so that pressing the **Probe ID** button selects a waveform displaying the channel, or defines a new waveform displaying the channel and invokes autoset on the new waveform.
- **Sequence Settings** sets the DSA so that pressing the **Probe ID** button selects the next setting in the sequence. See *Sequencing Through Stored Settings*, on page 236, for an explanation of sequencing.
- **Store Waveforms** sets the DSA so that pressing the **Probe ID** button causes all waveforms containing that channel (in their trace description) to be stored. Remember that stored waveforms can be stored either to disk or RAM. You specify where the waveform will be stored in the **Store Waveform** menu, by selecting either the **RAM** or **DISK** icons.

If no waveforms exist with this channel, a new waveform will be created and then stored.

Probes and Cables



Probes

Probe ID Function

Wfm Select Select New Sequence Store
 /New Wfm & AutoSet Settings Waveforms

To calibrate, deskew, and compensate probes:
 Connect a probe or input to the calibrator
 then select the channel from this menu.

A LEFT channel is required to deskew for
 maximum sample rate.

L1	C1	R1
L2	C2	R2
L3	C3	
L4	C4	

Calibrator	Modes	Probes	Color	Page to	Rem
				Utility 2	Wfm 1
Initialize	Time & Date	Label	Hue		Main
	13:56:35 12-OCT-90	Disp: On Mode: Man	150 °		Lightness
					0 %

The Probes Pop-Up Menu

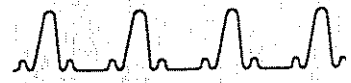

Probe Calibration

The Probes pop-up menu is also used to calibrate, deskew, and compensate probes. The following procedure may be used to calibrate, deskew, and compensate probes when you are using a standard single-ended plug-in amplifier:

- Step 1: Connect the probe or other input lead to the **CALIBRATOR** signal and ground connections.

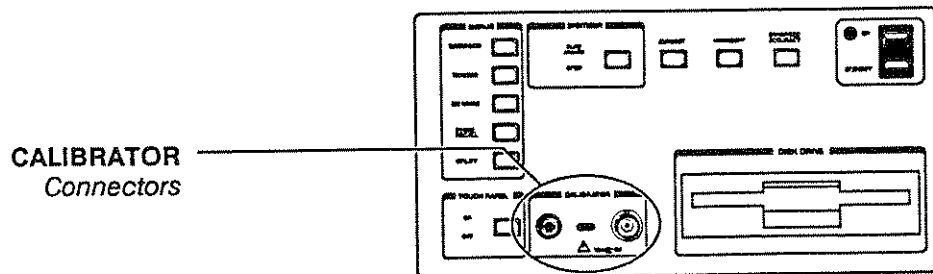

- Step 2: Select the channel of the probe or input lead from the **Probes** pop-up menu. The channel will be vertically calibrated and then deskewed against an internal reference signal. When this process is complete, a message will appear prompting you to compensate the probe, and the **Probe Compensation** menu will replace the **Probes** menu.

Probes and Cables



Probe Compensation					
Select		Exit			
Next Chan		Comp			
Calibrator	Modes	Probes	Color	Page to Utility 2	Rem Wfm 1 L1 Main
Initialize	Time & Date 14:09:58 12-OCT-98	Label Disp: On Mode: Man	Hue 150°		Lightness 0%

The Probe Compensation Menu

- Step 3: Adjust the compensation control on the probe so that the top of the square wave is flat.
- Step 4: If you wish to calibrate another channel, touch the **Select Next Chan** selector to return to the **Probes** pop-up menu. Otherwise, select **Exit Comp** to finish compensation.

The two probes used with a differential plug-in unit should be of the same type.

A different procedure is recommended to calibrate, deskew, and compensate probes when you are using a differential amplifier or differential comparator plug-in unit. This procedure will improve common mode rejection when you are using probes designed for use with a differential plug-in unit.

- Step 1: Connect one probe to the - input of the differential amplifier or comparator. There must be no probe connected to the + input.
- Step 2: Calibrate, deskew, and compensate the probe as described above, but do not exit the **Probe Compensation** menu.
- Step 3: Connect the other probe to the + input of the differential plug-in unit. Connect the probe to the **CALIBRATOR** signal and ground connections. Do not disconnect the

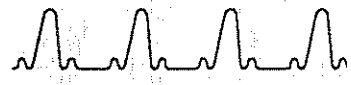

other probe from the **CALIBRATOR**. The waveform on the screen will become a straight line that might have a small spike where the step was displayed. The segments of the waveform before and after this point might be vertically displaced from each other.

- Step 4: Compensate the probe by eliminating the spike in the displayed waveform. If the probes have a DC attenuation adjustment, you should use it to eliminate any vertical displacement of the two waveform segments.
- Step 5: Select **Exit Comp** in the **Probe Compensation** menu, and disconnect the probes from the **CALIBRATOR**.

Probes and Cables

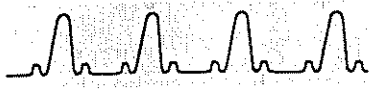

Record Length

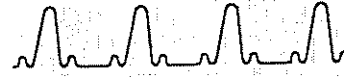

The number of samples that form a waveform is called the record length. You can select record lengths of 512, 1024, 2048, 4096, 5120, 8192, 10240, 16384, 20464, and 32768 points (samples).

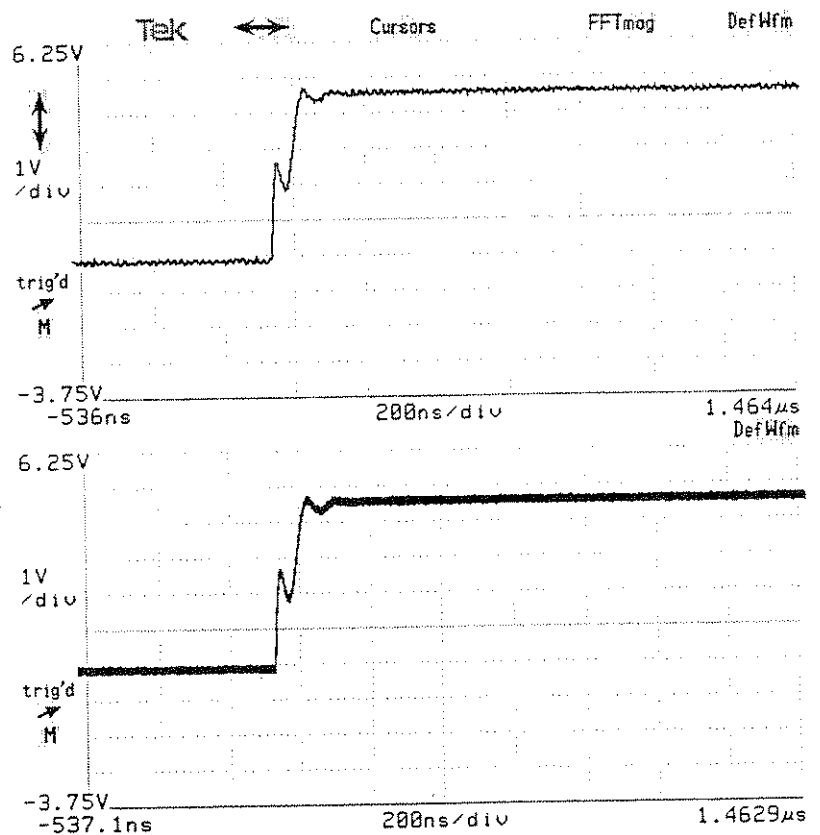

Waveforms with Record Lengths of 512 (top) and 20464 (bottom)

You control the record length by using the **Horizontal Desc** pop-up menu in the **Waveform** major menu. The **Main Record Length** and **Window Record Length** selectors assign the knobs to set the record lengths. The **Horizontal Desc** pop-up menu shows the sample intervals for the current settings.

Record Length

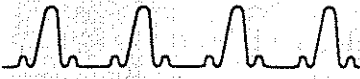

Record Length Section

Horizontal Description					
Acquiring Timebase: Main Main Sample Interval: 500ns/point F Window Sample Interval: 50ns/point					
Main Record Length: 1024 points			Window Record Length: 1024 points		
Display Persistence Normal Infinite Variable Persist Time 1s		Digitizer Interleave 165/sec Realtime Disabled			
XY Display Mode: X-Displayed Waveform					
Normal /T Wfm 1 L1 Main Displayed Waveforms Stored Waveforms RAM DISK					
Vertical Desc	Horizontal Desc	Acquire Desc	Graticules	Page to	Rem. Wfm
L1 Fast	Main 2MS/sec	Continuous	.	All Wfms Status	L1 Main
Input Parameters DC 1MQ/300MHz	FFT Control dBm Rectang	Act on Delta None	Main Size 50µ s/div	Fan/ Zoom Off	Main Position -6µ s

The Horizontal Desc Pop-Up Menu

Record Length

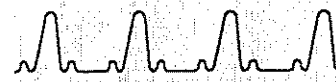

All waveforms on the main time base have the same record length. Window waveforms similarly share identical record length.

Persistence mode can only be used with waveforms having record lengths of 512, 1024, or 2048 points.

The 4096-, 8192-, 16384-, and 32768-point record lengths do not cover the entire horizontal length of the graticule. Each of these record lengths has the same sample interval as the next-larger record length. They are provided for use with Fast Fourier Transforms, which can only be performed on record lengths that are a power of two. The Fast Fourier Transform of the DSA operates on any waveform with a record length that is a power of two *except* 32768 points.

The record length selected also limits the horizontal size range (time/division) as follows:

Horizontal Size by Record Length

Record Length	Horizontal Size (Time/Division)
512 points	50 ps/div
1024 points	100 ps/div
2048 points	200 ps/div
4096 points	500 ps/div
5120 points	500 ps/div
8192 points	1 ns/div
10240 points	1 ns/div
16384 points	2 ns/div
20464 points	2 ns/div
32768 points	5 ns/div

Record Length



RS-232-C Parameters

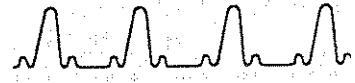

The DSA can be controlled by a remote computer through one of two interfaces. These interfaces are industry standards IEEE STD 488 and RS-232-C.

This manual does not discuss the details of connecting a remote computer to the DSA or the syntax and capabilities of remote commands. That information is found in the *DSA 601A and DSA 602A Programmer Reference*.

RS-232-C Connection

Connect the cable from your computer to the RS-232-C connector on the DSA rear panel. The DSA is configured as data communications equipment (DCE), and the computer must be configured as data terminal equipment (DTE).

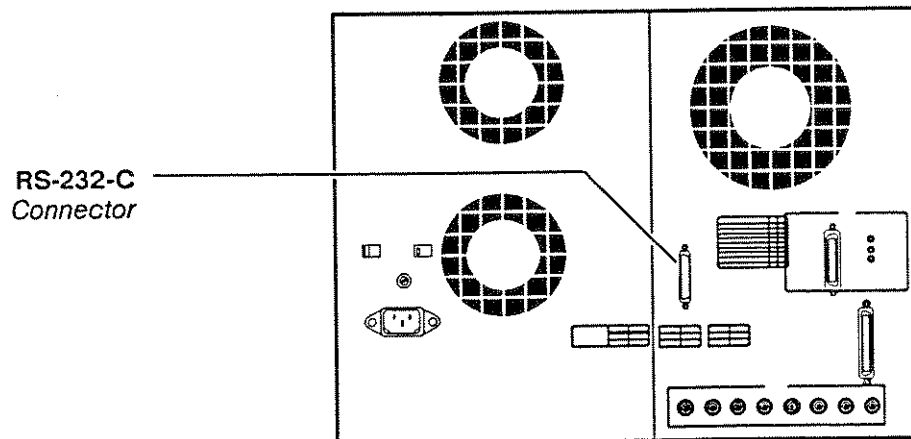

Location of the RS-232-C Connector on the Rear Panel

RS-232-C Parameters



**Setting
RS-232-C
Parameters**

Communication between the DSA and the attached computer can occur only if the two are configured in a compatible manner.

RS-232-C Parameters					
Baud Rate	Echo	Stop Bits			
9600 baud	Off	1			
Parity	Flagging	Delay			
None	Soft	0			
EOL String	Verbose	Debug			
CR/LF	Off	Off			
GPIB	RS-232-C	Hardcopy	Ident	Page to	Rem.
Talk/Listen	9600 baud	Bitmap Screen		Utility 3	Wfm 2
1					L1
Extended Diagnostic	Self Test	Teksecure Erase Mem	Window Size	Pan/Zoom	Window Position
			1μ s/div	Off	-15.8μ s

The RS232C Parameters Pop-Up Menu

Use the RS232C Parameters pop-up menu in the Utility 2 major menu to set the RS-232-C parameters directly, before you attempt to communicate with the attached computer. The following list describes each selector on the RS-232-C pop-up menu:

The RS-232-C parameters are not changed when you initialize the DSA.

- **Baud Rate** assigns the knobs to adjust baud rate and delay. You can set the baud rate to 110, 150, 300, 600, 1200, 2400, 4800, 9600, or 19200. You should set the baud rate to match the computer or peripheral you are using.
- **Echo** lets you set Echo to On or Off. If you observe two identical characters transmitted when you expect only one, Echo is On when it shouldn't be. If you see no character transmitted when one was expected, Echo might be set to Off inappropriately.



- **Stop Bits** lets you select among 1, 1.5, or 2 stop bits. Touch the selector repeatedly until the appropriate number is shown in the selector. You should set the number of stop bits to match the device that is attached.
- **Parity** lets you select among **Even parity**, **Odd parity**, or **None**. Touch the selector repeatedly until the appropriate setting is displayed in the selector. Parity is an error detection scheme. You should set parity to match that of the device you are using.
- **Flagging** lets you select among **Hard flagging**, **Soft flagging**, or **None**. Touch the selector repeatedly until the appropriate setting is displayed in the selector. Flagging is used by the DSA or the device to signal that its input buffer is full, and that the other device should stop transmitting until further notice. You should set the type of flagging to match the device you are using.
- **Delay** assigns the knobs to set the baud rate and delay. Delay is the minimum time that the DSA will wait before responding to a command sent from the computer. The delay setting can be 0 to 60 seconds.
- **EOL String** lets you select the end-of-line query terminator to one of the following: **LF** (Line Feed), **CR** (Carriage Return), **CR/LF**, or **LF/CR**. Touch the selector repeatedly until the appropriate setting is displayed in the selector.

RS-232-C Parameters



Verbose and Debug are used for external programming by computer. If you are using the RS-232-C port for printer/plotter output, set these parameters to Off.

- **Verbose** lets you set Verbose On or Off. When Verbose is On, the DSA posts to the computer a message stating the success or failure of each command sent to the DSA. When Verbose is Off, the computer can specifically query the DSA about the success or failure of each command.
- **Debug** lets you set Debug On or Off. When Debug is On, the DSA displays each command from the computer as it is executed. The messages appear at the top of the display. Debug Off is the normal mode of operation. Set Debug On if you need to watch the result of each DSA command of a program that is running in the computer. When Debug mode is on it slows performance significantly.

Stored Settings



When you initialize the DSA, you recall a stored setting that was established at the factory. You can save your own settings for quick recall to nonvolatile RAM or to disk.

If you establish a test setup, you might want to store the setting and go to another task. After the settings have been changed because of the intervening work, you could recall the test setting that you saved.

You can also use sequencing to recall saved settings in a specific order. This is useful if your work requires several DSA setups for standardized tests.

Stored settings are saved when you power off the DSA. They will be available when you power on.

The following are not saved with stored settings, and are not changed when settings are recalled:

- Stored waveforms
- GPIB and RS-232-C parameters
- Sequence settings mode

Stored Settings

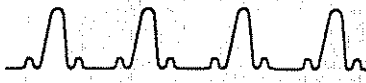

Storing Settings

Use the Store Setting pop-up menu in the Store/Recall major menu to store a setting. After you set the DSA, touch the Store Setting selector to display the pop-up menu.

Store Present Front Panel Setting To RAM DISK					
FPS 1		FPS 2		FPS 3	
1		2		3	
Menu Displayed with Stored Setting					
Waveform	Trigger	Measure	Store/	Utility 1	
Single Wfm	Main		Recall		
Status					
Waveform	Trigger	Cursors	Stored	Utility 2	
All Wfms'	Window		Nfm Scan		
Status					
Store Next	Free NonVolatile RAM			Set Next	
FPS	544 bytes			FPS Index	
					4
Store	Recall	Delete	Disk	Page	Rem
Waveform	Waveform	Waveform	Copy	to	Wfm 1
				Stored	L1
				Wfm Scan	Main
Store	Recall	Delete	Set Next		Set Next
Setting	Setting	Setting	FPS Index		FPS Index
			4		4

The Store Setting Pop-Up Menu

Stored Settings



You can choose the major menu that will display when the stored setting is recalled. Touch the selector for the desired major menu in the section of the pop-up menu titled **Menu Displayed with Stored Setting**.

You can choose whether to save the setting on a disk or in nonvolatile RAM by pressing the corresponding icon at the top of the **Store Setting** pop-up menu.

Storing Settings to Nonvolatile Ram

You can label stored settings. See Labeling on page 165.

After you choose the major menu you want recalled with the stored setting, touch **Store Next FPS** to store the setting. The FPS (Front Panel Setting) number that will be assigned to the setting appears under the label **Set Next FPS Index**. If you want to specify a number other than the default, you can assign the knobs to set the number by touching **Set Next FPS Index**. You can choose any number from 1 to 20. If you choose a number that is already in use, the word "Exists!" appears under the **Store Next FPS** label. If you store the setting under that number, the previously stored setting will be deleted.

As a shortcut, you can store a setting by touching one of the selectors in the upper part of the **Store Setting** pop-up menu. This removes any setting previously stored there. If no setting has been stored, no selector will appear.

Although there are twenty stored setting locations, the number of settings you can store is limited by the amount of memory available. You will not be able to store more than approximately four settings unless your DSA is equipped with Option 4C, Nonvolatile RAM.

Stored Settings



Storing Settings to Disk

After you choose the major menu you want recalled with the stored setting, touch **Store Next FPS** to store the setting. The file name that will be assigned to the setting appears under the label **Set Next FPS Index**. Disk files are named with a prefix, an index number, and an extension. The total number of prefix characters plus index characters is limited to eight. The default prefix is FPS. The prefix can be changed to any characters you want. If you want to specify a number other than the default, you can assign the knobs to set the number by touching **Set Next FPS Index**.

FPS 234. FPB



Prefix Index Extension
 Number

The Parts of a Disk File Name

If you try to save settings to an index number that is already in use, the word "Exists!" appears under the **Store Next FPS** label. If you store the setting under that number, the previously stored setting will be deleted.

You can change the prefix in the **File Ops** pop-up menu in the **Utility 3** major menu. Choose "settings" under the **File Type** selector and **Prefix**. Type in the prefix you want and touch **Enter**.



Recalling Stored Settings

You can recall a stored setting using the **Recall Setting** pop-up menu in the Store/Recall major menu. Touch the **RAM** or **DISK** icon and then the desired front panel setting selector.

Recall Front Panel Setting From RAM DISK					
FPS 1	FPS 2	FPS 3			
1	2	3			
Initialize Setting					
Sequence Front Panel Settings					
Sequencing			Next Setting Initiated By Probe ID Button Or Next Setting		
Off					
Store Waveform	Recall Waveform	Delete Waveform	Disk Copy	Page to Stored Wfm Scan Main	Rem Wfm 1
Store Setting	Recall Setting	Delete Setting	Set Next FPS Index 4		Set Next FPS Index 4

The Recall Setting Pop-Up Menu

The **Recall Setting** pop-up menu also provides a way to initialize the DSA. Touch the **Initialize Setting** selector to reset the DSA in the same way as when you touch the **Initialize** selector in the Utility 1 major menu. Initialization is described completely on page 159.

Stored Settings

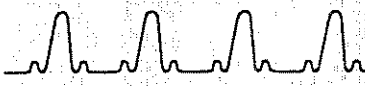

Deleting Stored Settings

Use the **Delete Setting** pop-up menu in the Store/Recall major menu to delete a stored setting. Select the setting or settings to delete by touching the selectors in the top part of the pop-up menu. As you touch these selectors, they highlight to show that they will be deleted when you touch the **Delete Selected Settings** selector. Touch a highlighted selector a second time to remove it from the list of settings to be deleted. Touching the **All Settings** selector is a quick way to select all the stored settings however, if you are selecting all settings on disk, you are limited to a maximum of 128 settings. If you have more than 128 settings stored on disk, you will have to delete settings one at a time until you have 128 or less on disk so you can use the **All Settings** selector.

Maximum Number of Settings Selectable with the All Settings Selector

Menu	RAM	DISK
Delete Setting	No Limit	128
Disk Copy RAM > DISK	No Limits	
Disk Copy DISK > RAM	128	

Stored Settings



Delete Front Panel Setting From RAM DISK					
FPS 1 1					
Delete Selected Settings			All Settings		
Store Waveform	Recall Waveform	Delete Waveform	Disk Copy	Page to Stored Wfm Scan	Rem Wfm 1 C2 Main
Store Setting	Recall Setting	Delete Setting	Main Size 20n s/div	Pan/Zoom Off	Main Position -70n s

The Delete Setting Pop-Up Menu

Stored Settings

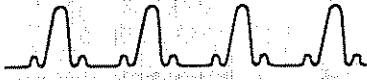

Sequencing Through Stored Settings

If you have several settings saved, you can cycle through the settings in order. This is useful if you have a series of test setups that you want to use repeatedly.

The sequencing order of stored settings is the same as the order in which they appear in the **Recall Setting** pop-up menu. When the settings are stored to RAM, the sequence number of a setting appears in the selector for that setting in the **Store Setting** and **Recall Setting** pop-up menus. When the settings are stored to disk, the time/date stamp will appear below the setting selector.

The **Sequencing** selector in the **Sequence Front Panel Settings** section of the **Recall Setting** pop-up menu allows you to turn sequencing on or off. The field beneath the **Recall Setting** selector shows which setting is displayed. **2 of 1: 6** means the second stored setting is being displayed from a total of six stored settings.

When sequencing is on, you can recall the next setting by touching the **Next Setting** selector in the **Sequence Front Panel Settings** section of the pop-up menu or by pressing a probe ID button, when the probe ID function is set to **Sequence Setting**. Setting the probe ID function is explained on page 215.

For settings stored to disk, sequencing recalls all files in the current directory as defined by the setting. If you recall a setting that was originally stored in a different directory than the current directory, the current directory will change to match that of the stored setting recalled.

Stored Settings



Copying Stored Settings

You can copy stored settings from disk to RAM or from RAM to disk using the **Disk Copy** pop-up menu. From the **Disk Copy** pop-up menu touch the **Stored Settings** selector. Then, at the top of the menu, select the **RAM** icon if you want to copy to disk from RAM, or the **DISK** icon if you want to copy to RAM from disk.

You can select the settings you want to copy or if you want to copy all of the stored settings, touch **All Settings** to select all of the settings (there are limits on how many settings can be selected using the **All Settings** selector, see the table below). To copy the settings, select **Copy Selected Settings**.

Maximum Number of Settings Selectable with the All Settings Selector

Menu	RAM	DISK
Delete Settings	No Limit	128
Disk Copy RAM > DISK	No Limits	
Disk Copy DISK > RAM	128	

The **Set Next FPS Index** in the **Disk Copy** pop-up menu shows the index of the next set of settings to be stored. The next available index is also shown at the top of the menu.

Stored Settings



Copy Stored Settings To DISK From RAM DISK
Starting with A:\FPS3.FPB

Stored Waveforms
Stored Settings

FPS 1
FPS 2
FPS 3

1
2
3

Copy Selected Settings
Set Next FPS Index
FPS3.FPB
All Settings

Store Waveform	Recall Waveform	Delete Waveform	Disk Copy	Page to Stored Wfm Scan	Rem Wfm 1 L1 Main
Store Setting	Recall Setting	Delete Setting	Main Size 50μ s/div	Pan/Zoom Off	Main Position -106μ s

The Disk Copy Pop-Up Menu

Stored Waveforms

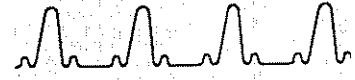

A stored waveform is a record of a single acquisition cycle. You can think of it as a "snapshot" of a waveform.

Once you have stored a waveform, you can use it as an element of waveform expressions in other waveforms. For example, you could define a waveform to be **L1-STO3**. This waveform acquires data from plug-in channel L1 and subtracts from each sample the data recorded in stored waveform number 3.

Storing Waveforms

When you store a waveform, you store a copy of the waveform record of the selected waveform. Use the selectors in the **Store Waveform** pop-up menu of the Store/Recall major menu to store waveforms to volatile RAM or with Option 4C, to non-volatile waveform RAM.

You can also store waveforms to disk. Use the selectors in the **Store Waveform** pop-up menu of the Store/Recall major menu to store waveforms to disk.

Store Waveform To					
RAM DISK					
Wfm 1		Wfm 2			
L1		L1			
Main		Window1			
Store All		Set Next			
		STO Index			
		STO1			
Free Stored Wfm RAM					
402432 bytes					
Store Waveform	Recall Waveform	Delete Waveform	Disk Copy	Page to Stored Wfm Scan	Rem Wfm 1 L1 Main
Store Setting	Recall Setting	Delete Setting	Set Next FPS Index: 4		Set Next FPS Index: 4

The Store Waveform Pop-Up Menu

Stored Waveforms

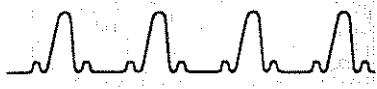

Storing Waveforms

You can label stored waveforms. See Labeling on page 165.

XY waveforms cannot be stored. Also, Infinite or Variable Persistence mode waveforms are stored as normal waveforms.

Use the following steps to store a waveform:

- Step 1: Create a stable waveform on the display.
- Step 2: Press the **Store/Recall** major menu button, and touch the **Store Waveform** selector. Then select either the **RAM** or **DISK** icon at the top of the **Store Waveform** pop-up menu.
- Step 3: The waveform will be stored under the number shown in the **Set Next STO Index** selector. If you want to change the number, touch this selector and use the knobs to change the number. You cannot store a waveform in a location where another waveform is already stored.
- Step 4: Touch the selector that represents the waveform you want to store. All displayed waveforms are listed.

You can also use the **Store All** selector to store all the displayed waveforms as separate stored waveforms. In this case, the **Set Next STO Index** number is the first storage number that will be used.

Stored Waveforms

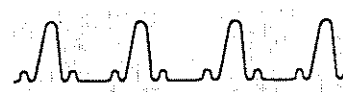

The Stored Waveform Time Stamp Format

A time stamp is displayed in the status field of each selector for a waveform stored in volatile RAM or in non-volatile waveform RAM, if Option 4C is installed. The first line of this time stamp shows the time, in hours, minutes, and seconds, that the waveform was stored. The second line can show either the date the waveform was stored, or hundredths of seconds. You may want to display hundredths of seconds, for example, when you have acquired waveforms in the Repetitive Single Trigger or Act on Delta mode.

For disk files, the time stamp of the file is the time the file was stored, not the time the file data was acquired.

Select **Stored Wfm Time Fmt**, in the **Modes** pop-up menu in the **Utility 1** major menu, to change the format of the time stamp for data stored in RAM. This selector can be set to **Show Date** or **Show Hundredths**. The **Stored Wfm Time Fmt** selector does not affect to disk files.

Stored Waveforms

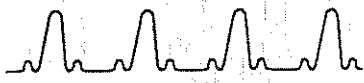

Stored Wfm
Time Fmt
Selector

Instrument Modes					
Autoset					
Vertical	Horizontal	Undo Last			
Pk-Pk	Period	AutoSet			
Miscellaneous					
Multitrace	Pan/Zoom	Averaging	Enhanced		
Pan/Zoom	Pivot	Type	Accuracy		
Off	Center	Background	Manual		
Vectorized	Zoom	Stored Wfm	Incremental		
Waveforms	Intp	Time Fmt	Acquire		
On	Sin(x)/x	Show	Disabled		
	Prefilter	Date			
Waveform	Audio	Cursor	Cursor		
Scaling	Feedback	Paired	Hold		
Optional	On	Dots	Off		
Trigger					
DC Level					
Screen					
Calibrator	Modes	Probes	Color	Page to	Rem
				Utility 2	Wfm 1
					L1
					Main
Initialize	Time &	Label	Main	Pan/	Main
	Date	Disp: On	Size	Zoom	Position
	15:10:41	Mode: Man	50μ	Off	-6μ
	10-OCT-90		s/div		s

The Modes Pop-Up Menu

Stored Waveforms

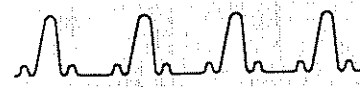

**Recalling
Stored
Waveforms**

Once a waveform is stored, you can use it in any waveform expression. To create a waveform that displays a stored waveform, touch the **DefWfm** icon, then in the pop-up menu touch the **Stored Waveforms** selector. Then touch either the **RAM** or **DISK** icon, the selector for the stored waveform you want to display, and the **Enter Desc** selector.

The **Recall Waveform** pop-up menu provides a simpler way to do the same thing. Press the **STORE/RECALL** major menu button and touch the **Recall Waveform** selector to display the pop-up menu. In the pop-up menu, touch either the **RAM** or **DISK** icon and the selector for the stored waveform you want to display.

Recall Stored Waveform From RAM DISK					
ST01 13:07:24 3-JAN-00					
Store Waveform	Recall Waveform	Delete Waveform	Disk Copy	Page to Stored Wfm Scan	Rem Wfm 1 C2 Main
Store Setting	Recall Setting	Delete Setting	Main Size 20n s/div	Pan/ Zoom Off	Main Position -70n s

The Recall Waveform Pop-Up Menu

Stored Waveforms



**Scanning
Stored
Waveforms**

You can scan only waveforms in RAM, you can't scan waveforms on disk.

You can visually scan through a set of waveforms stored in RAM. The DSA will display each stored waveform briefly and you can stop the scanning when you see a waveform of interest. You can scan through a specified set of stored waveforms, such as the waveforms stored using Repetitive Single Trigger, to find the record of an event of interest. For more information on the Repetitive Single Trigger capability, see page 44.

To scan through stored waveforms, select **Page to Stored Wfm Scan** in the Store/Recall major menu. This will display the **Stored Waveform Scan** major menu. The selectors in this menu allow you to select a set of stored waveforms for scanning, scan through them, stop and restart scanning, keep a waveform for display and set the scan rate.

Previous	Scan/Stop	Next	Scan	Page	Rem
ST03	Stopped	ST01	Rate	to	Wfm 2
REP2			1	Store/	L2
			wfms/sec	Recall	Main
Scan Using	Scan	Keep For	Scan		Scan
All Wfms	from: 1	Display	From		To
	to: 3		1		3

The Stored Waveform Scan Menu

You will not be able to initiate scanning if there are already eight waveforms on the display.

Start and stop scanning by touching the **Scan/Stop** selector. The name of the waveform that is currently displayed appears in this selector. You can step through the sequence manually by touching the **Next** and **Previous** selectors. The **Scan/Stop** selector will not be selectable when there are already eight waveforms on the display, because one displayed waveform must be created for scanning.

When you identify a waveform you would like to examine in more detail, you can select **Keep for Display** to make a copy of it. This will create a displayed waveform with the same label as the stored waveform it displays. If eight waveforms are already displayed, **Keep for Display** will not be selectable.

Stored Waveforms

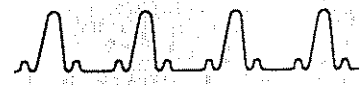

You can only scan waveforms in RAM. The RAM icon must be selected in one of the waveform menus in the **Store/Recall** major menu to enable **Stored Wfm Scan**.

For more information on base labels, see Labeling on page 165.

You can specify a set of stored waveforms that will be displayed in scanning. The **Scan Using** selector displays a pop-up menu that lets you scan only waveforms with a particular base label. Select **All Stored Waveforms** in the upper section of this menu to include all waveforms in the scan. The lower section of the pop-up menu displays a selector for every existing base label. Touch one of these selectors to limit the scan to waveforms stored in the Repetitive Single Trigger mode using that base label.

Scan Using					
All Stored Waveforms					
Base Labels					
REP					
Previous	Scan/Stop	Next	Scan Rate	Page to	Rem. Wfm 2
ST03	Stopped	ST01	1	Store/	L2
REP2			wfms/sec	Recall	Main
Scan Using	Scan	Keep For	Scan		Scan
All Wfms	from: 1	Display	From		To
	to: 3		1		3

The Scan Using Pop-Up Menu

Stored Waveforms

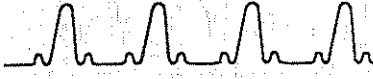

You can also limit the *range* of stored waveforms displayed. The **Scan** selector shows the numbers of the first and last stored waveforms in the scanning range. Touch this selector to assign the knobs to control the limits of the scanning range. Coarse resolution will let you adjust the limits in increments of ten; fine resolution gives you increments of one. By specifying the first and last waveforms, you can further restrict the *set* of waveforms to be scanned.

You can set the rate at which scanned waveforms are displayed. Select **Scan Rate** to assign the knobs to adjust the rate. You can scan as fast as ten waveforms per second or as slowly as one waveform every ten seconds.

Deleting Stored Waveforms

You can delete waveforms stored in RAM or on the disk by using the **Delete Waveform** pop-up menu in the Store/Recall major menu. The **Delete Waveform** pop-up menu is also used to delete displayed waveforms.

In the **Delete Waveform** pop-up menu, touch the selectors for the displayed and stored waveforms you want to delete. The waveforms are not deleted until you touch the **Delete Selected Waveforms** selector. You may select several waveforms to be deleted before touching the **Delete Selected Waveforms** selector. As you select waveforms to delete, their selectors highlight to tell you they will be deleted. If you touch a waveform selector by accident, touch it again to remove the highlighting.

When you select a stored waveform with a label that matches the current base label, all stored waveforms with labels that match that base label will be selected. You can use this method to delete a set of waveforms stored with the Repetitive Single Trigger function.

Stored Waveforms

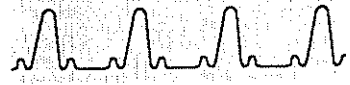

If you want to delete all the displayed and stored waveforms, touch the **All Waveforms** selector, then touch the **Delete Selected Waveforms** selector. There is a limit to the number of waveforms that can be selected with the **All Waveforms** selector, depending on whether you are selecting waveforms in RAM (no limits) or on disk (128). See the table below for more information. Note that the **All Waveforms** selector is still selectable even if there are more than 128 disk waveforms. Thus, you can still select all the *displayed* waveforms by using the **All Waveforms** selector.

Maximum Number of Waveforms Selectable with the All Waveforms Selector

Menu	RAM	DISK
Delete Waveforms	No Limit	128
Disk Copy RAM > DISK	No Limits	
Disk Copy DISK > RAM	128	

You cannot delete a stored waveform if it is being used as part of a displayed waveform. In the **Delete Waveform** pop-up menu on the next page, stored waveform 1 is used in the waveform definition of displayed waveform 3. The selector for stored waveform 1 cannot be selected.

Stored Waveforms



Delete Waveforms					
Displayed Waveforms		Stored Waveforms			
Wfm 1	Wfm 2	ST01	ST02	ST03	RAM DISK
C2	C1	13:07:24	13:18:51	13:18:51	
Main	Main	3-JAN-00	3-JAN-00	3-JAN-00	
Wfm 3		ST04			
ST01*3		13:18:51			
		3-JAN-00			
Delete Selected Waveforms				All Waveforms	
Store Waveform	Recall Waveform	Delete Waveform	Disk Copy	Page to Stored Wfm Scan	Rem. m 3 01
Store Setting	Recall Setting	Delete Setting	Horizontal Magnify 1 x	Horizontal Zoom On	Horizontal Pos. Gr. 0 pts

The Delete Waveform Pop-Up Menu

Copying Stored Waveforms

You can copy stored waveforms from disk to RAM or from RAM to disk using the **Disk Copy** pop-up menu. First touch the **Stored Waveforms** selector. Then, at the top of the menu, select the **RAM** icon if you want to copy to disk from RAM, or the **DISK** icon if you want to copy to RAM from disk.

You can select the waveforms you want to copy or if you want to copy all of the stored waveforms, touch **All Waveforms** to select all of the waveforms (see the restriction on the **All Waveforms** selector on page 247). To copy the waveforms, select **Copy Selected Waveforms**.

Stored Waveforms



The **Set Next STO Index** in the **Disk Copy** pop-up menu shows the index of the next waveform to be stored. The next available index is also shown at the top of the menu.

Copy Stored Waveforms To DISK From RAM DISK Starting with A:\STO1.WFB					
Stored Waveforms			Stored Settings		
ST01	ST02	ST03			
20:24:30	7:25:57	17:26:12			
26-JAN-91	29-JAN-91	30-JAN-91			
Copy Selected Waveforms		Set Next STO Index ST01.WFB	All Waveforms		
Store Waveform	Recall Waveform	Delete Waveform	Disk Copy	Page to Stored Wfm Scan	Rem Wfm 1 L1 Main
Store Setting	Recall Setting	Delete Setting	Vertical Size: L1 2 V/div	Chan Sel L1	Vertical Offset: L1 0 V

The Disk Copy Pop-Up Menu

Stored Waveforms



Recovering Deleted Stored Waveforms

With Option 4C, you can try to recover waveforms that might have been deleted unintentionally from non-volatile RAM. In the **Delete Wfm** pop-up menu, touch the **Attempt to Recover Stored Waveforms from NVRAM** selector. A message will appear at the top of the graticule indicating the status of the search. The recovered waveforms will be numbered sequentially, starting with the next index number shown under the **Set Next STO** selector.

Time and Date

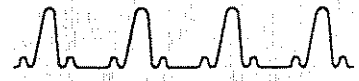

The DSA has an internal clock that keeps track of the time and date. You can set the clock using the **Time & Date** pop-up menu in the Utility 1 major menu.

This menu also shows you how many times the DSA has been powered on, and how many hours it has been on.

Time and Date	
Time:	21:29:38
Date:	3-FEB-91
Ontime:	734.8hrs
Powerups:	243 times
Time	Date
Hours	Month
21	FEB
Minutes	Day
29	3
Seconds	Year
38	91

Calibrator	Modes	Probes	Color	Page to Utility 2	Rem Wfm 1 L1 Main
Initialize	Time & Date	Label	Month Set		Day Set
	21:29:38	Disp: On	2		3
	3-FEB-91	Mode: Man			

The Time & Date Pop-Up Menu

When you touch the **Hours**, **Minutes**, **Seconds**, **Month**, **Day**, or **Year** selector, one of the knobs is assigned to set that clock parameter.

Time and Date



Triggering





A trigger is an electrical event on which acquisition is based. The trigger event occurs when the trigger *source*, the signal being monitored by the trigger circuits, passes through a specified voltage *level* in the specified direction (the trigger *slope*). This event becomes a reference point in time when waveform samples are combined into a waveform record. In the absence of a trigger event, the DSA cannot align a waveform record to a fixed point in time and the signal becomes *untriggered*.



The trigger status is shown to the left of the graticule. If the selected waveform is triggered, the status appears as *trig'd*. Otherwise, *!not trig'd* appears. Depending on the trigger *mode*, acquisition may stop when the signal becomes untriggered, leaving the last triggered waveform record frozen on the display. When acquisition continues in the absence of an adequate trigger, acquired samples will be displayed but will not be positioned properly, producing an unstable waveform display.



You can set the trigger signal source to be a plug-in channel, a combination of plug-in channels, or the AC line. You can also set the trigger *coupling* to selectively pass part or all of the trigger signal to the trigger circuits. To improve trigger stability, you can adjust the trigger *holdoff*, the period after a trigger event during which triggers are ignored.

The DSA has a set of *extended trigger* options that allow you to define more specific conditions in which triggering can occur. These extended trigger capabilities include Boolean triggering, time-qualified triggering, and level-qualified triggering.

Window waveforms are acquired on a separate time base that may be triggered either from the Main trigger or from a distinct Window trigger. The trigger icon to the left of each graticule shows which trigger applies to the selected waveform on that graticule. The Main trigger icon appears as an arrow over the letter M (); the Window trigger as an arrow over the letter W (.

To find out more about window waveforms, see Windows on page 297.



Use the trigger icon ( or ) to assign the knobs to set the trigger level and holdoff.

You can assign the knobs to set the trigger level and time holdoff of the selected waveform by touching the trigger icon ( or ). Use the selectors in the Trigger major menu to access all other trigger controls.

Triggering



Trigger Selection

Trigger Select selects the Main or Window trigger. Selections you make from the Trigger major menu affect the selected trigger. You can also select the trigger by touching the trigger icon ( or ).

Source

The **Source Desc** selector displays a pop-up menu that allows you to define the trigger source. You can choose any plug-in channel, combine channels from the center and left plug-ins by adding and subtracting them, or select the AC line as the trigger source. As you type in the trigger source description, it appears at the top of the **Source Desc** pop-up menu. Use **Backspace** to correct errors as you type in the description. Press **Enter Desc** to enter the description and remove the pop-up menu. You can cancel your selection and remove the pop-up menu at any point by pressing **Cancel**.

The current trigger description is displayed in the bottom line of the **Source Desc** pop-up menu. If the description is four characters or less, it will also be displayed under the trigger icon to the left of the graticule. The DSA trigger bandwidth is also reported in this pop-up menu. (The system trigger bandwidth also depends on the plug-in amplifier used and may be less than the DSA trigger bandwidth.)

You can also select extended triggering functions from the **Source Desc** pop-up menu. These functions appear under **Boolean Triggering**, **Trigger on Edge WHILE at Level**, and **Time Qualified Triggering** in the **Source Desc** pop-up menu. See **Extended Triggering** on page 262 for more information about these triggering functions.

When a single channel is being acquired from a plug-in amplifier in the left compartment at the maximum sampling rate (1 Gsample/s for the DSA 601A and 2 Gsample/s for the DSA 602A), selecting a different channel from the same plug-in amplifier as the trigger source will cause acquisition to revert to equivalent time mode, although you can select a channel from a different plug-in amplifier without affecting the real-time acquisition of the channel. Similarly, if two channels from the left and right compartments are being acquired at half the maximum sampling rate, choosing as the trigger source a channel from the left compart-

Triggering



ment other than the one already being acquired will force the DSA to revert to equivalent time acquisition.

Main Trigger Source Description					
L1	C1	R	Boolean Triggering		
L2	C2		NOT	AND	
L3	C3		OR	XOR	
L4	C4		Trigger on Edge WHILE at Level WHILE		
Line + -			Time Qualified Triggering		
			<t1	>t1	
Trigger Bandwidth = 1 GHz			>t1<t2	<t1>t2	
Enter Desc	Back Space	Cancel	TO		
Current Main Trigger Description					
L1					
Trigger Select Main	Source Desc L1	Level 3.6V	Time Holdoff 2µs	Mode Auto	Mem Wfm
Coupling DC	Slope +	Timer t1 Timer t2 2ns 1ms	Main Trig Level 3.6V		Main Time Holdoff 2µs

The Trigger Major Menu and Source Desc Pop-Up Menu

Triggering

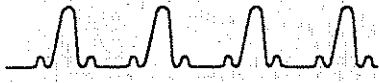

Coupling

None of the AC trigger coupling options are available when extended trigger functions are used.

The **Coupling** selector displays a pop-up menu that allows you to specify one of several trigger coupling options.

- **AC coupling** attenuates signals at frequencies below 60 Hz.
- **DC coupling** triggers acquisition when the DC level of the trigger signal reaches the specified trigger level.
- **AC Low Freq Reject** rejects the DC component of the trigger signal and attenuates signals at frequencies below 80 kHz.
- **AC High Freq Reject** rejects the DC component of the trigger signal and attenuates high-frequency signals above 30 kHz.
- **DC High Freq Reject** retains the DC component of the trigger signal and attenuate signals above 30 kHz.
- **AC Noise Reject** rejects the DC component of the trigger signal. It requires a greater peak-to-peak amplitude than other AC coupling selections to produce a trigger event.
- **DC Noise Reject** also requires a greater peak-to-peak signal than other DC coupling selections to produce a trigger event.

Triggering



Main Trigger Coupling					
AC		DC			
AC Low Freq Reject					
AC High Freq Reject		DC High Freq Reject			
AC Noise Reject		DC Noise Reject			
Trigger Select	Source Desc	Level	Time Holdoff	Mode	Main Win
Main	L1	3.6V	2 μ s	Auto	
Coupling	Slope	Timer t1	Main Trig Level		Main Time Holdoff
DC	+	2ns 1ms	3.6V		2 μ s

The Coupling Pop-Up Menu

Slope

The **Slope** selector selects between + (a rising slope trigger event) and - (a falling slope trigger event). The trigger slope must always be positive when extended trigger functions are used.

Level and Holdoff

The **Level** selector assigns the knobs to set the trigger level (and trigger holdoff). Touching this selector is the same as touching the trigger icon to the left of the graticule.

The **Time Holdoff** selector assigns the knobs to set the trigger holdoff (and trigger level). This is the same as touching the trigger icon. If you have a window time base defined with trigger holdoff by events, this selector will appear as **Events Holdoff** when the window trigger is selected.

Triggering



To find out more about Boolean triggering, see page 263.

Trigger DC Level

The Main time base holdoff can be set to any value from 2 μ s to 500 seconds. The range of the Window time base holdoff by time is from 35 ns to the end of the Main record duration, up to 1000 seconds. Window time base holdoff by events may be from one to one billion events.

When one of the waveforms on the display matches the trigger signal, the trigger indicator (\blacktriangleright) appears on the waveform to show the trigger level, except when there is a Boolean function using both trigger circuits or when an AC coupled trigger mode is selected.

The trigger DC level may be set either as a fixed level on the display or as a fixed value in vertical axis units (usually volts). To change the way trigger DC level is set, select **Trigger DC Level** in the **Modes** pop-up menu in the **Utility 1** major menu. This selector shows **Screen** or **Absolute** as status.

When **Trigger DC Level** is set to **Screen**, the trigger DC level is independent of the vertical offset (vertical position) of the trigger source. If you change the offset of the trigger source, the trigger level will remain at the same vertical level on the screen.

When **Trigger DC Level** is set to **Absolute**, the trigger DC level is an absolute voltage (or other vertical axis unit) level. If you change the vertical offset of the trigger source, the trigger level is also offset; it remains at the same level relative to the input signal.

Window Triggering

You specify a separate trigger for the Window time base by choosing Window holdoff by time or events. The Window trigger will occur on the Window trigger signal only after a specified amount of time or number of events have elapsed since the Main trigger event. You can specify trigger holdoff on the Main time base by time only.

When **Window Trigger** is selected, the **Source Desc** pop-up menu allows you to select **Window Triggered From Main**, **Window Holdoff By Time** or **Window Holdoff By Events**. These selectors choose how the window record is positioned and triggered.

Triggering



Window Triggered From Main disables the window trigger. You can position the window record relative to the main trigger by using the front panel knobs.

Window Holdoff By Time enables the window trigger. You can specify a time following the main trigger for the window trigger using the right front panel knob.

Window Holdoff By Events enables the window trigger on the *n*th window event or trigger after the main trigger by using the right front panel knob.

You can specify different trigger sources for the Window trigger and the Main trigger, but you cannot use different trigger sources from the same plug-in unit. For example, if the Main trigger source is channel **L1**, you can define the Window trigger source to be **L1**, or even **L1 + C1**, but not **L1 + L2**. If you want to change the source description for both the Main and the Window trigger to **L1 + L2**, you must first eliminate the separate Window trigger (by selecting **Window Triggered From Main**) so that the trigger sources will not conflict.

A status indicator appears between the knob labels in the Trigger major menu. This indicator tells you which trigger applies to the selected waveform (not which trigger is selected).

Triggering



Window Trigger Source Description			
L1	C1	R	Boolean Triggering NOT
L2	C2		Time Qual Triggering
L3	C3		t1
L4	C4		t1
Line	+	-	t1+t2
Enter Desc	Back Space	Cancel	t1+t2
Trigger Bandwidth = 1 GHz			

Window Trigger Mode		
Window Holdoff	Window Holdoff	Window Triggered
By Time	By Events	From Main

Current Window Trigger Description

L1					
Trigger Select Window	Source Desc	Level	Time Holdoff	Mode	Rem Wfm 1
	L1	5.5V	35ns	Normal	L1 Main
Coupling	Slope	Timer t1	Timer t2	Wdw Trig Level	Main Trig Wdw Time Holdoff
DC	+	2ns	1ms	5.5V	35ns

The Source Desc Pop-Up Menu for the Window Trigger

Triggering

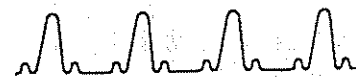

Trigger Mode

The **Mode** selector displays a pop-up menu that allows you to select **Auto Level**, **Auto**, or **Normal**.

In **Auto Level** mode, the DSA automatically sets the trigger level on a triggering signal. You can change the level within 20% to 80% of the peak-to-peak signal. In the absence of an adequate trigger signal, the DSA will acquire and display waveform samples without reference to a trigger event. **Auto Level** mode is not available when extended trigger functions are used.

Auto mode is available for the Main trigger only. This mode provides triggered signal acquisition when the trigger level is correctly set and an adequate trigger signal is present. When the trigger signal is inadequate or the level is inappropriate, acquired samples are displayed without reference to a trigger event.

Normal mode is similar to **Auto** mode, except that acquisition stops when the trigger signal is inadequate or the level setting is inappropriate. When acquisition is stopped, the previously acquired waveform record remains "frozen" on the display. The **Normal** mode should be used to acquire signals with repetition rates below 30 Hz.

If the digitizer is stopped, any adjustment of the horizontal, vertical or trigger parameters will clear your waveform since any parameter change will no longer apply to the waveform as captured.

You can, however, turn on **Pan/Zoom** and alter the waveform horizontally without clearing the waveform.

You can also prevent waveform clearing when altering vertical parameters by initially defining the waveform as high precision. (See **Waveform Scaling** on page 294.)

Triggering

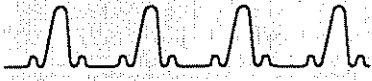

Trigger Mode					
Auto Level					
Auto					
Normal					
Main					
Trigger Select Window	Source Desc	Level	Time Holdoff	Mode	Rem Wfm 1
	L1	5.5V	35ns	Normal	L1 Main
Coupling	Slope	Timer t1 Timer t2	Wdw Trig Level	Main Trig	Wdw Time Holdoff
DC	+	2ns 1ms	5.5V		35ns

The Mode Pop-Up Menu

Extended Triggering

In addition to its basic triggering capabilities, the DSA provides Boolean triggering, time-qualified triggering, and level-qualified triggering.

These extended triggering options may be used separately or, with some exceptions, can be combined in the trigger source description. When any of these triggering options is used, the trigger bandwidth is limited to 500 MHz. Also, the trigger coupling must be set to DC, DC Noise Reject, or DC High Frequency Reject, the trigger slope must be positive, and the trigger mode must be Auto or Normal. If other trigger settings are selected, the DSA will automatically change the trigger settings when you enter an extended trigger expression.



Boolean Triggering

With Boolean triggering, a trigger event occurs whenever a Boolean function of up to two trigger sources changes from false to true. The Boolean value of a trigger source is true if the trigger source voltage is above a level you set for that source. You can use the Boolean logic operators NOT, AND, OR, and XOR to construct a Boolean trigger function. The Boolean trigger function must be false a minimum of 2 ns before the transition, and must remain true a minimum of 2 ns after the transition, in order to be recognized.

Use the **Source Desc** pop-up menu in the Trigger major menu to enter a Boolean trigger expression. Selectors for the operators **NOT**, **AND**, **OR**, and **XOR** appear under the heading **Boolean Triggering**.

The unary operator NOT may be applied to a trigger source to create a function that is true whenever the trigger source voltage is below the level you set for the source. You can use this operator along with the other Boolean operators or with the other extended triggering options. The NOT operator may be used for the Main or Window trigger.

The binary operator AND combines two trigger source descriptions into a function that is true only when both of the components of the function are true.

The binary operator OR combines two trigger source descriptions to form a function that is true whenever either, or both, of the components is true.

The binary operator XOR (exclusive OR) may be used to create a function that is true when either of its components is true, but false when both are true or both are false.

Triggering

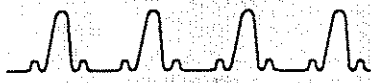

When you define a Boolean trigger expression, you must set the level that distinguishes a “high” or “true” value from a “low” or “false” value. Touch the **Level** selector and use the left knob to adjust the level. If you have entered a binary Boolean trigger expression, the **Level** selector changes to show **Level A Level B**. When you touch this selector, the left knob is assigned to control the level (**Level A**) for the first source in the Boolean expression and the right knob controls the level (**Level B**) for the second source.

Level A
Level B
Selector

Trigger Select Main	Source Desc L1 XOR C	Level A Level B -4.5V 1.05V	Time Holdoff 2μs	Mode Auto	Mem Win
Coupling DC	Slope +	Timer t1 Timer t2 2ns 1ms	Main Size 10μ s/div	Main Position -27μ s	

The Trigger Major Menu with a Binary Boolean Trigger Expression

You cannot define a separate Window trigger when you are using binary Boolean triggering.

The binary operators AND, OR, and XOR are available only for the Main trigger. You cannot use a binary Boolean expression in conjunction with level-qualified (see page 267) or comparison time-qualified triggering (see page 266). You cannot have a separate window trigger when you are using binary Boolean triggering; the Window time base will automatically be set to trigger on the Main trigger.

You can use the same trigger source on either side of a boolean trigger expression, for example **L1 AND NOT L1**. In this case, the settings for **Level A** and **Level B** determine the logic thresholds for the first and second use of the trigger source.

Triggering

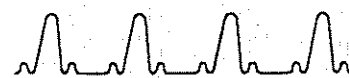

When there is a Boolean function using both trigger circuits, and the corresponding waveforms are displayed on the screen, horizontal annotation lines will show the trigger levels instead of the trigger arrow. An arrow at the bottom of the graticule shows the trigger horizontal position. Also appearing at the bottom of the graticule is the **RemAnno** icon. This icon will remove the annotation bars. When measurement annotation bars are displayed simultaneously, the **RemAnno** icon will remove the annotations most recently selected.

RemAnno
Icon

Trigger Select	Source Desc	Level A	Level B	Time Holdoff	Mode	Rem Wfm S
Main	LINE OR L1	-1.9div	12.6V	2 μ s	Auto	FFTr Main
Coupling	Slope	Timer t1	Timer t2	Horizontal Magnify	Pan/Zoom	Horizontal Pos Gr
DC	+	2ns	1ms	50	On	250 pts

Trigger Major Menu with RemAnno icon

Time-Qualified Triggering

When you define a time-qualified trigger expression, a trigger will be generated when the state of one or two trigger sources meets the timing requirement you set. The length of time that a trigger source remains above the transition level is compared to the set time. When the timing restrictions are satisfied, a trigger event occurs. You can use time-qualified triggering and Boolean trigger functions together.

Triggering

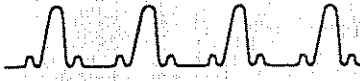

The $>t1 <t2$ and $<t1 >t2$ selectors are not available if a separate (Main or Window) trigger expression already uses one of the timers.

Use the $<t1$ selector in the **Time Qualified Triggering** section of the **Source Desc** pop-up menu to specify that a trigger will occur when the trigger source has been above the transition level for a time period less than the specified limit, $t1$. Similarly, if you select $>t1$, a trigger will occur on the true-to-false transition of a trigger source pulse longer than the time limit $t1$. If the trigger source description does not include any binary Boolean operators, you can define a separate time interval for the Window trigger. An example of a time-qualified triggering expression is **NOT L1 $<t1$** , which specifies that triggering occurs after the trigger source has remained *below* the transition level for a time no longer than $t1$.

The $>t1 <t2$ and $<t1 >t2$ selectors let you specify a range of duration for the trigger source to exceed the transition level. The value of $t2$ must always be greater than the value of $t1$. Select $>t1 <t2$ to have a trigger event occur after a pulse of the trigger source with duration between the values of $t1$ and $t2$. Select $<t1 >t2$ to have a trigger event occur when the trigger source has been above the transition level for a time outside the boundaries defined by $t1$ and $t2$; that is, a time less than $t1$ or greater than $t2$. You can use these timing functions for either the Main trigger or the Window trigger, but not for both. If the trigger source description includes a binary Boolean expression, a separate Window trigger will not be available.

You can use the operator **TO** to create a comparison time-qualified triggering expression. The time between transitions on two trigger signals is then compared to the timing restrictions. Comparison timing may not be used with binary Boolean expressions, nor can it be used for the Window trigger expression. Use the **Level A Level B** selector in the Trigger major menu or the trigger icon () to assign the knobs to set the transition levels for the two signals compared.

Select **Timer t1** **Timer t2** in the Trigger major menu to set the knobs to control the values of $t1$ and $t2$.

Triggering



An example of Time Qualified Triggering is shown on page 268, using Levels. In this example you can trigger if the waveform transition through the trigger levels selected is greater than the selected time interval, t_1 . Note that Level A applies to the first channel(s) in the trigger expression. Level B applies to the second channel in the trigger expression. `<first channel> Boolean Operator <second channel> <timer>`. You can remove the trigger annotations by touching the **RemAnno** icon.

Level-Qualified Triggering

You can define a trigger expression in which trigger events on the trigger source signal are valid only when a second source is above or below a certain level.

To use level-qualified triggering, enter the trigger source on which the trigger event, or edge, will occur in the **Source Desc** pop-up menu, select **WHILE**, and enter the description of the source whose level will determine whether trigger events are recognized. Neither trigger source can include binary Boolean operators. You can use the unary operator **NOT** to indicate a negative-slope transition for the first source or, for the second source, to accept trigger events only when the source is *below* the level. Use the **Level A Level B** selector in the Trigger major menu or the trigger icon (↕) to assign the knobs to control the qualifying levels of the two trigger sources.

You cannot define a separate Window trigger when you are using Level-qualified triggering.

Level-qualified triggering is available for the Main trigger only; a separate Window trigger may not be defined. Level-qualified triggering and time-qualified triggering cannot be combined in a trigger source description.

Triggering

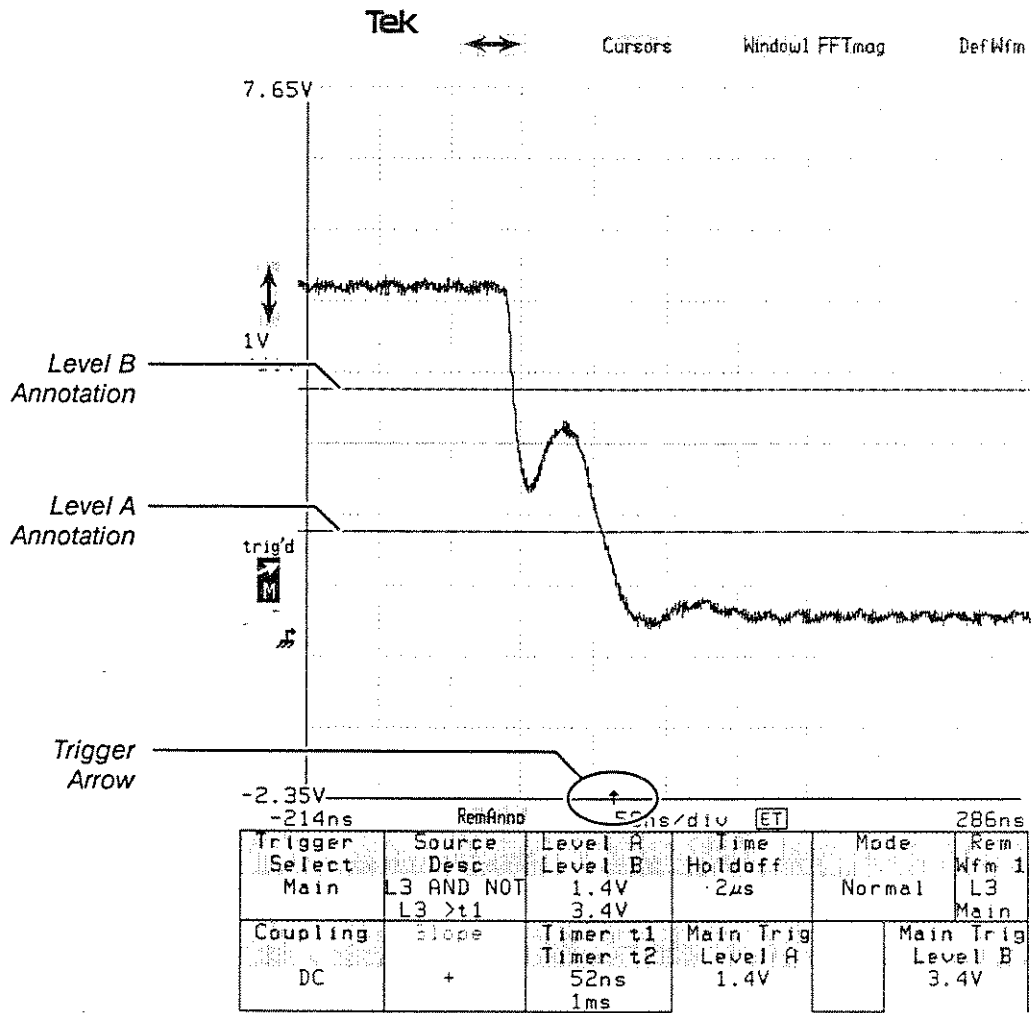
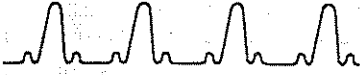

Example of Time Qualified Triggering

Utilities

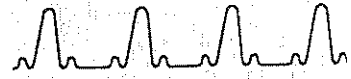

The DSA provides three utility menus available by pressing the **UTILITY** button.

Utility 1 Major Menu

The Utility 1 major menu contains selectors for:

- Calibrating and initializing the DSA. (See Calibrator on page 77 and Initialization on page 159.)
- Adjusting methods of acquiring and displaying waveforms. (See the Modes pop-up menu in the At a Glance section on page 25.)
- Displaying time and date. (See Time and Date on page 251.)
- Calibrating, deskewing, and compensating probes. (See Probes and Cables on page 213.)
- Labeling waveforms or settings and displaying text on the screen. (See Labeling on page 165.)
- Selecting display colors. (See Color Display on page 79.)

There are three Utility Major Menus

Calibrator	Modes	Probes	Color	Page to Utility 2	Rem Wfm
Initialize	Time & Date 16:14:42 15-OCT-90	Label Disp: On Mode: Man	Hue 150 *		Lightness: 0 %

Utility 1 Major Menu

Utilities

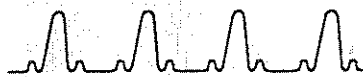

This menu also includes miscellaneous commands for:

- Waveform scaling. (See Waveform Definition and Management on page 281.)
- Changing the time stamp format of stored waveforms. (See Stored Waveforms on page 239.)
- Automatic self-calibration. (See Enhanced Accuracy on page 111.)
- Controlling the autoset operation. (See Autoset on page 65.)

Utility 2 Major Menu

The Utility 2 major menu contains selectors for:

- Controlling the DSA by a remote computer. (See GPIB Parameters on page 135 and RS-232-C Parameters on page 225.)
- Printing a paper copy of the display. (See Hardcopy on page 143.)
- Verifying that the DSA is operating properly. (See Diagnostics on page 91.)
- Erasing all information stored in nonvolatile RAM (See Teksecure command in the Initialization section on page 159.)

GPIB	RS-232-C	Hardcopy	Ident	Page to	Mem
TalkListen	9600 baud	Bitmap		Utility 3	Wfm
1		Screen			
Extended	Self	Teksecure	Main		Main
Diagnostic	Test	Erase Mem	Size		Position
			10μ		-27μ
			s/div		s

Utility 2 Major Menu

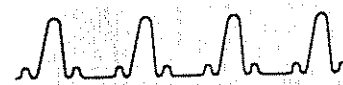

The Utility 2 major menu also contains a pop-up menu showing unit identification, firmware version numbers, and installed options. (See Instrument Configuration on page 163.)

Utility 3 Major Menu

The Utility 3 major menu contains selectors affecting the disk drive. There are three pop-up menus that define operations concerning the disk, file directories, and files.

- The **Disk Ops** pop-up menu contains commands for formatting, labeling, and checking the disk.
- The **Directory Ops** pop-up menu contains commands for changing, making, renaming, removing directories and listing directories and files.
- The **File Ops** pop-up menu contains commands for renaming, copying, and deleting files and for changing the mode between read only and read/write. You can also specify the data format and set a default file prefix.

For more information see the Disk Drive section on page 97.

Disk Ops	Directory Ops	File Ops		Page to Utility 1	Rem Wfm 3 C1 Wind...
			Window Size 1μ s/div	Pan/Zoom Off	Window Position -7.5μ s

Utility 3 Major Menu

Utilities

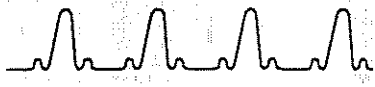

Vectored Waveforms

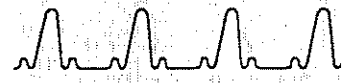

Vectored waveforms is a display mode that enhances the appearance of displayed waveforms by eliminating any gaps or discontinuities.

The waveform display area is 512 pixels (dots) wide. When a waveform with a record length of 512 samples is displayed, each sample has its own unique horizontal position on the display. When waveforms with record lengths longer than 512 samples are displayed, two or more samples must share the same horizontal location. For a waveform of 5120 samples, each horizontal place shows the results of ten samples.

When two or more samples share the same horizontal location, the resulting display is always a series of vertical lines, called columns, that extend from the top sample to the bottom sample.

The DSA normally extends the columns to “touch” adjacent columns, so that no gaps are shown in the waveform. You can turn this waveform vectoring off so that no intermediate data is assumed for display purposes.

Waveform vectoring makes the greatest difference in the appearance of a waveform with 512 samples. As the record length of a waveform increases, the visual enhancement of waveform vectoring becomes less evident.

When you display a 512-sample waveform or *magnify (Pan/Zoom) longer record lengths to display 512 points* with waveform vectoring turned off, the individual samples of the waveform appear as dots.

Vectored Waveforms

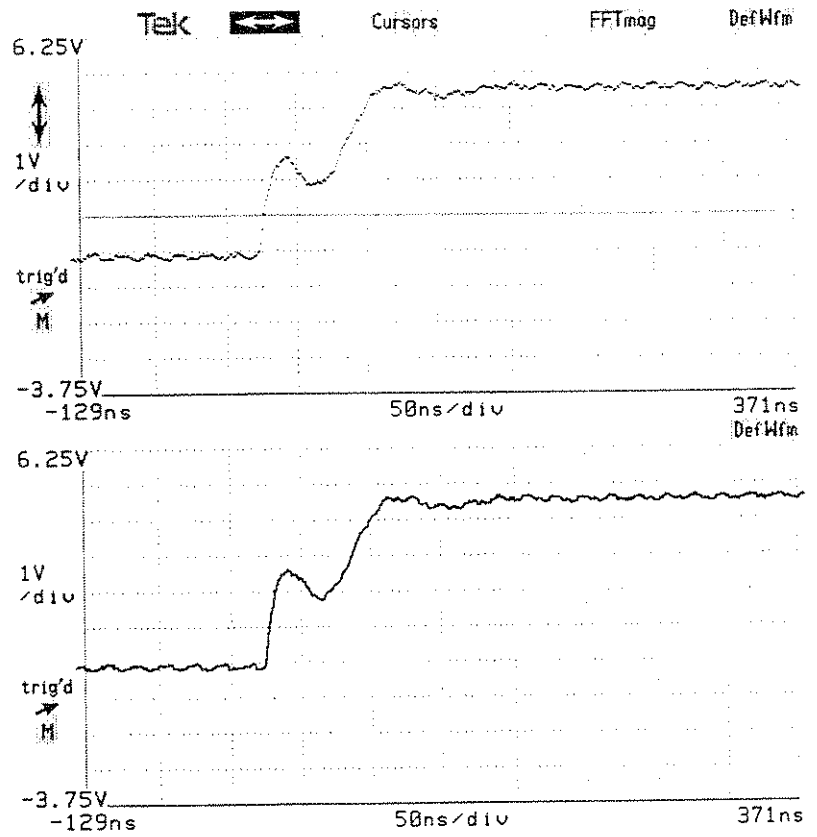

Identical 512-Point Waveforms without Waveform Vectoring (top)
and with Waveform Vectoring (bottom)

Vectored Waveforms



You turn waveform vectoring on or off using the **Modes** pop-up menu in the Utility 1 major menu. Touch the **Vectored Waveforms** selector to set it to **Off** or **On**.

Interpolation

When the **Vectored Waveforms** selector is set to **On**, you can choose from four types of interpolation by touching the **Zoom Intp** selector. The selected type of interpolation fills in between the dots providing a continuous waveform display. The four choices are **None** (no interpolation), **Linear** interpolation (default), **Sin(x)/x** interpolation, and **Sin(x)/x PreFilter** interpolation. The purpose of prefiltering with the $\sin(x)/x$ interpolation is to reduce the ringing caused by the interpolation algorithm on fast transition signals.

If you select interpolation, the DSA will display in the annotation color, the individual data points as well as the interpolated waveform. For single channel waveform descriptions (L1,C2, etc.), the dots represent the actual acquired data points. The other displayed points are interpolated from those points. For all other waveform descriptions, the dots represent calculated data points. These points are calculated from acquired data points. The other displayed points are interpolated from the calculated data points. The following restrictions apply.

- There must be less than four traces on the screen.
- Data points will be displayed in the annotation color when the magnification factor is sufficient to distinguish them from adjacent points.
- If you select **sinx/x prefilter** the data points determined by the prefilter will be displayed. However, cursors will indicate the position of non-filtered data points.

Vectored Waveforms

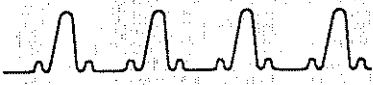

Vectored Waveforms Selector

Instrument Modes					
Autoset					
Vertical	Horizontal	Undo Last			
Pk-Pk	Period	AutoSet			
Miscellaneous					
Multitrace	Pan/Zoom	Averaging	Enhanced		
Pan/Zoom	Pivot	Type	Accuracy		
Off	Center	Backweight	Manual		
Vectored Waveforms	Zoom	Stored Wfm	Incremental		
On	Intp	Time Fmt	Acquire		
	Sin(x)/x	Show	Disabled		
	Prefilter	Date			
Waveform	Audio	Default	Cursor		
Scaling	Feedback	Cursor	Hold		
Optional	On	Paired	Off		
		Dots			
Trigger					
DC Level					
Screen					
Calibrator	Modes	Probes	Color	Page to	Rem
				Utility 2	Wfm 1
					L1
					Main
Initialize	Time &	Label	Main	Pan/	Main
	Date		Size	Zoom	Position
	15:18:41	Disp: On	50μ	Off	-6μ
	10-OCT-90	Mode: Man	s/div		s

The Modes Pop-Up Menu

Vertical Controls

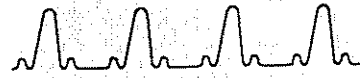

The vertical controls let you set the vertical size and placement of your waveforms. Touch the vertical icon (↕) to access these controls.

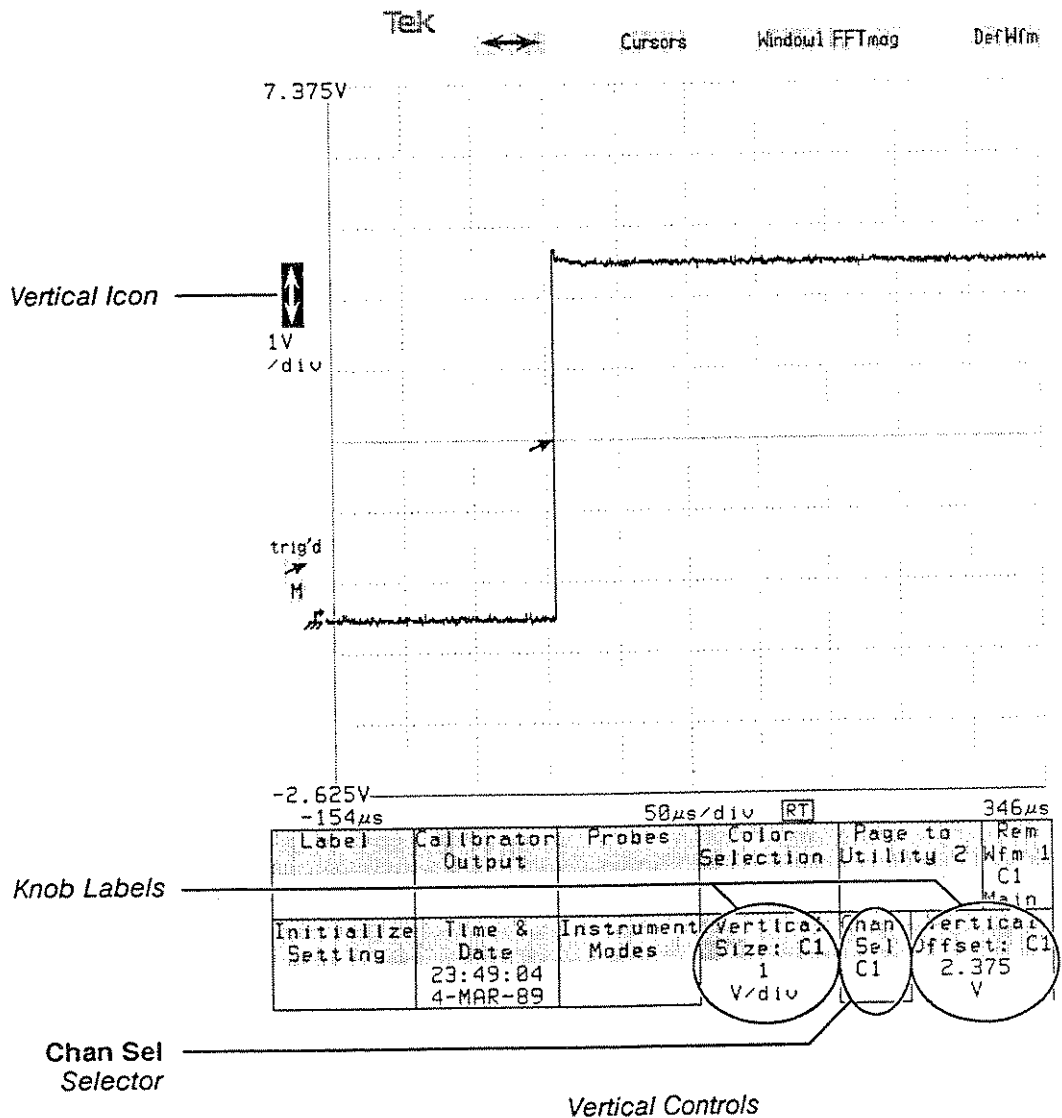

Vertical Controls

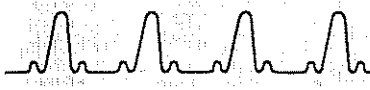

Setting Vertical Size and Offset

Touch a knob label to display the keypad pop-up menu. This lets you set vertical size and offset numerically, or set them to maximum or minimum limits.

If the digitizer is stopped, any adjustment of the horizontal, vertical or trigger parameters will clear your waveform since any parameter change will no longer apply to the waveform as captured. You can, however, turn on Pan/Zoom and alter the waveform horizontally without clearing the waveform. You can also prevent waveform clearing when altering vertical parameters by initially defining the waveform as high precision. (See Waveform Scaling on page 294.)

You can change the vertical magnification, or *size*, of a waveform. You can also move the waveform up or down on the display. This is called adjusting the vertical *offset*. To do either, touch the vertical (\updownarrow) icon; this assigns the knobs to adjust the vertical size (left knob) and offset (right knob) of a channel of the selected waveform.

If you want to change the size or offset of a different waveform, touch the desired waveform to select it. Then use the knobs to adjust vertical size and offset.

Adjusting Channels and Adjusting Waveforms

When you adjust the vertical size or offset of a waveform, you are adjusting the sensitivity or DC offset of one of the channels that is in the waveform expression. If the waveform you are adjusting has the waveform expression $L1 + L2$, for example, you can adjust the vertical size of only one channel at a time. This has the following side effects:

- Changing the channel size or offset for this waveform changes the channel size or offset for all the other waveforms that display that channel.
- If the waveform you are adjusting has more than one channel in its waveform expression, changing the vertical size of one channel does not change the size of the other channels. If the vertical scale factors of all the channels in a waveform do not match, the vertical size of the waveform is undefined.

For example, in the case of the waveform $L1 + L2$, if $L1$ has a vertical size of 50 mV/div and $L2$ has a vertical size of 100 mV/div, the waveform will have undefined vertical units.

You can select the channel you want to adjust. Whenever the vertical icon (\updownarrow) is highlighted, the **Chan Sel** selector appears between the knob labels. This selector always shows the channel the knobs are set to adjust. You can touch this selector until it shows the channel you want to adjust, then use the knobs to adjust the channel.

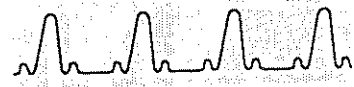

Adjusting High Precision Waveforms

High precision waveforms use floating-point arithmetic in their calculation. When the selected waveform is a high precision waveform, you will see **High Prec** in the bottom line of the **Vertical Desc** selector in the Waveform major menu.

You can adjust the vertical magnification and position of high precision waveforms without adjusting a channel.

See Waveform Scaling on page 294 for a description of high precision waveforms.

When you adjust the vertical controls of a high precision waveform, the **Chan Sel** selector can be used to specify the individual channel to adjust, and to specify the **Calcd Wfm**, or calculated (high precision) waveform. When you specify that you want to adjust the calculated waveform, the knobs adjust the magnification and position of the waveform without changing the vertical size and position of other waveforms displaying that channel.

Trace Separation

When you adjust the vertical size and offset of a waveform on a Window time base, the **Chan Sel** selector can be used to specify the individual channel to adjust, and to specify **Trc Sep Md**, or trace separation mode. This vertical offset control lets you move a window waveform up or down, to visually separate it from other window waveforms or from the Main time base waveform.

Vertical Controls

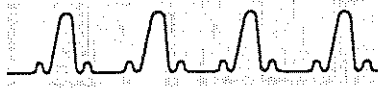

Waveform Definition and Management

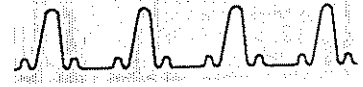

Waveforms are the visible representation on the display of the electrical signals, or combinations of signals, that the DSA acquires and digitizes. You can define and display up to eight waveforms simultaneously.

Defining New Waveforms

You define new waveforms on a window time base using the **Window1** and **Window2** icons, described on page 297.

You can define a new waveform by:

- Pressing the appropriate Channel button on a plug-in amplifier.
- Entering a waveform description.

A waveform description is a definition of the signal sources and mathematical computation that determines the waveform display. An example of a simple waveform description is **L1**, which specifies that a waveform should show the signal source applied to channel 1 of the left plug-in amplifier.

An example of a more complex waveform description is **Log(L1 + L2)**, which specifies that the signals from channels 1 and 2 of the left plug-in amplifier are to be algebraically added, and the base 10 log of the sum is to be shown as the final waveform.

Waveform Definition and Management



Defining Waveforms Using the Channel Button

To define a waveform that represents a plug-in amplifier channel, press the channel button on the plug-in amplifier. There are two limitations to this method of defining waveforms:

- The channel must not be displayed as part of any other waveform being displayed. If the yellow channel light is on, pressing the channel button removes all waveforms that include that channel as part of their waveform definition.
- The waveform description will consist only of this channel. You cannot use this method to enter complex waveform descriptions.

Defining Waveforms Using the DefWfm Icon

To enter waveform descriptions using the **DefWfm** icon, touch the **DefWfm** icon above the top right corner of the graticule on which you want to define a new waveform. When you touch the icon, the **DefWfm** pop-up menu is displayed.

Use the selectors on the pop-up menu to “type” your waveform description. As you type, the waveform description you are building appears at the top of the pop-up menu. The **Back Space** selector lets you correct errors as you type. When your waveform description is complete, touch the **Enter Desc** selector to remove the pop-up menu and create the new waveform description.

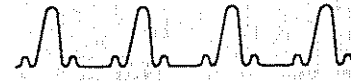

For example, to enter the description $\text{Log}(L1 + L2)$, touch the following selectors in sequence: $\text{Log}(, L1, +, L2,)$, Enter Desc.

Waveform Description Being Entered

Channel Selectors

Numeric Keypad

Waveform Functions, Stored Waveforms or Adjustable Constants

Syntax Selectors

Vertical Description					
L1	C1	R1	7	8	9
L2	C2	R2	4	5	6
L3	C3		1	2	3
L4	C4		0	.	EEK
Waveform Functions		Signum()	Smooth()	Sqrt()	Convolve()
Stored Waveforms		RAM	Correlat()	Dejitter()	Delay()
		DISK			Pulse()
Adjustable Constants		FFTMag()	FFTphase()	PAGE↑	PAGE↓
Enter Desc		()	Back Space	Cancel	
Vertical Desc	Horizontal Desc	Acquire Desc	Graticules	Page to	Rem Wfm 1
L1	Main	Continuous		All Wfms	L1
Fast	2MS/sec			Status	Main
Input Parameters	FFT Control	Act on Delta	Main Size	Pan/Zoom	Main Position
DC	dBm	None	50μ	Off	-6μ
1MQ/300MHz	Rectang		s/div		s

The DefWfm Pop-Up Menu

Waveform Definition and Management

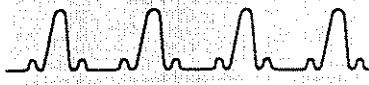

The selectors in the DefWfm pop-up menu are grouped into the following categories:

- **Channel Selectors** appear in the top left portion of the screen. This lets you specify a channel of an installed plug-in amplifier. Only the channel numbers of installed plug-in amplifiers are displayed.
- **Numeric Keypad** appears in the top right portion of the screen. It lets you enter a numeric value, or one of the four arithmetic operators (+, -, *, and /), as part of your waveform description.
- **Waveform Functions** are specified using the selectors in the center of the screen. This area of the menu is shared with several other lists. If the **Waveform Functions** selector is highlighted, the waveform function selectors are shown. Touch the **Waveform Functions** selector to return to the waveform functions list if one of the other lists is shown.
- **Displayed Waveforms** are listed in the center portion of the screen. The **Displayed Waveforms** selector is available after specifying a waveform function that accepts a displayed waveform as a parameter. See page 287 for applicable waveform functions.
- **Stored Waveforms** list all the waveforms that have been stored. This area of the menu is shared with the waveform functions selectors described above. If the **Stored Waveforms** selector is highlighted, the stored waveforms selectors are shown. Touch the **Stored Waveforms** selector to highlight it if any other list is shown.

You can combine **Waveform Functions** and **Stored Waveforms** in the same waveform description by using the **Waveform Functions** and **Stored Waveforms** selectors. The description $L1-(2*\text{Smooth}(\text{STO1}, 5))$ is entered as L1, -, (, 2, *, Smooth(, Stored Waveforms, STO1, , , 5,),), Enter Desc.



- **Adjustable Constants** are scalar constants that you can specify and they can be used in waveform definitions or function argument lists. Touch **Adjustable Constants** in the **DefWfm** pop-up menu. This allocates the knobs to **Adjust Const1** and **Adjust Const2**, enabling you to vary the value of these constants. For example, entering **Filter (L1, Const1)** allows you to vary the risetime parameter of the filter function by knob control and observe the results on the displayed waveform. To reallocate the knobs to the adjustable constants, touch **DefWfm** or enter the **Vertical Description** pop-up menu and touch the **Adjustable Constants** selector.

Waveform Definition and Management



Vertical Description					
L1	C1	R	7	8	9 +
L2	C2		4	5	6 -
L3	C3		1	2	3 *
L4	C4		0	EEX	✓
Waveform Functions:		const1	const2		
Stored Waveforms:		RAM			
Adjustable Constants:					
Enter Desc		()	Back Space	Cancel	
Vertical Desc	Horizontal Desc	Acquire Desc	Graticules	Page to All Wfms Status	Rem Wfm 1 L1 Main
L1 Fast	Main 1MS/sec	Continuous	.		
Input Parameters	FFT Control	Act on Delta	Adjust Const1		Adjust Const2
DC 1M0/300MHz	dBm Rectang	None	200m		1

DefWfm Pop-Up Menu with Adjustable Constants



All waveform functions have an opening parenthesis. You must use a closing parenthesis to enclose the function arguments.

- **Syntax Selectors** let you specify the order of mathematical operations. Each opening parenthesis must be matched with a closing parenthesis. Use the comma (,) selector to separate arguments to functions, like **Smooth(**, that require more than one argument. Use **Back Space** to correct errors as you enter the waveform description. Always finish your waveform description by touching the **Enter Desc** selector.

Using Waveform Functions in Waveform Descriptions

You can cycle among three pages of waveform functions. The functions operate on arguments that are waveform descriptions or constants. A specified function is applied to each individual sample of the argument waveform. The waveform that is displayed results from the function being applied to each sample.

Constants in waveform descriptions may be either numerical values, expressions, or adjustable constants.

The **Convolve**, **Correlate**, **Delay**, **FFTmag**, **FFTphase**, **FFTreal**, **FFTimag**, **IFFT**, **Smooth**, and **Filter** functions accept arbitrary waveforms, previously defined and displayed, as parameters.

In the Waveform major menu, touch the **Page to All Wfms Status** selector, then touch **Show Full Wfm Desc** to see a full description of all displayed waveforms.

Backweighted averaging, summation averaging (see page 71), and enveloping can be applied to previously defined waveforms currently being displayed.

Waveform Functions

Function	Effect on Arguments
Abs (<i>wfm</i>)	Provides the absolute value of the argument waveform.
Avg (<i>wfm</i>)	Averages several waveform record acquisitions of the argument. The number of records acquired is controlled by the knobs after touching the Avg N selector in the Acquire Desc pop-up menu.
Convolve (<i>wfm1</i>, <i>wfm2</i>)	Performs a non-circular convolution of the waveform arguments.

Waveform Definition and Management

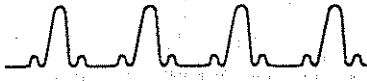

Waveform Functions (Cont.)

Function	Effect on Arguments
Correlate (<i>wfm1</i> , <i>wfm2</i>)	Performs a correlation of the waveform arguments.
Dejitter (<i>wfm</i>)	Compensates for the horizontal effects of noise to remove jitter from a repetitive signal. Dejitter can be applied only to a waveform consisting of a single input channel. A second argument, a number from 0 to 9, determines the noise tolerance; maximum dejitter is performed with a second argument of 0. Waveforms that do not match at any point in the pattern are discarded.
Delay (<i>wfm</i> , <i>const</i>)	Delays the argument waveform by the specified number of waveform points.
Diff (<i>wfm</i>)	Provides the differential of the argument.
Env (<i>wfm</i>)	Provides the limit of excursion of several waveform record acquisitions of the argument. The number of records acquired is controlled by the knobs after touching the Env N selector in the Acquire Desc pop-up menu.
Exp (<i>wfm</i>)	Provides the natural antilog of the argument.
FFTimag (<i>wfm</i>)	Provides the imaginary part of the Fast Fourier Transform of the specified waveform.
FFTmag (<i>wfm</i>)	Provides a Fast Fourier Transform magnitude display of the specified waveform.
FFTphase (<i>wfm</i>)	Provides a Fast Fourier Transform phase display of the specified waveform.
FFTreal (<i>wfm</i>)	Provides the real part of the Fast Fourier Transform of the specified waveform.

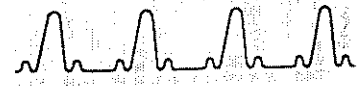

Waveform Functions (Cont.)

DELETED

Function	Effect on Arguments
Filter (<i>wfm</i> , <i>const</i>)	Generates an N pole filtered output of the selected waveform. The cutoff frequency is specified in terms of the rise time (specified as a constant).
IFFT (<i>wfm1</i> , <i>wfm2</i>)	Provides the inverse Fast Fourier Transform of the specified waveforms. Wfm1 is assumed to be the real component and Wfm2 the imaginary component of a complex FFT.
Intg (<i>wfm</i>)	Provides the integral of the argument.
Intp (<i>wfm</i>)	Interpolates the waveform record by replacing null points with the average value of the points on either side of the null point. You can apply the Interpolate function to any single active waveform or to any single stored waveform.
Ln (<i>wfm</i>)	Provides the natural logarithm of the argument.
Log (<i>wfm</i>)	Provides the base 10 logarithm of the argument.
Pulse (<i>const</i> , <i>const</i>)	Provides a pulse with a specified starting point and a specified width.

NOTE:
All arguments referred to as **Const** may be either constant or **Adjustable Constants**.

Waveform Definition and Management

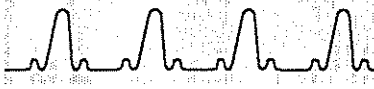

Waveform Functions (Cont.)

Function	Effect on Arguments
Signum (<i>wfm</i>)	Provides the sign of the argument. Returns 1 if the vertical data point is greater than zero, -1 if it is less than zero, and 0 if it is equal to 0.
Smooth (<i>wfm, const</i>)	Provides a moving average of the specified waveform. This function has two arguments, separated by a comma (,). The first argument is the waveform to be smoothed; the second is the number of samples in the moving average. If the second argument is 9, then 4 samples before each point and 4 samples after each point are averaged with the point value. If the second argument is an even number, one is subtracted from it to make it odd.
Sqrt (<i>wfm</i>)	Provides the square root of the argument.

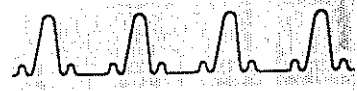

Waveform Numbers

When you define a new waveform, the DSA assigns it a waveform number. Waveform numbers range from 1 through 8. New waveforms are assigned the lowest available number. Once a number is assigned to a waveform, the number does not change.

Selecting Waveforms

The selectors, knobs, and buttons operate on the selected waveform. The graticule axis labels show the vertical and horizontal size and position of the selected waveform. Selectors that show waveform status, such as the **Vertical Desc** and **Horizontal Desc** selectors in the Waveform major menu, show the status of the selected waveform. When you use the horizontal (↔) and vertical (↑↓) icons to assign the knobs to horizontal or vertical size and position, the adjustments affect the selected waveform.

When you have more than one waveform on the display, you can select any waveform. Select a waveform by touching it on the display or by using the **All Wfms Status** page of the Waveform major menu.

The graticule axes change color to match the color of the selected waveform. When you define a new waveform, the graticule axes become the color of the new waveform.

Selecting Waveforms by Touch

The fastest way to select a waveform is to touch it on the display. When you touch the graticule area of the display, a box is displayed that shows the boundaries of your touch. If a single waveform passes through the boxed area when you remove your finger, that waveform will become the selected waveform. The touch box disappears when you remove your finger from the display and select a waveform.

You can drag your finger across the display to change the position of the box before you lift your finger to select the waveform.

Waveform Definition and Management

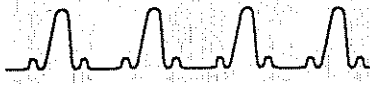

If several waveforms pass through the area indicated by the touch box, one becomes the selected waveform when you remove your finger from the display. Touching the same area repeatedly will select different waveforms. You can select waveforms by touching the same spot on the display repeatedly until the waveform you want is selected.

Selecting Waveforms Using the All Wfms Status Menu

You can see the status of all displayed waveforms at once using the **All Wfms Status** menu. You are shown the waveform number, the first part of the waveform description, the time base, and the vertical and horizontal size per division.

To view this information, touch the **Page to All Wfms Status** selector in the **Waveform** major menu or press the **WAVEFORM** button to display the **All Wfms Status** menu. The light beside the **Waveform** button remains lighted.

This menu shows one selector for each displayed waveform. You can select any waveform by touching its selector. The selector for the selected waveform is always highlighted. Touch the **Page to Single Waveform** selector or press the **WAVEFORM** button to restore the previous **Waveform** major menu.

You can show the full description of all the waveforms by touching **Show Full Wfm Desc** in the **All Wfms Status** menu.

1:L1 Main 5V 10 μ s	2:L2 Main 1V 10 μ s		Show Full Wfm Desc	Page to Single Waveform	Rem Wfm 2 L2 Main
			Main Size 10 μ s/div	Pan/ Zoom Off	Main Position -27 μ s

The All Wfms Status Menu



Modifying or Redefining Waveforms

You can change the waveform description of the selected waveform. When you touch the **Vertical Desc** selector in the Waveform major menu, the **Vertical Desc** pop-up menu is displayed.

This menu is identical to the pop-up menu that is displayed when you touch the **DefWfm** icon. When you display the **Vertical Desc** pop-up menu, the waveform description of the selected waveform appears at the top of the pop-up menu. You can use the **Back Space** selector to modify or redefine the waveform, or you can extend the waveform description. When you touch the **Enter Desc** selector, the new waveform description is applied to the selected waveform.

Removing Waveforms

You can remove waveforms from the display in three different ways: use the **Rem Wfm** selector in the knob menu, use the Channel button on the plug-in amplifier, or use the Delete Waveforms menu in the Store/Recall major menu.

Removing Waveforms Using the Rem Wfm Selector

The **Rem Wfm** selector in the status area always shows the number, the waveform description, and the time base of the selected waveform. The status area is displayed at all times, so the **Rem Wfm** selector is available regardless of the major menu displayed.

When you touch the **Rem Wfm** selector, a pop-up menu asks whether you want to remove or clear the selected waveform. This prevents accidental removal of waveforms. For more information about clearing waveforms, see page 48.

Waveform Definition and Management

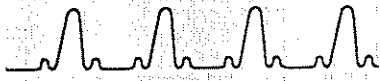

			Rem Wfm 1 L1 Main
Main Size 50 μ s/div	Pan/ Zoom Off	Main Position -6 μ s	

The Rem Wfm Selector in the Knob Menu

Removing Waveforms Using the Channel Button

You can use the CH button on the plug-in amplifier to remove all waveforms displaying that channel as part of their waveform description.

When a channel on a plug-in amplifier is incorporated as part of a waveform, the yellow channel light on the plug-in amplifier is on. If you press the channel button when the light is on, *all* waveforms displaying that channel are removed.

Waveform Scaling

When you define a new waveform, it is defined as either a fast waveform or a high precision waveform. Fast waveforms are computed with integer arithmetic, and operate significantly faster than high precision waveforms. High precision waveforms use floating-point arithmetic to provide highest precision and accuracy.

Normally, the waveform is defined to be fast unless some part of the waveform description forces high precision. Floating-point functions such as `Diff()` and `Log()` will force the waveform to be defined as high precision.



You can force all waveforms, including all single channel traces, to be defined as high precision waveforms. To do this, touch **Modes** in the Utility 1 major menu. The **Modes** pop-up menu appears. In this pop-up menu, the **Waveform Scaling** selector can be set to **Optional** or **Forced**. When set to **Optional**, new waveforms are defined as fast waveforms if they can be implemented as fast waveforms. When set to **Forced**, new waveforms are defined as high precision waveforms.

Once a waveform is defined, its waveform scaling cannot be changed. The setting of the **Waveform Scaling** selector affects only the definition of new waveforms.

For high precision waveforms, care must be exercised that the underlying channel(s) do not overrange the digitizer. It is possible to have a displayed waveform that appears to be properly scaled when the underlying input channel is overranging the digitizer. When this occurs, spikes will appear in the display running from the waveform to the top or bottom of the screen. These problems can be fixed by selecting the channel selector in the knob menu and adjusting the input channel sensitivity or offset until the spikes disappear or by creating a fast, single-channel waveform of the underlying channel and adjusting the vertical size and offset until it is on the screen.

Waveform Definition and Management

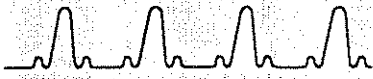

Waveform
Scaling
Selector

Instrument Modes					
Autoset					
Vertical	Horizontal	Undo Last			
Pk-Pk	Period	AutoSet			
Miscellaneous					
Multitrace	Pan/Zoom	Averaging	Enhanced		
Pan/Zoom	Pivot	Type	Accuracy		
Off	Center	Backweight	Manual		
Vectored	Zoom	Stored Wfm	Incremental		
Waveforms	Intp	Time Fmt	Acquire		
On	Sin(x)/x	Show	Disabled		
Waveform	Audio	Default	Cursor		
Scaling	Feedback	Cursor	Hold		
Optional	On	Paired	Off		
		Dots			
Trigger					
DC Level					
Screen					
Calibrator	Modes	Probes	Color	Page to	Rem
				Utility 2	Wfm 1
					L1
					Main
Initialize	Time &	Label	Main	Pan/	Main
	Date	Disp: On	Size	Zoom	Position
	15:10:41	Mode: Man	50μ	Off	-6μ
	10-OCT-90		s/div		s

The Modes Pop-Up Menu

Windows

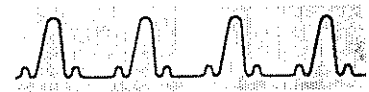

A window waveform is a waveform that represents a horizontally magnified portion of another waveform. A window waveform is acquired separately from the main waveform that it magnifies.

Creating a Window

You create a window by touching the **Window1** icon above the graticule. When you touch the **Window1** icon, the DSA creates a second graticule to show the window waveform. If a second graticule already exists, the window waveform will be displayed on the lower graticule.

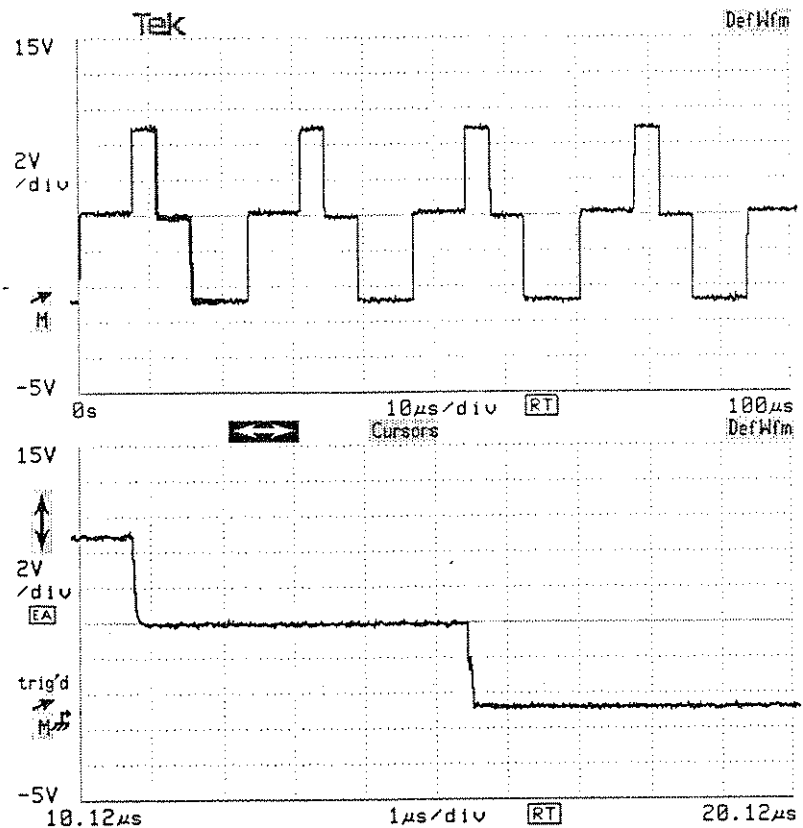
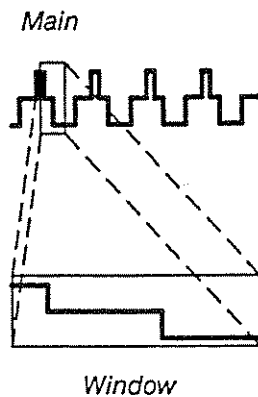

A Window Waveform Display

Windows

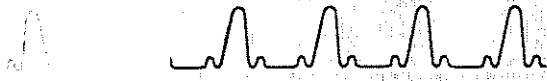

When you create a window waveform, it becomes the selected waveform. The DSA shows this waveform in the selected window waveform color and highlights the windowed portion of the main waveform in this color.

Window Time Base and Trigger

For more information on Triggering, see page 253.

The window waveform has the same waveform expression as the main waveform. The difference between the two is the time base that each uses; the main waveform uses the Main time base, while the window waveform uses a Window time base. The **Horizontal Desc** selector in the Waveform major menu always shows the time base of the selected waveform.

The Window time base can be triggered from the Main trigger or by a separate Window trigger. To define a window trigger, set **Trigger Select** in the Trigger major menu to **Window**, then select either **Window Holdoff By Time** or **Window Holdoff By Events** from the lower section of the Window Trigger Source Desc pop-up menu. You can then set the Window trigger source, level, and holdoff just as you set the Main trigger. If you define a Window trigger, the Window trigger icon () will appear to the left of the graticule when a window waveform is selected and a second trigger arrow may appear on the main waveform.

For more information on Record Length, see page 221.

You can set the record length for window waveforms by touching the **Window Record Length** selector in the **Horizontal Desc** pop-up menu. The knobs will be assigned to adjust the Main and Window record lengths.

The window waveform is independent of the main waveform. Once a window waveform is established, you can remove the main waveform or move the window waveform from graticule to graticule.

Creating a Second Window

You can create two window waveforms from each main waveform. After you create one window waveform, the **Window2** icon becomes available when the main waveform is selected. Touching this icon creates a second window waveform. Once a window waveform is created, touching the **Window1** or **Window2** icon simply selects that waveform. You cannot create a window waveform of a window waveform.

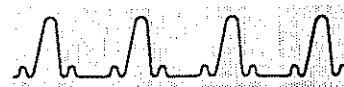

Changing Window Size and Position

All window waveforms are the same horizontal size. If you change horizontal size on one window waveform, you change horizontal size on all window waveforms.

You can change the size and position of a window waveform just as you do with any main waveform. Touch the horizontal icon (↔) to assign the knobs to horizontal size and position. Complete information about horizontal size and position is on page 153.

All main waveforms share the same time base, so all have the same horizontal size and position. Each window waveform can have a different horizontal position. However, each window shares the same time base and consequently the same size. When you touch the horizontal icon (↔), the knobs are assigned to **Window Size** and **Window1 Position** or **Window2 Position**. The window size is always less than or equal to the main horizontal size. Main and Window records will always overlap by at least one point.

As you change the horizontal size or position of a window waveform, the highlighted portion of the main waveform changes size and position. This allows you to always see the portion of the main waveform that the window waveform magnifies.

Trace Separation

When you touch the vertical icon (↓), the **Chan Sel** selector will indicate **Trc Sep Md**, or trace separation mode. In trace separation mode, the knobs are labeled **Trace Separation** and move the selected waveform up or down without moving other waveforms that show the same channels as the selected waveform. The offset of the plug-in channel is not changed. This lets you visually separate the selected window waveform from other window or main waveforms that may overlap it.

When you have used trace separation mode to move a window waveform, the graticule labels and ground reference indicator (⚡) always apply to the selected window waveform.

You can use the **Chan Sel** selector to select a channel, and then adjust the vertical size or offset just as you would with any main waveform. Touch the **Chan Sel** selector until it indicates the channel you want. Complete information about vertical size and offset is on page 277.

Windows



XY Waveforms



Most waveforms show a signal voltage (the vertical axis) as it varies over time (the horizontal axis). You can display a waveform that compares the amplitudes of two waveforms, independent of time. Such an XY waveform shows the signal voltage of one waveform on one axis against the signal voltage of the other waveform on the other axis.

You cannot take measurements of XY waveforms.

At most one actively acquired XY waveform or two stored XY waveforms may be displayed at one time.

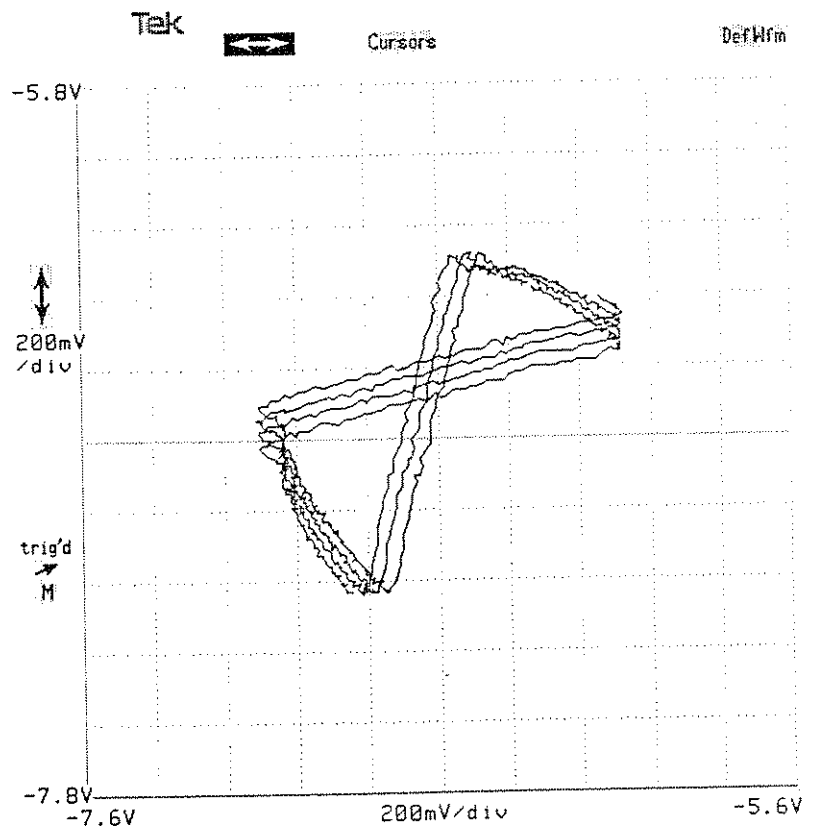

An XY Waveform

Fast and high-precision waveforms are described in Waveform Scaling on page 294.

You can create an XY waveform to compare the amplitudes of two high-precision waveforms, or of two fast waveforms, but you cannot combine a fast waveform with a high-precision waveform.

XY Waveforms



Creating an XY Waveform

You initiate and control an XY waveform using the Horizontal Desc pop-up menu in the Waveform major menu. The XY Display Mode section of this menu allows you to choose Displayed Waveforms or Stored Waveforms.

Horizontal Description					
Acquiring Timebase: Main Main Sample Interval: 500ns/point RT Window Sample Interval: 50ns/point					
Main Record Length 1024 points			Window Record Length 1024 points		
Display Persistence Normal Infinite Variable Persist Time 1s			Digitizer Interleave 1GS/sec Realtime Disabled		
XY Display Mode: X=Displayed Waveform					
Normal YF		Wfm 1 L1 Main			
Displayed Waveforms					
Stored Waveforms		RAM DISK			
Vertical Desc L1 Fast	Horizontal Desc Main 2MS/sec	Acquire Desc Continuous	Graticules Main Size 50µ s/div	Page to All Wfms Status	Rem Wfm 1 L1 Main
Input Parameters DC 1MQ/300MHz	FFT Control dBm Rectang	Action Delta None	Main Size 50µ s/div	Pan/Zoom Off	Main Position -6µ s

XY Waveform Section

The Horizontal Desc Pop-Up Menu

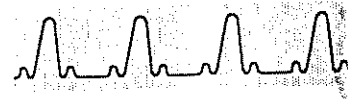

The sequence to follow when creating an XY waveform is:

- Step 1: Define a waveform that shows the information you want on the X-axis (the horizontal axis). This waveform may be any displayed waveform or stored waveform.
- Step 2: Define and display a waveform with the information you want on the Y-axis (the vertical axis).
- Step 3: Touch or otherwise select the waveform that displays the Y-axis information.
- Step 4: Press the **WAVEFORM** major menu button, and touch the **Horizontal Desc** selector to display the pop-up menu.
- Step 5: If the waveform that shows the information for the X-axis is a displayed waveform, verify that **Displayed Waveforms** is selected in the **XY Display Mode** section of the pop-up menu. If the X-axis waveform is a stored waveform, **Stored Waveforms** should be selected.
- Step 6: Touch the selector in the **Horizontal Desc** pop-up menu that represents the waveform showing the X-axis information.

When you touch the X-axis waveform selector in the **Horizontal Desc** pop-up menu, the selected waveform is immediately converted into an XY waveform on the display. The waveform description of the X-axis waveform appears in the **Horizontal Desc** selector, and the waveform description of the Y-axis waveform appears in the **Vertical Desc** selector.

If the waveform defining the X-axis information is a displayed waveform, this process will leave two waveforms on the display: the XY waveform and the X-axis information waveform. Once the XY waveform is established, you can remove the waveform defining the X-axis information.

XY Waveforms

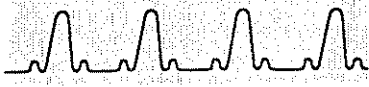

To restore an XY waveform to normal YT (voltage versus time) mode, select the XY waveform and touch the **Normal** selector in the **Horizontal Desc** pop-up menu.

Adjusting Size and Position

You can adjust the vertical and horizontal size and position of an XY waveform.

Touch the vertical icon (\updownarrow) to adjust the vertical size and position of the XY waveform. The knobs will be assigned to adjust **Vertical Size** and **Vertical Offset** of a channel that is displayed as part of the vertical axis description of the XY waveform. If the vertical axis description includes more than one channel, you can select and adjust the channels separately by touching the **Chan Sel** selector. The selected channel appears in the **Chan Sel** selector and in the knob labels.

Touch the horizontal icon (\leftrightarrow) to assign the knobs to adjust the horizontal size and position of the XY waveform. Since voltage information is displayed along the horizontal axis, horizontal position is controlled by adjusting the vertical size and offset of the channel(s) of the X-axis waveform. The knob labels will display **Horizontal Pos: XY** and **Horizontal Size: XY**, and the channel controlled by the knobs will appear in the **Chan Sel** selector. If more than one channel is displayed along the X-axis, use the **Chan Sel** selector to select each displayed channel.

When you adjust the horizontal or vertical size and position of an XY waveform that displays stored waveform information, the **Chan Sel** selector displays **Calcd Wfm**, and adjusting the size and position scales the waveform.

Appendix A: Accessories

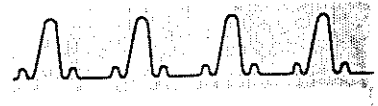

Standard Accessories

The DSA 601A or DSA 602A instrument package includes the following standard accessories:

- *DSA 601A and DSA 602A Tutorial*, Tektronix part number 070-8180-00.
- *DSA 601A and DSA 602A User Reference* (this manual), Tektronix part number 070-8181-00.
- *DSA 601A and DSA 602A Programmer Reference*, Tektronix part number 070-8182-00.
- *DSA 601A and DSA 602A Quick Reference*, Tektronix part number 070-8183-00.
- *DSA 600 Series Service Reference*, Tektronix part number 070-8184-00.
- Power Cord (North American 120 V), Tektronix part number 161-0066-00.

To obtain replacements, refer to a Tektronix products catalog or contact your local Tektronix field representative.

Instrument Options

The following options are available for the DSA 601A and DSA 602A Digitizing Signal Analyzers. For additional information and prices, see a Tektronix products catalog or contact your local Tektronix field representative.

- Option 1R Rack Mount, converts the DSA for rack mounting.
- Option 1C Loop-through BNC's, adds eight BNC's to the front and rear panels so that signals may be routed from the front panel to the rear panel (or rear to front).
- Option 4C Nonvolatile RAM, adds nonvolatile memory for internal storage of 468,288 waveform points.

Accessories

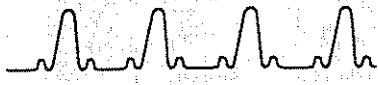

Optional Accessories

- Option 1P HC-100 Four-Color Pen Plotter.
- Option 2P 4697 ColorQuick Ink-Jet Printer.
- Option 3P 4693DX Color Image Printer.

The following optional accessories have been selected from our catalog specifically for the DSA 601A and DSA 602A Digitizing Signal Analyzers. For detailed information and prices, see a Tektronix products catalog or contact your local Tektronix field representative.

- Two-meter GPIB cable, Tektronix part number 012-0991-00.
- Ten-foot RS-232-C cable, Tektronix part number 012-0911-00.
- Ten-foot Centronics printer cable, Tektronix part number 012-0555-00.
- Tektronix 4697 ColorQuick Ink-jet printer, 4693DX Color Image Printer, 4696 Color Ink-jet printer, or Tektronix HC-100 pen plotter.
- Tektronix P6701 and P6702 optical to electrical converters.
- Tektronix P6408 word recognizer probe.

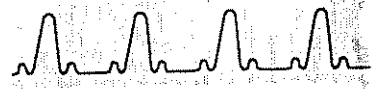

Power Cord Options

The following power cords are available for the DSA:

- Option A1 Universal European 220 V/6A, 50 Hz, Tektronix part number 161-0066-09.
- Option A2 United Kingdom 240 V/13A, 50 Hz, Tektronix part number 161-0066-10.
- Option A3 Australian, 240 V/10A, 50 Hz, Tektronix part number 161-0066-11.
- Option A4 North American 240 V/15A, 60 Hz, Tektronix part number 161-0066-12.
- Option A5 Switzerland 220 V/10A, 50 Hz, Tektronix part number 161-0154-00.

Accessories



Appendix B: Specifications

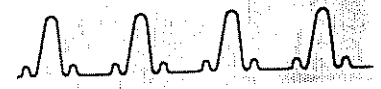

The electrical characteristics apply to the following conditions:

- The DSA has had a 20-minute warm-up period.
- The DSA is operating in an environment that meets the limits described in Environmental Specifications in this section.

Vertical System Specifications

MEASUREMENT SYSTEMS CORPORATION

Characteristic	Specifications
Input sources	3 plug-in amplifiers, up to 12 channels
Bandwidth	Dependent on plug-in amplifier
Rise time	Dependent on plug-in amplifier
Vertical gain accuracy	$\pm 1\%$ of full-scale range, in Enhanced Accuracy state
Vertical resolution	8 bits Signal averaging of N acquisitions increases bit resolution by $\log_2(N)$ up to a limit of 14 bits
Input sensitivity	Dependent on plug-in amplifier
Vertical acquisition resolution	
Single graticule	25 points/div
Dual graticule	25 points/div
Vertical display resolution	
Single graticule	50 pixels/div
Dual graticule	25 pixels/div
Antialiasing Filter	
Bandwidth	100 MHz
Attenuation	-17 dB at 250 MHz, -25 dB at ≥ 500 MHz

Specifications



Time Base Specifications

DSO6010A, DSO6020A, DSO6020A, DSO6020A, DSO6020A, DSO6020A, DSO6020A, DSO6020A, DSO6020A, DSO6020A

Characteristic	Specification														
Internal reference clock	500 MHz surface acoustic wave resonator oscillator														
Time Base Accuracy	+0.005%, -0.015%, from 0°C to 45°C														
Sample rate DSA 601A	1 GSample/s maximum (single channel, from Left plug-in compartment)														
DSA 602A	2 GSample/s maximum (single channel, from Left plug-in compartment)														
Record Length	User selectable, 512, 1024, 2048, 4096, 5120, 8192, 10240, 16384, 20460, or 32768														
Sweep rates	In general, a 1-2-5 sequence from 50 ps/div to 100 s/div														
Record duration	512 ps to 1023.95 s														
Dynamic Accuracy	Typical dynamic accuracy, main-frame with Sample Clock Dither Jumper in ON position (dither disabled), 11A72 plug-in, Sample Rate of 1 GS/s in DSA 601A or 2 GS/s in DSA 602A only, with no signal averaging or digital filtering; measured with p-p sine amplitude = 90% of digitizer full scale at 1 kHz.														
	<table border="1"> <thead> <tr> <th>Frequency</th> <th>Effective Bits</th> </tr> </thead> <tbody> <tr> <td>1 kHz</td> <td>7.2</td> </tr> <tr> <td>10 MHz</td> <td>7.2</td> </tr> <tr> <td>100 MHz</td> <td>6.7</td> </tr> <tr> <td>250 MHz</td> <td>6.3</td> </tr> <tr> <td>500 MHz</td> <td>5.7</td> </tr> <tr> <td>1 GHz</td> <td>4.5</td> </tr> </tbody> </table>	Frequency	Effective Bits	1 kHz	7.2	10 MHz	7.2	100 MHz	6.7	250 MHz	6.3	500 MHz	5.7	1 GHz	4.5
Frequency	Effective Bits														
1 kHz	7.2														
10 MHz	7.2														
100 MHz	6.7														
250 MHz	6.3														
500 MHz	5.7														
1 GHz	4.5														

Specifications

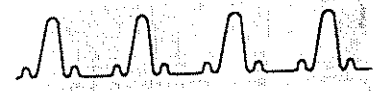

Input and Output Specifications

Characteristic	Specification
Touch panel	Infrared beam touchable array, 22 rows of 11 columns
Knobs	2 general-purpose knobs, set by user to desired function
Calibrator output: DC Levels	DC voltages suitable for calibrating the gain of 10X probes from the probe tip at ≤ 5 V/div
Calibrator output: Low-Frequency AC Square Wave	
Frequency	1.000 kHz \pm 0.1%
Voltage	5.0 V \pm 3% into 1 M Ω load, 500 mV \pm 3% into a 50 Ω load. Positive polarity with baseline at 0 V.
Output Resistance	450 Ω \pm 0.5%
Calibrator output: High Frequency AC Square Wave	
Frequency	1.024 MHz \pm 0.1%

Specifications

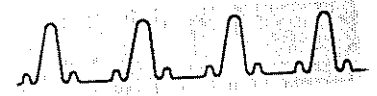

Trigger Specifications (Cont.)

Characteristic	Specification
Trigger sensitivity DC coupled	0.4 division from DC to 10 MHz, increasing to 1 division at maximum trigger bandwidth
DC Noise-Reject Coupled	1.2 division from DC to 10 MHz, increasing to 3 divisions at maximum trigger bandwidth
DC High-Freq. Reject Coupled	0.5 division from DC to 30 kHz
AC coupled	0.4 division from 60 Hz to 10 MHz, increasing to 1 division at maximum trigger bandwidth
AC Noise-Reject Coupled	1.2 divisions from 60 Hz to 10 MHz, increasing to 3 divisions at maximum trigger bandwidth
AC High-Freq. Reject Coupled	0.5 division from 60 Hz to 30 kHz.
AC Low-Freq. Reject Coupled	0.5 division from 80 kHz to 10 MHz, increasing to 1 division at maximum trigger bandwidth
Maximum trigger bandwidth	Equals selected plug-in bandwidth up to 1 GHz, 500 MHz with Extended Triggering
Main holdoff	Minimum 2 μ s holdoff
Window holdoff	Minimum 35 ns holdoff
Boolean trigger Minimum TRUE time	The Boolean trigger function must remain TRUE a minimum of 2 ns in order to be recognized
Minimum FALSE time	2 ns prior to being recognized

Specifications

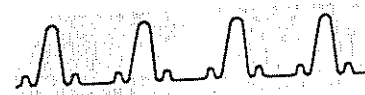

Display Specifications

Characteristic	Specification
CRT	10 inch diagonal, color, magnetic deflection. Nominal screen size 168 mm (6.6 inch) vertical by 130 mm (5.1 inch) horizontal
Video resolution	704 pixel vertical by 552 pixel horizontal
Character display	44 lines of 55 characters
Character height	Minimum 2.6mm (upper case)
Character cell	16 pixel vertical by 10 pixel horizontal

AC Line Power Specifications

Characteristic	Specification
Voltage Ranges	90 to 132 V rms or 180 to 250 V rms Voltage ranges apply for waveform distortion, which reduces peak line voltage 5% or less
Frequency	48 Hz to 72 Hz
Power	
DSA 601A	465 W
DSA 602A	585 W
Maximum Line Current	
DSA 601A	8 A rms at 50 Hz, 90 V line
DSA 602A	9.5 A rms at 50 Hz, 90 V line
Fuse Rating	12 A, 250 V slow blow

Specifications

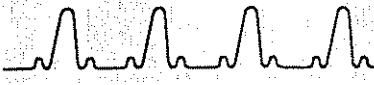

Mainframe Environmental Specifications

Characteristic	Specification
Temperature	Meets MIL-T-28800C, Type III, Class 5, tested per paragraphs 4.5.5.1.3 and 4.5.5.1.4
Operating	0°C to 45°C
Non-operating	-40°C to +75°C (Possible loss of nonvolatile memory and clock information below -40°C)
Humidity	Exceeds MIL-T-28800C, Type III, Class 5, tested per paragraph 4.5.5.1.2.2 Up to 95% relative humidity, at up to 45°C
Altitude	Meets MIL-T-28800C, Type III, Class 5
Operating	Up to 4.5 km (15,000 ft)
Non-operating	Up to 15 km (50,000 ft)
Vibration	Operating, plug-in units not installed: meets MIL-T-28800C, Section 4.5.5.3.1, Type III, Class 5
Shock	Non-operating, plug-in units not installed: meets MIL-T-28800C, Section 4.5.5.4.1, Type III, Class 5, Equipment not operating
Bench handling	Operating: meets MIL-T-28800C, Type III, Section 4.5.5.4.3, Class 5
Packaged product vibration and bounce	Packaged product, plug-in units not installed: meets ASTM D99-75, Method A, Para 5 (NSTA Proj. 1A-B-1)

Specifications

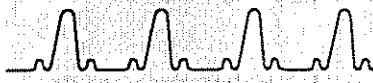

Disk Drive Environmental Specifications

UNCLASSIFIED//FOR OFFICIAL USE ONLY

Characteristic	Specification
Operating, performing R/W operations. Atmospheric constraints imposed by media.	20% humidity +4°C to +50°C.
	80% humidity +4°C to +30°C.
Non-operating	5% humidity -40°C to +65°C.
	95% humidity -40°C to +42°C.
Altitude	
Operating	To 15,000 feet. Maximum operating temperature decreases 1°C for each 1000 feet above 5000 feet.
Non-operating	To 50,000 feet.

Appendix C:

Acquisition Operation



Two 8-bit digitizers in the DSA 601A allow simultaneous, 500 MS/s, single-shot acquisition from two channels; or you can elect to interleave the digitizers to achieve a 1 GS/s sample rate from one channel (see figure on page 320).

Interleaving can be enabled from the Horizontal Description pop-up menu. When interleaving is active, the input signal path is internally shared between the digitizers. The clock for each digitizer is skewed by 1/2 the sample rate so that the input signal can be sampled every nanosecond.

The DSA 602A has four 8-bit digitizers capable of 500 MS/s simultaneous single-shot acquisition from four channels, 1 GS/s from two channels, or, with digitizer interleaving enabled, 2 GS/s from one channel (see figure on page 320).

Actual real-time sample intervals for each channel are internally determined based upon a number of factors – the location and number of active plug-in channels (see figure on page 321), the record length and the sweep rate (see the table beginning on page 322), and the pre-trigger conditions – but will always be an integer multiple of 1 ns in the DSA 601A, or 500 ps in the DSA 602A.

For each channel being acquired, one Main and two Window records may be acquired (Main and Window Records in the DSA 600A Series is similar to Main Sweep and Delayed Sweep acquisitions in analog oscilloscopes). Window records provide enhanced detail in areas of interest on the Main waveform.

1 GHz system bandwidth (available with the 11A71 and 11A72 plug-ins) captures frequency content up to Nyquist. Both main-frames are equipped with an anti-alias filter to prevent the inclusion of high frequency information into low frequency data.

Acquisition Operation

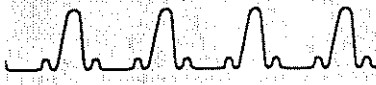

DSA 601A

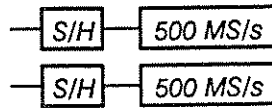

DSA 602A

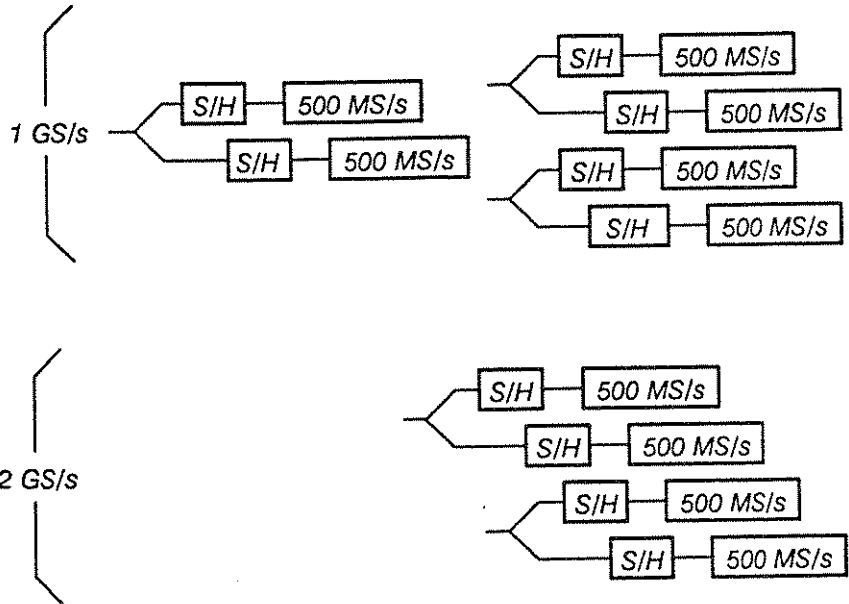
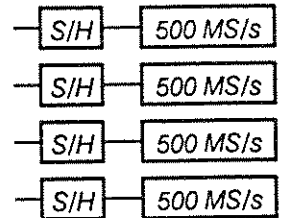

Digitizer interleaving allows for 1 GS/s maximum sample rate in the DSA 601A and 2 GS/s in the DSA 602A



DSA 601A

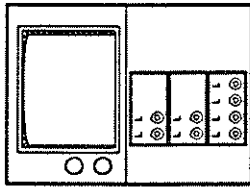

Four Channel Concurrent Acquisition (Not Available*)

*Except at Sample Rates 200 S/s and Slower.

DSA 602A

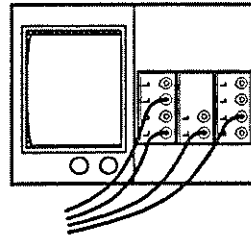

Four Channel Concurrent Acquisition at up to 500 MS/s

Use any two channels from the left plug-in, plus any one channel from the center plug-in, plus any one channel from the right plug-in.

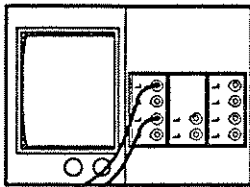

Two Channel Concurrent Acquisition at up to 500 MS/s

Use any two channels from the left plug-in,

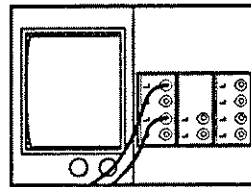

Two Channel Concurrent Acquisition at up to 1 GS/s

Use any two channels from the left plug-in,

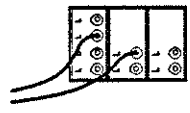

or any one channel from the left plug-in, plus any one channel from the center plug-in,

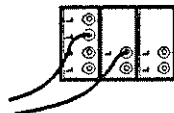

or any one channel from the left plug-in, plus any one channel from the center plug-in,

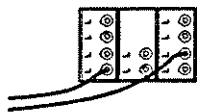

or any one channel from the left plug-in, plus any one channel from the right plug-in,

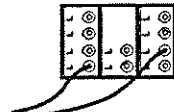

or any one channel from the left plug-in, plus any one channel from the right plug-in,

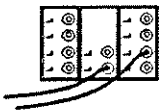

or any one channel from the center plug-in, plus any one channel from the right plug-in.

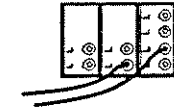

or any one channel from the center plug-in, plus any one channel from the right plug-in.

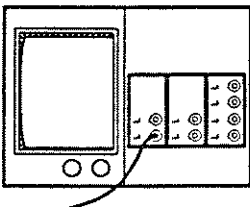

Single Channel Acquisition at up to 1 GS/s

Use any one channel from the left plug-in.

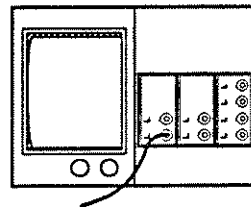

Single Channel Acquisition at up to 2 GS/s

Use any one channel from the left plug-in.

Channel Locations for Real-Time Acquisition

Acquisition Operation



Resultant Sampling Rates Based on Record Length and Sweep Speed

Sweep Speed	512	1024	2048	4096*	5120
100.0 s/div	500.0 mS	1.0 S	2.0 S	5.0 S	5.0 S
50.0 s/div	1.0 S	2.0 S	4.0 S	10.0 S	10.0 S
20.0 s/div	2.5 S	5.0 S	10.0 S	25.0 S	25.0 S
10.0 s/div	5.0 S	10.0 S	20.0 S	50.0 S	50.0 S
5.0 s/div	10.0 S	20.0 S	40.0 S	100.0 S	100.0 S
2.0 s/div	25.0 S	50.0 S	100.0 S	250.0 S	250.0 S
1.0 s/div	50.0 S	100.0 S	200.0 S	500.0 S	500.0 S
500.0 ms/div	100.0 S	200.0 MS	400.0 S	1.0 kS	1.0 kS
200.0 ms/div	250.0 S	500.0 MS	1.0 kS	2.5 kS	2.5 kS
100.0 ms/div	500.0 S	1.0 kS	2.0 kS	5.0 kS	5.0 kS
50.0 ms/div	1.0 kS	2.0 kS	4.0 kS	10.0 kS	10.0 kS
20.0 ms/div	2.5 kS	5.0 kS	10.0 kS	25.0 kS	25.0 kS
10.0 ms/div	5.0 kS	10.0 kS	20.0 kS	50.0 kS	50.0 kS
5.0 ms/div	10.0 kS	20.0 kS	40.0 kS	100.0 kS	100.0 kS
2.0 ms/div	25.0 kS	50.0 kS	100.0 kS	250.0 kS	250.0 kS
1.0 ms/div	50.0 kS	100.0 kS	200.0 kS	500.0 kS	500.0 kS
500.0 μs/div	100.0 kS	200.0 kS	400.0 kS	1.0 MS	1.0 MS
200.0 μs/div	250.0 kS	500.0 kS	1.0 MS	2.5 MS	2.5 MS
100.0 μs/div	500.0 kS	1.0 MS	2.0 MS	5.0 MS	5.0 MS
50.0 μs/div	1.0 MS	2.0 MS	4.0 MS	10.0 MS	10.0 MS
40.0 μs/div	—	—	—	—	—
20.0 μs/div	2.5 MS	5.0 MS	10.0 MS	25.0 MS	25.0 MS
10.0 μs/div	5.0 MS	10.0 MS	20.0 MS	50.0 MS	50.0 MS
8.0 μs/div	—	—	—	—	—
5.0 μs/div	10.0 MS	20.0 MS	—	100.0 MS	100.0 MS
4.0 μs/div	—	—	50.0 MS	—	—
2.5 μs/div	—	—	—	—	—
2.0 μs/div	25.0 MS	50.0 MS	100.0 MS	250.0 MS	250.0 MS
1.0 μs/div	50.0 MS	100.0 MS	—	500.0 MS	500.0 MS





Resultant Sampling Rates Based on Record Length and Sweep Speed

Sweep Speed	512	1024	2048	4096*	5120
800.0 ns/div	—	—	250.0 MS	—	—
500.0 ns/div	100.0 MS	—	—	1.0 GS	1.0 GS
400.0 ns/div	—	250.0 MS	500.0 MS	—	—
250.0 ns/div	—	—	—	2.0 GS	2.0 GS
200.0 ns/div	250.0 MS	500.0 MS	1.0 GS	—	—
100.0 ns/div	500.0 MS	1.0 GS	2.0 GS	5.0 GS	5.0 GS
50.0 ns/div	1.0 GS	2.0 GS	4.0 GS	10.0 GS	10.0 GS
25.0 ns/div	2.0 GS	—	—	—	—
20.0 ns/div	—	5.0 GS	10.0 GS	25.0 GS	25.0 GS
10.0 ns/div	5.0 GS	10.0 GS	20.0 GS	50.0 GS	50.0 GS
5.0 ns/div	10.0 GS	20.0 GS	40.0 GS	100.0 GS	100.0 GS
4.0 ns/div	—	—	—	—	—
2.0 ns/div	25.0 GS	50.0 GS	100.0 GS	250.0 GS	250.0 GS
1.0 ns/div	50.0 GS	100.0 GS	200.0 GS	500.0 GS	500.0 GS
500.0 ps/div	100.0 GS	200.0 GS	—	1.0 TS	1.0 TS
400.0 ps/div	—	—	500.0 GS	—	—
200.0 ps/div	250.0 GS	500.0 GS	1.0 TS	—	—
100.0 ps/div	500.0 GS	1.0 TS	—	—	—
50.0 ps/div	1.0 TS	—	—	—	—

*These record lengths do not extend over the full ten divisions. They are limited to approximately 8 divisions, with the exception of the 32,768 record length which is 6.4 divisions.

Real-time Sampling

 DSA 601A — 1 to 2 channels;
 DSA 602A — 1 to 4 channels;
 DSA 601A, 3+ channels, and DSA 602A, 5+ channels, are acquired in real time by alternating between channels.

 DSA 601A — 1 channel;
 DSA 602A — 1 to 2 channels

 DSA 602A — 1 channel.

Equivalent-time Sampling

 DSA 601A or DSA 602A — when 1 or more channels are in equivalent time.

Acquisition Operation

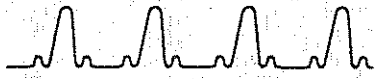

Resultant Sampling Rates Based on Record Length and Sweep Speed

Sweep Speed	8192*	10240	16384*	20480	32768*
100.0 s/div	10.0 S	10.0 S	20.0 S	20.0 S	50.0 S
50.0 s/div	20.0 S	20.0 S	40.0 S	40.0 S	100.0 S
20.0 s/div	50.0 S	50.0 S	100.0 S	100.0 S	250.0 S
10.0 s/div	100.0 S	100.0 S	200.0 S	200.0 S	500.0 S
5.0 s/div	200.0 S	200.0 S	400.0 S	400.0 S	1.0 kS
2.0 s/div	500.0 S	500.0 S	1.0 kS	1.0 kS	2.5 kS
1.0 s/div	1.0 kS	1.0 kS	2.0 kS	2.0 kS	5.0 kS
500.0 ms/div	2.0 kS	2.0 kS	4.0 kS	4.0 kS	10.0 kS
200.0 ms/div	5.0 kS	5.0 kS	10.0 kS	10.0 kS	25.0 kS
100.0 ms/div	10.0 kS	10.0 kS	20.0 kS	20.0 kS	50.0 kS
50.0 ms/div	20.0 kS	20.0 kS	40.0 kS	40.0 kS	100.0 kS
20.0 ms/div	50.0 kS	50.0 kS	100.0 kS	100.0 kS	250.0 kS
10.0 ms/div	100.0 kS	100.0 kS	200.0 kS	200.0 kS	500.0 kS
5.0 ms/div	200.0 kS	200.0 kS	400.0 kS	400.0 kS	1.0 MS
2.0 ms/div	500.0 kS	500.0 kS	1.0 MS	1.0 MS	2.5 MS
1.0 ms/div	1.0 MS	1.0 MS	2.0 MS	2.0 MS	5.0 MS
500.0 μs/div	2.0 MS	2.0 MS	4.0 MS	4.0 MS	10.0 MS
200.0 μs/div	5.0 MS	5.0 MS	10.0 MS	10.0 MS	25.0 MS
100.0 μs/div	10.0 MS	10.0 MS	20.0 MS	20.0 MS	50.0 MS
50.0 μs/div	20.0 MS	20.0 MS	—	—	100.0 MS
40.0 μs/div	—	—	50.0 MS	50.0 MS	—
20.0 μs/div	50.0 MS	50.0 MS	100.0 MS	100.0 MS	250.0 MS
10.0 μs/div	100.0 MS	100.0 MS	—	—	500.0 MS
8.0 μs/div	—	—	250.0 MS	250.0 MS	—
5.0 μs/div	—	—	—	—	1.0 GS
4.0 μs/div	250.0 MS	250.0 MS	500.0 MS	500.0 MS	—
2.5 μs/div	—	—	—	—	2.0 GS
2.0 μs/div	500.0 MS	500.0 MS	1.0 GS	1.0 GS	—
1.0 μs/div	1.0 GS	1.0 GS	2.0 GS	2.0 GS	5.0 GS



Resultant Sampling Rates Based on Record Length and Sweep Speed

Sweep Speed	8192*	10240	16384*	20480	32768*
800.0 ns/div	—	—	—	—	—
500.0 ns/div	2.0 GS	2.0 GS	4.0 GS	4.0 GS	10.0 GS
400.0 ns/div	—	—	—	—	—
250.0 ns/div	—	—	—	—	—
200.0 ns/div	5.0 GS	5.0 GS	10.0 GS	10.0 GS	25.0 GS
100.0 ns/div	10.0 GS	10.0 GS	20.0 GS	20.0 GS	50.0 GS
50.0 ns/div	20.0 GS	20.0 GS	40.0 GS	40.0 GS	100.0 GS
25.0 ns/div	—	—	—	—	—
20.0 ns/div	50.0 GS	50.0 GS	100.0 GS	100.0 GS	250.0 GS
10.0 ns/div	100.0 GS	100.0 GS	200.0 GS	200.0 GS	500.0 GS
5.0 ns/div	200.0 GS	200.0 GS	—	—	1.0 TS
4.0 ns/div	—	—	500.0 GS	500.0 GS	—
2.0 ns/div	500.0 GS	500.0 GS	1.0 TS	1.0 TS	—
1.0 ns/div	1.0 TS	1.0 TS	—	—	—
500.0 ps/div	—	—	—	—	—
400.0 ps/div	—	—	—	—	—
200.0 ps/div	—	—	—	—	—
100.0 ps/div	—	—	—	—	—
50.0 ps/div	—	—	—	—	—

*These record lengths do not extend over the full ten divisions. They are limited to approximately 8 divisions, with the exception of the 32,768 record length which is 6.4 divisions.

Real-time Sampling

DSA 601A — 1 to 2 channels;
 DSA 602A — 1 to 4 channels;
 DSA 601A, 3+ channels, and DSA 602A, 5+ channels, are acquired in real time by alternating between channels.

DSA 601A — 1 channel;
 DSA 602A — 1 to 2 channels

DSA 602A — 1 channel.

Equivalent-time Sampling

DSA 601A or DSA 602A — when 1 or more channels are in equivalent time.

Acquisition Operation

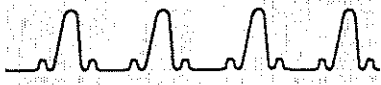

Record Length

Record Length is selectable from 512 to 32,768 points, providing the ability to capture and analyze long, single-shot or repetitive events in all their detail.

To make the most of the capabilities of the DSA 600A Series, Option 4C—Non-Volatile RAM—provides more than 450,000 points of storage, enough memory for the most demanding applications. NVRAM stores waveform data when the DSA 600A is turned off or when there is a power failure.

Single-Shot Acquisition

	DSA 601A		DSA 602A		
Sample Rate	500 MS/s	1 GS/s	500 MS/s	1 GS/s	2 GS/s
Number of Channels	2	1	4	2	1
Time Resolution	2 ns	1 ns	2 ns	1 ns	500 ps
Record Length	512 to 10K pts	512 to 20K pts	512 to 10K pts	512 to 20K pts	512 to 32K pts



Repetitive Single-Shot Acquisition

Repetitive Single-Shot Acquisition lets the user **automatically** capture, store, label, and time and date stamp a waveform; re-arm the trigger; and then repeat this process up to 918 times¹.

Any number of repetitions, from 1 to 918, can be selected, depending on the record length.

The average repetition rate is up to 150 waveforms per second for a 512 point record length. The repetition rate is reduced for longer record lengths and slow sample rates (see the chart below).

Coupled with the DSA 600A Series' Extended Trigger capabilities, the Repetitive Single-Shot Acquisition feature is a powerful tool for selectively capturing anomalous events within repetitive signals. This feature also makes it easy to store acquired waveforms for later examination using the Stored Waveform Scan capability.

Repetition Rates for Repetitive Single-Shot Acquisition

Record Length (points)	Average Number of Waveforms Stored per Second Number of Active Channels			
	1	2	3	4
512	150	95	70	57
1024	110	64	51	38
2048	76	45	31	24
4096	48	26	18	14
5120	40	22	15	12
8192	28	15	10	8
10240	23	12	8	6
16384	14	8	NA	NA
20464	12	7	NA	NA
32768	8	NA	NA	NA

¹Option 4C is required to obtain the maximum number of waveforms in the Repetitive Single acquisition mode.

Acquisition Operation



Fast Data Transfer

The ASCII command, REPCURVE, does repetitive single-shot acquisitions (as is done with repetitive single-shot) and transfers each acquisition over the bus at a rate of approximately 100 waveforms per second. See Chart B for actual transfer rates for multiple waveforms and various record lengths.

Acquisition and Transfer Rates Using the REPCURVE Command

Record Length (points)	Average Number of Waveforms Transferred per Second Number of Active Channels			
	1	2	3	4
512	120.8	60.3	39.2	29.4
1024	78.7	38.1	24.9	19.0
2048	46.5	23.2	15.5	11.6
4096	25.2	12.7	8.4	6.3
5120	20.9	10.4	6.9	5.2
8192	13.3	6.6	4.4	3.3
10240	10.9	5.4	3.6	2.7
16384	6.6	3.3	NA	NA
20464	5.5	2.72	NA	NA
32768	3.4	NA	NA	NA

Summation Averaging: Averages per Second

Record Length	Realtime Sample Rate		
	500 MS/s	1 GS/s	2 GS/s
512	165	130	110
1024	130	105	90
2048	90	80	70
4096	55	50	50
8192	30	30	30
10240	25	25	25
16384	NA	17	17
20464	NA	15	15
32768	NA	NA	9



Backweighted Averaging: Averages per Second

RECORD LENGTH (BYTES) 512 1024 2048 4096 8192 10240 16384 20464 32768

Realtime Sample Rate

Record Length	500 MS/s	1 GS/s	2 GS/s
512	170	135	110
1024	135	110	95
2048	95	85	75
4096	60	55	50
8192	35	30	30
10240	30	25	25
16384	NA	19	19
20464	NA	15	15
32768	NA	NA	10

Acquisition Operation

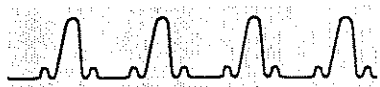

Appendix D: Algorithms

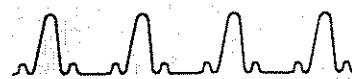

Digitized waveforms are a sequence of samples stored as 16-bit signed integers. The samples are numbered from 0 through the waveform record length less one; a 512-point waveform record numbers samples from 0 through 511.

Three sample values represent invalid data points:

- The value $-32,768$ (8000_{hex}) represents *null*, an unacquired data point. A waveform that is defined but has never been acquired contains null values. Clearing a waveform fills it with null values.
- The value $-32,767$ (8001_{hex}) represents a data value below the dynamic range of the digitizer. This is called *underrange*. Underrange values do not appear on a displayed waveform.
- The value $+32,767$ ($7FFF_{hex}$) represents a data value above the dynamic range of the digitizer. This is called *overrange*. Overage values do not appear on a displayed waveform.

When a waveform function encounters one of these three data values, it passes the invalid data value as its output. When a measurement encounters one of these three data values, the measurement is qualified by \leq , \geq , $?$, or noted as an error. There are exceptions to these rules, as noted below. All waveform functions assume that the waveform record contains data other than these three values, unless specifically noted.

Algorithms

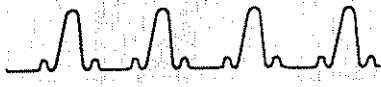

Waveform Functions

Absolute Value

$$Abs(w(n)) = w(n)$$

$$\text{for } w(n) \geq 0$$

$$Abs(w(n)) = -w(n)$$

$$\text{for } w(n) < 0$$

where:

n = index into the record of data points

$w(n)$ = input sampled data point

Average

$$Avg_p(w(n)) = w(n)$$

$$\text{for } p = 1$$

$$Avg_p(w(n)) = Avg_{p-1}(w(n)) + \frac{w(n) - Avg_{p-1}(w(n))}{p}$$

$$\text{for } 1 < p < P$$

$$Avg_p(w(n)) = Avg_{p-1}(w(n)) + \frac{w(n) - Avg_{p-1}(w(n))}{P}$$

$$\text{for } p \geq P$$

where:

n = index into record of data points

$w(n)$ = input sampled data point

p = record number

P = total number of waveform records specified for average



Convolution

The DSA convolves two time domain waveforms by multiplying their FFT transforms and then returning to the time domain by applying the inverse FFT to the complex product.

$$X_1(k) = FFT(x_1(n))$$

$$X_2(k) = FFT(x_2(n))$$

where:

FFT is the forward Fourier transform.

$$x(n) = Re\{IFFT(X_1(k) \times X_2(k))\}$$

where:

IFFT is the inverse Fourier transform.

The *Convolve(WFMA, WFMb)* function performs non-circular convolution between the two waveforms. The correlation is done in fixed-point math, discarding any plug-in offset the waveforms may have had. In other words, the convolution is done using the waveforms as they appear on the screen, assuming that 0 volts is at the center of the screen vertically.

Both waveforms are required to have the same record length, and since a radix-2 FFT is used, the record length must be a power of 2. Rectangular windowing is used, and the waveforms are padded with zeros to twice their true length before the FFTs are performed. The result of the convolution function will thus be the sum of the input lengths.

Note that although the FFT is used, the **FFT Control** pop-up menu selections are ignored by this function. The DSA 600A performs the computation assuming both waveforms were acquired at the same sample rate, so care should be taken when using stored waveforms.

Algorithms



Since convolution is the area of the product of the two waveforms being shifted, computation takes into account the time per division in order to compute the area. Thus, to get a DC gain of 1, the area under the filter must sum to 1 for the time per division being used. Note that convolution isn't really being done from +infinity to -infinity, therefore, there will be some end-of-waveform effects.

Correlation

The DSA performs the correlation of two waveforms in several steps. First it computes the FFT transforms of the two input sequences.

$$X_1(k) = FFT(x_1(n))$$

$$X_2(k) = FFT(x_2(n))$$

where:

FFT is the forward Fourier transform.

Next, the complex product, $X_1(k) \times X_2^*(k)$ is computed,

where $X_2^*(k)$ is the complex conjugate of $X_2(k)$.

Finally the resulting output waveform is obtained by extracting the real part of the inverse FFT on $X_1(k) \times X_2^*(k)$.

$$x(n) = Re\{IFFT(X_1(k) \times X_2^*(k))\}$$

The *Correlat(WFMa,WFMb)* function performs a normalized correlation between the two waveform parameters. The correlation is done in fixed-point math, discarding any plug-in offset the waveforms may have had. In other words, the correlation is done using the waveforms as they appear on the screen, assuming that 0 volts is at the center of the screen vertically.

Algorithms



Both waveforms are required to have the same record length, and since a radix-2 FFT is used, the record length must be a power of 2. Rectangular windowing is used, and the waveforms are padded with zeros to twice their true length before the FFTs are performed. The result of the correlation function will thus be the sum of the input lengths.

Note that although the FFT is used, the **FFT Control** pop-up menu selections are ignored by this function.

Algorithms



Dejitter

To perform the dejitter function, the DSA chooses a reference edge on the first acquisition of a waveform. This reference edge is found within the first $\frac{3}{4}$ of the waveform record, excluding the first $\frac{1}{8}$ of the record. On all subsequent acquisitions of the waveform, the DSA attempts to line up the appropriate edge of the waveform with the reference edge.

Edges are lined up to within a minimum tolerance that is determined by second argument (a number between 0 and 9) to the dejitter function. The smaller the number, the smaller the acceptable variation will be.

Delay

$$\text{Delay } (w(n), d) = w(n + d)$$

$w(n)$ = input waveform

d = record number

The waveform boundary points are extensions of the end points of the source waveform. The reference for delay is the first point of the acquired waveforms, that is, the left edge of the screen.

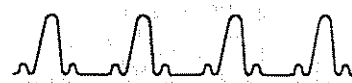
**Differentiate**

$$\text{Diff}(w(n)) = 0$$

for $n = 0$

$$\text{Diff}(w(n)) = [w(n+1) - w(n-1)] / (2T)$$

for $1 \leq n \leq (R-1)$

$$\text{Diff}(w(n)) = [w(R-1) - w(R-2)] / T$$

for $n = (R-1)$

where:

n = index into the record of data points

$w(n)$ = input sampled data point

T = time interval between successive samples

R = record length

Algorithms



Envelope

$$Env_p(w(n)) = \text{null}$$

$$\text{for } p = 0$$

$$Env_p(w(n)) = \text{Minimum of } [Env_{p-1}(w(n)), w(n-1), w(n)]$$

$$\text{for } p > 0 \text{ and } n \text{ odd}(1, 3, 5, \dots, R-2)$$

$$Env_p(w(n)) = \text{Maximum of } [Env_{p-1}(w(n)), w(n), w(n+1)]$$

$$\text{for } p > 0 \text{ and } n \text{ even}(2, 4, 6, \dots, R-1)$$

where:

n = index into record of data points

$w(n)$ = input sampled data point

p = record number

R = record length

P , the total number of records specified for enveloping, is used only to determine completion for conditional acquisition, when acquisition is stopped on envelope complete.

Exponential

$$Exp(w(n)) = e^{w(n)}$$

where:

n = index into record of data points

$w(n)$ = input sampled data point

This function is implemented by a polynomial series approximation in the waveform processor.

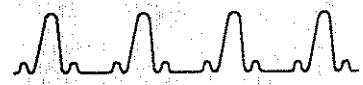

Fast Fourier Transform

The DSA computes an integer radix-2 FFT of a complex sequence:

$$x(n) = w(n) + jb(n)$$

where

$w(n)$ = the time-domain waveform point

$b(n) = 0$

$X(k)$, the complex sequence representing the Discrete Fourier Transform of the sequence $x(n)$, is computed as:

$$X(k) = \frac{1}{R} \sum_{n=0}^{R-1} x(n) \times W_R^{k \times n}$$

$$\text{for } k = [0 \dots R-1]$$

where

R , the record length, is a power of 2

$$W_R = e^{-j\frac{2\pi}{R}}$$

The linear magnitude ($FFTmag$) and the phase ($FFTphase$) of the FFT are computed as:

$$FFTmag(k) = \sqrt{A(k)^2 + B(k)^2}$$

$$FFTphase(k) = \arctan\left(\frac{B(k)}{A(k)}\right)$$

where

$A(k)$ = real part of $X(k)$

$B(k)$ = imaginary part of $X(k)$

The magnitude and phase for negative frequencies are discarded, and linear interpolation is used to expand the positive frequencies to fill the entire record length.

Algorithms

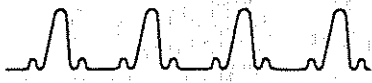

The magnitude of the frequency spectrum in decibels is given as:

$$FFTmag_{dB}(k) = 20 \log(FFTmag(k))$$

where the 0 dBm point is defined as the sine wave of 0.316 V peak (0.224 V rms), which gives 1.0 mW into 50 Ω .

Filter

Applies the Smooth function to a trace two times. The filter function has two arguments. The first argument is the trace to be filtered; the second argument is a rise time. Each time Filter is evaluated, the record length, time per division, and the specified rise time are used to calculate the number of dots to be used in the smoothing algorithm.

$$Filter(w(n)) = Smooth(Smooth(w(n)))$$

where:

$$Smooth(w(n)) = (1/s) \left[\sum_{m=0}^{n+h} w(m) + (h-n) \times w(0) \right]$$

for $n < h$

$$Smooth(w(n)) = (1/s) \left[\sum_{m=n-h}^{n+h} w(m) \right]$$

for $h \leq n \leq R-1-h$

$$Smooth(w(n)) = (1/s) \left[\sum_{m=n-h}^{R-1} w(m) + (M-1-n) \times w(M-1) \right]$$

for $l > M-1-h$

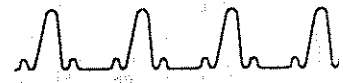

where

n = index into record of data points
 $w(n)$ = input sampled data points
 s = smoothing interval = Round (sf)

$$sf = \frac{\text{risetime}}{(\text{time per dot}) \times 1.10557}$$

risetime = the second argument to Filter

where

$\text{risetime} > 4$ ps and < 1000 s
 h = half interval: $(s - 1)/2$ rounded up
 R = record length in points

The smoothed trace is derived by computing the average value of the corresponding point of the original trace and some number of points of the original trace on either side of the corresponding point. The number of points on either side is derived from the smoothing interval, the second argument of the Smooth function. Near the ends of the trace, nonexistent points beyond the ends of the trace are required for averaging. The nonexistent points are assumed to be the value of the corresponding end points. This method of extending the trace is arbitrary, so the results within a smoothing interval of the ends of the trace must be interpreted accordingly.

FFT Real and FFT IMAG

These functions extract the real and imaginary parts of the complex fast Fourier transform.

$$FFTreal(w(n)) = Re \{FFT(w(n))\};$$

$$FFTimag(w(n)) = Im \{FFT(w(n))\}.$$

The DSA compensates for the loss of energy due to FFT windowing functions. The resulting FFT output is multiplied by the inverse of the coherent gain of the window. However, if performing an IFFT on the real and imaginary components created with one

Algorithms

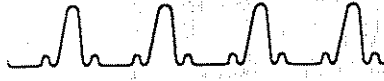

window while using another window, the correction will not work right and the resulting scale of the IFFT output will be wrong.

FFT Windowing Functions

The selected FFT windowing function is applied to the time-domain waveform before the FFT is computed. The FFT windowing functions are as follows:

Blackman
$$x(n) = 0.42 - 0.5 \cos(2\pi n/N) + 0.08 \cos(4\pi n/N)$$

for $n = 0, \dots, N-1$

Blackman-Harris
$$x(n) = 0.35875 - 0.48829 \cos(2\pi n/N) + 0.14128 \cos\left(\frac{4\pi n}{N}\right) - 0.01168 \cos(6\pi n/N)$$

for $n = 0, \dots, N-1$

Hamming
$$x(n) = 0.54 - 0.46 (1 - \cos 2\pi n/N)$$

for $n = 0, \dots, N-1$

Hanning
$$x(n) = 0.5 (1 - \cos 2\pi n/N)$$

for $n = 0, \dots, N-1$

Rectangular
$$x(n) = 1$$

for $n = 0, \dots, N-1$

Triangular
$$x(n) = \frac{2n}{N}$$

for $n = 0, \dots, \frac{N}{2}$
$$x(n) = 2 - \frac{2n}{N}$$

for $n = \frac{N}{2}, \dots, N-1$

where

R = the record length, which must be a power of 2.



The filter characteristics of the FFT windowing functions are summarized in the table below.

Filter Characteristics of FFT Windowing Functions

Windowing Function	Highest Side-lobe (dB)	Noise Band-width (bins)	3 dB Band-width (bins)	6 dB Band-width (bins)	Scallop Loss (dB)	Worst Loss (dB)
Rectangular	-13	1.00	0.89	1.21	3.92	3.92
Triangular	-27	1.33	1.28	1.78	1.82	3.07
Hanning	-32	1.50	1.44	2.00	1.42	3.18
Hamming	-43	1.36	1.30	1.81	1.78	3.10
Blackman	-58	1.73	1.68	2.35	1.10	3.47
Blackman-Harris	-92	2.00	1.90	2.72	0.83	3.85

These numbers are taken from a table in Frederic J Harris: *Handbook of Digital Signal Processing*, edited by Douglas F. Elliot, Academic Press, San Diego, 1987, pp. 254-255.

where

bins refers to the frequency bins, the even-numbered points in the FFT waveform

highest sidelobe is the minimum stopband attenuation, which indicates how well leakage is blocked.

noise bandwidth is the equivalent noise bandwidth (the width of an equivalent rectangular spectral response that would pass the same noise power as this windowing function).

3 dB bandwidth and **6 dB bandwidth** apply to the major lobe. These affect the frequency resolution.

scallop loss is the attenuation of the windowing function at the odd-numbered (interpolated) points in the FFT waveform.

worst loss is the worst-case processing loss (the sum of the scallop loss and the equivalent noise bandwidth, in dB.)

Algorithms



Integrate

$$\text{Intg}(w(n)) = 0$$

for $n = 0$

$$\text{Intg}(w(n)) = \left[1/2 w(0) + \sum_{m=1}^{n-1} w(m) + 1/2 w(n) \right] \times T$$

for $1 \leq n \leq R$

where:

n = index into record of data points

$w(n)$ = input sampled data point

T = time interval between successive samples

R = record length in points

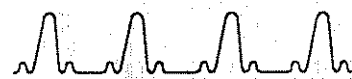

Interpolate

$$\text{Intp}(w(n)) = w(l) + \left[\frac{w(r) - w(l)}{r - l} \right] \times (n - l)$$

for all n ; $l \geq 0$ and $r \leq R-1$

$$\text{Intp}(w(n)) = w(r)$$

for all n ; $l < 0$ and $r \leq R-1$

$$\text{Intp}(w(n)) = w(l)$$

for all n ; $l \geq 0$ and $r > R-1$

$$\text{Intp}(w(n)) = w(n)$$

otherwise

where

n = index into record of data points

$w(n)$ = input sampled data point

R = record length in points

l = index of the acquired data point preceding the unacquired data

r = index of the acquired data point following the unacquired data

Inverse Fourier Transform

Given the two waveform parameters of the IFFT function $x_1(n)$ and $x_2(n)$, the algorithm will compute the inverse fourier transform of the complex sequence $x_1(n) + jx_2(n)$.

$$X(n) = \sum_{k=0}^{R-1} [x_1(k) + jx_2(k)] W_R^{-n \times k}$$

Algorithms

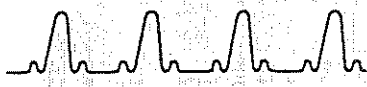

$X(n)$ itself is a complex sequence and the resulting waveform output, $x(n)$ is:

$$x(n) = \text{Re}\{X(n)\}$$

$W_R = e^{-j \frac{2\pi n}{R}}$, where R is the record length, a power of 2.

Note that the $1/R$ scaling factor which could be applied either to the forward or inverse FFT transformation, is used in the first one. A second note is on the use of FFT windowing function. The scale of the FFT output was adjusted to compensate for the loss of energy due to FFT windowing functions. When performing the IFFT, the user must use the same type of windowing function in order to get a correct factor for the resulting waveform.

Logarithm

$$\text{Log}(w(n)) = \log_{10}(w(n))$$

where:

n = index into record of data points
 $w(n)$ = input sampled data point

This function is implemented by a polynomial series approximation in the waveform processor.

Natural Logarithm

$$\text{Ln}(w(n)) = \log_e(w(n))$$

where:

n = index into record of data points
 $w(n)$ = input sampled data point

This function is implemented by a polynomial series approximation in the waveform processor.

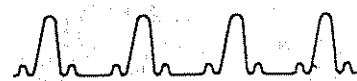

Pulse

The pulse function is defined as:

$$\begin{aligned} \text{Pulse}(t_1, t_2) &= 0 \\ &\text{for } nT < t_1 \text{ and } nT > t_1 + t_2 \end{aligned}$$

$$\begin{aligned} \text{Pulse}(t_1, t_2) &= 1 \\ &\text{for } t_1 < nT < t_1 + t_2 \end{aligned}$$

where T is the sample interval, t_1 is the pulse delay and t_2 the width of the pulse, in time units. The time reference for the pulse is the first point of the acquired waveform, that is the left edge of the screen.

Signum

$$\text{Signum}(w(n)) = 1$$

$$\text{for } w(n) > 0$$

$$\text{Signum}(w(n)) = 0$$

$$\text{for } w(n) = 0$$

$$\text{Signum}(w(n)) = -1$$

$$\text{for } w(n) < 0$$

where:

n = index into record of data points

$w(n)$ = input sampled data point

Algorithms

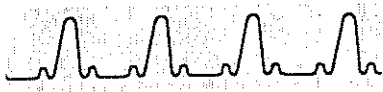

Smooth

$$\text{Smooth}(w(n)) = (1/s) \left[\sum_{m=0}^{n+h} w(m) + (h-n) \times w(0) \right]$$

for $n < h$

$$\text{Smooth}(w(n)) = (1/s) \left[\sum_{m=n-h}^{n+h} w(m) \right]$$

for $h \leq n \leq R-1-h$

$$\text{Smooth}(w(n)) = (1/s) \left[\sum_{m=n-h}^{R-1} w(m) + (R-1-n) \times w(R-1) \right]$$

for $n > R-1-h$

where:

n = index into record of data points

$w(n)$ = input sampled data point

s = smoothing interval in samples; the second argument

h = half interval: $(s - 1)/2$ rounded down

R = record length in points

The smoothed waveform is derived by computing the average value of the corresponding point of the original waveform and some number of points of the original waveform on either side of the corresponding point. The number of points on either side is derived from the smoothing interval, the second argument of the Smooth function.

Near the ends of the waveform, nonexistent points beyond the ends of the waveform are required for averaging. The nonexistent points are assumed to be the value of the corresponding end points. This method of extending the waveform is arbitrary, so the results within a smoothing interval of the ends of the waveform must be interpreted accordingly.



Smoothing results in a bandwidth reduction which is a function of the effective sample interval, T , and the number of points smoothed, s .

$$BW_{-3\text{ dB}} = \frac{1}{2.26 \times s \times T}$$

Square Root

$$\text{Sqrt}(w(n)) = (w(n))^{1/2}$$

where:

n = index into record of data points

$w(n)$ = input sampled data point

This function is implemented by a polynomial series approximation in the waveform processor.

Interpolation

Prefilter for Pan/Zoom Sinx/x Interpolation

In case of very fast rising edge signals, with few acquired points during rise time, the sinc/x interpolation will introduce severe ringing on the interpolated waveform.

In order to minimize this effect, the acquired data which meets the above described criterias, is preprocessed, "prefiltered" by applying the following algorithm.

Analyze six consecutive points p_0, \dots, p_5 , and their five corresponding slopes, s_0, \dots, s_4 .

If slope s_2 is radically different than slopes s_1 and s_3 , and if the curve is much steeper at slope s_2 than the rate of change around p_1 and p_4 would seem to indicate, then move both p_2 and p_3 closer to each other vertically, by applying a correction:

Algorithms

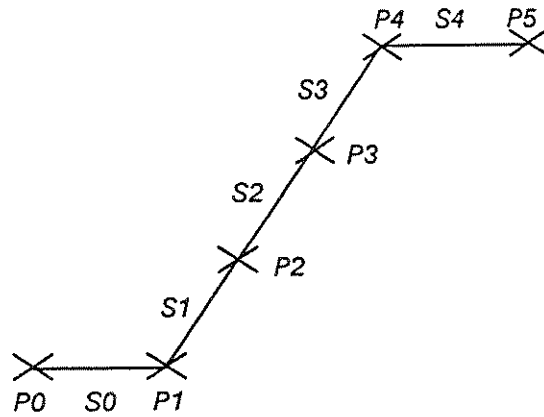

Pan/Zoom Interpolation with Pre-Filter

$$\left. \begin{aligned}
 &\text{if } ((\text{abs}(s1 - s3) + \epsilon) \leq (\text{abs}(s1 + s3 - 2 \times s2))) \\
 &\quad \text{if } (\text{abs}(s0 - s1) \leq (\text{abs}(s2)/4)) \\
 &\quad \quad p2 = p2 - \text{correction} \times s2; \\
 &\quad \text{if } (\text{abs}(s3 - s4) \leq (\text{abs}(s2)/8)) \\
 &\quad \quad p3 = p3 + \text{correction} \times s2;
 \end{aligned} \right\}$$

where

$$\epsilon = 0.390625$$

$$\text{correction} = 0.145$$

have been determined empirically to limit overshoot to 3.5%.

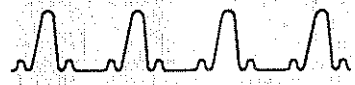

Histogram Statistics

Waveform data is collected in 512 histogram buckets, in the array *histogram[512]*. The total number of samples acquired within the histogram box is *N*.

Peak_Peak Value

START_bucket is the first non-empty entry in the histogram array.
STOP_bucket is the last non-empty entry in the histogram array.

$$Peak_Peak = STOP_bucket - START_bucket + 1$$

Mean value (μ)

The histogram mean value is determined as:

$$\mu = \frac{\sum_{i=START_bucket}^{STOP_bucket} i \times histogram[i]}{N}$$

Standard Deviation (RMS Δ)

The standard deviation of the sample distribution is σ :

$$\sigma = \sqrt{\frac{\sum_{i=START_bucket}^{STOP_bucket} histogram[i] \times (i - \mu)^2}{N - 1}}$$

Sample Distribution ($\mu \pm \alpha\sigma$)

The sample distribution in percentage is:

$$\mu \pm \alpha\sigma[\%] = \frac{\sum_{i=\mu-\sigma}^{\mu+\sigma} histogram[i] \times 100}{N}$$

Algorithms

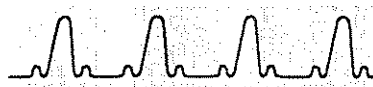

Measurements

Measurements are taken using the measurement parameters. You can directly set many of the measurement parameters, or you can specify that some are to be determined automatically by the DSA. It is common to have the DSA dynamically measure topline and baseline.

You specify automatic topline and baseline positioning by turning tracking to Both in the individual measurement pop-up menus. The mesial level, once the topline and baseline values have been determined, is calculated:

$$mesial = [(m\%/100) \times (topline - baseline)] + baseline$$

where $m\%$ is the percentage of topline to baseline height to use for mesial level. Proximal and distal levels are calculated similarly from percentage levels. These percentage levels are set using the knobs.

When you use tracking, the topline and baseline are determined from a histogram of the waveform, as follows:

1. Create a histogram of the waveform data points. For each possible vertical value, count the number of data points having that value.
2. The largest value that has a non-zero point count is the maximum value.
3. The smallest value that has a non-zero point count is the minimum value.
4. Determine the median value, halfway between the maximum and minimum values.
5. Examine the point counts between the median value and the maximum value, to find the largest point count. If this point count is greater than the *Floor* value (defined below), the value associated with the point count is the topline. If the largest point count is not greater than *Floor*, then the maximum value is used as the topline.

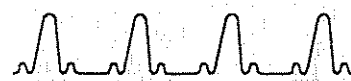

6. Examine the point counts between the median value and the minimum value, to find the largest point count. If this point count is greater than the *Floor* value (defined below), the value associated with the point count is the baseline. If the largest point count is not greater than *Floor*, then the minimum value is used as the baseline.

The *Floor* value is calculated as the maximum of two values, *AVE* and *Correction*, to insure that the topline or baseline calculated is appropriate for the waveform measurement zone.

$$AVE = \frac{2}{n} \sum_{j=1}^n count_j$$

where:

$count_j$ = the j th non-zero point count in the waveform histogram

n = the number of non-zero point counts in the waveform histogram

$$Correction = 8 + MULT \frac{n}{512}$$

where:

n = the number of points in the measurement zone

MULT is determined by signal amplitude:

MULT = 1 for signal amplitude > 7.5 divisions

MULT = 2,

5.0 divisions < signal amplitude < 7.5 divisions

MULT = 3,

2.5 divisions < signal amplitude < 5.0 divisions

MULT = 4,

signal amplitude < 2.5 divisions.

Algorithms

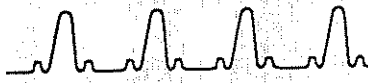

Area+

$$Area+ = \sum_{j=m}^{n-1} \frac{Abs[w(j+1) - R] + ABS[w(j) - R]}{2} \times T$$

where:

- m = index of left-most measurement zone sample
- n = index of right-most measurement zone sample
- $w(j)$ = input sampled data point
- R = reference level measurement parameter
- T = time interval between successive samples
- Abs = the absolute value function

Area-

$$Area- = \sum_{j=m}^{n-1} \frac{[w(j+1) - R] + [w(j) - R]}{2} \times T$$

where:

- m = index of left-most measurement zone sample
- n = index of right-most measurement zone sample
- $w(j)$ = input sampled data point
- R = reference level measurement parameter
- T = time interval between successive samples

Cross

The cross measurement finds the left-most crossing of the reference level of the proper slope that is within the measurement zone. The horizontal position of the crossing point is displayed.

Linear interpolation between vertical points and between time intervals is necessary to determine the crossing time, when the reference level value does not correspond to acquired data.

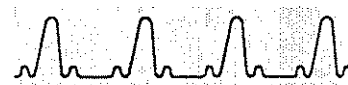

Delay

1. On the selected waveform, search the measurement zone for the left-most mesial crossing. The horizontal position is $Cross_1$.
2. On the same waveform, search the measurement zone for the right-most mesial crossing. The horizontal position is $Cross_2$.
3. Calculate the delay:

$$Delay = Cross_2 - Cross_1$$

Linear interpolation between vertical points and between time intervals is necessary to determine the crossing time, when the mesial value does not correspond to acquired data.

Duty Cycle

1. Calculate the *Period* of the selected waveform (perform a period measurement).
2. Calculate the pulse width of the selected waveform (perform a width measurement). This value is *Width*.
3. If the positive portion of the part of the waveform measured for the *Period* measurement lies between the first two mesial crossings in the measurement zone, then:

$$DutyCycle = \frac{100 \times Width}{Period} \%$$

If the positive portion of the part of the waveform measured for the *Period* measurement lies between the second and third mesial crossings in the measurement zone, then:

$$DutyCycle = 100 - \frac{100 \times Width}{Period} \%$$

Algorithms



Energy

$$Energy = \sum_{j=m}^{n-1} \frac{w(j+1)^2 + w(j)^2}{2} \times T$$

where:

- m = index of left-most measurement zone sample
- n = index of right-most measurement zone sample
- $w(j)$ = input sampled data point
- T = time interval between successive samples

Fall

1. Find the first point in the measurement zone that is greater than the distal value, searching from left to right.
2. From this point, find the first distal crossing and note the time, t_d .
3. From the distal crossing, examine points to the right, looking for the proximal crossing t_p . Update t_d if subsequent distal crossings are found.
4. Calculate the fall time:

$$Fall = t_p - t_d$$

Linear interpolation between vertical points and between time intervals is necessary to determine the crossing times, when the proximal and distal values do not correspond to acquired data.



Frequency

1. Search the measurement zone for the left-most mesial crossing of positive slope. Continue the search to the right to find the first upper signal/noise ratio level crossing to the right of the first mesial crossing. The horizontal coordinate of this crossing is $Cross_p$.
2. Search the measurement zone for the left-most mesial crossing of negative slope. Continue the search to the right to find the first lower signal/noise ratio level crossing to the right of the second mesial crossing. The horizontal coordinate of this crossing is $Cross_n$.
3. If $Cross_p < Cross_n$, set $Cross_1 = Cross_p$, $Cross_2 = Cross_n$, and $Slope = positive$.
If $Cross_p > Cross_n$, set $Cross_1 = Cross_n$, $Cross_2 = Cross_p$, and $Slope = negative$.
4. If $Slope = positive$, search for the third left-most mesial crossing, and continue the search to find the next upper signal/noise ratio level crossing to the right. If $Slope = negative$, use the next lower signal/noise ratio level crossing to the right. The horizontal coordinate of this crossing is $Cross_3$.
5. Calculate the frequency:

$$Frequency = \frac{1}{Cross_3 - Cross_1}$$

Linear interpolation between vertical points and between time intervals is necessary to determine the crossing time, when the mesial value does not correspond to acquired data.

Algorithms



Gain

1. Calculate the peak-to-peak value of the reference waveform. (Perform a Peak-Peak measurement). This value is $PeakPeak_{ref}$.
2. Calculate the peak-to-peak value of the selected waveform. (Perform a Peak-Peak measurement). This value is $PeakPeak_{sel}$.
3. Calculate the gain:

$$Gain = PeakPeak_{sel} / PeakPeak_{ref}$$

Main→Window Trigger Time

The Main→Window trigger time measurement is performed in the digitizer. The value reported is the time from the trigger event for the Main time base to the trigger event for the Window time base.

Max

The maximum digitized or calculated data point in the measurement zone of the waveform record. An overrange value in the waveform record will qualify the measurement readout with "≥". If the waveform is null, the measurement value will show "error".

Mean

$$Mean = \sum_{j=m}^{n-1} \frac{w(j+1) + w(j)}{[2(n-m)]}$$

where:

- m = index of left-most measurement zone sample
- n = index of right-most measurement zone sample
- $w(j)$ = sampled data point

The summation extends over the interval of time corresponding to one period when Data Interval is set to one period, or the entire measurement zone when Data Interval is set to the entire zone.

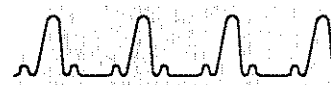

Mid

$$Mid = \frac{Max + Min}{2}$$

An overrange value in the waveform record will qualify the measurement with “≥”, and an underrange value in the waveform record will qualify the measurement with “≤”. If the waveform record has both underrange and overrange values, the measurement readout will be “0.0000 ?V”. If the waveform is null, the measurement value will show “error”.

Min

The minimum digitized or calculated data point in the measurement zone of the waveform record. An underrange value in the waveform record will qualify the measurement readout with “≤”. If the waveform is null, the measurement value will show “error”.

Overshoot

$$OverShoot = 100 \frac{Max - topline}{topline - baseline} \%$$

If the values of *topline* and *baseline* are equal, the measurement value will show “error”.

Peak-Peak

$$PeakPeak = Max - Min$$

An overrange or underrange value in the waveform record will qualify the measurement with “≥”. If the waveform record has both underrange and overrange values, the measurement readout will be qualified with “≥”. If the waveform is null, the measurement value will show “error”.

Algorithms



Period

1. Search the measurement zone for the left-most mesial crossing of positive slope. Continue the search to the right to find the first upper signal/noise ratio level crossing to the right of the first mesial crossing. The horizontal coordinate of this crossing is $Cross_p$.
2. Search the measurement zone for the left-most mesial crossing of negative slope. Continue the search to the right to find the first lower signal/noise ratio level crossing to the right of the second mesial crossing. The horizontal coordinate of this crossing is $Cross_n$.
3. If $Cross_p < Cross_n$, set $Cross_1 = Cross_p$, $Cross_2 = Cross_n$, and $Slope = positive$. If $Cross_p > Cross_n$, set $Cross_1 = Cross_n$, $Cross_2 = Cross_p$, and $Slope = negative$.
4. If $Slope = positive$, search for the third left-most mesial crossing, and continue the search to find the next upper signal/noise ratio level crossing to the right. If $Slope = negative$, use the next lower signal/noise ratio level crossing to the right. The horizontal coordinate of this crossing is $Cross_3$.
5. Calculate the period:

$$Period = Cross_3 - Cross_1$$

Linear interpolation between vertical points and between time intervals is necessary to determine the crossing time, when the mesial value does not correspond to acquired data.



Phase

1. Calculate the period value of the reference waveform. (Perform a Period measurement). This value is *Period*.
2. Calculate the delay from the reference waveform to the selected waveform. (Perform a Skew measurement). This value is *Skew*.
3. Calculate the phase shift:

$$Phase = \left(\frac{Skew}{360 \times Period} \right) MOD 360^\circ$$

where:

MOD 360° is the “modulo 360” function.

If the measurement of either *Period* or *Skew* results in an error, the *Phase* measurement will show “error”.

Prop Delay

1. On the selected waveform, search the measurement zone for the left-most mesial crossing of the specified slope. The horizontal position is *Cross_{sel}*.
2. On the delayed waveform, search the measurement zone for the left-most mesial crossing of the specified slope. The horizontal position is *Cross_{dy}*.
3. Calculate the delay:

$$PropDelay = Cross_{sel} - Cross_{dy}$$

Linear interpolation between vertical points and between time intervals is necessary to determine the crossing time, when the mesial value does not correspond to acquired data.

Algorithms

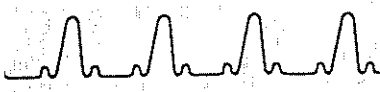

Rise

1. Find the first point in the measurement zone that is less than the proximal value, searching from left to right.
2. From this point, find the first proximal crossing and note the time, t_p .
3. From the proximal crossing, examine points to the right, looking for the distal crossing t_d . Update t_p if subsequent proximal crossings are found.
4. Calculate the rise time:

$$\text{Rise} = t_d - t_p$$

Linear interpolation between vertical points and between time intervals is necessary to determine the crossing times, when the proximal and distal values do not correspond to acquired data.

RMS

$$\text{RMS} = \sum_{j=m}^{n-1} \frac{[w(j+1)^2 + w(j)^2]^{1/2}}{2(n-m)}$$

where :

- m = index of left-most measurement zone sample
- n = index of right-most measurement zone sample
- $w(j)$ = sampled data point

The summation extends over the interval of time corresponding to one period when Data Interval is set to one period, or the entire measurement zone when Data Interval is set to the entire zone.



Skew

1. On the reference waveform, search the measurement zone for the left-most mesial crossing of the specified slope. The horizontal position is $Cross_{ref}$.
2. On the selected waveform, search the measurement zone for the left-most mesial crossing of the specified slope. The horizontal position is $Cross_{sel}$.
3. Calculate the skew:

$$Skew = Cross_{sel} - Cross_{ref}$$

Linear interpolation between vertical points and between time intervals is necessary to determine the crossing time when the mesial value does not correspond to acquired data.

Under Shoot

$$UnderShoot = 100 \frac{baseline - Min}{topline - baseline} \%$$

If the values of $topline$ and $baseline$ are equal, the measurement value will show "error".

Algorithms

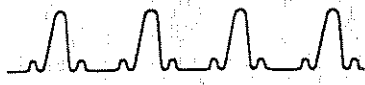

Width

1. Search the measurement zone for the leftmost mesial crossing of positive slope. Continue the search to the right to find the first upper signal/noise ratio level crossing to the right of the first mesial crossing. The horizontal coordinate of this crossing is $Cross_p$.
2. Search the measurement zone for the leftmost mesial crossing of negative slope. Continue the search to the right to find the first lower signal/noise ratio level crossing to the right of the second mesial crossing. The horizontal coordinate of this crossing is $Cross_n$.
3. If $Cross_p < Cross_n$, set $Cross_1 = Cross_p$, $Cross_2 = Cross_n$, and $Slope = \text{positive}$. If $Cross_p > Cross_n$, set $Cross_1 = Cross_n$, $Cross_2 = Cross_p$, and $Slope = \text{negative}$.
4. Calculate the width:

$$Width = Cross_2 - Cross_1$$

Linear interpolation between vertical points and between time intervals is necessary to determine the crossing time, when the mesial value does not correspond to acquired data.

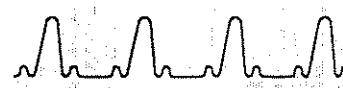

Frequency Domain Measurements

There are two modes of operation, harmonic and peak search. If Search Mode is set to harmonic, the instrument will determine the fundamental frequency, f_0 , by searching for the highest peak of the FFT magnitude in the measurement zone. The harmonic components are computed as $n \times f_0$ where n is the user defined harmonic number. Note that harmonic components will be searched for outside the measurement zone as well. The upper limit is the 1000th harmonic. The components larger than the Nyquist frequency will fold back in the Nyquist range, $\frac{f_s}{2}$, (f_s is the sampling frequency); they are the aliased components of the frequency spectrum.

In the peak search mode, no harmonic relations are assumed between the spectral components. A spectral peak is defined as a peak of the FFT magnitude waveform greater than a user adjustable reference level. The index of the spectral peak to be measured can be user specified.

In order to improve the frequency measurement and magnitude resolution beyond the sampling resolution, the frequency and magnitude of a peak (in either harmonic or peak search mode) is determined by using a FFT interpolation algorithm.

Spectral Frequency

Harmonic Mode

- Scan measurement zone on FFT magnitude waveform to find the highest spectral peak, $S_1 = S(\ell)$, where ℓ is the waveform index of the highest peak.
- Determine the largest adjacent spectral component, $S_2 = S(\ell-1)$ or $S_2 = S(\ell+1)$.
- Using FFT window characteristics, find the fundamental frequency by interpolating between the two largest spectral components.

$$f_1 = (\ell + a\delta) f_0,$$

Algorithms

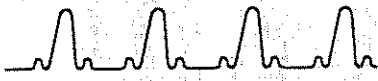

where:

f_1 = fundamental frequency

f_0 = frequency resolution

ℓ = index of the highest peak

$$\delta = \frac{icoeff(0) \times S_2 - icoeff(1) \times S_1}{icoeff(2) \times S_2 + S_1}$$

$\alpha = +1$ if $S_2 = S(\ell + 1)$

$\alpha = -1$ if $S_2 = S(\ell - 1)$

$icoeff(i)$ is an array of interpolation coefficients which depend on the type of FFT Windowing Function.

- The n^{th} frequency harmonic of the waveform is determined by multiplying the user specified harmonic number by fundamental frequency, then searching the waveform for the nearest spectral peak. The interpolation algorithm is applied again in order to prevent the increase of the error rate by the harmonic number.

NOTES:

All even points of the frequency magnitude waveform are results of FFT calculation, and all odd points are linearly interpolated points. Thus, the algorithm ignores all odd points. The real frequency resolution is twice the frequency per point of the waveform.

Interpolation Coefficients

FFT Window	icoeff(0)	icoeff(1)	icoeff(2)
Blackman	2.5486667398	1.5170635356	1.0632064084
Blackman-Harris	3.2326135798	2.1999343343	1.0653584909
Hamming	1.8732586725	0.7978694346	1.1507784758
Hanning	2.0	1.0	1.0
Rectangular	1.0	0	1.0
Triangular	1.7708896670	0.7177145486	1.1063502367

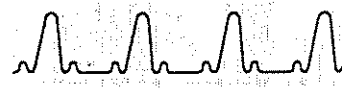

Peak Search Mode

- Scan the FFT Magnitude waveform to find the n th spectral peak. A spectral peak is defined as a waveform peak above a user adjusted reference level.
- Apply the FFT interpolation algorithm described above, to find the spectral frequency.

Spectral Magnitude

Harmonic Mode

The DSA computes the magnitude of a harmonic frequency by interpolating the FFT magnitude waveform and compensating for the FFT windowing function effect.

- The fundamental frequency is determined as described in the spectral frequency algorithm.
- Given the frequency of the spectral component, the routine identifies the two consecutive bins between which the harmonic component is to be found. S_{max} is the amplitude of the highest of the two adjacent spectral components.
- The amplitude of the harmonic peak is calculated by using the frequency interpolation factor δ calculated for the fundamental frequency (see spectral frequency).

$$A_n = \frac{S_{max}}{\sin(\bar{n}\delta) / \bar{n}\delta} \times w_{correct}$$

$$w_{correct} = \frac{w_{coeff}[0]}{w_{coeff}[0] + \sum_{i=1}^m \frac{w_{coeff}[i] \times \delta^2}{\delta^2 - i^2}}$$

Algorithms



where:

- A_n = amplitude of the n^{th} harmonic
- w_{correct} = window correction factor
- m = the FFT window order
- $w_{\text{coeff}}[i]$ = FFT window coefficients given in next table.
- δ = interpolation factor (see Spectral Frequency)

Window Coefficients

FFT Window	wcoeff(0)	wcoeff(1)	wcoeff(2)	wcoeff(3)	m
Blackman	0.42	-0.5	0.08	0	2
Blackman-Harris	0.35875	-0.48829	0.14128	-0.01168	3
Hamming	0.54	-0.46	0	0	1
Hanning	0.5	-0.5	0	0	1
Rectangular	1.0	0	0	0	0
Triangular	0.5	0	0	0	-1

Peak Search Mode

In peak search mode, apply the FFT interpolation algorithm and magnitude correction to the spectral component which is the n^{th} peak of the FFT magnitude waveform.

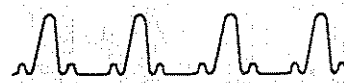

THD (Total Harmonic Distortion)

- Determine the fundamental frequency.
- Find the magnitude of the highest spectral peak and of adjacent values: $S(\ell - 1)$, $S(\ell)$, $S(\ell + 1)$ in the FFT magnitude waveform,

$$A_1 = S(\ell) + \frac{(S(\ell - 1))^2 + (S(\ell + 1))^2}{S(\ell - 1) + S(\ell) + S(\ell + 1)}$$

- For each of the first ten harmonic components determine the three highest adjacent waveform points in the FFT magnitude waveform, $S(\ell - 1)$, $S(\ell)$, $S(\ell + 1)$ and compute:

$$A_n = S(\ell) + \frac{S(\ell - 1) + (S(\ell + 1))^2}{S(\ell - 1) + S(\ell) + S(\ell + 1)}$$

for $n=2, \dots, 10$

- Compute Total Harmonic Distortion

$$THD = \frac{\sqrt{A_2^2 + A_3^2 + \dots + A_{10}^2}}{A_1}$$

Algorithms



Appendix E: Hardcopy Defaults



The following table summarizes the factory default settings associated with each printer selection in the **Hardcopy** pop-up menu. These settings are not affected by initialization.

Hardcopy Defaults

Printer	Screen Format	Direction	Data Format	Output Port
8 pin	HiRes	N/A	N/A	Centronics
24 pin	HiRes	N/A	N/A	Centronics
Tek 4692	Screen	Vertical	N/A	Centronics
Tek 4696	Dithered	Vertical	N/A	Centronics
Tek 4697	Dithered	Horizontal	N/A	Centronics
Bitmap Dump	Screen	Vertical	BinHex Compacted	Centronics
Alt Inkjet	Draft	Horizontal	N/A	Centronics
HPGL	Screen	N/A	N/A	Centronics

The default settings for the color map associated with a color printer setting may be recovered by selecting **Default Color Map** in the **Hardcopy** pop-up menu.

Hardcopy Defaults

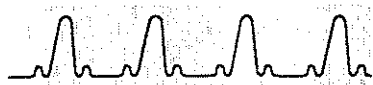

Appendix F: Messages



The DSA displays a message at the top of the display whenever one of the following events occurs:

- Errors indicate that the DSA cannot perform a requested operation.
- Warnings are displayed when the DSA performs the requested operation, but warns you that the results may be corrupted or meaningless.
- Ready Messages indicate that the DSA is waiting for your response to complete the task.
- Operation Complete Messages indicate that an operation is complete.

When a message appears on the display, you can remove it by performing any operation: touching the graticule area, making a menu selection, or pressing a button.

When a hardcopy is made using the **HARDCOPY** button, any message on the display is removed immediately before making the copy. If a hardcopy is initiated via the **ASCII COPY** command, any message on the display will be included on your printed copy.

Selected Message Descriptions

The meaning of most messages is self-evident. This section lists some of the messages that might be unclear, and gives more information about the cause of the message.

Autoset - not functional with this waveform type.

The selected waveform is a window waveform that has no "parent" waveform on the Main time base, and the Main time base is not triggered.

Messages

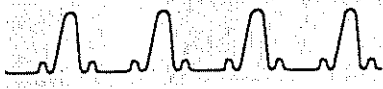

That XY waveform has incompatible components.

You cannot create an XY waveform that compares a Fast waveform (a waveform acquired using integer arithmetic) to a High Precision waveform.

Front panel locked out.

A command from a computer on a remote interface (GPIB or RS-232-C) has disabled the touch panel. The DSA will ignore front panel selections until the remote computer restores touch panel operation.

Hardcopy absent or off-line.

The **PRINTER** (Centronics) output port is selected, and there is no printer connected to the **PRINTER** port, or the printer is off-line. Be sure you have selected the appropriate output port from the **Hardcopy Options** pop-up menu, and check the printer.

Hardcopy Aborted.

The user has aborted the print via "Flush Queue" or by pressing the **HARDCOPY** button a second time. This message also appears if the output port is set to "Disk" and the print terminates abnormally due to a disk error, for example "Directory Full."

Appendix G: Safety



The following safety information is provided for your protection and to prevent damage to the DSA, and applies to all operators and service personnel.

Terms in Manuals

CAUTION statements identify conditions or practices that could result in damage to the equipment or other property.

WARNING statements identify conditions or practices that could result in personal injury or loss of life.

Terms on Equipment

CAUTION indicates a personal injury hazard not immediately accessible as one reads the marking, or a hazard to property including the equipment itself.

DANGER indicates a personal injury hazard immediately accessible as one reads the marking.

Symbols in Manuals



Static Sensitive Devices

Symbols on Equipment



DANGER
High Voltage



Protective
ground (earth)
terminal



ATTENTION
Refer to
manual

Safety



Power Source

This product is intended to operate from a power source that will not apply more than 250 V rms between the supply conductors or between either supply conductor and ground.

Grounding the DSA

The DSA is grounded through the power cord. To avoid electric shock, plug the power cord into a properly wired receptacle where earth ground has been verified by a qualified service person. Do this before making connections to the input or output terminals of the DSA.

Without the protective ground, all parts of the DSA are shock hazards. This includes knobs and controls that may appear to be insulators.

Use the Proper Fuse

Using an improper fuse can create a fire hazard. Always use fuses that exactly meet the specifications in the parts list. Match fuse type, voltage rating, and current rating.

Do Not Remove Covers or Panels

To avoid personal injury, do not operate the DSA without the panels or covers.

Do Not Operate in Explosive Atmospheres

The DSA provides no explosion protection from static discharges or arcing components. Do not operate the DSA in an atmosphere of explosive gases.

Electrostatic Discharge

Never apply a voltage to a plug-in unit that is outside the range printed on the front panel of the plug-in unit. Operate the DSA only in a static-controlled environment.

CAUTION

Operating the DSA without the covers in place may cause overheating and harm the DSA.



CAUTION

Applying a voltage outside the range printed on the plug-in unit can result in damage. Static electricity is also a hazard.



Packaging for Shipment

If you ship the DSA, pack it in the original shipping carton and packing material. If the original packing material is unavailable, package the DSA as follows:

- Step 1: Obtain a corrugated cardboard shipping carton with inside dimensions at least 15 cm (6 in) taller, wider, and deeper than the DSA. The shipping carton must be constructed of cardboard with 375 pound test strength.
- Step 2: If you are shipping the DSA to a Tektronix field office for repair, attach a tag to the DSA showing the DSA owner and address, the name of the person to contact about the DSA, the DSA type, and the serial number.
- Step 3: Wrap the DSA with polyethylene sheeting or equivalent material to protect the finish.
- Step 4: Cushion the DSA on all sides by tightly packing dunnage or urethane foam between the carton and the DSA, allowing 7.5 cm (3 in) on each side.
- Step 5: Seal the carton with shipping tape or an industrial stapler.

Safety

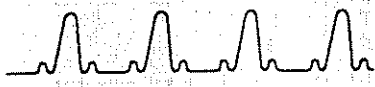

Glossary

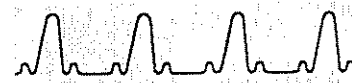

Acquisition

The process of sampling the signals coming through the input channels and accumulating the samples into waveforms.

Act On Delta

An acquisition mode in which the DSA monitors an active waveform for variations outside an enveloped waveform.

Active Graticule

In a dual-graticule display, the graticule that shows the selected waveform.

Annotation Lines

Lines that appear on the display to show the measurement or trigger parameters.

Autoset

A means of letting the DSA set itself to provide a stable and meaningful display of a given waveform.

Averaging

Displaying a waveform that is the averaged result of several acquisitions, thereby reducing apparent noise.

Axis Label

There are three notations on each axis. The first and last notation on each axis show the numeric value of the graticule edge (*not* the edge of the displayed points, which are slightly outside the graticule). The center notation is the scale factor expressed in units per division.

Bandwidth

The frequency range within which an instrument's performance with regard to a particular characteristic falls within specified limits. For DSAs and plug-in amplifiers, bandwidth is usually given as an upper limit (the lower limit is DC).

**Base Label**

The non-numeric portion of the label of a waveform acquired in the repetitive single trigger or Act on Delta acquisition mode. The label of each such waveform consists of the base label followed by a sequentially assigned number.

Bitmap Dump

A hardcopy mode in which an image of the display is sent, usually to a computer, as a series of binary or binhex data.

Calibration

Fine-tuning of the system for vertical and horizontal (time base) accuracy. The DSA, plug-in units, and probes or cables must be calibrated together as a system for best accuracy.

Channel

The input connector on a plug-in unit, to which you attach a probe or cable connected to the signal source. Also, the smallest component of a waveform expression.

Channel Number

The number assigned to a specific signal input connector.

Command Line

See Entry Line

Compensation

For probes, the adjustment of controlling elements that compensate for undesirable characteristics. Voltage probes must be compensated. A screw on the probe is adjusted to compensate the probe.

Control Knob

see Knob

Coupling

Coupling is used to block or pass all or part of a signal into the digitizer or the trigger.

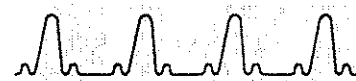
**Cursor**

Any of four styles of paired markers that you position with the knobs. The DSA displays the positions of the cursors and the distance between them in axis units.

Default Measurement Parameter

A value from the default set of measurement parameters. You can change the default values. Whenever a waveform is created, the measurement parameters are copied from the default set.

Deflection Factor

The ratio of input signal to response; the reciprocal of sensitivity.

Degauss

To remove the magnetism of a mass of magnetic material. Current probes must be degaussed before use. The CRT in the DSA is degaussed at power up.

Dejitter

A waveform function that compensates for horizontal jitter in a waveform by aligning waveform records horizontally.

Delayed Sweep

See Window

Display

The face of the screen on which waveforms, menus, icons, and messages appear. The display also includes the touch panel for user input and selection.

Distal

The most distant point from a reference point. As used in the DSA 601A and DSA 602A, the ending measurement point for timing measurements.

**Dithered**

A hardcopy mode in which two colors or a black-and-white pattern are used to produce varying shades of gray or color corresponding to the different display colors.

Dithering

Pseudo-random noise added to the horizontal system to enhance equivalent time performance. Also noise added to the vertical system to enhance vertical resolution of averaged signals.

Dragging

The act of changing your touch panel selection by moving your finger without removing it from the screen. The selection that is activated is the last one that you were touching before removing your finger from the display.

Dual Graticule

A display with two graticules. Each one is half the height of the single graticule.

Enhanced Accuracy

An automatic self-calibration of the DSA and any installed plug-in units as a system. Probes or cables must also be calibrated as part of the system for best accuracy.

Entry Line

A text line that shows your input as you enter selections in a pop-up menu.

Enveloping

Displaying a waveform that shows the extremes of variation of the input signal(s) over several acquisitions.

Equivalent Time

An acquisition mode in which waveform data from several triggered sweeps of the time base are combined into a single waveform record.

**Fast Fourier Transform (FFT)**

A function that produces a display of the frequency spectrum of a waveform. The DSA can display the magnitude and the phase of components, as well as the real and imaginary components in the frequency spectrum.

Fill

Refers to the completeness of a waveform record. 100% fill is a complete record.

 GPIB (General Purpose Interface Bus)

An interface (IEEE standard 488) that can be used for remote computer control of, and data capture from, the DSA.

Graticule

The grid where waveforms are displayed.

Hardcopy

A paper print of the display.

Holdoff

The interval between acquisitions during which the time base and trigger circuit are inhibited.

Horizontal Description

See Waveform Description

Horizontal Size

The span of time displayed within each horizontal graticule division.

Icon

A special selector near the edge of the graticule or in a menu that performs a specific function when touched.

Initialization

Setting the DSA to a known, default condition.

**Interpolation**

A function used to derive values for points between known sampled values.

Keypad Menu

A pop-up menu that controls knob resolution and lets you enter specific numeric values for any control to which a knob is assigned.

Knob

One of the two large rotary controls below the DSA screen.

Knob Assignment

The value that a knob will adjust at a given time.

Knob Menu

The on-screen menu that always displays the current knob assignment. The knob menu also lets you display the Keypad menu.

Knob Resolution

The amount of change caused by each click of a knob.

Main Size

The span of time displayed within each horizontal graticule division on the Main time base.

Main Time Base

The primary time base on which waveforms are acquired.

Major Menu

A menu that is displayed across the bottom of the screen. One of the major menus is always displayed.

Major Menu Button

A labeled button to the right of the display that determines which major menu is displayed.

**Measurement**

An automated numeric readout that the DSA provides and updates directly from the displayed waveform in real time.

Measurement Parameter

One of several controls, including reference values and limits, that determine how measurements are taken. You can change these parameters to control the automated measurements.

Measurement Statistics

The accumulation of a history of individual measurement readouts, showing the maximum, minimum, mean, and standard deviation values of a selected number of measurement samples.

Measurement Tracking

The process of automatically adjusting the measurement parameters to reflect changes in the waveform.

Mesial

The middle point of a range of points. As used in the DSA, the middle measurement point between proximal and distal points for timing measurements, and the intermediate height between baseline and topline for amplitude measurements.

Offset

A user-specified control that subtracts a specified voltage or amperage from the input signal to vary the position of the displayed signal.

Ontime

The cumulative number of hours the DSA has been powered on.

Outline Box

A visual feedback mechanism of the touch panel. Your potential selection is always indicated by a box while your finger is touching the screen.

Overdrive

A condition that occurs when amplifiers are driven into a non-linear operating range.

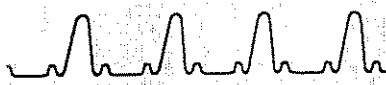
**Overload**

A condition that occurs when a potentially damaging voltage is applied to the input connector.

Persistence Mode

A mode of operation where the DSA displays newly acquired waveform data points while keeping the previously acquired data points on the screen.

Pixel

A visible point on the display. The DSA display is 552 pixels wide and 704 pixels high. Each pixel may be set internally to any of the display colors.

Polarity

Changing the waveform or trigger polarity inverts the channel's signal.

Pop-up Menu

A temporary menu that provides an interactive dialog for a specific function. A sub-menu of a major menu.

Principal Power Switch

The master power switch located on the rear panel of the DSA.

Probe ID

A button on a probe that invokes actions in the mainframe when pressed. The action is specified in the Probes pop-up menu of the Utility 1 major menu.

Proximal

The point closest to a reference point. As used in the DSA 601A and DSA 602A, the beginning measurement point for timing measurements.

Queuing (Spooling)

The temporary storage of data in preparation for output to an external device, for example a printer or computer.

**Real Time**

An acquisition mode in which all the samples for a waveform record are taken from a single triggered sweep of the time base.

Record Length

The number of samples (data points) that make up a waveform record.

RS-232-C

An interface that can be used for remote computer control of, and data capture from, the DSA.

Sample Interval

The time interval between successive samples in a waveform record.

Sample Rate

The speed with which the DSA acquires samples, expressed in samples per second. The inverse of sample interval.

Selected Waveform

The waveform that is acted on by the knobs and menu selectors, and to which measurement readouts apply.

Selector

An area of a menu that performs some action when you touch it.

Sensitivity

The ratio of the input signal to the displayed response. Most often in input units/division.

Setting

The state of the front panel and system at a given time.

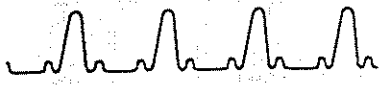
**Single Trigger**

An acquisition mode in which acquisition is stopped after a single trigger is detected and the time base duration has expired.

Single Sweep

See Single Trigger

Single Shot

See Single Trigger

Soft keys

Refers to the keys on the display panel, (the keys displayed on the CRT). Also called selectors.

Spooling

See Queuing

Standby

A condition in which input power is disconnected from all but a few of the DSA's circuits. Standby is generally used when the DSA is not in use.

Stored Setting

A complete copy of the instrument's status at a particular time that is saved in non volatile memory.

Stored Waveform

A collection of sampled points that constitute a single waveform record that is saved in memory or on a disk.

Sweep Speed

See Horizontal size

Time Base

The time-dependent specifications that control the acquisition of a waveform. The time base determines when and for how long to acquire and digitize signal data points.

**Time/Division**

See Main Size

Trace

See Waveform

Tracking

The process of automatically adjusting the measurement parameters or window position to reflect changes in the waveform.

Trigger

An electrical event that is used as a horizontal reference for acquired waveform samples.

Vertical Description

See Waveform Description

Vertical Size

The number of vertical axis units displayed within a vertical division of the graticule. Usually the vertical units are volts, and the vertical size corresponds to plug-in amplifier sensitivity.

Volts/Division

See Vertical Size

Waveform

The visible representation of an input signal or combination of signals.

Waveform Description

The definition of what the waveform displays. It can include one or more channels combined arithmetically and modified by functions.

**Waveform Number**

A number assigned by the DSA to identify a waveform. Displayed waveforms are numbered 1 through 8. A new waveform is always given the lowest available number.

Waveform Record

The data points that make up a waveform on the display or in memory.

Window

A waveform that represents a horizontally expanded portion of another waveform.

Window Timebase

The alternate timebase on which window waveforms are acquired. The window time base always has a faster sweep speed (smaller horizontal size) than the main timebase.

XY Waveform

A graphical comparison of two waveforms. Both horizontal and vertical position of the data points in an XY waveform reflect signal data.

Yt Waveform

A waveform where the vertical position of the waveform data points reflects signal data, and the horizontal position of the waveform data points reflects time.

Index



Symbols

- . (pointer), 104
- .. (pointer), 104

A

- Accuracy, Enhanced, 111–112
- Acquire Desc** pop-up menu, 39–42, 44, 46, 59, 61, 72–75
- Acquisition, 33–42, 44, 46–52, 59
 - conditional, 39–42, 44, 46, 59, 61
 - Digitizer Interleave, 38, 51
 - equivalent time, 34–35
 - Incremental Acquire, 46–48
 - real time, 33–38, 51
 - sample rate, 321
 - single shot, 50, 52, 326, 327
 - Slow Sweep, 46–48
 - stopping and starting, 39, 59
 - transfer rate, 328
- Act on Delta, 46, 53–61
 - delta actions, 57–59
 - Delta Description, 54–55
 - Delta event, 54, 56
- Act on Delta** pop-up menu, 54–9
- Adjustable Constants, 285–286
- Algorithms
 - histograms, 351
 - measurement, 331, 352–364
 - waveform function, 331–332, 334, 336–349
- All Wfms Status menu, 292
- All Wfms Status selector, 292
- Amplifiers. *See Plug-in units*
- Annotations, 187
 - RemAnno icon, 265
- Audio feedback, 63

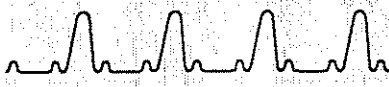

- Autoset, 65–69
 - Horizontal, 67–68
 - Pan/Zoom, 69
 - search, 65
 - stored waveforms, 69
 - Vertical, 67
 - window, 69
 - XY waveforms, 69
- AUTOSET** button, 65
- Autostore Parameters** pop-up menu, 43–44
- Averaging, 71–75
 - Back-Weighted, 71, 328
 - Summation, 71, 328
- Axis labels, 139

B

- Back-Weighted Averaging, 71, 328
- Bandwidth, plug-in channels, 206
- Base Label, 182
- Baseline, 352–353
- Beep. *See Audio feedback*
- Brightness. *See Display Intensity*
- Buttons, 2
 - AUTOSET**, 65
 - DIGITIZER**, 2–3, 39, 59
 - ENHANCED ACCURACY**, 2–3, 111–112
 - HARDCOPY**, 2–3, 151
 - MEASURE**, 2–3, 12–13
 - PROBE ID**, 215
 - STORE/RECALL**, 2–3, 12–13
 - TRIGGER**, 2–3, 12–13
 - UTILITY**, 2–3, 12–13
 - WAVEFORM**, 2–3, 12–13



C

- Cables, 213, 269
- Calibration, 269
 - probes, 77, 217–219
 - self, 270
- Calibrator, 77, 217–219
 - frequency, 77–78
 - output connector, 77
 - output voltage, 77–78
- Calibrator Output** pop-up menu, 77–78
- Calipers. *See* *Cursors*
- Chan Sel** selector, 278
- Channel button, 202
- Clear Waveform** pop-up menu, 48–49
- Clearing waveforms, 48–49
- Clock. *See* *Time and date*
- Color, 79–82
 - display, 269
 - pop-up menu, 79, 81, 107
 - windows, 298
- Computer, remote control, 270
- Connectors, 2, 4–5
 - CALIBRATOR** Output, 77
 - GPIB**, 135–136, 143
 - POWER**, 209
 - PRINTER**, 143
 - RS-232-C**, 143–144, 225
- Constants, Adjustable, 286
- Copying Settings to Disk/RAM, 237
- Coupling
 - plug-in channels, 205
 - trigger, 256
- Coupling** pop-up menu, 256–257
- Cursor Type** pop-up menu, 85



Cursors, 83–90

D

Data format, 98

Default Format, 98

DefWfm

icon, 282

pop-up menu, 115, 282–285, 287

Delete Setting pop-up menu, 234–235, 238

Delete Waveform pop-up menu, 246, 248, 250

Diagnostics, 91–95, 270

extended, 91, 93–95

power-on, 91–92

self-test, 91, 93

Digitizer, 33

DIGITIZER button, 39, 59

Digitizer Filter, 206

Digitizer Interleave, 38, 51

Directory

changing a directory, 102

contents, 104

file list, 104

making a directory, 102

naming a directory, 102

removing a directory, 102

renaming a directory, 102

Directory Operations, 98, 102, 271

Disk

chkdsk command, 100

default prefix, 232

files, 232

format command, 100

label command, 100

storing settings, 232

Disk Copy pop-up menu, 248–249

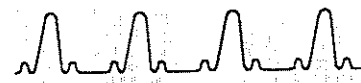

Disk Drive, 97–104, 106
 Disk Operations, 98, 100, 271
 Display, 2, 6–7
 Display intensity, 81, 107
 Display Persistence, 109–110
 Displaying labels, 170–171

E

Enhanced Accuracy, 111–112, 211
 Enveloping, 71–75
 Equivalent time sampling, 34
 Erasing nonvolatile RAM, 160–161
 Error messages, 373–374
 Errors, measurements, 194–195

F

Fast. *See* *Waveform Scaling*
 Fast Fourier Transforms, 113–131, 133
 aliasing, 120
 Blackman-Harris window, 129
 defining, 114
 FFT Control pop-up menu, 116, 120–121
 FFTmag icon, 116–117
 FFTpha icon, 116
 hamming window, 127
 hanning window, 126
 imaginary component, 114
 imaginary components, 113
 magnitude formats, 113
 measurements, 130, 131
 phase format selector, 116
 real component, 113–114
 record length, 113
 rectangular window, 124

DSA Index

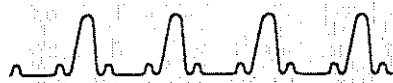

triangular window, 125
windowing functions, 123 – 129

File

attributes, 104
data format, 104

File Data Format, 106

File extension number, 98

File List, 98

File Operations, 98, 104, 232, 271

File Type, selector, 99

Files

copying, 105
deleting, 105
prefix, 104, 105
read only, 104
read/write, 104
renaming, 104

Filter, digitizer, 206

Format, 100

default, 98

Disk Ops pop-up menu, 100

Fuse, 4 – 5, 209, 315

G

Glitch capture. *See Act on Delta*

GPIO, 135 – 138

connector, 135 – 136, 143

pop-up menu, 137 – 138

Graticules, 139 – 142

Graticules pop-up menu, 141 – 142

Ground reference, indicator, 299

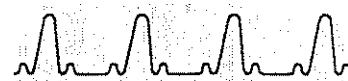

H

Hardcopy, 143–152, 270

button, 151

color map, 147–148

defaults, 371

pop-up menu, 98, 145–150, 152

HARDCOPY button, 151

Hardcopy Options pop-up menu, 371

High precision. *See* **Waveform Scaling**

Histogram, 196, 198, 200

acquisition, 198

clearing, 200

controls, 196

creating, 196

displaying, 196

displays, 198

Refresh Rate, 199

scaling, 199

size, 198

statistical values, 200

Histograms, algorithms, 351

Horizontal

controls, 153–158

icon, 153, 299

Pan/Zoom, 155–156, 158

size and position, 35–38, 51, 153–158, 299

Horizontal Desc pop-up menu, 35–36, 109, 110, 221–222, 302–304

Horizontal icon, 36, 153

I

Icons, 8

Cursors, 84

DefWfm, 282

DISK, 103, 248

DSA Index



- FFTmag**, 116 – 117
- FFTpha**, 116
- horizontal, 36, 153, 299
- main trigger, 253
- RAM**, 103
- RemAnno**, 265
- RemCurs**, 84
- vertical, 277 – 279, 299
- window trigger, 253, 298
- Window1**, 297 – 298
- Ident** pop-up menu, 163
- Impedance, 204
- Incremental Acquire, 46 – 48
- Infinite persistence, 109
- Information
 - erasing, 270
 - storage, 105
- Initialization, 159 – 161, 270
 - erasing nonvolatile RAM, 160 – 161
- Initializing, 269
- Input connectors. *See Probes*
- Input Parameters, pop-up menu, 204 – 206
- Input parameters, 203
 - pop-up menu, 203
- Input Parameters** pop-up menu, 202
- Instrument Configuration, 163, 271
- Instrument Modes** pop-up menu, 63, 112, 157 – 158, 275 – 276
- Intensity, display, 81
- Interpolation, zoom, 275
- Inverse FFT, 113

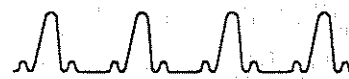

K

- Keypad pop-up menu, 10–11
- Knob menu, 10–11
- Knobs, 2, 10–11

L

- Label pop-up menu, 166–170
- Labelling disks, 100
- Labels, 165–171, 269
 - base label, 170
 - displayed on graticule, 170–171
 - positioning, 171
- LINE VOLTAGE SELECTOR switch, 209
- Lower Graticule pop-up menu, 141–142

M

- Main position. *See Horizontal size and position*
- Main size. *See Horizontal size and position*
- Measurements, 173, 175–189, 192–193
 - algorithms, 331, 352–364
 - Area+, 175, 354
 - Area-, 175, 354
 - comparing to references, 183–184
 - Cross, 174, 354
 - default parameters, 192–193
 - defining, 176–178
 - Delay, 174, 355
 - Duty Cycle, 174, 355
 - Energy, 175, 356
 - Errors, 175, 176
 - errors, 194–195
 - factors affecting accuracy, 75
 - Fall, 174, 356
 - Frequency, 174, 357

DSA Index

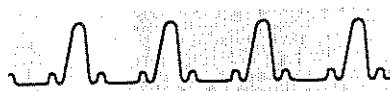

- Gain, 173, 358
 - individual measurement pop-up menus, 185–186
 - Main-Win Trig Time, 174, 178–179, 358
 - Max, 173, 358
 - Mean, 173, 358
 - Mid, 173, 359
 - Min, 173, 359
 - Over Shoot, 173, 359
 - parameters, 185–189
 - Peak-Peak, 173, 359
 - Period, 174, 360
 - Phase, 174, 361
 - PropDelay, 174, 361
 - Rise, 174, 362
 - RMS, 173, 362
 - setting up a waveform, 175–176
 - Skew, 174, 363
 - stored waveforms, 182
 - trigger, 178–179
 - Under Shoot, 173, 363
 - Width, 174, 364
- Measurements** pop-up menu, 176–178, 180
- Memory wraparound, repetitive single trigger, 43–45
- Menus, 12–29
- Messages, 373–374
- Mode** pop-up menu, 261–262
- Modes** pop-up menu, 66–67, 241–242, 295–296
- Multitrace Pan/Zoom, 158

N

- Nonvolatile RAM, erasing, 160–161



O

- Offset, vertical, 206
- ON/STANDBY** switch, 209
- Option 4C, 231, 239, 241, 244, 246, 250
- Output port, 98
- Overall intensity, 81

P

- Packaging, 377
- Pan/Zoom, 155–158
 - multitrace, 158
 - pivot, 157
- Persistence, 109
- Phase Format selector, 116
- Plug-in units, 201–208
 - bandwidth, 206
 - channel button, 202
 - compartments, 2
 - coupling, 205
 - DC circuit loading, 207
 - impedance, 204
 - input parameters, 203
 - installation, 201–202
 - overdriving, 208
 - removal, 201
- Pointers, 104
- Pop-up menus, 6–7
 - Acquire Desc**, 39–42, 44, 46, 59, 61, 72–75
 - Act on Delta**, 54–59
 - Autostore Parameters**, 43–44
 - Calibrator Output**, 77–78
 - Clear Waveform**, 48–49
 - Color**, 79–82, 107
 - Coupling**, 256–257
 - Cursor Type**, 83–85

DSA Index

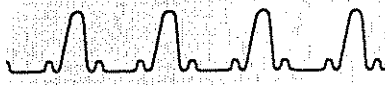

- DefWfm, 115, 282–287**
- Delete Setting, 234–235, 238**
- Delete Waveform, 246, 248, 250**
- Directory Ops, 98, 103**
- Disk Copy, 237, 248–249**
- Disk Ops, 98–99, 101**
- FFT Control, 120–121**
- File Ops, 98, 232**
- GPIB Parameters, 137–138**
- Graticules, 141–142**
- Hardcopy, 145–149, 150, 152**
- Hardcopy Options, 371**
- Horizontal Desc, 35–36, 109–110, 221–222, 302–304**
- Ident, 163**
- individual measurement, 185–186**
- Input Parameters, 202–206**
- Instrument Modes, 63, 112, 157–158, 275–276**
- Keypad, 10–11**
- Label, 166–170**
- Lower Graticule, 141–142**
- Measurements, 176–178, 180**
- Mode, 261**
- Modes, 66–67, 241–242, 295–296**
- Probe Compensation, 217, 218–219**
- Probes, 215–219**
- Recall Setting, 233**
- Recall Waveform, 243**
- Rem Wfm, 49**
- RS232C Parameters, 226–228**
- Scan Using, 245**
- Source Desc (Main trigger), 254–255**
- Source Desc (Window trigger), 260**
- Statistics Comp & Def, 180–181, 183–184, 192–193**
- Store Setting, 230, 231, 236**
- Store Waveform, 239–240**
- Time & Date, 251**
- Upper Graticule, 141–142**
- Vertical Desc, 283–285, 287, 293**
- POWER connector, 209**
- Power-on, 209–211**

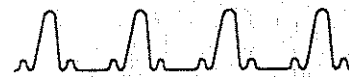

Prefix, default, 232
PRINCIPAL POWER SWITCH, 209
PRINTER connector, 143
 Printing. *See Hardcopy*
 Probe Calibration, 77, 217–219
Probe Compensation pop-up menu, 217–219
Probe ID button, 215–216
 Probes, 77, 213–219, 269
 connection, 214
 installation, 214
 intelligent, 215
 Probe ID function, 215
Probes pop-up menu, 215–219

R

Real Time sampling, 33–38, 51, 322–325
Recall Setting pop-up menu, 233
Recall Waveform pop-up menu, 243
 Record length, 221–223, 322–325, 326
 windows, 298
Rem Wfm pop-up menu, 49
 Repetitive Single Trigger, 42, 44
RS-232-C connector, 143–144, 225
RS232C Parameters pop-up menu, 225–228

S

Safety, 375–377
 Sample rate, 38, 51, 320, 322–325
Scan Using pop-up menu, 245
 Sensitivity, vertical, 206
 Sequencing, 236
Set Next FPS, 231–232

DSA Index

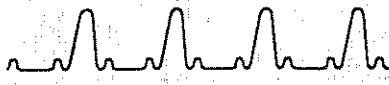

- Set Next FPS Index, 237**
- Set Next STO, 250**
- Set Next STO Index, 249**
- Settings
 - copying, 237
 - default, 159–160
 - initialize, 159–160
 - sequencing, 229, 236
 - stored, 105, 229–231, 233–236, 238
 - storing to disk, 232
- Shipping, 377
- Single Shot acquisition, 326, 327
- Single Sequence, 42
- Single Sweep. *See Single Trigger*
- Single Trigger, 42
- Source Desc (Main trigger) pop-up menu, 254–255**
- Source Desc pop-up menu (Window trigger), 260**
- Specifications, 30–312, 315–316, 318
- Spectral Frequency, 175
- Spectral Magnitude, 175
- SRQ, 58
- Statistics, 180–182
 - stored waveforms, 182
- Statistics Comp & Def pop-up menu, 180–181, 183–184, 192–193**
- Store Next FPS, 231**
- Store Next FPS, 232
- Store Setting pop-up menu, 230–231, 236**
- Store Waveform pop-up menu, 239–240**
- Stored settings, 229
- Stored Waveforms, 239–246, 248–249
 - recovering from NVRAM, 250
 - scanning, 244–246
 - time stamp format, 241–242

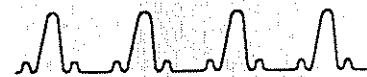

- Storing Information, 105
- Summation Averaging, 71
- Sweep. *See Waveforms*
- Sweep mag. *See Pan/Zoom*
- Sweep Speed, 322–325
- Switches, 2, 4–5
 - LINE VOLTAGE SELECTOR, 209**
 - ON/STANDBY, 209**
 - PRINCIPAL POWER SWITCH, 209**
- System Identification. *See Instrument Configuration*

T

- Teksecure, 159, 270
- Text, displaying on screen, 269
- Time & Date pop-up menu, 251**
- Time and Date, 269
 - stored waveforms, 241–242
- Time and date, 251
- Time bases, 154
- Topline, 352–353
- Total Harmonic Distortion, 175
- Touch panel, 6–7
- Trace. *See Waveforms*
- Trace Separation, 299
- Trigger
 - DC Level, 258
 - external. *See Triggering source*
 - internal. *See Triggering source*
- Trigger holdoff, range, 258
- Trigger icon, 253
- Triggering, 253–264
 - Auto Level Mode, 261
 - Auto mode, 261, 263–264

DSA Index



- Boolean, 263–264
- coupling, 253, 256
- events holdoff, 257
- extended, 253, 262–267
- holdoff, 253, 258–260
- indicator, 258
- level, 257
- level-qualified, 267
- mode, 261
- Normal mode, 261
- source, 253
- source description, 258
- status, 259
- time holdoff, 257
- time-qualified, 265–266
- windows, 253, 258, 298

U

- Upper Graticule pop-up menu, 141–142
- Utility Major Menu, 269–271
 - Page to selector, 97

V

- Variable persistence, 109
- Vectored waveforms, 273–276
- Vertical
 - accuracy. *See Enhanced Accuracy*
 - icon, 277–279, 299
 - offset, 206
 - polarity. *See Waveforms, defining*
 - position. *See Vertical offset*
 - sensitivity, 206
 - size and offset, 277–279, 299
- Vertical Desc pop-up menu, 283–285, 287, 293

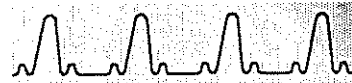

W

Waveform, scaling, 294

Waveforms, 281 – 285, 287, 290 – 296

clearing, 48 – 49

defining, 281 – 285, 287

displaying, 270

functions, 72, 287 – 290

modifying, 293

removing, 293 – 294

scaling, 270, 294 – 296

selecting, 140 – 141, 291 – 292

size and position, 299

Stored, 182

stored, 105, 239 – 246, 248 – 250, 270

Trace Separation, 279

vectoring, 273 – 276

waveform descriptions, 281 – 284, 287

waveform function algorithms, 331 – 332, 334, 336 – 349

waveform numbers, 291

XY, 301 – 304

Wildcards

?, 104

*, 104

Windows, 297 – 299

color, 298

holdoff, 258

icons, 297

record length, 298

time base, 298

trigger icon, 298

triggering, 258, 298

xs:

DSA Index

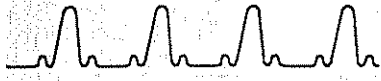

X

XY waveforms, 301 – 304

Z

Zoom Interpolation, 275